

PHILIPS

Data handbook



Electronic
components
and materials

**Semiconductors and
integrated circuits**

Part 4c July 1978

Discrete semiconductors for

Hybrid thick and thin-film circuits

PHILIPS

Data handbook



Electronic
components
and materials

**Semiconductors and
integrated circuits**

Part 4c July 1978

Discrete semiconductors for

Hybrid thick and thin-film circuits

SEMICONDUCTORS AND INTEGRATED CIRCUITS

PART 4c - JULY 1978

DISCRETE SEMICONDUCTORS FOR HYBRID THICK AND THIN-FILM CIRCUITS

GENERAL

SOLDERING RECOMMENDATIONS

TYPE NUMBER SURVEY

SELECTION GUIDE

DEVICE DATA

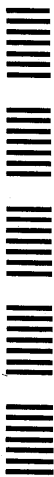

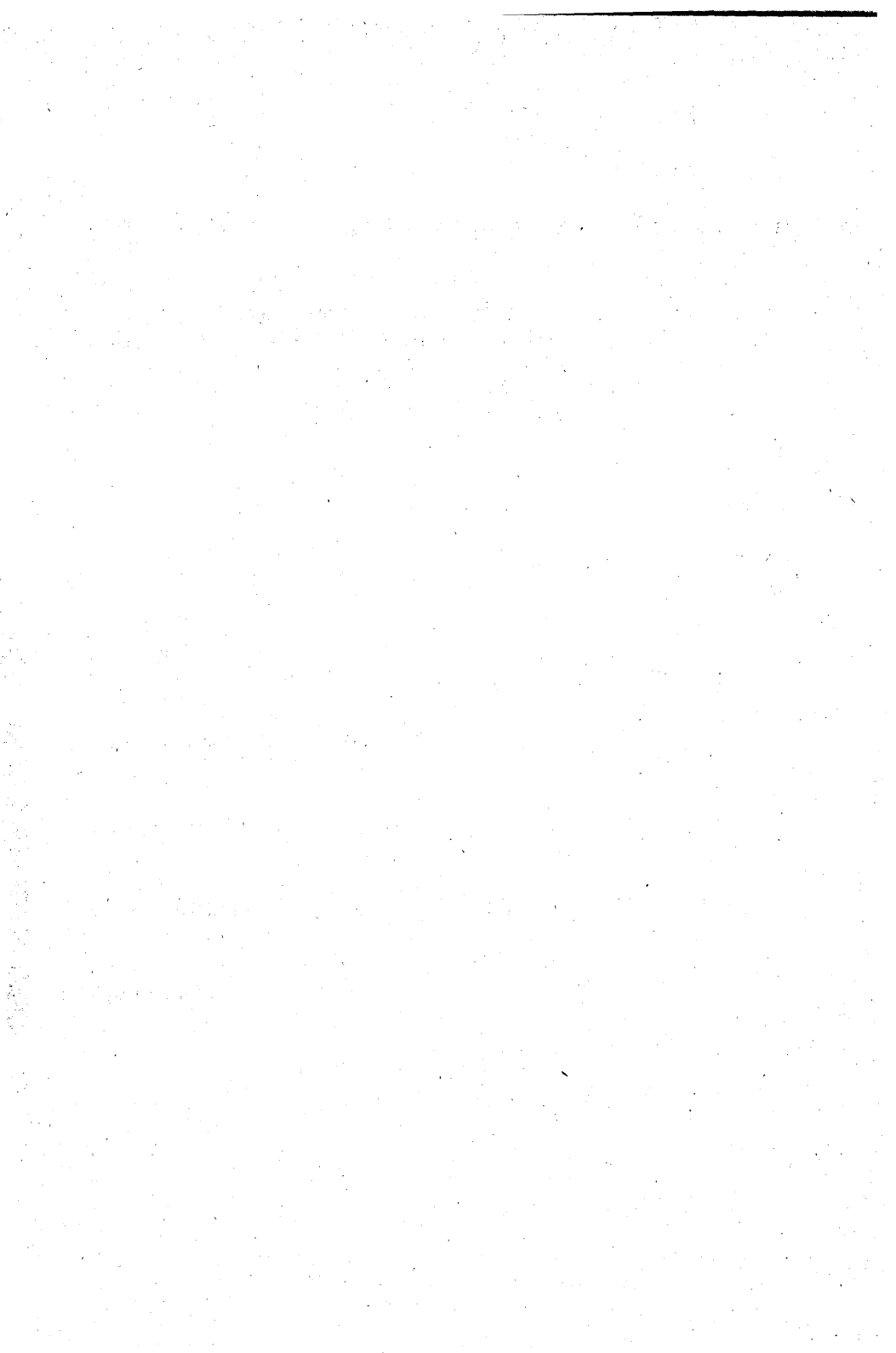

**DATA HANDBOOK SYSTEM
INDEX OF SEMICONDUCTORS**

DATA HANDBOOK SYSTEM

Our Data Handbook System is a comprehensive source of information on electronic components, sub-assemblies and materials; it is made up of three series of handbooks each comprising several parts.

ELECTRON TUBES	BLUE
SEMICONDUCTORS AND INTEGRATED CIRCUITS	RED
COMPONENTS AND MATERIALS	GREEN

The several parts contain all pertinent data available at the time of publication, and each is revised and reissued periodically.

Where ratings or specifications differ from those published in the preceding edition they are pointed out by arrows. Where application information is given it is advisory and does not form part of the product specification.

If you need confirmation that the published data about any of our products are the latest available, please contact our representative. He is at your service and will be glad to answer your inquiries.

This information is furnished for guidance, and with no guarantee as to its accuracy or completeness; its publication conveys no licence under any patent or other right, nor does the publisher assume liability for any consequence of its use; specifications and availability of goods mentioned in it are subject to change without notice; it is not to be reproduced in any way, in whole or in part without the written consent of the publisher.

ELECTRON TUBES (BLUE SERIES)

Part 1a	December 1975	ET1a 12-75	Transmitting tubes for communication, tubes for r.f. heating Types PE05/25 to TBW15/25
Part 1b	August 1977	ET1b 08-77	Transmitting tubes for communication, tubes for r.f. heating, amplifier circuit assemblies
Part 2a	November 1977	ET2a 11-77	Microwave tubes Communication magnetrons, magnetrons for microwave heating, klystrons, travelling-wave tubes, diodes, triodes T-R switches
Part 2b	May 1978	ET2b 05-78	Microwave semiconductors and components Gunn, Impatt and noise diodes, mixer and detector diodes, backward diodes, varactor diodes, Gunn oscillators, sub- assemblies, circulators and isolators
Part 3	January 1975	ET3 01-75	Special Quality tubes, miscellaneous devices
Part 4	March 1975	ET4 03-75	Receiving tubes
Part 5a	March 1978	ET5a 03-78	Cathode-ray tubes Instrument tubes, monitor and display tubes, C.R. tubes for special applications
Part 5b	May 1975	ET5b 05-75	Camera tubes, image intensifier tubes
Part 6	January 1977	ET6 01-77	Products for nuclear technology Channel electron multipliers, neutron tubes, Geiger-Müller tubes
Part 7a	March 1977	ET7a 03-77	Gas-filled tubes Thyratrons, industrial rectifying tubes, ignitrons, high-voltage rectifying tubes
Part 7b	March 1977	ET7b 03-77	Gas-filled tubes Segment indicator tubes, indicator tubes, switching diodes, dry reed contact units
Part 8	May 1977	ET8 05-77	TV picture tubes
Part 9	March 1978	ET9 03-78	Photomultiplier tubes; phototubes

SEMICONDUCTORS AND INTEGRATED CIRCUITS (RED SERIES)

Part 1a	March 1976	SC1a 03-76	Rectifier diodes, thyristors, triacs Rectifier diodes, voltage regulator diodes ($> 1,5$ W), transient suppressor diodes, rectifier stacks, thyristors, triacs
Part 1b	May 1977	SC1b 05-77	Diodes Small signal germanium diodes, small signal silicon diodes, special diodes, voltage regulator diodes ($< 1,5$ W), voltage reference diodes, tuner diodes
Part 2	November 1977	SC2 11-77	Low-frequency and dual transistors
Part 3	January 1978	SC3 01-78	High-frequency, switching and field-effect transistors
Part 4a	June 1976	SC4a 06-76	Special semiconductors* Transmitting transistors, field-effect transistors, dual transistors, microminiature devices for thick and thin-film circuits
Part 4b	July 1978	SC4b 07-78	Devices for optoelectronics Photosensitive diodes and transistors, light emitting diodes, displays, photocouplers, infrared sensitive devices, photoconductive devices
Part 4c	July 1978	SC4c 07-78	Discrete semiconductors for hybrid thick and thin-film circuits
Part 5a	November 1976	SC5a 11-76	Professional analogue integrated circuits
Part 5b	March 1977	SC5b 03-77	Consumer integrated circuits Radio-audio, television
Part 6	October 1977	SC6 10-77	Digital integrated circuits LOCOS HE4000B family
Signetics integrated circuits	1978		Bipolar and MOS memories Bipolar and MOS microprocessors Analogue circuits

* The most recent information on field-effect transistors can be found in SC3 01-78, on dual transistors in SC2 11-77, and on microminiature devices in SC4c 05-78.

COMPONENTS AND MATERIALS (GREEN SERIES)

Part 1	June 1977	CM1 06-77	Assemblies for industrial use High noise immunity logic FZ/30-series, counter modules 50-series, NORbits 60-series, 61-series, circuit blocks 90-series, circuit block CSA70(L), PLC modules, input/output devices, hybrid circuits, peripheral devices, ferrite core memory products
Part 2a	October 1977	CM2a 10-77	Resistors Fixed resistors, variable resistors, voltage dependent resistors (VDR), light dependent resistors (LDR), negative temperature coefficient thermistors (NTC), positive temperature coefficient thermistors (PTC), test switches
Part 2b	February 1978	CM2b 02-78	Capacitors Electrolytic and solid capacitors, film capacitors, ceramic capacitors, variable capacitors
Part 3	January 1977	CM3 01-77	Radio, audio, television FM tuners, loudspeakers, television tuners and aerial input assemblies, components for black and white television, components for colour television
Part 4a	October 1976	CM4a 10-76	Soft ferrites Ferrites for radio, audio and television, beads and chokes, Ferroxcube potcores and square cores, Ferroxcube transformer cores
Part 4b	December 1976	CM4b 12-76	Piezoelectric ceramics, permanent magnet materials
Part 5	July 1975	CM5 07-75	Ferrite core memory products Ferroxcube memory cores, matrix planes and stacks, core memory systems
Part 6	April 1977	CM6 04-77	Electric motors and accessories Small synchronous motors, stepper motors, miniature direct current motors
Part 7	September 1971	CM7 09-71	Circuit blocks Circuit blocks 100 kHz-series, circuit blocks 1-series, circuit blocks 10-series, circuit blocks for ferrite core memory drive
Part 8	February 1977	CM8 02-77	Variable mains transformers
Part 9	March 1976	CM9 03-76	Piezoelectric quartz devices
Part 10	April 1978	CM10 04-78	Connectors

INDEX OF TYPE NUMBERS

Data Handbooks SC1a to SC4c

The inclusion of a type number in this publication does not necessarily imply its availability.

type no.	part	section	type no.	part	section	type no.	part	section
AA119	1b	PC	BA220	1b	WD	BAX13	1b	WD
AAZ15	1b	GB	BA221	1b	WD	BAX14	1b	WD
AAZ17	1b	GB	BA222	1b	WD	BAX14A	1b	WD
AAZ18	1b	GB	BA243	1b	T	BAX15	1b	WD
AC125	2	LF	BA244	1b	T	BAX16	1b	WD
AC126	2	LF	BA280	1b	T	BAX17	1b	WD
AC127	2	LF	BA314	1b	Vrg	BAX18	1b	WD
AC128	2	LF	BA314A	1b	Vrg	BAX18A	1b	WD
AC128/01	2	LF	BA315	1b	Vrg	BB105A	1b	T
AC132	2	LF	BA316	1b	WD	BB105B	1b	T
AC187	2	LF	BA317	1b	WD	BB105G	1b	T
AC187/01	2	LF	BA318	1b	WD	BB106	1b	T
AC188	2	LF	BA379	1b	T	BB110B	1b	T
AC188/01	2	LF	BAS16	4c	Mm	BB110G	1b	T
AD161	2	P	BAS17	4c	Mm	BB117	1b	T
AD162	2	P	BAS18	4c	Mm	BB119	1b	T
AF367	3	HFSW	BAV10	1b	WD	BB204B	1b	T
ASZ15	2	P	BAV18	1b	WD	BB204G	1b	T
ASZ16	2	P	BAV19	1b	WD	BB205A	1b	T
ASZ17	2	P	BAV20	1b	WD	BB205B	1b	T
ASZ18	2	P	BAV21	1b	WD	BB205G	1b	T
BA100	1b	AD	BAV45	1b	Sp	BBY31	4c	Mm
BA102	1b	T	BAV70	4c	Mm	BC107	2	LF
BA145	1a	R	BAV99	4c	Mm	BC108	2	LF
BA148	1a	R	BAW21A	1b	WD	BC109	2	LF
BA182	1b	T	BAW21B	1b	WD	BC140	2	LF
BA216	1b	WD	BAW56	4c	Mm	BC141	2	LF
BA217	1b	WD	BAW62	1b	WD	BC146	2	LF
BA218	1b	WD	BAX12	1b	WD	BC147	2	LF
BA219	1b	WD	BAX12A	1b	WD	BC148	2	LF

AD = Silicon alloyed diodes
 GB = Germanium gold bonded diodes
 HFSW = High-frequency and switching transistors
 LF = Low-frequency transistors
 Mm = Discrete semiconductors for hybrid thick and thin-film circuits
 P = Low-frequency power transistors

PC = Germanium point contact diodes
 R = Rectifier diodes
 Sp = Special diodes
 T = Tuner diodes
 Vrg = Voltage regulator diodes
 WD = Silicon whiskerless diodes

INDEX

type no.	part	section	type no.	part	section	type no.	part	section
BC149	2	LF	BCW33;R	4c	Mm	BD138	2	P
BC157	2	LF	BCW69;R	4c	Mm	BD139	2	P
BC158	2	LF	BCW70;R	4c	Mm	BD140	2	P
BC159	2	LF	BCW71;R	4c	Mm	BD181	2	P
BC160	2	LF	BCW72;R	4c	Mm	BD182	2	P
BC161	2	LF	BCX17;R	4c	Mm	BD183	2	P
BC177	2	LF	BCX18;R	4c	Mm	BD201	2	P
BC178	2	LF	BCX19;R	4c	Mm	BD202	2	P
BC179	2	LF	BCX20;R	4c	Mm	BD203	2	P
BC200	2	LF	BCX51	4c	Mm	BD204	2	P
BC264A	3	FET	BCX52	4c	Mm	BD226	2	P
BC264B	3	FET	BCX53	4c	Mm	BD227	2	P
BC264C	3	FET	BCX54	4c	Mm	BD228	2	P
BC264D	3	FET	BCX55	4c	Mm	BD229	2	P
BC327	2	LF	BCX56	4c	Mm	BD230	2	P
BC328	2	LF	BCY30A	2	LF	BD231	2	P
BC337	2	LF	BCY31A	2	LF	BD232	2	P
BC338	2	LF	BCY32A	2	LF	BD233	2	P
BC368	2	LF	BCY33A	2	LF	BD234	2	P
BC369	2	LF	BCY34A	2	LF	BD235	2	P
BC546	2	LF	BCY55	2	DT	BD236	2	P
BC547	2	LF	BCY56	2	LF	BD237	2	P
BC548	2	LF	BCY57	2	LF	BD238	2	P
BC549	2	LF	BCY58	2	LF	BD262	2	P
BC550	2	LF	BCY59	2	LF	BD262A	2	P
BC556	2	LF	BCY70	2	LF	BD262B	2	P
BC557	2	LF	BCY71	2	LF	BD263	2	P
BC558	2	LF	BCY72	2	LF	BD263A	2	P
BC559	2	LF	BCY78	2	LF	BD263B	2	P
BC560	2	LF	BCY79	2	LF	BD266	2	P
BC635	2	LF	BCY87	2	DT	BD266A	2	P
BC636	2	LF	BCY88	2	DT	BD266B	2	P
BC637	2	LF	BCY89	2	DT	BD267	2	P
BC638	2	LF	BD115	2	P	BD267A	2	P
BC639	2	LF	BD131	2	P	BD267B	2	P
BC640	2	LF	BD132	2	P	BD291	2	P
BCW29;R	4c	Mm	BD133	2	P	BD292	2	P
BCW30;R	4c	Mm	BD135	2	P	BD293	2	P
BCW31;R	4c	Mm	BD136	2	P	BD294	2	P
BCW32;R	4c	Mm	BD137	2	P	BD329	2	P

DT = Dual transistors
 FET = Field-effect transistors
 LF = Low-frequency transistors

Mm = Discrete semiconductors for hybrid.
 thick and thin-film circuits
 P = Low-frequency power transistors

INDEX

type no.	part	section	type no.	part	section	type no.	part	section
BD330	2	P	BDX65A	2	P	BF198	3	HFSW
BD331	2	P	BDX65B	2	P	BF199	3	HFSW
BD332	2	P	BDX66	2	P	BF200	3	HFSW
BD333	2	P	BDX66A	2	P	BF240	3	HFSW
BD334	2	P	BDX66B	2	P	BF241	3	HFSW
BD335	2	P	BDX67	2	P	BF245A	3	FET
BD336	2	P	BDX67A	2	P	BF245B	3	FET
BD433	2	P	BDX67B	2	P	BF245C	3	FET
BD434	2	P	BDX77	2	P	BF256A	3	FET
BD435	2	P	BDX78	2	P	BF256B	3	FET
BD436	2	P	BDX91	2	P	BF256C	3	FET
BD437	2	P	BDX92	2	P	BF324	3	HFSW
BD438	2	P	BDX93	2	P	BF327	3	FET
BD645	2	P	BDX94	2	P	BF336	3	HFSW
BD646	2	P	BDX95	2	P	BF337	3	HFSW
BD647	2	P	BDX96	2	P	BF338	3	HFSW
BD648	2	P	BDY20	2	P	BF362	3	HFSW
BD649	2	P	BDY90	2	P	BF363	3	HFSW
BD650	2	P	BDY91	2	P	BF422	3	HFSW
BD675	2	P	BDY92	2	P	BF423	3	HFSW
BD676	2	P	BDY93	2	P	BF450	3	HFSW
BD677	2	P	BDY94	2	P	BF451	3	HFSW
BD678	2	P	BDY96	2	P	BF457	3	HFSW
BD679	2	P	BDY97	2	P	BF458	3	HFSW
BD680	2	P	BF115	3	HFSW	BF459	3	HFSW
BD681	2	P	BF167	3	HFSW	BF480	3	HFSW
BD682	2	P	BF173	3	HFSW	BF494	3	HFSW
BDX35	2	P	BF177	3	HFSW	BF495	3	HFSW
BDX36	2	P	BF178	3	HFSW	BF550;R	4c	Mm
BDX37	2	P	BF179	3	HFSW	BF622	4c	Mm
BDX62	2	P	BF180	3	HFSW	BF623	4c	Mm
BDX62A	2	P	BF181	3	HFSW	BFQ10	3	FET
BDX62B	2	P	BF182	3	HFSW	BFQ11	3	FET
BDX63	2	P	BF183	3	HFSW	BFQ12	3	FET
BDX63A	2	P	BF184	3	HFSW	BFQ13	3	FET
BDX63B	2	P	BF185	3	HFSW	BFQ14	3	FET
BDX64	2	P	BF194	3	HFSW	BFQ15	3	FET
BDX64A	2	P	BF195	3	HFSW	BFQ16	3	FET
BDX64B	2	P	BF196	3	HFSW	BFQ17	4c	Mm
BDX65	2	P	BF197	3	HFSW	BFQ18A	4c	Mm

FET = Field-effect transistors

P = Low-frequency power transistors

HFSW = High-frequency and switching transistors

Mm = Discrete semiconductors for hybrid
thick and thin-film circuits

INDEX

type no.	part	section	type no.	part	section	type no.	part	section
BFO19	4c	Mm	BFW16A	3	HFSW	BLY91A	4a	Tra
BFO23	3	HFSW	BFW17A	3	HFSW	BLY92A	4a	Tra
BFO24	3	HFSW	BFW30	3	HFSW	BLY93A	4a	Tra
BFO32	3	HFSW	BFW45	3	HFSW	BLY94	4a	Tra
BFO34	3	HFSW	BFW61	3	FET	BPW22	4b	PDT
BFR29	3	FET	BFW92	3	HFSW	BPX25;29	4b	PDT
BFR30	4c	Mm	BFW93	3	HFSW	BPX40	4b	PDT
BFR31	4c	Mm	BFX34	3	HFSW	BPX41	4b	PDT
BFR49	3	HFSW	BFX89	3	HFSW	BPX42	4b	PDT
BFR53;R	4c	Mm	BFY50	3	HFSW	BPX70	4b	PDT
BFR64	3	HFSW	BFY51	3	HFSW	BPX71	4b	PDT
BFR65	3	HFSW	BFY52	3	HFSW	BPX72	4b	PDT
BFR84	3	FET	BFY55	3	HFSW	BPX94	4b	PDT
BFR90	3	HFSW	BFY90	3	HFSW	BPX95	4b	PDT
BFR91	3	HFSW	BG1895-541	1a	R	BR100	1a	Th
BFR92;R	4c	Mm	BG1895-641	1a	R	BR101	3	HFSW
BFR93;R	4c	Mm	BGY37	3	HFSW	BRY39	1a	Th
BFR94	3	HFSW	BLW60	4a	Tra	BRY39(SCS)	3	HFSW
BFR95	3	HFSW	BLW64	4a	Tra	BRY39(PUT)	3	HFSW
BFR96	3	HFSW	BLW75	4a	Tra	BRY61	4c	Mm
BFS17;R	4c	Mm	BLX13	4a	Tra	BSR12;R	4c	Mm
BFS18;R	4c	Mm	BLX14	4a	Tra	BSR30	4c	Mm
BFS19;R	4c	Mm	BLX15	4a	Tra	BSR31	4c	Mm
BFS20;R	4c	Mm	BLX65	4a	Tra	BSR32	4c	Mm
BFS21	3	FET	BLX66	4a	Tra	BSR33	4c	Mm
BFS21A	3	FET	BLX67	4a	Tra	BSR40	4c	Mm
BFS22A	4a	Tra	BLX68	4a	Tra	BSR41	4c	Mm
BFS23A	4a	Tra	BLX69A	4a	Tra	BSR42	4c	Mm
BFS28	3	FET	BLX91A	4a	Tra	BSR43	4c	Mm
BFT24	3	HFSW	BLX92A	4a	Tra	BSR56	4c	Mm
BFT25;R	4c	Mm	BLX93A	4a	Tra	BSR57	4c	Mm
BFT44	3	HFSW	BLX94A	4a	Tra	BSR58	4c	Mm
BFT45	3	HFSW	BLX95	4a	Tra	BSS38	3	HFSW
BFT46	4c	Mm	BLX96	4a	Tra	BSS50	3	HFSW
BFT92;R	4c	Mm	BLX97	4a	Tra	BSS51	3	HFSW
BFT93;R	4c	Mm	BLX98	4a	Tra	BSS52	3	HFSW
BFW10	3	FET	BLY87A	4a	Tra	BSS60	3	HFSW
BFW11	3	FET	BLY88A	4a	Tra	BSS61	3	HFSW
BFW12	3	FET	BLY89A	4a	Tra	BSS63;R	4c	Mm
BFW13	3	FET	BLY90	4a	Tra	BSS64;R	4c	Mm

FET = Field-effect transistors
HFSW = High-frequency and switching transistors
Mm = Discrete semiconductors for hybrid
thick and thin-film circuits
PDT = Photodiodes or transistors

R = Rectifier diodes
Th = Thyristors
Tra = Transmitting transistors

type no.	part	section	type no.	part	section	type no.	part	section
BSS68	3	HFSW	BTX18 series	1a	Th	BY476	1a	R
BSV15	3	HFSW	BTX94 series	1a	Tri	BYX10	1a	R
BSV16	3	HFSW	BTX95 series	1a	Th	BYX22 series	1a	R
BSV17	3	HFSW	BTY79 series	1a	Th	BYX25 series	1a	R
BSV52;R	4c	Mm	BTY87 series	1a	Th	BYX29 series	1a	R
BSV64	3	HFSW	BTY91 series	1a	Th	BYX30 series	1a	R
BSV78	3	FET	BU105	2	P	BYX32 series	1a	R
BSV79	3	FET	BU108	2	P	BYX35	1a	R
BSV80	3	FET	BU126	2	P	BYX36 series	1a	R
BSV81	3	FET	BU132	2	P	BYX38 series	1a	R
BSW41A	3	HFSW	BU133	2	P	BYX39 series	1a	R
BSW66	3	HFSW	BU204	2	P	BYX42 series	1a	R
BSW67	3	HFSW	BU205	2	P	BYX45 series	1a	R
BSW68	3	HFSW	BU206	2	P	BYX46 series	1a	R
BSX19	3	HFSW	BU207A	2	P	BYX48 series	1a	R
BSX20	3	HFSW	BU208A	2	P	BYX49 series	1a	R
BSX21	3	HFSW	BU209A	2	P	BYX50 series	1a	R
BSX45	3	HFSW	BU326A	2	P	BYX52 series	1a	R
BSX46	3	HFSW	BUX80	2	P	BYX55 series	1a	R
BSX47	3	HFSW	BUX81	2	P	BYX56 series	1a	R
BSX59	3	HFSW	BUX82	2	P	BYX71 series	1a	R
BSX60	3	HFSW	BUX83	2	P	BYX90	1a	R
BSX61	3	HFSW	BUX84	2	P	BYX91 series	1a	R
BT126	1a	Th	BUX85	2	P	BYX96 series	1a	R
BT128 series	1a	Th	BUX86	2	P	BYX97 series	1a	R
BT129 series	1a	Th	BUX87	2	P	BYX98 series	1a	R
BTW23 series	1a	Th	BY126	1a	R	BYX99 series	1a	R
BTW24 series	1a	Th	BY127	1a	R	BZV10	1b	Vrf
BTW30 series	1a	Th	BY164	1a	R	BZV11	1b	Vrf
BTW31 series	1a	Th	BY176	1a	R	BZV12	1b	Vrf
BTW32 series	1a	Th	BY179	1a	R	BZV13	1b	Vrf
BTW33 series	1a	Th	BY184	1a	R	BZV14	1b	Vrf
BTW34 series	1a	Tri	BY187	1a	R	BZV15 series	1a	Vrg
BTW38 series	1a	Th	BY188 series	1a	R	BZV38	1b	Vrf
BTW40 series	1a	Th	BY206	1a	R	BZW70 series	1a	TS
BTW42 series	1a	Th	BY207	1a	R	BZW86 series	1a	TS
BTW43 series	1a	Tri	BY208 series	1a	R	BZW91 series	1a	TS
BTW45 series	1a	Th	BY209	1a	R	BZW93 series	1a	TS
BTW47 series	1a	Th	BY223	1a	R	BZX55 series	1b	Vrg
BTW92 series	1a	Th	BY409	1a	R	BZX61 series	1b	Vrg

FET = Field-effect transistors
 HFSW = High-frequency and switching transistors
 Mm = Discrete semiconductors for hybrid thick and thin-film circuits
 P = Low-frequency power transistors
 R = Rectifier diodes

Th = Thyristors
 Tri = Triacs
 TS = Transient suppressor diodes
 Vrf = Voltage reference diodes
 Vrg = Voltage regulator diodes

INDEX

type no.	part	section	type no.	part	section	type no.	part	section
BZX70 series	1a	Vrg	CQY11B	4b	LED	OSM9410	1a	St
BZX75 series	1b	Vrg	CQY11C	4b	LED	OSS9110	1a	St
BZX79 series	1b	Vrg	CQY24A	4b	LED	OSS9210	1a	St
BZX84 series	4c	Mm	CQY46	4b	LED	OSS9310	1a	St
BZX87 series	1b	Vrg	CQY47	4b	LED	OSS9410	1a	St
BZX90	1b	Vrf	CQY49B	4b	LED	RPY18	4b	Ph
BZX91	1b	Vrf	CQY49C	4b	LED	RPY19	4b	Ph
BZX92	1b	Vrf	CQY50	4b	LED	RPY20	4b	Ph
BZX93	1b	Vrf	CQY52	4b	LED	RPY33	4b	Ph
BZY78	1b	Vrf	CQY53	4b	LED	RPY55	4b	Ph
BZY88 series	1b	Vrg	CQY54	4b	LED	RPY58A	4b	Ph
BZY91 series	1a	Vrg	CQY58	4b	LED	RPY71	4b	Ph
BZY93 series	1a	Vrg	CQY79	4b	LED	RPY76A	4b	I
BZY95 series	1a	Vrg	CQY81	4b	D	RPY82	4b	Ph
BZY96 series	1a	Vrg	CQY81A	4b	D	RPY84	4b	Ph
BZZ14	1a	Vrg	CQY84	4b	D	RPY85	4b	Ph
BZZ15	1a	Vrg	CQY88	4b	LED	1N821	1b	Vrf
BZZ16	1a	Vrg	OA47	1b	GB	1N823	1b	Vrf
BZZ17	1a	Vrg	OA90	1b	PC	1N825	1b	Vrf
BZZ18	1a	Vrg	OA91	1b	PC	1N827	1b	Vrf
BZZ19	1a	Vrg	OA95	1b	PC	1N829	1b	Vrf
BZZ20	1a	Vrg	OA200	1b	AD	1N914	1b	WD
BZZ21	1a	Vrg	OA202	1b	AD	1N914A	1b	WD
BZZ22	1a	Vrg	ORP10	4b	I	1N916	1b	WD
BZZ23	1a	Vrg	ORP13	4b	I	1N916A	1b	WD
BZZ24	1a	Vrg	ORP23	4b	Ph	1N916B	1b	WD
BZZ25	1a	Vrg	ORP52	4b	Ph	1N4009	1b	WD
BZZ26	1a	Vrg	ORP60	4b	Ph	1N4148	1b	WD
BZZ27	1a	Vrg	ORP61	4b	Ph	1N4150	1b	WD
BZZ28	1a	Vrg	ORP62	4b	Ph	1N4151	1b	WD
BZZ29	1a	Vrg	ORP66	4b	Ph	1N4154	1b	WD
CNY22	4b	PhC	ORP68	4b	Ph	1N4446	1b	WD
CNY23	4b	PhC	ORP69	4b	Ph	1N4448	1b	WD
CNY42	4b	PhC	OSB9110	1a	St	1N5729B	1b	Vrg
CNY43	4b	PhC	OSB9210	1a	St	1N5730B	1b	Vrg
CNY44	4b	PhC	OSB9310	1a	St	1N5731B	1b	Vrg
CNY46	4b	PhC	OSB9410	1a	St	1N5732B	1b	Vrg
CNY47	4b	PhC	OSM9110	1a	St	1N5733B	1b	Vrg
CNY47A	4b	PhC	OSM9210	1a	St	1N5734B	1b	Vrg
CNY48	4b	PhC	OSM9310	1a	St	1N5735B	1b	Vrg

AD = Silicon alloyed diodes

D = Displays

GB = Germanium gold bonded diodes

I = Infrared devices

LED = Light-emitting diodes

Mm = Discrete semiconductors for hybrid thick and thin-film circuits

PC = Germanium point contact diodes

Ph = Photoconductive devices

PhC = Photocouplers

St = Rectifier stacks

V_{rf} = Voltage reference diodes

V_{rg} = Voltage regulator diodes

WD = Silicon whiskerless diodes

type no.	part	section	type no.	part	section	type no.	part	section
1N5736B	1b	Vrg	2N2483	2	LF	2N4858	3	FET
1N5737B	1b	Vrg	2N2484	2	LF	2N4859	3	FET
1N5738B	1b	Vrg	2N2894	3	HFSW	2N4860	3	FET
1N5739B	1b	Vrg	2N2894A	3	HFSW	2N4861	3	FET
1N5740B	1b	Vrg	2N2904	3	HFSW	2N5415	3	HFSW
1N5741B	1b	Vrg	2N2904A	3	HFSW	2N5416	3	HFSW
1N5742B	1b	Vrg	2N2905	3	HFSW	61SV	4b	I
1N5743B	1b	Vrg	2N2905A	3	HFSW	40820	3	HFSW
1N5744B	1b	Vrg	2N2906	3	HFSW	40835	3	HFSW
1N5745B	1b	Vrg	2N2906A	3	HFSW	40838	3	HFSW
1N5746B	1b	Vrg	2N2907	3	HFSW	56200	2,3,4a	A
1N5747B	1b	Vrg	2N2907A	3	HFSW	56201	2	A
1N5748B	1b	Vrg	2N3019	3	HFSW	56201c	2	A
1N5749B	1b	Vrg	2N3020	3	HFSW	56201d	2	A
1N5750B	1b	Vrg	2N3055	2	P	56201j	2	A
1N5751B	1b	Vrg	2N3375	4a	Tra	56203	2	A
1N5752B	1b	Vrg	2N3442	2	P	56218	2,3,4a	A
1N5753B	1b	Vrg	2N3553	4a	Tra	56230	1a	HE
1N5754B	1b	Vrg	2N3632	4a	Tra	56231	1a	HE
1N5755B	1b	Vrg	2N3823	3	FET	56233	1a	A
1B5756B	1b	Vrg	2N3866	4a	Tra	56234	1a	A
1N5757B	1b	Vrg	2N3924	4a	Tra	56245	2,3,4a	A
2N918	3	HFSW	2N3926	4a	Tra	56246	1a to 4a	A
2N929	2	LF	2N3927	4a	Tra	56253	1a	DH
2N930	2	LF	2N3966	3	FET	56256	1a	DH
2N1613	3	HFSW	2N4030	3	HFSW			
2N1711	3	HFSW	2N4031	3	HFSW	56261	2	A
2N1893	3	HFSW	2N4032	3	HFSW	56261A	2	A
2N2218	3	HFSW	2N4033	3	HFSW	56262A	1a	A
2N2218A	3	HFSW	2N4036	3	HFSW	56263	1a to 4a	A
2N2219	3	HFSW	2N4091	3	FET	56264A	1a	A
2N2219A	3	HFSW	2N4092	3	FET	56268	1a	DH
2N2221	3	HFSW	2N4093	3	FET	56271	1a	DH
2N2221A	3	HFSW	2N4347	2	P	56278	1a	DH
2N2222	3	HFSW	2N4391	3	FET	56280	1a	DH
2N2222A	3	HFSW	2N4392	3	FET	56290	1a	HE
2N2297	3	HFSW	2N4393	3	FET	56293	1a	HE
2N2368	3	HFSW	2N4427	4a	Tra	56295	1a	A
2N2369	3	HFSW	2N4856	3	FET	56299	1a	A
2N2369A	3	HFSW	2N4857	3	FET	56309B	1a	A

A = Accessories
 DH = Diecast heatsinks
 FET = Field-effect transistors
 HE = Heatsink extrusions
 HFSW = High-frequency and switching transistors

I = Infrared devices
 LF = Low-frequency transistors
 P = Low-frequency power transistors
 Tra = Transmitting transistors
 Vrg = Voltage regulator diodes

INDEX

type no.	part	section	type no.	part	section	type no.	part	section
56309R	1a	A	56334	1a	DH	56356	2,3	A
56312	1a	DH	56337	1a	A	56359	2	A
56313	1a	DH	56339	2	A	56359a	2	A
56314	1a	DH	56348	1a	DH	56360	2	A
56315	1a	DH	56349	1a	DH	56360a	2	A
56316	1a	A	56350	1a	DH	56363	2	A
56318	1a	DH	56351	2	A	56364	2	A
56319	1a	DH	56352	2	A	56367	2	A
56326	2,3	A	56353	2	A	56368	2	A
56333	2,3	A	56354	2	A	56369	2	A

A = Accessories

DH = Diecast heatsinks

GENERAL



Pro Electron Type designation
Rating Systems
Letter Symbols
S-parameters

PRO ELECTRON TYPE DESIGNATION CODE
FOR SEMICONDUCTOR DEVICES

This type designation code applies to discrete semiconductor devices — as opposed to integrated circuits —, multiples of such devices and semiconductor chips.

A basic type number consists of:

TWO LETTERS FOLLOWED BY A SERIAL NUMBER

FIRST LETTER

The first letter gives information about the material used for the active part of the devices.

- A. GERMANIUM or other material with band gap of 0,6 to 1,0 eV.
- B. SILICON or other material with band gap of 1,0 to 1,3 eV.
- C. GALLIUM-ARSENIDE or other material with band gap of 1,3 eV or more.
- R. COMPOUND MATERIALS (e.g. Cadmium-Sulphide).

SECOND LETTER

The second letter indicates the function for which the device is primarily designed.

- A. DIODE; signal, low power
- B. DIODE; variable capacitance
- C. TRANSISTOR; low power, audio frequency ($R_{th\ j-mb} > 15\ ^\circ C/W$)
- D. TRANSISTOR; power, audio frequency ($R_{th\ j-mb} \leq 15\ ^\circ C/W$)
- E. DIODE; tunnel
- F. TRANSISTOR; low power, high frequency ($R_{th\ j-mb} > 15\ ^\circ C/W$)
- G. MULTIPLE OF DISSIMILAR DEVICES — MISCELLANEOUS; e.g. oscillator
- H. DIODE; magnetic sensitive
- L. TRANSISTOR; power, high frequency ($R_{th\ j-mb} \leq 15\ ^\circ C/W$)
- N. PHOTO-COUPLER
- P. RADIATION DETECTOR; e.g. high sensitivity phototransistor
- Q. RADIATION GENERATOR; e.g. light-emitting diode (LED)
- R. CONTROL AND SWITCHING DEVICE; e.g. thyristor, low power ($R_{th\ j-mb} > 15\ ^\circ C/W$)
- S. TRANSISTOR; low power, switching ($R_{th\ j-mb} > 15\ ^\circ C/W$)
- T. CONTROL AND SWITCHING DEVICE; e.g. thyristor, power ($R_{th\ j-mb} \leq 15\ ^\circ C/W$)
- U. TRANSISTOR; power, switching ($R_{th\ j-mb} \leq 15\ ^\circ C/W$)
- X. DIODE: multiplier, e.g. varactor, step recovery
- Y. DIODE; rectifying, booster
- Z. DIODE; voltage reference or regulator (transient suppressor diode, with third letter W)

TYPE DESIGNATION

SERIAL NUMBER

Three figures, running from 100 to 999, for devices primarily intended for consumer equipment. One letter (Z, Y, X, etc.) and two figures, running from 10 to 99, for devices primarily intended for industrial/professional equipment.

This letter has no fixed meaning except W, which is used for transient suppressor diodes.

VERSION LETTER

It indicates a minor variant of the basic type either electrically or mechanically. The letter never has a fixed meaning, except letter R, indicating reverse voltage, e.g. collector to case or anode to stud.

SUFFIX

Sub-classification can be used for devices supplied in a wide range of variants called associated types. Following sub-coding suffixes are in use:

1. VOLTAGE REFERENCE and VOLTAGE REGULATOR DIODES: *ONE LETTER and ONE NUMBER*

The LETTER indicates the nominal tolerance of the Zener (regulation, working or reference) voltage

A. 1% (according to IEC 63: series E96)

B. 2% (according to IEC 63: series E48)

C. 5% (according to IEC 63: series E24)

D. 10% (according to IEC 63: series E12)

E. 20% (according to IEC 63: series E6)

The number denotes the typical operating (Zener) voltage related to the nominal current rating for the whole range.

The letter 'V' is used instead of the decimal point.

2. TRANSIENT SUPPRESSOR DIODES: *ONE NUMBER*

The NUMBER indicates the maximum recommended continuous reversed (stand-off) voltage V_R . The letter 'V' is used as above.

3. CONVENTIONAL and CONTROLLED AVALANCHE RECTIFIER DIODES and THYRISTORS: *ONE NUMBER*

The NUMBER indicates the rated maximum repetitive peak reverse voltage (V_{RRM}) or the rated repetitive peak off-state voltage (V_{DRM}), whichever is the lower. Reversed polarity is indicated by letter R, immediately after the number.

4. RADIATION DETECTORS: *ONE NUMBER*, preceded by a hyphen (-)

The NUMBER indicates the depletion layer in μm . The resolution is indicated by a version LETTER.

5. ARRAY OF RADIATION DETECTORS and GENERATORS: *ONE NUMBER*, preceded by a stroke (/).

The NUMBER indicates how many basic devices are assembled into the array.

RATING SYSTEMS

The rating systems described are those recommended by the International Electrotechnical Commission (IEC) in its Publication 134.

DEFINITIONS OF TERMS USED

Electronic device. An electronic tube or valve, transistor or other semiconductor device.

Note

This definition excludes inductors, capacitors, resistors and similar components.

Characteristic. A characteristic is an inherent and measurable property of a device. Such a property may be electrical, mechanical, thermal, hydraulic, electro-magnetic, or nuclear, and can be expressed as a value for stated or recognized conditions. A characteristic may also be a set of related values, usually shown in graphical form.

Bogey electronic device. An electronic device whose characteristics have the published nominal values for the type. A bogey electronic device for any particular application can be obtained by considering only those characteristics which are directly related to the application.

Rating. A value which establishes either a limiting capability or a limiting condition for an electronic device. It is determined for specified values of environment and operation, and may be stated in any suitable terms.

Note

Limiting conditions may be either maxima or minima.

Rating system. The set of principles upon which ratings are established and which determine their interpretation.

Note

The rating system indicates the division of responsibility between the device manufacturer and the circuit designer, with the object of ensuring that the working conditions do not exceed the ratings.

ABSOLUTE MAXIMUM RATING SYSTEM

Absolute maximum ratings are limiting values of operating and environmental conditions applicable to any electronic device of a specified type as defined by its published data, which should not be exceeded under the worst probable conditions.

These values are chosen by the device manufacturer to provide acceptable serviceability of the device, taking no responsibility for equipment variations, environmental variations, and the effects of changes in operating conditions due to variations in the characteristics of the device under consideration and of all other electronic devices in the equipment.

The equipment manufacturer should design so that, initially and throughout life, no absolute maximum value for the intended service is exceeded with any device under the worst probable operating conditions with respect to supply voltage variation, equipment component variation, equipment control adjustment, load variations, signal variation, environmental conditions, and variations in characteristics of the device under consideration and of all other electronic devices in the equipment.

DESIGN MAXIMUM RATING SYSTEM

Design maximum ratings are limiting values of operating and environmental conditions applicable to a bogey electronic device of a specified type as defined by its published data, and should not be exceeded under the worst probable conditions.

These values are chosen by the device manufacturer to provide acceptable serviceability of the device, taking responsibility for the effects of changes in operating conditions due to variations in the characteristics of the electronic device under consideration.

The equipment manufacturer should design so that, initially and throughout life, no design maximum value for the intended service is exceeded with a bogey device under the worst probable operating conditions with respect to supply voltage variation, equipment component variation, variation in characteristics of all other devices in the equipment, equipment control adjustment, load variation, signal variation and environmental conditions.

DESIGN CENTRE RATING SYSTEM

Design centre ratings are limiting values of operating and environmental conditions applicable to a bogey electronic device of a specified type as defined by its published data, and should not be exceeded under normal conditions.

These values are chosen by the device manufacturer to provide acceptable serviceability of the device in average applications, taking responsibility for normal changes in operating conditions due to rated supply voltage variation, equipment component variation, equipment control adjustment, load variation, signal variation, environmental conditions, and variations in the characteristics of all electronic devices.

The equipment manufacturer should design so that, initially, no design centre value for the intended service is exceeded with a bogey electronic device in equipment operating at the stated normal supply voltage.

LETTER SYMBOLS FOR TRANSISTORS AND SIGNAL DIODES

based on IEC Publication 148

LETTER SYMBOLS FOR CURRENTS, VOLTAGES AND POWERS

Basic letters

The basic letters to be used are:

I, i = current
V, v = voltage
P, p = power.

Lower-case basic letters shall be used for the representation of instantaneous values which vary with time.

In all other instances upper-case basic letters shall be used.

Subscripts

A, a	Anode terminal
(AV), (av)	Average value
B, b	Base terminal, for MOS devices: Substrate
(BR)	Breakdown
C, c	Collector terminal
D, d	Drain terminal
E, e	Emitter terminal
F, f	Forward
G, g	Gate terminal
K, k	Cathode terminal
M, m	Peak value
O, o	As third subscript: The terminal not mentioned is open circuited
R, r	As first subscript: Reverse. As second subscript: Repetitive. As third subscript: With a specified resistance between the terminal not mentioned and the reference terminal.
(RMS), (rms)	R. M. S. value
S, s	{ As first or second subscript: Source terminal (for FETS only) As second subscript: Non-repetitive (not for FETS) As third subscript: Short circuit between the terminal not mentioned and the reference terminal
X, x	Specified circuit
Z, z	Replaces R to indicate the actual working voltage, current or power of voltage reference and voltage regulator diodes.

Note: No additional subscript is used for d. c. values.

LETTER SYMBOLS

Upper-case subscripts shall be used for the indication of:

- a) continuous (d. c.) values (without signal)
Example I_B
- b) instantaneous total values
Example i_B
- c) average total values
Example $I_{B(AV)}$
- d) peak total values
Example I_{BM}
- e) root-mean-square total values
Example $I_{B(RMS)}$

Lower-case subscripts shall be used for the indication of values applying to the varying component alone:

- a) instantaneous values
Example i_b
- b) root-mean-square values
Example $I_{b(rms)}$
- c) peak values
Example I_{bm}
- d) average values
Example $I_{b(av)}$

Note: If more than one subscript is used, subscript for which both styles exist shall either be all upper-case or all lower-case.

Additional rules for subscripts

Subscripts for currents

Transistors: If it is necessary to indicate the terminal carrying the current, this should be done by the first subscript (conventional current flow from the external circuit into the terminal is positive).

Examples: I_B , i_B , i_b , I_{bm}

Diodes: To indicate a forward current (conventional current flow into the anode terminal) the subscript F or f should be used; for a reverse current (conventional current flow out of the anode terminal) the subscript R or r should be used.

Examples: I_F , I_R , i_F , $I_{f(rms)}$

Subscripts for voltages

Transistors: If it is necessary to indicate the points between which a voltage is measured, this should be done by the first two subscripts. The first subscript indicates the terminal at which the voltage is measured and the second the reference terminal or the circuit node. Where there is no possibility of confusion, the second subscript may be omitted.

Examples: V_{BE} , v_{BE} , v_{be} , V_{bem}

Diodes: To indicate a forward voltage (anode positive with respect to cathode), the subscript F or f should be used; for a reverse voltage (anode negative with respect to cathode) the subscript R or r should be used.

Examples: V_F , V_R , v_F , V_{rm}

Subscripts for supply voltages or supply currents

Supply voltages or supply currents shall be indicated by repeating the appropriate terminal subscript.

Examples: V_{CC} , I_{EE}

Note: If it is necessary to indicate a reference terminal, this should be done by a third subscript

Example: V_{CCE}

Subscripts for devices having more than one terminal of the same kind

If a device has more than one terminal of the same kind, the subscript is formed by the appropriate letter for the terminal followed by a number; in the case of multiple subscripts, hyphens may be necessary to avoid misunderstanding.

Examples: I_{B2} = continuous (d.c.) current flowing into the second base terminal

V_{B2-E} = continuous (d.c.) voltage between the terminals of second base and emitter

Subscripts for multiple devices

For multiple unit devices, the subscripts are modified by a number preceding the letter subscript; in the case of multiple subscripts, hyphens may be necessary to avoid misunderstanding.

Examples: I_{2C} = continuous (d.c.) current flowing into the collector terminal of the second unit

V_{1C-2C} = continuous (d.c.) voltage between the collector terminals of the first and the second unit.

Application of the rules

The figure below represents a transistor collector current as a function of time. It consists of a continuous (d. c.) current and a varying component.

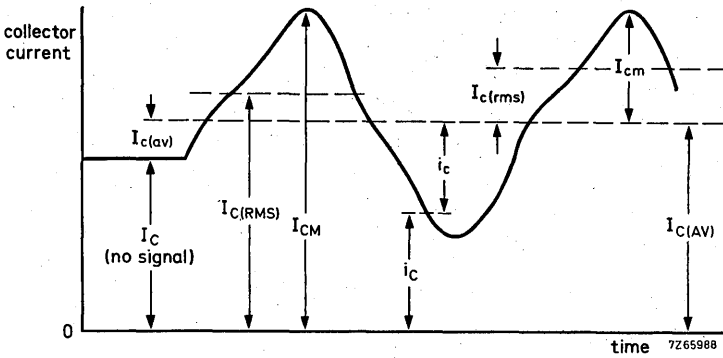

LETTER SYMBOLS FOR ELECTRICAL PARAMETERS

Definition

For the purpose of this Publication, the term "electrical parameter" applies to four-pole matrix parameters, elements of electrical equivalent circuits, electrical impedances and admittances, inductances and capacitances.

Basic letters

The following is a list of the most important basic letters used for electrical parameters of semiconductor devices.

- B, b = susceptance; imaginary part of an admittance
- C = capacitance
- G, g = conductance; real part of an admittance
- H, h = hybrid parameter
- L = inductance
- R, r = resistance; real part of an impedance
- X, x = reactance; imaginary part of an impedance
- Y, y = admittance;
- Z, z = impedance;

Upper-case letters shall be used for the representation of:

- a) electrical parameters of external circuits and of circuits in which the device forms only a part;
- b) all inductances and capacitances.

Lower-case letters shall be used for the representation of electrical parameters inherent in the device (with the exception of inductances and capacitances).

Subscripts

General subscripts

The following is a list of the most important general subscripts used for electrical parameters of semiconductor devices:

F, f	= forward; forward transfer
I, i (or 1)	= input
L, l	= load
O, o (or 2)	= output
R, r	= reverse; reverse transfer
S, s	= source

Examples: Z_S , h_I , h_F

The upper-case variant of a subscript shall be used for the designation of static (d. c.) values.

Examples: h_{FE} = static value of forward current transfer ratio in common-emitter configuration (d. c. current gain)
 R_E = d. c. value of the external emitter resistance.

Note: The static value is the slope of the line from the origin to the operating point on the appropriate characteristic curve, i. e. the quotient of the appropriate electrical quantities at the operating point.

The lower-case variant of a subscript shall be used for the designation of small-signal values.

Examples: h_{fe} = small-signal value of the short-circuit forward current transfer ratio in common-emitter configuration

$Z_e = R_e + jX_e$ = small-signal value of the external impedance

Note: If more than one subscript is used, subscripts for which both styles exist shall either be all upper-case or all lower-case

Examples: h_{FE} , y_{RE} , h_{fe}

Subscripts for four-pole matrix parameters

The first letter subscript (or double numeric subscript) indicates input, output, forward transfer or reverse transfer

$$\begin{array}{l} \text{Examples: } h_i \text{ (or } h_{11}) \\ h_o \text{ (or } h_{22}) \\ h_f \text{ (or } h_{21}) \\ h_r \text{ (or } h_{12}) \end{array}$$

A further subscript is used for the identification of the circuit configuration. When no confusion is possible, this further subscript may be omitted.

$$\text{Examples: } h_{fe} \text{ (or } h_{21e}), h_{FE} \text{ (or } h_{21E})$$

Distinction between real and imaginary parts

If it is necessary to distinguish between real and imaginary parts of electrical parameters, no additional subscripts should be used. If basic symbols for the real and imaginary parts exist, these may be used.

$$\begin{array}{l} \text{Examples: } Z_i = R_i + jX_i \\ y_{fe} = g_{fe} + jb_{fe} \end{array}$$

If such symbols do not exist or if they are not suitable, the following notation shall be used:

$$\begin{array}{l} \text{Examples: } \text{Re}(h_{ib}) \text{ etc. for the real part of } h_{ib} \\ \text{Im}(h_{ib}) \text{ etc. for the imaginary part of } h_{ib} \end{array}$$

SCATTERING PARAMETERS

In distinction to the conventional h, y and z-parameters, s-parameters relate to traveling wave conditions. The figure below shows a two-port network with the incident and reflected waves a_1 , b_1 , a_2 and b_2 .

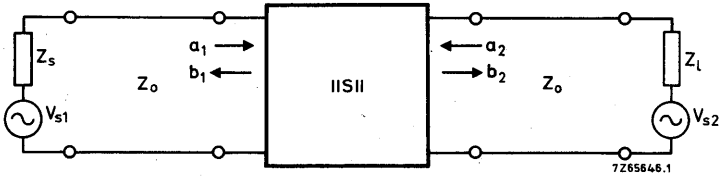

$$a_1 = \frac{V_{i1}}{\sqrt{Z_0}}$$

$$a_2 = \frac{V_{i2}}{\sqrt{Z_0}}$$

$$b_1 = \frac{V_{r1}}{\sqrt{Z_0}}$$

$$b_2 = \frac{V_{r2}}{\sqrt{Z_0}}$$

1)

Z_0 = characteristic impedance of the transmission line in which the two-port is connected.

V_i = incident voltage

V_r = reflected (generated) voltage

The four-pole equations for s-parameters are:

$$b_1 = s_{11}a_1 + s_{12}a_2$$

$$b_2 = s_{21}a_1 + s_{22}a_2$$

Using the subscripts i for 11, r for 12, f for 21 and o for 22, it follows that:

$$s_i = s_{11} = \left. \frac{b_1}{a_1} \right|_{a_2 = 0}$$

$$s_r = s_{12} = \left. \frac{b_1}{a_2} \right|_{a_1 = 0}$$

$$s_f = s_{21} = \left. \frac{b_2}{a_1} \right|_{a_2 = 0}$$

$$s_o = s_{22} = \left. \frac{b_2}{a_2} \right|_{a_1 = 0}$$

1) The squares of these quantities have the dimension of power.



S-PARAMETERS

The s-parameters can be named and expressed as follows:

$s_i = s_{11}$ = Input reflection coefficient.

The complex ratio of the reflected wave and the incident wave at the input, under the conditions $Z_1 = Z_0$ and $V_{s2} = 0$.

$s_r = s_{12}$ = Reverse transmission coefficient.

The complex ratio of the generated wave at the input and the incident wave at the output, under the conditions $Z_s = Z_0$ and $V_{s1} = 0$.

$s_f = s_{21}$ = Forward transmission coefficient.

The complex ratio of the generated wave at the output and the incident wave at the input, under the conditions $Z_1 = Z_0$ and $V_{s2} = 0$.

$s_o = s_{22}$ = Output reflection coefficient.

The complex ratio of the reflected wave and the incident wave at the output, under the conditions $Z_s = Z_0$ and $V_{s1} = 0$.

SOLDERING RECOMMENDATIONS



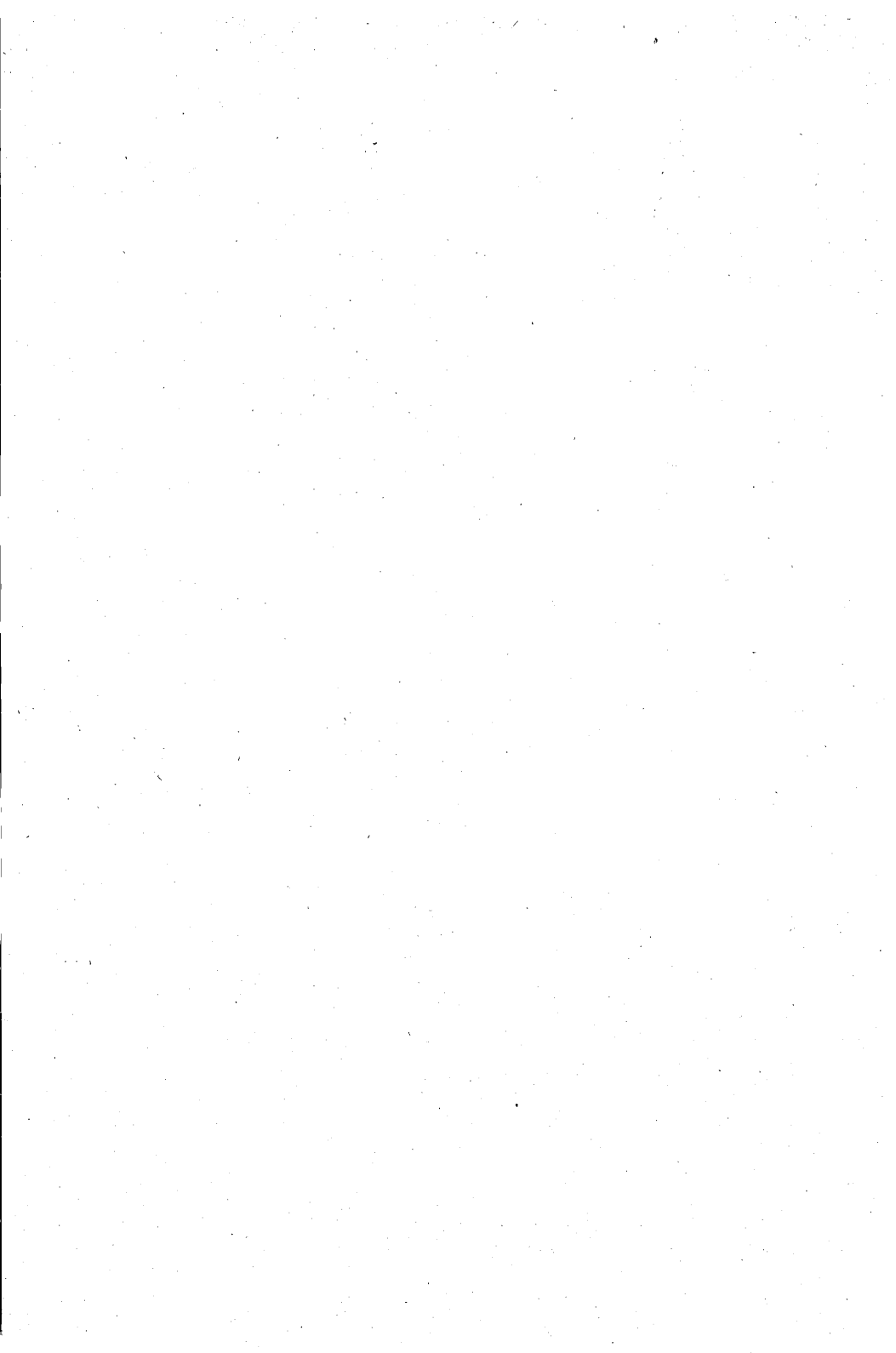

SOLDERING RECOMMENDATIONS SOT-23 AND SOT-89

REFLOW SOLDERING

The preferred technique for mounting microminiature components on hybrid thick and thin-film is the method of reflow soldering.

The tags of both SOT-23 and SOT-89 envelopes are pre-tinned and the best results are obtained if a similar solder is applied to the corresponding soldering areas on the substrate. This can be done by either dipping the substrate in a solder bath or by screen printing a solder paste.

For reliable connections it should be kept in mind that:

The maximum temperature of the leads or tab during the soldering cycle does not exceed 275 °C.

The flux must affect neither components nor connectors.

The residue of the flux must be easy to remove.

Good flux or solder paste with these properties are available on the market.

The most economic method of soldering is a process in which all different components are soldered simultaneously for example SOT-23 or SOT-89 devices, capacitors and resistors.

Having first been fluxed, all components are positioned on the substrate. The slight adhesive force of the flux is sufficient to keep the components in place. Solder paste contains a flux and has therefore good inherent adhesive properties which eases positioning of the components.

With the components in position the substrate is heated to a point where the solder begins to flow. This can be done on a heating plate or on a conveyor belt running through an infrared tunnel. The maximum allowed temperature of the plastic body of a device must be kept below 250 °C during the soldering cycle. For further temperature behaviour during the soldering process see Figs 1 and 2.

The surface tension of the liquid solder tends to draw the tags of the device towards the centre of the soldering area and has thus a correcting effect on slight mispositionings. However, if the layout leaves something to be desired the same effect can result in undesirable shifts; particularly if the soldering areas on the substrate and the components are not concentrically arranged. This problem can be solved using a standard contact pattern, which leaves sufficient scope for the self-positioning effect.

After the solder has set and cooled the connections are visually inspected and, where necessary, put right with a soldering iron. Finally the remnants of the flux must be removed carefully.

IMMERSION SOLDERING

Maximum allowed temperature of the soldering bath is 235 °C. Maximum duration of soldering cycle is 5 seconds and forced cooling must be applied.

HAND SOLDERING

It is possible to solder SOT-23 and SOT-89 devices with a miniature hand-held soldering iron, but this method has particular drawbacks and should therefore be restricted to laboratory use and/or incidental repairs on production circuits.

1. It is time-consuming and expensive.
2. The device cannot be positioned accurately and therefore the connecting tags may come into contact with the substrate and damage it.
3. There is a great risk of breaking either substrate or internal connections inside the encapsulation.
4. The envelope may be damaged by the iron.

**SOLDERING
RECOMMENDATIONS**

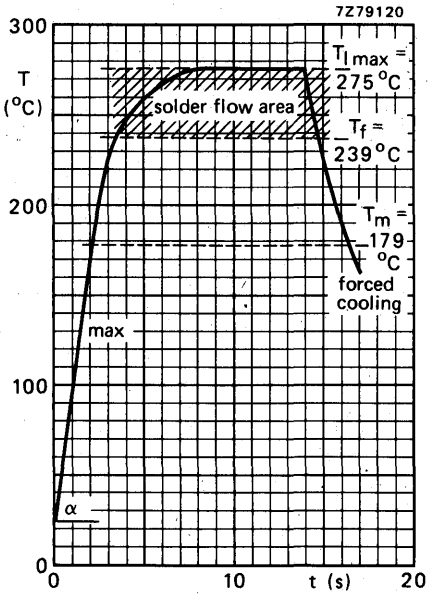

- $T_{l\max}$ = Maximum lead or tab temperature is 275 °C.
- T_f = Flow temperature of the solder is 239 °C.
- T_m = Melting point of the solder is 179 °C.
- α = Maximum permissible rate of temperature change is 75 °C/s.
- T_{amb} = 25 °C.

Fig. 1 Reflow soldering without pre-heating.

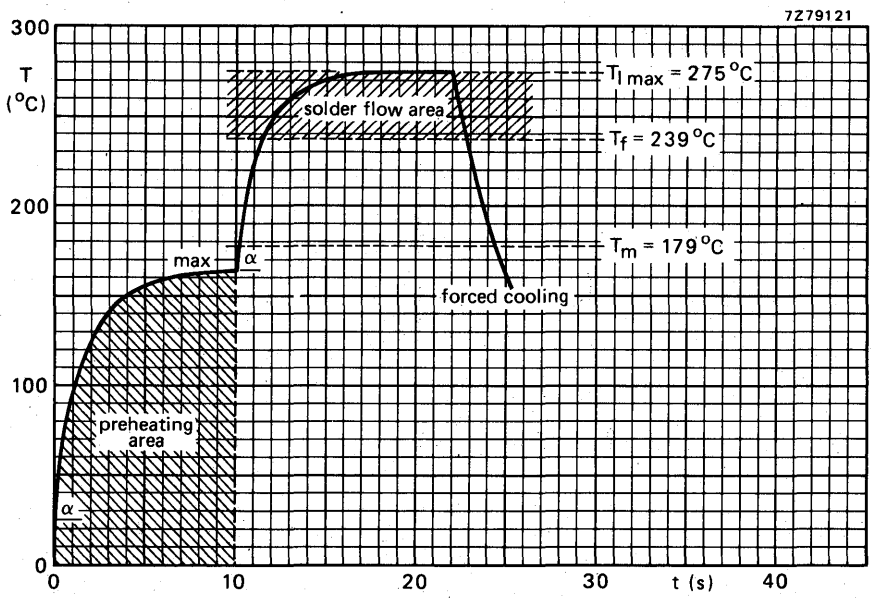

Fig. 2 Reflow soldering with pre-heating.

Minimum required dimensions of metal connection pads on hybrid thick and thin-film substrates.

Dimensions in mm

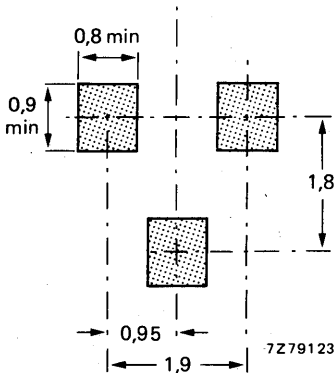

Fig. 3 SOT-23 pattern.

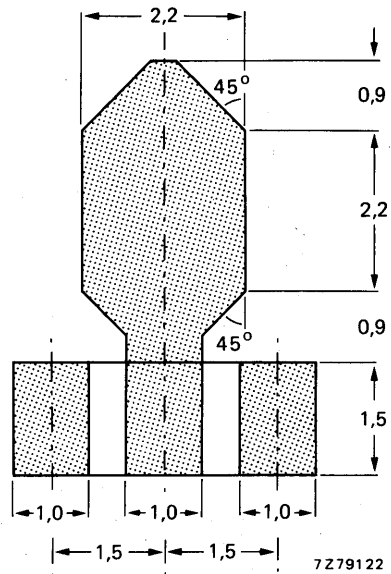

Fig. 4 SOT-89 pattern.

GENERAL NOTES

Recommended metal-alloy

- 62 Sn/36 Pb/2 Ag (85% metal weight, when solder paste is used).
- 60 Sn/40 Pb.

Pre-heating

Pre-heating is recommended for good soldering and avoiding damage to the SOT-23 or SOT-89 devices, other components and the substrate. Maximum pre-heating temperature is 165 °C while the maximum pre-heating duration may be 10 seconds.

Duration of soldering cycle

The maximum duration of soldering cycle without pre-heating is 14 seconds; with pre-heating 22 seconds (see Figs 1 and 2). Pre-heating duration may be 10 seconds.

TYPE NUMBER SURVEY



**NUMERICAL INDEX
REVERSE TYPES
Mark and Marking code
Nearest conventional types**

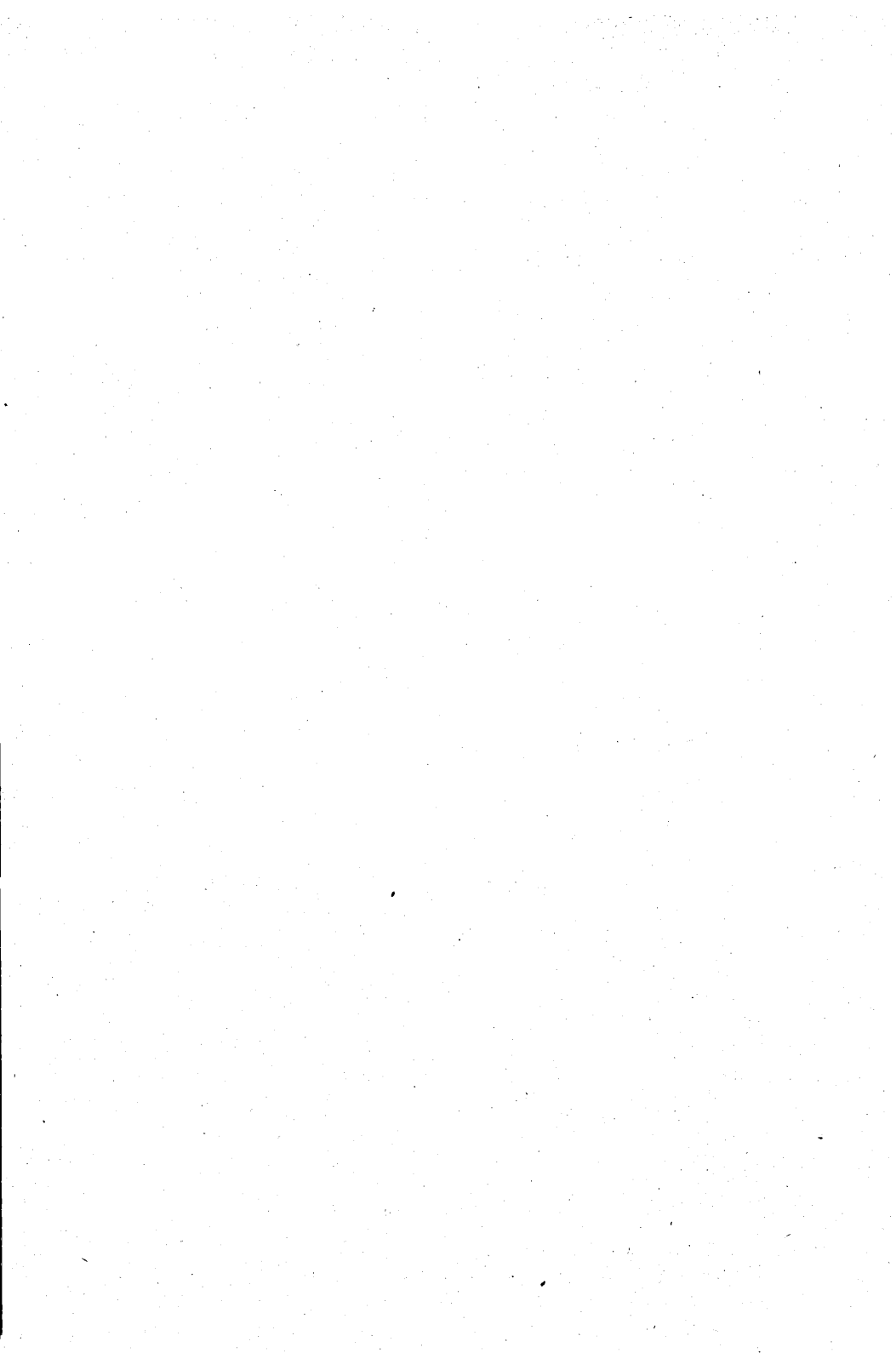

NUMERICAL TYPE LIST

The full type number is marked on the encapsulation of semiconductors mounted in SOT-89. Types in SOT-23 are marked with a code.

type number	marking	reverse type	marking	outline	device type	complement	nearest conventional type
BAS16	A6			SOT-23	D		BAW62/1N4148
BAT17	A3			SOT-23	D		BA280
BAT18	A2			SOT-23	D		BA182/BA243
BAV70	A4			SOT-23	D		BAW62/1N4148
BAV99	A7			SOT-23	D		BAW62/1N4148
BAW56	A1			SOT-23	D		BAW62/1N4148
BBY31	S1			SOT-23	D		BB105G
BCW29	C1	BCW29R	C4	SOT-23	PNP	BCW31; R	BC178A/BC558A
BCW30	C2	BCW30R	C5	SOT-23	PNP	BCW32; R	BC178B/BC558B
BCW31	D1	BCW31R	D4	SOT-23	NPN	BCW29; R	BC108A/BC548A
BCW32	D2	BCW32R	D5	SOT-23	NPN	BCW30; R	BC108B/BC548B
BCW33	D3	BCW33R	D6	SOT-23	NPN	-	BC108C/BC548C
BCW69	H1	BCW69R	H4	SOT-23	PNP	BCW71; R	BC177A/BC557A
BCW70	H2	BCW70R	H5	SOT-23	PNP	BCW72; R	BC177B/BC557B
BCW71	K1	BCW71R	K4	SOT-23	NPN	BCW69; R	BC107A/BC547A
BCW72	K2	BCW72R	K5	SOT-23	NPN	BCW70; R	BC107B/BC547B
BCX17	T1	BCW17R	T4	SOT-23	PNP	BCX19; R	BC327
BCX18	T2	BCW18R	T5	SOT-23	PNP	BCX20; R	BC328
BCX19	U1	BCW19R	U4	SOT-23	NPN	BCX17; R	BC337
BCX20	U2	BCX20R	U5	SOT-23	NPN	BCX18; R	BC338
BCX51				SOT-89	PNP	BCX54	BC636
BCX52				SOT-89	PNP	BCX55	BC638
BCX53				SOT-89	PNP	BCX56	BC640
BCX54				SOT-89	NPN	BCX51	BC635
BCX55				SOT-89	NPN	BCX52	BC637
BCX56				SOT-89	NPN	BCX53	BC639
BF550	G2	BF550R	G5	SOT-23	PNP		BF450
BF622				SOT-89	NPN	BF623	BF422
BF623				SOT-89	PNP	BF622	BF423
BFQ17				SOT-89	NPN		BFW16A
BFQ18A				SOT-89	NPN		BFQ34
BFQ19				SOT-89	NPN		BFR96
BFR30	M1			SOT-23	FET		BFW11
BFR31	M2			SOT-23	FET		BFW12
BFR53	N1	BFR53R	N4	SOT-23	NPN		BFW30/BFW93



TYPE NUMBER SURVEY

type number	marking	reverse type	marking	outline	device type	complement	nearest conventional type
BFR92	P1	BFR92R	P4	SOT-23	NPN	BFR92; R	BFR90
BFR93	R1	BFR93R	R4	SOT-23	NPN	BFR93; R	BFR91
BFS17	E1	BFS17R	E4	SOT-23	NPN		BFY90/BFW92
BFS18	F1	BFS18R	F4	SOT-23	NPN		BF185/BF495
BFS19	F2	BFS19R	F5	SOT-23	NPN		BF184/BF494
BFS20	G1	BFS20R	G4	SOT-23	NPN		BF199
BFT25	V1	BFT25R	V4	SOT-23	NPN		BFT24
BFT46	M3			SOT-23	FET		BFW13
BFT92	W1	BFT92R	W4	SOT-23	PNP	BFR92; R	-
BFT93	X1	BFT93R	X4	SOT-23	PNP	BFR93; R	BFQ23/24
BRY61	A5			SOT-23	PNPN		BRY56/BRY39 PUT
BSR12	B5	BSR12R	B8	SOT-23	PNP	BSV52	2N2894A
BSR30				SOT-89	PNP	BSR40	
BSR31				SOT-89	PNP	BSR41	BSV16/17
BSR32				SOT-89	PNP	BSR42	2N4030-4033
BSR33				SOT-89	PNP	BSR43	
BSR40				SOT-89	NPN	BSR30	
BSR41				SOT-89	NPN	BSR31	BSX46/47
BSR42				SOT-89	NPN	BSR32	2N3019/3020
BSR43				SOT-89	NPN	BSR33	
BSR56	M4			SOT-23	FET		2N4856
BSR57	M5			SOT-23	FET		2N4857
BSR58	M6			SOT-23	FET		2N4858
BSS63	T3	BSS63R	T6	SOT-23	PNP	BSS64; R	BSS68
BSS64	U3	BSS64R	U6	SOT-23	NPN	BSS63; R	BSS38
BSV52	B2	BSV52R	B4	SOT-23	NPN	BSR12	BSX20/2N2369
BZX84-							
-C4V7	Z1						
-C5V1	Z2						
-C5V6	Z3						
-C6V2	Z4						
-C6V8	Z5						
-C7V5	Z6						
-C8V2	Z7						
-C9V1	Z8						
-C10	Z9						
-C11	Y1			SOT-23	D		BZX79 SERIES
-C12	Y2						
-C13	Y3						
-C15	Y4						
-C16	Y5						
-C18	Y6						
-C20	Y7						
-C22	Y8						
-C24	Y9						
-C27	Y10						
-C30	Y11						

TYPE NUMBER SURVEY

type number	marking	reverse type	marking	outline	device type	complement	nearest conventional type
BZX84-							
-C33	Y12	}					BZX79 SERIES
-C36	Y13						
-C39	Y14						
-C43	Y15						
-C47	Y16		SOT-23	D			
-C51	Y17						
-C56	Y18						
-C62	Y19						
-C68	Y20						
-C75	Y21						



CONVERSION LIST

MARKING SOT-89

The full type number is marked on the encapsulation of semiconductors mounted in SOT-89.

MARKING CODE SOT-23

Types in a SOT-23 envelope are marked by the following code.

MARKING CODE

	A	B	C	D
1	BAW56		BCW29	BCW31
2	BAT18	BSV52	BCW30	BCW32
3	BAT17			BCW33
4	BAV70	BSV52R	BCW29R	BCW31R
5	BRY61	BSR12	BCW30R	BCW32R
6	BAS16			BCW33R
7	BAV99			
8		BSR12R		
9				
	E	F	G	H
1	BFS17	BFS18	BFS20	BCW69
2		BFS19	BF550	BCW70
3				
4	BFS17R	BFS18R	BFS20R	BCW69R
5		BFS19R	BF550R	BCW70R
6				
7				
8				
9				
	K	M	N	P
1	BCW71	BFR30	BFR53	BFR92
2	BCW72	BFR31		
3		BFT46		
4	BCW71R	BSR56	BFR53R	BFR92R
5	BCW72R	BSR57		
6		BSR58		
7				
8				
9				

TYPE NUMBER SURVEY

	R	S	T	U
1	BFR93	BBY31	BCX17	BCX19
2			BCX18	BCX20
3			BSS63	BSS64
4	BFR93R		BCX17R	BCX19R
5			BCX18R	BCX20R
6			BSS63R	BSS64R
7				
8				
9				

	V	W	X	
1	BFT25	BFT92	BFT93	
2				
3				
4	BFT25R	BFT92R	BFT93R	
5				
6				
7				
8				
9				

	Y		Y		Y		Z	
1	BZX84-C11	10	BZX84-C27	19	BZX84-C62	1	BZX84-C4V7	
2	-C12	11	-C30	20	-C68	2	5V1	
3	-C13	12	-C33	21	-C75	3	5V6	
4	-C15	13	-C36			4	6V2	
5	-C16	14	-C39			5	6V8	
6	-C18	15	-C43			6	7V5	
7	-C20	16	-C47			7	8V2	
8	-C22	17	-C51			8	9V1	
9	-C24	18	-C56			9	10V	





SELECTION GUIDE



GENERAL PURPOSE TRANSISTORS

type	RATINGS				h _{FE}		V _{CEsat}		f _T typ. MHz
	V _{CBO} V	V _{CEO} V	I _c mA	P _{tot} mW	min/max at I _c /V _{CE} mA/V	max at I _c /I _B V mA			
P-N-P									
BCW29;R	30	20	100	200	120/260	2/5	0,30	10/0,5	150
BCW30;R	30	20	100	200	215/500	2/5	0,30	10/0,5	150
BCW69;R	50	45	100	200	120/260	2/5	0,30	10/0,5	150
BCW70;R	50	45	100	200	215/500	2/5	0,30	10/0,5	150
BCX17;R	50	45	500	310	100/600	100/1	0,62	500/50	100
BCX18;R	30	25	500	310	100/600	100/1	0,62	500/50	100
BCX51	45	45	1000	1000	40/250	150/2	0,50	500/50	50
BCX52	60	60	1000	1000	40/160	150/2	0,50	500/50	50
BCX53	100	80	1000	1000	40/160	150/2	0,50	500/50	50
N-P-N									
BCW31;R	30	20	100	200	110/220	2/5	0,25	10/0,5	300
BCW32;R	30	20	100	200	200/450	2/5	0,25	10/0,5	300
BCW33;R	30	20	100	200	420/800	2/5	0,25	10/0,5	300
BCW71;R	50	45	100	200	110/200	2/5	0,25	10/0,5	300
BCW72;R	50	45	100	200	220/450	2/5	0,25	10/0,5	300
BCX19;R	50	45	500	310	100/600	100/1	0,62	500/50	200
BCX20;R	30	25	500	310	100/600	100/1	0,62	500/50	200
BCX54	45	45	1000	1000	40/250	150/2	0,50	500/50	130
BCX55	60	60	1000	1000	40/160	150/2	0,50	500/50	130
BCX56	100	80	1000	1000	40/160	150/2	0,50	500/50	130

VIDEO B/W AND COLOUR TELEVISION

type	RATINGS				h _{FE}		V _{CEsat}		f _T typ. MHz
	V _{CBO} V	V _{CEO} V	I _c mA	P _{tot} mW	min/max at I _c /V _{CE} mA/V	max at I _c /I _B V mA			
P-N-P									
BF623	250	250	20	1000	50/-	25/20	-	-	60
N-P-N									
BF622	250	250	20	1000	50/-	25/20	-	-	60

SELECTION GUIDE

HIGH-FREQUENCY TRANSISTORS

type	RATINGS				hFE		F		f _T typ. MHz	C _{re} typ. pF
	V _{CB0} V	V _{CEO} V	I _c mA	P _{tot} mW	min/max at I _c /V _{CE}	mA/V	typ. at f	MHz		
P-N-P										
BF550;R	40	40	25	180	50/-	1/10	2	0,1	325	0,5
N-P-N										
BFS18;R	30	20	30	200	35/125	1/10	4	100	200	0,85
BFS19;R	30	20	30	200	65/225	1/10	4	100	260	0,85
BFS20;R	30	20	25	200	40/85	7/10	-	-	450	0,35

SWITCHING TRANSISTORS

type	RATINGS				hFE		V _{CEsat}		t max	
	V _{CB0} V	V _{CEO} V	I _c mA	P _{tot} mW	min/max at I _c /V _{CE}	mA/V	max at I _c /I _B	V	on/off at I _c /I _B	ns
P-N-P										
BSR12;R	15	15	100	200	30/120	50/1	0,45	100/10	20/30	30/3
BSR30	70	60	1000	1000	40/120	100/5	1,2	500/50	500/650	100/5
BSR31	70	60	1000	1000	100/300	100/5	1,2	500/50	500/650	100/5
BSR32	90	80	1000	1000	40/120	100/5	1,2	500/50	500/650	100/5
BSR33	90	80	1000	1000	100/300	100/5	1,2	500/50	500/650	100/5
BSS63;R	110	100	100	200	30/-	25/1	2,5	25/2,5	-	-
N-P-N										
BSR40	70	60	1000	1000	40/120	100/5	1,2	500/50	250/1000	100/5
BSR41	70	60	1000	1000	100/300	100/5	1,2	500/50	250/1000	100/5
BSR42	90	80	1000	1000	40/120	100/5	1,2	500/50	250/1000	100/5
BSR43	90	80	1000	1000	100/300	100/5	1,2	500/50	250/1000	100/5
BSS64;R	120	80	100	200	20/80	10/1	0,2	50/15	/1000	15/1
BSV52;R	20	12	100	200	40/120	10/1	0,4	50/5	12/18	10/3
P-N-P-N										
BRY61	V _{CA} max. 70 V; I _A max. 175 mA; I _p = 5/1 μA; I _V = 30/50 μA									

WIDEBAND TRANSISTORS

type	RATINGS				h _{FE}		d _{im}		f _T typ GHz	G _{um}	
	V _{CBO} V	V _{CEO} V	I _c mA	P _{tot} mW	min/max	at I _c /V _{CE} mA/V	typ.	at f MHz		at f = MHz	200/500/800
P-N-P											
BFT92;R	20	15	25	180	20/-	14/10	60	493,25	5	- 18	-
BFT93;R	15	12	35	180	20/-	30/5	60	493,25	5	- 16,5	-
N-P-N											
BFQ17	40	25	150	1000	25/-	150/5	-	-	1,2	16	- 6,5
BFQ18A	25	15	150	1000	25/-	100/10	60	793,25	3,6	-	-
BFQ19	20	15	75	500	25/-	75/10	-	-	5,0	18,5	- 7,5
BFR53;R	18	10	50	180	25/-	50/5	60	217,0	2,0	22	- 10,5
BFR92;R	20	15	25	180	25/-	14/10	60	493,25	5,0	- 18	-
BFR93;R	15	12	35	180	25/-	30/5	60	493,25	5,0	- 16,5	-
BFS17;R	25	15	25	200	20/150	2/1	45	217	1,3	-	-
BFT25;R	8	5	2,5	30	20/-	1/1	-	-	2,3	25	- 12

FIELD-EFFECT TRANSISTORS

type	RATINGS				-I _{GSS} max. nA	I _{DSS} min/max. mA	-V _{PGS} max. V	Y _{fs} min. mA/V	C _{rs} max. pF	V _n max. μV
	V _{DS} V	-V _{GSO} V	I _D mA	P _{tot} mW						
BFR30	25	25	10	200	0,2	4/10	5	1	1,5	0,5
BFR31	25	25	10	200	0,2	1/5	2,5	1,5	1,5	0,5
BFT46	25	25	10	200	0,2	0,2/1,5	1,0	1,0	1,5	0,5
BSR56	40	40	-	200	1	50/-	10	-	5	-
BSR57	40	40	-	200	1	20/100	6	-	5	-
BSR58	40	40	-	200	1	8/80	4	-	5	-

SELECTION GUIDE

SWITCHING DIODES

type	description	RATINGS		t_{rr} max. ns	V_F max. V at $I_F =$ mA 10/100	C_d max. pF
		V_R V	I_F mA			
BAS16	high-speed switch	75	100	6	855/1300	2
BAT17	Schottky barrier	4	30	—	600/—	1
BAT18	band switch	35	100	—	—/1200	1
BAV70	common cathode double diode	70	100	6	855/1300	1,5
BAV99	two diodes in series	70	100	6	855/1300	1,5
BAW56	common anode double diode	70	100	6	855/1300	2

VARIABLE CAPACITANCE DIODE

type	RATINGS		CHARACTERISTICS				
	V_R	I_F	I_R at V_R		C_d at V_R	capacitance ratio typ.	r_D
	V	mA	nA	V	pF	V	Ω
BBY31	28	20	< 50	28	typ. 17,5/1 typ. 11,5/3 1,8 — 2,8/25	5	< 1,2

VOLTAGE REGULATOR DIODES BZX84-series

type suffix	V_{Znom} V	r_{diff} Ω	S_Z mV/°C	type suffix	V_{Znom} V	r_{diff} Ω	S_Z mV/°C
—C4V7	4,7	80	0,2	—C20	20	55	18,0
—C5V1	5,1	60	1,2	—C22	22	55	20,0
—C5V6	5,6	40	2,5	—C24	24	70	22,0
—C6V2	6,2	10	3,7	—C27	27	80	25,3
—C6V8	6,8	15	4,5	—C30	30	80	29,4
—C7V5	7,5	15	5,3	—C33	33	80	33,4
—C8V2	8,2	15	6,2	—C36	36	90	37,4
—C9V1	9,1	15	7,0	—C39	39	130	41,2
—C10	10	20	8,0	—C43	43	150	46,6
—C11	11	20	9,0	—C47	47	170	51,8
—C12	12	25	10,0	—C51	51	180	57,2
—C13	13	30	11,0	—C56	56	200	63,8
—C15	15	30	13,0	—C62	62	215	71,6
—C16	16	40	14,0	—C68	68	240	79,8
—C18	18	45	16,0	—C75	75	255	88,6

—C4V7 to —C24 at $I_Z = 5$ mA; —C27 to —C75 at $I_Z = 2$ mA.
BZX84 series; $I_{FRM} = I_{ZRM} = 200$ mA; $P_{tot} = 200$ mW.

DEVICE DATA



SILICON PLANAR EPITAXIAL HIGH-SPEED DIODE

Silicon epitaxial high-speed diode in a microminiature plastic envelope. It is intended for high-speed switching in hybrid thick and thin-film circuits.

QUICK REFERENCE DATA

Continuous reverse voltage	V_R	max.	75 V
Repetitive peak reverse voltage	V_{RRM}	max.	85 V
Repetitive peak forward current	I_{FRM}	max.	200 mA
Junction temperature	T_j	max.	150 °C
Forward voltage at $I_F = 50$ mA	V_F	<	1,1 V
Reverse recovery time when switched from $I_F = 10$ mA to $I_R = 10$ mA; $R_L = 100 \Omega$; measured at $I_R = 1$ mA	t_{rr}	<	6 ns
Recovery charge when switched from $I_F = 10$ mA to $V_R = 5$ V; $R_L = 500 \Omega$	Q_s	<	45 pC

MECHANICAL DATA

Dimensions in mm

Marking code

Fig. 1 SOT-23.

BAS16 = A6

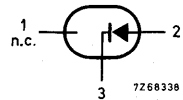
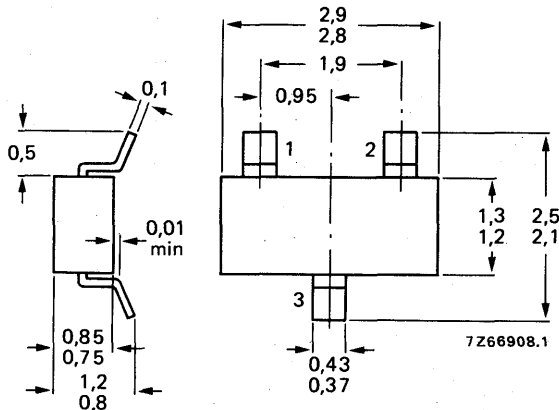

See also *Soldering recommendations*.

RATINGS

Limiting values in accordance with the Absolute Maximum System (IEC 134)

Continuous reverse voltage	V_R	max.	75 V
Repetitive peak reverse voltage	V_{RRM}	max.	85 V
Average rectified forward current * (averaged over any 20 ms period)	$I_{F(AV)}$	max.	100 mA
Forward current (d.c.)	I_F	max.	100 mA
Repetitive peak forward current	I_{FRM}	max.	200 mA
Storage temperature	T_{stg}		-65 to +150 °C
Junction temperature	T_j	max.	150 °C

THERMAL RESISTANCE

From junction to ambient mounted on a ceramic substrate of 7 mm x 5 mm x 0,5 mm

$R_{thj-a} = 0,62 \text{ } ^\circ\text{C/mW}$

CHARACTERISTICS

$T_j = 25 \text{ } ^\circ\text{C}$ unless otherwise specified.

Forward voltage

$I_F = 1 \text{ mA}$	V_F	<	715 mV
$I_F = 10 \text{ mA}$	V_F	<	855 mV
$I_F = 50 \text{ mA}$	V_F	<	1100 mV
$I_F = 100 \text{ mA}$	V_F	<	1300 mV

Reverse current

$V_R = 25 \text{ V}; T_j = 150 \text{ } ^\circ\text{C}$	I_R	<	30 μA
$V_R = 75 \text{ V}$	I_R	<	1 μA
$V_R = 75 \text{ V}; T_j = 150 \text{ } ^\circ\text{C}$	I_R	<	50 μA

Diode capacitance

$V_R = 0; f = 1 \text{ MHz}$	C_d	<	2 pF
------------------------------	-------	---	------

Forward recovery voltage (see also Fig. 2)
when switched to $I_F = 10 \text{ mA}; t_p = 20 \text{ ns}$

$V_{fr} < 1,75 \text{ V}$

Reverse recovery time (see also Fig. 3)
when switched from $I_F = 10 \text{ mA}$ to $I_R = 10 \text{ mA};$
 $R_L = 100 \text{ } \Omega;$ measured at $I_R = 1 \text{ mA}$

$t_{rr} < 6 \text{ ns}$

Recovery charge (see also Fig. 4)
when switched from $I_F = 10 \text{ mA}$ to $V_R = 5 \text{ V};$
 $R_L = 500 \text{ } \Omega$

$Q_s < 45 \text{ pC}$

* Measured under pulse conditions. Pulse time = $t_p \leq 0,5 \text{ ms}.$
For sinusoidal operation $I_{F(AV)} = 65 \text{ mA}$ averaging time $t_{(av)} \leq 1 \text{ ms}.$

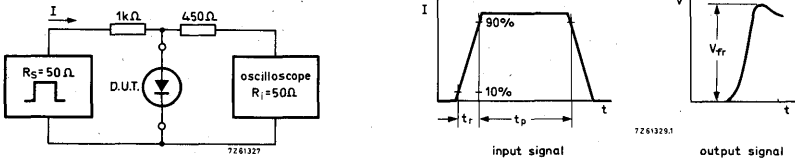

Fig. 2 Forward recovery voltage test circuit and waveforms.

Input signal: forward pulse rise time = $t_r = 20$ ns; forward current pulse duration $t_p = 120$ ns; duty factor = $\delta = 0,01$.
 Oscilloscope: rise time = $t_r = 0,35$ ns.
 Circuit capacitance $C \leq 1$ pF ($C =$ oscilloscope input capacitance + parasitic capacitance).

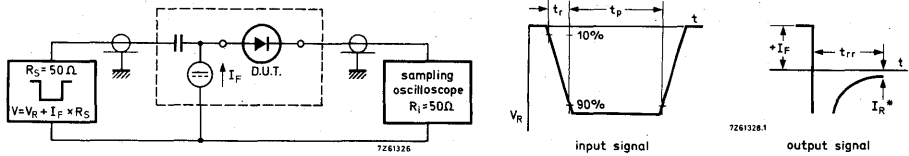

Fig. 3 Reverse recovery time test circuit and waveforms.

Input signal: reverse pulse rise time = $t_r = 0,6$ ns; reverse pulse duration = $t_p = 100$ ns; duty factor = $\delta = 0,05$. * t_{rr} up to $I_R = 1$ mA.
 Oscilloscope: rise time = $t_r = 0,35$ ns.
 Circuit capacitance $C \leq 1$ pF ($C =$ oscilloscope input capacitance + parasitic capacitance).

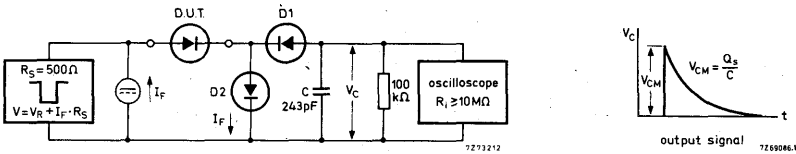

Fig. 4 Recovery charge test circuit and waveform.

D1 = BAW62; D2 = diode with minority carrier life time at 10 mA: < 200 ps

Input signal

Rise time of the reverse pulse	t_r	=	2 ns
Reverse pulse duration	t_p	=	400 ns
Duty factor	δ	=	0,02

Circuit capacitance $C \leq 7$ pF ($C =$ oscilloscope input capacitance + parasitic capacitance).

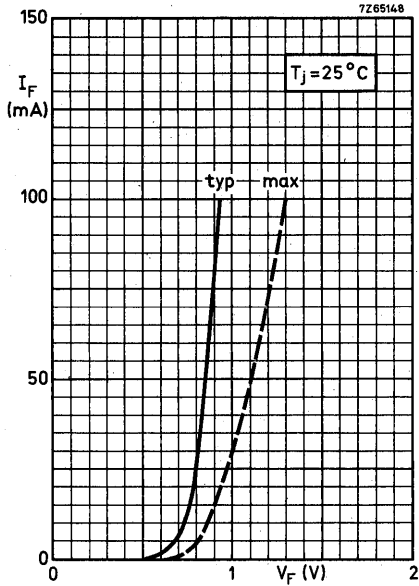

Fig. 5.

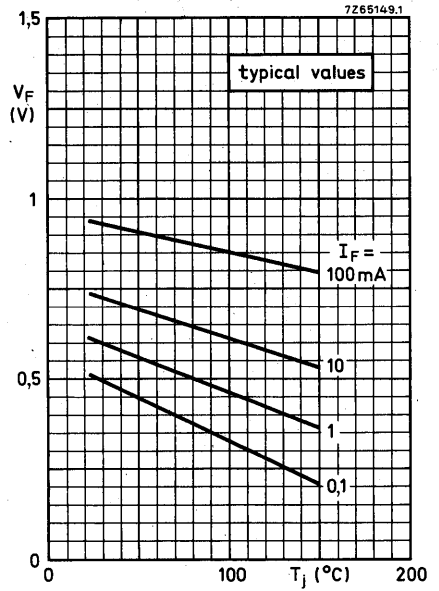

Fig. 6.

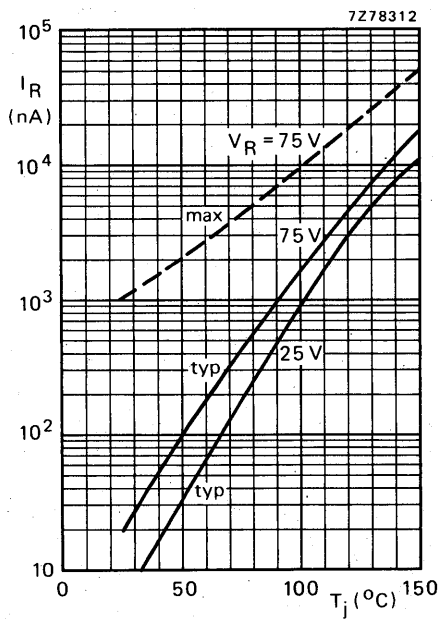

Fig. 7.

SCHOTTKY BARRIER DIODE

Silicon epitaxial diode in a microminiature plastic envelope. Intended for u.h.f. mixer and fast switching applications in thick and thin-film circuits.

QUICK REFERENCE DATA

Continuous reverse voltage	V_R	max.	4 V
Forward current (d.c.)	I_F	max.	30 mA
Junction temperature	T_j	max.	100 °C
Thermal resistance from junction to ambient	R_{thj-a}	=	0,62 °C/mW
Forward voltage at $I_F = 10$ mA	V_F	<	600 mV
Diode capacitance at $V_R = 0$; $f = 1$ MHz	C_d	<	1,0 pF
Noise figure at $f = 900$ MHz	F	<	8,0 dB

MECHANICAL DATA

Dimensions in mm

Marking code

BAT17 = A3

Fig.1 SOT-23.

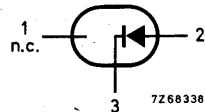
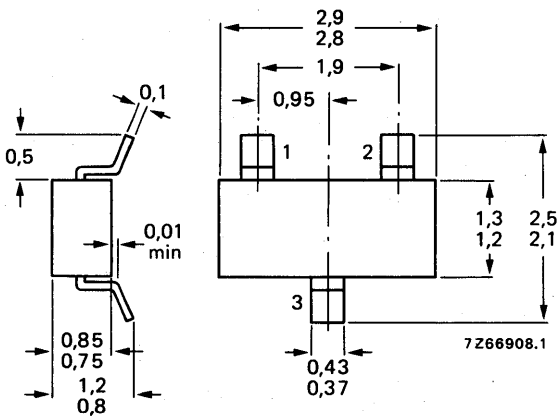

See also *Soldering recommendations.*

RATINGS

Limiting values in accordance with the Absolute Maximum System (IEC 134)

Continuous reverse voltage	V_R	max.	4 V
Forward current (d.c.)	I_F	max.	30 mA
Storage temperature	T_{stg}		-65 to +100 °C
Junction temperature	T_j	max.	100 °C

THERMAL RESISTANCE

From junction to ambient mounted on a ceramic substrate of 7 mm x 5 mm x 0,5 mm

$$R_{th\ j-a} = 0,62\text{ °C/mW}$$

CHARACTERISTICS

$T_{amb} = 25\text{ °C}$ unless otherwise specified

Reverse current

$$V_R = 3\text{ V}$$

$$I_R < 0,25\ \mu\text{A}$$

$$V_R = 3\text{ V}; T_{amb} = 60\text{ °C}$$

$$I_R < 1,25\ \mu\text{A}$$

Reverse breakdown voltage

$$I_R = 10\ \mu\text{A}$$

$$V_{(BR)R} > 4\text{ V}$$

Forward voltage

$$I_F = 10\text{ mA}$$

$$V_F < 600\text{ mV}$$

Diode capacitance

$$V_R = 0; f = 1\text{ MHz}$$

$$C_d < 1,0\text{ pF}$$

Noise figure at $f = 900\text{ MHz}$ *

$$F < 8,0\text{ dB}$$

Series resistance at $f = 1\text{ kHz}$

$$I_F = 5\text{ mA}$$

$$r_D < 15\ \Omega$$

* The local oscillator is adjusted for a diode current of 2 mA. I.F. amplifier noise $F_{if} = 1,5\text{ dB}$; $f = 35\text{ MHz}$.

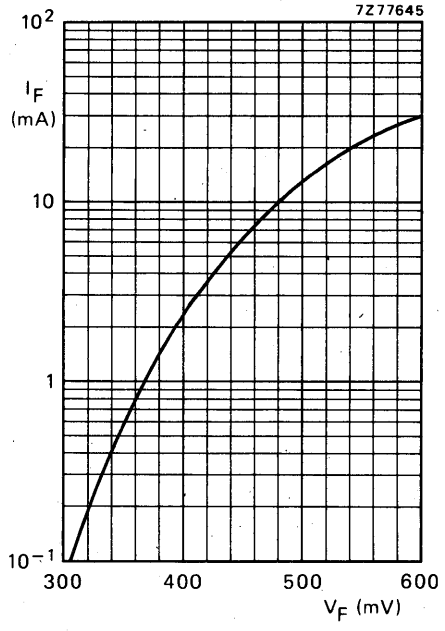
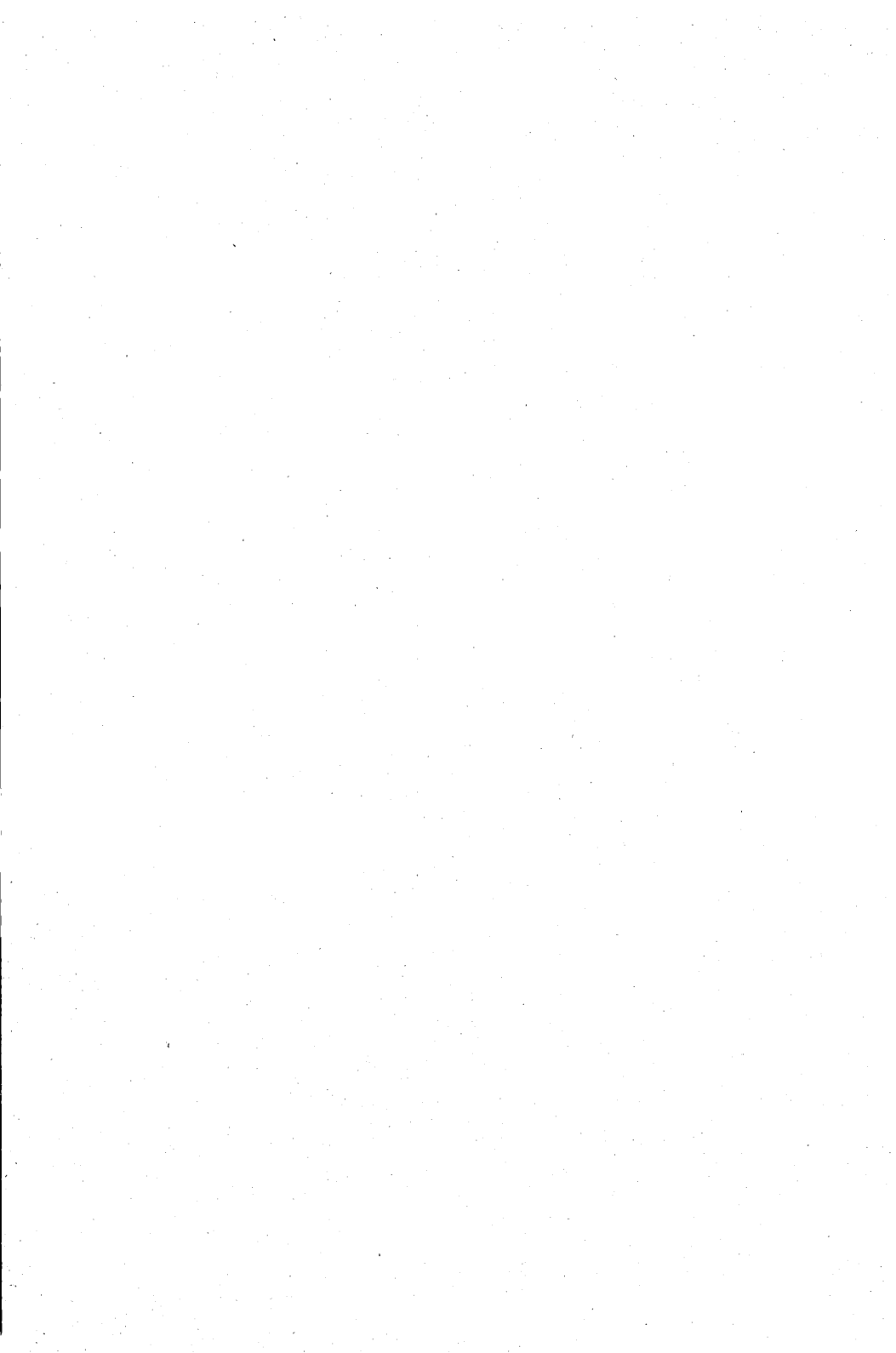

Fig. 2.





SILICON PLANAR DIODE

Switching diode in a microminiature plastic envelope. Intended for thick and thin-film circuits.

QUICK REFERENCE DATA

Continuous reverse voltage	V_R	max.	35 V
Forward current (d.c.)	I_F	max.	100 mA
Junction temperature	T_j	max.	100 °C
Diode capacitance at $f = 1$ MHz $V_R = 20$ V	C_d	typ. <	0,8 pF 1,0 pF
Series resistance at $f = 200$ MHz $I_F = 5$ mA	r_D	typ. <	0,5 Ω 0,7 Ω

MECHANICAL DATA

Dimensions in mm

Marking code

Fig. 1 SOT-23.

BAT18 = A2

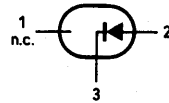
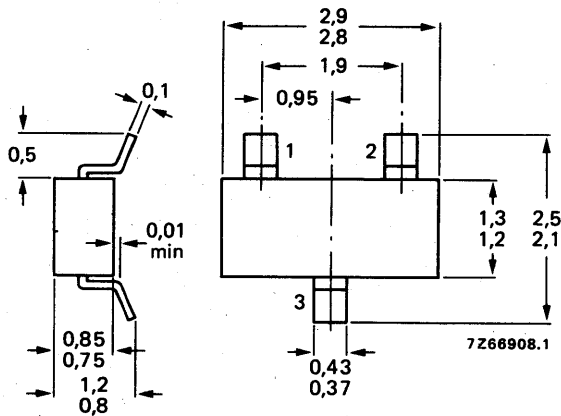

See also *Soldering recommendations*.

RATINGS

Limiting values in accordance with the Absolute Maximum System (IEC 134)

Continuous reverse voltage	V_R	max.	35 V
Forward current (d.c.)	I_F	max.	100 mA
Storage temperature	T_{stg}		-55 to +100 °C
Junction temperature	T_j	max.	100 °C

THERMAL RESISTANCE

From junction to ambient mounted on a ceramic substrate of 7 mm x 5 mm x 0,5 mm

$$R_{thj-a} = 0,62 \text{ } ^\circ\text{C/mW}$$

CHARACTERISTICS

$T_j = 25 \text{ } ^\circ\text{C}$ unless otherwise specified

Forward voltage at $I_F = 100 \text{ mA}$

$$V_F < 1,2 \text{ V}$$

Reverse current

$$V_R = 20 \text{ V}$$

$$I_R < 100 \text{ nA}$$

$$V_R = 20 \text{ V}; T_j = 60 \text{ } ^\circ\text{C}$$

$$I_R < 1 \text{ } \mu\text{A}$$

Diode capacitance at $f = 1 \text{ MHz}$

$$V_R = 20 \text{ V}$$

$$C_d \begin{matrix} \text{typ.} & 0,8 \text{ pF} \\ < & 1,0 \text{ pF} \end{matrix}$$

Series resistance at $f = 200 \text{ MHz}$

$$I_F = 5 \text{ mA}$$

$$r_D \begin{matrix} \text{typ.} & 0,5 \text{ } \Omega \\ < & 0,7 \text{ } \Omega \end{matrix}$$

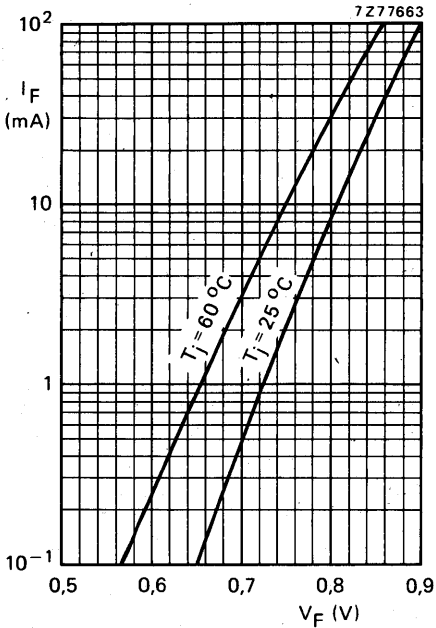

Fig. 2 Typical values.

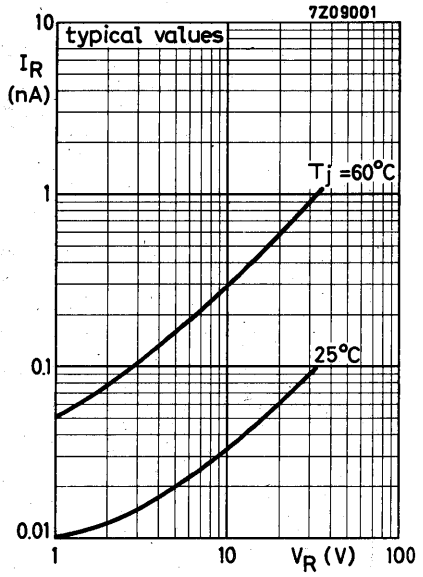

Fig. 3.

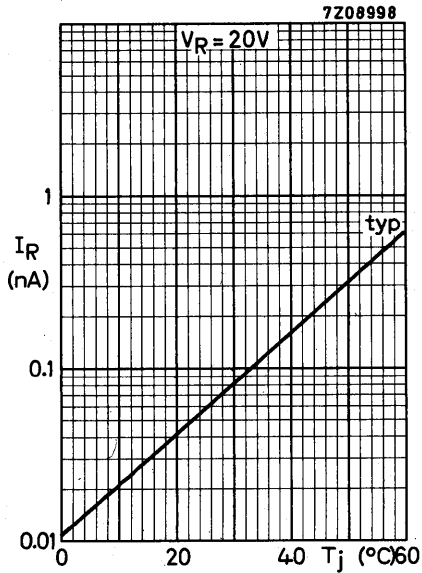

Fig. 4.

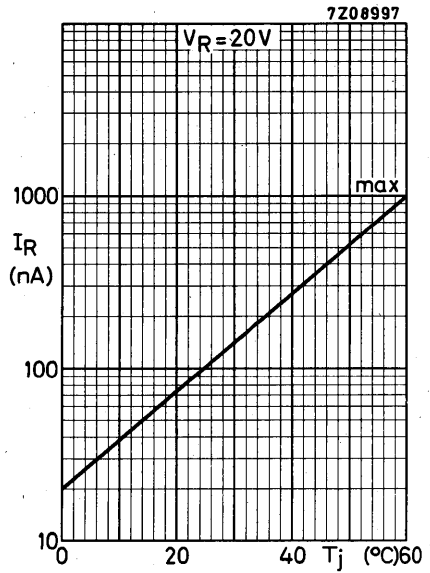

Fig. 5.

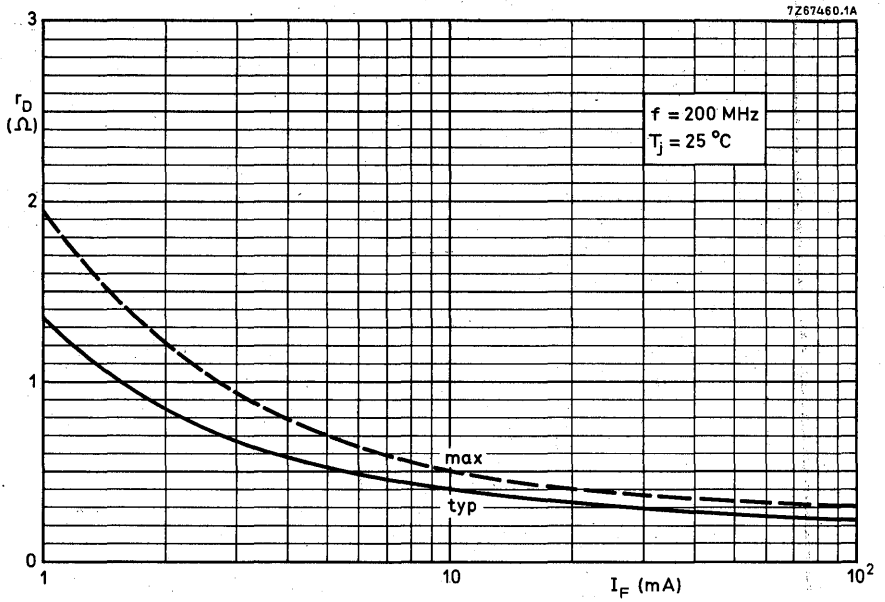

Fig. 6.

SILICON PLANAR EPITAXIAL HIGH-SPEED DIODES

The BAV70 consists of two diodes in a microminiature plastic envelope. The cathodes are commoned and the unit is intended for high-speed switching in thick and thin-film circuits.

QUICK REFERENCE DATA (per diode)

Continuous reverse voltage	V_R	max.	70 V
Repetitive peak reverse voltage	V_{RRM}	max.	70 V
Repetitive peak forward current	I_{FRM}	max.	200 mA
Junction temperature	T_j	max.	150 °C
Forward voltage at $I_F = 50$ mA	V_F	<	1,1 V
Reverse recovery time when switched from $I_F = 10$ mA to $I_R = 10$ mA; $R_L = 100 \Omega$; measured at $I_R = 1$ mA	t_{rr}	<	6 ns
Recovery charge when switched from $I_F = 10$ mA to $V_R = 5$ V; $R_L = 500 \Omega$	Q_s	<	45 pC

MECHANICAL DATA

Dimensions in mm

Marking code

Fig. 1 SOT-23.

BAV70 = A4

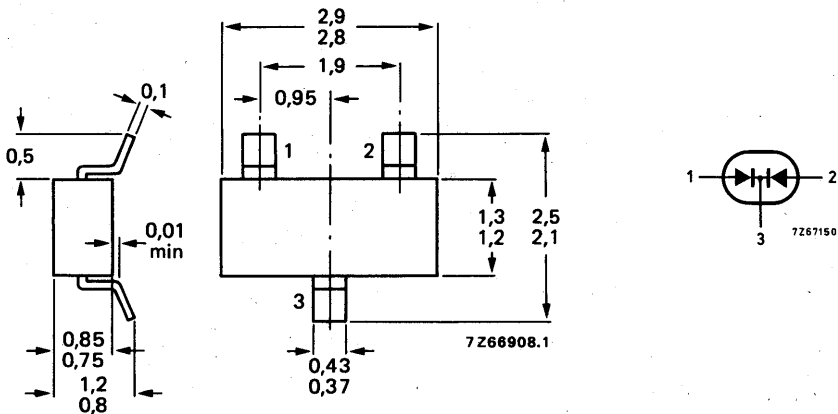

See also *Soldering recommendations*.

RATINGS (per diode) Limiting values in accordance with the Absolute Maximum System (IEC 134)

Voltages

Continuous reverse voltage	V_R	max.	70	V
Repetitive peak reverse voltage	V_{RRM}	max.	70	V

Currents

Average rectified forward current (averaged over any 20 ms period)	$I_{F(AV)}$	max.	100	mA ¹⁾
Forward current (d. c.)	I_F	max.	100	mA
Repetitive peak forward current	I_{FRM}	max.	200	mA

Temperatures

Storage temperature	T_{stg}	-65 to +150	°C
Junction temperature	T_j	max. 150	°C

THERMAL RESISTANCE (per diode)

From junction to ambient
mounted on a ceramic substrate of
7 mm x 5 mm x 0,5 mm

both diodes loaded simultaneously

$$R_{th\ j-a} = 1,10 \text{ } ^\circ\text{C/mW}$$

one diode loaded

$$R_{th\ j-a} = 0,67 \text{ } ^\circ\text{C/mW}$$

¹⁾ Measured under pulse conditions : pulse time $t_p \leq 0,5$ ms.

For sinusoidal operation $I_{F(AV)} = 65$ mA; averaging time $t_{(av)} \leq 1$ ms).

CHARACTERISTICS (per diode)

$T_j = 25\text{ }^\circ\text{C}$ unless otherwise specified

Forward voltage

$$I_F = 1\text{ mA}$$

$$V_F < 715\text{ mV}$$

$$I_F = 10\text{ mA}$$

$$V_F < 855\text{ mV}$$

$$I_F = 50\text{ mA}$$

$$V_F < 1100\text{ mV}$$

$$I_F = 100\text{ mA}$$

$$V_F < 1300\text{ mV}$$

Reverse current

$$V_R = 25\text{ V}; T_j = 150\text{ }^\circ\text{C}$$

$$I_R < 60\text{ }\mu\text{A}$$

$$V_R = 70\text{ V}$$

$$I_R < 5\text{ }\mu\text{A}$$

$$V_R = 70\text{ V}; T_j = 150\text{ }^\circ\text{C}$$

$$I_R < 100\text{ }\mu\text{A}$$

Diode capacitance

$$V_R = 0; f = 1\text{ MHz}$$

$$C_d < 1,5\text{ pF}$$

Forward recovery voltage when switched to

$$I_F = 10\text{ mA}; t_r = 20\text{ ns}$$

$$V_{fr} < 1,75\text{ V}$$

Test circuit and waveforms :

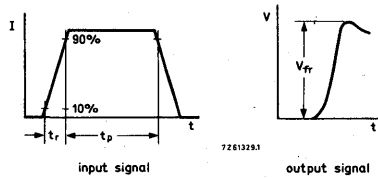
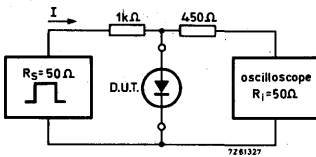

Input signal : Rise time of the forward pulse

$$t_r = 20\text{ ns}$$

Forward current pulse duration

$$t_p = 120\text{ ns}$$

Duty factor

$$\delta = 0,01$$

Oscilloscope : Rise time

$$t_r = 0,35\text{ ns}$$

Circuit capacitance $C \leq 1\text{ pF}$ ($C = \text{oscilloscope input capacitance} + \text{parasitic capacitance}$)

CHARACTERISTICS (per diode) (continued)

$T_j = 25\text{ }^\circ\text{C}$

→ Reverse recovery time when switched from

$I_F = 10\text{ mA}$ to $I_R = 10\text{ mA}$; $R_L = 100\ \Omega$;
measured at $I_R = 1\text{ mA}$

$$t_{rr} < 6\text{ ns}$$

Test circuit and waveforms:

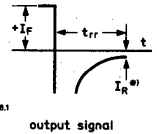
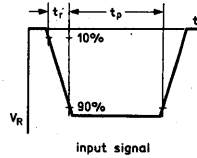
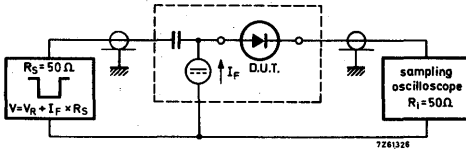

Input signal : Rise time of the reverse pulse

$$t_r = 0,6\text{ ns}$$

*) $I_R = 1\text{ mA}$

Reverse pulse duration

$$t_p = 100\text{ ns}$$

Duty factor

$$\delta = 0,05$$

Oscilloscope: Rise time

$$t_r = 0,35\text{ ns}$$

Circuit capacitance $C \leq 1\text{ pF}$ ($C =$ oscilloscope input capacitance + parasitic capacitance)

Recovery charge when switched from

$I_F = 10\text{ mA}$ to $V_R = 5\text{ V}$; $R_L = 500\ \Omega$

$$Q_s < 45\text{ pC}$$

Test circuit and waveform:

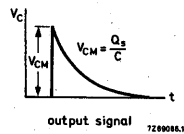
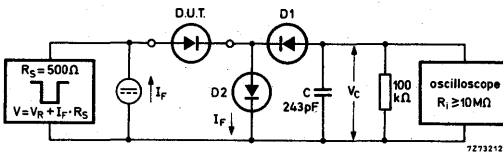

D1 = BAW62

D2 = diode with minority carrier life time at 10 mA: $< 200\text{ ps}$

Input signal : Rise time of the reverse pulse

$$t_r = 2\text{ ns}$$

Reverse pulse duration

$$t_p = 400\text{ ns}$$

Duty factor

$$\delta = 0,02$$

Circuit capacitance $C \leq 7\text{ pF}$ ($C =$ oscilloscope input capacitance + parasitic capacitance)

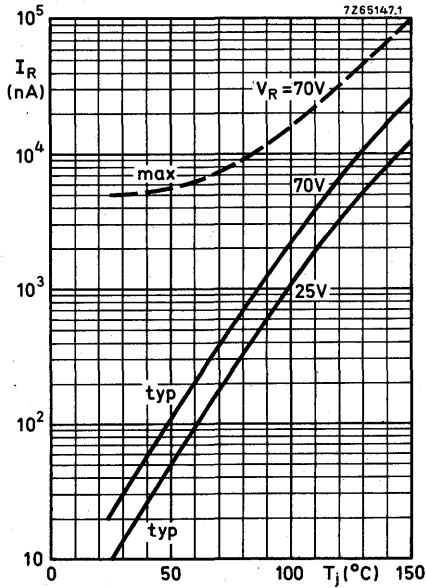
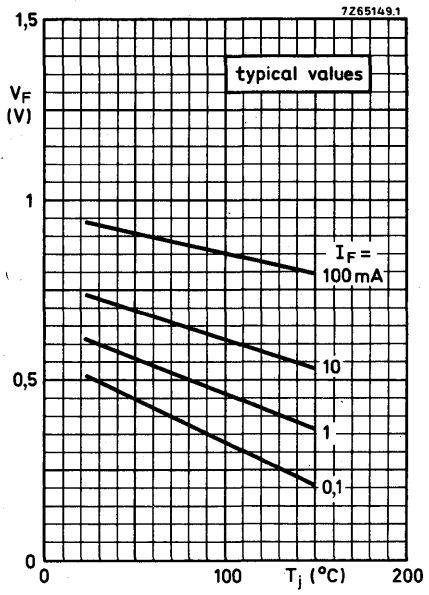
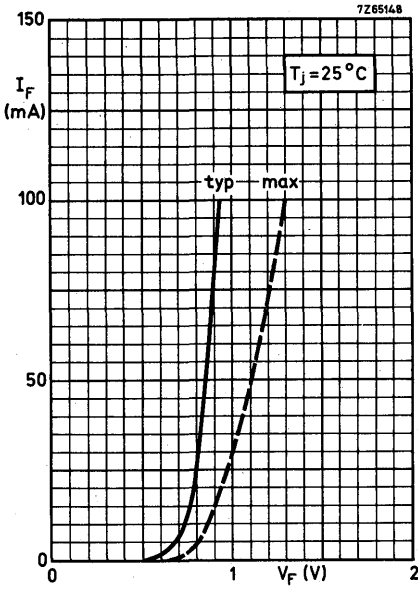



SILICON PLANAR EPITAXIAL HIGH-SPEED DIODES

The BAV99 consists of two diodes in a microminiature plastic envelope. The diodes are connected in series and the unit is intended for high-speed switching in thick and thin-film circuits.

QUICK REFERENCE DATA (per diode)

Continuous reverse voltage	V_R	max.	70 V
Repetitive peak reverse voltage	V_{RRM}	max.	70 V
Repetitive peak forward current	I_{FRM}	max.	200 mA
Junction temperature	T_j	max.	150 °C
Forward voltage at $I_F = 50$ mA	V_F	<	1,1 V
Reverse recovery time when switched from $I_F = 10$ mA to $I_R = 10$ mA; $R_L = 100 \Omega$; measured at $I_R = 1$ mA	t_{rr}	<	6 ns
Recovery charge when switched from $I_F = 10$ mA to $V_R = 5$ V; $R_L = 500 \Omega$	Q_s	<	45 pC

MECHANICAL DATA

Dimensions in mm

Marking code

Fig. 1 SOT-23.

BAV99 = A7

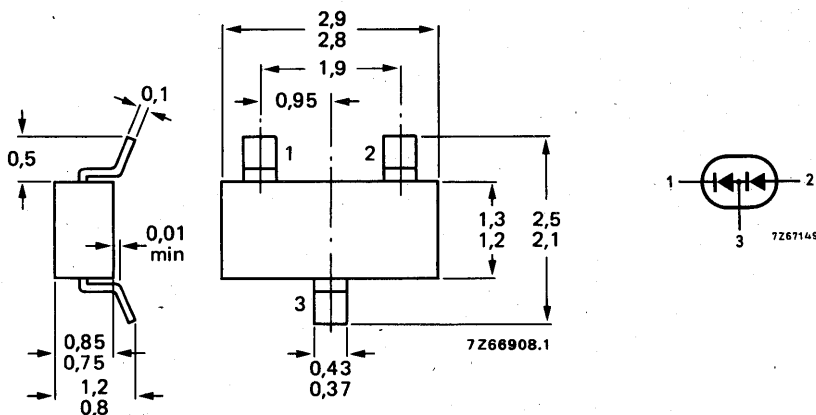

See also *Soldering recommendations*.

RATINGS (per diode) Limiting values in accordance with the Absolute Maximum System (IEC 134)

Voltages

Continuous reverse voltage	V_R	max.	70	V
Repetitive peak reverse voltage	V_{RRM}	max.	70	V

Currents

Average rectified forward current (averaged over any 20 ms period)	$I_{F(AV)}$	max.	100	mA ¹⁾
Forward current (d. c.)	I_F	max.	100	mA
Repetitive peak forward current	I_{FRM}	max.	200	mA

Temperatures

Storage temperature	T_{stg}	-65 to +150	°C
Junction temperature	T_j	max. 150	°C

THERMAL RESISTANCE (per diode)

From junction to ambient mounted on a ceramic substrate of 7 mm x 5 mm x 0,5 mm				
both diodes loaded simultaneously	$R_{th\ j-a}$	=	1, 10	°C/mW
one diode loaded	$R_{th\ j-a}$	=	0, 67	°C/mW

¹⁾ Measured under pulse conditions: pulse time $t_p \leq 0,5$ ms.
For sinusoidal operation $I_{F(AV)} = 65$ mA; averaging time $t_{(av)} \leq 1$ ms..

CHARACTERISTICS (per diode)

$T_j = 25\text{ }^\circ\text{C}$ unless otherwise specified

Forward voltage

$I_F = 1\text{ mA}$	$V_F < 715\text{ mV}$
$I_F = 10\text{ mA}$	$V_F < 855\text{ mV}$
$I_F = 50\text{ mA}$	$V_F < 1100\text{ mV}$
$I_F = 100\text{ mA}$	$V_F < 1300\text{ mV}$

Reverse current

$V_R = 25\text{ V}; T_j = 150\text{ }^\circ\text{C}$	$I_R < 30\text{ }\mu\text{A}$
$V_R = 70\text{ V}$	$I_R < 2,5\text{ }\mu\text{A}$
$V_R = 70\text{ V}; T_j = 150\text{ }^\circ\text{C}$	$I_R < 50\text{ }\mu\text{A}$

Diode capacitance

$V_R = 0; f = 1\text{ MHz}$	$C_d < 1,5\text{ pF}$
-----------------------------	-----------------------

Forward recovery voltage when switched to

$I_F = 10\text{ mA}; t_R = 20\text{ ns}$	$V_{fr} < 1,75\text{ V}$
--	--------------------------

Test circuit and waveforms:

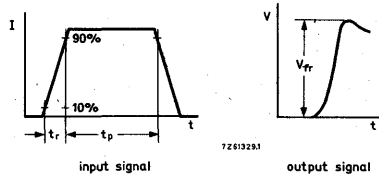
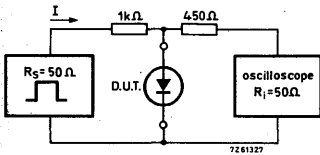

Input signal : Rise time of the forward pulse	$t_R = 20\text{ ns}$
Forward current pulse duration	$t_p = 120\text{ ns}$
Duty factor	$\delta = 0,01$

Oscilloscope: Rise time $t_R = 0,35\text{ ns}$

Circuit capacitance $C \leq 1\text{ pF}$ ($C = \text{oscilloscope input capacitance} + \text{parasitic capacitance}$)

CHARACTERISTICS (per diode) (continued)

$T_j = 25\text{ }^\circ\text{C}$

→ Reverse recovery time when switched from

$I_F = 10\text{ mA}$ to $I_R = 10\text{ mA}$; $R_L = 100\ \Omega$;
measured at $I_R = 1\text{ mA}$

$t_{rr} < 6\text{ ns}$

Test circuit and waveforms:

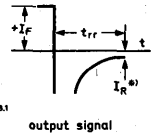
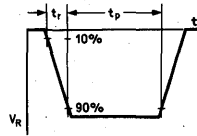
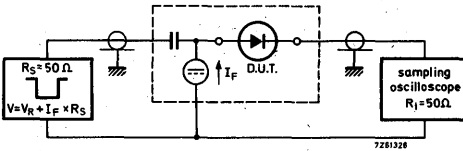

Input signal : Rise time of the reverse pulse

$t_r = 0,6\text{ ns}$

*) $I_R = 1\text{ mA}$

Reverse pulse duration

$t_p = 100\text{ ns}$

Duty factor

$\delta = 0,05$

Oscilloscope: Rise time

$t_r = 0,35\text{ ns}$

Circuit capacitance $C \leq 1\text{ pF}$ ($C =$ oscilloscope input capacitance + parasitic capacitance)

Recovery charge when switched from

$I_F = 10\text{ mA}$ to $V_R = 5\text{ V}$; $R_L = 500\ \Omega$

$Q_s < 45\text{ pC}$

Test circuit and waveform:

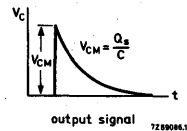
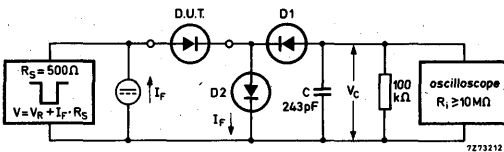

D1 = BAW62

D2 = diode with minority carrier life time at 10 mA: $< 200\text{ ps}$

Input signal : Rise time of the reverse pulse

$t_r = 2\text{ ns}$

Reverse pulse duration

$t_p = 400\text{ ns}$

Duty factor

$\delta = 0,02$

Circuit capacitance $C \leq 7\text{ pF}$ ($C =$ oscilloscope input capacitance + parasitic capacitance)

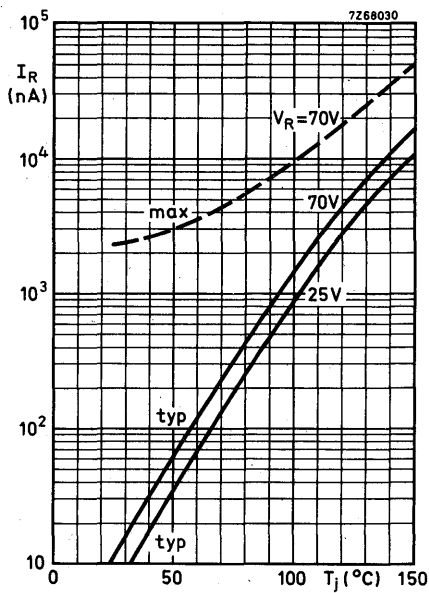
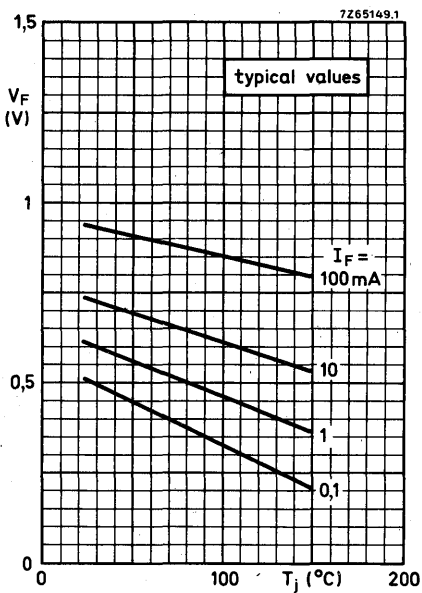
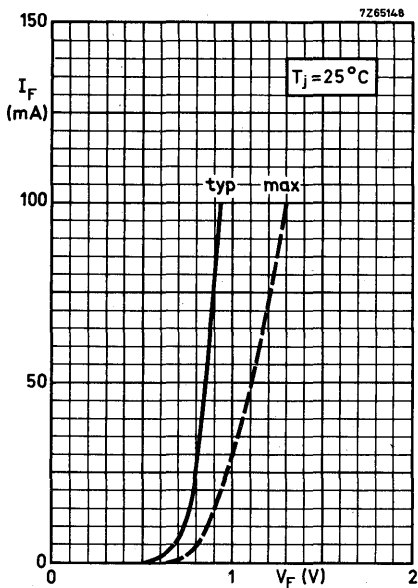

SILICON PLANAR EPITAXIAL HIGH-SPEED DIODES

The BAW56 consists of two diodes in a microminiature plastic envelope. The anodes are commoned and the unit is intended for high-speed switching in thick and thin-film circuits.

QUICK REFERENCE DATA (per diode)

Continuous reverse voltage	V_R	max.	70 V
Repetitive peak reverse voltage	V_{RRM}	max.	70 V
Repetitive peak forward current	I_{FRM}	max.	200 mA
Junction temperature	T_j	max.	150 °C
Forward voltage at $I_F = 50$ mA	V_F	<	1,1 V
Reverse recovery time when switched from $I_F = 10$ mA to $I_R = 10$ mA; $R_L = 100 \Omega$; measured at $I_R = 1$ mA	t_{rr}	<	6 ns
Recovery charge when switched from $I_F = 10$ mA to $V_R = 5$ V; $R_L = 500 \Omega$	Q_s	<	45 pC

MECHANICAL DATA

Dimensions in mm

Marking code

Fig. 1 SOT-23.

BAW56 = A1

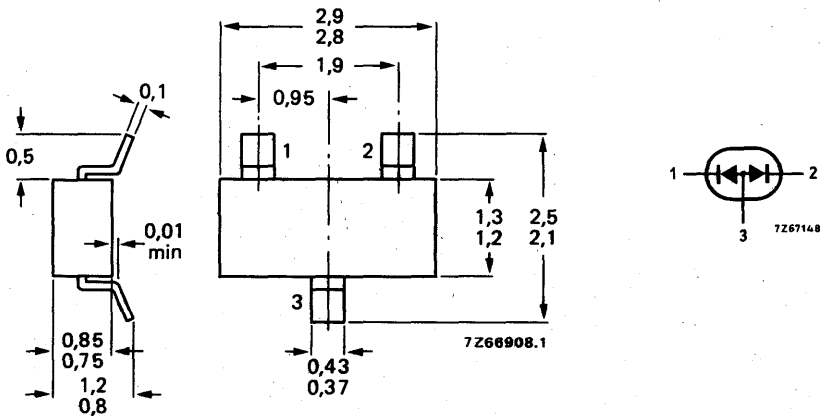

See also *Soldering recommendations*.

RATINGS (per diode) Limiting values in accordance with the Absolute Maximum System (IEC 134)

Voltages

Continuous reverse voltage	V_R	max.	70	V
Repetitive peak reverse voltage	V_{RRM}	max.	70	V

Currents

Average rectified forward current (averaged over any 20 ms period)	$I_{F(AV)}$	max.	100	mA ¹⁾
Forward current (d. c.)	I_F	max.	100	mA
Repetitive peak forward current	I_{FRM}	max.	200	mA

Temperatures

Storage temperature	T_{stg}	-65 to +150	°C
Junction temperature	T_j	max. 150	°C

THERMAL RESISTANCE (per diode)

From junction to ambient
mounted on a ceramic substrate of
7 mm x 5 mm x 0,5 mm

both diodes loaded simultaneously	$R_{th\ j-a}$	=	1,10	°C/mW
one diode loaded	$R_{th\ j-a}$	=	0,67	°C/mW

¹⁾ Measured under pulse conditions : pulse time $t_p \leq 0,5$ ms.
For sinusoidal operation $I_{F(AV)} = 65$ mA; averaging time $t_{(av)} \leq 1$ ms.

CHARACTERISTICS (per diode)

$T_j = 25\text{ }^\circ\text{C}$ unless otherwise specified

Forward voltage

$I_F = 1\text{ mA}$

$V_F < 715\text{ mV}$

$I_F = 10\text{ mA}$

$V_F < 855\text{ mV}$

$I_F = 50\text{ mA}$

$V_F < 1100\text{ mV}$

$I_F = 100\text{ mA}$

$V_F < 1300\text{ mV}$

Reverse current

$V_R = 25\text{ V}; T_j = 150\text{ }^\circ\text{C}$

$I_R < 30\text{ }\mu\text{A}$

$V_R = 70\text{ V}$

$I_R < 2,5\text{ }\mu\text{A}$

$V_R = 70\text{ V}; T_j = 150\text{ }^\circ\text{C}$

$I_R < 50\text{ }\mu\text{A}$

Diode capacitance

$V_R = 0; f = 1\text{ MHz}$

$C_d < 2\text{ pF}$

Forward recovery voltage when switched to

$I_F = 10\text{ mA}; t_r = 20\text{ ns}$

$V_{fr} < 1,75\text{ V}$

Test circuit and waveforms:

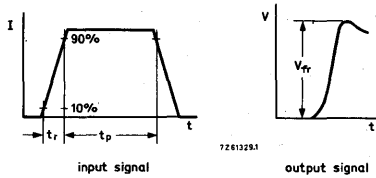
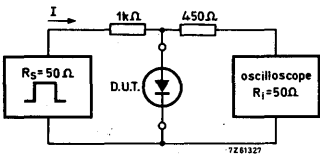

Input signal : Rise time of the forward pulse

$t_r = 20\text{ ns}$

Forward current pulse duration

$t_p = 120\text{ ns}$

Duty factor

$\delta = 0,01$

Oscilloscope : Rise time

$t_r = 0,35\text{ ns}$

Circuit capacitance $C \leq 1\text{ pF}$ ($C = \text{oscilloscope input capacitance} + \text{parasitic capacitance}$)

CHARACTERISTICS (per diode) (continued)

$T_j = 25\text{ }^\circ\text{C}$

→ Reverse recovery time when switched from

$I_F = 10\text{ mA}$ to $I_R = 10\text{ mA}$; $R_L = 100\ \Omega$;
measured at $I_R = 1\text{ mA}$

$$t_{rr} < 6\text{ ns}$$

Test circuit and waveforms :

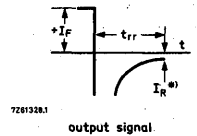
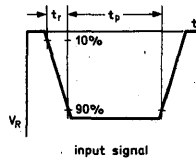
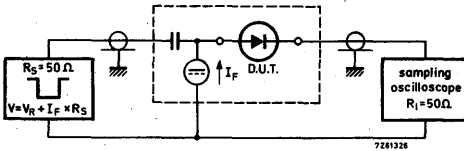

Input signal : Rise time of the reverse pulse

$$t_r = 0,6\text{ ns}$$

*) $I_R = 1\text{ mA}$

Reverse pulse duration

$$t_p = 100\text{ ns}$$

Duty factor

$$\delta = 0,05$$

Oscilloscope: Rise time

$$t_r = 0,35\text{ ns}$$

Circuit capacitance $C \leq 1\text{ pF}$ ($C =$ oscilloscope input capacitance + parasitic capacitance)

Recovery charge when switched from

$I_F = 10\text{ mA}$ to $V_R = 5\text{ V}$; $R_L = 500\ \Omega$

$$Q_s < 45\text{ pC}$$

Test circuit and waveform :

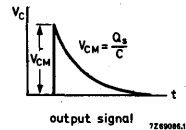
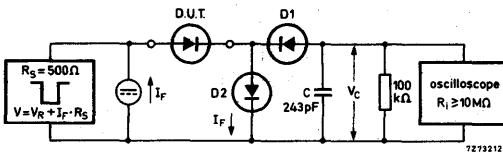

D1 = BAW62

D2 = diode with minority carrier life time at 10 mA: $< 200\text{ ps}$

Input signal : Rise time of the reverse pulse

$$t_r = 2\text{ ns}$$

Reverse pulse duration

$$t_p = 400\text{ ns}$$

Duty factor

$$\delta = 0,02$$

Circuit capacitance $C \leq 7\text{ pF}$ ($C =$ oscilloscope input capacitance + parasitic capacitance)

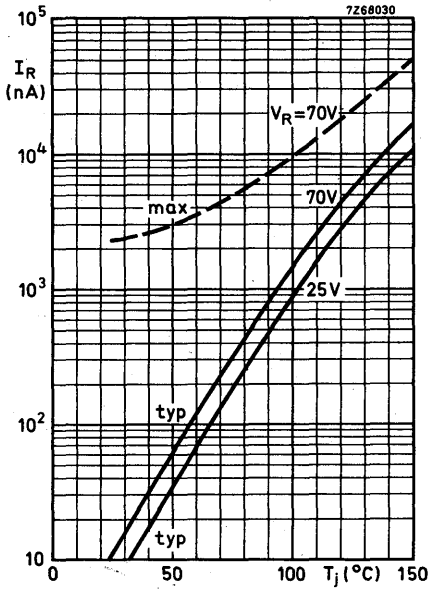
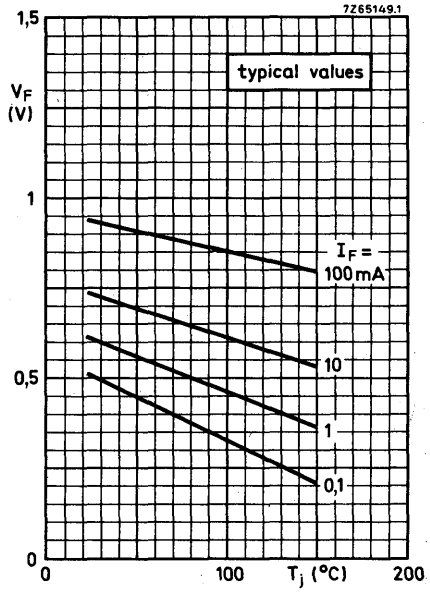
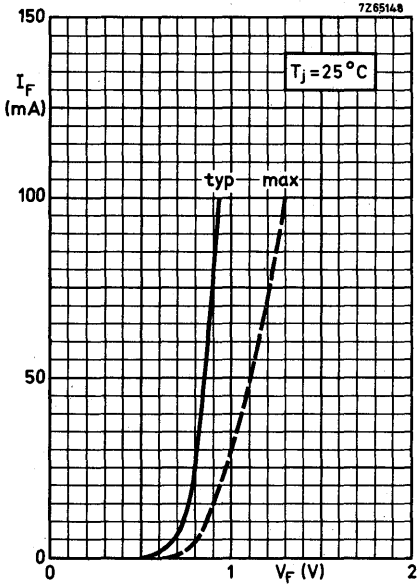

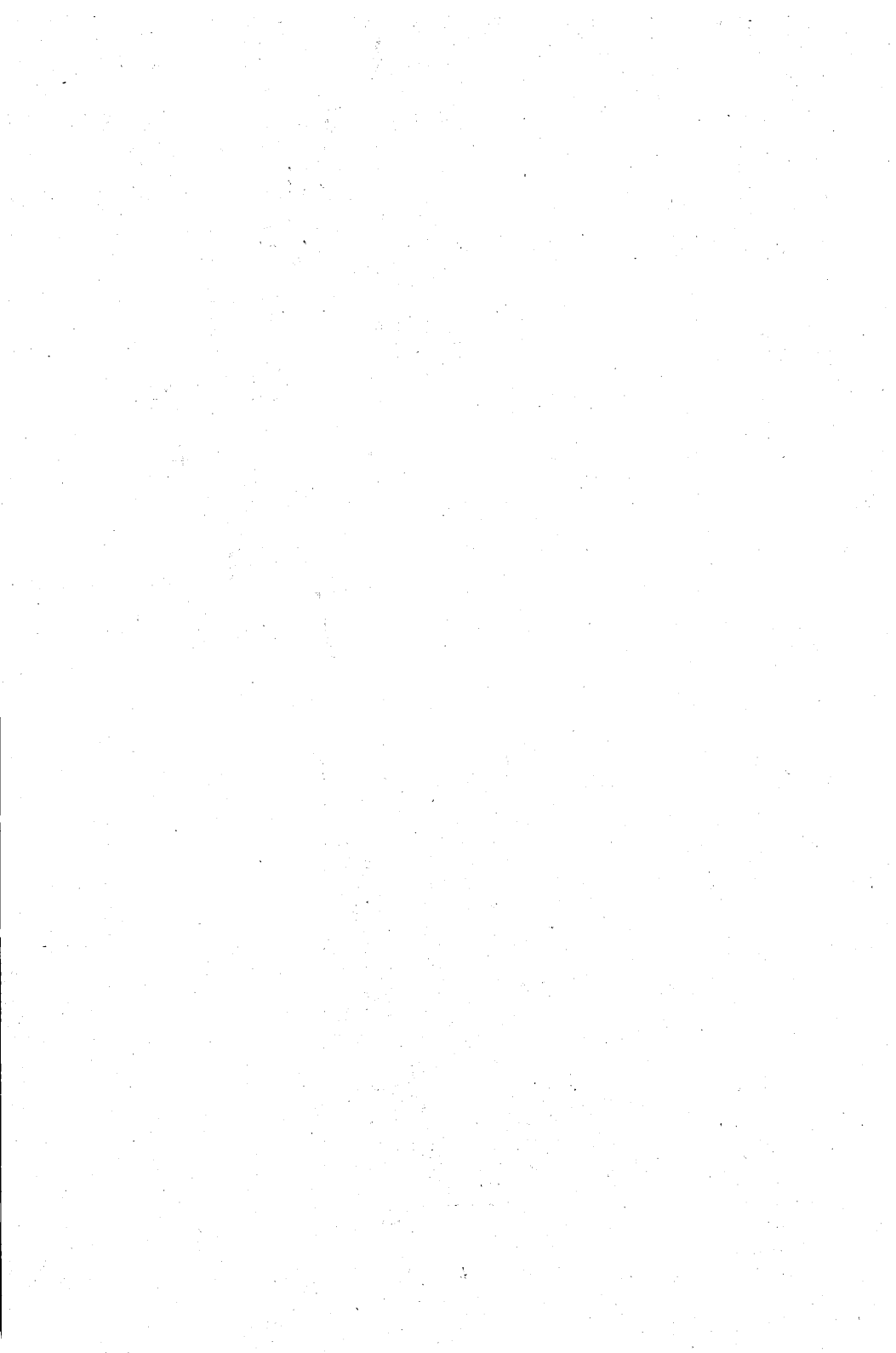

VARIABLE CAPACITANCE DIODE

Silicon planar variable capacitance diode in a microminiature envelope. It is intended for electronic tuning applications in thick and thin-film circuits.

QUICK REFERENCE DATA

Reverse voltage	V_R	max.	28 V
Reverse current at $V_R = 28$ V	I_R	<	50 nA
Diode capacitance at $f = 1$ MHz $V_R = 25$ V	C_d		1,8 to 2,8 pF
Capacitance ratio at $f = 1$ MHz	$\frac{C_d(V_R = 3\text{ V})}{C_d(V_R = 25\text{ V})}$	typ.	5
Series resistance at $f = 470$ MHz $V_R =$ that value at which $C_d = 9$ pF	r_D	<	1,2 Ω

MECHANICAL DATA

Dimensions in mm

Marking code

Fig. 1 SOT-23.

BBY31 = S1

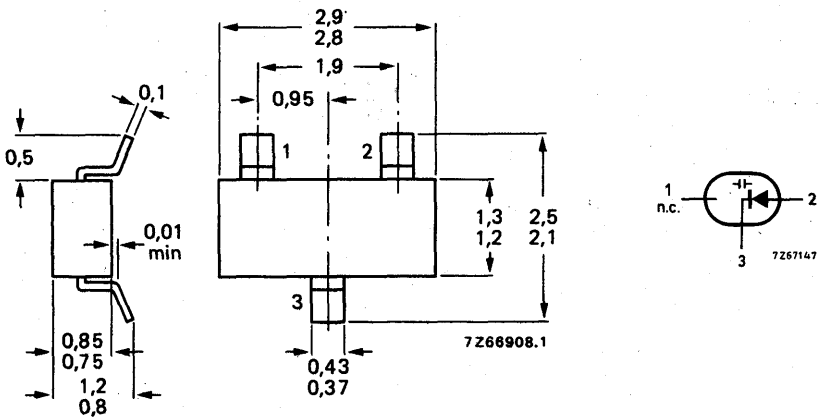

See also *Soldering recommendations*.

RATINGS Limiting values in accordance with the Absolute Maximum System (IEC 134)

Continuous reverse voltage	V_R	max.	28	V
Reverse voltage (peak value)	V_{RM}	max.	30	V
Forward current (d.c.)	I_F	max.	20	mA
Storage temperature	T_{stg}		-65 to +100	°C
→ Operating junction temperature	T_j	max.	85	°C

THERMAL RESISTANCE

From junction to ambient
mounted on a ceramic substrate of
7 mm x 5 mm x 0,5 mm

$$R_{th\ j-a} = 0,62 \text{ } ^\circ\text{C/mW}$$

CHARACTERISTICS
 $T_j = 25 \text{ } ^\circ\text{C}$ unless otherwise specified
Reverse current

$V_R = 28 \text{ V}$	I_R	<	50	nA
→ $V_R = 28 \text{ V}; T_j = 85 \text{ } ^\circ\text{C}$	I_R	<	1000	nA

Diode capacitance at $f = 1 \text{ MHz}$

$V_R = 1 \text{ V}$	C_d	typ.	17,5	pF
$V_R = 3 \text{ V}$	C_d	typ.	11,5	pF
$V_R = 25 \text{ V}$	C_d		1,8 to 2,8	pF

Capacitance ratio at $f = 1 \text{ MHz}$

$$\frac{C_d(V_R = 3 \text{ V})}{C_d(V_R = 25 \text{ V})} \text{ typ. } 5$$

Series resistance

at $f = 470 \text{ MHz}$ and at that value
of V_R at which $C_d = 9 \text{ pF}$

$$r_D < 1,2 \text{ } \Omega$$

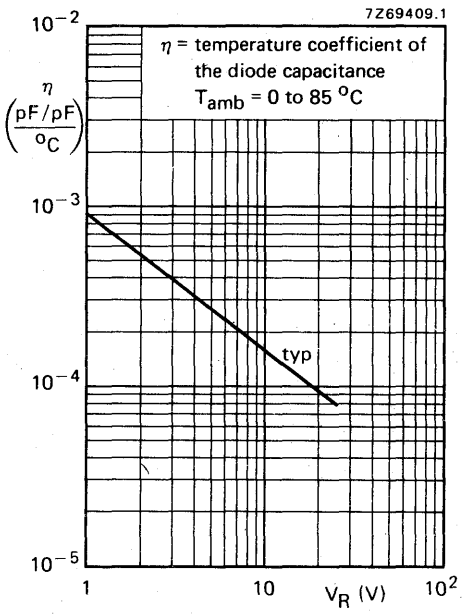
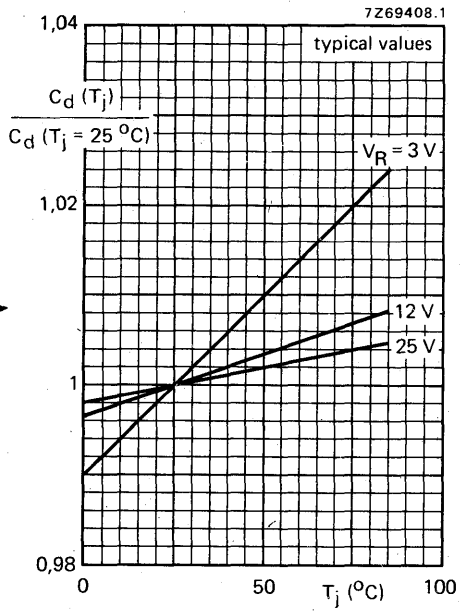
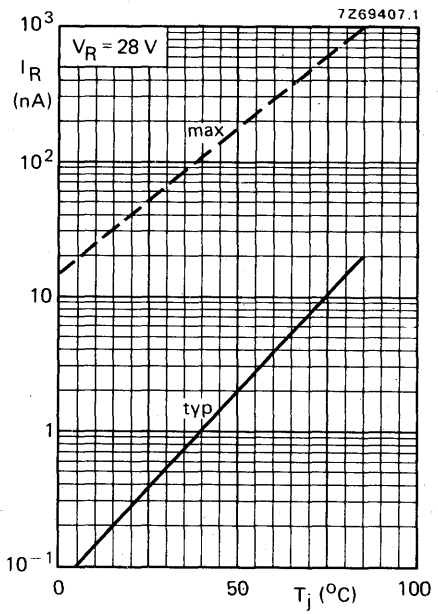
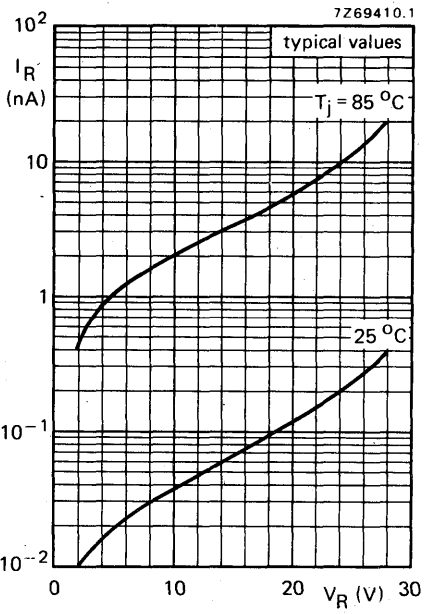

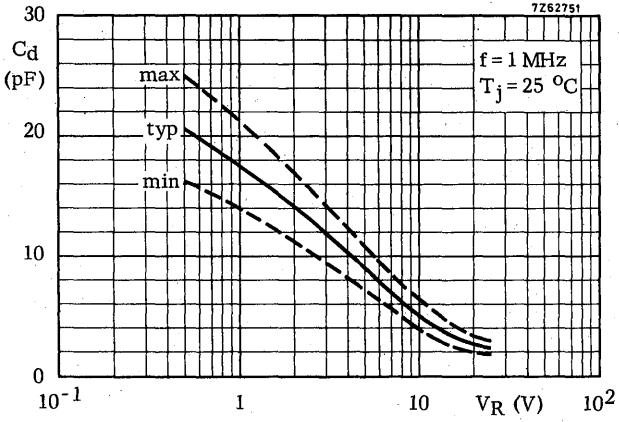

SILICON PLANAR EPITAXIAL TRANSISTORS

P-N-P transistors, in a microminiature plastic envelope, intended for low level general purpose applications in thick and thin-film circuits.

QUICK REFERENCE DATA

		BCW29		BCW30	
		BCW29R		BCW30R	
D.C. current gain at $T_j = 25\text{ }^\circ\text{C}$ $-I_C = 2\text{ mA}; -V_{CE} = 5\text{ V}$	h_{FE}	>	120	215	
		<	260	500	
Collector-base voltage (open emitter)	$-V_{CBO}$	max.	30		V
Collector-emitter voltage (open base)	$-V_{CEO}$	max.	20		V
Collector current (peak value)	$-I_{CM}$	max.	200		mA
Total power dissipation up to $T_{amb} = 25\text{ }^\circ\text{C}$	P_{tot}	max.	200		mW
Junction temperature	T_j	max.	150		$^\circ\text{C}$
Transition frequency at $f = 35\text{ MHz}$ $-I_C = 10\text{ mA}; -V_{CE} = 5\text{ V}$	f_T	typ.	150		MHz
Noise figure at $R_S = 2\text{ k}\Omega$ $-I_C = 200\text{ }\mu\text{A}; -V_{CE} = 5\text{ V};$ $f = 1\text{ kHz}; B = 200\text{ Hz}$	F	<	10		dB

MECHANICAL DATA

Fig. 1 SOT-23.

Dimensions in mm

Marking code

BCW29 = C1
BCW30 = C2

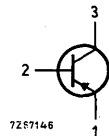
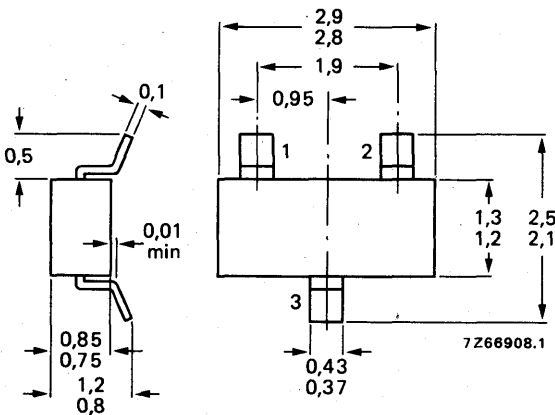

BCW29R = C4
BCW30R = C5

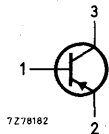

See also *Soldering recommendations.*

BCW29 BCW30

RATINGS Limiting values in accordance with the Absolute Maximum System (IEC134)

Voltages

Collector-base voltage (open emitter)	$-V_{CBO}$	max.	30 V
Collector-emitter voltage ($V_{BE} = 0$)	$-V_{CES}$	max.	30 V
Collector-emitter voltage (open base) $-I_C = 2 \text{ mA}$	$-V_{CEO}$	max.	20 V
Emitter-base voltage (open collector)	$-V_{EBO}$	max.	5 V

Currents

Collector current (d.c.)	$-I_C$	max.	100 mA
Collector current (peak value)	$-I_{CM}$	max.	200 mA

Power dissipation

Total power dissipation up to $T_{amb} = 25 \text{ }^\circ\text{C}$ mounted on a ceramic substrate of 7 mm x 5 mm x 0.5 mm	P_{tot}	max.	200 mW
--	-----------	------	--------

Temperatures

Storage temperature	T_{stg}	-65 to +150	$^\circ\text{C}$
Junction temperature	T_j	max. 150	$^\circ\text{C}$

THERMAL RESISTANCE

From junction to ambient mounted on ceramic substrate of 7 mm x 5 mm x 0.5 mm	$R_{th \text{ j-a}}$	=	0.62 $^\circ\text{C}/\text{mW}$
---	----------------------	---	---------------------------------

CHARACTERISTICS

Collector cut-off current

$I_E = 0$; $-V_{CB} = 20 \text{ V}$; $T_j = 25 \text{ }^\circ\text{C}$	$-I_{CBO}$	<	100 nA
$T_j = 100 \text{ }^\circ\text{C}$	$-I_{CBO}$	<	10 μA

Base-emitter voltage

$-I_C = 2 \text{ mA}$; $-V_{CE} = 5 \text{ V}$; $T_j = 25 \text{ }^\circ\text{C}$	$-V_{BE}$	600 to 750	mV
---	-----------	------------	----

CHARACTERISTICS (continued)

$T_j = 25\text{ }^\circ\text{C}$ unless otherwise specified

Saturation voltages

$-I_C = 10\text{ mA}; -I_B = 0.5\text{ mA}$

$-I_C = 50\text{ mA}; -I_B = 2.5\text{ mA}$

$-V_{CEsat}$	typ. 80 mV
	< 300 mV
$-V_{BEsat}$	typ. 720 mV
$-V_{CEsat}$	typ. 150 mV
$-V_{BEsat}$	typ. 810 mV

D.C. current gain

$-I_C = 10\text{ }\mu\text{A}; -V_{CE} = 5\text{ V}$

$-I_C = 2\text{ mA}; -V_{CE} = 5\text{ V}$

	BCW29	BCW30
h_{FE}	typ. 90	150
h_{FE}	> 120	215
h_{FE}	< 260	500

Collector capacitance at $f = 1\text{ MHz}$

$I_E = I_e = 0; -V_{CB} = 10\text{ V}$

$C_C < 7.0\text{ pF}$

Transition frequency at $f = 35\text{ MHz}$

$-I_C = 10\text{ mA}; -V_{CE} = 5\text{ V}$

f_T typ. 150 MHz

Noise figure at $R_S = 2\text{ k}\Omega$

$-I_C = 200\text{ }\mu\text{A}; -V_{CE} = 5\text{ V}$
 $f = 1\text{ kHz}; B = 200\text{ Hz}$

$F < 10\text{ dB}$



BCW29
BCW30

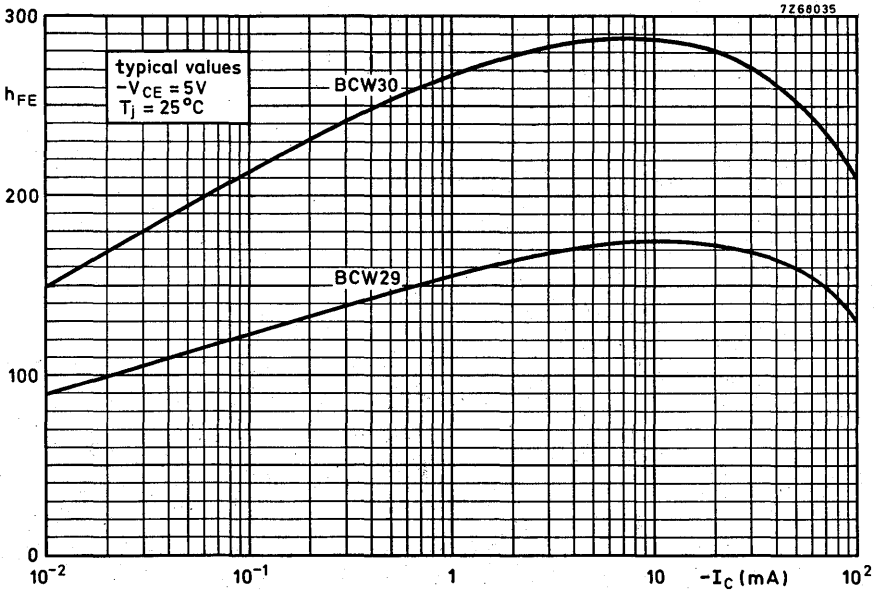
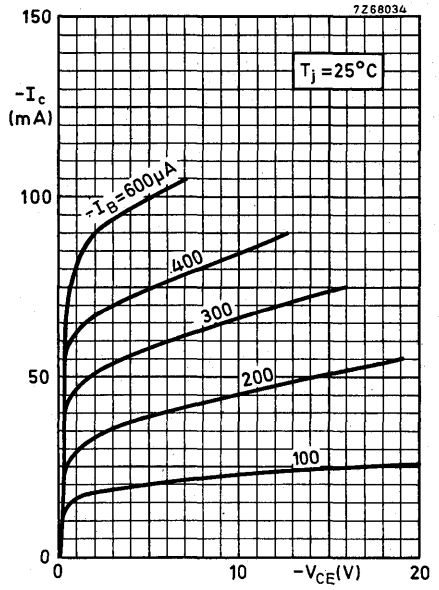
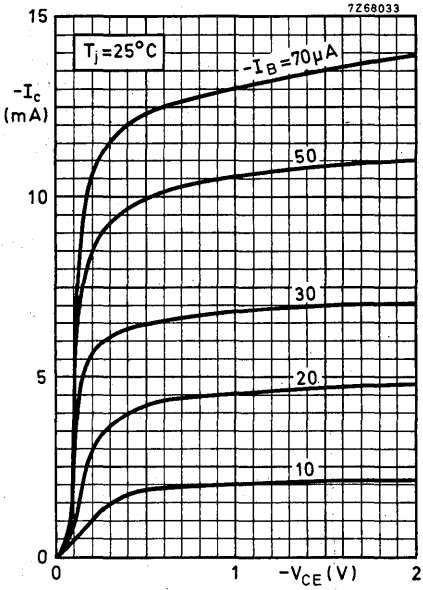

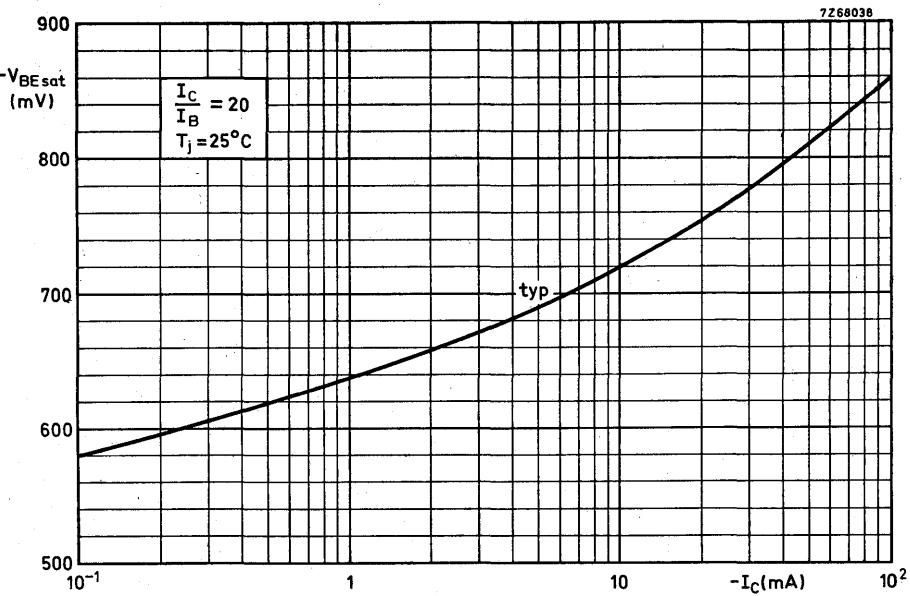
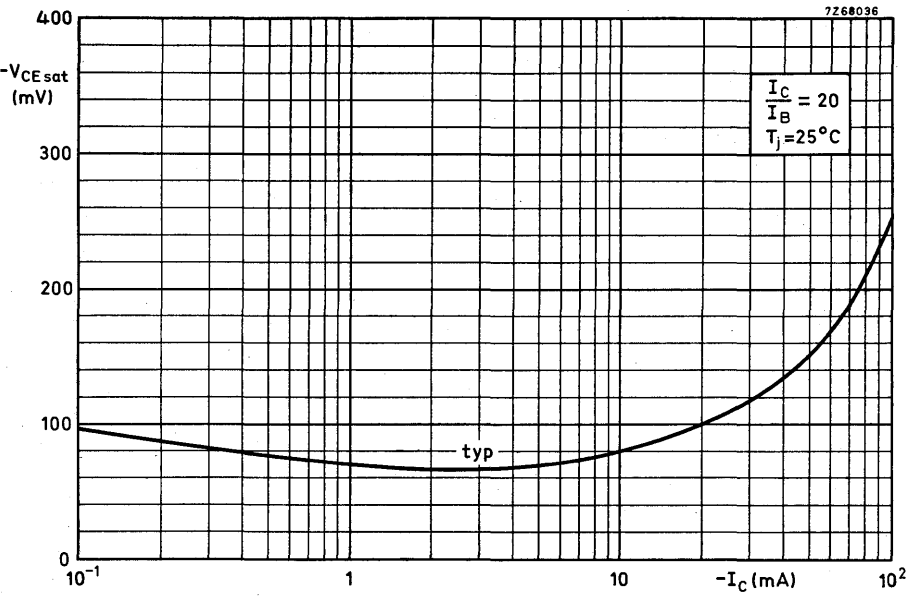

BCW29
BCW30

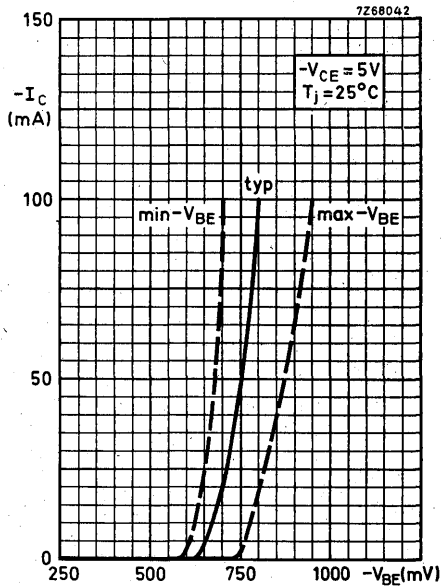
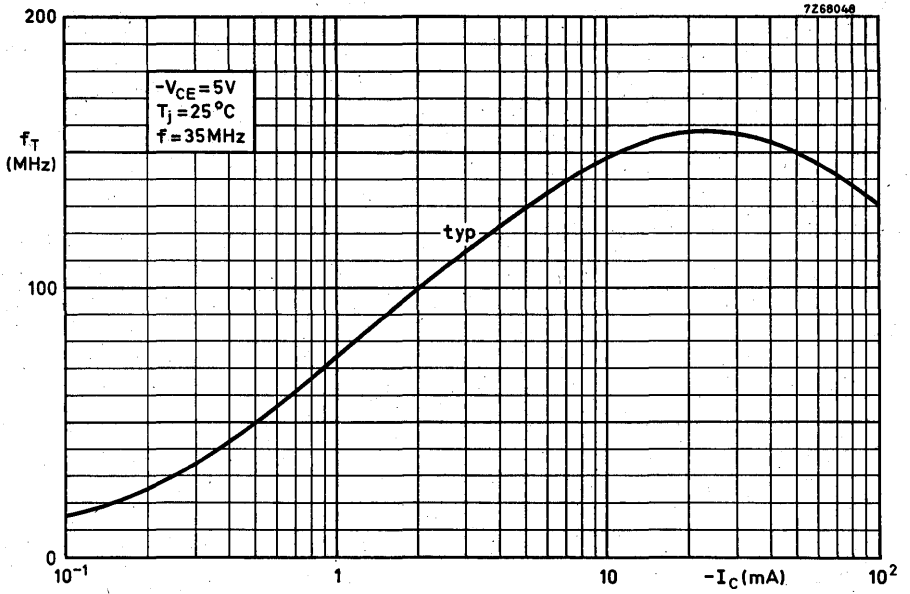

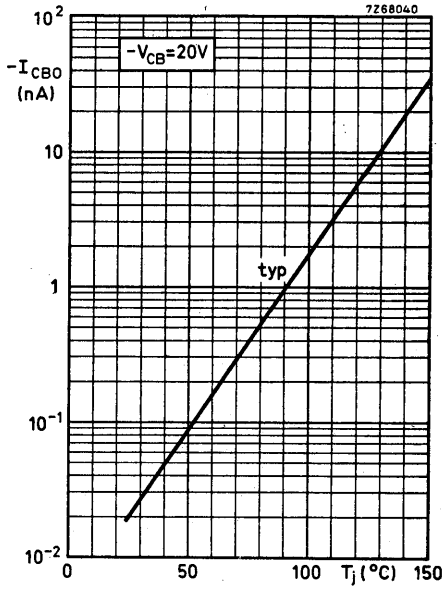
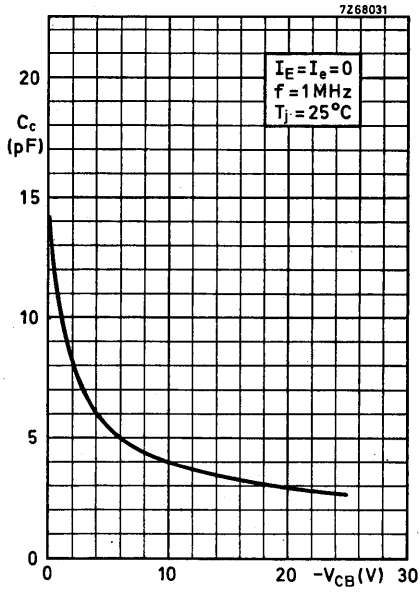

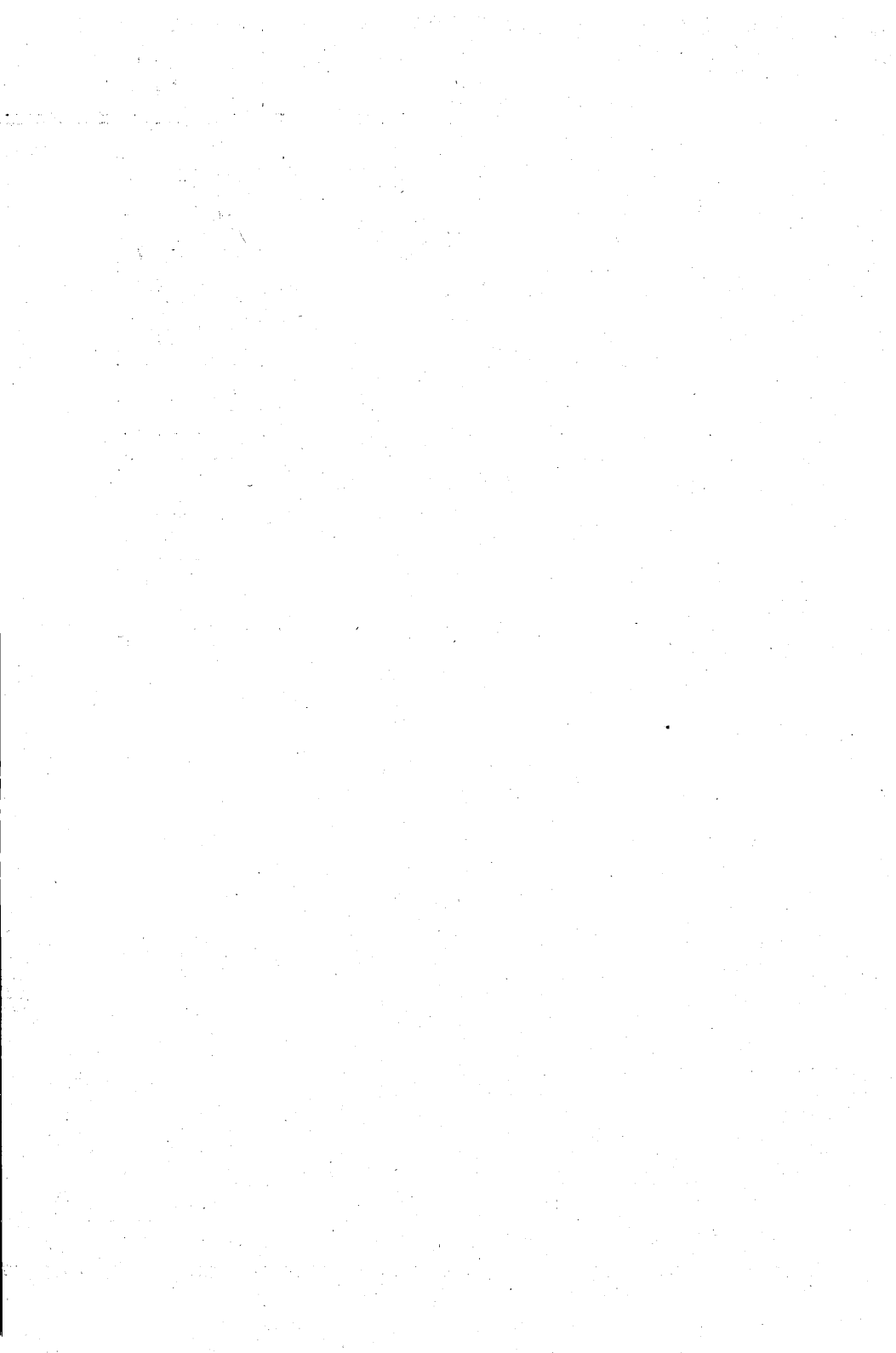

SILICON PLANAR EPITAXIAL TRANSISTORS

N-P-N transistors in a microminiature plastic envelope. They are intended for low level general purpose applications in thick and thin-film circuits.

QUICK REFERENCE DATA

			BCW31 BCW31R	BCW32 BCW32R	BCW33 BCW33R
D.C. current gain at $T_j = 25\text{ }^\circ\text{C}$ $I_C = 2\text{ mA}; V_{CE} = 5\text{ V}$	h_{FE}	> <	110 220	200 450	420 800
Collector-base voltage (open emitter)	V_{CBO}	max.		30	V
Collector-emitter voltage (open base)	V_{CEO}	max.		20	V
Collector current (peak value)	I_{CM}	max.		200	mA
Total power dissipation up to $T_{amb} = 25\text{ }^\circ\text{C}$	P_{tot}	max.		200	mW
Junction temperature	T_j	max.		150	$^\circ\text{C}$
Transition frequency at $f = 35\text{ MHz}$ $I_C = 2\text{ mA}; V_{CE} = 5\text{ V}$	f_T	typ.		300	MHz
Noise figure at $R_S = 2\text{ k}\Omega$ $I_C = 200\text{ }\mu\text{A}; V_{CE} = 5\text{ V};$ $f = 1\text{ kHz}; B = 200\text{ Hz}$	F	<		10	dB

MECHANICAL DATA

Dimensions in mm

Marking code

Fig. 1 SOT-23.

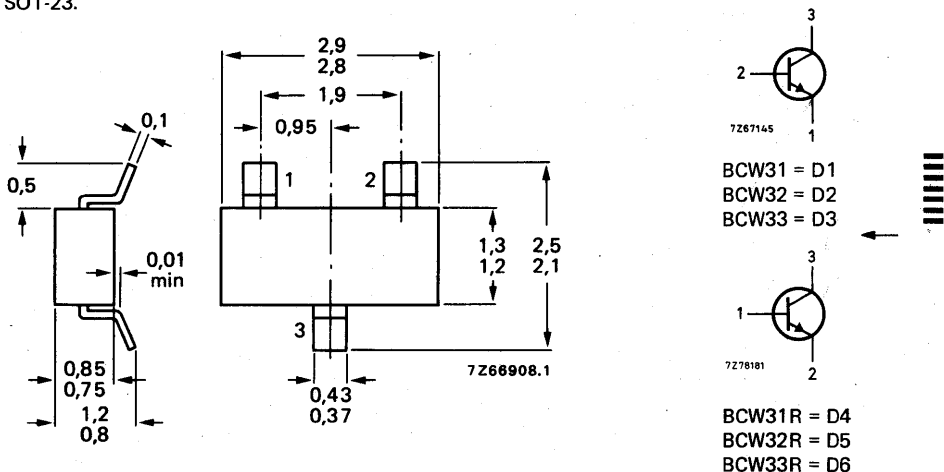

See also *Soldering recommendations*.

RATINGS Limiting values in accordance with the Absolute Maximum System (IEC 134)

Voltages

Collector-base voltage (open emitter)	V_{CBO}	max.	30 V
Collector-emitter voltage (open base) $I_C = 2 \text{ mA}$	V_{CEO}	max.	20 V
Emitter-base voltage (open collector)	V_{EBO}	max.	5 V

Currents

Collector current (d.c.)	I_C	max.	100 mA
Collector current (peak value)	I_{CM}	max.	200 mA

Power dissipation

Total power dissipation up to $T_{amb} = 25 \text{ }^\circ\text{C}$ mounted on a ceramic substrate of 7 mm x 5 mm x 0.5 mm	P_{tot}	max.	200 mW
--	-----------	------	--------

Temperatures

Storage temperature	T_{stg}	-65 to +150	$^\circ\text{C}$
Junction temperature	T_j	max. 150	$^\circ\text{C}$

THERMAL RESISTANCE

From junction to ambient mounted on ceramic substrate of 7 mm x 5 mm x 0.5 mm	$R_{th \text{ j-a}}$	=	0.62 $^\circ\text{C/mW}$
---	----------------------	---	--------------------------

CHARACTERISTICS

$T_j = 25 \text{ }^\circ\text{C}$ unless otherwise specified

Collector cut-off current

$I_E = 0; V_{CB} = 20 \text{ V}$	I_{CBO}	<	100 nA
$I_E = 0; V_{CB} = 20 \text{ V}; T_j = 100 \text{ }^\circ\text{C}$	I_{CBO}	<	10 μA

Base-emitter voltage

$I_C = 2 \text{ mA}; V_{CE} = 5 \text{ V}$	V_{BE}	550 to 700	mV
--	----------	------------	----

CHARACTERISTICS (continued)

$T_j = 25\text{ }^\circ\text{C}$ unless otherwise specified

Saturation voltages

$I_C = 10\text{ mA}; I_B = 0.5\text{ mA}$

V_{CEsat} typ. 120 mV
< 250 mV

$I_C = 50\text{ mA}; I_B = 2.5\text{ mA}$

V_{BEsat} typ. 750 mV
 V_{CEsat} typ. 210 mV
 V_{BEsat} typ. 850 mV

D.C. current gain

$I_C = 10\text{ }\mu\text{A}; V_{CE} = 5\text{ V}$

	BCW31	BCW32	BCW33
h_{FE} typ.	90	150	270
$h_{FE} >$	110	200	420
$h_{FE} <$	220	450	800

$I_C = 2\text{ mA}; V_{CE} = 5\text{ V}$

Collector capacitance at $f = 1\text{ MHz}$

$I_E = I_e = 0; V_{CB} = 10\text{ V}$

C_c < 4.0 pF

Transition frequency at $f = 35\text{ MHz}$

$I_C = 10\text{ mA}; V_{CE} = 5\text{ V}$

f_T typ. 300 MHz

Noise figure at $R_S = 2\text{ k}\Omega$

$I_C = 200\text{ }\mu\text{A}; V_{CE} = 5\text{ V}$
 $f = 1\text{ kHz}; B = 200\text{ Hz}$

F < 10 dB



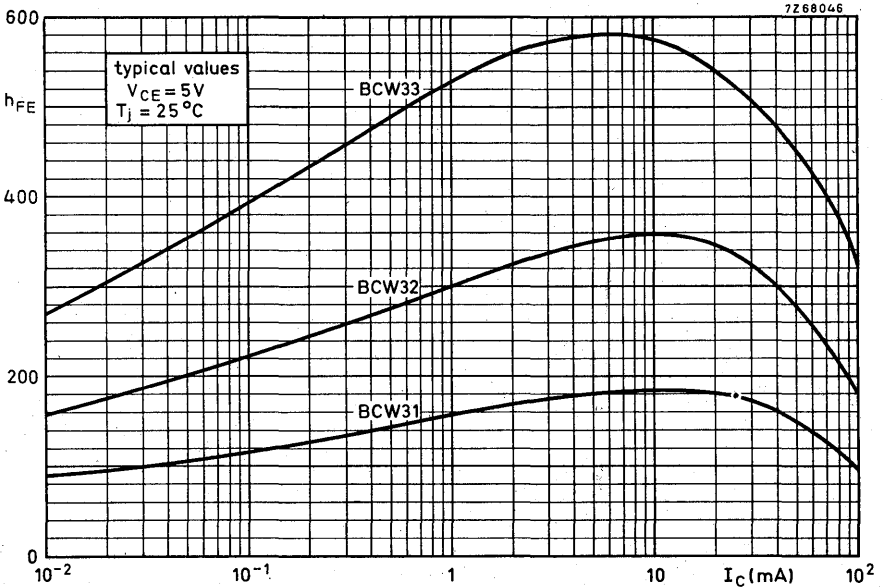
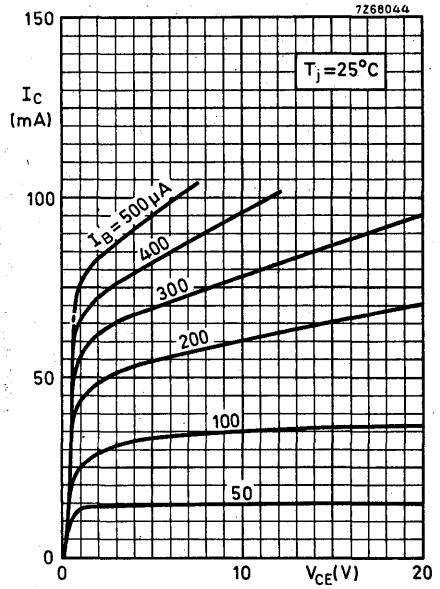
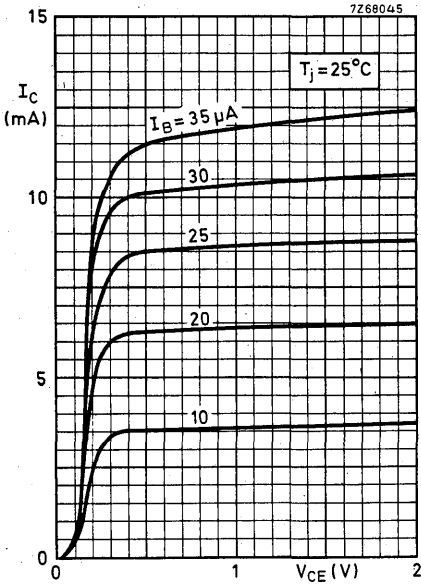

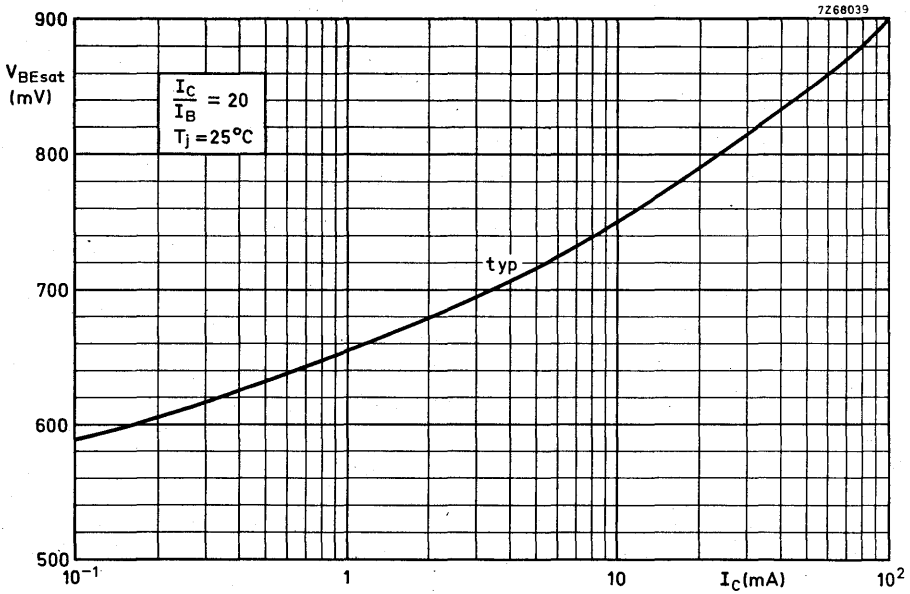
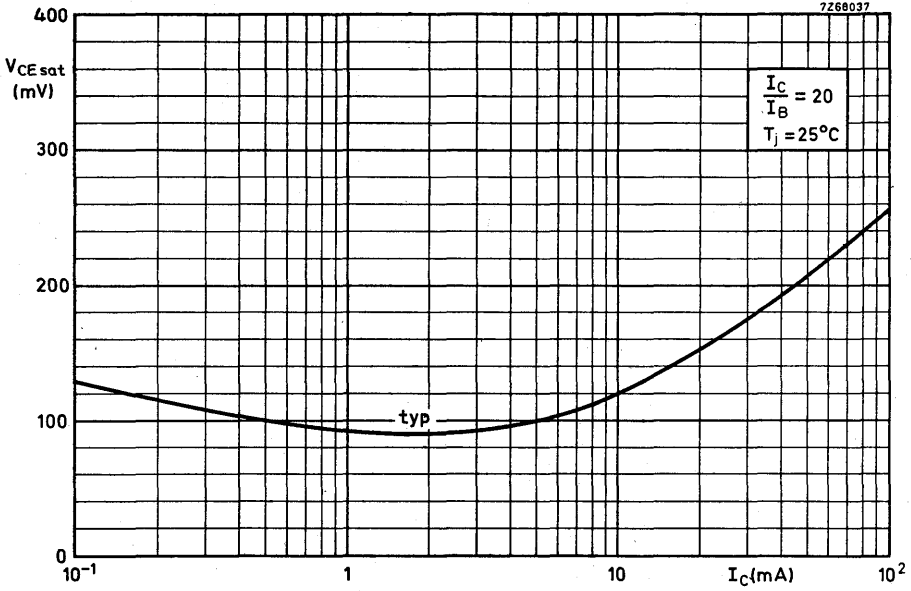

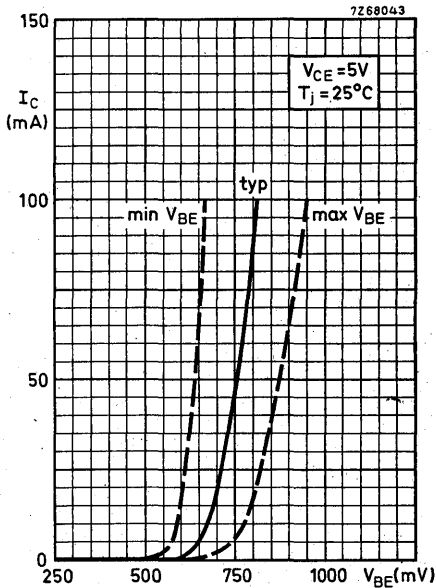
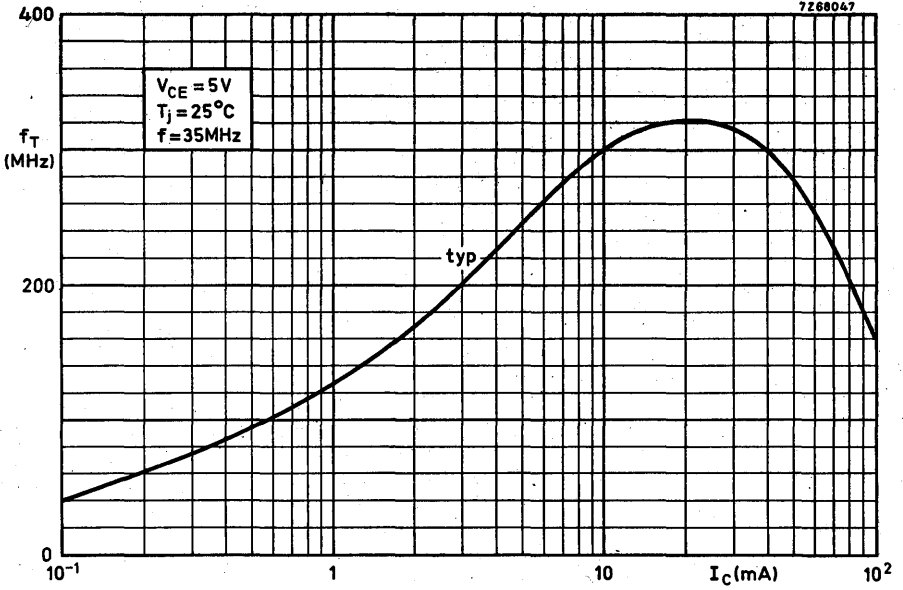

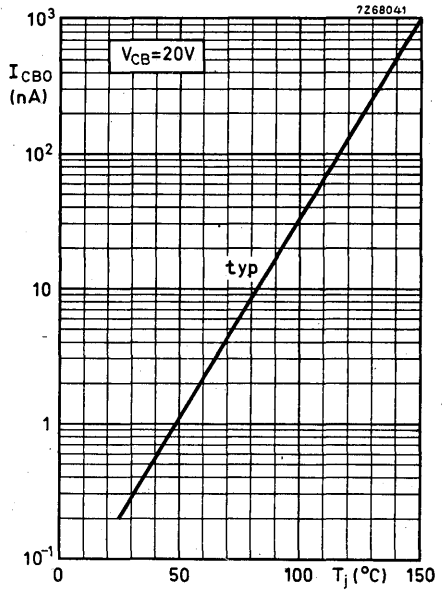
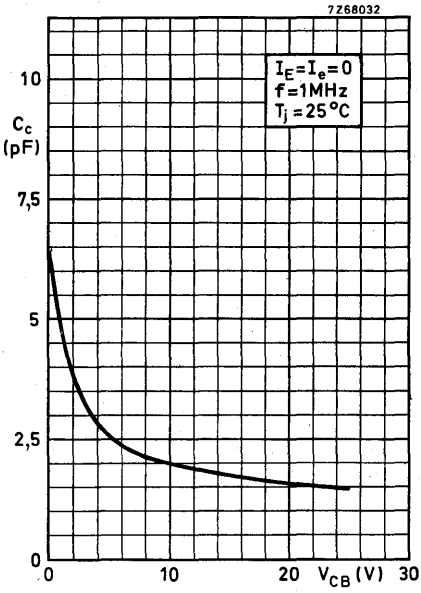

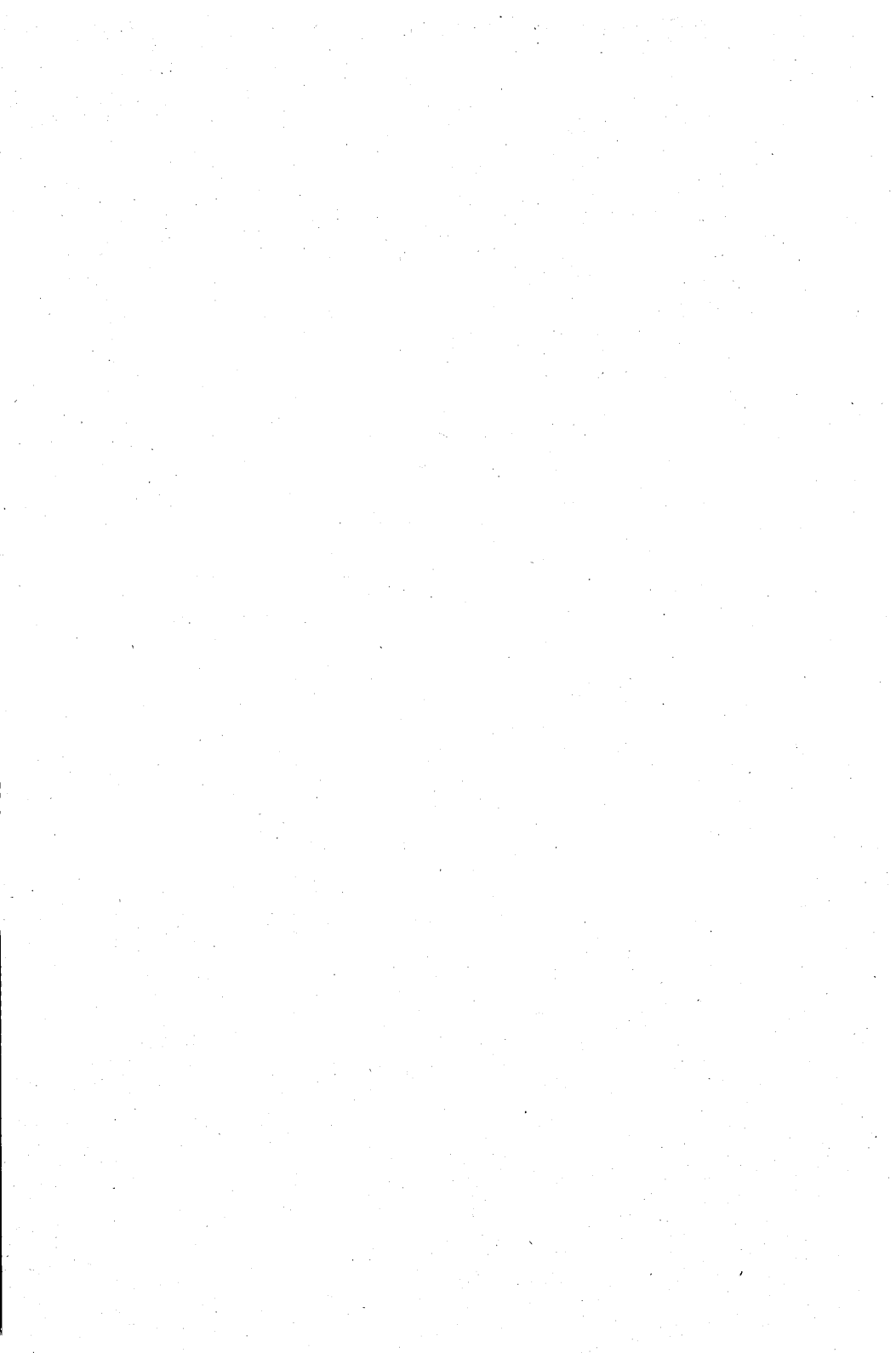

SILICON PLANAR EPITAXIAL TRANSISTORS

P-N-P transistors, in a microminiature plastic envelope, intended for low level general purpose applications in thick and thin-film circuits.

QUICK REFERENCE DATA

		BCW69		BCW70	
		BCW69R		BCW70R	
D.C. current gain at $T_j = 25\text{ }^\circ\text{C}$ $-I_C = 2\text{ mA}; -V_{CE} = 5\text{ V}$	h_{FE}	>	120	>	215
		<	260	<	500
Collector-base voltage (open emitter)	$-V_{CBO}$	max.	50		V
Collector-emitter voltage (open base)	$-V_{CEO}$	max.	45		V
Collector current (peak value)	$-I_{CM}$	max.	200		mA
Total power dissipation up to $T_{amb} = 25\text{ }^\circ\text{C}$	P_{tot}	max.	200		mW
Junction temperature	T_j	max.	150		$^\circ\text{C}$
Transition frequency at $f = 35\text{ MHz}$ $-I_C = 10\text{ mA}; -V_{CE} = 5\text{ V}$	f_T	typ.	150		MHz
Noise figure at $R_S = 2\text{ k}\Omega$ $-I_C = 200\text{ }\mu\text{A}; -V_{CE} = 5\text{ V};$ $f = 1\text{ kHz}; B = 200\text{ Hz}$	F	<	10		dB

MECHANICAL DATA

Fig. 1 SOT-23.

Dimensions in mm

Marking code

BCW69 = H1
BCW70 = H2

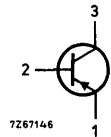
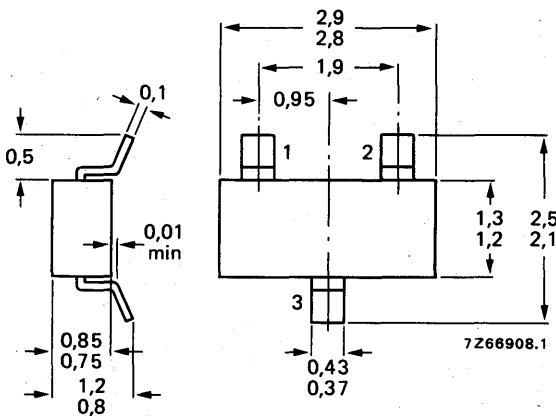

BCW69R = H4
BCW70R = H5

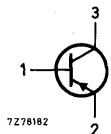

See also *Soldering recommendations.*

BCW69 BCW70

RATINGS Limiting values in accordance with the Absolute Maximum System (IEC134)

Voltages

Collector-base voltage (open emitter)	$-V_{CBO}$	max.	50 V
Collector-emitter voltage ($V_{BE} = 0$)	$-V_{CES}$	max.	50 V
Collector-emitter voltage (open base) $-I_C = 2 \text{ mA}$	$-V_{CEO}$	max.	45 V
Emitter-base voltage (open collector)	$-V_{EBO}$	max.	5 V

Currents

Collector current (d. c.)	$-I_C$	max.	100 mA
Collector current (peak value)	$-I_{CM}$	max.	200 mA

Power dissipation

Total power dissipation up to $T_{amb} = 25 \text{ }^\circ\text{C}$ mounted on a ceramic substrate of 7 mm x 5 mm x 0.5 mm	P_{tot}	max.	200 mW
--	-----------	------	--------

Temperatures

Storage temperature	T_{stg}	-65 to +150	$^\circ\text{C}$
Junction temperature	T_j	max.	150 $^\circ\text{C}$

THERMAL RESISTANCE

From junction to ambient mounted on a ceramic substrate of 7 mm x 5 mm x 0.5 mm	$R_{th \text{ j-a}}$	=	0.62 $^\circ\text{C/mW}$
---	----------------------	---	--------------------------

CHARACTERISTICS

Collector cut-off current

$I_E = 0; -V_{CB} = 20 \text{ V}; T_j = 25 \text{ }^\circ\text{C}$	$-I_{CBO}$	<	100 nA
$T_j = 100 \text{ }^\circ\text{C}$	$-I_{CBO}$	<	10 μA

Base-emitter voltage

$-I_C = 2 \text{ mA}; -V_{CE} = 5 \text{ V}; T_j = 25 \text{ }^\circ\text{C}$	$-V_{BE}$	600 to 750	mV
---	-----------	------------	----

CHARACTERISTICS (continued)

$T_j = 25\text{ }^\circ\text{C}$ unless otherwise specified

Saturation voltages

$-I_C = 10\text{ mA}; -I_B = 0.5\text{ mA}$

$-V_{CEsat}$ typ. 80 mV
< 300 mV

$-V_{BEsat}$ typ. 720 mV

$-I_C = 50\text{ mA}; -I_B = 2.5\text{ mA}$

$-V_{CEsat}$ typ. 150 mV
 $-V_{BEsat}$ typ. 810 mV

D. C. current gain

$-I_C = 10\text{ }\mu\text{A}; -V_{CE} = 5\text{ V}$

		BCW69	BCW70
h_{FE}	typ.	90	150
h_{FE}	>	120	215
h_{FE}	<	260	500

$-I_C = 2\text{ mA}; -V_{CE} = 5\text{ V}$

Collector capacitance at $f = 1\text{ MHz}$

$I_E = I_e = 0; -V_{CB} = 10\text{ V}$

C_C < 7.0 pF

Transition frequency at $f = 35\text{ MHz}$

$-I_C = 10\text{ mA}; -V_{CE} = 5\text{ V}$

f_T typ. 150 MHz

Noise figure at $R_S = 2\text{ k}\Omega$

$-I_C = 200\text{ }\mu\text{A}; -V_{CE} = 5\text{ V}$
 $f = 1\text{ kHz}; B = 200\text{ Hz}$

F < 10 dB

**BCW69
BCW70**

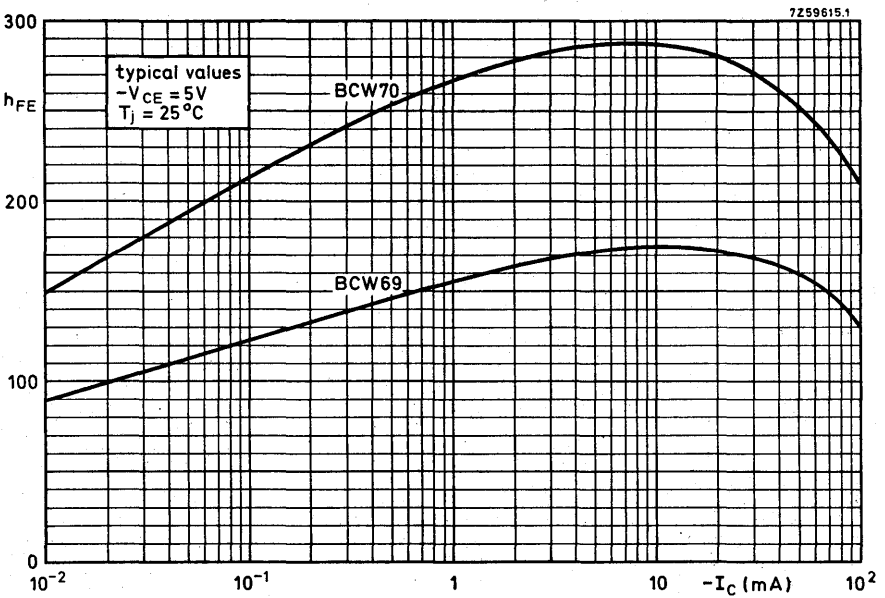
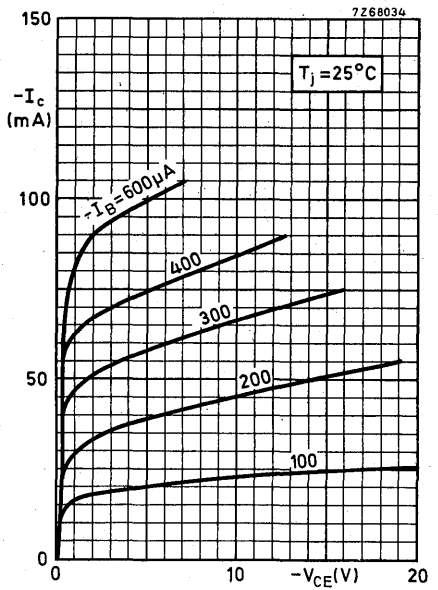
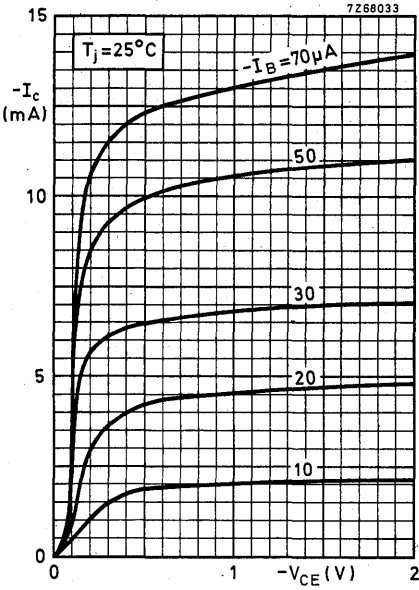

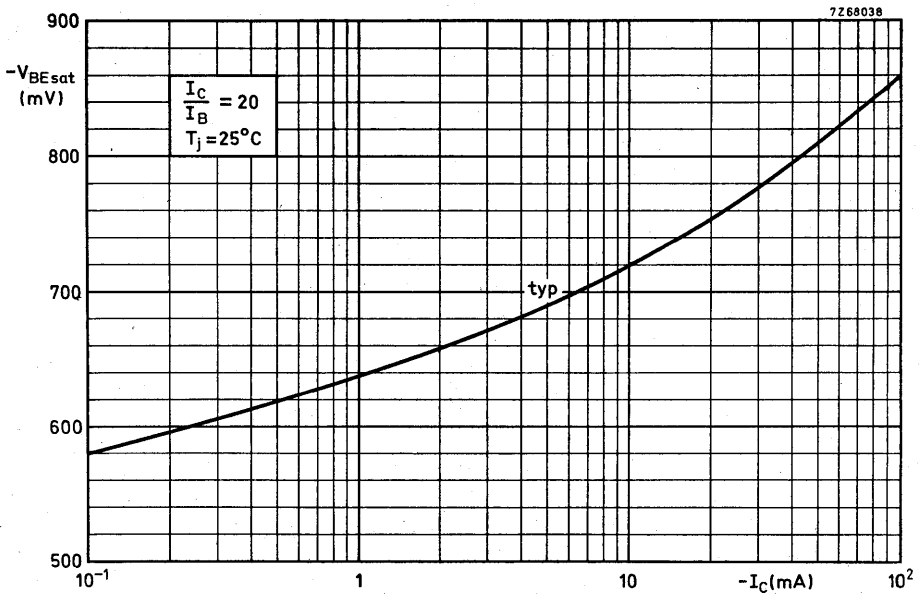
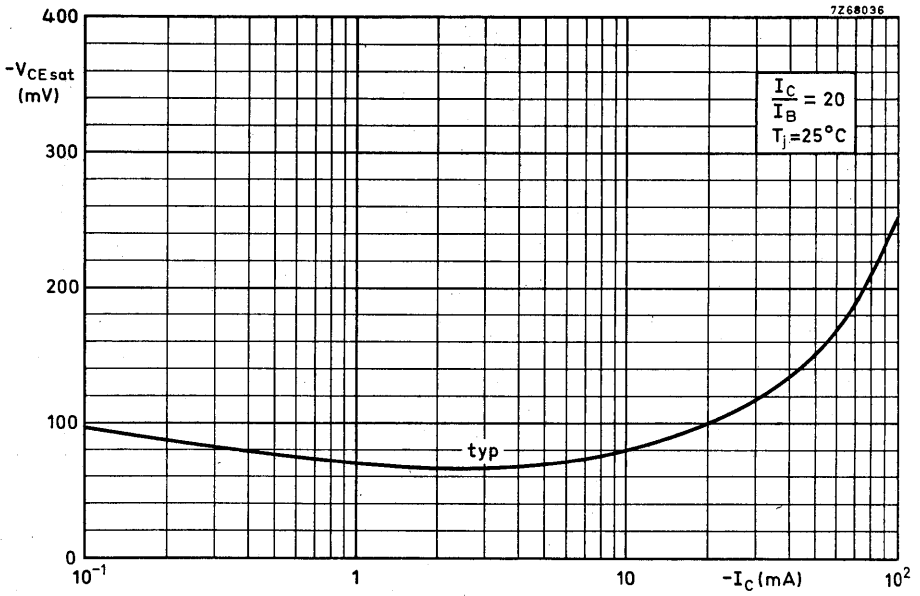

BCW69
BCW70

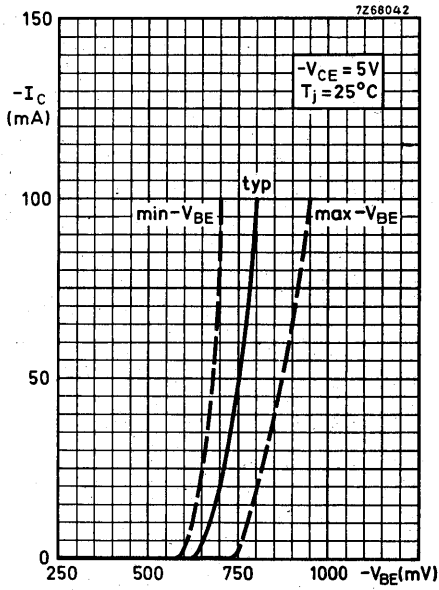
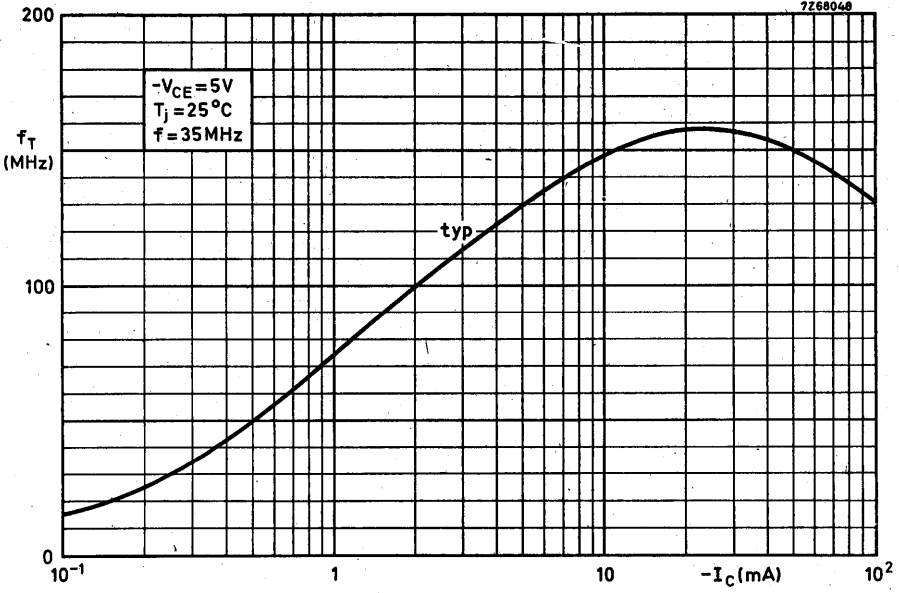

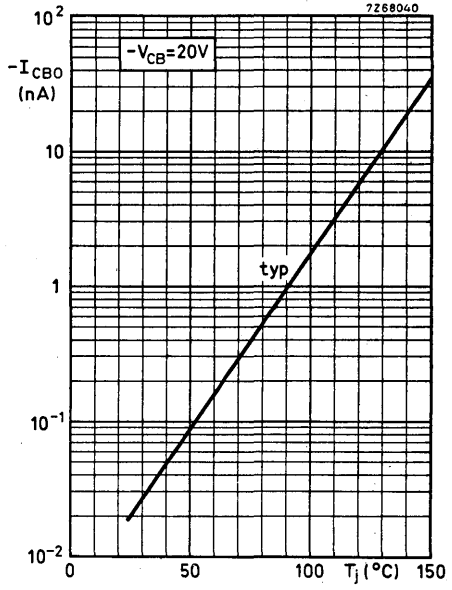
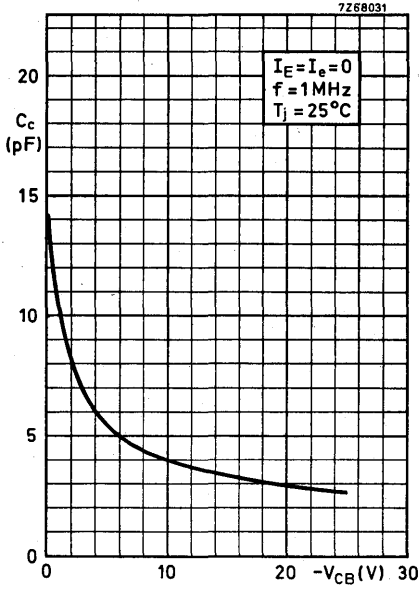

SILICON PLANAR EPITAXIAL TRANSISTORS

N-P-N transistors, in a microminiature plastic envelope, intended for low level general purpose applications in thick and thin-film circuits.

QUICK REFERENCE DATA

		BCW71		BCW72	
		BCW71R		BCW72R	
D.C. current gain at $T_j = 25^\circ\text{C}$ $I_C = 2\text{ mA}; V_{CE} = 5\text{ V}$	h_{FE}	$>$	110	200	
		$<$	220	450	
Collector-base voltage (open emitter)	V_{CBO}	max.	50		V
Collector-emitter voltage (open base)	V_{CEO}	max.	45		V
Collector current (peak value)	I_{CM}	max.	200		mA
Total power dissipation up to $T_{amb} = 25^\circ\text{C}$	P_{tot}	max.	200		mW
Junction temperature	T_j	max.	150		$^\circ\text{C}$
Transition frequency at $f = 35\text{ MHz}$ $I_C = 10\text{ mA}; V_{CE} = 5\text{ V}$	f_T	typ.	300		MHz
Noise figure at $R_S = 2\text{ k}\Omega$ $I_C = 200\text{ }\mu\text{A}; V_{CE} = 5\text{ V};$ $f = 1\text{ kHz}; B = 200\text{ Hz}$	F	$<$	10		dB

MECHANICAL DATA

Fig. 1 SOT-23.

Dimensions in mm

Marking code

BCW71 = K1
BCW72 = K2

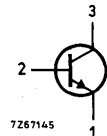
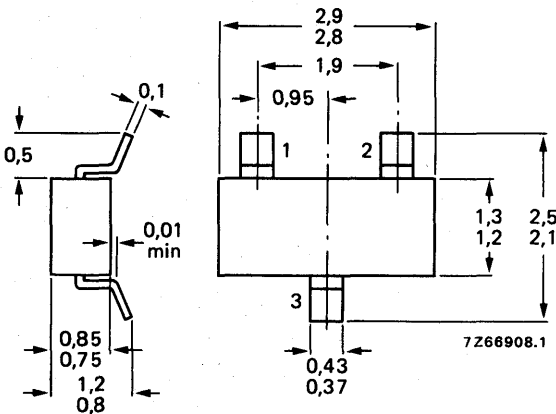

BCW71R = K4
BCW72R = K5

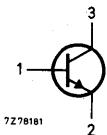

See also *Soldering recommendations*.

RATINGS Limiting values in accordance with the Absolute Maximum System (IEC 134)

Voltages

Collector-base voltage (open emitter)	V_{CBO}	max.	50 V
Collector-emitter voltage (open base) $I_C = 2 \text{ mA}$	V_{CEO}	max.	45 V
Emitter-base voltage (open collector)	V_{EBO}	max.	5 V

Currents

Collector current (d. c.)	I_C	max.	100 mA
Collector current (peak value)	I_{CM}	max.	200 mA

Power dissipation

Total power dissipation up to $T_{amb} = 25 \text{ }^\circ\text{C}$
mounted on a ceramic substrate of
7 mm x 5 mm x 0.5 mm

P_{tot}	max.	200 mW
-----------	------	--------

Temperatures

Storage temperature	T_{stg}	-65 to +150 $^\circ\text{C}$
Junction temperature	T_j	max. 150 $^\circ\text{C}$

THERMAL RESISTANCE

From junction to ambient
mounted on a ceramic substrate of
7 mm x 5 mm x 0.5 mm

$R_{th \text{ j-a}}$	=	0.62 $^\circ\text{C/mW}$
----------------------	---	--------------------------

CHARACTERISTICS

$T_j = 25 \text{ }^\circ\text{C}$ unless otherwise specified

Collector cut-off current

$I_E = 0; V_{CB} = 20 \text{ V}$	I_{CBO}	<	100 nA
$I_E = 0; V_{CB} = 20 \text{ V}; T_j = 100 \text{ }^\circ\text{C}$	I_{CBO}	<	10 μA

Base emitter voltage

$I_C = 2 \text{ mA}; V_{CE} = 5 \text{ V}$	V_{BE}	550 to 700 mV
--	----------	---------------

CHARACTERISTICS (continued)

$T_j = 25^\circ\text{C}$ unless otherwise specified

Saturation voltages

$I_C = 10\text{ mA}; I_B = 0.5\text{ mA}$

V_{CEsat} typ. 120 mV
< 250 mV

$I_C = 50\text{ mA}; I_B = 2.5\text{ mA}$

V_{BEsat} typ. 750 mV
 V_{CEsat} typ. 210 mV
 V_{BEsat} typ. 850 mV

D. C. current gain

$I_C = 10\ \mu\text{A}; V_{CE} = 5\text{ V}$

		BCW71	BCW72
h_{FE}	typ.	90	150
h_{FE}	>	110	200
h_{FE}	<	220	450

$I_C = 2\text{ mA}; V_{CE} = 5\text{ V}$

Collector capacitance at $f = 1\text{ MHz}$

$I_E = I_e = 0; V_{CB} = 10\text{ V}$

C_c < 4.0 pF

Transition frequency at $f = 35\text{ MHz}$

$I_C = 10\text{ mA}; V_{CE} = 5\text{ V}$

f_T typ. 300 MHz

Noise figure at $R_S = 2\text{ k}\Omega$

$I_C = 200\ \mu\text{A}; V_{CE} = 5\text{ V}$
 $f = 1\text{ kHz}; B = 200\text{ Hz}$

F < 10 dB



BCW71
BCW72

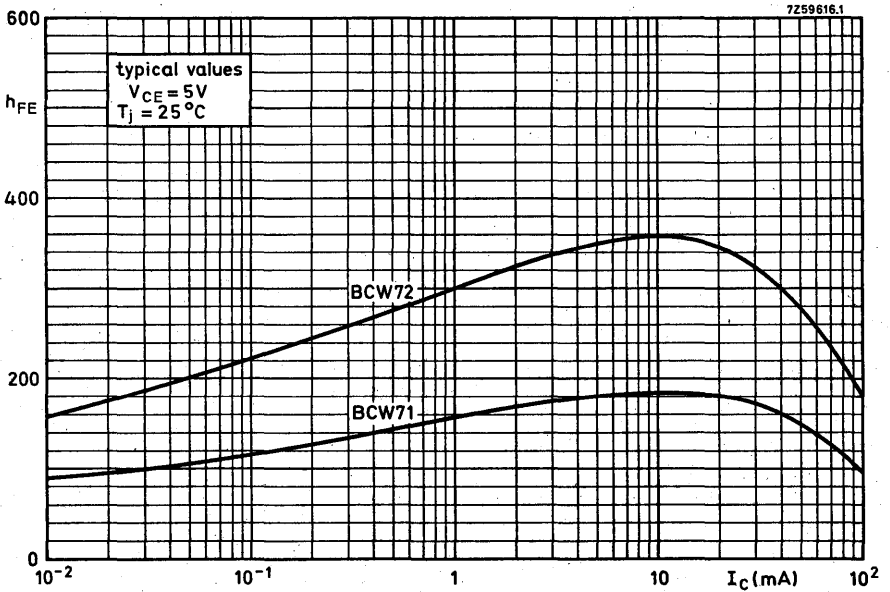
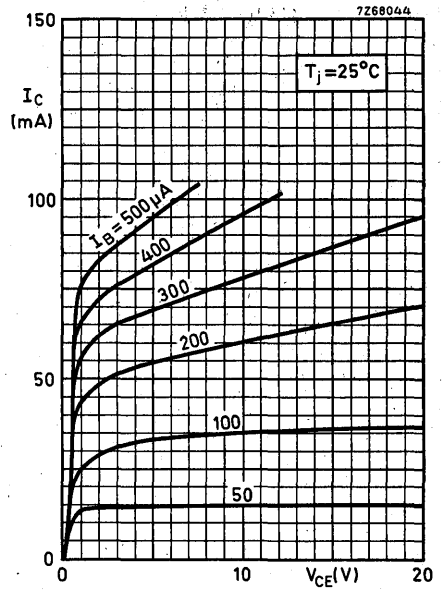
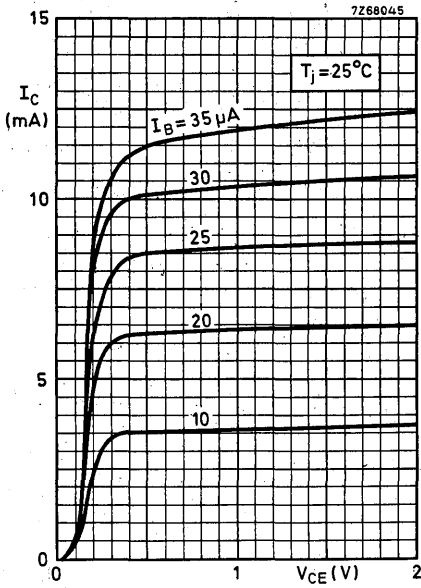

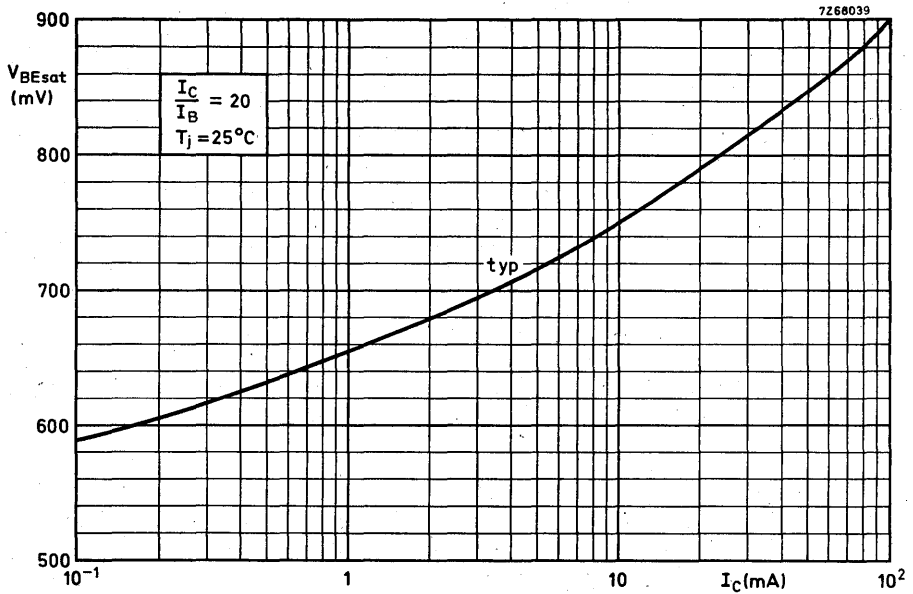
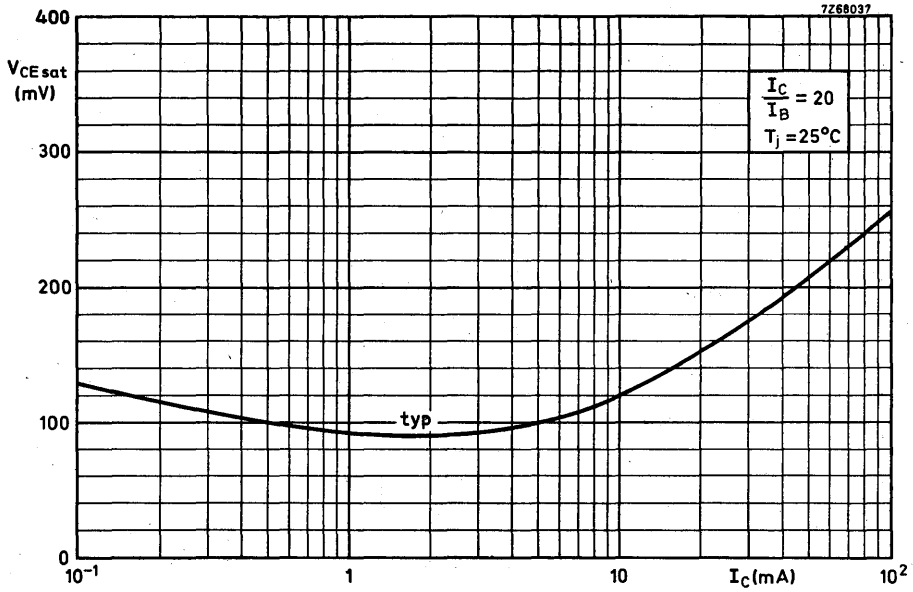

BCW71
BCW72

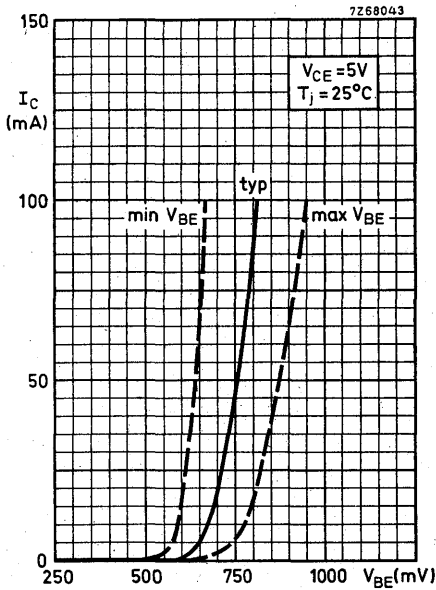
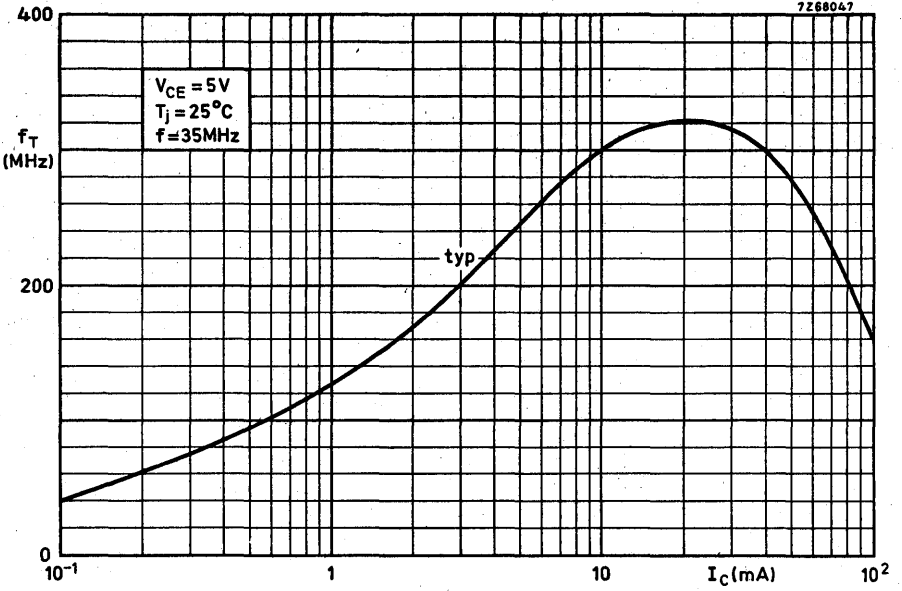

7Z68032

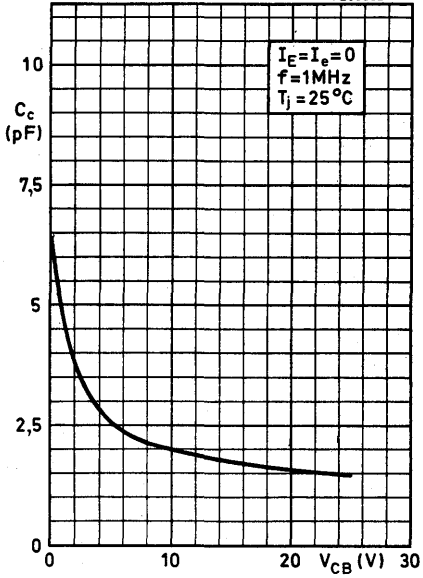

7Z68041

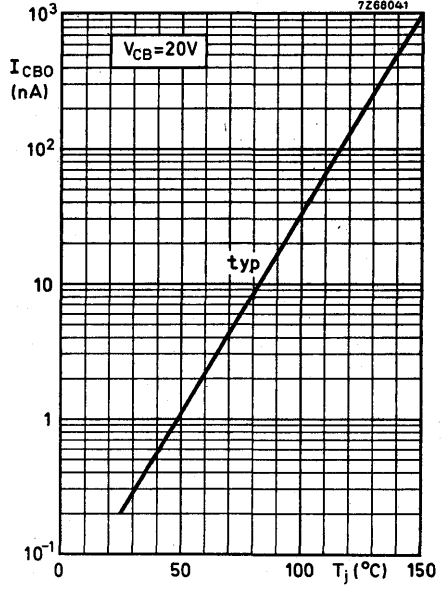



SILICON PLANAR EPITAXIAL TRANSISTORS

P-N-P transistors, in a microminiature plastic envelope, intended for application in thick and thin-film circuits. These transistors are intended for general purposes as well as saturated switching and driver applications for industrial service.

N-P-N complements are BCX19; 19R and BCX20; 20R respectively.

QUICK REFERENCE DATA

		BCX17		BCX18		
		BCX17R		BCX18R		
Collector-emitter voltage ($V_{BE} = 0$)	$-V_{CES}$ max.	50		30		V
Collector-emitter voltage (open base)	$-V_{CEO}$ max.	45		25		V
Collector current (peak value)	$-I_{CM}$ max.		1000			mA
Total power dissipation up to $T_{amb} = 25^\circ\text{C}$	P_{tot} max.		310			mW
Junction temperature	T_j max.		150			$^\circ\text{C}$
D.C. current gain $-I_C = 100\text{ mA}; -V_{CE} = 1\text{ V}$	h_{FE}		100 to 600			
Transition frequency $-I_C = 10\text{ mA}; -V_{CE} = 5\text{ V}; f = 35\text{ MHz}$	f_T typ.		100			MHz

MECHANICAL DATA

Fig. 1 SOT-23.

Dimensions in mm

Marking code

BCX17 = T1
BCX18 = T2

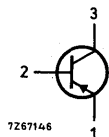
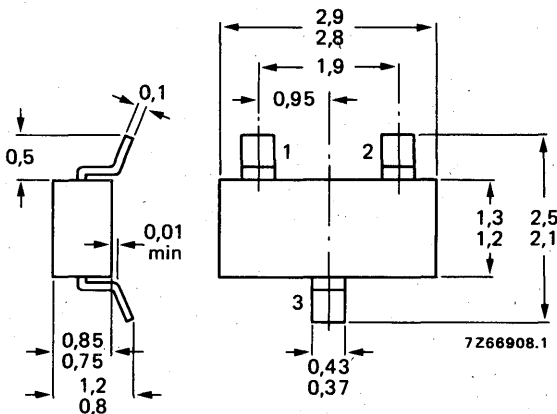

BCX17R = T4
BCX18R = T5

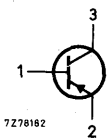

See also *Soldering recommendations*.

BCX17 BCX18

RATINGS Limiting values in accordance with the Absolute Maximum System (IEC134)

			BCX17	BCX18	
<u>Voltages</u>					
Collector-emitter voltage ($V_{BE} = 0$)	$-V_{CES}$	max.	50	30	V
Collector-emitter voltage (open base)					
$-I_C = 10$ mA	$-V_{CEO}$	max.	45	25	V
Emitter-base voltage (open collector)	$-V_{EBO}$	max.	5	5	V

Currents

Collector current (d.c.)	$-I_C$	max.	500	mA
Collector current (peak value)	$-I_{CM}$	max.	1000	mA
Emitter current (peak value)	I_{EM}	max.	1000	mA
Base current (d.c.)	$-I_B$	max.	100	mA
Base current (peak value)	$-I_{BM}$	max.	200	mA

Power dissipation

Total power dissipation up to $T_{amb} = 25$ °C mounted on a ceramic substrate of 15 mm x 15 mm x 0,5 mm	P_{tot}	max.	310	mW
---	-----------	------	-----	----

Temperatures

Storage temperature	T_{stg}		-65 to +150	°C
Junction temperature	T_j	max.	150	°C

THERMAL RESISTANCE

From junction to ambient in free air mounted on a ceramic substrate of 15 mm x 15 mm x 0,5 mm	R_{thj-a}	=	0,4	°C/mW
---	-------------	---	-----	-------

CHARACTERISTICS

$T_j = 25\text{ }^\circ\text{C}$ unless otherwise specified

Collector cut-off current

$I_E = 0; -V_{CB} = 20\text{ V}$ $-I_{CBO} < 100\text{ nA}$

$I_E = 0; -V_{CB} = 20\text{ V}; T_j = 150\text{ }^\circ\text{C}$ $-I_{CBO} < 5\text{ }\mu\text{A}$

Emitter cut-off current

$I_C = 0; -V_{EB} = 5\text{ V}$ $-I_{EBO} < 10\text{ }\mu\text{A}$

Base emitter voltage ¹⁾

$-I_C = 500\text{ mA}; -V_{CE} = 1\text{ V}$ $-V_{BE} < 1, 2\text{ V}$

Saturation voltage

$-I_C = 500\text{ mA}; -I_B = 50\text{ mA}$ $-V_{CEsat} < 620\text{ mV}$

D. C. current gain

$-I_C = 100\text{ mA}; -V_{CE} = 1\text{ V}$ $h_{FE} 100\text{ to }600$

$-I_C = 300\text{ mA}; -V_{CE} = 1\text{ V}$ $h_{FE} > 70$

$-I_C = 500\text{ mA}; -V_{CE} = 1\text{ V}$ $h_{FE} > 40$

Transition frequency at $f = 35\text{ MHz}$

$-I_C = 10\text{ mA}; -V_{CE} = 5\text{ V}$ $f_T \text{ typ. } 100\text{ MHz}$

Collector capacitance at $f = 1\text{ MHz}$

$I_E = I_e = 0; -V_{CB} = 10\text{ V}$ $C_c \text{ typ. } 8\text{ pF}$

1) $-V_{BE}$ decreases by about $2\text{ mV}/^\circ\text{C}$ with increasing temperature.

BCX17
BCX18

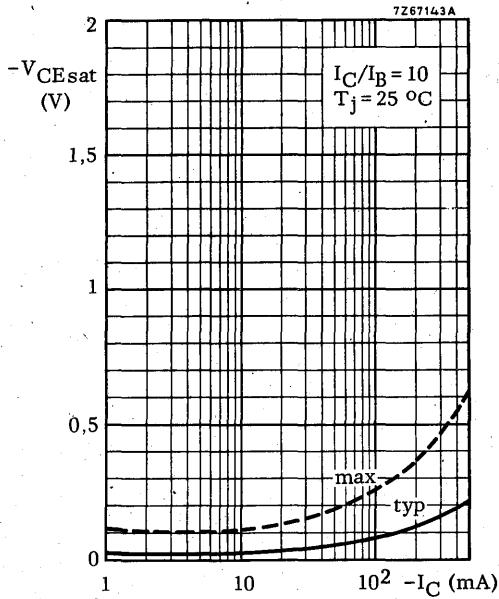
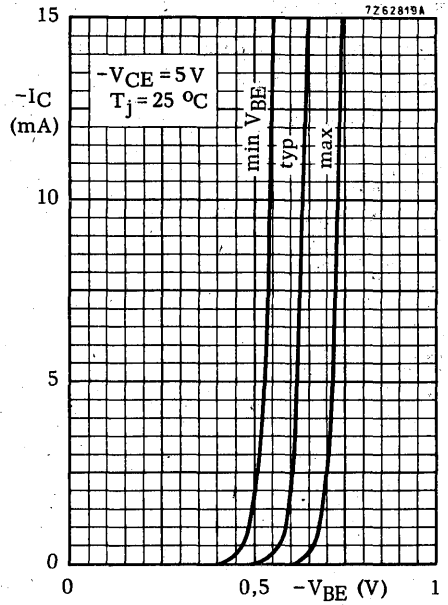
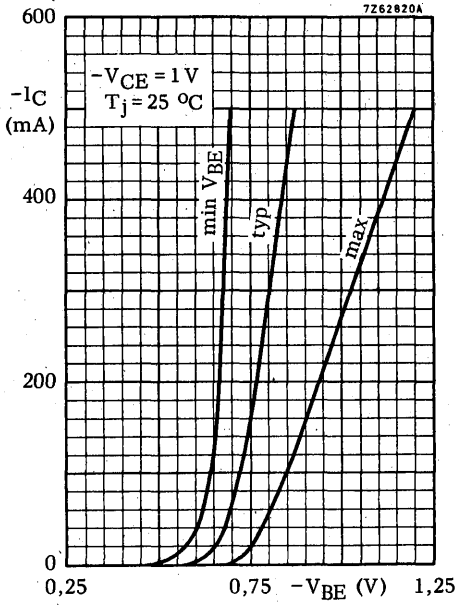

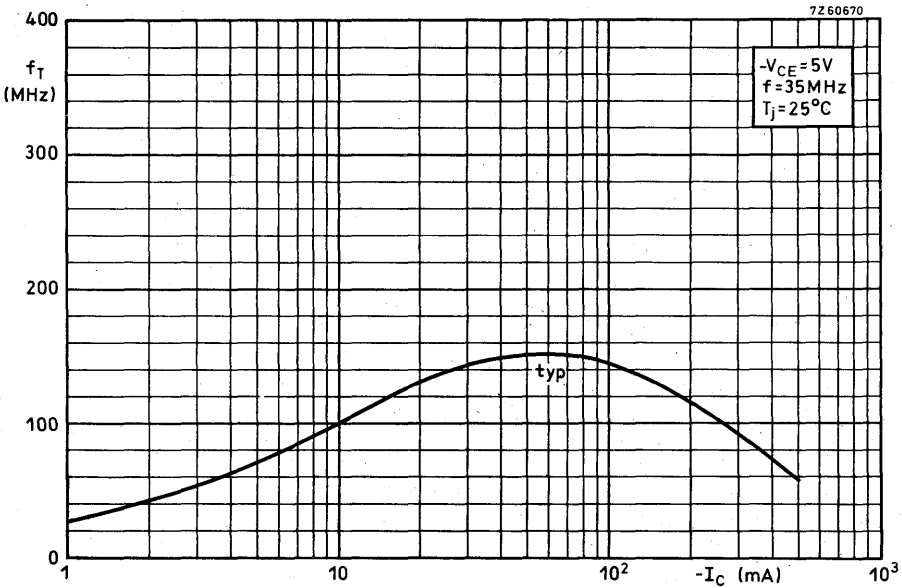
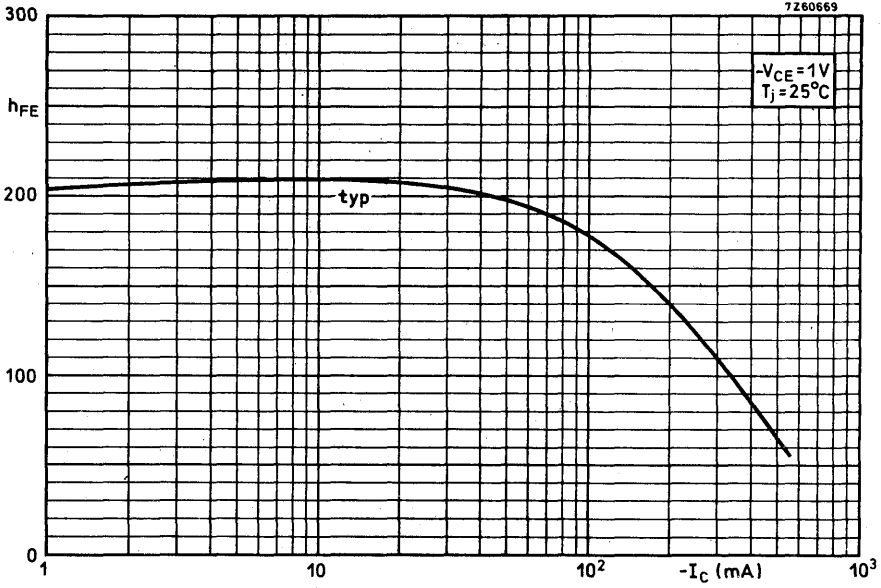

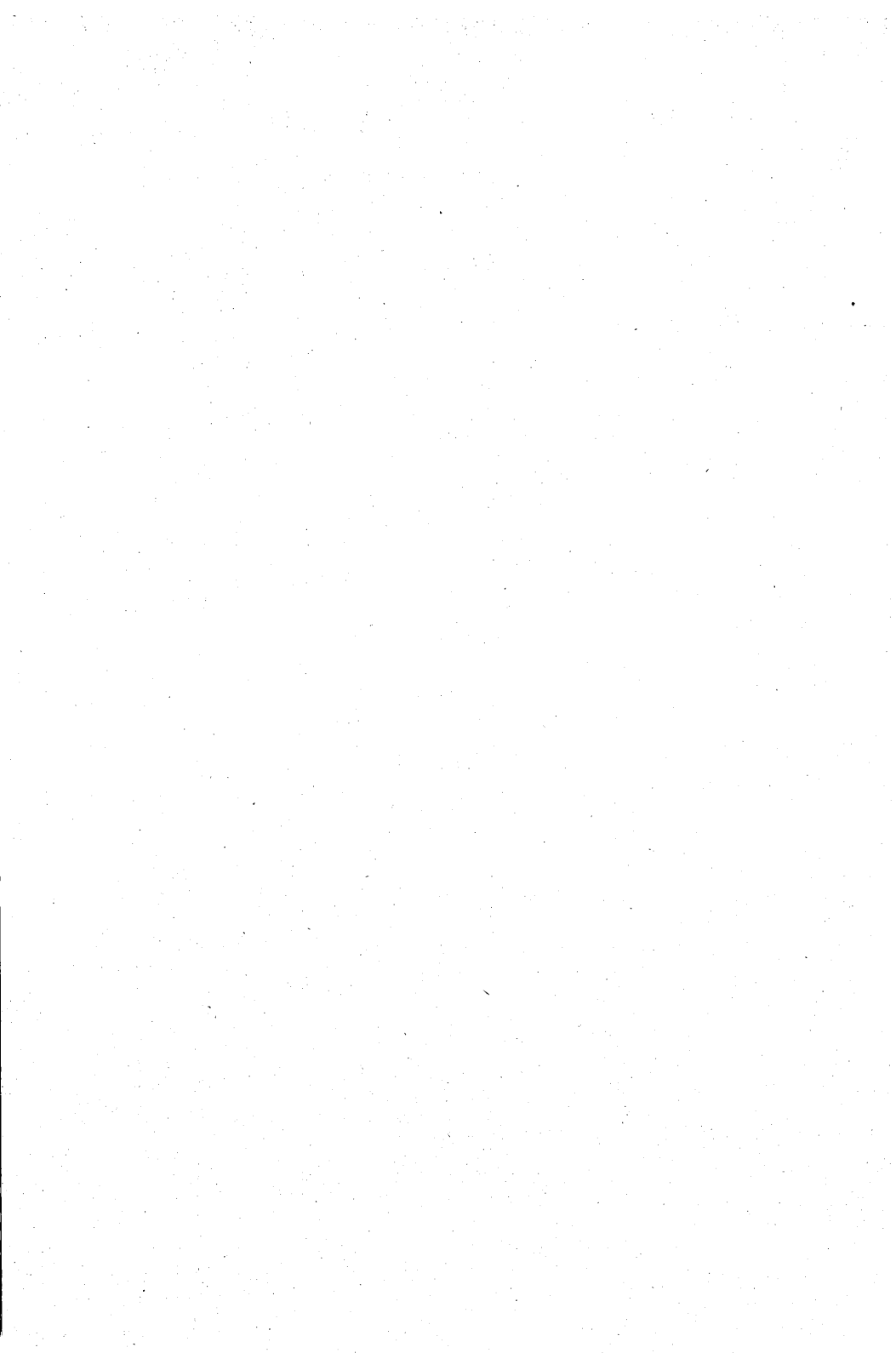

SILICON PLANAR EPITAXIAL TRANSISTORS

N-P-N transistors, in a microminiature plastic envelope, intended for application in thick and thin-film circuits. These transistors are intended for general purposes as well as saturated switching and driver applications for industrial service.

P-N-P complements are BCX17; 17R and BCX18; 18R respectively.

QUICK REFERENCE DATA

			BCX19	BCX20	
			BCX19R	BCX20R	
Collector-emitter voltage ($V_{BE} = 0$)	V_{CES}	max.	50	30	V
Collector-emitter voltage (open base)	V_{CEO}	max.	45	25	V
Collector current (peak value)	I_{CM}	max.	1000		mA
Total power dissipation up to $T_{amb} = 25\text{ }^{\circ}\text{C}$	P_{tot}	max.	310		mW
Junction temperature	T_j	max.	150		$^{\circ}\text{C}$
D.C. current gain $I_C = 100\text{ mA}; V_{CE} = 1\text{ V}$	h_{FE}		100 to 600		
Transition frequency $I_C = 10\text{ mA}; V_{CE} = 5\text{ V}; f = 35\text{ MHz}$	f_T	typ.	200		MHz

MECHANICAL DATA

Fig. 1 SOT-23.

Dimensions in mm

Marking code

BCX19 = U1

BCX20 = U2

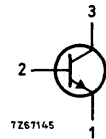
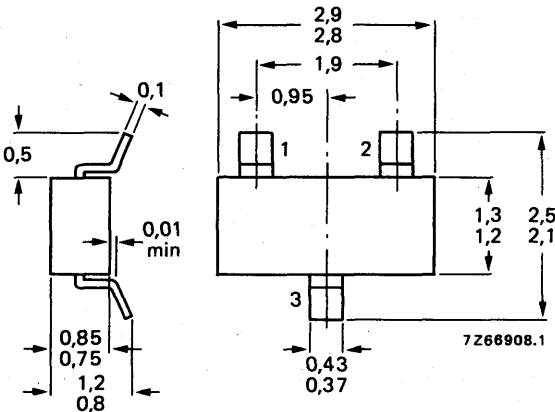

BCX19R = U4
BCX20R = U5

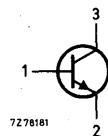

See also *Soldering recommendations*.

BCX19 BCX20

RATINGS Limiting values in accordance with the Absolute Maximum System (IEC134)

			BCX19	BCX20	
<u>Voltages</u>					
Collector-emitter voltage ($V_{BE} = 0$)	V_{CES}	max.	50	30	V
Collector-emitter voltage (open base) $I_C = 10$ mA	V_{CEO}	max.	45	25	V
Emitter-base voltage (open collector)	V_{EBO}	max.	5	5	V

Currents

Collector current (d.c.)	I_C	max.	500	mA
Collector current (peak value)	I_{CM}	max.	1000	mA
Emitter current (peak value)	$-I_{EM}$	max.	1000	mA
Base current (d.c.)	I_B	max.	100	mA
Base current (peak value)	I_{BM}	max.	200	mA

Power dissipation

Total power dissipation up to $T_{amb} = 25$ °C mounted on a ceramic substrate of 15 mm x 15 mm x 0,5 mm	P_{tot}	max.	310	mW
---	-----------	------	-----	----

Temperatures

Storage temperature	T_{stg}		-65 to +150	°C
Junction temperature	T_j	max.	150	°C

THERMAL RESISTANCE

From junction to ambient in free air mounted on a ceramic substrate of 15 mm x 15 mm x 0,5 mm	$R_{th j-a}$	=	0,4	°C/mW
---	--------------	---	-----	-------

CHARACTERISTICS

$T_j = 25\text{ }^\circ\text{C}$ unless otherwise specified.

Collector cut-off current

$I_E = 0; V_{CB} = 20\text{ V}$

$I_{CBO} < 100\text{ nA}$

$I_E = 0; V_{CB} = 20\text{ V}; T_j = 150\text{ }^\circ\text{C}$

$I_{CBO} < 5\text{ }\mu\text{A}$

Emitter cut-off current

$I_C = 0; V_{EB} = 5\text{ V}$

$I_{EBO} < 10\text{ }\mu\text{A}$

Base emitter voltage ¹⁾

$I_C = 500\text{ mA}; V_{CE} = 1\text{ V}$

$V_{BE} < 1, 2\text{ V}$

Saturation voltage

$I_C = 500\text{ mA}; I_B = 50\text{ mA}$

$V_{CEsat} < 620\text{ mV}$

D.C. current gain

$I_C = 100\text{ mA}; V_{CE} = 1\text{ V}$

$h_{FE} 100\text{ to }600$

$I_C = 300\text{ mA}; V_{CE} = 1\text{ V}$

$h_{FE} > 70$

$I_C = 500\text{ mA}; V_{CE} = 1\text{ V}$

$h_{FE} > 40$

Transition frequency at $f = 35\text{ MHz}$

$I_C = 10\text{ mA}; V_{CE} = 5\text{ V}$

$f_T \text{ typ. } 200\text{ MHz}$

Collector capacitance at $f = 1\text{ MHz}$

$I_E = I_e = 0; V_{CB} = 10\text{ V}$

$C_c \text{ typ. } 5\text{ pF}$

1) V_{BE} decreases by about $2\text{ mV}/^\circ\text{C}$ with increasing temperature.

**BCX19
BCX20**

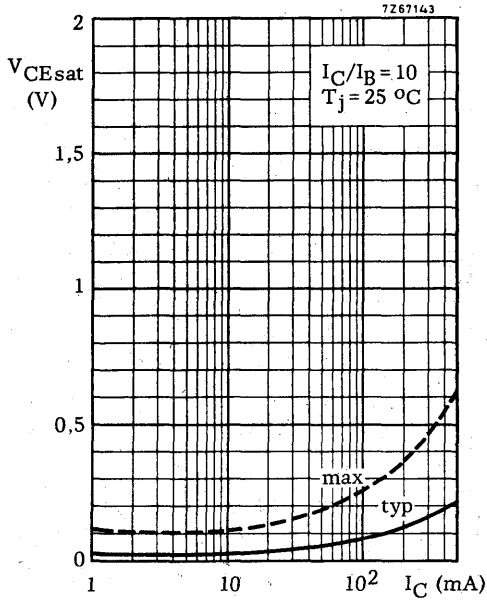
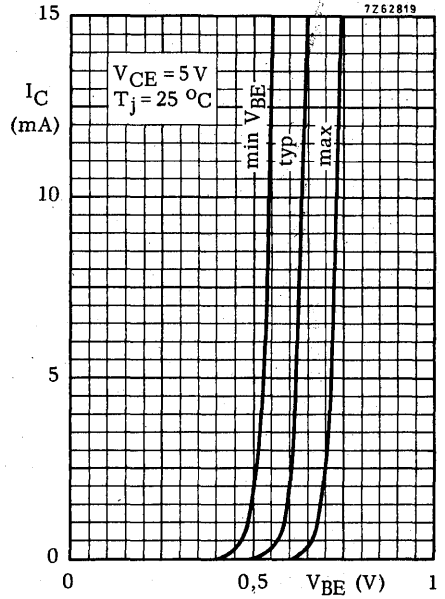
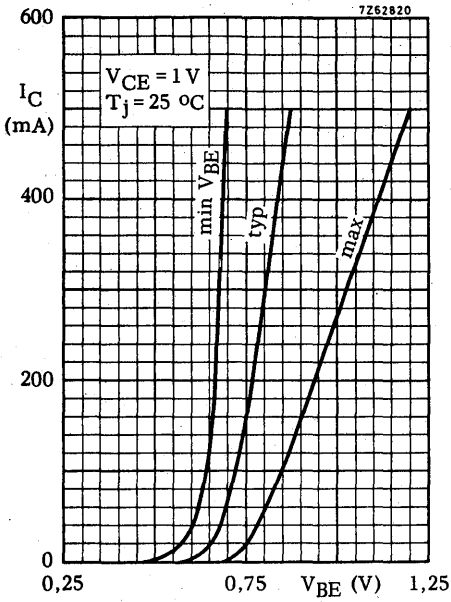

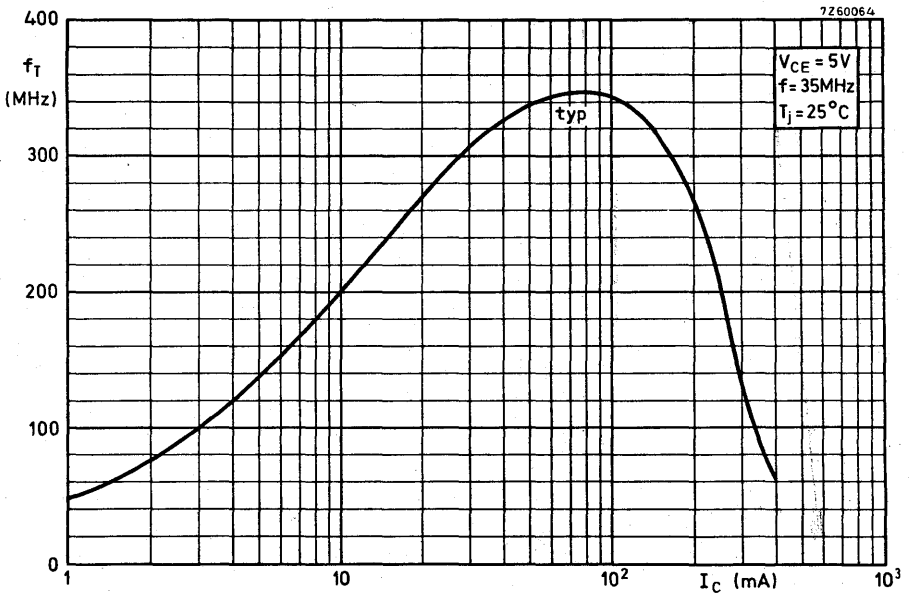
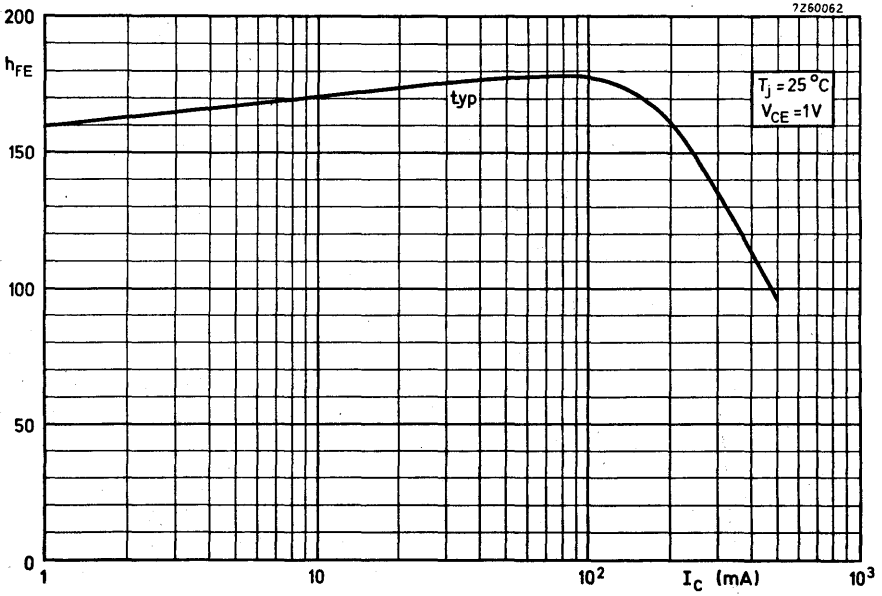

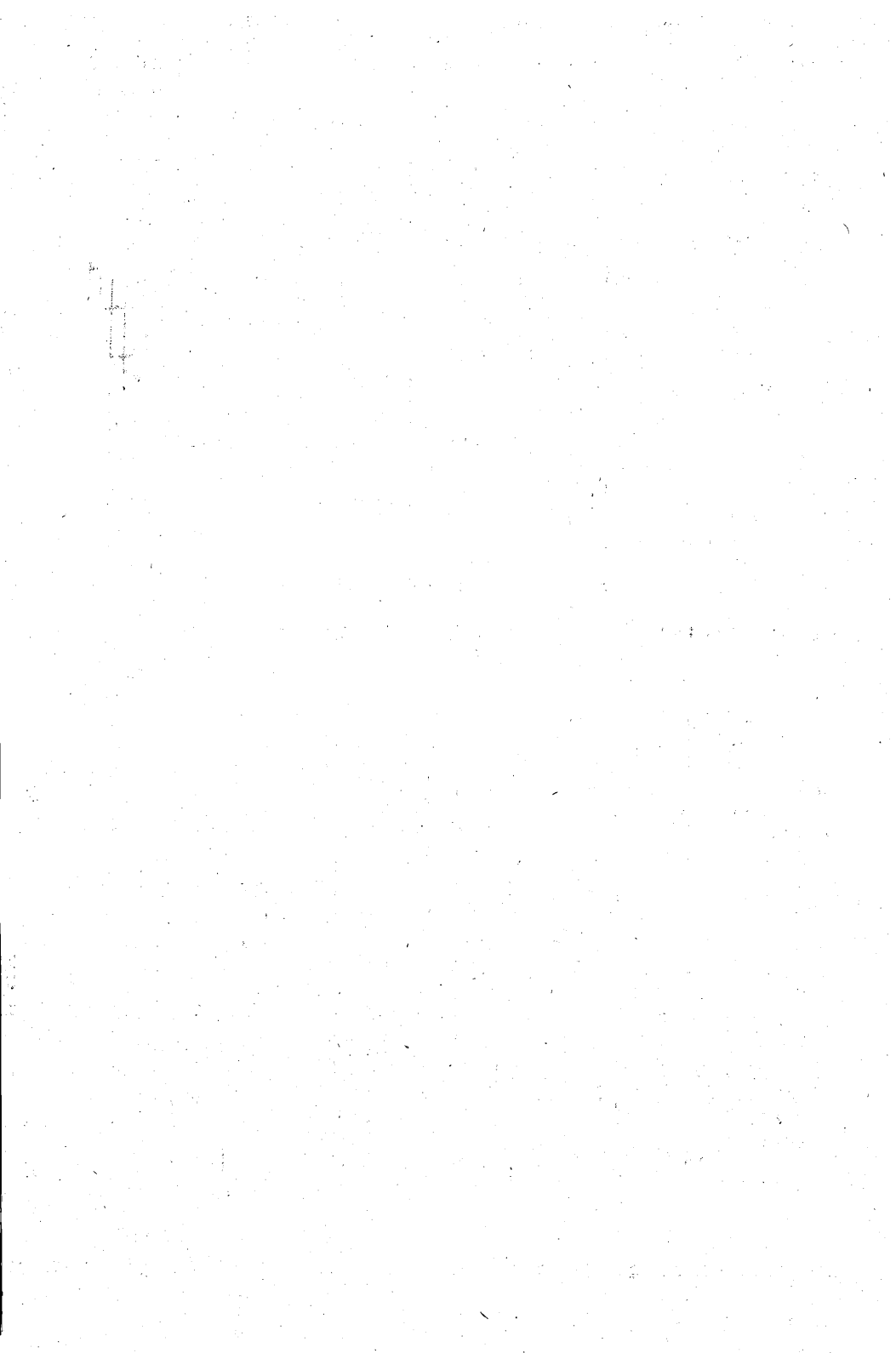

SILICON PLANAR EPITAXIAL TRANSISTORS

Medium power p-n-p transistors in a miniature plastic envelope intended for applications in thick and thin-film circuits. These transistors are intended for general purposes as well as for use in driver stages of audio amplifiers.

N-P-N complements are BCX54, BCX55 and BCX56 respectively.

QUICK REFERENCE DATA

		BCX51	BCX52	BCX53
Collector-base voltage (open emitter)	$-V_{CBO}$ max.	45	60	100 V
Collector-emitter voltage (open base)	$-V_{CEO}$ max.	45	60	80 V
Collector-emitter voltage ($R_{BE} = 1 \text{ k}\Omega$)	$-V_{CER}$ max.	45	60	100 V
Collector current (peak value)	$-I_{CM}$ max.	1,5	1,5	1,5 A
Total power dissipation up to $T_{amb} = 25 \text{ }^\circ\text{C}$	P_{tot} max.	1	1	1 W
Junction temperature	T_j max.	150	150	150 $^\circ\text{C}$
D.C. current gain				
$-I_C = 150 \text{ mA}; -V_{CE} = 2 \text{ V}$	$h_{FE} >$	40	40	40
	$h_{FE} <$	250	160	160
Transition frequency at $f = 35 \text{ MHz}$				
$-I_C = 10 \text{ mA}; -V_{CE} = 5 \text{ V}$	f_T typ.	50	50	50 MHz

MECHANICAL DATA

Fig. 1 SOT-89.

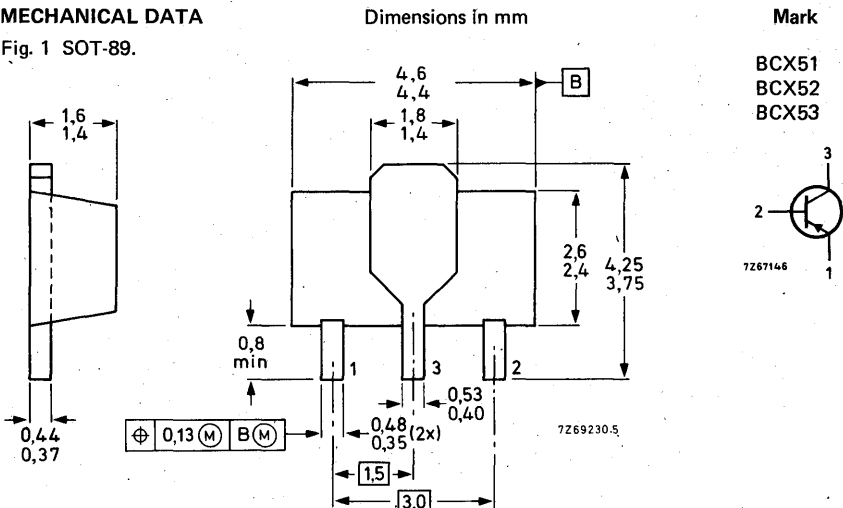

See also *Soldering recommendations*.

RATINGS Limiting values in accordance with the Absolute Maximum System (IEC 134)

Voltages

			BCX51	BCX52	BCX53	
Collector-base voltage (open emitter)	$-V_{CBO}$	max.	45	60	100	V
Collector-emitter voltage (open base)	$-V_{CEO}$	max.	45	60	80	V
Collector-emitter voltage ($R_{BE} = 1 \text{ k}\Omega$)	$-V_{CER}$	max.	45	60	100	V
Emitter-base voltage (open collector)	$-V_{EBO}$	max.	5	5	5	V

Currents

Collector current (d.c.)	$-I_C$	max.		1,0		A
Collector current (peak value)	$-I_{CM}$	max.		1,5		A
Base current (d.c.)	$-I_B$	max.		0,1		A
Base current (peak value)	$-I_{BM}$	max.		0,2		A

Power dissipation

Total power dissipation up to $T_{amb} = 25 \text{ }^\circ\text{C}$
 mounted on a ceramic substrate
 area = 2,5 cm²; thickness = 0,7 mm

P_{tot}	max.		1,0		W
-----------	------	--	-----	--	---

Temperatures

Storage temperature	T_{stg}		-65 to +150		$^\circ\text{C}$
Junction temperature	T_j	max.	150		$^\circ\text{C}$

THERMAL RESISTANCE

→ From junction to collector tab	$R_{th j-tab} =$		10		$^\circ\text{C/W}$
From junction to ambient in free air mounted on a ceramic substrate area = 2,5 cm ² ; thickness = 0,7 mm	$R_{th j-a} =$		125		$^\circ\text{C/W}$

CHARACTERISTICS

$T_{amb} = 25\text{ }^{\circ}\text{C}$ unless otherwise specified

Collector cut-off current

$I_E = 0; -V_{CB} = 30\text{ V}$ $-I_{CBO} < 100\text{ nA}$

$I_E = 0; -V_{CB} = 30\text{ V}; T_j = 125\text{ }^{\circ}\text{C}$ $-I_{CBO} < 10\text{ }\mu\text{A}$

Emitter cut-off current

$I_C = 0; -V_{EB} = 5\text{ V}$ $-I_{EBO} < 10\text{ }\mu\text{A}$

Base-emitter voltage

$-I_C = 500\text{ mA}; -V_{CE} = 2\text{ V}$ $-V_{BE} < 1\text{ V}$

Saturation voltage

$-I_C = 500\text{ mA}; -I_B = 50\text{ mA}$ $-V_{CEsat} < 0,5\text{ V}$

D. C. current gain

$-I_C = 5\text{ mA}; -V_{CE} = 2\text{ V}$ $h_{FE} > \begin{array}{|c|c|c|} \hline \text{BCX51} & \text{BCX52} & \text{BCX53} \\ \hline 25 & 25 & 25 \\ \hline \end{array}$

$-I_C = 150\text{ mA}; -V_{CE} = 2\text{ V}$ $h_{FE} > \begin{array}{|c|c|c|} \hline 40 & 40 & 40 \\ \hline \end{array}$

$-I_C = 500\text{ mA}; -V_{CE} = 2\text{ V}$ $h_{FE} < \begin{array}{|c|c|c|} \hline 250 & 160 & 160 \\ \hline \end{array}$

$-I_C = 500\text{ mA}; -V_{CE} = 2\text{ V}$ $h_{FE} > \begin{array}{|c|c|c|} \hline 25 & 25 & 25 \\ \hline \end{array}$

Transition frequency at $f = 35\text{ MHz}$

$-I_C = 10\text{ mA}; -V_{CE} = 5\text{ V}$ $f_T \text{ typ. } 50\text{ MHz}$

7267754

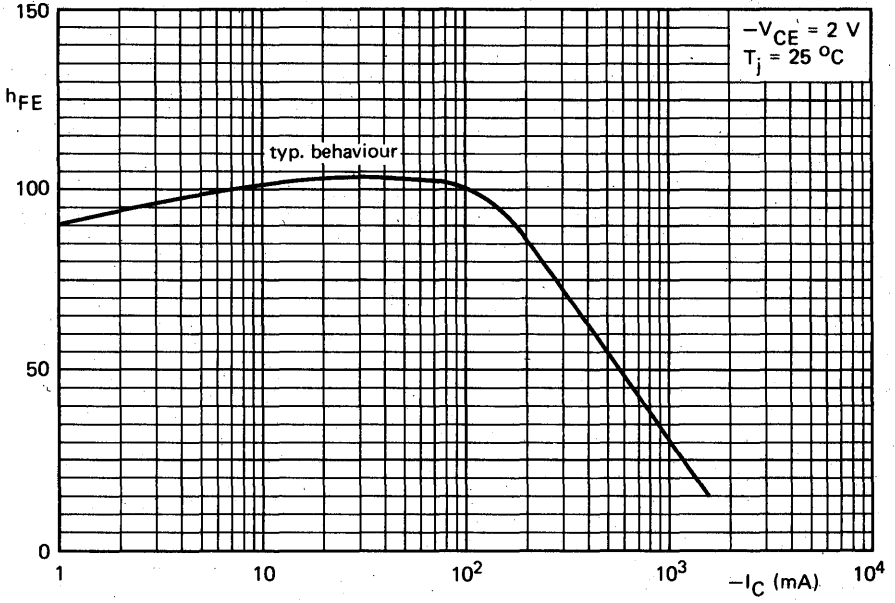

7272893

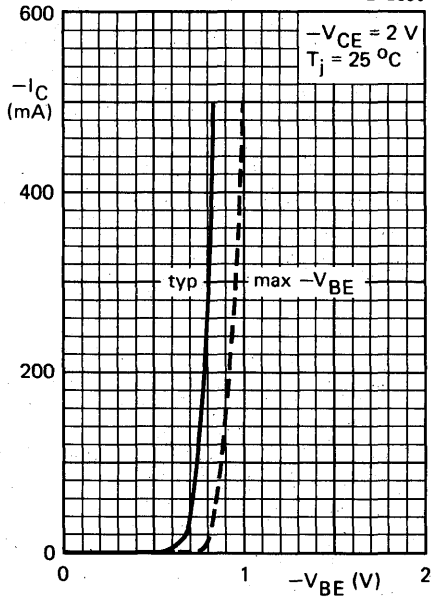

7Z72891

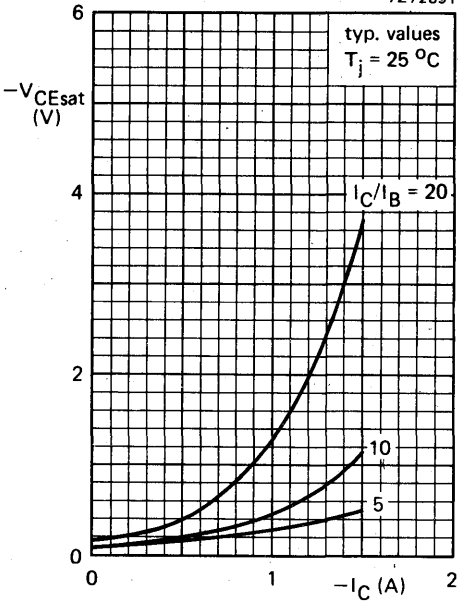

7Z72888

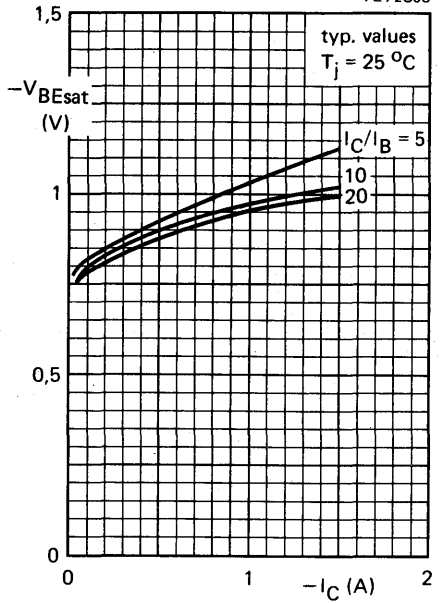

7Z67719

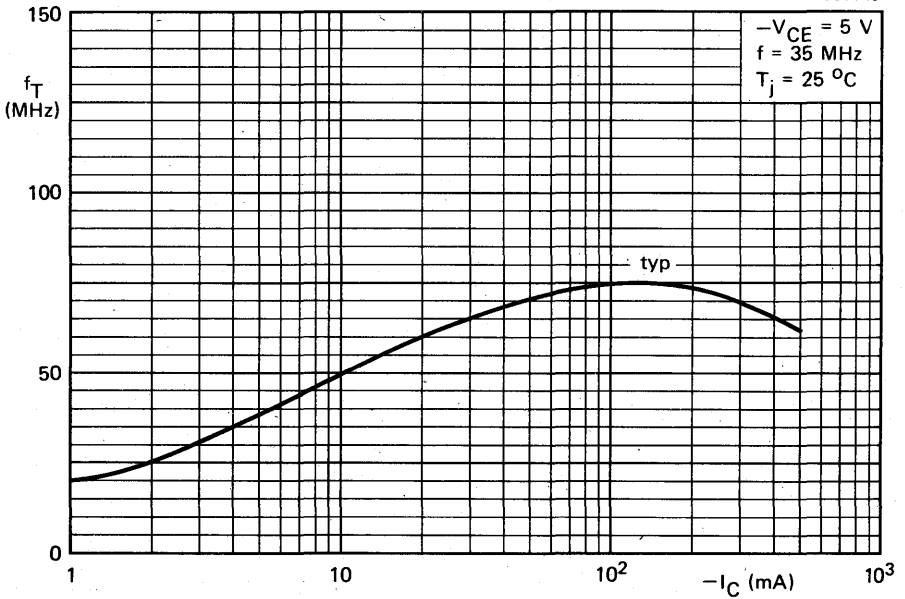

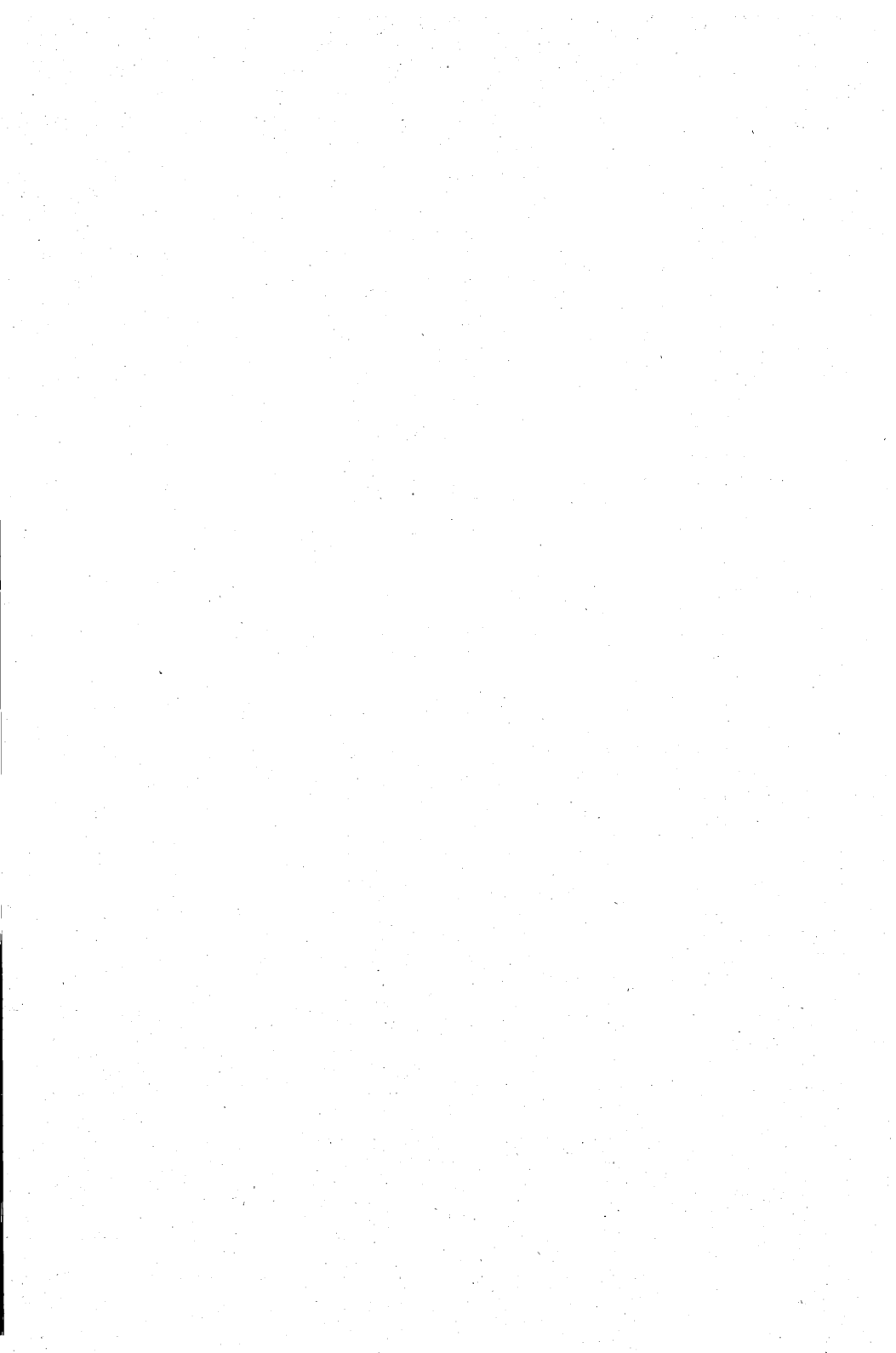

SILICON PLANAR EPITAXIAL TRANSISTORS

Medium power n-p-n transistors in a miniature plastic envelope intended for applications in thick and thin-film circuits. These transistors are intended for general purposes as well as for use in driver stages of audio amplifiers.

P-N-P complements are BCX51, BCX52 and BCX53 respectively.

QUICK REFERENCE DATA

		BCX54	BCX55	BCX56
Collector-base voltage (open emitter)	V_{CBO} max.	45	60	100 V
Collector-emitter voltage (open base)	V_{CEO} max.	45	60	80 V
Collector-emitter voltage ($R_{BE} = 1 \text{ k}\Omega$)	V_{CER} max.	45	60	100 V
Collector current (peak value)	I_{CM} max.	1,5	1,5	1,5 A
Total power dissipation up to $T_{amb} = 25 \text{ }^\circ\text{C}$	P_{tot} max.	1	1	1 W
Junction temperature	T_j max.	150	150	150 $^\circ\text{C}$
D.C. current gain	h_{FE}	> 40 < 250	40 160	40 160
Transition frequency at $f = 35 \text{ MHz}$	f_T typ.	130	130	130 MHz

MECHANICAL DATA

Fig. 1 SOT-89.

Dimensions in mm

Mark

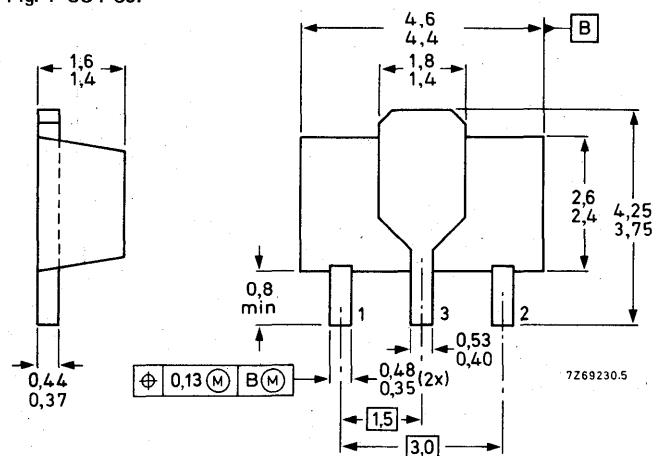

BCX54
BCX55
BCX56

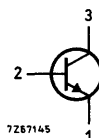

See also *Soldering recommendations.*

RATINGS Limiting values in accordance with the Absolute Maximum System (IEC 134)

Voltages

		BCX54	BCX55	BCX56	
Collector-base voltage (open emitter)	V_{CB0}	max. 45	60	100	V
Collector-emitter voltage (open base)	V_{CEO}	max. 45	60	80	V
Collector-emitter voltage ($R_{BE} = 1 \text{ k}\Omega$)	V_{CER}	max. 45	60	100	V
Emitter-base voltage (open collector)	V_{EBO}	max. 5	5	5	V

Currents

Collector current (d.c.)	I_C	max.	1,0	A
Collector current (peak value)	I_{CM}	max.	1,5	A
Base current (d.c.)	I_B	max.	0,1	A
Base current (peak value)	I_{BM}	max.	0,2	A

Power dissipation

Total power dissipation up to $T_{amb} = 25 \text{ }^\circ\text{C}$ mounted on a ceramic substrate area = 2,5 cm ² ; thickness = 0,7 mm	P_{tot}	max.	1,0	W
--	-----------	------	-----	---

Temperatures

Storage temperature	T_{stg}		-65 to +150	$^\circ\text{C}$
Junction temperature	T_j	max.	150	$^\circ\text{C}$

THERMAL RESISTANCE

→ From junction to collector tab	$R_{th\ j-tab}$	=	10	$^\circ\text{C/W}$
From junction to ambient in free air mounted on a ceramic substrate area = 2,5 cm ² ; thickness = 0,7 mm	$R_{th\ j-a}$	=	125	$^\circ\text{C/W}$

CHARACTERISTICS

$T_{amb} = 25\text{ }^{\circ}\text{C}$ unless otherwise specified

Collector cut-off current

$I_E = 0; V_{CB} = 30\text{ V}$

$I_{CBO} < 100\text{ nA}$

$I_E = 0; V_{CB} = 30\text{ V}; T_j = 125\text{ }^{\circ}\text{C}$

$I_{CBO} < 10\text{ }\mu\text{A}$

Emitter cut-off current

$I_C = 0; V_{EB} = 5\text{ V}$

$I_{EBO} < 10\text{ }\mu\text{A}$

Base-emitter voltage

$I_C = 500\text{ mA}; V_{CE} = 2\text{ V}$

$V_{BE} < 1\text{ V}$

Saturation voltage

$I_C = 500\text{ mA}; I_B = 50\text{ mA}$

$V_{CEsat} < 0.5\text{ V}$

D. C. current gain

$I_C = 5\text{ mA}; V_{CE} = 2\text{ V}$

	BCX54	BCX55	BCX56
$h_{FE} >$	25	25	25
$h_{FE} >$	40	40	40
$h_{FE} <$	250	160	160
$h_{FE} >$	25	25	25

$I_C = 150\text{ mA}; V_{CE} = 2\text{ V}$

$I_C = 500\text{ mA}; V_{CE} = 2\text{ V}$

Transition frequency at $f = 35\text{ MHz}$

$I_C = 10\text{ mA}; V_{CE} = 5\text{ V}$

f_T typ. 130 MHz

7Z67755

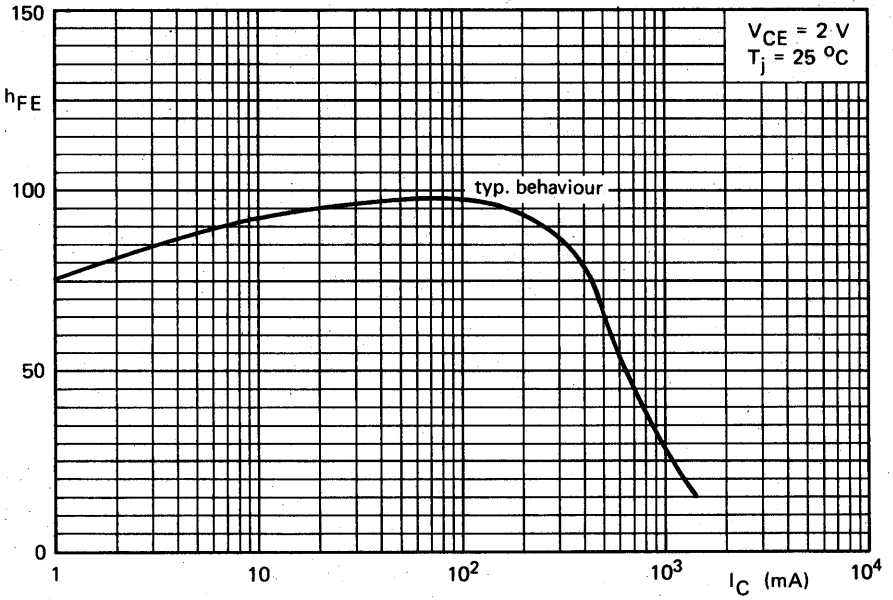

7Z72889

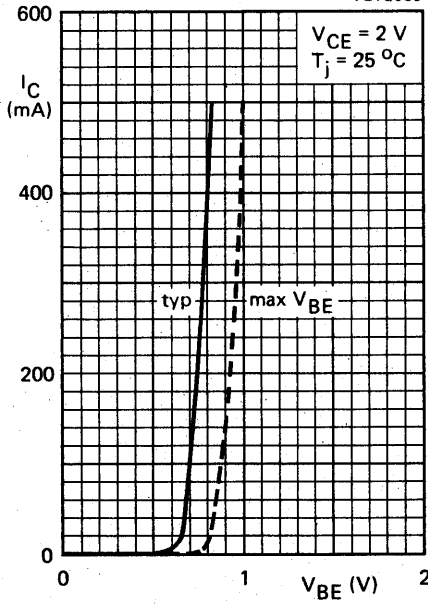

7Z72892

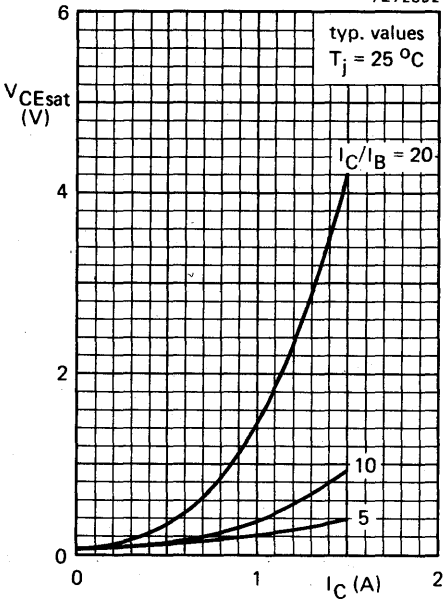

7Z72890

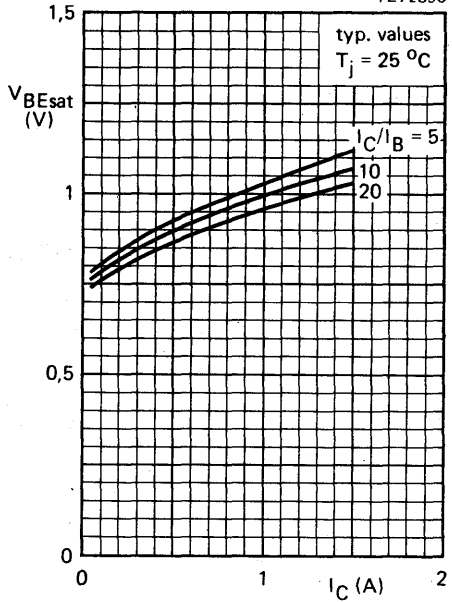

7Z72945

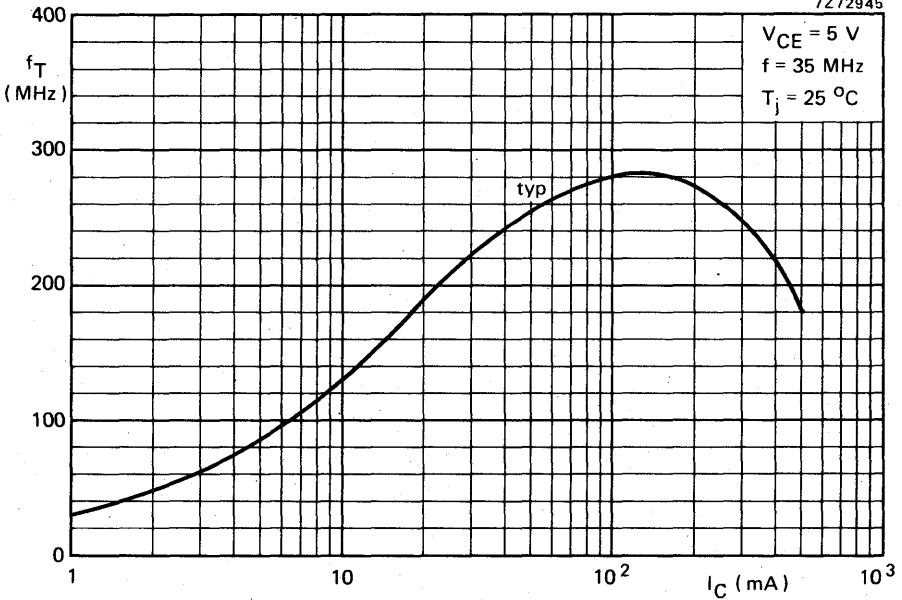



DEVELOPMENT SAMPLE DATA

This information is derived from development samples made available for evaluation. It does not form part of our data handbook system and does not necessarily imply that the device will go into production

BF550
BF550R

SILICON PLANAR EPITAXIAL TRANSISTOR

P-N-P transistor, in a microminiature plastic envelope, intended for applications in thick and thin-film circuits. This transistor is primarily intended for use in i.f. detection applications.

QUICK REFERENCE DATA

Collector-base voltage (open emitter)	$-V_{CBO}$	max.	40 V
Collector-emitter voltage (open base)	$-V_{CEO}$	max.	40 V
Collector current (d.c.)	$-I_C$	max.	25 mA
Total power dissipation up to $T_{amb} = 60\text{ }^\circ\text{C}$	P_{tot}	max.	180 mW
Junction temperature	T_j	max.	150 $^\circ\text{C}$
D.C. current gain at $T_j = 25\text{ }^\circ\text{C}$ $-I_C = 1\text{ mA}; -V_{CE} = 10\text{ V}$	h_{FE}	>	50
Transition frequency at $f = 100\text{ MHz}$ $-I_C = 1\text{ mA}; -V_{CE} = 10\text{ V}$	f_T	typ.	325 MHz
Noise figure at $R_S = 300\text{ }\Omega$ $-I_C = 1\text{ mA}; -V_{CE} = 10\text{ V}; f = 100\text{ kHz}$	F	typ.	2 dB

MECHANICAL DATA

Dimensions in mm

Marking code

Fig. 1 SOT-23

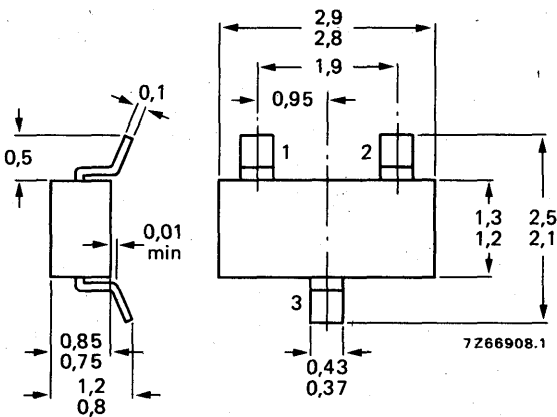

BF550 = G2

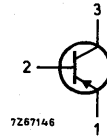

BF550R = G5

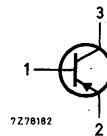

See also *Soldering Recommendations*.

RATINGS

Limiting values in accordance with the Absolute Maximum System (IEC 134)

Collector-base voltage (open emitter)	$-V_{CBO}$	max.	40 V
Collector-emitter voltage (open base)	$-V_{CEO}$	max.	40 V
Emitter-base voltage (open collector)	$-V_{EBO}$	max.	4 V
Collector current (d.c.)	$-I_C$	max.	25 mA
Total power dissipation up to $T_{amb} = 60\text{ }^\circ\text{C}$ *	P_{tot}	max.	180 mW
Storage temperature	T_{stg}		-55 to +150 $^\circ\text{C}$
Junction temperature	T_j	max.	150 $^\circ\text{C}$

THERMAL RESISTANCE *

From junction to ambient	$R_{th\ j-a}$	=	0,5 $^\circ\text{C}/\text{mW}$
--------------------------	---------------	---	--------------------------------

CHARACTERISTICS

$T_{amb} = 25\text{ }^\circ\text{C}$ unless otherwise specified

Collector cut-off current $I_E = 0; -V_{CB} = 30\text{ V}$	$-I_{CBO}$	<	50 nA
Emitter cut-off current $I_C = 0; -V_{EB} = 3\text{ V}$	$-I_{EBO}$	<	100 μA
Base-emitter voltage $-I_C = 1\text{ mA}; -V_{CE} = 10\text{ V}$	$-V_{BE}$	typ.	750 mV
D.C. current gain $-I_C = 1\text{ mA}; -V_{CE} = 10\text{ V}$	h_{FE}	>	50
Transition frequency at $f = 100\text{ MHz}$ $-I_C = 1\text{ mA}; -V_{CE} = 10\text{ V}$	f_T	typ.	325 MHz
Feedback capacitance at $f = 1\text{ MHz}$ $-I_C = 1\text{ mA}; -V_{CE} = 10\text{ V}$	C_{re}	typ.	0,5 pF
Noise figure at $R_S = 300\ \Omega$ $-I_C = 1\text{ mA}; -V_{CE} = 10\text{ V}; f = 100\text{ kHz}$	F	typ.	2 dB

* Mounted on a ceramic substrate of 15 mm x 10 mm x 0,5 mm.

SILICON EPITAXIAL TRANSISTOR

- for video output stages

N-P-N transistor in a miniature plastic envelope intended for application in thick and thin-film circuits. This device is intended for class-B video output stages in colour television receivers.

P-N-P complement is BF623.

QUICK REFERENCE DATA

Collector-base voltage (open emitter)	V_{CBO}	max.	250 V
Collector-emitter voltage (open base)	V_{CEO}	max.	250 V
Collector current (peak value)	I_{CM}	max.	100 mA
Total power dissipation up to $T_{amb} = 25\text{ }^{\circ}\text{C}$	P_{tot}	max.	1 W
Junction temperature	T_j	max.	150 $^{\circ}\text{C}$
D.C. current gain $I_C = 25\text{ mA}; V_{CE} = 20\text{ V}$	h_{FE}	>	50
Transition frequency at $f = 35\text{ MHz}$ $I_C = 10\text{ mA}; V_{CE} = 10\text{ V}$	f_T	>	60 MHz
Feedback capacitance at $f = 1\text{ MHz}$ $I_C = 0; V_{CE} = 30\text{ V}$	C_{re}	<	1,6 pF

MECHANICAL DATA

Dimensions in mm

Mark

Fig. 1 SOT-89.

BF622

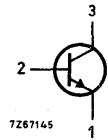
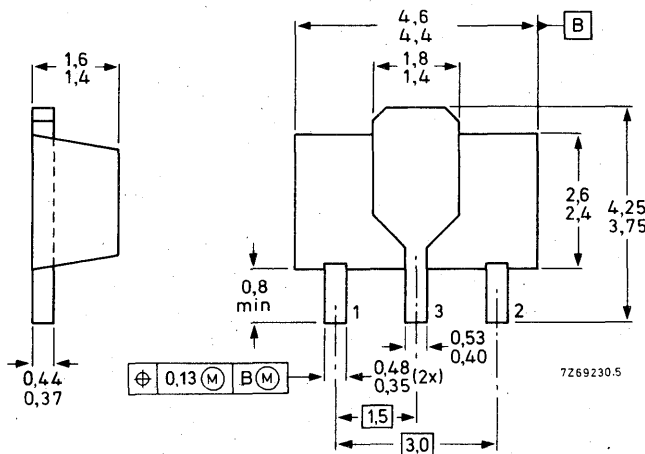

See also *Soldering recommendations*.

RATINGS

Limiting values in accordance with the Absolute Maximum System (IEC 134)

Collector-base voltage (open emitter)	V_{CBO}	max.	250 V
Collector-emitter voltage (open base)	V_{CEO}	max.	250 V
Emitter-base voltage (open collector)	V_{EBO}	max.	5 V
Collector current (d.c.)	I_C	max.	20 mA
Collector current (peak value)	I_{CM}	max.	100 mA
Total power dissipation up to $T_{amb} = 25\text{ }^\circ\text{C}$ mounted on a ceramic substrate area = 2,5 cm ² ; thickness = 0,7 mm	P_{tot}	max.	1 W
Storage temperature	T_{stg}		-65 to +150 °C
Junction temperature	T_j	max.	150 °C

THERMAL RESISTANCE

From junction to collector tab	$R_{th\ j-tab}$	=	25 °C/W
From junction to ambient in free air mounted on a ceramic substrate area = 2,5 cm ² ; thickness = 0,7 mm	$R_{th\ j-a}$	=	125 °C/W

CHARACTERISTICS

$T_j = 25\text{ }^\circ\text{C}$ unless otherwise specified

Collector cut-off current

$$I_E = 0; V_{CB} = 200\text{ V}$$

$$I_{CBO} < 10\text{ nA}$$

$$R_{BE} = 10\text{ k}\Omega; V_{CE} = 200\text{ V}; T_j = 150\text{ }^\circ\text{C}$$

$$I_{CER} < 50\text{ }\mu\text{A}$$

Emitter cut-off current

$$I_C = 0; V_{EB} = 5\text{ V}$$

$$I_{EBO} < 10\text{ }\mu\text{A}$$

Base-emitter voltage

$$I_C = 25\text{ mA}; V_{CE} = 20\text{ V}$$

$$V_{BE} \text{ typ. } 0,73\text{ V}$$

D.C. current gain

$$I_C = 25\text{ mA}; V_{CE} = 20\text{ V}$$

$$h_{FE} > 50$$

High-frequency knee voltage at $T_j = 150\text{ }^\circ\text{C}$ *

$$I_C = 25\text{ mA}$$

$$V_{CEK} \text{ typ. } 20\text{ V}$$

Transition frequency at $f = 35\text{ MHz}$

$$I_C = 10\text{ mA}; V_{CE} = 10\text{ V}$$

$$f_T > 60\text{ MHz}$$

Feedback capacitance at $f = 1\text{ MHz}$

$$I_C = 0; V_{CE} = 30\text{ V}$$

$$C_{re} < 1,6\text{ pF}$$

Feedback time constant at $f = 10,7\text{ MHz}$ **

$$I_C = 10\text{ mA}; V_{CE} = 20\text{ V}$$

$$r_{bb'}C_{b'c} < 70\text{ ps}$$

* The high-frequency knee voltage of a transistor is that value of the collector-emitter voltage at which the small-signal gain, measured in a practical circuit, has dropped to 80% of the gain at $V_{CE} = 50\text{ V}$. A further reduction of the collector-emitter voltage results in a rapid increase of the distortion of the signal.

** $r_{bb'}C_{b'c} = \frac{|h_{rb}|}{\omega}$.

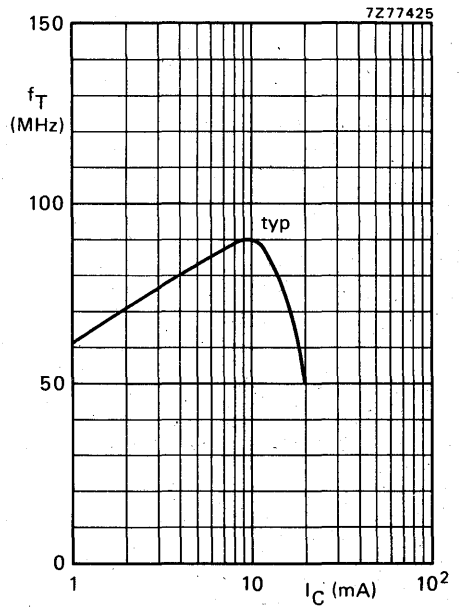
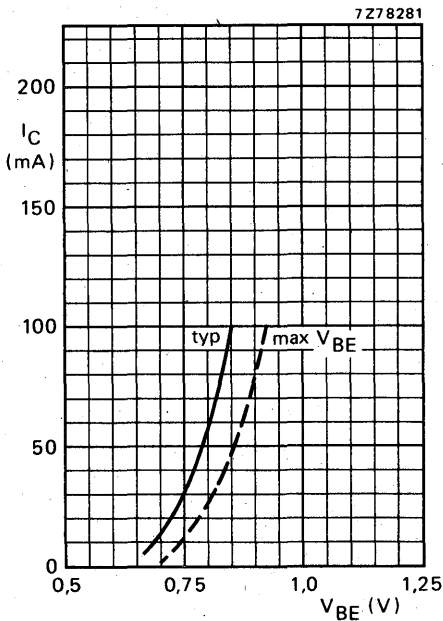
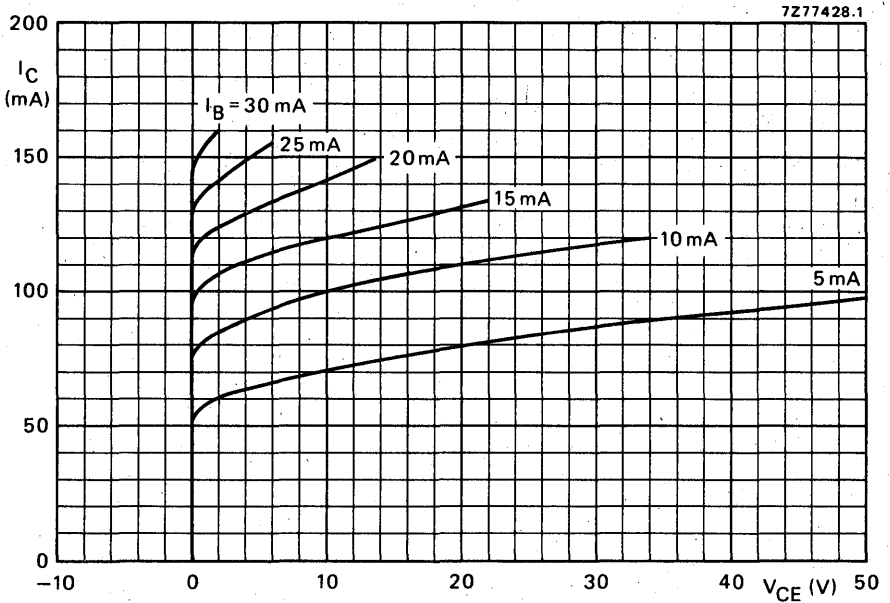

7277674

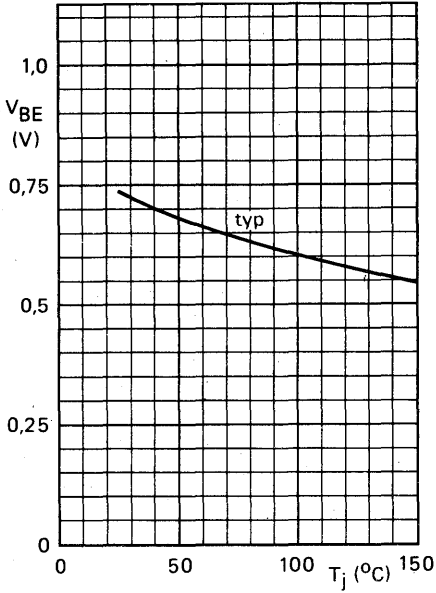

Fig. 5 $I_C = 25 \text{ mA}$; $V_{CE} = 20 \text{ V}$.

7278283

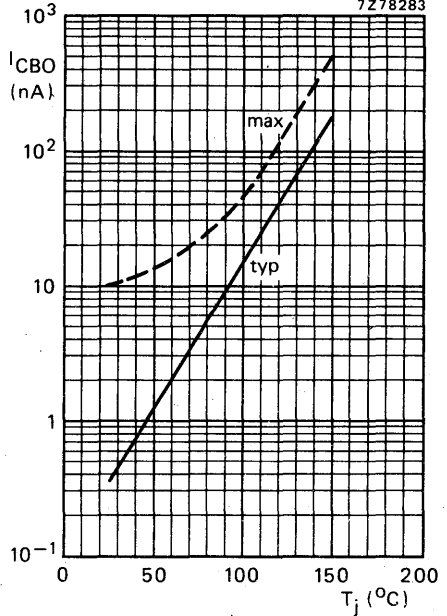

Fig. 6 $V_{CB} = 200 \text{ V}$.

7278282

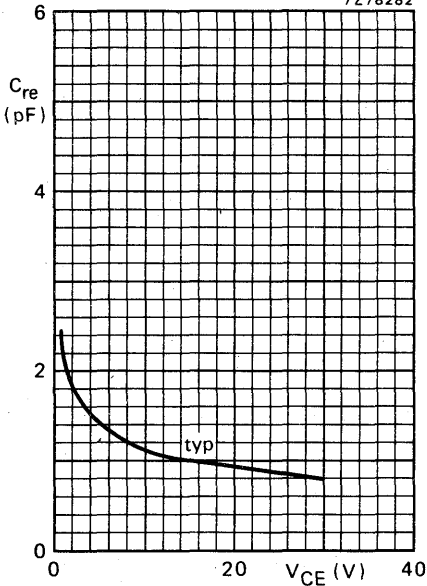

Fig. 7 $I_C = 0$; $f = 1 \text{ MHz}$; $T_j = 25 \text{ }^{\circ}C$.

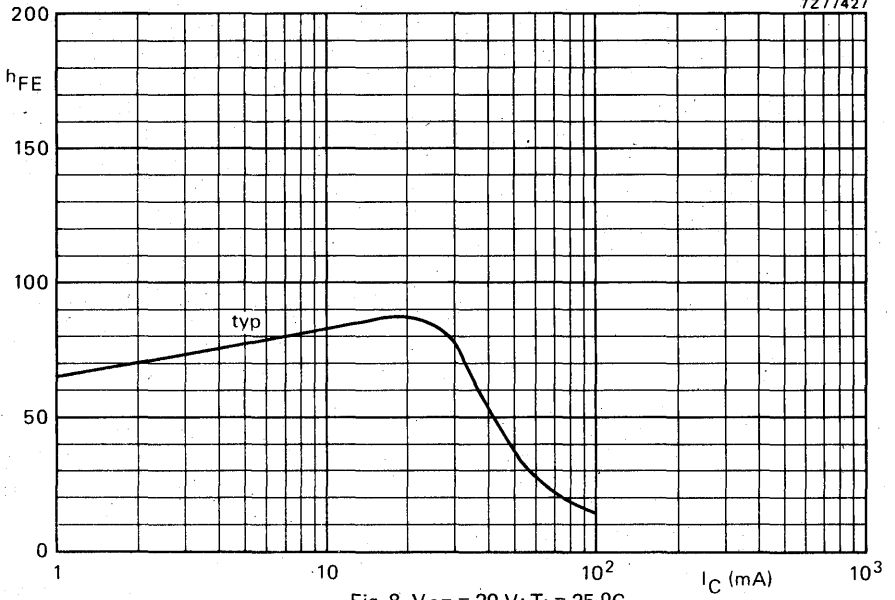

Fig. 8 $V_{CE} = 20 V; T_j = 25 ^\circ C.$

SILICON EPITAXIAL TRANSISTOR

• for video output stages

P-N-P transistor in a miniature plastic envelope intended for application in thick and thin-film circuits. This device is intended for class-B video output stages in colour television receivers.

N-P-N complement is BF622.

QUICK REFERENCE DATA

Collector-base voltage (open emitter)	$-V_{CBO}$	max.	250 V
Collector-emitter voltage (open base)	$-V_{CEO}$	max.	250 V
Collector current (peak value)	$-I_{CM}$	max.	100 mA
Total power dissipation up to $T_{amb} = 25\text{ }^{\circ}\text{C}$	P_{tot}	max.	1 W
Junction temperature	T_j	max.	150 $^{\circ}\text{C}$
D.C. current gain			
$-I_C = 25\text{ mA}; -V_{CE} = 20\text{ V}$	h_{FE}	>	50
Transition frequency at $f = 35\text{ MHz}$			
$-I_C = 10\text{ mA}; -V_{CE} = 10\text{ V}$	f_T	>	60 MHz
Feedback capacitance at $f = 1\text{ MHz}$			
$I_C = 0; -V_{CE} = 30\text{ V}$	C_{re}	<	1,6 pF

MECHANICAL DATA

Dimensions in mm

Mark

Fig. 1 SOT-89.

BF623

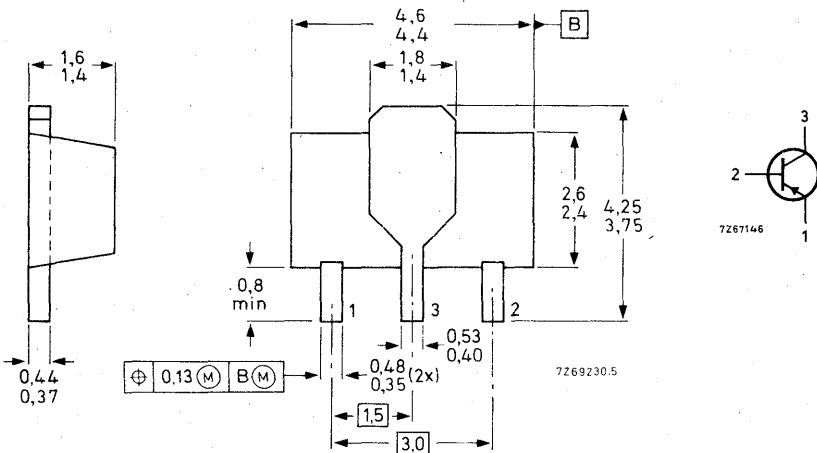

See also *Soldering recommendations.*

RATINGS

Limiting values in accordance with the Absolute Maximum System (IEC 134)

Collector-base voltage (open emitter)	$-V_{CBO}$	max.	250 V
Collector-emitter voltage (open base)	$-V_{CEO}$	max.	250 V
Emitter-base voltage (open collector)	$-V_{EBO}$	max.	5 V
Collector current (d.c.)	$-I_C$	max.	20 mA
Collector current (peak value)	$-I_{CM}$	max.	100 mA
Total power dissipation up to $T_{amb} = 25\text{ }^\circ\text{C}$ mounted on a ceramic substrate area = 2,5 cm ² ; thickness = 0,7 mm	P_{tot}	max.	1 W
Storage temperature	T_{stg}	-65 to +150	$^\circ\text{C}$
Junction temperature	T_j	max.	150 $^\circ\text{C}$

THERMAL RESISTANCE

From junction to collector tab	$R_{th\ j-tab}$	=	25 $^\circ\text{C/W}$
From junction to ambient in free air mounted on a ceramic substrate area = 2,5 cm ² ; thickness = 0,7 mm	$R_{th\ j-a}$	=	125 $^\circ\text{C/W}$

CHARACTERISTICS

$T_j = 25\text{ }^\circ\text{C}$ unless otherwise specified

Collector cut-off current

$$I_E = 0; -V_{CB} = 200\text{ V}$$

$$-I_{CBO} < 10\text{ nA}$$

$$R_{BE} = 10\text{ k}\Omega; -V_{CE} = 200\text{ V}; T_j = 150\text{ }^\circ\text{C}$$

$$-I_{CER} < 50\text{ }\mu\text{A}$$

Emitter cut-off current

$$I_C = 0; -V_{EB} = 5\text{ V}$$

$$-I_{EBO} < 10\text{ }\mu\text{A}$$

Base-emitter voltage

$$-I_C = 25\text{ mA}; -V_{CE} = 20\text{ V}$$

$$-V_{BE} \text{ typ. } 0,75\text{ V}$$

D.C. current gain

$$-I_C = 25\text{ mA}; -V_{CE} = 20\text{ V}$$

$$h_{FE} > 50$$

High-frequency knee voltage at $T_j = 150\text{ }^\circ\text{C}$ *

$$-I_C = 25\text{ mA}$$

$$-V_{CEK} \text{ typ. } 20\text{ V}$$

Transition frequency at $f = 35\text{ MHz}$

$$-I_C = 10\text{ mA}; -V_{CE} = 10\text{ V}$$

$$f_T > 60\text{ MHz}$$

Feedback capacitance at $f = 1\text{ MHz}$

$$I_C = 0; -V_{CE} = 30\text{ V}$$

$$C_{re} < 1,6\text{ pF}$$

Feedback time constant at $f = 10,7\text{ MHz}$ **

$$-I_C = 10\text{ mA}; -V_{CE} = 20\text{ V}$$

$$r_{bb'}C_{b'c} < 70\text{ ps}$$

* The high-frequency knee voltage of a transistor is that value of the collector-emitter voltage at which the small-signal gain, measured in a practical circuit, has dropped to 80% of the gain at $-V_{CE} = 50\text{ V}$. A further reduction of the collector-emitter voltage results in a rapid increase of the distortion of the signal.

** $r_{bb'}C_{b'c} = \frac{|h_{rb}|}{\omega}$

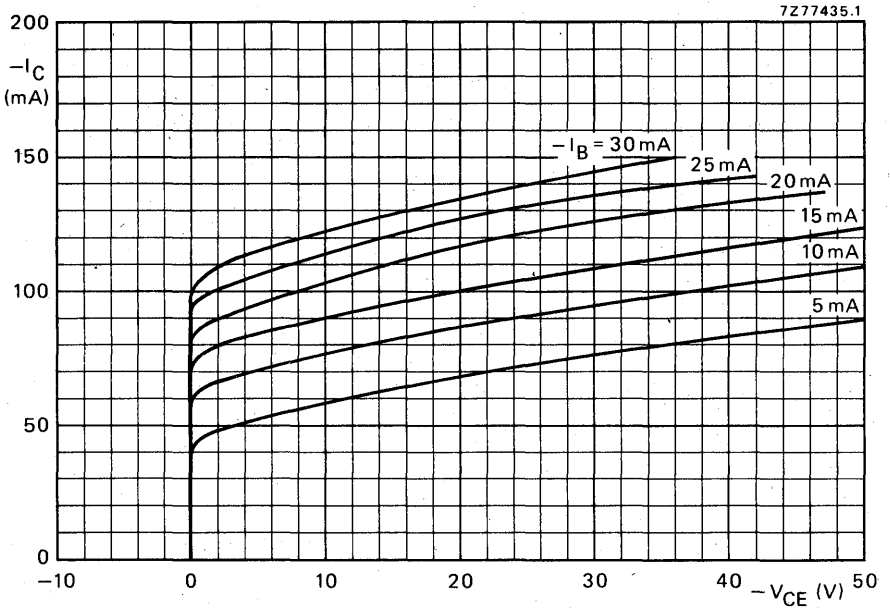

Fig. 2 Typical values at $T_j = 25^\circ\text{C}$.

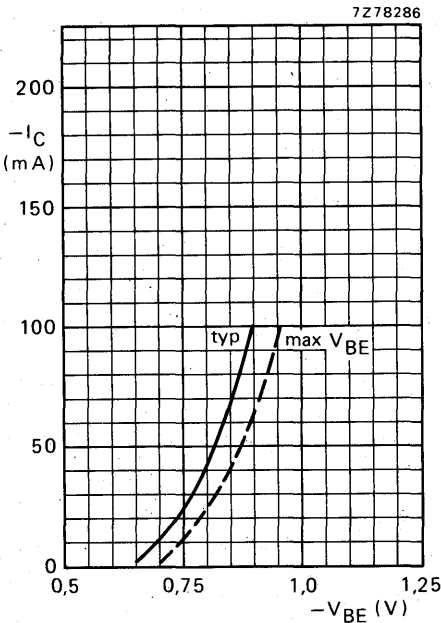

Fig. 3 $-V_{CE} = 20$ V; $T_j = 25^\circ\text{C}$.

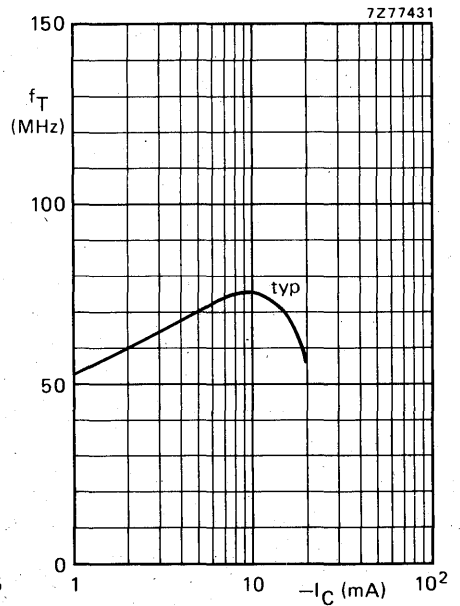

Fig. 4 $-V_{CE} = 10$ V; $T_j = 25^\circ\text{C}$; $f = 35$ MHz.

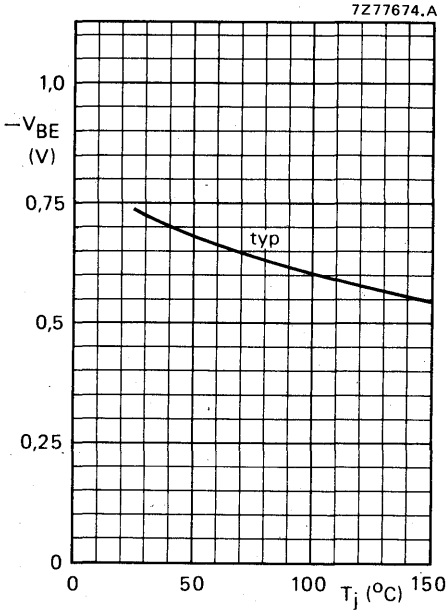

Fig. 5 $-I_C = 25 \text{ mA}$; $-V_{CE} = 20 \text{ V}$.

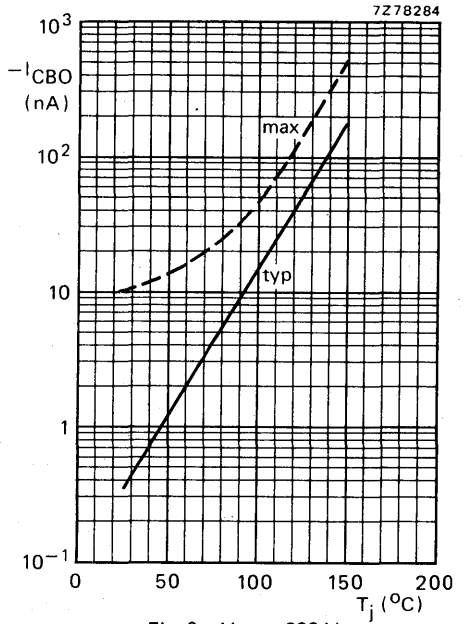

Fig. 6 $-V_{CB} = 200 \text{ V}$.

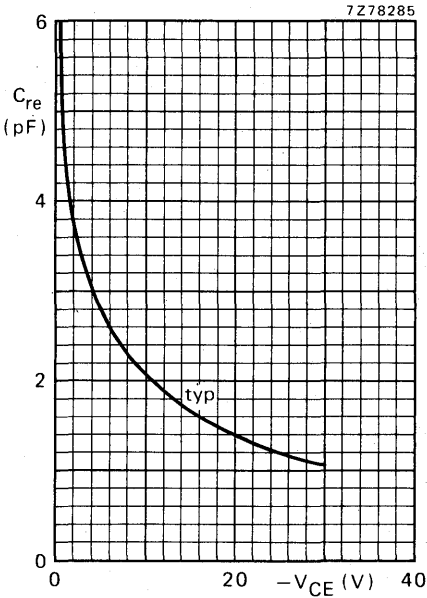

Fig. 7 $I_C = 0$; $f = 1 \text{ MHz}$; $T_j = 25 \text{ }^{\circ}\text{C}$.

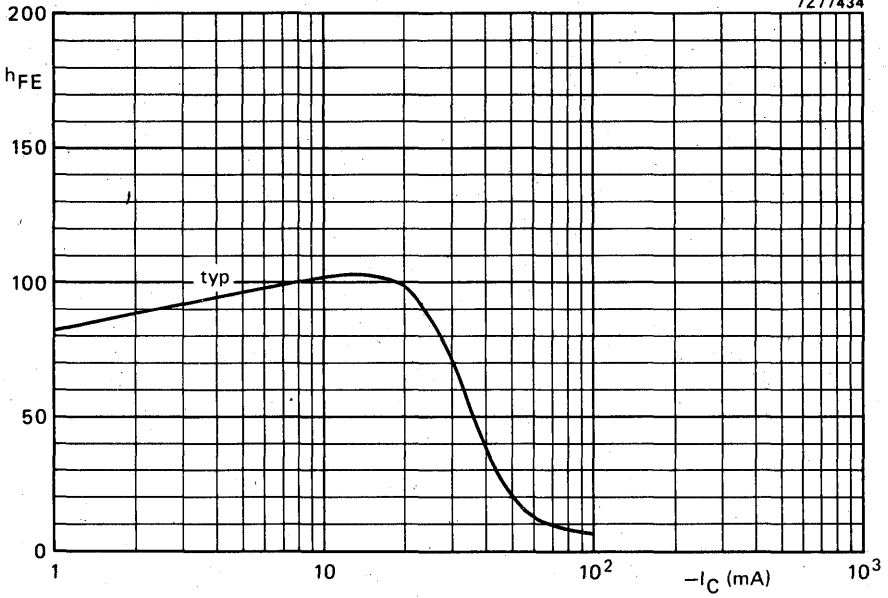

Fig. 8 $-V_{CE} = 20 \text{ V}; T_j = 25 \text{ }^\circ\text{C}.$

SILICON PLANAR EPITAXIAL TRANSISTOR

N-P-N multi-emitter transistor in a miniature plastic envelope intended for application in thick and thin-film circuits. The transistor has extremely good intermodulation properties and a high power gain. It is primarily intended for:

- Output and driver stages of channel and band serial amplifiers with high output power for bands I, II, III and IV/V (40–860 MHz).
- Output and driver stages of wideband amplifiers.

QUICK REFERENCE DATA

Collector-base voltage (open emitter; peak value)	V_{CBOM}	max.	40 V
Collector-emitter voltage (open base)	V_{CEO}	max.	25 V
Collector current (peak value; $f > 1$ MHz)	I_{CM}	max.	300 mA
Total power dissipation up to $T_{amb} = 25$ °C	P_{tot}	max.	1 W
Junction temperature	T_j	max.	150 °C
Transition frequency at $f = 500$ MHz $I_C = 150$ mA; $V_{CE} = 15$ V	f_T	typ.	1,2 GHz
Feedback capacitance at $f = 1$ MHz $I_C = 10$ mA; $V_{CE} = 15$ V; $T_{amb} = 25$ °C	C_{re}	typ.	1,9 pF

MECHANICAL DATA

Dimensions in mm

Mark

Fig. 1 SOT-89.

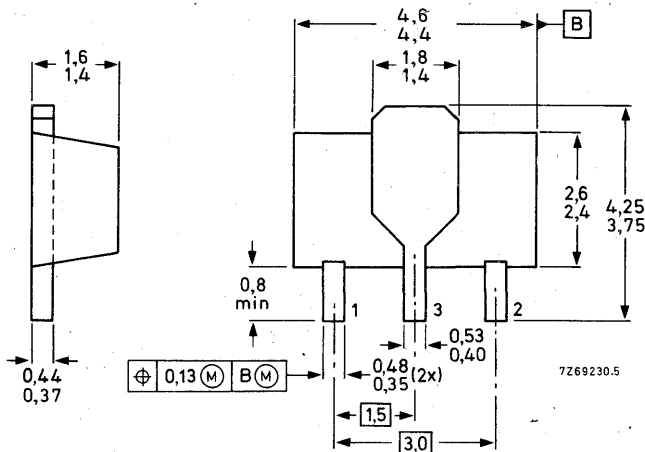

BFQ17

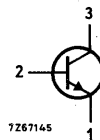

See also *Soldering recommendations*.

RATINGS Limiting values in accordance with the Absolute Maximum System (IEC 134)

Voltages

Collector-base voltage (open emitter; peak value)	V_{CBOM}	max.	40	V
Collector-emitter voltage ($R_{BE} \leq 50 \Omega$; peak value)	V_{CERM}	max.	40	V 1)
Collector-emitter voltage (open base)	V_{CEO}	max.	25	V 1)
Emitter-base voltage (open collector)	V_{EBO}	max.	2	V

Currents

Collector current (d. c.)	I_C	max.	150	mA
Collector current (peak value; $f > 1$ MHz)	I_{CM}	max.	300	mA

Power dissipation

Total power dissipation up to $T_{amb} = 25 \text{ }^\circ\text{C}$ mounted on a ceramic substrate area = 2,5 cm ² ; thickness = 0,7 mm	P_{tot}	max.	1	W
--	-----------	------	---	---

Temperatures

Storage temperature	T_{stg}	-65 to +150	$^\circ\text{C}$
Junction temperature	T_j	max. 150	$^\circ\text{C}$

THERMAL RESISTANCE

From junction to collector tab	$R_{thj-tab}$	=	30	$^\circ\text{C/W}$ ←
From junction to ambient in free air mounted on a ceramic substrate area = 2,5 cm ² ; thickness = 0,7 mm	R_{thj-a}	=	125	$^\circ\text{C/W}$

1) $I_C = 10$ mA.

CHARACTERISTICS

$T_j = 25\text{ }^\circ\text{C}$ unless otherwise specified

Collector cut-off current

$I_E = 0; V_{CB} = 20\text{ V}; T_j = 150\text{ }^\circ\text{C}$

$I_{CBO} < 20\text{ }\mu\text{A}$

Saturation voltage

$I_C = 100\text{ mA}; I_B = 10\text{ mA}$

$V_{CEsat} < 0,5\text{ V}$

D.C. current gain

$I_C = 50\text{ mA}; V_{CE} = 5\text{ V}$

$h_{FE} > 25$

$I_C = 150\text{ mA}; V_{CE} = 5\text{ V}$

$h_{FE} > 25$

Transition frequency at $f = 500\text{ MHz}$ 1)

$I_C = 150\text{ mA}; V_{CE} = 15\text{ V}$

$f_T \text{ typ. } 1,2\text{ GHz}$

Collector capacitance at $f = 1\text{ MHz}$

$I_E = I_e = 0; V_{CB} = 15\text{ V}$

$C_c < 4\text{ pF}$

Feedback capacitance at $f = 1\text{ MHz}$

$I_C = 10\text{ mA}; V_{CE} = 15\text{ V}; T_{amb} = 25\text{ }^\circ\text{C}$

$C_{re} \text{ typ. } 1,9\text{ pF}$

Max. unilateral power gain (s_{re} assumed to be zero)

$$GUM \text{ (in dB)} = 10 \log \frac{|s_{fe}|^2}{(1 - |s_{ie}|^2)(1 - |s_{oe}|^2)}$$

$I_C = 60\text{ mA}; V_{CE} = 15\text{ V}; T_{amb} = 25\text{ }^\circ\text{C};$

$f = 200\text{ MHz}$

$f = 800\text{ MHz}$

$GUM \text{ typ. } 16\text{ dB}$

$GUM \text{ typ. } 6,5\text{ dB}$

1) Measured under pulse conditions.

7Z72947

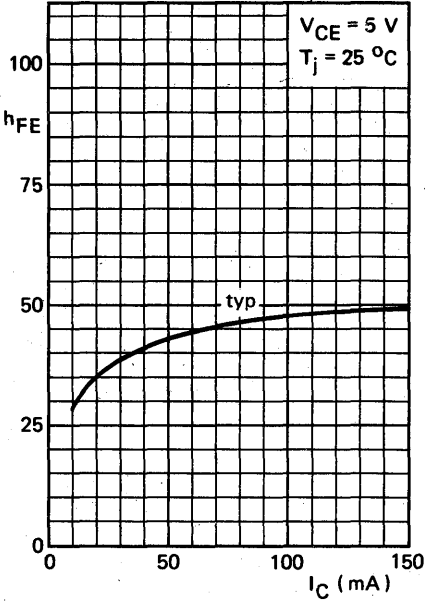

7Z72950

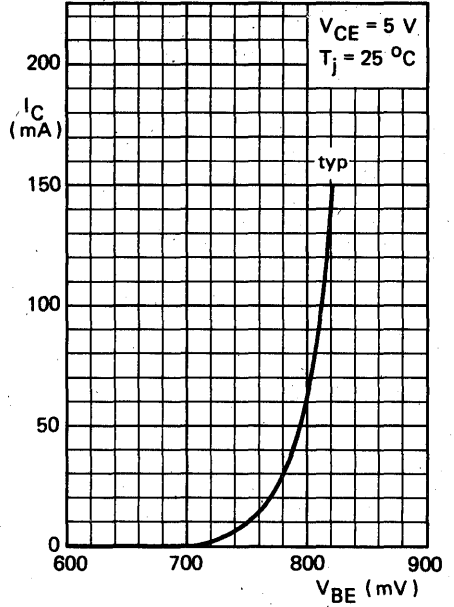

7Z72948

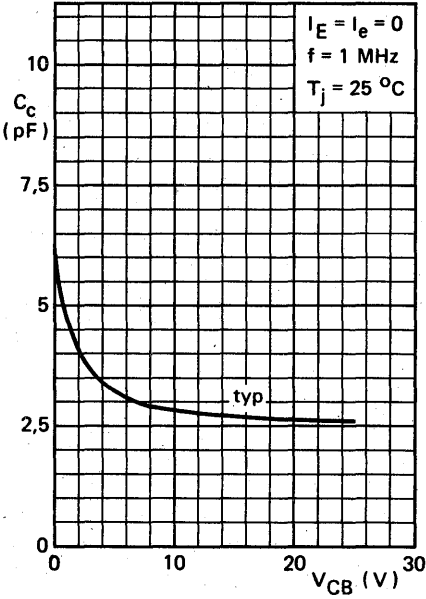

7Z73167

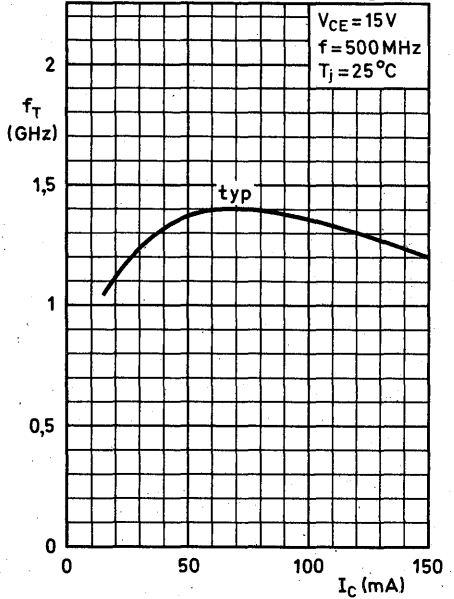

DEVELOPMENT SAMPLE DATA

This information is derived from development samples made available for evaluation. It does not form part of our data handbook system and does not necessarily imply that the device will go into production

BFQ18A

SILICON PLANAR EPITAXIAL TRANSISTOR

N-P-N transistor in a miniature plastic envelope intended for application in thick and thin-film circuits. It is primarily intended for MATV purposes.

QUICK REFERENCE DATA

Collector-base voltage (open emitter)	V_{CBO}	max.	25 V
Collector-emitter voltage (open base)	V_{CEO}	max.	15 V
Collector current (d.c.)	I_C	max.	150 mA
Total power dissipation up to $T_{amb} = 25\text{ }^\circ\text{C}$	P_{tot}	max.	1 W
Junction temperature	T_j	max.	150 $^\circ\text{C}$
Transition frequency at $f = 500\text{ MHz}$ $I_C = 100\text{ mA}$; $V_{CE} = 10\text{ V}$	f_T	typ.	3,6 GHz
Feedback capacitance at $f = 10,7\text{ MHz}$ $I_C = 0$; $V_{CE} = 10\text{ V}$	C_{re}	typ.	1,2 pF
Intermodulation distortion $I_C = 80\text{ mA}$; $V_{CE} = 10\text{ V}$; $R_L = 75\text{ }\Omega$ measured at $f_{(p+q-r)} = 793,25\text{ MHz}$	d_{im}	<	-60 dB

MECHANICAL DATA

Dimensions in mm

Fig. 1 SOT-89.

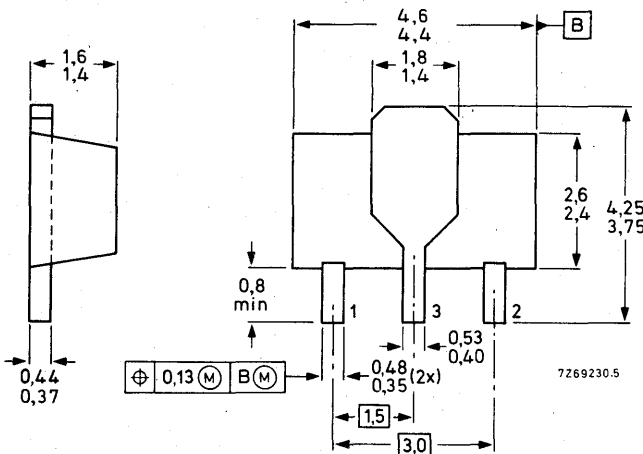

Mark
BFQ18A

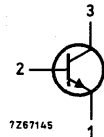

See also *Soldering recommendations*.

RATINGS

Limiting values in accordance with the Absolute Maximum System (IEC 134)

Collector-base voltage (open emitter)	V_{CBO}	max.	25 V
Collector-emitter voltage (open base)	V_{CEO}	max.	15 V
Emitter-base voltage (open collector)	V_{EBO}	max.	2 V
Collector current (d.c.)	I_C	max.	150 mA
Total power dissipation up to $T_{amb} = 25\text{ }^\circ\text{C}$ *	P_{tot}	max.	1 W
Storage temperature	T_{stg}		-65 to + 150 $^\circ\text{C}$
Junction temperature	T_j	max.	150 $^\circ\text{C}$

THERMAL RESISTANCE

From junction to collector tab	$R_{th\ j-tab}$	=	25 $^\circ\text{C/W}$
From junction to ambient in free air *	$R_{th\ j-a}$	=	125 $^\circ\text{C/W}$

CHARACTERISTICS

$T_{amb} = 25\text{ }^\circ\text{C}$ unless otherwise specified

D.C. current gain **

$I_C = 50\text{ mA}; V_{CE} = 10\text{ V}$

$I_C = 100\text{ mA}; V_{CE} = 10\text{ V}$

$h_{FE} > 25$

$h_{FE} > 25$

Transition frequency at $f = 500\text{ MHz}$ **

$I_C = 50\text{ mA}; V_{CE} = 10\text{ V}$

$I_C = 100\text{ mA}; V_{CE} = 10\text{ V}$

f_T typ. 3,2 GHz

f_T typ. 3,6 GHz

Collector capacitance at $f = 1\text{ MHz}$

$I_E = I_e = 0; V_{CB} = 10\text{ V}$

C_c typ. 2,0 pF

Emitter capacitance at $f = 1\text{ MHz}$

$I_C = I_c = 0; V_{EB} = 0,5\text{ V}$

C_e typ. 11 pF

Feedback capacitance at $f = 10,7\text{ MHz}$

$I_C = 0; V_{CE} = 10\text{ V}$

C_{re} typ. 1,2 pF

* The device mounted on a ceramic substrate area = 2,5 cm²; thickness = 0,7 mm.

** Measured under pulse conditions.

Intermodulation distortion (see Fig. 2)

$$I_C = 80 \text{ mA}; V_{CE} = 10 \text{ V}; R_L = 75 \Omega$$

$$V_p = V_o = 700 \text{ mV at } f_p = 795,25 \text{ MHz}$$

$$V_q = V_o - 6 \text{ dB at } f_q = 803,25 \text{ MHz}$$

$$V_r = V_o - 6 \text{ dB at } f_r = 805,25 \text{ MHz}$$

$$\text{Measured at } f_{(p+q-r)} = 793,25 \text{ MHz}$$

$$d_{im} < -60 \text{ dB}$$

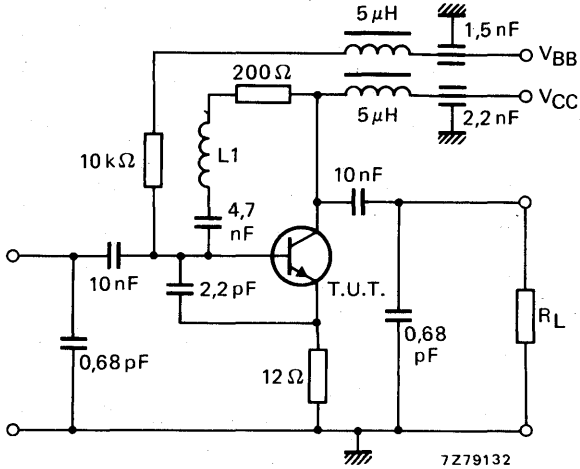
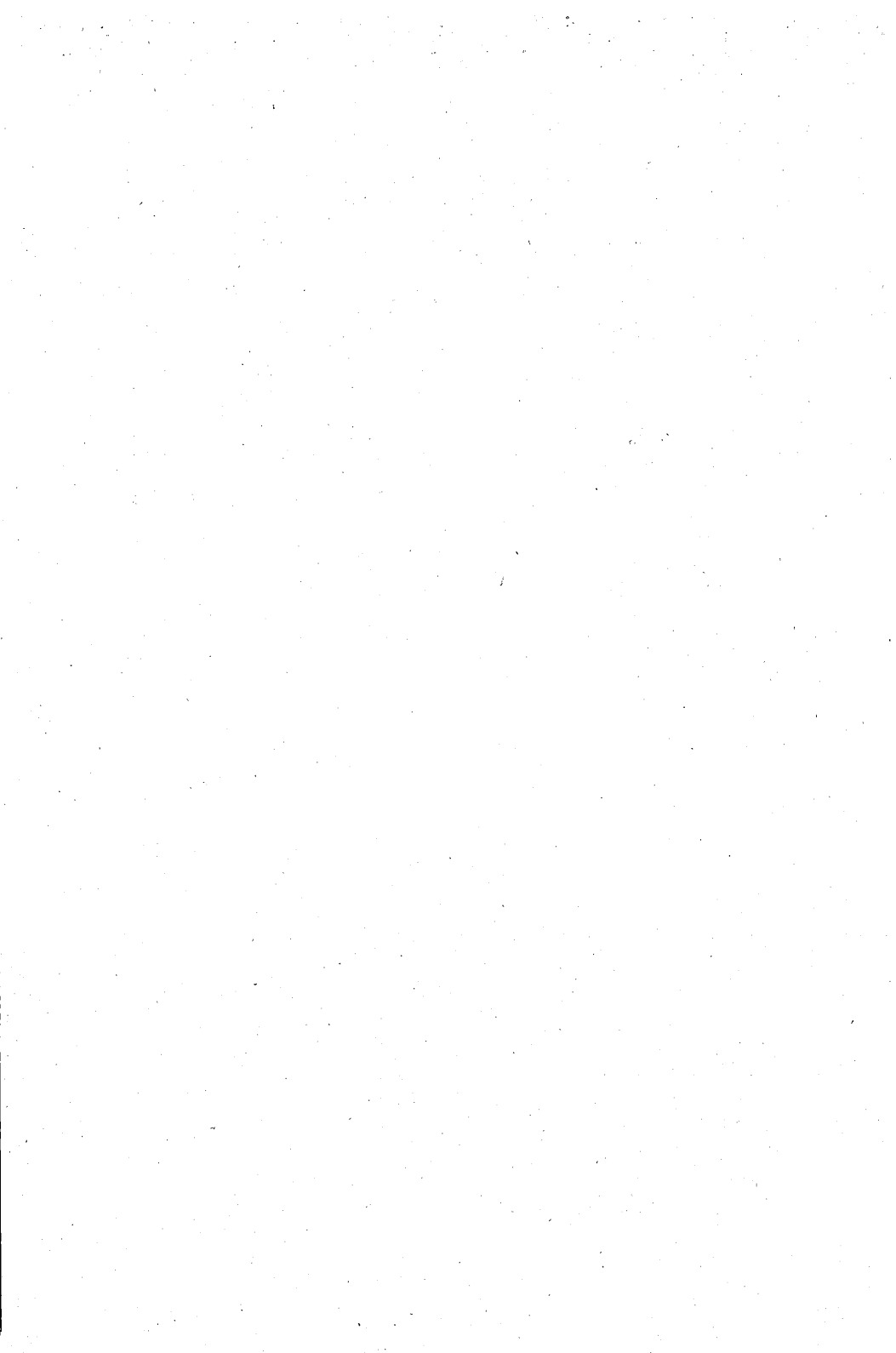

Fig. 2 MATV-test circuit (40–860 MHz).



SILICON PLANAR EPITAXIAL TRANSISTOR

N-P-N transistor in a miniature plastic envelope intended for application in thick- and thin-film circuits.

It is primarily intended for use in u.h.f. and microwave amplifiers such as in aerial amplifiers, radar systems, oscilloscopes, spectrum analysers etc.

The transistor features very low intermodulation distortion and high power gain. Thanks to its very high transition frequency, it also has excellent wideband properties and low noise up to high frequencies.

QUICK REFERENCE DATA

Collector-base voltage (open emitter)	V_{CBO} max.	20 V
Collector-emitter voltage (open base)	V_{CEO} max.	15 V
Collector current (d. c.)	I_C max.	75 mA
Total power dissipation up to $T_{amb} = 87,5\text{ }^\circ\text{C}$	P_{tot} max.	500 mW
Junction temperature	T_j max.	150 $^\circ\text{C}$
Transition frequency at $f = 500\text{ MHz}$ $I_C = 50\text{ mA}$; $V_{CE} = 10\text{ V}$	f_T typ.	5 GHz
Feedback capacitance at $f = 1\text{ MHz}$ $I_C = 10\text{ mA}$; $V_{CE} = 10\text{ V}$; $T_{amb} = 25\text{ }^\circ\text{C}$	C_{re} typ.	1,3 pF
Noise figure at optimum source impedance $I_C = 50\text{ mA}$; $V_{CE} = 10\text{ V}$; $f = 500\text{ MHz}$; $T_{amb} = 25\text{ }^\circ\text{C}$	F typ.	3,3 dB

MECHANICAL DATA

Fig. 1 SOT-89.

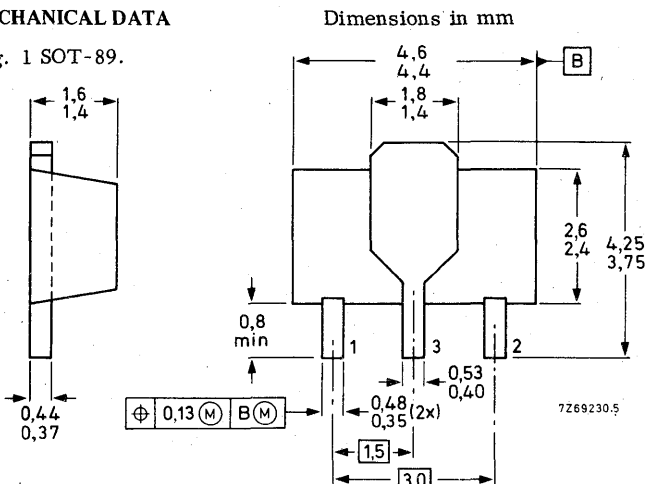

Mark

BFQ19

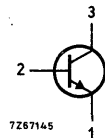

See also Soldering recommendations.

RATINGS Limiting values in accordance with the Absolute Maximum System (IEC134)

Voltages

Collector-base voltage (open emitter)	V_{CBO}	max.	20	V
Collector-emitter voltage (open base)	V_{CEO}	max.	15	V
Emitter-base voltage (open collector)	V_{EBO}	max.	3,0	V

Currents

Collector current (d. c.)	I_C	max.	75	mA
Collector current (peak value); $f > 1$ MHz	I_{CM}	max.	150	mA

Power dissipation

Total power dissipation up to $T_{amb} = 87,5$ °C
 mounted on a ceramic substrate
 area = $2,5$ cm²; thickness = $0,7$ mm

P_{tot}	max.	500	mW
-----------	------	-----	----

Temperatures

Storage temperature	T_{stg}	-65 to +150	°C
Junction temperature	T_j	max.	150 °C

THERMAL RESISTANCE

From junction to collector tab	$R_{thj-tab} =$	40	°C/W	←
From junction to ambient in free air mounted on a ceramic substrate area = $2,5$ cm ² ; thickness = $0,7$ mm	$R_{thj-a} =$	125	°C/W	

CHARACTERISTICS

$T_j = 25\text{ }^\circ\text{C}$ unless otherwise specified

Collector cut-off current

$I_E = 0; V_{CB} = 10\text{ V}$ $I_{CBO} < 100\text{ nA}$

D.C. current gain 1)

$I_C = 50\text{ mA}; V_{CE} = 10\text{ V}$ $h_{FE} > 25$
typ. 50

$I_C = 75\text{ mA}; V_{CE} = 10\text{ V}$ $h_{FE} > 25$
typ. 52

Transition frequency at $f = 500\text{ MHz}$ 1)

$I_C = 50\text{ mA}; V_{CE} = 10\text{ V}$ $f_T > 4,0\text{ GHz}$
typ. 5,0 GHz

$I_C = 75\text{ mA}; V_{CE} = 10\text{ V}$ $f_T > 4,4\text{ GHz}$
typ. 5,5 GHz

Collector capacitance at $f = 1\text{ MHz}$

$I_E = I_e = 0; V_{CB} = 10\text{ V}$ C_c typ. 1,6 pF

Emitter capacitance at $f = 1\text{ MHz}$

$I_C = I_c = 0; V_{EB} = 0,5\text{ V}$ C_e typ. 5,0 pF

Feedback capacitance at $f = 1\text{ MHz}$

$I_C = 10\text{ mA}; V_{CE} = 10\text{ V}; T_{amb} = 25\text{ }^\circ\text{C}$ C_{re} typ. 1,3 pF

Noise figure at optimum source impedance

$I_C = 50\text{ mA}; V_{CE} = 10\text{ V}; f = 500\text{ MHz}; T_{amb} = 25\text{ }^\circ\text{C}$ F typ. 3,3 dB

Max. unilateral power gain (s_{re} assumed to be zero)

$$G_{UM} \text{ (in dB)} = 10 \log \frac{|s_{fe}|^2}{(1 - |s_{ie}|^2)(1 - |s_{oe}|^2)}$$

$I_C = 50\text{ mA}; V_{CE} = 10\text{ V}; T_{amb} = 25\text{ }^\circ\text{C};$

$f = 200\text{ MHz}$ G_{UM} typ. 18,5 dB

$f = 500\text{ MHz}$ G_{UM} typ. 11,5 dB

$f = 800\text{ MHz}$ G_{UM} typ. 7,5 dB

1) Measured under pulse conditions.

7Z72859

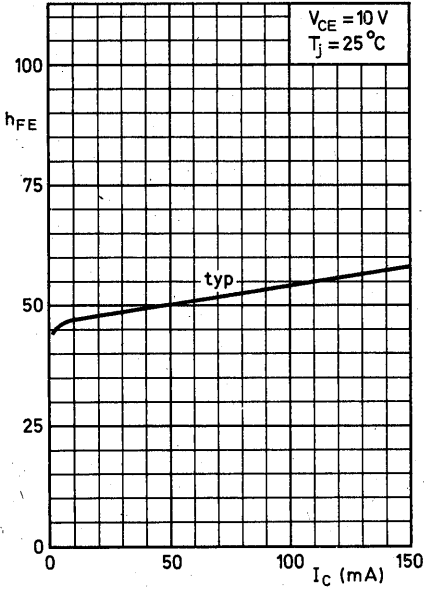

7Z72950

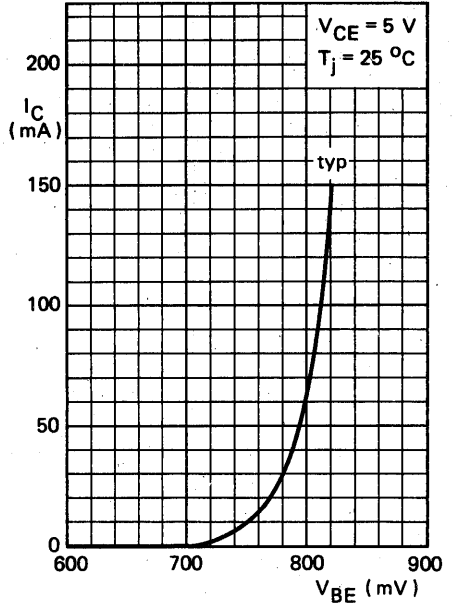

7Z72949

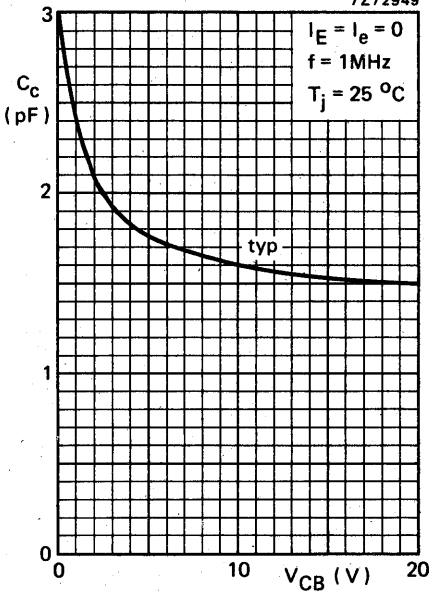

7Z72655

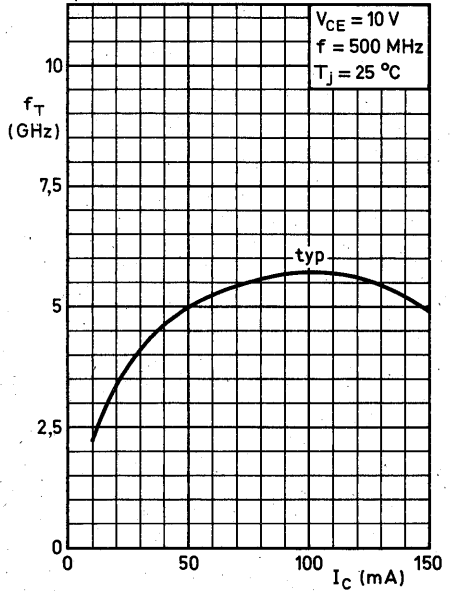

N-CHANNEL SILICON FIELD EFFECT TRANSISTOR

Planar epitaxial junction field effect transistor in a microminiature plastic envelope. It is intended for low level general purpose amplifiers in thick and thin-film circuits.

QUICK REFERENCE DATA

Drain-source voltage	$\pm V_{DS}$	max.	25	V	
Gate-source voltage (open drain)	$-V_{GSO}$	max.	25	V	
Total power dissipation up to $T_{amb} = 25\text{ }^{\circ}\text{C}$	P_{tot}	max.	200	mW	
Drain current $V_{DS} = 10\text{ V}; V_{GS} = 0$	I_{DSS}	>	BFR30: 4	BFR31: 1	mA
		<	10	5	mA
Transfer admittance (common source) $I_D = 1\text{ mA}; V_{DS} = 10\text{ V}; f = 1\text{ kHz}$	$ Y_{fs} $	>	1,0	1,5	mA/V
		<	4,0	4,5	mA/V

MECHANICAL DATA

Fig. 1 SOT-23.

Dimensions in mm

Marking code

BFR30 = M1

BFR31 = M2

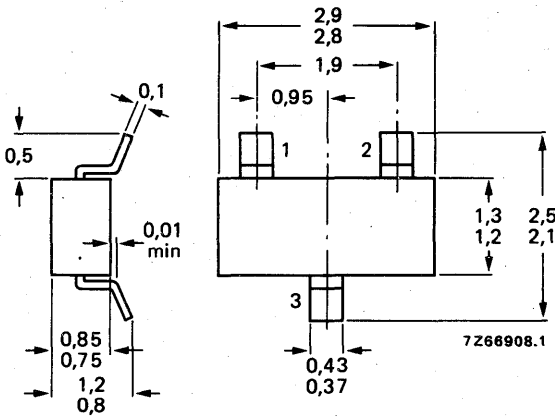

See also *Soldering recommendations*.

RATINGS Limiting values in accordance with the Absolute Maximum System (IEC 134)

Voltages

Drain-source voltage	$\pm V_{DS}$	max.	25	V
Drain-gate voltage (open source)	V_{DGO}	max.	25	V
Gate-source voltage (open drain)	$-V_{GSO}$	max.	25	V

Current

Drain current	I_D	max.	10	mA
Gate current	I_G	max.	5	mA

Power dissipation

Total power dissipation up to $T_{amb} = 25\text{ }^\circ\text{C}$
mounted on a ceramic substrate of
7 mm x 5 mm x 0.5 mm

P_{tot}	max.	200	mW
-----------	------	-----	----

Temperatures

Storage temperature	T_{stg}	-65 to +150	$^\circ\text{C}$
Junction temperature	T_j	max. 150	$^\circ\text{C}$

THERMAL RESISTANCE

From junction to ambient
mounted on a ceramic substrate of
7 mm x 5 mm x 0.5 mm

$R_{th\ j-a}$	=	0.62	$^\circ\text{C}/\text{mW}$
---------------	---	------	----------------------------

CHARACTERISTICS

$T_j = 25\text{ }^\circ\text{C}$ unless otherwise specified

		BFR30	BFR31
<u>Gate cut-off current</u>			
$-V_{GS} = 10\text{ V}; V_{DS} = 0$	$-I_{GSS}$	< 0.2	0.2 nA
<u>Drain current</u>			
$V_{DS} = 10\text{ V}; V_{GS} = 0$	I_{DSS}	> 4 < 10	1 mA 5 mA
<u>Gate-source voltage</u>			
$I_D = 1\text{ mA}; V_{DS} = 10\text{ V}$	$-V_{GS}$	> 0.7 < 3.0	0 V 1.3 V
$I_D = 50\text{ }\mu\text{A}; V_{DS} = 10\text{ V}$	$-V_{GS}$	< 4.0	2.0 V
<u>Gate-source cut-off voltage</u>			
$I_D = 0.5\text{ nA}; V_{DS} = 10\text{ V}$	$-V_{(P)GS}$	< 5	2.5 V
<u>y parameters</u>			
Transfer admittance at $f = 1\text{ kHz}; T_{amb} = 25\text{ }^\circ\text{C}$			
$I_D = 1\text{ mA}; V_{DS} = 10\text{ V}$	$ y_{fs} $	> 1.0 < 4.0	1.5 mA/V 4.5 mA/V
$I_D = 200\text{ }\mu\text{A}; V_{DS} = 10\text{ V}$	$ y_{fs} $	> 0.5	0.75 mA/V
Output admittance at $f = 1\text{ kHz}$			
$I_D = 1\text{ mA}; V_{DS} = 10\text{ V}$	$ y_{os} $	< 40	25 $\mu\text{A/V}$
$I_D = 200\text{ }\mu\text{A}; V_{DS} = 10\text{ V}$	$ y_{os} $	< 20	15 $\mu\text{A/V}$
Input capacitance at $f = 1\text{ MHz}$			
$I_D = 1\text{ mA}; V_{DS} = 10\text{ V}$	C_{is}	< 4	4 pF
$I_D = 200\text{ }\mu\text{A}; V_{DS} = 10\text{ V}$	C_{is}	< 4	4 pF
Feedback capacitance at $f = 1\text{ MHz}; T_{amb} = 25\text{ }^\circ\text{C}$			
$I_D = 1\text{ mA}; V_{DS} = 10\text{ V}$	C_{rs}	< 1.5	1.5 pF
$I_D = 200\text{ }\mu\text{A}; V_{DS} = 10\text{ V}$	C_{rs}	< 1.5	1.5 pF
<u>Equivalent noise voltage</u>			
$I_D = 200\text{ }\mu\text{A}; V_{DS} = 10\text{ V}$ $B = 0.6\text{ to }100\text{ Hz}$	V_n	< 0.5	0.5 μV



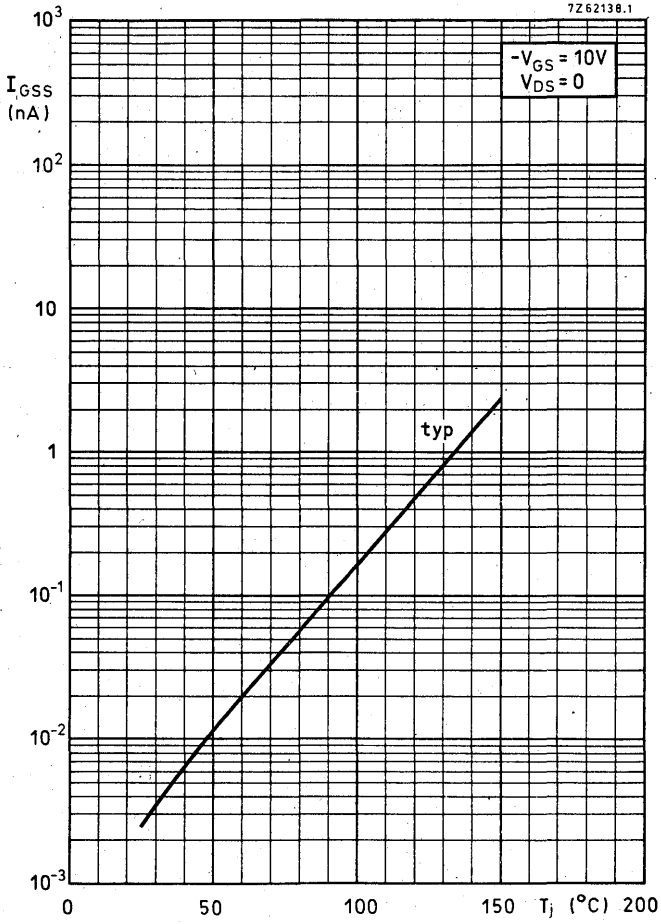

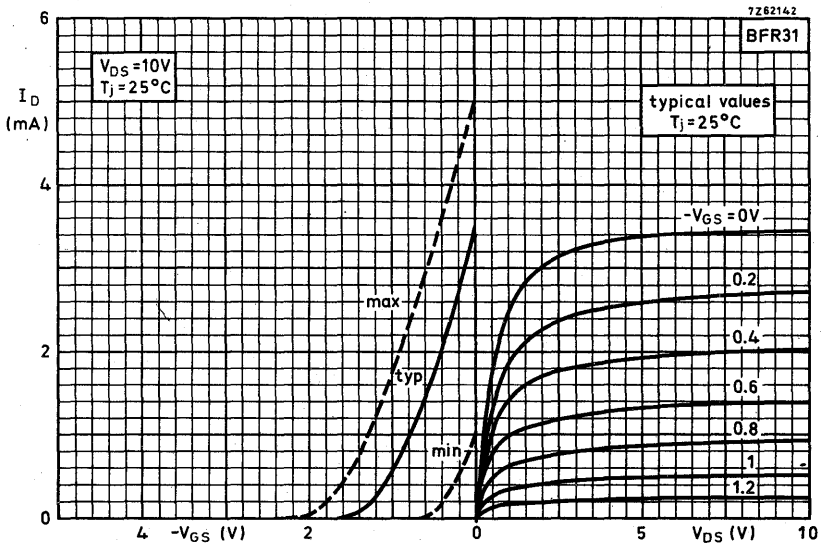
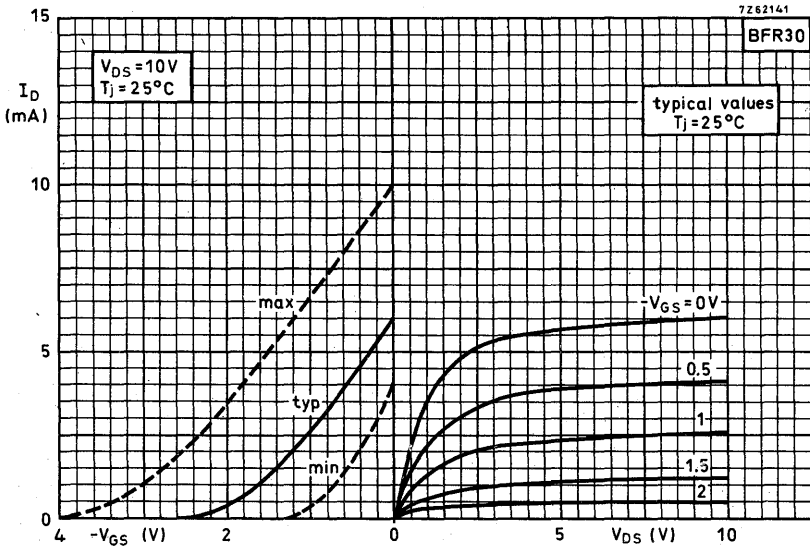

BFR30; BFR31

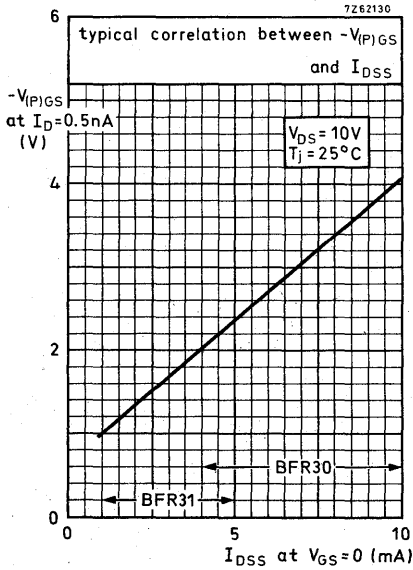
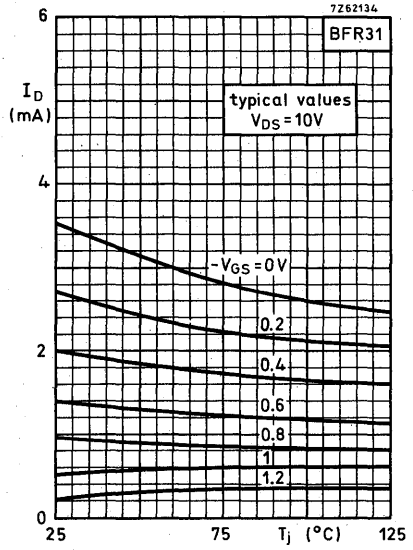
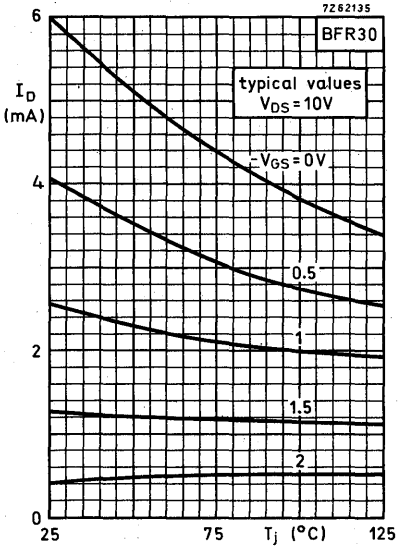

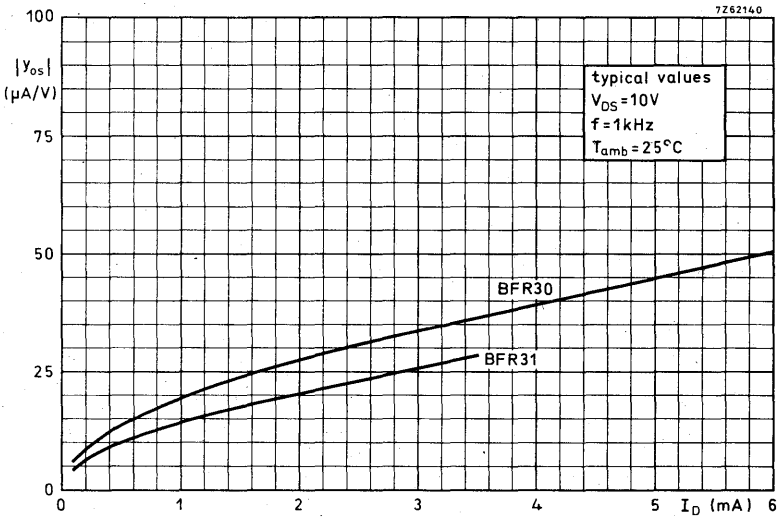
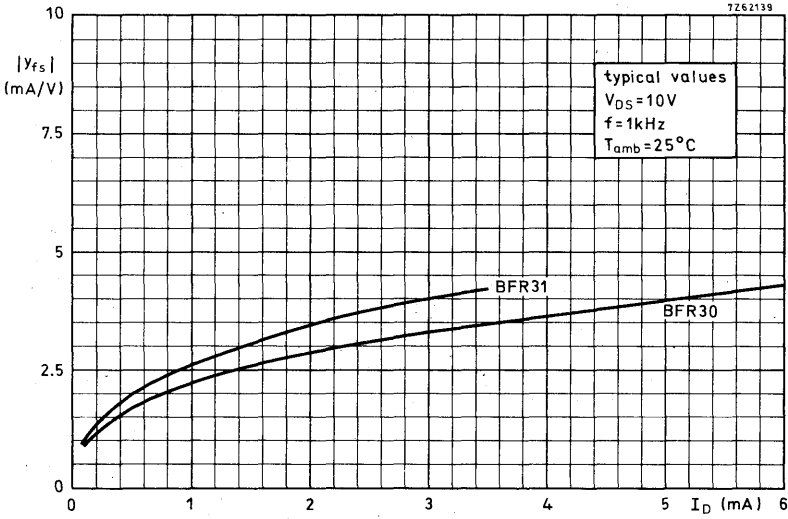

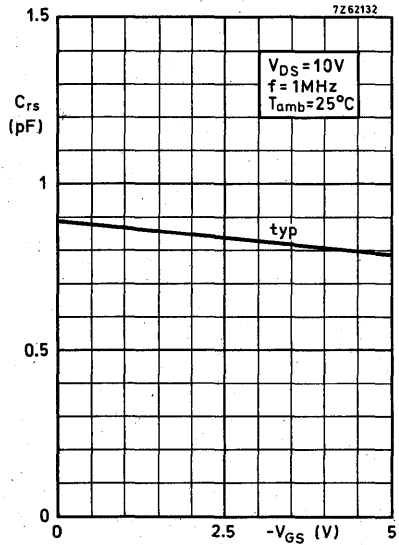
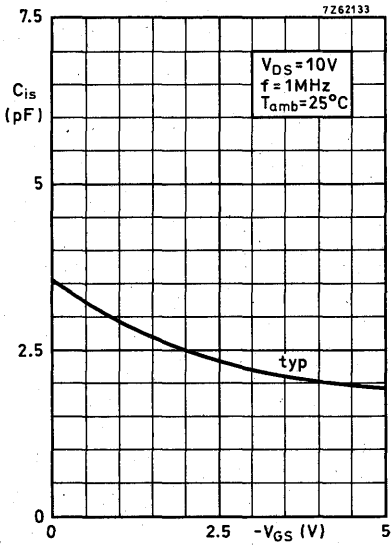
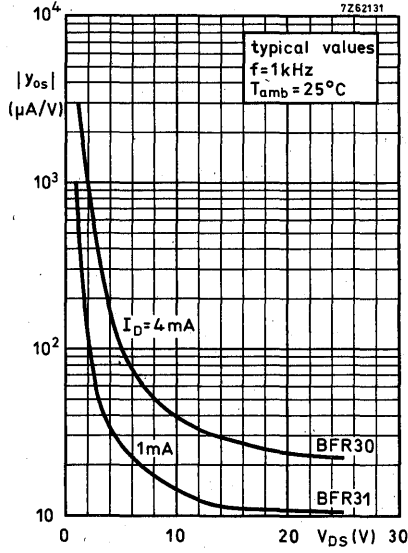

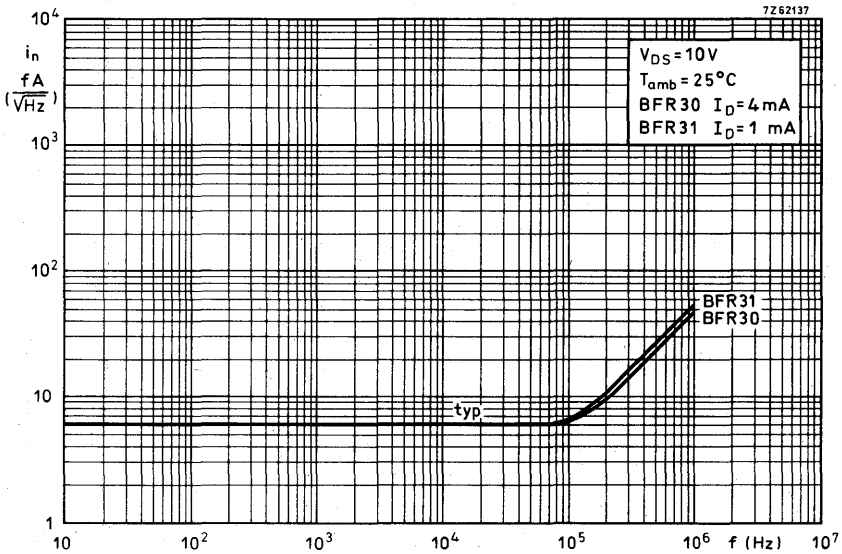
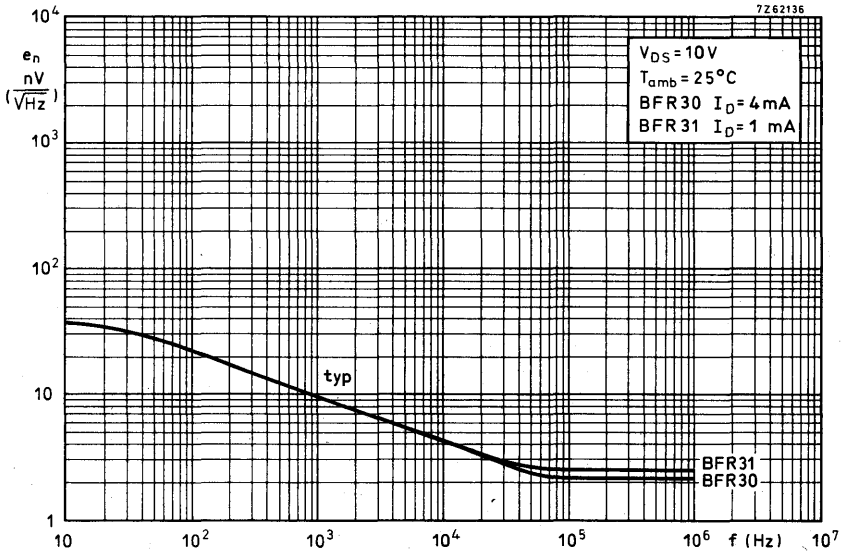



SILICON PLANAR EPITAXIAL TRANSISTOR

N-P-N multi-emitter transistor in a microminiature plastic envelope intended for application in thick and thin-film circuits. The transistor has very low intermodulation distortion and very high power gain. It is primarily intended for:

- Wideband vertical amplifiers in high speed oscilloscopes.
- Television distribution amplifiers.

QUICK REFERENCE DATA

Collector-base voltage (open emitter)	V_{CB0}	max.	18 V
Collector-emitter voltage (open base)	V_{CE0}	max.	10 V
Collector current (peak value; $f > 1$ MHz)	I_{CM}	max.	100 mA
Total power dissipation up to $T_{amb} = 60$ °C	P_{tot}	max.	180 mW
Junction temperature	T_j	max.	150 °C
Feedback capacitance at $f = 1$ MHz $I_C = 2$ mA; $V_{CE} = 5$ V; $T_{amb} = 25$ °C	$-C_{re}$	typ.	0,9 pF
Transition frequency at $f = 500$ MHz $I_C = 25$ mA; $V_{CE} = 5$ V	f_T	typ.	2,0 GHz
Max. unilateral power gain (see page 3) $I_C = 30$ mA; $V_{CE} = 5$ V; $f = 200$ MHz; $T_{amb} = 25$ °C $I_C = 30$ mA; $V_{CE} = 5$ V; $f = 800$ MHz; $T_{amb} = 25$ °C	GUM GUM	typ.	22 dB 10,5 dB
Intermodulation distortion at $T_{amb} = 25$ °C $I_C = 30$ mA; $V_{CE} = 5$ V; $R_L = 37,5$ Ω $V_o = 100$ mV at $f_p = 183$ MHz $V_o = 100$ mV at $f_q = 200$ MHz measured at $f(2q-p) = 217$ MHz	d_{im}	typ.	-60 dB

MECHANICAL DATA

Fig. 1 SOT-23.

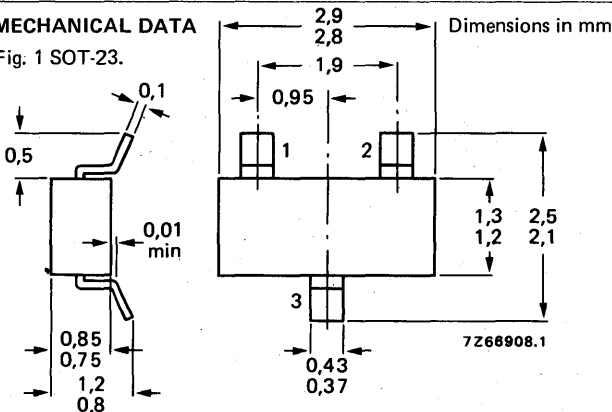

See also *Soldering recommendations*.

Marking code

BFR53 = N1

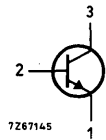

BFR53R = N4

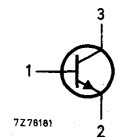

RATINGS Limiting values in accordance with the Absolute Maximum System (IEC134)

Voltages

Collector-base voltage (open emitter)	V_{CBO}	max.	18	V
Collector-emitter voltage (open base)	V_{CEO}	max.	10	V
Emitter-base voltage (open collector)	V_{EBO}	max.	2,5	V

Currents

Collector current (d. c.)	I_C	max.	50	mA
Collector current (peak value; $f > 1$ MHz)	I_{CM}	max.	100	mA

Power dissipation

Total power dissipation up to $T_{amb} = 60$ °C mounted on a ceramic substrate of 15 mm x 10 mm x 0,5 mm	P_{tot}	max.	180	mW
--	-----------	------	-----	----

Temperatures

Storage temperature	T_{stg}	-65 to +150	°C
Junction temperature	T_j	max. 150	°C

THERMAL RESISTANCE

From junction to ambient in free air mounted on a ceramic substrate of 15 mm x 10 mm x 0,5 mm	$R_{th\ j-a}$	=	0,50	°C/mW
---	---------------	---	------	-------

CHARACTERISTICS

$T_j = 25\text{ }^\circ\text{C}$ unless otherwise specified

Collector cut-off current

$I_E = 0; V_{CB} = 10\text{ V}$ $I_{CBO} < 50\text{ nA}$

D.C. current gain ¹⁾

$I_C = 25\text{ mA}; V_{CE} = 5\text{ V}$ $h_{FE} > 25$

$I_C = 50\text{ mA}; V_{CE} = 5\text{ V}$ $h_{FE} > 25$

Transition frequency at $f = 500\text{ MHz}$ ¹⁾

$I_C = 25\text{ mA}; V_{CE} = 5\text{ V}$ f_T typ. 2.0 GHz

Collector capacitance at $f = 1\text{ MHz}$

$I_E = I_e = 0; V_{CB} = 5\text{ V}$ C_c typ. 0.9 pF

Emitter capacitance at $f = 1\text{ MHz}$

$I_C = I_c = 0; V_{EB} = 0.5\text{ V}$ C_e typ. 1.5 pF

Feedback capacitance at $f = 1\text{ MHz}$

$I_C = 2\text{ mA}; V_{CE} = 5\text{ V}; T_{amb} = 25\text{ }^\circ\text{C}$ C_{re} typ. 0.9 pF

Noise figure at $f = 500\text{ MHz}$ ²⁾

$I_C = 2\text{ mA}; V_{CE} = 5\text{ V}; T_{amb} = 25\text{ }^\circ\text{C}$
 $G_S = 20\text{ mA/V}; B_S$ is tuned $F < 5\text{ dB}$

Max. unilateral power gain (s_{re} assumed to be zero)

$$G_{UM} \text{ (in dB)} = 10 \log \frac{|s_{fe}|^2}{(1 - |s_{ie}|^2)(1 - |s_{oe}|^2)}$$

$I_C = 30\text{ mA}; V_{CE} = 5\text{ V}; f = 200\text{ MHz}; T_{amb} = 25\text{ }^\circ\text{C}$ G_{UM} typ. 22 dB

$I_C = 30\text{ mA}; V_{CE} = 5\text{ V}; f = 800\text{ MHz}; T_{amb} = 25\text{ }^\circ\text{C}$ G_{UM} typ. 10.5 dB

¹⁾ Measured under pulse conditions.

²⁾ Crystal mounted in a BFW30 envelope.



CHARACTERISTICS (continued) $T_{amb} = 25\text{ }^{\circ}\text{C}$ unless otherwise specifiedIntermodulation distortion ¹⁾ $I_C = 30\text{ mA}$; $V_{CE} = 5\text{ V}$; $R_L = 37.5\text{ }\Omega$ $V_o = 100\text{ mV}$ at $f_p = 183\text{ MHz}$ $V_o = 100\text{ mV}$ at $f_q = 200\text{ MHz}$ Measured at $f(2q-p) = 217\text{ MHz}$ d_{im} typ. -60 dB

Test circuit:

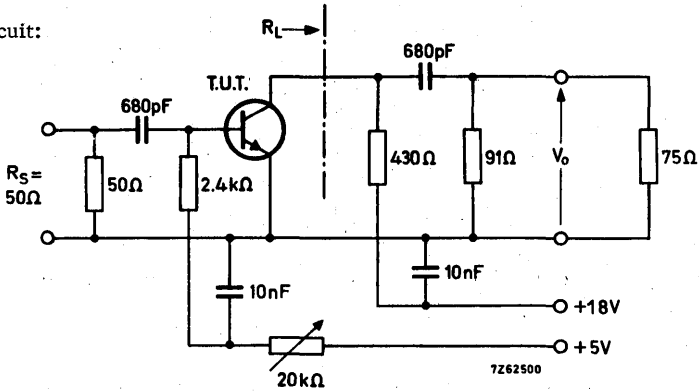

¹⁾ Crystal mounted in a BFW30 envelope.

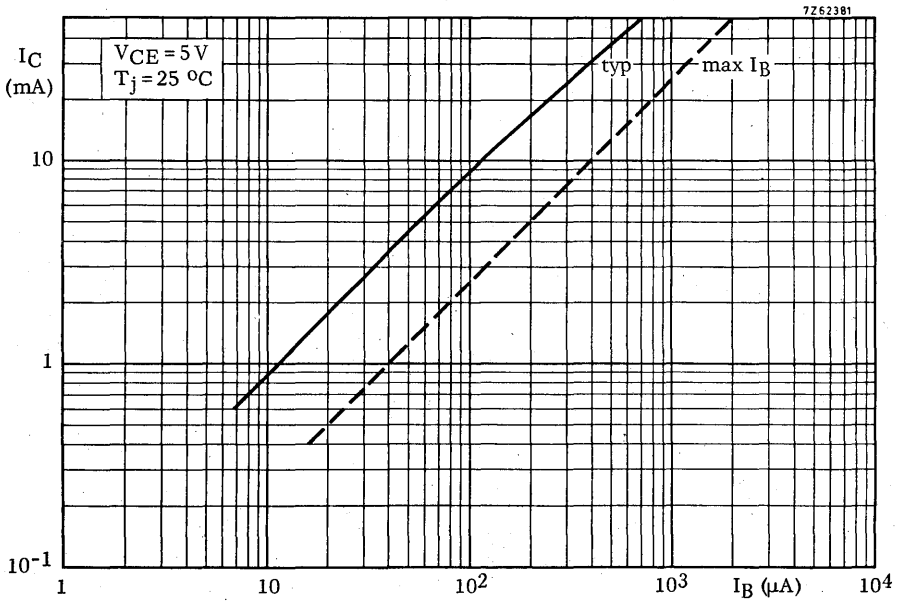
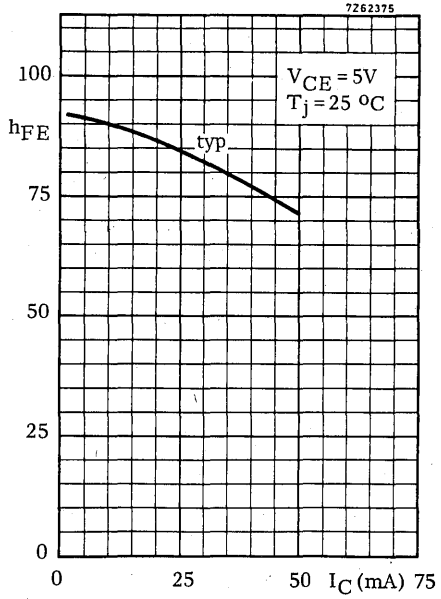
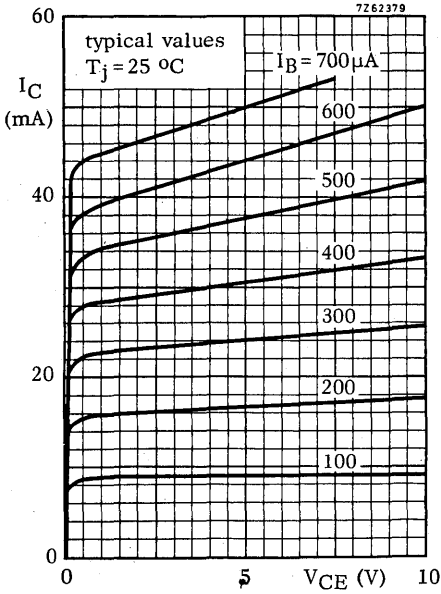

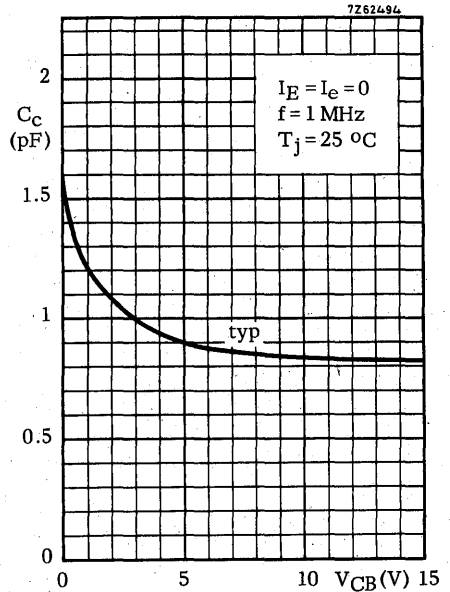
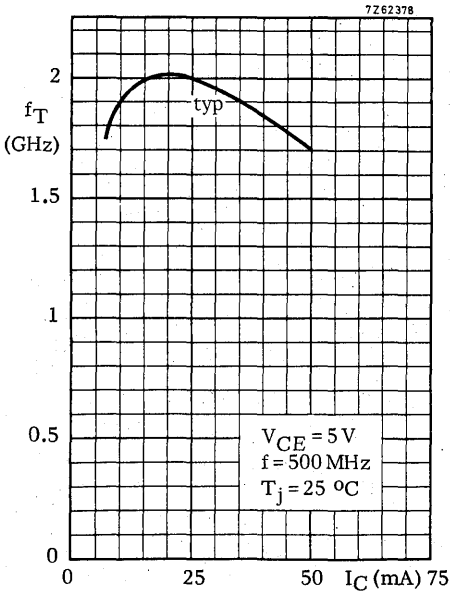
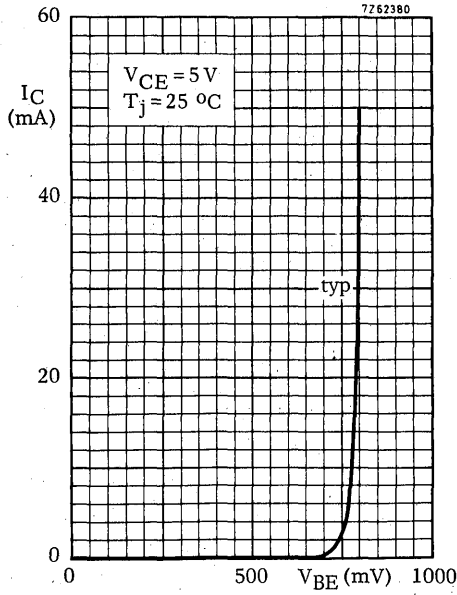

circles of constant noise figure

7262501

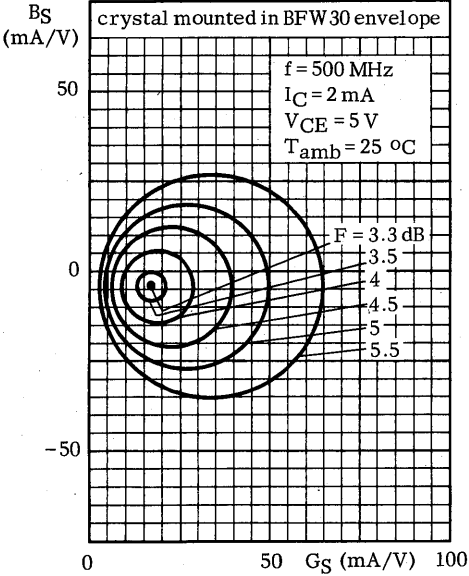

7262377

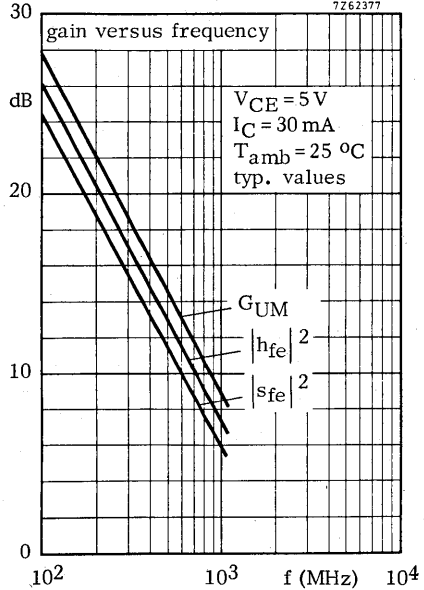

7262495

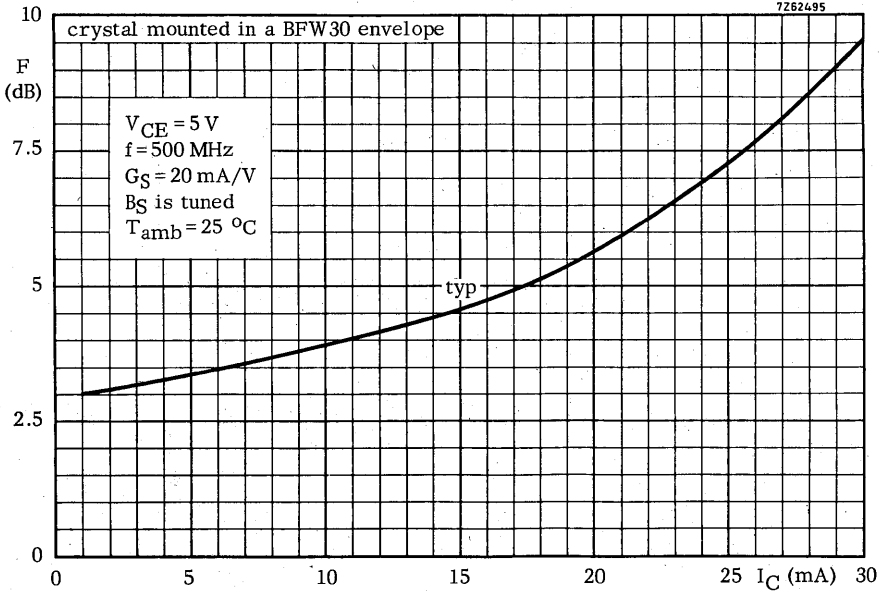

BFR53

$V_{CE} = 5 \text{ V}$
 $I_C = 30 \text{ mA}$
 $T_{amb} = 25 \text{ }^\circ\text{C}$

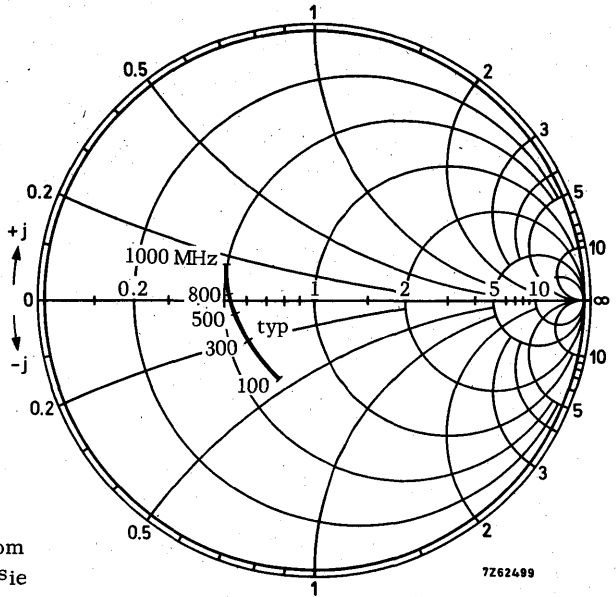

Input impedance derived from
 input reflection coefficient s_{ie}
 coordinates in ohm x 50

$V_{CE} = 5 \text{ V}$
 $I_C = 30 \text{ mA}$
 $T_{amb} = 25 \text{ }^\circ\text{C}$

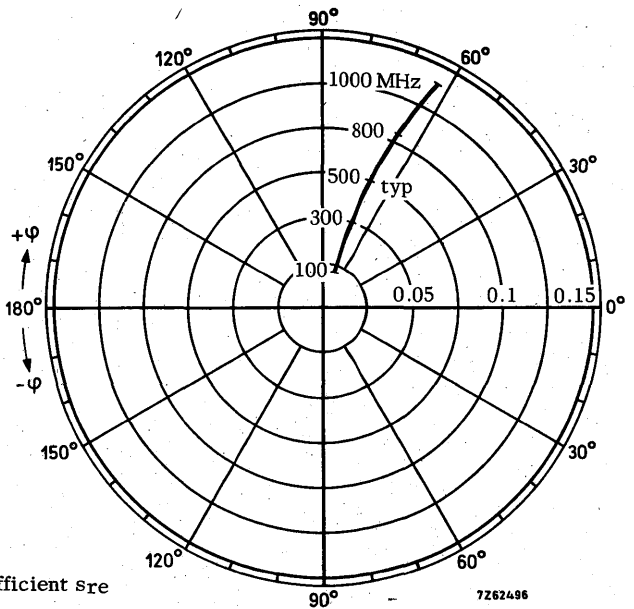

Reverse transmission coefficient s_{re}

$V_{CE} = 5\text{ V}$
 $I_C = 30\text{ mA}$
 $T_{amb} = 25\text{ }^\circ\text{C}$

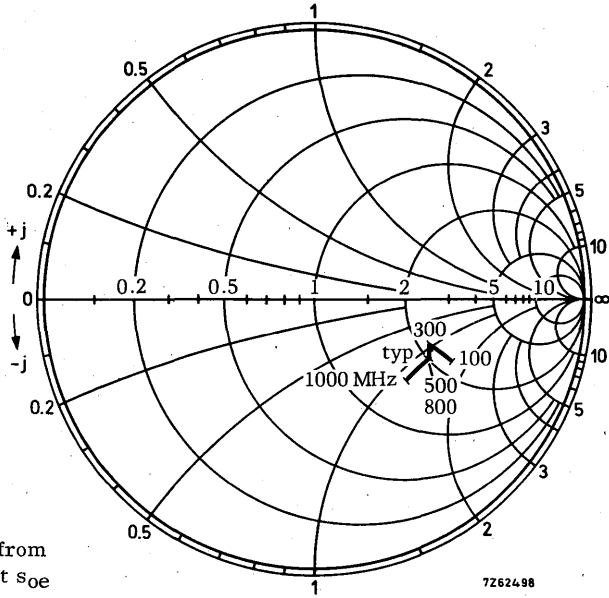

$V_{CE} = 5\text{ V}$
 $I_C = 30\text{ mA}$
 $T_{amb} = 25\text{ }^\circ\text{C}$

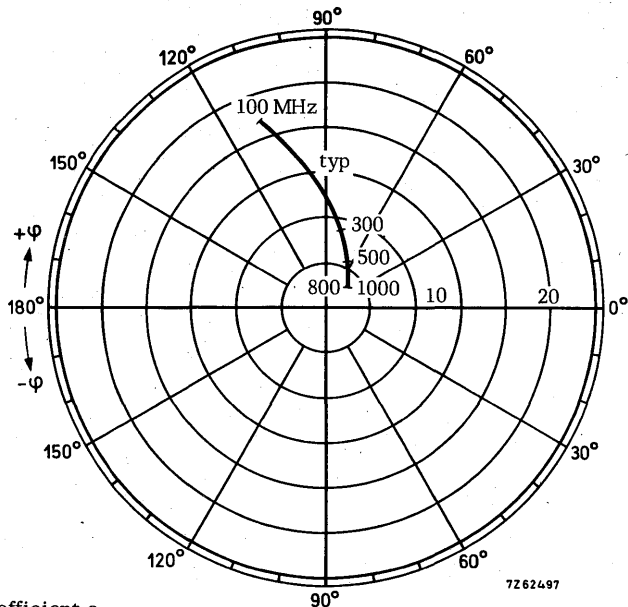

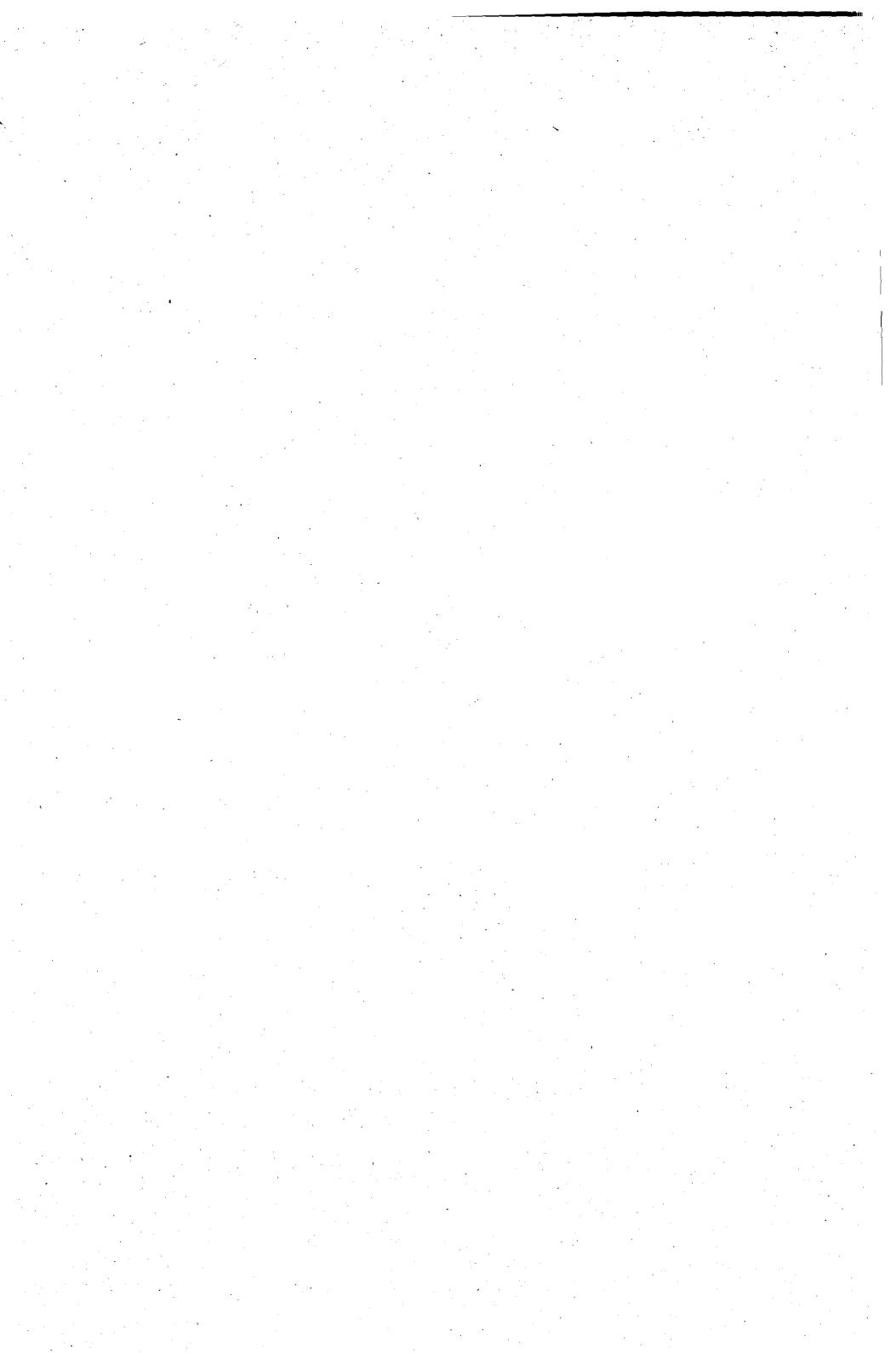

SILICON PLANAR EPITAXIAL TRANSISTOR

N-P-N transistor in a microminiature plastic envelope. It is primarily intended for use in u.h.f. and microwave amplifiers in thick and thin-film circuits, such as in aerial amplifiers, radar systems, oscilloscopes, spectrum analysers etc. The transistor features low intermodulation distortion and high power gain; thanks to its very high transition frequency, it also has excellent wideband properties and low noise up to high frequencies.

QUICK REFERENCE DATA

Collector-base voltage (open emitter)	V_{CBO}	max.	20 V
Collector-emitter voltage (open base)	V_{CEO}	max.	15 V
Collector current (d.c.)	I_C	max.	25 mA
Total power dissipation up to $T_{amb} = 60\text{ }^\circ\text{C}$	P_{tot}	max.	180 mW
Junction temperature	T_j	max.	150 $^\circ\text{C}$
Transition frequency at $f = 500\text{ MHz}$ $I_C = 14\text{ mA}$; $V_{CE} = 10\text{ V}$	f_T	typ.	5 GHz
Feedback capacitance at $f = 1\text{ MHz}$ $I_C = 2\text{ mA}$; $V_{CE} = 10\text{ V}$; $T_{amb} = 25\text{ }^\circ\text{C}$	C_{re}	typ.	0,7 pF
Noise figure at optimum source impedance $I_C = 2\text{ mA}$; $V_{CE} = 10\text{ V}$; $f = 500\text{ MHz}$; $T_{amb} = 25\text{ }^\circ\text{C}$	F	typ.	2,4 dB
Max. unilateral power gain (see page 3) $I_C = 14\text{ mA}$; $V_{CE} = 10\text{ V}$; $f = 500\text{ MHz}$; $T_{amb} = 25\text{ }^\circ\text{C}$	GUM	typ.	18 dB
Intermodulation distortion at $T_{amb} = 25\text{ }^\circ\text{C}$ $I_C = 14\text{ mA}$; $V_{CE} = 10\text{ V}$; $R_L = 75\text{ }\Omega$; $V_o = 150\text{ mV}$ $f_{(p+q-r)} = 493,25\text{ MHz}$ (see page 4)	d_{im}	typ.	-60 dB

MECHANICAL DATA

Fig. 1 SOT-23.

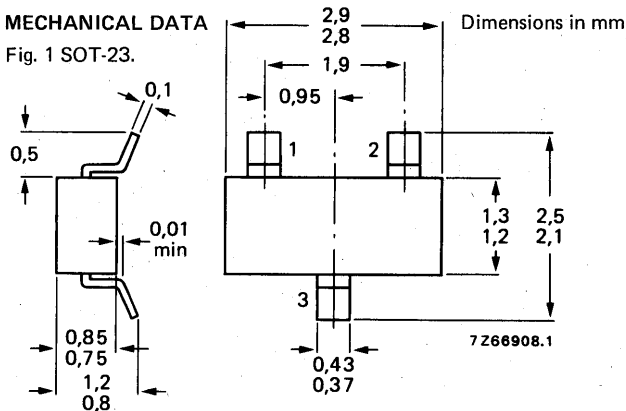

See also *Soldering recommendations*.

Marking code

BFR92 = P1

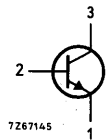

BFR92R = P4

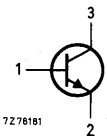

RATINGS Limiting values in accordance with the Absolute Maximum System (IEC134)Voltages

Collector-base voltage (open emitter)	V_{CBO}	max.	20	V
Collector-emitter voltage (open base)	V_{CEO}	max.	15	V
Emitter-base voltage (open collector)	V_{EBO}	max.	2,0	V

Current

Collector current (d. c.)	I_C	max.	25	mA
---------------------------	-------	------	----	----

Power dissipation

Total power dissipation up to $T_{amb} = 60\text{ }^{\circ}\text{C}$
mounted on a ceramic substrate of
15 mm x 10 mm x 0,5 mm

P_{tot}	max.	180	mW
-----------	------	-----	----

Temperatures

Storage temperature	T_{stg}	-65 to +150	$^{\circ}\text{C}$
Junction temperature	T_j	max. 150	$^{\circ}\text{C}$

THERMAL RESISTANCE

From junction to ambient in free air
mounted on a ceramic substrate of
15 mm x 10 mm x 0,5 mm

$R_{th\ j-a}$	=	0,5	$^{\circ}\text{C}/\text{mW}$
---------------	---	-----	------------------------------

CHARACTERISTICS

$T_j = 25\text{ }^\circ\text{C}$ unless otherwise specified

Collector cut-off current

$I_E = 0; V_{CB} = 10\text{ V}$

$I_{CBO} < 50\text{ nA}$

D. C. current gain ¹⁾

$I_C = 14\text{ mA}; V_{CE} = 10\text{ V}$

$h_{FE} > 25$
typ. 50

Transition frequency at $f = 500\text{ MHz}$ ¹⁾

$I_C = 14\text{ mA}; V_{CE} = 10\text{ V}$

f_T typ. 5 GHz

Collector capacitance at $f = 1\text{ MHz}$

$I_E = I_c = 0; V_{CB} = 10\text{ V}$

C_c typ. 0,75 pF

Emitter capacitance at $f = 1\text{ MHz}$

$I_C = I_c = 0; V_{EB} = 0,5\text{ V}$

C_e typ. 0,8 pF

Feedback capacitance at $f = 1\text{ MHz}$

$I_C = 2\text{ mA}; V_{CE} = 10\text{ V}; T_{amb} = 25\text{ }^\circ\text{C}$

C_{re} typ. 0,7 pF

Noise figure at optimum source impedance ²⁾

$I_C = 2\text{ mA}; V_{CE} = 10\text{ V}; f = 500\text{ MHz}; T_{amb} = 25\text{ }^\circ\text{C}$

F typ. 2,4 dB

Max. unilateral power gain (s_{re} assumed to be zero)

$$G_{UM} \text{ (in dB)} \hat{=} 10 \log \frac{|s_{fe}|^2}{(1 - |s_{ie}|^2)(1 - |s_{oe}|^2)}$$

$I_C = 14\text{ mA}; V_{CE} = 10\text{ V}; f = 500\text{ MHz}; T_{amb} = 25\text{ }^\circ\text{C}$

G_{UM} typ. 18 dB

1) Measured under pulse conditions.

2) Crystal mounted in a BFR90 envelope.

CHARACTERISTICS (continued)

Intermodulation distortion at $T_{amb} = 25\text{ }^{\circ}\text{C}$

$I_C = 14\text{ mA}$; $V_{CE} = 10\text{ V}$; $R_L = 75\text{ }\Omega$; V.S.W.R. < 2

$V_p = V_o = 150\text{ mV}$ at $f_p = 495,25\text{ MHz}$

$V_q = V_o - 6\text{ dB}$ at $f_q = 503,25\text{ MHz}$

$V_r = V_o - 6\text{ dB}$ at $f_r = 505,25\text{ MHz}$

Measured at $f_{(p+q-r)} = 493,25\text{ MHz}$

d_{im} typ. -60 dB

Intermodulation test circuit:

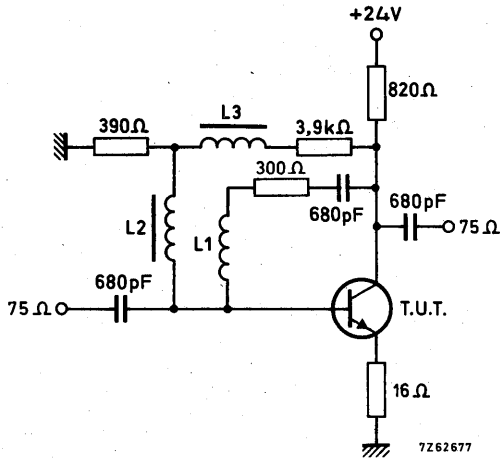

L1 = 4 turns Cu wire (0,35 mm); winding pitch 1 mm; int. diam. 4 mm

L2 = L3 = 5 μH (code number: 3122 108 20150)

7262669

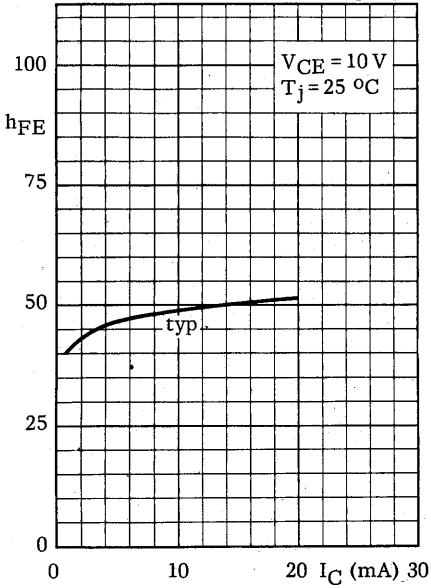

7262903

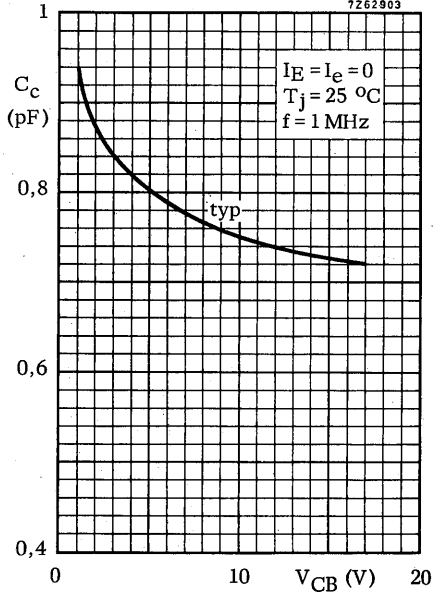

7262673

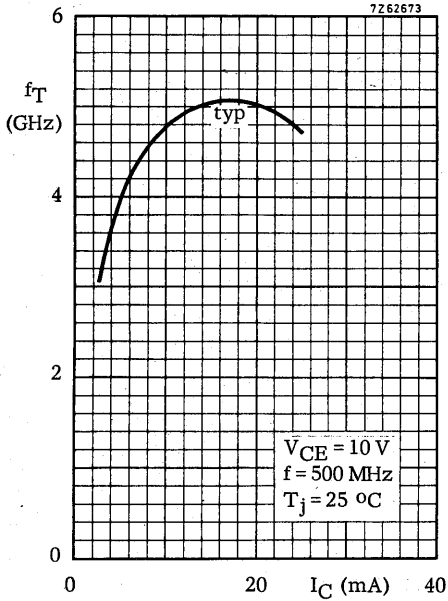

7262769

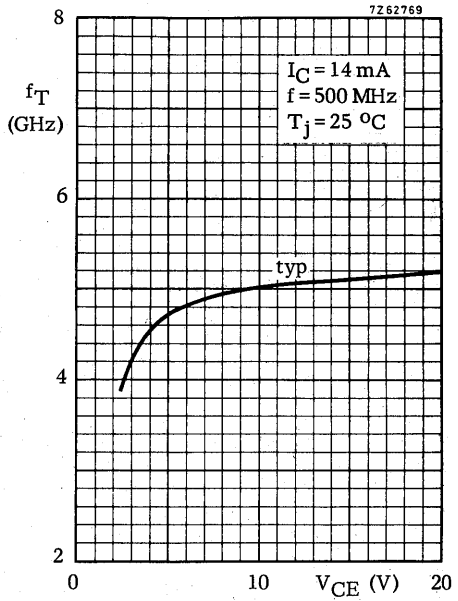

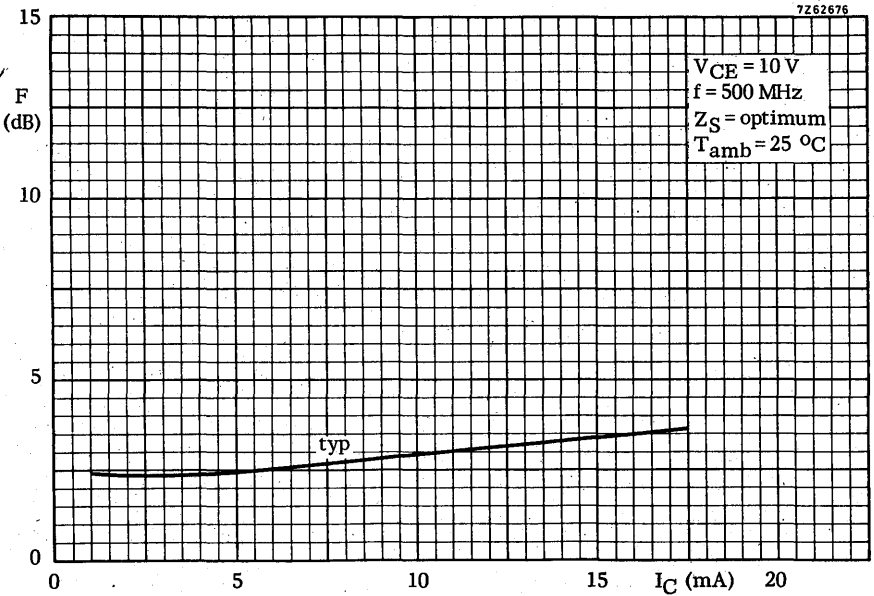
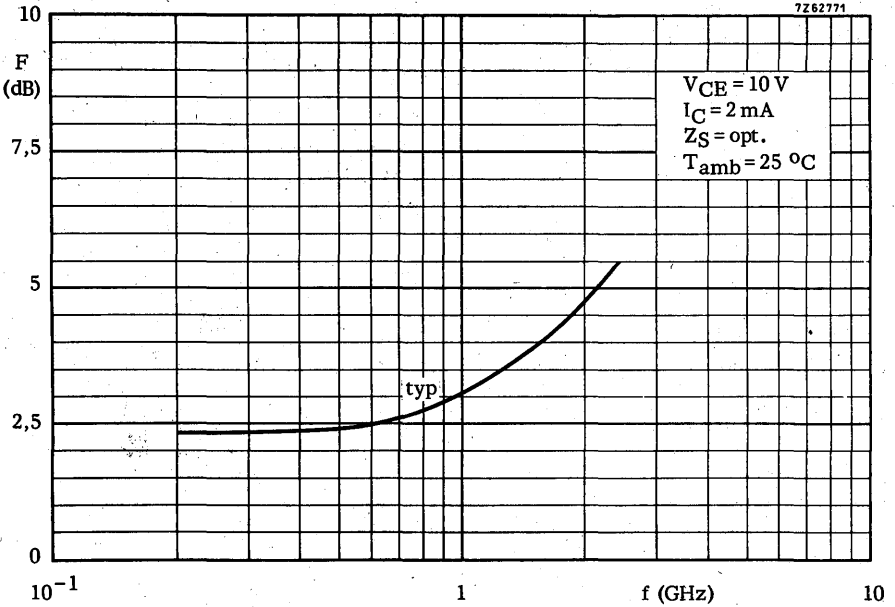

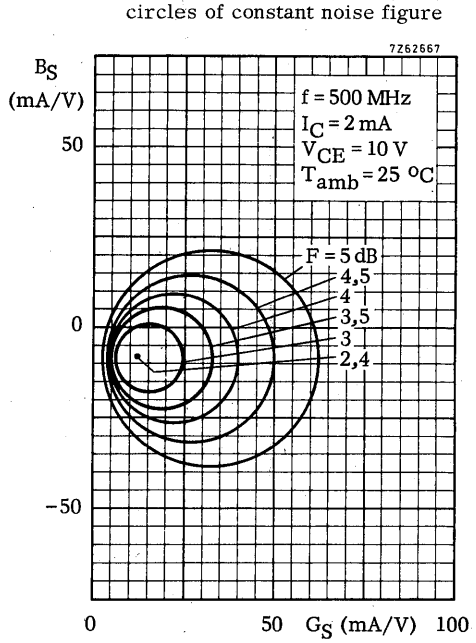
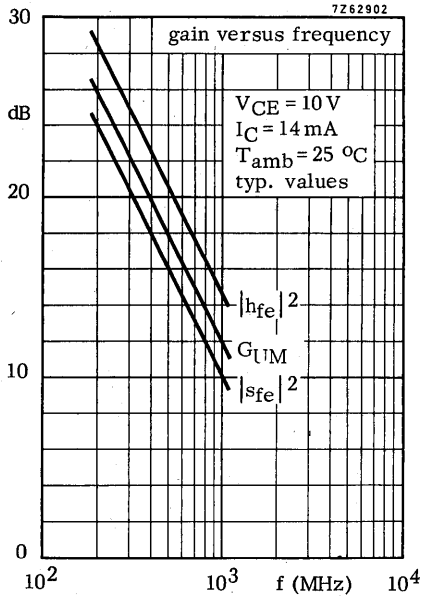

BFR92

$V_{CE} = 10 \text{ V}$
 $I_C = 14 \text{ mA}$
 $T_{amb} = 25 \text{ }^\circ\text{C}$

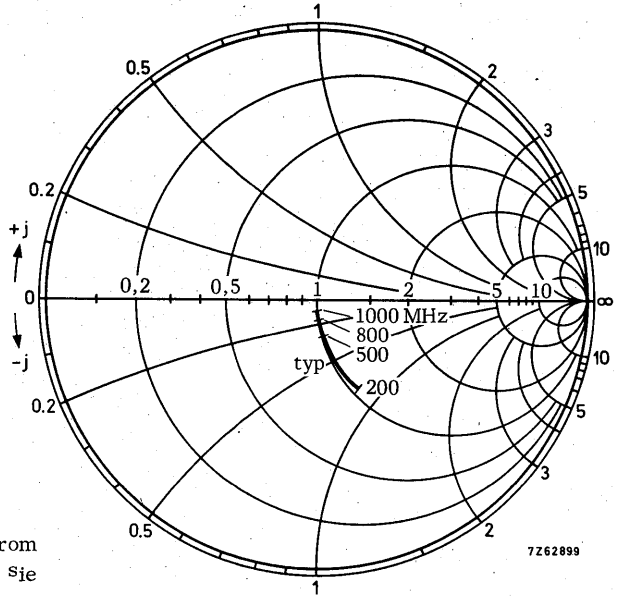

Input impedance derived from
 input reflection coefficient s_{ie}
 coordinates in ohm $\times 50$

$V_{CE} = 10 \text{ V}$
 $I_C = 14 \text{ mA}$
 $T_{amb} = 25 \text{ }^\circ\text{C}$

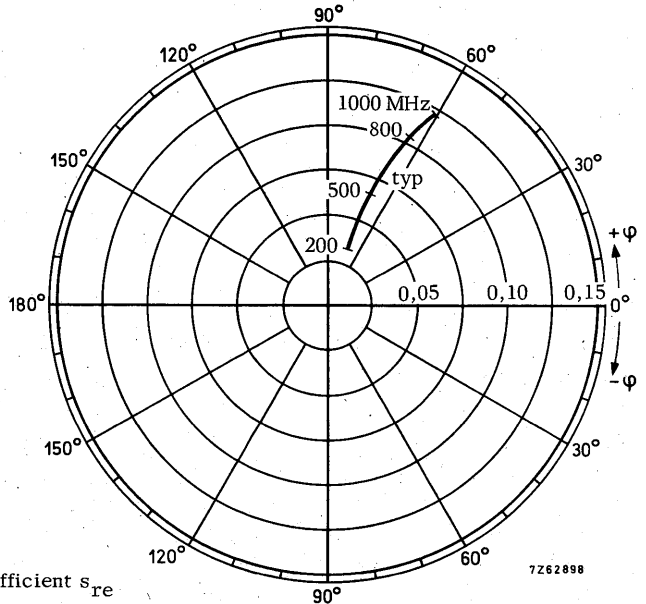

Reverse transmission coefficient s_{re}

$V_{CE} = 10\text{ V}$
 $I_C = 14\text{ mA}$
 $T_{amb} = 25\text{ }^\circ\text{C}$

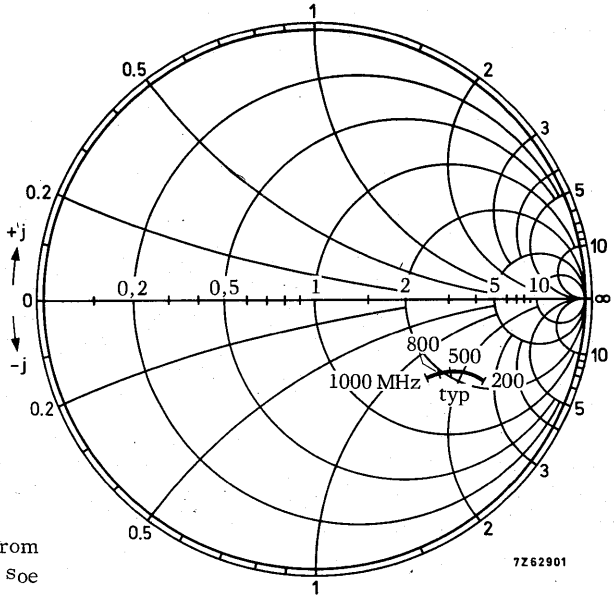

$V_{CE} = 10\text{ V}$
 $I_C = 14\text{ mA}$
 $T_{amb} = 25\text{ }^\circ\text{C}$

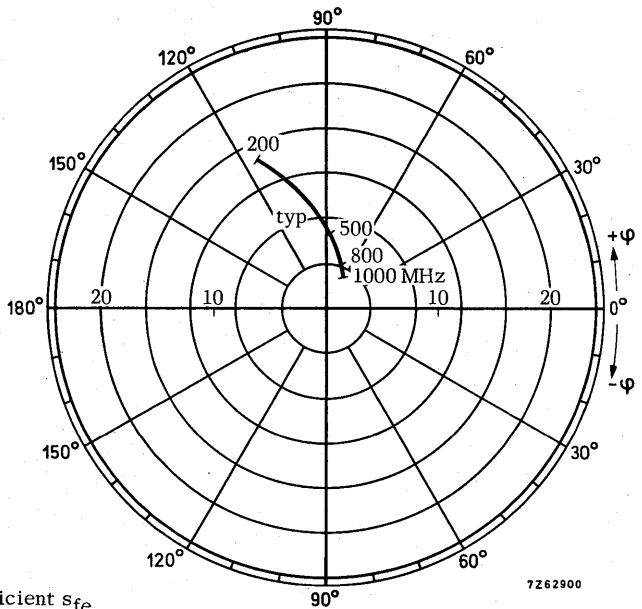

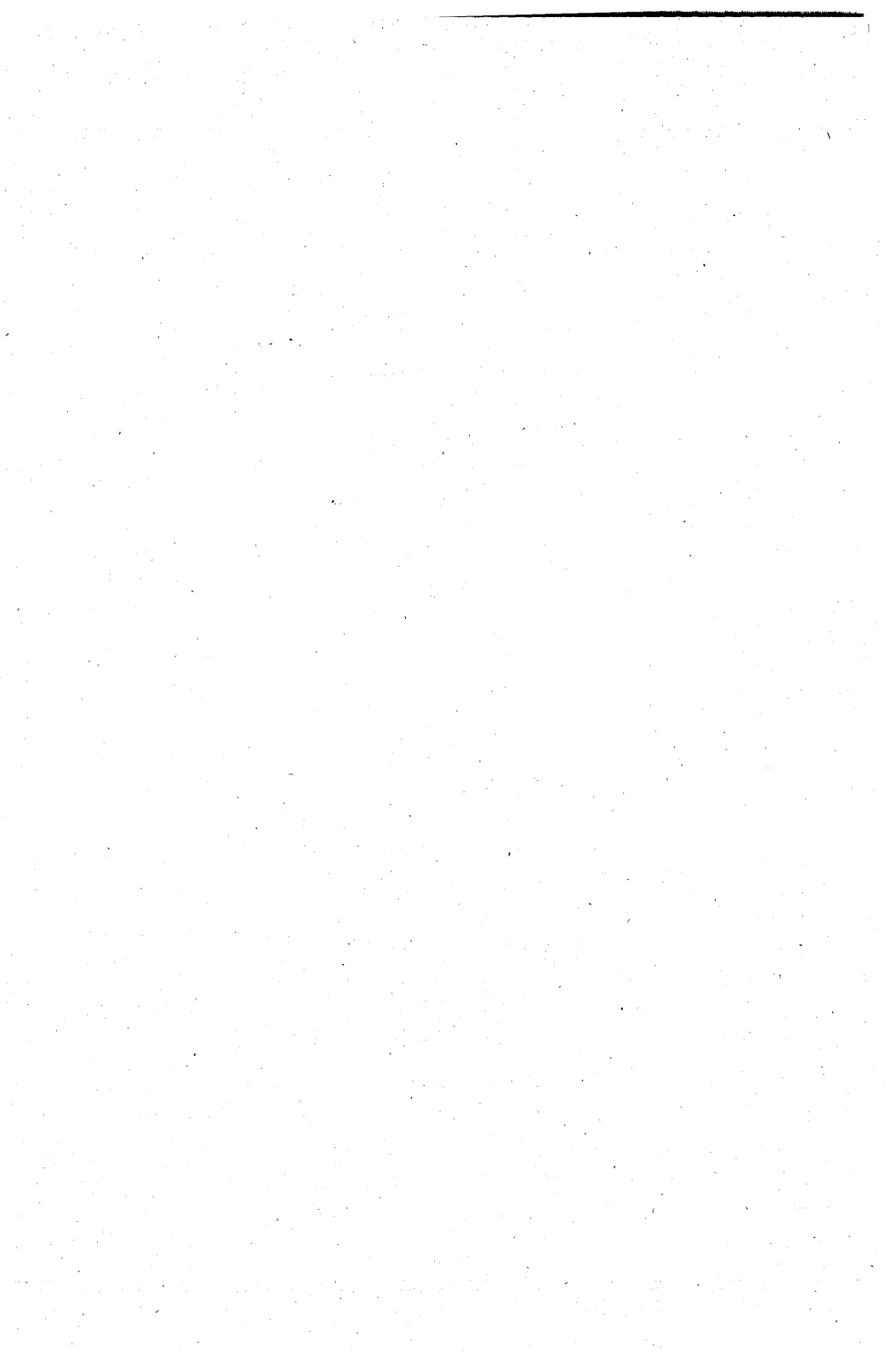

SILICON PLANAR EPITAXIAL TRANSISTOR

N-P-N transistor in a microminiature plastic envelope. It is primarily intended for use in u.h.f. and microwave amplifiers in thick and thin-film circuits, such as in aerial amplifiers, radar systems, oscilloscopes, spectrum analysers etc. The transistor features very low intermodulation distortion and high power gain; thanks to its very high transition frequency, it also has excellent wideband properties and low noise up to high frequencies.

QUICK REFERENCE DATA

Collector-base voltage (open emitter)	V_{CBO}	max.	15 V
Collector-emitter voltage (open base)	V_{CEO}	max.	12 V
Collector current (d.c.)	I_C	max.	35 mA
Total power dissipation up to $T_{amb} = 60\text{ }^\circ\text{C}$	P_{tot}	max.	180 mW
Junction temperature	T_j	max.	150 $^\circ\text{C}$
Transition frequency at $f = 500\text{ MHz}$ $I_C = 30\text{ mA}$; $V_{CE} = 5\text{ V}$	f_T	typ.	5 GHz
Feedback capacitance at $f = 1\text{ MHz}$ $I_C = 2\text{ mA}$; $V_{CE} = 5\text{ V}$; $T_{amb} = 25\text{ }^\circ\text{C}$	C_{re}	typ.	0,8 pF
Noise figure at optimum source impedance $I_C = 2\text{ mA}$; $V_{CE} = 5\text{ V}$; $f = 500\text{ MHz}$; $T_{amb} = 25\text{ }^\circ\text{C}$	F	typ.	1,9 dB
Max. unilateral power gain (see page 3) $I_C = 30\text{ mA}$; $V_{CE} = 5\text{ V}$; $f = 500\text{ MHz}$; $T_{amb} = 25\text{ }^\circ\text{C}$	GUM	typ.	16,5 dB
Intermodulation distortion at $T_{amb} = 25\text{ }^\circ\text{C}$ $I_C = 30\text{ mA}$; $V_{CE} = 5\text{ V}$; $R_L = 75\text{ }\Omega$; $V_o = 300\text{ mV}$ $f(p+q-r) = 493,25\text{ MHz}$ (see page 4)	d_{im}	typ.	-60 dB

MECHANICAL DATA

Fig. 1 SOT-23.

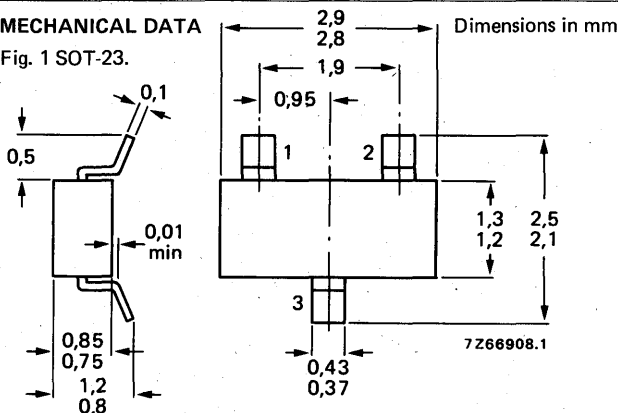

Marking code

BFR93 = R1

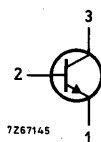

7Z67145

BFR93R = R4

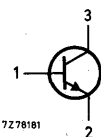

7Z78181

See also *Soldering recommendations*.

RATINGS Limiting values in accordance with the Absolute Maximum System (IEC134)

Voltages

Collector-base voltage (open emitter)	V_{CBO}	max.	15	V
Collector-emitter voltage (open base)	V_{CEO}	max.	12	V
Emitter-base voltage (open collector)	V_{EBO}	max.	2,0	V

Current

Collector current (d.c.)	I_C	max.	35	mA
--------------------------	-------	------	----	----

Power dissipation

Total power dissipation up to $T_{amb} = 60\text{ }^{\circ}\text{C}$
mounted on a ceramic substrate of
15 mm x 10 mm x 0,5 mm

P_{tot}	max.	180	mW
-----------	------	-----	----

Temperatures

Storage temperature	T_{stg}	-65 to +150	$^{\circ}\text{C}$
Junction temperature	T_j	max. 150	$^{\circ}\text{C}$

THERMAL RESISTANCE

From junction to ambient in free air
mounted on a ceramic substrate of
15 mm x 10 mm x 0,5 mm

$R_{th\ j-a}$	=	0,50	$^{\circ}\text{C}/\text{mW}$
---------------	---	------	------------------------------

CHARACTERISTICS

$T_j = 25\text{ }^\circ\text{C}$ unless otherwise specified

Collector cut-off current

$I_E = 0; V_{CB} = 10\text{ V}$

$I_{CBO} < 50\text{ nA}$

D.C. current gain ¹⁾

$I_C = 30\text{ mA}; V_{CE} = 5\text{ V}$

$h_{FE} > 25$
typ. 50

Transition frequency at $f = 500\text{ MHz}$ ¹⁾

$I_C = 30\text{ mA}; V_{CE} = 5\text{ V}$

f_T typ. 5 GHz

Collector capacitance at $f = 1\text{ MHz}$

$I_E = I_e = 0; V_{CB} = 10\text{ V}$

C_c typ. 0,7 pF

Emitter capacitance at $f = 1\text{ MHz}$

$I_C = I_c = 0; V_{EB} = 0,5\text{ V}$

C_e typ. 1,8 pF

Feedback capacitance at $f = 1\text{ MHz}$

$I_C = 2\text{ mA}; V_{CE} = 5\text{ V}; T_{amb} = 25\text{ }^\circ\text{C}$

C_{re} typ. 0,8 pF

Noise figure at optimum source impedance ²⁾

$I_C = 2\text{ mA}; V_{CE} = 5\text{ V}; f = 500\text{ MHz}; T_{amb} = 25\text{ }^\circ\text{C}$

F typ. 1,9 dB

Max. unilateral power gain (s_{re} assumed to be zero)

$$G_{UM} \text{ (in dB)} = 10 \log \frac{|s_{fe}|^2}{(1 - |s_{ie}|^2)(1 - |s_{oe}|^2)}$$

$I_C = 30\text{ mA}; V_{CE} = 5\text{ V}; f = 500\text{ MHz}; T_{amb} = 25\text{ }^\circ\text{C}$

G_{UM} typ. 16,5 dB

¹⁾ Measured under pulse conditions.

²⁾ Crystal mounted in a BFR91 envelope.



CHARACTERISTICS (continued)

Intermodulation distortion at $T_{amb} = 25\text{ }^\circ\text{C}$

$I_C = 30\text{ mA}$; $V_{CE} = 5\text{ V}$; $R_L = 75\ \Omega$; V. S. W. R. < 2

$V_p = V_o = 300\text{ mV}$ at $f_p = 495, 25\text{ MHz}$

$V_q = V_o - 6\text{ dB}$ at $f_q = 503, 25\text{ MHz}$

$V_r = V_o - 6\text{ dB}$ at $f_r = 505, 25\text{ MHz}$

Measured at $f_{(p+q-r)} = 493, 25\text{ MHz}$

d_{im} typ. -60 dB ¹⁾

Intermodulation test circuit:

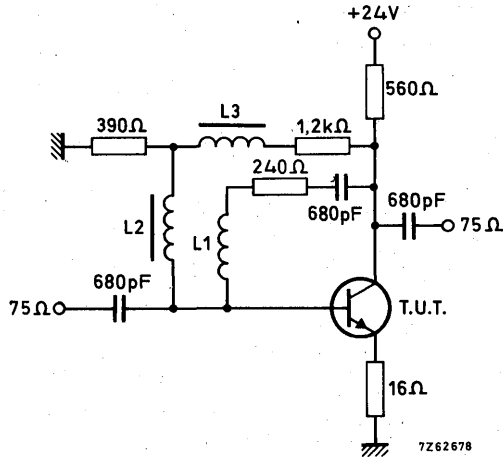

L1 = 4 turns Cu wire (0,35); winding pitch 1 mm; int. diam. 4 mm
 L2 and L3 5 μH (code number: 3122 108 20150)

1) Crystal mounted in a BFR91 envelope.

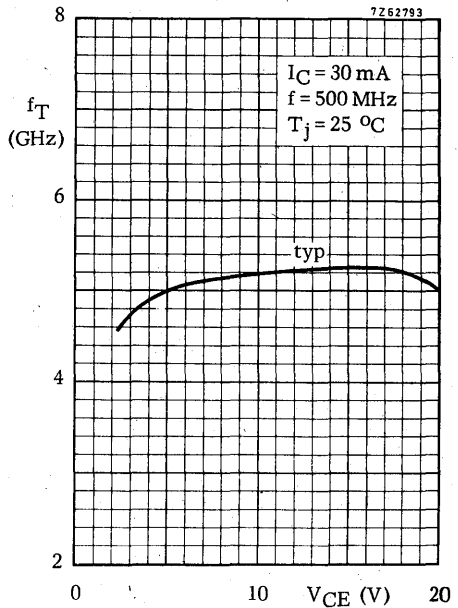
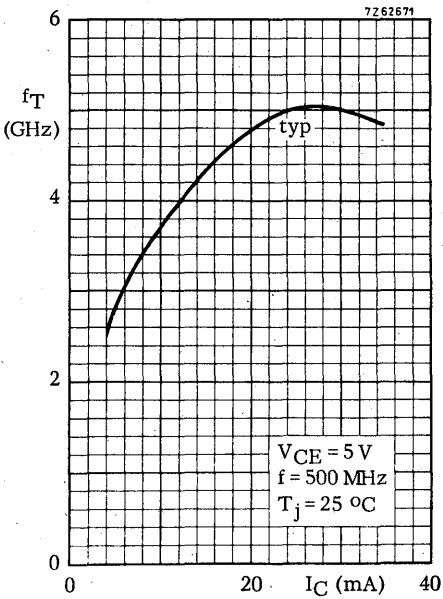
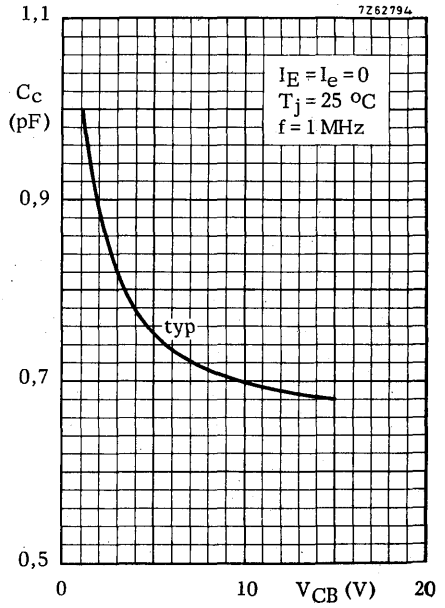
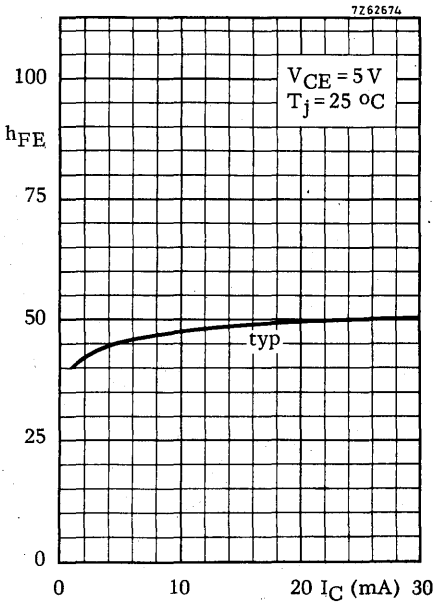

7262799

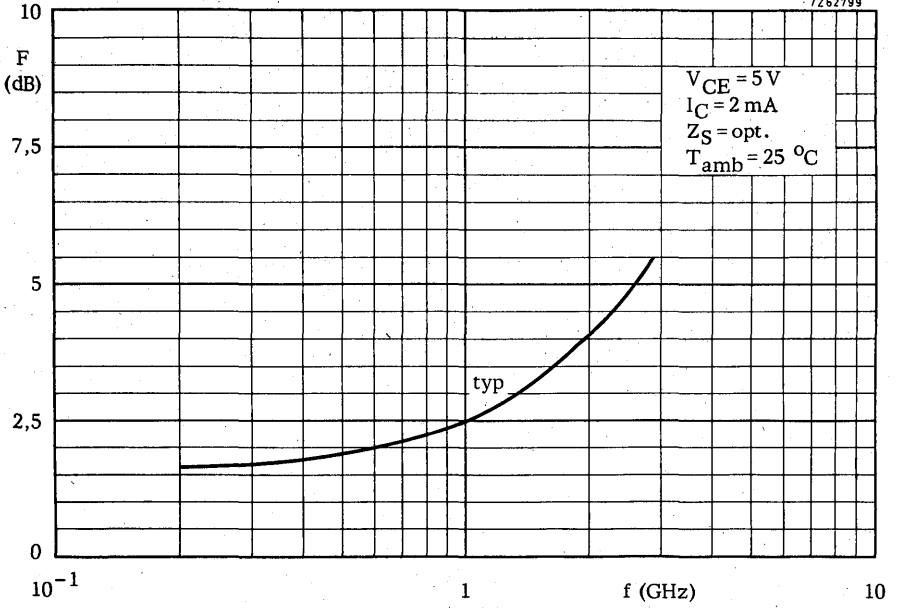

7262675

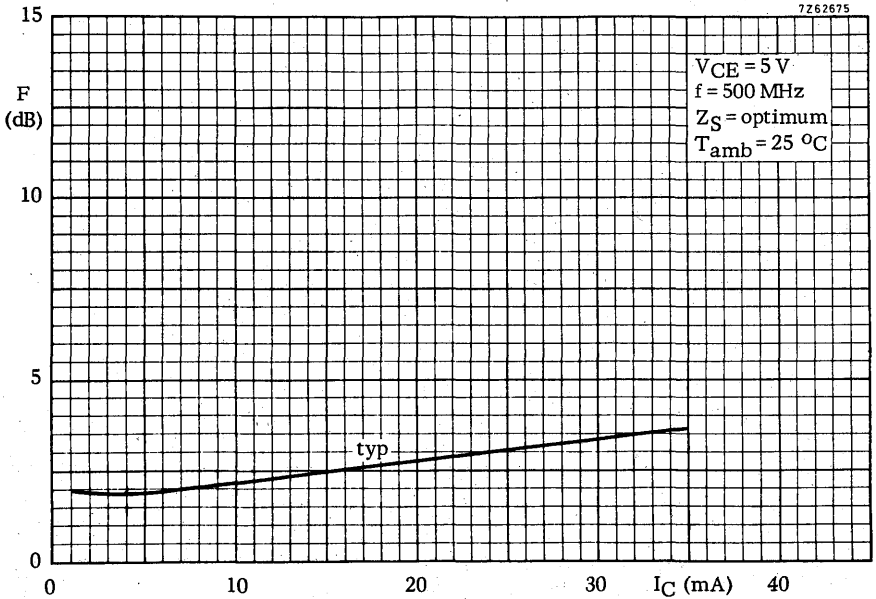

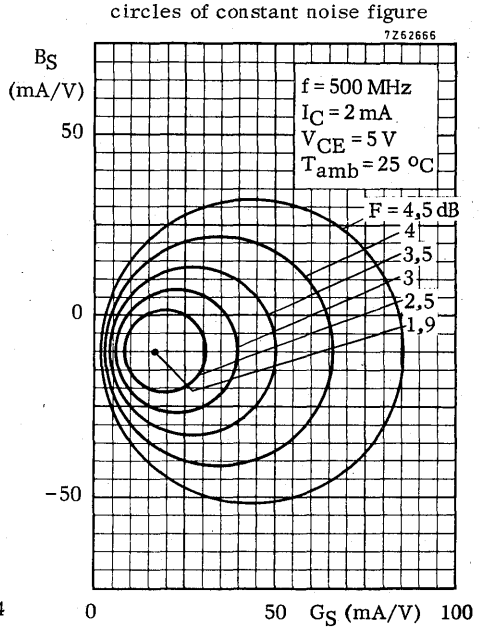
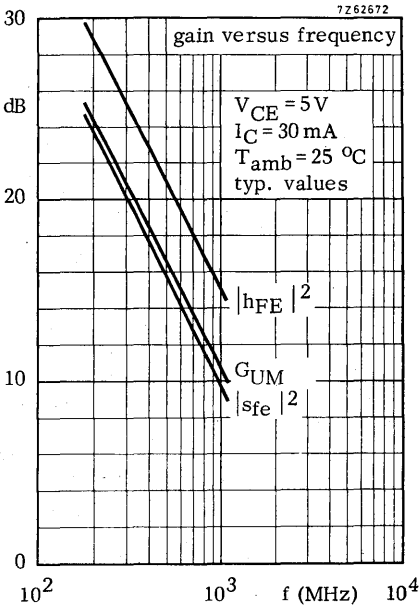

BFR93

$V_{CE} = 5 \text{ V}$
 $I_C = 30 \text{ mA}$
 $T_{amb} = 25 \text{ }^\circ\text{C}$

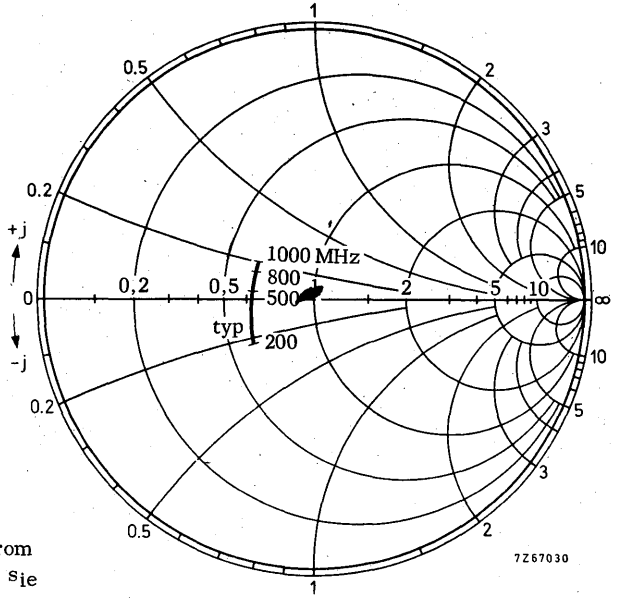

Input impedance derived from
 input reflection coefficient s_{ie}
 coordinates in ohm x 50

$V_{CE} = 5 \text{ V}$
 $I_C = 30 \text{ mA}$
 $T_{amb} = 25 \text{ }^\circ\text{C}$

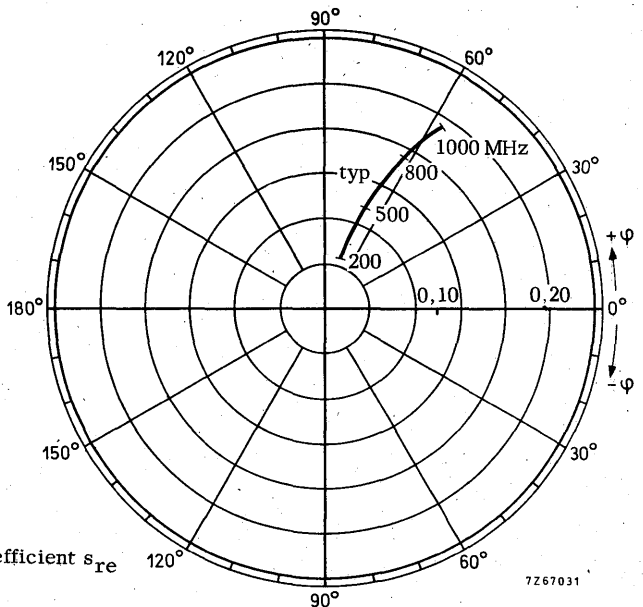

Reverse transmission coefficient s_{re}

$V_{CE} = 5\text{ V}$
 $I_C = 30\text{ mA}$
 $T_{amb} = 25\text{ }^\circ\text{C}$

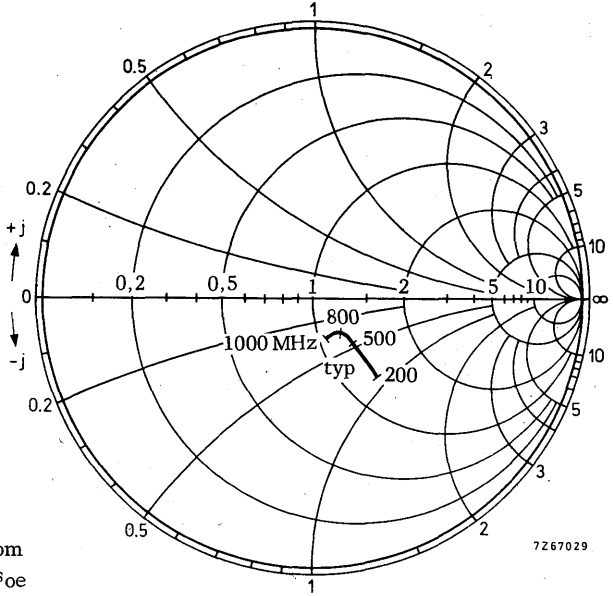

$V_{CE} = 5\text{ V}$
 $I_C = 30\text{ mA}$
 $T_{amb} = 25\text{ }^\circ\text{C}$

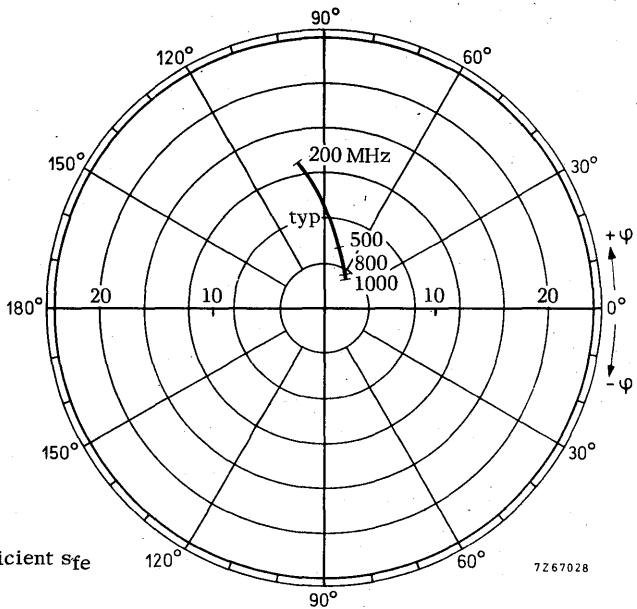

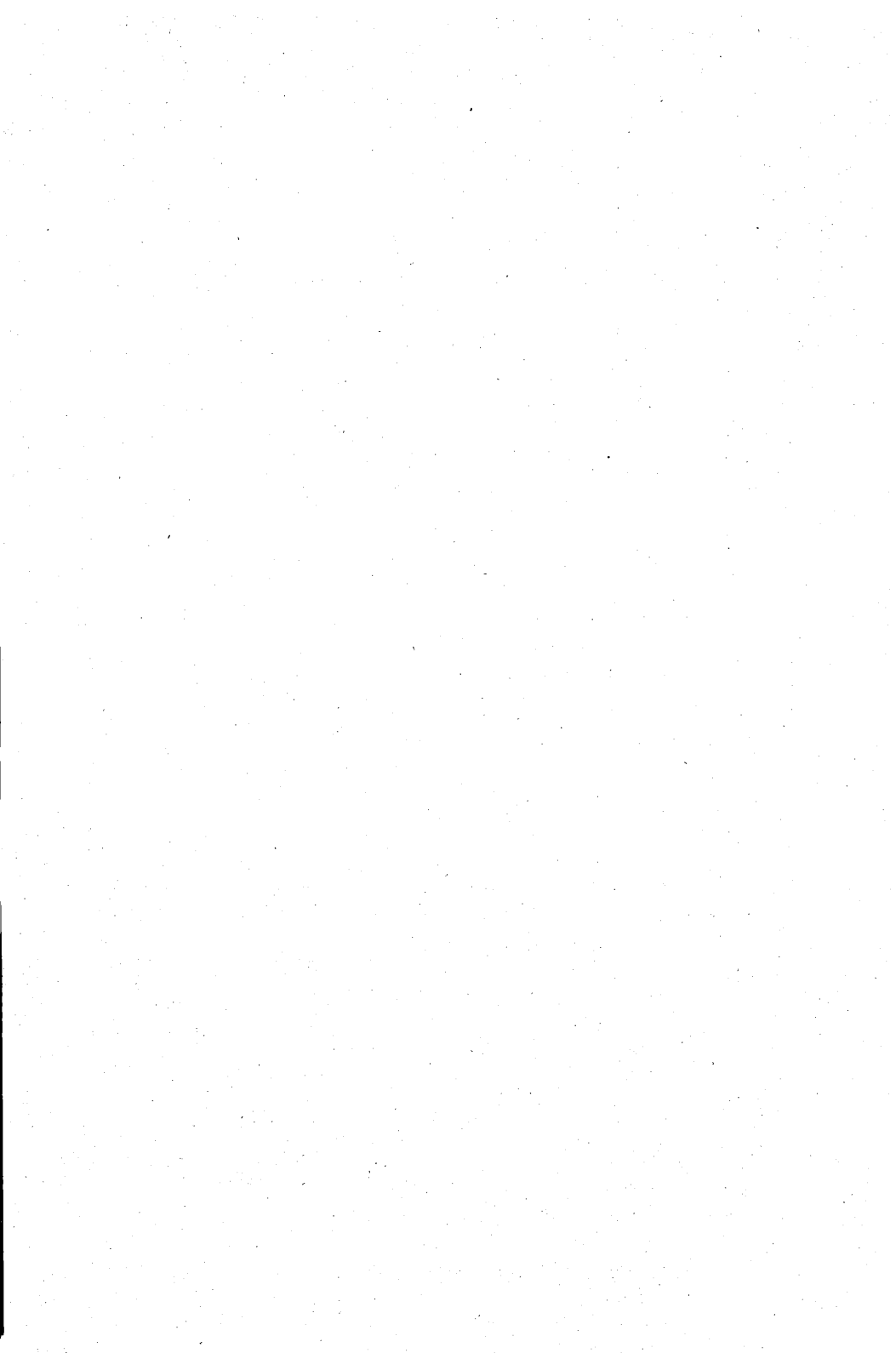

SILICON PLANAR EPITAXIAL TRANSISTOR

N-P-N transistor in a microminiature plastic envelope. It is intended for a wide range of v.h.f. and u.h.f. applications in thick and thin-film circuits.

QUICK REFERENCE DATA

Collector-base voltage (open emitter; peak value)	V_{CBOM} max.	25 V
Collector-emitter voltage (open base)	V_{CEO} max.	15 V
Collector current (peak value)	I_{CM} max.	50 mA
Total power dissipation up to $T_{amb} = 25\text{ }^{\circ}\text{C}$	P_{tot} max.	200 mW
Junction temperature	T_j max.	150 $^{\circ}\text{C}$
D.C. current gain	h_{FE}	20 to 150
$I_C = 2\text{ mA}; V_{CE} = 1\text{ V}$		
Transition frequency	f_T typ.	1,3 GHz
$I_C = 25\text{ mA}; V_{CE} = 5\text{ V}; f = 500\text{ MHz}$		
Noise figure	F	typ. 4,5 dB
$I_C = 2\text{ mA}; V_{CE} = 5\text{ V}; R_S = 50\text{ }\Omega; f = 500\text{ MHz}$		

MECHANICAL DATA

Fig. 1 SOT-23.

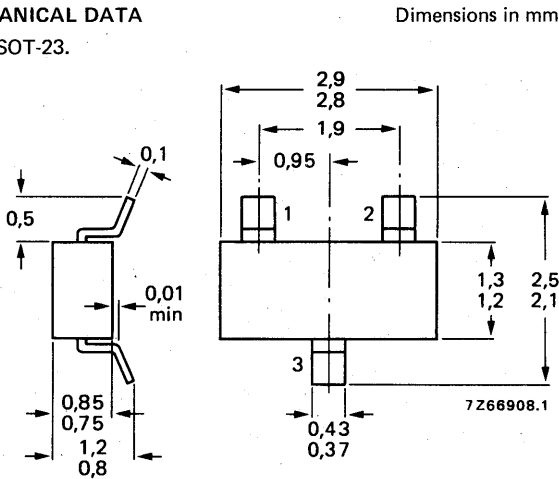

Marking code

BFS17 = E1

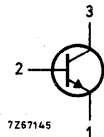

BFS17R = E4

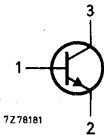

See also *Soldering recommendations*.

RATINGS Limiting values in accordance with the Absolute Maximum System (IEC134)

Voltages

Collector-base voltage (open emitter; peak value)	V_{CBOM}	max.	25 V
Collector-emitter voltage (open base) $I_C = 10 \text{ mA}$	V_{CEO}	max.	15 V
Emitter-base voltage (open collector)	V_{EBO}	max.	2.5 V

Currents

Collector current (d.c.)	I_C	max.	25 mA
Collector current (peak value)	I_{CM}	max.	50 mA

Power dissipation

Total power dissipation up to $T_{amb} = 25 \text{ }^\circ\text{C}$ mounted on a ceramic substrate of 7 mm x 5 mm x 0.5 mm	P_{tot}	max.	200 mW
--	-----------	------	--------

Temperatures

Storage temperature	T_{stg}	-65 to +150	$^\circ\text{C}$
Junction temperature	T_j	max.	150 $^\circ\text{C}$

THERMAL RESISTANCE

From junction to ambient mounted on a ceramic substrate of 7 mm x 5 mm x 0.5 mm	$R_{th \text{ j-a}}$	=	0.62 $^\circ\text{C}/\text{mW}$
---	----------------------	---	---------------------------------

CHARACTERISTICS

$T_j = 25 \text{ }^\circ\text{C}$ unless otherwise specified

Collector cut-off current

$I_E = 0; V_{CB} = 10 \text{ V}$	I_{CBO}	<	10 nA
$I_E = 0; V_{CB} = 10 \text{ V}; T_j = 100 \text{ }^\circ\text{C}$	I_{CBO}	<	10 μA

D.C. current gain

$I_C = 2 \text{ mA}; V_{CE} = 1 \text{ V}$	h_{FE}	20 to 150
$I_C = 25 \text{ mA}; V_{CE} = 1 \text{ V}$	h_{FE}	> 20

CHARACTERISTICS (continued)

$T_j = 25\text{ }^\circ\text{C}$ unless otherwise specified

Transition frequency

$I_C = 2\text{ mA}; V_{CE} = 5\text{ V}; f = 500\text{ MHz}$	f_T	typ.	1.0 GHz
$I_C = 25\text{ mA}; V_{CE} = 5\text{ V}; f = 500\text{ MHz}$	f_T	typ.	1.3 GHz

Collector capacitance at $f = 1\text{ MHz}$

$I_E = I_e = 0; V_{CB} = 10\text{ V}$	C_c	<	1.5 pF
---------------------------------------	-------	---	--------

Emitter capacitance at $f = 1\text{ MHz}$

$I_C = I_c = 0; V_{EB} = 0.5\text{ V}$	C_e	<	2.0 pF
--	-------	---	--------

Feedback capacitance at $f = 1\text{ MHz}$

$I_C = 2\text{ mA}; V_{CE} = 5\text{ V}$	C_{re}	typ.	0.65 pF
--	----------	------	---------

Noise figure

$I_C = 2\text{ mA}; V_{CE} = 5\text{ V}$ $f = 500\text{ MHz}; R_S = 50\text{ }\Omega$	F	typ.	4.5 dB ¹⁾
--	-----	------	----------------------

Intermodulation distortion

$I_C = 10\text{ mA}; V_{CE} = 6\text{ V}; R_L = 37.5\text{ }\Omega; T_{amb} = 25\text{ }^\circ\text{C}$ $V_o = 100\text{ mV}$ at $f_p = 183\text{ MHz}$ $V_o = 100\text{ mV}$ at $f_q = 200\text{ MHz}$ measured at $f(2q-p) = 217\text{ MHz}$	dim	typ.	-45 dB
---	-------	------	--------

¹⁾ Crystal mounted in a BFY90 envelope.

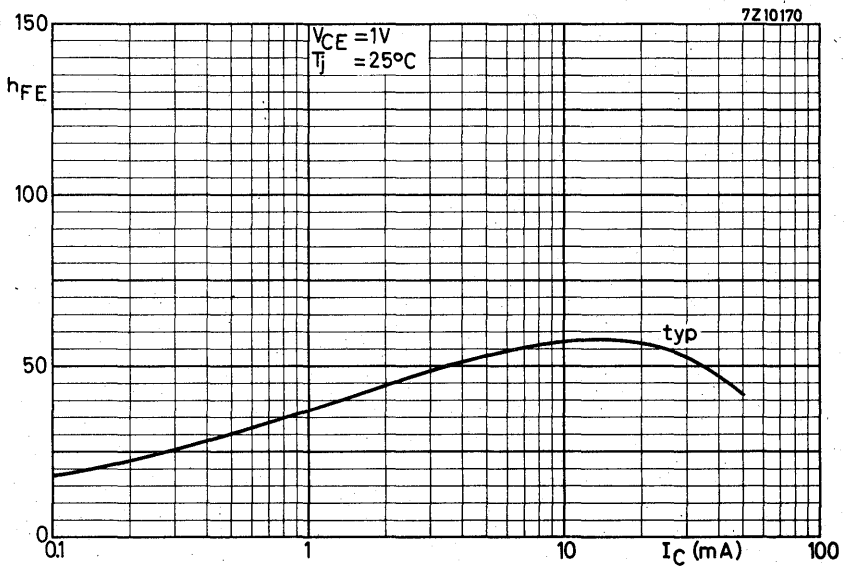
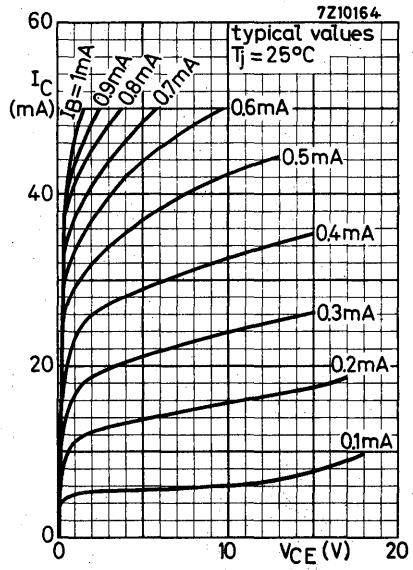
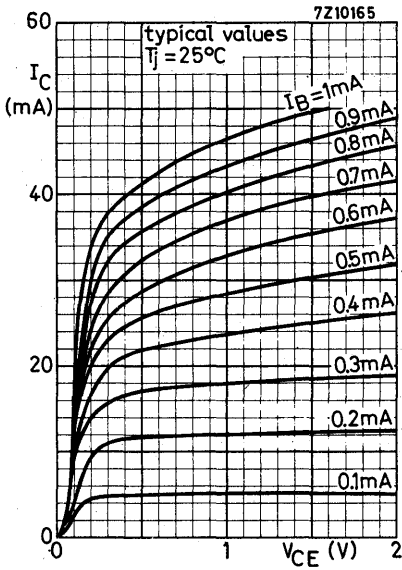

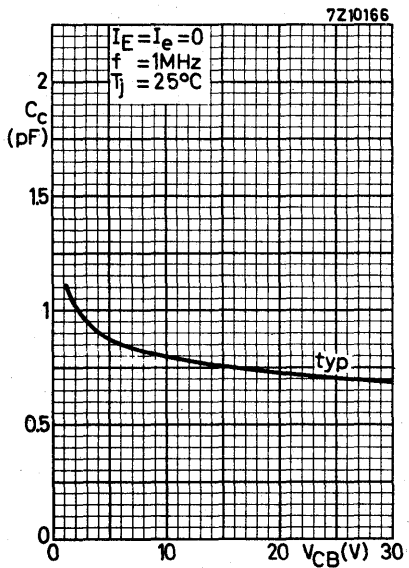
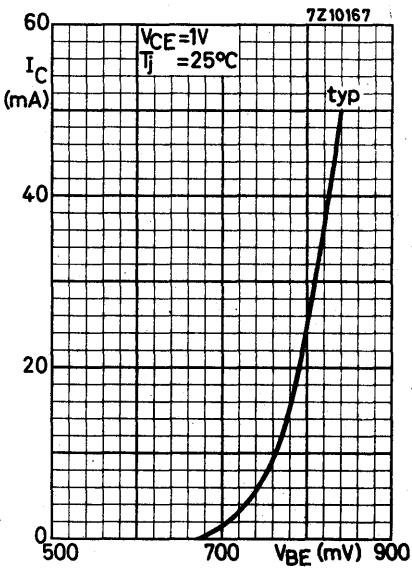
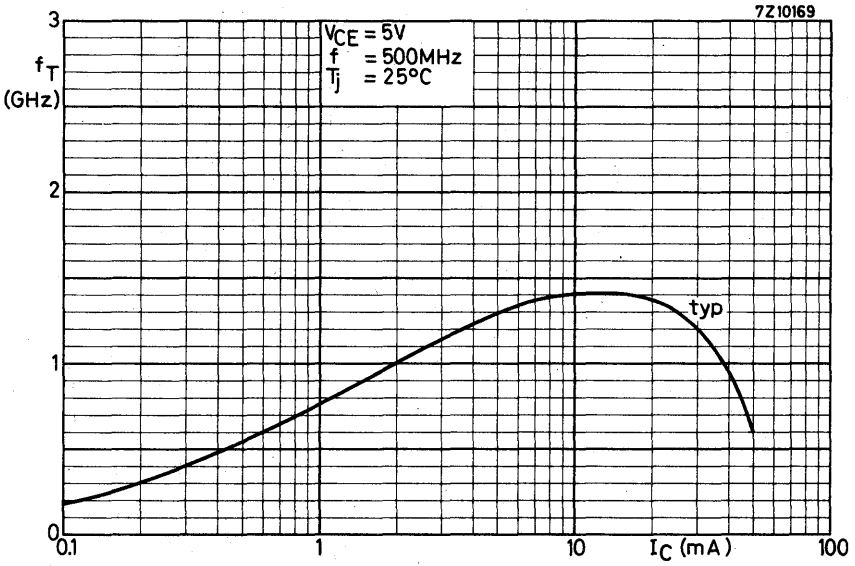

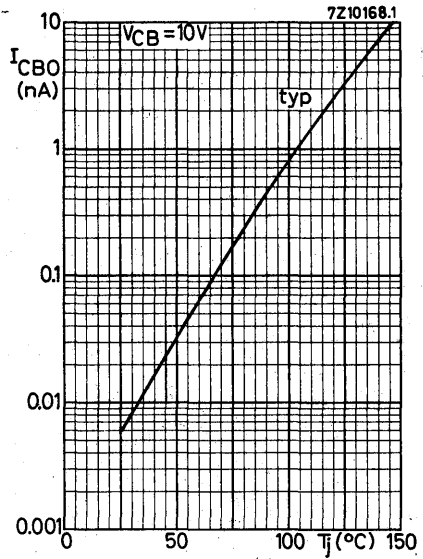
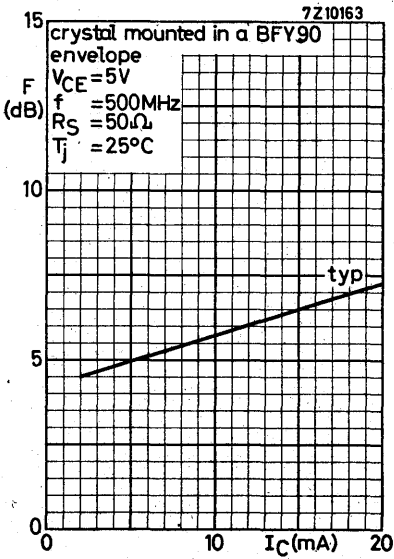
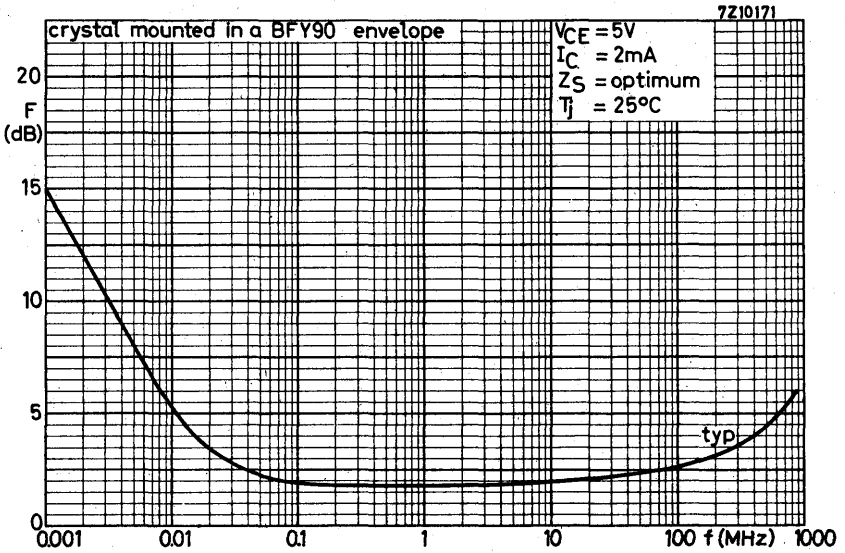

SILICON PLANAR EPITAXIAL TRANSISTORS

N-P-N transistors in a microminiature plastic envelope. They are intended for general purpose and h.f. applications in thick and thin-film circuits.

QUICK REFERENCE DATA

Collector-base voltage (open emitter)	V_{CBO}	max.	30	V
Collector-emitter voltage (open base)	V_{CEO}	max.	20	V
Collector current (d.c.)	I_C	max.	30	mA
Total power dissipation up to $T_{amb} = 25\text{ }^\circ\text{C}$	P_{tot}	max.	200	mW
Junction temperature	T_j	max.	150	$^\circ\text{C}$
D.C. current gain	h_{FE}		BFS18	BFS19
$I_C = 1\text{ mA}; V_{CE} = 10\text{ V}$			35 to 125	65 to 225
Transition frequency at $f = 100\text{ MHz}$	f_T	typ.	200	260
$I_C = 1\text{ mA}; V_{CE} = 10\text{ V}$				
Noise figure at $f = 100\text{ MHz}$	F	typ.	4	dB
$I_C = 1\text{ mA}; V_{CE} = 10\text{ V}; G_S = 10\text{ m}\Omega^{-1}$				

MECHANICAL DATA

Dimensions in mm

Marking code

Fig. 1 SOT-23.

BFS18 = F1
BFS19 = F2

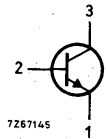
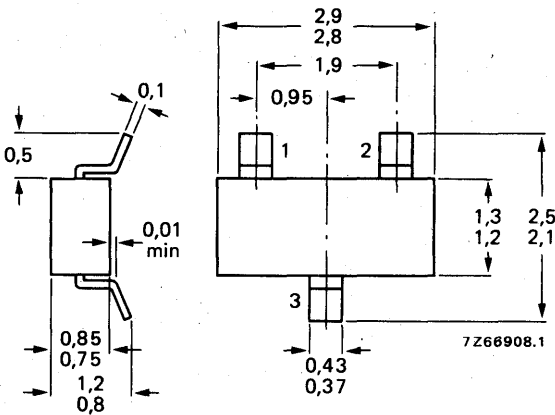

BFS18R = F4
BFS19R = F5

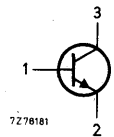

See also *Soldering recommendations*.

BFS18 BFS19

RATINGS Limiting values in accordance with the Absolute Maximum System (IEC 134)

Voltages

Collector-base voltage (open emitter)	V_{CBO}	max.	30 V
Collector-emitter voltage (open base) $I_C = 2 \text{ mA}$	V_{CEO}	max.	20 V
Emitter-base voltage (open collector)	V_{EBO}	max.	5 V

Currents

Collector current (d.c.)	I_C	max.	30 mA
Collector current (peak value)	I_{CM}	max.	30 mA

Power dissipation

Total power dissipation up to $T_{amb} = 25 \text{ }^\circ\text{C}$
mounted on a ceramic substrate of
7 mm x 5 mm x 0.5 mm

P_{tot}	max.	200 mW
-----------	------	--------

Temperatures

Storage temperature	T_{stg}	-65 to +150 $^\circ\text{C}$
Junction temperature	T_j	max. 150 $^\circ\text{C}$

THERMAL RESISTANCE

From junction to ambient
mounted on a ceramic substrate of
7 mm x 5 mm x 0.5 mm

$R_{th \text{ j-a}}$	=	0.62 $^\circ\text{C/mW}$
----------------------	---	--------------------------

CHARACTERISTICS

$T_j = 25 \text{ }^\circ\text{C}$ unless otherwise specified

Collector cut-off current

$I_E = 0; V_{CB} = 20 \text{ V}$	I_{CBO}	< 100 nA
$I_E = 0; V_{CB} = 20 \text{ V}; T_j = 100 \text{ }^\circ\text{C}$	I_{CBO}	< 10 μA

Base-emitter voltage

$I_C = 1 \text{ mA}; V_{CE} = 10 \text{ V}$	V_{BE}	0.65 to 0.74 V
---	----------	----------------

CHARACTERISTICS (continued)

$T_j = 25\text{ }^\circ\text{C}$ unless otherwise specified

D.C. current gain

$I_C = 1\text{ mA}; V_{CE} = 10\text{ V}$

	BFS18	BFS19
h_{FE}	35 to 125	65 to 225

Transition frequency at $f = 100\text{ MHz}$

$I_C = 1\text{ mA}; V_{CE} = 10\text{ V}$

f_T	typ. 200	260 MHz
-------	----------	---------

Collector capacitance at $f = 1\text{ MHz}$

$I_E = I_e = 0; V_{CB} = 10\text{ V}$

C_C	typ. 1	pF
-------	--------	----

Feedback capacitance at $f = 1\text{ MHz}$

$I_C = 1\text{ mA}; V_{CE} = 10\text{ V}$

C_{re}	typ. 0.85	pF
----------	-----------	----

Noise figure

$I_C = 1\text{ mA}; V_{CE} = 10\text{ V}$
 $G_S = 10\text{ m}\Omega^{-1}; f = 100\text{ MHz}$

F	typ. 4	dB ¹⁾
---	--------	------------------

¹⁾ Crystal mounted in a BF115 envelope.

BFS18
BFS19

Typical behaviour of collector current versus collector-emitter voltage

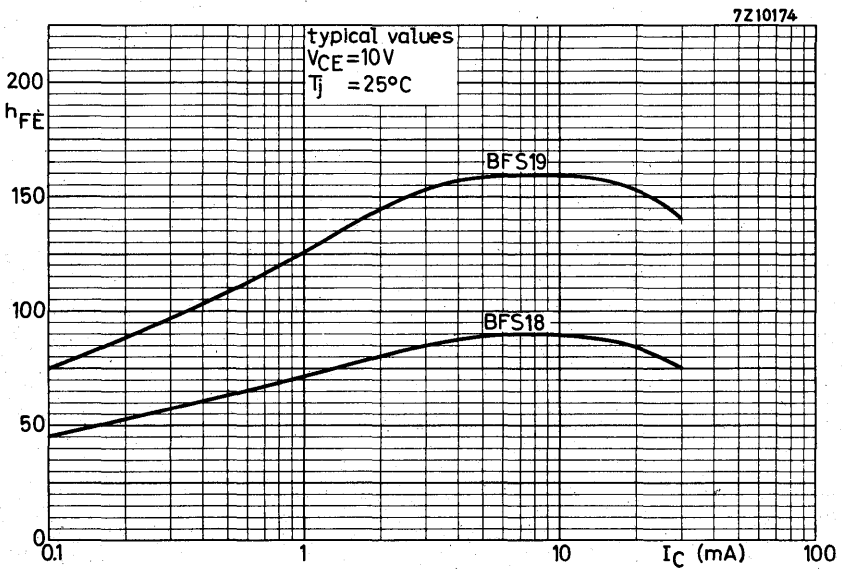
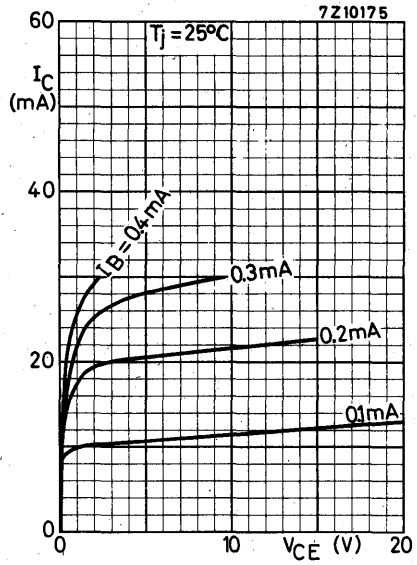
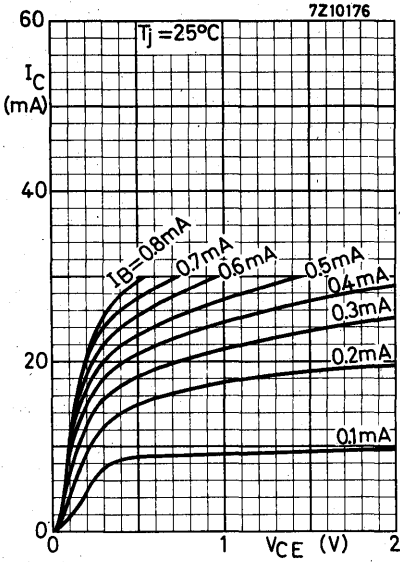

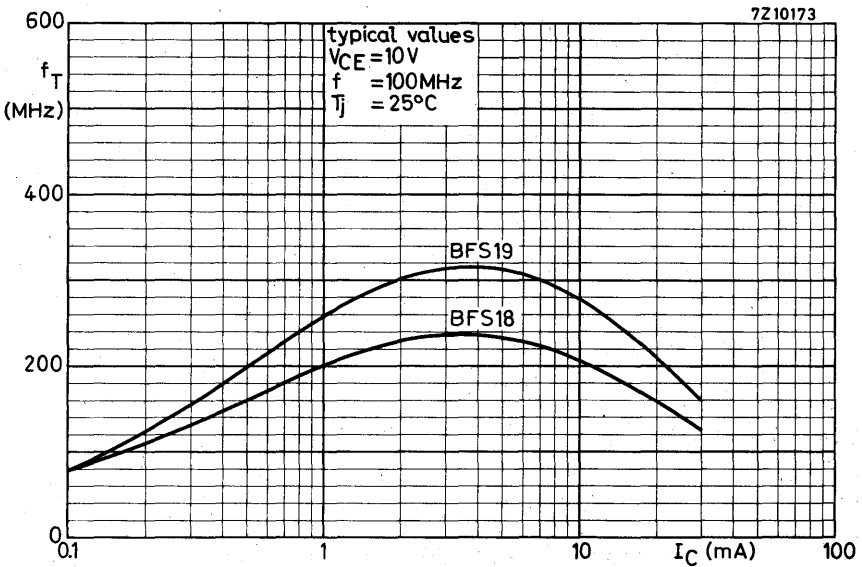
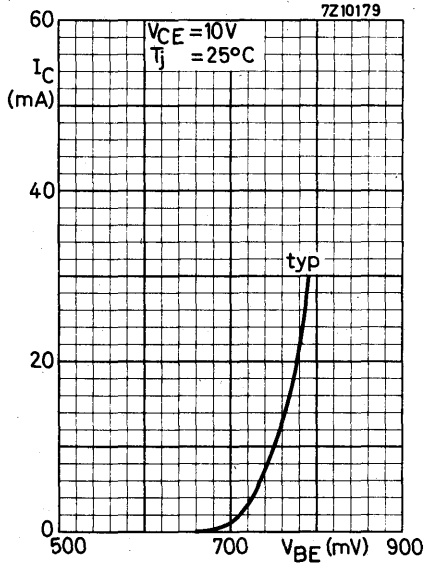

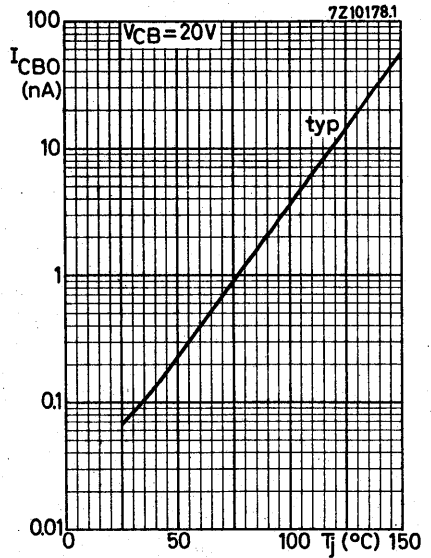
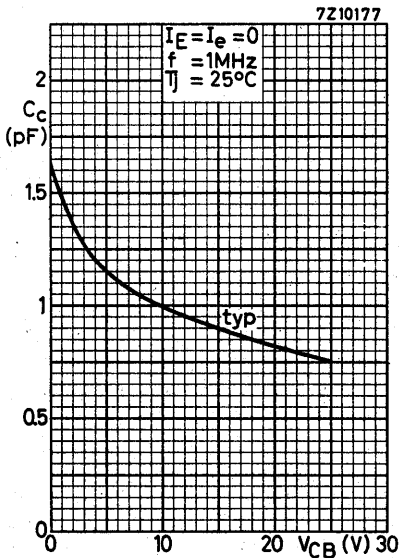
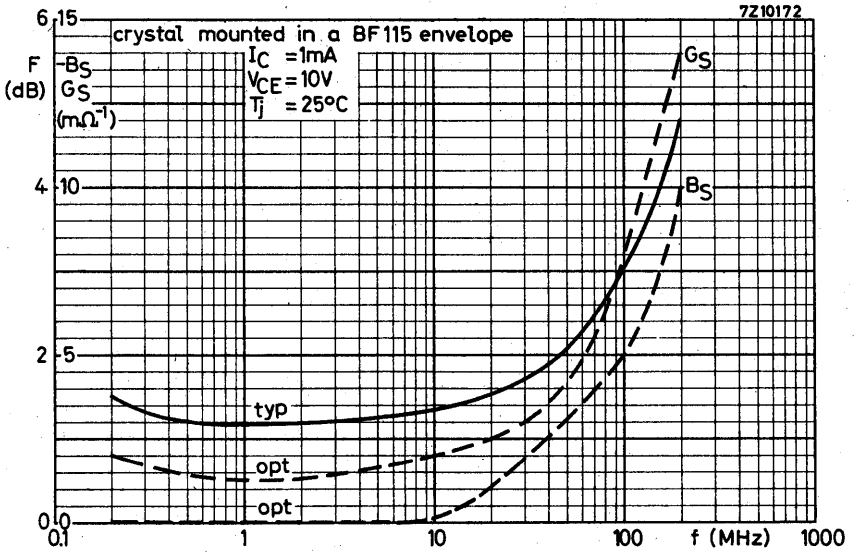

SILICON PLANAR EPITAXIAL TRANSISTOR

N-P-N transistor in a microminiature plastic envelope. It has a very low feedback capacitance and is intended for i.f. and v.h.f. applications in thick and thin-film circuits.

QUICK REFERENCE DATA

Collector-base voltage (open emitter)	V_{CBO}	max.	30 V
Collector-emitter voltage (open base)	V_{CEO}	max.	20 V
Collector current (d.c.)	I_C	max.	25 mA
Total power dissipation up to $T_{amb} = 25\text{ }^\circ\text{C}$	P_{tot}	max.	200 mW
Junction temperature	T_j	max.	150 $^\circ\text{C}$
D.C. current gain	h_{FE}	>	40
$I_C = 7\text{ mA}; V_{CE} = 10\text{ V}$			
Transition frequency at $f = 100\text{ MHz}$	f_T	typ.	450 MHz
$I_C = 5\text{ mA}; V_{CE} = 5\text{ V}$			
Feedback capacitance at $f = 1\text{ MHz}$	C_{re}	typ.	350 fF
$I_C = 1\text{ mA}; V_{CE} = 10\text{ V}$			

MECHANICAL DATA

Fig. 1 SOT-23.

Dimensions in mm

Marking code

BFS20 = G1

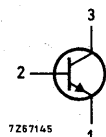
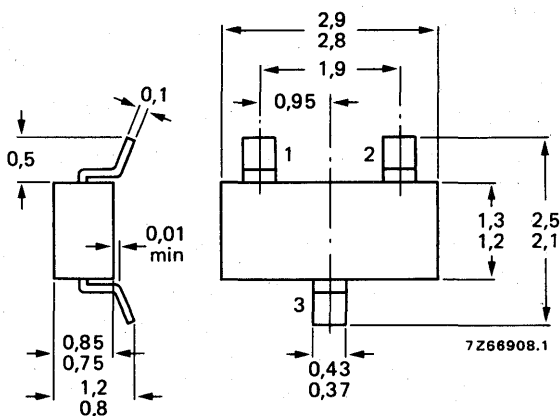

BFS20R = G4

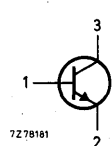

See also *Soldering recommendations*.

RATINGS Limiting values in accordance with the Absolute Maximum System (IEC 134)

Voltages

Collector-base voltage (open emitter)	V_{CBO}	max.	30 V
Collector-emitter voltage (open base) $I_C = 2 \text{ mA}$	V_{CEO}	max.	20 V
Emitter-base voltage (open collector)	V_{EBO}	max.	4 V

Currents

Collector current (d. c.)	I_C	max.	25 mA
Collector current (peak value)	I_{CM}	max.	25 mA

Power dissipation

Total power dissipation up to $T_{amb} = 25 \text{ }^\circ\text{C}$
mounted on a ceramic substrate of
7 mm x 5 mm x 0.5 mm

P_{tot}	max.	200 mW
-----------	------	--------

Temperatures

Storage temperature	T_{stg}	-65 to +150 $^\circ\text{C}$
Junction temperature	T_j	max. 150 $^\circ\text{C}$

THERMAL RESISTANCE

From junction to ambient
mounted on a ceramic substrate of
7 mm x 5 mm x 0.5 mm

$R_{th \text{ j-a}}$	=	0.62 $^\circ\text{C/mW}$
----------------------	---	--------------------------

CHARACTERISTICS $T_j = 25\text{ }^\circ\text{C}$ unless otherwise specifiedCollector cut-off current $I_E = 0; V_{CB} = 20\text{ V}$ $I_{CBO} < 100\text{ nA}$ $I_E = 0; V_{CB} = 20\text{ V}; T_j = 100\text{ }^\circ\text{C}$ $I_{CBO} < 10\text{ }\mu\text{A}$ Base-emitter voltage $I_C = 7\text{ mA}; V_{CE} = 10\text{ V}$ V_{BE} typ. 740 mV
< 900 mVD. C. current gain $I_C = 7\text{ mA}; V_{CE} = 10\text{ V}$ $h_{FE} > 40$
typ. 85Transition frequency at $f = 100\text{ MHz}$ $I_C = 5\text{ mA}; V_{CE} = 10\text{ V}$ $f_T > 275\text{ MHz}$
typ. 450 MHzCollector capacitance at $f = 1\text{ MHz}$ $I_E = I_e = 0; V_{CB} = 10\text{ V}$ C_c typ. 0.8 pFFeedback capacitance at $f = 1\text{ MHz}$ $I_C = 1\text{ mA}; V_{CE} = 10\text{ V}$ C_{re} typ. 350 fF

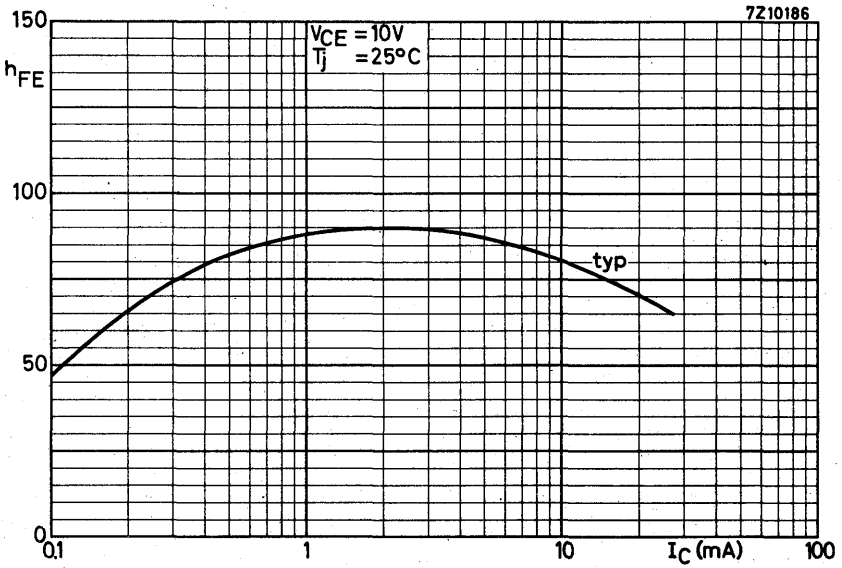
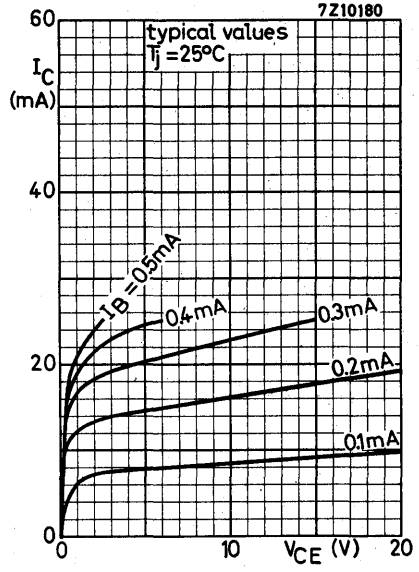
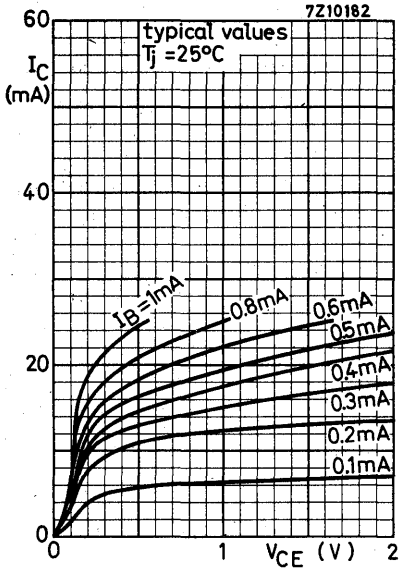

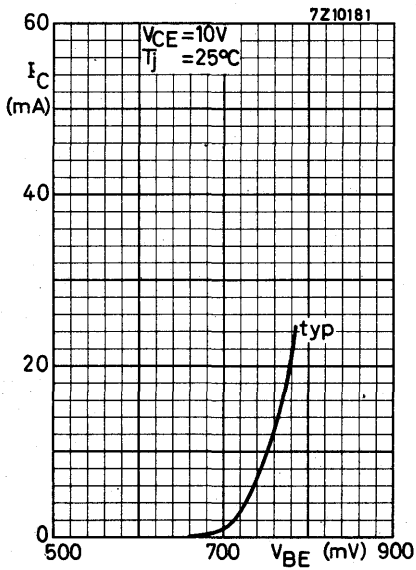
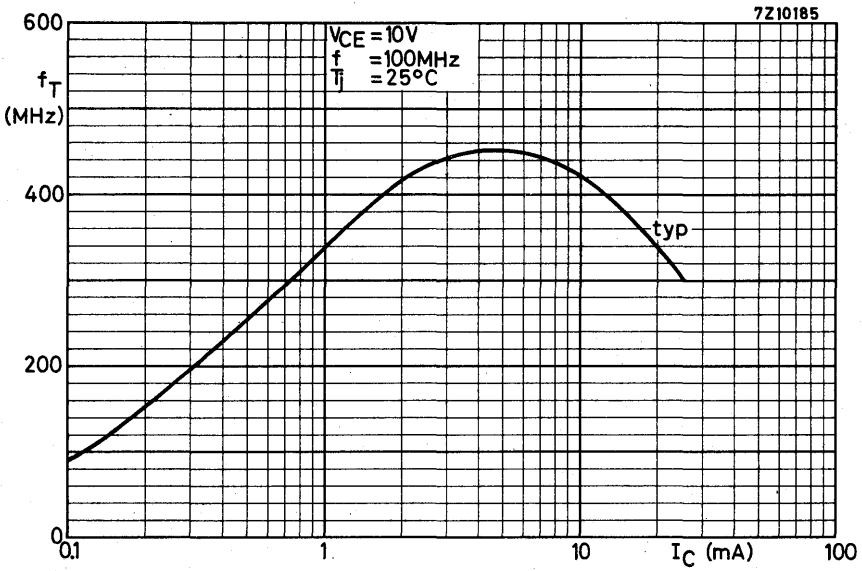

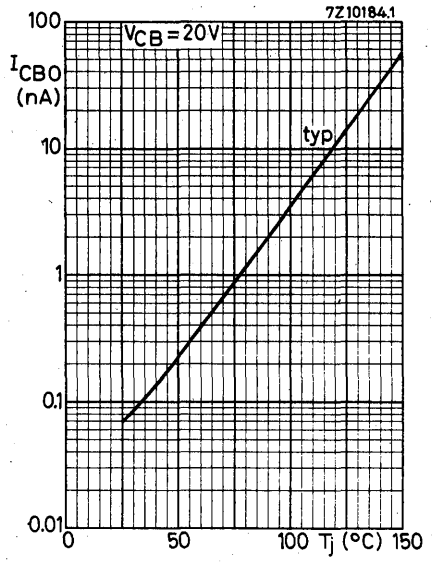
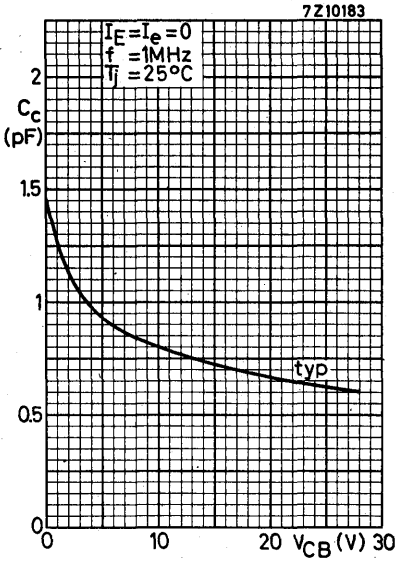

SILICON PLANAR EPITAXIAL TRANSISTOR

N-P-N transistor in a microminiature plastic envelope, primarily intended for use in u.h.f. low power amplifiers in thick and thin-film circuits, such as in pocket phones, paging systems, etc. The transistor features low current consumption (100 μ A – 1 mA); thanks to its high transition frequency, it also has excellent wideband properties and low noise up to high frequencies.

QUICK REFERENCE DATA

Collector-base voltage (open emitter)	V_{CBO}	max.	8 V
Collector-emitter voltage (open base)	V_{CEO}	max.	5 V
Collector current (d.c.)	I_C	max.	2,5 mA
Total power dissipation up to $T_{amb} = 135\text{ }^\circ\text{C}$	P_{tot}	max.	30 mW
Junction temperature	T_j	max.	150 $^\circ\text{C}$
Transition frequency at $f = 500\text{ MHz}$ $I_C = 1\text{ mA}; V_{CE} = 1\text{ V}$	f_T	typ.	2,3 GHz
Feedback capacitance at $f = 1\text{ MHz}$ $I_C = 1\text{ mA}; V_{CE} = 1\text{ V}; T_{amb} = 25\text{ }^\circ\text{C}$	C_{re}	<	0,45 pF
Noise figure at optimum source impedance $I_C = 1\text{ mA}; V_{CE} = 1\text{ V}; f = 500\text{ MHz}; T_{amb} = 25\text{ }^\circ\text{C}$	F	typ.	3,8 dB
Max. unilateral power gain (see page 3) $I_C = 1\text{ mA}; V_{CE} = 1\text{ V}; f = 500\text{ MHz}; T_{amb} = 25\text{ }^\circ\text{C}$	G _{UM}	typ.	18 dB

MECHANICAL DATA

Fig. 1 SOT-23.

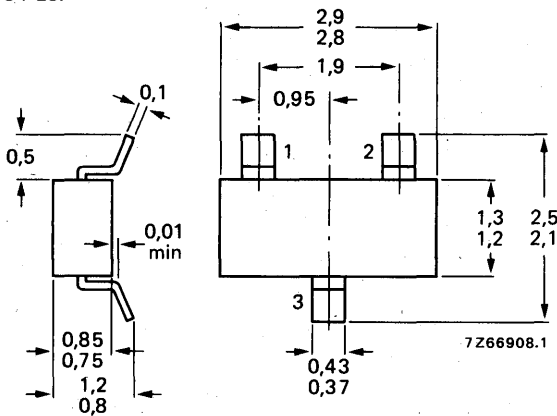

Marking code

BFT25 = V1

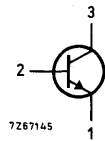

BFT25R = V4

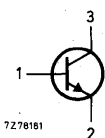

See also *Soldering recommendations*.

RATINGS Limiting values in accordance with the Absolute Maximum System (IEC134)

Voltages

Collector-base voltage (open emitter)	V_{CBO}	max.	8	V
Collector-emitter voltage (open base)	V_{CEO}	max.	5	V
Emitter-base voltage (open collector)	V_{EBO}	max.	2	V

Currents

Collector current (d. c.)	I_C	max.	2,5	mA
Collector current (peak value; $f > 1$ MHz)	I_{CM}	max.	5,0	mA

Power dissipation

Total power dissipation up to $T_{amb} = 135$ °C mounted on a ceramic substrate of 15 mm x 10 mm x 0,5 mm	P_{tot}	max.	30	mW
---	-----------	------	----	----

Temperatures

Storage temperature	T_{stg}	-65 to +150	°C
Junction temperature	T_j	max. 150	°C

THERMAL RESISTANCE

From junction to ambient in free air mounted on a ceramic substrate of 15 mm x 10 mm x 0,5 mm	$R_{th\ j-a}$	=	0,5	°C/mW
---	---------------	---	-----	-------

CHARACTERISTICS

$T_j = 25\text{ }^\circ\text{C}$ unless otherwise specified

Collector cut-off current

$I_E = 0; V_{CB} = 5\text{ V}$ $I_{CBO} < 50\text{ nA}$

D.C. current gain 1)

$I_C = 10\text{ }\mu\text{A}; V_{CE} = 1\text{ V}$ $h_{FE} > 20$
typ. 30

$I_C = 1\text{ mA}; V_{CE} = 1\text{ V}$ $h_{FE} > 20$
typ. 40

Saturation voltages

$I_C = 10\text{ }\mu\text{A}; I_B = 1\text{ }\mu\text{A}$ $V_{CEsat} < 200\text{ mV}$
 $V_{BEsat} < 750\text{ mV}$

$I_C = 1\text{ mA}; I_B = 0,1\text{ mA}$ $V_{CEsat} < 175\text{ mV}$
 $V_{BEsat} < 900\text{ mV}$

Transition frequency at $f = 500\text{ MHz}$ 1)

$I_C = 1\text{ mA}; V_{CE} = 1\text{ V}$ $f_T > 1,2\text{ GHz}$
typ. 2,3 GHz

Collector capacitance at $f = 1\text{ MHz}$

$I_E = I_c = 0; V_{CB} = 0,5\text{ V}$ $C_c < 0,6\text{ pF}$

Emitter capacitance at $f = 1\text{ MHz}$

$I_C = I_c = 0; V_{EB} = 0$ $C_e < 0,5\text{ pF}$

Feedback capacitance at $f = 1\text{ MHz}$

$I_C = 1\text{ mA}; V_{CE} = 1\text{ V}; T_{amb} = 25\text{ }^\circ\text{C}$ $C_{re} < 0,45\text{ pF}$

Noise figure at optimum source impedance

$I_C = 0,1\text{ mA}; V_{CE} = 1\text{ V}; f = 500\text{ MHz}; T_{amb} = 25\text{ }^\circ\text{C}$ F typ. 5,5 dB

$I_C = 1\text{ mA}; V_{CE} = 1\text{ V}; f = 500\text{ MHz}; T_{amb} = 25\text{ }^\circ\text{C}$ F typ. 3,8 dB

Max. unilateral power gain (s_{re} assumed to be zero)

$$G_{UM} (\text{in dB}) = 10 \log \frac{|s_{fe}|^2}{(1 - |s_{ie}|^2)(1 - |s_{oe}|^2)}$$

$I_C = 1\text{ mA}; V_{CE} = 1\text{ V}; f = 200\text{ MHz}; T_{amb} = 25\text{ }^\circ\text{C}$ G_{UM} typ. 25 dB

$I_C = 1\text{ mA}; V_{CE} = 1\text{ V}; f = 500\text{ MHz}; T_{amb} = 25\text{ }^\circ\text{C}$ G_{UM} typ. 18 dB

$I_C = 1\text{ mA}; V_{CE} = 1\text{ V}; f = 800\text{ MHz}; T_{amb} = 25\text{ }^\circ\text{C}$ G_{UM} typ. 12 dB

1) Measured under pulse conditions.

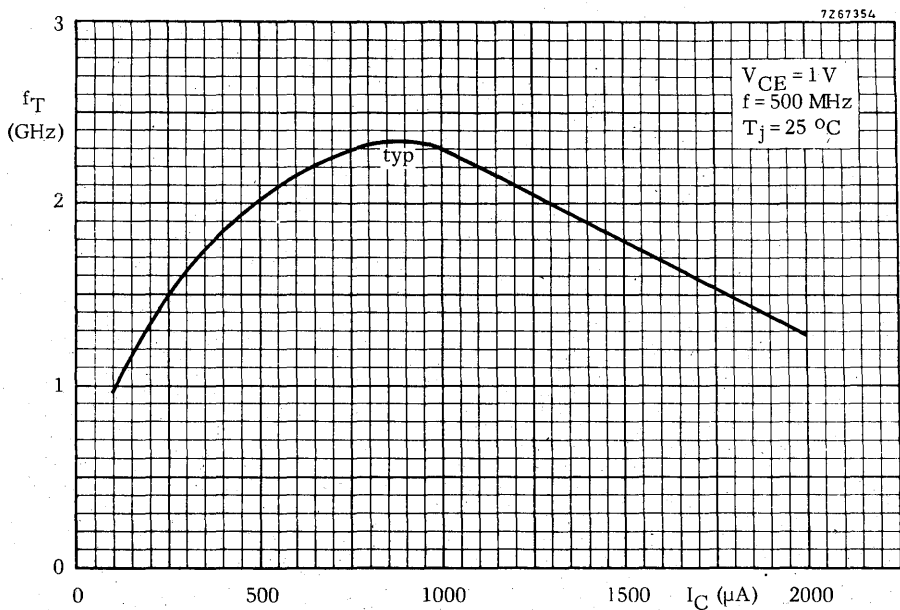
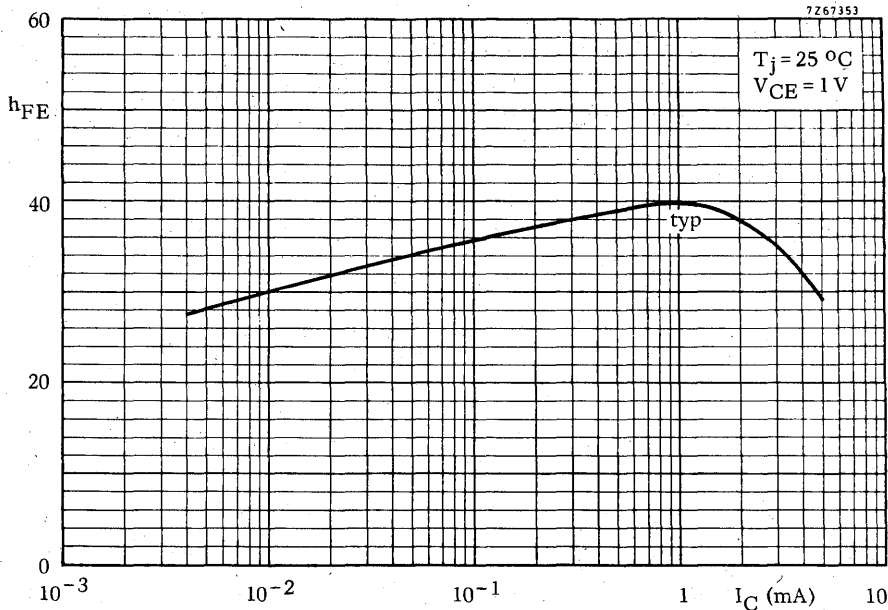

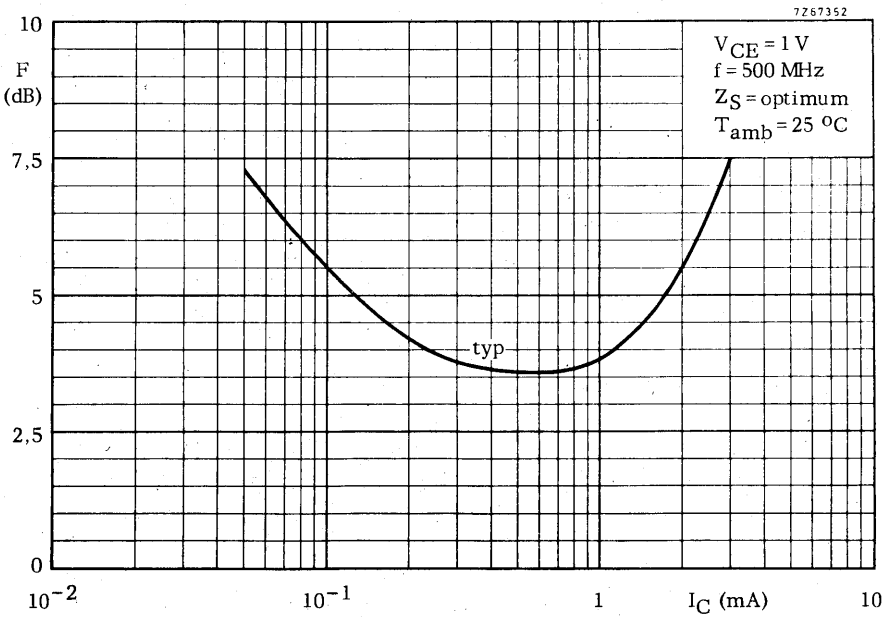
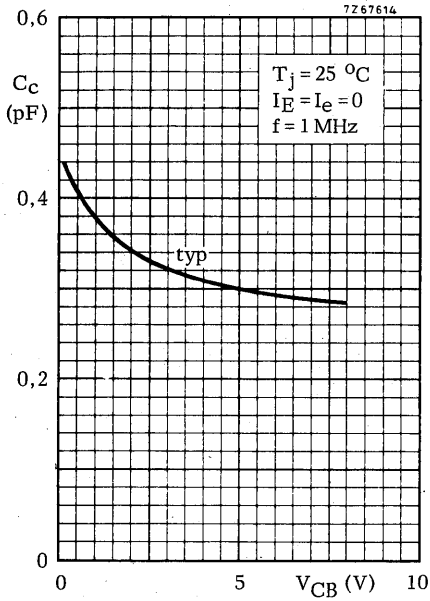

BFT25

$V_{CE} = 1\text{ V}$
 $I_C = 1\text{ mA}$
 $T_{amb} = 25\text{ }^\circ\text{C}$

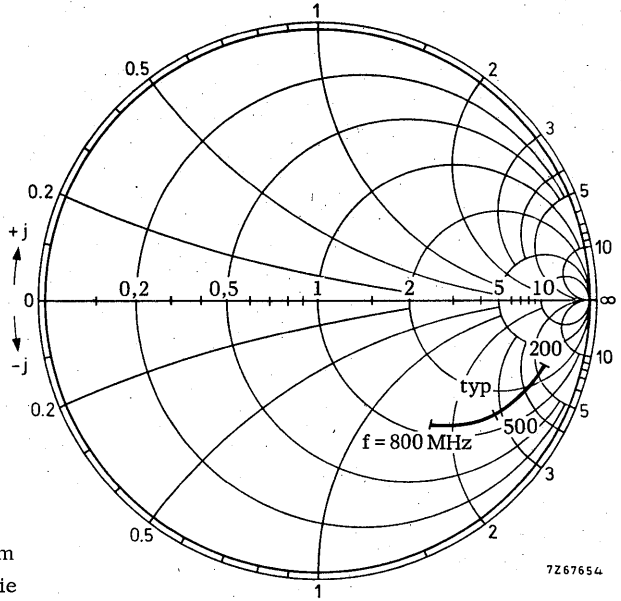

Input impedance derived from
input reflection coefficient s_{ie}
coordinates in ohm x 50

$V_{CE} = 1\text{ V}$
 $I_C = 1\text{ mA}$
 $T_{amb} = 25\text{ }^\circ\text{C}$

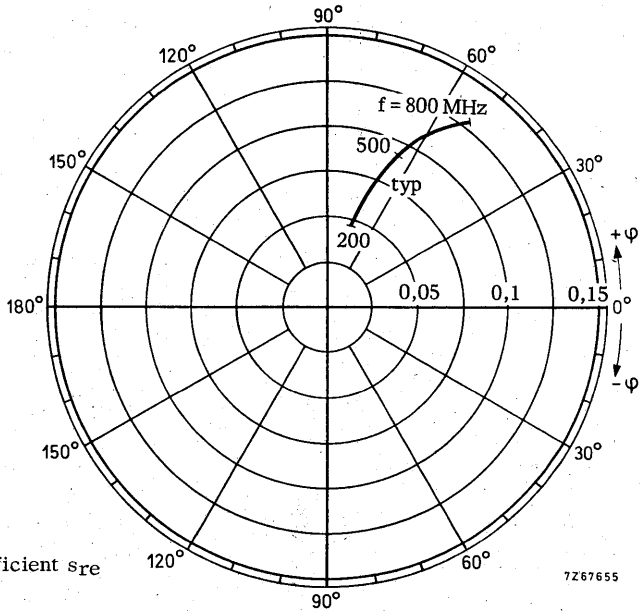

Reverse transmission coefficient s_{re}

$V_{CE} = 1\text{ V}$
 $I_C = 1\text{ mA}$
 $T_{amb} = 25\text{ }^\circ\text{C}$

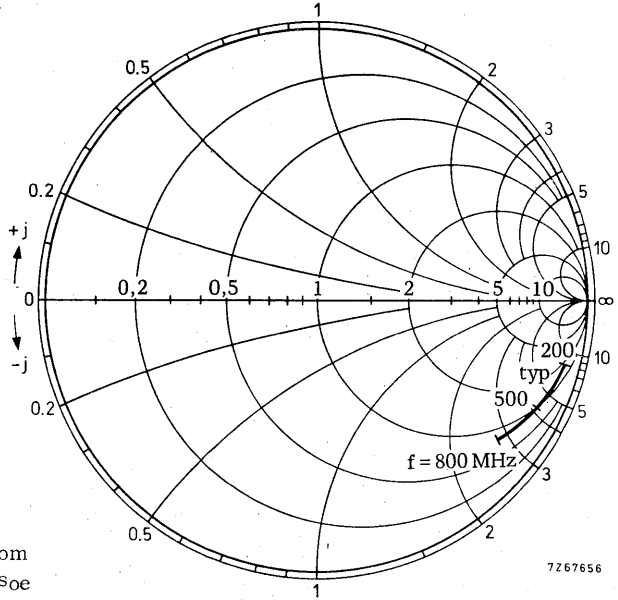

Output impedance derived from output reflection coefficient s_{oe} coordinates in ohm x 50

7267656

$V_{CE} = 1\text{ V}$
 $I_C = 1\text{ mA}$
 $T_{amb} = 25\text{ }^\circ\text{C}$

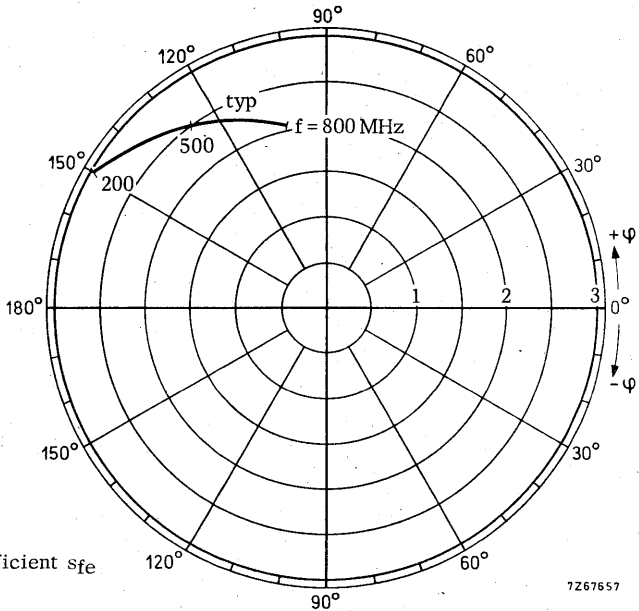

Forward transmission coefficient s_{fe}

7267657

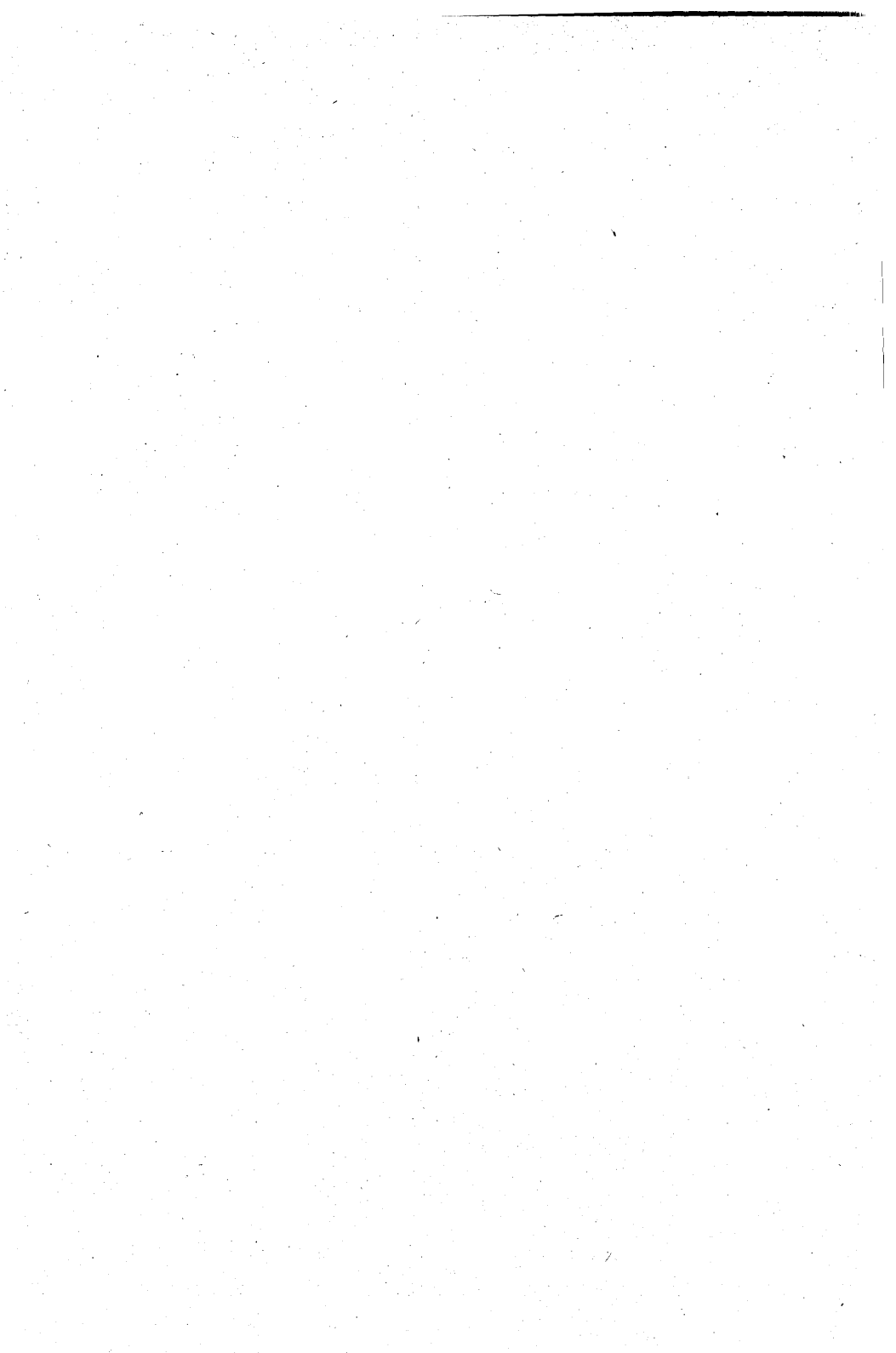

N-CHANNEL SILICON FET

N-channel silicon epitaxial planar junction field-effect transistor in a microminiature plastic envelope. The transistor is intended for low level general purpose amplifiers in thick and thin-film circuits.

QUICK REFERENCE DATA

Drain-source voltage	$\pm V_{DS}$	max.	25 V
Gate-source voltage (open drain)	$-V_{GSO}$	max.	25 V
Total power dissipation up to $T_{amb} = 25\text{ }^{\circ}\text{C}$	P_{tot}	max.	200 mW
Drain current $V_{DS} = 10\text{ V}; V_{GS} = 0$	I_{DSS}	>	0,2 mA
		<	1,5 mA
Transfer admittance (common source) $I_D = 0,2\text{ mA}; V_{DS} = 10\text{ V}; f = 1\text{ kHz}$	$ y_{fs} $	>	0,5 mA/V
		<	
Equivalent noise voltage $V_{DS} = 10\text{ V}; I_D = 200\text{ }\mu\text{A}; B = 0,6\text{ to }100\text{ Hz}$	V_n	<	0,5 μV
		>	

MECHANICAL DATA

Dimensions in mm

Marking code

Fig. 1 SOT-23.

BFT46 = M3

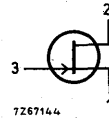
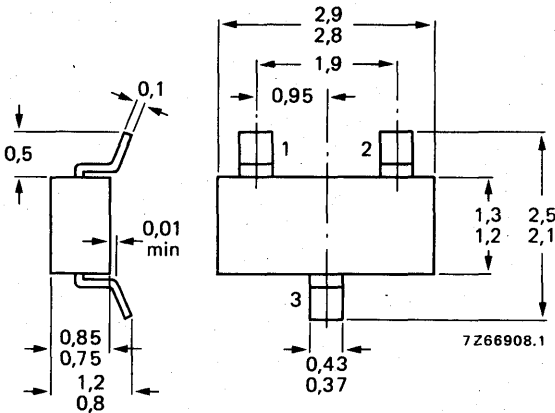

See also *Soldering recommendations*.

RATINGS

Limiting values in accordance with the Absolute Maximum System (IEC 134)

Drain-source voltage	$\pm V_{DS}$	max.	25 V
Drain-gate voltage (open source)	V_{DGQ}	max.	25 V
Gate-source voltage (open drain)	$-V_{GSO}$	max.	25 V
Drain current	I_D	max.	10 mA
Gate current	I_G	max.	5 mA
Total power dissipation up to $T_{amb} = 25\text{ }^\circ\text{C}$ *	P_{tot}	max.	200 mW
Storage temperature	T_{stg}		-65 to +150 $^\circ\text{C}$
Junction temperature	T_j	max.	150 $^\circ\text{C}$

THERMAL RESISTANCE

from junction to ambient *	$R_{th\ j-a}$	=	0,62 $^\circ\text{C}/\text{mW}$
----------------------------	---------------	---	---------------------------------

CHARACTERISTICS

$T_j = 25\text{ }^\circ\text{C}$ unless otherwise specified

Gate cut-off current $-V_{GS} = 10\text{ V}; V_{DS} = 0$	$-I_{GSS}$	<	0,2 nA
Drain current ** $V_{DS} = 10\text{ V}; V_{GS} = 0$	I_{DSS}	>	0,2 mA
		<	1,5 mA
Gate-source voltage $I_D = 50\text{ }\mu\text{A}; V_{DS} = 10\text{ V}$	$-V_{GS}$	>	0,1 V
		<	1,0 V
Gate-source cut-off voltage $I_D = 0,5\text{ nA}; V_{DS} = 10\text{ V}$	$-V_{(P)GS}$	<	1,2 V
Y parameters at $f = 1\text{ kHz};$ $V_{DS} = 10\text{ V}; V_{GS} = 0; T_{amb} = 25\text{ }^\circ\text{C}$			
Transfer admittance	$ y_{fs} $	>	1,0 mA/V
Output admittance	$ y_{os} $	<	10 $\mu\text{A}/\text{V}$
$V_{DS} = 10\text{ V}; I_D = 200\text{ }\mu\text{A};$			
Transfer admittance	$ y_{fs} $	>	0,5 mA/V
Output admittance	$ y_{os} $	<	5 $\mu\text{A}/\text{V}$
Input capacitance at $f = 1\text{ MHz};$ $V_{DS} = 10\text{ V}; V_{GS} = 0; T_{amb} = 25\text{ }^\circ\text{C}$	C_{is}	<	5 pF
Feedback capacitance at $f = 1\text{ MHz};$ $V_{DS} = 10\text{ V}; V_{GS} = 0; T_{amb} = 25\text{ }^\circ\text{C}$	C_{rs}	<	1,5 pF
Equivalent noise voltage $V_{DS} = 10\text{ V}; I_D = 200\text{ }\mu\text{A}; T_{amb} = 25\text{ }^\circ\text{C}$ $B = 0,6\text{ to }100\text{ Hz}$	V_n	<	0,5 μV

* Mounted on a ceramic substrate of 7 mm x 5 mm x 0,5 mm.

** Measured under pulse conditions.

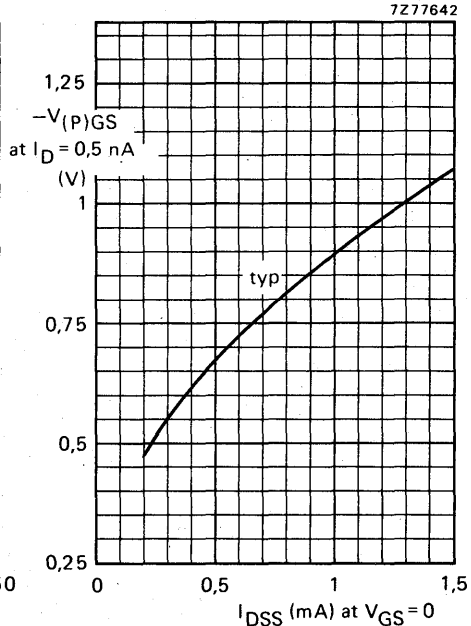
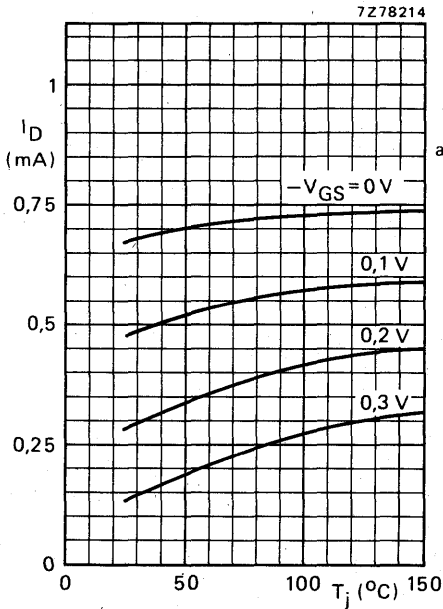
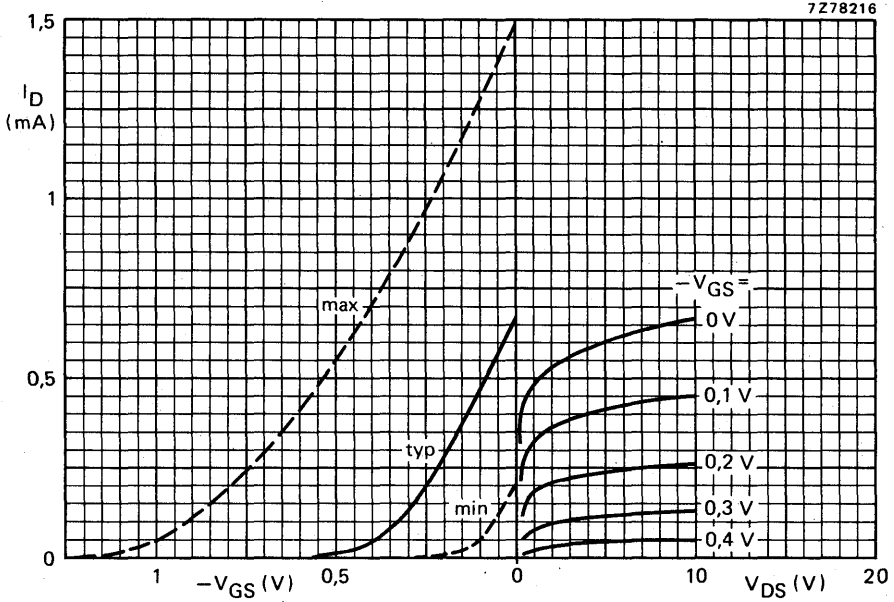

7Z77641

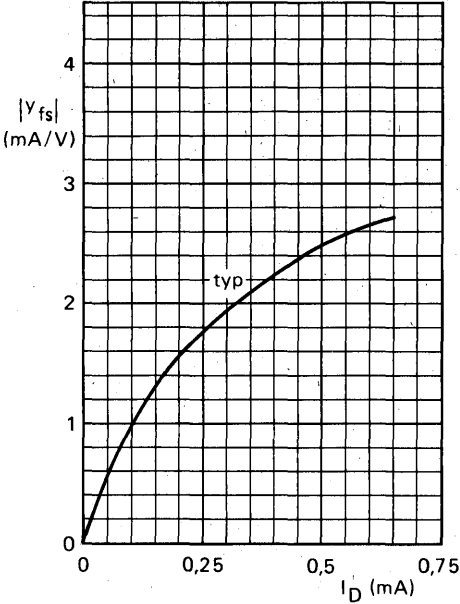

Fig. 5.

7Z77640

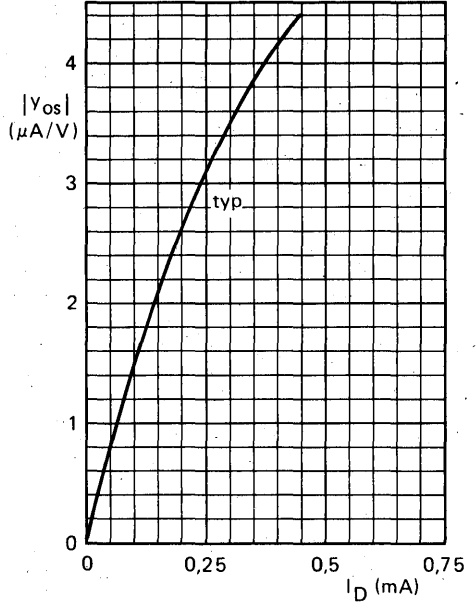

Fig. 6.

7Z77638

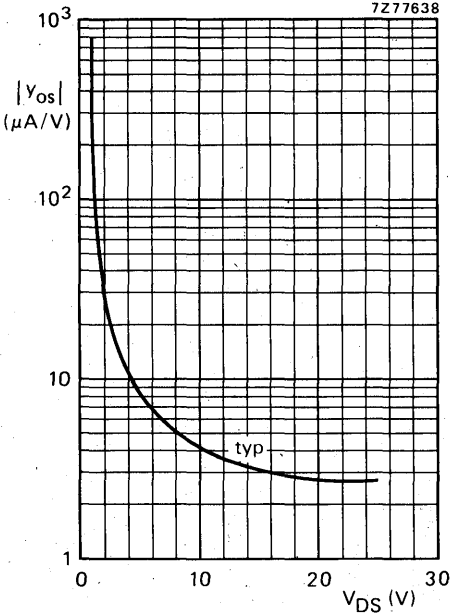

Fig. 7.

Fig. 5 $|y_{fs}|$ versus I_D .
 $V_{DS} = 10$ V; $f = 1$ kHz; $T_{amb} = 25$ °C.

Fig. 6 $|y_{os}|$ versus I_D .
 $V_{DS} = 10$ V; $f = 1$ kHz; $T_{amb} = 25$ °C.

Fig. 7 $|y_{os}|$ versus V_{DS} .
 $I_D = 0,4$ mA; $f = 1$ kHz; $T_{amb} = 25$ °C.

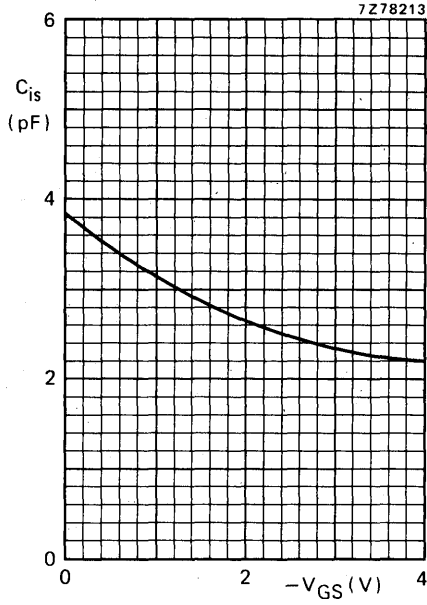

Fig. 8.

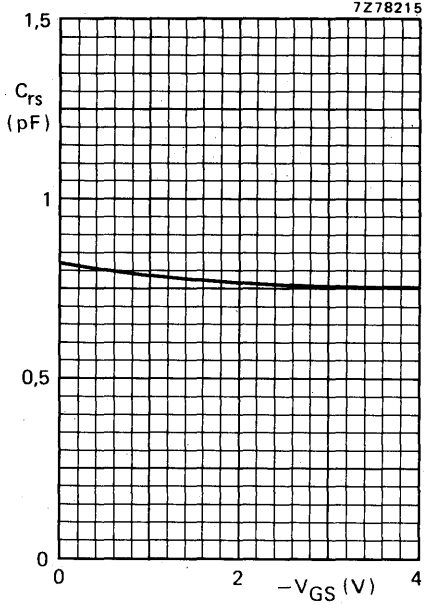

Fig. 9.

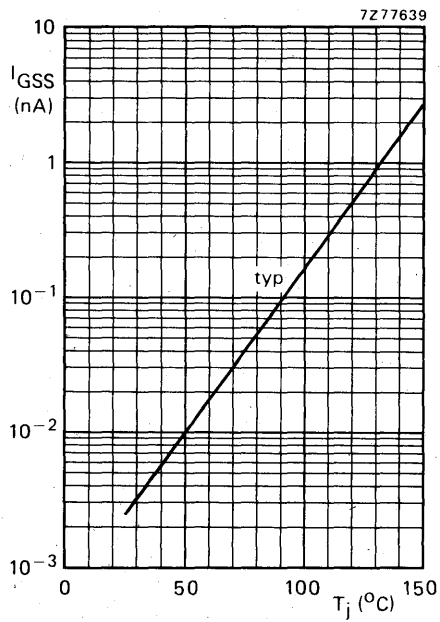

Fig. 10.

Fig. 8 Typical values.
 $V_{DS} = 10$ V, $T_{amb} = 25$ °C.

Fig. 9 Typical values.
 $V_{DS} = 10$ V, $T_{amb} = 25$ °C.

Fig. 10 I_{GSS} versus T_j .
 $-V_{GS} = 10$ V; $V_{DS} = 0$.

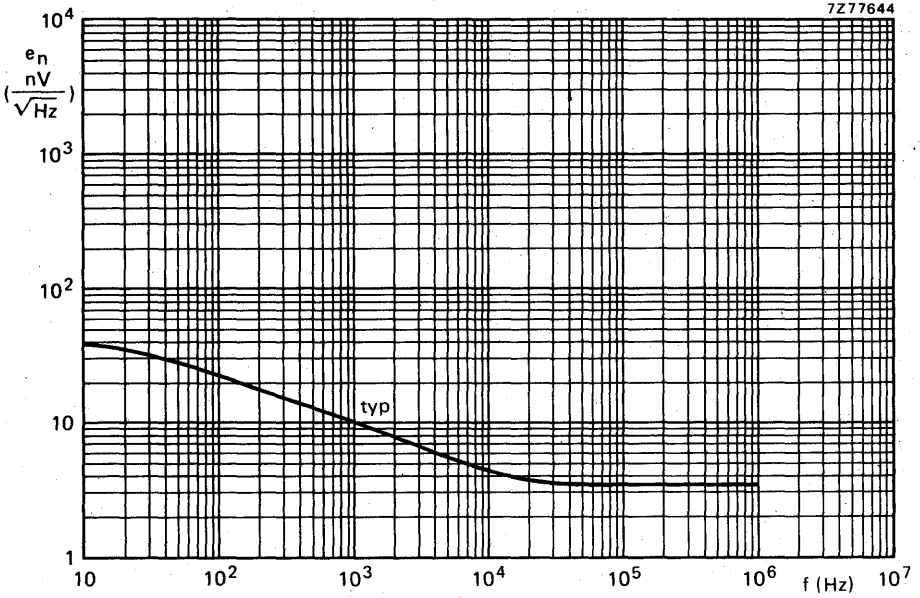

Fig. 11 $V_{DS} = 10 V$; $I_D = 0,2 mA$; $T_{amb} = 25 ^\circ C$.

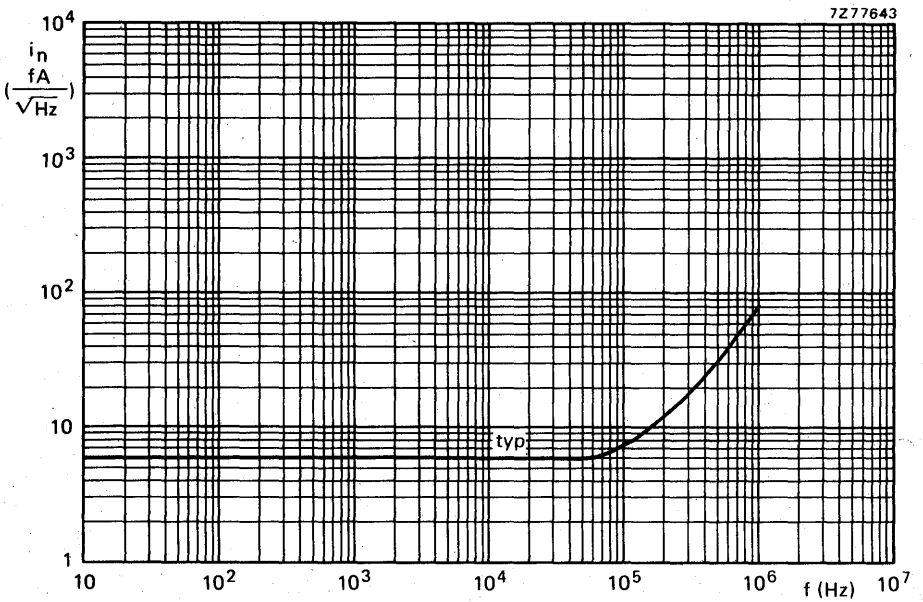

Fig. 12 $V_{DS} = 10 V$; $I_D = 0,2 mA$; $T_{amb} = 25 ^\circ C$.

SILICON PLANAR EPITAXIAL TRANSISTOR

P-N-P transistor in a microminiature plastic envelope. It is primarily intended for use in u.h.f. and microwave amplifiers in thick and thin-film circuits, such as in aerial amplifiers, radar systems, oscilloscopes, spectrum analysers, etc.

The transistor features low intermodulation distortion and high power gain; thanks to its very high transition frequency, it also has excellent wideband properties and low noise up to high frequencies.

This type is complementary to BFR92.

QUICK REFERENCE DATA

Collector-base voltage (open emitter)	$-V_{CB0}$	max.	20 V
Collector-emitter voltage (open base)	$-V_{CE0}$	max.	15 V
Collector current (d.c.)	$-I_C$	max.	25 mA
Total power dissipation up to $T_{amb} = 60^\circ\text{C}$	P_{tot}	max.	180 mW
Junction temperature	T_j	max.	150 $^\circ\text{C}$
Transition frequency at $f = 500$ MHz $-I_C = 14$ mA; $-V_{CE} = 10$ V	f_T	typ.	5 GHz
Feedback capacitance at $f = 1$ MHz $-I_C = 2$ mA; $-V_{CE} = 10$ V; $T_{amb} = 25^\circ\text{C}$	C_{re}	typ.	0,7 pF
Noise figure at optimum source impedance $-I_C = 2$ mA; $-V_{CE} = 10$ V; $f = 500$ MHz; $T_{amb} = 25^\circ\text{C}$	F	typ.	2,7 dB
Max. unilateral power gain (see page 3) $-I_C = 14$ mA; $-V_{CE} = 10$ V; $f = 500$ MHz; $T_{amb} = 25^\circ\text{C}$	G _{UM}	typ.	18 dB
Intermodulation distortion at $T_{amb} = 25^\circ\text{C}$ $-I_C = 14$ mA; $-V_{CE} = 10$ V; $R_L = 75 \Omega$; $V_O = 150$ mV $f_{(p+q-r)} = 493,25$ MHz (see page 3)	d_{im}	typ.	-60 dB

MECHANICAL DATA

Fig. 1 SOT-23.

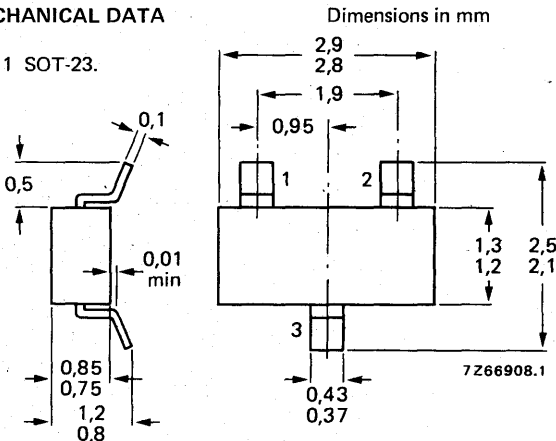

Marking code

BFT92 = W1

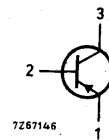

BFT92R = W4

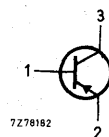

RATINGS

Limiting values in accordance with the Absolute Maximum System (IEC 134)

Collector-base voltage (open emitter)	$-V_{CBO}$	max.	20 V
Collector-emitter voltage (open base)	$-V_{CEO}$	max.	15 V
Emitter-base voltage (open collector)	$-V_{EBO}$	max.	2,0 V
Collector current (d.c.)	$-I_C$	max.	25 mA
Collector current (peak value; $f > 1$ MHz)	$-I_{CM}$	max.	35 mA
Total power dissipation up to $T_{amb} = 60$ °C mounted on a ceramic substrate of 15 mm x 10 mm x 0,5 mm	P_{tot}	max.	180 mW
Storage temperature	T_{stg}	-65 to +150	°C
Junction temperature	T_j	max.	150 °C

THERMAL RESISTANCE

From junction to ambient in free air
mounted on a ceramic substrate of
15 mm x 10 mm x 0,5 mm

$$R_{th\ j-a} = 0,5 \text{ °C/mW}$$

CHARACTERISTICS

$T_j = 25$ °C unless otherwise specified

Collector cut-off current

$$I_E = 0; -V_{CB} = 10 \text{ V}$$

$$-I_{CBO} < 50 \text{ nA}$$

D.C. current gain *

$$-I_C = 14 \text{ mA}; -V_{CE} = 10 \text{ V}$$

$$h_{FE} > \text{typ. } 20$$

Transition frequency at $f = 500$ MHz *

$$-I_C = 14 \text{ mA}; -V_{CE} = 10 \text{ V}$$

$$f_T \text{ typ. } 5 \text{ GHz}$$

Collector capacitance at $f = 1$ MHz

$$I_E = I_e = 0; -V_{CB} = 10 \text{ V}$$

$$C_c \text{ typ. } 0,75 \text{ pF}$$

Emitter capacitance at $f = 1$ MHz

$$I_C = I_c = 0; -V_{EB} = 0,5 \text{ V}$$

$$C_e \text{ typ. } 0,8 \text{ pF}$$

* Measured under pulse conditions.

CHARACTERISTICS (continued)

 $T_{amb} = 25\text{ }^{\circ}\text{C}$ Feedback capacitance at $f = 1\text{ MHz}$ $-I_C = 2\text{ mA}; -V_{CE} = 10\text{ V}$ C_{re} typ. 0,7 pF

Noise figure at optimum source impedance *

 $-I_C = 2\text{ mA}; -V_{CE} = 10\text{ V}; f = 500\text{ MHz}$

F typ. 2,7 dB

Max. unilateral power gain (s_{re} assumed to be zero)

$$G_{UM}(\text{in dB}) = 10 \log \frac{|s_{fe}|^2}{(1 - |s_{ie}|^2)(1 - |s_{oe}|^2)}$$

 $-I_C = 14\text{ mA}; -V_{CE} = 10\text{ V}; f = 500\text{ MHz}$ G_{UM} typ. 18 dB

Intermodulation distortion *

 $-I_C = 14\text{ mA}; -V_{CE} = 10\text{ V}; R_L = 75\text{ }\Omega; \text{VSWR} < 2$ $V_p = V_o = 150\text{ mV}$ at $f_p = 495,25\text{ MHz}$ $V_q = V_o - 6\text{ dB}$ at $f_q = 503,25\text{ MHz}$ $V_r = V_o - 6\text{ dB}$ at $f_r = 505,25\text{ MHz}$ Measured at $f(p + q - r) = 493,25\text{ MHz}$ d_{im} typ. -60 dB

Fig. 2 Intermodulation test circuit.

L1 = 4 turns Cu wire (0,35 mm); winding pitch 1 mm; int. dia. 4 mm.

L2 = L3 = 5 μH (catalogue number: 3122 108 20150).

* Crystal mounted in SOT-37 envelope.

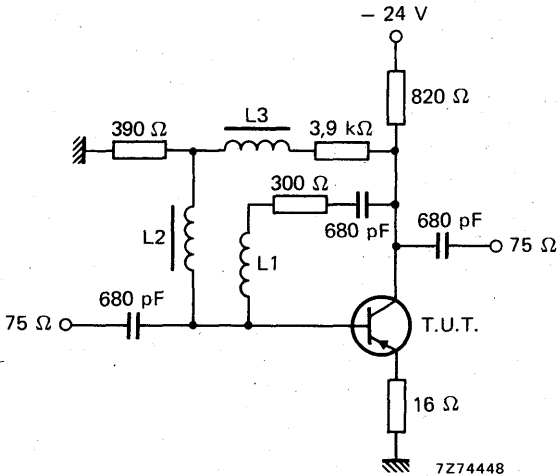
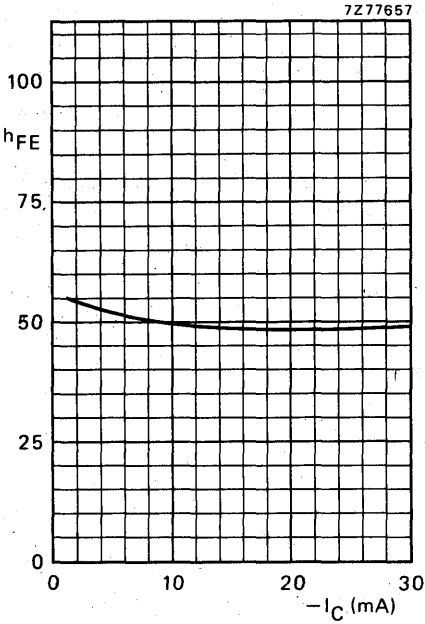

Fig. 3 $-V_{CE} = 10$ V; $T_j = 25$ °C.

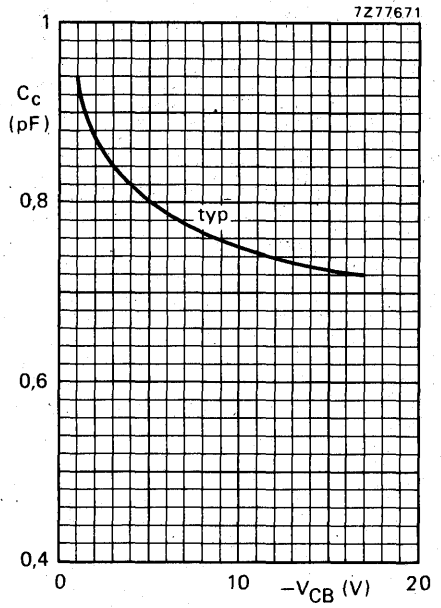

Fig. 4 $I_E = I_e = 0$; $T_j = 25$ °C; $f = 1$ MHz.

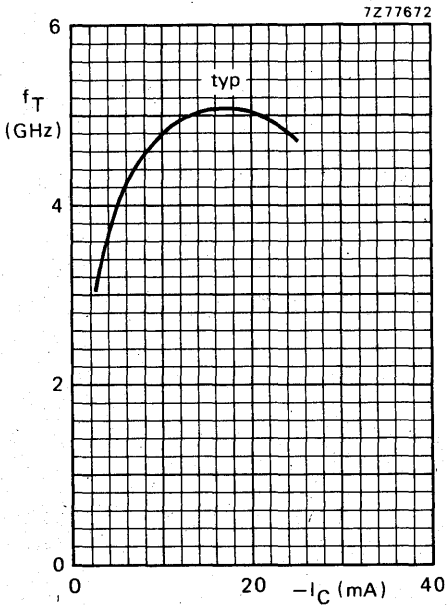
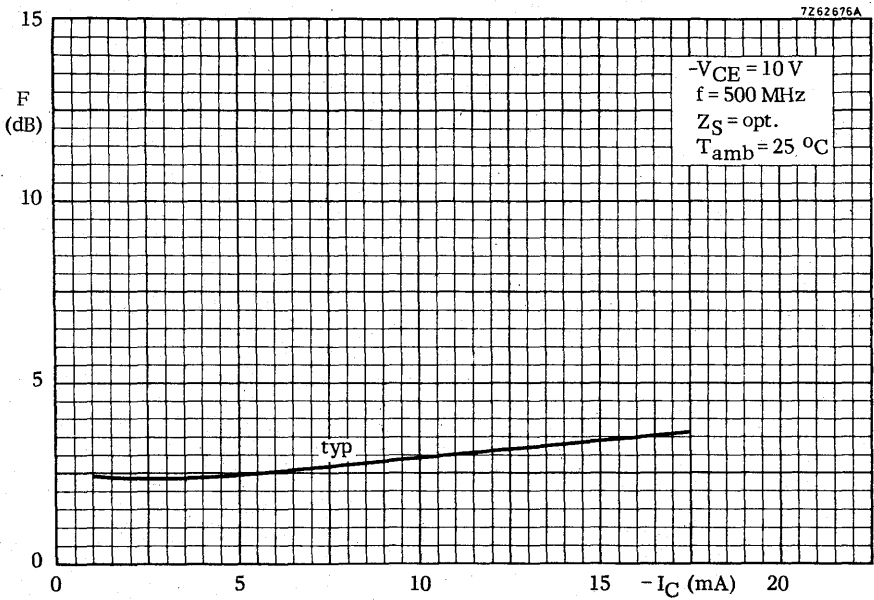
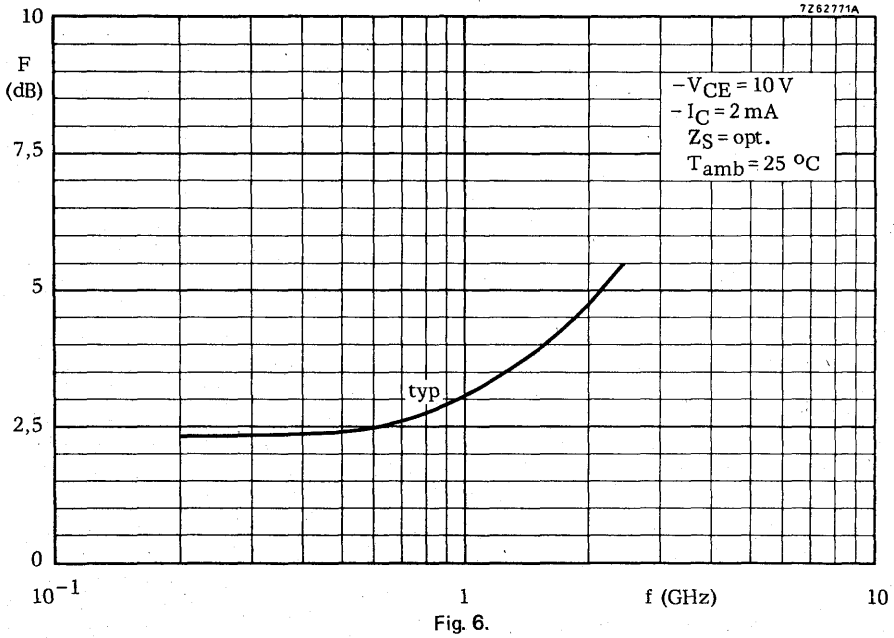
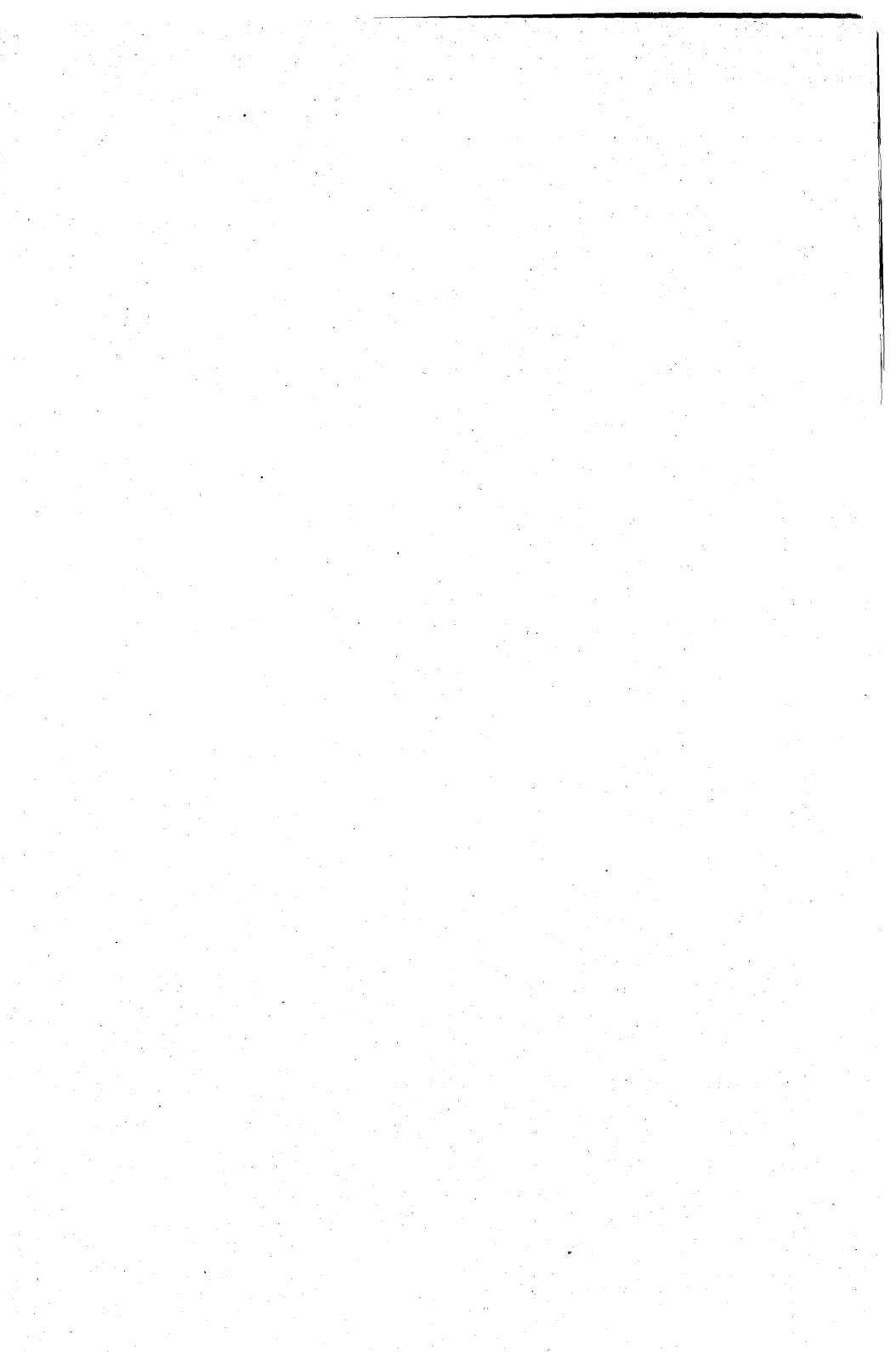

Fig. 5 $-V_{CE} = 10$ V; $f = 500$ MHz; $T_j = 25$ °C.





SILICON PLANAR EPITAXIAL TRANSISTOR

P-N-P transistor in a microminiature plastic envelope. It is primarily intended for use in u.h.f. and microwave amplifiers in thick and thin-film circuits, such as in aerial amplifiers, radar systems, oscilloscopes, spectrum analysers, etc.

The transistor features low intermodulation distortion and high power gain; thanks to its very high transition frequency, it also has excellent wideband properties and low noise up to high frequencies.

This type is complementary to BFR93.

QUICK REFERENCE DATA

Collector-base voltage (open emitter)	$-V_{CBO}$	max.	15 V
Collector-emitter voltage (open base)	$-V_{CEO}$	max.	12 V
Collector current (d.c.)	$-I_C$	max.	35 mA
Total power dissipation up to $T_{amb} = 60\text{ }^\circ\text{C}$	P_{tot}	max.	180 mW
Junction temperature	T_j	max.	150 $^\circ\text{C}$
Transition frequency at $f = 500\text{ MHz}$ $-I_C = 30\text{ mA}$; $-V_{CE} = 5\text{ V}$	f_T	typ.	5 GHz
Feedback capacitance at $f = 1\text{ MHz}$ $-I_C = 2\text{ mA}$; $-V_{CE} = 5\text{ V}$; $T_{amb} = 25\text{ }^\circ\text{C}$	C_{re}	typ.	1,0 pF
Noise figure at optimum source impedance $-I_C = 2\text{ mA}$; $-V_{CE} = 5\text{ V}$; $f = 500\text{ MHz}$; $T_{amb} = 25\text{ }^\circ\text{C}$	F	typ.	2,4 dB
Max. unilateral power gain (see page 3) $-I_C = 30\text{ mA}$; $-V_{CE} = 5\text{ V}$; $f = 500\text{ MHz}$; $T_{amb} = 25\text{ }^\circ\text{C}$	G _{UM}	typ.	16,5 dB
Intermodulation distortion at $T_{amb} = 25\text{ }^\circ\text{C}$ $-I_C = 30\text{ mA}$; $-V_{CE} = 5\text{ V}$; $R_L = 75\text{ }\Omega$; $V_o = 300\text{ mV}$ $f_{(p+q-r)} = 493,25\text{ MHz}$ (see page 3)	d_{im}	typ.	-60 dB

MECHANICAL DATA

Dimensions in mm

Fig. 1 SOT-23.

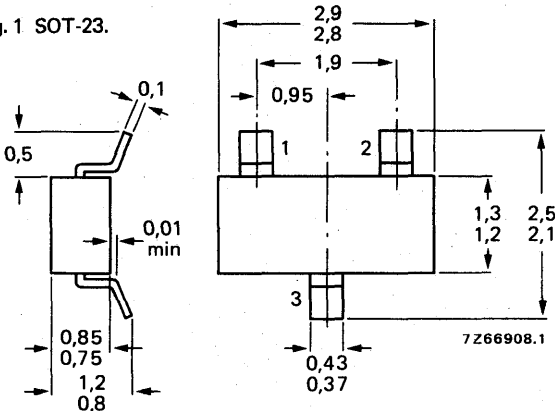

Marking code

BFT93 = X1

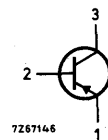

BFT93R = X4

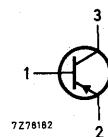

RATINGS

Limiting values in accordance with the Absolute Maximum System (IEC 134)

Collector-base voltage (open emitter)	$-V_{CB0}$	max.	15 V
Collector-emitter voltage (open base)	$-V_{CEO}$	max.	12 V
Emitter-base voltage (open collector)	$-V_{EBO}$	max.	2,0 V
Collector current (d.c.)	$-I_C$	max.	35 mA
Collector current (peak value; $f > 1$ MHz)	$-I_{CM}$	max.	50 mA
Total power dissipation up to $T_{amb} = 60^\circ\text{C}$ mounted on a ceramic substrate of 15 mm x 10 mm x 0,5 mm	P_{tot}	max.	180 mW
Storage temperature	T_{stg}		-65 to +150 °C
Junction temperature	T_j	max.	150 °C

THERMAL RESISTANCE

From junction to ambient in free air
mounted on a ceramic substrate of
15 mm x 10 mm x 0,5 mm

$$R_{th\ j-a} = 0,5 \text{ }^\circ\text{C/mW}$$

CHARACTERISTICS

$T_j = 25^\circ\text{C}$ unless otherwise specified

Collector cut-off current

$$I_E = 0; -V_{CB} = 5 \text{ V}$$

$$-I_{CBO} < 50 \text{ nA}$$

D.C. current gain *

$$-I_C = 30 \text{ mA}; -V_{CE} = 5 \text{ V}$$

$$h_{FE} > 20$$

typ. 50

Transition frequency at $f = 500$ MHz *

$$-I_C = 30 \text{ mA}; -V_{CE} = 5 \text{ V}$$

$$f_T \text{ typ. } 5 \text{ GHz}$$

Collector capacitance at $f = 1$ MHz

$$I_E = I_e = 0; -V_{CB} = 10 \text{ V}$$

$$C_c \text{ typ. } 0,95 \text{ pF}$$

Emitter capacitance at $f = 1$ MHz

$$I_C = I_c = 0; -V_{EB} = 0,5 \text{ V}$$

$$C_e \text{ typ. } 1,8 \text{ pF}$$

* Measured under pulse conditions.

CHARACTERISTICS (continued)

 $T_{amb} = 25\text{ }^{\circ}\text{C}$ Feedback capacitance at $f = 1\text{ MHz}$ $-I_C = 2\text{ mA}; -V_{CE} = 5\text{ V}$ C_{re} typ. 1,0 pF

Noise figure at optimum source impedance *

 $-I_C = 2\text{ mA}; -V_{CE} = 5\text{ V}; f = 500\text{ MHz}$

F typ. 2,4 dB

Max. unilateral power gain (s_{re} assumed to be zero)

$$G_{UM}(\text{in dB}) = 10 \log \frac{|s_{fe}|^2}{(1 - |s_{ie}|^2)(1 - |s_{oe}|^2)}$$

 $-I_C = 30\text{ mA}; -V_{CE} = 5\text{ V}; f = 500\text{ MHz}$ G_{UM} typ. 16,5 dB

Intermodulation distortion *

 $-I_C = 30\text{ mA}; -V_{CE} = 5\text{ V}; R_L = 75\text{ }\Omega; \text{VSWR} < 2$ $V_p = V_o = 300\text{ mV}$ at $f_p = 495,25\text{ MHz}$ $V_q = V_o - 6\text{ dB}$ at $f_q = 503,25\text{ MHz}$ $V_r = V_o - 6\text{ dB}$ at $f_r = 505,25\text{ MHz}$ Measured at $f(p + q - r) = 493,25\text{ MHz}$ d_{im} typ. -60 dB

Fig. 2 Intermodulation test circuit.

L1 = 4 turns Cu wire (0,35); winding pitch 1 mm; int. dia. 4 mm.

L2 and L3 = 5 μH (catalogue number: 3122 108 20150).

* Crystal mounted in SOT-37 envelope.

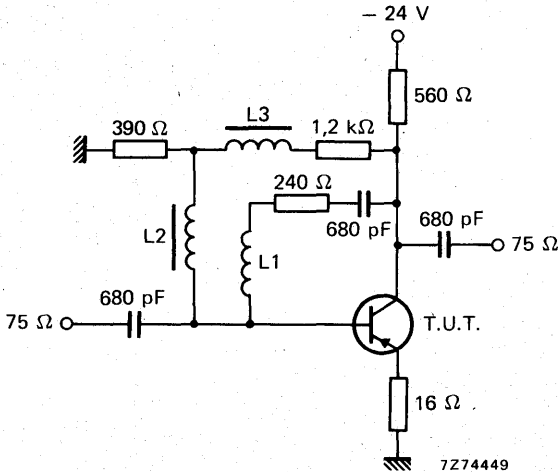
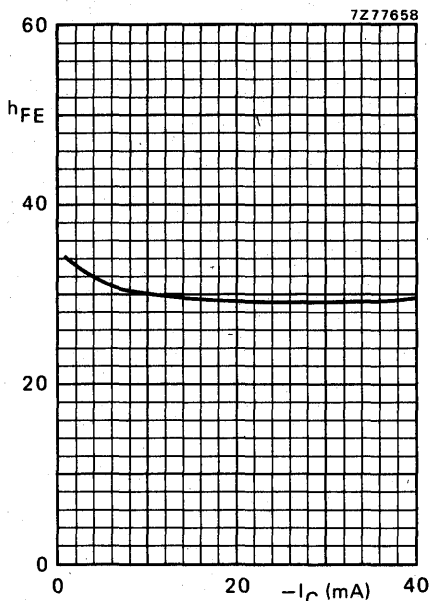

Fig. 3 $-V_{CE} = 5$ V; $T_j = 25$ °C.

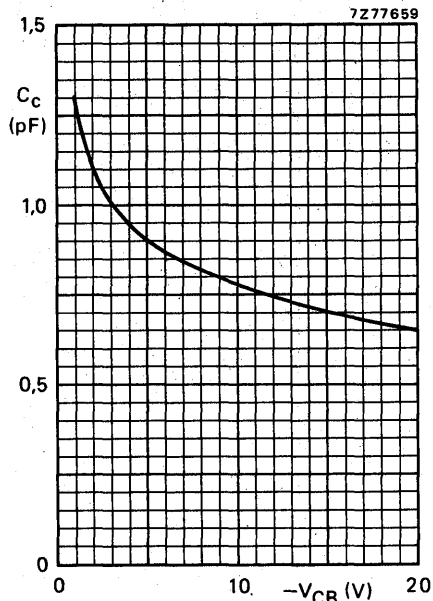

Fig. 4 $I_E = I_e = 0$; $T_j = 25$ °C; $f = 1$ MHz.

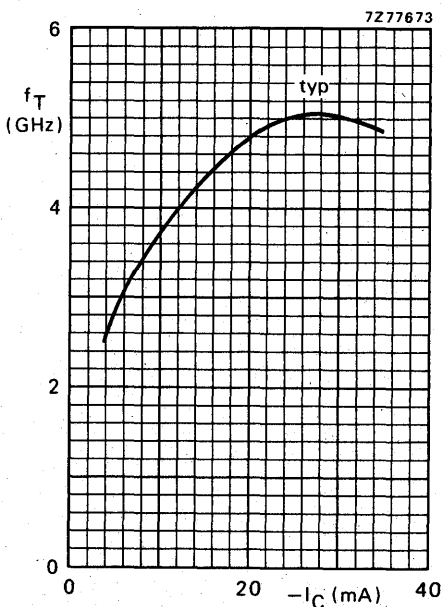

Fig. 5 $-V_{CE} = 5$ V; $T_j = 25$ °C; $f = 500$ MHz.

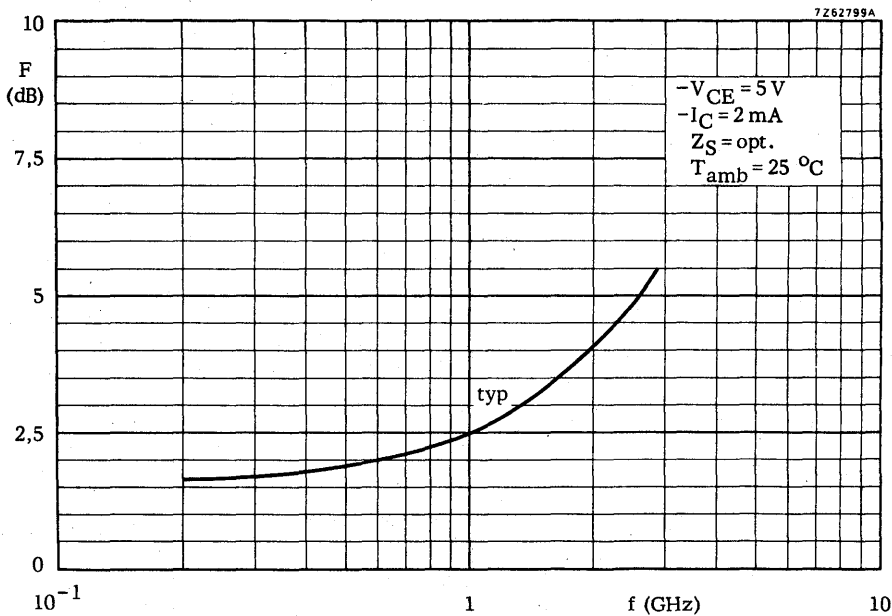

Fig. 6.

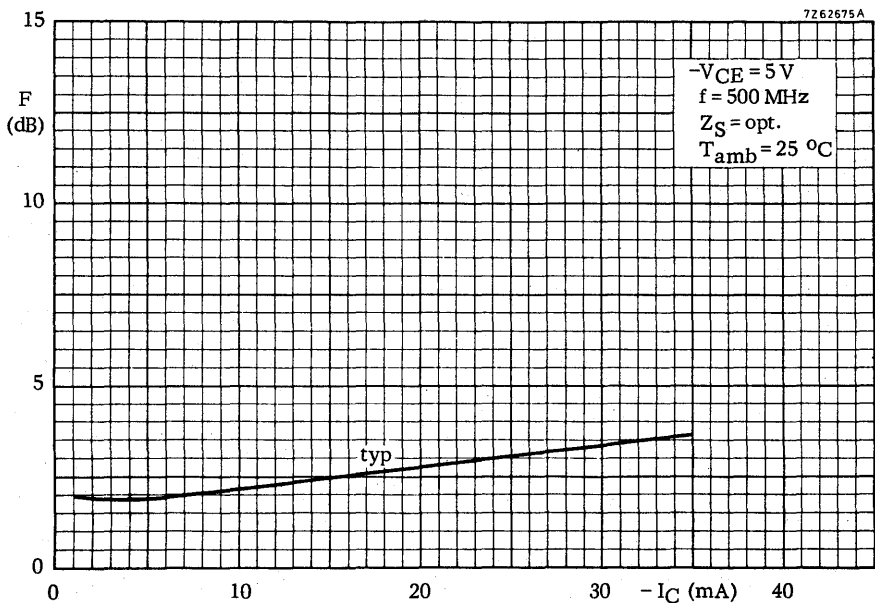

Fig. 7.



DEVELOPMENT SAMPLE DATA

This information is derived from development samples made available for evaluation. It does not form part of our data handbook system and does not necessarily imply that the device will go into production

BRY61

PROGRAMMABLE UNIJUNCTION TRANSISTOR

Planar p-n-p-n trigger device in a microminiature plastic envelope intended for applications in thick and thin-film circuits. It is intended for use in switching applications such as motor control, oscillators, relay replacement, timers, pulse shaper, trigger device etc.

QUICK REFERENCE DATA

Gate-anode voltage	V_{GA}	max.	70 V
Anode current (d.c.) up to $T_{case} = 85\text{ }^{\circ}\text{C}$	I_A	max.	250 mA
Junction temperature	T_j	max.	150 $^{\circ}\text{C}$
Peak point current	I_P	<	5 μA
Valley point current	I_V	>	30 μA
$V_S = 10\text{ V}; R_G = 10\text{ k}\Omega$			
$V_S = 10\text{ V}; R_G = 10\text{ k}\Omega$			

MECHANICAL DATA

Dimensions in mm

Marking code

Fig. 1 SOT-23.

BRY61 = A5

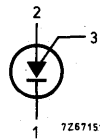
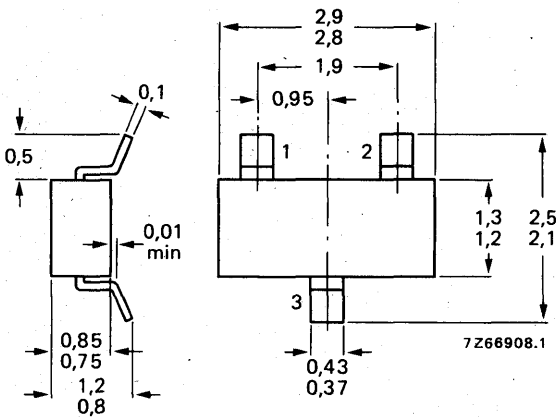

See also *Soldering Recommendations*.

RATINGS

Limiting values in accordance with the Absolute Maximum System (IEC 134)

Gate-anode voltage	V_{GA}	max.	70 V
Anode current (d.c.) up to $T_{amb} = 25\text{ }^{\circ}\text{C}$	I_A	max.	175 mA
Anode current (d.c.) up to $T_{case} = 85\text{ }^{\circ}\text{C}$	I_A	max.	250 mA
Repetitive peak anode current $t = 10\text{ }\mu\text{s}; \delta = 0,01$	I_{ARM}	max.	2,5 A
Non-repetitive peak anode current $t = 10\text{ }\mu\text{s}; T_j = 150\text{ }^{\circ}\text{C}$	I_{ASM}	max.	3 A
Rate of rise of anode current up to $I_A = 2,5\text{ A}$	$\frac{dI_A}{dt}$	max.	20 A/ μs
Storage temperature	T_{stg}		-65 to +150 $^{\circ}\text{C}$
Junction temperature	T_j	max.	150 $^{\circ}\text{C}$

THERMAL RESISTANCE

From junction to ambient in free air mounted on a ceramic substrate of 15 mm x 10 mm x 0,5 mm

$R_{th\ j-a} = 0,50\text{ }^{\circ}\text{C/mW}$

CHARACTERISTICS

$T_{amb} = 25\text{ }^{\circ}\text{C}$ unless otherwise specified

Peak point current

$V_S = 10\text{ V}; R_G = 10\text{ k}\Omega$

$I_P < 5\text{ }\mu\text{A}$

$V_S = 10\text{ V}; R_G = 1\text{ M}\Omega$

$I_P < 1\text{ }\mu\text{A}$

Valley point current (see also Figs 3 and 4)

$V_S = 10\text{ V}; R_G = 10\text{ k}\Omega$

$I_V > 30\text{ }\mu\text{A}$

$V_S = 10\text{ V}; R_G = 1\text{ M}\Omega$

$I_V < 50\text{ }\mu\text{A}$

Offset voltage

$I_A = 0$

$V_{offset} = V_P - V_S\text{ V}$

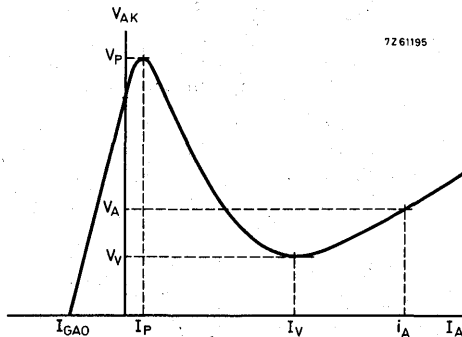

Fig. 2 See also Fig. 12.

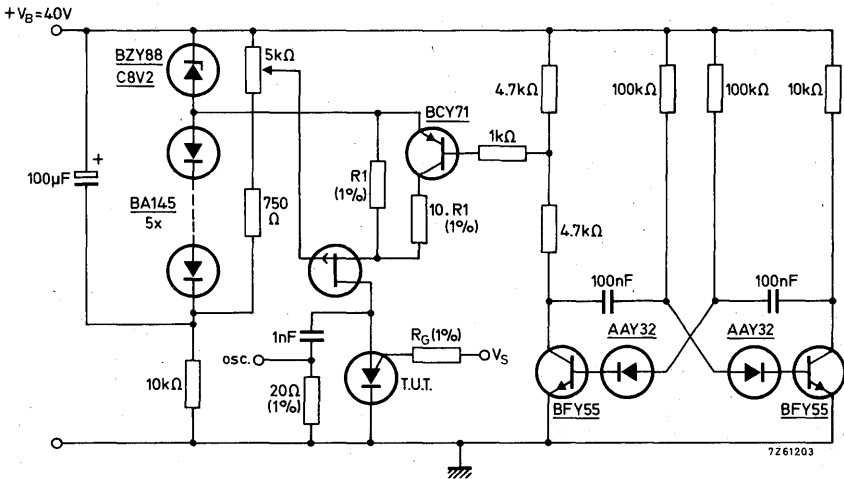
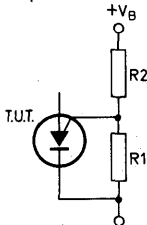

Fig. 3 Practical test circuit.

Notes

- Remove BCY71 during measurement of I_p .
- Value of R_1 depends on the voltage range of voltmeter.



(a) BRY61 with "program" resistors R_1 and R_2 .

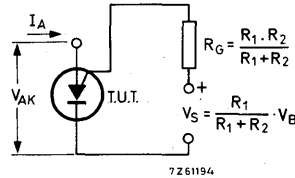

(b) Equivalent test circuit for characteristics testing.

Fig. 4 Equivalent test circuit.

Gate-anode leakage current

$I_K = 0; V_{GA} = 70 \text{ V}$

$I_{GAO} < 10 \text{ nA}$

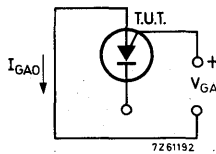

Fig. 5.

DEVELOPMENT SAMPLE DATA

Gate-cathode leakage current
 $V_{AK} = 0; V_{GK} = 70 \text{ V}$

$I_{GKS} < 100 \text{ nA}$

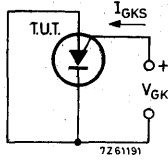

Fig. 6.

Anode voltage at $I_A = 100 \text{ mA}$

$V_A < 1,4 \text{ V}$

Peak output voltage

$V_{AA} = 20 \text{ V}; C = 200 \text{ nF}$ (see Fig. 13)

$V_{OM} > 6 \text{ V}$

Rise time

$V_{AA} = 20 \text{ V}; C = 10 \text{ nF}$ (see Fig. 13)

$t_r < 80 \text{ ns}$

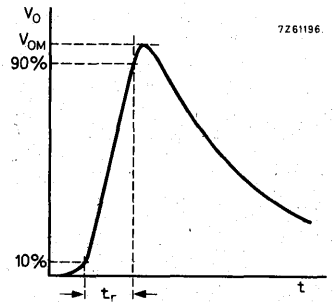

Fig. 7.

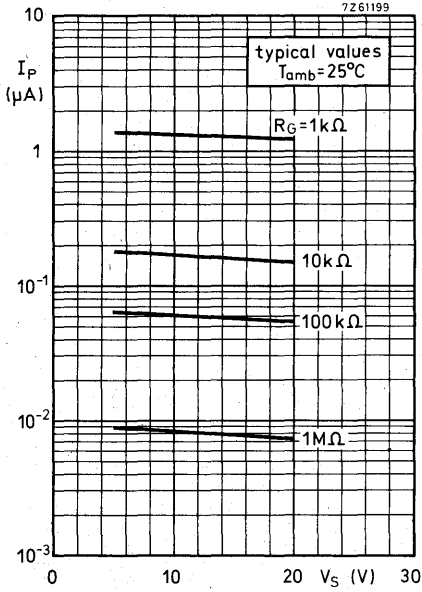

Fig. 8.

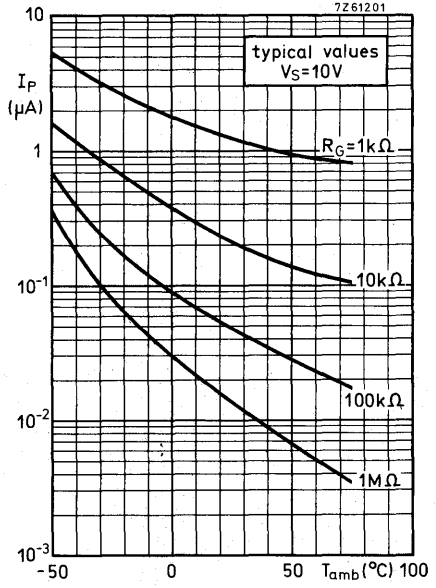

Fig. 9.

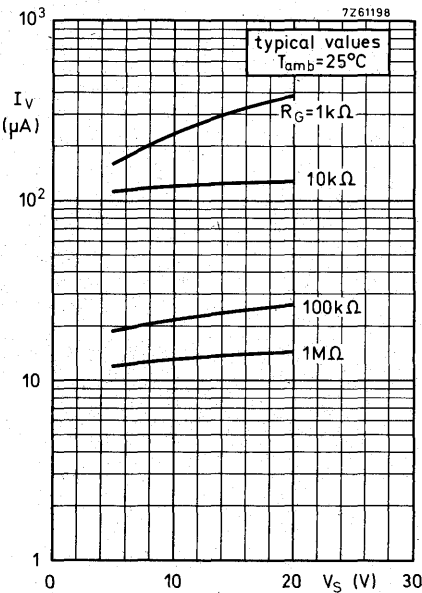

Fig. 10.

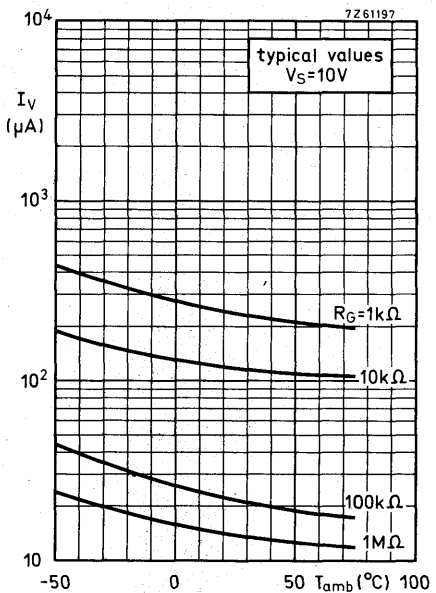

Fig. 11.

DEVELOPMENT SAMPLE DATA



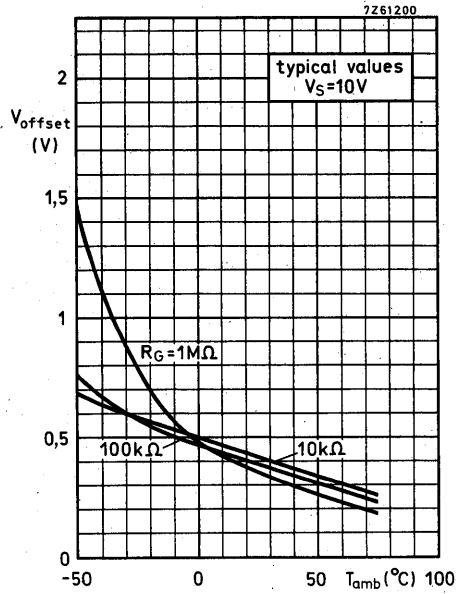

Fig. 12.

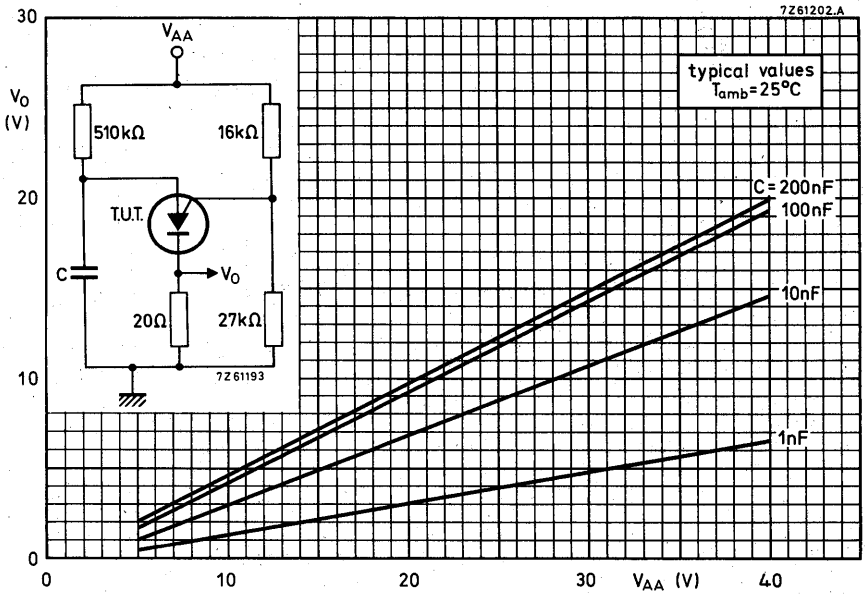

Fig. 13.

SILICON LOW-POWER SWITCHING TRANSISTOR

P-N-P silicon transistor in a microminiature plastic envelope. It is intended for high-speed, saturated switching applications for industrial service in thick and thin-film circuits.

QUICK REFERENCE DATA

Collector-base voltage (open emitter)	$-V_{CBO}$	max.	15 V
Collector-emitter voltage (open base)	$-V_{CEO}$	max.	15 V
Collector current (peak value)	$-I_{CM}$	max.	200 mA
Total power dissipation up to $T_{amb} = 25^\circ\text{C}$	P_{tot}	max.	200 mW
Junction temperature	T_j	max.	150 $^\circ\text{C}$
D.C. current gain			
$-I_C = 10\text{ mA}; -V_{CE} = 1\text{ V}$	h_{FE}	>	30
$-I_C = 50\text{ mA}; -V_{CE} = 1\text{ V}$	h_{FE}		30 to 120
Transition frequency at $f = 500\text{ MHz}$			
$-I_C = 50\text{ mA}; -V_{CE} = 10\text{ V}$	f_T	>	1,5 GHz
Turn-off time			
$-I_{Con} = 30\text{ mA}; -I_{Bon} = +I_{Boff} = 3,0\text{ mA}$	t_{off}	<	30 ns

MECHANICAL DATA

Dimensions in mm

Marking code

Fig. 1 SOT-23.

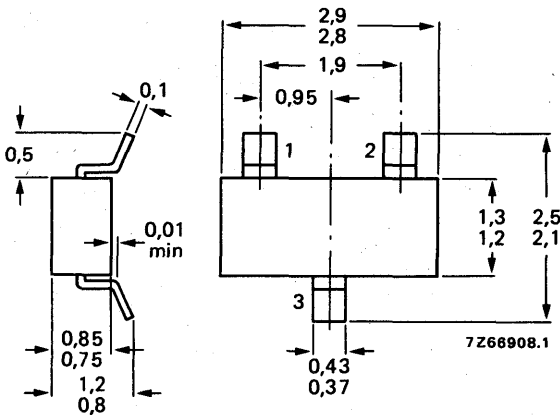

BSR12 = B5

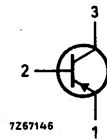

BSR12R = B8

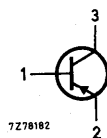

See also *Soldering recommendations*.

RATINGS

Limiting values in accordance with the Absolute Maximum System (IEC 134)

Collector-base voltage (open emitter)	$-V_{CB0}$	max.	15 V
Collector-emitter voltage (open base)	$-V_{CEO}$	max.	15 V
Emitter-base voltage (open collector)	$-V_{EBO}$	max.	3 V
Collector current (d.c.)	$-I_C$	max.	100 mA
Collector current (peak value)	$-I_{CM}$	max.	200 mA
Total power dissipation up to $T_{amb} = 25\text{ }^\circ\text{C}$ mounted on a ceramic substrate of 7 mm x 5 mm x 0,5 mm	P_{tot}	max.	200 mW
Storage temperature	T_{stg}	-65 to +150	$^\circ\text{C}$
Junction temperature	T_j	max.	150 $^\circ\text{C}$

THERMAL RESISTANCE

From junction to ambient mounted on a ceramic substrate of 7 mm x 5 mm x 0,5 mm

$$R_{th\ j-a} = 0,62\text{ }^\circ\text{C/mW}$$

CHARACTERISTICS

$T_{amb} = 25\text{ }^\circ\text{C}$ unless otherwise specified

Collector cut-off current

$$I_E = 0; -V_{CB} = 10\text{ V}$$

$$I_E = 0; -V_{CB} = 10\text{ V}; T_{amb} = 125\text{ }^\circ\text{C}$$

$$V_{BE} = 0; -V_{CE} = 10\text{ V}$$

$$-I_{CBO} < 50\text{ nA}$$

$$-I_{CBO} < 5\text{ }\mu\text{A}$$

$$-I_{CES} < 50\text{ nA}$$

Breakdown voltages

$$I_E = 0; -I_C = 10\text{ }\mu\text{A}$$

$$V_{BE} = 0; -I_C = 10\text{ }\mu\text{A}$$

$$I_C = 0; -I_E = 100\text{ }\mu\text{A}$$

$$-V_{(BR)CBO} > 15\text{ V}$$

$$-V_{(BR)CES} > 15\text{ V}$$

$$-V_{(BR)EBO} > 3\text{ V}$$

Collector-emitter sustaining voltage

$$I_B = 0; -I_C = 10\text{ mA}$$

$$-V_{CEOsust} > 15\text{ V}$$

Saturation voltages *

$$-I_C = 10\text{ mA}; -I_B = 1\text{ mA}$$

$$-V_{CEsat} < 130\text{ mV}$$

$$-V_{BEsat} \quad 725\text{ to }920\text{ mV}$$

$$-I_C = 50\text{ mA}; -I_B = 5\text{ mA}$$

$$-V_{CEsat} < 190\text{ mV}$$

$$-V_{BEsat} \quad 800\text{ to }1150\text{ mV}$$

$$-I_C = 100\text{ mA}; -I_B = 10\text{ mA}$$

$$-V_{CEsat} < 450\text{ mV}$$

$$-V_{BEsat} \quad 900\text{ to }1500\text{ mV}$$

* Measured under pulse conditions; $t_p = 300\text{ }\mu\text{s}$; $\delta = 0,01$.

D.C. current gain *

- $-I_C = 1 \text{ mA}; -V_{CE} = 1 \text{ V}$
- $-I_C = 10 \text{ mA}; -V_{CE} = 1 \text{ V}$
- $-I_C = 50 \text{ mA}; -V_{CE} = 1 \text{ V}$
- $-I_C = 50 \text{ mA}; -V_{CE} = 1 \text{ V}; T_{amb} = 55 \text{ }^\circ\text{C}$
- $-I_C = 100 \text{ mA}; -V_{CE} = 1 \text{ V}$

- $h_{FE} > 30$
- $h_{FE} > 30$
- $h_{FE} 30 \text{ to } 120$
- $h_{FE} > 30$
- $h_{FE} > 20$

Transition frequency at $f = 500 \text{ MHz}$

- $-I_C = 50 \text{ mA}; -V_{CE} = 10 \text{ V}$

- $f_T > 1,5 \text{ GHz}$

Collector capacitance

- $I_E = I_e = 0; -V_{CB} = 5 \text{ V}$

- $C_c < 4,5 \text{ pF}$

Emitter capacitance

- $I_C = I_c = 0; -V_{EB} = 0,5 \text{ V}$

- $C_e < 6,0 \text{ pF}$

Switching times

Turn-on time

- $t_{on} < 20 \text{ ns}$

Turn-off time

- $t_{off} < 30 \text{ ns}$

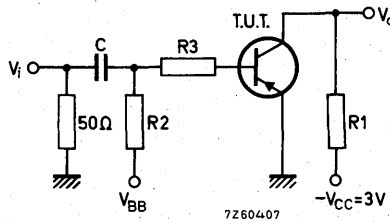

Fig. 2 Test circuit switching times.

Pulse generator

- Pulse duration $t_p = 400 \text{ ns}$
- Rise time $t_r < 1 \text{ ns}$
- Output impedance $Z_o = 50 \text{ } \Omega$

Sampling scope

- Rise time $t_r < 1 \text{ ns}$
- Input impedance $Z_i = 100 \text{ k}\Omega$

	V_i V	V_{BB} V	R1 Ω	R2 k Ω	R3 k Ω	$-I_{Con}$ mA	$-I_{Bon}$ mA	I_{Boff} mA	C μF
t_{on}	-6,85	0	94	1,0	2,0	30	3,0	-	0,1
t_{off}	11,7	-9,85	94	1,0	2,0	30	3,0	3,0	0,1

* Measured under pulse conditions; $t_p = 300 \text{ } \mu\text{s}; \delta = 0,01$.

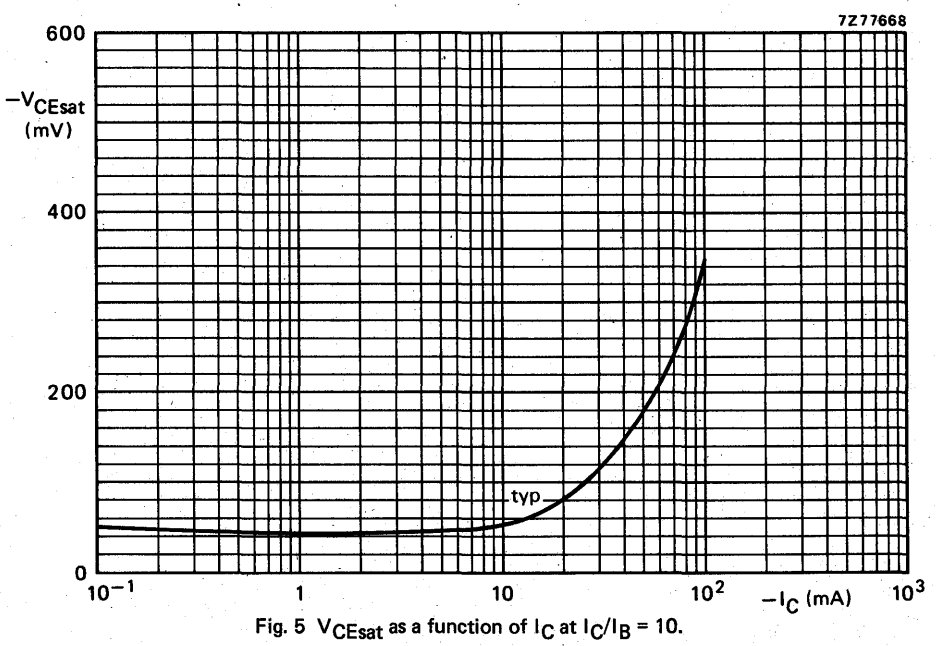
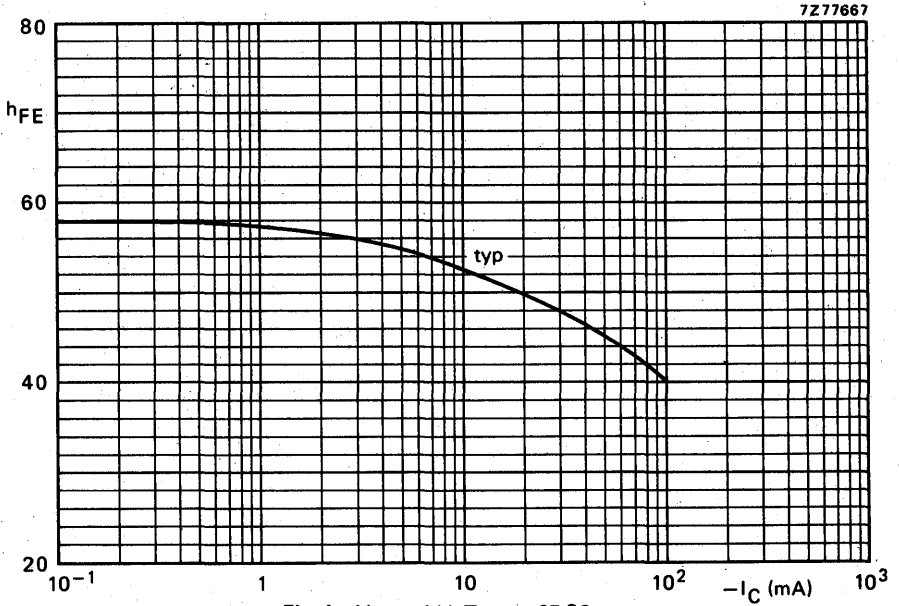

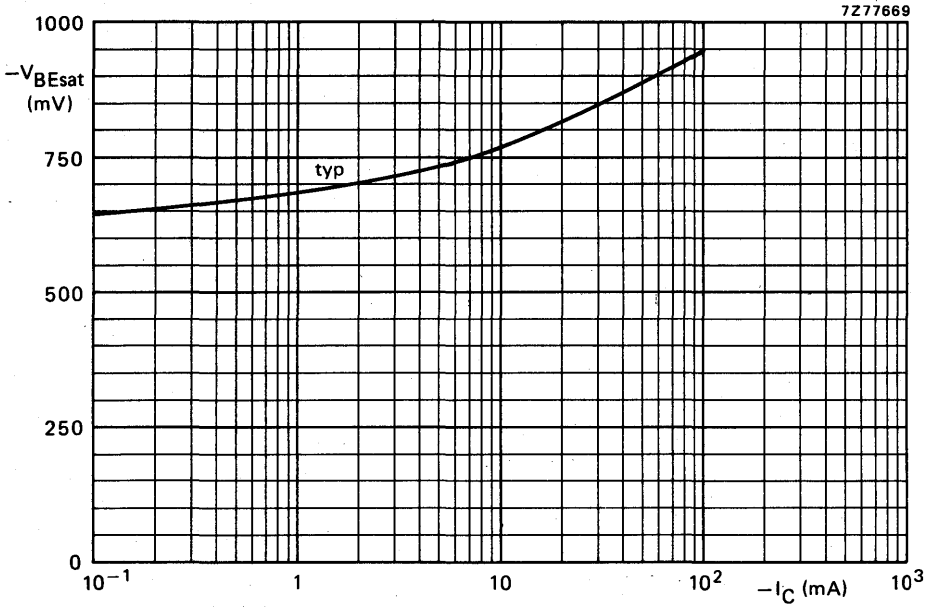

Fig. 6 V_{BEsat} as a function of I_C at $I_C/I_B = 10$.

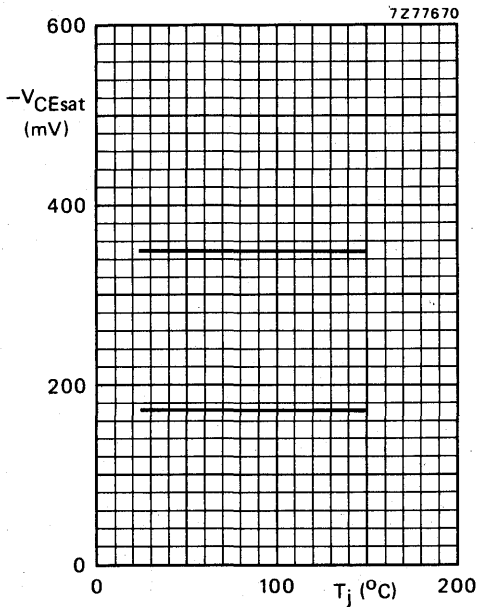
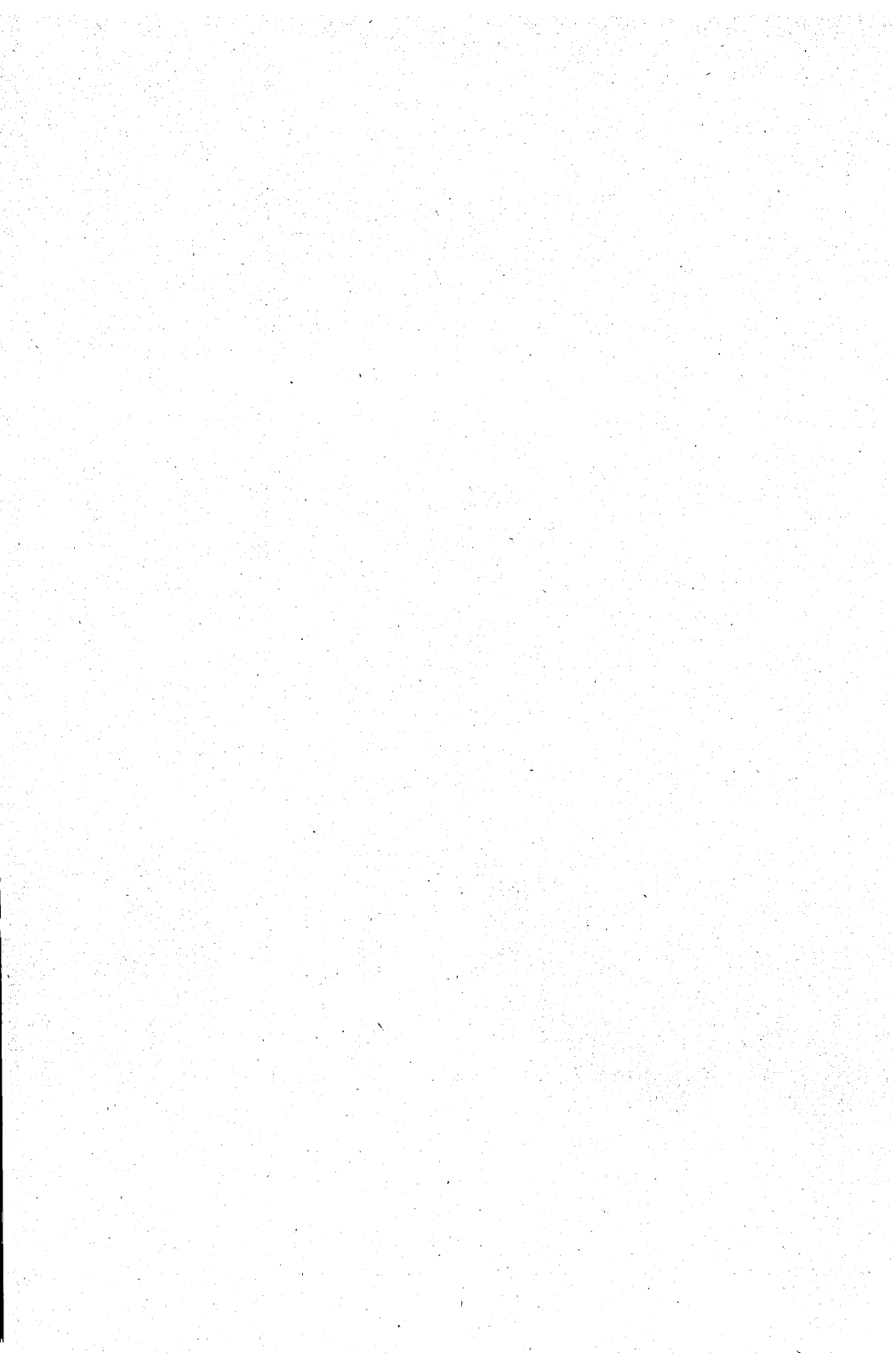

Fig. 7 V_{CEsat} as a function of T_j ; typical values.

Upper graph at $I_C = 100$ mA; $I_B = 10$ mA. Lower graph at $I_C = 50$ mA and $I_B = 5$ mA.



DEVELOPMENT SAMPLE DATA

This information is derived from development samples made available for evaluation. It does not form part of our data handbook system and does not necessarily imply that the device will go into production

BSR30 to 33

SILICON PLANAR EPITAXIAL TRANSISTORS

P-N-P transistors in miniature plastic envelopes intended for application in thick and thin-film circuits. They are intended for use in telephony and general industrial applications.

QUICK REFERENCE DATA

		BSR30	BSR31	BSR32	BSR33
Collector-base voltage (open emitter)	$-V_{CBO}$ max.	70	70	90	90 V
Collector-emitter voltage (open base)	$-V_{CEO}$ max.	60	60	80	80 V
Collector current (d.c.)	$-I_C$ max.	1	1	1	1 A
Total power dissipation up to $T_{amb} = 25^\circ\text{C}$	P_{tot} max.	1	1	1	1 W
Junction temperature	T_j max.	150	150	150	150 $^\circ\text{C}$
D.C. current gain					
$-I_C = 100\text{ mA}; -V_{CE} = 5\text{ V}$	$h_{FE} >$	40	100	40	100
	$h_{FE} <$	120	300	120	300
Transition frequency at $f = 35\text{ MHz}$					
$-I_C = 50\text{ mA}; -V_{CE} = 10\text{ V}$	$f_T >$	100	100	100	100 MHz

MECHANICAL DATA

Dimensions in mm

Mark

Fig. 1 SOT-89.

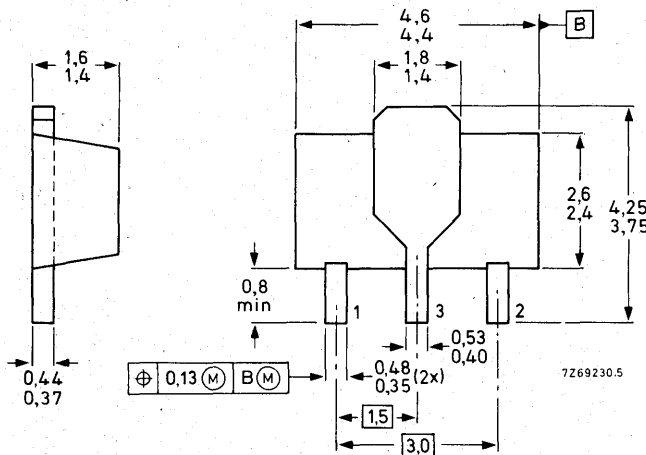

BSR30
BSR31
BSR32
BSR33

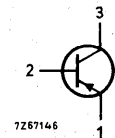

See also *Soldering recommendations.*

RATINGS

Limiting values in accordance with the Absolute Maximum System (IEC 134)

Voltages

		BSR30	BSR31	BSR32	BSR33
Collector-base voltage (open emitter)	$-V_{CBO}$ max.	70	70	90	90 V
Collector-emitter voltage (open base)	$-V_{CEO}$ max.	60	60	80	80 V
Emitter-base voltage (open collector)	$-V_{EBO}$ max.	5	5	5	5 V

Currents

Collector current (d.c.)	$-I_C$ max.			1	A
Base current (d.c.)	$-I_B$ max.			0,1	A

Power dissipation

Total power dissipation up to $T_{amb} = 25\text{ }^\circ\text{C}$ mounted on a ceramic substrate area = 2,5 cm ² ; thickness = 0,7 mm	P_{tot} max.			1	W
---	----------------	--	--	---	---

Temperatures

Storage temperature	T_{stg}			-65 to +150	$^\circ\text{C}$
Junction temperature	T_j max.			150	$^\circ\text{C}$

THERMAL RESISTANCE

From junction to collector tab	$R_{th\ j-tab} =$			10	$^\circ\text{C/W}$
From junction to ambient in free air mounted on a ceramic substrate area = 2,5 cm ² ; thickness = 0,7 mm	$R_{th\ j-a} =$			125	$^\circ\text{C/W}$

CHARACTERISTICS

$T_{amb} = 25\text{ }^{\circ}\text{C}$ unless otherwise specified

Collector cut-off current

$I_E = 0; -V_{CB} = 60\text{ V}$	$-I_{CBO}$	<	100	nA
$I_E = 0; -V_{CB} = 60\text{ V}; T_j = 150\text{ }^{\circ}\text{C}$	$-I_{CBO}$	<	50	μA

Breakdown voltages

			BSR30	BSR31	BSR32	BSR33	
$I_B = 0; -I_C = 10\text{ mA}$	$-V_{(BR)CEO}$	>	60	60	80	80	V
$V_{BE} = 0; -I_C = 10\text{ }\mu\text{A}$	$-V_{(BR)CES}$	>	70	70	90	90	V
$I_C = 0; -I_E = 10\text{ }\mu\text{A}$	$-V_{(BR)EBO}$	>	5	5	5	5	V

Saturation voltages *

$-I_C = 150\text{ mA}; -I_B = 15\text{ mA}$	$-V_{CEsat}$	<	0,25	0,25	0,25	0,25	V
	$-V_{BEsat}$	<	1,0	1,0	1,0	1,0	V
$-I_C = 500\text{ mA}; -I_B = 50\text{ mA}$	$-V_{CEsat}$	<	0,5	0,5	0,5	0,5	V
	$-V_{BEsat}$	<	1,2	1,2	1,2	1,2	V

D.C. current gain *

$-I_C = 100\text{ }\mu\text{A}; V_{CE} = 5\text{ V}$	h_{FE}	>	10	30	10	30
$-I_C = 100\text{ mA}; V_{CE} = 5\text{ V}$	h_{FE}	>	40	100	40	100
		<	120	300	120	300
$-I_C = 500\text{ mA}; V_{CE} = 5\text{ V}$	h_{FE}	>	30	50	30	50

Transition frequency at $f = 35\text{ MHz}$

$-I_C = 50\text{ mA}; -V_{CE} = 10\text{ V}$	f_T	>	100	MHz
--	-------	---	-----	-----

Collector capacitance at $f = 1\text{ MHz}$

$I_E = I_e = 0; -V_{CB} = 10\text{ V}$	C_C	<	20	pF
--	-------	---	----	----

Emitter capacitance at $f = 1\text{ MHz}$

$I_C = I_c = 0; -V_{EB} = 0,5\text{ V}$	C_e	<	120	pF
---	-------	---	-----	----

Switching times see page 4

* Measured under pulse conditions: $t_p = 300\text{ }\mu\text{s}; \delta < 0,01$.

CHARACTERISTICS (continued)

$T_{amb} = 25\text{ }^{\circ}\text{C}$

Switching times

$-I_{Con} = 100\text{ mA}; -I_{Bon} = +I_{Boff} = 5\text{ mA}$

Turn-on time

$t_{on} < 500\text{ ns}$

Turn-off time

$t_{off} < 650\text{ ns}$

Test circuit

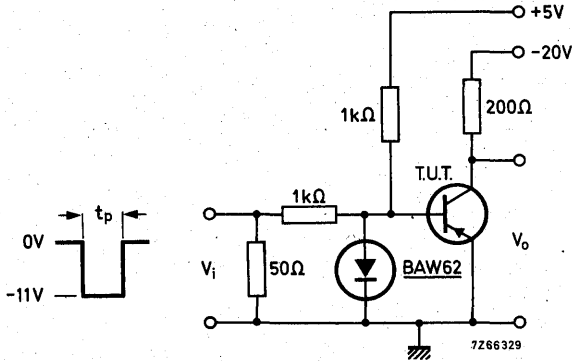

Pulse generator:

Pulse duration $t_p = 10\text{ }\mu\text{s}$
 Rise time $t_r \leq 15\text{ ns}$
 Fall time $t_f \leq 15\text{ ns}$
 Source impedance $Z_S = 50\text{ }\Omega$

Oscilloscope:

Rise time $t_r \leq 15\text{ ns}$
 Input impedance $Z_I \geq 100\text{ k}\Omega$

SILICON PLANAR EPITAXIAL TRANSISTORS

N-P-N transistors in miniature plastic envelopes intended for application in thick and thin-film circuits. They are intended for use in telephony and general industrial applications.

QUICK REFERENCE DATA

		BSR40	BSR41	BSR42	BSR43
Collector-base voltage (open emitter)	V_{CBO} max.	70	70	90	90 V
Collector-emitter voltage (open base)	V_{CEO} max.	60	60	80	80 V
Collector current (d.c.)	I_C max.	1	1	1	1 A
Total power dissipation up to $T_{amb} = 25^\circ\text{C}$	P_{tot} max.	1	1	1	1 W
Junction temperature	T_j max.	150	150	150	150 $^\circ\text{C}$
D.C. current gain					
$I_C = 100\text{ mA}; V_{CE} = 5\text{ V}$	h_{FE}	> 40	100	40	100
		< 120	300	120	300
Transition frequency at $f = 35\text{ MHz}$					
$I_C = 50\text{ mA}; V_{CE} = 10\text{ V}$	f_T	> 100	100	100	100 MHz

MECHANICAL DATA

Dimensions in mm

Mark

Fig. 1 SOT-89.

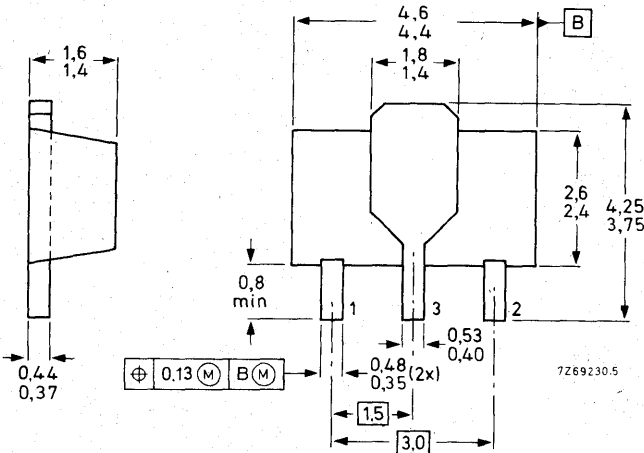

BSR40
BSR41
BSR42
BSR43

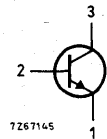

RATINGS

Limiting values in accordance with the Absolute Maximum System (IEC 134)

Voltages

		BSR40	BSR41	BSR42	BSR43
Collector-base voltage (open emitter)	V_{CBO}	max. 70	70	90	90 V
Collector-emitter voltage (open base)	V_{CEO}	max. 60	60	80	80 V
Emitter-base voltage (open collector)	V_{EBO}	max. 5	5	5	5 V

Currents

Collector current (d.c.)	I_C	max.		1	A
Base current (d.c.)	I_B	max.		0,1	A

Power dissipation

Total power dissipation up to $T_{amb} = 25\text{ }^\circ\text{C}$ mounted on a ceramic substrate area = $2,5\text{ cm}^2$; thickness = $0,7\text{ mm}$					
	P_{tot}	max.		1	W

Temperatures

Storage temperature	T_{stg}			-65 to +150	$^\circ\text{C}$
Junction temperature	T_j	max.		150	$^\circ\text{C}$

THERMAL RESISTANCE

From junction to collector tab	$R_{th\ j-tab}$	=		10	$^\circ\text{C/W}$
From junction to ambient in free air mounted on a ceramic substrate area = $2,5\text{ cm}^2$; thickness = $0,7\text{ m}$	$R_{th\ j-a}$	=		125	$^\circ\text{C/W}$

CHARACTERISTICS

 $T_{amb} = 25\text{ }^{\circ}\text{C}$ unless otherwise specified

Collector cut-off current

$I_E = 0; V_{CB} = 60\text{ V}$	I_{CBO}	<	100	nA
$I_E = 0; V_{CB} = 60\text{ V}; T_j = 150\text{ }^{\circ}\text{C}$	I_{CBO}	<	50	μA

Breakdown voltages

			BSR40	BSR41	BSR42	BSR43	
$I_B = 0; I_C = 10\text{ mA}$	$V_{(BR)CEO}$	>	60	60	80	80	V
$V_{BE} = 0; I_C = 10\text{ }\mu\text{A}$	$V_{(BR)CES}$	>	70	70	90	90	V
$I_C = 0; I_E = 10\text{ }\mu\text{A}$	$V_{(BR)EBO}$	>	5	5	5	5	V

Saturation voltages *

$I_C = 150\text{ mA}; I_B = 15\text{ mA}$	V_{CEsat}	<	0,25	0,25	0,25	0,25	V
	V_{BEsat}	<	1,0	1,0	1,0	1,0	V
$I_C = 500\text{ mA}; I_B = 50\text{ mA}$	V_{CEsat}	<	0,5	0,5	0,5	0,5	V
	V_{BEsat}	<	1,2	1,2	1,2	1,2	V

D.C. current gain *

$I_C = 100\text{ }\mu\text{A}; V_{CE} = 5\text{ V}$	h_{FE}	>	10	30	10	30
$I_C = 100\text{ mA}; V_{CE} = 5\text{ V}$	h_{FE}	>	40	100	40	100
	h_{FE}	<	120	300	120	300
$I_C = 500\text{ mA}; V_{CE} = 5\text{ V}$	h_{FE}	>	30	50	30	50

Transition frequency at $f = 35\text{ MHz}$

$I_C = 50\text{ mA}; V_{CE} = 10\text{ V}$	f_T	>	100	MHz
--	-------	---	-----	-----

Collector capacitance at $f = 1\text{ MHz}$

$I_E = I_e = 0; V_{CB} = 10\text{ V}$	C_c	<	12	pF
---------------------------------------	-------	---	----	----

Emitter capacitance at $f = 1\text{ MHz}$

$I_C = I_c = 0; V_{EB} = 0,5\text{ V}$	C_e	<	90	pF
--	-------	---	----	----

Switching times see page 4

* Measured under pulse conditions: $t_p = 300\text{ }\mu\text{s}; \delta < 0,01$.

CHARACTERISTICS (continued)

$T_{amb} = 25\text{ }^{\circ}\text{C}$

Switching times

$I_{Con} = 100\text{ mA}; I_{Bon} = -I_{Boff} = 5\text{ mA}$

Turn-on time

$t_{on} < 250\text{ ns}$

Turn-off time

$t_{off} < 1000\text{ ns}$

Test circuit

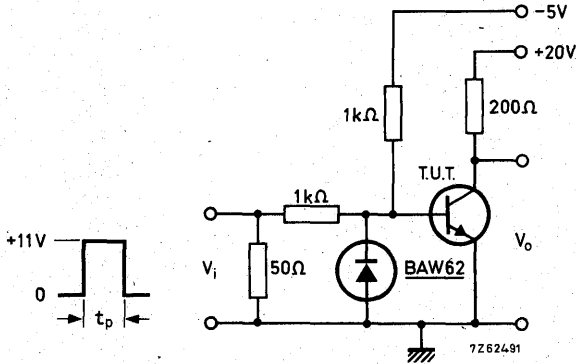

Pulse generator:

Pulse duration $t_p = 10\text{ }\mu\text{s}$
 Rise time $t_r \leq 15\text{ ns}$
 Fall time $t_f \leq 15\text{ ns}$
 Source impedance $Z_S = 50\text{ }\Omega$

Oscilloscope:

Rise time $t_r \leq 15\text{ ns}$
 Input impedance $Z_I \geq 100\text{ k}\Omega$

DEVELOPMENT SAMPLE DATA

This information is derived from development samples made available for evaluation. It does not form part of our data handbook system and does not necessarily imply that the device will go into production

BSR56
BSR57
BSR58

N-CHANNEL FETS

Silicon n-channel depletion type junction field-effect transistors in a plastic microminiature envelope intended for application in thick and thin-film circuits. The transistors are intended for low-power, chopper or switching applications in industrial service.

QUICK REFERENCE DATA

		BSR56	BSR57	BSR58
Drain-source voltage	$\pm V_{DS}$	max. 40	40	40 V
Total power dissipation up to $T_{amb} = 70^\circ C$	P_{tot}	max. 200	200	200 mW
Drain current $V_{DS} = 15 V; V_{GS} = 0$	I_{DSS}	> 50	20	8 mA
		< -	100	80 mA
Gate-source cut-off voltage $V_{DS} = 15 V; I_D = 0,5 nA$	$-V_{(P)GS}$	> 4	2	0,8 V
		< 10	6	4 V
Drain-source resistance (on) at $f = 1 kHz$ $I_D = 0; V_{GS} = 0$	$r_{ds on}$	< 25	40	60 Ω
Feedback capacitance at $f = 1 MHz$ $-V_{GS} = 10 V; V_{DS} = 0$	C_{rs}	< 5	5	5 pF
Turn-off time $V_{DD} = 10 V; V_{GS} = 0$ $I_D = 20 mA; -V_{GSM} = 10 V$ $I_D = 10 mA; -V_{GSM} = 6 V$ $I_D = 5 mA; -V_{GSM} = 4 V$	t_{off}	< 25	-	- ns
	t_{off}	< -	50	- ns
	t_{off}	< -	-	100 ns
	t_{off}	< -	-	-

MECHANICAL DATA

Fig. 1 SOT-23.

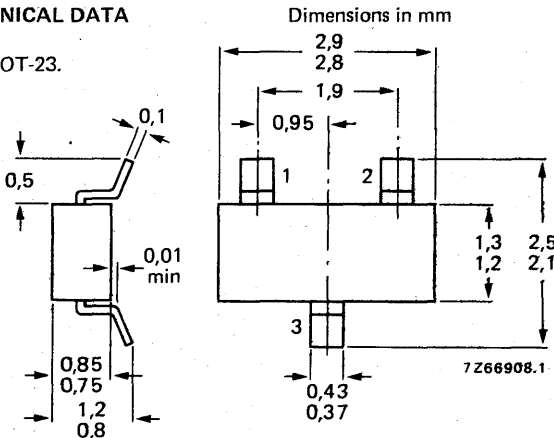

Marking code

BSR56 = M4
BSR57 = M5
BSR58 = M6

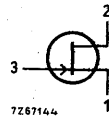

See also *Soldering Recommendations*.

RATINGS

Limiting values in accordance with the Absolute Maximum System (IEC 134)

Drain-source voltage	$\pm V_{DS}$	max.	40	V
Drain-gate voltage	V_{DGO}	max.	40	V
Gate-source voltage	$-V_{GSO}$	max.	40	V
Forward gate current	I_{GF}	max.	50	mA
Total power dissipation up to $T_{amb} = 70^\circ C$	P_{tot}	max.	200	mW
Storage temperature	T_{stg}		-55 to +150	$^\circ C$
Junction temperature	T_j	max.	150	$^\circ C$

THERMAL RESISTANCE

From junction to ambient in free air mounted on a ceramic substrate of 15 x 15 x 0,5 mm

R_{thj-a}	=	0,4	$^\circ C/mW$
-------------	---	-----	---------------

CHARACTERISTICS

$T_{amb} = 25^\circ C$ unless otherwise specified

Gate-source cut-off current $V_{DS} = 0 V; -V_{GS} = 20 V$	$-I_{GSS}$	<	1	nA
Drain cut-off current $V_{DS} = 15 V; -V_{GS} = 10 V$	I_{DSX}	<	1	nA

		BSR56	BSR57	BSR58
Drain current * $V_{DS} = 15 V; V_{GS} = 0$	I_{DSS}	> 50	20	8 mA
		< -	100	80 mA
Gate-source breakdown voltage $-I_G = 1 \mu A; V_{DS} = 0$	$-V(BR)_{GSS}$	>	40	40 V
Gate-source cut-off voltage $I_D = 0,5 nA; V_{DS} = 15 V$	$-V(P)_{IGS}$	>	4	0,8 V
		<	10	4 V
Drain-source voltage (on) $I_D = 20 mA; V_{GS} = 0$ $I_D = 10 mA; V_{GS} = 0$ $I_D = 5 mA; V_{GS} = 0$	V_{DSon}	<	750	- mV
		<	-	500 mV
		<	-	-
Drain-source resistance (on) at $f = 1 kHz$ $I_D = 0; V_{GS} = 0$	$r_{ds on}$	<	25	40
				60 Ω

* Measured under pulsed conditions; $t_p = 100 ms; \delta \leq 0,1$.

Switching times*

$V_{DD} = 10\text{ V}$; $V_{GS} = 0$
Conditions I_D and $-V_{GSM}$

BSR56 | BSR57 | BSR58

I_D	=	20	10	5 mA
$-V_{GSM}$	=	10	6	4 V
Delay time	t_d	< 6	6	10 ns
Rise time	t_r	< 3	4	10 ns
Turn-off time	t_{off}	< 25	50	100 ns

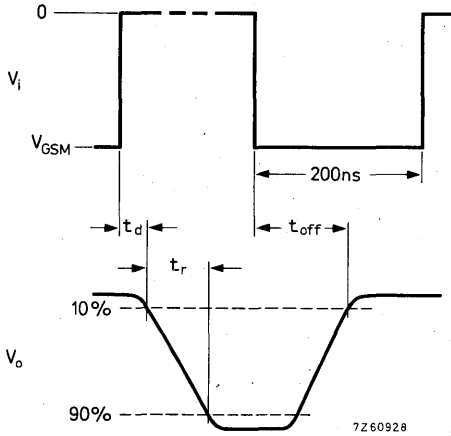

Fig. 2 Switching times waveforms.

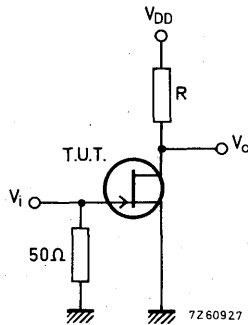

Fig. 3 Test circuit.

BSR56; $R = 464\ \Omega$
BSR57; $R = 953\ \Omega$
BSR58; $R = 1910\ \Omega$

Pulse generator

$t_r = t_f \leq 1\text{ ns}$
 $\delta = 0,02$
 $Z_0 = 50\ \Omega$

Oscilloscope

$t_r \leq 0,75\text{ ns}$
 $R_i \geq 1\text{ M}\Omega$
 $C_i \leq 2,5\text{ pF}$

* Switching times measured on devices in SOT-18 envelope.

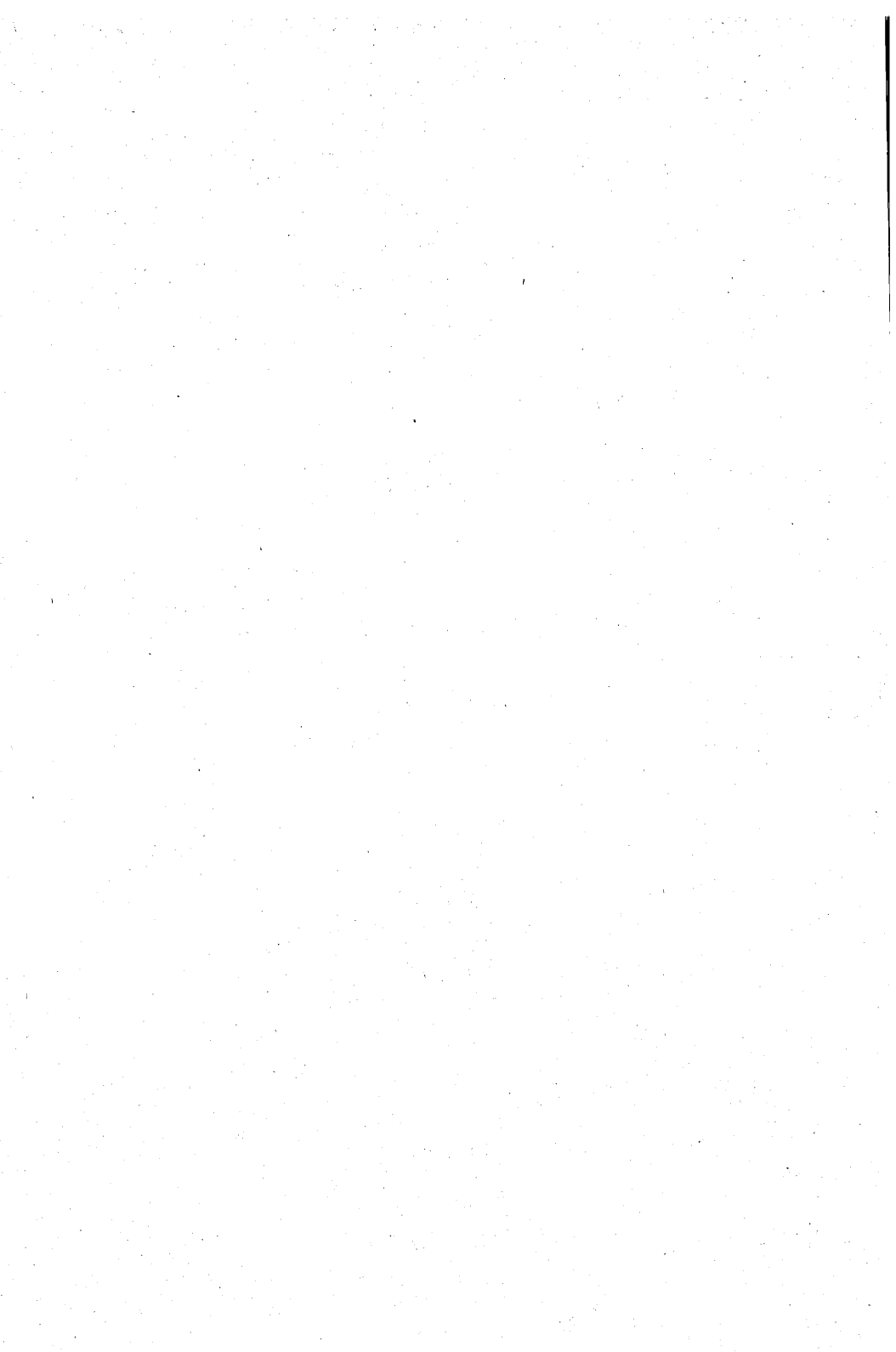

HIGH VOLTAGE P-N-P TRANSISTOR

Silicon planar epitaxial transistor in a microminiature plastic envelope intended for application in thick and thin-film circuits. This transistor is intended for high voltage general purpose and switching applications.

QUICK REFERENCE DATA

Collector-base voltage (open emitter)	$-V_{CBO}$	max.	110 V
Collector-emitter voltage (open base)	$-V_{CEO}$	max.	100 V
Collector current (peak value)	$-I_{CM}$	max.	100 mA
Total power dissipation up to $T_{amb} = 25\text{ }^{\circ}\text{C}$	P_{tot}	max.	200 mW
Junction temperature	T_j	max.	150 $^{\circ}\text{C}$
D.C. current gain at $T_j = 25\text{ }^{\circ}\text{C}$ $-I_C = 25\text{ mA}; -V_{CE} = 5\text{ V}$	h_{FE}	>	30
Transition frequency at $f = 35\text{ MHz}$ $-I_C = 25\text{ mA}; -V_{CE} = 5\text{ V}$	f_T	>	50 MHz
		typ.	85 MHz

MECHANICAL DATA

Dimensions in mm

Fig. 1 SOT-23.

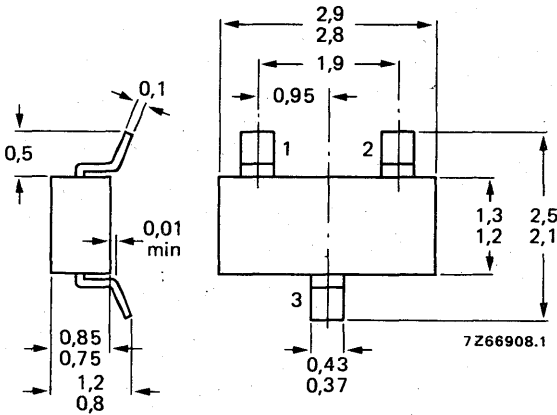

Marking code

BSS63 = T3

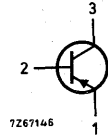

BSS63R = T6

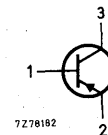

See also *Soldering recommendations*.

RATINGS

Limiting values in accordance with the Absolute Maximum System (IEC 134)

Collector-base voltage (open emitter) $-I_C = 10 \mu A$	$-V_{CBO}$ max.	110 V
Collector-emitter voltage (open base) $-I_C = 100 \mu A$	$-V_{CEO}$ max.	100 V
Emitter-base voltage (open collector) $-I_E = 10 \mu A$	$-V_{EBO}$ max.	6 V
Collector current (d.c.)	$-I_C$ max.	100 mA
Collector current (peak value)	$-I_{CM}$ max.	100 mA
Base current (peak value)	$-I_{BM}$ max.	100 mA
Total power dissipation up to $T_{amb} = 25 \text{ }^\circ\text{C}$ *	P_{tot} max.	200 mW
Storage temperature	T_{stg}	-65 to +150 $^\circ\text{C}$
Junction temperature	T_j max.	150 $^\circ\text{C}$

THERMAL RESISTANCE

From junction to ambient in free air *	R_{thj-a} =	0,62 $^\circ\text{C}/\text{mW}$
--	---------------	---------------------------------

CHARACTERISTICS

$T_j = 25 \text{ }^\circ\text{C}$ unless otherwise specified

Collector cut-off current $I_E = 0; -V_{CB} = 90 \text{ V}$	$-I_{CBO}$	<	100 nA
$I_E = 0; -V_{CB} = 90 \text{ V}; T_j = 150 \text{ }^\circ\text{C}$	$-I_{CBO}$	typ.	0,25 μA
		<	50 μA
Emitter cut-off current $I_C = 0; -V_{EB} = 6 \text{ V}$	$-I_{EBO}$	<	200 nA
Saturation voltage $-I_C = 25 \text{ mA}; -I_B = 2,5 \text{ mA}$	$-V_{CEsat}$	<	250 mV
	$-V_{BEsat}$	<	900 mV
D.C. current gain $-I_C = 10 \text{ mA}; -V_{CE} = 1 \text{ V}$	h_{FE}	>	30
$-I_C = 25 \text{ mA}; -V_{CE} = 1 \text{ V}$	h_{FE}	>	30
Collector capacitance at $f = 1 \text{ MHz}$ $I_E = I_e = 0; -V_{CB} = 10 \text{ V}$	C_c	typ.	3 pF
Transition frequency at $f = 35 \text{ MHz}$ $-I_C = 25 \text{ mA}; -V_{CE} = 5 \text{ V}$	f_T	>	50 MHz
		typ.	85 MHz

* Device mounted on a ceramic substrate of 7 mm x 5 mm x 0,5 mm.

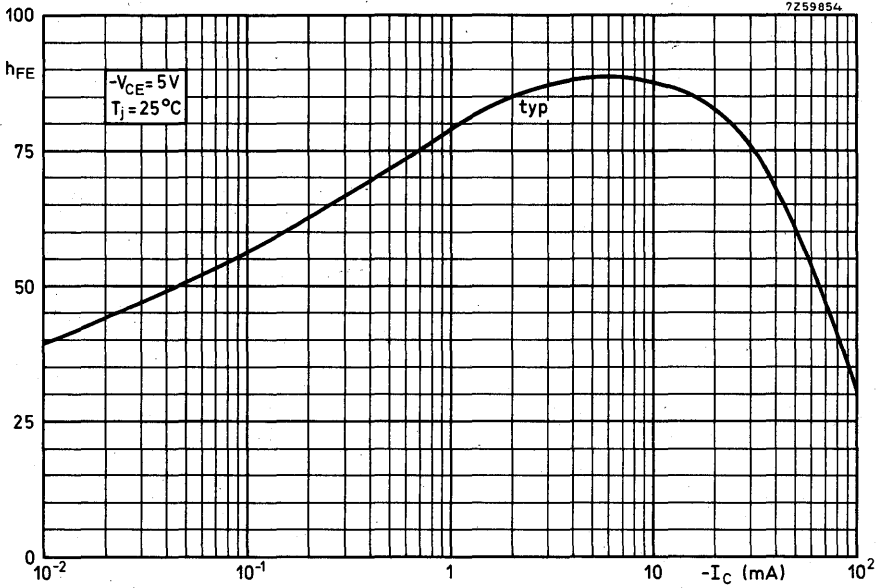

Fig. 2.

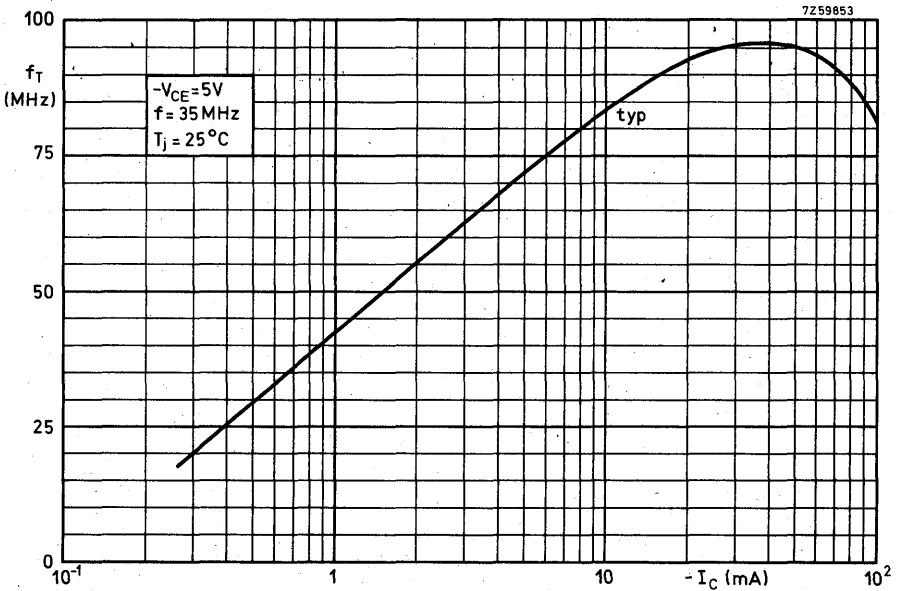

Fig. 3.

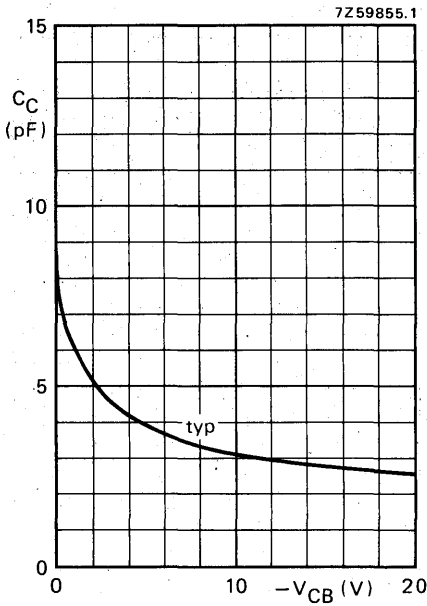

Fig. 4 Typical values collector capacitance as a function of collector-base voltage. $I_E = I_e = 0$; $T_j = 25^\circ\text{C}$; $f = 1\text{ MHz}$.

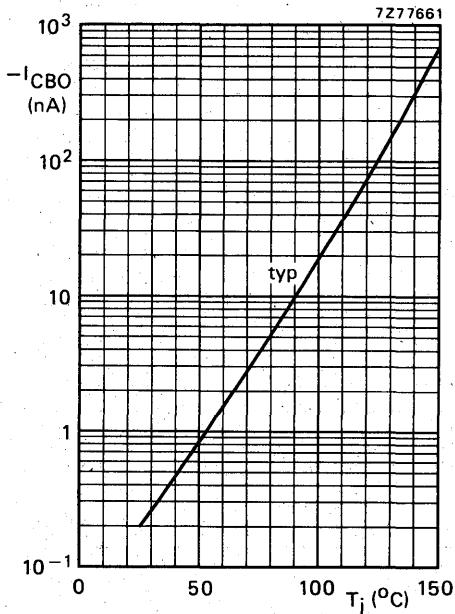

Fig. 5 Typical values collector-base current as a function of the junction temperature at a collector-base voltage of -90 V .

HIGH-VOLTAGE N-P-N TRANSISTOR

Silicon planar epitaxial transistor in a microminiature plastic envelope intended for application in thick and thin-film circuits. This transistor is intended for high-voltage general purpose and switching applications.

QUICK REFERENCE DATA

Collector-base voltage (open emitter)	V_{CBO}	max.	120 V
Collector-emitter voltage (open base)	V_{CEO}	max.	80 V
Collector current (peak value)	I_{CM}	max.	250 mA
Total power dissipation up to $T_{amb} = 25\text{ }^{\circ}\text{C}$	P_{tot}	max.	200 mW
Junction temperature	T_j	max.	150 $^{\circ}\text{C}$
D.C. current gain	h_{FE}	>	20
$I_C = 10\text{ mA}$; $V_{CE} = 1\text{ V}$; $T_j = 25\text{ }^{\circ}\text{C}$		typ.	80
Transition frequency at $f = 35\text{ MHz}$	f_T	>	60 MHz
$I_C = 4\text{ mA}$; $V_{CE} = 10\text{ V}$			
Turn-off time	t_{off}	<	1 μs
$I_C = 15\text{ mA}$; $I_{Bon} - I_{Boff} = 1\text{ mA}$			

MECHANICAL DATA

Dimensions in mm

Marking code

Fig. 1 SOT-23.

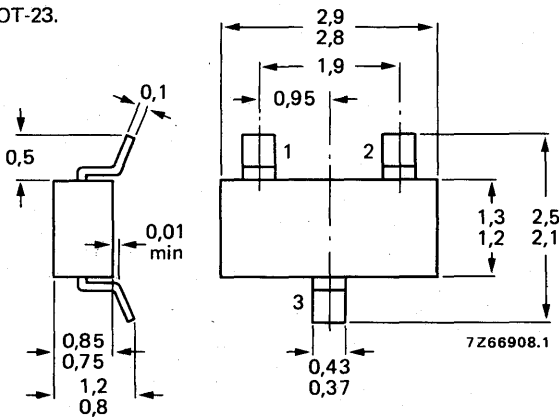

BSS64 = U3

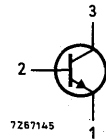

BSS64R = U6

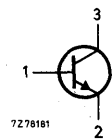

See also *Soldering recommendations*.

BSS64 BSS64R

RATINGS

Limiting values in accordance with the Absolute Maximum System (IEC 134)

Collector-base voltage (open emitter) $I_C = 100 \mu A$	V_{CBO}	max.	120 V
Collector-emitter voltage (open base) $I_C = 4 \text{ mA}$	V_{CEO}	max.	80 V
Emitter-base voltage (open collector) $I_E = 100 \mu A$	V_{EBO}	max.	5 V
Collector current (d.c. or averaged over any 20 ms period)	I_C	max.	100 mA
Collector current (peak value)	I_{CM}	max.	250 mA
Base current (peak value)	I_{BM}	max.	100 mA
Total power dissipation up to $T_{amb} = 25 \text{ }^\circ\text{C}$ *	P_{tot}	max.	200 mW
Storage temperature	T_{stg}		-65 to +150 $^\circ\text{C}$
Junction temperature	T_j	max.	150 $^\circ\text{C}$

THERMAL RESISTANCE

From junction to ambient in free air *

$R_{th\ j-a}$	=	0,62 $^\circ\text{C}/\text{mW}$
---------------	---	---------------------------------

* Device mounted on a ceramic substrate of 7 mm x 5 mm x 0,5 mm.

CHARACTERISTICS

$T_j = 25\text{ }^\circ\text{C}$ unless otherwise specified

Collector cut-off current

$I_E = 0; V_{CB} = 90\text{ V}$

I_{CBO} typ. 1 nA
< 100 nA

$I_E = 0; V_{CB} = 90\text{ V}; T_j = 150\text{ }^\circ\text{C}$

I_{CBO} typ. 0,25 μA
< 50 μA

Emitter cut-off current

$I_C = 0; V_{EB} = 5\text{ V}$

I_{EBO} typ. 0,5 nA
< 200 nA

Saturation voltages

$I_C = 4\text{ mA}; I_B = 400\text{ }\mu\text{A}$

V_{CEsat} < 150 mV

V_{BEsat} < 1200 mV

V_{CEsat} < 200 mV

$I_C = 50\text{ mA}; I_B = 15\text{ mA}$

D.C. current gain

$I_C = 1\text{ mA}; V_{CE} = 1\text{ V}$

h_{FE} typ. 60

> 20

h_{FE} typ. 80

$I_C = 10\text{ mA}; V_{CE} = 1\text{ V}$

h_{FE} typ. 55

$I_C = 20\text{ mA}; V_{CE} = 1\text{ V}$

Transition frequency at $f = 35\text{ MHz}$

$I_C = 4\text{ mA}; V_{CE} = 10\text{ V}$

f_T > 60 MHz
typ. 100 MHz

Collector capacitance at $f = 1\text{ MHz}$

$I_E = I_e = 0; V_{CB} = 10\text{ V}$

C_c typ. 3 pF
< 5 pF

Turn-off switching time

$I_{Con} = 15\text{ mA}; I_{Bon} = -I_{Boff} = 1\text{ mA}$

t_{off} < 1 μs



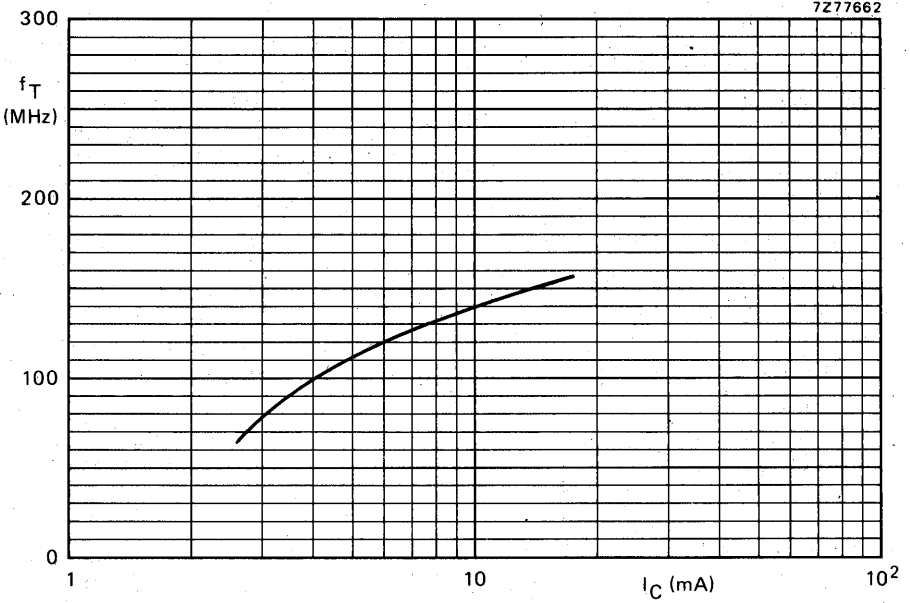

Fig. 2 Typical values transition frequency.
 $V_{CE} = 10 \text{ V}$; $f = 35 \text{ MHz}$; $T_j = 25 \text{ }^\circ\text{C}$.

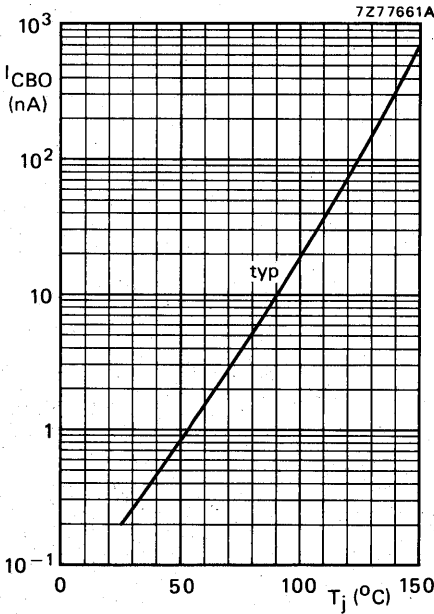

Fig. 3 Typical values collector-base currents as a function of the junction temperature at a collector-base voltage of 90 V.

SILICON PLANAR EPITAXIAL TRANSISTOR

• High-speed switching

N-P-N transistor in a microminiature plastic envelope. It is intended for very high-speed saturated switching in thick and thin-film circuits.

QUICK REFERENCE DATA

Collector-base voltage (open emitter)	V_{CBO}	max.	20 V
Collector-emitter voltage ($V_{BE} = 0$)	V_{CES}	max.	20 V
Collector-emitter voltage (open base)	V_{CEO}	max.	12 V
Collector current (peak value)	I_{CM}	max.	200 mA
Total power dissipation up to $T_{amb} = 25\text{ }^{\circ}\text{C}$	P_{tot}	max.	200 mW
Junction temperature	T_j		-65 to +150 $^{\circ}\text{C}$
D.C. current gain			
$I_C = 10\text{ mA}; V_{CE} = 1\text{ V}$	h_{FE}		40 to 120
$I_C = 50\text{ mA}; V_{CE} = 1\text{ V}$	h_{FE}	>	25
Transition frequency at $f = 100\text{ MHz}$			
$I_C = 10\text{ mA}; V_{CE} = 10\text{ V}$	f_T	>	400 MHz
		typ.	500 MHz
Storage time			
$I_C = I_B = -I_{BM} = 10\text{ mA}$	t_s	<	13 ns

MECHANICAL DATA

Fig. 1 SOT-23.

Dimensions in mm

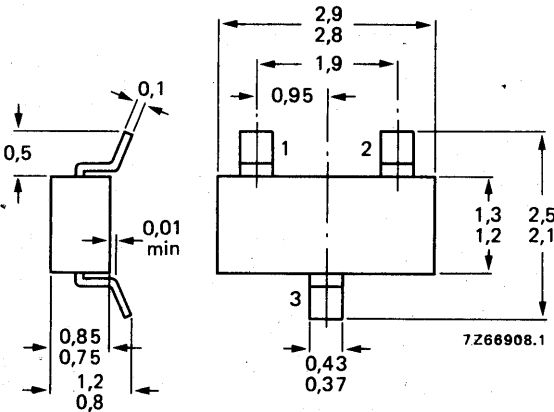

Marking code

BSV52 = B2

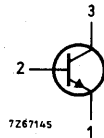

BSV52R = B4

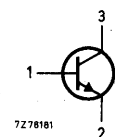

See also *Soldering recommendations*.

BSV52

RATINGS Limiting values in accordance with the Absolute Maximum System (IEC 134) Voltages

Collector-base voltage (open emitter)	V_{CBO}	max.	20 V
Collector-emitter voltage ($V_{BE} = 0$)	V_{CES}	max.	20 V
Collector-emitter voltage (open base) $I_C = 10 \text{ mA}$	V_{CEO}	max.	12 V
Emitter-base voltage (open collector)	V_{EBO}	max.	5 V

Currents

Collector current (d.c.)	I_C	max.	100 mA
Collector current (peak value)	I_{CM}	max.	200 mA

Power dissipation

Total power dissipation up to $T_{amb} = 25 \text{ }^\circ\text{C}$ mounted on a ceramic substrate of 7 mm x 5 mm x 0.5 mm	P_{tot}	max.	200 mW
--	-----------	------	--------

Temperatures

Storage temperature	T_{stg}	-65 to +150	$^\circ\text{C}$
Junction temperature	T_j	max. 150	$^\circ\text{C}$

THERMAL RESISTANCE

From junction to ambient mounted on a ceramic substrate of 7 mm x 5 mm x 0.5 mm	$R_{th \text{ j-a}}$	=	0.62 $^\circ\text{C/mW}$
---	----------------------	---	--------------------------

CHARACTERISTICS

$T_j = 25 \text{ }^\circ\text{C}$ unless otherwise specified

Collector cut-off current

$I_E = 0; V_{CB} = 10 \text{ V}$	I_{CBO}	<	100 nA
$I_E = 0; V_{CB} = 10 \text{ V}; T_j = 125 \text{ }^\circ\text{C}$	I_{CBO}	<	5 μA

Saturation voltages

$I_C = 10 \text{ mA}; I_B = 300 \text{ } \mu\text{A}$	V_{CEsat}	<	300 mV
$I_C = 10 \text{ mA}; I_B = 1 \text{ mA}$	V_{CEsat}	<	250 mV
	V_{BEsat}	700 to 850	mV
$I_C = 50 \text{ mA}; I_B = 5 \text{ mA}$	V_{CEsat}	<	400 mV
	V_{BEsat}	<	1200 mV

CHARACTERISTICS (continued)

D.C. current gain

$I_C = 1 \text{ mA}; V_{CE} = 1 \text{ V}$	h_{FE}	>	25
$I_C = 10 \text{ mA}; V_{CE} = 1 \text{ V}$	h_{FE}		40 to 120
$I_C = 50 \text{ mA}; V_{CE} = 1 \text{ V}$	h_{FE}	>	25

Transition frequency at $f = 100 \text{ MHz}$

$I_C = 10 \text{ mA}; V_{CE} = 10 \text{ V}$	f_T	>	400 MHz
		typ.	500 MHz

Collector capacitance at $f = 1 \text{ MHz}$

$I_E = I_e = 0; V_{CB} = 5 \text{ V}$	C_c	<	4 pF
---------------------------------------	-------	---	------

Emitter capacitance at $f = 1 \text{ MHz}$

$I_C = I_c = 0; V_{EB} = 1 \text{ V}$	C_e	<	4.5 pF
---------------------------------------	-------	---	--------

Switching times

Storage time $I_C = I_B = -I_{BM} = 10 \text{ mA}$	t_s	<	13 ns
--	-------	---	-------

Test circuit:

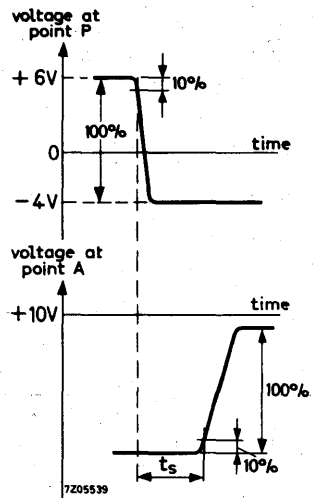
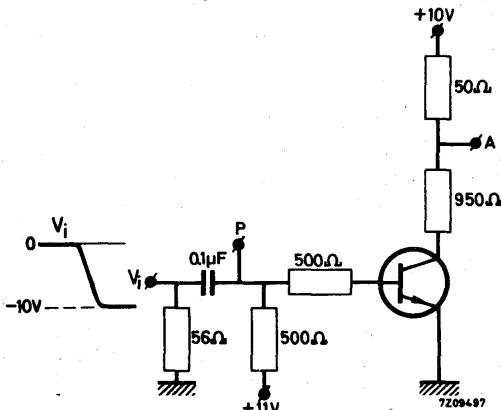

Pulse generator:

Rise time	$t_r < 1 \text{ ns}$
Pulse duration	$t > 300 \text{ ns}$
Duty cycle	$\delta < 0.02$
Source impedance	$R_S = 50 \Omega$

Oscilloscope:

Input impedance	$R_i = 50 \Omega$
Rise time	$t_r < 1 \text{ ns}$

CHARACTERISTICS (continued)

$T_j = 25\text{ }^\circ\text{C}$ unless otherwise specified

Switching times

Turn on time when switched from
 $-V_{BE} = 1.5\text{ V}$ to $I_C = 10\text{ mA}$; $I_B = 3\text{ mA}$

$$t_{on} < 12\text{ ns}$$

Turn off time when switched from
 $I_C = 10\text{ mA}$; $I_B = 3\text{ mA}$
 to cut-off with $-I_{BM} = 1.5\text{ mA}$

$$t_{off} < 18\text{ ns}$$

Test circuit:

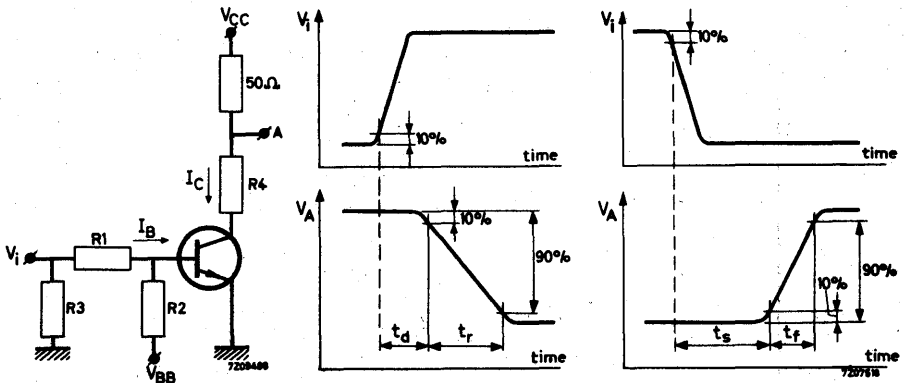

Pulse generator:

$$\text{Rise time } t_r < 1\text{ ns}$$

$$\text{Pulse duration } t > 300\text{ ns}$$

$$\text{Duty cycle } \delta < 0.02$$

$$\text{Source impedance } R_S = 50\text{ }\Omega$$

Oscilloscope:

$$\text{Input impedance } R_i = 50\text{ }\Omega$$

$$\text{Rise time } t_r < 1\text{ ns}$$

I_C (mA)	I_B (mA)	$-I_{BM}$ (mA)	V_{CC} (V)	$R_1; R_2$ (k Ω)	R_3 (Ω)	R_4 (Ω)	turn on time			turn off time	
							$-V_{BB}$ (V)	$-V_{BE}$ (V)	V_i (V)	$-V_{BB}$ (V)	$-V_i$ (V)
10	3	1.5	3	3.3	50	220	3.0	1.5	15	12.0	15

Note

$-I_{BM}$ is the reverse current that can flow during switching off. The indicated $-I_{BM}$ is determined and limited by the applied cut-off voltage and series resistance.

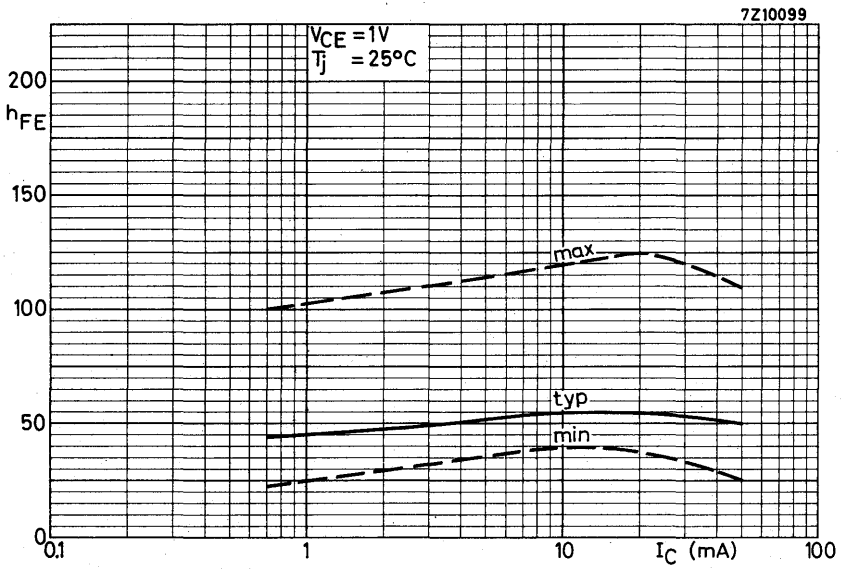
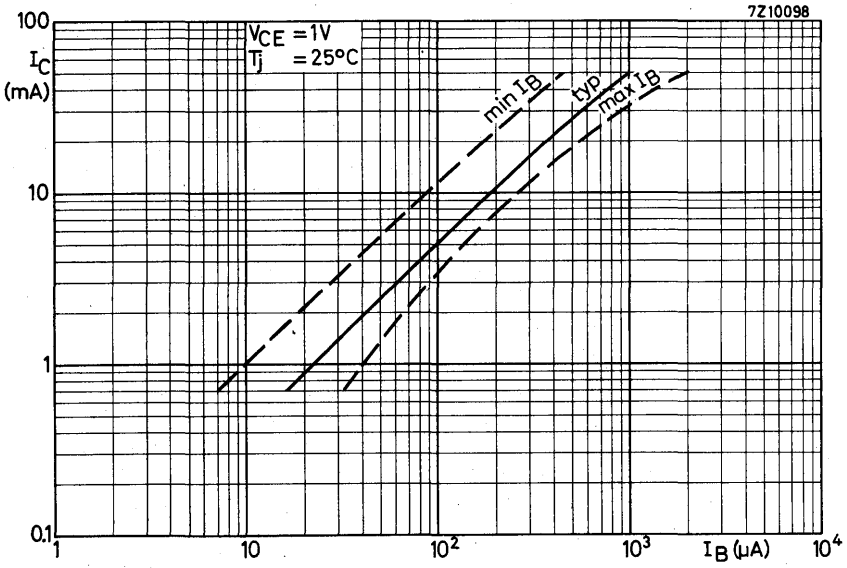

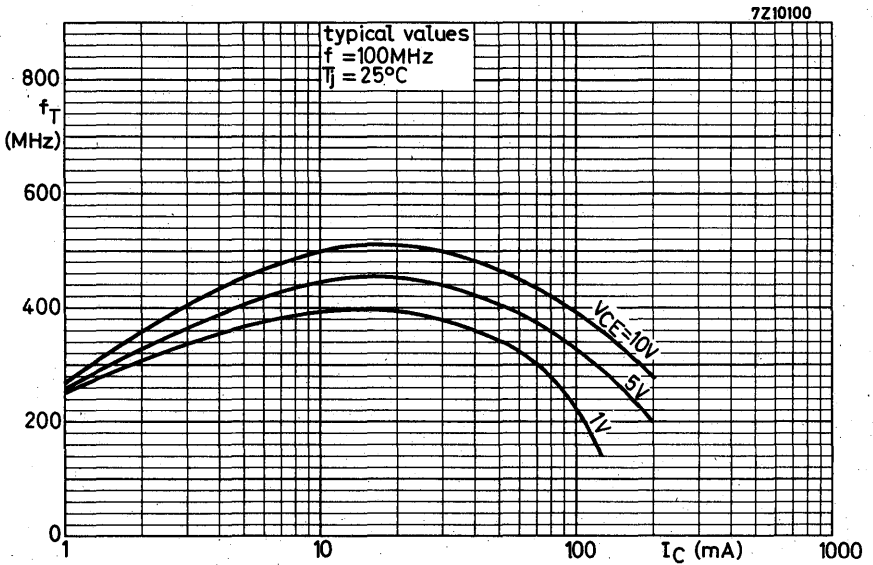
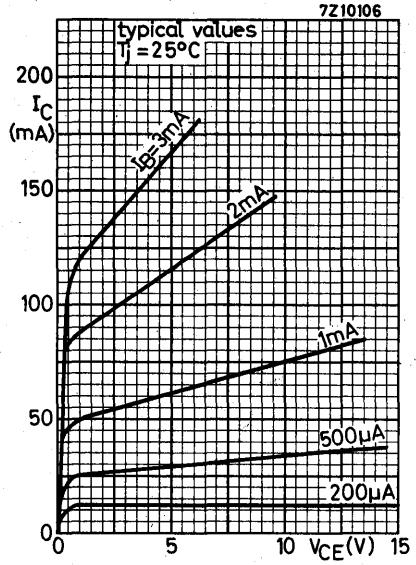
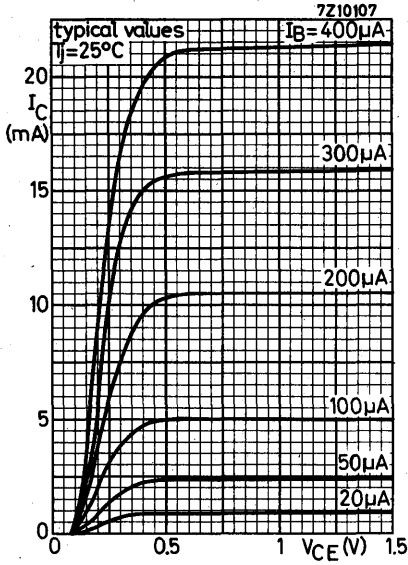

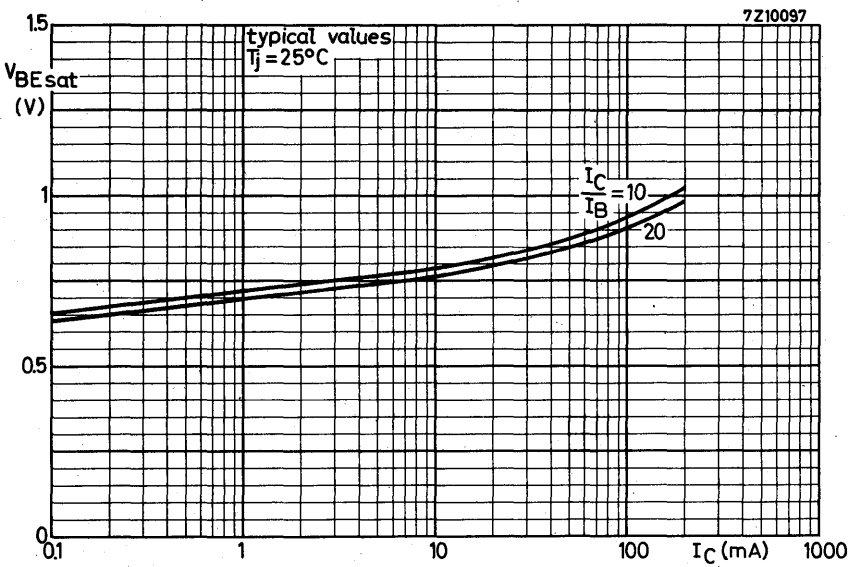
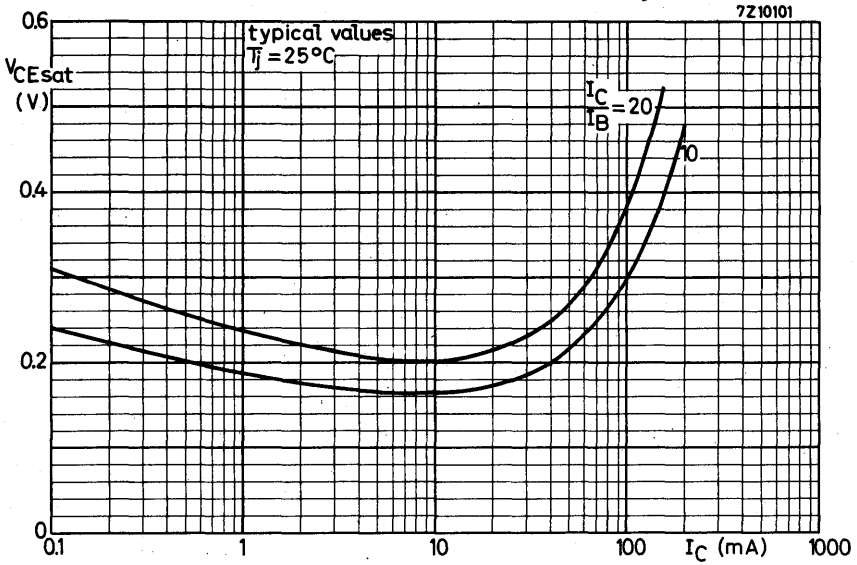

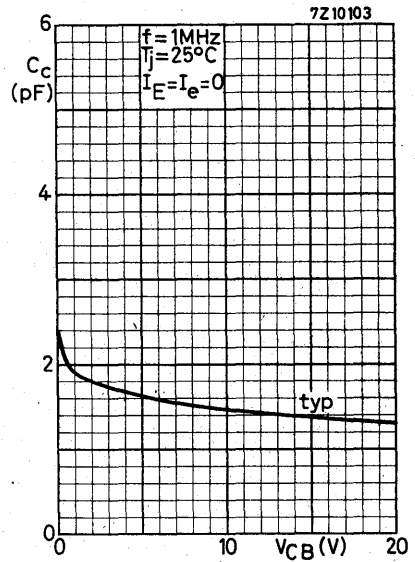
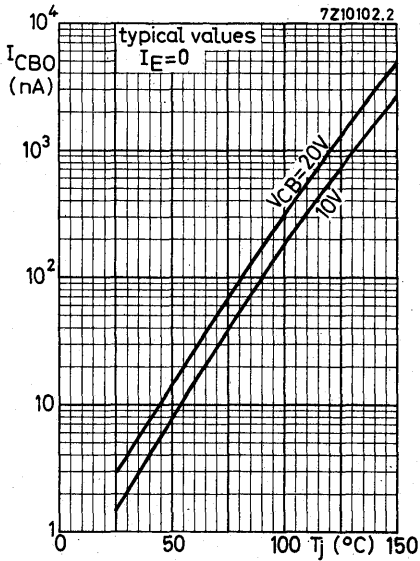
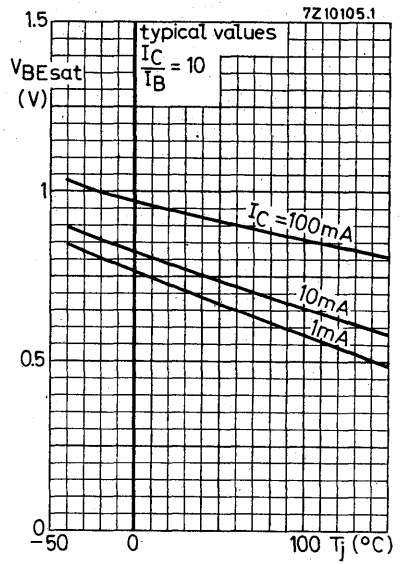
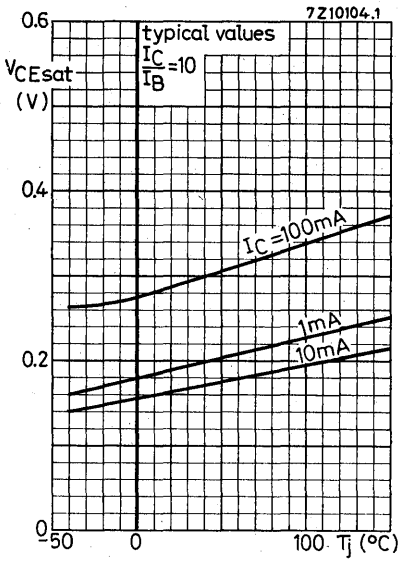

SILICON PLANAR VOLTAGE REGULATOR DIODES

Low power general purpose voltage regulator diodes in a microminiature plastic envelope intended for application in thick and thin-film circuits. The series covers the whole normalized range of nominal working voltages from 4,7 V to 75 V with a tolerance of $\pm 5\%$.

QUICK REFERENCE DATA

Working voltage range	V_Z	nom.	4,7 to 75 V
Working voltage tolerance			$\pm 5\%$
Total power dissipation up to $T_{amb} = 25^\circ C$	P_{tot}	max.	200 mW
Junction temperature	T_j	max.	150 $^\circ C$

MECHANICAL DATA

Dimensions in mm

Fig. 1 SOT-23.

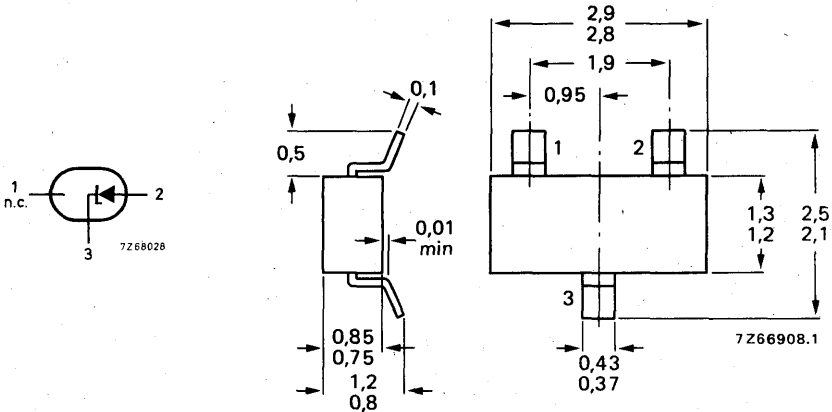

See also *Soldering recommendations*.

Marking code

BZX84-C4V7 = Z1
 C5V1 = Z2
 C5V6 = Z3
 C6V2 = Z4
 C6V8 = Z5
 C7V5 = Z6
 C8V2 = Z7
 C9V1 = Z8
 C10 = Z9
 C11 = Y1

BZX84-C12 = Y2
 C13 = Y3
 C15 = Y4
 C16 = Y5
 C18 = Y6
 C20 = Y7
 C22 = Y8
 C24 = Y9
 C27 = Y10
 C30 = Y11

BZX84-C33 = Y12
 C36 = Y13
 C39 = Y14
 C43 = Y15
 C47 = Y16
 C51 = Y17
 C56 = Y18
 C62 = Y19
 C68 = Y20
 C75 = Y21

BZX84 SERIES

RATINGS Limiting values in accordance with the Absolute Maximum System (IEC 134)

Currents

Repetitive peak forward current	I_{FRM}	max.	200	mA
Repetitive peak working current	I_{ZRM}	max.	200	mA

Power dissipation

Total power dissipation up to $T_{amb} = 25\text{ }^{\circ}\text{C}$
 mounted on a ceramic substrate of
 7 mm x 5 mm x 0,5 mm

P_{tot}	max.	200	mW
-----------	------	-----	----

Temperatures

Storage temperature	T_{stg}	-65 to +150	$^{\circ}\text{C}$
Junction temperature	T_j	max. 150	$^{\circ}\text{C}$

THERMAL RESISTANCE

From junction to ambient
 mounted on a ceramic substrate of
 7 mm x 5 mm x 0,5 mm

$R_{th\ j-a}$	=	0,62	$^{\circ}\text{C}/\text{mW}$
---------------	---	------	------------------------------

CHARACTERISTICS

$T_j = 25\text{ }^{\circ}\text{C}$

Forward voltage

$I_F = 10\text{ mA}$	V_F	<	0,9	V
----------------------	-------	---	-----	---

→ Reverse current

BZX84-C4V7	$V_R = 2\text{ V}$	I_R	<	3000	nA
BZX84-C5V1	$V_R = 2\text{ V}$	I_R	<	2000	nA
BZX84-C5V6	$V_R = 2\text{ V}$	I_R	<	1000	nA
BZX84-C6V2	$V_R = 4\text{ V}$	I_R	<	3000	nA
BZX84-C6V8	$V_R = 4\text{ V}$	I_R	<	2000	nA
BZX84-C7V5	$V_R = 5\text{ V}$	I_R	<	1000	nA
BZX84-C8V2	$V_R = 5\text{ V}$	I_R	<	700	nA
BZX84-C9V1	$V_R = 6\text{ V}$	I_R	<	500	nA
BZX84-C10	$V_R = 7\text{ V}$	I_R	<	200	nA
BZX84-C11	$V_R = 8\text{ V}$	I_R	<	100	nA
BZX84-C12	$V_R = 8\text{ V}$	I_R	<	100	nA
BZX84-C13	$V_R = 8\text{ V}$	I_R	<	100	nA
BZX84-C15 to C75	$V_R = 0,7\text{ V}_{Znom}$	I_R	<	50	nA

CHARACTERISTICS (continued)

$T_j = 25\text{ }^\circ\text{C}$ ←

E24 ($\pm 5\%$) logarithmic range.

BZX84-...	Working voltage		Differential resistance		Temperature coefficient			Diode capacitance	
	V_Z (V)		r_{diff} (Ω)		S_Z (mV/ $^\circ\text{C}$)			C_d (pF); $f = 1\text{ MHz}$	
	at $I_Z = 5\text{ mA}$		at $I_Z = 5\text{ mA}$		at $I_Z = 5\text{ mA}$			$V_R = 0$	
	min.	max.	typ.	max.	min.	typ.	max.	typ.	max.
C4V7	4,4	5,0	50	80	-3,5	-1,4	0,2	130	180
C5V1	4,8	5,4	40	60	-2,7	-0,8	1,2	110	160
C5V6	5,2	6,0	15	40	-2,0	1,2	2,5	95	140
C6V2	5,8	6,6	6	10	0,4	2,3	3,7	90	130
C6V8	6,4	7,2	6	15	1,2	3,0	4,5	85	110
C7V5	7,0	7,9	6	15	2,5	4,0	5,3	80	100
C8V2	7,7	8,7	6	15	3,2	4,6	6,2	75	95
C9V1	8,5	9,6	6	15	3,8	5,5	7,0	70	90
C10	9,4	10,6	8	20	4,5	6,4	8,0	70	90
C11	10,4	11,6	10	20	5,4	7,4	9,0	65	85
C12	11,4	12,7	10	25	6,0	8,4	10,0	65	85
C13	12,4	14,1	10	30	7,0	9,4	11,0	60	80
C15	13,8	15,6	10	30	9,2	11,4	13,0	55	75
C16	15,3	17,1	10	40	10,4	12,4	14,0	52	75
C18	16,8	19,1	10	45	12,4	14,4	16,0	47	70
C20	18,8	21,2	15	55	14,4	16,4	18,0	36	60
C22	20,8	23,3	20	55	16,4	18,4	20,0	34	60
C24	22,8	25,6	25	70	18,4	20,4	22,0	33	55
	at $I_Z = 2\text{ mA}$		at $I_Z = 2\text{ mA}$		at $I_Z = 2\text{ mA}$				
	min.	max.	typ.	max.	min.	typ.	max.	typ.	max.
C27	25,1	28,9	25	80	21,4	23,4	25,3	30	50
C30	28,0	32,0	30	80	24,4	26,6	29,4	27	50
C33	31,0	35,0	35	80	27,4	29,7	33,4	25	45
C36	34,0	38,0	35	90	30,4	33,0	37,4	23	45
C39	37,0	41,0	40	130	33,4	36,4	41,2	21	45
C43	40,0	46,0	45	150	37,6	41,2	46,6	21	40
C47	44,0	50,0	50	170	42,0	46,1	51,8	19	40
C51	48,0	54,0	60	180	46,6	51,0	57,2	19	40
C56	52,0	60,0	70	200	52,2	57,0	63,8	18	40
C62	58,0	66,0	80	215	58,8	64,4	71,6	17	35
C68	64,0	72,0	90	240	65,6	71,7	79,8	17	35
C75	70,0	79,0	95	255	73,4	80,2	88,6	16,5	35



BZX84 SERIES

→ CHARACTERISTICS (continued)

$T_j = 25\text{ }^\circ\text{C}$

E24 ($\pm 5\%$) logarithmic range.

BZX84-...	Working voltage			Differential resistance		Working voltage			Differential resistance	
	V_Z (V)			r_{diff} (Ω)		V_Z (V)			r_{diff} (Ω)	
	at $I_Z = 1\text{ mA}$			at $I_Z = 1\text{ mA}$		at $I_Z = 20\text{ mA}$			at $I_Z = 20\text{ mA}$	
	min.	nom.	max.	typ.	max.	min.	nom.	max.	typ.	max.
C4V7	3,7	4,2	4,7	425	500	4,5	5,0	5,4	8	15
C5V1	4,2	4,7	5,3	400	480	5,0	5,4	5,9	6	15
C5V6	4,8	5,4	6,0	80	400	5,2	5,7	6,3	4	10
C6V2	5,6	6,1	6,6	40	150	5,8	6,3	6,8	3	6
C6V8	6,3	6,7	7,2	30	80	6,4	6,9	7,4	2,5	6
C7V5	6,9	7,4	7,9	30	80	7,0	7,6	8,0	2,5	6
C8V2	7,6	8,1	8,7	40	80	7,7	8,3	8,8	3	6
C9V1	8,4	9,0	9,6	40	100	8,5	9,2	9,7	4	8
C10	9,3	9,9	10,6	50	150	9,4	10,1	10,7	4	10
C11	10,2	10,9	11,6	50	150	10,4	11,1	11,8	5	10
C12	11,2	11,9	12,7	50	150	11,4	12,1	12,9	5	10
C13	12,3	12,9	14,0	50	170	12,5	13,1	14,2	5	15
C15	13,7	14,9	15,5	50	200	13,9	15,1	15,7	6	20
C16	15,2	15,9	17,0	50	200	15,4	16,1	17,2	6	20
C18	16,7	17,9	19,0	50	225	16,9	18,1	19,2	6	20
C20	18,7	19,9	21,1	60	225	18,9	20,1	21,4	7	20
C22	20,7	21,9	23,2	60	250	20,9	22,1	23,4	7	25
C24	22,7	23,9	25,5	60	250	22,9	24,1	25,7	7	25
	at $I_Z = 0,1\text{ mA}$			at $I_Z = 0,5\text{ mA}$		at $I_Z = 10\text{ mA}$			at $I_Z = 10\text{ mA}$	
	min.	nom.	max.	typ.	max.	min.	nom.	max.	typ.	max.
C27	25,0	26,9	28,9	65	300	25,2	27,1	29,3	10	45
C30	27,8	29,9	32,0	70	300	28,1	30,1	32,4	15	50
C33	30,8	32,9	35,0	75	325	31,1	33,1	35,4	20	55
C36	33,8	35,9	38,0	80	350	34,1	36,1	38,4	25	60
C39	36,7	38,9	41,0	80	350	37,1	39,1	41,5	25	70
C43	39,7	42,9	46,0	85	375	40,1	43,1	46,5	25	80
C47	43,7	46,8	50,0	85	375	44,1	47,1	50,5	30	90
C51	47,6	50,8	54,0	90	400	48,1	51,1	54,6	35	100
C56	51,5	55,7	60,0	100	425	52,1	56,1	60,8	45	110
C62	57,4	61,7	66,0	120	450	58,2	62,1	67,0	60	120
C68	63,4	67,7	72,0	150	475	64,2	68,2	73,2	75	130
C75	69,4	74,7	79,0	170	500	70,3	75,3	80,2	90	140

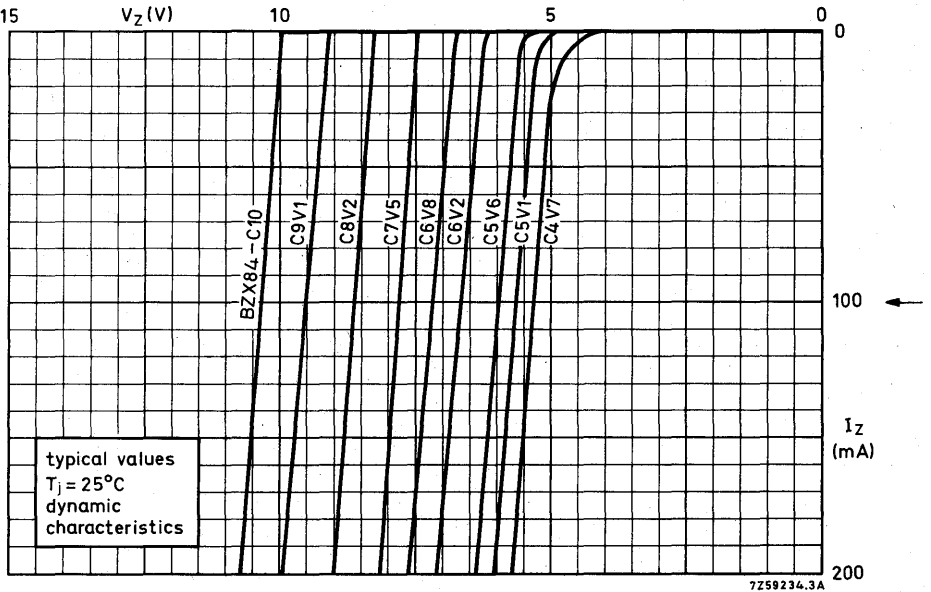
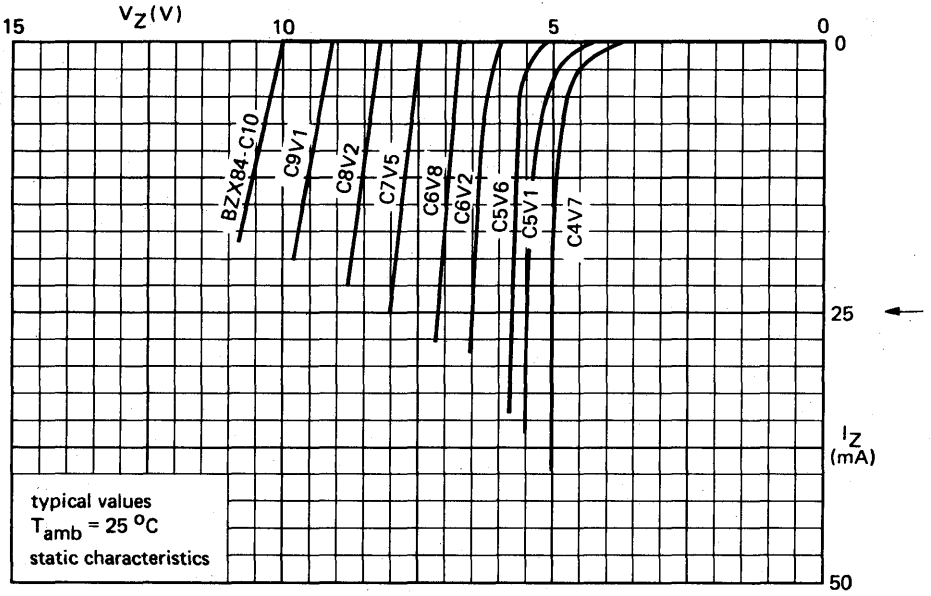

BZX84
SERIES

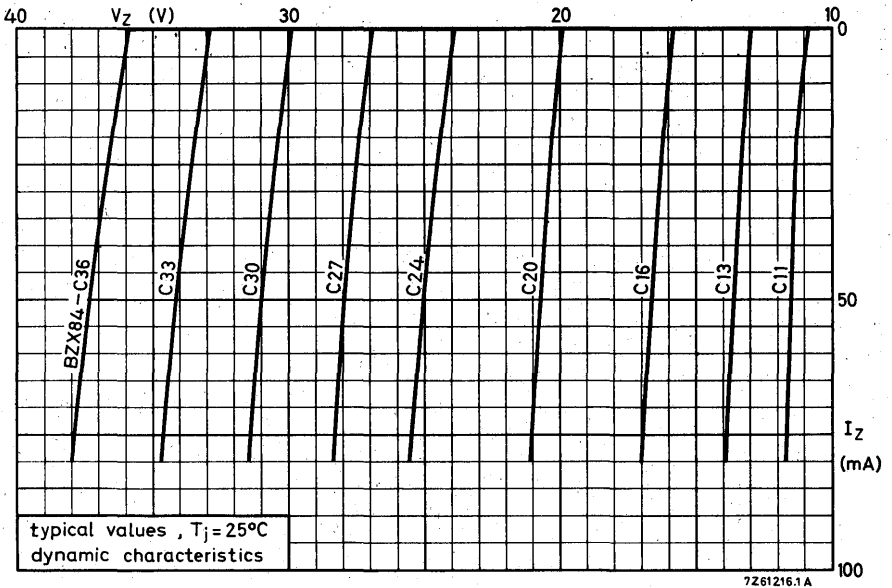
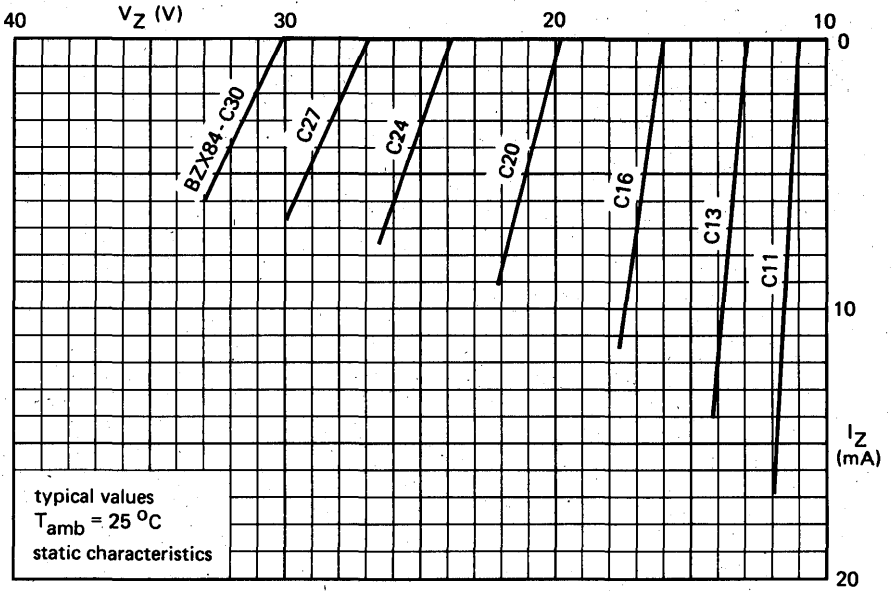

BZX84 SERIES

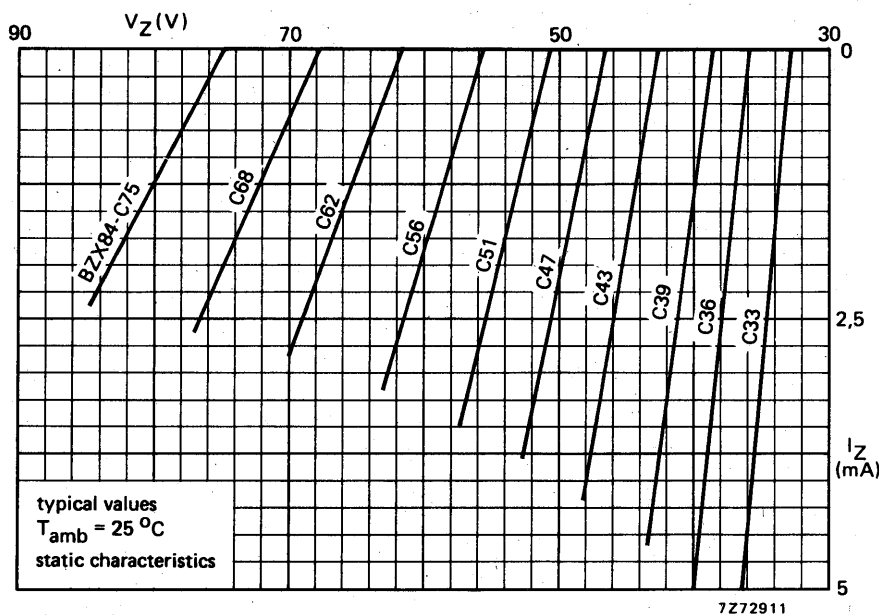
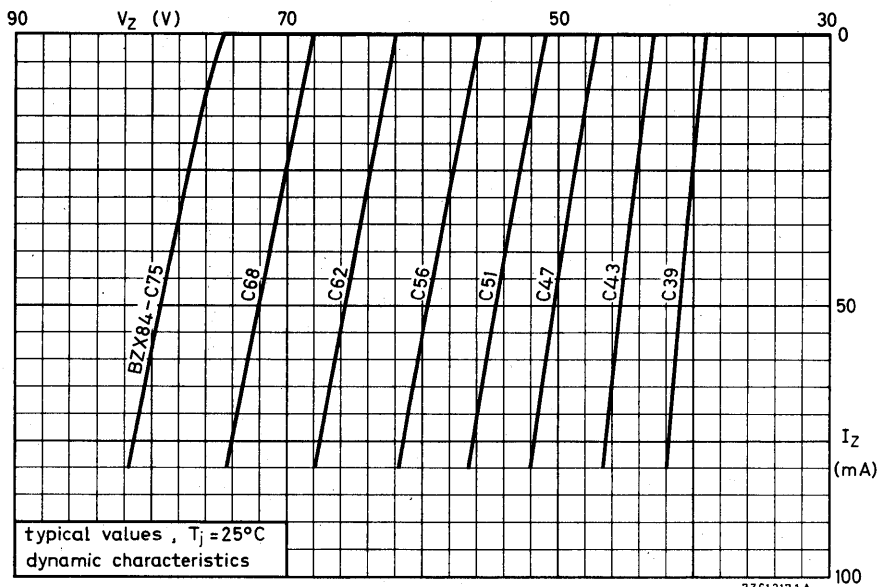

BZX84 SERIES

7Z59230A

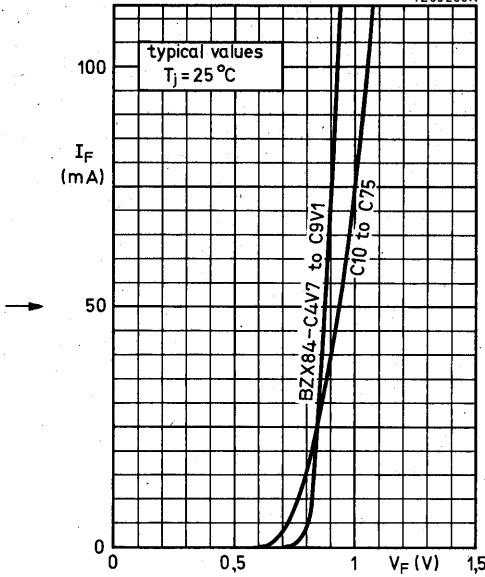

7Z59256.2

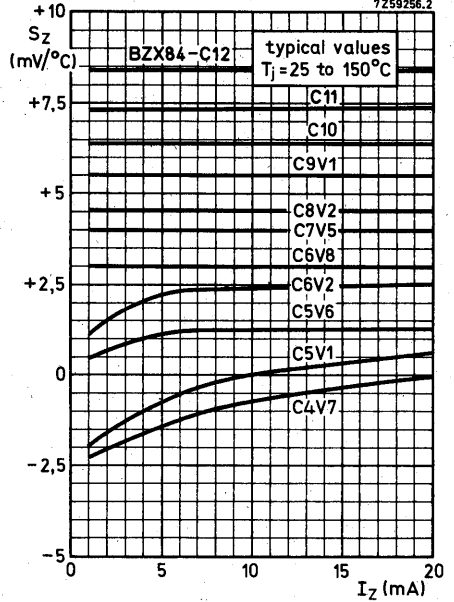

7Z72909

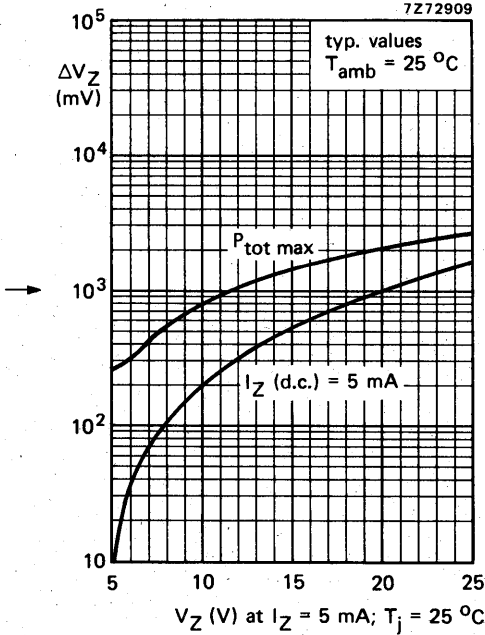

7Z72908

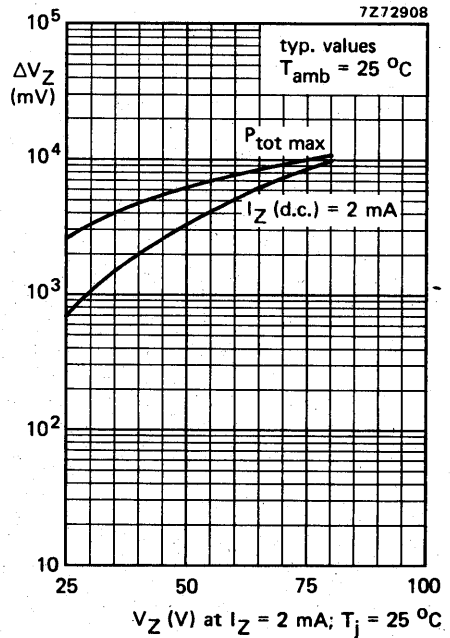

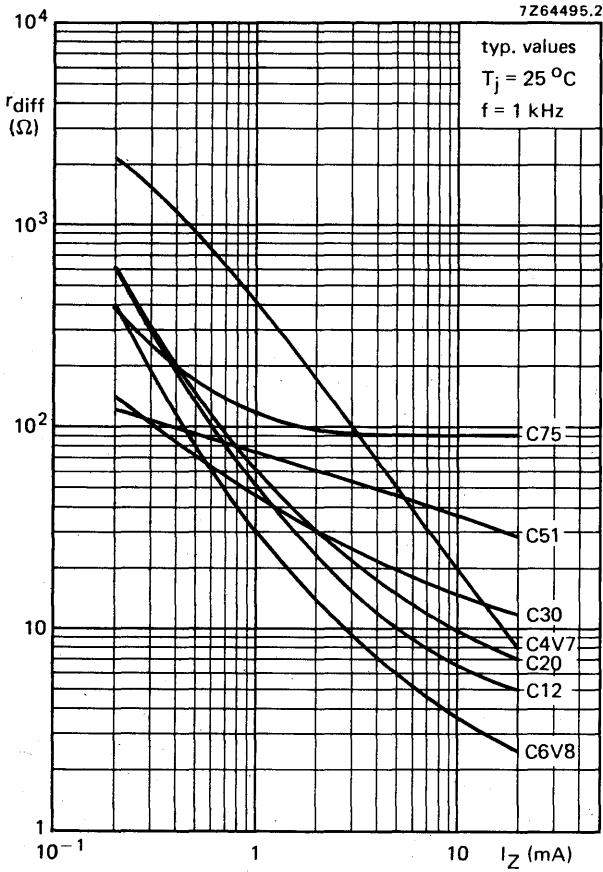



DISCRETE SEMICONDUCTORS FOR HYBRID THICK AND THIN-FILM CIRCUITS



GENERAL

SOLDERING RECOMMENDATIONS

TYPE NUMBER SURVEY

SELECTION GUIDE

DEVICE DATA



Argentina: FAPESA I.y.C., Av. Crovara 2550, Tablada, Prov. de BUENOS AIRES, Tel. 652-7438/7478.

Australia: PHILIPS INDUSTRIES HOLDINGS LTD., Elcoma Division, 67 Mars Road, LANE COVE, 2066, N.S.W., Tel. 427 08 88.

Austria: ÖSTERREICHISCHE PHILIPS BAUELEMENTE Industrie G.m.b.H., Triester Str. 64, A-1101 WIEN, Tel. 62 91 11.

Belgium: M.B.L.E., 80, rue des Deux Gares, B-1070 BRUXELLES, Tel 523 00 00.

Brazil: IBRAPE, Caixa Postal 7383, Av. Paulista 2073-S/Loja, SAO PAULO, SP, Tel. 284-4511.

Canada: PHILIPS ELECTRONICS LTD., Electron Devices Div., 601 Milner Ave., SCARBOROUGH, Ontario, M1B 1M8, Tel. 292-5161.

Chile: PHILIPS CHILENA S.A., Av. Santa Maria 0760, SANTIAGO, Tel. 39-40 01.

Colombia: SADAPE S.A., P.O. Box 9805, Calle 13, No. 51 + 39, BOGOTA D.E. 1., Tel. 600 600.

Denmark: MINIWATT A/S, Emdrupvej 115A, DK-2400 KØBENHAVN NV., Tel. (01) 69 16 22.

Finland: OY PHILIPS AB, Elcoma Division, Kaivokatu 8, SF-00100 HELSINKI 10, Tel. 1 72 71.

France: R.T.C. LA RADIOTECHNIQUE-COMPELEC, 130 Avenue Ledru Rollin, F-75540 PARIS 11, Tel. 355-44-99.

Germany: VALVO, UB Bauelemente der Philips G.m.b.H., Valvo Haus, Burchardstrasse 19, D-2 HAMBURG 1, Tel. (040) 3296-1.

Greece: PHILIPS S.A. HELLENIQUE, Elcoma Division, 52, Av. Syngrou, ATHENS, Tel. 915 311.

Hong Kong: PHILIPS HONG KONG LTD., Comp. Dept., Philips Ind. Bldg., Kung Yip St., K.C.T.L. 289, KWAI CHUNG, N.T. Tel. 12-24 51 21.

India: PHILIPS INDIA LTD., Elcoma Div., Band Box House, 254-D, Dr. Annie Besant Rd., Prabhadevi, BOMBAY-25-DD, Tel. 457 311-5.

Indonesia: P.T. PHILIPS-RALIN ELECTRONICS, Elcoma Division, 'Timah' Building, Jl. Jen. Gatot Subroto, JAKARTA, Tel. 44 163.

Ireland: PHILIPS ELECTRICAL (IRELAND) LTD., Newstead, Clonskeagh, DUBLIN 14, Tel. 69 33 55.

Italy: PHILIPS S.p.A., Sezione Elcoma, Piazza IV Novembre 3, I-20124 MILANO, Tel. 2-6994.

Japan: NIHON PHILIPS CORP., Shuwa Shinagawa Bldg., 26-33 Takanawa 3-chome, Minato-ku, TOKYO (108), Tel. 448-5611.
(IC Products) SIGNETICS JAPAN, LTD., TOKYO, Tel. (03) 230-1521.

Korea: PHILIPS ELECTRONICS (KOREA) LTD., Philips House, 260-199 Itaewon-dong, Yongsan-ku, C.P.O. Box 3680, SEOUL, Tel. 44-4202.

Mexico: ELECTRONICA S.A. de C.V., Varsovia No. 36, MEXICO 6, D.F., Tel. 5-33-11-80.

Netherlands: PHILIPS NEDERLAND B.V., Afd. Elonco, Boschdijk 525, NL-4510 EINDHOVEN, Tel. (040) 79 33 33.

New Zealand: Philips Electrical Ind. Ltd., Elcoma Division, 2 Wagener Place, St. Lukes, AUCKLAND, Tel. 867 119.

Norway: ELECTRONICA A/S., Vitaminveien 11, P.O. Box 29, Grefsen, OSLO 4, Tel. (02) 15 05 90.

Peru: CADESA, Jr. Ilo, No. 216, Apartado 10132, LIMA, Tel. 27 73 17.

Philippines: ELDAC, Philips Industrial Dev. Inc., 2246 Pasong Tamo, MAKATI-RIZAL, Tel. 86-89-51 to 59.

Portugal: PHILIPS PORTUGESA S.A.R.L., Av. Eng. Duharte Pacheco 6, LISBOA 1, Tel. 6831 21.

Singapore: PHILIPS SINGAPORE PTE LTD., Elcoma Div., POB 340, Toa Payoh CPO, Lorong 1, Toa Payoh, SINGAPORE 12, Tel. 53 88 11.

South Africa: EDAC (Pty.) Ltd., South Park Lane, New Doornfontein, JOHANNESBURG 2001, Tel. 24/6701.

Spain: COPRESA S.A., Balmes 22, BARCELONA 7, Tel. 301 63 12.

Sweden: A.B. ELCOMA, Lidingövägen 50, S-10 250 STOCKHOLM 27, Tel. 08/67 97 80.

Switzerland: PHILIPS A.G., Elcoma Dept., Edenstrasse 20, CH-8027 ZÜRICH, Tel. 01/44 22 11.

Taiwan: PHILIPS TAIWAN LTD., 3rd Fl., San Min Building, 57-1, Chung Shan N. Rd, Section 2, P.O. Box 22978, TAIPEI, Tel. 5513101-5.

Turkey: TÜRK PHILIPS TICARET A.S., EMET Department, Inonu Cad. No. 78-80, ISTANBUL, Tel. 43 59 10.

United Kingdom: MULLARD LTD., Mullard House, Torrington Place, LONDON WC1E 7HD, Tel. 01-580 6633.

United States: (Active devices & Materials) AMPEREX SALES CORP., Providence Pike, SLATERSVILLE, R.I. 02876, Tel. (401) 762-9000.
(Passive devices) MEPCO/ELECTRA INC., Columbia Rd., MORRISTOWN, N.J. 07960, Tel. (201) 539-2000.
(IC Products) SIGNETICS CORPORATION, 811 East Arques Avenue, SUNNYVALE, California 94086, Tel. (408) 739-7700.

Uruguay: LUZIELECTRON S.A., Rondeau 1567, plso 5, MONTEVIDEO, Tel. 9 43 21.

Venezuela: IND. VENEZOLANAS PHILIPS S.A., Elcoma Dept., A. Ppal de los Ruices, Edif. Centro Colgate, Apdo 1167, CARACAS, Tel. 36 05 11.