

# COMPUTERS

*a n d* A U T O M A T I O N

D A T A P R O C E S S I N G • C Y B E R N E T I C S • R O B O T S

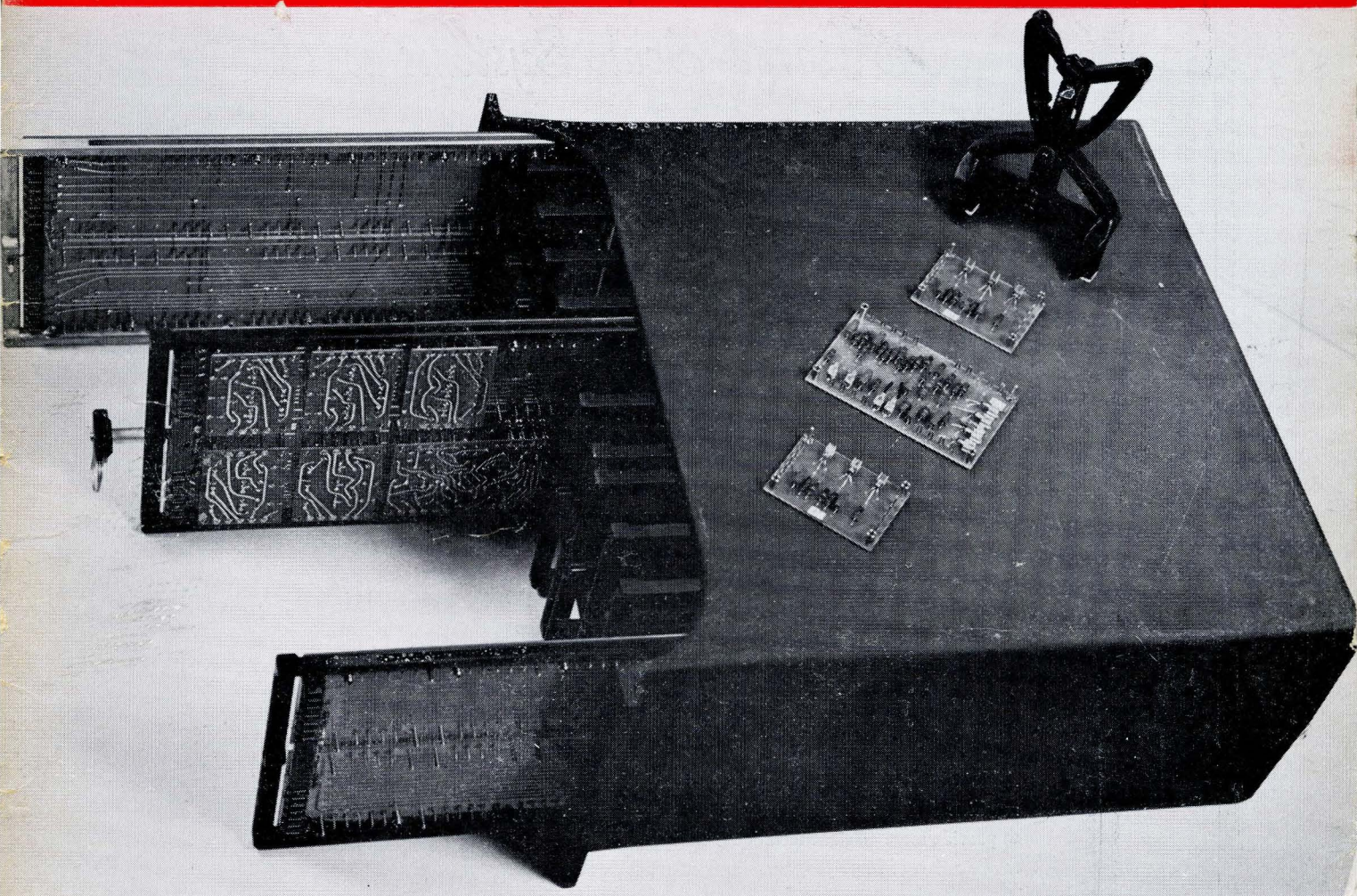

1959 PICTORIAL REPORT ON THE COMPUTER FIELD

Maintenance Methods for Digital Computers

DECEMBER

1959

•

VOL. 8 - NO. 12

# COMPUTER PROGRAMMERS

*Contribute to the Formulation  
of Totally New Techniques Applicable  
to Large-Scale Systems at*



MITRE, formed under the sponsorship of the Massachusetts Institute of Technology, has as a primary responsibility the design and development of computer-based air defense systems. An important part of this effort is the formulation of totally new programming techniques.

Supported by such computer equipment as an IBM 704 and an experimental SAGE AN/FSQ-7 (soon to be augmented by an IBM 7090 and a solid state SAGE computer) MITRE engineers and scientists are involved in broad applied and creative programming areas. A significant part of this effort involves the development of computer programs to:

- **Provide simulation vehicles for testing missiles, interceptors, guidance systems and tracking procedures**
- **Carry out data reduction and analyses**
- **Assist in the study of man-machine relations**
- **Assist in the design and evaluation of new systems**
- **Check out equipment and subsystems**

Additionally, MITRE has undertaken a number of challenging projects in the study of machine design and programming research; programming systems are being developed to provide more efficient techniques that will facilitate the writing, testing, operation and modification of large programming systems such as SAGE.

There are career openings for systems-oriented programmers at MITRE's modern facilities in suburban Boston, Massachusetts; Fort Walton Beach, Florida & Montgomery, Alabama.

To arrange an immediate and confidential interview please forward your inquiries to Dana N. Burdette, Personnel Director

**THE MITRE CORPORATION**  
244 WOOD STREET — LEXINGTON 73, MASSACHUSETTS

PHILCO BRINGS YOU THE WORLD OF TOMORROW TODAY

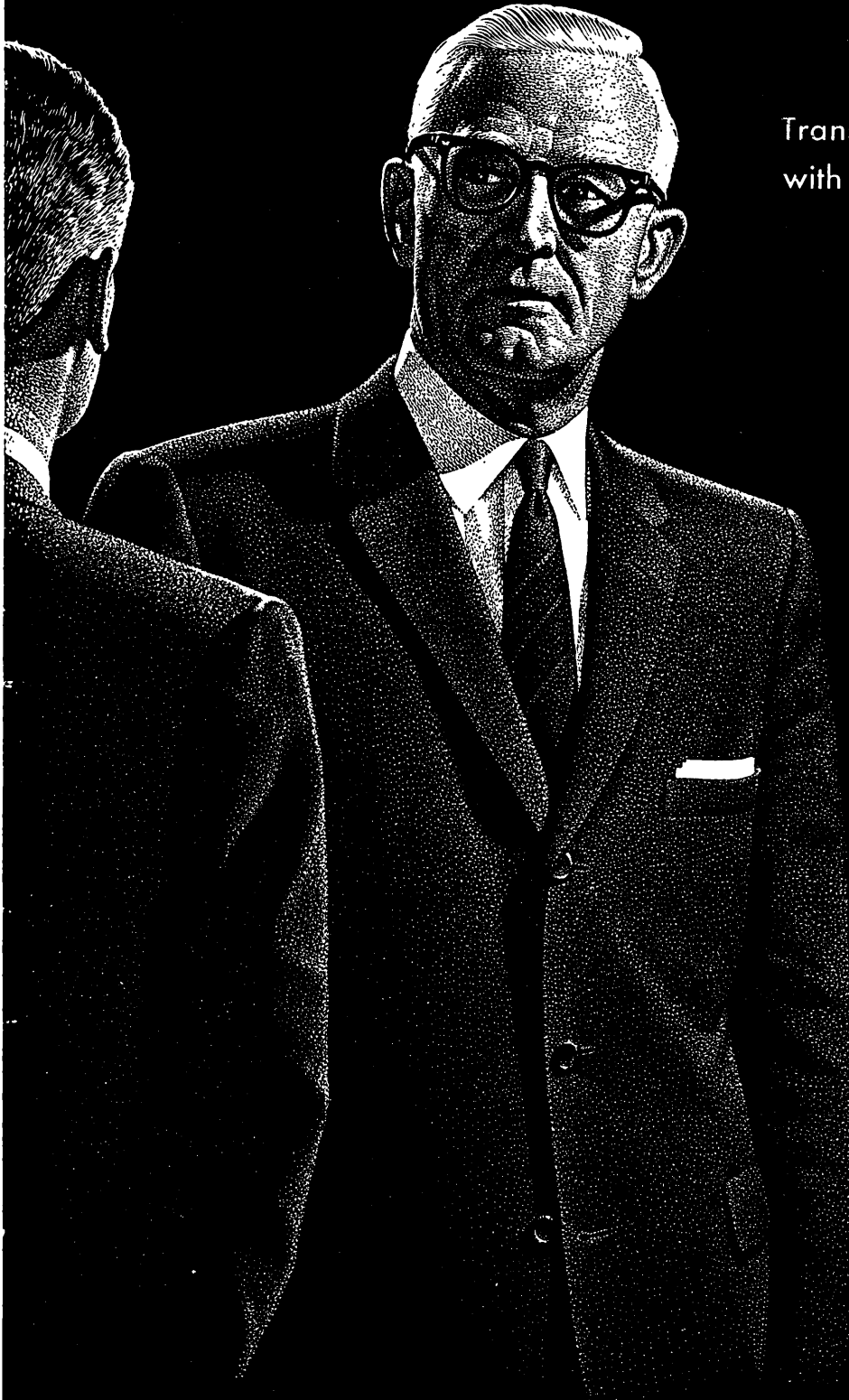

## Transac S-2000 ... the system with built-in longevity

The Philco Transac S-2000 all-transistor data processing system will keep pace with your business today... and for generations to come. True asynchronous operation permits system updating and expansion without reprogramming. It performs with incredible speed, delivering 213,000 arithmetic calculations per second. Transac S-2000 also offers major savings in space, installation, operation and maintenance. If your company is ready for large scale data processing, look ahead to Transac... first in fully transistorized data processing... the computer that brings you the world of tomorrow today!

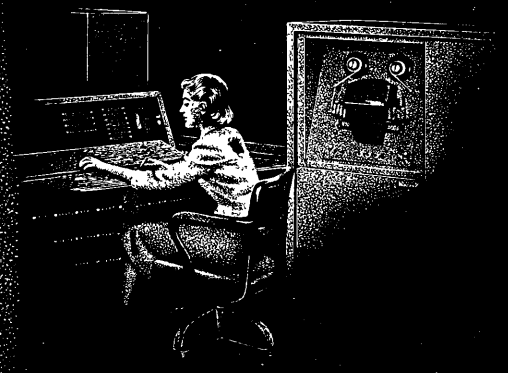

*transac s-2000* by PHILCO®

*First in Transistorized Data Processing*

# COMPUTERS

## and AUTOMATION

DATA PROCESSING • CYBERNETICS • ROBOTS

Volume 8  
Number 12

DECEMBER, 1959

Established  
September 1951

EDMUND C. BERKELEY *Editor*  
H. JEFFERSON MILLS, JR. *Assistant Editor*  
NEIL D. MACDONALD *Assistant Editor*  
MOSES M. BERLIN *Assistant Editor*  
PATRICK J. MCGOVERN *Assistant Editor*

**SERVICE AND SALES DIRECTOR**  
MILTON L. KAYE MURRAY HILL 2-4194  
535 Fifth Ave. New York 17, N.Y.

**CONTRIBUTING EDITORS**  
ANDREW D. BOOTH  
JOHN W. CARR, III  
NED CHAPIN  
ALSTON S. HOUSEHOLDER

**ADVISORY COMMITTEE**  
MORTON M. ASTRAHAN  
GEORGE E. FORSYTHE  
ALSTON S. HOUSEHOLDER  
HOWARD T. ENGSTROM  
RICHARD W. HAMMING  
HERBERT F. MITCHELL, JR.  
SAMUEL B. WILLIAMS

**ADVERTISING REPRESENTATIVES**  
*Middle Atlantic States* MILTON L. KAYE  
535 Fifth Ave. New York 17, N.Y.  
MURRAY HILL 2-4194

*Washington 6, D.C.* ROBERT CADEL  
1519 Connecticut Ave. Columbia 5-9727  
*San Francisco 5* A. S. BABCOCK  
605 Market St. YUKON 2-3954  
*Los Angeles 5* W. F. GREEN  
439 S. Western Ave. DUNKIRK 7-8135  
*Elsewhere* THE PUBLISHER  
Berkeley Enterprises, Inc.  
815 Washington St., Newtonville 60, Mass.  
DECATUR 2-5453 or 2-3928

### 1959 PICTORIAL REPORT ON THE COMPUTER FIELD . . . . . 8

**FRONT COVER**  
Seeking Utmost Reliability Under Extreme Conditions  
—Sylvania's Mobidic . . . . . 1, 17

**ARTICLE**  
Maintenance Methods for Digital Computers, FRED  
LIGUORI . . . . . 20

**READERS' AND EDITOR'S FORUM**  
Greetings to Computers . . . . . 6  
Controversy and "Computers and Automation" . . . . . 6  
Mathematics Laboratories . . . . . 6  
Calendar of Coming Events . . . . . 24  
Computer Accessory . . . . . 24

**REFERENCE INFORMATION**  
Survey of Recent Articles, M. M. BERLIN . . . . . 26  
Who's Who in the Computer Field (Supplement) . . . . . 31  
New Patents, R. R. SKOLNICK . . . . . 32

**INDEX OF NOTICES**  
Advertising Index . . . . . 34  
Back Copies . . . . . see Oct., page 39  
Bulk Subscriptions . . . . . see Oct., page 39  
Computer Directory and Buyers' Guide, 1959  
see Nov., page 31  
Manuscripts . . . . . see August, page 28  
Reference and Survey Information . . . . . see August, page 29  
Who's Who Entry Form . . . . . see August, page 32

COMPUTERS and AUTOMATION is published monthly at 160 Warren St., Roxbury 19, Mass., by Berkeley Enterprises, Inc. Printed in U.S.A.

**SUBSCRIPTION RATES:** (United States) \$5.50 for 1 year, \$10.50 for 2 years; (Canada) \$6.00 for 1 year, \$11.50 for 2 years; (Foreign) \$6.50 for 1 year, \$12.50 for 2 years.

Address all Editorial and Subscription Mail to Berkeley Enterprises, Inc., 815 Washington St., Newtonville 60, Mass.

ENTERED AS SECOND CLASS MATTER at the Post Office at Boston 19, Mass.

**POSTMASTER:** Please send all Forms 3579 to Berkeley Enterprises, Inc., 160 Warren St., Roxbury 19, Mass.

Copyright, 1959, by Berkeley Enterprises, Inc.

**CHANGE OF ADDRESS:** If your address changes, please send us both your new address and your old address (as it appears on the magazine address imprint), and allow three weeks for the change to be made.

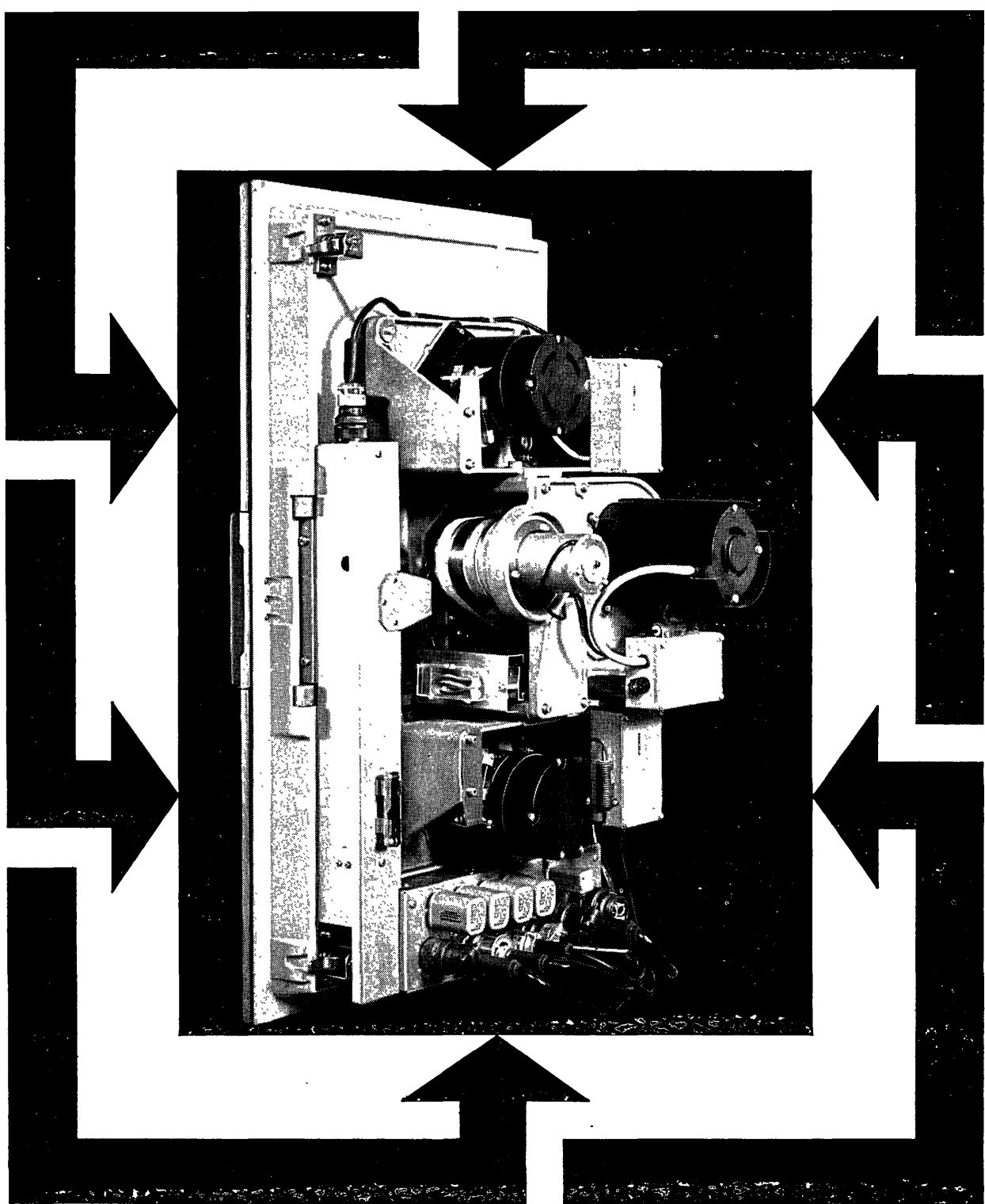

## AMPEX PRECISION NOW 'LOCKED IN'

Lose the precise alignment of tape guiding and driving components in an instrumentation recorder and you lose the fine edge of designed-in performance. As alignment is lost, flutter and skew set in.

In the new Ampex FR-100B analog recorder, the possibility of misalignment—even under conditions of shock and vibration incidental to shipment or installation—is now eliminated by a framework of three precision castings with machined 'V' mating surfaces that lock all critical parts into a single rigid unit. The result: an instrumentation recorder with built-in performance and reliability that stays built in.

Other advanced features: 1. A unique electrical hold-back system keeps tape tension constant within narrow

limits, reducing flutter and eliminating mechanical feedback of speed variations. 2. Modular plug-in amplifiers and power supplies give quick versatility for direct, FM carrier, PDM, and NRZ digital recording. 3. Front-panel, four-speed switching over a six-speed range from  $1\frac{7}{8}$  to 60 ips allows flexibility in selecting upper frequency limit for maximum tape economy.

These and other features of the new Ampex FR-100B add up to unmatched performance and reliability. The full story is available in the new Ampex FR-100 brochure.

AMPEX INSTRUMENTATION,  
934 Charter Street, Redwood City, Calif.

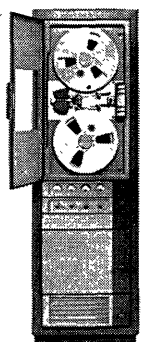

# Readers' and Editor's Forum

## GREETINGS TO COMPUTERS

FOR CHRISTMAS, WE wish our subscribers, our readers, and all computer people:

$$\begin{array}{r}
 \text{M E R R Y} \\
 \times \quad \text{M A S} \text{ and a} \\
 \hline
 \text{A T A W W Y} \\
 \text{E Y B S S T} \\
 \text{S N E S A S} \\
 \hline
 = \text{N Y B M M B W Y,} \\
 + \text{S A S N A R T E Y S B} \\
 \hline
 = \text{S A N E N E W Y E A R,}
 \end{array}$$

24619 59956 65743 85219 60145 65743 2453000. (Solve for the digits; each letter stands for just one digit 0 to 9, although one digit may be represented by more than one letter.)

This is a Numble, a number puzzle for nimble minds. For hints for solution if needed, write us. The solution will appear in January.

We repeat our annual challenge to automatic computers — to solve this kind of problem by an automatic program. The challenge, offered now for the sixth December, remains unanswered so far as we know.

## CONTROVERSY AND "COMPUTERS AND AUTOMATION"

I. From: E. J. Teagle  
Maracaibo, Venezuela

This is my last subscription unless you cut out that c--p about social responsibility and devote more space to applications.

II. From: George A. Hall, Jr.  
Asst. Editor, ISA Journal  
Pittsburgh, Pa.

We here are particularly interested in your continued support and promotion of the social responsibility of computer scientists — and by implication automatic control engineers — in the columns of your magazine. This is fine work: please keep it up.

III. From the Editor's Notes, Computers and Automation, April 1954 (Vol. 3, No. 4), p. 4 ff:

We believe in the value of controversy, in the field of computers and automation as well as in all other fields. A controversial subject is an interesting subject, an important one to argue about and seek the truth about, through discussion, investigation, and the clash of different views. It is not necessary to lose one's temper in discussion, but it is necessary that each party in the discussion have his fair chance to express his views, without being called names or having his integrity or loyalty to anybody or anything attacked. . . .

In the pages of this magazine we shall do our best to promote controversy, honorable controversy, which truthfully and honestly explores ideas, and which tries to make sure that each side of a question is expressed fairly — without calling names, attacking reputations, or hugging orthodoxy.

## IV. From the Editor:

This is still exactly what we believe in — and the subject of the social responsibility of computer scientists is worth quantities of discussion and argument.

## MATHEMATICS LABORATORIES

I. From: J. F. Clark  
21054 Clark Ave., RR3  
Langley, British Columbia  
Canada

I am teaching mathematics in one of two Junior-Senior High Schools in this district. Our total enrolment in Grades 7-13 is approximately 1600. Our School Board is at present planning to spend about \$30,000 on a music-band room in one school to satisfy the demands of a Music Specialist. Full band equipment, music scores, piano, record-player, etc., are already provided.

As a mathematics specialist I am green with envy. The total appropriation for mathematics equipment in the last 10 years would scarcely buy the piano. In order to rectify this situation I am contacting the major American suppliers of mathematics laboratory equipment. Your address has been obtained from a publication of the National Council of Teachers of Mathematics.

I therefore request your serious consideration in supplying me with catalogues, descriptive literature, and material which can be of use in approaching the School Board and selling them on the necessity of mathematics laboratories.

Our local Board is one of the best and I can assure you they will respond to reasonable demands.

## II. From the Editor to Mr. Clark:

Thank you for your recent letter. We are happy to enclose our announcements of the things we publish and our Brainiac kit. Good luck to you in what you are trying to do, and if we can be of any further help to you, write us again.

## III. From the Editor to the readers of Computers and Automation:

If you have any information or announcements which relate to school mathematics laboratories which might be of interest to Mr. Clark, will you please send them to him?

*Important News for Computer Designers!*

## New **RCA MEMORY CORES**

feature 1 microsecond performance with...

**25% Reduction in Power Requirements!**

**40% Increase in Operating Margin!**

*Dramatic improvement over present standard cores offers  
greater design flexibility, top performance  
in high-speed coincident current memory applications*

New 1- $\mu$  sec memory cores 226M1 (XF-4028) and 228M1 (XF-4257) developed at RCA's Materials Lab in Needham Heights, Mass., represent an important step forward in ferrite core design for military and commercial computers. See chart for the significant improvements in power requirements and operating margin now possible in 1- $\mu$  sec operation.

Call your local RCA Field Representative and learn how the new 226M1 and 228M1 can fit into your new computer designs. He can also give you information on the entire line of RCA Ferrite Memory Cores, Planes and Stacks available to meet your specific design requirements. For technical data, write RCA Commercial Engineering, Section L-90-NN, Somerville, N. J.

NOMINAL OPERATING CHARACTERISTICS AT 25°C							
Type	Size	Full Driving Current (Im) (ma)	Partial-Write Current (I <sub>pw</sub> ) (ma)	Pulse Rise Time (T <sub>r</sub> ) ( $\mu$ sec)	Switching Time (T <sub>s</sub> ) ( $\mu$ sec)	Response	
						"Undisturbed 1" ( $\mu$ V <sub>i</sub> ) (mv)	"Disturbed 0" (dV <sub>i</sub> ) (mv)
228M1 (XF-4257)	.080" x .050" x .025"	620	310	0.2	1	160	18
226M1 (XF-4028)	.050" x .030" x .015"	380	190	0.2	1	75	10

#### RCA FIELD OFFICES:

**East:**  
744 Broad Street, Newark, N. J.  
HUmboldt 5-3900

**Northeast:**  
64 "A" Street  
Needham Heights 94, Mass.  
Hillcrest 4-7200

**East Central:**  
714 New Center Bldg., Detroit 2, Mich.  
TRinity 5-5600

**Central:**  
Suite 1154, Merchandise Mart Plaza  
Chicago, Ill., WHitehall 4-2900

**West:**  
6355 E. Washington Blvd.  
Los Angeles, Calif., RAYmond 3-8361

**Gov't:**  
224 N. Wilkinson St., Dayton, Ohio  
BALdwin 6-2366  
1625 "K" Street, N.W.  
Washington, D.C., DIstrict 7-1260



**RADIO CORPORATION OF AMERICA**  
Semiconductor & Materials Division • Somerville, N. J.

# 1959 Pictorial Report on the Computer Field

This is a pictorial report for 1959 on the computer field, including computers, data processors, components, etc. To put together this report, we sent out a letter to many organizations in the computer field, asking for: "interesting, striking, and dramatic pictures related to the computer field in 1959 — pictures that answer questions:

What does a . . . . . look like?

What goes into a . . . . . ?

How is a . . . . . made?

How does a . . . . . operate?

and similar questions."

We said we wanted to avoid pictures that showed only "smooth and featureless outside coverings."

A number of good pictures have been sent to us, and we are grateful for them. Many of these have been printed as a part of this report, which includes the front cover also; but there is not room for all of them to be published in this issue, and so we shall plan to publish more of them in later issues.

The present report is a continuation of our previous pictorial reports: "A Pictorial Manual on Computers," first printed in two parts, one in December 1957, the other in January 1958, subsequently reprinted as a special issue of *Computers and Automation*, vol. 6, no. 12B; and "1958 Pictorial Report on the Computer Field," printed in the December 1958 issue of *Computers and Automation*, vol. 7, no. 12.

## I. Computers

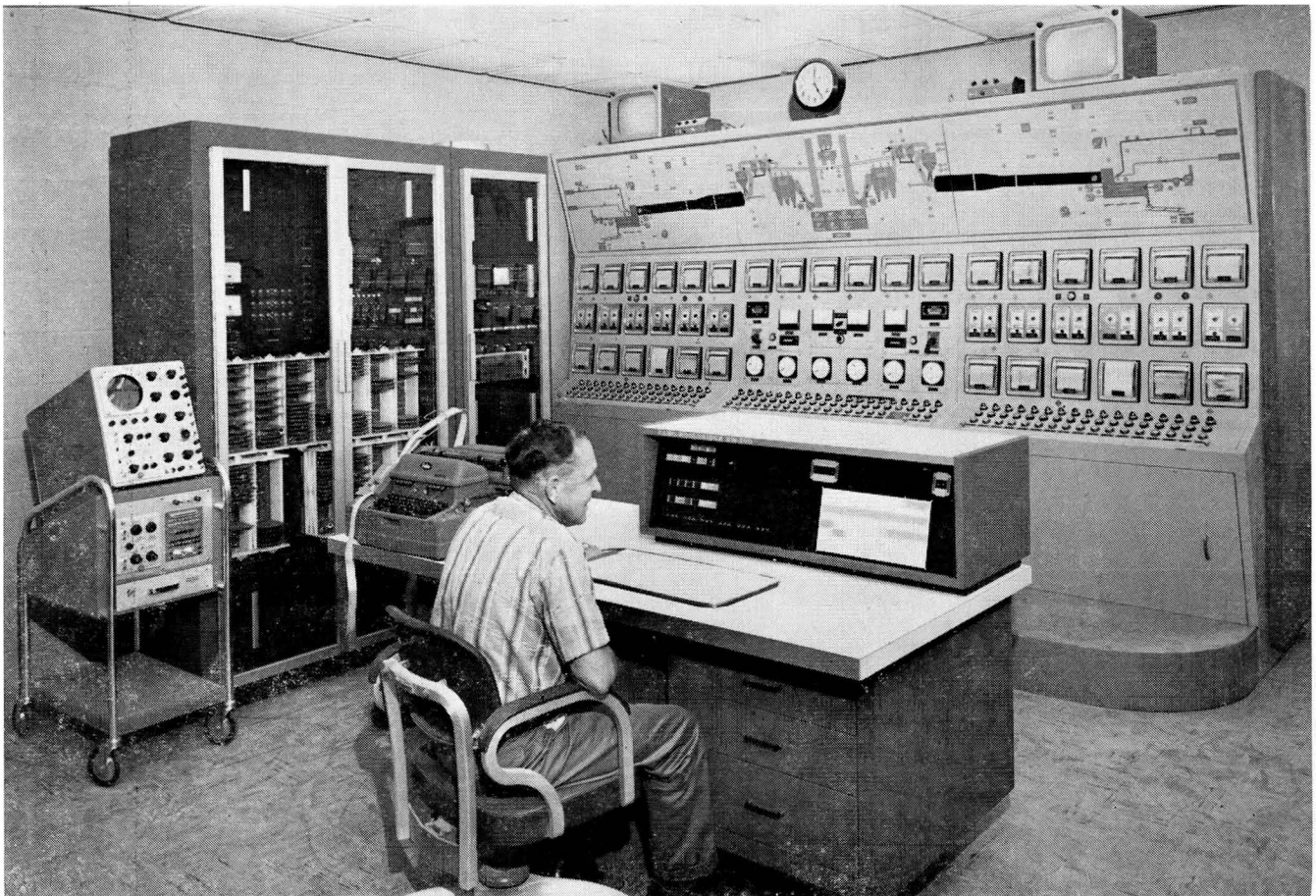

This is an automatic digital computer being used for control purposes in a cement-mixing company. It directs the blending and storage of raw materials, and will eventually exercise closed-loop control over the kilns. The machine is an RW 300 made by Thompson-Ramo-Wooldridge Products Co., Beverly Hills, Calif., and is in use at the Riverside Cement Co., Oro Grande, Calif. (Figure 1)



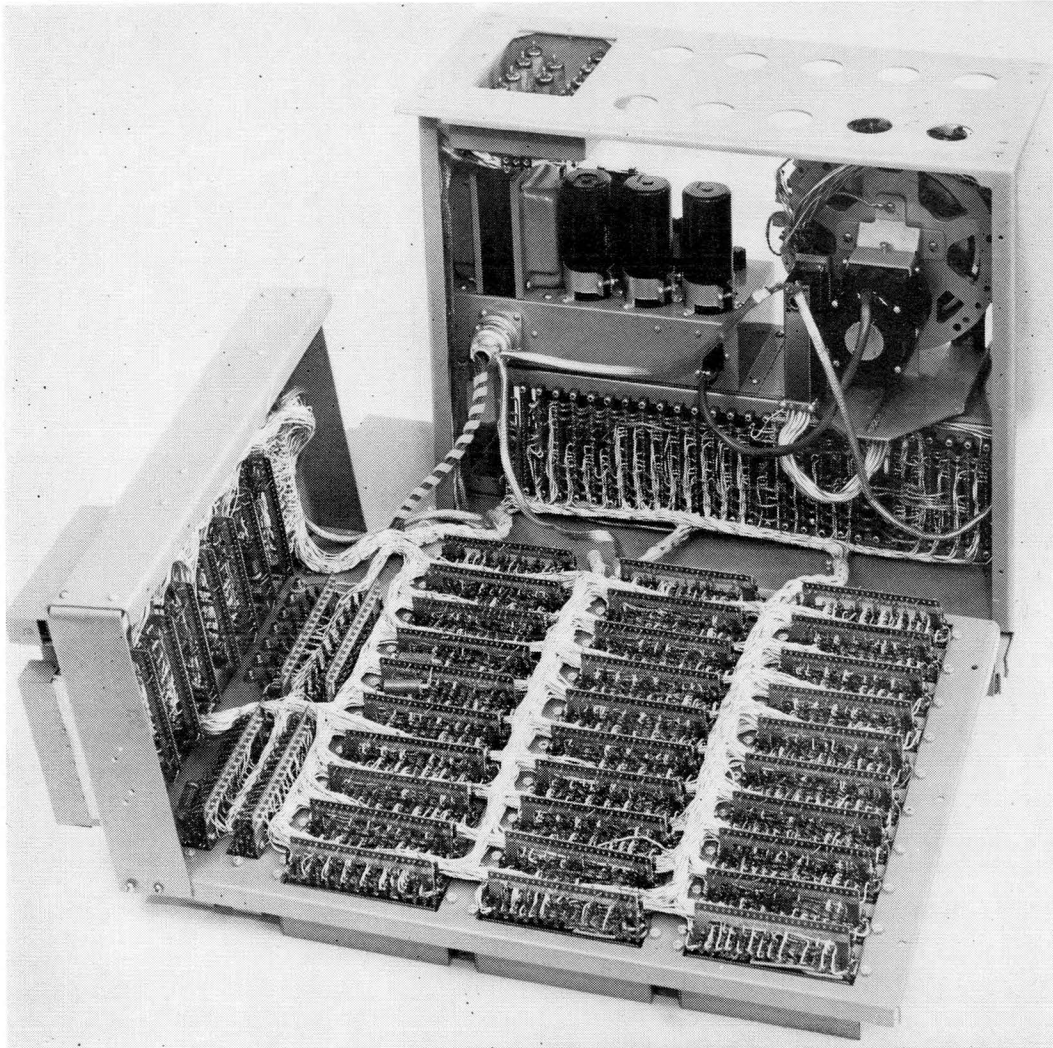

One of the lowest-priced (under \$20,000) complete automatic digital computers is the DE 60 of Clary Corporation, San Gabriel, Calif. (Figure 2). Part of the programming is accomplished by a plugboard, and more by sequential instructions from the keyboard. The arithmetic unit (Figure 3) is contained in the box under the typewriter, and is shown opened in Figure 3. No tubes are used in the logical operations of the computer; the thyatrons are power tubes.

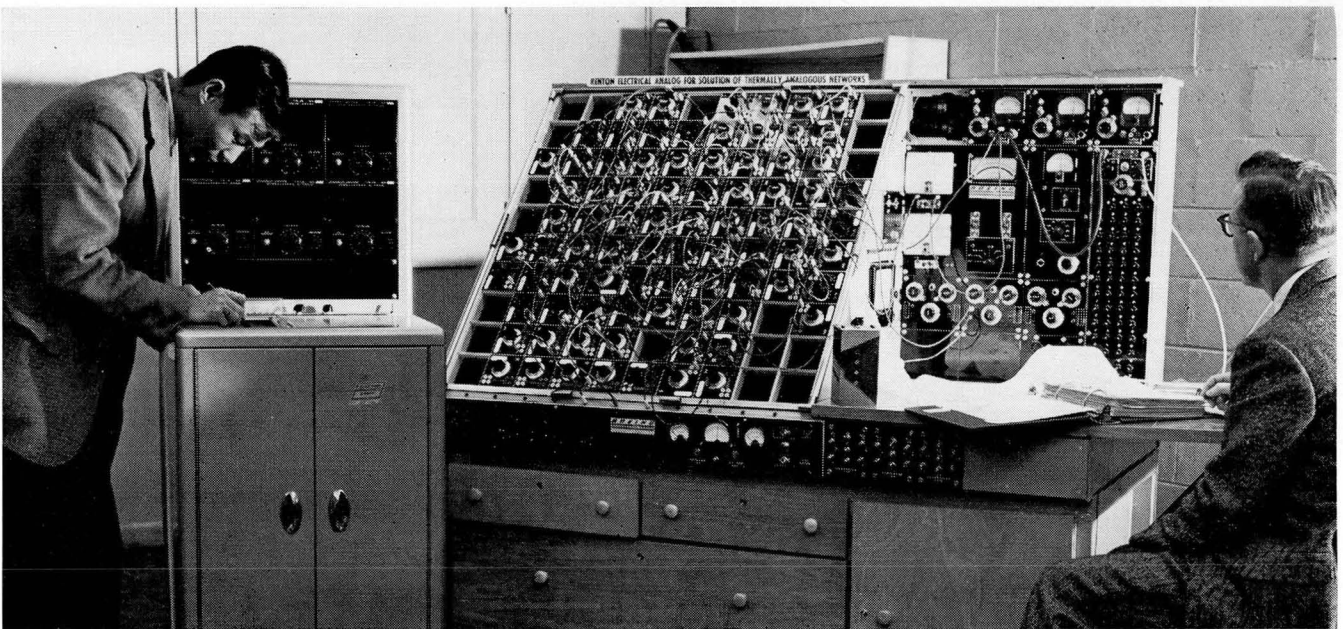

This is a general purpose analog computer constructed by and in use at Boeing Airplane Co., Seattle, Wash., for solving heat-transfer problems in the design of manned supersonic aircraft. It is about  $1/8$  the size and  $1/10$  the cost of comparable models. It is assembled from 11 kinds of standard boxed units, which are connected from in front. In a steady-state heat-transfer problem, where skin temperatures are assumed to be constant, interior temperatures can be found simultaneously at 400 different locations. The computer has been named Reastan. (Figure 4)

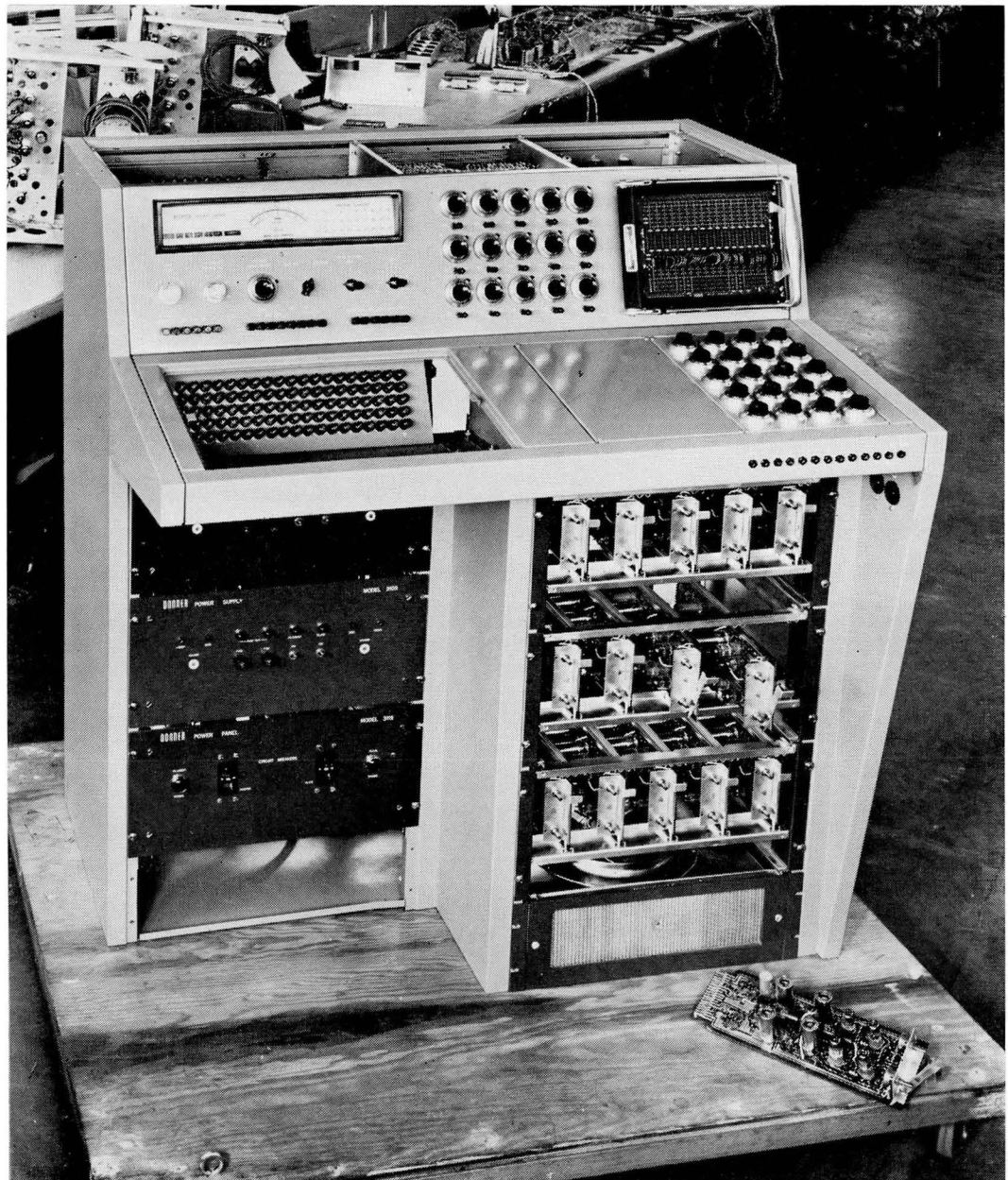

This is a new general-purpose analog computer with 30 amplifiers and 35 to 55 potentiometers, desk size, expandable, able to solve linear and non-linear differential equations, etc. The machine is the Model 3100 analog computer made by Donner Scientific Co., Concord, Calif. (Figure 5)

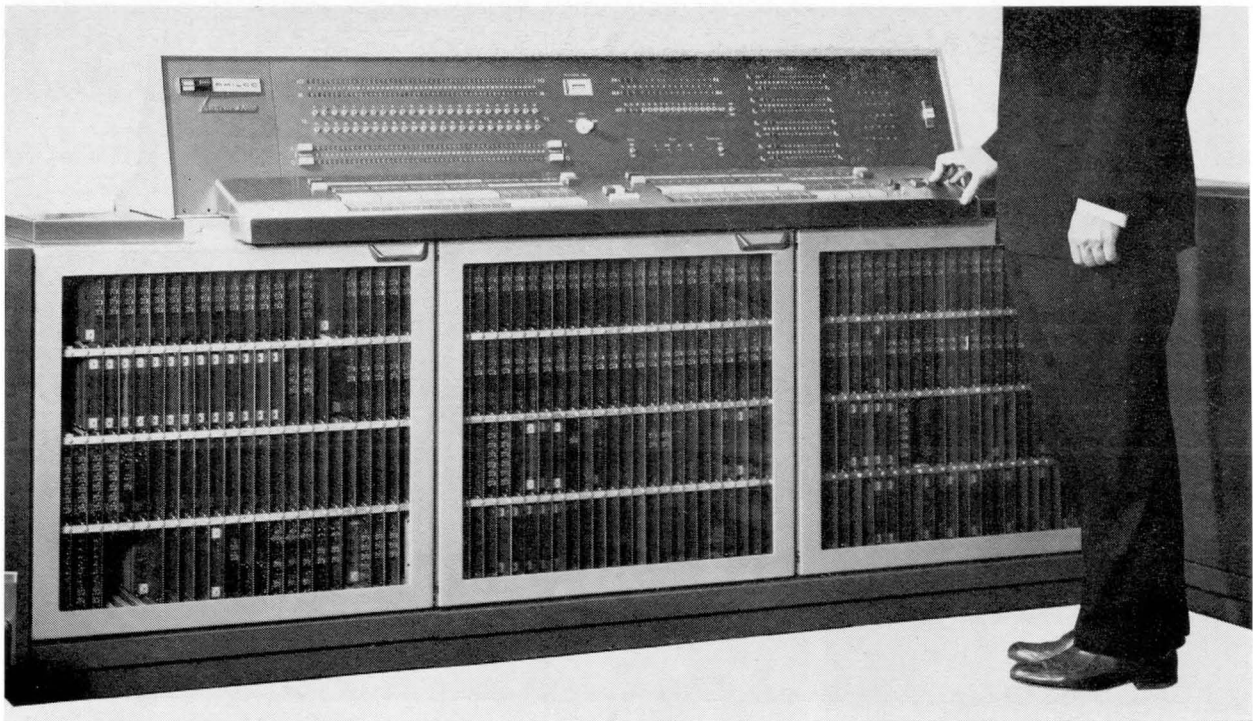

This shows the console of the central computing unit of the very large-scale and powerful computer, the Transac S 2000 made by Philco Corp., Philadelphia, Pa. The plug-in circuit boards appear through the glass windows of the front of the console. (Figure 6)



This machine is sorting checks at the rate of 25 a second, by means of magnetic ink characters printed or entered on each check. The characters record account number, amount, and other information. The sorter is an element of the Burroughs B 251 Visible Record Computer made by Burroughs Corp., Detroit, Mich. (Figure 7)

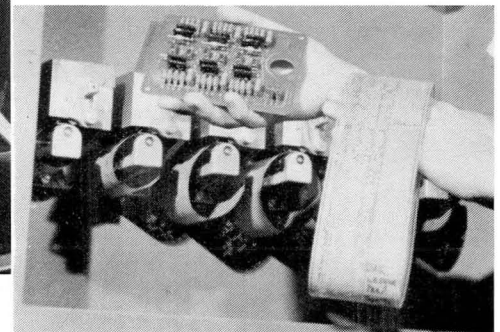

Here is shown a band of Mylar plastic tape containing about 200 instructions for the operation of the Burroughs B 251 Visible Record Computer. Up to 12 tape readers may be installed, so that the computer may refer to more than 2500 programming instructions. Also shown is one of the small transistorized printed circuit boards. (Figure 8)



Here is a small general-purpose digital computer, with: electric typewriter input and output; paper tape reader and punch; and at the right, the main computing unit (Figure 9). This is the Recomp II made by Autonetics division of North American Aviation, Downey, Calif. Below is the computer unit opened up. (Figure 10).

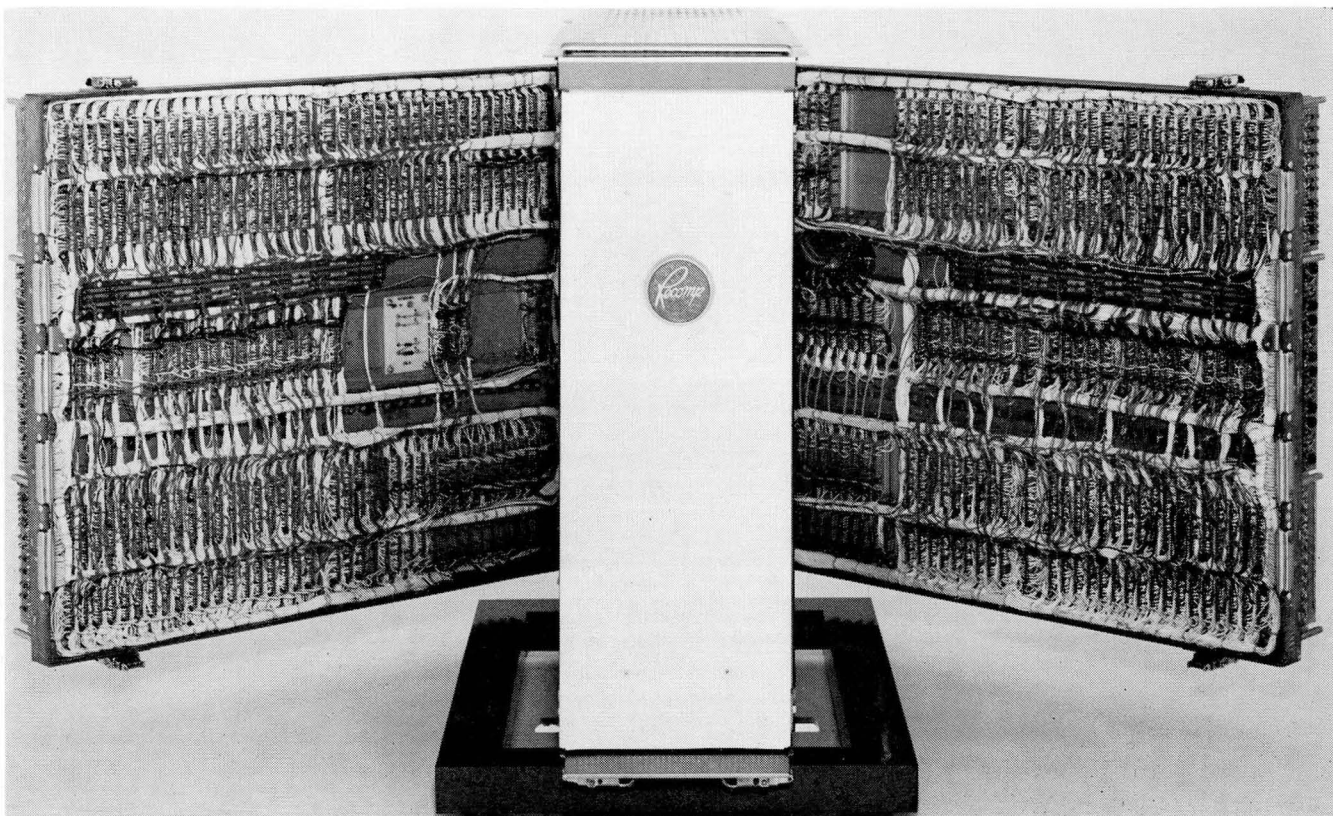

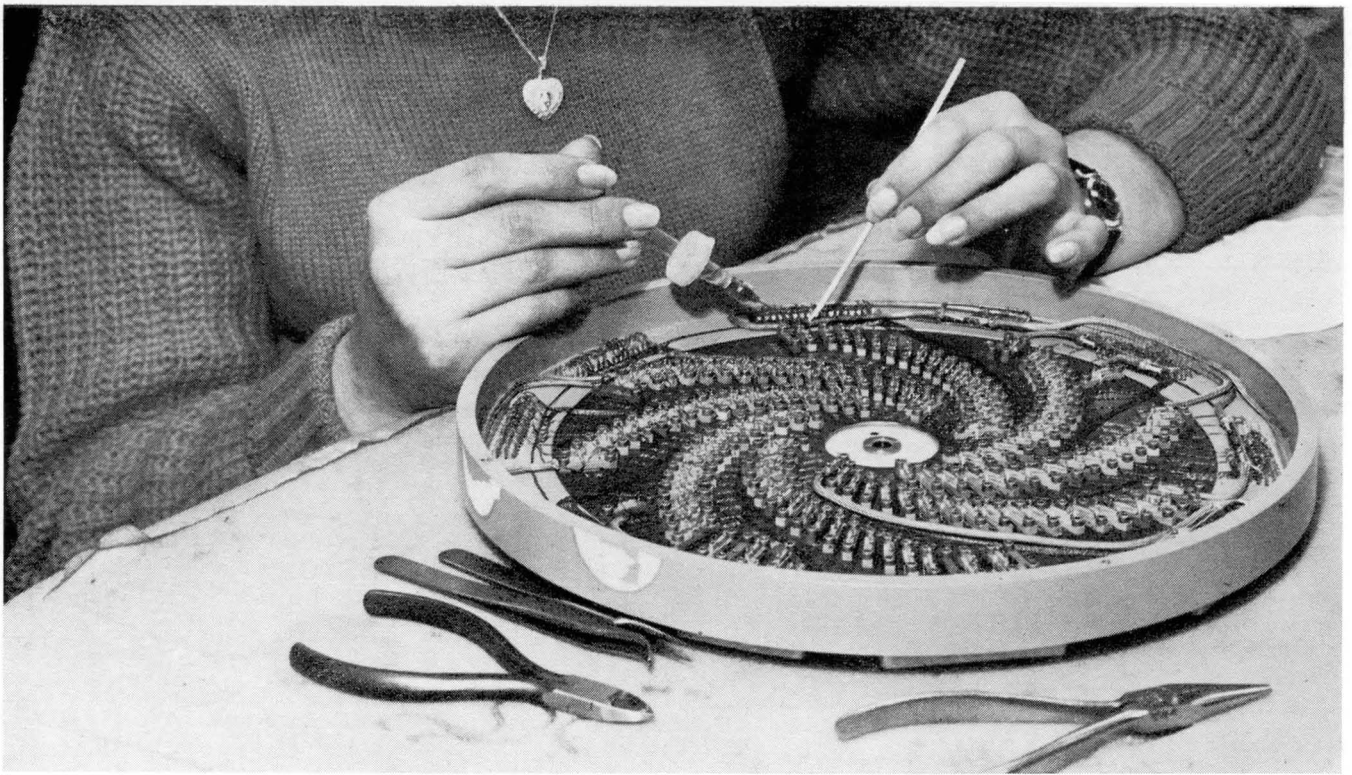

Here is part of the magnetic drum memory of the Recomp II being assembled and wired. The capacity of the memory is 4096 words of 40 binary digits each. (Figure 11)

The purpose of this machine is to convert information from magnetic tape to paper tape. It is made by Telemeter Magnetics, Los Angeles, Calif., and contains among other components a magnetic tape reader made by Ampex Instrumentation, Redwood, City, Calif. (Figure 12)

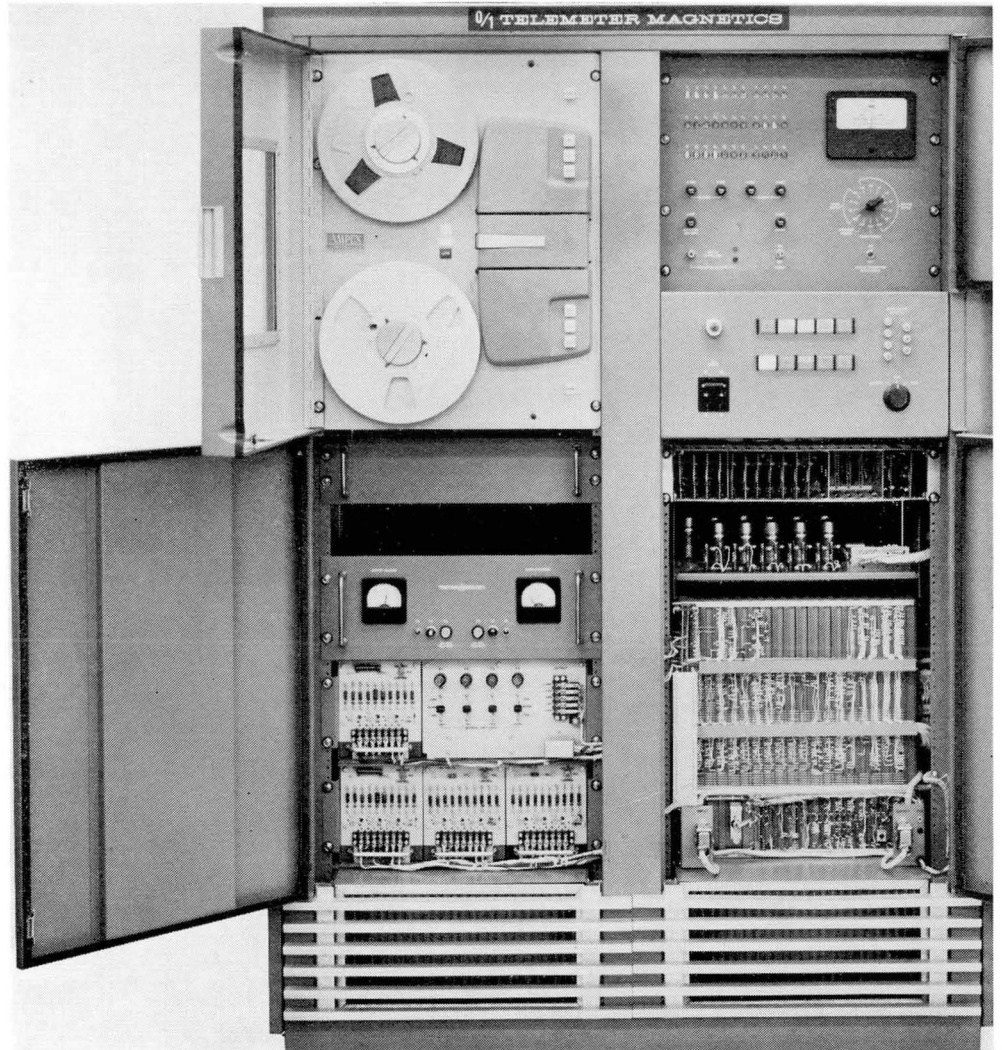

## 2. Input

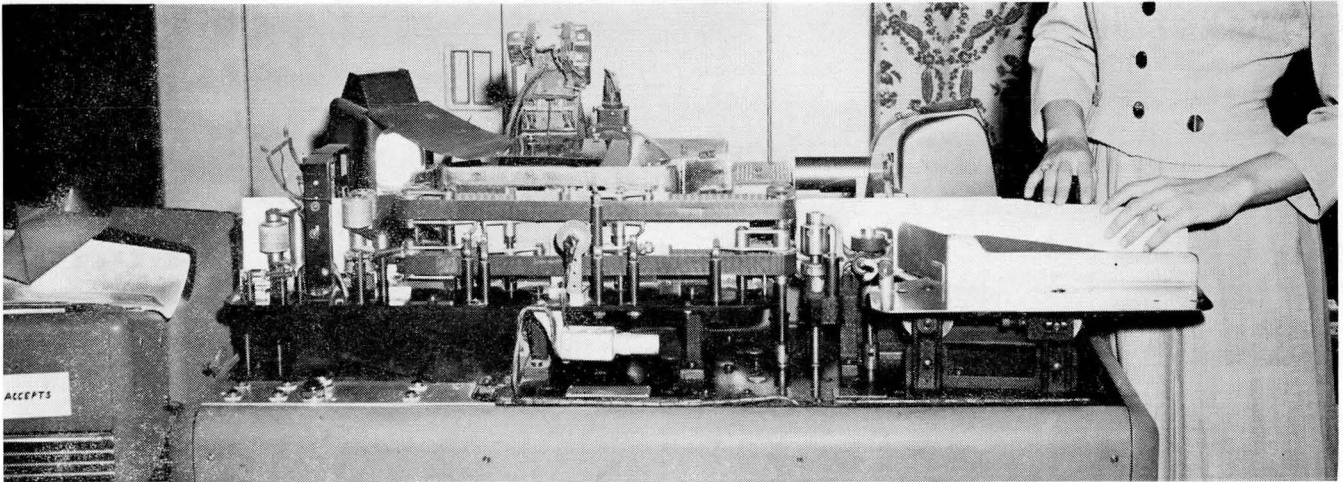

This is an automatic electronic reader of typewritten or printed characters in correspondents' addresses on ordinary mailed envelopes. The model is being developed further, under a contract with the U.S. Post Office Department, by Intelligent Machines Research Corp., a subsidiary of Farrington Manufacturing Co., Needham Heights, Mass. (Figure 13)



Pictorial information can be converted into digital data for computer input. The machine shown takes stereophotographs and with the aid of an operator converts highway cross-section measurements into digital form punched on punch cards or punch tape. The machine is the Terrain Data Translator made by the Benson Lehner Corp., Los Angeles 64, Calif. (Figure 14)

### 3. Output



Here is a tape punch which punches 120 characters per second. It is part of FLAC, the Florida Automatic Computer. This machine was designed and is operated by the RCA Service Co., Missile Test Project, Patrick Air Force Base, Florida. (Figure 15)



The machine shown above puts out digital and other symbolic displays (eight numbers or symbols printed in parallel) at speeds of up to one display per second. The machine also draws lines. In fact, it can draw any picture consisting of a series of straight lines; for the mapmaker it draws maps; for the highway engineer it draws terrain cross sections and profiles; for the petroleum geophysicist it prints subsurface contours; and for the petroleum production man it presents oil well production information. This machine is the Electroplotter Model S made by Benson Lehner Corp., Los Angeles 64, Calif. (Figure 16)

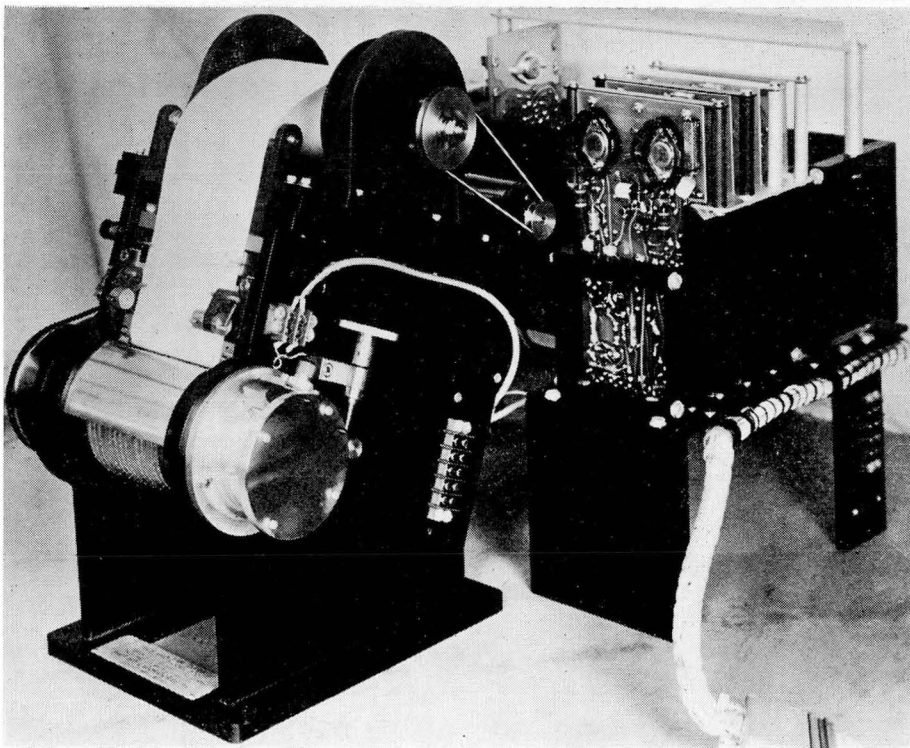

This is a high-speed paper-tape-imprinting output device. While the paper tape runs continuously, the typewheels make up to 30 revolutions a second, each wheel bearing 64 characters. Hammers actuated by precisely timed solenoids strike the pressure-sensitive paper, and character face in 50 millionths of a second, so there is no smearing of the impression. Another model can type up to 190 characters per line at rates up to 15 lines per second. The machine is made by Shepard Laboratories, Summit, N.J. (Figure 17)

## 4. Components

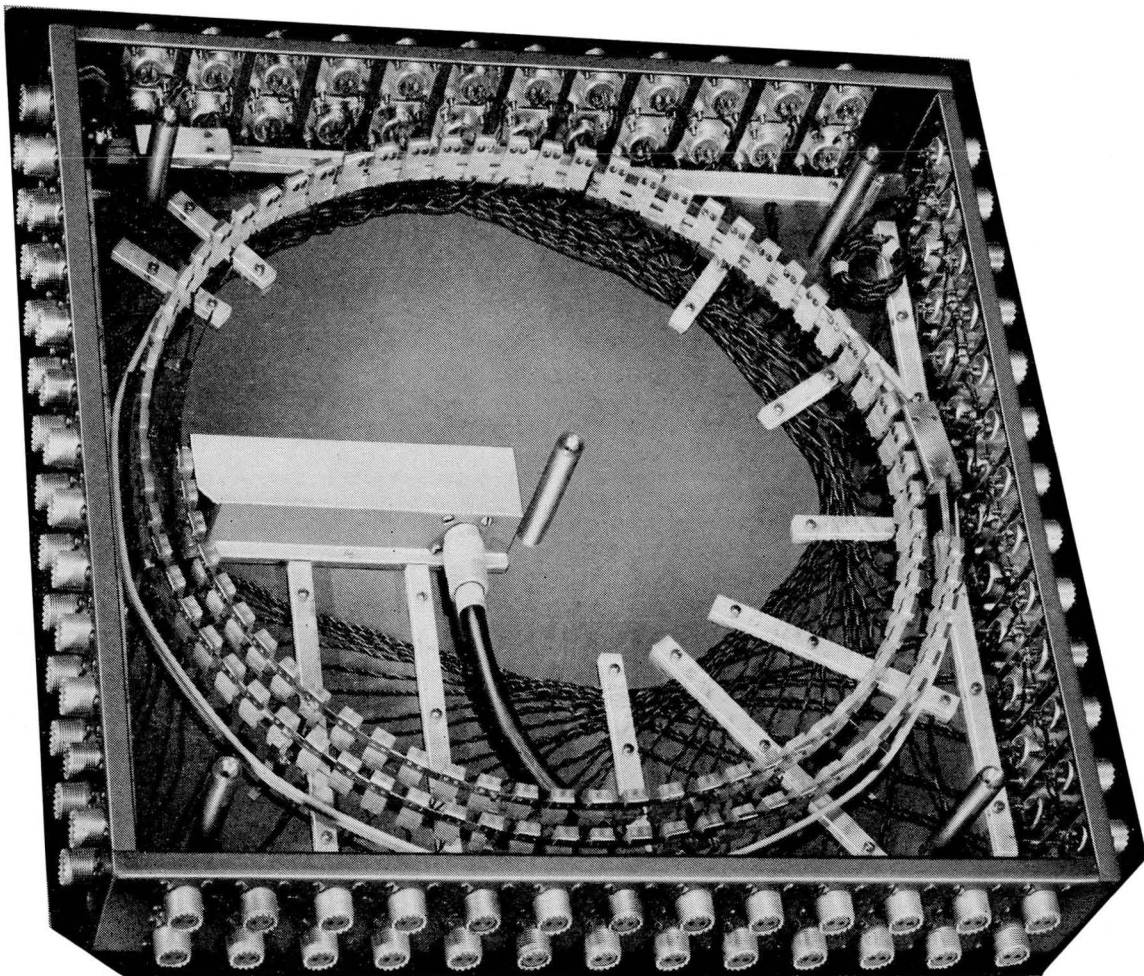

This is a magnetostriction delay line, a memory which stores information based on the change of physical dimensions of a material when it is magnetized as compared with when it is not magnetized. The manufacturer is Ferranti Electric Co., Hempstead, N.Y. (Figure 18)



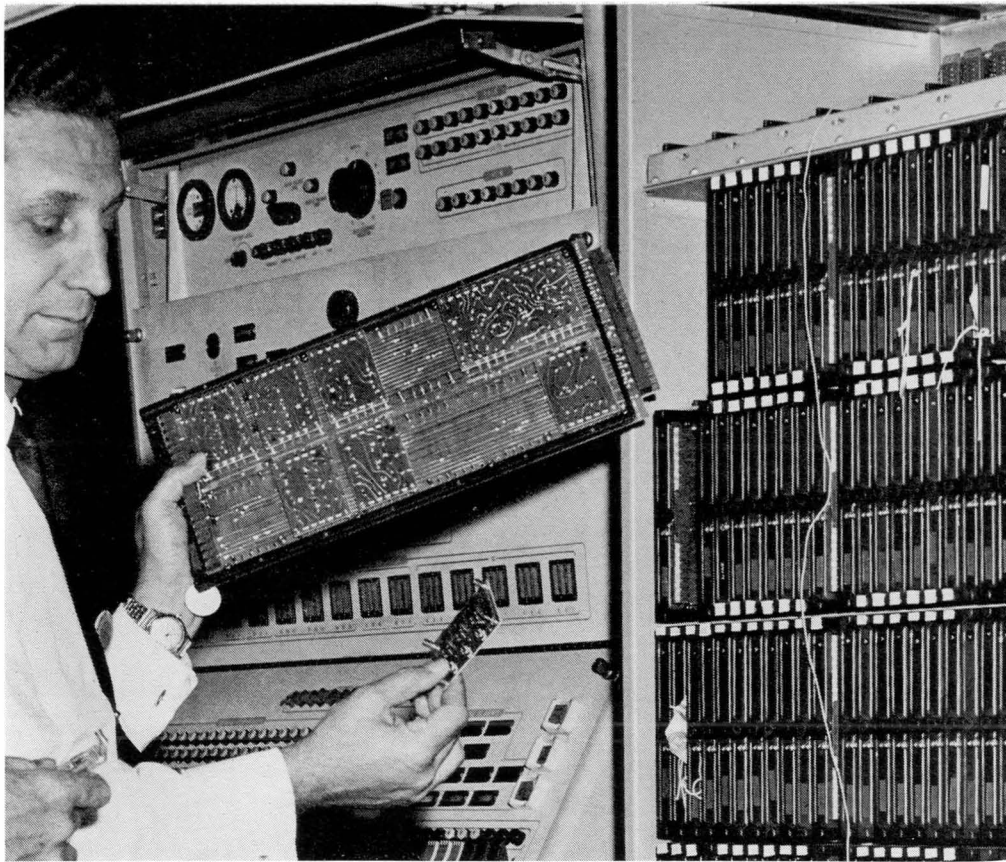

The utmost reliability under very rigorous conditions has been sought in the components of the mobile digital computer, Mobidic (Figures 19 and 20, and the Front Cover). It is being built by Sylvania Electronic Systems, Needham, Mass. for the U.S. Armed Forces. The components have been constructed in three levels of packaging: (1) small printed circuit plaques with components mounted and soldered; (2) larger printed circuit boards with the plaques mounted upon them; and (3) frames in which the larger boards may slide in and out. For other purposes than Mobidic, the frames also have been made removable and insertable. (See Front Cover)

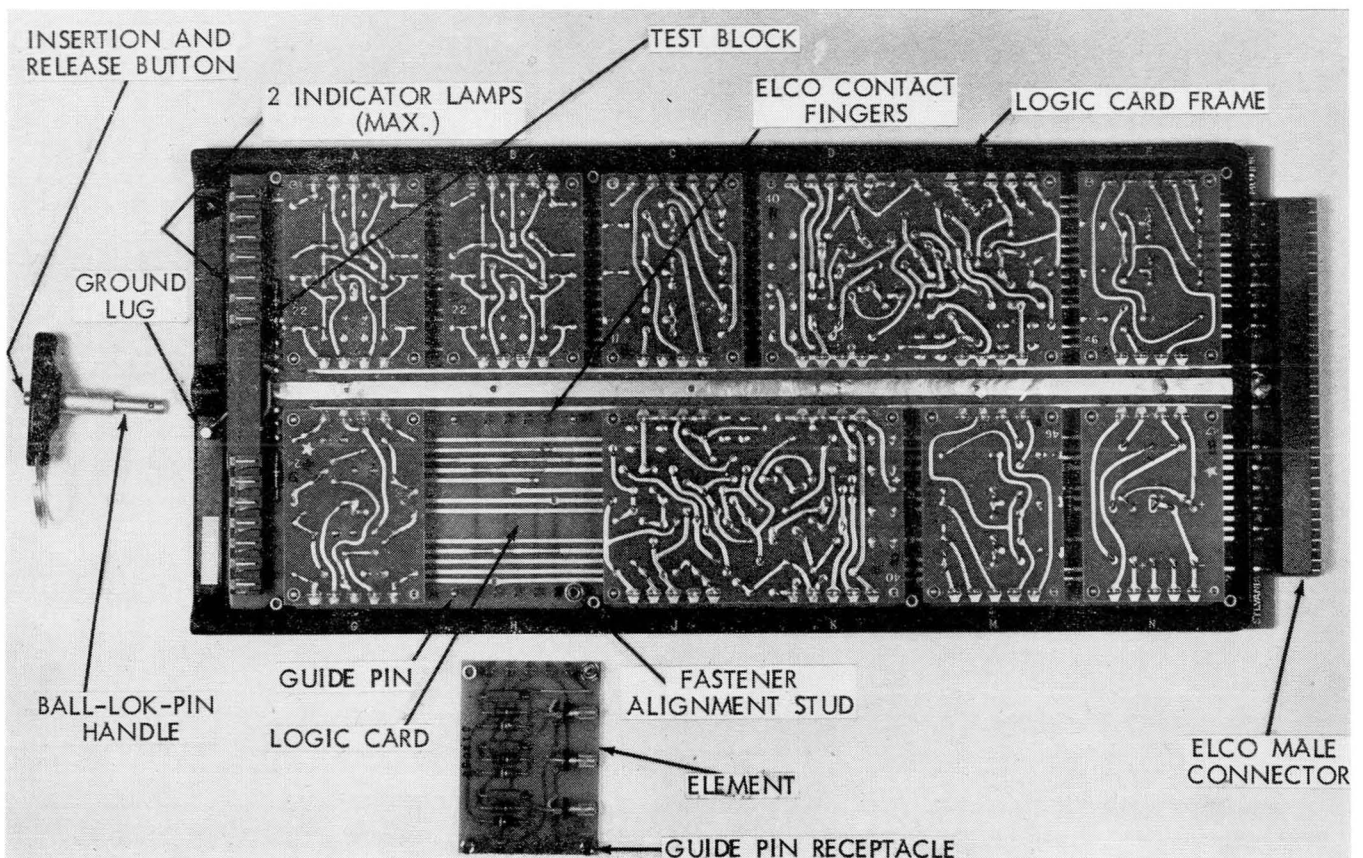

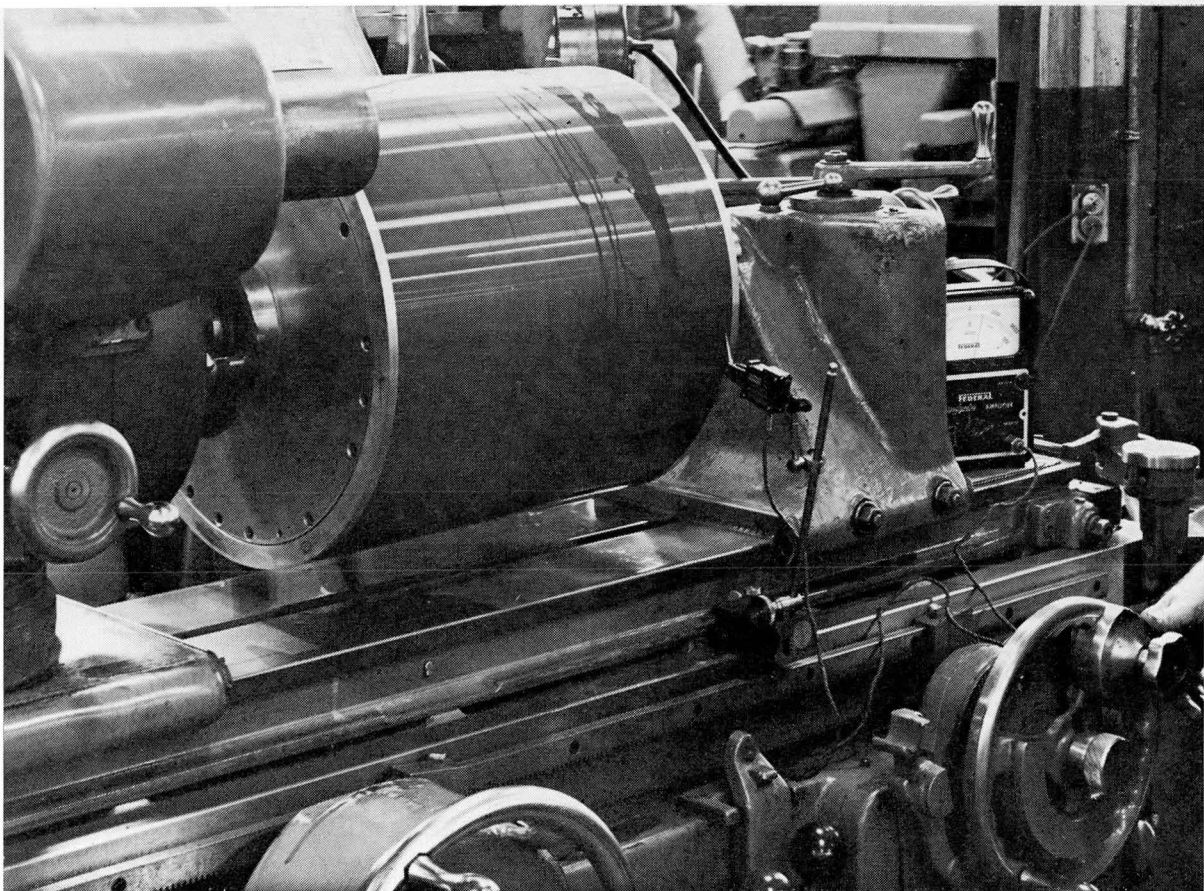

Above the magnetic oxide coating for a magnetic drum is being inspected for concentricity with a micro-probe amplifier. The concentricity tolerance on this particular drum was 70 millionths of an inch. The manufacturer is Bryant Computer Products Division, Springfield, Vermont. (Figure 21). Below holes are being machined into the drum housing in order to fasten the magnetic read/record heads. (Figure 22)





This picture high-lights a current computer application to a U.S. Army war-game problem. The game (called SYNTAC) is used to evaluate the feasibility of operational and organizational concepts; it is played manually by two opposing teams maneuvering on a map. The teams are members of the Combat Research Operations Group (CORG) of Technical Operations Inc., Burlington, Mass., associated with Combat Development System, U.S. Continental Army Command, Fort Monroe, Va. The umpire is a Control Group assisted by an LGP-30 computer, made by Royal McBee Corp., Port Chester, N.Y.; the computer is essential for quickly and accurately judging the moves. (Figure 23)

Checking and maintaining the operation of computers is perhaps the most fundamental of all computer requirements. This picture shows a technician checking a logic chassis in the RCA-501 electronic data processing system, in the RCA plant, Camden, N.J. The most recently delivered RCA 501 was installed in Denver in October for supervision and control over records of air reservists. (Figure 24)

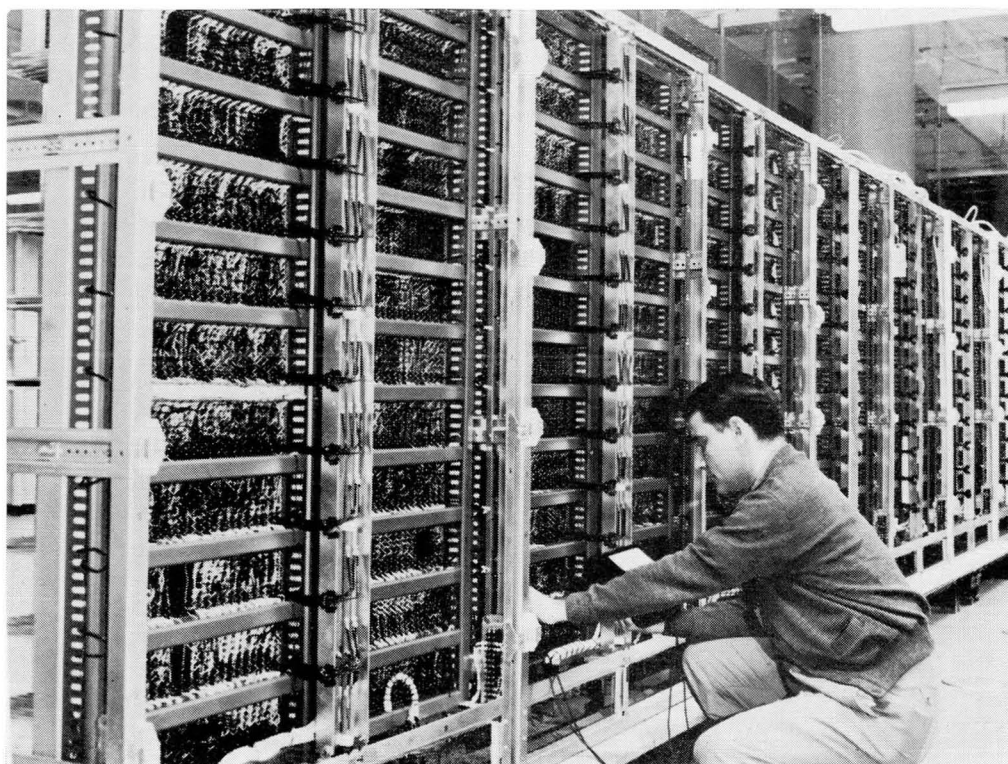

# MAINTENANCE METHODS FOR DIGITAL COMPUTERS

Fred Liguori

Sperry Gyroscope Co., Marine Div.  
Syosset, L.I., N.Y.

Supplying an adequate maintenance manual concurrently with or shortly after the delivery of an elaborate equipment is never a simple task. The problem of anticipating actual operating conditions and the reliability of the equipment has no simple solution. In the case of digital computers, however, two additional factors further complicate the problem:

(1) Almost unlimited flexibility of operation based on an easily changed, stored program makes the computer's ultimate use unpredictable.

(2) The dependence of computer operation on stored data requires tests other than the usual tests on physical hardware.

The usual solution to the checkout and maintenance problem is to utilize the computer itself to isolate or at least localize the trouble area. This requires a well developed test program that checks memory data as well as the system electronics. The use of test programs, however, present problems of their own.

The main purpose of this article is to consider various methods of attacking the maintenance problem and to discuss the merits and disadvantages of the methods considered.

## Maintenance based on Permanently Stored Test Programs

The desirable features of a well designed test procedure based on programs permanently stored in the computer memory are:

- (1) Thoroughness of checkout
- (2) Minimum of time required
- (3) Minimum possibility of human error
- (4) Actual operating conditions can be simulated
- (5) Minimum knowledge required by technician
- (6) Minimum of test devices and maintenance literature required

Items (1) and (2) are closely interrelated since it is the rapid action of programmed tests that enables all circuitry and each memory cell to be checked out within a reasonable time. For the average computer the time required for such tests is about fifteen minutes if no faults are encountered. A similar test by manual procedures would require hours or even days for larger computers.

Human error is obviously minimized by semi-automatic testing that requires only the use of a selector switch and actuating button.

The inherent computational speed of the computer enables the system to be checked out while operating at

normal speed. Thus the programmed test gives the truest indication of operability. Such a test would be impossible by means other than automatic.

Programmed tests can be performed by the operator since a minimum knowledge of computer theory is required. The results obtained are compared to predicted results to determine faulty areas. Such tests serve as an excellent checkout procedure before putting the computer "on line."

A minimum of technical literature is required to explain the operation of tests because of their simplicity. If the computer is well-designed, no auxiliary test devices are required for the first stage of checkout and troubleshooting. For detailed trouble isolation, a minimum of equipment is required. Usually a fast-sweep oscilloscope and a vacuum tube volt meter are sufficient.

With these powerful advantages, it is difficult to belittle the stored program troubleshooting approach. Yet there are a few items that must be considered since it may be impossible to depend on stored program troubleshooting.

- (1) There may be failures in the test program.
- (2) Space may not be available for storing the required test programs.
- (3) Reliance on test programs hinders the development of the maintenance man.

There is always the possibility that the test program itself will fail. Such a failure can be due to a damaged portion of the memory or to an electronic failure in the computer hardware. A well-designed memory is almost indestructible in normal operation, or at least its life expectancy can be fairly well determined beforehand. False failures can be eliminated by accepted verification routines. An electronic failure hindering the test program will in all probability result in an operational failure as well. Thus such a failure is the very reason for which the test program exists. By analyzing the point of failure, a good insight to the difficulty is obtained. Here, however, the burden is placed on the test program designer to avoid false indications when displaying test program results.

The space problem in programmed testing is of no concern where an adequate storage facility is incorporated in the computer memory. But it is important enough to be prohibitive where storage space is not available. The solution to this problem is not nearly so simple as "providing an adequate storage" may sound. The problem of anticipating the storage space required for operational programs is one of the most difficult problems in computer design. The cost of the memory unit is too great to employ a large safety factor in estimating its storage require-



# The New Ramo-Wooldridge Laboratories *in Canoga Park*

...an environment dedicated to  
technological research and development

The new Ramo-Wooldridge Laboratories in Canoga Park, California, will provide an excellent environment for scientists and engineers engaged in technological research and development. Because of the high degree of scientific and engineering effort involved in Ramo-Wooldridge programs, technically trained people are assigned a more dominant role in the management of the organization than is customary.

The ninety-acre landscaped site, with modern buildings grouped around a central mall, contributes to the

academic environment necessary for creative work. The new Laboratories will be the West Coast headquarters of Thompson Ramo Wooldridge Inc. as well as house the Ramo-Wooldridge division of TRW.

The Ramo-Wooldridge Laboratories are engaged in the broad fields of electronic systems technology, computers, and data processing. Outstanding opportunities exist for scientists and engineers.

*For specific information on current openings write to Mr. D. L. Pyke.*



**THE RAMO-WOOLDRIDGE LABORATORIES**

8433 FALLBROOK AVENUE, CANOGA PARK, CALIFORNIA

ments. Modular design of storage is possible so space could be added after the completed design. This, however, still requires some costly provisioning in the original design that may never be utilized. Also, most modular memory units with a reasonable capacity are not fast-access memories; therefore they would slow down the testing operation. Thus after painstaking design of a suitable test routine, it may not fit into the computer together with the operational program without a costly compromise of one or both programs.

Finally, the maintenance man must be considered. If, as is the case with armed forces installations, there is a rapid turnover of personnel, simple test procedures are a must. But undue reliance on simplified routines gives the maintenance man little occasion to become really familiar with computer theory. He is subsequently hampered in dealing with problems not isolated by the routines. This is a more severe problem in experimental or constantly changing computer applications where analytical ability is required of the maintenance man in addition to general experience and know-how.

#### Maintenance based on Programs in Temporary Storage

Besides the permanent storage space, computers also have temporary storage space in varying proportions to permanent storage. The storage is temporary in that this space is required for intermediate or "scratch-pad" computations during normal computer operation. Thus its contents are automatically destroyed, by re-writing in these cells under the direction of the program.

The advantages of utilizing temporary storage space for test programs are as follows:

- (1) The use of valuable permanent storage space required is minimized, or unnecessary.
- (2) Substantially all advantages of permanent storage test routines can be realized.

Item (1) is an advantage only if the temporary storage is adequate for test programs or if sufficient additional space is available in permanent storage. For a thorough checkout procedure, however, temporary storage facilities are usually inadequate.

Utilizing temporary storage space reduces the speed of testing inherent in permanently stored test programs because the routine must be loaded into memory before each use.

Where temporary storage space is inadequate, it is possible to use permanent storage space in the same manner as temporary storage, but this is further complicated by the need to re-load the operational program when the test program operation is completed. Such an operation allows some human error into the picture, but this can be minimized as follows:

- (a) Have the temporary program automatically stop itself when the test program is fully loaded.
- (b) Have the same input device (tape, etc.) also contain that portion of the operational program to be restored.
- (c) Make part of the procedure for the test a simple switch action that continues the loading operation through the operating data reload cycle upon completion of the test operation.

Verification of the re-loaded program is still a must, but there are well established techniques for that.

The disadvantages of relying on temporary test programs are:

- (1) Items (1) and (3) of those discussed for permanently stored tests.
- (2) Speed of operation is greatly reduced by the need for loading and possibly reloading and verification.
- (3) There is at least a partial increase in potential human error.

#### Maintenance based on Manual Testing Procedures

Even with the best programmed test procedures, there comes a time when the final analysis of the trouble depends on conventional troubleshooting techniques with auxiliary test devices. If the computer has a well-designed test program, however, this is only the last step in the repair procedure. The computer will normally have been put back into operation by replacing a modular unit before detailed testing of circuits begins. The modular unit itself is tested by the auxiliary devices without the pressure of having to get the computer back "on line."

There are certain advantages to a complete manual troubleshooting technique despite its seemingly old-fashioned approach. Most of these advantages, however, diminish in relative importance as the computing system increases in size and complexity. Among the paramount advantages are:

- (1) There is little or no need for storage space.
- (2) There is no drain on programming time in setting up procedures.
- (3) The testing approach is more independent of the computer itself.
- (4) The technician must learn more of the system.
- (5) With intelligent modular design this may be at least as fast as using temporary storage programs.

## SCAN YOUR FUTURE IN THE COMPUTER FIELD

The design of a new static state digital computer has created several openings in real-time control of industrial processes especially in the power, petroleum and chemical fields. The computer is used as a direct tool for process control as well as scientific computing.

### LOGICAL DESIGNER

Work with customer requirements and translate them into circuit design to meet varied application problems. Computer design experience preferred or related experience such as transistor and switching circuits, high gain linear amplifiers and selection matrices.

### PROGRAMMER

Experienced in time shared programming techniques. Analytical experience on scientific problems required. Emphasis on coding techniques, system programming, real time simulation, information storage and retrieval.

The growth of our organization and the success of our computer endeavors has created these openings. For a confidential interview or for more particulars forward a complete resume to Mr. W. A. Wecker, Personnel Director,

### INFORMATION SYSTEMS, INC.

7350 N. Ridgeway  
Skokie, Illinois

## Explorer VI

is a

space laboratory

orbiting

around

the

earth

with

paddles

capturing

sunlight

for

power

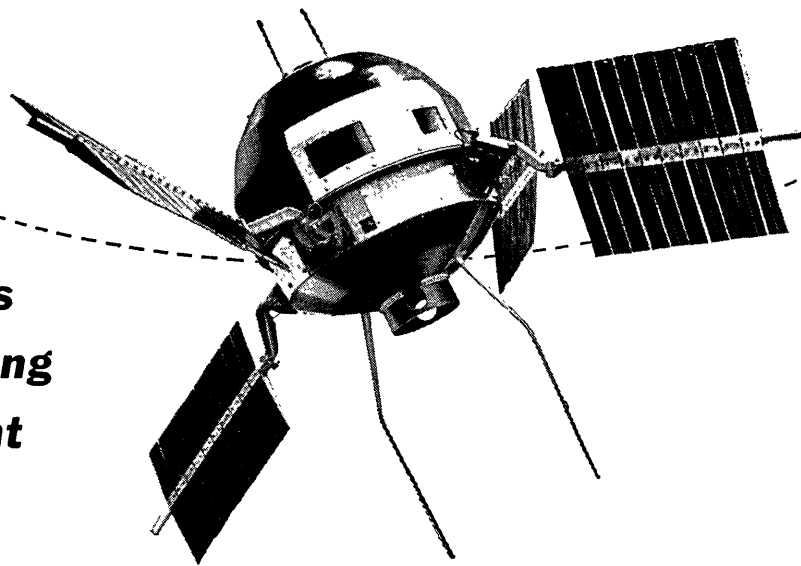
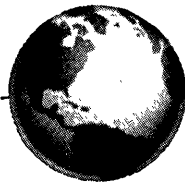

The scientific data that will some day enable us to probe successfully to the very fringes of the universe is being recorded and transmitted at this moment by the space laboratory Explorer VI, a satellite now in orbit around the earth ● This project, carried out by Space Technology Laboratories for the National Aeronautics and Space Administration under the direction of the Air Force Ballistic Missile Division, will advance man's knowledge of: *The earth and the solar system . . . The magnetic field strengths in space . . . The cosmic ray intensities away from earth . . . and, The micrometeorite density encountered in inter-planetary travel* ● Explorer VI is the most sensitive and unique achievement ever launched into space. The 29" payload, STL designed and instrumented by STL in cooperation with the universities, will remain "vocal" for its anticipated one year life.

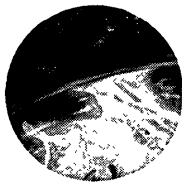

How? Because Explorer VI's 132 pounds of electronic components are powered by storage batteries kept charged by the impingement of solar radiation on 8,000 cells in the four sails or paddles equivalent to 12.2 square feet in area ● Many more of the scientific and technological miracles of Explorer VI will be reported to the world as it continues its epic flight. The STL technical staff brings to this space research the same talents which have provided systems engineering and over-all direction since 1954 to the Air Force Missile Programs including Atlas, Thor, Titan, Minuteman, and the Pioneer I space probe.

**Important staff positions in connection with these activities are now available for scientists and engineers with outstanding capabilities in propulsion, electronics, thermodynamics, aerodynamics, structures, astrophysics, computer technology, and other related fields and disciplines.**

**Space Technology**



**Laboratories, Inc.**

*Inquiries  
and resumes  
are  
invited.*

*P. O. Box 95004  
Los Angeles 45, California*

Since many computer routines require the use of storage a valid test must also utilize storage space. The temporary storage is adequate for such simple storage problems, however. All instructions in this approach are entered manually so the often lengthy loading operation is not required.

An important advantage in the early stages of computer development is the independence of this technique. The programming time is often preoccupied with evaluation

---

### CALENDAR OF COMING EVENTS

- Dec. 1-2, 1959: 4th Midwest Symposium on Circuit Theory, Marquette Univ., Milwaukee, Wisc.  
Dec. 1-3, 1959: Eastern Joint Computer Conference, Statler Hotel, Boston, Mass.  
Dec. 7-9, 1959: Cooperating Users Exchange (CUE) Meeting, (users of Burroughs 220), Statler Hotel, St. Louis, Mo.  
Feb. 25-26, 1960: Univac Users Association Semi-Annual Meeting, Greenbrier Hotel, White Sulphur Springs, W. Va.  
March 21-24, 1960: IRE National Convention, Coliseum and Waldorf Astoria Hotel, New York, N.Y.  
April 18-19, 1960: Third Annual Conference on Automatic Techniques, Cleveland-Sheraton Hotel, Cleveland, Ohio.  
May 2-6, 1960: Western Joint Computer Conference, San Francisco, Calif.  
August 23-25, 1960: Annual Meeting of the Association for Computing Machinery, Marquette Univ., Milwaukee, Wisc.
- 

## COMPUTER PROGRAMMERS-ANALYSTS

Broadview Research Corporation is seeking computer programmers and applications analysts to work in the areas of scientific calculations, systems programming, and commercial data processing.

Company experience includes: satellite orbit computations, numerical solution of differential equations, simulation of communication systems, application of data processing techniques in the areas of logistics, personnel, and administration.

Qualifications: programming experience with medium-large scale computer systems.

Openings exist at Burlingame, California, Alamogordo, New Mexico, and Fort Huachuca, Arizona.

Contact: Mr. William J. Petersen

**Broadview Research Corporation**  
1811 Trousdale Drive  
Burlingame, California

and operational programs so that a period might exist where no test programs are available even if it is intended to develop them.

In programmed tests there is always some dependence on basic computer operations which may not be available due to the malfunction that exists. The failure indication when the test program cannot be completed cannot always be anticipated by the procedure. This complication is avoided in a manual testing procedure.

Advantage (4) might sound like a disadvantage but there is merit to making the technician work at troubleshooting. In difficult troubles where programmed tests fail, the technician's reservoir of experience and familiarity with theory are valuable assets. These assets are acquired only through working with the circuitry.

The speed with which the computer is returned to operation is of utmost importance in large scale computers where operating time is in hundreds of dollars per hour. There, this serious disadvantage to manual techniques exists. Indeed it is often prohibitive. Yet with modular design in vogue, large sections of the computer can be replaced by simply exchanging pluggable packages without even shutting off power. A good technician need not make too many calculated guesses to replace the faulty circuit. Then the testers do the rest when the computer has been returned to operation. A good maintenance manual is a valuable aid in this "mental" troubleshooting process. Troubleshooting charts of the "yes - no" variety that are well thought out can do a lot of the thinking and eliminate much of the pressure when first attempting the repair.

The major disadvantages of the completely manual approach to testing are:

- (1) The enormity of the system may make it virtually impossible to use this method exclusively.
- (2) Where useable, the method will almost always be slower.
- (3) It requires a high-calibre technician and close familiarity with the system.
- (4) It requires a better-than-average maintenance manual.
- (5) The storage system must be almost infallible if it is very large, since manual checking of stored data is impractical.

---

### COMPUTER ACCESSORY

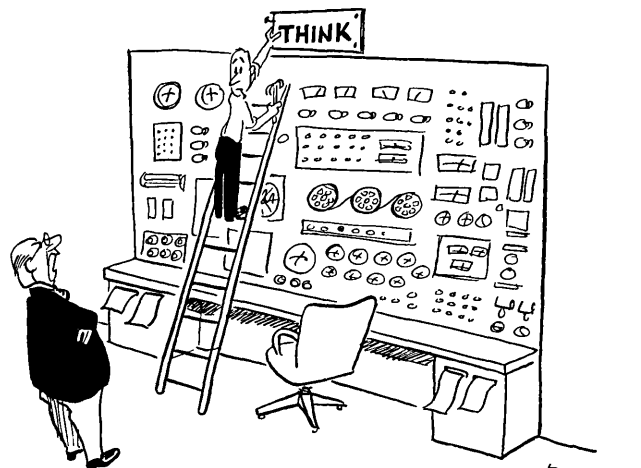

"Really, Henshaw, I don't feel that's necessary!"



# new improved "Memo-Scope"<sup>®</sup> oscilloscope

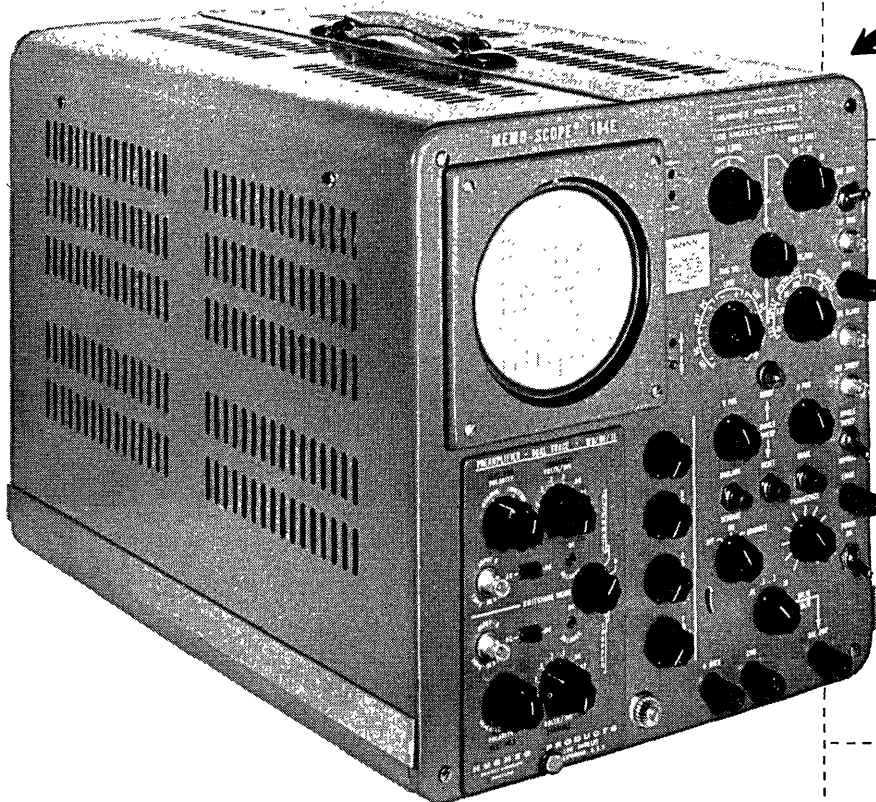

**Still using "old-fashioned" methods** for measuring non-recurring transients? If so, now is the time to investigate the easy way to solve your most difficult transient measurement problems with the latest model Hughes "Memo-Scope" oscilloscope.

**Why?** Because *new* features, *new* advanced circuitry, *new* panel layout and *new* mechanical design now assure maximum accuracy in all your transient measurements—*plus* higher performance, greater dependability and easier operation!



*The Hughes "Memo-Scope" oscilloscope (Model 104E) stores nonrepetitive events for an indefinite period—hours, or days—keeping them available for thorough study until intentionally erased.*

## new improved features

- Simplified panel layout, redesigned trigger circuit...assure easier operation,
- Advanced mechanical design gives:
  - Better cooling for longer component life,
  - Far greater accessibility for maintenance,
  - Increased ruggedness; resistance to vibration,
- Built-in single-sweep circuit ("1-shot" trigger) at no extra cost,
- Available for either 110 v. or 220 v. operation.

## applications

- Data reduction equipment trouble-shooting
- Physical testing: shock, stress, strain
- Ultrasonic flaw detection
- Semiconductor testing
- Ballistics and explosives research ...and many others.

INDUSTRIAL SYSTEMS DIVISION

**HUGHES PRODUCTS**

*For complete information on the new improved Hughes "Memo-Scope" oscilloscope (Model 104E), detailed data sheets and application analysis of your transient measurement problems, write or wire: HUGHES PRODUCTS Industrial Systems Division, International Airport Station, Los Angeles 45, California*

© 1959, HUGHES AIRCRAFT COMPANY

# SURVEY OF RECENT ARTICLES

Moses M. Berlin

Cambridge, Mass.

We publish here a survey of articles related to computers and data processors, and their applications and implications, occurring in certain magazines. We seek to cover at least the following magazines:

Automatic Control  
Automation  
Automation and Automatic  
Equipment News (British)  
Business Week  
Control Engineering  
Datamation  
Electronic Design  
Electronics  
Harvard Business Review  
Industrial Research  
Instruments and Control  
Systems  
ISA Journal  
Proceedings of the IRE  
Management Science

## The Office Scientific American

The purpose of this type of reference information is to help anybody interested in computers find articles of particular relation to this field in these magazines.

For each article, we shall publish: the title of the article / the name of the author(s) / the magazine and issue where it appears / the publisher's name and address / two or three sentences telling what the article is about.

**Building-Block Circuits for Transistorized Digital Computers** / C. J. Creveling and others, (Staff Group of the Electronics Div.), U.S. Naval Res. Lab., Washington, D.C. / *Electronic Design*, vol. 7, no. 18, Sept. 2, 1959, p 18 / Hayden Pub. Co., Inc., 830 Third Ave., New York 22, N.Y.

This article offers an aid to the computer design engineer, by presenting several key building-block circuits. The circuits were originally designed for a unit computing at a 500 kc rate with logic performed in one micro-second wide synchronized pulse positions; but it can serve as a guide for the design of other computer systems.

**Data Storage and Display with Polarized Phosphors** / H. P. Kallman and J. Rennert, Physics Dept., Institute of Mathematical Sciences, New York University, New York / *Electronics*, vol. 32, no. 35, Aug. 28, 1959, p 39 / McGraw-Hill Pub. Co., Inc., 330 West 42 St., New York 36, N.Y.

Used in computers as well as photography, a system known as "persistent internal polarization" stores data on a phosphor. The process produces a separation of charges with d-c fields and radiation, and provides longer storage life in the memory of the computer.

**Automatic Programming in the Soviet Union** / A. P. Ershov, Chief, Theoretical Programming Dept., Computing Center, Academy of Sciences of the USSR; as related to E. J. Guerin, European Editor, *Datamation* / *Datamation*, vol. 5, no. 4, July-August, 1959, p 14 / *Datamation*, 10373 W. Pico Blvd., Los Angeles 64, Calif.

This article describes early coding methods developed in Russia and applied to Soviet computers. Various schemes are given, and arithmetic, logical readdressing, restoring and double-counting operators are included.

**Analog-Digital Converters, Part III** / *Electromechanical Design*, vol. 3, no. 8, Aug., 1959, pp 27-33 / Benwill Publishing Corp., 1357 Washington St., West Newton 65, Mass.

The performance characteristics of the converters are described. Tables are given, which list the commercially available types; however, as is stated at the outset, the scope of the report is limited strictly to converters, excluding digital voltmeters which constitute a particular class of converter with visual read-out.

**Progress in Computers and Office Automation** / V. J. Ford, Regional Mgr., Electrodata Div., Burroughs Corp., Detroit / *Journal of Machine Accounting*, vol. 10, no. 8, Aug., 1959, p 14 / National Machine Accountants Assn., 720 Kensington Rd., Arlington Heights, Ill.

From the Eniac to today's massive, high-speed computers, great strides have been made in twelve years of automatic data processing. This article reports on



**SOUTH BEND**

needs immediately

## **ANALOG COMPUTER ENGINEER**

B S Mechanical Engineer, Aero Engineer, Physics M S preferred. At least three years of experience in the use of analog computers for studying dynamic problems. Applications are in the field of aircraft and missile propulsion control systems, dynamics of landing gear systems, hydraulic and pneumatic devices and heat transfer.

The computer facilities include a repetitive analog, a precision real time analog and digital computers. Salary commensurate with experience. Comprehensive benefit program is offered including; moving and transportation allowances, group insurance, vacations, and tuition assistance for advanced degrees at the University of Notre Dame.

Call or write immediately to:

**John M. Evans**  
Administrative Engineering  
Bendix Products Division  
401 North Bendix Drive  
South Bend, Indiana

## **product development**

An unusual opportunity for a man with a B.S. degree in Physics or Electrical Engineering plus practical experience in the business machine industry. An advanced degree in business administration or industrial management is especially desirable.

Assignments will include determination of research requirements and the evaluation of research programs in areas associated with our present and future products, encompassing business machines, systems, and EDP applications. Summation and critical evaluations of findings are to be made for research management.

For further information on this excellent opening, contact Technical Placement, Section D-5.

## **The National Cash Register Company**

Dayton 9, Ohio

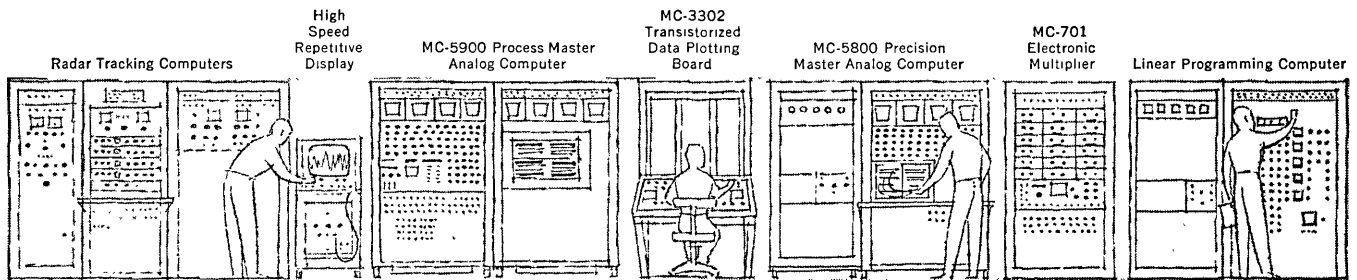

**Some people can prove man and mouse are identical**

It's all according to the points of similarity you choose. Differences are what really *prove* the superiority of man over mouse. Computers have differences, too. In fact, it's in these differences that the CSI-designed MC-5800 obsoletes every other Analog Computer. The best proof lies in

cold  
hard  
Specifications

- Exclusive dynamic memory makes automatic iterative solution of statistical or optimization problems a reality.
- Stable amplifier operation over the entire feed-back range from zero to infinity.
- Lowest amplifier grid-current  $<10^{-9}$  ampere.
- Amplifiers provide lowest noise level output—less than one millivolt at unity gain.
- Amplifier frequency response—flat to 10,000 cps and only 3 db down at 28 kc.
- Real-time precision @ speeds to 60 solutions/sec.
- Exclusive electronic generators of the function of two-or-more variables may be programmed at patch-board in same time required for setup of single-variable generators.
- Will program 134 amplifiers, 30 electronic multipliers, 18 diode function generators, 2 time-delay generators, 8 relay amplifiers, and 6 servos from one 2128-hole patchboard.
- Highest performance electronic multiplier—flat to 10,000 cps and only 3 db down at 20 kc.
- Dynamic memory + high-speed quick-reset rep-op provide practical approach to solution of simultaneous partial differential equations.
- Dynamic memory with time-base accuracy of  $\pm 10 \mu\text{sec}$  provides automatic parameter searching by iteration—an exclusive capability.
- Solution of problems with up to 15 amplifiers in closed loops.
- Plug-in dynamic components ease maintenance.
- Lowest computer cross-talk—rejection greater than 2,000 to 1.
- Selection of real-time, expanded-time or high-speed compressed-time without reprogramming.
- Passive networks stabilized at  $< 1^\circ\text{C}$  above room ambient—no oven required.
- EVERY SPECIFICATION IS GUARANTEED TO BE TRUE PERFORMANCE STANDARD—IN SUSTAINED OPERATION.
- Only diode function generators utilizing resistors, potentiometers, and diodes of equal quality to those in computing networks.
- Only diode function generators with individual hi-lo gain positions for *each* segment.
- Lowest function generator drift  $< 5 \text{ mv}/8 \text{ hrs}$ .
- Lowest servo step-function overshoot—less than 1%.
- DC tachometer feedback on all servos.
- Complete control of all amplifiers, multipliers, dividers, and non-linear equipment at patchboard.
- Exclusive equipment-door packaging for free access and quick maintenance *without* shutdown.
- Insulated patchboard prevents costly shorting accidents.
- Power supplies eliminated from console—lowest, most stable operating temperatures—rise  $< 3^\circ\text{C}$ .
- Field expandable without mechanical rework or rewiring.

# MAN IS A MOUSE



There are many more differences (over a hundred, in fact). Before you buy or lease your next analog computer, compare them all... and we think you'll agree with us when we say: The MC-5800 obsoletes every other analog computer made.

Computer Systems, Inc.—designers and manufacturers of the *high-est* precision analog computers and computer accessories.

# JOIN THE RCA BREAKTHROUGH IN ELECTRONIC DATA PROCESSING

RCA . . . world leader in electronics . . . is currently expanding its electronic data processing operations as a result of one of the most significant breakthroughs in modern electronics—the all-transistor RCA 501 system. Already the RCA 501 is being talked about as the world's most efficient electronic data processing system; its sales curve is slanting sharply upwards.

If you have experience in EDP sales or technical services, and are ready to step up to more challenging and rewarding assignments, investigate today the many new career openings at RCA. Current positions, dealing with medium and large-scale systems, include the following:

**EDP SALES REPRESENTATIVE**—background should include a thorough systems knowledge and at least one year of field experience with either government or commercial clients.

**EDP PROGRAMMERS AND METHODS ANALYSTS**—local openings for qualified men to work closely with both customer and sales personnel in the development of specific applications, related procedures, and programs.

*For a strictly confidential interview with RCA management, please send a detailed résumé of your background and personal qualifications to:*

Mr. E. C. Baggett  
Professional & Administrative Employment  
RCA, Dept. L-8L  
Bldg. 10-1  
Camden 2, N. J.



**RADIO CORPORATION of AMERICA**

ELECTRONIC DATA PROCESSING DIVISION

progress in the industry and reveals some interesting applications of computers.

**The Use of Univac in Processing and Analyzing Origin-Destination Data for the Washington, D.C., Metropolitan Area** / Dr. E. E. Blanche, Chief Res. Scientist, E. E. Blanche & Associates, Inc. / *Journal of Machine Accounting*, vol. 10, no. 8, Aug., 1957, p 26 / NMAA, 720 Kensington Rd., Arlington Hts., Ill.

The use of high-speed computers have made possible the design of systems which save time and accurately process origin-destination data. The article describes the operation of the system, giving examples of actual data processed by computer.

**Showcase Your Computer!** / E. Whitmore / *Management and Business Automation*, vol. 2, no. 1, July, 1959, p 18 / *The Office Appliance Co.*, 600 W. Jackson Blvd., Chicago 6, Ill.

This article questions the wisdom of executives who seem to "soft-pedal" their company's use of automation, and points to a large stock advising firm, which attempts to publicize their computer installation, and informs their customers and employees of the benefits to be derived from electronic data processing.

**Machine Translation of Russian** / C. H. Johnson, Editor, *Journal of Machine Accounting* / *Journal of Machine Accounting*, vol. 10, no. 8, Aug., 1959, p 100 / NMAA, 720 Kensington Rd., Arlington Hts., Ill.

The National Bureau of Standards has been studying the problem of translating languages by computer. This article describes a process which resulted from experiments in translation. The process goes beyond word-to-word translation, taking into account grammatical, syntactical and lexicological properties of the words.

**English Abstracts of Russian Technical Journals** / Publications, and Public Information Div., Office of Technical Services, U.S. Dept. of Commerce, Washington 25, D.C. / 1959, printed, (5" by 8" card form on card stock), cost: see below

A listing of the numerous abstracts available, has been issued by the OTS. Listed according to subject— aeronautics, astronomy and mathematics, chemistry and chemical engineering, civil engineering, electrical engineering, fuel and power, geography and geology, mechanical engineering, mining and metallurgy, physics, science and technology-general— single issue prices and subscription rates are given.

**Governor's Island File Computer** / L. Feidt / *Computing News*, vol. 7, no. 16, Aug. 15, 1959, pp 155-3 / *Computing News*, P.O. Box 90424, Airport Station, Los Angeles 45, Calif.

Statistical and qualification data on more than 60,000 people in the active First Army are processed by a computer located at the New York Army base. This

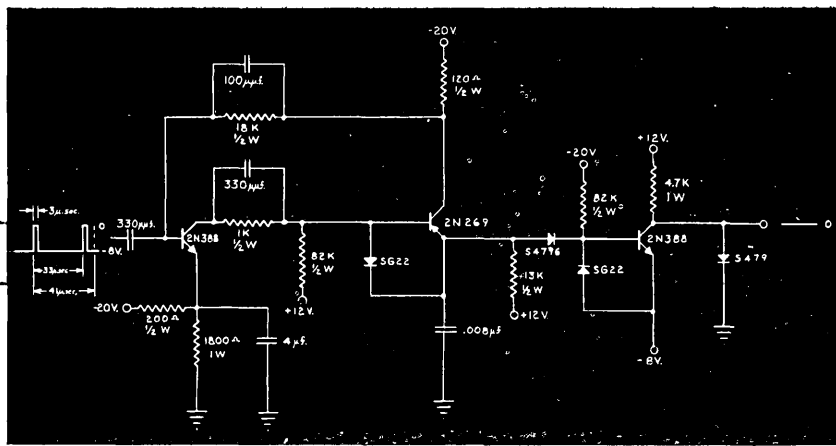

**ELECTRONIC ENGINEERS . . . PHYSICISTS . . . CHEMISTS:**  
**NATIONAL OFFERS**  
**CHALLENGING OPPORTUNITIES**  
**IN YOUR FIELD**

The National Cash Register Company—a leader in the application of automation to business machines—has organized its Research and Development Division to provide ideal working environments for technically trained men and women of the highest calibre. Proj-

ects in progress are of an exciting, stimulating nature . . . for instance, considerable work is being done on Encapsulation and thin film memory and switching components. Your training and experience may qualify you for a position in one of these areas:

**DATA PROCESSING RESEARCH AND DEVELOPMENT**

Computer Theory  
 Computer Component Development  
 Machine Organization Studies  
 High-Speed Non-Mechanical Printing and Multi-Copy Methods  
 Direct Character Recognition  
 Systems Design

**ELECTRONIC ENGINEERING DEVELOPMENT**

High-Speed Switching Circuit Techniques  
 Random Access Memory Systems  
 Circuit and Logical Design  
 Advanced Storage Concepts Utilizing Electron Beams  
 Microminiaturization of Components and Circuitry

**SOLID STATE PHYSICS**

Electrodeposited Magnetic Films  
 Vacuum Deposited Thin Magnetic Films  
 Ferrites and Ferromagnetics  
 Electroluminescence-Photoconductor Investigations  
 Advanced Magnetic Tape Studies

**CHEMISTRY**

Plastics and Polymers Encapsulation  
 (A process for producing microscopic capsules containing liquids or reactive solids)  
 Photochromic Materials (Studies of National-developed compounds which are photosensitive to specific wave lengths of light, for application to memory, printing and photocopy devices)  
 Magnetic Coatings

**NATIONAL'S NEW RESEARCH AND DEVELOPMENT** Center is located in Dayton, Ohio, one of the midwest's most progressive cities. There are also attractive positions available at our Electronics Division in Hawthorne, California.

**FOR COMPLETE INFORMATION**, simply send your resume to Mr. T. F. Wade, Technical Placement, F-3A, The National Cash Register Company, Dayton 9, Ohio. All correspondence will be kept strictly confidential.

**THE NATIONAL CASH REGISTER COMPANY, Dayton 9, Ohio**

**ONE OF THE WORLD'S MOST SUCCESSFUL CORPORATIONS**

1039 OFFICES IN 121 COUNTRIES • 75 YEARS OF HELPING BUSINESS SAVE MONEY  
 COMPUTERS and AUTOMATION for December, 1959

\*TRADEMARK REG. U. S. PAT. OFF.

*National*

**VERSATILE DATA PROCESSING  
 ADDING MACHINES • CASH REGISTERS  
 ACCOUNTING MACHINES • NCR PAPER  
 DIVERSIFIED CHEMICAL PRODUCTS**



**wanted:  
WAR  
GAME  
PLAYERS**

Very large-scale air-battle digital computer simulations are now going on at the Washington Research Office of *tech/ops*. Present operations call for *top-flight mathematicians, mathematical statisticians, senior programmers, operations research analysts.*

These computer air battles are stochastic models which involve design and evaluation, and development of unusual techniques for studying sensitivity of these models to input changes. Associated activity involves design of advanced programming systems and of common language carriers which are expected to be independent of the first computer used—the computer itself augmenting and improving the language for use on later and more sophisticated computers.

If challenging work, stimulating atmosphere, and an opportunity to participate in an unusual company/employee investment program interest you . . . write or wire collect:



Kingsley S. Andersson

**Technical Operations, Incorporated**

3520 PROSPECT STREET, NORTHWEST • WASHINGTON 7, D. C.

\*Final position in the famed simultaneous exhibition at Pernau, 1910: Nimzovich (white) vs Ryckhoff (black).

article describes the functions to be controlled by the computer, and illustrates the economy and efficiency of the system.

The Real Pushbutton War / M. Carasso / Journal of Machine Accounting, vol. 10, no. 7, July, 1959, pp 7-12 / National Machine Accountants Assn., 720 Kensington Rd., Arlington Hts., Ill.

Computers which have decision-making ability, will be used to control the mobilization of the U.S., if the "cold" war becomes "hot." Electronic data processing will perform a mass of calculations to direct industry in the mobilization. This article describes a number of computer systems which are performing functions similar to the wartime operation. A hypothetical control system is discussed—"MADCAP", or, Mobilization Analyzer for Determination and Control of Allocations and Priorities.

GE's 704-709 Provides a Dynamic Computer Approach to Business Measurements / A. Keller, Mgr., Operations Research and Synthesis, General Electric / Journal of Machine Accounting, vol. 10, no. 7, July, 1959, p 17 / NMAA, 720 Kensington Rd., Arlington Hts., Ill.

This article discusses a 704/709 computer program aimed at an integrated solution to the total business numbers Problem in General Electric's Medium Steam Turbine, Generator, and Gear Dept. The system will be used for scheduling, ordering, accounting, engineering design calculations, and payrolls, among other applications. The article includes examples of information which the computer furnishes.

Developing Mathematical Models for Computer Control / Dr. D. B. Brandon, Thompson-Ramo-Wooldridge Prods. Co., Los Angeles, Calif. / ISA Journal, vol. 6, no. 7, July, 1959, p 70 / Instrument Society of America, 313 Sixth Ave., Pittsburgh 22, Pa.

This paper describes a method which has been successfully used in designing mathematical models used in the development of computer control systems for processes. The paper emphasizes the interesting fact that the required equations can be written for many incompletely understood processes.

"Fortransit," A Universal Automatic Coding System for the IBM 650 / B. C. Borden, Applied Science Representative, IBM / Journal of Machine Accounting, vol. 10, no. 7, p 44 / NMAA, 720 Kensington Rd., Arlington Hts., Ill.

This paper deals with automatic programming in general, defining a number of terms which are used in the "Fortransit" system. It includes as well, a review of "Fortran," and an introduction to "Fortransit," the automatic coding system for the IBM 650. It is hoped that the new system will eliminate many delays that present programming methods cause.

# WHO'S WHO IN THE COMPUTER FIELD

## (Supplement)

A full entry in the "Who's Who in the Computer Field" consists of: name / title, organization, address / interests (the capital letters of the abbreviations are the initial letters of Applications, Business, Construction, Design, Electronics, Logic, Mathematics, Programming, Sales) / year of birth, college or last school (background), year of entering the computer field, occupation / other information such as distinctions, publications, etc. An absence of information is indicated by - (hyphen). Other abbreviations are used which may be easily guessed like those in the telephone book.

Every now and then a group of completed Who's Who entry forms come in to us together from a single organization. This is a considerable help to a compiler, and we thank the people who are kind enough to arrange this. In such cases, the organization and the address are represented by . . . (three dots).

Following are several sets of such Who's Who entries.

Burroughs Corp., ElectroData Div., 460 Sierra Madre Villa, Pasadena, Calif.  
 Brown, Leland W / Electronic Engr, . . . / A, punched card perif equip / '22, Univ of Ark, '50, engr  
 Canova, G M / Assoc Engr, . . . / ADEL / '30, CIT, '54, electronic engr / Research Asst, E E Dept, Caltech '58-59  
 Lindley, P L / Mgr, Spec Products Engrg Sec, . . . / ACDEL / '22, Ohio Wesleyan Univ, Purdue Univ, '47, electronic engr / M.S. Thesis "Magnetic Recording for Digital Compr Memory," Member Sigma Xi, RESA  
 Reaction Motors Div., Thiokol Chemical Corp., Ford Rd., Denville, N.J.  
 Behar, Joseph / Sr Prgrmr, . . . / ALMP / '32, CCNY, NY Univ, '57, apld mathn  
 Morrill, Duncan E / Supv, Compr Aplns Unit, . . . / AMP / '28, Univ of Miss, '54, mathn  
 Robinson, Richard / Jr Prgrmr, . . . / AMP / '34, Fairleigh Dickinson Univ, '58, mathn  
 Shell Oil Co., Midland Area, PO Box 1509, Midland, Texas  
 Anstine, L. Paul / prgrmr, . . . / ABP / '25, Hastings Coll, '57, data prog acct  
 Bailey, Joe A / prgrmr, . . . / ALMP / —, Texas Univ, —, systems analyst  
 Fragapane, Lou C / prgrmr, . . . / ABMP / '30, Pitt, Penn State, '56, mathn  
 Gant, William T / Chief, Data Processor, . . . / ABDELMP / '27, Okla State, '51, data progct

Hutto, J. Merrell / Supt of Machines, . . . / ABP / '20, Hardin Simmons, '58, machine operator  
 Romberg, F. Arnold / prgrmr, . . . / ABDLMP / '34, Rice, Harvard, '57, mathn  
 Shaner, Douthea E / prgrmr, . . . / ALP / '34, Texas Christian Univ, '57, prgrmr  
 Thompson, Warren L / prgrmr, . . . / AMP / '19, L S U, '54, analyst  
 Tool, Myrtle A / prgrmr, . . . / AIMP / '29, Central State, Okla Univ, '57, mathn  
 Wagner, Harry H / prgrmr, . . . / ABP / '24, Univ of Nebr, '53, data proc acct  
 Rechenzentrum der Rhein, Westf. Technischen Hochschule, Krämerstrasse 20-34, Aachen, Germany  
 Haupt, Dieter / Diplom-Mathematiker, . . . / ACLMP / '28, Rheinisch-Westfälische Technische Hochschule Aachen, '56, math prgmg  
 Moeskes, Max / Diplom-Ingenieur, . . . / ACDELMP / '30, Rheinisch-Westfälische Technische Hochschule Aachen, '57, devt, prgmg, math  
 Bryant Computer Products Division, P.O. Box 620, Springfield, Vt.  
 Ashbridge, Jr, G Harry / Mgr, Prod Planning, . . . / ABES / '29, Ill Inst of Tech, '55, electronics engr-bus mgr / Triangle, RESA  
 Casey, James P / Asst Sales Mgr, . . . / S / '28, Brown Univ, '58, sales engr  
 Cheney, George D / design engr, . . . / D / '30, MIT, mech engr  
 Foley, Tim / Western Sales Mgr, . . . / S / '28, Seton Hall Univ, '50, sales engr  
 Forand, Joseph / Sales Engr, . . . / BS / '29, Norwich Univ, '58, sales engr  
 Foster, Theodore C / Electronic Components Dept Foreman, . . . / A, mfg / '33, Northeastern Univ, '56, ind engr  
 Francois, Alex C / Circuit Designer, . . . / DEL / '26, Fairleigh Dickinson Univ, —, electronic engr  
 Karpin, Jay H / Devt Engr, . . . / D / '24, I.C.S., '58, tool engr  
 Lohan, Frank J / Sr Devt Engr, . . . / ELM / '29, Drexel Inst of Techn, '50, devt engr  
 Mitchell, Darrell L / Supv of Engrg Stds & Design, . . . / D / '22, Univ of N.H., '55, mech engr  
 Pozner, W S / Prodn Mgr, . . . / C / '18, Pratt Inst, '55, mfg engr  
 Quick, Lloyd S / Supv of Assy & Test, . . . / Assy & testing of memory systems / '32, Cornell Univ, '57, mechl engr  
 Ripley, Merton L / Chief Designer, . . . / D / '29, Dunwoody Inst, '56, designer  
 Ramon, Ray J / Midwest Sales Mgr, . . . / ADELS / '24, Northwestern Univ, '47, component design; sales  
 Smith, Joseph E / Genl Mgr, . . . / ABCDS, electro-mech & magnetic memory systems, electro-mechl peripheral eqpm / '21, Lehigh Univ, '55, mngt / several patents on electro-mechl file  
 Smith, Prentiss L / Sales Mgr, . . . / ABDES / '22, Norwich Univ, '56, sales  
 Spahr, J. Alan / Sales Engr, . . . / AS / '34, MIT, '57, sales engr  
 Stover, Richard A / Chief Engr, . . . / comp design / '29, Univ of Maine, '56, mechl engr



### and at tech/ops' Monterey

Research Office, in California, equally interesting and challenging work developing computer applications for planning, feasibility testing, and real time control of operational and logistical problems (for the Navy and industry) . . . Here, too, *tech/ops* needs scientists who habitually seek original thought patterns, and who respond to challenge. The over-all Company policies in the areas of fringe benefits and profit-sharing plans are unique. If challenge and reward appeal to you . . . write or wire collect:

**Harold E. Kren  
 Technical  
 Operations,  
 Incorporated**



305 WEBSTER STREET  
 MONTEREY, CALIFORNIA

# FROM START OF LOGICAL DESIGN TO COMPLETED SYSTEM IN MONTHS

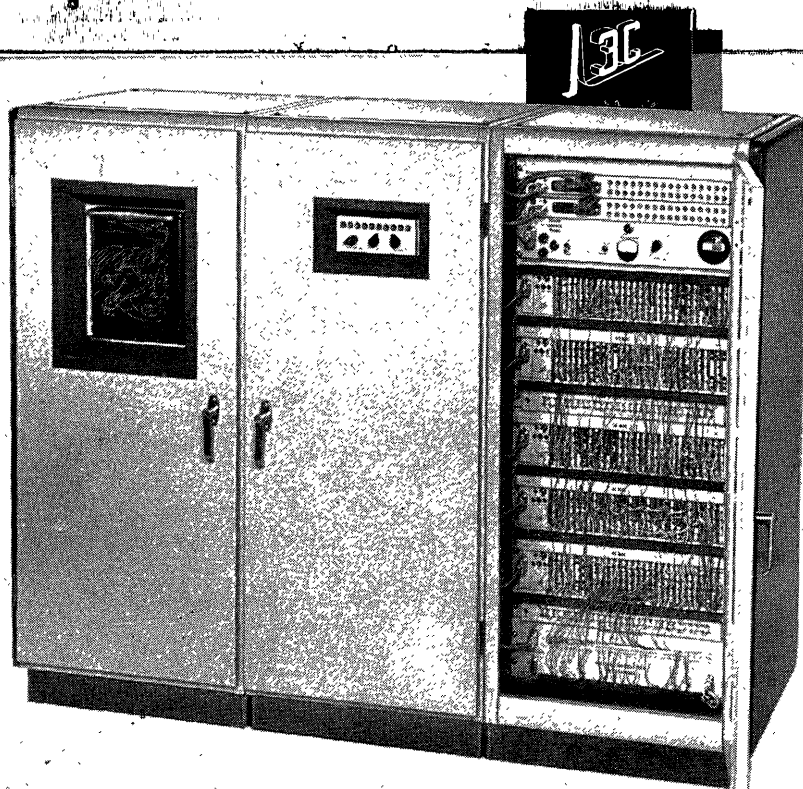

## SCHEDULE TIMESAVERS:

With T-PACs you go directly from your logical design to system wiring.

Wiring is rapid, reliable, and permanent; yet, is easy to modify at any time.

System debugging is routine, thanks to standard logical elements and standard waveforms.

### TYPICAL PROBLEM:

A rush project to implement a high speed digital data handling or computing system.

### OPTIMUM SOLUTION:

Standard T-PAC digital modules by Computer Control.

### T-PACs:

Transistorized • compact • plug-in modules • etched circuits • taper pin solderless connectors • one megacycle repetition rate • standard waveform throughout • reliable • no external-to-the-package coupling components • fully guaranteed •

Write for product catalogs

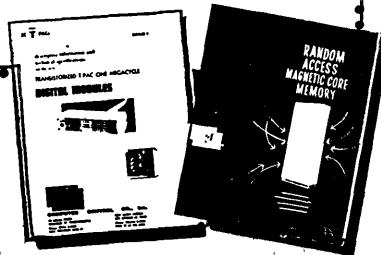

## COMPUTER CONTROL Co., Inc.

983 CONCORD STREET • FRAMINGHAM • MASSACHUSETTS

### WESTERN DIVISION

2251 BARRY AVENUE • LOS ANGELES 64 • CALIFORNIA

## NEW PATENTS

RAYMOND R. SKOLNICK

Reg. Patent Agent

Ford Inst. Co., Div. of Sperry Rand Corp.  
Long Island City 1, New York

THE following is a compilation of patents pertaining to computers and associated equipment from the "Official Gazette of the United States Patent Office," dates of issue as indicated. Each entry consists of: patent number / inventor(s) / assignee / invention. Printed copies of patents may be obtained from the U.S. Commissioner of Patents, Washington 25, D.C., at a cost of 25 cents each.

June 2, 1959 (cont'd):

2,889,543 / Erich Block, Poughkeepsie, N.Y. and Robert C. Paulsen, Boonton, N.J. / International Business Machines Corp., New York, N.Y. / A magnetic not or circuit.

June 9, 1959: 2,890,439 / Raymond Bird, Letchworth, and Brian Taylor, Wiltshire, Eng. / The British Tabulating Machine Co., Lim., London, Eng. / A data storage apparatus made up of a matrix of storage devices.

2,890,441 / Simon Duinker, Eindhoven, Netherlands / North American Philips Co., Inc., New York, N.Y. / A magnetic memory Device.

June 16, 1959: 2,890,829 / J. R. Logan, Norristown, Pa. / Sperry Rand Corp., a corp. of Del. / A logical binary Powering circuit.

2,890,830 / W. Letchworth, Eng. / The British Tabulating Machine Co., Lim., London, Eng. / An electronic adder apparatus with sum radix correction means.

2,890,831 / Ralph Townsend, Letchworth, Eng. / The British Tabulating Machine Co., Lim., London, Eng. / A serial adder with radix correction.

2,891,237 / Robert L. Sink, Altadena, and Glyn A. Neff, Pasadena, Calif. / A data processing apparatus.

2,891,238 / David L. Nettleton, Haddonville, N.J. / Radio Corp. of America, a corp. of Del. / A memory system.

June 23, 1959: 2,891,723 / Edward A. Newman, Teddington, Donald W. Davies, Southsea, and David O. Clayden, Heston, Eng. / National Research Development Corp., London, Eng. / A programmed control means for data transfer apparatus.

2,891,724 / Otto P. Fuchs, Haverford, Pa., and Horst Kottas, Vienna, Austria / — / An automatic apparatus for transforming statistical or stochastic functions.

2,891,725 / Irwin S. Blumenthal, Manhattan Beach, Ross M. Chiles and Chester W. Larsen, Jr., Inglewood, and Kenneth M. Stevenson, Jr., Palos Verdes, Calif. / Northrop Corp., Hawthorne, Calif. / A reset integrator.



2,891,726 / Richard O. Decker, Murrsville, and Kan Chen, Wilkinsburg, Pa. / Westinghouse Electric Corp., East Pittsburgh, Pa. // A four quadrant analog multiplier circuit.

2,891,727 / Paul Kaufman, Deal, N.J. / — / An analogue device for computing the numerical value of the standard deviation of a given set of numerical values.

2,891,728 / Nick A. Schuster, Ridgefield, Conn. / Schlumberger Well Surveying Corp., Houston, Tex. / An electronic computing apparatus for computing a root or a power of the ratio of two quantities.

2,892,084 / Dwight D. Wilcox, Jr., Los Altos, Calif. / U.S.A. as represented by the Sec. of the Navy / A pulse gating circuit.

2,892,103 / Alfred D. Scarborough, Los Angeles, Calif. / Thompson Ramo Wooldridge, Inc., Cleveland, Ohio / Gating circuits for electronic computers.

2,892,147 / Morton W. Bell, Monrovia, Calif. / Consolidated Electro-dynamics Corp., Pasadena, Calif. / A digital-to-analog converter.

June 30, 1959: 2,892,587 / John V. Blankenbaker, Los Angeles, Calif. / Hughes Aircraft Co., a corp. of Del. / An arithmetic unit for performing an operation of addition or subtraction upon binary-coded decimal numbers represented by electrical input signals.

2,892,588 / Frederic C. Williams, Timperley, Tom Kilburn, Davyhulme, Manchester, and Arthur A. Robinson, Scunthorpe, Eng. / International Business Machines Corp., New York, N.Y. / A multiplying arrangement for digital computing machines.

2,892,589 / Robert T. Blakely, Poughkeepsie, N.Y. and Dorval C. Sprong, Long Beach, Calif. / An electronic accumulator.

2,892,590 / Joseph R. Esher, Jr., Schenectady, N.Y. / General Electric Co., a corp. of N.Y. / An apparatus for generating a trigonometric function and multiplying by a D.C. voltage.

July 7, 1959: 2,893,636 / Herman D. Parks, Schenectady, N.Y. / General Electric Company, a corp. of N.Y. / A network for effecting mathematical multiplication.

2,894,151 / Louis A. Russell, Poughkeepsie, N.Y. / International Business Machines Corp., New York, N.Y. / A magnetic core inverter circuit.

2,894,253 / Lawrence R. Peaslee and Murray Rosenblatt, Waynesboro, Va. / General Electric Co., a corp. of N.Y. / A selsyn exciter for positioning programming control systems.

2,894,254 / Raymond P. Mock, Needham Heights, Mass. / Raytheon Co., a corp. of Del. / A conversion of binary coded information to pulse pattern form.

July 14, 1959: 2,894,686 / Thomas G. Holmes, Melbourne, Fla. / — / A binary coded decimal to binary number converter.

2,895,124 / Ben A. Harris, Rochester, N.Y. / General Dynamics Corp., Rochester, N.Y. / A magnetic core data storage and readout device.

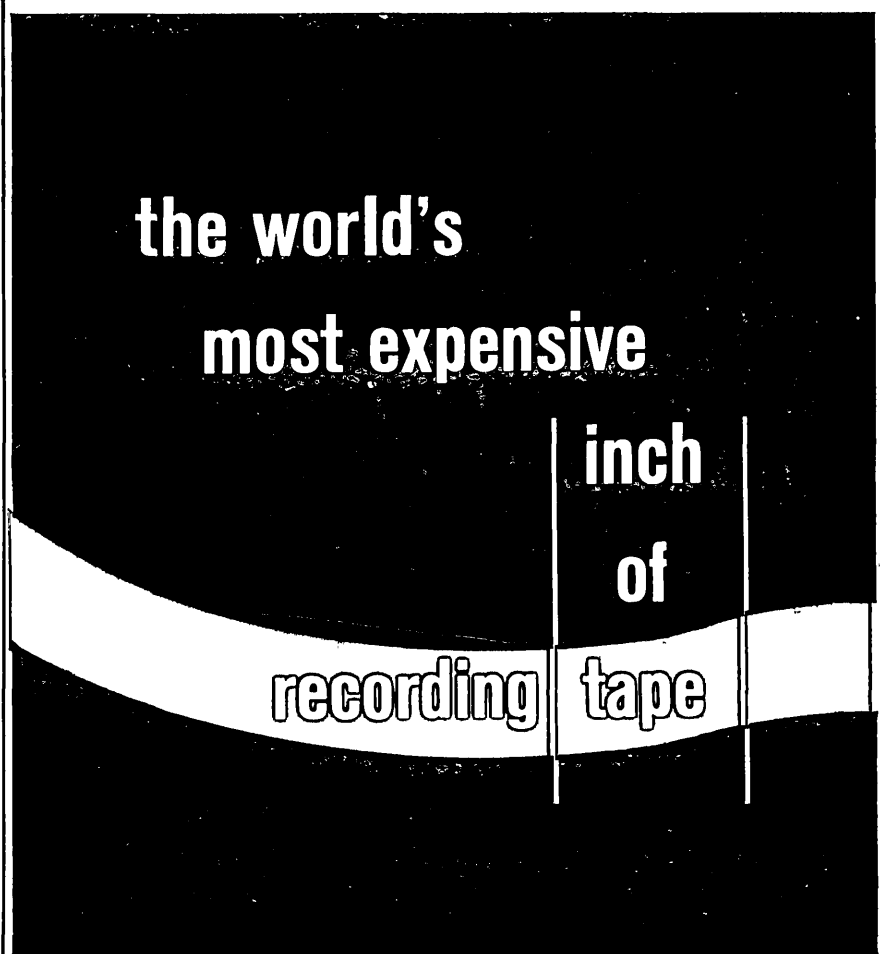

There's no question about it—if there were a dropout in this inch of tape it could cost you plenty. That's why our customers invariably demand perfection from our EP Audiotape—the *extra precision* magnetic recording tape for computers, automation, telemetry and seismography.

Audio Devices' battery of Automatic Certifiers is one of the unique means used to make sure EP Audiotape always meets customers specifications. The Automatic Certifier records and plays back every inch of the EP Audiotape under test. These tests can be so demanding that if the tape fails to reproduce just *one* test pulse out of the 40 million put on a single reel, the entire reel is rejected. There are no *if's*, *and's*, or *but's*.

This is just one of many special quality-control operations. From raw material to hermetically sealed containers, every reel of EP Audiotape gets individual attention.

For more information write for free Bulletin T112A. Write Dept. TL, Audio Devices, Inc., 444 Madison Avenue, New York 22, N. Y.

**TYPE EP audiotape** TRADE MARK

**AUDIO DEVICES, INC.**  
 444 Madison Ave., N. Y. 22, N. Y.  
 In Hollywood: 840 N. Fairfax Ave.  
 In Chicago: 5428 Milwaukee Ave.  
 Export Dept.: 13 East 40th St., N. Y., 16  
 Rectifier Division: 620 E. Dyer Rd., Santa Ana, Calif.

July 21, 1959: 2,895,671 / Andrew St. Johnston, Buntingford, Eng. / International Business Machines Corp., New York, N.Y. / An electronic digital computing machine.

2,895,672 / Arthur H. Dickinson, Greenwich, Conn. / International Business Machines Corp., New York, N.Y. / An electronic multiplying system.

2,895,673 / Frederic C. Williams, Romiley, Eng. / National Research Development Corp., London, Eng. / A transistor binary adder.

2,895,783 / Samuel G. Cohen, Ossining, N.Y. / General Precision Lab., Inc., a corp. of N.Y. / A data correlator for correlating by serial numbering two data recorders emitting graphic and punched card records respectively of identical data.

2,896,193 / Richard C. Herrmann, Chicago, Ill. / Zenith Radio Corp., a corp. of Del. / A magnetic memory storage apparatus.

2,896,198 / Robert R. Bennett, Los Angeles, Calif. / Hughes Aircraft Co., a corp. of Del. / An electrical analog-to-digital converter.

July 28, 1959: 2,897,355 / Arnold Lesti, Arlington, Va. / International Standard Electric Corp., New York, N.Y. / A diode coincidence gate.

2,897,380 / Carl Neitzert, Morris County, N.J. / General Time Corp., New York, N.Y. / A magnetic pulse counting and forming circuit.

2,897,480 / Tom T. Kumagai, West Los Angeles, Calif. / Hughes Aircraft Co., Culver City, Calif. / An error detecting system.

2,897,482 / Milton Rosenberg, Santa Monica, Calif. / Telemeter Magnetics, Inc.,

a corp. of Calif. / A magnetic core memory system.

2,897,486 / Matthew A. Alexander and Raymond Stuart-Williams, Pacific Palisades, Calif. / Telemeter Magnetics, Inc., a corp. of Calif. / An analog-to-digital conversion system.

August 4, 1959: 2,898,040 / Floyd G. Steele, La Jolla, Calif. / Digital Control Systems, Inc., a corp. of Calif. / A computer and indicator system.

2,898,041 / Hubert J. Crawley, Beckenham, and Christopher Stracheg, London, Eng. / International Business Machines Corp., New York, N.Y. / An instruction modifier means for electronic digital computing machines.

2,898,043 / Robert A. Mathias, Pittsburgh, and Leo A. Finzi, Irwin, Pa. / U.S.A. as represented by the Sec. of the Navy / An electronic circuit for performing analytic operations.

2,898,460 / Morris J. Taubenslag and Edward G. May, Baltimore, Md. / U.S.A. as represented by the Sec. of the Navy / A D.C. Discriminator gating circuit.

2,898,578 / Floyd G. Steele, La Jolla, Calif. / Digital Control Systems, Inc., La Jolla, Calif. / A magnetic reading device for selectively passing an applied timing signal to either a first or second output terminal, respectively.

August 11, 1959: 2,899,133 / John G. Tryon, Chatham, N.J. / Bell Telephone Laboratories, Inc., New York, N.Y. / A serial binary computing circuit for adding or subtracting two binary numbers in which the digits of the numbers appear successively spaced by a predetermined time period.

2,899,134 / Yves Rocard, Paris, Fr. / Compagnie Generale de Telegraphie

## DIGITAL ANALYST

To logically design, evaluate and select digital computers for inertial guidance and surveillance systems programs. Experience desired in digital systems analysis, logical systems design, Z transform analysis of digital servo loops and digital computer error analysis.

To arrange interview call collect, Niagara Falls BUTler 5-7851, or send resume to:

**Supervisor Engineering  
Employment**

**BELL AIRCRAFT  
CORPORATION**  
BUFFALO 5, NEW YORK

Sans Fil, a corp. of Fr. / An electrical analog computing system for solving ordinary and partial non-linear differential equations.

## ADVERTISING INDEX

Following is the index of advertisements. Each item contains: Name and address of the advertiser / page number where the advertisement appears / name of agency if any.

Ampex Corp., Instrumentation Div., 934 Charter St., Redwood City, Calif. / Page 5 / McCam Erickson, Inc.

Audio Devices, Inc., 444 Madison Ave., New York 22, N.Y. / Page 33 / Marsteller, Rickard, Gebhardt & Reed, Inc.

Bell Aircraft Corp., Buffalo, N.Y. / Page 34 / The Rumrill Co., Inc.

Bendix Aviation Corp., Computer Div., 5630 Arbor Vitae St., Los Angeles, Calif. / Page 35 / Shaw Advertising Inc.

Bendix Products Div., 401 No. Bendix Dr., So. Bend., Ind. / Page 26 / MacManus, John & Adams, Inc.

Broadview Research Corp., 1811 Trousdale Dr., Burlingame, Calif. / Page 24 / L. C. Cole Co., Inc.

Computer Control Co., 983 Concord St., Framingham, Mass. / Page 32 / Briant Advertising

Computer Systems, Inc., 611 Broadway, New York 12, N.Y. / Page 27 / Smith, Winters, Mabuchi, Inc.

Hughes Products, Industrial Systems Div., International Airport Station, Los Angeles 45, Calif. / Page 25 / Foote, Cone & Belding

Information Systems, Inc., 7350 No. Ridgeway, Skokie, Ill. / Page 22 / A. N. Baker Advertising Agency, Inc.

The Mitre Corp., 244 Wood St., Lexington 73, Mass. / Page 2 / Deutsch & Shea, Inc.

National Cash Register Co., Dayton 9, Ohio / Pages 26, 29 / McCann Erickson, Inc.

Philco Corp., Government & Industrial Div., 4700 Wissahickon Ave., Philadelphia 44, Pa. / Page 3 / Maxwell Associates, Inc.

Radio Corp. of America, Semiconductor and Materials Div., Somerville, N.J. / Pages 7, 36 / Al Paul Lefton Co., Inc.

The Ramo Wooldridge Laboratories, 8433 Fallbrook Ave., Canoga Park, Calif. / Page 21 / The McCarty Co.

Space Technology Laboratories, Inc., P.O. Box 95004, Los Angeles 45, Calif. / Page 23 / Gaynor & Ducas, Inc.

Technical Operations, Inc., 3520 Prospect St., N.W., Washington 7, D.C. / Page 30 / Dawson MacLeod & Stivers

Technical Operations, Inc., 305 Webster St., Monterey, Calif. / Page 31 / Dawson MacLeod & Stivers

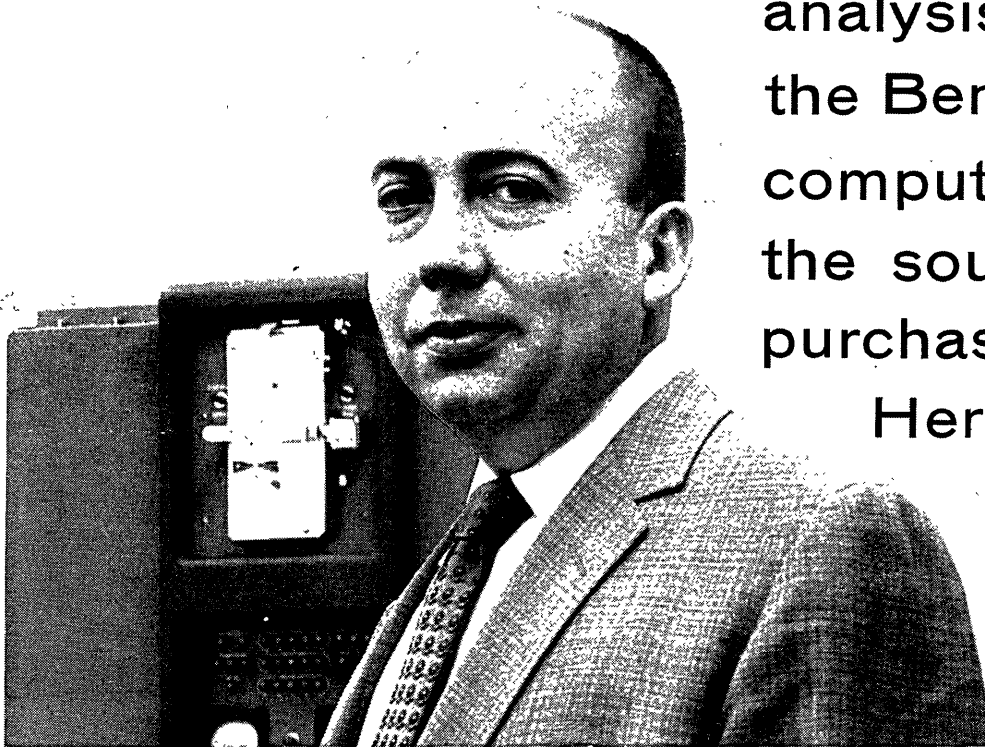

“Our detailed analysis proved the Bendix G-15 computer the soundest purchase.

Here’s why”

ROBERT C. MEISSNER,  
PRESIDENT,  
MEISSNER ENGINEERS, INC.  
CHICAGO, ILLINOIS

Over 200 firms are enthusiastic users of the Bendix G-15 computer. Many, like the consulting engineering firm of Meissner Engineers, Inc., are involved in the heavy construction industry. Before purchasing, Meissner meticulously studied all medium-scale computers. “Only the G-15 gives us the *speed, expandability, price, and ease of operation* we require,” says Mr. Meissner.

Mr. Meissner continues:

**Speed:** “The G-15 is faster than other computers in its price range, and for many problems gives us the answers we need in less than 1% of the time required by manual methods.”

**Expandability:** “The variety of accessories for the G-15 is a very important feature. As we developed and expanded our applications, we added magnetic tape units, punched card equipment, and other special accessories.”

**Ease of Operation:** “Our engineers find the G-15 Intercom 1000 programming system easy to master. It permits them to write versatile programs which can handle practically all of our problems.”

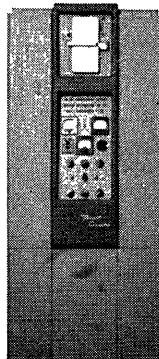

The G-15 is the leader in its field for many other reasons as well: A price much lower than any other medium-scale computer, a built-in, magazine-loaded photoelectric paper tape reader, and tape punch as standard equipment, an active user’s group that shares hundreds of proven programs, and fast, nationwide service.

G-15’s are being applied successfully in a great many fields — business data processing, scientific and engineering calculations. Write us your specific problems.

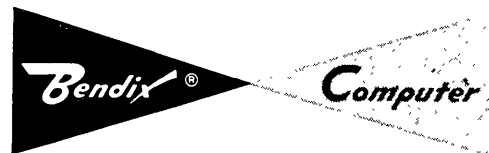

DIVISION OF BENDIX AVIATION CORPORATION

DEPT. D-17  
LOS ANGELES 45, CALIFORNIA

RCA

# MESA

## COMPUTER TRANSISTORS

2N1300 • 2N1301

feature

**HIGH POWER DISSIPATION  
FAST-SWITCHING TIMES  
AT LOW COST**

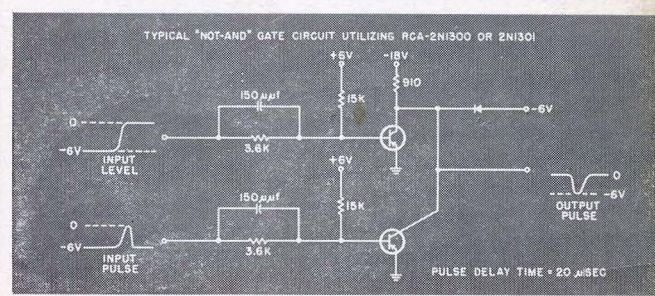
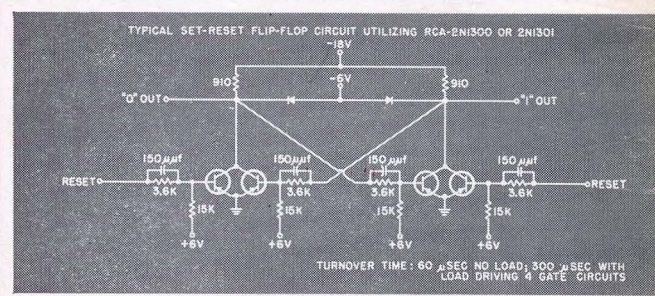
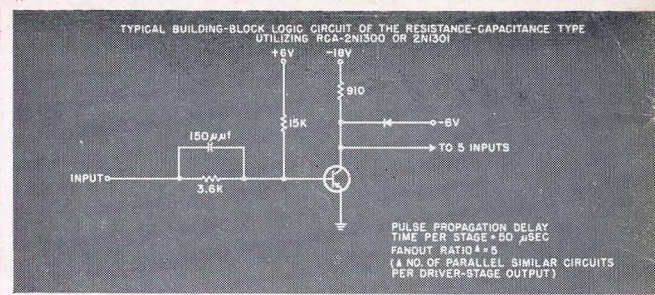
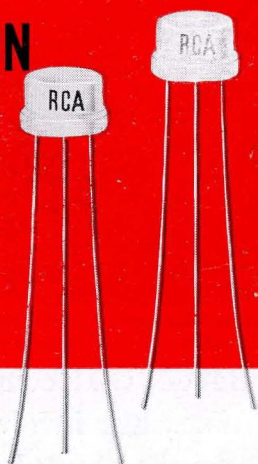

RCA TYPE	Maximum Ratings—Absolute-Maximum Values							Characteristics: Common-Emitter Circuit, Base Input—Ambient Temperature = 25°C		
	Collector-to-Base Volts	Collector-to-Emitter Volts	Emitter-to-Base Volts	Collector Ma.	Transistor Dissipation Milliwatts			Minimum DC Current Transfer Ratio		Gain-Bandwidth Product <sup>▲</sup> Mc
					at 25°C	at 55°C	at 71°C	at collector ma = -10	at collector ma = -40	
2N1300	-13	-12	-1	-100	150	75	35	30	-	40
2N1301	-13	-12	-4	-100	150	75	35	30	40	60

▲For collector ma = -10 and collector-to-emitter volts = -3

RCA's Germanium P-N-P Mesa Transistors 2N1300 and 2N1301 combine low-cost and quantity availability with these major benefits for designers of switching circuits:

- high power dissipation—150 milliwatts maximum at 25°C, 75 milliwatts maximum at 55°C
- fast switching times—made possible by high frequency response and low total stored charge
- rugged Mesa structure—with an extremely small base width to insure top performance at high frequencies
- high current transfer ratio—permits high fanout ratios (number of paralleled similar circuits per driver-stage output)
- high breakdown-voltage and punch-through voltage ratings—result of the diffusion process
- high current ratings—improves overall system speed
- especially well suited for use at pulse repetition rates up to 10 Mc
- rugged overall design—units have unusual capabilities to withstand severe drop tests and electrical overloads
- electrical uniformity—a result of the diffused-junction process used by RCA in the manufacture of Mesa Transistors

Contact your RCA Field Representative for prices and delivery. For technical data, see your HB-10 Semiconductor Products Handbook, or write RCA Commercial Engineering, Section L-90-NN, Somerville, N. J.

**RCA FIELD OFFICES**

- East:** 744 Broad St., Newark, N. J. HUmboldt 5-3900
- Northeast:** 64 "A" Street, Needham Heights 94, Mass. Hillcrest 4-7200
- East Central:** 714 New Center Bldg., Detroit 2, Mich. TRinity 5-5600
- Central:** Suite 1154, Merchandise Mart Plaza, Chicago 54, Ill., WHitehall 4-2900
- West:** 6355 E. Washington Blvd., Los Angeles 22, Calif., RAymond 3-8361
- Gov't:** 224 N. Wilkinson Street, Dayton, Ohio BALdwin 6-2366  
1625 "K" Street, N.W., Washington, D.C. DIstrict 7-1260

Another Way RCA Serves Industry and the Military Through Electronics  
**RCA RADIO CORPORATION OF AMERICA**  
 SEMICONDUCTOR AND MATERIALS DIVISION • SOMERVILLE, N. J.

ALSO AVAILABLE THROUGH YOUR LOCAL RCA SEMICONDUCTOR DISTRIBUTOR.