

~~AN ILLUSTRATION~~

# computers and automation

The Art  
of Computing  
for  
Scientists and  
Engineers

Problems of  
Education  
in Science  
and  
Engineering

Computers in  
Medicine:  
Progress and  
Potential

High School Programming Course—Assessment  
Two Years Later

JULY  
1962

Vol. XI — No. 7

**PAYROLLS  
INVOICES  
RESERVATIONS  
ORDERS  
SCHEDULES  
REPORTS  
PRODUCTION  
MINUTES  
TICKETS  
PURCHASING  
TELEMETERING  
ACCOUNTING  
SALES DATA  
INVENTORIES**

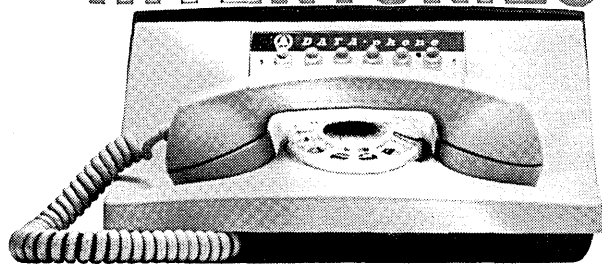

## **SEND IT ALL BY TELEPHONE.**

Data processing has a new dimension. It's called DATA-PHONE service. It lets business machines talk over regular telephone lines . . . at regular telephone rates . . . and at great speeds.

It means you can transmit operating data of all kinds between your headquarters and outlying addresses in a fraction of the time it takes you now.

Call your Bell Telephone Business Office and ask for one of our Communications Consultants. He'll study your operation, then tell you how this new service can work efficiently and profitably for you.



**BELL TELEPHONE SYSTEM**

•  
tio  
•  
lat  
pro  
•  
pe  
•  
a b  
ma  
•  
cu  
—  
Th  
nev  
is  
con  
sof  
cat  
ma  
As

10  
CO

# MANAGEMENT ENGINEERED

Engineered to meet the major demands of modern management, the Bendix G-20 data processing system is designed to increase profits in an era of critically spiralling costs. □ Specifically designed as a central, integrated system, the G-20 is capable of concurrently handling the computer workloads of all of your company's major departments: accounting, marketing, engineering, manufacturing, administration, warehousing and distribution. □ Bendix G-20 automatic programming and linear programming systems open the door to a vast range of applications. For instance, a Bendix G-20 in a typical business organization could, at this moment, be performing these functions: *design automation and cost analysis, inventory control, budget analysis, production and facility control, sales analysis and forecasting, raw material flow, market research and product planning, order processing, advertising planning, and operations research...* all these in addition to more standard business and scientific applications. As workloads increase, G-20 modularity allows you to expand your system without reprogramming. ■ Backing up the proven hardware-software capabilities of the Bendix G-20 is a nationwide team of experienced applications specialists, providing systems support in depth... from preliminary evaluation through systems analysis, programming, installation and on-site maintenance and service. ■ Your nearby Bendix Computer representative will be glad to introduce you to the Bendix G-20 solution to swiftly rising costs: or write for the brochure, "A Solution to the Profit Squeeze," Bendix Computer Division, 5630 Arbor Vitae Street, Los Angeles 45, California, Dept. D39.

**Bendix Computer Division**



## THE BENDIX G-20 COMPUTING SYSTEM

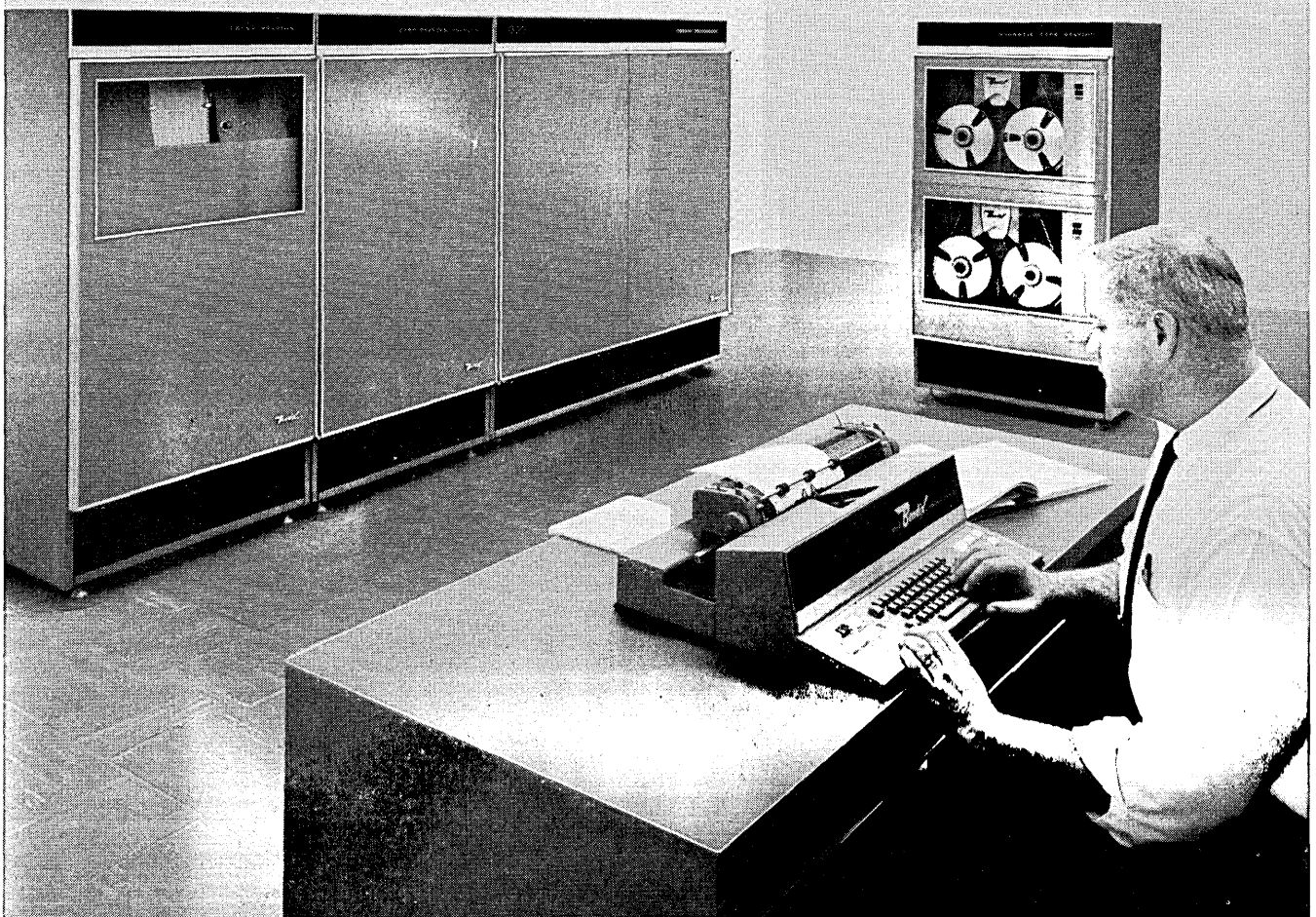

**NOW IN OPERATION—Battelle Memorial Institute, Columbus, Ohio**

# COMPUTERS and AUTOMATION

COMPUTERS AND DATA PROCESSORS, AND THEIR CONSTRUCTION,  
APPLICATIONS, AND IMPLICATIONS, INCLUDING AUTOMATION

Volume XI  
Number 7

JULY, 1962

Established  
September, 1951

EDMUND C. BERKELEY *Editor*  
PATRICK J. MCGOVERN *Assistant Editor*  
MOSES M. BERLIN *Assistant Editor*  
NEIL D. MACDONALD *Assistant Editor*  
ANN B. BAKER *Production Manager*

## CONTRIBUTING EDITORS

ANDREW D. BOOTH  
JOHN W. CARR, III  
PETER KUGEL  
NED CHAPIN  
ALSTON S. HOUSEHOLDER

## ADVISORY COMMITTEE

HOWARD T. ENGSTROM  
RICHARD W. HAMMING  
HERBERT F. MITCHELL, JR.  
GEORGE E. FORSYTHE  
ALSTON S. HOUSEHOLDER

## SALES AND SERVICE DIRECTOR

PATRICK J. MCGOVERN  
815 Washington St.  
Newtonville 60, Mass.  
DEcatur 2-5453

## ADVERTISING REPRESENTATIVES

*Los Angeles* 5 WENTWORTH F. GREEN  
439 So. Western Ave. DUUnkirk 7-8135  
*San Francisco* 5 A. S. BABCOCK  
605 Market St. YUkon 2-3954  
*Elsewhere* PATRICK J. MCGOVERN  
815 Washington St. DEcatur 2-5453  
Newtonville 60, Mass.

COMPUTERS and AUTOMATION is published monthly at  
815 Washington St., Newtonville 60, Mass., by Berkeley Enter-  
prises, Inc. Printed in U.S.A.

SUBSCRIPTION RATES: United States, \$15.00 for 1 year,  
\$29.00 for 2 years, including the June Directory issue; Canada,  
add 50c a year for postage; foreign, add \$1.50 a year for post-  
age. Address all Editorial and Subscription Mail to Berkeley  
Enterprises, Inc., 815 Washington St., Newtonville 60, Mass.

ENTERED AS SECOND CLASS MATTER at the Post Office  
at Boston, Mass.

POSTMASTER: Please send all Forms 3579 to Berkeley Enter-  
prises, Inc., 815 Washington St., Newtonville 60, Mass.

Copyright, 1962, by Berkeley Enterprises, Inc.

CHANGE of ADDRESS: If your address changes, please send us  
both your new address and your old address (as it appears on the  
magazine address imprint), and allow three weeks for the change  
to be made.

## FRONT COVER

Binary Adder That Operates at 125 Megacycles . 1, 6

## ARTICLES

The Art of Computing for Scientists and Engineers,  
by RICHARD W. HAMMING . . . . . 8  
Tiros Weather Observation and Computers . . . . . 11  
Problems of Education in Science and Engineering, by  
T. KEITH GLENNAN . . . . . 12  
High School Programming Course—Assessment Two  
Years Later, by MARVIN M. WOFSEY . . . . . 30  
Computers in Medicine: Progress and Potential, by  
MOSES M. BERLIN . . . . . 32

## READERS' AND EDITOR'S FORUM

The Spread of Computers . . . . . 6  
The Computer Directory and Buyers' Guide, 1962, 8th  
Annual Edition, the Regular June Issue of "Computers  
and Automation" . . . . . 6  
Calendar of Coming Events . . . . . 6

## ACROSS THE EDITOR'S DESK

New Installations . . . . . 17  
New Products . . . . . 19  
Automation . . . . . 21  
New Applications . . . . . 23  
People of Note . . . . . 25  
Business News . . . . . 26  
Computing Centers . . . . . 26  
New Contracts . . . . . 27  
New Firms, Divisions, and Mergers . . . . . 28

## REFERENCE INFORMATION

Books and Other Publications, by MOSES M. BERLIN 38  
New Patents, by RAYMOND R. SKOLNICK . . . 39

## INDEX OF NOTICES

Advertising Index . . . . . 42  
Computer Directory and Buyers' Guide . . . . . 38  
Glossary of Computer Terms . . . . . 42  
Manuscripts . . . . . See March, page 18  
Reference and Survey Information . . . . . See March, page 24  
Who's Who Entry Form . . . . . 39

# IBM® asks basic questions in communications

## What just happened “everywhere?”



*IBM TELE-PROCESSING® systems give decision-makers the critical information they need to take action.*

Last week's information can disrupt today's business or military decisions. To tell what is happening now . . . and what effect it is having . . . and what may be done about it, IBM is designing TELE-PROCESSING systems which process distant data as it is developed. These systems link the many branches of complex organizations into central control networks.

A TELE-PROCESSING operations control system balances information demands against cost to fit an organization's essential needs. Before a single piece of equipment is chosen, IBM systems engineers analyse the character and volume of the data which will be communicated daily throughout the network. They study the operation of the organization to determine the system's response requirements and tolerance for errors. From this and other information, they can simulate the system mathematically. Testing the mathematical model on a digital computer will indicate which combination of terminals, communications linkages, communications control devices, central processing units and file storage is needed to provide optimum performance.

*What is going to happen next?* To further the development of operational control systems which require communications, IBM is investigating new techniques in the fields of microwaves, lasers, fiber optics and ferroelectrics.

One group is studying electronically self-modulated antennae arrays in connection with the processing of satellite data. To assure survival of our national communications system, another group is working on the development of stored program techniques that will permit automatic reconfiguration of military networks in the event of nuclear attacks. Out of their research may come advanced control systems to work in connection with communications linkages of tomorrow.

If you have been searching for an opportunity to make important contributions in control or data processing systems using advanced communications techniques, or any of the other fields in which IBM scientists and engineers are finding answers to basic questions, please contact us. IBM is an Equal Opportunity Employer. Write to: Manager of Professional Employment, IBM Corp., Dept. 539T, 590 Madison Avenue, New York 22, N. Y.

# Readers' and Editor's Forum

## FRONT COVER: BINARY ADDER THAT OPERATES AT 125 MEGACYCLES

The front cover shows an experimental computer element, a full serial binary adder, which has been operated at the rate of 125 megacycles.

The adder is composed of fourteen matched-pair tunnel diode circuits. The wire loops above the circuit board are coaxial cable delay lines. The computer circuit was developed at the Thomas J. Watson Research Center, IBM, Yorktown, New York. Two new circuits, called the Balanced Line Logical Element and the Balanced Inductor Logical Element, were worked out and used, to accomplish the result.

## THE SPREAD OF COMPUTERS

The third national Pulp and Paper Symposium of the Instrument Society of America met in April for 2 and 1/2 days in Jacksonville, Fla. One of the five sessions—20 per cent of the meeting—presented "Analog Computer Applications in the Paper Industry." Ten panelists began the discussion during the first hour; two hours of discussion from the meeting as a whole followed.

The twentieth national technical society was accepted into membership by the Council of the International Federation for Information Processing at a recent meeting of the council. This society is the *Norwegian Society for Electronic Information Processing*. It will be represented on the IFIP Council by its President, J. V. Garwick of the Norwegian Defense Research Establishment.

It is a far cry from September, 1947, at Columbia University, New York, when about 75 people met at the very first meeting of any computer society as such. This was the first meeting of the "Eastern Association for Computing Machinery," which the next year took the name of the "Association for Computing Machinery."

## THE COMPUTER DIRECTORY AND BUYERS' GUIDE, 1962, 8TH ANNUAL EDITION, THE REGULAR JUNE ISSUE OF "COMPUTERS AND AUTOMATION"

The Computer Directory and Buyers' Guide for 1962, the 8th annual edition, which is the regular June issue of *Computers and Automation*, was published at the end of June. It contains 160 pages, reporting the following reference information:

<i>Title</i>	<i>No. of Pages</i>
Roster of Organizations	33
Roster of Products and Services:	
The Buyers' Guide	41
Survey of Computing Services	8
Survey of Consulting Services	4
Descriptions of Digital Computers	16
Survey of Commercial Analog Computers	2
Survey of Special Purpose Computers and Data Processors	3
Automatic Computing Machinery—List of Types	3
Components of Automatic Computing Machinery—List of Types	2
Over 500 Areas of Application of Computers	5
Computer Users Groups—Roster	2
Roster of School, College, and University Computer Centers	7
Robots—Roster of Organizations	1
Roster of Computer Associations	3

Most of our subscribers receive the June Computer Directory issue (as part of their \$15.00 a year subscription); but some do not since their annual subscription to *Computers and Automation* (at \$7.50 instead of \$15.00), does not include the June issue. They subscribe to the magazine without the Directory, choosing to consult the Directory in a nearby library. If any of our readers however do have difficulty consulting a copy of the Directory, please see page 38 of this issue for ordering information, or write us for answers to questions or tearsheets.

## CALENDAR OF COMING EVENTS

July 17-18, 1962: Rochester Conference on Data Acquisition and Processing in Medicine and Biology, University of Rochester Medical Center, Rochester, N. Y.; contact Mr. Kurt Enslein, University of Rochester, Rochester 20, N. Y.

July 18-19, 1962: Data Acquisition & Processing in Medicine & Biology, Whipple Auditorium, Strong Memorial

Hospital, Rochester, N. Y.; contact Kurt Enslein, Brooks, Inc., 499 W. Comm. St., P. O. Box 271, E. Rochester, N. Y.

August 9-11, 1962: Northwest Computing Association Annual Conference, Seattle, Wash.; contact Robert Smith, Conference Director, Box 836, Seahurst, Wash. (Please turn to Page 37)

# SKIRMISH OVER A COMPUTER-TO-INERTIAL-PLATFORM INTERPRETER

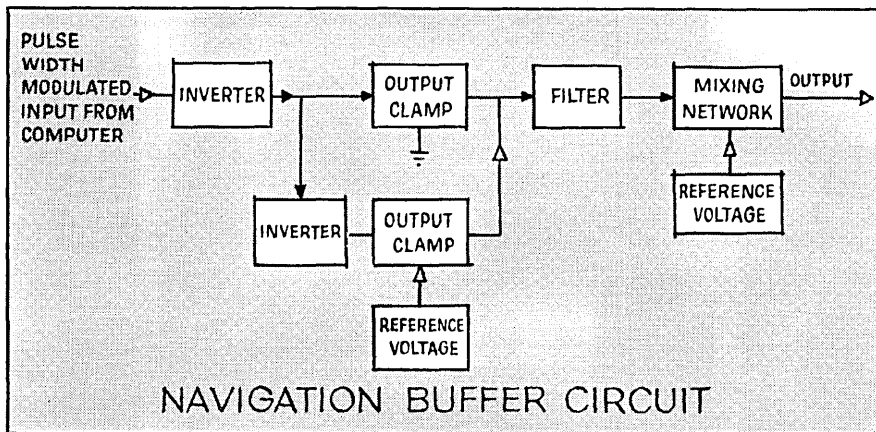

What is the best way to implement the digital-to-analog conversion circuitry required to convert binary incremental signals from a digital computer to precise d.c. voltages for gyro torquing in an airborne tactical data system? This was a problem faced by Litton data systems engineers.

Several engineers who had participated in the development of an earlier navigation buffer employing the digital servo technique were strongly inclined towards playing it safe by adopting an identical approach. To permit the navigation system to sustain the longer flights required under the new program, they proposed engineering greater accuracy into the existing buffer. Somehow, they felt, the additional requirements for lesser weight and volume could also be met. Preliminary investigation revealed that this scheme would require at least 20 pounds of hardware.

Feeling that a better way could be found, other engineers studied alternate approaches and finally proposed a scheme for generating d.c. gyro torquing voltages scaled according to width-modulated pulses linearly related to computer word length. This approach appeared to hold promise of an accuracy of at least 1 part in 4000 (0.025%), which was specified for two of the required eight signals (six for the inertial subsystem; two for the cockpit display system). The pulse width modulation/demodulation method also appeared to require far less hardware than would the digital servo technique because of the elimination of heavy electromechanical components.

Skeptics were quick to point out that the specified precision would be impossible to obtain in view of errors inherent in pulse-width modulation, delays and rise times in the precision switch, switch offset volt-

age, reference supply voltage, filter capacitor leakage and stability, filter lags, drum speed variation, and signal line ground currents.

Undaunted, the advocates of the new method pressed ahead, conducted detailed studies and laboratory investigations to nullify all objections and verified the complete feasibility of their proposed scheme.

Now functioning as part of a tactical data system installed in a carrier-based aircraft, this eight-signal navigation buffer is packaged on five 3" x 3" cards and two small assemblies. Weight and volume are about one-fifth of that required for a digital servo type of buffer. More recently, new packaging techniques have enabled reduction of the buffer unit by an additional 40% to two cards and two assemblies without degrading accuracy.

*Litton management recognizes the value of results stimulated by healthy controversy. Security and proprietary restrictions preclude our discussing current activities, but new programs offering many new technical challenges are now being conducted. And Litton continues to encourage an environment in which engineers can propose and pursue other than safe approaches to problems. If you've been frustrated in your attempts to follow through on new approaches to digital data handling and display functions, write Harry E. Laur, Litton Systems, Inc., Data Systems Division, 6700 Eton Avenue, Canoga Park, California; or telephone DIamond 6-4040.*

An Equal Opportunity Employer

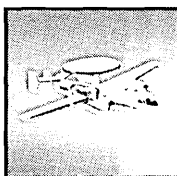
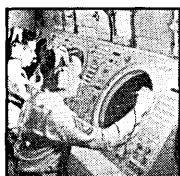

**DATA SYSTEMS DIVISION  
LITTON SYSTEMS, INC.**

A DIVISION OF LITTON INDUSTRIES

DATA HANDLING & DISPLAY SYSTEMS • COMPUTER SYSTEMS • MODULAR DISPERSED CONTROL SYSTEMS

# The Art of Computing for Scientists and Engineers

Richard W. Hamming  
Bell Telephone Laboratories  
Murray Hill, N. J.

(Reprinted from "Chapter N + 1" in "Numerical Methods for Scientists and Engineers" by R. W. Hamming, published by McGraw Hill Book Company, Inc., New York, 1962, 411 pp. Copyright © 1962 by McGraw Hill Book Company, Inc. Used by permission)

## Importance of the Topic

It is unusual in a book on computing to include a discussion on the vague, general topic of how to approach and solve problems, using computing machines. The title of this discussion is itself ambiguous; it could refer to the art as practiced by a person computing for scientists and engineers, or it could refer to the art as practiced by scientists and engineers; in fact, it is meant for both.

The subject should not be taken lightly just because at times it is opinion rather than established fact. It seems to the author to be more important than many of the specific results discussed in other parts of the book. At present, the subject is more an art than a science, but this situation is rapidly changing because the presence of computers themselves had made possible the mechanization of many processes once believed to require human thought, and active research is now going on in this important area. The more we learn about how we solve problems, the more work we shall be able to shift from ourselves to the machines. The art of solving problems, using computing machines, is of interest in its own right; it can also help the user in many situations and greatly increase the value of the machine computations now being done.

Most scientists seem to have been afraid to explore what is generally considered to be the creative process of discovery, but there have been some notable exceptions. Among the mathematicians, "The Method" by Archimedes is one of the earliest examples, and we now have the recent classic "How to Solve It" by G. Polya (Princeton Univ. Press, Princeton, N. J., 1945). Both, however, are concerned with the attack on well-formulated problems, whereas we are concerned with a larger framework of vaguely defined problems from which we hope to extract results to fit an equally vaguely defined situation. The motto of this book:

THE PURPOSE OF COMPUTING IS INSIGHT NOT NUMBERS

illustrates our broad frame of reference.

## What Are We Going to Do With the Answer?

Polya in his book "How to Solve It" emphasizes the importance of understanding the problem. From many years' experience in computing for others, I have found that usually the first question to ask is "What are we going to do with the answers?" Will the answers computed actually answer the questions that should have been asked? Do we need all the answers? Do we need more? Would something else provide a better basis for insight?

In order to answer some of these questions, typical answer sheets can be imagined and then examined for their usefulness. More times than one would expect,

the requested answers will not answer the needs of the research project. The original request may have been to get the answers to a set of simultaneous equations. Sometimes this is all that the computing can give, but many times other items, such as the difficulty of solution, can add to the understanding of the situation being examined. Further, what is to be the measure of accuracy: Accuracy in the unknowns? Accuracy in the residuals? Were the simultaneous equations necessary? Would an alternative formulation give more insight?

Before going on in this vein, let it also be observed that one cannot expect the problem proposer to know exactly what he wants. In research and in many stages of development, it is in the nature of the process that we do not know exactly what we are seeking. Indeed, it may be said, "In research, if you know what you are doing, then you shouldn't be doing it." In a sense, if the answer turns out to be exactly what you expected, then you have learned nothing new, although you may have had your confidence increased somewhat. (P. Debye has said, "If a problem is clearly stated, it has no more interest to the physicist.")

Trite and obvious as the remark may be, it is important to know what you are seeking. It is less well understood that you should also plan your work to increase the chances that an unusual observation will be found. It is usually worth adding a small amount to the total machine time if in the process many side checks on the model being studied can be included. Many of the greatest discoveries were made by prepared minds making a chance observation and realizing the importance of it. Thus, even though it puts a little extra burden on the output equipment, it is well to include a few wisely chosen numbers beyond the bare minimum when planning the output formats.

In summary, while there are exceptions, it is a good general rule to begin a problem in computation with a searching examination of "What are we going to do with the answers?" An active, imaginative mind can make great contributions to the whole research problem at this stage, and a dull, lazy one can prevent any real insight from emerging from all the hours of machine time used to get the obvious numbers.

One of the most common mistakes in planning a problem is to request too many answers. This is particularly true in problems having many parameters. In such situations, what is generally needed is a good statistician who understands *the design of experiments* theory. Very often he can plan the search in such a fashion that only a small fraction of



the original cases need be solved. The sheer volume of answers can often stifle insight.

### What Do We Know?

Having decided, tentatively, what we expect to get out of the computation, we next ask "What do we know?" What information do we have? What is the input? Are we putting in all that we know? For example, if the answer is known to go through the origin, have we included that fact in the input?

Again we remind the reader that Polya emphasizes the importance of understanding the problem, but again he is considering mathematically formulated problems and is supposing that there is a complete statement. In the application of mathematics this is, of course, not the situation, nor is it true even in mathematical research. Often further probing of the situation being explored will bring further information to light. In the least-squares fitting of a polynomial in Section 13 of Chapter 17, we first ignored the fact that the curve should go through the origin, and as a result we had to do the problem over again. When we used this information, we found a more satisfactory answer.

Sometimes it is difficult to include all the known information in our formulation. Thus, in the above case, we knew that the first term had a positive coefficient. We did not include this fact in the input but saved it for an output check. Nevertheless, it is well to get clearly in mind all the relevant information that is available before going on to the next stage.

Sometimes this exploration of the unknown situation will reveal alternative formulations of the problem, and these in turn may suggest new ideas to be explored. Sometimes we find that unnecessarily restrictive assumptions have been made on the model, and that, with little or no extra effort, they can be removed. In any case, their role should be understood, and checks that will throw light on the validity of some of the assumptions should be included in the computation. Thus the exploration of the input may reveal new or different output requirements.

### Arranging the Computation

Only after we have clearly in mind where we are and where we want to be should we turn to serious work on the question "How do we get from here to there?" This is the domain of Polya's book; all his remarks are relevant, and we assume that the reader is familiar with them.

Although a problem is posed as one suited to a computing machine, the necessity for using a computer should be questioned. An analytical answer is often very much superior to a numerical result; and sometimes, even when it is more difficult to compute than the original problem, the error estimates may be made much more accurately. Our exploration of what we know about a problem may produce one or more formulations of the problem, some of them merely simple mathematical transformations of the same problem and some, perhaps, quite different. It is expensive to explore a machine-computation plan for all of them, and some initial choices must be made. As a general rule (with many exceptions) the closer the mathematical statement to the funda-

mental concepts of the field the better, always assuming that scale transformations have been made to make the equations dimensionless. Fancy mathematical transformations often introduce difficult computational situations.

The plan of computation adopted should make use of as much of the initial information as can be included conveniently. The various mathematical approximations made by the formulas used should be in harmony with the model adopted. The effects of sampling should be examined.

The plan of computation should include plans for checking both the coding and the results. This point is too often overlooked; thus we recommend asking the questions "How shall I know if the answer is the one that is wanted?" and "What tests shall I apply or have the machine apply?" It is essential that some redundant information be computed or found from other sources, so that some checks can be made. It is the experience of the author that a good theoretician can account for almost anything produced, right or wrong, or at least he can waste a lot of his time worrying about whether it is right or wrong.

### Iteration of the Above Steps

We have acted as if these three stages can be completely separated, when in fact they are often inter-related. Nevertheless, it is well to keep the three stages clearly in mind and iterate around them as new information at one stage sheds new light on another. It is the author's experience that rushing into the stage of arranging the details of the computation is the most common mistake. This is especially true of the computer expert, because there he feels at home and can show his skill. But all his skill is wasted if he works on the wrong problem or produces numbers that do not answer the real questions.

It is, of course, difficult to be expert enough in a particular field to ask suitable questions about the importance of what is being computed as compared with some other things that might be computed instead. But there is an art in asking questions. Socrates claimed not that he knew truth but that he knew how to ask the proper questions of a man and draw the truth from him. He spoke of himself as a midwife. And it is in somewhat the same way that the consulting computer expert must approach the man with a problem. In the final analysis, the man with the problem must make the choices and do the research, but well-chosen suggestions from the outsider can help to clarify the nature of the choices and aid in the decisions that must be made at many stages of the work.

### Estimation of the Effort Needed to Solve the Problem

In any reasonably mature science, it is necessary to make estimates as to what will happen *before* spending time and money. In a sense, the more mature the field, the more accurate the estimates. Judged by this standard, computing is in an elementary state. Often only the poorest estimates are available.

Some of the estimates that should be made are the following:

1. Will the roundoff errors be serious, and if so, to what extent?

2. Will the interval spacing be adequate?
3. If there is an iteration process, how many iterations may reasonably be expected?
4. How much time will it take to code and debug?
5. How will the answers be checked to assure that they are right?
6. How much machine time will be required?
7. When will the answers finally be available?

A glance at these questions will convince the average computing expert that the present state of the art leaves much to be desired. This is no reason for not trying to make estimates that are as realistic as possible. Furthermore, proper organization of the computer facility can greatly improve the estimates made for questions 4 and 7. The provision of monitor systems, automatic coding systems, debugging systems, and a short "turn-around time" on the computer are "musts" if these two items are to be estimated accurately.

This book has tried to approach a number of these questions in various ways. In particular, Part III is believed to provide a basis for many estimates. However, many of the approaches in the book are merely tentative starts in the direction of making reliable estimates, and much remains to be done.

A person who aspires to become a computer expert in the consulting field should not dismiss these questions as unanswerable but should recognize that reasonably accurate estimates are the mark of a capable craftsman—estimates that are neither too optimistic nor too pessimistic.

#### Learning from Changes in the Plan

It is almost inevitable that as the computation progresses, new information becomes available and changes in the plan must be contemplated. But before adopting a change in plan, an effort should be made to understand why the wrong choice was made in the first place. Does the change shed any light on the model being used? Should we still try to get the same kind of answers? Does the change suggest new or different checks on the validity of the model? Can some new insights be obtained either from the failure or from a new plan?

A change in plan should not be hastily patched in but should receive the same careful thought and planning as went into the original plan. As remarked before, if things go as planned, not much can be learned—it is from the unexpected that the great new insights can occasionally come. Thus a situation which forces a change in plan should be regarded as an opportunity rather than a failure. Of course, if the change was due to carelessness or failure to think, then it should be taken as another example of the value of preliminary planning and should be charged to stupidity.

It is all too tempting, when involved in running a problem, to be rushed into making small changes without considering the consequences and the implications, especially if the results have been promised at a certain time. Yet haste at this time can undo much of the earlier careful work. It is well to remember that "the man should be the master, not the machine," and by proper organization of the com-

puting facility much can be done to keep this clear to the user.

#### The Open-Shop Philosophy

If we believe that *the purpose of computing is insight, not numbers*, then it follows that the man who is to get the insight must understand the computing. If he does not understand what is being done, he is very unlikely to derive much value from the computation. The bare numbers he can see, but their real meaning may be buried in the computation.

Eddington has an illuminating story of a man who went fishing with a certain-sized net. When he found that the fish caught had a minimum size, he concluded that this was the minimum size of the fish in the sea; he made the mistake of not understanding how the fishing was done. And so it is with computing; what comes out depends on what goes in and how it is processed. Without an understanding of the processes used, it is likely that effects due to the model used in the computing will be confused with effects of the model adopted by the user when he formulated the problem.

It has further been found that frequently the process of computing sheds great light on the model being computed. Computing is a tool that supplies numerical answers, but it is also an intellectual tool for examining the world.

It is not likely that great physical insights will arise in the mind of a professional coder who routinely codes problems. If insights are to arise, and they are what we most want, then it follows that the man with the problem must comprehend and follow the computing. This does not mean that he must do all the detailed work, but without a reasonably thorough understanding of what the computer is doing it is unlikely that he can either arrange his work to get maximum benefit from the computer or achieve the insights which can and do result from properly arranged computations.

Experience indicates that it is generally easier and better to convert an expert in a given field into a partial expert in computing than it is to try to make a computing expert into an expert in the given field. But if we are to require this, then it falls on the computing experts to make every effort to reduce the burdens of learning and using the computer. Arbitrary rules, special jargon, meaningless forms, changes in the methods and form, delays in access to the machine, all should be reduced to a minimum and carefully monitored to reduce them further when the next machine offers new opportunities to lift the burden of the nonessentials of computing from the outsider.

The study of numerical methods and library routines to be used to increase insight rather than mere machinery efficiency is still in its infancy, and it is one of the most important areas of future research. To work in this field requires experience in the use of computing in everyday work. It is, however, a field well worth cultivating.

It should not be necessary to remind the reader that most of the above remarks are personal opinions developed by the author while working in a particular

laboratory, and they are not necessarily of universal applicability. But in defense of them, they seem to be grounded in common sense as well as in experience. If the reader does not like them, he should not argue the topic but should try to develop his own.

It is important to the progress of machine computation that the intuitive methods that we now use become more clearly understood and reduced, when possible, to explicit formulations suitable for use with a computer.

# Tiros Weather Observation and Computers

(Reprinted with permission from the *Industrial Bulletin*, March, 1962,  
published by Arthur D. Little, Inc., Cambridge, Mass.)

TIROS IV went into orbit on February 8, 1962. One of a series of experimental weather satellites launched under the auspices of the National Aeronautics and Space Administration, it is now transmitting to earth photographs of cloud formations and measurements of radiation in the atmosphere. A picture taken by the satellite's cameras can be relayed to earth and analyzed, and the analysis disseminated to weather stations around the world in as little as two and a half hours, to aid in making both short- and long-range weather forecasts. The name TIROS is an acronym for Television and Infra-Red Observation Satellite.

The TIROS vehicles are launched so that they spin on their vertical axes and travel about 450 miles above the earth. Because of the rotation of the sun, the satellites cover different areas each time around (one complete orbit takes between 90 and 100 minutes); their range is the area between the 50° latitudes north and south, so they cover about four-fifths of the earth's surface. If this same area were to be surveyed from the earth in the same detail, thousands of observing stations would be necessary.

As TIROS passes over the present data acquisition stations at Wallops Island, Virginia, and Point Mugu, California, it is instructed to take pictures of certain areas on its next orbit—in this way, pictures are always taken in the daylight hours. TIROS I and II each carried two television cameras, one with a wide-angle lens, and the other a narrow-angle lens—the wide-angle lens could cover an area of about 750 miles square, and the narrow-angle lens, 75 miles square with the camera pointed directly at the earth. The cameras could take up to 32 consecutive pictures at intervals from 10 to 30 seconds, depending upon instructions from the control centers. The wide-angle photographs taken by TIROS I and II made possible an Immediate Operational Use (IOU) program; consequently both TIROS III and IV were provided with television cameras with wide-angle lenses, and one of the lenses on TIROS IV was considerably improved over the earlier models. Pictures from TIROS IV can either be transmitted directly to earth, or stored on magnetic tape and returned to earth later.

The cloud photographs taken by TIROS must first be interpreted before they can be used as indicators of atmospheric processes. Cloud brightness, texture, structure, pattern and shape, and the sizes of patterns

and shapes are all involved in the process of interpretation; the location of the pictures must be determined, and all pictures must be scaled to reflect actual dimensions and positions.

After each picture is magnified, a computer calculates and draws latitude and longitude grids to fit it—to do this the computer must be given the time of the photograph and data on the satellite's orbit. After the picture has been oriented geographically, the meteorologists go to work, entering the data on a base map, copies of which are transmitted through Weather Bureau, Navy and Air Force circuits.

Plans are now under way to transfer the whole process of interpreting TIROS pictures to computers. It is now possible for computers to do part of the interpreting, through the use of a specified set of photographic "keys." All but one of the characteristics of clouds—i.e., pattern, texture, etc.—can be programmed; brightness is still difficult to measure quantitatively on films, but new theories of reflectivity are being used to define, to a still limited degree, the relationship of brightness to cloud formation.

It is now known that well-organized storms are usually indicated by large areas of solid cloud; where clouds are absent, downward motions (technically referred to as subsidence) are probably taken place. Clouds that are disturbed somewhat at random usually indicate weak circulation systems; the stronger a circulation system, the better is the organization of the clouds. As more and more information is gathered from the TIROS photographs, cloud patterns will be related to wind, temperature and moisture patterns which have already been observed by more conventional means.

The TIROS pictures will serve other purposes as well as meteorological analysis. Weather briefings are transmitted to Idlewild airport for use in planning flight patterns across the Atlantic. TIROS IV has already helped to survey patterns of ice formation and flow on the St. Lawrence River—its findings were supplemented by aerial reconnaissance planned as a cooperative effort by U.S. and Canadian agencies. If the experiment proves successful, daily surveillance of ice and snow areas will probably be done by satellite. Satellites could also watch flood and drought areas, and aid substantially in geophysical and oceanographic research.

# Problems of Education in Science and Engineering

T. Keith Glennan

President, Case Institute of Technology  
Cleveland, Ohio

(Based on a talk before the American Institute of Electrical Engineers,  
New York, January, 1962)

## The Age of Accelerating Change

... The problems of education in engineering and science are of great concern to all of us.

This time in which we are living has been called many things—the age of electronics—of the atom—of space. All of these are appropriate. But, in a more generally applicable sense, I think it might be called the age of accelerating change.

So rapid has been the pace of scientific and technological discovery, we have compressed into the past 50 years more developments affecting seriously the lives of the people than in all of our previous history. Repetition is often useful when discussing major areas of progress. Let me list only a few.

First, your own profession of electrical engineering has moved from generators, circuits and vacuum tubes to plasmas, super conductors, masers and transistors in less than 25 years.

Second, we have altered so profoundly the methodology of warfare through the development of weapons of mass destruction that a major conflict would threaten the entire race of man. The destructive effects of nuclear weapons are so great, and the new weapons delivery systems are so invulnerable, as yet, that the military rivalry between the two great competing powers has reached a virtual stalemate.

Third, in the industrial nations the advent of mass production techniques has made possible the satisfaction of the human desire to escape the burden of back-breaking manual toil. The parallel rise in productivity has increased the supply of consumer goods to levels that would have been thought impossible at the turn of the century. In these technologically advanced nations, more people live better than ever before.

Fourth, during the past 40 years the rapid advances in the technology of communications, and the widespread use of educational and propaganda media of all types have had a profound influence on the undeveloped nations of the world. They have seen the examples of freedom and affluence set by the more advanced nations, and they will not be content until their own potentials are realized.

Fifth, the combination of automation and computer science, when applied in industrial design, machine and process control, and data processing is having a profound effect on our industrial economy. Familiar patterns of industrial life are changing rapidly and new problems of employment, involving a very considerable upgrading of skills and the displacement of workers of lesser skills, must be solved.

Sixth, advances in the detection, diagnosis and cure of disease have lengthened by a very great number of years the span of man's life wherever they have been applied.

But more remarkable than any of these individual advances is the fact that—under the combined pressures of the cold war, increasing economic competition in both the domestic and international markets, and steadily increasing expenditures for research—the *acceleration in the rate of change appears to be continuing.*

## Funds for Research

To those of us whose lives have spanned the last half century it seems almost incredible that the rate of discovery and application could be *maintained*—let alone *increased*. Yet look at the picture. According to a study made by McGraw-Hill in 1961, research and development spending stood at about \$2 billion in 1945. It rose to approximately \$4 billion in 1950; to \$6.4 billion in 1955, and to about \$12.5 billion in 1960. By any yardstick this represents a dramatic increase in research and development expenditures. How long will this growth rate continue? The simple answer is—as long as there is sufficient demand for the products and services that result from research.

## Research Tools

We are also getting better research tools. We are building up a fantastic accumulation of information. We are spending more time and treasure on *basic* research—the mother lode of new knowledge. More importantly, in a few areas of research we are applying a “critical mass” of brainpower that tends to catalyze greater efforts and higher rates of discovery, not only directly, but in peripheral fields as well.

In my years with the National Aeronautics and Space Administration, I was privileged to watch the effects of this “critical mass” concept in action. In a program made urgent by the pressure of competition with the Soviet Union, the needs of our defense establishment, and the bright and exciting challenge of space, researchers in industry, in universities and in government were integrated in a drive deep into the frontier regions of most of the scientific and engineering disciplines; and this drive is continuing. They are conducting the most concentrated studies ever attempted on the nature and structure of materials. They are learning how to deal with high vacuum, incredibly high temperatures, and environments at near absolute zero. They are making exciting advances in data processing, information storage and retrieval and automatic control. They continue

to pioneer in such widely diversified fields as systems engineering, micro-miniaturization, life-support systems, communications and fuels.

The advances in these and other areas of research and development have been so rapid that we can now say that a trip to the moon—which our space programmers confidently expect within a decade—can no longer be considered a basic scientific problem. Rather, it is a problem in design and engineering!

### **Mastery of Environment**

As a member of the human race, I am proud of the fact that man is gaining mastery of his environment. As a citizen of the United States, I am proud of our position of leadership in so many areas of science and engineering, and happy to see us making significant progress in our efforts to regain leadership in those areas in which we may have fallen behind. As a consumer, I am proud, and yet at the same time humble, in the enjoyment of a standard of living that makes the average American the envy of most of the peoples of the earth.

### **Challenge to Education**

But as an educator I am disturbed and challenged. I can see that education in the United States has made great advances during the past few decades; but I am not at all sure that we are keeping abreast of our obligations to adapt education to the needs of the times, particularly in the fields of science and engineering. Faced by a pressing need for scientists and engineers in defense and industry, and a growing need for engineering assistance in the undeveloped countries, are we moving to fulfill our responsibilities?

### **Graduates in the United States and the Soviet Union**

First, let us look at sheer numbers. A 900-page study by Nicholas DeWitt, Associate of the Russian Research Center of Harvard, published earlier this month by the National Science Foundation, reveals that the Soviet Union is producing more than twice as many scientific and technical professional graduates yearly as the United States. While we produce about 90,000 engineering, science and applied science professionals each year, the Soviet Union's production is currently 190,000 annually. Projections indicate that during the decade of the 1960's the Soviet rate will reach 250,000 annually, more than double the anticipated rate for the United States.

As to quality, the author, in speaking about 4-year programs, concludes that "although qualitative variation in the Soviet effort is substantial, Soviet professional higher education in most scientific and engineering fields is at least equivalent to, and sometimes more extensive than in the United States or West European institutions of higher learning." There is another aspect to this which I will refer to later.

The disparity in quantity is not so great in graduate education, but the mix is disturbing. The Soviet production of candidate degree holders, roughly equivalent to the American Ph.D., is about the same as ours—roughly 8,500 per year. But 75% of Soviet advanced degrees granted are in the fields of science and engineering, in contrast to 55% in the United States.

Taken together, these figures again serve notice to American education and to the American people that we must increase our emphasis on this crucial educational field.

### **Training, Motivation, Talent**

Greater than the need for sheer numbers, however, is the growing need for highly *trained*, highly *motivated*, highly *talented* manpower. In a world rocking with change, we need men with: advanced training, research-mindedness, a high capacity for innovation, an inner flexibility enabling them to adjust to changing circumstances, and a willingness to assume social, economic and political—as well as professional—responsibility.

I will comment only briefly on these points, for their urgency is apparent. Few would argue with the need for more managers and engineers with advanced training. Our social, political and economic system has become so complex that only men with graduate training—or many years of experience, perhaps—can hope to fill many of the key jobs successfully.

### **Research-Mindedness**

The need for research-mindedness on the part of engineers as well as scientists is also being proved today across the board in industry and government. In a world in which competition and defense are twin spurs, we can no longer safely rely on a given material or a given practice because it is "tried and true." We must be sure that it is the *best* material and the *best* practice—and this means an increasing reliance on research, the rigors of the scientific method, and the role of "optimization" in our engineering designs.

### **Capacity for Innovation**

Competition and defense also place a high premium on another human factor that is sorely needed: the capacity for innovation. There is room for the less creative thinker; probably he will always be in the majority. He acts as a check and balance on the wider-ranging mind of the innovator, and keeps the complex instruments, machines and processes operating efficiently. Yet, as competition becomes more intense; as the disciplines become more complex, and as the boundaries between the disciplines become less well-defined, we need the man who can look for the new solution—by-pass the obstruction—relate the hitherto unrelated—make the quantum jump from one synthesis to another.

### **Social Responsibilities of Scientists and Engineers**

But sheer number, and excellence and flexibility in the fields of science and engineering are not enough. Science and technology do not exist in a social vacuum. Increasingly, the professional man—no matter what his specialty—must accept total responsibility for his professional actions in all of their ramifications.

I would pose the questions: Does the scientist or the engineer have a share of the responsibility for the social, economic and political consequences of the space program? The atomic energy program? The trend in automation? In communications? Of research and development in the human sciences? Of aid programs for underdeveloped nations?

To all of these questions—and to other similar questions which might be added—my answer is unequivocal: yes, he does! As a professional man and as a citizen in a democracy he must learn to apply his special knowledge and insights to the problem of helping the society adjust to the very changes he is helping to bring about.

To you as working engineers, I am sure that the demands of your profession in this era of change are a constant challenge. Each day brings some new demand, and many of the problems you face today bear little resemblance to the ones you learned to solve in school.

### Responsibilities of Educators

Imagine, then, the challenge to educators responsible for the curricula, course content and teaching methods for students who will face the world of the year 2000. Who can foresee the long-term demands of progress in design and systems? In molecular biology? Energy production methods? Information technology? Computer science? Marketing? Clearly, no one. How, then, can we plan for tomorrow?

### Thirst for Knowledge

It seems to me that four clear educational imperatives have emerged from our experiences during the postwar years, particularly during the past decade. First, if we are to prepare students who will be leaders in the professions in tomorrow's world, we must train them to question, to seek new ways, to have a thirst for knowledge, to build habits of thought and investigation that will lead them to a lifetime of learning. To this end we must also provide easier, more practical means by which they can keep abreast of new discoveries and new techniques while pursuing their professional careers.

### Mathematics and the Basic Sciences

Second, if we are to prepare students who will be leaders—or even adequate professionals—in engineering as well as science, we must provide them with a more solid footing in mathematics and the basic sciences, taught by men who themselves are working at the very cutting edge of discovery in their particular field.

Third, we must not shy away from the fact that in the maelstrom of change the boundaries of the traditional engineering disciplines are shifting, rearranging themselves, and sometimes disappearing altogether. In many instances this is requiring an *interdisciplinary approach* not only the work of engineering, but to the teaching of engineering as well.

### Closing the Gap Between Scientists and Society

Fourth, we must move to bridge the gap between the scientist and the engineer on the one hand, and the society of which they are a part on the other. This is a two-way problem, of course. The public must be brought to a greater awareness of the methods, the contributions and the limitations of the professional community, but a major responsibility of the school is to bring to the young student the awareness of his responsibilities as a citizen.

Whether these principles will be adequate or not only the test of time will tell. But I believe in them

—and I think I practice what I preach. For my own guidance at Case I have summed up the objectives of our education programs in these words—it is our purpose to provide an education so solid in the fundamentals of science and technology, and so well supported by a distinguished program in the humanities and social sciences as to prepare the student effectively to meet the rapidly changing requirements of the future—a future in which he will be serving as a competent professional man dealing with the problems facing government, industry and the society of his day.

### Habits of Life-Long Learning

Specifically, we are attempting to build habits of learning—in the classroom and in the laboratory—which will lead the student consciously to continue seeking new knowledge after he leaves our campus.

We are making mathematics and the physical sciences the foundation stones on which the education of all our students must stand. This does not mean that we are confusing science and engineering. The scientist is concerned with expanding our understanding about how things happen in nature. The engineer is concerned with the design, construction, and bringing into being of machines, structures and systems that have not previously existed. In this role, the engineer needs, at every turn, an understanding of how and why things happen. He uses much of the knowledge that the scientists and mathematicians have accumulated. More often than not, however, he needs even more basic knowledge and must then find out for himself. Engineering problems stimulate scientific discovery; scientific discovery opens new avenues for engineering.

The scientist emerging from Case—regardless of his specific job—will continue to be a searcher for new knowledge; his primary concern will be that of discovery. The engineer will continue to be concerned with taking such discoveries and using them to design a structure, a device or a system, and to make it work. But for the engineer as well as the scientist the basic tools of science, the scientific method, and familiarity with the frontier regions of knowledge will be essential in providing the adequacy and adaptability needed in tomorrow's world.

### Interdisciplinary Engineering

Modern problems of engineering are no respecters of traditional boundaries between the specialties. Therefore, we have made two broad moves which will go far to establish interdisciplinary approaches in engineering education at Case. At the undergraduate level we have consolidated the departments of chemical, civil, electrical and mechanical engineering into a single administrative unit—the Engineering Division. The engineering faculty are re-grouping in a natural way according to their common professional interests such as systems, design, energy conversion, materials, information processing and other emerging fields.

A revised curriculum is also under study. As now envisioned, it will first include a two-year core curriculum required of all Case students, with heavy emphasis on science, mathematics and the humanities.

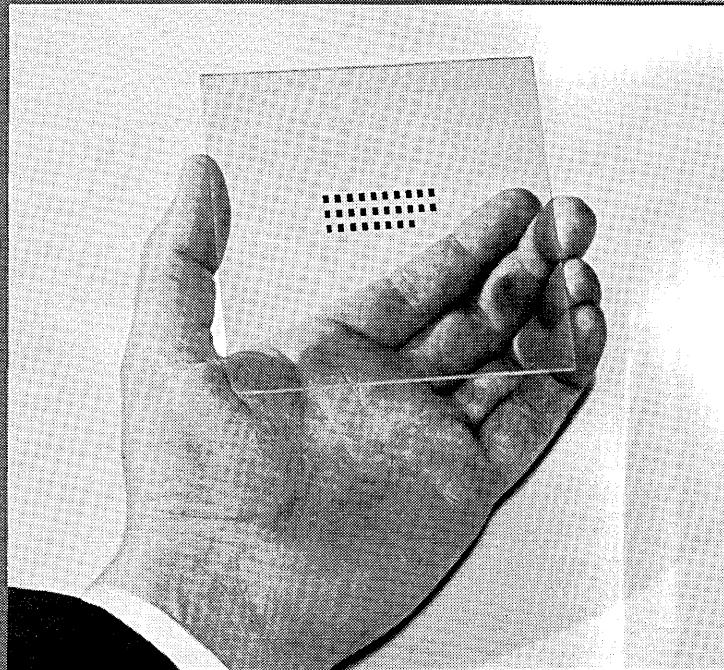

**An entire metropolitan newspaper could be recorded in the tiny dots above!**

Every page, every word, every picture in an entire edition of a metropolitan newspaper could be recorded and reduced to microscopic proportions, thanks to an amazing new photochromic micro-image technique developed by NCR Research.

Using a photochromic material consisting of molecules of light-sensitive dyes, it makes possible completely grain-free clear reductions far finer than those achieved with the finest micro-film.

Actually, the little plate above is big enough to record 1,312 newspaper pages

... micro-images that can be enlarged to almost perfect copies of the original documents.

To put it another way... this new NCR development makes it possible to store the entire contents of a 400 page book on one square inch. Thus the library of the future could store all its volumes on small, expendable memory cards. The cards could be read at home with viewers which magnify the image for easy reading.

Or, put another way, documents that now require 250,000 square feet of filing

space can be stored in 6¼ square feet. Think of what this will mean to business concerns in the years to come, as space becomes more and more valuable.

The point is... this is only one of the many new and exciting projects at NCR's Research and Development Division, whose major objective is...

*To provide the finest total business systems—from original entry to final report—through NCR accounting machines, cash registers or adding machines, and electronic data processing.*



New sign of The National Cash Register Company, Dayton 9, Ohio—1,133 offices in 120 countries—78 years of helping business save money

The courses in this program are largely concentrated in the first two years, although a sequence of humanities follows through the complete four years. Secondly, all of the engineering students will study an additional one-year core program, although the courses in this program may be taken at various times during the three upper class years. Finally, electives totaling one year of study will be offered to complete the four-year program. They are distributed over three years, with particular emphasis on the senior year.

Degrees in electrical, mechanical, civil and chemical engineering will continue to be granted, but a new degree at Case—probably named Bachelor of Science in Engineering—will be offered. It will give the student the opportunity to plan his elective program—with faculty advice—to suit his career interests. Such a program can be designed to lead more effectively into advanced work.

There is little doubt that the four-year graduate will continue to play an important role in industry, but there is an ever-increasing need for the engineer with the depth of knowledge and experience produced by work at the advanced graduate level.

#### **Centers for Joint Work on Problems by Faculty and Students**

In a related move, Centers are being established where faculty and students, both graduate and undergraduate, from many disciplines can work together on problems of mutual interest, sharing equipment and knowledge to achieve a common goal.

The Engineering Design Center is a laboratory where challenging design problems can be attacked on an interdisciplinary basis. This Center is well equipped and has a distinguished supporting staff to carry through a design from the germinal idea to a working prototype. Undergraduate as well as graduate students participate actively in the work of this new Center.

The Systems Research Center brings together faculty and students from all fields of engineering, plus the departments of mathematics and management, to investigate the modeling, simulation and behavior of complex systems, and methods and techniques for optimizing the performance of these systems.

The Computing Center is a laboratory for research in numerical analysis, logic and machine computation; for broad investigations into computer theory, and the application of computer techniques in the fields of sciences and engineering, and in the areas of production and management.

A Center for Materials is now in its formative stages. Housed in a building now being constructed, it will provide laboratory facilities and equipment for advanced research in many types of materials. We will be training some of the men who will be seeking a better understanding of the structure and properties of matter in an effort to create the materials and the processes that will undergird tomorrow's technology.

#### **The Humanities**

We are continuing our efforts to make more effective our work in the field of the humanities and social sciences. We regard it as essential that, in addi-

tion to his professional studies, the student be made aware of the pattern of human history which has formed the society in which he finds himself; of the artistic, ethical and spiritual values which are part of the larger world in which he operates, and of his role as a citizen as well as a professional man.

There are some who may question—even at this late date—the value of these studies of man and his society, and the emphasis on citizenship. But in a tour I was privileged to take of Soviet universities in 1958, I observed the dedication of the students and faculty to the task of developing professional skills—and the almost total lack of anything that might be called a great disciplines of the humanities. I decided then that, in the long run, this may prove to be our great advantage. Against their narrow specialization we will be pitting our breadth, our awareness of the total human problem—the system of man, if you will. If we have the strength and the will, I think the advantage of our approach will be a decisive one.

#### **Doubling the Number of Graduates**

Finally, cutting across all of these areas of academic change, Case is in the process of doubling the size of its graduate program, raising the number of resident graduate students from 450 to approximately 900 by 1970. We have noted the need for holders of advanced degrees in science and engineering in all elements of our economy. To highlight only one such element, we know that there are now approximately 150 accredited engineering schools. In 1960, these schools awarded 780 doctorates in engineering in this nation. If *every one* of these Ph.D.'s joined the faculties of these 150 institutions *each year* there would still be a critical shortage of teachers for the next generation of engineering students. But with government and industry clamoring for Ph.D.'s I can assure you that the teaching profession is not likely to get even a majority of these young men.

By doubling our graduate enrollment during the remainder of this decade, we hope to do our share to meet this need.

Taken together, we feel that these emphases—a lifetime of learning, a solid footing in mathematics and basic science, the use of an interdisciplinary approach in many areas, a strong involvement with the humanities and social sciences, and a very substantial increase in our graduate program—will help to provide the kind of men needed in tomorrow's world.

#### **A Renaissance of Learning**

I have talked at length about Case and its program; but I can tell you with almost equal pride that many of the better educational institutions of higher learning are moving on a similar broad front to assume their growing obligations to the nation. Their administrations and their faculties realize that the need is great, and that the time is now; for it seems clear that the measure of national progress in the coming years will depend upon the excellence of the educative process. The scholars of the next century may look back upon the 1960's as the beginning of a new renaissance of learning—a fitting accompaniment to an age of accelerating change—the breaching of the professional frontier.



# NEWS of Computers and Data Processors

## NEW INSTALLATIONS

### ROME, N.Y., AIR DEVELOPMENT CENTER GETS TWO SPECIAL-PURPOSE COMPUTERS

Ford Motor Company's Aeronutronic Division, Newport Beach, Calif. has delivered the AN/GSQ 38 (Logic Processor) computer set and the GLA-12 Electronic Data Analyzer Set to the Rome Air Development Center (RADC) at Griffiss Air Force Base, New York.

The Logic Processor within three minutes can search through a tape file of more than 6000 Air Force men and tell which ones meet certain requirements to accomplish a specific mission. The complete service record of 6626 Air Force men is stored on a reel of standard 2600 foot magnetic tape. The information search is accomplished at the rate of 46,000 characters per second through the use of thousands of tiny high-speed BIAX computer elements. This computer has a high speed BIAX memory unit and uses BIAX logic elements.

The computer set consists of a magnetic tape transport and control unit, a comparator and logic evaluator, a magnetic core memory, an electric typewriter with a paper tape punch and reader, and a high-speed instruction memory.

Other areas of application for the Logic Processor also include: library search and retrieval of technical information on a specified subject; searching an inventory to locate and determine the availability of specified types of equipment; and language translation.

The second special-purpose computer, known as the GLA-12 Electronic Data Analyzer Set, also makes use of BIAX computer elements. This machine will be used for "quick look" evaluation and analysis of data.

The Rome Air Development Center is testing both machines to determine their adaptability to future field use.

### HELICOPTER COMPANY INSTALLS IBM 7070

Bell Helicopter Co., Division of Textron, Fort Worth, Texas, has installed an IBM 7070 to provide the computing capacity the company needs to automate major record and control functions required in the manufacture of helicopters. A previously installed IBM 1401 data processing system will serve as an input-output communication link with the larger computer.

The IBM 7070 works at speeds equal to 16,600 five-digit additions or subtractions or 860 10-digit multiplications a second. Internal storage or "memory" capacity is 50,000 digits or 5,000 words.

This equipment is one more step in a five-year program to integrate all major operating systems at Bell into a single "total system" which is operated and controlled primarily by computers.

### THREE G-20s INSTALLED IN JAPAN, ITALY

Bendix Computer Division, Los Angeles, Calif., has installed three G-20 systems at customer locations in Japan and Italy.

The first two systems are in operation at the Japan National Railway Technical Research Institute, Tokyo, and the corporate offices of C. Itoh and Co., also in Tokyo.

The third machine was delivered to the University of Naples, Italy.

### ASI 210 COMPUTER FOR NASA

A high-speed, desk-type ASI 210 computer has been delivered to the National Aeronautics and Space Administration (NASA), Goddard Space Flight Center, Greenbelt, Md., by Advanced Scientific Instruments, Inc., Minneapolis, Minn.

This is a solid-state electronic digital computer, suited to scientific data analysis,

process control, and real-time systems control as in missile and satellite guidance. NASA will use the ASI 210 computer for orbital space flight calculations in current space flight tests.

#### EDISON VOLTA IN ITALY TO RECEIVE 500TH UNIVAC SOLID-STATE COMPUTER

The 500th UNIVAC solid-state computer has been shipped to Milan, Italy, for Edison Volta, Italy's largest electrical utility company. The system is produced by the Univac Division of Sperry Rand Corp., New York, N.Y., and operates in millionths of a second. It will be used by the company for customer billing, statistics, inventory control, payroll and scientific applications.

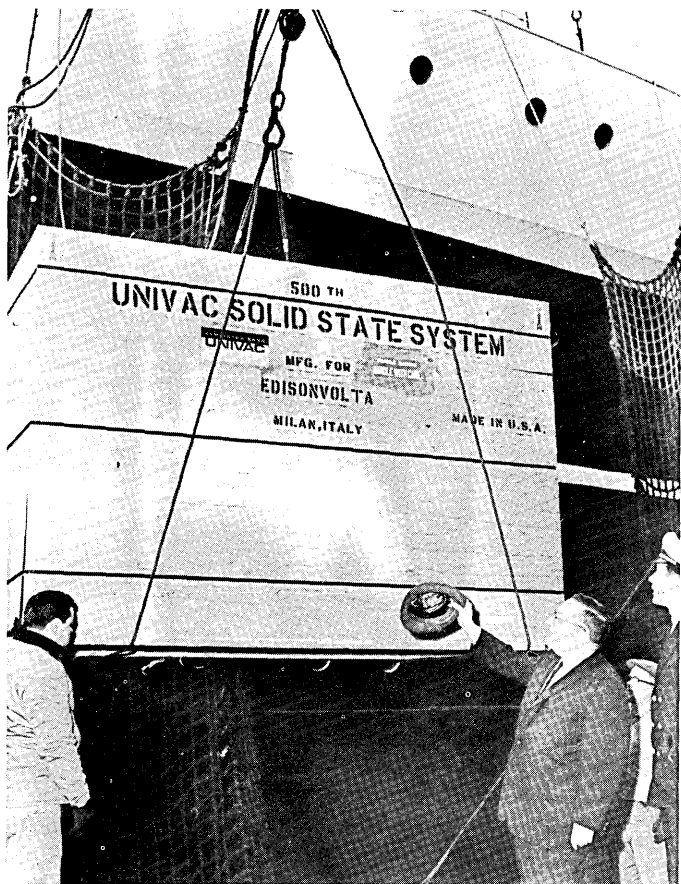

#### WILLYS MOTORS, INC. TO INSTALL NCR 315 COMPUTER SYSTEM

Willys Motors, Inc., Toledo, Ohio, manufacturer of the internationally-known "Jeep" vehicles, will become the first company in the auto industry to install National Cash Register's new 315 computer system. The electronic data processing system will be installed by Willys to schedule vehicle production and perform a variety of record-keeping tasks. It is expected to process over a half-million inventory parts monthly for civilian and military Jeep vehicles. Eventually the system

is expected to maintain control of over 30,000 replacement parts for 1700 Jeep dealers throughout North America, print shipping notices, and give Willys a more accurate and detailed picture of various manufacturing costs.

#### REFUELING CONTROL SYSTEM INSTALLED AT O'HARE AIRPORT

Electronic Control Products, Division of Electronic Fabrication Laboratories, Dunellen, N.J. has completed installation of the refueling control system at O'Hare International Airport, Chicago.

The system, known as the Mark IV Supervisory/Control System will control the field's new \$5 million remote refueling complex. The Mark IV is being used to send information, fuel levels, pressure, and pump status, at the rate of 360 bits/second over a single pair of telephone lines from nine satellite pumping stations to a control house. It provides a constant check on the over-all function of the entire satellite area and will shut down affected areas in case of fire or other emergency.

The system is a tone-modulated carrier transmitter/receiver connected to a scanning device. In addition to providing fool-proof monitoring, the Mark IV will also perform control functions in any type of plant, either continuously or on a periodic basis.

#### UNION SQUARE SAVINGS AUTOMATES WITH TWO DESK-SIZE COMPUTERS

A compact computer system designed expressly for medium-size and smaller savings banks has been installed in the headquarters office of the Union Square Savings Bank, New York, N.Y. The system consists of two National Cash Register Type 390 computers. It is processing all of the bank's depositor accounts, preparing payrolls, and performing a multitude of daily bookkeeping chores formerly done manually.

The computer keeps traditional "hard-copy" records and passbooks, yet obtains the efficiency and speed of electronic data processing. The 390 utilizes an inexpensive ledger card with magnetic tape fused to its back. When the operator inserts the ledger card into the console carriage, the information stored on the tapes is transmitted directly into the computer. The ledger card also tells the machine how to act on this information.

The entire electronic system represents an investment by the bank of only slightly more than \$100,000.

order  
called  
System  
apoli

compu  
that  
speed  
trans  
other  
ation

addit  
used  
denic  
Under  
ters  
being  
eerin  
will  
Arts

ITT

Force  
Excha  
new g  
Syste  
Watch  
vide  
world

Watch  
infor  
feed  
ing u  
disk-  
gram  
conti

at OI

ation  
craft

COM

## NEW PRODUCTS

### RADICAL NEW COMPUTER WITH SUBMINIATURIZED MULTIPLE CIRCUITS

Fairchild Semiconductor  
545 Whisman Road  
Mountain View, Calif.

A new computer called the Martac 420, an "integrated circuit" electronic control computer, has been built by the Martin Company, Denver, Colo. The new computer incorporates integrated Micrologic circuits developed by Fairchild Semiconductor, and manufactured in six logical types.

Integrated circuits differ radically from conventional computer circuitry. The Martin Company has reduced the number of components used in a modern electronic computer from over 20,000 to about 5500, by the use of Micrologic circuits. This has resulted in an unusually reliable control computer.

Integrated each Micrologic circuit is contained in a single silicon chip no bigger than one digit in the date on a penny. It is packaged in a standard transistor can about the size of an eraser at the end of a lead pencil. More than one million hours of life tests have been completed on these elements with not one single failure.

Martac 420 is the first computer to be built using Micrologic circuits. Other computers are now being constructed using the device.

### 18-POUND COMPUTER FOR SPACE

Minneapolis-Honeywell Regulator Co.  
Aeronautical Division  
St. Petersburg, Fla.

A new computer, called Pico, weighing 18 pounds, approximately the size of a table radio, has been developed for missiles and space guidance.

Pico has for memory over 75,000 cores, set in biaxial strips; a 24-bit word can be read out in 12 microseconds without destroying its record. The computer uses welded circuitry throughout.

This small computer opens like a book, allowing access to each section for checking or repair.

Decisional Control Associates, Inc.  
644 Terminal Way  
Costa Mesa, Calif.

This company has developed some digital modules which may be flip flop, gate amplifier, or power amplifier. The FF26 Versallogic card, for example, contains six flip-flops, which may be wired for binary or decimal counting, as a shift register, or as six independent control flip-flops for either clocked or asynchronous operation.

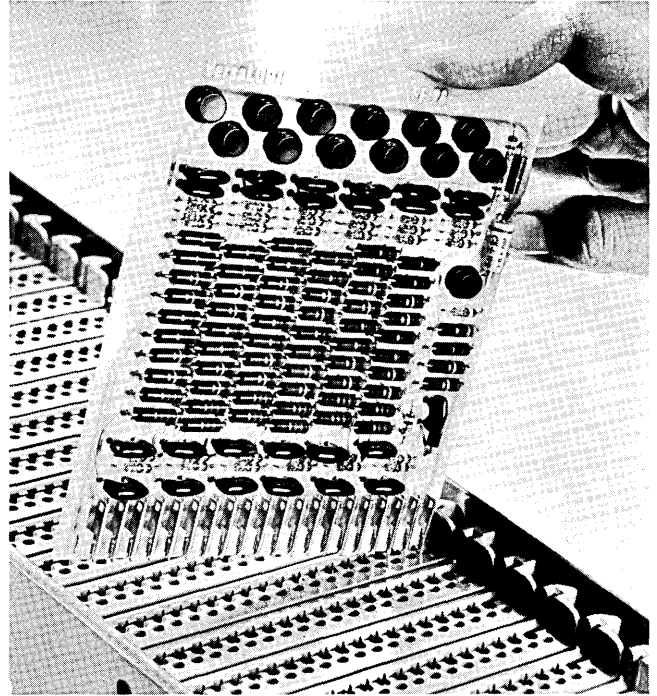

The card performs all logic and signal restoring operations at clock rates up to two megacycles.

Circuits are packaged on glass-epoxy etched circuit cards with 40 plug-in pins. Accessory equipment available includes compatible supplementary circuits and a card frame mounting 25 cards in  $\frac{5}{8}$  inches of panel space.

### FAST, SMALL ANALOG COMPUTER MULTIPLIER

Intectron, Inc.  
2300 Washington St.  
Newton Lower Falls, Mass.

A fast-response electronic analog multiplier has been developed by this company to meet requirements in computers, simulator and control systems, and special analytical instruments. The multiplier is based on the quarter square principle,  $\frac{(x+y)^2 - (x-y)^2}{4} = xy$ .

4

A number of multiplication channels can be provided by time sharing. Division can be performed by altering interconnections of the basic module or by using the multiplier with an inverse function generator.

The device is of subminiature modular construction and uses solid-state diodes and subminiature vacuum tubes combined in six plug-in modules.

#### NEW 5.5 MILLION BIT MEMORY DRUM

Digital Development Corporation  
7541 Eads Avenue  
La Jolla, Calif.

A new memory drum storing 5½ million binary bits has been developed by this company. The new drums will be installed in process-control computers at hydro-electric and steam power-generation plants. The 1100 track drum has a design life in excess of 10 years. It may be operated in an oxygen-purged nitrogen atmosphere to extend bearing life. All read-write amplifiers and selection drivers are mounted in the housing cover.

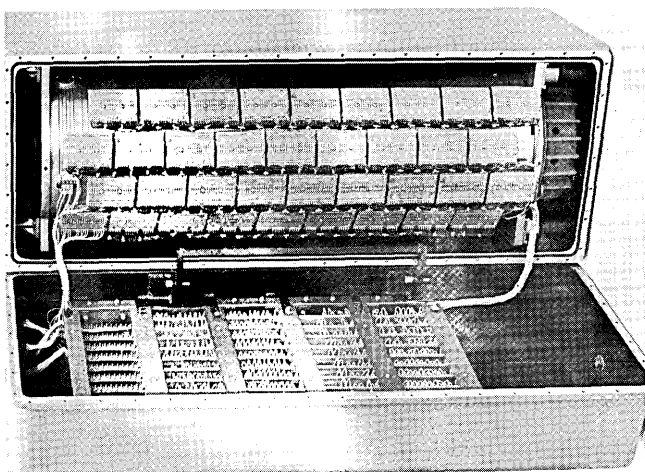

#### SELECTIVE TAPE LISTING OF MAGNETICALLY SORTED CHECKS

IBM Corporation  
112 East Post Road  
White Plains, N. Y.

A new device has been developed that speeds up the banking transit operation performed by electronic banking equipment with magnetic ink character recognition.

Called selective tape listing, it enables an IBM 1403 printer to print as many as eight individual tape listings of groups of checks sorted electronically.

This will allow many banks to "kill" a high percentage of their transit sendings (sending of deposited checks to other banks) with a single pass of documents through the machine.

If wide-form printing is required, the selective tape listing feature can be moved to one side so that the printer is quickly ready for other applications.

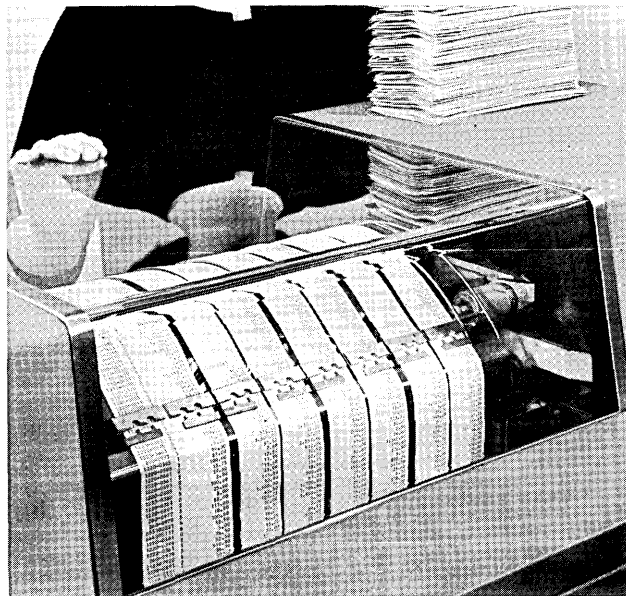

#### NEW INFORMATION RETRIEVAL SYSTEM Documentation Incorporated 7900 Norfolk Ave. Bethesda, Md.

A new, low-cost information storage and retrieval system has been developed by this company. It is called a Continuous Multiple-Access Comparator, and consists of a solid-state information retrieval machine and compact, externally-stored punched cards. It was fabricated by Benson-Lehner, Corp., Santa Monica, Calif.

The machine gives rapid answers to search questions expressed in either punched card or printed form. The system takes only one minute to search a file of 100,000 items by electronic internal comparison. Each card stores 12 addresses, providing 12 times the usual capacity of conventional punched cards. New descriptor terms and documents can be accepted at any time.

The system was designed for small and medium size information-handling needs such as special libraries, product development test files, hospital personnel records, scientific literature, and plant inventory files.

# AUTOMATION

## STEEL PLANT'S USE OF POWER

A Midwestern steel mill soon will have an automatic control installation, an analog computer to watch electric furnace operations so that optimum use of power is obtained.

The special-purpose computer, developed by Minneapolis-Honeywell's Special Systems Division, Pottstown, Pa., will supervise power requirements, automatically stopping or turning on furnaces, to prevent exceeding maximum load.

The computer, operating in real time, functions in the following way:

- continuously measures the actual energy consumed by the furnaces over elapsed time.
- "predicts", on the basis of instantaneous usage, the amount of power that will be used over the remainder of the interval.
- totals these two figures and compares the sum with the demand set point.

From this comparison, the computer's automatic programmer will stop or turn on furnaces in accordance with the sequence push-button selected by the operator. Complete knowledge of system load will be available to the operator by indicators and alarms, enabling appropriate changes to be made in priority schedules.

Application of the computer can be made in any manufacturing plant that contracts with electric utilities for large amounts of power in some intervals only and can interrupt its energy consumption.

## CONTINUOUS, AUTOMATIC CHEMICAL ANALYSIS FOR YEAST PRODUCTION

The application of continuous, automatic chemical analysis is spurring the manufacture of torula yeast — a high protein foodstuff — at the yeast plant of Charmin Paper Products Co., Green Bay, Wisc. The plant produces over 10 million pounds of yeast a year.

The AutoAnalyzer<sup>®</sup>, developed by Technicon Controls, Inc., Chauncey, N.Y., is the key to this development. The system at the Charmin plant provides process control by chemical analysis. It also monitors use and demand of chemicals.

The system is able to determine concentrations down to parts per billion for a host of materials

AutoAnalyzers are currently in use in diverse industries, ranging from antibiotics to petroleum, from chemicals to beverages, from vitamins to soap.

## MONORAIL TRAIN WITH AUTOMATIC SPEED LIMITATION

One of the features of Seattle's Century 21 Exposition is a 4-million dollar Alweg monorail train, with an automatic electronic speed control system, supplied by the General Railway Signal Company, Rochester, N.Y.

The system continually monitors the train's speed and enforces the motorman's compliance to predetermined speeds as the train proceeds over various sections of the track. An audible signal first warns the motorman if the train exceeds these speeds. The brakes go on automatically if he does not immediately slow down. Top speed on the monorail straightaway is 50 miles per hour.

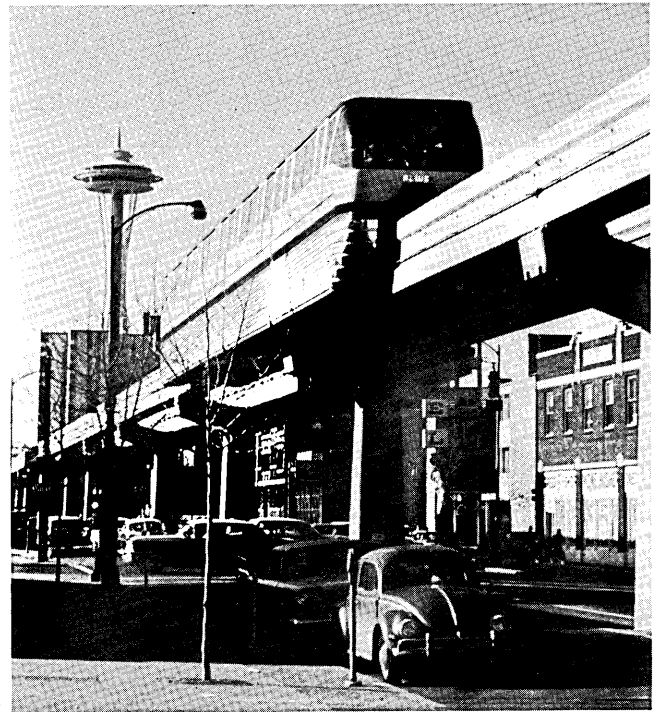

Ultrasonic sensing equipment automatically resets the circuits to operate in the return-trip direction. The train equipment is integrated with propulsion and brake controls. If the train equipment fails to receive and interpret information transmitted from the wayside, an automatic brake stops the train.

The trip of 1.2 miles from Westlake Terminal in downtown Seattle to the Fairgrounds takes only 95 seconds. During peak traffic hours, it might take a motorist as much as 20 minutes to make the same trip.

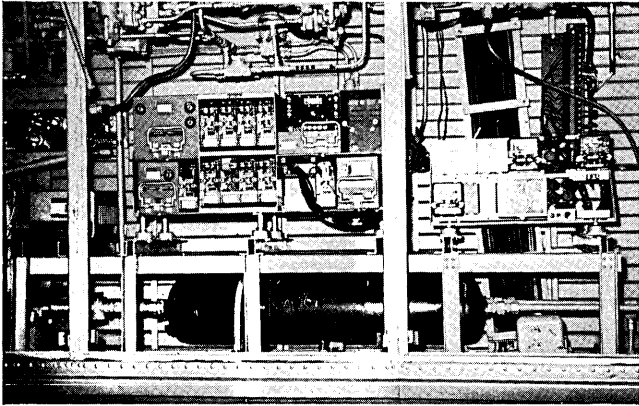

#### NEW ELECTRONIC CASH AND INVENTORY CONTROL SYSTEM FOR CAFETERIAS

The American Machine & Foundry Company, 261 Madison Ave., New York 16, N.Y. has developed a new electronic machine which will increase profits for the nation's 15,000 cafeterias through more accurate control of cash receipts and food inventory.

The new "Amficon-Inventrol" is a combination of a cash register and an inventory machine. Attachments include: a device to compute a state sales tax; a cash keyboard to indicate cash received; a unit that makes change; and an attachment that makes it possible for the operator to total a second tray while the first customer is getting out his money. Operation of the machine requires less skill and training than flash adders or experienced cashiers receive.

The new system totals the quantity of each item sold, provides a running total of sales, a total of the amount of sales tax collected, and a total number of customers served.

Solid-state techniques, diodes and transistors, have been used throughout the system, where applicable. There are no electronic tubes. Electromechanical switching and relay devices have been used in many places for reliability and economy. The entire system is built on a series of modules which make it possible to effect minor repairs with great speed and no great knowledge.

#### PAPER MILLS TAKE FIRST STEPS IN USE OF COMPUTER CONTROLS

Paper mills are getting their first introduction to computer controls. Southern Land, Timber, & Pulp Corp. is building in South Georgia a 43-million dollar pulp and paper mill that will include a General Electric 312 computer. Potlatch Forests, Inc., Lewiston, Idaho, plans to go over to full on-line, open-loop computer control on one of its two Kraft paper-making machines. A Model 2 IBM 1710 control system is being installed to do this job.

Southern Land's mill, for the first year, will study the input and output of every step in paper-making to determine optimum conditions at each stage. Based on these findings, the mill supervisors will then decide where and how to use computer control.

Potlatch first connected its computer last November. The project joined an earlier model of the IBM 1710 control system with a multi-grade paper-board machine at the "wet end". The wet end is where pulp and water are deposited on a moving wire screen to form a web of paper. Instrumentation on Potlatch's paper-board machine picks up readings on more than 40 variables — water flow, pulp consistency, etc. — and these go through an analog-to-digital converter and on to a computer. Every five minutes, readings are printed out on an operator's log sheet. A \$600,000-a-year increase in marketable paper-board is expected when the computer is fully on-line.

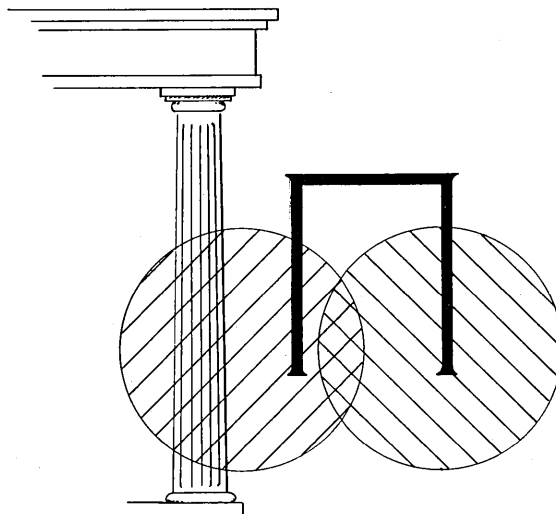

N  
stree  
the m  
puter  
Maint  
Y., w  
light  
are c  
ance  
goes  
as it  
repor  
by pu  
light  
made,  
The c  
locat  
mater  
pair  
whole  
repor  
rate  
being  
clear  
phabe  
up to  
has l  
pleme  
Chalm  
major  
new d  
& Vog  
kee,  
the p  
tanne  
produ  
accor  
that  
each  
troni  
mecha  
regul  
accur

## NEW APPLICATIONS

### NEW YORK CITY LIGHTS KEEP SIGNALING WITH HELP OF UNIVAC 60

The 75,000 traffic lights and 80,000 street lights in New York City have space in the memory of a Univac 60 Computer. The computer is located in the offices of Broadway Maintenance Corporation, Long Island City, N. Y., whose job it is to see that the street lights and traffic lights of New York City are clean, repaired, and give light and guidance as needed.

A repair truck, reached by two-way radio, goes to the scene of a light failure as soon as it is reported. It makes the repairs and reports the completion. The Univac 60, fed by punch cards, is told the location of the light, nature of the repairs, when they were made, and about 20 other items of information. The computer can be called upon to reveal the location of the nearest store of any needed material, that the truck may not have, to repair the ailing light. It can also tell the whole repair history of the light as has been reported to it.

The computer can read and remember at a rate of 100 to 1,000 times faster than a human being doing the same job. It reports in a clear typewriter hand. (A Remington Rand Alphabetical Tabulator Model 3, which can print up to 6,000 lines of information per hour and has 100 printing positions on each line, supplements the Univac in its work.)

### ELECTRONIC AREA COMPUTER IN LEATHER TANNING APPLICATION

An electronic area computer made by Allis Chalmers, Milwaukee 1, Wisc., is solving a major problem in the tanning industry. The new device, recently installed at the Pfister & Vogel Tanning Company, Inc. plant in Milwaukee, Wisc., enables the tannery to speed up the processing and insure uniform sizing of the tanned skins.

All of the pieces of leather (98% go into production of shoes) must be sized and sorted according to thickness and quality to assure that the appropriate leather is utilized for each specific final use. With the new electronic equipment, which replaces previous mechanical methods, tanned skins (all of irregular sizes) can be rapidly sized with great accuracy.

The system contains a conveyor which moves the hides past an aperture under which are 60 photoelectric cells. Above the aperture, focused on one cell each, are 60 lights. Each combination of cell and light monitors one square inch of leather. As the leather passes over the cells, in 1/2 inch increments, dark areas are recorded and added up.

The apparatus senses a constant increment of area passed across the scanning elements and produces a pulse representative of the area. An electronic counter accumulates the total pulses produced and reads out the full integrated area in square feet. The system also includes a scanning frame, a digital tachometer, scanner circuitry, and an electronic counter with readout apparatus.

Passage of an object through the frame with its photoelectric cells interrupts the illumination of specific cells, causing an immediate change in conductivity. This change is noted by the scanner which actuates the counter.

### ARMY ENGINEERS IN OMAHA USE COMPUTER FOR FLOOD CONTROL

The Corps of Engineers, Omaha District, Nebraska, is using an RCA 301 electronic data processing system to help control a river network winding more than 2000 miles through seven states.

This computer proved its capability during the Missouri Basin spring floods, providing endangered cities as much as five days advance notice of levee locations requiring a concentrated flood fight. It accurately pinpointed critical points where sandbagging was needed and estimated the needed height of temporary levees. The RCA 301, working with snow reports from key points, was used to compute a series of water surface profiles for anticipated peak discharges. Such a profile for the Floyd River was delivered to Sioux City, Iowa, five days before the high water mark was reached -- and the prediction was within 2/10th of a foot of the actual peak. In the post-flood period, the computer was put to work turning out flood damage and levee evaluation reports.

The Army Engineers, using the RCA 301, conduct river stabilization studies, determine where dikes should be erected, how much dirt or other material will be required and where in the area it can best be obtained. Among its more vital tasks is that of electronic supervision of the vast Missouri Basin reservoir system. A projection five years into the future enables better planning of water storage requirements. The computer is also used

to conduct stress studies on materials employed in the construction of retaining walls, powerhouses and other structures — all of which must be earthquake-proof because of the occasional ground tremors experienced in the Basin.

#### APPLIED DYNAMICS INC. ANALOG COMPUTATION CENTER

An analog computation center has been set up in Ann Arbor, Mich., by Applied Dynamics Inc., manufacturer of analog computers. The emphasis will be on business forecasting and trend analysis; scientific, industrial and engineering problems will also be solved.

The analog computer can be set up for business problems in about three hours' work. After another short period to adjust the potentiometers for the desired input conditions, a full year of business operation can be projected in a fraction of a second. Different business parameters can then be varied singly or in multiples by adjusting the potentiometers. The new forecast could be available virtually as soon as the adjustment is finished. Projections would be displayed permanently by being recorded using an X-Y plotter.

Prior to the establishment of this center, only 13 analog computation centers were listed in the country. Most of these were for university, governmental, or industrial research.

#### STORE OPERATION BEING "COMPUTERIZED"

Porters of Arizona (Phoenix), which has been supplying cowhands and dudes with everything from boots to saddles since 1885, will use a General Electric computer for inventory-control, billing, sales analysis, and purchasing procedures. The work will be done at General Electric's Information Processing Center at Tempe, Arizona.

Porters' chain of stores and factories has operated under an automated centralized accounting system since 1958. The previously used punched card system, with tabulating equipment, was not fast enough to meet cycle-billing deadlines and the store management was not given enough information for adequate sales analysis, according to George H. Price, credit manager. He expects the computer system will overcome these disadvantages.

The computers will figure sales commissions, city, state, and excise taxes, and even the number of trading stamps due up-to-date charge accounts. Inventory status will be kept up to date. Information furnished as

a by-product will enable management to determine which of Porters' 19 departments are the most profitable; how and when to buy; and when to have special sales in which departments. Every item in stock and every item sold will be known.

#### SAN FRANCISCO ATTACKS TRAFFIC PUZZLE

A computer has been drawn into the struggle against traffic congestion in the Bay Area of San Francisco with its six existing bridges. Statistical Tabulating Corporation has the computer, an IBM 1400-series system, at its San Francisco center.

The California Department of Public Works, Division of San Francisco Bay Toll Crossings, has been passing out to motorists pre-punched cards to indicate which bridge each motorist was crossing, which way he was going, date and hour of crossing, and whether his vehicle was private or commercial. About a half million of these cards (one-third of those passed out) with the motorists' notations, are the raw data from which STC has been working.

Cloverdale and Colpitts, traffic engineers, will use the computed information to determine its recommendations to the Department of Public Works regarding the proposed Tiburon Bridge from San Francisco to Marin County. It would be the longest suspension bridge in the world. The current studies will also analyze the need for a proposed southern crossing of the bay. In order to ensure that new crossing facilities will be adequate for future as well as present needs, simulated conditions will be computed for various population projections.

#### RETAIL CHAIN USERS NCR 390

The J. C. Penney Company, nationwide retail chain, has a new computer system developed by The National Cash Register Company.

The computer, an NCR 390, will show the amount of merchandise sold in every department in 30 of the company's West Coast stores. The new system will also compute the commissions and salaries paid to store employees, automatically calculating overtime pay as well as the amounts to be deducted for taxes, hospitalization, social security and other benefits. The J. C. Penney Company plans to install a second NCR 390 computer this spring.



## PEOPLE OF NOTE

### PRESIDENT OF MOLECULAR SCIENCE CORPORATION

James R. Nall of Los Altos, Calif., has been named president of the recently-formed Molecular Science Corp., 3939 Bohannon Drive, Menlo Park, Calif. (subsidiary of Universal Microtron Corp., Beverly Hills, Calif.).



Mr. Nall was formerly head of microelectronics research at Fairchild Semiconductor. Prior to this he had been in semiconductor and microminiaturization research at the National Bureau of Standards and at the Army's Diamond Ordnance Fuze Laboratories. He has received the DOFL Certificate of Achievement for work in photolithographic and printing circuit techniques to produce integrated electronic sub-assemblies. He shared with 4 colleagues in a \$25,000 award from the Department of Defense for his work in microelectronic technology.

### AUTHORITY ON COMPUTER SOFTWARE BECOMES DIRECTOR OF SYSTEMS PROGRAMMING FOR UNIVAC

Robert W. Bemer has been named Director of Systems Programming for the UNIVAC Division of Sperry Rand Corporation. He will be responsible for the development of major programming packages for all UNIVAC systems.



During the six and a half years prior to assuming his new post with UNIVAC, Mr. Bemer was associated with International Business Machines Corporation, his last title being Director of Programming Standards.

Mr. Bemer delivered the principal address before the annual meeting of the British Computer Society in September of 1960, the first time that this honor was conferred on an American. He will be Chairman of the IFIP Congress Symposium on Programming Languages, to be held in Munich, Germany, this September.

### IBM NAMES DR. EMANUEL R. PIORE

Dr. Emanuel R. Piore has been named a member of the corporate management committee of International Business Machines Corporation, New York, N. Y. He will continue to direct the company's scientific and technological efforts as vice president, research and engineering.

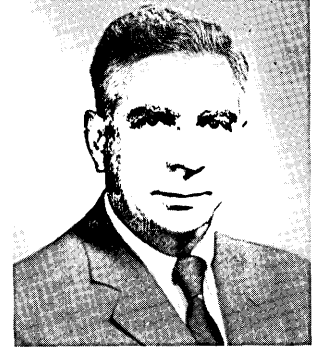

Dr. Piore is a member of the President's Science Advisory Committee and also of the Visiting Committee of the Department of Physics of Harvard College.

### CHARLES CONCORDIA AWARDED AIEE 1961 LAMME MEDAL

Dr. Charles Concordia, General Electric Company, Schenectady, N.Y. has been named the recipient of the 1961 Lamme Medal by the American Institute of Electrical Engineers. Dr. Concordia, Manager, General Analytical Engineering, for General Electric, was cited "For meritorious achievements in the design of electrical machinery; more specifically, for analyses of synchronous machine characteristics leading to improved designs and for exceptional contributions to the application and control of machines used in electric power systems."



Dr. Concordia is the author of more than 65 technical papers and of a book on synchronous machines. He holds six patents in the fields of automatic inspection, automatic control, rotating machinery, electric power systems and centrifugal compressors. He has been a member of the Council of the Association for Computing Machinery.

### WM. E. FRADY OF PACKARD BELL COMPUTER

William E. Frady has been appointed vice president and director of data and industrial systems for Packard Bell Computer Corp., Los Angeles, Calif. He came to PBC from the Aeronutronic Division of Ford Motor Company, where he served as manager of the Telemetry and of the Computer Engineering Departments for four years.

He will direct Packard Bell's activities in the field of computer-controlled and data-acquisition systems.

## Computing Centers

### ASSOCIATION FOR COMPUTING MACHINERY ELECTIONS

The membership of the Association for Computing Machinery (ACM) has elected the following officers for the 1962-64 term:

President - Dr. Alan J. Perlis, Head, Computation Center and Department of Mathematics, Carnegie Institute of Technology

Vice-President - Dr. Bruce Gilchrist, Director, Systems Engineering Technology, IBM Corporate Staff

Secretary - Herbert S. Bright, Manager, Programming and Planning, Philco Computer Division

ACM is now in its 16th year, and has a world-wide membership of 10,000, including representatives from 24 countries. More than 35 chapters in the United States hold regular meetings.

## BUSINESS NEWS

### MAGNETIC TAPE LAWSUIT: AUDIO DEVICES VS. COMPUTRON, INC.

Audio Devices, Inc., New York, N.Y., manufacturer of magnetic tape, has filed a complaint in the United States District Court in Boston, Mass., asking for an injunction and damages against Computron, Inc., Waltham, Mass.

The Court has been asked to enjoin Computron, Inc., and individuals in that company formerly employed by Audio Devices, from using techniques, equipment, proprietary information, and patents allegedly developed by Audio Devices in the manufacture of magnetic tapes.

The President of Computron, Inc., Mr. Frank Radocy, has declared that the suit is an attempt to limit improvements in the field of magnetic tape. Past litigation concerning magnetic tape has, he said, already established that its manufacture is not a unique art. He stated that, "We at Computron are producing a heavy duty tape that is a result of our own modern and advanced techniques developed at Computron, and is the outcome of intensive experimentation and testing."

### COMPUTER TO SEARCH INTERNATIONAL TRADEMARKS

Trade Mark International, Detroit, Mich., and The Service Bureau Corporation, New York, N.Y., have announced a computer service to search trademarks in every country in the world. More than one million different trademarks in 22 countries, including the United States, will have been recorded on a magnetic tape master file by SBC when the service begins operating in September. Within two years trademarks from almost all other countries will be added.

A proposed mark will be compared with a master file of trademarks in the computer. IBM 7090/1401 equipment will be used. When the comparison is complete, SBC's computer will print out a report on the marks found in various categories showing the country or countries in which the marks are registered, the expiration or reference dates, the owner or mark number, and the classification. Using this service, search time will be reduced from the present minimum of 8 months to less than a week.

The service will be internationally available.

### NEW INFORMATION PROCESSING CENTER ESTABLISHED BY GENERAL ELECTRIC

A large, modern information processing center has been established in Schenectady, New York, by General Electric's Computer Department to service organizations in Eastern New York State and Western New England. The "Schenectady Information Processing Center" will emphasize computer applications in such fields as education, government, banking, finance, manufacturing, wholesaling, and retailing. Computing services will be marketed to business, industry, and government. The center is being equipped with a General Electric GE-225 computer.

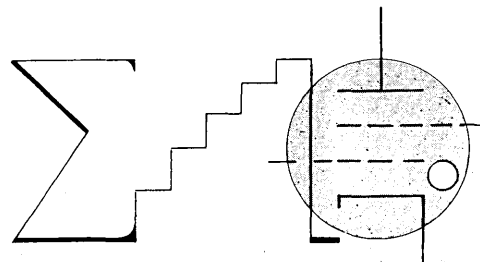

# NEW CONTRACTS

## CORNELL UNIVERSITY ORDERS CONTROL DATA COMPUTER SYSTEM

Cornell University, Ithaca, N. Y., has ordered a high-speed digital computer system called the Control Data Satellite Computer System from Control Data Corporation, Minneapolis, Minn.

The system combines two Control Data computers -- the 1604 and a desk-size 160-A that are able to communicate directly at high speed. The computers, eight magnetic tape transports, a 1000-line-a-minute printer and other auxiliary equipment will go into operation before Cornell's fall semester.

University officials report that the new addition to the computing center will be used mainly as a research and graduate academic tool for all departments of the school. Undergraduates will be introduced to computers and the computing art, with programming being made a required course for all engineering students. The biggest single users will be the Colleges of Engineering, and Arts and Sciences.

## ITT 7300 AUTOMATIC DATA EXCHANGE SYSTEM ORDERED BY THE U.S. AIR FORCE

The Air Weather Service of the U.S. Air Force has ordered an ITT 7300 Automatic Data Exchange System for use with the service's new global weather alarm system. The ADX System will be an integral part of "Met-Watch" -- a weather system designed to provide the Air Force with early indications of worldwide weather conditions in real-time.

The role of the ADX System in "Met-Watch" will be to receive incoming weather information from many teleprinter lines and feed data into a high-speed computer processing unit and a large-volume random-access disk-storage unit. The system will be programmed to select certain stations daily for continuous "Met-Watch" processing.

The system is scheduled to be installed at Offutt A.F.B., Omaha, Neb., this summer.

## IBM TO DEVELOP GUIDANCE SYSTEM FOR GEMINI SPACECRAFT

International Business Machines Corporation has been selected by McDonnell Aircraft Corporation to develop an advanced

electronic guidance computer to help steer NASA's two-man Gemini spacecraft into orbital rendezvous with another spacecraft. McDonnell is prime contractor to the National Aeronautics and Space Administration for the Gemini spacecraft.

IBM will design and develop the Gemini guidance computer and its manual data insertion unit which enables the astronauts to enter new information into the system during flight. IBM will also be responsible for inertial guidance system performance and integration and for connecting the computer with related devices to be supplied by other contractors.

The work will be carried out at IBM's Space Guidance Center, Owego, N.Y., where other NASA projects are currently underway.

## NASA ORDERS FOUR GE 225 COMPUTERS

The National Aeronautics and Space Administration has ordered four GE 225 computers which will perform scientific and engineering data analysis on the design of the Saturn booster vehicle. Two of the computers have already been installed at NASA's George C. Marshall Space Flight Center at Huntsville, Ala. The other two are scheduled for installation at the center within a few weeks.

Two of the GE 225 computers are for the center's Propulsion and Vehicle Engineering Division, one for the Aeroballistics Division and the other for the Astrionics Division. One computer is a real-time, digital-acquisition, processing system for testing of the Saturn structural design. The other computers will check aerodynamic, guidance and control design associated with the Saturn.

All four computers have been manufactured by General Electric's Computer Department, Phoenix, Ariz.

## F.A.A. AWARDS \$1.8 MILLION CONTRACT

The Federal Aviation Agency awarded a \$1.8 million contract to General Precision, Inc., Tarrytown, N. Y., for work to be done on air traffic control data processing and display equipment at the National Aviation Facilities Experimental Center (NAFEC) near Atlantic City, N.J. The contract calls for putting into operational readiness part of the equipment previously delivered for evaluation.

## INDIA COMPUTER TO BE PROVIDED BY EAI

A contract to produce one of the first computers for India has been awarded by the India Supply Mission to Electronic Associates, Inc., Long Branch, N.J.

The computer, a PACE 231R general purpose analog system, will be installed at the Ministry of Defense in New Delhi and will be used by Indian companies and organizations engaged in scientific research projects for the government.

## SIGNAL CORPS AWARDS \$5-MILLION CONTRACT FOR SATELLITE COMMUNICATION

The radio division of The Bendix Corporation, Baltimore, Md., has received a \$5-million contract from the U.S. Army Signal Corps for the design and construction of ground terminals for a program to determine the feasibility of a satellite communication system. The contract covers design, development, and production of an air-transportable, self-contained ground complex for tracking and communicating with satellites.

The project is a National Aeronautics and Space Administration research and development program to determine the feasibility of an around-the-world communications system using satellites at an altitude of 22,300 miles.

## New Firms, Divisions, and Mergers

### DATA PRODUCTS CORPORATION FORMED

Data Products Corporation, 8535 Warner Drive, Culver City, Calif., has been formed to supply technologically advanced products and services to the data processing industry, including communications and automation. The company will concentrate its efforts on design, development, manufacture and marketing of equipment and services. The company is headed by Erwin Tomash, Pres.

The Data Systems Division of the Telex Corporation has been separated from Telex and added to this new corporation. The division's two products, a Mass Random Memory System and a High-Speed Line Printer, were included in the transfer. Both products are in production and have backlogs of orders.

Informatics, Inc., an organization headed by Dr. Walter Bauer, has become a subsidiary of Data Products Corporation and will specialize in computer system analysis and programming services.

### ON-CALL DATA VANS FOR HIRE

Truck-borne data acquisition and processing equipment is now available for short-term leasing to the electronics industry. A Boston firm -- Applied Data Systems, Inc., -- is offering immediate on-location access to a full range of integrated analog sensing, sampling, digital conversion, computing and processing equipment.

A Packard Bell Computer PB 250 is the heart of the mobile system. It communicates directly with a wide variety of equipment, including paper tape readers and punches, card readers and punches, magnetic tape transports, high speed buffer registers, multiplexers and/or commutators, and digital-analog conversion devices.

A prospective customer obtains the mobile service by calling the ADS office and specifying such application requirements as information sampling rates, number of channels, data formats, and other processing details. Using standard equipment, ADS selects the proper system mixes, control settings, and programming packages. The mobile data systems are then dispatched to the installation site.

The ADS control computer fits snugly in one corner of the ADS van. The PB 250, about half the size of an automatic vending machine, uses solid state circuits and has a highly reliable memory. Even when the van is moving, the computer can be operated from a standard battery at peak performance.

### DATA SYSTEMS DEVICES OF BOSTON, INC., FORMED

Data Systems Devices of Boston, Inc., of Boston, Mass., and Minneapolis, Minn., has been formed to manufacture high-speed printing devices and other peripheral equipment for computers. The company will have an office in Minneapolis; headquarters and manufacturing will be in the Boston area.

The firm's first product will be a printer capable of speeds up to 1000 lines per minute with a skip rate of at least 50 inches per second.

made  
has  
of the  
rt of  
role

this  
d his  
in a  
es in  
and  
ills—  
nt be  
ided  
e our  
ation  
f the  
will.  
e ad-

aca-  
g the  
er of  
ately  
ers of  
n all  
one  
proxi-  
1960,  
ng in  
d the  
there  
r the  
with  
I can  
likely

g the  
share

es—a  
matics  
y ap-  
n the  
ntial  
pro-  
ld.

ram;  
many  
earn-  
sume  
r ad-  
need  
clear  
ming  
ative  
look  
enais-  
n age  
profes-

1962

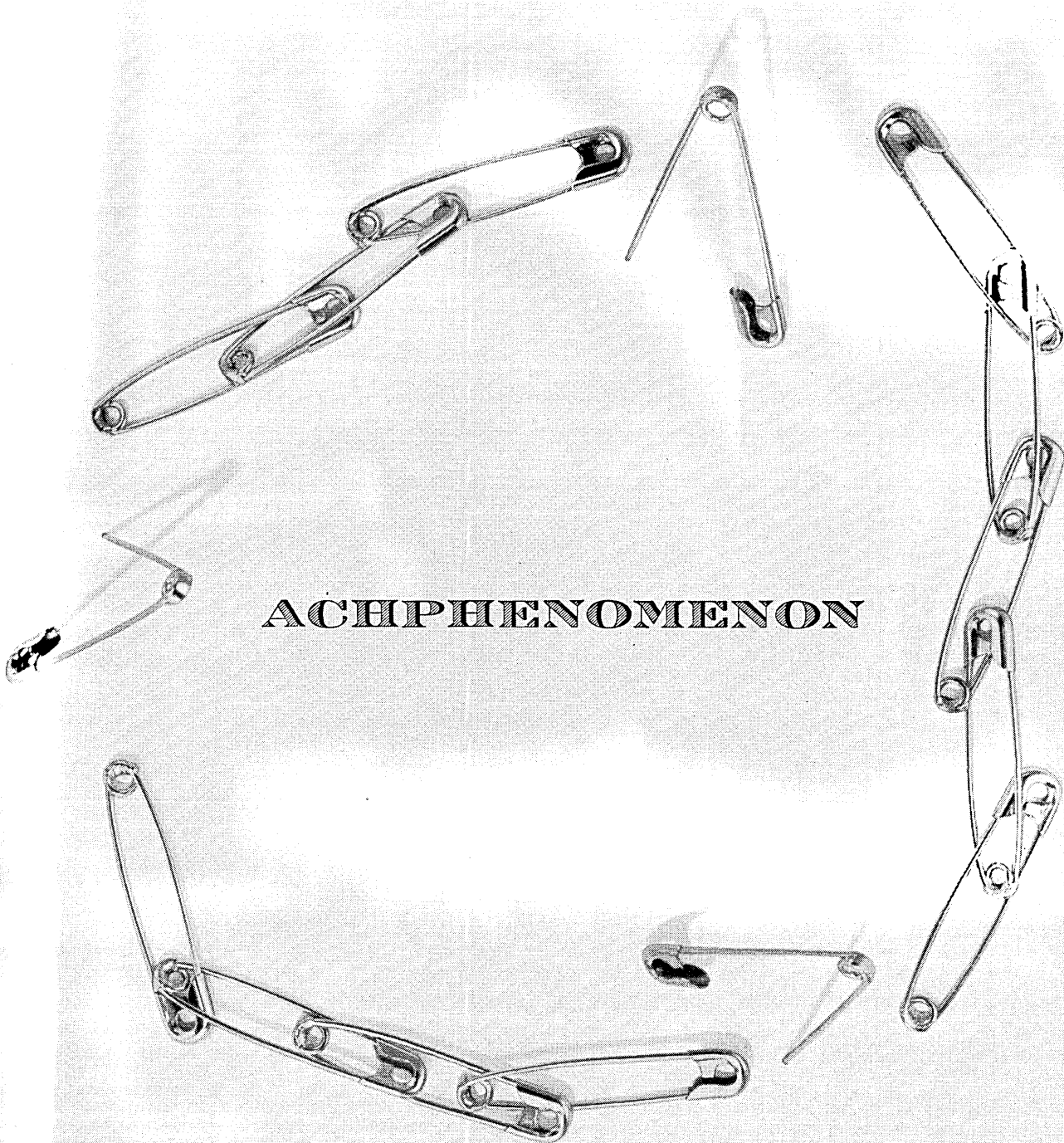

## ACHPHENOMENON

A cursory analysis leads some to say that five breaks and rejoins are required to make a fifteen-link chain out of five chains of 1, 2, 3, 4, and 5 links. If you say four, you show imagination and perception. The optimal solution, three, requires the ingenuity, acumen—Achphenomenon, if you will—that is welcome at Litton Systems.

We are looking for engineers who can disregard the brick-and-mortar approach and see the unobserved. Engineers who avoid the tendency to think in traditional channels. If you're relatively unhampered by stereotypes, send a resume to Mr. Don B. Krause, Manager Professional and Scientific Staffing. Anticipate a prompt reply.



**LITTON SYSTEMS, INC.**

**GUIDANCE AND CONTROL SYSTEMS DIVISION**

5500 CANOGA AVENUE, WOODLAND HILLS, CALIF.

Guidance Systems • Control Systems • Computers • Computer Components

An Equal Opportunity Employer

# High School Programming Course— Assessment Two Years Later

Marvin M. Wofsey  
Center for Technology and Administration  
The American University  
Washington, D. C.

Programming and computer courses are being taught more frequently as a part of the high school curriculums. Two years have elapsed since the first computer programming course was taught in 1960 in a high school, Northwood High School, Montgomery County, Maryland. Perhaps now is time to pause for a moment and investigate whether or not such courses are worth the effort both of those who teach them and of those who take them.

Has the course helped the students in their college studies? Did it influence their choice of a major? Have any of them actually worked in the computer industry? What was the influence of this course in the choice of a career? In summary, was the course of value to the student, science, and the computer industry?

In 1960 I was the Director of Data Processing of a Navy bureau with a newly-installed UNIVAC SS80 and a tape computer on order. The original intent of the high school course was to introduce high school students to the computer, and to provide them with a powerful tool, if ultimately their careers turned to science. A second purpose was to develop a group of programmers to work at the Navy installation between college terms and possibly after graduation.

Northwood High School in Montgomery County, Maryland, was the site of the computer programming experiment.<sup>1</sup> The school proposed 56 juniors and seniors with high I.Q.'s, good class marks, and mathematical aptitude. They were told the class would be from 9:00 a.m. to noon Saturdays, with eight hours of homework per week. There was to be no school credit and no one was promised a job. The Remington-Rand programmer aptitude test was given to them, and the results are shown in Table I. As may be seen, it was not very successful as a selection device in this situation because of the concentration of those with a mark of "A."

TABLE I  
PROGRAMMER APTITUDE TEST RESULTS

Grade	Number
A+	1
A	33
B	3
C	2
TOTAL	39

The A+ student, 18 A students, and one B student were selected for the class. (The B student, by the way, turned out to be one of the best programmers and is on the Dean's List in one of our

best technical universities.) Thirteen were seniors, seven were juniors. (As a group, the seniors were not more successful as programmers than the juniors.) The class was given a normal programming course on the card UNIVAC SS80.

## Questionnaire 2 Years Later

After two years a questionnaire was sent to the 19 students who could be located. Completed questionnaires were returned by 14 of the 19 and comprise the data for this article. All 14 are attending a college or university, although one of the girls has married and is attending a university full-time. The schools attended are listed in Table II.

TABLE II  
COLLEGE OR UNIVERSITY ATTENDED

College or University	Number
Massachusetts Institute of Technology	3
University of Maryland	2
Case Institute of Technology	1
Columbia College	1
University of Michigan	1
Johns Hopkins University	1
University of Pennsylvania	1
United States Naval Academy	1
Virginia Polytechnic Institute	1
Wake Forest College	1
Yale University	1
	14

## Effect on College

Counting A as 4, B as 3, C as 2, and D as 1, average college marks ranged from 3.9 to 2.4 with an average of 3.3. Significantly, five students from the class are majoring in mathematics, three in physics, and two in engineering. Eight of the fourteen felt that the course had helped them in their college studies. One said: "It helped to develop an interest and enthusiasm in an area of my 'major,' which I intend to pursue further. Specifically, the course helped in logic, organization and general study habits."

One student felt that the course did not help him directly, but added: "However, it trains a person to think in a logical, systematic way, and to allow for all possibilities. This is invaluable in a classroom."<sup>2</sup>

<sup>1</sup> Rosemary Hills Elementary School, Montgomery County, Maryland, was the site of a machine language programming course early in 1962. The course was given for school credit to selected students in the fourth to sixth grades. Also a 57 instruction program was written and debugged by 24 of the 30 students.

<sup>2</sup> Dr. Burton R. Wolin of System Development Corporation reports similar reactions in a Santa Monica analysis.

Every p  
an enti  
paper  
micros  
amazin  
techniq  
Using  
ing of  
makes  
reducti  
with th  
Actu  
enough

Only two felt that the course would not be helpful in their future; two others were doubtful. Eleven of the fourteen have taken additional computer courses.

### Effect on Employment and Vocation

When questioned concerning employment in automatic data processing, eleven had had such employment during the summer of 1960, nine in 1961, and nine anticipated it in 1962. In each of the years 1960 and 1961, eight were employed as programmers, the others as operators or data processing clerks.

One of the questions asked concerned the intended career of the programming students. Table III lists these fields. The choices exceed 14, since some respondents were considering more than one field.

TABLE III  
INTENDED CAREER

Vocation	Number
Mathematics	4
Physics	4
Teaching	4
Engineering	2
Navy Officer	1
Languages	1
Undecided	1
	17

Five respondents felt that the course influenced their choice of career and three others were undecided concerning its effect. Two of the answers follow: "The programming course allowed me to work at Goddard, where I became acquainted with physical problems dealing with astronomy (orbit calculations), in which I became very much interested."

"It is one of the chief causes for my original interest in math, one of my present career considerations."

Twelve of the fourteen believed the course would help them in their careers. Some of the answers are quoted:

"Almost all areas of science and mathematics today utilize computers by necessity to a greater or lesser extent. Since this will undoubtedly be my career, there is no question that it will help."

"Many problems in physics involve fantastic amounts of calculations for which a computer provides the ideal method for solution."

"To the extent that it will be helpful in analyzing the more complex computers presently coming into the fleet, especially in the field of nuclear submarines. Further, if I should choose to enter naval research, it will be compulsory that I have a knowledge of computers."

"Summer employment."—This last reply is particularly interesting, because the average summer income of the nine who worked in 1961 exceeded \$1,000. This places them in the top bracket of college student summer earnings, despite the fact that some were working in between the Freshman and Sophomore years and the others had not yet attended college.

### Other Comments

Practically all replies indicated a belief in the importance of taking such a course during the junior

or senior years in high school. Some of the more provocative replies follow:

"It provided me with a means of support and earning power which many high school students with academic concentrations do not have. It gave me training to get a job with good prospects and a means to finish college."

"Besides the acquisition of background and fundamentals, I have lost a great deal of the course through lack of application. In a very practical sense, it was not then necessary to my educational career, since I was unable to make use of the information." This reply points out the necessity of studying further or of actually working in the field. Without either or both of these the benefits tend to be transitory.

"I had always done well in mathematics courses in school, but this was the extent of my attachment for the subject. Never before had I been so stimulated and challenged in an academic pursuit. This alone, aside from any material benefit I may have derived from the course, is sufficient for my high estimation of it."

"I got a job in line with my interests early in my college career, and was able to supplement my classroom knowledge."

"It enabled me to visualize the potentiality of computer data processing and to orient myself with science and math in modern-day engineering."

All replies favored course repetition, possibly with a newer computer, for other students.

Some comments to the unsigned questionnaires are listed below:

"To the majority of students the value of the general understanding of computers to be gained from the course is not commensurate with the time involved. I would not recommend it as a regular part of the High School curriculum." This comment emphasizes the necessity of careful student selection.

"The course and what it has led to has been one of my most rewarding experiences."

A final comment—"The course I took at Northwood did not prove directly applicable, since I never once even saw a SS80 after finishing the course. But the opportunities that presented themselves as a result of this training have helped in determining my career, given me three summer jobs which I would not have otherwise had, and taught me how to think a little better. . . . I think other high school juniors and seniors can get results equal to mine."

### Summary

The course definitely was worth the time and effort involved. It directed college effort towards a major in one of the scientific fields, and helped most of those concerned in their college study. Almost 80% of the respondents worked in the computer field and almost 30% were influenced in their choice of career.

One of the employers of four of this class, after the first summer was over, said: "They put us on the air." I found that those employed at the Navy bureau programmed at least as rapidly and as accurately as my best other programmers. From my own standpoint the student reaction to the course and the heart-warming questionnaire returns have resulted in one of my most rewarding experiences.

# Computers in Medicine: Progress and Potential

Moses M. Berlin, Engineer

Programming & Analysis Laboratory, Sylvania Electronic Systems—East  
Needham, Mass.

(Paper presented at a conference on aerospace medicine, Dayton, Ohio, May, 1962)

Computer engineers and medical specialists have collaborated, in recent years, on the application of digital, analog and special purpose electronic systems to medical diagnosis and research. This collaboration has produced a number of useful tools for the physician, and in addition has helped create a strong foundation for the establishment of a new field: Medical Electronics. The useful tools directly attributable to the joint efforts of engineers and doctors have aided in the diagnostic process and have afforded opportunities for palliative treatments which otherwise would be less effective or impossible.

Some of these accomplishments will here be described, and using these accomplishments as a basis, potential applications will be discussed. Each of the applications deserves more attention than space permits, but this space will allow the scope of the field to be demonstrated.

## Three Levels of Application

In the following discussion of computers in medicine three perhaps arbitrary levels of application have been established. My intention is to demonstrate how the classical uses for data processing, which have been implemented in other fields, can similarly be applied to medicine.

The first level of applications, though not actually examples of computers in medical research, make use of electronic sensory devices which have proved useful to doctors, and also have produced outputs that presently cannot be analyzed fully without a computer. I suggest, therefore, that the data analysis techniques applied in other fields, be applied to the analysis of the sensory outputs produced by the electronic measuring devices described on the "first level."

The "second level" of application includes devices which make use of the computer for data analysis, and in addition for data reduction and interpretation. On this level, too, computer techniques are applied to medicine as they have been in other fields, and the value of such application is demonstrated.

The "third level" is the one on which all the computer's facilities are implemented. Examples are given of computer applications to medicine which involve data analysis, reduction, retrieval, computer simulation, and computer prediction on the basis of data correlation and comparison.

<sup>1</sup> The fetal electrocardiogram has been manufactured by Hemathermatrol Corp., and the Park Electronics Co. In 1961, *Electronic News* reported in separate articles the work of researchers at the Indiana University Medical Center and the Uruguay School of Medicine in Montevideo, on the device. This resulted in an interchange of information, which aided the design and development of the device.

## Applications: The First Level

The first group of applications, assigned to the first level, are special purpose in nature, compact by design.

a) For example, the obstetrician has encountered difficulty in isolating the fetal heartbeat, due to the stronger and dominant beat of the mother's heart. An electronic device which detects, isolates and records the fetal electrocardiogram during labor is now available.<sup>1</sup> An electrode is inserted through the birth canal and attached to the fetal scalp. When the points at the tip of the electrode touch the fetal scalp, a plastic sleeve covering the points is pushed forward, inducing them to pierce the fetal scalp skin. An electronic circuit with positive, negative and neutral ground is established. The fetal monitoring device produces an accurate reproduction of wave shape on an oscilloscope; a neon bulb flashes for each heart beat; and a continuous readout by a cardiometer is produced audibly, and is permanently recorded on an electrocardiograph. Similar devices register, in addition, the arterial pressure of the mother, and indicate possible injurious repercussions which such pressure may have on the fetus. The device is used to detect possible evidences of illness in the unborn child which may require immediate medical attention upon birth. The electrocardiograph has produced data which cannot readily be interpreted due to their diversity; this data can eventually be processed by computer, and undoubtedly, will provide useful information for diagnostic study.

b) A second example of application on the first level is an ingestible measuring device which measures internal physiological properties without introducing conditions that might affect the measurements.<sup>2</sup> The pill-size device is 0.7 cm in diameter and 2.5 cm in length, and consists of an inductance and a capacitor, each of which may serve as the transducer. An external transmitter supplies bursts of energy whose frequency is at or near the resonant frequency of the pill. A part of this energy is absorbed by the pill and when the transmitter is turned off, the pill dissipates this absorbed energy at its own resonant frequency. The frequency of this returned energy is a direct measure of physiological phenomena.

The ingestible device has been used in clinical tests to detect and record pressures in the gastrointestinal tract. Its almost infinite life allows it to be

<sup>2</sup> Radio Corporation of America designed and constructed the models on which the ingestible measuring device is based. Airborne Instruments Laboratory, Inc. is currently manufacturing the device.



permanently implanted in the body for periodic measurements.

The similarity of the device's outputs to radar outputs suggests that computer techniques used to analyze radar signals be applied to the analysis of frequencies generated by the ingestible measuring device.

c) Another example of electronic devices for internal measurement is a microminiature device for intravascular diagnosis. It has been applied to detecting and recording intracardiac sounds while simultaneously producing both artefact-free pressure measurements and blood samples from a single catheter.<sup>3</sup> The cardiologist can obtain accurate readings without distortions that result from fluid-column catheters, due to the gravity and viscosity of the fluid.

The microminiature micromanometer is an electromagnetic device mounted at the tip of a catheter; its diameter is 2.6 millimeters and its length, 6 millimeters. Its sensitivity to liquid pressures and murmurs allows it to transmit intracardiac sounds, which the device filters and records. Outputs are produced on an oscilloscope and on an audio tape recorder.

d) Applications of electronics to medicine have not been limited to the United States. In Russia, scientists have developed an instrument which uses high-frequency sound waves to diagnose illness.<sup>4</sup> The device, called a Biolocator, consists of a piezo-electric reciprocal transformer in a vessel containing distilled water. Although the device is in the experimental stage, its method of operation is of interest because of its possible use in cardiography. In operation, a rubber membrane is applied to the body. Ultrasonic waves are then transmitted through the membrane. The piezo-electric crystal traps are reflected waves from the oscillations of the water and converts them into electrical pulses. These are amplified and transmitted to a cathode ray tube. The Biolocator will be used to detect the narrowing of cardiac valves, which otherwise goes undetected in the ordinary cardiogram. Moreover, the device is more sensitive than X-ray to tissues of certain thicknesses, thus suggesting its use in detecting malignant and non-malignant tumors at an early stage.

#### Applications on the Second Level

More complex versions of devices heretofore described, and in some cases, combinations of such devices, have been used in medical research. The complexity of the devices, the additional tasks they perform, and their actual or potential implementation of additional computer facilities, place them in a second category, on a second level of application.

a) An example is a medical data telemetry system which was introduced in 1961.<sup>5</sup> The system measures fourteen physiological parameters of high-altitude aircraft pilots and telemeters the data to ground sta-

<sup>3</sup> Dallons Laboratories, subsidiary of International Rectifier Corp., designed and manufactured the micromanometer and other bio-electronic monitoring devices which have been used in the Mercury project and for private and hospital use.

<sup>4</sup> Research on and development of this device is being performed by the U.S.S.R. Research Institute of Medical Instruments and Equipment, and by the Institute of Biophysics of the U.S.S.R. Academy of Sciences.

<sup>5</sup> The telemetry system was developed by Gulton Industries, Research and Development Division, and CG Electronics, a subsidiary of Gulton.

tion systems where they are recorded and processed. The parameters include: seven temperature measurements taken at various parts of the body; galvanic skin resistance measured by electrodes attached to the calf of each leg; respiration flow detected by strain gauges mounted in a face mask; respiratory volume determined by a chest-band strain gauge (either respiration flow or volume is transmitted); and electrocardiograph signals, respiration rate, heart rate and systolic blood pressure.

The signals from the various sensors are amplified to fall within the 0 to 10 volt range. The system's airborne and ground station conversion equipment includes an analog-to-digital converter which produces non-return-to-zero digital signals representing each physiological parameter. As each value is computed, it is recorded on a tape recorder. Some of the data are currently displayed, thus allowing for both in-flight and post-flight analysis of the physiological data.

b) Computer techniques are finding application in medical research and experimentation. One example of such application is the Cytoanalyzer.<sup>6</sup> This instrument automatically reads microscope slides of smears prepared from the cells of body secretions and determines whether or not abnormal cells are present among the normal ones. The smear image is presented by an optical microscope and converted into an electrical signal by a Nipkow disc microscanner. A series of video pulses is produced, with the duration of each pulse in direct proportion to the length of the nucleus chord of each particle and the amplitude of absorption. Selection circuitry determine whether or not the particles fall within established cytological rules for acceptance as cell nuclei; totalizers count the number of particles which are categorized as normal and abnormal. Whether or not the smear is normal is determined on the basis of a percentage of abnormal counts after an established number of normal counts.

Special purpose computers have been designed for application to specific medical procedures. Two examples follow.

c) A computer system has been designed for analysis of radioactive specimens. The Read-O-Matic Computer Scaler Well Counting System<sup>7</sup> employs a spectrometer to selectively measure specific gamma radiation energies, excluding other energies. The computer is an "events-per-unit-time" device and is used for work involving medium and long time base intervals. Its applications include: measurement of urinary content; measurement of red cell mass in the diagnosis of pernicious anemia; measurement of fat digestion and absorption; and studies of thyroid function. The computer can be used in applications which require counting of gamma-emitting isotopes in liquid or solid form.

In addition to console display outputs, the computer produces permanent records on paper tape.

d) A final example of application on the second level is a compact and highly reliable computer spe-

<sup>6</sup> The Cytoanalyzer was developed by Airborne Instruments Laboratory with the support of the American Cancer Society and the National Institutes of Health.

<sup>7</sup> The Computer was designed and manufactured by C. W. Reed Co., Automation Division, and the Landsverk Electrometer Co.

cially designed to measure circulating blood volume, by means of the radio-isotope-dilution principle. The Volemetron<sup>8</sup> thus allows the physician to obtain accurate and frequently repeated determinations of blood loss, and thus to determine how much blood must be replaced. Some examples of its usefulness are given below.

The Volemetron measures the radioactive content of a dose of radioactivated albumin, which is to be injected into the patient. When the dose has been measured, a sample of blood is taken from the patient to be used as a reference for determination of blood volume loss. Following injection of the albumin, the radioactive content of the syringe used for injection is measured. (This radioactive content is due to un-injected albumin.) In addition, a measurement of background radiation is taken. These are subtracted from the first measurement, thus "correcting" the first measurement. After a ten-minute interval to allow the blood to circulate, a sample of blood is withdrawn from the patient, at a different point from the one of injection. The amount of dilution of the albumin is measured, giving an accurate measurement of blood volume.

The Volemetron is a self-contained, mobile instrument which can be operated by personnel of ordinary technical competence. Its gauge provides for adult or child measurements. Its ancillary equipment—syringes, needles, sample tubes—are expendable.

The instrument includes built-in alarm devices which prevent the use of doses whose activity is greater or less than necessary for accurate measurement. Thus there is no radiation hazard.

The instrument has been used successfully to monitor blood loss during operational procedures, where over- or under-transfusion can be fatal. It has been applied to monitoring concealed hemorrhages, and for the diagnosis of hypervolemia, where it is necessary to remove an exact amount of blood at a propitious time. In general, the accuracy, speed, and convenience of the device make it possible to broaden the scope of blood-volume studies in the laboratory, operating room and clinic.

### The Third Level of Application

The applications thus far described have been assigned to the first two levels. On these levels, many other electronic devices have been developed, and many will be. At present, medical doctors are most desirous of special purpose electronic instruments which accomplish specific tasks reliably, in diagnostic and clinical study. It is, however, on the third level, that the greatest potential exists. On this level, digital computers, with their well-known facilities of speed, accuracy, reliability, and memory capacity, can serve medicine in a highly beneficial manner.

On this level, the digital computer has been applied in psychological studies to reduce and analyze large amounts of data. In the field of behavioral science, computers have been used as pattern generators for perceptual research and for simulation of interaction in small groups.

There are a number of applications in the diagnosis and treatment of heart disease. Computers have been used for electrocardiogram interpretation; integration of electrocardiograms, phonocardiograms, ballistocardiograms, and arterial pulse; statistical analysis of clinical data; cardiovascular physiology studies; and arterial physiology research.<sup>9</sup>

On the basis of these applications it is possible to envisage other computer applications on the third level. Two examples of such applications will now be discussed.

### The Medical Computer Center

Medical research, like research in other fields, suffers when research findings are not widely and rapidly disseminated. In the case of medical research the importance of dissemination is quite literally a matter of life and death.

A medical computer center, or a group of centers which would be linked with one establishment, could serve to compile, categorize and make known current activities in many branches of medical research and practice. The center would consist of a large digital computer with many types of memories and input-output equipment: card; paper tape; magnetic tape; magnetic cores; and discs.

When the amounts of medical information fed into the center exceed its storage and processing capacity, subsidiary centers would be used for specific branches of research. Thus if a doctor desired literature on the treatment of a certain disease, he would refer to the center, which in turn would communicate with the subsidiary center for the disease. Rapidly, data retrieval would produce the desired sources of literature, and possibly, a reprint of the literature.

It is often said and often agreed that output from computers is only as good as the input. What does this imply in the case of a medical computer center?

The value of this center would be constrained by the limitations of the medical and computer specialists who would maintain and use it, and would depend, for its success, on devoted collaboration.

The opinions of medical researchers and practitioners on a computer center range from effusive optimism to cynical pessimism. This can be seen from the following:

"It is difficult to estimate the effect on medical practice of the inevitable delay in the application of new preventive medicine methods, diagnostic techniques or therapeutic measures. It seems highly desirable to have computer aids to make current information readily available in whatever detail is required, for these will make it possible for physicians to evaluate the potential usefulness of information, under the particular circumstances at hand."

The following example is then given:

"Consider the delay from the time of its publication in the literature to the time of the general

<sup>9</sup>A number of papers on these applications were delivered at the Scientific Sessions of the Heart Association of Southeastern Pennsylvania, on "The Application of Computers in Cardiovascular Disease." Some of the papers have been published in *Science*, and in *Circulation Research*.

<sup>8</sup>The Volemetron was designed by Dr. John Williams, Beth Israel Hospital, Boston, and is manufactured by the Atomium Co. The instrument is described in a paper cited in the bibliography.

use of the preventive measure for retrolent fibroplasia, a disease causing blindness in premature infants (and prevented by lowering the oxygen content of the incubator). During this time approximately 5,000 cases of blindness occurred from the cause. Let us assume these cases might have been prevented by computer information methods, at a cost of 20¢ per case, or, \$1,000. Observing that for each case of blindness about \$10,000 will be spent by city and state governments for special educational and other facilities to care for these blind children, we note that a \$50,000,000 saving could have been made."<sup>10</sup>

On the opposition side, in the published proceedings of a Congressional hearing on biomedical research, a "law" was stated on why there is reluctance to use data retrieval systems.

Moore's law: "An information retrieval system will tend not to be used whenever it is more painful and troublesome for a customer to have information than for him not to have it."<sup>11</sup>

The "law" demonstrates an extreme feeling of cynicism on the part of some.

A large number of doctors have opinions which fall between these two extremes. They feel that a medical computer center would be desirable, but its implementation must follow from careful planning and thorough preparation of data. Some doctors suggest that the data storage and retrieval capabilities first be applied to clinical studies which would aid in screening small groups of patients for further treatment. Thus, the computer center should first be applied locally, handling data on relatively small groups. A medical computer center of this type is being established in Michigan by the Commission on Professional and Hospital Activity. There, the records of patients discharged from a group of hospitals will be processed by a computer in an attempt to improve patient care and hospital efficiency.<sup>12</sup>

#### Simulation of Physiological Behavior in Flight

b) The second example of computer application to medicine on the third level is in the field of simulation. Computers have successfully simulated mechanical processes; and in-process simulation has been accomplished.

For example, in-flight simulation which allows for comparisons between the pilot's performance and the machine's indications of "optimum" performance.

The success thus far of the Mercury project indicates that the physical condition and well-being of the human pilot can be maintained regardless of the space environment. It is reasonable to assume that during a trip to the Moon, similar physical protection will be afforded. Some of the devices that have been discussed in this paper are obviously useful for monitoring physiological behavior during space travel.

<sup>10</sup> From the paper, "Computers in Medical Data Processing," Robert S. Ledley and Lee B. Lusted, *Operations Research*, Vol. 8, No. 3, May-June, 1960, P. 299.

<sup>11</sup> The "law" appears in the published, "Hearing before the Subcommittee on Reorganization and International Organizations, of the Committee on Government Operations, U. S. Senate, 86th Congress, Second Session," U. S. Govt. Printing Office, Wash., D. C., P. 149.

<sup>12</sup> The Minneapolis-Honeywell 400 Computer is being used at the center. Dr. Virgil Slee, Ann Arbor, Michigan, may be contacted for additional information.

The "outputs" are transmittable from the space vehicle to ground recording stations.

#### Psychological Behavior

The psychological reactions and behavior of the human being in space must also be studied and in fact predicted, to prevent failures that might adversely affect the trip.

A digital computer can be used for such study, and with adequate inputs, derived from previous experience and known psychological behavior patterns, can help predict reactions during a Moon trip. The psychological environment during a trip to the Moon, naturally a function of the physical environment, can be programmed to make the pilot's adaptation easier and his performance more reliable.

For example, it may be necessary to provide a diurnal-nocturnal cycle so that the pilot can experience night and day in the space vehicle, and be able to sleep. The computer would program the duration of each phase of the cycle, and control the conditions which constitute night: darkness, less humidity, cooler temperature, less noise. The presence of fatigue in the pilot could be determined (by measurement of blood sugar content) and periods of rest would then be scheduled optimally. If more than one pilot is aboard, the relative psychological condition of each pilot would be evaluated and an alternating assignment of command established.

Such feelings as tension, depression, or elation, resulting from such circumstances as lack of contact with earth, or impending arrival on the Moon, for example, could be analyzed and to a certain degree predicted. It might be necessary to simulate the normal terrestrial condition that the ground is always down, or to narcotize the pilot to arrest any elation that might hamper his performance. If two pilots are in the vehicle, it might prove desirable to isolate them. And it might be necessary to compensate for the pilot's inability to smoke or consume alcoholic beverages.

In all, without assigning super-intelligence to the computer, it is conceivable that the machine could process various and large amounts of data relating to psychological reaction, and produce useful techniques for environmental control.

#### Summary: The Computer as a Tool

Each actual and potential application epitomizes the nature of the field of medical electronics: electronics as a tool, to rapidly process physiological and psychological variations and to help interpret them, to separate and study abnormal variations, to solve problems of diagnosis, and to perform accurate measurements quickly and reliably.

By no means is it proposed that electronics and computers are panaceas for all problems in health and medical research. Nor is it the intention of this paper to bring about "automated medicine," an inane and dangerous idea. Rather, the computer can serve to free some of the doctor's time by performing tasks he need not, thereby allowing more time and thought for the ultimate tasks: the conquest of disease, the easing of pain, the prolonging of healthful life. These tasks human beings particularly can work on; electronics can help.

The social implications of computers in medicine are not easy to evaluate definitively. They seem, however, markedly beneficial and ameliorating. Past accomplishments in the field have proved that, as in opening a safety deposit box, each half of the partnership must cooperate and contribute a key. It is hoped that past success will provide inducement to medical and computer scientists to continue in this fruitful collaboration.

### Glossary

artefact—A structure which appears in a tissue or cell, due to the use of reagents.

ballistocardiogram—A record of measurements of the movement of the body as it recoils from the contraction of the heart and the movement of blood throughout the body.

capacitor—An instrument for holding or storing an electrical charge.

catheter—A small, tubular instrument which is introduced into the body, usually to draw off fluids from a cavity, or to place an instrument in the cavity.

electrocardiogram—A record of the heart's action as indicated by changes of electrical potential occurring during the heartbeat.

galvanic skin resistance—The resistance of the skin to electric current.

hypervolemia—The condition of having a plethora of blood, and the diagnosis of which results in drawing some blood from the patient.

inductance—The property of an electric circuit by which it lags in receiving, in full measure, the force of a current, or when the circuit is cut off, in decreasing to zero.

intravascular—Pertaining to a system of vessels which convey fluids, e.g., the circulatory system.

isotope—Any of two or more forms of the same chemical element which are distinguishable by physical differences such as weight or radioactive behavior.

phonocardiogram—A record of measurements of the sounds caused by the mechanical activity of the valves of the heart, and movement of blood within the heart.

piezo-electric—Electric polarity due to pressure or heat.

spectrometer—An instrument for observing a spectrum of radiant energy such as light, heat, sound, etc., and measuring the derivation of refracted rays.

systolic blood pressure—The pressure due to the contraction of the heart by which blood is forced onward, and circulation is kept up.

transducer—A device actuated by power from one system and supplying power to another system.

### Bibliography

Note: The starred (\*) references were particularly useful in the preparation of this paper:

Beurle, R. L., "Electronic Aids for the Blind," Third International Conference on Medical Electronics, 1960.

\*Bushor, W. E., "Medical Electronics," Seven parts, *Electronics*, 1-20-61—1-19-62.

Cady, Lee D., Jr., M. M. Gertler, L. G. Gottsch and M. A. Woodbury, "The Factor Structure of

Variables Concerned with Coronary Artery Diseases," *Behavioral Science*, Vol. 6, No. 1, 1-61.

Grabbe, E. M., "Digital Computers for Automatic Control in Medical Applications," Second Annual Conceptual Symposium, Automatic Research Center, Inc., 1959.

\*Ledley, R. S., and L. B. Lusted, "The Use of Electronic Computers to Aid in Medical Diagnosis," *Proceedings of the IRE, Bio-Medical Electronics Issue*, 11-59.

Lillehei, C. W., and others, "Transistor Pacemaker for Treatment of Complete Atrioventricular Dissociation," *Journal of the American Medical Association*, 1172, 4-62.

McKnight, J. D., "Mathematical Neurophysiology," Office of Technical Services, No. 148941.

Voskresenskiy, A. D., and A. I. Prokhorov, "The Use of Electronic Computers in Various Fields of Medicine," *OTS*, 59-31020.

\*Williams, John A., and Jacob Fine, "Measurement of Blood Volume with a New Apparatus," *New England Journal of Medicine*, 264, 4-27-61.

\*Zworykin, V. K., J. J. Farrar, R. C. Bostrom, F. L. Hatke and B. J. DeBoo, "The Measurement of Internal Physiological Phenomena Using Passive-Type Telemetering Capsules," 1961 IRE International Convention Record, Part 9.

The following periodicals include articles and papers on applications in the field: *Behavioral Science*; *Circulation Research*; *Computers and Automation*; *Computer Journal*; *Electronics*; *Electronic News*; *Medical Electronics News*; *Operations Research Journal*; *Proceedings of IRE*, (November, 1959); *IRE Transactions on Medical Electronics*; *Science*.

The Office of Technical Services, U. S. Dept. of Commerce, Washington 25, D. C., publishes selected bibliographies on computer applications in medicine. The latest appeared in Sept. 1961; its publication number is SB-473.

### Acknowledgments

There are many who contributed to the preparation of this paper. Their contributions and assistance are here acknowledged with gratitude. At the same time, they are completely absolved of any responsibility for any errors or unclarity; those are entirely my own.

Carl Berkley, Radio Corp. of America; L. E. Berlin, Process Analyst; William E. Bushor, Senior Associate Editor, *Electronics*; J. T. Cataldo, Executive Vice President, Dallons Laboratories, Inc.; Fred L. Hatke, Radio Corp. of America; Dr. Martin D. Keller, Director of Clinical Services, Beth Israel Hospital, Boston; Dr. Robert S. Ledley, President, National Biomedical Research Foundation; C. W. Reed, Landsverk Electrometer Co.; Dr. John Williams, Instructor in Surgery, Harvard Medical School, and Staff Surgeon, Beth Israel Hospital.

Also the following, of Sylvania Electronic Systems-East: Dr. Lamson Blaney, Division Medical Director; Gerald Cohen, Senior Engineer; Robert Geller, Technical Editor; Dr. John A. Moody, Head, Systems Design; Martin Cooperstein, Manager, Programming and Analysis; members of his technical staff, including R. W. Carpenter, W. L. Congleton, A. H. Hatch, J. E. Lynch, M. Sadwin and P. Segenchuk.

## CALENDAR OF COMING EVENTS

(Continued from Page 6)

Aug. 21-24, 1962: 1962 Western Electronic Show and Convention, California Memorial Sports Arena and Statler-Hilton Hotel, Los Angeles, Calif.; contact Wescon Business Office, c/o Technical Program Chairman, 1435 S. La Cienega Blvd., Los Angeles 35, Calif.

Aug. 27-Sept. 1, 1962: 2nd International Conference on Information Processing, Munich, Germany; contact Mr. Charles W. Adams, Charles W. Adams Associates, Inc., 142 the Great Road, Bedford, Mass.

Sept. 3-7, 1962: International Symp. on Information Theory, Brussels, Belgium; contact Bruce B. Barrow, Postbus 174, Den Haag, Netherlands

Sept. 3-8, 1962: First International Congress on Chemical Machinery, Chemical Engineering and Automation, Brno, Czechoslovakia; contact Organizing Committee for the First International Congress on Chemical Machinery, Engineering and Automation, Vystaviste 1, Brno, Czechoslovakia.

Sept. 4-7, 1962: British Computer Society Annual Conference, Cardiff, South Wales (immediately after I.F.I.P. Congress in Munich); contact G. J. Morris, International Computers & Tabulators Ltd., Putney Bridge House, London, S.W. 6, England

Sept. 19-20, 1962: 11th Annual Industrial Electronics Symposium, Chicago, Ill.; contact Ed. A. Roberts, Comptometer Corp., 5600 Jarvis Ave., Chicago 48, Ill.

Sept. 19-21, 1962: 7th National Conference of the Bendix G-15 Users Exchange Organization, Sheraton Hotel,

Philadelphia, Pa.; contact Dr. Arthur L. Squyres, Chairman, Bendix G-15 Users Exchange Organization, E. I. du Pont de Nemours & Co., Inc., Eastern Laboratory, Gibbstown, N. J.

Sept. 19-22, 1962: Institute on Information Retrieval, Univ. of Minn., Minneapolis 14, Minn.; contact Director, Center for Continuation Study, Univ. of Minn., Minneapolis 14, Minn.

Sept. 20-21, 1962: JUG-CODASYL Decision Tables Symposium, Barbizon Plaza Hotel, New York, N. Y.; contact L. V. Parent, Trunkline Gas Co., P. O. Box 1642, Houston 1, Tex.

Oct. 2-4, 1962: National Symposium on Space Elec. & Telemetry, Fountainbleu Hotel, Miami Beach, Fla.; contact Dr. Arthur Rudolph, Army Ballistic Missile Agency, R & D Op. Bldg. 4488, Redstone Arsenal, Ala.

Oct. 8-10, 1962: National Electronics Conference, Exposition Hall, Chicago, Ill.; contact National Elec. Conf., 228 N. LaSalle, Chicago, Ill.

Oct. 8-26, 1962: Seminar in Search Strategy, Drexel Inst. of Technology, Philadelphia, Pa.; contact Mrs. M. H. Davis, Seminar in Search Strategy, Graduate School of Library Science, Drexel Inst. of Technology, Philadelphia 4, Pa.

Oct. 15-18, 1962: Conference on Signal Recording on Moving Magnetic Media, The Hungarian Society for Optics, Acoustics and Cinetechnics, Budapest, Hungary; contact Optikai, Akusztikai, es Filmtechnikai Egyesulet, Szabadsag ter 17, Budapest V, Hungary

## SPACE SYSTEMS PROGRAMMING

Laboratory for Electronics, Inc. programming staff is engaged in developing tracking programs for research and operational applications.

Expansion of our technical staff offers substantial growth opportunities for professional advancement in the areas of mathematical analysis and programming, systems design, and data handling.

Positions currently are available at all levels for graduate mathematicians or physicists with large scale digital computer experience.

Please send resume in complete confidence to:  
**Mr. W. E. Daly.**



MONTEREY LABORATORY

An Equal Opportunity Employer

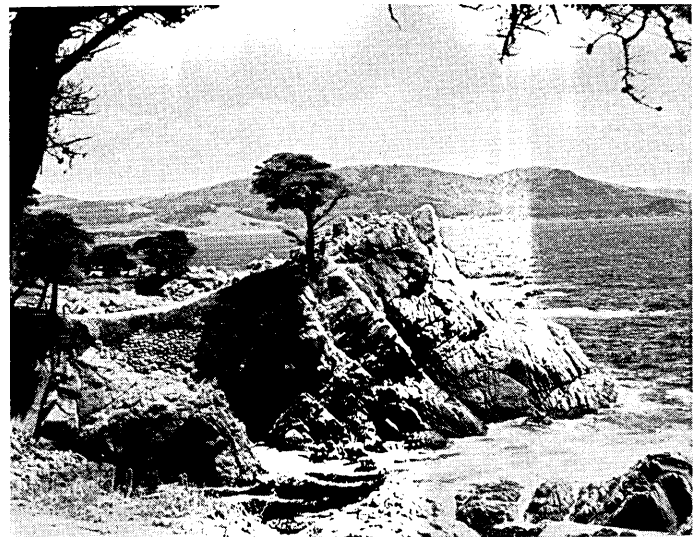

Lone Cypress on 17 Mile Drive

We are located just two hours from San Francisco on the Monterey Peninsula . . . one of the most desirable living and working areas in the West. Monterey enjoys a temperate, smog-free climate year round and offers an unmatched professional, cultural and recreational environment.

## LFE ELECTRONICS

A DIVISION OF LABORATORY FOR ELECTRONICS, INC.  
305 WEBSTER STREET MONTEREY, CALIFORNIA

**IN THE COMPUTER FIELD  
Who? What? Where?**

*Answers,*

*Basic Source Information,  
Available to You from*

**COMPUTERS  
and AUTOMATION**

**DIRECTORY:**

The Computer Directory and Buyers' Guide, 1962, 160 pages long (the June 1962 issue of COMPUTERS AND AUTOMATION), containing the following reference information:

- Roster of Organizations in the Computer Field
- Roster of Products and Services: Buyers' Guide to the Computer Field
- Survey of Computing Services
- Survey of Consulting Services
- Descriptions of Digital Computers
- Survey of Commercial Analog Computers
- Survey of Special Purpose Computers and Data Processors
- Automatic Computing Machinery — List of Types
- Components of Automatic Computing Machinery — List of Types
- Over 500 Areas of Application of Computers
- Computer Users Groups — Roster
- Roster of School, College, and University Computer Centers
- Robots — Roster of Organizations
- Roster of Computer Associations

Directory . . . . \$12.00

**GLOSSARY OF TERMS AND EXPRESSIONS IN THE COMPUTER FIELD:**

Over 860 careful, clear, understandable definitions. 5th cumulative edition . . . \$3.95 (10 or more copies, 20% discount)

**BACK COPIES:**

For eleven years of publication: \$1.50 each, except Directory issues, June 1955 to June 1961, \$5.00 each.

**SUBSCRIPTIONS:**

U.S.A. one year, \$15.00; two years, \$29.00; add 50c per year for Canada, \$1.50 per year elsewhere.

**BULK SUBSCRIPTIONS:**

These rates apply to prepaid subscriptions to **COMPUTERS and AUTOMATION** coming in together direct to the publisher.

**BULK SUBSCRIPTION RATES  
(United States)**

Number of Simultaneous Subscriptions	Rates for Each Subscription, and Resulting Saving:	
	One Year	Two Years
7 or more	\$11.40 — 24%	\$20.00 — 31%
4 to 6	12.60 — 16	22.00 — 24
3	13.65 — 9	24.30 — 16
2	14.25 — 5	26.40 — 9

For Canada, add 50 cents for each year; outside of the United States and Canada, add \$1.50 for each year.

*Send prepaid orders or requests for more information to:*

**COMPUTERS and AUTOMATION**

815 Washington St., Newtonville 60, Mass.

*If not satisfactory, returnable in seven days for full refund.*

**BOOKS AND  
OTHER  
PUBLICATIONS**

**Moses M. Berlin**

Allston, Mass.

We publish here citations and brief reviews of books and other publications which have a significant relation to computers, data processing, and automation, and which have come to our attention. We shall be glad to report other information in future lists if a review copy is sent to us. The plan of each entry is: author or editor / title / publisher or issuer / date, publication process, number of pages, price or its equivalent / comments. If you write to a publisher or issuer, we would appreciate your mentioning **Computers and Automation**.

**Graf, Rudolph F., compiler / Modern Dictionary of Electronics / Howard W. Sams & Co., Inc., 1720 East 38 St., Indianapolis 6, Ind. / 1961, printed, 384 pp, \$6.95.**

More than 10,000 electronics words and terms in current use are here defined. The cross-reference system is used for important terms. Pronunciations of 1,000-odd entries are given in a section following the definitions.

**Pask, Gordon / An Approach to Cybernetics / Harper & Brothers, 49 East 33 St., New York 16, N. Y. / 1962, printed, 136 pp, \$2.50.**

This book discusses "control systems that lay their own plans and make their own decisions"—cybernetics processes. In addition to an exposition of the logic and mechanics of control systems, the book discusses the impact on society of the science of cybernetics. The eight chapters are: "The Background of Cybernetics," "Learning, Observation, and Prediction," "The State-Determined Behaviour," "Control Systems," "Biological Controllers," "Teaching Machines," "The Evolution and Reproduction of Machines," and "Industrial Cybernetics." Seven appendices include additional information and comments. Glossary, references and index.

**Linnik, Yu. V. / Method of Least Squares and Principles of the Theory of Observation / Pergamon Press, 122 East 55 St., New York 22, N. Y. / 1961, offset, 364 pp, \$12.50.**

This English translation from the Russian discusses the theory of the method of least squares, emphasizing mathematical-statistical interpretations of the data the method produces. Following an introductory chapter which includes examples and applications, the author devotes three chapters to "Necessary Knowledge of Algebra, the Theory of Probability and Mathematical Statistics." The remaining eleven chapters include: "Direct Measurements of Equal Accuracy," "Indirect Unconditional Measurements," "Reduction by Means of Correlates," "Parabolic Interpolation by the Method of Least Squares," and a final chapter on "Miscellaneous Additional Results." An appendix gives five tables relating to the subject matter. Bibliography; no index.

(6) **OTS Selective Bibliographies / Office of Technical Services, U. S. Dept. of Commerce, Washington 25, D. C. / 1961, offset, pp given below, 10c each.**

These are six bibliographies of reports listed in the journals "U. S. Govt. Research Reports" and "Technical Translations." They are: 1. Machine Translations, SB-470, 6 pp; 2. Magnetic Recording Systems, SB-471, 6 pp; 3. Computers, SB-472, 31 pp; 4. Computer Research: Medicine, Human Engineering, and Learning Machines, SB-473, 14 pp; 5. Information Storage and Retrieval, SB-475, 13 pp; 6. Data Processing and Programming, SB-474, 26 pp. The bibliographies list the title of the report, author, publisher, price, and medium of publication (for instance, microfilm).

**Lafuze, David L. / Magnetic Amplifier Analysis / John Wiley & Sons, Inc., 440 Park Ave. South, New York 16, N. Y. / 1962, printed, 252 pp, \$9.75.**

A systematic procedure for analyzing magnetic amplifier circuits, including both half and full wave amplifiers, is here presented. The generalized approach is founded on the equivalent circuit, and, the block diagram of servo theory. Among twenty-three topics are: "The Magnetic Core," "The Elementary Half-Wave Amplifier," "Basic Derived Circuits," "Feedback," "Effects of the Power Supply," "The Effects of Ambient Temperature," and "Other Core Properties." An explanation of symbols, a bibliography, and an index are included.

**Lytel, Allan / Transistor Circuit Manual / Howard W. Sams & Co., Inc., 1720 East 38 St., Indianapolis 6, Ind. / 1961, printed, 263 pp, \$4.95.**

Schematic diagrams and notes on parts values and component parameters for 200-odd transistorized circuits are here presented. Following an introductory chapter on the design and application of semiconductor devices, fifteen circuit categories are covered. Included are industrial, commercial and entertainment applications. The final section discusses "Special Circuits," including transistor ignition systems, transistor testers, and diode protective circuits.

**Fairthorne, R. A. / Towards Information Retrieval / Butterworth Inc., 7235 Wisconsin Ave., Washington 14, D. C. / 1961, printed, 234 pp, \$6.50.**

The problems of storing and recovering records according to subject matter are discussed in this collection of papers and notes originally written by the author 1947 to 1961. The aim of the collection is to "provoke thought among those who put documents to work, put machines to work, or put mathematics to work"—applying the mathematical viewpoint to library science. Among the sixteen chapters are: "The Mathematics of Classification," "Information Theory and Clerical Systems," "The Patterns of Retrieval," "Basic Postulates and Common Syntax," and "Documentary Classification as a Self-organizing System." Index by Calvin N. Mooers.

**Bukstein, Edward / Industrial Electronics Measurement and Control / Howard W. Sams & Co., Inc., 1720 East 38 St., Indianapolis 6, Indiana / 1961, photo offset, 192 pp, \$3.95**

Measurement and control techniques currently in common use in industrial applications are described. The first part of the book, Measurement Techniques, contains nine chapters including: "Pressure," "Illumination and Color," "Time and Speed," "Frequency," (which discusses digital techniques and the ratemeter), and "Flow Rate." Part two, Control Techniques, includes seven chapters. Two appendices provide information about industrial tubes and a glossary. Index.

**WHO'S WHO IN THE  
COMPUTER FIELD —  
CUMULATIVE EDITION,  
1962**

Computers and Automation will publish this summer a cumulative edition of "Who's Who in the Computer Field."

If you are interested in computers, please fill in the following Who's Who entry form (which may be copied on any piece of paper) and send it to us for your free listing. If you have friends in the computer field, please call their attention to sending us their Who's Who entries. The cumulative edition will include only the entries of persons who send us their Who's Who information.

Name? (please print) .....

Your Address? .....

Your Organization? .....

Its Address? .....

Your Title? .....

Your Main Computer Interests?  
 Applications  
 Business  
 Construction  
 Design  
 Electronics  
 Logic  
 Mathematics  
 Programming  
 Sales  
 Other (specify): .....

Year of birth? .....

College or last school? .....

Year entered the computer field? ....

Occupation? .....

Anything else? (publications, distinctions, etc.) .....

When you have filled in this entry form please send it to: Who's Who Editor, **Computers and Automation**, 815 Washington Street, Newtonville 60, Mass.

**NEW PATENTS**

**RAYMOND R. SKOLNICK**

Reg. Patent Agent

Ford Inst. Co., Div. of Sperry Rand Corp., Long Island City 1, New York

The following is a compilation of patents pertaining to computer and associated equipment from the "Official Gazette of the U. S. Patent Office," dates of issue as indicated. Each entry consists of patent number / inventor(s) / assignee / invention. Printed copies of patents may be obtained from the U. S. Commissioner of Patents, Washington 25, D. C., at a cost of 25 cents each.

**January 30, 1962—continued**

- 3,018,959 / Walker H. Thomas, Poughkeepsie, N. Y. / I.B.M. Corp., New York, N. Y. / A computing device.
- 3,018,960 / Gerhard Dirks, 44 Morfelder Landstrasse, Frankfurt am Main, Ger. / ———/ An electronic adder-subtractor apparatus employing a magnetic drum.
- 3,018,962 / Ha. J. Jones and John A. Morrison, Jr., Dallas, Texas / Texas Instruments Inc., Dallas, Texas / An apparatus for determining the correlation coefficients of data.
- 3,018,965 / Sidney Saslovsky, Bridgeport, Conn., and Carl Machover, Yorktown Heights, and Elliott J. Siff, Whitestone, N. Y. / United Aircraft Corp., East Hartford, Conn. / A movable magnetic core force vector summing device.
- 3,019,392 / William J. Heacock, Jr., Levittown, N. Y. / U. S. A. as represented by the Sec. of the Navy / A storage timer gating device.
- 3,019,417 / Aaron P. Dornbausch, Wabon, and John E. Mekota, Jr., Belmont, Mass. / Minneapolis-Honeywell Reg. Co., Minneapolis, Minn. / A data processing apparatus.
- 3,019,418 / Jan A. Rajchman, Princeton, N. J. / R.C.A., a corp. of Del. / A magnetic memory system using transfluxors.
- 3,019,420 / William H. Reimboltz, La Crescenta, Calif. / General Precision, Inc., a corp. of Del. / A matrix memory.
- 3,019,421 / William H. Saylor, Altadena, Calif. / United Aircraft Corp., East Hartford, Conn. / A helical magnetic storage assembly.
- 3,019,422 / Joseph J. Eachus, Cambridge, Mass. / Minneapolis-Honeywell Reg. Co., Minneapolis, Minn. / A data processing apparatus.

**February 6, 1962**

- 3,019,976 / Jordan M. Taylor, Poughkeepsie, N. Y. / I.B.M. Corp., New York, N. Y. / A data processing system including an indicating register.
- 3,019,977 / Simon Duniker and Herman J. Heijn, Eindhoven, Netherlands / North American Philips Co., Inc., New York, N. Y. / A parallel-operating synchronous digital computer capable of performing the calculation  $\times + YZ$  automatically.
- 3,019,979 / Ralph Townsend, Darien, Conn. / International Computers and Tabulators, Lim. / An electronic adding circuit.
- 3,019,980 / Erwin Spingies, Hamburg-Farmen, and Herbert Rose, Wohltorf, Lauenburg, Germany / Brunsviga Maschinenwerke Aktiengesellschaft, Braunschweig, Germany / An apparatus for the reception, storage, and re-emission of positive and negative numerical val-

(Please turn to Page 12)

**COMPUTER  
RESEARCH  
ENGINEERS &  
LOGICAL  
DESIGNERS**

Rapid expansion of the Computer Laboratory at Hughes-Fullerton has created several attractive professional opportunities for qualified Computer Research Engineers and Logical Designers. These positions require active participation in broad computer R & D activities in connection with Army/Navy computer systems and new large-scale, general-purpose computers. These multiple processor computers utilize advanced solid-state circuitry, gating and resolution times in the millimicrosecond regions; combine synchronous and asynchronous techniques for maximum speed and reliability.

These professional assignments involve broad areas of logical design, programming and system conception. Fields of interest include:

- Distributed computers ■ Advanced arithmetic processing techniques ■ Mechanized design
- Asynchronous design techniques ■ Utilization of parametrons in computers ■ Studies in the utilization of multiple processor computers.

These professional assignments involve such R & D areas as:

- Solid state digital circuitry involving millimicrosecond logic
- Microwave carrier digital circuits
- Sub-microsecond core memory
- Thin film storage techniques
- Functional circuit concepts
- Micro-miniaturization concepts
- Tunnel diodes ■ Microwave parametrons ■ Circuit organization for maximal-speed computing.

Located in Southern California's Orange County (the nation's fastest growing electronics center), Hughes-Fullerton offers you: a stimulating working environment; private or semi-private offices; long-term stability.

**CALL COLLECT TODAY!**

For complete information on these challenging assignments, call us collect today! Ask for:

**Mr. J. E. TENNEY at:  
TRojan 1-4080, ext. 3741.**

Or, airmail resume to: **HUGHES-FULLERTON R & D, P. O. Box 2097, Fullerton 1, California.**

An equal opportunity employer.



# Honeywell Computers Tackle Higher Mathematics with **AUTOMATH**

Higher education, in the form of assemblers and compilers, gives computers the ability to accept and act upon instructions phrased in other than a basic machine-language vocabulary. FACT, and COBOL, for example, are business-oriented compilers that enable Honeywell computers to handle business problems couched in business terms.

Now, Honeywell announces an equally powerful family of engineering and scientific programming aids, called AUTOMATH, for its full line-up of computers. AUTOMATH, which is completely compatible with FORTRAN, is designed to take full advantage of the many exclusive features of Honeywell systems. The AUTOMATH family includes algebraic compilers for the Honeywell 400 and 1800 computers and embraces an advanced version of the existing Honeywell 800 algebraic compiler. Engineers and scientists can learn to use AUTOMATH in less than a week's time. AUTOMATH greatly reduces the time and cost of preparing programs, improves accuracy, and increases computer productivity by minimizing human intervention.

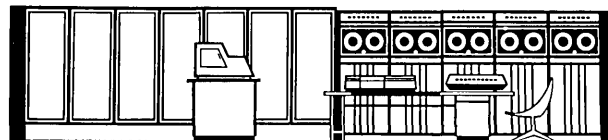

II  
W  
Last  
or m  
... a  
done  
tems  
Thes  
organ  
A TE  
infor  
tion's  
ment  
chara  
mun  
the c  
syste  
error  
simu  
emat  
whic  
ages,  
ing u  
perfo  
COM



## Small users get big benefits

The Honeywell 400 is a powerful business data processing system which also has scientific capabilities that rival or exceed those of many larger, more expensive machines. AUTOMATH 400 capitalizes on this ability, and includes the following major characteristics:

1. AUTOMATH 400 is designed for use on a system that has 2000 or more words of memory, four or more magnetic tape units, a printer, a punch and a card reader.
2. A monitor feature provides Load-and-Go operation whereby one, or a series of programs can be compiled and executed without interruption.
3. An elaborate diagnostic system enables the programmer to remove rapidly any errors that he may have introduced.
4. Fixed-point constants and variables may have values ranging up to nine significant digits.
5. Programs too large to be contained in memory may be executed by bringing portions into memory only as needed, and by permitting areas of memory to be shared by various portions of the program.
6. The ability to insert hand-code permits the employment of other peripheral equipment, such as paper tape units, as well as the insertion of special program checkout statements.

## How to move medium-size mountains

AUTOMATH 800 is an advanced version of the Honeywell 800 Algebraic Compiler which incorporates a basic scientific language and takes advantage of the high-speed capabilities of the computer. Additional power has been provided by modifications which speed up the compiling process and permit more efficient use of available memory. AUTOMATH 800 includes the following features:

1. Batch compiling of programs onto a tape in such a way that they can be immediately executed.
2. Fixed-point variables provide accuracy ranging up to 14 significant digits. Floating-point values may range from  $10^{-65}$  to  $10^{+63}$  in decimal, or from  $16^{-65}$  to  $16^{+63}$  in binary form.
3. Provision for buffering tape input and output operations can be used to increase program execution speed.
4. Problem data and parameters can be included with the program being compiled, making it available for immediate use.
5. AUTOMATH 800 is designed for use on a machine with 4000 or more words of memory and for four or more magnetic tape units.

## The bigger the job, the harder it works

The Honeywell 1800, newest and fastest of all Honeywell computers, has a particularly broad and powerful scientific capability. AUTOMATH 1800 has been developed to gain maximum efficiency from this capability. AUTOMATH 1800 can compile source programs written for 400 and 800 systems, and can be used on Honeywell 800 computers that have sufficiently large equipment configurations. Major characteristics of AUTOMATH 1800 include the following:

1. AUTOMATH 1800 is designed for use on a Honeywell 1800 with 16,000 or more words of memory and seven or more magnetic tape units. This provides extremely fast, efficient compilation.
2. Load-and-Go operation takes a series of programs through compilation and execution at extremely high speeds.
3. Memory utilization is automatically and dynamically optimized by a compiler monitor system throughout execution of the generated program. This greatly increases the maximum size of programs that can be handled.
4. Input-output operations are automatically buffered, substantially speeding their execution.
5. A full set of logical decision statements and relational operations are provided; adjustable dimension statements and complex and double-precision arithmetic are permitted. This enables the programmer to create a much more flexible program with greater ease.

## Basic benefits go across the board

All three Honeywell AUTOMATH compilers are compatible to the extent that you can start small and grow through the ranks without reprogramming. Programs created for a Honeywell 400 can be used immediately by the more powerful compilers. A full library of mathematical and scientific routines is available to all three compilers and optimum use is made of hardware features such as automatic error correction and simultaneous operations. If your interest in computers lies strongly in their scientific or engineering capabilities, you will want all the facts on Honeywell AUTOMATH. Write to Honeywell EDP Division, Wellesley Hills 81, Mass. In Canada, Honeywell Controls Limited, Toronto 17, Ontario.

# Honeywell



*Electronic Data Processing*

# GLOSSARY OF COMPUTER TERMS

Computers and Automation's Fifth Edition of the

## Glossary of Terms in Computers and Data Processing

96 pages long, this edition contains over 860 computer terms and expressions with their definitions, EXPLAINED so that people new to the computer field can understand them. (Our previous edition, October, 1956, contained 490 terms.) This is an invaluable guide to "understanding your way around" the computer field. Returnable for full refund within 10 days if not satisfactory. . . . \$3.95

### Special Combination Offer:

Each monthly issue of *Computers and Automation* contains 12 additional pages of "News of Computers and Data Processors: ACROSS THE EDITOR'S DESK." Of course, articles, ideas, forum, reference information, surveys, etc., are all there still; and the June issue is the annual edition of "THE COMPUTER DIRECTORY AND BUYERS' GUIDE." Regular subscription rate, U. S. A., one year, \$15.00.

**SPECIAL COMBINATION OFFER:** both our Glossary and *Computers and Automation* for one year. . . . \$15.00. You save \$3.95, over 20%.

#### MAIL THIS COUPON, OR A COPY OF IT

To: COMPUTERS AND AUTOMATION  
815 Washington St., R109, Newtonville 60, Mass.

- Please send me the Glossary. I enclose \$3.95.
- Please send me the special combination offer of both *Computers and Automation* for one year and the Glossary. I enclose \$15.00.

My name and address are *attached*.

### NEW PATENTS

(Continued from Page 39)

- ues, especially for use with standard office machines.
- 3,019,981 / Morton H. Lewin, Princeton, N. J. / R.C.A., a corp. of Delaware / A binary adder employing negative resistance elements.
- 3,019,984 / Robert R. Bockemuehl, Birmingham, Mich. / General Motors Corp., Detroit, Mich. / An electronic multiplying circuit.
- 3,020,336 / Esmond P. Wright, London, England / International Standard Electric Corp., New York, N. Y. / A data processing system.
- 3,020,410 / Edwin R. Bowerman, Jr., Whitestone, N. Y. / General Telephone and Electronics Lab., Inc., a corp. of Del. / A shift register.

### February 13, 1962

- 3,021,064 / Floyd G. Steele, La Jolla, Calif. / Digital Control Systems, Inc., La Jolla, Calif. / An ordered time internal computing system.
- 3,021,067 / Dale M. Jahn, Garden City, N. Y. / Sperry Rand Corp., New York, N. Y. / A time-sharing digital computer.
- 3,021,068 / Edward D. Ostroff, South Sudbury, Mass. / Laboratory for Electronics, Inc., Boston, Mass. / A computing apparatus.
- 3,021,070 / Paul Mallery, Murray Hill, N. J. / Bell Telephone Lab., Inc., New York, N. Y. / A binary adder.
- 3,021,439 / John L. Anderson, Poughkeepsie, N. Y. / I.B.M. Corp., New York, N. Y. / A superconductive shift register.

- 3,021,511 / Albert W. Vinal, Owego, N. Y. / I.B.M. Corp., New York, N. Y. / A magnetic memory system.

### February 20, 1962

- 3,022,007 / William F. Steagall, Merchantville, N. J. / Sperry Rand Corp., New York, N. Y. / A serial binary adder.
- 3,022,428 / William M. Carey, Jr., South Lincoln, Mass. / Minneapolis-Honeywell Regulator Co., a corp. of Del. / A digital data storage and manipulation circuit.
- 3,022,495 / Robert R. Williamson, Tujunga, and Robert L. Terry, San Fernando, Calif. / General Precision, Inc., a corp. of Del. / An information storage system.

### February 27, 1962

- 3,022,949 / Floyd G. Steele, La Jolla, Calif. / Digital Control Systems, Inc., La Jolla, Calif. / A difunction computing element.
- 3,022,950 / Gerhard Dirks, 44 Marfelder Landstrasse, Frankfurt am Main, Germany / ——— / An electronic computing means.
- 3,022,951 / John L. Anderson, Poughkeepsie, N. Y. / I.B.M. Corp., New York, N. Y. / A full adder.
- 3,023,400 / Richard R. Booth, Peckskill, N. Y. / I.B.M. Corp., New York, N. Y. / A non-destructive readout ferrite memory element.
- 3,023,401 / David Loev, Plymouth Meeting, Pa. / Burroughs Corp., Detroit, Mich. / A reversible shift register.
- 3,023,402 / Eric E. Bittmann, Downingtown, Pa. / Burroughs Corp., Detroit, Mich. / A magnetic data store.
- 3,023,404 / Jack A. Dickerson, Hyde Park, N. Y. / I.B.M. Corp., New York, N. Y. / A magnetic drum head positioning system.

### March 6, 1962

- 3,023,962 / Roger A. Stafford, Champaign, Ill. / Thomson Ramo Wooldridge, Inc., Cleveland, Ohio / Serial-parallel arithmetic units without cascaded carries.
- 3,023,963 / Edward J. Schmitt, Collingswood, and James G. Smith, Haddonfield, N. J. / R.C.A., a corp. of Del. / A digital computing system.
- 3,023,964 / Lowell S. Bensky, Levittown, Pa., and Ivan H. Sublette, Haddonfield, N. J. / R.C.A., a corp. of Del. / A digital computing system.
- 3,024,418 / Walter C. Lanning, Plainview, N. Y. / Sperry Rand Corp., New York, N. Y. / An electronic programming circuit.

## ADVERTISING INDEX

Following is the index of advertisements. Each item contains: Name and address of the advertiser / page number where the advertisement appears / name of agency if any.

- American Telephone & Telegraph Co., 195 Broadway, New York 7, N. Y. / Page 2 / N. W. Ayer & Son, Inc.
- Bendix Computer Division, 5630 Arbor Vitae St., Los Angeles 45, Calif. / Page 3 / John B. Shaw Co., Inc.
- Burroughs Corp., Detroit 32, Mich. / Page 43 / Campbell-Ewald Co.
- Computron, Inc., 122 Calvary St., Waltham, Mass. / Page 44 / Larcom Randall Advertising, Inc.
- Honeywell Electronic Data Processing, Wellesley Hills 81, Mass. / Pages 40, 41 / Batten, Barton, Durstine & Osborn.

- Hughes Aircraft Co., Culver City, Calif. / Page 39 / Foote, Cone & Belding
- International Business Machines Corp., 590 Madison Ave., New York 22, N. Y. / Page 5 / Benton & Bowles, Inc.
- Laboratory For Electronics, Inc., 305 Webster St., Monterey, Calif. / Page 37 / Fred L. Diefendorf Agency
- Litton Systems, Inc., Data Systems Div., 6700 Eton Ave., Canoga Park, Calif. / Page 7 / Compton Advertising, Inc.
- Litton Systems, Inc., Guidance & Control Systems Div., 5500 Canoga Ave., Woodland Hills, Calif. / Page 29 / Compton Advertising, Inc.
- The National Cash Register Co., Main & K Sts., Dayton 9, Ohio / Page 15 / McCann-Erickson, Inc.

Engin  
to inc  
G-20  
ing, n  
progr  
G-20  
cost a  
flow,  
addit  
expar  
G-20  
evalu  
Bend  
write  
Los A

T

COM

# IF

- *you're weary of matching one assembler instruction per one machine language instruction*
- *you're spending half of your machine time translating compiler programs into machine language programs of questionable efficiency*
- *you're using up time and money with hunt-and-peck machine language debugging and reprogramming*
- *you're tired of seeking, teaching or even becoming a bilingual programmer—fluent in both problem and machine languages*
- *you're fed up with programming methods that are cumbersome, time-consuming and costly*

---

Then, you'll be interested in Burroughs B 5000, a new kind of information processing system which is the result of a total departure from traditional computer design concepts. A system in which *software* dictates equipment designs and specifications to bridge the communication gap between man and machine.

As a problem oriented system, its software capa-

bilities accept ALGOL and COBOL statements directly because its logic matches the logic of problem-language programming. Instead of an instruction-address-instruction-address sequence, there's a continuous flow of instructions with table references when addresses are required. Addresses are independent of instructions.

The system language is designed to implement the problem language for extremely rapid translations allowing program translation each run. Object programs, as efficient as those written in machine language, can be created far faster than with the most advanced conventional computers.

The need for the programmer to know both problem and machine languages is eliminated. Now for the first time, the programmer is free to concentrate on the processing problem itself. Free of the gymnastics he used to employ to make his problem acceptable to the machine, he merely states the problem and the Burroughs B 5000 provides an efficient, rapid solution.

Burroughs—TM

*Burroughs Corporation, Detroit 32, Michigan*

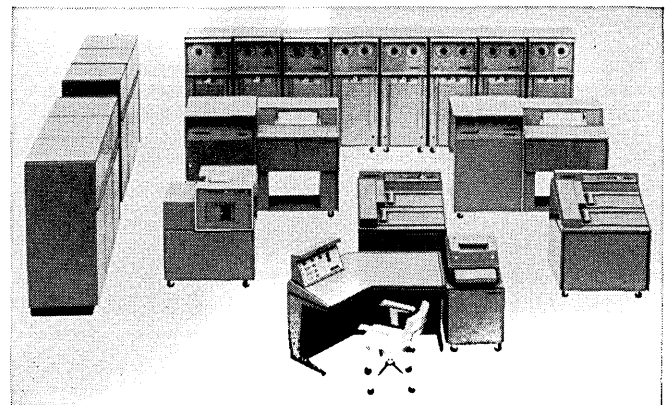

**Burroughs Corporation**



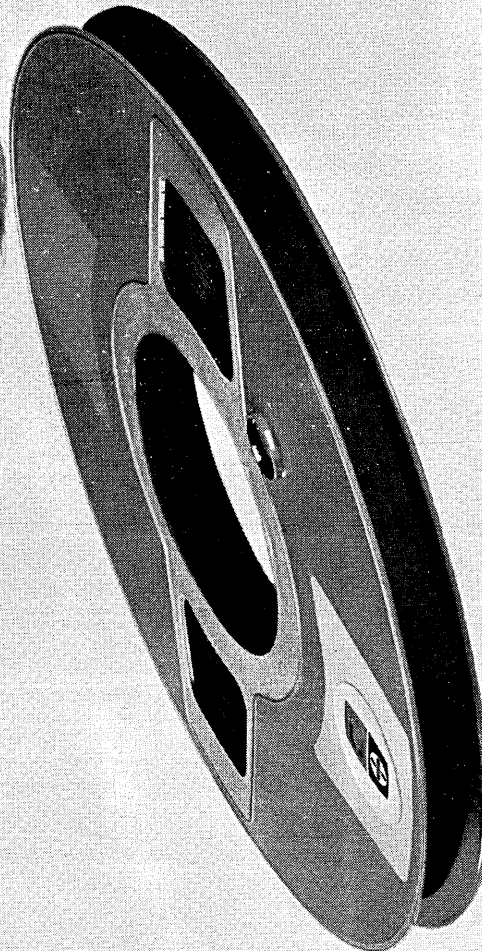

*There's something magnetic  
about you, Computape.*

My special oxide coating,  
Penelope. It's revolutionary.  
Specially designed for high  
density, high resolution data  
recording. Helps me guarantee  
*556 or 800* bits per inch with  
no dropouts for severest  
computer applications.

P. S. Computape doesn't really talk, of course. But in a computer, Computape *reliability* will deliver its own message. New COMPUTAPE, the premium quality computer and instrumentation tape, is the product of the only company devoted exclusively to the manufacture of quality tapes for data processing and instrumentation. *Investigate new Computape today. Better still, immediately.*



**COMPUTRON INC.**  
122 Calvary Street, Waltham, Massachusetts