

independent, INTERCONNECTED, physically separated, functionally similar switching and computing MODULES, each with its own logic, MEMORY and hardware. See Figure 1.

and computing MODULE communicates with another module by building a PATH to it. A path may be direct or may include intermediate modules. Path building instructions are generated at the ORIGINATING module by a subscriber and TRANSMITTED along the PATH as it grows. Highly PARALLEL computers are called HOLLAND machines in the literature.

In voice data call

switching NETWORKS, all PATH building is completed prior to CHANNEL UTILIZATION.

Message switching modules include BUFFER storage to hold DELAYED messages during path building. Message switching networks may also include SPECIAL CODE, SIGNALLING and Timing conversion.

data transmission traffic is of the VOICE networks of the COMPANIES and ADMINISTRATIONS and the Western Union. The first network were established BEFORE any voice or DATA TRANSMISSION begins.

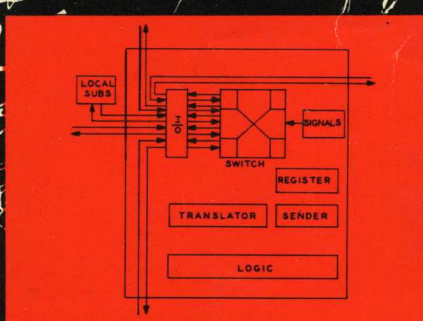

COMMUNICATIONS SWITCHING & BUFFERING

switching MODULES differ from message switching modules in that no buffer storage is required. One of the general OPERATING PRINCIPLES and functional requirements of COMMUNICATIONS SWITCHING and buffering logic.

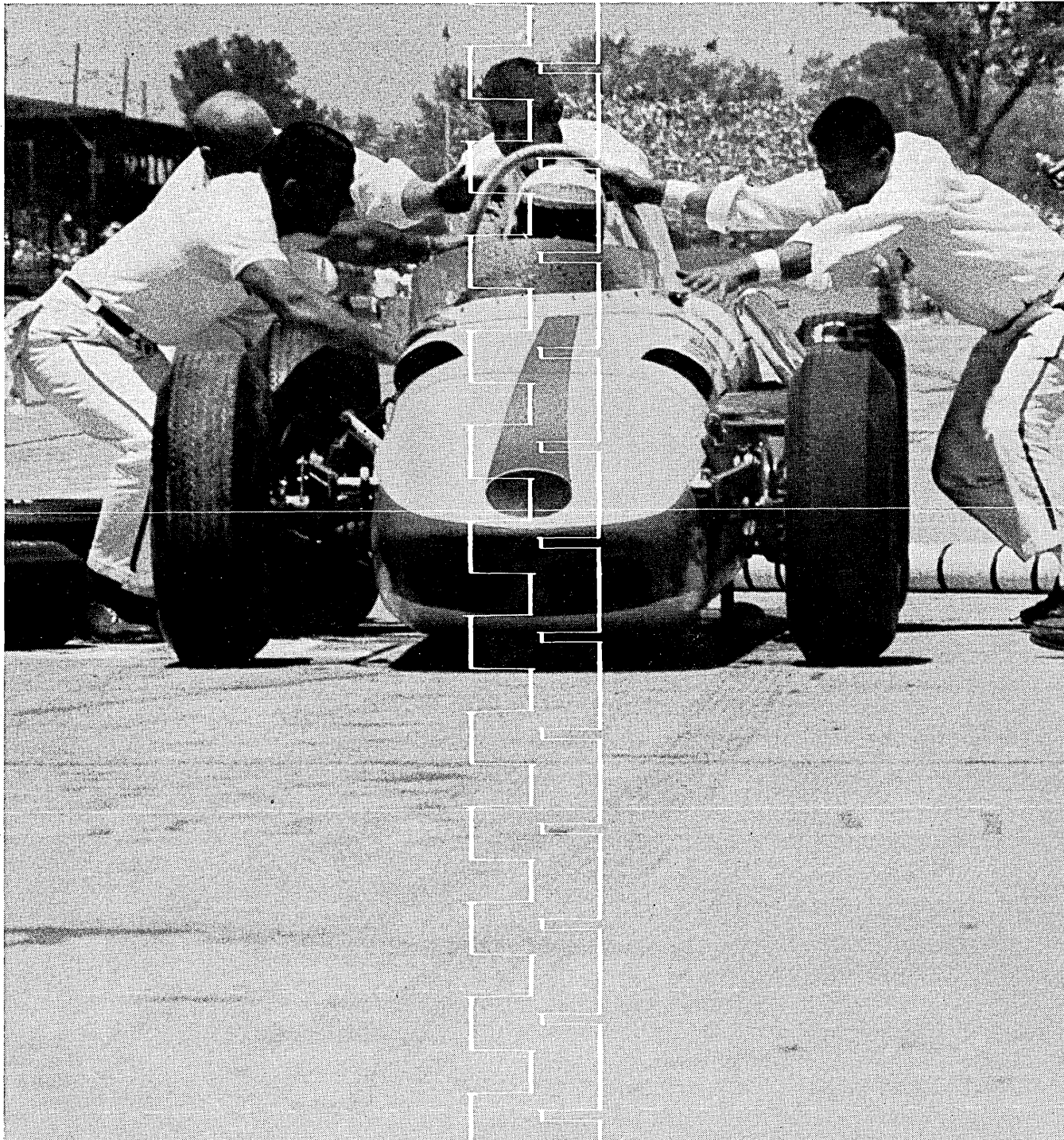

What new high speed tape transport means less down time?

AMPEX TM-5

Here's how it's done. The highly stable, solid state servo requires less adjustment. Capstan rollers are quickly changed. Settings are quickly made. The head assembly is isolated. (This makes the tape path highly stable. In fact, dynamic skew at start time is less than dynamic skew continuous.) And precision practices reduce static skew. There's no tape flap; an erase head isn't needed. Positive safety interlocks eliminate tape damage. Instantaneous speed

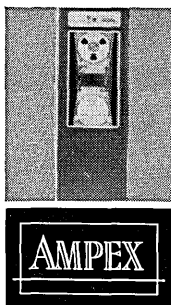

variation has been reduced. Plus: up to 150 ips tape speeds; 2 ms maximum start time; 1.5 ms maximum stop time; 800 bpi capability with or without clock track; available as a complete tape memory system with transfer rates up to 240 kc. And above all, there's Ampex reliability and ruggedness throughout. The TM-5 is made by the Ampex Computer Products Co., Culver City, Calif. For information write Ampex Corp., Redwood City, Calif. Worldwide sales, service.

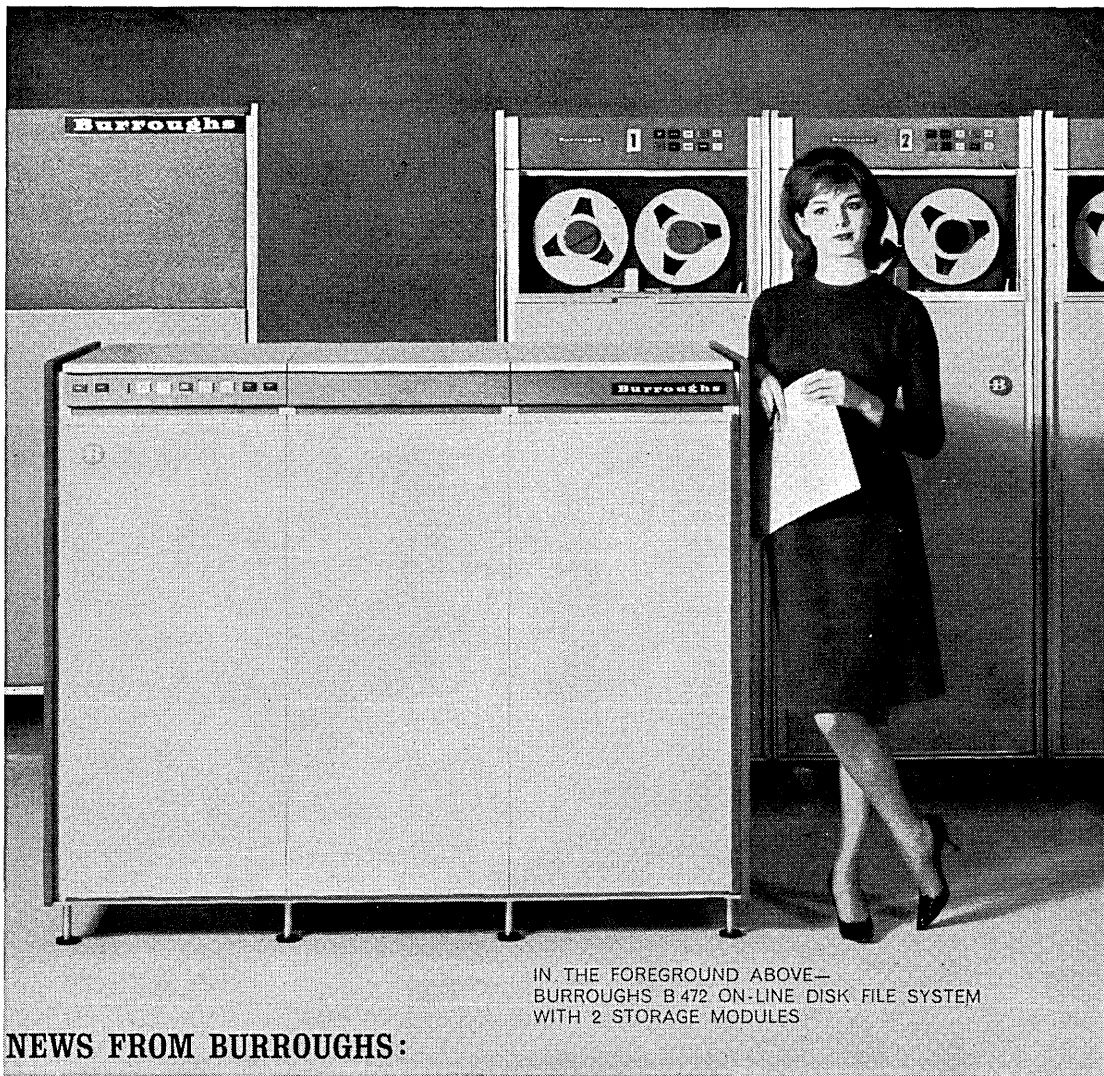

IN THE FOREGROUND ABOVE—
BURROUGHS B 472 ON-LINE DISK FILE SYSTEM
WITH 2 STORAGE MODULES

NEWS FROM BURROUGHS:

Burroughs—TM

**A SIGNIFICANT
advance in
random
access
DATA PROCESSING**

Burroughs introduces a new type of random access magnetic disk file which—with its data communications and inquiry devices—makes practical real time applications possible.

In addition, it allows significant advances in memory capacity, reliability and economy.

The new file eliminates hydraulic or mechanical read/write head positioners and gives each track of information an electronic head of its own. This head-per-track principle allows an average access speed of 20 milliseconds—five times faster than the best of its type now available.

Instant availability of data eliminates the need for artificial file organization techniques—and the programing and use problems which they impose.

Read/write head assemblies self-adjust to maintain a uniform, precision-controlled air gap between head and disk. Retraction is automatic as disks decelerate. Result: a completely reliable system.

A totally new disk-plating technique allows high packing density. Per-module capacity is 9.6 million alphanumeric characters. Thus data storage can be “built up” in small economical increments to a maximum of nearly one billion characters. Modules can be added to your system as needed.

The new disk file greatly extends the application range of our B 5000 and B 200 series, while giving both systems additional immunity to obsolescence. For additional details, write us at Detroit 32, Michigan. Remember: our business is computation for all businesses of all sizes, everywhere.

Burroughs Corporation



CIRCLE 4 ON READER CARD

THE GOAL

General Electric's new family of computers lets you
programs... peripherals...

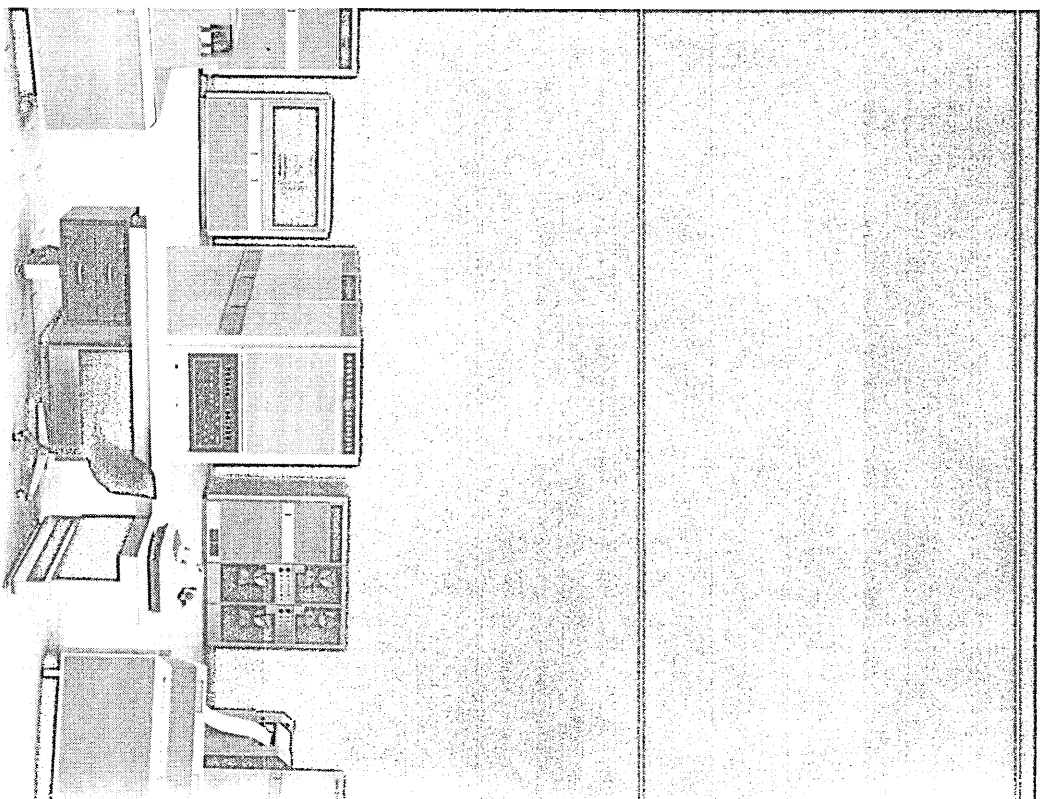
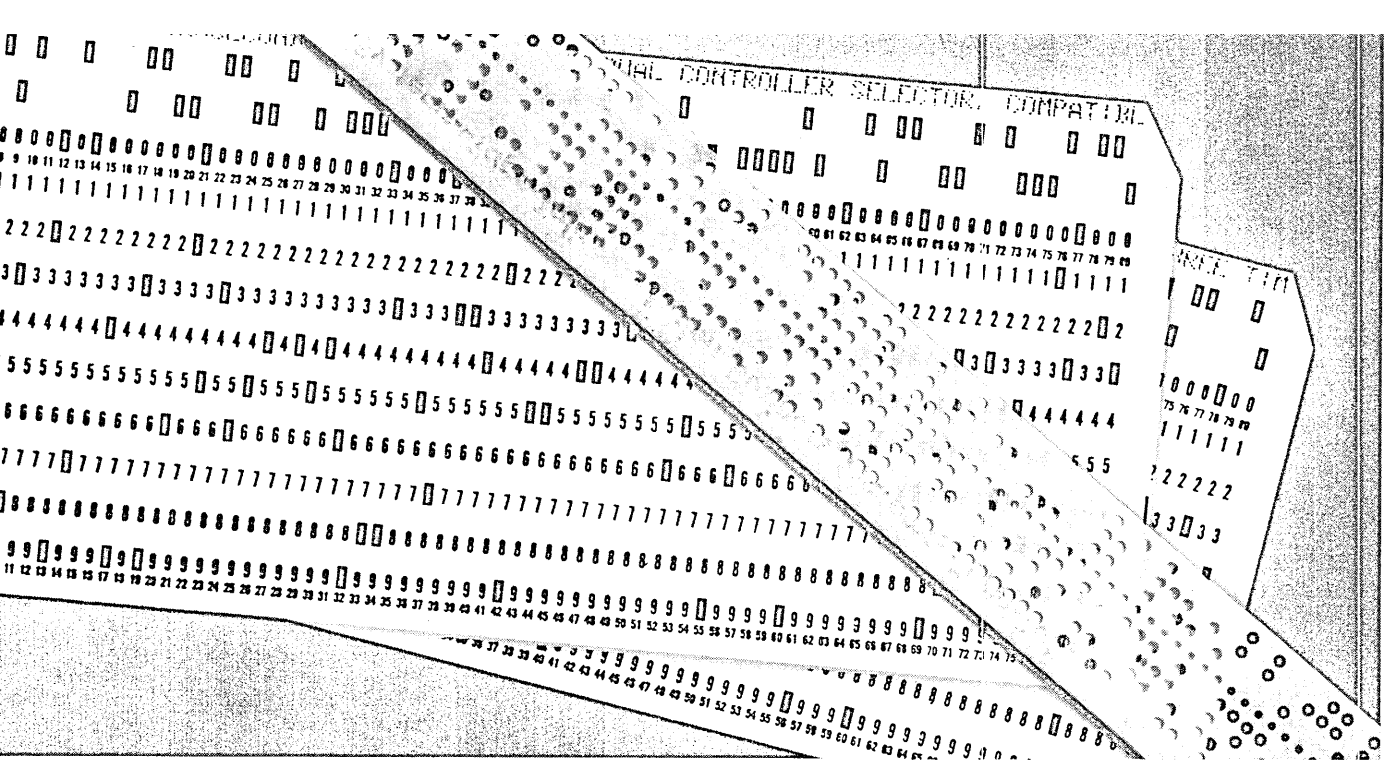

PATIBLES

increase your computing power without changing...
or people

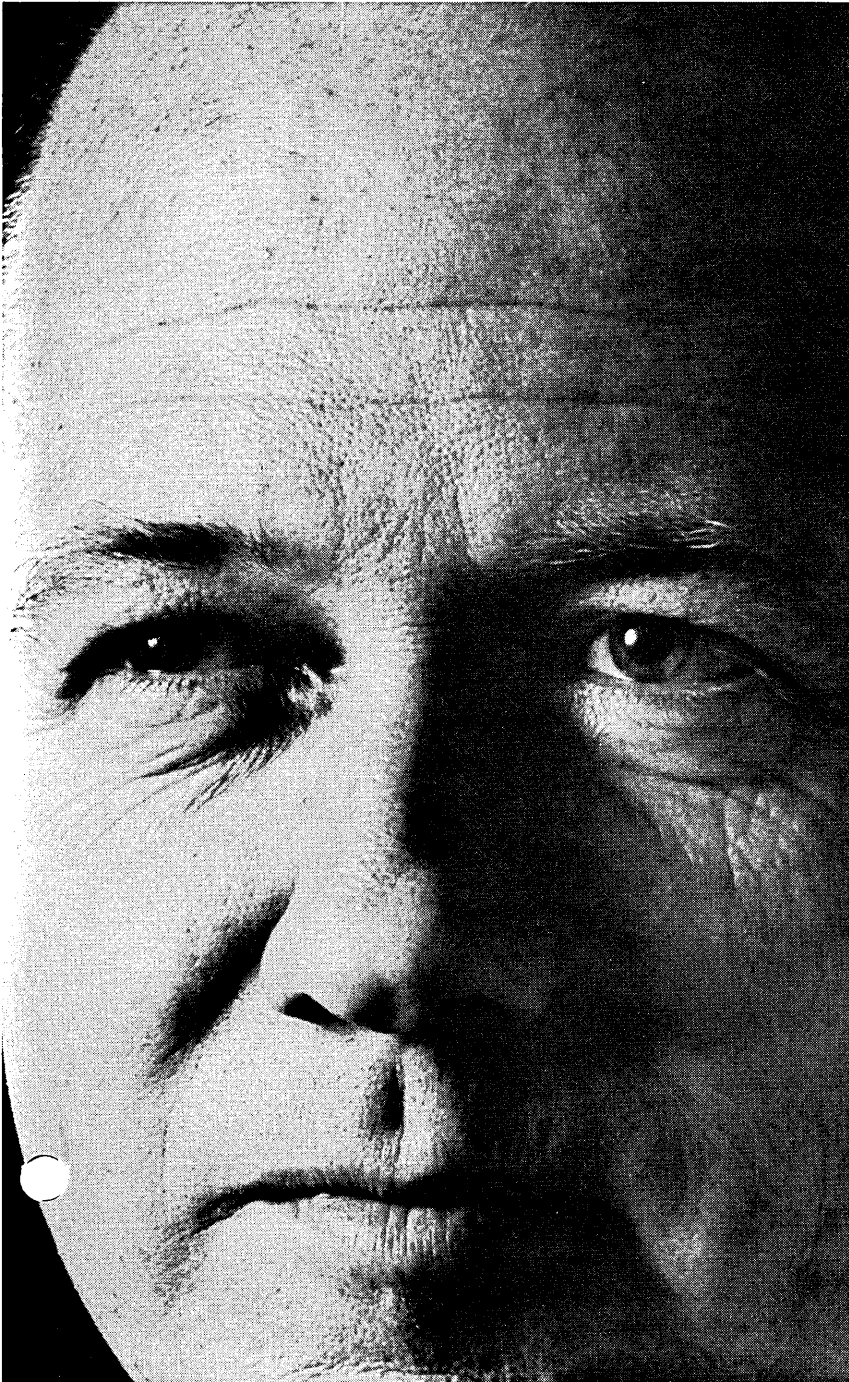

You can move up from a minimum cost system to bigger, faster systems by simply changing the central processor. The programs are the same—but they run faster. The peripheral equipment is the same—only you can apply it more efficiently. The people are the same ones you trained in the first place.

So, before you buy or replace your system, investigate The Compatibles. Write General Electric Computer Department, Section J-7, Phoenix, Arizona.

GE-215

Tops in its price range:
36 microsecond word time

GE-225

Medium-sized, versatile system:
18 microsecond word time

GE-235

Most powerful in the family to date:
6 microsecond word time

Progress Is Our Most Important Product

GENERAL  ELECTRIC

CIRCLE 5 ON READER CARD

POTTER MT-120:

AN OPEN AND SHUT CASE

It doesn't require lengthy trial to determine if MT-120 is compatible with your computer system. It is. This highly advanced digital magnetic tape transport features exceptional performance in a COMPLETELY STANDARD, LOW COST PACKAGE. For example, a patented tape handling system* eliminates program restrictions—permits Start/Stop, Reverse/Stop or Forward/Reverse operation at up to 200 commands per second and at tape speeds to 120 ips.

To learn more about the MT-120 and its unprecedented 1-year warranty of reliability, write to our Director of Marketing. We'll send you full specifications, then you can judge for yourself.

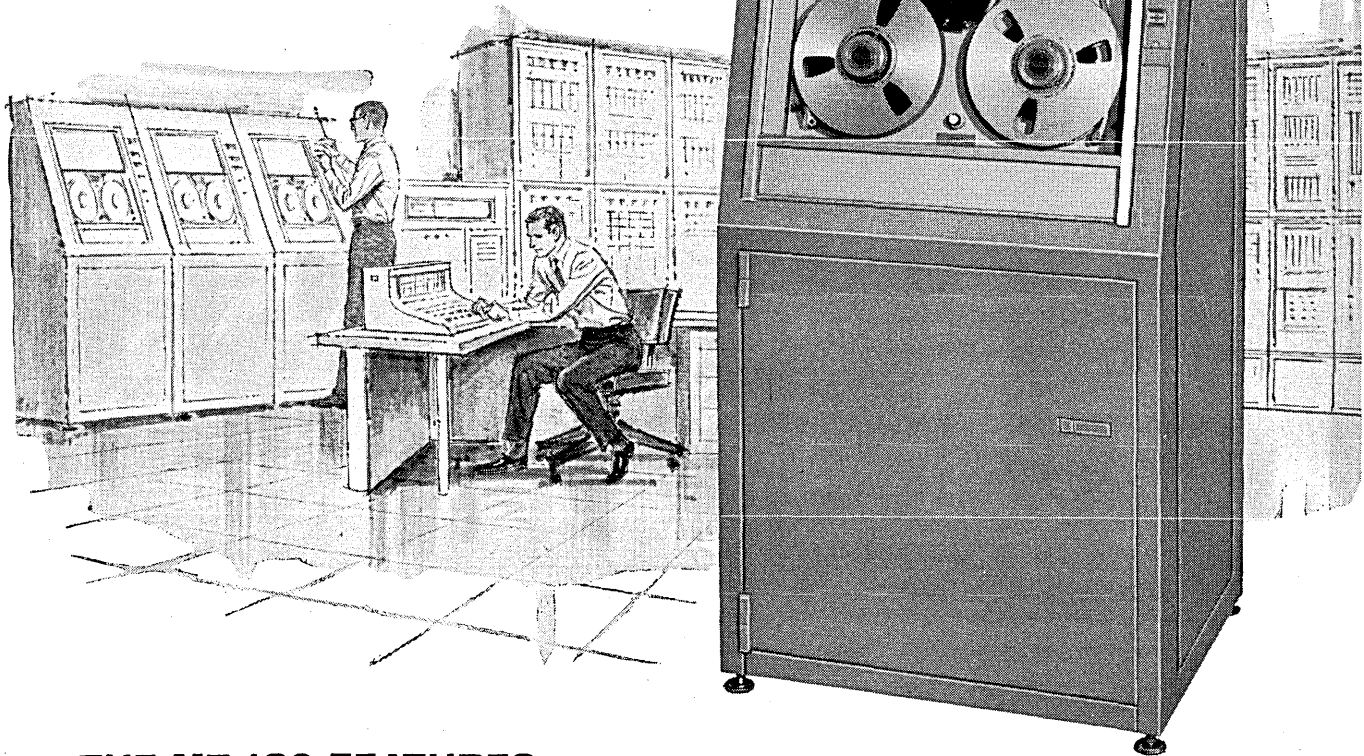

THE MT-120 FEATURES:

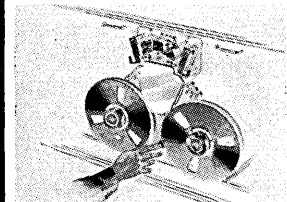
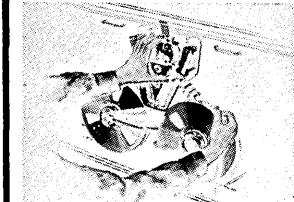
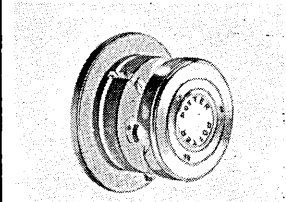
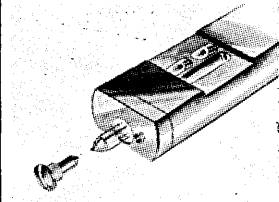
| | | | |
|--|--|--|--|
|  <p>PUSH BUTTON TAPE LOADING initiates automatic electrical retraction of loop control and low-tape sensing arms...</p> |  <p>... Special interlocking devices prevent inadvertent arm retraction when reel drive motors are energized.</p> |  <p>Potter "quick-lock" NARTB reel hubs and IBM reel hubs are available as standard accessories.</p> |  <p>IBM and split-post type EOT and BOT sensing amplifiers are available for positive tape control.</p> |
|--|--|--|--|

*Potter Patent No. 3,016,207



T.M.

POTTER INSTRUMENT COMPANY, INC.
MARKETING DIVISION • 151 Sunnyside Boulevard, Plainview, New York

CIRCLE 6 ON READER CARD

volume 9, number

7

Staff

President **FRANK D. THOMPSON**

Publisher **GARDNER F. LANDON**

Vice President & Publication Manager **RICHARD W. NIELSON**

Editor **ROBERT B. FOREST**

Managing Editor & Art Director **CLEVE MARIE BOUTELL**

Assistant Editor **EDWARD YASAKI**

News Editor **VALERIE ROCKMAEL**

Editorial Advisers
DANIEL D. McCracken
ROBERT L. PATRICK

Contributing Editor **H. R. J. GROSCH**

Technical Consultant **DON B. PRELL**

Production Manager **MARILEE PITMAN**

Circulation Mgr. **ALGENE TRAINA**

Eastern District Manager
JAY S. MARTIN
141 E. 44th St., New York 17, N.Y.
Murray Hill 7-5180

New England District Manager
WARREN A. TIBBETTS
112 West Haven Rd.,
Manchester, N.H., National 5-9498

Midwest District Manager
JOHN BRENNAN
201 N. Wells St., Chicago 6, Ill.
Financial 6-1026

Western District Manager
& Vice President
HAMILTON S. STYRON
1830 W. Olympic Blvd., Los Angeles 6, Cal.
385-0474

EDITORIAL OFFICES

1830 WEST OLYMPIC BLVD.
LOS ANGELES 6, CALIF.

Microfilm copies of DATAMATION may be obtained from University Microfilms, Inc., 313 No. First St., Ann Arbor, Mich.

Feature Articles

- 24 Communications Switching and Buffering Networks, by *John D. Beierle*
- 28 Compiling in English, by *Jerry Schwalb*
- 31 A Modern-Day Medicine Show, by *Robert L. Albrecht*
- 34 Building Internal Accounting Controls, by *S. M. Salvino*
- 36 ACM Meets in Denver
- 45 The '63 Spring Joint
- 46 Wescon '63: A Preview
- 47 COBOL and Compatibility, by *Robert M. Gordon*
- 50 Electronic Retina Character Reader
- 51 The Datanet-30 and 600
- 69 Libraries and Automation
- 73 The IBM 7094 II

Departments

- 6 Important Dates in Datamation
- 10 Letters to the Editor
- 17 Datamation in Business and Science
- 23 The Editor's Readout
- 55 News Briefs in Datamation
- 58 People in Datamation
- 63 New Products in Datamation
- 67 Component Products in Datamation
- 71 New Literature in Datamation
- 74 Advertisers' Index

THIS ISSUE — 45,423 COPIES

Cover

Graphically illustrated on the cover is the mad scramble of messages, incoming and outgoing, reduced to relative placidity in switching and buffering networks, this month's feature article. Art Director Cleve Boutell creates design from this seeming array of confusion.

Circulation audited by
Business Publications Audit



Member, National
Business Publications

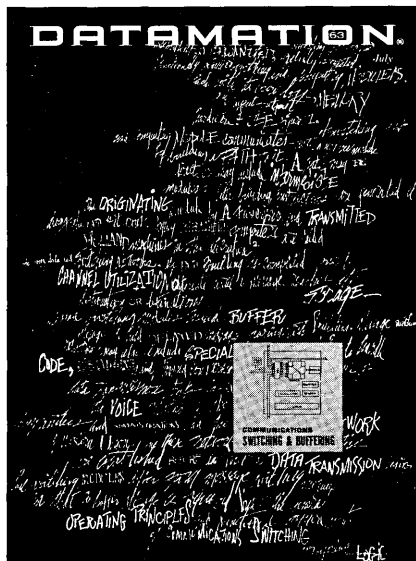

DATAMATION is published monthly on or about the tenth day of every month by F. D. Thompson Publications, Inc., Frank D. Thompson, president. Executive, Circulation and Advertising offices, 141 East 44th St., New York 17, N.Y. (Murray Hill 7-5180). Editorial offices, 1830 W. Olympic Blvd., Los Angeles, 6. Published at Chicago, Ill. Controlled Circulation paid at Columbus, O. Form 3579 to be sent to F. D. Thompson Publications, Inc., 201 N. Wells St., Chicago 6, Ill. Copyright 1963, F. D. Thompson Publications, Inc. Printed by Beslow Associates, Inc.

important DATES

- The sixth annual Summer Conference, sponsored by the Northwest Computing Assoc., will be held August 8-9 at the Pacific Science Center, Seattle, Wash.
- The Western Electronics Show and Conference (WESCON) will be held August 20-23 at the Cow Palace, San Francisco, Calif. Sponsors are Region 6, WEMA, and all PGs.
- The first annual meeting of the Assn. for Machine Translation and Computational Linguistics will be held August 25, 26 at the Hilton hotel, Denver, Colo., immediately preceding the ACM conference.
- The 1963 ACM National Conference will be held Aug. 27th through 30th in Denver, Colorado.
- The second Institute on Electronic Information Display Systems will be held September 16-20 at The American Univ., Washington, D.C.
- The 12th annual Industrial Electronics Symposium will be held September 18-19 at Michigan State Univ., E. Lansing, Mich. Sponsors are PGIE, AIEE, and ISA.
- The fourth annual Symposium on Switching Circuit Theory and Logical Design will be held Oct. 7-11 in Chicago, Ill. Sponsor is the AIEE subcommittee on Logic and Switching Circuit Theory.
- The BEMA (Business Equipment Manufacturers Assn.) Exposition/Conference will be held Oct. 28 to Nov. 1 at the Coliseum, New York, N.Y.
- The 1963 Fall Joint Computer Conference will be held in the Las Vegas, Nev., Convention Center, Nov. 12-14.
- The annual meeting of the American Mathematical Society will be held January 20-24, 1964, in Miami, Fla.
- The 1964 Spring Joint Computer Conference will be held at the Sheraton Park Hotel, Washington, D.C., April 21-23.

Take
me
to
your
reader

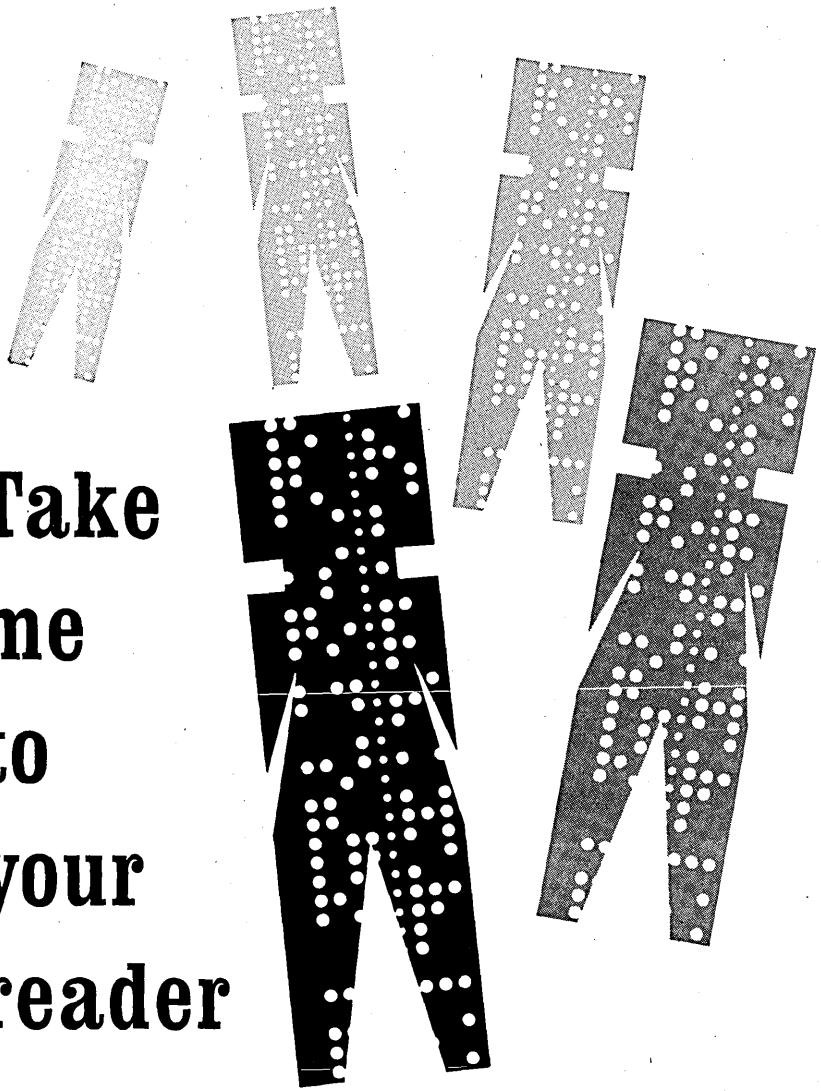

An invasion from Mars? . . . No, an innovation from Dura. This tape belongs in the Reader of Dura's remarkable MACH 10* DIGITAL COORDINATOR*. It's the automatic typewriter that gives you "systems control" over your business data.

To set up a DC* "instant" office system you simply put all of your pertinent data on the MACH 10 master tape or edge-punched cards. You then punch out a control tape with specific program instructions on it and place it in the DC unit. By taking instructions from this control tape, the MACH 10 picks out and automatically types at 175 words a minute only that information needed for a particular function.

With the MACH 10 DC you can still use your old forms. There is no costly electronic changeover to go through. If you change forms, just change the DC tape. What's more, the MACH 10 DC automatically controls the position of typing, reading, and punching a by-product tape for further data processing. Its versatility is amazing.

Write: Dura Business Machines, Inc., Dept. P, 32200 Stephenson Highway, Madison Heights, Michigan.

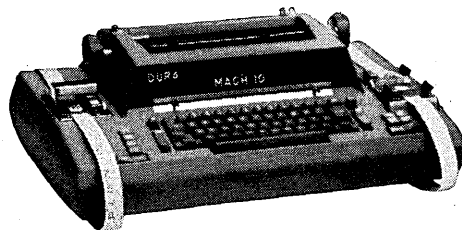

DURA

BUSINESS MACHINES, INC.

subsidiary DC* dura corporation

*Trademark Dura Business Machines, Inc.

CIRCLE 7 ON READER CARD

DATAMATION

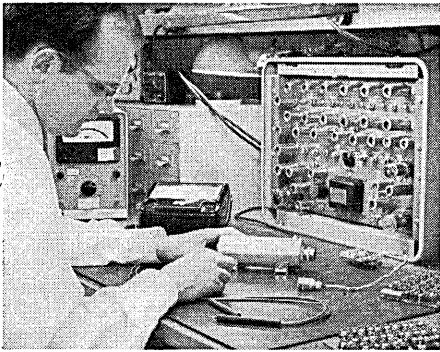

Here, at Lockheed Missiles & Space Company's Space Communications Laboratory, scientists are re-investigating the possibility of using the moon to facilitate earth communications. Possibilities for the use of the moon as a relay station for earth-to-earth communications have been largely neglected because the moon's shape and rugged surface greatly distorted a return signal. But Lockheed research into the extension of communications on difficult communication channels, using techniques applicable to dispersive time variant channels, is making significant inroads into this problem.

Another area receiving intense study at Lockheed is satellite tracking of deep space probes. Since tracking accuracy

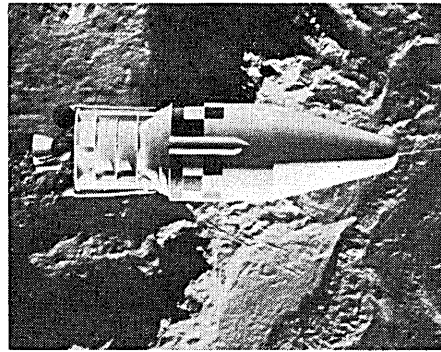

depends greatly on stations being as far from each other as possible, while retaining line-of-sight communications, Lockheed is studying the use of two earth-orbiting satellite tracking stations, 8000 miles apart. Not only would great accuracy be gained by the separation, but it would be further enhanced by the positioning of the stations above the earth's atmosphere, thus eliminating atmospheric distortion.

Examples of other research projects being pursued by Lockheed in the communications area include: Random multiplexing, satellite readout techniques, scatter communications, radar mapping, submarine tracking, modulation of optical energy, communications over multipath channels, and learning systems.

LOOK AT LOCKHEED... AS A CAREER

Consider Lockheed's leadership in space technology. Evaluate its accomplishments—such as the Polaris missile and the Agena vehicle's superb record of space missions. Examine its outstanding advantages—location, advancement policies, creative climate, opportunity for individual recognition.

Then write for a brochure that gives you a more complete Look at Lockheed. Address: Research & Development Staff, Dept. M-43C, P.O. Box 504, Sunnyvale, California. Lockheed is an equal opportunity employer.

SCIENTISTS & ENGINEERS: In addition to positions in the research and development of communications and optics, other important openings include: Inertial guidance • Orbit thermodynamics • Electromagnetics • Mission & trajectory analysis • Gas dynamics • Chemical and nuclear propulsion • Systems engineering

LOCKHEED

MISSILES & SPACE COMPANY

A GROUP DIVISION OF LOCKHEED AIRCRAFT CORPORATION

Sunnyvale, Palo Alto, Van Nuys, Santa Cruz, Santa Maria, California • Cape Canaveral, Florida • Huntsville, Alabama • Hawaii

LOOK AT LOCKHEED IN SPACE COMMUNICATIONS:

Where outstanding successes have created aerospace leadership

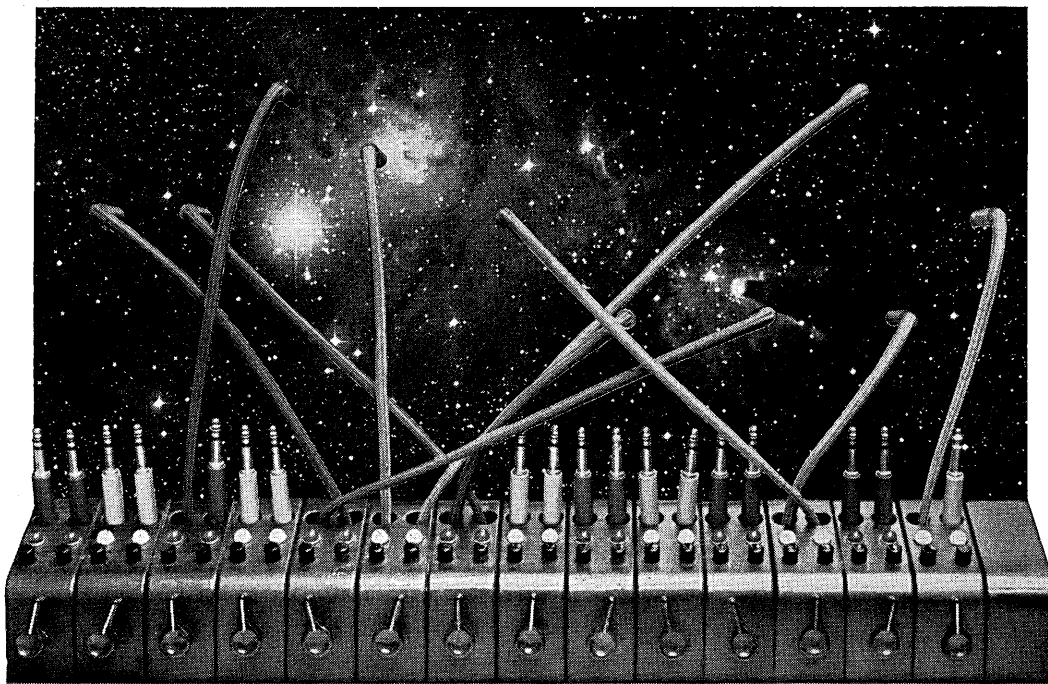

"Wouldn't it be simpler to have one reference source for just about every known computer?"

"Sure—but where can I find such help?"



"Right here. Auerbach/BNA Standard EDP Reports cover 44 major computer systems in use in the U.S.A."

"And the price for all this is \$900. Quick—how can I get Standard EDP Reports?"

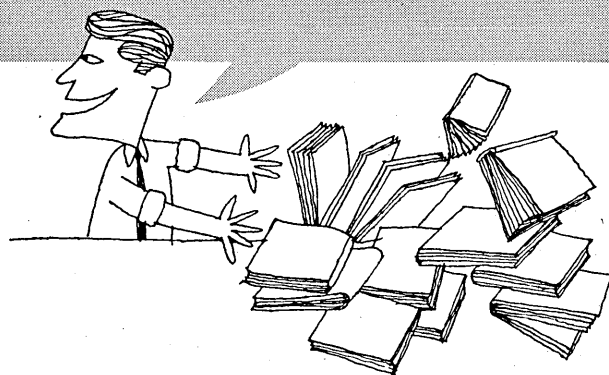
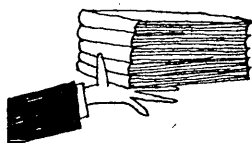

"Use the convenient order form below."

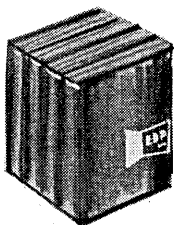

Gentlemen:

Please enter our order for _____ set(s) of AUERBACH/BNA Standard EDP REPORTS. Each five-volume set covers 44 major computer systems. The price per set is \$900.

Name _____ Title _____

Company _____

Address _____

City _____ Zone _____ State _____

For detailed information write: **AUERBACH/BNA** 1231 24th Street, N.W., Washington 7, D.C.

WHAT MAKES THESE TAPE READERS THE BEST IN THE WORLD?

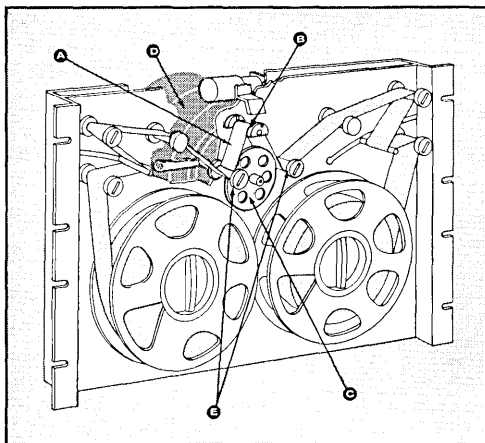
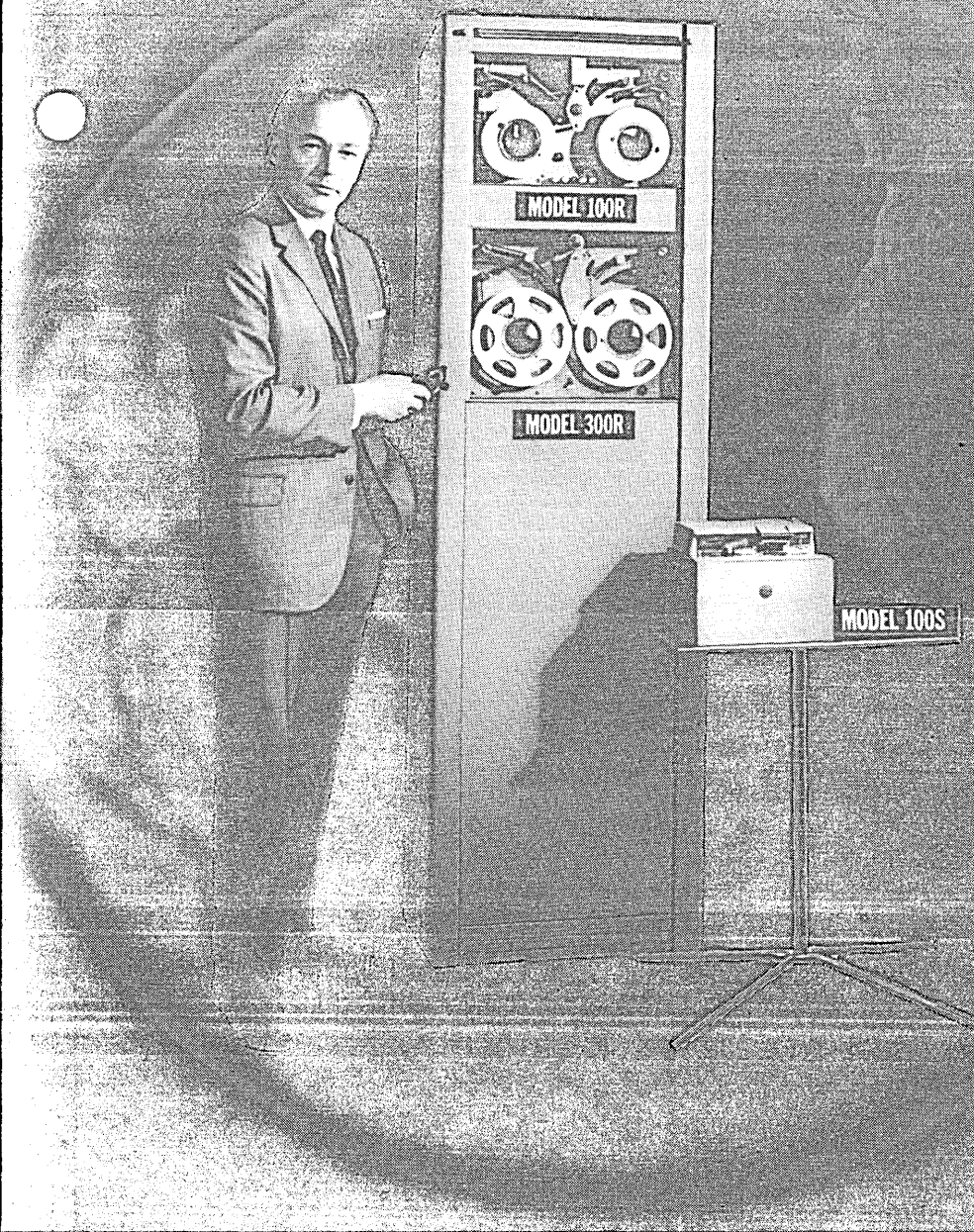

Mechanical simplicity . . . which yields a degree of reliability unattainable by any other paper tape reader! Simplicity made possible through the utilization of the revolutionary PMI printed motor direct drive servo. Movement of the tape through the read head is achieved by merely starting and stopping a printed motor. The brakes, clutches and pinch rollers that cause big trouble and down time in conventional tape transports are completely eliminated.

Line by line cycle: movement of tape (A) over read head (B) is controlled by drive capstan (C)—attached directly to shaft of PMI printed motor* (D); spring-loaded rollers (E) hold tape gently against capstan, keeping tape movement in exact accord with capstan rotation; advance command pulse accelerates motor, capstan, and tape; as read head detects next sprocket hole, a reverse pulse to motor halts capstan and tape with next character perfectly aligned in read head. *U.S. Patents of Printed Motors, Inc. Pending.

PHONE, WIRE OR WRITE FOR COMPLETE INFORMATION

Photocircuits
CORPORATION
TAPE READER DIVISION
Glen Cove, N. Y.

NEW OUTPUT from Prentice-Hall

• Programming the IBM 1401:

A Self-Instructional Programmed Manual

Learn to program more quickly, with greater ease, and more thoroughly—aided by extensive, crystal-clear explanations and examples. Avoid costly errors and gain quick insight into techniques and shortcuts usually discovered only after long experience. Get immediate feed-back of correct answers to all problems. By James A. Saxon & William S. Plette, *United Research Services, Inc.* 208 pp., illus., \$9.

• Programming the IBM 7090:

A Self-Instructional Programmed Manual

Obtain all the essentials for actually programming the IBM 7090 (also applicable to the IBM 709/7094 computers, and to some degree to the IBM 704). Master these vital specifics: the functions of the Data Channel; the characteristics of card and tape devices; the three phases of computer processing (input, computation, and output); and the four steps of planning, all designed for ease of programming. By James A. Saxon, *Saxon Research Corp.* 210 pp., illus., \$9.

• Programming the IBM 1620

You'll be able to write, assemble and run SPS programs on the 1620 by the time you are one-third of the way through this new book. Gives you all the major 1620 programming methods plus the Symbolic Programming System (SPS), FORTRAN, GOTRAN, and the Interpretative Programming System (IPS). By Clarence B. Germain, *Coll. of St. Thomas.* 186 pp., illus. (paper-bound), \$6.

• Logic of Computer Arithmetic

A complete coverage of high-speed parallel binary computer arithmetic. Deals exclusively with logic, not circuitry. Includes complete dissection of floating point arithmetic, thorough treatment of special purpose arithmetic units, and the first presentation of its kind of residue arithmetic and its applications. Also covers binary number representations; basic high-speed adders; short-cut multiply and divide algorithms; and square root and polynomial logic. By Ivan Flores, *Private Consultant.* 493 pp., illus., \$15.

• COBOL:

A Self-Instructional Programmed Manual

Pub. June, 1963—Enables you to write programs for a variety of computers. With small modifications, a COBOL program is equally applicable to IBM, Burroughs, Remington Rand, Honeywell, and other computers. Self-contained, complete course of some 200 problems, specially prepared for self-education. By James A. Saxon, *Saxon Research Corp.* 200 pp., illus., \$6.

10-DAYS' FREE TRIAL USE

PRENTICE-HALL, INC.
Englewood Cliffs, N. J.

Send me book(s) checked below for 10-days' examination on approval. In 10 days I will remit for book(s) I keep plus a few cents for postage and insurance, and return unwanted book(s). NOTE—We pay postage and insurance costs if you remit with this coupon—same return privilege.

- Saxon & Plette—Prog. the IBM 1401, \$9.
 Saxon—Prog. the IBM 7090, \$9.
 Germain—Prog. the IBM 1620, \$6.
 Flores—Logic of Computer Arithmetic, \$15.
 Saxon—COBOL, \$6.

Name _____

Address _____

City _____ Zone _____ State _____

1

D-0000-Jm

letters

unclear comparison

Sir:

I find it difficult to understand the comparison in "The 301 and 1401 — A User's Critique" (April, p. 33). While Mr. Kurzenknabe acknowledges a specifications edge for the IBM 7330 tape drive, he claims a 30 per cent superior performance for the RCA 381. On what does he base this—the color of the tape drive? It seems to me that four 7330's would be able to replace the six (or more) 381's, and result in less user time on the system.

Another comment that appears to be above me concerns the "modular expansibility" of the 301. The 1401 mainframe holds 4K storage. To go to 16K requires another unit, but it appears that the 1401, together with auxiliary storage, could fit within the 301 mainframe — and leave space for a 7330. Nearly any manufacturer could use a packaging method which would provide space for system modification. But I was of the impression that the trend was toward taking as little floor space as the system required.

W. V. SEBESTA

Johnson City, N. Y.

(Editor's note: Comparing tape drives, Kurzenknabe pointed out design features which favor the 381, saying: "So there are other advantages, aside from net performance characteristics; it's also how much labor time is involved in set-up, handling, and attrition of reruns." On the point of the commodious accommodations within the 301 mainframe, of greater significance is the resultant accessibility for servicing and the ease of system expansion.)

translation to MAD

Sir:

Regarding "Automatic Program Translation" by Ascher Opler (May, p. 45), the Univ. of Michigan executive system has a FORTRAN-to-MAD translator, MADTRAN, which has been available through SHARE for almost two years. The translator, itself written in MAD, very likely inspired the SIFT translator effort.

MADTRAN is used by MIT as a substitute for FORTRAN in its time-sharing system, in which MADTRAN output is immediately processed by MAD. The entire translation time is less than that for FORTRAN alone, although the resulting program suffers from the usual, slight MAD loss in object program efficiency.

I might add that this work was itself

influenced by a FORTRANSIT-to-GAT (both on the 650) translator written in GAT and first used in 1959.

Although I don't share this view, it should be pointed out that some people call this class of programs, "translators." It seems likely, however, that there exists a spectrum of programs of this type, ranging from the relatively trivial to the ultra-complex.

ROBERT ROSIN

Cooley Electronics Laboratory

University of Michigan

Ann Arbor, Michigan

on-line comments

Sir:

I have read with great interest the article, "Programming On-Line Systems," by Frank, Gardner and Stock (May, p. 29). It is regrettable that such a thoroughgoing and lucid presentation should be marred by a few apparent misunderstandings about certain facets of commercial real-time systems.

In referring to an airline reservation system's inability to achieve a particular response time, the authors note that "the delay in the response is not catastrophic since no data is lost and the additional time does not significantly affect system performance." Actually, a delay in response in such a system may well be catastrophic if it is chronic . . . Airline reservation systems must be designed to avoid delays.

Concern is expressed about simultaneity of file references in multi-terminal systems, such as developed for savings banks: "Thus, two essentially simultaneous transactions executed by independent functions upon the same record may invalidate both transactions . . ." As a practical matter, this does not turn out to be a significant problem in many real-time systems. The basic record has the characteristic of being called in from the system files only at the customer's request. And since the customer cannot normally appear at two counter positions at the same time, there is built-in protection from simultaneous references to the same record. Other sources of demand for these records can be classified as internally originated by the system, and subject to control by the system designer to eliminate competition for records.

ROBERT V. HEAD

IBM Systems Research Institute

New York, N.Y.

(Editor's Note: The authors reply, "Mr. Head's first comment is justified from the point of view of the system designer whose responsibility is to specify bounds on response time (deterministic or statistical), select equipment, and manage the programming implementation. The intent of the example was to illustrate the programming difference between input rates that are controllable and those, such as continuous radar data, where there is no control. Relaxation of the response time in the reservation system does not lead to lost data

while, of course, it could lead to lost sales.

"The concern expressed regarding simultaneity of file reference is intended to be just that: a concern—to indicate to the programmer that he must guard against such a circumstance. As indicated by Mr. Head the problem is usually met in the system design."

of girls & foreign computers

Sir:

Datamation shares with *Playboy* the distinction of being read ahead of turn as I attack my ever growing backlog of unread magazines. But time remains to correct and supplement specs in your list of foreign computers by Adams Associates (May, p. 41). Information on the Stantec Zebra and many others could have been cribbed from Bulletin 13 of the Provisional International Computation Centre, April 1961. Or "Ask the Man Who Owns One."

On the Zebra, I submit:
 Add time: 312 usec
 Storage Cycle: 10 msec (random access)
 Instr. Addresses: 1 drum + 1 fast
 Paper Tape In: 100 cps (not 200)
 Paper Tape Out: 50 cps (not 10)
 Software: interpretive "Simple Code" for scientific computing
 Not Supplied: Mag Tape, Buffering, Random Access File, Cards, Printer, Program Interrupt.

W. L. CLINK
 Department of National Defence
 Defence Research Board
 Suffield Experimental Station
 Ralston, Alberta, Canada

Sir:

I was surprised to find omitted from your list of foreign computers the Italian Elea 6001 and Elea 9003, manufactured by Olivetti. Technical specifications are as follows:

| | Elea 9003 | Elea 6001 |
|-----------------|---------------------------|--------------|
| First delivery | 1960 | 1960 |
| Storage | 20-160K core 360K drum | 10-100K core |
| Word length | 1a | 1a |
| Add time | 200 usec | 364 usec |
| Cycle time | 10 usec | 6 usec |
| Mag tape | 45 KC | 22.5 KC |
| Printer | 600 lpm | 600 lpm |
| Card reader | 500 cpm | 150 cpm |
| Card punch | 50 cpm | 50 cpm |
| Index registers | 40 | 16 |

Gianfranco Biraghi
 Schede Perforate e Calcolo Elettronico
 Via Manara, 11
 Milano, Italy

July 1963

This is the only
 computer you need



to figure your savings
 on exports via
 BOAC Air Cargo

Exporting adding machines, typewriters, computers, cash registers or data processing systems to Britain? Direct BOAC flights to London, Manchester/Liverpool and Glasgow put your shipments next door to any business or industrial center in Britain.

Not down the new BOAC Specific Cargo Rates for office machines — for example, you can ship typewriters, adding and duplicating machines from New York to London, Manchester/Liverpool or Glasgow for as little as 22¢ per lb.; office machines and electronic computers, 36¢ per lb.

Subtract what you'll save with lighter packaging, lower insurance rates, faster inventory turnover, minimal warehousing expense, more efficient use of working capital, and no costly refurbishing of mishandled goods.

Then add the advantages of speedy delivery, conscientious handling, and the fastest air cargo clearance and transfer in Europe through BOAC's new cargo facilities at London Airport. You'll find that BOAC's combined fleet of Rolls-Royce 707 jets and DC-7F wide-door freighters provide the most frequent and comprehensive service from the U.S.A. to Britain.

Ask for your free copy of our new Air Cargo Digest. It pinpoints the rates for world trade via BOAC Air Cargo.



ALL OVER
 THE WORLD

B·O·A·C

TAKES GOOD CARE
 OF YOUR CARGO

BRITISH OVERSEAS AIRWAYS CORPORATION

530 Fifth Ave., N. Y. 36 • MU 7-8900

Air Cargo Offices in all principal cities

On-line Air Cargo service from New York, Boston, Philadelphia, Washington, Chicago, Detroit, Los Angeles, San Francisco, Honolulu, Toronto, Montreal.

CIRCLE 11 ON READER CARD

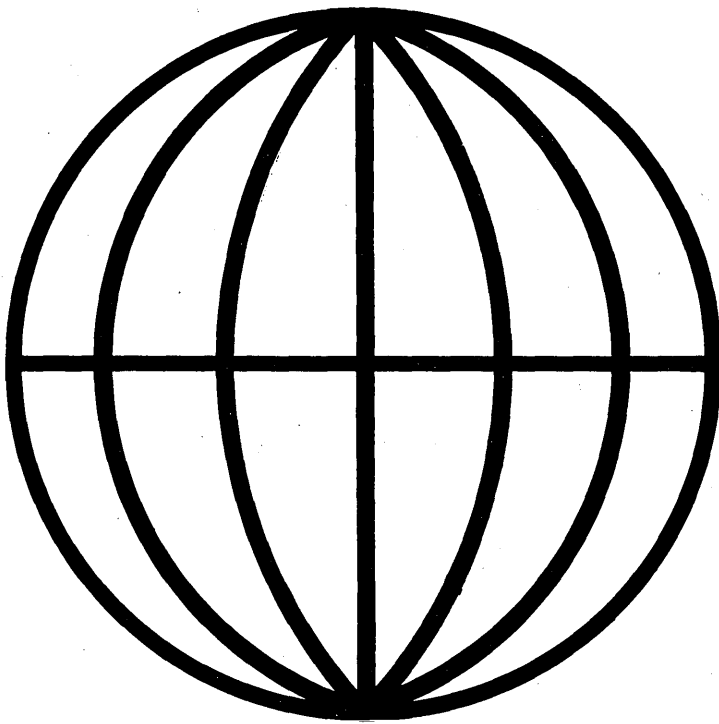

...and what,
in space?

what on earth does a systems man do here?

Under our collective roofs in Paramus, New Jersey, International Electric Corporation houses one of the largest aggregations of systems specialists in the nation... and probably the largest group of programming and software experts. Here is a partial breakdown of their activities that relate to space as well as earthbound systems situations:

Command & Control Technology

Parametric System Analysis
Airborne, Terrestrial Data
Processing & Displays
Survivable Communications
Distributed/Centralized
Data Bases
Weapons Systems C&C

Advanced Development Projects

Advanced Display
& Control Systems
Advanced Information Storage,
Retrieval & Distribution
Recon. Mapping & Data Recording
Data Acquisition Sensing &
Detection Systems
Simulation & Training Complexes

Advanced Systems Projects

Space Range Systems
Surveillance Systems
Space Command & Control
Space & Ground Military
Information Handling Systems

Management Information Systems

Control Systems
Communications
Data Processing Systems

Human Factors Sciences

Man-Machine Integration
Personnel Subsystem Analysis
Command Staff/System Exercising
& Evaluation
Human Engineering

Systems Sciences

Optimization Techniques in
System Design & Control
Real Time Management & Control
System Simulation & Scheduling
Control & Staffing of Human &
Human Linked Subsystems
Gaming Technology

Space Science

Life Sciences - Bioastronautics,
Psychoastronautics
Manned Space Subsystem
Integration Analysis
Psychophysiological Support Reqmts.
Bio-Medical Data Subsystem Reqmts.

Whether your own background is largely theoretical, or design... systems hardware, or software oriented... if you'd like to join us in these efforts, we invite your early inquiry. Write fully in strict confidence to Mr. E. A. Smith, Manager of Employment, Division 35-MK, International Electric Corp., Route 17 & Garden State Parkway, Paramus, New Jersey. (An Equal Opportunity Employer)



INTERNATIONAL ELECTRIC CORPORATION

CIRCLE 92 ON READER CARD

NEW RCA ADVANCES IN FERRITE TECHNOLOGY EXTEND MEMORY STACK CAPABILITIES

RCA offers Wide-Temperature-Range Stacks... Microferrite Stacks... Temperature Controlled Stacks ... Conventional Memory Stacks... in virtually any configuration to meet today's computer demands

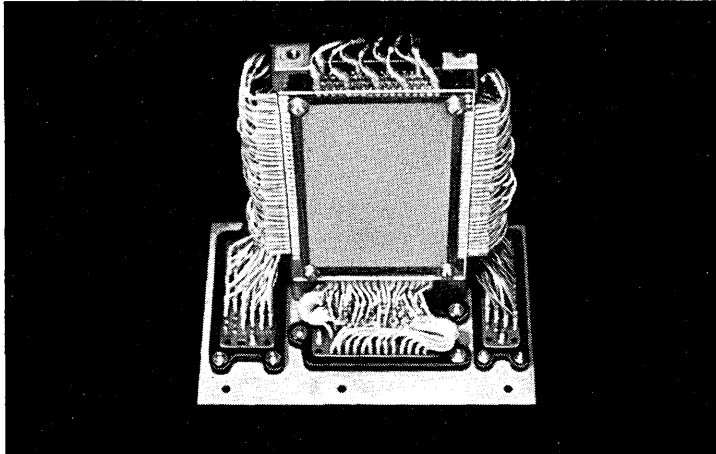

RCA WIDE-TEMPERATURE-RANGE STACKS COVER 80°C SPAN

New RCA wide-temperature-range ferrite cores permit the construction of planes and stacks that operate over any 80°C range within the limits of -60°C to +125°C without peripheral temperature-control equipment. In those applications where small size, minimum weight and reduced peripheral equipment are required, these devices can help you achieve vital space and cost savings.

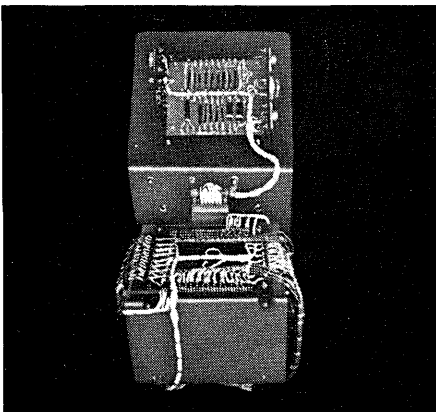

RCA CONTROLS STACK TEMPERATURE TO WITHIN $\pm 2^\circ\text{C}$ OVER A 120°C RANGE

RCA Memory Stacks, temperature-controlled within $\pm 2^\circ\text{C}$ are designed to meet MIL Specifications. Available in conventional or high density packages, these stacks can be utilized where specifications call for conventional core operation over extreme temperature ranges (up to a 120°C span).

RCA's versatile line of memory stacks now includes sizes from 256 words by 8 bits to 16,304 words by 32 bits, with ferrite cores from .030" to .080" O.D. for system speeds as fast as 375 nsec.

RCA stacks can be supplied in a wide range of configurations and operating characteristics to meet your design needs, including types designed to meet stringent environmental specifications for shock and vibration. In addition, you can select from a broad range of plane constructions—new molded epoxy, phenolic, and printed-circuit types, or aluminum types designed to meet MIL specifications. All RCA stacks are 100 percent dynamically tested to assure dependability under actual operating conditions.

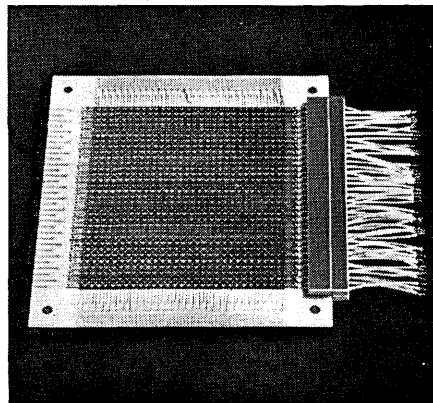

RCA's EXCLUSIVE MICROFERRITE STACK ACHIEVES 65 nsec. SWITCHING

New RCA microferrite memory stacks complete a full read/write cycle in 300 nano seconds with less than 350 ma driving current and bit outputs of 50 mv.

These revolutionary word-address systems, using proved ferrite cores, achieve packing densities to 2,000 bits per cubic inch. Available in multiples of 32 words by 32 bits.

RCA CONVENTIONAL MEMORY STACKS MEET LOW-COST REQUIREMENTS

RCA conventional memory stacks may be used where temperature extremes are not a critical problem, but where RCA's high quality and reliability are required at lowest possible cost. Hundreds of these stacks are now in use with an outstanding record of reliability.

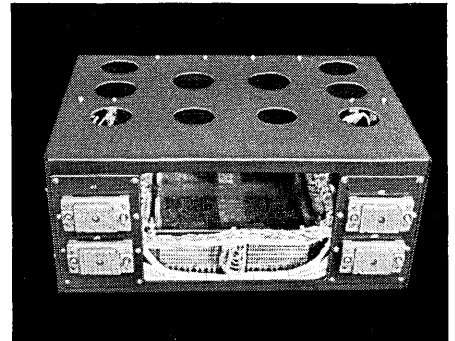

Service: Your local RCA Semiconductor and Materials Division Field Representative is prepared to provide a completely coordinated application service, covering ferrite cores and memory systems, and semiconductor devices. Call him today. For further technical information, write RCA Semiconductor and Materials Division, Memory Products Department, Section FD6, 64 "A" Street, Needham, Mass.



THE MOST TRUSTED NAME IN ELECTRONICS

636

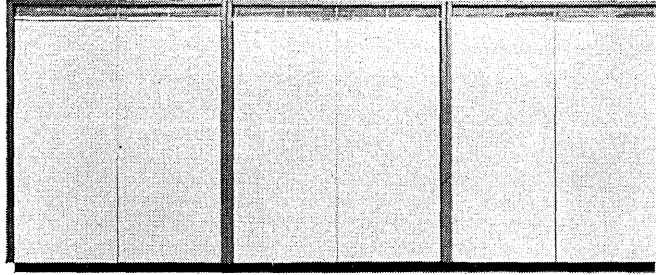

the computer that experience built

These few facts tell the reliability story for Daystrom's new 636 General Purpose Digital Computer:

- The 636 is the product of more than a quarter century of experience by Daystrom computers in actual on-line operation.
- During this accumulated span of almost 26 years, Daystrom computers have set an average availability record of better than 99.5 per cent. Each of the computers listed must operate 24 hours a day, 7 days a week.

In addition to providing the assurance fostered by this proven record of reliability, the Daystrom 636 gives you the problem-solving speed you require for today's complex computing applications.

Here is the full-size computer that can handle complex real-time data acquisition and control problems requiring programmed core-drum memory in capacities up to 294,912 words . . . that has excess speed capacity for simultaneous on-line and off-line use . . . that provides true direct memory access for input-output with no computation slow-down.

The 636 merits your attention for on-line monitoring and control . . . off-line conversion . . . engineering and scientific problem-solving . . . telemetering . . . any applications requiring a full-size computer.

Getting the facts is as easy as circling the reader service number for this booklet, or calling your local Daystrom office.

BASIC 636: \$95,000.

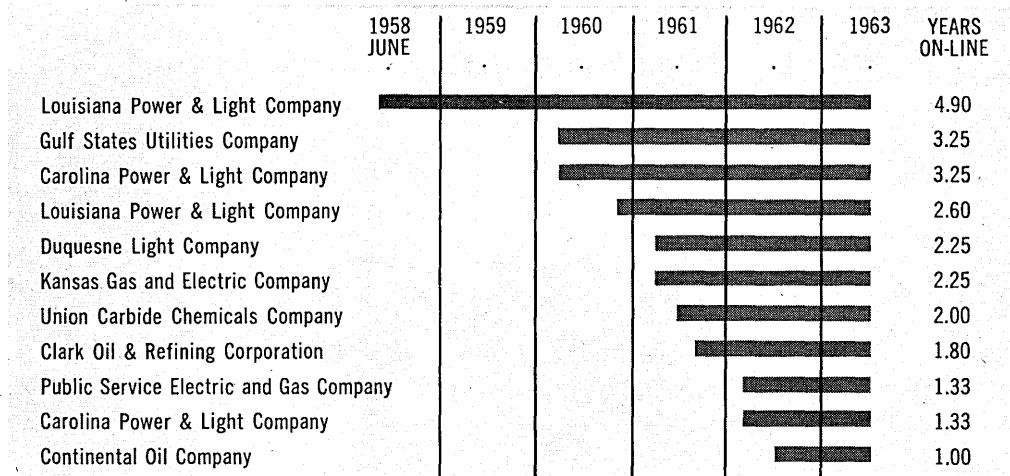

Average availability: 99.5 per cent.

25.96

DAYSTROM, INCORPORATED
CONTROL SYSTEMS DIVISION

Miramar Road, La Jolla, California • Telephone: 454-0421 Area Code 714
CIRCLE 14 ON READER CARD

compatibility plus

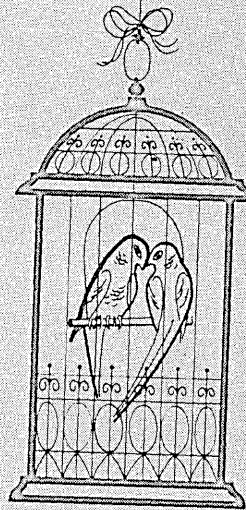
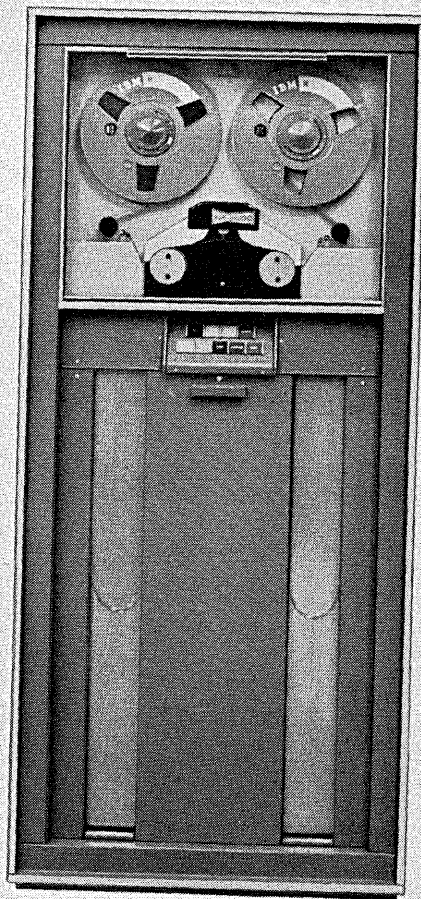

*[we could sing a song of praise . . . but it all comes back to the simple phrase
... COMPATIBILITY PLUS]*

M I D W E S T E R N
I N S T R U M E N T S
41ST & SHERIDAN RD. / TULSA, OKLA.

The SDS 9300 is faster than the 7090.

It costs \$215,000.

Kiss the computer speed/cost barrier goodbye!

The SDS 9300 adds in 1.75 microseconds and multiplies in 7 microseconds, including indexing. With optional hardware, it executes 48-bit floating point multiply in 14 microseconds. Compared to a 7090, that's over 100% faster at less than 25% the cost. And there's more to the 9300's speed than arithmetic: Input/output rates exceed 2-million characters per second simultaneous with computation (you can operate eight high-speed tape units, all running at 96Kc, concurrent with arithmetic execution). The price of the basic 9300 is \$215,000. With over-

lapping 8K memory, floating point hardware and a mag-tape unit, it costs \$330,000. First delivery: December.

If you'd like more information on the computer that represents an order of magnitude increase in answers per dollar for a wide range of scientific and systems applications, request a copy of our 9300 Computer brochure.

SDS 9300
SCIENTIFIC DATA SYSTEMS 1649 Seventeenth St., Santa Monica, Calif.

CIRCLE 16 ON READER CARD

**Programmers
GROW
with the
Programming
Systems Division
of Honeywell EDP**

The Programming Systems Division of Honeywell EDP is one of the first software-based divisions in the computer industry. With their own specially constructed facility in suburban Boston, Honeywell programmers engage in assignments involving the design and development of COBOL, FACT and ALGOL type Compilers, Executive Routines, Scientific Libraries, and other advanced software packages.

Backed by the Honeywell Corporation's 76 years of technical management experience, we've created and produced a growing line of business and scientific digital computer systems that include the H800, H400 and H1800. Earlier this year our powerful new computer system, the H1400 was announced. Compatible with our other systems, it has broadened and deepened the software production requirements of our Programming staff and has helped create many new additional career opportunities for Honeywell Programmers.

Opportunity to join our staff exists in the following departments:

**Scientific Programming
Automatic Programming**

Previous experience is necessary in the programming of scientific and engineering problems.

Address your resume to:

Mr. Edmund Murray
Employment Supervisor
Programming Systems Division
60 Walnut Street, Dept. 786
Wellesley Hills 81, Massachusetts

Honeywell
ELECTRONIC DATA PROCESSING

Opportunities also exist in other Honeywell divisions. Send resume to H. E. Eckstrom, Honeywell, Minneapolis 8, Minnesota. An equal opportunity employer.

DATAMATION

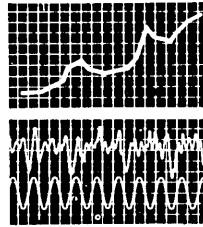

**BUSINESS
& SCIENCE**

PHILCO REORGANIZES,
NARROWS MARKETING SIGHTS

Amidst rumors and reminiscences of last year's Bendix "consolidation," Philco last May announced that it was pulling its Computer Division into the Communications & Electronics Division. Dropping the six-month-old 4000 from the line, Philco will now concentrate on the large-scale systems market, emphasizing military and scientific, areas of greatest success to date. The 1000 will be sold only as a satellite for 2000-series, which now represent, according to Philco, roughly 10% (23 systems) of those installed costing \$40K/month or more. Personnel cutbacks involve only 4000 specialists, with no reduction in 2000 sales or support activities, according to newly named computer marketing manager Bill Doherty.

Philco sights are set squarely on the command and control market, centering mainly on 7090-94 FORTRAN and COBOL users, says Doherty.

Current re-structuring of 2000 prices, says the balding, beaming Philco executive, "will make us competitive." And he points to "a quite encouraging" 212 backlog as added reason for healthy optimism. Also coming up: "significant" hardware and software announcements.

FORTRAN IV:
A BRIEF PROGRESS REPORT

The current wait and see upgrading mode has not affected software, where the spotlight is on the FORTRAN IV race. Here's a quick run-down on present progress among some of the big boys:

Burroughs, all of its scientific language eggs in the ALGOL basket, has made no decision on a IV compiler yet.

CDC says its 1604 version of "FORTRAN '63" was in field test in mid-June, with the 3600 model ready soon. The 1604 version hangs up on some statements but will eventually accept and compile all but IV data statements. Compiling speeds are about the same as earlier version; object codes are "near maximum efficiency."

GE, according to one source, will announce in August a compiler combining "II language with IV capabilities," part of a monitor system, with quoted 80% efficiency.

Honeywell's Automath 1800, already announced, contains the IBM IV language as a subset, requires 15K memory. Features include an alternate form of the data

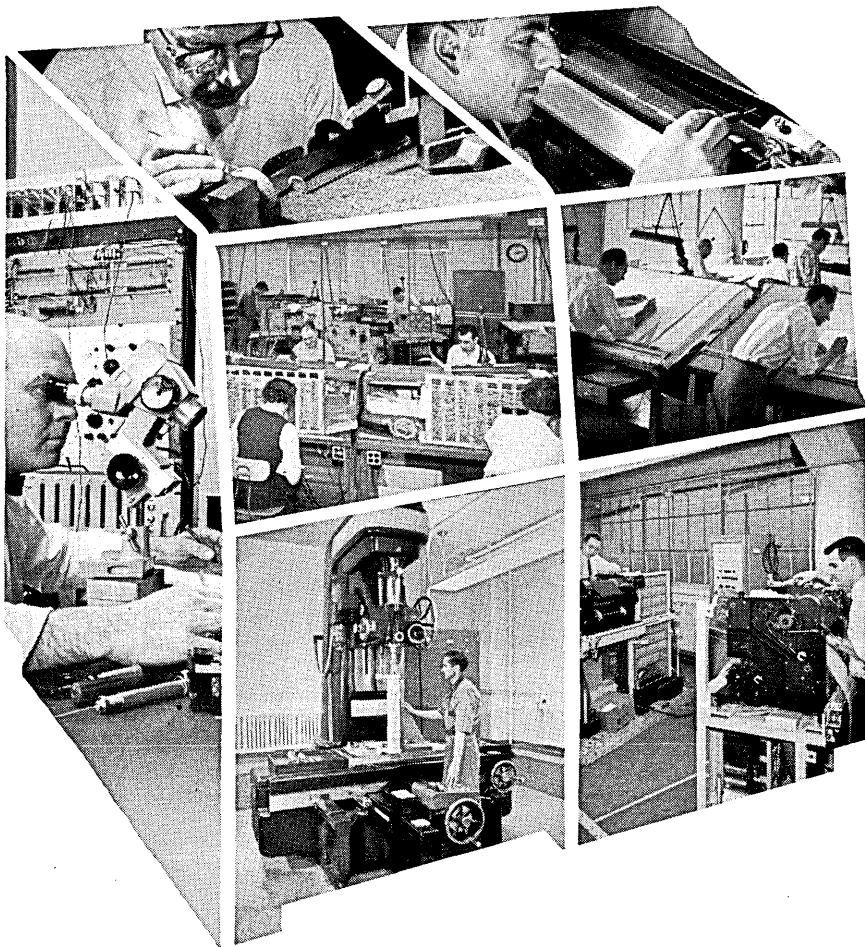

INSIDE VIEW OF

ANELEX HIGH SPEED PRINTER SYSTEMS

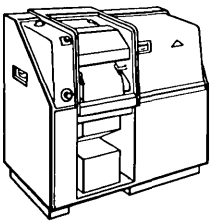

When you look inside Anelex Printer Systems, you can't see the things that really make them great . . . the plant, the tools and most of all the people. The fact is it takes a lot of plant . . . more than 2½ acres of machine tools, instruments and special equipment . . . and a lot of people . . . over 900 of us . . . to build the variety and numbers of standard and special purpose printer systems which bear the Anelex symbol of quality. For your next system, be sure of the finest printer; write Anelex for further information.



ANELEX®

155 CAUSEWAY ST., BOSTON 14, MASSACHUSETTS

CIRCLE 17 ON READER CARD

DATAMATION

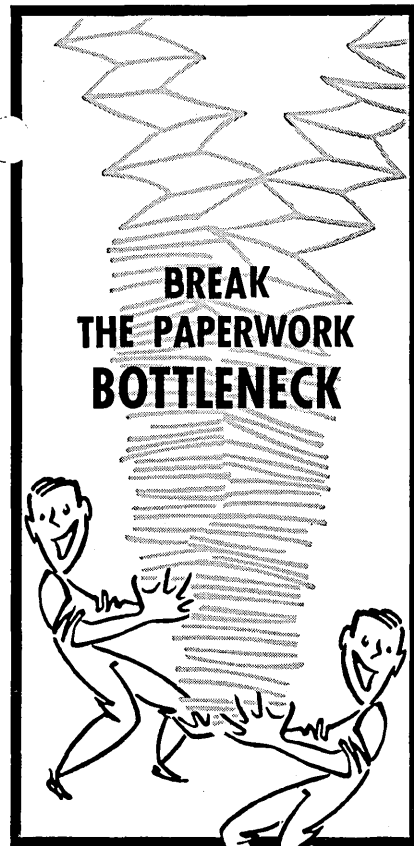

with
a dsd 1260

HIGH-SPEED PRINTER

Document rate adds up to dollars. In most applications you can almost **DOUBLE THE OUTPUT** of your data processing system with this completely new high-speed line printer featuring superior print quality on all types of single and multi-part forms.

PARTIAL SPECIFICATIONS

Printing Speed 1200 lines/min.
Skip Rate . . . 60"/sec.
Form Width . . 3" minimum
22" maximum,
132 columns

Presently being demonstrated at

dsd DATA SYSTEMS DEVICES OF BOSTON, INC.
342 Western Ave., Boston 35, Massachusetts
Area Code 617 AL 4-0440

CIRCLE 36 ON READER CARD

NA
TIT
CO
AD
CI

PRC

| |
|----|
| 1 |
| 10 |
| 19 |
| 28 |
| 37 |
| 46 |
| 55 |
| 64 |
| 73 |

NA
TIT
CO
AD
CI

PRC

| |
|----|
| 1 |
| 10 |
| 19 |
| 28 |
| 37 |
| 46 |
| 55 |
| 64 |
| 73 |

statement, variable sized arrays, octal constants. A Honeywell SIFT for the 800 is due September 1.

FORTTRAN father IBM, reportedly having trouble with its 90 IV compiler -- said to be running slower than the not-notoriously swift II -- says the IV will be part of a comprehensive 90-series IJOB system; this makes direct comparisons difficult. One independent source says the IV is slower only on shorter programs. Trouble or not, the company has hired consultant CUC to review its 90/94 programming support program and evaluate competitive software.

Philco says work on its IV compiler is winding up; it will be available to the field "later this year."

RCA is "well down the road" on an enhanced II, scheduled for field test on the 354 (scientific 301) around the first of July.

Univac says its IV for the 1107 is in operation, has been accepted by a major gov't agency. Said to be "two to 10 times as fast as the IV on the 94," the compiler is rated by one independent consultant as the tightest, most efficient he's yet seen. A IV compiler for the Univac III will be ready this fall.

TWO COMPUTER BILLS UP;
WASHINGTON THUMBS DOWN?

All that publicity about computers was bound to back-fire. Now Washington is trying to do something about their proper procurement and use. Hearings have been conducted lately on two bills, one sponsored by Texas Representative Jack Brooks, the other by veteran Senate watchdog Paul Douglas.

The Brooks bill, HR 5171, wants to charge the GSA with the responsibility for all EDP purchase/lease decisions, the evaluation of their effective use, and establish a revolving fund for purchase of computers, which would be rented to agencies. The Douglas bill, S-816, would establish P/L review authority in the Executive office of the President.

Both bills reflect the growing push for more government purchasing of computers. An unspoken industry fear: purchase will strengthen the healthy IBM grip on the government market, make it harder to justify the switch to other machines. Strong opposition is also raised by department heads who consider such legislation a usurpation of cabinet secretaries' authority. Insiders feel that neither bill is likely to pass this session.

WASHINGTON AGAIN --
THE FLEET'S IN

Another hot government trend--fleet purchases of computers, with the Air Force playing the lead role. Following up the AFLC order for 30 301's (May Datamation), the Air Force has announced plans to install between 160 and 174 NCR 390's for payroll processing at some 105 US and 25 overseas bases. The two orders sandwiched a dinky order for 19 CDC 160A's for an AF Satellite Control Facility tracking network.

But the fun is only beginning. The USAF Electronic

Systems Division has asked 24 manufacturers to submit proposals "for the installation of an edp system at some 152 Air Force bases throughout the world." The application: base-level inventory control. Proposals were due July 20, and a coded benchmark program is to be turned in by high noon, August 15. Proposals will be evaluated by the ESD's Data Processing Equipment office, and the contract awarded by GSA.

And DOD, evidently getting ready to make use of beaucoup computers, has purchased rights to reproduce and distribute Auerbach Corporation's programmed course in COBOL, distributed by Basic Systems, Inc., NYC.

CLIPPINGER'S REPLACEMENT
IN X3.4 CHAIR IS NAMED

Dr. Franz Alt, of the Bureau of Standards, has been named chairman of ASA X3.4--Common Programming Languages--succeeding Dick Clippinger. Dr. Alt has had no previous association with ASA, but has achieved sufficient prominence to merit mention in "American Men of Science."

THE B 5000:
HARDWARE IN,
SOFTWARE FIRING UP

A mite tardy getting off the ground, the B 5000 was flying high last month with eight installations, three within Burroughs. Two more systems are scheduled for delivery this month. Number one was delivered March 31 to United Tech. Center, Division of United Aircraft in Sunnyvale. Initial hardware tests used a prototype Master Control Program and extended ALGOL '60 5000 compiler. Using a FORTRAN translator, the B 5000 handled a rocket engine analysis problem, translated it into ALGOL, compiled and ran approximately 2.5 times as long as the original 90 program without multiprocessing on a machine about one-third the cost of a 90.

The second 5000 at NASA Huntsville includes one processor, four consoles (three slightly remote), four I/O channels, four memory modules (with four more on order), a 700 lpm printer and 12 tapes, plus some special telemetry coupling gear which acts as four pseudo-tapes. Both systems were in acceptance test in mid-June. Other 5000's shipped since include Northern Natural Gas, Dow Chemical, and L. A. Board of Education.

On the software front, Burroughs says its extended '60 ALGOL compiler was completed with the addition of I/O in early June. Goodies added to '60 ALGOL include stream procedures for handling character oriented logic, ability to handle partial word fields and symbolic monitor and dump debugging aids. COBOL, minus the SORT construction, is now being used to debug customer programs, and was supposed to be ready this month. A final-format MCP was installed in June, although more work will be done on it, says Burroughs. The FORTRAN translator is reportedly running well at both UTC and NASA.

All this programming tape was made

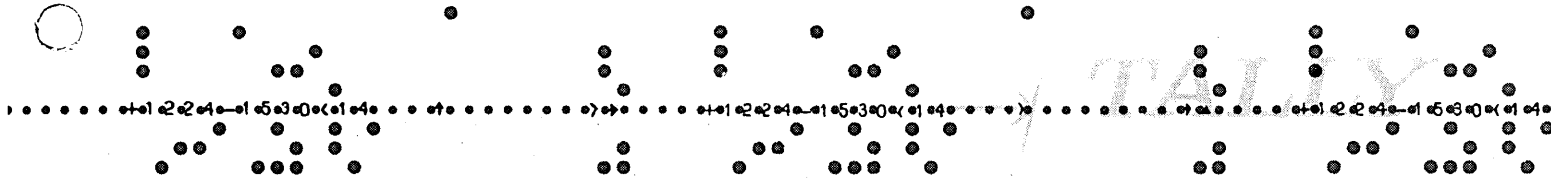

on the new Tally Printing Perforator.

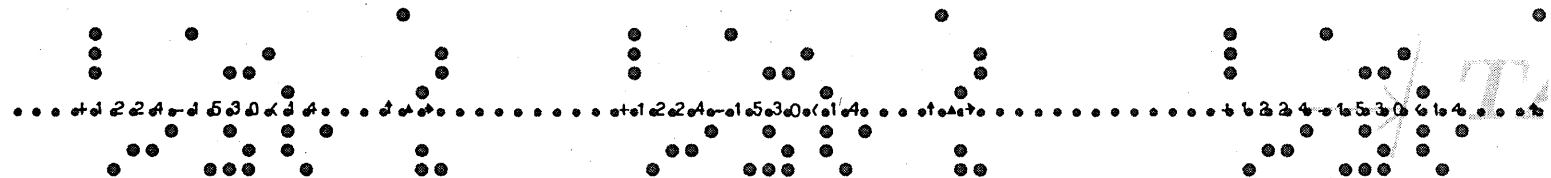

You can make even more!

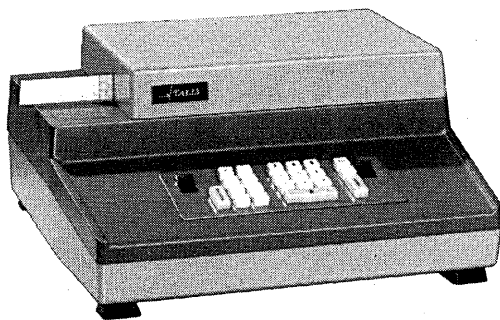
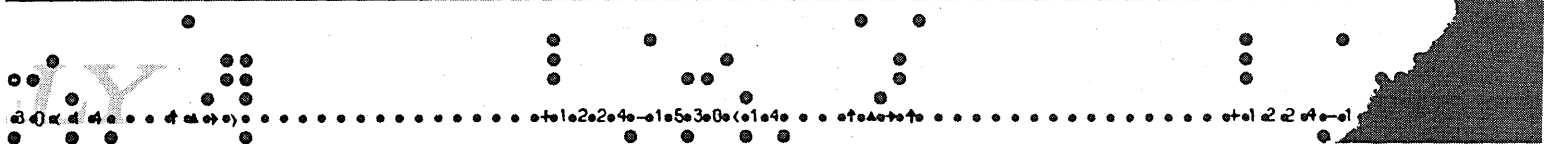

Model 430 Printing Perforator

Where your perforated tape preparation problems concern numerical control, computer programming, inventory recording, accounting, or data recording, you should see how the new Tally Printing Perforator can work for you.

Here is a versatile, modestly priced approach to all kinds of source data recording. Technically, this new unit is an 8 channel, fixed code, printing perforator which will operate at 8 characters per second with entry provided by a 20 character keyboard consisting of a standard 10 character adding machine keyboard plus 10 additional characters. At the time of punching, the entry is printed directly to the left of the sprocket hole and in line with the coded character. The tape can be automatically positioned for visual verification. You can select any alpha-numeric-symbolic code combination desired at the time of order. A full 1000 foot tape supply is standard. Price is a low \$1,395 and quantity discounts apply.

For a demonstration, call your Tally sales representative. For more information, please write Tally Corporation, 1310 Mercer Street, Seattle 9, Washington.

TALLY®

CIRCLE 18 ON READER CARD

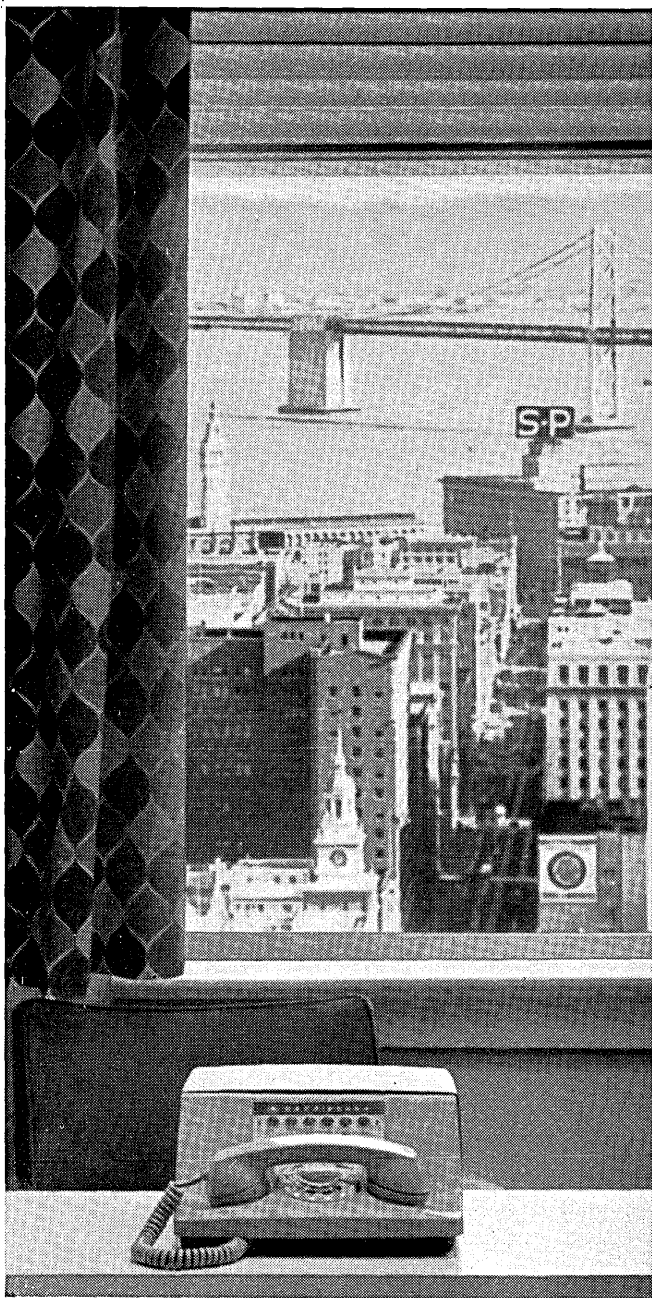

Give your computers a 3000-mile reach

Put DATA-PHONE service to work for your company and your business machines can reach anywhere there are regular telephone lines.

Send any kind of data that can be put on punched cards or tape—any time of the day or night at regular telephone rates.

Think how DATA-PHONE service can save you time and money in shipping vital word and figure data to and from all your business locations. See one of our Communications Consultants about it. Just call your Bell Telephone Business Office and ask for him.



Bell Telephone System

CIRCLE 19 ON READER CARD

DATAMATION

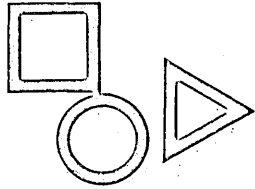

EDITOR'S READOUT

ON SCIENCE AND SOCIETY: A DEVOUT WISH FOR AFIPS

At its most recent meeting at the Detroit SJCC, the AFIPS Board of Governors decided to establish a central office in New York City, manned by an executive secretary yet to be chosen. Also still missing: a well defined public information program for AFIPS. This is understandable. Only two years old, AFIPS is still feeling its way toward a satisfactory understanding of its relationship to its member societies and to the world at large.

But it is devoutly to be wished that AFIPS does not underestimate the importance of public information—the responsibility of any scientific or technical community to inform society of its work. More important, it is the responsibility to help evaluate—and prepare for—the impact of that work upon society.

This responsibility is especially critical in a democratic society, where the general public, through elected representatives, plays so large a role in determining technical expenditures and progress. And information processing is undoubtedly affecting our society more directly, broadly and dramatically than any other single technology, even in its infancy.

Already in its short history, AFIPS has built the foundations of a sound public information program. The machinery for presenting talks on information processing to lay groups has been established; press seminars have been conducted at several conferences and relationships established with the press; the framework for a speakers' and information bureau has been set up; an eight-page pamphlet introducing information processing has been prepared. The prognosis for AFIPS public information is healthy: new chairman Don Madden is an enlightened and articulate advocate of a sound, aggressive and progressive public information program.

We hope that the AFIPS executive committee shares and supports his public information policies; and we hope that they will help him select an executive secretary capable of putting them into effect. But this isn't really enough. Members of AFIPS societies at every level must realize, too, their public information responsibilities.

This can mean writing a letter to an editor of a local paper . . . or participating in local, state or federal government citizens' committee work involving information processing. It should mean, certainly, a more direct and active participation in AFIPS and its member societies. They are what you make them. And what you make them may determine how well our free society makes use of computers and information processing.

COMMUNICATIONS SWITCHING AND BUFFERING NETWORKS

principles and requirements

by JOHN D. BEIERLE, Automatic Electric Laboratories, Inc., Northlake, Illinois



Structurally, a communications switching network is a highly parallel computer consisting of a grid of independent, interconnected, spatially separated, functionally similar switching and computing modules, each with its own logic, memory and input-output hardware.¹ See figure 1. A switching and computing module communicates with another module by building a path to

it. A path may be direct or may include intermediate modules. Path building instructions are generated at the originating module by a subscriber and transmitted along the path as it grows. Highly parallel computers are called Holland machines in the literature.²

In voice/data call switching networks, all path building is completed prior to channel utilization, which is then bidirectional. In unidirectional store and forward message switching networks, path building and channel utilization alternate until a message reaches its destination or destinations. Message switching modules include buffer storage to hold delayed messages during path building. Message switching networks may also include specialized buffer modules to handle code, signalling, and timing conversions.

message switching and computing modules

The functional organization of a store and forward message switching module is depicted in figure 2. The principal functions of the module are:

- (a) Monitor lines for incoming messages either from subscribers or other modules.

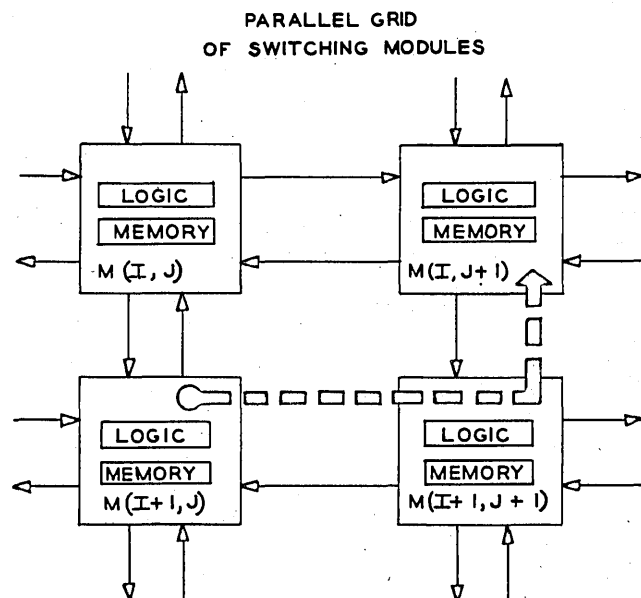

FIGURE 1

- (b) Switch incoming messages into high speed buffer storage.
- (c) Analyze path building instructions received with messages to determine message destination, route and priority level in accordance with message format specifications. Provide optimum routing of messages where possible.
- (d) Find idle outgoing lines, make them busy, and transmit messages over them from high speed buffer memory.
- (e) Perform message format, code and speed conversion, where necessary.
- (f) Maintain a log of messages, including time received and time transmitted. Administer assignment of message identification numbers.
- (g) Transmit messages to multiple destinations as directed by path building instructions. Buffer messages until all replicas have been transmitted.

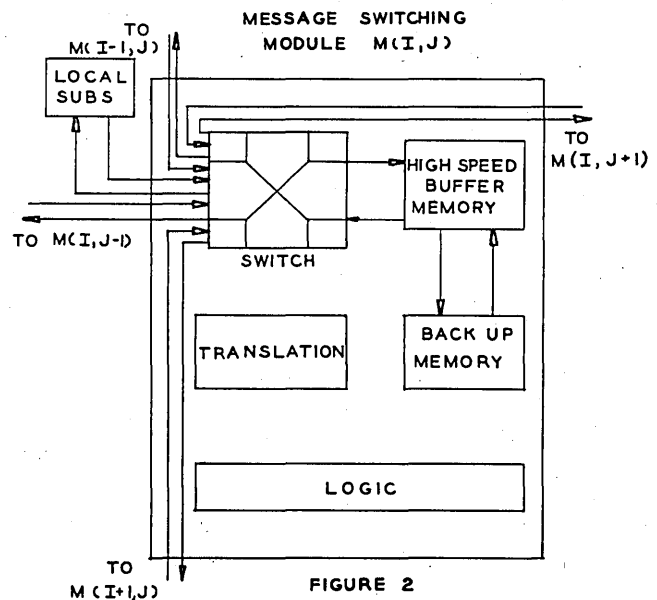

FIGURE 2

- (h) Transmit messages in proper order of priority, and administer queue discipline in buffer memory for messages waiting behind busy outgoing lines.
- (i) Monitor buffer memory for overflow, and divert messages in excess of high speed buffer capacity to medium speed, large scale back up memory.
- (j) Monitor lines for transmission errors. Provide error detection and correction.
- (k) Monitor lines and internal subsystems for errors and faults, and generate maintenance messages when faults are detected.
- (l) Perform message accounting; assemble information for customer billing.

The principal functional subsystems of the module are the Switch, High Speed Buffer, Back-Up Memory, Translation and Logic.

The Switch permits local subscriber and incoming and outgoing line messages to be switched in and out of the Buffer Memory. The Buffer Memory and Back-Up Memory function in an obvious way to store messages awaiting idle outgoing lines. The Translator consists of a look up table of routing instructions for first choice and alternate routes, which is accessed using path building instructions received from local subscribers or other modules. These functions and subsystems operate under control of the Logic.

stored program message switching

Store and forward message switching has been handled in the past by electromechanical hardware. Examples of such systems are the Army's AN/FGC-30, the Navy's 82B1 System, and the Air Force Plan No. 55 Equipment.

In recent years, much attention has been paid to the possibility of handling message switching with real time, on-line digital computers. A number of such computers have been proposed, developed or installed by communications and computer equipment manufacturers.³⁻⁷

In a real time digital computer solution, a high speed random access core memory functions as the high speed buffer, with magnetic tape, disk file or drum memory being used for buffer back-up. The logic of the message switching module is built into the computer's stored program of instructions. The translator may use either high or medium speed memory, depending on the complexity

and housekeeping operations which are executed only when a message is offered for processing, and (2) simple but highly repetitive operations concerned with reception and dispatch of messages and their component characters.

Given the processing speeds available in today's generation of computers, careful attention must be given to systems and software design in order to avoid excessive real time occupancy due to type (2) functions. Some real time relief may be obtained by letting per-line hardware handle line synchronization and character construction from serial code, as indicated above. However, directed scanning of line units by the computer to detect the presence of new characters could be highly consumptive of real time. A well known solution to this problem is the program interrupt technique.

An interrupt feature enables a line unit containing a character destined for the memory buffer to stop the computer in its present task, and causes the computer to execute a short program to serve the line unit. All vital control register contents in the computer are saved in buffer memory when the interrupt occurs, and restored when the actions requiring interrupt are completed. Following restoration actions, the computer resumes its normal sequence of instructions.

An extension of the interrupt technique called multi-sequencing is particularly applicable to stored program message switching. This technique has been described in the literature by Ackley.^{8, 5} In a multi-sequence system, line units are ordered in priority classes. Priority classes are independent of particular message priorities but depend on the speeds of the channels associated with the line units. Obviously, high speed lines are given a higher priority than low speed lines, since they require more frequent attention. In general, incoming lines have a higher priority than outgoing lines.

Lines may interrupt programs associated with lines of lower priority, but not lines of equal or higher priority. Any line may interrupt the main housekeeping program which has zero priority. Multi-sequence operation requires hardware which determines, among all active line unit interrupt requests, which has the highest priority, and then matches the priority of this interrupt against the priority of the program currently being executed.

alternative software techniques

Techniques for eliminating line units and multi-sequencing hardware have been reported recently by Helman *et al.*⁹ These software and systems techniques presuppose digital circuitry operating at a 4 mc clock rate, and a high speed random access memory with 2 usec full cycle time and 1 usec read or write cycles.

Very high speed line scanning at a 280 usec rate replaces the line units, which are reduced to a simple level detector element. Scanning is controlled by a wired logic input-output unit which steals the system memory from the computer every 280 usecs.

A memory block assignment technique eliminates the requirement for stored program transfer of characters to memory and for multi-sequence hardware. A small number of back-up words for character storage are assigned to each line. As the input-output unit begins to fill the back up words, it puts up a flag which is scanned at a leisurely rate by the computer. When the computer observes the flag up, it finds an idle block of storage and puts its address in the first back-up word. The input-output unit then continues to fill this assigned block.

Many functions of a message switching module may be performed either by hardware or software. Functions most susceptible to software realization are those per-message functions involving relatively complex data manipulation. Hardware solutions appear most suited for the simple,

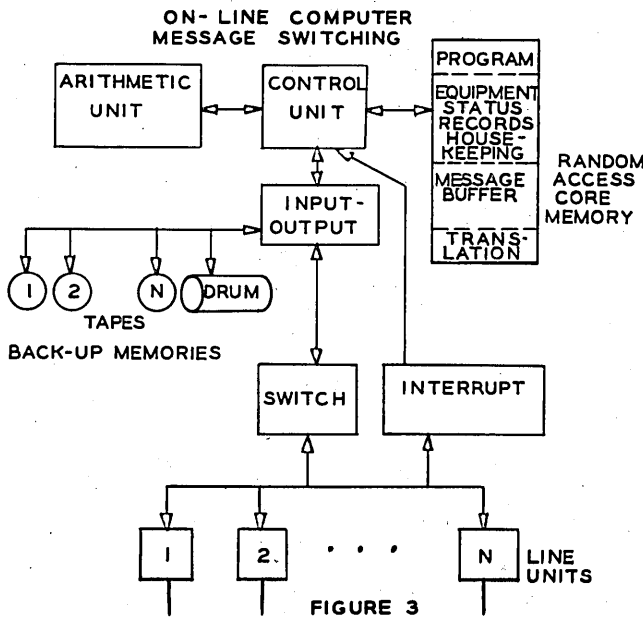

FIGURE 3

of table look-ups required. Figure 3 illustrates a typical computer application.

The line units operate as series-parallel converters and serve as a one or two character buffer between the line and the computer. Line units also handle start-stop synchronization.

program interrupt and multi-sequencing

In an electromechanical message switching installation, many identical units operate in parallel to carry the message processing traffic load. In a computer controlled message switching system, a single server time shares its control, arithmetic and memory access circuits over all message traffic, operating in a serial, one instruction at a time, mode. The computer's functions may be divided into two types: (1) complex data manipulation, arithmetic

highly repetitive functions of the module. Even here, a desire for flexibility might lead to a stored program solution.

voice/data call switching modules

A large volume of data transmission traffic is expected to utilize the voice networks of the telephone operating companies and administrations and the broadband switching network of Western Union. In these networks, end-to-end paths are established before any voice or data transmission begins. Call switching modules differ from message switching modules in that no buffer storage is required, and in

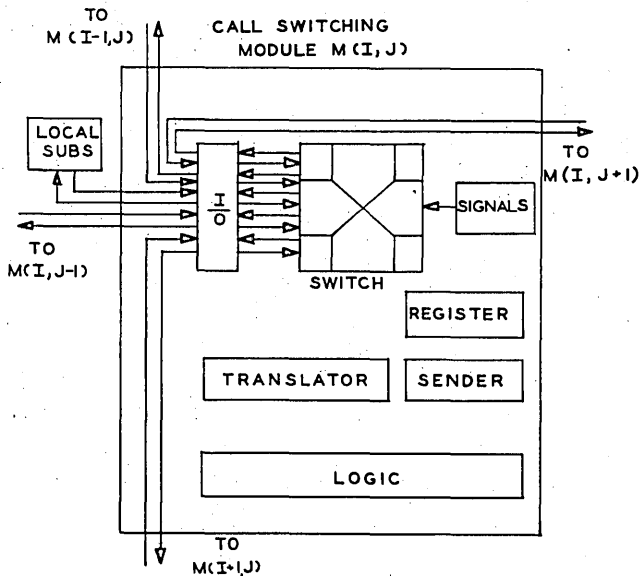

FIGURE 4

that no switching of data takes place between lines and memory. A typical call switching module is depicted in figure 4. The principal functions of the module are:

- Supervise local subscribers and incoming and outgoing paths for origination (seizure), answer, disconnect, and flashing. Transmit answer and disconnect supervision.
- Register path-building instructions transmitted over lines and paths either by d-c or multi-frequency signalling.
- Analyze and translate registered path-building instructions to determine call destination, route, and new path-building instructions if the path is incompletely built.
- If the call destination is local, test local subscriber for busy, and if idle, ring the local subscriber and return ring-back tone to the originating path or subscriber. If busy, return busy tone. Remove ringing and ring-back tone when answer is detected.
- If the call destination requires more path-building, send the new path-building instructions to the next module. If an idle path meeting either primary or alternate route translation specifications cannot be found, return all path busy tone to the incoming path or subscriber.
- Maintain traffic data on calls.
- Monitor lines, paths, and internal subsystems for errors and faults; diagnose faults.
- Record terminal identities and time toll calls from answer to disconnect. Assemble customer billing information.

The principal functional subsystems of the call module are the Switch, the Input-Output, the Register, the Sender, the Translator, and the Logic. The Switch is used to interconnect local subscribers, tones, ringing signals, incoming

paths, and outgoing paths. Connections may be set up from subscriber to subscriber, subscriber to path, path to subscriber, and path to path. The Input-Output unit functions to permit the extraction of path-building instructions from subscriber's and incoming paths, and to permit the insertion of path-building instructions into outgoing paths. The Register contains memory for recording path-building instructions as they are received. Because of code differences, specialized originating registers may service local subscribers, and incoming registers may service paths. The Sender contains memory for storage of path-building instructions while they are being inserted into outgoing paths. The Translator is a look up table permitting the random association of path-building codes with internal module terminal numbers. It also stores routing instructions and path-building instructions. All functions operate under control of the Logic.

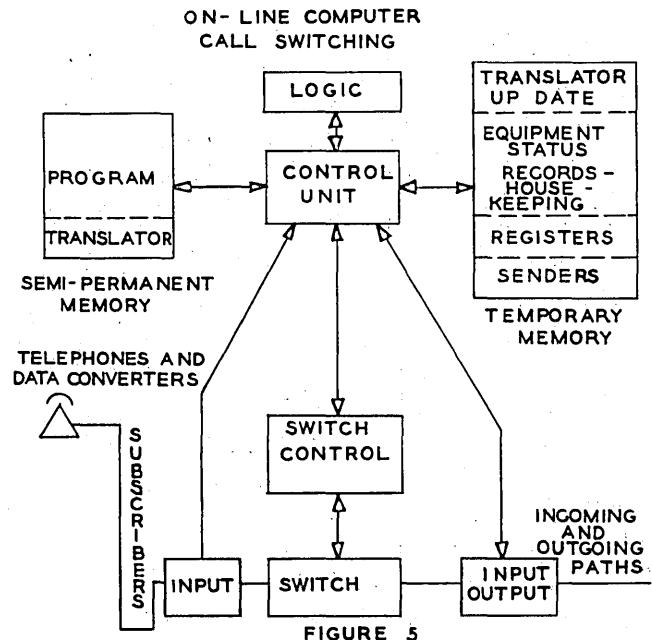

FIGURE 5

stored program call switching

As is the case with message switching, voice/data call switching has been processed using exclusively electro-mechanical equipment. Recently, the Bell System successfully concluded a trial of an electronic central office (ECO) in Morris, Illinois.¹⁰ The Morris ECO consisted of an ultra-reliable, duplicated, special purpose computer operating on-line to control a switching matrix. Similar systems, either projected or under development, have been described in the literature by other organizations.^{11,12} There can be no question that real time computers will come to have increasing importance in the operation of voice/data call switching exchanges.

A typical stored program computer call switching system is illustrated in figure 5. In the computer solution, high speed random access semi-permanent memory (mechanically but not electrically alterable) is favored for storage of programs and translation information. The choice of semi-permanent memory is dictated by factors of cost and reliability. Temporary memory (for example, core) is used for up-dating the translator between major changes, busy-idle status records for subscribers and paths, house-keeping records for switch control, traffic records, maintenance status, and message accounting, and for register and sender memory. Input-output equipments are used for insertion and extraction of supervisory signals and path-building instructions, but not as channels for the data being switched. The call switching computer contains no

high speed buffer memory or back-up memory for storage of messages.

software considerations in call switching

The logic of all system functions, including line and path supervision, registration, translation and sending, is imbedded in the stored program of instructions. Analogous to the case of message switching, programs may be classified into: (1) those performing complex logical manipulations in connection with calls offered to the system, and (2) those performing simple but highly repetitive operations in connection with the detection and transmission of supervisory signals and path-building instructions.

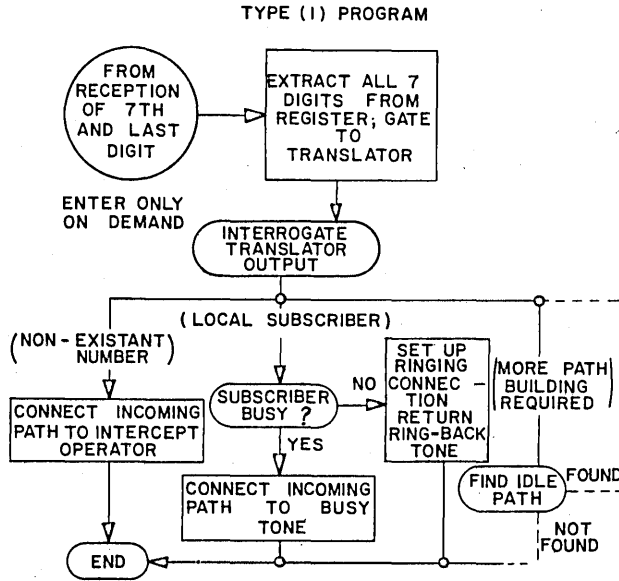

FIGURE 6

Figure 6 illustrates the functions of a typical program of type (1). The figure shows just a few of the processes which must be included in the program which is entered when a final digit of a path-building instruction is de-

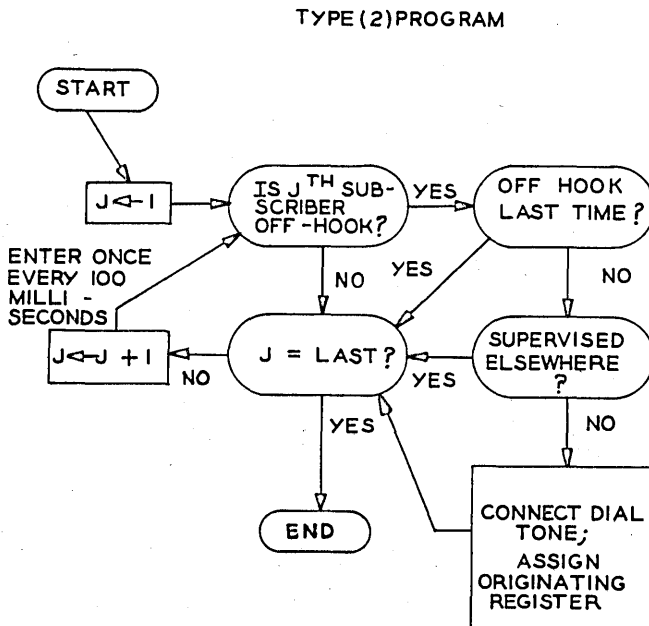

FIGURE 7

tected and registered. Figure 7 shows an exceedingly simple program of type (2) used to detect subscriber origination. Such programs can consume heavy percentages of the available real time in the computer. In

switching modules serving small numbers of subscribers and paths, a single processor can handle these programs. In larger applications, relief can be obtained by implementing type (2) programs with:

- (a) Wired logic input/output units.
- (b) Auxiliary computers with simple order structures for input/output processing.

In either case, flag or interrupt hardware is used to permit intercommunication of the computer and auxiliary equipments.

summary

Some of the general operating principles and functional requirements of communications switching and buffering networks have been presented. A distinction has been drawn between call and message switching systems.

The last few years have seen an increased interaction between the communications switching and data processing industries—interaction which is certain to accelerate in the next decade. Recent years have seen successful applications of digital computers operating on-line to control call and message switching. Message switching computers will find additional applications in the on-line connection of centralized general purpose computers to data terminals.⁴ Increased use of digital computers in communications switching applications gives promise of a new generation of low cost, flexible, fast and reliable data and voice communications systems. ■

REFERENCES

1. Allen Newell, "On Programming a Highly Parallel Machine to be an Intelligent Technician," *Proceedings WJCC*, May, 1960.
2. J. H. Holland, "A Universal Computer Capable of Executing an Arbitrary Number of Sub-programs Simultaneously," *Proceedings EJCC*, December, 1959.
3. T. L. Genetta, H. P. Guerber, A. S. Rettig, "RCA's Automatic Store and Forward Message Switching System," *Proceedings WJCC*, May, 1960.
4. J. R. Kersey, "The Programmed Transmission Control," *IEEE Winter General Meeting, 1963, Conference Paper CP 63-287*.
5. J. N. Ackley, "The ADX Automatic Data Exchange System," *IEEE Winter General Meeting, 1963, Conference Paper CP 63-307*.
6. E. Avakian, H. Wolfson, "An On-Line Computer Communications Terminal," *IEEE Winter General Meeting, 1963, Conference Paper CP 63-286*.
7. James H. Barker, "Control Data Model 8050 Message and Data Switching Center," *IEEE Winter General Meeting, 1963, Conference Paper CP 63-369*.
8. J. N. Ackley, "The Multi-sequence Computer as a Communications Tool," *Proceedings EJCC*, December, 1959.
9. D. R. Helman, E. E. Barrett, R. Hayum, F. O. Williams, "'Vade': A Versatile Automatic Data Exchange," *IEEE Winter General Meeting, 1963, Transactions Paper 63-308*.
10. G. Haugk, B. J. Yokelson, "Experience with the Morris Electronic Switching System," *AIEE Summer General Meeting, 1962, Transactions Paper 62-1036*.
11. H. H. Adelaar, F. A. Clemens, J. Masure, "Outlines of a TDM Two-Wire Telephone Switching System and its Control," *Proceedings IEE, Part B Supplement No. 20, Vol. 107, 1960*.
12. G. Lindberg, B. G. Magnusson, "The Experimental Space-Division Electronic Exchange 'Test'," *Proceedings IEE, Part B Supplement No. 20, Vol. 107, 1960*.

This article was written, and is based upon experience gained, while the author was a programmer at General Electric's Missile and Space Division, Philadelphia, Pa.

COMPILING IN ENGLISH

by JERRY SCHWALB, Advanced Programming, RCA-EDP,
Camden, New Jersey

experiences at GE



In March 1961, the Business Data Processing Operation at the Missile and Space Division (MSD) ordered a GE 225 which was installed in December 1961. The original configuration consisted of a central processor with 8,192 words of core storage, four magnetic tape units, a card reader, card punch, and high-speed printer. In September 1962, two additional tape units

were installed.

Ninety-nine per cent of the programs for this computer have been written in the 1960 GECOM (GENERAL COMPILER) source language, an English language programming system for the 225. The specifications of this compiler language are similar to those of COBOL.

The factors influencing an early decision to use English language programming were as follows:

1. Due to the volume and complexity of applications at MSD, a language which would be flexible, easily modified, and reasonably efficient was needed. It appeared that GECOM would fulfill these requirements.
2. It was expected that, with no change, GECOM programs could be compiled on future General Electric computers.
3. It was felt that experienced English language programmers could readily modify existing GECOM programs for other COBOL-like compilers.

applications

From May 1961 until December 1962, eight full-time programmers had been involved in writing GECOM programs. These programmers have developed a total of 200 English language programs.

In order to more fully appreciate the flexibility offered by a COBOL-like language, a brief description of a few of the applications which have been programmed with an English language compiler will be presented.

Vendor Rating

The purpose of this system is to compute a vendor and commodity quality rating based on inspection of parts and

components of a product. Inspections are inputted to the system in the form of punched cards. Each inspection is tested against a table of previously defined sampling criteria to determine quality rating. The system has the ability to monitor the procedures for inspection and to suggest changes in these procedures where applicable. This is a nine-phase system; approximately 900 inspections are processed weekly against a master file of 10,000 items. Processing time is 90 minutes per week.

Information Retrieval

The purpose of this system is to retrieve technical information in the Division's technical documents library upon request. The information retrieval master file includes approximately 10,000 document references and is growing at the rate of 1,000 per month. Requests for information consist of an unlimited number of descriptors which are logically connected by the following relationship (or any combination thereof):

"AND"
"OR"
"AND NOT"

This system consists of five phases, and is capable of processing 60 requests per hour.

Receiving Control

The purpose of this system is to maintain inventory control over incoming material and supplies ordered from vendors. The inventory master file includes approximately 6,000 records. The system processes a daily input of 600 receiving vouchers. Processing time, including updating of the master file and outputting of three reports, is 1½ hours. The three reports include two complete inventory listings in different sequences, and a listing of material received with no supporting purchase vouchers.

Facilitates Reporting

This system is used in the area of plant and facilities maintenance and special building projects. The system is intended to aid management in allocating available manpower and supplies to areas demanding specialized skills. This purpose is accomplished by correlating planned hours and supplies with available manpower and supplies.

The facilities master file contains 9,000 records. Weekly

input is approximately 1,200 records. Processing time to update the master file and output four reports is 3½ hours. A separate reporting system is maintained for two plant locations. Each location receives a variance report showing the variations between actual and planned dollars and hours, and a forecast report showing planned labor hours and dollars for five future weeks.

advantages and disadvantages

Operating the computer during compilation is a comparatively simple matter. The operator need only place the source program cards in the card reader and depress the computer start button. No further operator action is required until compilation is complete. At the conclusion of a compilation, the operator removes the source and object listing from the printer and the object deck from the card punch. He is then ready to compile the next program. Experience has shown that individual compilation time is excellent. Eighty per cent of the programs compile in less than 20 minutes. Of the 200 programs compiled, less than 12 exceeded a half-hour and none more than 45 minutes.

Object Program Efficiency

In order to obtain the advantage of a compiler language MSD has been willing to forego the optimum efficiency possible but rarely, if ever, achieved with hand coded programs. In using a COBOL-like language, however, reasonably efficient programs are expected. The compiler has not lived up to expectations in this respect. In some of the worst cases, reports have printed at the rate of 250 lines per minute compared to the rated printer speed of 900 per minute. One program reads cards at the rate of 150 per minute which is less than one-half of card read speed. It is probable that, at best, GECOM-produced object programs run at 60 to 70 per cent of the speed attained by the comparable hand coded program. With additional English language programming experience it is likely that this efficiency ratio would approach 90 per cent.

Analysis has shown that lack of efficiency is due in the main to the generalized nature of conversion and character move subroutines. Fields requiring simple editing pay a time penalty because they must use these subroutines.

programming considerations

Training—Experience with assembly languages has shown that the average trainee requires at least two months before producing simple programs. With the introduction of English language programming, this time has been decreased to one month.

An experienced programmer, on the other hand, will become productive almost immediately, whether programming in machine or compiler language. However, his amount of production will be significantly larger when programming in a language like COBOL or GECOM.

Debugging—The debugging tools offered by the compiler are excellent. The diagnostics during compilation quickly pinpoint the source language errors, thus decreasing the number of compilations required to produce a running program. The object program listings produced during compilation may be easily traced to the source program. This has been a great help in determining source language statements which generate improper coding. From time to time, changes have been made directly to object programs. Because of the ease of change, many unnecessary recompilations have been avoided.

In the past, program testing has been concerned with both problem and machine logic. GECOM has, to a large extent, eliminated the tedious tracing of machine instructions. At present, 90 per cent of the programs can be

debugged at the source language level. Debugging runs today are much more effective because of the decision to use English language programming.

Knowledge of Machine Language—It has been found definitely not necessary for all of the programmers to be familiar with machine language. At MSD, three of the eight GECOM programmers are proficient GE-225 language programmers. The functions of the three programmers include analysis of the coding produced by GECOM and the correction of erroneous coding. These programmers have been able to handle the problems of the entire programming staff satisfactorily.

Documentation—The use of English language programming has allowed a standard method of documentation. Communication between programmers has improved considerably. Programmers have circulated, among themselves, various programming techniques and source language pitfalls. Program maintenance and change are no longer the problem they have been in the past. It is now relatively simple for one programmer to change a program written by another.

Program Implementation Time

For the purposes of this discussion, program implementation time will be defined as the elapsed time from the initial writing of a program until that program is ready for production. The implementation cycle for an object program consists of the following:

1. Writing of the program;
2. Keypunching of the program;

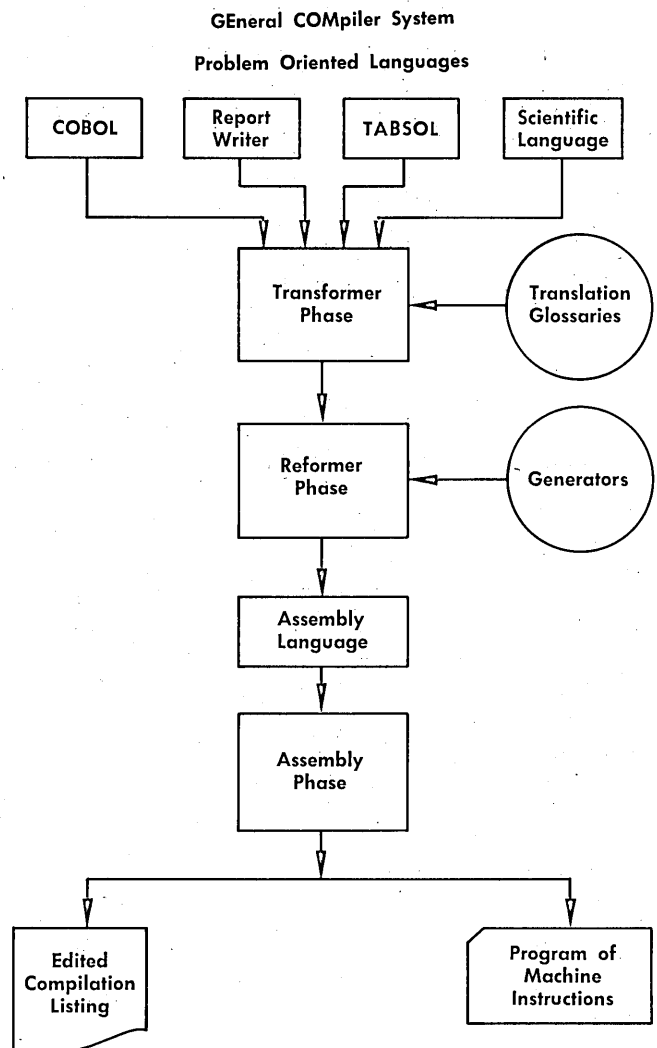

3. Compilation;
4. Eliminating source language errors (if necessary);
5. Testing of the object program;
6. Correction (if necessary) of the object program.

This may include recompilation.

During the period from February 1962 until August 1962, program implementation time had been poor. In this seven months' period GECOM required six tapes for compilation, which was the total configuration of tape units. In order to save set-up time and therefore increase machine utilization, it was decided to compile batches of programs at one time and then to batch checkouts at another. This meant that the programmers had to wait one day between each machine run of their programs. The result was that program implementation time for the very simplest of programs, even assuming no error, was two days.

In September 1962, two additional tape units were received. Also, an improved GECOM system which allows compilation with less than six tapes is now in use. With the availability of additional tape units, savings through batching of compilations and checkouts are no longer realized. Therefore, checkouts are presently being run concurrent with production. Programmers now are able to compile and execute on the same machine run; this has reduced program implementation time considerably. The minimum implementation time for a simple program with no errors is presently one day.

to improve the use

During the early days of GECOM at MSD, there was no great concern with object program efficiency. Emphasis was placed mainly on writing programs which would compile and execute successfully, and on improving program implementation time.

To further these aims a GECOM workshop which met weekly was established. Each programmer on the staff attended these meetings. The main topic of discussion included GECOM statements and data descriptions which, in certain cases, halted compilation or caused incorrect coding. At this time, a list of procedural verbs which were working successfully was drawn up and distributed to the programmers. These workshops proved invaluable as a means of communication among programmers. As a result, the number of compilations per successful program decreased from six-to-one to five-to-one.

It was felt that the most direct method of decreasing program implementation time was to eliminate object listings of source programs. This approach was experimented with for a two-week period. During this time, individual compilation decreased by a time factor of 25 per cent.

It was discovered, however, that in some cases debugging from the source language alone was not possible. In these cases it was found necessary to recompile merely to obtain an object listing. These additional compilations cost more computer time than the savings realized by eliminating the object listings. At the end of the two-week period, the experiment was discontinued and MSD returned to the former method of compiling.

After most of the early bugs had been corrected in GECOM, successful program compilation and execution became more certain. At this time, the three programmers familiar with machine language proceeded to examine methods to increase object program efficiency. They developed a generalized subroutine for the high-speed printer. This subroutine, which was written in assembly language, speeded up printing time for double-spaced reports as much as 100 per cent. Another important contribution was an analysis of data description and file designs. It was found that unpacking files will result in a

time saving of about 25 per cent when these files are processed.

time comparison

Only two programs have been written in General Assembly Program (GAP) language. The following is a comparison of these with GECOM programs of similar size:

| | GECOM | | GAP | |
|---|-------|-------|-------|-------|
| | I | I | II | II |
| Number of Instructions | 5,500 | 5,250 | 4,950 | 4,800 |
| Man hours for Programming | 184 | 328 | 160 | 304 |
| Number of Assemblies/Compilations | 4 | 10 | 4 | 8 |
| Machine hours for Assemblies/Compilations | 1.4 | 1.2 | 1.2 | 1.0 |
| Machine hours for Debugging | 0.8 | 1.1 | 0.7 | 0.9 |

For the user the true measure of a compiler is its effect on the amount of production attained in a particular time period. As of December 1962, MSD had compiled, debugged, and executed 200 programs. Of these, 140 are on a regular production basis and the balance have

Figure 1

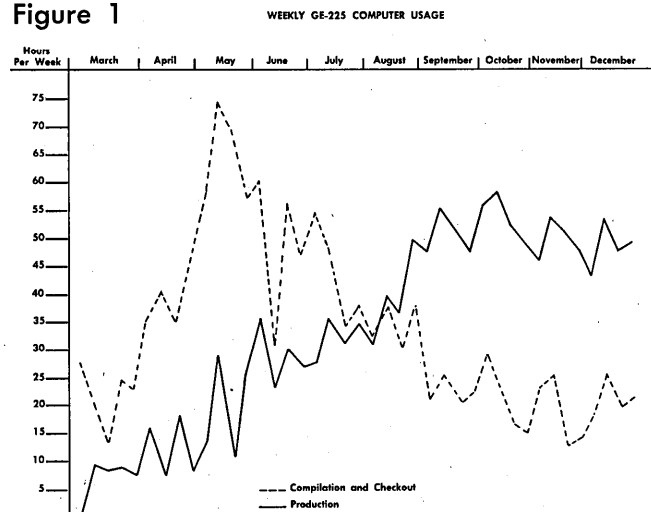

been specials. As may readily be observed (See Fig. 1), production has increased steadily. The increase is due to improvements in the GECOM system and additional experience in its use. For the last week of December 1962, production runs consumed 49 hours a week, and 20 hours of the week were spent in compilation and checkout. These figures reflect a notable achievement in machine utilization. It is difficult to estimate what total productive time would be without an English language compiler. Most assuredly, productive utilization would be considerably less than half of what it is today.

future expectations

As a result of experience with COBOL language, this installation has led to some conclusions regarding certain features that would be desirable in GECOM and in future compilers. The first of these is a Report Writer. Today it is found that programmers are recompiling because of simple format errors. A Report Writer should reduce these types of relatively useless recompilations. The second is a Compile-and-Go option. This feature will facilitate the running of compilation and checkout concurrently.

A MODERN-DAY MEDICINE SHOW

by ROBERT L. ALBRECHT, Control Data Corp.,
Denver, Colorado



During the summer of 1962, the Denver, Colorado, office of Control Data Corporation gave a course in the use of computers to a group of gifted mathematics students from Denver's George Washington High School (GWHS). Emphasis was placed on the use of a computer as a computational tool to assist students in solving mathematical problems. We had so much fun that we continued the course at GWHS throughout the 1962-63 school year, and extended the program to eight other schools in Denver and Jefferson counties. So far, more than 200 students have been introduced to the hardware as a handy device for getting answers to mathematical problems.

On March 24, a CONTROL DATA 160A and a Flexewriter were moved to GWHS and placed in charge of four students. For the next four days, these students put on a computer demonstration which had many of the characteristics of a "Medicine Show". The show was promoted, produced, and directed by the four students, who were also the stars.

The medicine show at GWHS was the high point of a computer educational program which began quite by accident. In the spring of 1962, I acquired a new neighbor, Irwin Hoffman, a mathematics teacher at GWHS. Irwin invited me to speak to the Math Club at his school on the use of computers for the solution of mathematical problems. Following this talk, several students inquired about the possibility of receiving computer training. I conferred

with Irwin and we decided to organize and teach a course during the summer.

In this initial course, 35 students from GWHS met every Wednesday evening from 7 to 10 P.M. at the Control Data Denver office. We spent the first few meetings discussing computer fundamentals and describing the FORTRAN programming language for the 160A. By mid-summer, the students had become reasonably proficient at writing programs and operating the computer. For the rest of the summer, the Wednesday evening meetings were used primarily for the analysis, programming, and computer solution of mathematical problems. Of the 35 students who began the course, 25 were still going strong at the end of the summer.

The summer course was merely an appetizer for many of the students. They clamored for more training. During the fall semester we set up an advanced course for 12 students. (The rest had graduated.) A bleary-eyed mathematics teacher (Hoffman), a bleary-eyed Control Data instructor (me), and 12 bright-eyed young scholars met every Thursday morning from 7:30-8:30 A.M. before regular school hours. This course was conducted on a seminar basis, using the algebra of polynomials as the mathematical subject. The instructors posed problems. The students did the required mathematical analysis, developed problem solving procedures, programmed their solutions in FORTRAN and ran their problems on the 160A. Introductory courses were set up for beginners. The courses were conducted on an auto-instructional basis with seminar students serving as instructors.

In March, we decided to put on a medicine show at

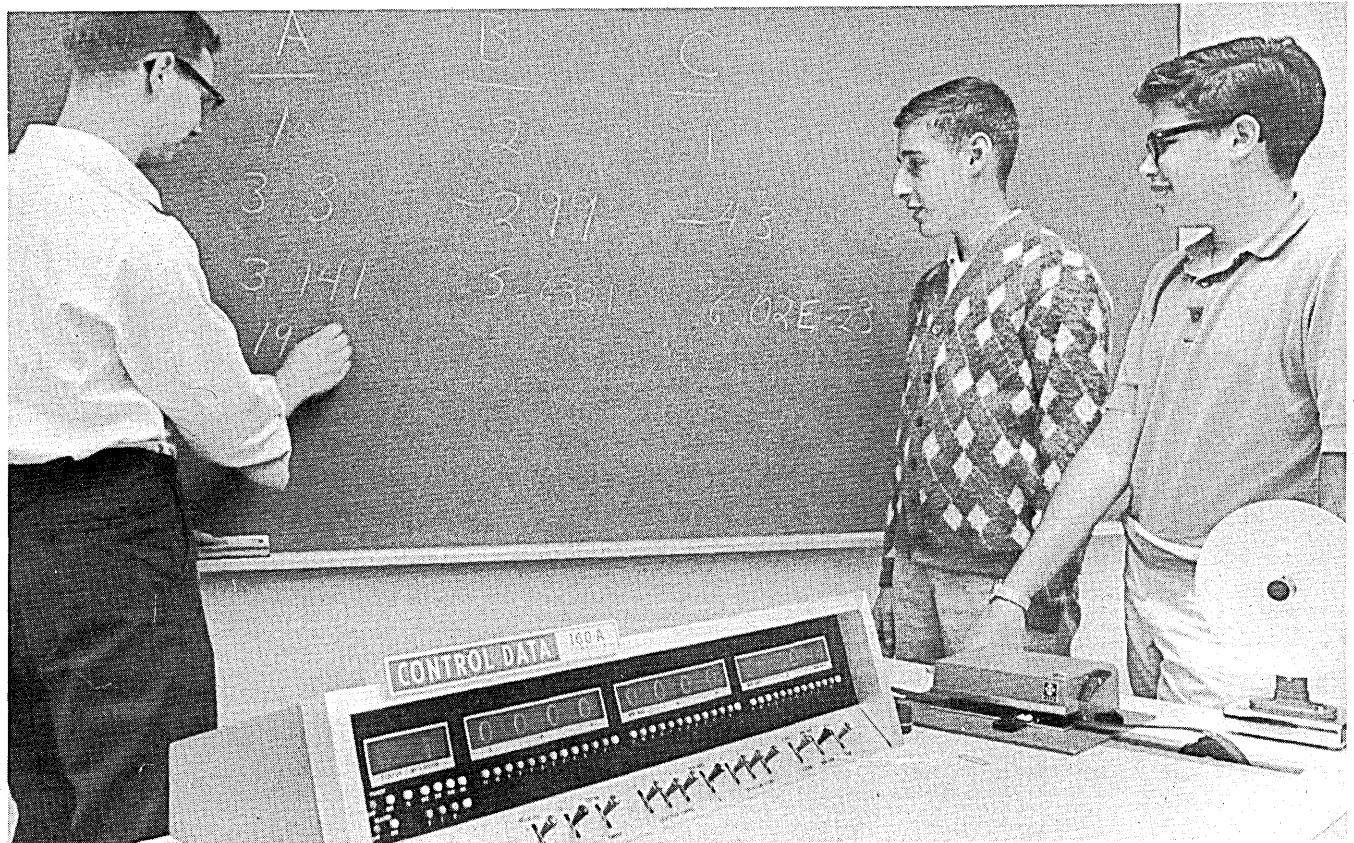

GWHS. We decided that it would be done entirely by students without any adult supervision. By this time we had about 40 students at various levels of proficiency. We picked Bob Kahn, Al Nelson, Randy Levine, and Fred Ris to run the show. (Bob, Randy, and Fred were juniors, Al was a senior.) We outlined our project to the students and sat back to watch the fireworks.

During the week before the show, the four students

arranged for the use of a room, obtained the equipment and supplies needed, and began an intensive promotional campaign. They drew up a master schedule for the 20 math classes which were to attend, and distributed the schedules to the teachers who were responsible for the classes. After some haggling, they agreed upon a demonstration program, wrote the source program, and checked it out after the 160A had arrived at the school.

Figure 1

```

0
0
C      GWHS TEACHER DEMO PROGRAM
C      PROGRAMMED BY RANDY LEVINE
1      FORMAT (45Hi ;have ;heard ;you ;do ;not ;like ;assistance ;. ;. ;.)
2      FORMAT (36Hhere ;is ;your ;iddy ;biddy ;answer ;. ;. ;)
3      FORMAT (50Hhere ;is ;ye ;olde ;easy ;answer ;. ;. ; ;lazy ;tiger ;. ;. ;)
4      FORMAT (38Hi ;will ;be ;a ;more ;courteous ;gw ;patriot .)
5      FORMAT (27Hname ;the ;new ;baby ;after ;me .)
6      FORMAT (39Hyou ;coach ;. ;. ; ;let ;me ;teach ;the ;class .)
7      FORMAT (45Hwhan ;that ;aprille ;with ;his ;shoures ;shoote . ;. ;.)
8      FORMAT (43Hwhen ;i ;consider ;how ;my ;light ;is ;spent ;. ;. ;.)
9      FORMAT (35Hi ;have ;to ;be ;excused ;from ;the ;room .)
10     FORMAT (I5, 4E16.8)
11     FORMAT (4E16.8)
500    READ 10, JWHICH, A, B, C
      GO TO (15, 25, 35, 45, 55, 65, 75, 85, 95, 105), JWHICH
15     PUNCH 1
      GO TO 105
25     PUNCH 2
      GO TO 105
35     PUNCH 3
      GO TO 105
45     PUNCH 4
      GO TO 105
55     PUNCH 5
      GO TO 105
65     PUNCH 6
      GO TO 105
75     PUNCH 7
      PUNCH 8
      GO TO 105
85     PUNCH 8
      GO TO 105
95     PUNCH 9
105    DSCRIM = (B*B) - (4*A*C)
      IF (DSCRIM) 100, 200, 200
200    X1 = (-B + SQRTF(DSCRIM))/(2*A)
      X2 = (-B - SQRTF(DSCRIM))/(2*A)
      PUNCH 11, A, B, C
      PUNCH 11, X1, X2
      PAUSE 500
      GO TO 500
100    X1REAL = (-B)/(2*A)
      X2REAL = X1REAL
      X1IMAG = (SQRTF(DSCRIM))/(2*A)
      X2IMAG = -X1IMAG
      PUNCH 11, A, B, C
      PUNCH 11, X1REAL, X1IMAG, X2REAL, X2IMAG
      PAUSE 500
      GO TO 500
      END
      END

```

Articles, plugging the show, appeared in the school paper, and daily spot announcements over the P.A. system reminded the student body of the forthcoming event. By opening day, our students were indeed prepared.

the medicine show

The 160A was moved in on the afternoon of Monday, the 24th, and turned over to the students the next morning. The demonstration program, chosen in the hope that it would be meaningful and entertaining to the attendees, was checked out. Their source program, shown in Figure 1, was a procedure to compute the real or complex roots of the quadratic equation, $AX^2 + BX + C = 0$. However, it had a gimmick.

By means of a code number entered with the data, the computer could be directed to precede the answers with a Hollerith message. These messages were terms favored by the instructors in their classroom presentations, and which had become cliches familiar to students. During demonstrations, students were asked to provide data for processing; for these results, no Hollerith message was punched. Then the teacher was asked for a set of data; when his results were listed, he was confronted by a familiar phrase preceding the answers. Some samples are shown in Figure 2.

The formal demonstrations were held Wednesday and Thursday, about every half hour, from 8:45 to 3:30 P.M., with a few left over for Friday morning. Because many of the classes were discussing the quadratic formula, a frequently heard request was, "Would you please ask the computer to do the odd exercises on page 263 of our text?" Bob Kahn accommodated one class by running one night's homework on the 160A, and using the Flexowriter to cut a Ditto master of the output tape. He presented a copy to each member of the class.

When the hardware was not being used for demonstrations, it was in constant use by students in the computer educational program. They practically fought over it. In fact, they coerced Irwin Hoffman into arriving every morning at 6:30 to let them into the school, and the custodian had to practically throw them out every evening at 6:00 in order to lock up.

The four "barkers" were excused from classes during

would have to move the computer to make room for a meeting. They rolled the 160A out of the room, down the hall, and set up shop in the main lobby. There, they were immediately surrounded by curious students, and ran informal demonstrations until the middle of the afternoon. At that time, a moving van rolled up to the front door, the gear was packed up, and the medicine show moved on to the next stop.

the show gets results

Well organized and conducted with imagination and showmanship, the performance was a tremendous success. It generated a great deal of interest in additional introductory computer courses. Anticipating this, the boys had already arranged for the use of our classroom facilities and the 160A during spring vacation. Sixty students were signed up during the show, the results of a flyer which they printed and distributed, inviting spectators to enroll in introductory FORTRAN classes.

Sessions began a week later, organized into four sections of 15 students each. The courses were run on an auto-instructional basis. We provided 60 copies of a workbook, *Introduction to FORTRAN Programming*, which we are writing and reproducing in our office to teach the use of computers for mathematical problem-solving in the secondary schools. For a week, the student instructors answered questions and tutored individuals. During the second week, spring vacation, the instructors brought each section to our office for a day of problem-solving on the 160A. Every student had executed at least one FORTRAN program by the end of the week, and several had run more. They chose their own problems, most of them coming from their mathematics text books.

At Washington High, as a result of this activity, we now have nearly 100 students who will be clamoring for additional training during the next school year.

plans for next year

We are sold on medicine shows. In fact, the second show was put on by five students at Denver's Abraham Lincoln High School, and more are anticipated during the next school year.

It will be a year of growth. In adjacent Jefferson

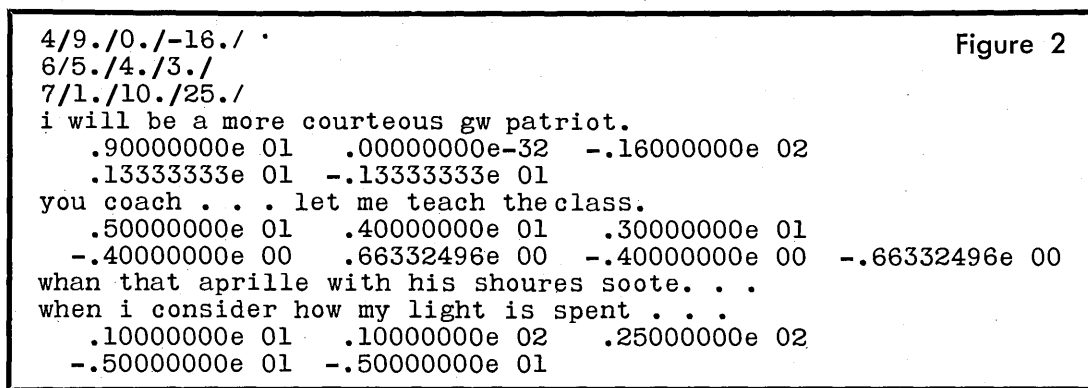

Figure 2

most of the show. On Friday morning, Fred Ris rejoined his algebra class just as it began a discussion of the problem, "Given a set of N people in a room, what is the probability that two of them have their birthdays on the same day of the year?" The class set up some specific cases, and began hand computing the results. Fred jumped up, mumbled something about a computer, and dashed out the room. He ran downstairs, wrote a FORTRAN source program to tabulate the desired probabilities for N=2 to N=150, then compiled and executed the program. He managed to get back to his algebra class before the end of the hour to display his results.

Friday noon, the students were informed that they

County, public school officials are making arrangements to train high school teachers in computer methods, and have invited several universities in the area to assist in implementing an extensive program in computer education. During the next school year, we expect to have courses there in computers and computing, as well as the present courses in problem-solving and answer-getting with FORTRAN. Recognized as a leader in evaluating and adopting new ideas, the Jefferson County public school system's program should provide us with some data for evaluation of several approaches to computer education in the secondary schools. ■

BUILDING INTERNAL ACCOUNTING CONTROLS

for daily
accounts receivable processing

by S. M. SALVINO, The Peoples Gas Light & Coke Co.,
Chicago, Illinois



With the increased speed of computers, "on time" or nearly on time accounts receivable systems are possible for even some of the largest receivable operations. At Peoples Gas in Chicago, a daily updating system for approximately one million customers is currently in operation, utilizing an IBM 7070. In this operation all accounts recorded on our Main File, which consists of 50 reels of magnetic tape, are processed each evening, updating the file to include transactions generated during the preceding daytime hours.

In designing this system, many new and different accounting control problems were encountered. Probably the most formidable problem was created by the rapid processing of the entire file. This allows only a few hours to isolate and correct out-of-balance conditions before the entire file is processed again during the next evening, to avoid the compounding of any unresolved error condition.

We decided to provide the maximum amount of controls, consistent with the economics of the operation, to allow immediate or almost immediate resolution of error conditions. The programming is such that an error is brought to hard copy as soon as it is detected. Thus the source of the error (type of input, area of program, etc.) is isolated. This approach was particularly advantageous during conversion, when a minimum of personnel was available for dealing with computer system controls. Conversion of some four million card records to the computer system was accomplished in the relatively short period of four months.

The Main File is designed with a control record at the end of approximately 1,000 customer records. Included in the control record is a count of active accounts and a complete distribution of the outstanding receivables. As each account is processed, the outstanding items are cross-footed and checked to the total due for the account. In addition, the distribution of input items, and outstanding

items before and after posting are accumulated for proving to the control record. In processing the control record, the sums of the transactions plus the previous outstanding balances are proven to the new outstanding totals. Any out-of-balance condition causes a type-out on the console log. Immediate corrective action is required, since a serious programming error or machine error condition is indicated.

Thus far, few instances of console out-of-balance typing have occurred. However, in each case detection and correction at that point avoided re-doing a considerable amount of computer work. A check of this type while the system is in operation assures us that the accounts are being processed properly. To determine an out-of-balance condition at a later point in such a system may not allow sufficient time for corrective measures without serious delay in related clerical areas.

separate control run

In addition to the account-by-account and control record check as the Main File is being processed, a separate control run processes all the various input and Main File totals to prove out the overall computer system including distribution. In addition, this control run isolates any error condition to a particular input, program, or other area. Rapid location of errors allows for corrective measures to be taken before the next system operating day.

Within the system the two levels of control, one over the Main File accounts as they are processed, and the other over all computer operations, assures proper processing. In addition, we have a manual ledger control with which the daily totals of the computer system must balance. This precludes the possibility of not detecting input tapes that may not have been processed, or of updating a Main File tape other than the current one, or other such operating errors. Available each day from the system are total receivables by type, number of active customers, number of meters, amount of cash posted, amount of cash received, number and amount of bills rendered, and several other significant control statistics.

In a utility billing system, billing amounts are calculated from "meter reading differences," rates, and other information. ("Meter reading difference" is the quantity of gas used between two consecutive meter readings.) Since billing is an internal operation, we must rely on certain checks to prove that bill calculations are accurate and that we are billing each account once, but not more than once. Bill calculation is verified in a separate statistics run, in which the total quantity of gas billed at each "block" of the various rates is re-calculated and compared with the total amount actually billed. As to duplicate or missing bills, our overall statistics prove no mass errors exist. The presence of a meter reading input document, with or without a reading, is required to generate a bill. The absence of a meter reading input document is reported in a memorandum issued by the computer, and prompt investigation is made to insure against failure to issue and record a proper bill. Pre-printed serial numbers on the bill forms are used to prove that the number of bill forms used is in agreement with the number of bills rendered as shown in the computer system statistics.

batch input techniques

All inputs involving accounts receivable are "batched" separately by type of entry, and are balanced to predetermined totals at the point of entry into the system. Cash receipt input (approximately 28,000 items per day) is optically read by an IBM 1418 scanner, is batch-listed and is simultaneously recorded on magnetic tape. The total number of items and amount of cash, by batch, are developed during the processing of cash receipts, and are also recorded on magnetic tape. Other charges and credits are similarly batch-listed and balanced. The batch totals written to tape are verified on the initial input runs to establish that all items charged to the computer system were actually received. The input totals of cash and other entries are posted to a manual ledger for overall computer system balancing. For auditing purposes, all entry input to the system is available on batch listings in the same sequence as the original documents.

semi-annual runs

As of June 30 and December 31, a special run of the entire Main File is made, using a special program to audit the file, extract certain infrequently used data, prepare special reports, and fulfill many one-time requests for data from the file. The special, semi-annual run is a relatively inexpensive means of protecting against file deterioration, and of developing management information

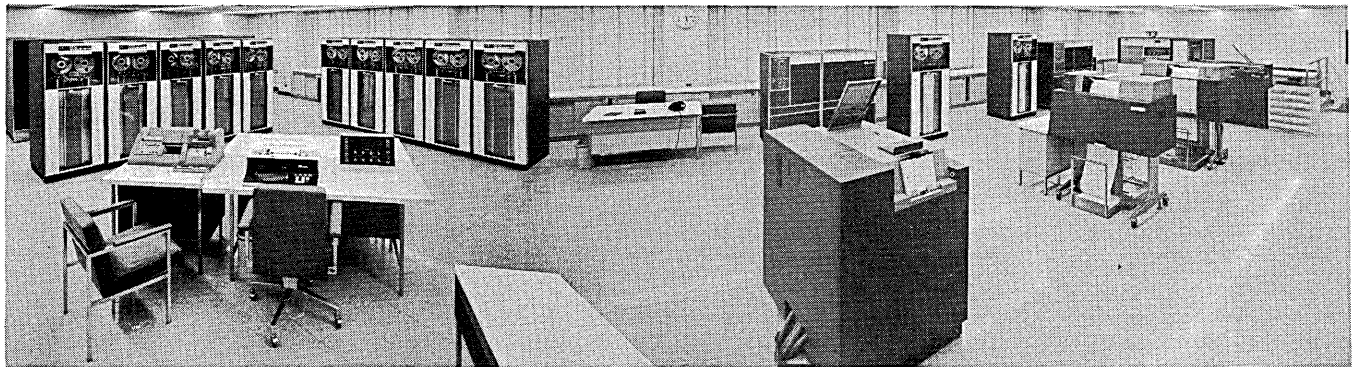

which would be too expensive to produce daily. For auditing purposes, such a run is capable of producing numerous meaningful statistics, developing information for circularization of accounts receivable, reviewing for file deterioration, testing accounts for a variety of conditions, and selecting accounts for audit follow-up. The cost of the additional audit programming and additional machine time is insignificant.

control system performance

Our experience with the system controls has been excellent. We have had out-of-balance conditions, but in each instance the condition was readily recognized and corrected. Computer system error conditions have been handled well within the hours available before the system is scheduled to operate again. The emphasis placed on adequate controls, with the computer used to isolate the areas out-of-balance, has allowed us to convert to our computer system on schedule, and to operate with assurance that the accounts are well protected.

One particularly difficult problem involves the control of transactions not acceptable to the computer system. All input to our system must pass certain validity checks before it is allowed to reach the point of being posted to the file. Failure to pass the validity tests creates a printed memorandum giving notice of the item's rejection and the reason for rejection. At the point of posting, the transaction is further subjected to comparisons with data on the Main File to prove that the item is for the proper account, or in some cases to prove that the item is consistent with previous data recorded for the same account. For example, meter readings are screened to prove that the "meter reading difference" is in reasonable agreement with previous consumption. It is the entirely manual control of the rejected items which creates problems. These are the exceptional items and, as in most systems, they create a disproportionate amount of work since they require some "look-up" and corrective action. Our auditors, both internal and external, are aware of the need for scrutinizing this area of the overall system. Fortunately, the volume of such items is relatively small.

There are many other control features which are relatively standard in computer systems. For physical file protection, we use a storage company to pick up and store, out of the city, one "generation" of the Main File each week. By this technique we are adequately protected from fire, tampering, and other local hazards. Through the use of magnetic tapes, remote storage of some 360 million characters of customer information is economically feasible. (Recently, a plan was adopted whereby an additional generation of the Main File is stored in a Kansas "Salt Mine." Rotation of this file is on a bimonthly basis, permitting us to have major disaster protection at a reasonable cost.)

system design and accounting controls

Adequate accounting controls are inherent in good system designs. As control features have evolved in manual ac-

counting systems, so also in computer systems, multi-level checks, controls within files, and facilities for error location and correction can and are being established. Auditors, evaluating internal controls to assure management that the company's assets are being protected, have begun to consider the competency of the systems staff, particularly in terms of its ability to interpret management policy and directives in systems design. ■

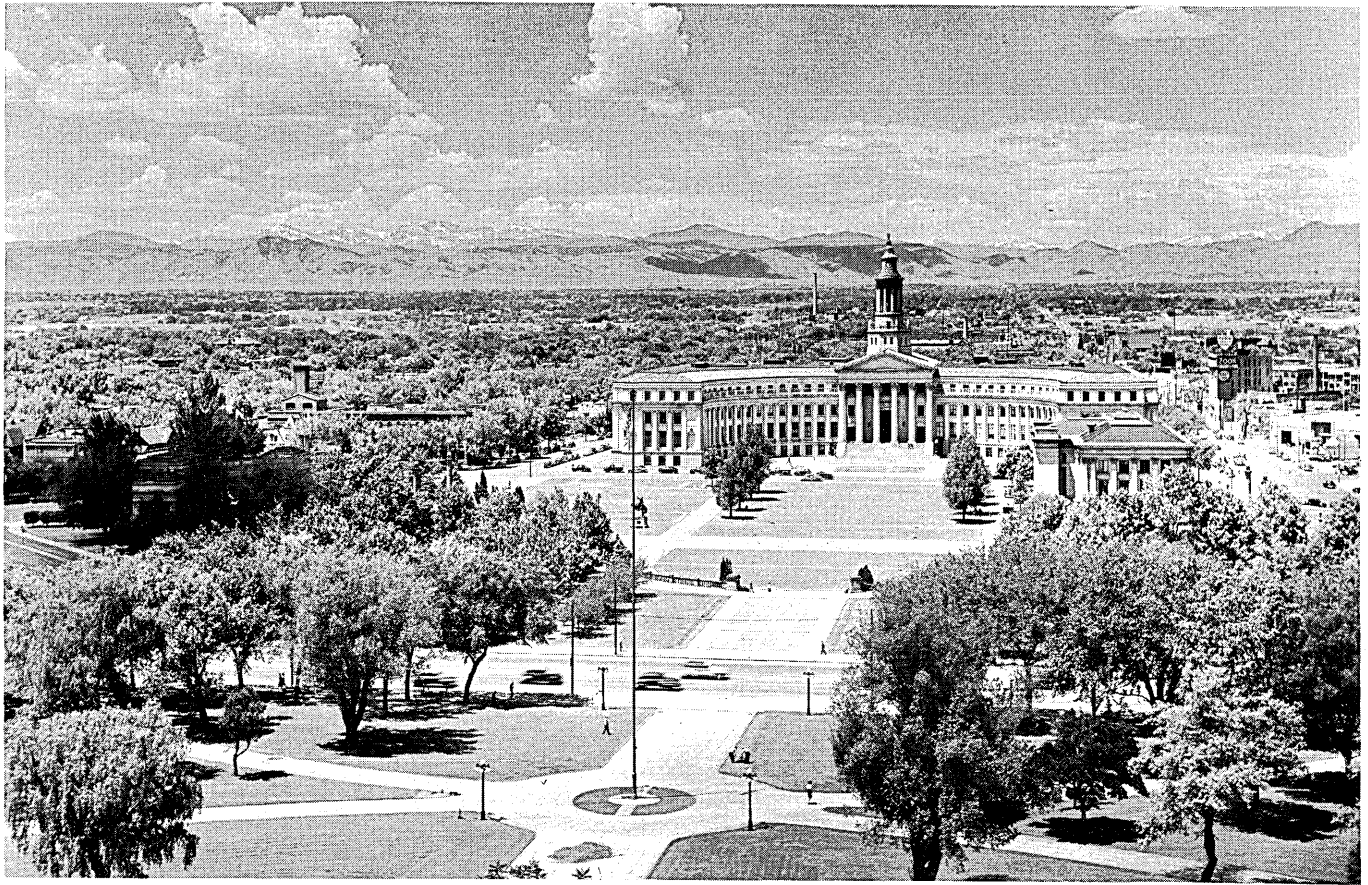

ACM MEETS IN DENVER

August 27-30

The Mile High City and the Univ. of Denver will host the '63 ACM conference, August 27 to 30. Conference headquarters will be the Denver Hilton hotel. The technical program, under the chairmanship of Fred P. Venditti, Univ. of Denver, will consist of 33 sessions, including 80 contributed papers (from among 165 submitted), eight invited papers, seven panel discussions, three Halls of Discussion, and three evening tutorials. Abstracts of all papers are available in booklet form to attendees in advance of the conference.

The registration fee is \$10 for members, \$12 for non-members, and \$5 for students. Rooms at the Hilton are being reserved until August 17.

Special reports will be presented by G. G. Heller, IBM, Washington, D.C., "Report on Information Processing Education," and by Victor Yngve, MIT, "Report on Annual Meeting of Association for Machine Translation and Computational Linguistics."

Speaking on "The Computer Industry — A Look Toward the Future," will be the keynote speaker, William C. Norris, president, Control Data Corp., Minneapolis, Minn. There will also be a tour of the United States Air Force Academy at Colorado Springs, and the National Bureau of Standards scientific laboratories at

Boulder, Colo.

The 14 subject categories of the conference are logic, compilers, numerical analysis, pattern recognition, mathematical programming, bio-medical programming and processing, education and programmer training, information retrieval, hardware, programming languages, software, language and learning, simulation and graphical output, and merging and sorting.

Topics of the panel sessions are information retrieval, multiprocessors, social aspects of computers in politics, business dp, programmer training, computer science curriculum, and medical diagnosis.

Evening tutorials will be "On the Construction of a Compiler for ALGOL 60," Arthur Evans Jr., Carnegie Tech., Pittsburgh, Pa.; "COBOL, Up-Dated," William L. Donally, IBM, New York, and "PERT/CPM," James W. McCauley, Control Data Corp., Denver.

Hall of Discussion sessions and their chairmen are "Phase-in of New Systems," G. M. Fitzgerald, Tennessee Gas Transmission Co., Houston, Texas; "Decision Tables," Sol Pollack, The RAND Corp., Santa Monica, Calif., and Michael Montalbano, IBM, San Jose, Calif., and "Mathematical Programming," Robert L. Graves, Systems Programming Inc., Arlington, Va.

ACM technical sessions . . .

TUESDAY
August 27

Tuesday, August 27, Senior Ballroom, 2 p.m.

Session 1A: Information Retrieval
Chairman: James E. Feeley, Martin-Marietta Corp.

1A.1: New Methods in Automatic Abstracting, H. P. Edmundson, TRW Inc.

1A.2: Effective Information Searching Strategies Without "Perfect" Indexing, R. J. Tritschler, IBM

1A.3: FIRE Information Processing System, J. R. Berry, North American Aviation Inc.

1A.4: The Effect of Varying Word Lengths on the Accuracy of Matching Documents with Readers' Interests, A. B. Barnes, A. Resnick, IBM

1A.5: Computer-Produced Indexes, D. C. Roper, W. D. Timberlake, IBM.

Tuesday, August 27, Junior Ballroom 2 p.m.

Session 1B: Mathematical Programming I
Chairman: David M. Smith, Systems Programming, Inc.

1B.1: Computational Techniques for Scheduling Problems with Deferral Costs, E. L. Lawler, University of Michigan

1B.2: Tests on a Computer Method for Constructing Time Tables, J. Csima, C. C. Gottlieb, Univ. of Toronto

1B.3: A Double Parametric Algorithm for Linear Programming, Peter Sandor, KCS Ltd.

1B.4: A Procedure for Determining the Convex Hull of a Set of Points or Hyperplanes, A. J. Goldstein, Bell Telephone Lab.

1B.5: Optimization by Function Contouring Techniques, Gary A. McCue, North American Aviation Inc.

Tuesday, August 27, Silver Room, 2 p.m.

Session 1C: Hall of Discussion Phase-In of New Systems

Chairman: G. M. Fitzgerald, Tennessee Gas Transmission Co.

Tuesday, August 27, Senior Ballroom, 3:40 p.m.

Session 2A: Invited Papers

Chairman: W. F. Miller, Argonne National Lab.

2A.1: Programmed Memory Organization and Data Bases for Retrieval, A. W. Holt, Applied Data Systems

2A.2: The Illinois Pattern Recognition Computer, B. H. McCormack, Univ. of Illinois

Tuesday, August 27, Junior Ballroom, 3:40 p.m.

Session 2B: Numerical Analysis I

Chairman: Paul Hultquist, Univ. of Colorado

2B.1: Simplified Predictor-Corrector Methods for Ordinary Differential Equations, M. Alan Feldstein and Hans J. Stetter, U.C.L.A.

2B.2: Higher Order Approximations of Runge-

Kutta Type, E. Baylis Shanks, Vanderbilt Univ. and Marshall Space Flight Center

2B.3: An Efficient Composite Formula for Multidimensional Quadrature, Henry C. Thacher, Jr., Argonne National Lab.

2B.4: Computational Procedure for the Calculation of the Subdivisions of the Components of the Analysis of Variance, M. C. Miller, III, Univ. of Oklahoma Medical School

2B.5: A Fast Direct Solution of Poisson's Equation Using Fourier Analysis, R. Hockney and O. Buneman, Stanford Univ.

Tuesday, August 27, Junior Ballroom, 8 p.m.

Session 3B: Tutorial

3B.1: On the Construction of a Compiler for ALGOL 60, Arthur Evans, Jr., Carnegie Tech.

WEDNESDAY
August 28

Wednesday, August 28, Senior Ballroom, 9 a.m.

Session 4A: Panel on Information Retrieval
Moderator: Louis C. Ray, System Development Corp.

Panelists: Jack Belzer, Western Reserve Univ.; John C. Costello, Jr., Batelle Memorial Institute, Ronald E. Wyllys, System Development Corp.

Wednesday, August 28, Junior Ballroom, 9 a.m.

Session 4B: Numerical Analysis II
Chairman: Glenn E. Lewis, National Center for Atmospheric Research

4B.1: A Comparison of Methods for Determining Optimum Paths in the Problem of Bolza, Frank D. Faulkner and E. Warren Seibel, U.S. Naval Postgraduate School

4B.2: Interpolatively Generated Iteration Functions, J. F. Traub, Bell Telephone Laboratories Inc.

4B.3: Matrix Symmetrization Methods for the Algebraic Eigenproblem, James L. Howland and Francis J. Farrell, Univ. of Ottawa

4B.4: Rapid Methods of Structural Change Analysis, Bertram Klein, Hughes Aircraft Co.

4B.5: On the Numerical Solution of Certain Classes of Boundary Value Problems, Lewis E. Hulbert and Francis W. Niedenfuhr, Ohio State Univ.

Wednesday, August 28, Silver Room, 9 a.m.

Session 4C: Logic

Chairman: Dan Slotnick, Westinghouse Electric Corp.

4C.1: An Algorithm for Boolean Simplification, J. J. Rothmeier, Cornell Aeronautical Laboratory Inc.

4C.2: Relationships Between Groups of Isomorphisms and Sets of Equivalence Classes of Input for Automata, Bruce Barnes, Pennsylvania State Univ.

4C.3: A Multi-Layer Iterative Circuit Computer, Rudolfo Gonzales, Univ. of Michigan.

4C.4: Incremental Data Assimilation in Man-Computer Systems, Lionello A. Lombardi, M.I.T.

4C.5: Test for Synchronizability of Finite Automata and Variable Length Codes, Shimon Even, Sperry Rand Research Center

Wednesday, August 28, Grand Ballroom, 10:40 a.m.

Session 5A: Panel on Multiprocessors and Multiprocesses

Moderator: Frank Wagner, Informatics Inc.
Panelists: Fernando J. Corbato, M.I.T.; Nance Drummond, IBM; Clark Oliphant, Burroughs Corporation; John McCarthy, Stanford University.

Wednesday August 28, Junior Ballroom, 10:40 a.m.

Session 5B: Mathematical Programming II
Chairman: Ivan Hebel, Colorado School of Mines

5B.1: Alternative Systems of Linear Equations in the Minimization of Quadratic Functions, Alex Orden, Univ. of Chicago.

5B.2: A Reduced Version of the Simplex Quadratic Programming Algorithm for Solutions Using a Medium-Size Digital Computer, R. E. Murphy, Stanford Univ.

5B.3: Geometric Programming in Manufacturing and Engineering, R. N. Little and B. Mittman, Illinois Tech. Research Institute

5B.4: Vehicle Scheduling by Computer, J. W. Wright, Univ. of Manchester, England

5B.5: Shared Waiting Space Distribution of Single Server Queues, Gerald Harrison, Tele-register Corp.

Wednesday, August 28, Silver Room, 10:40 a.m.

Session 5C: Language and Learning

Chairman: Herbert Bailey, Colorado State University

5C.1: A procedure for a Transformational Decomposition of English Sentences, Aravind K. Joshi, Univ. of Pennsylvania

5C.2: ALMS — Analytic Language Manipulation System, Frederick W. Blackwell, Space Technology Laboratories Inc.

5C.3: An Association Scheme for Artificial Intelligence, K. N. Leibovic, Cornell Aeronautical Laboratory Inc.

5C.4: A Simple Computer Program with Learning Capability, J. H. Ahlberg and J. E. Hutchison, United Aircraft Corp.

5C.5: Thinking—Human vs. Machine Process, Posheng Yen, Western Electric Co.

Wednesday, August 28, Senior Ballroom, 2 p.m.

Session 6A: Invited Papers

Chairman: S. D. Conte, Purdue University

6A.1: Growing Applications of Linear Programming Places, New Demands on Computer Systems, J. S. Aronofsky, Socony Mobil Oil Co. Inc.

6A.2: The Design of Data Processing Compilers for Large-Scale Computers, Roy Nutt and Charles J. Swift, Computer Sciences Corp.



CONTROL DATA[®] 3600 Computers Selected for

Real-Time Computer System

The Atlantic Missile Range will place in operation a dual CONTROL DATA 3600 real-time computer system to provide data for range safety at Cape Canaveral. High internal speed in the 3600 compute module is matched by the speed with which the CONTROL DATA 3600 can accept information from multiple sources, decide which is most accurate, then compute and transmit the results in the form of a missile impact point every 50 thousandths of a second. □ The major elements of the Real-Time Computer System are two standard CONTROL DATA 3600 computers, the world's most powerful computers commercially available. Along with its high speed, another major advantage of the CONTROL DATA 3600 is the provision for modularity built into the machine. Additional memory modules, compute modules, and input/output data

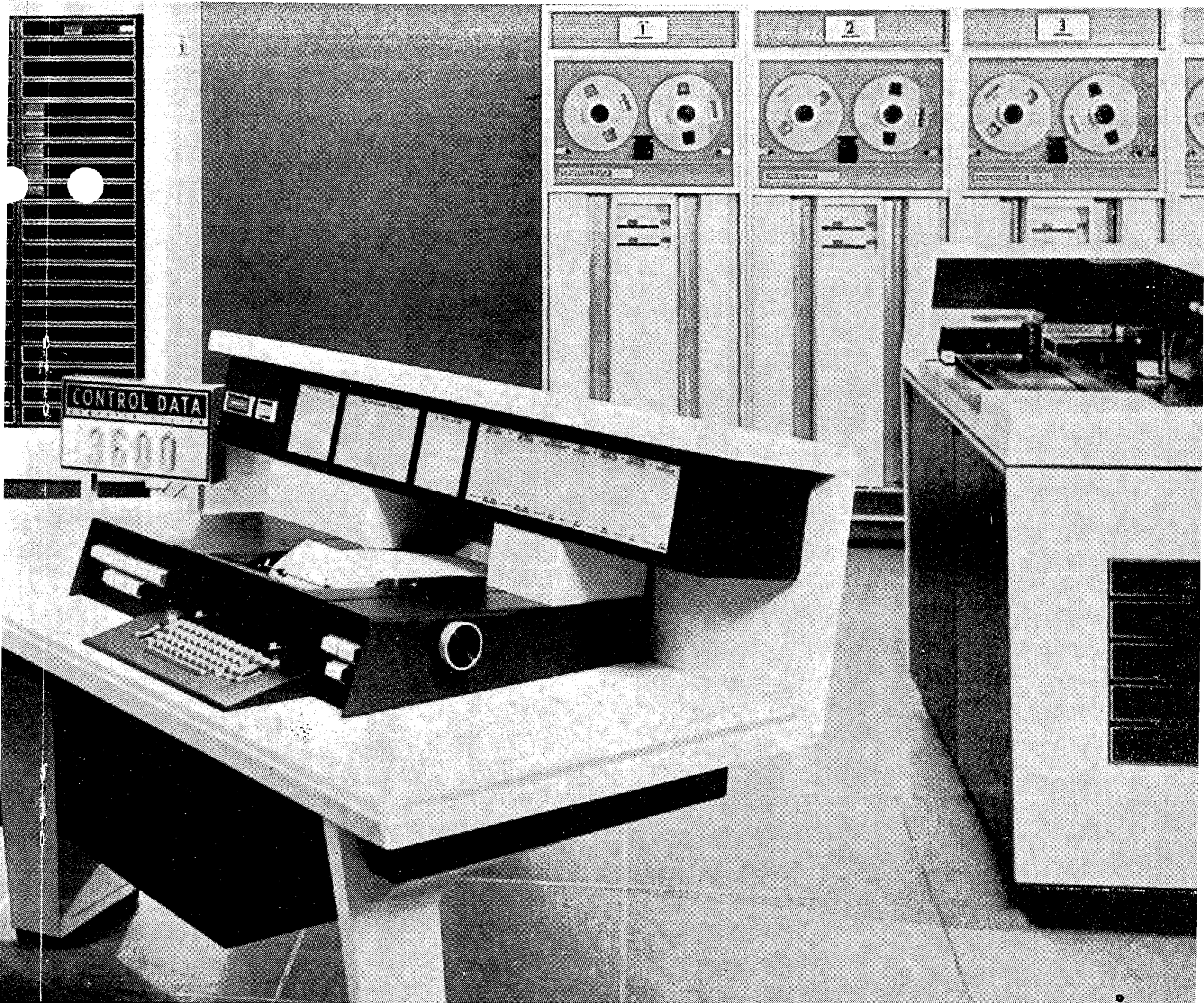

Atlantic Missile Range

channels can easily be included to handle increased data processing requirements as needed. This means that the Atlantic Missile Range will start out with a system commensurate with their requirements. As AMR's data processing needs grow in size and complexity, additional units can be included without replacing the original equipment. □ Control Data's total system capability for this real-time system is provided by the Company's **Government Systems Division**...and includes problem analysis, system design, hardware implementation, system integration, programming, installation and maintenance. □ To learn more about the 3600 and Control Data's total system design capability, contact the Control Data representative nearest you.

CONTROL DATA
CORPORATION

8100 34th Ave So., Minneapolis 20, Minn.

• Los Altos • Minneapolis • Newark • New York City • Norfolk • Orlando • Philadelphia • San Diego • Seattle • Washington, D.C. / Luzern • Zurich • Bad Homburg • Paris • Melbourne

HERE'S RELIABILITY AND MAINTAINABILITY

Bryant Auto-Lift* Drums with Uni-Just* Aerodynamic Heads

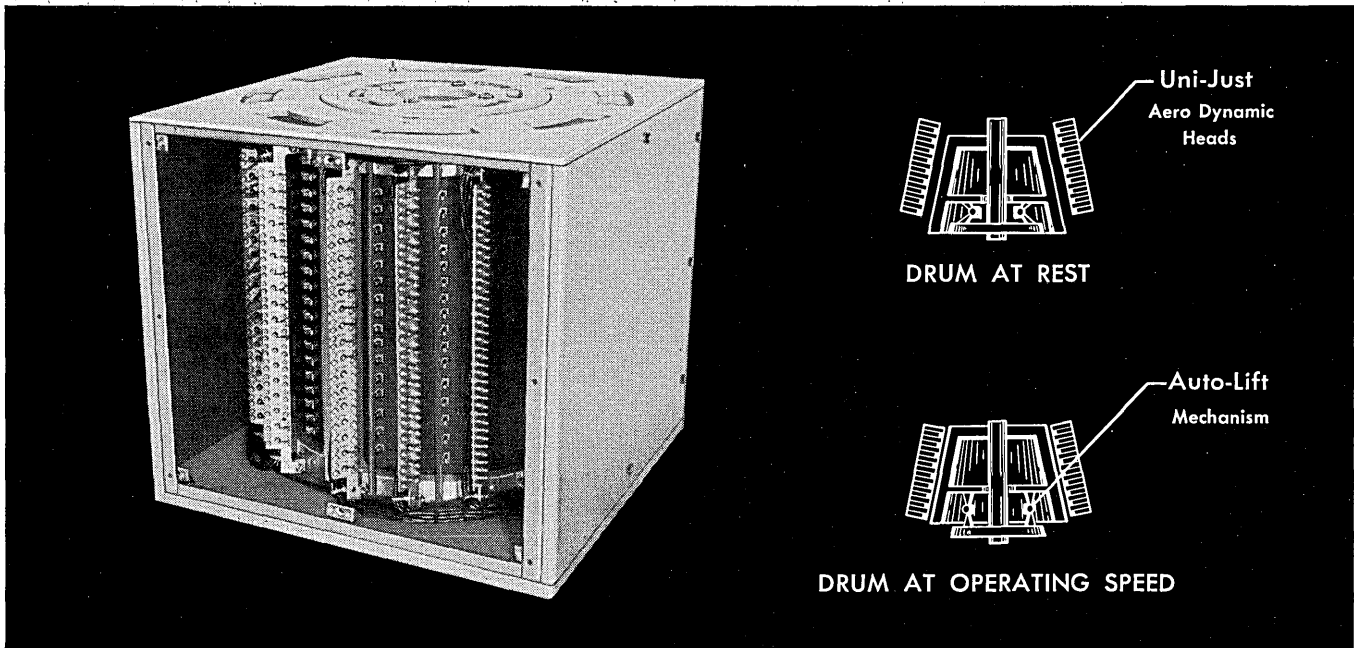

AUTO-LIFT DRUM FEATURES:

- No head-drum contact.
- Centrifugal lift raises tapered drum to heads at operating speed.
- Tapered drum retracted axially on stop cycle.
- One simple, fail-safe Auto-Lift regardless of number of heads.
- Auto-Lift maintains fixed adjustment of heads.
- Auto-Lift is automatic, requires no external power, controls or adjustment.
- Auto-Lift unit unaffected by temperature, shock, or vibration.
- Full range of standard sizes and speeds in production.
- Interchangeable production parts throughout.
- All drums expandable to full capacity in field.
- Motor and bearings field serviceable without loss of data.

UNI-JUST AERODYNAMIC HEAD FEATURES:

- True aerodynamic heads fly continuously — no skipping or bouncing.
- Negligible playback envelope modulation.
- Fail-safe individual adjustment to match playbacks.
- Individual heads replaceable without loss of data.
- Head adjustment and replacement with drum running.
- Full range of frequency and pulse density satisfied by production heads.
- Unlimited recording modes.

*Trademarks

STANDARD SPECIFICATIONS

MODELS:

- Series 5000 — 5 inch diameter — 4710 bits/track**
- Series 7500 — 7.5 inch diameter — 7080 bits/track**
- Series 10000 — 10 inch diameter — 9240 bits/track**
- Series 18500 — 18.5 inch diameter — 17400 bits/track**

CAPACITIES:

**300 bits per inch.

Up to 16.5 megabits at 300 BPI with single bit alteration. Higher capacities available using NRZ, block format.

AVERAGE ACCESS TIME:

2.5 to 33.3 milliseconds depending on drum size.

MOTORS:

900 to 12,000 RPM, Induction or Synchronous.

MAGNETIC MEDIUM: hard oxide coating.

READ-WRITE HEADS:

Individually adjustable, true aerodynamic heads.

ENVIRONMENT:

Storage: -65°F to +160°F.

Operating: +32°F to +140°F.

Thermal shock: Drum with covers in place will withstand 50°F step change in operation.

Altitude: Operating to 15,000 feet.

Humidity: to 95% RH.

Shock: 5 G's any plane with standard mounts.

Vibration: 0-10 CPS 5 mils excursion.

10-250 CPS 2 mils excursion.

25-50 CPS 1 mil excursion.

Over 50 CPS 0.5 mil excursion with maximum acceleration of 2 G's.

Military Auto-Lift Drums are also available to meet these typical specifications: Mil-E-5400, Mil-E-4970, Mil-E-4158, and Mil-E-16400.



COMPUTER PRODUCTS

850 Ladd Road, Walled Lake, Michigan • U.S.A. • TEL. 624-4571, TWX. 313-624-4564

A DIVISION OF EX-CELL-O CORPORATION

CIRCLE 20 ON READER CARD

ACM technical sessions . . .

Wednesday, August 28, Junior Ballroom, 2 p.m.
Session 6B: Sorting and Merging
 Chairman: John Flynn, Martin-Marietta Corp.
6B.1: Selective Dissemination of Information (SDI-4): An IBM 1401 & 7090 Data Processing System, A. B. Barnes, H. Fallon, C. B. Hensley,

M. E. Kane, A. Resnick and A. J. Sowarby, IBM; T. R. Savage, Documentation, Inc.
6B.2: A Tree Structure System for Sorting, Search and Maintenance, Leon Bloom, Litton Systems Inc.
6B.3: Sorting by Replacement Selecting, Betty Jane Gassner, Dept. of the Air Force
6B.4: The Organization of Structured Files, B. J. Dzubak and C. R. Warburton, IBM
6B.5: An Economical Subroutinized Sorting Technique, J. L. Kenney, IBM

Wednesday, August 28, Grand Ballroom, 3:40 p.m.
Session 7A: Panel on Social Aspects of Computing: The Responsible Use of Computers in Politics
 Moderator: Edward Bailey, University of Colorado
 Panelists: William McPhee, University of Colorado; Father Harry E. Hoewischer, Regis College, Denver; Louis L. Sutro, M.I.T.

Wednesday, August 28, Junior Ballroom, 3:40 p.m.
Session 7B: Hall of Discussion—Decision Tables
 Co-Chairman: Sol Pollack, RAND Corporation; Michael Montalbano, IBM

Wednesday, August 28, Silver Room, 3:40 p.m.
Session 7C: Hardware
 Chairman: George Heyliger, Martin-Marietta Corp.
7C.1: Timing Simulation of a Large Asynchronous Computer, R. L. Chew and A.J.R.G. Milner, Ferranti, Ltd.
7C.2: Internal Forces in a Wound Reel of Magnetic Tape, H. Tramosch, IBM.
7C.3: Random Generation of Test Routines, Richard D. Eldred and Bruce Donaldson, Minneapolis-Honeywell
7C.4: Magnetic Permanent Storage: The Rope Memory, P. Kuttner, Burroughs Corp.
7C.5: Unate Codes for Data Retrieval and Display Devices, Joseph A. O'Brien, Mitre Corp.

THURSDAY August 29

Thursday, August 29, Grand Ballroom, 9 a.m.
Session 8A: Invited Papers
 Chairman: L. R. Lavine, Philco Corporation
8A.1: The Real Problem in Programmer Training, Daniel D. McCracken, McCracken Associates Inc.
8A.2: Expanding the Editing Function in Language Data Processing, L. B. Doyle, System Development Corp.

Thursday, August 29, Junior Ballroom, 9 a.m.
Session 8B: Pattern Recognition
 Chairman: Robert Albrecht, Control Data Corp.
8B.1: ARGUS—A Handwritten-Character Recognition Program, Warren Teitelman, M.I.T.
8B.2: GIT—A Heuristic Program for Testing

Pairs of Directed Line Graphs for Isomorphism, S. H. Unger, Columbia Univ.
8B.3: The Use of List-Structured Descriptions for Programming Manipulations on Line Drawings, Thomas G. Evans, Air Force Cambridge Research Laboratories
8B.4: Optimal Decision Functions for Computer Character Recognition, J. T. Chu, Univ. of Pennsylvania
8B.5: A "Fact Organizer" for Pattern Recognition and Language Manipulation, J. Philip Benkard and Leonard Uhr, Univ. of Michigan.

Thursday, August 29, Junior Ballroom, 10:40 a.m.
Session 9B: Hall of Discussion, Mathematical Programming
 Chairman: Robert L. Graves, Systems Programming Inc.

Thursday, August 29, Silver Room, 10:40 a.m.
Session 9C: Education and Programmer Training
 Chairman: Gloria Silvern, North American Aviation Inc.
9C.1: A Conversational Teaching Machine, Wallace Feurzeig, Bolt Beranek and Newman Inc.
9C.2: Report on COBAL Training Through Programmed Instruction, Carl A. Powers, Burroughs Corp.
9C.3: The Auerbach Programmed Course in

COBOL, Martha B. Bullard, Auerbach Corp.
9C.4: Simulating Socrates, R. E. Packer, Thompson Ramo Wooldridge.
9C.5: Computer Education in the Secondary Schools, R. L. Albrecht, Control Data Corp.
 Thursday, August 29, Junior Ballroom, 3 p.m.
Session 10B: Invited Papers
 Chairman: A. M. Paster, Sperry Rand Corporation
10B.1: Applications of Computers to Clinical Medicine, Theodor D. Sterling, Univ. of Cincinnati
10B.2: UNCOL—Progress and Prospects, T. B. Steel, Jr., System Development Corp.
 Thursday, August 29, Silver Room, 3 p.m.
Session 10C: Panel on Business Data Processing
 Moderator: John A. Postley, Advanced Informations Systems Inc.
 Panelists: Ascher Opler, Computer Usage Co.; Gary Carlson, Brigham Young Univ.

Thursday, August 29, Grand Ballroom, 4:30 p.m.
Session 11A: Panel on Programmer Training
 Co-Moderators: Gloria Silvern, North American Aviation Inc.; Marvin Wofsey, American University
 Panelists: Martha B. Bullard, Auerbach Corp.; Carl A. Powers, Burroughs Corp.; R. L. Albrecht, Control Data Corp.; Robert E. Packer, Thompson Ramo Wooldridge; Wallace Feurzeig, Bolt Beranek and Newman Inc.

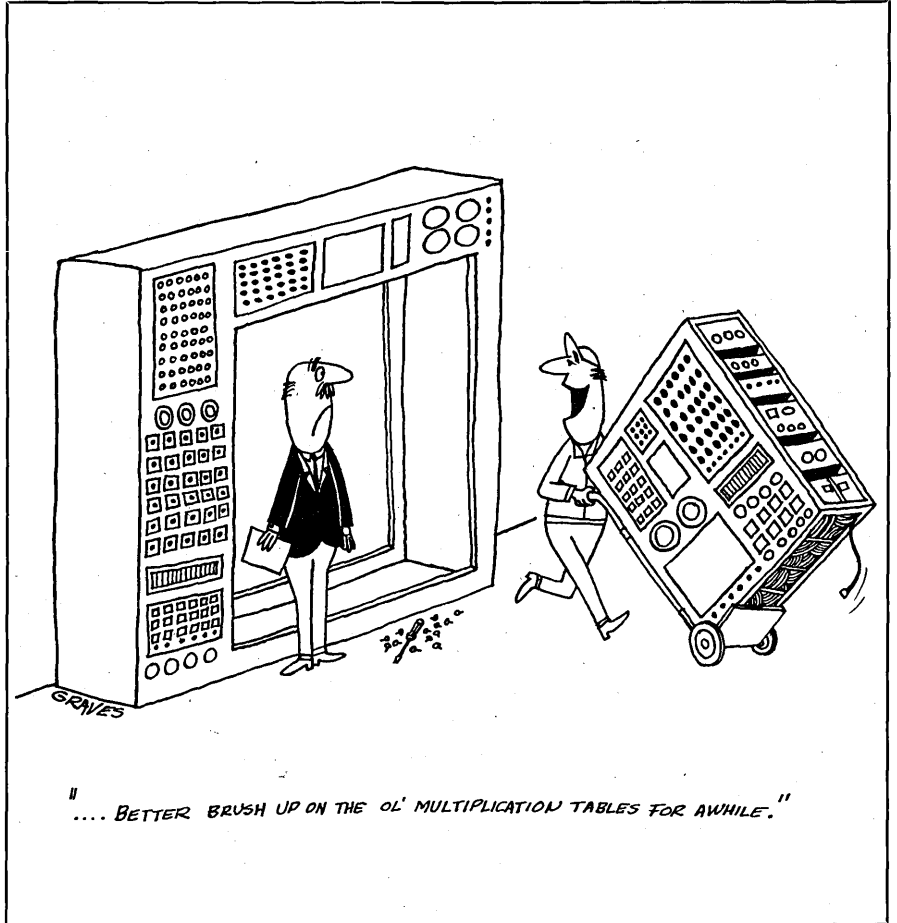

ACM technical sessions . . .

Thursday, August 29, Junior Ballroom, 4:30 p.m.

Session 11B: Bio-Medical Programming and Processing

Chairman: Glenn Dalrymple, University of Colorado Medical Center

11B.1: A Mathematical Model of Neuron Behavior For Computer Simulation, E. E. Nelson and H. F. Wolf, Astropower, Inc.

11B.2: Establishing an Integrated Statistical Program Library, Seymour V. Pollack, Univ. of Cincinnati

11B.3: Programming the CDC 160-A for Brain Research Data Processing, John R. B. Whitteley, Univ. of California Medical Ctr.

11B.4: Computer Analysis of Cystic Fibrosis Transmission Patterns, Theron L. Smith, General Dynamics Corp.

11B.5: Digital Computers and Problems of Cellular Regulation, Robert Rosen, Univ. of Chicago

Thursday, August 29, Silver Room, 4:30 p.m.
Session 11C: Automatic Programming Languages

Chairman: Don Thurneau, Marathon Oil Co.

11C.1: An Improved Equivalence Algorithm, Bernard A. Galler and Michael J. Fischer, Univ. of Michigan

11C.2: EULER: A Generalization of ALGOL, And Its Implementation, Niklaus Wirth, Univ. of California

11C.3: Translation Algorithm for a Multiple Processor Computer, Jon S. Squire, Univ. of Michigan.

11C.4: A Syntax-Structured Compiler, Herbert Kanner, Paul R. Kosinski and Charles L. Robinson, Univ. of Chicago

11C.5: A Tree-Structured Symbol Table for An ALGOL Compiler, Paul R. Kosinski, Herbert Kanner and Charles L. Robinson, Univ. of Chicago

11C.6: An Efficient Structure for Compiled ALGOL 60 Programs, Charles L. Robinson, Herbert Kanner and Paul R. Kosinski, Univ. of Chicago.

Thursday, August 29, Junior Ballroom, 8 p.m.
Session 12B: Tutorial

12B.1: COBOL, Up-Dated, William L. Donally, IBM

Thursday, August 29, Silver Room, 8 p.m.

Session 12C: Tutorial

12C.1: PERT/CPM, James W. McCauley, Control Data Corp.

FRIDAY August 30

Friday, August 30, Grand Ballroom, 9 a.m.

Session 13A: Panel on Computer Science Curriculum

Moderator: W. F. Atchison, Georgia Tech.

Panelists: Bruce W. Arden, Univ. of Michigan; Alan J. Perlis, Carnegie Tech.; George E. Forsythe, Stanford Univ.; David E. Muller, Univ. of Illinois; Saul Gorn, Univ. of Pennsylvania; Robert R. Korfhage, Purdue Univ.

Friday, August 30, Junior Ballroom, 9 a.m.

Session 13 B: Compilers for Small Computers,
Chairman: Edward L. Manderfield, North American Aviation Inc.

13B.1: Implementation of a Symbol Manipulator For Heuristic Translation, Lee O. Schmidt, Beckman Instruments Corp.

13B.2: A Syntax Directed SMALGOL For the 1401, V. A. Schorre, U.C.L.A.

13B.3: A SMALGOL Compiler for the ALWAC III-E At Oregon State University, Philip H. Hartman, Harvard Univ.

13B.4: A Parameterized Compiler Based on Mechanical Linguistics, Howard H. Metcalfe, Planning Research Corp.

13B.5: 1620 ALGOL — A Hardware Representation of ALGOL 60 for the IBM 1620, William Blose, Stanley Pope and Charles Wright, Jr., Southern Illinois Univ.

Friday, August 30, Grand Ballroom, 10:40 a.m.

Session 14A: Use of Computers for Medical Diagnosis

Chairman: Robert S. Ledley, National Biomedical Research Corp.

Panelists: Theodore D. Sterling, Univ. of Cincinnati; Clifton F. Mountain, Univ. of Texas; Caesar, Dept. Health Education and Welfare; C. Stanley Woodson, Lovelace Medical Clinic; Joseph Balintfy, Tulane Univ.

Friday, August 30, Junior Ballroom, 10:40 a.m.

Session 14B: Software, I/O Buffering

Chairman: R. S. Essert, National Center for Atmospheric Research

14B.1: Data Flow and Storage Allocation For the PDQ Program on the Philco-2000, C. J.

Pfeifer, Westinghouse Electric Corp.

14B.2: A Non-Sequential Buffering System Using a Variable Number of Tapes, D. W. Barron and D. F. Hartley, University Mathematical Laboratory, Cambridge, England; C. R. Spooner, Ferranti, Ltd.

14B.3: Data Processing System Delays Due to Magnetic Tape Storage, Marvin Gang, International Electric Corp. and Samuel Gorenstein, System Development Corp.

14B.4: Multiprogramming Concepts, Laurence Press, IBM.

14B.5: An Analysis of Merging from Random, Access Storage Devices, George U. Hubbard, IBM

Friday, August 30, Silver Room: 10:40 a.m.

Session 14C: Simulation and Graphical Output

Chairman: Jack Schultz, Dow Chemical Co.

14C.1: Computer-Made Perspective Movies as a Scientific and Communication Tool, E. E. Zajac, Bell Telephone Laboratories, Inc.

14C.2: Mesh of Points, John F. Dollries, General Electric Co.

14C.3: A Program for a General-Purpose Digital Computer to Perform Analog Type Simulations, Edward R. Byrne, Bell Telephone Laboratories Inc.

14C.4: Hypervelocity Interceptor Simulation, Carlton E. Gebhart and David H. Brandin, Illinois Tech Research Institute

14C.5: An Incremental Algorithm for Digital Plotting, J. E. Bresenham, IBM. ■



TRW gives you **FULL VALUE** Programming support

TRW-FORTRAN II

Use this efficient one-pass compiler for operational convenience. Merge engineering subroutines with FORTRAN statements for greater efficiency. TRW-FORTRAN II will work on either a minimum paper tape or a magnetic tape system.

SYMBOLIC ASSEMBLER

Use this basic programming tool in machine or symbolic language for maximum operating speeds. Tailor your library to suit your needs by automatically relocating TRW's subroutines onto your own paper or magnetic tape—in convenient magnetic tape format.

LOAD-AND-GO INTERPRETER

Use this easy-to-learn system for "open shop" operations, and wherever fast problem throughput is a must. You can also use it in program development work to test, verify and evaluate new algorithms and numerical methods.

SUBROUTINE LIBRARY

Use this multi-million dollar repertoire of scientific/engineering and general purpose subroutines for your own computing needs. The library now contains over 200 routines and is continually growing.

STORED LOGIC SYSTEM DESIGN

Use the all-around power of this advanced design concept, which TRW has now proven in nearly 100 operational installations. Use its unparalleled flexibility to optimize your "bread and butter" programs. Stored Logic also lets you expand your machine's instruction repertoire indefinitely as your computing needs change and grow.

TRW Computer Division

Dedicated to excellence in computer technology and customer service, the TRW Computer Division is the dependable company to grow with. Five years ago TRW pioneered the field of automatic industrial control, and still leads—world-wide—in number and value of installations. The TRW-130 (AN/UYK-1) "Stored Logic" military computer paces its field. Let TRW's *dependable excellence* serve your needs.

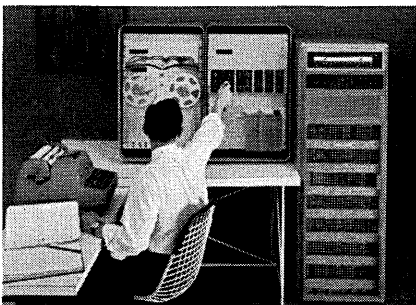

TRW-230 "Stored Logic" Multiple Purpose Computer. \$2,050 per month, including FORTRAN II and TRW FULL VALUE programming support. Full line of peripherals. 60-day delivery.

For details, contact one of our representatives: Atlanta, Boston, Chicago, Cleveland, Houston, Huntsville, Los Angeles, New York, Rome, N.Y., Washington, D.C.

TRW COMPUTER DIVISION

THOMPSON RAMO WOOLDRIDGE INC. 8433 Fallbrook Avenue • Canoga Park, California

CIRCLE 21 ON READER CARD

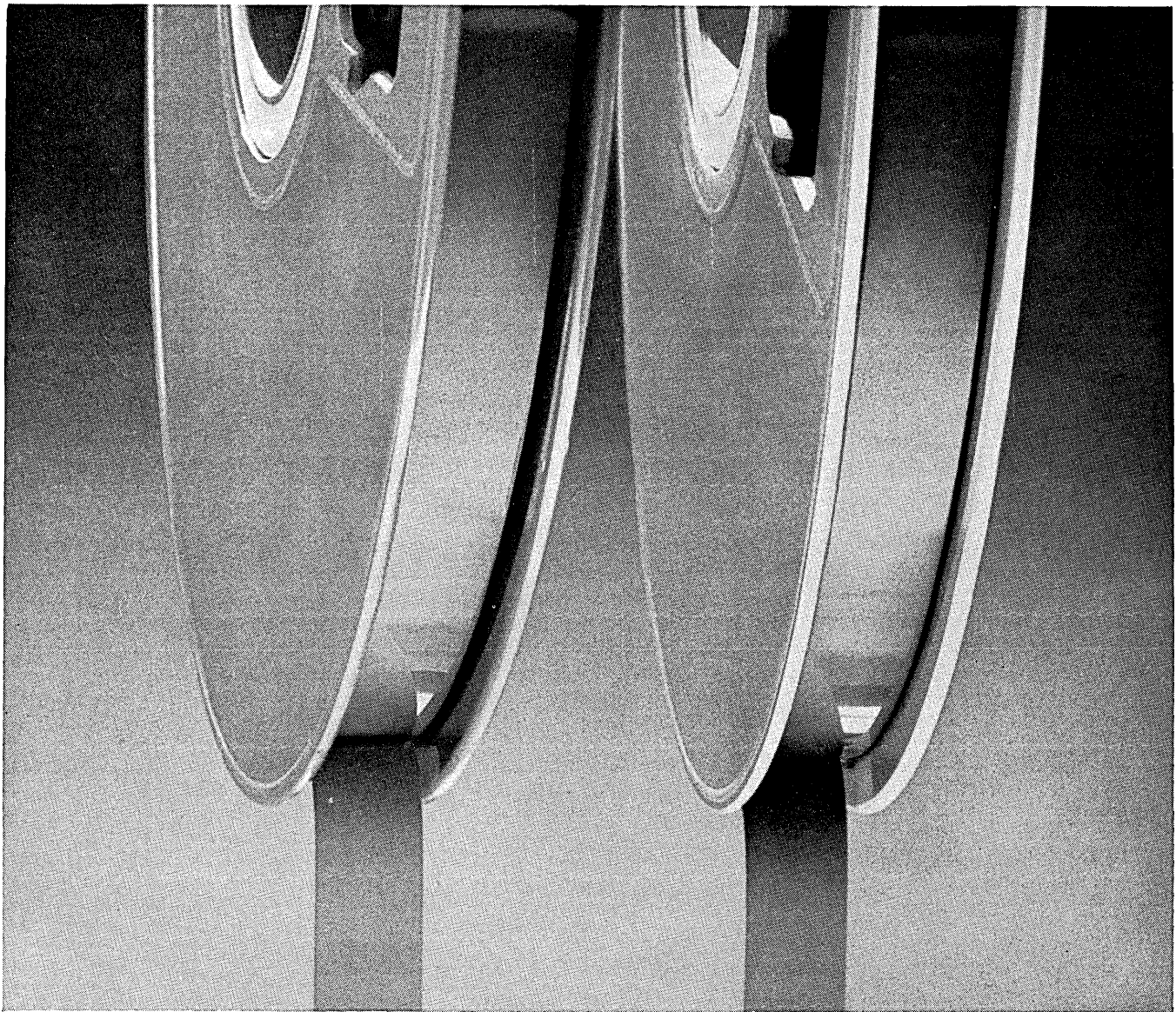

BOTH THESE MAGNETIC TAPES HAVE A POLYESTER BASE ...BUT ONLY ONE IS MYLAR® (8 YEARS PROVEN)

Eight years ago computer tape of Du Pont MYLAR* polyester film appeared on the scene and set new standards of reliability. Naturally enough, people whose needs called for a magnetic tape of highest performance couldn't risk a tape other than MYLAR. ■ Now, other polyester films are beginning to appear. They are not all the same: MYLAR is a polyester film, but other polyester films are

not MYLAR. In the past you could safely assume you were getting MYLAR when you specified "polyester base". *Today you cannot.* ■ There's only one way to be sure you're getting the MYLAR you've used and trusted for magnetic tapes of proven reliability: specify MYLAR by name. E. I. du Pont de Nemours & Co. (Inc.), 10452 Nemours Bldg., Wilmington 98, Delaware.

*Du Pont's registered trademark for its polyester film.



BETTER THINGS FOR BETTER LIVING . . . THROUGH CHEMISTRY

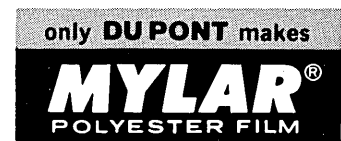



THE '63 SPRING JOINT

**Detroit
revisited**

□ In a movie shown at the recent SJCC, one of the "stars"—a champion checker player—notes of the computer he is playing against, "Gee, it's a real glutton for punishment."

The same might be said for the some 2000 attendants, who spent three days talking and listening computers and related topics with quite a bit of drinking and walking—and very little sleeping—thrown in.

The movie—a production of the National Film Board of Canada entitled "The Living Machine"—may have been the most significant single event at the show. It is a masterful and frightening hour-long exploration of the wonders and worries of computers, posing the most important and basic questions of all: What is the difference between man and machine, and what is their relationship? Joining the computer in lead roles are MIT's Dr. Warren McCulloch and Margaret Mead. *Datamation* rates it as a four-star must see.

In the living color, three-D world of the display floor, most attention went to the Burroughs B 5000, on exhibit for the first time. Many touched it, earning buttons so announcing. Outside of the B 5000, there was little new in main frames. One exception: the DSI 1000, roughly 3800 cubic inches, featuring 1.6 usec cycle time and a 2,048-word (12 bits) glass acoustic delay line memory with an average access time of 100 usec. Multiply and divide are programmed, but hardware versions for extra dollars are available. Prices begin at \$9980. DSI stands for Data Systems, Inc., a 12-man outfit in Grosse Pointe Woods, Mich., which says it has a \$400K backlog. The

company will offer a "sophisticated macro assembler with limited FORTRAN capabilities," according to DSI president Sam Irwin.

As prominent by their absence as many were in attendance were Honeywell, RCA and RemRand Univac. IBM made a token appearance, both on the floor and in the technical sessions, where only three out of 37 papers, and one out of 63 panelists were represented by the industry's biggest company.

The technical sessions ranged the usual gamut of excellence and interest. The session on list processing was rated so-so by our sources; the two sessions on analog and hybrid systems were reported as excellent, with healthy attendance, pretty well divided between analog and digital types, few of whom raised their hands in answer to the chair's request for those who know both fields. The degree of interest was evidenced by the fact that the discussion continued at one of the sessions 45 minutes after it had been officially adjourned.

A big crowd which came to see fireworks in the evening panel conducting "critical analyses of the current state of the art," were generally disappointed. One comment: "I'm afraid there's not much courage up there," which maybe meant "not much criticism." The panel, headed by Ted Glaser of Burroughs Paoli, included DOD's Campaigne, Lincoln Lab's Selfridge, Wilkes of Cambridge University, Dick Hamming, Bob Barton and D. F. Blumberg, of Pennsylvania Research Associates.

Blumberg tried to get things going by stating that the "one man most influential in moving the computer

industry forward was the IBM salesman." Wilkes was applauded for saying that manufacturers could save money by forgetting software and "giving away 8 or 16K of memory." Barton said simply, "It's time to set up standards for machine languages. Period." (See Editorial Readout in the June '63 *Datamation*). Campaigne stressed the transitional status of the industry at present, while Hamming claimed that his field of computing was dull and would remain so.

It was Selfridge who tried to put the discussion on the track of more basic issues, to frame it in the context of larger questions. "The real purpose of computers and science," he said, "is to help people govern themselves and to work together properly." But, he added, the sub-goal of science is too often treated as a primary goal.

The rest of the session divided itself amongst questions from the floor concerning the standardization of machine languages—"Are you kidding" types, mostly — and the witty wisdom of Selfridge.

The luncheon speaker, Walter A. Rosenblith — MIT Professor of Communications Biophysics — blended learning and clarity in his discussion of "Computers and Brains — Competition and/or Coexistence." Providing a brief historical background to his topic, he argued that this is not an "either-or" problem — that researchers must

not try to imitate all of the brain, but attempt to use machines to "perform part of a function better, differently than the brain." He concluded, "Cooperation, and/or coexistence? The ideal model will represent a reasonably monogamous marriage. May the offspring be not too well adjusted so that evolution won't stop."

He was preceded at the luncheon by George Romney, who was thanked for his interest in the conference by Chairman Calvin Johnson, after the Governor had paeaned his glorious state. Keynoter Ray R. Eppert, Burroughs president, used the podium to mount an attack upon administration taxation of overseas manufacturers.

Winning the award for the best paper (content) were D. T. Ross and J. E. Rodriguez of the MIT Electronic Systems Laboratory, for "Theoretical Foundations for the Computer-Aided Design System." Proposed prizes: two all-expense-paid tours of Poughkeepsie, or perhaps some CDC stock.

A final note: Cobo Hall is a grand setting for a conference, although it could use some more spots for sitting and talking. The less said about the hotel accommodations and their non-handling of communications the better. Las Vegas, anyone? ■

WESCON '63

a preview

Technical papers of interest to computer personnel will be among those presented during four special and 20 regular sessions at the 1963 Western Electronic Show and Convention (WESCON), August 20-23, in San Francisco's Cow Palace.

It is sponsored by the San Francisco and Los Angeles sections of the IEEE, and the Western Electronic Manufacturers Association. The computer-oriented sessions include the following:

Trainable Systems: Realization and Simulation. In this session, August 21, 10 a.m. to 12:30 p.m., are the following papers: "A Large Self-Contained Learning Machine," A. E. Brain, G. E. Forsen, D. J. Hall, C. A. Rosen, Stanford Research Institute, Menlo Park, Calif. "Design of a Magnetic Variable-Gain Component for Adaptive Networks," H. S. Crafts, Stanford Research Institute. "Influence of Component Imperfections on Performance of Trainable Systems," P. R. Low, IBM, Poughkeepsie, N.Y., and Stanford Univ. "Simulation of Adaptive Linear Decision Functions Using the IBM 7090," J. S. Griffin Jr., J. H. King, C. J. Tunis, IBM, Endicott, N.Y.

Information Processing in Living Systems. August 21, 2 to 4:30 p.m. "Unit Properties in Nervous Intergration," Donald Kennedy, Stanford Univ. "Rod and Cone Receptor Potentials from Monkey Retinas," Kenneth T. Brown, Univ. of Calif. Medical School, San Francisco. "Methods Used by a Simple Eye to Improve Its Spatial and Temporal Resolving Power," Charles S. Stevens, Univ. of

Washington Medical School, Seattle, Wash. "Tactile Perception with Electric Stimuli," Robert H. Gibson, Carnegie Tech, Pittsburgh, Pa. "Sensory Perception — Focal Point of Interdisciplinary Research by Biologists and Engineers," C. D. McCann, Caltech, Pasadena, Calif.

Trainable Systems: Theory and Applications. August 22, 10 a.m. to 12:30 p.m. "The Artificial Intelligentsia — A Critique of Various Camps in Artificial Intelligence," Louis Fein, Palo Alto, Calif. "Simulation Studies of Four-Layer and Cross-Coupled Perceptrons," Frank Rosenblatt, Cornell Univ., Ithaca, N.Y. "An Adaptive Prediction Technique and Its Application to Weather Forecasting," Richard O. Duda, Jack W. Machanik, Stanford Research Institute. "Some Applications for Adaptive Data Processing Systems," Bernard Widrow, Lee Talbert, Gabriel Groner, Fred Smith, Michael Hu, Donald Specht, Stanford Univ.

Among papers in the session on Switching Circuits will be "Application of Nanosecond Logic Circuits," J. S. Jamison, T. E. Gilligan, J. Bacon, Burroughs Corp., Paoli, Pa.

Among other sessions are Component Reliability, August 20, 10 a.m. to 12:30 p.m.; Control Theory, August 22, 10 a.m. to 12:30 p.m.; and Data Coding & Switching Theory, August 23, 10 a.m. to 12:30 p.m.

Eleven tours are scheduled, including the Univ. of California Electronic Research Lab, Systron-Donner Co., and NASA's Ames Laboratory. ■

If the growth of COBOL users is not rivalled closely by the number of COBOL translators, there is reason to believe that it soon will. This increasing activity presages an interest

in COBOL and compatibility, a subject which warrants the scrutiny exhibited here by a member of the ASA's X3.4.6 Glossary subcommittee.

COBOL AND COMPATIBILITY

by ROBERT M. GORDON, Arthur D. Little, Inc.,
Cambridge, Mass.



Variants of the word "compatible" are very fashionable in the computing world today if one is to judge by the ubiquitousness of them. It is surprising, therefore, that "compatible" can be found in no glossary of terms in widespread use by computing people. On the other hand, *everyone* knows what the word means; as it turns out, no one *knows*: one gets as many defini-

tions as there are people to be asked.

Hence, it makes sense to begin this discussion with a definition of "compatible:"

(1) An element A is said to be compatible with an element B over a set of characteristics S if A and B are indistinguishable—i.e., are interchangeable—with respect to the members of S.

Let us make the definition more particular for our universe of discourse, COBOL compilers:

(2) A COBOL compiler, C₁, is said to be compatible with a COBOL compiler, C₂, over all programs written according to the rules known as Required COBOL 61, if C₁ and C₂ are indistinguishable with respect to such programs.

It is not difficult to verify that the set of compatible COBOL compilers is void (at the time this sentence is written: 9 April 1963). That is to say, there do not exist even two COBOL compilers which are compatible in the sense of definition (2)! This conclusion may come as a surprise—even a shock—to some readers; it may be regarded as a catastrophe by others. Surprise it may be; catastrophe it is not.

Consider this simple obstacle to compatibility: the alphabets used by computers—and, hence, COBOL compilers—of the several manufacturers are not identical. This difference imposes the requirement that some uniform substitution of acceptable characters be made for the unacceptable ones. Although this is a trivial requirement, nevertheless it means that the definition of compatibility is violated.

Or, consider another obstacle. The Environment Division of a COBOL program exists for the purpose of informing the compiler what computer is available for compilation, what computer is to be used for execution of the so-called object code. Is it really surprising that the COBOL compiler for the Burroughs B5000 will not accept—without any

further thoughts

alteration, even in the Environment Division—programs originally intended to be both compiled and executed on the RCA 301? But, it almost goes without saying, it is a trivial act to modify the Environment Division of a COBOL program if it is to be compiled by a computer different from the one for which the program was written initially. Granting the triviality of the effort does not mitigate the incompatibility!

Let us admit, therefore, that compatibility, according to definition (2) is a chimera. Such an admission will not preclude consideration of the many benefits that COBOL—the language—and COBOL compilers confer on their users. Of course, we can weaken the constraints imposed by the set S—in this case, Required COBOL 61—until we get a definition which allows compatibility to exist. We contend that to follow the latter course is futile: like the philosopher's stone, a "meaningful" compatibility does not exist.

Let us now consider the matter of compatibility as the term might be applied separately to the four divisions of Required COBOL 61; afterwards we will consider how compatibility is affected if elective features of, and extensions to, Required COBOL are available and used. Then we shall consider possible benefits to the user of COBOL irrespective of any effect due to compatibility—or incompatibility, for that matter.

First of all, let us dispose of the matter of the alphabet, consideration for which applies in all of the divisions of COBOL: until a universally accepted set of characters is found, the COBOL compilers of the several manufacturers will likely be trivially incompatible. Of course, agreement on a restricted set of characters might be had, but this does not seem very probable at this time.

The source of incompatibility with respect to the Identification Division is in the alphabet. This is a trivial difficulty.

With respect to the Environment Division the sources of incompatibility are two, the alphabet and the computers. The alphabetic incompatibility is trivial; in a sense, so is that of the computers. Changes required because a different computer is used for compilation and execution are easily attended to. One question often asked is whether Computer 1 could compile programs to be executed on Computer 2 for an arbitrary choice of computers 1 and 2. It is unreasonable to expect an affirmative answer to this question, as even a little thought will disclose. This facet of

incompatibility has an effect on the writing of the Data Division, as will be pointed out below.

In the Data Division the difficulty of the alphabet is easily attended to. Herein, however, arise the first and most demanding questions that emphasize the machine-dependent aspects of the use of COBOL: the structure of the data can have a profound effect on the "efficiency" of the object program created by the compiler. Although "efficiency" is unrelated to "compatibility", it is probably of concern to the writer of a COBOL program. For reasons of efficiency, therefore, it is likely that the Data Division will be given careful attention when it is first written; and it will be examined in detail if the program is to be recompiled on a computer in which representation and manipulation of data are different from those features of the original computer.

In the Procedure Division the problem of compatibility—so long as S is Required COBOL 61—is the trivial one of the alphabet.

The implementation of either elective features or extensions by compiler writers, and the use of these elements by writers of programs raise the first serious questions of compatibility. Suppose we denote by S_1 all those programs written according to the rules of Required COBOL and by C_1 a compiler which accepts such program; denote by S_2 all those programs written according to the rules of Required COBOL plus any elective features and extensions and by C_2 a compiler which accepts such programs.

We assert that C_1 and C_2 are incompatible; that is, not all programs which can be compiled by C_2 can be compiled by C_1 (even making exception for the trivial incompatibilities previously noted). It should be clear, however, that all programs which can be compiled by C_1 can be compiled by C_2 (except for the trivial instances).

The writer of COBOL programs is faced with a dilemma: does he wish to write programs which can be altered with minimal effort to be executed by more than one computer? Or does he wish to take advantage of all the richness provided by any language which includes—and is more than—Required COBOL (in which case he will almost certainly write programs which can be recompiled only after considerable revision)? We do not presume to resolve this difficulty for the reader, but merely wish to say that it merits his closest attention.

Even allowing for the shortcomings of COBOL which have been highlighted above, is there any merit in the argument that the user of COBOL—the language—has much, if anything, to gain? The answer must be that there is substantial advantage; the following discussion will illuminate some of the benefit:

1. COBOL provides standards of documentation which, if they do not comprise a complete set, represent a substantial foundation on which to build. In the case of the novice, this set of standards offers the possibility of sharing the benefits of standardization where more experienced data processing organizations have already reaped them.

2. COBOL programs are easy to read. If there is a lot of easy-to-read literature available, people—programmers *are* people, after all—may be inclined to read some of it. People who read a lot tend to be critical readers; critical readers have a better chance to write good literature. Since most of the people who read programs also write them, there is a fair chance that the installation using COBOL will witness an improvement in the quality of its programming as well as in the quality of its documentary literature.

3. Good documentation—the chance for which is improved by the use of COBOL—will encourage users of computers to do for themselves many of the tasks which they now insist be performed by the manufacturers—to the mutual disservice of both groups. It is a mistake to believe

the computer manufacturer can do for all of his customers all of the things customers need to run a good shop: the manufacturer

- a. doesn't have the human resources to do the optimum job for each of his customers; and
- b. even if he did, he couldn't afford to do it under present pricing policy or practice; besides
- c. he cannot and should not be expected to act in the *best* interests of all his customers all the time.

4. The widespread use of COBOL will promote program exchanging. What is the equivalent result, the use of the language can ease the burden of replacing a computer with a better one. How much relief will be afforded is a function of many variables: the quality of the programs to be converted, the need or desire to redesign the "system," structural and functional similarities — and dissimilarities — of the two computers involved, etc.

5. So far, no importance has been attached to the questions of availability and "efficiency" of machine translators — i.e., compilers — for COBOL programs. We assert that the benefits described here accrue to the user of COBOL irrespective of the availability of a compiler which satisfies him. Only a little reflection is required to satisfy the reader of the merit of this argument. While it is true that the availability of a compiler offers added advantage to its users, no universally acceptable criteria have been advanced for what constitutes a "good" compiler. Arguments still rage in hotel corridors and on conference and convention floors regarding the desired attributes of a compiler.* A few of the important attributes might be mentioned here.

- a. Program testing facilities in the source language must be provided. In the case of COBOL, for instance, this means that COBOL must contain linguistic elements which make it possible to monitor the execution of the compiled program.
- b. Fast compilation.
- c. "Efficient" object code.
- d. Comprehensive diagnostic facilities. That is, the compiler must be able to help the programmer locate errors in his code, errors in syntax as well as violations of other rules.

6. One of the complaints about COBOL and COBOL compilers is a direct result of our ignorance concerning formal languages and machine translation. We may expect to learn more about formal procedure-oriented languages — like COBOL — and their translators from attempts to use them. The use of COBOL for this reason constitutes an investment, the return on which can only be imagined; it is not unrealistic — in the light of the preceding discussion — to expect the gain to be substantial. The profit will be measured not only by money standards, but also by the power of a tool to control our environment.

A principal purpose of this paper has been to point out the error of focusing attention on the name-of-the-thing at the expense of the-thing-itself. In our case a poorly defined term, compatibility, has been used to obscure the case for consideration of the merits of a particular procedure-oriented language, COBOL. Benefits from the use of COBOL have been sacrificed to fatten an irrelevance:

*All COBOL compilers are compatible;
Some COBOL compilers are more compatible
than others.*

Let the bickering cease; let us get on with the important business at hand. ■

*See, for example, John A. Blatt's Comments from a Fortran User, *Communications of the ACM*, September, 1960. In subsequent issues, in letters to the editor, the dispute is continued.

IBM reports on the field of applications programming.

Who trains computers for new jobs?

The program that a computer follows in doing its work is a logical series of simplified directions. To develop these, the programmer must thoroughly understand the problem he wishes the computer to solve. IBM has studied its customers' problems diligently and has worked out families of applications to which general program systems may be most efficiently applied.

In an unusual example of applications programming, IBM assisted the U. S. Weather Bureau in programming a system for global weather simulation on an IBM STRETCH (7030). The computer program is based upon a mathematical model formulated by the General Circulation Research Laboratory at the Weather Bureau, for research on the problems of long-range forecasting. In this massive system the basic processes of weather are simulated for the entire globe in a more detailed and

fundamental manner than ever before. The simulated weather is calculated for as many as 10,000 grid points at each of nine atmospheric levels and for time intervals as small as five minutes, so that over ten billion calculations may be required to simulate the weather for a single day. Even in the highly efficient STRETCH language, over 15,000 instructions were required for this versatile system, which incorporates such varied factors as radiation, turbulence, clouds, oceans, mountain ranges, and forests.

The breadth of applications being studied by IBM is demonstrated by these current projects: aerospace, airlines, banking, biomedicine, brokerages, public utilities, railroads, steel industries, and warehousing. If you wish to look into the opportunities open at IBM, an Equal Opportunity Employer, write to: Manager of Employment, IBM Corp., Dept. 701G, 590 Madison Ave., New York 22, N. Y.

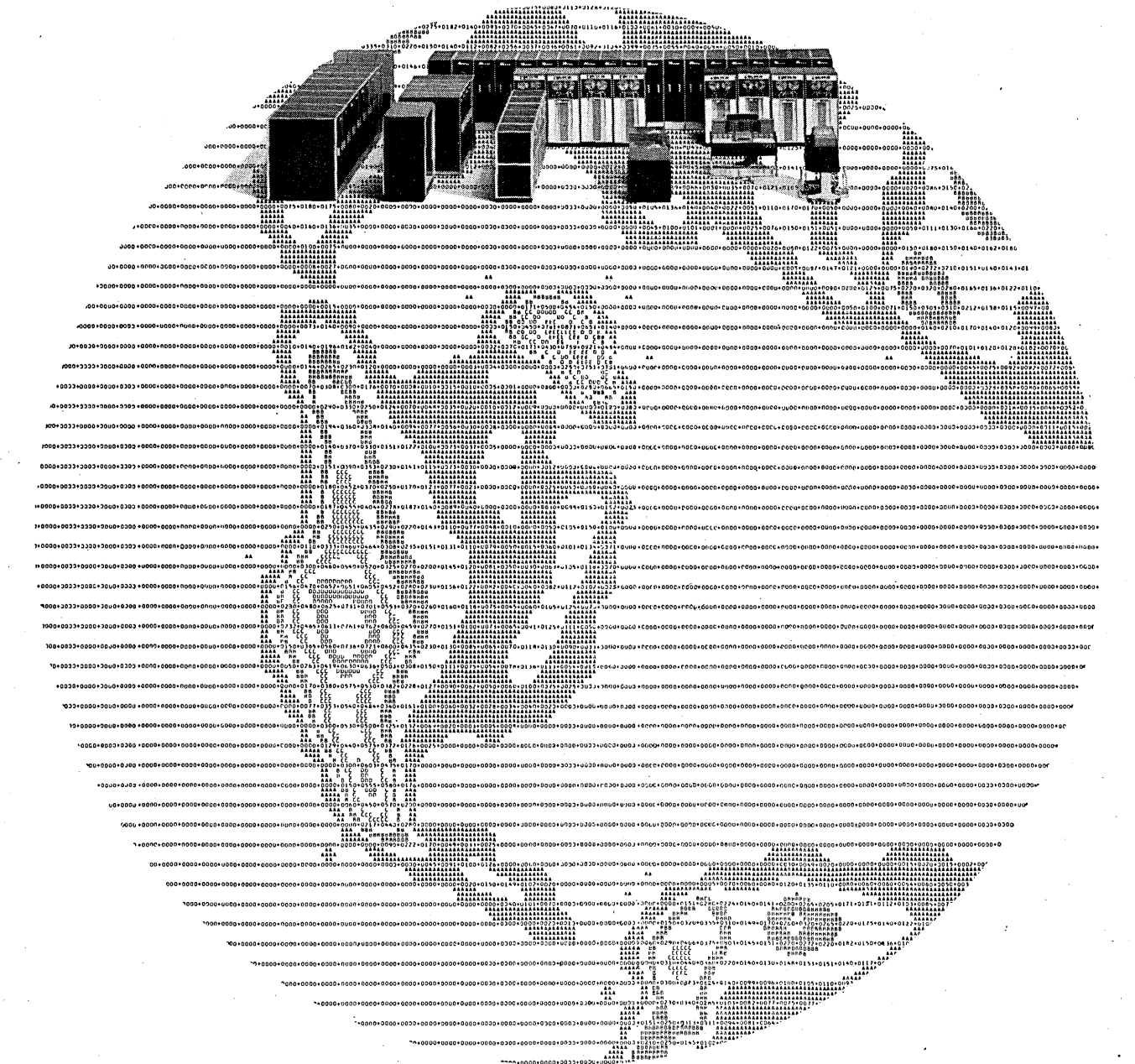

ELECTRONIC RETINA CHARACTER READER

a modular optical system

A modular, gp optical character reading system has been announced by Recognition Equipment Inc., Dallas, Texas. It is based upon an Electronic Retina Character Reader, supplied with a variety of I/O devices and a gp computer.

The configurations range from a single-font numeric reader to a system capable of recognizing six or more type fonts intermixed with numerals, upper and lower case alphabetic characters, and special symbols in each. A mark-sensing capability is optional. Available input devices to the reader include a page carrier, document carrier, card punch, and journal tape carrier. A microfilm carrier is being readied. Output devices from the control computer would be a mag tape unit, card punch, large scale computer, data transmission devices, and paper tape punch.

The reader operates at up to 2,400 cps, and has the ability to sense black, white and, reportedly, infinite shades of gray.

The page carrier operates at a speed of 15 $8\frac{1}{2}$ " x 11" pages per minute when 60 lines are read from each page.

Information is scanned alternately from three drums which secure the pages, reducing time lost from the handling of paper. Documents from $3\frac{1}{4}$ " x $4\frac{1}{2}$ " to 11 x 14, from nine to 30-pound stock, can be handled.

The document carrier handles intermixed documents in two size ranges, 2" x 2" to $3\frac{1}{4}$ " x $8\frac{3}{4}$ ", and $3\frac{1}{4}$ " x $3\frac{1}{4}$ " to 5" x $8\frac{3}{4}$ ". It will read two full printed lines from each document, and operates at 600 to 1,200 items per minute. Intermixed paper and card stock from nine pounds to punched cards, with staples, dog-ears, and tears up to $\frac{1}{2}$ " long, are accommodated. Output pockets and collating/sorting modules are available.

The journal tape carrier is designed to handle cash register and adding machine tapes from $1\frac{5}{16}$ " to 6" in width. Effective operating speed is 1,200 to 1,800 lpm. The maximum width of printing which can be read on a line is $4\frac{1}{2}$ ".

The card punch is for use when the information to be read is printed on one or two lines of a tab card. Each line of characters on an 80-column card may be up to 8" long. Punching speed is 600 to 1,200 cpm.

A microfilm carrier, operating much as the journal tape carrier, accepts standard width microfilms.

More than one document handling machine can be in a system. The principal function of the computer is to convert the output from the recognition module to machine language, while also enabling the reader to perform context editing, accumulate totals and balance against controls, control document sorting, and accomplish check digit computations. It is included in the system at the same price as a single-function conversion unit. ■

For information: **CIRCLE 100 ON READER CARD**

FASTEST PAPER TAPE SYSTEM

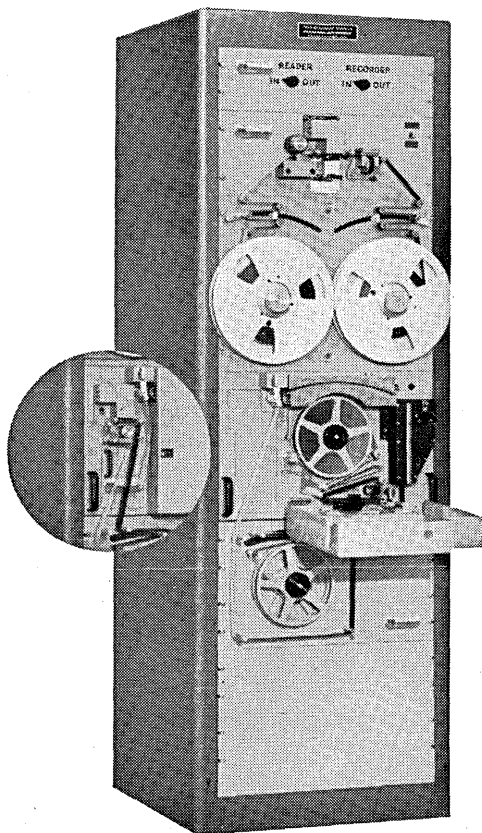

At 300 to 1000 characters per second of five to eight bits, the Tele-Dynamics system is the fastest paper tape presentation available for retrieving from and reading information into a digital computer or communications link. Printing electrostatically, it produces a permanent recording of coded information without mechanical punching, chemical processing, or paper burning. The reflected light reader reads both punched and electrostatic tape.

Building as the job grows is fully practical since printer, reader, and accessory units are modular in construction. Speed can be adjusted simply by changing pulleys and/or adding standard printed circuit cards. Edge-printed alphanumeric presentation of the coded character can be attained by plugging an additional chassis into the printer. Parallel-to-serial conversion is available as standard plug-in cards. Code conversion is accomplished by connecting an additional chassis. Either the recorder or reader can be procured separately.

This standard electrostatic equipment has a wide range of usefulness in data handling and communications systems to provide high speed recording with slow or high speed playback. (Inset—low speed reader may be combined in the same chassis as high speed printer to buffer speed for input to mechanical page printer.) Typical applications include computer input/output message speed buffering, message routing by torn tape, and digital data communications systems. Write today for detailed information.

TELE-DYNAMICS

DIVISION

AMERICAN BOSCH ARMA CORPORATION

5000 Parkside Avenue, Philadelphia 31, Pa.

9127

CIRCLE 23 ON READER CARD

THE DATANET-30 AND 600

communication switching and terminal devices

Two new products combining high-speed communications with electronic data processing have been announced by General Electric Company's Computer Department.

Datanet-30, a stored-program data communications processor, is a solid-state, binary, digital processor that handles both messages and data over two or four-wire voice or telegraph-quality lines at selected speeds, ranging from 60 to 3,000 words per minute.

The Datanet-600 paper tape terminal automatically sends, receives and monitors binary digital data over two-wire, voice-quality phone circuits at 500 words per minute. Both units employ five, six, seven or eight-level codes, and are compatible with GE-215, 225 and 235 computers and with each other.

The Datanet-30, which will handle intermixed data speeds as well as a mixture of all digital transmission codes, automatically stores data in memory and routes messages to correct destinations according to address and priority. It can address 127 full duplex lines. Core memories available with the unit are 4K, 8K or 16K. Eighteen-bit words are used, with seven-usec access time.

Optional equipment for the Datanet-30 are the GE Disc Storage Unit, storing up to 34 million numeric digits or 18 million alphabetic characters, and a mag tape system having a storage capacity of 11 million characters on-line. Disc and tape storage may be used for message overflow, intercept or journal storage, data accumulation and on-line file storage.

Purchase price of a typical Datanet-30 with 8K-word memory system is approximately \$163,000, or monthly rental of \$3,500. Delivery is 12 months.

Datanet-600

Comprising a compact electronic controller and combination reader/punch, Datanet-600 is used with a Dataphone 202A, or equivalent, for access to the communications circuit. When not handling data, the suitcase-size Datanet-600 can be used off-line to duplicate tapes, combine short tapes into longer ones, purge faulty areas, and produce clean tapes. Purchase price of a Datanet-600 is approximately \$8,200. Monthly rental is \$275. Delivery is on a six-month schedule. ■

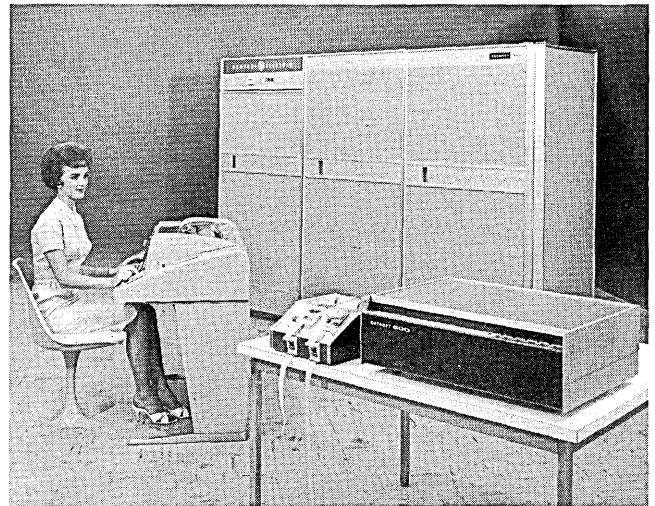

REQUIRED COBOL-1961

A self-instructional course* in

This Basic Systems program delivers...

- effective on-site training with minimal work interruption
- uniformly high student performance independent of prior computer experience
- for volumes with student reference manual and self-teacher portfolio
- operational final examination plus five interim quizzes

...in approximately fifty student hours.

- DOD has purchased this program for use throughout the Government.
- 80 COBOL programmers already trained by major petroleum company with this program.
- REQUIRED COBOL-1961 was validated with students from industrial firms, computer manufacturers, and the armed forces.

Available to companies for unlimited internal use under licensing agreement, or in small quantities for evaluation.

WRITE FOR BROCHURE AND FEE SCHEDULE TO: **BASIC SYSTEMS INCORPORATED**
2900 Broadway, New York 25, N.Y.

*DEVELOPED BY THE AUERBACH CORPORATION

3 NEW DIGITAL PLOTTERS TAGGED FOR TOP VALUE

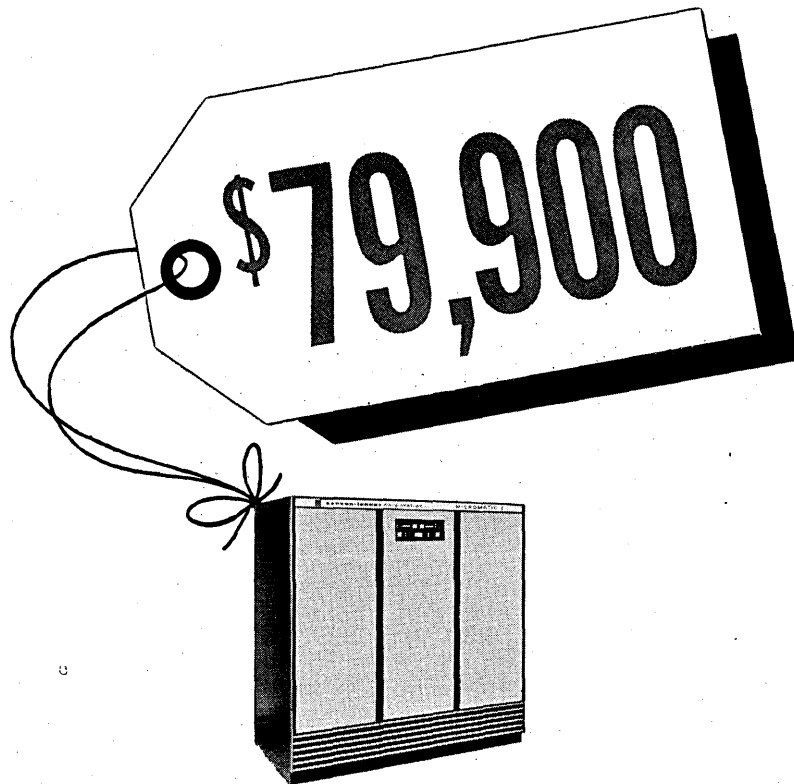

SOUNDS EXPENSIVE!!!

Until you compute the value in productivity of electronic printing and plotting at computer speeds: This new Benson-Lehner/Transdata 944 is 3 times faster, yet 1/3 the price of systems already proving their worth in actual operation. ■ Input: BCD Magnetic tape. Compatible with most tape drives. Accepts 200, 500 and 800 CPI record densities at speeds up to 62.5 KC. Binary on-line units available at same price ■ Output: 35MM Microfilm. Optional quick look (4 second) 9 inch wide hard copy. ■ Speed: 30,000 lines per minute; 62,500 characters per second; 33,000 points per second. ■ Accuracy: Characters are distinct, uniform and precisely registered; Plotting/drawing resolution and accuracy have introduced new standards for digital CRT recorders. 3 character sizes and 4 orientations.

NOW COMPUTERS ARE DRAWING IN 4 COLORS THROUGH THE ALL NEW ELECTROPLOTTER II

Here is the finest digital plotter made, offering higher speeds, increased accuracy and flexibility. This unit can be tailored to changing needs as its modular construction allows field installation of all options. The Electroplotter II features 4 pen option (4 color—4 line width), 48 character alpha-numeric printer and variable speed line drawing, all under input control. Inputs include punched cards, punched tape, mag tape, or computer on-line. Outputs are final multi-colored and/or multi-line-width drawings of engineering precision and quality. Reliability? Benson-Lehner's exclusive New Double Warranty Policy gives you six months of factory service at no charge. It's backed by the nation's largest field service organization specializing in graphic input and output devices!

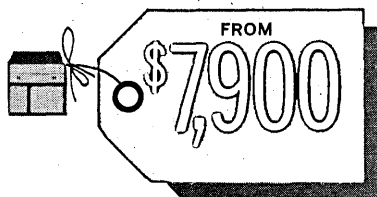
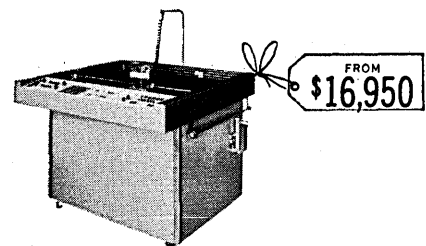

Miniplotter: For quick yet economical conversations with your computer—the all new 11 x 17 Miniplotter ■ Inputs: Magnetic tape, paper tape, cards.

Over 70 sales and service engineers to serve you both here and in Europe.

MAIN OFFICE: USA • 14761 Califa St., Van Nuys, Calif. • Phone: 781-7100
Benson-France • 1 Rue George-Mandel, Paris, France • Phone: TRE 2982
Benson-Lehner Ltd. • W. Quay Rd., Southampton, Eng. • Phone: S.H. 2-7831

benson-lehner corporation
14761 califa street / van nuys, california

THE PROGRAMMER . . .



. . . AS SEEN BY MANAGEMENT

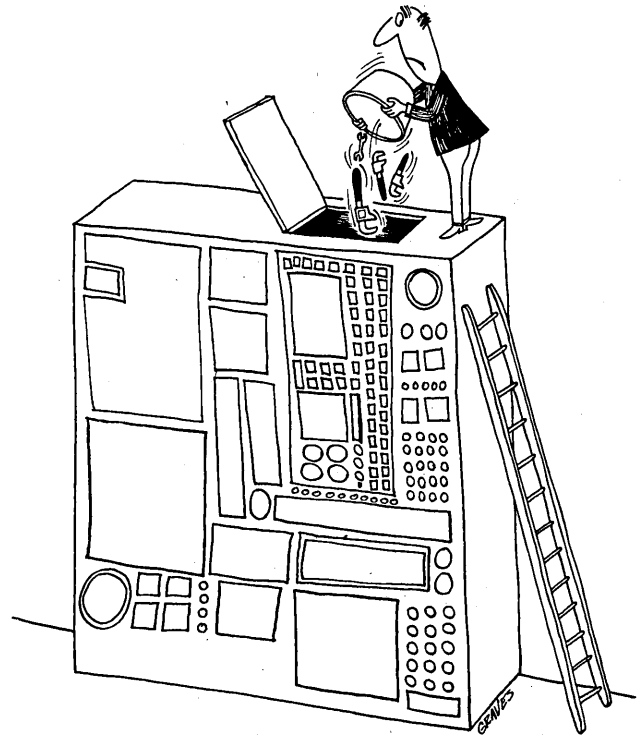

. . . AS SEEN BY THE FIELD ENGINEER

Many times the professional man is too busy to check the progress of his career and relate it to the future . . . that's what we're for . . . A professional placement organization for the professional man.

Director, Data Systems

Will direct activities including command and control, collection, Processing and transmission of Data for space vehicles, Data Collection Systems for military and nonmilitary applications. to 40K

Creative Programmers

Work with complex problems such as Simulation, Compilers, Heuristic Programs and Pattern Recognition. Prestige firm 10K-19K

Computer Design

Digital Logic, Counter Circuits, Transistorized Circuits. Minimum BSEE. . to 18K

McGOVERN SENTER & ASSOCIATES, INC.



Electronics Highway • Route 128
Stoneham Massachusetts

OFFERED AT REDUCED PRICE

"BENSON LEHNER ELECTROPLOTTER J" WITH MAGNETIC TAPE CONVERTER

SPECIFICATIONS

- | | |
|--------------------------------|--|
| INPUT: | Magnetic tape (low density), IBM Summary Punch |
| PLOTTING AREA: | 30" x 30" |
| SPECIAL FEATURES: | <ol style="list-style-type: none"> 1. Line Drawing 2. Random Symbol Selection 3. Origin offset & Scale Control from Input 4. Free Run mode 5. Word Switch Selection 6. High Speed Rewind |
| PLOTTING SPEED: | IBM cards—limited by Summary Punch speed Magnetic Tape—100 to 300 points per minute depending upon type of plotting Magnetic Tape (Free Run Mode)—up to 4000 points per minute |
| PAPER TYPES: | Roll or Sheet Stock |
| RELIABILITY: | Up time greater than 95% |
| INITIAL PURCHASE PRICE: | Approx. \$58,000 September 1962 |
| MAINTENANCE: | This equipment has been maintained by factory trained technicians since its purchase. A maintenance contract is available anywhere in the U.S.A. at very favorable rates. |

For Further Information Concerning This Equipment Write or Call an offer to:

DAPAC
Box 2686
Culver City, Calif.

CONRAD Corp.
1643 Artesia Blvd.
Manhattan Beach, Calif.
772 4616

5 TR 156641 ORD 76-9-44854
3 TR 156567 ORD 76-9-44861

DOING ALL POSSIBLE ON THESE TERMS



Why a Teletype 4-Row Keyboard?

Simple. The new top row of keys makes it unnecessary to shift for numbers and common punctuation marks.



Now when your operator wants to type a "6," she just touches the "6" key—instead of having to shift first, type "6," then unshift. Isn't it easy to see that this typewriter-like keyboard saves key strokes, cuts errors, and means that every typist in your office is now a potential operator?

The Teletype 4-row keyboard makes it easier to send

payrolls, make reservations, print out data, order a part, report a theft, take an order... even cancel one! It provides important operating benefits, whether your communication requirement is for integration into a computer system or to send plain ordinary messages.

Check the many new advantages offered by Teletype printers. Contact: Teletype Corporation, Dept. 81-G, 5555 Touhy Avenue, Skokie, Illinois.

This equipment is made for the Bell System and others who require dependable communications at the lowest possible cost.



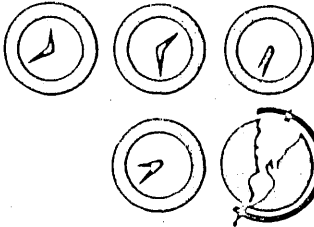

NEWS BRIEFS

STAFF CONTROL PROGRAM FOR 7090 IS DEMONSTRATED

A school management decision program for professional staff control was demonstrated recently by its designer, Dr. Frank A. Yett, Pasadena, Calif. The school district version was said to be applicable to management in private industry, as well. The 7090 program serves as a simulator of probable outcomes which are functions of personnel policies imposed by management, the training and experience of the staff, and the interaction of the two.

Input to the program includes the imposition of personnel policies on hiring, retention, dismissal, salary schedules, fringe benefits, experience or hypotheses concerning staff turnover, and differences between sexes and age groups within sex. The output, in cycles of one year, is a number of tables with a summary description of staff, salary schedule distribution (by training and experience), analysis of promotions, and summaries of demand for staff in terms of grade levels, school sites, and job descriptions.

Originally prepared on a 7094, the program can be parcelled for a 1620, or run in its entirety on a 1620 with disc file.

INFORMATION INTERCHANGE CODE APPROVED BY ASA

The American Standards Association has given final approval to a new code for information interchange, developed by the X3.2 subcommittee on coded character sets and data formats.

The seven-level code has assigned some 64 graphic characters and 30 control functions to its 128-character set, with the remainder yet to be assigned.

Approval ends an uphill fight for the code, which is the first American standard to be established over the objection of its sponsoring committee (BEMA). Final ASA approval was won, however, after BEMA decided not to appeal the overriding. The final decision was aided by early support for the code provided by the DOD, which has announced that the new code will eventually replace Fieldata as the official mili-

COMPUTER COURSES INCLUDED IN WAYNE STATE'S MBA

Establishment of a master's degree in Administrative Sciences in the School of Business Administration, with emphasis on ADP and the computer, has been announced by Wayne State Univ., Detroit, Mich. It is open to students in business administration, liberal arts, engineering, education, or social sciences.

The course of study will include "Principles of Automatic Data Processing," "Organization, Management and Computers," and "Computer Systems Design." Prerequisites include at least one course in accounting, economics, math, statistics, philosophy or psychology, and computer programming.

Practical experience will be gained in the recently completed computer center and the Administrative Sciences teaching laboratory.

NBS DEVELOPS MACRO-INSTRUCTION SYSTEM

A macro-instruction system for the 7090 has been developed at the Boulder Laboratories of the National Bureau of Standards. Called BOUMAC - Boulder Laboratory Macro System - it is an elaboration

tary standard . . . and by European moves toward a 7-level code which will include a transitional standard 6-bit subset.

The Bell System cut over to the new code for its TWX network in January of this year. And Teletype, with mixed bravery and foresight, announced last year a new equipment line conforming to the requirements of the new code.

The big question now: how rapidly will industry members move to implement the new code? Dick Utman, BEMA's Data Processing Group Director of Standards, expects a perforated tape proposal embodying the new code will be available to X3 in three months, with proposals for mag tape ready in nine months, and punched card "some-time in '64."

of an earlier version conceived and established about five years ago by Dr. Sopka of the Boulder staff.

BOUMAC was programmed by John H. Devenney and includes a repertoire of 13 mnemonic codes for such functions as matrix inversion, transposition, linear correlation, solution of simultaneous equations, and variable input format.

RCA 501 USERS OFFERED SPEED MODIFICATION

RCA has announced Speed-Pak modifications which can be applied on site to its 501's. It includes an increase in memory cycle speed from 15 usec to 12 usec, a three-character adder, left-to-right comparison of two numbers, and three-way simultaneity.

Users reportedly can produce "30 hours of work in 22 hours" with the modification. No program change is required.

H-400 COBOL IS ANNOUNCED

A Honeywell 400 COBOL compiler which will operate with a 2K memory and a minimum of four mag tape drives has been announced. It is said to have all the language elements of COBOL '61 plus such electives as segmentation, MOVE corresponding, the ENTER verb, the USE verb and a variety of I/O techniques such as DEMAND READ and DEMAND WRITE.

The compiler will operate under control of the 400 monitor. Object programs may be combined with EASY assembly system programs to create a mixed COBOL and EASY master program tape.

● Delivery of two TRICE digital differential analyzers to NASA for Project Apollo's space orbital and trajectory simulation studies has been announced by Packard Bell. The 1.4 megabuck order represents the largest TRICE systems ever developed. Each hybrid configuration includes a PB250, console and typewriter, four computing modules,

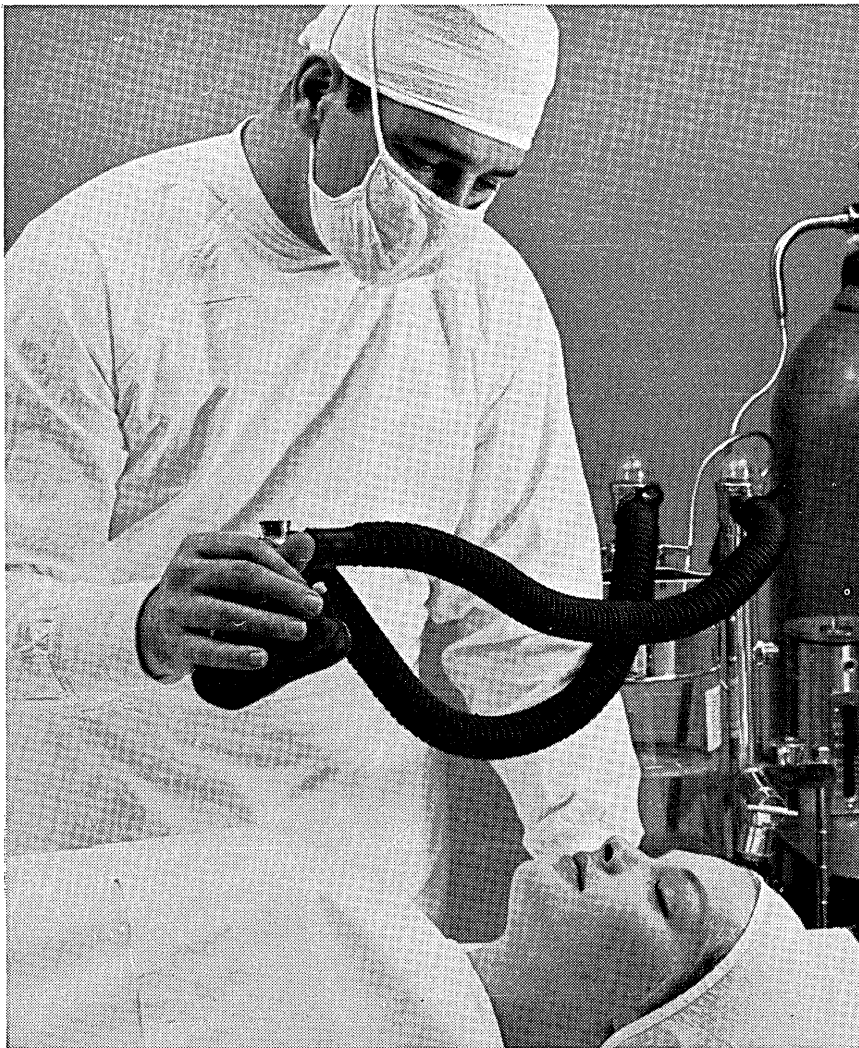

Sometimes inventory control is a life or death proposition

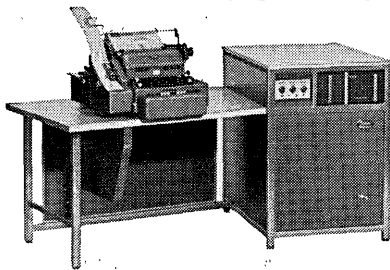

It is if the products you sell save lives.

The Foregger Company of Roslyn Heights, New York, does just that: it makes a complete line of ether- and oxygen-giving equipment. From the small mouth-to-mouth insufflator to the giant Pulspirator, used in open-heart surgery.

Says the Foregger Company:

"We sell the type of product you can't run out of. Ever. Which is why we automated our inventory control with the Friden Computyper.®"

"The Computyper is an automatic typing and figuring machine. We use it to automate our invoicing. The

perpetual inventory control is an automatic by-product of this invoicing operation.

"We keep all product data and customer information on edge-punched cards. At billing time, we just insert the cards into the Computyper. The machine reads out the information, types up the invoice, and figures all the line extensions. At the same time, the Computyper subtracts the quantity ordered from the amount on hand, and prepares an up-dated inventory record for us."

The Computyper can automate your invoicing and inventory control operations too. For complete details, call your local Friden Systems man. Or write: Friden, Inc., San Leandro, California.

This is practical automation by Friden for business and industry.

Friden

Sales, Service and Instruction Throughout the U.S. and World

CIRCLE 29 ON READER CARD

NEWS BRIEFS . . .

two racks of a-d and d-a converters, and a linkage rack to connect the system to large-scale digital computers.

- The first major academic computer center in the Near East is being established by the American University of Beirut. Equipment will include IBM 1401 and 1620 computers and tab equipment.

- NCR says it has developed a programming instruction course for its 390 which makes combined use of a workbook and a tape recorder.

- Magnavox has received a \$1,299,630 contract from the U.S. Army Missile Command at Redstone Arsenal for an Automated Engineering Drawing Storage and Retrieval System, an outgrowth of the company's MEDIA and Magnacard systems.

The system will be installed at the Missile Command's Directorate Documentation Branch, which currently has a file of 1½ million frequently called for drawings of missile parts and assemblies.

- A \$240K hybrid computer has been delivered by Computer Control Co. Inc., Framingham, Mass., to North American Aviation, Columbus Division. The system, to be used in real-time simulated navigation problems, is built around a DDP-19 and the DR-19 digital resolver. The analog device is NAA-supplied.

- The Teleregister Corp., Stamford, Conn., has become the 44th member of BEMA and its Data Processing Group. The company reported a net income of \$864,284, or \$0.30 per share, during 1962, up from \$819,864 or \$0.29 the previous year. Stockholders' equity was \$4.11 per share, compared with \$3.81 for 1961.

- A program utilizing the 1401 to generate its own patch cards of corrections to an assembled program deck has been announced by Datatrol Corp., Silver Spring, Md. It is called DPG (Datatrol Patch Generator). Corrections, listed in a format similar to Autocoder or SPS, are generated on cards which are placed in front of the final transfer card of the program deck.

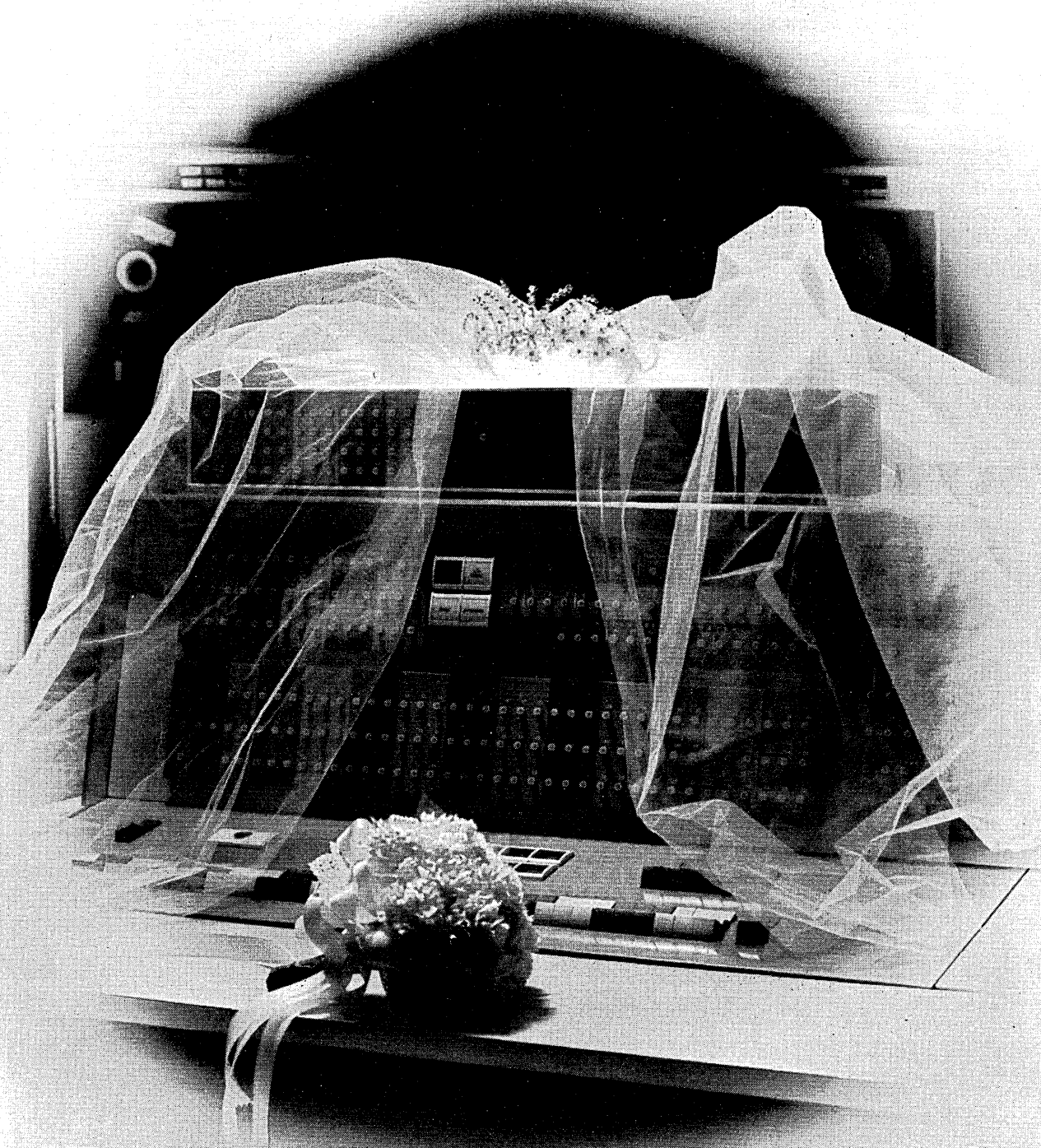

I love you

Don't laugh ♡ Plenty of programmers are wedded to their machines. ♡ Now if you're my kind of programmer, let's set the date soon. Then we can settle down with Computer Concepts, Inc., nation's fastest growing computer consulting firm. ♡ In this soft-ware-house of problem-solving ingenuity, promising young programmers as well as systems analysts can function creatively in such areas of information processing as machine

translation, computer efficiency studies, management information systems, computer applications programming and operations research... ♡ Salaries range to \$20,000 annually and relocation expenses are paid... send resume to **COMPUTER CONCEPTS, INCORPORATED**, 1012 14th Street, N. W., Washington, D. C... branch offices are located in Los Angeles and New York City. ♡ PS: don't forget the ring. (area code 202: 783-7215)

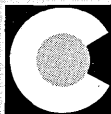

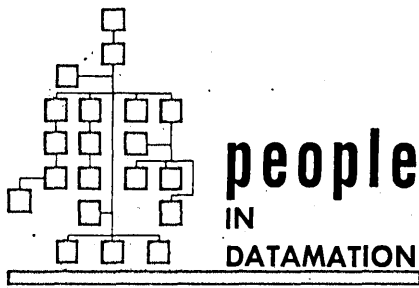

■ AFIPS Chairman Don Madden has left System Development Corp., Santa Monica, Calif., to join IBM as an assistant to C. H. Reynolds, manager, Systems Planning & Development, Data Systems Div., Poughkeepsie, N.Y. In the Data Processing Div., Dr. Louis Robinson has been promoted to director of scientific computing. He was formerly manager of systems engineering.

■ With consolidation of the Philco Computer Division into the Communication and Electronics Division, control has transferred to Henry E. Hockeimer, VP and general manager. Dr. S. Dean Wanlass, who had held that position in the Computer Division, has been appointed VP-technical planning on the corporate level. Named computer marketing manager was William Doherty, formerly head of the Eastern regional marketing office in Willow Grove, Pa.

■ Dr. Gary Carlson has been appointed director of the computer center, Brigham Young Univ., Provo, Utah. He was formerly a senior research specialist at Advanced Information Systems Inc., Los Angeles.

■ Dr. Charles E. Stewart, Aeronutronic Div., Ford Motor Co., Newport Beach, Calif., has been named manager, Scientific Applications, Systems Programming Corp., Santa Ana, Calif.

■ Malcolm D. Smith, manager of special programming projects, Honeywell EDP, has been elected chairman of the data processing committee, National Office Management Assn.

■ International officers of the Systems and Procedures Association have been announced. Arthur Weiss, Altschuler, Melvoin & Glasser, Chicago, was elected president; N. Louis Sensensieb, Space Technology Laboratories Inc., Los Angeles, VP; Allen M. Motter, J & L Steel Corp., Pittsburgh, secretary, and Michael Miskulin, Computer Methods Corp., White Plains, N.Y., treasurer.

EDIT TAPED INFORMATION or splice torn tapes without losing a single code

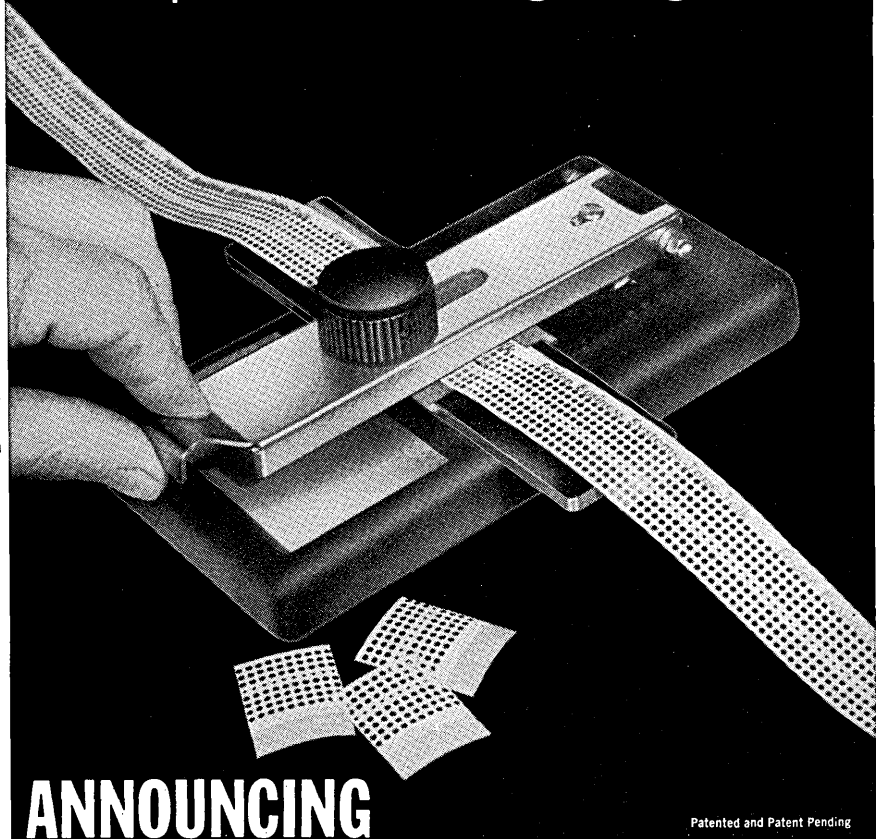

ANNOUNCING

ROBINS GIBSON GIRL[®] PUNCHED TAPE SPLICERS

Patented and Patent Pending

Now it's easy to edit and splice oiled or oil-free punched tapes—add or delete information, repair torn tapes, splice-in new rolls or make loops. The reason: the new Robins Gibson Girl punched tape splicers. They speed editing and splicing, saving costly man hours formerly spent in repunching tapes. They handle almost any splicing or editing need without the loss of a single code. There's a model for each type of punched tape: 5, 6, 7 or 8 channels.

Precise, fast, easy and clean; no glue, no heat, no odors. Can be used in office or lab by non-technical personnel. Field tests have shown that it saves up to 5 minutes per splice.

The splicer cuts a slight "waist" at the point of the splice known as the Gibson Girl shape. This permits the tape to feed smoothly through any reader without adhesive or edges catching in the code readers.

Pre-cut, ready-to-apply perforated pressure sensitive patches of polyester are designed to provide splices of higher tensile strength than the paper tape itself in either oiled or oil-free paper tape. This is made possible by an oil resistant adhesive that is precisely controlled for tackiness, thickness and cold flow.

The splicers are supplied in kit form. Each kit contains: splicer, supply of patches, burnishing roller, and a complete instruction booklet. Additional patches available from stock.

ROBINS INDUSTRIAL SPLICERS FOR MAGNETIC TAPES

A complete line of splicers for magnetic tapes from ¼ to 1½". These splicers, due to their high precision and high reliability, have become the "standard" of the industry and are now being used by more than 200 major corporations and government agencies. Write today for further information. Dept. D-7.

ROBINS INDUSTRIES CORP., FLUSHING 56, NEW YORK

CIRCLE 31 ON READER CARD

DATAMATION

PSA

PACIFIC SOUTHWEST AIRLINES "THE NATION'S LEADING INTRA-STATE SCHEDULED AIRLINE"

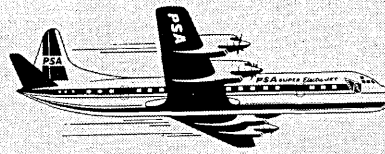

"WHY WE CHOSE THE NCR 390 COMPUTER."

PACIFIC SOUTHWEST AIRLINES, SAN DIEGO, CALIFORNIA

"The NCR 390 Computer provides us with the fastest, most accurate system for travel agency billing, for corporate account billing, for maintaining ticket inventory, and for writing our payroll records.

"By improving service to our customers and to our employees, the NCR electronic system helps PSA maintain an edge in the highly-competitive air travel industry.

"Information on flight tickets is automat-

ically punched in code in strips of paper tape each day. Information about each travel agent and corporate customer is printed on a unique magnetic ledger card that also carries the data in strips of magnetic tape on the back of the card. The program of the NCR 390 enables us to post our statements and ledgers electronically, and keep our ticket inventory automatically.

"In addition to handling this specialized

data processing job, the NCR 390 also handles the payroll records for our entire organization."

J. Floyd Andrews, President
PSA (Pacific Southwest Airlines)

NCR PROVIDES TOTAL SYSTEMS — FROM ORIGINAL ENTRY TO FINAL REPORT — THROUGH ACCOUNTING MACHINES, CASH REGISTERS OR ADDING MACHINES, AND DATA PROCESSING. The National Cash Register Co. • 1,133 offices in 120 countries • 79 years of helping business save money

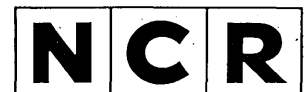

CIRCLE 27 ON READER CARD

*I must be getting smarter, Computape.
Suddenly, I can see right through you!*

It's the Computron people who are getting smarter, Penelope. This new transparent LEXAN* reel is the most sensational, fabulous, and otherwise terrific thing that's ever happened to computer tape!



You'll have to pardon Computape's exuberance, but he's all wound up about his new LEXAN reel—a very important first in the computer tape field. LEXAN reels cost more than conventional polystyrene reels. They are worth it. Much tougher and stronger. Much higher impact strength. Much more resistance to heat distortion and warpage.

*REG. T.M. GENERAL ELECTRIC CO.

Extra fire resistance. (LEXAN is self-extinguishing.) *You just don't get this kind of protection with any other reel of tape.* And by the way — what's wound on the reel is still the same Computape. (556 or 800 bits per inch. No drop-out.) Which is to say, the best there is. Investigate today. Better still, *immediately.*

COMPUTRON INC.
122 Calvary Street, Waltham, Massachusetts



CIRCLE 32 ON READER CARD.

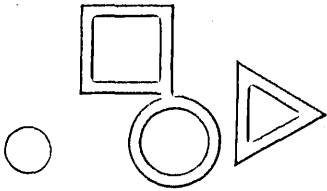

NEW PRODUCTS

gp computer

The DSI 1000 is a serial, binary, real time computer with a 2K, 12-bit word, glass acoustic delay line memory. The average random access time is 100 usec. The instruction repertoire has 38 commands, including double-precision arithmetic. It can automatically process up to 64 individually priority-rated, real-time interrupts.

The 1000 has provisions for 64 I/O devices, and accepts one, three, six, eight or 12-bit bytes, serial or parallel input or output. The power consumption is 100 watts. It is operable from 0 to +55°C. Size is 10½" x 19" x 19¼". Prices begin at \$9,980. DATA SYSTEMS INC., 20535 Mack Ave., Grosse Pointe Woods, Mich. For information:

CIRCLE 200 ON READER CARD

digital demultiplex system

Model 4400 is able to receive up to 144 channels of telemetered data and reproduce the data to within ¼ of one per cent of its original characteristics. The system accepts telemetered data in analog form, screens out noise and converts the

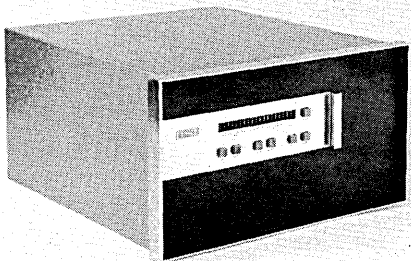

data into a digital format for immediate display or evaluation by digital computers. The system is priced from \$15K to \$40K. BECKMAN INSTRUMENTS, INC., SYSTEMS DIV., 2400 Harbor Blvd., Fullerton, Calif. For information:

CIRCLE 201 ON READER CARD

miniaturized filing system

DOCUFORM is a microfilm system that is able to cut filing space by a 200 to 1 ratio. DOCUFORM uses a single, flat, transparent sheet of film which can contain reproductions of over 100 pages of standard-size documents, permitting instant selection from the file and speeding up of

retrieval time. DOCUMENTATION, INC., 4833 Rugby Ave., Bethesda, Md. For information:

CIRCLE 202 ON READER CARD

mag film memory system

The FFM-202 features a 300-nano-second time for total memory cycle and a read/write time of 200 nano-seconds. The system has a capacity

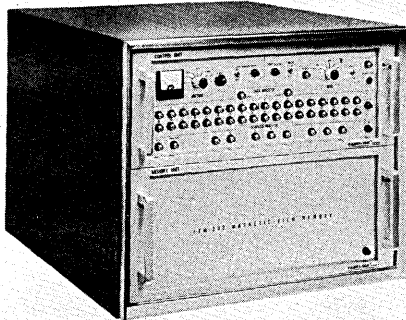

of up to 512 words of 36 bits each; address selection can be either random or sequential. FABRI-TEK INC., Amery, Wis. For information:

CIRCLE 203 ON READER CARD

chart & map making

The Electroplotter II translates numerical data into graphic form for visual interpretation and can receive its design and color instructions from magnetic tape, punched cards or tape, or directly from a computer. It will accommodate graphs as small as 8½ by 11 inches and charts as large as 42 by 58 inches. The basic unit is priced at \$16,950. BENSON-LEHNER CORP., 14761 Califa St., Van Nuys, Calif. For information:

CIRCLE 204 ON READER CARD

tape transport

The TM-5 reduces static and dynamic skew through precise stop and start characteristics and precision tape guiding. It delivers 800 bpi packing density at 120 ips. AMPEX CORP., 934 Charter St., Redwood City, Calif. For information:

CIRCLE 205 ON READER CARD

card reader

The 405 is a 1200 card-per-minute punched card reader which features individual card reading on demand, and a halt reading operation with

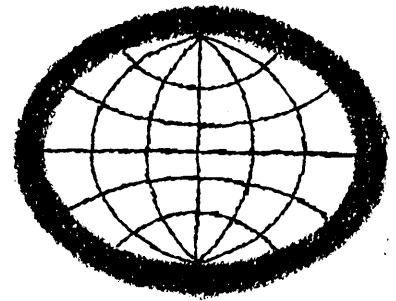

**an invitation and a challenge to:
SENIOR PROGRAMMERS
ANALYSTS
PROGRAMMING
ENGINEERS ... from**

C-E-I-R INC.

C-E-I-R, the international problem-solving firm, is the world's most experienced in computer services, electronic data processing, and operations research, among other capabilities. Because of the dynamic expansion of its consulting activities, C-E-I-R has major openings in both the Washington Center and the New York Center.



WASHINGTON: Positions for senior scientific analyst-programmers who can assume managerial responsibility. Requirements include M.S. or Ph. D. in applied mathematics, statistics, engineering, or related fields, and considerable programming capability.



NEW YORK: Positions for programmers with 4-5 years of experience, with at least one year of experience, on the IBM 7090. Backgrounds in PERT or Critical Path Methods are desirable.

IBM 7090 and 1401 computers are on our premises. Examples of C-E-I-R's applications include reliability systems, celestial mechanics, medicine, operations research, information retrieval, and management sciences.

Salaries are commensurate with education and experience.

Submit resumes, in confidence, to:

Mr. R. H. Meyer
Director of Personnel
C-E-I-R, Inc.
One Farragut Square South
Washington 6, D. C.

An Equal Opportunity Employer

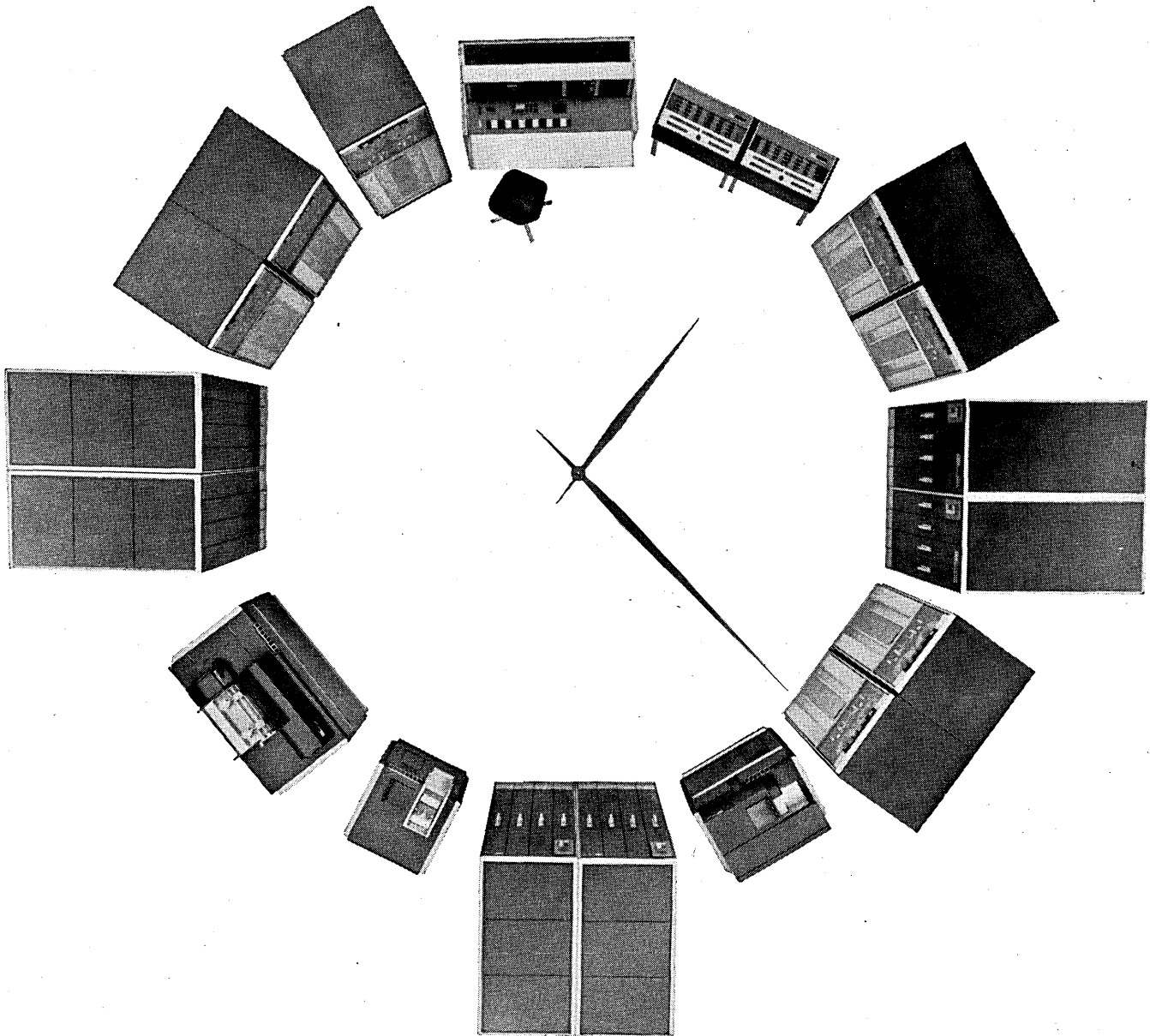

Our offices work for you... by the job or by the minute

SBC data processing service is the fast, efficient, and economical way for getting computing done—without investing in equipment or personnel. Our offices turn your time-consuming work over to computers. You get management facts and figures as you need them, when you need them.

SBC service is tailored to your specific applications—expands your work capacity and office facilities on a flexible, as needed basis with: Problem solving, by the job, using IBM systems ■ Computer solutions for periodic

overloads ■ Programs written to your order ■ An ever-expanding library of ready-to-use Programmed Applications for business, scientific, and engineering problems ■ IBM computer time at block rates.

SBC makes data processing service and computer results as easy to get as dialing our nearby office. You'll find SBC listed in the "Yellow Pages" under Data Processing Service. Solve problems today with computer solutions that are made to order for you—contact SBC.



The Service Bureau Corporation
A subsidiary of IBM
425 Park Avenue
New York 22, New York

NEW PRODUCTS . . .

the next card in a retrieval position; fail-to-pick signal and margin checks for timing, card sorting to a 240-card capacity secondary receiving tray, and addition or removal of punched cards from any tray while the reader is in operation. CONTROL DATA CORP., 8100 34th Ave., South, Minneapolis 20, Minn. For information:

CIRCLE 206 ON READER CARD

magnetic drums

The D500 series has packing densities to 1200 per inch NRZ and total storage capacities from 475,000 bits NRZ to 16,650,000 bits NRZ. The new series features a magnetic medium of hard nickel-cobalt plate for surface

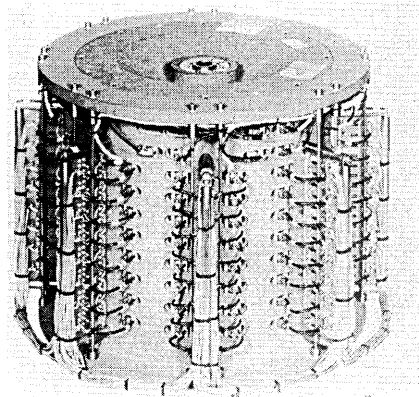

hardness and has a maximum speed of 12,000 rpm at a diameter of six inches. MAGNE-HEAD DIV. OF GENERAL INSTRUMENT CORP., 3216 W. El Segundo Blvd., Hawthorne, Calif. For information:

CIRCLE 207 ON READER CARD

tape reader

Model 625 uni-directional perforated tape reader operates at up to 25 cps asynchronously and 55-60 cps synchronously. Areas for application include code converter, typewriter, digital-to-analog converter, data processing and numerical control systems. The 625 is priced at \$395. TALLY REGISTER CORP., 1310 Mercer St., Seattle 9, Wash. For information:

CIRCLE 208 ON READER CARD

data acquisition system

By combining a new input scanner/programmer and card punch coupler with the DY-2401A integrating digital voltmeter, the DY-2010E data acquisition system offers input flexibility with computer compatible output. The input scanner/programmer can be set-up to scan up to 25 different types and levels of three-wire inputs. The system measuring instrument pro-

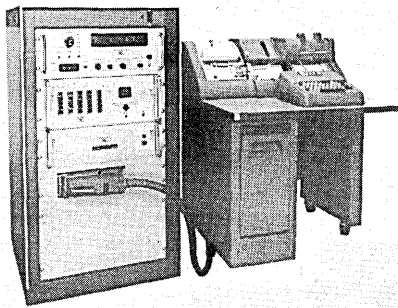

vides a 5-digit in-line visual readout and BCD outputs to the card punch coupler. DYMEC, DIV. OF HEWLETT-PACKARD CO., 395 Page Mill Rd., Palo Alto, Calif. For information:

CIRCLE 209 ON READER CARD

data conversion

The DY-2030 series digital data plotting system is able to convert digital information stored on punched cards or perforated tape to x-y point plots. The DY-2030B and D systems accept all standard format computer tapes and plot at up to 120 points per minute. The DY-2030A and C are able to read punched cards produced by parallel or serial at speeds up to 50 points per minute. DYMEC, DIV. OF HEWLETT-PACKARD CO., 395 Page Mill Road, Palo Alto, Calif. For information:

CIRCLE 210 ON READER CARD

mag tape unit

The D 2020 computer mag tape unit has data transfer rates ranging from 600 cps to 25,000 cps. The units are available with electrically-selectable dual speed operation. Price range is from \$4,000 to \$9,000. DATAMEC CORP., 345 Middlefield Rd., Mountain View, Calif. For information:

CIRCLE 211 ON READER CARD

magnetic core memories

The TCM-32 is a new series of compact five-microsecond, random access, magnetic memories which are available in parallel word lengths from 8 to 48 bits and word capacities from 128 to 4096. COMPUTER CONTROL CO., INC., Old Connecticut Path, Framingham, Mass. For information:

CIRCLE 212 ON READER CARD

tape reader-spooler system

Model RRS-101 photocell punched tape reader and spooler system operates at a speed of 100 cps continuously or 60 cps line-at-a-time mode. The unit has a rewind rate of 40 inches per second. RHEEM ELECTRONICS, 5200 W. 104th St., Los Angeles 45, Calif. For information:

CIRCLE 213 ON READER CARD

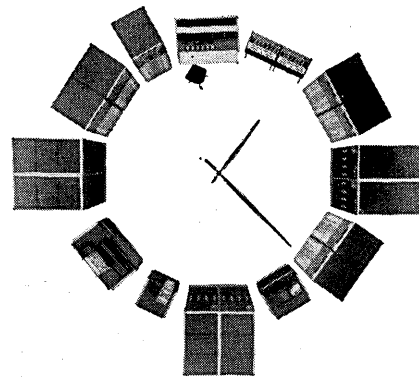

SBC[®]

Research and Engineering Computing Services...

by the job or by the minute, SBC offers you broad computing capabilities.

- Programming services by a large professional staff with wide experience in computer applications.
- Computer time rental in any increment on SBC-installed IBM 1401, 1620, 7090, 7094.

Ready-to-use Programmed Applications:

- AUTORATE—mechanized work-measurement and cost-control information retrieval.
- GIFS—Generalized Interrelated Flow Simulation for process-control industries.
- SDP—Survey Data Processing for questionnaire market research.
- And Linear Programming, Statistics, PERT, Piping Flexibility Analysis, Hydraulic Network Analysis, Rocket Fuel Evaluation, Numerical Control.

For specific details, just complete the coupon below and mail it today.

The Service Bureau Corp., Dept. SH
425 Park Avenue, New York 22, N. Y.

Send me, without cost or obligation, more information on SBC Data Processing Service in:

Programming Computer-Time GIFS
 AUTORATE SDP Other_____

Name_____

Firm_____

Address_____

City_____Zone_____State_____

CIRCLE 33 ON READER CARD

Decision-Making: Logistics Support, What, Where, When?

Centuries ago the critical factor in logistics support was providing basic supplies—food, armaments, raw materials for simple industries. A few decades ago, carrying capacity—sea and land transportation—ruled as the decisive element. Within the last decade, a new critical element in logistics support has emerged. It has been created by the complex, interfacing governmental, industrial and military structure of today. This new factor is up-to-the-minute information—gathered from afar, varied in content, immense in volume.

To help provide and control this flow of information, SDC scientists, engineers and computer programmers have helped cre-

ate a new technology: information systems which aid managers in determining the “what, where and when” of logistics support for world-wide and continental activities and forces.

In developing these systems which provide information processing assistance, SDC scientists, engineers and computer programmers have evolved an interdisciplinary approach. Teams of computer programmers, operations research scientists, engineers and human factors scientists work together in these major system development steps: analyzing the system, synthesizing the system, instructing computers within the system, training the system,

evaluating the system—and helping adapt the system to the changing needs of its users. The system itself, not the hardware within the system, is their concern.

Computer programmers, scientists and engineers interested in joining this growing field, are invited to write Mr. A. H. Granville, Jr., SDC, 2401 Colorado Ave., Santa Monica, California. Positions are open at SDC facilities in Santa Monica; Washington, D.C.; Lexington, Massachusetts; Paramus, New Jersey; Dayton, Ohio. “An equal opportunity employer”



SDC

System Development Corporation

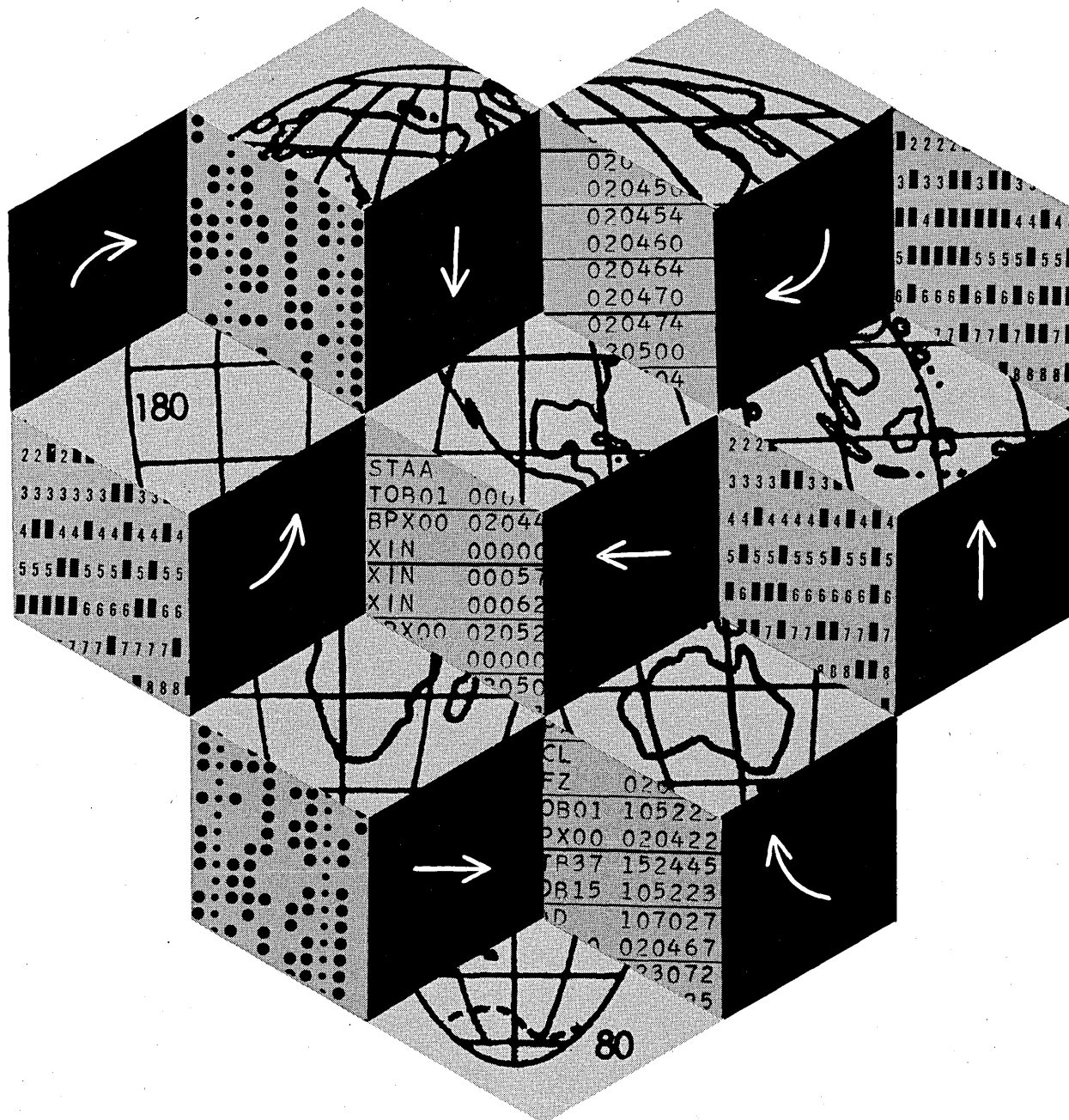

CIRCLE 77 ON READER CARD

21-902



COMPONENT PRODUCTS

recording device

The 1030 data collection system is able to transmit product information, entered by use of a pocket-size recording device, directly to a computer for immediate analysis. This

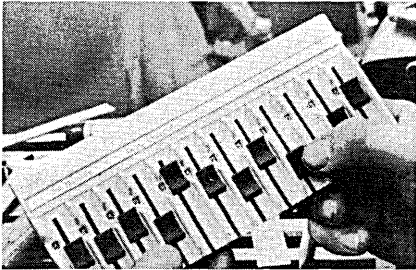

data cartridge can be carried in a pocket until ready for data transmission. IBM CORP., DATA PROCESSING DIVISION, 112 E. Post Rd., White Plains, N.Y. For information: **CIRCLE 240 ON READER CARD**

delay line

The SD-4 magnetostrictive delay line can store up to 7,000 bits at a digit rate of 1.5 Mc in an NRZ mode. Price of the SD-4 is \$125. SONIC MEMORY CORP., 494 Oak St., Copiague, N.Y. For information: **CIRCLE 241 ON READER CARD**

digital clock

This transistorized digital clock is applicable in data logging systems, process control systems, time display systems, high speed computer systems or other digital systems utilizing programming or time control. Cost of the clock begins at \$1,100. PARABAM, INC., 12822 Yukon Ave., Hawthorne, Calif. For information: **CIRCLE 242 ON READER CARD**

tape adapter

This new high-density tape adapter allows the S-C 4020 to accept data from mag tape at rates up to 62,500 six-bit cps. This unit, the F-53, acts as a buffer to the 4020 and its data source. The F-53 is also compatible with the IBM 729 II, IV, V, VI, and 7330 tape transports using high density tapes. GENERAL DYNAMICS/ELECTRONICS, P.O. Box 127, San Diego 12, Calif. For information: **CIRCLE 243 ON READER CARD**

UNIVAC®

*"Opportunity
to match
your
ability"*



Univac has pioneered in the modular concept of real-time systems centered around the use of multiple "Unit" computers. A typical example is the Naval Tactical Data System. This concept is the result of forward thinking, advanced programming and system design techniques.

We need experienced help in designing future systems. Here are a few of the computer features available to you . . .

- Internal high-speed ferrite core storage with a cycle time of 8 microseconds and a capacity of 32,768 words.
- 30-bit word length.
- 14 input and 14 output channels for rapid data exchanges with external equipment without program attention.
- Unit computer is very compact and reliable with a mean time to failure of 1500 hours.

MULTIPLE COMPUTER PROGRAMMING

Immediate Openings for:

Military Systems Analysts and Scientific Programmers for systems development and programming on multiple computer utilization concepts. Several levels of experience are required in each category. Engineering or scientific degree preferred with two or more years' experience on systems using modern real-time computers.

Senior Systems Programmers for business and/or scientific systems language development and the development of Executive, Communications Control and Compiling Systems. Mathematics or business degree preferred with five or more years' programming experience on modern large-scale data processing systems, including ALGOL and FORTRAN.

These openings are at St. Paul, Minnesota and other Univac locations including New York City.

Address inquiries with a resume of your education and experience to:

| | | |
|------------------------|----|-------------------------|
| R. K. PATTERSON | OR | W. K. LOWE |
| UNIVAC | | UNIVAC |
| Univac Park | | P. O. Box 6248 |
| St. Paul 16, Minnesota | | San Diego 6, California |

UNIVAC®

DIVISION OF SPERRY RAND CORPORATION

(An Equal Opportunity Employer)

You'll go farther faster at

Check these key professional opportunities

Marketing Division—Nationwide Locations

Computer Sales Engineers: Openings exist now for persons with digital computer experience in sales, engineering and/or applications programming.

Applications Analysts: Positions include consulting with customers to analyze their problems for computer applications. Experience required in scientific programming for medium or large-scale computers. Knowledge of FORTRAN or other scientific compilers is helpful.

SEND RESUME TO H. K. TRADER, CONTROL DATA CORP., 8100 34TH AVENUE SO., MINNEAPOLIS 20, MINNESOTA.

Computer Division—Palo Alto, Calif., Location

Systems Programming: Participate in the development of advanced programming systems, including compiler development, monitor and executive routines and language analysis. Digital computer experience and BS degree required.

Systems Evaluation: Participate in the development of quality assurance techniques for general purpose programming systems. These positions require a good understanding of systems programming techniques and creative imagination. Large-scale computer experience and BS degree required.

Software Documentation: Development of reference manuals, teaching aids, sales aids and other forms of documentation for programming systems.

Technical Applications: Technical programming for applications such as nuclear reactors, general simulation, information retrieval, linear and non-linear programming.

Computer Division—Nationwide Locations

Systems Installation: Technical representative at customer site. Responsibilities include orientation, training, programmer consultation and software systems installation for large-scale Control Data 3600 and 1604 computer customers. (Various locations in continental United States.) Large-scale computer experience and BS degree required.

SEND RESUME TO: B. A. CRIPE, CONTROL DATA CORPORATION, 3330 HILLVIEW AVE., PALO ALTO, CALIFORNIA.

CONTROL DATA

CORPORATION

Industrial Group— Minneapolis Location

Data Collection, Data Communications, Message and Data Switching:

Control Data Corporation's rapidly-growing Industrial Data Processing Group is seeking a man with applications or design experience in the above or related fields to fill key positions in the design and marketing of digital data transmission and message switching systems.

Product Managers: Superb opportunities exist for men with heavy technical backgrounds to move into marketing responsibilities. Those selected will have responsibility for product planning, analyzing and communicating system requirements to engineering and programming personnel, providing technical liaison to customer, working with Marketing Division personnel in preparation of proposals and sales promotion literature as well as determining service and training needs relative to the systems involved. Technical degree and heavy experience in system design or applications is required.

Design Engineers: These positions provide immediate professional, technical challenges in the logical design of digital data communications devices and systems. A degree in electrical engineering and experience in digital communications design are required. Positions are open for men with limited as well as heavy experience.

SEND RESUME TO: B. L. HANSON, CONTROL DATA CORPORATION, 718 Central Ave. N.E., Minneapolis 14, Minnesota.

AN EQUAL OPPORTUNITY EMPLOYER

CIRCLE 91 ON READER CARD

July 1963

LIBRARIES AND AUTOMATION

scientists confer

Amid the picturesque setting of the Airlie Foundation in the hunt country of Virginia, 103 invitees gathered at the behest of the Council on Library Resources, the National Science Foundation, and the Library of Congress to confer on libraries and automation. After a warm welcome by L. Quincy Mumford, the Librarian of Congress, the session got off to a rousing start with an address by Don R. Swanson (ex-TRW, now Dean, Graduate School of Library Science, University of Chicago).

Swanson described the library of the future, a computer-based system with on-line consoles for public use. He described consoles which worked in a "conversation mode" with the computer. A few buttons, a display tube, a keyboard, a printer, and a whole of a lot of programming will allow a user to describe a document, to refine this description through a conversation with the computer and finally to request his selection(s) from automated stacks. The system was said to be both a teaching machine for the neophyte and a learning device so that successful search trails could be followed again. The system could further supply the library administrator with dynamic usage statistics and cost data for the management of the store.

In the following three days, papers were presented concerning the organization and establishment of the basic files necessary to such a system; how such files could be accessed (on-line consoles); the part microfilm might play in such a system; what the printed outputs might be; how a communication network might be tied in to provide remote interrogation and response; and finally a closing summary. As might be expected the attendees rapidly fractionated into two groups, the INs and the OUTs. The ins were still struggling with EAB procedures and their first 1401 program. The outs retained the antiquated methods of the turn of the century, but were willing to "go along, if sufficient benefits accrue." Thus the outs were so far out they were way out.

The three days of discussion involved the size of the character set involved for output printing, how this affected the input problem, batching vs on-line operations, centralized vs decentralized operations, and turn-around time on service requests. Two salient points stand out: a) Unless the library community standardizes and presents a united front, a sufficient demand may not exist for any manufacturer to develop the required equipment. b) The community has been debating relative cataloging schemes since 1938, and agreement is not yet in sight.

In the end, sober heads prevailed. The grand vision of Swanson was revered as a goal. In the meantime the attendees were invited to learn something of computers, to try and state their requirements, and to obtain some current cost data. The session adjourned to await the forthcoming report on the automation of the Library of Congress (10⁷ volumes) and a bound report of the proceedings to be published by the Government Printing Office in Fall, 1963. ■

FREE Data Processing Opportunities Bulletin

Shows the positions you could have in the field of Data Processing.

Cadillac Associates, the nation's largest executive and professional placement service, represents the majority of the nation's top companies in Data Processing. Their best jobs, at salaries from \$6,000 to \$75,000 appear in our monthly Data Processing Opportunities Bulletin.

Both the Bulletin and our completely confidential placement service are available to you absolutely free of charge. Client companies pay our fees.

For your free Bulletin without any obligation, circle Subscriber Service Card No. 75. Please use home address only.



LON D. BARTON
President
Cadillac Associates, Inc.*

29 E. Madison Bldg.
Chicago 2, Illinois
FI 6-9400

**Where More Executives Find Their Positions Than Anywhere Else in the World*

In Los Angeles—Lon Barton Associates 3275 Wilshire Blvd.
In San Francisco—Lon Barton Associates, 120 Montgomery St.

CIRCLE 75 ON READER CARD

DIGITAL COMPUTER PROGRAMMERS

Melpar, a recognized leader in electronics research, has openings for machine language programmers with real-time experience to participate in design of closed loop man-machine systems.

These computer complexes will include:

- Single computer installations
- Multiple computer installations
- Hybrid systems
- General purpose computers
- Special purpose equipment
- Common memory systems

Experience is required in design of clock controlled programs, executive control techniques, minor cycle programming and basic understanding of computer operation.

For further details, write to:

John A. Haverfield
Manager—Professional Placement

MELPAR INC

A SUBSIDIARY OF WESTINGHOUSE AIR BRAKE COMPANY

3390 Arlington Blvd. Falls Church, Virginia

(a suburb of Washington, D. C.)

an equal opportunity employer

CIRCLE 82 ON READER CARD

**A Message to
Eminent Men
From The
General Precision
Aerospace Group**

IMPORTANT APPOINTMENTS TO BE MADE AT THE AEROSPACE RESEARCH CENTER

Your interest is enlisted in a recently established scientific community entirely concerned with scientific and technical investigations; totally divorced from administrative or development duties. Studies here are related as closely as possible to urgent needs of government agencies, determined through personal consultation with their representatives. Particular (but not exclusive) emphasis is placed on problems bearing on navigation, guidance and control of upper atmosphere and space vehicles . . . areas where General Precision has long held a leadership position in the development of systems and components.

Principal staff scientists are now sought. Very brief descriptions of these positions follow below. For more detailed information and to discuss your own professional interests, we invite you to communicate directly with Dr. R. C. Langford, Director of Research, or Mr. Lorin Beehler at the Aerospace Research Center.

COMPUTER SECTION HEAD

Mature mathematician, experienced in numerical analysis, will initiate, supervise, and direct scientific computation programs. These studies will include program analysis and numerical analysis of specific programs for the IBM 7090 Digital Computer and PACE 231 Analog Computer. PhD in mathematics with related experience.

MANAGER, SCIENTIFIC COMPUTATION

To supervise and direct Scientific Computation studies for Aerospace Research Center. He will direct a group of Numerical Analysts and Programmer Analysts supplying scientific programs for IBM 7090 Digital Computer and PACE 231R Analog Computer. Will report to the Head of the Mathematics Department and service problems for all groups in A.R.C. as well as initiate his own programs in Government programs in Aerospace disciplines. Requires PhD in Mathematics plus 5 years' experience in numerical analysis.

**GENERAL
PRECISION
AEROSPACE**
GENERAL PRECISION, INC.

**KEARFOTT DIVISION
GPL DIVISION
SYSTEMS DIVISION
RESEARCH CENTER**

Dept. 23-G, 1150 McBride Avenue, Little Falls, New Jersey
An Equal Opportunity Employer

CIRCLE 81 ON READER CARD

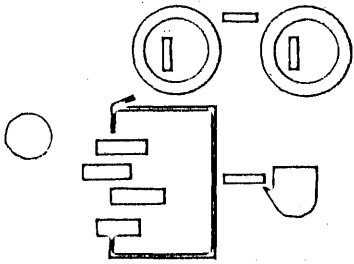

NEW LITERATURE

PATCH GENERATOR: This illustrated leaflet explains the uses for and specifications of DPG 1401 patch card generator. DATATROL CORP., 8115 Fenton St., Silver Spring, Md. For copy:

CIRCLE 130 ON READER CARD

SYSTEM REPORTS: The latest supplement of Standard EDP Reports offers a review in depth of the Univac 1107, IBM 7010 and 1401. THE BUREAU OF NATIONAL AFFAIRS, INC., 1231 24th St., N.W., Washington 7, D.C. For copy:

CIRCLE 131 ON READER CARD

'62 IFIP CONGRESS: The official Proceedings of the Congress contain the full texts, along with abstracts, of 82 submitted papers, the full texts of 23 invited papers, and accounts of 26 symposia and panel discussions. Topics include business information systems, scientific information processing, information retrieval, artificial perception, language translations, and advanced techniques in programming languages and systems design. The volume is priced at \$46. NORTH-HOLLAND PUBLISHING CO., P.O. Box 103, Amsterdam, The Netherlands.

PROGRAMMING AIDS: An illustrated brochure contains information on a magnetic visual system of arrows and programming boards to facilitate the establishment and use of PERT, CPM and LESS program networks. METHODS RESEARCH CORP., 103 Willow Ave., Staten Island 5, N.Y. For copy:

CIRCLE 133 ON READER CARD

REFERENCE WORKS: APT Language Dictionary, APT Postprocessor Standards, Postprocessor Input Data Format are three works available at a nominal cost to companies planning to implement and maintain the ADAPT system. ARMOUR RESEARCH FOUNDATION, ILLINOIS INSTITUTE OF TECHNOLOGY, Technology Center, Chicago 16, Ill.

MAG TAPE & PERFORATED TAPE SYSTEMS: A product data sheet presents features, specifications, and accessories for the MT-36 magnetic tape transport. Another data sheet describes the PTR/PTS-500 perforated tape system and includes descriptions of mechanical design, features and specifications. POTTER INSTRUMENT CO., INC. 151 Sunnyside Blvd., Plainview, L.I., N.Y. For copy:

CIRCLE 135 ON READER CARD

636 COMPUTER: This brochure fully describes the 636 digital computer, designed principally for the central unit of real-time data acquisition and control systems. DAYSTROM, INC., CONTROL SYSTEMS DIVISION 4455 Miramar Rd., La Jolla, Calif. For copy:

CIRCLE 136 ON READER CARD

OMNI-DATA DIGEST: Issue No. 8 contains a chart for determining the length of paper tape remaining on a given reel at any given time. Also included is an article on a photoreader system for the NASA orbiting-observatory program. OMNITRONICS, INC., 511 N. Broad St., Philadelphia 23, Penna. For copy:

CIRCLE 137 ON READER CARD

DATA TONE TRANSMISSION SYSTEM: This eight-page bulletin highlights the B770 solid state, frequency-shift, narrow band carrier communication system designed for transmission of digital data, control and teletype information. LYNCH COMMUNICATION SYSTEMS INC., 695 Bryant St., San Francisco 7, California. For copy:

CIRCLE 138 ON READER CARD

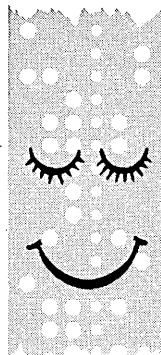

We like punched tape!

Some sophisticates in data processing upstage it. But at EECO Computer Tape Conversion Service we like it. We like to make punched tapes from your IBM, Burroughs, RCA, or Remington Rand magnetic tapes or your 80-column IBM cards. Or vice versa.

Nor are we the least bit snobbish about any of the punched-tape formats. Conversions to or from Teletype, Friden-Flexewriter, NCR, and IBM are equally welcome. As are all levels: 5, 6, 7 or 8. We even supply the formatting for upper case, lower case and hyphenating for automatic typesetter tapes.

Being wholly democratic we have nothing against magnetic tape either, and will gladly translate to or from your IBM, Burroughs, RCA, or Remington Rand magnetic tape system.

And even though it's not polite to brag, we can't resist mentioning that your tape or cards will be in expert hands. We've done more conversions for more leading industrial, commercial and aerospace firms than any similar translation service.

Contact John Norburg, Mail Station 310, for brochure on how helpful we can be at what we like to call the hole-and-track game. EE 3-68R

EECO CTCS *computer tape conversion service*

A service of Electronic Engineering Co. of California, 1601 East Chestnut Avenue, Santa Ana, California. P.O. Box 58. Telephone: (714) 547-5501. In East: Century, Inc. of N.Y., 52 Vanderbilt Ave., N.Y. 17 MU 6-0740



CIRCLE 35 ON READER CARD

computer careers

Our clients have present critical needs in the \$9,000-\$25,000 class for Managers and Seniors and men who can accept management responsibility and professional growth.

NATIONWIDE CHOICE

N.Y., N.J., MASSACHUSETTS, WASHINGTON, D.C., BALTIMORE, PHILADELPHIA, HUNTSVILLE, HOUSTON, DALLAS, FLORIDA, OHIO, UTAH, CALIFORNIA & OTHERS

Contact us if you have experience or interest in any one of the following:

- Scientific Computation or Analysis** — For unusual Aerospace and Lunar programs. IBM 7000 type experience & strong Mathematics
- Real Time** — Programming
- Software Development** — Languages, Compilers, Assemblers, Monitor Systems, Etc.
- Operations Research/Analysis** — Linear Programming plus Computer Applications
- Systems** — Planning, Design, Analysis of State of the Art Massive Data Handling Systems
- Programming** — Large Scale Computers
- Digital & Logical Design**
- Information Retrieval**

Personalized individual service by our technically trained staff helps you locate that unique position.

*Command & Control Real Time
Mgr. Operational Programming
To \$25,000*

*Mgr. Advanced Systems
To \$24,000*

All expenses are assumed by our client companies.

Write in confidence outlining Parameters or call (collect) Mr. Albert (Area Code 212) PLaza 9-1720

a&n

ALBERT, NELLISSEN, INC.

*Leading Consultants to Management
in the Data Processing Field*

510 MADISON AVENUE, N.Y. 22, N.Y.

CIRCLE 80 ON READER CARD

FREE!

*First Edition of our unique
and comprehensive exclusive
East Coast Data Processing*

CAREER OPPORTUNITIES BULLETIN

A complete and comprehensive listing of outstanding positions, at salaries from \$6,000 to \$30,000 with over 300 select East Coast Companies from Maine to Florida in the field of:

DATA PROCESSING

Our professional staff combines Customized Service with technical know how to insure for you maximum career development in the following areas:

- MATH ANALYSIS
- PROGRAMMING
- OPERATIONS RESEARCH
- SYSTEMS DESIGN
- INFORMATION RETRIEVAL
- COMPUTER SALES ENGINEERS

No charge to you for our custom service. Employers pay our fee.

For your free bulletin without any obligation, circle subscriber service card No. 84. Please use home address only.



La Salle Associates

409 South Thirteenth St., Philadelphia 7, Pa.

CIRCLE 84 ON READER CARD

COMPUTER PROGRAMMERS and ANALYSTS

PRC now in its 10th year as a profit making research organization invites qualified computer programmers to join its expanding technical divisions devoted to high quality service to both industry and government.

QUALIFICATIONS:

Experience with large computers such as 1604, 709-90, with working knowledge in the complete spectrum of problems from requirements through systems analysis and design including programming and check out.

RESPONSIBILITIES

Will work directly with the Command Staff personnel on problems which can be automated and assist them to do the job better by applying your knowledge to the Command systems problems. Will organize and design large files in the fields of Logistics Planning and Intelligence systems reflecting at all times the requirements of the operational environment. Assignments in weapons systems design and electronic component reliability are also available.

REMUNERATION

Excellent salaries, liberal benefits and opportunity for personal growth on broad and long term assignments plus scientific and professional environment make this an ideal opportunity.

TO APPLY

Send your complete resume in confidence to
Director of Personnel—Department D-1



PLANNING RESEARCH CORPORATION

1333 Westwood Blvd., Los Angeles, Calif.

An Equal Opportunity Employer

CIRCLE 85 ON READER CARD

DATAMATION

PROGRAMMERS . . . ANALYSTS . . . ENGINEERS . . .

If you're looking for top job opportunities . . .

DATA CONCEPTS has excellent listings with leading national companies in the computer and electronics fields.

Our many clients have openings throughout the country in programming, systems analysis, logic design, installation and service, research and development or circuit design.

Whether your training or experience has been in engineering, physics or business administration, you may qualify for a critical assignment with one of our outstanding clients . . . and they assume all expenses.

Your resume or inquiry will bring prompt, confidential action from our experienced staff.

A handsome gold money clip will be sent, with our compliments, to each applicant submitting a resume.



**DATA
CONCEPTS**

201 Nassau Street • Princeton • New Jersey

CIRCLE 86 ON READER CARD

COMPUTER PERSONNEL WASHINGTON, D.C. and N.Y. POSITIONS ARE NOW BEING FILLED THROUGH OUR SPECIALIZED PLACEMENT SERVICE

positions also available in other preferred locations

| | |
|------------------------|----------------------------|
| PROGRAMMING | ADVANCED TECHNIQUES |
| Applied | Compilers |
| Scientific | Languages |
| Administrative | Processors |
| COMPUTER DESIGN | TOTAL SYSTEMS |

\$7,000 — \$20,000

all positions require bachelors, or advanced degree

ALL EXPENSES AND FEES PAID BY EMPLOYER

all inquiries treated confidentially

write or forward resume to

SYSTEMAT

"Serving the E.D.P. Industry"

in Washington, D.C.
1107 Spring Street
Silver Spring, Md.
JU 7-4200

in New York
Suite 3020
60 E. 42nd St.
New York, N.Y.
OX 7-1886

CIRCLE 87 ON READER CARD

THE 7094 II upgrading the 90

The recently announced IBM 7094, model II, features increased speed through the use of overlapped memories and a new instruction processing unit which reduces the number of cycles for multiplication and division. Its memory access time is 1.4 usec, compared with two usec for the 7094, and 2.18 for the 90. The add time is 2.8 usec.

It now appears that two 7090's can be replaced by one 94 II, with a significant (about \$40K per month) saving to the customer. Renting for some \$12K per month more than the 90, the system offers 2½ times as much performance, and becomes competitive with the CDC 3600 and the Philco 212. The interleaved addressing feature provides, in effect, two 16K memory banks, allowing simultaneous accessing of two instructions or retrieval of an instruction while the previous instruction is being executed.

Users currently renting a 7094 are being offered modifications at the installation within 96 working hours, including system testing. A 90 is said to be expandable to a 94 II within 120 working hours, including a display panel on the console for the additional index registers. The three systems are program compatible.

Peripheral devices which can be used with the 7094 II include up to five 1301 disc and/or 7320 drum files, up to 20 Hypertape units, and 80 729 tape drives.

Software support includes FORTRAN, COBOL, the IJOB processor, and a monitor program.

A typical 7094 II configuration sells for \$3,225,000, and rents for \$76K per month. Initial delivery is scheduled for the spring of 1964.

prō grā măt ik, *adj.*

Of, pertaining to, or of the nature of a program (e.g., a plan or doctrine) . . .

—WEBSTER'S NEW INTERNATIONAL DICTIONARY

The **programs** we're talking about are computer programs, of course. We couldn't be advertising in computer magazines otherwise.

But we also have a **plan**. We plan to complete your software project sooner than you think we can. We'll split the loss with you if we don't.

As for **doctrines**, they're not a strong point with us. But how about our determination to keep working until we give you a program you can use? How about our willingness to come back months later and fix that final bug? Are those doctrines?

Anyway, we'd like to hear about your software problems . . . and send you our brochure.

programmatics

INCORPORATED

33 Malaga Cove Plaza
Palos Verdes Estates, California

378-8756 • 378-7230 • Area Code 213

| Label | Command | Address | Comments |
|-------|---------|---------------|-----------------------|
| | CALL | PROGRAMMATICS | FOR SOFTWARE SERVICES |

CIRCLE 34 ON READER CARD

ADVERTISERS' INDEX

| | |
|---|----------------|
| American Telephone & Telegraph Co. | 22 |
| Albert Nellissen, Inc. | 72 |
| Ampex Corp. | Cover 2 |
| Anelex Corporation | 18 |
| Auerbach/BNA | 8 |
| Basic Systems Incorporated | 51 |
| Bellcomm, Inc. | 76 |
| Benson-Lehner Corporation | 52 |
| Bryant Computer Products, A Division of Ex-Cell-O Corporation | 40 |
| Burroughs Corporation | 1 |
| British Overseas Airways Corporation | 11 |
| Cadillac Associates, Inc. | 70 |
| C-E-I-R, Inc. | 63 |
| Computer Concepts, Inc. | 57 |
| Computron Inc. | 62 |
| CONSAD Corp. | 53 |
| Control Data Corporation | 38, 39, 68, 69 |
| DAPAC | 53 |
| Data Concepts | 73 |
| Data Systems Devices of Boston, Inc. | 59 |
| Daystrom, Incorporated | 14 |
| E. I. du Pont de Nemours & Co. (Inc.) | 44 |
| Dura Business Machines, Inc. | 6 |
| Electronic Engineering Company of California | 71 |
| Ferrocube Corporation of America | Cover 4 |
| Ford Motor Company | 74 |
| Friden, Inc. | 56 |
| General Electric Computer Department | 2, 3 |
| General Precision Aerospace | 70 |
| General Precision, Inc., Commercial Computer Division | Cover 3 |

| | |
|--|--------|
| Honeywell Electronic Data Processing Division | 60 |
| IBM Corporation | 49, 75 |
| ITT-International Electric Corporation | 12 |
| J. B. M. Consultants | 74 |
| La Salle Associates | 72 |
| Lockheed Missiles & Space Company | 7 |
| McGovern Senter & Associates, Inc. | 53 |
| Melpar, Inc., A Subsidiary of Westinghouse Air Brake Company | 70 |
| Midwestern Instruments | 15 |
| The National Cash Register Co. | 61 |
| Photocircuits Corporation, Tape Reader Division | 9 |
| Planning Research Corporation | 72 |
| Potter Instrument Company, Inc. | 4 |
| Prentice Hall | 10 |
| Programmatics Incorporated | 73 |
| RCA Semiconductor and Materials Division | 13 |
| Robins Industries Corp. | 58 |
| Scientific Data Systems | 16 |
| The Service Bureau Corporation, A Subsidiary of IBM | 64, 65 |
| System Development Corporation | 66 |
| SYSTEMAT division of National Personnel Center | 73 |
| Tally Register Corporation | 21 |
| Tele-Dynamics Division American Bosch Arma Corporation | 50 |
| Teletype Corporation | 54 |
| TRW Computer Division Thompson Ramo Wooldridge Inc. | 43 |
| UNIVAC | 67 |

NEW DATA PROCESSING DIVISION

No Fees

- 1 Manager \$14-\$17,000
- 2 Asst. Managers \$11-\$15,000
- 10 Systems Men \$8-\$12,000

Major corporation is now staffing exclusively thru us. A complete new data processing division. Ground floor opportunities for men with some systems background. Many positions not listed here. Investigate with us immediately.

ASSISTANT TREASURER

\$12-\$14,000 Free

Some knowledge of Systems desired. Co. has an unusual position with an excellent future. Urgent.

ASSISTANT DATA PROCESSING MANAGER

\$12,000 Free

Above average man for something unusual. Will train for top spot within (2) years. Outstanding potential.

DATA PROCESSING MGR.

\$15-\$18,000 Free

Large company needs a man to take charge of all Data Processing functions. A real challenge for the right man.

No Obligation. Co. pays all expenses.

Write or Phone: Mr. Simpson

J. B. M. CONSULTANTS

"America's Finest Personnel Service"

67 East Madison AN 3-6950
Chicago 3, Ill.

NUMERICAL CONTROL

PART PROGRAMMING LEADER

Numerically controlled machining is gaining momentum in Ford Motor Company and offers new opportunities to those individuals who are looking ahead to their future. There is an unusual opportunity for a leader with extensive experience in Part Programming, preferably by the APT system. The successful applicant will lead the development of Part Programming for numerically controlled machining.

You, too, may be looking for greater challenges and want to consider joining us in a professionally satisfying career. A mathematics or Engineering degree or the equivalent in related experience, plus a knowledge of computer programming will enhance your opportunities in this new activity. If you are looking for an opportunity with a greater challenge submit your resume to:

L. S. Doll, Supervisor
Placement Section
Industrial Relations Staff
Dearborn, Michigan



MOTOR COMPANY

An Equal Opportunity Employer

in the art of programming
IBM
now offers these career opportunities
for experienced programmers

Opportunities at IBM have never been better for challenge...for achievement...for advancement. As a programmer at IBM's Data Systems Division, you can make significant contributions in research, development, and applications of programming systems. Opportunities exist along specialist or managerial routes at all experience levels. Far-sighted benefits programs are designed for you—and your family. Excellent salaries keep pace with your progress at IBM.

Supervisory Programs: development of control programs such as: Automatic Operator · Time Sharing · Systems Supervisor · Symbolic I/O · Interrupt Control · Machine Control · Stack Job Scheduling · IOCS · Symbolic Debugging · Peripheral I/O Multi-processing.

Programming Languages: development of generalized programming languages, using machine-oriented languages such as SAP and problem-oriented languages such as FORTRAN and COBOL.

Advanced Programming Techniques: research and development in such areas as: New compiler techniques · Operating systems · Symbolic debugging of source language programs · Non-numeric algebraic manipulations on computers · Information retrieval systems · Time sharing systems.

Business-Oriented Programming: advanced development of sorting techniques, merging, report generators, and file-maintenance programs.

These opportunities are located mainly in Poughkeepsie, N.Y., a suburban environment about 70 miles from New York. Other programming facilities are located in White Plains and New York City, N.Y.; Boston, Mass.; and Beverly Hills, Calif. IBM is an Equal Opportunity Employer. Relocation expenses are paid. Do you want more information?

No
 yes

Please write, briefly outlining your background and interests, to:
John B. Zwynenburg, Dept. 701G
IBM Data Systems Division
Box 390
Poughkeepsie, N.Y.

IBM

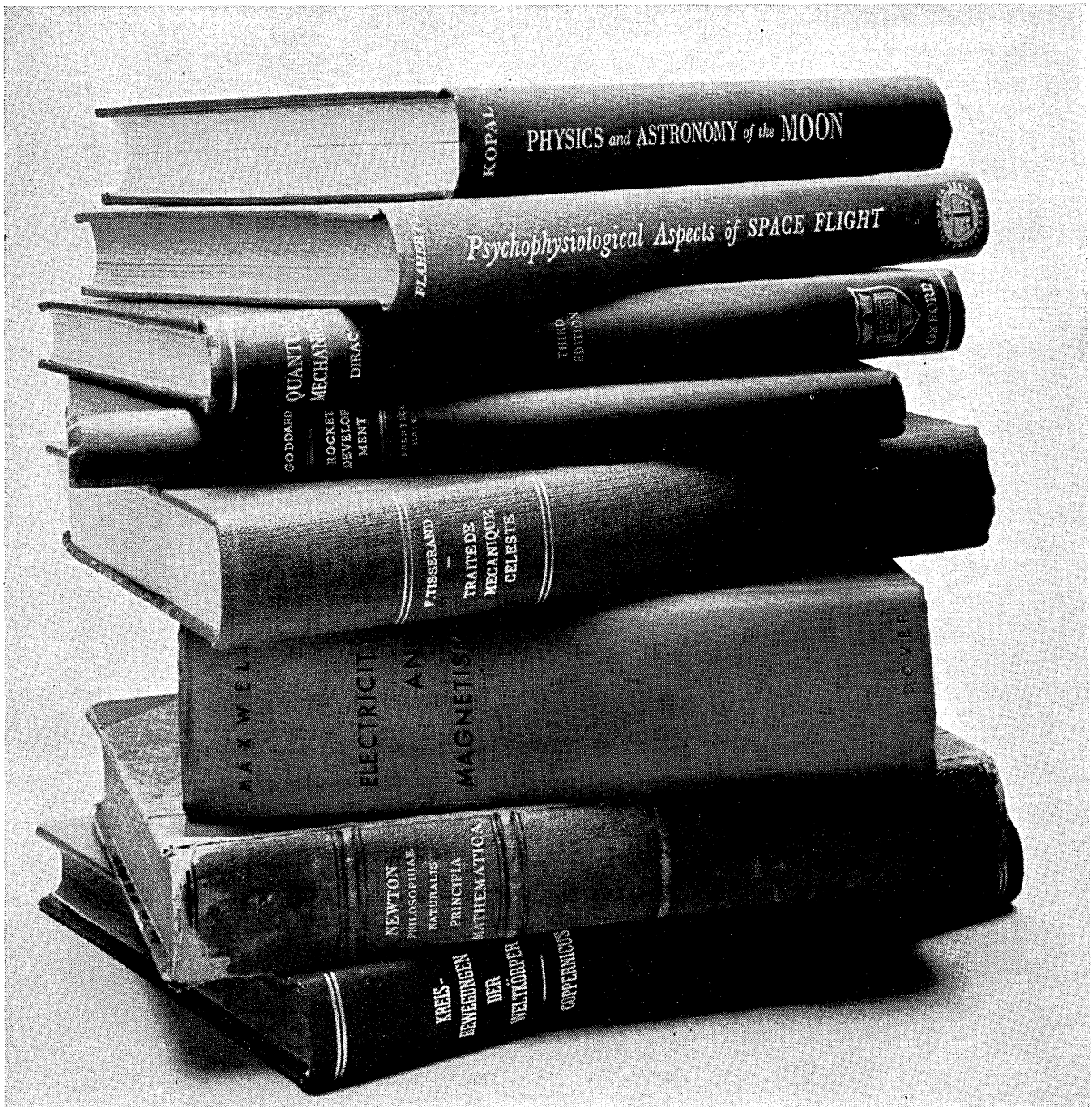

Stairway to the Moon

There are no surer steps to the moon than the accumulation of scientific and technological knowledge that is being brought together and organized for this important venture in space.

Bellcomm is building upon every known reference, from the earliest works of science to the most recent studies of NASA, for whom it plans systems that will enable man to travel to the moon and back.

Such work offers attractive opportunities for men

who are well qualified in such fields as: physics, chemistry, psychology, mathematics, flight mechanics, computing and programming, propulsion, aerodynamics and aeronautical engineering.

If you would like to help fashion a giant stairway to the moon, Bellcomm will welcome your résumé. Address it to Mr. W. W. Braunwarth, Personnel Director, Bellcomm, Inc., Room 1116T, 1100 17th Street, N. W., Washington 6, D. C. Bellcomm is an equal opportunity employer.



BELLCOMM, INC.
A Bell Telephone System Company

CIRCLE 90 ON READER CARD

Computer and Data System Designers:

rotating magnetic memory devices from General Precision

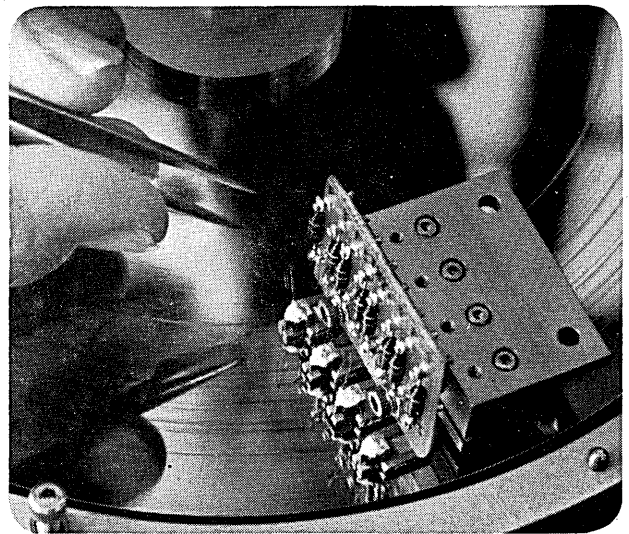
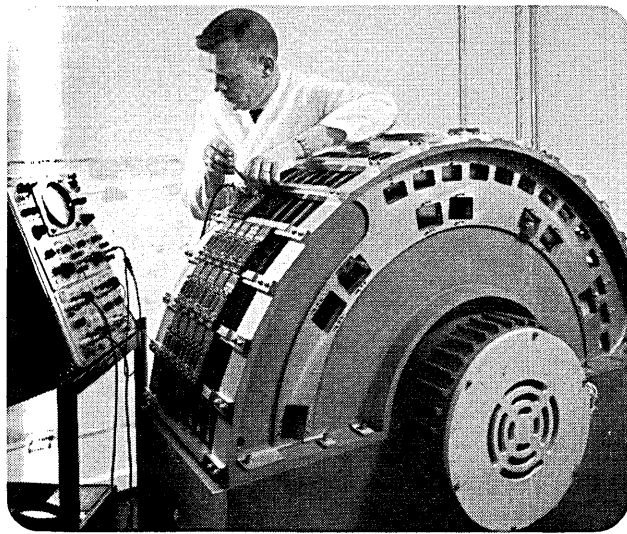
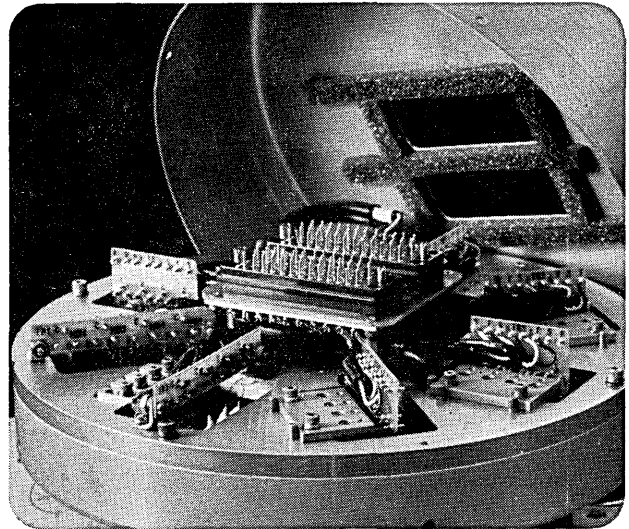

discs—Many computer and data system designers are turning to the high storage capacity of magnetic discs. For example, General Precision Random Access Magnetic Discs furnish storage up to 7,680,000 bits per disc. "Flying" heads permit high packing density of 400 bits/inch. Exclusive GP-produced plated-cobalt disc coating gives exceptionally high resolution. Excellent thermal shock resistance. Heads replaceable without special tools or danger of disc surface damage. Ultra-precision Grade 9 bearings give a service life of 10 years at 3600 rpm. Meets MIL-E-4970A. DRUMS—Pick the magnetic drums with a proved history of reliable

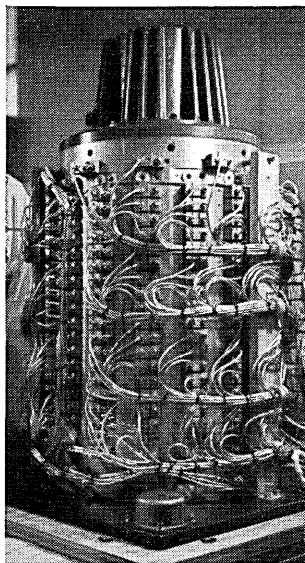

performance in electronic computing systems designed for Navy, Air Force, NASA, business, engineering, and educational applications. Send for full information on drums and discs, from Commercial Computer Division, Information Systems Group (Librascope Division/Commercial Computer Division) General Precision, Inc., 100 East Tujunga Avenue, Burbank, California. □ TWX BRB 9884, Phone 849-6061.

SERIES L100 SINGLE DISCS (ONE-SIDE MAGNETIC MEMORY)

| Model No. | Disc Diameter | Maximum Tracks | Max. Bits per Track | Total Bit Capacity | Rotational Speed (rpm) |
|-----------|---------------|----------------|---------------------|--------------------|------------------------|
| L104 | 4" | 8 | 2400 | 19,200 | 3600-12,000 |
| L106 | 6" | 16 | 3600 | 45,600 | 1800-12,000 |
| L108 | 8" | 32 | 4800 | 153,600 | 1800-12,000 |
| L111 | 11" | 64 | 6600 | 422,400 | 1200- 8000 |
| L116 | 16" | 128 | 10,000 | 1,280,000 | 900- 3600 |
| L124 | 24" | 256 | 15,000 | 3,840,000 | 900- 3600 |

For Series L100 and L200 discs (all models):

Maximum bits per inch: 400. Head inductance: 25 to 150 microhenries. Type of recording: phase modulation. Recording surface: plated cobalt coating. Playback: 50 millivolts (under most conditions). Write currents: 40 to 100 milliamperes. Ambient temperature: 32°F to 149°F limits. Thermal shock: ΔT ambient in 10 seconds. Vibration: 15 to 55 cps (0.015 db amp., 3 directions). Mechanical shock: 4-inch edge test (4 drops).

SERIES L200 DOUBLE DISCS (TWO-SIDE MAGNETIC MEMORY)

| Model No. | Disc Diameter | Maximum Tracks | Max. Bits per Track | Total Bit Capacity | Rotational Speed (rpm) |
|-----------|---------------|----------------|---------------------|--------------------|------------------------|
| L208 | 8" | 64 | 4800 | 307,200 | 1800-12,000 |
| L211 | 11" | 128 | 6600 | 844,800 | 1200- 8000 |
| L216 | 16" | 256 | 10,000 | 2,560,000 | 900- 3600 |
| L224 | 24" | 512 | 15,000 | 7,680,000 | 900- 3600 |

COMMERCIAL COMPUTER DIVISION

**GP GENERAL
PRECISION**

INFORMATION SYSTEMS GROUP
100 E. TUJUNGA AVE., BURBANK, CALIF. • VI 9-6061

CIRCLE 2 ON READER CARD

every bit assured...

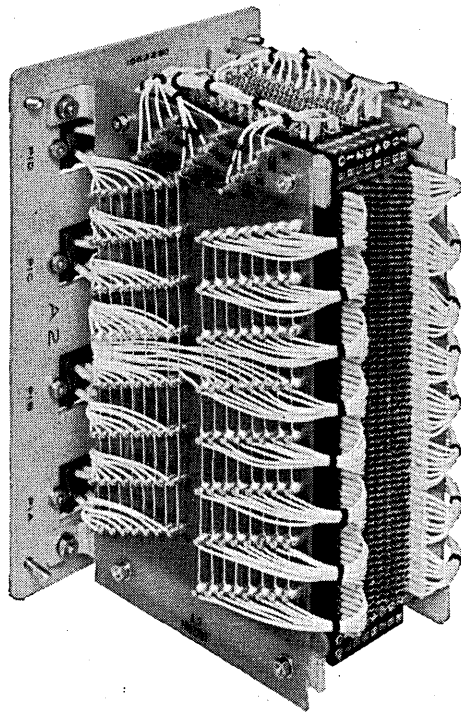

300% TESTED

THREE 100% QUALITY AND PERFORMANCE TESTS ELIMINATE MARGINAL PERFORMANCE AND ASSURE OPTIMUM OPERATING LEVELS IN EVERY **FERROXCUBE** MEMORY STACK...

Narrow range quality control standards, starting with the firing of the individual core, and carried through to the finished, cabled stack, assure optimum operating levels in Ferroxcube ferrite memory planes and stacks. Cores are individually tested, 100%, on all electrical parameters with disturb ratios of 0.61 or greater . . . then a 100,000 lot sampling and measurement on special highly precise, linear standard core tester. Each core is again tested, 100%, after wiring into the plane. Highest possible disturb ratios are employed so marginal cores can be isolated and replaced. The plane test includes measurements with all "1", all "0", and double checkerboard pattern. The completed stack is given a final operational test which includes a complete 100% testing of all bits in the stack.

With Ferroxcube planes and stacks, you are every bit assured . . .

Write for complete data . . .

FERROXCUBE
CORPORATION OF AMERICA
SAUGERTIES, NEW YORK

CIRCLE 3 ON READER CARD

