

# DATA MATION 83

AUGUST/4.00 U.S.A.

## NANOTRENDS

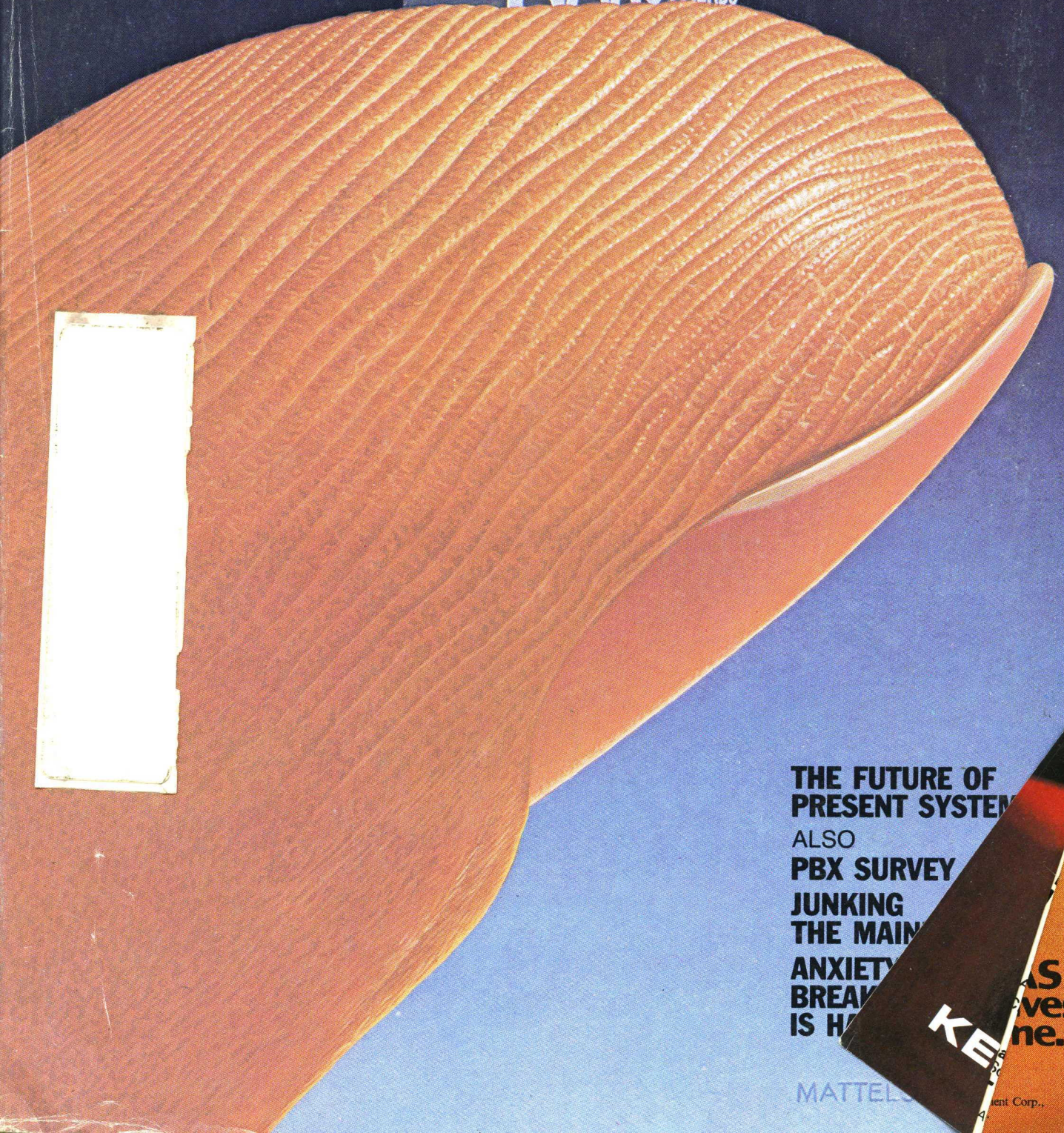

**THE FUTURE OF  
PRESENT SYSTEM**

ALSO

**PBX SURVEY**

**JUNKING  
THE MAIN**

**ANXIETY**

**BREAK**

**IS H**

**AS  
ves  
ne.**

**KE**

MATTEL

ent Corp.,

# Kennedy. The first family in Winchester disk drives.

8 inch and 14 inch Winchesters  
from 24 megabytes to 165 megabytes.

Write or call  
for complete information.

**KENNEDY**

*An Allegheny International Company*

1600 Shamrock Ave. Morrovia, CA 91016

(213) 857-8831 TELEX 472-0116 KENNEDY

TWX 910-535-3249

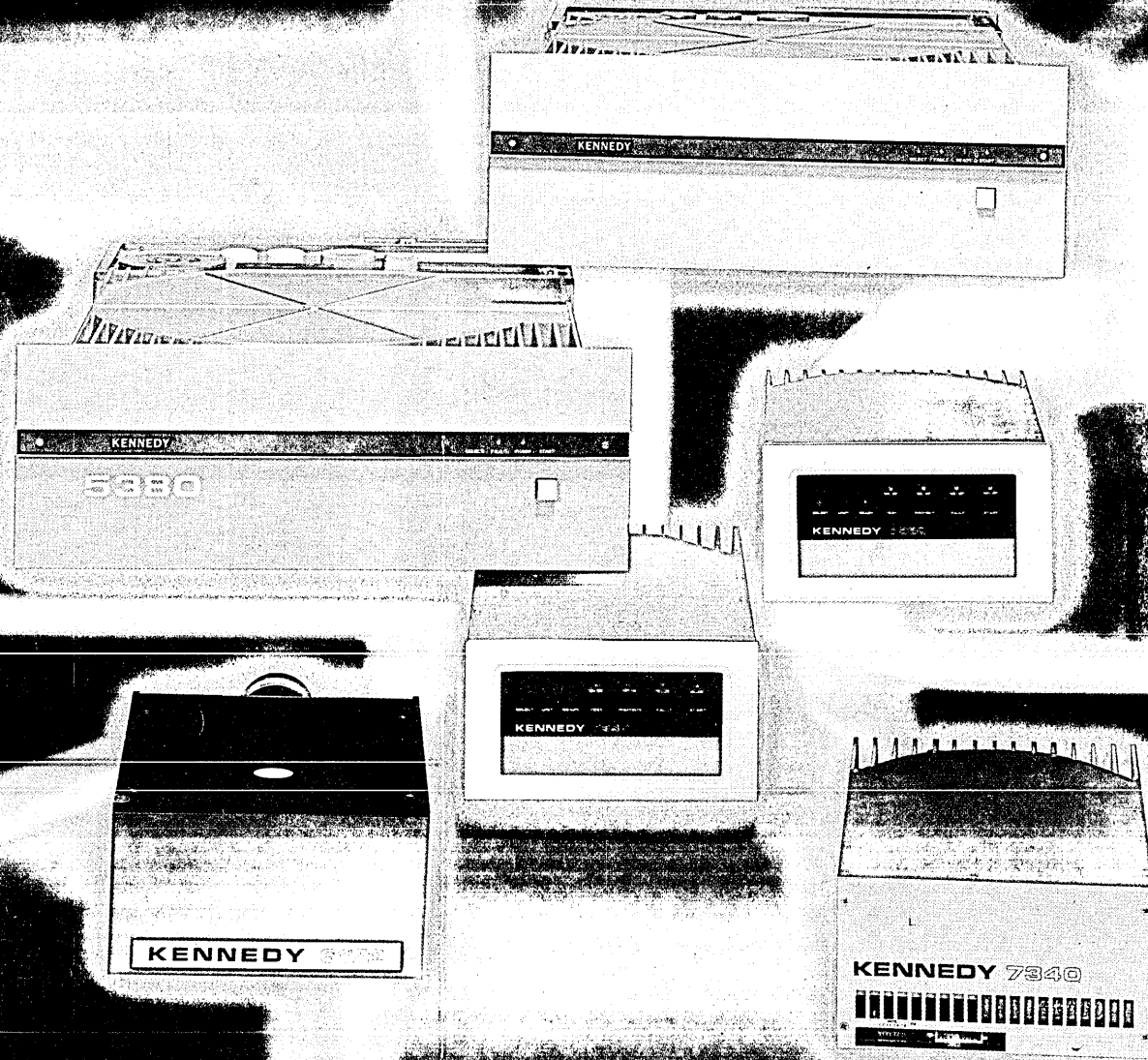

**KENNEDY • QUALITY • COUNT ON IT**

CIRCLE 1 ON READER CARD

# Now there are remedies for local networking headaches.

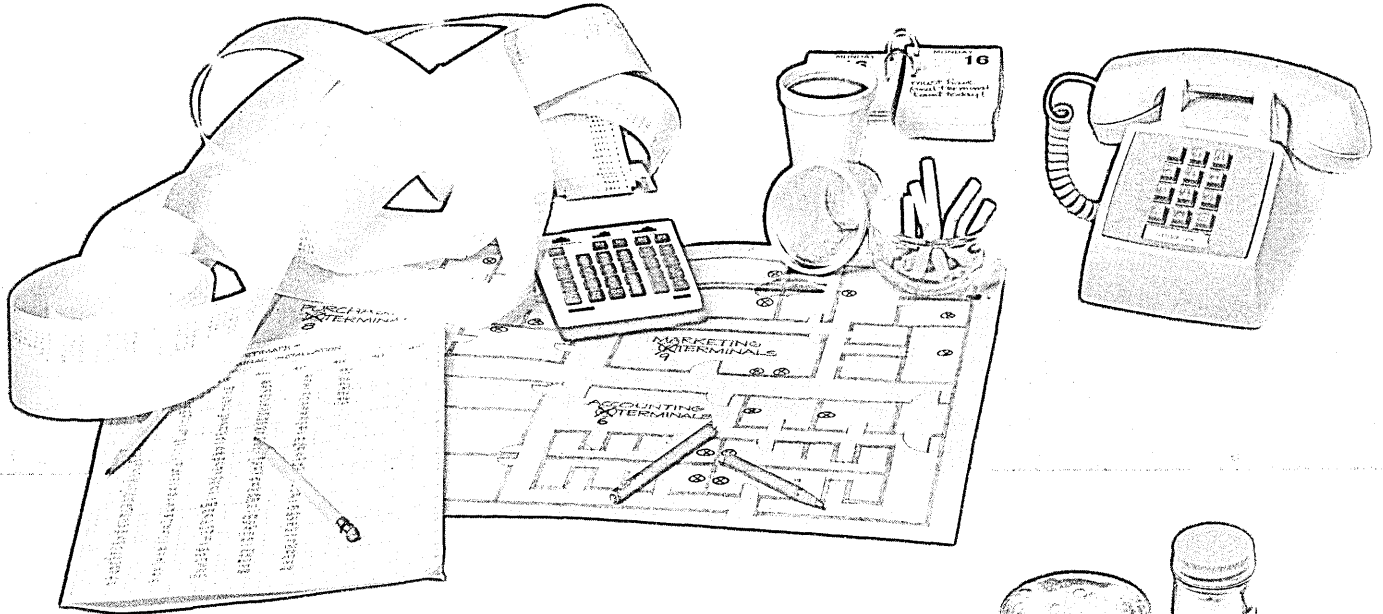

## Headache

It's too early to make a long-term commitment to baseband or broadband.

We don't want to get involved with more layers of protocol and more incompatibilities.

Fiber optic cable and coax is expensive and messy to install.

We're not ready to put in a whole network now.

We already own a good deal of datacomm gear.

Division/Group DP Managers want control of their own local datacomm.

We need Gateways:

- To the switched phone network
- To Packet Data Networks
- To other local networks.

**WE NEED IT FAST!**

We don't want to spend an arm and a leg.

## Remedy

Don't make one.

You don't have to.

Use your existing telephone wiring instead.

Install a piece at a time as you're ready.

Good. Connect it to the new network.

Give it to them.

○ Use dial-in and dial-out. No big deal.

○ Opt for X-25 compatibility.

○ Good thought. Use networks that are easy to interconnect.

Put in MICOM's INSTANET™—the *instant* local network.

That's the best part! Call or send today for literature and a pricelist.

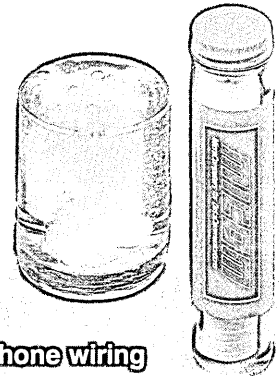

**MICOM**® *MicroComputers for DataCommunications™*

MICOM SYSTEMS, INC. • 20151 Nordhoff Street • Chatsworth, CA 91311 • Telephone (213) 998-8844 • TWX 910/494-4910  
Regional Sales/Service • Atlanta, GA • (404) 435-2999 • Boston, MA • (617) 527-4010 • Chicago, IL • (312) 642-3603 • Dallas, TX  
(214) 258-0774 • Philadelphia, PA • (609) 778-0133 • St. Louis, MO • (314) 576-7626 • Woodbridge, NJ • (201) 750-1120  
MICOM-BORER LTD. • Bel Court • 15 Cradock Road • Reading, Berkshire RG20JT, England • (0734) 866801 • Telex 847135

# Candle's Performance Seminars

## MVS IMS CICS

Candle Corporation, developer of OMEGAMON<sup>®</sup>, announces a series of comprehensive two-day technical seminars on performance analysis and tuning for MVS, IMS, and CICS. These in-depth presentations are designed for interme-

diated or advanced level systems programmers and technically oriented managers. Sessions cover both introductory concepts as well as more detailed analysis of typical performance problems.

**San Francisco** Oct. 13-14  
**New York City** Oct. 17-18

**New York City** Oct. 20-21  
**Dallas** Nov. 3-4

**Los Angeles** Nov. 7-8  
**Chicago** Nov. 14-15

### Day 1

8:00 - 9:00 A.M. Registration  
9:00 - 10:30 A.M.

#### G01: GENERAL SESSION

- Introduction to Performance Tuning Methodologies for MVS, IMS, and CICS Using Candle's Products
- Degradation Analysis
- Future Directions in Performance Analysis and Tuning

11:00 - 12:15 P.M.

#### G02: IBM's Directions for the Large System Environment

- IBM's Directions and their Impact on Users
- Effects on Performance Analysis and Tuning
- The Evolution of MVS, VM, IMS, and CICS
- Extended Architecture and Beyond

#### MVS

1:30-4:45 P.M.

#### M01: SRM ANALYSIS AND TUNING

- SRM Functions
- Adjusting SRM Parameters
- Monitoring the SRM Using RMF, OMEGAMON, DEXAN, and EPILOG<sup>™</sup>
- MVS/XA Considerations

#### IMS

1:30-4:45 P.M.

#### I01: IMS COMMUNICATIONS

- General Communications Flow
- IMS Communications Pools
- Communications Queueing Considerations

#### CICS

1:30-4:45 P.M.

#### C01: CICS INTERNALS

- CICS Task Control Internals and Performance
- CICS Transaction Flow
- CICS Task Dispatcher Internals and Performance

### Day 2

9:00-12:15 P.M.

#### M02: I/O CONFIGURATION ANALYSIS AND TUNING

- Detailed Analysis of How MVS Performs I/Os
- Optimizing I/O Configurations for Performance
- Shared DASD Considerations
- Differences in MVS/XA

9:00-12:15 P.M.

#### I02: IMS SCHEDULING

- General Scheduling Flow
- Scheduling Options
- Scheduling Pools

9:00-12:15 P.M.

#### C02: CICS PERFORMANCE TIPS AND HINTS

- Establishing Performance Objectives
- A Practical Approach to CICS Performance
- Performance Methodology and Detailed Solutions
- Operating Systems

1:30-4:45 P.M.

#### M03: PAGING/SWAPPING

- ASM Algorithms
- How to Configure the I/O Subsystem for Paging/ Swapping
- How to Measure the Impact of Paging/ Swapping
- MVS/XA Considerations

1:30-4:45 P.M.

#### I03: IMS APPLICATION EXECUTION

- Introduction to Execution Phases
- Application Phases
- Database I/O
- Data Communications Activity
- SYNC-POINT
- Database Pools Tuning
- Futures

1:30-4:45 P.M.

#### C03: CICS VSAM PERFORMANCE AND CICS STORAGE ANALYSIS

- File Control Functions
- VSAM Performance and its Effects on CICS
- CICS Storage Control

The cost for the two-day seminars, including all reference materials and lunches, is \$340 per person. Early registration is recommended

as attendance will be limited. For further details and registration, call Candle's Educational Services Department.

**Candle<sup>®</sup>**

10880 Wilshire Boulevard, Suite 2404, Los Angeles, California 90024 (213) 207-1400  
CIRCLE 5 ON READER CARD

# DATAAMATION®

AUGUST 1983/\$4.00 U.S.A.  
VOLUME 29 NUMBER 8  
This issue, 167, 392 copies

## FEATURES

### 36 IN FOCUS

"Breaking Up Is Hard to Do" asserts Laton McCartney in a report on the spin-off of AT&T's local operating companies, the startup of \$6 billion American Bell Inc., and the departure of Advanced Information Systems Division's president Archie McGill.

### 106 NANOTRENDS

**Nicholas Zvegintzov**  
The direction of future systems is largely determined by the trends in four areas: functionality, add-on, compatibility, and tools, with the added synergy of present staff.



### 120 JUNKING THE MAINFRAME

**Martin Healey**  
The mainframe won't die; it will just fade away as the micro takes over. The process, says the author, will be complete within 10 years.

### 139 MANAGING A PROGRAMMER SHORTAGE

**George H. Bosworth**  
A manager who has survived seven hiring freezes gives tips on how to sail successfully under adversity.

### 148 THE BRITISH CONNECTION

An international network that is smuggling computers to Russia and her satellites is under investigation by Western authorities.

### 156 VOICE/DATA PBX SURVEY

In the last of a four-part series on PBXs, a comparison is made of 22 features of the voice/data switches from 17 vendors. Names and addresses of major PBX vendors appear on p. 162.

### 166 BEYOND LOCAL NETWORKS

**William Stallings**  
A new area of communication expertise—internetworking protocols—has developed to deal with switching data among dissimilar networks.

### 180 A VECTOR PROCESSING TUTORIAL

**Lee Higbie**  
An explanation of the origin, use, and future of those specialized computers that have an essentially complete set of instructions operating on vectors.

### 204 CORPORATE STRATEGIES AND DP TACTICS

**Robert F. Hargraves Jr.**  
Information managers must determine what action plans will deliver data results that will support senior management's strategic plans.

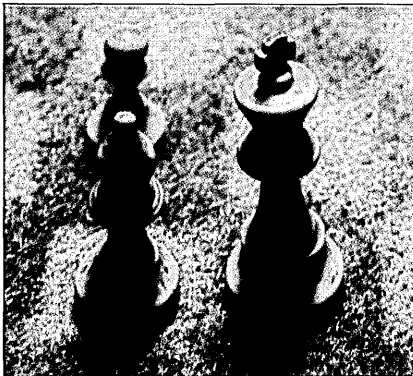

## NEWS IN PERSPECTIVE

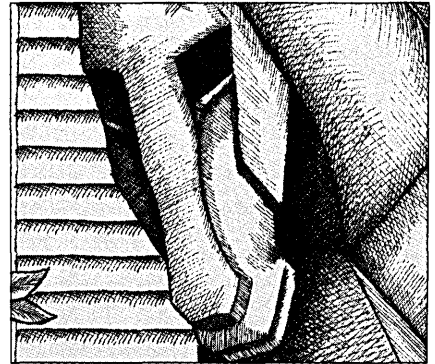

48 **MARKETING**  
Tracking the P.C. strategy.

55 **MAINFRAMES**  
NCR changes course.  
Amdahl vs. the world.  
Caught by surprise.

84 **NETWORKING**  
Men at work.  
Off the air.

92 **MICROCOMPUTERS**  
Reading users' lips.  
Micros for the future.

100 **OPERATING SYSTEMS**  
New mini relies on Unix.

104 **BENCHMARKS**

## DEPARTMENTS

- 8 **LOOKING BACK**
- 13 **LOOK AHEAD**
- 18 **CALENDAR**
- 23 **LETTERS**
- 33 **EDITORIAL**  
Mellon and the corporate image.
- 217 **HARDWARE**
- 227 **SOFTWARE & SERVICES**
- 235 **SOURCE DATA**
- 246 **ON THE JOB**
- 248 **ADVERTISERS' INDEX**
- 254 **MARKETPLACE**
- 259 **READERS' FORUM**

## INTERNATIONAL 216-1

- 3 **EUROPE'S LEADING LIGHTS**
- 6 **DATAAMATION'S EUROPEAN TOP 25**
- 11 **COMPANY PROFILES**

## OEM SUPPLEMENT 217-1

- 3 **PREVENTIVE MEDICINE**
- 8 **OF MICE AND MEGABYTES**
- 17 **THE NEW LOOK OF DISPLAYS**

COVER BY MARVIN MATTELSON

# Speaking graphically...



## it really pays to rent terminals and desktop computers from Genstar REI!

You can rent — right now, off-the-shelf, for as short as 30 days — Hewlett-Packard desktop computers, intelligent graphics terminals, graphics terminals, digitizers and thermal graphics printers. Plus, you can rent dot matrix printers, graphic printers, impact printers and teleprinters from Centronics, HP, Tally, Texas Instruments, Qume, and more. Also, data terminals from ADDS, Beehive, Computer Devices, HP, Lear Siegler, Tektronix, Televideo Systems, TI, and others. We've also got modems and acoustic couplers immediately available for rent throughout North America. Think of your bottom line in graphic terms. Rent from Genstar REI. Today!

**GENSTAR**

## Rental Electronics, Inc. (800) 227-8409

In California (213) 887-4000, (415) 968-8845 or (714) 879-0561

GSA Contract #GS-04S-23560

### Show me the savings picture, REI. Send me a Free Catalog now!

- It sounds great. Tell me more! Call me at \_\_\_\_\_
- I'm particularly interested in the following equipment: \_\_\_\_\_
- Send me your new Rental Catalog. \_\_\_\_\_
- I'd like a copy of your "like new" equipment for sale catalog, too. \_\_\_\_\_

NAME \_\_\_\_\_ TITLE \_\_\_\_\_

ORGANIZATION \_\_\_\_\_

ADDRESS \_\_\_\_\_ MAIL STOP \_\_\_\_\_

CITY/STATE/ZIP \_\_\_\_\_

TELEPHONE \_\_\_\_\_ D-883

Please complete coupon and mail to: Genstar Rental Electronics, Inc., 6307 DeSoto Avenue, Suite J, Woodland Hills, CA 91367 © Genstar Rental Electronics, Inc. 1982

CIRCLE 6 ON READER CARD

## DATAMATION

**Editor** John L. Kirkley  
**Managing Editor** Becky Barna  
**Senior Editor** Larry Marion  
**News Editor** John W. Verity  
**Features Editor** Kenneth Klee  
**Copy Editor** Florence Lazar  
**New Products Editor** Michael Tyler  
**Assistant Features Editor** Deborah Sojka  
**Assistant Copy Editor** Jill Grossman  
**Assistant Editor** Lauren D'Attilo  
**Editorial Assistant** Donna Lyons  
**Bureau Managers**  
**San Francisco** Edward K. Yasaki  
**Los Angeles** Edith D. Myers  
**Minneapolis** Jan Johnson  
**Boston** Ralph Emmett  
**Washington Correspondent** Willie Schatz  
**Editorial Advisor** Robert L. Patrick  
**Technical Advisor** Lowell Amdahl  
**Advisory Board** Howard Bromberg,  
 Philip H. Dorn, Joseph Ferreira,  
 Bruce W. Hasenyager, David Hebditch,  
 John Imlay, Terry G. Mahn  
 Angeline Pantages, Russell Pipe,  
 Carl Reynolds, F. G. Withington, Amy Wohl.  
**Contributing Editors** Laton McCartney,  
 Hesh Wiener

**International Editor** Linda Runyan  
**European Managing Editor** Paul Tate  
**Technology Editor, Europe** Fred Lamond  
**Correspondents**  
**London** Malcolm Peltu  
**Paris** James Etheridge  
**Sydney, Australia** Norman Kemp

**Art Director** Kenneth Surabian  
**Assistant Art Director** Susan M. Rasco  
**Production Manager** Dolie Viebig  
**Assistant Production Manager** Bettye Wright

### EDITORIAL OFFICES

**Headquarters:** 875 Third Ave., New York, NY 10022. Phone (212) 605-9400; telex 429073. **New England:** 1 Chaucer St., RFD 2, Sandwich, MA 02563. (617) 888-6312. **Midwestern:** 3607 Garfield Ave. S., Minneapolis, MN 55409, (612) 827-4664. **Western:** 1801 S. La Cienega Blvd., Los Angeles, CA 90035, (213) 559-5111; 2680 Bayshore Frontage Rd., Suite 401, Mountain View, CA 94043, (415) 965-8222. **International:** 130 Jermyn St., London SW14UJ, England, (441) 839-3916, telex 914911; 13 Stanley Place, Budd Lake, NJ 07828, (201) 691-0592, telex 449-438.

### CIRCULATION

875 Third Avenue, New York, NY 10022

**Circulation Manager** Joseph J. Zaccaria  
**Operations Manager** Patricia Adamo  
**Research Director** Laurie Schnepf  
**Publisher** James M. Morris

## Technical Publishing

✓BPA Circulation audited  
by Business Publications Audit

★ABP Member American Business Press, Inc.

**DATAMATION** (ISSN 0011-6963) Magazine is issued monthly on or about the first day of every month. Published by Technical Publishing, a company of The Dun and Bradstreet Corp., John K. Abely, President. Executive, advertising, editorial offices, and subscription departments, 875 Third Ave., New York, NY 10022. Published at Lincoln, Nebr. Annual subscription rates: U.S. and possessions: \$42; Canada: \$60; Japan, Australia, New Zealand: \$100; Europe: \$90 air freight, \$190 air mail. All other countries: \$90 surface, \$190 air mail. Reduced rate for qualified U.S. students, public and school libraries: \$30. Single copy: \$4 in U.S. Special Datamation/Dataguide issue: \$25. Sole agent for all subscriptions outside the U.S.A. and Canada is J. B. Tratsart, Ltd. 154 A Greenford Road, Harrow, Middlesex HA13QT, England, (01)422-8295 or 422-2456. No subscription agency is authorized by us to solicit or take orders for subscriptions. Second-class postage paid at New York, NY 10001 and at additional mailing office. ©Copyright 1983 by Technical Publishing Co., a Division of Dun-Donnelley Publishing Corp., a company of The Dun and Bradstreet Corp. All rights reserved. "Datamation" registered trademark of Technical Publishing Company. Microfilm copies of Datamation may be obtained from University Microfilms, A Xerox Company, 300 No. Zeeb Road, Ann Arbor, Michigan 48106. Printed by Foote & Davies/Mid-America. POSTMASTER: Send address changes to Datamation, 875 Third Avenue, New York, NY 10022.

# SAS, Not Just for IBM

## ...Anymore

Since its beginnings, SAS® has provided a powerful and flexible software system to IBM users. Now SAS offers VAX™, ECLIPSE® and PRIME® users the same power and flexibility.

You get a twofold advantage with the SAS System. A library of ready-to-use procedures gives you the power to analyze data without formal training. SAS even provides an on-line help facility. With a few English-like commands, you can use SAS for data analysis, market research, capacity planning, financial reports, summary statistics, charts, plots, personnel reports and many other jobs.

In addition to these routine reports, the SAS System provides extensive data management and retrieval tools, combined with a macro facility, to handle all your complicated programming needs.

In short the SAS System gives you the analytical tools for a complete Decision Support System, integrating SAS for data management, statistical analysis and report writing; SAS/GRAPH™ for color graphics; SAS/ETS™ for econometric and financial modeling, and forecasting; and SAS/FSP™ for data entry, letter writing and financial spreadsheet reporting.

Now you can enjoy the power and flexibility of mainframe software on a minicomputer—with SAS.

Call or write today. SAS Institute Inc., SAS Circle, Box 8000, Cary, NC 27511 USA. Telephone (919) 467-8000. Telex 802505.

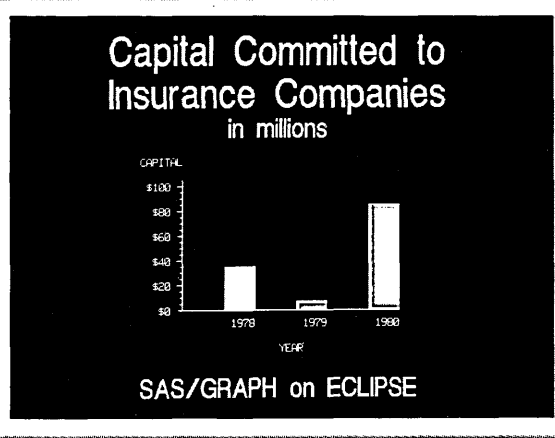
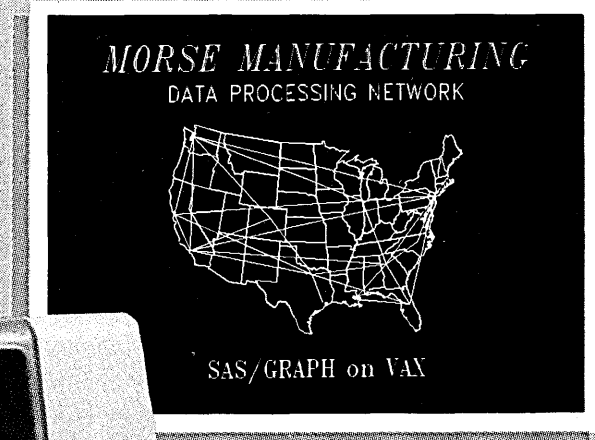
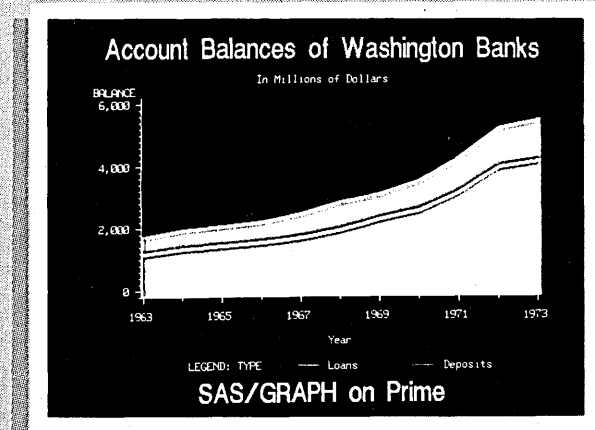

SAS Institute GmbH,  
Rohrbacher Strasse 22, D-6900  
Heidelberg 1, West Germany.  
Telephone 06221-29014. Telex 461581.

SAS Software Limited,  
The Centre, 68 High Street,  
Weybridge, Surrey KT13 8BL,  
UK. Telephone 0932-55855.  
Telex 946138.

SAS Institute (NZ) Ltd.,  
Level 9, Greenock House, 39 The Terrace, PO Box 10-109,  
Wellington, New Zealand. Telephone (04) 727-595. Telex NZ 31525.

SAS Software Pty. Ltd.,  
Level 60, MLC Center, 19-29 Martin Place, GPO Box 4345, Sydney,  
NSW 2001, Australia. Telephone (02) 235-2199. Telex AA 71499.

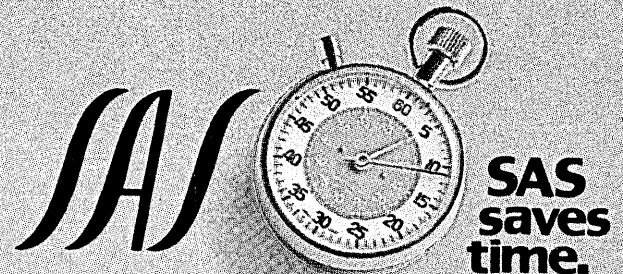

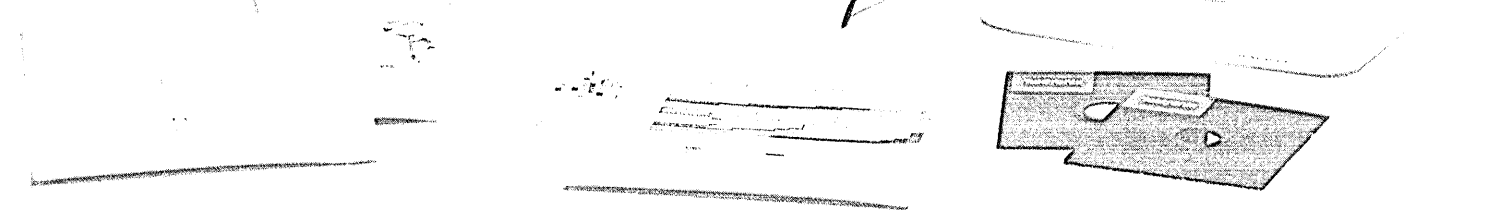
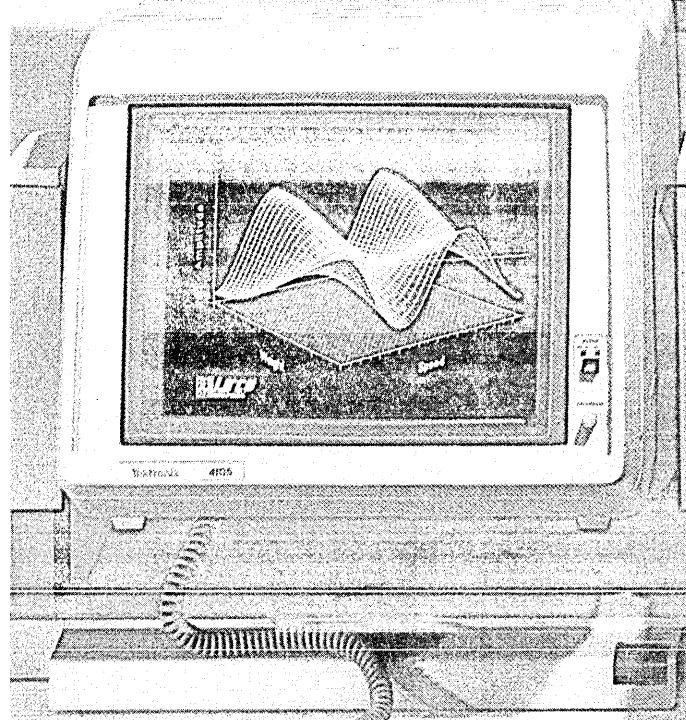
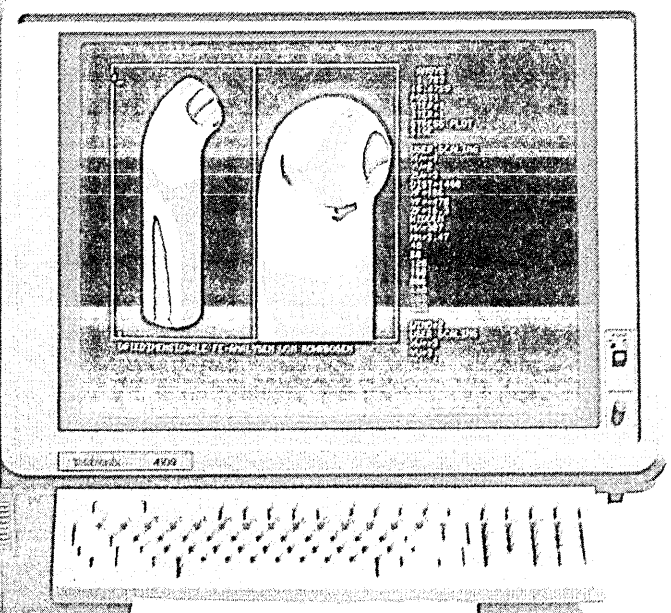
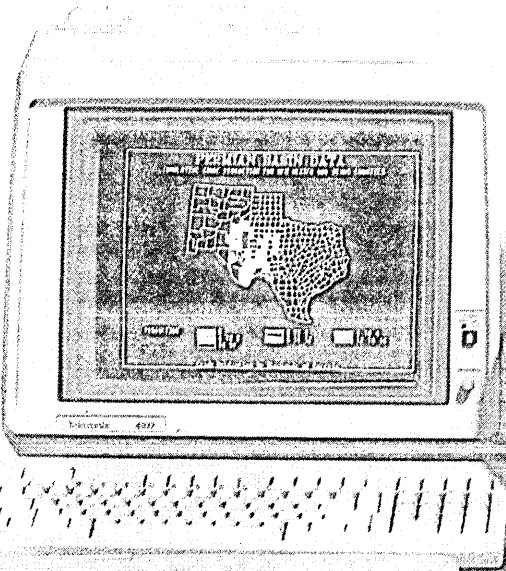



# Powerful text editing. High-speed graphics. Color copies. The new desktop family from Tek!

**VT100 text editing and PLOT 10 color graphics are now packaged as basic desktop units and priced from \$3995 complete.**

Tek's new 4100 Series desktop terminals answer a range of resolution, screen size, color palette and local intelligence needs. All three feature outstanding 60 Hz non-interlaced displays and rapid 16-bit graphic processing speeds.

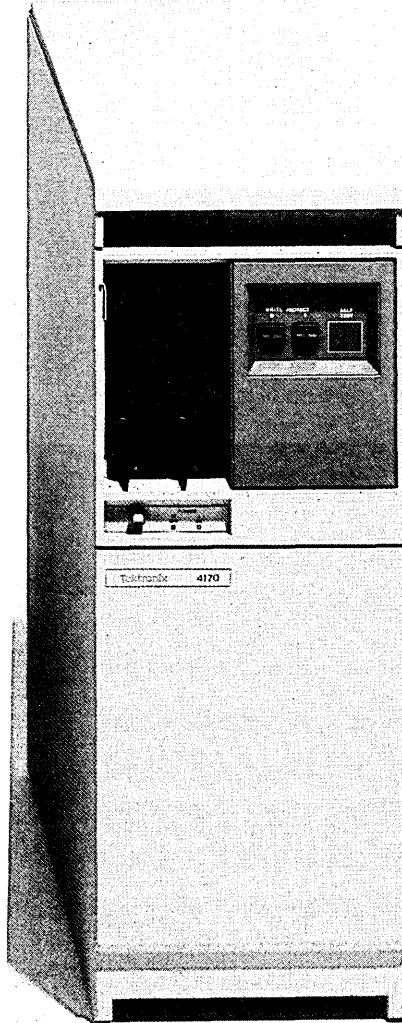

As simulated, Tek's 60 Hz refresh rate and bright phosphors result in a flicker-free image with perceivably better definition than that provided by 30 Hz terminals quoting greater pixel densities.

Standard capabilities include 38.4K baud communications; easy color selection from the keyboard; 4096 x 4096 addressable display space; a separate display surface for alphanumerics or communications dialog; and compatibility with ANSI X3.64 screen editors, including DEC VT100 extensions.

Each offers an unconditional, one-year on-site warranty. Tek Warranty-Plus extends this coverage two additional years at minimal cost.

	4105	4107	4109
Display Size	330mm (13")	330mm (13")	483mm (19")
Displayable Colors			
Graphics	8	16	16
Alphanumeric	8	8	8
Palette	64	64	4,096
Resolution	480x360	640x480	640x480
Segment Memory		128K Bytes	256K Bytes
Price	\$3,995	\$6,950	\$9,950
Warranty-Plus	\$195	\$295	\$395

**For less than \$1,600, you can add Tek's compact, plug-compatible 4695 Color Graphics Copier.** With a palette of up to 125 shades, the 4695 lets you reproduce graphic and alphanumeric displays on report-size paper or transparency film at the push of a button.

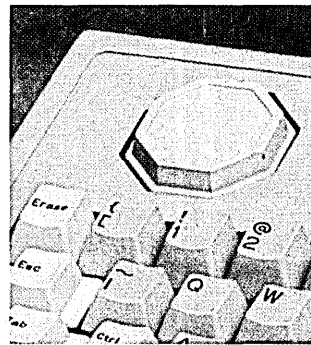

All 4100 Series terminals feature programmable keyboards with innovative Joydisk for convenient graphics input.

**At any time, you can plug into Tek's new 4170 Local Graphics Processing unit.** The CP/M-86-based 4170

provides up to 886K RAM for standalone programming and pre- or post-processing—to help you conserve host power while you build upon a central data base.

**Factor in compatibility with Tek PLOT 10 software and 4110 Series terminals, and you'll discover the first desktop graphics that you can't outgrow.** Call your Tek Sales Engineer for a demonstration. For the number, or for literature, contact:

**U.S.A., Asia, Australia, Central & South America, Japan**

Tektronix, Inc.  
P.O. Box 4828  
Portland, OR 97208  
Phone: 800/547-1512  
Oregon only: 800/452-1877

**Europe, Africa, Middle East**

Tektronix Europe B.V.  
Postbox 827  
1180 AV Amstelveen  
The Netherlands  
Telex: 18312—18328

**Canada**

Tektronix Canada Inc.  
P.O. Box 6500  
Barrie, Ontario L4M 4V3  
Phone: 705/737-2700

# COMBOARD™ / HASP

the high  
thruput  
DEC/IBM  
interconnect

■ Your high volume data transfers to IBM or CDC centrals are achieved quickly by the COMBOARD 1231 because it supports transfer rates to 56,000 bps over private or leased networks.

■ Fast transfers between systems means higher productivity in all applications, and is particularly important in critical applications such as computer aided design. Effective system usage is increased as job turn around time is decreased.

■ COMBOARD is a 16 bit CPU based single board computer that plugs into your DEC UNIBUS™. Then the COMBOARD, not the DEC host, handles all the real-time interrupts and protocol processing associated with data communications.

■ COMBOARD 1231 is the high speed model in the series and the leader in low overhead/high thruput DEC to IBM or CDC interconnects.

■ For more details dial

1-614-421-2094

**SOFTWARE  
RESULTS  
CORPORATION**

2887 Silver Drive  
Columbus, Ohio 43211  
TWX 810-482-1631

COMBOARD™ Software Results Corporation

DEC UNIBUS™ Digital Equipment Corporation

CIRCLE 8 ON READER CARD

Twenty Years Ago/Ten Years Ago

# LOOKING BACK

## EUROPEAN SCENE

*August 1963:* In his article on the development, and in some cases the lack, of computers in Europe, A.S. Douglas, of C-E-I-R (U.K.) Ltd., wrote that it was in very different stages in different places, with a tendency to take on local or national character. For instance, Dutch development had produced some very successful small machines, since large systems were used by only one or two big companies there, like Shell and Philips.

In Belgium, practically no real interest in computing had yet developed. At that time the most powerful computer in the country was a Ferranti Mercury (IBM 1410 class) at Belgium's nuclear energy establishment.

Norway, said Douglas, was in pretty good shape, largely because of the pioneer work of Dr. Jan Garwick of the Atomic Energy Authority, and in Sweden the Board of Computing Machinery sponsored development of BESK, which was based on the IAS/ILLIAC systems.

The Germans thought that in order to compete with the U.S. they had to copy U.S. methods, for which there was an inordinate amount of admiration, Douglas noted. As a result, large and small machines were being installed by U.S. firms, while France's Bull and Britain's ICT managed to get a few orders. IBM and Univac were battling it out in Germany's large machine field.

The German manufacturers had not really gotten going. The first TR4s were due for delivery by Telefunken, and Siemens was just about ready to enter the field. A small firm, Zuse AG, had been making small scientific machines, and its Z23 (IBM 650 class) was in much use in university departments.

Olivetti was doing pretty well in Italy, but had yet to make an impact outside its own country. Its accounting machines, with paper tape by-products and equipment for recording factory information on paper tape, were cheaper and better designed than its IBM and NCR counterparts. Even with the International Computing Center in Rome and Euratom in Ispra, progress in the computer field had been slow. There were also severe shortages of trained programmers in key areas such as Milan.

In France, Bull had a strong sales

organization, but few products of its own to sell. It was successfully marketing the RCA 301 as the Gamma 30, even with the competition from Britain's ICT, which was selling the RCA machine as the ICT 1500.

The U.K. had machines from IBM and the BUNCH installed, but as far as its own manufacturers were concerned, there were too many varieties of machines that were mostly incompatible with each other. IBM's biggest competitor there, said Douglas, was ICT, which had a solid sales organization for punched card equipment and was well entrenched in the U.K. despite IBM's great strides in that field. Douglas said that in the computer field at present, ICT was "a marketing organization searching for products to market. Somehow it has never been able to create an engineering organization wholly within itself which can design and build a successful computer."

## PRIVATE LINES

*August 1973:* Edgar A. Grabhorn, of Arthur D. Little, reported that for almost 10 years, several U.S. companies had taken steps to enter the business of providing private line communications, a business that had been raking in \$1 billion a year for AT&T. Battling the strong opposition of the established carriers (AT&T and Western Union), these companies, known as specialized common carriers (SCCs), had been attempting to finance and build microwave radio networks linking major U.S. cities. At the time Grabhorn wrote this article, he said, only two SCCs were providing customer services: Microwave Communications Inc. (MCI) and Western Tele-Communications Inc. (WTCI). MCI handled the St. Louis to Chicago route, and WTCI had one between El Paso and Los Angeles. He did, however, note that six other SCCs had networks under construction and were expected to offer private line services by the beginning of '74.

After 1974 Grabhorn felt they would have some rough competition from AT&T and Western Union because each would be offering end-to-end, all-digital transmission services, which would be very attractive to data communications users; and domestic satellite systems would be available and would probably result in lower prices for long-haul bulk transmission.

—Lauren D'Attilio

# The ADABAS Seminar For DBMS Evaluators



Spend a morning, save a bundle.

You're busy. You don't have the time, or the patience, to attend yet another "management seminar." And for once, you would like *hot* coffee and a *fresh* Danish.

We understand. We also know that if you have spent any time looking at data base management systems you've discovered a problem: while evaluating a DBMS is difficult, you know you should study all of your options before you choose the one you're going to live with for a long time to come. Since you want to be sure you have made the right choice, it makes sense to attend an ADABAS seminar.

Give us part of your day and we'll give you hard facts and no hype about ADABAS for data base management on your IBM 4300, 370, or plug compatible computer. You'll find out why our DBMS can be installed in a day while others can take months. You'll also learn how user-

friendly a relational-like system can be. And you'll experience the benefits of using NATURAL, a productivity tool that can reduce application development time by up to 90%.

A DBMS is a major investment. We urge you to enroll in one of our free seminars to get the facts on ADABAS and NATURAL. Use the coupon to get the latest schedule and enrollment information.

-----  
Software AG Worldwide  
Software AG  
of North America, Inc.  
11800 Sunrise Valley Drive  
Reston, Virginia 22091  
(703) 860-5050

In Europe:  
Software AG  
Hilpertstrasse 20  
D-6100 Darmstadt  
West Germany  
06151-84072

- Please send me information on:
- Your free DBMS seminars;
  - ADABAS, your data base management system;
  - NATURAL, your online program development language;
  - COM-LETE, your TP monitor.

Name \_\_\_\_\_

Title \_\_\_\_\_

Company \_\_\_\_\_

Address \_\_\_\_\_

City \_\_\_\_\_ State \_\_\_\_\_

Zip Code \_\_\_\_\_ Telephone (\_\_\_\_) \_\_\_\_\_

CPU \_\_\_\_\_ Operating System \_\_\_\_\_

**SOFTWARE AG**  
OF NORTH AMERICA, INC.

CIRCLE 9 ON READER CARD

DM 0883

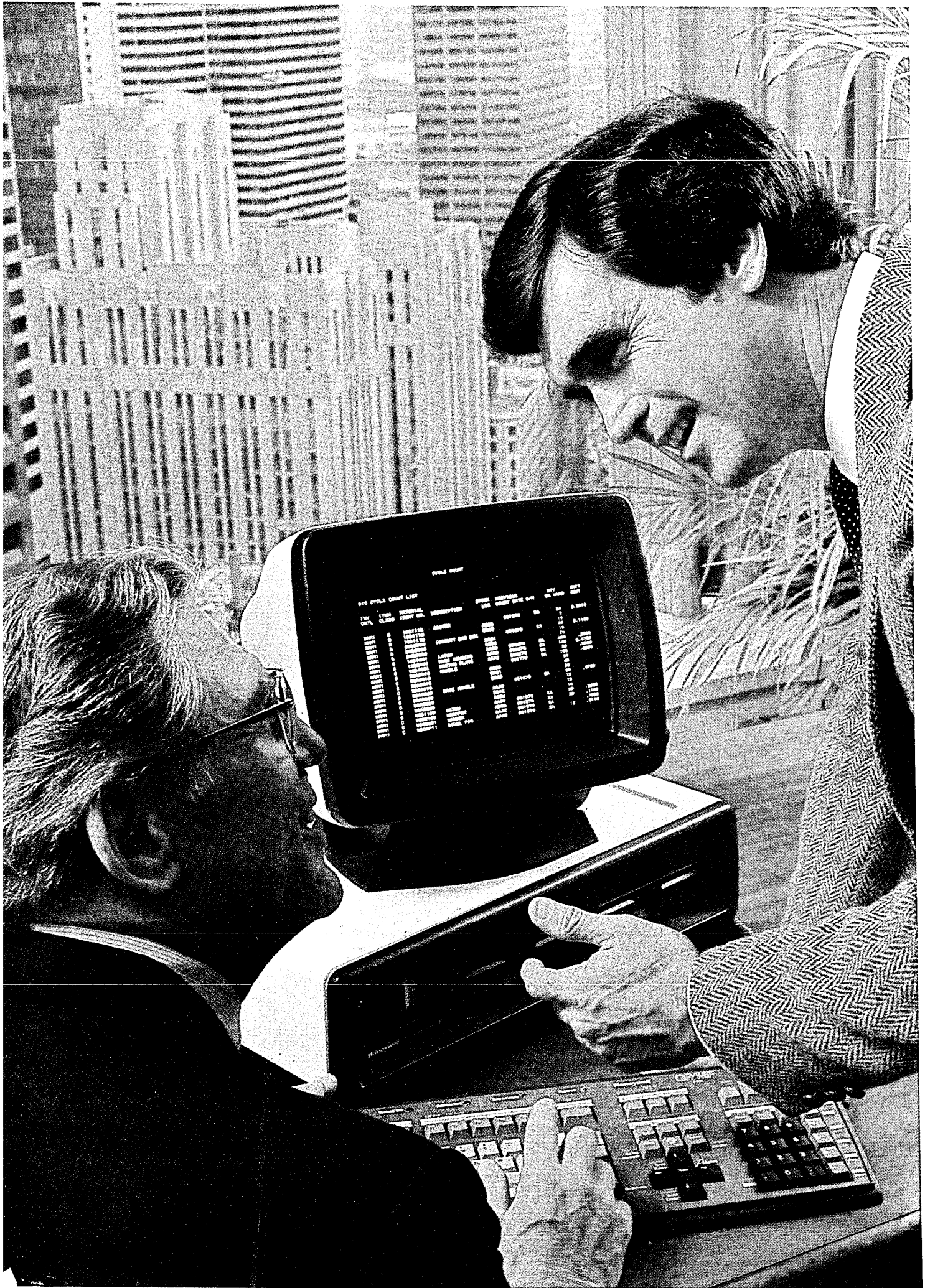

# At last, help for companies wrestling with the problems created by personal computers.

"Overrun."  
"Invaded."  
"Swamped."

DP managers use a variety of terms to describe the arrival of so many different personal computers on the business scene. But the *feeling* is always the same.

After all, most managers have spent *years* developing well-controlled information systems. Now, almost overnight, they are losing control.

And while there's no arguing that PCs are valuable tools for individual productivity, everyone would prefer a more integrated approach for the company.

What's needed is a system that combines corporate data base capability with the personal computer capabilities employees now insist upon. A system with the capacity to extend the functionality of the corporate network to the individual local level. This is exactly what Honeywell has built.

## **The microSystem 6/10.**

The cost-efficient microSystem 6/10 is a multi-personality workstation that provides an impressive range of functions – including networking.

Besides personal computing, the system handles data processing and word processing. It can function as a network end-point and a

terminal emulator. What's more, power and flexibility make the microSystem 6/10 perfect for adaptation to industry-specific applications.

The microSystem 6/10 helps ensure organizational unity through excellent communications – it talks to IBM mainframes as readily as to our own.

It also offers expandable hardware and our time-proven GCOS operating system, which is compatible across the entire range of Honeywell minicomputer products, including even the most powerful 32-bit systems. This compatibility assures easy progress along your growth path by eliminating the need to re-create applications and retrain personnel.

## **Fight fire with fire.**

Best of all, perhaps, the microSystem 6/10 will be an immediate hit with employees wed to their PCs. Because it accepts popular software packages based on CP/M-86® and MS-DOS®, chances are your people won't have to give up their favorite programs.

The microSystem 6/10.

Here's the way to win the battle against "PC Pandemonium."

And the war for control.

For more information, call **800-343-6665** (within the 617 area, call 392-5246) or write to the Honeywell Inquiry Center, 200 Smith Street (MS 440), Waltham, Massachusetts 02154.

**Together, we can find the answers.**

# Honeywell

CP/M-86 is a registered trademark of Digital Research, Inc. MS-DOS is a registered trademark of Micro Soft, Inc.

**CIRCLE 10 ON READER CARD**

# IMMEDIATE, PRECISE, SECURE, ON-LINE, REALTIME, ACCOUNTS PAYABLE CONTROL. NOW.

The new SOFTWARE INTERNATIONAL realtime Accounts Payable System puts state-of-the-art technology to work in the real world. Both data processing and accounting departments can benefit directly.

Taking advantage of realtime capabilities, the package enables accountants to get information they need, in the format they are most comfortable with. Immediately. Because the system is on-line, it frees data processing from the burden of continually generating and maintaining cumbersome, costly reports.

Built-in on-line validation features let the accountant enter data faster and more accurately, with more assurance that decisions are made with correct, up-to-date information.

The sophisticated system architecture provides extensive security, and coupled with instant, user-friendly inquiry, improves overall control.

The new Software International Accounts Payable System is compatible with a variety of hardware, and addresses multinational as well as domestic accounting issues. The package interfaces with our popular

General Ledger and Financial Reporting System, forming a comprehensive financial management structure. This powerful base can be enhanced further by adding our Accounts Receivable, Fixed Asset, and Payroll/Personnel products.

For almost two decades, Software International Corporation has provided state-of-the-art software for business problem-solving. The solution is THE SOFTWARE, financial systems that are an industry standard. Only THE SOFTWARE gives you the confidence that comes from thorough training and documentation, stringent quality control, and worldwide customer support.

As a wholly-owned subsidiary of General Electric Information Services Company, Software International Corporation is part of an international family of more than 5,000 computer and business professionals.

Call or write today and learn more about our realtime Accounts Payable System. It's the latest reason you can have confidence in every package that comes from Software International.

Corporate Headquarters: One Tech Drive, Andover, MA 01810.

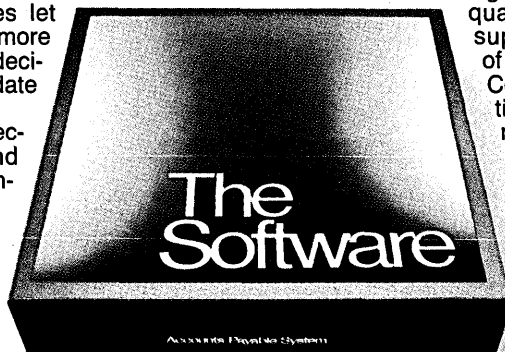

CONFIDENCE IN EVERY PACKAGE

CALL TOLL FREE 1-800-343-4133  
(IN MASSACHUSETTS 1-800-322-0491)



**SOFTWARE  
INTERNATIONAL**

CIRCLE 11 ON READER CARD

# LOOK AHEAD

## LISA SLIPS A DISK

While Apple Computer has apparently sold out its 1983 production of Lisa computers, a total of about 20,000 units, blank diskettes for the new machine are few and far between. It seems the two designated floppy suppliers, 3M and Verbatim, have not filled the pipeline to Apple distributors, leaving Lisa users stuck with the dozen or so floppies supplied under the system's \$9,995 price tag. Apple chose nonstandard diskette formats in order to pack 860K bytes onto a single diskette. The manufacturer attributes the lack of retail diskettes to a snafu in distribution while distributors themselves speculate that not enough diskettes were ordered in the first place. That, or production problems are at fault. All this may add up to a painful thorn for Apple because many Lisa users now are much-needed software developers whose efforts could seriously be hindered by a lack of floppy media.

## BACK-END STARTUP

A Dallas startup is just completing venture capital funding to bring out a back-end database machine that will be aimed primarily at large shops with many different types of processors and storage devices, and large, evolving databases. SMC Technology Corp. was formed as a joint venture between Set Theoretic Information Systems of Ann Arbor, Mich., and Productivity International of Dallas. The former, a software house, specializes in large database systems, while the latter does systems work in CAD/CAM. The company's storage manager, to be based initially on an off-the-shelf 32-bit minicomputer, is expected to hit the market by the end of next year. Follow-on systems will use custom hardware.

## NEW 4300 COMING...

Look for IBM to come out this fall with a new low-end 4300 supermini/cluster controller that will first ship in the second quarter of next year. The system is expected to use a new 1,500-gate ECL chip and have a base price of about \$40,000. IBM's smallest current 4300 goes for about \$80,000 and has left the door open to many supermini vendors such as Digital Equipment and Prime. IBM's new system is expected to use the VM/CMS operating system, link closely with personal computers, and fit well into the company's long-expected local network. Thus, the system will boost IBM's business not only in the office automation market, but also in the scientific/engineering markets being pursued by Apollo Computer.

# LOOK AHEAD

## ...AND GOING

Meanwhile, the industry leader may hold back on introducing a high-end 4300, rated at about 2.5 MIPS, for fear of hurting sales of the 3083. The company's concern, however, is that leasing companies may sell large numbers of used 3033s to those users who can't wait for the 4300 and don't want to pay 308X prices. IBM has had a bonus plan in place to help close 3083 and 3081 sales, a sign of an impending cpu introduction, many observers think.

## DEC LAN IN THE AIR

The do-it-yourself gloss appears to be peeling off Digital Equipment's effort to develop its own local area network. DEC watchers point out that although the company has spent about \$50,000 on modems from MA/COM and lured away key designers from Wang Laboratories, it is about to opt for a broadband networking scheme from Sytek Inc., Mountain View, Calif. Neither company is talking, but a formal announcement is expected by year-end.

## SCANDINAVIA GOES MINI

LM Ericsson's latest push into office automation involves the acquisition this month of David Computer, a Stuttgart mini and terminal maker. With an installed base of some 3,500 machines, David has offices throughout Europe and in Irvine, Calif. Ericsson beat out Burroughs and Philips in acquiring the company which is understood to have floundered in a recent effort to develop a new microcomputer line. Ericsson is to take care of David's DM5 million debt as part of the undisclosed price it paid. Meanwhile, Norsk Data of Norway has bought an 80% stake in West German Dietz Computer Systems with an option to buy the remaining 20%. Dietz gives Norsk Data an established sales and service force to further penetrate European markets with its 32-bit minis.

## AI MARKETS DEVELOP

Look for Teknowledge Inc. to introduce next year its first artificial intelligence products for general distribution, including expert systems for IBM's P.C. The Palo Alto company has also formed a joint marketing venture in Europe with Framatome, a Parisian nuclear power engineering company. Meanwhile, Symbolics Inc., a Cambridge, Mass., maker of LISP computers, which are widely used in AI, has shipped its 100th machine, giving it a wide lead over Xerox in external sales.

## RUMORS AND RAW RANDOM DATA

A situation somewhat akin to the collapse of ITEL is said to be shaping up for third party lessors of Wang Labs word processing systems. The shared logic machines are suffering from extreme competition from microcomputers and, soon, an upgrade from IBM of its popular Displaywriter.



# NOW!

## IBM® PC is a Perfect Match for IBM System 34/38 with AST-5251

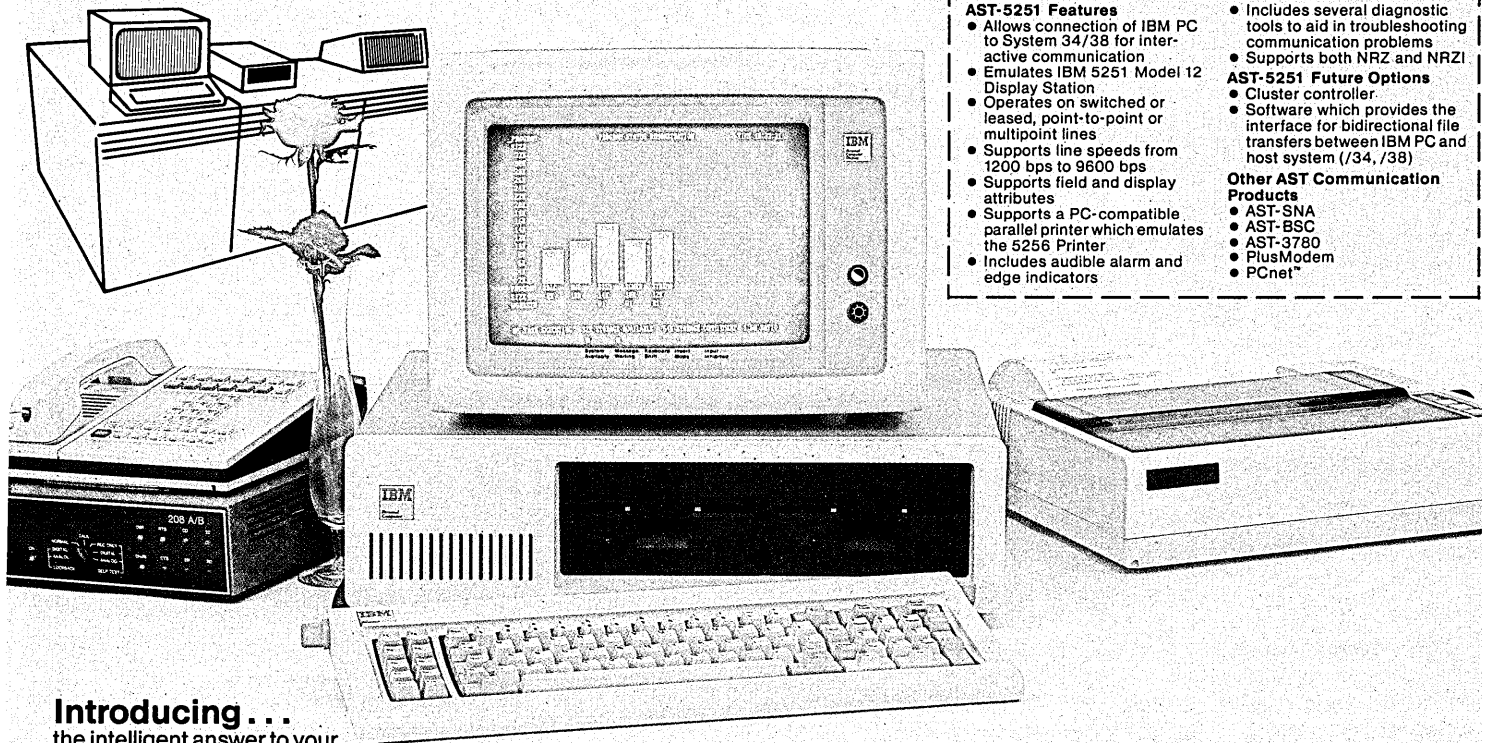

### AST-5251 Features

- Allows connection of IBM PC to System 34/38 for interactive communication
- Emulates IBM 5251 Model 12 Display Station
- Operates on switched or leased, point-to-point or multipoint lines
- Supports line speeds from 1200 bps to 9600 bps
- Supports field and display attributes
- Supports a PC-compatible parallel printer which emulates the 5256 Printer
- Includes audible alarm and edge indicators

- Includes several diagnostic tools to aid in troubleshooting communication problems
- Supports both NRZ and NRZI

### AST-5251 Future Options

- Cluster controller
- Software which provides the interface for bidirectional file transfers between IBM PC and host system (/34, /38)

### Other AST Communication Products

- AST-SNA
- AST-BSC
- AST-3780
- PlusModem
- PCnet™

### Introducing...

the intelligent answer to your dumb terminal: the **AST-5251**! The AST-5251 is a hardware/software product which allows for the connection of the IBM Personal Computer to the System/34 or System/38 for interactive communication under the IBM-supplied remote work station support for 5251 Model 12 Display Stations. In other words, your IBM Personal Computer and AST-5251 appear to the host system as an IBM 5251 Model 12 Display Station with an 83-key EBCDIC keyboard and an attached IBM 5256 dot matrix printer.

With the AST-5251, the IBM PC is connected to the host system directly through synchronous modems or direct attachment to the IBM/34, /38 communications adapter without additional external hardware. Emulating the 5251 Model 12 remote work station with an attached

5256 Printer, the AST-5251 performs transparently under the standard operating system support of the System/34 or System/38 on switched, leased, point-to-point, or multipoint lines at speeds from 1200 bps to 9600 bps. It may coexist with 5251 terminal clusters in a communications network.

**Best of all**, the package is available for immediate delivery from **AST Research Inc.**, the Number One IBM PC communications add-on products manufacturer. You get the exceptionally high quality, reliability, and total support that comes with all AST products.

### Other AST Products for IBM PC

AST also offers a full array of PC add-on products:

- AST-SNA
- AST-BSC
- AST-3780
- PCnet™
- PlusModem™
- I/O Plus II™
- MegaPlus™
- ComboPlus™
- Memory Expansion Boards

### Cluster Controller Available Soon!

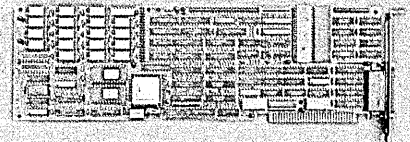

(Designed to be used as a PC co-processor using 186 CPU technology)

# AST

## RESEARCH INC.

2372 Morse Ave., Irvine, CA 92714  
Telephone (714) 540-1333

# How to get a computer company to help unclog your applications bottleneck.

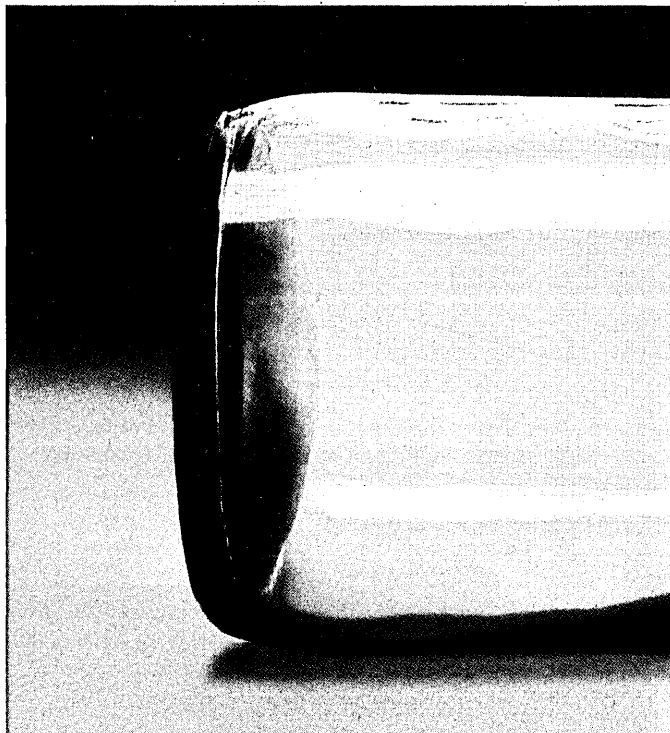

Consider this scenario.

Suddenly, all your management users become able to develop their own special applications. On-line, using their own desktop terminals.

They have immediate access to updated information within their authorized data bases, regardless of where it's entered. They're able to reformat reports and even redefine parameters. Themselves.

You're still very much in control of things, but not burdened by detail. You're free to manage the on-going workload. And the major applications.

It could all happen with the Sperry MAPPER™ System. Not quite "suddenly," but in very short order.

MAPPER is that powerful. Simply stated, it's the most advanced information management tool yet developed.

A tall claim, to be sure. But we're prepared to back it up, conclusively. We'll put MAPPER to work on a real and specific application development problem that a user has given you.

**SOMETHING  
FOR EVERYONE.**

MAPPER's simple English-

©Sperry Corporation 1983 MAPPER is a trademark of Sperry Corporation.

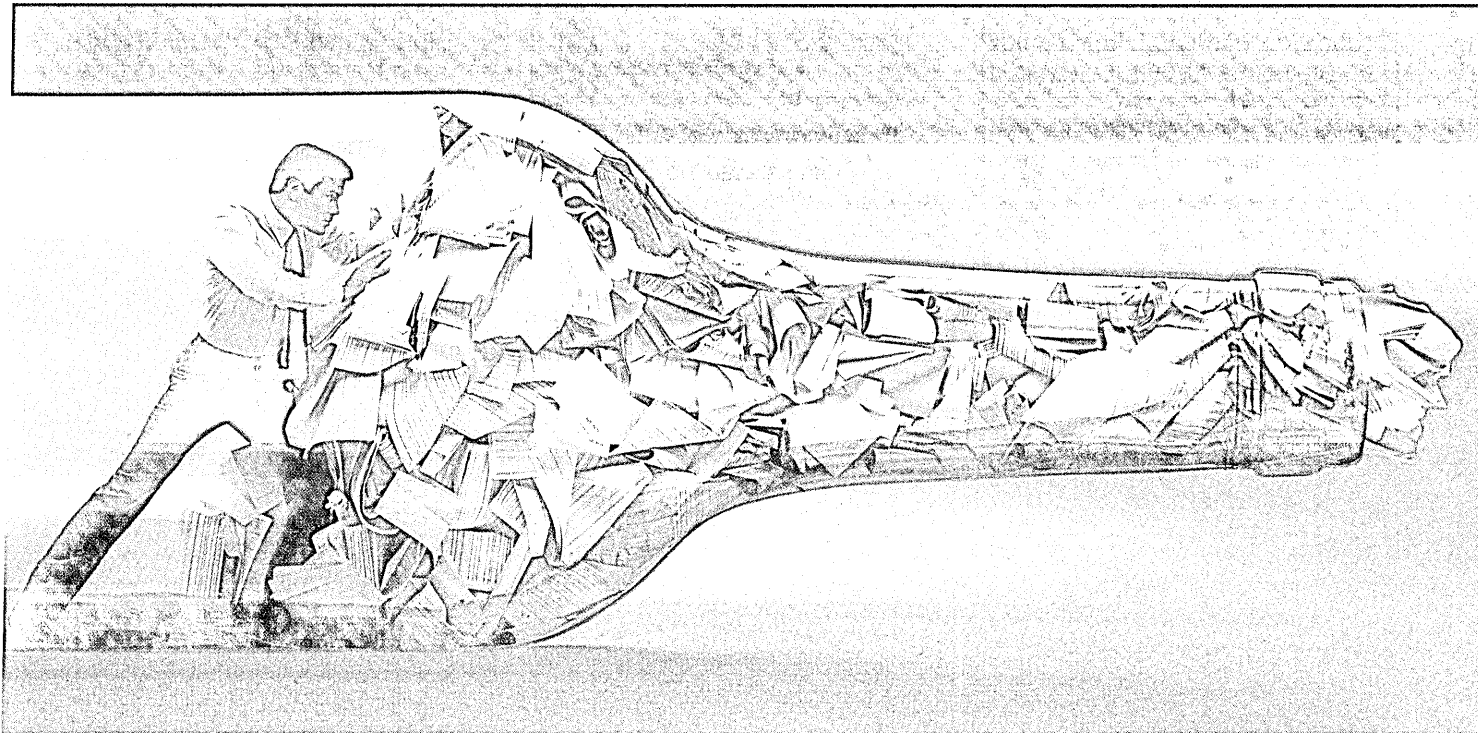

## MAPPER™ CHALLENGE

language commands and non-procedural flexibility make it easy for the most computer-shy user to gain proficiency in a day or two. The fact is, MAPPER can be used in all departments of your company and at various levels within the organization. And the MAPPER concept of "user friendly" far transcends anything you've seen.

### HERE'S THE OFFER.

Accept our MAPPER Challenge. Bring us an application develop-

ment project. Bring along the user. We'll show you — without any obligation or cost — how quickly and easily MAPPER gets the job done. It will be an awesome experience for the user. And maybe astonishing even for you.

**800-547-8362**

But first things first. Have us send you a copy of our brochure, "How to Take the MAPPER

Challenge." Call toll-free: 800-547-8362 (9 a.m. to 5 p.m. E.D.T.). Or send us the coupon.

Sperry Corporation  
Computer Systems  
Department 100  
P.O. Box 500  
Blue Bell, PA 19424

Please send me a copy of "How to Take the MAPPER Challenge."

Name \_\_\_\_\_

Title \_\_\_\_\_

Company \_\_\_\_\_

Address \_\_\_\_\_

City \_\_\_\_\_ State \_\_\_\_\_ ZIP \_\_\_\_\_

We understand how important it is to listen.

 SPERRY

CIRCLE 13 ON READER CARD

# CALENDAR

## AUGUST

### **National Conference on Artificial Intelligence (AAAI-83).**

Aug. 22-26, Washington, D.C., contact: Claudia Mazzetti, AAAI, 445 Burgess Dr., Menlo Park, CA 94025, (415) 328-3123.

### **IBM PC Faire.**

Aug. 26-28, San Francisco, Calif., contact: Jim Warren, Computer Faire, 345 Swett Rd., Woodside, CA 94062-9990, (415) 851-7077.

### **Eurographics '83.**

Aug. 31-Sept. 2, Zagreb, Yugoslavia, contact: ATLAS, Congress Dept., P.O.B. 17, YU-41001 Zagreb, Yugoslavia, telex: 22413 yu atlcon.

## SEPTEMBER

### **Federal Computer Conference.**

Sept. 13-15, Washington, D.C., contact: Federal Computer Conference, P.O. Box 368, Wayland, MA 01778, (617) 358-5301.

### **Word Processing & Office Environment Trade Show & Conference, (WPOE '83).**

Sept. 13-15, San Jose, Calif., contact: Cartridge & Associates Inc., 4030 Moorpark Ave., San Jose, CA 95117, (408) 554-6644.

### **Euromicro '83.**

Sept. 14-16, Madrid, Spain, contact: Euromicro, TH Twente, P.O. Box 217, Dept. INF, room A312, 7500 AE Enschede, the Netherlands, telex: 44200 Thes.

### **IFIP Ninth World Computer Congress.**

Sept. 18-23, Paris, France, contact: AFIPS, 1815 N. Lynn St., Arlington, VA 22209, (703) 558-3600.

### **Sixth International Conference on Digital Satellite Communications.**

Sept. 19-23, Phoenix, Ariz., contact: Conference Administrator, c/o COMSAT, 950 L'Enfant Plaza S.W., Washington, DC 20024, (202) 863-6248.

### **SICOB '83.**

Sept. 21-30, Paris, France, contact: International Trade Exhibition, France, 8 West 40 St., New York, NY 10018, (212) 869-1720.

### **COMPCON Fall '83.**

Sept. 26-30, Arlington, Va., contact: IEEE, P.O. Box 639, Silver Spring, MD 20901, (301) 589-8142.

### **Telecommunications Association Conference (TCA '83).**

Sept. 27-29, San Diego, Calif., contact: TCA Conference Office, P.O. Box 208, West Covina, CA 91793, (213) 960-1838.

## OCTOBER

### **Eighth Data Communications Symposium —1983.**

Oct. 3-6, Cape Cod, Mass., contact: Datacomm, P.O. Box 639, Silver Spring, MD 20901, (301) 589-8142.

### **INFO '83.**

Oct. 10-13, New York, N.Y., contact: INFO '83, 708 Third Ave., New York, NY 10017, (212) 661-8410.

### **Seventh International Fiber Optics and Communications Expo and Second International Expo on Local Area Networks (FOC/LAN '83).**

Oct. 10-14, Atlantic City, N.J., contact: Michael A. O'Bryant, General Manager, Information Gatekeepers Inc., 167 Corey Rd., Brookline, MA 02146, (617) 739-2022.

### **EduTech/East '83.**

Oct. 13-15, Philadelphia, Pa., contact: Carol Houts, Judco Computer Expos, Inc., 2629 N. Scottsdale Rd., Scottsdale, AZ 85257, (800) 528-2355.

### **SYSTEMS '83.**

Oct. 17-21, Munich, Germany, contact: Kallman Associates, 5 Maple Ct., Ridgewood, NJ 07450, (201) 652-7070.

### **The National Software Show.**

Oct. 19-21, San Francisco, Calif., contact: Raging Bear Productions, Inc., 21 Tamal Vista Dr., Corte Madera, CA 94925, (415) 924-1194.

### **ACM '83.**

Oct. 24-26, New York, N.Y., contact: the Association for Computing Machinery, 11 W. 42 St., New York, NY 10036, (212) 869-7440.

### **Ninth International Conference on Very Large Data Bases.**

Oct. 31 - Nov. 2, Florence, Italy, contact: Mario Schkolnick, K55-281, IBM Research Labs, 5600 Cottle Rd., San Jose, CA 95193, (408) 256-1648.

## NOVEMBER

### **Federal Office Automation Conference.**

Nov. 1-3, Washington, D.C., contact: Federal Office Institute, P.O. Box E, Wayland, MA 01778, (800) 343-6944.

### **Integrated Office Technology Conference and Exposition (INTECH '83).**

Nov. 1-3, Chicago, Ill., contact: Mary Beth Gouled, National Trade Productions Inc., 9418 Anapolis Rd., Lanham, MD 20706, (301) 459-8383.

# The printer for the people who need hardcopy now.

Dataproducts B-Series line printers help you put the paper in the hands of the people who need it. When they need it.

The family of three, the B-300, B-600 and the B-1000, was designed to whisk out the printout, from 300 lines per minute to as much as 1100 LPM. And to operate at those speeds day after day.

**How could we build 160,000 line printers and not make an impression?**

We've produced more line printers than all other independent computer printer makers combined.

So why isn't Dataproducts a household word? Because most Dataproducts line printers are delivered to end users with somebody else's name on them.

Virtually every major OEM in the business has selected our B-Series printers for the systems they sell. Each has made that selection after months, sometimes a year, of intensive evaluation.

More than anything else, they look for a machine that can perform reliably over a long period of time. Their reputations are at stake.

Which is why the safest choice for your company may be a printer you've never heard of.

**The best printers are the easiest to use.**

Dataproducts probably knows more about the people who use computer printers than anybody. We know how they slam cabinets. How

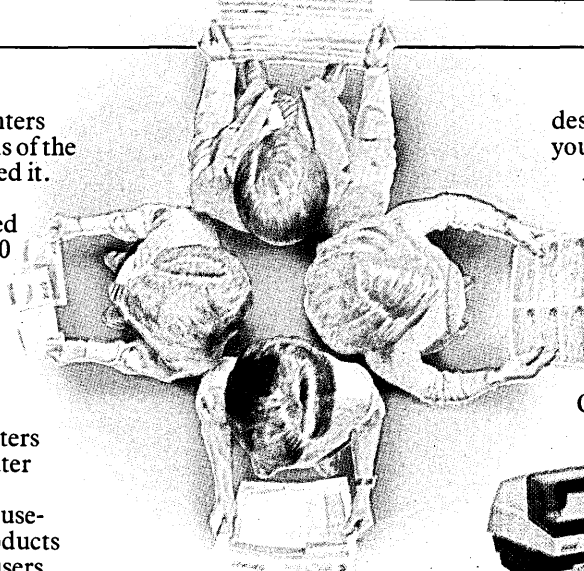

designed to help service people get you back on-line quickly.

And because we make so many of these printers, we don't have to charge a lot of money for yours. You get low initial cost. And low cost of ownership.

If you'd like to know more about our B-Series printers, or the name of our distributor in your area, call (213) 887-3924. Or send the coupon below.

they jam paper. How they smear ink on their pants.

We conceived the B-Series for the operator. Extensive diagnostics help the operator locate and correct troubles fast. Long-life ribbon cartridges are

quick and clean to load. The machines open wide so all controls are easy

to see and easy to reach.

In less than a minute, the operator can even change the print band—to a different typeface, a different language.

**The best printers are the least expensive to own.**

90% parts commonality within the family minimizes spares inventories and training. Power consumption is low.

Operators fix most problems. When they can't, the B-Series is

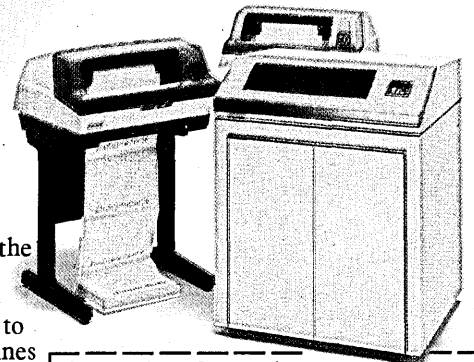

**PIR Systems**

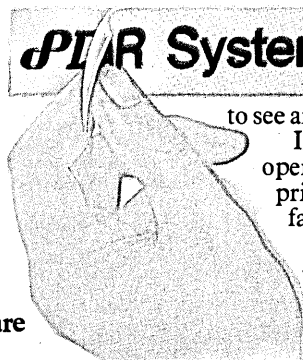

Dataproducts Corporation, 6200 Canoga Ave., Woodland Hills, CA 91365

Send details!  Send a sales rep!

Name \_\_\_\_\_

Title \_\_\_\_\_

Company \_\_\_\_\_

Type of business \_\_\_\_\_

Address \_\_\_\_\_

City \_\_\_\_\_ State \_\_\_\_\_ Zip \_\_\_\_\_

Telephone \_\_\_\_\_ Ext \_\_\_\_\_

Also send information on:  
 120-200 LPM dot matrix printers  Graphics and label printers  
 35-55 CPS letter quality printers  1500-2000 LPM high performance printers  Printer supplies

Dataproducts is a registered trademark. B-300, B-600 and B-1000 are trademarks of Dataproducts Corporation.

# DATAPRODUCTS

*The Printer Company*



# *“Rockwell International eliminates order management paperwork and ships products faster with a Tandem NonStop Computer System.”*

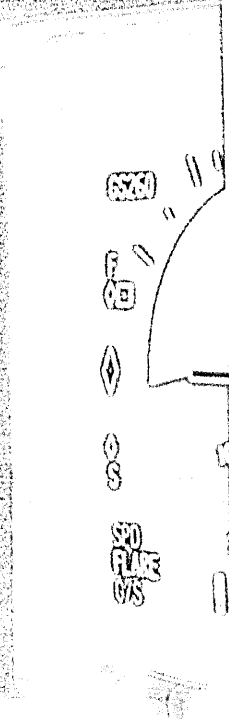

Rockwell International, 1700 Rockwell Drive  
Arling House  
Rockwell International Corporation

“Our Tandem NonStop computer helps us dramatically streamline order tracking for our broad line of products here at the Collins avionics facilities in Cedar Rapids. This automated operation has meant we’ve been able to ship our products faster, as well as respond to customer inquiries in a much more timely, accurate fashion.

“The Tandem system consolidates all data pertaining to the orders, from order entry to scheduling, inventory issue to packing lists, and

right on down the line to shipping. And because the system is on line, other departments have immediate access to this information as well. Accounting, for example, now generates invoices automatically, resulting in much improved cash flow. Manufacturing is saving \$175,000 a year in internal freight charges due to the reorganization of ordering and shipping procedures, and the Group as a whole has been able to eliminate more than 300,000 reproduced documents a year.

“Other system benefits contributing to our improved

customer service include better control of backorders, more accurate carrying inventory, and the ability to make detailed forecasts of market conditions for planning purposes. The net result is an operation that is helping us achieve some very significant gains in plant productivity.

The NonStop system, ideally suited to on-line transaction processing where continuous availability of up-to-the-second information is critical to your business.

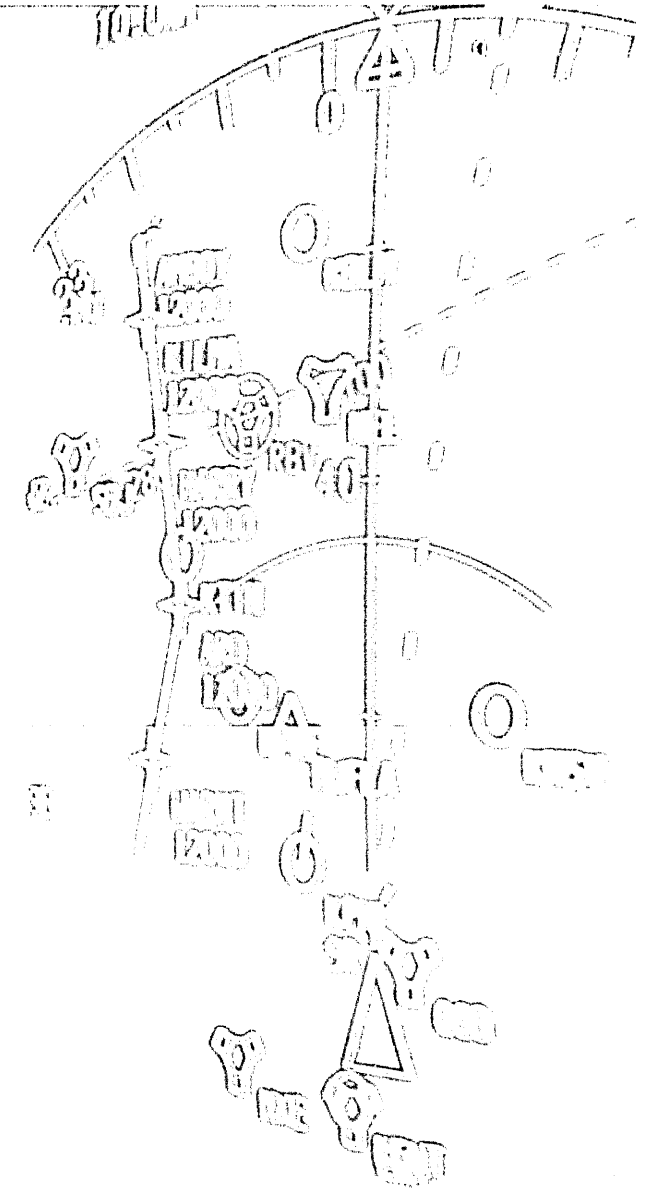
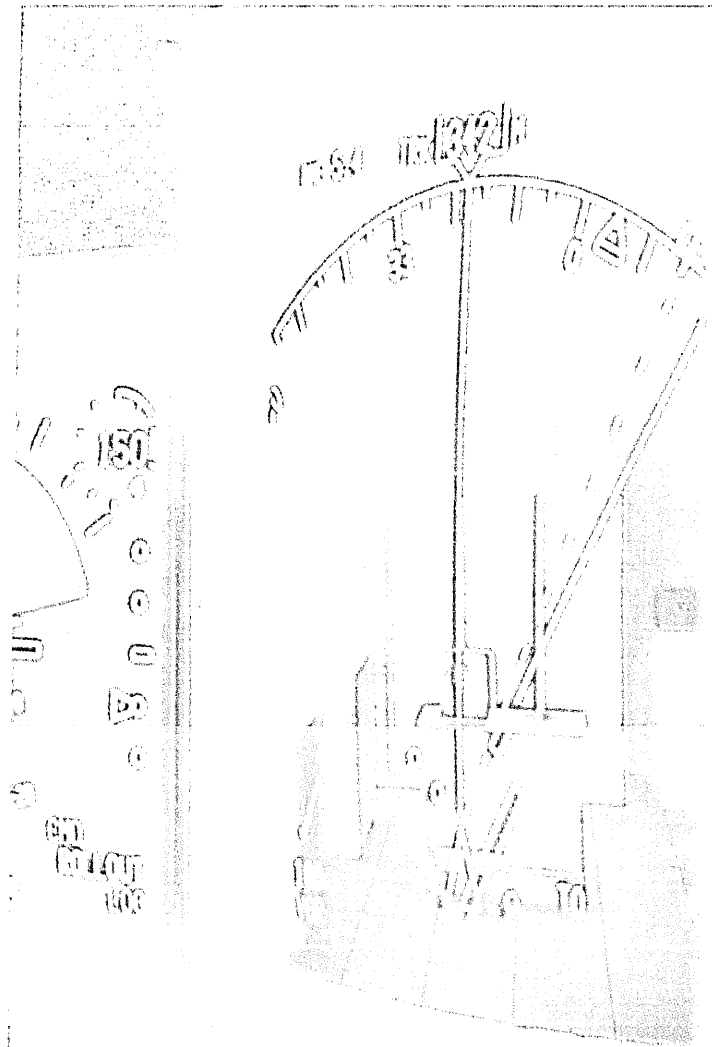

Tandem. Fully supported  
by a worldwide sales, training,  
service and manufacturing  
organization.

For information on  
how a Tandem NonStop  
system can improve your  
productivity or your P/L  
statement, call your local  
sales office or Tandem  
Computers Incorporated,  
19363 Vallec Parkway, Cupertino,  
California 95014, U.S.A.  
Toll Free 800-482-6636 or  
(415) 745-7500 in California.

# TANDEM

## NonStop Transaction Processing

© 1984 Tandem Computers Incorporated

Price and specifications subject to change without notice.

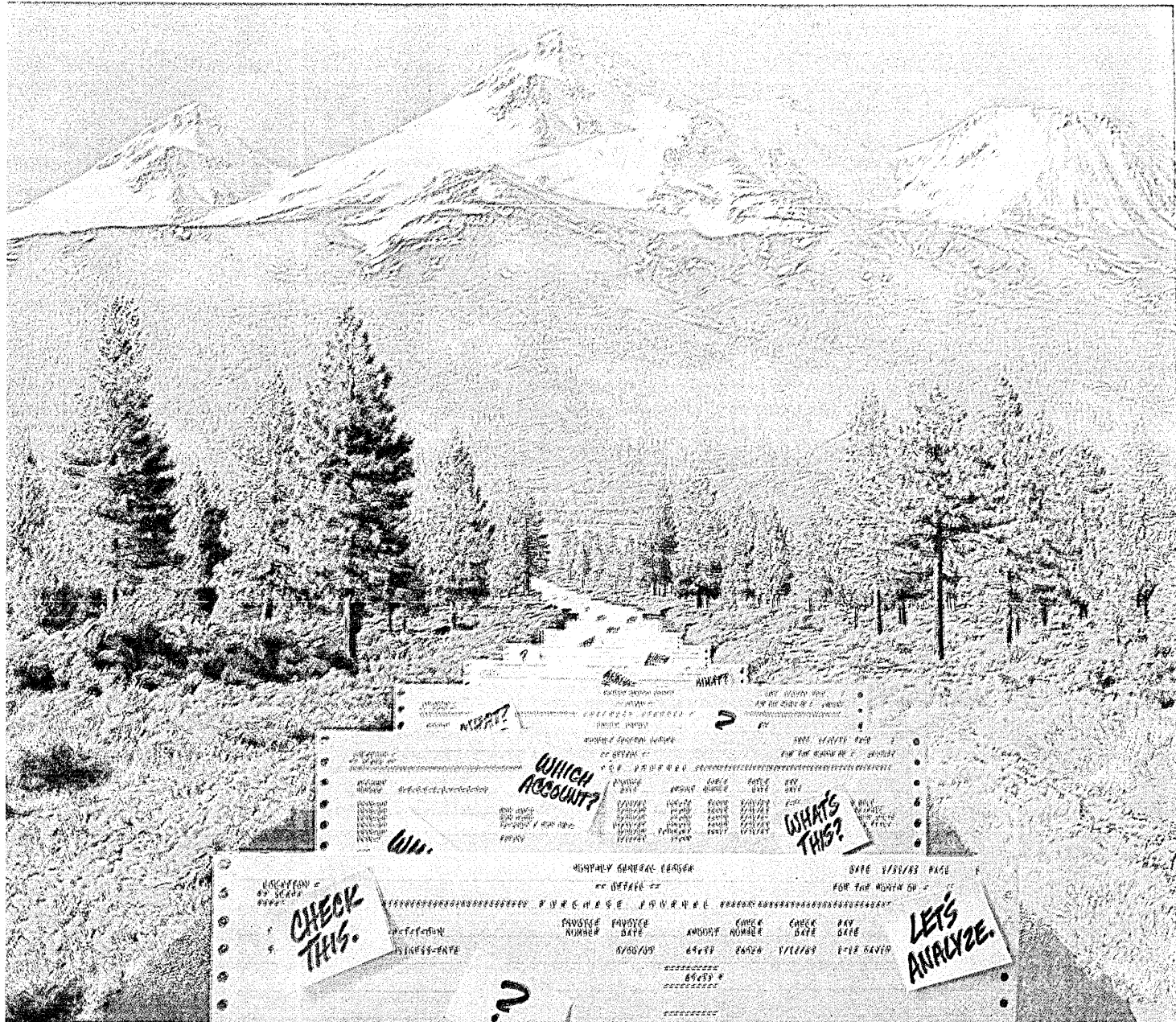

# THESE POINTS OF INTEREST ARE BROUGHT TO YOU BY POST-IT NOTES.

When you're facing miles of data, it helps to have a few signs to point the way.

Post-it® Notes are handy for calling attention to questions or problem areas, for indexing print-outs, even for temporarily labeling computer tapes. Their unique adhesive sticks when you want it to, comes unstuck when you want it to.

Post-it Notes are available from your local office supply dealer. Ask for a free sample, or phone toll-free 1-800-621-5282. Commercial Tape Division/3M.

"Post-it" is a trademark of 3M.

3M hears you...

# 3M

CIRCLE 16 ON READER CARD



# LETTERS

## HARDLY A THORN IN IBM'S SIDE!

In your May issue you discussed the matter of IBM source code in a story titled "Plugging the Mole Holes" (News in Perspective, p. 56). Since you mentioned 10 companies by name, including Boole & Babbage, I am compelled to respond. In general, you paint a worrisome picture for these 10 companies. While I cannot speak for the others, Boole & Babbage does not feel threatened by this issue.

Boole & Babbage provides its customers productivity products that assist users in more effectively using IBM large systems. In this, we are not "a thorn in the company's side." First of all, they wouldn't feel it (our *annual* revenue approximates IBM's *daily* after-tax profit); secondly, we help their customers, which can only help IBM.

I heartily concur with Steve Ippolito's statement on p. 58: "IBM has no valid reason to deny source—because we'll abide by all their restrictions on its use. [That is, no duplication, reverse compilation/assembly, or engineering, and no distribution of the code.] We only need to look at it."

In addition, we do not need the machine-readable source; we need only fiche and logic manuals. Our purpose is to use the fiche as documentation. We need to understand the internals so we may assist our customers. Boole & Babbage's current products make no changes to IBM source code.

At this point I must support my friend Bob Patrick's position at the close of your story: "IBM's users are the largest unpaid software company in the world . . . as well as its largest unpaid maintenance crew."

Their knowledge comes from the fiche and logic manuals; for the near future, IBM requires their support. We believe that IBM clearly understands this; as long as IBM supports its customers, IBM will support Boole & Babbage as well. As a result, we

are not an "early casualty," nor are our "new product families threatened," nor has our "very existence been placed in jeopardy."

JACK E. VAN KINSBERGEN  
President  
Boole & Babbage Inc.  
Sunnyvale, California

## JERSEY RAISES A STINK

Aw, come on . . . They couldn't possibly make a manhattan as good as New Jersey (cartoon, May, p. 117)! No wonder we call all of you tourists "Bennies," as in please go home and quit messing up our state.

May the stings of 10,000 letters (if you have that much circulation in the U.S.A.'s highest-tech state) infest your sensory organs!

WHIT DOWNER  
Manager, Communications  
Electronic Associates Inc.  
West Long Branch, New Jersey

## STEPPED-ON TOES

In your article "A PBX Cookbook" (May, p. 216), Mr. Patrick stated that "Senior data processing personnel are acquainted with digital technology, are familiar with in-depth analysis, and are (more or less) comfortable running multimillion dollar projects in the limelight."

So far so good, but then Mr. Patrick goes on to imply that none of these statements holds true for the current crop of telephone administrators. I feel this is grossly misrepresenting the facts concerning some present telephone administrators, including me. I am presently director of telecommunications at Villanova University, Villanova, Pa.

In my nearly seven years as a data processing manager, computer programmer, operator, and now as coordinator of voice and data communications, I am acutely aware of the fluctuating changes in digital technology, including AIS 85, MCI's digital network, and other digital systems as



"This manhattan tastes like New Jersey."

## LETTERS

well. I have attended numerous conferences across the country and can assuredly state that I am a highly representative example of a well-informed telecommunications administrator.

In addition, I am well acquainted with current systems analysis, a fact that can be shown through the planning, supervision, and control of our multimillion dollar switch at the university. Our division of voice and data is currently responsible for issuing and maintaining highly reliable traffic reports and for planning and expanding our growing voice and data network.

Your statements claiming that the current crop of telephone administrators is misinformed on digital technology and systems analysis is a misrepresentation of a small but expanding telecommunications industry—and a well-informed industry at that. Although I am not doubting the fact that some telephone administrators are not as well informed as others, it certainly does not hold true for most of us in both business and educational divisions today.

MARK B. CARRIG

Director of Voice and  
Data Communications  
Villanova University  
Villanova, Pennsylvania

### WE GOT CAUGHT

In your "Playing by the System" article (March, p. 63), the following example is given: "Give me all wide receivers who are free agents, who can run the 40 in less than 4 min. 7 sec. . . ." I would just like to comment that anyone who cannot run the 40 in less than 4 min. 7 sec. has no business being a professional athlete. I think you meant 4.7 seconds?

DEBI TECLAW

San Marcos, California

### A MINI BY ANY OTHER NAME

In your May issue, I noticed under the heading News In Perspective-Minicomputers ("Low-End Action at IBM," p. 75) that the upgrade of the IBM System 38 to 8 megabytes was mentioned. The first System 38 was delivered three years ago but a large portion of the dp industry is still showing its lack of knowledge of the product by calling it a minicomputer. It was interesting to see a system with a 48-bit single-level virtual address space listed under minicomputers while the same issue contained several articles about IBM's new XA that extends the 30XX series from a 24-bit to a 31-bit address. Any time IBM wants to increase the memory of the System 38, all it has to do is plug in more or higher-density memory cards to its heart's content, and we won't have to change a single line of code or convert to a new operating system. I don't know if anybody can define the term minicomputer, but a computer with an 8MB memory, 5GB storage, and a 281 trillion byte virtual address space is not a minicom-

puter. If by some definition it is, then most of the IBM 360, 370, 4300, and some of the 303X computers are also minicomputers.

DANIEL PETERSON

Data Processing Manager  
Conservative Baptist Foreign  
Mission Society  
Wheaton, Illinois

### WHIRLWIND MEMORIES

W. David Gardner's "The Computer Museum" (May, p. 238) was interesting but not completely accurate in one aspect.

I don't recall anyone ever referring to the AN/FSQ-7 as Whirlwind II. Whirlwind II was located in the Barta Building on the MIT campus and was the prototype for several U.S. Air Force systems that were designed and built by a number of contractors at Lincoln Laboratory. One could walk through the Whirlwind II computer since it consisted of floor-to-ceiling racks spaced apart by aisles, and the computer filled a large room. It was used in a research project known as "Cape Cod" to test the software being written for AN/FSQ-7 and 8.

The AN/FSQ-7 and 8 were advanced versions of the prototype that became operational at a number of Air Force bases. The name of the operational system was SAGE (Semi-Automatic Ground Environment), and one of them was installed at the NORAD Facility at North Bay, Ontario, Canada.

It is nearly 30 years since I sat at a console on Whirlwind II as a Rand Corp. representative and worked at Lincoln, but I can recall every important detail in those early days of man-machine research and development.

LEONARD C. SILVERN

President  
Systems Engineering Laboratories  
Sedona, Arizona

### THE BUCK STOPS HERE

I found Deborah Sojka's article "Passing the Education Buck" (On the Job, April, p. 259) very interesting. Its title explains what industry is doing when it says there aren't enough well-trained students entering today's job market in the fields of electronics and computer science. There are few students entering the job market because most companies refuse to let them enter. These companies do not want to spend the time or the energy to train people for the positions they want filled. They expect others (technical training schools, universities, and colleges) to do that for them, yet they complain that the students turned out are not properly trained. Instead of complaining about the situation, the companies should do something more constructive with their time and help. Education desperately needs their help financially, especially in the state of Illinois, where money going toward education is decreasing in amount as well as in importance. The University of Wisconsin, on the other hand, is very privileged to get

monetary contributions, faculty, and equipment from industry. Unfortunately, this very rarely happens.

But what of the students who have been trained in these fields, and yet corporations refuse to hire them? They are unemployed because these companies say they are not well trained (i.e., previous work experience is a prerequisite for most employment). Perhaps companies could take these students and train them in an intern program. It is obvious they are quite capable of learning (from having completed all their required courses) and could do quite well in the business world with a little on-the-job training. But many companies are promoting from within, denying these students the chance to join this growing field by receiving on-the-job experience.

The executives should stop their complaining and take these graduates and give them some short training so that they may be able to become fully trained professionals, which the companies state are in short supply. I am a graduate myself and have been trying to become a programmer in this field since my graduation last August. I have known many others in the same situation as I so I am qualified to say that there are plenty of qualified people for the companies to train. Finally, the companies must stop moaning, do something about their complaints, and stop passing the buck.

LINDA GRALOW

Melrose Park, Illinois

### COVER YOUR ASSETS

The excellent article by Willie Schatz, "Micro vs. Macro" (News in Perspective, April, p. 72), emphasizes companies' management responsibility for controlling the integration of personal computers into their companies. As inexorable as the tides, the coming waves of PCs will sweep management overboard if it is caught unprepared. Two of the most serious problems caused by the day-to-day business use of PCs, however, were not directly addressed in this article.

Information security and information recoverability are problems even in centralized dp organizations where management control is strongest. With the proliferation of PCs, these problems become geometrically more difficult. With weak or nonexistent standards and with incompatible hardware, data integrity suffers. The limitations of PCs and available software for them make proper audit trails and authentication/authorization protocols (almost taken for granted on large mainframes) difficult—often impossible—to obtain. Networking PCs opens a nightmare of privacy, defalcation, and human error problems that weak or absent data integrity will compound.

Hazardous as that is, it gets worse: users begin to depend on the PCs for day-to-day business operations. Lose the PC or its data and a part of the company becomes

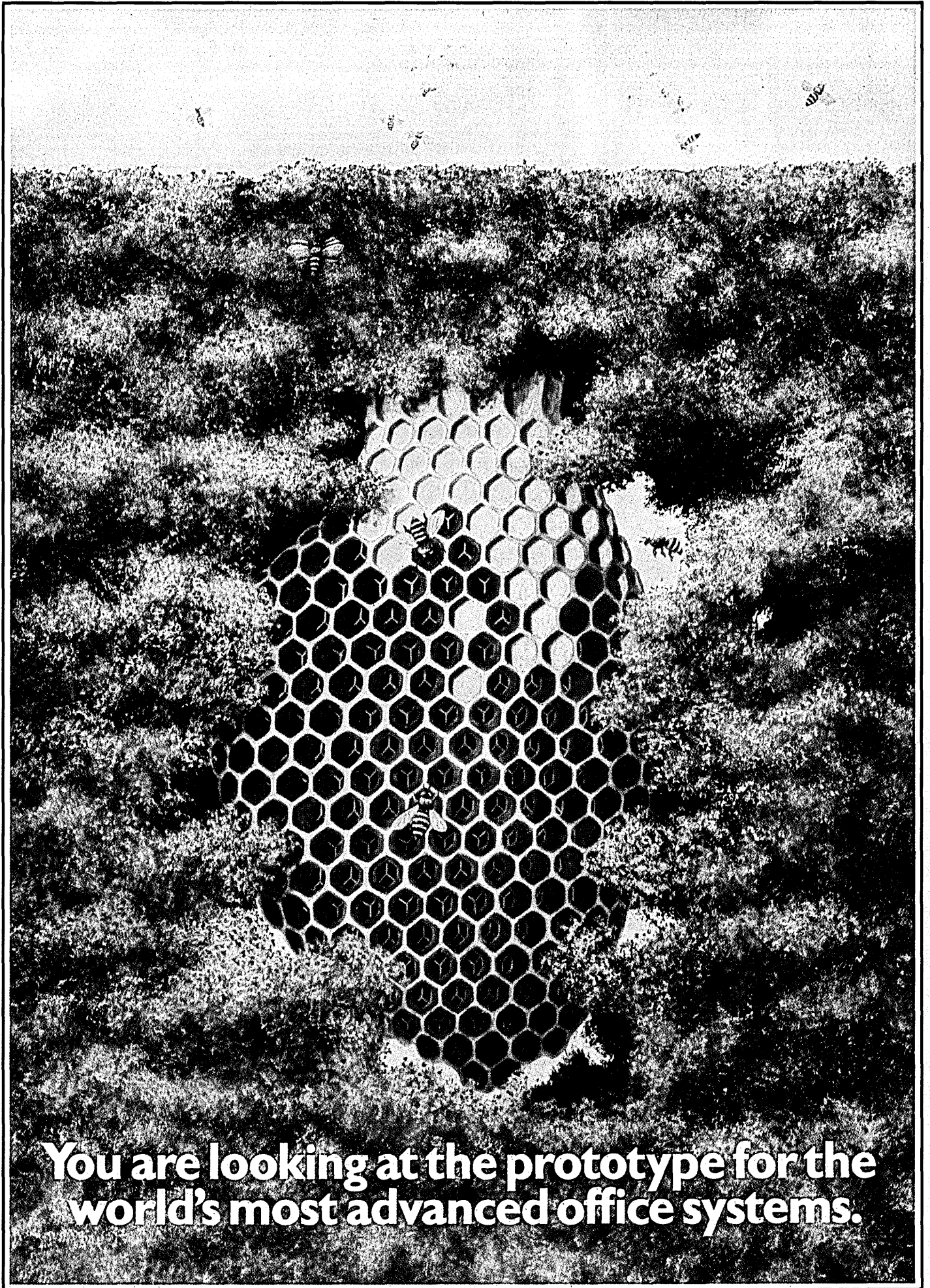

**You are looking at the prototype for the world's most advanced office systems.**

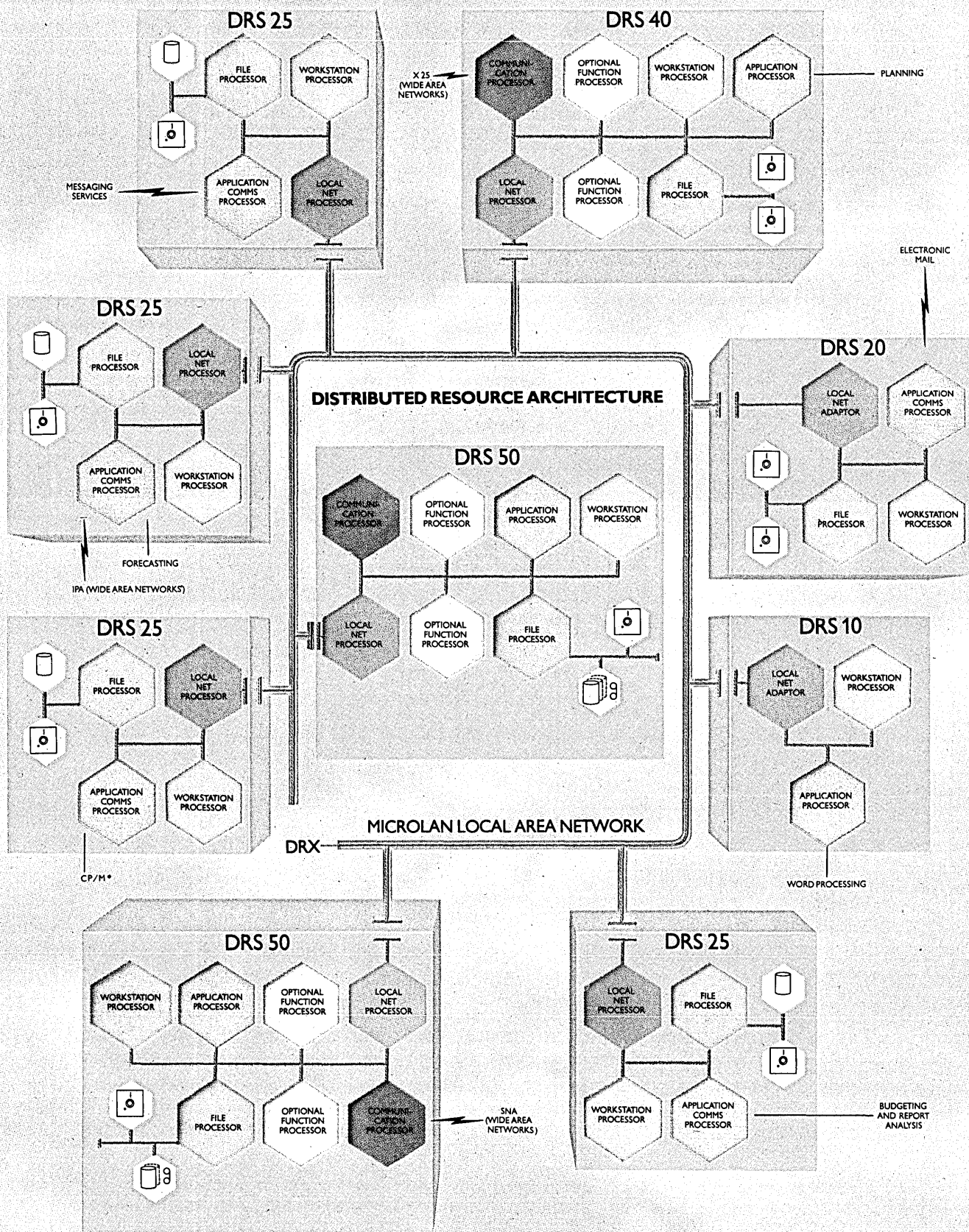

Faced with a company's information needs, there is one thing of which the systems designer can be sure.

They will change.

That is why ICL – Europe's leading computer company – has developed distributed office systems with an architecture flexible and expandable enough to handle new workloads or applications, scheduled or unscheduled.

At the heart of ICL's approach to office systems lies DRS – the Distributed Resource System. ICL recognises that the key to success of any office system is the optimum management of information. And this is a task for which DRS is uniquely qualified.

#### **A natural networking structure.**

The management of resources necessary to provide the controlled distribution of functions within the system is achieved by a unique architecture – DRA (Distributed Resource Architecture) – which delivers a wide range of services to workstations within a network of DRS systems.

DRA is a multi-microprocessor architecture. Each multi-function workstation in the DRS system contains a cluster of microprocessors, each dedicated to a specific function: filing, communication, workstation management, and application processing.

Distributed Resource Architecture is a natural networking structure. Not only does it handle multiple microprocessors within a single DRS node, it also allows multiple nodes, wherever they are located, to communicate via the MICROLAN local area network.

This means that files can be retrieved and processed from any workstation or server in the whole network, providing total flexibility of systems design and operations.

Flexibility is the keynote. The basic structure of DRA has been designed to accommodate a mixed microprocessor architecture which enables systems to be expanded and enhanced by the replacement/addition of microprocessors.

#### **The management of resources.**

By selective configuring of function processors, a range of DRS nodes can be

designed to provide a range of capabilities within a DRS network: intelligent multi-function workstations, data-base servers, electronic filing servers, communications controllers, and personal computing systems.

This inter-dependent network is managed by the Distributed Resource Executive (DRX), one of the first truly distributed operating systems.

This network management system enables all the resources of the network to be shared by all the nodes within the system.

A key feature of DRX is the ability to manage functions, independent of where they are physically located, within a node or between nodes within the network. So an application processor in one workstation can access files controlled by the file processor in another, elsewhere in the network, providing all the control and security necessary to manage the system.

#### **Planning for the future.**

Many industry standard languages are embraced by DRX, including Microfocus CIS COBOL, Microsoft Basic, and PASCAL.

Concurrent communication and wide area networking are facilitated by ICL's Information Processing Architecture (IPA), which supports the ISO model for open systems interconnection, IBM's Systems Network Architecture, and X25 packet switching services.

ICL's Distributed Resource System is already being used for a wide variety of applications in organisations which operate both locally and remotely networked intelligent workstations for distributed computing, personal computing, and terminal systems, utilising mixed data and word processing facilities.

The manner in which DRS builds entire intercommunicating networks from simple nodes and clusters may indeed be reminiscent of nature's oldest structural principles.

But seldom has architecture been designed with the future held so firmly in mind.

**We should be talking to each other.**

The ICL logo consists of the letters 'ICL' in a bold, sans-serif font. The letter 'I' is a simple vertical bar. The letter 'C' is a thick, rounded shape. The letter 'L' is a thick vertical bar with a small horizontal tick at the top left corner.

CIRCLE 17 ON READER CARD

FOR MORE INFORMATION, WRITE TO ICL INFOPOINT, ICL HOUSE, PUTNEY, LONDON SW15 1SW, GREAT BRITAIN.

## LETTERS

nonoperational. Since PCs are not treated with the same care as multimillion dollar mainframes and since the "operators" of PCs are not data processing professionals, failures through accident, negligence, or abuse are far more likely. Carefully documented recovery procedures are far less likely. And the absence of a system development process that would address recoverability, restart, and rerun procedures can cause painful, expensive outages.

Personal computers increase the need for strategic information resource management. Information is a valuable resource. Proper care must be exercised to ensure that, regardless of the form in which it is found or the processing through which it goes, the information remains protectable, recoverable, and auditable.

RALPH SPENCER POORE  
Director, Advanced Technology  
Total Assets Protection Inc.  
Arlington, Texas

### CREDIT WHERE IT'S DUE

In the May issue, "The Cpu Market: A

Survey" (In Focus, p. 40) included a chart (Fig. 5) entitled "Expanding Amdahl Share of Pcm Systems User Population." That chart shows the Amdahl population share as having grown from 52% to 60% in the past year, with the National Advanced Systems share shrinking from 18% to 15%.

These figures are, I'm sure, as much a surprise to Amdahl as they are to us and to our customers, particularly since not only has our share *not* declined over the past year, it was not smaller than that of Amdahl to begin with (in the time frames surveyed)! Indeed, for at least the past two years, our installed base has exceeded that of Amdahl (DATAMATION portrays it as one fourth Amdahl's) in both total count and percentage gain. Nor is my claim hearsay; twice in the past year I've shared the dais at various conventions with executives of Amdahl. Each of our presentations included slides covering installed, and our base was always at least 100 greater than Amdahl's.

It's easy to forget that NAS is the only pcm offering a full spectrum of cpus, spanning the 4341 to the 3084 in perfor-

mance, and numbering 12 as of this writing. This philosophy makes NAS far less subject to the vagaries of the marketplace and its effect on limited-line vendors. And, it has made us for over two years now the owner of the largest pcm systems installed base in the world, a fact that is stunning by its omission from the knowledge of the writer of the article.

We're justifiably proud of the achievement and ask only that credit be given where due.

DAVID P. GOLDSMITH  
Vice President, Communications  
National Advanced Systems  
Mountain View, California

### WE WANT COSMOS!

Congratulations for an excellent editorial, "The Data Processing Center at the End of the Universe" (April, p. 29). It could be the seed for another *Cosmos* series.

With regard to the convergence of functions (office automation, telecommunications, and data processing) with the dispersion of power to the user community, the information center concept does not add complexity to the situation—it is the answer. Most users are not trained to plan and control any of these technological functions properly, let alone three. These functions should not be dispersed without central guidelines in place.

ANDRÉ LAMONTAGNE  
Ottawa, Ontario

### A SCAM INDEED!

As a corporate microcomputer user, I was sorry to see in your editorial, "Are Micros A Macro Scam?" (May, p. 37), that some members of your editorial advisory board still cannot talk about micros without speaking "vehemently." MIS managers need to put their fear, panic, and anger aside and start rationally evaluating micros and their advantages to the user.

As for "using our micros for paperweights," your advisor might be interested to know that we use a wide variety of programs on our PCs. Some of these are quite complex programs that we have written. Other programs include DBMSs, graphics, word processing (including spelling and grammar checking), income tax preparation, and, yes, even electronic spreadsheets.

We use telecommunications software to get financial information about other companies from Dow Jones, to do financial modeling on CompuServe, to get credit reports from D&B, to send telexes via ITT, and to get financial data from our banks.

If your advisor thinks that a tool that saves time and money is "a fad, a new and interesting entertainment that will fade away as quickly as it arrived," he is seriously deluding himself and your readers.

NELSON FORD  
Houston, Texas

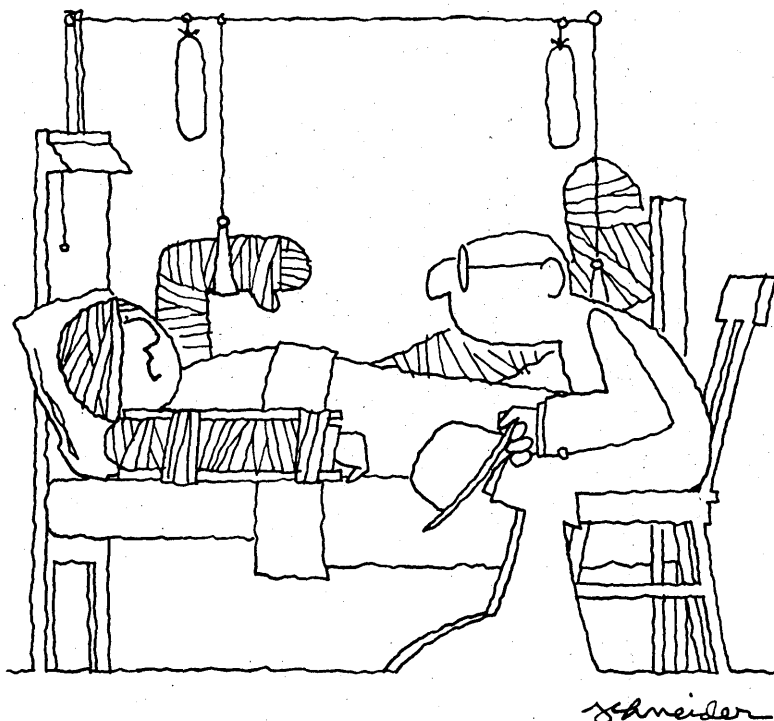

"The auto accident was minor, but the other driver took umbrage at my bumper sticker."

CARTOON BY JACK SCHNEIDER

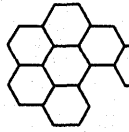

# Building On Naturally Superior Architecture.

## *The Cellular Perspective.*

*Over the past fourteen years, Beehive has gained a unique point of view on terminal systems. By focusing all our efforts on that all-important window into your system. By delivering technology to thousands of terminal users throughout the U.S. and over 40 nations abroad. By creating design classics, then improving upon them.*

*The result brings a new era in Terminal/System design. Elegant in simplicity. Meticulous in construction.*

*Currently, Beehive is shipping the most advanced terminals in the industry, including emulators for IBM and Burroughs. In addition, we continue to advance the state-of-the-art with new developments in microprocessor computing systems.*

*Share our viewpoint and make Beehive the architect of your success.*

*For more information, contact:*

*Beehive International,  
4910 Amelia Earhart Drive,  
Salt Lake City, Utah 84125*

*Toll Free Number:  
1-800-453-9454*

**The Terminal/System  
Architects**



**BEEHIVE**<sup>TM</sup>

# The true victims of office automation won't be the people who lose their jobs.

But, the system also may keep their jobs but lose them to a more efficient machine.

Office automation is the alternative. One has mastered it, you'll be a single step away from being the first to be replaced.

It's not just the computer that's the problem. It's the people who are using it. They're not just people who are using it. They're people who are using it to do a job that's not theirs to do.

It's not just the computer that's the problem. It's the people who are using it. They're not just people who are using it. They're people who are using it to do a job that's not theirs to do.

mastered. With it you can tie together everything. Your entire information base. Your proliferating PCs. Your heretofore incompatible machines. And you can even do it, on a system that you own.

It's mastered by the people who are using it. It's mastered by the people who are using it. It's mastered by the people who are using it. It's mastered by the people who are using it. It's mastered by the people who are using it.

It's mastered by the people who are using it. It's mastered by the people who are using it. It's mastered by the people who are using it. It's mastered by the people who are using it. It's mastered by the people who are using it.



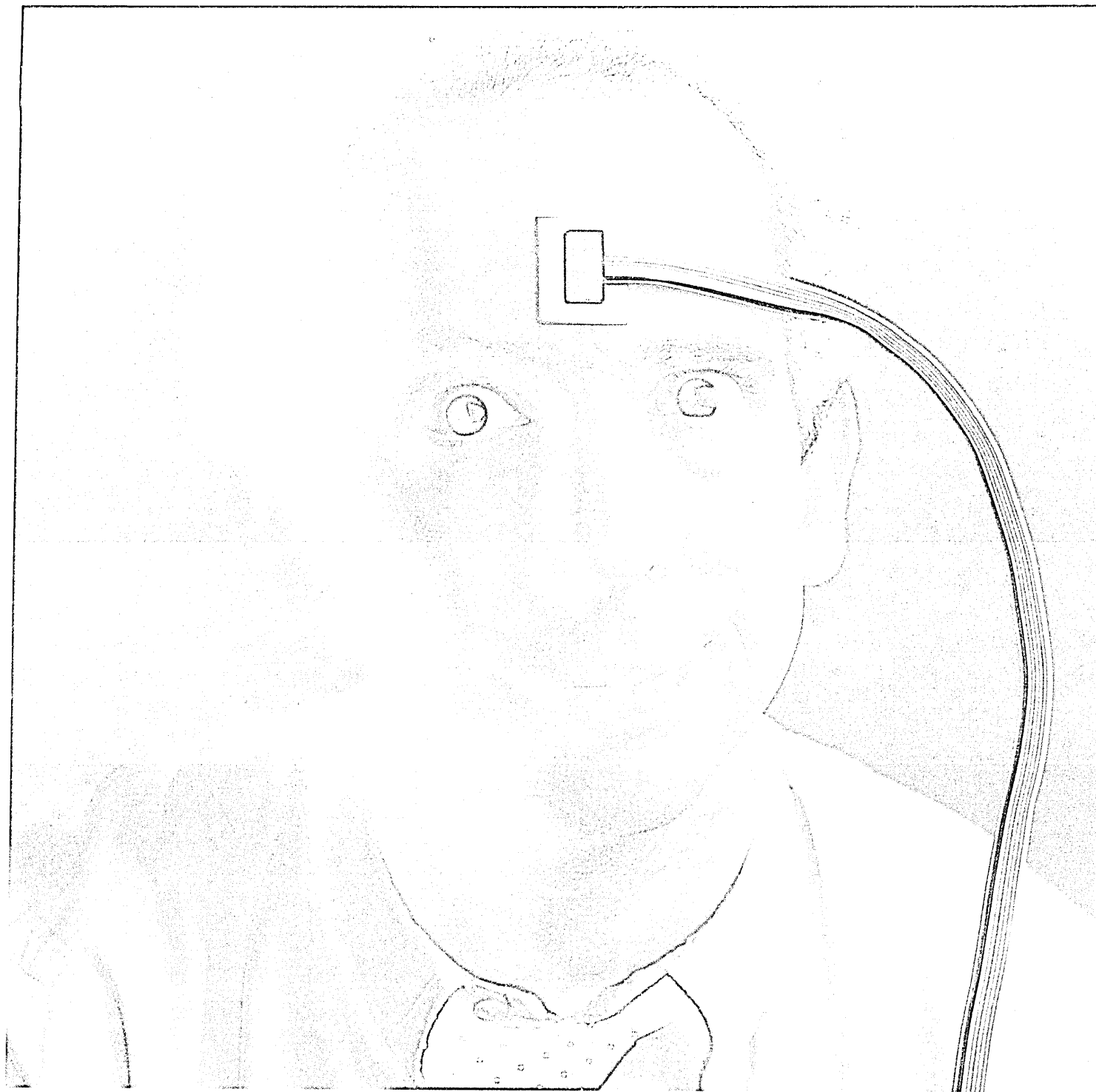

you how to use itself.

The day of the automated telephone, with its bewildering array of unuseable features, is over. With the Personal Teleterminal, dialing up a conversation between two computers is as easy as getting your voice messages and electronic mail. Which is as easy as calling home.

And you can use its RS-232 port to attach a printer, a terminal, or even a personal computer—if you still need one.

Automation saw people as imperfect machines whose jobs could be better done by machines of plastic and silicon. But Office Humanation sees people as a resource to nurture, as an investment whose growth can compound dramatically over time, given the proper leverage.

And the products of Office Humanation are designed to provide that leverage. Because a job worth keeping is a job worth keeping human.

## The Office Humanation Company. CXC

CXC Corporation, 2852 Alton, Irvine, CA 92714 (714) 760-7171. Personal Teleterminal,<sup>™</sup> Office Humanation,<sup>™</sup> Office Humanation Company<sup>™</sup> and Rose<sup>™</sup> are registered trademarks of CXC Corporation.

**CIRCLE 4 ON READER CARD**

History will record as a profound irony  
that the most powerful word processing package  
ever created for the IBM® Personal Computer  
wasn't created by IBM.

## **LEADING EDGE.®**

Leading Edge Products Inc., Fortune 1300 Division, 21 Highland Circle, Needham Heights, Mass. 02194 (800) 343-3436 (617) 449-6762  
Headquarters and Retail Division, 225 Turnpike Street, Canton, Mass. 02021 (800) 343-6833 (617) 828-8150

\*IBM is a registered trademark of International Business Machines Corporation.

**CIRCLE 20 ON READER CARD**

# EDITORIAL



## MELON AND THE CORPORATE IMAGE

When our longtime friend Persiflage Melon walked into our office one recent midsummer day, we knew at once something was amiss.

Melon, a successful management consultant and noted amateur herpetologist, had called earlier, saying he wished to discuss "a personal transformation." Now he stood before us, his forehead glistening with a light sheen of perspiration, his normally magnificent mustache somehow subdued. But it was a moment before we noticed the most striking change in his appearance.

Melon is normally given to somewhat colorful and eccentric dress. Yet here he was, his angular frame supporting a dark blue suit, a white button-down shirt, tasteful rep tie, and most amazing of all, on his feet, heavy wing-tipped cordovan shoes. He looked decidedly uncomfortable.

Melon, we said, what's going on? Why are you dressed just like . . .

"An IBM salesman?" Melon finished for us. "Yes, it's my new image. I have seen the future and this is it," he said, picking a microscopic piece of lint off his lapel.

Alright, Melon, explain yourself, we demanded.

"As you know, I have been for some time an interested observer of your madcap industry," he replied. "I pride myself on being able to see the big picture, the grand and sweeping vista; to be able, in short, to read the handwriting on the wall. What's written there is three large letters—IBM.

"How, you might ask, did I arrive at this conclusion?" he continued.

Tell us, we said, knowing that nothing short of a grand mal seizure could stop him now.

"Well," he said, shooting his cuffs, "I did some research. It seems that all of IBM's competitors making input/output devices, magnetic storage

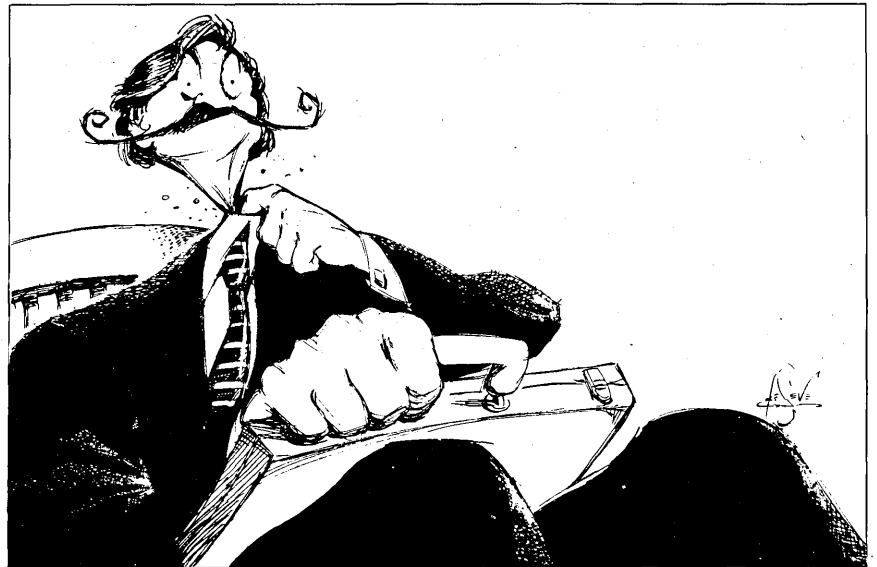

boxes, printers, memories, terminals, etc. have accepted IBM standards. The mainframe companies, once called the Seven Dwarfs, have been pared down to the BUNCH, and all of them are looking for either IBM compatibility or niches to hide in. The IBM personal computer is the runaway winner in the corporate marketplace. When it comes to software, every young scribe plugging away at his coding sheets, and the big software companies, as well, are writing to the IBM marketplace.

"When it comes to communications," he continued, "the picture is even more convincing. All the new communications processors, front ends and CBXs are adopting SNA and those companies with different architectures are building SNA interfaces. Terminals all have to look like 3780s . . . and so it goes."

So that's why the new image, we said.

"Right . . . the clean-cut corporate look for me," Melon responded, tugging at his collar. "Although," he mused, "I must admit I do feel a bit

constricted. And concerned. Suppose, by accepting IBM standards, your industry has taken a wrong turn and is painting itself into a technological corner? And isn't it true that the overwhelming presence of one company tends to stifle true innovation?

"But yours is a young and vigorous industry," he said, brightening perceptibly. "Plus, all this Japanese-inspired talk about a fifth generation may lead to something new and different. So, I'm keeping my options open."

With that, he opened his rather large Land's End briefcase and began heaping changes of clothing on our desk. There was a Silicon Valley Frisbee All-Stars T-shirt, an engineer's white short-sleeved shirt complete with clip-on tie and nerd pack, an academic's nubby gray tweed jacket that reeked of pipe smoke and artificial intelligence, and last, but certainly not least, a billowing kimono and a pair of wooden sandals.

"Ever onward," said Melon, and made for the door. \*

NETWORKING VS. NOTWORKING:

# ANNOUNCING THE NET RESULTS.

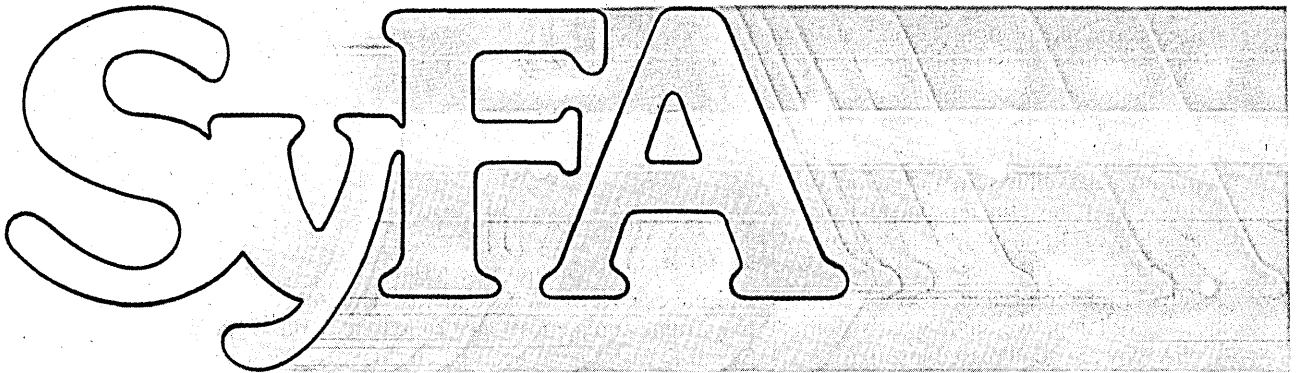
The logo for SyFEA is presented in a stylized, outlined font. The letters 'S', 'y', 'F', 'E', and 'A' are interconnected. The 'S' is a large, flowing cursive letter. The 'y' is a smaller, lowercase cursive letter. The 'F', 'E', and 'A' are uppercase letters in a bold, blocky font. The entire logo is set against a background of a grid pattern, which is partially obscured by the letters. The logo is contained within a rectangular frame.

SyFAnet. The fully integrated system that answers your business needs today. Only from ComputerAutomation.

Multi-function workstations, resource and database sharing, global information access and expansion capabilities are among SyFAnet's major advanced features.

The net result?

A network that works. Perfectly. We built SyFAnet on a proven

reliability. Even if one processor goes down, the others keep the system up.

We chose a broadband system to give you more channels and more available frequencies. So expansion is easy. Add more terminals whenever and wherever you want. And with each

terminal, you get more power.

You can start small and expand without undermining your investment *and* you can even attach the most popular personal computers. SNA and X.25 capabilities

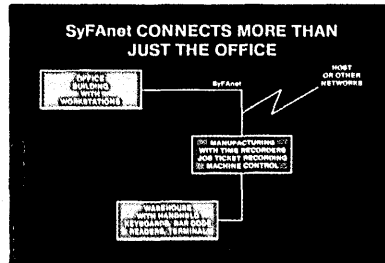

# SyFAnet

foundation of hardware and software using SyFA, our interactive, distributed data processing system with network control.

We added microprocessor-based workstations and CP/M-86® to give you more functionality.

We divided the workload of one CPU among several processors, to give you greater performance and

let you reach any mainframe. And SyFAnet's bridge and gateway processors provide transparent access to other networks anywhere in the world.

SyFAnet—designed to solve your networking problems today, tomorrow and into the foreseeable future.

For more information, please write today.

 **ComputerAutomation**  
Commercial Systems Division

2181 Dupont Drive/Irvine, CA 92713 / 714-833-8830  
TWX: 910-595-2543 / TLX: 4722105

CP/M-86® is a registered trademark of DIGITAL RESEARCH, INC.

# INFOCUS

## BREAKING UP IS HARD TO DO

**AT&T's local operating companies are going, and Archie McGill's already gone. Where does that leave the customers?**

by Laton McCartney

A Wall Street analyst was on his way out to Morristown, N.J., in early June to interview Archie J. McGill when he got a call from McGill's office. In a shaky voice, McGill's secretary told him the interview had been canceled. She didn't offer a reason or propose a meeting at a later date.

She didn't really have to; the explanation was in all the newspapers the next day. McGill, president of American Bell's Advanced Information Systems division and the man most emblematic of the new, stripped-down, post-consent-decree AT&T, wasn't going to be working there anymore. For the past few months the analyst had been hearing more than the usual quota of AT&T rumors, many of them disquieting to customers and stockholders alike. Now he'd learned that the AT&T executive whose job it was to reach out and touch business customers was gone, and the immediate question was why.

What were the reasons behind McGill's abrupt departure, and what effects would his resignation and the ensuing reshuffling have on AT&T customers?

For answers one has to track McGill's career as well as related developments at AT&T. The biggest company in the world is, of course, currently in the midst of divestiture, spinning off its 22 wholly owned operating companies and undertaking a traumatic reconfiguration of its core. In conjunction with divestiture, the company launched one of the most ambitious ventures ever attempted, a \$6 billion startup dubbed American Bell Inc.\* Some 74,000 employees drawn from the various operating companies and divisions of Ma Bell were slated to move over to the new enterprise. All new customer premise equipment (including PBXs, data terminals, and key systems) was to be sold through ABI's two divisions—Customer Products, which would handle consumer sales, and Advanced Information Systems, which was responsible for all government and business sales.

\*U.S. District Court Judge Harold Greene has subsequently ruled that AT&T must relinquish all future use of the Bell name, so American Bell will probably be renamed.

Clearly, AIS was the key to AT&T's success in the deregulated market that the consent decree had opened up; it was AT&T's vehicle for challenging IBM and the rest of the computer and communications vendors in head-on competition. And McGill was its principal architect.

But by early June the prognosis for the new company was far from encouraging. Wall Street was abuzz with stories of huge ABI cost overruns, major shortfalls in revenues, significant product problems, and possible losses for the new company of as much as \$1.5 billion in 1983. The situation was deteriorating rapidly, but few outside AT&T knew just how rapidly until the June 8 announcement that McGill had resigned as part of an ABI shakeup.

McGill signed on with AT&T in 1973, a time when there was no real marketing expertise anywhere in the corporation. True, the operating companies had had sales forces in place since the early 1960s. But, as former Bell System sales account executive John Malone, now president of Eastern Management Co. in Morris Plains, N.J., notes, "The sales force had no real competition nor incentive to be any more a sales force than that of a water or electric company." Ma Bell was functioning as a utility, an order taker, but even then the company's senior management under chairman of the board John D. deButts sensed that changes were necessary. As a result, AT&T brought in McKinsey & Co., the New York-based management consulting company, to help map out a strategy for the future.

With digital communications looming ever larger on the horizon, McKinsey recognized that AT&T was facing some

**As befits a cage rattler, McGill's approach was direct, often abrasive, and ascerbic.**

highly attractive opportunities to expand its traditional analog market. But before it could capitalize on these opportunities, AT&T had to initiate a number of internal changes. Chief among them was the need to put a marketing staff in place that could provide centralized direction and coordination among the various operating companies. Marketing talent was also needed to gauge new applications for digital or computer-based products such as switching systems, modems, PBXs, and the like and initiate the development of these products. McKinsey recommended AT&T hire a former IBM whiz kid to join General Departments, the holding company that runs the communications behemoth and is often referred to as the "think tank of the Bell System." Archie McGill's charter was to head up the newly formed market management organization, the group within General Departments that would determine what new products should be developed and which



## IN FOCUS

new applications represented the biggest potential payoffs.

McGill had been on a fast track since his career began. He had risen to become the youngest group vice president in IBM history, then left to set up his own consulting outfit. At AT&T his rapid ascent continued, despite the conservative, bureaucratic nature of the organization. His small market management group quickly expanded to 400 employees, many of them former colleagues McGill had brought in from IBM. He had been reporting to executive vice president-marketing Kenneth J. Whalen, but once he had the vehicle for product development in place, McGill was promoted to vice president of marketing for the entire AT&T organization (Whalen moved into another area within AT&T) and soon had a 1,000-person organization reporting to him.

But McGill hadn't simply been brought into AT&T to set up and run a marketing organization. "When McGill was hired on, the highest levels of AT&T management had decided they not only required someone with a clear-cut understanding of what was needed to establish an effective marketing effort, but also someone who could function as a catalyst for the whole organization," Malone notes. "They weren't looking for operations management. The company was top heavy with operations management. They wanted someone who could bring about change."

"McGill was cut from the same cloth as T. Vincent Learson [a senior IBM executive who was noted for his tough management approach]," adds John Connell of Office Technology Research Group, Pasadena, Calif. "He rattled a lot of cages at AT&T, but that's what was needed, and that's what he was brought in for."

As befits a cage rattler, McGill's approach was direct, often abrasive, and acerbic, AT&Ters report. In no uncertain terms he told the operating companies their marketing organizations must mirror the organization he was building—despite the fact that, technically at least, the people in the operating companies didn't report to McGill.

Nor was he hesitant to criticize a fellow executive. Says Malone, "He was an imposing figure, and if he believed, for example, that an operating company didn't know how to market or had a sales force that stank, he'd have no problem telling the president of the company exactly how he felt."

To old-time AT&Ters, McGill seemed to evince a disdain for the traditional, analog-oriented AT&T organization and its slow, conservative ways of doing things. Even AT&T customers didn't escape unscathed. At an International Communications Association meeting in the late 1970s, he told the audience—communications managers from the 500 largest communica-

tions users in the U.S.—that they were, in effect, out of date, their careers wedded to a passé voice technology that was rapidly being supplanted by digital communications. Henceforth, his marketing people would bypass these relics and go directly to the decision makers, senior management to whom the communications people reported. "He made it extremely clear that he thought dealing with us was nothing but a complete waste of time," an ICA member who was present says.

When the consent decree was issued in 1982, it was no doubt greeted with jubilation in McGill's camp. The man who had been placing depth charges throughout his AT&T career was witnessing the ultimate corporate depth charge in the form of divestiture. The old regulated Bell world had been shattered by the Justice suit, and AT&T would have to transform itself into a fighting machine.

The principal vehicle for attack, of course, was to be American Bell, which was launched with great fanfare June 15, 1982. AT&T chairman Charles L. Brown cited the event as "a major moment in the history of our business." McGill was equally ebullient, speaking of an opportunity to advance "our business . . . toward

### **"ABI vastly underestimated what was required in developing the kind of product like Net 100."**

new vistas" and touting ABI's first offering, AIS/Net 1, a data network product that Bell insiders say was McGill's brainchild—one that had previously been called ACS and Bell Data Network. Net 1, McGill proclaimed, would be the cornerstone of ABI's new generation of services.

Unfortunately for ABI, these projections soon lost their rosy hue. Although, according to sources close to the company, AT&T had been anticipating divestiture and the launching of an ABI-like entity for as long as five years, the breakup seemed to create many more problems than had been expected. "AT&T did a good job on selling the positive possibilities of the breakup until last January when things seemed to really fall apart," says Anthony O. Penna, chairman of the ICA vendor liaison committee and a telecommunications executive with Beneficial Data Processing, Peapack, N.J. "Until then, most of the people I talked to believed the transition was going to be far easier than it turned out to be."

"An enormous amount of confusion sprang up," adds Bruce W. Hasenyager, Kidder Peabody & Co.'s director of information systems. Indeed, in the wake of the consent decree, confusion seemed the order of the day. Multibillion dollar companies that had done business with AT&T for years were suddenly asked for credit references before being permitted to buy a

\$1,000 modem, while certain types of equipment such as loudspeakers or "holler downs" used on Wall Street became impossible to order. Customers and even many AT&Ters weren't sure which entity in the company would be doing what. AT&T sent out mountains of memos and pamphlets explaining how employees would be able to transfer to new groups within the organization and detailing what would happen to pension plans and seniority. The more the company tried to clarify the issues, however, the murkier they seemed to get, employees say.

Consider the following excerpt from a May 4, 1983 memo that went out to AT&T financial executives regarding the conversion of billing records, and you'll understand why AT&T was experiencing post-consent headaches:

"The transfer of billing records in 1983-1985 will require cooperation and coordination between the BOCs, AT&T, and ABI. The Consumer Products Division (CPD) will be faced with the conversion of large volumes of noncomplex accounts. The Advanced Information Systems (AIS) Division will convert complex accounts.

"While the schedule reflects the extract encompassing only a one-month period in each company, operations needs may require this extract period to span a two- or three-month period. The need for such a spread of the extract will be determined based on the operating impact of the early conversions. For example, if a high volume of customer calls ensues from these early conversions, then later extracts must be spread over a longer time frame to allow the business office entities to properly handle these calls. Steps are already being taken to minimize the total impact of the records conversion on the business offices by planning a phase-in of support systems prior to the extract. However, a flexible approach to extract timing is required to address potential customer reaction."

Even if the AIS and CPD divisions did master "a flexible approach to extract timing," they still were faced with a formidable problem. The company with perhaps the greatest R&D resources in the world came up with an order entry system that flat out didn't work, AT&Ters assert. As a result, ABI faced serious delays in converting customer records.

At the same time ABI was experiencing major problems with some of its products. Insiders say McGill had difficulty getting the company's manufacturing and R&D operations to respond as quickly to ABI's product needs as he'd hoped. "AT&T's R&D was not structured to be responsive to a competitive market," explains Steven G. Chrust, director of technical research for Sanford C. Bernstein & Co. Inc., New York. "The idea had always been not to obsolete the customer base, to come out



# The height of productivity.



Is your company paying the high price of reduced productivity because your computer systems don't fit the people who use them?

At Nixdorf, we go to great pains to eliminate the problems that can result from inflexible systems—problems like eye strain, neck strain, backaches and headaches.

In fact, the comfort of the people who will use our equipment is as important as any other consideration in the design process. Human engineering isn't just a buzzword with us. It's a way of life. And when you look, the advantages are obvious.

Since people can't change their height, Nixdorf makes workstations, desks and chairs that change theirs. To minimize eye strain, years of development went into the micro-mesh filter that cuts reflection and glare in our adjustable display screen.

We also developed flicker-free numbers and letters, displayed in an optimum size, shape and color. And a movable, low-profile keyboard with rounded keys that help the

human fingertip glide more quickly from A to Z, and provide reassuring feedback to the user.

All of which means a more comfortable, confident and productive relationship between people and systems.

For 31 years, Nixdorf has been providing solutions for the information processing needs of all kinds of businesses. And today, we're a successful international company with 16,000 people and over 110,000 computer systems installed around the world.

So when you choose Nixdorf, you have a rare opportunity to make everyone happy. The people who buy the computer system, and the people who use it.

Nixdorf Computer Corporation,  
300 Third Avenue, Waltham, MA 02154

**NIXDORF**  
**COMPUTER**

# "What can Lanier add to my office automation program that I don't already have?"

**Complete control. Over your entire office automation program. Lanier will work with you to develop and implement a master plan for all the applications you need. Nationwide. We'll fit into your current plan for office automation, since we're committed to designing our equipment to be SNA compatible. (If you don't have a plan, we'll help you develop one.) Then we'll go one step further—we'll work with you to sell the program to your company.**

**"How will you help me get control?"**

**"Consistent implementation. Typically, office automation is introduced in a fragmented way. Various offices use equipment differently, unnecessarily reinventing applications. Data communications standards are ignored. Equipment which isn't compatible is installed. And you're left with managing and supporting a wide variety of incompatible devices. Lanier gives you control over all this. By developing uniform policies and making sure they're standardized throughout your company."**

**"Can Lanier actually help promote my program?"**

**"Absolutely. Your Corporate Account Team is applications trained. They know how offices move information. With this clear understanding, they'll help conduct an 'Internal Feasibility Study' to cost justify and configure your Lanier systems. Then 'Executive Orientation' seminars will be scheduled. To explain the bottom line value and benefits of your program to your key people—in plain English."**

**"What else is crucial for the success of my program?"**

**"Timing. You have to be able to get standardized applications to users promptly. That's why we've developed the National Applications Registry. A customized, confidential file of your applications maintained and documented by Lanier. Through the Registry, branch users receive applications and your forms—on disc—along with solid documentation in the Branch Launch Kit."**

**"Can you support my program anywhere we have a branch?"**

**"Anywhere. Lanier has over 300 sales, support and service offices in the U.S. alone. Lanier representatives will assist your line**

**managers and operators in understanding and using your equipment. Assistance through presentations, meetings and individual review sessions. So your systems are productive right away. And your office automation program stays on schedule."**

**Lanier offers a solution to give you control over your total office automation program. A kind of "electronic teamwork." It gives you comprehensive, uniform documentation at your fingertips. It gives you freedom from support worries. It gives you consistency for your long term plans throughout your entire organization. And it's backed by a national account team to sell your program for you. We'll work with you. Wherever you need us. Now and into the future.**

**Send us this coupon, or call Jennifer Scott at (800) 241-1706 for more information about Lanier's electronic office systems. Except in Alaska and Hawaii. In Georgia, call collect: (404) 321-1244.**

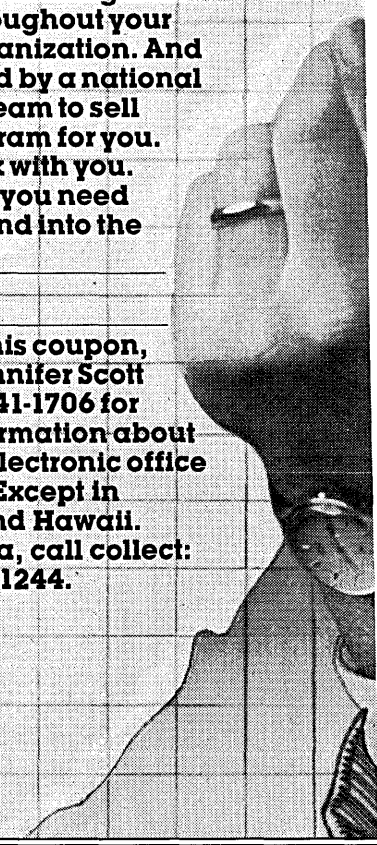

**"Control."** *Reg Parker, Director, National Accounts Marketing,  
Electronic Office Systems Division*

**Send to: Lanier Business Products, Inc.**  
**1700 Chantilly Drive N.E.**  
**Atlanta, GA 30324**  
**Attn: Jennifer Scott**

Name	
Title	
Phone	Best time to call
Firm	
Address	County
City	State
August '83 Datamation 4A4HH3	
Zip	

*We'll change your mind about the future.  
Right here and now.*

**LANIER®**

Let Lanier change your mind about the future. Right here and now. Circle 23.

## IN FOCUS

with a new product that the customers could migrate to gradually and not something so different it would have a significant impact." When R&D was suddenly called upon to produce something dramatically different, it couldn't deliver, Chrust maintains.

The System 85 voice/data PBX was late to market and isn't state of the art, a well-regarded industry consultant asserts. Unlike PBXs offered by several of American Bell's competitors, larger models tend to block at a relatively low level of use. American Bell has said that in the future it will offer a 100% nonblocking option for customized systems of up to 4,000 lines, but for now a customer's only alternative to the blocking switch is to pay 5% more for a configuration dubbed "essentially non-blocking," or ENB.

And ABI's "cornerstone" has presented even graver concerns. At a press conference announcing the product, Sal Barbera, one of ABI's top executives at the time, was asked by a reporter how ABI could come out with a product named Net 1 when Ungermann-Bass already had a Net 1 on the market. Barbera looked momentarily confused and then asked, "What's an Ungermann-Bass?"

Subsequently, ABI changed the name to Net 1000, but that didn't seem to help. "I think ABI vastly underestimated what was required in developing this kind of product," adds John Connell. "The software problems were enormous" (see "T-Net Twins Tested," April, p. 139).

To date ABI has installed Net 1000s at Dow Jones, Western Electric, Pacific Telephone, and TransAmerica Corp. Pacific is reportedly ready to throw out the system because it isn't working properly and TransAmerica hasn't paid for its system yet for the same reason. Some industry analysts are speculating that Net 1000 will soon be taken off the market. At a June 29 press conference, however, Frank Vigilante, ABI's president of product development, said the company is "on plan" with Net 1000, and called the product "vitaly important." He said Net 1000 has "about two dozen" customers.

ABI's problems extended to other areas as well. McGill's strategy of circumventing the telecommunications manager—described as "end run" marketing by Harry Newton, president of the Telecom Library in New York—alienated a number of long-term Bell customers. "The salespeople came on with an arrogance they hadn't earned," says Kidder's Bruce Hasenyager. "Archie's guys thought they could ignore the telecom people and go over their heads, but the policy really backfired on them. The top executives they were trying to sell to don't get excited about communications. They think of communications as being like tires. You have to have them, but you don't concern yourself with them unless they

don't work. And no ceo I know wants to go up against a telecom manager and challenge him on a technical basis."

Despite the widespread criticism leveled at McGill's policy, "Archie's guys" seemed remarkably insensitive to the hostility it engendered. An ICA member tells of an incident at the ICA meeting in Los Angeles this spring. "ABI held a special closed door session for its customers, and they were apparently ready for the first question about the end run policy," he recounts. "As soon as it was asked, the ABI people came out with a Mickey Mouse telephone to present to the guy who'd raised the question. The significance was that he'd asked a Mickey Mouse question, and this annoyed a lot of people even though it got a few laughs."

So serious was the issue of McGill's approach that some 80% of ICA members attending the L.A. session indicated in a poll that it remained one of their most serious concerns.

There is no way to gauge the full extent of the backlash against this policy, but unquestionably it has been significant. Robert L. Patrick, a West Coast dp consultant, tells of one client who was trying to choose between ABI and Northern Telcom after listening to sales presentations by rep-

### **McGill's departure was inevitable, but it was hastened by ABI's problems and the unforeseen tremors set off by divestiture.**

representatives of both firms. Before he was able to make up his mind, someone from AT&T took the client's boss out on the golf course, and the message was subsequently relayed down to give the AT&T salesperson a second hearing. "I listened to his pitch again," the client told Patrick angrily. "But I processed a week's worth of mail while he was making it, and then signed with Northern Telcom."

A further obstacle to ABI's success was the fact that its prime architect was viewed as an outsider by much of the AT&T community. "I summer in Maine," notes Harry Edelson, an analyst with First Boston Corp., "and if you weren't born there, the natives consider you an outsider even if you moved there as a baby. That's the way AT&T is. If you didn't begin your career there, you're seen as an intruder. McGill has been there 10 years and he was still considered the new kid on the block."

Moreover, during those 10 years, McGill had made a number of enemies. Not among the people who worked for him—they generally seemed to hold him in high regard—but among the other entities, particularly the operating companies. "A lot of the operating people felt he'd stepped on their toes by telling them to do things in a certain way," Malone of Eastern Manage-

ment says. "As a result McGill was not the most popular person ever to work at AT&T."

"The operating companies were really looking for a chance to stick it to McGill," adds a communications consultant.

At best, many of the operating people seemed reluctant to move in the direction McGill was trying to steer them. "Bringing in McGill was like grafting the head of a racehorse on to the body of a donkey," the consultant continues. "The head says 'go, go, go,' and the body says 'hell no, I'm not budging.'" At worst they were highly resentful of McGill and his new enterprise.

Divestiture provided the operating companies with the opportunity to "stick it" to McGill and ABI. "The animosity toward McGill surfaced once the consent decree was signed," Hasenyager says. Technically, the operating companies couldn't compete with ABI until after Jan. 1, 1984, when they would officially be cut free of the AT&T system. But in reality they became competitive with the decree, and customers report that the operating companies often refused to coordinate services with ABI representatives and were sometimes reluctant to provide even bread-and-butter products like local loops to customers who had opted to go with ABI.

In addition, McGill had set up Business Service Centers to deal with business customers' needs. Operating companies were instructed to refer inquiries they received from these customers to the centers, but many refused, a source close to AT&T asserts, and instead offered to service the customers themselves with embedded base products.

One such product was the Centrex 101 CU Switching system that AT&T had taken off the market—at McGill's insistence AT&Ters say—several years ago. Suddenly, after the consent decree operating companies were offering enhanced Centrex systems, and telling customers who were reluctant to buy that they would be charged for the existing wiring in their facilities if they failed to sign on the dotted line, a source asserts.

Ultimately McGill's demise, however, probably had more to do with Western Electric than it did with the operating companies. As committed as AT&T was to getting ABI off the ground, it had to keep revenues up and stockholders happy as a number one priority. Its manufacturing arm, Western Electric, had generated close to \$13 billion last year in selling to a captive market, but now because of divestiture that market was free to buy from whomever it saw fit. "What happened at Western Electric had a direct bearing on why McGill left," says Malone. "Western was clearly on the threshold of some fairly hard times. With the loss of its captive market the po-

# The Economics of Ergonomics.

(Or some valuable input on how to increase your output.)

There is no such thing as the average person.

Yet if you look at the typical data processing department today, you'll find it filled with furniture designed with that average individual in mind.

As a result, people of all shapes and sizes may spend entire careers working at a desk or sitting in a chair made for a statistic.

No wonder people are nowhere near as comfortable or productive as they could be.

That's where ergonomics comes in.

Ergonomics is the science of creating work environments that can adapt to the comfort needs of people. And if you think ergonomics sounds good in theory, you should see it in action.

For a recent U.S. Government controlled laboratory study has shown that, compared with conventional office furniture, ergonomically designed work stations *increased worker productivity by 24% on average!*

The equipment evaluated in this study included IBM Synergetix® Work Station Products: IBM's own line of ergonomically designed chairs, worktables, terminal bases and modular components.

Our IBM Synergetix Products are specifically engineered to adjust easily to workers in all shapes and sizes, thereby reducing backaches as well as arm and hand fatigue. By maximizing workers' comfort we help maximize their output.



And like all IBM products, IBM Synergetix Work Station Products meet the highest standards of IBM quality and performance.

What's more, IBM Synergetix Work Station Products are relatively inexpensive when you consider the huge investment a company makes in its people and equipment.

And you don't need a calculator to know an investment in productivity makes very good dollars and sense.

That's the economics of ergonomics—a science that business is getting very comfortable with.

To find out just how quickly we can make *your* business comfortable (or for some additional input) call *IBM Direct* toll free at 1 800 631-5582\* ext. 49 or visit one of our IBM Product Centers. Or send in the coupon below.

IBM SYNERGETIX WORK STATION PRODUCTS

Mail to: IBM Corporation, Attn: *IBM Direct*,  
One Culver Road, Dayton, New Jersey 08810

NAME \_\_\_\_\_ TITLE \_\_\_\_\_

COMPANY \_\_\_\_\_ TELEPHONE \_\_\_\_\_

ADDRESS \_\_\_\_\_

CITY \_\_\_\_\_ STATE \_\_\_\_\_ ZIP \_\_\_\_\_

\*In Alaska and Hawaii call 1 800 526-2484 ext. 49.

## IN FOCUS

tential for that \$13 billion to fall off dramatically was great."

AT&T was faced with some extremely tough choices. ABI wasn't progressing smoothly while Western Electric needed substantial shoring up. Significantly, James E. Olsen, vice chairman of AT&T, was brought in to take the reins at Western. Olsen, regarded as one of the two or three top heavyweight executives in the Bell organization, is an old-time AT&T'er with a reputation as an excellent manager and strategic planner. Bringing him in was a clear indication that AT&T was redefining the role of Western and providing it with a strong sense of direction, an AT&T observer notes.

At the same time there were increasing signs that McGill's regime was on shaky ground. Western tried to take over the residential and small business entity that had originally been allotted to ABI, and McGill was only able to keep it under his wing after putting up a battle, sources inside the company say. Subsequently, American Bell's senior executive, Salvatore J. Barbera, was transferred—by mutual consent, AT&Ters say—to a vice presidential position at Mid-Atlantic Telephone.

McGill's turn came next. The consensus among AT&T observers was that he was offered a less glamorous position (as one Wall Streeter put it, any position in AT&T would have been less glamorous than

the highly visible job McGill held) at Western Electric and opted to bail out. By squeezing McGill out of ABI, AT&T decided to take the short-term losses McGill's departure signified in exchange for the long-term gains it believed it would realize by installing operational management—Robert J. Casale as president for sales and marketing and Frank S. Vigilante as president of product development—to stabilize ABI. As a catalyst McGill had outlived his usefulness. His departure was inevitable, but it was hastened by ABI's problems and the unforeseen tremors set off by divestiture. As an AT&T'er McGill would never see the company bring out its first pure dp products, the Series 100, 200, 300, and 400 personal computers. Nor would he be present when, and if, Net 1000 finally got off the ground.

Not that it really mattered because McGill would land in the catbird seat, signing on as president and ceo of a big venture capital concern, Rothschild Ventures Inc. (that's Rothschild as in French banking, fine wine, and big bucks). When last heard of, McGill had been visiting his new employers in their French chateau, stopping off in Bermuda on the way home to be named a director of Trilogy.

As for AT&T, even its severest critics don't doubt the communications giant will ultimately right its course. The only

real losers in this tale seem to be the communications users, particularly the smaller ones who don't have the resources to put together tailored networks and with divestiture suddenly find they can no longer rely on a single vendor to supply all their communications needs. "The smaller users are going to have a difficult time of it," says F. G. Withington of Arthur D. Little in Cambridge, Mass. "They're going to find themselves spending far more time and money shopping than they probably ever anticipated. With multivendors and different sets of bills, they're going to have to spend more time administering the communications function. And they're going to be charged more for local service."

"The customers took it right between the eyes in this one," adds a communications consultant. "They're the real victims of all this in-fighting and confusion."

If nothing else, divestiture and the saga of Archie McGill and ABI have brought home one lesson to users. "We've learned we have to take control of our own telecommunications destiny," says John S. Kemper, a dp and telecom executive with the Kemper Group in Long Grove, Ill. \*

Laton McCartney, a former managing editor of DATAMATION, is currently a freelance writer in New York and a regular contributor to this magazine.

## Teetering from an applications imbalance?

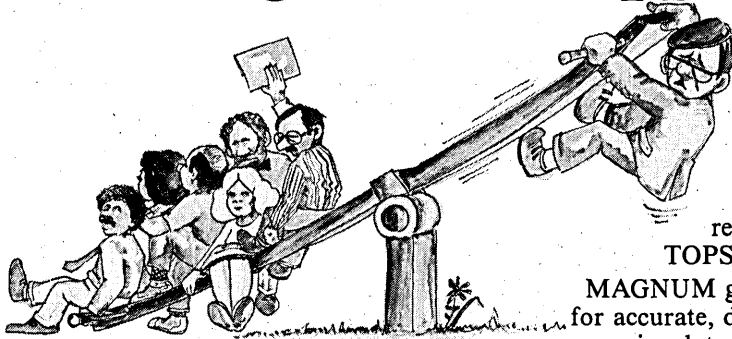

As DP Manager, you want to make your department as productive as possible.

To design and implement new applications while reducing program maintenance costs.

And not be weighed down by project management problems and a backlog of end user needs.

That's why you need MAGNUM®, Tymshare's relational data base management system, for your DEC TOPS-20 or VAX/VMS\* system.

MAGNUM gives your end users the convenience of using screens for accurate, data entry...the ease of producing ad hoc reports and accessing data with a query language...the freedom from worry that

comes with error-checking and updating capabilities...the facility to run both simple and complex programs.

And MAGNUM's high-level procedure language increases programmer productivity—by cutting back on tedious programming details.

To find out how to regain your balance, call MAGNUM Marketing at (408) 446-6255.

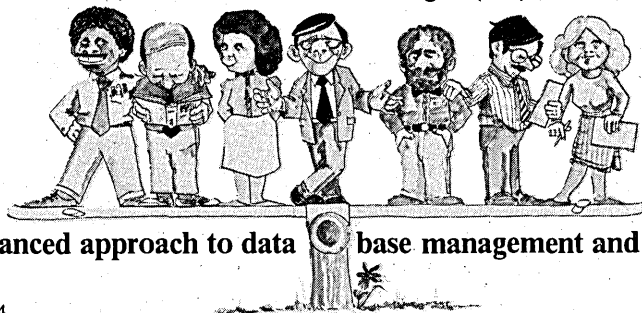

**MAGNUM**—a balanced approach to data base management and applications development

\* VAX/VMS version available in early 1984.

TOPS-20, VAX, and DEC are trademarks of Digital Equipment Corporation. MAGNUM is a registered trademark of Tymshare, Inc.

 **TYMSHARE**®

CIRCLE 25 ON READER CARD

# 3270 Users ...

# Get 3278 Features for less than 3178 Prices. ...from PHAZE

## A superior value

IBM announced its 3178 on March 8, 1983. The PHAZE P3278 has been available since November 8, 1982. Our lower cost, more functional 3278/3178 alternative is available **now**. And, at \$1545, our coax plug-compatible P3278 will be the star of your add-on and replacement program. That's because PHAZE makes the addition easy. More importantly, you'll get a host of special features not found on theirs. That makes PHAZE a good buy, and a superior value.



### Easy to use

The compact, modular P3278 can be installed in less than 60 seconds. Without heavy lifting. Without tools. Easy installation reflects the human engineering features of the unit. Features like an easy-on-the-eyes, non-glare screen that tilts and swivels with fingertip command. A thin movable keyboard, with a continuously adjustable angle through the optimum range. And PHAZE meets the tough European human factors requirements.

### Extras that don't cost extra

Standard features include an 87-key typewriter keyboard with 24 program function keys, a 12-key numeric keypad, automatic video shutdown,

combination security locks, a numeric lock and an audible alarm. The only option to buy is a light pen.

### Satisfaction guaranteed

PHAZE makes your purchasing decision risk-free. In addition to our standard 90-day warranty, we offer a 30-day money back guarantee if you're not completely satisfied with our product.

Terrific price. An unusual range of features. Money-back guarantee. And liberal quantity discounts. PHAZE will make you a purchasing legend in your own time. Call us today to place your order or to obtain more information. Ask for H. P. Watson at **(602) 991-6855**.

PHAZE is a registered trademark of PHAZE Information Machines Corporation.

**PHAZE**  
INFORMATION MACHINES CORPORATION

### We make the addition easy

PHAZE Information Machines Corporation  
7650 East Redfield Road  
Scottsdale, Arizona 85260  
CIRCLE 26 ON READER CARD

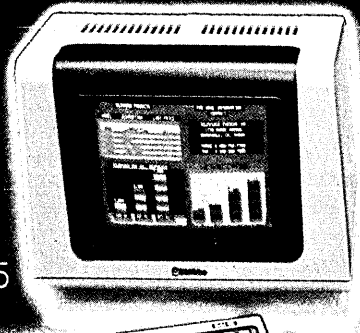

925

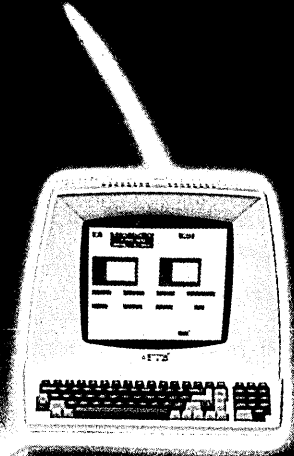

910 PLUS



950

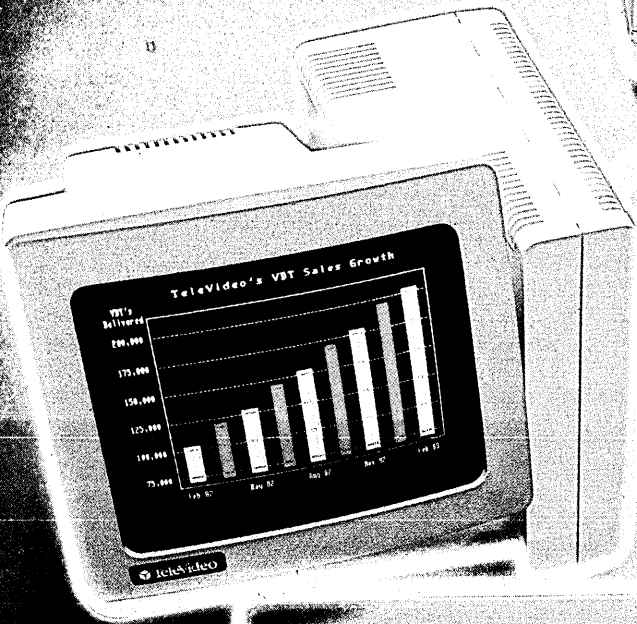

970

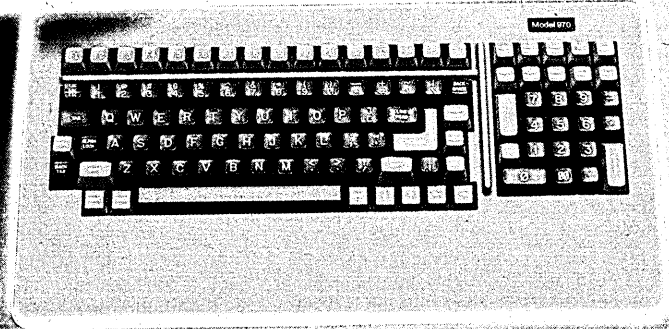

Model 970



# We started out giving you more terminal for your money. We still do.

We know where we started, and we know where we're going. We first entered the terminal market by offering high quality terminals with more features and functionality for less money. Our approach helped reshape the entire industry, making TeleVideo the world's leading manufacturer of computer terminals.

But these days a good combination of price and performance is expected. Manufacturers must provide more in order to be taken seriously. So we've extended the lead of our entire product line through innovation. From the economical 910 PLUS, through our advanced design 925 and 950 series, up to today's revolutionary 970, we continue to anticipate and deliver exactly what you want in your terminals.

Though the world changes around us, we always stay ahead. But our philosophy of providing more terminal

for less money does not change. For information, call toll-free 800-538-8725 (in California call (408) 745-7760), or send us this coupon.

TeleVideo Systems, Inc.  
Dept. 8D  
1170 Morse Avenue  
Sunnyvale, CA 94086

Yes, I'd like to know more about  
TeleVideo's family of terminals:

Name \_\_\_\_\_

Address \_\_\_\_\_

City \_\_\_\_\_

State \_\_\_\_\_ Zip \_\_\_\_\_

Telephone (\_\_\_\_\_) \_\_\_\_\_

Santa Ana/California 714-557-6095  
Sunnyvale/California 408-745-7760  
Atlanta/Georgia 404-399-6464  
Dallas/Texas 214-980-9978  
Chicago/Illinois 312-351-9350  
Boston/Massachusetts 617-668-6891  
New Jersey/New York 201-267-8805  
Woking, Surrey/United Kingdom 44-9905-6464

 **TeleVideo Systems, Inc.**

CIRCLE 27 ON READER CARD

# NEWS IN PERSPECTIVE

## MARKETING

# TRACKING THE P.C. STRATEGY

**The Personal Computer has emerged as the building block for a whole new IBM.**

by Ralph Emmett

IBM has mounted a personal computer blitzkrieg on the desks of white collar America. In only two years the company's Personal Computer has become so pervasive that IBM is fast becoming the standard for computing's new end users as well as for the traditional mainframe population.

Harry Edelson, an analyst at First Boston Corp., New York, predicts IBM will ship 650,000 P.C.s by year-end, 20% of them overseas. Another IBM follower, International Resource Development (IRD), Norwalk, Conn., says this figure represents one third of the total market for business-related personal computers and workstations in 1983, which it puts between 1.5 million and 2 million units.

Edelson points out that the P.C.'s code name, Acorn, has proved to be unusually appropriate. "From this one seed, an enormous forest of end users has grown, and there will soon be lots more because other personal computers are on their way."

Edelson, like others on Wall Street, expects IBM to announce a portable P.C. by year-end, hot on the heels of the announcement of a home computer challenger (see accompanying sidebar). He predicts that the portable, code-named Crackerjack, will sell in the \$2,000 to \$4,000 range, and will be upward compatible with the new extended P.C. (the XT). Other sources add that the original P.C. is now a "dead issue" within IBM, and will cease to exist in its current packaged form in about a year.

The First Boston analyst also contends that IBM is readying a \$10,000 32-bit challenger to Apple's much-vaunted Lisa, and that this could come in the second quarter of next year. Others speculate that the system, dubbed Popcorn, will offer dp, word processing, graphics, data communications, and decision support—all the ingredients of a recent offering from the word processing giant NBI (July, p. 98). Because of the need for a full multi-user, multitasking operating system on the workstation, IBM is believed to have chosen a Unix/68000 combination over the MS/DOS-Intel package used on its P.C.

What this represents, according to

Dale Kutnick, research director of the Boston-based Yankee Group, is a willingness by IBM to do whatever it takes to capture the end user, build market share, and, above all else, be the low-cost producer.

"IBM's policy is to saturate the market with terminals and workstations and draw an expanding user base. More users means increased demand for disks, software, applications, computer power, etc.—all of which means more revenue for IBM."

Within this strategy, the P.C. acts as a modern-day Trojan horse placed within the user's installation, posits Kutnick. "The MIS manager wakes up to find that he's been invaded by these little machines. Then pretty soon the whole of IBM Corp. begins to pour out of each machine as it evolves, and the user starts connecting the P.C. up to the rest of the IBM world outside his site."

The "horse" might just as easily be seen sitting squarely in the middle of IBM competitors' encampments—strategic locations where an invasion could be most advantageous to IBM. Only recently, points out Pat Seybold, editor of the *Seybold Report on Professional Computing*, Xerox and other workstation suppliers dreamed of being the first to bring computing power to the executive's desk—but IBM beat them to it.

"The IBM P.C. is now so pervasive that large companies such as Xerox must now plan their product strategies to include the P.C.s that they know will be on people's desks," she notes.

Seybold adds that IBM's P.C. has "won the day" in terms of market share.

### **Wall Street analysts expect IBM to announce a portable P.C. by year-end, hot on the heels of the announcement of a home computer challenger.**

and the industry must find ways to coexist with the machine. She says the biggest blow to competitors, however, is the fact that the P.C. has become the software target for everyone, now dominating new software development.

"The aftermath," says George McQuilken, president of workstation challenger Spartacus Computers Inc., Burlington, Mass., "is that since we can't compete with IBM as low-cost producer, we've all been reduced to value-added P.C. suppliers.

One sensible strategy," he adds, "is to go somewhere IBM isn't. Apollo, for example, could be seen selling a very expensive, value-added PC to the technical professional." He notes that the majority of value-added competitors, however, are now concentrating on the critical communications and database links between IBM's workstation/P.C.s and the central host computers.

Notes Kenneth Bosomworth, presi-

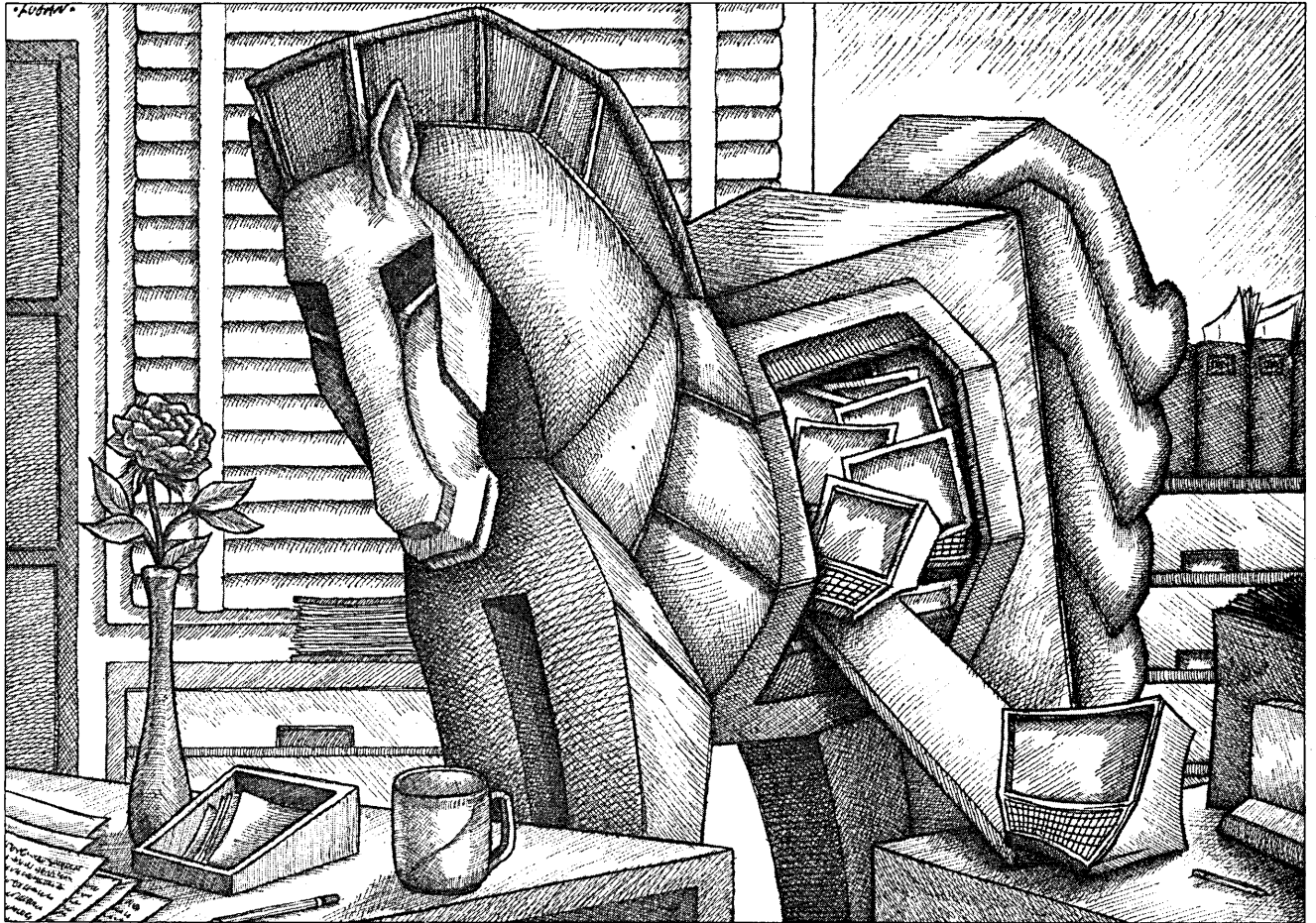

dent of IRD: "There has been a flood of communications products for the IBM P.C. In fact, the market is getting so saturated that some young companies are resorting to exotic hype and mystery to gain a marketing edge."

In recent months card modems for the P.C. have been announced by such companies as Hayes, Rixon, VenTel, Cactus Technology, BizComp, American High-Tech Industries, and the Microperipheral Corp. "In fact," claims Bosomworth, "there has been four times as much action in asynchronous communications for the P.C. as for the Apple."

The driving force behind this value-added wave is not the handling of electronic mail tasks, but rather the IBM customer's desire to link into his mainframe environment via 3270 emulation software, stresses the IRD president. In this vein, another wave of companies has started to offer ways to build a P.C. into the 3270, as well as software for the P.C. that allows it to emulate a 3270.

"Needless to say, if any connections to the host are to be made, IBM wants to be the one to make them," says Yankee Group's Kutnick. "That's why IBM has hit back hard recently with its own P.C./3270 bridges and emulation."

Despite these moves, IBM faces other, and more insidious, threats in its battle

to control the communications and database links to its victorious Trojan horse.

"Clearly, a strategy based on making the P.C. a replacement for the 3270 has one fatal flaw," suggests Gary Friedman, president of Fortune Systems, Belmont, Calif. "That is, the cost of the workstation." An IBM P.C. "starter" configuration of cpu, 320 Kbyte disk, monitor, and adapter is close to \$3,000. To make it into a 3270 you have to add another \$1,000 for communications software and an RS232 interface. Thus, in effect, the P.C. is considerably more expensive than a 3270, and an uneconomic substitute.

**Analyst Harry Edelson contends that IBM is readying a \$10,000 32-bit challenger to Apple's much-vaunted Lisa, and that this could come by second quarter 1984.**

The same applies, says Friedman, if you just add emulation software to the P.C. "So, buying a P.C. to use as a 3270 can only be justified if it can handle a variety of off-line tasks. Even then," stresses Friedman, "the user has paid \$5,000 or more for a P.C./workstation that doesn't handle multi-user/multitasks and local networking."

This has been the pitch that got Fortune started and allowed it to raise a whop-

ping \$100 million at its first public offering in March. "In contrast," explains Friedman, "we offer a workstation for \$1,500 complete with Ethernet local networking and concurrent multi-user or standalone capabilities." As with NBI and others, Fortune turned to a Unix/68000 to build an integrated controller that acts as file server and database center to a cluster of workstations and personal computers.

Says NBI president Tom Kavanagh: "Many IBM P.C.s are being purchased by what we term the casual professional. He uses them much as he would a calculator—intermittently. Such use doesn't justify investment in a modem, 3270 emulation, and the rest of the works. Often he just wants his own personal database or access to local shared disk and data on a cluster controller, for example."

This is probably the logic behind the anticipated Unix-based Popcorn from IBM which, allied to IBM's upcoming local area network, could pose a great threat to Fortune, NBI, Altos, and several others. "IBM, especially next year," says Yankee Group's Kutnick, "will bring a number of P.C. and 3270 cluster controllers into the field to nullify the challenge of competitors."

One of these cluster controllers is IBM's lackluster 8100, which Kutnick predicts will make something of a comeback.

ILLUSTRATION BY RON LOGAN

## NEWS IN PERSPECTIVE

"IBM has recently slashed its price 25% to 30% to an average \$30,000, or so. The 8100 can act as a departmental database and file exchange mechanism for a cluster of 20 or 30 P.C.s and Displaywriter word processors (also slashed around 30% to bring them closer to P.C. prices) and can offer automatic ASCII-to-3270 conversion for them," he conjectures.

The Series/1 mini also now offers similar cluster control functionality, for less cost than the 8100, but with less sophisticated document exchange capabilities and slightly poorer support from IBM, says Kutnick.

Several experts have pointed out that the 8100 doesn't really run 370 code very well, and is geared more to the eventual use of IBM's innovative System/38 as its host. Kutnick claims that IBM will circumvent this problem by announcing a 4300-based controller for \$30,000, probably in the September-October time frame. "In ad-

### **IBM insiders speculate that the company may soon attempt to buy a controlling stake in one of the mini peripheral companies—conceivably Tandon or Seagate.**

dition, a bridge from the 8100 to the 4300 cluster controller will be offered," he predicts.

The Yankee Group researcher describes these competitive actions as IBM's pincer movement. "It works in a four-level hierarchy—the P.C. or workstation layer, where IBM has wreaked such havoc with its Trojan horse maneuver; a departmental database level, where the cluster controllers reside; a higher control level, where the divisional database is situated; and the central host and database control point."

Kutnick says IBM will soon address the divisional level with its new 4300 technology to produce distributed applications controllers. "These won't be as dependent on the MVS host as, for example, the 8100/ Series 1 communications controllers. They will act as hosts in their own right to supervise multiple departmental P.C./workstation clusters."

IBM's recent efforts at the MVS host level have resulted in virtual memory extensions of MVS that allow new populations of thousands of terminals to flourish.

And, in the thick of it all, says analyst Edelson, is the P.C., IBM's new work engine, which he reckons will be popping up everywhere in "robots, switchboards, word processors, 3270s, and on and on." The only limits Edelson and other experts see are the production constraints of IBM's suppliers. One source claims that IBM can't utilize the full 100,000-unit-a-month P.C. production capacity of its Boca Raton and

### **IBM AT HOME**

In a bold move into territory it has so far virtually ignored, IBM will soon enter the home computer market.

Knowledgeable sources contend that "a large, established U.S. company" is currently manufacturing huge volumes of a new microcomputer to IBM's specifications. The machine, code-named Peanut, is believed by insiders to be an intelligent keyboard with built-in floppy disk and various expansion slots. It is expected to sell for about \$900 retail, complete with joystick for playing games. Sources say IBM will attempt to introduce the machine as early as September to capitalize on the holiday shopping season.

Says one source, "IBM is gearing up for the Christmas period and believes it can sell 100,000 units by the year's end."

Both the targeted market—home consumers—and the design approach to the product are radical departures for IBM. Its original Personal Computer is handled through assembly facilities in Boca Raton, Fla., and in Greenock, Scotland. Though IBM doesn't actually make its P.C. from scratch (it and the XT are largely subcontracted), it does provide the keyboard and handle assembly and test, insiders explain.

"This isn't the case with Peanut," says one source close to the development. "The machine won't see Boca Raton or Greenock because it's being manufactured by another U.S. company under IBM's direction. We're not even sure whether IBM is contributing the keyboard," he adds.

The home market, of course, does have its drawbacks. A bitter price war between the two leading contenders, Commodore and Texas Instruments, has driven PC prices down to the floor—and contributed

Greenock plants because of a current shortage of floppy disks. IBM's supplier is believed to be California-based Tandon, which is expected by analysts to pump out close to 1.5 million 5¼-inch floppies this year to grab a dominant 32% of the business. "But it's still not enough for IBM," confides the source.

Conceivably, supplier problems could pop up in other areas too, as IBM cranks up to an estimated 100,000 units per month through 1984. One weak area could be hard Winchester disks, where oem quality seems to have slipped of late, according to reports. All of this has led to speculation from IBM insiders that the company may soon attempt to buy a controlling stake in one of the mini peripheral companies—conceivably Tandon or Seagate—to protect its interests.

Edelson, for one doesn't seem to be concerned. He expects the IBM P.C. phenomenon to roll on and on. "During 1987 we project that IBM will achieve close to \$10 billion in personal computer-related revenues."

to the recent quarterly loss of \$100 million at TI. At the same time, home buyers are beginning to catch on to the fact that their spending doesn't stop with the so-called bargain price of \$200 for a 64K intelligent keyboard; they then have to spend a small fortune to equip it with the necessary peripherals.

This situation has led some vendors to adopt a new strategy for growing the home computer market—namely, bundling. Coleco Industries, for instance, will crank up its ad campaign in September for its \$600 marvel, Adam, a game-playing/word processing machine that includes a letter-quality daisywheel printer in its all-in-one price.

IBM is clearly adopting a similar strategy by bundling in the floppy disk storage, but its storage price of \$900 is not expected to include a printer. Analysts are already questioning whether Coleco can manufacture Adam for a \$600 selling price and still make money—particularly since the quality of the Coleco printer appears better than was anticipated.

Sources claim that IBM currently manufactures its P.C. for a little more than one fifth its selling price. The company will be looking for similar margins with Peanut, one source says, because the watchword at every major IBM meeting for the past nine years has been "low-cost producer."

"The low-cost producer is not always the low-priced seller," points out Peter Cunningham, president of Input, the Mountain View, Calif., research firm. "Coleco's Adam might be state of the art for the home market and have the lowest retail price, but it will probably be IBM that makes all the money." —R.E.

It's worth bearing in mind that IRD puts the total personal computer/workstation market worldwide at \$25 billion during that year. By that time, says Yankee Group's Kutnick, IBM will probably have a virtual machine (VM) P.C. out in the field based on Intel's 286 chip and its planned on-board data storage protection mecha-

### **IBM may soon attempt to buy a controlling stake in one of the mini peripheral companies**

nism. Says Kutnick, "The P.C. will run IBM's existing VM/CMS stream on one side and Unix/MS/DOS software on the other."

Perhaps more than anything else, Edelson likes to point out that the P.C. will completely revolutionize IBM. The 360 mainframe was the foundation on which the present-day IBM day built. In similar manner, the P.C. has emerged as the building block for a whole new IBM. With the P.C., IBM will experience a rebirth—despite its already awesome size—as a high-technology growth company.

# Built In Beats Bolted-On

## Braegen's Way Puts IBM-Compatible Personal Computing Inside A Low-Cost, 3274-Compatible Cluster Controller.

Several companies now offer personal computing capability as part of their 3270 terminal package. Their approach, however, has built-in problems—primarily because the personal computing *isn't* built in, but just bolted on.

Braegen's way works better. Because our new 8410 Cluster Controller features integral personal computing, the user gets maximum processing versatility and performance while the DP Manager gets maximum control and cost savings.

**More Versatility And Power.** You can attach up to eight ergonomic display stations to the 8410—and with one keystroke turn all of them into true 16-bit PCs.

You can access a wide range of applications software operating under MP/M-86. And you can upgrade from 128 to 640 Kb of RAM—or integrate a 10-Mb

Winchester drive for optimum multi-user response and security.



**More Control And Economy.** Undoubtedly, it is the control you gain and the dollars you save that really distinguish the 8410. Because the PC capability is integrated into the controller, the DP manager gets data security while the user gets economical access to a communications network.

As for economy, consider first the 8410 is more cost-effective when used just as a 3274 controller alternative. Add the multi-user PC capability and you can save thousands of dollars—and a lot of space—in equipment alone.

There's no investment in additional software for each workstation, or in additional communications lines. Expensive resources—such as letter-quality printers and Winchester drives—can be shared. And a unique remote-maintenance feature that lets our Field Engineers dial up and diagnose the 8410 from any location reduces downtime costs.

**More Sales And Service Support.** For ten years now, Braegen's way has worked for an impressive base of customers. The 8410 with personal computing and the 8400 Remote Cluster Controller with up to 16 attachments are two reasons why. Reasons made even more persuasive with our nationwide sales and on-site service network.

Put Braegen's way to work for you. Call or write The Braegen Corporation, 525 Los Coches Street, Milpitas, CA 95035. (408) 945-8150, TWX: 910-338-7332.

# BRAEGEN

# HOW TO GET USERS OFF YOUR BACK AND ON YOUR SIDE.

GOOD MORNING,

THIS IS YOUR INFORMATION CENTER,

HOW CAN I HELP YOU? =

The answer is in front of you.  
SYSTEM 2000.<sup>®</sup>

Intel's Database Management  
System.

And iDIS.<sup>™</sup>

Intel's Database Information System.

Together, they allow your corporate  
decision makers to gather all the infor-  
mation they need.

From your information  
center data base.

Not from their personal  
computer.

And users get their data  
from a terminal. Right in their  
office. Right on their desk. In  
seconds.

Versus the days it might take you,  
just to get to their request. Days that  
can seem like weeks.

Especially when management is  
breathing down your neck.

iDIS is a fully integrated, XENIX\*  
based, multi-user microcomputer sys-  
tem. Featuring the Intel 86/735 micro-  
computer-based system. The most  
versatile, most powerful 16-bit system  
on the market.

Industry-standard VLSI and peri-  
pheral technology are also designed-in,  
to protect your long-term investment.

And to protect your information  
from unauthorized use, iDIS maintains  
complete data security at every terminal.

iDIS gives users the ability to per-  
form local database definition and crea-  
tion, as well as updating and reporting.

But iDIS doesn't stop there. Users  
also get a wide range of software, to aid

them in planning, analysis and office  
management.

iDIS even has tools for data  
processing. By using the XENIX com-  
mand interpreter, menu/forms and  
conventional programming languages,  
programmers can create custom appli-  
cations for users.

	1	2	3	4	5	6	7
1	Q1	Q2	Q3	Q4	ANNUAL		
2	SALES FORECAST						
3	Base		Judged		Upside		
4	5	James	5220	7500	13500		
5	6	Smith	2100	8725	10000		
6	7	Ellis	2100	2000	10000		
7	8		-----	-----	-----		
8	9	Reg. total	10400	10225	40500		
9	10						
10	11	12	13	14	15	16	17
11	12	13	14	15	16	17	18
12	13	14	15	16	17	18	19
13	14	15	16	17	18	19	20
14	15	16	17	18	19	20	21
15	16	17	18	19	20	21	22
16	17	18	19	20	21	22	23
17	18	19	20	21	22	23	24
18	19	20	21	22	23	24	25
19	20	21	22	23	24	25	26
20	21	22	23	24	25	26	27
21	22	23	24	25	26	27	28
22	23	24	25	26	27	28	29
23	24	25	26	27	28	29	30
24	25	26	27	28	29	30	31
25	26	27	28	29	30	31	32
26	27	28	29	30	31	32	33
27	28	29	30	31	32	33	34
28	29	30	31	32	33	34	35
29	30	31	32	33	34	35	36
30	31	32	33	34	35	36	37
31	32	33	34	35	36	37	38
32	33	34	35	36	37	38	39
33	34	35	36	37	38	39	40
34	35	36	37	38	39	40	41
35	36	37	38	39	40	41	42
36	37	38	39	40	41	42	43
37	38	39	40	41	42	43	44
38	39	40	41	42	43	44	45
39	40	41	42	43	44	45	46
40	41	42	43	44	45	46	47
41	42	43	44	45	46	47	48
42	43	44	45	46	47	48	49
43	44	45	46	47	48	49	50
44	45	46	47	48	49	50	51
45	46	47	48	49	50	51	52
46	47	48	49	50	51	52	53
47	48	49	50	51	52	53	54
48	49	50	51	52	53	54	55
49	50	51	52	53	54	55	56
50	51	52	53	54	55	56	57
51	52	53	54	55	56	57	58
52	53	54	55	56	57	58	59
53	54	55	56	57	58	59	60
54	55	56	57	58	59	60	61
55	56	57	58	59	60	61	62
56	57	58	59	60	61	62	63
57	58	59	60	61	62	63	64
58	59	60	61	62	63	64	65
59	60	61	62	63	64	65	66
60	61	62	63	64	65	66	67
61	62	63	64	65	66	67	68
62	63	64	65	66	67	68	69
63	64	65	66	67	68	69	70
64	65	66	67	68	69	70	71
65	66	67	68	69	70	71	72
66	67	68	69	70	71	72	73
67	68	69	70	71	72	73	74
68	69	70	71	72	73	74	75
69	70	71	72	73	74	75	76
70	71	72	73	74	75	76	77
71	72	73	74	75	76	77	78
72	73	74	75	76	77	78	79
73	74	75	76	77	78	79	80
74	75	76	77	78	79	80	81
75	76	77	78	79	80	81	82
76	77	78	79	80	81	82	83
77	78	79	80	81	82	83	84
78	79	80	81	82	83	84	85
79	80	81	82	83	84	85	86
80	81	82	83	84	85	86	87
81	82	83	84	85	86	87	88
82	83	84	85	86	87	88	89
83	84	85	86	87	88	89	90
84	85	86	87	88	89	90	91
85	86	87	88	89	90	91	92
86	87	88	89	90	91	92	93
87	88	89	90	91	92	93	94
88	89	90	91	92	93	94	95
89	90	91	92	93	94	95	96
90	91	92	93	94	95	96	97
91	92	93	94	95	96	97	98
92	93	94	95	96	97	98	99
93	94	95	96	97	98	99	100

Credit our spreadsheet, with quick numbers  
directly from the corporate data base.

MENU OPERATIONS	
mail	Electronic mail
cal	Maintain appointment calendar
wp	Word processing
ss	Spread sheet
db	Data base operations
file	File management
help	Get help information

For ease-of-use, our menu format is made-  
to-order.

Faster than management can send  
you a data request.

And while iDIS is helping you,  
SYSTEM 2000 will be helping users to  
help themselves.

By creating greater user self-suffi-  
ciency and increased productivity.  
Producing better control of information,  
for higher quality decisions.

Call us toll-free, for more informa-  
tion. (800) 538-1876. In California,  
(800) 672-1833.

Or write us. Lit. Dept. H 14, 3065  
Bowers Avenue, Santa Clara, CA 95051.

Or contact the Intel Sales Office  
nearest you.

We'll back you, with all the support  
you'll need.

To get users on your side.

\*XENIX is a trademark of Microsoft, Inc.

**intel** delivers  
solutions

# WHAT THE HECK IS AN EXECUTIVE WORKSTATION?

A lot of people have the wrong idea of how you should use a personal computer. And fancy phrases like "executive workstation" only hide the benefits of personal computing under a cloud of tech-babble.

The fact is, instant information and a computer on every desktop don't always mean bigger profits and more efficient workers.

Because when "non-computer people" use personal computers in business, the *software* they use is always more important than the hardware that's used with it.

But sometimes this software's just too hard to use, or can't do the job. Or it's already out-of-date. All of which confuses the same people it should be helping. We'd like to clear up some of that confusion.

## THE CONTEXT MBA: IT TURNS EXECUTIVE WORKSTATIONS INTO "EXECUTIVE THINK-STATIONS."

The Context MBA is software that lets you use the personal computer as a creative tool for better business decisions:

We've combined the five most useful business functions of all personal computer software - electronic spreadsheet, graphics, information management, report writing, and communications - into one easy-to-use, *integrated* product. Designed for businesspeople, not programmers.

This means you only need one software package to make your personal computer do everything it was designed to do in the first place. And then some.

## TURN BUSINESS DATA INTO BUSINESS INTELLIGENCE. INSTANTLY.

By building five major functions into one software package, the Context MBA helps you to make better decisions from the large amount of data that's unique to your business.

With the MBA, for instance, you can connect a personal computer to your company's main computer to retrieve business information. Like

sales figures, operating expenses, or product reports. In minutes.

Store, edit, sort, or modify this information on your personal computer and use the MBA's electronic spreadsheet to create a "model" of your business. Develop plans and forecasts in a fraction of the time it would take to do them by hand, or by using a single-function software package.

While using the MBA's spreadsheet function, you can instantly graph and chart vital figures on the same screen. So, as you make cost or revenue assumptions, you can see immediately how the result would affect your business - this year, and five years from now.

And when you've made your decision, use the MBA's executive report writer to put words, numbers, and graphs together in a clean, printed report.

It doesn't take a computer to tell you that this kind of control over business facts, figures, and alternatives gives you an edge on the competition and a head start on each new day.

## SEE IT NOW.

The Context MBA can be used on the IBM Personal Computer, the IBM PC-XT, and the Hewlett-Packard Series 200 personal computers.

Call us at 1-800-437-1513 (in California, call 1-800-592-2527) for the name of your nearest Context MBA dealer and a copy of our tell-it-like-it-is brochure, *Software Explained*.

If you have an IBM PC, we'll also be glad to send you a free copy of our Context MBA Sampler Disk that gives you a live demo of the MBA.

CONTEXT MANAGEMENT SYSTEMS  
23868 Hawthorne Blvd.  
Torrance, CA 90505 (213) 378-8277

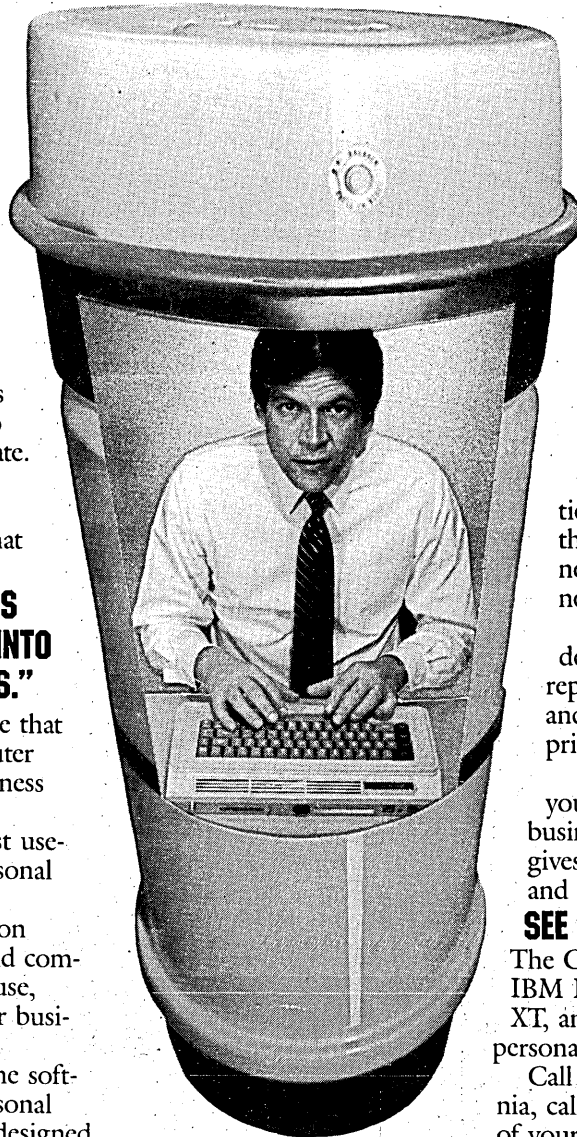

## Context MBA™

**Personal Computer Software for Business Decisions.**



**NEWS IN PERSPECTIVE**

**MAINFRAMES**

**NCR  
CHANGES  
COURSE**

**Part II of a look at the revamped mainframer with a new bag of tricks.**

**by Jan Johnson**

At first glance, NCR Corp.'s new hybrid marketing structure—part industry specialists, part product specialists—is confusing. One industry consultant, after looking it over, simply threw up his hands and pronounced it “incomprehensible.” As for NCR's new management policy of pushing decision making and profit and loss responsibility down to the plant manager level, you get the uneasy feeling you are looking at a mine field of management disasters waiting to happen. NCR, of course, doesn't see it that way.

What NCR sees is the culmination of five years of rethinking, planning, and re-writing of company goals, strategies, and structures (see July, News In Perspective, p. 50, for Part I). The Dayton, Ohio-based company has made a fundamental change in corporate strategy. It is attempting to reposition itself, both in terms of product strategy and organization structure, as a company that sells primarily to large organizations rather than to smaller ones.



**TOM MILLER:** “There has been a tremendous interest” in the 32-bit chip set from mini and mainframe makers that want to build machines that can make use of existing software.

While that may sound like a minor tune job, the decision led to some major changes in product strategy and corporate organization. To compete successfully for business from large corporations, NCR's executives determined they needed products with leading-edge technology and a nimble development and production organization that could constantly generate new ideas and get them out the door—fast.

The development and production side of the house was one of the first organizations to get hit by a wave of renovation. The main thrust was to push decision mak-

ing down to the plant level. Plant managers now operate much like small company presidents, with profit and loss and R&D responsibilities, to name only two.

Contrasted against NCR's 100-year-old tradition of top-down, committee-riddled management structure, the new approach was like a breath of fresh air. “Product direction used to be handed down from a centralized product management organization,” recalls William Buster, executive vice president responsible for development and production. Plant managers were “just implementors compared to the present

**Memory Upgrades from EMC<sup>2</sup>**

**PRIME<sup>®</sup> users save \$4,200**

The PRIME Compatible E8 Memory Card with 1MByte Capacity, ECC, and Wide Word.

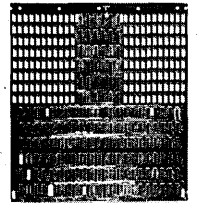

**WANG<sup>®</sup> users save \$7,000**

The WANG VS-90 and VS-100 Memory Card with 1MByte Capacity and ECC.

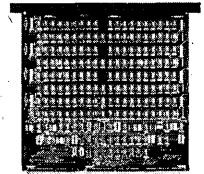

**digital users save \$6,500**  
**VAX<sup>®</sup>**

The VAX 730 and 750 VX Memory Card with 1MByte Capacity and ECC.

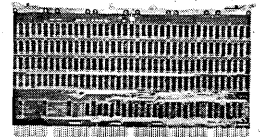

© Registered Trademark of Prime Computer Wang Laboratories Digital Equipment Corporation

**EMC<sup>2</sup>** 385 Elliot Street Tel: (617) 244-4740  
Newton, MA 02164 TLX: 922531

PRIME  WANG  VAX Please send me information about EMC MEMORY CARDS for the CPU family I have checked.

Name \_\_\_\_\_  
Company \_\_\_\_\_  
Address \_\_\_\_\_  
City \_\_\_\_\_ State \_\_\_\_\_ Zip \_\_\_\_\_  
Phone \_\_\_\_\_ Ext. \_\_\_\_\_

6-83-DAT

**CIRCLE 31 ON READER CARD**

# When users rated their cc guess which name came

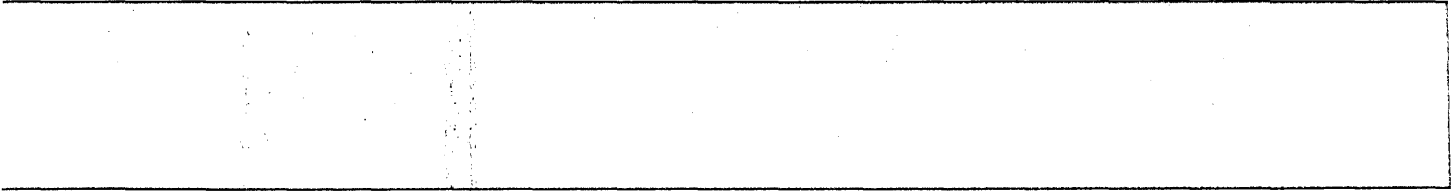

# Computers' communications, through loud and clear?

## Hewlett-Packard HP 3000

Data Decisions, an independent research firm, surveyed users of business computer systems from the major suppliers. When the 3,042 responses were tallied, the top score for Best Overall Performance in Data Communications went to Hewlett-Packard's HP 3000 computer family.

We were pleased, but not surprised. And neither were the thousands of HP customers who for years have relied on our networks.

As a pioneer in distributed processing, HP long ago took on the challenge of creating reliable data communications that were also easy to use.

Today, HP/DSN (Distributed Systems Network) is used to tie business and technical computers together in a company-wide information network. We've developed local area networks (LAN), so workstations can share data bases and peripherals. In addition, we provide links to IBM's SNA.

While we believe in a flexible approach to communications, we're also firmly committed to standards. Our systems implement X.25 packet switching and we've just introduced DSN/PBX, which can save you a bundle on installation costs by using existing phone lines for local networks. And we worked with the IEEE committee to develop the 802.3 LAN stan-

dard that will help to make datacomm more uniform for everyone.

In everything we do, we're committed to making communications easy to install and easy to use. For instance, we can have a network up and running in just two days.

So if you want to communicate better, call your local HP sales office and ask a Business Computer Specialist about all our networking capabilities. Or write to Hewlett-Packard, Attn: Tom Rappath, Dept. 04181, 19447 Pruneridge Avenue, Cupertino, CA 95014. In Europe contact: Henk van Lammeren, Hewlett-Packard Nederland B.V., Dept. 04181, P.O. Box 529, 1180 AM Amstelveen, The Netherlands.



HEWLETT  
PACKARD

## NEWS IN PERSPECTIVE

process. Now they are encouraged to get out into the marketplace, see how their products are used, and generate their own ideas."

"The previous [management] approach involved a group of staff people who had opinions but no responsibilities; responsibilities were greatly dispersed," agreed Hugh Lynch, vice president, general

### **NCR is attempting to reposition itself as a company that sells primarily to large organizations rather than to smaller ones.**

purpose systems, who reports to Buster. "What we are trying to do now is give production people a great deal of control without having to have committee decisions." Lynch's organization developed and produces the Tower 1632 and the 9300, a breadbox-sized mainframe.

"We are as entrepreneurial as we could become. That was the idea behind the new structure." That is how Don Coleman summed it up. Coleman, who also reports to Buster, is vice president, C/MEG systems (commercial, industrial/medical, educational, government). Coleman's organization developed and produces the Decision Mate V.

Under the wing of each of the 24

general managers is manufacturing, engineering, R&D, purchasing, financial, MIS, and product management. In addition, each GM is responsible for developing a business plan and directing his or her own development projects. There is a great possibility for product development overlap.

So how does a \$3.5 billion company manage all that independence? To keep a lid on wild and uncoordinated product development efforts, such as producing a product that does not interconnect to any other NCR product, there is a rigorous review system in place. Each GM reports to a systems vice president, who in turn reports to executive vp Buster, who also serves as a member of the office of the chief executive.

Buster is one of five persons who sit on NCR's new top-level management team. Other members of the office of the chief executive are William Anderson, chairman; Charles Exley Jr., president and chief executive officer; Manuel Garcia, executive vice president responsible for marketing and sales; and Don Herman, executive vice president (and founder of what is now NCR/Comten Inc.), responsible for integrated systems, basically those business units that are self-contained or don't fit well anywhere else. Herman's realm includes NCR/Comten, NCR/Telecom, Applied Digital Data Systems, micrographics, and the office systems division.

"They [the plant managers] are responsible for developing their own plans," confirmed Exley. "But we have regular meetings to listen to those plans. I earn a living being a professional audience." Exley estimates he spent about 100 days out on the road last year attending long-range planning reviews. With that kind of top-level involvement and interaction, Exley is confident that "if somebody is proposing something crazy" it will be caught and stopped. He added, "We see their numbers regularly."

As for "overlap," no one seemed too concerned. "The executive office makes sure we don't have two people designing the same product," said Coleman. "But we expect to have a lot of people

### **Plant managers now operate much like small company presidents, with profit and loss and R&D responsibilities, to name only two.**

designing very similar products. That kind of redundancy doesn't bother us. One will win and one will lose." As for Exley's attitude: "Let many flowers bloom."

Keeping careful track of customer needs was another issue that received close attention. The goal at each plant is to see that those who actually do the design and



## TEAR OUT AND COMPARE TO 5251s

THE PCI 51, AN ASCII SOLUTION THAT'S KEYSTROKE FOR KEYSTROKE 5251-11 KEYBOARD COMPATIBLE. SYSTEM 34/38 5251 EMULATION WITH PCI's 1051.

Name \_\_\_\_\_  
 Company Name \_\_\_\_\_ Phone \_\_\_\_\_  
 Address \_\_\_\_\_  
 City \_\_\_\_\_ State \_\_\_\_\_ Zip \_\_\_\_\_ DM 8/83

- Send me more information on the PCI 51 and PCI 1051.
- Send me information on all PCI products.

**PCI** PROTOCOL COMPUTERS, INC.  
 (800) 423-5904  
 (213) 716-5500 (In California)

6150 Canoga Ave. Suite 100, Woodland Hills, CA 91367-3773



CIRCLE 32 ON READER CARD

**COMING SOON TO A SYSTEM NEAR YOU!**

# 9600E

**A Totally New Dimension  
 In Intelligent Communications.**



**comspec, inc.**  
 10000 Old Katy Rd. #275  
 Houston, Texas 77055  
 (713) 461-4487  
 Telex: 910-881-4763

CIRCLE 33 ON READER CARD

# WHAT TO WEAR TO WORK IF YOU BUY THE WRONG DBMS INSTEAD OF OUR MODEL 204.

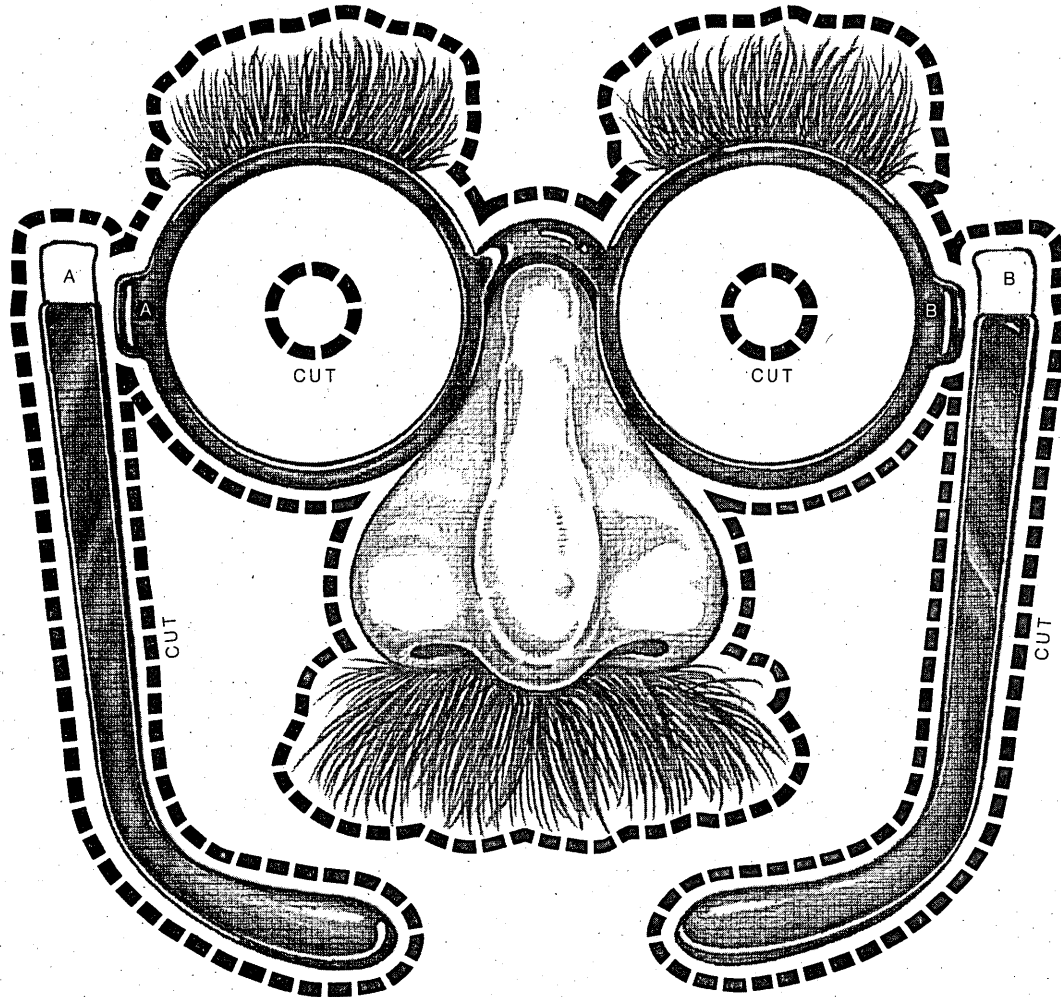

Picking the best, most productive DBMS for an OS, DOS or CMS environment requires the use of all your faculties. Because many DBMSs never live up to their promises. And sooner or later those deficiencies are bound to catch up with you. Leaving you looking for something to hide behind.

Computer Corporation of America doesn't have to put on an act to convince you. Our MODEL 204 DBMS is the only commercial DBMS ever designed from scratch for online systems. Every other DBMS was converted from batch. And that means new applications come up faster with MODEL 204. In fact, 5 to 50 times faster. And your applications and databases are much easier to maintain.

What about performance? If you end up with a DBMS that can barely carry a few million records and a dozen or so users, you won't be able to mask the fact forever. Especially if someone finds out that MODEL 204 can handle up to 513 billion records and 999 concurrent updates.

Now the advantages of MODEL 204 are available for the DOS/VS(E) and native CMS environments. Without sacrificing either performance or productivity.

In the DOS world, MODEL 204 is the only DBMS with a direct teleprocessing interface. Which saves the resources and

productivity costs of a terminal monitor.

Our native CMS implementation outperforms other DBMSs because it utilizes its own I/O routines without modification to either VM or CMS.

Finally, two other things that no other DBMS can say. MODEL 204 received the highest overall rating in a recent *Datapro* survey: 3.5.<sup>1</sup> And it's the fastest growing system for IBM mainframes from an independent vendor.<sup>2</sup>

Now faced with these facts wouldn't you look silly buying anything but MODEL 204 DBMS?

## MORE ON MODEL 204 DBMS.

DM-8-G

- Make a presentation.       Let's put MODEL 204 in and benchmark.  
 Send me a brochure.       Send me info on free DBMS seminars.

Operating Environment:  OS  DOS  CMS

NAME \_\_\_\_\_ TITLE \_\_\_\_\_  
 COMPANY \_\_\_\_\_  
 ADDRESS \_\_\_\_\_  
 CITY \_\_\_\_\_  
 STATE \_\_\_\_\_ ZIP \_\_\_\_\_  
 TELEPHONE \_\_\_\_\_

**Computer  
Corporation  
of America**

Four Cambridge Center, Cambridge, MA 02142 (617) 492-8860

1. *Datapro*: "User Ratings of Proprietary Software-COMLETE" November 1982. 2. *Computerworld*: December 20, 1982.

Other Offices: New York, Houston, Dallas, Los Angeles, San Francisco, Chicago, Philadelphia, Washington, D.C., Morristown, NJ, Stamford, CT/Representatives: Canada, U.K., Europe, Australia, Japan, Saudi Arabia.

## NEWS IN PERSPECTIVE

development work get out among the folks who actually use this equipment. "We don't want our software developers to have the narrow perspective of someone who designs only bisync drivers," commented Lynch. "We send young software developers out on major proposals with the marketing guys, or on field trials or during an extended testing/customer verification. Headquarters' management demands this kind of behavior, while at other organizations they say it is 'okay, but get your primary job done first.'"

Of course development/production is only half the equation. Without marketing/sales, all the other is for naught. So the NCR executives created a scheme in which production is not bound to working only with NCR's marketing organization. If production becomes dissatisfied with marketing's performance, then a plant manager can go outside NCR and try to sell product through any other viable distribution channels. Likewise, if marketing does not like what production unveils, they, too, can go outside of product to sell. A bit of healthy competitive tension to keep everyone on their toes, it seems.

The general attitude among systems vice presidents on the manufacturing side, though, is that it would be "silly" to ignore NCR's "huge" marketing organization. In addition to broad U.S. coverage, NCR's marketing arms reach into more than 120 foreign countries, which is better coverage than most other computer companies can offer.

Given that a plant manager will be using NCR's marketing organization, the game works like this: a product manager within a plant puts together a product pro-

**"We expect to have a lot of people designing very similar products. That kind of redundancy doesn't bother us."**

motion package geared toward whipping up enthusiasm among the marketing folks and making them sign up to sell lots of product. The next order of business is to support marketing in their sales efforts. The strategy among systems vice presidents and plant managers is to fill these product manager slots with the best marketing people they can lure away.

"We have more cooperation between marketing and the plant groups than before when we had controls in place to enforce it," observed Coleman. "Marketing is their customer and they make calls to marketing all the time. They use each other now to a much higher degree than ever before."

Four of the five manufacturing groups that report to Buster operate as explained. Those four are general purpose systems, financial systems, retail systems,

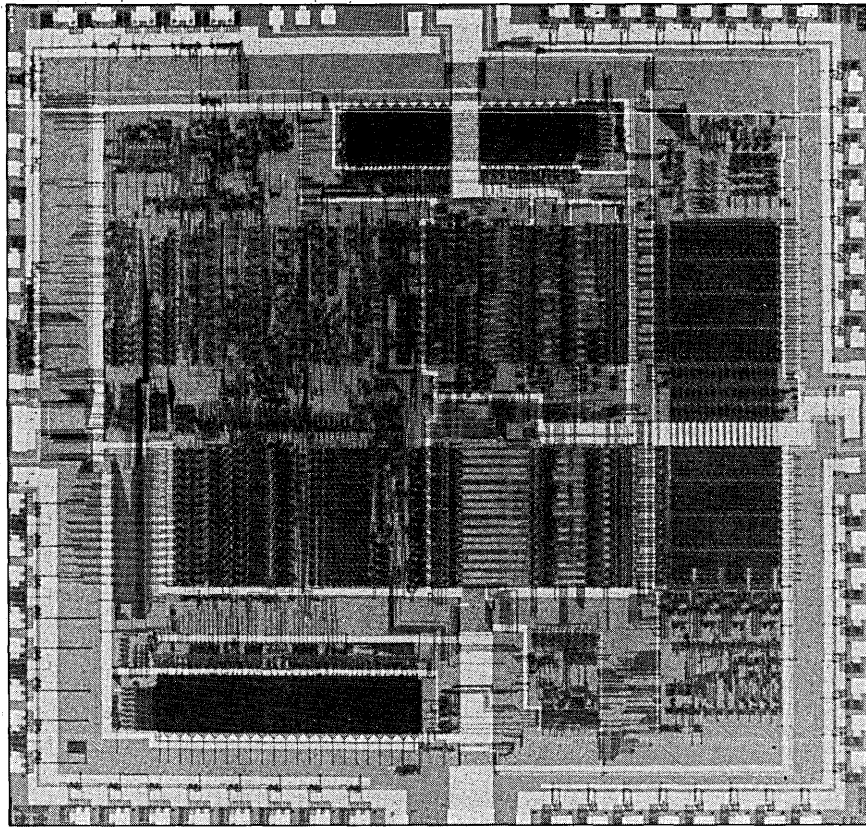

THE 32-BIT CHIP SET is NCR's hot product, and the company is marketing it aggressively to outside parties.

and CI/MEG systems. Basically, CI/MEG produces all the vocational product, with the exception of financial and retail. "Generally, we take general purpose products and specialize them to a specific industry," said CI/MEG vice president Coleman, although his group did originate, develop, and produce the Decision Mate V.

Buster's fifth group is the microelectronics division. It operates a bit differently from the rest in that it handles everything itself, from development to manufacturing to marketing. At present, the 32-bit chip set is the hot product, and NCR is marketing it aggressively to any interested outside parties. Tom Miller, director of VLSI processor products, said, "There has been tremendous interest" from mini and mainframe makers that want to build machines that can make use of existing software. Customer names and order rates are considered proprietary information by NCR.

Although customer sampling began in June, Miller does not expect to see 32-bit chip-based product from outside customers come into production until the end of 1984. Sample price is \$750 per processor chip, while production price is expected to slide down to \$150 in 1984, said Miller.

NCR is not a newcomer to the merchant semiconductor business. It has been selling 64K and 128K ROM chips, and last month it added the 256K ROM to its product list. Currently the company generates more

than 60% of its semiconductor sales outside the company, estimated one inside source. "It's not a big operation," said the source. "In 1982 it did about \$40 million to \$45 million, but it's going to be a fairly fast-growing business, we hope." NCR is banking that the 32-bit chip set will contribute to stronger revenue growth.

Even though NCR comes to the semiconductor market with a previous reputation, Steve Morgan, assistant vice president marketing, microelectronics division, admits that NCR still has to "prove that we are real, that we will not abandon a customer to support NCR first." When defending NCR's commitment to its merchant semiconductor business, Morgan points to the size of NCR's investment. "We have a manufacturing capability that is able to support a \$100 million to \$200 million business. Our capability rivals that of many wafering processing companies in the \$250 million range, as opposed to startups like BTI or LSI Logic."

The outcome of NCR's new product strategy has been a rapid-fire stream of product announcements during the past 11 months. Most of these announcements have been "general purpose" in nature—the Tower, the 9300, the Decision Mate V. None of those are aimed at a specific application, but all are highly adaptable to many applications. Steve McClellan, a computer industry analyst with Salomon Brothers Inc., New York City, suggests NCR may be

# ADDITIONAL NEW FEATURES ACCESS SECURITY TO YOUR VALUABLE COMPUTER SYSTEM.

**Unauthorized computer access.** A major security threat to large companies, and a potential disaster to smaller ones. But no more. Because the Defender™ provides two new levels of access security to your computer files.

The state-of-the-art access control system provides the most sophisticated security available to protect your files. The Defender™ attempts to prevent unauthorized access to your files — which makes the system a valuable investment.

Then, it provides what is probably the most significant advance in computer access security. The Defender™ searches its database for that ID card that automatically calls a voice bank at the one telephone number authorized to make calls. Even if an intruder

manages to break the log-on procedures, he must also be physically located at the telephone to be authorized access to the user's ID card. It's a virtually impenetrable

security barrier. Usually on any host computer, the Defender™ is installed on the computer. In some cases, the Defender™ is installed on the telephone. Available in both configurations up to 100 simultaneous users — or spreads up to 25000 logs.

For more information, write for our brochure at Digital Pathways, 1060 East Meadow Circle, Palo Alto, CA 94303, or call us at (415) 493-5544.

© 1984 Digital Equipment Corporation

**DIGITAL  
PATHWAYS**

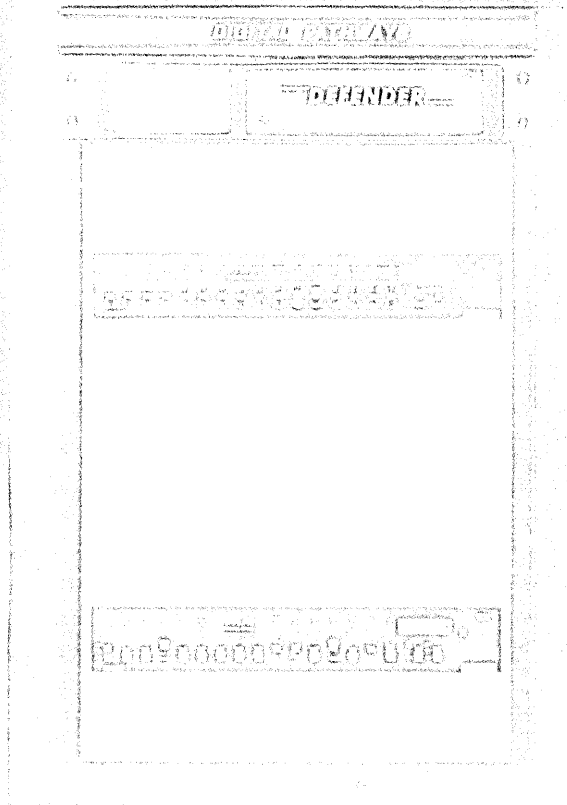

United States Headquarters: (415) 493-5544 • Eastern Regional Office: (301) 997-6886 • Canada: (403) 286-2744  
 England: 0403 813 813 • Germany: (089) 60 60 71-72 Telex: 5216290 isio d • Switzerland: 022/310587 Telex 289191

CIRCLE 35 ON READER CARD

# The next millennium begins in the year 2000.

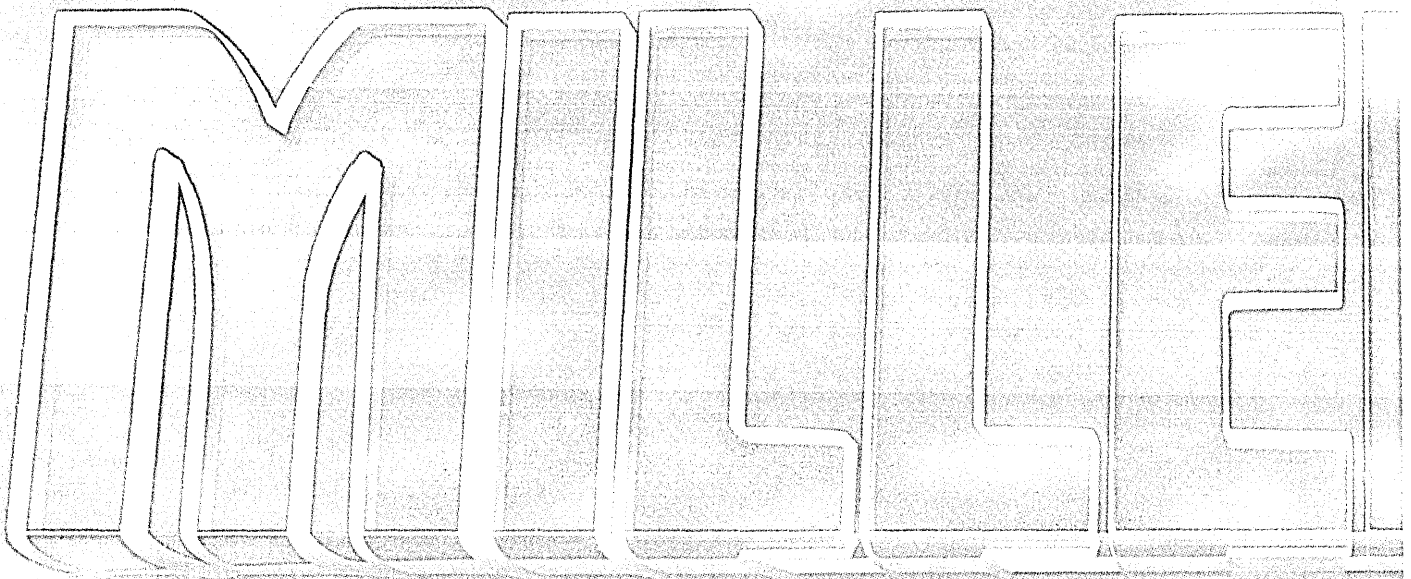

MILLENNIA

Nearly two decades ago, our industry took on the formidable task of writing faster, more powerful, more user-oriented software than users themselves could create. Vendors did this by isolating each specific business application—such as general ledger, accounts payable and fixed assets—and developing the best specific programs and commands for each one.

McCormack & Dodge was in the forefront of this movement, leading the way with its Plus series: G/L Plus, A/P Plus, F/A Plus—systems so advanced they became the choice of the world's most advanced companies. In a market competing to produce separate products for separate applications, they became known as the most

competitive products of all. Benchmarks of sophistication.

The reason was research. Since its founding, McCormack & Dodge has been a research-driven company. To enhance our packages, we have always urged researchers not to simply look ahead—but to look ahead regardless of the outcome.

Four years ago, a team of top McCormack & Dodge researchers began to question the fundamental assumption under which all major software vendors were competing, including ourselves. Why, they asked, must borders exist between business systems? Why not common programs and commands for all applications? Why not a real-time integrated environment for all



For McCormack & Dodge users, it begins today.

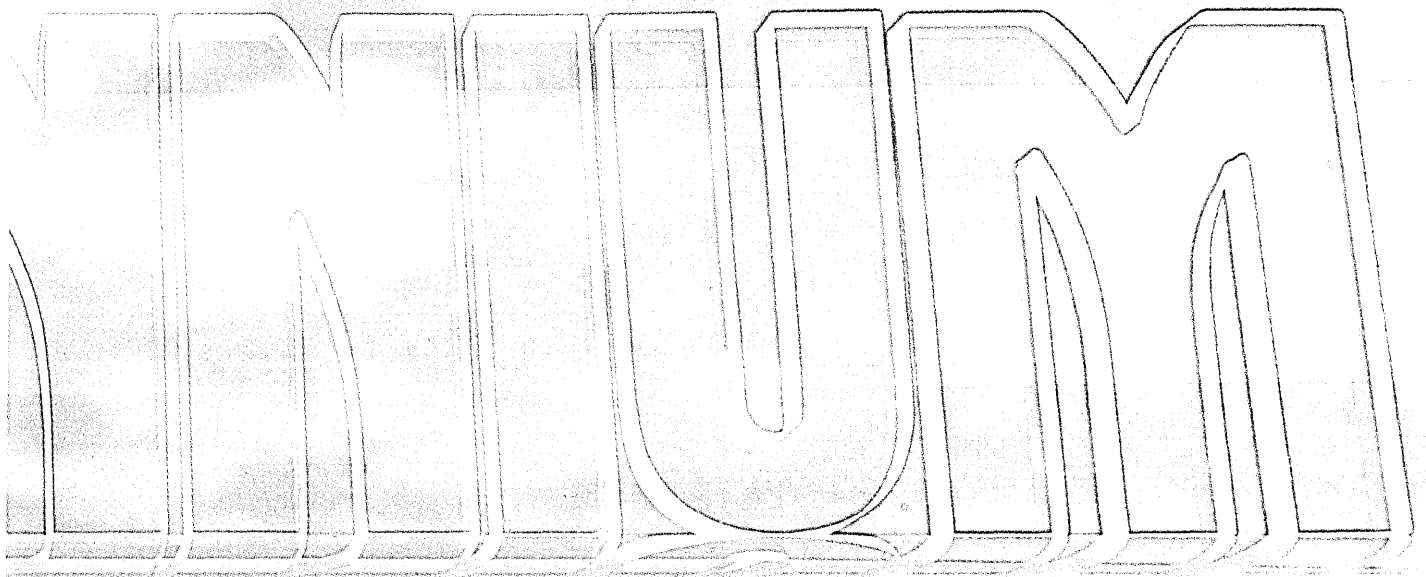

of a user's software systems? So that a person asking a question in one system might instantly enter a correction in another, seek an answer in a third, update a fourth—moving freely through the entire vast information universe, a universe unencumbered by boundaries, walls, separations. Where time would be real-time. Where delays would be a thing of the past. Of the previous millennium.

We are proud to announce a new millennium. And we are eager to introduce you to our new Millennium business software. The software of tomorrow. Today.

## Introducing Millennium. Tomorrow's software today.

General Ledger  
Accounts Payable  
Fixed Asset Accounting  
Payroll/Personnel  
Purchase Order Management  
Capital Project Analysis  
For IBM mainframe systems.

(800) 343-0325\*

\*New 710-343-0325

McCormack & Dodge

offices throughout North and South America, Europe, Asia, Australia and Africa.

**DBB** a company of  
The Dun & Bradstreet Corporation

CIRCLE 36 ON READER CARD

## NEWS IN PERSPECTIVE

taking "a big risk" as it zigs by offering "general purpose" machines, when the rest of the industry is zagging with application-specific product strategies.

Perhaps a better description of NCR's new product strategy might be "flexible," for flexible is what NCR will have to be if it intends to improve its growth performance by making inroads into large corporations. These large corporations, of course, are not pristine fields for the new computer vendor. There is a lot of installed base to contend with, most of which is IBM dominated.

The same flexible attitude is reflected in NCR's reorganization of marketing. At first one might wonder why, when everyone else is dropping the old product line marketing orientation, NCR comes out in support of it? It gets back to the overall picture again—NCR's fundamental repositioning as a company that sells primarily into large organizations.

Prior to the March reorganization of the U.S. Data Products Group (USDPG), NCR did not have a sales force structure that addressed large companies. NCR had been oriented around industry specialists. It also

had a one NCR person per one customer approach to account management. Both philosophies were put in place over a decade ago.

"When selling to small companies, solutions are everything," explained David Laws, vice president, product management and quality assurance. "They can't afford to do their own thing. That's why you have to have someone that understands their business. A big company knows all about its business. What can NCR teach a GM about making cars? Big companies want to deal with people who have an in-depth understanding of the products." But in a rapidly expanding, rapidly changing business, added Exley, "retaining product knowledge just gets away from you."

To address those shortcomings, NCR added product specialists. "We have not abandoned our industry specialists," explained Exley. "What we have tried to do is add product specialization to it."

Today, there are six divisions under USDPG. Four are industry focused—retail systems division, financial systems division, the EFT and data services division, and the data pathing division, which sells shop floor data collection equipment. Within these divisions some product specialists have been added, such as the ATM group

**"At the moment, the type of individual who is good at selling word processing equipment is not the normal data processing man."**

that recently joined the financial systems division. Most of the product specialists, however, reside under the CI/MEG division. (The letters mean the same as the CI/MEG group in development/production, but the marketing group deals with a broader product range. Exley mentioned he is thinking of shortening CI/MEG to "Workstation Systems.") The sixth division handles customer services.

The CI/MEG division (in marketing) has been broken into three different product groups. Interactive systems handles the I-series products, such as the new I-9300, which was built using the 32-bit chip set. Special purpose systems sells the Decision Mate V and the Tower 1632, and General Purpose systems sells the V-series, such as the V-8600 family. While the industry aligned divisions within USDPG are expected to continue doing what they have always done, it appears the task of opening new accounts in large corporations falls primarily on the shoulders of CI/MEG's three product specialist groups.

The strength of this new structure within USDPG, as NCR executives see it, is having both industry and product specialists work together. To encourage joint sales efforts, the company has worked out a special joint commission plan.

**WHEN YOUR  
DEC SYSTEM  
IS ON THE ROPES,  
WE'LL GET IT UP  
AND SWINGING. FAST.**

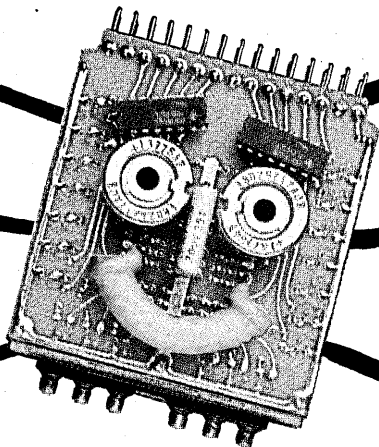

**CALL CONTROL DATA.  
800/328-3980**

IN MINNESOTA 612/931-3131

If your DEC system is down for the count, call us. We maintain your processors and associated peripherals; get them back in fighting trim quickly. You'll get complete service as well as preventive maintenance. Just what you'd expect from the largest independent supplier of computer peripherals in the world.

**GD CONTROL DATA**

*Addressing society's major unmet needs  
as profitable business opportunities*

## NEWS IN PERSPECTIVE

USDPG is the largest of the eight groups that make up marketing. The others are four foreign marketing groups; a service group; Systemedia, which sells business forms and suppliers; and the new independent marketing organization, which sells to outside resellers. All marketing groups report to Garcia, the executive vice president responsible for marketing/sales. Recall that Garcia, along with Anderson, Exley, Buster, and Herman, make up the office of the chief executive.

Don't look for the office systems division, the group that markets such products as the WorkSaver line and FirstStep, under USDPG. It resides within Herman's domain. "We think the word processing area, which is the backbone of the office systems business, was a little different, at least when it started, from data processing," explained Anderson, when asked why office systems was off by itself. "If there is a merge, we are not blind to that. But at the moment, the type of individual who is good at selling word processing equipment is not the normal data processing man. Rather than take data processing people and teach them word processing, we started a brand-new division from scratch and hired new people who were word processing specialists."

Over the past five years, NCR has made a number of fundamental changes to its organization, most of which have actually come to pass within the past two years. While NCR's goals and strategies appear to be well grounded, the critical test will be how well the company manages the resulting changes within the organization.

Can redundant product development and needless waste of resources always be quickly spotted? Can NCR's top executives realistically maintain that rigorous review schedule that is central to making the system work? Is the incentive plan within marketing strong enough to produce an active cross play between the industry and product specialists?

Who knows, maybe NCR's management is zigging in the wrong direction. Maybe they are wrong in thinking that distributed processing systems, designed to be compatible with any number of industry standards, will win the hearts and pocketbooks of large corporations. But then again, maybe they are right. For instance, orders for the 9300, which was introduced in March, were running 250% ahead of plan by June, said one NCR insider. And orders for the Decision Mate, which was introduced in January, were running about 40% above forecast, estimated Gary Horning, an NCR program manager in marketing.

Give them a year, perhaps to the end of 1984, and then look to see what major corporations have been added to the customer list. As Anderson said, "The proof of the pudding is in the eating," and NCR has just brought its pudding to the table.



## DBMS-1 FROM COMPUCORP

It finds records in a flash—  
even if there are tens of thousands of them.

DBMS-1 from Compucorp is a highly sophisticated software system that enables you to find individual records in seconds—even if there are tens of thousands of them. It gives your desk-top system the formatting and retrieval power of a mainframe. Information can be automatically sorted, selectively altered, and instantly recalled in nearly any format you devise.

With DBMS-1, records can be retrieved in a variety of ways. For example, retrieval based on a partial command, as in typing "Budl" to get "Budlongstrovitz". Or retrieval based on a numerical rating, such as your highest volume salesman. This information can be merged into a document, such as the monthly sales activity roster, in practically any format you wish. And it's as easy to use as word processing itself.

These capabilities make DBMS-1 a powerful tool in preparing many different types of documents, such as sales reports, personnel files, price lists and inventory lists. And DBMS-1 can be used on OmegaNet™, Compucorp's own local area network.

For more information:

1-800-556-1234 (Ext. 28)

or in California:

1-800-441-2345 (Ext. 28).

Send to  
**Compucorp**

2211 Michigan Avenue,  
Santa Monica, CA 90404.

I am interested in Compucorp's  
DBMS-1. Send information right  
away.

Name \_\_\_\_\_

Title \_\_\_\_\_

Company Name \_\_\_\_\_

Street Address \_\_\_\_\_

City \_\_\_\_\_

State \_\_\_\_\_

Zip \_\_\_\_\_

Area Code \_\_\_\_\_

Telephone \_\_\_\_\_

D-D-8-83

CIRCLE 39 ON READER CARD

## SDM/70 Methodology. The industry standard.

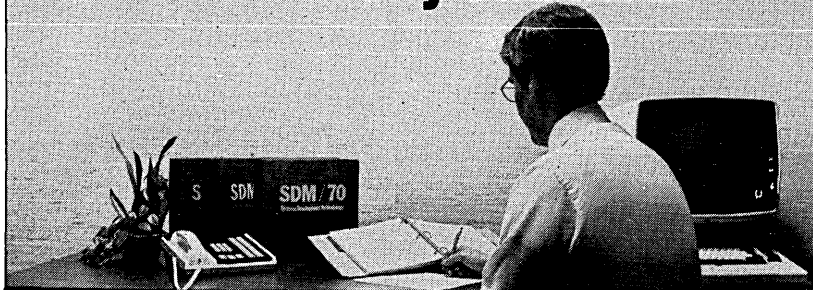

SDM/70 is the proven standard in systems development methodologies. More than 400 major companies and government agencies throughout the world use it to develop and manage a wide variety of information systems development projects.

SDM/70 defines how to organize and manage work; how and why to perform tasks and in what sequence; how to estimate costs and schedules; how to ensure effective documentation and user training; how to set up quality control procedures and groups; and how to manage and administer projects. The SDM/STRUCTURED™ version of the methodology incorporates the most up-to-date structured analysis and design disciplines into the proven system development life cycle of SDM/70.

SDM/70 and SDM/STRUCTURED are part of a complete portfolio of system development

and project management tools available only through AGS Management Systems, including automated project management systems, automated estimating, information systems planning, training and consulting services.

For more detailed information about SDM/70 or SDM/STRUCTURED, or any of our other products and services, just call or write.

**AGS  
Management  
Systems** INC.

The world's leader in project management systems  
320 Walnut Street  
Philadelphia, PA 19106 **215/265-1550**

Formerly Atlantic Management Systems, Inc./  
International Systems, Inc.

CIRCLE 40 ON READER CARD

## NEWS IN PERSPECTIVE

# AMDAHL VS. THE WORLD

The Sunnyvale pcm takes on new markets while cultivating its original mainframe business.

by Edward K. Yasaki

Contrary to the worst predictions of its detractors, Amdahl Corp. continues as a profitable manufacturer of IBM-compatible equipment for the large-scale user, offering more performance for a lower price than Big Blue. The Sunnyvale, Calif., firm, buffeted by IBM's price changes, performance upgrades, and new operating systems, manages to stay competitive and do so without massive reverse engineering.

Following IBM's release of the new MVS/XA software in May, Amdahl in June announced its intention to ship XA in the second quarter of 1984, supporting it both on its new 580 series of mainframes and the older, now out-of-production 470s. The so-called 580/Extended Architecture supports up to 2 gigabytes of real and virtual address-

Besides increased pressure from IBM, the company will soon face competition from Trilogy Systems.

ing, bimodal operation, and all functions of the dynamic channel subsystem.

While IBM's VM/XA migration aid allows the 3081 user to run MVS/XA in test mode only, not production, in one of the mainframe's dyadic processors, and to run production-mode MVS/370 in the other processor, Amdahl has announced an XA conversion assist feature that allows its mainframe to be partitioned in any ratio desired by the user. In addition, illustrating the increment of extra performance that the pcm tries to offer, the user will be allowed to run MVS/370 in production or test mode in one partition and MVS/XA in test or production mode in the other. And that partition can be moved with a console command, a necessity as the new XA user gets more applications converted.

Similarly, while IBM's support of XA is extended only down to the smallest of the 308X family, the 3083-E, and not to any of the 303Xs, Amdahl will do so on the smaller and older 470s, the manufacture of which ended during the second quarter of this year. Thus, any 470s that come off lease could be remarketed as XA test machines.

The installed base of 470s is expect-

**STATE-OF-THE-ART  
SOFTWARE FOR  
THE 80'S**

1969 **DYL-250**

1972 **DYL-260**

1979 **DYL-AUDIT  
FIXED-FORM**

1981 **DYL-AUDIT  
FREE-FORM**

1981 **DYL-280\***

**NEW**  
1983 **DYL-280\***  
with a TRUE Structured  
Programming Facility

Report writing, utility, data management and audit software products that stand the test of time. Always state-of-the-art. Designed with your data processing needs in mind. Proven products developed and supported in-house by Dylakor since 1968.

■ For IBM 360, 370, 30xx, 43xx and compatibles.

■ Use everyday, English language to write reports with speed and ease. Ideal for your end-users in an information center environment.

■ Perform highly sophisticated utility and development functions. Save valuable system programming time.

■ Experience DYL-280's NEW Release 3.0 with a Structured Programming Facility, COBOL Data Definition Support, Cross Reference, Exponentiation and much more - for as little as 20¢ per hour.

\*Over 1000 installations in its first year.

**Dylakor**

A Sterling Software Company  
17418 Chatsworth Street  
P.O. Box 3010  
Granada Hills, CA 91344  
(213) 366-1781

CIRCLE 41 ON READER CARD

# SUPPORT THIS UNION AND AVOID A WORK SLOWDOWN.



Organize your DP operation around a VAX computer and Direct 831 terminals and enjoy an important benefit of a DEC-Direct union. More power. The kind that gets work done faster.

To the 831's VT100-compatible features you can add an optional integral modem to put the power of your VAX in the hands of anyone with a telephone.

Or add PLOT 10 graphics and deliver the big picture when there's no time to wade through words.

But that's just for starters.

The 831's block mode frees your VAX from the chore of creating and editing data. (That's why many users, including DEC itself, view block mode as an answer for overburdened CPUs.)

And if that's not enough, you can unite host and personal processing by field-upgrading the 831 to our Direct 1031, a self-contained terminal/personal computer. The 1031 makes the entire array of CP/M-compatible software available to off-load your host, leaving you more VAX processing power for the jobs only a VAX can handle.

To further our cause, we're prepared to stage a demonstration at your place of business. Contact us at Direct, Inc., 4201 Burton Drive, Santa Clara, CA 95054. Telephone 800-538-8404 (408-980-1414 in California). Direct and DEC. It's one union that gives you more than you bargained for.

## DIRECT

DEC, VAX, and VT100 are registered trademarks of Digital Equipment Corporation. CP/M is a registered trademark of Digital Research, Inc. ©1982 Direct, Inc.

CIRCLE 42 ON READER CARD

# Introducing the High Touch™ Terminals. Because there's more to ergonomics than simply separating keyboard from monitor.

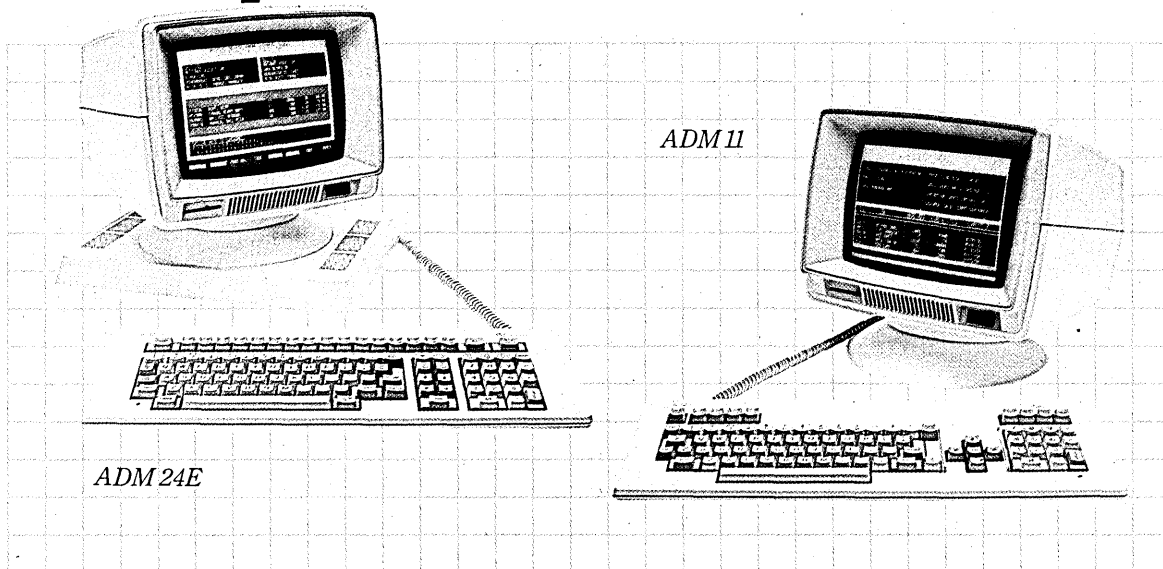

Have you ever noticed that the more high technology we put into the workplace, the more human touches the workers put in?

We noticed. Plants, pictures, macrame. Funny coffee cups.

We decided that people were trying to tell us something. There's a real need to soften the interface between people and high technology.

So we designed our new High Touch™ terminals from the desktop up to work together

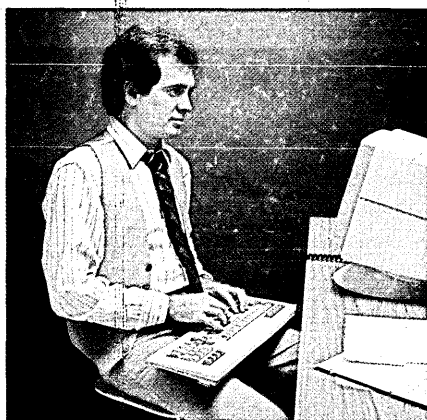

6' coiled cable lets you put the keyboard anywhere.

with biology, not just with technology.

**Because if our product doesn't feel good, you DP managers and OEMs don't look good.**

There's more to ergonomics than simply tacking on a few faddish features as an afterthought. We put our thinking in up front. We spent a long time studying the way humans relate to computers. And we came up with a whole new way for computers to relate to humans.

No aspect of terminal design escaped our deepest consideration. Or reconsideration.

And the result is a terminal that's downright considerate.

Because whether you're a DP manager or an OEM, the fact remains that the terminal represents your system. So High Touch terminals are made to feel as good as they look to the people who use them.

Dozens of little touches add up to the convenience and comfort of High Touch. For

example, we put the power "on/off" switch and contrast control knob in front where they're easy to reach.

The monitor not only tilts and swivels, it



Low profile DIN-standard keyboard with adjustable tilt.

stops positively in almost any position. With other tilt-and-swivel terminals, the cables always seem to reposition the monitor for you the moment you have it adjusted perfectly.

The clean, crisp display features a large character matrix on an easy-to-read non-glare screen—made even easier to read by the hooded bezel.

The low profile, DIN-standard keyboard is not only tapered, its angle of tilt is easily adjusted for maximum operator comfort.

And the Selectric® layout with its sculptured keys and tactile home row positioning make data

entry almost as natural as talking.

**Because the only thing that should be difficult is making an error.**

On the ADM 11, for example, you'll find the separate

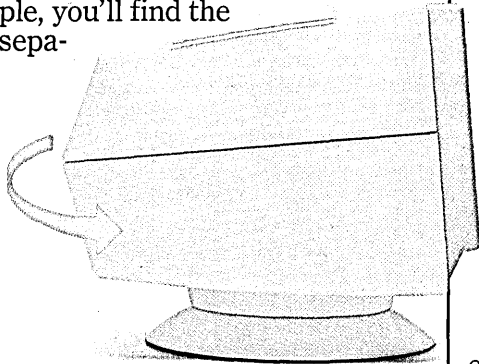

Monitor tilts and swivels to almost any position. Both models available with 12 or 14 inch screens.

rate cursor control keys logically arranged in a cross for ease of use without looking.

We placed the control and escape keys close to the alphanumeric keys, where people just naturally expect to find them.

And there are no keys at all next to the space bar, so no one can accidentally hit them.

Our uncluttered keyboard, with its logical and physical separations between key groupings, improves your efficiency.

On the whole, we've taken the approach that if something isn't needed, it shouldn't be there. That's why the ADM 11 has just four function keys shift-able to eight.

And speaking of staying out of the way, our High Touch terminals' small footprint will fit as easily on a secretary's return as on an executive's credenza.

**Because styling and comfort are just the first steps toward increased productivity.**

No terminal has ever been so easy to live with. But don't get the idea that High Touch is the opposite of High Tech. It isn't.

The ADM 11, for example, is a High Touch conversational terminal that accepts data continuously at 19.2 kilobauds.

Block mode terminals simply can't match this high throughput.

In addition there are four programmable function keys (shift-able to eight) with two levels of setup mode to reduce errors while still giving the operator maximum flexibility.

On the other hand, for a High Touch terminal that's more intelligent and has more functions and features, choose the ADM 24E. It features a moveable 24-line window you can use to look at 48 (or optionally, 96) lines of memory.

There are eight non-embedded attributes with embedded mode for existing applications, and 16 programmable non-volatile function keys (shift-able to 32) with legends on the status line (25th line). It runs in either conversational or block mode.

The ADM 24E also offers

base. We've been continuously implementing state-of-the-art technology in an ever-expanding line longer than any other major manufacturer.

So it's no surprise we're introducing the most advanced stage of terminal evolution. Who else would?

Our terminals are used in more computer-based systems than any other. And survey after survey shows we're the world's favorite terminal manufacturer. When you buy Lear Siegler, you're buying proven quality and reliability, backed by the broadest network of full service centers anywhere. That means you can get walk-in Express Depot™ service, on-site service and extended warranty service in 3,000 cities nationwide.

Lear Siegler High Touch terminals are made in America—designed, engineered, manufactured and shipped from Anaheim, California to provide

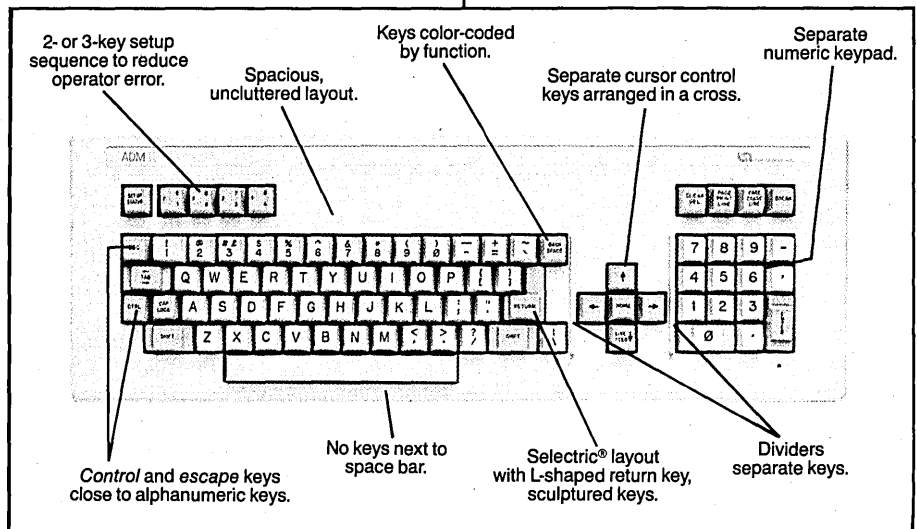

plenty of additional space for OEMs, with up to 56K ROM and 22K RAM.

When it comes to terminal technology, we're the historic leader with the largest installed

you with the best local support. That's one reason they're called the American Dream Machines.

Our new High Touch terminals. Because it's high time.

**LEAR SIEGLER, INC.**  
**DATA PRODUCTS DIVISION**

901 East Ball Road, Anaheim, CA 92805 800-532-7373 • 714-774-1010

**Everybody makes terminals. Only we make Lear Siegler's.**

Call your favorite Authorized Distributor: Advanced Technology • Consolidated Data Terminals • Continental Resources • The Datastore • Data Systems Marketing • David Jamaison Carlyle, Inc. • Gentry Associates • Hall-Mark Electronics • M/A-COM Alanthus, Inc. • Marva Data Services • M.T.I. • National Computer Communications • Pioneer (Standard, Harvey, Gaithersburg) • 2M Corp. • Wyle Electronics. Or call Lear Siegler at 800/532-7373. Selectric® is a registered trademark of IBM Corporation. High Touch™ and Express Depot™ are trademarks of Lear Siegler, Inc.

# TO CELEBRATE OUR 1,500<sup>th</sup> UFO CICS INSTALLATION, WE'D LIKE TO GIVE YOU A FREE GIFT.

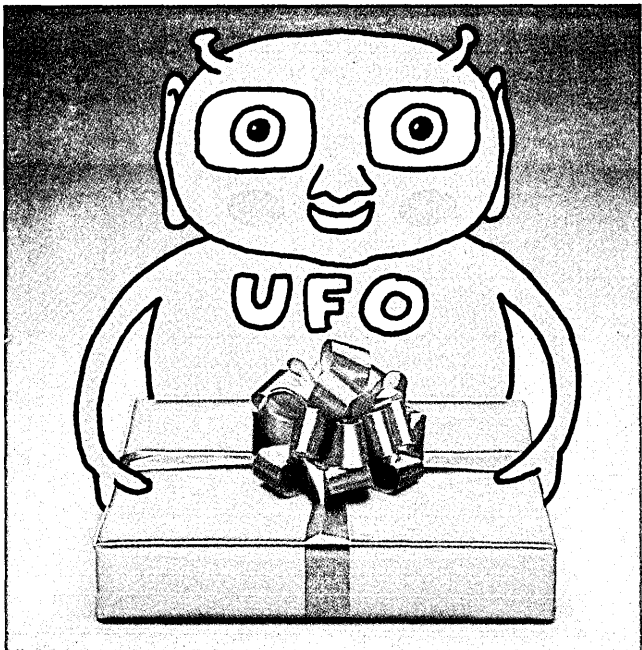

Before Labor Day, we'll be installing our 1,500th UFO applications development system for CICS. That's more installed systems than all of the other independent suppliers *combined*. And to celebrate, we'd like to give everyone who schedules a UFO trial this summer a free gift worth \$3,000. The gift is Oxford's data compression software package called SQUEEZE . . . that will pay big benefits by reducing on-line terminal response time up to 25%. And it's yours absolutely free, just for scheduling a UFO trial this summer and seeing for yourself why UFO is the #1 CICS application development system.

**More than any other system, UFO takes the time, expense and frustration out of CICS applications development and maintenance.**

Our celebration is only one of the reasons to schedule a UFO trial this summer. Most importantly, you'll see with your own applications how the versatility of UFO lets you develop, test and maintain complete on-line applications better than any other system . . . do it faster, with less cost and with greater security.

Right from installation, you'll see your staff become more productive . . . especially those with no prior CICS experience. And you'll see their productivity steadily increase because UFO is a powerful, non-procedural system that uses automatic preprogrammed functions to replace complicated CICS coding. With UFO, functions like add, update, browse and display are accomplished without writing one line of code. And when UFO's Executive Inquiry, Data Dictionary, Screen PAINTing and Automatic Access to files . . . including DL/1 databases are combined with UFO's Pre-Programmed Functions, you can reduce your applications development requirements by as much as 90%.

No other company knows more about applications development systems than Oxford. And no other company can provide you with as much valuable in-depth support. Make this summer the time you begin to do something about your CICS backlog. Schedule a UFO trial . . . and get a free SQUEEZE on us!

 **OXFORD SOFTWARE CORPORATION**  
174 BOULEVARD/HASBROUCK HEIGHTS, NJ 07604/201 288-1515  
**800 631-1615**

## A GIFT CERTIFICATE FROM OXFORD

- Please contact me about scheduling a UFO trial this summer . . . and installing my free SQUEEZE Data Compression Software Package when I begin my trial. (One per installation.)
- Please contact me with details on UFO and SQUEEZE.

Name \_\_\_\_\_  
 Title \_\_\_\_\_  
 Company \_\_\_\_\_  
 Address \_\_\_\_\_  
 City \_\_\_\_\_ State \_\_\_\_\_  
 Zip \_\_\_\_\_ Phone No. \_\_\_\_\_



## NEWS IN PERSPECTIVE

ed to remain in place for some time, keeping the vendor busy performing field upgrades. The largest of that family, the V/8, runs at about 6.5 MIPS, making it faster than the IBM 3083-B. In the Amdahl lineup opposite the 3083-J is the newest member, the so-called 5840. The 5850 is the equivalent of the 3081-D and G, the 5860 is opposite the 3081-K, and the 5870 and 5880 do battle with the 3084-Q.

The demise of the 470 is a significant milestone for the company. Back in October 1975 the 470V/6 was the first computer installed by the company, following a startup investment of more than \$50 million. Since that time, the company has installed almost 800 of the 470s. What the termination also indicates is the high degree of confidence the vendor has in its follow-on family of processors, the 580s. It was with the first of this series, the 5860, that Amdahl Corp. experienced manufacturing difficulties that delayed first customer shipment until last August and exposed the egg on its face.

"We lost some business as a result of that," acknowledges John C. Lewis, president and ceo. Not only were deliveries late but the company found its machine ran slow under MVS and it was forced to make costly engineering changes. Only as recently as last March were the changes incorporated in machines on the manufacturing

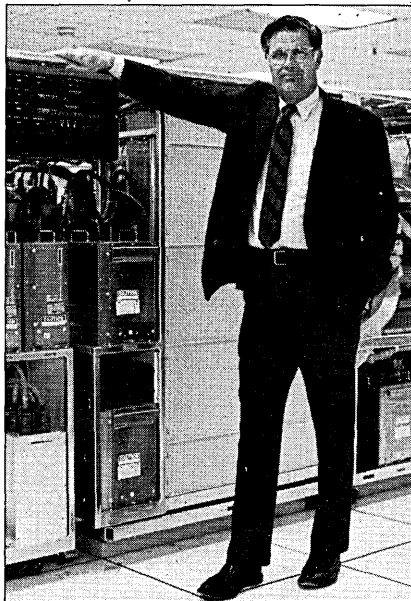

A MAN AND HIS CPU: "I don't think I could deliver a 30-MIPS uniprocessor in 1986," says John C. Lewis, president of Amdahl Corp, "but I think I can deliver a machine as big as Trilogly can deliver in '86."

floor and in models installed earlier at customer sites. By the middle of June, however, the installed base of 5860s approximated

90, officials said.

But of all the negative factors that a pcm like Amdahl can experience in the marketplace, adds Lewis, what surprises him most is the success IBM is having in convincing users that they will need the XA software immediately—and therefore should go with IBM instead of Amdahl.

And, as if it weren't bad enough chasing IBM's coattails, Amdahl Corp. must now face the impending competition of Trilogly Systems, the new venture of Dr. Gene M. Amdahl (May, p. 62). Trilogly seeks to build a uniprocessor in the 30 MIPS class by 1985 or 1986 and to offer an MTBF of some 32,000 hours.

"I don't think I could deliver a 30-MIPS uniprocessor in 1986," says Lewis, "but I think I can deliver a machine as big as Trilogly can deliver in '86." He refers to a dual-processor configuration, but refuses to say how much bigger than 30 MIPS it could get. According to a former Amdahl executive, the company plans to produce a uniprocessor with 20% more speed than the 5860 in 1985, one that could be manufactured for \$750,000 and sold for \$2.5 million. It purportedly also has slated a dyadic machine that runs at 27 MIPS, has a manufacturing cost of \$1.4 million, and a price of \$4.5 million. Lewis, neither confirming nor denying this, merely says the company has "a number of scenarios" it can consider.

# A First for IBM . . .



“...AND THE 2314X BEGAT  
THE 3330X, AND THE 3330X  
BEGAT THE 3350X, AND THE  
3350X BEGAT THE 33800...”

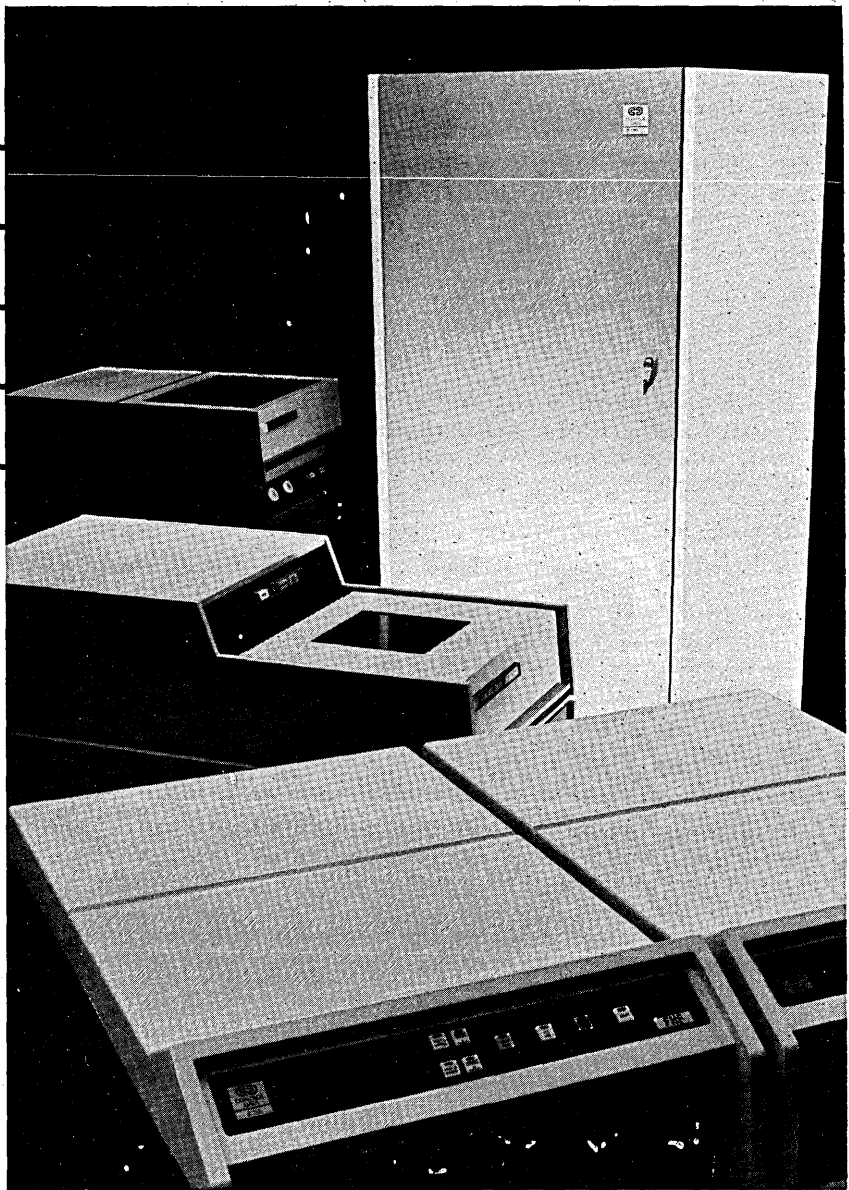

**PCM COMMITMENT YOU CAN  
COUNT ON FOR GENERATIONS**

For five PCM generations, Control Data has been building cost-effective, plug-compatible storage systems. This long-term commitment has paid off with increasingly effective storage systems. We were the first to introduce double-density versions of earlier models, like the 3350 disk drive. And now our commitment has paid off again.

Introducing the 33800 and 33750—two new and even more effective IBM-compatible storage systems from Control Data. Who else?

Better products, backed by outstanding service. Together they tell the story of Control Data's commitment to PCM. Today. Tomorrow. Always. For more information, call 612/553-4311.

**GD CONTROL DATA**

CIRCLE 46 ON READER CARD

## NEWS IN PERSPECTIVE

About the Trilogy plan, he says, "I think it's a very aggressive schedule." He's sure Trilogy has some good technology and that the machine will be quite reliable, but adds, "You have to remember that machines are always the most reliable before they're built."

In anticipation of not only this added competition but also the needs of larger users in the years to come, Amdahl for more than four years has been developing a transaction processing operating system that would be more general purpose than IBM's Airline Control Program (ACP). According to Lewis, this software, code-named Aspen, is installed at four accounts, including an insurance company, a bank, and an airline, but will probably require an additional year of shakedown before its commercial release.

As if to show that it does not merely react to announcements by IBM, Amdahl was perhaps the first company to support Unix on a mainframe. It did so for use internally by engineers who had had much exposure to the environment on Digital Equipment DEC-10s and PDP-11s. In 1977 Unix was thus ported to an Amdahl and in 1980 emerged as an Amdahl product called Universal Time Sharing system. Until about a year ago there were only about 10 or 12 sites using it, but new interest in Unix has brought that number up to 40. It's the kind

of product that can get a company like Amdahl into new accounts, a prospect that is far from unattractive.

For years, executives at Amdahl have lamented the rebuffs its sales force receives at so many large and prestigious IBM accounts, companies that buy only blue mainframes. They have recognized the need to instill at those prospects a confidence in the quality of products and services available from this California upstart. Amdahl's offering of disk drives patterned after IBM's, viewed by most people as an attempt by the company to get into the system business, actually serves this additional purpose. The company has some 90 customers for its drives, of which 10 to 15 have no Amdahl mainframes. The same applies to its communications products, which provide an entrée into the door of new customers, and to its educational activities. Half the students at its technical courses come from firms without an Amdahl processor.

The company is now into five lines of businesses—processors, disk drives, communications products, software, and education. When asked whether it might also offer terminals, say, or workstations, Lewis explains that such products might flow from the company, being hardware that big users buy, but hardly something the firm would undertake to develop and build.

"We try to make sure we put our

R&D money into those areas where we think we can do something better," he says. And the same would apply to anything outside the five activities it has entered so far. "Unless we can bring something to the party that makes it more advantageous for them to buy from us, there's no reason for us to spend the money." The company, he adds, already has a long list of projects on which it might spend its R&D funds, "for things we think we do better than other people."

## CAUGHT BY SURPRISE

**Computer lessors almost missed their chance to fight pending Congressional bills that would hurt them in the pocket.**

**by Willie Schatz**

Looking to make a few bucks and have Uncle Sam pick up the tab? Has the government got a deal for you!

All you have to do is drop in on the

---

# A First for IBM...

# Provided by Data Switch



# BEFORE VISICORP™ CHOSE ANSWER™/DB, SOME PEOPLE THOUGHT IT WAS JUST ANOTHER GOOD REPORT WRITER.

Since the recent announcement of a jointly developed Informatics and VisiCorp product, it's clear that Answer/DB is much more.

For the last two years DP professionals have been installing Answer/DB, the personal reporting system, for good reasons.

Answer/DB operates with standard OS/DOS files.

Answer/DB, unlike ordinary report writers, features multiple data base access that is transparent to end users.

Answer/DB accesses IMS, TOTAL, Adabas, IDMS data bases and others too.

Answer/DB is designed to provide efficient utilization of computer resources tuned by the DP professional.

Answer/DB also provides security through user profiles designed to selectively control

data base access to the record, segment, field, and value level.

While obviously sophisticated enough to satisfy the most professional DP person, Answer/DB is also so simple to operate that end users are very happy with it.

Answer/DB provides online personal access to data.

Answer/DB requires no specialized computer background to use and doesn't even necessitate formal Answer/DB training.

Answer/DB can be learned in less than an hour. It lets end-users interactively and selectively develop their own report requests at a terminal with as few as four easy statements.

Answer/DB, more importantly, is the key to the intelligent, selective mainframe to micro connection coming very soon.

Incidentally, Answer/DB can be installed today!

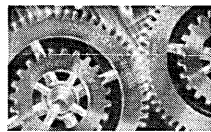

Informatics General Corporation  
(213) 716-1616 Telex 69-8473  
21050 Vanowen Street  
Canoga Park, CA 91304

D-8-83

- Send me the complete details.  
 Have a marketing rep call.

Name \_\_\_\_\_ Title \_\_\_\_\_

Company \_\_\_\_\_

Address \_\_\_\_\_

City \_\_\_\_\_ State \_\_\_\_\_ Zip \_\_\_\_\_

Telephone (\_\_\_\_) \_\_\_\_\_

Computer \_\_\_\_\_ Operating System: DOS VS \_\_\_\_\_ OS VS \_\_\_\_\_

 **Informatics** TP Monitor: IMS/DC \_\_\_\_\_  
general corporation .. CICS/VS \_\_\_\_\_ TSO \_\_\_\_\_ CMS \_\_\_\_\_

## THE SOFTWARE ENGINEERS

## NEWS IN PERSPECTIVE

nearest tax-exempt entity and offer to buy whatever it has for sale. In the case of Bennington College, it could be the entire school, land included. You say academia's not for you, but you're mad about the military? Then tell the Navy you'll charter one of its 13 Rapid Deployment Force cargo ships. That way the Navy doesn't have to buy the boats, saving it money, and you, the shrewd investor, receive that most desired manna from heaven—a tax benefit, saving you money.

So a good time is had by all. Make that all but one. And that one is tired of counting the money it's losing. If Rep. J.J. Pickle (D-Tex.) and friends have their way, all deals are off as of May 23.

Pickle, who said the leasing largesses created by the depreciation changes in the Economic Recovery Tax Act (ERTA) of 1981 have created an "Alice in Wonderland world of off-budget financing," would solve the problem by the Government Leasing Act of 1983 (H.R. 3110). The bill would alter the depreciation schedule to withdraw most of the favors granted by ERTA to investors who lease property and equipment to tax exempt institutions.

Property, in the allegedly omniscient eyes of Capitol Hill, includes more than planes and boats and trains. The computer industry, innocent though it may be, has been caught in the reformers' dragnet.

Once trapped, it will be extraordinarily difficult to break free.

"We are clearly suffering for the sins of others," contends Paul Oosterhuis, attorney for the Computer and Business Equipment Manufacturers Association (CBEMA). "For computers and office equipment it's not that often that companies are obtaining an investment tax credit (ITC) on leases. Most of the time leases aren't even

**"Short-lived equipment clearly doesn't give rise to the same abuses long-lived equipment does," says CBEMA's lawyer Oosterhuis.**

eligible for an ITC. Our problem is with the depreciation change.

"I really don't even know what we're doing in this bill," adds Oosterhuis. "I think Pickle used this as a mechanism to bring people out and help him analyze the issue. I wouldn't say he did it for shock value, but I would say he did it for informational purposes."

"Pickle drafted a very tough bill to ensure people would speak out," confirms a staffer for a Ways and Means member. "The way things work around here, sometimes you put things in a bill just so you can take them out. That may be what Pickle intended with the computer industry."

Whatever the good legislator's mindset was at the time he took pen in hand, industry trade groups are doing their damndest to change it.

"Short-lived equipment clearly doesn't give rise to the same abuses long-lived equipment does," Oosterhuis says. "The people on the Hill understand that, but it's going to be very difficult politically to exempt us from this bill."

Enter CBEMA and the Computer Dealers and Lessors Association (CDLA). Their task is to reduce the very difficult to the merely hard. So far the House Ways and Means Committee, where the bill currently rests, has seen the error of most of its ways. That's almost, but not quite enough, for the two trade groups.

As originally drafted, the bill changed the current "accelerated cost recovery system" (ACRS) depreciation schedule for leased computer equipment to the straight-line method with a 12-year recovery period.

"That has absolutely no relation to reality," Oosterhuis says. "It's totally absurd. In other industries it might make sense. In the computer industry, equipment that might remain mechanically usable can be technologically obsolete or at least non-competitive with newer equipment. And that's in five years, never mind 12.

"At least we've gotten them to

# Data Switch Announces . . .



## NEWS IN PERSPECTIVE

agree that that's ridiculous. We've gotten them down to either five or six years on the straight line. What we really want is to get them to go that extra mile and leave us alone."

Actually, what CBEMA and CDLA really crave is to turn the clock back to 1980, when a lease was a lease was a lease. Then, depreciation deductions were easier and faster, and there was incentive for nonprofit institutions to lease all the bytes and MIPS they could get their hands on.

Since the birth of ERTA, though, and the spawning of its 1982 offspring, the Tax Equity and Fiscal Responsibility Act (TEFRA), industry spokesmen complain that their members have never had it so bad. The party line is that while the rest of the world was helped considerably by the changed depreciation schedules, the computer leasing business was hurt.

"The change to the ACRS substantially increased the tax benefits for real estate and long-lived equipment," CBEMA vp Bob Coyer says. "But it did not provide

**"If they really wanted to help us, they'd let us depreciate over three years, not five," says CDLA chief Jim Benton.**

any benefits for short-lived equipment. It actually made leasing computers and other short-lived equipment less desirable for nonprofit organizations and governments than the old schedule. And now to 'correct' the situation, they're proposing to make computer leasing even harder."

"The tax act of 1981 clearly discriminated against computer leasing," confirms Ken Pontikes, president of Comdisco, the nation's largest dealer in the IBM remarketing business. "The computer and electronics industries were the only two that were hurt by the '81 law. The depreciation change made it less efficient to lease than before the law passed."

So now hear this, Congress. You owe us one. If the Philadelphia 76ers of the National Basketball Association delivered six years after they first promised a championship to their fans, you, the mighty Congress, can come through for us. We're not talking megabucks here. The real issue is stopping the Benningtons and Navies of the country from stealing Uncle Sam blind. In light of those scams, CBEMA and CDLA say, what's a little accelerated depreciation between friends?

That question was to be answered sometime after Congress returned from its Independence Day recess. Markup of H.R. 3110 was originally scheduled for June 29, but had to be postponed when the Ways and Means members could not agree on what to do to whom. A committee source indicated markup was expected to occur the week of July 11.

It was difficult to determine which

of the parties was more desperate for a vacation. The legislators, beset by requests for relief from affected industries, needed to clear their heads. Industry groups, still somewhat shell-shocked by the affair, needed to catch their breath.

"We were definitely caught by surprise," admits Jim Benton, executive director of the CDLA. "Fortunately, we caught it before markup. We've got friendlier ears up there [in Congress] than we used to."

In an advisory memorandum to his members, Benton wrote that "computer leasing has not abused past laws, and we are not a direct target of the bill." He warned that the dealers and lessors could be "injured unjustly" by Congress's effort to eliminate abusive lease practices by other industries.

"We've never taken the ITC on equipment leased to tax-exempts," Benton asserts. "We're as pure as the driven snow. . . . well, we've been good. Anyway, she's [the bill] shaping up pretty well now," he says. "I think we can get a fix."

Any one of these three will do, he says: 1. outright exclusion of computers, 2. exclusion of all property that is on a short-term lease of five years or less, 3. exclusion of all property that was not helped under the 1981 law.

"They keep talking about helping high tech," Benton says. "If they really wanted to help us, they'd let us depreciate over three years, not five. Think about what happens to technology in five years. You can't stimulate the industrialization of America by continuing to impose restrictions on high-technology industries, including computers."

Ah, but you can. Not only that, you will. According to one of the tax men on Ways and Means, the computer industry is in the bill to stay. The best the committee will offer is a six-year straight-line depreciation method. That's not what the industry ordered, but it's much less distasteful than what it could have been swallowing. A more palatable prescription may be available in the Senate, where Finance Committee chair Bob Dole (R-Kans.) has introduced S. 1564, the Government Lease and Reform Financing Act. Unlike H.R. 3110, this bill would continue the accelerated depreciation for real property leased to a tax-exempt entity for four and one-half years or less.

"Unlike the House version, this bill provides an exemption [from the slower depreciation rules] for the computer industry," Dole said upon introducing the bill. "The inability to obtain economic leases may have a devastating effect on high-technology industries and educational institutions."

"There's no way we're going to come out better than we are under present law even though present law is worse than

old [pre-1981] law," Oosterhuis says. "If the House bill passes, it's going to make computer leases less of an attractive investment from the lessors' view and there's going to be a significant but not overwhelming diminution in tax benefits for leasing. And there will be some increase in rates to customers."

No argument there. The only question is how much more the lessee will pay. CBEMA's best but admittedly unquantified estimate is 10%. That's not insignificant when you're a nonprofit organization.

"I think lessors will charge a little more, but this is an industry where the prices are going down consistently," the Ways and Means tax man says. "We've already made the bill much more attractive to the computer people than when we started out. All we're trying to do is eliminate any tax motive for leasing by the tax exempts. The government's losing enough money as it is. [As much as \$2 trillion could be transferred to private investors and then leased back, according to a Congressional Budget Office estimate.] We just want to achieve neutrality with respect to the lease/buy decision on the part of the tax exempts. They certainly don't need any more tax breaks."

The House apparently feels similarly about the computer industry. But rest assured, CBEMA and CDLA are keeping the faith. They may yet get their members out of this pickle.

## NETWORKING

# MEN AT WORK

**Australia is installing a huge SNA network, with little help from IBM.**

by Norman Kemp

Wang Labs, Amdahl Corp., and Storage Technology are in and IBM, for the most part, is out. That was the government's surprise verdict in awarding to those three firms a total of \$118 million worth of contracts to supply Australia's Social Security Department with a nationwide distributed processing network.

Besides being one of the largest civilian data networks ever to be planned outside of the United States, the network has been the focus of intense marketing efforts by a small group of companies. The big loser was IBM Australia, which has fought bitterly with Fujitsu of Japan for several years in Australia, industry observers say.

# A New Industry Standard

## Introducing the Model 1200 Intelligent Peripheral Switch for IBM and compatible computers.

The Model 1200 is more than the industry's most reliable peripheral matrix switch. It also performs these advanced functions:

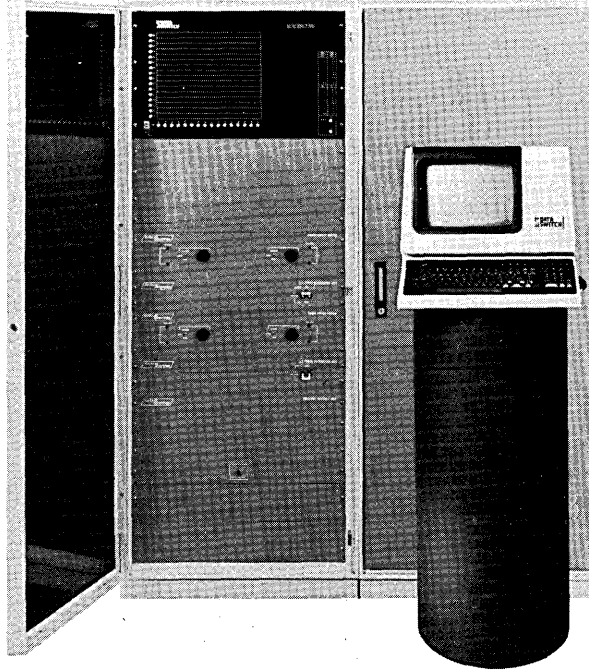

### User Definable Matrices

The Model 1200 computer/peripheral switch can be configured to respond to the shifting equipment and application requirements in a data processing installation. The User Definable Matrix lets you dynamically segment the switch into four logical matrices dedicated to particular equipment groups or applications, such as a printer pool or FEP group. Segments of the switch can be restricted by password control.

### Test I/O

The Model 1200 Test I/O function lets you determine the operational status of any device on any IBM or compatible channel without jeopardizing the channel or CPU operation. Test I/O helps to safely bring a peripheral subsystem on-line by ensuring device integrity *before* the peripheral is logically attached to the CPU. This reduces the risk of lengthy downtime

caused by attaching faulty equipment. If one of your on-line devices fails, Test I/O assists you in pinpointing the faulty control unit or device.

### Global Monitoring and Control

The Model 1200 Data Path Activity Monitor allows you to display graphically on a CRT terminal the channel activity of *all* CPUs connected to the switch. This gives you a *global* view of channel activity in your entire data processing installation. (IBM doesn't do that.) Data Path Activity Monitor lets you determine data flow bottlenecks in real-time and then reconfigure your computer/peripheral interconnections to balance loads for better performance.

### Other Important Features

- **Local CRT Control.** From one or two CRT terminals, with a color option, that are attached directly to the switch, you can predefine and store equipment interconnections, view

the predefined configurations, and then execute the configuration in seconds.

- **Distributed Control.** Up to 56 Model 1200s at local or remote sites can be monitored and controlled from a minicomputer-based Configuration Management System.
- **Broad Range of Matrix Sizes** from  $2 \times 4$  to  $16 \times 48$ . The Model 1200 can be expanded on-line as your installation grows.
- **Reliable Semiconductor Technology** that is consistent with modern computer environments.
- **Total Reliability.** Multiple redundant components built into the Model 1200 ensure no single point of failure.
- **High-Speed Synchronous Switching.** The Model 1200 handles channel speeds to 5 megabytes per second, making it suitable for operation with current and future processors.



# We Make Your IBM Systems Fault-Tolerant from End to End

CIRCLE 45 ON READER CARD

## NEWS IN PERSPECTIVE

Fujitsu, part owner of Amdahl, has used the Australian market as a testing ground for new products, marketing techniques, and English documentation as it prepares for a push into the U.S. mainframe market.

Ordered as part of the four-year contract, which was tendered in April 1982 under the name Stratplan, were seven Amdahl 580 series mainframes worth \$28 million, \$17 million worth of Storage Tech disk drives, and a whopping \$73 million worth of Wang office systems and communications gear. For Wang, the order represents a value almost equal to its total revenues in Australia last fiscal year, industry observers point out.

The contracts were issued by the social security agency in Canberra to upgrade and replace an aging batch processing sys-

### **Wang, Amdahl, and Storage Tech are enhancing local production facilities as part of their contracts.**

tem that was supplied mainly by IBM. The Amdahl mainframes are to be installed at seven capital cities, servicing some 16,000 employees at 180 regional offices who process 70 million social security payments each year.

Although the project will require the largest concentration ever of mainframes in Australia, the main responsibility for the project's success will be in the hands of Wang, regarded by many observers as the biggest surprise in the contract's award. The Massachusetts company's contract calls for it to supply 445 VS minicomputers, fifty-two 640-megabyte disk drives, 7,266 color workstations, and 1,475 general purpose, letter-quality printers, all of which will be tied together under IBM's Systems Network Architecture (SNA) networking software. Observers see the planned network as an acid test of Wang's ability to configure an SNA network, a key element in the firm's plans to survive in the IBM-dominated world of data processing/office automation.

To win their pieces of the contract, Wang, Amdahl, and Storage Tech each proposed Australian-based facilities. Wang plans to build a factory in Canberra to produce the bulk of the color terminals to be used in the network. The factory will also give Wang a manufacturing beachhead in Asia and the South Pacific, employing some 300 workers, according to the firm. Amdahl and Storage Tech said they would increase local production facilities, investing some \$3.5 million in Canberra.

Evaluation of bids was undertaken by the Social Security Department with assistance from some 140 consultants. Many of these were sent to the U.S. to evaluate equipment that was not yet available in Australia, sources said, noting that various combinations of devices were tested for

their ability to be integrated. It was during these tests, some of which entailed a random mix and match of different manufacturers' devices, that Wang demonstrated convincingly that its machines would handle SNA communications effectively. Network losers at this stage of the evaluation were said to be Prime Computer and Data-point.

Dr. Ted Prince, a system coordinator at the social security agency, said that about 100 man-years had gone into the software development for the project before the contracts were awarded. Wang won the bulk of the deal, he noted, because the firm "met all specifications at the lowest price."

Present planning calls for the system's first regional office to go live in March 1984 and the entire system to be functional by 1986 or 1987. The first major innovation in the agency's operation will be on-line inquiry into a National Computer Center in Canberra. That will be followed by on-line access to regional files and, by 1985, the ability to update and change computer records on-line from any terminal on the system. Australian officials expect the system to serve the department through the rest of the century.

From the beginning, when bidding was opened in April 1982, the project has been controversial because of its strict IBM-compatible nature. The traditional BUNCH mainframe companies (Burroughs, Univac, NCR, Control Data, and Honeywell) were effectively kept out of the running because the Canberra government insisted that the network use IBM-compatible mainframes, IBM operating software, IBM communications protocols, and SNA-compatible office systems.

IBM Australia bid 308X machines, National Advanced Systems bid its AS/9000, and Amdahl its 580 series. Fujitsu, trading in Australia as Facom, bid IBM-compatible systems under that trade name.

(Interestingly, Amdahl has sold its machines in Australia since 1979 through a jointly owned division of Facom. The two companies, although related by Fujitsu's strong interest in Amdahl Corp. in Sunnyvale, Calif., were able to compete with each other in Australia. According to reports circulating in Australia at press time, however, Amdahl was soon to form a wholly owned subsidiary in Australia. Amdahl is said to have 13 mainframes installed at 10 Australian sites.)

The U.S. company campaigned heavily to win the contract, joining technological forces with its eventual partner, Wang, as well as giving support to Data-point and IBM 8100 proposals in the course of early evaluations and elimination procedures.

The Wang office systems are to deliver word processing, electronic mail, voice store-and-forward, SNA emulation, and other data processing services. Wang

will use its VS Alliance software.

For Wang Australia's New Zealand-born managing director, Mike Clarkin, the company's initial \$73 million contract is only the start of a boom. He predicted that the value of orders over the next few years will jump to more than \$110 million with maintenance, training, and support taken into consideration.

He claimed that the new deal would help Wang displace International Computers Ltd. (ICL) of Britain from its traditional second-place ranking in the Australian computer market.

The new Canberra plant will cost more than \$1 million to set up; and in its first year is to produce some 2,000 color display units, Clarkin said. About 80 workers will be employed at first.

Amdahl is to install its first processor, a 24-megabyte, 24-channel model 5860, this month. It will be followed by other 5860s and processors in the 580 range in the capital cities of Melbourne, Adelaide, Brisbane, Perth, and Hobart (Tasmania). Darwin, in the Northern Territory, will share a processor with Adelaide some 2,000 miles south. The initial disk storage of 30 gigabytes in Canberra and 25 gigabytes in Sydney will be supplied by Storage Technology.

IBM Australia, though left out of the main hardware contracts, will have a hand in the system through its MVS/SP operating system, certain equipment already present, and a number of supporting software packages.

One surprise winner in the contract was Computer Corp. of America, Cam-

### **Amdahl will install its first mainframe in Canberra this month, where it will handle a national database for on-line inquiries.**

bridge, Mass., which through its Australian distributor, Computer Power, will supply the model 204 database management system. Meanwhile, such suppliers as Memorex and Raytheon are supplying small quantities of specialized products such as terminals, cluster controllers, and printers, sources said. Boole & Babbage won a contract to supply performance monitoring software while Computer Sciences will provide production control software.

Four Australian-developed IBM communications interface units currently being manufactured under license in the U.S. are being supplied by a Sydney company, Systems Technology. British supplier Quest Automation will supply pilot installations of a signature verification device. Storage Tech is to supply a mixture of ninety-eight 3350 and 3380-type disk drives, as well as 32 disk controllers, 65 tape drives, 10 solid-state disks, and 23 printers, a spokesman said.



# Everything you always wanted to know about your employees,



Who's due for review?



Does he require a time card?



What is her sick leave balance?

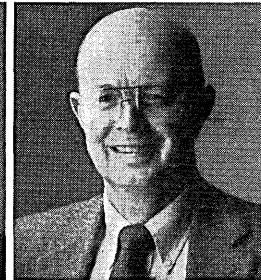

Which managers currently attend school?



Which clerical employees are on leave?



When did he transfer?



Is she Spanish speaking?



Which shift is he on?



What's her salary range?

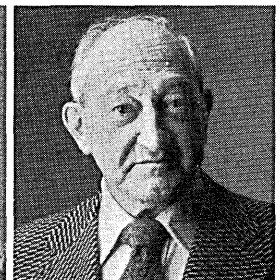

Where did he last work?



Is he exempt from overtime?



Which states does he work in?



Is she the best applicant?



What on-the-job accidents did he have?

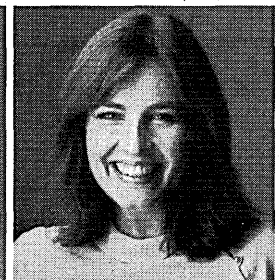

Which single employees have multiple exemptions?

## but couldn't until now.

Our human resource package gives you real-time on-line lookup and changes. So you can call up screens, review the issues and make authorized updates instantly, all from a desktop terminal. In addition, our exclusive open-ended query system lets you find answers to aggregate payroll and human resource problems. Define the question and research it to a solution, moving back and forth between related screens with ease. Why wait for tomorrow's software when you can have McCormack & Dodge today?

### McCormack & Dodge

- |   |  |
|---|--|
| <input type="checkbox"/> Payroll/Personnel      | <input type="checkbox"/> General Ledger            |
| <input type="checkbox"/> Accounts Payable       | <input type="checkbox"/> Purchase Order Management |
| <input type="checkbox"/> Fixed Asset Accounting | <input type="checkbox"/> Capital Project Analysis  |
- Mainframe and minicomputer systems.

**(800) 343-0325\***

\*Telex: 710-325-0329

## Tomorrow's software today.

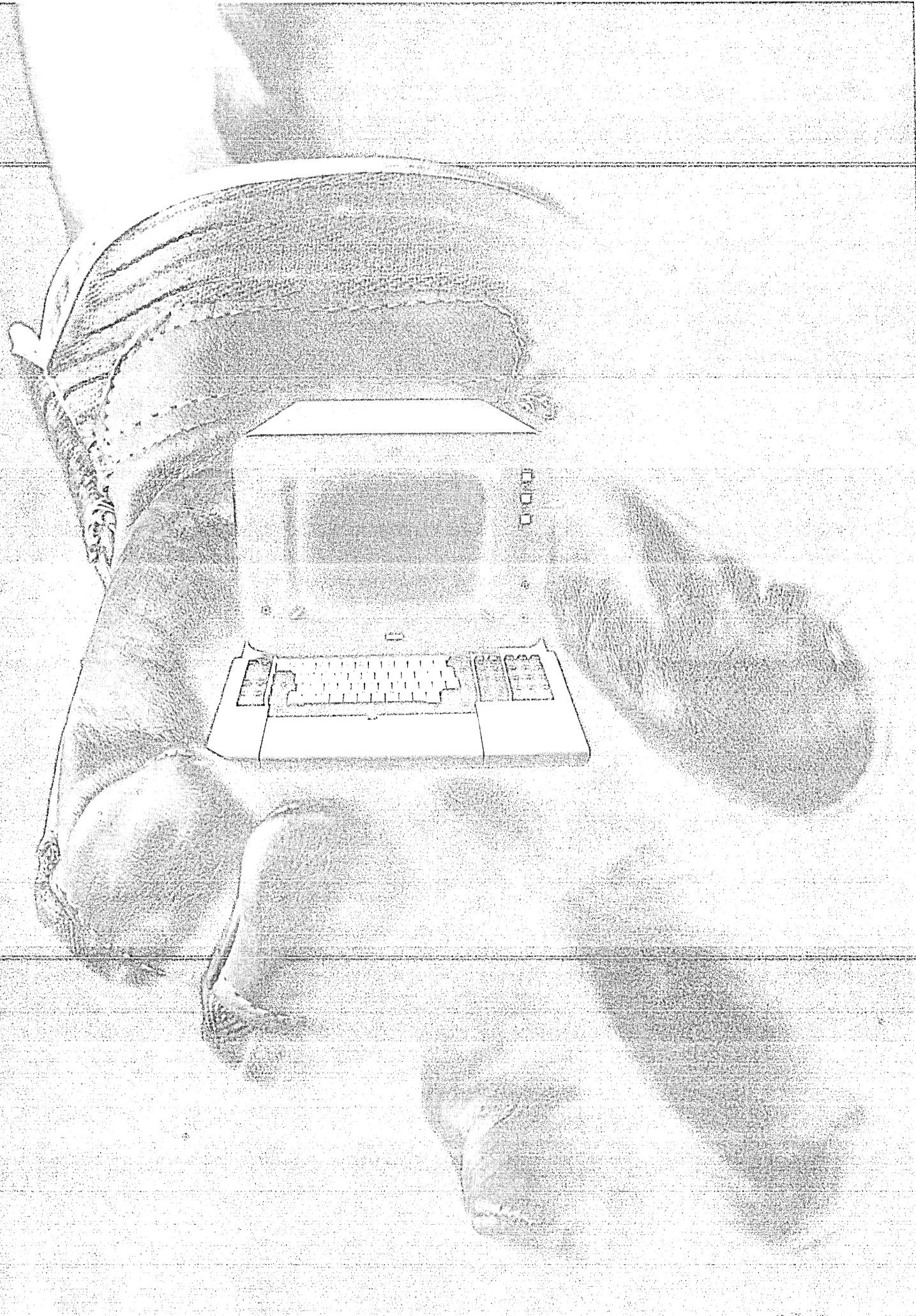

# At last, manufacturing and business systems that work together. Only from MSA.

**MSA introduces the Extended Closed Loop™ Manufacturing System**—a new systems concept we've been working towards for more than 12 years.

Put simply, we've taken the classical Closed Loop model of integrated business functions and provided the integrated systems to make it work.

At MSA, we're committed to nothing less than the *total integration of business and manufacturing systems* to support the overall business plan.

In short, our goal is to provide the systems that can help make your company's business plan a manufacturing reality.

The Extended Closed Loop concept is vitally important for anyone using or choosing application software anytime in the next five years.

And it's even more important if you're looking at manufacturing systems *now*. Here's why.

## Only MSA has all the components

As the world's largest independent application software supplier, MSA—and only MSA—currently offers the components needed to implement the Extended Closed Loop System.

The Bill of Materials chart below shows how all of MSA's software products and service components work together to create the Extended Closed Loop System.

### It starts with MRP II

The MSA Manufacturing System consists of a complete line of integrated MRP II modules, including: Manufacturing Standards, Historical Forecasting,

Inventory Record Control, Master Production Scheduling, Material Requirements Planning, Capacity Requirements Planning, Shop Floor Control, Procurement Management and Cost Management.

These components, together with MSA's structured implementation methodology, are designed for *successful* Closed Loop MRP II.

So, if your immediate need is manufacturing software, you can choose the MSA Manufacturing System now, and easily add other Extended Closed Loop components as you need them.

### Extending the Closed Loop: The Business Connection

At MSA, we offer the integrated business systems to make Extended Closed Loop manufacturing a practical reality.

For 12 years we've developed integrated systems with common architecture, including: Payroll and Labor Distribution, General Ledger, Accounts Payable, Budgeting and Planning, Fixed Assets Accounting, Accounts Receivable, Personnel Management and Currency Management.

And with more than 7400 systems installed worldwide, we offer something else that's unique: We call it 'inter-application expertise.' It's the understanding we've gained by integrating MSA applications to meet our customers' requirements.

Our people know the manufacturing industry (more than 1300 manufacturers use MSA systems around the world).

Our implementation techniques are thorough, practical, and field-proven

many times over. We'll show you how to reduce overall implementation costs significantly.

We offer the most extensive customer training program in the industry (this year alone, MSA will conduct more than 100,000 student-hours of customer training).

At MSA, we provide the total software support to keep your systems up-to-date.

### Not if, but when

In order to survive, your company must not only reach its goals of efficiency and increased productivity; it *must* remain profitable. And continued profitability can only be achieved with improved decision support information—the kind provided by total systems integration.

Industry experts consistently name MSA as the leader in systems integration.

And providing total systems integration is what the MSA Extended Closed Loop Manufacturing System is all about.

### Send for free literature

We've prepared a brochure that further explains the MSA Extended Closed Loop™ System.

For your free copy, call Robert Carpenter at (404) 239-2000. Or clip this coupon.

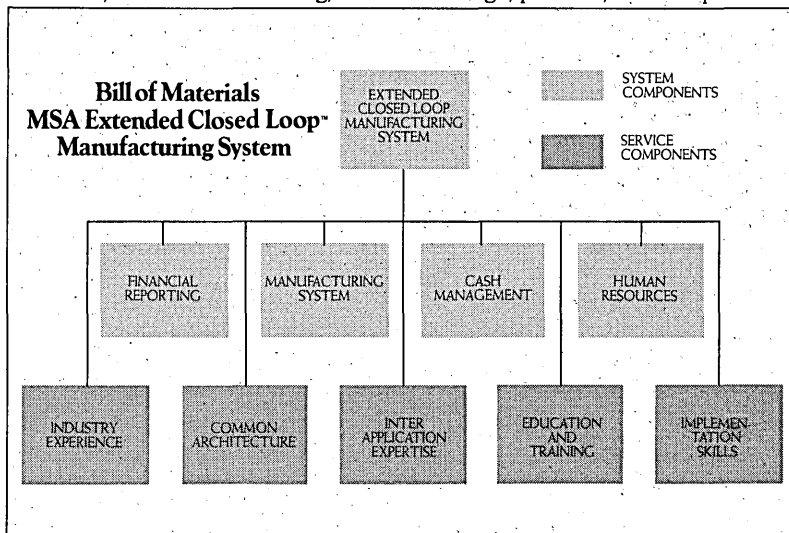

Management Science America, Inc.  
3445 Peachtree Road, N.E.  
Atlanta, Georgia 30326

- Please send me free, detailed literature on the MSA Extended Closed Loop™ Manufacturing System.
- I'm also interested in MSA integrated business and Payroll/Personnel Systems.

Computer Type/Model \_\_\_\_\_ / \_\_\_\_\_

NAME \_\_\_\_\_

TITLE \_\_\_\_\_

COMPANY \_\_\_\_\_

ADDRESS \_\_\_\_\_

CITY \_\_\_\_\_

STATE \_\_\_\_\_ ZIP \_\_\_\_\_

BUSINESS PHONE ( \_\_\_\_\_ ) \_\_\_\_\_

**MSA**

**The Software Company**

# OFF THE AIR

**IBM is facing major penalties for not completing software for a German videotex system on schedule.**

by Maureen O'Gara  
IBM blew it.

It is one of the most glamorous, highly visible, and widely publicized contracts in its stable and IBM blew it. As a result, Big Blue may have to pay anywhere from \$800,000 to \$4 million in penalties for missing a major deadline.

IBM has already notified the German PTT that the software it's been developing these last 22 months for Germany's groundbreaking nationwide videotex system won't be ready in time for its long-awaited September launch date.

The latest estimates out of both IBM and Germany's Federal Ministry of Post and Telecommunications predict an eight-month delay. It will be next May, at least, before the system is operational.

In the meantime, the German Post Office, the agency responsible for implementing videotex, will pack up what it can

of the IBM system and take it to the prestigious International Radio Exhibition in Berlin next month. For over two years, the Post Office has said that this international forum would be its videotex launch pad. Now, however, it will have to unveil an unfinished product with as much dignity and Teutonic face-saving as it can muster.

When the show's over, IBM, the Post Office, and the Federal Ministry will sit down and start figuring out just how much IBM should pay of the noncompletion penalties that are stipulated in its 1981 contract. According to the ministry, the fines levied will be based on what IBM has delivered versus what remains to be done. Right now, it seems that neither the government nor IBM knows exactly what state the project will be in come September or how much these fines might be.

IBM spokesmen venture that the company probably won't have to pay more than \$800,000 or \$1 million in fines, if anything. They feel that such a sum is little enough to pay for a contract initially worth \$20 million for phase-one hardware, software, and licenses, though they are noticeably leaving out any mention of the company's own internal cost overruns. On the other hand, the penalties figure being bandied about the ministry is closer to \$1.4 million, and worldly wise competitors, chuckling over IBM's predicament, claim

it's more likely to be in the neighborhood of \$4 million.

IBM apparently hopes to negotiate the penalties down to nothing and diffuse the blame during the course of its September discussions with the Post Office. But at all cost, it says, it wants to avoid any litigation over the matter despite the fact that some quarters are predicting such an outcome. Legal entanglements, in IBM's view, would only mar a continued good relationship with the Post Office and the ministry.

Needless to say, it's important to IBM long term to keep its foot in the door with the authorities. Market projections are hard to come by in Germany, but conservative estimates say the system could generate upwards of \$100 million in revenues for the firms involved in getting it off the ground. Based on the test marketing of a non-IBM Prestel network that is currently under way in Berlin and Dusseldorf, the Post Office predicts it will sign 150,000 computer-literate Germans to participate in the IBM-based videotex system by the end of 1984. The number should be 400,000 at the end of 1985, it says, and 1 million by the end of 1986.

Currently, IBM's strongest negotiating point with the PTT may be the recent public statements made by the new Post and Telecommunications minister himself, Dr. Christian Schwarz-Schilling. Equating the German videotex project with a landing on the moon, Schwarz-Schilling allowed that both the PTT and IBM may have underestimated what it would take to finish the project by September. The deadline schedule

## The world's two leading project management systems

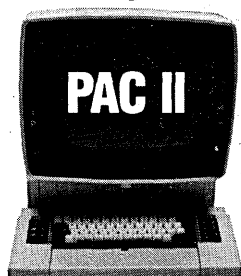
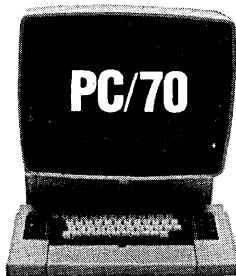

are brought to you by one company.

PC/70 and PAC II are the acknowledged leaders in automated project management systems. More than 2000 major companies and government agencies throughout the world use them to plan, budget, monitor, analyze, cost and manage a wide variety of projects.

Choose the system that best suits your requirements. Although they differ architecturally, both PC/70 and PAC II simulate, schedule, allocate resources, evaluate networks, develop float (or slack), provide target scheduling and fully support the project manager. Both standard and custom reports are available, along with color graphics options.

PAC II and PC/70 are part of a complete portfolio of project management tools

available only through AGS Management Systems, including methodologies, automated estimating, information systems planning, training and consulting services.

For more detailed information about PAC II or PC/70, or any of our other products or services, just call or write.

**AGS Management Systems INC.**

The world's leader in project management systems  
320 Walnut Street  
Philadelphia, PA 19106 **215/265-1550**

Formerly Atlantic Management Systems, Inc./  
International Systems, Inc.

### The company hopes to negotiate the penalties down to nothing.

may have been too stringent, he implied, echoing one of the defenses IBM has been offering ever since its flub became public knowledge.

With characteristic reticence, Big Blue has not pinpointed exactly where its major stumbling blocks with the videotex project are. It's not a hardware problem, its people are quick to say; the difficulty is all in the software. But where in the software it's not telling.

The specifications for the German videotex system, unlike Prestel in the U.K. and the German test markets, demand that IBM create a universal public system that any mainframe—be it IBM-compatible like Amdahl's or Hitachi's or proprietary like Honeywell Bull's—can hook into. The real trick is to make all that heterogeneous gear communicate with each other according to the system's Uniform Communications (EKHP) protocols. In this respect Germany's videotex system, which the Germans themselves call Bildschirmtext or BTX, is revolutionary as well as complex.

Two years ago, when IBM walked

CIRCLE 54 ON READER CARD

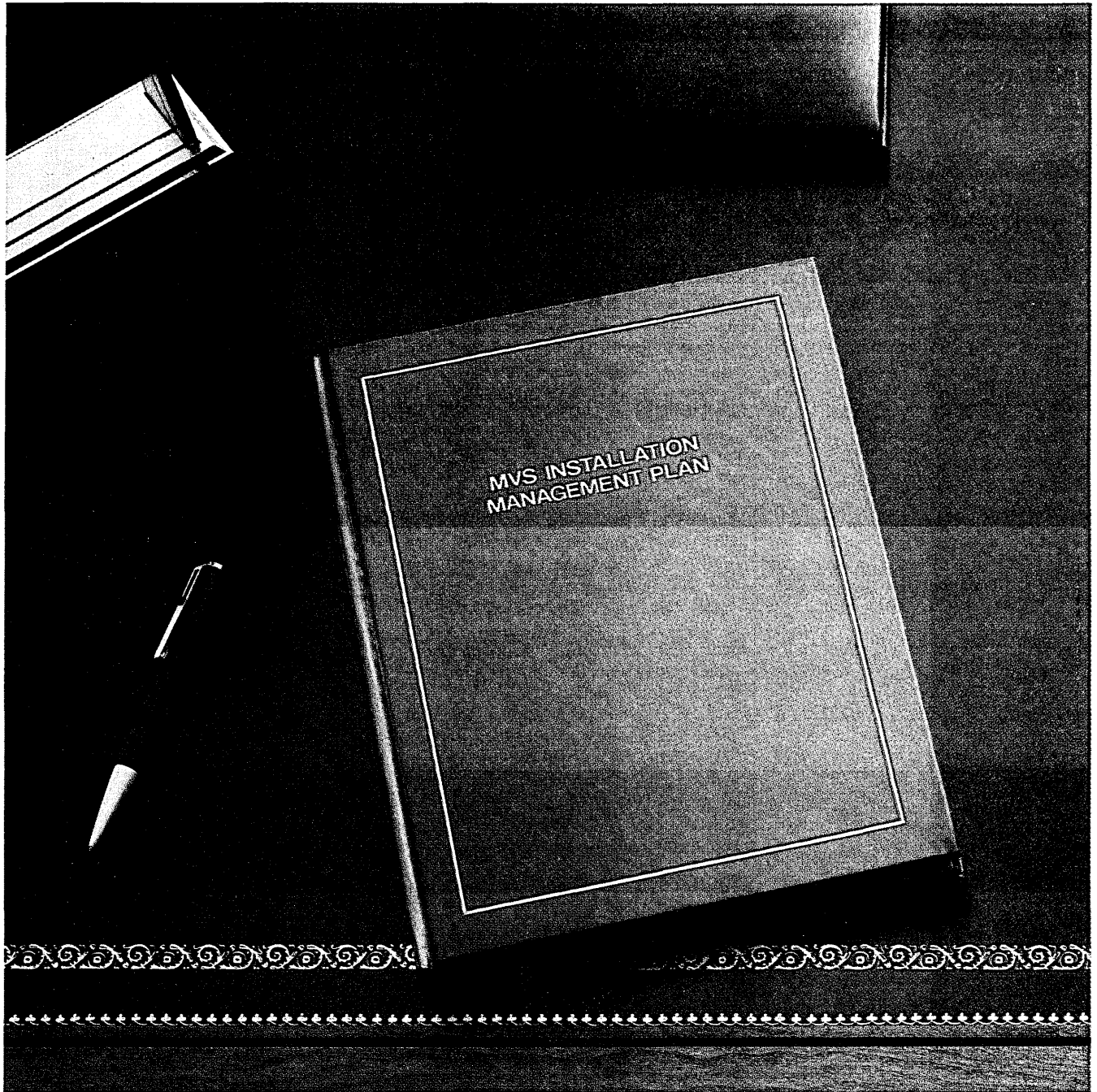

## For the concerned computer executive... a rare first edition.

It costs you nothing. But it details how your company can save staff time and hardware upgrades through the use of MICS, our MVS Integrated Control System.

It analyzes your installation's current environment and recommends a specific course of action for realizing these savings. It gives the names of executives like you who have taken advantage of our suggestions.

And the plan is yours for the asking. Unconditionally.

Simply direct a member of your staff to request a plan questionnaire. Have it filled in and returned to us.

We'll do the rest.

We want you to know us and MICS. To understand why 19 of the top 20 Fortune 500 industrial firms are our users. And to recognize us as the standard-setters for MVS installation management. That's why we're making you this offer.

It's in the book!

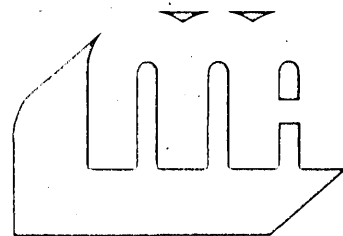

**MORINO ASSOCIATES**

<b>MORINO ASSOCIATES, INC.</b>	<b>MORINO ASSOCIATES (UK) Ltd.</b>
8133 Leesburg Pike	118 Victoria Street
Vienna, Virginia	St. Albans
22180	Hertfordshire
U.S.A.	England AL1 3TG
Tel: (703) 734-9494	Tel: St. Albans (0727) 37464

CIRCLE 55 ON READER CARD

## NEWS IN PERSPECTIVE

away with the prestigious contract for which ITT Standard Elektrik Lorenz and GEC competed, it knew the project would be demanding. Nonetheless, it says that at the beginning it thought it would surely meet the deadline. The complete specifications, however, were initially not absolutely defined and over time the project of enabling all equipment to communicate has just gotten bigger and bigger.

The system IBM is designing calls for the Post Office to establish a mother node in Ulm housing two IBM 3083s. These systems will run standard 3083 systems software. Then there are to be 11 decentralized sites scattered around the country, each running multiple Series/1s. The exact number of S/1s required will depend on how heavy the videotex traffic becomes. IBM says traditional Series/1 operating system software, which is being used in the project, has had to undergo considerable elaboration to equip it with BTX features.

With all its talk of the complexity of the videotex communications and its Germanic desire to produce a system that is a quality product rather than a result of deadline pressures, it must be a comfort to IBM that Minister Schwarz-Schilling says he is convinced IBM is the only company that could develop the German Bildschirmtext.

## MICROCOMPUTERS

# READING USERS' LIPS

**Can Savvy, a natural language query processor for microcomputers, find success in the world of IBM's P.C.?**

by Jan Johnson

Since Excalibur Technologies started business in early 1980, a strange mixture of skepticism and optimism has hung over the company and its sole product, Savvy, a natural-language interpreter for microcomputers.

Excalibur has received seemingly more than its fair share of financial attention, considering how small its revenues have been and how slowly Savvy has moved into the marketplace. Despite revenues for the last fiscal year, ending in February, of only \$50,000, the company's current value in the stock market is upwards of \$70 million. Savvy, which sells for only \$950, is in the hands of less than a thousand users, according to Willard K. Rice Jr., vice president of marketing.

Either the company is doing something very right, or something very wrong.

Mostly right is what Rice and chairman James Dowe would say, pondering the attempts they've made to sell their peripheral to users of Apple II micros. Very right is what they expect to say later this year when a new version of the peculiar product is introduced for IBM's Personal Computer.

Savvy, for those that haven't been following the Albuquerque company, is essentially a set of software routines that analyze free-format English statements and perform functions against a database. The product uses pattern recognition techniques, as opposed to more common parsing methods, to handle the multitude of ways users ask simple questions of the computer. Dowe, a cocreator of the system, claims his machine mimics the "neural nets" of the human brain in processing inquiries (see box).

Savvy's advantage over most user-friendly interfaces is that users can misspell words, leave out words, and generally be sloppy in their inputs. The system, running on a Z80 add-in card in the Apple, looks for patterns in the words' characters themselves and does not deal in strict grammatical analysis of sentences.

Excalibur, after several years of quite unspectacular business, is hoping Savvy on the IBM P.C. will compete head-on with other "artificially intelligent" query systems like Intellect from Artificial Intelligence Inc., Cambridge, Mass. Explains

## HOW SAVVY WORKS

The logical structure of Savvy, Excalibur Technologies' natural language processing and database system, is an open network that the user helps shape and define according to his informational needs. Unlike traditional programming systems and database managers whose internal structure is tree-like, Savvy's data are stored in a network whose nodes are interrelated according to their meaning to the user.

The nodes of a Savvy network may be programs, files, or items related to files. The name of each node also defines the address of the node. This scheme enables the system to navigate quickly through the network without keeping excessively long lists of indexes.

As the user loads information into Savvy, he must format it and its relationships to other information using a system of templates. Templates are built from what Excalibur calls actions, participants, and integrators. Thus, the input GIVE ME THE NAMES OF EMPLOYEES IN ARKANSAS contains the action GIVE ME, the participants EMPLOYEES and ARKANSAS, and integrator IN.

Savvy thus produces a highly personalized database, one whose structure relates closely to the way the user's definitions interrelate to each other. The company

Rice: "The IBM P.C. has more horsepower in it than the Apple does. We'll be able to take advantage of that in bringing computing power to the nontechnologist."

Savvy's obscure odyssey began in 1980 when Dowe and partner decided their idea for an adaptive pattern recognition had commercial potential, especially as it appeared that microcomputers would soon be integral to business life, but that not everyone needing one would be able to learn

## Artificial intelligence experts were skeptical when first shown the product.

enough programming. "We tried to go the classical venture capital route that most startups go, but at the time we had nothing more than a single \$30,000 prototype that took two minutes to perform the most rudimentary functions," recalls Dowe. "The venture capitalists contacted established experts in AI and pattern recognition and asked them to take a look. Almost uniformly, after reading our prospectus and technical background, they would advise that our method wouldn't work."

Skepticism kept Excalibur's founders from getting venture money the unusual way and forced them to go public immediately. Through a now-defunct underwriter in Denver, OTC Net Inc., the New Mexican entrepreneurs raised \$2 million in a \$1-per-share offering in August 1980.

Development work continued, the

describes the system as approaching the structure of the human brain's "neural nets."

A set of adaptive pattern recognition processing routines compares incoming requests for action with previously stored templates and tries to fit the data into them. If no proper fit can be found, the system will request that the user restate his query and the process is begun again.

The pattern recognition software also eliminates the need for precise spelling because it codes incoming words according to their general shape, not their specific spelling. That coding adapts to the changing nature of incoming information and continuously compares it to previously stored information. The result is that as differences are detected, new nodes are defined and connections made.

Savvy's pattern recognition routines are said to differ widely from those used in traditional natural language processing systems in that Savvy's algorithms are general and not tied to specific problem domains or subject matter. It is thus possible for the system to serve a wide range of uses and for it to adapt to changing requirements. Traditional approaches call for specific algorithms to be defined up front and not deviated from.

—J. J.



# Aim your data traffic straight for the target: data link analysis by Wandel & Goltermann

Constant readiness and reliability of your data link are achievable only through planned care and systematic diagnosis. Look at our new DNE Diagnostic Network Control System and what it can do for you:

- ★ Patching of a monitor and analyzer such as our model DA-10
- ★ Looping in of a simulator (e.g. the DA-10)
- ★ Configuration reporting of your network
- ★ Display the key control signals of your data interfaces
- ★ Reroute and reconfigure data channels
- ★ Make fallback connections of channels and auxiliary modules,

also preset emergency backup equipment

- ★ Report alarms, provide status displays and document events and system activities.

The DNE System can be tailored to your requirements for any size — from the basic manual system with 1 to 13 channels, to the high capacity system under remote computer control. The DNE will result in improved measurement routines on your data facilities and you will stay in control without messy cable arrangements. Clarity of connection begets secure communications links. Keep yourself informed about what is new from Wandel & Goltermann.

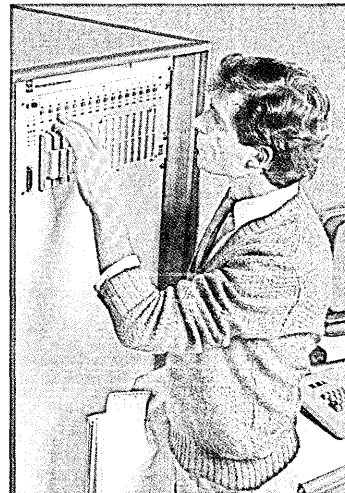

- Please send
- Brochures on DNE systems
  - Digest on datacom technology
  - A sales engineer

Name .....

Company .....

Address .....

Country .....

Tel. No. ....

## W&G Instruments Inc.

119 Naylor Avenue  
Livingston NJ 07039  
Tel. 201-994-0854  
Tlx. 710-994-4859w+ginstr.

DATA 8/83 USA

E 3267 KF



In Europe contact: Wandel & Goltermann · P.O.B. 45 · D 7412 Eningen · Fed.-Rep. of Germany

CIRCLE 56 ON READER CARD

# Racal-Vadic has the Ultimate 212A. It's like getting a Porsche at Volkswagen prices!

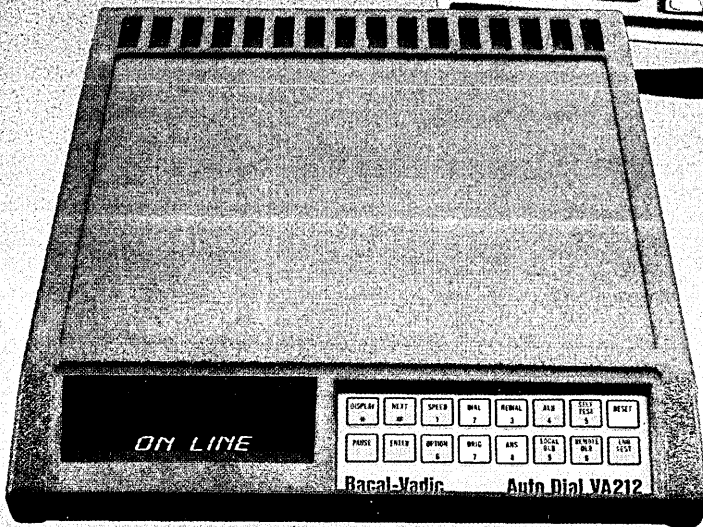
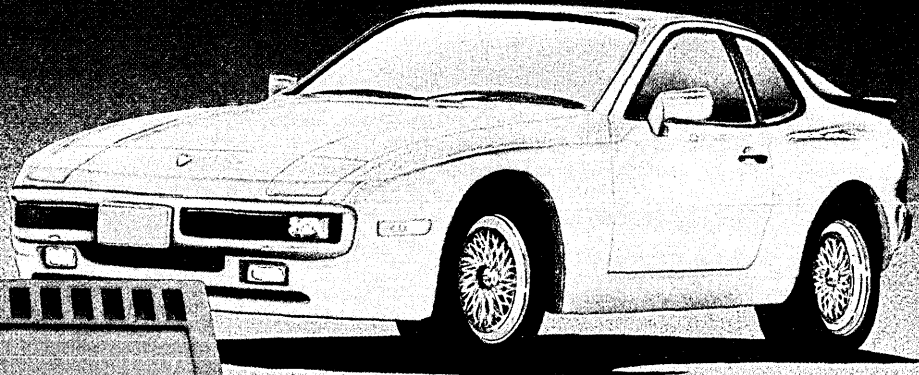

## The Auto-Dial VA212... For Those Who Want Everything

Racal-Vadic has the ultimate 212A-compatible modem. It operates at 1200 and 0 to 300 bps and has a built-in automatic dialer with a non-volatile memory that can store as many as 15 phone numbers, up to 31 digits each. Non-volatile means the memory is retained even if you lose power.

This remarkable modem "talks" to the terminal operator using English words and phrases to indicate call progress, option status, and telephone numbers in memory. Calls can be originated or answered from the terminal keyboard or the modem front panel.

The front panel is really something. It has a 16-key tactile-touch keyboard and an eight character liquid crystal display. Twenty-six user programmable options are stored in the modem's memory, and can be keyed in from the front panel... eliminating the need to open the modem to change options.

## The VA212LC... For The Economy Minded

For those who don't want auto-dial, Racal-Vadic has the perfect modem. It's called the VA212LC. LC means low cost... just \$495 in single quantity.

This is not a stripped down model. The VA212LC is a full-featured 212A-compatible modem with manual originate and automatic answer. It operates at 1200 and 0 to 300 bps full-duplex.

The VA212LC's extensive diagnostics include remote digital loopback and self test. Remote loopback allows end-to-end testing over the phone from any of Racal-Vadic's regional diagnostic centers. The carrier indicator shows when you've established connection.

Now there is a real choice in the 212A market... A Porsche at a Volkswagen price... or the Volks itself at an even lower price.

Phone or write Racal-Vadic today!

PHONE: 800-543-3000, Operator 507

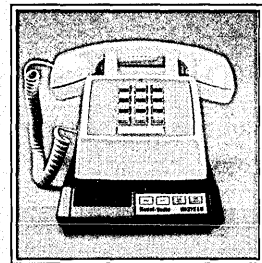

**Racal-Vadic** Member IDCMA

1525 McCarthy Boulevard, Milpitas, CA 95035  
Tel: (408) 946-2227 • TWX: 910-339-9297

CIRCLE 50 ON READER CARD

**RACAL**



## NEWS IN PERSPECTIVE

Savvy product was brought to market for the Apple II, and a distribution company, Savvy Marketing International, was set up. Sales never were spectacular, Dowe concedes, but perhaps it isn't fair to judge the company too harshly because although it is public, it is still in the classic startup stage.

Says Sanford Garrett, industry analyst and Savvy user at Paine Webber in New York: "As a public company, Excalibur has some glaring weaknesses, but if viewed as a startup it is an extraordinary success. What they are doing is straightforward for a company in a startup environment."

While sales to the Apple community never took off, the company's technology found appreciation at Microdata, the McDonnell-Douglas minicomputer subsidiary. Microdata in early 1982 advanced Excalibur \$500,000 that at Microdata's option was to be applied toward a stock purchase or used as an advance towards royalty payments incurred by the firm's use of Savvy.

Marketing vice president Rice says Microdata has yet to introduce a product using Savvy but he thinks the company is still working on it. Microdata has signed a licensing agreement giving it marketing rights for all Savvy-based products designed to work under the Pick operating system, says Dowe, noting, "We can't cover the whole world. We'd like to cut this kind of deal with more computer makers."

By early 1983, Excalibur was all but broke. Even a four-color article in *Fortune* hadn't brought it success, but it had helped keep the company's stock price buoyant in the \$10-to-\$11-a-share range. Investors remained optimistic and in February a small group of them led by Allen & Co., New York, bought 1.3 million shares in a private offering, paying only \$2.75 a share.

Perhaps those putting up the money were eager to cash in on what some observers say is Savvy's applicability to other sorts of pattern recognition. The most lucrative of those would probably be voice input, says Rice, noting that the firm has already hired several linguists to explore that avenue. No products will be discussed until next year, he notes.

Since the Allen cash infusion, Excalibur has boosted its marketing forces with a buy-back of Savvy Marketing and the hiring of Rice, who joined early this year from Itek, a graphic arts company. The separate marketing company was not working out, notes Dowe, and its elimination from the picture was dictated by Allen.

Rice has repackaged Savvy, introducing two new versions of the product to join the original version which was bundled with financial applications software. Savvy Pro offers Savvy's full facilities but, at \$495, leaves out the applications software. Savvy One goes a step further and for \$349 supports only a single diskette drive on the Apple. Savvy Pro, Rice hopes, will appeal to system developers, students, and other

sophisticated users who will build their own applications systems around the machine.

It was found early on that Savvy's routines required more computing power than the Apple's 6502 microprocessor

### **Some observers see Savvy particularly well suited to voice recognition applications.**

would deliver, so Savvy was designed to use a Z80-based coprocessor board that is included in the price of the Savvy offering. Rice says the system could easily be adapted to any of the many Z80-based micro-

computers on the market but so far no moves have been made in that direction.

Portability is not a problem, insists Dowe. "First we write modules for a 'virtual' machine, then we put Savvy on top of that. What we move is only the virtual machine." He figures it would take a single programmer three to four months to move Savvy from the Z80 to 8088. Its virtual machine uses a 1,000-bit word width, he claims, which means it will run faster and faster as mpus grow in word width.

Needless to say, that job is under way or even finished and the company expects to introduce such a product later this



# Guess who trains America's best-run corporations?

## We do.

### Technology Transfer Institute

Call **(213) 394-8305**  
or write for **FREE FULL-COLOR**  
Fall 1983 Catalogue of Computer/  
Communications & Data  
Processing Courses

**Technology Transfer Institute**  
741 10th Street  
Santa Monica, CA 90402

CIRCLE 58 ON READERCARD



XEROX

## Introducing a quantum leap in developing complex applications.

Developing large-scale software systems involving complex tasks, such as computer-aided design, expert systems and VLSI circuit designs, is no longer the time-consuming job it used to be.

Now you can do it in months, instead of years.

Because the new Xerox 1108, a compact, low-cost workstation, speeds things up by handling the drudgery of programming for you. Quickly and accurately.

It offers integrated, interactive facilities for program development, editing, debugging, executing, filing and documenting.

It simplifies things even further with its large, high-resolution display, keyboard, mouse and facilities for the Ethernet local network.

And you can use the same Xerox 1108 for economical widespread delivery of your completed systems.

The culmination of 10 years of development in Lisp-based processors by the Xerox Palo Alto Research Center, the Xerox 1108 software is based on the Interlisp-D artificial intelligence programming technology.

For complete details, write to Marketing Manager, Xerox Special Information Systems, 250 North Halstead Street, Pasadena, California 91109, or call (213) 351-2351, extension 2128.

**The Xerox 1108.  
Team Xerox.**

## NEWS IN PERSPECTIVE

year. It is hoped that IBM P.C. owners will find more use for Savvy, which some say was introduced in its original version as too raw a product.

"It's not something for the masses," says Paine Webber's Garrett. "It is more geared to the people who are programming systems and applications and would like to do so with more facility than ever before."

DATAMATION asked several Savvy users to comment on the system. "It does what they say it will do," says Howard Morgan, chairman of Advanced Office Concepts, Bala Cynwyd, Pa. But the system doesn't have any programmed help functions; it's not menu driven, and the manual is so poorly written it's almost useless as a training guide, he added.

Charles Beauchamp, director of ambulatory care at Veterans Administration Hospital, Ann Arbor, Mich., and a computing neophyte, finds Savvy helpful in dealing with a database of 8,000 medical terms. "I can even mistype the drug name and [Savvy] will still go and retrieve the information I wanted." The acid test will come when he puts in 20,000 terms, he says, adding that installing such a database in Savvy is no easy task.

Sherry Painter, a California businesswoman planning to build a client accounting business around Savvy, found the system hard to use and poorly documented. "I like the idea of [Savvy] and I can sense there is tremendous power there, but I have this awful feeling I can't get to that power," she remarks.

Dowe says Excalibur is aware of the manual's shortcomings and is working on correcting it. Meanwhile, the company is preparing for the IBM marketplace and, if all goes well, will watch revenues finally grow to meet expectations. Already, the firm had first quarter revenues of \$60,000, more than the previous year's total.

# MICROS FOR THE FUTURE

**Remote computing services companies are betting that the microcomputer will open up new sources of revenues.**

by Jan Johnson

The remote computing services (RCS) business has hit the doldrums. Revenues are flattening, user interest dwindling. The computing services users once sought are often shunned as in-house computing does work cheaper and with more control.

"Clearly, the economy has had a major impact on the business," began Al Fenn, vice president of network technology at Tymshare Inc. "People have become more sparing of their use of outside services." But, says Fenn, the current situation parallels what happened to the service business in the late '60s and early '70s. "Scientific users who made up the bulk of the timeshare users in the late '60s began using minis and calculators. What we are finding today is that the simpler applications are migrating to in-house timesharing organizations," remarks Fenn.

To get back on track with user

needs, the service companies have been looking for a midlife kicker, a new direction, some pizzazz. It seems they have found all three in the personal computer. "The micro is the biggest thing to come along in a long time that is capable of expanding the potential user population of remote computer services," contends Fenn.

"Anyone who regards the micro-computer as a threat is crazy. It's a fantastic opportunity. I can't think of a better life cycle extender [for the RCS business] than micros," is the enthusiastic position of Bob Simmons, vice president and general manager of the delivery systems products de-

## The 1983 JAMES MARTIN SEMINAR

### A new seminar which no analyst or programmer can afford to miss

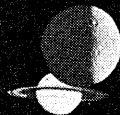

### So what if James Martin can predict your future?

Since 1960, James Martin's prognostications about technology, and the computer industry in particular, have proven uncannily accurate. James Martin has consistently identified precedent-setting capabilities before they were discussed by experts within the DP and telecommunications communities.

**The James Martin Seminar:** designed to dramatically increase your organization's productivity.

James Martin will not only predict your future, but he will guide you through the

emerging technologies that require an understanding of the newest methods, design techniques, systems organization, and patterns of management. 16,000 attendees worldwide have discovered their future... have you? Attend a James Martin Seminar this Fall and discover why James Martin is recognized as the leading expert in the computer industry.

Call **(213) 394-8305** or mail the coupon today for a detailed brochure.

New York	October 10-14, 1983
Toronto	October 24-28, 1983
Los Angeles	Oct. 31-Nov. 4, 1983
Atlanta	November 14-18, 1983

NAME \_\_\_\_\_

COMPANY NAME \_\_\_\_\_

ADDRESS \_\_\_\_\_

CITY/STATE/ZIP \_\_\_\_\_

TELEPHONE \_\_\_\_\_

DA 3-83

**TECHNOLOGY TRANSFER INSTITUTE**  
741 10th ST. SANTA MONICA, CA 90402

CIRCLE 60 ON READER CARD

## NEWS IN PERSPECTIVE

partment at General Electric's Information Systems Co., Rockville, Md.

Many remote computing companies are not only jumping on the PC bandwagon, but they intend to push their way toward the front to be one of the bandleaders. Their strategy is to provide dp managers with an innovative approach for integrating micros into a distributed corporate computing network. "We are in the era of integration, where much more thought and attention is being given to the word 'service,'" says Arthur Sims, executive vice president at United Information Services Inc., a subsidiary of United Telecom Computer Group, Kansas City. Sims and other industry executives see their companies and the RCS business in general as being in the midst of a critical transition. "The best [RCSs] will become information service companies; the worst will continue to be timeshare companies and see business fall away through the '80s," Sims claims.

What the RCS companies envision for tomorrow is a computing network in which a mixture of mainframes, minis, and micros from different vendors, and in some cases from different companies, share information processing loads.

One of the first steps the RCSs have taken towards such integration of hardware is to become distributors of microcomputers. Control Data's Cybernet offers the

CDC 110, Tymshare chose DEC's PC, Geisco signed a \$10 million contract for IBM P.C.s. United Information has yet to choose which PC it will market, but hopes to have something nailed down "soon." Among its first PC software offerings is a communications package that allows the micro user to format data and send them to the host reliably.

Control Data, which appears to be furthest along in getting its version of the communications product to market, has come out with a program called Connect for its CDC 110. Priced at \$100 for the software

**"It is no longer just a timesharing business, but a consulting business as well," says one manager.**

on disk and the manual, Connect packages for the Apple II, the TRS-80 Mod III, and the IBM P.C. are soon to follow. "Connect is only the first piece in an evolving strategy for Cybernet," said Mary Nordberg, director of product marketing there.

Like the other RCS companies, CDC's strategy is to make utility products like Connect run on most popular hardware, perhaps even other mainframes as well as micros and minis. Then the idea is to build applications around that product that take advantage of the micro's power as well as the mainframe's. One of the first applica-

tions that CDC is wrapping around Connect is called Micro IPF, a simple data manager aimed at managers who need to make ad hoc reports.

What should not be overlooked, though, is the long-range goal of the RCS strategy: to provide a family of software tools and utilities that enables a user to create applications that split the work between a micro and other devices on the network. "There is a whole raft of applications that would become economically justifiable through a combination of centralized and decentralized processing," claims Tymshare's Fenn. The trick, reminds CDC's Nordberg, is that moving between the different systems in a mixed environment "should be relatively transparent to the user. He should not have to be aware that something is being done on the micro or on the mainframe."

Another example of a distributed computing network is a rail car tracking system application operated by Tymshare. Permitting various companies to track the movement of rail cars, the application was put up on the RCS host. The host pulls in information from several computer systems at various company sites.

The RCS managers believe they are especially well positioned to act as the interface between a home host and its field office locations.

If You Are Involved In MIS Or DP Management, This Is The THE Software Event Of The Year!

# SOFTWARE/expo

September 13 - 15  
McCormick Place

SOFTWARE/expo-National is your opportunity to talk face-to-face with all of the major vendors of package software. You'll be able to discuss your specific problems... and find the solutions that will work for you.

Hundreds of systems and applications software packages in more than 30 product categories will be displayed, including:

- Data Management
- Manufacturing
- Financial
- Accounting
- Communications
- Payroll/Personnel
- Distribution
- Text Processing
- Medical
- Education
- Graphics
- Information Retrieval

AUERBACH Publishers, in conjunction with INFOSYSTEMS Magazine, has coordinated a series of twenty-one information-packed conference sessions, running all three days of SOFTWARE/expo-National. Topics range from DBMS software selection criteria to electronic mail software, from graphics to office automation.

For Your FREE Badge and Complete Information,

**Call Toll-Free: 800-323-5155**

(Inside Illinois, call: 312-299-3131)

OR Write To: SOFTWARE/expo, Suite 205, 2400 E. Devon, Des Plaines, IL 60018

DISCOVER THE DYSAN DIFFERENCE

# Pack All Your Troubled Packs and Cartridges in an Old Kit Bag

And Save. Save. Save!



**SPECIAL LIMITED OFFER..  
DOUBLE TRADE-IN VALUE:**

If you act now, you can receive twice the trade-in credit you normally earn toward the purchase of Dysan's superior quality disc packs and cartridges. So, pack up your old disused disc packs and contact Dysan by August 31, 1983.

Need more information? Call your nearby Dysan Representative or use our toll free 800-551-9000 number. Or simply fill in the coupon. Discover the difference Dysan's precision magnetic media can make. For your system *and* your budget.



Corporate Headquarters  
5201 Patrick Henry Drive  
Santa Clara, CA 95050  
(800) 551-9000

CIRCLE 62 ON READER CARD



**SPECIAL LIMITED OFFER!**

- Yes, I'm interested in Dysan's Double Trade-In Value Offer.
- Yes, I'd like a free copy of your rigid media service brochure.

D 8/83

Name: \_\_\_\_\_

Company: \_\_\_\_\_

Address: \_\_\_\_\_

City: \_\_\_\_\_ State: \_\_\_\_\_ Zip: \_\_\_\_\_

Phone: (\_\_\_\_) \_\_\_\_\_

## NEWS IN PERSPECTIVE

"An RCS is all set up to do this anyway," points out United Information's Sims. "We have the hosts, the protocol, the log-ins, the network, and support people in offices around the country that can serve these branch offices."

Another key element in the survival picture, predict managers, is that the RCS company of tomorrow will have to have a field operation capable of providing a variety of consulting and programming services. Clients may need advice on how to set up a system that can integrate several micros and hosts and perhaps general database services residing on the RCS systems. They also may need custom programming and service and support for applications that are up and running.

"The cost of communications is driving people to decentralize," observes Tymshare's Fenn. "But a company, with operations in several locations across the country is not going to be able to maintain the same quality of timeshared services at all its locations unless it is able to distribute enough service and support people to cover those areas. That becomes a very costly endeavor. All major computer services companies have scattered support organizations but they can deploy their people across several customers, achieving economies of scale that no in-house operation can achieve."

To meet the demands of the future, to have all the pieces needed to accommodate the integrated environment, will take a lot of capital, something that many RCS companies are running short of these days. It also takes guts. As an official at CDC/Cybernet puts it, "We are taking a gamble." The RCS companies are gambling that by spending today to develop an integrated shared resource network, they will survive and prosper tomorrow.

## OPERATING SYSTEMS

# NEW MINI RELIES ON UNIX

**Pyramid Technology's first product enters a market where competitors and users are coming on-stream simultaneously.**

by Edward K. Yasaki

It's getting to the point where some products just resist classification. An example is the so-called 90X, first product of startup Pyramid Technology Corp. Introduced just this month, the 90X is 32-bit supermini-

computer, making Pyramid one of about a dozen such vendors. But its only operating system is Unix; there must be half a dozen vendors of Unix-based minis, but they all have a proprietary operating system in addition to Unix. Finally, the 90X also allows the user to add performance incrementally as needs grow.

"I call Unix not an operating system but a market," says Edward W. Dolinar, president of the Mountain View, Calif., company. While his product is a supermini, it's the operating system that determines his marketing strategy. "We just happen to be going into the Unix marketplace with a

high-performance, 32-bit, virtual memory superminicomputer," he adds. "And so we've selected the high end of the Unix marketplace as our niche."

In the world of micros, where there are a hundred or more manufacturers offering systems running Unix, as many as half have no other operating system. Makers of minis, on the other hand, have been slow in getting on this bandwagon. Inevitably, many say, that will change.

"I would say that probably in the next five years you'll see Unix accounting for a significant—I won't say a majority, but a significant—portion of mini manufac-

**COMPUTER SUPPORT SYSTEMS**

**Heads. you win.**

**PROGRAMMED POWER 75KVA**

**Liebert**  
World leader in computer support systems  
CIRCLE 63 ON READER CARD

turers' revenues," says Eileen Skrabutenas, multiclient market research manager at Yates Ventures, Los Altos, Calif. The business of mini makers is being eroded by micros, she explains. Thousands of micros are finding homes at their user sites, and those users want to integrate this disparate hardware with their host mini.

"As a result," she adds, "there's a tremendous pressure on them for the influx of micros being used as workstations to offer some kind of compatibility. The mini manufacturers have to turn to a standard, and that standard's going to be Unix." Those mini vendors will continue to offer

their proprietary operating systems ("You know, VMS is not going to die") and their proprietary software will continue to be important, he continues, but some standard software will also become an important marketing tool.

Although some people might associate the VAX and Unix with scientific computing, both are also found in the business environment. The people at Pyramid Technology are looking at both markets, but wish to develop and show their credentials first in the scientific/technical marketplace. "I'm not going to try to convince a DEC VMS user to move to Unix," says Dolinar. In his

first year of business, he sees plenty of opportunity among prospects already committed to Unix. He also believes, however, that business dp eventually will be the larger market.

"I believe that that will begin to be very evident in two years," he says. "And I think in three to four years, a high percentage of our business will be end user-oriented," not merely from OEMs and systems integrators.

For the business market to blossom, of course, the ready availability of applications packages would be a big help. Such packages have been predicted, have begun to appear, but not in profusion. One reason for this, it is advanced, is that it takes from 24 to 30 months to develop an applications program for Unix. "We're seeing a lot of

### The Pyramid supermini will be expandable from 1 MIPS to 7 or 8 MIPS.

products that were started back in 1981 beginning to come out on the market now," observes Skrabutenas of Yates Ventures. "Over the next six months there will be a tremendous explosion in applications that are released."

One such developer is Horizon Software Systems Inc., San Francisco, Calif., a company that considers itself the market-maker for applications in the Unix environment. The firm's marketing vp, Paul Miller, says there's no retail market for Unix packages yet, but he's confident that will come about in time.

"Clearly, what the world wants is more functionality behind a homogeneous user interface," says Miller. "I think products like 1-2-3 are leading the way. People want to be able to get to spreadsheet, word processing, graphics, and database, all from a common interface. So that's the direction we're headed for."

According to Yates Ventures, which is notorious for its optimistic forecasts on Unix implementations, more than 100,000 Unix systems will be installed by the end of this year. Some 93% of them will be commercial systems, they say, compared with 54% in mid-'82, when there were only some 8,000 systems.

This includes companies like Pyramid, whose computer incorporates some features of the RISC (reduced instruction set computer) design being studied on U.S. campuses of late. It is one that purports to offer enhanced performance in high-level language environments. From this design base has evolved an extendable computer.

"So we wanted to design a system that answered the user's need from the growth standpoint," says Dolinar. For the first year of production, the spectrum of power offered is expected to range between 1 MIPS and 3 or 4 MIPS, but this could extend in the future up to 7 or 8 MIPS, he explains.

BY LIEBERT

# Tails you win.

When you choose from the two best power protection systems You can't lose!

**The Programmed Power Center™**  
When uninterruptible power is required specify the ultimate in space-saving, energy efficient operation. The only UPS system to obtain UL Listing.

**The Power Management Center™**  
Features patented Datawave® technology for maximum cost efficiency. Provides unsurpassed line conditioning, virtually maintenance-free operation and high reliability.

Don't take chances where your computer investment is involved. Look to Liebert for the two best power protection alternatives and pick the one that's best for you!

Liebert Corporation, 1050 Dearborn Drive,  
P.O. Box 29186, Columbus, Ohio 43229  
Phone 614-888-0246 Telex 246655 LIEBERT WOGN

**Send me complete details.**

Name: \_\_\_\_\_

Title: \_\_\_\_\_

Company: \_\_\_\_\_

Address: \_\_\_\_\_

City: \_\_\_\_\_

State: \_\_\_\_\_ Zip: \_\_\_\_\_

Phone: \_\_\_\_\_ DTM83

Have a salesman call.

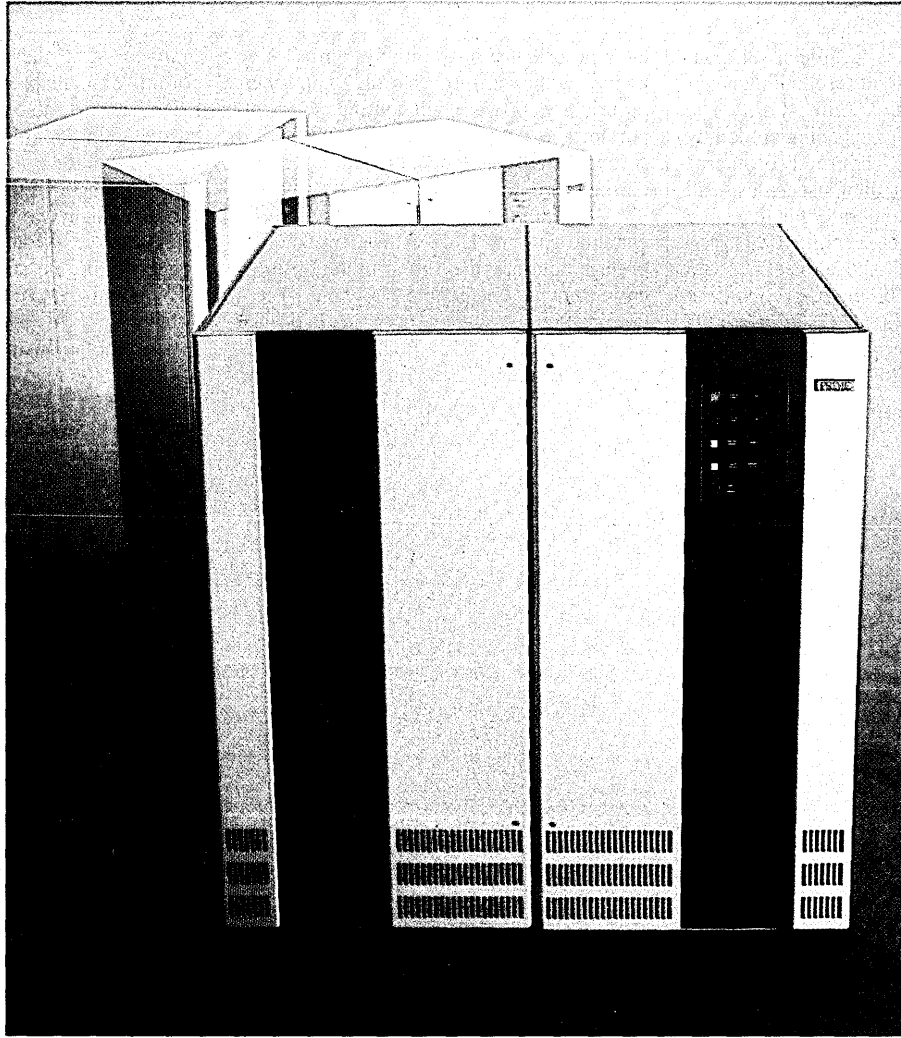

**INTRODUCING  
PRIME'S  
LATEST  
AND  
GREATEST.**



## **THE PRIME 9950.**

# **THE NEWEST AND MOST POWERFUL EXAMPLE OF OUR COMMITMENT TO TECHNOLOGICAL LEADERSHIP.**

When we introduced the world's first virtual memory, 32-bit supermini we set the pace for leadership that still drives our business today.

For proof we offer the Prime 9950 – the most powerful, most technologically advanced computer we've ever designed.

It uses high speed Emitter Coupled Logic – a rarity in minicomputers. Advanced pipeline architecture and unique branch cache memory allow five instructions to be processed in parallel and 255 user processes to be handled at once. 2MB memory boards allow you to economically configure systems up to 16MB. These technical advances provide the power, throughput and price/performance of the Prime 9950.

Like all Prime 50 Series systems, the Prime 9950 runs with PRIMOS, the operating system that makes it possible to easily and economically move software among all Prime systems, or upgrade your system without costly reprogramming or recompiling.

Add the Reliability, Availability and Serviceability built into the Prime 9950 with its new diagnostic processor, and the result is a distinctive combination of a highly affordable, high performance computer, backed by the service and support you expect from a Fortune 500 company.

The Prime 9950. It's our latest and greatest technological achievement. And there's nothing else like it. Anywhere.

For more on the Prime 9950, or on the entire Prime family of compatible computers, call **1-800-343-2540** (Mass., 1-800-322-2450), or write Prime Computer, Prime Park, MS 15-60, Natick, MA 01760. In Canada call 416-678-7331. In Europe write, One Lampton Road, Hounslow Center, Hounslow, Middlesex, TW3 1JB, England. In the Far East, write Unit 1005, Tannery Block, 35 Tannery Road, Singapore 1334.

**PRIME**  
**Computer**  
Offices worldwide.

## NEWS IN PERSPECTIVE

### BENCHMARKS

**IBM INVESTS:** The industry leader agreed to purchase a 15% interest in Rolm Corp., a Santa Clara maker of PBX equipment, for about \$228 million. At the same time, IBM dropped an agreement it had with Canadian PBX maker Mitel to jointly develop a data switching device for office use. The Rolm deal calls for the two firms to work on making their respective equipment work together efficiently. Industry analysts saw the deal as a strong endorsement for Rolm, which has been a leading PBX maker for some years, and a worthy move by IBM to counter expected marketing moves by AT&T's American Bell subsidiary. IBM is to pay \$59 a share in a new stock offering by Rolm and to limit its total ownership to a maximum of 30%. IBM also gains two seats on Rolm's board of directors. The deal was similar to one IBM signed late last year to gain a piece of Intel Corp., the chip maker. Meanwhile, Digital Equipment and the shunned Mitel said they would jointly develop interfaces to make their systems compatible. Initially, DEC's VAX computer, used as the basis for the firm's All-in-One office system, will be linked to Mitel's SX2000 PBX, according to a DEC spokesman.

**VIDEOTEK:** AT&T entered the videotex market with a consumer-oriented terminal and IBM enhanced its videotex system with teleconferencing and new color graphics facilities. AT&T's new Sceptre terminal is based on the 8088 microprocessor used by IBM in its popular P.C. and is equipped with about 170K bytes of main memory. It attaches to a customer's phone line and television receiver, providing videotex services for about \$900 per terminal. American Bell officials said the terminal would first be sold in southern Florida, an affluent market where the Knight-Ridder newspaper chain plans to begin offering consumer videotex services this summer, with an introductory price of \$600. American Bell also enhanced its frame creation system, used by videotex system operators to develop pages of information for electronic distribution. IBM said it boosted its Series/1-based videotex systems to use either the British Prestel or NAPLPS videotex protocols, and introduced software to help Series/1 videotex hosts gain access to databases resident on large IBM mainframes. Also, a new teleconferencing feature enables a videotex terminal to distribute pages of information to several other terminals simultaneously.

**HAT IN RING:** Still another mainframe software vendor has entered the lucrative microcomputer software market. Applied Data Research of Princeton, N.J., has teamed up with VisiCorp to offer a series of micro packages that will couple tightly with ADR mainframe packages and run in the lat-

ter company's VisiOn environment. VisiOn manages various applications programs on a micro, giving each a separate window on the crt screen. VisiOn is to run initially on the IBM P.C. and is scheduled for availability in October. ADR, however, will not have its micro packages, to be priced at between \$500 and \$1,500, ready for shipment until next year, according to a spokesman. The purpose of the new packages will be to download functions from the mainframe to micro. Included will be a front-end micro package for ADR's relational database system, Datacom. VisiCorp has joined hands with other software manufacturers, including Informatics General, in its bid to maintain leadership in the hotly competitive microcomputer software arena. ADR said it has no interest in making its packages compatible with Apple Computer's upcoming Lisa computer. Apple recently signed a joint development deal with Cullinet, the vendor of the IDMS database manager.

**GSA CONTRACT:** A coalition of six small companies managed to score a coup over Xerox, Tandy, Computerland, and other major retail microcomputer outlets in the bidding for a \$148 million, three-year contract with the General Services Administration. The contract entitles these six companies—The Math Box, Software Centers International, MAI/Sorbus, Moore Business Centers, M/A Com Sigma Delta Inc., and PC Telemart—to set up a pilot retail computer store and training center for federal employees. The store, which opens Aug. 16, will be located in the GSA headquarters in Washington, D.C. Under the terms of the deal, The Math Box will act as a hardware and software sales agent; micros manufactured by IBM, Apple, DEC, Osborne, Compaq, and Fortune Systems will be stocked. Software Centers International will provide the software, MAI/Sorbus will handle maintenance, and Moore Business Centers will stock the supplies. M/A Com Sigma Delta will manage related services and do all employee training, and PC Telemart will hook up an on-line computer library for associated products. The database is taken from their PC Clearinghouse Directory, a Yellow Pages of sorts listing over 21,000 software packages for microcomputers. PC Telemart—which went public last month—recently introduced kiosks into 90 retail stores; these kiosks provide links to the database for customers and a collective purchasing arrangement for dealers, by which many dealers can pool their purchases to qualify for greater bulk discounts. Larry Stockett, the Fairfax, Va., vendor's ceo, expects to see 3,000 kiosks in stores within a year.

**GIVEAWAY:** IBM, coming on as a strong second to Computervision in the computer aided engineering and design marketplace, selected 20 universities to receive some \$40

million worth of CAD/CAM equipment. The schools will use the equipment to enhance their courses in engineering. IBM also said it would soon select five universities to receive \$10 million in cash grants for similar purposes. Chairman John Opel was on hand in New York for the presentation ceremonies, commenting, "We are on the threshold of a new era in manufacturing technology and there is critical need in industry for people who can make full use of that technology and enhance it in years to come." He noted that IBM's donation of equipment and cash is the largest single-program educational program the company has ever conducted. Recipients of equipment were Arizona State, Boston, Brigham Young, University of California, California Polytech, University of Florida, George Washington, Georgia Tech, University of Illinois at Champaign-Urbana, Lehigh, University of Massachusetts, Michigan Technological University, University of Missouri-Rolla, Ohio State, Brooklyn Polytech, Rensselaer Polytech, San Jose State University, University of Texas at Austin, Utah State, and Virginia Polytech, IBM said.

**GOES MICRO:** As a major step towards its goal of delivering financial and other information to executive workstations, Computer Associates International Inc., Jericho, N.Y., bought Information Unlimited Software Inc., a leading supplier of microcomputer packages, based in Sausalito, Calif. Computer Associates paid \$5 million in cash up-front and will pay another \$5 million in an earn-out deal that gives it access to IUS's popular Easywriter II package for word processing, a number of other micro products, and, perhaps most important, a brand name. Computer Associates is expecting to "integrate" its mainframe packages with new systems that run on microcomputers, a spokesman said. The company's CA-Universe relational database package has already been ported from an IBM mainframe to run under Unix on an Altos microcomputer, a combination that may be used for future workstation products. No current revenue figures were given for IUS, but it was said the company has delivered over 120,000 software packages for Apple, IBM, and Texas Instruments Professional computers. The company employs about 100 persons.

**AVAILABLE:** The AT&T Basic Packet Switching service, a specialized switching service designed to transport large quantities of data from one location to another, has been released for use by business customers, according to the company's Long Lines Department. The service acts as a switching arrangement that enables businesses to send data quickly to any number of geographically dispersed computer terminals. The service is available at transmission rates of 9.6 or 56 kilobits per second.

Due to popular demand, we've created a new display that fits both tight spaces and tight budgets.

Our new ITT Courier 1700.

The 1700 is compatible with the 3278 model 2. Yet its footprint is only 13 x 12 inches (24% smaller than IBM's 3178). And its keyboard is only 16 inches wide (17.9% smaller than the 3178).

Still, the 1700 is big on

ergonomics and the kind of performance features you expect from ITT.

Its screen tilts and swivels, and its keyboard adjusts for optimum operator comfort.

It has Reveal to aid program development. Capture to aid troubleshooting. And Variable Field Underline to increase productivity.

Things you don't get with the IBM 3178.

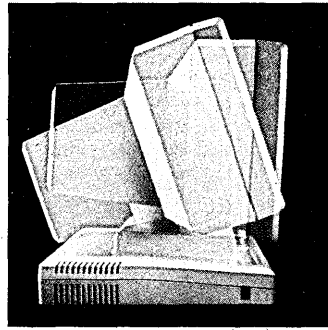

ITT 1700 tilts, swivels and has a smaller price than IBM 3178.

Even with all this, the ITT 1700 is priced lower than IBM's 3178.

The ITT Courier 1700. The economy-sized 3270 display that really is economical. 1-800-528-1400 Ext. 7796 Sales Support Department ITT Courier Headquarters Marketing, 1515 W. 14th Street, Tempe, Arizona 85281

**ITT Courier**

# WE HAVE 3270 COMPATIBILITY IN THE NEW ECONOMY SIZE.

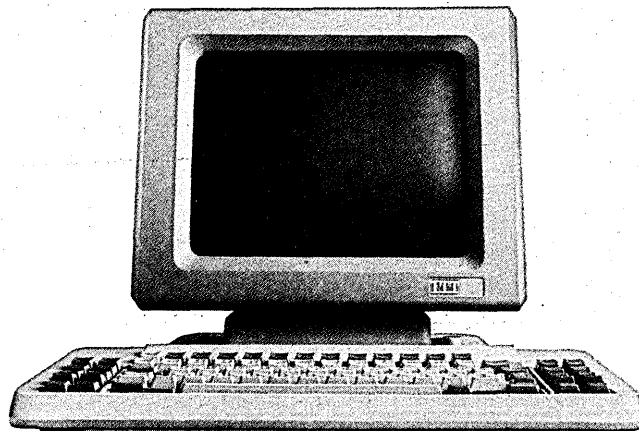

ITT Courier 1700.

CIRCLE 65 ON READER CARD

**Will programmerless programming replace present systems? Maybe, but don't burn those COBOL manuals yet. You're going to be working with your predecessors for some time to come.**

**by Nicholas Zvegintzov**

"The most reliable way to anticipate the future is by understanding the present." These are the words of John Naispitt, author of *Megatrends*, explaining his technique for analyzing social trends by measuring the content of news stories. The method bases predictions of the future on the reality of the present. By contrast, many predictions of the future of data process-

# NANOTRENDS



ILLUSTRATION BY JOAN STEINER

ing are based on the predictor's commercial or philosophical aims. Extrapolating the sweetest dreams of James Martin, Adam Osborne, Japan's fifth generation computer project, and the U.S. Defense Department's trademarked Ada language, we might envisage the future thus: a world in which many use computers but few understand them; a world in which a cordless device in one's top pocket delivers just the information

one wants just as soon as one desires it; a world in which computing has conquered old age, pollution, and urban decay; a world in which every computer command is expressed in a language as powerful as poetry and as unambiguous as a kick in the belly.

This may be a potent dream with which to shape our efforts, but as a prediction it's not worth much. A different world—more quirky, more richly textured, and, above all, more

plausible—emerges when we predict the future of dp on the basis of news about its present. For several years I have been collecting material about computer systems as they are. I use many sources: news stories, surveys, personal observation while consulting, and the comments and experience of participants at seminars that I give for managers and programmers with responsibility for present systems. On the basis of this material I see four

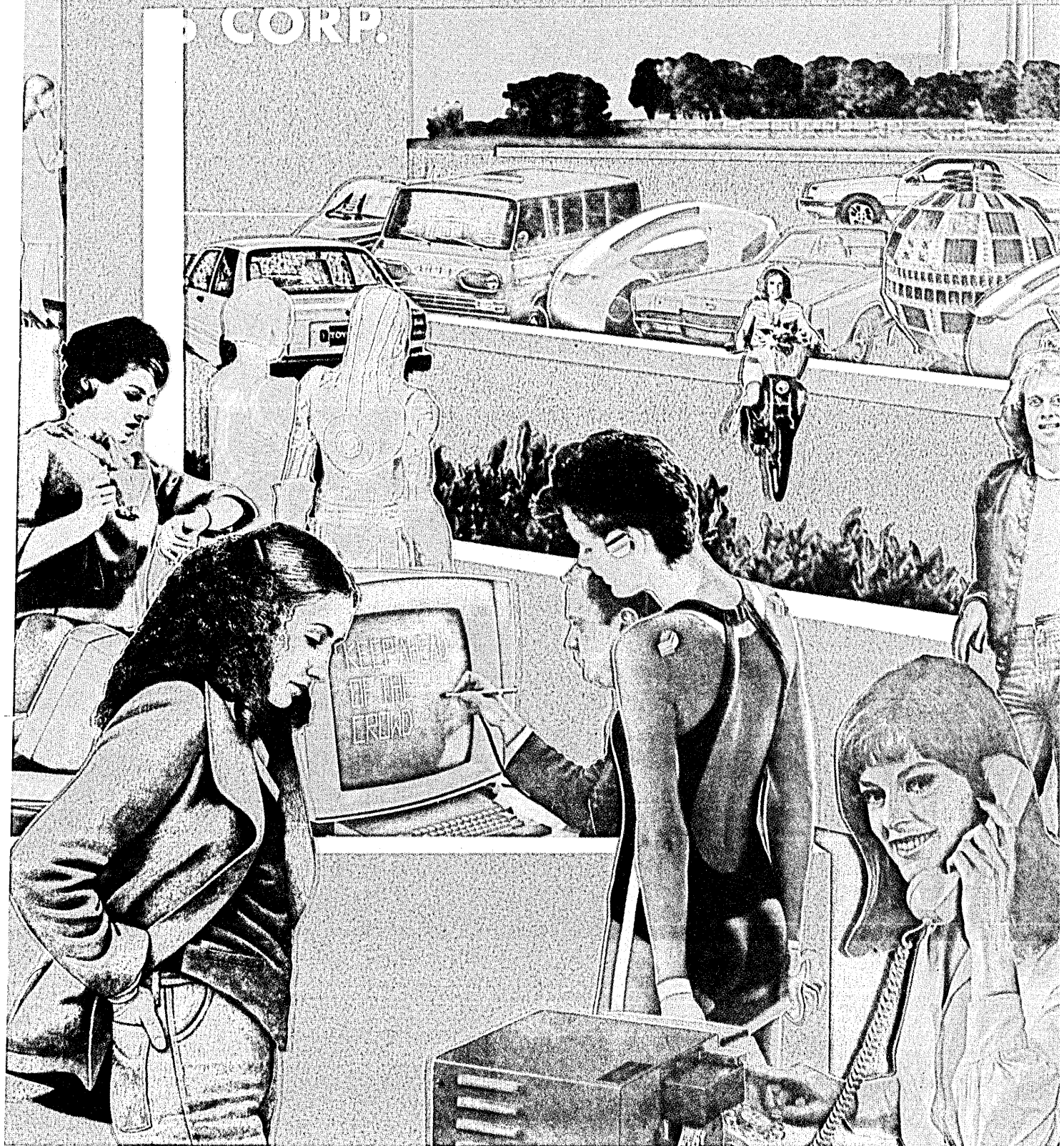

# Present systems are managed by functionality, not by technicality.

trends that characterize present systems:

- Present systems are managed by functionality, not by technicality.
- Functions are added on, not replaced.
- The technical criterion for new functions is compatibility, not perfection.
- The software market is in tools, not systems.

I will discuss each of these trends individually, and then offer some predictions and advice based on them.

### Functionality, not technicality.

Where is the real challenge of the dp? What is the essential difficulty of dp that requires organizations to pay large salaries to large staffs to support it? What are the organizations paying for?

Many studies show that people's perceptions of their jobs accurately reflect the objectives, spoken or unspoken, of their employers. I therefore asked participants in my seminars—managers and programmers with responsibility for present systems—how they classified themselves.

Do they classify themselves by a dp role—business analysts, systems analysts, designers, coders, testers, documentors? Do they classify themselves by technical specialty—telecommunications, transaction processing, database applications? Or do they classify themselves by their functional specialty—payroll, accounting, engineering, systems software? The overwhelming response is, by function.

I have found a few cases of specialization: sometimes an individual will be a floating consultant, providing expertise in one specialty to a whole group; sometimes an individual will be in charge of library control or release management; and, among the largest shippers of software (IBM, for example), the group that shoots bugs in the last release may be separate from the group that creates the next release.

These are exceptions, however. The rule is that the people responsible for present systems define their job as "whatever it takes to keep the system productive." They are business analysts, systems analysts, designers, coders, testers, and documentors all on the same day, sometimes within the same hour; often they are user consultants, operations liaison, librarians, historians, archaeologists, and Dear Abbys as well.

This observation confirms operationally what many exasperated non-dp managers have tried to tell the dp profession—that the bottom line of dp is not dp. Computer science may stress algorithms and languages, methodologists may stress ideal structures for development projects, and the advertisements in DATAMATION may stress magic boxes with colored lights, but when the system is on the floor, algorithms, methodologies, and magic

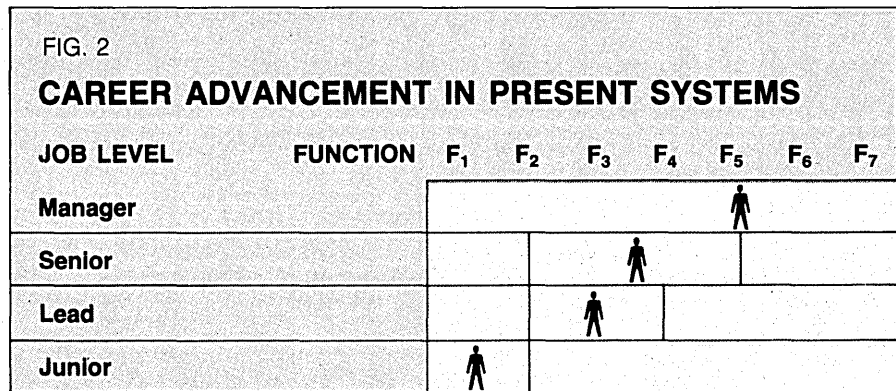
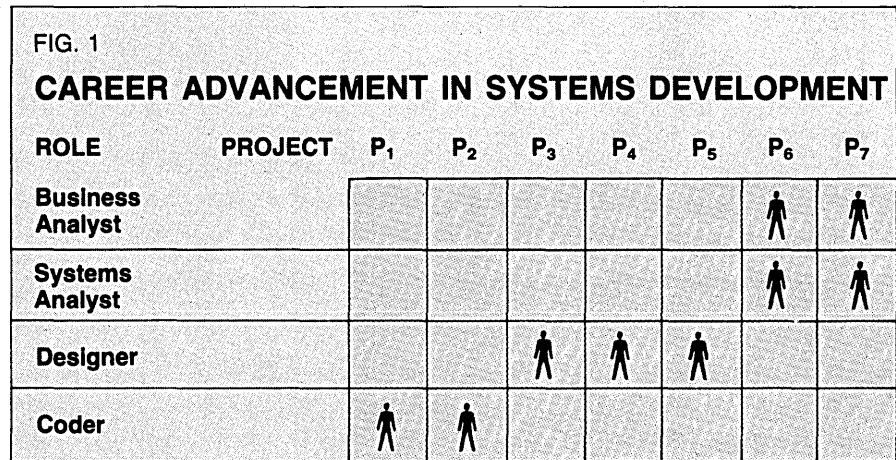

boxes take second place to function. The way present systems staff perceive their jobs accurately reflects this priority.

This difference of roles between development systems and present systems extends also to a difference in career paths. Development systems staff identify themselves by their skills, not by their projects, which they regard as temporary assignments. Moving to a new project may be job enrichment, but it is not career advancement; advancement is moving to a higher role (see Fig. 1).

### PRESENT SYSTEMS STAFF

Present systems staff are not classless either; there are status and job-level distinctions among them also, but these are distinctions of scope, not role. A programmer advances by being given a larger or more important slice of the total business/software function to look after—either by adding functions to those already assigned, or by moving to a more complex or more sensitive function (see Fig. 2).

Although people in charge of present systems do not usually regard themselves as managers, their career paths more closely resemble those of managers than of technicians—a continually widening responsibility

for a collection of divergent resources. The logic of this trend is clear: the technicalities of a dp system—its language, its interfaces, its modules—predominate when it is developed; after it is installed its functionality—its content, its behavior, its meaning—outweighs anything else. The staff of an existing system is valued above all for understanding and facilitating the function.

One of the most stable statistics in all of dp is the proportion of software resources devoted to present systems versus systems under development—about half and half. This proportion has been remarkably constant since first reported by Robert Riggs in DATAMATION in 1969. It has been confirmed through DATAMATION surveys from 1976 to 1981; by IBM Marketing Group managers Fjelstad and Hamlen in 1979; UCLA professors Lientz and Swanson in 1980; and U.S. General Accounting Office analyst Steven Merritt in 1981. Fig. 3 plots all reliable published estimates of the proportion of programming resources devoted to present systems, using Os for survey results and Xs for individual observations.

Nobody knows why half of all programming resources are assigned to present systems, but according to classic economic analysis, the proportion must represent the

# Predictable

...and your future is in sight with 3M diskettes.

When it comes to keeping track of precious data, predictable means simply being able to count on every diskette, every time. And you can count on that with every diskette. We've been in the data storage media business for over 30 years. And we've never settled for less than the best in improving and perfecting our product line, from our hard drive and data cartridges to floppy disks.

3M diskettes are made at 3M. That way, we have complete control over every step of the manufacturing process. And you can have complete confidence in the reliability of every 3M diskette you buy.

Look for the yellow Pages under Computer Supplies and Parts for the 3M distributor nearest you. In Canada, write 3M Canada, Inc., 10000 16th Avenue, Richmond, BC V6V 1R7, or telephone (604) 273-3000.

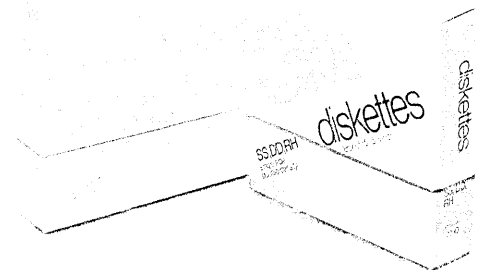

3M hears you...

# 3M

CIRCLE 66 ON READER CARD

## The overriding importance of compatibility ensures the survival into the foreseeable future of the current computer languages.

mix of activities that gives the dp department the best value for its money. An hour of work on new systems is balanced by an hour of work on present systems; more of either one, and the value of the other diminishes. One clue, also derived from surveys, is that more than half of the costs devoted to present systems are incurred in adding new functions. A large proportion of the work on present systems appears to be in providing a basis for new developments.

Every new function, however state of the art—an intelligent query language, a web of microcomputers, a real-time animation screen—has to be tied into the present system. To use a metaphor from dentistry, the new tooth has a crown, which is new and visible and at the cutting edge, but it is attached to the jaw at the root, which is old and hidden and full of blood and nerves. The dentist's job, to be feasible at all, must require as little replacement as possible. If a new tooth required a new gum or a new jaw or a new mouth or a new head, most of us would have hollow smiles.

We find that pieces of systems are not replaced except for overriding economic or technical reasons. If a function changes radically, the corresponding subsystem will be changed; if incompatible hardware is brought in, the functions on the old hardware may be reprogrammed if they cannot be converted; but if the intent is to modify functionality or capability or even performance, the trend is to add code, a front end, or a box. Replacement of functions incurs a redevelopment cost that most dp organizations will not bear. "Add on, not replace" is the trend in software.

*Compatibility, not perfection.* If add-on is the message of software development, then compatibility is its medium. The overwhelming amount of added software is written in languages or on systems that are compatible with existing systems. An incompatible system is a system out of communication, and a system out of communication is doomed. In 1983 we are in the middle of an obvious example of this principle: after a couple of years of euphoria about freestanding micros and personal computers, we observe all the activity in announcements of interfaces. A similar evolution can be seen in the case of so-called fourth generation languages—query and report languages linked to databases. The easy sales have been made to peripheral groups such as research units, and to development groups with completely new applications; the current competition is to see which fourth generation language is effective in linking into existing data streams. A symbolic instance of both developments is the change of name of the well-established Cullinane Database Systems Inc. to Cullinet

FIG. 3

### ESTIMATES OF PROGRAMMING RESOURCES DEVOTED TO PRESENT SYSTEMS

PERCENT

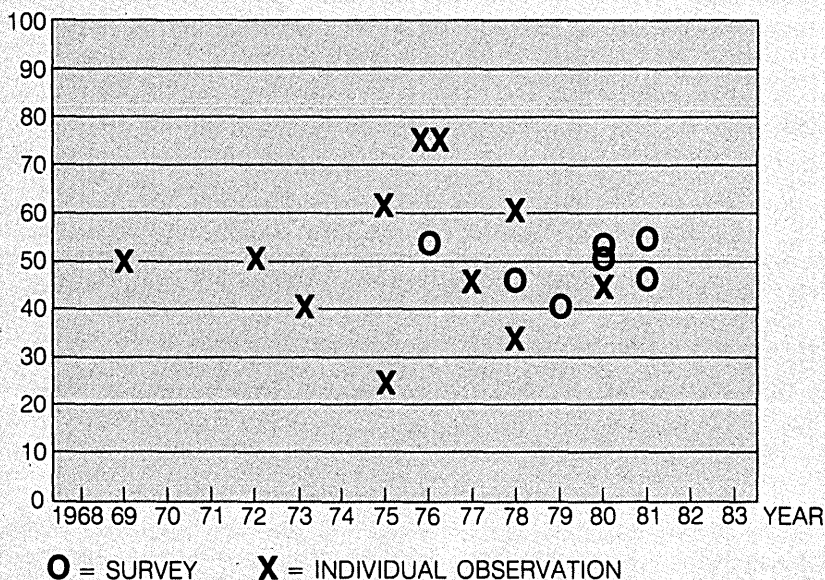

Software Inc.

After functionality ("Does the system do its job?") the only criterion for good system components is compatibility ("Does it fit with the rest of what we have?"). Criteria such as elegance and state-of-the-art technology have little influence. The relative cost of components (this package versus that package) is dwarfed by the cost of compatibility or incompatibility.

### CURRENT LANGUAGES WILL LAST

The overriding importance of compatibility ensures the survival into the foreseeable future of the current computer languages. COBOL is holding its own as the language of about half of all computer code in the U.S.; runners-up are FORTRAN (particularly in scientific and engineering applications), RPG, PL/1, BAL, and BASIC. All other languages, including computer scientists' favorites such as APL, ALGOL, and Pascal, plus the fourth generation languages, share 10% of the code.

The leading computer languages, like all human languages, hold their position through an add-on development of their own. They sprout new verbs and control structures; they incorporate report generators and screen formatters; they admit calls and interfaces to database systems and teleprocessing monitors. At an ACM conference I heard an Ar-

gonne National Laboratory analyst make a memorable remark about languages: "I don't know what language scientific applications will be written in by the year 2000—but I know what that language will be called: FORTRAN." He might also have said: "I don't know what language business applications will use by the year 2000—but I know what that language will be called: COBOL."

The survival of functions, the survival of code, and the survival of languages are all synergistic. "If it ain't broke, don't fix it" applies particularly strongly to software, which does not wear out. In surveys, data processing managers have given five years as the average age of their most heavily used software systems. Parts of these systems are certainly much older. A revealing section of advertisements can be found in DATAMATION's Software Services Marketplace, those offering conversion services. Still advertised is 1401 Autocode to COBOL service. The last 1401 was built in 1965; the code concerned is at least 18 years old, yet there is still enough of it in service for conversion to be a commercially viable activity. Even this code is enhanced by add-on development. One conversion specialist at C-S Computer Systems Inc. told me that he often converts Autocode that has been continuously modified until the retirement of the Autocode expert from the client company.



# Here's your blueprint for getting into graphics... quickly, economically, and safely.

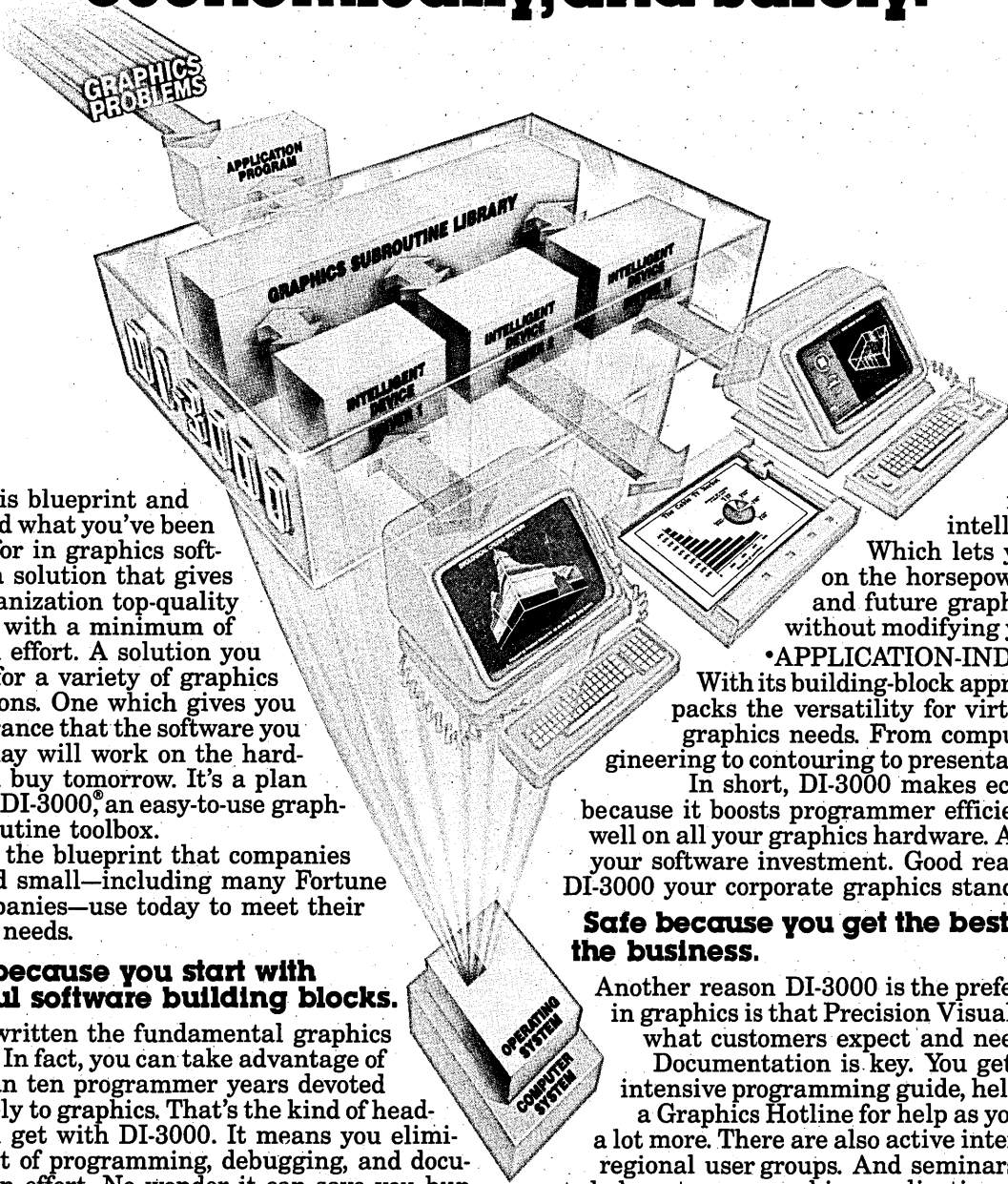

Study this blueprint and you'll find what you've been looking for in graphics software... a solution that gives your organization top-quality graphics with a minimum of time and effort. A solution you can use for a variety of graphics applications. One which gives you the assurance that the software you build today will work on the hardware you buy tomorrow. It's a plan based on DI-3000®, an easy-to-use graphics subroutine toolbox.

This is the blueprint that companies large and small—including many Fortune 500 companies—use today to meet their graphics needs.

## Quick because you start with powerful software building blocks.

We've written the fundamental graphics software. In fact, you can take advantage of more than ten programmer years devoted exclusively to graphics. That's the kind of head-start you get with DI-3000. It means you eliminate a lot of programming, debugging, and documentation effort. No wonder it can save you hundreds of hours. And speed you to the graphics solution you've been looking for.

## Economical because a little programming effort delivers a lot of software life.

DI-3000 will save you significant software development dollars. Because DI-3000 is:

- **MACHINE-INDEPENDENT.** Its modular structure works as well on a microcomputer as it does on a super-mini or mainframe. That means freedom from software obsolescence.
- **DEVICE-INDEPENDENT.** You're not locked into specific graphics devices either. You can choose from

more than 50 intelligent drivers.

Which lets you capitalize on the horsepower in current and future graphics hardware without modifying your software.

## • APPLICATION-INDEPENDENT.

With its building-block approach, DI-3000 packs the versatility for virtually all your graphics needs. From computer-aided engineering to contouring to presentation graphics.

In short, DI-3000 makes economic sense because it boosts programmer efficiency. It works well on all your graphics hardware. And it protects your software investment. Good reasons to make DI-3000 your corporate graphics standard.

## Safe because you get the best support in the business.

Another reason DI-3000 is the preferred solution in graphics is that Precision Visuals has learned what customers expect and need in support.

Documentation is key. You get an example-intensive programming guide, helpful tutorials, a Graphics Hotline for help as you need it, and a lot more. There are also active international and regional user groups. And seminars and courses to help get your graphics applications operating on time and within budget.

This is the blueprint you can trust. It's been proven by companies both large and small who need top-quality graphics solutions...quickly, economically, and safely.

Call or write Precision Visuals for complete details.



## Precision Visuals

6260 Lookout Road  
Boulder, Colorado 80301  
(303) 530-9000/TELEX 45-0364  
TWX 910-940-2500

CIRCLE 67 ON READER CARD

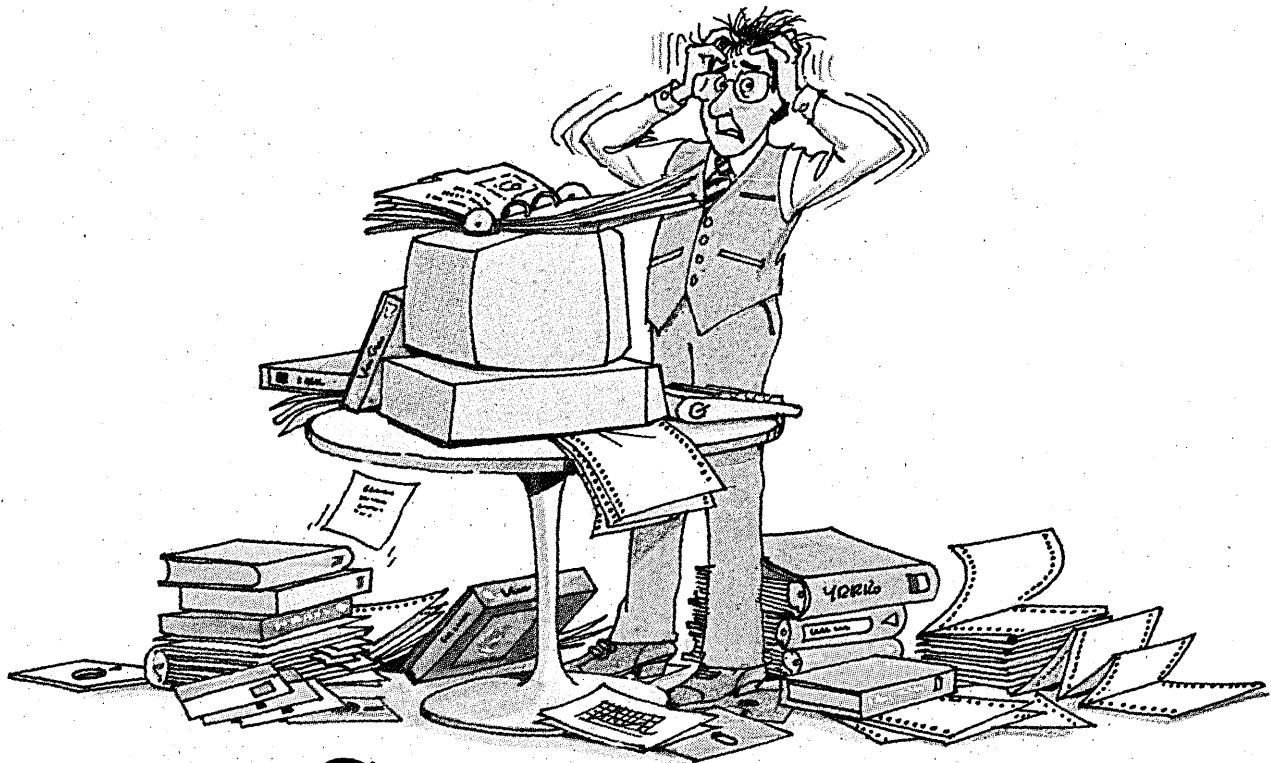

**Growing pains.**

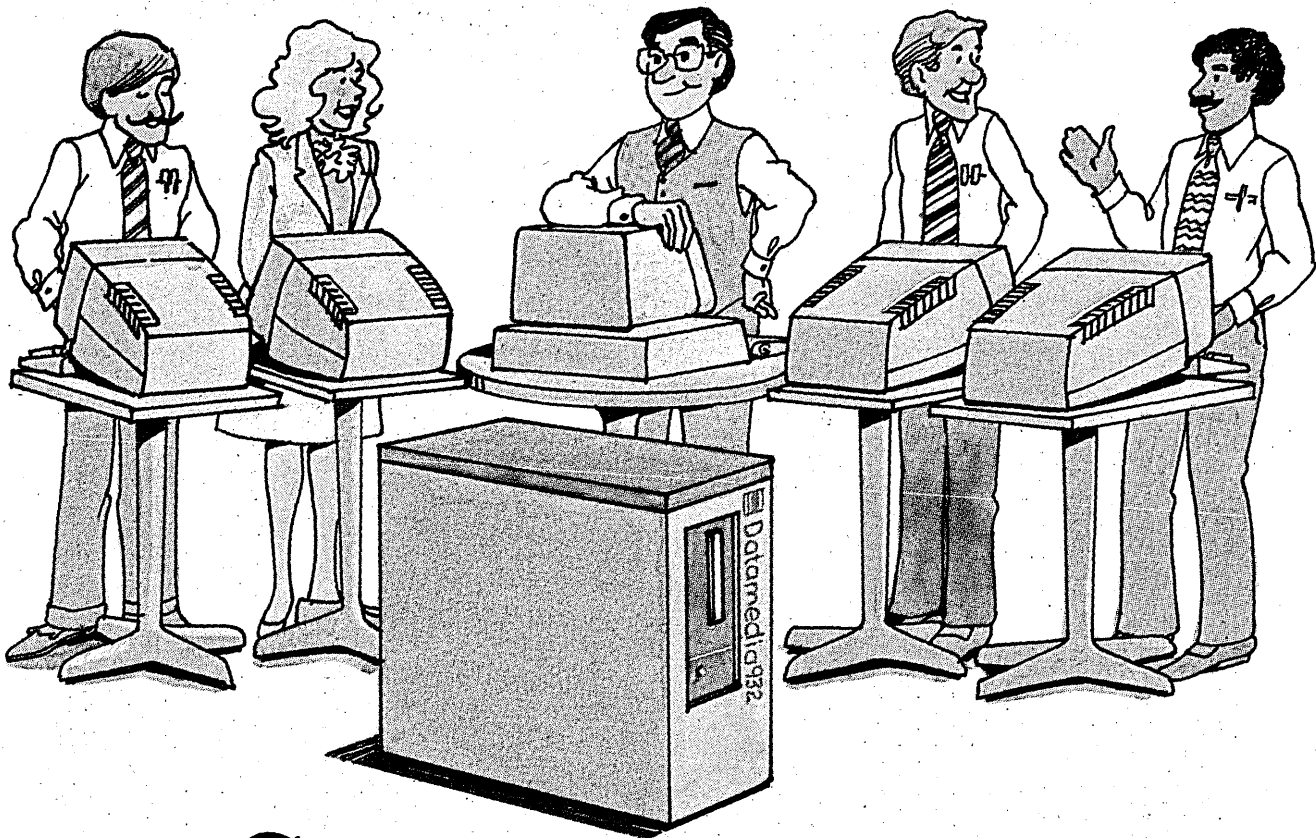

**Growing business.**

Nothing gives a business more growing pains than an overloaded personal computer. Unless it's a network of personal computers – an inefficient, costly way of sharing a common data base.

If you're about to get into office automation, or if you're about to get in deeper with an additional investment in personal computers, consider the advantages of *departmental* computing with the Datamedia 932 System.™

A 932 lets up to 16 people do whatever computing they need, as much as they need, simultaneously from their own workstations. Accounting. Job Costing. Word Processing. Sales Analysis. You name it. They do it while sharing the 932's powerful, 32-bit central processing unit, a common data base, and an interactive operating system.

An integral part of the Datamedia 932's operating system is its relational data base management software – the most powerful DBMS in the minicomputer industry, and the first one available in a microcomputer system. It makes the operating system very easy to use, no matter how unsophisticated the user. It also permits data to be shared among multiple users and departments. Which in turn eliminates all the data access barriers that can exist in systems in which each department has a separate file.

Data entering the data base are recorded only once – by the controlling user or department. Which eliminates the need for duplication by other users or departments that access it.

Because the 932 is a shared computer system, the cost per workstation is low. With very little duplication of effort among users, efficiency and productivity are high. And because users access the same data base, consistency prevails.

When you invest in a Datamedia 932 System, you get a system that has been configured according to your specific requirements.

You can choose from Datamedia's broad line of color, graphics and ASCII editing terminals, use the personal computers and word processors you may already have, or use a combination, adding more workstations as your requirements grow.

However your Datamedia 932 System is equipped, you'll have access to the broadest range of big-system business applications software you can find, as well as a variety of standard software such as word processing, electronic worksheet, business graphics, accounting, and more. And you'll receive continued support from us – and from an expanding network of knowledgeable, service-minded dealers.

The Datamedia 932 System is the computing system for growing companies. Find out more about it, and the location of the authorized Datamedia dealer nearest you, by calling 1-800-DMC-CORP. (In New Jersey, call 1-609-665-5400.) Or write Datamedia Corporation, 7401 Central Highway, Pennsauken, NJ 08109.

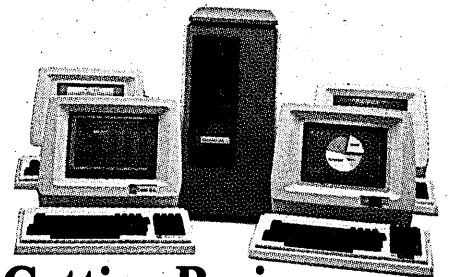

**Getting Business  
Computing Together.**

## DON'T SHOOT THE PROGRAMMERS

by Alex and Dan Pines

Is it true that business application programmers are ready for the glue factory? Some software industry gurus have been promoting just such a point of view. In the near future, they say, increasingly sophisticated application tools will be placed in the hands of increasingly sophisticated end users, eliminating the programmer entirely.

We are reminded of a similar scenario put forth in the scientific community. In that arena, the most effective scientific groups are often those in which scientists and engineer/technicians work collaboratively with appropriate tools, each side contributing its specialized talents. At least one school of thought, however, holds that for most scientific applications engineers should be obsolete. After all, by securing components in ready-made modules, researchers (who are the end users) can build their own equipment. You take a laser here, a digitizer there, mix in an amplifier, and presto—the experiment is ready to roll. This bypasses the “low productivity” route of submitting jobs to the shop and waiting months for delivery.

There often comes a point in first-class experimental science, however, when this approach doesn't quite work. For example, experiments frequently demand elements of creativity and novelty that transcend the capabilities of standard modules. Rather than call in the specialized, creative engineer, an individual might simply shift terrain—studying the necessary quantum electronics and laser design, for example, or becoming handy with a soldering iron or fluent in schematics.

At first glance, it would appear that the group has gotten the best of two worlds—the scientific and the technical. But, in fact, it may well have lost the services of a scientist, replacing him or her with a mediocre hybrid. When something goes wrong—the machine doesn't quite work, or needs to be tweaked to work faster, or requires a slight alteration in its wire wrapping—it's this pseudoengineer who gets called. Since he or she can't possibly keep up in both realms, over the long run proficiency is maintained in neither, adding to the problems of maintenance and productivity rather than alleviating them.

This is one of the problems with the notion of “computers without programmers” or “programmerless programming.” Not that the idea isn't a laudable one—for in a typical company, the connection between a dp department and its end-user clientele is tenuous at best. Users, who know little of computers or procedural lan-

guages, must treat the dp department as they would a black box: put a request in, get a program out. But the program is not so much in the idea of a dp-user or engineer-scientist enterprise as it is in the faulty implementation of that idea. What should be a highly efficient collaborative effort gets muddled with tremendous backlogs, inflexibility in design change, and low productivity.

It has been argued that a few years from now procedural languages will disappear from the business application world and, consequently, programmers will become extinct. Instead, users will have at their disposal a sufficient array of tools (high-level business languages) that we collectively term application generators. By answering some prompts, formatting a few screens, and entering appropriate parameters, all in the language of the business application itself, the user will automatically end up with a smoothly running application. Indeed, the programmer and the user will at last be one and the same, amalgamating the traditionally separate dp and user functions. We agree that this trend is, in principle, a necessary and positive one. Its implementation is already clearly discernible as inexpensive computers proliferate and computer literacy increases.

But even the most avid proponents of this scenario admit a critical and paradoxical limitation: the more parameters provided for the sake of flexibility, the more cumbersome a package becomes to use. Sooner or later, an application will require more than such a system can provide, thus demanding the flexibility of procedural programming provided by dp “engineers.” Some kind of escape mechanism is thus required that allows you to write and incorporate your own routines—and you're back in the world of procedural languages.

Like scientists turned engineers, many end users may well have the ability to master the fine art of programming. In doing so, however, they inadvertently set themselves up as a de facto dp department. Although they will probably learn a great deal about computers, their companies will effectively lose the creative services of business managers. Thus, user-oriented tools can certainly make a viable and valuable contribution, but they do not represent a complete solution to the problem of business software productivity.

The problem with the programmerless approach is that it institutes a simple software solution that attempts to achieve two conflicting goals: universal flexibility and extreme ease of use. For many situa-

tions, end-user-oriented application generators will indeed come into their own. But for custom business requirements that demand creative software solutions, it is necessary to increase productivity by catering to the needs of flexible procedural programming with dp-oriented tools.

For example, COBOL is a widely used, business-oriented procedural language, structured to move, manipulate, and format enormous quantities of data. Unlike many end-user tools, it provides the flexibility to accommodate virtually any business application with minimum system overhead. Furthermore, large investments in COBOL cannot simply disappear overnight, even under the most ideal circumstances. In fact, the popularity of COBOL has increased with its high-level implementation for business microcomputers, such as Ryan McFarland's RM/COBOL and Micro Focus's Level II COBOL.

If COBOL is currently an example of a widely used language combining flexibility and friendliness, it is also criticized as outdated and time-consuming to write, modify, and maintain, all of which, it is claimed, makes it responsible for much of the current productivity problem. But hardly anyone would disagree that there are a few select programmers in the world writing healthy, easy-to-use, reliable applications with low maintenance requirements. These “superstars” are many times more productive than their average counterparts.

Thus, given that most programmers are not productive either in quality or quantity, the problem is not COBOL, but its implementation. Because of low-quality work in particular, programmers can spend as much as 80% of their time maintaining applications that took only a fraction of that effort to produce. This largely wasted effort prevents them from devoting their creative energies to new applications.

Although COBOL and other procedural languages have their faults, we're not quite ready to shoot the programmers. While getting applications tools into the hands of users, why not also get programming tools into the hands of dp personnel? Such tools are also forms of higher-level languages that we collectively term program generators. Tools of this type can dramatically increase programmer productivity, allowing higher volume and quality of programmed applications.

A good program generator retains the flexibility of a procedural language but makes programmers more productive and brings data processing and users closer together. For example, it can:

## Of the three major software successes in the micro market, two were utilities and only one was an application.

- Reduce lead time on new applications to allow rapid prototyping,
- Replace the tedious coding process with prompts and "painting" techniques for screen formats and report layouts,
- Eliminate debugging almost completely by automating the programming process with precoded skeleton modules,
- Simplify modifications in design and provide a mechanism for incorporating manually coded routines,
- Ensure transportability of applications between different systems and software environments,
- Speed programming by generating modules that can be used in many applications,
- Serve as a training device for new dp personnel, allowing them to become proficient in less time, and
- Provide an easy-to-use interface between the application and the user with menus, prompts, and help messages.

Until we have artificial intelligence on the level of 2001's HAL, the ideal dp environment will not settle on a single software solution. Meanwhile, we need an integrated approach in which the tenuous link between the dp department and the user is strengthened and the two parties are joined by both user-oriented application generators and dp-oriented program generators.

For many situations, users can purchase ready-made packages or generate their own applications with consulting assistance from the dp staff. At the same time, they will have the resources of dp programmers who will themselves benefit from productivity tools. In this way, programmers can participate constructively in the transition from the current dp scenario to the utopian future of high-level programmerless languages.

This approach of providing an integrated set of tools for both sides of the business application field realistically merges the expertise and specialized talents of the different parties in an efficient, mutually beneficial process. After all, creativity derives at least in part from long-term and thoughtful immersion in a particular area, and two groups as divergent in their talents as dp personnel and business-application users should be cultivated individually, while working toward a business environment of collaboration, flexibility, and productivity. \*

Alex and Dan Pines are founders and senior executives of Bytel Corp. (formerly Bytek), a company specializing in software productivity tools for business applications.

The bottom line of this trend is that you cannot easily sell a system or language as a replacement unless one of three conditions is satisfied: the new system is completely compatible (a pcm, for example), a conversion is mandatory, or the conversion is largely automatic. We do not have the technology for automatic conversion at present, but the possibility of converting languages and systems while preserving functions is the province of software tools, which is the subject of the last nantrend.

*The tools market.* The fourth trend that I observe is the growth in the market for software tools—software elements that are not themselves components of systems, but which enable dp staff to deal with systems. The usefulness of tools is that they recognize that function is already built into present systems; the challenge is to dig that function out, clarify it, extend it, tune it, and make it compatible with other functions.

There have always been tools in the marketplace (Autoflow, for instance, was first marketed in 1966), but tools belong to the mature phase of the dp environment, after a substantial functionality has already been programmed.

The late 1970s saw the beginning of a steady expansion of the tool market. A tools panel was featured at the 1981 National Computer Conference; a Tools Fair was held in conjunction with the International Conference on Software Engineering the same year; and in July of this year a full-scale Softfair tools conference took place.

The largest working tool kit is for the most mature software environment—the COBOL language (plus extensions) under IBM-compatible operating systems. Well-documented and well-advertised systems exist to:

- expand and cross-reference Job Control Language (ASC, System Analyzer, JCLCHECK),
- cross-reference and index COBOL (DCD-II, SYDOC),
- unravel COBOL's pathological control structure (SCAN/370),
- provide symbolic debugging and/or one-step processing in COBOL (ABEND-AID, Interactive Debug, XPEDITER),
- instrument COBOL for run-time dynamic analysis and profiling (OPTIMIZER III, TCAT, tracmacs, TRAILBLAZER),
- generate test files from production files and production programs (Datamacs), and
- handle source files—comparing them (RESQ, Source Compare/Audit Facility), formatting them (HAWKEYE), or controlling them (The Librarian, PANVALET).

Besides the tools themselves, there are even tool services, consulting groups such as The Catalyst Corp. or Adpac Corp. that apply a battery of tools to a client's sys-

tem in order to restructure or redocument it.

The existence of such a tool kit makes the difference between a basement hobbyist and a professional, and it adds another dimension to the synergy of present functions, present systems, and present languages. The promoters of newer operating systems and programming languages have to play catch-up in the same market. The originators of Unix boosted its popularity by coining the term "The Programmer's Workbench," and Kernighan and Plauger's well-known book, *Software Tools* (Addison-Wesley, Reading, Mass. 1976), showed the user how to get started on a personal tool kit under Unix. The sponsors of Ada, the Department of Defense's trademarked language for embedded systems, began to standardize the tool kit—the Ada Programming Support Environment—even before completing the standardization of the language. Of the three major software successes in the micro market, two were utilities—the operating system CPM and the language BASIC—and only one was an application (VisiCalc).

Software tools and large systems form a positive feedback. Tools thrive in the systems environment in which the largest functions are expressed; large functions migrate to the environment with tools.

### DIRECTION OF FUTURE SYSTEMS

These four trends—functionality, add-on, compatibility, and tools—express the synergy of present functions, present code, present languages, and present tools. These, with the added synergy of present staff, create the momentum of present systems, which largely determines the direction of future systems. What can we predict on the basis of these trends?

In the staff environment, half of all dp personnel will continue to work on existing systems, the other half on new systems. Programmers will tend to disappear—but not because languages will be so nontechnical that no technical expertise is needed. Programmers working on present systems will accumulate functional expertise, and functional managers will acquire technical expertise, until the two groups merge. Development specialists will move toward a staff role in technical consulting. Maintenance of modules in oddball or incompatible languages will be a dead-end assignment. (For another view, see accompanying box.)

In the language environment, all present computer languages will retain their present rank. Business systems will still be written in COBOL and engineering systems in FORTRAN. These languages will be upwardly compatible and will continually incorporate new functions and new control structures. Screen editors, report generators, query sys-

## In the software marketplace, survivor firms will be those that offer a supermarket of tools and techniques built up over years.

tems, and visual modeling tools will find places as compatible partners of existing procedural languages. Ada will find a niche as a language for real-time embedded systems, particularly in defense applications, but it will not supplant existing implementation languages (such as IBM's PL/S) or existing applications languages (such as COBOL and FORTRAN). Every large system will contain code from every decade; the oldest code will be in the deepest functions, with the newest code at the user interfaces.

In the systems environment, the major mainframe operating systems dating from the 1960s (OS, VM, MULTICS, MCP, etc.) will hold their relative positions. Mini and micro hardware will mimic mainframe hardware. As hardware costs continue to drop, the 360/370 architecture and its associated operating systems will dominate the mini and micro market also. We already see one minicomputer, the Formation 4000, offering IBM 370 software compatibility, and a recent paper in the *IBM Journal of Research and Development* describes microprocessor implementation of the 360/370 architecture. The dominant systems architecture will be a network of processors, each running a larger or smaller subset of the same operating system, and communicating via SNA. A DATAMATION panel in October 1981 called current operat-

ing systems dinosaurs; they should note that dinosaurs are gone, but lizards and salamanders—their descendants—are alive and well and found under every rock.

In the applications environment, the momentum of present systems will dominate the character of the dp group in each organization. No technological breakthrough will tip the balance between functional management and dp management of an organization; if there is dissatisfaction between these two groups, they will have to resolve it by political trade-offs. System modules (hardware and software) that are compatible with the commonest languages and protocols will be upgraded through new upwardly compatible releases, but they will not be redesigned or replaced. System modules in uncommon languages and protocols will be most vulnerable to replacement. The high cost of such replacement will make incompatible modules a sore cost point for the dp manager.

In the software marketplace, survivor firms will be those that offer a supermarket of tools and techniques built up over years (for example, Applied Data Research Inc. or Informatics General Corp.) and those with a dominant hold on a functional area (for example, Management Science America Inc.). Good prospects are those with specialized tools that service present systems (for exam-

ple, Candle Corp. or Computer Associates International Inc.), provided they can live peaceably under the IBM umbrella. In trouble are those whose business depends on replacing a dominant system, however bad the present system is and however good the replacement is—including fourth generation languages, teleprocessing monitors, database systems, etc. In recent months we have seen trouble at STSC Inc. (APL) and at Altergo Inc. (Shadow Teleprocessing Monitor); expect other shakeouts, particularly in the fourth generation language market.

If you are procuring software, use "survivor" firms. Don't buy or develop replacement systems unless you can cost-justify, not merely the new applications to be written under the replacement system, but the cost of replacing existing applications. Buy all the tools you can find. Push vendors for more and better tools. Tools are your major leverage with your existing inventory of systems and people, which are your major capital asset. Distrust vendors who promise a revolutionary comprehensive integrated transformation of information processing; they are selling snake oil.

If you are vending software, try to present your product as enhancing the functionality that is already in present systems. Avoid the terms "revolutionary," "comprehensive," and "integrated"; try "evolutionary," "versatile," and "compatible."

If you are making a career in dp, remember that cutting-edge technical expertise is only one avenue of advancement. Functional area expertise is another. Liaison between the two may be best of all. Don't underestimate your predecessors; don't underestimate the deep quality of the systems they left to you; learn to mine that quality.

If you work or pay others to work for you, do not expect that computers will change that. I do not know what the daily activity of the mass of humankind will be by the year 2000, but I know what that activity will be called: work. \*

Nicholas Zvegintzov is a New York City consultant and coauthor with Girish Parikh of the *Tutorial on Software Maintenance*, published last April by the IEEE Computer Society Press.

### REPRINTS AVAILABLE

Reprints of all DATAMATION articles, including those in all 1982 issues, are available in quantities of 100 or more. Details may be obtained by telephoning Mary Ann Hanle, (212) 606-9729 or by writing to Reprints Department, DATAMATION magazine, 875 Third Ave., New York, NY 10022.

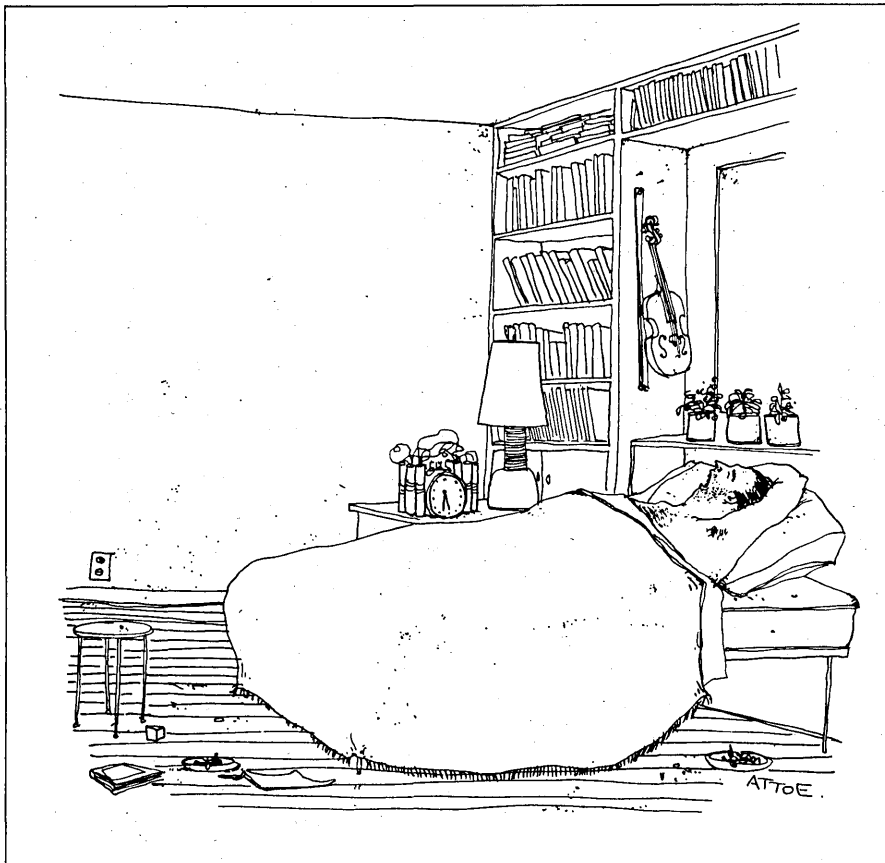

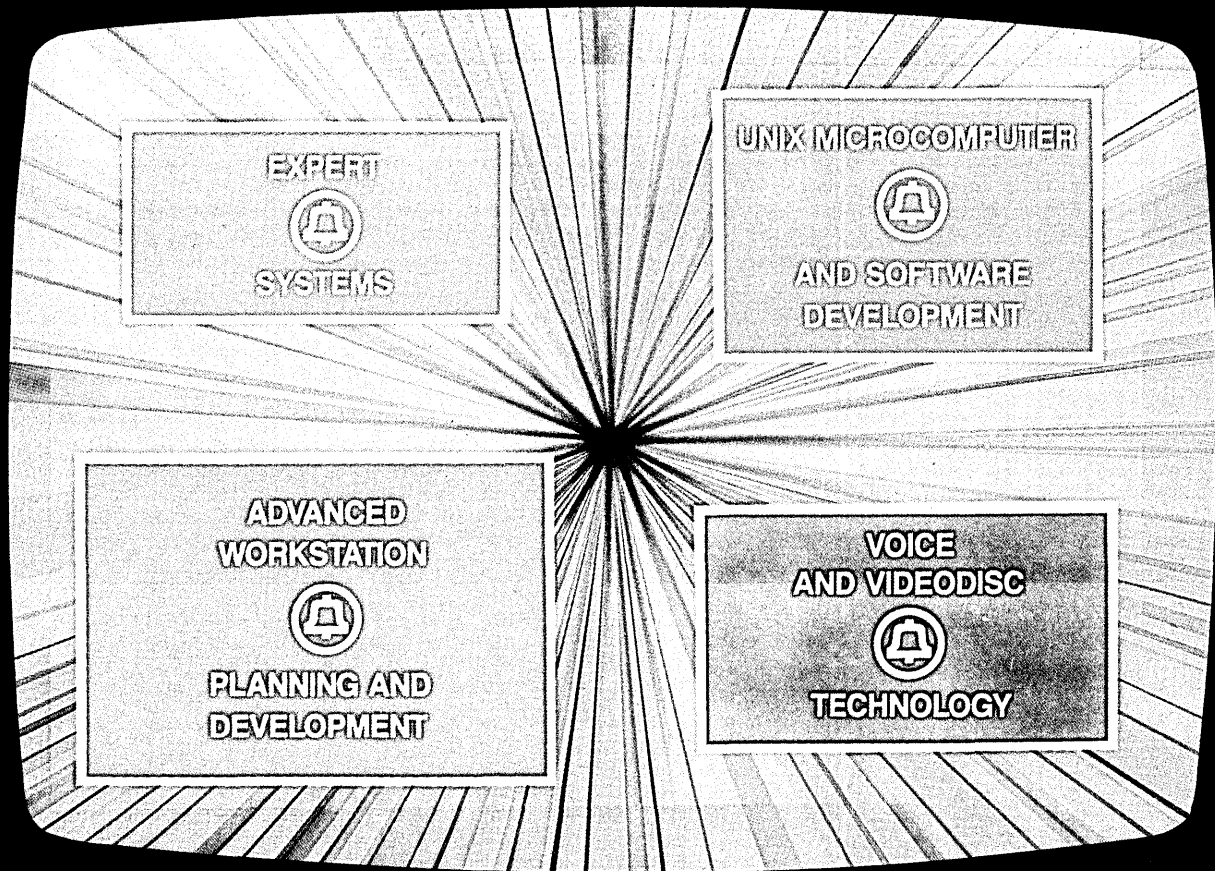

## REACH OUT AND TOUCH TOMORROW

Bell Laboratories is moving in new directions to develop sophisticated UNIX™ applications for microcomputers. Here, at the home of UNIX, we are applying advanced technology to every facet of information systems.

One of our newest developments is ARIEL, an interactive information retrieval system, the first to bring audio, text and video together in a centrally controlled network. ARIEL is inviting visitors at Disney's EPCOT Center to 'reach out and touch me' to see and hear about attractions in the park, make reservations for dinner and even speak to guides over a two-way video system.

And ARIEL is just the beginning...

The microcomputer is going everywhere and we are going everywhere with it.

To assist us in developing unique applications for tomorrow's microcomputers, we need talented software and computer engineers who are in close touch with one or more of the expertises displayed above and who have an MS or PhD degree or a BS degree with at least five or more years of highly relevant experience.

Successful candidates will have the opportunity to work creatively to:

- Develop software for UNIX-based microprocessors
- Develop software for advanced display systems

- Develop voice and text applications for intelligent workstations in the UNIX environment
- Identify and develop management decision support software for various vertical applications
- Plan and develop videodisc-based information retrieval systems
- Develop knowledge-based, expert systems using artificial intelligence techniques.

At Bell Labs, you will have a wide spectrum of technical resources readily available to you. Processor, software and communications capabilities will be at your finger tips. You will work with some of the best minds in your field in an atmosphere that fosters free exchange of ideas.

Openings are located at our Laboratories in New Jersey.

If you have the required credentials and are interested in joining us in shaping the future of microcomputers, please send your resume detailing education and experience to:  
 Director, Technical Employment,  
 Bell Laboratories, Dept. 65/4531/83,  
 150 John F. Kennedy Parkway,  
 Short Hills, New Jersey 07078.

An equal opportunity employer.

# Bell Laboratories







**THIS IS ONE FORM OF  
REAL TIME SCHEDULING.**

**OUR SOFTWARE IS ANOTHER.**

Our ADC2, Automated Data Center, is innovative, non-traditional software that manages critical components of IBM's MVS computer operating system.

ADC2 is a real-time job scheduler, and monitor of job and system performance. It dynamically gathers job performance statistics and maintains this information as current and historical data for on-line access. ADC2's innovative approach takes unique advantage of IBM's MVS subsystem architecture.

And, of course, ADC2 is very user-friendly. It easily builds schedules and accesses all the information you need to insure increased throughput under the most demanding of circumstances.

ADC2 also allows scheduling to be decentralized: different departments and remote sites can develop their job schedules with simple commands.

ADC2 is so simple, so quick and so good, that while other job scheduling systems typically require 6 to 18 months of pre-planning and data entry before actually going to work, ADC2 can be productive the very same day it's installed.

For a demonstration of ADC2 or further information on the Cambridge A\*\*2 family of high performance software systems, we invite you to call Shawn McLaren direct: 415/941-4558.

He'll be glad to tell you about a software system that allows you to schedule jobs in calmer waters.

The Cambridge Systems Group



24275 Elise, Los Altos Hills, CA 94022, U.S.A., (415) 941-4558 • Telex 357437  
London Paris Munich

CIRCLE 70 ON READER CARD

**The 3081s of today are the Dodge Polaras of tomorrow.**

# JUNKING THE MAINFRAME

by Martin Healey

It's pretty easy to say that the history of the computer industry can be divided into three eras: the 1950s and 1960s, which were marked by the dominance of the central mainframe; the 1970s, which became the decade of the mini; and the 1980s, which saw the emergence of the microcomputer. Yet this division is not strictly true. Specifically, the '70s were more dominated by mainframes than minis, if we measure by installed base value. (I dare not use MIPS as a yardstick, for I fear we would come up with pocket calculators as the dominant computing devices.) Minis were unarguably the most interesting new development, bringing computers into new areas of process control, communications, etc., and totally dominating the market for small business systems. Manufacturers refused to acknowledge the existence of minis one year and then claimed to be leading suppliers the next—such was the impact of minis. Yet minicomputers did not cut into the market for mainframes, but expanded the entire computer market.

Already the '80s are being hailed as the decade of the micro. Smaller minis are being superseded by micros. New applications areas such as word processing have been popularized by micros. Yet despite personal computers abounding in homes and offices, the mainframe still dominates value sales. Since the mini did not hurt the mainframe, pundits might say, neither will the micro—or will it?

I believe that the micro will totally destroy the current mainframe concept. I also believe that this will be a gradual evolutionary trend, not an overnight revolution. Technological revolutions are with us already; computing, however, is about solving problems and providing services, not just about technology. There is an enormous inertia behind a computer system, involving methods of data input and dissemination, user accep-

tance and training, etc. System revolutions are quite simply recipes for disaster. Thus the computer industry must learn how to harness technological revolutions so as to produce systems evolution.

Perhaps the most disturbing and, in the end, most influential element in the evolution of computer systems is the growing end-user involvement. The end user tends only to see his or her immediate problems, with little thought as to the effects they (or their solutions) might have on others. Rightly or wrongly, they favor the micros, an undeniable and irreversible trend.

The scene I wish to portray is therefore one of the relatively gentle demise of the mainframe with a gradual takeover of the micro. The time scale is almost impossible to predict, but I expect serious changes within five years and the complete demise of the mainframe within 10 years. I dare not predict what will come after that.

(While I see these changes as affecting the entire industry, some companies and some segments may not be so affected. Just as Texas Instruments was the only component manufacturer to survive the transition from thermionic devices to semiconductors, so I would not be surprised to see a small percentage of today's large computer manufacturers survive; the others may simply disappear. It is easier for new companies with new technologies to grow than for old companies to change.)

Progress in large-scale integration (LSI) technology is the key to this evolution. Quite simply, an electronic circuit comprising hundreds of thousands of active, interconnected components—transistors—can be made at low cost on a single silicon chip. A 256KB memory two years ago needed 128 chips; today it only needs thirty-two 64K chips and by next year the count will be down to eight using 256K parts. The more complex chip is more expensive than the simpler one, but since fewer complex chips are required,

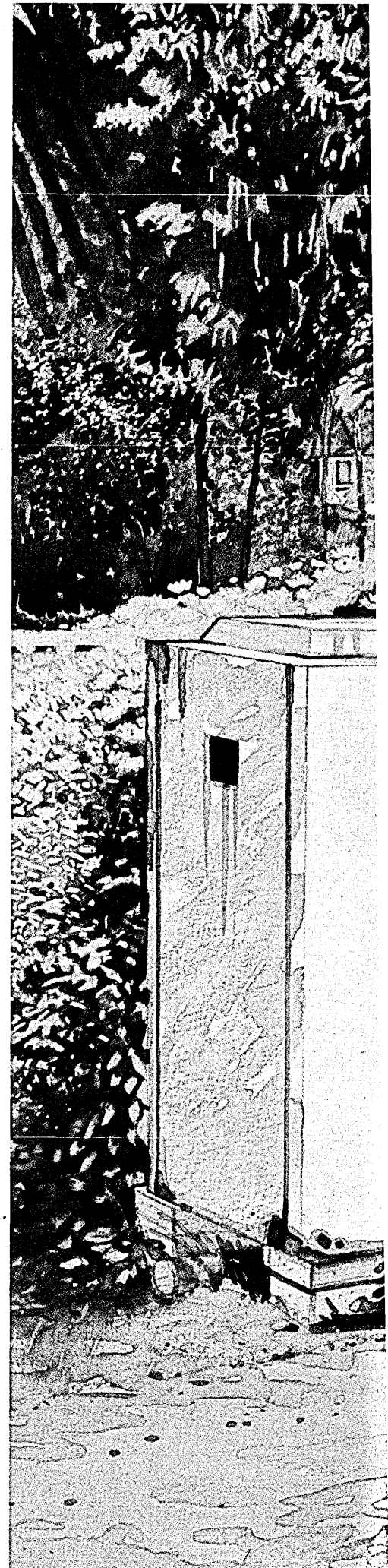

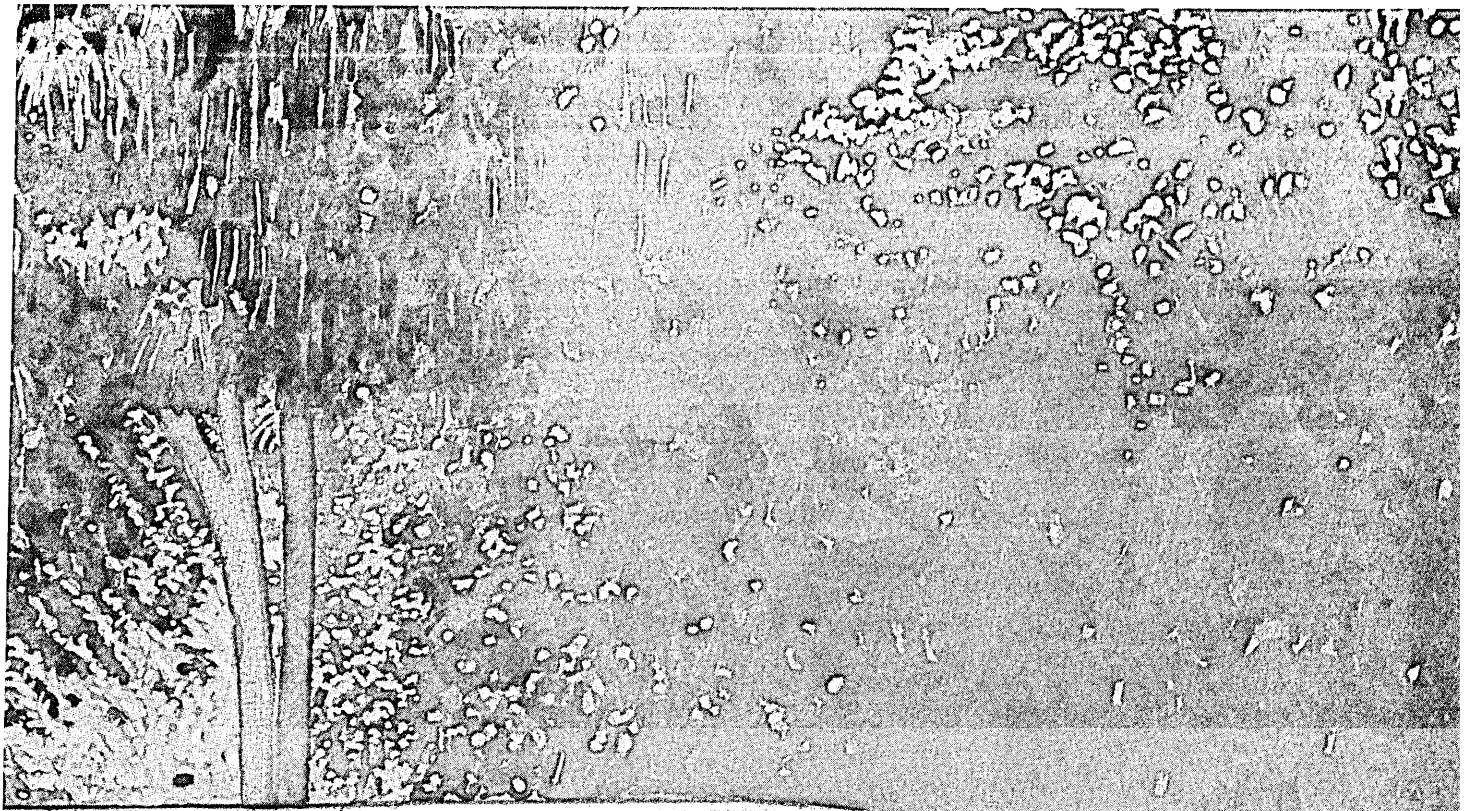

## ON THE OTHER HAND . . .

The future path of the mainframe is, to say the least, a subject of debate. While one argument—as put forth here by Martin Healey—postulates that the evolution of micro technology will eventually force the mainframe into extinction, a countering argument holds that mainframe technology will also progress rapidly and will produce a bright future for large computer systems.

The same LSI and VLSI technology that has fueled the growth of micros and networks will also lead to technological improvements in mainframes, providing them with additional computational capabilities and opening up new avenues for their application, according to Predicasts, a Cleveland-based market research firm.

They see the overall U.S. mainframe market as growing at better than 4% a year for the next dozen years—a \$16.8 billion market by 1995, the year by which Healey predicts they will have perished. U.S. mainframe sales stood at \$9.6 billion in 1981, the most recent year for which figures were available. Throughout the period, Predicasts sees mainframes as dominating (in dollar value) the computer industry.

Predicasts sees the banking industry as being a large contributor to the continued health of the mainframe computer and to

the continued wealth of its manufacturers—who, the firms says, should maintain about the same market share they have now over the next decade. The banks constitute about 22% of the total mainframe market, a figure that should go down in the next few years as automation efforts come to fruition. Nonetheless, late in the decade a large replacement market is expected to emerge, again boosting the relative positions of the banks in the mainframe market.

Another traditionally strong area for mainframes, manufacturing, is also expected to grow substantially in the next 10 years, and especially in the next two or three years, as companies pull out of the recession and automate their facilities. Other traditional mainframe users, such as services and the government, are expected to continue using mainframes, but with virtually no growth or decline. Wholesale and retail trade companies, which traditionally have not been heavy mainframe users, are expected to enter the market in force over the next decade as the predicted new technology drives down the cost and increases the power of the computer systems. The Predicasts forecasts are included in a 93-page report entitled "Mainframes and Supercomputers." The report costs \$1,095.

—Michael Tyler

the overall cost is much less. Further, less board space is required; one board instead of several can be used, saving money in connector and assembly costs. The power supply and casing may also be smaller. Thus, LSI reduces cost/performance ratios by a squared law characteristic.

LSI parts also reduce the time taken and the total cost of a new design. Gone are time scales and costs that dictate that a product must have a 10-year life span. Thus, LSI means that smaller companies are commercially viable, because of reduced R&D overhead.

## LSI AFFECTS SOFTWARE

Even software is affected by the LSI revolution, and here, too, the effect is detrimental to the long-term survival prospects of the mainframe. Hardware costs are falling and manpower costs are rising, so presumably software costs also rise.

This traditional concept is being turned into a misconception by LSI technology. High-power/low-cost hardware means that software techniques can be developed that optimize development, debugging, and ease of use at the expense of run-time efficiency, speed, and program size. We already see many high-level languages, program generators, and query languages being developed, all of which are heavy users of (cheap) hardware. This effectively reverses the rising cost of conventional programming.

These advances in software technology are taking place at the micro level, not the mainframe level. Current editors and compilers on micros are ahead of mainframes, and they are still in their infancy.

The negative influence of LSI technology on mainframe software relative to micro software is also due to the small number of common microprocessors used in popular microcomputers. Of all the micros on the market today, the 6502, Z-80, 8086, and 68000 have an almost total dominance, so software need only be developed for four instruction sets. Common operating systems have grown up for these cpus, which have attracted common compilers, which have begotten common applications packages. So LSI cpus have restructured the microcomputer industry into a "horizontal" concept, while current minis and mainframes have a "vertical" posture, in which software is rarely compatible with machines of several vendors. The effect of this is that micro packages are sold on very high volumes of machines at dramatically reduced prices.

Moreover, the rate of LSI technological development is not slowing down. Already the 16-bit micro has usurped the earlier 8-bit processors. A microprocessor like the Intel 8086 or Motorola 68000 has the pro-

cessing power of a midrange mini cpu like a Series/1 or PDP-11. Indeed, an 8086 will outperform LSI-based minis by factors of two or three and will also give extended address space. This addressing capability will doom the 16-bit minis more than anything, because it will enable microcomputer systems to catch up with systems like the IBM System/34; microcomputer cpus have already surpassed mini cpus, and the gap between mini systems and micro systems closes monthly. There is in my mind absolutely no doubt that microprocessor cpus with the power of today's small mainframes will become common within the next two years. The best applications of that power are not yet clear, but I cannot imagine that they will consist of using cheaper boxes to continue what is done today.

One of the key peripherals in a system is disk storage, an area in which mainframes have long kept minis and micros at bay. The smaller systems could not match centralized memory capabilities of the larger computers, although the large memory was needed for many applications. But thanks to IBM's Winchester technology, 5¼-inch hard disks can hold 5MB, 10MB, or 20MB at a cost of a few thousand dollars. Drives that can handle 100MB and more are already being sampled, and the latest experiments with head design and perpendicular recording techniques suggest that 5¼-inch Winchester drives will have 500MB capacities by 1985. Video storage techniques, offering a gigabyte per disk, are also only a few years away from becoming commercial products. Therefore, high-

capacity local storage is becoming a viable alternative to centralized storage, eroding yet another of the mainframe's traditional strengths.

One way to take advantage of improved cost/performance ratios is to do the same things, but cheaper. This is just a small element of the equation, however. Lower cost means that new applications become commercially possible, thereby dramatically widening the net of users. We saw this happen with the advent of minis, but it is much more widespread with micros. These new users have no history of using computers and, because of home computing, little fear of them. Take, as a case in point, word processing. Text processing by computer has been used in special cases such as newspaper typesetting for decades; however, there were few takers for \$50,000 typewriters. There were more people interested in \$15,000 dedicated systems, but at only \$5,000 (purely due to micro technology) many more commercial users are interested. The market and the new user base is created by LSI technology.

As a result, while traditional dp applications are well served by mainframes for batch processing and adequately by transaction processing (let us not pretend that mainframes and interactive terminals are happy bedmates; the mini's success was based on far easier, although better, terminal processing), they are hardly the right vehicle for this new range of high-volume, user-oriented applications.

For example, a feature of most new computing concepts—those based on office

System  
Network  
Architecture

To: Gina  
From: Bill  
Subject: IBM Technology

Here's the partial list I promised you of our past and present technological achievements. There are lots of things here that should be of real interest to the scientific, engineering and academic communities. What's your choice for the next topic in this series?

- |   |   |
|---|---|
| Vacuum tube digital multiplier                  | System/360 compatible family              |
| IBM 603/604 calculators                         | Operating System/360                      |
| Selective Sequence Electronic Calculator (SSEC) | Solid Logic Technology                    |
| Tape drive vacuum column                        | System/360 Model 67/Time-Sharing System   |
| Naval Ordnance Research Calculator (NORC)       | One-transistor memory cell                |
| Input/output channel                            | Cache memory                              |
| IBM 608 transistor calculator                   | Relational data base                      |
| FORTRAN   | First all-monolithic main memory          |
| RAMAC and disks                                 | Thin-film recording head                  |
| First automated transistor production           | Floppy disk                               |
| Chain and train printers                        | Tape group code recording                 |
| Input/Output Control System (IOCS)              | <u>Systems Network Architecture</u>       |
| STRETCH computer                                | Federal cryptographic standard            |
| "Selectric" typewriter                          | Laser/electrophotographic printer         |
| SABRE airline reservation system                | First 64K-bit chip mass production        |
| Removable disk pack                             | First E-beam direct-write chip production |
| Virtual machine concept                         | Thermal Conduction Module                 |
| Hypertape                                       | 288K-bit memory chip                      |
|   | Robotic control language                  |

*Bill -  
SNA is becoming more  
important every day.  
Let's tell the story.  
P.W.C.*

**Figure 1. EVOLUTION OF SNA NETWORKS**

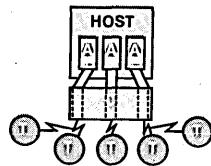
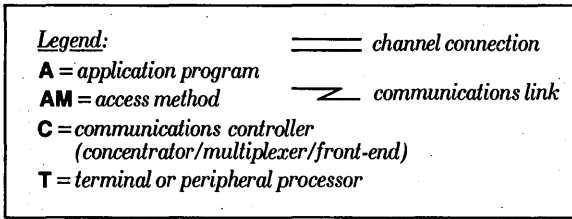

(a) In a typical pre-SNA network, communications links and terminals were dedicated to single uses or applications. All terminals on a link had to connect to the same application program, which included communications software. Usually, changing the terminal or link connections also forced the application programs to be changed.

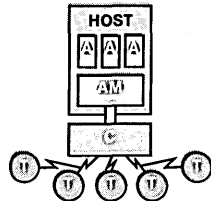

(b) Early SNA introduced sharing of links among various application programs. A host access method permitted easy access from any terminal to any application program in the host processor. The connections could be readily changed without affecting the application programs.

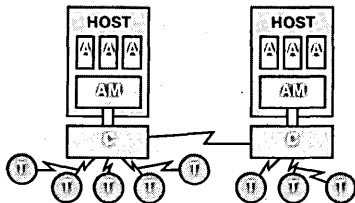

(c) Subsequently, SNA configurations were enhanced to allow access between host processors for distributed processing and data-base sharing. Moreover, any terminal could access any application program at any host.

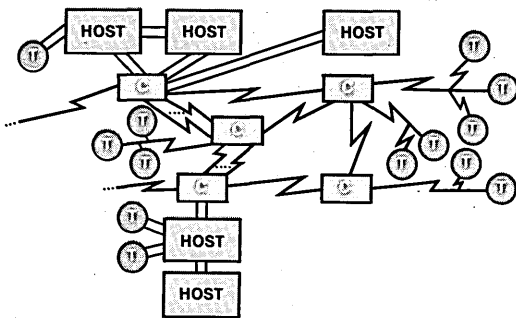

(d) Today, SNA networks can be fully meshed configurations. Parallel links between adjacent communications controllers allow increased network availability and traffic balancing. Access from host to host and terminal to host is permitted over multiple routes. The number of different types of network nodes has increased considerably, particularly among terminals and peripheral processors. SNA networks include open interconnection of both IBM and non-IBM nodes.

Advances in computing, processing and communications technologies have prompted increased interconnection of terminals, processors and communications facilities.

These various devices have been linked into networks for distributed access to processing and data-base resources.

A variety of networking applications has been developed for airline reservations, banking, store checkout, process control, remote job entry, office systems and personal computing.

Networks include a broad range of cost/function trade-offs and technologies, in such diverse components as analog/digital converters, specialized and general-purpose terminals, line concentrators and multiplexers, communications links and low- to high-capacity processors.

The networking environment requires a master interconnection strategy so that these diverse products and applications can share computational and communications facilities while interacting compatibly.

Since its introduction in 1974, IBM's Systems Network Architecture has provided the blueprint by which the capabilities of IBM networking products have evolved in an orderly fashion. SNA provides rules for all levels of interaction, from physical/electrical interconnection of computing devices and terminals to meaningful application-oriented processing.

Thus one uniform design now eliminates the complexity and inefficiencies inherent when each type of product had to have its own specialized agreement with each other type. SNA is now integrated into the whole range of IBM products—from large mainframe computers to terminals to personal computers.

By eliminating the chaos once caused by incompatible implementations, SNA allows a computer user to communicate from office to office or from continent to continent.

An important feature of SNA is the organization of functions into multiple layers. In the most basic sense, different products can be configured into networks simply by adapting them to the transmission and electrical characteristics of the media interconnecting them. But physical interconnection does not result in meaningful communication. The lower layers control only the basic transfer of bits, while the higher layers support meaningful exchange of messages and documents and allow application-

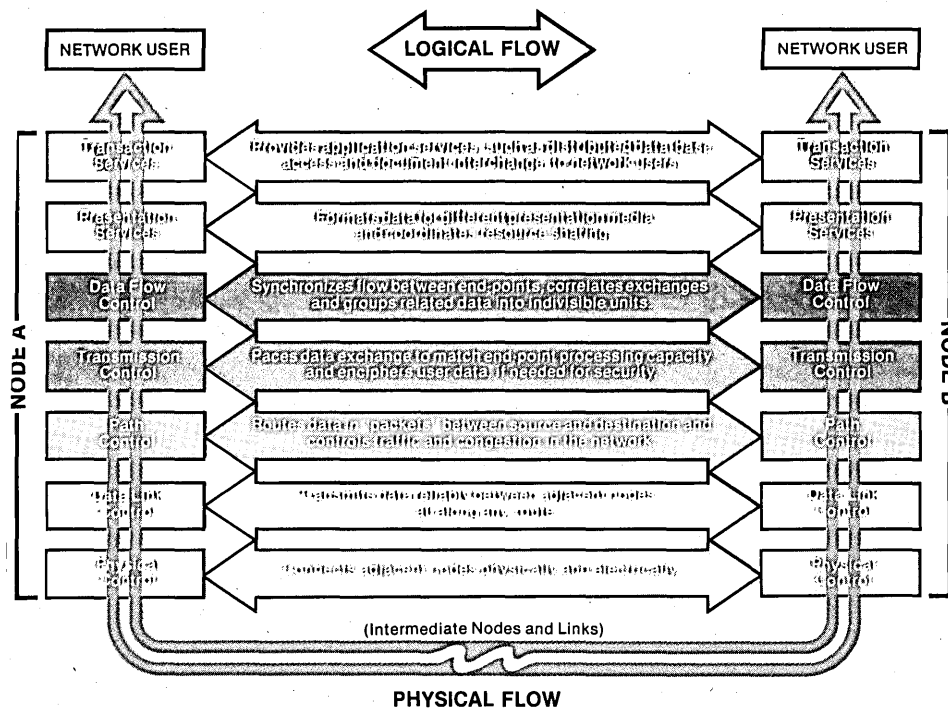

**Figure 2.** Each node in an SNA network separates functions into multiple layers. Logically, a given layer in one node communicates with the corresponding layer in another node. This peer-to-peer communication relies on lower layers to transport the data.

program interactions and data-base sharing. SNA's separation of independent functions into multiple layers means that changes in technology and capabilities can be confined to individual layers. This modular design eases adaptation to network evolution.

SNA includes a variety of functions at different layers of the architecture. For example, SNA's Synchronous Data Link Control offers increased efficiency over earlier techniques. State-of-the-art advances also have been made in traffic routing, congestion control and network availability. Additionally, SNA office systems provide document encoding uniformity and support distributed interchange, filing and retrieval services.

SNA has also incorporated protocols adopted by national and international standards organizations. This means SNA is compatible with standards such as X.25 public packet switching, High-Level Data Link Control and the Data Encryption Standard.

SNA management aids include product capabilities and software tools for planning, installing, changing, operating and maintain-

ing networks. In today's environment, where annual growth and change typically can involve 20-50% of a network's facilities, aids such as these are critical to reduce operational expense and to foster optimal levels of network availability and performance.

IBM scientists, programmers and engineers around the world have spent collectively thousands of years of development on SNA. They continue to improve SNA's usability, manageability and performance, and also to extend its capabilities. Recent studies have focused on local-area networking, more dynamic reconfiguration within networks and interconnection of independent SNA networks.

SNA's success in reducing customer cost, while promoting ease of development of network applications, is reflected by a recent milestone — more than 10,000 large-system installations now incorporate SNA networking technology.

Systems Network Architecture is one example of IBM's commitment to product and technological leadership. Last year IBM's total worldwide investment in research, development and engineering was \$3 billion.



For free additional information on SNA, please write:  
IBM Corporation, Dept. 605G/002  
P.O. Box 12195, Research Triangle Park, NC 27709

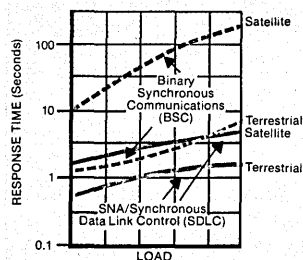

**Figure 3.** Illustration of dramatic improvements in response time (using comparable display terminals) of SNA/SDLC over older data link controls such as BSC. For long-propagation-delay circuits, such as in satellite technology, the improvements in response time can be better than an order of magnitude.

CIRCLE 71 ON READER CARD

# Microprocessor cpus with the power of today's small mainframes will be common by 1985.

automation rather than on traditional dp—is user-oriented displays in text processing, spreadsheets, graphics, and other areas. To cope with these new displays, processing power is needed at the terminal itself rather than at a central site. High-power, low-cost micros operating as this improved user interface represent the right way to harness the new LSI technology.

## CHANGING ROLE OF DP

In addition to the new technology, other factors point to the demise of the mainframe. Data processing has, to date, totally dominated computing. But with microcomputers entering homes and microprocessors finding their way into cars, washing machines, and other devices, this will hardly continue to be the case.

Data processing will become only a part of the total computer industry, and dp-related vendors will have to compete for staff with vendors in other parts of the expanding industry. Product development may be dictated by other requirements, resulting in cheaper components. These will be used, most likely, by new companies rather than by the traditional suppliers. The modern personal computer is such an example. It was scorned by the dp world as a domestic toy only a few years ago, but no one needs to be reminded of the current impact of home computers like Apples and TRS-80s on professional computing. Now, even DEC and IBM have been forced to join the ranks of believers. That these machines will sell is undoubted; whether they will be commercial successes is not so sure. Can DEC and IBM carry their overheads on such low-priced products, or will their PC sales damage sales of more profitable lines?

In passing, let us also note that as 16-bit micros take market share from older minis, the mini-makers themselves are becoming more and more vulnerable. Their reaction is to move up-market with more powerful 32-bit machines, thereby competing with smaller mainframes. In general, machines like the VAX 11/780 and 4331 have similar power, but they tend not to be direct competitors since the VAX is clearly the better interactive machine and the 4331 the better general purpose batch processor. But with machines made by other vendors, the issues are not so clear. The resulting friction is likely to drive the user toward DEC or IBM for safety—but I believe that these users would be better off moving to micros instead, using a sophisticated network scheme.

My reasoning is as follows. Traditional computers—mainframes, minis, and some micros—use dumb terminals to access a shared computing resource; this setup was caused by the relatively high cost of hard-

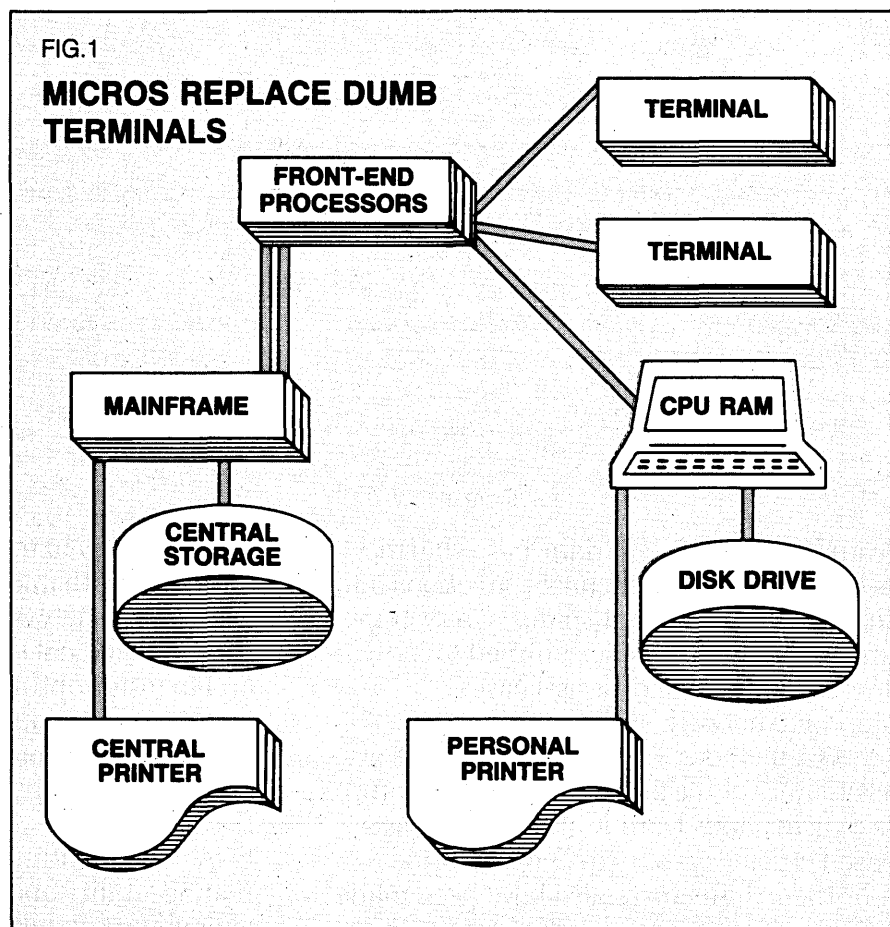

ware. The trade-off was that displays could be updated only as fast as the line would permit; even using local speeds of 9,600 baud, a screen takes around two seconds to fill. This has proved more than adequate for simple timesharing and transaction processing—conventional dp. But all the new applications, and they are the high-volume ones, make frequent modifications to displays, so they must be quick. Inserting a word in a text display, drawing a graph, or building a spreadsheet are examples of applications where the user will not tolerate a delay of several seconds. Thus the basic concept of minis and mainframes with terminals is simply wrong for office automation.

The answer, of course, is to place the processor close to the screen so that screen updates can be achieved at the processor's speed instead of the line speed—in milliseconds rather than seconds. This was recognized by the dedicated wp manufacturers like Wang, AES, and even IBM with its Displaywriter. Then VisiCalc brought the power of computerized spreadsheets together with the speed of local processing, so that now users expect power and speed and will not tolerate line delays.

While a PC with its own storage provides a better solution for user applications than a terminal linked to a computer, it does not resolve several problems. Among these are the need to store large databases with complete integrity, the need to share data among many users, and the inefficiency of providing each user with a complete computer system, including resources such as high-speed printers. The answer lies in connecting the local processors to shared resource managers over a local area network (LAN). On a LAN the resource managers serve the users on the workstations. Only the workstations execute applications code. The network concept then provides the vehicle for solving the new user requirements that the traditional mainframe approach cannot. Networks are hardware intensive and thus can only become commercial realities with LSI technology advances.

## SUPERIOR MICRO SOFTWARE

Given the power of a modern workstation, software is being developed largely as though it were for a single user; the network provides the sharing. Gone are the horrors of TP monitors. The sin-



# The solution is now in hand.

- Simulate terminals, modems and CPU's
- Monitor data between DTE and DCE
- 1023 character Send and Receive buffers
  - 100 character User buffer
  - 25 character Trigger and Mask buffers
- All memory contents saved with power off
  - Buffer editing and search commands
  - Synchronous, asynchronous or HDLC
  - Full or half-duplex
  - Half-duplex "ping-pong" operation
  - BCC generation and checking
  - Stored FOX and user entered messages
  - ASCII, EBCDIC or HEX codes
  - Control character decoding
  - Operating parameters menu selected
  - Programmable send and receive triggers
- Programmable word length, stop bits, and parity
- 17 data rates from 50 to 19,200 bps
- BERT/BLERT with 63, 511, 2047, and 4095 bit patterns
- Bias distortion measurements
- Pulse trapping and counting
- RTS-CTS delay measurement
- 16 character alphanumeric display
- Full function Interface Test Set
- Portable battery operation
- Self-testing

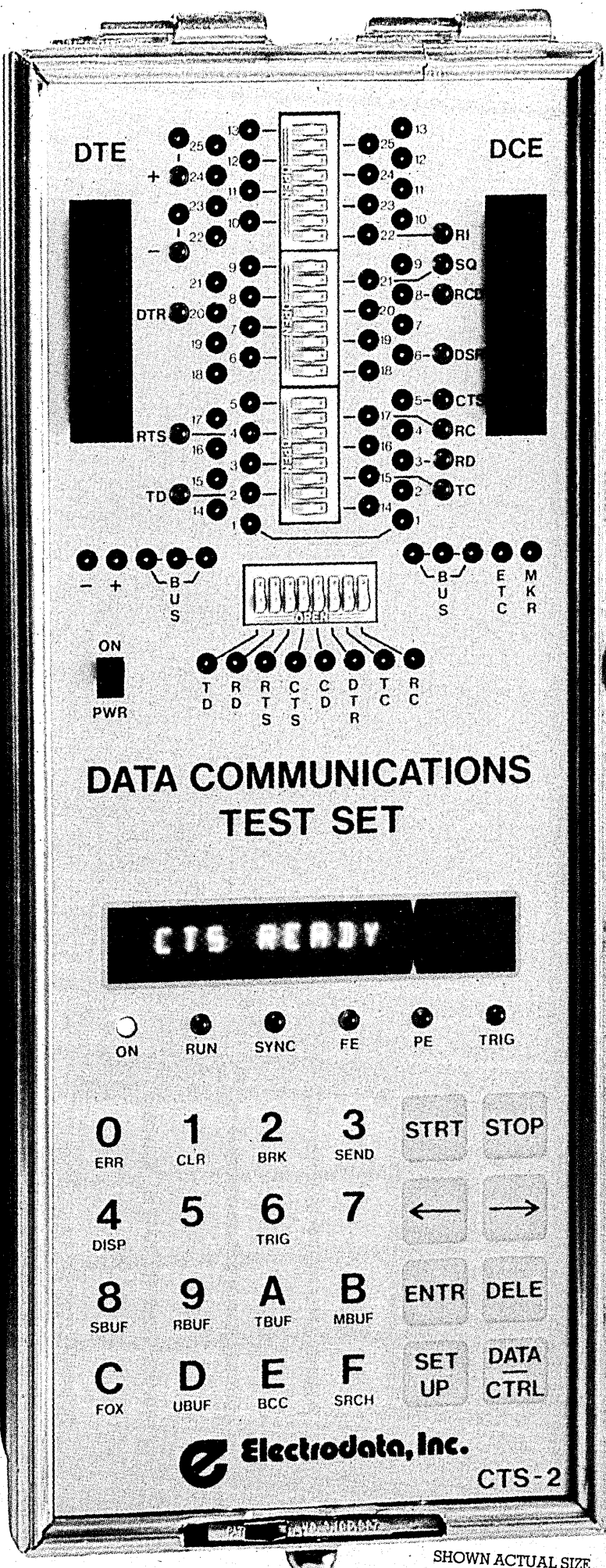

**Electrodata, Inc.**  
CTS-2

**Electrodata, Inc.**  
23020 Miles Road  
Bedford Heights, Ohio 44128  
(216) 663-3333 TWX: (810) 427-2280

CIRCLE 170 ON READER CARD

SHOWN ACTUAL SIZE

## The next two years will see major inroads, with most progress in the individual modules, such as workstations and LANs.

gle-user workstation is a vastly easier tool to use to develop software. For this reason, we can expect that software developed for workstations will be superior in quality to that developed for mainframes. Remember that the best products currently offered on mainframes are the result of many years of work and are nearing the limits of the machine architectures. Equivalent micro packages are raw but already are superior in many areas, such as screen-based editors.

With the fast displays of micros come features like windows developed for the Xerox Star, copied on Apple's Lisa, and in development for PCs in packages like VisiOn, 1-2-3, and MBA. With operating systems like Concurrent CP/M-86, the user can run several programs simultaneously, switching to look at a calendar entry, say, while in the middle of editing a document and transmitting a file to the mainframe. Concurrency is impossible with a terminal-based system, but users whose first exposure to computing is in micros will consider this to be an obvious function and will not be able to understand how anyone could be so clever as to cope with loading and unloading programs and working with TP monitors. Once exposed they will not accept the constraints of traditional solutions.

Concurrent CP/M-86 deserves a special mention since it is the first multitasking operating system developed for micros and is the first product designed with the idea of throwing away raw cpu power to make the system easy to use. Lisa and the other user-conscious systems are equally welcome and equally bad news for mainframes.

There is a current myth that all of these features do indeed mean that micros will grow rapidly, but that their use will still be limited to fairly simple jobs—the kinds that an individual user might have. Micros cannot handle the heavy processing loads of engineering calculations or financial modeling, the myth goes, because of the required power and memory size.

But the pendulum is swinging. Micros with the power of a mini and half a megabyte of main memory, possibly with a hard disk, actually offer more power and memory than a share of a mainframe. The big jobs can just as easily be done on micros as on mainframes, as long as there is enough overall processing power and memory to serve all the users.

That's where local networks enter the picture. LANs occur in many shapes, sizes, speeds, and costs. The dust has certainly not settled. IBM has made no positive announcement. Ethernet has been adopted as an international standard (IEEE 802 and ECMA), but broadband and PBX networks are other alternatives. Simpler, manufacturer-specific "micronets" are proliferating. The situation

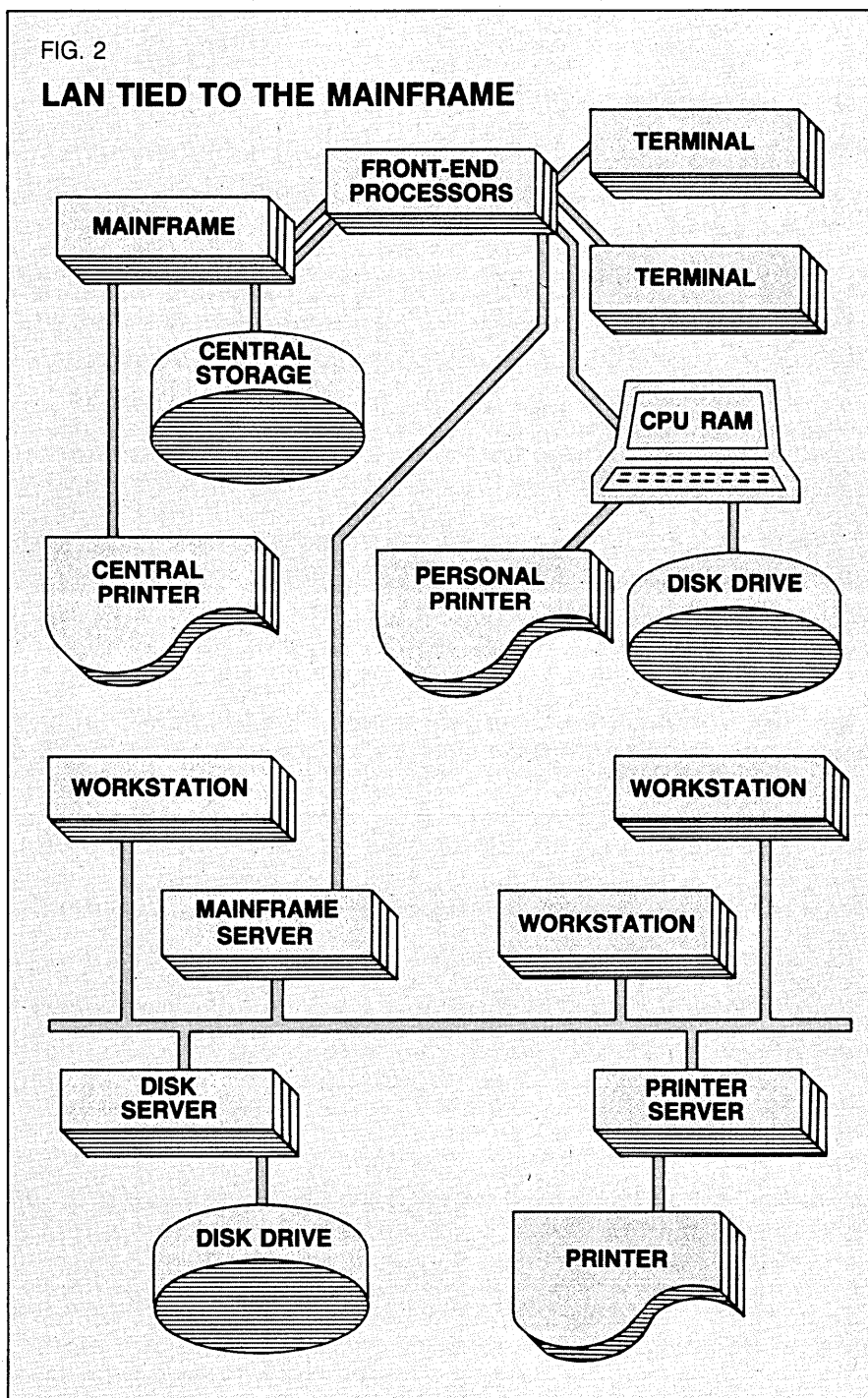

is messy, but moving in the right direction.

Proper user/server software is still in its infancy. Most so-called file servers are really disk servers, providing ISAM support for COBOL programs running in workstations. Communication servers to give access to X.25, SNA, etc. are just now being built. Special software for electronic mail and messaging is also being introduced. Standards are only agreed at the lower levels; high-level

standards such as character sets, document formats, and file transfer protocols are still under discussion. They will be resolved.

There are many current arguments as to the cost effectiveness of LANs, but make no mistake, they are inevitable. People like networks, and once networks are established they will not like anything less. As a parallel, consider the growth of telephone networks and ask yourself if people would go back to



# “GET IBM 3270, 3780 AND HASP COMMUNICATIONS—ADDING A ONE-BOARD PROCESSOR TO MY PC?”

## “YOU CAN WITH PERSYST.”

### The Persyst DCP/88. The only compatible front end communications processor that can support a range of IBM communications.

It's a Persyst exclusive.

The DCP/88 distributed communications processor. A one-board computer that can be configured by software to handle communications between a PC and another computer system.

In fact, the DCP/88 enables the IBM or TI PC to support a range of sophisticated IBM communications—all with just one processor.

So it gives corporate users unprecedented, low-cost flexibility to incorporate the PC into virtually any environment.

### Convert any PC into an IBM 3270 terminal. An IBM 2780/3780 RJE workstation. Or a HASP/RJE workstation—**instantly.**

Just combine the DCP/88 with Persyst software—and you can connect your PC to any compatible host mainframe or minicomputer.

PC/3270 enables your PC to emulate an IBM 3274 Cluster control unit and 3278 terminal, supporting up to four additional devices. Including a printer and

PC/HASP Dynamic design lets you assign incoming I/O streams to different devices—disk files, printers and RS-232 ports.

three other PCs functioning as 3278 terminals.

PC/3780 converts your PC into a 2780/3780 remote job entry terminal that can send and receive batch files to and from the host.

And with PC/HASP, your PC instantly becomes a full-function HASP/RJE workstation that can support up to seven input and seven output multi-leaved job streams concurrently.

### Capability to support your communications needs now. And in the future.

Because the DCP/88 supports bisync, SDLC, HDLC and async protocols, it is the only communications processor you'll ever have to buy.

Use it to connect your PC to an expanding network of IBM communications. Configure your system to meet virtually any communications need—without adding another piece of hardware. Or expense.

All of which makes the DCP/88 as practical as it is powerful.

### The Persyst Coax/3278. Still another way to expand your IBM communications.

Here's another fast way to incorporate the PC into existing SNA or bisync data processing installations.

The Coax/3278. A single-slot expansion board that converts your PC into an IBM 3278 display terminal. And with its high-speed coaxial port, you can connect the PC directly to IBM 3274 or 3276 cluster controllers.

### Sophisticated communications products for the corporate user. Insist on Persyst.

Persyst communications products are designed to make corporate information systems more powerful. And more efficient.

Write or call Persyst today for complete information.

# PERSYST™

Persyst Products, Personal Systems Technology, Inc., 15801 Rockfield Blvd., Suite A, Irvine, CA 92714. Telephone (714) 859-8871. Telex: 467864.

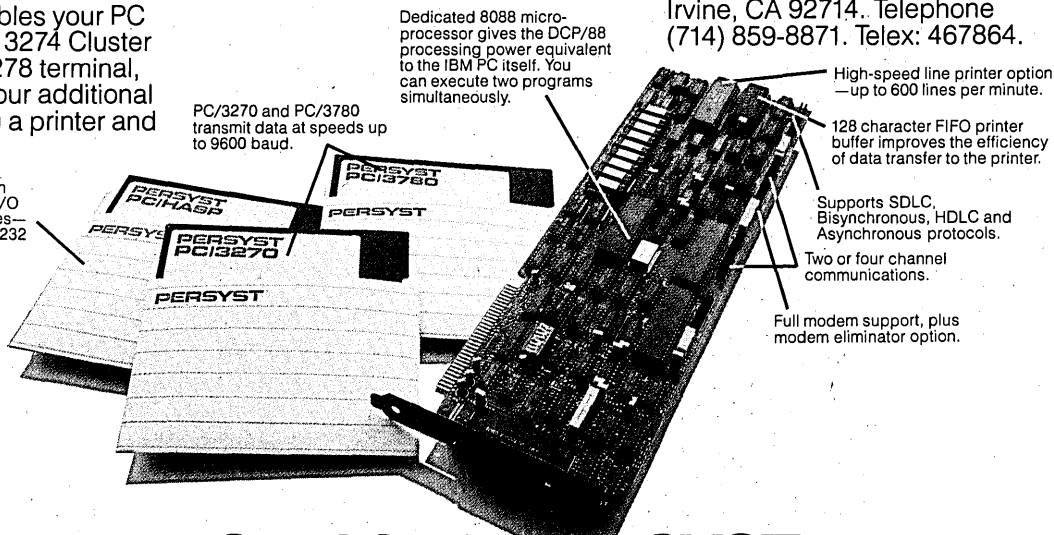

PC/3270 and PC/3780 transmit data at speeds up to 9600 baud.

Dedicated 8088 micro-processor gives the DCP/88 processing power equivalent to the IBM PC itself. You can execute two programs simultaneously.

High-speed line printer option—up to 600 lines per minute.

128 character FIFO printer buffer improves the efficiency of data transfer to the printer.

Supports SDLC, Bisynchronous, HDLC and Asynchronous protocols.

Two or four channel communications.

Full modem support, plus modem eliminator option.

# THE DCP/88™ BY PERSYST.

CIRCLE 72 ON READER CARD

**The  
mainframe  
hits the  
mainstream.**

The IBM mainframe has always lived in its own world and talked its own language. Getting a peripheral device to communicate with it cost more than the device itself.

Until now.

**Introducing the ROLM® Gateway.™**

Now most ASCII devices can talk directly to Big Blue. (BSC and SNA/SDLC, thank you.) All the protocol conversion is right there in the ROLM computer-controlled business communication system.

That means mainframes for the masses. Give us your PCs, your word processors, your ASCII terminals/printers. The ROLM Gateway can be shared by hundreds of devices. Using the CBX's switching capability, you can welcome the most casual users and not worry about tying up ports.

Anyone can call a public data base. Anyone can join a network or modem pool. And anyone can access every other device in the system as easily as the mainframe. (You can even put your personal computer into the network and call the mainframe from home!)

You'll save money on new hardware - modems, synch modems, cluster controllers. But - more importantly - you'll be able to bring all your existing devices

into a coherent, cost-effective network. And, of course, if you want to relocate those devices, there's no coax, so it's no big thing. Just plug them into our new digital phone and get back to work.

Another bonus: Along with all this fancy networking, you'll be able to find out who's networking whom with what. And for how long.

When can you have all this wonderful stuff?

**ROLM**

Now. These systems are realities, available today.

In fact, there are more than 12,000 ROLM CBXs worldwide and over 10,000 data devices communicating through ROLM systems. (That's more than all other PBX manufacturers combined.) And they're doing it now. Not tomorrow. Now.

Call us at (800) 538-8154. In Alaska, California and Hawaii, call (408)

986-1000, ext. 3025. Or write us at: ROLM, 4900 Old Ironsides Drive, M/S 626, Santa Clara, CA 95050.

ROLM. The largest supplier of computer-controlled business communication systems in the world. Now including the IBM world.

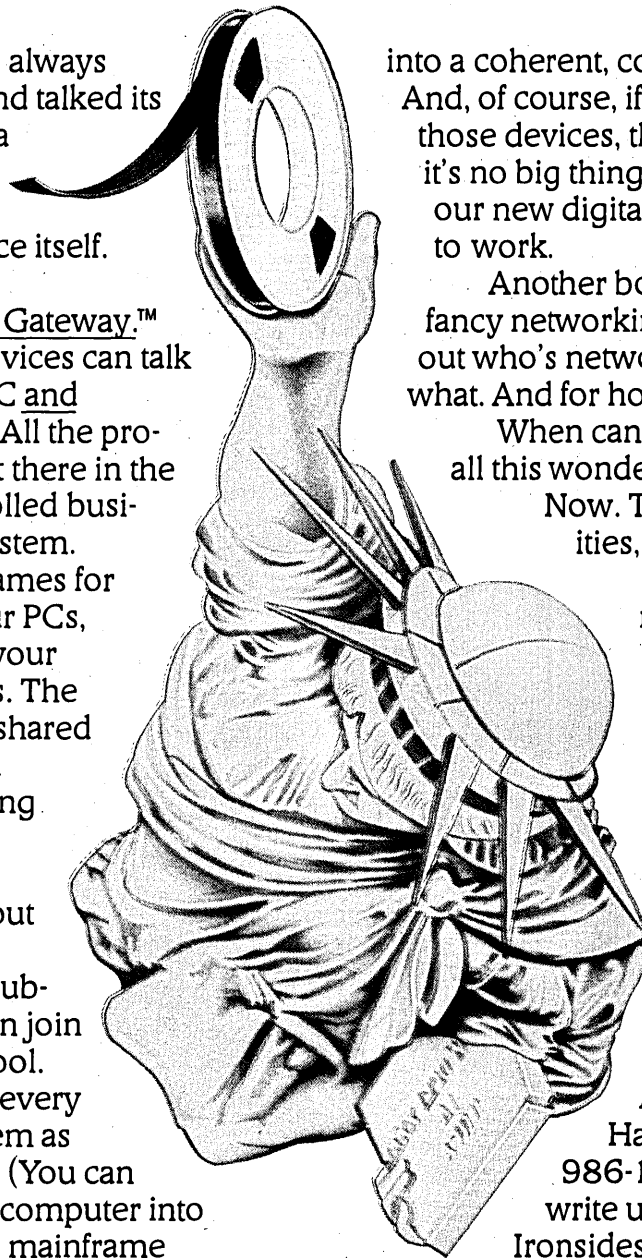

# ROLM. NOW.

CIRCLE 73 ON READER CARD

operator-controlled switching.

While the workstation/LAN concept is clearly the way to harness LSI technology for the broadening range of office automation systems, it is also the best solution for traditional data processing, even with its concerns for large jobs, auditability, and accountability. (The shortsighted solution to the problem of integrating OA and dp is to use LSI technology to produce more mainframes with better cost/performance ratios; this will lengthen the life span of the mainframe, but is nothing more than an evolutionary step toward its ultimate demise. It's a way to provide basic dp services until the micro technology is more developed.)

### MICRO AS TERMINAL EMULATOR

The Achilles' heel of the mainframe is that with the growth of interactive processing, one hardware unit is being subdivided into multiple logical machines by software. Sharing a cpu when cpus are cheap is fundamentally wrong. Thus the micro invasion has started from the weak spot. Emulating conventional IBM terminals on microcomputers is relatively easy. Straight 3270 emulations only offer cost advantages; protocol converters that emulate a 3274 controller but use ordinary RS232 async terminals instead of 3278 coax cables are more interesting since they open up the mainframe to a wide variety of terminals.

Whichever way it is implemented, the use of a micro as a terminal emulator gives the possibility of additional local processing (Fig. 1). The simple early approach will be to use a multitasking workstation and run the emulator as one of the many tasks. Next will be the invention of file transfer software via the 3270 emulation. Unlike RJE (3780) emulation, this is not easy since there is no equivalent mainframe spooler support. Thus there will unfortunately be a variety of protocols dictated by the mainframe support software.

Once this point is passed, however, the door opens. The next products must provide record access to the mainframe files, using a new protocol that allows a micro emulating a 3270 to execute local programs using mainframe data and/or local data in a standard micro program. Then all application programs—even the largest ones—can be developed and run in the workstation, with the mainframe being relegated to the role of database manager. Examples of such interface programs are being developed by suppliers of proprietary mainframe software. Peachtree's micro software accesses MSA's mainframe ISAM files, and VisiCorp's VisiAnswer package allows asynchronous access to Informatics' database files for local VisiCalc processing.

These are only the starting examples;

FIG. 3  
A HIERARCHY OF LANS

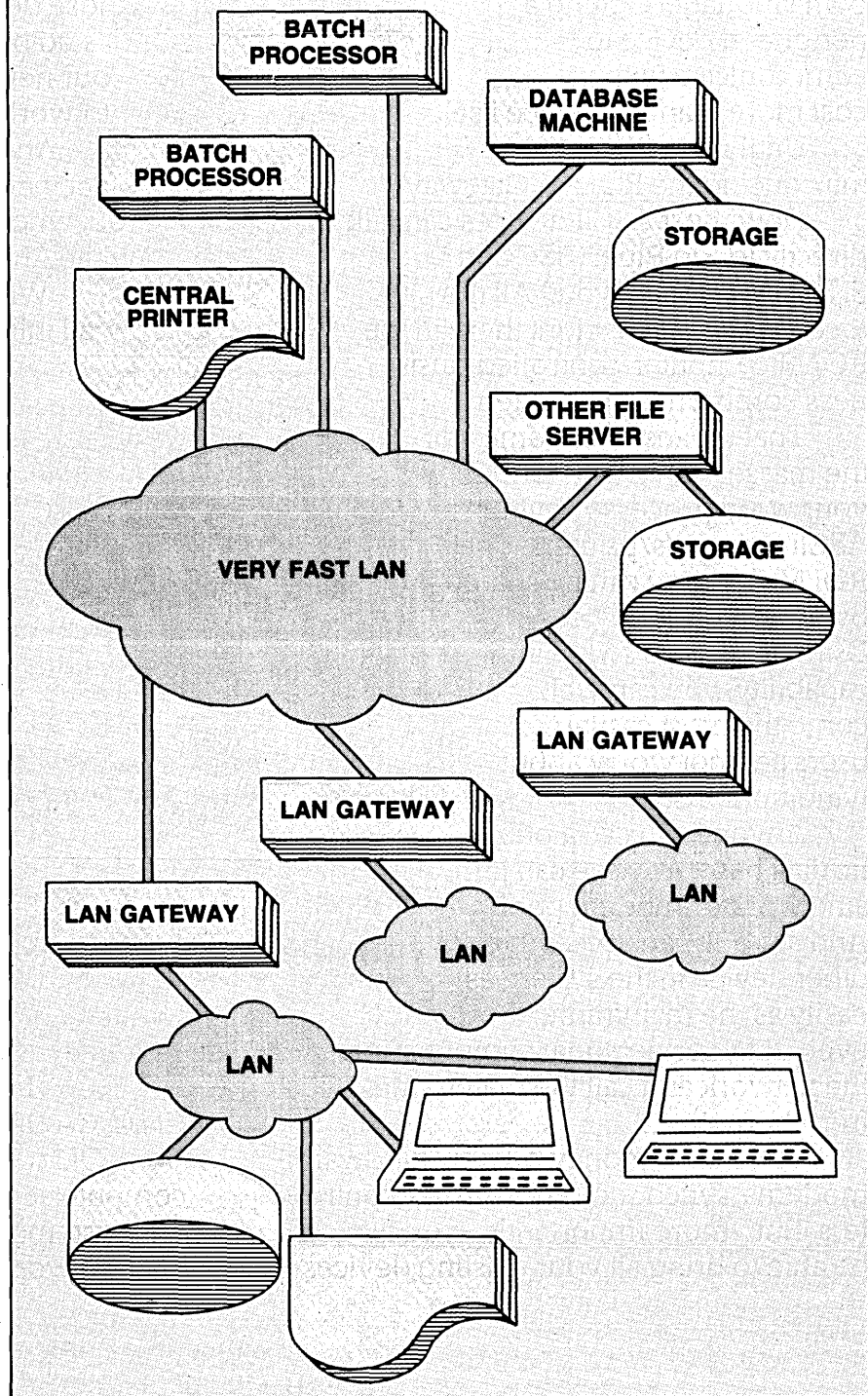

what is needed—and eventually recognition of the need will produce the product—is a general purpose mainframe package, with a defined protocol any micro manufacturer can support, which will give access to any database software. This concept will be extended to LANS with a special purpose mainframe interfacing server, so that all users can access the mainframe data (Fig. 2).

The importance of the preceding concept lies in the fact that it is evolutionary. All

the currently developed batch and TP programs continue to work. Use of the existing programs by terminal emulation follows. New applications can be developed to run in workstations, which can be either 3270-like or LAN based. New LAN systems can be introduced without disturbing the ongoing data processing work. Eventually all interactive processing will migrate to the workstation, leaving the batch and database management to the mainframe.

# SCHOLAR/TEACH 3<sup>®</sup> makes every terminal a virtual teacher.



## We know.

At Boeing Computer Services, we know the importance of good teachers. But even good teachers can only be in one place at a time.

After years of experience with both classroom training and computerized learning, we have developed a unique software product that lets you deliver your best teaching. On request. Repeatedly. No student travel required. It's called SCHOLAR/TEACH 3, and it can train 3,500 students a week.

Our training background with many different kinds of employees helped us create flexible authoring and presentation software to support any number of subjects. From making reservations to handling insurance claims to creating COBOL programs.

Furthermore, SCHOLAR/TEACH 3 is designed to fit your equipment. You can author or present your training sessions on your IBM or compatible mainframe. Or IBM PCs. Or use our MAINSTREAM<sup>®</sup> teleprocessing network.

And, because SCHOLAR/TEACH 3 was designed by experts in both training and computing, we can meet

your special training needs.

We've trained more than 500,000 employees both within The Boeing Company and other major corporations throughout the world. Now we'd like to share what we know with you.

---

Send for your FREE copy of *Ten Things You Should Know About CBI*.

---

Just write Boeing Computer Services, Education & Training Division, P.O. Box 24346, M.S. 9A-90-8E, Seattle, WA 98124. Or call us today toll-free at 800-342-7700. Discover the lesson we've learned: behind all good CBI is the spirit of a good instructor.

# BOEING COMPUTER SERVICES

A Division of  
The  
Boeing Company

©SCHOLAR/TEACH 3 and ©MAINSTREAM are registered service-marks of The Boeing Company.

CIRCLE 74 ON READER CARD

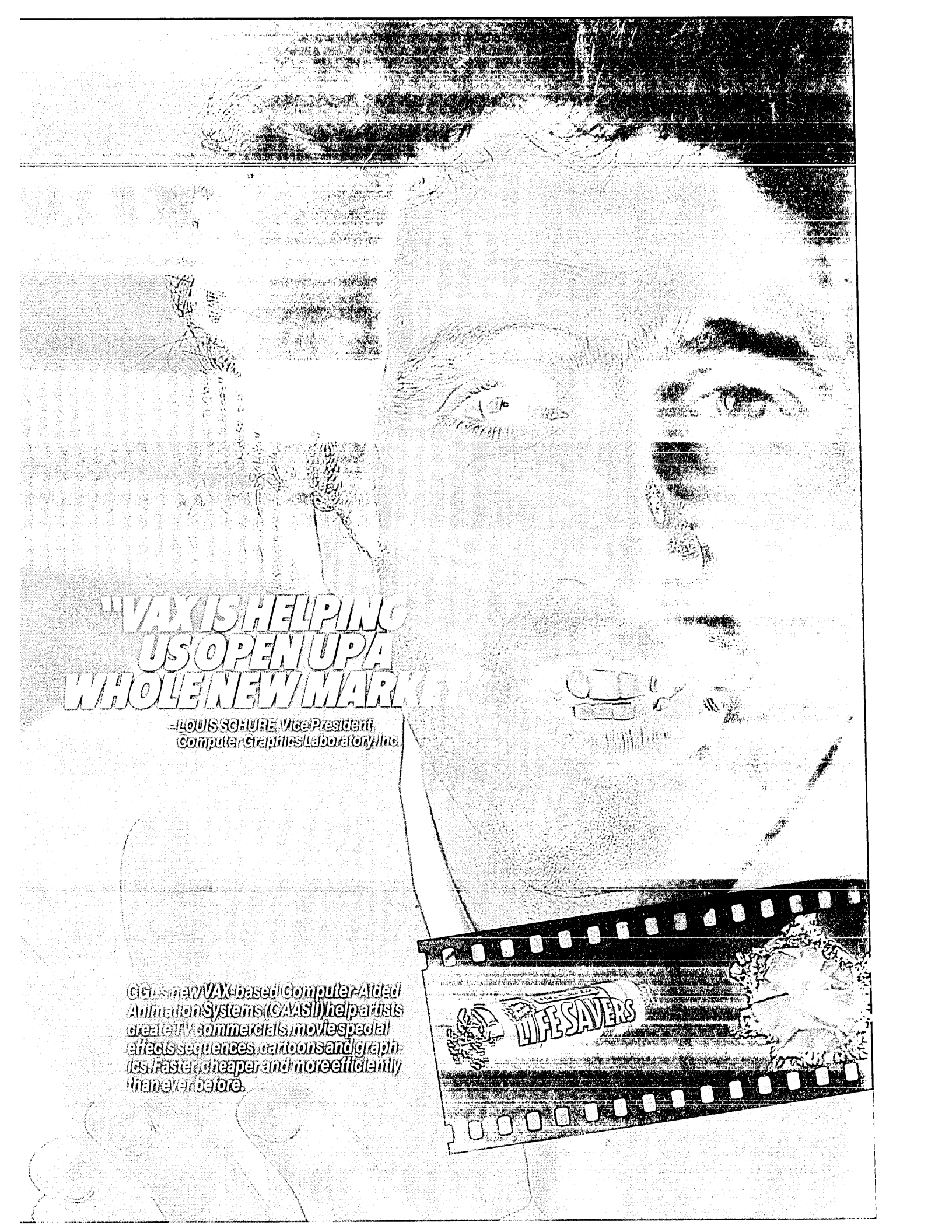

**"VAX IS HELPING  
US OPEN UP A  
WHOLE NEW MARKET"**

**-LOUIS SCHURE, Vice President,  
Computer Graphics Laboratory, Inc.**

CGI's new VAX-based Computer-Aided Animation Systems (CAAS II) help artists create TV commercials, movie special effects sequences, cartoons and graphics. Faster, cheaper and more efficiently than ever before.





"It takes three things to make a computer useful to an artist," says Louis Schure. "Enough power to capture the exact idea he has in mind. Enough speed for realtime playback at every step in the creative process. And easy interfacing with the rather strange peripherals we use in

# VAX

this business. VAX™ systems gave us all three – and at a price that gave us a wide open market.

"The fact that VAX is a family of products with consistent operating and application code environments has also been very important. We sell VAX-11/780s for 3D modeling. VAX-11/750s for animation. And we'll have the new VAX-11/730s for our smaller systems. These products make us one of the leading OEMs in computer art and technology. With Digital's service and support around the world there's almost no limit to our market.

"With 32-bit addressability and virtual storage, VAX can create images you simply can't tell are computer-generated," he says. "The artist can use an infinite number of brush strokes. Millions of colors. Any number of overlays. Each frame can be flopped, enlarged or reduced, zoomed, panned or erased in realtime."

For the artist, VAX performance means freedom. Freedom from drudgery and repetition. Freedom to spend more time thinking creatively.

Today VAX is many success stories. To learn more about the art of computing at Digital, call toll-free: 1-800-DIGITAL, extension 200. Or write: Digital Equipment Corporation, 200 Baker Avenue, Attention: Media Response Manager, CF01/M94, West Concord, MA 01742.

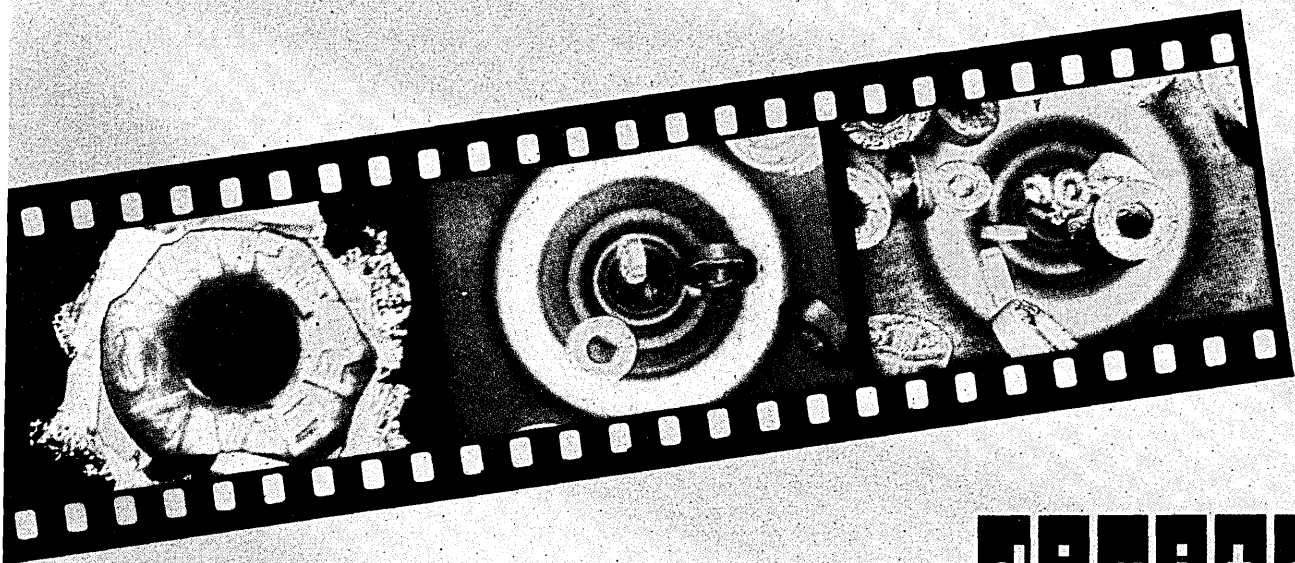

digital

# One terminal. Our modem. No phone.

The AJ 1211-AD auto dial double modem. It's a 1200 bps 212A modem and a 300 bps 103/113 modem. All in one. With auto answer and protocol selection. You can automatically dial ten or more telephone numbers from the terminal keyboard—and change them easily. No telephone required. The AJ 1259-AD triple modem does all this and also includes VA 3400 protocol.

Manufactured, sold, leased, and serviced by AJ. Write for our free catalog. Anderson Jacobson, Inc., 521 Charcot Avenue, San Jose, California 95131.



When you need more than  
just communications.



Sales and service throughout North America and Europe. Regions: Eastern (201) 794-9316; Central (312) 671-7155; Western (408) 946-2900. Subsidiaries: Canada (416) 475-5510; France 657-12-10; Germany 02204-53051; U.K. Slough 25172.

CIRCLE 76 ON READER CARD

Arch-supporters of mainframes will argue that this evolutionary trend will not occur because the mainframe is still required for multistream batch processing, the kind of major jobs often done overnight or on weekends. But this requirement can be overcome by adding a number of single-stream dedicated batch processing servers on the LAN, each using the next generation of LSI processors. Certainly the mainframe architecture is not right for a dedicated database machine. One 500MB drive has one head mechanism; five 100MB 5¼-inch Winchester drives have five heads, so that with proper distribution of the data, much improved performance will result. Parallel searching of drives is possible, necessitating specialized processing hardware with the accent on content addressability and parallel processing. Such database machines with highly integrated, specialized hardware and software are already on the market. These, and not mainframes, are the machines best suited to take advantage of multiple drives.

The concept of a LAN joining workstations, batch processors, database machines, etc., is of course not practical, because of bandwidth limitations. It is obvious then that a hierarchy of LANS must be developed; a subnet linking the batch processors and database machines at a very high speed will replace the mainframes of today. Other LANS of workstations and other servers, including more localized file servers, can be linked economically to the fast LANS (Fig. 3).

The critical element to this argument is that LAN-based workstations can be progressively integrated with current data processing. Applications can migrate over several years to the workstations with relatively little disruption of current services. In this way the user and the dp department will achieve the object of taking maximum advantage of revolutionary technology in evolutionary systems.

Time scales are difficult to predict. The key element is the general access to mainframe data management systems and the development of LANS in general and mainframe interface servers in particular. The next two years will see major inroads, with most progress in the individual modules, such as workstations and LANS. Within five years we will see the concept fully developed and mainframes reduced to the role of maintaining current programs. And in 10 years' time, with the exception of scientific supercomputers for weather prediction and other massive single stream computations, the commercial mainframe will have ceased to exist.

Martin Healey is a professor of microprocessor engineering at University College, Cardiff, Wales. Author of five textbooks and numerous papers, he specializes in office automation, workstations, and LANS. In 1979 he helped found Future Technology Systems, a manufacturer of high-performance workstations and networks, based near Glasgow in Scotland.

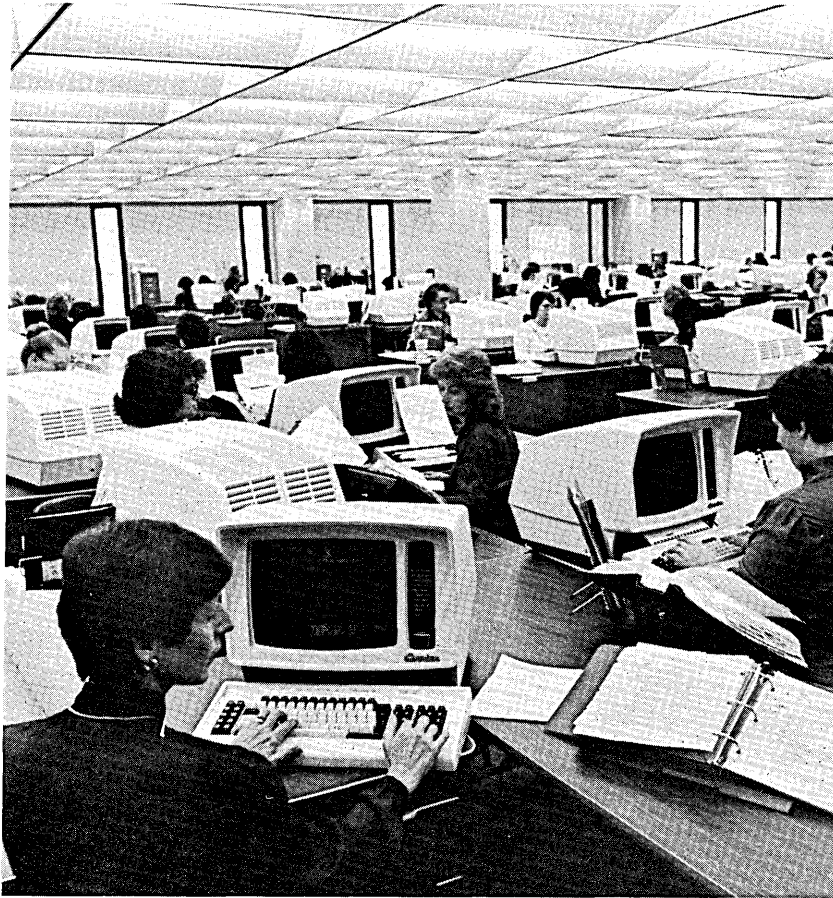

**You have the  
information.  
We have the  
way to move it.**

It's extraordinary how far American business has gone in managing information in the office.

And how frustrating it can be to get that information where it's needed, once it leaves the office.

It seems clear that something must be done to bring the movement of information outside the office to the same sophisticated level as inside the office.

## **Our Communications Spectrum**

Improving the movement of this information is precisely what we at ITT Worldcom are doing now with our Spectrum of Communications Services.

Our Spectrum is a new range of worldwide information movement services created specifically to bring together the latest advances in data, record and voice communication.

For example, now your computers and terminals can talk to other incompatible terminals, anywhere in the world. Even those on other networks.

You can even deliver the same information to an unlimited number of terminals, automatically.

And we're continually adding new features with an eye to satisfying your future requirements.

### **Now throughout the U.S.**

Best of all, our Spectrum was created with the same expertise and quality we're known for around the world.

The way we look at it, whatever other productivity problems American business has, it's producing more and more information.

And getting that information where it's needed speedily, reliably, efficiently and economically—that's what ITT Worldcom is all about.

I'd like more information. My area of particular interest is in:

Communications within the U.S.

International Communications.

Name \_\_\_\_\_

Title \_\_\_\_\_

Company \_\_\_\_\_

Address \_\_\_\_\_

City \_\_\_\_\_ State \_\_\_\_\_ Zip \_\_\_\_\_

Marketing Department (A/PR)

D-08-83

ITT World Communications Inc.

67 Broad Street  
New York, New York

10004

ITT World Communications Inc.

CIRCLE 77 ON READER CARD

# **SCIENCE/SCOPE**

A Very High Speed Integrated Circuit chip built for the U.S. military uses technology that makes it inherently hardened against radiation. The chip, produced after less than two years of development, draws on complementary metal oxide semiconductor/silicon on sapphire technology. It has circuit dimensions of 1.25 micrometers, or about 50 millionths of an inch. The VHSIC program is being conducted by the Department of Defense to develop chips that will give electronic systems a tenfold increase in signal processing capability. The high-speed, compact VHSIC chips will be more reliable and will require less power than integrated circuits now in use. Hughes Aircraft Company is the only contractor in the tri-service program pursuing CMOS/SOS technology.

Studies have begun to see how an advanced airborne surveillance radar might serve military forces late in this century. The radar would have a large phased-array antenna capable of generating many pencil-shaped beams and would complement the Airborne Warning and Control System (AWACS), which performs command and control duties as well as surveillance. One use of the new radar might be to listen in directions other than that of its transmitter beam. If it were to detect another active radar transmitter, the radar could turn its transmitter off (thus foiling an enemy's antiradiation missile) and do its surveillance by using the other radar's transmitted pulse. These concepts are being investigated by Hughes under several study contracts for the U.S. Air Force's Rome Air Development Center.

A new era in sonar for U.S. Navy antisubmarine ships has begun with the first installation of the SQS-53B aboard the USS Moosbrugger. This surface-ship sonar is far more powerful and capable than existing systems. It detects, tracks, and classifies many targets simultaneously. The SQS-53B's sonar bulb creates sound waves and detects their echoes off targets. The system also is used to listen for unusual sounds. Hughes is building systems for more than 40 ships.

Of the improvements in productivity of electronics offered by computers, some of the most dramatic can be found on the manufacturing floor. Computer-controlled automation yields important savings through increased efficiency, flexibility, and accuracy. Computers can repeat virtually all processes -- machining, chemical processing, circuit board fabrication and assembly, quality inspection, and functional testing -- with infallible precision well beyond the abilities of a human. In the production of digital electronics modules at Hughes, productivity sometimes has been increased by a factor of 10 or more. Hughes is spending \$240 million over five years on computer-aided manufacturing.

Career growth opportunities exist at all levels at Hughes Support Systems for a variety of engineers qualified by degree or extensive work experience. They include systems engineers and software and hardware design engineers for major simulation and test equipment programs. Also, field engineering posts throughout the U.S. offer travel, autonomy, and responsibility for the life cycle of Hughes electronics systems. Please send your resume to Lowell Anderson, Professional Employment, Dept. SE, Hughes Aircraft Company, P.O. Box 9399, Long Beach, CA 90801-0463. Equal opportunity employer.

*Creating a new world with electronics*

**HUGHES**

HUGHES AIRCRAFT COMPANY

For more information please write:  
P.O. Box 11803, Los Angeles, CA 90291

**Understaffed? Here's how to keep productivity and morale high anyway.**

# MANAGING A PROGRAMMER SHORTAGE

by **George H. Bosworth**

In today's economic climate, many organizations are short of programmers for software development. This causes lower software output, larger backlogs of undeveloped software, and end-user disappointment and distrust. It's not unusual for a dp shop to face all of the following constraints at once:

- A hiring freeze has been imposed and internal transfers restricted.
- Demand for continued development (including maintenance) of earlier developed software remains strong.
- Several new software applications are urgently needed.
- Several programmers have resigned. One of them was the only programmer who knew a large application that had been developed earlier. Two were software designers who evaluated and designed new software.

These circumstances add up to an increase in software requirements, a decrease in programmers to work on the requirements, and an inability to add more programmers. When they occur, they result in minor irritation or extreme disaster.

If you are suffering from some of these circumstances, you can cope with them by means of strategies that minimize the bad effects of a programmer shortage and maximize the ongoing development of valuable software. The goal is to achieve productivity consistent with capability, to cope with adversity rather than sinking under it, and to have these facts known to management. The strategies include staffing actions, productivity improvement steps, workload replanning, and public relations.

The personnel strategies aim at retaining, realigning, and possibly increasing the staff available for software development. Programmer shortage seldom strikes evenly across a software development function.

Usually, loss of important or indispensable talent disrupts forward progress. Shortage of a particular skill—for example, analysis, design, coding, documenting, or testing—delays schedules or hurts quality in all the projects that require it. You can deal with a talent shortage by stretching existing staff and setting up ways to motivate, educate, monitor, and assist people who are performing unfamiliar jobs.

If it's analysis and design skills you lack, assign analysis and design tasks to less experienced programmers. Often the programmers will be highly challenged by these assignments and will work hard and intently at them. To cover their inexperience, install extra review and walk-through sessions with experienced analysts and designers who are still on board. Consider the use of buddy-system assignments linking one experienced and one inexperienced employee.

A paucity of programmers to do coding and unit testing can be remedied by assigning these tasks to analysts, designers, or testers. Often these assignments will be seen as good experience, or as opportunities for renewal of earlier used talents. In other cases, you will need to point out that the alternative is not to develop the software at all, or to develop it on an unacceptable schedule. Consider sprinkling the unfamiliar staff over several projects and provide extra education as needed.

If you face a shortage of documentors or testers, consider making collateral assignments of documentation or testing jobs to programmers. Programmers can continue with their coding and unit testing, but also become responsible for documenting and/or system testing. Often programmers value the additional experience and the insight into other parts of the total software development job that these collateral assignments give. Install extra documentation review cycles and insist

on well-made system test plans.

Your business may have clear descriptions of progressive job levels for various software development disciplines. In taking steps to stretch existing talent over required tasks, you may need to interpret the job descriptions loosely, but with the understanding that the measures are temporary.

## ESCAPE HIRING FREEZE

Hiring freezes are usually announced as absolute, but are seldom implemented absolutely. Since it costs very little to argue to be exempted, argue at least once, and argue whenever a particularly good case occurs—such as the start of a high-priority project, or the opportunity to meet an important schedule by replacing an employee who has quit, or when an outstandingly good candidate is available for hire. In making your case, you will need to think through the scope of the exemption (division, area, department, project) and the size of the exemption (unlimited, several programmers, one programmer). Clearly, the most successful exemption is an unlimited one for multiple projects, and the exemption that you will most easily achieve is one programmer for one project.

If there's a hiring freeze, there's probably little money to obtain the services of consultants. Nevertheless, you may be able to employ consultants on a short-term or single-job basis to supply missing talent or expertise. For relatively little money you can sometimes start or continue an otherwise impossible project, at less cost and more quickly than if existing staff were to be trained. In other cases, the hiring freeze and the budget may be out of kilter, and unspent salary money can be spent on consultants.

An improved job environment helps to retain existing staff. But if the hiring freeze you're experiencing is widespread among

# Learn how IBM boosts application development productivity.

You and your whole department can benefit from IBM's self-study course series, "Managing the Application Development Process." And you'll save education travel dollars as well.

These six courses teach the same techniques that have helped IBM boost productivity and bring in over 90% of its projects on time and within budget.

With self-study, you proceed at your own pace, starting with the basic methodology and guidelines for managing application development projects. Move on to discover how to meet users' needs through proper planning and management of the requirements phase. Then, learn estimating techniques that have been time-tested on hundreds of projects. Next, learn how to plan for a more productive implementation phase. You'll also see how to review plans, monitor progress and receive early warnings of real or potential problems. The final part of this series discusses practical guidelines for planning and managing conversion projects.

The volumes are filled with forms, examples and valuable techniques. They comprise nearly 70 hours of training that can be used over and over again. You will find this self-study method a very inexpensive way to train your project team. More than 2,500 IBM customers have already purchased "Managing the Application Development Process." Order now, and examine the courses for ten days. Return them if not fully satisfied.



---

Managing the Application Development Process (SR20-7360).....	\$212
Managing the Requirements Definition Phase (SR20-7400) .....	\$195
Managing the Implementation Phase (SR20-7512) .....	\$195
Estimating Application Development Projects (SR20-7333) .....	\$258
Managing the Application Development Process:	
Project Reviews (SR20-7297) .....	\$150
Managing Application Conversion Projects (SR20-7285) .....	\$239

---

Here's the easiest way for IBM customers to order:  
Call toll free: 1 800 631-5582  
Alaska and Hawaii: 1 800 526-2484  
Or, call your local IBM Marketing Representative today.



# You may need to interpret job descriptions loosely, but with the understanding that the measures are temporary.

FIG. 1

## SOFTWARE DEVELOPMENT TOOLS AND TECHNIQUES

FUNCTION	TOOL OR TECHNIQUE
<b>Management</b>	Overall software development structure and philosophy, with phases and milestones. Automated project control system.
<b>Analysis and Design</b>	Formal design methodologies (e.g., "structured," "top-down") and tools for design representation. Data dictionary. Architecture and design reviews.
<b>Coding and Unit Testing</b>	Use of high-level programming languages. Code reviews. Source code manager, including facility for change history and cross-referencing. Debugging package, including on-line debugging aids and file comparator utilities.
<b>Integration and System Testing</b>	Integration control facility (configuration management system). Automated test-case librarian, driver, and scorekeeper.
<b>Documentation</b>	Word processor, with document storage, retrieval, and archiving.

companies in your area, so that little job changing is going on, why put effort into improving the job environment? For two reasons: first, if your talent is stretched thin, the next resignation may be catastrophic. Second, when the job market wakes up, a poor job environment, or one that's become poor during the hiring freeze, will hurt your ability to hire. When evaluating job environment, you may be unable to change parts of it—for example, salary structures, job definitions, or physical work conditions. But many other important things are easy to change. Examples are public recognition for outstanding performance, thoughtful attention to new responsibility assignments, stepped-up individual counseling, intragroup and intergroup communication opportunities, exploitation of training opportunities, and staff involvement in self-improvement steps. If the prevailing management style is harsh or punitive, or leads to firing employees who attain less than 100% of assignments, now is the time to cultivate a less rigid, more supportive attitude, with attention to helping poor performers become at least adequate.

If your software development function deals directly with end users, see if you can restructure the interface to preserve or regain staff. For example, if you have temporarily assigned programmers to end-user departments to install a new application or provide education on some aspect of data processing, consider reversing this strategy and

asking end-user departments to make temporary assignments of staff into your area, for application installation planning or data processing familiarization.

### ACQUIRE & INSTALL TOOLS

Installing and using new tools and techniques for software development is a good idea any time. In times of programmer shortage, productivity improvement is even more important. But not all tools will work—you need tools that will bring significant, measurable, appreciated improvement. If you already know what tools you want, the onset of a programmer scarcity period is an excellent time to acquire and install them.

If you don't have a shopping list for tools, you have to make one. This is an excellent opportunity for improving the job environment by involving programmers in the tool evaluation and decision process. Suggested techniques are an internal task force drawn from several project areas, under the leadership of an experienced staff member, and the establishment of a new or revised quality circle, if your organization wants to use quality circles. But in all cases keep management involved, particularly if management approval or spending authorization will be needed.

Many articles and books offer advice on how to select, acquire, and introduce software development tools and techniques. For

convenience, Fig. 1 lists several popular tools and techniques. If your software development function is using only a few of them, you have a good opportunity to improve productivity substantially.

In spite of good efforts to maintain earlier standards, programmer shortages will in many cases unavoidably decrease productivity. In these cases, it's best to replan the responsibilities of the software development function, rather than extend project schedules across the board. This often means doing less, sometimes means doing more, and usually means doing differently. Workload replanning has three usual steps: inventory the situation, identify and evaluate alternatives, and make and implement decisions.

A good way to inventory your software development responsibilities is to list, for each project under way or proposed, the value of the project and the cost to complete or continue it. For example:

Project	Value	Cost
A	High	Low
B	High	High
C	Low	Medium
D	Medium	High

You'll have to define "project" according to your situation—you may use the term to describe a separate application, for example, or one piece of a larger software development, or a major function of a proposed large program. But each project should be sufficiently independent of other projects that it could be canceled or rescheduled without large cross-effects. The "value" column in your list could contain a value determined by another part of your business or organization, such as management, end user, or customer, or it could be your personal estimate. The "cost" column should include at least the programmer-months or programmer-years required. Alternate scheduling for a given project transforms it into an alternate project with lower (or higher) value, available at a later (or earlier) time at a lower (or higher) cost. Many other elements can be added to your list, but each should relate to value, cost, or interproject constraints or dependencies.

Alternative lists of project responsibilities should aim at increasing the overall value-to-cost ratio. Several variations are possible:

1. Drop low-value, high-cost projects; then medium-value, high-cost projects and low-value, medium-cost projects; then projects with equal value and cost. Keep going until the total cost is within sight.

2. Consider decomposing projects into more attractive groupings. Generally, this involves selecting the highest-value, lowest-cost components of a project and isolating them into an alternate project, either

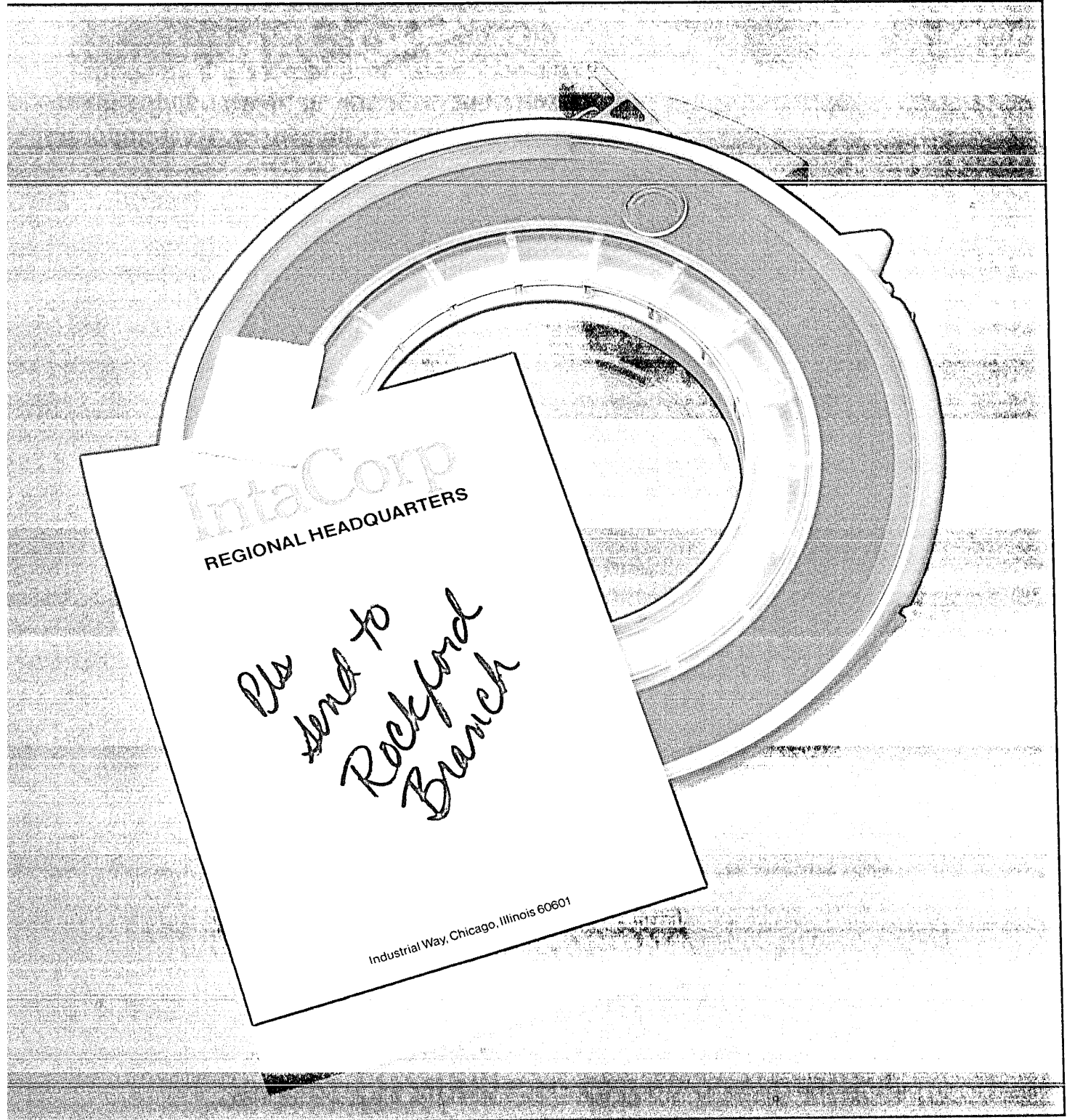

## The same, identical software you develop for our largest HP 3000 can run on our smallest.

Most companies need a range of business computers. What they don't need is the high cost of converting software to run on the different systems.

With the HP 3000 family, that cost is zero. Because we never change its compatibility, even though we're constantly expanding its performance.

Without rewriting a word of code or recompiling, you can use the same programs right up the line. From our inexpensive Series 39 that can serve a single user in a branch

office. To our Series 68 distributed mainframe that can handle 400 in your regional headquarters.

That frees you for more productive things like reducing that applications backlog. Here again, the HP 3000 can help dramatically.

Its special programmer productivity tools have cut months off program development schedules. And, with our long list of off-the-shelf software packages, there are many programs you may not have to write at all.



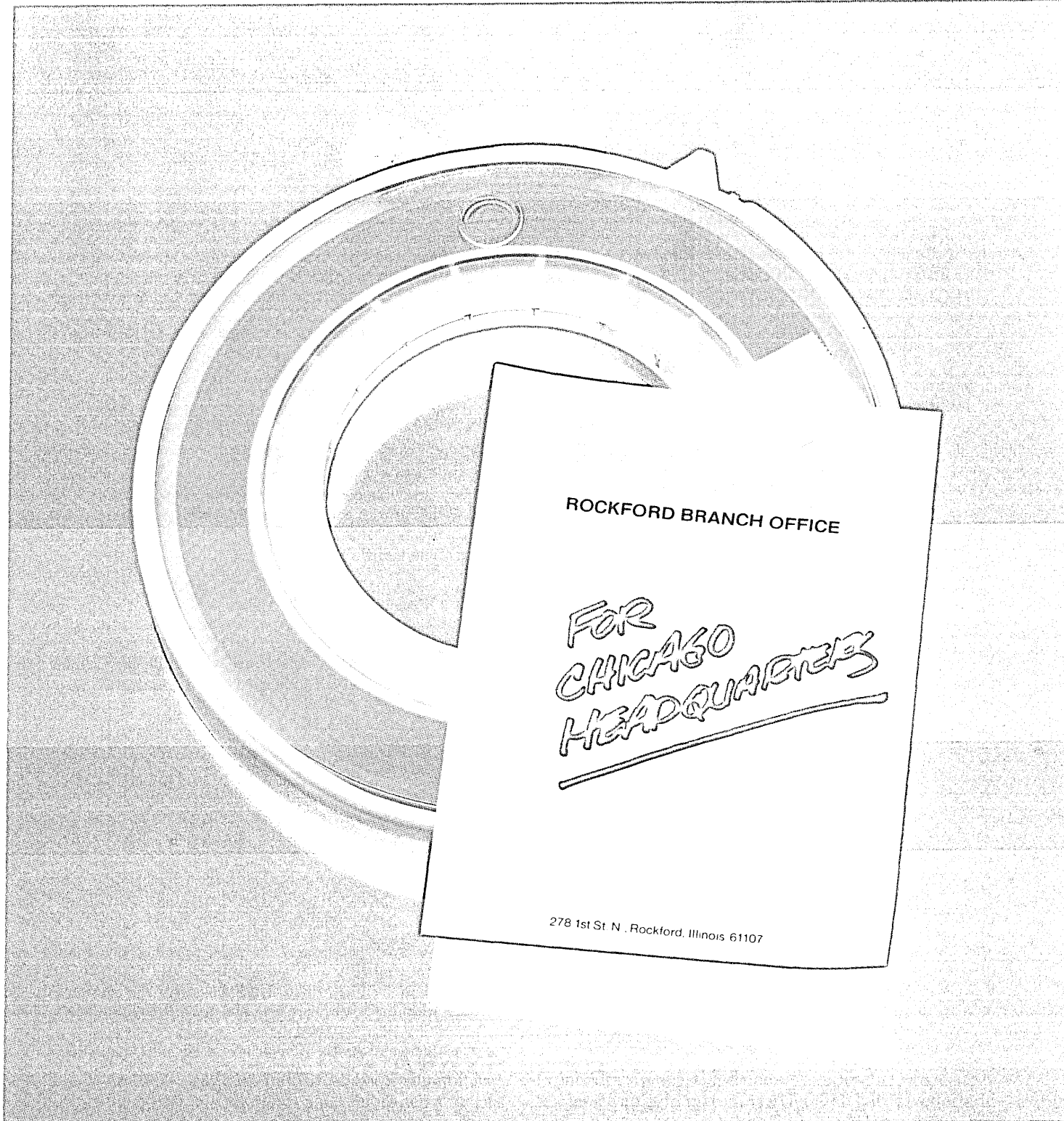

## And vice versa.

But your savings actually start with the hardware. The HP 3000 family delivers equal performance for up to 40% less than comparable systems. And their flexible communications make it easy to build local and remote networks, as well as links to IBM, one step at a time. You get what you need now. Then add more as you grow.

Small wonder the HP 3000 is one of the most popular business computer families in the country. If you'd like to see it in action, call the nearest HP office listed in the

white pages. Ask for a Business Computer Specialist. Or write to Tom Rappath, Hewlett-Packard, Dept. 04183, 19447 Pruneridge Avenue, Cupertino, CA 95014. In Europe, write to Henk van Lammeren, Hewlett-Packard, Nederland B.V., Dept. 04183, P.O. Box 529, 1180 Amstelveen, The Netherlands.



**HEWLETT  
PACKARD**

## If you already know what tools you want, the onset of a programmer scarcity period is an excellent time to acquire and install them.

dropping the other components or grouping them as a "Phase II" project. (This is the same thing that happens when a troubled development project drops high-cost elements to regain schedule.)

3. Consider combining projects. This is especially attractive when a high-value, low-cost project is available for the merger, and you want to have a larger project or a smaller number of projects.

4. If there are few high-value projects, consider the more extreme alternative of dropping one or more low-value projects and attempting to add a high-value project that has not yet been assigned, or possibly not yet conceived.

Dropping a project may mean outright cancellation or delaying its start until after the planning period. More constructively, a software development project may be

eliminated by licensing in its place a relevant package, such as a common business application or a database management, inquiry, and reporting product.

### MAKE AND IMPLEMENT DECISIONS

In some situations you will be able to replan your responsibilities and start down a new path without getting anyone else to agree. More typically, you will need to persuade management, customers, or end users that the revised plans are worthwhile. If you have replanned to maximize value and minimize cost, as described above, you already have good grounds for a persuasive presentation. If some people are likely to be persuaded easily and then support your position in subsequent encounters, by all means approach these people first. You may need to make multiple persuasion at-

tempts, possibly with some further replanning in between. Once you've convinced those whose agreement is necessary, don't forget that you also have to sell (or at least break the news to) the software development staff. If you have involved key members of the staff in the replanning and persuasions, you've already begun. But in all cases you should think out how to announce the new plan, involve other people in the announcement if they can help, and use informal discussions as well as a group announcement.

So far, replanning has been described for the onset of a programmer shortage. But the replanning process is generic and should be repeated at many other times: when user requirements shift, for example, before projects are completed, and whenever replanning hasn't been done for a while.

If you are taking some of the steps that have been described for staffing, productivity, and replanning, you are coping with programmer shortage. But taking these steps also creates both requirements and opportunities for showing people that you're coping with the problem. An important way to do this is by making oral and written presentations. Some presentations are persuasive; they must be made and must succeed to get approval for a step you want to take. Other presentations are informative; they are not obligatory but they build understanding and credence. Here are examples of both kinds of presentations:

You can persuade management with presentations on a revised work plan, or end-user liaison changes you'd like to make. You'll have to be especially persuasive when you explain why you should be exempted from the hiring freeze, why you should be able to hire consultants, and why you should go beyond your budget to install certain productivity tools.

You can improve your credibility by describing ways you have already stretched talent, improvements you've made in the job environment, and productivity tools you've installed within your budget.

In making oral and written presentations on coping with programmer shortage, avoid the trap of conditioning management to believe that the reduced size of your software development function is "correct" and should persist when hiring resumes. As soon as an end to the programmer shortage is in sight, replan responsibilities again and start the steps to add staff for more high-value software projects. \*

George H. Bosworth consults on software development business plans in Los Altos Hills, Calif. While managing software development in large companies, he survived seven hiring freezes.



"The problem as I see it, Upton, is that you're not packaging yourself very well."

# Spinning through software changes and new versions?



## Softool's Change and Configuration Control (CCC™) opens the door.

**CCC is a software product that automates:**

- management of changes
- management of different configurations (versions)
- control over who can make what type of changes and where

**CCC can handle anything.** It can manage: source code, object code, test data, documents, ... and it can deal with programs in any language: Fortran, Cobol, Pascal, C, Ada®, Jovial, Assembly, ...

**CCC provides every feature you need.** It supports

automatic reconstruction of previous versions, problem tracking, difference reports, management reports, access control, archiving, compression, encryption, automatic recovery, ...

**CCC is easy to use.** It is interactive and friendly. You need only learn a small set of commands. Help is available on-line. Interactive tutorials are included for both management and programmers. The user interface is the same for all computers supported.

**There is more.** CCC is a stand-alone component of SOFTOOL®. An integrated Programming Environment is also available.

**Our credentials.** Over 750 SOFTOOL products are installed worldwide. A growing number of computer manufacturers offer SOFTOOL as part of their product line. These include: Digital

Equipment Corporation, Gould S/E/L, Hewlett-Packard and Honeywell.

**Available now.** SOFTOOL is supported on the DEC VAX, DC, MV, Gould S/E/L 32 series, and IBM/370, 30XX and 43XX computers. It will soon be available for Honeywell 6000, Level 66 and DPS 8, and HP 9000 computers.

Call Softool Corporation for more details or to arrange a hands-on demonstration.

640 South Kellogg Avenue,  
Goleta, California 93117  
Phone: (805) 964-0560, Telex: 653334

France: Eurosoft, 33, BD Henry Sellier, 92150 Suresnes,  
Phone: (1) 506 18 18

Germany: Sicos Eurosoft, Brienner Strasse 5, 8000  
München 2, Phone: (89) 22 23 24

Israel: ATL, Atidim, Neve Sharef, Devora Hanevia Street,  
Tel Aviv 61130, Phone: 03-491262



 **Softool Corporation**

Ada® is a trademark of the U.S. Government.  
DEC and VAX are trademarks of Digital Equipment Corp.

CIRCLE 57 ON READER CARD

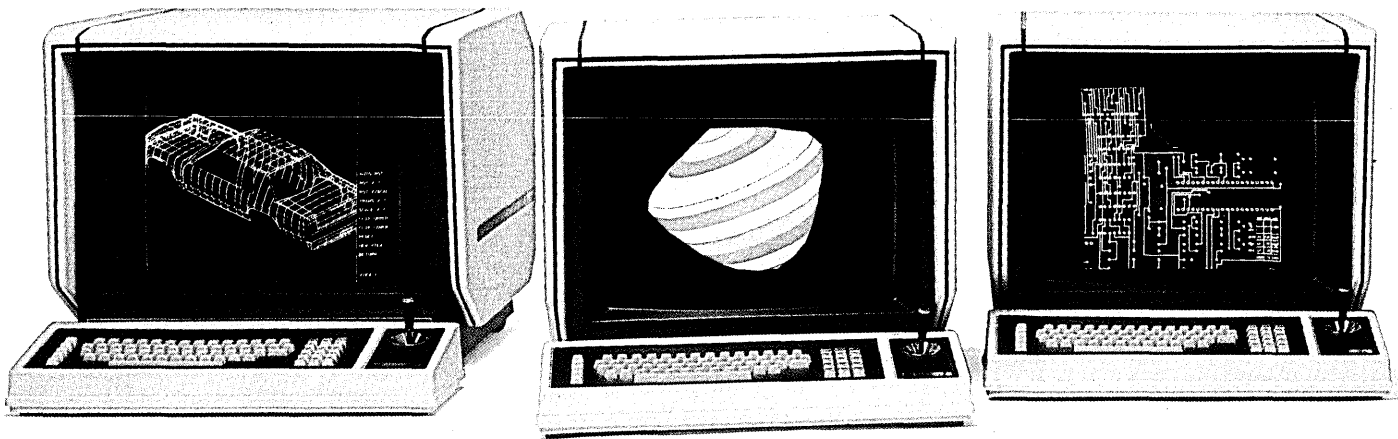

### **What's Megateknology?**

Everybody else claims to make state-of-the-art computer graphics systems. We don't. At Megatek, we're making history out of state-of-the-art. In fact, we're turning it into state-of-the-past. It's what we call Megateknology.

### **Meet Our Family.**

Meet our family of Whizzards. One graphics miracle after another. Innovative, sophisticated systems that set industry standards others can only try to match. Tomorrow's design solutions today. In short, graphics Whizzardry.

### **The 7600 System. Power and Performance.**

Our top of the line Whizzard® The powerful 7600 perhaps provides the greatest range of operator interaction of any system today. Dual-bus architecture supports both high resolution stroke refresh and color raster displays. Up to two. Real time dynamics on color raster displays make frame updates at stroke refresh speeds for both 3D, wireframe and solid surface objects.

State-of-the-art doesn't even come close to the 7600.

### **The Whizzard 7200. Graphics Excellence.**

Customize your own system to meet specific design needs. The 7200 offers unprecedented flexibility and speed. Modular architecture supports both high resolution stroke and real time dynamic color raster displays providing powerful, economical system configurations. Working in 2D or 3D, this Whizzard provides solid solutions for any design application, today or tomorrow.

### **Our 6200. Economical graphics terminals.**

Whizzard 6200 graphics terminals are completely self-contained with their own desk, display monitors and interactive devices. They combine the high vector density of a raster terminal with the 12-bit virtual addressability and dynamics of a vector refresh system. And, our 6200 can display real time data and static overlays simultaneously. Efficient, effective and economical design tools that minimize host computer burden and reduce communications through local display list architecture.

# That's Meg

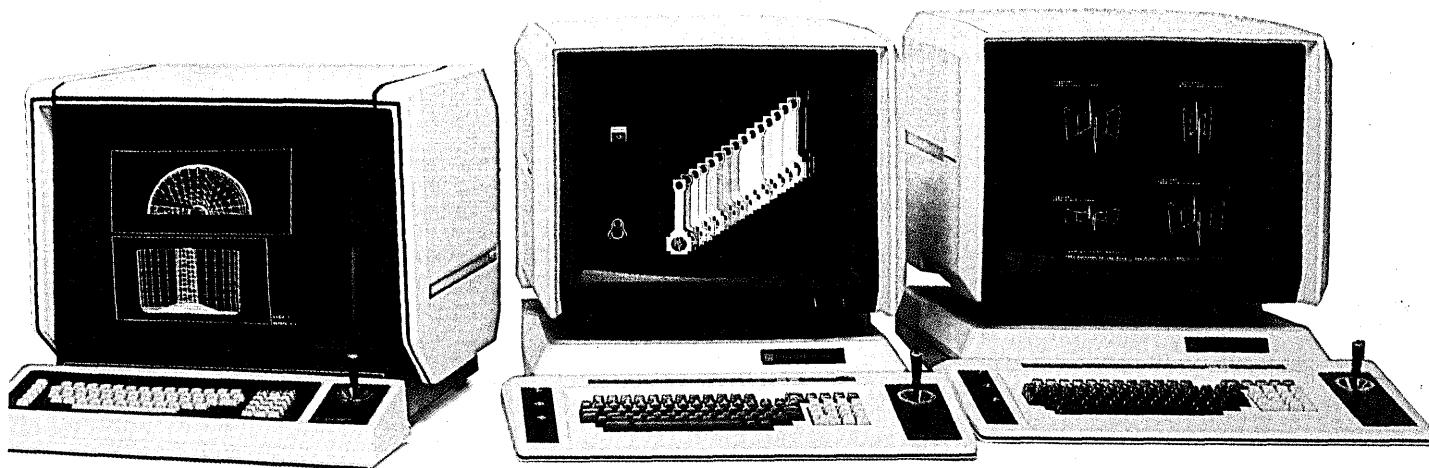

**The Whizzard 1600s. Desktop miracles abound.**

Then, consider our 1600s for creating graphics miracles right on your desk. With all the features of our more powerful, expensive Whizzards but in a compact, highly efficient 2D design station, right at your fingertips. Everything an engineer or designer could ever want in desktop computer graphics. Color or monochrome. High quality and resolution. VT-100™ compatibility. Greatly increased productivity thanks to ergonomic design. Megateknology, pure and simple.

**Graphics Software is Megateknology, too.**

The Whizzard's WAND™ Upward and downward compatibility throughout our graphics family. It lets you write applications programs that run on either vector refresh or color raster systems for both 16- and 32-bit computers.

Or take TEMPLATE®. Computer and device independent software support for 32-bit or larger mainframes. 2D and 3D dynamic or static applications in batch or interactive modes. Creates, displays, modifies or stores graphics for a myriad of applications.

**That's Megatek.**

Everything you could want in graphics hardware and software. Examples of innovative pioneering in computer graphics technology. Power, greatly increased productivity, multi-functionality, versatility, simple design excellence and solutions.

But then, there's state-of-the-art. Or by comparison, state-of-the-past. Why choose it when you can put Megateknology to work solving your graphics problems? It'll make miracles for you, too.

Making History out of  
State-of-the-Art.



VT100 is a trademark of Digital Equipment Corporation.

**ateknology™**

World Headquarters • 3985 Sorrento Valley Blvd. • San Diego, California 92121 • 619/455-5590 • TWX: 910-337-1270  
European Headquarters • 34 avenue du Tribunal-Fédéral • CH-1005 Lausanne, Switzerland • Telephone: 41/21/20 70 55 • Telex: 25 037 mega ch

CIRCLE 81 ON READER CARD

## A worldwide network of computer smugglers shipped DEC minis to the Russians and their satellites.

# THE BRITISH CONNECTION

On a cliché of an English rainy day in mid-May, a customs officer at the port of Dover on the Channel coast decided, quite at random, to open two packing crates labeled "typesetting equipment" and bound for Moscow via Amsterdam. Inside the wooden containers were not Linotype machines or some vintage press, but two PDP-11/34s, the venerable 16-bit minicomputer from Digital Equipment Corp. The customs officer immediately halted the mislabeled shipment, of course, because high-end PDP-11s are not supposed to be sent to the Soviet Union or any Eastern European country under its influence.

The publicity that followed the innocuous opening of a packing case at Dover also brought into the open an investigation by Western defense and customs authorities. A cooperative effort by German, British, and American officials, code named "project exodus," has discovered an entirely new and potentially frightening level of Soviet computer espionage, DATAMATION has learned.

An international computer equipment consultant, uninvolved in the investigations, explains why voices and tempers are raised. "The special thing about what has been discovered is that complete systems, not merely components, have been spirited out of the West by people who are not from Eastern Europe," he says. In the past, front organizations were set up in Silicon Valley and elsewhere and operated by East Germans, Poles, or Soviet agents. Their mission: to try to buy chips or components directly from manufacturers. "Now they seem to have sucked in innocent, or greedy, Brits," the consultant adds.

An English company named Datalec Ltd., located in the village of Ferndown in Dorset, is the key link in the chain of events that connected DEC's factories and the Soviet Union, though several intermediaries and a circuitous route were involved. The discov-

ery of the two PDP-11/84s at Dover in May was apparently the tip of the iceberg—at least three VAX-11/780s for advanced research and computer aided design were also shipped through the Iron Curtain as part of deals arranged by Datalec.

A little background is in order to understand how and why the hardware was discovered near the white cliffs of Dover. Datalec was established in 1979 by Bryan Williamson, and its shareholders include Technical Development Capital Ltd., the venture capital subsidiary of the Industrial and Commercial Finance Corp., a London organization that is owned by Britain's major banks. Officially the company's product was computer aided design services; however, it was widely known to be a dealer of used DEC and Data General minicomputers. Williamson has said that in 1981, 80% of Datalec's approximately \$500,000 in revenues were from exports.

The U.S. Department of Commerce has been watching Williamson since 1968, when it issued the first of four orders denying him permission to ship electronics gear to Communist countries. In effect, he was blackballed from the computer export trade. Apparently to evade the blacklist, Williamson and other Datalec directors bought a 35% stake in Datagon GmbH of Cologne, West Germany, once a DEC original equipment manufacturer (oem), now in the local version of bankruptcy proceedings. By February 1983 Datalec officials had poured hundreds of thousands of dollars into the German company.

Investigators from NATO customs and security offices and DATAMATION have traced how Datalec and Datagon acquired and then delivered PDP-11/84s and VAX-11/780s to the Soviet Union and its close ally, Bulgaria. The two PDP-11s discovered in Dover were on the last leg of the trip that starts in DEC's Massachusetts factories.

### VAX'S ROUTE TO BULGARIA

Here is how the first VAX found its way to Bulgaria: a year ago Computer Maintenance of Minneapolis ordered a VAX from DEC. The system was trucked to Boston's Logan Airport and flown by Lufthansa cargo airplane to Frankfurt. Another truck brought the equipment to Datagon's warehouse in suburban Cologne. The Commerce Department's export license specified that the shipment was for Datagon only, and that the goods could go to West Germany, Holland, France, or the United Kingdom *but no further*.

The crates stayed unopened in Datagon's Cologne warehouse while new documentation was prepared. An international shipper then delivered the equipment to Datalec in Dorset. Ivor Edwards, the Welsh director of Datagon, accompanied the machines to England for checkout; he was the company's senior hardware engineer. Sources indicate that inspection and testing of the computers on Datalec's premises was performed by technicians from England, Germany, and Bulgaria. After system checkout, the Bulgarians accepted the hardware and the VAXs were repackaged for delivery to Bulgaria. New shipping documents, with innocuous labels ("typesetting equipment" seems to have been a favorite choice) were attached, and the crates were loaded on trucks for the Channel crossing to Amsterdam's Schiphol airport. Then they were loaded on another cargo plane and delivered to Bulgaria in August. Apparently, Datagon and Datalec did not leave matters there: on-site commissioning and training courses for the Bulgarians were provided by company representatives; by October the system was running. Authorities estimate that by year-end at least three VAX systems were acquired by the Bulgarians through this route.

Around the time the three VAX computers were delivered to the Bulgarians, Al-



# A BOOTH SPACE AT INTERFACE '84 IS MORE THAN

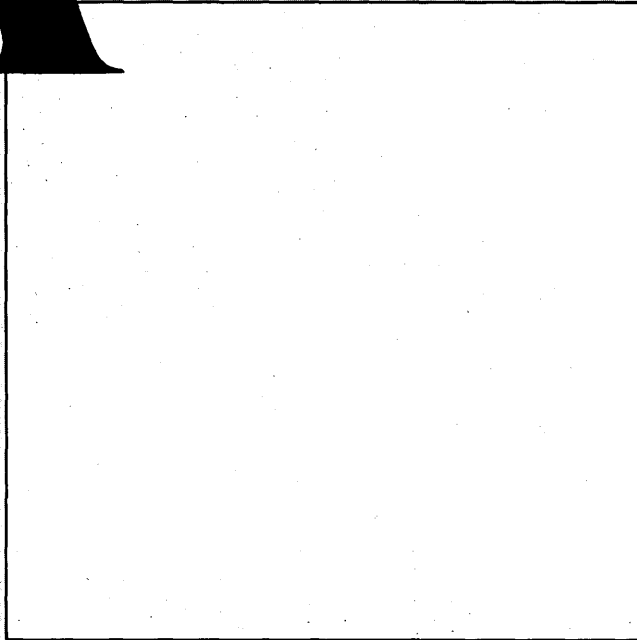

## PRIME REAL ESTATE!

INTERFACE '84 Annual Conference & Exposition puts you at the center of a very powerful marketplace. Exhibiting at INTERFACE '84 makes you visible to top level data communications/information processing specialists and the executives with decision-making power. That's why a booth at INTERFACE '84 is more than prime real estate.

From March 12 to 15, these executives will be in Las Vegas at INTERFACE '84 to find solutions to their data communications/information processing systems problems. They are the people who control the budgets for their corporation's information processing systems purchases, and by their presence at INTERFACE they are making the statement that they are ready to do business. Just like they've been doing at INTERFACE for the past 11 years.

At INTERFACE '84, they could be looking for the product or service you have to offer: Local Area Nets  Front Ends & Modems  Network Services  Desktop Computers  Satellite Links  Network Monitors  and the elements that constitute office/information systems integration.

And the INTERFACE Conference delivers the kind of professional audience you want. The INTERFACE Conference is a program of 75+ informative sessions featuring the industry's leading experts. They address communications/information systems technology and its benefits to the corporation. The result is that informed professionals are ready to talk to you about your products.

Exhibit space at INTERFACE '84 is more than prime real estate because attendees want to do business. To reserve your INTERFACE '84 exhibit space today, or for more information, call (800) 325-3330. In Massachusetts, call (617) 449-6600. Or write to INTERFACE '84, 300 First Avenue, Needham, MA 02194.

## INTERFACE '84

TWELFTH ANNUAL CONFERENCE & EXPOSITION

Co-Sponsored by **BusinessWeek** and **Data Communications**

March 12 to 15  Las Vegas Convention Center



A presentation of The INTERFACE GROUP, Inc., world's leading producer of computer conferences and expositions including INTERFACE '84, COMDEX/Fall, COMDEX/Europe, COMDEX/Spring, FEDERAL DP EXPO, and the nationwide COMPUTER SHOWCASE EXPOS.



# TECHNOLOGICAL BREAKTHROUGH IN BUSINESS COMPUTERS!

**CADO introduces world's first tri-level, 16-bit supermicro...  
all the power you need to support up to 64 users at incredible speeds!**

New CADO TIGER family has up to 14 processors in a three-level architecture that share the work load and give you the power and response to do *all* your processing jobs at the same time.

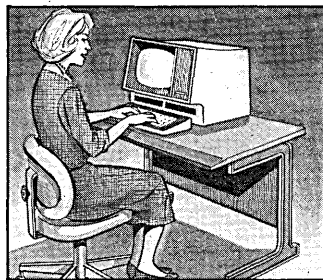

First, there's the Transaction Processor. The workhorse of the system, it interfaces with user terminals, printers, modems and other peripheral devices. Alone, each Transaction Processor has more computing capacity than many complete computer systems.

Secondly, the Intranet Processor takes on the long processing jobs to free up the Transaction Processor.

Finally, the Control BiProcessor interfaces to the disk-and-tape-storage devices to speed up disk access and memory-to-memory transfers.

Three levels of processors working *together* give you more power and faster response than any other micro—or mini—computer can match.

CADO makes it easy to grow with your TIGER, too. You start with a few peripherals and 15 million bytes of storage. And you can end up with 64 devices and 1.1 billion bytes of data storage!

Whether it's your first or next system, chances are this CADO TIGER will be all the computer your business will ever need.

And you'll be amazed at how little all this power costs. No more than lesser micros. And much, much less than minicomputers.

CIRCLE 82 ON READER CARD



Now part of the \$3.9 billion Contel organization, CADO has been a leader in business systems technology for seven years and is sold and serviced by over 180 distributors worldwide.

Your nearby CADO Distributor is a data processing professional. He sells business computers. He has software packages proven in many businesses like yours or will design custom software just for you.

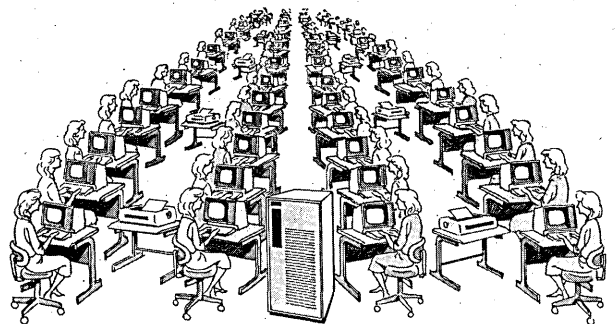

So before you choose your next business computer, call your nearby CADO Distributor or send in the coupon below. For the name of your CADO Distributor or more information, call us at **800-556-1234, ext. 128**; in California, **800-441-2345, ext. 128**. Ask about the CADO TIGER—the technological breakthrough that just made all other business computers obsolete.

## CADO A Contel Company

2055 West 190th Street • P.O. Box 3759 • Torrance, CA 90510  
(213) 323-8170 • Telex: 66-4711 CADO TRNC

**Please rush me more information.**

NAME \_\_\_\_\_  
TITLE \_\_\_\_\_  
COMPANY \_\_\_\_\_  
ADDRESS \_\_\_\_\_  
CITY \_\_\_\_\_ STATE \_\_\_\_\_ ZIP \_\_\_\_\_  
TELEPHONE \_\_\_\_\_

## Nobody has been paid for the machines; DEC Germany had to help liquidate a debtor.

lied authorities were on the trail. In a February 1983 series of coordinated raids, on both sides of the Atlantic, armed American and German agents seized records of Computer Maintenance in Minneapolis, Datalec in Dorset, and Datagon in Cologne, including a search of the homes of key company officials. No charges have yet been filed against any of the individuals or companies involved in the computer smuggling.

Ironically, neither Datagon, Datalec, Computer Maintenance, nor DEC has been paid in full for the machines, let alone the subsequent aggravation from inquiring government agents and reporters. Datagon folded in May with debts of around \$2 million, or DM4 million; DEC Germany was forced to help Datagon liquidate its inventory as the only way the VAX maker could recoup some of the \$200,000 or so it claims is owed by the German company.

Indeed, Datagon was something of a thorn in DEC's side for some time. Frank Burger, head of DEC's oem marketing effort in West Germany, says with a sneer that the smuggling scandal "couldn't have happened to a better company."

Though at least 145 illegal computer shipments to the Soviets or their agents were seized in Britain over the past few years, the flow of the computers to the Soviet Union continued. DATAMATION has learned of another access point. A totally innocent Swiss company, an official oem for DEC, was approached by a British national who had provided them with consulting services and training help in the past. The Englishman, formerly an IBM customer engineer, asked if the Swiss firm would like to boost its volume—and therefore decrease its unit costs—by forwarding DEC terminals, PDP-11s, and VAXs to his new company based in Greece.

The Swiss connection was soon established—DEC would air-freight the hardware to Zurich direct and then the equipment would be forwarded by Swissair to Athens. Instead of loading the crates onto trucks for delivery to Greek customers as promised, however, the DEC gear was transferred to another cargo flight, without going through customs. The next port of call was Luxembourg, the tiny country in central Europe. The DEC machines then flew to Finland, because it was just a short hop from the capital, Helsinki, to Leningrad, the real destination. Commerce Department officials say they are hot on the trail of the Englishman, who authorities believe is the mastermind.

Nevertheless, the Swiss connection is one more example of the after-the-fact porosity of Western restrictions on high-technology exports with potential military applications. While most sophisticated computer equipment made in the U.S. must have a spe-

cial license from the Commerce Department Office of Export Administration before it can be exported via a harbor or airport, Project Exodus revealed that the procedures are either largely ineffective or at best frequently ignored. In the opinion of many authorities, including British agents, the trickle of computer smuggling attempts in the 1960s has turned into a flood over the past 10 years.

### DESPERATE FOR DEVICES

The Soviets and their dependents in Rumania, Poland, Bulgaria, and other Eastern European nations seem desperate to obtain three types of devices reflecting their problems in the component and systems sectors of data processing technology. First, at the head of the Communists' shopping list are any items used in the manufacture of semiconductors. Western intelligence and customs officials suspect that automated photo resist developers, integrated circuit testers, and other fabrication gear are being smuggled into Eastern Europe and then to Russia, in a route that includes the United Kingdom and Spain.

Secondly, the Russians apparently are unable to meet Iron Curtain demands for 16-bit minicomputers. A Soviet look-alike for the PDP-11, called the SM series, is not produced in sufficient quantities, according to one specialist. "Their weakness is in manufacturing machines," he says. Consequently, DEC systems are going east "by the plane-load," according to one British dealer.

Thirdly, the Soviets have not yet been able to produce 32-bit minicomputers, now considered essential for advanced scientific research and for industrial processes like computer aided design and manufacturing. An overseas DEC dealer says he's been approached by suspicious buyers eight times over the past year to sell DEC's popular 32-bit systems, the VAX line. "I knew very well where these computers would go," he claims. Interestingly, one approach was made by the Vienna, Austria, office of a major multinational corporation.

Now, American officials say they are convinced that British nationals are the worst offenders of the high-technology export rules agreed upon by the NATO countries and the Japanese members of the Coordinating Committee for Multilateral Export Control (COCOM). Secretary of Defense Caspar Weinberger reportedly complained about the lax British scrutiny in a recent meeting with British Prime Minister Margaret Thatcher. The "Iron Lady" in turn argued that a blanket prohibition was unnecessary because the bulk of the commercial computers now available does not have obvious military applications. "Mrs. Thatcher is said to be taking a very hard line with the Americans," a British

source told DATAMATION.

Europeans in general and Mrs. Thatcher in particular are said to be annoyed at what they see as a double standard from the Reagan Administration. If it's okay for President Reagan to permit grain shipments to the Soviet Union and relent on the Siberian gas pipeline equipment restrictions, then the flow of commercial computers like the 13-year-old PDP-11 family should continue.

It must be particularly galling for the Europeans to watch President Reagan encourage domestic vendors to ship advanced computers to other Communist countries, such as the People's Republic of China. Over the past few years sophisticated Hewlett-Packard computers, such as its HP3000 minicomputer and several recently introduced desktop models, have been delivered.

Europeans also see that the issue of high-tech exports to the Soviet Union is the subject of heated debate within the States, with hawks like Fred Bucy of Texas Instruments arguing against such exports, while Control Data's William Norris favors them, with the familiar argument, "If the U.S. companies do not supply these goods, then European and Far Eastern countries will."

Consequently, tensions are higher than ever between American and British officials faced with slowing the flow of high-technology gear to Eastern Europe, despite official protestations to the contrary. Consider the warning made by Commerce Department officials at a June meeting of the COCOM: if the flow of high technology to Eastern Europe was not slowed, certain computer shipments to the U.K. would be banned. This astounding threat between two trading partners, with billions of dollars of computer exports at stake, is likely to keep the issue at the top of the agenda in vendor and user planning sessions. Meanwhile, the illicit trade is expected to continue at a high rate.

Why? Consider the observations of a British programmer, recently returned from a month's assignment in Bulgaria. He says that many of the older DEC computers overseas, the PDP-11s, are burned out—"clapped out" is the term he used. Not only are the Russians and their Eastern Bloc partners unable to build minicomputers, they can't fix the ones they already have, and it is doubtful whether they can maintain a VAX. Yet with the taste of advanced technology whetting their appetites, the Soviets' hunger for Western computer gear will not easily be satiated. \*

A team of DATAMATION representatives, including Roger Mark, Maureen O'Gara, and Paul Tate, researched this story in England, Germany, and the U.S., along with reporters from the *Sunday Times* of London.

# THE INFORMATION ANALYSIS SYSTEM THAT WON'T PLAY A BIT PART!

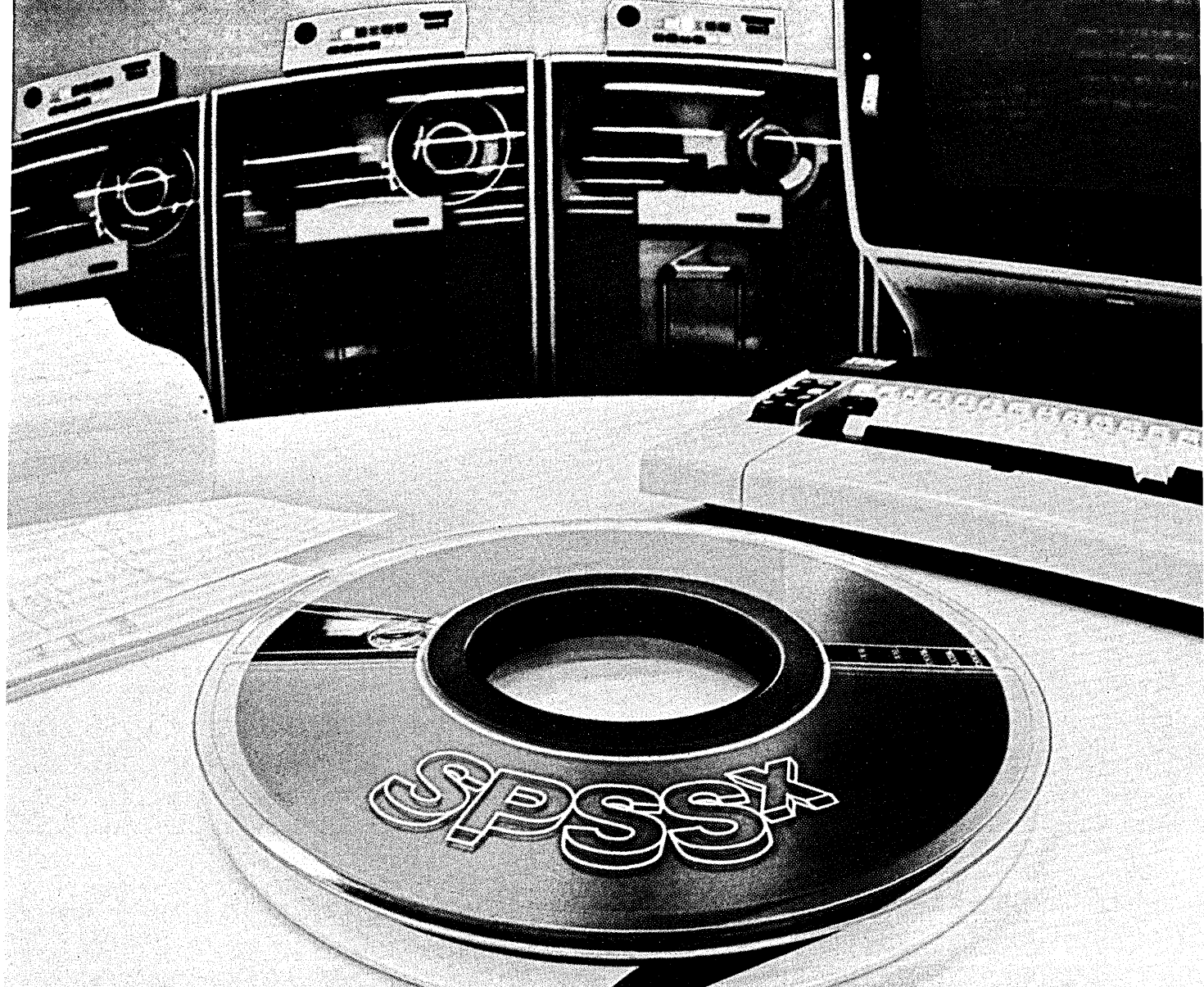

Some software systems are like walk-on actors; they're usually kept standing offstage. But not SPSSX™. Because SPSSX offers everything you need to organize, summarize and display information in scores of productive ways. It's a totally new Information Analysis System which we've designed with the most advanced statistical capabilities yet. To play a leading role in any DP or Information Center environment.

**Want to enhance efficiency?** With minimal training, anyone in your organization can start using SPSSX to get the critical information they're after. In the time it takes users to explain a problem to a programmer, they could be obtaining answers and putting them to work. Permitting the programmer to devote more time to other applications.

**Need advanced file management capabilities?** SPSSX lets you define and combine data from any number of files, regardless of complexity or structure.

**Searching for sophisticated statistics?** Over 50 major statistical procedures are at your command, from simple table and plot procedures for

novice users to state-of-the-art multivariate techniques for more sophisticated users.

**Interested in evaluating computer performance?** SPSSX gives you the power to read and analyze SMF and RMF type data, and to turn this system performance information into concise, understandable reports.

These are just a few of the many capabilities that make the SPSSX Information Analysis System such an incredibly productive performer. For more information, call or write for our descriptive brochure today.

© Copyright 1983, SPSS Inc.

**PRODUCTIVITY  
RAISED TO  
THE HIGHEST POWER™**



SPSS Inc. 444 N. Michigan Ave. Chicago, Illinois 60611  
(312) 329-2400

SPSSX currently runs on IBM OS, CMS and Digital VAX™ systems. Conversions will soon be available for IBM DOS, DEC 10 and 20, PRIME, Univac 1100, Data General MV 8000 series and other minis and mainframes.

Photographed at IBM Data Center, Chicago, IL

CIRCLE 84 ON READER CARD

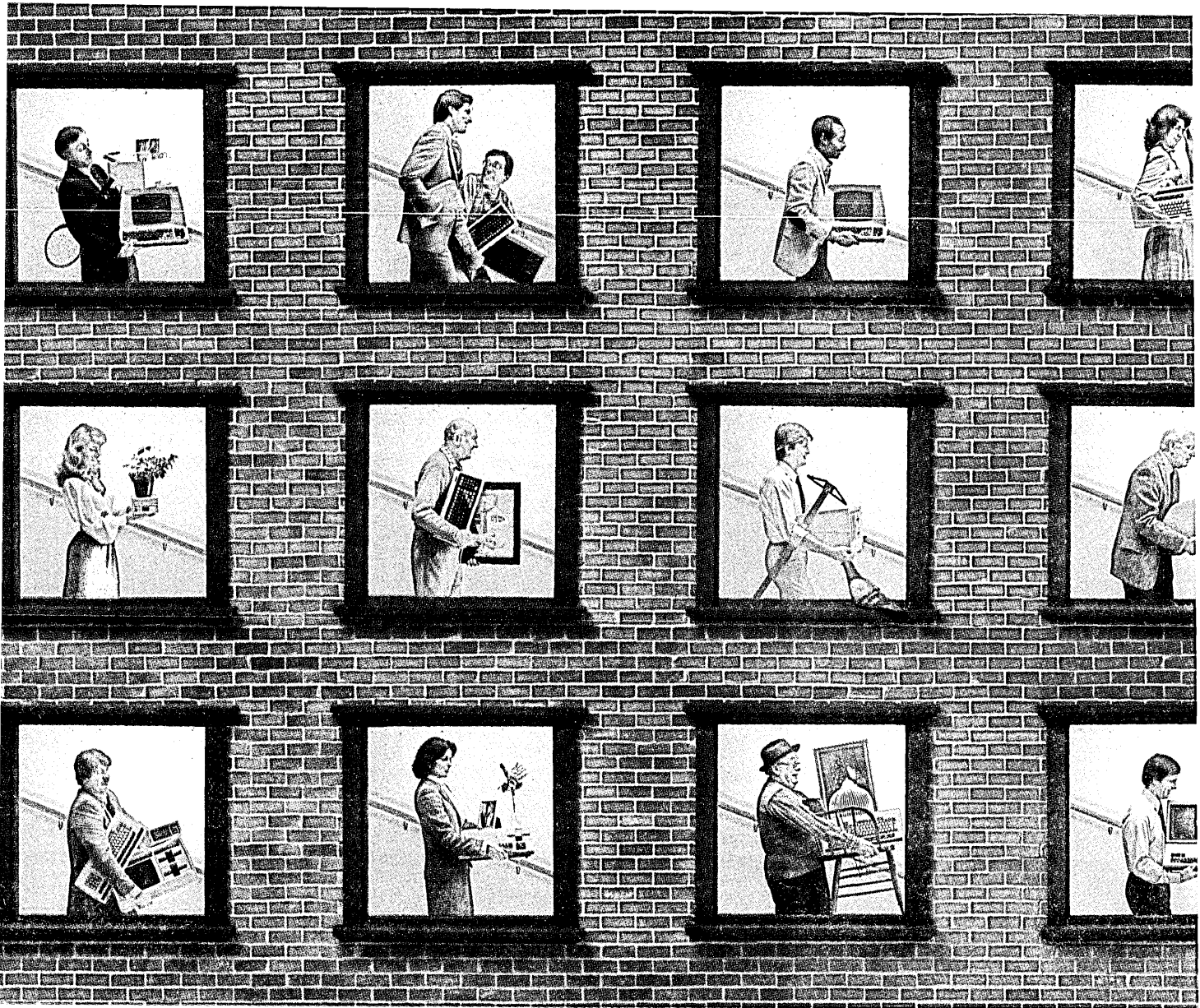

# LocalNet<sup>TM</sup> networks make industry managers downwardly mobile.

And upwardly mobile. Whichever way they have to move.

For instance, look at The Foxboro Company.

Hundreds of companies rely on Foxboro process management and control systems when they move liquids, gasses, and energy across plants and factories.

And Foxboro relies on a LocalNet system when it moves both people and computers from office to office. Or floor to floor.

At Foxboro, a single LocalNet cable distributes the power of four computers from busy R&D labs to executive corner offices. While multiple taps, already installed for less than \$50 each, make the network instantly accessible.

So at Foxboro, the company doesn't stop moving because people are.

And that helps Foxboro control one more thing. Its cost of doing business.

It takes experience to design local area networks with this kind of flexibility. Ours comes from more than 18,000 connections to more than 250 LocalNet networks worldwide. More than any other open network supplier.

And we transfer this experience to LocalNet users in government, finance, and academia.

If people in your company are going places, contact us at Sytek, Inc. 1225 Charleston Road, Mountain View, California 94043. Telephone (415) 966-7333.

It'll be a smart move.



## How voice/data switches from 17 different vendors stack up against each other.

# VOICE/DATA PBX SURVEY

There are PBXs and then there are PBXs. When we first started this survey, we had a population of 90 switches from 13 different manufacturers. The matrix that appears on the following page lists only one model (or family) from each of 17 vendors.

The vendors we listed are those that offer a PBX that can handle both voice and data in an integrated manner. Thus we eliminated the manufacturers who make voice-only systems (though some of them may have plans to enter the voice/data market), and all of the specialty switches that handle only data.

The *Business Communications Review Manual of PBXs* (see May, p. 326) enumerates over 300 facets of a modern PBX and provides detailed data on these items for a grand total of 37 switches. In reviewing that array, we tried to determine which features were important in discriminating between two competitive vendors.

Further, we found some features that are so important in the mixed voice and data environment that they should be highlighted in any survey. We wound up with a matrix of 22 items we think any PBX feasibility study should address. Readers who followed the first three articles of this series (in March, April, and May) will notice an additional feature—nonblocking architecture—that's conspicuous by its absence. For a discussion of this important but elusive quality, see the box on p. 160.

Some of the column heads need explanation. The *Installed Base* is the total number of systems a vendor has installed. This total includes both voice-only systems and systems that handle voice and data. We included the voice-only systems to provide an indication of the financial size of the vendor

The material in this survey is based on information in "Communications Systems," a monthly updated loose-leaf information service available by subscription from Data Decisions, 20 Brace Road, Cherry Hill, NJ 08034, (609) 429-7100.

and the maturity of his support organization.

*Date First Shipped* indicates the year when the first manufactured article using the vendor's current architecture was delivered. This pinpoints the age of the design.

*Average Voice/Data Lines Installed:* for the subset of the vendor's installed base that handles both voice and data, this column indicates the typical size of those systems. Because the data handling capabilities are so new, the reader must be careful in interpreting these numbers. Large vendors with thousands of installations may not have any more systems carrying data than some small vendors that have only several dozen customers.

*Average Cost per Voice Line:* one attractive way to get a new PBX is to install a voice-only system on a one-to-one replacement basis. Then, after the system is in and settled down and the voice traffic has justified recabling the plant, you can add data. Thus we obtained numbers from the vendors describing the typical cost for installing a voice-only system. These numbers include the cost of the switch, new cabling, the handsets, installation, freight, and the first year's warranty.

*Average Cost per Voice/Data Line:* addressing just the subset of those systems that handle both voice and data, we asked the vendors to provide the average cost per line for these systems. Thus if the costs in the two adjacent columns are the same, you can conclude that a data line with its line card and desktop termination costs as much as a voice line with its line card and handset. Remember, the data circuit terminates on the desk with a plug to which *your* terminal can be connected, whereas the voice line has a telephone on the end.

*Redundancy:* a redundant architecture is a complicated subject that could require one or more complete articles for adequate discussion. We would, however, like to remind potential PBX purchasers that the degree of redundancy built into a PBX determines the uptime for any specific family of electronic components. Thus if two PBXs were designed in the same year using the same components,

the one with the most redundancy would generally be the more reliable. You can explore these matters in depth with your vendors.

*Digitized Voice Handset:* most all of the modern PBXs switch digital signals and use pulse coded modulation (PCM) as an encoding technique. But some vendors offer, usually at extra cost, an option that digitizes the voice in the telephone handset and transmits a digitally encoded signal from the handset to the line card in the switch. Other vendors transmit from the handset to the switch in analog and encode the voice at the line card adjacent to the switch. Thus an affirmative entry in the matrix indicates that voice can be digitized at the handset (by means of a codec) and not at the PBX line card. This allows digital devices to be readily supported.

*Number of Paired Wires:* be careful to avoid confusion between the number of copper wires (which is what we list here) and the number of pairs. These are frequently muddled in early conversations with the PBX salesman. Simple analog voice telephone requires one pair (two wires). Many offices today are wired with 25 pair cable (about 3/4 of an inch in diameter) to support voice, intercom, buzzers, etc. With the new systems only the number of wires indicated will be required. This number is sufficient for voice, data, or a group secretary serving a dozen programmers.

*Synchronous and Asynchronous Data Speeds:* these two columns indicate the fastest data stream the vendor has announced for his switch. Most vendors offer a spectrum of speeds up to this maximum. We allowed a vendor to insert the highest speed he has designed for and offered for sale, even though he may not have installed any systems to date with that data handling capability.

*Protocol Converters Available:* over the years many of us have become painfully aware that the office automation vendors and the computer vendors use different logical protocols over lines with the same electrical and signaling characteristics. There are even some small electronics houses that make a business connecting brand X terminals to

# ALL PBXs ARE NOT CREATED EQUAL

VENDOR/MODEL	FEATURES								
	Installed Base	Date First Shipped	Av. Voice/Data Lines Installed	Av. \$Cost per Voice Line	Av. \$Cost per Voice/Data Line	Redundancy	Digitized Voice Handset	Number of Paired Wires	Synchronous Data Speed
American Bell AIS/System 85	6	1982	N/A	250-400/mo.	300-500/mo.	no	no	4	
Anderson Jacobson IOX-1000	N/A	1984	250-800	800-1,200	900-1,200	yes	yes	2	19.2 kbps
Ericsson MD 110	30,000 worldwide	1982	800	800-1,000	1,250-1,450	yes	yes	2	56 kbps
GTE Auto. Elect. Omni SII	100	1982	350	750	750	yes	yes	2	56 kbps
Harris/Digital Sys. D1200 Family	8,000 +	1975	500	690	760	yes	no	2	9.6 kbps
Intecom S-40	30 +	1981	1950	1,000	1,000	yes	yes	2	56 kbps
ITT CS-1024	30	1978	30	750-800	850-950	no	no	2	
Mitel SX-2000	6	1982	400	400	400	yes	yes	2	
NEC 22 Series	320	1979	912	700	1,000-1,100	yes	no	2	56 kbps
Northern Telecom SL1 Family	6,300 +	1976	400	1,000	1,000	yes	no	2	56 kbps
OKI Electric Spectrum Series	25	1983	64 to 128	N/A	N/A	yes	yes	2	
Prolink PCBX	N/A	1982	40	350-500	350-500	yes	no	2	56 kbps
Rolm CBX Family	1,200 +	1975	200	800	400	yes	yes	2	64 kbps
Siemens Saturn II & III	150 +	1982	N/A	300-600	600-800	yes	yes	2	
Solid State Systems CEO	700 +	1975	511	450	450	no	yes	2	9.6 kbps
United Technologies UTX 1001	35	1981	300	800	800	yes	yes	2	56 kbps
ZTEL PNX	1	6/83	N/A	900	1,060	yes	yes	2	56 kbps

	<i>Asynchronous Data Speed</i>	<i>Protocol Converters Available</i>	<i>X.25 Interface</i>	<i>T-1 Interface</i>	<i>Direct Inward Dialing (DID)</i>	<i>Route Optimization</i>	<i>Call Queuing</i>	<i>Call Detail Recording</i>	<i>Administrative RJE to Host</i>	<i>Wiring Trace Software</i>	<i>Office Automation</i>	<i>Security</i>	<i>Energy</i>
19.2 kbps	no	yes	yes	yes	yes	yes	yes	yes	no	yes	yes	yes	
19.2 kbps	yes	no	no	yes	yes	yes	yes	yes	no	yes	no	no	
19.2 kbps	yes	yes	yes	yes	yes	yes	yes	yes	yes	yes	no	no	
19.2 kbps	no	no	yes	yes	yes	yes	yes	yes	no	yes	no	no	
9.6 kbps	no	no	no	yes	yes	yes	yes	no	yes	yes	no	no	
19.2 kbps	yes	yes	yes	yes	yes	yes	yes	yes	yes	yes	no	no	
4.8 kbps	no	no	no	yes	yes	yes	yes	yes	no	no	no	no	
19.2 kbps	yes	no	no	yes	yes	yes	yes	yes	no	yes	no	no	
19.2 kbps	no	no	yes	yes	yes	yes	yes	no	no	yes	yes	yes	
19.2 kbps	no	no	no	yes	yes	yes	yes	yes	yes	yes	yes	no	
4.8 kbps	no	no	no	yes	yes	yes	yes	yes	no	no	no	no	
19.2 kbps	no	no	no	no	yes	yes	yes	yes	no	yes	no	no	
19.2 kbps	yes	yes	yes	yes	yes	yes	yes	yes	yes	yes	yes	yes	
19.2 kbps	no	no	yes	yes	yes	yes	yes	yes	no	yes	no	no	
4.8 kbps	no	no	no	yes	yes	yes	yes	yes	yes	yes	yes	yes	
19.2 kbps	no	no	no	yes	yes	yes	yes	no	no	yes	yes	yes	
19.2 kbps	yes	yes	Rel. 2	yes	yes	yes	yes	yes	Rel. 2	yes	Rel. 2	Rel. 2	



# CalComp's \$1 vs. their \$16,0

Why settle for a plodding plotter when you can double your throughput with an all-new Model 945 or Model 965 beltbed plotter from CalComp for approximately the same price?

Productivity gains can range from 25% to more than 500%. It's like having up to two plotters for the price of one.

*CalComp Model 945 beltbed plotter (left) for sheets up to ANSI size D (or ISO size A1), and Model 965 plotter for drawings up to sheet size E (or size A0).*

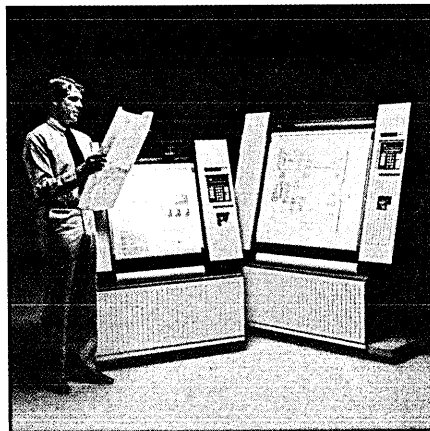

What's the difference? The basic philosophy behind each plotter design. Their plotters trade off speed for one-time economies of smaller size, lighter weight, less powerful components. *You* pay the price in plotting time with each pen and paper movement (their 24-ips maximum vs. CalComp's 42-ips) and each excursion of the single-pen carriage to a side-mounted carousel.

CalComp's Model 945 and Model 965 plotters, by comparison, allow you to map up to 16 logical pens to four physical pens continuously poised over the plot surface—ready to be activated



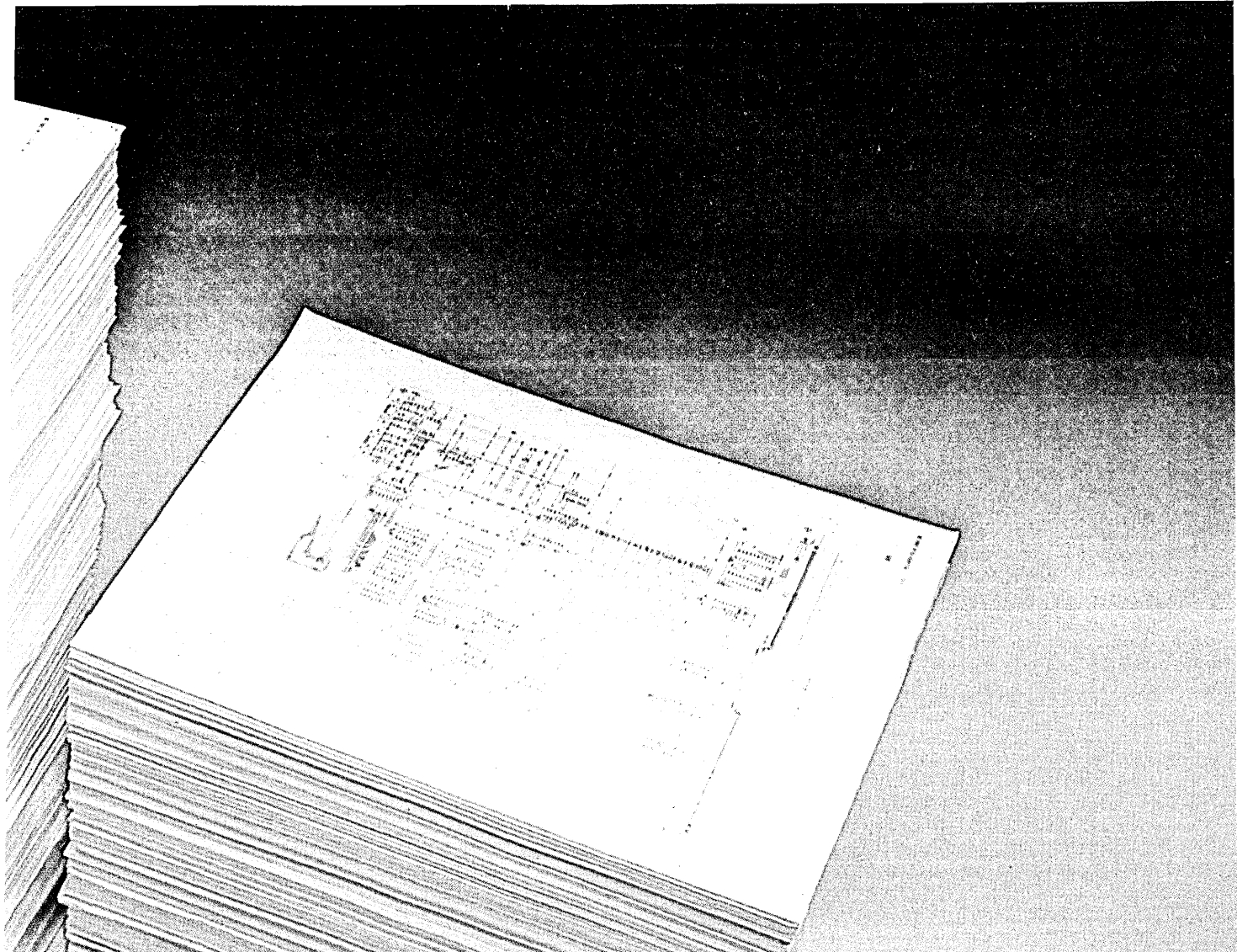

# 6,000 plotter 00 plodder.

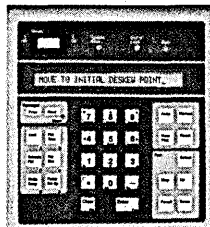

in a fraction of a second. If more than four pens are needed, the plotter performs an automatic stop and prompts the operator to change pens.

Plus the user-friendly control panel provides local control and plot manipulation with easily understood English language messages.

The same interactive firmware gives the operator complete control

over plot parameters. Training time is all but eliminated.

Your CalComp Model 945 or Model 965 plotter starts delivering high-speed plots the day it is installed, without changing a line of industry-standard software. Industry-standard because it was developed by CalComp—world leader in computer graphics and CAD/CAM.

So write or phone today for your illustrated copy of "The Plotter and the

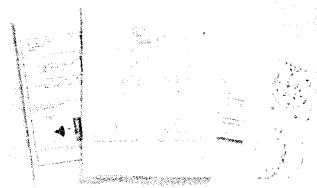

Plodder." Compare the performance specifications. Then make your own move into the fast track of plotter technology—with CalComp. California

Computer Products, Inc., 2411 West La Palma Avenue, Anaheim, CA 92801.  
714-821-2011 TWX: 910-951-1154

**CALCOMP**

A Sanders Graphics Company



**SANDERS**

CIRCLE 86 ON READER CARD

## Properly installed and documented, your building wiring may suffice to support a series of PBXs in the next 20 years.

brand Y computers. Some of the newer PBXs recognize that one may wish to send text from a Lanier to a Wang, DEC, or IBM system. When these vendors designed their PBXs, they provided for protocol converters as an architectural option. Special order cards integrated into the switch allow the PBX to automatically invoke the proper translator since it knows when translation is required. These PBXs rate a yes in our matrix.

Similarly, the *X.25 Interface* and the *T-1 Interface* are important switch features for the future. If a vendor's switch handles these interfaces normally and naturally, it rates a yes in the appropriate column.

*Direct Inward Dialing*, *Route Optimization*, and *Call Queuing* are standard telephone features common to most third generation PBXs. These columns are included here because a purchaser's feasibility study team should investigate them in detail and explore how these features are affected (or bypassed) by the digital traffic through the switch.

*Call Detail Recording* also requires careful study. When a vendor says this feature is available, it means he at least logs each outgoing long distance call so you can reconcile your monthly telco bill when you receive it. Some vendors, however, go further and also log all of the internal calls, be they voice or data, so communications traffic analyses and in-plant billing for communications services are possible. In talks with your vendor, be sure to determine whether he offers the standard or the deluxe logging package.

*Administrative RJE to Host*: if you buy a switch with a good logging package, you'll also want to move the call detail records to your billing computer so you can reconcile your monthly telephone bill and your records of who called whom and when. Some switches only print hardcopy records of the call logs, others provide a magnetic tape that you can physically transport, and still others have a communications link that looks like an RJE to your host. Since the switches normally have low quality printers for maintenance purposes, and since your business computer system probably already has software to publish your internal telephone directory, you may also wish to inquire whether other files such as the directory and the maintenance log can also be transmitted from your PBX to your host computer using the RJE link.

*Wiring Trace Software*: one of the problems with connecting your new PBX to the telephone wiring that exists in your building today lies with the poor quality of the typical set of wiring records. Your local telco had a work order and maybe even a spec when your building was wired initially. But "as built" records are rare. If you have been in your facility very long, you've seen a steady stream of telco installers who moved

### NONBLOCKING ARCHITECTURE

The architecture of the vendor PBX offerings was a column in the comparison matrix until we found how many interpretations (some self-serving) could be attached to a relatively simple concept. To most users a good working definition of nonblocking would be, can all the connected devices be active simultaneously? E.g., if I have 1,000 telephones and 500 terminals, can all 1,500 devices be active at once? If so, the switch is nonblocking.

The vendors that do not allow 100% activity will support some reduced level, say 20%. Above that level the next person requesting service gets a busy signal. Some vendors will allow you to spend more money and choose some arbitrary service level with a typical range of 15% to 50%. The discussion, however, rapidly degenerates to the individual line activity patterns (measured in hundred-call-seconds, or CCS) and how a statistical mix of these can be supported until the limiting component (time slots through the switch, PBX computer MIPS to process the traffic, or memory to hold the tables and working storage) inhibits further throughput.

If a vendor has a blocking switch (as ABI, Rolm, and Northern do), there are a variety of scheduling strategies available to allocate the limiting resource based on call type (voice or data), standing priority, or contention. Although much sophistication is contained in these scheduling algorithms, the problem is a familiar one to computer people—the available resource may be insufficient to handle the peak demand. Computer people engage in performance analysis and tuning; telephone people call it traffic engineering, but the principles are the same. Further, the expense is the same—

substantial and ongoing—if your facility is growing or there are a lot of moves and changes.

As in computing, you can have enough total capacity but find local bottlenecks that limit your throughput (traffic). One of the popular PBXs has intercache cabling that proves to be limiting. The architecture is so confusing that many of the company's salesmen are offering something the product can't deliver. A discussion with a design engineer revealed that the sample rates on the gates that put pulses on the intercache cables are the limiting component. You could engineer this PBX for worst-case traffic and experience no problems until one marketing group was relocated so it was served by the same physical switch hardware as purchasing. Then you'd find your telephone service mysteriously degraded.

A nonblocking architecture will allow all devices to be active simultaneously. Capacity is unaffected by the physical connection pattern, and you can do moves and changes without traffic engineering as long as the total load does not exceed the capacity of the installed system—an attractive feature for stable long-term operation.

Nonblocking architectures are design features of the generation of PBXs just emerging from the design laboratories (with the noteworthy exception of ABI). Think about your needs, your growth, and your future options. Then exercise your salesman vigorously. If necessary, visit the factory and insist on talking to someone who knows the design. All systems are not equal and some companies are anxious to unload their old iron on you.

—Robert L. Patrick

phones, added cables, and kept informal records. After several years of these procedures, accurate wiring records no longer exist. Some of the PBX vendors have recognized that you would like to rewire your building only one more time. Thus they provide a database program for the perpetual maintenance of the cabling and station wiring within your building. Properly installed and documented, your building wiring may suffice to support a series of PBXs in the next 20 years. The accurate maintenance of that wiring database should be a major concern to your feasibility study team.

*Office Automation, Security, and Energy* are three advanced applications some vendors claim to support. While the definitions of these terms are imprecise, a PBX vendor who claims to have designed his product with these services in mind is clearly one to

interview if you have these requirements.

Just as this survey was being prepared, several vendors announced advanced features related to local area networks (LANs) and videoconferencing. We made an attempt to prepare satisfactory working definitions for these advanced communications features, but didn't have much success. Thus the reader's feasibility study team is left to determine its own requirements and then explore the vendors' offerings in these advanced areas.

The matrix we have provided is designed to help your PBX study team get off the ground. It is not intended to substitute for more in-depth discussions with potential suppliers. On p.162 we have listed the names and addresses of all the major PBX vendors (including those that don't currently offer data switching), so your team can establish contact and get first-hand information.

# MicroFCS: The Final Link in Distributed Decision Support Systems.

**Every decision counts.**  
At every level of management.

And now there's a way to bring the power of the computer into every management decision made in your company . . . to allow every decision to be based on current information, to be shared, to be consolidated with other decision results, to be easily analyzed and used.

It's called Distributed Decision Support. And it works only with FCS-EPS, the first major DSS available for virtually any microcomputer, mini-computer or mainframe.

For all computers, FCS-EPS incorporates standard financial functions. "Black boxing" automates the most complex custom applications. Powerful report writers and color graphics produce exactly the output you need. A relational database, a natural progression from simple row/column "calc" processing to multidimensional consolidation. Statistical analysis, risk analysis and much more. That's FCS-EPS.

Distributed Decision Support through FCS-EPS means a multiplied return on your investment in existing EDP resources and in existing management talent. And standardized budgeting,

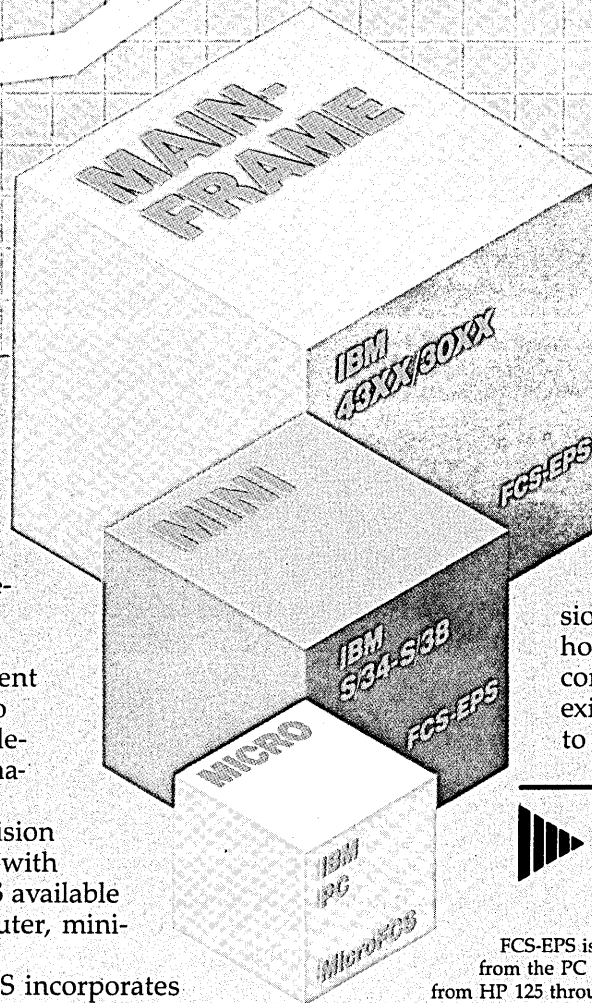

forecasting, expenditure management, and dozens of other key processes within the organization.

**Your Distributed Decision Support** begins with one decision. Call EPS today. Find out how the power of the micro-computer can work within your existing planning environment to improve profitability this year.



**EPS**

One Industrial Drive  
Windham, NH 03087  
603-898-1800

FCS-EPS is available today on all IBM computers from the PC through 43xx and 30xx; Hewlett Packard from HP 125 through HP 3000, plus Wang, Honeywell, Univac, DEC, Prime, Data General, SEL, Burroughs, ONYX and CPM or UNIX-based microcomputers.

- Tell me more about Distributed Decision Support
  - Tell me about Micro FCS
  - Tell me about an EPS DSS Seminar in my area.
- Name/Title \_\_\_\_\_  
Company \_\_\_\_\_  
Address \_\_\_\_\_  
City/State/Zip \_\_\_\_\_  
Telephone Number \_\_\_\_\_

## PBX VENDORS

### American Bell Inc.

100 Southgate Parkway  
P.O. Box 1955  
Morristown, NJ 07960  
(201) 898-8000

**FOR DATA CIRCLE 400 ON READER CARD**

### American Telecom

3190 Mira Loma Avenue  
Anaheim, CA 92806  
(714) 630-7721

**FOR DATA CIRCLE 401 ON READER CARD**

### Anaconda Ericsson Information Systems

7465 Lampson Avenue  
Garden Grove, CA 92641  
(714) 635-0150

**FOR DATA CIRCLE 402 ON READER CARD**

### Anderson Jacobson Inc.

Anaheim Business Center  
Building 2  
125 West Cerritos Avenue  
Anaheim, CA 92805  
(714) 999-1212

**FOR DATA CIRCLE 403 ON READER CARD**

### Executone

Two Jerico Plaza  
Jerico, NY 11753  
(800) 645-7246

**FOR DATA CIRCLE 404 ON READER CARD**

### GTE Automatic Electric

400 North Wolf Road  
Northlake, IL 60164  
(312) 681-7100

**FOR DATA CIRCLE 405 ON READER CARD**

### Harris Corp.

1 Commerce Blvd.  
P.O. Box 1188  
Novato, CA 94947  
(415) 472-2500

**FOR DATA CIRCLE 406 ON READER CARD**

### Information Dynamics Corp.

1711 Dallas North Parkway  
Plano, TX 75074  
(214) 423-1555

**FOR DATA CIRCLE 407 ON READER CARD**

### Intecom Inc.

601 Intecom Drive  
Allen, TX 75002  
(214) 727-9141

**FOR DATA CIRCLE 408 ON READER CARD**

### IPC Technologies Ltd.

Winthrop Road  
Chester, CT 06412  
(203) 526-9581

**FOR DATA CIRCLE 409 ON READER CARD**

### ITT Business Communications Corp.

300 East Park Drive  
Harrisburg, PA 17111  
(717) 564-4343

**FOR DATA CIRCLE 410 ON READER CARD**

### Melco Labs Inc.

14408 NE 20th Street  
Bellevue, WA 98007  
(206) 643-3400

**FOR DATA CIRCLE 411 ON READER CARD**

### Mitel Corp.

350 Legget Dr.  
P.O. Box 13089  
Kanata, Ont. K2K 1X3  
(613) 592-2550

**FOR DATA CIRCLE 412 ON READER CARD**

### NEC Telephones Inc.

532 Broad Hollow Road  
Melville, NY 11747  
(516) 752-9700

**FOR DATA CIRCLE 413 ON READER CARD**

### Northern Telecom Network Systems Group

1201 East Arapaho Road  
Richardson, TX 75081  
(214) 234-5300

**FOR DATA CIRCLE 414 ON READER CARD**

### OKI Electronics of America Inc.

4031 NE 12th Terrace  
Fort Lauderdale, FL 33334  
(800) 327-1285

**FOR DATA CIRCLE 415 ON READER CARD**

### Plessey Canada Limited

235 Yorkland Blvd.  
Suite 109  
Willowdale, Ont M2J 4W9  
(416) 499-5545

**FOR DATA CIRCLE 416 ON READER CARD**

### Prolink Corp.

5757 Central Avenue  
Boulder, CO 80301  
(303) 447-2800

**FOR DATA CIRCLE 417 ON READER CARD**

### Rolm Corp.

**Telecommunications Div.**  
4900 Old Ironsides Drive  
Santa Clara, CA 95050  
(408) 988-2900

**FOR DATA CIRCLE 418 ON READER CARD**

### Siemens Corp.

#### Telecommunications Eng.

58th Street  
Boca Raton, FL 33431  
(305) 994-8100

**FOR DATA CIRCLE 419 ON READER CARD**

### Solid State Systems Inc.

1990 Delk Industrial Blvd.  
Marietta, GA 30067  
(404) 952-2414

**FOR DATA CIRCLE 420 ON READER CARD**

### Stromberg-Carlson Corp.

1000 North Ashley Drive  
Tampa, FL 33601  
(813) 273-5200

**FOR DATA CIRCLE 421 ON READER CARD**

### Tele/Resources

Northway 10, Executive Park  
Ballston Lake, NY 12019  
(518) 877-8571

**FOR DATA CIRCLE 422 ON READER CARD**

### Telesciences Inc.

#### The Electronic Office

One Brick Road  
Marlton, NJ 08053  
(609) 596-9300

**FOR DATA CIRCLE 423 ON READER CARD**

### Telicom Inc.

11411 Addison Street  
Franklin Park, IL 60131  
(312) 455-8520

**FOR DATA CIRCLE 424 ON READER CARD**

### Teltone Corp.

91 Telson Road  
Markham, Ont L3R 1E4  
(416) 495-0837

**FOR DATA CIRCLE 425 ON READER CARD**

### TIE/Communications Inc.

5 Research Drive  
Shelton, CT 06484  
(203) 929-7373

**FOR DATA CIRCLE 426 ON READER CARD**

### United Technologies Lexar

31829 West La Tienda Drive  
Westlake Village, CA 91362  
(213) 706-1000

**FOR DATA CIRCLE 427 ON READER CARD**

### ZTEL Inc.

Andover Industrial Center  
York Street  
Andover, MA 01810  
(617) 470-2900

**FOR DATA CIRCLE 428 ON READER CARD**

HANG ON  
TO YOUR HAT,  
CHARLIE...



# THE CORONA PC'S<sup>TM</sup> ARE HERE.

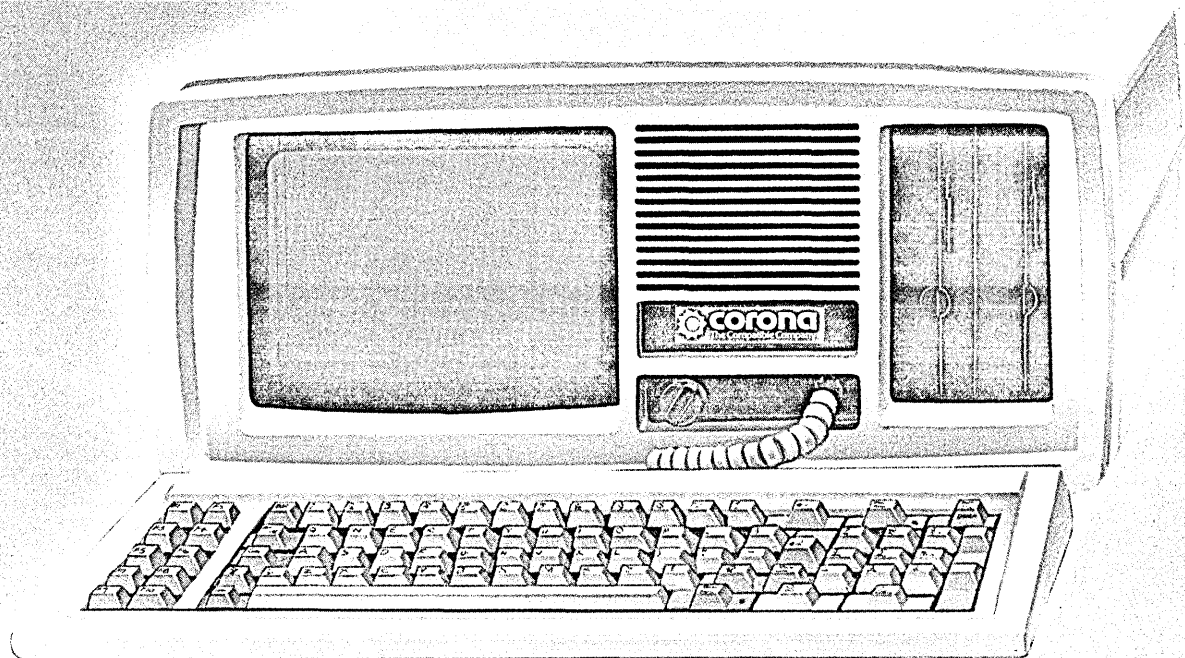

The Corona PC's, desktop and portable, give you everything you've ever wanted in an IBM-compatible PC and more. For a great deal less.

## **Compatible and more.**

The Corona PC is a 16-bit microcomputer based on the 8088 microprocessor, just like the IBM PC. And like the IBM PC, it runs any software that conforms to the IBM standard.

But unlike the IBM PC, the Corona PC comes with 128K of memory. Supports up to 512K on the main board. Includes a 320K floppy drive, a communication port, a printer port and an improved IBM PC keyboard.

Both the desktop and portable Corona PC's include high-resolution monitors and built-in graphics. Higher character definition makes both models easier to read, and our 640 x 325 pixel high-resolution graphics are over 60% better than the

IBM PC. It's a complete system, the standard for microcomputing in the IBM-compatible world.

## **You can take it with you.**

And unlike IBM, we have a portable version.

Its high-resolution, high-contrast 9" display is easy to read. It has all the power and features of our desktop, but lets you take it to the office next door, across the country or just conveniently tuck it onto a corner of your desk.

## **More expandability.**

You may never add a thing to your Corona PC because we've built in so much capability.

But just in case, we've built all the important components into the main system board, leaving the four expansion slots free. And provided an extra large power supply to support any capabilities you may want to add in the future.

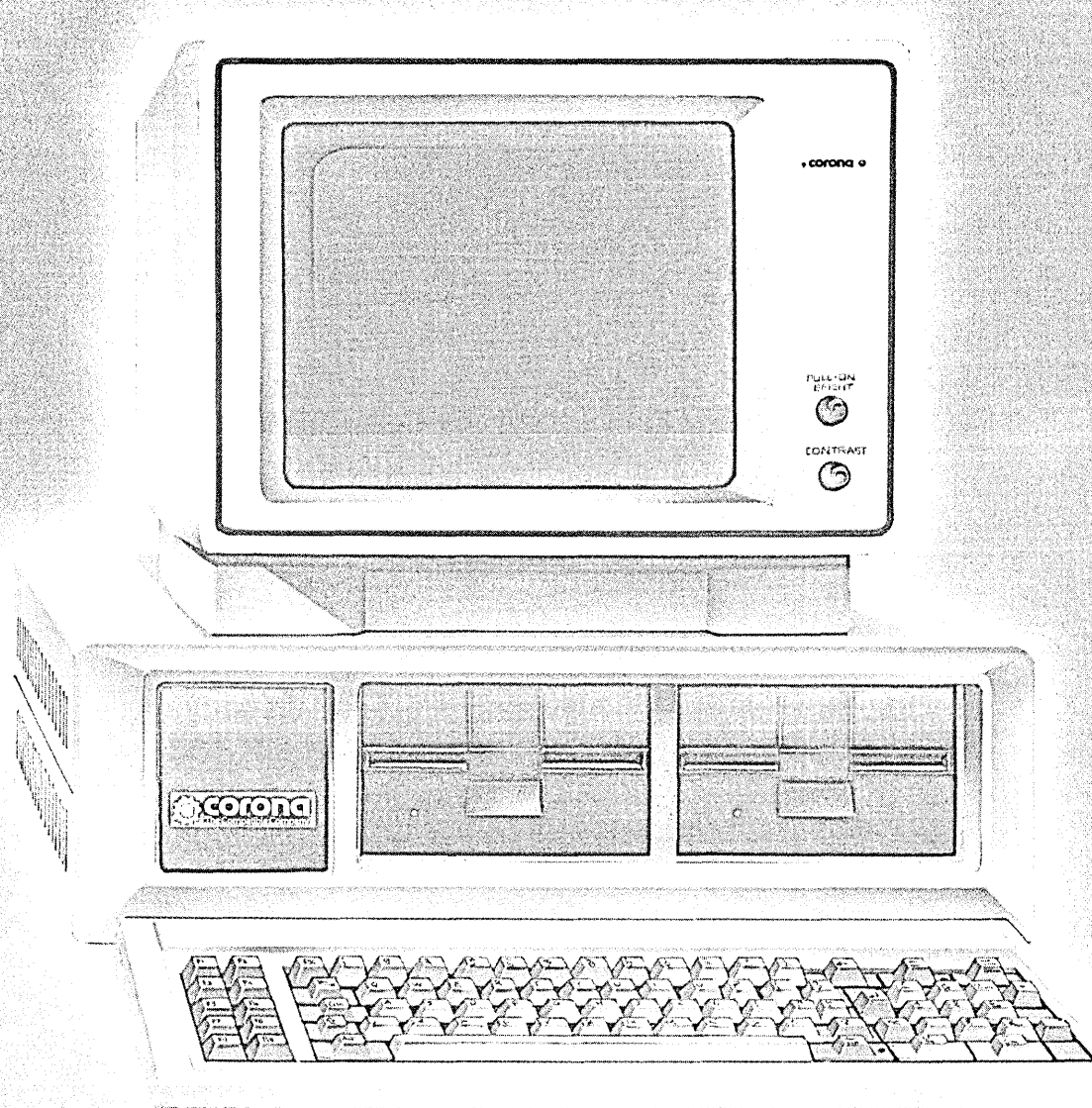

### **RAM-disk for incredible speed.**

Our RAM-disk software lets you treat an area of your computer's memory as if it were a disk drive. So you can copy your programs and data into memory, then watch your work get done faster.

### **More software.**

The Corona PC includes the MS-DOS operating system and comes with GW-BASIC, the MultiMate<sup>1</sup> word processor and the PC Tutor<sup>2</sup> training course. So you can start being productive immediately.

And you can run Context MBA<sup>3</sup>, dBASE II<sup>4</sup>, LogiCalc<sup>5</sup> and LogiQuest<sup>5</sup>, the EasyFamily<sup>6</sup>, Wordstar<sup>7</sup> and the "Star" family, the SuperWare<sup>8</sup> series, T.I.M.<sup>9</sup>, the VisiSeries<sup>10</sup> and Perfect Series<sup>11</sup> of programs and most other popular software.

### **And it improves your bottom line.**

The Corona Portable PC™ is \$2,545, the desktop

version is \$2,595. Both about a thousand dollars less than the equivalent IBM PC.

For more information, contact Corona Data Systems, 31324 Via Colinas, Westlake Village, CA 91361. (213) 991-1144. Call (800) 621-6746 toll-free.

Or better yet, just grab your hat and head to the nearest Corona PC dealer for a very convincing demonstration.

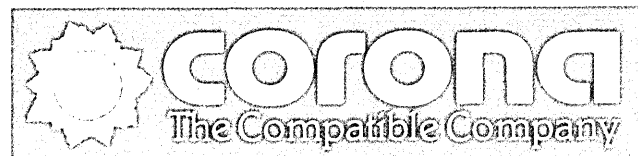

© Corona Data Systems 1983 1: TM Softword Systems. 2: TM Comprehensive Software Support. 3: TM Context Management Systems. 4: TM Ashton-Tate. 5: TM Software Products International. 6: TM Information Unlimited Software. 7: TM Micropro. 8: TM Sorcim Corp. 9: TM Innovative Software. 10: TM Visicorp. 11: TM Perfect Software Inc.

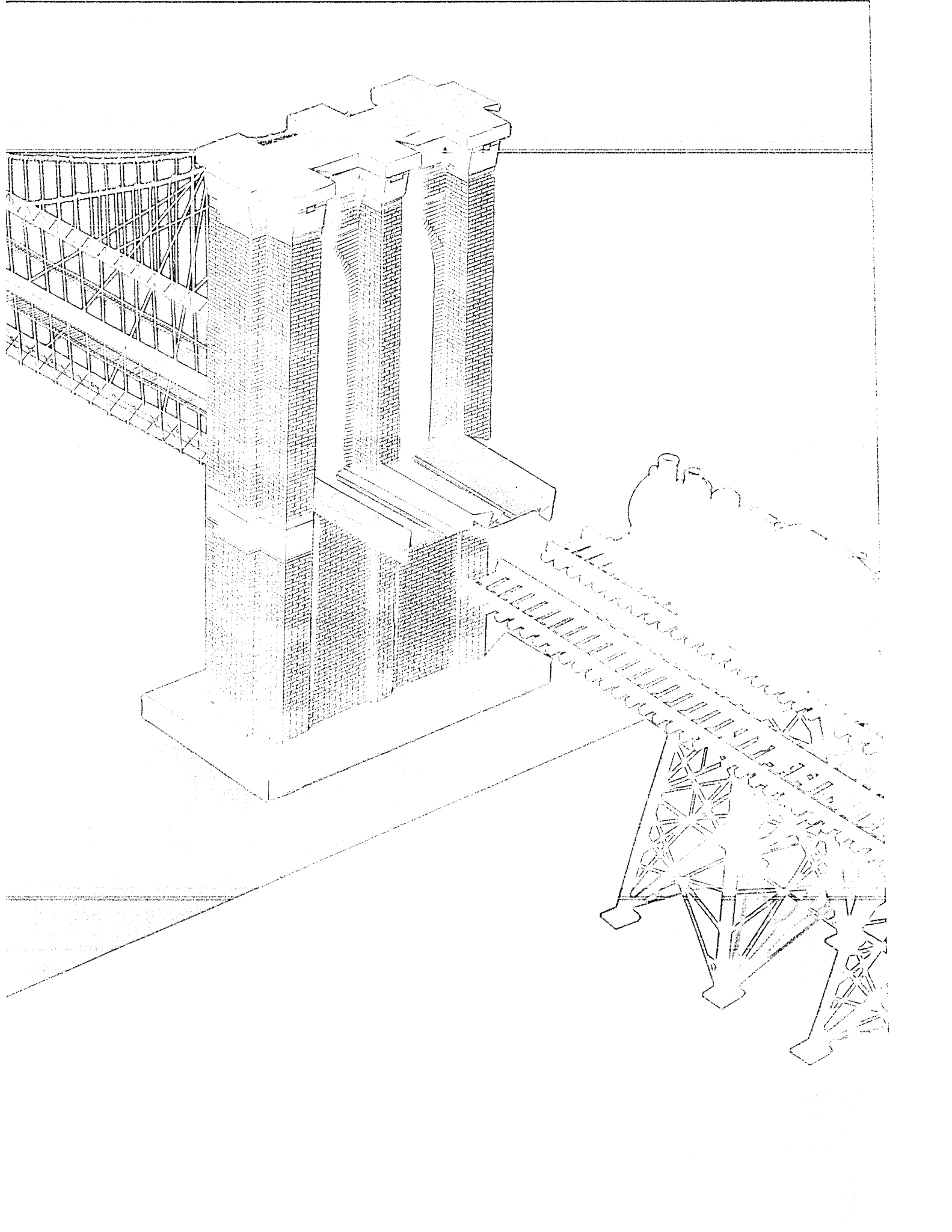



How bridges and gateways make it possible to switch data among dissimilar networks.

# BEYOND LOCAL NETWORKS

by William Stallings

The story of local networks is by now a familiar one to data processing managers. The proliferation of small computers throughout large organizations has created the need for some means of connecting them and enabling them to share data and access to costly peripherals. The local network alone, however, hardly solves all of a manager's interconnection problems.

Like it or not, more than one local network will probably be required to service the wide-ranging mix of computers found in typical corporations. Word processors in one department, personal computers in another, and mainframes in the back room all need their own kinds of local networks, whether they are sold under that name or not. From simple twisted-pair cabling to hyperfast coax, local networks of many sorts are finding their way into offices and labs, necessitating a new level of communications expertise: internetworking protocols.

This networking of networks takes place within single buildings and across continents as corporations strive to provide company-wide access to electronic files, services, and resources. Electronic mail systems, for instance, gain value geometrically as new users are brought on-line, a procedure that often requires differing local networks to be linked efficiently and transparently.

These various interactions are depicted in Fig. 1. There are a number of local networks, some of which may be in the same building, some not. Local networks may be linked point-to-point (e.g., with a private or leased line) or through a packet-switched network. Devices on the local networks, plus those on the long-haul net, may communicate. The figure shows two types of devices for linking networks, the bridge and the gateway. A bridge is a relatively simple device for linking two local networks that use the same protocols. The gateway is more complex and intended for heterogeneous cases.

To understand the action of the bridge, first consider how communication takes place among stations attached to a single local network. Fig. 2 is an example using a bus-topology local network; the principle is similar for the ring and tree topologies.

Data on a local network are transmitted in packets. So, for example, if station X wishes to transmit a message to station Y, X breaks its message up into small pieces that are sent, one at a time, in packets. Each packet contains a portion of X's message plus control information, including Y's network address. Based on some medium-access protocol (e.g., CSMA/CD or token passing), X inserts each packet onto the bus. The packet propagates the length of the bus in both directions, reaching all other stations. When Y recognizes its address on a packet, it copies the packet and processes it.

Now, suppose two local networks using the same protocols are to be linked. This is accomplished in Fig. 3 using a bridge that is attached to both local networks (frequently, the bridge function is performed by two "half-bridges," one on each network). The functions of the bridge are few and simple: it reads all packets transmitted on network A, and accepts only those addressed to stations on B; it buffers each accepted packet for retransmission on B, using the medium access protocol; and it does the same for B-to-A traffic.

The bridge makes no modifications to the content or format of the packets it handles, nor does it encapsulate them with an additional header. If any modifications or additions were made, we would be dealing with a more complex device—a gateway. This is discussed later. Essentially, the bridge provides a transparent extension to the local network. It appears to all stations on the two local networks that there is a single network, a composite of the two separate nets. All stations may be addressed in the same fashion.

For similar but geographically separate local networks, the desirability of a bridge is clear. It provides a simple and efficient means of interconnecting devices in a number of locations. But the bridge is useful even when all devices are local to each other, for the following reasons:

**Reliability.** The danger in connecting all data processing devices in an organization to one network is that a fault on the network may disable communications for all devices. By using bridges, the network can be partitioned into self-contained units.

**Performance.** In general, perfor-

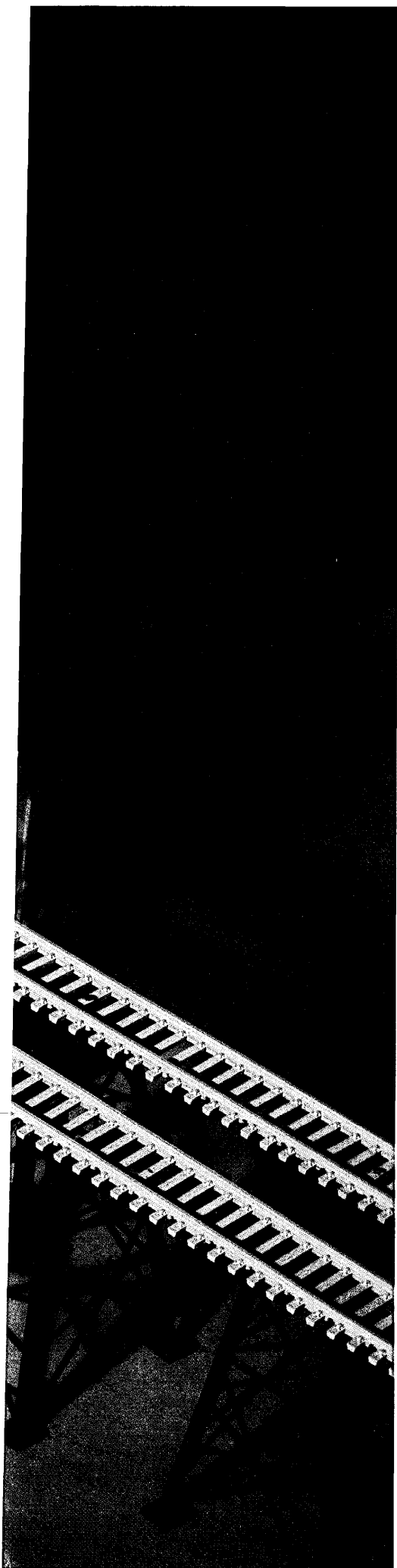

## For similar but geographically separate local networks, the desirability of a bridge is clear.

mance on a local network declines with an increase in the number of stations or the length of the wire. A number of smaller networks will often give improved performance if devices can be clustered so that intranetwork traffic significantly exceeds inter-network traffic.

**Security.** A bridge architecture can enhance network security. For example, sensitive data (accounting, personnel, strategic planning) could be isolated on a single local network. The bridge can prevent those data being sent out to other networks.

**Convenience.** It may simply be more convenient to have multiple networks. For example, if a local network is to be installed in two buildings separated by a highway, it may be far easier to use a microwave bridge link than to attempt to string coaxial cable between the two buildings.

### GATEWAYS MORE COMPLEX

When connecting different types of local networks, a gateway is required. As with bridges, paired half-gateways are commonly used, each being attached to its respective local network. A gateway is generally a more complex device than a bridge, for it must accommodate differences between local and long-haul networks. These differences include the following:

- Addressing schemes. The networks may use different end-point names, addresses, and directory maintenance schemes.
- Maximum packet sizes. Packets from one network may have to be broken into smaller pieces to move on another network. This process is referred to as fragmentation.
- Interfaces. The interface to a local network is usually defined through various protocols, including one governing access to the network wire itself. Long-haul networks generally use different protocols (X.25, etc.) than local nets.
- Time-outs. Generally a connection-oriented transport service (e.g., a file transfer, as opposed to electronic mail) will await in acknowledgement until a time-out expires, at which time it will retransmit its segment of data. Generally, longer times are required for successful delivery across multiple networks. Internetwork timing procedures must facilitate successful transmission that avoids unnecessary retransmissions.
- Error recovery. Internetwork services should not depend on or be interfered with by the nature of the individual network's error recovery capability.
- Status reporting. Networks can report status and performance differently, yet it must be possible for the gateway to provide such information on internetworking activity.
- Routing techniques. Intranetwork routing may depend on fault detection and congestion

FIG. 1

### INTERCONNECTED NETWORKS

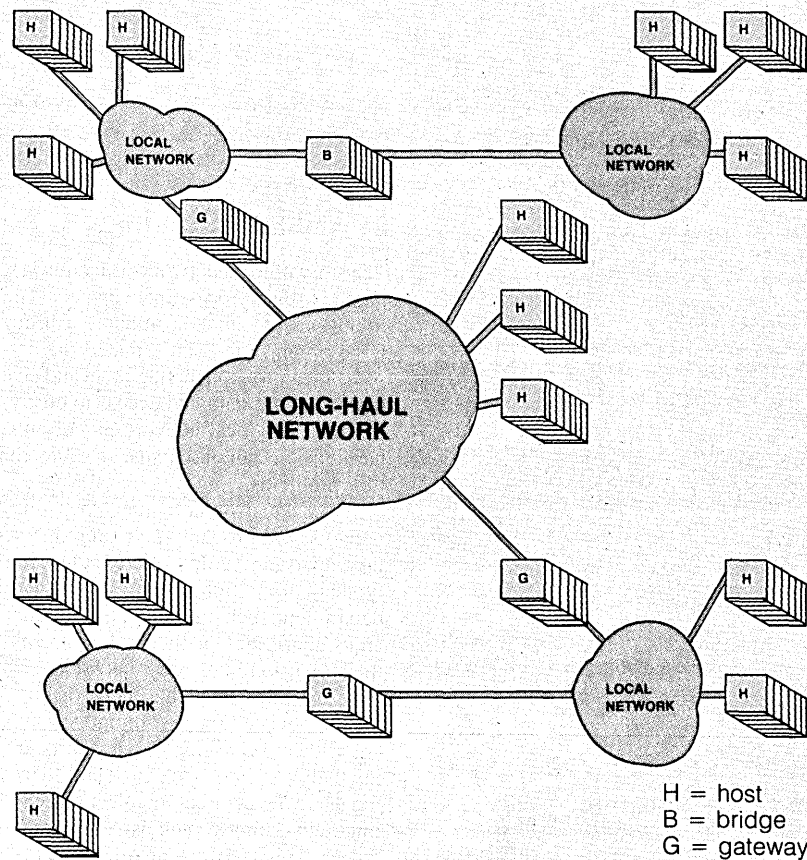

FIG. 2

### INTRANETWORK COMMUNICATIONS

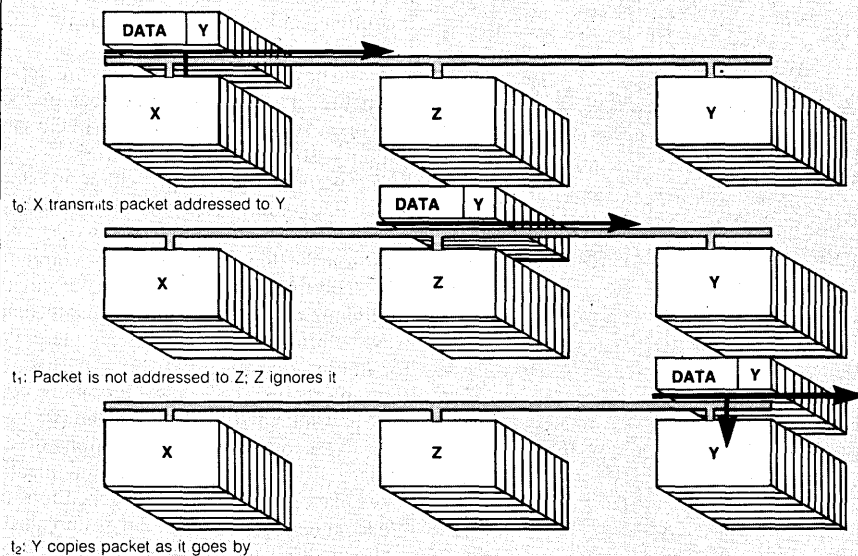

FIG. 3

## INTERNETWORK COMMUNICATIONS

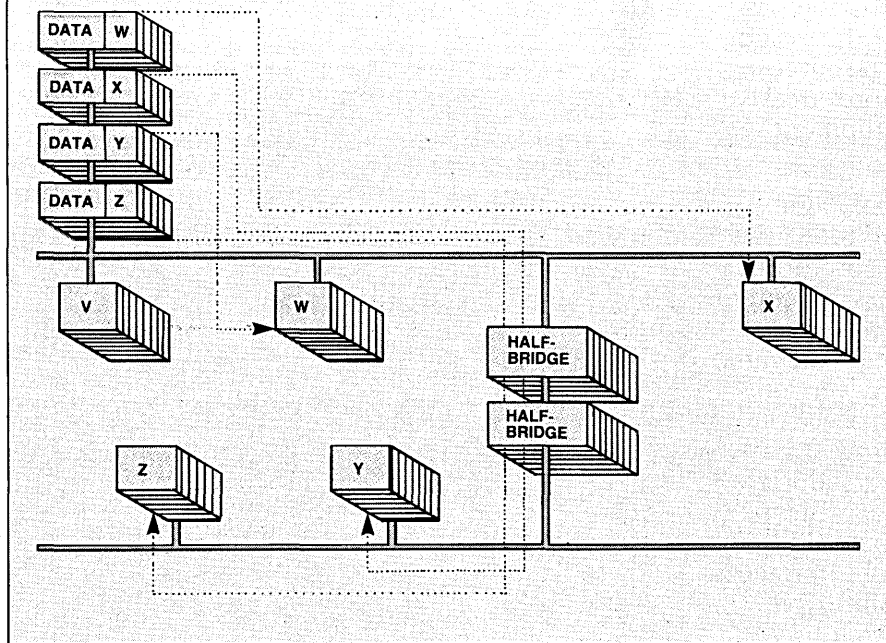

FIG. 4

## THE ROLE OF IP IN A COMMUNICATIONS ARCHITECTURE

<b>7 APPLICATION</b>	Application services
<b>6 PRESENTATION</b>	Formatting and data presentation
<b>5 SESSION</b>	Connection control
<b>4 TRANSPORT</b>	End-to-end transmission service
<b>IP</b>	Internetwork routing and delivery
<b>3 NETWORK</b>	Internetwork routing and delivery
<b>2 DATALINK</b>	Reliable point-to-point transmission
<b>1 PHYSICAL</b>	Physical and electrical connection

control techniques peculiar to each network. The internetworking facility must be able to coordinate these to route data adaptively between stations on different networks.

- Access Controls. Each network will have its own user access control technique. These must be invoked by the internetwork facility as needed. Further, a separate internetwork access control technique may be required.
- Connection, connectionless. Individual networks may provide connection-oriented (e.g., virtual circuit) or connectionless (datagram) service. The internetwork service should not depend on the nature of the connection service for the individual networks.

A number of approaches have been tried for accommodating these differences among networks. At one extreme, a special-purpose gateway, known as a protocol converter, can be built for each particular pair of networks. Typically, a protocol converter ac-

cepts a packet from one network, strips off the control information to recover the data, and then retransmits the data using the protocols of the other network. The disadvantage of this approach, of course, is that a different gateway must be built for each pair of networks.

At the other extreme is the X.75 protocol, which is an extension of the X.25 packet-switch network interface standard that makes it possible to set up a virtual circuit between two stations on the same network. In effect, X.75 provides a logical connection between disjoint stations by stringing together virtual circuits across several networks. The drawback of this approach is that all of the networks must use X.25, a standard not used by most local networks. Furthermore, public-access networks, such as Telenet and Tymnet, do not accommodate X.75 links to private networks.

A more promising approach is the internet protocol (IP), initially developed for Arpanet. Versions of IP have been standardized by both the Department of Defense and National Bureau of Standards. The philosophy of IP is that the gateways and stations share a common protocol for internet traffic, but that the stations and networks are otherwise undisturbed. In terms of the usual open system interconnection (OSI) model for communications architecture, IP fits between the network (routing) and transport (end-to-end delivery) layers (Fig. 4).

IP provides what is known as a datagram service; that is, it will handle each packet of data independently. Multiple packets may arrive out of sequence. If a connection-oriented service is required, communicating hosts must share a common higher-layer protocol. Fig. 5 depicts the operation of IP for data exchange between host A on a local network and host B on a local network through an X.25 long-haul packet-switched network, and shows the format of the data packet at each stage. Each host must have the IP layer, plus some higher layers, in order to communicate. Intermediate gateways need only protocol software up to the IP level.

The data to be sent by A are encapsulated in a datagram with an IP header specifying a global network address (host B). This datagram is then encapsulated with the local network protocol and sent to a gateway that strips off the local network header. The datagram is then encapsulated with the X.25 protocol and transmitted across the network to a gateway. The gateway strips off the X.25 fields and recovers the datagram, which is then wrapped in a local network header and sent to B.

IP makes no assumptions about the underlying network protocol. Each host or gateway that uses IP interfaces with its network in the same fashion as for intranetwork communication.

### OPERATION OF AN IP CATANET

A collection of interconnected networks using IP is often referred to as a catanet. Consider two hosts, A and B, on different networks in the catanet. Host A is sending a datagram to host B. The process starts in host A. The IP module in host A constructs a datagram with a global network address and recognizes that the destination is on another network. So the first step is to send the datagram to a gateway (example: host A to gateway 1 in Fig. 5). To do this, the IP module appends to the IP datagram a header appropriate to the network that contains the address of the gateway. For example, for an X.25 network, a layer 3 packet is formed by the IP module to be sent to the gateway.

Next, the packet travels through the

R&D had certain requirements that had to be met; manufacturing, accounting and marketing had others. Then microcomputers started showing up on desktops, with modems and printers here and there. Now you face the task of making it all work together. Sharing resources. Sharing information. And making more effective use of the information processing equipment you've already invested in.

**NET/ONE LEAVES YOU IN CONTROL OF EQUIPMENT DECISIONS.**

Net/One® is a general purpose communications system that turns equipment from different vendors into a fully functional, fast, powerful, information processing network. Because it can connect equipment from virtually any vendor, you remain free to choose equipment based on capability, rather than compatibility.

Off the shelf, Net/One supports industry-standard equipment interfaces—Async, Bisync, SDLC, through RS-232, V.35, RS-449 and IEEE-488 — as well as many high speed parallel interfaces. The list is expanding every month. But if you have special equipment that isn't in that list, Net/One is the only local area network that's fully programmable at every level so special interface protocols can be added now, or when you need them, later.

**BROADBAND, BASEBAND, OR ANY COMBINATION THEREOF. YOU CALL THE SHOTS ON MEDIA, TOO.**

Net/One is the only local communications system that gives you the option of broadband or baseband or a combination of both, with architecture that will allow you to add other media such as fiber optics in the near future.

**YOU DON'T HAVE TO KNOW EXACTLY WHERE YOU'RE GOING TO BUY A NETWORK THAT WILL GET YOU THERE.**

Everything about Net/One has been designed to respond to your needs, as they evolve, and to remain fully adaptable to evolving communications technology. System architecture is completely modular, so it can grow at the

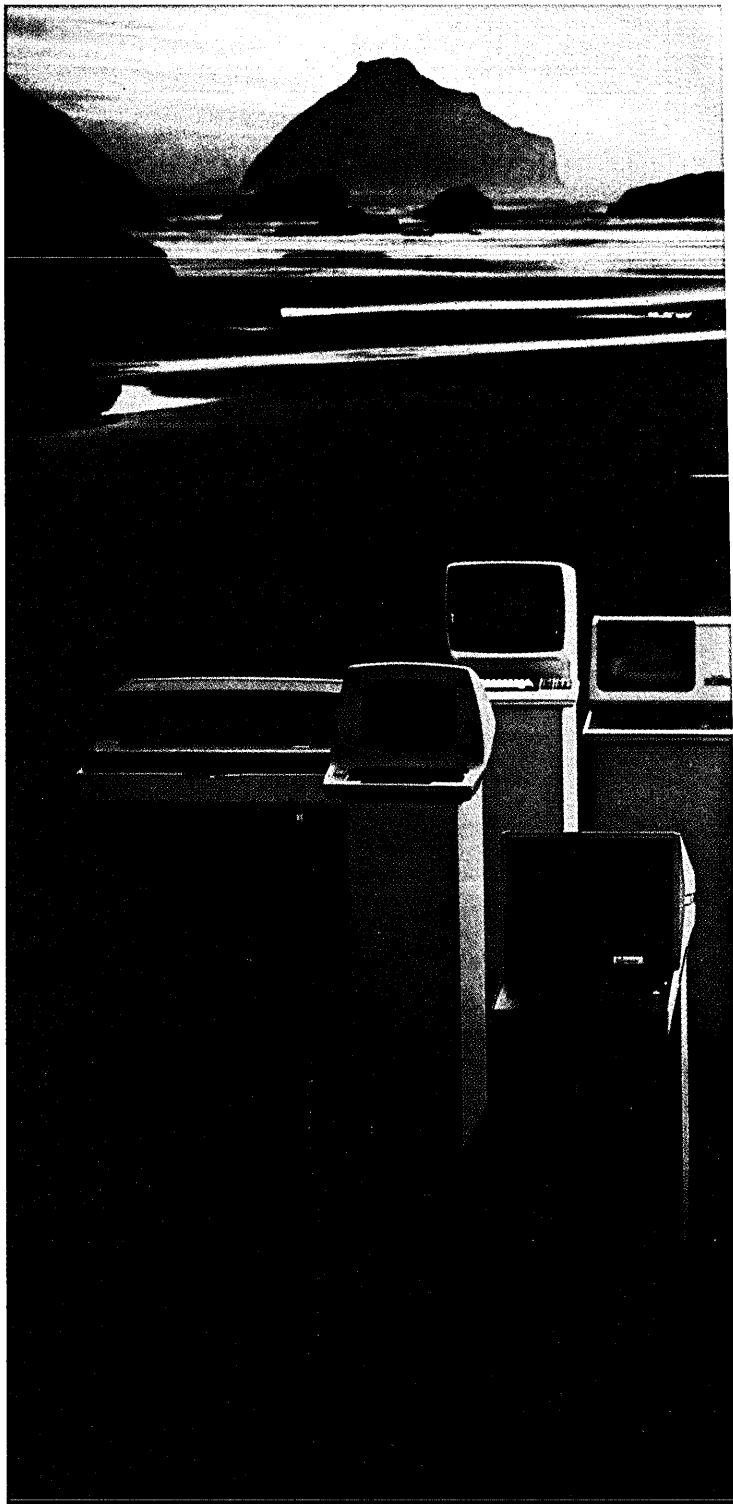

# Net/One turns the e now into the netwo



same time and in the same direction you do. Regardless of the direction that turns out to be.

When separate divisions within a company or a campus need to share resources, one Net/One system can be bridged to others, and to remote networks. These bridges can interconnect baseband, broadband, or Net/One systems that include both. And like vendor independence and media independence, this bridging capability is available now from Ungermann-Bass.

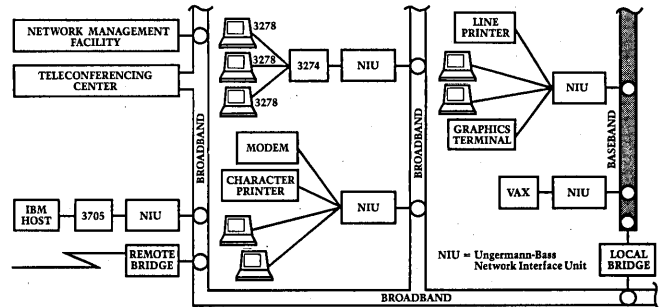

**NOW, THE IMPORTANT DIFFERENCE BETWEEN TALKING A GREAT NETWORK AND DELIVERING ONE.**

We've been installing Net/One since July of 1980. Hundreds of our systems are already out there moving information for people like Control Data, Caltech, Fairchild, ITT, RCA, Boston University, U.S. Forest Service, and Ford Aerospace.

So we can do more than talk about what you need in a local area network. We can actually deliver one, now. And we can refer you to a long list of customers who are actually using one (or two or three) now.

Let's talk about how to turn the equipment you have, now — whatever it is — into the network you want, now. And the network that can take you wherever you want to go from here. Net/One.

Ungermann-Bass, Inc., 2560 Mission College Boulevard, Santa Clara, California 95050. Telephone (408) 496-0111.

Net/One from Ungermann-Bass 

# equipment you have work you want. Now.

FIG. 5  
DATA ENCAPSULATION WITH IP

network to the gateway. The gateway unwraps the packet to recover the original datagram. The gateway analyzes the IP header to determine whether this datagram contains control information intended for the gateway, or data intended for a host farther on. In the latter instance, the gateway must make a routing decision. There are four possibilities:

1. The destination host is directly connected to one of the networks to which the gateway is attached.

2. The destination host is on a network that has a gateway that directly connects to this gateway. This is known as a "neighbor gateway."

3. To reach the destination host, more than one additional gateway must be traversed. This is known as a "multiple-hop" situation.

4. The gateway does not know the destination address.

In case 4, the gateway returns an error message to the source of the datagram. In the first three cases, the gateway must select the appropriate route for the data, which it then inserts into the appropriate network with the appropriate address. For case 1, the address is the destination host address. For cases 2 and 3, the address is a gateway address.

Before actually sending data, however, the gateway may need to fragment the datagram to accommodate a smaller packet size. Each fragment becomes an independent IP datagram. Each new datagram is wrapped in a lower-layer packet and queued for transmission. The gateway may also limit the length of its queue for each network it attaches to so as to avoid having a slow network penalize a faster one. Once the queue limit is reached, additional datagrams are simply dropped.

The process described above continues through as many gateways as it takes for the datagram to reach its destination. As with a gateway, the destination host recovers the IP datagram from its network wrapping. If fragmentation has occurred, the IP module in the destination host buffers the incoming data until the entire original data field can be reassembled. This block of data is then passed to a higher layer which is responsible for the proper sequencing of a stream of datagrams and for end-to-end error and flow control.

The internet protocol is most easily understood by looking at its header format (Fig. 6). Data to be transmitted are inserted into a datagram with the IP header. The header is largely self-explanatory. Some clarifying remarks:

*Lifetime:* in the NBS version, this field indicates the maximum number of gateways a datagram may visit so as to prevent endlessly circulating datagrams. DoD specifies this field in units of seconds, for the same purpose, and also to permit reassembly to be aborted at time-out.

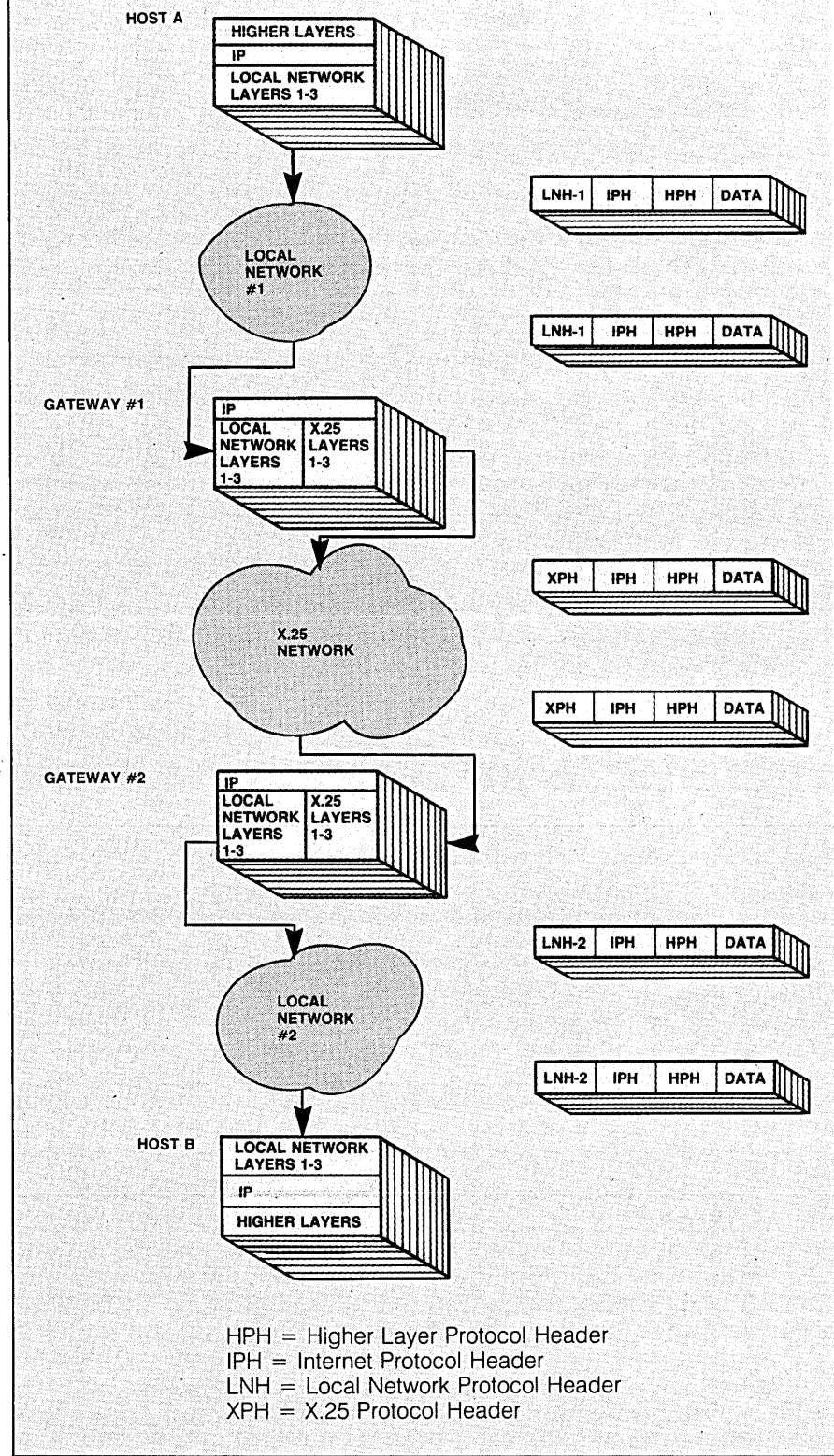

pose, and also to permit reassembly to be aborted at time-out.

*Checksum:* this is computed at each gateway for error detection.

*Address:* specifies a hierarchical address consisting of network identifier plus host identifier.

*Options:* the only option NBS has defined so far is a security field to indicate the security level of the datagram. In addition, DoD defines source routing, which allows the source host to dictate the routing; record route, used to trace the route a datagram takes; and internet time stamp.



With all the clamor about personal computers, a fundamental fact is often overlooked: some simply *work* better than others.

## Consider the COMPAQ Portable.

A computer will make you more productive. A computer will make you more efficient. You hear it everywhere. But you don't hear about which computer actually *works* best.

A computer isn't magic. It's a tool. And just like other tools, some computers work better than others.

The COMPAQ™ Portable is a combination of 20th-century electronics and 19th-century pragmatism. It simply does personal computing better. Here's why.

### Works in more places

You don't do all your thinking in one place. Why have a computer that stays in one place?

The COMPAQ Portable has all the capabilities of a large desktop computer. But now those capabilities can go where you go.

You can move it from office to office to share its resources. You can move it into the conference room to answer questions when and where they come up.

With the COMPAQ Portable, you can be as productive in your hotel room or your lake house as in your own office. It's a reliable companion on a business trip. It's a powerful sales aid in your customer's office.

What's more productive than a computer? A computer that works for you in more places.

### Works with the greatest number of programs

The most important consideration when you choose a computer is "what programs will it run?" And that's one more reason for choosing the COMPAQ Portable.

The COMPAQ Portable runs more programs

*The COMPAQ Portable was designed to fit under a standard airline seat so you can take it on business trips.*

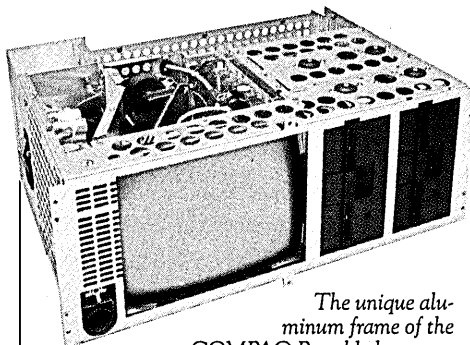

*The unique aluminum frame of the COMPAQ Portable has cross-members that strengthen it front-to-back, side-to-side, and top-to-bottom. It's a design practice commonly used in race cars.*

than any other portable. In fact, it runs more than most non-portables. That's because it runs all the popular programs written for the IBM® Personal Computer. There are hundreds of them. They are available in computer stores all over the country, and they run without any modification, right off the shelf.

Imagine the power of a *portable* word processor. There are dozens of different word processing programs available for the COMPAQ Portable.

Planning, problem-solving, and "what-ifs" are a cinch with a variety of popular electronic spreadsheet programs. The COMPAQ Portable runs them all.

There are accounting programs for anything from computerizing your family budget to full-scale professional management of payables, receivables, inventory, and payroll for your company.

There are programs for making charts and programs for communicating with other computers. Or if you want something really specialized, there are even program languages for writing your own programs.

So, you get portability and you don't give

up problem-solving power. The combination adds up to the most useful personal computer on the market today.

### Works better because it's easy to read

The display screen of the COMPAQ Portable measures nine inches diagonally. It shows a full "page width" of 80 characters on a line so tasks like word processing are easier. And those characters are big enough to read even if you're leaning back in your chair.

The display shows both high-resolution graphics and easy-to-read, upper- and lowercase characters. One screen

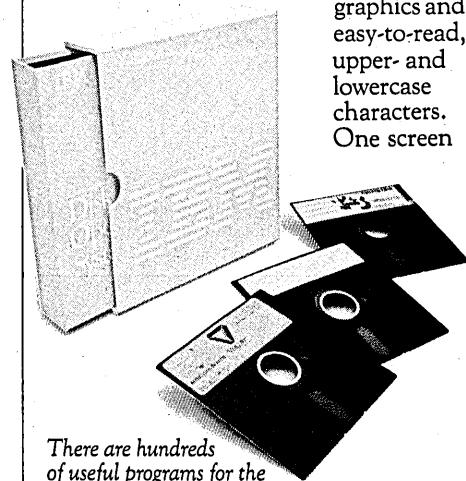

*There are hundreds of useful programs for the COMPAQ Portable because it runs all the popular programs written for the IBM.*

for all the information. With some personal computers, including the IBM, you can have either the graphics or the legible characters, but you can't have both unless you buy two different displays.

Incidentally, computer prices are often quoted without a display. The display of the COMPAQ Portable is built in, of course.

### Add-on options make it work the way you work

Inside the COMPAQ Portable are three open slots. Electronic devices called expansion boards fit those slots and give the COMPAQ Portable new powers.





Just like the programs, expansion boards designed for the IBM work with the COMPAQ Portable, so there are dozens available right now. With them, you can make your personal computer more personal.

Want to check a stock price? Or look up something in The New York Times Information Service? One expansion board enables the COMPAQ Portable to handle those communications over ordinary phone lines.

Want to use your company's central computer files while you're on a trip? There are boards that allow the COMPAQ Portable to communicate with a variety of large mainframe computers.

Other boards let you hook up controllers for computer games or increase memory capacity. Still others let you connect personal computers in a network so several people in your office can share the same information.

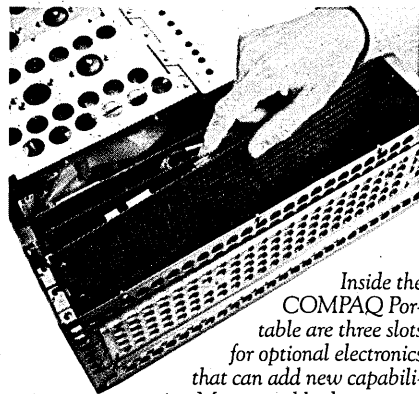

Inside the COMPAQ Portable are three slots for optional electronics that can add new capabilities. Most portables have none.

### Works better because it's tough enough for the road

Portable doesn't just mean smaller. Portable means tough, too.

The COMPAQ Portable was built to withstand the hard knocks of constant travel. An aluminum frame within the case completely surrounds the computer's working components. Each disk drive is mounted in rubber shock absorbers instead of being bolted directly to the frame.

To test internal components, the COMPAQ Portable was subjected to impacts of 40 G's while running a program. After impacts on each side, there was no internal damage and the program was still running. Without error.

Computers are for getting rid of worries, not giving you new ones.

### Designed to help you work better, too

The COMPAQ Portable was designed to feel good.

## Specifications

### Software

- Runs all the popular programs written for the IBM PC

### Memory

- 128K bytes RAM
- Expandable to 640K bytes

### Storage

- One 320K-byte minifloppy disk drive, second drive optional

### Display

- 9-inch (diagonal) monochrome screen
- 25 lines by 80 characters
- Upper- and lowercase, high-resolution text characters
- High-resolution graphics

### Expansion board slots

- Three IBM PC-compatible slots

### Interfaces

- Parallel printer interface
- RGB color monitor interface
- Composite video monitor interface
- TV RF modulator interface
- Communications interface optional

### Physical specifications

- Totally self-contained and portable
- 20" W × 8½" H × 16" D

The keyboard is detached so it can fit into your most comfortable working position.

The keyboard cable remains connected at all times. So you don't have to unpack it and hook it up every time you use your computer.

Because the display is built in, the COMPAQ Portable makes a neat,

small package on your desk, instead of a big obstacle you have to talk around. The built-in display also avoids the usual cable clutter because there's no need for separate cables for the display.

The COMPAQ Portable even has an electronically synthesized sound to create the familiar keyclick of a typewriter. With a simple keyboard command you can adjust the volume to suit the level of background noise in your office.

### The added usefulness is free

The COMPAQ Portable can do what desktop computers do and do it in more places. But it doesn't cost any more than an ordinary desktop.

In fact, it costs hundreds less than a comparably equipped IBM or Apple® III. The COMPAQ Portable comes standard with one disk drive and 128K bytes of memory, both of which are usually extra-cost options. A second disk drive and additional memory are available to make your COMPAQ Portable even more powerful.

The bottom line is this—you just can't buy a more practical, useful, productive computer. Before you decide on a computer, you owe it to yourself to compare the COMPAQ Portable.

**For the location of the Authorized Dealer nearest you, call 1-800-231-9966.**

©1983 COMPAQ Computer Corporation  
COMPAQ™ is a trademark of COMPAQ Computer Corporation.  
IBM® is a registered trademark of International Business Machines Corporation.  
Apple® is a registered trademark of Apple Computer Inc.

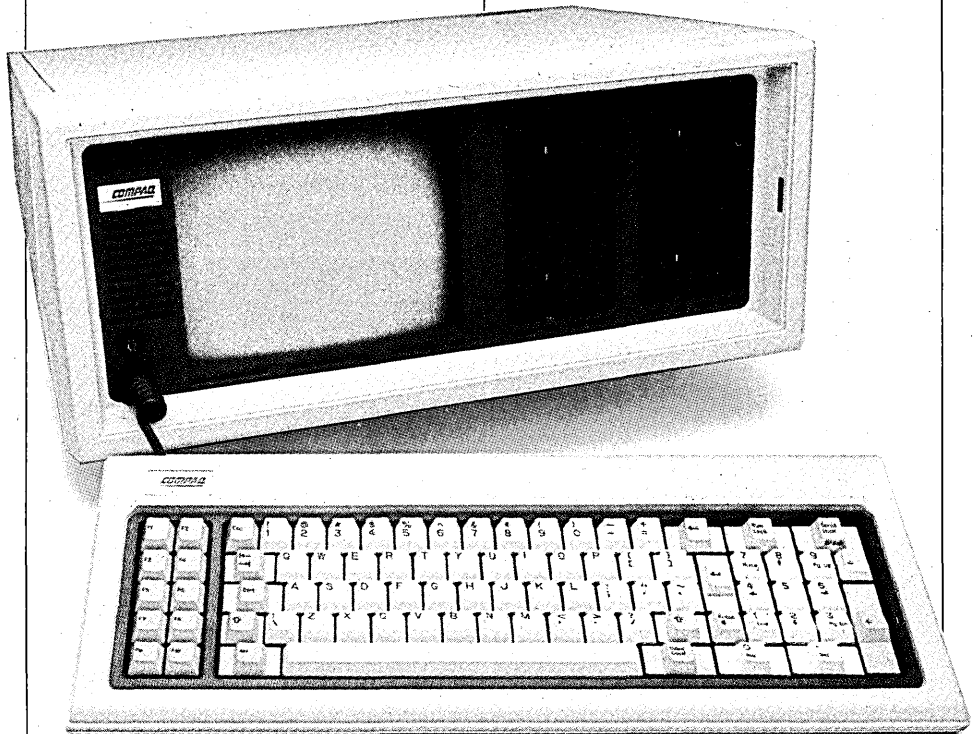

CIRCLE 92 ON READER CARD

**COMPAQ™**

Common sense and uncommon design

## LOCAL NETS AND CATANETS

Most research and experimentation with catanets to date has not involved local networks. While the principles of internetworking remain the same, there are some unique features of local networks that complicate the problem.

Consider the most general case of connecting a local network to a catanet consisting of long-haul networks and other local networks. A common internet protocol is needed to bind these networks together. The difficulty of doing so in a cost-effective way stems from two distinct differences between local and long-haul networks—their speed and how they handle outstanding packets.

Local network links typically operate in the range of 1 megabit to 50 megabits per second. Long-haul networks, on the other hand, generally operate at much lower speeds, usually less than 56 kilobits per second. The local network, moreover, usually uses no intermediate switches to route packets and is fast enough to deliver one packet before another is transmitted. On a long-haul network, however, there may be a number of packets outstanding, or undelivered, while still more are being transmitted.

This type of speed mismatch can re-

FIG. 6

### IP HEADER FORMAT

NAME	SIZE (in bits)	PURPOSE
Version	4	Version of Protocol
IHL	4	Header length in 32-bit words
Grade of service	8	Specify priority, reliability, and delay parameters
Data unit length	16	Length of datagram in octets
Identifier	16	Unique for protocol, source, destination
Flags	3	Includes more flag
Fragment offset	13	Offset of fragment in 64-bit units
Lifetime	8	Number of allowed hops
User protocol	8	Protocol layer that invoked IP
Header checksum	16	Applies to header only
Source address	64	16-bit net, 48-bit host
Destination address	64	16-bit net, 48-bit host
Options	Variable	Specifies additional services
Padding	Variable	Ensures that header ends on 32-bit boundary

sult in a local network flooding a slower long-haul network with packets. Without an effective flow control procedure, the long-haul network may simply discard excess packets. A positive feedback mechanism can arise in which the local net sends new packets to the gateway and retransmits unacknowledged old packets.

If packets do not arrive at their destination in the order that they are sent, it may be left to the local network host to buffer and reorder them. This of course is a processing

burden on local network hosts.

In conclusion, the manager of local networks needs to be careful when connecting dissimilar networks, for although the technology has made major advances, there are still several pitfalls to avoid. \*

Dr. William Stallings is a senior communications consultant with Honeywell Information Systems in McLean, Va. He is author of *Local Networks: An Introduction* (Macmillan, 1983).



## TEAR OUT AND COMPARE TO 3278s

THE PCI 78, AN ASCII SOLUTION THAT'S KEYSTROKE FOR KEYSTROKE 3278 KEYBOARD COMPATIBLE. SNA/SDLC 3270 EMULATION WITH PCI'S 1076.

Name \_\_\_\_\_  
 Company Name \_\_\_\_\_ Phone \_\_\_\_\_  
 Address \_\_\_\_\_  
 City \_\_\_\_\_ State \_\_\_\_\_ Zip \_\_\_\_\_ DM 8/83

- Send me more information on the PCI 78 and PCI 1076.
- Send me information on all PCI products.

**PCI PROTOCOL COMPUTERS, INC.**  
 (800) 423-5904  
 (213) 716-5500 (In California)

6150 Canoga Ave. Suite 100, Woodland Hills, CA 91367-3773



CIRCLE 180 ON READERCARD

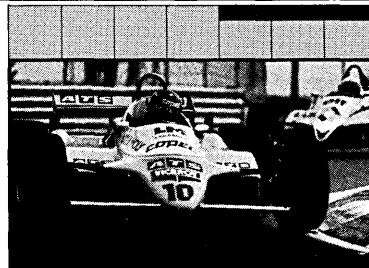

**IN THE RACE TO DEVELOP MICROCOMPUTER APPLICATIONS — DON'T BE LEFT AT THE START.**

Our MICROBENCH™ software packages harness the power of Pascal, FORTRAN-77, cross assemblers and simulators to the complete line of DEC PDP-11 computers. They create a powerful environment to speed applications development for all popular Intel, Motorola and Zilog microprocessors. You'll use the world's most sophisticated development software and will save money on hardware and software as well.

**VIRTUAL SYSTEMS**

1500 Newell Avenue, Suite 406  
 Walnut Creek, CA 94596  
 (415) 935-4944

\*MICROBENCH is a Trademark of Virtual Systems, Inc.

CIRCLE 181 ON READERCARD

# Get SNA on-line without hurting your bottom line.

Northern Telecom not only offers you on-line systems with SNA/SDLC (PU-2 level) compatibility, we offer them to you at a good price. Our remote systems, including our 296C "small cluster" (up to 8 devices), 294-51C "medium cluster" (up to 12 devices), and 294C "large cluster" (up to 32 devices) are all priced substantially below IBM. A low price to pay for such sophisticated technology.

## Switch protocols at the flick of a switch.

To make our Model 290 systems even more economical, we've included some very special features. For example, if you're moving from bisync to SNA/SDLC you can easily switch with a flick of a switch. Both models feature a special dual adapter, so you can use either protocol without extra hardware.

These systems are designed with the human factor in mind too—with a special non-glare display, an adjustable stand and a highly efficient keyboard designed to give your operators more comfort and convenience. And that pays off in productivity.

## Our on-line's on time, too.

At Northern Telecom, we believe that you shouldn't have to wait for tomorrow to get the technology you need today. You can have our on-line systems working for you without a long wait for delivery.

To find out more about these efficient and economical SNA on-line systems, call (800) 621-6476 (in Illinois (312) 572-6724), or send in the coupon.



To Northern Telecom Inc.  
 P.O. Box 10934, Chicago, IL 60660

I would like to know more about your Model 290 systems.

Send me more information.

Have a sales representative contact me.

Name \_\_\_\_\_

Title \_\_\_\_\_

Company \_\_\_\_\_ Phone \_\_\_\_\_

Address \_\_\_\_\_

City \_\_\_\_\_ State \_\_\_\_\_ Zip \_\_\_\_\_

CIRCLE 93 ON READER CARD

D

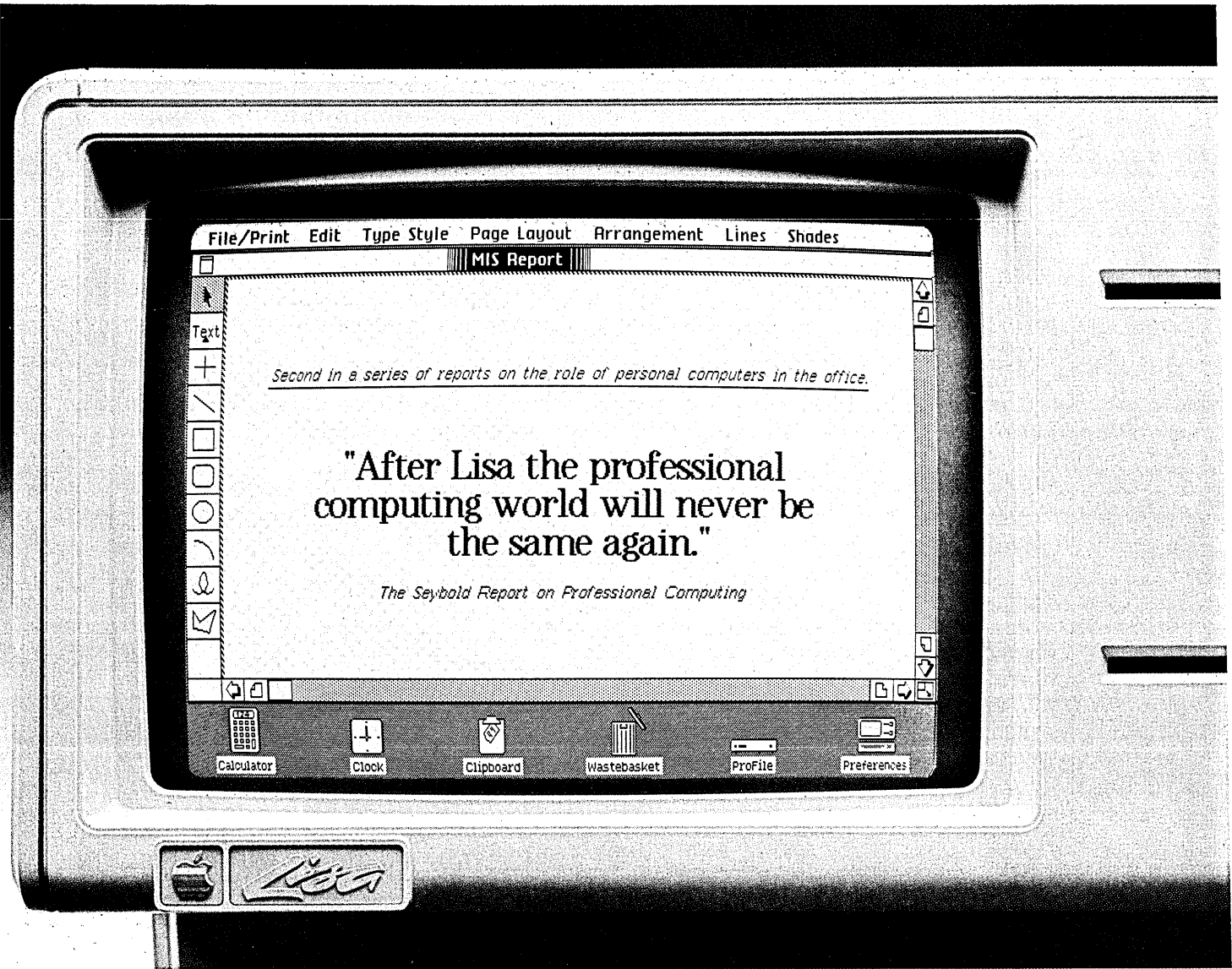

Apple's new Lisa is the world's most powerful personal computer.

Its 32-bit MC68000 micro-processor gives it the processing capability of a mid-range mainframe.

It also has one million bytes of internal memory. And, with a 5-Megabyte hard disk, more than 15 times the on-line mass storage of standard microcomputers.

Given these most imposing credentials, one could get the impression Lisa was designed solely to scare one's socks off.

On the contrary.

What makes Lisa totally revolutionary is that, for the first time, all this phenomenal power is contained in a business computer you can learn to use in under 30 minutes.

## 200 years of hard work made it easy.

To tell Lisa what to do, all you have to do is point.

But achieving this simple concept required a totally new

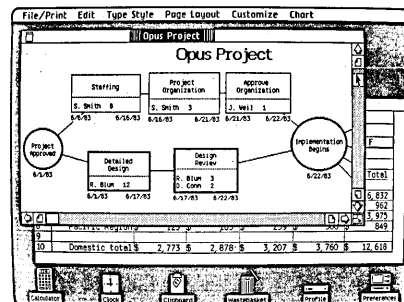

Lisa's revolutionary software lets users perform several applications simultaneously, even "cut" and "paste" them together. The powerful project management program seen here is a Lisa exclusive.

approach to software and 200 person-years of development.

Lisa replaces complex computer commands with symbols

familiar to anyone who's ever worked at a desk.

Even someone who's never touched a computer before can learn Lisa in under half an hour. Versus the 20 hours or more required to unriddle conventional PC's.

To information managers, that means dramatically reduced training time and increased productivity.

But people don't just learn faster on Lisa, they also work faster. Each of Lisa's powerful applications\* use symbols and commands common to all.

So with little practice, users can move from LisaCalc to Lisa-Graph to LisaWrite without missing a beat. Or use them all at once, "cutting" information from one program and "pasting" it directly into another.



There's even a program — LisaProject — that lets you use the mouse to chart the progress of complex projects, automatically recalculating when deadlines or resources change.

On paper, Lisa is just as exceptional. With its dot matrix and daisy wheel printers, it produces printed materials just as you see them on the screen.

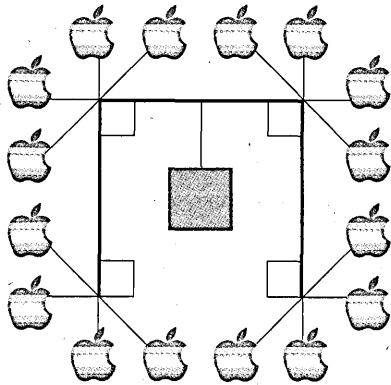

AppleNet, available soon, will let Lisas and other Apples share information, and costly peripherals.

## Powerful connections.

Any Lisa system can become part of a powerful Lisa network through AppleNet, our own low-cost local area network.

It enables a user to transfer documents from one department to another, so they can be rapidly reviewed. Or modified. Or passed on to other Lisas.

The same network allows Lisas to branch out to other Apples. Or share disks, printers and other costly peripherals.

Using the LisaTerminal program, Lisas can tie into mini and mainframe computers, by emulating VT 100-type or 3270-type terminals.

And soon Lisa will provide a revolutionary link to Cullinet's Information Database for mainframes.

In short, one Lisa can do the chores of many terminals. All of which means swifter response times and better distribution of resources.

## Stay on top of new developments.

Lisa's unique user interface lets programmers develop programs with unaccustomed speed.

But that's not Lisa's only programming attraction.

The Lisa Workshop provides a powerful environment in which to develop COBOL applications. A full screen Lisa-like editor, code generator, and multiple windows make a

visible difference in development times.

Apple also supplies all the documentation, instruction, and support a developer requires to integrate applications into the Lisa environment — no matter how sophisticated their information processing needs.

## We support the whole family.

Apple now offers nationwide on-site service for all Apples in conjunction with RCA Service Company.

The hand operated mouse lets you use Lisa without touching the keyboard. All you have to do is point.

Plus a host of special services for Lisa — including a toll-free support line.

All of which you may never need.

A diagnostic program called LisaTest instantly isolates any defective board or component.

And the modular "plug-in" design of Lisa's five basic circuit boards and two disk drives allows parts to be replaced in seconds, with just one tool: Your fingers.

For the whole story, call our National Account Program at (800) 538-9696.

No matter how large your company, Apple has all the elements to improve your information systems management.

Including Lisa, the computer that makes headlines.



\*With more programs on the way, Lisa's library now includes LisaCalc electronic spreadsheet, LisaList data base, LisaWrite word processing, LisaGraph business graphics, LisaDraw presentation graphics, LisaProject electronic project management and LisaTerminal data communications. For information regarding corporate purchases through our National Account Program, call (800) 538-9696. In Canada, call (800) 268-7796 or (800) 268-7637. Or write to Apple Computer Inc., MIS/EDP Marketing Dept. 20525 Mariani Ave., Cupertino, CA 95104. ©1983 Apple Computer Inc.

**Why these massive number crunchers developed the way they did, and how they'll be used in the future.**

# A VECTOR PROCESSING TUTORIAL

by Lee Higbie

The fact that data processing is frequently applied systematically to large sets of data was undoubtedly known to Babbage, but current vector processors trace their history mostly to work by Unger (1958), Shoeman (1960), and Slotnick (1962). As far as I can determine, the first operational array or vector processor was the Orthogonal Computer in October 1967.

From those beginnings, the Texas Instruments ASC and the Control Data Star-100 were the first multiple-copy vector machines; each was in production in the early '70s. The Cray-1 and the Floating Point Systems adjunct processors were the first two vector machines that can be considered very successful, but there may have been special purpose vector processors in the interim.

The term "array processor" has been used to describe two rather different types of machine. One is an array of simple processors that operate in concert, the other a computer that operates on arrays of data. Notice that an array of processors will naturally operate on arrays but that many other systems can have array processing as their natural mode of operation.

The latter definition has become common partly because of the use of array in the "FORTRAN 8X" proposal. This confusion will be avoided here by using the terms "vector" and "vector processor," which have not been so variously applied. The other common use of the term vector—as a sort of synonym for arrow—is sufficiently different that confusion is unlikely. Physicists' vectors have direction and magnitude, and some obey a right-hand rule. Dyslexic computer scientists

have no problem with vectors because theirs are merely regular datasets that have no handedness.

Definition: a *vector* is an array of data stored in a computer's memory with a fixed increment or stride between its successive elements (Fig. 1).

Definition: a *vector processor* is a computer that has an essentially complete set of instructions that operate on vectors.

Rows or columns of matrices or tables are typical data vectors. Arrays of temperatures, pressures, and so on, where each element of the array is one data sample of a physical variable, are among the most common vectors. Such physical vectors occur in computational areas like weather forecasting (where they may represent temperature or pressure at each latitude-longitude cell at a specific time) and seismic data processing, and in many other areas of scientific and engineering computation. A FORTRAN one-dimensional array is a vector, as is a row, column, diagonal, or reverse diagonal of a FORTRAN multidimensional array.

Because of their training in matrix algebra, scientists and engineers frequently express computational tasks in vector or array form. Traditionally, this has been converted into a scalar form by programming the computations as DO loops in FORTRAN for execution on a scalar computer. The underlying vector structure of the problem is known, however, and they recognize that the vector statement of the computations is much simpler.

If these vector instructions could be directly executed, one would intuitively expect a considerable saving in control operations because each vector operation replaces

a loop of scalar operations. Indeed, the relative compactness of APL programs illustrates this reduction. The observation that this structure is common and that repetitive hardware is relatively inexpensive has led to the design of vector machines.

A major problem with vector machines is that they tend to be designed for small classes of computational problems and are sometimes difficult to program for general applications. Data formatting, table lookup, recursion, and program control are typical of the types of procedures that are difficult to impossible to vectorize, procedures that occur in most programs. Also, poorly structured routines are generally more difficult to vectorize than well-structured areas because any vectorizer, like any code maintainer, finds them more difficult to understand.

Because of the small incremental expenses of adding vector capability no matter what processor technology is used, however, vector/scalar processing systems will become increasingly common. This follows because it is easy to justify almost any hardware approach that doubles or triples the speed of many programs for only 5% more hardware cost.

## VECTOR PROCESSOR HISTORY

In 1958 Unger, in the *Proceedings of the IRE*, proposed an array of processors for performing calculations on variables defined on a mesh. This appears to be the first modern proposal in print to build such a machine and is cited by Slotnick in his paper suggesting the Solomon and so can be presumed to be the philosophical ancestor of the ILLIAC-IV. It is note-

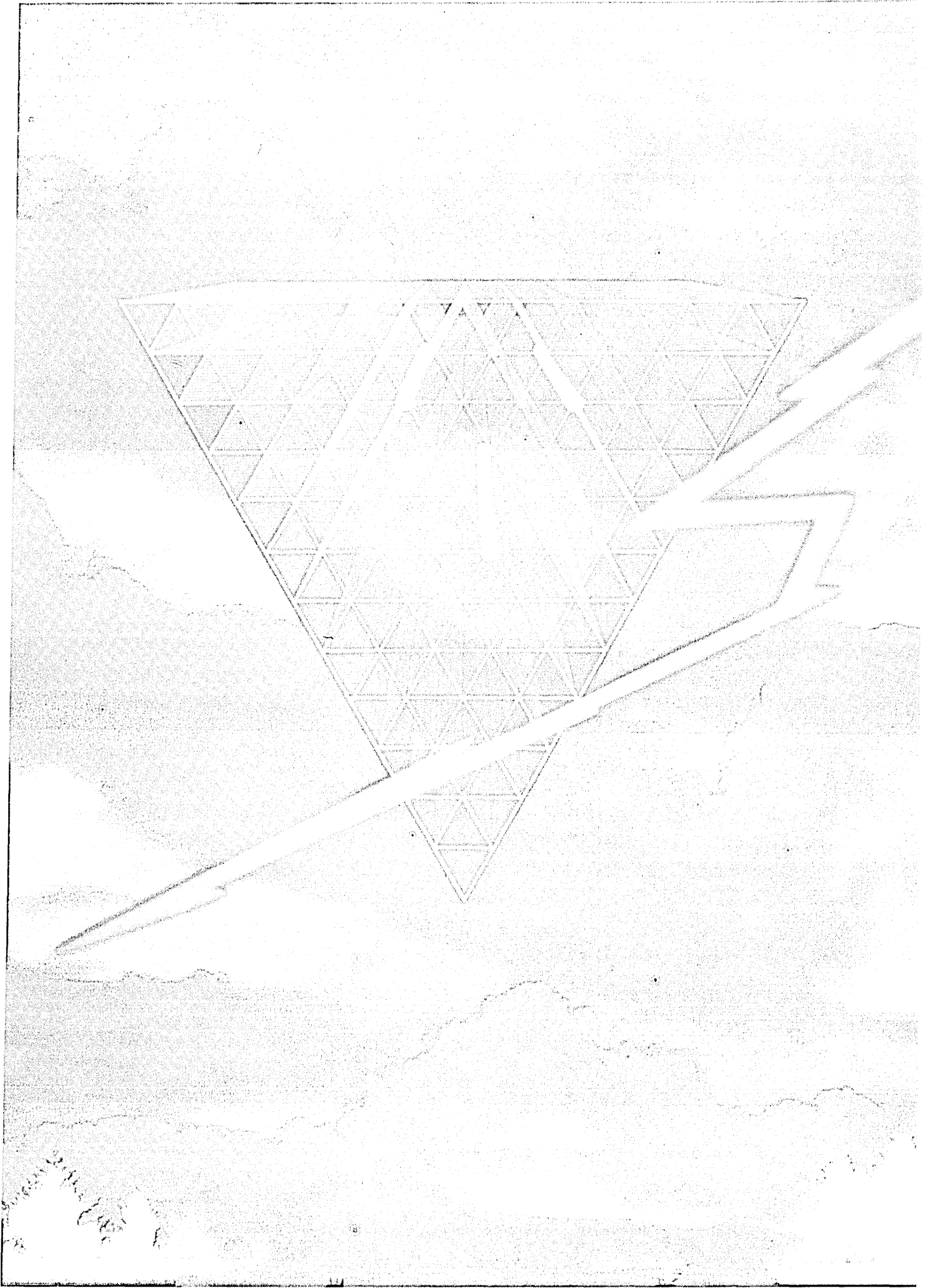

# There was another preview of the future in the Orthogonal Computer: vector and scalar capabilities.

worthy that Unger's machine, the Solomon computer described by Slotnick at the Fall Joint Computer Conference in 1962, and the ILLIAC-IV described by Barnes et al in 1972, were all viewed as matrix machines, at least until extensive programming was undertaken.

At the 1960 Eastern Joint Computer Conference, Shooman proposed the first vector machine and his concept led to the first operational vector or array machine. It was built by Sanders Associates as an Orthogonal Computer and was in operation before the end of 1967, quite a few years before any other vector or array computer that I am acquainted with. Fig. 1 shows how Shooman and Unger visualized their machines. There was another preview of the future in the Orthogonal Computer: vector and scalar capabilities. Not until the Cray-1 appeared did another vector machine with comparable scalar emphasis appear.

Many machines that are philosophical descendants of Shooman's and Unger's machines have been proposed, and a few others—for example, the Staran and MPP at Goodyear, the DAP at ICL, and the ILLIAC-IV at Burroughs—have been built. The mainstream of vector computing, however, went in a different direction: pipelining.

Operation pipelining in computers

FIG. 1  
**SHOOMAN'S AND UNGER'S ARRAY PROCESSORS.**

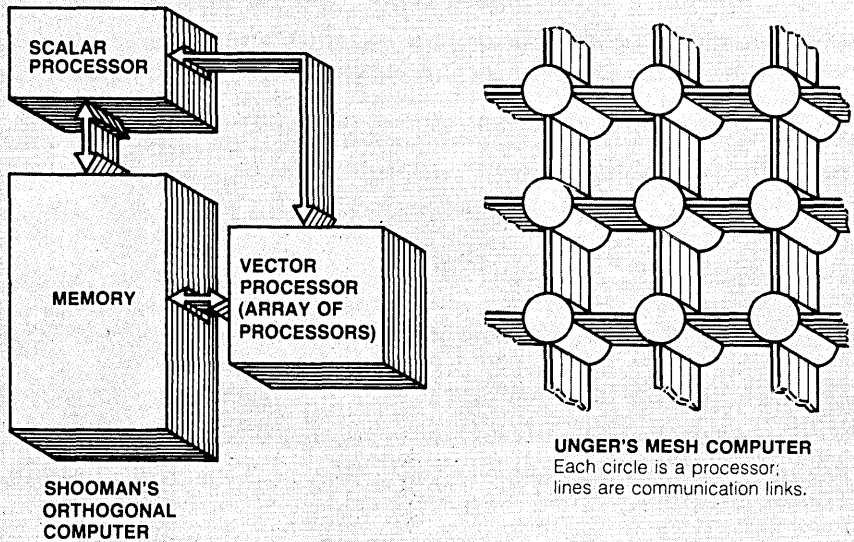

Shooman visualized processing vectors of data, while Unger appears to have visualized processing two-dimensional data structures.

## ELEMENTS, INSTRUCTION SETS, AND WAYS TO DO NOTHING

1. One can see that 100-element vectors are typical by noting that the interesting problems for supercomputers have  $2\frac{1}{2}$  to 3 dimensions, and time raises the total to  $3\frac{1}{2}$  or 4 computational dimensions. This implies that doubling the grid size increases the computational time and memory requirement by a factor of 10 to 16 ( $2^{3.5}$  to  $2^4$ ).

Large programs are generally memory-size limited or cpu-time limited. Those that are memory-size limited currently use about 1 million words of memory, which for  $2\frac{1}{2}$  to 3 dimensions means 100 to 250 elements per mesh side ( $250^{2.5} \approx 100^3 = 1$  million, maximum). A two-order-of-magnitude increase in memory size only allows a fivefold increase in linear mesh dimension.

A two-order-of-magnitude increase in computer speed allows one to increase the mesh edge size of a speed-limited code by about a factor of 3 (the  $3\frac{1}{2}$ th and 4th roots of 100 are 3.7 and 3.2). In fact, mesh sizes should increase less than this because improvement in the physics of the models as the meshes are made finer will increase the computation per mesh point. Thus, even a huge increase in computational speed will increase average vector length to at most a few hundred.

2. The studies of reduced instruction set

computers have shown that simple instruction sets are preferable to complicated ones by almost any measure. There are several probable reasons why few commercial machines conform to reduced instruction set philosophy:

- Microprogramming allows the addition of instructions at almost no hardware cost, even after machines have been delivered.
- Customers request specific instructions or classes of them for various applications. These users shouldn't be programming in machine language as much as they do and apparently, despite using assembly code, have never discovered macros.
- Most machines are designed by committees, and groups always find it easier to say yes to individual requests than to say no.

Just as most scalar machines have peculiar instructions that are virtually useless, so do most vector machines. One typical example is a vector Boolean operation, where the control for the operation was a vector; i.e., given

$\mathbf{X} = (x_1, x_2, \dots)$  and  $\mathbf{Y} = (y_1, y_2, \dots)$  data vectors  $\mathbf{C}$  a control vector, i.e., its elements are 4-bit integers denoting one of the 16 possible Boolean operations the operation on  $X_k$  and  $Y_k$  is given by  $C_k$ .

For example, if

$\mathbf{C} = (0, 4, 3, 1, E, F, 6, C)$  the operations generated are (Zero, not X and Y, not Y, AND, OR, one, XOR, Y)

These unusual instructions tend to be ignored by the compiler and by experienced programmers and consequently create few difficulties. Problems result from having several ways to do something, not from having a way to do nothing.

3. For standard library functions the compiler can use special names to guarantee calling sequence compatibility. It might change the ATAN function names to

ATAN.SCALAR.SCALAR.  
ATAN.VECTOR.VECTOR.  
ATAN.VECTOR.SCALAR.  
ATAN.SCALAR.VECTOR.

The existence of the period in the name would guarantee that no FORTRAN program would call the routine directly (by mistake or otherwise). It is possible to treat all scalar operations as unit length vectors, but this is so inefficient that few systems do so. Those systems, however, that treat vector-vector and vector-scalar operations uniformly can reduce the number of required ATAN routines to two or one.

—L.H.





**"Graham's Epoch 480  
tape is cheaper in the  
long run because  
it lasts longer."**

Even when you've been making good tape as long as we have, it pays to talk to the experts. People who use it every day. That's why we had a research firm survey our customers and prospects. And that is what one of them said.

He didn't mean Epoch 480 is inexpensive. He meant that for the money, no other tape does quite the job in critical areas like data transfer, back-up and archival storage.

We planned it that way, with the finest binder system we could devise. Because of lower oxide shedding, you get error-free performance pass after pass after pass. In short, Epoch 480 is clean and durable.

We know that being considered the tape company worldwide, we can't deliver anything less than the best. It's just nice to know that the experts know it, too.

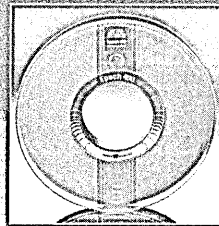

**Talk to the  
Media Management  
Specialist at  
Graham Magnetics  
The tape company.**

 **GRAHAM MAGNETICS**

Toll Free: 1-800-433 7632, 433 7633 In Texas: (817) 231 9450

CIRCLE 35 ON READER CARD

**CARLISLE**



**RELAX!**

## I FOUND THE INFORMATION

*The selection was easy. Because the entire EDP industry is now organized, defined, cross-referenced, re-surveyed, updated and delivered to me four times a year for \$60.*

*Cuts my search time . . . gives me all my options . . . and saves my company money.*

DATA SOURCES has sorted all significant EDP vendors and products for you—and compiled them in two easy-to-use volumes. Supported by an extensive data base, each issue is re-surveyed, updated and mailed every 90 days to keep you current with the latest product information.

DATA SOURCES' format provides you consistent product listings and comparison charts—including capability, compatibility,

and cost . . . to allow fair and accurate evaluations. It is fully indexed and cross-referenced each quarter—by product type, supplier and system fit.

**NEW!**

**Market Tracking:** Exclusive product trend feedback from the publication data base

**NEW!**

**Before You Buy:** Product selection criteria and checklists

**NEW!**

**Product Comparison Charts:** At-a-glance review, compares each vendor's product feature by feature

Over 26,000 products: from micros to mainframes

14,000 software packages: systems, utilities and applications



# ..... IN DATA SOURCES

- o Over 12,000 hardware and communications products: from systems to peripherals . . . from modems to complete networks
- o 7,200 company profiles: current names, addresses and phone numbers

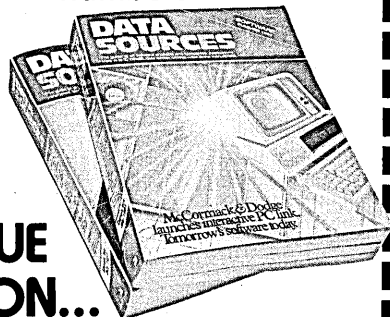

**WHEN THE ISSUE  
IS INFORMATION...**

**DATA SOURCES**

P.O. Box 5845 • Cherry Hill, N.J. 08034.

CIRCLE 96 ON READER CARD

DATA SOURCES

P.O. Box 5845 • Cherry Hill, N.J. 08034

TO37

**Yes, I need accurate information delivered  
4 times a year.**

Please send me the current edition of DATA SOURCES and enter my one year subscription at \$60 (A 50% savings off the regular rate of \$120.)

Check enclosed.  Bill me.

NAME \_\_\_\_\_

TITLE \_\_\_\_\_ PHONE (\_\_\_\_) \_\_\_\_\_

COMPANY \_\_\_\_\_

ADDRESS \_\_\_\_\_

CITY \_\_\_\_\_ STATE \_\_\_\_\_ ZIP \_\_\_\_\_

NATURE OF CO. BUSINESS \_\_\_\_\_

**OR, ORDER DIRECT!!! 1-800-227-1617 ext. 251  
(in California, 1-800-772-3545 ext. 251)**

Residents of CA, CO, CT, DC, FL, IL, MA, MI, MO, NJ, NY, VT,  
PLEASE ADD APPLICABLE STATE TAXES.

## Pipelining tends to increase the utilization efficiency of hardware, no matter what other architectural features are used.

was present in the Univac Larc and IBM Stretch and undoubtedly in some earlier systems. The first pipelined vector machines were the Star-100 from CDC and the ASC from TI. Both of these systems were used extensively and yielded tremendous insight into the nature of vectorization. They showed that vectors tend to be short (perhaps no more than 100 elements long most of the time) and that scalar instructions are frequent (see box, note 1). The first commercially successful vector machine was the Cray-1, which had two significant performance differences from its ancestors: vector startup time was so small that five-element vector operations were faster than scalar loops (on *any* machine), and scalar speed was faster than on any other machine.

The Star-100 design was modified to provide high-speed scalar operations and introduced as the Cyber-200 series, which now appears to be a successful vector computer.

The other major contribution made by Cray Research, CDC, and TI is the demonstration that vectorizing compilers are feasible and no more expensive than optimizing but nonvectorizing compilers. The commercial success of both the Cyber-205 and Cray-1 machines depends to a large extent on their automatic vectorization of standard FORTRAN, for it is this feature that allows the immediate vectorization of existing programs, which constitute the bulk of their customers' code.

Several systems have been built that used arrays of processors executing a single instruction stream—for example, the Orthogonal Computer at Sanders, the ILLIAC-IV, and the BSP of Burroughs. All successful vector machines, however, use pipelined operations. The probable reasons for this are:

- Hardware is expensive. (Software is relatively cheap, current proverbs notwithstanding. On most commercial computers, software development cost is well amortized but hardware replication cost is comparatively high.) Pipelining tends to increase the utilization efficiency of hardware no matter what other architectural features are used. Also, pipelining naturally lends itself to variable vector lengths.

- Arrays of processing elements tend to use expensive memory-processor switches or to strongly favor array placements that are incompatible with FORTRAN (see Fig. 2).

- Vector lengths tend to be relatively short, so that the promise of arbitrarily high speeds by means of arbitrarily large numbers of processors is only realizable for specific applications. Theoretical techniques for "lengthening vectors" exist, but this technology has found its way into compilers to only a limited extent. (In some common cases a nest of DO loops can be trivially collapsed into a single loop; analogously, a loop of vector operations can be collapsed into long vector operations.)

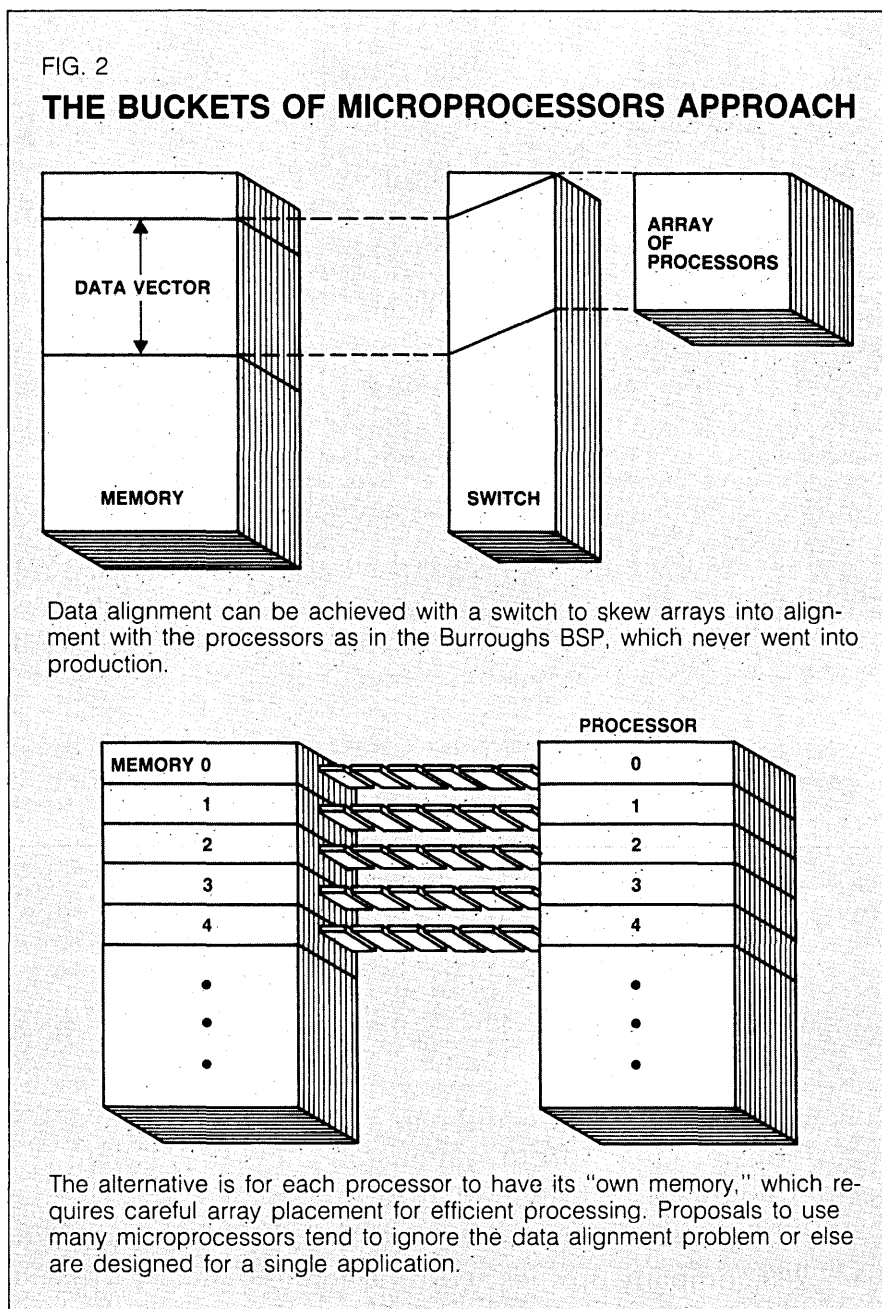

ations can be collapsed into long vector operations.)

- The price advantage of buckets of microprocessors is not as great as it may appear. For example, the price/performance ratio variation on all machines is not several orders of magnitude. Comparison of microprocessor chip costs to supercomputer system costs is meaningless. The slightly better cost effectiveness of some microsystems over the supercomputers is lost for large problems where huge memory space or severe time constraints are involved.

- There is a substantial fraction of nonvectorizable code in most programs, so the speedup

of infinite vector-speed machines is rather limited compared to scalar machines. Experience indicates that about half of programs are vectorizable but that 90% may be vectorizable with the best possible vectorizers. This means that even with an infinite vector-speed machine the speed increase will generally be only in the range of two to 10 times.

Because array-of-processing element machines are hardware efficient, most are merely paper designs; though of academic interest, they will not be considered further.

Pipelined operation seems easiest to explain with an example; Fig. 3 illustrates pipelined multiplication. In actual machines,



- ☆ OPERATES FASTER THAN A SPEEDING BULLET
- ☆ MORE POWERFULL THAN A LOCOMOTIVE
- ☆ ABLE TO LINK BIG COMPUTERS IN A SINGLE TERMINAL
- ☆ A SUPER PERFORMER



## The MEGAIT™ Terminal System

The Truly Generic Terminal System:

- ☆ IBM 3278-2-3-4 and 5\* Plug-to-Plug Compatible
- ☆ IBM 3101\*, DEC VT-100\* OR ADM-3A\* FOR YOUR ASCII NETWORK (ASCII PROTOCOLS MAY BE CHANGED OR UPGRADED WITHIN MINUTES.)
- ☆ Optional 64K CP/M® Based Business Computer

\*Subject to trademark claims



### TERM-TRONICS INCORPORATED

7408 TRADE STREET, SAN DIEGO, CALIFORNIA 92121 • (619) 271-1770

# THE NAME VS.

*Alpha Micro's 1042E has more power than an IBM® System 36.*

*It has more memory and more storage.*

*Fact is, there's only one area in which the IBM has a higher number than the Alpha Micro:*

*The price.*

*Of course, IBM is, well, uh, they're IBM.*

*And we know how nice and safe and easy*

*it is to go with a big, old company like that.*

*But we're not exactly new to this.*

*Alpha Micro's been making micro-computers longer than just about anybody else in the business. Including IBM.*

*We developed AMOS®, a multi-user and multi-tasking operating system that lets you go from one to over 40 users without changing software. (It's the ideal system for*

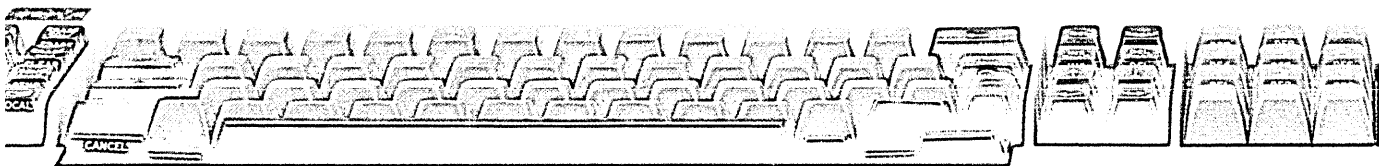
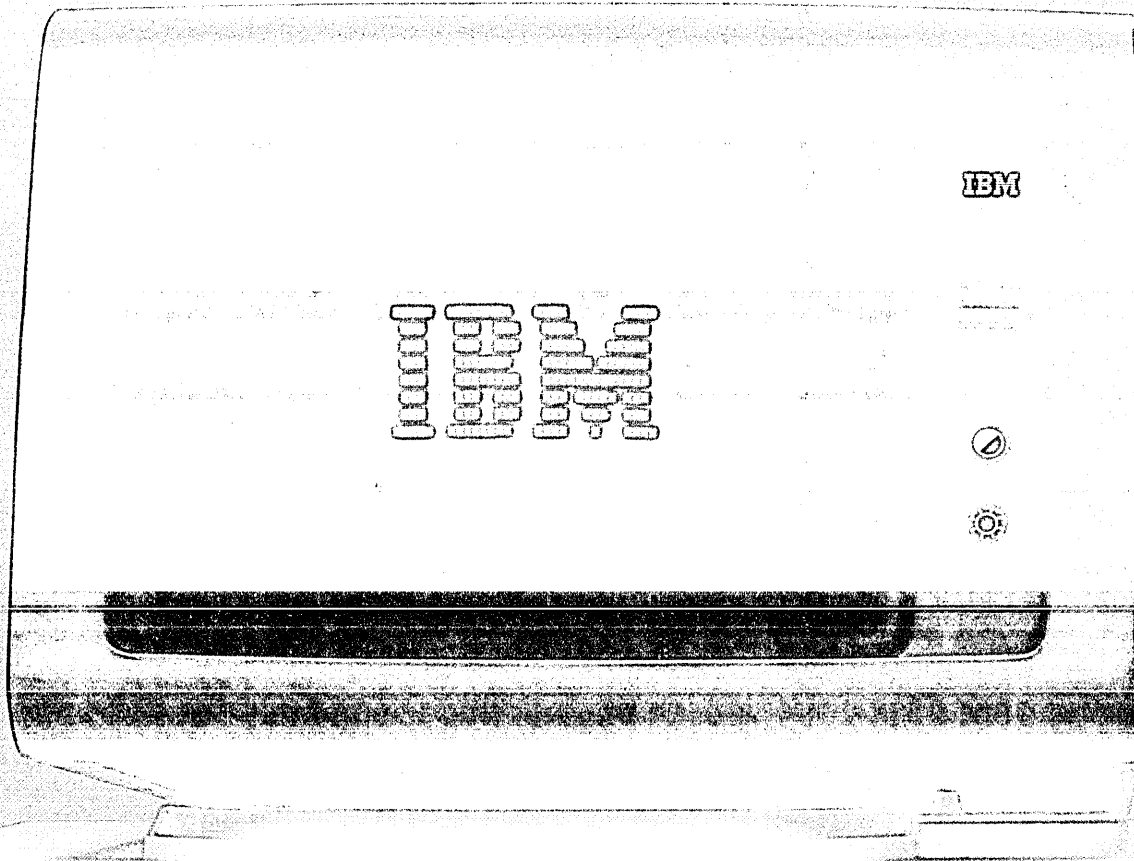

# THE NUMBERS.

*word processing, inventory control, spread sheet, scientific research and more.)*

*And, we have an international network of dealers and factory-trained specialists to give you all the service and support you'll ever need.*

*So if you want a big name and a price to match, go ahead and call good old What's-Their-Name.*

*But if power, speed, expandability, and price mean anything to you, there's only one number you need to remember:*

*800-854-8406. (In California, call collect 714-641-0386.)*

## ALPHA MICRO

*Everything a computer's supposed to be. Except expensive.*

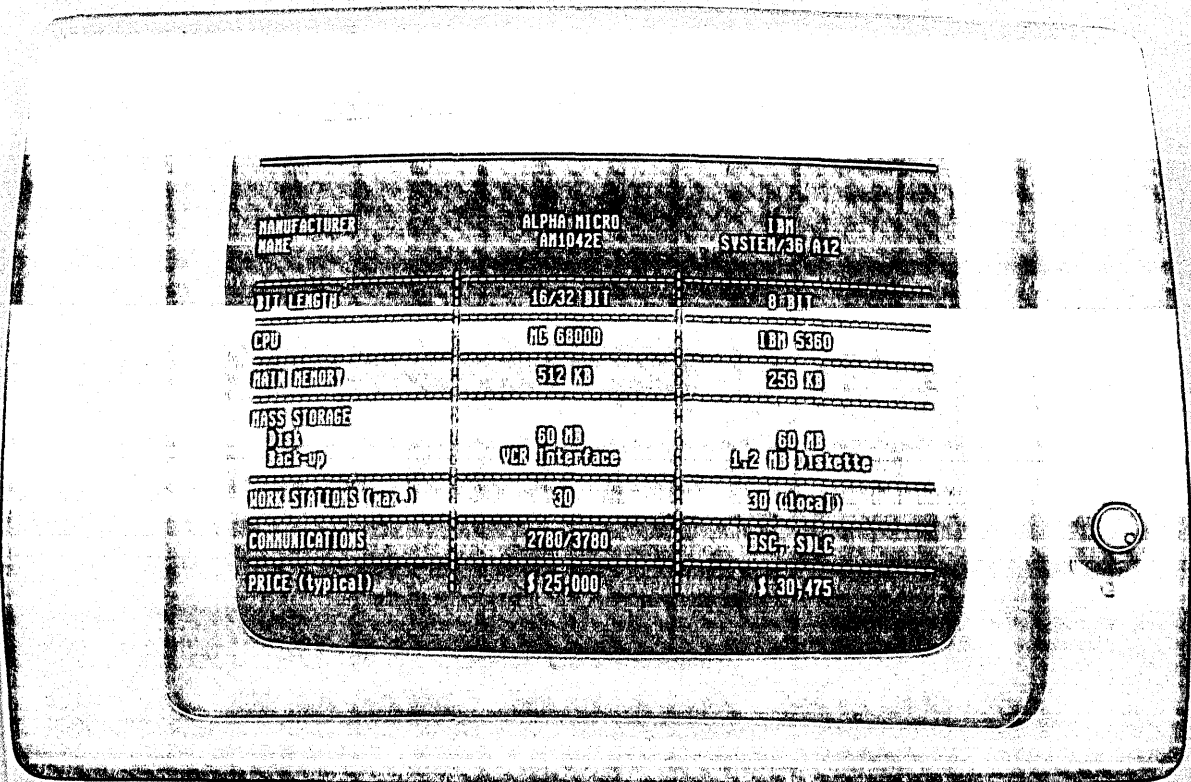

# The scalar loop requires many more instruction fetches.

FIG. 3  
VECTORIZATION SPEEDUP

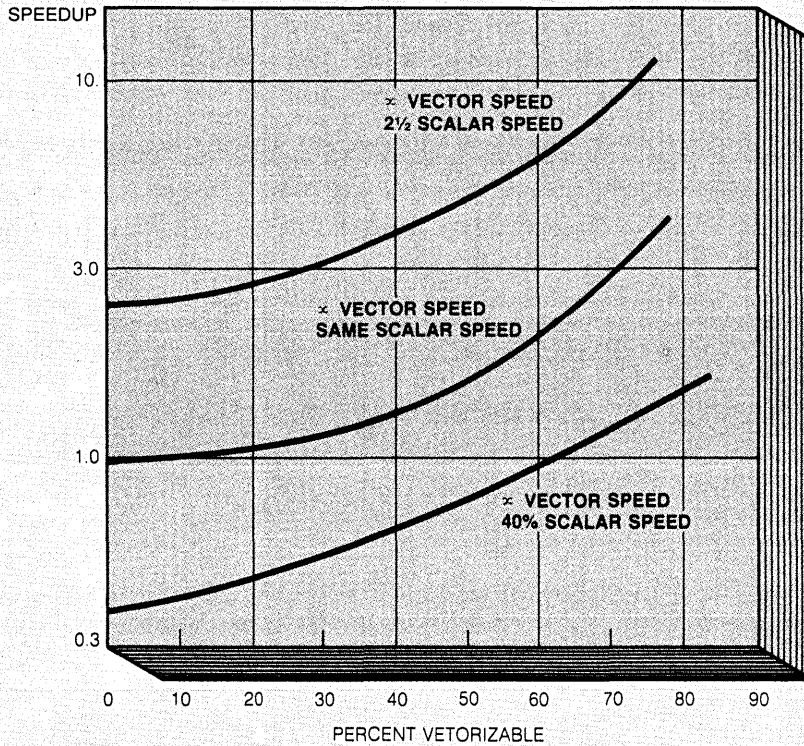

Even for a machine with infinite speed on vector operations, high-speed scalar operation is essential, and a good vectorizer is required to realize its potential. Cray-1 scalar is about 2½ times 7600 scalar, and Star-100 scalar probably less than 40% of 7600 scalar. Current compilers seem to vectorize about 20% to 60% of most programs. (Baskett and Keller, 1977, and Kuck, Muraoka, and Chen, 1972.)

there are generally fewer stages to the pipeline.

Vector operations, if reprogrammed as loops, always include some bookkeeping instructions that prevent scalar speed from approaching very close to vector speed. Fig. 4 illustrates a simple dyadic vector operation showing where the scalar loop incurs necessary overhead. Not shown is the fact that the scalar loop requires many more instruction fetches, introducing the possibility of further scalar speed decrease due to memory contention. Fig. 5 shows the relative performance of scalar, vector register, and memory-to-memory vector architectures.

## TYPICAL VECTOR OPERATION

Consider in detail a typical vector operation: add two vectors *A* and *B* and store the result at *C*. Several pieces of information must be specified: the

number of operations or "vector length," the three memory increments or strides, and the starting or base addresses of the vectors. On a memory-to-memory architecture, the following code might be used:

```

Check vector length against maximum allowable by hardware (assume less)
Set vector length
Set three base addresses
ADD
    
```

On a vector register machine, the following code might be used:

```

Set vector length to segment remainder length
Set three memory strides (if not unity)
Set three base addresses
LOAD A segment
LOAD B segment
ADD
STORE C segment
If segments are all done EXIT
    
```

## A seminar on R.

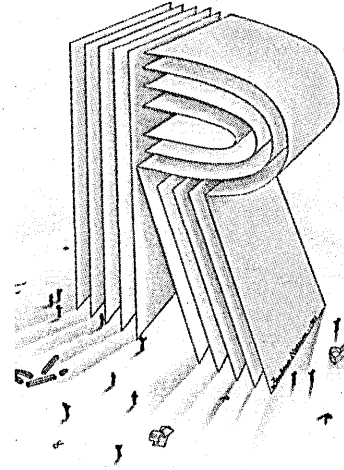

Seminars on Cullinet's relational database management system, IDMS/R, will be held in the following cities during the next few weeks.

Atlanta, GA	Sep. 14	Montreal, QUE.	
Augusta, GA	Sep. 1	(Fr.)	Sep. 15
Austin, TX	Sep. 15	Nashville, TN	Sep. 13
Boston, MA	Sep. 20	New Orleans, LA	Sep. 29
Calgary, ALTA	Sep. 15	New York, NY	Sep. 21
Charlotte, NC	Sep. 22	New York	
Chicago, IL	Sep. 7	Long Island, NY	Sep. 13
Cincinnati, OH	Sep. 7	New York	
Cleveland, OH	Sep. 22	Rye, NY	Sep. 7
Columbus, OH	Sep. 9	Norfolk, VA	Sep. 28
Dallas, TX	Sep. 7	Omaha, NE	Sep. 29
Des Moines, IA	Sep. 28	Ottawa, ONT	Sep. 13
Eau Claire, WI	Sep. 21	Parsippany, NJ	Sep. 23
Evansville, IN	Sep. 27	Philadelphia, PA	Sep. 23
Grand Rapids, MI	Sep. 15	Sacramento, CA	Sep. 27
Hartford, CT	Sep. 14	St. Louis, MO	Sep. 6
Houston, TX	Sep. 29	Salt Lake City, UT	Sep. 27
Indianapolis, IN	Sep. 20	San Diego, CA	Sep. 13
Jacksonville, FL	Sep. 29	San Francisco, CA	Sep. 15
Kansas City, MO	Sep. 22	Savannah, GA	Sep. 29
Lexington, MA	Sep. 7	Seattle, WA	Sep. 29
Los Angeles, CA	Sep. 21	Southfield, MI	Sep. 15
Louisville, KY	Sep. 7	Toledo, OH	Sep. 27
Memphis, TN	Sep. 20	Toronto, ONT	Sep. 20
Miami, FL	Sep. 29	Tucson, AZ	Sep. 28
Milwaukee, WI	Sep. 13	Washington, DC	Sep. 7
Minneapolis, MN	Sep. 8	Wichita, KS	Sep. 20
Montreal, QUE.		Winnipeg, MB	Sep. 28
(Eng.)	Sep. 14	Worcester, MA	Sep. 22

I'm interested in reserving a place at the IDMS/R seminar

in (city) \_\_\_\_\_ on (date) \_\_\_\_\_

Name \_\_\_\_\_

Title \_\_\_\_\_

Company \_\_\_\_\_

Address \_\_\_\_\_

Operating Environment \_\_\_\_\_

Cullinet Software works with all IBM 360, 370, 30XX and 43XX computers—or plug compatible equivalent.

Cullinet Software  
400 Blue Hill Drive, Westwood, MA 02090 8/83 DM



The one and only R.

Cullinet's production/end user relational DBMS.

IDMS/R is a single solution to the two-sided problem of providing useful database applications for both end user and production tasks.

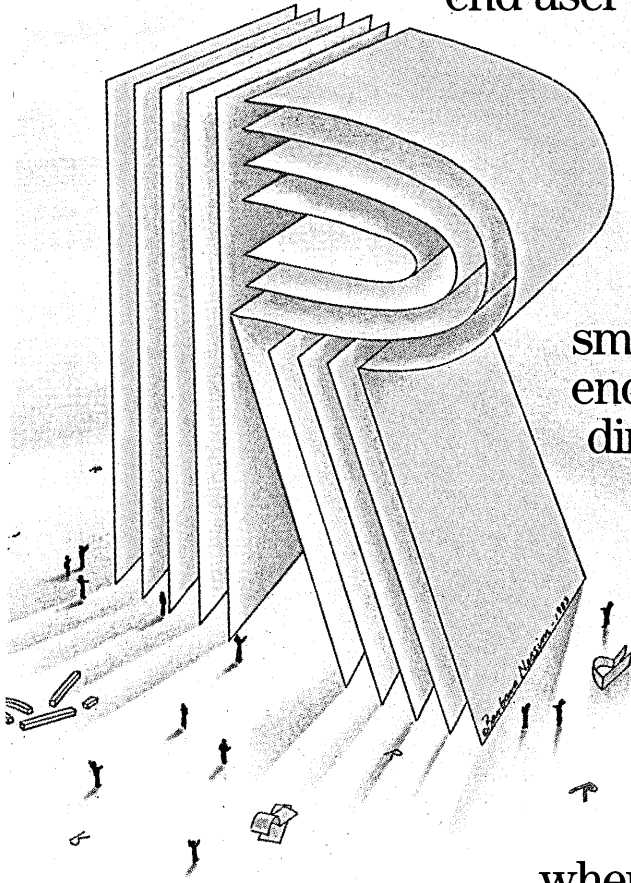

This is how it works:

As a true relational system, it allows you to select data from separate and unrelated files; join it, then project it in ways that make it possible for you to handle small-scale applications and unstructured end user requests for information quickly, directly and intelligently.

What's unique is that IDMS/R also allows you to handle high-volume production applications with the proven technology best suited for the job.

It's this marriage of architectures that makes Cullinet's relational DBMS stand apart. In fact, where others have tried to propose relational or pseudo-relational components that exist separately from the production database, Cullinet's is the only one that lets both work together. Thus serving the whole corporation by serving all of the needs within it.

The answer is software.

And software is Cullinet.

**Put your  
mainframe  
where your  
mouth is.**

If you want to talk to a mainframe or a mini, talk to it. You don't have to talk to a computer person who talks to a computer. Now you can go to the source. With a ROLM® Cypress™ Personal Communication Terminal.

**ROLM**

Want your five-year plan, sales by territory, capital budget, access to the IBM SNA world, or even your favorite public data bases? That's easy.

The ROLM Cypress Personal Communication Terminal combines a digital phone with a smart computer terminal. You can pre-store terminal profiles, so there is no changing settings like baud rates each time you call a different information source.

It even stores your auto log-on sequence, so calling the computer is as easy as calling home.

Now, slide

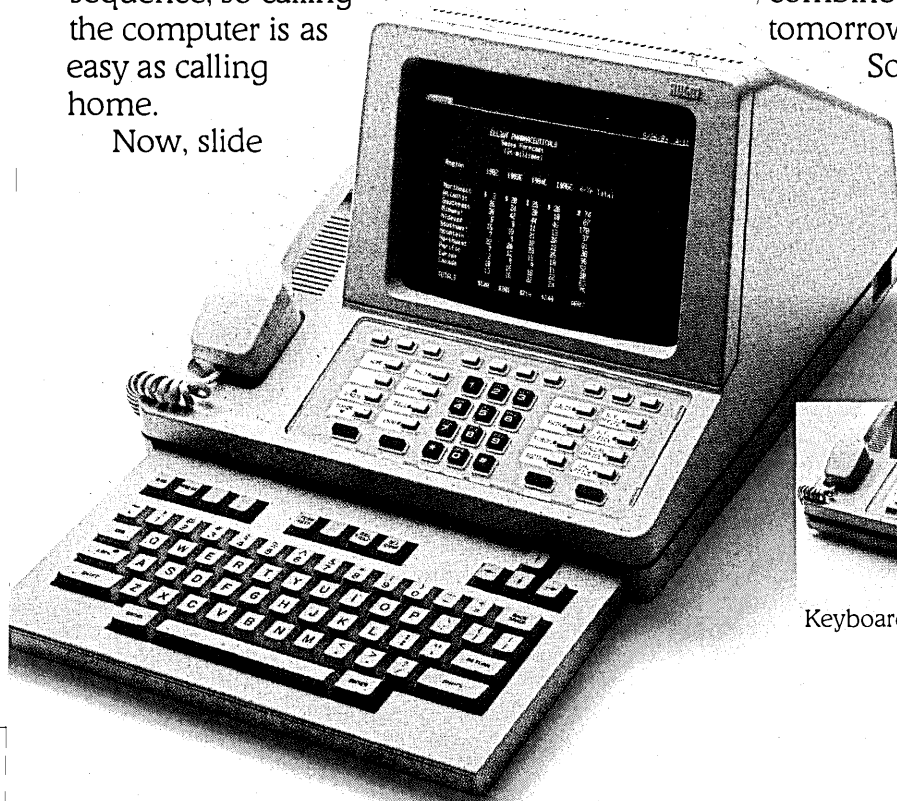

in the keyboard and you're looking at the slickest, easiest-to-use executive phone in the business today. Auto-dial, customized phone functions, phone list, access to the ROLM PhoneMail™ system, a clock, calculator and more. In one beautiful package.

Cypress is one more happy result of the most advanced, complete, proven, problem-free business communication system in the world: The ROLM CBX.

ROLM is the choice of the top FORTUNE companies, and - increasingly - the preferred solution to digital networking. In fact, there are more than 12,000 ROLM CBXs worldwide and over 10,000 data devices communicating through ROLM systems. (That's more than all other PBX manufacturers combined.) And they're doing it now. Not tomorrow. Now.

So before you spend another day trying to talk to the people who talk to the computers, talk to us. Call (800) 538-8154. In Alaska, California or Hawaii, call (408) 986-1000, ext. 3025. Or write: ROLM, 4900 Old Ironsides Drive, M/S 626, Santa Clara, California 95050.

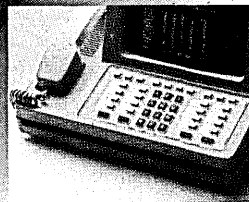

Keyboard disappears..

ROLM. We're closing the gap between business information systems and the people who own them.

**ROLM. NOW.**

CIRCLE 100 ON READER CARD

# The crucial feature in vector processors is that there is only one point of control, or instruction stream.

```
Set vector length to max value
Increment three base addresses
Loop
```

This is very similar to the code for a scalar register-based machine except that each loop iteration here adds many operand pairs.

Conceptually, a vector processor is like the orthogonal processor shown in Fig. 1. The crucial feature to note about vector processors is that there is only one point of control, i.e., there is only one instruction stream. In any type of multiprocessor, where there are several instruction streams there is far greater control complexity. An operating system must worry about allocating any separately controllable resource, and individual programs must maintain synchronization and communication if they use several processors. With one single instruction stream, all of these considerations are moot.

The arithmetic, Boolean, shift, and data manipulation operations that frequently occur in loops are all candidates for the vector instruction set. The architect of a vector/scalar computer could adopt a "holier than thou" attitude and only provide instructions that are generated by compilers, but a more realistic assumption is that assembly coding will be done, especially in important kernels of major codes. Thus, it is common to find vector operations that do not map in obvious ways from common loops, but are useful in other contexts. The APL compress operation, which squeezes out elements of a data vector if the corresponding elements of a control vector are "false," is useful in many situations but is unlikely to be generated, even by vectorizing FORTRAN compilers.

The machine language programmer on any computer has a set of operations available for doing typical arithmetic, logic, and control manipulation instructions. In the vector/scalar systems there are also vector analogs of most of these as given in Fig. 6. Thus, one uses these vector instructions when many values are to be operated on, i.e., some loops are replaced by vector instructions reducing the amount of programming.

To see the extent of this analogy, in the Cray-1, each instruction has one extra bit—a 7-bit opcode in the Cray-1 compared to 6 bits for the CDC 6600. The "extra" bit indicates a vector operation if one is set. The scalar subsystem of the Cray-1 and the 6600 are very similar and the vector data manipulation operations are analogous up to a point. Also, some vector operations are available on scalar machines: operations such as MOVE many characters, or LOAD an entire set of registers are vector operations that have been added to simplify programming or speed up operation in many systems. In truth, whenever there are several ways to code an operation, any good programmer will try to opti-

FIG. 4

## OPERATION TO ADD TO VECTORS: $C \leftarrow A + B$

CYBER-205 (Memory-to-memory vector operation)	CRAY AND SCALAR CASES (General Register Operation)
Setup vector operation	Loop Setup
ADD: $C \leftarrow A + B$	LOAD A (I)      ] Scalar
	LOAD B (I)      ]
	ADD                      X-MP
	STORE result at C(I)      ] Scalar
	loop and increment      ]
	till done

Brackets denote simultaneous operations on Cray X-MP and on best scalar system.

The vector setup on the 205 is longer than the setup for the Cray X-MP which is longer than that for the best scalar design possible. The 205 asymptotically adds once per clock period. The Cray suffers a startup delay on each vector segment for the ADD and the STORE, but the looping operation is concurrent with the store; thus, it will run approximately one add every 1.2 clock periods. For the scalar code, there is a delay, approximately equaling the startup delay, before the ADD and again before the STORE so addition runs substantially below one per clock cycle, depending on memory cycle, cache block size, and cache fill rate.

mize his code; thus, the extra instructions on a vector machine make programming more complex, just as extra instructions do in scalar machines (see box, note 2).

Given that vector processors differ from conventional processors only in that they have data aggregate operations as well as data pair operations, the impact on the operating system for such a machine is minimal. It should be noted, however, that multiprocessors and networks of processors do have more complex operating systems than uniprocessors. The addition of an adjunct processor, because it is a separate autonomous system, does affect the operating system. Multiprocessors also have more severe language and compiler restrictions than do vector/scalar computer systems. The salient difference is that all these other systems have several instruction streams instead of only one.

In languages and compilers, there are profound differences between conventional and vector processors. APL was probably designed as a natural programming system for scientists and engineers who think in terms of vectors. VECTRAN (developed by G. Paul at IBM) and the proposed array processing module in FORTRAN 8X, on the other hand, appear to be designed to facilitate compilation for vector processors.

### AUTOMATIC COMPILING NEEDED

Vector processing affects the compiler in its libraries and in other language-related areas such as the link-loader. A successful vector/scalar computer requires a compiler that can automatically compile existing codes to use the vector hardware. This automatic vectorization is currently available in several products and presents no theoretical difficulties.

The compiler analysis required for vectorization is the same as that required for extensive optimization.

In other words, many good optimizing compilers can do vectorization with little additional effort, provided the arithmetic library routines all have vector versions as well as scalar versions. In addition, some of the highly optimized application libraries will probably require vector routine additions. For example, both of the following FORTRAN loops are vectorizable:

```
DO 1 I = 1,N
  1 X(I) = SQRT(Y(I)**2 + Z(I)**2)
```

```
DO 2 J = 1,N,M
  A = X1(J) + X2(J)
  B = X1(J) - X2(J)
  Z(J) = A**2 + B**2 - A*B
2 Y(J) = 2*TAN(A/B)
```

Neither of these loops requires much

Introducing the Series 100 statistical multiplexors from DCA. So versatile, you may never have to replace them. And so reliable, you'll never want to.

Each Series 100 unit is engineered to expand with your network. The System 110 with 2-to-8 port capacity can be upgraded to a System 120 with 32 port capacity. The System 120 can be upgraded to a System 125 multidrop master.

Both Systems 110 and 120 can serve as slaves to the System 125 and can be multidropped along a single telephone line wherever terminals are clustered.

Further, since all DCA products are compatible, your Series 100 statistical multiplexor can grow to become a Series 300

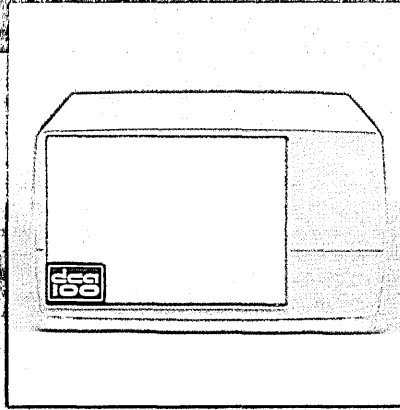

network processor with features such as unlimited port capacity, host selection and port contention. All by adding—instead of replacing—DCA components. So your investment is protected all the way down the line.

For more information about our newest statistical multiplexors, call toll-free: 1-800-241-5793. Or write: Digital Communications Associates, Inc., 303 Research Drive, Norcross, Georgia 30092. Somewhere down the line, you'll be glad you did.

**dca.**

Digital Communications Associates, Inc.  
DCA products are available worldwide.  
CIRCLE 101 ON READER CARD

**SOMEWHERE DOWN THE LINE,  
YOU'LL BE GLAD YOU CHOSE A SERIES 100  
STATISTICAL MULTIPLEXOR.**



more analysis than normally needed for optimization. The square root function in loop 1, however, does require a vector SQRT routine in the FORTRAN library, if it is not a hardware function.

Loop 2 illustrates some hardware features that are required for many problems. First, the x1, x2, y, and z vectors are all stored in memory in noncontiguous locations. Vectors in memory must be accessible even when the successive elements are separated by M (not unity) locations. Second, the intermediate results A and B can advantageously be kept in vector registers, if present. If a machine has no vector registers, like the Cyber-205 for example, the compiler must allow large temporary storage locations in memory for A and B. The only actual requirement of the program fragment above is storing the final (scalar) A and B values.

If a vectorizing compiler is compared to one that does not optimize, then the vectorizing one would be more complex. It should be remembered, however, that most of any compiler is related to language processing and code generation, not to optimization or vectorization. Various technical notes on vectorization give a relatively thorough discussion of vectorization from the programmer's viewpoint for each manufacturer's compiler/machine.

Recapitulating, the compiler for a vector/scalar computer should vectorize loops automatically most of the time and it should not be much more complex than any good optimizing compiler. The libraries of mathematical routines will generally have vector as well as scalar versions, and perhaps vector-scalar versions as well:

```

ATAN (U,V)
ATAN (X(*), Y(*))
ATAN (X(*), 1.5)
ATAN (PI, Y(*))

```

Where X(\*) represents a vector of X values, all these routines might be referenced by a program; this requires four different ATAN routines to maximize performance. Because of the much greater variety of routines, the link-loader should check to make sure that the calling sequences are compatible. For the standard library routines this checking is not necessary, but should be done for user-defined functions (see box, note 3).

Another area that is closely related to compilation is preprocessing. Certain types of vectorization analysis are so complex that it is undesirable to burden every compilation with them. Almost any type of code block restructuring and reordering or global vectorization falls in this category. These analyses are relegated to a preprocessor (usually manual at the present time) that can be run on a program once, producing cleaned up, re-ordered code. In this manner a programmer

FIG. 5  
TIMING DIAGRAM

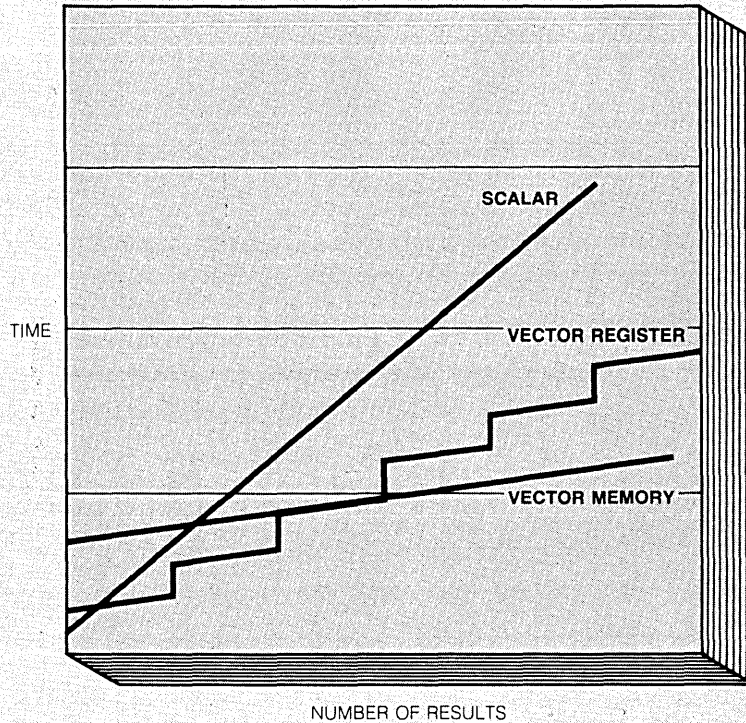

Scalar is fastest—at first. The register vector machine is fastest at intermediate vector lengths, and the memory-to-memory vector machine is fastest for long vectors.

FIG. 6  
VECTOR AND SCALAR INSTRUCTIONS

SCALAR INSTRUCTION CATEGORY	VECTOR ANALOG AND EXAMPLES
<b>Arithmetic</b> Add Multiply	<b>Vector Arithmetic</b> Add vectors or vector-scalar, elementwise Multiply vectors or vector-scalar, elementwise
<b>Boolean</b> AND XOR	<b>Vector Boolean</b> AND vector or vector-scalar, elementwise XOR vector or vector-scalar, elementwise
<b>Branch</b> JUMP on condition (some IFs)	<b>Merge</b> $V1_k$ $V2_k$ if $V4_k$ true $V3_k$ if $V4_k$ false (elementwise merge)
<b>Indexing</b> Normal Subscripted subscripts Indirection, pointers	<b>Stride Length</b> Fixed stride = vectors Gather/scatter = nonvectors
<b>Control</b> CALL (system service or subroutine) I/O JUMP, some cases	<b>No Vector Analog</b> Intrinsically serial operations

Most scalar instructions have two vector analogs, and vice versa: one vector-op-vector and one scalar-op-vector analogous to each scalar-op-scalar data manipulation instruction. Though vector instructions for Gather and Scatter operations may exist, these are executed as tight scalar loops in the hardware.

# New from Interactive Systems/3M:

## The first high-speed broadband local-area network that guards against data crashes.

If you've been thinking of investing in a contention network, consider this: How do you guard against data crashes during times of heavy system use?

Answer: You don't, because contention schemes simply don't provide any kind of data insurance.

Fortunately, there is a new type of network that *does* protect against data loss. It's called 3M Videodata® LAN/1. And it's the first intelligent broadband local-area network that's designed to get data through on time, no matter how much traffic is on the cable.

### Videodata® LAN/1: The efficiency of token-passing plus the proven flexibility and expandability of broadband.

Token-passing networks eliminate contention troubles and data crashes by passing an electronic "token" from terminal to terminal. When a terminal has to transmit, it grabs the token and sends data packets to the receiving device. Receipt is acknowledged and the token is automatically released to continue its rounds. Because the system assigns a network entry address to each user, everyone has an opportunity to send data during each token cycle.

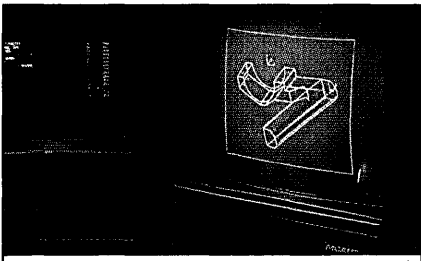

Because Videodata LAN/1 is a broadband system, dedicated channels can be used for full-motion video applications such as CAD/CAM and teleconferencing. These video signals are kept entirely separate from digital traffic on the network's token-passing channels.

So far, so good. But most token-passing networks are baseband systems, meaning that terminals must share a common channel as they would in a typical contention network. This can limit speed and capacity in some applications.

LAN/1 overcomes this possible limitation by combining token-passing with a proven *broadband*

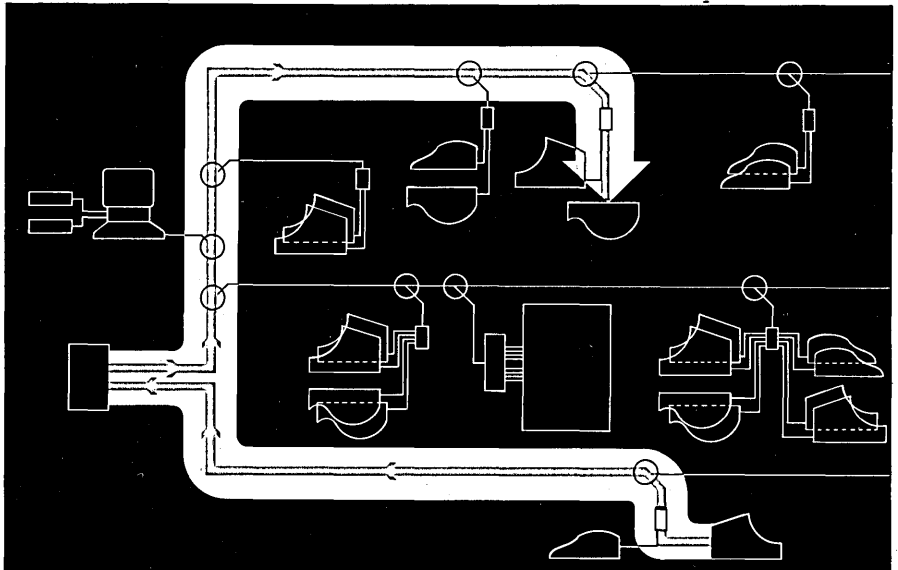

In the Videodata LAN/1 network, messages can be sent from any terminal to any other without going through the host processor. Network Interface Units (NIUs) connect digital devices to mechanical taps (shown as small circles) on the main coaxial cable. A Network Monitoring Unit, or NMU, keeps a statistical record of network performance.

technology that allows many channels to be put on a single cable. The payoff: higher channel speeds, ranging up to 2.5 MB/s over a maximum seven-mile radius, with terminal data rates of up to 19.2 KB/s. Plus a capacity of up to 10,000 devices to allow plenty of room for future expansion.

### Self-monitoring, with a printed record of network performance.

LAN/1 gives statistical proof of its own performance in printed form, thanks to a microcomputer-based Network Monitoring Unit (NMU). This unit, which also helps in routine maintenance and troubleshooting, may be used for remote monitoring as well.

### Separate channels for voice, video, and graphics. Plus the ability to work in point-to-point applications.

Because LAN/1 is a broadband network, channels can be set aside for real-time voice, video, and high-speed graphics. This can be done without compromising digital traffic capacity.

LAN/1's broadband design also permits flexibility in network architecture, so that it can be used in high-speed point-to-point applica-

tions which can't be served efficiently with contention systems.

Other benefits include full transparency, an automatic shut-off feature to keep any one terminal from capturing the token, and compatibility with both dumb and intelligent terminals. The list of features goes on and on.

For the full story on the new Videodata LAN/1 network from Interactive Systems/3M, call 800-328-1684 toll free. (In Minnesota, 800-792-1072.) Or mail the coupon.

Mail to: Interactive Systems/3M  
P.O. Box 33050 D-8  
3M Center  
St. Paul, MN 55133

Please send details on your new Videodata LAN/1 intelligent network.

Please have a representative call.

Name \_\_\_\_\_

Title \_\_\_\_\_

Company \_\_\_\_\_

Phone ( ) \_\_\_\_\_

Address \_\_\_\_\_

City \_\_\_\_\_

State \_\_\_\_\_ ZIP \_\_\_\_\_

3M hears you...

**3M**

# How to make work like a

First, neatly cut out the "370" label.

Now, when nobody's looking, nonchalantly tape it to your terminal, just under the "IBM," as if it really belonged there.

Then wait for your chance and quickly slip a dBASE II® disk into your main drive.

That's it.

Your IBM Personal Computer is now ready to run a relational database system, the kind that IBM put on their mainframes last year.

And you're ready with more data handling power than you would have dreamed possible before dBASE II.

## You'll wonder how you managed without it.

You'll find that dBASE II, because it's a relational database management system (DBMS), starts where file handling programs leave off.

dBASE II handles multiple databases and simplifies everything from accounting to department staffing to monitoring rainfall on the Upper Volta.

With a word or two, you CREATE databases, APPEND new data instantly, UPDATE, MODIFY and REPLACE fields, records and entire databases. Organize months worth of data in minutes with the built-in REPORT. Do sub-field and multi-field searches, then DISPLAY some or all of the data for any condition you want to apply.

And you've just begun to tap the power of dBASE II.

## Easy to look at, easy to use.

Input screens and output forms couldn't be easier—just "paint" your format on the CRT and what you see is what you'll get.

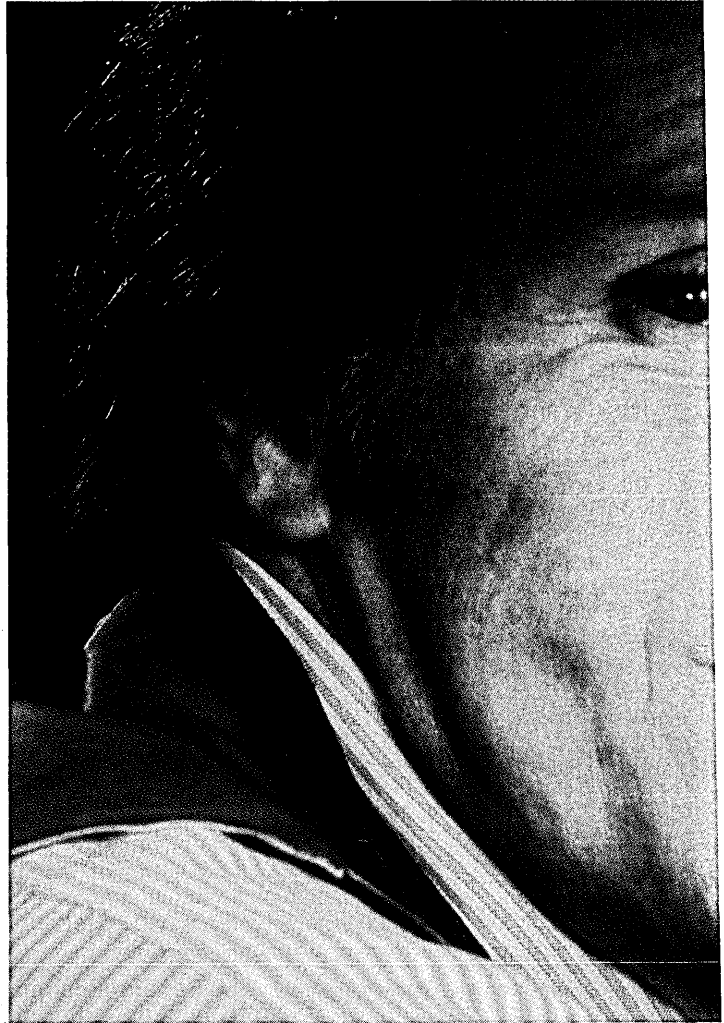

You can do automatic calculations on fields, records and databases, accurate to 10 digits.

And you can use dBASE II interactively for answers right now. Or save your instructions, then repeat everything with two words: DO Manhours, DO ProjectX, DO whatever has to be done.

## Use dBASE II to help make your choice:

If you've got a 96k IBM PC, send us \$700 and we'll send you a copy of dBASE II to use free for 30 days.



# e your micro mainframe.

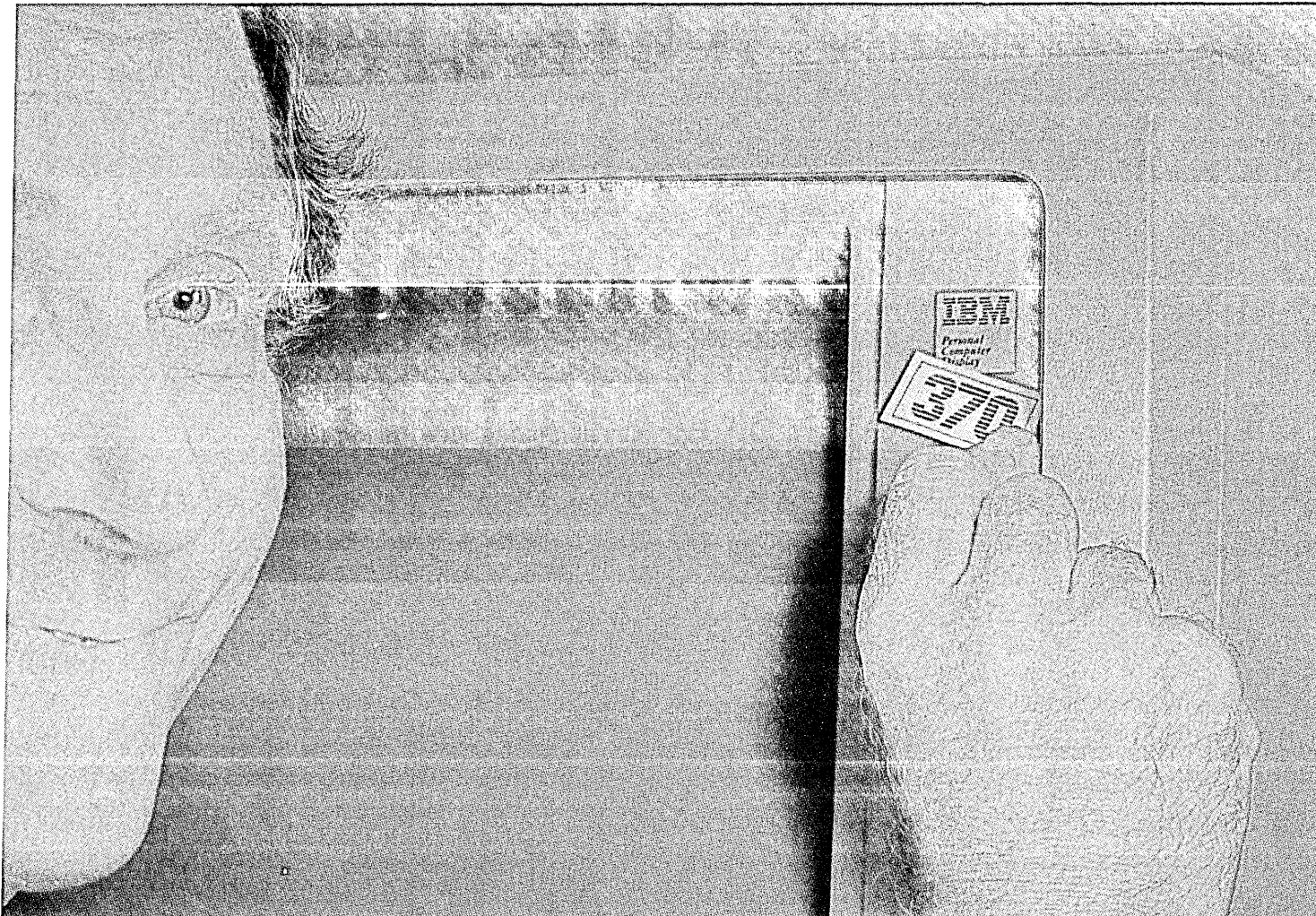

Instead of just poring over a manual, run it and make sure that it does what you need done. Then if you find it isn't right for you, send it back and we'll return your money, no questions asked.

But if you do that, you'll have to remove that label. Because nothing short of a mainframe works like dBASE II.

Call (213) 204-5570 today or drop by your local computer store for the rest of the story.

Ashton-Tate, 10150 W. Jefferson Blvd., Culver City, CA 90230.

ASHTON · TATE

©Ashton-Tate 1983  
dBASE II is a registered trademark of Ashton-Tate.

CIRCLE 103 ON READER CARD

## Sales of supercomputers will follow the good software, probably following the best optimizing/vectorizing compilers.

can preprocess codes that are in production or near production, and do future maintenance on the restructured version of the program.

The ease with which vectorization and vector processing increase the speed of computation ensures that these techniques will be widely used. Other approaches to supercomputing, such as the dataflow and polycyclic techniques may be useful but will not be important until a FORTRAN compiler can be generated for them or until some new language that is superior to FORTRAN appears. Languages that are supposedly better than FORTRAN continually appear, but few catch on. Pascal and Ada are two obvious candidates to replace FORTRAN, and each has or will in certain situations. As has been observed many times, the structure of the programmers' methodology is far more important than the language they use. My personal opinion is that FORTRAN 8X is the most likely replacement for current FORTRAN in most of the traditional applications. Further, the inherent synchronization and communication overhead of most nonvector supercomputers will prevent them from matching the efficiency of vector processing in most situations as Gajski et al have shown.

The sales of supercomputers will follow the good software, probably follow the best optimizing/vectorizing compilers. Fig. 7 lists a number of architectural features discussed in this paper and their effect on programming and compilation.

Once compilers and other software aids are developed, vectorization will always pay. Vector hardware will always be cheaper per computation than comparable scalar hardware because the control can be distributed over more computations and because many fewer instructions need to be fetched. This technology-independence seems to guarantee vector processing a place in everyone's future.

Vector processing is efficient in both the commercial and scientific/engineering computing worlds. While there has been no discussion of vectorization of non-FORTRAN programs, a few languages present as many difficulties as FORTRAN, because of features such as EQUIVALENCE, COMMON, and separate compilation. \*

Lee Higbie received a BS in physics and an MS in math during the Paleozoic era of the computer age. He has worked as a computer architect for two decades, designing Von Neumann, associative, vector, and vector/scalar systems for such companies as Itek, Sanders Associates, Cray Research, and Gould. He is now at the Gould Research Center, where he is in charge of the computer architecture research group.

FIG. 7

### EFFECTS OF ARCHITECTURAL FEATURES

FEATURE	GOOD POINTS	BAD POINTS
<b>Memory-to-Memory</b>	Vector length homogeneity	1. Partial result storing 2. Startup; long vector operation required 3. Virtual-memory difficulties
<b>Register-to-Register</b>	1. Traditional register optimization techniques applicable 2. Lower memory band width 3. Fixed partial result length 4. Fast short vector operation	1. Vector segmenting required
<b>Unit Memory Stride</b>	1. Simple hardware arrays must be transposed 2. Not FORTRAN-like	1. Multiaccess
<b>Variable Memory Stride</b>	1. FORTRAN compatible 2. Easy to program	
<b>Vector Adjunct</b>	1. Software support of any kind	1. Little manufacturer software support of any kind 2. Multiple instruction stream, requiring explicit control

FIG. 8

### ARCHITECTURAL COMPARISONS

FEATURE	IMPLEMENTATION RANGE OR CHARACTERISTICS
<b>Arrays of Processing Elements (PEs)</b>	ILLIAC-IV—64 PEs; ESP—16 PEs; Orthogonal Computer—64 PEs; DAP—4096 PEs. Efficiency saw-tooths as vector length increases.
<b>Pipelined Operation</b>	Star-100, Cyber-200; Cray-1; vector adjunct machines. Efficiency grows asymptotically with vector length.
<b>Memory-to-Memory</b>	Star-100, Cyber-200; adjuncts. Requires high memory bandwidth; variable stride vectors much more difficult.
<b>Register-to-Register</b>	Cray-1. Requires vector segmentation, buffers memory dataflow rates, simplifies cpu; tends to make assembly code vector-register-length dependent, reducing family price performance range; vector registers can replace cache.
<b>Vector Adjunct</b>	All "FFT boxes" are adjuncts. Generally an I/O bottleneck exists between adjunct and host; synchronization must always be explicit.
<b>Vector/Scalar System</b>	Cray-1; Cyber 200. Only one instruction stream for both vector and scalar instructions, only one memory so there are no communication or synchronization difficulties.

# XEROX

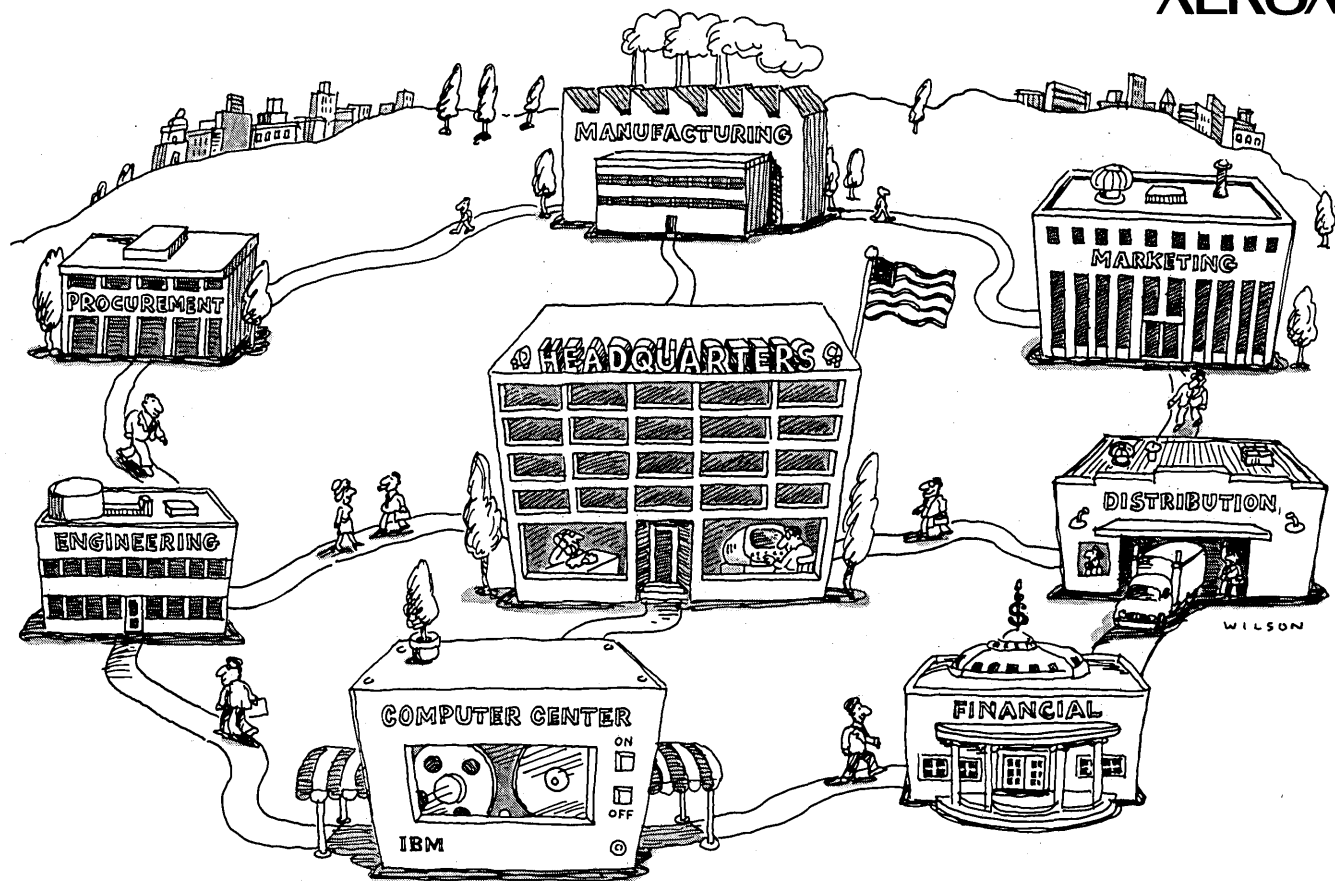

## Presenting a complete, unified software system for manufacturers.

Developing a manufacturing planning and control system takes skill and time. You can buy various parts from different vendors and build the interfaces yourself. Then test and implement the software.

Or you can have the Xerox Manufacturing System.

An advanced software architecture from Xerox has done all the work for you. Integrated applications, systems software, analytical tools, and personal computers joined in one complete, unified system.

Every department works with information from the same database. Closed-loop business applications help you plan and execute your priorities and manage costs at optimum levels. Master scheduling, MRP II, inventory, order entry, costing, production control, procurement, receivables, payables, and financial modules are combined in the most powerful operating management tool available today.

Plus, easy-to-use programs for inquiry, reporting, data manipulation, modeling, forecasting, and graphic display. And a personal computer link to your mainframe, the first practical application of its kind.

Xerox software is completely portable across all

IBM 4300, 370, and 3000 computers and operating systems. You can use it on your computer or, as an option, start with our timesharing service. Then, when you're ready, move the software and database in-house. In one weekend. Our systems run on Digital VAX minicomputers, too.

Implementation support, consulting, and education services are available nationwide. For more information, call toll-free (800) 323-2818, Operator 148. In Illinois, call (800) 942-1166. Or return this coupon.

### Xerox Computer Services

D8/83

c/o Ron Rich, 5310 Beethoven Street, Los Angeles, California 90066

Send me your *Xerox Manufacturing System* brochure.

I'm interested in your software for:

IBM 43XX  IBM 370  IBM 30XX  Digital VAX

Name/Title \_\_\_\_\_

Company \_\_\_\_\_

Street \_\_\_\_\_

City \_\_\_\_\_ State \_\_\_\_\_

Zip \_\_\_\_\_ Tel. ( ) \_\_\_\_\_

XEROX® is a trademark of XEROX CORPORATION. VAX® is a trademark of Digital Equipment Corporation. IBM® is a trademark of International Business Machines Corporation.

CIRCLE 104 ON READER CARD

Introducing the  
PT-88 jet printer.

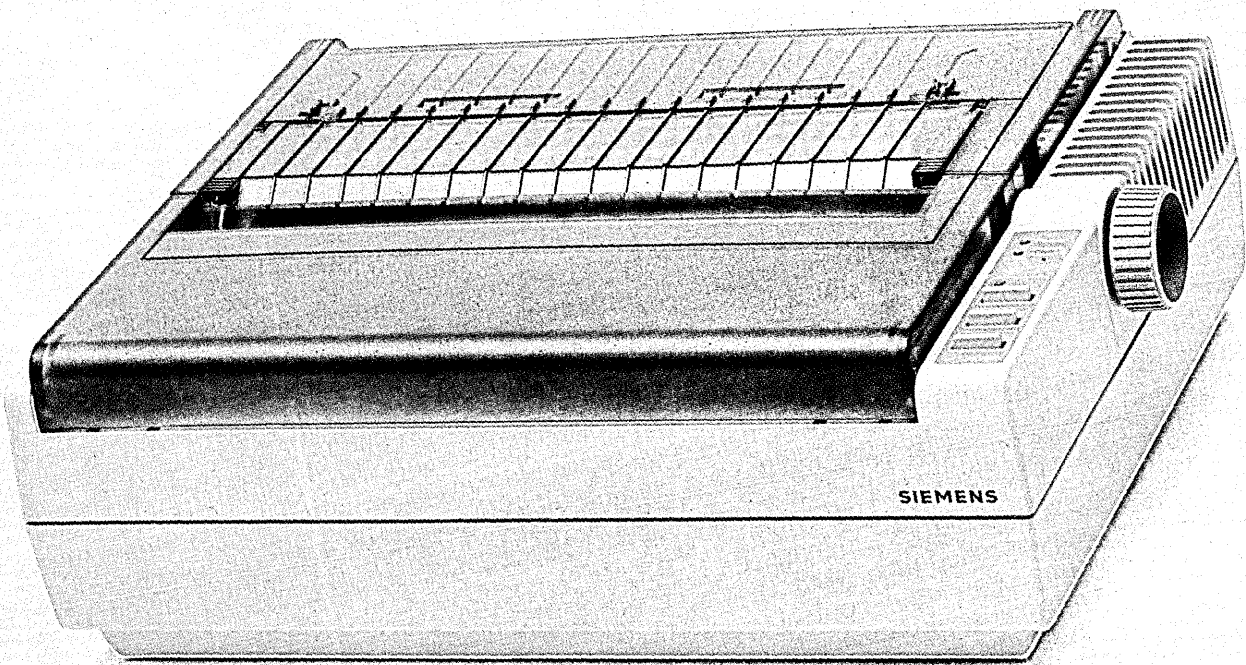

# Anything else is just a lot of noise.

In a market where noisy superlatives such as "incomparable", "second-to-none", and "the epitome of excellence" are casually applied to a wide variety of printers, Siemens has taken a more quiet and purposeful approach.

The PT-88 is our new jet matrix printer. Upon close inspection, you'll see that it is equipped with all the features your business can benefit from—consistent print quality in a variety of type styles, high speed (150 cps), tractor or single-sheet plain paper feed, full graphics capability, universal interface with personal or desk computers, and modular design for simplified service, if it is ever required.

But in addition to this, the PT-88 offers you something that many others simply can't... a QUIET working environment. Listen very carefully. The super-silent PT-88 whispers while it works, at less than 50 dBA. Compare it to those that operate at more than twice that sound level and clang, screech, rattle and shriek. Then think of how nice it will be to accept phone calls or conduct meetings while the PT-88 is hard at work... right next to your work place if you wish.

In short, the PT-88 puts it all together—reliability, flexibility, performance, and low-cost operation—all in one compact, super-silent unit. The result is a printer of exceptional long-term value. Now the question remains—Is it incomparable? Second-to-none? The epitome of excellence? We'd want you to decide for yourself. One thing's for sure. It's remarkably quiet. And in an increasingly noisier business environment, we think that's something you can appreciate.

For more information, contact:  
Siemens Communication Systems, Inc.  
Office Terminals Division  
186 Wood Avenue South  
Iselin, NJ 08830  
(201) 321-3400 or  
240 East Palais Road, Anaheim, CA 92805  
(714) 991-9700.

Quietly impressive printers...  
from Siemens.

**The job of information systems managers is bigger than the management of information systems.**

# CORPORATE STRATEGIES AND DP TACTICS

by Robert F. Hargraves Jr.

Different corporate strategies require different results from information systems. Four broad classes of information system results can be pinpointed—product cost reduction, product growth support, management information, and information technology products. Senior management establishes the corporate strategic plan. Information systems managers determine the results needed to support that strategy, selecting action plans that deliver the appropriate information system results.

A strategic planning aid often used by Arthur D. Little Inc. in its work for clients is the strategic condition matrix. Within this framework, products of a strategic business unit have a life cycle of four stages: embryonic, growth, mature, and aging. Fig. 2 characterizes the hypothetical sales, profit, and cash flow that strategic planners expect to achieve for a business unit. Sales rise rapidly from the embryonic through the growth period, leveling off in the mature stage, and dropping in the aging phase as market saturation and technological displacement occur.

Because of early investments in product development and marketing, profits do not become substantial until near the end of the growth stage. Cash flow may peak in the aging stage, due to depreciation of previously invested assets and investment limitations. Overall, industry maturity generally passes through these same four stages. Occasionally strategic business units can return to an earlier phase through planning and innovation.

The competitive position of a strategic business unit within an industry can be classified in five ways—dominant, strong, favorable, tenable, or weak. Dominant organizations may have strongly protected tech-

nological leadership or a quasimonopoly. Strong competitors can maintain long-term positions and select strategies independent of their rivals' actions. While favorable competitors have certain exploitable strengths and can improve their positions, tenable competitors have potential to survive—but sometimes only in a protected niche or with tacit consent of industry leaders. Finally, weak competitors have had unsatisfactory performance, but may have strengths that lead to improvement.

The strategic condition matrix illustrates both industry maturity and competitive position. Fig. 3 superimposes strategic option areas onto this matrix.

The four previously mentioned classes of results that can be expected from information systems are appropriate to different areas of the strategic condition matrix as illustrated in Fig. 4. Achieving the different objectives requires different actions on the part of information systems organizations.

One information systems strategic objective is to reduce the cost of a product or service through the use of a computer system. Examples of such information systems results are automated health insurance claims settlement, computer-controlled warehousing, and electronic funds transfer (EFT).

These are typical automation applications. Computerization was initially used to help reduce clerical and manufacturing labor costs; now all product-related costs are potential targets of automation. Cost reduction may be important during the growth phase if an organization's strategy is to increase market share through price leadership. Cost reduction is also important during the mature and aging stages of a favorable, strong, or dominant competitor because large sales volume leads to maximal profit potential.

## PRODUCT COST REDUCTION

To achieve the objective of product cost reduction, information systems managers may have to make changes both inside and outside their own departments. Cost savings through automation are important during the growth stage, both because the marketing advantages of price leadership can be achieved, and because there is a long remaining product lifetime over which to spread development costs. If the investment is to be large and to last a long time, it is critical that information system requirements be well executed throughout the definition, specification, development, and operation phases.

Examples of activities aimed at product cost reduction are:

- Develop a single information system to control an inventory of expensive spare parts distributed throughout multiple small depots,
- Implement a pattern placement algorithm to minimize waste sheet metal when planning custom duct work, and
- Provide all customer service representatives with on-line access to all customer records in order to satisfy inquiries in a single telephone call.

As a product approaches maturity, the costs of data processing itself may come under scrutiny as an important component of product costs. Information systems managers must then consider how to reduce these costs, as dictated by the business unit strategic plan. Examples of potential actions are:

- Allocate information systems costs to product costs accurately, and monitor and pare unit transaction costs continually,
- Create potential for cost competition between multiple internal information services centers, and possible external dp services,
- Centralize information systems operations,

PHOTOGRAPH BY STEVE COOPER

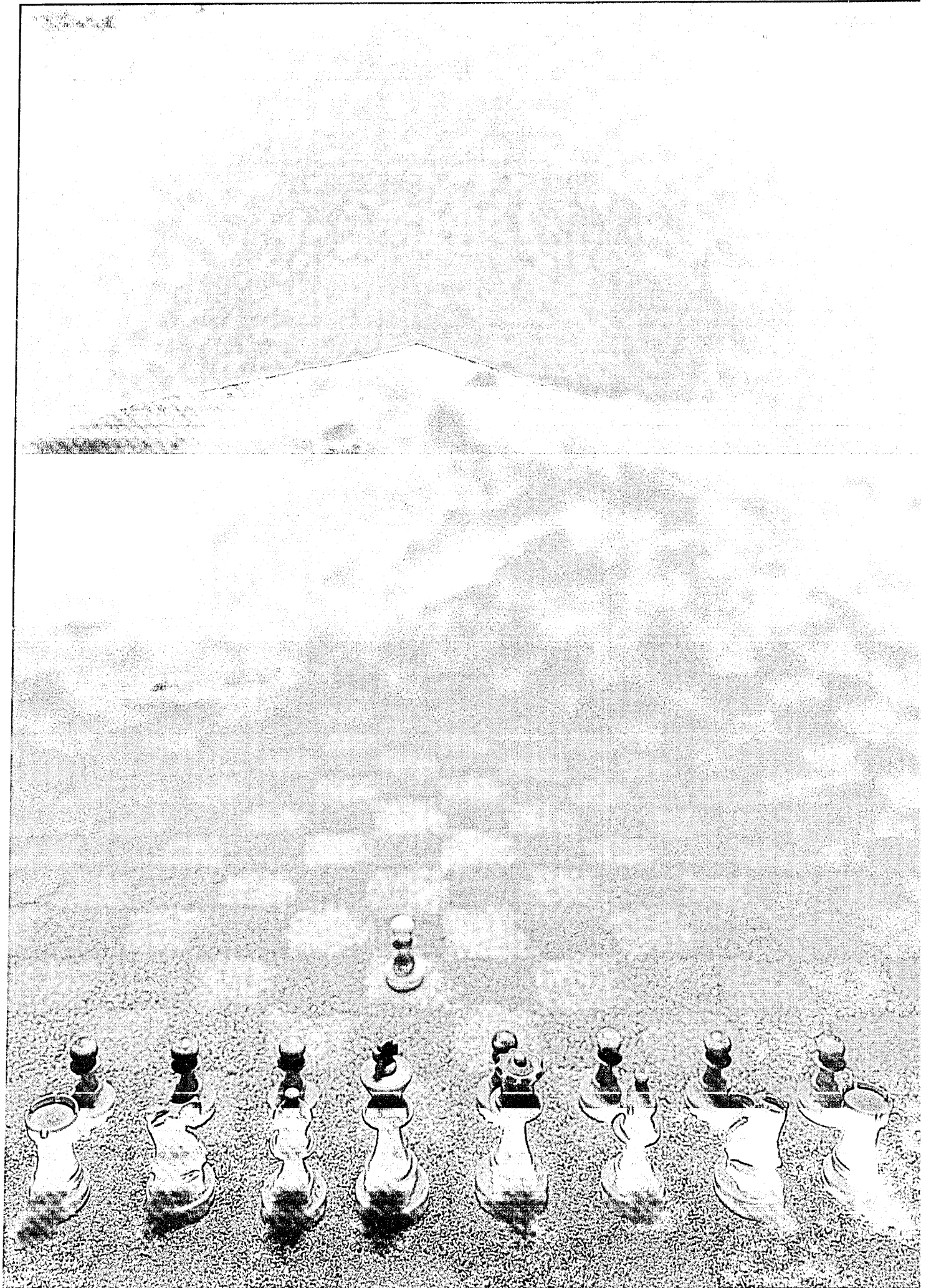

- Reduce programming staff, avoid unnecessary systems changes, and use older hardware, and
- Use standard rather than custom software and adapt administrative procedures to match.

Where a mature product is concerned, managers should be cautious about considering plans to reengineer entire information systems to facilitate future changes, or to undertake projects with long payback periods.

In the aging stage of a product, the life-cycle phasing of a software project may be very important. Today any significant software project takes over one year to develop, and the payback period extends for a period of years after the software is put into use. Regardless of how software development costs are expensed, an applications software development project must be eyed as an investment.

Of course, the useful lifetime of an applications software system is limited, and for two reasons. First, functional requirements change after the system has been put into use. To the extent that the initial architecture did not provide for the changed requirement, each successive modification becomes more and more difficult, time-consuming, limiting, and expensive. Eventually it becomes more economical to redesign the system than to pursue another modification. Second, new computer hardware and software become available that provides improved functionality at lower prices; function/cost ratios are averaging a 30% per year improvement. The installation of a new, technically superior computer system often spurs the rewrite of an applications system.

Applications software typically has a life span of five to 10 years. Where the lifetime of the applications system coincides with the remaining product life planned by the strategic business unit, proper phasing becomes critical. A very important part of the enterprise strategy is to reduce invested assets to generate cash flow during the late mature and aging stages of the product. Fig. 5 illustrates an optimal phasing of applications system life cycles relative to the product strategic life plan.

There are three separate cycles of net software asset changes, each rising as a software system is developed and falling as the asset is amortized. Fig. 6 illustrates the triple horror of an overrun of the software project labeled "Cycle 3" in the previous figure. Cash flow is much less than planned for two reasons—the profit improvement due to the benefit of the project is delayed, and the investment in the project is more than expected. Also, the remaining product life is not sufficient to permit full recovery of the invested software asset.

FIG. 1

## INFORMATION SYSTEMS STRATEGIC OBJECTIVES: THE MISSING LINK

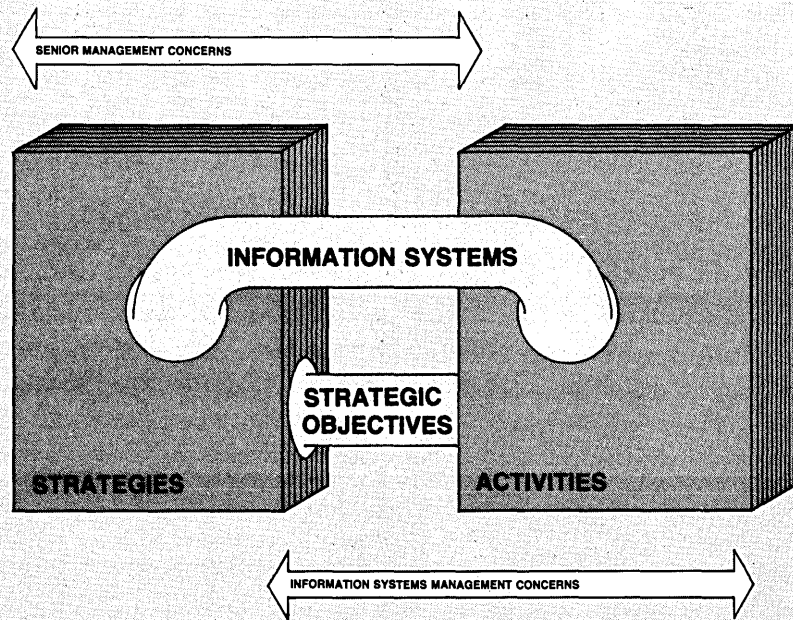
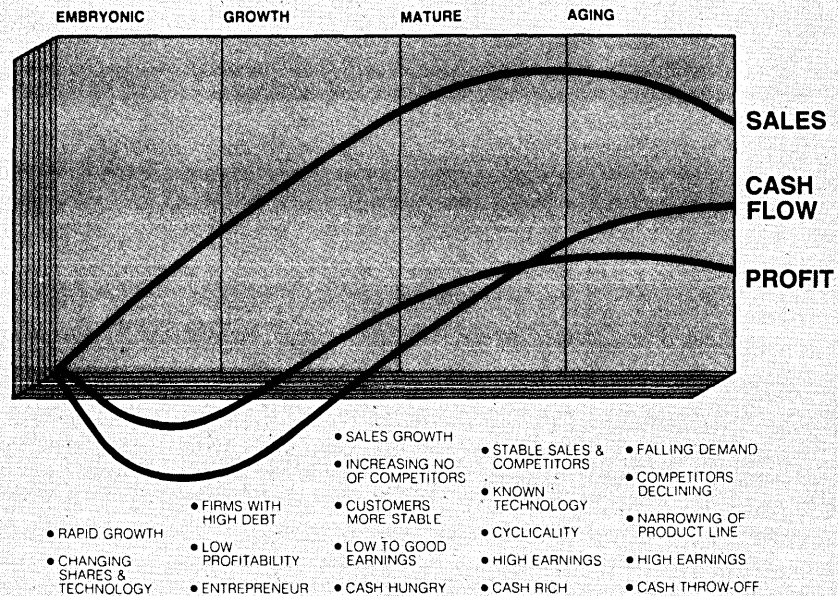

FIG. 2

## INDUSTRY MATURITY



### PRODUCT GROWTH SUPPORT

Another information systems strategic objective is support of rapid development of new products or services. This support, provided by such means as computer aided design, a demographic study of the marketplace, critical path scheduling, and quality control manage-

ment of customer services, can assist either product development or marketing functions.

Information systems can be used to help develop a product to be sold, to help adapt the product to match the evolving market needs, and to help gain market share through informed, targeted marketing. The primary concern is timeliness. Whether aim-



# Spelling errors can be a capital offense.



## FREE YOUR USERS.

If you build computer systems (hardware or software), you should provide spelling assistance to your users by selecting the right Proximity OEM Software Solution. They deserve it. In fact they are probably starting to demand it, because the news is out that computerized spelling assistance is truly beneficial.

Computers that spell can help us write, and that's welcome news for the millions of us who are less-than-perfect spellers! So don't stop with word processing. Spelling assistance is needed in Electronic Mail, Databases and Spreadsheets.

For micros—or mainframes—Proximity's high quality OEM software provides immediate integrated solutions to the problems of spelling error detection, correction and hyphenation. With our highly portable C-language modules, integration is a breeze. And the results will be

fast, compact and accurate. Look to us for future products that can deliver even more linguistic advantages in an integrated environment.

Our devotion to quality is not limited to programming. Proximity's English data bases are edited and supported through an exclusive partnership with Merriam-Webster Inc.—publishers of the best-selling dictionary of the English Language.

Whether you're in software development or in marketing, you'll find that we have designed our systems for you. We'd like to free your users from the consequences of pointless spelling errors while helping them to create in a more supportive environment.

*Let us show you how our technology can help your products spell. And sell.*

**PROXIMITY™**

3511 NE 22nd Avenue Fort Lauderdale, Florida 33308

1-(800) 323-0023

CIRCLE 106 ON READER CARD

# MEMEMO

## 3270 Compatible Display Stations

### **Memorex is compatible.**

When we say compatible, we mean plug-to-plug compatible. In monochrome or color. As you mix and match with Memorex, you'll protect in-place investments in applications programs, existing hardware and user training.

**Memorex is reliable.** We produce some of the most reliable products in the industry. Backed by a worldwide network of Memorex personnel dedicated to excellence. From production at headquarters to support in the field, you can count on us.

**Memorex is user-friendly.** Comfortable operators are more productive. So we led the industry by introducing a monitor that tilts so you don't have to. Our non-glare, smudge proof screen reduces eye fatigue. An operator information line keeps users aware of error conditions and helps reduce mistakes.

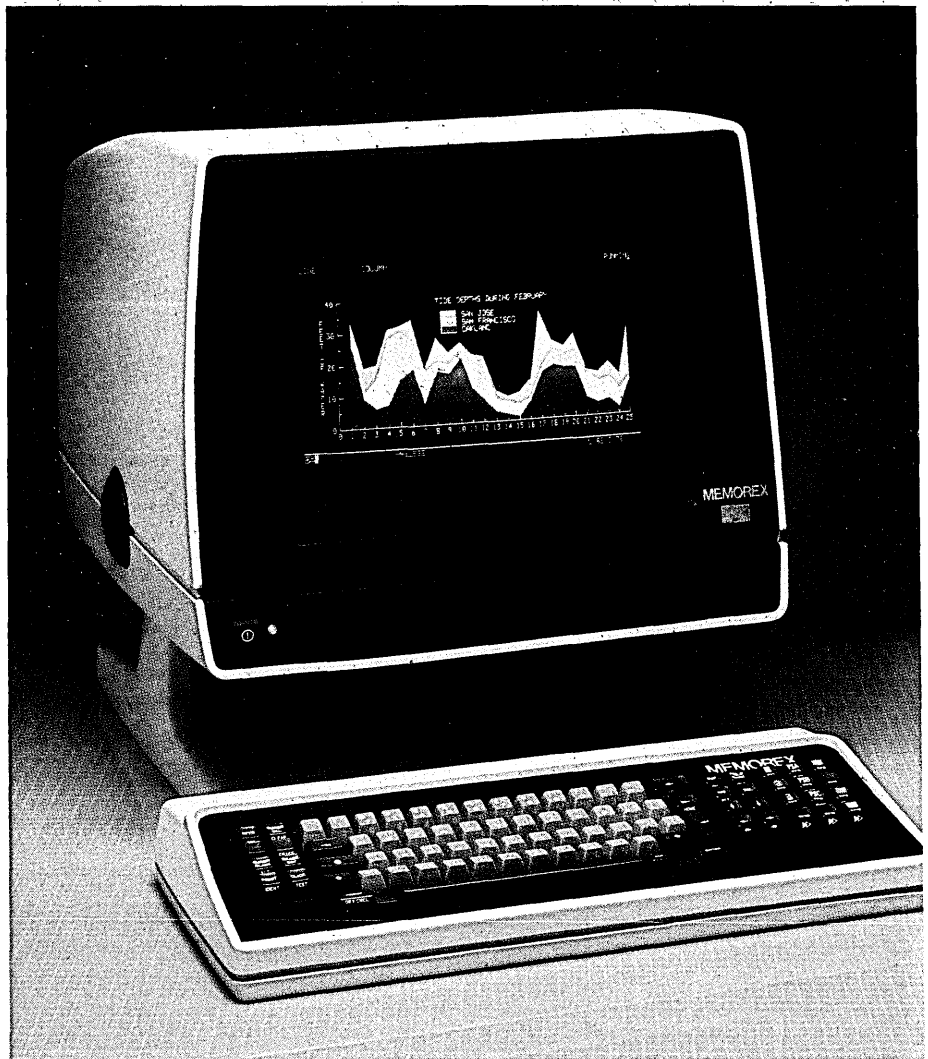

Memorex 2079 Color Display Station

**Memorex is a leader.** We're the only plug-compatible vendor with seven colors and graphics. And, our colors are crisper, cleaner and *always* in focus. By design, there is no need to perform time consuming convergence routines or to worry about magnetic fields that may interfere with the clarity of the display.

**Memorex is productive.** Graphics displayed on our screens allow you to absorb informa-

# MEMOREX



Memorex 2078 Display Station

tion, spot trends and make decisions faster.

**Memorex is economical.** Along with being competitively priced, we save you money over the long haul. Our display stations use substantially less power than our competitors... up to 58% less. And if you leave the display unattended for more than 20 minutes, its screen will automatically dim to prevent screen burn, extend the life of internal components,

and conserve energy.

**Memorex is flexible.** We offer a full choice of models and a wide range of options including a selection of 16 keyboards. Plus our display stations function in bisynchronous and SNA/SDLC environments.

**Memorex is available.** Instantly, in many cases. Ask about our quick delivery program. You'll find that, when you need us, we'll be there.

**Memorex is experienced.** We offer computer peripherals and magnetic media of consistent quality to satisfied customers and have for over 22 years. Our worldwide sales and service organization spans the globe providing you the best solutions and support.

So call us, now. Toll free, dial (800) 538-9303. In California, we're at (408) 996-9000. Ask for extension 616. Or write to us at 18922 Forge Drive, Cupertino, CA 95014-0784.

**MEMOREX**  
A Burroughs Company

CIRCLE 107 ON READER CARD

## Computerization was initially used to help reduce clerical and manufacturing labor costs.

ing to develop a new product or to gain a significant share of the available distribution outlets, the purpose of information systems support is to speed the process so as to meet the objectives before the natural development of the industry places such strategic goals out of reach.

In this stage the information systems costs are usually high, fixed, and out of proportion to sales revenues. Such costs should be treated as one-time investments to be amortized over the life of the product. For product growth support, timeliness is paramount, and costs can reasonably be recovered from future product sales.

Examples of activities that information systems managers might undertake to support product growth are:

- Install interactive terminals and software productivity tools to speed up applications development,
- Install and support a straightforward database management system with coordinated applications generators,
- Provide the means to support nonprofessional programming activities in other departments,
- Reduce administrative impediments to rapid changes in software, equipment, and schedules; distribute authority and control over data processing activities, and
- Develop reserve capacity in hardware, software, and personnel; make use of outside computer services and systems developers.

Caution must be exercised in certain situations. Management should be wary of sharing computer resources with cost-sensitive operational systems. Information systems that already support a mature or aging product are likely to be fully utilized, running on tight schedules, with overriding cost concerns. A conflicting cost-control strategy may bog down all requests for changed equipment, software, or schedules; thus a principal benefit of information systems support of product growth—saving time—may be lost.

### DON'T ISOLATE IS STAFF

It is important that the information systems development staff not be isolated from the dynamics of the marketplace as new products make entrances and customer receptivity is gauged. Product developers and market planners work with imperfect information, and the ability to make midcourse corrections in response to business needs is important.

Also, it may be unwise to initiate a grandiose information system development effort in the embryonic or early growth stages, for needs are bound to change. A long developmental period also means a long period in which no new benefits are received. It

FIG. 3

### STRATEGIC OPTION ZONES

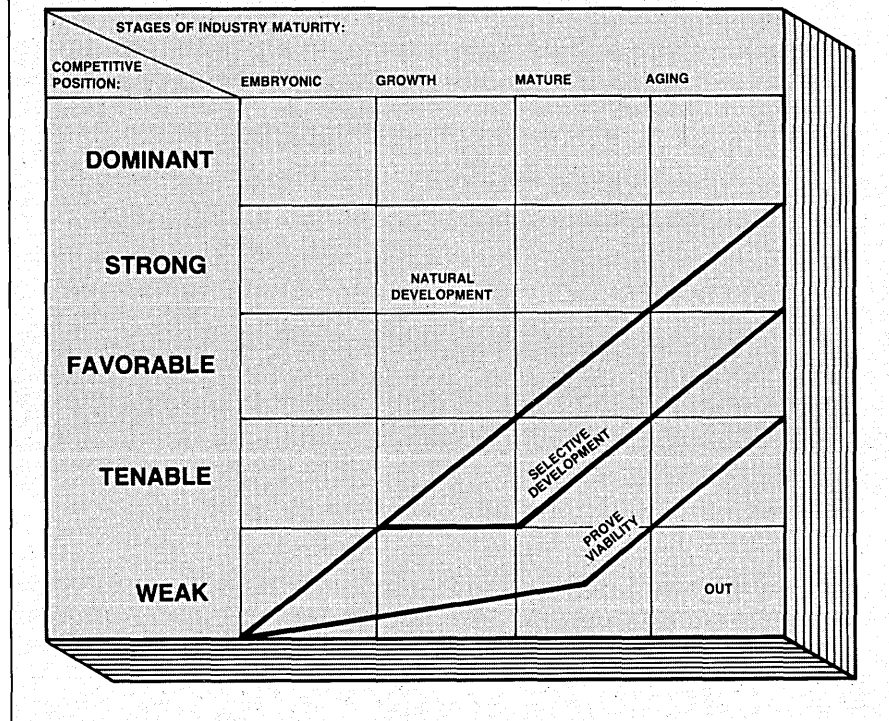

may be wiser to encourage the development of a progression of short-term projects, each with incremental benefits.

Too little prototyping is another potential pitfall. Experience shows that programmers trying to build efficient systems from the outset usually optimize too many unimportant details. Optimization is better considered after some operational experience has been acquired. Modern software tools and project management techniques permit rapid development of functionally operationally prototype information systems—and at one tenth the time and cost of traditional methods.

The drawback sometimes cited is higher computer usage expenses compared to traditionally constructed applications systems. Efficiency can be sacrificed for expediency in support of product growth. Operational costs are a more important concern for mature or aging stages. There is no sense in building an expensive system to support a high transaction volume if the expected sales never materialize. Even if a prototype system is discarded and the application reimplemented, this is not burdensome if the initial implementation did not cost much, and if the prototype system did support the early growth stages of the product.

Another strategic objective of infor-

mation systems is to provide management information, meaning the summarized reports and messages managers use when making decisions. Excluded from this category are operational records such as manufacturing inventory tallies, waybills, and insurance policy records. Many companies with well-developed operational information systems still lack management information systems that deliver timely, relevant, concise information to assist in the decision-making process.

The purpose of a management information system is to coordinate and control an organization, with the objective of improving the quality of managers' decisions. Information systems used to supply management information include management accounting systems, electronic mail, and financial modeling and simulation systems. A good management information system can speed up the decision-making process and is especially helpful when positions on the corporate strategic condition matrix change rapidly.

Some activities that information systems managers might undertake to improve management information are:

- Install an integrated system for management accounting and financial reporting,
- On a monthly basis, copy reported, summarized data and backup information into easily accessed databases; provide managers

# 21 MIPS—Move over VAX and MV/10000, the fast lane belongs to Perkin-Elmer.



© 1983 The Perkin-Elmer Corporation

The benchmarks are in. Perkin-Elmer has won again—by executing 21 MIPS on our Model 3200MPS with a sustained I/O bandwidth of 40 MB/sec.

## King of the road

Consider this. The VAX 11/780 can execute 1.2 MIPS. The Eclipse MV/10000 fares a little better at 2.5 MIPS. But the Perkin-Elmer 3200MPS gives you a plug-in parallel processing system that starts at 3 MIPS and can be expanded up to an astonishing 21 MIPS.

## Maneuverability

The Model 3200MPS gives you new freedom in estimating jobs that are difficult to size. You can start with a 3 MIPS processor priced at only \$150,000. Then, as your needs grow, you can add anywhere from one to nine Auxiliary Processing Units (APUs) at

an extremely affordable \$35,000 each.

## Automatic shifting

The Model 3200MPS is designed to handle demanding real-time applications as well as heavy streams of independent number-crunching tasks. You can segment your application into multiple task modules, with each APU performing a set of related functions.

Our virtual task manager gives you full virtual capability without the virtual overhead.

## Ease of handling

The Model 3200MPS provides maximum flexibility for software development, system maintenance, and system extension.

Our state-of-the-art universally optimizing FORTRAN VII Z enables you to use modular programming techniques for programmer productivity while

maximizing real-time efficiencies.

The Model 3200MPS can be structured to permit continued system operation though one or multiple APUs may fail.

To find out more about 21 MIPS mainframe-style crunching on our Model 3200MPS write or call today: The Perkin-Elmer Corporation, Two Crescent Place, Oceanport, NJ 07757. **Tel: 800-631-2154.** In NJ 201-870-4712.

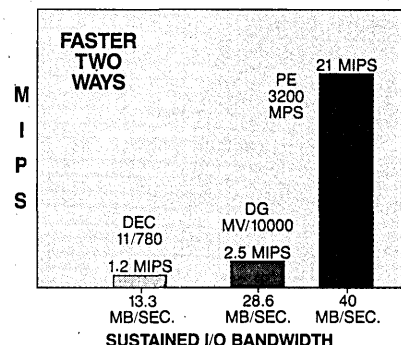

# PERKIN-ELMER

# Others say they solve your computer power problems.

## We say they're not keeping current.

Most power conditioners are based on technologies developed decades ago. It's old technology attempting to protect the new technology of the 80's.

No one adequately protects the ultra-sensitive microelectronics in your computer from harmful electric noise. As a result, no one provides the steady current your computer needs to operate effectively.

Not one. Except Oneac.

Only Oneac power conditioners are designed specifically for your modern computer. Some one can't hold a candle to Oneac's complete power protection capability.

### Power in pulses.

Your computer uses pulses of electric current. It takes large pulses to start it up, smaller ones to keep it running.

The only way other power conditioners can provide these large pulses of current is to be overloaded.

This results in a serious trade-off. Overloaded conditioner power conditioners stand to be unstable. They cause the electric power to waver out of control—which permanently damage your computer.

There are no such trade-offs with Oneac. Exclusive technology eliminates all harmful electrical noise. Yet, this same sys-

tem still provides the steady current pulses your computer needs from first startup and all through the day.

No overloading involved. Oneac power conditioners provide steady operation with the same 200-watt normal household circuit.

What's more, Oneac products protect all equipment. And they're fully compatible with most modern computers.

### Don't hesitate.

Altogether, many leading brands of business computers have selected Oneac to solve their power problems. Shouldn't you do the same for your computer?

We invite you to compare ours with the others. Ask them about current. Ask them about noise. And ask them about the trade-offs they want you to make.

Then, ask us. We'll prove to you that they're not keeping current.

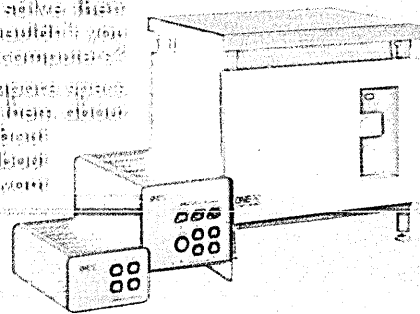

# Oneac: Power that performs.

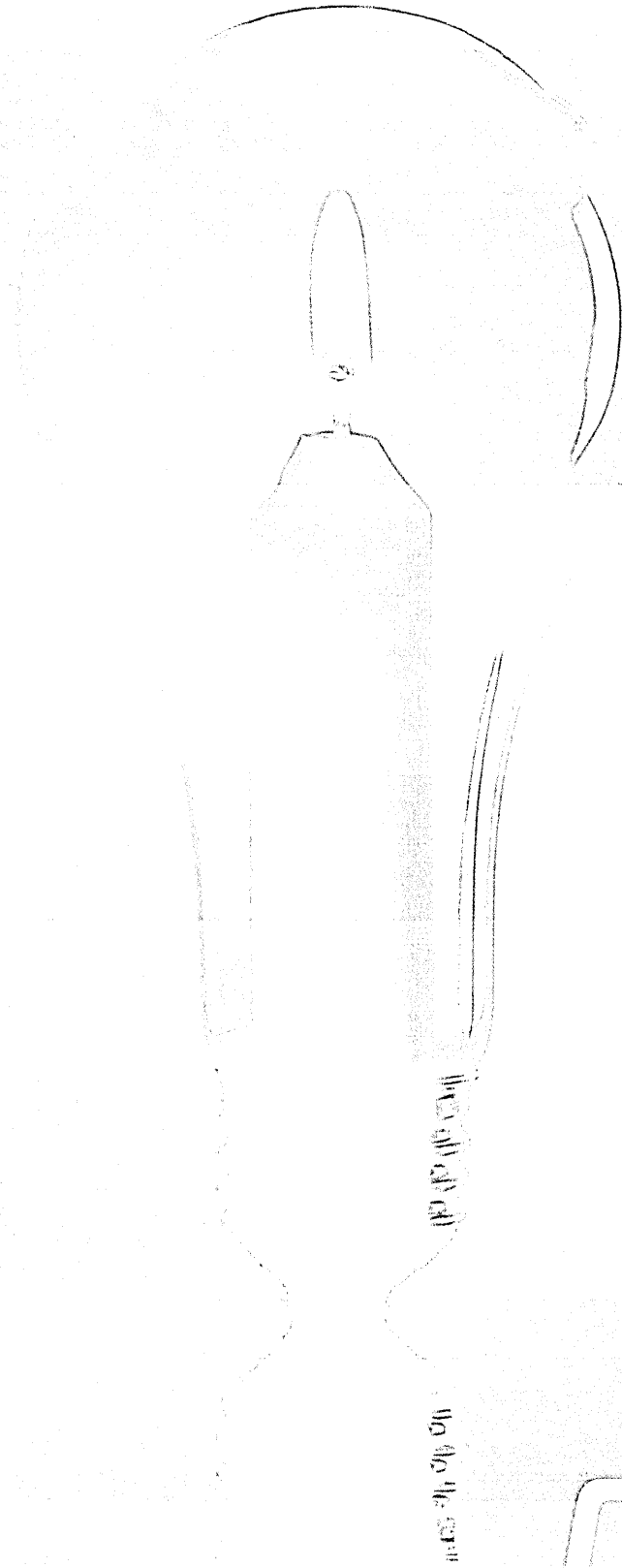

# ONEAC

Omega Corporation  
2207 Lakeside Drive  
Barrington, Illinois 60015  
312/295-2800

# Programmers trying to build efficient systems usually optimize too many unimportant details.

with interactive terminals and good inquiry software,

- Conduct an enterprise analysis, such as Business System Planning, to better inform information systems personnel of business processes and to better articulate management's information needs,
- Measure critical success factors that senior management has identified, and
- Promote information as a shareable corporate resource; develop corporate data description and communication standards.

Here, too, some cautions need to be noted. Management information system activities may not be attributable to a particular line of business, and therefore they increase sensitive overhead costs. It is also difficult to quantify the return on this investment, because even if the quality of managers' decisions appears to be improved, it is hard to ascribe how much of the credit belongs to the managers and how much to the management information system.

Two other pitfalls are old information and voluminous, rigid reports, both of which can do more harm than good. Because managers must make quick decisions, MIS reports are of value only if they are current and concise, and presented in the changing forms appropriate to managers whose needs change regularly.

Although we have previously considered information systems support for product growth, there is a growing class of products and services based on information technology itself. Among them are environmental control and security systems in buildings, telephone bill-paying services, remotely accessed database information retrieval services, microprocessor-controlled sewing machines, and user-programmed, call-forwarding telephone exchanges.

Because information systems management is likely to be only an initial proponent of an information technology product opportunity, only the "embryonic" area of the strategic condition matrix in Fig. 4 is indicated. Beyond that stage, responsibility rapidly moves to a line organization.

New product or service planning and development are usually accomplished in departments other than information systems. But the IS department may be the best equipped to understand the potential impact of forthcoming information technologies. If the information processing managers are conversant with business issues and strategic alternatives facing the enterprise, they can propose and analyze information-technology products.

These managers can also assist the organization in other ways, including keeping product planners and senior management abreast of information technology advances

FIG. 4

## POTENTIAL INFORMATION SYSTEM STRATEGIC OBJECTIVES

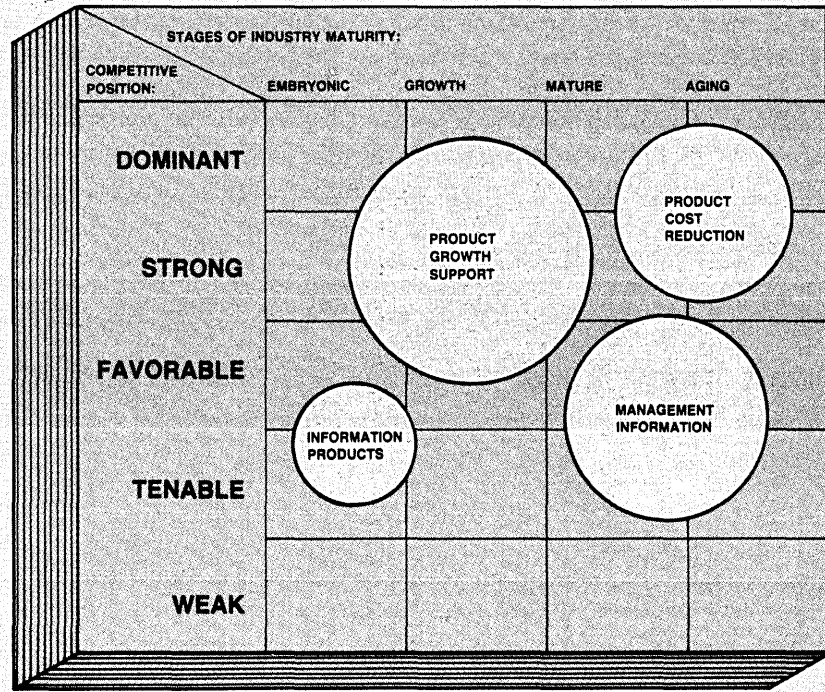
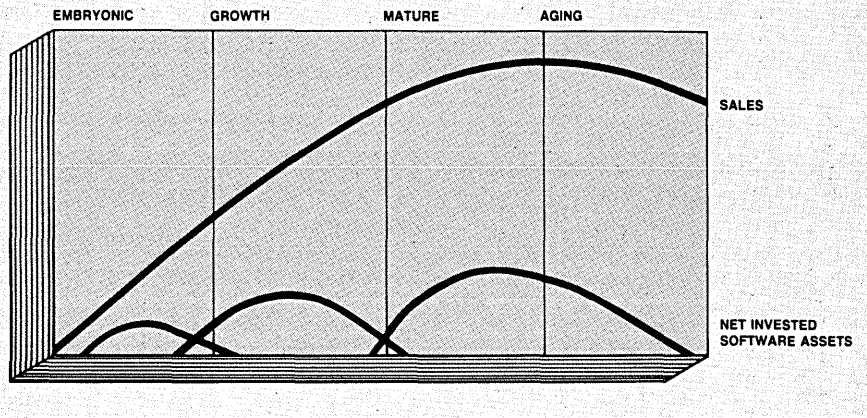

FIG. 5

## SOFTWARE LIFE CYCLES



that conceivably relate to the enterprise strategies. They could also plan software support environments for the development of microcomputer-controlled products, and evaluate new digital telecommunications networks for distributing time-valued information services to customers.

Information systems management

may have to be satisfied with a purely advisory role, because the responsibilities for introducing new products and services generally lie elsewhere within the enterprise.

The very existence of a new information technology does not necessarily mean that a profitable business can be built with it in the given enterprise. A business proposal



# TAB Ergonomic Computer Furniture

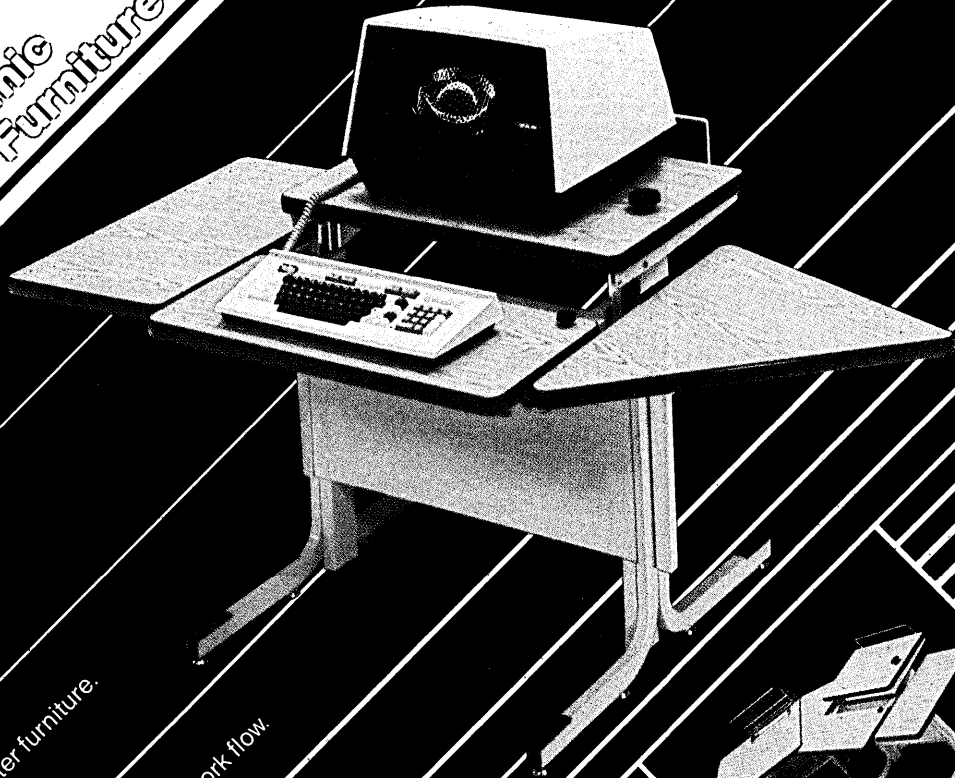

**HUMANETICS™**  
A new selection of computer furniture.

**HUMANETICS™**  
Adjustable for comfort, function, and work flow.

**HUMANETICS™**  
Designed for real humans... and real budgets.



**HUMANETICS™**  
Furniture, business computers and terminals.

Available now from your local TAB representative.  
See the Yellow Pages under "Data Processing Supplies,"  
or write us at 2690 Hanover Street, Palo Alto, CA 94304.  
In Canada: 550 McNicoll Ave., Willowdale, Ontario M2H 2E1.

**TAB**  
PRODUCTS CO.

# Save for the silver lining.

There's an old song that advises you to look for the silver lining. Certainly a good piece of advice. But here's some *better* advice! *Save* for the silver lining.

Oh, it's all right to look on the bright side and try to be optimistic about cloudy skies, but you've got to try and do something about them as well. *Save*.

Save enough to line those dark clouds. In fact, it's easy. Buy U.S. Savings Bonds through the Payroll Savings Plan. On the plan, you set aside a little each payday for Savings Bonds. And that'll chase some gloom away, right off. Knowing you're actually saving something on a regular schedule.

Of course, nothing can keep the dark skies away forever. But if they should appear, remember, Bonds can help you find the sunny side of life.

**Take stock in America.**



*When you put part of your savings into U.S. Savings Bonds you're helping to build a brighter future for your country and for yourself.*

**Ad Council** A public service of this publication and The Advertising Council.

## Planning and development for new products and services are usually accomplished in departments other than information systems.

FIG. 6

### SOFTWARE OVERRUN

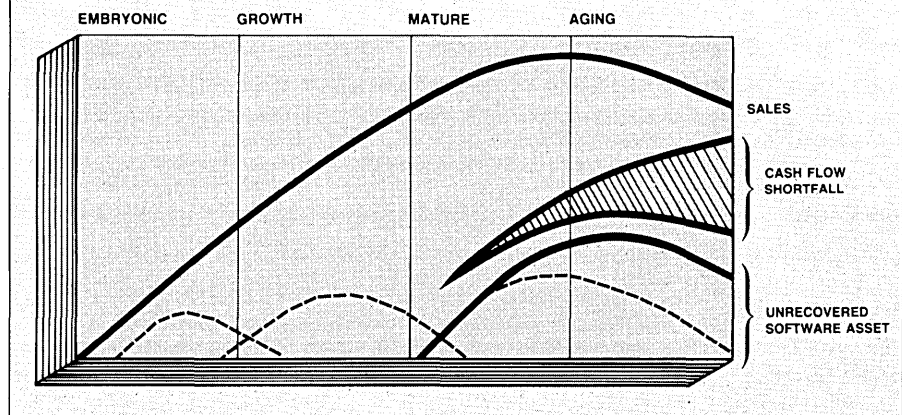

must be founded upon a believable market demand for the product or service, and on some strategic resource of the enterprise that permits a competitive advantage over other potential market entrants.

Incrementalism has generally been a successful enterprise response to the opportunities presented by new technologies. It is easier to make selective improvements to existing products than it is to develop revolutionary new products.

### STRATEGIC SYSTEMS PLANNING

Different strategic business units may enjoy different stages of industry maturity or competitive position. As they call upon information systems to support differing strategies, they can create conflicting objectives within the information systems support organizations themselves. A common criticism is, "We spend too much on data processing and never get our new systems when we need them."

The strategic condition of a business unit affects the strategic objective of the information services organization. Such a service department is itself not able to rationalize the conflicting demands for product cost reduction, product growth support, management information, and information technology products. These demands may come from different strategic business units with differing strategic conditions.

Activities to be undertaken in support of different strategic objectives may conflict. A variety of software and hardware systems, personnel skills, and even information systems organizations may be needed to support the different strategic conditions of various business units.

Information systems management can display leadership in strategic information systems planning, starting with learning stra-

tegic planning principles and the existing strategies of the enterprise.

Information systems managers should anticipate the likely effects of competitors' actions on their information systems departments. Information systems managers can comprehend future information systems technology, and they should keep senior management aware by interpreting such intelligence in business terms. Because strategic plans are generally formulated continuously and incrementally, information systems management has every opportunity to influence the process. Regular communication with senior management and with business unit management can keep information systems managers apprised of the strategic conditions of the enterprise's business units.

From an understanding of the strategic conditions of the various business units, senior management and information systems management can participate in determining information systems strategic objectives—product cost reduction, product growth support, management information, or information technology products. \*

Dr. Hargraves is a member of the professional staff of the Information Systems Section at Arthur D. Little Inc., Cambridge, Mass., where he currently concentrates on the assessment of planning and management to exploit emerging information technologies. Previously, as president and founder of DTSS Inc., he built a professional staff to develop and market the Dartmouth Time-Sharing System. Dr. Hargraves is adjunct associate professor of mathematics at Dartmouth College. He received a PhD in physics from Brown University in 1967 and an AB from Dartmouth College in 1961.

# HARDWARE

## OFF-LINE

One version of the old "chicken or the egg" conundrum in this business has to do with disk capacities: which came first, the drive or the medium? Kodak recently showed that the medium can come first, with an Isomax technology that can pack up to 10MB of data onto a single 5¼-inch diskette. The magnetic particles are arranged vertically rather than horizontally on the diskette, allowing for recording densities of 100,000 flux changes per inch. Kodak says that some U.S. manufacturers will have comparable drives by year-end; in the meantime, the disk can run at conventional densities.

Because IBM is so tight-lipped, it's always fun to speculate on what's about to happen in Armonk. Some thoughts from the Yankee Group concerning the Personal Computer: IBM will market the P.C. XT to business as the primary workstation, relegating the older P.C. to home users. Moreover, when the "Peanut" P.C. comes out later this year, it will likely be a stripped-down, integrated version of the old P.C. that can be upgraded modularly. The Peanut will then replace the P.C., the thought goes, within a year. But then, that's only speculation....

The apparent success of several voice mail packages in office automation systems -- such as Sperrylink and Wang's DVX -- has spurred Digital Equipment to ink a contract with Voicemail International, of Santa Clara, Calif. The contract calls for Voicemail to supply voice processing technology for DEC PDP and VAX office systems, with delivery beginning late this year on VAX units and immediately on the PDPs. Prices range from \$100,000 to over \$1 million, depending on configurations. From four to 256 lines are supported.

## SYSTEM/36

Based on seven microprocessors, this vendor's long-expected successor to the widely installed System/34 is largely, although not completely, compatible with the S/34. The general purpose cpu offers menu-driven operations with extensive help facilities, for applications in data and word processing, business color graphics, and office management functions. The system also includes self-diagnostic capabilities to help ensure reliability.

The S/36 system unit offers 128KB to 512KB of main memory and 30MB to 400MB of internal disk storage. Up to 30 local displays or printers can be attached, along with up to 64 remote units. Many of the specialized industry terminals that can be used on the System/34 can also be used on the System/36.

A basic entry system with 128KB main memory and 30MB disk storage, two displays, a printer, and the operating system costs \$34,000. A fully loaded 512KB system with 400MB disk storage, 26 displays, three printers, a tape drive, the operating system, and languages and utilities costs \$176,000. The system is now currently available. The S/34 is now in limited new production. IBM CORP., Town of Rye, N. Y.

**FOR DATA CIRCLE 301 ON READER CARD**

## OMNINET TO SNA

The Corvus SNA Gateway enables IBM Personal Computer and Corvus Concept users on an Omnet network to communicate with IBM mainframes in program-to-program mode using the SNA protocols. The product allows the micros to function as interactive remote terminals for the mainframes or to deal with the host computers in batch mode. The product is designed to replace the cluster controllers found with terminals of traditional SNA networks.

The Gateway features synchronous data link control and provides full IBM 3278 terminal emulation and 3287 emulation for both local and host addressable printing. It provides all seven levels of the SNA protocol. The SNA Gateway consists of the SNA Gateway Box with built-in Omnet interface and SDLC card, and SNA network access

software. The software emulators for the Concept or P.C. are priced together at \$250; the 3278 emulator without the 3287 emulator costs \$200. The emulations reside on the Omnet shared disk. The total SNA Gateway costs \$7,500. CORVUS SYSTEMS, San Jose, Calif.

**FOR DATA CIRCLE 302 ON READER CARD**

## P.C. ENHANCEMENT BOARD

The Easiboard plug-in board for the IBM Personal Computer combines the capabilities of 11 products into one board. The board contains Easisort, which allows sorting of complicated data; Easispool, a printer buffer/spooler that allows printing and computing simultaneously; three Easidisks, high-speed solid-state electronic disk emulators that reduce access times because they avoid mechanical action; Easitime and Easidate, a clock and calendar; Easiswap, which allows switching between two printers when both are connected to the same P.C.; a parallel printer port; a communications port for modems or additional printers; and memory expansion of 64KB or 256KB RAM.

The product fits in both the P.C. and the P.C. XT in any available slot. The Easimaster software package is included with the Easiboard, which costs \$325. The product is available at authorized IBM P.C. dealers. EASITECH CORP., Atlanta, Ga.

**FOR DATA CIRCLE 303 ON READER CARD**

## MAGNETIC PRINTER

The MP6090 magnetic printer offers 6,000 lines per minute speed (88 pages) and uses perpendicular recording technology to produce 240 × 240 dot resolution. The unit was designed and is manufactured by the vendor's parent company, French-based Cii-Honeywell Bull.

The unit employs a magnetic drum that is used in conjunction with the perpendicular recording heads and a single-component toner. In operation, the magnetic recording heads record the desired information on the drum. The drum rotates through the toner, which is attracted to the magnetized portions of the drum. The toner is then transferred to the fanfold paper. The vendor

# Introducing RELATE

## The First Practical Relational Language

RELATE is the leading 4th generation language now offers something new—relational access to data in the form that it already exists.

With RELATE an optional component of R/VMS II you can take important decisions on all of your data no matter how it is stored. You can develop new types of database supported systems without costly data conversion or replication charges.

RELATE retrieves and combines data stored in R/VMS VSAVI and sequential files, or R/VMS II databases or the any of the other databases to which R/VMS II provides access: IMS, IDB, IDAMS, ADVANSYS, or TITAN.

RELATE retrieves data without limits on file size or on the amount of data selected while making efficient use of hardware.

RELATE offers the power of relational theory using simple English-like commands making the system easy to use for technical and non-technical staff alike.

Join the users at more than 800 IBM installations who are already making better decisions thanks to VPC software.

Upgrade to R/VMS II Standard and save money. RELATE can give you an extra edge.

For more information call or write:



**Mathematica**  
Products Group, Inc.

PO Box 2392 Princeton NJ 08540  
(609) 257-5077 (609) 799-2100  
Telex 840247

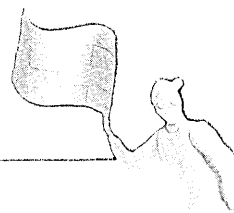

# RAMIS II...The Leader by Design

## HARDWARE

estimates that the MP6090's drum will last 10 million pages, with planned maintenance slated at two service calls per year. The printer costs \$25,000. CYNTHIA PERIPHERAL CORP., Palo Alto, Calif.

**FOR DATA CIRCLE 304 ON READER CARD**

### 70MB 5¼-INCH DISK DRIVES

The 510 series of hard disk drives use plated media and a linear voice coil actuator to achieve capacities of up to 70MB with average access times of 25 milliseconds. All three models support the 5¼-inch industry standard interface, bezel size, and mounting points. The vendor will manufacture its own media for the drives.

The model 512 has a 30MB capacity, while the 513 has a 50MB capacity and the 514 has a 70MB capacity. Access times are 3ms track to track, 25ms average, and 45ms

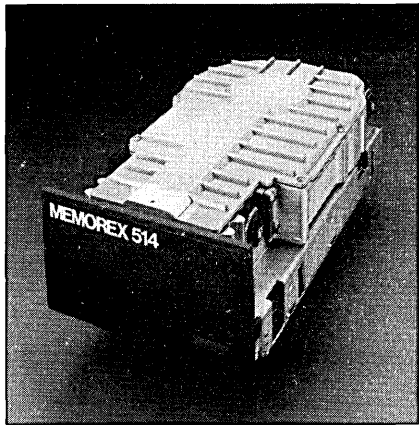

maximum, including settling time. The linear voice coil actuator and closed loop servo system support the current products as well as future products with higher capabilities and faster access times, the vendor says.

The drives have built-in self-test capabilities and a diagnostic port. The port also allows access to the drives' error accumulators, providing status reporting capabilities not found on some other 5¼-inch drives. Each drive contains five on-board micros to handle normal drive functions and provide adaptive control systems to monitor critical parameters continuously throughout the life of the drive. The drives will not be available in production until the fourth quarter. MEMOREX CORP., Santa Clara, Calif.

**FOR DATA CIRCLE 307 ON READER CARD**

### FACSIMILE TERMINAL

The Telecopier 495-1 facsimile transceiver is designed to integrate facsimile images with information stored in computers and office automation networks. The unit can also receive computer information for printing or redistribution to remote facsimile sites.

The applications are enabled by an RS232C interface option available on the terminal. The product interface specification for the option will be available to customers at no charge so that customers can then develop their own applications software for the interface.

The 495-1 is designed for high-volume applications and can send or receive a one-page letter in about 30 seconds. An automatic dialer option allows messages to be sent to a series of receiving fax units. A second option prints the date, time, and terminal ID number on received copies and maintains an activity log. Installations of the terminal will begin in the third quarter in several major cities, with a national rollout shortly thereafter. The fully loaded terminal with all options costs \$13,000. XEROX CORP., Office Products Div., Dallas, Texas.

**FOR DATA CIRCLE 305 ON READER CARD**

### PC WITH 256K CHIPS

This vendor's Micro 16s personal business computer incorporates a 1MB plug-in memory board based on four 256KB dynamic RAM chips. The micro can be configured to provide up to 40MB of Winchester capacity, an 8-inch external floppy disk system with 1.2MB of storage per drive, two built-in 5¼-inch 320KB floppy drives, dual Z-80 and 8086 microprocessors, RS232 port, and serial and parallel printer ports.

The computer system comes bundled with the CPM and CPM-86 operating systems and the WordStar word processing and SuperCalc electronic spreadsheet programs. The base package costs \$4,000, and will be available this summer. The megabyte dynamic RAM board will cost an additional \$2,500 when it becomes available in the fourth quarter; the 5¼-inch Winchester drive will cost \$2,000 and the 8-inch floppy drive system will cost \$3,000 when both drives become available next month. The system can also run the Concurrent CPM-86 operating system for multitasking. FUJITSU MICROELECTRONICS INC., Santa Clara, Calif.

**FOR DATA CIRCLE 306 ON READER CARD**

### TELEPHONE TERMINAL

The TelTerminal is an integrated telephone and asynchronous computer terminal designed to give professionals access to computer databases without going through the process of learning all about computers. The unit looks like a business telephone with a typewriter keyboard and a small display screen attached. The screen offers a four line by 80 column liquid crystal display.

The unit's functionality is based pri-

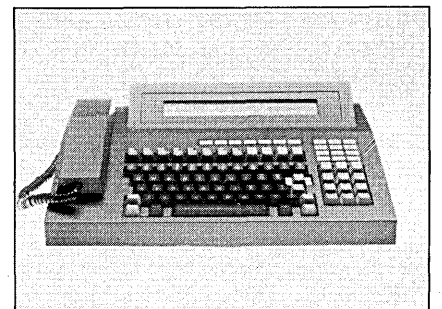

## HARDWARE SPOTLIGHT

### EXECUTIVE MICRO

This micro-based Executive System provides professionals with a user interface free of mice or keyboards. Rather, the user's terminal consists of a full-size touch-sensitive display monitor with a telephone handset underneath. All other hardware can be stowed elsewhere.

System capabilities include an electronic telephone, electronic mail and videoconferencing, voice store and forward, voice over text, decision support graphics, word processing, personal calendar, calculator, and full personal computer capabilities. Each of these functions is represented by a full-color icon on the screen. By touching the icon desired, the monitor becomes a "virtual device"; that is, if the telephone icon were pressed, the monitor would show a telephone keypad, and each key could be pressed to dial a phone number. These symbols lead the user through all phases of the system, assisting her in accessing and presenting data and ideas as rapidly as needed.

The telephone handset, in addition to acting as a conventional phone, is also used for data entry and editing.

Supporting the system's voice and touch screen operations is an electronics module containing an array of microproces-

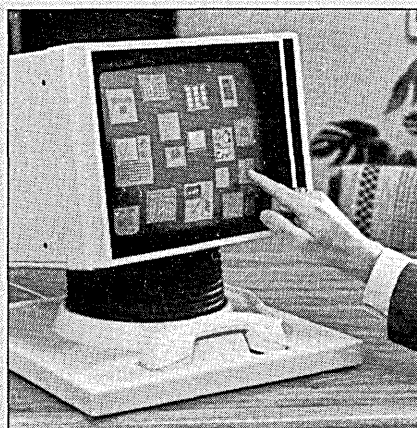

sors with a megabyte of RAM and 80MB of storage capacity. A secretary's console and a data entry terminal are also integral parts of the system. The Executive System can handle multiple users and local and global networking. It is also compatible with the CPM-86 operating system so that standard software packages can be used.

No price has been set on the unit, which is still in prototype form. Formal release is slated for later this year. SANTA BARBARA DEVELOPMENT LABS INC., Santa Barbara, Calif.

**FOR DATA CIRCLE 300 ON READER CARD**

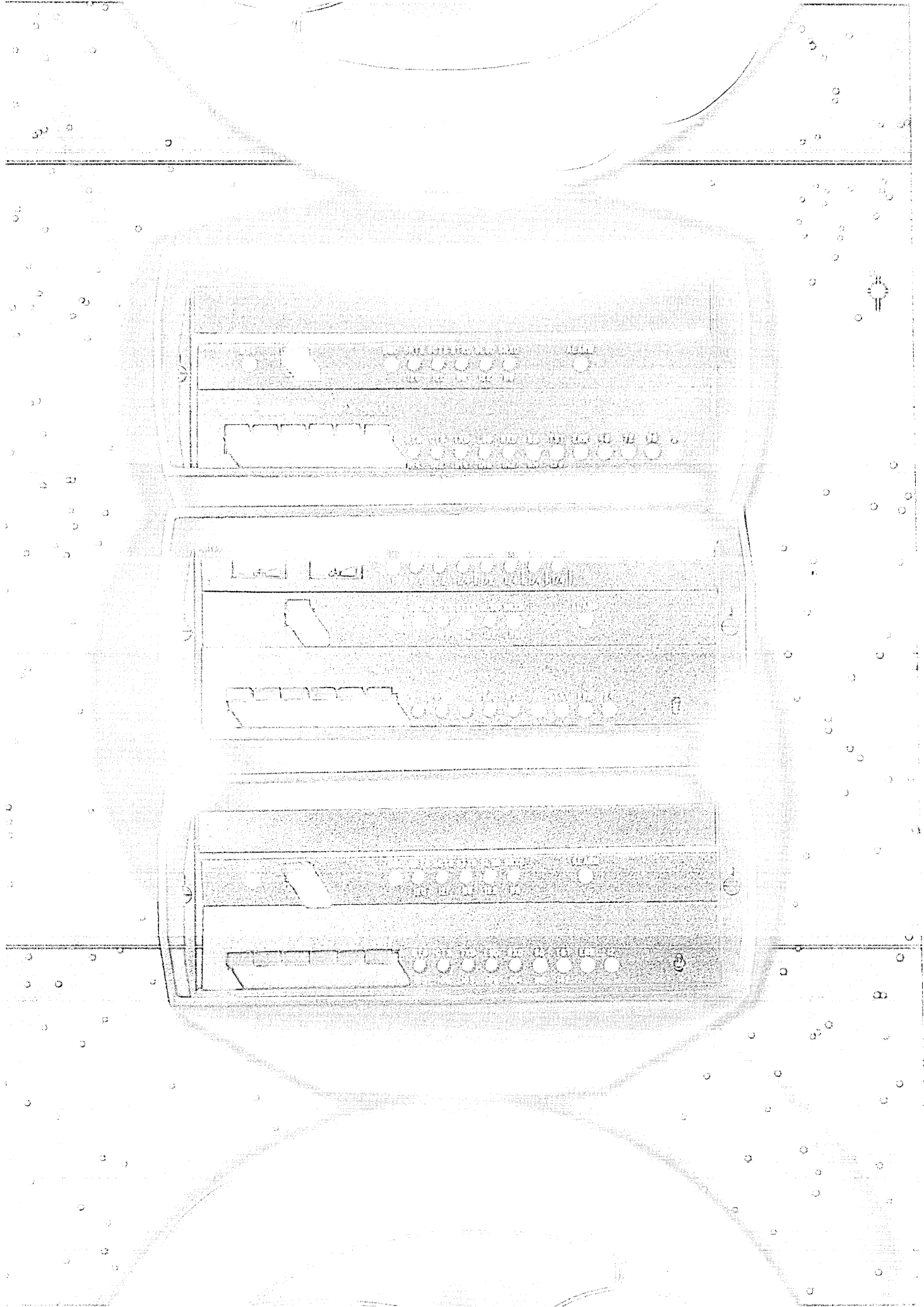

**NEW**

# PARADYNE'S MPX MODEM FAMILY

and a new Advanced Network Management System

Announcing Paradyne's **NEW MPX family of high speed, signal processing modems.** They're quick to install – make three connections, push a few buttons for modem strapping – and they're user ready. Easy up, rarely down. **Modem speeds of 2400, 4800, 9600 bits per second,** operating point-to-point or multipoint, all with automatic adaptive equalization.

**Lower power consumption and smaller size too!** Only 3½ inches high, 8½ inches wide and weighing 5½ pounds.

You're in total control. Press a few keys on the **NEW ANALYSIS 5500 Series advanced network management system, and down-line load strapping** to the MPX modems. ANALYSIS constantly monitors a **wider range of phone line parameters than ever before.** Controlling your modem network is essential and it's at your fingertips.



**Flexibility.** The 5500 Series is modular in design for easy upgrade in capacity and features. It's distributed system design supports from a few – to hundreds of lines – in virtually any network architecture.

Business efficiency. Business expansion. Data networks today are the mainstream of business communications. Hundreds, perhaps thousands of your employees and customers, depend on your network to be up, not down.

ANALYSIS 5500, together with the new family of MPX high speed signal processing modems, can provide the most technologically advanced communication network available today. **Built with Paradyne's quality. Backed with Paradyne's service – around the world.**

Efficiency, expansion, control. Another Paradyne systems solution. If you want your network up, not down, give us a call or return the form below.

Paradyne Corp. Dept. DM-8  
P.O. Box 1347  
Largo, FL 33540

**paradyne**

Name \_\_\_\_\_  
Title \_\_\_\_\_  
Company \_\_\_\_\_  
Address \_\_\_\_\_  
City \_\_\_\_\_  
State \_\_\_\_\_ Zip \_\_\_\_\_  
Telephone (\_\_\_\_) \_\_\_\_\_

## HARDWARE

marily on the telephone, with the terminal capabilities added on. All data communications must go through the PBX. A management assistance package gives users single key access to an array of communication and information capabilities. Executives can input a speed call directory of up to 250 numbers, including local and network access numbers, and sign-on and security identifiers. Using the directory, users can send and receive attended and unattended voice and data messages.

In addition to several telephone features, the terminal can connect to an IBM P.C. and operate the P.C. software. A personality module allows the user to customize the TelTerminal to provide specific menu drivers, protocol or format needs, and transmission requirements for accessing proprietary databases. DIGITAL TRANSACTIONS INC., Stamford, Conn.

**FOR DATA CIRCLE 308 ON READER CARD**

### GRAPHICS TERMINAL

The GTC 214 dual processor color graphics terminal employs a system architecture with buffering and balanced processing to provide faster throughput. One of the 8/16 bit processors operates as a graphics engine, while the other is housed on an I/O board to control all interfaces to the user. The I/O processor interprets and compresses the terminal's high-level graphics command language (compatible with Tektronix 4027) into compacted binary primitives that are displayed by the graphics engine.

The GTC 214 comes with a standard 12K ROM, 2K RAM memory, although it can be expanded to a total of 63KB. Specific functions can be added to the terminal because the engines are general purpose chips. The terminal, which also handles dot-addressable alphanumeric fonts, is controlled by a full keyboard with 32 function keys. The unit costs \$4,900. PSITECH, Tustin, Calif.

**FOR DATA CIRCLE 309 ON READER CARD**

### 3.3MB FLOPPY DRIVES

The model 1560 5¼-inch floppy disk drive provides up to 3.3MB of unformatted capacity using double-sided recording at a density of 9,500 bpi at 170 tracks per inch over 160 tracks on each side of the diskette. The drive's interface is functionally compatible

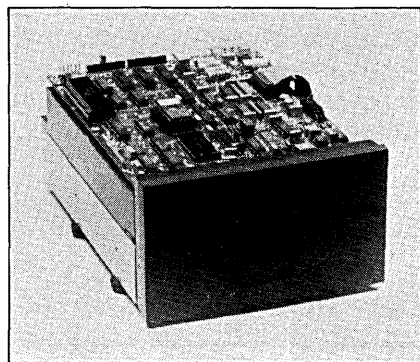

with that of the Shugart Associates SA460 minifloppy drive or its equivalent, except that the 1560 has a 500Kbps data transfer rate.

The model 1860 provides up to 3.2MB of unformatted data capacity using double-sided recording at a density of 9,500 bpi at 170 tpi over 154 tracks on each side of the diskette. Its interface is functionally compatible with the SA850 maxifloppy drive or its equivalent.

Both drives use the standard UHR-II high coercivity 600 oersted flexible diskette and record data using FM or MFM encoding in commonly used formats. Each drive incorporates an Intel 8051 microprocessor to handle a number of real-time control functions, including the capability of reading diskettes recorded at standard densities of 48, 96, or 100 tpi. This allows users to upgrade their data storage capacity without obsoleting current software or requiring a database conversion. Each drive costs \$370 in 500-unit quantities. AMLYN CORP., San Jose, Calif.

**FOR DATA CIRCLE 310 ON READER CARD**

### COLOR PRINTER

The Act-II Chromajet uses color ink jet technology to provide 140 × 85 dots per inch with 125 color shades. The unit has a DuraPulse ink jet head with three integral secondary reservoirs that maintain constant pressure levels. The nozzle array of 12 piezoelectric crystal jets is composed of four jets for each of the three colors. The automatic jet-cleaning mechanism and the vendor's proprietary nonwater-based inks overcome the clogging problems common in the vendor's earlier printers.

The printer is designed for high reliability, the vendor says, with an MTBF of 6,000 hours. Modular construction to be employed in the printer will keep the MTTR to about 15 minutes, the vendor says. The unit comes with serial and parallel interfaces, which are externally accessible for easier reconfiguration. The printer costs \$6,400. ADVANCED COLOR TECHNOLOGY INC., Chelmsford, Mass.

**FOR DATA CIRCLE 312 ON READER CARD**

### SUPERMINI

The MC-30 superminicomputer offers 3 MIPS processing speed by overlapping execution of four instructions at one time via a balanced four-stage pipeline. Instruction overlap is handled by separating each instruction into four phases: instruction fetch, address preparation, operand fetch, and execution. A new instruction can be started every 300ns.

The cpu is designed to connect directly with up to 256 terminals or, using this vendor's Loop local area network, multiple Loop stations with up to 64,000 end points per station. The system can support a mix of up to eleven 1MB memory boards and channel controllers (such as disk and tape han-

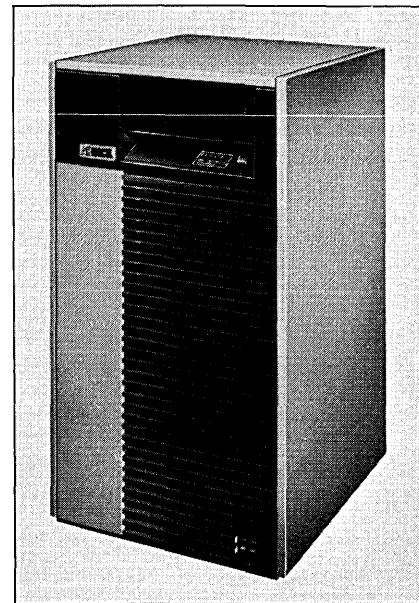

dlers and multiplexors).

The mini runs C, Pascal, BASIC, FORTRAN and, soon, COBOL, all running under the Unix-compatible IDRIS operating system. The system ranges from \$40,000 to \$100,000 in oem quantities. A.B. DICK CO., Chicago, Ill.

**FOR DATA CIRCLE 311 ON READER CARD**

### PCM MAINFRAME

The AS/8000 series of mainframe processors is designed to satisfy the requirement of users who have outgrown medium-scale systems such as the vendor's AS/6600. The AS/8040 provides 10% to 20% greater performance than IBM's competing 3083E, the vendor says. The AS/8050 provides 25% to 30% greater performance than the AS/8040, and the AS/8060 about 25% to 30% greater performance than the AS/8050. Model upgrades can be performed in the field.

The processors support the standard IBM operating systems, including XA. The AS/8040, which starts at \$1.3 million, can accommodate from 8MB to 16MB of main memory, with a range of eight to 16 communication channels. The AS/8050 (starting at \$1.8 million) and AS/8060 (starting at \$2.4 million) can each accommodate from 8MB to 32MB of main memory, with from eight to 24 channels. Using more than 16 channels requires the MVS/XA feature. The AS/8040 and AS/8050 are currently available, while the AS/8060 will be available in the first quarter.

The vendor's 7380 high capacity Winchester disk drive subsystem, which will be available this month, is functionally compatible with IBM's 3380 disk system. The subsystem requires less floor space than the 3380 and offers rotary actuators and dual porting. A typical configuration, with 10GB of storage, costs \$355,000. NATIONAL ADVANCED SYSTEMS, Mountain View, Calif.

**FOR DATA CIRCLE 314 ON READER CARD**



# NEW BOLD IMAGE!



Try new Moore Clean Print carbonless paper and get remarkably legible, copyable impressions at an affordable price.

New Moore Clean Print® is the advanced carbonless paper with the new Bold Image. But, you can enjoy its benefits for the same price as ordinary carbonless paper. New technology from Moore research and development makes it possible.

New MCP Bold Image also gives you all the time and money saving advantages associated with carbonless paper. This remarkable new paper is available in all Moore off-the-shelf forms and in forms we can custom design for you—computer-printed, typed, or handwritten.

New Bold Image does make a big difference in new Moore Clean Print. How big? Return the coupon, or call toll-free 1-800-842-9000, Ext. 20, and see for yourself.

©1983 Moore Business Forms, Inc.



**MOORE  
BUSINESS  
FORMS**

Moore Business Forms, Inc.  
1205 Milwaukee Avenue  
Glenview, IL 60025

D-8/83

I'm getting a good impression of new MCP Bold Image already. Please tell me more.

Name \_\_\_\_\_ Title \_\_\_\_\_

Company \_\_\_\_\_

Address \_\_\_\_\_

City \_\_\_\_\_ State \_\_\_\_\_ Zip \_\_\_\_\_

## HARDWARE

### MODEM BOARD

The Smartmodem 1200B board modem slides inside the IBM Personal Computer to provide remote communication capability without occupying extra desk space. The modem, which comes with the Smartcom II communications software program, operates at 1,200 or 300bps. It is functionally equivalent to the vendor's Smartmodem 1200 connected to the IBM Asynchronous Communications Adapter.

The Smartmodem 1200B can be installed in a system expansion slot; its circuitry eliminates the need for a separate communications card. A telephone jack on the board permits direct connection to the telephone line. The modem is approved by the FCC for direct connection to any U.S. telephone system for pulse and Touch-Tone dialing. Both types of dialing may be used in a single call, e.g., using the pulse to access a PBX and the Touch-Tone to dial an outside number. The unit automatically calls and answers calls from remote computers. A speaker with volume control, mounted on the board, allows the user to monitor audibly the progress of the call.

The modem is compatible with Bell 212A-type modems communicating asynchronously. It costs \$600, including board, cable, manual, software, and software manual. HAYES MICROCOMPUTER PRODUCTS INC., Norcross, Ga.

**FOR DATA CIRCLE 313 ON READER CARD**

### VIDEO TELECONFERENCING

The Mini Conference System (MCS) is a compact video-teleconferencing system designed for use in a small conference room or in an office. The system consists of three components. A color monitor and camera are used for motion video and high-quality audio; a portable graphics unit allows conferees to share graphics; and a movable stand houses the system. The graphics unit includes a color camera, lighting, and a glass background plate.

A handheld controller provides video and graphics selection, audio volume and privacy modes, and camera control. The MCS can operate at any selected motion video rate from 384Kbps to 2.048Mbps or send still frames at 56Kbps. The system can be connected to other systems over a broadband local area network; the same network can also tie the system to a conventional

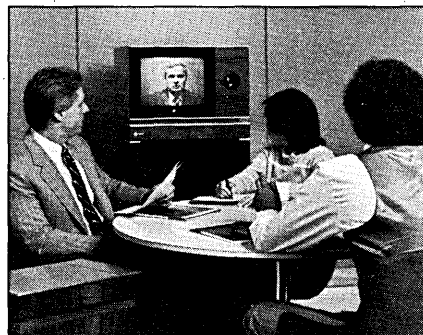

videoconferencing room within the same facility. The system will be available in the first quarter of 1984 and will cost \$35,000. COMPRESSION LABS INC., San Jose, Calif.

**FOR DATA CIRCLE 315 ON READER CARD**

### POCKET DATASETS

The Micro400 local dataset models 430 and 431 measure 2 x 2 3/4 x 3/4 inches, about the size of a pack of cigarettes, and can connect terminals and computers in local

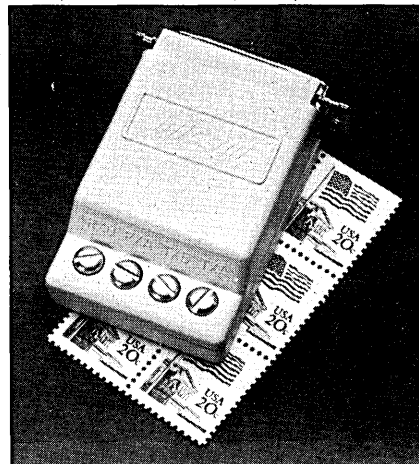

environments. They plug directly into a terminal or computer RS232 interface and are powered by the unit they support, so they do not need other cables or cords.

The units provide full-duplex asynchronous communications over the distances encountered on typical campuses or within a building. They can send data over three miles when operating at 9,600bps, further at lower speeds. The 430 is intended for use on customer-owned lines, while the 431 complies with Bell Publication 43401 for operation over telephone company-supplied limited distance private circuits. The 430 can cover distances up to a mile at 19.2Kbps. The 430 costs \$85, and the 431 costs \$95. MICOM SYSTEMS INC., Chatsworth, Calif.

**FOR DATA CIRCLE 316 ON READER CARD**

### IMAGE RECORDER

The Palette computer image recorder is designed for use with personal and small business computers to make presentation-quality color or b & w graphics hardcopy on the vendor's transparency films or print films. The desktop unit connects to the computer by means of a black and white video line and an RS232C communication line.

Currently, the unit runs with the IBM and Apple computers, using several graphics software packages. It comes with diskette software to extend compatibility to additional software. Other computers will be able to use the recorder if independent vendors develop the proper device driver software.

With its flat-faced, medium-resolution monochrome video screen and tricolor filter wheel, Palette allows color or mono-

chrome computers with graphics capability to produce color hardcopy. The computer and software match exposure parameters to the film being used, while letting the user control color selection and location. The program diskette supplied with the system permits color selection from a table. The system costs \$1,300, including software, 35mm camera back and adapter plate, and rapid-access 35mm Autoprocess transparency hardware. POLAROID CORP., Cambridge, Mass.

**FOR DATA CIRCLE 317 ON READER CARD**

### MICRO FLOPPY DRIVE

The Amdisk II is a 3-inch dual disk drive system designed to be compatible with the Radio Shack color computer. The system provides up to 624KB of double-density formatted storage capacity. The system is supported by both the TRSDOS and Flex operating systems and can be configured in several ways to provide users with flexibility.

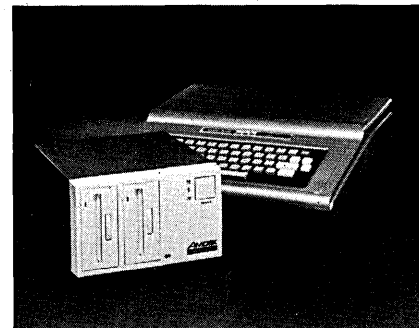

The cartridge-type media are constructed of hard plastic and include an automatic shutter mechanism for protection. The drive costs \$600. AMDEK CORP., Elk Grove Village, Ill.

**FOR DATA CIRCLE 318 ON READER CARD**

### MODEM/CONTROLLER

The Executive Telecommunications Controller 140 is a microprocessor-controlled 103/202-compatible, auto dial/auto answer intelligent modem designed for multiterminal, multitasking shared resource access between computers with dissimilar protocols. The ETC-140 terminal ports can be configured for any type of terminal or computer from mainframe to micro, allowing any of the connected terminals to access the modem, printer control buffer, time/date clock, message system and encryption unit.

The controller has three RS232 ports and a parallel printer port; any port may access the modem, the encryption unit, the printer, or any other terminal. Communications rates vary from 45bps to 19,200bps. The encryption unit follows the NBS standard for file encryption or modern transmission, with higher security modes accessible. The unit is based on the 6809E microprocessor with up to 64KB RAM and a 32KB PROM. It costs \$1,600. COMPUTER DEVELOPMENT, INC., Newport Beach, Calif.

**FOR DATA CIRCLE 320 ON READER CARD**

## HARDWARE

### PORTABLE WINCHESTER

This vendor's Kaypro II portable computer, which costs the same as the Osborne portable computer and offers a similar array of software, can be enhanced with a Winchester disk storage system. The Kaypro 10, as the upgraded machine is called, incorporates a 10MB hard disk into one of the two spaces available in the machine for drives; the other drive would still be a floppy drive.

The system is based on the Z80A microprocessor with 64KB of RAM. Communications are supported by two serial and one parallel port, as well as by a light pen connection for input. The Selectric-like keyboard with numeric pad folds out from the main cabinet when in use, and closes in to protect the screen and drives. The 9-inch screen has a 25 × 80 display with a 160 × 100 pixel graphics resolution. Software included with the system provides CPM, S-BASIC, and four packages from Perfect Software (Speller, filer, word processing, and spreadsheet). The price for the Kaypro 10 had not been set by press time; the Kaypro II, with a pair of floppy drives, costs \$1,800. NON-LINEAR SYSTEMS, Solana Beach, Calif.

**FOR DATA CIRCLE 321 ON READER CARD**

### 16-BIT MICRO

The Eagle PC offers IBM Personal Computer compatibility at a price of \$2,000 for a sin-

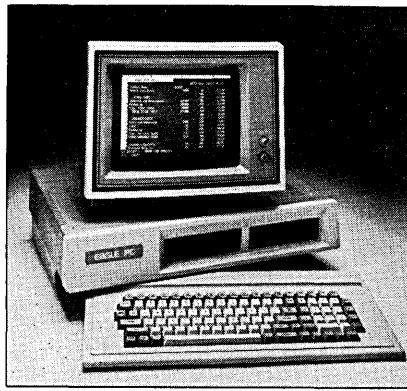

gle disk drive system. The unit is based on the 8088 microprocessor with 64KB to 512KB of main memory. Two serial ports and a parallel port are also provided on the cpu board. The system runs the MS/DOS and CP/M-86 operating systems and can produce business graphics with a 720 × 352 video resolution.

The PC is designed to fit onto compact desktops, and is 14 inches deep. The keyboard can retract into a recess below the disk drives when the computer is not in use. The main processor cabinet weighs about 30 pounds, roughly the same as the Osborne or similar portable computers.

Options for the system include Winchester storage. Fully configured models, with two disk drives, maximum main mem-

ory, graphics, and software, cost \$3,500. EAGLE COMPUTER, INC., Los Gatos, Calif.

**FOR DATA CIRCLE 322 ON READER CARD**

### PORTABLE COMPUTER

Here's a computer that wants to fit in the handheld market but have the power of full-sized microcomputers. The result is a machine the size of a hardcover book that has an 8 × 40 display, a typewriter-sized keyboard, and 40KB of memory.

The TRS-80 model 100 is one of the first computers that combines a multiline display and built-in application programs with a battery-powered cpu. Four AA size batteries will let users operate the unit virtually anywhere. The five built-in application programs provide for basic text editing, work scheduling (a personal electronic calculator), list management (an electronic phone book), communications and BASIC.

The communication program works in conjunction with an integral modem for RS232 communications with dial-up information services. The unit contains 8KB of user memory (optionally 24) for storing BASIC programs and data. A ROM port is available for packaged software, although none was announced with the unit. The model 100 costs \$800, or \$1,000 with the expanded memory. RADIO SHACK, Fort Worth, Texas.

**FOR DATA CIRCLE 319 ON READER CARD**

# DeVry Computer Science graduates hit the ground running.

Our Bachelor's Degree grads have already spent a good 2,280 lab and classroom hours learning advanced programming techniques and applications ... using COBOL, BASIC, RPGII and BAL in problem-solving situations...with added emphasis on accounting and information management skills.

Our business-oriented curriculum, designed and kept up-to-date with industry input, is taught by faculty members who also have had full-time business experience.

See for yourself how quickly DeVry grads can deliver. For free hiring assistance, contact us now.

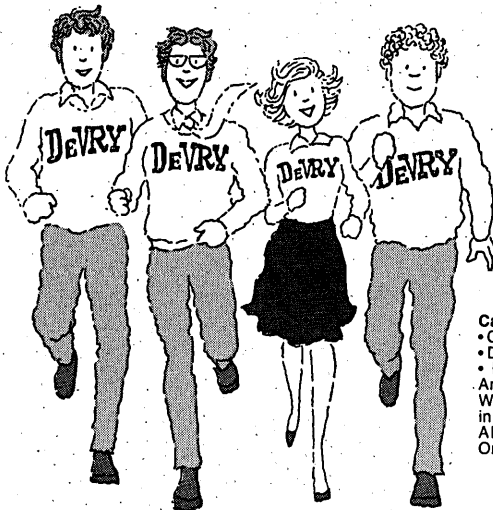

**Campuses in Atlanta**  
 • Chicago • Columbus  
 • Dallas • Kansas City  
 • Lombard, IL • Los Angeles • Phoenix • Woodbridge, NJ and in Canada: Calgary, Alberta • Toronto, Ontario

# DEVRY

**INSTITUTE OF TECHNOLOGY**

BELL & HOWELL EDUCATION GROUP  
 2201 W. Howard St.  
 Evanston, IL 60202

**(800) 225-8000**

In Illinois, call (312) 328-8100.  
 Ask for Mike Bouman.  
 In Canada, call (416) 741-9220.  
 Ask for Jim White.

Mr. Bouman:  
 Please send my **Free book** on Hiring Technical Graduates.

Please contact me regarding availability of DeVry Computer Science graduates in my area.

NAME  MR  MS \_\_\_\_\_

TITLE \_\_\_\_\_

COMPANY \_\_\_\_\_

ADDRESS \_\_\_\_\_

CITY \_\_\_\_\_

STATE \_\_\_\_\_ ZIP \_\_\_\_\_

PHONE \_\_\_\_\_

# **T**he Information Center

## **Theirs:**

**DB2, QMF,  
SQL, QBE, GIS,  
STAIRS, APL,  
Etc...**

## **Ours:**

**INQUIRE<sup>®</sup>**

**H**elp users help themselves. That's the idea behind IBM's Information Center, where the data processing department will provide and maintain tools to allow users to retrieve, analyze, manipulate and present data (including textual material) more effectively.

**They've got the right idea, but the wrong tools.**

When productivity is all-important, why buy, learn, and support a hodge-podge of ever-changing systems in your Information Center?

With a single non-procedural language easily learned in a few hours, **INQUIRE** can boost user productivity, DP productivity, and support the entire decision-making process.

We've been helping companies establish information centers since 1968. If you run MVS, VM/CMS, or VSI, call us toll-free today to find out how.

### **Infodata**

Infodata Systems Inc.  
5205 Leesburg Pike  
Falls Church, Virginia 22041  
**800-336-4939**  
In Virginia, call 703-578-3430

Offices in:  
Cleveland, Dallas, Houston, Los Angeles,  
New York, Rochester NY, Tampa, Chicago,  
San Francisco, Washington, DC

\*INQUIRE is a registered trademark of Infodata Systems Inc.

©1983 Infodata Systems Inc.

# SOFTWARE AND SERVICES

## UPDATES

What do you do when you've made a big blunder and as a result have a dwindling market share? That's the question Digital Research has been asking itself ever since it let MicroSoft supply MS/DOS as the principal operating system for the IBM Personal Computer. With only 10% of P.C.s running a CP/M based operating system, Digital Research has decided to make all of its language compilers available under the PC/DOS system. Although they won't admit it, this roughly translates to "If you can't beat 'em, join 'em." Digital Research says it's a way to capture the growing market for concurrent OSs.

Cullinet continues to add third party software to its IDMS product line. The Westwood, Mass., vendor has integrated an updated version of Anacom's CIS retail banking software into the IDMS database management system. The software is targeted at banks with assets in the range of \$300 million to \$1 billion.

Xerox has finally begun to license its much-ballyhooed Smalltalk-80 programming language and operating system. The software, developed at Xerox's Palo Alto Research Center, can be had for a \$20,000 commercial license for internal use. Effective next year, a license will be available for \$150 for each computer unit with a Smalltalk-80 system marketed by a licensee. Educational licenses cost \$400.

Systems software houses continue to see greener grass on the other side -- else they wouldn't be expanding into applications. Latest in this trend is Oracle, whose new Applications Product Group will sell a micro version of the company's DBMS to software vendors who want to write their own applications for the DBMS.

## MICRO UNIX

Microcomputer users will finally be able to use the Unix operating system, provided their computers are based on the Motorola 68000, the National Semiconductor 16032, or the Intel iAPX 286 microprocessors. Until this vendor's recent announcement of full Unix System V support on those processors, micro users who wanted Unix had to settle for Unix-like systems that had been converted to run on micros from the mini-computer-based Unix III.

This vendor has announced that a generic version of Unix System V, functionally equivalent to the minicomputer version announced in January, will be developed for each of the chips. Moreover, the vendor is providing the same full support for the micro versions that it is for the mini versions, including a lineup of 16 technical and nontechnical courses announced recently.

Since several vendors have already announced and begun shipping microcomputer-based products using proprietary Unix-like operating systems, they are now in the position of having to offer Unix under their Unix imitations. The result could be confusion among users of such systems, as well as fluctuations in the sales of independent Unix-like systems. WESTERN ELECTRIC/BELL LABORATORIES, New York, N.Y.

**FOR DATA CIRCLE 326 ON READER CARD**

## MICRO-MAINFRAME LINK

The Data Pipeline hardware and software are designed to link mainframe computer databases with personal computers. The product is built around the vendor's iDIS 86/735 database information system, a microcomputer-based traffic manager that interprets, stores, and distributes mainframe data to and from personal computers and terminals. The Data Pipeline uses the System 2000 database management system for data storage and retrieval. The System 2000 has been enhanced for use with the Data Pipeline, so that it now includes a relational capability, graphics, and a fourth generation architecture called System 2000 On-Line Operation.

The iDIS/735 component costs

\$35,000, including an 8086-based iSBC 86/30 cpu, floppy, and Winchester disk drives, the Xenix operating system, the C language, data extract facilities, SQL, communications, and the vendor's "Seamless Software." A stripped-down oem version, the iDIS/730, costs \$18,944 in quantities of 20. The System 2000 extensions required by the Data Pipeline range from \$40,000 to \$165,000, depending on the class of mainframe and which extensions are chosen. INTEL CORP., Santa Clara, Calif.

**FOR DATA CIRCLE 327 ON READER CARD**

## TRANSPORTATION SYSTEM

The Motor Carrier Maintenance System (MCMS) is intended for use in transportation-related industries for management of parts inventory, equipment maintenance, performance, dispatch, and license/warranty tracking. Users, such as large trucking companies, private fleets, municipalities, and utilities, can also track cost per vehicle and produce management exception reports.

The system is intended to require little training. Maintenance department personnel operate on-site terminals to ensure current information, audit control, and security. Operator and transactions can be identified on the system. MCMS is capable of producing current reports that allow immediate response to potential problems.

The system meets the ATA's Vehicle Maintenance Reporting standards and consists of seven components: inventory control, purchase order management, preventive maintenance scheduling, vehicle performance, licence plate management, vehicle warranty management, and management reporting. The modules incorporate standard IBM software. The service is available on a timesharing or license basis. SUN INFORMATION SERVICES CO., Radnor, Pa.

**FOR DATA CIRCLE 328 ON READER CARD**

## S/1 TELECOM

The Comm/1 telecommunications program is designed to handle most communications needs of IBM Series/1 minicomputers running the EDX operating system. Compatible with communications software on the S/1

# How do you create a microcomputer to match the power of the UNIX<sup>TM</sup> operating system?

Imagine. You are perfecting a revolutionary operating system. In about two years, it will be the system of choice for 16-bit microcomputers.

It will be called the UNIX operating system.

But the breakthrough features of this operating system are going to make stringent demands on the computer.

The microcomputer developed specifically for the UNIX operating system more than two years before its commercial distribution is called ONYX.<sup>TM</sup>

ONYX will live up to every demand and expectation.

To achieve the ultimate flexibility, simplicity, efficiency and productivity, the UNIX operating system will incorporate a file system of highly uniform sets and sub-sets of directories, arranged in a tree-like hierarchical structure.

And flexible directory and file protection modes, allowing all combinations of "read," "write," and "execute" access, independently for each file or directory, or for a group of users.

But these advantages will require intensive disk access, and superior memory management. In simple language, disk access must be as fast as possible, and the disk must have an unusual capacity to maintain complex file systems on-line at all times.

Floppy disks with their low capacities and high access times won't do.

Winchester disk drives that utilize slow-moving stepper motor head positioning devices won't do.

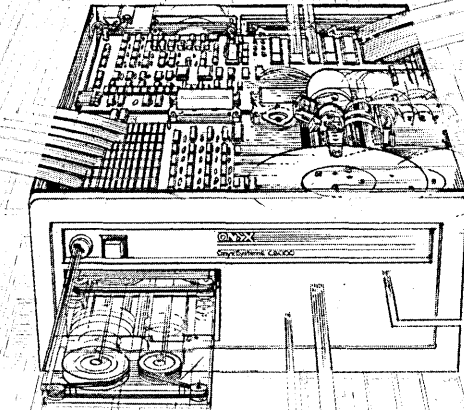

ONYX's IMI Winchester disk storage system, with its servo-driven voice coil head positioning, is more than twice as fast!

So, obviously the ONYX C8002 will do.

And, as developed, the ONYX C8002 features expandable memory up to 1 Mbyte, and disk storage up to 160 Mbytes on-line. Its cartridge tape backup offers cyclical redundancy checking on every backup. Both the Winchester disk storage system and the cartridge tape backup are *internal*.

In the UNIX operating system environment, the disk becomes an extension of main memory. "Swapping" programs between the disk and main memory

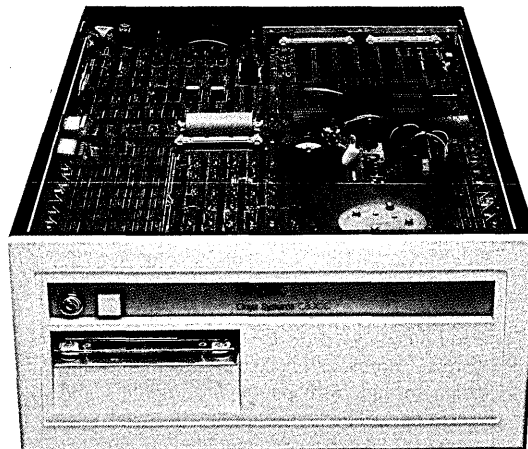

increases the number of operations that can run concurrently. ONYX's memory management system utilizes "scatter" instead of "contiguous" allocation, and the more efficient swapping minimizes demand on the disk channel. That's why ONYX assures a highly efficient environment for the UNIX operating system.

Now it's 1982. The UNIX system's preeminence among 16-bit operating systems is established. And ONYX is the only company that has significant production experience with UNIX systems.

ONYX has installed over 1500 UNIX systems.

Today there are a lot of systems being developed to operate UNIX (and "look-alike") operating systems. But there are many reasons why you should consider ONYX and the UNIX operating system as inseparable.

## System III available now for immediate delivery.

Phone this special number: (408) 946-6330 Ext. 251. Ask about these System III enhancements, including:

- Multi-key index sequential files under RM COBOL;
- "Term Cap" capability that supports a wide variety of terminal interfaces;
- Enhanced printer handling capability;
- SCCS to maintain edit histories in text management applications.

\*UNIX is a trademark of Bell Laboratories.

Make the Connection

# ONYX UNIX

OPERATING SYSTEM

Onyx Systems Inc., 25 East Trimble Road, San Jose, CA 95131

CIRCLE 116 ON READER CARD

## SOFTWARE & SERVICES

and other machines, Comm/1 will transmit any file from one Series/1 to another, or between a Series/1 and a mainframe, mini, or personal computer. It handles the 2780 and 3780 protocols, and supports all EDX and PXS data, including files, programs, and printed reports. It is capable of running dial, leased, and digital lines, with point-to-point and multipoint protocols, using master/slave or contention techniques, at center or tributary sites. Line speeds range from 1.2Kbps to 56Kbps. Record lengths up to 512 bytes can be handled. Received data are printed immediately or written to disk.

The package can transmit to and receive from timesharing services and allows for attended or unattended operation by responding to commands entered from the terminal or read from disk. Additional capabilities include manual or automatic answer, multiple file transmission, manual or automatic dial, and data transparency. The product requires a Series/1 with EDX and a 24K partition, any bisynch communications protocol, and a telephone with syn-

chronous modem. It costs \$965. FIRESIGN COMPUTER CO., San Francisco, Calif.

**FOR DATA CIRCLE 329 ON READER CARD**

### CP/M TO UNIX

BASTOC is designed for use in migrating programs written for the CP/M environment to newer systems employing Unix or Unix-like operating systems. The program translates programs written in any of several varieties of BASIC into the C language. By converting programs to C, users are able to maintain and enhance them by using the software development tools within the Unix environment.

In addition to its use as a conversion aid, BASTOC (BASIC to C) serves as a conventional BASIC compiler when used in conjunction with a C compiler as a preprocessor. The translator is implemented in a modular fashion, with about 25 user-configurable options. The default dialect of BASTOC is Microsoft's BASIC, but the user can tailor BASTOC to another version by editing the configuration file provided with the

package. The user can also configure multiple BASTOC translators if several versions of BASIC are to be supported on one system. The package costs \$300. JMI SOFTWARE CONSULTANTS INC., Roslyn, Pa.

**FOR DATA CIRCLE 330 ON READER CARD**

### VOYAGE ESTIMATOR

This turnkey package is designed as a tool for voyage estimating, including the calculation of anticipated revenue and expense of proposed tanker and dry cargo voyages. The package takes into account characteristics about the ship, cargo, and voyage itinerary.

The system will calculate port and sea time, fuel consumption and cost, cargo revenues, loading expenses, voyage costs, and profit. It also performs deadweight checks and bunker calculations, so that break-even rates can be quickly determined. Hypothetical modifications are provided.

The MMS Voyage Estimator, as it is called, can provide for the printout of a full

## SOFTWARE SPOTLIGHT

### RAMIS II ENGLISH

Based on artificial intelligence technology, the English processor component of this vendor's RAMIS II database management system offers users the ability to interface directly with the database using common English words and sentences. As a result, no file-specific dictionaries or other intermediaries are required.

The component processes ordinary

English requests and responds to questions with direct yes/no answers, to questions concerning "how many," and to requests requiring tabular or graphic reports. Requests can be phrased as questions or statements, such as "How many employees . . . ?" or "I need to know the number of employees . . ." If the request is ambiguous, the software resolves the uncertainty by paraphrasing the request in such a way as

to remove the ambiguity, and then asking the user to confirm the interpretation or revise it. The vendor says that the software has been engineered to be especially cautious of ambiguities, since slightly less fluency—i.e. more paraphrases—is preferable to an incorrect interpretation and subsequent wrong report.

The software is designed to "learn" additional vocabulary. It comes with a substantial general vocabulary, but users who have a specific jargon—engineering, business, professional, etc.—can teach the system the jargon. For example, an accountant might tell the system, "Suppose profit equals price minus mfgcost." Whenever that user then uses the word profit, the software automatically computes the value from the listed values in the database of price and manufacturing cost.

When a user teaches the system additional vocabulary, that vocabulary is applicable only to that user, although a log keeps track of all such changes for all users. Then MIS can insert common changes into the general vocabulary as desired.

The product is designed to be used by people with no knowledge of the computer, but a facility allows users to see the equivalent RAMIS II Reporter language syntax for any request to the system, so that users can learn RAMIS II if they wish.

The English processor is offered as a fully integrated component of RAMIS II; data do not have to be copied or restructured since access is direct. The processor costs \$12,000 to \$24,000 depending on cpu rating, until Sept. 30. After that, the price will increase. MATHEMATICA PRODUCTS GROUP, Princeton, N.J.

**FOR DATA CIRCLE 325 ON READER CARD**

display the total units sold and profits received from each customer for each prodnum.

give me a subtotal as well.

SOME PROBLEMS HAVE OCCURRED IN INTERPRETING YOUR REQUEST.

PARAPHRASE OF REQUEST:

PRINT THE TOTAL UNITS ENTRIES AND THE TOTAL PROFIT ENTRIES SORTED BY CUSTOMER AND PRODNUM.

PRINT SUBTOTALS AS WELL.

PROFIT IS DEFINED AS UNITS\*(LISTPRICE-UCOST).

IS THIS OKAY?

PLEASE ENTER "YES" OR "NO":

yes

PAGE 1

CUSTOMER	PRODNUM	UNITS	PROFIT
COMP. DEVELOPMENT, LTD.	15PUM21	4405	109,244.00
	21TRA12	10822	319,249.00
	42PUL29	2305	48,635.50
	42PUL65	1373	62,128.25
	50PUL64	1841	17,673.60

## SOFTWARE & SERVICES

or summary estimate. These estimates can also be stored for later modifications or for transmission via data communications networks. The system, which is menu driven, is based on the IBM Personal Computer. MARINE MANAGEMENT SYSTEMS INC., Stamford, Conn.

**FOR DATA CIRCLE 331 ON READER CARD**

### COBOL DICTIONARY

The Robot/3000 Dictionary System is a self-generating and self-maintaining COBOL source code dictionary for the HP 3000 minicomputer. The product cross-references copy libraries and source code automatically and provides eight different crt display screens for instant access to its IMAGE database. The system consists of 22 programs that keep track of all changes and enhancements made to COBOL applications to provide application system integrity and quality assurance; e.g., when a new software package is brought on-line that affects a certain item in the database, Robot/3000 lists all COBOL programs that access that item and that therefore need to be updated.

The program is intended to be able to run immediately, without training. If all of the data items/fields, data sets/files, and databases are defined in one or more copylibs, Robot/3000 loads itself automatically, the vendor says. It first scans all the copylibs, and then the remainder of the source code library, without manual assistance.

The program maintains itself daily, taking a few minutes of cpu time to update itself and providing a hardcopy log of all the changes. If it finds a copy statement in a program without a corresponding copybook in the copylib, it will report the inconsistency. The package costs \$5,000. PRODUCTIVE SOFTWARE SYSTEMS INC., Edina, Minn.

**FOR DATA CIRCLE 332 ON READER CARD**

### CICS MEASUREMENT

The Monitor is a CICS performance measurement package that identifies potential CICS resource problem areas and measures the extent of the trouble. It provides seven-color graphics on 3279 terminals with no additional devices, and monochrome graphics on other 3270-type terminals.

The Monitor allows up to 20 target areas to be displayed simultaneously at the terminal. The user may select desired targets from a supplied set of 26 graphable areas, or may resort to intelligent defaults. Among the target areas offered are transaction activity, task response time, paging rate, file volume, CICS dynamic area, journal I/O count, journal rate time, and other measures. Once the user chooses the target areas to be displayed, display time intervals are left to user discretion. When a chosen CICS threshold is exceeded, data center personnel are alerted via an audio or visual alarm. On the color terminal, the graphed element exceeding threshold is painted red.

The Monitor is supported by DOS/

VSE, MVS, and VSI. It requires 30K resident memory, and costs about \$10,000. LAND-MARK SYSTEMS CORP., Alexandria, Va.

**FOR DATA CIRCLE 333 ON READER CARD**

### INTEGRATED PC APPLICATIONS

The VALDOCS software is intended to complement this vendor's QX-10 personal computer to provide an operating environment that novices and professionals can use without using computer languages or too many menus. The software takes advantage of the computer's human applications standard computer interface (HASCII) keyboard, which has function keys labeled by function instead of numerically.

VALDOCS combines word processing, scheduling, calculations, graphics, filing, and electronic mail into a single package. When the QX-10 running VALDOCS (short for "valuable documents") is powered up, the user is automatically entered into the word processing mode. From the word processing mode, other modes can be entered without terminating the wp operations; in this way, numerical and graphical results can be entered into a text and vice versa.

A graphics module queries the user for parameters and then generates pie or bar charts and business or scientific line graphs. A scheduling module can keep track of appointments, a filing module stores documents for later recall, and electronic mail speeds messages to their destinations. Each of these can be entered with a single keystroke, so that if, for instance, a user is doing some graphics when the phone rings, he can switch to the calendar mode, enter or modify an appointment, and then go back to the graphics mode exactly where he left off. The VALDOCS software comes with the QX-10; it is produced by Rising Star Industries. EPSON AMERICA INC., Torrance, Calif.

**FOR DATA CIRCLE 334 ON READER CARD**

### HARNESS RACING

One of the more vertical applications packages to come down the pike recently is this Harness Trade Distribution System, which is designed to maintain owner purses and driver fees-paid history, as well as other functions. The system also handles posting of races and adjustments on a continual basis, allows transaction detail to be kept for each year, provides computer-generated checks and check reconciliation functions, and provides screen access to all data.

The system includes preprepared reports and year-end 1099 forms, as well as extensive data file integrity checks. Backup/restore facilities are also included. The system can handle harness tracks of any size, and is currently available. It's based on the Televideo 806 multi-user microcomputer with a 20MB hard disk; the complete system costs \$15,000. ADVANCED SYSTEMS INC., Reisterstown, Md.

**FOR DATA CIRCLE 335 ON READER CARD**

### DATA RETRIEVAL SERVICE

Subscribers to this vendor's public access network are able to call upon the resources of the Berkeley, Calif., research firm of Information on Demand (IOD) for independent data retrieval over the network. Subscribers can retain IOD for data searches for information on business competitors, schools and institutions with highly specialized programs and services, computer and electronics-related topics, or other researchable topics. IOD can retrieve information from 200 databases in the U.S. and abroad.

Subscribers receive a 20% first-time discount on all labor charges and services incurred in using IOD. Regular hours are \$60 per hour for research labor and \$14 per hour for articles to be retrieved. The average cost of a database search is about \$200, the vendor says. IOD is listed on the vendor's Information Service Reference Library menu, or can be accessed with the command "GO IOD." COMPUSERVE INC., Columbus, Ohio.

**FOR DATA CIRCLE 336 ON READER CARD**

### NUCLEAR SOFTWARE

The Power Package is a computer service based on a nuclear energy analysis applications library. The library was jointly developed by this vendor and the NUS Corp., under the terms of a year-old agreement. This vendor is marketing the service to nuclear power utilities, consulting firms, and architectural engineering firms. The programs in the library run on the vendor's Supra service using a Cray 1S supercomputer.

The nuclear applications library was established in accordance with Nuclear Regulatory Commission requirements for quality assurance. The computer programs are supported and maintained by nuclear engineers at NUS. Applications areas include reactor physics, safety analysis, thermal hydraulics, radiation and shielding, probabilistic risk assessment, fuel management, and operational support. UNITED INFORMATION SERVICES INC., Kansas City, Mo.

**FOR DATA CIRCLE 337 ON READER CARD**

### APPLICATION GENERATOR

The System Builder application generator was designed for use with the vendor's recently introduced System 4200 family of business computers running the Pick operating system. The System Builder is a block-by-block construction tool that can be used by end users or by dp staff. Instead of creating code, the way other application generators do, the System Builder creates a relational database. The system has on-line help and menus and prompts to guide users.

The product runs on the System 4200 hardware, based on the 68000 microprocessor running at 10MHz. The family of systems includes desktop and floor cabinet models and can support up to 35 terminals. The System 4200, including the Pick oper-



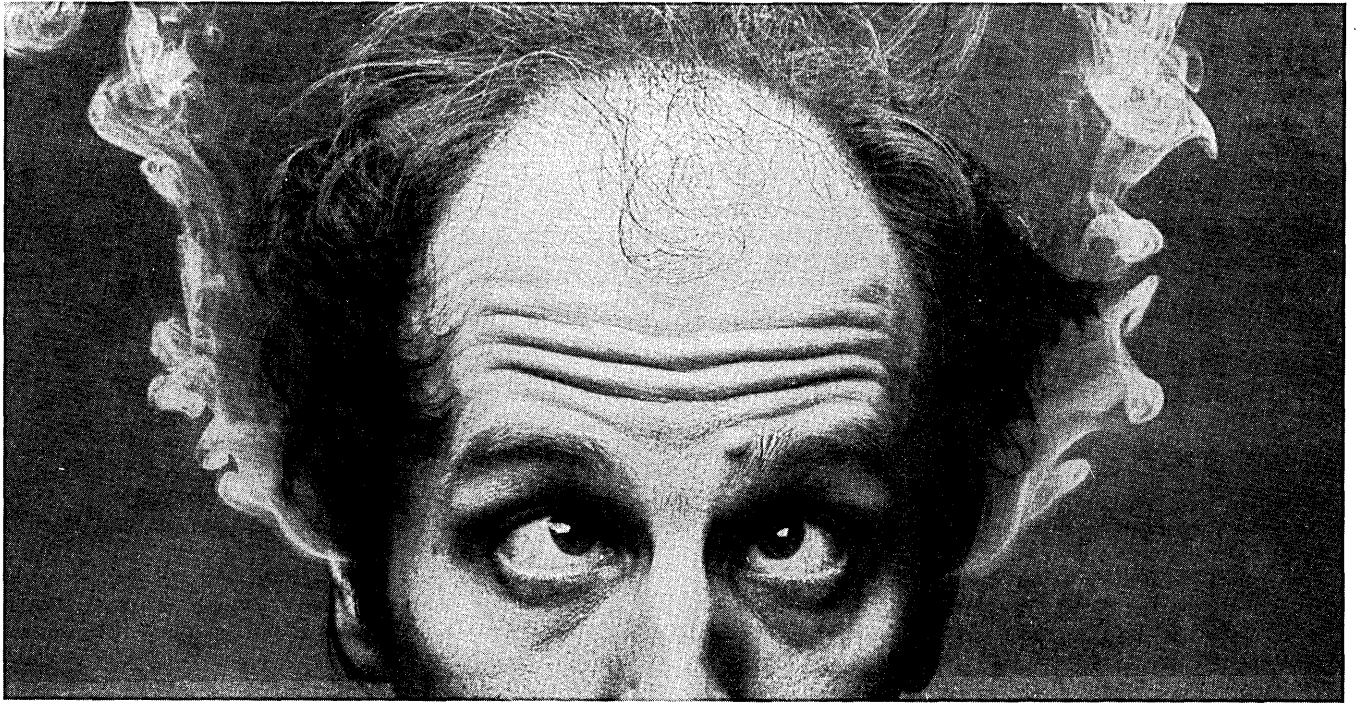

# Send the coupon. Save a programmer.

Right now, every one of your programmers may be a serious candidate for "programmer burnout." That's because without realizing it, they spend much of their time rewriting existing source code – a tedious task for them, and a major productivity drain for you.

MANAGER SOFTWARE PRODUCTS' SOURCEMANAGER™ frees your programmers from this task and lets them get on with the challenge and pleasure of writing procedural code. Which of course greatly reduces the time required to develop COBOL applications in an IBM environment.

SOURCEMANAGER is an on-line, dictionary-driven, COBOL application development system. It automatically generates standardized data definitions and program documentary sections. It helps programmers develop a library of re-usable code – and helps them develop procedural code. It even detects standards and style violations, and provides efficiency controls.

SOURCEMANAGER performs brilliantly as a stand-alone system. Yet it can be fully integrated with other dictionary-driven products in MSP's MANAGER family – such as DATAMANAGER™, the data and information resource management system, and DESIGNMANAGER™, the logical data base design and modeling system.

Find out how SOURCEMANAGER can help you prevent programmer burnout and increase productivity. Send the coupon today. Or call (617) 863-5800 (Telex 710 326 6431).

# mSP

MANAGER SOFTWARE PRODUCTS INC

Offices worldwide: Australasia, Benelux, Canada, Italy, Japan, Scandinavia, Spain, Switzerland/Austria, U.K./Eire, U.S.A., West Germany.

Send me more information about MANAGER SOFTWARE PRODUCTS' family of integrated, dictionary-driven products:

SOURCEMANAGER  DATAMANAGER  
 DESIGNMANAGER

Name \_\_\_\_\_ Title \_\_\_\_\_

Company \_\_\_\_\_

Address \_\_\_\_\_

City/State/ZIP Code \_\_\_\_\_

Telephone Number (\_\_\_\_\_) \_\_\_\_\_

Send coupon to MANAGER SOFTWARE PRODUCTS INC,  
131 Hartwell Ave., Lexington, MA 02173.

Or call (617) 863-5800. Telex 710 326 6431

D 8/83

## SOFTWARE & SERVICES

ating system and the System Builder application generator, begins at \$15,000. PER-TEC COMPUTER CORP., Irvine, Calif.

**FOR DATA CIRCLE 338 ON READER CARD**

### FINANCIAL INFORMATION

UCC-Customer Management Information (UCC-CMI) is an integrated system that gives financial industries control over customer information. The product combines a customer information file (CMI-Central) with marketing (CMI-Market) and profitability (CMI-Value) analysis capabilities. The three components form an integrated network that synthesizes information from sources throughout an institution.

UCC-CMI's open architecture allows for integration of information with existing applications, whether developed in-house or by another vendor. The product is also tied to the vendor's UCC-MBA, a decision support system for the IBM Personal Computer that is based on Context Management Systems' MBA software. With UCC-MBA, UCC-CMI users are capable of modeling, graphics, text processing, and data communications applications. UNIVERSITY COMPUTING CO., Dallas, Texas.

**FOR DATA CIRCLE 339 ON READER CARD**

### PAYROLL

This vendor's payroll accounting system, designed to run on the IBM 5280 computer systems, is intended to provide all of the necessary capabilities to handle multicompartment processing, entry validation, employee record maintenance, custom paycheck production, check reconciliation, and annuity processing.

Pay periods can be run at user-selected intervals, with complete current and YTD information on each check stub. Up to 13 pay types and 15 deduction categories are available. User reports are available with the system, including a payroll journal, a check register, deduction registers, tax reporting, and employee history listing. Employee label printing capability is also included. The payroll system costs \$1,500, which includes source and object code, documentation, and maintenance. MARION COMPUTING SYSTEMS INC., Lenexa, Kans.

**FOR DATA CIRCLE 340 ON READER CARD**

### ARCHITECTURAL MODELING

This Architectural Modeling package has been added to the vendor's recently announced Sigma III CAD system. With the package, architects and space planners will be able to generate three-dimensional, color shaded views of building interiors and exteriors, including furnishings. The designer creates a solid model by specifying surface colors and lighting sources; the software then removes hidden lines and surfaces and generates a perspective view on the model from a point in space.

The modeling package allows the user to "walk through" a building, or a

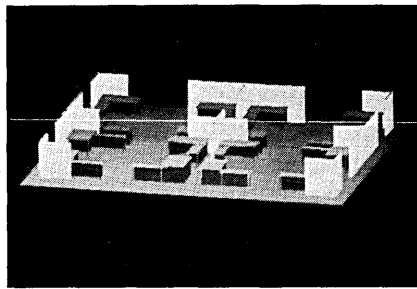

specific cluster of offices within a building, and make modifications in color, style, or arrangement. Final views can be used in client presentations. The solids modeling package costs \$10,000. SIGMA DESIGN, Englewood, Colo.

**FOR DATA CIRCLE 341 ON READER CARD**

### PAGE MIGRATION

The VM/SP Enhanced Page Migration (EPM) program provides additions to the page migration support within IBM's VM/SP Control Program. The package is designed to improve performance by making more high-use pages available on the high-speed preferred system paging devices, in order to alleviate system bottlenecks. As a result, I/O paging takes up less time.

The product adapts its behavior to the activity level of the system automatically. Disk paging I/O operations are performed less frequently and the migration of pages is performed smoothly, based on individual page reference patterns. Migration is suspended when only high-use pages occupy the high-speed paging devices and when EPM treats high-speed paging as a fair share resource on a dynamic basis. Favoring can be used to ensure that a specific virtual machine receives a designated portion of the high-speed paging resource, and monitoring commands provide feedback about page migration.

EPM is offered with a per-cpu license for a monthly charge of \$250, including maintenance. EPM can also be purchased, for \$9,000. THE ADESSE CORP., Ridgefield, Conn.

**FOR DATA CIRCLE 342 ON READER CARD**

### RETAIL SOFTWARE DATABASE

This on-line database for microcomputer users contains information on 21,000 software packages, identifying their applications and publishers, with analysis and critical reviews on many of them. Users can determine what software is available and obtain descriptive information about specific software through a menu-driven procedure. Customers can also order the software through the service in some cases, the vendor says.

The service is expected to be available in retail stores. A market test in Washington, D.C., preceded the national rollout of the service on a lease basis in the form of in-store booths with terminals and printers. The service also comes as a processor-only

service for stores with their own terminals and peripherals.

The services are expected to be supported by the PC National Software Library in Fairfax, Va. The library will house a collection of microcomputer software and the hardware necessary to demonstrate and evaluate the software packages. The library is expected to open this summer and will be open to retailers and users on a subscription or fee basis. The software listings in the library and on the service are taken from the *PC Clearinghouse Software Directory*, which lists 21,000 packages, 2,900 publishers, and 200 hardware manufacturers. PC TELEMART INC., Fairfax, Va.

**FOR DATA CIRCLE 343 ON READER CARD**

### MAP GENERATOR

The Screens Made Easy (SME) free-form interactive screen design aid is independent of the environment in which the screen will function: either MFS or BMS code can be generated. The product, which is fully interactive, can be used for existing or new system development. Screens can be designed for any existing 3270 or compatible terminal.

The product can be used to develop screens for Assembler, PL/I, or COBOL applications; the application program need not be modified to accept the screen.

Screens can be prototyped immediately after design, with no assemblies or intermediate steps. Chained screens can be previewed in series or individually, all before any application code is written. The product costs \$7,500. BUSINESS INFORMATION SYSTEMS INC., Fort Wayne, Ind.

**FOR DATA CIRCLE 344 ON READER CARD**

### CALL ACCOUNTING

Additions to this vendor's Standalone call accounting system allow telecommunications and data processing managers to collect, process, and transfer call data from the vendor's microcomputer-based telephone accounting system to an IBM mainframe. An enhancement converts the standard formatted 8-inch disks from the Standalone system into IBM standard EBCDIC code. The system combines a call-rating package with the collection device.

The Enhanced Standalone system uses vertical and horizontal coordinates to assign the cost to calls more accurately than could be accomplished by averaging them by area code. Calls can be identified by destination city and state, in addition to the called number. The systems offer local storage of 10,000 to 100,000 stored calls, depending on the hard disk capacity, and accommodate from 40 to 2,000 lines. Prices begin at \$19,000. The converter enhancement is available as an option on new Standalone systems or as a retrofit for existing units. It costs \$3,500. CP NATIONAL, New York, N.Y.

**FOR DATA CIRCLE 345 ON READER CARD**

—Michael Tyler

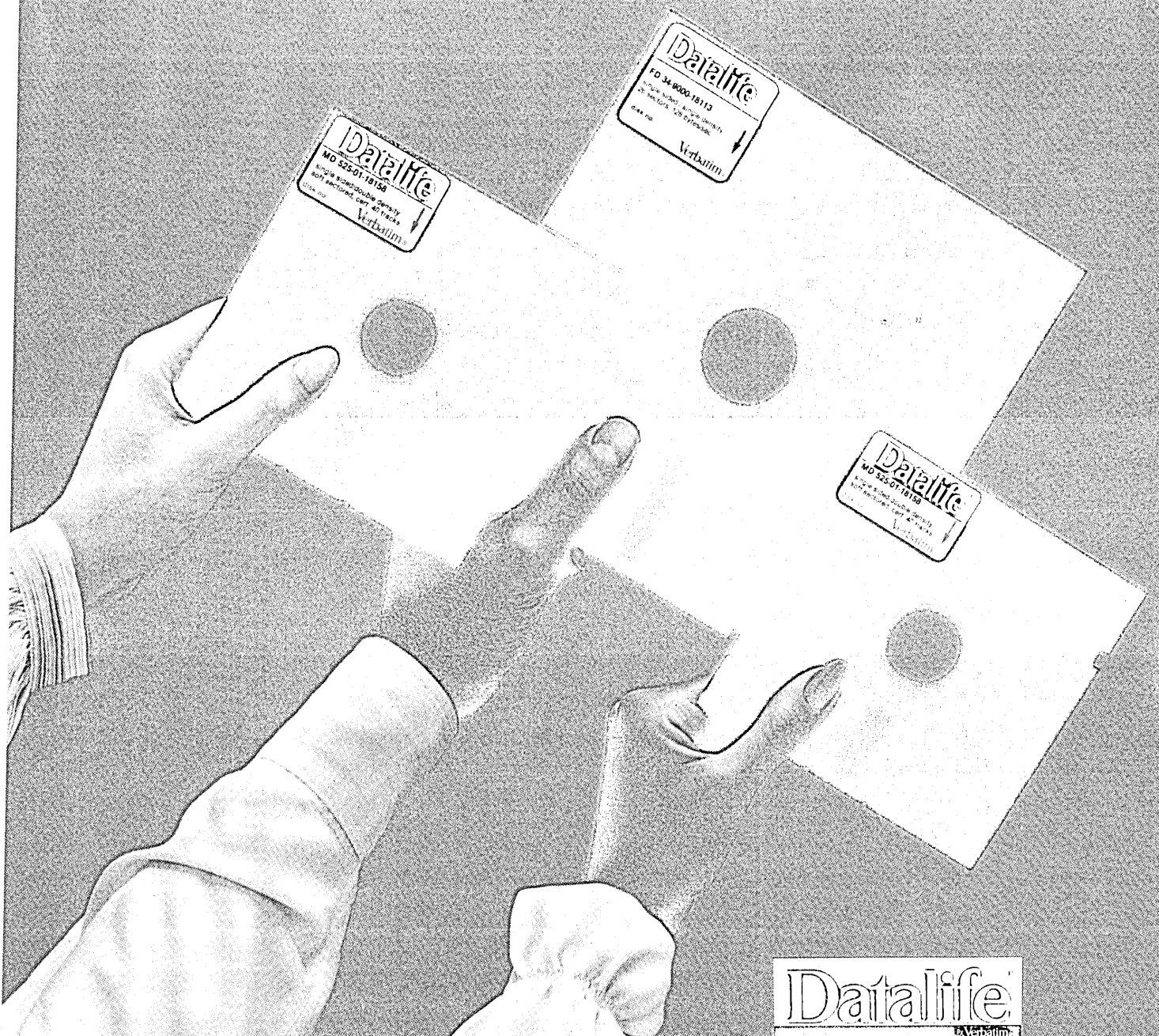

## To win the computer revolution, you need the right ammunition.

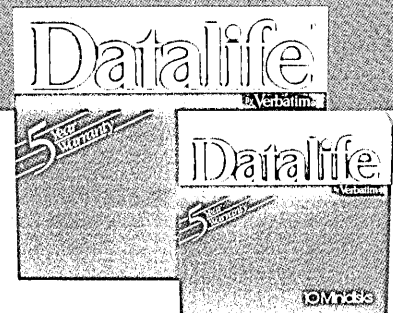

The computer revolution is changing the way we do so many things including the way we make mistakes. But many computer errors aren't really the computer's fault. Often, it's the flexible disk that's become weak or worn out.

Problems like that won't happen if you use Datalife™ flexible disks. They're certified 100% error free and backed by a 5-year warranty, which means the information you put on one stays put.

So, if you're part of the computer revolution, make sure you always come out a winner. Use Datalife by Verbatim, the world's leading producer of flexible disks.

For your nearest Verbatim dealer, call toll-free 800-538-1793; in California or outside the U.S., call collect (408) 737-7771.



# CP/M '83 EAST

Hynes Auditorium  
Thursday-Saturday  
September 29-October 1, 1983  
Show Hours: 10:30AM to 5:30PM daily  
Sponsored by Digital Research, Inc.

# THOUSANDS OF CP/M COMPATIBLES AND SOFTWARE PACKAGES ARE GATHERING IN BOSTON...

## THE MOST SUCCESSFUL NEW COMPUTER SHOW IS COMING EAST.

CP/M '83 held last January in San Francisco, was the largest event organized around a single product in the history of all products. It was larger than any first or second year technology event ever held anywhere, drawing over 40,000 attendees and more than 600 displays. This September 29 through October 1, Northeast Expositions, Inc., the foremost producer of computer events, and Digital Research Inc., the inventors of CP/M, will present CP/M '83-East at Boston's Hynes Auditorium.

## IF YOU DO ANYTHING IN CP/M YOU ABSOLUTELY CAN'T AFFORD TO MISS CP/M '83-EAST.

CP/M '83 is much more than a Show—it's an educational forum to help people learn about using, developing and marketing CP/M software. It's an incredibly effective medium for manufacturers to meet buyers or marketers, to meet developers. Noted leaders from the software industry will conduct the most extensive group of workshops on microcomputer software ever presented at any conference... ever. These informative discussions will explore CP/M applications, technical information, development aids, uses in different professions and support services. The conference program will also strive to show users how to get the most from their CP/M computers.

During each day of CP/M '83-East, from 8:30AM to 10:30AM, special industry workshops will be held for Independent Software Vendors (ISV's), distributors, dealers and manufacturers. These seminars will cover the ins and outs of developing, packaging and marketing microcomputer software. They will also offer you a chance to cultivate important industry contacts including venture capitalists.

## THE WORLD OF CP/M UNDER ONE ROOF

CP/M '83-West was the largest end-user Computer Show and Sale ever; the East Coast version will be just as large an extravaganza. At CP/M '83-East you'll find everything new for your CP/M computer under one roof. In a couple of days, you can sample software, accessories and services for every conceivable application you have. The Show includes over eight thousand different kinds of products including computers, peripherals, printers, hard disks, modems, memory cards, game cartridges, video displays, and plug-in boards—plus publications, support services and an absolutely incredible array of software application packages and development aids. All the CP/M compatible hardware and software for business, industry, the professions, government, education, home and personal use, is there. And best of all, you'll save hundreds, even thousands of dollars because everything that is on display is for sale at special Show prices.

## ADMISSION FEES:

One-Day Exhibits-Only ticket \$10

Tickets on sale at door

Three-Day Exhibits & Conference ticket \$25

## FOR MORE INFORMATION:

If you're interested in attending or exhibiting at CP/M '83-East, call 800-841-7000 (inside Massachusetts 617-739-2000). Or you can write us and we will be happy to mail you a comprehensive pamphlet which includes the schedule of seminars, workshops and conferences plus Boston hotel reservation information. Our address is 822 Boylston Street, Chestnut Hill, Massachusetts 02167.

CP/M '83-East is produced by Northeast Expositions, Inc., the foremost nationwide producer of special audience and specific product personal computer shows, including Applefest, PC '83 (for IBM PC users), The National Computer Shows, and Softcon—an International Conference and Tradefair for the Software Industry.

CP/M is the registered trademark of Digital Research, Inc.

## PREREGISTRATION FORM

- Enclosed is my payment for \_\_\_\_\_ QUANTITY Three-Day Exhibits & Conference badge(s) at \$25 which admits the attendee to the Show on Thursday, Friday and Saturday and to the Conference on all three days.
- Enclosed is my payment for \_\_\_\_\_ QUANTITY One-Day Exhibits Only ticket(s) at \$10 each.

Name \_\_\_\_\_

Company (if any) \_\_\_\_\_

Address \_\_\_\_\_

City \_\_\_\_\_ State \_\_\_\_\_ Zip \_\_\_\_\_

Telephone (area code) \_\_\_\_\_ ext \_\_\_\_\_

Mail to National Computer Shows, 822 Boylston Street, Chestnut Hill, MA 02167



# CP/M '83 EAST

# SOURCE DATA

## BOOKS

### **MICRO MAN: COMPUTERS AND THE EVOLUTION OF CONSCIOUSNESS**

by Gordon Pask and Susan Curran

There must be a few dozen books like *Micro Man* either already written or as yet forthcoming. These books detail the computer age, thus familiarizing the reader with the transformation of society. Such books purportedly exist to help confused readers better comprehend a world that is being thrust upon them like a third bowl of pasta.

As the score goes with most of these books, *Micro Man* isn't bad. It is a British book written by Gordon Pask, a professor in the department of cybernetics at Brunel University, and Susan Curran, director of an English consulting firm that "analyzes the social and economic impact of new technology."

*Micro Man* (an awful title, more befitting a Village People song or a comic book hero) features impressive graphics, well-turned color prints, and some fetching paintings of spacecraft crashing in outer space.

It's also a rigorous work that carries the reader from jacquard looms to Terry Winograd, with express stops at Leibniz, Markov, and Turing. The authors are conscientious with their history, and the writing is coherent, factual, and not without humor.

But Pask and Curran have written some audacious things in *Micro Man*, things that could make a John Lilly blush. These two are neither ashamed nor afraid to write from way out on a limb. "Computers are no longer our tools. They are a species in their own right," they baldly assert. Has anyone informed the zoologist? The authors have engendered another new species, taxonomically dubbed Micro Man, which is a dialectical mishmash of man and machine. Stranger things have happened, but they are not usually announced with such aplomb.

As futurists, Pask and Curran are only slightly reformed millenarians, heralding the informational Armageddon. They point to 2000 as a year of almost mystical significance, the watershed for Micro Man. In their discussions of the future, Pask and Curran are at their most daring and confounding. Presumably having gained the right by detailing the history of computing, the authors proceed to harangue the reader with a dubious and bewildering vision of the future. It is a discomfiting if inexact picture of a world where "Togethernessists" destroy Hamburg, and our earth is a "timeless mathematical labyrinth." It's tough to figure out what the writers intend, but offhand it seems to be a forecast easily refuted.

The authors' contention that in the year 2000 "distinction between white collar and blue" will have "no meaning," or their corollary that society will be classless by then, might appear pretty foolish on the cold dawn of New Year's Day 17 years hence.

Pask does admit to being a juvenile in regard to politics. He also admits that today's problems are quite real and unlikely to vanish. He nevertheless asserts that "Our world of AD 2000 is not a world in which the problems of nuclear war, overpopulation, or racial problems are dominant."

Those who clear their own visions of the future are often unable to see the forest for the trees. Pask and Curran, being too involved with the microprocessor to judge the nature of their predictions, are no exceptions. In their quest for informational salvation, they overlook not only the problems, but the rest of the world as well.

No one will deny that the world is changing and has changed. We need only consider the hours in 1662 that Samuel Pepys spent learning the multiplication tables so he could perform his duties as naval clerk. In the day of the pocket calculator, we consider those hours wasted. But while the steam engine (to pick a technology) has certainly transformed the nature of life, it has not, to any overwhelming degree, affected consciousness. The medieval inno-

ventions of the windmill and watermill made the advances of the 18th century possible.

The world probably won't change with the rapidity or to the degree envisioned by the authors of *Micro Man*. All people will not work at home in 2000, nor will travel have become "seldom necessary to existence." People will still make ceramics in East Liverpool, Ohio, and haul sacks of lentils in the East Midlands. They will do so with or without Team Design Systems, window sandwiches, domestic robots, or any other gadget mentioned in *Micro Man*.

In his *Essays*, Francis Bacon wrote that all prophecies ought to be despised and "ought to serve but for winter talk by the fireside." The modern stuff should at best be reserved for winter talk by the tv. When Curran and Pask trumpet their New Albion 2000 AD, they get carried away with the technological accomplishments of the past 25 years. What is happening is not insubstantial, but it cannot be called cataclysmic or even revolutionary. A future of actual cataclysm, as predicted in *Micro Man*, looks to be a long shot. Change will most likely move more slowly than the clouds across the sky.

The book's best chapter is "The Maverick Machines," in which the authors present some unconventional computing devices, the "machines which deviate from the mainstream of computer development." Included here are the hydraulic computer, biochips, an analog computer at the London School of Economics made of glass and filled with variously colored fluids, and the dendritic computer (as developed by R.M. Stewart of California in 1963). The dendritic computer grows computing structures from electrically activated ferrous sulphate and sulphuric acid. In this discussion, the distinction between programming and adaptation (the computer reacts to sound, vibration, electric light) becomes muddled. Such devices have proved too cumbersome for practical, nonlogical computation. Biotechnology now seems more appropriate.

The authors ask us to reconsider the back streets, the promised dead ends of



***“Do you realize, Rutherford,  
if Ripley gets his hands on those reports  
he could run off to Rio!”***

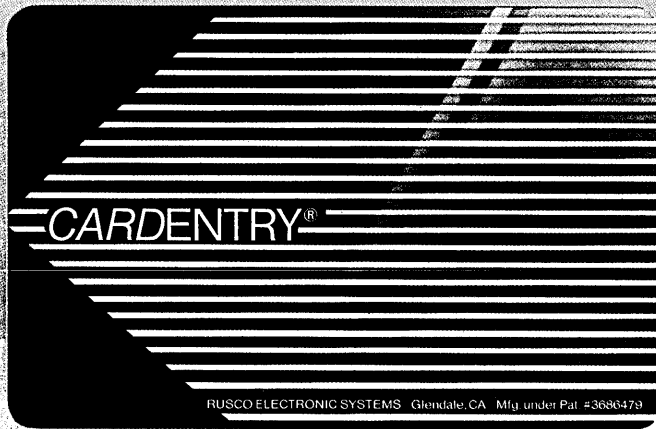

**How to keep an eye on the company files,  
guard the computer room, patrol the halls  
and watch the back door, all at the same time.**

To be in 14 places at once, you need a system. The Cardentry® system from RES, the leader in access control.

It all starts with a card. A durable, wallet-size plastic card. With its coded information inside, invisible, and protected.

Insert the card into a Cardentry reader, and the code is instantly transmitted to the controller. If the person's authorized, the door opens. If not, the door stays shut. In either case, his name, location and time of day are recorded.

Aha, you say, what if I lose power or communications from the card reader to the controller? You're still in control. Because, like the controller, the card reader has a mind (and memory) of its own. It still lets the right people in, and keeps the wrong people out. That kind of security only comes with the Cardentry system.



Well, you say, what if I expand my operations, outgrow the system and have to junk it? Can't happen. Each Cardentry system integrates, on site, with the next system up. So you can upgrade, anytime, easily. (That's something else no other company offers.)

What's more, with a Cardentry host processor, the system becomes a powerful and flexible data processor. One that gives you detailed management reports, all in plain English, the moment you need them. All while your controllers and card readers are controlling who goes in what door, when.

If you can't be everywhere at one time, get the system that can. The Cardentry system, from RES.

Because if Ripley never reads those reports and runs off to Rio, Reynolds might.

RES, Headquarters, 1840 Victory Blvd., Glendale, Ca. 91201.  
 Offices in principal cities worldwide. Call toll free: 1 (800) 528-6050 x691; Arizona: 1 (800) 352-0458 x691; Phoenix: (602) 954-4600 x691; Alaska and Hawaii: 1 (800) 528-0470 x691.

**RES** RUSCO  
 ELECTRONIC  
 SYSTEMS  
 A FIGGIE INTERNATIONAL COMPANY   
 CIRCLE 119 ON READER CARD

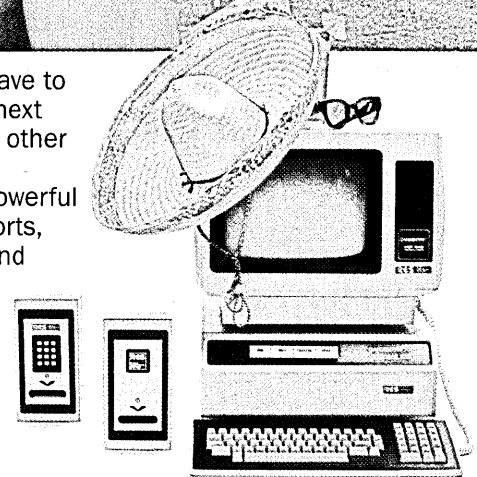

## SOURCE DATA

technology, in order to think in new ways. Pask and Curran recognize the need to reclaim what is worthy from the past and to relinquish what will become barren in the future.

The authors have not shied away from epistemological matters, particularly in their sections on language and artificial intelligence. They demonstrate a sense of semantics, analytical thought, and intuition. But they are still too eager to cast their lot with the artificialist. "Thought is not necessarily or uniquely," they write, "a property of biological fabric." As evidence they cite Pask's art work, *Colloquy of Mobiles*, as an example of a mechanism capable of organizing societal interplay. There are references to Grey Walter's mechanical tortoises, the 1950-ish contraptions that bump into one another and thus demonstrate cooperative behavior among machines. These are models of organic behavior that can be put together to simulate biological structures. This accomplished, the distinctions between living and nonliving structures are gone.

But the authors are too willing to hold up plucked chickens when asked the definition of featherless biped. Walter's tortoises possess only one lifelike quality. Will populations of such mechanisms ever attain the complex organizing ability of the Galapagos tortoises? All in all, *Micro Man* and Walter's tortoise amount to little more than nice conceits. Most of us would prefer to lie with real dogs, not mechanical contrivances.

Although it is possible to perceive a somewhat quaint Anglican tack through *Micro Man*, the sirens of Sunnyvale have drawn Pask and Curran perilously close to the rocks. It is regrettable that the authors were unable to bring more of their nativity to bear in their discussions of the evolution of consciousness. They have forsaken any

august English stentorianism for a fuzzy Californian dialect. As a result, the authors entertain some rather lame notions about social interaction and romantic love. Unfortunately, the book becomes just another example of the Californian influence in Great Britain.

But as an overview of information technology for the semigeneral reader, *Micro Man* does fairly well. It is current and should remain so for a couple of years. Its millenarian promise of salvation is undoubtedly naive, but it is still a decent introduction to the technological changes that have occurred since the invention of the semiconductor.

*Micro Man*, as a history of indications, is good. Too bad the authors did not stick with the delineation of fact, but stumbled into some embarrassing speculations about the future. Macmillan, New York (1982, 222 pp., \$14.75).

—Leopold Froehlich

## ALGENY by Jeremy Rifkin

In some ways *Algeny* is a serious book and in other ways it's a silly, gee-whiz book. *Algeny* is right up there with the vaporings of *Omni*, Douglas Hofstadter, Carl Sagan, Robert Jastrow, and the Futurists in general. At best they are equipment sellers and stock promoters.

Rifkin tells us that we are in the middle of a vast revolution on the order of the industrial revolution. True enough. He talks about a conceptual revolution driven by information (the topic he should have focused on) and bioengineering, which, really, is only a subset of this informationalization of the universe. We're talking in terms of a vast, informational-economic change in which the borders of nations are dissolved and new, yet curiously ancient, modes of thinking are brought into play.

New technology comes on-line, and alchemical-genetic changes in organisms are promised and may even be delivered. Don't hold your breath.

Throughout his book, Rifkin uses the words "we" and "humanity" in a broad, sweeping way. But it is only a small subpopulation that is making, promoting, and forcing these changes on the rest of mankind. For example, Rifkin says, "The average American child now spends approximately 28 hours per week with electronic learning tools . . ." He doesn't consider the number of children who have no access to these tools, nor ever will have. There are no such learning tools in the ghettos or in migrant worker camps, not to mention the underdeveloped world.

Rifkin is particularly good at raising questions about the social nature of scientific theory and the technology that flows from a social outlook. His main thesis is that the scientific world view of any age reflects the social thinking of that age. But, again he fails to specify that only a few people think this way. He proceeds to challenge the Darwinian concept of evolution, showing it to be a function of Victorian industrialists and political economists. He demonstrates the concept to be mechanistic, gradualistic, a proceeding from the simple to the complex, much like accumulating capital in dribs and drabs for an ongoing enterprise. Spicing his material with interesting quotes, Rifkin shows the gaps not only in such thinking but in the supposedly supporting geological record. Fine. This challenge has to be made.

Rifkin goes on to demonstrate that the gaps require rethinking, and he challenges the notion of gradualistic adaptation and selection, the very concept of the struggle for existence. He asserts Darwinian theory is a peculiar mode of thought that assumes each surviving organism is perfectly selected to fit into a particular ecological niche. Open to question. Perhaps, Rifkin suggests, there are vast evolutionary and revolutionary leaps, incredible changes in a relatively short period of time. He brings catastrophe theory into his argument, but here he runs into trouble. Catastrophe theory is a mathematical game that falls apart when applied to social and biological events. The application of mathematics to reality incorporates a mode of thought that goes back at least to the Pythagoreans and hasn't yet been seriously challenged. If changes in the environment are sudden, then there is a gap through which a Creationist could drive a truck. Or perhaps we are forced to lean toward Velikovskian thought.

Rifkin's schema reflects the thinking (and he does take pains to point this out) of the most modern theoreticians. He begins to slide into pure metaphysics when he proposes a temporal theory of evolution. This is too complicated to explicate, but the

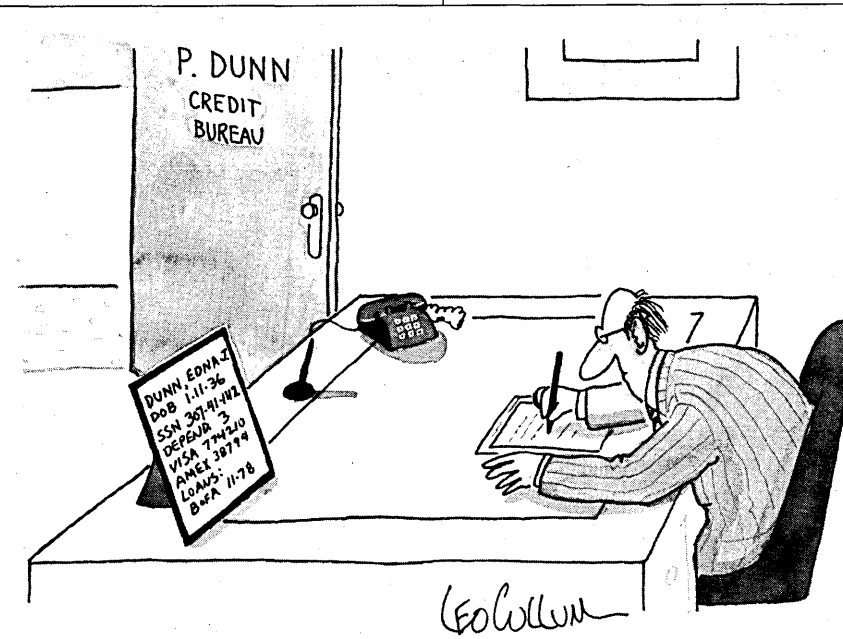

CARTOON BY LEO CULLUM



# Too many MIS Directors spend money on something that can pay for itself.

Many companies depend on a micrographics service bureau for Computer Output Microfilm (COM). Tapes are picked up one day, delivered the next. Even if you need your data right away.

And since bureaus charge so much for a master, it's sometimes hard to justify sending out the smaller jobs. So they stay in-house where they're processed on paper at a far greater cost in time, materials and storage space.

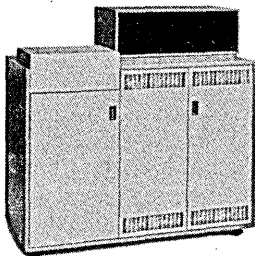

On-line AutoCOM II interfaces with IBM and IBM-compatible mainframes.

And let's not forget the data that's too sensitive to leave the office in the first place.

## Take total control.

Why not recover control of your data output

instead of paying a service bureau to take it? With COM in your own office, job priority is based on urgency. Not on somebody else's delivery schedule.

By working around your own requirements instead of the bureau's, you can literally save weeks of time each year.

## A 35% ROI the first year alone.

COM has always been far less expensive than putting the same amount of data on paper. But when you eliminate the middleman, the numbers jump off the page. In fact, many companies reap a 35% return on investment during the first year alone.

## The easy way out.

For once, the best way is also the easiest.

COM installation takes less than a day. And, with on-line operation and bar code-based automatic fiche duplication, it's practically a "hands off" operation. If you compare the output speeds, information access and storage capability of COM to any other medium, you'll quickly see for yourself.

For more information, call or write us at Datagraphix. It's one of the wisest investments in time your company will ever make.

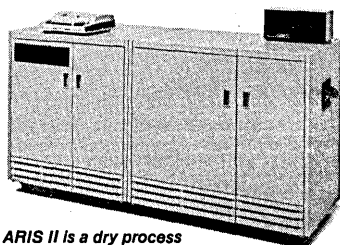

ARIS II is a dry process on-line recorder with advanced laser imaging.

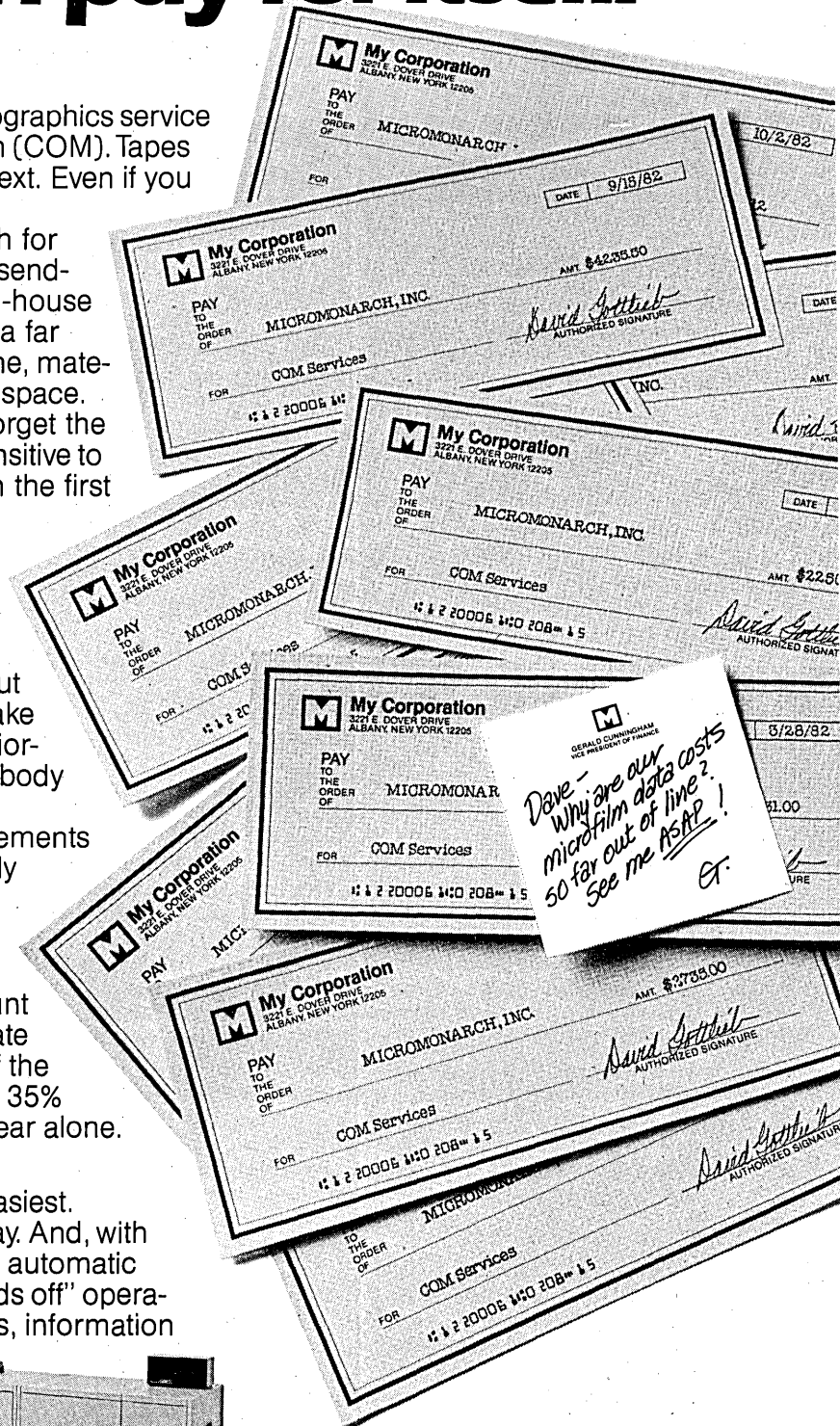

## Datagraphix®

The Computer Output Management Company  
a General Dynamics subsidiary.

Dept. 3515, P.O. Box 82449, San Diego, CA 92138  
(619) 291-9960, Ext. 5581  
TWX: 910-335-2058

## SOURCE DATA

gist of it is that "... the new theory sees organisms as either adapting, or failing to adapt, to changing temporalities." This is a peculiar way of putting it since all temporal changes are also geophysical changes; the separation of time from mass, energy, and velocity is not made and seems to be a metaphysical way of looking at things. This thinking is curiously like that of modern bankers and the way they play with time in terms of interest rates. The theory proposes, a la Whitehead, that each organism foresees the future, at least unconsciously. This is very much like risk analysis. Bankers and accountants are the most metaphysical and abstract of humans, squeezing all economic behavior into time slots, depending on the nature of their debt-portfolios. Bankers and investors need a foreseeable future. This temporal analysis of the universe and its inhabitants supposes a perfect foreseeability, a knowledge of all events in all time... in which Bishop Berkeley's thought is revived: God sees the universe and it is.

Rifkin goes on to become even more mystical by then filling the universe with Mind, of which all living organisms are an aspect. Here we begin to reapproach the thinking of ancient Brahmanic mythographers, for whom material reality (life and creatures) is only an illusion. The Great Background, the omnium, is the only reality. This is fashionable thinking of our day, as expressed in Capra's *The Tao of Physics* and Zukov's *The Dancing Wu Li Masters*.

Mind, then, and the evolution of Mind, leads to the notion of this new evolution. All that happens, whether in nature or constructed by humans, becomes an evolutionary aspect of this Mind. Rifkin proceeds to the bioengineering industry and expresses both his enthusiasm and his fears. On the one hand, he uncritically accepts the way in which "we" will be able to do anything, echoing the promoters of bioengineering, promising great wonders. On the other hand, he draws back when he considers the ethical implications. He chides those who want to change the world, indeed the universe, into an environment that will fit their preconceptions. He never questions whether in fact they can do it.

The great difficulty with Rifkin's book is that he too quickly accepts the promotional material of the information age, again, the promise of great wonders. Not only is it unclear whether the bioengineers can deliver on most of their promises; when it comes to human engineering, it is especially doubtful. Most of the bioengineering companies are currently running into trouble. For example, when or if genetically tailored organisms produce insulin, it will be two or three times more expensive to buy than it is now. The conflict doesn't lie between scientific theory and technology here, but between science and business. The bioengineer must produce profitable,

marketable products in a short time. And if the industry doesn't live up to its advance notices, business will abandon it.

But more new difficulties are flowing out of changes, confirmed by experimentation, in genetic theory. At first genetics was treated as information. Change the information and you change the organism. But genetic engineering and theory become more and more complex every day as new variables are discovered by experimentation. It is comparatively easy to engineer a microorganism; redesigning a human is a vastly more complex task, requiring perhaps 30 or 40 years, if it can be done at all. Like all grand theories, the genetic paradigm crumbles day by day. For instance, a virus has been discovered that replicates with no DNA or RNA.

Deeper than that is the very concept of the information revolution and its meaning. Everything begins to be defined in terms of information—what's more, computer assisted information processing. The computer, however, is a solidified and limited mode of thought, basically mechanistic, a logic requiring strict cause-and-effect relations. But Rifkin has accepted this change in thought uncritically, failing to see that what we have been given is only a grand metaphor for reality. The confusion lies in the match-up between information and living things. Information is easily manipulable; the natural world is not. It's a retreat to the world of magic.

It is an ancient tenet of magic that there is a connection between the microworld and the macroworld: "As above, so below." The modern microworld is information; the world outside is linked to the microworld. As Rifkin points out, if one manipulates information, the world outside should change, but only if there is a direct connection and the world is Mind itself. A doubtful proposition.

Rifkin laments the changes, but only on the basis that the connection is direct or that the information one has about the universe is correct. Clearly, it is not. He laments the changes that are taking place, linking the drive toward an informationalized, biologically engineered world to a drive toward immortality. He states that all people desire immortality. Doubtful; only a handful of people are obsessed with immortality.

What Rifkin should properly be alarmed about is the fact that more and more investment goes into the technologically run world, a world that is seen as information. These investments not only suck up money from other parts of the world's economy, but the returns are getting smaller and smaller. Rifkin complains that we (again, which "we"?) reject the world as it is given and seek to separate ourselves from a community of life that is not only humans, but all organisms—the universe itself as life and mind.

There is always a difficulty in writing books like *Algeny*. One needs to know a lot of science and to separate the theoretical or spacey from the solid. The writers of such books should be more careful to think out the underlying assumptions. True, Rifkin quotes scientists, but he also quotes popular books and newspapers, and accepts what they say as true. He should have proceeded with more care. Viking Press, New York (1983, 298 pp., \$14.75.)

—Sol Yurick

## REPORTS & REFERENCES

### CAD/CAM SURVEY

If you contacted 18 vendors and asked each of them 175 questions about their CAD/CAM products (including hardware, software, displays, I/O devices, capabilities, nongraphic processing, and training and service), you'd come up with *A Survey of CAD/CAM Systems, 3rd Edition*, the Leading Edge Publishing Inc. publication. The book was edited by Dr. John J. Allan III and consists of 86 pages of charts, where the above-mentioned 175 questions are answered. In addition, chapter four, Management Considerations, contains some fundamental information for those new to the world of CAD/CAM. The book also includes a chapter on technical considerations and a final section on the future of CAD/CAM. The volume is directed toward the information needs of prospective CAD/CAM purchasers; the price is \$96. Contact Leading Edge Publishing Inc., 317 Forest Central Two, 11551 Forest Central Dr., Dallas, TX 75243, (214) 341-9606.

### GRAPHICS FIND

"The S. Klein Directory of Computer Graphics Suppliers: Hardware, Software, Systems and Services" is published by Technology & Business Communications Inc. The current 1982-'83 volume is 128 pages, and provides the names, addresses, phone numbers, and contacts for 300 computer graphics companies. Other information, such as top management, company size, sales volume, and year of origin is also listed for the firms. Of course, each company's products are briefly described, as well as its services. This is a black and white book, but there is quite a bit of colorful graphics advertising within the directory's pages. Price: \$47. Contact Technology & Business Communications Inc., 730 Boston Post Rd., Suite 27, Sudbury, MA 01776, (617) 443-4671.

### COMPUTER CAMP

Whether you're interested in opening your own computer camp, attending one, or sending your kids to one, *The Computer Camp Book* attempts to address your needs. The book includes interviews with campers and their parents, counselors, and camp administrators. It also provides some guide-

# programmers

## READ THIS...

NOW, I KNOW I CAN MAKE BIG MONEY WRITING AND SELLING MY PROGRAMS. THIS BOOK TOLD ME WHAT TO WRITE — WHO TO SELL IT TO — THOUSANDS OF NAMES, ADDRESSES, IDEAS, GUIDELINES. THE "\$SOFTWARE WRITER'S HANDBOOK" IS FANTASTIC!



- \* WHO TO SELL YOUR PROGRAMS TO
- \* THOUSANDS OF COMPANY NAMES AND ADDRESSES, WITH DETAILED LISTINGS SHOWING:
  - (1) WHAT PROGRAMS PUBLISHERS ARE LOOKING FOR
  - (2) HOW THEY WANT YOU TO SUBMIT YOUR PROGRAM
  - (3) HOW MUCH THEY PAY — AND WHEN!
- \* 100 CATEGORIES — FROM "ACCOUNTS RECEIVABLE" TO "GAMES" TO "VIDEO CONTROL" PROGRAMS
- \* HOW TO WRITE CLEAR DOCUMENTATION
- \* DEBUGGING TECHNIQUES

Enclose check or money order for \$19.95 (No C.O.D.'s) to:

IPF Publications  
146 Country Club Lane  
Pomona, NY 10970  
(914) 354-5585

Name .....

Address .....

City..... State..... Zip.....

**Reserve Your Copy Today!**

## SOURCE DATA

lines for selecting the camp that is best suited to your (and your family's) needs, and for successfully establishing and running your own computer camp. Ideas and materials for learning and teaching, computer literacy activities, a nationwide guide to computer camps, courses and workshops, and a guide to good computing resources such as periodicals and books are just some of the chapter topics. The book is written by Tom Copley, camp director (and associate professor at Antioch College in Yellow Springs, Ohio) for the Yellow Springs Computer Camp. After his camp's first season in the summer of '82, Copley learned of the need for literature on computer camps. His purpose in writing this book was to give both adults and children some background information on the subject. For \$12.95, the book is an interesting, reasonably priced first look at computer camps. Contact Sharon Sandusky or Chel White, 8327 Sheridan Lane, Eden Prairie, MN 55344, (612) 937-2066.

### DIRECT LINE TO CONSULTANTS

According to publisher J. Dick & Co., the July '83 edition of the *Leading Consultants in Computer Software* is the first directory of consultants and custom programmers who write and modify programs for micros, minis, and mainframes. Over 1,230 consultants are listed, and they can be looked up either by the state and city they work in or by using the keyword index of 850-plus headings. Each listing includes the consultant's address, phone number, years of experience, and size of firm, along with the hardware, applications, systems, languages, and machine language expertise that can be found at any particular company. A new version will be released in early '84, but so far, this copy of the directory sells for \$67. Incidentally, the directory was laser-published on a Xerox 9700 electronic printing system in approximately one minute—the copy is consistently clear and legible. Contact J. Dick & Co., 500 Hyacinth Place, Highland Park, IL 60035, (312) 433-0824.

### A CITY WITH STANDARDS

New York City has revised its procedures for computer security. The Department of Investigation (DOI) released "System Security Standards for Electronic Data Processing," a 142-page volume that is available from Citybooks, the city's official bookstore. All city agencies must comply with the regulations contained in this book, which are designed to protect computer systems from fraud, waste, abuse, and errors. Rolf Moulton (author of "Network Security," July), director of DOI's Computer Security Services Unit, worked on the Standards volume and stated that it is applicable to private industry as well as government agencies. From bomb threat procedures to disaster recovery manual instructions and

choosing "no smoking" sign locations, all types of security problems are mentioned in the book. It also contains a computer security questionnaire at the back that consists of 145 questions. It is available for \$10, prepaid, from Citybooks, Municipal Building, One Centre St., Room 2213, New York, NY 10007.

## SEMINARS

### PERSONAL UPS AND DOWNS

Future Computing Inc. is holding a two-day seminar entitled "Opportunities and Pitfalls." It includes eight sessions and provides data and forecasts for the personal computer industry market segments, distribution, hardware, and software. Included in the sessions will be predictions on how newcomers will fare, and where the personal computer market is headed. The seminar will be held in September in San Diego and in November in Fort Lauderdale. Cost per person is \$795. Contact Future Computing Inc., 900 Canyon Creek Center, Richardson, TX 75080, (214) 783-9375.

### ANOTHER INTERFACE

Interface '83, the seventh national conference on technology and the humanities, will take place Oct. 20-21 at the Northwest Atlanta Hilton in Marietta, Ga. Cosponsored by the Department of English and History of the Southern Technical Institute and the Humanities and Technology Association, this year's conference will cover such topics as the ramifications of technology in ethics, public policy toward science and technology, and curriculum design for the humanities and technology. For more information, contact Becky Kelly or Sandy Pfeiffer, Department of English and History, Southern Technical Institute, Marietta, GA 30060, (404) 424-7202 or 7203.

### GOIN' EAST

CP/M '83 East will take place Sept. 29-Oct. 1 at the Boston Hynes Auditorium. The show is billed as an international conference and exposition for the CP/M industry and CP/M users. It will feature manufacturers, independent software developers, oems, venture capitalists, software publishers, distributors, and dealers. The conference program is large—it will contain almost 100 sessions. Further information is available from Northeast Expositions, 822 Boylston St., Chestnut Hill, MA 02167, (800) 841-7000 or (617) 729-2000.

### PROLOG

The Japanese fifth generation computer project has adopted Prolog as its core language; the language has also been used successfully in database and expert systems, rapid software prototyping, operating systems, natural language processing, and compiler development. Because of the language's versatility and growing impor-

tance, Brandeis University and the IEEE Computer Society are cosponsoring an intensive introduction to Prolog Sept. 11-14. After taking the course, attendees will "be able to write Prolog programs, will have a good understanding of the rationale behind Prolog, and will be able to judge Prolog's effectiveness in developing expert systems in database interfacing, or in implementing specific applications." IEEE members will pay \$325 for the course, nonmembers \$350. Contact Office of Continuing Studies, Brandeis University, Waltham, MA 02254, (617) 647-2796.

### HARD-HITTERS

The Information Industry Association, Washington, D.C., has two events planned for September and November. The first, "Integrating External Databases with the Corporate MIS," will take place Sept. 20-21 at the Mark Hopkins Hotel, San Francisco. The targeted audience for this seminar is technologists, MIS directors, and ceos. In New York City, IIA will present the 15th Annual Convention & Exhibition, "The Information Industry Talks with Wall Street," Nov. 7-9 at the World Trade Center and Vista International Hotel. Keynote speakers will be James Martin, James Martin Investments Inc.; Charles W. Moritz, Dun & Bradstreet Corp.; and Rep. Tim Wirth, U.S. House of Representatives. Details can be obtained from IIA, 316 Pennsylvania Ave. S.E., Suite 400, Washington, DC 20003, (202) 544-1969.

### HARDCOPY

"Intelligent Copier/Printers: New Developments and Trends in Electronically Controlled Printers, Extended Reprographic Devices, and Multifunction Systems" is the lengthy title of this Institute for Graphic Communication conference. Technologies, products, applications, and markets for this new breed of copiers and printers will be explored at the Sept. 20-22 conference in Andover, Mass. Contact the Institute for Graphic Communications, 375 Commonwealth Ave., Boston, MA 02115, (617) 267-9425.

### NOT BY INVITE ONLY

The 1983-'84 series of the Invitational Computer Conferences will begin Sept. 13 at the Newton Marriott Hotel, Newton, Mass. The ICCs are a 12-year-old tradition. According to the promoters, this is still the only set of one-day regional conferences directed to large-volume buyers such as oems, system houses, and large end users. The next September date is the 29th, when the ICC will be at the Radisson South Hotel, Minneapolis, Minn. The shows continue through to March 1984; for more information, contact Susan Fitzgerald, Conference Manager, B.J. Johnson & Associates Inc., 3151 Airway Ave., #C-2, Costa Mesa, CA 92626, (714) 957-0171.

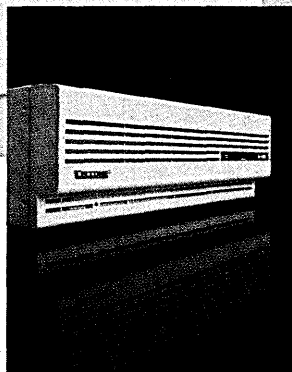
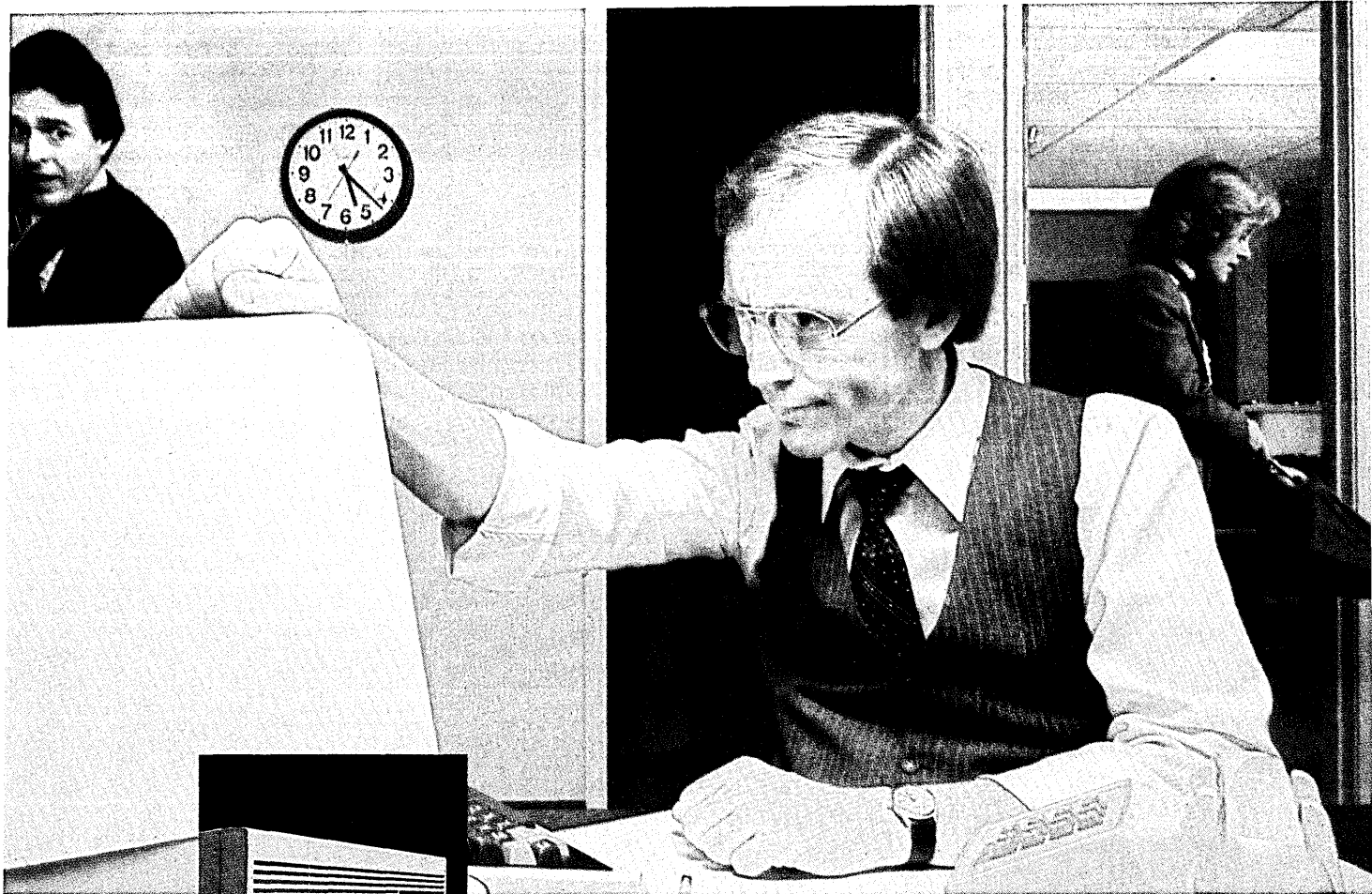

## “What good is 9600 baud if your stat mux slows you down?”

Speed can be addictive, that's a fact. Once users get accustomed to fast feedback they just don't want to hear that your lines are overloaded or your mux just can't keep pace. They want their data and they want it now.

To help you avoid these baud rate bottlenecks, Teltone is happy to introduce our new M-860 Statistical Multiplexer.

You want speed? It's a thoroughbred at up to 78,600 bps, so you can take full advantage of 56K bps DDS circuits. You need flexibility? It's a chameleon that offers six different data link interfaces—two with integral modems.

Efficiency? It's an unparalleled performer that delivers multiplexing efficiencies of 800% and more. Friendliness? This is your mux—fully programmable from the local or remote end with an interactive menu system that also provides access to diagnostics and statistics. You'll never deal with DIP switches again. The M-860 is compatible with our own DCS-2 Data Carrier system and voice-grade lines, but it works equally well over microwave, coaxial cable and fiber-optic hookups.

Want more? How about local or remote echoplex, full field expansion, CRC error detection and ARQ retransmission, speed conversion—plus the same dependable service we've been giving the telecommunications industry for more than 15 years.

It's a combination that's really hard to beat, in a mux for people who'd rather be working than waiting. Call 1-800-227-3800 Ext. 2301 or write Teltone Corp., PO Box 657, Kirkland, WA 98033. In Canada call (416) 475-0837 or write 183 Amber Street, Markham, Ontario L3R 3BR.

**TEL TONE**<sup>®</sup>

CIRCLE 122 ON READER CARD

*The data flood.  
How are you riding it out?*

The flow of data keeps growing, seemingly unchecked. Space requirements have more than doubled in the last three years.

And, as applications continue to expand, there's no end in sight. Your datasets will continue to multiply and storage needs

are simply going to explode.

There is one company — UCC — that can help you do something about this flood. Our complete line of Dataset Management software works together to manage your datasets . . . automatically. That includes their crea-

tion, usage, storage and retention or disposal — whether they're on disk, tape or MSS.

After all, Data Processing is automated . . . isn't it about time Dataset Management was, too?

Call 800-527-5012  
(in Texas 214-353-7312.)

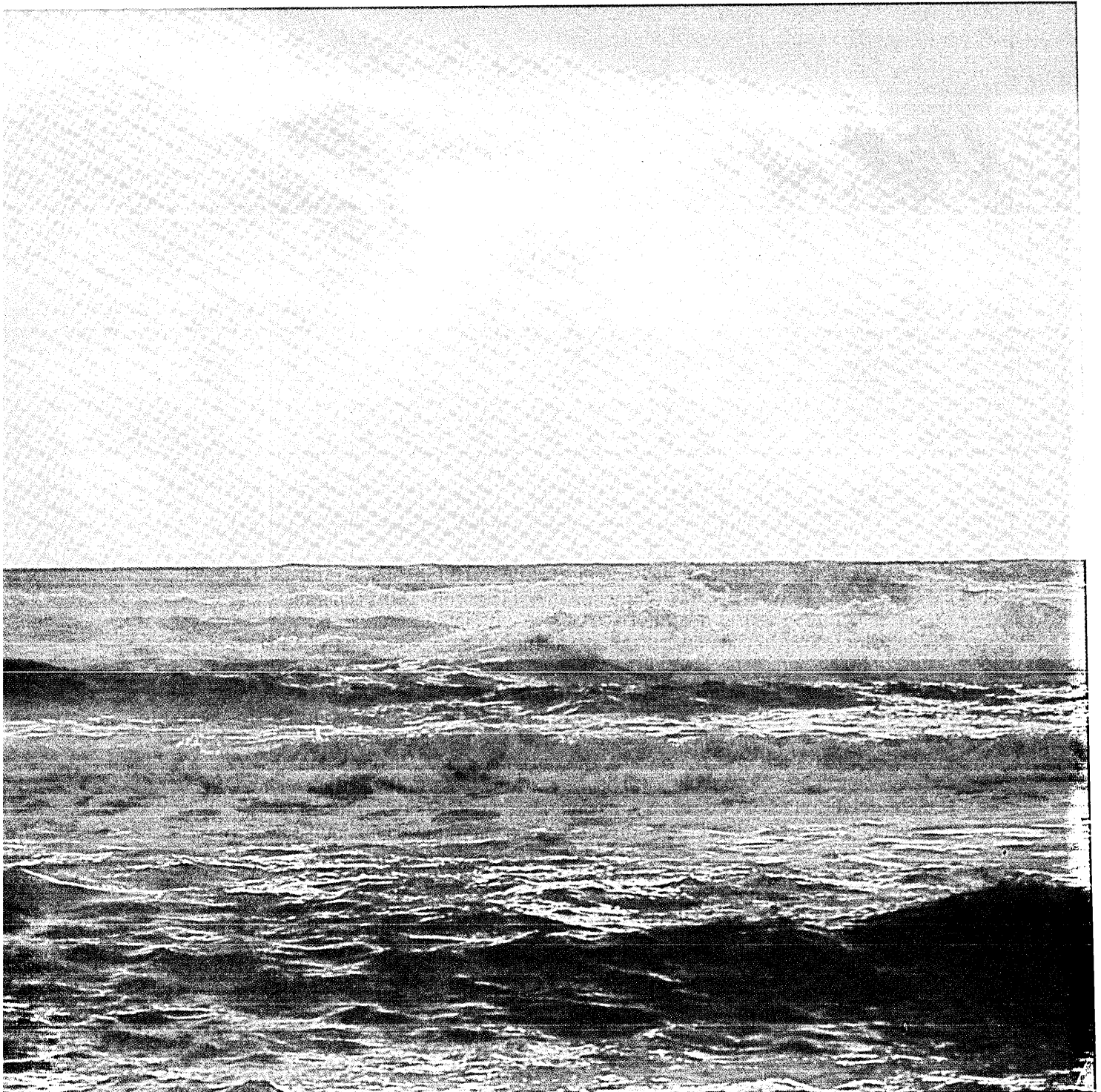

*UCC is a subsidiary of Wyly Corporation (NYSE). For more information and an annual report, write 1000 UCC Tower, Exchange Park, Dallas, Texas 75235.*



**THE MOST COMPLETE  
SOFTWARE COMPANY  
IN THE WORLD.**

**CIRCLE 123 ON READER CARD**

*University Computing Company • Dallas • Toronto • London • Paris • Dusseldorf*

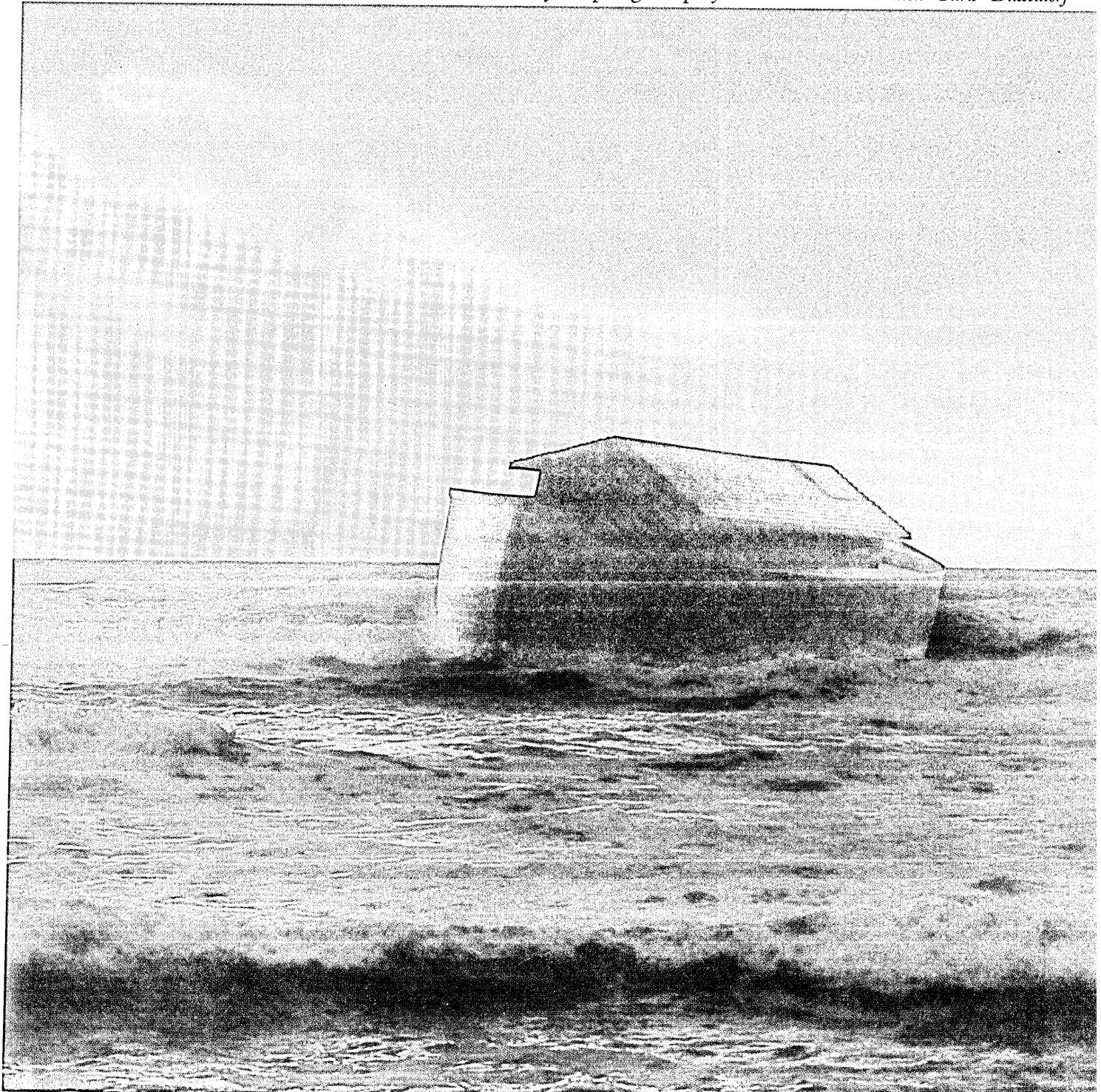



## Does business stress cause high blood pressure?

Stress on the job is a real problem for most of us. Many people think high-pressure jobs cause high blood pressure.

Scientists and doctors aren't sure if stress causes high blood pressure. But, one thing is for sure: *anybody*, no matter how they react to stress, can have high blood pressure.

If you have high blood pressure, you can control it—with medication, weight control, less salt, and whatever else your doctor tells you to do, every day.

No matter what you do for a living, keep on living.

**High blood pressure.  
Treat it and live.**

National High Blood Pressure Education Program,  
National Heart, Lung, and Blood Institute,  
U.S. Department of Health and Human Services

## Employment Scene

# ON THE JOB

### COLLEGE CONVERSION

The 95 employment execs who responded to a Deutsch, Shea & Evans, New York, N.Y., survey were asked about the supply of skilled workers. Almost unanimously, they answered that there is still a severe shortage even during this time of high unemployment. Those questioned were all members of large corporations, and 68% of them favored converting two-year community colleges into advanced technical training schools, wherever feasible, to help alleviate the deficiency. One respondent warned, "The problem is that quality [education] is decreasing rapidly. Current public funding cutbacks will have a serious effect on the future availability of trained manpower in the U.S."

### DOCTORAL DEPRESSION

Indeed, poor-quality education is a major problem. Compounding it is the fact that, depending on whose statistics you believe, there are between five and 35 jobs waiting for each of the approximately 250 people in the U.S. who earned computer science doctorates this year. The computer industry needs these people to bolster its research and development programs, but academia needs them to teach as assistant professors. This dilemma is apparent to students as well as to faculty members and businesspersons. William Cox, a University of Wisconsin-Madison (UW-M) computer science student, obtained his master's degree and then had to decide whether to pursue a doctorate and receive relatively low pay while being a teaching assistant or go straight into industry for a higher salary. Cox, like many other master's holders, opted for industry and better money.

According to the National Science Foundation, people with master's degrees in computer science outnumber those with doctorates by 15 to one. In engineering, the ratio is six to one, and in chemistry it's 1.1 to one. Additionally, many institutions have noticed a decline in the quality of computer science students applying for PhD programs; industry reaps the best of the crop before they even enter graduate school. Robert R. Meyer, chairman of UW-M's computer science department, said that between a fourth and a third of his department's 200 graduate students plan to obtain their doctorates. Some of them fail the tough screening exam, but many are lured away by industry. Of the university's 1983 graduating doctoral students, about

half are expected to take jobs with computer firms. The other half will become assistant professors and earn about \$10,000 less than their counterparts in industry. Some people fear this 50/50 split may soon change in industry's favor. A number of grads are willing to trade high industrial salaries for the flexibility of a university, particularly the opportunity to pursue their own research interests. But, they are not willing to take on heavy teaching loads that might interfere with those efforts.

The end result of these trends is that, since 1975, undergraduate enrollment in computer science has more than doubled while the number of computer science professors has remained virtually the same.

There are ways for industry to share the burden. For instance, let's take the case of Gregory F. Johnson, another UW-M master's graduate who opted to go into teaching. He received a \$4,167 "forgivable loan" from General Electric Corp., one of several firms trying to ease the manpower and equipment problems of computer science departments. Although the loan is only a small amount of money, it did clarify Johnson's "sense of commitment" to teach. He will not have to repay the loan if he teaches for three years after graduating.

### TEACHING SOLUTIONS

What do Harvard and the Universities of Arizona, New Mexico, Wisconsin, British Columbia, and Rochester (among others) have in common? They all have at least one faculty member with a PhD in MIS from Purdue University's Krannert Graduate School of Management. This school is one of the leading producers of new MIS PhDs—about 20 graduates in the last 13 years. Professor Andrew B. Whinston, director of the Management Information Research Center at Purdue, estimates there were approximately 150 openings for MIS faculty around the country in 1982, while only 15 to 20 doctorates were awarded. Because the number of graduates in this particular field is so small, assistant professors of MIS are generally paid higher salaries than full professors in other disciplines. Nearly all of the Krannert school MIS graduates have taken faculty positions at universities. Currently, six students are enrolled in the MIS doctoral program. Two of them graduate this year, and they've already accepted teaching positions at the Universities of Tulsa and New Mexico.

—Deborah Sojka





**The industry standard  
for CICS testing hits new heights.**

## Introducing InterTest 2.3

Over 1200 users know that InterTest raises CICS productivity by simplifying testing and debugging. Now InterTest 2.3 has features that push productivity even higher than before.

### Easier to use

InterTest release 2.3 really flies with a menu-driven format. So new users can become more productive right away. A HELP facility and new documentation make InterTest easier than ever to install, learn, and use.

### More powerful

InterTest 2.3 includes powerful new tools that simplify and speed up

CICS testing. Conditional breakpoints let you define conditions that will stop program execution, such as a program variable changing its value. COBOL source code is now displayed online, so you don't have to wait for printed listings. Limits can be set on the amount of main storage or the number of CICS requests that a program is allowed to issue. With InterTest 2.3, your CICS productivity and reliability will really soar.

### Continuous support keeps you flying high

On-Line Software is fully committed to InterTest support and development. We've taken the product through nine releases of CICS, and continuously added new features. And all InterTest users automatically get new release tapes, so you're never left behind.

### Take a test flight

You can try InterTest 2.3 for 30 days at no charge. If it doesn't live up to your expectations, just return it.

Join over 1,200 users who are convinced that for CICS testing, InterTest is the only way to fly! Just send the coupon or call us toll free (800) 526-0272.

- Send me the forms for my 30-day trial of InterTest 2.3.  
 I need more information:  
 Call me     Send literature  
 Send Videotape:  VHS  Beta  3/4"

Name \_\_\_\_\_

Title \_\_\_\_\_ Phone \_\_\_\_\_

Company \_\_\_\_\_

Address \_\_\_\_\_

City \_\_\_\_\_ State \_\_\_\_\_ Zip \_\_\_\_\_

 **ON-LINE  
SOFTWARE**  
INTERNATIONAL

Fort Lee Executive Park, Two Executive Dr.  
Fort Lee, NJ 07024 (201) 592-0009  
Toll Free (800) 526-0272

# EXTEND YOUR PRINTER CABLE



## PS3910 Line Printer Controller

The HAL PS3910 Line Printer Controller System allows you to "extend" the cable of your mainframe printer. The PS3910 connects between the printer and mainframe using a standard dial-up telephone line. Data compaction and error correction are used to handle printer speeds up to 600 LPM. Full interactive data exchange is provided on the two-way communications link so that the computer and printer operate just as if they were sitting side-by-side. When you need a remote high speed printer, use the PS3910 and save the cost of an additional mainframe computer. Some of the features of the PS3910 are:

- Manual, automatic-answer dial-up, or dedicated line service
- Data is compacted and error-corrected
- Printer speeds up to 600 LPM
- Full two-way communications between printer and mainframe
- Printer status relayed to mainframe
- Interface to ® Centronics-compatible printer port
- Optional ® Dataproducts or ® HP Universal-Differential Interface
- Use one PS3910 at mainframe and one PS3910 at printer
- No change required to existing printer support software
- Local and remote printer testing included
- Switch selection of local or remote printer
- Control multiple printers from one mainframe
- One or more printers may be driven by multiple mainframes
- Economical and efficient

Find out more about the remarkable HAL PS3910 system. Contact us today.



HAL Communications Corp.  
P.O. Box 365  
Urbana, Illinois 61801  
(217) 367-7373  
TWX: 9102450784 HALCOMM

® Centronics - TM of Centronics Data Computer Corp.  
® Dataproducts - TM of Dataproducts  
® HP and Universal-Differential Bus - TM of Hewlett-Packard

## ADVERTISERS' INDEX

AGS Management Systems.....	74,90
*Allison-Ross .....	216-5
Alpha Micro Systems.....	188,189
Anderson Jacobson.....	136
Apple Computer Inc.....	178,179
Arc Associates .....	264
Ashton Tate.....	198,199
**Associated Computer Consultants .....	217-6
AST Research.....	15
Auerbach.....	268
*Auerbach.....	216-27
Beehive.....	29
*Beehive International .....	216-15
Bell & Howell .....	225
Bell Laboratories .....	117
*Bell Manufacturing .....	216-19
Boeing Computer Service .....	133
Braegan Corporation .....	51
Cado Systems Corp.....	151
CalComp.....	158,159
**Callan Data Systems.....	217-14,217-15
Cambridge Systems Group.....	118,119
Candle Corporation.....	2
**CIE Systems.....	217-24
**CIE Terminals .....	217-2,217-13
*Comdex/Europe '83 .....	216-10
COMPAQ Computer .....	174,175
Compucorp.....	73
Computer Automation .....	34,35
Computer Corp of America .....	59
Computer Faire.....	261
Computer Security Institute .....	263
Comspec Exploration .....	58
Context Management Systems.....	54
Control Data Corporation.....	64,80
Corona Data Systems .....	163,164,165
Cullinet.....	190,191
CXC Corporation .....	30,31
*Cynthia Peripheral.....	216-8,216-9
Datagraphix.....	239
Data Media .....	112,113
Dataproducts.....	19
Data Sources .....	184,184A-B,185
Data Switch .....	79,81,83,85
Digilog Inc.....	173
Digital Communications Associates ..	195
Digital Equipment Corp.-VAX.....	134,135
Digital Pathways .....	61
Digital Research .....	65-72,234
Direct, Inc. ....	75
Dylakor.....	74
Dysan Corporation .....	99
Electrodata .....	127
EMC Corp.....	55
*Emulex Corp.....	216-13
EPS Inc.....	161
*Fusion Products International.....	216-30
Genstar Rental Electronics .....	4
Graham Magnetics .....	183
Hal Communications.....	248
Hewlett-Packard.....	56,57,142,143
**Hewlett-Packard.....	217-10
Honeywell Infosystems.....	10,11
Hughes.....	138
IBM.....	43,123,124,125,140
ICL.....	25,26,27
Infodata.....	226
Informatics .....	82
Innovation Data Processing.....	253
Intel .....	52,53
IPF .....	241
**C. Itoh Electronics.....	217-7
ITT Courier .....	105
ITT Worldcom .....	137
Kennedy .....	Cover 2
**Kennewick Industrial .....	217-20

Lanier Business Products.....	40,41
Leading Edge.....	32
Lear Siegler Inc. ....	76,77
Lee Data.....	Cover 3
Liebert Corp. ....	100,101
Manager Software Products.....	231
Mathematica.....	218
McCormack & Dodge.....	62,63,87
Megatek.....	146,147
Memorex.....	208,209
Micom Systems.....	1
*Microtron.....	216-2
Moore Business Forms.....	223
Morino Associates.....	91
MSA.....	88,89
Munich Fair Authority.....	266
Nixdorf Computer.....	39
*Norsk Data.....	216-29
Northern Telecom.....	177
*Olivetti.....	216-17
Oneac Corporation.....	212,213
On-Line Software International.....	247
Onyx Systems Inc.....	228
Oxford Software Corporation.....	78
Paradyne.....	220,221
Perkin Elmer.....	211
Persyst.....	129
Phaze Info Machines.....	45
*Philips Telecommunications.....	216-22,216-23
*Philips Test & Measuring.....	216-26
Precision Visuals.....	111
Prime Computer.....	102,103
Proximity Devices.....	207
Protocol Computer, Inc.....	58,176
Racal Vadic.....	94
**RC Data.....	217-5
Rolm Corporation.....	130,131,192,193
Rusco Electronics.....	236,237
SAS Institute.....	5
Siemens Corp.....	202,203
*Siemens AG.....	216-20,216-21
Softool Corporation.....	145
Software AG.....	9
Software International.....	12
Software Results Corp.....	8
Sperry Corp.....	16,17
SPSS.....	153
Sytek.....	154
TAB Products Company.....	215
**Tai Song.....	217-12
Tandem Computers.....	20,21
**TEAC Corp.....	217-23
Technology Transfer Institute.....	95,97
Tektronix.....	6,7
Teletype Corp.....	Cover 4
**Teletype Corp.....	217-21
Televideo.....	46,47
Telton.....	243
Term-Tronics.....	187
**Thorn EMI.....	217-9
Three M.....	22,109,197
Tymshare, Inc.....	44
UCC.....	244-245
Ungermann Boss.....	170,171
Verbatim.....	233
Virtual Systems.....	176
Wandel & Golterman.....	93
**Western Peripherals.....	217-22
*Wollongong Group.....	216-25
**Wyse Technology.....	217-18
Xerox Corporation.....	96,201
**ZILOG Systems Div.....	217-16

\*International \*\*OEM Edition

# Are your backups running into your prime shift?



## Incremental Backups can reduce your backup time by 50 to 80%.

User can specify that ABR is to backup changed data sets only until a limit count is reached. At that time, ABR will interpose a full volume dump. This technique greatly reduces backup time while providing a periodic image of the entire volume.

- Automatic Volume Reconstruction
- Automatic Tracking of Backups
- Preallocation
- Unlike Device Support

# FDR™

## AUTOMATIC BACKUP & RECOVERY™

Available for IBM OS/VS & MVS  
90 Day Free Trial

**INNOVATION  
DATA PROCESSING**

970 Clifton Ave., Clifton, NJ 07013 • 201-777-1940

CIRCLE 125 ON READER CARD

# The Marketplace... SOFTWARE SERVICES

## SOFTWARE SERVICES

Amcor Computer Corp.....254  
 Applied Information Systems, Inc.. 254  
 Beemak Plastics.....255  
 DASD Corporation .....255  
 Dataware, Inc.....254  
 Dataware, Inc.....254  
 Dataware, Inc.....254  
 Mitchell & Gauthier  
 Associates, Inc. ....254  
 North America MICA, Inc. ....254

## DP MARKETPLACE

University of Idaho .....255

## BUY, SELL, LEASE

International Computer  
 Remarketing .....255  
 Thomas Business Systems, Inc....255

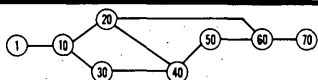

**WE DARE YOU TO COMPARE ANY  
 PROJECT MANAGEMENT SYSTEM TO**

### PMS-II/RMS-II

- IJ Critical Path
- Draws Activity Diagram
- Complete Bar Charting
- Super- and Sub-Networking
- Resource Conflict Control
- Budget and Actual Cost Control
- Funding Schedule and Graph
- Earned Value Analysis
- True and Free Float
- Meets Corps of Eng's. Specs
- Runs on any Micro!

**pms-II— \$1295.00 rms-II— \$995.00**

REQUIRES CPIM (TM) AND CBASIC-2 (TM)  
 DEMO SYSTEM — \$1000  
 SEND FOR FREE LITERATURE

**NORTH AMERICA MICA, INC.**  
 11772 Sorrento Valley Rd., San Diego, CA 92121  
 619-481-6998

**CIRCLE 500 ON READER CARD**

## PDP-11 & VAX Software

EasyEntry  
 Quick form design  
 and data entry system

AIS-PL/I

ANSI Subset G  
 PL/I Compiler

BURCOM-11

PDP-11/Burroughs  
 Communications System

1-800-334-5510

applied information systems

500 Eastowne, #207  
 Chapel Hill, NC 27514  
 (919) 942-7801

**CIRCLE 501 ON READER CARD**

## ACSL

The Advanced Continuous Simulation Language is a powerful but easy to use program designed for modelling the behavior of dynamic systems. Applications range from control system analysis to chemical plant models to urban dynamics.

- Interactive or Batch Graphics
- Unlimited Problem Size
- FORTRAN Compatibility
- Stiff Integration

ACSL reduces program development time by factors of two to ten: ACSL is available for CDC 6000/7000, IBM 360/370, UNIVAC 1100, SEL 32, PDP 10/20, VAX II, PRIME 50 and HARRIS computers. Access through BCS, CYBERNET and other national networks.

MITCHELL AND  
 GAUTHIER ASSOCIATES, INC.  
 P.O. Box 685, Concord, Ma. 01742  
 (617) 369-5115

**CIRCLE 502 ON READER CARD**

## DEC

AMBASE® a complete application development tool and DBMS. Increasing the productivity of programming staffs worldwide from 100%-900%.

## RSTS

- DATA BASE MANAGEMENT SYSTEM

## VAX

- REPORT GENERATOR
- QUERY LANGUAGE
- SCREEN FORMAT GENERATOR

## DBMS

- AUTOMATIC CODE GENERATOR
- USER FRIENDLY REPORT WRITER

## SOFTWARE

DEC GOLD STAR RATED ICP MILLION DOLLAR AWARDED

amcor computer corp.

an NEC Automation Group Company  
 1900 Plantfield Dr., Louisville, KY 40299 • (502) 491-9820  
 "Regional Offices Nationwide"



**CIRCLE 503 ON READER CARD**

## AUTOCODER/SPS to COBOL

Dataware's software translator automatically converts a high percentage of SPS/1400 Autocoder source code to ANS COBOL (DOS or OS).

The Translator converts from:

- IBM 1401
  - IBM 1401 SPS
  - IBM 1440
  - IBM 1410
  - IBM 7010
- can be mixed in a single source program.

For more information, call or write today.

The Conversion Software People  
**Dataware, Inc.**

2565 Elmwood Avenue  
 Buffalo, New York 14217  
 (716) 876-8722 • TELEX: 91519

**CIRCLE 504 ON READER CARD**

## Dataware Software Translators

### RPG to COBOL

Converts RPG and RPG II programs to the industry standard ANS COBOL (DOS or OS). The translator achieves an extremely high percentage of automatic conversion (approaching 100%) of the source code.

### RPG to PL/1

Converts RPG and RPG II programs to an optimized PL/1 (DOS or OS). The translator achieves an extremely high percentage of automatic conversion (approaching 100%) of the source code.

For more information, call or write today.

The Conversion Software People  
**Dataware, Inc.**

2565 Elmwood Avenue  
 Buffalo, New York 14217  
 (716) 876-8722 • TELEX: 91519

**CIRCLE 505 ON READER CARD**

## COBOL to COBOL

One of the many successful Translators offered by Dataware is our COBOL Converter, a table-driven conversion system designed to convert COBOL programs from one vendor or operating system to another.

This converter plus our other conversion tools meet the needs of a changing computer industry.

Our conversion approach provides the major solution to management's conversion problems and facilitates the recovery of the initial capital investment in systems development.

For more information, call or write today.

The Conversion Software People  
**Dataware, Inc.**

2565 Elmwood Avenue  
 Buffalo, New York 14217  
 (716) 876-8722 • TELEX: 91519

**CIRCLE 506 ON READER CARD**

# Conversion with no surprises Call 800-558-5148\*

Our free brochure, "Conversion With No Surprises," describes D ASD's proven methodology in detail. Our three-phase approach assures that the conversion you need is the conversion you get. We'll also give you details on our low cost "benchmark" offer that will let you test our software conversion capabilities for yourself. Call now.



PEOPLE/PRODUCTS/RESULTS  
D ASD Corporation • Corporate Services Center  
9045 North Deerwood Drive • Milwaukee, WI 53223 • 414-355-3405

Member of the Cap Gemini Sogeti group 

\*In Wisconsin, call 414-355-3405, collect.

CIRCLE 507 ON READER CARD

## Tabcard Holders

supplying holders for all types of D.P. systems

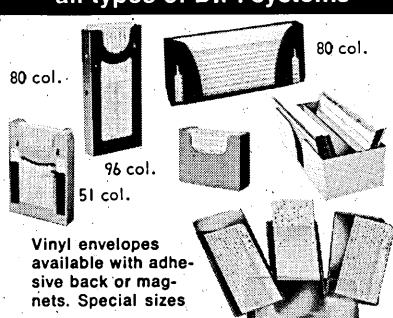

Vinyl envelopes available with adhesive back or magnets. Special sizes

**SINCE 1951**  
**BEEMAK™ PLASTICS**  
7424 Santa Monica Boulevard  
Los Angeles, Ca. 90046 • (213) 876-1770  
Outside California—call our Toll Free number:  
**1 (800) 421-4393**

CIRCLE 508 ON READER CARD

BUY, SELL, LEASE



**INTERNATIONAL COMPUTER REMARKETING**  
A Division of Pinzone & Associates, Inc.  
807 South Main Street  
Duncanville, Texas 75137  
214-780-1600 TELEX 73-0121 Pinzone DCVL  
Ill 217-351-1982  
CA 408-554-8717  
NE 702-457-5333

CIRCLE 509 ON READER CARD

## USE THE DATAMATION MARKETPLACE ADVERTISING SECTION

### CALL KATHY 800-223-0743 OR SHIRLEY

DP MARKETPLACE

### ACCREDITED ENGINEERING VIDEO COURSES FOR GRADUATE WORK OR PROFESSIONAL DEVELOPMENT

Complete your Master's of engineering degree now at work or at home with ABET approved video courses. Tremendous opportunity to continue your education, improve your career, increase your income potential at amazing low prices and flexible time. Write:

ITV/Video Outreach  
Janssen Engineering Building  
University of Idaho  
Moscow, Idaho 83843

CIRCLE 511 ON READER CARD

## SYSTEMS • PERIPHERALS • PARTS

# DG

*Phil Thomas*  
305/392-2006

# DEC

*Bryan Eustace*  
305/392-2005

*Jennifer Eustace*  
305/392-2007  
TELEX 568-670

### BUY • SELL • TRADE • LEASE

## THOMAS BUSINESS SYSTEMS, INC.

CIRCLE 510 ON READER CARD

**Don't miss America's #1 computer trade show. Whether you're an old pro or new-to-market ISO, COMDEX is for professionals who want to turn ideas into profit.**

It's not easy for today's ISO to keep up in the ever-changing computer market. Hot today, gone tomorrow.

That's why COMDEX is America's #1 computer show. It's the place for competitive ISOs who want to stay up front.

And COMDEX/Fall '83 is where you'll make contacts, pick up new lines and learn ways to improve the profitability of your business in 1984.

Where you'll find the world's leading manufacturers and suppliers as well as the up-and-coming stars. More than 1200 exhibitors in 5000 booths.

Where you'll find the newest products and services that will make headlines in the trade press after they debut here.

And the COMDEX Conference sessions are where you'll keep pace with the latest business strategies. Where internationally-prominent industry experts keep you abreast on everything from computer retailing to marketing strategy and management methods.

# Profit from America's #1 Computer Show



## COMDEX™/Fall '83

**November 28-December 2, 1983**

**LAS VEGAS, NEVADA**

- Las Vegas Convention Center • Riviera Hotel
- Las Vegas Hilton Hotel • Sahara Hotel

### **I WANT TO TURN IDEAS INTO PROFIT!**

Send me information on attending COMDEX/Fall '83

Name \_\_\_\_\_

Title \_\_\_\_\_

Company \_\_\_\_\_

Address \_\_\_\_\_

City/State/Zip \_\_\_\_\_



**THE  
INTERFACE  
GROUP, Inc.**

MAIL TO:  
COMDEX/Fall '83  
Registration Department  
300 First Avenue  
Needham, Massachusetts 02194  
(617) 449-6600

World's leading producer of computer conferences and expositions including COMDEX/Spring, COMDEX/Fall, COMDEX/Europe, INTERFACE, FEDERAL DP EXPO and the nationwide COMPUTER SHOWCASE EXPOS.

## ADVERTISING OFFICES

Advertising Sales Mgr.: **William J. McGuire**  
New York, NY 10022  
875 Third Ave.  
(212) 605-9715

Eastern District Managers:  
**Francie Bolger, John M. Gleason**  
New York, NY 10022  
875 Third Ave.  
(212) 605-9400

New England District Managers:  
**Jack Orth, John M. Gleason**  
Newton, MA 02159  
181 Wells Ave.  
(617) 964-3730

Mid-Atlantic District Mgr.: **Patricia Joseph**  
Plymouth Meeting, PA 19462  
Plymouth Plaza, Suite 201  
(215) 825-4410

Southern District Mgr.: **Warren A. Tibbetts**  
West Palm Beach, FL 33406  
7621 West Lake Dr., Lake Clark Shores  
(305) 964-6298

Midwest District Mgr.: **Joseph P. Gleason**  
Chicago, IL 60601  
3 Illinois Center Building, 303 East Wacker Dr.  
(312) 938-2926

Western District Managers:  
**William M. Wilshire**  
Los Angeles, CA 90035  
1801 S. La Cienega Blvd.  
(213) 559-5111

**James E. Filiatrault**  
Mountain View, CA 94043  
2680 Bayshore Frontage Rd., Suite 401  
(415) 965-8222

U.K., Scandinavia, Benelux, France, Manie  
**Robert Saidel, Martin Sutcliffe, Vivian James**  
Technical Publishing Co.  
130 Jermyn Street, London, SW1 4UJ, England  
Tel: 01-839-3916, Telex: 914911

Germany, Austria, E. Europe: **Robert S. Gibson**  
Regional Manager, Technical Publishing  
6000 Frankfurt 60  
Scheidswaldstr 41, West Germany  
Tel: (611) 439625, Telex: 4170039TP

Italy: **Luigi Rancati**  
Milano San Felice Torre 7  
20090 Segrate, Milano, Italy  
Tel: 2-7531445,  
Telex: 311250 PPMII Per Rancati 7531445

Switzerland: **Andre Lehmann**  
ALAS AG, CH-6344  
Meierskappel/LU  
Tel: (042) 64 2350, Telex: 864958

Japan: **Shigeru Kobayashi**  
Japan Advertising Communications, Inc.  
New Ginza Building, 3-13 Ginza 7-chome  
Chuo-ku, Tokyo 104, Japan  
Tel: (03) 571-8748, Telex: J22745

Israel: **Igal Elan**  
Daphna Str. 24, Tel-Aviv  
Tel: 268020, Telex: 341667

**John K. Abely**, President  
**Robert L. Dickson**, Exec Vice President  
**John R. Emery**, Senior Vice President  
**Walter M. Harrington**, Vice President/Finance and  
Administration

**Technical Publishing**

 A company of  
The Dun & Bradstreet Corporation

# A NOTED AUTHORITY ON CRIME PREVENTION TELLS YOU HOW TO SNIFF OUT MAIL FRAUD.

Most of the time when you shop by mail, you get exactly what you were promised. After all, mail-order companies know that it's good business to make sure that you're satisfied.

Unfortunately, some people aren't out to do good business—they're out to rip you off. By promising things that they can't, or won't, deliver.

Mail fraud is a serious crime. So if you suspect mail fraud, get help. Just call your Postal Inspector or local Postmaster. If you'd like more information about mail fraud and what you can do about it, write:

Chief Postal Inspector, P.O. Box  
23900A, Wash., D.C. 20024.  
Together, we can stop mail fraud.



© USPS 1983

# Success Story!

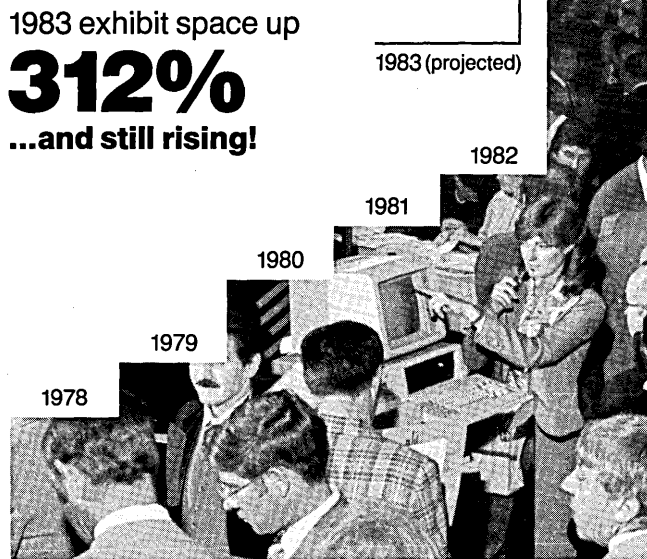
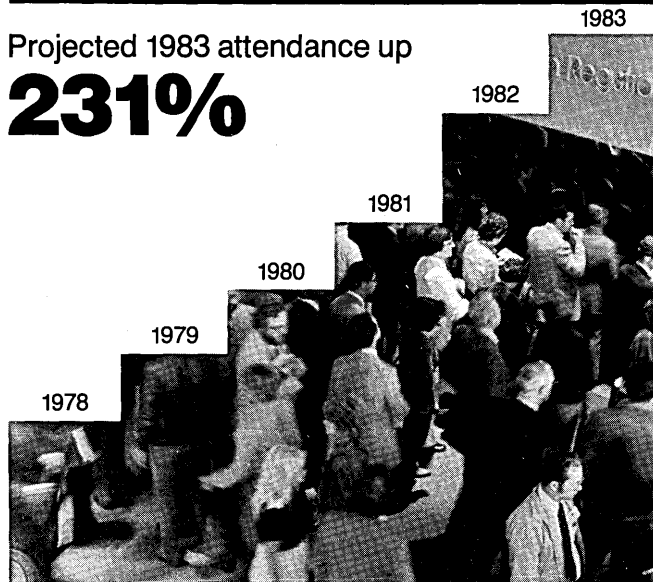

In just five years, the Federal Computer Conference has grown to become the biggest show of its kind anywhere. Quality is why. A quality Program and quality speakers. Quality attendees and quality exhibitors. A quality Exposition. The Federal Computer Conference — moving in 1983 to a new and bigger home...the Washington, D.C. Convention Center. For information on attending or exhibiting, send the coupon. Or call 800-225-5926 Toll-Free.\*

\*In Massachusetts: 617-358-5181 Collect.

**Federal Computer Conference • P.O. Box 368 • Wayland, Massachusetts 01778**

- I am interested in attending. Please send me your 1983 Conference Program and fee schedule.
- My company may want to exhibit. Please send full information and the 1983 Exposition Floor Plan.

Name \_\_\_\_\_

Title \_\_\_\_\_

Organization \_\_\_\_\_

Address \_\_\_\_\_

City \_\_\_\_\_ State \_\_\_\_\_ Zip \_\_\_\_\_

Telephone (\_\_\_\_\_) \_\_\_\_\_  
Area Code



**FEDERAL  
COMPUTER  
CONFERENCE**™

Sponsored by Federal Education Programs

**Sept. 13, 14 & 15, 1983 • Exposition: Sept. 14 & 15 • Washington Convention Center • Washington, D.C.**



# READERS' FORUM

## STONE AGE STANDARDS

At a major television network, even though an 11-volume set of standards manuals exists, a team of consultants has been busy on various documentation projects for the past three years. Within the MIS division of a huge film company, although the revenue system has been in place for a year, no standards exist for turning material over to hundreds of users based at branches throughout the country. Sorting out the resulting chaos has become the company's top priority. A national food distributor has standards manuals that cover everything, but recently hired a writer to "make the corporate systems standards workable." Standards, whether created or maintained, are a big headache.

Hardware comes with a manual. So does software. When the two are put together to create processing systems, MIS divisions issue standards.

There are standards for systems design and projects, for programming and testing, for vendor packages and project installation, for JCL, CICS, VSAM, VTAM, BDAM, and much more. Everyone admits that data processing would collapse without standards for applications, technical support, and operations. Yet most dp professionals not only dislike standards but would agree that this area is handled unevenly and often poorly by most MIS divisions. Wherever I've worked, "standards" for some important area has been synonymous with "pass the buck."

We're all familiar with the standards manuals of the past. First of all, they were very large. Secondly, most of them were put on the shelf soon after being issued, and there they stayed. Although well intentioned, manuals of this type did little more than soothe the conscience of whoever was asked, "Does your department have standards?" With relief, the answer was, "Sure, we've got standards, right here!" But after the first few months did anyone really use the standards? Did programmers and systems analysts actually search through the big books? Did anyone ever update the manuals after they were written? Did directors make workable standards a priority? A few well-run companies no doubt did all the above, but the rest of us went crazy with restart and recovery details, and let other vital areas, like program maintenance standards, go to pot.

When dp was in its infancy, respect for the machine was such that anything relating to computers was written as if it were involved in a satellite launching. In the area of standards, we are still under the weight of these books, most of which are superfluous in the business world. Just as hardware has consistently lost weight and diversified, standards need a new, trim style and versatility for the '80s and beyond. Standards that are bulky or overly complex tend to be ignored, and lax standards in any area are an open

invitation to all kinds of problems. Among other things, fraud is easier and maintenance is more difficult. Sophisticated security measures may be protecting a system that is otherwise quite vulnerable.

A great many corporate systems throughout America run only because operators, programmers, and designers have little penciled lists of commands, parameters, indexes, recovery procedures, etc., which they carry around with them in their wallets. This is one way to run a system, but it's not reliable, secure, or professional. What happens when these people leave and take their wallets with them?

To survive in this decade, whether dealing with users, programmers, operators, or MIS directors, a few rules must be observed:

1. Standards in all areas are a must. If they are ignored, they will come back to haunt you.
2. Standards that are not practical and easy to use are no good. More is usually not better.

3. Standards in most areas do not need tedious, bone-grinding detail. While hardware standards must be extremely detailed, standards used for quick reference cannot afford to be tedious or hard to find.

4. Standards have to be regularly updated. Ideally, standards should be reviewed every time an important new piece of hardware or software is taken on. Many companies run fourth generation hardware with standards from the second generation.

Standards in the '80s must confront several new areas, one of which is the increased importance and greater variety of users. This group has developed dramatically in the past 10 years, and although some software and hardware companies have tried to produce user-friendly manuals, few corporations have guidelines for bridging the gap between programmer and user. Documentation for users varies from real procedure guides to memos to nothing more than information relayed over the phone. A system centered in New York with branches throughout the country will find that the system operates differently at every branch if standards for users are sloppy.

From an MIS point of view, users are a type of ultimate consumer. Tight standards for dealing with them are especially important because they are likely to have limited or sporadic training in dp. Information handed to users from programmers cannot be simply "figured out." A few indispensable guidelines are:

- Give the users only what they must know, such as what they will enter on a terminal, or actually see on a screen. Any other information is confusing.
- Avoid buzzwords and use English whenever possible. If terminology is required, define each word.
- Pay attention to graphic layouts when dealing with users. Many good standards are defeated by poorly designed forms having boxes too small for filling in crucial data, dates that can't be located on a large page, etc. For a user, size and placement indicate emphasis.

## READERS' FORUM

From management's point of view, the bottom line must be "Good standards are simply those that are used by happy users."

Standards for the future must also deal differently with programmers and analysts. When creating standards of any kind for these groups, the distance between the creator and the user must be as short as possible. Corporate-wide standards established for programmers can only be successful on the most general levels. Without close contact, the following may happen: the software people downtown who are customizing the macro level CICS have no contact with the programmers uptown who are using the command level. But the software people issue all CICS standards, and to avoid missing anything, a 60-page memo is issued. The programmers end up solving their CICS questions by trial and error, and through discussions among themselves. The memo is not used because no one ever got past the 16th page before trying to find an easier method of getting at the desired information.

Programmers, analysts, and managers dislike the type of standards manuals put out by IBM and others. These books are precise, but in being all things to all people, are very cumbersome and unnecessarily picky. The personnel who need these manuals must be able to get their information quickly and easily. Issuing a 15-page excerpt on standards from a CICS manual, with a good table of contents and index, is a much better idea than relying on the original 300-page book.

Data processing is moving rapidly into the fourth and fifth generations. Most standards manuals, however, whether issued internally or acquired externally, are still at the stage of really being "everything you don't want and don't need to know about: systems design, program documentation, testing, vendor packages, project installation, JCL, CICS, VSAM . . ." How much sense does it make to conceptualize it, build it, sell it, and program it, and then run the whole thing according to the rules of the last decade?

—Lindsay Wilson  
New York, New York

# ERGONOMICS IN TECHNICAL COMMUNICATION

One of today's most popular buzzwords is ergonomics, or human engineering. This concept of producing tools that are comfortable for nontechnologists to use is long overdue. The dp field has traditionally turned out systems that are complicated, inconsistent, and illogical from the user's viewpoint. This damn-the-user attitude on the part of systems designers has resulted in tremendous waste of time and talent. Many high-visibility, expensive systems sit gathering dust soon after implementation because they are difficult for users to operate. Such systems might be deemed technical successes since they run according to their specifications, but they are practical failures in that they are used, if at all, only under duress. These systems owe their continued existence to the fact that their use is decreed by management or business necessity; the user simply has no other choice.

One reason for the new emphasis on human engineering is probably the competition in the dp community from consumer-oriented personal computers. The executive whose 11-year-old son balances the family budget on an Apple II is going to wonder why stewarding his department budget on the firm's multimillion dollar supercomputer is so difficult. The major difference between the two tasks is simply one of scale. Ironically, the upstart popular-computer market is putting the pressure on the older, so-called computer professionals to turn out systems designed for people, rather than other dp professionals.

In addition to nearly unusable computer systems, the dp community has also produced poor verbal and written communication, especially when the recipient is a nontechnical user. In everything from overwhelming presentations to incomprehensible user manuals to simple one-on-one training or debugging sessions, the dp professional has trouble getting his point across to the user clearly, simply, and concisely. There are various theories as to why this situation prevails. My own is that, in many cases, the computer professional, perhaps unconsciously, wants to confuse the reader or listener. After all, if the user understood too much, the computer mystique would disappear, and the professional's *raison d'être* would be questionable. Then again, the reason may be less sinister: the knowledgeable ones in any field are anxious to impress the uninitiated.

How can we make communication within dp and with users more ergonomically "clean"? We should apply the same ergonomic principles to our written and spoken communications that we apply to a new user-oriented on-line computer system. Let's look at the characteristics of a friendly system:

- Its overall structure should be apparent to the user.
- The system should be congenial without being chatty or too personal.
- Its nomenclature and syntax must be consistent throughout all functions.
- The system's logic must not trap users in loops, but should lead them straight to their goals.

No doubt additional characteristics could be added to this list, but these four were selected for two reasons. First, as a user of terminals, I've found these elements to be among the most important ones a system can have. Secondly, I chose these characteristics of friendly systems because they have such obvious parallels in technical communications.

The system's overall structure is a road map with which the user orients himself and keeps his bearings. Most times, it is hierarchical; at the top level is a menu of function commands. Once the

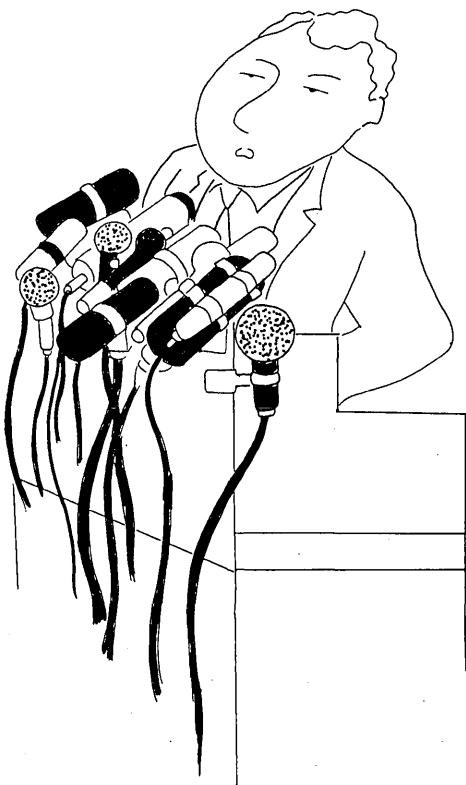

"No comment"

CARTOON BY WALTER URBAN

# The IBM PC Faire

**550 Exhibits by 300 Companies**

- Hardware
- Services
- Software
- Instruction

**Full 3-day Conference Program**

Tutorials for Novices  
Technical Talks for New Users  
Product Discussions & Presentations

**10 In-Depth Seminars**

How to Select a Computer  
Detailed Applications Tutorials  
Valuable Reference Materials  
(extra fee for seminars & hands-on seminars)

*and*

**Plan to Attend PC World's "Micro Ease" Hands-on Seminars**

**Conference & Exhibits: \$18 for all 3-days**  
door prizes including an IBM PC  
San Francisco Civic Auditorium & Brooks Hall  
August 26-28, 1983

9am-6pm (Fri & Sat)      10am-5pm (Sun)

an independent event by Computer Faire, Inc., 345 Sweitt Road, Woodside CA 94062-9990

CIRCLE 128 ON READER CARD

## READERS' FORUM

user selects a command, he is presented with a second-level menu of subcommands. In IBM's TSO, for instance, one of the top-level commands available to the user is "Full-Screen Edit," or FSE. Once in FSE, he can perform a variety of subcommands, such as "Page Forward," "Insert," and "Save." The command "End" usually returns the user to the structure's next highest level. As long as the system is not too deep (that is, the user does not get down so many levels that he can't find his way back to the top), the structure of the system is human, or friendly. The user knows that he can just keep typing "End" and get back to the surface.

To read a technical document, the user also needs a road map or structure diagram. This is normally the table of contents. Depending on the size of the document, we might divide the whole thing into chapters, or, in the case of a loose-leaf binder with tabs, we might call the top-level subdivisions "sections." Each section can then be divided into units, each unit into topics, and so on. The exact terminology used to name these parts is not important, but the terms must be consistent and accurate. The other requirement is that discussions or passages at equivalent levels of detail occur at the same structural levels throughout the document.

One way to keep the user oriented in a large technical manual is to have a hierarchy of indices. (This has been the practice in automobile shop manuals for years.) The top-level index, appearing at the front of the volume, might list the section titles, and following each section title, list the units within that section. This gives the reader enough information in the master index to know which section he wants, without going into too much detail. At the beginning of each section is a section index that lists the units in the section, and following each unit name, the topics covered therein. The same technique can be carried further, but, like the terminal program, the more levels there are, the greater the chance the user or reader will become disoriented. The point is that, at any level, the index presents the user with only two levels of detail (section-unit, unit-topic, etc.).

We might term this a top-down approach to document organization, borrowing from programming once again. Top-down program structures are supposed to do for the programmer what the same approach does for the reader of a technical document and the user of a terminal program: keep him oriented by presenting him with a limited number of choices at any one time. With this hierarchical organization in a manual, the reader doesn't have to divide his attention between understanding the content and wondering where he is and where he is going. It is also good discipline for the writer. As with top-down programming, if the author establishes the structure of the document at the start, he doesn't get lost and just ramble on, as so often happens. Once the skeleton is there, putting meat on the bones is a fairly straightforward process; both author and user benefit in the end.

Five or 10 years ago, computer assisted instruction had a

heyday. Several application languages for programming lessons were available, and CAI programmers became infatuated with the languages' ability to personalize a terminal session. Typically, the computer would start off with, "Hello, my name is Ogden. What is your name?" The student would then key in his name. From that point on, the computer would take every opportunity to address the student by name.

Needless to say, this overpersonalization fooled no one, not even the six-year-old at the terminal. In fact, it quickly became annoying. About the only people who seemed to get a kick out of it were the programmers who set up the lessons. Today, we still get computer-generated solicitations in the mail. "Dear Mr. Smith: How would you like to be the first person in Pleasantville to have these outstanding tulips growing in your front yard on Maple Avenue?" Not only is this annoying (it can be quite funny if, for example, the recipient's job title was entered into the name field, the name into the street-address field, etc.), but it actually distracts the reader from absorbing the intended message. He starts searching for the next appearance of his name, and misses the point of the sales pitch.

In communications, likewise, the writer or speaker must tread the line between being overly formal and too personal. Most technical writers err toward the former, addressing the reader as "the reader" or "the user," and himself as "the writer." One of the first rules of writing is to identify your intended audience. We often neglect to address that audience directly. For instance, if you are instructing the reader to enter data into a terminal, say, "Enter the data beginning in column 10," not "The user enters the data beginning in column 10," and certainly not "The data are entered beginning in column 10." The first is direct without being cute. The second is correct, but impersonal and unnecessarily complicated, having two unnecessary words: the user. The third construction, a favorite of technical writers, is worst, because the passive voice hides the doer of the action. Too many writers are somehow convinced that the presence of the words "I" and "you" in a document render it unprofessional. I remember a programming manual that contained the statement "The Data Control Block is completed when the file is opened." Exactly whose responsibility it was to complete the DCB was left to the reader's imagination. The sentence could equally well be taken to mean either "You, the programmer, must complete the DCB, etc." or "The operating system will complete the DCB, etc." The difference was rather critical. One frustrated reader used to refer to the doer of action in these circumstances as "mysterious forces."

One of the things about TSO that drives users crazy is its inconsistent punctuation. For example, sometimes parameters are enclosed in parentheses following the command, as in `SCRSIZE(27, 132)`. Other times, parameters follow an equal sign, as in `LOG-MODE = T3278M5`. Such inconsistencies probably exist because the package was developed by several different groups, most likely at different times, with no general agreement on format standards. In an `ATTRIBUTE` command, the user indicates "fixed blocked" by keying `RECFM(FB)`. In a `COPY` command, he types `RECFM(FB)` without the space between the F and B. This is certainly not what is meant by user friendly. Such inconsistencies are distracting and frustrating for the user. He'll have to interrupt his concentration and consult a reference book to proceed, or else retry the command in a trial-and-error mode.

Consistency of punctuation can be critical to communicating with users, yet most technical documents are poorly punctuated. The use of commas and hyphens is particularly important, as in the following example: "IPG is an interactive program generator." This sentence tells us that IPG is a program generator that is interactive in nature; that is, the programmer sits at a terminal while generating a program.

The writer really meant to say: "IPG is an interactive-program generator." This version means that IPG generates interactive programs, not that it generates programs interactively. The second version doesn't tell us if the programming process is interactive,

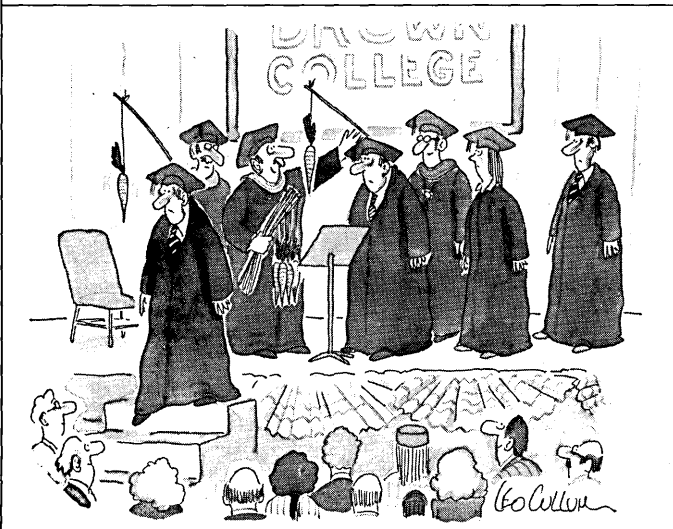

CARTOON BY LEO CULLUM

Plan now to attend

# "The Computer Security Event of the Year"

the 10th Annual Computer Security Conference  
November 7-9, 1983, New York Statler Hotel

For the computer security practitioner, there's no better way to keep abreast of this critically important, fast-changing area.



## 11 GENERAL SESSION PRESENTATIONS

Featuring expert and effective speakers who will share their expertise and experiences, describing the latest developments in their fields.



## 48 WORKSHOPS

The wide variety of offerings allows everyone to find special value in this conference. Each person will choose from these intensive, highly focused workshops led by experienced practitioners from across the U.S. and Canada.



## SPECIAL INTEREST SESSIONS

Conferees will meet in unstructured peer groups to exchange ideas, problems, and solutions.

## 6 OPTIONAL ONE-DAY SEMINARS

These seminars, presented before and after the regular Conference, offer you excellent opportunities to further increase your knowledge and understanding in specific areas of computer security.



## NATIONAL COMPUTER SECURITY EXHIBITION

The only national trade show for the computer security industry, this exhibition gives participants the opportunity to learn about new products and services. Conferees can take advantage of an optional service—scheduled appointments with the exhibitors.

## ECONOMY

In an effort to help you fight inflation, CSI has negotiated exceptionally low hotel rates for conferees. In addition, for the last two years CSI has been able to offer conferees discounts of up to 40% on air fares through Eastern Airlines.

## SPOUSES' PROGRAM

To make the conference enjoyable for your entire family, CSI sponsors this program of sightseeing, education, and fun.

## COMPUTER SECURITY INSTITUTE

The conference is sponsored by Computer Security Institute, the only full-service membership organization devoted to helping computer security practitioners safeguard their organization's data processing assets. Members of Computer Security Institute receive the 520-page *Computer Security Manual*, the bimonthly *Computer Security* newsletter, and special reduced rates for attending CSI-sponsored conferences, seminars, and workshops, and for subscribing to *Computer Security Journal*. Annual membership in Computer Security Institute is only \$85 (\$105 overseas). For more information, send in the coupon, or call 617/845-5050.

Computer Security Institute  
Dept. E-2  
43 Boston Post Road  
Northborough, MA 01532  
(617) 845-5050

## FOR MORE INFORMATION...

- Please send me full details of the 10th Annual Computer Security Conference.
- Please send me information on how I can exhibit my company's products/services at the 1983 National Computer Security Exhibition.
- Please send me information about subscribing to *Computer Security Journal*, the first journal devoted solely to computer security.
- Please send me information about joining Computer Security Institute.

NAME \_\_\_\_\_  
TITLE \_\_\_\_\_  
ORGANIZATION \_\_\_\_\_  
ADDRESS \_\_\_\_\_  
CITY \_\_\_\_\_ STATE \_\_\_\_\_ ZIP \_\_\_\_\_  
TELEPHONE (     ) \_\_\_\_\_

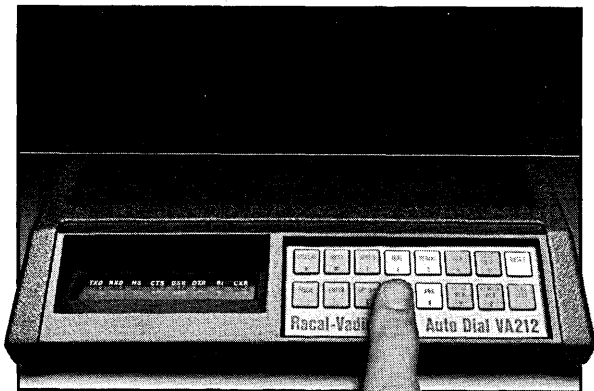

## YOUR FIRST CHOICE IN MODEM STORES

Modem Mart features a full line of modems including Racal-Vadic's 212 auto-dialer. Modem Mart can be the single source for your data communications needs.

Send for your free 48 page catalog today!



Modem Mart  
905 Bassett Road  
Westlake, OH 44145

In Ohio: 800-362-6883 • Outside Ohio: 800-321-2510

CIRCLE 130 ON READER CARD

## Computer Industry Analyst Senior Level

*Investment research—  
a rewarding field  
utilizing your technological  
and financial expertise*

Leading investment bank and brokerage firm, with headquarters in New York City, seeks highly-motivated, articulate professional to join its Investment Research Department as a Computer Industry Analyst with an orientation toward main-frame companies. This individual must have knowledge of state-of-the-art technology, a financial orientation and an interest in the securities markets.

Compensation is competitive and commensurate with experience and qualifications. Qualified candidates should send resume in strict confidence, to:

DEPT 312789  
1501 Broadway, New York, N.Y. 10036  
*An equal opportunity employer M/F*

CIRCLE 131 ON READER CARD

## READERS' FORUM

only that the programs produced are used interactively.

Technical writers tend to string together groups of nouns and adjectives, but they seldom hyphenate correctly. I recently ran across this monstrosity in a technical monograph on linear programming: "crude oil distillation capacity consumption incidence." This is almost impossible to unscramble. Any flow or momentum of understanding must stop while the reader ponders the meaning of this cumbersome phrase. Properly hyphenated (hyphens between each successive pair of words except the last), it is still difficult. A more ergonomic approach might be: "the incidence of consuming crude-oil-distillation capacity."

On-line systems are famous for trapping the user in logic loops. Here is a typical conversation between TSO and a frustrated user.

User: LOGON TKO6/PAUL  
TSO: PASSWORD NOT AUTHORIZED, REENTER  
User: LOGON TKO6/PETER  
TSO: INVALID KEYWORD, TKO6/PETER REENTER THIS OPERAND  
User: TKO6  
TSO: INVALID KEYWORD, TKO6 REENTER THIS OPERAND  
User: PETER  
TSO: INVALID KEYWORD, PETER REENTER THIS OPERAND  
User: LOGON  
TSO: INVALID KEYWORD, LOGON REENTER THIS OPERAND  
User: LOGOFF  
TSO: INVALID KEYWORD, LOGOFF REENTER THIS OPERAND

At this point, no response works, including LOGON, LOGOFF, PETER (the correct password), TKO6, or any combination thereof. By now, all but the most mentally stable of users have stomped back to their desks, leaving the problem of getting out of the loop to the next unlucky person who needs the terminal.

In technical communication, too, certain writing habits trap the user and make further progress difficult. We saw one example in the discussion on hyphens. Another such habit is what I call the suspended sentence. It starts out with a list of subjects and the verb is suspended until the end. Here's an example: "The cpu ID, the start time and date, and the SMF record type are included in this listing."

By the time the reader gets to "are included," he's forgotten what is included and must reread the first part of the sentence. It is better to say: "This listing includes the cpu ID, the start time and date, and the SMF record type."

The former sentence is merely a time waster and a concentration breaker. But consider the following: "The program may not have access to the entire database." This one is a real trap; the negative construction leaves the reader up in the air as to which interpretation to take. He cannot proceed until he decides whether it means "The entire database is inaccessible to the program," or "The program can access only part of the database. This sentence is disturbing because it raises questions, rather than communicating information. The reader must look elsewhere for the answer.

Technical communicators must be sensitive to anything in the document or presentation that will disrupt the reader's or listener's train of thought. Keep sentences short and direct; avoid negation where possible. The idea is for the reader to sequentially process the material from start to finish without interruption.

The ability to produce high-quality technical communications is not developed overnight, and only a few of the techniques for improving it are covered here. Courses and books abound, but perhaps the best teacher is experience. A user manual is like a program for a person; like a computer program, it must go through a shakedown stage. Users are not consulted often enough about the quality of technical documentation. Is it clear? Is it concise? Is it accurate? The proper way to learn good technical communication is to observe and consult with actual users. Unfortunately, in the heat of winding up a project, this shakedown of the user documentation is usually overlooked.

This article is a plea for ergonomics in technical communi-

*“Instruct a wise man  
and he will be wiser still.”*

Proverbs 9:9

Even wise choices in Computer-Based Manufacturing Systems cost a lot of money and require commitment from everyone. Although these systems *can* improve productivity and achieve many other cost efficiencies, they need to be well implemented. But, where can you go to get the information you need to make such important decisions?

The InfoResearch Institute has prepared a pair of reports to guide you through the needs analysis, evaluation, selection and implementation processes with computer-based systems in the manufacturing environment — alternatives and strategic solutions that address your problems. And all information is based upon extensive studies of user and supplier experiences.

The *Executive Report* is written for and covers issues to be addressed by the *non-EDP executive*. The *Industry Report* is written for the *EDP executive* and highlights criteria for system preparation and installation.

With such important decisions, its nice to be a little wiser!

To order your reports,  
call 612/835-0448

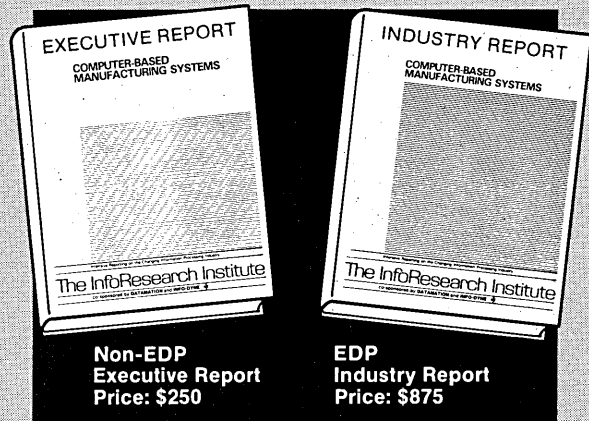

To get free, descriptive  
brochures, mail this coupon

The InfoResearch Institute  
c/o Info-Dyne, Inc.  
7417 Bush Lake Road  
Minneapolis, Minn. 55435

Please send me  
a free Manufacturing Systems brochure:

- The Non-EDP Executive Report  
 The EDP Industry Report

Name \_\_\_\_\_ Title \_\_\_\_\_

Company \_\_\_\_\_

Street \_\_\_\_\_ State \_\_\_\_\_ Zip \_\_\_\_\_

Telephone (\_\_\_\_) \_\_\_\_\_

(please print)

**The InfoResearch Institute**

co-sponsored by DATAMATION and INFO-DYNE <>

# SYSTEMS 83<sup>®</sup>

Computer and Communication  
8th International Trade Fair  
and International User  
Congress



**17 - 21 October**  
**Munich - Trade Fair Centre**

- International Trade Fair for the EDP and Software Industry (more than 700 firms)
- International Seminars on EDP Application

## Coupon SYSTEMS 83

Please submit detailed information on

Trade Fair       User Congress

Name \_\_\_\_\_

Address \_\_\_\_\_

US-Representative:

Gerald G. Kallman Associates, 5 Maple Court,  
Ridgewood, New Jersey 07450, Tel. (201) 652-7070

CIRCLE 133 ON READERCARD

## READERS' FORUM

ations. I've covered four qualities we look for in a friendly, user-oriented system. The technical communicator must be a "human engineer," because a communication, like a computer system, can be a technical success, but a practical failure if its design discourages its use.

—Peter Martin  
Morristown, New Jersey

## THE VALUE OF MICROS

The advent of microcomputers will significantly change the way that MIS staff supports corporate management. Managers who are users (hereafter referred to as managers) will become more active in the design and implementation of computer-driven analyses of their problems. Selecting the data needed to analyze a problem and formatting the reports that present the data are functions that will be taken over by managers. These are jobs that users were totally dependent on MIS personnel to perform.

We will also see more managers using computers to do one-time analyses. Whereas we once used computers only for large number-crunching batch tasks, such as accounts receivable and billing, managers will use the computer to look at questions like, "What happens to my P&L if I increase prices by 7%?" or "What was our average cost of capital for the last five years?"

Much of the information managers use to analyze projects on their micros can be entered manually. Efficient analysis of many management problems, however, will require access to corporate accounting, budgets, sales, or personnel databases now maintained on mainframes. This brings us to an important question, namely, how can access to corporate databases be controlled?

Corporate policies that restrict database access are usually well intentioned. Indeed, few would say that all information should be accessible to all users. Salary records, for example, must be kept confidential. On the other hand, there are simple and effective ways to prevent unauthorized access and ensure the identity of users. Even so, other concerns are often raised. Here are my responses to some of the most common ones:

"First we have to study different micros to decide which would best access our mainframe." The IBM P.C. and the Apple II can now be modified to serve as IBM 327X terminals. If an installation is already totally committed to IBM, the choice should be simple, even though the IBM P.C. is likely to be more expensive than the Apple II or any of the new P.C.-compatible micros.

"First we have to do a cost-benefit study to see which kind of micro software would be best to access our mainframe databases." Communications software packages for micros are relatively cheap, so price is not much of a factor in selecting one. In this instance, the MIS people's role should be to list the features necessary for a program to access the mainframe. Choosing the actual communications package depends upon how the manager wants to use the data from the mainframe, and he can select the one that best suits his requirements. Of course, centralized purchasing of such programs may help the company get discounts from software distributors.

"We can't adjust our communications equipment to accept just any micro." Micro communications software packages have advanced rapidly in the past few years. A good many can be configured to match the communications protocols of almost any mainframe, including IBM's.

"Micro users can write programs that can crack our security." Absolute security is probably impossible to obtain. The real issue is, what level of security do we need for management to be comfortable? Several levels of security, such as multiple passwords, WATSBOS codes, and periodic changes of passwords and phone numbers are generally accepted in many corporations. In



# What you don't know about your DEC\* computer can't help you.

## DEXPO® West 83 can.

### 400 Reasons to Mail the Coupon

Wouldn't you like to get just a little more out of your DEC\* system? All it takes these days are the right DEC-compatibles. And you'll find them by the thousands at DEXPO West 83. Your most complete DEC-compatible resource.

Don't decide now. Just mail the coupon.

Want *more* reasons? How about *more* compatible software, *more* compatible hardware, and *more* compatible services? DEXPO West features nearly 400 vendors with more for every DEC computer. Personals, Micros. Minis. Mainframes. All the latest DEC-compatibles designed to make your information systems work a little harder. And a lot smarter.

### Attending DECUS\*? Then, DEXPO is Free

If you're planning to be in Las Vegas for the DECUS meetings, make sure DEXPO West is on your schedule for Sunday . . . before the meetings start. Of course, you'll probably want to come back on Monday, Tuesday and Wednesday, too. So be sure to use our five-minute shuttle bus services. It's free. And so is the Show when you bring your DECUS badge.

### Plus 60 In-Depth Sessions on How to Put the Latest DEC-Compatibles to Work

\*DEC and DECUS are registered trademarks of Digital Equipment Corp.

### DEXPO® West 83

The Fourth National DEC-Compatible Industry Exposition

Las Vegas  
Convention Center  
October 23-26, 1983  
Sunday-Wednesday

#### MAIL TODAY TO SAVE TIME AND MONEY

- Send \_\_\_\_\_ money-saving tickets plus complete details on the Show.  
 Send information on special travel discounts.

NAME \_\_\_\_\_

TITLE \_\_\_\_\_

COMPANY \_\_\_\_\_

ADDRESS \_\_\_\_\_

CITY \_\_\_\_\_

STATE \_\_\_\_\_

ZIP \_\_\_\_\_

Mail to: EXPOCONSUL INTERNATIONAL, INC.  
55 Princeton-Hightstown Road  
Princeton Junction, NJ 08550

a CPD

# MICROWORLD

Count on  
Auerbach  
because  
you can  
count on  
change.

Making evaluations in the fast-changing world of microprocessing calls for a systems approach.

With *MicroWorld*, Auerbach answers the need to control and centralize your micro software/hardware purchase decisions. *MicroWorld: Software/Hardware Selection Guide* provides over 800 pages of unbiased, easily-accessed, up-to-date facts and side-by-side charts. Compare and match 850 micro software packages and 650 microcomputers and peripherals. Be confident your micro software and hardware are compatible.

*MicroWorld* is one of Auerbach's newest, monthly-updated, loose-leaf information services. It's the latest example of Auerbach's commitment to meeting the needs for DP management information. Whether it's for comprehensive-yet-specialized data, or for resources to help MIS and DP Managers move more efficiently in the corporate environment. And with *Telephone/TELEX Information Service* you get fast, personal answers to your pressing DP questions.

When there's a call for information, Auerbach answers.

Test us. Use *MicroWorld* for 15 days. Free, with no obligation. 2 volumes: \$375 per year.



AUERBACH

Auerbach Publishers Inc.  
6560 N. Park Drive  
Pennsauken, NJ 08109 USA

**800/257-8162**

(In NJ call 609/662-2070)  
TELEX 831 464

**CIRCLE 135 ON READER CARD**

## READERS' FORUM

addition, certain less-critical applications can be kept separate on another timesharing computer. An alternative is the use of "call in, call back" procedures that force the user to identify himself and where he's calling from to a human operator before access is allowed. Here in the Treasury Department we access almost a dozen banks' computers and transfer millions of dollars a day via computer. We find the banks are adopting multiple passwords as the most preferred security procedure.

"Micro users can steal [download] information from our databases." Let's not make the mistake of equating downloading with stealing. Authorized users should be able to receive information from the corporate database and manipulate it according to their needs. They can easily be prevented from changing data that are kept on an important centralized database, but should be allowed to read and use the data.

"We already have what you need to handle that application on the mainframe." Large-scale computers are amazingly fast at retrieving and sorting data. They are also quick at relating and manipulating data, but if the programs doing these things are hard to learn and cumbersome to use, few managers will become active users.

Microcomputer software has a clear edge over most of the software we run on mainframes in terms of ease of use. For example, it is easy to learn. Micro software is characterized by common-sense, English-like commands for advanced users, or by "menus" of detailed options for beginners. It also has built-in instructions, such as the "help" functions, that users can access on-line. There is also the quality I call forgiveness, which is characterized by the ability to back up to where you were before you made a mistake, without losing everything. In addition, we have the benefit of flexible formatting. Users of paper spreadsheets are limited to the size of the paper, and electronic reports can exceed the screen size of a crt. But a crt can be made to scroll up, down, and sideways to accommodate vast electronic worksheets.

"Our vendor is coming out with [or has announced, or is developing, etc.] a program that will do what we want." Sometimes waiting is a valid strategy, but only if you know what you're waiting for. Pressure is mounting from managers who know that acceptable software is available now, and it can get their jobs done. The managers' response to a purported lack of electronic spreadsheets and database software is similar to the response one might get by threatening to replace a secretary's word processor with a manual typewriter.

It is interesting that microcomputers have been so successful in companies that already have large centralized computer installations. Mostly this is because the new easy-to-use microcomputer software packages enable managers to analyze problems more quickly, more efficiently, and in greater depth than ever before. Yet, for micros to be used to their full potential, micros and mainframes have to live side by side. Then, managers should be able to select, retrieve, and read (though not necessarily alter) data that are maintained on the mainframe. Once the data are in the micro, they can be manipulated to analyze individual problems.

The software that enables micros to access, retrieve, and manipulate data from mainframes is available today. In some instances, managers are more knowledgeable about this aspect of microcomputing than people in the corporate MIS department. A basic conflict arises because MIS people want to gain experience with micro capabilities before they make policy decisions, while managers who already use them are reluctant to wait for MIS people to get educated. A compromise that would allow controlled access to corporate databases by micros is a worthwhile starting point.

—Thomas E. Klein  
Deerfield, Illinois

If you'd like to share your opinions, gripes, or experiences with other readers, send them to the Forum Editor, DATAMATION, 875 Third Ave., New York, NY 10022. We welcome essays, poems, humorous pieces, or short stories.

# Why two when one will do?

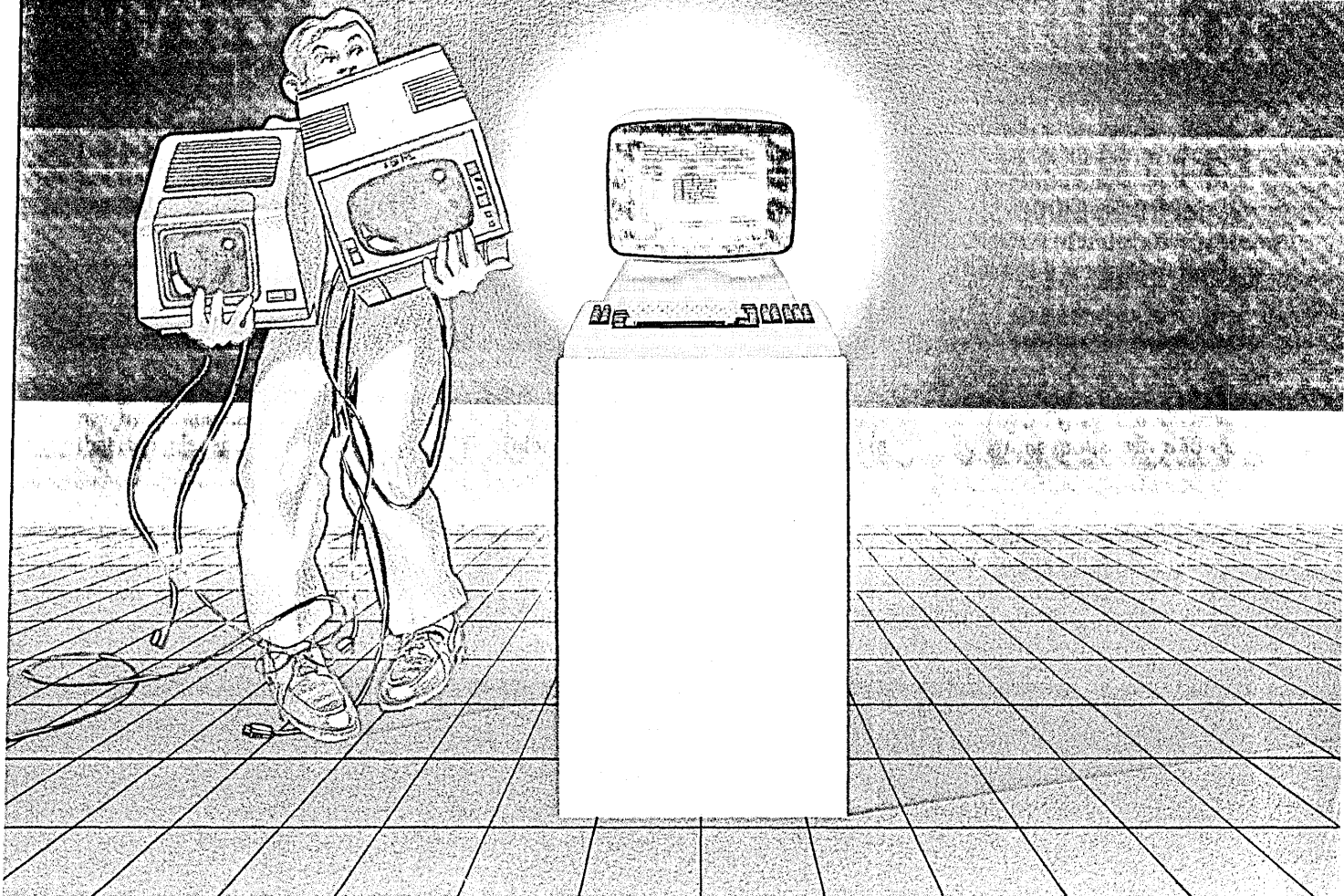

## Lee Data's universal terminal system design provides access to both 3270 and VT100 applications.

Now with Lee Data's new 3270/Async Communication System (Series 400) you can eliminate the cost and inconvenience of needing separate displays for access to 3270 and VT100 applications.

The Lee Data universal terminal system approach is another innovative Lee Data design that allows a single Lee Data display to access applications and data from an IBM CPU, a non-IBM system such as DEC, H-P or Prime, and timesharing services. And a simple command entered from the display keyboard is all that is required to switch from 3270 to VT100 operating mode and back again. What could be easier?

The Series 400 System incorporates a new hybrid approach to system operation that is simpler and more efficient than

protocol conversion. This approach allows a Lee Data controller to provide dedicated 3270 and VT100 processors for concurrent, but independent application access.

In addition, a single Lee Data controller provides you 3270 compatibility via either a remote BSC or SNA/SDLC or a local SNA or non-SNA interface, as well as 1 to 16 RS232C ports for your asynchronous application needs. Line speeds available are from 300 to 19,200 BPS.

The Series 400 System also provides you support for up to 32 devices, including Lee Data's unique All-In-One display that offers dynamic selection of 4 screen sizes—three 80-column and one 132-column. Lee Data's 3279-compatible color displays and a full line of printers are

also available as part of the 32-device complement.

3270 and VT100 capabilities combined in a single terminal system—a reality with the new 3270-plus-Async system from Lee Data.

Discover what our system can do for your company's terminal network. Call our system specialists toll free:

**800/328-3998.**

**Designers of innovative systems  
for the information worker**

**LEE DATA  
CORPORATION**

**7075 Flying Cloud Drive  
Minneapolis, MN 55344**

CIRCLE 2 ON READER CARD

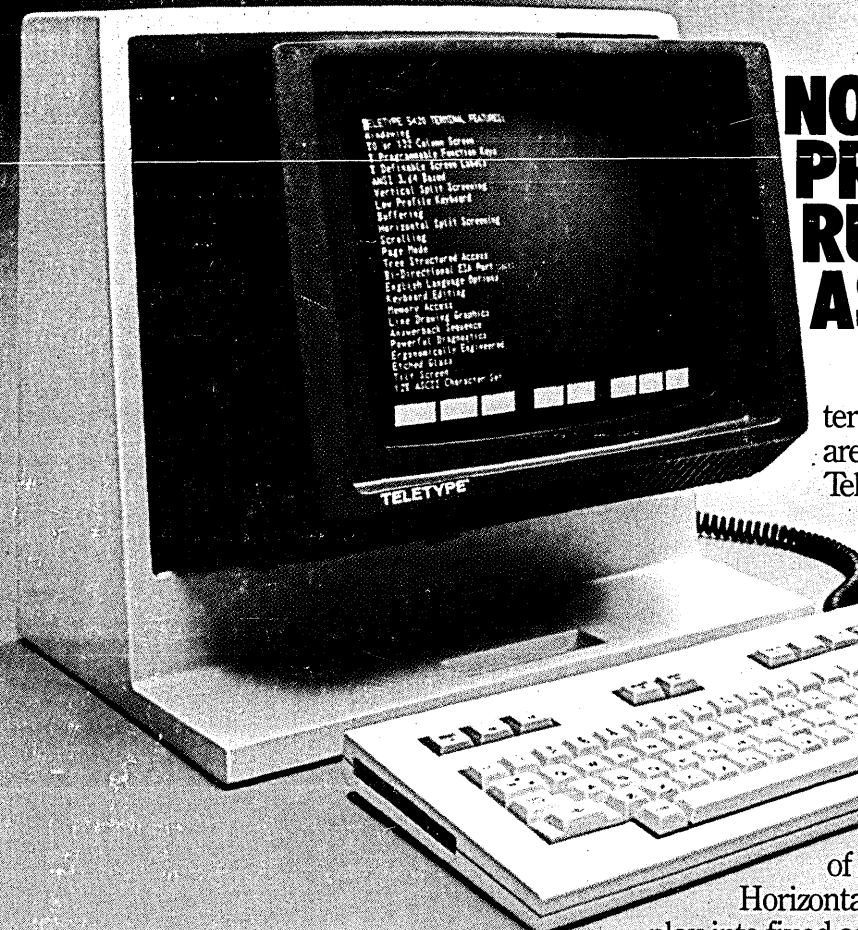

# NO OTHER FEATURE PRESENTATION RUNS AS LONG AS OURS.

Introducing the 5420, an editing terminal that's chock-full of features that are sure to make it a hit. That's because Teletype Corporation built it to be everything you'd ever want in an ANSI 3.64 based asynchronous terminal.

To begin with, there are four ways to access and manipulate the display

and memory. Scroll mode lets you scan all 72 lines of available memory with the display.

Horizontal split screen separates the display into fixed and scrolling regions. Windowing

divides the display into as many as four viewports and workspaces that let you process groups of data simultaneously. Page mode makes the terminal perform as if it were three.

Another example of the amazing value the 5420 represents, is that it lets you change from an 80 to 132 column mode to put more data—including accounting spreadsheets—on display.

In addition to eight system defined function keys that can be down-line loaded from a host, you get eight non-volatile user defined function keys that can be entered locally. All 16 function keys are easily associated with screen labels. When the function of these keys is changed, the screen labels can change right along with them. And a variety of local terminal features can be accessed through the screen labeled keys.

As if that's not enough, there's an English menu for fast set up when optioning. The 5420 is also buffered so you can send a character, line or page of data at a time. Plus, you get character, word and line insert/delete. A bi-directional, buffered EIA printer port is standard.

We didn't skimp on ergonomics, either. That's evident in the detachable, low-profile keyboard you can operate on your lap. And in the crisp, clear images you get with the tiltable, high resolution, non-glare screen.

Self-diagnostics help pinpoint problems. And you can count on our established nationwide service organization for fast service.

Looks like we've run out of room for features. Get the rest of the presentation from your Teletype supplier.

## TELETYPE® VALUE SETS US APART.



Teletype Corporation, 5555 Touhy Ave., Dept. 3223-A, Skokie, IL 60077. Tel. 1 800 323-1229, Extension 204. "Teletype" is a registered trademark and service mark of Teletype Corporation.