

DATA**MATION**

AUGUST 1, 1988
A CAHNERS PUBLICATION
INTERNATIONAL EDITION

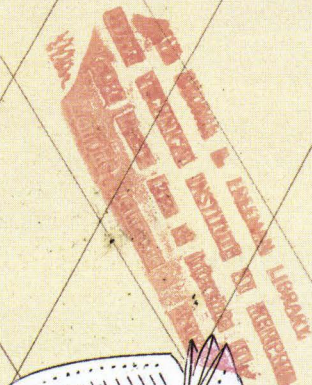

CIO: Misfit or Mismomer?

A Status Report by
DATAMATION and
Coopers & Lybrand

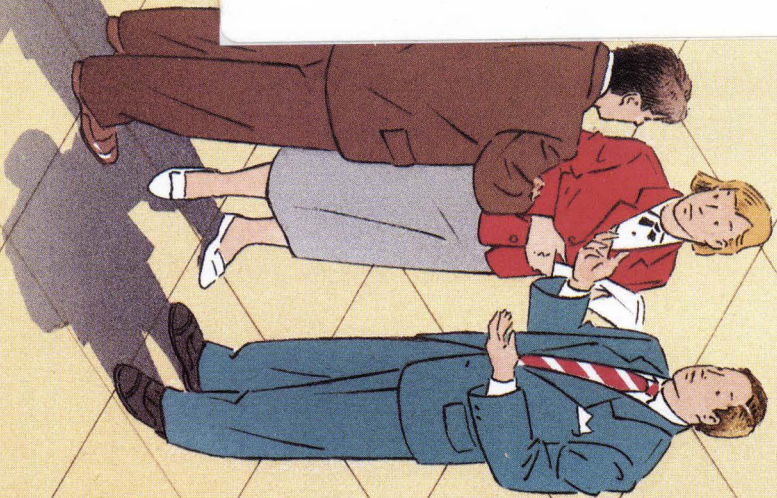

P 2443422 (8812) 063/ 95
STATE TECH INST MEMPHIS
LIBRARY PERIODICALS
5983 MACON COVE
MEMPHIS TN 38134

- Also in this Issue:**
- **Managing Systems Transformation**
 - **The Evolution of ARPANET**
 - **Inside Drug Company Databases**
 - **Has AS/400 Cleared Up the Confusion?**

ANYTHING ELSE AND YOU'RE JUST SPINNING

The simple truth is it's the media, not the drives, that store data. And the price of picking an inferior cartridge or tape reel goes much further than its cost. It's a high-stakes game where the risk is not lost data but your entire company.

The fact is, use anything but Carlisle media products and you're just spinning your reels when it comes to protecting vital corporate data assets. No other company certifies its media to published standards as strict as ours. Or backs its products with as extensive product warranties. Or is as committed to pioneering even higher capacities and performance for removable data-storage media.

Industry leaders, DEI and Graham Magnetics Incorporated, now combined as Carlisle Memory Products, offer quality, customer

YOUR REELS

service and technical expertise for the finest quarter-inch data cartridges, 3480 data cartridges and half-inch computer tapes. All backed by the support and resources of one of the industry's largest media suppliers and the only one devoted solely to computer data storage.

So put a stop to reel-spinning in your operation. For more information and a free subscription to our Carlisle Quarterly newsletter - containing the latest news and analysis about corporate data-asset storage technology - call your Carlisle Memory Products Group representative today. Call today: 1-800-334-8273



CARLISLE
MEMORY PRODUCTS GROUP

CARLISLE COMPANIES INCORPORATED

**GRAHAM
MAGNETICS**

BECAUSE MEDIA, NOT DRIVES, STORE DATA

©1988 Graham Magnetics Incorporated. DEI is a registered trademark of Data Electronics Incorporated. Graham Magnetics is a trademark of Graham Magnetics Incorporated.

Circle 1 on Reader Card



**At level 2,
no one hears
you scream.**

But it doesn't matter anymore.

Now, for the first time, there's Eyewitness™—a *unique* product that helps systems programmers solve the mystery behind CICS system dumps. It's quick, easy, and revolutionary.

At last, you can take system dumps in *less than two minutes*—minimizing the impact on other production regions. Enjoy menu-driven screens. Take advantage of a 50% savings in disk storage space. Rapidly debug dumps with online diagnostics. Instantly analyze storage violations, CICS abends, operator cancels, and snap dumps—**online**.

Eyewitness. There's nothing like it. Best of all, it's another product from the makers of The Monitor for CICS, Landmark Systems Corporation.

For a *free, 30-day trial*, call us today at **1-800-227-8911** or 1-703-922-7101—and scream no more!

LANDMARKTM

*eyewitness*TM
SOLVE THE MYSTERY

Landmark Systems Corporation
6551 Loisdale Court, Springfield, Virginia 22150

DATA MAT

NEWS

11 **Look Ahead**

Bechtel Corp. plans to market its IS products.

17 **Standards**

With a lone exception, the groups spearheading the drive for open systems have had no Japanese participation. Jeff Moad explores their reluctance to join up, and what it means to users awaiting the benefits of truly worldwide standards.

19 **IS Cutbacks**

Willie Schatz examines how the Department of Defense campaign to close its budget gap will hit IS. For government users, it means a slowdown now, and possibly lost jobs later; for some vendors, it's cryin' time.

22 **Strategies**

Gary McWilliams probes the meaning of IBM moves to position the AS/400 and its midrange brethren in the market via applications. With:

25 *Where the Application System/400 Fits Into SAA*

28 **Patents**

Robert Francis finds IBM's push to collect back royalties from PC-clone makers may portend higher prices and limits on users' IBM-compatible choices.

41 **Behind the News**

Pharmaceutical makers and the FDA increasingly are using databases to help track dangerous side effects and interactions of drugs. These databases also are taking a role in the review of drugs for regulatory approval. Susan Kerr reports. With:

42 *Preventing Drug-Induced Illness*

Sometimes the treatment is worse than the disease.

FEATURES

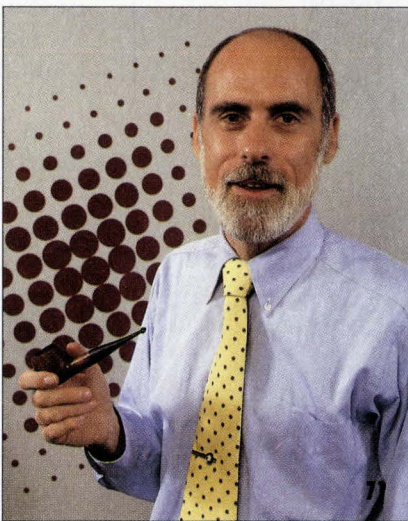
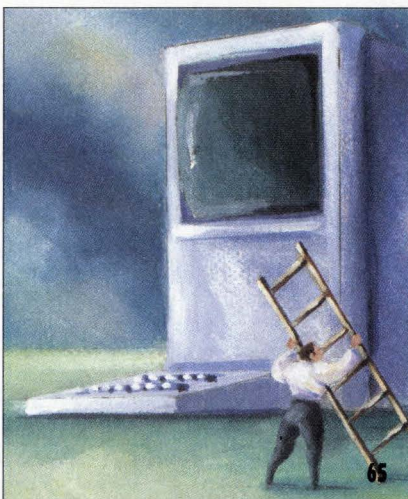

50 **CIO: Misfit or Misnomer?**

BY RALPH EMMETT CARLYLE

What is the true status of the much vaunted chief information officer? The mythology has it that this bridge between the executive suite and the computer room is a vital piece of the management mix, and perhaps the breeding ground for future ceos. But a survey conducted by DATAMATION and Coopers & Lybrand finds few in IS even hold the title, and those who perform the function find they have little corporate bite.

With:

53 *Kodak's Katherine Hudson: Clearly a CIO Model*

A conversation with an IS director who is also a corporate vp.

65 **Managing a System Transformation**

BY FREDERIC G. WITHINGTON

What do you do when business requirements mandate that your entire information processing environment be transformed? Panic? No need. New products and the experience of others will make the task easier.

71 **The Evolution of ARPANET**

BY BRAD SCHULTZ

ARPANET, the first packet switching network, had hosted U.S. datacom research activities well, but technology has passed it by. Its progeny, the Internet, is ready to assume the helm for IS-critical research.

With:

72 *A Close-up on TCP/IP*

How this Internet transport protocol works.

ION

NEW PRODUCTS

77 Hardware

Compaq brings 386 power to its low end, as IBM launches three versions of the PS/2 Model 70-386. In Trends: what does the V.42 modem error-control standard promise users?

80 Software

IBM debuts an optical-based document management system. In Trends: U.S. user companies are placing off-site operations in Ireland.

DEPARTMENTS

4 Letters

82 Calendar

Even if the Cards aren't in the pennant race, St. Louis still has the ShowCASE Conference to look forward to in September.

83 Career Opportunities

88 The Marketplace

88 Advertisers' Index

INTERNATIONAL 48-1

Does not appear in all copies.

-1 The European 25: Smashing the \$50B Barrier

BY PAUL TATE

1987 saw key shifts in IS development and purchasing patterns that will affect European vendors' fortunes in the '90s. Meanwhile, revenues for the top 25 IS firms in Europe were up 26.5%. With financial data on:

-2 The DATAMATION European 25

-6 The 25 Leading European-Based IS Companies

-8 IBM Europe's Major Markets

Cover illustration by Min Jae Hong

INTERNATIONAL
EDITION

AUGUST 1, 1988
VOLUME 34
NUMBER 15
THIS ISSUE, 181,247
COPIES



1988 JESSE H. NEAL
AWARD



1987 JESSE H. NEAL
AWARD

Editorial

Removing a Chief Information Obstacle

If you work in an organization that lacks a chief information officer, by title, don't worry—it doesn't mean you're employed by a Stone Age company run by Neanderthals. In fact, your IS situation is the norm, not the exception. Only two out of 400 user organizations actually have titled CIOs, according to a recent survey conducted by DATAMATION and Coopers & Lybrand that forms the basis for this issue's cover story.

Resistance by ceos and chief operating officers is nearly the biggest barrier to CIOs. According to the survey, the chief complaints of IS execs include a lack of acceptance by ceos, a lack of IS knowledge by top officers, and a lack of understanding of the CIO's role. Barely a quarter (26%) of those execs even report directly to ceos. Far more (35%) answer to cfos—small wonder that IS luminaries such as Michael Simmons, former technology chief at Fidelity Investment, Boston, complain that systems outlays are still treated as expenses instead of capitalized investments.

IS execs are themselves leery of the CIO name. Almost half don't even think the title is necessary, believing in some cases that it needlessly elevates the position within companies and only creates confusion among employees and shareholders. They prefer business cards identifying themselves as vice presidents of technology, for example. In cases where they do see the title as necessary, a majority believe the CIO should be fourth on the corporate totem pole—after the ceo, chief operating officer, and cfo.

More telling than these perceptions, however, are measures of how IS execs—whether CIOs in title or just in function—operate within their environments. Despite all the noise about integrating business and technology plans, very little synergy exists. According to the survey, the IS execs have extremely limited policy-setting roles outside their traditional areas. In marketing, for example, only 15% of them have significant input.

This fault, more than any other, disturbs us. For how can any organization hope to integrate its hardware, software, and communications systems if it can't even coordinate its core operations, including technology management?

If the title CIO has become an obstacle in the path toward true integration, which we suspect it has, let's drop it.

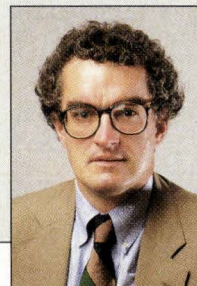

Tim Mead

TIM MEAD
EDITOR-IN-CHIEF

DATAMATION

Editor-in-Chief Tim Mead

Senior Editor Linda Runyan

Managing Editor/News & Features David R. Brousell

Senior Writer Ralph E. Carlyle

Deputy News Editor Theresa Barry

Deputy Features Editor Marsha J. Fisher

New Products Editor Mary Kathleen Flynn

Editorial Assistant Karen J. Scher

Editorial Secretary Anne M. Mangieri

Managing Editor/Production &

Special Projects Parker Hodges

Copy Chief Steven Korn

Production Editor Hernalee Walker

Copy Editors René Matthews, John Quain

Production Assistant Suzanne P. Jones

International Editor Paul Tate

Editorial Assistant (London) Lauren Murphy

Correspondents James Etheridge, Paris; David

Hebditch, Eastern Europe; Janette Martin, Milan

U.S. Bureau Managers

Boston Gary McWilliams

Dallas Robert Francis

Los Angeles Tom McCusker

San Francisco Jeff Moad

San Jose Susan Kerr

Washington Willie Schatz

Art Director Robert L. Lascaro

Associate Art Director Anne Cooney

Assistant Art Director Carolee Young

Contributing Editors Joseph Kelly, Fred Lamond,

Hesh Wiener

Advisory Board Joseph Ferreira, John Imlay,

Angeline Pantages, Russell Pipe, Carl Reynolds,

F.G. Withington

Publishing Director Donald Fagan

Associate Publisher William Segallis

Promotion Manager Stacy Aaron

Production Manager Eric Jorgensen

Research Manager Laraine Donisi

Director of Production Robert Elder

Director of Art Department Barrie Stern

Circulation Manager Cheryl Barnett

EDITORIAL OFFICES

Headquarters: 249 W. 17 St., New York, NY 10011, (212) 645-0067; telex 127703; fax (212) 242-6987. **New England:** 199 Wells Ave., Newton, MA 02159, (617) 964-3730; **Washington, D.C.:** 4451 Albemarle St. NW, Washington, DC 20016, (202) 966-7100; **Central:** 9330 LBJ Freeway, Suite 1060, Dallas, TX 75243, (214) 644-3683; **Western:** 12233 W. Olympic, Los Angeles, CA 90064, (213) 826-5818; 582 Market St., Suite 1007, San Francisco, CA 94104, (415) 981-2595; 3031 Tisch Way, Suite 100, San Jose, CA 95128-2593, (408) 243-8838. **International:** 27 Paul St., London EC2A 4JU, England, (44-1) 628-7030, telex 914911; CPO Box 665, Tokyo, Japan, (81-3) 201-2335, fax 2135053.

DATAMATION (ISSN 0011-6963) Magazine is issued twice monthly on the 1st and 15th of every month by The Cahners Publishing Company, A Division of Reed Publishing USA, 275 Washington St., Newton, MA 02158-1630. William M. Platt, Chief Executive Officer; Terrence M. McDermott, President; Frank J. Sibley, Group Vice President; Jerry D. Neth, Vice President/Publishing Operations; J.J. Welsh, Financial Vice President/Magazine Division; Thomas J. DeLamaria, Vice President/Production and Manufacturing. Editorial and advertising offices, 249 W. 17th St., New York, NY 10011. Published at Woodstock, IL. Annual subscription rates: U.S. and possessions: \$60; Canada: \$85; Japan, Australia, New Zealand: \$155 air freight; Europe: \$135 air freight, \$250 air mail. All other nations: \$135 surface, \$250 air mail. Reduced rate for U.S. public and school libraries: \$40. Single copy: \$3 in U.S. Sole agent for subscriptions in Japan is Maruzen Co. Ltd., 3-10 Nihonbashi, 2-Chome, Chuo-ku, Tokyo 103, J; sole agent for all other foreign subscriptions is J.B. Tratsart Ltd., 154 A Greenford Rd., Harrow, Middlesex HA13QT, England, (01) 422-8295 or 422-2456. No subscription agency is authorized by us to solicit or take orders for subscriptions. Circulation records are maintained at 44 Cook Street, Denver, CO 80206. Phone (303) 388-4511. Second-class postage paid at Denver, CO 80206 and at additional mailing office. DATAMATION copyright 1988 by Reed Publishing USA; Saul Goldweitz, Chairman; Ronald G. Segel, President and Chief Executive Officer; Robert L. Krakoff, Executive Vice President. All rights reserved. DATAMATION is a registered trademark of Cahners Publishing Co. Reprints of articles are available; contact Frank Pruzina (312) 635-8800. Microfilm copies of DATAMATION may be obtained from University Microfilms, A Xerox Company, 300 N. Zeeb Rd., Ann Arbor, MI 48106. Printed by Graftek Press Inc. All inquiries and requests for change of address should be accompanied by mailing label from latest issue of magazine. Allow two months for change to be made. POSTMASTER: send address changes to DATAMATION, 44 Cook St., Denver, CO 80206.



Letters

Unix Topix

What an interesting editorial David Brousell wrote in the April 15 issue of DATAMATION ("Unix is Old News," p. 3); it put so many things about Unix into perspective that I intend to use it as a checklist whenever an opponent or proponent of Unix seeks to present a one-sided view of the subject.

Your observations that Unix has become a symbol "of liberation from machine dependency" and that it represents "the democratization of computing" convey what is driving the interest of information resource managers in the public and private sectors. This does not mean that all forms of proprietariness are bad, but those that restrict the future choices available to users in the marketplace and limit competition should be identified and avoided in order to accelerate the application of information technology for everyone's benefit.

FRANK J. CARR

Commissioner

General Services Administration

Washington, D.C.

If, as the Unix camp is suggesting, Unix becomes the standard operating system of the future, I fear that this would spell doom for the information technology industry. The IT industry has thrived on innovation, as technology moves extremely fast, with vendors competing on speed, reliability, etc.

To standardize on a cumbersome 15-year-old operating system will constrain most of this traditional innovation. Hopefully, in 15-to-20 years' time, we will not be writing applications programs as we do today, but if the Unix camp has its way, stagnation is very likely.

I cannot get excited about any operating system; I just need the system to run an application and to shield me from the operating system.

Let innovation continue to be the major platform for the future of the IT industry. I can only echo the final sentence of David Brousell's editorial: "When we see more announcements about successful business solutions and less about standards conformance, we'll know we're on the road to fulfilling computing's promise."

ALED HUGHES

Independent Consultant

Bålsta, Sweden

Dino Users

We read with great interest your editori-

al entitled "Who Speaks for Users?" (May 15, p. 3), especially since specialized user training has been the focus of our firm for seven years.

The passive user is the dinosaur of the information age. Today's users need to know exactly what kind of information they need and how to work with the development group to make that information happen. In our experience, many users need to become more progressive and proactive—and that's exactly what we train them to be.

While many users have micros and mainframes at their fingertips, they seem to have everything but essential elements—the analytical skills to become effective. Users must be able to identify and define their problems—to think in a problem-solving mode, much like systems analysts. They need to become what we call "user analysts."

Who will speak for users? With proper training, we find that users who develop the right practical skills can do pretty well for themselves.

JOHN C. SILVESTRI

J.C. Silvestri Associates Ltd.

Addison, Ill.

Thank You

I want to thank you for your recent articles about disabilities and computers, specifically "For People With Handicaps Computers=Independence" (May 1, p. 39). My husband and I began SpecialLink, a nonprofit high-tech resource center for persons with disabilities, and the more exposure that can be given to the possibilities that computers bring to this population, the better.

My daughter is mentally retarded and has been our motivator. Liz will probably not use the technology in a working environment, but she will use it to extend her learning experiences, improve her coordination, and, most important, build her self-esteem and self-confidence.

SpecialLink is part of Apple's National Special Education Alliance. Currently, we are not funded, but are actively seeking funds. The service we, and other centers, are providing is a needed one—the perfect candidate for a United Way Agency. Awareness and understanding of disabilities and the computer is something that is slowly happening. Thank you for helping in this process.

ELAINE HACKETT

Director

SpecialLink

Cincinnati

VMCENTER II

Smart Economics.

At Nielsen Media Research, the top-rated program isn't on the air.

It's on the system. And it's
VMCENTER II.

VMCENTER II is the most powerful, comprehensive systems management tool available for VM users. It's also a key factor in Nielsen's consistent ability to deliver the online ratings information the television industry depends on.

No wonder Nielsen depends on VMCENTER II to keep operations running smoothly while making the most of data processing resources.

CRITICAL FUNCTIONALITY PLUS EASIER CHARGEBACKS.

With customers dialing into the system daily, reliability is crucial for Nielsen. VMCENTER II's unsurpassed backup and recovery facilities have virtually eliminated this source of concern. At the same time, other VMCENTER II facilities are saving DASD, simplifying scheduling, reducing manual tape management, and automating overnight batch jobs.

Equally important, VMCENTER II

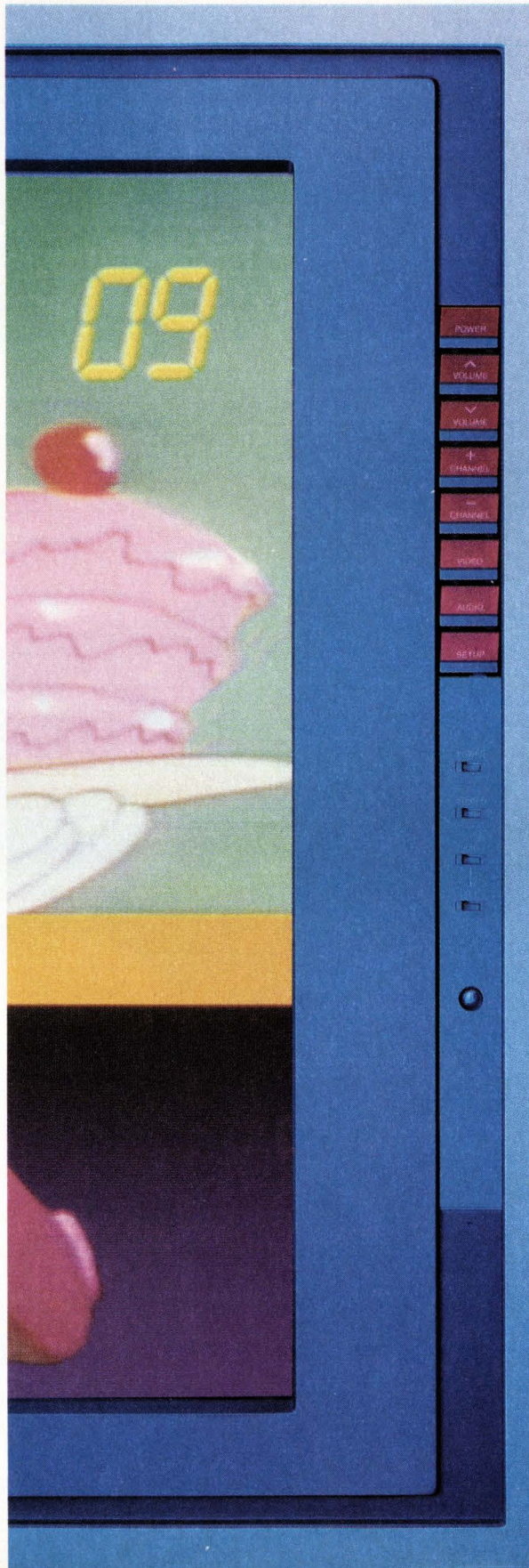

has made it easier than ever to track individual project costs within data processing. Results: More cost-effective operations. More accurate project billing. And more satisfied users.

VMCENTER II. *THE VM SYSTEMS MANAGEMENT TOOL FOR THE FUTURE.*

This record is impressive. But it's only the beginning. With its broad capability and proven time-saving features, VMCENTER II is the single most important tool available for all your VM systems — from 9370 to 3090 to whatever the future may bring.

So why delay? Get VMCENTER II today. And get set for some of the best programming you'll ever see. For more information, write or call:

800-562-7100
703-264-8000

VM Software, Inc.
1800 Alexander Bell Drive
Reston, Virginia 22091



The VM Experts

What computer users can learn from the Chinese warlords.

When the computer industry was first born, its propagators set up individual fiefdoms, much like the ancient Chinese warlords.

Each company staked its claim in different ways, but each ensured that its customers would remain indentured.

How?

Because Company X computers worked only with other Company X computers. Because Company Y computers

communicated only with other computers from the same vendor. And because the technology to open up these barriers was either too complicated or too expensive.

But like the reign of the Chinese warlords, the computer monopoly also is coming to an end at the hands of progress.

Today's users are demanding openness. They want to move data easily among dissimilar computer systems, to take an application from one computer and run it on another. They want to choose products based on what they need and how well it serves their

UNIX

purposes, not because it's the only option.

This openness will fundamentally change the computer industry. And because so much is riding on our ability to meet this challenge, it is crucial that it be met intelligently, aggressively.

Perhaps there is something to learn from the fate of the Chinese warlords.

The information processing industry is feuding over two sets of standards for openness. This is a disgrace.

The need for openness and user interest in it should come before the selfish interests of vendors trying to protect their schemes.

The issue isn't whether AT&T's UNIX[®] prevails over the newly formed Open Software Foundation's.

The issue is that open systems are not a figment of some consultant's imagination. They are a fact.

The issue is that even users of proprietary systems benefit from open systems because of greater access to new and more plentiful applications.

The issue is that this is a great opportunity for the computer industry to band together to encourage progress and shape it for the greater good.

And finally, the fact is that unless we all do it together, history proves how disunity is the quickest formula for failure.

If you think a unified UNIX[®] standard is important, tell your computer company. There's no time to lose and everything to gain.



iSYS

The power of ²

You're looking at a group that can change life. Through LIFE™ The Linked Information Environment from Motorola. A pow-

erful group of integrated applications that lets them do the impossible. Using techniques that were previously unavailable.

LIFE



LIFE Is A Group

LifE works the way workgroups do—dynamically, interactively, and cooperatively. Because people need different, more powerful tools to work

in groups than to work alone.

Such as LifE•Forms. A forms-oriented procedure automation tool that lets your workgroup develop many of its own applications. Because LifE's forms are intelligent, they have commands and instructions built into them—like formulas in a spreadsheet. And the instructions stay “live,” even when sent through a network.

So your workgroup can really work as a group. Interactively. On the same project. At the same time.

LifE•Plans. A powerful, multi-user spreadsheet with a simple Lotus-like front end, and the ability to search through any database in the network. Local or remote. In mainframes or minis. On LANs or PCs.

LifE•Lines. An electronic mail application that works with the other modules to

automate reporting and routing functions.

And LifE•Works. A high performance data entry module that can update multiple databases simultaneously.

All these LifE activities are available to all of your workgroup, all of the time. So each person can work with the tool they like best and

never be left out. And because LifE runs on the Motorola multi-user supermicro computer, it fits into whatever corporate

computing structure you have. So everybody in your company can enjoy LifE, no matter where they are.

If you work in a group, you owe it to yourselves to find out more by calling 800-556-1234, Ext. 165. In California: 800-441-2345, Ext. 165.

And see what a productive group experience LifE can be.

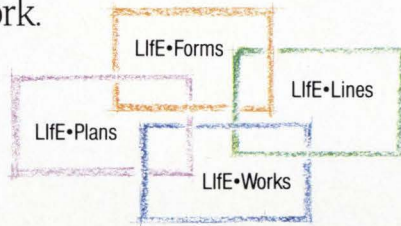

LifE is a Linked Information Environment. LifE's components work together dynamically and interactively, the same way workgroups do.



MOTOROLA
Computer Systems

10700 North De Anza Boulevard, Cupertino, CA 95014

© 1988 Motorola Computer Systems. Motorola Computer Systems is a subsidiary of Motorola, Inc. Motorola and the Motorola logo are registered trademarks of Motorola, Inc. LIFE is a trademark of Motorola Computer Systems, Inc. Lotus is a registered trademark of Lotus Development Corporation. Lotus does not manufacture or license LIFE.

p Experience.

Circle 7 on Reader Card

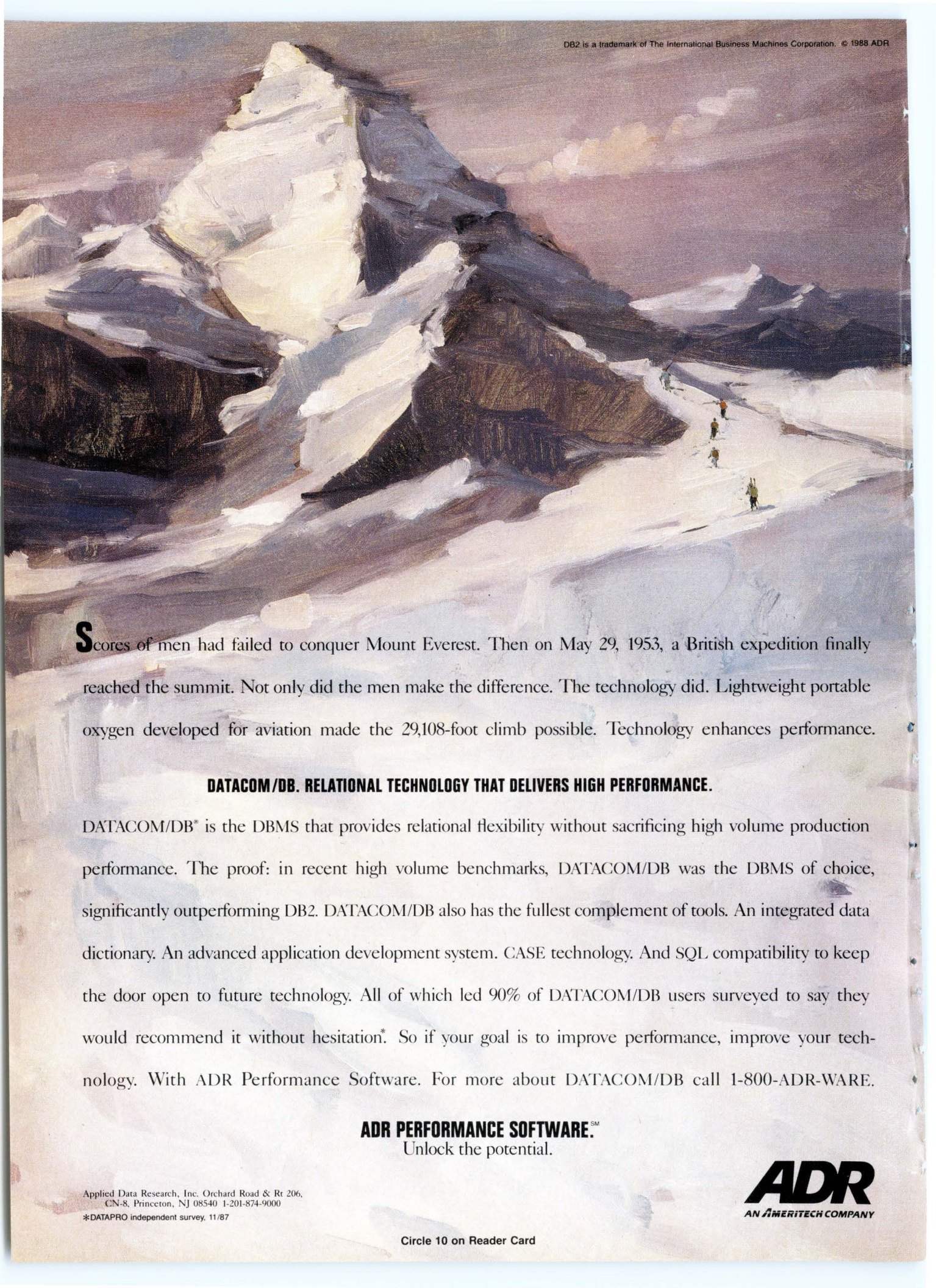

Scores of men had failed to conquer Mount Everest. Then on May 29, 1953, a British expedition finally reached the summit. Not only did the men make the difference. The technology did. Lightweight portable oxygen developed for aviation made the 29,108-foot climb possible. Technology enhances performance.

DATAKOM/DB. RELATIONAL TECHNOLOGY THAT DELIVERS HIGH PERFORMANCE.

DATAKOM/DB® is the DBMS that provides relational flexibility without sacrificing high volume production performance. The proof: in recent high volume benchmarks, DATAKOM/DB was the DBMS of choice, significantly outperforming DB2. DATAKOM/DB also has the fullest complement of tools. An integrated data dictionary. An advanced application development system. CASE technology. And SQL compatibility to keep the door open to future technology. All of which led 90% of DATAKOM/DB users surveyed to say they would recommend it without hesitation*. So if your goal is to improve performance, improve your technology. With ADR Performance Software. For more about DATAKOM/DB call 1-800-ADR-WARE.

ADR PERFORMANCE SOFTWARE.™
Unlock the potential.

Applied Data Research, Inc. Orchard Road & Rt 206,
CN-8, Princeton, NJ 08540 1-201-874-9000

*DATAPRO independent survey, 11/87

ADR
AN AMERITECH COMPANY

Circle 10 on Reader Card

Look Ahead

BECHTEL TO MARKET IS PRODUCTS

SAN FRANCISCO -- Engineering giant Bechtel Corp. is the latest company moving to exploit the profit potential of its IS organization. Bechtel recently reorganized its large, central Information Services organization to create two separate units. One will provide information services to Bechtel units internally, the other--the Bechtel Information Technology group--will market IS products, services, and support outside to other companies. Bill Howard, Bechtel's top IS official under the old organization, moves over to run the Information Technology group, while his number two man, John Campbell, steps up to take over the internal IS operations. The Information Technology group will control applications software and expert systems technology to be marketed outside the company, plus a records management program that Bechtel runs for the SEC.

NETVIEW PRODUCT UNDER STUDY

WHITE PLAINS, N.Y. -- It seems that IBM may not be too quick in announcing phase two details on its NetView Network Definer product. First unveiled in June 1987 as an easy-to-use program to create a network of 9370s, the product was to have shipped by the end of last year but instead was deferred until this year. Now, an IBM official tells us that the product itself is "under evaluation." Perhaps a signal of the success of the 9370 itself? Robert Anderson, IBM manager of telecommunications software product management, says, "We're continuing the evaluation on the right place to put the software and applications that help a customer create, describe, and define a network in the 9370 environment." So, while IBM is committed to the idea of ease of use, there may not be a need for a separate 9370 product. But Anderson admits that "the scope and complexity of the network [meant] we had to go back and visit... what is the right way to implement it."

DEC FIXING CRACKS IN ITS WINDOWS

MAYNARD, MASS. -- Digital Equipment Corp. is now planning a fall debut of its DECwindows, a graphical user interface and applications set designed as a front end to VMS, Ultrix, and MS/DOS operating systems. This delay of six to seven months from an earlier timetable is blamed on normal development problems and the desire to showcase the environment on planned VAXstation workstations with better price/performance than is currently available.

EAST BLOC KNOCKING ON MAP/TOP DOOR

WASHINGTON, D.C. -- If you're having trouble imagining IBM and DEC willingly bowing to user demands for open systems, here's one that should make your eyebrows

Look Ahead

rise. Members of the U.S. MAP/TOP Steering Committee say they recently received letters from representatives of the USSR and several Eastern Bloc countries inquiring about membership in the group that oversees development of the open networking standard. Are state planners from the other side of the iron curtain really interested in open systems? Top members of the MAP/TOP Steering Committee say they are reviewing the requests for membership.

TOGETHER IN PERFECT HARMONY

SANTA CLARA -- A group of leading networking vendors is getting set to demonstrate harmony through network management at next month's TCP/IP Interoperability Exhibition scheduled to take place here. According to George Marshall, a 3Com Corp. product manager and a leader of the demonstration effort, a Sun Microsystems workstation will act as a network management console--monitoring, checking alarms, and reconfiguring up to a dozen vendors' networking equipment. This effort is the result of nearly two years' work by vendors to develop some type of standard. The work should allow a smoother transition into the OSI model: the TCP tools are based on the ISO/OSI CMIS/CMIP standard.

X/OPEN READIES ITS STAMP

SAN FRANCISCO -- X/Open is ready to launch a branding and verification program, which will give its organizational seal of approval to software vendors conforming to its view of the software world. X/Open's chief marketing officer Robert Ackerman says the group initially will open verification centers--two each in the U.S. and Europe and one in the Far East--which will be run by X/Open personnel. Users will be able to run their own tests by late fall, with X/Open providing a strong "policing mechanism," says Ackerman. Testing fees will be nominal, he adds.

RUMORS AND RAW RANDOM DATA

The Open Software Foundation will do no R&D on its own, says Jack McCredie, DEC's director of external research programs. OSF has decided to put its R&D money into colleges and universities. A "multimillion dollar" war chest of hard cash is being created to parcel out funds on "a proposal basis." . . . Computer Network Technology, Minneapolis, says it will be coming out next month with a high-performance DEC-to-DEC network using the VAX BI bus. The model 8400-VAX BI will implement IP protocols in the network and utilize user-defined applications to a QIO interface. Company officials say they developed the product for a systems integrator involved in a DOD contract covering SDI-type applications.

PRINT THICK FORMS WITHOUT GETTING BENT OUT OF SHAPE.

If printing multipart forms gives you multipart hassles, don't lose your cool. Lose the printer. And pick up a Datasouth DS 400 printer instead.

Datasouth specializes in building printers that put in long hours on the toughest jobs, without breaking down. And the DS 400 includes all the details essential to smooth multipart forms operations.

Details such as a straight paper path and a high torque stepper motor. So really fat forms feed straight through without creeping and bunching.

And a high power 18-wire ballistic printhead, backed up by a flat aluminum platen, to print clearly and legibly through six copies.

The DS 400 prints fast, too. Draft text at 400 cps, memo quality at 180 cps, and near letter quality at 120 cps.

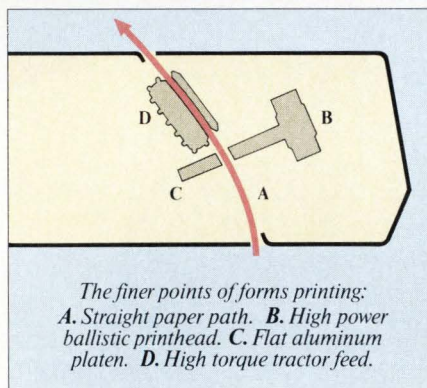

*The finer points of forms printing:
A. Straight paper path. B. High power ballistic printhead. C. Flat aluminum platen. D. High torque tractor feed.*

Datasouth has, for over ten years, built printers known for their reliability and industrial strength. That means you can count on the DS 400 to crank out those endless batches. Without a wrinkle.

So stop dealing with your printer's bad form, and start dealing with a Datasouth distributor. For more information, call 800-222-4528 or fill out the coupon below.



Datasouth
AMERICA'S HIGH PERFORMANCE
PRINTER COMPANY

P.O. Box 240947, Charlotte, NC 28224
Tel: (704) 523-8500, Tlx: 6843018 DASO UW
Sales: 1-800-222-4528; Service: 1-800-438-5050
West Coast Office: (415) 940-9828

Circle 9 on Reader Card

Please send me more information on how to get my forms output into shape.



Mail to: Datasouth Computer Corporation
P.O. Box 240947, Charlotte, NC 28224

NAME _____
TITLE _____
COMPANY _____
STREET ADDRESS _____
CITY/STATE/ZIP _____
() _____
PHONE _____

**"IT'S DECIDED...
WE GO WITH THE NUMBER ONE
DIGITAL PBX IN THE WORLD—
NORTHERN TELECOM'S!"**

†Trademark of Northern Telecom © 1988 Northern Telecom

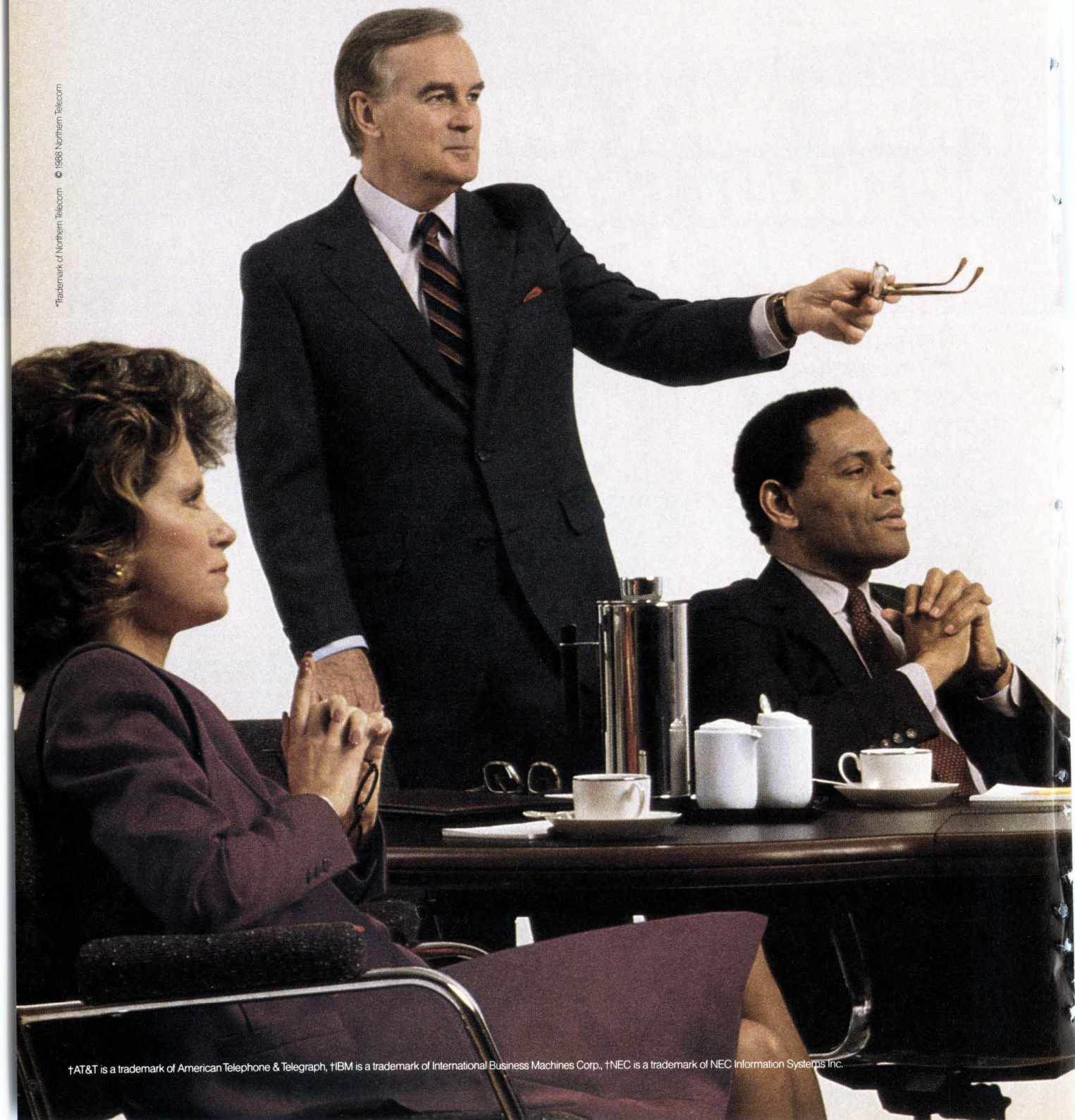

†AT&T is a trademark of American Telephone & Telegraph, †IBM is a trademark of International Business Machines Corp., †NEC is a trademark of NEC Information Systems Inc.

Last year, more PBX buyers chose Northern Telecom than AT&T,[†] IBM,[†] NEC[†] or anyone else. This according to an independent research company whose job is finding the facts. Today Northern Telecom Meridian* SL-1* and SL-100* PBXs provide more than a third of the digital PBX lines in the world. And that's more than anyone else, too.

Behind the numbers are thousands of businesses, universities, government agencies, hospitals—all kinds of organizations—that trust Northern Telecom. They know

that an investment in a Northern Telecom Meridian PBX is an investment in the future, because we design PBXs to be upgraded not traded. Every Meridian SL-1 ever made can be expanded (from 30 lines to thousands) and equipped with advanced ISDN features. And through Meridian Customer Defined Networking* each can be part of a unified corporate information network.

For all the facts and features you need to decide on Northern Telecom, call 1-800-328-8800.



meridian sl-1

**NETWORKING LEADERSHIP
FROM NORTHERN TELECOM**

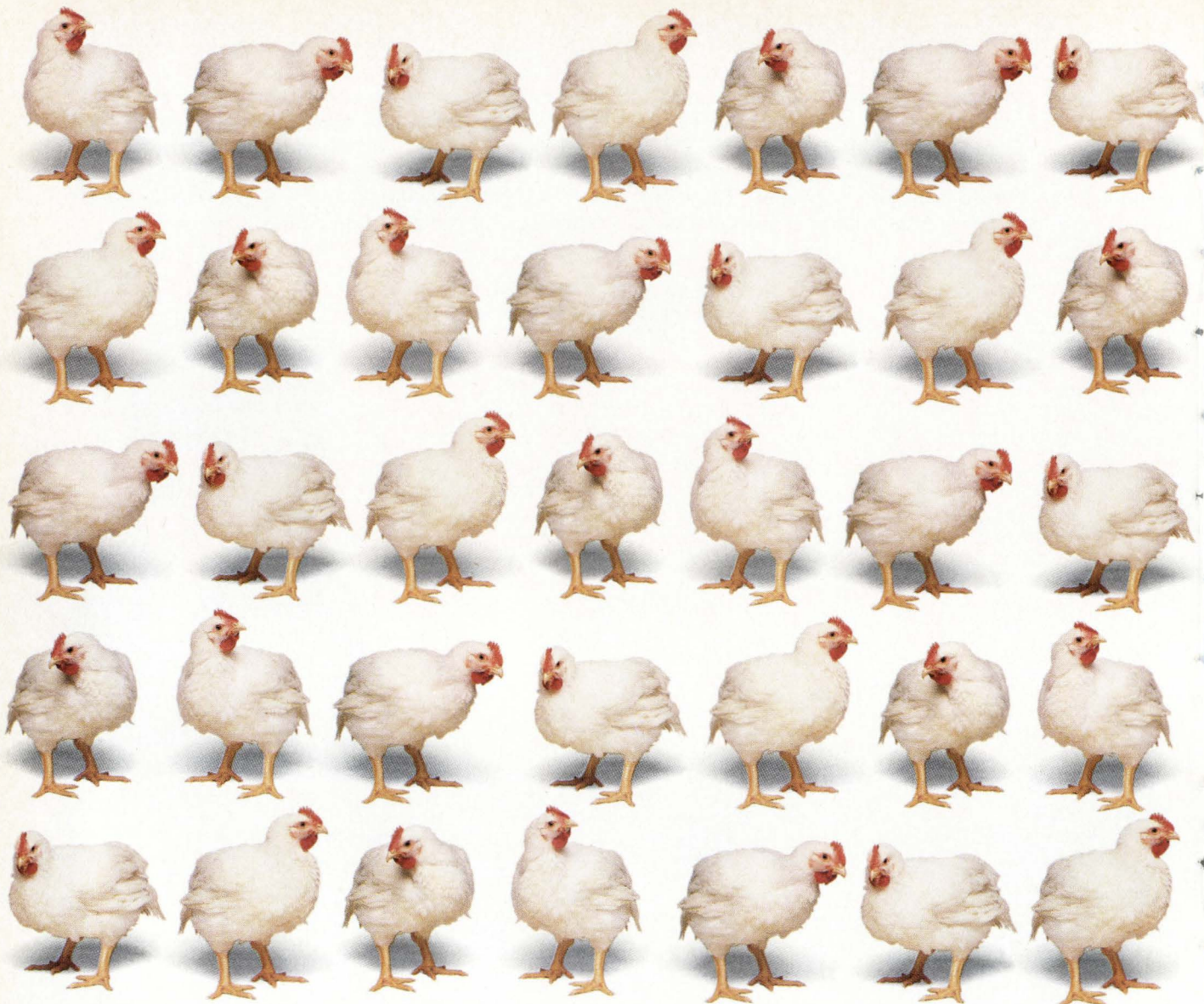

CINCOM Boosts Production At Holly Farms.

PROBLEM: Improving programmer productivity in order to reduce a large applications backlog

CINCOM SOLVED IT: With MANTIS Application Development System

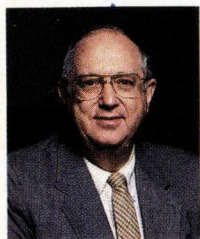

Mr. Bill Clontz
Director of Computer Services
Holly Farms Foods

During a period of explosive growth, Holly Farms found itself with two problems: a large applications backlog and a short supply of programmers able to step in and produce immediate results. The solution was MANTIS[®], the application development system from Cincom[®].

"MANTIS was ideal for us because you don't need 2-3 years of experience to use it," explained Bill Clontz, Director of Computer Services at Holly Farms. "It lets us take new graduates, quickly train them and, in a matter of weeks, turn them into valuable programmers."

As a result, programmer productivity at Holly Farms has reached an all-time high. "We've seen substantial improvement ratios," Clontz said. "In the time a programmer might turn out one CICS command-level program, he can turn out from six to eight programs on MANTIS."

Most of the 500-plus MANTIS applications now in production at Holly Farms are aimed at streamlining costs. For example, Data Processing used MANTIS to develop a model of how chickens consume feed over the course of their lives, allowing Holly Farms to cut production at one of its feed mills by 1½ days a week.

"We've got key users who are picking up on the term 'MANTIS,'" Clontz noted. "Around here, MANTIS has become a synonym for 'get it done quickly.'"

Find out how MANTIS can boost your productivity. Call us today for more product and customer success information. Or, write Marketing Services Department, Cincom World Headquarters, 2300 Montana Avenue, Cincinnati, OH 45211.

1-800-543-3010

In Ohio, 513-661-6000

In Canada, 1-800-387-5914

 **CINCOM**

The Better The Solution, The Better The Value.

© 1987 Cincom Systems, Inc.

News in Perspective

STANDARDS

Will East Ever Meet West in the Campaign for Open Systems?

So far, only Fujitsu has joined U.S. and European companies in the open systems movement. But it's no surprise, since the Japanese have different motivations.

BY JEFF MOAD

In recent months, the idea of open systems has been gaining momentum faster than a fire in a windstorm. It's not just users who are beginning to recognize the benefits of shedding proprietary technologies in favor of open software and communications standards; even the largest of entrenched vendors are now suddenly saying they are open systems believers. Everyone, it seems, has converted to the religion of open systems.

Well, almost everyone. While groups such as the IBM and Digital Equipment Corp.-led Open Software Foundation and the European-spawned X/Open consortium have succeeded in spreading the open systems gospel and in recruiting large U.S. and European vendors and users, they have found it much more difficult to get active participation from Japanese and other Asian vendors.

Japan Is Barely Represented

To date, only one of the major groups engaged in open systems standards endorsement and product development has managed to sign up a top Japanese vendor as a board-level sponsor or participant.

Some users and observers are concerned that if groups such as OSF and the AT&T-Sun consortium fail to attract support from the major Japanese vendors, open systems standards in Japan will diverge from those being adopted in the rest of the

world, and IS users and vendors alike will miss out on the benefits of truly worldwide open systems standards.

Most major Japanese IS vendors have not been involved in U.S. and European open systems product groups in part because of Japanese reticence, and in part because the open systems groups' or-

did not and do not have a notion to exclude them."

The X/Open consortium initially put recruitment of Japanese members on its "to do later" list because its plate was too full, first with organizing European vendors, then with adding U.S. vendors and users. "Our intent has always been to make the

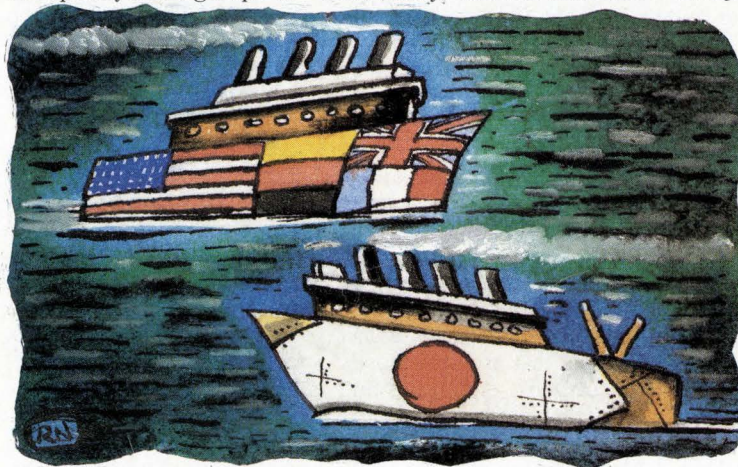

organizers chose initially to focus their energies and resources where their chances for success were best: in the U.S. and Europe.

"Ours was a problem of having the capacity to do it all," says Henry Crouse, president of the Lawrence, Mass.-based Open Software Foundation, a nonprofit consortium formed May 17 by IBM, DEC, Hewlett-Packard, and others to develop open systems software around IBM's AIX version of the Unix operating system.

At the time OSF was formed, asserts Crouse, "we were working 16-hour days, and we did not have the time to talk to the Japanese. But we

[X/Open] Common Applications Environment worldwide. To be successful it will have to be," says X/Open chief marketing officer Robert R. Ackerman Jr.

Recently, X/Open became the first Western open systems group to attract a major Japanese vendor as a member. Fujitsu Ltd., Japan's leading mainframe vendor, announced that it had joined 13 U.S. and European vendors as an X/Open sponsor. As such, Fujitsu will help define X/Open's Unix-based Common Applications Environment (CAE). Fujitsu and other X/Open members will then market products based on the CAE specs.

Other open systems groups such as OSF and the AT&T-Sun consortium—which are both specifying standards and developing products—have so far had less success attracting Japanese members, however.

Recruitment Mission to Japan

About a month after OSF was formed, the group dispatched its chairman, HP senior vp John L. Doyle, to Japan to introduce OSF to major Japanese vendors and to try to recruit them as members. Doyle held a Tokyo press conference and met with several vendors. By the end of his trip, OSF officials said one or two Japanese vendors seemed

ready to join up, one possibly as a \$14 million sponsor. The most likely candidates were said to be Fujitsu, Toshiba, and Canon. But, as of press time, none had joined.

Western open systems group officials strongly deny suggestions that they made recruitment of Japanese members a lower priority because many U.S. and European open systems vendors don't want active

Japanese participation in an effort that, if successful, is likely to lead to standardized products and lower prices. As a high-ranking participant in one of the open systems groups says, "For some of these vendors, Japanese participation is the last thing in the world they want."

Untrue, says OSF's Crouse. "The Japanese, like everyone else, will have to decide what they will do above and beyond the standard to add value. Most of our current members are quite confident of their own abilities to do that very well. OSF is not a mechanism to help U.S. companies defend their turf against the Japanese or any-

one else," Crouse declares.

Both OSF and X/Open say they plan to open Tokyo offices by the end of the year as part of what they call long-term efforts to recruit Japanese vendors to their causes. "It is, to some extent, premature to expect [the Japanese] to understand [OSF] right away," says Crouse.

Crouse is right about one thing, says John Stern, executive director of the Tokyo-based U.S. Electronics Industry Japan office of the American Electronics Association: it will take time to get Japanese participation in Western open systems efforts. But it's not because the Japanese don't follow or understand consortia such as OSF or X/Open. On the contrary, says Stern, "the Japanese follow these things very closely. MITI [the Japanese Ministry of International Trade and Industry] has set up study groups to follow U.S. standards and open systems protocols. In fact, they feel so confident about adequately following what is going on from Japan that they do not need to get directly involved."

Do the Japanese Even Want In?

The Japanese vendors themselves are characteristically circumspect when it comes to saying whether they want to participate in Western open systems projects. Fujitsu Ltd. spokesman Yoshio Egawa, for example, will say only, "We are following the activities of OSF and AT&T very closely."

Japanese vendors actually have mixed feelings about the open systems movement, observers say. On one hand, they view open systems and the rise of Unix as a vehicle for moving away from a market that is dominated by proprietary operating systems controlled by U.S. companies such as IBM with MVS. On the other hand, they are wary of



OSF'S CROUSE: There is no notion to exclude the Japanese.

cooperative software projects that include IBM, and they're cautious about any movement that could open up their own home markets to easier entry by U.S. and European vendors.

But that has already begun to happen. U.S. vendors DEC, Sun Microsystems, and Apollo Computer, have been making significant gains in Japan in recent months with Unix-based technical workstations that are sold mostly to software engineers and other technical users.

Japanese vendors have a better history of cooperating on open systems projects that focus on broad standards specifications rather than actual product development. Fujitsu's recent commitment to X/Open is an example of that. Japanese vendors also have been active participants in the IEEE's Posix push to specify a Unix programming interface. There has also been Japanese representation in ISO's OSI specification. When groups such as OSF or AT&T-Sun attempt to build open systems products cooperatively, however, the Japanese say, "Thanks, but no thanks," remarks Larry Crume, president of AT&T Unix Pacific, which oversees Asian Unix licensing.

"The Japanese think Americans give away far too much product development information. But that doesn't mean they have to do the same thing," says Crume.

AT&T has been trying to recruit Japanese vendors to join its Unix-based open systems development effort with Sun Microsystems, which is seen by many as a competitor to OSF. Recently, AT&T invited several Japanese companies to a meeting of leading Unix vendors to discuss responses to OSF. Sources say representatives from NEC, Hitachi, and Mitsubishi attended the meeting. "But," says an attendee, "they just came to listen." To date, AT&T, like OSF, has failed to attract a major Japanese vendor.

Meanwhile, the Japanese are working on some Unix-based, open systems projects of their own. And, while Japanese efforts such as MITI's \$164 million Sigma Project do have some U.S. vendor participation and do make use of standards such as AT&T Unix System V version 2.0 and TCP/IP, there are some major differences between U.S. open systems standards and Sigma.

Sigma, for example, is developing its own network management and control sys-

tems that may or may not be compatible with what OSF or AT&T-Sun come up with.

Many observers expect that if Sigma is successful, the standards it will settle on will become important in Japan as Unix-based systems find their way into business applications.

However, if those Japanese standards differ from the standards used by open systems vendors in the rest of the world, the push for a worldwide open systems movement will have a hard time ever getting off the ground.

Synergy Isn't Fujitsu's Goal

Although Fujitsu would seem to be in a position to steer Japanese and Western open systems in the same direction, company spokesman Egawa says that "is not a prime motivation" behind the company joining X/Open. "If it works out, that would be good, but it's not one of our primary goals," says Egawa.

Some users would like to see the idea of worldwide open systems take wings. According to Chuck Gardner, technical associate for standards and protocols for Eastman Kodak Co., Rochester, N.Y., and a member of the X/Open advisory council, "It's like having worldwide telecommunications standards. We absolutely needed a phone system that worked the same way around the world to compete in the worldwide market. Now we're extending that idea to data."

Or as Lockheed Corp. is vp Dean Allen says, "If you're ever going to achieve the objective of open systems, sooner or later it's got to be worldwide. So far, we've been lining up the big players [vendors] here and in Europe. Now we've got to go beyond that. It's getting so that the Japanese are becoming conspicuous by their absence." ■

IS CUTBACKS

Proposed IS Cutbacks at DOD Chill Users and Suppliers

For government users it could mean project deferrals and lost jobs; for suppliers that rely on federal contracts, it could spell disaster, particularly for small businesses.

BY WILLIE SCHATZ

So, here comes the Department of Defense admitting in public that it's spending too much money too quickly and that it has too many people in too many places. But we already knew *that*, what's the big deal?

Plenty, especially for the information technology industry. The latest word from Deputy Secretary of Defense William Howard Taft IV has resulted in deferred contractual actions on new requirements for personal computers/software development, office automation, and the lease of dp equipment and information technology, with the exception of "INF [intermediate nuclear forces], and strategic and direct readiness programs."

This "thaw" of sorts from May's DOD spending freeze to eliminate excess outlays was expected by Sept. 30—the end of fiscal year 1988. At press time, DOD was about \$1.7 billion over budget.

Gunning for IS Savings

Most of that excess apparently was going to be taken out of IS's hide. Despite what seem to be carefully crafted guidelines, Taft's recent memo didn't give users or vendors much of a clue as to how the thaw would be implemented.

"It depends on what environment you're in and what purchasing stage you were in," says Wulf Berg, information resources manager of the supply department at the

Norfolk Naval Base. "If you bought equipment before the freeze [May 19], there was no impact. If you planned to buy the week of the freeze, you got hit."

Berg's department was in the process of acquiring a data link to tie together the department's laptops. When

lays were intended to slow things down, and I think they'll accomplish that. We're still going to be able to get things done, though. And," he adds, "the effects won't be catastrophic."

Maybe not for him, as a government user, but to the vendors doing most or all of



FALCON'S YOUNG: A "severe setback" in revenue from DOD in June.

the freeze came, the data link was put on ice. So was the rest of the project.

"That's an annoyance more than anything else," Berg says. "It's not going to significantly affect our operation. If it were going to do that, we would have applied for a mission-critical waiver."

"You've got to look at those systems that are extremely critical and those that aren't," says a high-ranking naval IS director who asked not to be identified. "Things are obviously going to slow down. Are users ever happy about things slowing down? Of course not."

"The restrictions in out-

lays were intended to slow things down, and I think they'll accomplish that. We're still going to be able to get things done, though. And," he adds, "the effects won't be catastrophic."

"We don't know the total effects yet, but we suffered a severe setback in DOD revenue in June," says Dendy Young, president of Falcon Systems, a Bethesda, Md.-based systems integrator that derives about 50% of its revenue from DOD contracts. "We're considering seriously reducing our DOD sales force."

"We have no objection to the overall philosophy behind the cutbacks or DOD's attempt to stay within its budget. It's the disparity in the pain and hurt that's disturbing. They're getting a small

savings and it's all coming out of a few people's hides."

Some members of Congress apparently agree, which puts them in the incongruous position of complaining about DOD actually following Congress's orders.

Uncertainty for Small Business

"It's completely inconsistent to agree with the President to control outlays, then tell DOD how to do exactly that," says a House staff member. "We've abrogated our agreement with Reagan, and we're wreaking havoc with the whole budget process. The freeze has definitely created an uncertainty for small businesses whose work is DOD related. But DOD has taken the path of least resistance. If the big guys feel pain, they'll be up here screaming and it'll be stopped."

The big boys won't be the only ones screaming on Capitol Hill if another DOD policy comes to life. The "Review of Unified and Specified Command Headquarters," a report written by a team chaired by Derek Vander Schaaf, DOD's deputy inspector general, recommends eliminating 7,350 military and civilian positions from the headquarters structure of 59,510 jobs by the end of fiscal year 1989. Heads would roll throughout the armed forces staff, including IS personnel.

The report's recommendations include: wiping out (or "disestablishing" in DOD-speak) the Caribbean Joint Intelligence Center (CaribJIC) and its five IS positions; reducing the Data Processing Service Center Pacific by 10% (11 positions); consolidating several subcommand IS offices; and having the Joint Chiefs of Staff examine "the manpower intensiveness of the Worldwide Military Command and Control System [WWMCCS] and consider whether or not alternatives

OUR NEW PRINTERS MAKE EVEN BAD WRITING LOOK GOOD.

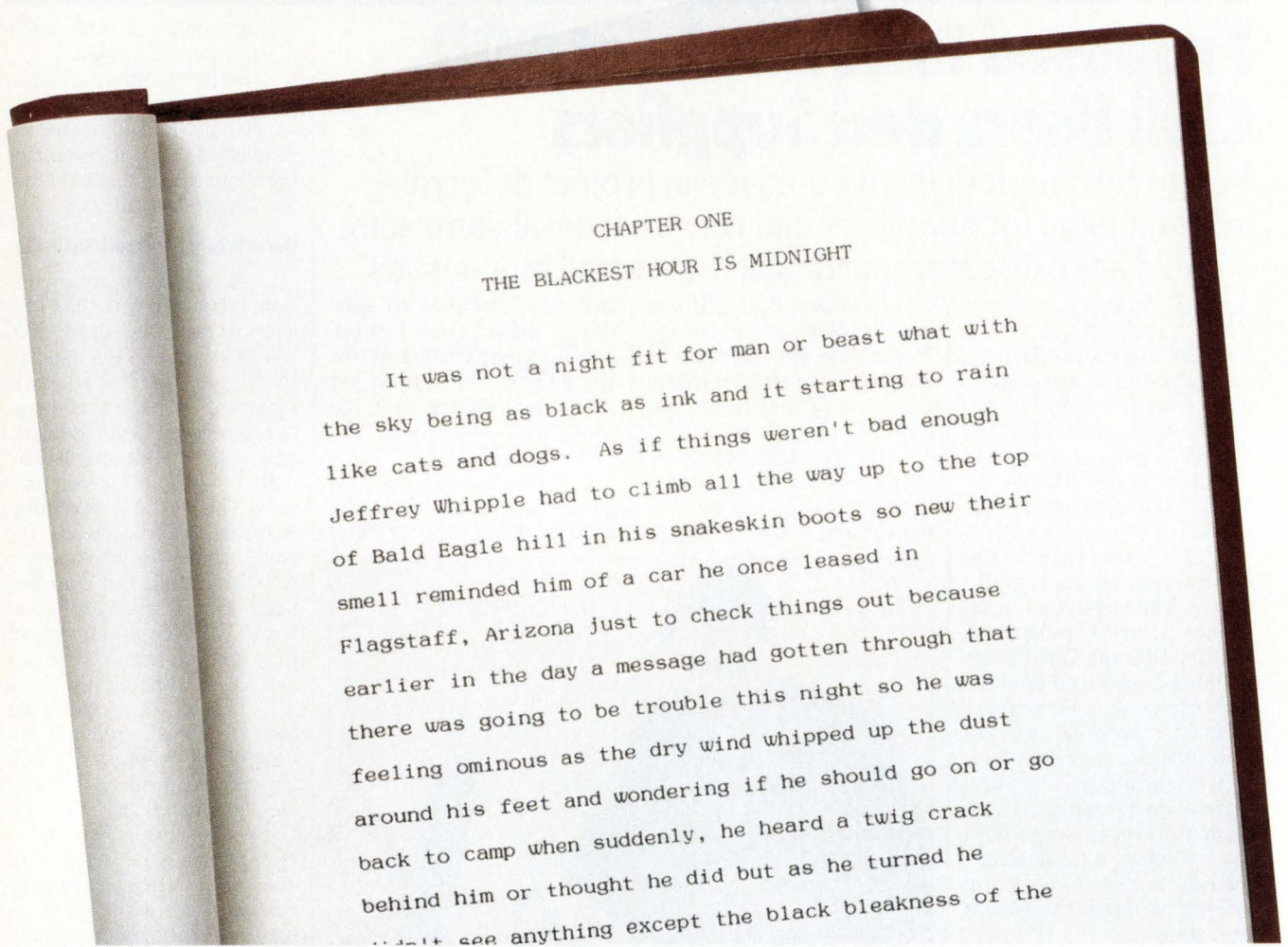

We're sorry that our new 24-wire Pinwriter® P5200 and P5300 printers can't do much for the quality of your writing. But they can certainly do wonders for the way it looks. The secret is the ribbon. Other dot matrix printers only use a fabric ribbon. Our Pinwriters print with both a fabric and a letter-quality, multi-strike film ribbon—the same kind used on executive typewriters.

The NEC Pinwriters can also enhance your writing in other ways. They have seven resident type styles. Plus four more are available on plug-in font cards. Which means you can express your thoughts with just the right typeface. You can also get an inexpensive, user-installed color option. And if graphics are part of your story, these Pinwriters produce the highest resolution of any printer you can buy.

Call NEC Information Systems at 1-800-343-4418 to see how much better our new Pinwriter P5200 and the wider P5300 can make your writing look.

Whether you're a budding Hemingway, or a Hemingway & Company.

**NEC PRINTERS. THEY ONLY STOP
WHEN YOU WANT THEM TO.**



NEC

NEC Information Systems, Dept. 1610, 1414 Massachusetts Ave., Boxborough, MA 01719.

THERE IS A BETTER WAY TO MANAGE CICS: CICS MANAGER.



CICS MANAGER Version 2 is the better way, the new approach to CICS management. An approach that helps you avoid CICS crises and meet growing service level demands 24-hours a day, 7-days a week.

The push to 100% availability.

CICS MANAGER gives you the tools you need to achieve optimum availability and response time. Users have found that CICS MANAGER lets them maximize CICS performance, achieving greater than 99% availability with sub-second response time. CICS MANAGER operates outside of CICS, so it is not affected by CICS performance problems. And your time is spent managing CICS – rather than reacting to crises.

More than a monitor. It's a manager.

CICS MANAGER lets you actively manage CICS performance:

- Warning screens alert you to impending problems.
- Informational data helps you find the cause.
- Extensive Action services let you execute effective solutions.

You can tune multiple, even remote, CICS regions from a single terminal. Switching across regions, machines and data centers is as simple as changing the name of the CICS region on your screen. Even novice users can identify and solve problems within a single session.

CICS MANAGER puts you in control.

With detailed on-line monitoring. Instant replay of recent data for system tuning. A unique Performance Reporting Language that lets you design historical reports for efficient planning. And CICS MANAGER works in concert with other Boole & Babbage performance tools, so you can get the most from your entire system.

See how it can work for you.

For a free demonstration of CICS MANAGER, call Don Mitchell today. In California: 800-624-5566. Outside California: 800-822-6653.



International sales and support provided through The European Software Company and a worldwide distribution network.

are available that could be geared specifically toward reducing manpower for that system."

Manpower Reductions at GTE

The manpower already has been reduced at GTE Government Systems, the WIS (WWMCCS Information System) prime contractor. Last spring, the company laid off 30 people after the final fiscal year 1988 budget reconciliation, but it doesn't expect any further employee reduction.

DOD may or may not tread the same path. Vander Schaaf recommends that the Secretary of Defense direct the Joint Chiefs of Staff to check out the manpower intensiveness of WIS and think about available alternatives that could be targeted specifically toward reducing WIS's manpower.

If that and other recommendations are followed precisely, the report projects savings of \$336 million in fiscal year 1990 and \$1.7 billion in fiscal years 1990 to 1994.

They're talking real money, but so far it's only worth the paper it's printed on. Turning those projections into reality is something else.

"Although probably no one will agree with all of the recommendations contained in this report," Vander Schaaf writes, "I believe that substantial savings can be made without jeopardizing military readiness and without curtailing useful and necessary work conducted by headquarters. In many cases, output will actually increase when staff sizes are reduced."

Only Adm. William Crowe, chair of the Joint Chiefs of Staff, and Secretary of Defense Frank Carlucci know whether that hypothesis will be tested. The report currently rests with Crowe, who undoubtedly will have several things to say before passing the document to Carlucci. The defense secretary

then will decide whether some, all, or none of the report reaches the ultimate arbiter. The timetable for this sequence at press time was "as soon as possible," according to a DOD spokesperson.

"It will be interesting to watch how the Congress reacts to any recommendations that are accepted for implementation," the report says. "Some of the proposals will represent a clear test of the congressional commitment to follow up on their demands for a more efficient DOD, since civilian personnel reductions and transfers of jobs from one location to another are required. These transfers and reductions in force will no doubt be viewed the same as base closings."

Will Congress Accept Cuts?

So, what's the problem? Doesn't every member of Congress believe passionately that shutting down obsolete armed forces bases is a terrific way to slash the budget deficit? Absolutely—as long as it doesn't happen in their district or their state. The representatives and senators undoubtedly will have the same reaction when it's time to vote on transferring jobs and personnel from their hometown to someone else's. You think Spinks was scared when he faced Tyson? We're talking sheer terror here.

Does any legislator really want to be the first to cast an "aye" vote to disestablish the CaribJIC and its proposed \$400,000 increase in IS equipment and support contracts for fiscal years 1989 to 1992? Very unlikely, despite the report's conclusion that the "CaribJIC appears to be a redundant facility and hence unnecessary."

Maybe that facility won't disappear. But DOD still has to make its expenditures equal its budget. And when it cuts, IS is likely to be the first to bleed. ■

STRATEGIES

IBM Suits Up Its Midrange Lines

Will the applications segmentation of the AS/400, 9370, and System/88 lines affect the goals of SAA?

BY GARY McWILLIAMS

With a big chunk of expected growth—as well as corporate pride—at stake, IBM is being very careful to dress its recently introduced Application System/400 computer family in the software equivalent of a gray flannel suit.

AS/400's commercial bent comes from its RPG language ancestry. The applications or operating system areas designated for IBM's other midrange lines—technical, on-line transaction processing, and Unix—are largely derivative as well.

But, given IBM's practice

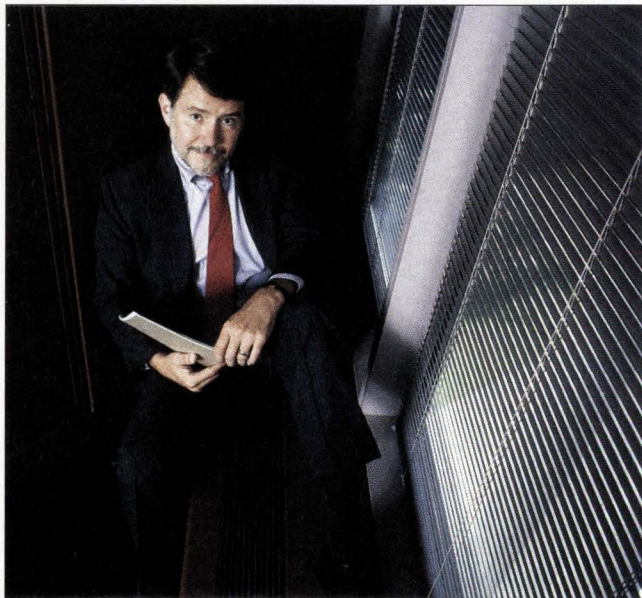

UNION CARBIDE'S SMITH: The Application System/400 fits into SAA.

As much an acknowledgment of its System/38 heritage as the business attire is, it is also intended to set the AS/400 apart from its midrange peers. Whether the suit says more about historical reality or about how the AS/400 fits into Systems Application Architecture (SAA) is something that remains to be seen.

Certainly the commercial garb illustrates the new family's lineage. As the clear migration path for System/36 and System/38 users, the

in the past of classifying the System/36, System/38, and 9370 by user organization size, the newer market positioning is a step closer to the SAA applications philosophy. For instance, IBM says the AS/400 sports no Unix operating system or technical computing labels. Instead, as third-party developers carry over their suite of System/36 and System/38 applications, there is de facto support for a business designation. The AS/400's present lack of FOR-

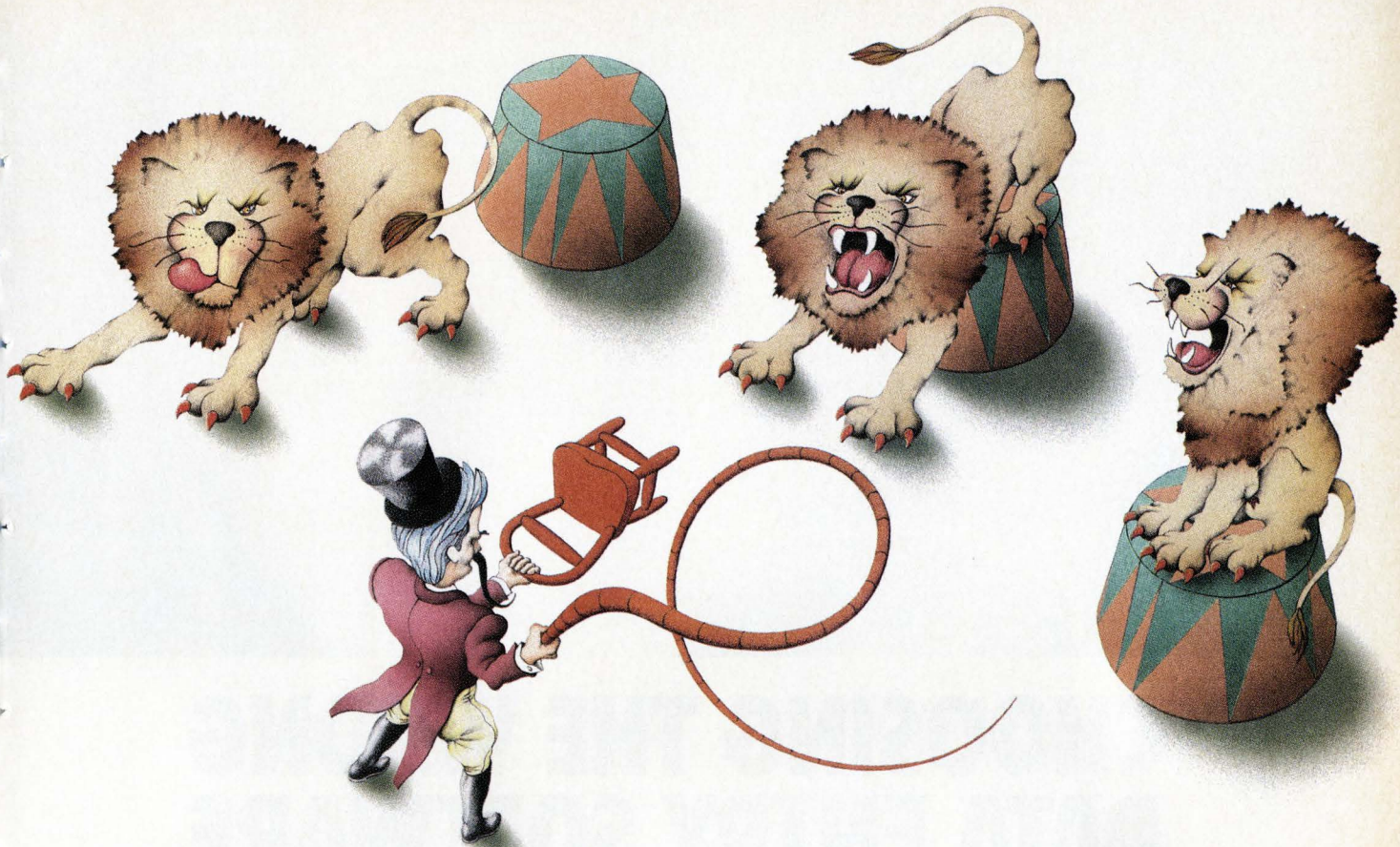

The definitive solution to three formidable problems.

Data storage management hasn't been getting any simpler. As a matter of fact, it's been getting more and more demanding.

Space demands.
Performance demands.
Budget demands.

Amdahl saw all this coming. And responded with DEI.

DEI is short for DASD Effectiveness Inventory. It's a consulting service with a unique methodology — developed by Amdahl — to give you a way to balance these demands, now and in the future.

Our DEI consultants will work with you on site, whether you're an Amdahl customer or not. They'll help you gain real financial savings and productivity improvements.

When they've addressed your concerns to your complete satisfaction, they'll *give* you the DEI methodology.

And from then on, *you* have the tools that enable you to manage those demands.

Find out what other corporations have been learning from DEI: That you can take control of your storage operations and investments — for good.

Call and ask about DEI, only from Amdahl. 1-800-233-9521, ext. 17 or 1-800-233-5727, ext. 17 in California.

Amdahl Corporation
1250 East Arques Avenue
Sunnyvale, CA 94088-3470

amdahl
The VALUE Choice

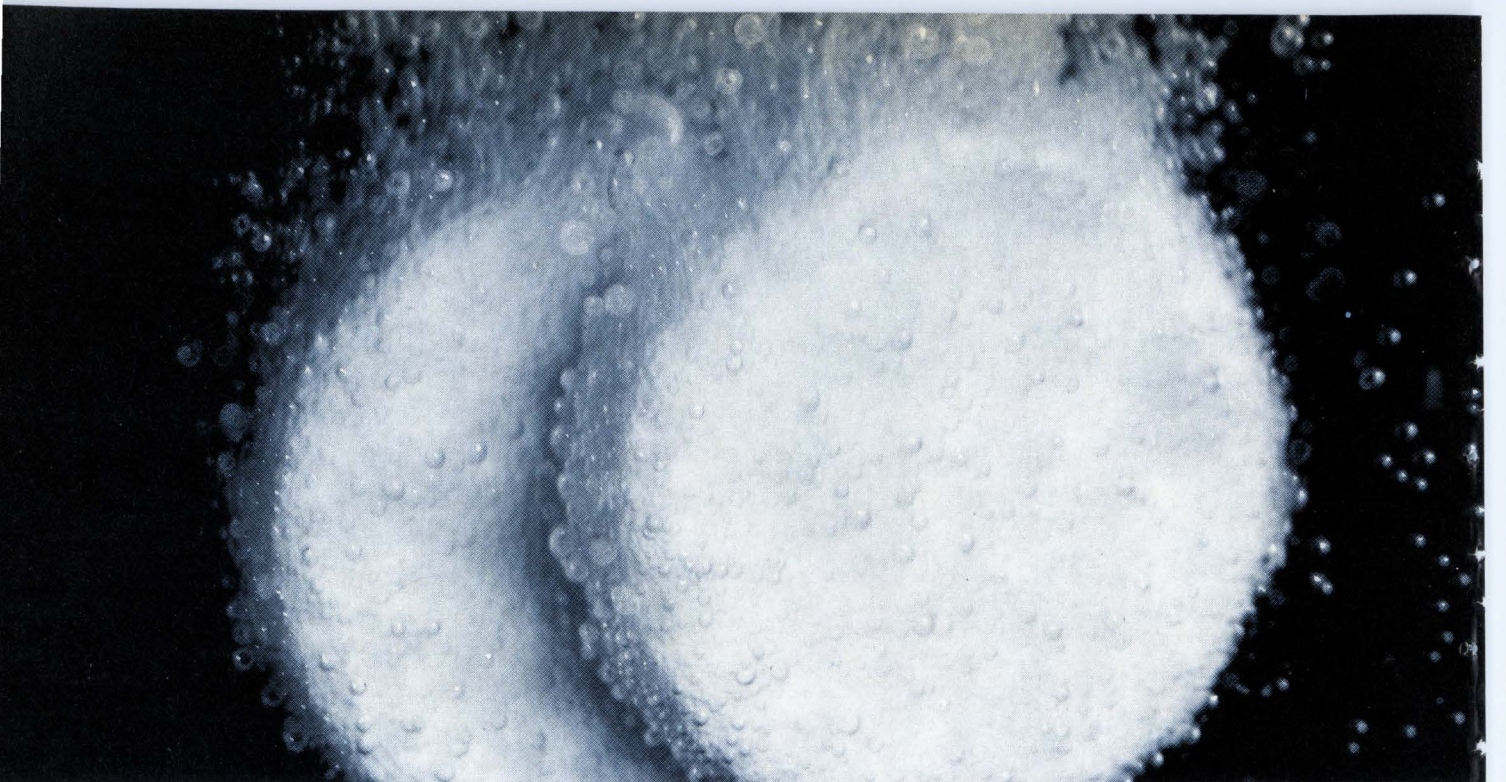

CHOOSING THE WRONG DATA ENTRY SOFTWARE CAN BE UPSETTING TO YOUR SYSTEM.

If you're considering changing your data entry system, you need to make the right decision. Choosing data entry software that's less than perfect can be upsetting to your system. FALCON and PC/FALCON can offer some fast relief.

Quite simply, FALCON is the best data entry software you can buy. In the May 1987 DATAPRO Report on Software, FALCON topped the ratings in overall user satisfaction. DATAPRO said, "If you are in the market for a highly efficient, highly flexible data entry system, you owe it to yourself to look at FALCON."*

So call (800) 622-9292 and ask for our free FALCON video. Or ask about our free 30-day trial program. Either way, you'll see for yourself that FALCON is strong medicine for data entry headaches.

FALCON runs with MVS/SP/XA and VSE/SP under CICS and stand-alone under VTAM. PC/FALCON runs under MS/DOS.

FALCON and PC/FALCON are proprietary products of Phoenix Software Company, 5933 West Century Boulevard, Suite 1200, Los Angeles, CA 90045.



*Reprinted with permission from "DATAPRO REPORTS ON SOFTWARE: SW45-713UO-201—Systems Enhancements," DATAPRO RESEARCH CORPORATION.

Circle 14 on Reader Card

TRAN and C languages and its weak floating point computational abilities also reinforce that commercial view.

Moreover, the AIX operating system and existing CAD/CAM applications on the 9370, IBM's other SAA-conforming midrange offering, are intended to lend it a technical and engineering aspect.

The IBM System/88, the non-SAA participant among IBM's trio of midrange offerings, is the only one to have fault tolerant as well as OLTP capabilities.

SAA Is "Investment Protection"

Positioning of the trio according to their applications provides a means of distinguishing between them, but do such designations conflict with the subsumption of architectural differences encouraged by SAA?

IBM says not to confuse SAA's subtleties with marketing realities. "SAA is a bridging between IBM architectures. It is investment protection, not market segmentation," says

William O. Grabe, who is IBM vice president and assistant general manager of Application Business Systems.

IBM watcher Brian Jeffery, managing director of International Technology Group, Los Altos, Calif., says IBM has returned to its 1960s and early 1970s marketing approaches.

"What they've done is segment by architecture with the idea that each product line supports a different applications software base," he says. "In essence, it's trying to let applications drive the hardware base."

Brad Friedlander, a senior consultant with Arthur D. Little Inc., Cambridge, Mass., argues, "This isn't a change in direction so much as a ratification of reality." He views the AS/400's positioning as "not so much an SAA or cooperative processing statement, but saying, 'Here's an impressive alternative [to the 9370] in the midrange.'" Friedlander says that poor 9370 sales are forcing IBM to distin-

guish between the otherwise general purpose systems by applications areas.

What then for the engineering and scientific area that IBM has designated for the 9370? Some users and analysts consider the positionings as a way for IBM to de-emphasize the 9370 gracefully. More to the point, IBM is consciously trying to find a new audience for the AS/400. There is no effort to force a replacement of existing 3X systems. IBM says that those users who have grown attached to their 3X systems will find continued availability.

Expanded Customer Base Sought

Expansion of IBM's customer base is the chief objective of the AS/400, adds vp Grabe. "I position the AS/400 for anybody who is using computers for the first time," he says. That novice user is essential to IBM's growth objectives.

"The fastest growing segment of the world econ-

omy is not the Fortune 500 but those we are targeting with the AS/400," Grabe says. He estimates their number at 4 million in the U.S., 16 million worldwide.

But depicting the AS/400 as a new generation computer—albeit with many familiar applications—leads Digital Equipment Corp. to suggest that another architecture is being launched. Gary Hoppe, DEC's manager of U.S. sales consultants, calls the AS/400 no less than a new IBM environment, "another operating system on yet another platform. It doesn't appear to have clarified things," he argues.

However DEC prefers to view the AS/400, its lineage is apparent to users familiar with the System/38's 48-bit address space, Control Language, relational database, and idiosyncrasies.

"The essentially System/38 design of the machine pleased me," says Ron Gadwah, a System/38 consultant based in Hooksett, N.H. While there's no breakthrough in technology, he says the operating system is a System/38 derivative with enough modifications to smooth the transfer of those legions of RPG II language applications written for the System/36.

Those familiar features, as well as integrated token ring network software and optional personal computer support software, have been in such wide demand that they seem to have touched a nerve, especially among those with large System/3X installations. For instance, Chicago-based Morton Thiokol Inc. uses four System/38s and seven System/36s for administrative applications in its chemical division's plants, says IS specialist Randy Palubicki. "Down the line," says Palubicki, "we intend to replace all our S/36s" with AS/400 models.

Where the Application System/400 Fits Into SAA

As the designated successor to an estimated 300,000 System/3X computers around the world, the AS/400 has an important role in IBM's SAA strategy. More than a consolidation of two families, it is the only computer family designed as part of the SAA umbrella.

It's no wonder then that IBM keyed much of the new line's communications and languages to SAA. The initial release, for example, supports Advanced Peer-to-Peer Networking, Document Interchange Architecture, and SNA Distribution Services. SQL is one of three languages available. IBM promises that C, FORTRAN, and Rexx plans will be disclosed with initial shipments this month.

The relational database that comes with the AS/400 omits some SAA elements, which will curtail full SAA conformance for some time. "There are four or five items you will not have in the initial release," says Mark Anderson, an IBM database developer in Rochester, Minn. "We're looking very closely at enhancing the capabilities so there will be full compliance with SAA." But due to its System/38 heritage, the AS/400's relational

database doesn't fit the model described in the SAA bible, the Common Program Interface reference manual.

IBM won't say how quickly those capabilities will come. Dick Dowdell, director of R&D at McCormack & Dodge Inc., Natick, Mass., believes adding those enhancements will delay full SAA database compatibility until late next year. IBM does say the system's integration of operating system, database, and communications won't spur a flurry of revisions. It expects to make no more than two or three operating system releases a year.

While its 3X heritage inhibits the CPI database model, it has endowed the AS/400 with one feature the other SAA environments do not yet support. IBM added Distributed Data Manager (DDM), a means of distributing database sets, to the SAA product list. Released previously for the System/36, it now runs on all AS/400 family members. As an announced member of the SAA specification set, DDM's availability on all four SAA environments—OS/2, OS/400, VM, and MVS—is required within two years.



Communicate With and Beyond

Tymnet has a way to let you communicate within and beyond your SNA network quickly and unobtrusively.

How?

Tymnet's communication solutions are based on software, not on installing another piece of hardware equipment.

That saves you both time and money. Plus, when you tie into Tymnet's network, you extend your SNA network out to the whole world of international data access and delivery, without disrupting your IBM host or front-end software.

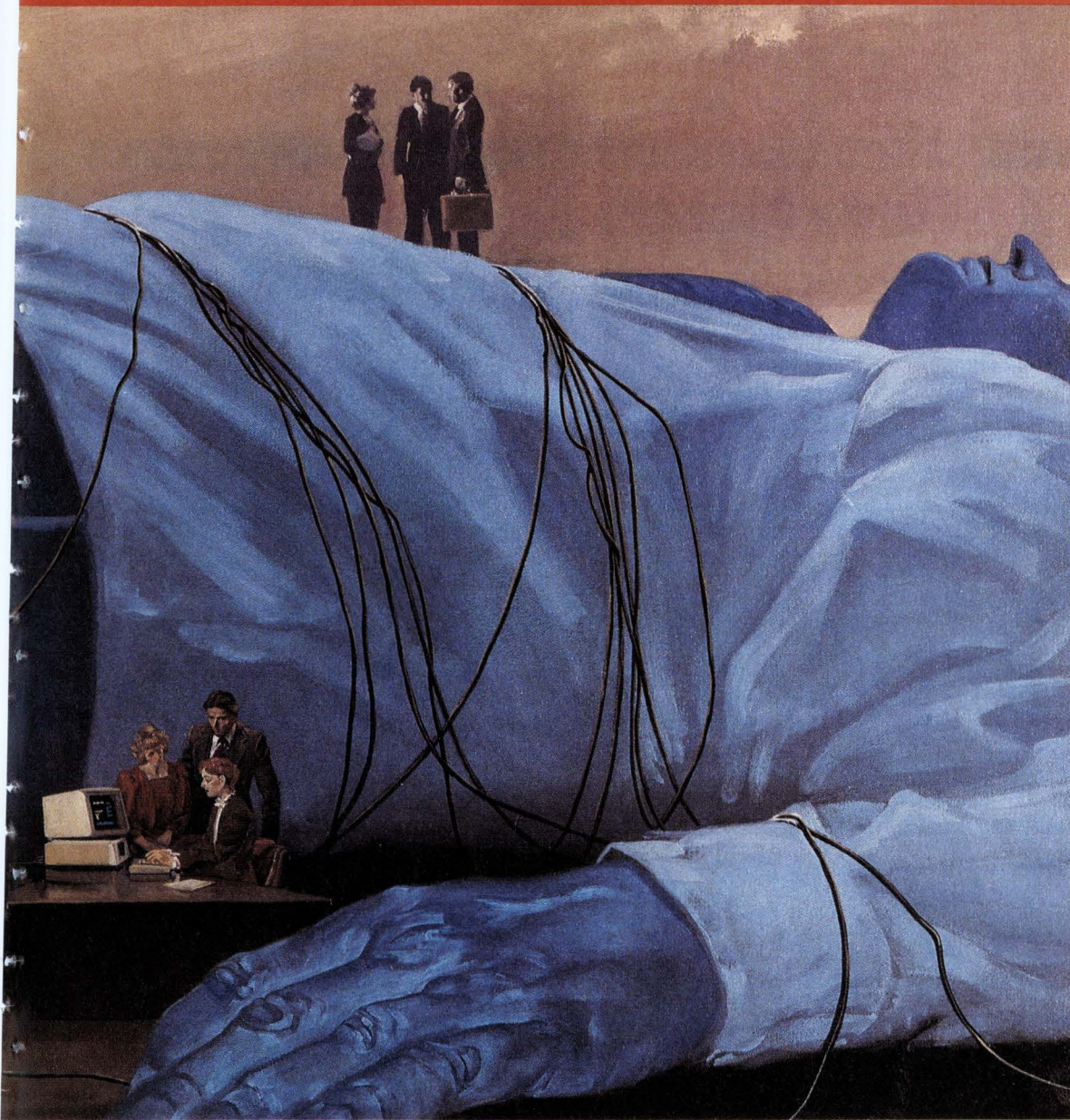

Big Blue Without Disturbing Him.

Tymnet offers these cost-saving IBM services in public, private, and hybrid network solutions:

- file transfer
- PC connectivity
- X.25-SNA integration
- Async-to-3270 protocol conversion

Tymnet can be your solution to communicate effectively within and beyond the SNA environment. It's easy.

Call 800-872-7654 for all the information you need to make your decision.

Tymnet

2560 N. First Street
P.O. Box 49019
San Jose, CA 95161-9019

We Build Networks.

MCDONNELL DOUGLAS

PATENTS

Clone Makers Get Warning on Patents

IBM's hefty patent fees and back royalties for PC clones may increase prices and stifle innovation.

BY ROBERT FRANCIS

IBM's recent aggressive attitude toward protecting its patents may mean higher prices for pc customers in the short run and possibly fewer IBM-compatible hardware choices of all systems varieties in the long run.

The back royalty pay-

market. Right now, the industry seems more evolutionary than revolutionary."

Some trace IBM's patent campaign back to its 1987 introduction of its new family of personal computers, the PS/2. At that time, the company made it clear that it didn't want to see the world flooded with clones, as had occurred

For some involved with the System/38, the consolidation was welcome for other reasons. The Union Carbide Corp., Danbury, Conn., uses five Model 700s at its headquarters and 34 other System/38s of varying sizes around the world. Ted B. Smith, manager of systems development at Union Carbide, sees the systems' SAA designation as an assurance. "As it fits into SAA, there will be more compatibility among it, the mainframe, and smaller systems," says Smith (see "Where the Application System/400 Fits Into SAA").

U.K. Post Office Picks AS/400

The British Post Office, which chose the AS/400 following a runoff with DEC's MicroVAX II, likewise found that the price/performance and ease of use was compatible with its needs. The Post Office is installing the systems in some 70 district offices to handle mail routing and office automation. "We were trying to judge the machines we felt would do the job," says John Handby, director of information technology for the British Post Office, London. "Between the benchmark results and support package—when we looked at that combination—it was no choice at all."

Having earlier selected System/370 and PC architectures as Post Office standards, the expected inclusion of AS/400 in the SAA operating environments influenced the decision, says distributed systems support manager Ken E. Taylor.

It will be some time before we hear from the new users at whom IBM is targeting the AS/400. Disregarding the engineering and scientific users for now, there is enough glee among those with existing 3X installations to issue the AS/400 a business welcome, and that, after all, appears to be what IBM has craved most. ■



OFFICE SCIENCES' EISEN: Fewer pcs for the same dollar amount.

ments that IBM is seeking from PC-clone makers will pressure them to raise systems prices, which are already on the rise because of higher component prices. Moreover, the broad licensing and strict enforcement of IBM patents may stifle innovation and imitation by competitors.

PS/2 Spurs IBM's Campaign

"This new posture by IBM could have grave effects for the so-called garage operators," says Clare Fleig, an industry analyst at International Technology Group, Los Altos, Calif. "The industry is maturing," she adds, "and as it matures, it's more difficult for new vendors to enter the

when it introduced its PC. Veiled legal threats surrounded the hardware in the machine, notably the Micro Channel Architecture, and IBM even worked to get two companies to stop using "/2" in their advertising.

The campaign gained significant momentum this spring after IBM officials, having sized up favorable legal rulings on patent protection and set out in pursuit of new revenue streams, decided to increase royalty rates on future patent licenses. To the consternation of many in the massive IBM PC-compatible industry, Big Blue vowed to seek back royalties (up to 1%) on machines sold prior to the policy change.

(According to an IBM spokesman, IBM's worldwide portfolio of patents exceeds 32,000 and applies to hardware only. Software is covered under copyright restrictions.)

According to industry executives and patent attorneys, IBM should reap rewards directly because of the increase in royalty rates and indirectly by making the cost of entering into competition with IBM prohibitive, thereby limiting the number of competitors in the marketplace.

Compaq Has Reserve Fund

"What they're asking will put [IBM] at an unfair advantage," says Rod Canion, president of Compaq Computer Corp., Houston, the most successful PC-compatible maker with \$1.2 billion in 1987 sales. "They could control the entire market and who they compete with."

Compaq has set aside funds (up to \$30 million by some estimates) to pay for royalties on past sales.

Although it is difficult to determine if the lack of entrants into the PS/2-compatible market is due to legal roadblocks or simply from the lack of demand for the product, the situation does provide an example of what IBM is doing in the area of patents.

Due to the fact that many of the PC-compatible manufacturers are in negotiations with Big Blue, all declined to be quoted directly on the process. But, according to an executive at one PC-clone maker, IBM is protecting its patents much more zealously than in the past, despite the company's statements that its policy has remained the same: "What they've done is limit the competition, and, in fact, they've found a way to make some money off the competition. It really makes sense if you look at it."

IBM may well be able to pull off this new patent strate-

Exclusive!

Your Choice of V.32 Modems From The Philips Family

 **Rack Mountable**

 **Stand-Alone**

 **V.32-PC Card**

Rack mounted, stand-alone or PC Card, Philips V.32 modems offer the winning combination of outstanding performance, international data communications technology and cost-saving features!

The Philips V.32 offers:

- Full CCITT V.32 Compatibility
- Software Configuration
- Autoadaptive Digital Echo Cancellation
- Identical Cards for Both Stand-Alone and Rack Mount
- Fully Automatic Dial Back-Up
- V.25 bis, Hayes AT Async Dialer
- SDLC Sync Dialer
- Phase Roll Compensation
- Network Management

The Philips V.32 family offers outstanding performance, including both international and domestic communications versions. For central site applications, a combination of up to 12 rack mounted modems can be accommodated, including Philips V.27, V.29, V.32, V.33 and short-haul modems.

Philips Information Systems Company

A Division of North American Philips Corporation
15301 Dallas Parkway
Suite 300
Dallas, TX 75248
1-800-443-6004

Call today for complete information on the Philips family of V.32 modems and other outstanding data communications products as well as Personal Computer Workstations from Philips Information Systems.

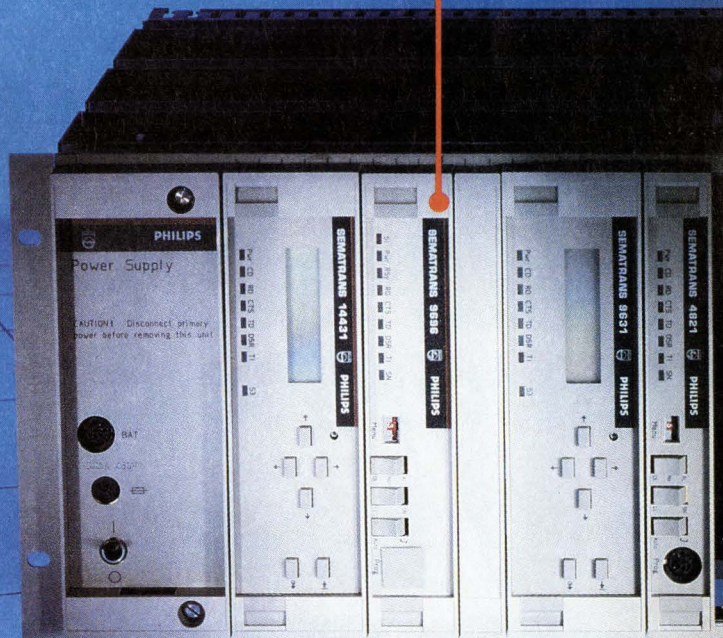

PHILIPS

**CAST
YOUR
VOTE**

**WATCH FOR IT
IN THE NEXT ISSUE
OF DATAMATION!**

**AND WIN
VALUABLE
VIDEO
PRIZES.**

ANNOUNCING DATAMATION'S READER VOTE CONTEST.

GRAND PRIZE

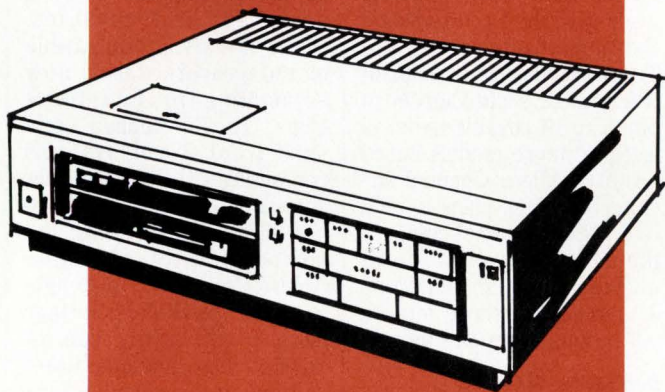

VHS VIDEO
CASSETTE RECORDER

4 FIRST PRIZES



SONY
WATCHMAN™ TV

Enter the *Datamation* Reader Vote Contest and you may win a valuable VHS video cassette recorder or Sony Watchman™ TV.

It's easy to enter. Just follow these three simple steps:

1. Select the 5 ads in the *AUGUST 15TH ISSUE* of *Datamation* that you think your fellow readers will choose as being the *most helpful* and *most informative*.
2. List your selections on the entry card provided in the *AUGUST 15TH ISSUE*.
3. Mail your entry card by September 19, 1988.

CONTEST RULES

1. List your top 5 ads in rank order on the entry card provided in the *AUGUST 15TH ISSUE* of *Datamation*. Indicate the name of the advertiser (company or organization) and the page number. Ads placed by Cahners Publishing Company, *Datamation* or other Cahners publications cannot be considered in this contest.
2. No more than one entry may be submitted by any one individual. Entry blank MUST be filled in completely or it will not be considered.
3. To qualify, you MUST be engaged in information processing, supervising or managing MIS/DP personnel, or setting standards for selection of information

processing or telecommunications hardware, software or services.

4. Contest void where prohibited or taxed by law. Liability for any taxes on prizes is the sole responsibility of the winners.
5. Entries that most closely match the rank selected by *Datamation* readers will be declared winners.
6. Entry cards must be postmarked before September 19, 1988.
7. In case of a tie, the earlier postmark will determine the winner. Decisions of the contest judges will be final.
8. In the event that a prize is not available, the publisher may substitute an alternative prize of equal value without prior notice.

DATAMATION

Cahners Publishing Company
A Division of Reed Publishing USA

News in Perspective

gy, judging from recent legal rulings in support of companies that have sued to protect their patents.

TI Making Money on DRAMs

"Our feeling," says a spokesman for Texas Instruments Inc., "is that IBM is building on some of the work we've done in the patent area over the past couple of years." The chip and systems manufacturer successfully battled foreign manufacturers of dynamic random access memories (DRAMs)—the very components that are driving up pc prices—through the courts and the International Trade Commission to receive licensing fees from foreign chip suppliers that are selling DRAMs based on TI patents in the U.S.

TI garnered some healthy

greenbacks in its pursuit of royalties, receiving \$191 million in 1986 alone from the various Japanese and South Korean chip makers involved in the company's patent-infringement dispute. TI subsequently has received between \$20 million and \$30 million a quarter in royalty payments.

Fewer Choices, Higher Prices?

For corporate pc purchasers, IBM's recent actions may mean fewer pc choices and possibly higher prices. While they're not yet up in arms, they are considering the possible ramifications. Jerry Eisen, president of management consulting firm Office Sciences International, Iselin, N.J., says that "companies may purchase one pc less than they planned, but they'll purchase the same dollar

amount."

A good indicator of how IBM will handle the large clone industry that grew up in the wake of its first generation of PCs is the settlement it reached with Dell Computer Corp., Austin, Texas.

In the Dell-IBM agreement, made public as part of Dell's registration statement for an initial public offering made with the Securities and Exchange Commission, the Texas-based compatible manufacturer says it had agreed to pay up to 5% royalties from all sales of future models based on IBM's Micro Channel Architecture. Dell plans to ship two Micro Channel-compatible machines in the fourth quarter. Company officials say pricing for those models will be announced this month.

Dell Settles With IBM

In addition, Dell has reached a settlement with IBM over payment of royalties for past sales of compatibles, but terms of that agreement have not been released. According to industry observers, IBM was willing to settle with Dell on fairly easy terms because Dell owned up to its past sins. A Dell spokesman says it's too soon to determine if those royalty payments will trigger price hikes.

In May, Dell raised the price on most of its pcs, but a Dell spokesman insists that it was because of the shortage of DRAM chips and not because of the company's royalty agreement with IBM.

PC-clone makers such as Dell, which has no technology to trade with IBM, may suffer more at the hands of IBM than firms that have something to barter, says Tim Bjarin, executive vp for market research firm Creative Strategies Inc., Santa Clara. Consequently, users of pcs made by nontraders may also be hit by the higher prices.

Those who use pcs made by companies such as Com-

paq, Tandy, and Zenith may be spared price hikes to some degree. Of the three, only Tandy openly admits it has a cross-licensing agreement with IBM; Compaq and Zenith have had agreements with IBM in the past but will not say if they do now.

There are already other factors at work in the PC-compatible industry besides IBM's desire for back royalties. Many domestic compatible manufacturers are now scrambling to find DRAM chips. They're feeling pressure from Asian systems competitors that have easier access to memory components, and are finding the competition for corporate America's pc dollar too tough.

The DRAM chip shortage has been particularly acute for small-volume manufacturers because of the entry of Samsung Semiconductor & Telecommunications, Mitsubishi Electronics, and other Asian manufacturers into the low-priced PC-clone market.

Taking IBM Seriously

When IBM first admitted it was seeking back royalties, many compatible manufacturers thought that meant only token payments as an entry fee of sorts into the Micro Channel clone games. And corporate pc purchasers thought the industry squabble would not affect them directly. The tough terms apparently meted out to Dell may have changed that attitude. One clone manufacturer, who did not wish to be named, says it appears IBM will not back down easily from its policy of retroactive payments.

"We were surprised by this and I think everyone else in the industry was as well. It's going to cause some price increases; how much I don't know," he says. "Still, it seems like someone can always come up with a hot new product and turn the industry on its ear." ■

NEC TAKES CARE OF ITS OWN.

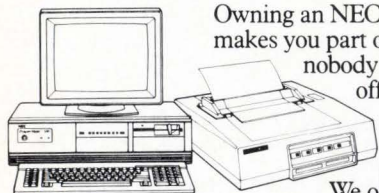

Owning an NEC computer or printer makes you part of the NEC family. And nobody takes more pride in offering you quality service than the family of NEC Customer Engineering and its authorized dealers.

We offer a full range of service options, quality parts, and comprehensive maintenance contracts. Call us, and find out about the many ways NEC Information Systems takes care of its own.

Service Excellence Through People, Pride and Professionalism™

1-800-325-5500

C&C Computers and Communications

NEC

Accelerate.



Now there's room for everyone on the fast track.

Compaq introduces the best
of 80386 technology
for every computer user.

The new 16-MHz
COMPAQ
DESKPRO 386S



The 16-MHz
COMPAQ
DESKPRO 386



When Compaq pioneered high-performance personal computing and introduced the industry's first 32-bit PC's based on the Intel® 386* chip, we gave performance-hungry business users, engineers, analysts and software developers the tools they needed to run complex applications faster and better.



The 20-MHz
COMPAQ
DESKPRO 386/20



The new 25-MHz
COMPAQ
DESKPRO 386/25

Now, we're introducing the new COMPAQ DESKPRO 386S and COMPAQ DESKPRO 386/25. And extending our high-performance 80386 line in both directions. To meet the increasing demands of today's general business users *and* to provide our power users with more power than ever. So *everyone* can enjoy the speed and future capabilities of 80386 computing.

In each COMPAQ 80386 PC, our exclusive design lets every component operate at optimum speed. Giving COMPAQ personal computers a considerable edge in system performance, ensuring compatibility with industry-standard software and hardware, and providing what may well be the ultimate in connectivity for

high-performance,
network environments.

The new COMPAQ DESKPRO 386S is the first personal computer designed specifically to let general business PC users head straight for the performance and potential of 80386 personal computing.

For more advanced applications, the original COMPAQ DESKPRO 386 and the COMPAQ DESKPRO 386/20 deliver even higher levels of performance.

And now at the top of our line is the COMPAQ DESKPRO 386/25. The most powerful personal computer available.

With our two newest machines, we're not just pushing 80386 technology forward; we're *widening* it. To let every personal computer user take advantage of everything COMPAQ 80386 power has to offer.

COMPAQ

It simply works better.

Now, breakthrough technology from Compaq brings the power and potential of 80386-based personal computing to millions of business PC users. The first personal computer powered by the new Intel 386SX* microprocessor, the new COMPAQ DESKPRO 386S is designed specifically as an affordable, high-performance alternative to 80286-based PC's.

Surrounding its revolutionary microprocessor are high-performance components and a 32-bit architecture that run your current software up to 60% faster than most 10-MHz 80286 PC's. Plus give you the power to run 32-bit software that 80286 PC's won't run at all. And exciting new multi-tasking software such as

Microsoft® Operating System/2 from Compaq and Microsoft Windows/386.

With its sleek, "small footprint" design, the COMPAQ DESKPRO 386S takes up far less room than its competition.

But it gives you room for four internal storage devices.



So you can easily tailor it to your exact needs. Choose from fast 20-, 40-, and 110-Megabyte Fixed Disk Drive options; 5 1/4-inch and 3 1/2-inch diskette drives; even tape backup options.

We give you one full megabyte of high-speed memory standard. And you can expand to 13 megabytes *without* using an expansion slot. This will

come in handy when you're ready to thoroughly exploit the MS® OS/2 operating system and advanced 80386 business software.

We even built features like advanced VGA graphics and standard interfaces for a mouse, printers and other peripherals into the system. This saves your slots for modems, network boards and much more.

You'll also find two more standard features: the same sophisticated engineering and uncompromising quality that set all COMPAQ 80386 computers apart. So head for the performance you really need for today's applications. And the 80386 potential you'll need for tomorrow's. With the new COMPAQ DESKPRO 386s.



Get into the passing lane.

Introducing the COMPAQ DESKPRO 386s.
New technology delivers affordable 80386 performance
for anyone considering 80286 PC's.

COMPAQ

It simply works better.



Once again, Compaq introduces a personal computer that leaves every other PC in the dust. With its unsurpassed Intel 25-MHz 386* microprocessor, exclusive COMPAQ Flexible Advanced Systems Architecture, and up to 1.2 gigabytes of storage, the new COMPAQ DESKPRO 386/25 is the ultimate expression of 80386 technology.

Its FLEX Architecture uses separate memory and peripheral buses operating in concert to reach maximum system performance, while maintaining compatibility with industry-standard hardware and software. By splitting

the work, they also prevent information bottlenecks in the system. The 25-MHz cache memory controller keeps data instantly accessible, and that lets the processor tear through applications with 0 wait states 95% of the time. All this translates into performance that's up to 60% faster than most 20-MHz 80386-based PC's.

And, with the optional Intel 387* or Weitek™ coprocessor, you'll even be able to match the numeric processing power of a dedicated engineering workstation at a fraction of the cost.



Now, fasten your seat belt.

Introducing the 25-MHz COMPAQ DESKPRO 386/25.
The most powerful personal computer available.

You can go from one megabyte of standard, high-speed memory all the way to 16 megabytes. And for storage-hungry applications, such as networks using disk fault tolerance and multi-user systems, the COMPAQ DESKPRO 386/25, with two optional COMPAQ 300-/600-Megabyte Fixed Disk Drive Expansion Units, is able to provide up to a massive 1.2 gigabytes of high-performance storage. With an average access time as low as 20 milliseconds.

Of course, we give you a choice of 5¹/₄" or 3¹/₂" diskette drives and high-capacity tape backup options.

For sophisticated PC users who require the ultimate in power, compatibility, connectivity and overall system performance, no other personal computer comes close to the new COMPAQ DESKPRO 386/25.

It's simply the most powerful personal computer available. But then, that's what Compaq users have come to expect. Again and again and again.

COMPAQ

It simply works better.

Full speed ahead.

Next to high performance, the advantage of COMPAQ 80386 computing is compatibility with both today's and tomorrow's software. From MS-DOS® to the exciting new MS OS/2 operating system. And beyond.

Thanks to a close and longstanding working relationship between Compaq and the industry's independent software developers, the COMPAQ line of 80386 personal computers is especially capable of letting you tap the full potential of all the new multitasking software.

You'll run MS-DOS 3.3, plus MS OS/2, Microsoft Windows/386, XENIX®, UNIX® and the thousands of applications written for them. And with any computer from the COMPAQ 80386 line, you'll run them all *faster*.

Take one for a quick spin and you'll see why COMPAQ computers earn unsurpassed satisfaction ratings from users and industry experts. For the location of the nearest Authorized COMPAQ Computer Dealer or for more details, call 1-800-231-0900. Ask for Operator 63. In Canada, call 1-800-263-5868, Operator 63.

COMPAQ® and COMPAQ DESKPRO 386® are trademarks of Compaq Computer Corporation. Microsoft®, MS-DOS®, XENIX® and MS® are trademarks of Microsoft Corporation. MS® OS/2 and MS® Windows/386 are products of Microsoft Corporation. Product names mentioned herein may be trademarks and/or registered trademarks of their respective companies. *Registered U.S. Patent and Trademark Office. COMPAQ DESKPRO 386/25 graphics ©1988 Accent Software, Inc. ©1988 Compaq Computer Corporation. All rights reserved.

*Hereafter referred to as 80386SX, 80386 and 80387 respectively.

COMPAQ

It simply works better.

Behind the News

PHARMACEUTICALS INDUSTRY

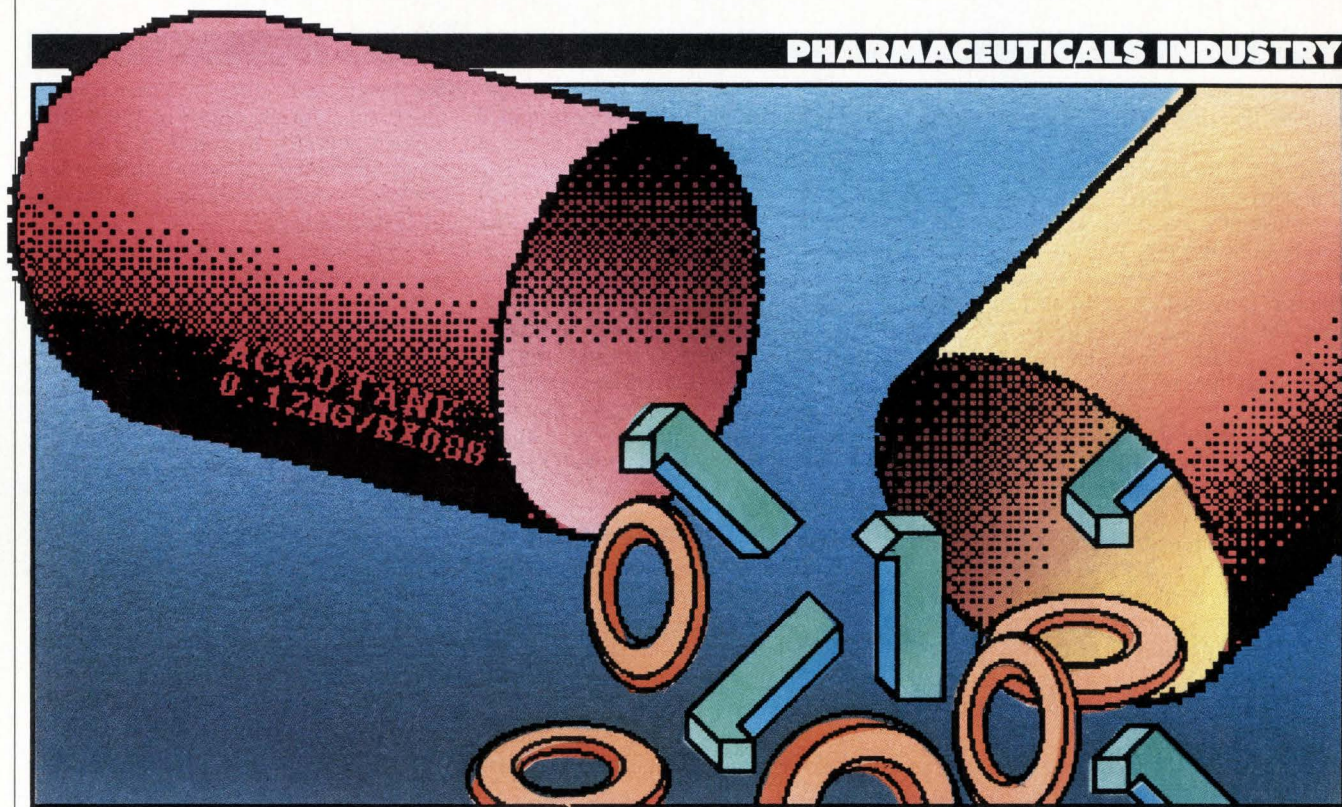

IS: the Best Medicine For Drug Monitoring

Pharmaceutical manufacturers and the FDA are turning to drug databases to spot dangerous side effects and to speed the approval of new drugs.

BY SUSAN KERR

On average, each American this year will come into contact with three prescription drugs. Add to that the countless over-the-counter substances, such as aspirin and alcohol, plus the roster of illegal drugs, and a maze of harmful—sometimes deadly—interactions can result.

"No drug is without side effects," says Janet Arrowsmith, an epidemiologist with the Food and Drug Administration. Drugs are designed to cause reactions. It's when a reaction is unexpected that Arrowsmith and others become concerned.

Such was the response this past April when it was brought to public attention that Accutane, the acne medicine manufactured by Hoffmann-La Roche Inc., based in Nutley, N.J., was related to 62 documented cases of severe birth defects.

The task of monitoring such drugs is assuming monumental proportions. Approximately 55,000 adverse reaction reports will be filed with the FDA this year, 50% more than were filed some two to three years ago.

Building Databases To Track Problems

Catching problems before a pharmaceutical is mass marketed—or even afterward—is a big task for agencies charged with protecting public health and for manufacturers who fear liability claims that conceivably could destroy their companies. To help with this task, many varieties of computer technology increasingly are being applied at hospitals, pharmacies, insurance companies, government agencies, and drug companies to facilitate access to medical databases that are vital to lives and company reputations.

The sooner problems are diag-

nosed, the sooner drugs can be re-labeled, withdrawn, or cleared of alleged ill effects. While a drug rarely is pulled from the market, a couple of times a month the FDA does re-label drugs to list new precautions and usage instructions.

The hope behind the use of these new systems is that public safety will be improved and that the slow and cumbersome government approval process all drugs must undergo before they can be marketed will be shortened considerably.

It's still too early to conclude that the systems now being implemented will address these safety and time issues successfully, but there is strong evidence indicating that they may. As is true of most systems development, however, a few hurdles, such as a lack of standardization, still must be cleared.

Probably the most significant system to attempt to meet those goals is an information technology exchange experiment called CANDAs (computer assisted new drug applications) now under way between the FDA and major pharmaceutical makers. Another system to make side effect information readily available is being designed in Rhode Island. There, an experiment is under way that potentially could chronicle residents' medical histories from cradle to grave—every visit to the drug store or the hospital, and ev-

Behind the News

ery claim filed with Blue Cross/Blue Shield. The project is an attempt to see how effective prescription drugs are and how they interact when used in conjunction with each other.

Roughly 7% of all hospitalizations are related directly to drug-induced illnesses (see "Preventing Drug-Induced Illness"), according to Health Information Designs Inc., Arlington, Va. The firm accesses Medicaid and private health care files on 9 million Americans in order to review drug effects and efficacy. One example of HID's work is its current effort to determine if a link exists between multiphasic birth control pills and ovarian cysts.

The Rhode Island group, Health Data Resources Inc., was called in by Smith-Kline Beckman Corp., Philadelphia, to clear up concerns that its Tagamet antiulcer drug was related to the oc-

currence of adverse side effects, including stomach cancer. It was determined that there was insufficient evidence to warrant pulling Tagamet from the market.

On the flip side, an example of FDA database detection that did turn up conclusive, negative results is Supofren. This drug from McNeil Pharmaceutical, North Wales, Pa., eventually was withdrawn from the market because reports linked it to severe flank pain symptoms. FDA database activities turned up inconclusive evidence linking New York-based Pfizer Inc.'s Feldene with gastrointestinal bleeding.

The Reasons for Increased Monitoring

That drug monitoring has become critical is partly due to more stringent FDA guidelines. Another theory that is popular, if less provable, is that as people

live longer they come into contact with more substances. Many of those substances, dubbed by some as designer drugs, are being created with the help of advanced computer aided molecular modeling tools.

"As science gets more sophisticated, you know there are more things to look at, and you start to see more of the interaction of this drug and that drug," says Bob Bell, director of the office of management at the FDA's Center for Drug Evaluation and Research. "The world is more complicated," he says. Unfortunately, while the number of complications is rising, the FDA budget isn't.

To bypass its budget crunch, the FDA is using computer equipment loaned by pharmaceutical manufacturers to permit on-line access into the companies' research databases, which include data on clinical trials or premarketing trials involving humans. A dozen companies are participating in this experiment in the hope that it will cut down the average two-year review process for new drug applications (NDAs). Without FDA approval, companies cannot legally market their products in the U.S.

While the FDA is searching for ways to cope better with its increasing workload, there is another element. An FDA reviewer's worst fear is that he or she will fail to spot a problem before a drug is approved for general circulation. Being allowed to manipulate data on-line, rather than being restrained by paperwork, should help reduce that risk.

Financial Motive for Using Computers

Much of the motive, however, is financial. By the time a drug receives the FDA seal of approval, its manufacturer probably has spent upwards of \$125 million and 10 years in development. Two of those 10 years are spent in the NDA cycle, when federal researchers review massive amounts of data compiled by the manufacturers. In a market as competitive and as lucrative as the pharmaceutical industry, two years is a long time. Added to the companies' profit motives is the fact that there are people who could benefit from the use of these new drugs.

Today, most NDAs are paper volumes, which the FDA must sift through and, in some cases, re-key into its computers. William Passas, Hoffmann-La Roche Inc. research systems and technology director, estimates that an upcoming drug from the company will re-

Preventing Drug-Induced Illness

Computers could turn out to be the ultimate weapon in solving the case of the \$10 prescription that led to a \$10,000 hospitalization bill.

Roughly 7% of all U.S. hospital visits are believed to be associated with the misuse of pharmaceutical drugs. The cost of these hospital stays amounts to over \$5 billion a year, with another \$2.7 billion spent annually on outpatient care to treat the adverse effects of drugs.

These are just numbers, however. They don't do justice to the associated suffering that some people undergo. Drugs are intended to make you better, but sometimes the treatment is worse than the disease.

Such was the case of a relatively healthy 46-year-old woman with what was termed mild hypertension. She turned to prescription drugs and ended up with a peptic ulcer and depression.

Initially, the woman was prescribed an anti-hypertensive medication containing an ingredient with the potential to cause ulcers and depression. Four months later, she was diagnosed with anxiety and was prescribed an anti-anxiety agent. For the next three months, still using both drugs, she had gastritis/duodenitis (GI) complaints.

She was prescribed a drug to treat the GI conditions, which were later diagnosed as being the results of a peptic ulcer. So, added to her medicine cabinet were antiulcer drugs. Needless to say, her anxiety became worse, and she was diagnosed with a depressive disorder.

Given the increasing number of drugs on the market, cases such as this could become common. But one company, Health Information Designs Inc. (HID), Arlington, Va., is using its DURbase computerized drug utilization review system to help private corporations, insurance companies, and others catch potential drug-induced illnesses before they get out of hand.

With DURbase, individual patient histories are continuously updated from health care claims data. The computer generates a patient profile whenever it finds that a preestablished risk threshold is exceeded. Physicians and pharmacists confirm the clinical relevancy of the data. A warning letter is then automatically sent to the patient's doctor or pharmacist.

The reason that major corporations, such as General Motors Corp. or McDonnell Douglas, are willing to subscribe to DURbase is that while drugs are cheap, health care isn't. HID cites one study in which DURbase found that almost half of the diabetics working at a company it prefers not to name also were on drugs that raised blood sugar levels.

FOCUS is the only fourth-generation language with anywhere near that many users. And that makes us the number one 4GL on mainframes, minis, and micros.

Why? Because FOCUS does what a 4GL is supposed to do. And if you're skeptical, make us prove it.

Just give us a call and we'll come to your place, install FOCUS, and create a prototype application that (and here's the trick) runs against your production database. Or, if you prefer, against FOCUS' own shared-relational database manager.

Either way, we'll do it in four hours. At no charge.

What's more, we'll write the entire application in the FOCUS language—with no exits to COBOL, FORTRAN, or C for the hard parts.

FOCUS is such a complete language you can use it to write almost any application—from heavy-duty transaction systems to any type of online inquiry system.

Moreover, FOCUS can directly access every major database system running on every major hardware platform.

We're talking about online access here, not merely batch data extracts. And FOCUS will address multiple databases simultaneously, and perform outer joins.

We'll take that a step further. If two computers communicate, a FOCUS user on one

can, via FOCUS on the second machine, access any major database running there.

FOCUS supports IBM 370, PC and PS/2, VAX/VMS, UNIX V, Wang VS and others.

With, we might add, full portability. An application developed in any of these environments will immediately execute in any other.

That means, for example, that you can use a PC as a workbench for mainframe application development.

SQL compatibility? However you need it, FOCUS can do it.

There's more. Developers' Windows let your professional programmers use a windowed interface to create

window-driven applications quickly and easily. The result is great-looking software with a superior user interface.

TableTalk is the FOCUS point-and-pick windowed interface that lets your end users create their own inquiries, customized reports, or even rela-

tively complex applications—using only the arrow keys and the enter key.

And FOCUS lets you set the security and access levels you want.

Sound too good to be true? It's not. But don't believe

this ad. Make us prove it. Just call 1-212-736-4433, Ext. 3700, and ask for details. And if you give the word, one of our technicians will come out to your place and make it happen.

Right before your eyes.

400,000 USERS CAN'T BE WRONG.

Who says we're number one?

"Information Builders' 4GL products were, once again, the only ones to lead in their niche in mainframes, minis, and micros. No other vendor has duplicated this feat in the seven-year history of this research effort."

—Software Magazine 1988 Software Market Survey



Behind the News

sult in an NDA of 600 volumes, each 350 pages thick. The company will probably ship it to the FDA in a trailer truck.

An NDA includes clinical trial, statistical, chemical, and biopharmaceutical data. So far, the CANDAs pilots involve just the first two types of data.

Only one drug, Hytrin, from Abbott Laboratories, North Chicago, has made it through the CANDA process. Thus, it's too early to say what impact computerization eventually may have on the system. "We're on the very steep part of a learning curve," says Carol Grundfest, manager for scientific services for the Pharmaceutical Manufacturers Association. The PMA hopes to provide guidance on CANDA, but Grundfest points out current roadblocks, including a lack of computer standards and the need to train some FDA medical reviewers in the ways of computers.

There are obvious benefits once that learning curve has been completed. Under the current process, the reviewer either calls or writes the drug manufacturer if he or she wants to arrange the data differently or needs more detailed medical files on clinical trial participants. A couple of weeks later, the reformatted information is mailed back. By then, the reviewer might be working on a different project or perhaps even has forgotten just what he or she was after in the first place.

"CANDA would cut that dead time," says Bell. "I see that time collapsed to zero."

Efficiency Is the Buzzword

Efficiency is the buzzword behind CANDA. Since the drug company already has the information in its database, it seems illogical to print it out and ship it to the FDA, where it may even have to be rekeyed.

Syntex Corp., a pharmaceuticals company based in Palo Alto, keeps NDA information on an IDMS database. Within the last year, Syntex decided to supply IBM PCs to the FDA to allow remote access to its information. Mark Noguchi, Syntex manager for corporate systems IS development, believes that the process works, but he cites potential problems. For starters, each company has its own—and typically different—choice of computer equipment. ICI, Wilmington, Del., for example, just submitted the first NDA based on optical technology.

"What happens if the medical reviewer works with five different firms

and five different terminals? Those problems will crop up," says Noguchi.

They will, agrees Bell of the FDA, but they haven't yet. Nor does he think that the FDA has the authority or expertise to set a standard computer mechanism for CANDA. "I hope for a de facto standard," Bell says.

De facto is about all it will be. "As a general rule, we tend not to like standards since all companies have different ways of doing things," explains PMA's Grundfest. "When we have enough experience to synthesize, we will come up with guidance, but not a guideline, about what seems to work better." That time is a long way off, she adds, because the manufacturers are at odds. John Parker,



ACCESSIBILITY TO THE END USER IS IMPORTANT.

vp of information resources for Squibb Corp., Princeton, N.J., points out that "there are no standards within companies on how to handle clinical data. The success of commercial packages here has been noticeably absent, and research organizations are substantially different from company to company. You tend to mirror that difference in your system."

Squibb will be filing six NDAs in the near future, the result of a "massive ramp-up of drugs," Parker says. Squibb has made a substantial investment in hardware and personnel and has experimented in computer projects, such as putting terminals in the offices of doctors involved in clinical trials.

There's a lot of hope for CANDA, but one inescapable problem is that clinical trial information is limited. Typically, participants do not include children, the elderly, or women of child-bearing age.

Syntex is now preparing an NDA for Ticlopidine, which Syntex believes prevents strokes. It has been tested on 5,000 patients over the last five years. Even with that length of time, latent reactions may not yet have appeared. Computers are helpful in discerning drug interactions during the drug design phase

and clinical trials, but a drug sometimes has to become widely used before reactions will show up. Thus, "our lives are our computers," says the FDA's Arrowsmith.

Sources of Surveillance Activity

The post-marketing surveillance activities at the FDA are computer intensive, but they don't rely strictly on adverse reaction reports filed by manufacturers. For example, the FDA, HID, and several university medical schools spearheaded a study assessing the relative rate of upper gastrointestinal tract bleeding associated with nonsteroidal anti-inflammatory drugs. They used billing data from Medicaid patients in Michigan and Minnesota. From a base of 100,124 patients who used these drugs and who fit other criteria, they were able to determine that the rate of bleeding differed among seven drugs. They related that result to each drug's dosage levels. Also, they discovered a definite, negative interaction between alcohol and drugs.

The manufacturers do their own checking, too, since their reputations are on the line. "Clinical trial and adverse reaction reports are some of the most competitive areas in the business," says one pharmaceutical firm's MIS executive.

The IS tools that drug makers use vary, although relational database technology is definitely coming into vogue. Hoffmann-La Roche plans to move to an Oracle Corp. database system, which will reside on its Digital Equipment Corp. minicomputers. Syntex built its own system called DER, or Drug Experience Reporting, and runs it on an IBM 3081. Squibb uses a number of different database technologies throughout the company, including DB2 and Oracle, and will move clinical data onto a not-yet-designated SQL-based database system to tie together different hardware platforms.

"What's important is the accessibility to the end user," says Noguchi. "You don't have to ask a programmer any more to generate a report. With the 4GLs, it's much easier."

Granting investigators easy access to as much data as possible is crucial. Part of what's useful is the ability to integrate different clinical studies, says Squibb's Parker; the larger the sampling, the better. There may be no way of knowing whether a patient who was prescribed a drug actually took it or whether he or she smokes or drinks. So, the bigger the database, the easier it is to estab-



EVERY HAYES MODEM MUST SURVIVE 8 HOURS OF TORTURE ON THE RACK.

The Rack. It's 8 straight hours of burn-in testing. Yet only one of many trials every Hayes modem must go through before it's packed and shipped.

In all, there are over 20 tests and inspections for quality and reliability. Thus allowing us to offer the most comprehensive performance warranty in the business.

Today, while all too many manufacturers are content to perform only the most perfunctory tests on their products and then only on a random

basis, we believe in testing all of our modems. With no exceptions.

At Hayes we've been making dial-up data communications as common and as reliable as ordinary phone calls for over a decade. Whether PC-to-PC, PC-to-Host or PC-to-LAN, Hayes has set the standards.



And we intend to let nothing lower those standards. Especially one of our own modems.

For your nearest Hayes dealer, call 800-635-1225. Hayes Microcomputer Products, Inc., P.O. Box 105203, Atlanta, GA 30348.
© 1988 Hayes Microcomputer Products, Inc.

Hayes[®]

Circle 20 on Reader Card

Behind the News

lish a cause-and-effect relationship.

Because large databases are so important, seven pharmaceutical manufacturers, including Smith-Kline, Merck, and Sterling Drugs, each have paid \$50,000 to Health Data Resources to get access to this type of general population

information. "We abstract every hospitalization in Rhode Island, or 130,000 visits a year," says John Norton, president of Providence-based Health Data Resources. Part owner of the group is Rhode Island Blue Cross/Blue Shield, which will input its records into the data-

base. By the year's end, the database should consist of 90% of all retail drug prescriptions and 80% of all hospital discharges in the state.

While no patient names will be kept in the public database and pharmaceutical companies won't be able to check marketing information, such as which doctor prescribed their drugs the most, the hope is that this large amount of data will present new correlations between drugs and certain health conditions.

One new source of information is drugs prescribed within hospitals. John Pezzullo, director of the Center for Information Technology at the Rhode Island

"... Joiner Associates (Jnet[®]) has quietly created a viable, tactical approach to IBM-DEC host connectivity."

"The Joiner (Jnet[®]) approach will satisfy many mainstream user needs for file transfer, printing and job submissions among DEC, IBM, and other processors without major commitments in expenditures, re-education and program development."

George J. Weiss
Program Director
November 20, 1987



GARTNER GROUP, INC.

**TOO EARLY
TO SAY IF IS
WILL RELIEVE
PROBLEMS.**

Hospital, notes that the 719-bed institution recently began to put into its IDMS database the drugs a patient takes as well as details such as dosage. Previously, they kept only billing information. "As drugs get more complex, as the population ages, and as diseases get more complicated, you need new ways to monitor these activities," Health Data Resources' Norton says.

A Label Can't Prevent Misuse

One sad truth is that even if a drug is known to have adverse reactions, a label can't stop its misuse. Hoffmann-La Roche's Accutane was labeled with warnings of its potential to cause birth defects. Now, the FDA is exploring stiffer curbs on the medication's use—six years after Accutane's appearance on the market. No final decision had been reached as of press time, but two possibilities are a stronger label on the package or the requirement that users sign a release form before being given the prescription.

"If you follow the rules, to a certain extent, you're protected by the process," says Squibb's Parker. "Everybody would like to be 100% safe all the time, but if you do that you would never develop a new pharmaceutical. We try to make the process as safe as possible." ■

We couldn't have said it better.

Jnet[®]

Joiner Associates Inc. 3800 Regent Street, P.O. Box 5445, Madison, WI 53705-0445 USA 608-238-8637

Jnet is a registered trademark of Joiner Associates Inc.

The COBOL systems you want to develop may be the systems you already have.

Take a good look at the new systems development requests piling up in your shop and you'll see something interesting. What many users are really asking for aren't "new" systems; they're enhanced versions of your existing systems.

Why do they want enhancements? Because existing systems remain crucial to the day-to-day workings of your company, regardless of how error-prone and difficult to maintain they become.

Yet, inside every old program, beneath the bug fixes and layers of chaotic code, well-written elements of the original design wait to be discovered. Imagine how productive your shop would be if you could systematically reach inside, extract those fundamental design concepts and build upon them.

Maintenance and enhancement would be simplified. And you could use those elements in new development, reducing the time, effort and risk involved.

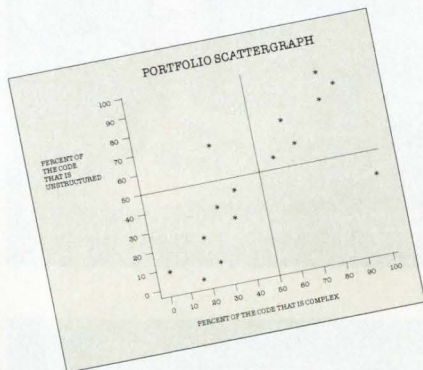

At a glance, the Portfolio Scattergraph can reveal the comparative quality of every system in your software portfolio.

These are the benefits you'll realize with re-engineering tools from Language Technology.

Our products apply Computer Aided Software Engineering (CASE) to the work that dominates the average mainframe shop: maintaining and enhancing existing systems.

RECODER is the leading re-engineering tool today. It can turn any program – no matter how complex and hard to comprehend – into a structured version that you can understand and maintain more easily.

INSPECTOR is the only COBOL quality assurance tool that uses industry standard measurements to objectively evaluate code. You can also customize INSPECTOR to measure any standards you want to create.

At Mellon Bank, Shell Oil, The Hartford Group, Ford and more Fortune

```

BEFORE
004700 IF NOT (RUN-DATE = TODAY OR RUN-DATE = LAST-BACKUP
004800 OR MINIMUM-RUN AND - MAXIMUM-RUN OR SHIP-DATE >
005000 MINIMUM-RUN AND ORDER-DATE)
005100 THEN PERFORM DONT-SHIP-IT
005200 ELSE PERFORM SHIP-IT
005300

AFTER
001040 IF RUN-DATE = TODAY OR
001050 RUN-DATE = LAST-BACKUP
001060 PERFORM SHIP-IT
001070 ELSE
001080 IF RUN-DATE = MINIMUM-RUN AND
001090 RUN-DATE = MAXIMUM-RUN
001100 PERFORM SHIP-IT
001110 ELSE
001120 IF SHIP-DATE = MINIMUM-RUN AND
001130 SHIP-DATE = ORDER-DATE
001140 PERFORM SHIP-IT
001150 ELSE
001160 PERFORM DONT-SHIP-IT
    
```

After software re-engineering, users achieve a 20-50% increase in programmer productivity. They also see fundamental design concepts that were previously hidden.

500 companies, Language Technology tools boost programmer productivity and enhance the quality of existing systems every day.

If you spend 50% or more of your programming dollar maintaining and enhancing existing systems, re-engineering tools from Language Technology will be a cost-effective weapon in your CASE tool kit.

Our Re-engineering Information Package details the facts and substantial rewards of this comprehensive strategy. Our Software Portfolio Analysis will clearly illustrate specific areas where you'll save time and money by applying re-engineering techniques to your existing COBOL systems. Both are free.

Don't wait for maintenance and enhancement efforts to overwhelm you. Return the coupon or call Language Technology, toll-free, 1-800-RECODER (in MA, call collect, 617-741-1507).

ALL PROGRAMS	PERCENT OF THE CODE THAT IS UNSTRUCTURED	OVERVIEW TABLE 1		ADVANT. FAILURES	PROCESSOR OVERLAPS	MCVARS STRUCTURE
		NUMBER OF PAGES	NUMBER OF PAGES			
ADDRESSAGE ORIGINAL	87	268	146	4	0	104
ADDRESSAGE STRUCTURED	0	20	0	0	0	0
BASE ORIGINAL	87	49	0	0	0	0
BASE STRUCTURED	0	0	0	0	0	0
INSURANCE ORIGINAL	94	110	60	0	0	0
INSURANCE STRUCTURED	0	0	0	0	0	0
PROCS ORIGINAL	85	600	333	0	0	206
PROCS STRUCTURED	0	0	0	0	0	0

ALL PROGRAMS	PERCENT OF THE CODE THAT IS COMPLEX	OVERVIEW TABLE 2		STATEMENTS	LINES
		NUMBER OF PAGES	NUMBER OF PAGES		
ADDRESSAGE ORIGINAL	87	268	146	2048	9001
ADDRESSAGE STRUCTURED	0	20	0	108	891
BASE ORIGINAL	87	49	0	407	1284
BASE STRUCTURED	0	0	0	0	0
INSURANCE ORIGINAL	94	110	60	758	1500
INSURANCE STRUCTURED	0	0	0	0	0
PROCS ORIGINAL	85	600	333	8460	3204
PROCS STRUCTURED	0	0	0	0	0

The Program Overview Table helps programming managers target the programs which will benefit most – in terms of enhanced code quality and greater efficiency – from re-engineering.

The CASE for re-engineering

LANGUAGE TECHNOLOGY

Show me how re-engineering will simplify maintenance and enhancement while saving me time and money.

Send your free Information Package.

Tell me more about the Free Software Portfolio Analysis.

Please contact me as soon as possible.

Name _____
 Company _____
 Address _____
 City _____ Phone _____

State _____

Zip _____

Language Technology
 27 Congress Street
 Salem, MA 01970
 1-800-RECODER

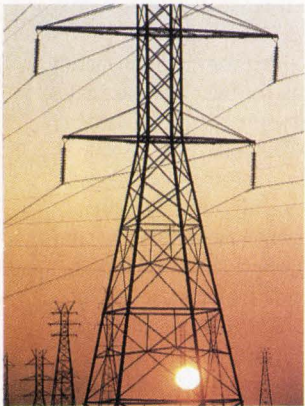
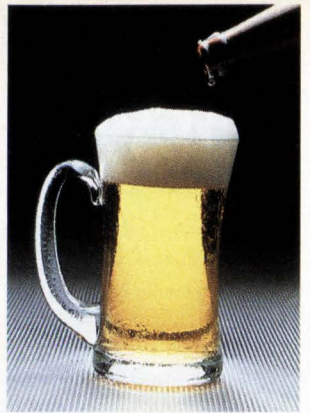
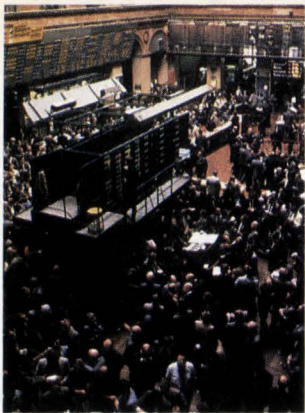

Who makes modems for all lines of business?

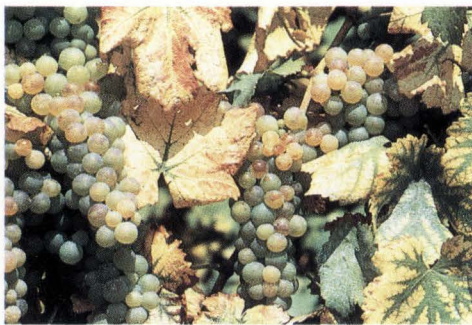

You may well recognize your line of business here. And even if you don't, it's almost certain that Nokia has just the modem for your business communication needs.

But what if your needs require a special data communications solution not found in our range of fifty standard modem types? Then we put our heads together and come up with one that does. As we did for the West German railway. And for the farming business in Denmark.

This approach has seen us grow from a mere modems manufacturer into a full-service supplier of dedicated modems. High-quality modems for all lines

of business. And that's important when, in these days of mass production and compromise, you want equipment to meet your specific data communications needs.

And one thing more. You can be certain that Nokia modems are compatible with your computer environment.

NOKIA
Data Communications

P.O.Box 780 SF-00101 Helsinki, Finland
Phone +358 0 5671, Telex/teletex 1000627, Fax +358 0 5673722

T

he year 1987 likely will signify the end of '80s-style computing in Europe. During its frantic 12 months there were a number of key shifts in information systems development and purchasing that set the scene for the New Age of IS, which will dominate the next decade.

Features from 1987 that will become the foundations for European IS include open systems, international standards for networks and operating systems, flexible purchasing options, and an emphasis on competitive edge end-user applications. The year also saw trading barriers within the traditionally fragmented European market breaking down, a stronger presence for European IS vendors, and desperate attempts by IBM to halt its market share losses.

Yet, despite the fundamental changes these trends represent, in financial terms, the European IS business remained strong and steady last year. The

THE
EUROPEAN
25

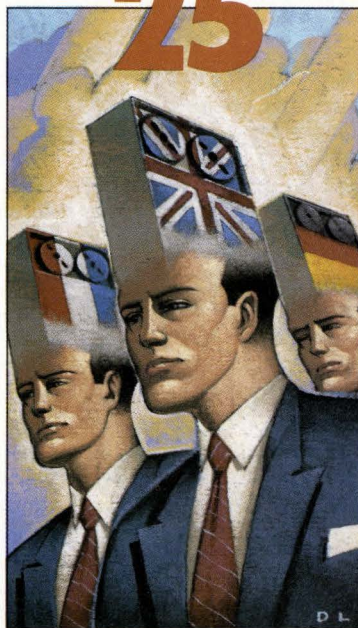

Market Close-up

SMASHING THE \$50B BARRIER

European IS vendors approach 1992 at breakneck speed as open systems and standards become widespread. The top 25's revenues grew 26.5% in '87.

dollar's nosedive in international currency markets toward the end of the year and the continuing growth in European revenues for the major IS firms helped the DATAMATION European 25 companies—the top IS money-makers in Europe—smash through the \$50 billion barrier for the first time.

Total Revenues up 26.5% Over 1986

Total revenues for the DATAMATION European 25 firms amounted to \$56.3 billion during 1987—up by a massive 26.5% over 1986. Around 14% of that rise can be accounted for by the weak dollar and the difference in exchange rates between 1986 and 1987, but even when the growth rate is adjusted to take account of the dollar's slide, it still leaves a healthy 12% growth in real revenues among the top companies.

In a market valued at \$86 billion by industry research firm International Data Corp., Framingham, Mass., those sales accounted for 65.5% of the total European expenditure on information sys-

tems in 1987. The companies that benefited the most from that market growth were pc makers, leasing firms, midrange suppliers, and plug-compatible manufacturers. The two companies that suffered most were Groupe Bull, which had a hard time in its home market in France, and IBM, which had an even harder time in virtually every one of its major markets when its performance is measured in local currencies.

Big Blue has lost massive amounts of market share in the European market over the last few years. It accounted for only 32.5% of the total revenues of the DATAMATION European 25 last year, down from 35.3% in 1986, and a long way from its heady shares of the mid-1980s—42% in 1984, and 39% in 1985.

In 1986, IBM's largest international subsidiary, in West Germany, was off by almost 13% in market share. In 1987, the West German company was down another 3.5%. In two of IBM's other major European markets, France and the U.K., the company's revenues were below the

1986 level. In the Netherlands, IBM suffered another massive drop in business, down 18.2% in 1987 following an 8.1% fall in 1986. The only bright star in IBM's European firmament last year was Italy, up by a healthy 13.5% (see "IBM Europe's Major Markets").

Despite the poor performance in Europe in actual accounting currencies, IBM's business in the Old World is still a major area of growth when measured in dollars. Its European revenues showed a total increase of 16.8% in dollars because of the favorable exchange rates. That, in turn, helped IBM Corp. report an overall increase in worldwide revenues and profits for 1987. In contrast to the 16.8% increase in Europe, IBM reported a 4% drop in the proportion of its revenues coming from the U.S.

Europe Is Source of Strongest Growth

In fact, markets outside the U.S. are where growth is strongest for most of the companies in the DATAMATION European 25. A look at U.S. IS revenues as a

The DATAMATION European 25

1987 RANK	1986 RANK	COMPANY	HEAD-QUARTERS	1987 EUR IS REV	% CHG \$ U.S.	% CHG IN AAC	TOTAL IS REV	% CHG \$U.S.
1	1	IBM	U.S.	\$18,332.5	16.8	16.8	\$50,485.7	5.9
2	2	Siemens AG	W. Germany	4,961.6	28.5	6.4	5,703.0	30.1
3	4	Ing. C. Olivetti & Co. SpA	Italy	3,802.5	29.3*	12.4	4,637.2	19.8
4	3	Digital Equipment Corp.	U.S.	3,533.0	27.2	27.2	10,391.3	23.5
5	7	Nixdorf Computer AG	W. Germany	2,652.2	38.9	15.1	2,821.5	36.1
6	5	Groupe Bull	France	2,345.8	(2.8)	(15.7)	3,007.5	17.1
7	6	Unisys Corp.	U.S.	2,272.9	15.7*	15.7	8,742.0	6.8
8	8	NV Philips Gloeilampenfabrieken	Netherlands	2,055.2	20.1*	(0.7)	2,601.6	32.2
9	9	Hewlett-Packard Co.	U.S.	1,800.0	21.2	21.2	5,000.0	11.1
10	10	STC plc	U.K.	1,720.4	20.9	8.8	2,123.9	21.3
11	11	NCR Corp.	U.S.	1,583.6	29.2	29.2	5,075.7	15.7
12	12	LM Ericsson	Sweden	1,284.9	7.4	(4.4)	1,511.6	12.5
13	—	Alcatel NV	France	1,272.3	NA	NA	2,052.1	20.9
14	—	Inspectorate Intl. Ltd.	Switzerland	1,033.0	NA	NA	1,225.0	NA
15	—	Société Générale	France	970.1	44.2	25.0	970.1	44.2
16	20	Atlantic Computers plc	U.K.	892.7	125.5	276.4	959.7	123.4
17	14	Honeywell Bull	U.S.	885.4	26.6	26.6	2,059.0	8.9
18	—	Memorex Intl.	Netherlands	832.9	NA	NA	1,041.1	NA
19	15	Wang Laboratories Inc.	U.S.	822.3	40.0	40.0	3,045.7	14.1
20	18	Mannesmann AG	W. Germany	617.0	38.7	14.9	686.0	40.4
21	22	Apple Computer Inc.	U.S.	547.4	68.4	68.4	3,041.2	49.7
22	24	Cap Gemini Sogeti	France	545.8	85.7	61.0	682.3	62.4
23	—	Econocom Intl. BV	Netherlands	525.9	51.0	25.0	674.3	54.9
24	—	Amstrad plc	U.K.	501.0	101.0	80.1	533.0	94.5
25	—	Amdahl Corp.	U.S.	493.1	81.9	81.9	1,505.2	55.8

All currency figures are in millions. NA = Not Available *1986 numbers were restated.

THE EUROPEAN 25

percentage of total IS revenues and the consequent percentage change over the previous year (see "The DATAMATION European 25") reveals that less of these firms' revenues are coming from the U.S. For example, the U.S. proportion of Cap Gemini's revenues is down 10%, Olivetti's is down 6%, mostly due to its partner AT&T overstocking Olivetti pcs the year before, Unisys's is down 7% in the U.S., and DEC's is down 5%.

This means that future competition among the major vendors for a slice of the European action will be even more cutthroat, and especially harder for U.S. companies. In the 1987 ranking, nine of the DATAMATION European 25 firms are from the U.S., compared with 11 in 1986 and 12 in 1985. The 16 European companies from eight European countries in the latest survey account for 46% of the top 25's revenues—up from 41% in 1986 and 36.6% in 1985. European companies are clearly increasing their strength in their local markets.

What's more, the combined world-

wide revenues of the top 25 European-owned companies (see "The 25 Leading European-Based IS Companies") rose to \$33.2 billion last year—an awesome increase of 42% over the previous year.

The rise in the threshold for entry into the top 25 is one of the most significant changes in this year's survey. In 1986, that threshold was \$283 million—this time Amdahl holds the 25th position with \$493 million. That raging increase results from two things: the low dollar exchange rate, which once again inflates the revenue figures over 1986; and the entry of seven new names to the list, a result of European merger mania and some real revenue growth among these firms last year.

Seven New Firms Among the Top 25

Among the seven new firms are Alcatel and Memorex, which both existed as other entities before. Alcatel is the result of the merging of ITT's European business and the communications and dp interests of the French CGE group. Me-

morex International, meanwhile, was the result of a buy-out by European management from the merged Burroughs and Sperry company Unisys. But 1987 will go down as its only year as an independent company. In January, it merged with the U.S. Telex organization.

There are three new leasing companies in this year's ranking—an indication of the growing strength of the European leasing community as buyers search for more flexible methods to obtain the equipment they need to stay competitive. The firms—Inspectorate International, based in Switzerland; the French group Europe Computer Systems, which is owned by French bank Société Générale; and Netherlands-based Econocom International—have burst onto the scene riding the crest of this European leasing boom. It is now estimated that almost a third of all large systems acquired by European companies are financed on a leasing basis.

The other two new firms on the table have won their places on the back of IBM technologies. U.K. PC-clone maker Amstrad plc has become Europe's fastest-growing pc company, with IS revenues up by 80% in Europe last year. It dominates the U.K. market for pc shipments and gets the rest of its European revenues mainly from France, Italy, and Spain. Pcm Amdahl Corp., with its European revenues up by 82% in '87, is also a new entry. Since Amdahl offered better price/performance than IBM for almost all its product range, last year it was able to convince a lot of European users to switch to the pcm option.

In many ways, the success of Amdahl in Europe during 1987 is one of the reasons for IBM's poor fortunes, and there is no indication that this trend will ease up. IBM is going to have to become much more aggressive in its marketing if it is to manage to hold on to its already depleted mainframe market in Europe.

DEC Continues To Dominate the Midrange

As IBM is suffering, DEC is having a ball in Europe. With revenues up by 27.2% in 1987, it continues to dominate the European midrange market, despite the strong performance of companies lower down the list, such as Nixdorf of West Germany and Hewlett-Packard.

Even so, DEC has dropped from third place to fourth on this year's table because of a slightly higher growth rate from Italy's Olivetti. The Italian company didn't have a great year for sales, but the inclusion of the European revenues of its West German office equipment

% CHG IN AAC	EUR IS REV AS % OF TOT IS REV	% CHG	US IS REV AS % OF TOT IS REV	% CHG	NET INCOME	1987 EMPLS	FISCAL YEAR END
5.9	36	3	46	(4)	5,258.0	389,384	Dec.
7.7	87	(1)	81	(2)	1,709.4	359,000	Sept.
4.2	82	6	9	(6)	310.0	58,087	Dec.
23.5	34	1	51	(5)	1,284.3	116,800	June
12.6	94	2	NA	NA	146.9	29,440	Dec.
1.5	78	(16)	5	0	37.5	26,337	Dec.
6.8	26	2	56	(7)	578.0	92,500	Dec.
9.3	79	(8)	14	0	403.8	336,700	Dec.
11.1	36	3	51	(2)	644.0	82,000	Oct.
8.8	81	0	NA	NA	221.1	33,860	Dec.
15.7	31	3	45	(4)	419.3	62,000	Dec.
.1	85	(4)	5	NA	115.9	70,893	Dec.
2.9	62	NA	31	NA	398.9	137,000	Dec.
NA	84	NA	15	NA	NA	7,698	Dec.
25.0	100	0	0	0	NA	NA	Dec.
100.3	93	1	5	(3)	42.3	1,134	Dec.
8.9	43	6	53	(2)	17.4	20,500	Dec.
NA	80	NA	20	NA	47.0	14,106	Nov.
14.1	27	5	60	(4)	94.5	30,855	June
16.2	90	(1)	8	5	NA	9,457	Dec.
49.7	18	2	72	(2)	280.5	7,927	Sept.
40.9	80	10	20	(10)	44.3	10,600	Dec.
28.1	78	(2)	20	2	NA	1,600	Dec.
74.4	94	3	3	(3)	172.7	1,009	June
55.8	33	5	63	(1)	146.0	7,600	Dec.

Source: DATAMATION

SIEMENS

The MX 300 is Siemens' state-of-the-art SINIX Computer.

The MX 300 is the new SINIX^{®*} multistation computer designed with teamwork in mind. It is capable of supporting up to 12 workstations which makes it the natural choice for departments and branch offices of large companies and the ideal solution to a variety of tasks in medium-size businesses.

The MX 300 is truly impressive – both inside and out. Its elegant slimline tower looks so good it seems a shame to hide it under a desk.

And inside, it has a certain quality that speaks for itself. It is so powerful and fast that each of the 12 users will think he has the computer entirely to himself.

For all this it is stunningly simple to use, offering windows, mouse control and graphics at eight workstations. The MX 300 can be tailored to suit your individual requirements in terms of the number of screens and printers, the size of main memory and the capacity of the hard disk. If ever your needs grow the MX 300 can grow with them.

And let's not forget all the other SINIX computers with their new levels of performance, such as the new X20 single-station system with its super high-speed processor, and the flagship model, the MX 500, which can now support 64 workstations – twice as many as before.

Find out more from Europe's No. 1 in UNIX computers: Siemens AG, Infoservice 134/Z388 P.O.B. 23 48, D-8510 Fürth, Federal Republic of Germany.

Siemens is Europe's No. 1 in UNIX.



A19100-D-Z208-X-7600

*SINIX is the Siemens version of UNIX. UNIX is a registered trademark of AT&T (Bell Laboratories).

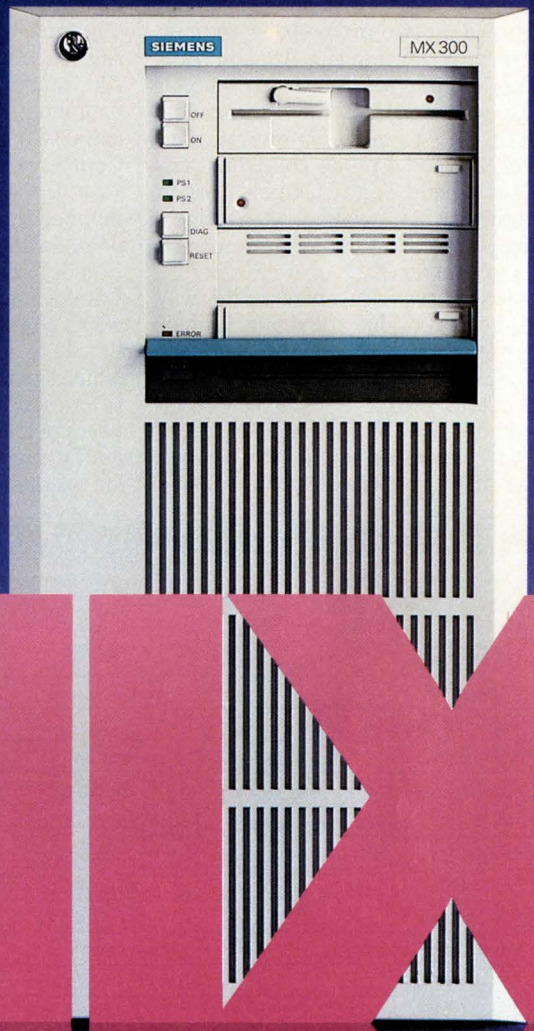

SINIX

subsidiary Triumph Adler helped it record a 29.3% increase, pushing it up to the coveted number three position behind IBM and Siemens.

Tracking the Ups and Downs

Four other companies rose in the 1987 rankings. West Germany's Nixdorf continued its rapid expansion of business and moved up two more places to number five. U.K. leasing star Atlantic rocketed up another four places to number 16; Apple cashed in on the European pc boom in 1987 to move up one place to number 21; and French computer services company Cap Gemini Sogeti strengthened its position as Europe's leading services firm with a rise of two places to number 22.

Most of the companies on the way down, however, did not deserve their falls from grace. DEC dropped one place despite 27% growth, Honeywell Bull fell three places although its business increased by 27%, Wang slid four places with an even more impressive growth rate of 40%, and Mannesmann dipped

two places despite a 15% increase. In almost all these cases, new companies entering the DATAMATION European 25 caused the decline. The one company that deserved its fall was French company Groupe Bull, which lost 15% of its European revenues last year.

France's CGE was one of the companies that disappeared from the list in 1987, due to its merger with ITT to create Alcatel, which is on the list at number 13. Also off the list is BASF, which merged its pcm interests with those of Siemens to create Comparex Information Systems. Comparex is not featured in the DATAMATION European 25, but it comes in at number 18 in the list of the top 25 European-owned companies. Other absent friends in the 1987 ranking were Control Data, Commodore, Rank Xerox, Norway's Norsk Data, and Data General.

One company on the list now, and which certainly won't be there next year, is Ericsson Information Systems. After years of losses the division's parent sold it off to aggressive Finnish company Nokia to create Nokia Data Systems.

The list of the five fastest-growing companies on the 1987 table indicates how the European market shifted in 1987. The top of the top performers for the second year running was the U.K.'s leasing company Atlantic, which reported a stunning surge in revenues from both increased sales and acquisitions. Second was Amdahl with an 81.9% boost in sales. The U.K.'s pc success story Amstrad came in third with 80% growth, followed by another pc maker, Apple, which increased by 68.4% in Europe last year. Fifth was Cap Gemini Sogeti with a 61% boost in business.

These trends show how the need for users to find cheaper ways of investing in the technologies they required helped leasing firms such as Atlantic and pcm companies such as Amdahl make a killing. The pc surge kept Amstrad and Apple busy last year, while Cap Gemini Sogeti was able to offer the software and services that companies needed to streamline their IS systems and create competitive edge applications.

In fact, Cap Gemini is well placed for even more significant growth in its business in the next few years on the back of other major trends that emerged last year. The information services sector in Europe is already worth \$31 billion according to industry research firm Input, which estimates the sector will grow to \$71 billion by 1992.

That is certainly possible, since 1992 is the deadline for changes in the trading procedures of the major European countries that, in theory, will create a single European market for goods and services. This is the goal of the Single European Act, passed by the European Parliament in Luxembourg in June last year and which already is having devastating effects on the structure of European business. The preparation for the event really got under way in the first half of this year with mergers such as that to form the new services company created by Systems Designers and Scicon, two of the U.K.'s top firms.

Electronic Links Aid Services Industry

The reason the services industry is going to be so important is that many of the new trading links in the unified market are going to be electronic; the highly competitive market that it is supposed to generate will mean much more emphasis on competitive edge end-user applications. Services companies can provide these for European firms.

This development has not escaped the notice of IBM Europe. Big Blue decid-

The 25 Leading European-Based IS Companies

COMPANY	COUNTRY	WORLD IS REV (\$ MIL)	% CHG	% CHG IN AAC
1 Siemens AG	W. Germany	\$5,703.0	30.1	7.7
2 Ing. C. Olivetti & Co. SpA	Italy	4,637.2	19.8	4.3
3 Groupe Bull	France	3,007.5	17.1	1.5
4 Nixdorf Computer AG	W. Germany	2,821.5	36.1	12.6
5 NV Philips Gloeilampfabrieken	The Netherlands	2,601.6	32.2	9.3
6 STC plc	U.K.	2,123.9	21.3	8.8
7 Alcatel NV	Belgium	2,052.1	20.9	2.9
8 LM Ericsson	Sweden	1,511.6	12.5	0.1
9 Inspectorate Intl. Ltd.	Switzerland	1,225.0	359.1	908.4
10 Memorex Intl.	The Netherlands	1,041.1	NA	NA
11 Société Générale	France	970.1	70.8	48.2
12 Atlantic Computers plc	U.K.	959.9	123.4	100.3
13 Mannesmann AG	W. Germany	686.0	40.4	16.2
14 Cap Gemini Sogeti	France	682.3	62.4	40.9
15 Econocom Intl. BV	Netherlands	674.3	54.9	28.1
16 Rank Xerox	U.K.	615.0	34.0	20.2
17 Racal Electronics plc	U.K.	549.1	16.1	4.1
18 Amstrad plc	U.K.	533.0	94.5	74.4
19 Comparex Info. Systeme GmbH	W. Germany	530.8	NA	NA
20 Finsiel SpA	Italy	424.1	39.5	21.3
21 Norsk Data AS	Norway	422.6	21.1	10.3
22 Ferranti plc	Italy	398.8	18.8	6.5
23 Nokia Corp.	Finland	375.3	37.3	19.0
24 Scicon Intl. Ltd.	U.K.	287.0	14.5	2.6
25 Thorn EMI plc	U.K.	246.1	23.4	10.7

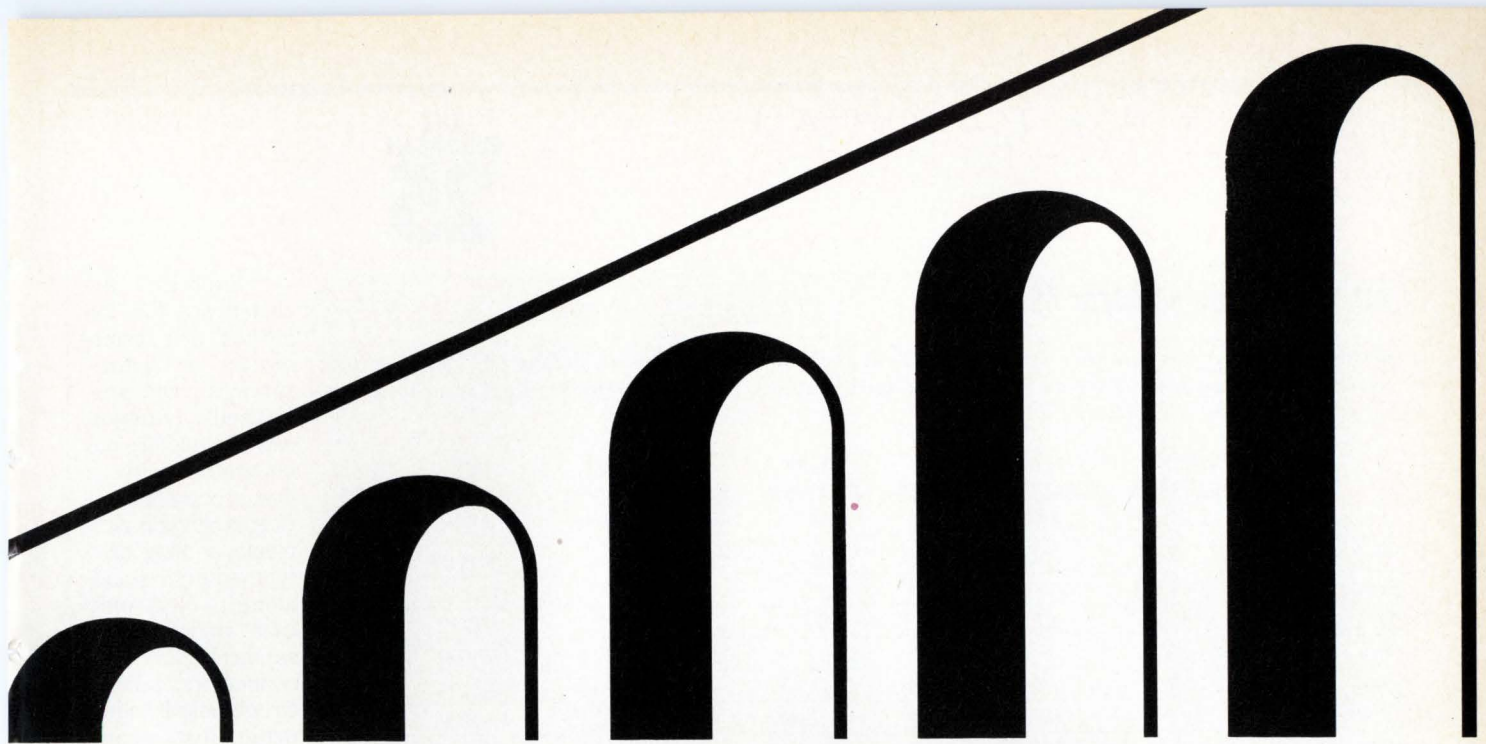

**An effective
System Architecture
should be an open bridge
to future growth.**

Olivetti takes a straightforward, functional approach to information management. It's a modular plan called Open System Architecture. With a minimum of constraints, Olivetti is able to combine modules in new - and unlimited - ways that assure your system of a smooth bridge, open to other possibilities and open to the future.

Sensible, evolutionary growth.

Olivetti planned Open System Architecture to change the way your functional needs change: in measured, gradual evolutionary steps.

Open System Architecture was also designed to take account of all the technological advances that will inevitably happen in the future.

This applies to all parts of the system. As a result, you won't ever be cut off from whatever business opportunities these advances bring.

Olivetti's modular approach protects your investment over the long term. This means as you build your system, none of the additions you make will cause your existing equipment to become obsolete.

A plan you can implement now.

Among the building blocks in Open System Architecture is a range of minicomputers, systems software, and applications.

The LSX 3000 minicomputer family uses a very sophisticated mono- and multi-processor technology that allows an easy extension of the CPU you already have in the field. At the low end, the LSX 3005 links typically four users; while the LSX 3080 links two hundred. Olivetti also offers a full range of general purpose and specialised peripherals.

Open System Architecture supports operating systems standards that ensure easy growth and protected investment. Its foundation is a UNIX-based system, which conforms to the UNIX System V and X/OPEN standards. In the Open System Architecture, Olivetti maintains its commitment to MOS, the Olivetti operating system developed for specific market sectors and a range of Olinet products aligned to the ISO/OSI standard facilitates Local and Wide Area Networking communication. In addition full connectivity to the corporate database is ensured. And Open System Architecture includes a host of applications software (including full integration with the world of MS-DOS) calculated to satisfy the most demanding needs.

Olivetti is represented in all European, Far Eastern and Western countries. For further information about Olivetti systems please contact the Marketing Department of the Olivetti Head Office in your country.



olivetti

IBM Europe's Major Markets

■ IBM's three largest European subsidiaries barely held onto their 1986 revenue levels last year and profits were down in many others. The 18.2% drop in business in the Netherlands has put Spain into fifth place among IBM's major Euromarkets.

	1987 LOCAL SALES (\$ MIL)	1987 LOCAL SALES AAC	% CHG AAC	*1987 TOTAL REV AAC	% CHG AAC	NET INCOME (\$ MIL)	NET INCOME AAC	% CHG AAC
West Germany	3,870.8	DM6,957	-3.5	DM1,151	-4.0	303.2	DM545	5.1
France	3,068.7	FF18,439	-0.4	FF37,511	2.5	373.3	FF2,243	-9.2
U.K.	2,691.3	£1,646	-0.3	£3,483	12.8	192.7	£315	19.9
Italy	2,636.1	L3,419,000	13.5	L5,391,000	20.2	352.4	L457,000	-15.7
Spain	921.6	P113,831	3.1	P177,457	-1.5	179.8	P22,206	2.4
The Netherlands	833.8	G1,689	-18.2	G3,216.7	-9.2	103.2	G209	-16.4
Sweden	688.0	Skr4,362	2.5	Skr7,640	-2.7	59.3	Skr376	-33.6

* Includes interarea transfers.

All currency figures are in millions.

Source: IBM Europe, Paris.

ed some time ago that this was the business to be in, but only over the last year or so has the company really begun to get involved in the European systems integration and services scene in a big way. So far, it has had some significant success with deals to integrate the systems of two consortiums of European airlines and the trading network for the Lloyds of London insurance market.

The other major factor for the future that IBM has begun to appreciate is that European businesses and governments are at the forefront of the move toward open systems. There have been vendor groups supporting the open systems concept in Europe since the early '80s, but the momentum has become so powerful and the message has traveled so widely that IBM now has no alternative but to go with the flow.

C. Michael Armstrong, the new head of IBM Europe, has a tough job to convince the Europeans that the company is serious about open systems, despite the setup of the Open Software Foundation a few months ago and the regular IBM claims that it has done more for Open Systems Interconnection (OSI) communications standards than anyone else.

Open systems in Europe is not just a future goal—it is fast becoming a reality. The European Commission in Brussels already has directed European governments to include OSI in all purchasing requirements for systems, while the X/Open group that began in Europe four years ago hopes to have a number of X/Open-compliant systems on the market by the end of this year.

These are the reasons that 1987 was the last of its kind in Europe for the IS

business. The emphasis on open systems, end-user applications, and new ways to cut the cost of IS investments will take the European IS industry into the 1990s. At the same time, the traditional barriers between countries and industry sectors will be broken down to create a different kind of market by 1992. What the next few years will determine is whether or not European companies can be the winners in that market. Although its continuing dominance of the market seems to suggest otherwise, it is by no means certain that IBM can maintain anything like its current position during the years of change ahead in Europe.

Methodology

For this survey, Europe includes Austria, Belgium, Denmark, Finland, France, Greece, Ireland, Italy, Luxembourg, the Netherlands, Norway, Portugal, Spain, Sweden, Switzerland, the U.K., and West Germany.

IS revenues are defined as being derived from sales of the following: computer systems, including mainframes, minicomputers, microcomputers, personal computers, workstations, word processors, office systems, and CAD/CAM systems; peripherals, including terminals, printers, plotters, disk drives, tape drives, magnetic media, and data entry devices; software, including operating systems and applications programs; data communications equipment, including communications processors, LANs, digital PBXs, multiplexors, modems, and facsimile machines; data services, including custom programming, systems integration, consulting, timesharing, and remote processing; maintenance and repair; computer leasing; and point-of-sale systems and automated teller machines.

for disk and tape drives; industrial control devices; central office telephone switches; analog PBXs; and computer-output micrographic systems.

Whenever possible, information in the DATAMATION European 25 is obtained from the companies themselves. When a company will not provide it in a form suitable for this survey, we have estimated the figures based on investigative reporting, coupled with an analysis of industry trends.

The net income reported for each company represents total earnings, not just earnings from information systems revenues. Revenues derived from sales to other divisions or units within a company are considered captive sales and are not included in this survey.

Currency Exchange Rates

Results for non-U.S. companies are converted into dollars using OECD average exchange rates. For those currencies not part of the OECD, exchange rate information was provided by the International Monetary Fund. For 1987, equivalents to \$1 in these currencies were as follows: European Currency Unit, ECU.87; Finland Fmk4.40; France, FF6.01; Italy, L1,296.97; the Netherlands, G2.03; Norway, Nkr6.74; Sweden, Skr6.34; Switzerland, Sfr1.50; the U.K., £.61; West Germany, DM1.80.

For 1986, equivalents to \$1 in these currencies were as follows: European Currency Unit, ECU1.02; Finland, Fmk5.07; France, FF6.93; Italy, L1,491.05; the Netherlands, G2.45; Norway, Nkr7.39; Sweden, Skr7.12; the U.K., £.68; West Germany, DM2.17. ■

BY PAUL TATE

DATA

Performance Measurement

W&G DATA FRAME ANALYSIS

F/T/R	STATUS	COUNT	START TIME	STOP TIME	IDLE	FRAME
R	EOT	0	13:40:39.28	13:40:39.28	0.19	
T	EOT	0	13:40:39.46	13:40:39.46	0.19	
T	POLL	4	13:40:39.46	13:40:39.47	0.00	40 00 7f 1f
R	EOT	0	13:40:39.48	13:40:39.48	0.20	
T	EOT	0	13:40:39.66	13:40:39.66	0.19	
T	POLL	4	13:40:39.67	13:40:39.67	0.01	40 00 7f 1f
R	I-ETB	245	13:40:39.71	13:40:39.92	0.23	02 40 4c 7d c2 5c 11 40 c1 c6 c1
T	ACK1	0	13:40:39.93	13:40:39.93	0.26	
R	I-ETB	243	13:40:39.94	13:40:40.14	0.02	02 11 c7 c7 11 c7 c9 11 c7 d7 11
T	ACK0	0	13:40:40.15	13:40:40.15	0.22	
R	I-ETB	243	13:40:40.16	13:40:40.37	0.02	02 11 d1 c6 11 d1 c9 11 d1 d7 11
T	ACK1	0	13:40:40.38	13:40:40.38	0.23	
R	I-ETX	33	13:40:40.38	13:40:40.41	0.01	02 5c d7 c6 f1 5c 40 40 40 40 40
T	ACK0	0	13:40:40.42	13:40:40.42	0.04	
R	EOT	0	13:40:40.43	13:40:40.43	0.02	
T	EOT					
T	POLL					

10:27:42

Line Utilization Screen Outbound Only

DEC 31 99

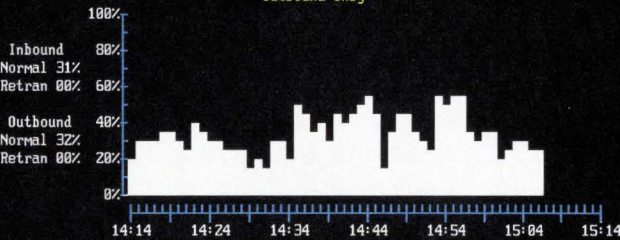

10:26:49

Average Response Time Profile Screen

DEC 31 99

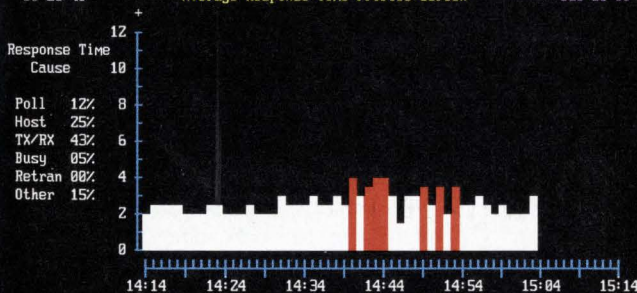

F1 MENU F2 TIME SEL F3 FREEZE F4 RUN F5 < TIME F6 TIME > F7 F8 PRINT

This is just a sample of the screens available.

Presenting the ultimate performance analyzer

An independent, PC-based analysis tool

The DPA-10™ Data Performance Analyzer helps you pinpoint causes of response time problems quickly and easily, while simultaneously functioning as a network surveillance device. It allows you to fine-tune your SNA or BSC network to maximize valuable communication assets and plan for future expansion. In addition, the unit can be used as a data line monitor or a data frame analyzer. It is an extremely powerful product by itself, and an ideal stand-alone companion for network management systems such as IBM's NetView™. As a full-featured performance analysis package, the DPA-10™ easily attaches between your front-end processor and modem.

A technician's dream

Easy-to-understand pop-up help screens and one step set-up make the DPA-10™ a breeze to operate. It has the best user interface in the industry, with clear color graphics that automatically highlight trouble spots.

Low cost & easy installation

With its low cost, the DPA-10™ will pay for itself the first time you identify an underutilized terminal. The software can be used on almost any IBM® compatible personal computer, saving you the expense of buying specialized hardware. The DPA-10™ comes complete with a PC board, cable, software diskette, and instruction manual.

Call for a free demonstration diskette simulating actual unit performance.

Argentina: Buenos Aires (1) 784-6642

Australia: Melbourne (03) 690 6700

Austria: Baden (02252) 85 52 10

Belgium: Koersel (011) 432412

Brazil: Rio de Janeiro (21) 221 3731

Canada: Scarborough (416) 291-7121

France: Paris (1) 30 55 81 90

Great Britain: London (1) 575-3020

Guatemala: Guatemala City (2) 31 80 65

Hong Kong: Hong Kong (5) 275339

Japan: Yokohama-shi (045) 931-5725

Netherlands: Huizen (02152) 66122

Spain: Madrid (91) 4086012

Sweden: Stockholm (08) 880480

Switzerland: Bern (31) 42 66 44

USA: Research Triangle Park, NC (919) 941-5730

FR Germany: Wandel & Goltermann, VMW, Postfach 1262, D-7412 Enningen, Federal Republic of Germany. Phone No: 07121/86-1570, Telex 729833, FAX 07121/88404

E 8001:3C

Wandel & Goltermann

Electronic Measurement Technology



CIO: Misfit or Misnomer?

In response to corporate America's desire to wield technology more effectively, a new executive position has been named and, in a few cases, assigned to IS managers. Unfortunately, the philosophical foundation for the chief information officer title—unifying and guiding the entire corporation's information technology—bears little resemblance to the realities of the job. A Coopers & Lybrand/DATAMATION survey has shown that, even for those IS executives who hold the title, the CIO job carries little of the authority necessary to develop and nurture long-term IS strategies that might better the businesses they serve.



BY RALPH EMMETT CARLYLE

According to the new IS mythology, a vital ingredient has been added to the churning mass of assets and people that is corporate America—a new breed of manager with unusual gifts; a bridge, it is hoped, between the alien cultures of the executive suite and the computer room.

A torrent of books and magazine articles have painted an idealized portrait of these new “renaissance” men and women, the so-called chief information officers, or CIOs. According to their legend, CIOs are corporate eagles, using the view from their aeries to plot long-term strategies that unite the business and technology sides of the house.

The cult grows daily. The Chicago-based Society for Information Management, one of the nation's more prestigious trade groups, has pushed for the spread of the CIO title; a magazine of that name has appeared; and top research companies, such as San Jose's Dataquest, have CIO advisory services.

Misconceptions Grow with the Myths

Unfortunately, as the mythology has grown, so have the misconceptions, as a startling new survey from Big Eight accounting firm Coopers & Lybrand and DATAMATION shows.

“Confusion over just what constitutes a CIO is rampant,” says John Highbarger, the Coopers & Lybrand partner responsible for Information Systems and for the survey of 400 top IS executives across the nation. “Fifty nine percent of respondents thought of themselves as CIOs, yet only 27% reported directly to the top of the company.” A direct pipeline to the top, he notes, is a prerequisite for the job. As planner of long-term strategies uniting the business and technology sides of the house, the CIO must be part of the inner circle of top officers to have any influence at all.

Even more confusing is the title. “You'd have to look long and hard through corporate America to find executives that are actually called ‘chief information officer,’” says Highbarger, who found only two in the survey. He adds that merely 14% of respondents felt the title actually described what they do. Applied Computer Research Inc., Phoenix, publisher of the *Directory of Top Computer Executives*, took a random sampling of 5,000 names for DATAMATION and came up with 36 CIOs.

What little research there has been in the international arena shows that the CIO concept hasn't yet caught fire overseas. “You don't find the title at all,” says Gwen Peterson, manager of Dataquest's

ISSUES

88

To unite the business and technology sides of the house, the CIO must be part of the inner circle of top officers.

CIO Advisory service, "but we believe the function is beginning to emerge, especially at European banks."

Small- and medium-sized companies in the U.S. don't yet have CIOs. "If the function exists at all," says Peterson, "it is part of the ceo's job. If not, outside consultants are used."

Academia is similarly bereft of CIOs, according to Prof. James Wetherbe, director of the University of Minnesota's MIS Research Center. "The operational and administrative sides of the campus computing environment have separate IS chiefs," he says. "There's no top IS executive responsible for the whole show."

Where CIOs do exist, it seems, is in large U.S. companies, especially at frontier organizations in the information-intensive services sector: banks, insurance firms, and airlines. Those who function as CIOs usually sit behind such recognizable nameplates as senior vp, vp of information services, or information resources manager. Given the infinite variety of titles for the CIO function, these executives will be referred to collectively as CIOs for the sake of clarity.

The CIO: Stairway to Corporate Heaven?

In the mythology, these men and women are seen as a new order: the information elite. Their advent is seen as part of a natural succession, a reprise of what happened when senior accountants blossomed into chief financial officers (cfos) in the 1960s. Cfos, the argument goes, look after the financial health of the corporation, and since it's money that makes the business world go 'round, many cfos have risen to become ceos. The old maxim that "information is power" has led many to speculate that CIOs in their turn will take the top corporate spot in the 1990s by virtue of their control of information.

The Coopers & Lybrand/DATAMATION survey debunks this notion. Only 7% of respondents believe they will ever secure the top position in their company. They believe the chances for advancement elsewhere are even slimmer. Only 3% expect eventually to become ceo of another company.

"The idea that we're some 'elite' that controls information is totally false and misleading," says John Hammit, vp, information management for Pillsbury Co., Minneapolis, who functions as the food giant's CIO. "We don't control information, we help make it flow."

Hammit is one of many top information managers who believe that the CIO moniker (and mythology) is not only

misleading, but harmful. "It's pompous and self-serving, and obscures the issues," he says. "It confers [on us] an authority we don't have. We're servants of the corporation," he says of the job. "We empower others to succeed."

Some of the more politically astute CIOs have been able to make a noticeable difference to their organizations by allying themselves with line managers to create innovative new systems. For example, Larry Burden, vp, information services, at Firestone Tire and Rubber Co., Chicago, designed a system that tracks each step for building a tire, from having the right amount of rubber on hand to checking the tread depth. At Fidelity Investments, Boston, Michael Simmons devised a way for the company

osity that its bearers gave it up happily. "It turned them into targets."

Wetherbe's view mirrors much of corporate reality for these executives, whatever their title. Rather than rallying around the CIO, most business managers seem to be doing their best to make the CIO's life a misery. The CIO movement is only as old as the decade, yet already the first wave of managers functioning in the role have drifted into a nomadic existence: victims of power politics and unrealistic expectations, as the C&L/DATAMATION survey shows.

"Few remain in their companies for more than four years," says Coopers & Lybrand's Highbarger, expressing surprise at the survey's findings. "Fifty-six percent of respondents—top IS execu-

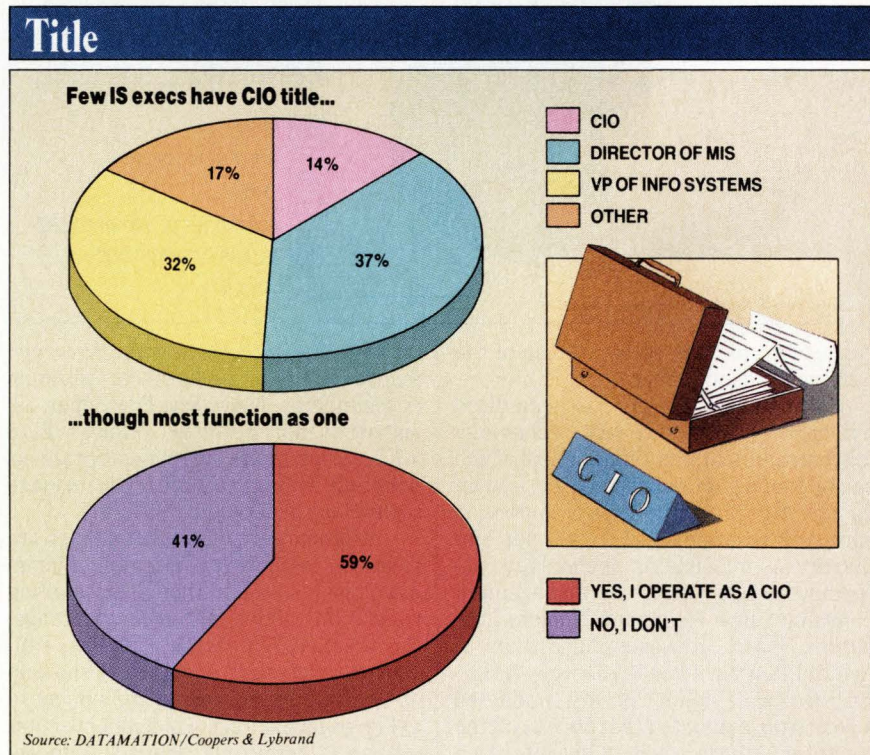

to become the only U.S. seller of mutual funds to offer hourly pricing.

In most corporations, however, as the survey shows, the CIO function has a toothless quality to it. As architect of the information system, the CIO sits on many corporate planning groups, but he or she has no direct control over any of the line organizations. "We don't state, we suggest," says Burden. The pervasive quality to the job, guiding the flow of information throughout the corporation, has made other managers nervous.

The University of Minnesota's Wetherbe says he knows of several cases in which the title created such ani-

tives, 59% of whom claim they are currently functioning as CIO—have been at their companies three years, and can be expected to move on soon."

CIOs Are Usually Corporate Outsiders

The data show that the majority of these men and women joined their employers as CIO and will leave in that capacity. They usually don't come up through the ranks of the company; they are outsiders when they arrive, and outsiders when they leave.

And though they survive the attacks of jealous peers who exist within all organizations, it seems there's one thing they

CIO: Misfit or Misnomer?

Power

Cfos still hold reins on IS execs...

Directly reports to:

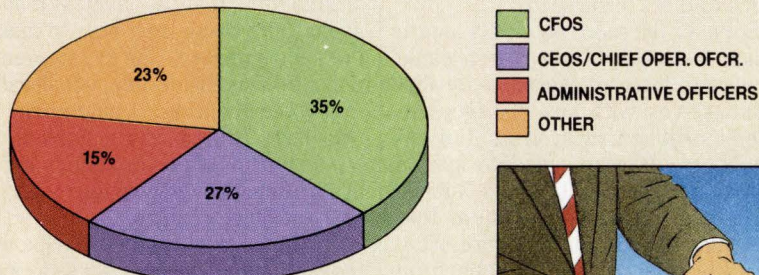

...although most believe ceos/chief operating officers should manage CIOs

Should report to:

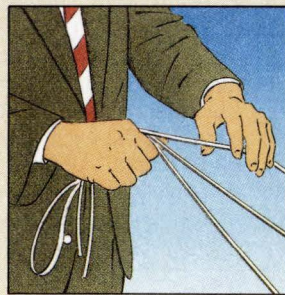
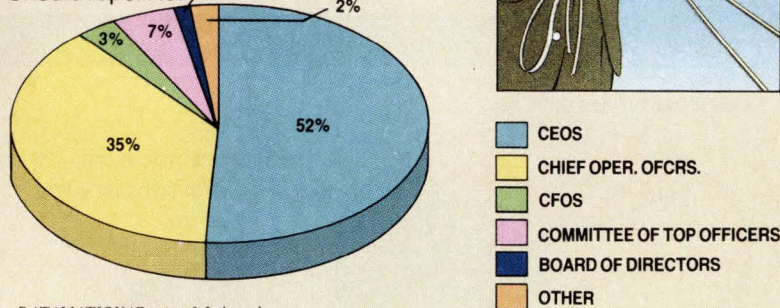

Source: DATAMATION/Coopers & Lybrand

cannot survive: the ruthless logic of the quarterly balance sheet.

Most often, the CIO has been hired by the ceo to correct past technology mismanagement, the symptoms of which can be found everywhere in American industry. By 1983, the typical American company was spending \$5,000 per employee on information technology, according to one survey by management consultant firm Nolan and Norton, Lexington, Mass., representing a four- to fivefold increase over 1979 levels. A Harvard Business School survey conducted a year later estimated that 50% of all the capital in America was going into such investments.

Many ceos found out after the fact that this spending binge had taken place without any unified vision or plan, and in a purely fragmented manner. Further, most of the new technology (upwards of 70%, according to the same surveys) had been purchased outside the central IS group, and thus was imbedded in all facets of the business. When quizzed by the Fordham Graduate School of Business Administration, New York, 1,500 ceos shouldered the blame for this legacy of unmanaged growth, and said they would try to do something. Enter the CIO.

"It's difficult to know whether the

CIOs are having to deal with gross mismanagement, or gross underutilization of technology," says Rod F. Monger, assistant dean at Fordham. "Unless there are reforms in the current corporate accounting system, any effort to manage technology is doomed to failure."

Highbarger points out that cfos are reluctant to allow capitalization of intangible assets, even though accounting regulations allow, and even encourage, this practice. "Intangibles," such as software development, consistently show up as expense items, and so are subject to every organizational whim and business change. "During takeovers and decentralization programs, for example, these nonstrategic investments usually are the first to go," Highbarger adds.

Desperately Seeking Stability

Such relentless pressure to perform in the short term usually precludes sustained executive commitment to long-term projects, killing a CIO's grand plans before they can materialize. If the ceo cannot be persuaded to invest for the long haul, the CIO's job becomes an exercise in frustration, even futility. So, faced with sporadic budgeting and an inability to see pet projects through to completion, many CIOs migrate.

Highbarger likens them to professional football coaches: "They keep moving from organization to organization in search of that winning team. And because the accounting system is the same at each company, the same old faces keep cropping up."

Michael Simmons is on that treadmill; a CIO on the move after a yearlong, and ultimately fruitless, battle with his ceo over MIS policy (see "A Rash of Top-Level Departures Erupts at IS Shops Across Nation," July 15, p. 21). Simmons, former president of the Boston-based Fidelity Investments systems arm, says his interviews at 10 large corporations have been a depressing experience, and confirm his suspicion that the nation is running out of technological gas. "All are slashing their technical research programs, and none have created advanced technology groups to monitor the timing and flow of new developments."

Such research, especially in the communications area, is inherently risky, says Monger. "Often it can take 10 years for a new piece of technology to bear fruit. But few managers have the wisdom to put the seed in the ground and let it grow undisturbed," he feels. Monger takes up the theme in a book called *Mastering Technology* (Macmillan/Free Press), due for release this month.

"Giving anything the label 'technical research' or 'long-term' is the kiss of death" in such a cost-conscious environment, says Jack Seafric, MIS director for the Dallas-based Maxus Energy Corp. Seafric's company, a spin-off of the once-proud Diamond Shamrock conglomerate (of Agent Orange fame) is in a consolidation phase. He says that by axing IBM's VM operating system, which he can live without, he can save his employer \$300,000 next year, just the kind of talk his bosses like to hear. Seafric says he'll be a "hero" soon, but in three years, when he goes hat-in-hand seeking money for new long-term applications, he knows it will be a different story. "I'll probably find the bank doors shut in my face," he comments.

Like Seafric, Bob Forte, vp, MIS, for Burger King in Miami, is used to facing closed doors, but he says that if you are prepared to gamble, you can go around them from time to time. That gamble is what he calls the common practice of hiding research in the budget by labeling it something else. He says such "creative bookkeeping" is the only way IS managers can save pet projects from the ax. Forte refers to such illicit research as

Eastman Kodak Co.'s Katherine Hudson: Clearly a CIO Model

Back in January, when Eastman Kodak Co. created its corporate information systems unit and tapped 40-year-old Katherine M. Hudson to head up the new operation, the company was also creating history. Never before in the giant manufacturing conglomerate's 107-year history had an IS director or a woman won the prestigious position of corporate vp.

The move clearly signals a recognition by Kodak of the increasing importance of IS and of Hudson herself, who has held a mélange of management and executive posts in her 18-year career at the Rochester manufacturer of photographic, information management, chemical, and health products.

As director of corporate IS at the \$15.6-billion company, Hudson is responsible for half of all corporate IS spending, which represents a hefty 2% of those total revenues. On the technology side, she oversees a shop that has IBM for its business applications and Digital Equipment Corp. wares on its factory floors. On the corporate side, her clout is undeniable.

Hudson reports directly to Kodak president and executive officer Kay R. Whitmore and works closely with vice chairman and executive officer J. Phillip Sampler.

DATAMATION senior editor Linda Runyan traveled up the Hudson to talk to Katherine Hudson and find out how she's shaping the new vision of information systems at Kodak.

LINDA RUNYAN: How do you view your role as director of corporate IS in terms of the overall company and its objectives?

KATHERINE HUDSON: There are IS directors in almost every unit of Kodak and several IS management councils that embrace different functional and geographic units within the company. My role is to offer them support when they need it, technology directions, and standards such as MAP, TOP, and OSI. Line management at Kodak can make multimillion dollar investments in technology, but if approval of those investments gets moved up to high levels such as the office of the chairman, then he will call me and ask "Is this the right direction for the company to go?" It's not veto power. I'd rather look at it as a supporting role.

RUNYAN: Is your position similar to the CIO model?

HUDSON: We endorse the concept of a CIO who reports directly to the office of the chief executive, making the Corporate Information Systems unit a very highly positioned organization that's worldwide in scope. The predecessor organization was not corporate in nature and there was no corporate officer who did what CIOs are supposed to do, which is to try to maximize the company's return on its IS investment and stay at the forefront of information technology.

RUNYAN: How do those IS strategies relate to Kodak's business strategies?

HUDSON: As a company, we're striving to be an industry lead-

er in four key segments: the consumer, photographic, and entertainment business; the information management sector; the industrial division, which is represented by our chemicals division and certain manufacturing groups; and health care. Our IS strategy is to have the decision support systems go from the customer need in the marketplace to the research scientist and development engineer, then to the factory floor, suppliers, and warehouses, and finally, the customers.

RUNYAN: What are you doing to ensure that this integrated, team approach is actually implemented at Kodak?

HUDSON: We want to make sure that our own IS people know how, if a customer wants a certain kind of system, to show that customer better alternatives, help him understand the technical differences and generate the business case to justify that decision.

RUNYAN: In the drive to integrate, has Kodak taken a thorough IS inventory throughout the corporation?

HUDSON: We've been doing it in a rather piecemeal fashion because we don't want to overburden the operating people. Before I got here, the network was studied. Now we're studying the data centers and we're just beginning to look at the actual applications on a corporate basis. On the communications side, we've decided to move toward ISDN. We'll be phasing in the development of a standard voice and data network over an 18-month period.

RUNYAN: Personnel takes the biggest bite out of the IS budget. What is Kodak doing to enrich its pool of IS talent?

HUDSON: We are setting up a human resources department within our IS operation because

we see such a need to work on career development, retraining, and compensation schemes.

RUNYAN: What is the skill mix that you want to cultivate among IS personnel?

HUDSON: I hope that by the time I'm finished in this job the IS people will have actually met a real customer—a K Mart, a Bank of America—the ultimate customer, not just our own end users. Then an IS person should be perfectly capable of handling the business issues associated with information systems within the company. We haven't had that in the past.

RUNYAN: In your 18-year career at Kodak you've certainly not been isolated. How would you characterize your career?

HUDSON: My career at Kodak has been very eclectic. I have been associated with almost every major division of the company except research and manufacturing, although manufacturing people reported to me when I was running the instant products unit. I have at least a five-year commitment to my current job. I have other things that I'd like to do at Kodak, but I do love my job. Last year was a great year. I turned 40, I had a baby, and I was made a corporate vp.



EASTMAN KODAK'S HUDSON: "We endorse the concept of a CIO."

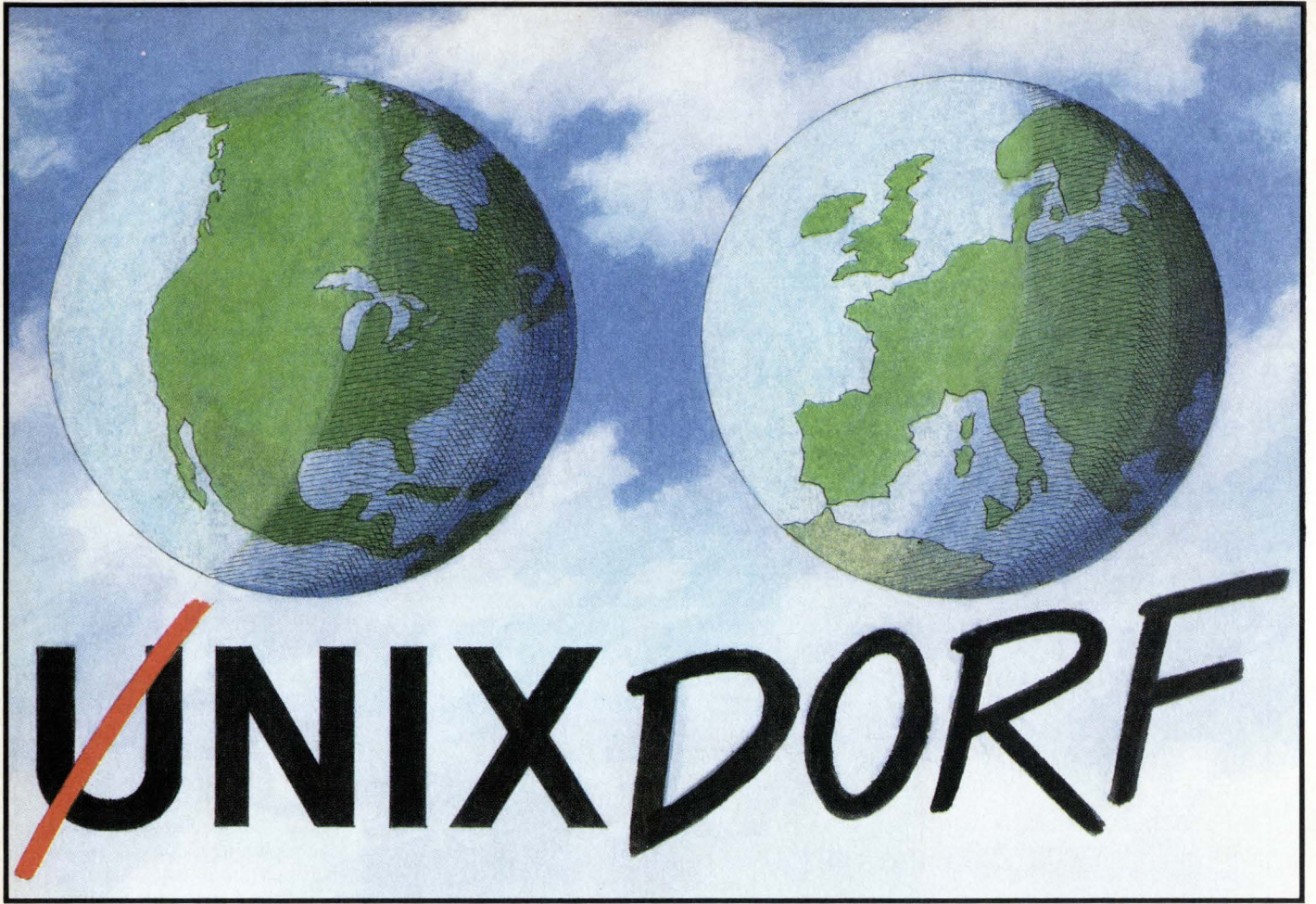

Nixdorf, together with Apollo, Groupe Bull, Digital, Hewlett-Packard, IBM, and Siemens, is a Founding Sponsor of the Open Software Foundation.

Nixdorf Targon

Introducing the Open System from the most solution-oriented company in the world

Nixdorf Targon makes the vision of truly open systems a reality, and fully exploits the exciting potential of UNIX®.

No matter how much technology advances, or how much your business environment changes, Targon gives you full access to a widening spectrum of international UNIX-based systems, offering fault-tolerant hardware and software, RISC architecture and distributed relational database facilities, all part of Nixdorf's advanced information processing architecture.

From the start, Nixdorf has been committed to open-systems solutions. We are a founding member of the X-Open Group

and OSI, and one of the seven Founding Sponsors of the Open Software Foundation.

As a true open-systems supplier, we are truly committed to solutions that won't lock you into anybody's proprietary hardware or software. Including our own.

Targon comes from the most solution-oriented company in the world. Nixdorf has built an international reputation for true partnership with its customers.

We steadfastly believe that true partnership is not achieved by allowing proprietary hardware or software to dominate a customer's flexibility. We have always endeavored to enhance the customer's freedom to obtain the optimum solution by taking a semi-custom, general-contractor approach. We have never tried to force our product where it won't fit—even at the expense of short-term gain.

Our orientation has been to the end-user.

We have always been in the forefront of the fight against obsolescence.

Most important, we have built our business on what has been accurately described as "a relentless commitment to quality service."

Targon continues this proud tradition, combining the freedom of open standards with the excellence and diversity of proven Nixdorf solutions.

In other words, the Best of Both Worlds.

Nixdorf Computer Corporation
300 Third Avenue
Waltham, MA 02154
Tel.: (617) 890-3600

The Best of Both Worlds
American ingenuity and German precision engineering

NIXDORF
COMPUTER

Circle 27 on Reader Card

CIO: Misfit or Misnomer?

Empire

Few IS execs manage non-IS functions...

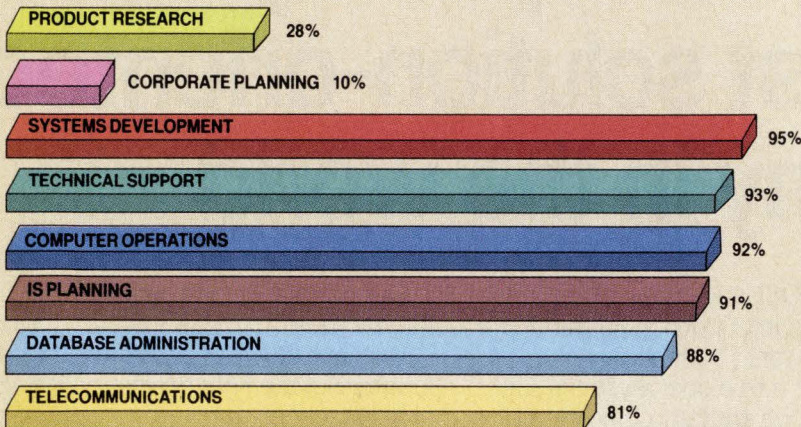

...nor do many work hand-in-hand with business units

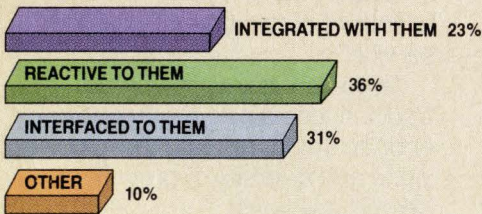

Source: DATAMATION/Coopers & Lybrand

Barriers

Barely a majority of IS execs believe CIO title is needed...

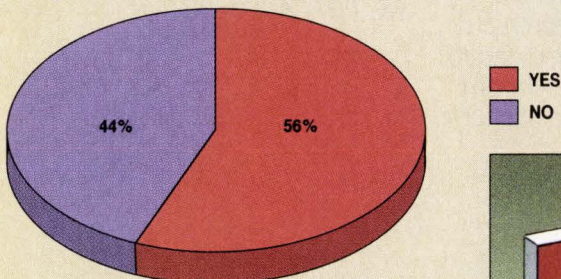

...perhaps because of the following barriers to the CIO position

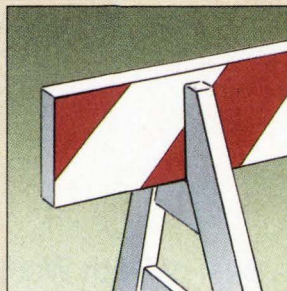
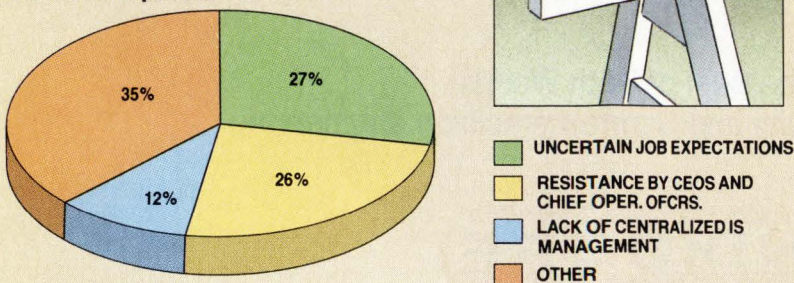

Source: DATAMATION/Coopers & Lybrand

"skunk work," because the aim is to dissuade the boss from taking too close a look at it.

Monger sees actions like those Forte describes as examples of IS professionals having "gotten creative in all the wrong ways to get what they yearn for." He says they are the victims of a myopic approach to technology management that threatens not only their profession, but the well-being of the nation.

The upshot of all this is that U.S. businesses have fallen behind those trading partners prepared to invest for the long term, such as Japan. Government figures show 1980 as the last time the U.S. high-technology sector had a trade surplus. The trade balance has sunk deeper into the red every year since.

As Monger points out, technology investment is risk investment. "No company knows what the benefits of, say, a new CIM (computer integrated manufacturing) plant will be when it's finally built. IBM took over six years to convert its Lexington, Ky., plant to robots and CIM. And each of those years the company took a hit against its bottom line for having the courage to make these investments."

Small Companies Can't Act Like IBM

Monger notes sadly that companies smaller than IBM trying to follow the computer giant's example could become takeover candidates because of the impact of such spending of their profits.

Some foreign nations recognize that the commercial sector cannot play banker to long-term technology investment. As a result, they have developed an external system of financing to deal with the problem, and discount the idea that an internal manager can reverse decades of mismanagement. "The Japanese realized that you can't expect the commercial sector to play banker to the long term given its accountability in the short term, and looked elsewhere—the government, educational, and scientific sectors—for a solution," Monger says.

In a paper for the U.S. House of Representatives task force on Space, Science, and Technology, Monger writes that we must do the same, or, better still, completely change our corporate accounting and taxation system to reflect the economic realities of technology investment.

Without such changes, he says, the first wave of CIOs will continue to see their visions wither on the vine, tackling a twenty-first century job with twentieth century tools.

What should
every company
demand
from a
computer
system?





Growth.

When your business is small, you can buy an IBM® Application System/400™, and it will be just the right size.

Later on, you'll still be smiling.

That's because as your company grows, your Application System/400 can grow right along with you. And the investments you made at first—in software, training and peripherals—will keep right on working.

That's what the IBM Application System/400 is all about. It's based on IBM's leadership with over a quarter million mid-size systems already in place, and it does what growing companies have told us they want.

It lets you grow into what you need, without outgrowing what you've paid for.

Introducing the IBM Applica



tion System/400.

Whatever your future may hold, there's one thing about it that you can be sure of. It starts today.

So, first things first, your computer system has to solve today's problems, and that's something you can count on from the new IBM Application System/400.

Never before has a mid-size computer been introduced with so much proven software ready to go.

You see, the Application System/400 may be new, but we didn't start from scratch. We built on experience.

Thousands of programs—for retail, manufacturing, accounting, construction, health care, distribution, office work and more—that run on the IBM System/36 and /38 can run on the Application System/400. And many will run faster.

Also, they'll keep on running no matter how



*The IBM Application System/400.
No matter what business you're in,
you're in business.*

Construction,

legal,

manufacturing,

distribution

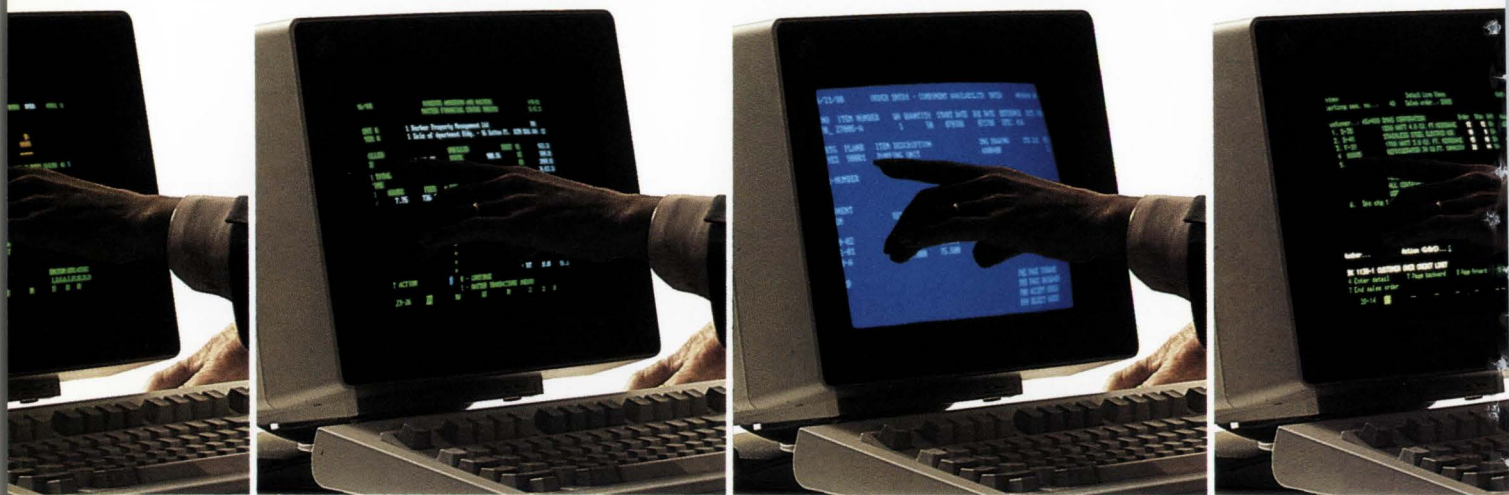

Today: Solutions from the leader in

big your system gets. All models of the Application System/400 share one architecture, and one operating system. So even if you're just starting out, you can make software decisions that won't fence you in later.

And you'll make those decisions with expert help. The people who support the IBM Application System/400 are specialists, not just in their field, but in yours. They can build a solution that's tailored for your kind of business, and your kind of company.

What you're looking for, after all, isn't just a computer. It's the work a computer can do for you. So that's where the IBM Application System/400 began. Not with circuitboards, but with solutions.

From day one, it's a workhorse.
Then it gets better.

office applications, and many more.

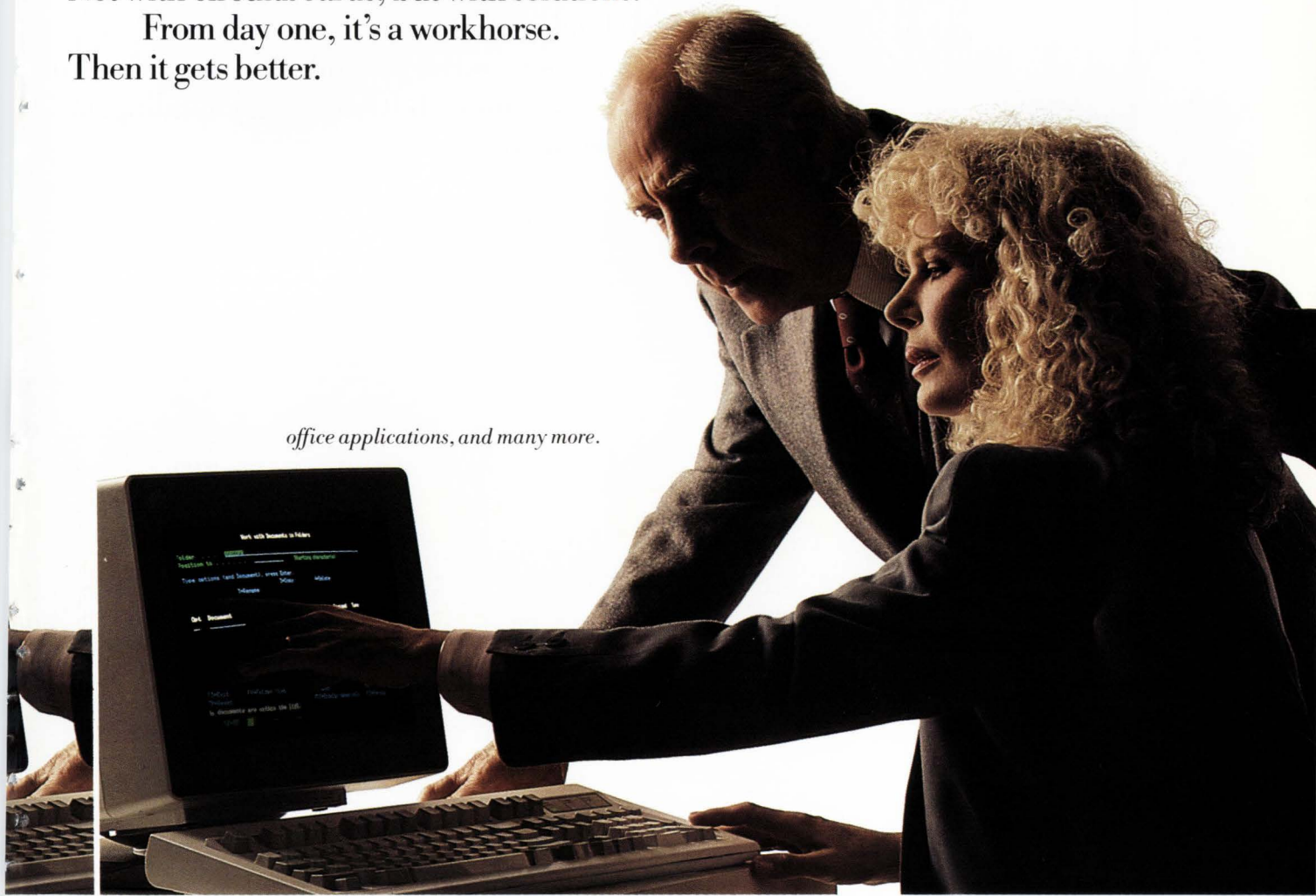

for your business, business solutions.

When you choose your IBM Application System/400 today, you won't have to guess how big it should be for tomorrow.

Because as you grow, it can grow. As you change, you can change it. The decisions you make today will make sense tomorrow, especially since your investments in software, training and equipment will be safe. Here's why.

The IBM Application System/400 comes in six basic sizes: Models B10, B20, B30, B40, B50 and B60.

So let's say you have a Model B30, and two dozen very good people. Suddenly your business takes off. You have scores of people. And you say to yourself, "Gee, I should have bought a Model B40."

Well, in many ways, you did. You can turn your Model B30 into a Model B40 simply by building on what you already have.

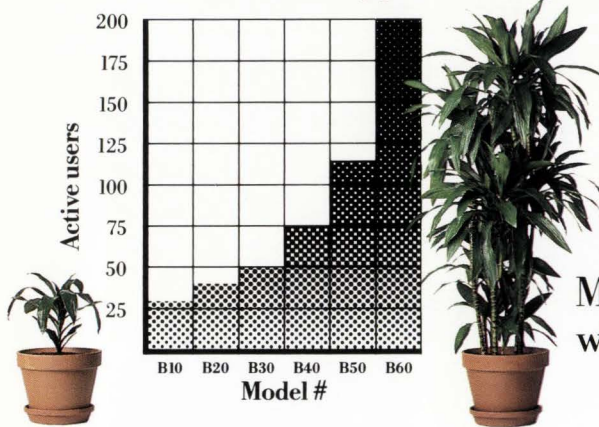

However big your IBM Application System/400 may get, the same software will always work.

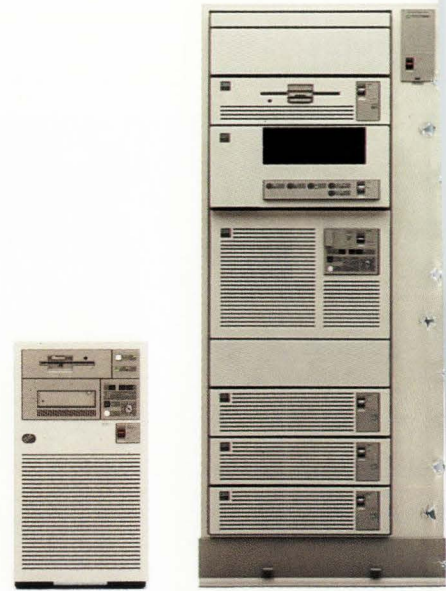

Tomorrow: Pro investment as your

From the Model B30 on up, the Application System/400 comes rack-mounted, like a stereo system. Components slide in and out. So you can upgrade right on the spot. You're not locked into any particular setup. Your system's only as big as you need, and making it bigger is easy.

What's more, since the architecture never changes, your software goes right on working. Which means your business does, too.

Also, the Application System/400 has a tutorial system that's second to none. New users can practically teach themselves, and tougher questions go on-line for help from experts.

But your toughest question, "What about the future?" is at least partly answered already. As your business grows, your IBM Application System/400 will be able to grow with you. And your investment will pay dividends.

*Rack-mounting
allows for
major growth
without
major surgery.*

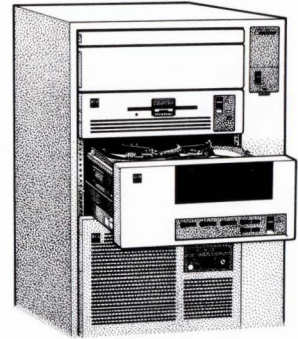

*From left to right, the IBM Application System/400:
Model B10, Model B30, Model B40, Model B50.*



tection for your business grows.

A life-support system for the life of your system.

A good person to see about the IBM Application System/400 is an IBM Marketing Representative. Or, you can go to an IBM Business Partner, who's a partner of both yours and ours. Either way, you'll get a solution—software, hardware, everything—that's just right for your business, plus solid support down the road.

You'll also find support within. Every Application System/400 comes with two kinds of help built in. One's a teacher, the other's a lifeguard.

The teacher is a new kind of on-line education system. Actually it's more like a private tutor. People can start or stop their sessions as they need, so they can learn and do real work at the same time.

The lifeguard gives you timely customer support by connecting you with experts at IBM, or at your IBM Business Partner. Questions can be answered and problems can be corrected, often by remote control.

There's even a new way to pay for your system. Through the IBM Credit Corporation, you can lease everything with one monthly payment.

The IBM Application System/400 comes with more support, more ways, than any of its competitors, and it's support you can always count on.

Because, small or big, you're part of The Bigger Picture at IBM.

For a free brochure, or to arrange for a detailed discussion about the IBM Application System/400, call 1-800-IBM-2468, ext. 81.



© 1988 IBM Corporation. IBM is a registered trademark and Application System/400 and AS/400 are trademarks of IBM Corp.



The Bigger Picture

Managing a System Transformation



Most IS managers live in dread of having to guide a comprehensive transformation of their corporation's IS environment. It is a monumental undertaking, but assistance, in the form of a consultant's advice and vendor's products, is available to accomplish it piece by piece. The aim: competitive advantage in the market.

BY FREDERIC G. WITHINGTON

Consider this: in an effort to handle rising competitive pressures and to conduct business more responsively and with fewer resources, your senior management thinks that an information system interconnected across the entire organization is a good idea. They have asked you, as systems manager, to work out the details.

As you ponder this Herculean task, you discover that you can't get there with the existing systems, which were created separately to put wheels on clerical processes. The disparity in applications interfaces, networks, and file formats makes it impossible to design an application that can look at several different files and produce complete, accurate, and up-to-date data.

In short, the entire information processing environment needs to be transformed. There has never been a transformation of this magnitude at your organization, you don't have experience managing such a transformation, and your management has never been asked to support one. Apart from this, it's a piece of cake.

Data Transfer Networks Fuel Change

Don't worry. New hardware and software products, industry standards, and the experience of many others have made the task a little easier. This article sets out to pass on some hard-won guidance for anyone undertaking a system transformation for the first time.

Companies in the automotive and grocery products sectors have been forced to initiate sweeping IS transformations to support data transfer networks

that had been implemented across their industries. Meanwhile, an increasing number of users have been demanding access to transaction files for pcs and departmental systems to synchronize their planning, scheduling, and marketing activities more efficiently.

One of the biggest problems is that most business operations applications—even the more advanced interactive applications such as those for order entry, manufacturing management, cash management, and customer information—have been implemented one at a time; experience with one supported the next. In each case, the new application's design used the old as a starting point.

While these applications may have been technically challenging, they mostly followed the KISS (keep it simple, stupid) principle of systems design and pushed every possible exception, reporting, or posting operation out of the on-line loop for subsequent batch processing. This was necessary because of the high cost and unreliability of on-line hardware and software. These early on-line applications usually had dedicated, simple network protocols because there was no cost-effective alternative.

The resulting separate ISAM or sequential transaction files, built at different times, are not properly defined, complete, or consistent, and they are updated in different ways and at different times. The only solution is to tear down the whole structure and build a new one, in which the following elements hold sway:

- the data elements are fully defined and maintained independently of the applications programs;
- the programs are modules with similar

Managing a System Transformation

structures so that they can intercommunicate and move around the network; and

- a single, transparent, general purpose network interconnects all of the system's nodes and users.

Making a Smooth Transition

Building this new structure will cost far more than any previous single application the organization has encountered, and it may take as long as 10 years. Skills and technologies that are new to the organization will be needed and people with the right experience may be hard to come by. Every file and program most likely will have to be converted to new standards, even those with unchanged functions. Most users will have to learn entirely new ways of working with the system. A smooth transition must occur so that the business isn't impeded.

Many organizations, including Citicorp, American Express, American Airlines, and American Hospital Supply, carried out such systems transformations years ago for competitive reasons. Their efforts have been well rewarded and each stimulated others in its industry to follow suit.

Other organizations, including some government agencies, were forced into systems transformations by the sheer growth of workload. The Social Security Administration and the Internal Revenue Service are both partway through systems transformations that have been painful and slow, but should be successful in the end. Manufacturing companies have responded to foreign competition with efforts to transform their information systems, as General Motors' acquisition of Electronic Data Systems, Dallas, illustrated.

Getting Management's Support

In theory, management thinks a new system will work wonders, but in practice, as you proceed with the project, management may find it requires more than they thought they bargained for. It is essential that you begin by laying a groundwork of firm, unwavering support that you will be able to count on during the trying times ahead.

First and foremost, inform your company's chief executive of your strategy for the project. Explain the general concept of the new integrated system and make an initial guess of the time, money, and resources that will be required. Be very pessimistic about the project's dollar cost: the brass will remember what you say. Five times the organization's total IS budget for last year is

in line with others' experience. Attempting to cost-justify the project will only bias your cost estimates.

If you don't have direct access to the chief executive, enlist the involvement and support of your immediate boss and use that support to move up. Securing the commitment of senior managers of user departments will make for smoother sailing. Newsletters, user group meetings, and sales conventions can be used to make people at various levels of the organization aware of the improvements that the new system will bring.

Once you are confident about management commitment, you can prepare the formal project plan. An experienced consultant can provide guidance on the complexities of the project and some of the required technologies, but you should be able to design the functions of the new system yourself. If you can't, you shouldn't attempt a system transformation.

The First Technical Steps

The initial technical tasks you should address in your plan are standards review and selection, database design, and screening of vendor-developed packages for possible usefulness. Only after these tasks are almost completed can you begin in-house applications development. User needs can be developed in parallel.

The plan will span several years, which means you'll have to convert the complete plan to a series of annual budget-oriented projects for which money will be appropriated. The process means that management will have to reaffirm its commitment annually, at the least. Any revisions to the yearly plans should be submitted before the next year's budget request, since managers hate unpleasant surprises at budget time.

Flexibility is important. It is impossible to avoid all delays or blindly fight all deviations from the plan without affecting management's confidence in the transformation. Fires of various kinds will break out and users will ask your technical people to leave the transformation project "temporarily" to help. Fixes and modifications will be sought for applications that are scheduled to be scrapped, on the basis that the business can't afford to wait for you to finish.

Perhaps the most formidable obstacle you will encounter is the "stretch it out for budget reasons" command that may come down from the top during a difficult year. Expenditures on your trans-

formation project rarely seem critical in the near term.

The Road Can't Go on Forever

If this command should sound, your staff will begin to wonder if the project will ever get finished and likely will seek transfers to projects with better prospects for success. Organizations rarely abandon transformation projects, they just delay them to death.

Support for the transformation can be boosted by demonstrating some benefits of the system as soon as possible. Most benefits probably will not appear until the new databases are up and running, but some services can be provided earlier. New workstations and local communications likely will be installed early on, along with desktop publishing and decision support tools. Electronic mail probably can be introduced as soon as the new network protocols are in place. Perhaps external services such as database access or intra-industry data interchange can be arranged.

In changing from the old systems to the new, users may be undergoing the biggest behavioral change the organization has ever seen. A consultant may be helpful in guiding you through preparations for that transition; the personnel department could be of real help.

The "buddy system," in which specially trained coworkers in each work group provide assistance, often will work better than will mere training courses. The helpers should be in place as soon as questions from users begin to arise, even if all the answers are not yet available. It is better to appear confused than to appear unresponsive.

The Rewards of a Successful Project

Don't try to accomplish all of this alone; management support may be more readily available than you think. Most managers have read the business press, seen other organizations manage transformations successfully, and observed the information systems of their foreign competitors. As a result, they may be ready, willing, and able to share your determination to see the project through. With that, you might be able to successfully transform your organization's information systems, and your career. People who lead successful system transformation projects usually become valued members of their organization's senior management groups. ■

Frederic G. Withington is a member of DATAMATION's advisory board.

World Class Performance

New PLUS line of 2400 bps modems



Full featured 2400/1200/600/300 bps **PLUS** modems support industry standard AT commands plus... additional commands for:

- advanced synchronous operation
- advanced data flow control
- advanced stored number control
- comprehensive user-friendly help screens, and... a complete package of LEDs and diagnostic capabilities.

Superior performance. CTS **PLUS** modems are designed for superb transmission over marginal telephone lines. CTS' patented digital signal processor, with adaptive equalization, is designed to give you years of highly reliable

performance and is backed by our 2-year limited warranty.

Excellent support. CTS offers an international distributor network and a reputation for technical support that is second to none.

Choose from two **PLUS** modem products. Competitively priced, the 2424ADH **PLUS** and 2424AMH **PLUS** offer substantial savings over comparable full featured synchronous/asynchronous modems.

■ **CTS 2424ADH PLUS**
V.22 bis, Bell 212A, 103,
Synch/Asynch.

Circle No. 28

■ **CTS 2424AMH PLUS**
V.22 bis, Bell 212A, 103,
Synch/Asynch.
MNP* Class 4 error correction

Call toll free today 1-800-328-6104

or write CTS Corporation, Systems & Datacomm Division, 6900 Shady Oak Road, Eden Prairie, MN 55344 for a specification sheet and the name of the stocking distributor nearest you.



CTS. MEANS RELIABILITY

CTS Corporation Systems & Datacomm Division

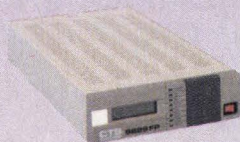

9629FP
Leased Line 9600 bps
V.29 Fast Poll Modem
Circle No. 35

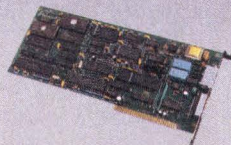

Full-Pak #24M
IBM** PC Compatible
2400 bps 10 Inch Card
Modem with MNP* Class 4
Circle No. 36

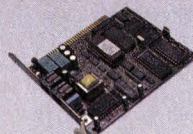

Half-Pak #24
IBM** PC Compatible Half
Card 2400 bps Modem
Circle No. 37

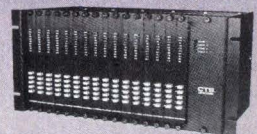

Universal Rack
Accommodates 16 Rackmount
2400 bps Modems with Optional
MNP* Class 4
Circle No. 38

New to the Industry Since 1896.

*Registered trademark of Microcom, Inc. **Registered trademark of International Business Machines, Inc.

Get the Facts from Your DBMS.

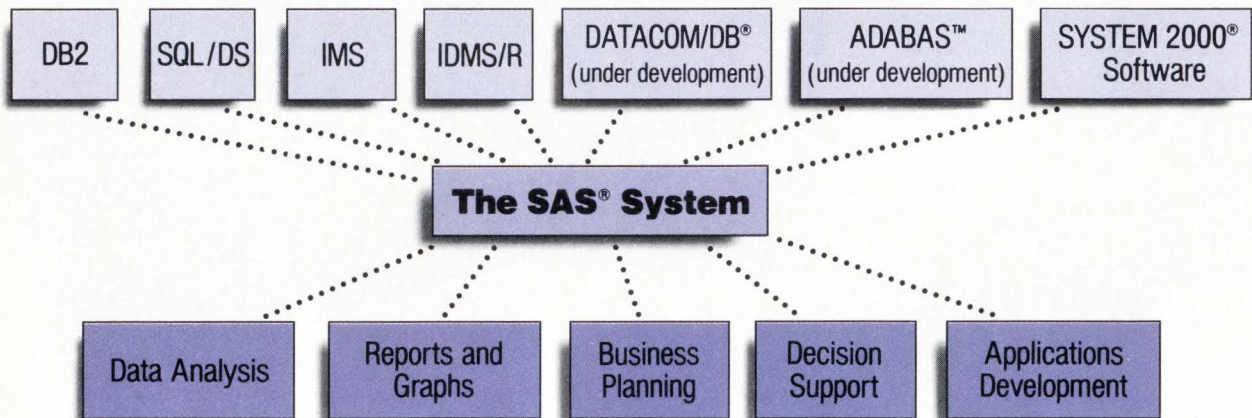

The most powerful applications software has joined forces with the most popular data base management systems. To turn raw data into meaningful facts. To analyze, estimate, optimize, simulate. To produce custom reports and color graphs. Whatever your information need, the SAS System delivers more from the data you store.

Don't Just Store Your Data. Explore Your Data.

The SAS System's ready-to-use tools uncover the real meaning of all those names and numbers. Forecast sales and cash flow. Perform statistical analyses. Build financial and planning models. Create spreadsheets of unlimited size. Schedule projects for best use of time and resources. Produce stacks of personalized letters. Generate calendars, charts, and many other formatted reports. Spot relationships and graph trends with powerful presentation graphics.

Or develop your own applications with the SAS System's efficient fourth-generation language. Customize these applications any way you wish.

If You Know Data Bases. And Even if You Don't.

Menu-driven interfaces link the SAS System with DB2, SQL/DS, IMS, or IDMS/R data bases, and with SYSTEM 2000® Data Management Software. End

users, even those who know nothing about data bases, have immediate access to the data they need. It's as easy as filling in the blanks!

Extract data from your DBMS for use in SAS System applications. Load data from the SAS System directly into your DBMS.

Update values in a data base directly from a SAS System application. All without risk to data security. The SAS System lets you choose which users browse or update specific files.

Get the Facts Today. And Get 30 Days FREE.

Bring the SAS System together with your data base. You'll receive high-quality software—plus training, documentation, and support—all from SAS Institute Inc. We'll even provide a free software trial to get acquainted. For details, call or write today.

```

DB2 INTERFACE          TABLE NAME: DB2.PERSONNEL
DATA EXTRACTION PANEL  SAS DATA SET: PERS.SUBSET
COMMAND=>

FUNC  COLUMN NAME      SAS NAME  FORMAT
***  TABLE: PERSONNEL  ***  COLUMNS- 14 * SELECTED- 0 *
S    LASTNAME          .....  $10.
S    FIRSTNAME         .....  $20.
S    MIDDLEINIT        .....  $2.
S    ADDRESS            .....  $20.
S    CITY              .....  $20.
S    STATE             .....  $2.
S    ZIP               .....  $10.
S    PHONE             .....  $11.
S    SSN               .....  $11.
S    HIREDATE          .....  $10.
S    DEPTCODE          .....  $5.
S    SUPERVIS          .....  $20.
S    DIVISION          .....  $10.
S    TITLE             .....  $15.

----- WHERE CLAUSE -----
city = baltimore_
    
```



SAS Institute Inc.
SAS Circle Box 8000
Cary, NC 27512-8000
Telephone (919) 467-8000
Fax (919) 469-3737

Get the SAS® System.

Ridge Medical Supplies Inc.

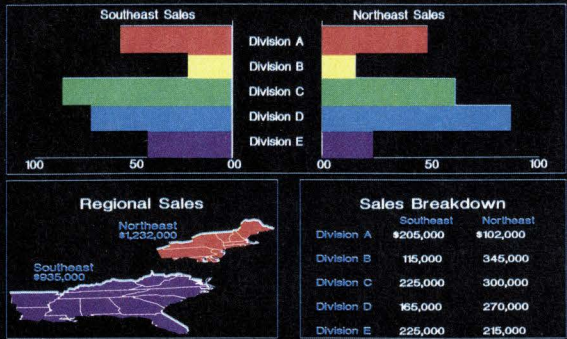

Morgan Cosmetics Inc. P Chart for Perfume Bottle Capacity

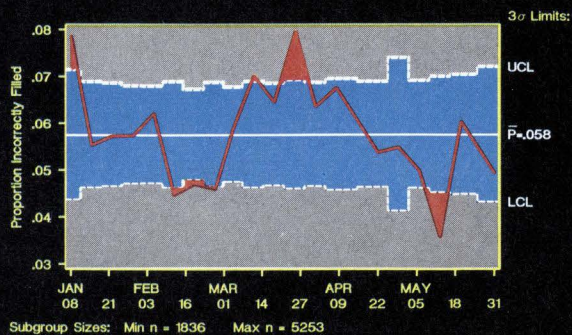

EMS Software International Countries with Products Installed As of January 1, 1987



Quarterly Sales

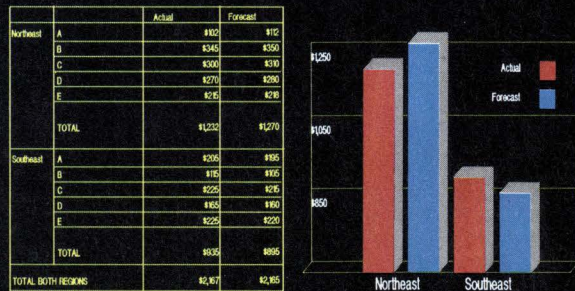

CPU Utilization by Hour

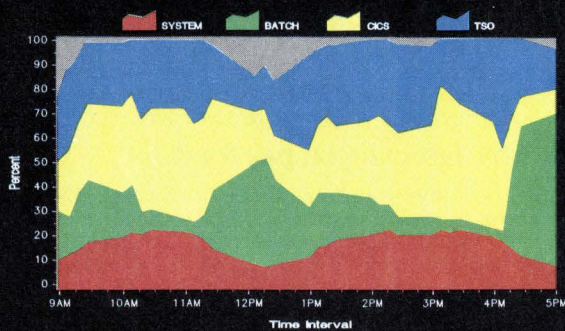

Schedule for Well No. 121-005

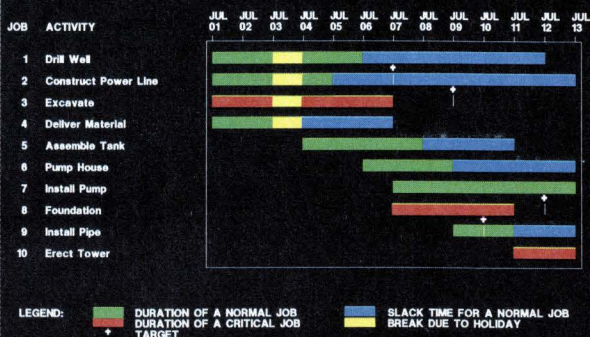

The SAS System runs on IBM Corp.'s 370/30xx/43xx and compatible machines, as well as minicomputers and personal computers.

SAS and SYSTEM 2000 are registered trademarks of SAS Institute Inc., Cary, NC, USA. DB2, SQL/DS, and IMS are products of IBM Corporation, Armonk, NY. IDMS/R is a product of Cullinet Software, Inc., Westwood, MA. DATACOM/DB is a registered trademark of Applied Data Research, Inc. Princeton, NJ. ADABAS is a trademark of Software AG, Reston, VA.

Copyright © 1988 by SAS Institute Inc. Printed in the USA.

THERE ARE FOUR WAYS TO MEASURE THE SPEED OF A LAN.

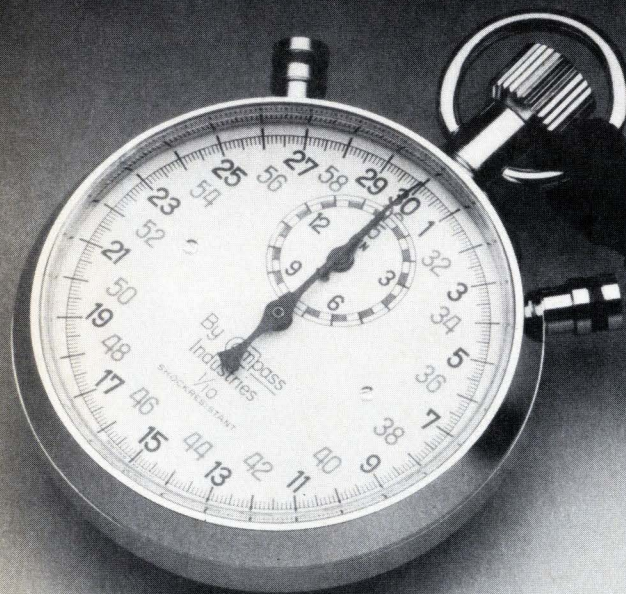

Ours only wins in three of them.

1. How fast does it install.

We have no competition in this category. LANLink 5X installs in about fifteen minutes, and it doesn't take a technician to do it. Since LANLink 5X uses standard parallel or RS-232 serial ports, installing a network means little more than connecting the cable and loading the software.

With hardware LANs, installation can easily take two days—one to set it up and one to tweak it. And it also takes someone who really knows what he's doing. That is, someone expensive.

2. How fast does it transmit.

Okay, this is the category we don't win; the hardware LANs are generally a little quicker. At least, they are under optimal conditions, which is how they rate themselves.

But LANLink 5X is pretty quick, too. At half a megabit per second, it's way out ahead of any other software LAN, and right at the heels of the hardware types. Which, of course, are far more expensive.

3. How fast does it maintain.

The real cost of a network is not so much the initial price as it is the continuing outlay for maintenance—adapting it to changing needs. That's something LANLink 5X does practically on its own.

Running under PC-MOS/386™ or PC-DOS, it turns your server PC into a multi-tasking controller, driving a truly expandable LAN that is easily and quickly upgradable.

A hardware LAN, on the other hand, becomes obsolete as new technology is introduced. And, to keep the network up and running as applications change, you need the attentions of a technician, on a continuing basis. A very well-paid technician.

4. How fast can you pay for it.

Now we've arrived at the bottom line, where LANLink 5X is toughest to beat. You can install a five-user LANLink network for about the same cost as the LAN board in a board-driven network. On top of that, factor in what you save on installation and maintenance time, and the difference is pretty dramatic.

LANLink 5X is available immediately, and it comes with a money-back guarantee. Its price of \$595 includes a server and a satellite module plus the network operating system. Additional satellites are available for \$125.

For complete details on the fastest software-driven network available, call 800-451-LINK.

LANLink 5X. Because three out of four ain't bad.

3577 Parkway Lane, Norcross, GA 30092 (404) 448-5465 FAX (404) 263-6474

LANLINK 5X



THE SOFTWARE LINK

The Evolution of ARPANET

ARPANET, the world's first packet switching network, has been a vital element in the nation's computer and communications research activities, but its managers determined that it was technologically obsolete. The ARPANET spirit lives on, however, in the networks it has spawned, now known as the Internet, which will supplant ARPANET for IS-critical research.

A BY BRAD SCHULTZ
torch in data communications research is being passed from ARPANET, the world's first packet switching network, to the Internet. It is on the Internet that most of the nation's important research about computers is done, with profound implications for commercial IS managers.

"The Internet" is the colloquial name for the largest operational superset of research-oriented internets. Its three major subnetworks are ARPANET (Advanced Research Projects Agency Network), CSNET (Computer Science Network), and NSFNET (National Science Foundation Network), each of which is a network of computer networks.

Allowing Researchers To Interact

According to Vinton G. Cerf, vp at the Corporation for National Research Initiatives, Reston, Va., ARPANET and its successors and progeny, "such as the NSFNET, CSNET, public data nets, local area networks, and regional networks, have formed the basis for interaction among a very large fraction of the computer science and engineering research community." He adds that "this infrastructure has been adopted by other researchers not directly involved in computer communications research."

The size and complexity of the Internet are awesome. Some university computer centers within it have local

area networks larger than the ARPANET, says internetworking consultant Einar Stefferud of Network Management Associates, Huntington Beach, Calif. It also dwarfs some commercial packet nets.

As Stefferud tells it, the commercial

networks—some wide-area, many more LANS—is unfathomable in such terms.

As evidenced at the Enterprise Networking Event in Baltimore last June (see "Enterprise Networking: MAP/TOP Clears Its Biggest Hurdle," June 1, p.

19), commercial IS managers have a big stake in the research on the Internet, which began with the development of the Internet Protocol (IP) and the Transmission Control Protocol (TCP) on ARPANET.

Eliminating Costly Gateways

The IP, which made the Internet feasible, allows networks that are proprietary—at the levels of links and interfaces between computers and links—to be networked without costly gateways (to the extent that IP modules run at the nodes of those networks). The TCP/IP protocol suite is eliminating the need for such costly commercial IS procurements as software systems, which track the flow of individual packets across a network, and gateways, which bridge mutually incompatible networks (see "A Close-up of TCP/IP").

Slated for termination, ARPANET is now only a small subnetwork of the Internet. Last December, U.S. Army Maj. John Mark Pullen, the Defense Advanced Research Projects Agency (DARPA) program manager responsible for ARPANET's \$10 million budget, and USAF Maj. Brian Boesch, who also manages DARPA distributed systems programs, decided that ARPANET had grown technologically obsolete as a high-risk

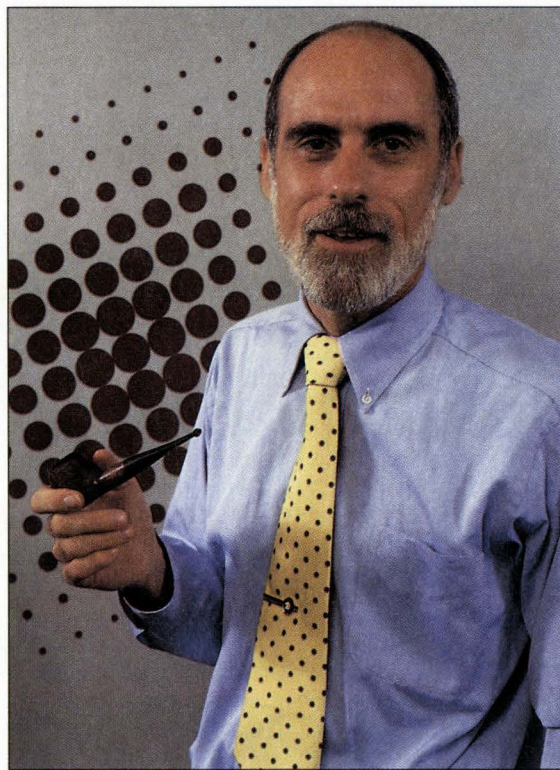

CNRI'S CERF: Replacement of ARPANET is an essential step.

IS manager who boasts of managing tens of thousands of terminals would probably provoke blank stares from internetworkers. Who could count terminals in the Internet? Who would want to? The Internet's nesting of networks within

A Close-up of Transmission Control Protocol/Internet Protocol (TCP/IP)

The entire Internet complies with the Internet Protocol (IP), which was developed along with the Transmission Control Protocol (TCP) to meet the Defense department's especially tough internetworking requirements. IP is implemented as a switching/routing module, usually software, on computers at an internet's nodes.

Connected by trunks, IP modules provide services for use by modules that implement higher-layer protocols, such as TCP. This is the definitive characteristic of layered protocol networks. Each layer (except the lowest) uses the services of lower layers and each layer (except the highest) offers services to higher layers.

The Internet implements transport protocols besides TCP, but TCP has certain advantages, given the needs of many Internet users, and generally runs with IP.

A considerable number of TCP/IP-conformant networks, some of them outside the Internet, now operate in the commercial sector, academic institutions, and civilian government agencies. Meanwhile, TCP-4 has emerged as an alternative to TCP, and the Connectionless Network Service (CLNS) has emerged as an alternative to IP. Both alternatives conform to the ISO's Open Systems Interconnection Reference Model.

The following sketch of TCP/IP builds on a physical mail metaphor and draws on advice from internetworking consultant Einar Stefferud of Network Management Associates, Huntington Beach, Calif. It also serves to describe TCP-4 and CLNS.

In a strictly TCP/IP internet, data travels between sender and receiver applications inside segments, created by TCP modules, which in turn travel inside packets of a special format called IP-datagrams. These IP-datagrams allow TCP segments that comprise a long applications datastream to take different routes through the internet toward their common destination.

TCP modules are active only at the communication path's end points, where applications data are inserted into or removed from TCP segments, which in turn are inserted into or removed from the IP-datagrams. IP modules are active at the end points in the layer below the TCP modules and at the switching/routing nodes across the internet.

Envision the full complement of data a user is trying to transmit across an internet as a document consisting of white typed pages, so numerous that they must be segmented in a series of separate interoffice envelopes, each inscribed with a segment number. Each of these interoffice envelopes is then inserted into a postal envelope, which is inscribed with the destination office address for mailing. Following the metaphor, the white pages represent applications data, the interoffice envelopes represent TCP segments, and the postal envelopes represent IP-datagrams. There are also yellow pages that represent data about white pages.

The sending system's TCP module accepts a set of white pages from an application, counts how many vowels are typed on each, and stuffs a certain number of white pages in each interoffice envelope along with a yellow page that states the

vowel total, the number and order of white pages in that envelope, and how those white pages should be concatenated with the white pages of other interoffice envelopes to reconstitute the original complete document.

The TCP module hands the interoffice envelopes to the IP module, which stuffs them into postal envelopes for mailing and inscribes on each the appropriate return and destination office addresses, as well as some damage detection indicators and the time when the envelope's value expires.

At the IP switching/routing nodes, IP modules route the postal envelopes to the designated offices on the basis of the inscribed postal addresses, but these modules ignore the interoffice envelopes until the postal destination is reached. IP switches also check the condition of envelopes and destroy damaged or overage envelopes.

At the receiving postal address, an IP module removes an interoffice envelope from each postal envelope and hands it to the indicated office (the appropriate TCP module) for processing. This office processing includes detection and correction of errors and disorder. To resolve errors, the receiving TCP module re-counts the vowels on the white pages in each interoffice envelope, compares that total with the yellow page total, and may ask the sending system to resend any segment for which the totals conflict.

To resolve disorder, the receiving TCP module compares what the yellow page says the order of white pages should be with their arrival order. The yellow page also guides the concatenating of those white pages with the white

pages of other interoffice envelopes. Protocols of a layer higher than TCP are concerned with such issues as the format of the white pages, and the style and grammar of what is typed on them, whereas protocols at the IP layer and below are concerned with postal carrier activities, such as bundling, unbundling, and sorting postal envelopes, and handling envelope bundles at airports and on aircraft.

The essential problem IP solves is how to build an internet from nodes and links that comply with a wide variety of lower-level protocols (such as X.25, Ethernet, and token passing). Because nodes and links differ as to the speed and method in which envelopes are bundled, unbundled, sorted, trucked, and flown, it is impractical to standardize exhaustively at the lower protocol layers in internets.

Internets always will need to satisfy the lower-layer protocol requirements peculiar to different generations of technology, let alone those peculiar to different systems architectures. So, IP was contrived to at least end divergence on postal envelopes. Without something such as IP, two networks that differ on envelope standards can only exchange data via a gateway, a system that opens and re-orders envelopes, and converts address information.

Gateways impose extra overhead and risks. IP obviates the need for them, while TCP provides the required higher-layer function of monitoring the condition of the data as the data arrive at the destination, as well as the state of the processes that move the data through the network.

TCP-4 HAS EMERGED AS AN ALTERNATIVE TO TCP.

The Evolution of ARPANET

research resource. Minor user activities occasionally were swamping major ARPANET arteries, Boesch says.

So, Pullen and Boesch notified ARPANET users that they would be moved, without serious disruption of their work, to a new Defense Research Internet (DRI). After those users are satisfactorily ensconced in DRI, and DRI proves to be stable, ARPANET will be killed. Boesch estimates that probably will occur in four years' time. He muses that some hardware that played a role in ARPANET's historic achievements may wind up on display at the Smithsonian Institution.

ARPANET's Honorable Discharge

ARPANET's obsolescence is no surprise, Cerf says, since it originally was created for 50Kbps lines and "technology has reached the point where 1.5Mbps links are needed to support the mass of data exchange now required."

With the growth of high-speed LANs operating at rates from 10Mbps to 178Mbps, he adds, it is evident that speeds of 100Mbps to 1.8Gbps and higher will be needed in the backbone, with switching capacity to match.

DRI will have experimental and operational subnetworks, says Boesch. The segregation is intended to insulate operational activities, such as routine electronic mail and computer conferencing, from the risks of experimental networking. But there is a catch-22, Boesch adds, because experiments on networking, aimed at verifying the value to users of alternative approaches to networking, need to involve a reasonable sampling of users doing what users normally do.

Trunk link speeds on DRI's experimental and operational subnetworks will both begin at 1.544Mbps, Boesch says, but the experimental subnetwork's link speed eventually will be phased up to top 1Gbps. "Although not without its awkward moments," Cerf says, "the replacement of the ARPANET with a much higher speed capability is an essential step toward the creation of a new information infrastructure for the research community and should be viewed positively by all parties interested."

The Internet, however, lives on. CSNET and NSFNET serve computer scientists and other scientists who need to use advanced data networks. CSNET was created mainly to let academic computer scientists share computational resources and exchange mail, explains one of its creators, David J. Farber, professor of both computer and information science

and electrical engineering at the University of Pennsylvania.

CSNET inspired NSFNET, which ties together several supercomputer centers and is also aimed at academia. The NSFNET, however, is directed at researchers interested in computers in any scientific discipline. Some researchers use what was the first major academic network, BITNET, Farber explains, but BITNET mainly serves academic administrators and falls short as an internet.

The value of research on the Internet is well exemplified by MEMNET, a fledgling project that Farber and his colleagues have in the works, which could eliminate the need for network protocols altogether and, in turn, a lot of products that commercial IS managers now must buy. MEMNET is concerned with the opportunities posed by ultrahigh-speed



MEMNET SHOWS THE VALUE OF RESEARCH ON THE INTERNET.

links, which can move at least a few hundred million bits per second.

A computer network configured as a MEMNET essentially operates as a single giant computer. How big can a MEMNET be? The size of a college campus? A county? Texas? The world? Farber and his colleagues plan to find out, implementing it initially on a slice of the Internet that spans the Middle Atlantic states.

MEMNET runs a high risk of failing to meet expectations and of posing unforeseen problems. But not to worry. The Internet, and especially ARPANET, throughout their histories have been intended as havens for high-risk research.

It was in that same spirit—to explore the then unknown merits of networking computers—that the agency now called DARPA hired Bolt, Beranek & Newman (BB&N), Cambridge, Mass., to create ARPANET, which opened in 1969.

Just after ARPANET opened, one of its principal designers, Robert E. Kahn, left BB&N for DARPA and began some high-risk research with packet switching ideas, from which the TCP/IP packet switching protocols ultimately emerged,

Cerf says. Last year, Cerf was made an IEEE fellow for having led the TCP/IP development. The TCP/IP protocol suite was first standardized by the U.S. Defense department and later was adopted as a de facto industry standard.

At DARPA, Cerf says, "Kahn started the packet satellite, packet radio, and internetting programs. Respectively, these looked at sharing a common satellite channel by multiple ground stations [dynamic allocation], sharing a common high-speed radio channel by a number of mobile digital radio units, and the establishment of a protocol architecture and specific protocols enabling heterogeneous packet networks to be linked and operated as if forming a common internet."

The research culminated in the first public demonstration of packet switching in 1972. "For the first time," Cerf says, "the technique of packet switching was demonstrated in a hands-on fashion. Especially impressive was the [ARPANET] network's ability to support echoplex operation [the echoing of characters back to the user for display on his or her video screen] in real time . . . [because] each character was packaged up as a packet, sent store-and-forward style through the packet net, processed by the host, re-packetized, and sent back for real-time display.

"Apart from demonstrating the feasibility of the packet switching concept," Cerf continues, "the ARPANET stimulated the development of a variety of new computer-based applications, such as electronic mail exchange, among hundreds of host computers and thousands of researchers. Before, the only electronic messaging available was found in much less responsive military systems, such as the AUTODIN network. With the introduction of electronic messaging in the highly heterogeneous host environment of the ARPANET, the value of layered protocols and common standards for computer communication was made dramatically apparent."

ARPANET's Ties to Commercial Ventures

The demonstration led BB&N to launch Telenet, the first commercial packet net, in 1975, with consequences that transformed the role of computers in commercial communications. BB&N's Telenet subsidiary went public, diminishing BB&N's share in its equity, and it later was acquired by GTE. Telenet Communications Corp., Reston, Va., is now a subsidiary of U.S. Sprint, a joint venture of GTE and United Telecommunications.

The Evolution of ARPANET

ARPANET was also the focal point for training two or three generations of graduate students in the difficult art of protocol and network design, Cerf notes.

"The many new startups arising in the mid-to-late 1970s and early 1980s in this field were often the direct result of ideas evolved from personal experiences with the ARPANET," Cerf says.

Examples include 3Com Corp., Mountain View, Calif., which was begun by Robert Metcalfe, the co-inventor of Ethernet; Bridge Communications, Mountain View, Calif. (now a division of 3Com), founded by Bill Carrico and Judy Estrin; and Advanced Computer Communications of Santa Barbara, Calif., founded by Roland Bryan.

ARPANET's progeny, the Internet, has no overarching formal management structure, although its operations are guided to varying degrees by a few boards and committees with members in common, generally organized by the federal government. Chief among them are the Federal Coordinating Council on Science, Engineering, and Technology (FCCSET, pronounced "fix it"), the Feder-

al Research Internet Coordinating Council (FRICC), and the FRICC's Internet Activities Board (IAB).

The FRICC was created to coordinate the development of a new major



ARPANET IS NOW A SUB- NETWORK OF THE INTERNET.

subset of the Internet, tentatively called the Interagency Research Internet (IRI), which would be the largest operational superset of civilian federal research internets. R&D-intensive civilian agencies such as NASA, and the companies that do business with them, would use IRI.

IRI was proposed about a year ago by the Network Working Group of the FCCSET's Committee on High Perform-

mance Computing. A spokesman for the group, Barry Leiner, assistant director at the Research Institute for Advanced Computer Science in Moffett Field, Calif., tells DATAMATION that "things are moving forward rapidly" on IRI.

"The various agency networks are being interconnected," says Leiner, "and agreements [are] being initiated to allow appropriate sharing of resources. NSFNET has played a key role in all of this by providing a coherent method for providing access for the university community.

"There will be some short-term rough spots," Leiner adds, "as the agencies and the FRICC try to cope with the massive explosion in the use of the networks, compared to the available resources [network and funding], but that is called being a victim of success, something we shouldn't really complain about." IRI's total operations budget would begin at around an equal level with ARPANET's (\$10 million per fiscal year) and would reach \$13 million by fiscal year 1991.

Internet's Boundaries Defy Definition

What complicates attempts to manage or even analyze the Internet is that its boundaries defy definition. Any computer in the world capable of IP-conformant communications (Berkeley Unix systems, for example) can connect to the Internet, in principle, though administrative policies exercised on both sides of the connection would determine availability of the Internet's resources. Access to the Armed Forces' MILNET, for example, is extremely restricted in order to preserve national security, yet the IP-conformant MILNET might be considered part of the Internet.

Because BITNET does not conform to IP, it can only exchange data with the Internet via a special gateway at the University of Wisconsin. For the same reason, commercial companies and individuals lacking IP modules need gateway services to exchange mail with Internet addresses.

One such gateway on the market is the DASNET gateway service of DA Systems, Campbell, Calif. A long list of commercial electronic mail services, including facsimile (Group 3), MCI Mail, Telemail, Telex, and Easylink, can front-end to DASNET and exchange electronic mail with ARPANET, CSNET, NSFNET, and most other Internet addresses. ■

Brad Schultz is a freelance writer based in New York City.

Mainframe Interconnection Is Our Line

Our Products Include:

- Blue Cable "New"
- Bus/Tag Testers
- And Much More



Our Pledge:

- Zero Defects
- Overnight Shipment
- Technical Support

Mainframe I/O Bus/Tag Cable Assemblies

For Pricing And Information Call

REN Electronics Corp.

(A Major OEM Supplier)

755 New Ludlow Road, South Hadley, MA 01075

East of Miss. R. & MN. 413-536-1800 West of Miss. R. 719-275-7595

HERE IS SOMETHING THAT WILL HIT YOUR HOT BUTTON



All IMS/VS networks—no matter the size—are faced with one or more of these hot buttons. But **DELTA IMS VIRTUAL TERMINAL** resolves each of these problems by its ability to *dynamically create the IMS/VS network*.

- Eliminates most terminal-related IMSGENS and decreases the frequency and length of all IMSGENS
- Provides virtual storage constraint relief and reduces the demand for real storage
- Ends the security problem of misdirected messages and enhances security through the automatic timer facility
- Decreases system shutdown/restart times
- Immediately adds new users and implements end-user changes

For more information on **DELTA IMS VIRTUAL TERMINAL** or to begin a 30-Day-Plus Free Trial, return the attached coupon, or give BMC Software a call.

In the U.S. and Canada: **1-800-841-2031**

In Texas, call collect: 713-240-8800

France (16-1) 48 77 77 77

Italy (02) 48193845

Japan (03) 837-8651

United Kingdom (0276) 24622

West Germany (069) 664060

BMC
SOFTWARE

BMC Software, Inc.

PO. Box 2002 • Sugar Land, TX 77487-2002

DM

Contact me about a 30-Day-Plus Free Trial of **DELTA IMS VIRTUAL TERMINAL**.

Contact me with more information on **DELTA IMS VIRTUAL TERMINAL**.

Name _____

Title _____

Company _____

Address _____

City _____ State/Prov. _____ Zip/PC. _____

Phone _____

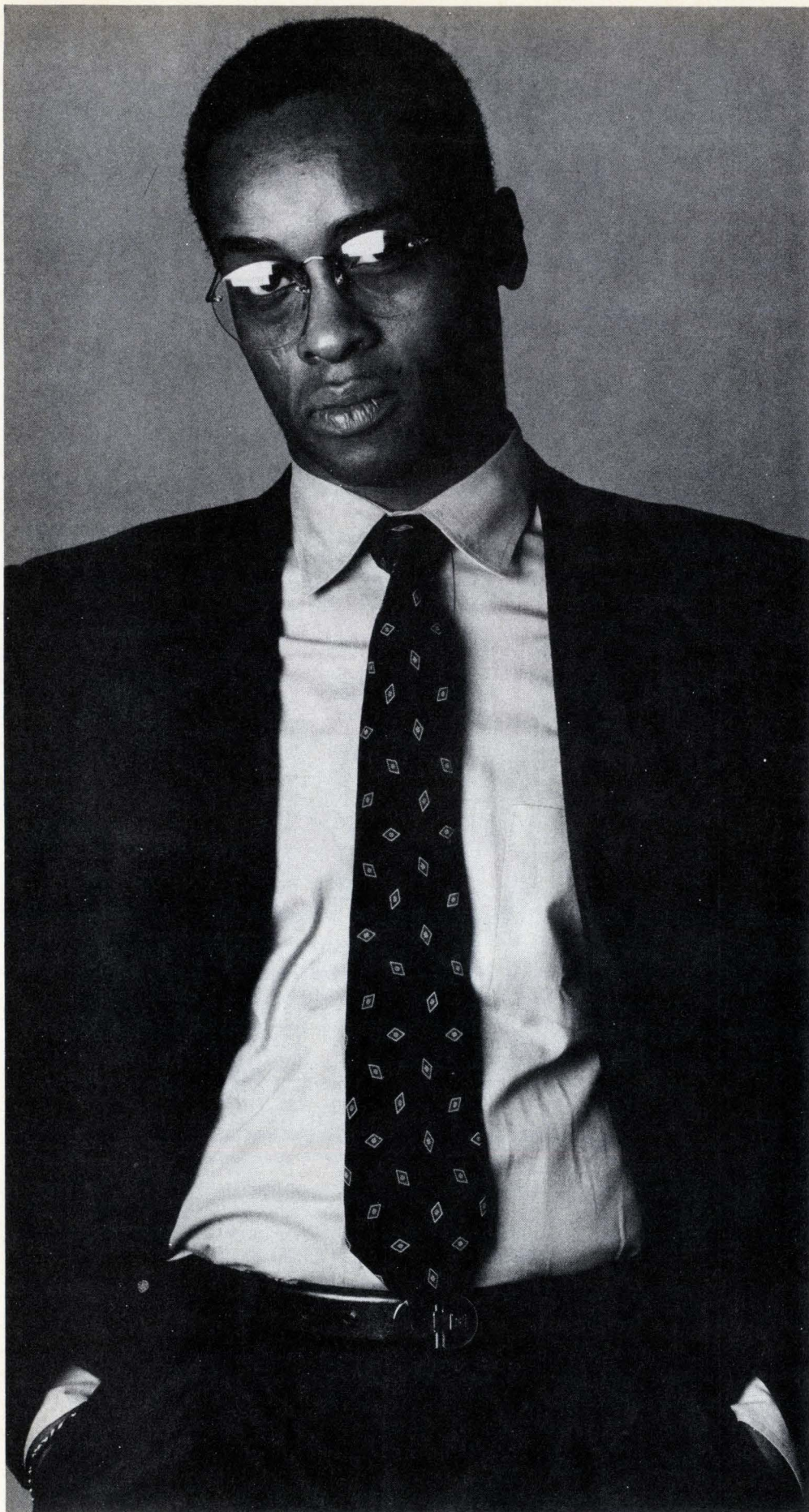

**The last thing
an addict needs
from you is
understanding.**

One of the first principles of modern management is understanding. With all the feelings of tolerance and agreement and working together that the word implies. A manager is supposed to care about the employee's needs.

It won't work with drugs.

You've got to offer the hard choice: Get well or get out.

Your toughness may be an addict's only hope. Because the threat of losing a job sometimes gets drug users into treatment. That's when you can be understanding—after the treatment has begun.

If you don't have a treatment program in your company, please call 1-800-843-4971. That's the National Institute on Drug Abuse hot line for managers and CEOs. It's manned by trained Employee Assistance Program planners and designers, from Monday through Friday, 9:00 a.m. to 8:00 p.m. Eastern Time. They won't tell you what to do, but they can outline the options. Then you can do the first thing an addict needs from you.

Partnership for a Drug-Free America

New Products

TRENDS

THE V.42 MODEM ERROR-CONTROL standard promises users several benefits. Recently finalized by CCITT, V.42 is expected to improve the integrity of data transmitted with modems, make error control a standard feature in modems, open the door to data compression, and, most important, provide compatibility.

In the micro modem world, the V.42 standard should help improve data integrity by bringing error correction to the modem, according to Rick Villars, a senior market analyst for International Data Corp., Framingham, Mass. This means users don't have to rely on devices such as pcs to handle it. As users move from leased lines to dial-up lines, error-free data transmission is crucial.

Another benefit V.42 may offer is the inclusion of error control as a standard feature. Villars predicts that error correction will be like PC AT command sets: "Today, no one buys a modem without AT command sets, which used to cost a lot of extra money. Now they're incorporated into the modem chip set. The same will happen to error control, and we'll see modems with V.42 at the same price as those without."

There are undefined parts of the standard that vendors are particularly fond of. As Villars explains, "There's room left for proprietary value-added features." For Dennis Hayes, president of Hayes Microcomputer Products Inc., Norcross, Ga., this means "the vendor can make enhancements without interfering with the progress of the standard." Hayes says his company plans to use this space for data compression.

Microcom Inc., Norwood, Mass., probably will use this space for increased compatibility between V.42 and Microcom Networking Protocol (MNP), IDC's Villars says. Although the ISDN-compatible LAPM (link access procedure modem) is the primary protocol in V.42, the standard also includes levels two through four of MNP, which Microcom says is in 500,000 installed modems. IDC estimates that 15% of all dial-modems shipped last year included MNP. Microcom reportedly will put MNP levels five through nine in the space left by V.42 for proprietary enhancements.

As Dennis Hayes says, the biggest benefit to users offered by V.42 is compatibility. Villars predicts that by the end of 1990, 20% of all modems will include V.42, and that by the end of 1993, 50% will be V.42-compatible.

If you'd like additional information about products covered in this issue's hardware Trends, please circle 221 on the reader service card.

HARDWARE

Compaq, IBM Deliver Powerful New Micros

Compaq brings 386 to the low end and uses 25MHz chip; IBM unveils PS/2 Model 70s.

BY MARY KATHLEEN FLYNN

Two and a half weeks after IBM brought out its fastest personal computer and bolstered its PS/2 line, Compaq Corp. rolled out two powerful additions to its Deskpro line of pcs.

The Deskpro 386/25 combines Intel's 25MHz 80386 with Compaq's Flex



Compaq brings out the Deskpro 386/25.

Architecture, which makes use of the 25MHz Intel 82385 cache memory controller operating with its own 32KB of static RAM. According to Compaq, the multibus Flex Architecture, which is based on IBM's AT bus, enables the 386/25 to run up to 60% faster than 20MHz noncache 80386-based Micro Channel systems such as IBM's Model 80-111 and the new Model 70-121.

The 386/25 comes in two models. Model 110 features a half-height 110MB fixed disk drive with average access time of 25msec; it is priced at \$10,299. Model 300 is priced at \$13,299 and features a full-height 110MB fixed disk drive with average access time under 20msec.

Aimed at more price-sensitive users, Compaq's Deskpro 386s, which runs at 16MHz, is the first pc to use Intel's new 386SX microprocessor. According to Intel, the new chip combines 16-bit hardware components, like those used in 286-based pcs, with the 32-bit programming model so that it can run software designed for 386-based machines.

Compaq claims the 386s provides greater overall storage capacity, better expansion capability, and between 35% and 60% better system performance than 1MHz 80286-based pcs, such as IBM's PS/2 Model 50 Z. It comes in three models: Model 1 is priced at \$3,799; Model 20, which adds a 20MB fixed disk drive with average access time less than 29msec, is priced at \$4,499; Model 40, with a 40MB fixed disk drive with average access time of 29msec, is priced at \$5,199.

The machines run Compaq's own version of DOS 3.3 and its own OS/2 1.0. COMPAQ CORP., Houston. CIRCLE 222

IBM has launched three versions of the PS/2 Model 70-386, its fastest personal computer, and has enhanced both the Model 50 and the Model 25.

The 386-based Model 70 comes in three configurations. The 70-A21 runs at 25MHz, includes a 120MB fixed disk drive, and is priced at \$11,295. It is available this quarter. The 70-121 runs at 20MHz and includes a 120MB fixed disk drive. It is available now and is priced at \$7,995.



IBM launches the PS/2 Model 70-386.

Also available now is the 70-E61, priced at \$5,995. It runs at 16MHz and has a 60MB fixed disk drive.

IBM's new version of its 286-based Model 50, the Model 50 Z, operates at

New Products

BRIEFS

zero wait state, which means that the processor isn't delayed by a slower memory. IBM claims the new model provides up to 35% better performance than the current Model 50. It also offers more and faster storage. Available now, the 30MB version is priced at \$3,995; the 60MB version is \$4,595. No upgrades or trade-ins are being offered.

An IBM Token Ring card and two fixed disk features have been added to the 8086-based Model 25. Available now, the Model 25 LAN Station is \$2,139 for monochrome display and \$2,484 for color. The fixed disk drives are \$795 each. IBM, Armonk, N.Y. CIRCLE 223

Workstations

Two 68030-based Unix workstations beef up Apollo's product line. Apollo Computer Inc. has filled out its workstation line with two Unix 68030-based desktop machines. Each of the machines is based on Motorola's 68030 microprocessor.

Apollo's 7MIPS Series 4500 Personal Super Workstation is its top desktop machine. The 4500's cpu and floating point coprocessor both run at 33MHz. It features 64KB of physical cache and 8MB to 32MB of interleaved memory and will



Three new workstation models from Apollo Computer Inc.

ship in the fourth quarter. Prices begin at \$18,990. The 4MIPS Series 3500 Personal Workstation is a step above Apollo's existing entry-level 3000 machine. Priced at \$9,990 for color display, which is approximately \$4,000 more than the 3000, the 3500 offers more memory, more mass storage, and a fifth graphics display option. Optional accelerators extend 2-D graphics performance by as much as 400%, and floating point performance by as much as 300%, according to Apollo. The monochrome version is priced at \$7,990. Both versions are available now. APOLLO COMPUTER INC., Chelmsford, Mass. CIRCLE 224

Laser Printer

BDT's new printer is designed for shared office environments.

BDT Products has introduced a departmental laser print station, which includes a 10 page-per-minute laser printer and a paper/envelope handling system for shared office environments.

Targeted at departmental use over a PC LAN or with multiple workstations tied to a central minicomputer or mainframe, the ErgoPrint 610 features seven input trays and 10 output trays. The trays can be dedicated to individual users and/or paper types for automated paper/envelope handling and collating. The printer, which can double as an office copier, can produce up to 25,000 sheets and envelopes per month. Available in September, pricing ranges between \$17,900 and \$19,900. BDT PRODUCTS INC., Irvine, Calif. CIRCLE 225

Networking

Hyperchannel-DX makes possible networks of networks.

Network Systems Corp. has launched a line of products called Hyperchannel-DX, which, it says, allows different networks to be joined together in a seamless network

of shared resources. Initial offerings are for supercomputers from Cray Research Inc., large IBM and plug-compatible mainframes, and minicomputers from Digital Equipment Corp., Hewlett-Packard, and Data General.

The Hyperchannel-DX products act as "traffic cops," explains

the vendor, accepting data from one processor or network and routing them to an assigned destination. The Hyperchannel units allow computers on a network to move data at the machines' full rated speed—up to 100Mbps.

Hyperchannel-DX products support coaxial cable, fiber-optic cable, twisted pair wire, high-speed telephone lines, and global communications links. They support the following communications protocols: Ethernet, TCP/IP, Hyperchannel, and FDDI and OSI. Available in the fourth quarter, prices range between \$30,000 and \$100,000. NETWORK SYSTEMS CORP., Minneapolis. CIRCLE 252

Lasergraphics Inc., Irvine, Calif., has brought out a **digital film recorder** for use with the Lasergraphics Rascol III standalone rasterizer. For mainframe, mini, and LAN users, the film recorder generates 4,000-line presentation slides. It's available for \$12,950. CIRCLE 226

Cermetek Microelectronics Inc., Sunnyvale, Calif., has chopped \$200 off the price of its **V.32 modem**. The Spectrum 9600 FR is now \$1,795. CIRCLE 227

Network General Corp., Mountain View, Calif., has brought out the Laptop Sniffer Model PA-302. The **laptop protocol analyzer and diagnostic tool for Ethernet-based LANs** is available for \$15,000. CIRCLE 228

Epson America Inc., Torrance, Calif., has added two **nine-pin dot matrix printers** to its FX product line. The 80-column FX-850 is priced at \$549. The 136-column FX-1050 is \$799. CIRCLE 229

RAD Data Communications, Rochelle Park, N.J., has rolled out the Remote Ethernet Management Station, a **dedicated control station for bridge/router networks**. Available now, pricing for the unit begins at \$5,950. CIRCLE 230

Emulex Corp., Costa Mesa, Calif., has brought out a **14.4Kbps CCITT V.33 leased line modem** with automatic dial backup. The Performance 1000 Dial Backup is priced at \$1,995. Without dial backup, the older Performance 1000 is priced at \$1,795. CIRCLE 231

Retix, Baltimore, has introduced a series of **intelligent wide area network controllers** for the IBM AT, XT, and PS/2 Models 30 and 50, and compatibles. The wide area network cards support both connection-oriented and connectionless network services, such as MAP, TOP, COS, NBS, and GOSIP OSI profiles. Available now, pricing for the PC 300 products begins at \$600. CIRCLE 232

Dallas Semiconductor, Dallas, has introduced a **single-chip microcontroller**, which can log events and schedule activities by date and time. The vendor claims the chip is the first to include a lithium energy source, a clock/calendar, and nonvolatile RAM for program and data storage. Available this month in 1,000-piece quantities, the DS500T comes in a 32KB memory version for \$80.75, and a 8KB memory version for \$64. CIRCLE 233

Some Datacomm Standards Should Be Carved in Stone

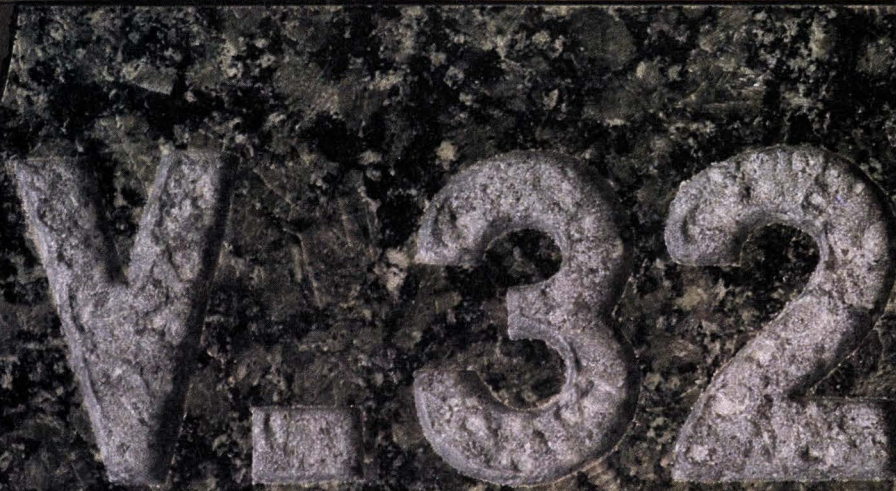
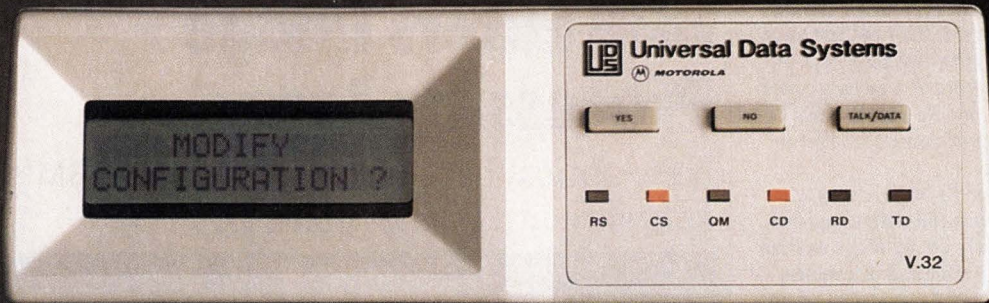

In the matter of full-duplex data communication at 9600 bps, a number of approaches have been discussed. There's the CCITT-approved V.32. There are even some "pseudo V.32s" around. Some suggest that, because of their somewhat lower cost, non-standard modems may be the answer.

At Universal Data Systems, our position is carved in stone: for full end-to-end compatibility, regardless of equipment source, standardization on true V.32 is the only workable solution.

That's why the fully featured UDS V.32 is the acknowledged price/performance leader.

Our exclusive near-end/far-end echo cancellation techniques, combined

with trellis coding, result in -17 dBm signal-to-noise ratio; that's plenty of horsepower for voice-grade lines.

As back-up for your dedicated four- or two-wire system, or for a 9600 bps upgrade of your present dial-up communications, check out the UDS V.32. It's the standard!

Universal Data Systems, 5000 Bradford Drive, Huntsville, AL 35805.

Telephone 205/721-8000;
Telex 752602 UDS HTV.

\$1595⁰⁰
Quantity One



Universal Data Systems



New Products

TRENDS

OFF-SITE IS OPERATIONS recently have traveled much farther afield. Over the last year, Ireland—long a favorite overseas location for U.S.-based hardware and software companies, such as DEC and Microsoft—has become the remote site of choice for several U.S. user companies.

Attracted by Ireland's large, cheap labor pool, GEISCO, McGraw-Hill, Travelers, and New York Life all have set up shops on Irish soil. The jobs being performed in Ireland—in-house software development, insurance claims processing, and magazine subscription fulfillment—are more sophisticated than the data entry tasks traditionally associated with overseas dp, says John O'Brien, a spokesman for the Industrial Development Association (IDA) of Ireland.

In addition to cost savings of 60% to 70% compared with American labor, the luck of the Irish is that they're well-educated, English-speaking, and they don't job-hop like their counterparts on the other side of the Atlantic. With unemployment at 19%, Ireland is eager for U.S. employers. IDA sweetens the pot by giving employment grants, picking up training tabs, and reminding prospects that Ireland has guaranteed until the end of the century its 10% corporate tax rate (compared with 34% in the U.S.) for software, computer services, and manufacturing firms.

N.Y. Life Insurance Co. is the newest kid on the Irish block and the second insurance company to make the move. Last year, Travelers Corp. of Hartford, Conn., hired 27 programmers to develop applications in Limerick. In February, N.Y. Life began to establish its first overseas dp facility at Castelisland, County Kerry. John Foy, vp of group claims, tells DATAMATION that by the end of 1989, N.Y. Life plans to employ 100 claims processors—half of whom already have been hired—at the Castelisland site. These new hires will handle between 12% and 15% of the company's claims, receiving claim forms by overnight courier and sending them back electronically over leased lines to an IBM 3090 in Clinton, N.J.

Foy, who was born in Ireland and is now a U.S. citizen, says he approached IDA. At N.Y. Life, he explains, "we see a continuing shortage of workers performing typical clerical operations in the U.S. from now until the end of the century." By farming out some clerical work, N.Y. Life hopes "to protect ourselves from U.S. demographics" trends.

If you'd like additional information about products covered in this issue's software Trends, please circle 247 on the reader service card.

SOFTWARE

IBM Enters Image Processing Arena

New optical-based system features IBM's software in a FileNet jukebox.

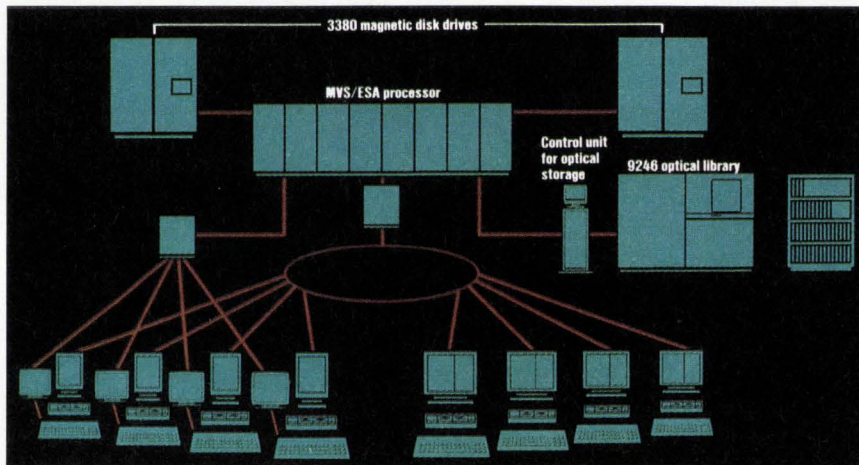

ImagePlus in an MVS/ESA environment. Installations are planned for the second quarter.

BY MARY KATHLEEN FLYNN

IBM has entered the image-processing arena with ImagePlus, its new optical-based document management system. It's designed for customers that process large amounts of paper, such as insurance companies and banks.

Image processing allows businesses to capture, store, process, and retrieve information on a computer electronically. According to IBM, its value lies in its ability to scan documents and store them in a database, giving users immediate and concurrent access to the information.

IBM has announced that ImagePlus components will include applications software; enhancements to IBM's Data Facility Systems Management Storage; on-line optical storage subsystem products, including write-once optical disk library units made by FileNet Corp. and 12-inch write-once optical disk drives made by Laser Magnetic Storage International Co.; PS/2-based intelligent workstations; and two new monochrome display monitors.

ImagePlus software is available for IBM's ESA/370 processors, the System/36 family, and the recently introduced Application System/400. Prices

range between \$200,000 and \$15 million. Some ImagePlus systems are already installed at selected customer sites. More System/36 and AS/400 installations are scheduled for the end of this year, and MVS/ESA installations are planned for the second quarter of 1989. IBM, Rye Brook, N.Y.

CIRCLE 234

Database Management

Distributed relational database server is introduced by startup.

VIA Information Systems Corp., a U.S.-Finnish joint venture, has brought its PC LAN distributed relational database management environment to the U.S. market.

The vendor claims that its product brings mainframe-like capabilities to the business PC LAN user. The system features a database server, which offers peer-to-peer communications; a single-stack relational database; automatic logging; dynamic recovery; C facilities; support for SQL; and an object-oriented programming environment for applications development.

Running on DOS and OS/2, the VIA/DRE server program is priced at \$3,500 and supports as many users as are on the LAN. For developers, the VIA/COOL (C ob-

New Products

ject-oriented language) module is \$1,395. A combined system is priced at \$4,500; a single-user VIA/DRE is priced at \$295. VIA INFORMATION SYSTEMS CORP., Princeton, N.J. CIRCLE 235

Executive Support System

Execucom offers its first ESS, which incorporates AI technology.

Executive Edge is Execucom's new executive support system (ESS). Designed for senior executives, the program incorporates a so-called artificial intelligence-based "plain English" explain facility. According to the vendor, it determines the most significant underlying causes of business trends and variances automatically.

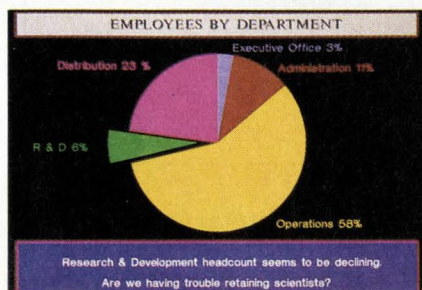

The product is based on Execucom's IFPS/Plus 3.6, a corporate planning and decision support system (DSS). Options include an analysis extension, a presentation extension, and interfaces to IBM's DB2 and SQL/DS DBMS.

Executive Edge is available now, priced between \$35,000 and \$150,000. The data management and DSS components run on IBM MVS or VM, DEC VAX, Prime Primos, Sun, or Apollo. The user interface and graphics components run on IBM PCs and compatibles under DOS. EXECUCOM, Austin, Texas. CIRCLE 236

Windows

Microsoft opens up Windows memory for 286s and 386s.

Microsoft has released Windows 2.03, which features added memory and is available for 286 and 386 machines. A new software development kit for building graphical applications also was introduced.

Microsoft says the new Windows/286 provides up to an extra 50KB of addressable memory when more than 1MB of extended memory is available in AT-style pcs and when 1MB is available in PS/2-style machines.

Windows/286 is available now for \$99. Windows/386 is available now for \$195. The software development kit is priced at \$500. MICROSOFT CORP., Redmond, Wash. CIRCLE 237

Oil Exploration

Landmark offers architecture for oil industry applications.

Landmark Graphics Corp., has unveiled a software architecture designed to provide a standard, windows-based interface for applications software in oil exploration and production applications.

Developed in conjunction with CogniSeis Development Inc., the OpenWorks environment is designed to address the growing need for integrating traditionally separate disciplines—geophysics, geology, and petroleum engineering—in the oil industry. Cray Research, CogniSeis, and two oil companies that wish to remain anonymous have adopted the architecture.

OpenWork consists of three components: SmartWindows, SmartData, and SmartBus. SmartWindows is a common graphics interface, which requires the geoscientist to learn only one methodology for all computer-related operations.

SmartData is a common database interface, which provides transparent shared access to databases, including those that already exist within oil companies.

SmartBus is a multivendor integration component. The SmartBus Development System Kit, which sits above Unix, TCP/IP, and Windows, is available now to software developers for in-house

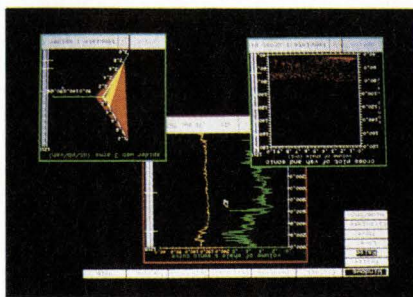

and commercial use. Pricing details can be obtained from the vendor.

Landmark plans to deliver applications based on the architecture in 1989's first quarter. Landmark is at work on versions for Sun, Macintosh II, PS/2, and Compaq 386 environments. LANDMARK GRAPHICS CORP., Houston. CIRCLE 238

BRIEFS

Computer Associates International Inc., San Jose, has enhanced its SuperCalc spreadsheet. New features include multisheets with hotlinks, which can link multiple spreadsheets and multiple pages of a spreadsheet. SuperCalc 5 runs under DOS 3.0 and will be available this quarter, priced at \$495. CIRCLE 239

Software Publishing Corp., Mountain View, Calif., has made available five accessory programs for its Harvard Graphics presentation graphics software, priced between \$99 and \$149. CIRCLE 240

Telenet Communications Corp., Anaheim, Calif., has made available an X.400-based service that enables users of IBM's Professional Office System to communicate with subscribers of the Telemail e-mail service. CIRCLE 241

On-Line Software, Fort Lee, N.J., has brought out a symbolic dump productivity tool for the CICS environment. SymDump, which is for use with InterTest, On-Line's CICS debugging and testing tool, is available now at \$6,250 per cpu for current InterTest customers and \$12,500 with a first-time purchase of InterTest. CIRCLE 242

Emissary Systems Ltd., Toronto, has introduced an e-mail package for PC LANs that is built directly on IBM's SNA Distribution Services. An MS/DOS-PC/DOS version of HERALD Mail is available now, priced at \$6,995. CIRCLE 243

Neuron Data, Palo Alto, has made available the NEXPERT OBJECT for the complete family of Sun Microsystems workstations. A C-based expert systems shell for commercial applications development, the complete development product on Sun systems is priced between \$5,000 and \$8,000. A run-time version also is available for between \$600 and \$1,500. CIRCLE 244

Encore Computer Corp., Marlborough, Mass., has a new parallel implementation of Ada running on the Encore Multimax multiprocessor system. Parallel Ada prices begin at \$20,000 for commercial and government users, and \$7,500 for users in education. CIRCLE 245

American Management Company Inc., Lexington, Mass., has a new version of its systems management software for VAX/VMS. V-X MASTER II version 1.4 is priced from \$3,500 to \$12,400. CIRCLE 246

ADVERTISING SALES OFFICES

Publisher
Don Fagan
Associate Publisher
William Segallis
Production Manager
Eric Jorgensen

EASTERN REGION

Eastern Regional
Sales Manager
Frances E. Bolger
249 W. 17th St.
New York, NY 10011
(212) 463-6552

Tom Carey
487 Devon Park Dr.
Suite 206
Wayne, PA 19087
(215) 293-1212

Northeast
Edward Rappaport
199 Wells Avenue
Newton, MA 02159
(617) 964-3730

Southeast
Larry Pullman
6520 Powers Ferry Road
Suite 395
Atlanta, GA 30339
(404) 955-6500

Middle Atlantic
Kathleen A. Murray
8 Stamford Forum
PO Box 10277
Stamford, CT 06904
(203) 328-2547

Midwest
John Stellwagen
1350 E. Touhy Avenue
Des Plaines, IL 60018
(312) 390-2967

WESTERN REGION

Western Regional
Sales Manager
Kaye Sharbrogh
3031 Tisch Way
Suite 100
San Jose, CA 95128
(408) 243-8838

West
Janet Engelbrecht
582 Market St.

Room 1007
San Francisco, CA 94104
(415) 981-2594

Bob Hubbard
18818 Teller Avenue
Suite 170
Irvine, CA 92715
(714) 851-9422

Texas
Richard W. Sheehan
9330 LBJ Freeway
Suite 1060
Dallas, TX 75243
(214) 644-3683

INTERNATIONAL

Cahners Publishing
Company
27 Paul I Street
London, EC2A 4JU, England
Tel: 44 1 628-7030
Telex: 914911 TEC PUB G
Fax: 44 1 839-6626

Managing Director—Europe
Edward Reuteler Jr.

U.K., Benelux
Jan Dawson
Tracey Lehane

Scandinavia
Martin Sutcliffe
France, Italy, Spain
Alasdair Melville

W. Germany, Austria,
Switzerland,
E. Europe
Uwe Kretzschmar

Israel
Roseline Lewin-Wainberg
Cahners Publishing
Company
68 Sokolov St.
Ramat Hasharon 47 235
Israel
Tel.: 03-49 12 69

Japan
Kaoru Hara
Dynaco Int'l Inc.
Suite 1003, Sun-Palace
Shinjuku
8-12-1 Nishishinjuku,
Shinjuku-ku
Tokyo, 160, Japan
Tel: (03) 366-8301
Telex: J2322609
Fax: 03-366-8302

Taiwan
Parson Lee
Acteam International
Marketing Corp.
6F, No. 43, Lane 13
Kwang-Fu South Road
Mailbox 18-91
Taipei, 10594,
Taiwan R.O.C.
Tel (02) 760-6209
Telex: 29809 ACTEAM

Hong Kong
John Byrne & Associates
1613 Hutchison House
10 Harcourt Road
Newline, Central, Hong Kong
Tel: 5-265474
Telex: 61708
Fax: 5-8106781

Singapore
Peter Cheong
Asia Pacific Media House
P.T.E. Ltd.
Newline 100 Beach Road
24-03 Shaw Tower
Singapore 0718
Tel: 291-5354
Telex: RS50026

DATAMATION CAREER OPPORTUNITIES

Roberta Renard
National Sales Manager
(201) 228-8602
Janet O. Penn
Eastern Sales Manager
(201) 228-8610
Maria Cubas
Production Assistant
(201) 228-8608
103 Eisenhower Parkway
Roseland, NJ 07068

Ellen Sherwood
Western Sales Manager
12233 West Olympic Blvd.
Los Angeles, CA 90064
(213) 826-5818

INFORMATION CARD DECKS

Liz Mullen
Department Supervisor
1305 E. Touhy Ave.
Des Plaines, IL 60018
(312) 390-2762

CAHNERS MAGAZINE DIVISION

William M. Platt
Chief Executive Officer

Terrence M. McDermott
President

Frank Sibley
Group Vice President

Jerry D. Neth
Vice President
Publishing Operations

Tom Dellamaria
VP/Production & Manufacturing

Cahners Publishing Company
A Division of Reed Publishing USA

Specialized Business Magazines for Building & Construction, Manufacturing, Foodservice & Lodging, Electronics & Computers, Interior Design, Printing, Publishing, Industrial Research & Technology, Health Care, and Entertainment. Specialized Consumer Magazines: American Baby and Modern Bride.

Departments

CALENDAR

AUGUST

National Conference on Artificial Intelligence.

Aug. 21-26, St. Paul. Contact Claudia Mazzetti, American Association for Artificial Intelligence, 445 Burgess Dr., Menlo Park, CA 94025, (415) 328-3123.

SEPTEMBER

ShowCASE Conference III.

Sept. 20-21, St. Louis. Contact Donna Skaggs, Washington University, Campus Box 1141, 1 Brookings Dr., St. Louis, MO 63130, (314) 889-5380.

OOPSLA '88 (Conference on Object Oriented Programming: Systems Languages and Applications).

Sept. 25-29, San Diego. Contact Barbara Noparstak, Digitalk Inc., 9841 Airport Blvd., Los Angeles, CA 92680, (714) 731-9022.

OCTOBER

TeleCon VIII (Teleconferencing Users Conference).

Oct. 10-11, Anaheim, Calif. Contact Applied Business teleCommunications, Box 1506, San Ramon, CA 94583, (415) 820-5563.

Info '88 (Information Management Exposition and Conference).

Oct. 11-14, New York. Contact Show Manager, Info '88, 999 Summer St., Stamford, CT 06905, (203) 964-0000.

FCC (Federal Computer Conference) and DGC (Defense and Government Computer Graphics Conference).

Oct. 25-27, Washington, D.C. Contact National Council for Education on Information Strategies (NCEIS), 15200 Shady Grove Rd., #350, Rockville, MD 20850, (301) 670-2818.

SYSTEC '88 (CAD/CAM/CIM Show).

Oct. 25-28, Munich. Contact Gerald G. Kallman, Kallman Associates, 5 Maple Ct., Ridgewood, NJ 07450-4431, (201) 652-3898.

Unix Expo (The Unix Operating System Exposition and Conference).

Oct. 31-Nov. 2, New York. Contact National Expositions Co. Inc., 15 W. 39th St., New York, NY 10018, (800) 223-2121; in N.Y., (212) 391-9111.

Career Opportunities

DATAMATION

1988 Editorial Calendar and Planning Guide

Issue Date	Recruitment Deadline	Editorial Emphasis
Aug. 15	July 27	Enterprise Computing
Sept. 1	Aug. 11	Japan 10
Sept. 15	Aug. 24	Best Computer Science Universities

Call today for information:

East Coast: **Janet O. Penn (201) 228-8610**

West Coast: **Ellen Sherwood (213) 826-5818**

National: **Roberta Renard (201) 228-8602**

COMPUTER SERVICES MANAGER

Milwaukee Library System. Requires: exper. with Concurrent Computer or Perkin-Elmer mini-computer technology, real time transaction processing, and very large database mgt.; 4 yrs. C, COBOL and Asembler programming; BS In computer science or related; 4 yrs. EDP exper. including 2 yrs. of systems analysis; 2 yrs. of supervisory experience; and residency in City within 6 mos. Familiarity with Reliance operating syts. desirable. Salary range: \$35K to 50s. SEND RESUME or contact for more info: Sharon Rogers, (414) 278-2029, City of Milwaukee, Personnel Box CSM, Room 706, City Hall, 200 E. Wells St., Milwaukee, WI 53202-3554. An Affirmative Action Employer.

TANDEM PROGRAMMERS

HIGH TECH CO SERVING TOP INT'L WALL STREET FIRMS NEEDS TANDEM PROGRAMMER WITH EXPERIENCE IN TAL/COBOL AND PATHWAY EXCELLENT SALARY. OPPORTUNITY FOR GROWTH CONTACT: FITEL 810 7TH AVE, 26TH FL NYC 10019 (212) 307-1616

INFORMATION SYSTEMS OPPORTUNITIES

The Avondale Division of Hewlett-Packard has Information Systems openings for programmer/analysts and manufacturing systems administrators.

You would be responsible for the implementation and support of complex information systems in a manufacturing/marketing organization. Programmer/analysis focus on software design, installation, and COBOL and/or 4GL programming in an HP3000 environment. Systems administrators emphasize the user interface to manufacturing information systems which includes training, reporting and process documentation.

The successful candidates must have a BS in a technical field which includes systems education and/or related manufacturing experience, possibly with personal computer applications. An advanced degree in MIS, CS, or MBA is preferred.

These positions offer attractive salaries commensurate with your experience and comprehensive benefits, including profit sharing and flexible work hours. Avondale is located 30 miles southwest of Philadelphia. Please indicate which position you are applying for and send your resume to S. Allen, HEWLETT-PACKARD CO. Box 900, Avondale, Pa. 19311. An Equal Opportunity Employer dedicated to Affirmative Action.



Auto-Cad Designer/ Draftsperson

Pilot Woodworking, a dynamic, growing entrepreneurial contract furniture manufacturer located in Carlstadt, New Jersey, and a subsidiary of Chartwell Group Ltd., is seeking several skilled Auto-Cad Designers.

Successful candidates should have one to five years knowledge/experience with Auto-Cad, Sun Microsystems-based system would be a plus, as would knowledge of architectural woodworking or custom furniture design.

We offer an attractive starting salary and an excellent benefits package including profit sharing and employee stock purchase plan along with an environment that will foster your personal and professional growth.

Please forward resume with salary history/requirement to: Mr. Geoffrey A. Nelson, Director of Human Resources, Pilot Woodworking Inc., a Chartwell Group Company, 105 Amor Avenue, Carlstadt, NJ 07072. An equal opportunity employer.



**Chartwell
Group Ltd.**

ASIAN DEVELOPMENT BANK

The Asian Development Bank, a multilateral finance institution, with Headquarters in Manila, Philippines, invites applications for the following position:

COMPUTER SYSTEMS SPECIALIST

Qualifications

- Bachelor's Degree in Computer Science Engineering or Mathematics.
- Minimum of six years professional experience in data processing of which at least three should be in ADABAS data base applications/administration.
- Extensive knowledge of ADABAS and NATURAL internals with programming experience in Assembler.
- Technical experience in MVS/CICS/TSO.
- Technical Support experience in problem determination and debugging in any large mainframe IBM environment.
- Knowledge of data administration, system development methodology, electronic mail system, and text retrieval system preferable.

Remuneration

A competitive salary paid in U.S. Dollars, normally free of tax, and an excellent benefits package.

Interested persons may send their curriculum vitae in English to the following:

**REF. No. 8809-E
HUMAN RESOURCES DIVISION
ASIAN DEVELOPMENT BANK
P.O. BOX 789, MANILA
PHILIPPINES**

Enquiries may be sent by telex (Numbers 63587 ADB PN; 40571 ADB PM; 23103 ADB PH) or Facsimile Number (632) 741-7961 or by phoning International Tel. Number (632) 711-3851.

ARABIAN AMERICAN OIL COMPANY

The Arabian American Oil Company continues the high standards of an industry leader. We are seeking highly qualified professionals to join us in Saudi Arabia.

If you're an upstream computer analyst in any of the following areas, and possess a related BS degree along with 5+ years' experience, you should consider us.

**COMPUTER PROGRAMMING
COMPUTER TRAINING
COMPUTER HARDWARE
PETROLEUM ENGINEERING SYSTEMS
EXPLORATION APPLICATION SYSTEMS
COMPUTER END USER
COMPUTER OPERATIONS**

With the Arabian American Oil Company, you will discover large-scale technology that will challenge you professionally. For confidential consideration, please send your resume to: **ASC, Employment, Dept. 06E-019-8, P.O. Box 4530, Houston, Texas 77210-4530.**

DID YOU KNOW? . . .

- 77% of over 182,000 of the most qualified Computer Systems/Operations/Data Processing and Software Engineering Professionals read **DATAMATION** regularly; at least 3 out of 4 issues.
- The **DATAMATION** reader spends 1 hour 14 minutes reading each issue, and has been doing so for 8 years.
- More than 64% of these readers go through each issue page-by-page, and pass the magazine along to an additional 5 people.

NOW, the **DATAMATION CAREER OPPORTUNITIES** section will bring you the latest in current job opportunities!

For more information, and to reserve your ad in our next issue call:

Roberta Renard **201/228-8602**
National Recruitment Sales Manager

Set your sights on new horizons.



Unsurpassed technological challenges and career growth opportunities are in sight with General Dynamics Data Systems Division. We develop highly innovative software to meet the technical and data processing requirements of General Dynamics Corporation. Our professionals enjoy the challenges of achieving their fullest professional potential while applying their talents toward career advancement.

Our Western Center is located in San Diego, which is as well-known for its many popular cultural and entertainment centers as it is for its beautiful bays and beaches. All provide enjoyment for the entire family year-

round. The diverse communities which surround downtown are easily accessible due to a well-planned freeway system, and allow a choice of affordable lifestyles in different settings.

If you're interested in all we have to offer, set your sights on one of the following positions.

Avionics Systems Software

- Guidance, Navigation & Control
- Advanced Sensors & Image Processing
- Real-time, Hardware-in-the-Loop Simulation
- Software Development, Tools & Environments

Digital Imagery Exploitation Systems Software

- Microprocessor distributed system development
- Large-scale Data Bases
- Photogrammetric and geopositioning technologies
- Interactive real-time graphics

Software Test Engineers

- Design, develop, integrate and document test systems for hardware/software systems
- Verify conformance to design requirements
- Develop test procedures, conduct test activities, analyze test data and prepare test reports.

Command & Control Systems Software

- Battle Management/C³I
- Mission Planning/Automated Routing
- Strike Planning
- Neural Networks

Each position requires experience in embedded software, Ada, FORTRAN and C in a VMS/VAX environment. Only candidates who meet the minimum requirements are urged to apply.

Please send your resume to: General Dynamics Data Systems Division, Western Center, Drawer 185, c/o MDK Confidential Reply Services, 401 West "A" Street, Suite 1150, San Diego, CA 92101.

And expand your world again.

GENERAL DYNAMICS

Data Systems Division

Equal Opportunity Employer

S O F T W A R E
S P E C I A L I S T S

Now is the time

Challenging opportunities exist for experienced Technical Professionals in our Customer Support Center in Colorado Springs.

We are looking for professionals who have superb communication skills—who thrive in a customer support setting—to consult with our customers on a one-to-one basis. You should be able to work as an active team member while researching and structuring innovative solutions to complex software problems.

We are looking for qualified applicants with a degree in Computer Science and/or the equivalent experience specific to the following disciplines:

VAX/VMS* **Support**

You must have 2 or more years experience with VMS as

a system manager or from a strong user level support role.

Network Support

You must have 2 or more years experience with one of the following Digital Networks and Communications products:

- DECnet,* VAX* and/or DECnet RSX*
- Ethernet Technology
- Ethernet Terminal Servers
- DECserver 100/200*

For immediate consideration, please send your resume to: Ms. Barbara Cusack, Dept. 0801 8807, Digital Equipment Corporation, 305 Rockrimmon Blvd. South, Colorado Springs, CO 80919.

We are an affirmative action employer.

*Trademarks of Digital Equipment Corporation

Be part of the story. . . now.

digitalTM

"YOU CAN'T DO THAT"

Build a large scale mainframe computer that will outperform the competition's leading model?

"IMPOSSIBLE!" they said.

But Amdahl did it back in the early 1970s. And today we are a leader in the development, manufacturing, marketing and support of general purpose and scientific computer systems, storage products, communications systems and software.

In less than two decades we have grown from 5 to more than 8,000 "can do" employees around the globe. Our success is a result of teamwork, innovation and commitment to achieve the impossible. If you are ready for challenge, creativity and growth, explore your opportunities with Amdahl in one of the following areas:

SYSTEM SOFTWARE DIVISION

In 1986 Amdahl introduced UTS*, the only native **UNIX® operating system running on 370 architecture, which we developed using AT&T System V. Now we have multiple software products under development which run on 370 architecture, and we have plans for many more, including advance data communications products, commercial On-Line Transaction Processing (OLTP), Network Management, and Trusted Systems. These efforts represent new market opportunities for Amdahl, and new career opportunities for software product management professionals.

Product Management—Communications & UNIX OS

YOU CAN take P&L responsibility for new software products. From developing the product requirements and the product statement to impacting the marketing plans and the sales strategy, you will drive your products to completion by leading all corporate organizations in product development. For one position you must have a strong technical orientation in large networks (over 500 terminals) including VTAM, SNA or X.25, TCP/IP; for the other position your technical background must emphasize UNIX operating system planning. For either position you must have a proven track record in completing projects. Any 370 experience is a plus. Bachelors degree (or equivalent) required, MBA preferred.

Strategic Alliances—Third Party Software

YOU CAN take responsibility for Amdahl's relationship with Third Party software vendors. You will define our need, survey available technology, negotiate contracts and take ownership of relations with our strategic allies. Your background must show a solid track record in Third Party software, contract negotiation, UNIX and/or 370 architecture, and the ability to make executive-level presentations.

Product Manager—Trusted Systems

YOU CAN direct Amdahl's entrance into the Trusted Information Systems arena. You will represent Amdahl to the National Computer Security Center and negotiate Amdahl's UTS Operating System products through the NCSC certification process. In addition, you will organize Amdahl's internal resources to support the NCSC processes. You must have at least 5 years of management experience, a conceptual understanding of the Orange Book, a track record working with Government agencies, and knowledge of computer system hardware architecture for this highly visible position. A Bachelors degree (or equivalent) is required, an MSCS is preferred.

Product Marketing—OLTP

YOU CAN define marketplaces for Amdahl's software technology. You will interact with customers to define requirements for our software and hardware products, then based on those customer requirements, you will define the overall business opportunities for Amdahl's present and future software products. You must have experience in commercial On-Line Transaction Processing (OLTP), UNIX and/or Tandem, VAX/VMS, 370 architectures, and in developing customer requirements and business opportunities.

YOU CAN join in the excitement of creating the computer systems of the future, while enjoying the benefits and competitive salary you would expect from an industry leader.

YOU CAN contact Doug Jones at (800) 538-8460, extension 6906, or send your resume to him at Amdahl Corporation, Employment Department 8-3, P.O. Box 3470, M/S 300, Sunnyvale, California 94088-3470. Principals only, please.

Amdahl Corporation is proud to be an equal opportunity employer through affirmative action.

*UTS is a registered trademark of Amdahl Corporation.
**UNIX® is a registered trademark of AT&T Bell Labs.

YOU CAN AT
amdahl

Marketplace

Advertisers' Index

Smooth Conversion with CTG/DATAWARE

Save money, time, and manpower on your conversion project with CTG/Dataware. Our skilled specialists work with you to ensure a smooth, timely, cost-effective conversion.

COBOL TO COBOL
RPG TO COBOL
ASSEMBLER TO COBOL
AUTOCODER TO COBOL
EASYCODER TO COBOL
PL/I TO COBOL
RPG TO PL/I
DOS TO MVS

CTG/Dataware has the total solution — software, methodology, and support services — to help you change hardware, programming languages, or operating systems smoothly and quickly. Call the conversion specialists, CTG/Dataware:

1-800-367-2687



COMPUTER TASK GROUP INC. DATAWARE CONVERSION SERVICES

3095 Union Road
Orchard Park, New York 14127-1214
(716) 674-9310 TELEX: 510-100-2155

CIRCLE 200 ON READER CARD

Circle		Page	Circle		Page
13	Amdahl Corp.	23	22	Nokia Datacommunications**	48
25	Ameritech***	48-49	—	Northern Telecom, Inc.	14-15
10	ADR	10			
32	BMC Software	75	24	Olivetti SPA**	48-7
8	Boole & Babbage	21			
1	Carlisle DEI/Memory Products Group	C2	17	Philips Information Systems Co.	29
11	Cincom Systems, Inc.	16	14	Phoenix Software	24
—	Compaq Computer	33-40			
200	Computer Task Group/Dataware*	88	31	REN Electronics Corp.	74
28, 35					
36, 37					
38	CTS Corporation/Systems & Datacomm Div.	67			
9	Datasouth	13	—	SAS Institute, Inc.	68-69
			23	Siemens AG**	48-4, 48-5
20	Hayes Microcomputer	45	30	Software Link	70
			2	Stratus Computer, Inc.	C3
—	IBM Corp.	57-64			
19	Information Builders, Inc.	43	15	Tymnet/McDonnell Douglas	26-27
—	Joiner Associates, Inc.	46	6	Unisys Corp.	6-7
			34	Universal Data Systems	79
4	Landmark Systems Corporation	1	5	VM Software, Inc.	5
21	Language Technology, Inc.	47			
			26	Wandel & Goltermann**	49
7	Motorola Computer Systems	8-9			
3	MSA	C4			
—	NEC Information Systems/Engineer	32			
—	NEC Information Systems/Peripherals	20			
27	Nixdorf Computer Corp.	54-55			

RECRUITMENT ADVERTISING83-87

Amdahl Corp.
Aramco
Asian Development Bank
City of Milwaukee
Digital Equipment Corp.
FITEL
General Dynamics/Data Systems Div.
Shartwell Group LTD.

*Marketplace
**International Edition
***Regional Advertiser

DID YOU KNOW...

The DATAMATION Career Opportunities

Section is on
Page 83 of
this Issue?

NOW AVAILABLE:

DATAMATION 1987 Editorial Index

An alphabetical listing of all articles, subjects and companies covered in DATAMATION throughout 1987.

A Great Reference Tool
for Only \$5.00!

To order your copy today, send a check made out to DATAMATION for \$5.00 to:

Ellen Lux
DATAMATION
249 West 17th Street
New York, NY 10011