

# Electronic Design 2

VOL. 19 NO.

FOR ENGINEERS AND ENGINEERING MANAGERS

JAN. 21, 1971

**Versatile scope system displays and stores with nine plug-ins that are interchangeable. Single and dual-beam modes are selectable. Up to four simultaneous signals**

**can be viewed. Time-base and amplifier plug-ins allow high-gain delayed-sweep measurements. System converts from bench-top to rack-mount in seconds. P. 83**

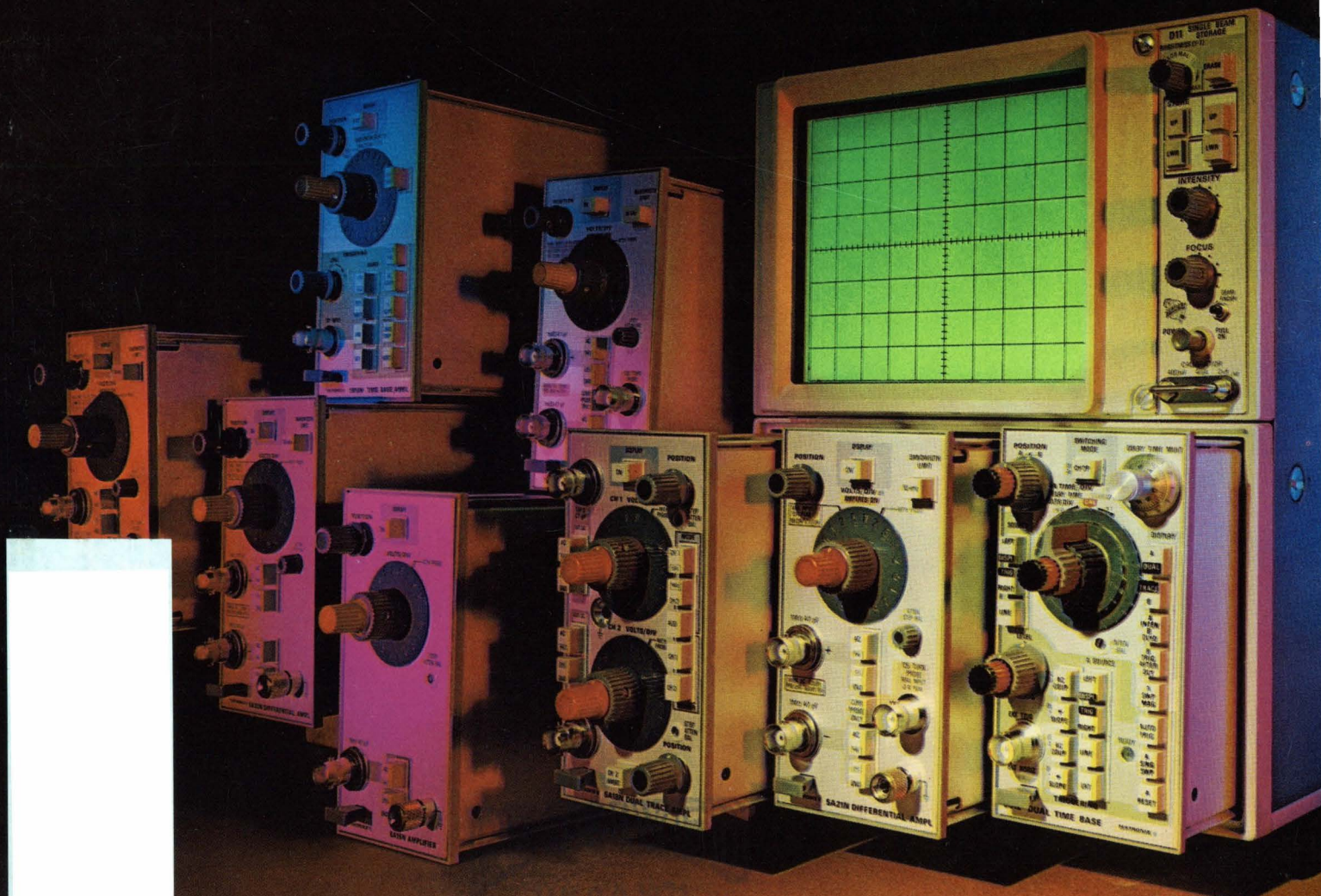

# Would you waste your money on a screwdriver like this?

Of course not. In this day of tight budgets, you don't want tools with a lot of unnecessary bells and whistles; you want tools that are functional—that give you the capabilities you need, without costing a fortune.

Hewlett-Packard understands. As electronic engineers ourselves, we know that an EE's "screwdriver" is his oscilloscope. And we know that the **last** thing you need at any time—and especially when your budget is pinched—is an expensive Buck Rogers Special loaded with non-functional extras.

That's why the key concept in our new scopes is **functionality**. State-of-the-art advances in measurement capability, but no chrome strips or foxtails. And that's also why a lot of people who used to just buy the first scope that came to mind are now taking a second look.

What they're discovering is that the HP 180 System is by far the best buy in general-purpose lab scopes today. If you don't believe it, look at these price/performance comparisons.

HP's 50 MHz dual-channel system, with an 8 x 10 cm display, 5 mV/div deflection factor, and 5 ns/div sweep, is only \$2,035—12% less than its main competitor.

HP's 100 MHz dual-channel system, with 10 mV/div deflection factor, 5 ns/div delayed sweep, and variable persistence and storage, is \$3,950—27% less than the competition.

HP's 250 MHz real-time dual-channel system, with 10 mV/div de-

flexion factor, and 1 ns/div sweep time is \$3,250. With delayed sweep, \$3,750. Unfortunately, there's no comparable instrument to match price tags with.

And HP's 1 GHz dual-channel sampling scope, with 2 mV/div sensitivity and internal triggering is only \$2,545—nearly 43% less than the competition's comparable model!

To get the full story on the functional, reasonably priced HP 180 System, call your local HP field engineer. Or write Hewlett-Packard, Palo Alto, California 94304. In Europe: 1217 Meyrin-Geneva, Switzerland.

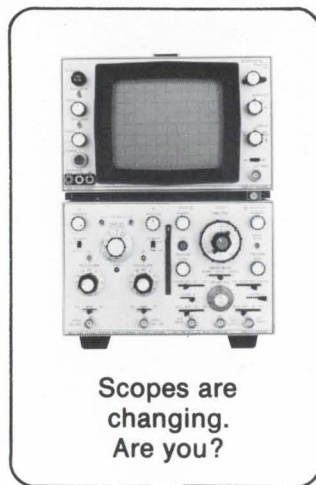
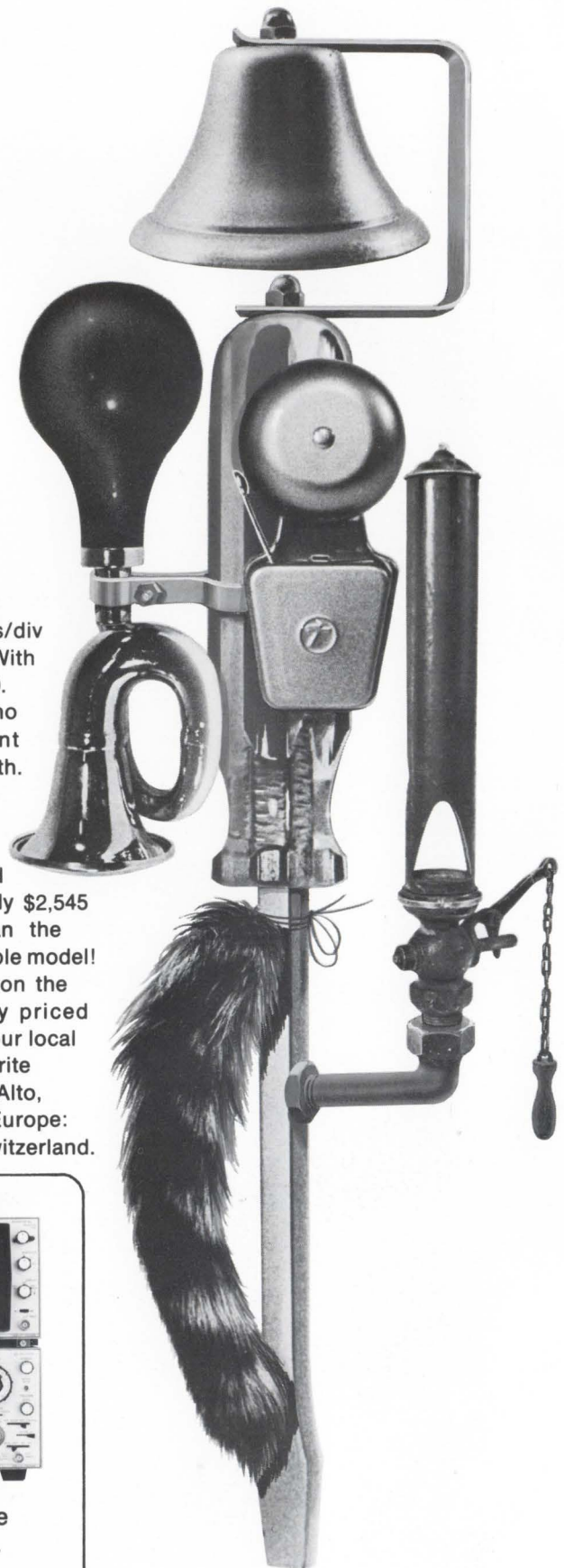

Scopes are  
changing.  
Are you?

081/5

HEWLETT  PACKARD

INFORMATION RETRIEVAL NUMBER 242

## Cutler-Hammer extends its Rockette Switch line with the first totally illuminated rocker.

Totally visual indication of operation. It's Cutler-Hammer's new illuminated Rockette Switch. Another example of how we go just a little further to meet your design and functional needs.

The little extras that are part of every Cutler-Hammer Rockette Switch, like the entirely translucent rocker, are what has made us Number 1. The switches people specify when designing commercial appliances and business machines—because quality equipment demands the best.

Our 9 rocker shapes, each in a

wide variety of colors, offer the finest in design flexibility and distinctive appearance. And, the legend is hot stamped.

AC-rated. AC/DC. Printed circuit terminations. Single pole. Two pole. Four pole. Dry-circuit capability, or up to 20 amps. 125 and 250 volt service. Single-, double-, and triple-throw contacts. You name it.

So, on the next piece of quality equipment you design, brighten it with a Rockette Switch from Number 1. Call your Cutler-Hammer Sales Office or Stocking Distributor. Or write for new full-line catalog LD-110-217

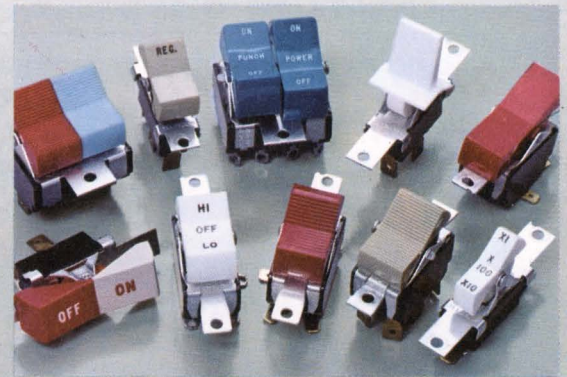

Quality switches for quality equipment. Check with your distributor for our Rockette Line of switches. AC. AC/DC. Low energy. Dry circuit. Up to 20 amps.

**CUTLER-HAMMER**  
SPECIALTY PRODUCTS DIVISION, Milwaukee, Wis. 53201



INFORMATION RETRIEVAL NUMBER 2

# Enlightenment.

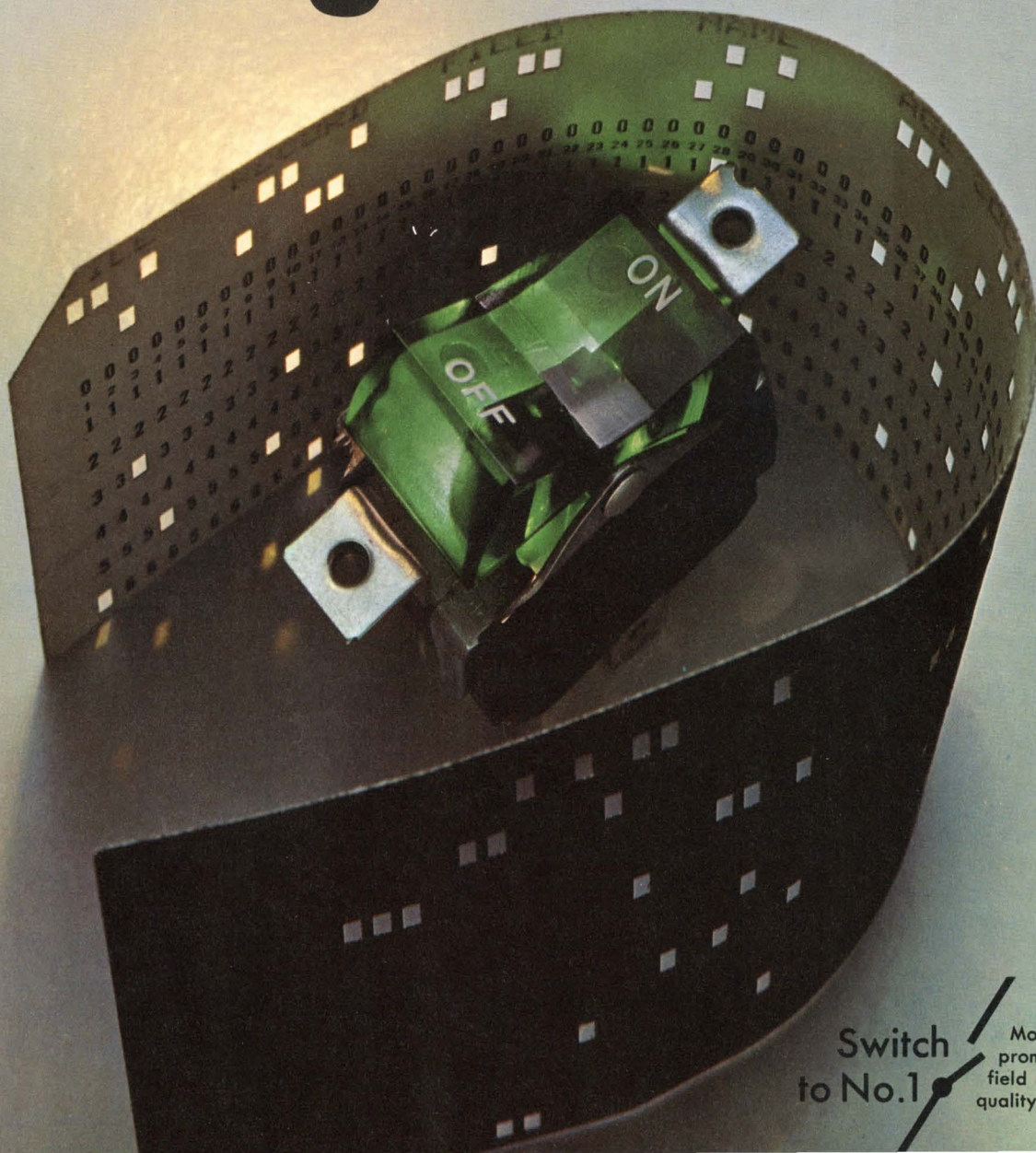

Switch  
to No.1

More than just switches;  
prompt availability,  
field help, innovation,  
quality assurance, too.

# TRW Presents 10 new RF power amplifier modules

Part #	$P_{in}$ (mW)	$P_o$ (Watts)	f (MHz)
MV .75	10	0.75	150-175
MV 1.5	40	1.5	150-175
MV 2.5	50	2.5	150-175
MV 7.5	150	7.5	150-175
MV 12.0	100	12.0	150-175
MX .75	20	0.75	400-512
MX 1.5	10	1.5	400-512
MX 2.5	20	2.5	400-512
MX 7.5	50	7.5	400-512
MX 12.0	150	12.0	400-512

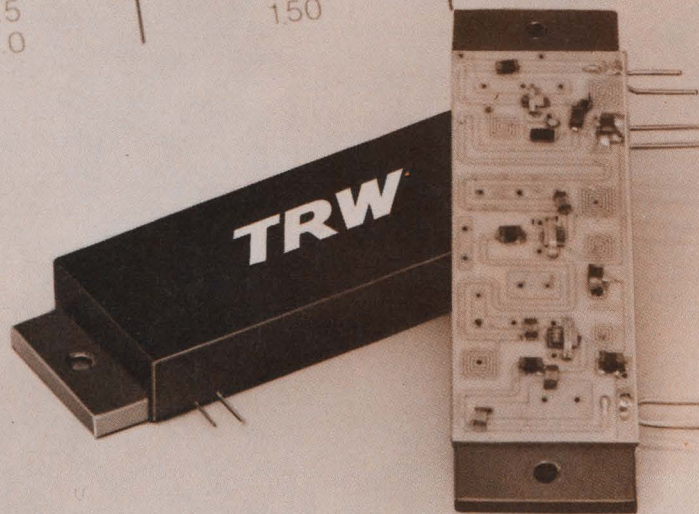

**16 to 21 dB gain... 0.75 to 12 W output...  $\infty$  VSWR**

A new series of broadband 12-volt amplifier modules developed by TRW covers the 150-175 MHz and 400-512 MHz mobile bands. They provide from 0.75 to 12 watts output power, and contain the entire amplifier function in a single microelectronic module. They are capable of 16 to 21 dB of gain, and can withstand infinite VSWR at 15 volts.

Compared to discrete compo-

ponents, these new modules offer the designer significant savings in size as well as design and production costs. They are stable under all operating conditions, and have a high level of harmonic rejection ( $-30$  dB min.).

Delivery is immediate on the standard units. Custom modules are also available for any band between 135 and 520 MHz. For complete information and tech-

nical data, contact TRW Semiconductor Div., 14520 Aviation Blvd., Lawndale, Calif. 90260. Phone: (213) 679-4561, Ext. 631. TWX 910-325-6206.

## TRW®

---

## NEWS

- 21 **News Scope**
- 24 **Digital filters with LSI** promise a new world of applications— including an improved nationwide telephone system.
- 28 **Introducing the electronic car:** six systems in experimental Triumph enhance driver safety and comfort while curbing air pollution.
- 30 **Army developing 30¢ tuning capacitor**
- 32 **Space-station program** needs custom-made sensors
- 36 **Technology Abroad**
- 39 **Washington Report**

---

## TECHNOLOGY

- 46 **Microstrip can reduce multiplier size** but it may enlarge the design problem. Understanding the circuit functions is the key to success.
- 55 **Speed up synchronous counters** by eliminating logic-gate delays in the front end and restricting gates to slowly changing signals.
- 62 **Don't minimize noise figure** to optimize the noise performance of your operational amplifier. Concentrate on maximizing the output S/N ratio.
- 68 **Firm name games are serious business.** Examples show the need for flexibility to avoid duplications.
- 74 **Ideas for Design**

---

## PRODUCTS

- 83 **Instrumentation:** New modular scope system includes 9 plug-ins.
- 87 **ICs & Semiconductors:** Analog switch works at  $\pm 10$ -V levels.
- 93 **Microwaves & Lasers:** Diode working at 6 GHz pulses out 100 W.
- 89 Data Processing
- 90 Modules & Subassemblies
- 92 Packaging & Materials
- 94 Components
- 104 Product Index

---

## Departments

- 45 **Editorial:** Do we want free trade—or fair play?
- 7 Letters
- 13 Designer's Calendar
- 96 Evaluation Samples
- 96 Design Aids
- 96 Application Notes
- 98 New Literature
- 100 Bulletin Board
- 101 Advertisers' Index
- 108 Information Retrieval Card

**Cover:** New modular oscilloscope system photographed by Larry Jackson of Tektronix, Inc., Beaverton, Ore.

# Fight noise pollution

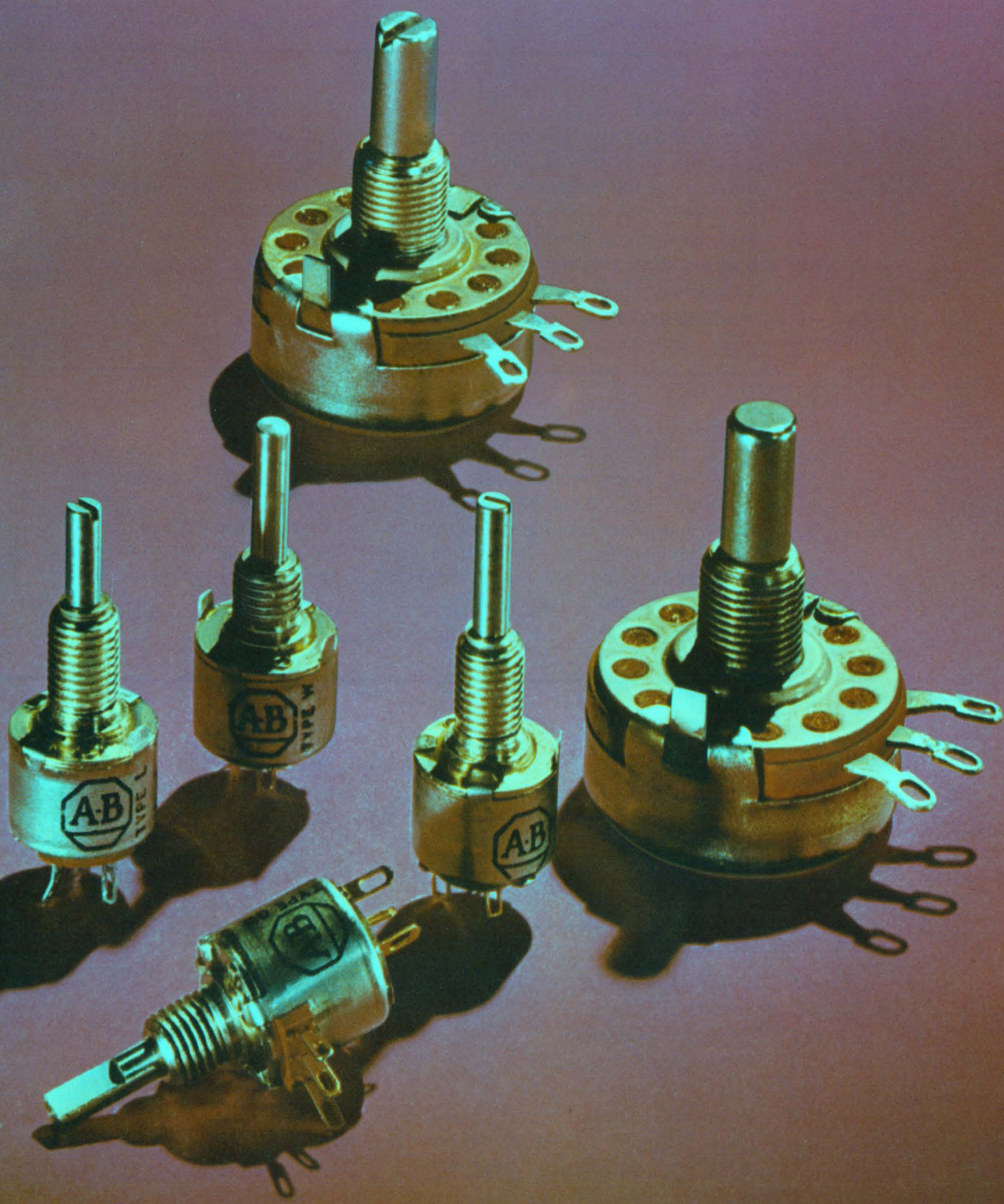

# with this quiet family.

Hot Molding with Allen-Bradley's exclusive technique, gives these composition variable resistors an unusually low noise level. And importantly, this low noise level actually decreases in use. Under tremendous heat and pressure the resistance track is molded into place. A solid element with a large cross-section is produced.

This important Allen-Bradley difference means better short-time overload capacity and a long operating life. Control is smooth, resolution almost infinite. These variable resistors are ideal for high frequency circuits. Why should you trust the performance of

your designs or your reputation to anything less than Allen-Bradley quality? Use the most thoroughly "field tested" (over 20 years) variable resistors available today. Quantity stocks of popular types J, G, W and GD available for immediate delivery from your appointed A-B industrial electronics distributor.

For information write: Marketing Department, Electronics Division, Allen-Bradley Co., 1201 South Second Street, Milwaukee, Wisconsin 53204. Export office: 1293 Broad Street, Bloomfield, N. J. 07003, U.S.A. In Canada: Allen-Bradley, Canada Ltd., 135 Dundas Street, Galt, Ontario.

## SPECIFICATIONS

	TYPE J— STYLE RV4	TYPE K	TYPE G— STYLE RV6	TYPE L	TYPE W	TYPE GD
CASE DIMENSIONS	5/8" deep x 1-5/32" dia. (single section)	5/8" deep x 1-5/32" dia. (single section)	15/32" deep x 1/2" dia.	15/32" deep x 1/2" dia.	15/32" deep x 1/2" dia.	35/64" deep x 1/2" dia.
POWER at + 70°C	2.25 W	3 W	0.5 W	0.8 W	0.5 W	0.5 W
TEMPERATURE RANGE	-55°C to +120°C	-55°C to +150°C	-55°C to +120°C	-55°C to +150°C	-55°C to +120°C	-55°C to +120°C
RESISTANCE RANGE (Tolerances: ±10 and 20%)	50 ohms to 5.0 megs	50 ohms to 5.0 megs	100 ohms to 5.0 megs	100 ohms to 5.0 megs	100 ohms to 5.0 megs	100 ohms to 5.0 megs
TAPERS	Linear (U), Modified Linear (S), Clockwise Modified Log (A), Counter-Clockwise Modified Log (B), Clockwise Exact Log (DB). (Special tapers available from factory)					
FEATURES (Many electrical and mechanical options available from factory)	Single, dual, and triple versions available. Long rotational life. Ideal for attenuator applications. Snap switches can be attached to single and dual.	Single, dual, and triple versions available. Long rotational life.	Miniature size. Immersion-proof. SPST switch can be attached.	Miniature size. Immersion-proof.	Commercial version of type G. Immersion-proof.	DUAL section version of type G. Ideal for attenuator applications. Immersion-proof.

## ALLEN-BRADLEY

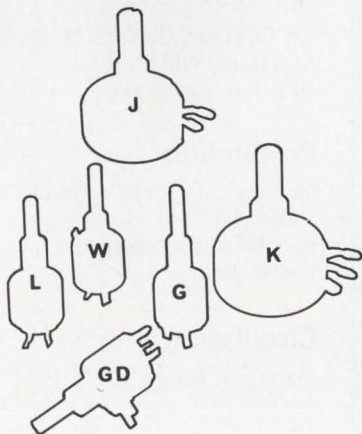

INFORMATION RETRIEVAL NUMBER 4

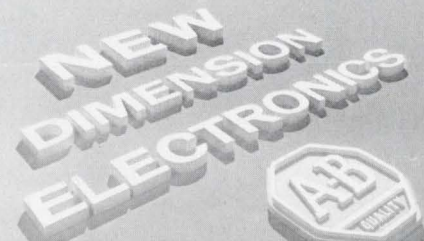

# WHY DO KEITHLEY ELECTROMETERS WIN ALL THE KUDOS?

Simple—they outperform all others.

We offer more sensitivity, stability and versatility, in more models and accessories, to make sure you get the most for your money.

Take our solid-state 610C. For an economical \$645, it measures 200  $\mu\text{V}$  to 100 V with  $10^{14}$  ohms input resistance, currents as small as  $6 \times 10^{-15}$  ampere, resistance to  $10^{14}$  ohms and charge from  $10^{-13}$  to  $10^{-5}$  coulomb. Our battery operated 602 goes for \$695, operates at 1500 volts off ground and provides performance similar to the 610C. Both models are available from stock.

For your digital needs, the systems-compatible 615 gives unparalleled accuracy and convenience, including optional BCD output. Other Keithley Electrometers and Picoammeters offer you many choices of performance and price. We've been innovating electrometer values like these for over 20 years. They've created an industry-wide reputation for kudos-winning performance. Win some kudos yourself. Call your Keithley Sales Engineer for technical literature and demonstrations. Or contact us direct. Keithley Instruments, Inc., 28775 Aurora Road, Cleveland, Ohio 44139. Telephone: 216/248-0400. In Europe: 14, Ave. Villardin, 1009 Pully, Suisse.

Prices slightly higher outside the U.S.A.

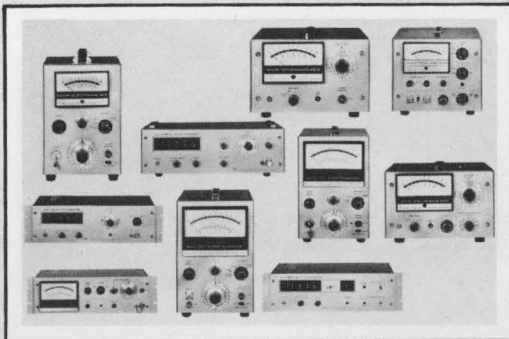

KEITHLEY



## Publisher

Hugh R. Roome

## Editors

New York Office  
850 Third Ave.  
New York, N.Y. 10022  
(212) 751-5530  
TWX: 710-581-2874  
Cable: Haydenpub

**Editor:** Frank Egan  
**Managing Editor:** Ralph Dobriner  
**Managing Editor:** Raymond D. Speer  
**Microelectronics,** Steven A. Erenburg  
**Microwaves,** Michael J. Riezenman  
**Management,** Richard L. Turmail  
**News,** John N. Kessler  
**Military-Aerospace,** John F. Mason  
**New Products,** Roger Allan  
**New Products,** Lucinda Mattera  
**Copy,** Marion Allen

## Field Offices

### Massachusetts

Jim McDermott  
P.O. Box 272  
Easthampton, Mass. 01027  
(413) 527-3632

### San Francisco

Elizabeth de Atley  
Suite 6, 95 Main St.  
Los Altos, Calif. 94022  
(415) 941-3087

### Los Angeles

David Kaye  
2930 Imperial Highway  
Inglewood, Calif. 90303  
(213) 757-0183

### Washington

Don Byrne  
1425 N St. NW  
Washington, D.C. 20005  
(202) 667-6568

## Editorial Production

Dollie S. Viebig  
Richard D. Grissom

## Art

**Art Director,** Clifford M. Gardiner  
**Assistant,** William Kelly  
Rita Jendrzejewski

## Production

**Manager,** Thomas V. Sedita  
Helen De Polo  
Kathleen McConkey  
Leslie Stein

## Circulation

**Manager,** Nancy L. Merritt

## Information Retrieval

Peggy Long



# letters

## Federal aid suggested for jobless engineers

(Editor's note: The following letter is one a reader sent to President Nixon, with a copy to Electronic Design.)

Mr. President:

The waste of our natural resources is a matter of prime concern to the nation. This is a healthy sign, since awareness of a problem is required before a solution can be found.

There is one resource presently being dissipated, however, about which few seem to be aware. This resource is the engineer—especially the engineer formerly employed by the large aerospace companies—who is presently unemployed or has been forced to engage in such diverse activities as selling insurance or operating a gasoline station or a tavern.

A tremendous number of these men can now be described as unemployable. They have worked for one company 10, 15, 20 years or more. They haven't the slightest notion of how to look for a job. Secure in their positions over the years, making fairly decent salaries, they constitute the middle class and upper-middle class of America. Now, with responsibilities heavy on their shoulders—children in school and college, heavily mortgaged homes and car payments to make—they suddenly find their services no longer required.

These people are truly an unemployable minority!

The writer, in the process of experiencing the frustration described, has a plan that could conserve this very valuable resource, provide countless benefits to the entire nation and, at the same time, would encourage students to return to the science and engineering

classes from which they fled when the mass layoffs began.

Many of us have the ability and desire to become entrepreneurs. We have ideas for new products, which could create new enterprises, industries and job opportunities—products created for man's improvement rather than destruction.

Let funds be made available so that those of us who desire can convert these products to reality. We have the technical ability to develop products to help medicine, law enforcement, agriculture and transportation. We lack the money for facilities and equipment. Our skills and interests have been directed to technical creativity and innovation, and we lack general know-how in marketing and business management.

This plan could be implemented in the same manner as the GI Bill for ex-servicemen. It is no secret that the GI Bill was one of the most profitable ventures in which the Government has ever engaged.

Machinery to put this plan into action already exists within the federal Government. The Small Business Administration could review presentations or applications prepared by the engineers. Experts such as the Service Corps of Retired Executives could critique and advise engineering applicants on the preparation of their plans and proposals. Creative and managerial talents could be brought together by means of computers, using data available from previous employers, state unemployment offices and the applicants themselves.

Some enterprises will fail, but the majority can succeed. The resulting benefits to the nation could be astronomical.

Milt M. Silverstein

6392 Tucker Drive  
San Jose, Calif. 95129

Electronic Design welcomes the opinions of its readers on the issues raised in the magazine's editorial columns. Address letters to Managing Editor, Electronic Design, 850 Third Ave., New York, N.Y. 10022. Try to keep letters under 200 words. Letters must be signed. Names will be withheld on request.

# 1% Tolerance SCHAUER 1-Watt ZENERS

## Immediate Shipment Low Prices

ANY voltage from 2.0 to 18.0

Quantity	Price each
1-99	\$1.07
100-499	.97
500-999	.91
1000-4999	.86
5000 up	.82



Gold plated leads

All welded and brazed assembly

No fragile nail heads

Write for complete rating data and other tolerance prices.

## Buy the kit- Save a lot

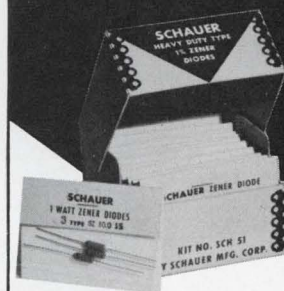

Kit contains a 51-piece assortment of SCHAUER 1% tolerance 1-watt zeners covering the voltage range of 2.7 to 16.0. Three diodes of each voltage packaged in reusable poly bags. Stored in a handy file box. Contact your distributor or order direct.

A \$54.57 value for  
ONLY \$24<sup>50</sup>

Semiconductor Division

# SCHAUER

Manufacturing Corp.

4511 Alpine Ave. Cincinnati, Ohio 45242  
Telephone: 513/791-3030

# In MOS/LSI, we're one-of-a-

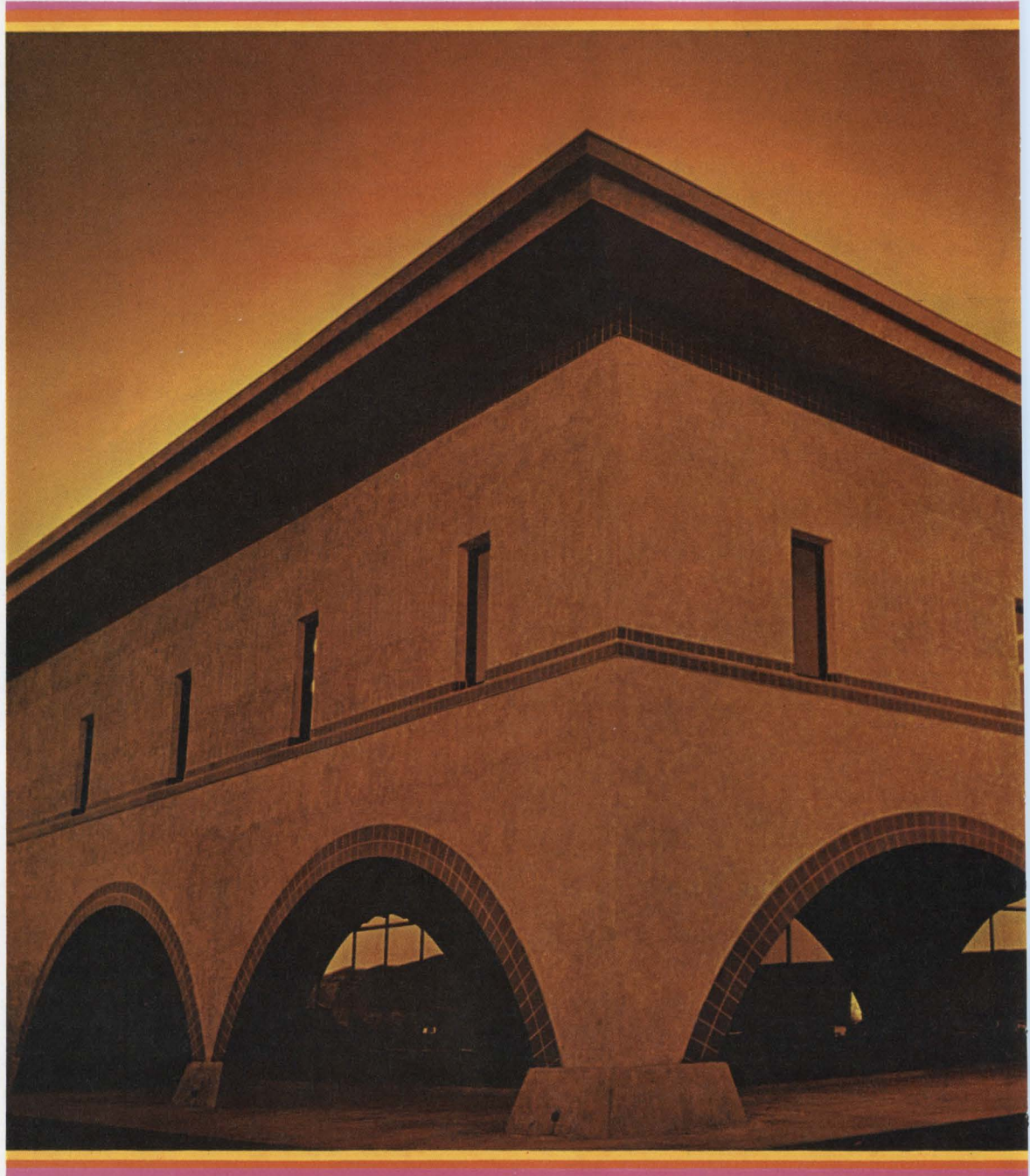

**Garrett**  
MICRO-CIRCUITS CORPORATION

# -kind

Back in the '60's, everyone predicted MOS would come of age by 1970. And it has. Right in our new one-of-a-kind MOS plant. In fact, it's the best facility in the world for high-volume manufacturing custom MOS devices — backed by the financial stability of The Garrett Corporation.

New designs. New processes. New ideas for an emerging MOS/LSI technology. You'll find them all in our 35,000-square-foot of floor space. We are currently the exclusive second source for American Micro-systems, Inc., supplying everything from design to delivery under one roof.

All our fabrication and assembly areas are in Class 100, laminar flow clean rooms and have poured electrically conductive floors (the kind you usually find only in hospitals or ordnance plants).

We use completely deionized water that's purified by reverse osmosis. It's 10 times purer than the water used to make pharmaceuticals. And when we're finished with it and put it back into the environment, it's three times purer than ordinary tap water.

And we have a temperature control system in critical areas that keeps everything at plus or minus  $\frac{1}{4}$  °F. And a humidity control system that keeps everything at plus or minus 2%.

You name it, we have it. Including a new one-of-a-kind diffusion furnace that has all the controls on the front . . . inside the clean room so operators don't have to enter unclean areas just to turn a couple of knobs.

We are establishing a complete and comprehensive set of computer aids for our design program. One of the benefits resulting from this effort is total and maximum interaction for the designer in all phases, including logic verification, placement and pattern generation.

We have all these things (and a lot more) so we can deliver a guaranteed product. Everytime. At the agreed upon price. On the specified date. Whether you're a medium or high-volume customer. You wouldn't buy from a substandard MOS house twice, and we know it. So we deliver.

And just for the record: every process and piece of equipment we have is devoted exclusively to MOS. Not bipolar *and* MOS. Our commitment to MOS is total. (Our new brochure tells the whole story.)

We're in business. We're in production. We invite your inquiries and will welcome your visit. Simply phone (714) 487-3000. Or write Garrett Micro-Circuits Corporation, 16701 West Bernardo Drive, San Diego, California 92127.

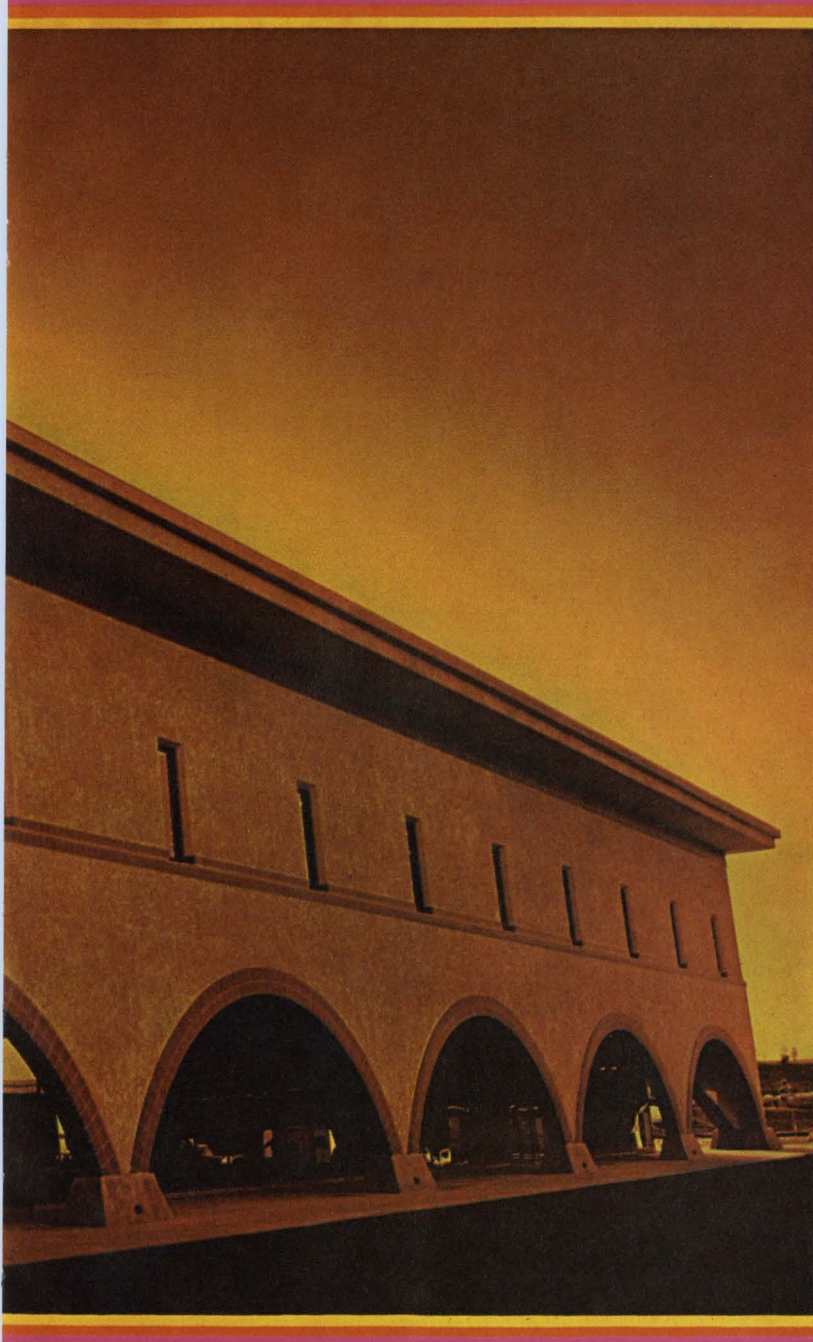

# Designers' Choice: 13 Motorola monolithic IC voltage regulators priced from 90¢ to \$10.00

TYPE		V <sub>o</sub> Range (Vdc)		I <sub>out</sub> (mA) Max	P <sub>D</sub> (Watts) Max		Load Regulation (% V <sub>o</sub> ) Max	Price 100-up
-55°C to +125°C	0°C to +70°C	Min.	Max.		T <sub>C</sub> = 25°C	T <sub>A</sub> = 25°C		
<b>POSITIVE VOLTAGE REGULATORS</b>								
	MC1460G MC1460R	2.5	17	200 500	1.8 17.5	0.68 3.0	0.13 0.05	\$2.50 3.50
	MC1560G MC1560R	2.5	17	200 500	1.8 17.5	0.68 3.0	0.13 0.05	7.00 8.50
	MC1461G MC1461R	2.5	32	200 500	1.8 17.5	0.68 3.0	0.13 0.05	3.50 4.50
	MC1561G MC1561R	2.5	37	200 500	1.8 17.5	0.68 3.0	0.13 0.05	8.50 10.00
	MC1469G MC1469R	2.5	32	200 500	1.8 17.5	0.68 3.0	0.13 0.05	2.00 2.50
	MC1569G MC1569R	2.5	37	200 500	1.8 17.5	0.68 3.0	0.13 0.05	4.50 4.95
	MC1723G MC1723L	2.0	37	150	2.1 —	0.8 1.0	0.20	1.90
	MC1723G MC1723L	2.0	37	150	2.1 —	0.8 1.0	0.15	3.90
	MFC4060	4.8	32	200	—	1.0	0.20	0.90
<b>NEGATIVE VOLTAGE REGULATORS</b>								
	MC1463G MC1463R	-3.8	-32	200 500	1.8 9.0	0.68 2.4	0.13 0.05	2.75 2.95
	MC1563G MC1563R	-3.6	-37	200 500	1.8 9.0	0.68 2.4	0.13 0.05	5.25 5.45
<b>SPECIAL PURPOSE REGULATORS</b>								
	MC1466L	0	(1)	(1)	(1)	(1)	(2)	5.00
	MC1566L						(3)	6.50

(1) Limited only by the characteristics of the series pass transistor.  
 (2) Load Regulation (voltage) 0.03% + 3 mV (current) 0.2% + 1 mA  
 (3) Load Regulation (voltage) 0.01% + 1 mV (current) 0.1% + 1 mA



## PREVIEW!

Coming soon . . .  
 the new State-of-the-Regulator-Art MC1567/1467

MC1567/1467 are ±15 V automatic thermal shut-monolithic voltage regula-down. They are internally-tors offering ±1% output compensated. Preliminary-voltage tolerance and information is available-burnout proofing through now.

## Together, the complete regulator family.

This is the industry's broadest line of monolithic IC voltage regulators, offering the most reasonable prices and the best price vs. performance tradeoffs. General purpose positive voltage types from the MFC4060 to the MC1561 cover the full range of Consumer, Industrial, and Military applications. Industrial and Military designers also find the negative voltage types extremely useful for supplying -15 V to op amps and other linear ICs. Special purpose regulators like the MC1566 are excellent for use as constant cur-

rent regulators or high voltage regulators and in Lab Power supplies and other laboratory type applications.

Make your choice today. Order from your nearest Motorola distributor or sales office. For a specially compiled data and applications brochure on Motorola voltage regulators, please write Motorola Semiconductor Products Inc., P.O. Box 20912, Phoenix, Arizona 85036 or circle the reader service number below.

 **MOTOROLA LINEAR**  
 —serving a greater range of analog designs!

# Know anybody who can use a Schmitt trigger for about 40 cents?

## know anybody who can't?

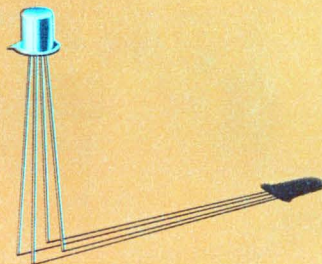

We've taken the Schmitt trigger out of the instrumentation category and packaged it for mass-produced equipment. Our TAA560 monolithic Schmitt trigger with built-in current amplifier sells for only 40¢ each in lots of 25,000. You can buy 50,000 for 35¢ each and 100,000 for only 30¢ each.

TAA560 delivers 50 mA of output current while operating on a 4.5 volt battery supply. More than a mere level sensor or logic element, the TAA560 can sound an alarm horn, light a lamp, or energize a relay... directly, with no further amplification. Typical applications for the TAA560 include alarms sensitive to temperature, light, sound, and level, etc., touch-operated switches, latching lamp or relay drives and sine-to-square wave converters.

Just as no other IC Schmitt can match the price and performance of the TAA560, no other supplier offers more "total applications" assistance

than you get from Amperex. We'll give you complete design data for any of the circuits we've developed for this unique TO-72 device. And our engineering staff stands ready to help you with any other applications. How can you go wrong?

For detailed information on the TAA560 and its applications, write Amperex Electronic Corporation, Integrated Circuits Division, Cranston, Rhode Island 02920 or phone 401-737-3200.

## **Amperex**<sup>®</sup>

TOMORROW'S THINKING IN TODAY'S PRODUCTS

A NORTH AMERICAN PHILIPS COMPANY



Take an idea . . . or do your own thing. Applications for Bourns Cermet Panel Controls turn up everywhere.

Cermet resistance elements offer you a wide advantage in performance over their old-fashioned carbon counterparts. Look for:

- BETTER STABILITY
- HIGHER POWER RATING
- SUPERIOR TEMPCO ( $\pm 150$  ppm/ $^{\circ}$ C)

Bourns Panel Controls **save space**, too. The  $\frac{3}{4}$ " diameter models extend only  $\frac{1}{4}$ " behind the panel — that's not far out.

Take a look at our new brochure on Panel Control Potentiometers — 16 pages of cutaways, photos, specifications and prices. Ask for it anywhere Bourns products are sold, or direct from the factory.

**HIGH PERFORMANCE**

Series 3852:  $\frac{3}{4}$ " dia.; metal bushing, locking or non-locking; 2 watts at 70 $^{\circ}$ C; res. to 5 meg.; tol. to  $\pm 5\%$ . Typical price per piece \$2.40; (2M) \$0.81.

Series 3862:  $\frac{1}{2}$ " dia.; 1 watt at 125 $^{\circ}$ C; res. to 5 meg.; tol. to  $\pm 5\%$ . Typical price per piece \$4.20; (2M) \$1.18.

**COMMERCIAL**

Series 3859:  $\frac{3}{4}$ " dia.; plastic bushing or quickly installed snap-in version; 2 watts at 70 $^{\circ}$ C; res. to 5 meg.; tol. to  $\pm 5\%$ . Typical price per piece \$1.95; (2M) \$0.66.

Now look at the Controls. **Stocked in depth by Bourns distributors all over. 24-hour delivery on standards.**



TRIMPOT PRODUCTS DIVISION • 1200 COLUMBIA AVE., RIVERSIDE, CALIF. 92507

INFORMATION RETRIEVAL NUMBER 10

# designer's calendar

## FEBRUARY 1971

S	M	T	W	T	F	S
	1	2	3	4	5	6
7	8	9	10	11	12	13
14	15	16	17	18	19	20
21	22	23	24	25	26	27
28						

Feb. 9-11

**Aerospace & Electronic Systems Winter Convention (WINCON)**, (Los Angeles). Sponsors: IEEE et al. William H. Herrman, Wincon '71, IEEE Los Angeles Council, 3600 Wilshire Blvd., Los Angeles, Calif. 90005.

CIRCLE NO. 403

Feb. 17-19

**International Solid State Circuits Conference** (Philadelphia, Pa.) Sponsors: IEEE et al. Lewis Winner, 152 W. 42nd St., New York, N. Y. 10036.

CIRCLE NO. 404

## MARCH 1971

S	M	T	W	T	F	S
	1	2	3	4	5	6
7	8	9	10	11	12	13
14	15	16	17	18	19	20
21	22	23	24	25	26	27
28	29	30	31			

March 22-25

**IEEE International Convention and Exhibition** (New York City). Sponsor: IEEE. J. M. Kinn, IEEE, 345 E. 47th St., New York, N. Y. 10017.

CIRCLE NO. 405

March 31-Apr. 2

**Reliability Physics Symposium** (Las Vegas). Sponsor: IEEE. O. D. Trapp, Fairchild Semiconductor, 464 Ellis St., Mountain View, Calif. 94040.

CIRCLE NO. 406

# NOW!

## 9 POWER/MATE POWER SUPPLIES REPLACES OVER 127 LAMBDA MODELS

WITH... MORE POWER IN LESS  
SPACE WITH BETTER REGULATION  
AND WITH THE  
SAME HIGH QUALITY  
YET AT LOWER COST.  
PLUS SAME DAY DELIVERY

A unique design concept developed by Power/Mate Corp. allows any UniPower supply to be set for a range of voltages. Therefore, you need only buy one supply in place of dozens. The entire UniPower Series can replace literally thousands of narrow-range supplies! Find out more how Power/Mate can cut your power supply costs. Write or call POWER/MATE CORP. today.

Uni-30C

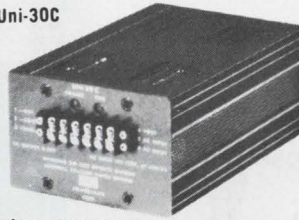

Price: \$134.00

### The UniPower Series of Nine

- Uni-76 — 0-34 volts, 0.5 amps — \$76.00
- Uni-88 — 0-34 volts, 1.5 amps — \$99.00
- Uni-30C — 0-30 volts, up to 4 amps — \$134.00
- Uni-30D — 0-30 volts, up to 6 amps — \$151.00
- Uni-30E — 0-30 volts, up to 12 amps — \$174.00
- Uni-30F — 0-30 volts, up to 15 amps — \$205.00
- Uni-30G — 0-30 volts, up to 24 amps — \$265.00
- Uni-30H — 0-30 volts, up to 34 amps — \$315.00
- UniTwin-164 — dual output 0-25 volts, 0.75 amps — \$164.00

### OUTPUT VOLTAGE vs. OUTPUT CURRENT FOR VARI-RATED UNI SERIES

MODEL	VOLTAGE															
	0-3	5	6	8	10	12	14	15	16	18	20	22	24	26	28	30
UNI-76	0.5 amp throughout range															
UNI-88	1.5 amps throughout range															
UNI-30C	4	4	4	4	4	3.75	3.6	3.5	3.4	3.25	3.0	2.9	2.75	2.5	2.5	2.1
UNI-30D	6	6	6	5.6	5.2	5.0	4.7	4.5	4.3	4.2	4.1	3.7	3.5	3.4	3.3	3.1
UNI-30E	12	12	11	10.5	9.5	9.3	8.5	8.0	7.7	7.5	7.0	6.5	6.0	5.7	5.5	5.2
UNI-30F	15	15	15	14.2	12.8	12.0	11.5	11.0	10.0	9.9	9.4	8.9	8.7	8.5	8.0	7.6
UNI-30G	24	22	21	20	18	17	16.5	16.0	15.5	15	14	13.5	13	12.5	12	11.5
UNI-30H	34	32	31	29	25	23	22	21	20	19	17	16.5	16	15.5	15	14.3

**SPECIFICATIONS:** Regulation — up to  $\pm 0.005\%$  or 1 MV for line and load; Ripple — Less than 250 microvolts; Response Time — Less than 20 microseconds; Overload and Short Circuit Protection — Solid state. Instantaneous recovery, and automatic reset. Cannot be damaged by prolonged short circuit or overload. Internal or External Adjustable OVP Available.

# P/M/C

## POWER/MATE CORP.

514 S. RIVER STREET, HACKENSACK, N. J. 07601

Phone (201) 343-6294 / TWX 710-990-5023

THE  
WORLD FAMOUS  
**Simpson®**  
**260®**

*Constant improvement makes  
it consistently the world's  
largest selling VOM*

**SERIES 5 1964**

Varistor protection from movement overloads of 200,000%. New Taut Band suspension that can't develop error-causing friction.

**SERIES 4 1962**

DC accuracy increased to 2%. Plus self-shielding movement and shock-resistant spring-loaded suspension.

**SERIES 3 1959**

Low resistance banana jacks and improved full wave rectifier circuit for increased sensitivity (5000  $\Omega/v$ ) and 3% AC accuracy. Added 50  $\mu a$  and 250 millivolt ranges and new adjust-a-view handle. First VOM with printed circuitry. Fuse added for circuitry protection.

**SERIES 2 1947**

Molded front panel with integral indicating instrument plus DC current measurement extended to 10 amps.

**SERIES 1 1938**

Beginning of the revolution in tester design—an instant success. First commercially available VOM with 20,000  $\Omega/v$  sensitivity. Complete range coverage for industrial and radio servicing.

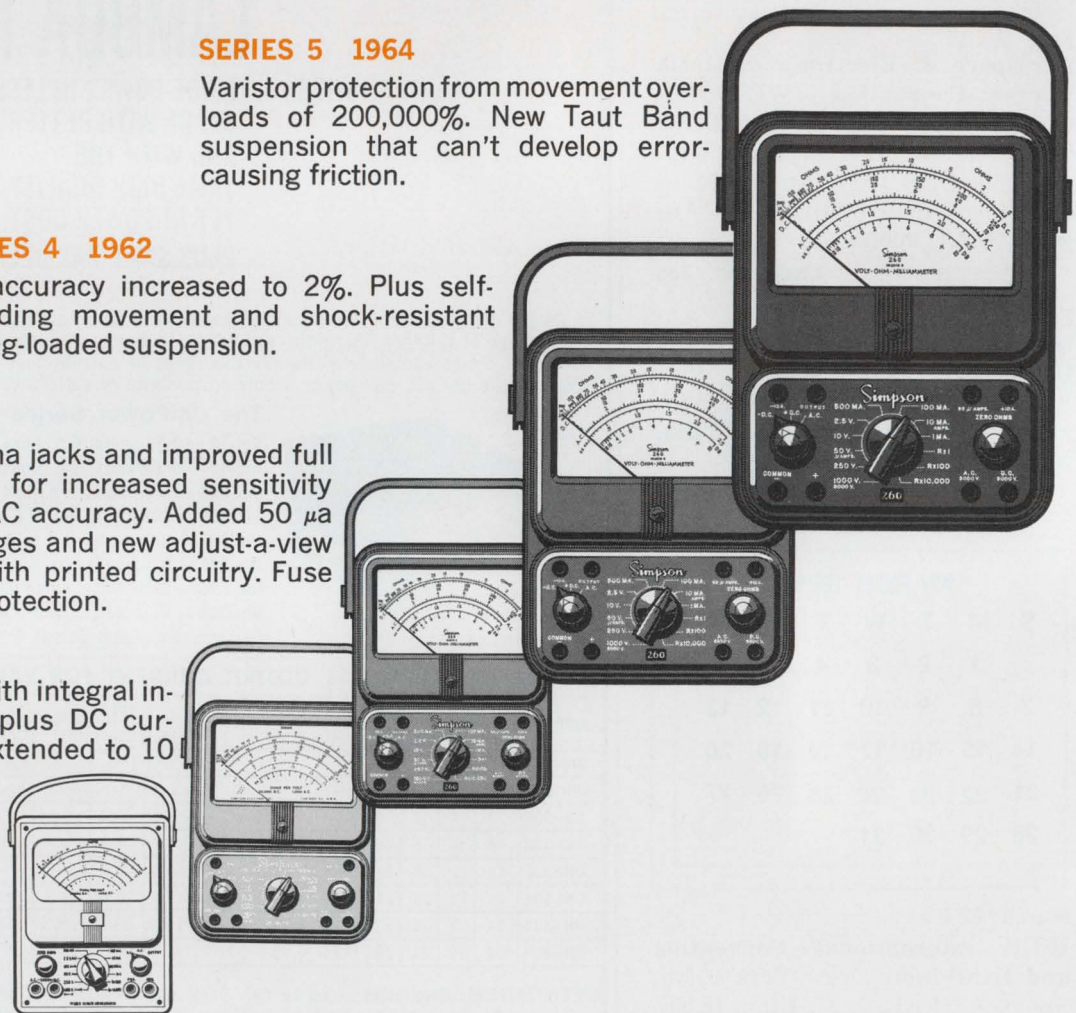

**Simpson®**  
INSTRUMENTS THAT STAY ACCURATE





**NOW...  
the new**

**Simpson**

**260<sup>®</sup>  
SERIES 6  
VOM**

THE NEW SERIES 6 HAS ALL THESE NEW FEATURES PLUS ALL THE ADVANCEMENTS IN THE SERIES 5:

- External access battery and fuse compartment.
- Clip-type fuse holder.
- 0-1 volt DC range.
- 0-500 volt AC and DC ranges.
- Available 5000 volt adapter-type DC safety probe.
- Multi-purpose, screw-on test leads with combination probe and alligator clips.
- Only 2 batteries . . . one 9-volt NEDA 1604 and one 1½-volt "D" cell.
- Rugged taut band movement.
- Varistor overload protection.

260-6 ..... \$65.00  
260-6M (Mirror scale) ..... \$67.00

EXTERNAL BATTERY AND FUSE COMPARTMENT

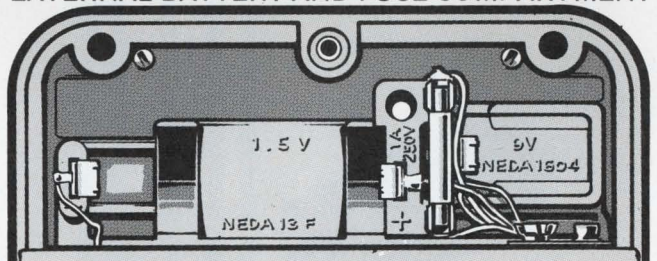

260-6RT (Roll-top protective case) ..... \$71.00  
260-6MRT (Mirror scale and roll-top case) \$73.00  
260-6P (Overload protected) ..... \$97.00  
260-6PRT (Overload protected and roll-top case) ..... \$103.00  
Safety Probe: 5000 volt DC adapter type #00506 ..... \$4.50

**GET "OFF THE SHELF" DELIVERY FROM YOUR LOCAL ELECTRONIC DISTRIBUTOR  
—OR WRITE TODAY FOR BULLETIN T-810.**

**SIMPSON ELECTRIC COMPANY**

5200 W. Kinzie St., Chicago, Ill. 60644, Phone: (312) 379-1121

Export Dept: 5200 W. Kinzie St., Chicago, Ill. 60644, Phone: (312) 379-1121, Cable SIMELCO  
IN CANADA: Bach-Simpson Ltd., London, Ontario

IN INDIA: Ruttonsha-Simpson Private, Ltd., International House, Bombay-Agra Road, Vikhroli, Bombay

INFORMATION RETRIEVAL NUMBER 12



DIVISION

System Designers...  
Make your move to MOSTEK for

# MOS static shift registers

If you're in the market for MOS static shift registers, your best move is to MOSTEK. Our *only* products are MOS... engineered to give you outstanding performance and economy. Want proof? Check these features:

**MK 1002P.** Dual 128-bit static shift register. Full DTL/TTL compatibility. Single-phase, independent clocks (capacitance less than 5 pF) can be driven directly by a single TTL or DTL gate. High speed (DC to 1MHz selectable to 2MHz) clock rates. Recirculate logic built-in. Sixteen-pin ceramic dual in-line package.

**MK 1002L.** Virtually the same features as the MK 1002P except package is the economical 10-lead TO-5 can. Same full DTL/TTL compatibility; single-phase DTL/TTL compatible clocks.

Check the advantages of MOSTEK static shift registers. Like no need for external components or interface circuitry (not even a resistor!). Like all inputs—data, recirculate and clock (yes, clock too)—driven directly by TTL or DTL gates. Finally, like *nobody* makes MOS as fully compatible with TTL as ours!

'Nuff said? Then contact our home office in Dallas at (214) 242-1494 and ask Gordon Hoffman for information and fast delivery of MOS shift registers... plus ROMs and RAMs. Or call your nearest Sprague Electric Company office or representative.

Make a smart move... to MOSTEK.

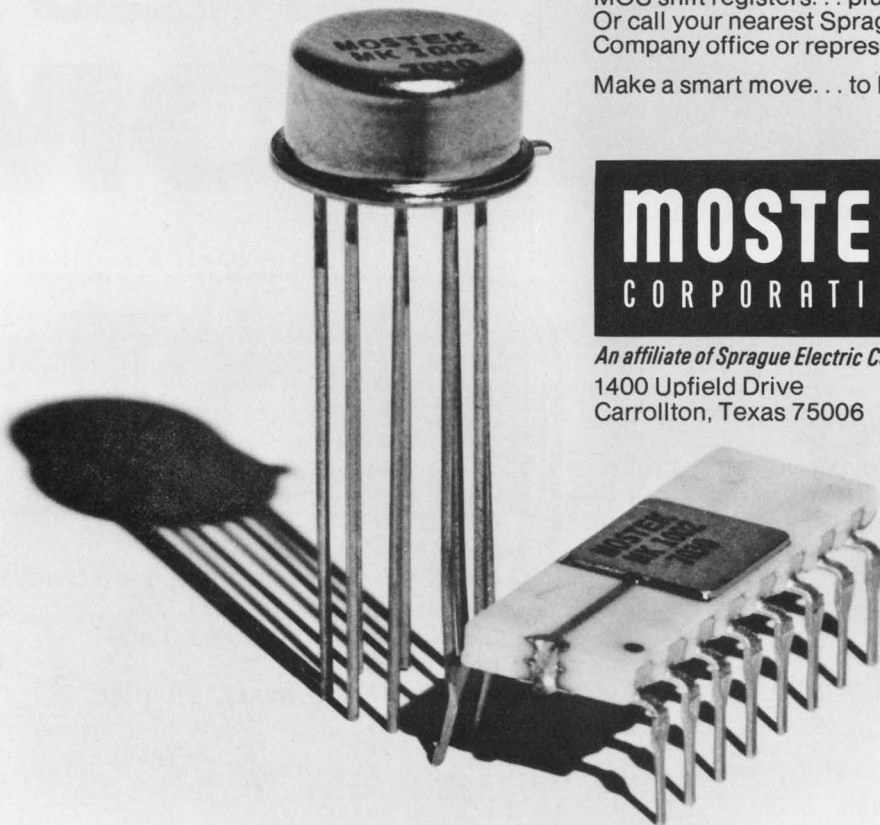

**MOSTEK**  
CORPORATION

*An affiliate of Sprague Electric Company.*

1400 Upfield Drive  
Carrollton, Texas 75006

# To celebrate our 40% price reduction, we're offering this special diode kit.



Model 5082-0050 Kit contains 8 each of:			
Type	5082-2800	5082-2811	5082-2833
Breakdown Voltage	70 v	15 v	10 v
Forward Current at 1v	15 ma	20 ma	100 ma
Capacitance	2 pf	1.2 pf	1.5 pf

If you've never designed around universal Schottky barrier diodes, here's your chance to upgrade circuit performance for pennies. HP will send you \$32 worth of these diodes for only \$8.40. That's right—only \$8.40 for 24 of the best diodes you ever got your hands on (see chart for specs). And they're packed in a handy leatherette folio along with complete data.

The big kit giveaway celebrates HP's across-the-board 35 to 40% price reductions on these great diodes—reductions that bring prices down to 35¢ each in 10K quantities, even less if you order more.

These general-purpose hot carrier diodes deliver better overall performance than P/N junction silicon or germanium diodes. Complementing the 0.4 volt turn-on is low series resistance, 100 picosecond switching speed and 1 mV/°C temperature coefficient. So now you can simplify circuit design and improve performance at the lowest possible cost.

Send for your HP diode bargain and find out for yourself.

## \$32.00 value only \$8.40!

(Offer expires May 1, 1971)

Clip this coupon and mail with check, money order, or P. O. to: Hewlett-Packard Associates, 620 Page Mill Road, Palo Alto, California 94304. Your nearby sales office can also handle this offer.

Name \_\_\_\_\_ Application \_\_\_\_\_

Company \_\_\_\_\_

City \_\_\_\_\_ State \_\_\_\_\_ Zip \_\_\_\_\_

HEWLETT  PACKARD  
COMPONENTS

01102

INFORMATION RETRIEVAL NUMBER 101

**Reliability is a notched memory  
and a double-jointed thumb**

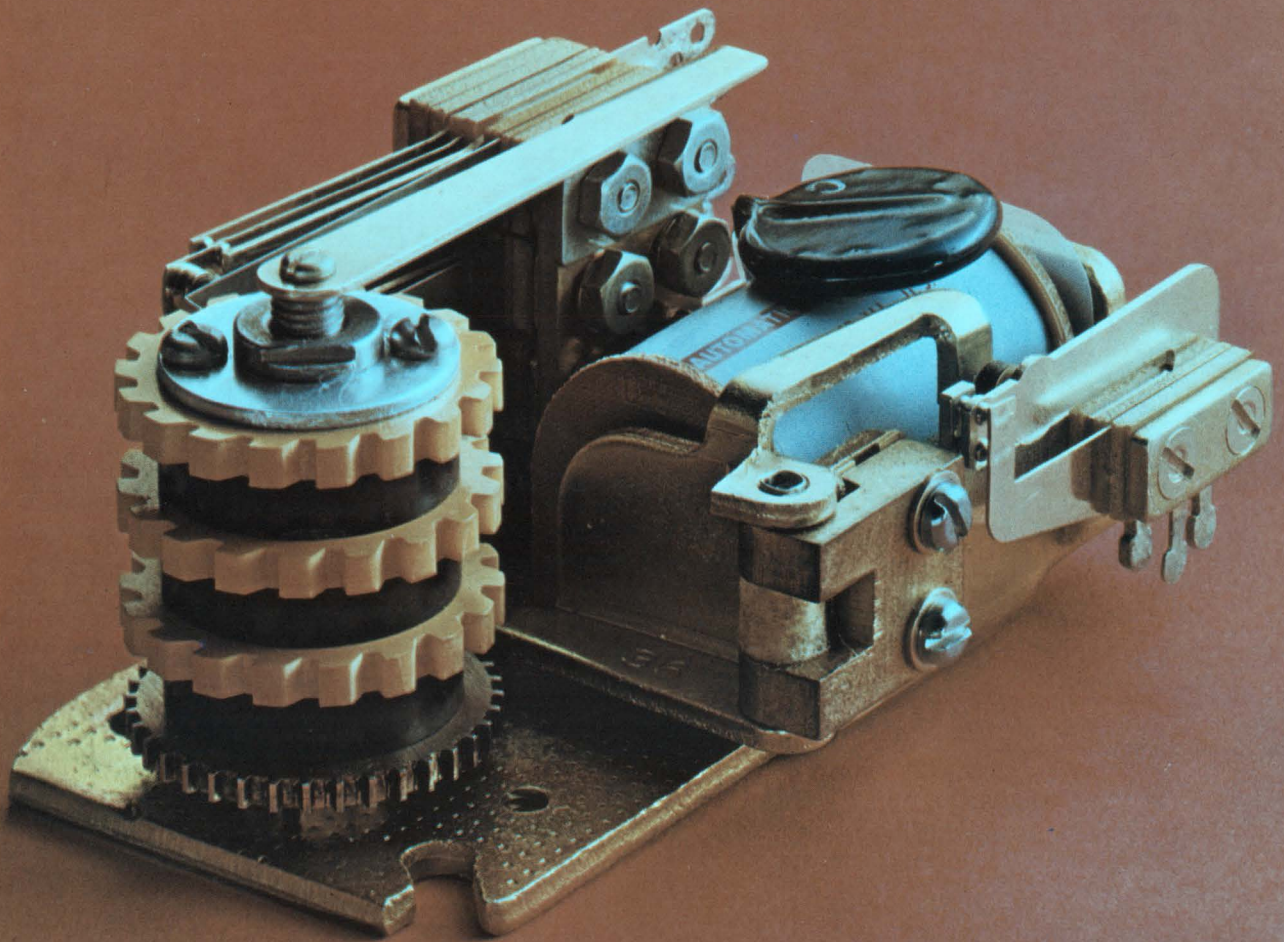

We combine the simplicity of a cam-operated relay with a tough, time-proven stepping switch to give you an uncomplicated and sturdy relay. The brains of our OCS relay are precisely notched cams that give it an unforgettable memory. Power blackouts won't change it.

### Faithfully redundant

There are no mysteries, no black boxes. First, phenolic cams are notched to your exact needs and every operation is faithfully repeated. The cams control the action. As the finger of the switch traces over the crests and the valleys of the cam, you get simple and precise "ons" and "offs" that you can use to control a variety of equipment. Pulse interval, pulse width—we'll let you make the decisions. Now we anchor the stack of



cams and a gear with two long bolts running exactly parallel with the camshaft axis. This keeps everything in line even under extreme vibrations or shock. You can't get this toughness in delicate latching relays.

### It clicks very carefully

A good brain deserves a rugged body. Ours is a time-proven stepping switch with our patented "free floating" pawl. The spring-loaded pawl swivels at the midsection of



a long, toothed, finger-like lever. Together they act like an index finger and a double-jointed thumb.

After it clicks and pushes the camshaft gear, the thumb floats over the teeth. Very carefully. Then the toothed finger locks the gear into place. You never have to worry about jamming and binding that are inherent with an old-style pawl stop and block. And you don't have to worry about wear on the gear teeth themselves.

That's because the gear is a little different. The way it's made, for one thing. First, we blank it, then shave it and finally caseharden it. Then it's super strong. Notice the big, square teeth that always provide a sure bite.

### A lot of attention to small details

Now we apply our finishing touch to the entire assembled product: a few drops of a highly refined mineral oil. Not any old oil will do. We figure that if you pay such close attention to details during the entire manufacturing process, why gum it all up trying to save a few pennies on oil. Right? Then every AE relay is inspected after thousands of run-in cycles, and relubricated for shipment to our customers. We don't know of any other relay manufacturer that does this. It may be a small detail, but here at Automatic Electric we pay big attention to small details. It's just that we've always worked that way.



How about you? Do you want to know more about our OCS relay? Here's where we are: Automatic Electric Company, Industrial Sales Division, Northlake, Illinois 60164.

**GTE AUTOMATIC ELECTRIC**  
INCORPORATED

# 14 ways to keep current on computer languages...equipment...terminology

**Discovering Basic: A Problem Solving Approach** Robert E. Smith. This new course starts the reader programming on page three, pinpointing the vocabulary of BASIC as it develops skill and confidence. Clear explanations speed the reader through the brief exercises and reviews which reflect this language's growing importance in timesharing systems. More than thirty-five pages of programs for the lessons and reviews are easily located at the back of the book. 224 pp., 5 3/8 x 8 1/4, illus., paper, #5783, \$5.95; cloth, #5784, \$7.95

**Basic Basic: An Introduction to Computer Programming in Basic Language** James S. Coan. Written in a precalculus mathematics setting, this new text is designed to work in conjunction with a math course or as a separate programming course. Progressing from short complete programs to more sophisticated programs, the text encourages the use of flowcharts as an aid in programming. Solutions to even-numbered problems appear in the text; the remainder, in a separate teacher's guide. 272 pp., 6 x 9, illus., paper, #5872; cloth, #5873

**Comprehensive Standard Fortran Programming** James N. Haag. This up-to-date course teaches how to program effectively using the full version of FORTRAN IV as standardized by the U.S.A. Standards Institute. From the outset, portions of the language are applied in writing programs drawn from a variety of disciplines. Mathematics are kept to a minimum as the book provides mastery of the thirty-two different FORTRAN instructions, as well as an understanding of computer capabilities and limitations. This well-organized, clearly written book is ideally suited for either self-study or classroom use. 312 pp., 7 1/8 x 9 3/4, illus., paper, #5811, \$6.95; cloth, #5812, \$8.95

**Comprehensive Fortran Programming** James N. Haag. The highly successful course in FORTRAN II teaches the language as used by the IBM 1620 compiler with an attached 1311 Disk Drive, with adaptations to suit other systems. Programming begins immediately, with applications to the BEST-SAM areas: Business, Engineering, Science, Technology, Social Science, Agriculture, and Mathematics. 246 pp., 7 3/8 x 10 1/8, illus., paper, #5646, \$5.95

**Basics of Digital Computers, Revised Second Edition** John S. Murphy. Offering a complete foundation in today's equipment and systems, the fully updated edition of this three-volume work is excellent for self-teaching or classroom use. Free of needlessly confusing jargon, it includes over 300 all-new illustrations to drive home its discussion of concepts relevant to all systems. The first volume explains how information is programmed into the machine to produce an answer or to be stored for later use. Volume two covers the construction and function of the various components. The linkup and control of an overall system, covered in volume three, completes the background needed to master specific systems. 391 pp., 6 x 9, illus. 3 vol. set, paper, #0737, \$11.25; 3 vol. combined, cloth, \$9.95; indiv. paper vols., #0738, #0739, #0740, \$3.75

**Basics of Digital Computer Programming** John S. Murphy. This invaluable introduction to business-data programming uses general programming examples to illustrate practical computer applications. Discussion is clarified through continual reference to the internal organization of a typical computer. 118 pp., 6 x 9, illus., paper, #0405, \$3.95

**Basics of Analog Computers** T. D. Truitt and A. E. Rogers. Three volumes in one—a concise review of the principles, hardware, and applications of the modern analog computer. It reveals the principles of analysis through analogy and simulation. 400 pp., 6 x 9, illus., cloth, #0256, \$12.50

**Computer Arithmetic** Henry Jacobowitz. A refresher course in the basic operations of all positional number systems with applications in computers, this compact volume explains binary, octal, hexadecimal, and ternary arithmetic, along with conversion methods. 128 pp., 5 1/2 x 8 1/2, illus., paper, #0297, \$3.75

**Computer Numbering Systems and Binary Arithmetic** Training Systems, Inc., and Stanley L. Levine. This programmed course proceeds gradually through all the required mathematical processes. No previous knowledge of binary or octal numbering systems, or with computers, is needed. 232 pp., 6 x 9, paper, #0380, \$5.45

**Standard Dictionary of Computers and Information Processing** Martin H. Weik. Widely praised for its broad scope, detailed definitions, and illustrative examples, this essential reference encompasses more than 10,000 hardware and software terms in general use throughout the burgeoning field of computers and their applications. Thorough cross-referencing permits complete mastery of the vocabulary of hundreds of topics: programming and computer engineering to input-output devices and checking systems. The Computer Tree, reproduced on the endpapers, traces the lineage of more than 500 computer models built to date. 336 pp., 6 x 9, illus., cloth, #5677, \$10.95

**Data Transmission and Data Processing Dictionary** James F. Holmes. A practical source to the proper definitions for more than 3,000 terms used in data processing, telephony, telegraphy, facsimile, and data transmission work. 103 pp., 6 x 9, paper, #0396, \$2.50

**Understanding Digital Computers** Ronald Benrey. A comprehensive guide for those who need in-depth understanding of computers, but not a technical grasp of the equipment. Describing computers in terms of similar, and simple building blocks that make up a system, the book stresses the function of these elements, rather than their actual electronic construction. Programming, binary arithmetic, logical design, and other key topics are fully explained. 166 pp., 6 x 9, illus., paper, #0473, \$4.75

**Digital Magnetic Tape Recording** Bernard B. Byer. This unique design tool fully describes functions and operations, also providing valuable data for specification, purchase and use of the equipment. 328 pp., 6 x 9, illus., cloth, #5031, \$12.50

**How to Build a Working Digital Computer** Edward Alcosser, James P. Phillips, and Allen Wolk. Popular book provides complete instructions for building an inexpensive computer that can be programmed to solve problems. 176 pp., 6 x 9, illus., paper, #0748, \$4.45

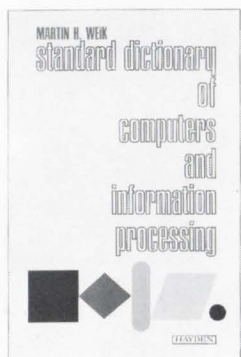
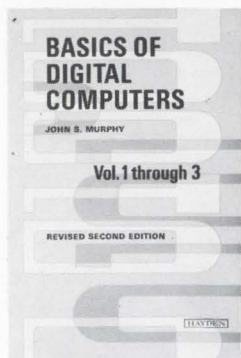
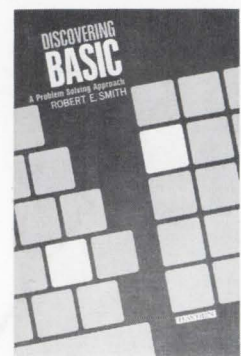

Send no money — clip or duplicate this coupon today!

**15-day  
FREE  
Examination**



Please send the book(s) listed on a 15-day free examination basis. At the end of that time, I will remit payment, plus postage, or return the book(s) without further obligation.

CAT. #	TITLE	PRICE	Name _____
_____	_____	_____	Firm/Institution _____
_____	_____	_____	Address _____
_____	_____	_____	City/State _____ Zip _____
_____	_____	_____	<input type="checkbox"/> Payment enclosed (Hayden pays postage). Same return guarantee. On all overseas orders, payment in U.S. dollars must be enclosed.

**HAYDEN BOOK COMPANY, INC. 116 W. 14 St., N.Y., N.Y. 10011**

71-4-1

# "Guaranteed specs, one more reason you should be using Fluke synthesizers."

Fluke Product Manager Paul Beihl tells you what to look for in a frequency synthesizer.



"At Fluke, we insist on clear, truthful, doubt-free instrument specifications. We know you depend on them, so we don't kid around. We guarantee not only the more easily measured specs; we guarantee the exotic specs, too.

"Take the case of our Model 645A and Model 645M (militarized) Frequency Synthesizers, for instance.

"We guarantee a non-harmonic spurious response greater than 100 db below the fundamental. We guarantee a noise floor less than -132 db. We guarantee switching times of less than 20 microseconds. As a matter of fact, we guarantee all the specs without weasel words, without 'ifs', 'ands' or 'buts'.

"It's part of our thing about customers and specs.

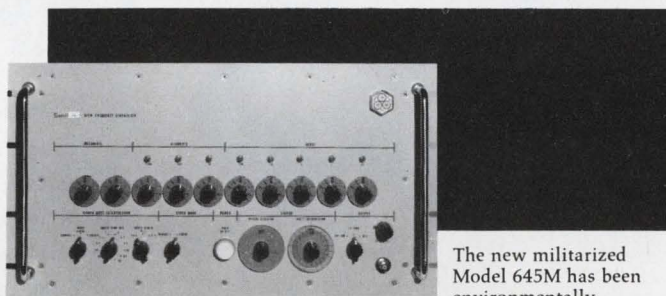

The new militarized Model 645M has been environmentally hardened to meet all environmental requirements of MIL-E 16400F, Amendment 5, Class IV. Electrically, it's equivalent to the Model 645A.

"Obviously, specs aren't everything in an instrument. Convenience counts, too. We built in a symmetrical search oscillator for filter and resonator testing. Automatic remote output leveling, BCD or 10 line code inputs make programming easy. Modular design makes service easy. Functional front panel controls simplify operation. Summing up, Fluke synthesizers are easy to use.

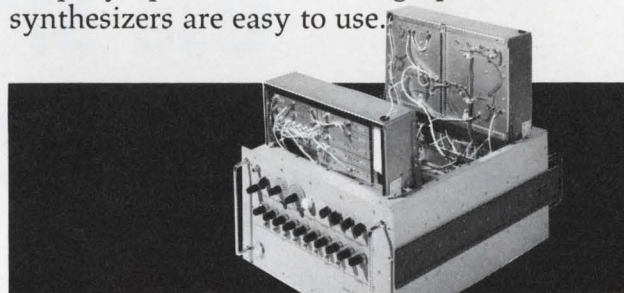

Model 645M with swing-out trays opened to demonstrate access to modular circuitry.

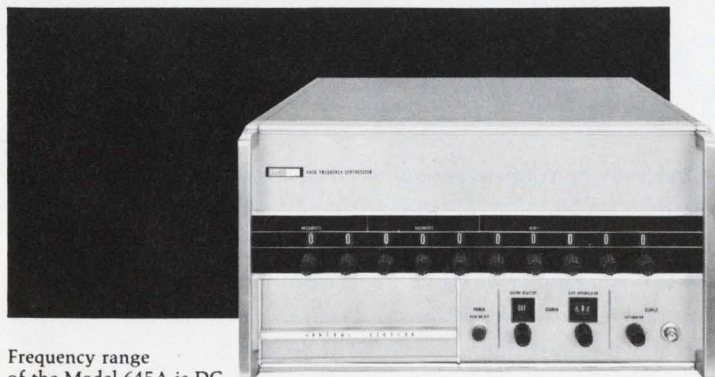

Frequency range of the Model 645A is DC to 50 MHz in increments of 0.01 Hz.

"Every synthesizer is designed and built to the Fluke standard of quality. Fluke Instruments are known world-wide for their reliability and accuracy. And we price them as though we were buying them with our own money.

"Let us send you the full details and arrange a demonstration. Call us here at the factory or better yet, contact your nearby Fluke representative."



Fluke, Box 7428, Seattle, Washington 98133. Phone: (206) 774-2211. TWX: 910-449-2850/In Europe, address Fluke Nederland (N.V.), P. O. Box 5053, Tilburg, Holland. Phone: (04250) 70130. Telex: 884-50237/In the U. K., address Fluke International Corp., Garnett Close, Watford, WD2 4TT. Phone: Watford, 27769. Telex: 934583.

**...like more capacitance in aluminum 'lytics?**

## Get **SPRAGUE Type 36D** **POWERLYTIC®** **CAPACITORS**



INFORMATION RETRIEVAL NO. 821

- Large cylindrical electrolytic capacitors for use in digital computer power supplies, industrial control equipment, energy storage applications, etc
- Low impedance construction
- Largest case (3" dia. x 8 5/8" high) provides 650,000  $\mu$ F at 3 volts!
- Can be operated at +85 C
- Tapped No. 10-32 terminals simplify filter bank assembly
- Available with or without outer plastic insulating sleeves
- Request Engineering Bulletin 3431C

4SC-9153R2

**...want high volume efficiency in tubular 'lytics?**

## Use **SPRAGUE Type 39D** **POWERLYTIC®** **CAPACITORS**

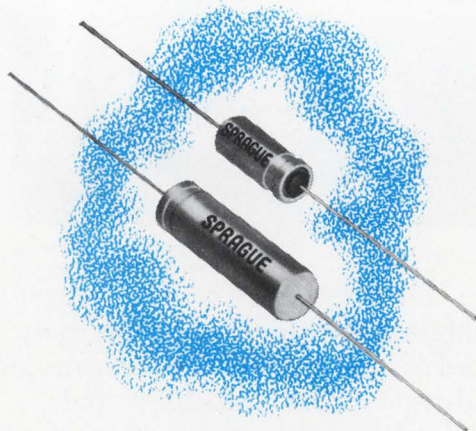

INFORMATION RETRIEVAL NO. 822

- Provide maximum capacitance in smaller cases with axial leads
- No internal riveted or pressure connections
- Welds at critical anode and cathode terminals
- Molded end covers
- Life expectancy of 10 years or more in normal service
- Very low effective series resistance and leakage current
- Request Engineering Bulletin 3415

4SC-9154R2

For Engineering Bulletins as noted above, write to:  
Technical Literature Service, Sprague Electric Co., 347  
Marshall Street, North Adams, Massachusetts 01247.



'Sprague' and '®' are registered trademarks of the Sprague Electric Co.

**THE BROAD-LINE PRODUCER OF ELECTRONIC PARTS**



# highlighting

THE ISSUE

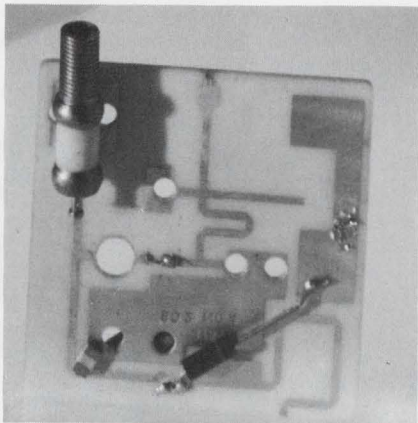

Typically, a solid-state microwave source consists of two basic elements: a transistor oscillator and a varactor multiplier. The design of the oscillator is fairly straightforward, but the multiplier presents some serious challenges. Its design requires nonlinear analysis, and the results are valid only under specific conditions.

When microstrip is used to reduce the size of the multiplier, the problems are compounded. It is difficult to predict the detailed behavior of microstrip circuits because the non-TEM waves that propagate on microstrip lines are not easy to describe analytically.

How can the designer overcome these problems and come up with a good, compact microstrip multiplier? The key is to understand clearly the functions of the multiplier circuitry external to the varactor diode itself.

**Page 46**



Making every telephone line in the country more efficient and more reliable is just one of the promises that digital filters can be expected to fulfill—once large-scale integration arrives. As digital ICs provide more functions on a single chip, digital filters can become more complex and less expensive, and they will take up less space.

When that day comes, digital filters will become a real threat to analog filters. But at present the digital filters that are available are really laboratory instruments offering a good deal of flexibility. With them, you can easily and quickly change filter characteristics by simply programming a different set of numbers that represent the filter you desire.

**Page 24**

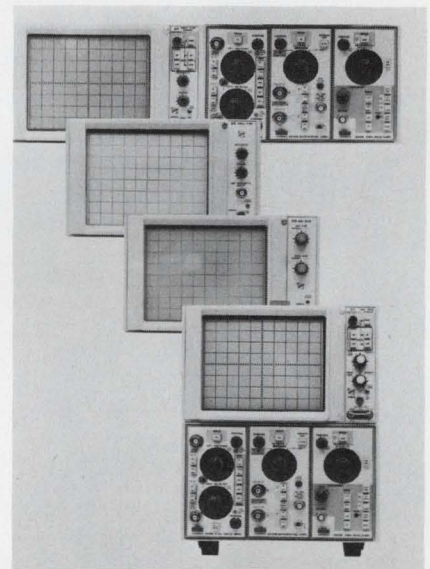

A new low-cost modular oscilloscope system offers the user a wide range of flexibility and the ability to choose economically the proper measurement system compatible with his needs. It also allows single and dual-beam storage and nonstorage displays, high-gain and delayed-sweep measurements, one to four-trace capability, X-Y or Y-T operation and bench-top to rack-mount mobility.

The system consists of four display modules, six amplifier and three time-base plug-ins. Each of the plug-ins and each of the display units is interchangeable for maximum versatility.

**Page 83**

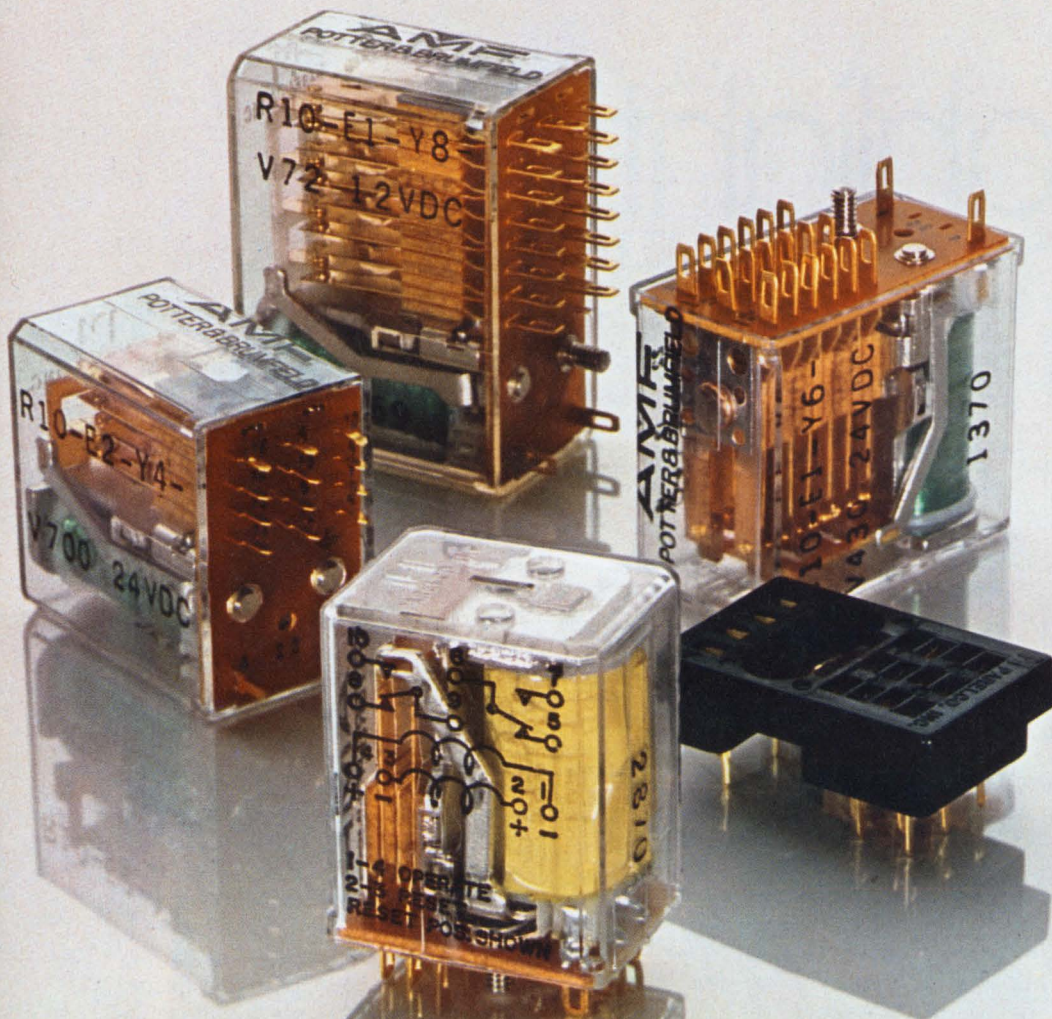

# R10: Our compact, multi-purpose relay.

You might say P&B designed it to be many things to many people.

Copiers, computer peripherals, business machines, precision instruments—you'll find our R10 in a multitude of applications requiring a compact, reliable, multi-pole relay. That's because it probably gives you more design options than any other single relay.

Consider these choices: Contact arrangements up to 8PDT. Ratings from dry circuit to 10 amperes. Six styles of contacts, including bifurcated. Sockets with solder or printed circuit terminals including one for mounting the relay horizontal to a printed circuit board—all with or without grounding provisions.

Mechanical life up to 100 million operations. Electrical life ranges from 100,000 to 100 million operations depending on load and voltage. Coils for DC operation from 3.0V to 115V can be supplied. AC-operated R10 relays to 2 Form C are also available. R10 relays have Underwriters' Laboratories' Component Recognition, File 42810.

The single lot price for a 4PDT, 2 amperes R10 relay is only \$3.60. Quantity discounts apply.

Order R10 relays from leading electronic parts distributors or call your P&B representative. For a complete, 194-page relay catalog, write Potter & Brumfield Division of AMF Incorporated, Princeton, Indiana 47570. Telephone: (812) 385-5251.

**AMF**  
POTTER & BRUMFIELD

**P&B performance. Nothing else comes close.**

## Soviet submarine expansion spurs rise in ASW market

Soviet submarines, which are now as familiar in the blue-green Mediterranean as dolphins at play and are fast becoming so in the Caribbean, have caused a reversal in at least one area of the generally depressed American military market: antisubmarine warfare.

"By 1974," according to an analysis just published by Frost & Sullivan, Inc., a New York-based defense and space market research organization, "the ASW equipment market will grow 20% from today's \$2.3-billion level." The annual figure includes, along with electronics, the cost of platforms—aircraft, ships and submarines.

Big outlays are expected to go for the following:

- Sonar for surface ships. Besides the updating of old ships, 30 destroyers (DD-963) are being built by Litton Industries, Inc., and all will need sonars. One detector already selected is a modified version of General Electric's giant sonar, the AN/SQS-26.

- Sonar for submarines. The new SSN-688 attack submarine calls for a big sonar order. International Business Machines alone has a \$50-million contract to develop five sonars for this new submarine class.

One thing for sonar makers to watch for, the report says, is the Navy's increasing interest in developing a common sonar that operates on both surface ships and submarines. This could possibly reduce costs, but it might also reduce the number of companies providing these complicated, expensive systems to the Navy.

- Sonobuoys, to be ejected from aircraft, and their related cockpit processors and displays. Spending for these will be in the hundreds of millions, the report states. The programs include LAMP (Light Airborne Multi-Purpose system)—

a destroyer-based ASW helicopter, of which 200 are to be delivered; the land-based P-3C ASW patrol plane; and the S-3A ship-based ASW patrol plane.

- Fixed underwater arrays to detect submarines. Purchases for the Caesar system of sonars, anchored to the floor of the Atlantic off the East Coast of the U. S., are slowing down after more than a decade, the report says, but hopes are high for initiation of a new moored sonobuoy system. Eleven companies are said to have announced intentions to bid on the latter program.

- Very-low-frequency and extremely-high frequency communications. These will continue to be good markets, the report says, as will magnetic anomaly devices, acoustic counter-countermeasures and explosive echo ranging systems.

The report is less than enthusiastic over the realistic potential of submarine detection by satellite.

### Price break predicted for semi memories

Semiconductor memories are encroaching upon the last stronghold of cores—the "extended core" memories above 4 million bits—according to David C. Conrad, vice president of marketing at Computer Microtechnology, Inc., Sunnyvale, Calif. By late 1972 the price of semiconductor memories will be down to 0.3¢ a bit, he says. This compares favorably with core price projections of about 0.8¢ a bit for a 10-million-bit system complete with power supply (see "The Big Memory Battle: Semis Take on Cores," ED 15, July 19, 1970, p. 70).

Primarily responsible for the price break in semiconductors, says

Conrad, will be a new 2048-bit dynamic MOS RAM, which CMI expects to ship during the second quarter of the year. The introductory price in prototype quantities will be between 3¢ and 4¢ a bit, but within a year after initial shipments, he predicts, they will be down to 0.3¢ a bit for 50,000 pieces in plastic packages.

Even bigger chunks of memory are coming along in multichip modules. By the third quarter of 1971, Computer Microtechnology will be shipping an 8-k-bit module that contains sixteen 512-bit static MOS storage chips and bipolar sense, drive and decode circuitry. The initial price will be about 5¢ a bit in prototype quantities, but Conrad sees them falling to 1.5¢ a bit by mid-1972.

### Microwave ILS proposed for tomorrow's airports

A special committee of the Radio Technical Commission for Aeronautics recommended to the Dept. of Transportation this month that it and other Government agencies develop the microwave scanning beam concept as the standard instrument landing system of the future.

As envisioned by the quasi-official aviation advisory group, the system would use two techniques: C-band guidance to touchdown and Ku-band guidance through flare-out. Using this modular approach the system would meet the needs of light aircraft, as well as airline and military equipment. It would be a fully automatic, all-weather system, capable of operating on multiple closely-spaced parallel runways.

RTCA recommended that the next phase of action be a year-long analysis by several Government and industry bodies and then that different manufacturers in different countries test the hardware.

### Flying command posts to communicate by satellite

The nation's first operational airborne satellite communications terminals are now being installed. They are going into the Air Force's Worldwide Airborne Com-

mand Posts, the electronic-laden EC-135 cargo planes from which the Air Force could direct a war.

The terminals, designated AN/ARA-64, were developed and built by Electronic Communications, Inc., in St. Petersburg, Fla., under contract with the Oklahoma City Air Material Area. They evolved from terminals the company built for the military to experiment with Les-5 and Les-6, experimental communications satellites built by Lincoln Laboratories. (See "Portable War" Electronics Gets First Pacific Test," ED 10, May 10, 1969, pp. 34 to 45.

The new terminals are solid-state and are lighter than their predecessors. Like the older ones, they operate at 70 MHz, the standard frequency for all Defense Dept. tactical satellite communications.

Each terminal can transmit and receive teletype, is equipped with a page printer, keyboard, tape reader and tape reformatting. They are being installed by the company's teams at Air Force bases in Hawaii, Europe and the U. S.

Meanwhile, the Joint Service Program for developing tactical communications satellite terminals for all the services—for use in the air, in vehicles and submarines—is still under way. Collins is building the uhf terminals and RCA the terminals that operate in the super-high-frequency range.

## Satellites to provide first intrastate TV

A proposed satellite ground station at Lena Point, near Juneau, Alaska, would make possible the first live television between the Juneau area and other parts of the state. The station, to be erected at a cost of \$1.5 million, would operate with the Intelsat TV communications satellite, pending the establishment of a domestic satellite system. A petition for the new station was submitted to the FCC at the end of December by RCA Alaska Communications, Inc. (Alascom), a subsidiary of RCA Global Communications, Inc.

Equipped with a 32-foot antenna, the Lena Point station would be connected to the Juneau telephone toll center by an existing micro-

wave route that has a present capacity of 300 voice circuits, according to Howard H. Hawkins, president of RCA Alascom Station design would also permit operation with Intelsat III or other alternative satellite systems.

## New heart pump uses advanced electronics

By combining the techniques of modern electronic signal processing with materials and medical technology, a team of engineers, doctors and physicists in Massachusetts has developed an artificial heart pump that has already saved six lives and holds great promise of saving many more. The intra-aortic balloon pump is the result of collaboration between the Massachusetts General Hospital in Boston and the Avco Everett Research Laboratory in Everett, Mass.

The balloon pump, which is inserted into the aorta through a small incision made in the femoral artery in the thigh, has been used to assist failing hearts during the crucial hours following heart attacks.

Naturally, to work properly with the patient's heart, the pump's action must be synchronized with it. In a healthy patient this would present no problem because the component of a normal electrocardiogram waveform that signals the start of each beat is about five times larger than the rest of the signal. In patients with failing hearts, however, the cardiogram can be very distorted, and discrimination is not so easy.

To overcome this problem, the engineers who designed the electronic circuitry for the heart pump had to use a combination of amplitude and frequency discrimination techniques to extract the all-important synchronization signal.

## Honeywell joins trend to instrument rentals

When the economy declines (as it did last year) and companies are reluctant to buy new capital equipment, rental of the equipment is often an attractive alternative. Noting this trend, Honeywell's Test Instrument Div. in Denver has

joined other electronics manufacturers in setting up a program for the short-term rental and long-term leasing, of testing, measuring and recording instruments.

Called Help (Honeywell Equipment Leasing Plan), the program gives customers outright-purchase options, as do other manufacturers.

According to Allan B. Dallas, Honeywell marketing vice president, customers can rent equipment and patient-monitoring systems for as short as two weeks or as long as five years.

As examples of monthly rental fees, Honeywell cites the following: a two-channel, low-frequency X-Y recorder for \$76.50, a 10-channel, medium-frequency oscilloscope for \$203 and a seven-channel, high-frequency magnetic recorder and playback unit for \$260.

## Color TV tube exports to 2 areas up 427%

U. S. exports of color TV tubes to West Germany and Britain rose 427% in the first nine months of 1970, according to the Electronic Industries Association.

Compared with the same period in 1969, American color tubes shipped to West Germany increased from 40,000 to 160,000, while tubes shipped to Britain rose from 2800 to 23,000.

## Radar weather data being sent by phone

If an airline dispatcher in Dubuque wants to see what the weather looks like in Kansas City, he's only a phone call away from a facsimile representation of that area's weather radar picture.

The facsimile service, offered over voice-grade telephone lines, is now available to the airlines for 15 regions of the country. By 1973, at least 50 regions will be covered.

The radar images are provided by National Weather Service satellites. The radar scope images are combined with geographical overlays and meteorological notations.

The service is being offered to the air transport industry by Aeronautical Radio, Inc., the industry's nationwide communications company. ■■

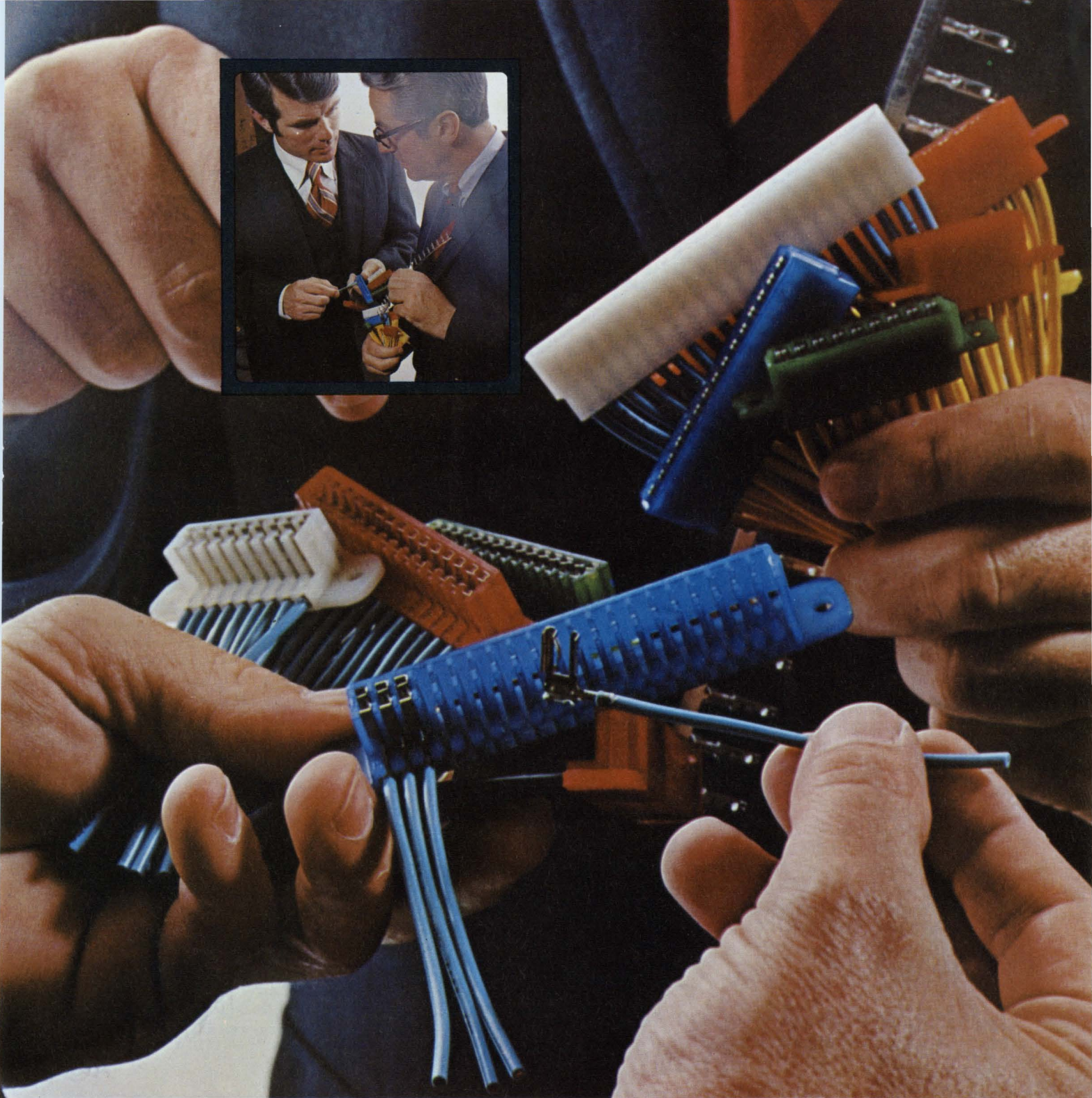

**THEY'RE MOLEX EDGE CONNECTORS.** "Straight-on" or "right-angle" types for printed circuit boards. Terminals crimped to wires automatically. Reliable? And how! Connector terminals are bifurcated. Provide a really solid contact. Yet you can slip the connector on and off time after time without any damage to the printed circuits. And it's not a preload unit. Carries only contacts required. From six to twenty-four. Comes in white or six other colors. Terminals available in tin-plated brass with gold plating or selec-

tive gold plating. ■ A good example of how Molex helps create high-speed low-cost devices that simplify circuitry. If you want to save assembly time, steps and money, take a close look at these Molex edge connectors. For *free* samples write: Molex Incorporated, Downers Grove, Illinois 60515. Or you can make connections by calling (312) 969-4550.

*... creating components that  
simplify circuitry*



# Digital filters with LSI promise a new world of applications

Making every telephone line in the country more efficient and more reliable is just one of the promises that digital filters can be expected to fulfill—once large-scale integration becomes practical. As digital ICs provide more functions on a single chip, digital filters can become more complex and less expensive, and they will take up less space.

When that day comes, digital filters will become a real threat to analog filters. Bell Telephone Laboratories, Murray Hill, N. J., actually expects the entire Bell System to go digital, with digital filters replacing the analog filters now used.

But at present the digital filters that are available are really laboratory instruments offering a good deal of flexibility. With them you can easily and quickly change filter characteristics simply by programming a different set of numbers that represent the filter you desire. Only two firms sell them: Rockland Systems Corp. of Blauvelt, N. Y., and Electronic Communications, Inc. of St. Petersburg, Fla.

## Applications are numerous

Besides laboratory work, these sophisticated filters can be used in many signal-processing applications—spectrum analysis, line equalization, satellite communications systems, and radar, sonar and audio work.

Spectrum analysis is made possible simply by adding interface circuitry and a display system to the output of the digital filter. Adaptive line equalizers can be implemented with digital filters because of the ease with which filter

characteristics can be changed.

Digital filters can also boost signal-to-noise ratios when used as linear, matched or comb filters in radar, sonar, audio and satellite communications systems. Other areas of application include geophysical and vibrational analysis and also medicine, where a digital filter can be used to pre-filter data for an electrocardiogram process.

## Digital versus analog

The current cost for a fully versatile digital filter is approximately \$20,000. But don't let price scare you. Digital filters offer some major inherent advantages over analog units. Temperature stability is a prime factor, according to Dr. James Kaiser, a member of the technical staff in Systems Theory Research at Bell Telephone Laboratories, Murray Hill, N. J.

"You are using nonlinear switching elements rather than linear passive components that reflect changes in temperature by changes in value," he notes. "The digital filter's characteristic is extremely predictable because it is solely dependent on the coefficients that are programmed into the filter."

Digital filters can also become economically feasible on a per-channel basis when there is a large number of signals to handle. Multiplexing becomes easy because digital signals can be handled with time division, and a bank of digital filters can share the same control system, like clock and power circuitry.

Dr. Leland Jackson, vice president of engineering for Rockland Systems Corp., notes:

"In the digital world, as in the analog world, there is no theoretical limit to the precision that you can achieve. However, when dealing

with analog components, you finally come down to a point where the components limit you because of thermal noise or size or impracticability. In the digital world there is only an economic limit to the number of bits that you can add to the filter.

"Usually the complexity of a digital filter varies linearly with its accuracy. If you want to double precision, you simply add another bit. It does not matter if that is the seventh bit or the 27th bit—it is not any harder to add that extra bit. Whereas, with the analog filter, every time you try to double precision, cost is squared or cubed because of the difficulty in building the components.

"Another consideration is the fact that integrated-circuit technology has been making greater strides in the digital world than in the linear. You can buy much more on a digital chip than on a linear one."

There are many ways to implement digital filtering, but there are only two types of digital filters that you can buy today: recursive, made by Rockland Systems, and nonrecursive, manufactured by

## What are digital filters?

Digital filters can be thought of as special-purpose computers. They implement the filtering function by working with samples of the input signal and samples of the desired filter characteristic. The arithmetic section of a digital filter basically consists of multipliers and adders that operate on corresponding samples of the stored signals.

Electronic Communications, Inc. Both filters use a sampling rate that is at least twice as fast as the highest frequency of the input signal.

### A look at a recursive design

Rockland's series 4000 recursive filters are able to simulate both poles and zeros for the filter transfer function. The input analog signal to be filtered is first sampled by an analog-to-digital converter, and these samples are stored in the instrument—as are coefficients that determine the filter characteristics.

The coefficients are the multipliers of the z-transform terms that represent the transfer function of the filter desired.

"The z transform is a special type of Laplace transform," Jackson explains. "It plays the same role in the design of digital filters that the Laplace transform does for analog filters.

"When you finish taking all your Laplace transforms of the sampled signal, you find that everything has the common term,  $e^{sT}$ . You finally get tired of writing that and call it z. And let

$$z = e^{sT},$$

where s is the Laplace transform parameter and T is the sampling period."

The coefficients that determine filter characteristics are the multiplying coefficients of the z-transform terms. They correspond to the passive-component values that you would have in an analog filter.

"You cannot say that this coefficient represents a resistor or another is a capacitor," Jackson says, "but you can say that this ensem-

ble of coefficients used in a certain way gives me a Butterworth filter, and another set will give me an elliptic filter."

From the frequency domain of the z transform, Rockland goes back to the time domain and processes (filters) the input signal with real-time digital circuits. These ICs perform a series of mathematical steps, primarily multiplication and addition, to realize the filtering function.

"Our digital filters are limited to applications where signal frequencies are 1 MHz or less," Jackson says. "Crystal filters are more economical at frequencies above this. However, our applications are still broad. We can handle baseband processing of audio or other low-frequency signals. We can also deal with i-f processing of signals that have been frequency-translated."

### Here is a nonrecursive design

The nonrecursive type of digital filter from Electronic Communications is actually a signal-processing instrument that performs the convolution integral in order to effect a filtering function. Dr. William Marquitz, group leader of Digital Communications Technology Div. there, explains:

"We stay away from the z-transform method and work strictly in the time domain. We represent a filter, not by its amplitude and phase characteristics, but by its impulse response. We begin by band-limiting the analog input signal with a low-pass analog prefilter. We must restrict the bandwidth of the incoming signal to something less than half the sampling rate.

In our model 999 digital filter, the standard sampling rate is 10 kHz, and the prefilter cutoff is 3.5 kHz."

Electronic Communications' digital filter has two identical shift-register memories. One stores samples of the band-limited input signal, while the other contains samples of the impulse function of the filter that is desired. The sampled impulse response is represented by coefficients that are the various amplitudes of samples spaced equidistant along the time axis.

The coefficients are obtained by using computer software available from the company and programmed into the digital filter via a paper tape. The tapes are set up so that the programs can be put on a time-shared computer system. Up to 200 coefficients can be stored in the sampled-impulse-response memory.

The contents of the two memories are fed into a single multiplier section that forms the product of corresponding samples from each memory. The output of the multiplier goes to an accumulator that puts out the digitized filtered version of the input waveform.

Because this digital filter is a transversal or nonrecursive one, it can simulate only zeros for the filter transfer function.

"However," Marquitz points out, "a nonrecursive filter is not a limited one. The concept of poles and zeros is only a mathematical tool to help analysis. We can represent any filter by its impulse response. There is no recursive filter that you can represent with poles and zeros whose impulse response you cannot find in order to use our nonrecursive model 999."

The need to band-limit the input



There are only two digital filters available to the user at this time. Both are primarily intended for use as flexible laboratory instruments and cost about \$20,000 when fully equipped. The Rockland Systems' filter (left) and



the Electronic Communications' filter (right) offer fully programmable filter characteristics. A set of numbers, which can be changed easily, completely determines the desired filter function.

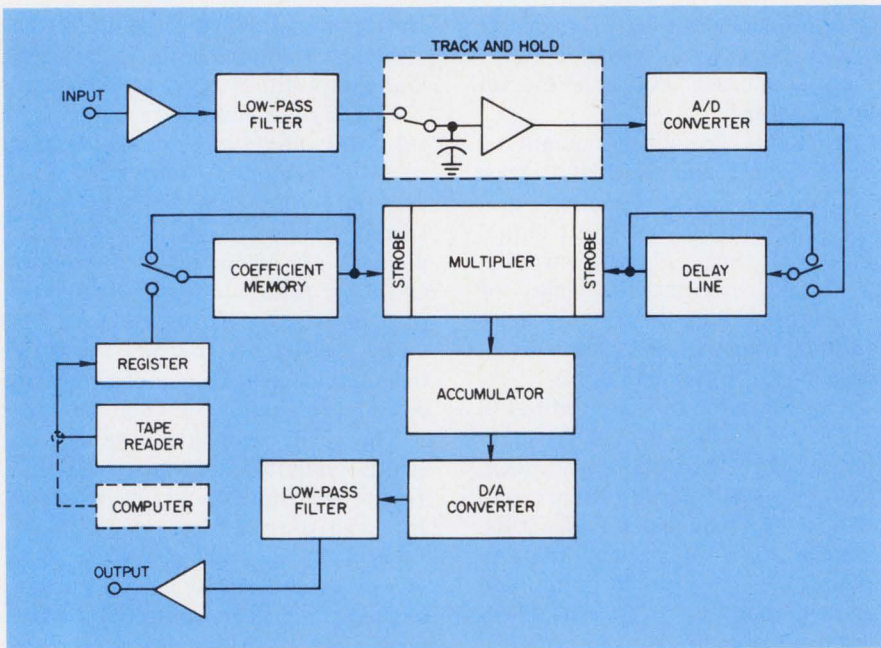

The digital filter from Electronic Communications is really a signal-processing instrument that performs the convolution integral. Its major function blocks are two memories, the multiplier, and the accumulator.

signal is not as restrictive as it might seem at first. Marquitz notes:

"We can increase bandwidth by adding multiplier sections. With two multipliers, for example, we can double bandwidth to 7 kHz without sacrificing filter selectivity. The upper frequency limit of our digital filter is really a function of how fast the accumulator can work."

Because it is actually performing the convolution integral, Electronic Communications' instrument is really a convolutional processor. This means that it can perform the cross-correlation function if the impulse-response samples represent some analog waveform. The auto-correlation function can be implemented if the impulse-response samples represent the input signal itself.

### Recursive versus nonrecursive

According to Marquitz, transversal filters offer a major advantage over recursive designs—independent control of amplitude and phase response.

"A customer can specify each one independently, and we can give it to him," Marquitz says. "This cannot be done with a recursive filter."

However, Jackson at Rockland

points out that recursive filters produce the sharper cutoffs. "We can approximate linear phase," he says, "so that the input signal comes out with an unaltered shape."

### The manufacturers look ahead

Both Rockland and Electronic Communications feel that the future of digital filters is strongly tied to the development of integrated circuit technology. As chip complexity increases, both companies expect the cost and size of digital filters to come down because multiplier sections can be greatly simplified. A direct result will also be broader applications.

Marquitz says: "Current prices will be approximately halved when we get the integrated circuits that we need. If we get better IC functional blocks, I think that within five years you will see a digital filter in a housing the size of a cigarette package."

Jackson notes: "There are two things that we will be doing. One is developing digital-filter products, and the other is utilizing digital filters in standard instruments, like wave analyzers, spectrum analyzers and voltmeters. These devices are currently using analog components. Whether we introduce the new instruments ourselves or simply provide the digital-filter subsystems

for them remains to be seen. Future applications depend on the technology available to us."

### A big user speaks out

The Bell System is expected to be a large user of digital filters because they can reduce costs, according to Dr. Henry McDonald, assistant director of the Communications Principles Research Laboratory of Bell Telephone Labs.

He says, "Parts costs will be reduced by a factor of 10, not to mention our savings on maintenance costs."

Bell is primarily interested in digital filters as tone detectors to implement its plan to convert the entire country to the Touch-Tone system. McDonald foresees useful digital filters coming out of the development stage by 1973 and installed in the Bell System by 1975.

"We install something like half a million channels a year, and most of these in long trunk lines that have tone detectors associated with them," McDonald says. "This is why we have quite an active research program going for the implementation of digital filters."

"We are now waiting for our custom integrated circuits from Western Electric. The commercial MSI that is available today takes 10 times more power and 10 times more silicon area than our custom experimental circuits will require. Instead of the 2-1/4 MSI chips now needed per bit of multiplier, we will get four bits of multiplier on one chip."

Some day all of Bell's needs will be fulfilled digitally with the aid of d/a and a/d converters, McDonald predicts.

"The reason for this," he notes, "is that large-scale integration will greatly reduce the number of wires and the number of parts. The number of wires will decrease because we could use time-division multiplexing to get many digital signals on the same wire. The number of parts will go down because we could get 100 circuits on one piece of silicon. Another factor is reliability. We hope to practically pay for the change because of what we will save on the maintenance costs."

"I see digital filters as very much a part of the Bell System. They are not just a laboratory curiosity." ■■



# 531

## Signetics announces third generation linears.

The 531 is a high slew rate op amp. It is the first in a series of linear devices developed to solve functional problems without the usual penalties. So begins the third generation of linear circuits.

Simplicity itself, the optimized 531 combines high DC performance equal to the best general purpose op amp available, with unique large-signal AC response ( $35V/\mu\text{sec}$  typical slew rate, regardless of gain setting). Stability: extraordinary. With no special precautions required in circuit board layout. Easy, single capacitor compensation.

Refined but totally realistic. 531 matches pin-outs with 741, 748, 101, etc. (Even uses a 10K offset null pot same as 741.) Cost competitive, immediate delivery from stock. Just call your Signetics distributor or salesman.

Third generation linears. IC's without the crutches. And 531's only the first in Signetics' advanced 500 series. Look

for three more new circuits on the shelves next month. We're committed to a complete third generation line within the year. When you want to get more, Signetics' got more to give.



### SIGNETICS COUNTS IN LINEAR

Signetics-Linear  
811 E. Arques Ave., Sunnyvale, Calif. 94086

We need a better deal in linear.

Please rush data sheets and complete specs on the 531 high slew rate op amp.

Sneak me an inside look at the 3 new circuits coming.

Name \_\_\_\_\_ Title \_\_\_\_\_

Company \_\_\_\_\_

Address \_\_\_\_\_

City \_\_\_\_\_ State \_\_\_\_\_ Zip \_\_\_\_\_

Telephone \_\_\_\_\_

SIGNETICS CORPORATION—A SUBSIDIARY OF CORNING GLASS WORKS

# Introducing, the electronic car: antiskid, antipolluting, pro-driver

The British version of the car of the future was recently unveiled by Joseph Lucas Ltd. of Birmingham, England. The car, an experimental British Triumph, was developed as part of a \$2.4-million R&D program and is fitted with six newly developed electronic systems. These are:

- Fuel injection.
- Wheel slide protection.
- Vehicle conditioning monitoring.
- Autocruise.
- Ignition.
- Permanent magnet alternator control.

**In the fuel-injection system,** a small digital computer called a Performance and Demand Analyzer determines the optimum air-fuel combination for engine speed and acceleration. The computer activates solenoid-operated injectors to achieve "perfect fuel control in all conditions," thereby curbing air pollution, according to Lucas.

**Wheel slide protection,** Lucas says, prevents skidding, wheel-locking, loss of stability and loss of steering control. Each wheel has an electronic module. Wheel speed is checked by an inductive sensor, and the pulse train from the sensor is converted by the module to a dc signal proportional to wheel speed. This signal is differentiated to determine wheel deceleration and then compared with a threshold value (about 1.3 g) to indicate any imminent skid. When the threshold value is exceeded, a power amplifier in the module triggers a solenoid control valve that controls pressure delivered by the brake fluid.

**The vehicle condition monitoring system** monitors eight vehicles con-

ditions: brake systems, brake fluid level, oil pressure, bulb failure, oil level, radiator coolant level, brake pad wear and window-washer fluid level. These conditions are monitored by both hydraulic and electronic sensors.

The alarms for the system consist of the following:

- Simple resistor and transistor circuits that derive an output from a pressure differential.
- Electrodes immersed in a fluid that fail to conduct when the fluid level falls below the probe.
- Series resistors in the supply to each bulb, with the voltage drop in the bulbs monitored by an alarm circuit.
- Heat sensors immersed in oil that get hot when the surrounding medium falls below a level and produces an impedance change.
- Simple contacts inserted below the brake pad that are exposed as the brakes wear.

**Autocruise**—essentially speed-sensing and correction—is accomplished by conversion of pulsed

signals from a prop shaft tachometer (whose frequency is proportional to vehicle speed) to a dc signal and then comparison of this signal with a value set on a potentiometer. Settings are variable from 30 to 80 miles per hour.

Difference signals between actual and desired speed are used to modulate the current of a solenoid control valve. The solenoid current controls a mechanical system that connects the accelerator pedal to the engine manifold via an actuating bellows arrangement.

If the vehicle speed exceeds or drops below the set speed, the bellows expand or contract their link to the throttle and correct the amount of gasoline flowing to the engine. To override the systems, the driver may change gear, step on the brakes or touch a speed-selector switch.

**The heart of the Lucas electronic injection system** is a thick-film (oscillator) package and an output power transistor connected to a printed-wiring board. This elec-

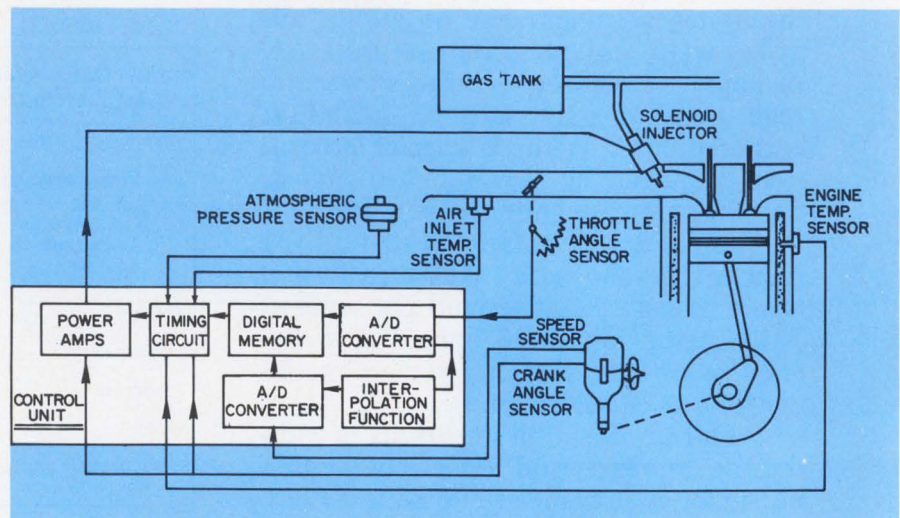

**Electronic fuel-injection system** developed by Lucas Ltd., Birmingham, England, uses small digital computer as control unit to regulate air-gas mixture. Engine performance meets air pollution laws.

John N. Kessler  
News Editor

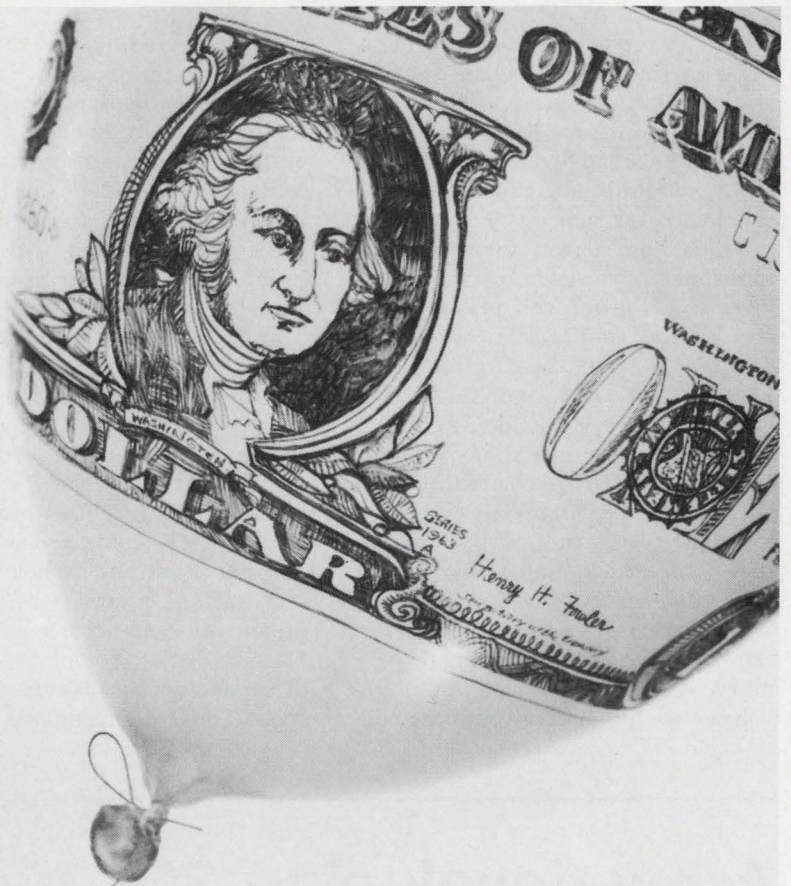

## Introducing: The anti-inflation circuit breaker.

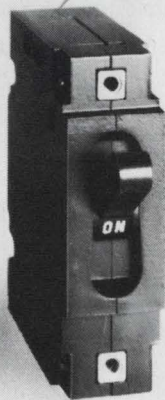

The new Heinemann Series AM1.

A direct replacement for our own Series AM12.

Costs less, all along the line.

A single-pole model with an auxiliary switch, for example, will save you 17 percent over a comparable AM12 model. A three-pole, 400-Hz model with auxiliary switch will save you about 34 percent.

And the AM1 offers the bonus of UL recognition. In any current rating up to 50 amp, at 240 Vac or 65 Vdc.

The Series AM1 is available with all the usual Heinemann options. Choice of time delays or instantaneous trip. And special-function internal circuits.

If you're tooled up to use AM12-type breakers, you could start using our Series AM1's immediately, without modifying a thing.

But, on second thought, there is one major change you'll have to contend with.

You'll have to revise your present component-parts cost.

Downwards.

Get in touch with your local Heinemann representative or write us for a copy of Bulletin 3306. Heinemann Electric Company, 2616 Brunswick Pike, Trenton, N.J. 08602.

**HEINEMANN**

4625

tronic assembly is housed in a little cylinder on the top of a standard distributor. The distributor points are replaced by encapsulated reed-switches, activated by a magnet attached to a high-tension rotor arm.

When the driver turns on the ignition, the power transistor energizes the ignition coil primary. As the engine is cranked, a ferrite coupling rod in the timing rotor passes across the face of the E-core of the pick-up module, and the oscillator breaks into high-frequency oscillation. This oscillating signal is rectified, amplified and used to switch off the output power transistor. Each time a ferrite rod (one for each cylinder) in the timing rotor passes across the face of the E-core, the ignition-coil primary circuit is broken. A high voltage is thus induced into the coil

secondary winding, and this creates a spark at the plug.

The permanent magnet alternator designed by Lucas provides its output to the battery through a controlled rectifier bridge. The bridge consists of three diodes and three SCRs, and it is turned on by high-frequency firing pulses applied to the gates of the SCRs. These firing pulses are generated by a voltage-controlled oscillator when the battery voltage falls below a predetermined value.

The rectifier delivers full output of the alternator to the battery when the firing pulses are present. Each SCR conducts one cycle of alternator output. When the battery voltage reaches the predetermined value, the firing pulses stop. Each SCR then completes its phase of conduction and becomes inoperative. Thus the complete rectifier

stops conducting after less than one cycle, and it remains inoperative until firing pulses resume.

This form of control means that the alternator's output is supplied in bursts with a duty ratio that adjusts automatically to the required average output for load balancing and battery charging. A warning light tells the driver if there is no output from the alternator. A light also goes on if excessive battery line voltage develops. All rectification and control circuits are housed in the alternator and are fan-cooled.

The price for this electronically controlled car? It cost Lucas more than \$132,000 to develop. But then prototypes are always costly. There's no estimate on what the motorist might be expected to pay if these electronic systems go into mass production. ■■

## Army developing 30¢ tuning capacitor

An electronically variable ceramic capacitor that has a number of advantages over conventional high-power tuning capacitors is under development at the Army Electronics Command's Electronic Component Laboratory, Fort Monmouth, N. J.

The capacitor will be used in automatic tuners in lightweight radios operating in the 30-MHz-to-70-MHz range.

It will be a tenth the size of presently available tuning capacitors, its developers say—equivalent to three quarters stacked one on top of the other. It will retune an antenna automatically, and it will be a hundredth the cost of a conventional capacitor—about 30¢ as opposed to \$30, the Army reports.

Though the work has not been completed, it was far enough along last month for the device's two developers to report their progress to a small group of research and development officials of the Army and the Dept. of Defense. The developers are Howard Wichansky, a ceramic engineer, and Francis J. Murdoch, a physicist, both employed by the Army Electronics Command.

The capacitor is a multilayer

structure made from a ferro-electric material—barium strontium titanate. It has an rf electrode on each end and a dc electrode going to the inner layer.

When the dc voltage is varied, the material's dielectric constant changes. Thus, the device can be combined with a digital logic network to retune the antenna automatically if any mismatch occurs between it and the transmitter.

"Manpack antennas often need retuning," Wichansky says, "especially when a man is walking up a

hill and the transmitted power is reflected back. Using a ceramic variable capacitor, the radio should retune itself automatically in a matter of milliseconds."

Murdoch says of the new capacitor:

"Some people might wonder why varactors weren't used. But to get high power with varactors, you have to use a large number of them. You have to put them in series, and when you do this, you cut down on capacitance. To get more capacitance, you then have to put the groups of series varactors in parallel, ending up with an unwieldy network.

"With a ceramic multilayer approach, you can have a whole stack of these networks in a very small package."

The development work is being done at the Fort Monmouth laboratory, except for the fabrication of a multilayer structure designed by the Army. The latter is being assembled by State of the Art, Inc., State College, Pa., for delivery in March.

Murdoch and Wichansky say they foresee a big future for the tuners in manpack and aircraft radios. ■■

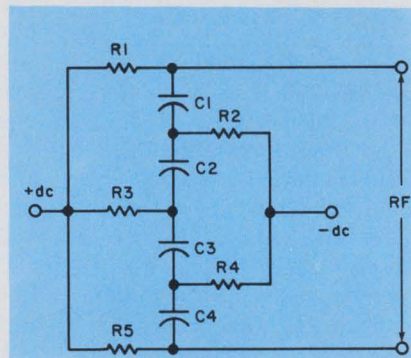

In an electronic tuning application a ceramic multi-layer capacitor ( $C_1 - C_4$ ) is connected with the resistors used to isolate the rf and dc voltages. The dc bias control voltage is set at a high level compared with the peak rf voltage.

▶ 10 YEAR OPERATING LIFE WITHOUT MAINTENANCE ▶ PROVEN  
 MUFFIN® FAN MOTOR ▶ COMPACT—ONLY 1 $\frac{1}{16}$ " DEEP ▶ FITS INSIDE  
 1 $\frac{3}{4}$ " RACK MOUNTED INSTRUMENTS ▶ HIGH PRESSURE BLOWER  
 PERFORMANCE ▶ LOW NOISE LEVEL ▶ AVAILABLE FROM STOCK

# Rotron's new BISCUIT® BLOWER is not revolutionary

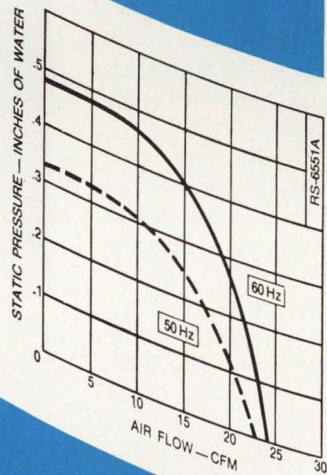

**It's unique!**

Want more information?  
 Call 914-679-2401 or  
 write Rotron Incorporated,  
 Woodstock, New York 12498



# Space-station program needs custom-made sensors

What does the space-station program need most—and before the end of the 70s? Several types of sensors, according to Dr. Carl L. Kober, program scientist at the Manned Spacecraft Operations of the Martin Marietta Corp., Denver, Colo.

“The space-station program will require a quantum step in technology—specifically in sensor performance—similar to what the Apollo program required during the 1960s,” Kober says. “In general the trends are: 10 to 1000 times improvement in resolution, time response, accuracy, digital output, and, most important, a greatly increased lifetime of several years.”

## Observing the universe

Most important among the astronomical sensors are electronic imaging systems, high-energy radiation detectors and X-ray jitter removal systems.

Imagers must be developed for use in the ultraviolet and X-ray regions that are as good or better in resolution than photographic film is in the optical region. Photocathode imaging systems that have high quantum efficiency ( $>10\%$ ), large area ( $>10\text{-cm}$  diameter) and wide spectral range ( $3000\text{-}12,000 \text{ \AA}$ ) are needed. They should also have high resolution ( $<5 \text{ cm}$  at  $50\%$  modulation transfer) and wide dynamic range (essentially linear over intensity ratios of  $10^3$ ). Photocathode imaging is accomplished by exposing a photocathode plate to the ultraviolet or X-ray source. The photocathode plate (detector) emits photons of visible light in the pat-

---

David N. Kaye  
West Coast Editor

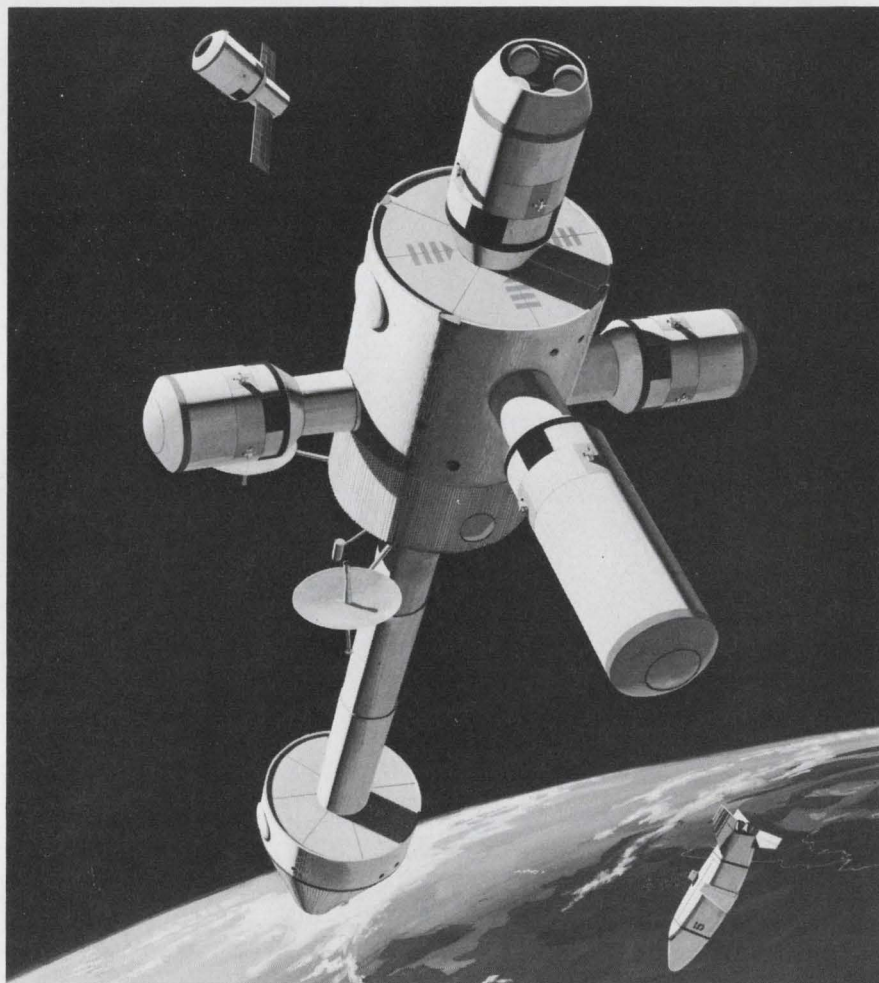

This 12-man space station proposed by the McDonnell Douglas Astronautics Co., Newport Beach, Calif., has experiment modules attached to its sides. These modules, as well as the free-flying experiment modules, will contain most of the sensors that need to be developed before the end of the decade.

tern of the non-visible image. These photons are collected on a screen yielding a visible image.

Development of X-ray and gamma-ray detectors is necessary to enable the energy spectra and precise location of the sources to be accurately determined. Also needed are large-area and volume-cooled solid-state detectors for use in spectrometers.

Telescopic sensors include de-

vices for calibration of the telescope itself, as well as detectors, filters and other accessory equipment. Most important of the telescope sensor needs is a method for calibrating the mirror on the telescope in orbit.

Shape control on the mirror surface must be held to within  $1/50\text{th}$  of a wavelength. During launch and while in orbit, distortions of the mirror can take place,



## What's so surprising about a new pulse generator with a rep rate of 1 Hz to 25 MHz, double pulse to 40 MHz, and rise time of 3 nanoseconds? The price: \$395.00

You can pay twice as much for what Cimron has designed into its new series of pulse generators. Or, you can spend the same money someplace else and get far less capability and performance. Even at its surprising price, the Model 3103 will handle just about any time domain testing requirement for the design and production of semiconductors and instruments.

First class features back up the 3103's great specs. There's simultaneous bipolar output, synchronous or asynchronous gating and a back-

matched output amplifier that delivers a usable pulse even in the unterminated mode.

Whether your application calls for a simple repetitive clock source, controlled gating or external triggering, you get more for your money at Cimron. Select the 3103, or one of two companion models, for your specific requirement. The Model 3101 Logic Driver (just the thing for IC testing at \$265) gives you a simultaneous complement output that eliminates the need for an external inverter. And for \$325, the 3102 sup-

plies a variable output to a full 10 volts into a 50 ohm load.

All our economical new pulse generators contain IC logic and are engineered with Cimron's "customer concern." So if you're ready to spend money on a general purpose timing pulse source, price Cimron. We wouldn't be surprised if you bought two of ours.

Write Cimron, Dept. E-122, 1152 Morena Boulevard, San Diego, Calif.



and these must be corrected. A system has been proposed that includes a laser interferometer and a batch of controllers that can introduce precise distortions to counteract unwanted changes in the shape of the mirror.

In order to get precise spectral distribution information about received emissions, it is necessary to develop low-noise increased-sensitivity detectors, preamplifiers and filters. Bolometric and photo-conductive detectors must be developed for the infrared region. And each detector must have a corresponding preamplifier to match particular voltage and impedance characteristics and to avoid capacitive losses while operating in the same environment as the detector.

General development of a parametric amplifier with a cooled ( $4.2^{\circ}\text{K}$ ) input stage is recommended. Infrared filters across a range of from 20 to  $500\mu$  with narrow bandwidths ( $\Delta\lambda/\lambda \sim 1/10$ ) are needed in order to break the spectrum into well defined regions.

### Bioanalytical studies made

Most important among the biological and physiological sensors that must be developed are those for mass determination and bioanalytical instrumentation.

For physiological studies on animals and plants it is important that mass should be determined to an accuracy of  $\pm 0.1$  mg. A device has been developed for use on the Skylab that will determine mass at zero-g to an accuracy of several grams. This is not nearly good enough for the proposed space-station experiments.

Although a great deal of bioanalytical instrumentation exists on the earth, several of these instruments must be adapted to work in a zero-g environment. In addition, the equipment must be reduced from normal laboratory size, and it must be made computer-compatible.

### Measuring the earth

Advances required in earth-resources sensors include precision altimetry, broadband ultraviolet to infrared detection, and broadband microwave radiometry.

Dynamic mapping of the surface of the earth requires an X-band precision altimeter with a  $\pm 10$ -cm altitude accuracy from orbit. Present equipment is more like  $\pm 10$  meters.

Earth-resources detection requires scanning over several important regions of the frequency spectrum. Among the most important is the region that goes from the infrared through the optical and into the ultraviolet. At present several discrete sensors are necessary to scan that region. A large-aperture, broadband, tunable detector is needed so that the job can be done with a single compact instrument. Another important frequency range is the microwave range from 1 to 30 GHz. A single tunable radiometer that would cover the whole range could replace several discrete radiometers needed to do the job.

### Understand the ionosphere

Vlf studies must be made to better understand the ionosphere. Most significant of the advances in space-physics sensors is the need for a vlf antenna that would

be stable in the space station's thermal and acceleration environment. If vlf crossed dipole antennas were used for wave-particle interaction experiments they would have to be perhaps as long as 45,000 feet from tip to tip. An antenna that long could never be kept sufficiently straight to make accurate measurements. A simple old-fashioned crossed-loop (magnetic-coil) antenna might do the job better. Studies are necessary to come up with the optimum antenna configuration.

### Stop the yaw

Present techniques provide knowledge of yaw attitude to an accuracy of approximately  $\pm 2^{\circ}$ . But for synthetic aperture radar and photographic experiments, without smear problems, vehicle yaw attitude will have to be controlled to an accuracy of  $0.1^{\circ}$  to  $0.01^{\circ}$ . Doppler radar with extremely accurate, narrow-band filtering may give the solution to this problem. This is the most significant of the pointing and control sensor problems that the space station faces. ■■

## Ultrasonics takes the needle out of sewing

A new ultrasonic machine "sews" without either needle or thread, using a new technique that welds together synthetic materials with ultrasonic (high-frequency) vibrations. And it makes good strong seams, straight or zig-zag, as required.

But don't throw your needles away—yet. The new machine, developed by Branson Sonic Power Co. of Danbury, Conn., is still too high-priced, because of development costs, for home use. Its initial application will probably be in the apparel, drapery, upholstery, bagging and packaging and related industrial fields.

The machine's ultrasonic vibrations generate localized heat by causing one piece of material to vibrate against the other, creating a molecular change that joins—or "sews"—the pieces together. The machine can operate at rates up to 50 feet per minute, in a variety of patterns. ■■



**Needle and thread are eliminated** by welding together synthetic materials with high-frequency vibrations. The new "sewing" machine is made by Branson Sonic Power Co., Danbury, Conn.



# As you can see, we're not just pussyfooting around in Tri-State logic:

## Nov. 1970:

- DM 8551N** Quad-D Flip-flop
- DM 8230N** Bus Line Demultiplexer
- DM 8831N** Party Line Driver

## Jan. 1971:

- DM 8551N** Quad-D Flip-flop
- DM 8230N** Bus Line Demultiplexer
- DM 8831N** Party Line Driver
- DM 8093N** Tri-State Quad Buffer Gate
- DM 8094N** Tri-State Quad Buffer Gate
- DM 8214N** Dual 4-Line-to-1-Line Multiplexer
- DM 8598N** 256 Bit Expandable ROM

## Soon:

- DM 0000N** Decade Counter & Latch
- DM 0000N** Hexadecimal Counter & Latch
- DM 0000N** 8-Line-to-1-Line Multiplexer
- DM 0000N** 2-Quad Input Multiplexer
- DM 0000N** 64-Bit RAM (16 x 4)

With a total of seven off-the-shelf devices ready for immediate delivery (and five more on the boards), you might say we're firmly committed to Tri-State logic. But we don't mind one bit, because frankly we believe that Tri-State logic is a very good thing. With it, you get all the desirable features of TTL, plus the ability to interconnect outputs of similar devices.

As you may recall from our November introductory ad, we said that Tri-State logic was a way to speed up bus-organized digital systems. We also mentioned that Tri-State logic allows you to work with fewer packages and without external open collector gates. And that with Tri-State, you can tie up to 128 outputs together while providing better wave form integrity than ever before possible.

Back then we introduced three devices.

Now we have seven and we'd like to say a few more nice things about Tri-State logic devices. For instance: they can literally be attached to a bus line at will (which makes modular TTL systems a practicality). Multiplexing can be performed right on the bus line.

Some of the other marvelous feats performed by Tri-State include high speed time sharing of decoder-drivers, fast random-access (or sequential) memory arrays and bi-directional line-driving.

The rest is all down in our handy Tri-State logic application notes. For your copy, write, call, TWX or cable us today. National Semiconductor Corporation, 2900 Semiconductor Dr., Santa Clara, Calif. 95051 / (408) 732-5000/TWX (910) 339-9240. Cable: NATSEMICON.

# National

# SQUEEZE PLAY

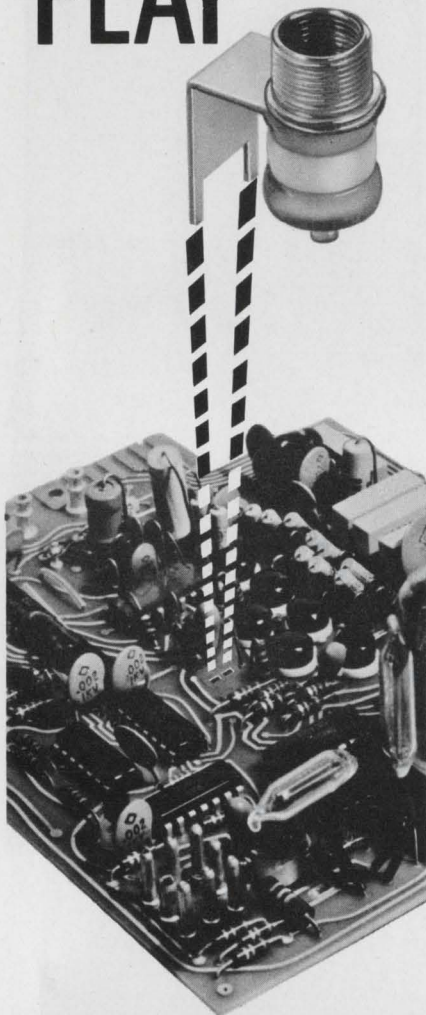

When every available inch on your circuit board is critical, bulky trimmers just won't do. Johanson's new Vertical Mount series allows you to "squeeze in" the added capacitor punch of an air trimmer, in less than half the space. Four basic models, all with high Q and low temperature coefficients, are available with both single and double leads. Before you get caught in a squeeze, send for full details on Johanson Vertical Mount capacitors.

*Johanson*

MANUFACTURING CORPORATION  
ROCKAWAY VALLEY ROAD  
BOONTON, NEW JERSEY 07005

ELECTRONIC ACCURACY THROUGH  
MECHANICAL PRECISION

INFORMATION RETRIEVAL NUMBER 24

## technology abroad

An experimental satellite receiving station is to be constructed by AEG-Telefunken, the German electrical giant at Leeheim (Hesse). It will be used in conjunction with an Italian synchronous satellite slated to be launched in 1972, as a means of studying ways of using the 10-to-20-GHz band for telecommunications purposes. The present Intelsat network operates on the 4 and 6-GHz bands. The 3.5-million Deutschmark contract will be funded by the German Ministry of Posts and Telecommunications.

IC masks to a 0.5-micron line width have been fabricated by engineers at Cambridge (England) Scientific Instruments by coupling their Stereoscan microscope to a flying-spot scanner. This is reported to be four to five times better than can be obtained by conventional optical masking methods. Cambridge engineers first coat the mask with a special electron resist. Then the microscope's main electron beam raster scans across the mask material, painting in circuit details. After exposure, the mask is etched by conventional chemical techniques.

A much-needed portable unsoldering tool could soon be used in computer maintenance and service. The tool was developed by the Cheltenham (England)-based Marconi research laboratories. Previously, unsoldering equipment was not portable since an air line was generally required to remove newly melted solder. In the new unit a metal piston drives electrically-heated molten solder. A vertical hole through the piston is fitted with one of a number of nozzles, shaped to accommodate different packages. The component to be removed is held in a spring-loaded remover. Thus, when the piston is depressed, molten solder wells up through

the holes and contacts the underside of the board. This melts the joint and permits removal of the component.

The job of producing a commercially viable vidicon with a solid-state target has been assigned to the research laboratories of semiconductor manufacturer Sescosem of Corbeville, France. So far they've produced a device with a solid-state target composed of 750,000 photodiodes. The target diameter is 2.1 mm; useful target area is 1.4 cm<sup>2</sup>. Sescosem says the tube has an extremely wide spectral response.

A new dielectric material has been developed by scientists at Mullard's Central Materials Laboratories at Mitcham, London. The material is a doped form of titanium dioxide that can be deposited on silicon chips to provide integrated circuits with a built-in high capacitance. The material has a wide range of properties, depending on subsequent treatment. One process produces a semiconductor material with a relative dielectric constant,  $\epsilon_r$ , of about one million. Another has an  $\epsilon_r$  of only 100 but with much lower losses and much greater stability than comparable materials.

Failure of the European Launcher Development Organization (ELDO) satellite to be placed in orbit last June has been traced to a prematurely loosened connector. As a result, the launch-vehicle heat shield failed to detach itself and the payload was more than doubled. This meant that the satellite was unable to attain the 7893 ms injection velocity. Main objectives of the launch are considered to have been met, however, and plans are going ahead for orbiting a 125-kg geostationary satellite with the Europa I launcher.

# Signetics

## SILICON GATE MOS

### Super Speed Dynamic Shift Registers

2506—3MHz Dual 100-bit

2507—3MHz Dual 100-bit

2504—10MHz Single 1024

2503—10MHz Dual 512

2502—10MHz Quad 256

2505—5MHz Single 512 with logic

2512—5MHz Single 1024 with logic

### Fully Decoded Random Access Memories

2501—256-bit Static

2508—1024-bit Dynamic

### Tri-State Output Static Shift Registers

2509—3MHz Dual 50-bit with logic

2510—3MHz Dual 100-bit with logic

2511—3MHz Dual 200-bit with logic

### High Speed Read Only Memories

2513—64x7x5 Character Generator

2514—512x5 Static ROM



Signetics begins the new 2500 Series in Silicon Gate MOS. Characterized, in production. The most devices and lowest costs in the field. Available now. Call or write Signetics Corporation for lit-packs: 811 E. Arques Avenue, Sunnyvale, California 94086. (408) 739-7700.

A subsidiary of Corning Glass Works.



# Siemens

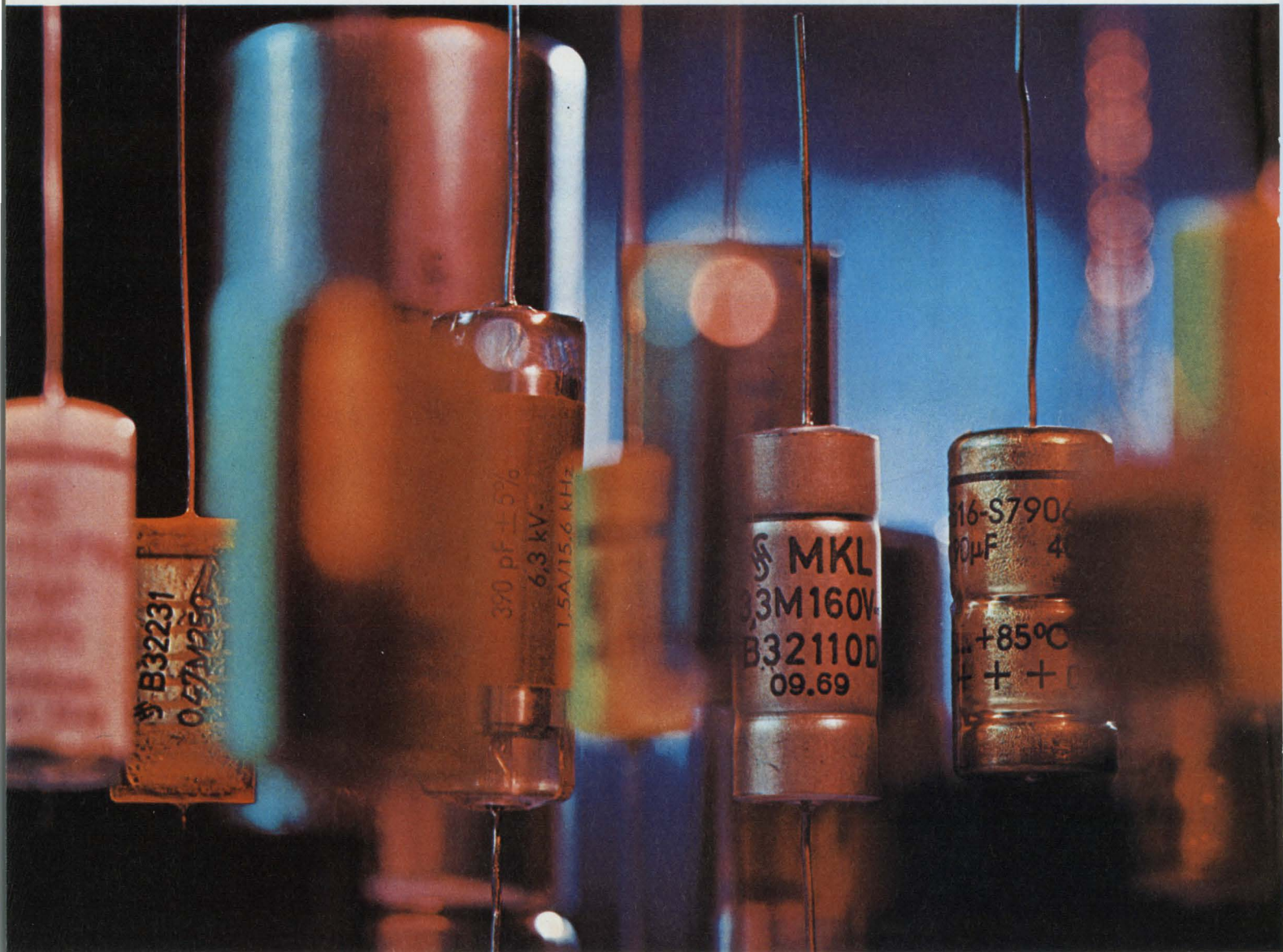

## **Our MKL metallized lacquer capacitors handle peak voltages four times their rated voltages.**

And that means you can use a much smaller capacitor for any given application. This is just one of many Siemens innovations. Our double anodized foil aluminum electrolytics are 30% smaller than competitive units. And our unique MKM metallized polycarbonate construction makes possible a

dramatic reduction in the size of film capacitors.

Our capacitor line is one of the most extensive available. Film and metallized film dielectrics of paper, lacquer, polyester, polycarbonate, polypropylene and polystyrene. Tantalum and aluminum electrolytics. All for immediate delivery.

More and more engineers are designing in Siemens capacitors. You can benefit by doing the same.

Siemens Corporation, 186 Wood Avenue South, Iselin, N.J., 08830. (201) 494-1000. Siemens. A three billion dollar name in quality products.  **SIEMENS**

# washington report

DON BYRNE, WASHINGTON BUREAU

## **Commerce Dept. offers to help companies push exports**

Electronics firms with 500 or less employees that want to explore the possibilities of overseas sales may be helped by a new Commerce Dept. plan aimed at helping small U. S. businesses penetrate foreign markets. The Bureau of International Commerce of the Commerce Dept. has launched a plan called the MBA (Master's of Business Administration) Export Expansion Program, which will seek applications from companies interested in overseas sales. A graduate student from one of 21 universities across the country will be assigned to the company to examine its capacity to begin export operations or to expand them. After sizing up the company, the student will examine international business data compiled by the Commerce Dept. and relating to the company's products and then draw up a set of recommendations for action. Data on users, competition, market size, expected gross profit margins and how to enter the market will be studied, and the names of customers, agents, distributors and needed licenses will be supplied. Any company interested should get in touch with a Commerce Dept. field office or with the Bureau of International Commerce in Washington.

## **Conference on DOD Lockheed proposal coming up**

Deputy Defense Secretary David Packard is expected to meet with House and Senate Armed Services Committees within the next two weeks to iron out kinks in a DOD proposal to help Lockheed head off bankruptcy. DOD has not spelled out a final figure needed in addition to existing contracts with Lockheed, but House sources indicated it would be in excess of \$1-billion. A bitter fight is expected when the issue comes to the floor with this year's appropriation bills.

## **New trade-bill battle looms in Congress**

Key figures in the Senate and House expect another round of hearings on import quotas in this session of Congress. Sen. Russell Long, chairman of Senate Finance Committee, and Rep. Wilbur Mills, chairman of the House Ways and Means Committee, both say they want early hearings to see what changes should be made in legislation that passed the House but died in the Senate in the last Congress. As expected, foes of the restrictive measure added so many amendments in the Senate that the bill became unacceptable to just about everyone. As it left the House, it contained import quotas for shoes and textiles but left the door open for protective measures to be extended to virtually any other industry—including, of course, electronics.

## **Hughes and GT&E enter domestic satellite race**

Hughes Aircraft and General Telephone and Electronics, filing separate applications for a joint system, have entered the competition for a domestic communications satellite system. Western Union and AT&T, with Comsat, have already filed, and Microwave Communications, Inc., is ex-

pected to file before the March 1 cutoff date set by the FCC. Hughes, the major shareholder in Teleprompter, the nation's largest cable television entity, said it planned to use the system for a nationwide CATV network and to lease eight of the 12 channels on one satellite to GT&E for long-distance telephone service. Hughes proposes to build two send-and-receive earth stations and at least 100 receive-only stations for its CATV net at a cost of between \$50-million and \$80-million. GT&E would build four earth stations at a gross investment of \$27-million. The two satellites, which would be built by Hughes, would weigh 1120 pounds and would be placed in synchronous orbit over the equator by Thor-Delta vehicles. Each would have 12 microwave radio channels and could transmit a wide variety of signals.

The eight channels to be leased by GT&E would have 10,560 voice grade circuits or eight TV circuits. The two Hughes transmitting antennas would be placed near New York and Los Angeles and employ 98-foot tracking antennas. The receive-only sites would be equipped with a 35-foot nontracking antenna. The four GT&E earth stations would be located in California, Florida, Indiana and Pennsylvania.

## **Little change expected in House Armed Services Committee**

Rep. F. Edward Hebert (D-LA.), the new chairman of the House Armed Services Committee, is expected to follow pretty closely in the footsteps of his predecessor, the late Rep. L. Mendel Rivers. Hebert, who has been in Congress since 1940, is described as a tough but fair chairman who made his reputation on the committee by hard-hitting investigations. A former newsman, the 69-year-old Hebert is expected to take a harder look at military budgets than Rivers did. He is regarded as a friend of the military but has led tough investigations into military waste, sole-source procurement and the practice of retired officers finding high salaried jobs in the defense industry. He is expected to be a little more conservative in seeking military funding than Rivers, who was wont sometimes to introduce money bills knowing they would not pass. Hebert, like Rivers, is a strong advocate of modernizing the Navy with a massive shipbuilding program and increased R&D funds over the next decade.

**Capital Capsules:** About 145 scientists from around the world are meeting at NASA's Houston Center to report findings from the analysis of lunar samples and to consider data from scientific experiment packages left on the moon. NASA has dubbed the meeting a "rock festival." . . . The House Committee on Foreign Affairs has issued a report that says **excellence in technology may be establishing a new set of standards that will determine a nation's worldwide leadership.** The new standards, says the report, may eclipse military power. The report also cites the effect of technology on U. S. foreign policy and diplomacy. Copies can be obtained from the committee at Room 2170, Rayburn Office Building, Washington, D. C. 20515. . . . **NASA has named George W. Cherry to head its Aeronautical Operating System Div.** in the Office of Advanced Research and Technology. He will direct R&D programs in navigation, aircraft control and the impact of aircraft on the environment. He was formerly with the Charles Stark Draper Laboratory of the Massachusetts Institute of Technology. . . . The Commerce Dept.'s National Bureau of Standards reports that **failure by the U. S. to go along with developing metric system product standards could deal a crippling blow to U. S. overseas trade.** An interim report of the U. S. metric study, run by the bureau, notes that European countries are moving toward an international system of Engineering standards for a variety of products, including electronics, and that failure to meet these standards could bar U. S. products from those countries.

# 50-MHz dual-beam oscilloscope



## 556

delayed  
sweep

7-ns  
risetime

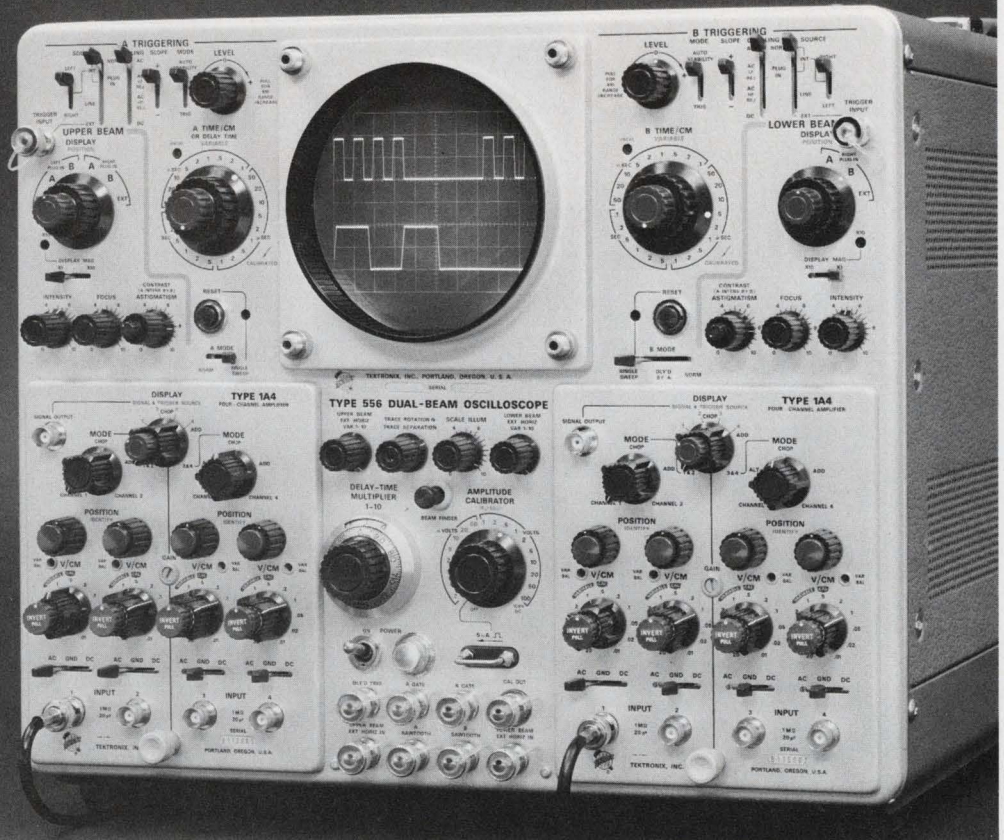

### Multi-Trace

The six waveforms are time related digital pulses. The upper four displays are A Sweep ( $2 \mu\text{s}/\text{cm}$ ) with the Type 1A4 Four-Channel Plug-In. The lower two displays are B Sweep Delayed ( $100 \text{ ns}/\text{cm}$ ) with the Type 1A2 Dual-Trace Plug-In.

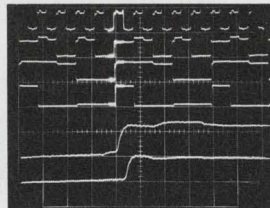

### Sampling and Real-Time

The upper beam shows a square wave at  $2 \mu\text{s}/\text{cm}$  as applied to a Type 1A2 Dual-Trace Plug-In. The lower beam shows the risetime of the same pulse with the Type 1S1 Sampling Plug-In at  $1 \text{ ns}/\text{cm}$ .

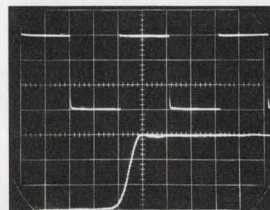

### Frequency and Time

The upper beam shows the spectral output of a 200 MHz gated oscillator applied to the Type 1L20 Spectrum Analyzer; calibrated dispersion is  $1 \text{ MHz}/\text{cm}$ . The lower beam shows a real-time display of the  $2.5 \mu\text{s}$  gating pulse.

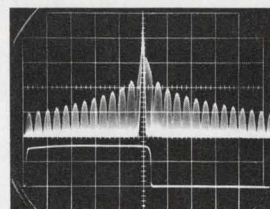

The Tektronix 556 Dual-Beam Oscilloscope features 50-MHz bandwidth, calibrated sweep delay,  $6 \times 10 \text{ cm}$  scan per beam and dual plug-in flexibility. Using two plug-ins at a time, the 556 offers many display combinations, including: **dual-beam single-shot**; multiple-trace; sampling and real-time; frequency and time; delaying and delayed sweep.

The two independent horizontal deflection systems provide full bandwidth triggering and calibrated sweep speeds from  $5 \text{ s}/\text{cm}$  to  $100 \text{ ns}/\text{cm}$ , extending to  $10 \text{ ns}/\text{cm}$  with the X10 magnifier. The calibrated sweep delay range is from  $100 \text{ ns}$  to 50 seconds.

The CRT shows two simultaneous single-shot pulse sequences displayed at two different sweep speeds, a measurement that is possible only with a truly dual-beam oscilloscope. The two 1A4 Four-Channel Plug-Ins provide eight channels, each with 7-ns risetime and DC to 50 MHz bandwidth. You can also select from differential plug-ins with bandwidths to 50 MHz, TDR and sampling plug-ins with 90-ps risetime, and spectrum analyzer plug-ins that cover the spectrum from 50 Hz to 40 GHz. The 556 is also available in a rackmount model.

For a demonstration, contact your nearby Tektronix field engineer or write: Tektronix, Inc., P. O. Box 500, Beaverton, Oregon 97005.

556 Dual-Beam Oscilloscope ..... \$3700  
1A4 Four-Channel Plug-In ..... \$ 895

U.S. Sales Prices FOB Beaverton, Oregon

Available in U.S. through the Tektronix lease plan.



## TEKTRONIX®

committed to progress  
in waveform measurement

INFORMATION RETRIEVAL NUMBER 27



# If you need 500 ns get us this coupon the fastest

You'll get the facts on our new 500ns memories and stacks. Memories and stacks that you can get two months faster than anybody else's.

Ours will likely beat anybody else's price per bit, too. On any size order.

Here's the new line: The CC-50 stack and the CC-50 memory. The CEX-50 stack and the CEX-50 memory.

Between them they'll meet about any need you have for 500ns cycle times.

If it's a million bits or less you need, you're best off with our CC-50. It's 3-wire, 3D. With 4K, 8K or 16K words.

Over a million bits puts you in our CEX-50 class. It comes in 3-wire, 2½D organization. Words: 16K, 32K or 64K.

And, stack or system—CC-50 or CEX-





# memories or stacks fast, way you can.

50—you'll get the only modular 500ns design anywhere.

There's something else unique about this new line. Something brand new. We don't have space enough to explain it here, but our spec sheets will give it all to you in glorious detail.

Quick, the coupon.

LOCKHEED ELECTRONICS Data Products Division/Los Angeles (213) 722-6810

- I'm drooling. E.D.—1/21/71  
Get me CC-50 and CEX-50 data immediately.
- Take your time.  
I only need CC-50 and CEX-50 data for my archives.

Name \_\_\_\_\_

Position \_\_\_\_\_

Company \_\_\_\_\_

Street \_\_\_\_\_

City \_\_\_\_\_ State \_\_\_\_\_ Zip \_\_\_\_\_

**Lockheed Electronics Company**

Data Products Division 6201 East Randolph Street, Los Angeles, California 90022

INFORMATION RETRIEVAL NUMBER 00

# Remex announces a bonus baby. A tape punch that gives you 75 characters/ second for the price of 50 or 60.

This is the year we're breaking out of our shell. Now we're making a whole line of peripheral equipment.

And we've come out with a new tape punch. The model 1075. Which, we must say, is some deal.

Besides giving you 75 characters/second for the price of 60, or even 50—our 1075 offers a lot more.

Features like ultra reliable punching of 5, 6, 7 and 8 track tapes. Paper and Mylar.<sup>®</sup>

Reels up to 8½ inches in diameter, with proportional spooling.

TTL compatible electronics that are highly modular, and mounted on highest quality circuit cards.

Back space for easy program or operator correction.

Rack mounted with integral power supply.

You can get the 1075 as a system. Or, if you'd rather do it yourself, you can get just the mechanism. Either version is ideal for use with mini-computer systems, typesetting, data collection or other applications requiring high performance.

And you can get the 1075 at an incredible price. Seventy-

five characters/second for the same price almost everybody else is charging for machines that punch only 50 or 60. (For the terminal market we also have a new extremely low cost 30 characters/second mechanism.)

Meanwhile, back at the shell—we're still doing what we've always done best. Making punch tape products that are the best around.

Help us punch out of our shell. Write us at 5250 W. El Segundo Blvd., Hawthorne, California 90250. In Europe and U.K., contact S.p.A., Microtecnica, Torino, Italy.

**REMEX** IS COMING OUT  
OF ITS SHELL.

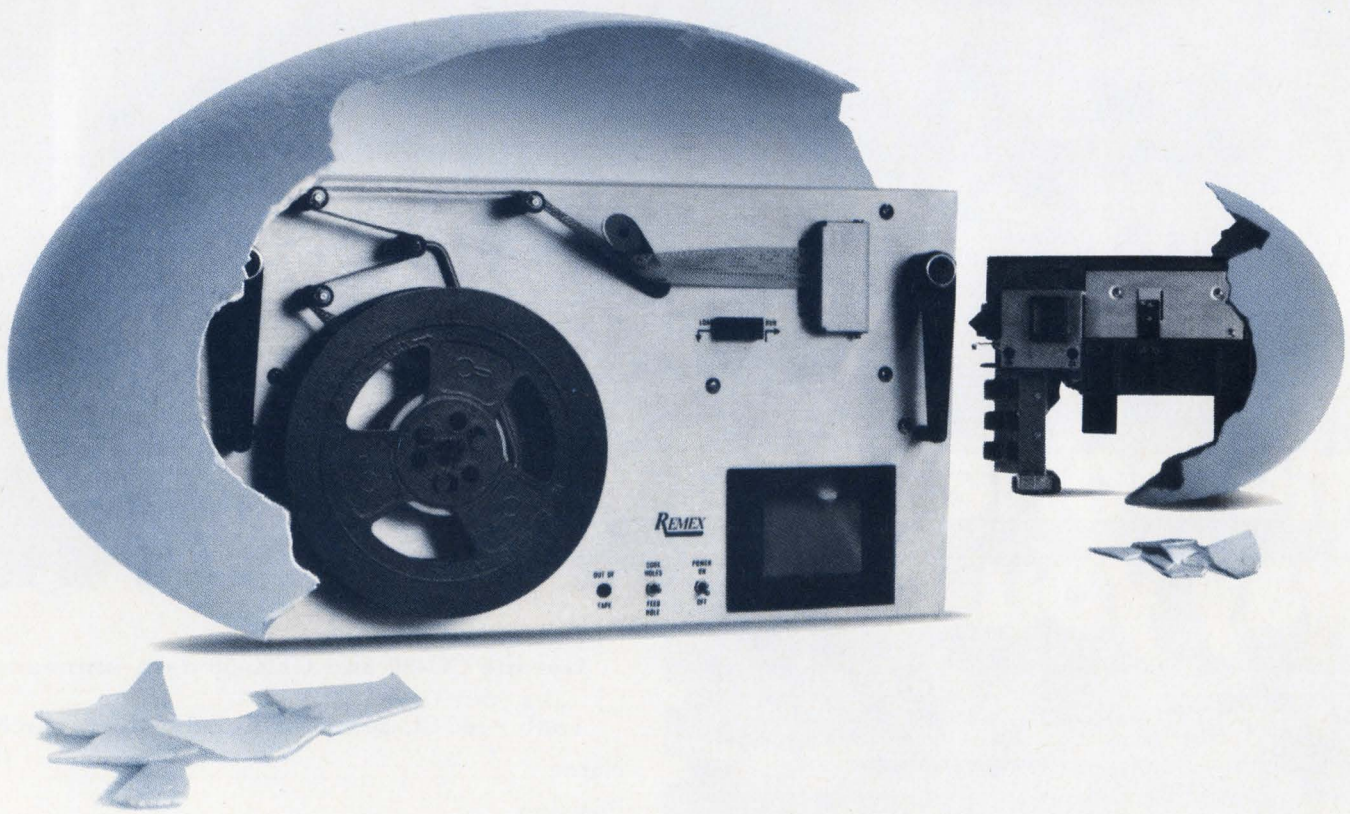

A UNIT OF



EX-CELL-O CORPORATION

INFORMATION RETRIEVAL NUMBER 29

## Do we want free trade – or fair play?

In our editorial of December 20, 1970, we stated that we are against the provisions of the recent import quota bill. We're against blind protectionism, because it invites retaliation and stifles trade for everyone. But we are also concerned about blind adherence to free-trade policies toward countries that don't reciprocate. We don't interpret free trade as a free ride for foreign companies in our markets.

Electronics companies throughout the U. S. are complaining about foreign restrictions on their exports to other countries, preferential treatment, through tariffs and quotas, of one country for the products of another, foreign import licensing procedures that slow or stop U. S. exports to the countries involved and pitifully low declared values on foreign imports to the U. S. None of these are in the spirit of free trade.

The Japanese, for instance, are accused of restricting or refusing our exports to Japan. Japanese companies that want to buy our goods must often obtain specific permission from their Ministry of International Trade and Industry. If the permission isn't denied outright, it can take months to get.

And executives at Wang Laboratories, Inc. complain of extremely low declared value on Japanese calculators imported to the U. S. Edward Lesnick, Director of Product Planning, says that the Japanese products are typically declared at 20% of their U. S. market value, rather than the customary 60%.

The Japanese pay only 7% tariff on this 20% declared value. Lesnick says that what annoys his Tewksbury, Mass., company most is that identical imports to Japan must be declared at full market value, and the Japanese tariff is 15%. Is our policy of free trade, he asks, being interpreted as "something for nothing?"

The U. S. electronics manufacturers interviewed by ELECTRONIC DESIGN don't want protection, they want fair play. They aren't afraid of foreign competition, and they want free trade, but not at the expense of our own industry. They want countries that take advantage of our free trade policies and our low tariffs to reciprocate with like policies of their own.

Our government is willing to listen to our industry's problems, and to act on our behalf. If you are aware of unfair trade practices involving electronic imports or exports, write Mr. Harold B. Scott, Director of the Bureau of International Commerce, U. S. Dept. of Commerce, Washington, D. C., 20230, (202) 967-5261.

RAYMOND D. SPEER



## Microstrip can reduce multiplier size

but it can also enlarge the design problem. Understanding the circuit functions is the key to success.

### First of two articles

Typically, a solid-state microwave source consists of two basic elements: a transistor oscillator and a varactor multiplier. The design of the oscillator is fairly straightforward,<sup>1</sup> but the multiplier presents some serious challenges. Its design requires nonlinear analysis, and the results are valid only under specific conditions.

When microstrip is used to reduce the size of the multiplier, the problems are compounded. It is difficult to predict the detailed behavior of microstrip circuits because the non-TEM waves that propagate on microstrip lines are not easy to describe analytically.

How can the designer overcome these problems and come up with a good, compact microstrip multiplier? The key is to understand clearly the functions of the multiplier circuitry external to the varactor diode itself. The functions are threefold:

- Separating the input and output frequencies.
- Matching the input and output impedances.
- Biasing the diode.

Although these functions are interrelated, it is helpful to keep them conceptually separated to avoid losing sight of the ultimate purpose of the circuitry.

### Frequency separation: Pick a filter

Bandpass filtering is usually the most effective method of frequency separation for multipliers. Ideally, the output filter (as seen by the diode) should pass the output frequency with low loss while presenting an open circuit to the fundamental and the unwanted harmonics. Similarly, the input filter should pass the fundamental and block all of the harmonics.

The complexity of the filters will be determined by the design requirements. Thus, for example, a multiplier with a requirement for a wide instantaneous bandwidth and a low level of spurious

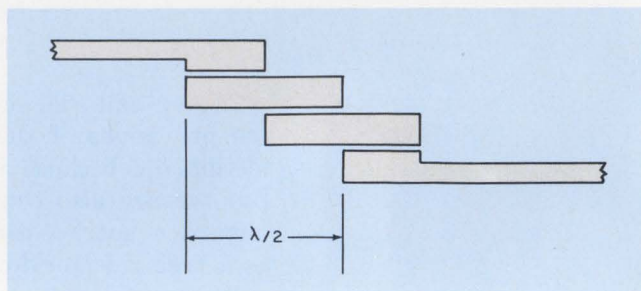

1. This filter looks like an open circuit at all frequencies below its passband—a property that makes it a popular design despite its several drawbacks.

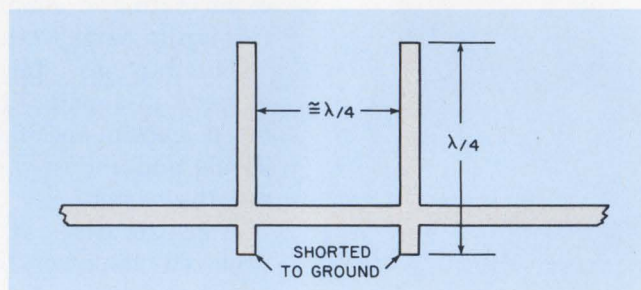

2. Compactness is this filter's strong point, but it suffers from poor selectivity at low frequencies and fabrication problems at the high end of the frequency band.

outputs will need filters with a large number of poles to reject adjacent harmonics.

A popular filter for microstrip multipliers is made from an array of closely spaced half-wave resonators (Fig. 1). The great attraction of this type of filter is that it acts as a high capacitive reactance at all frequencies below its passband. Its disadvantages are threefold: Its use of half-wave instead of quarter-wave resonators increases its size over competitive types; it has a very narrow gap between its resonators, requiring great care in its fabrication; and its operation is such that the calculation of its even-mode and odd-mode impedances is difficult.

A more compact type of filter is made of a string of direct-coupled quarter-wave resonators (Fig. 2). Calculating the resonant frequency and loaded Q of this type is easy; but the filter suffers from poor selectivity at the low microwave frequencies and from very tight spacing between

Bob Weirather, Microwave Engineer, Motorola, Government Electronics Div., 8201 E. McDowell Rd., Scottsdale, Ariz. 85252.

## A solid-state perspective

Where does the varactor-diode frequency multiplier fit in this day of Gunn, Impatt and LSA devices? The newer types of diodes have some definite advantages over oscillator-multiplier combinations in certain applications. But often, particularly at the lower microwave frequencies, the older approach comes out ahead.

For example, some direct-conversion devices require high power-supply voltages (90 V), have only pulse capabilities at low duty cycles, have poor efficiencies (2% to 5%), have narrow bandwidths and are quite noisy.

By contrast, the transistor-oscillator/varactor-multiplier combination needs only low voltages, can operate either continuous wave or pulsed, has higher efficiency (10% to 20%) and has wideband capabilities. Furthermore, its size disadvantage is not as great as one might at first imagine. This is because high-dielectric-constant substrate materials can shrink the size of the

oscillator-multiplier considerably, while the cavity or other resonant structure used with a direct-conversion device makes it a lot bigger than just a semiconductor chip.

The noise properties of the oscillator-multiplier may well be its strongest advantage. The multiplier adds no noise of its own to that of the oscillator. A well designed crystal-controlled transistor oscillator can be combined with a multiplier to provide very clean signals at very high frequencies.

Even in cases where the direct-conversion devices are clearly superior to the oscillator-multiplier for a variety of other reasons, noise considerations may make it necessary to combine the two approaches. One rather successful combination has been made by using a low-power crystal-controlled oscillator-multiplier source to injection-lock a high-power but noisy silicon Impatt oscillator.

the transmission line and the shorts at higher frequencies.

Another method of frequency separation is the use of a resonant-line filter. This approach, which will be described in detail in the second part of this article, uses a quarter-wave resonator spaced a quarter-wave from the diode. The resonant-line filter is a narrowband device, but it is quite satisfactory for many designs.

Simplicity is its major advantage while lack of suppression of out-of-band harmonics is its major disadvantage. This can be overcome, in a doubler, by adding additional stubs to the line to reject the third and higher harmonics.

In considering the bandwidth of the filters used in a frequency multiplier, one should not lose sight of the fundamental limitation on the bandwidth of any multiplier, even one using ideal (square-response) filters on the input and output. The theoretical maximum bandwidth, as a per-

centage of the center frequency, is  $(100/n)\%$  where  $n$  is the multiplication number. But in practice a good rule of thumb for maximum percentage bandwidth is  $(100/2n)\%$ .

### Impedance matching: First define it

The first problem in impedance matching to a diode is to decide what is meant by the diode's "impedance." Strictly speaking, impedance is defined only for linear circuits being driven by a single frequency in the sinusoidal steady state. The term, however, is used—and misused—in a much wider sense. In this article, we will define a diode's input or output impedance as that impedance which maximizes the multiplier efficiency under specified conditions of drive and bias.

Since the diode impedance levels, as defined above, will not necessarily correspond to the desired levels (usually 50 ohms), some matching

techniques will have to be employed. And a good way to accomplish this matching is to include it in the design of the input and output filters.

Since filters of more than one section have an axis of symmetry, two separate filters with identical responses and different impedance levels can be designed and joined to form a composite filter. One filter would be designed to operate with the specified multiplier load, say 50 ohms, and the other filter would be designed to operate with terminations equal to the diode impedance. These two filters can be divided and then rejoined at their axis of symmetry and equal internal impedance, and still retain the original bandpass characteristic.

An alternate approach to impedance matching is to add lumped elements—or their microstrip equivalents—to the diode to transform its impedance to the required level. The first approach has the important advantage of compactness. Matching is done by the filter and, therefore, adds nothing to the size of the multiplier.

#### Biasing: How it's applied is important

There are two ways to obtain the required dc bias across the diode: it can be supplied by an external dc source, or it can be internally generated by slightly overdriving the varactor and using the rectified forward current to develop a self-bias voltage across a parallel resistance.

Of more importance than the type of bias to be used is the method of applying it to the diode. Often, this aspect of multiplier design is treated too casually, with the result that the bias circuit interacts in unforeseen ways with the other circuits or causes breakup of the output signal by acting as a low-frequency idler. (An idler is a circuit that maximizes current flow in the diode at a particular frequency. Since the idler can modulate the output, it robs it of power and can break up the output signal.)

Two things can be done to minimize these problems: First, the bias can be applied through either the input or output filter, rather than across the diode terminals. Second, the bias can be applied through a resistance.

Keeping a filter between the diode and the bias source minimizes the chance that an idler frequency can exist. It should be recalled in this connection, however, that some types of filters are better than others at rejecting signals far removed from the passband.

Using resistive coupling simply ensures that any idler circuit that does exist will have a very low Q and so will not pose much threat of breakup, although it may cause some loss of output power and efficiency. ■■

(references continued on pg. 50)

## The how and why

A microstrip transmission line (see illustration) is a structure consisting of a strip transmission line separated from a ground plane by a dielectric material.<sup>3</sup> The development of good dielectric materials with high dielectric constants and uniform characteristics has made possible the construction of compact microwave integrated circuits (MICs).

Microstrip MICs have three big advantages over other transmission structures:

- Excellent repeatability in manufacture because photolithographic batch processing can be used.
- Easy access to circuitry because all the circuitry is on one side of a dielectric substrate.
- Small circuit size because materials with high dielectric constants can be used as the substrate.

The two most common substrate materials in use today are alumina ( $\text{Al}_2\text{O}_3$ ) and sapphire (the same material but in crystal form).

To design a circuit in microstrip (or in any other transmission structure, for that matter) three primary parameters should be determined: the characteristic impedance,  $Z_0$ ; the guide wavelength,  $\lambda_g$ ; and the attenuation per unit length,  $\alpha$ .

Two of these parameters,  $Z_0$  and  $\lambda_g$ , have been theoretically computed and experimentally checked. Sobol<sup>4</sup> has fitted curves to Wheeler's analysis<sup>5</sup>, and the results compare well with the experimental data. These design equations are summarized below. Other equations in the tabulation are for the calculation of losses and unloaded Q.

$$Z_0 = \frac{377h}{\sqrt{\epsilon_r} W \left[ 1 + 1.735 \epsilon_r^{-0.0724} (W/h)^{-0.836} \right]} \text{ (ohms)}$$

$$\lambda_g/\lambda_0 = \begin{cases} \left[ \frac{1}{1 + 0.63 (\epsilon_r - 1) (W/h)^{0.1255}} \right]^{1/2} & \text{for } W/h \geq 0.6 \\ \left[ \frac{1}{1 + 0.6 (\epsilon_r - 1) (W/h)^{0.0297}} \right]^{1/2} & \text{for } W/h \leq 0.6 \end{cases}$$

$$\alpha_c = \frac{1}{2Z_0 W} (R_{s1} + R_{s2}) \text{ (nepers/meter)}$$

$$\alpha_d = \frac{\pi}{\lambda_g} \frac{\epsilon''}{\epsilon'} \text{ (nepers/meter)} \quad Q_c = \frac{\pi f}{V_g \alpha_c}$$

$$Q_d = \frac{1}{\tan \delta} \quad \frac{1}{Q_t} = \frac{1}{Q_d} + \frac{1}{Q_c}$$

# of microstrip microwave circuits

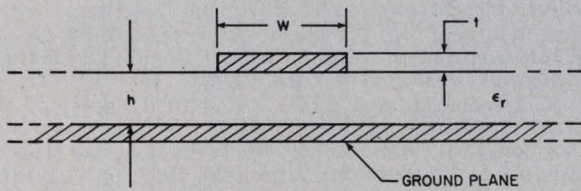

In the equations, the quantity  $\epsilon_r$  is the relative dielectric constant of the substrate material (permittivity of the material divided by the permittivity of free space) and is dimensionless. The quantity  $\lambda_g/\lambda_0$  is the ratio of the wavelength in microstrip to the wavelength of a signal of the same frequency, propagating through a vacuum. The dimensions  $W$  and  $h$  are explained in the illustration.

The quantities  $\alpha_c$  and  $\alpha_d$  are the attenuation factors of the conductors and the dielectric substrate, respectively.  $R_{s1}$  is the sheet resistivity (in ohms per square) of the top circuit metallization and  $R_{s2}$  is the sheet resistivity of the ground-plane metallization. The quantities  $\epsilon'$  and  $\epsilon''$  are the real and imaginary parts of the permittivity of the dielectric material ( $\epsilon = \epsilon' + j\epsilon''$ ).

$Q_c$  and  $Q_d$  are the Qs of the conductors and dielectric, respectively.  $V_g$  is the velocity of propagation in the microstrip line ( $V_g = f\lambda_g$ ).  $\tan \delta$  is the loss tangent of the dielectric. And,  $Q_t$  is the total Q of the circuit.

Plots of  $Z_0$  and  $\lambda_g/\lambda_0$  are shown below for the frequently used substrate material, alumina, with  $\epsilon_r = 9.5$ .

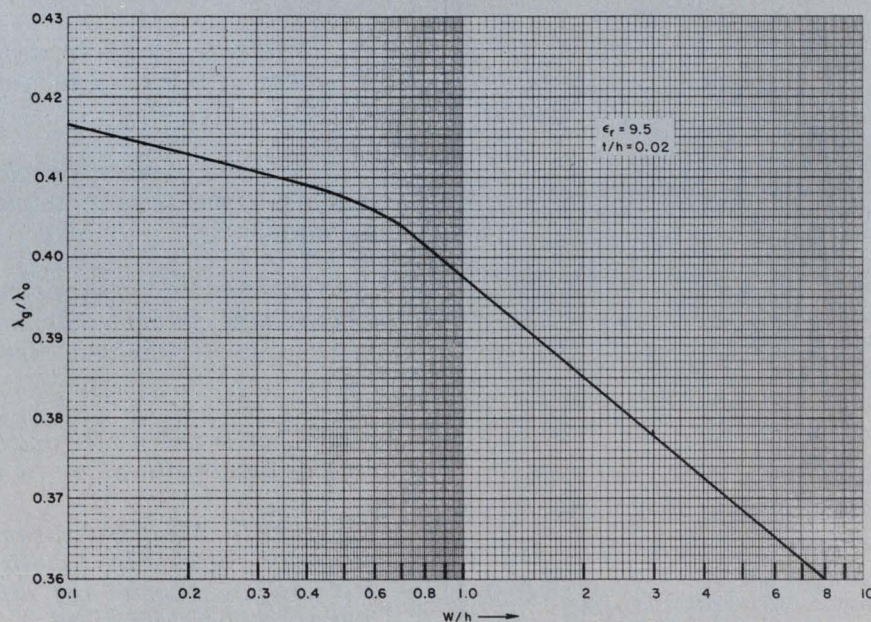
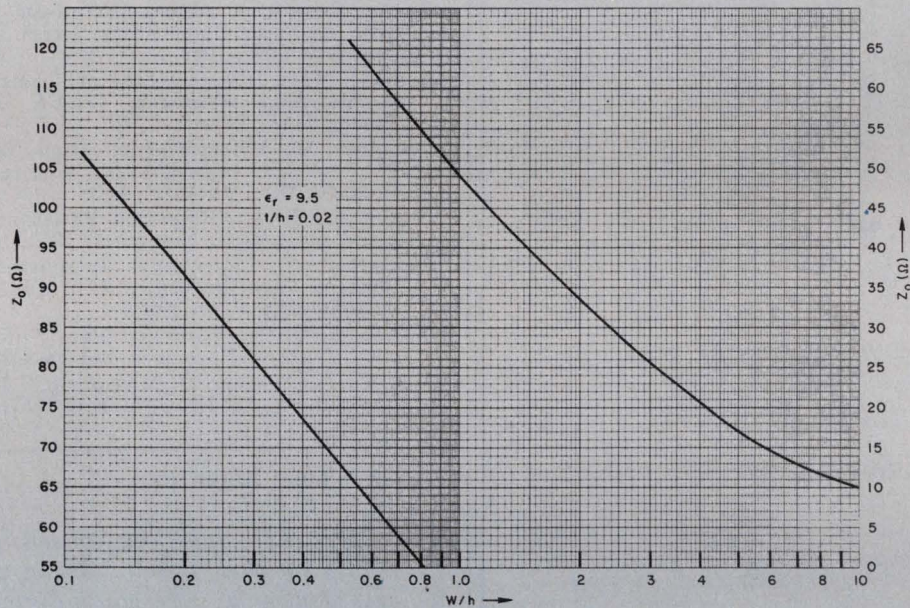

no lower price  
for  
mechanical  
refrigeration  
to  $-100^{\circ}\text{F}$

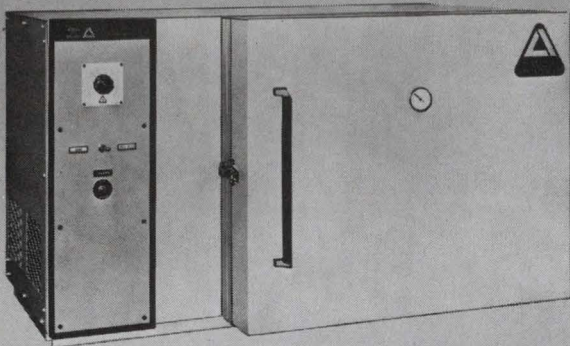

**Single compressor and  
solid state controller  
mean economy plus reliability**

Associated's Model SW-5101 Temperature Chamber offers a new concept in mechanical refrigeration that enables you to perform all military low-high temperature tests.

- full 1 cubic foot test area
- temperature range from  $-100$  to  $+350^{\circ}\text{F}$ .
- all solid state controller with  $\pm 3/4^{\circ}\text{F}$  stability
- delivery from stock
- adjustable high-temperature fail-safe with signal lamp
- indicating thermometer in door
- combination hinged and removable door
- bench-top design, can be modified for stacking
- stainless steel feed-through port,  $3/4$ " diameter

Check the SW-5101 specifications against your testing requirements. You'll find they add up to outstanding performance at a down-to-earth price—without sacrifice of quality or reliability.

The new Associated catalog of environmental chambers is yours for the asking. Write for your free copy today.



**ASSOCIATED TESTING  
LABORATORIES INC.**

200 Route 46, Wayne, N. J. 07470 • (201) 256-2800

West Coast Office:

1304 Seventh St., Santa Monica, Calif. 90401 • (213) 451-8521

#### References

1. Klein, Carl F., "Designing with microstrip is easy," *Electronic Design*, Jan. 4, 1970, pp. 100-104.
2. Westman, H. P., editor, *Reference Data for Radio Engineers*, fourth edition, International Telephone and Telegraph Corp., New York, 1956.
3. Assodourian and Rimai, "Simplified Theory of Microstrip Transmission Systems," *Proc. IRE*, December, 1962.
4. Sobol, H., "Extending IC Technology to Microwave Equipment," *Electronics*, March 20, 1967, pp. 112-124.
5. Wheeler, "Transmission Line Properties of Parallel Strips Separated by Dielectric Sheet," *IEEE Trans. Microwave Theory Tech.*, March, 1965, pp. 172-185.

#### Bibliography

- Burckhardt, C. B., "Analysis of Varactor Frequency Multipliers for Arbitrary Capacitance Variation and Drive Level," *Bell System Technical Journal*, April, 1965, pp. 675-692.
- Matthaei, Young and Jones, *Microwave Filters, Impedance Matching Networks, and Coupling Structures*, McGraw-Hill Book Co., New York, N. Y.
- Penfield and Rafuse, *Varactor Application*, MIT Press, Cambridge, Mass., 1962.
- Ragan, George L., editor, *Microwave Transmission Circuits*, Radiation Laboratory Series, McGraw-Hill Book Co., New York, 1948.
- Richardi, "The Insertion Loss of Transmission Line Used in Matching Networks," *IEEE Trans. Microwave Theory Tech.*, March, 1968.
- Schaffner, G., *Motorola Application Notes AN-147, AN-151, AN-159 and AN-213*, Motorola, Semiconductor Products Div., Phoenix, Ariz.
- Storer and King, "Radiation Resistance of a Two Wire Line," *Proc. IRE*, November, 1951, pp. 1408-1412.
- Weirather, R., "Microwave Integrated Circuit Medium Powered Varactor Multipliers," June, 1969, *MS Thesis*, Arizona State University.
- Wells, R., "Microwave Band Pass Filter Design," *Microwave Journal*, November and December, 1962.
- Wu, T. T., "Theory of Microstrip," *Journal of Applied Physics*, Vol. 23, No. 3, March, 1957, pp. 299-302.

#### Test Your Retention

Here are questions based on the main points of this article. Their purpose is to help you make sure you have not overlooked any important ideas. You'll find the answers in the article.

1. What are the three major functions of the external circuitry in a varactor multiplier?
2. How can a symmetrical filter be modified to perform impedance matching, as well as filtering?
3. Why is it important to apply the dc bias voltage through the input or output, rather than to apply it directly across the diode?
4. What is the maximum theoretical percentage bandwidth of a  $\times n$  multiplier?
5. Why is the parallel-coupled half-wave resonator filter (Fig. 1) often preferred in MIC designs despite the difficulties in its analysis and fabrication?



# do more testing...

- ... more ways
- ... more efficiently
- ... more economically
- ... faster
- ... automatically

## AUTOTEST

... Automatically Tests When Discrete Instruments Can't  
... Computers Shouldn't

Autotest is a new approach to automatic testing of your product or system. It offers precise, high-speed testing with unmatched flexibility and economy. The Autotest Control Unit uses a punched tape program (EIA Code) to feed the solid state BCD data storage which, in turn, routes the appropriate command signals for each measurement to the Instrumentation Bank. The Instrumentation Bank is extremely versatile and modular in that it can contain any programmable equipment with suitable interface. It can be assembled and re-assembled with different instruments making it immediately "Custom Designed" for that task. The result: simplified program preparation, reduced equipment costs, easily designed for a wide variety of measurement and test problems. AUTOTEST.

### LITERATURE AVAILABLE



**AUTOTEST** — General Capabilities — Dig./DC/Audio at card or unit level, etc.  
CIRCLE # 211



**AUTOTEST** — Auto — automatic Testing At RF  
CIRCLE # 212



**AUTOTEST** — Auto — automatic Testing In Avionics  
CIRCLE # 213

713



**MARCONI INSTRUMENTS**  
DIVISION OF ENGLISH ELECTRIC CORPORATION

111 CEDAR LANE □ ENGLEWOOD, NEW JERSEY 07631  
TELEPHONE: (201) 567-0607

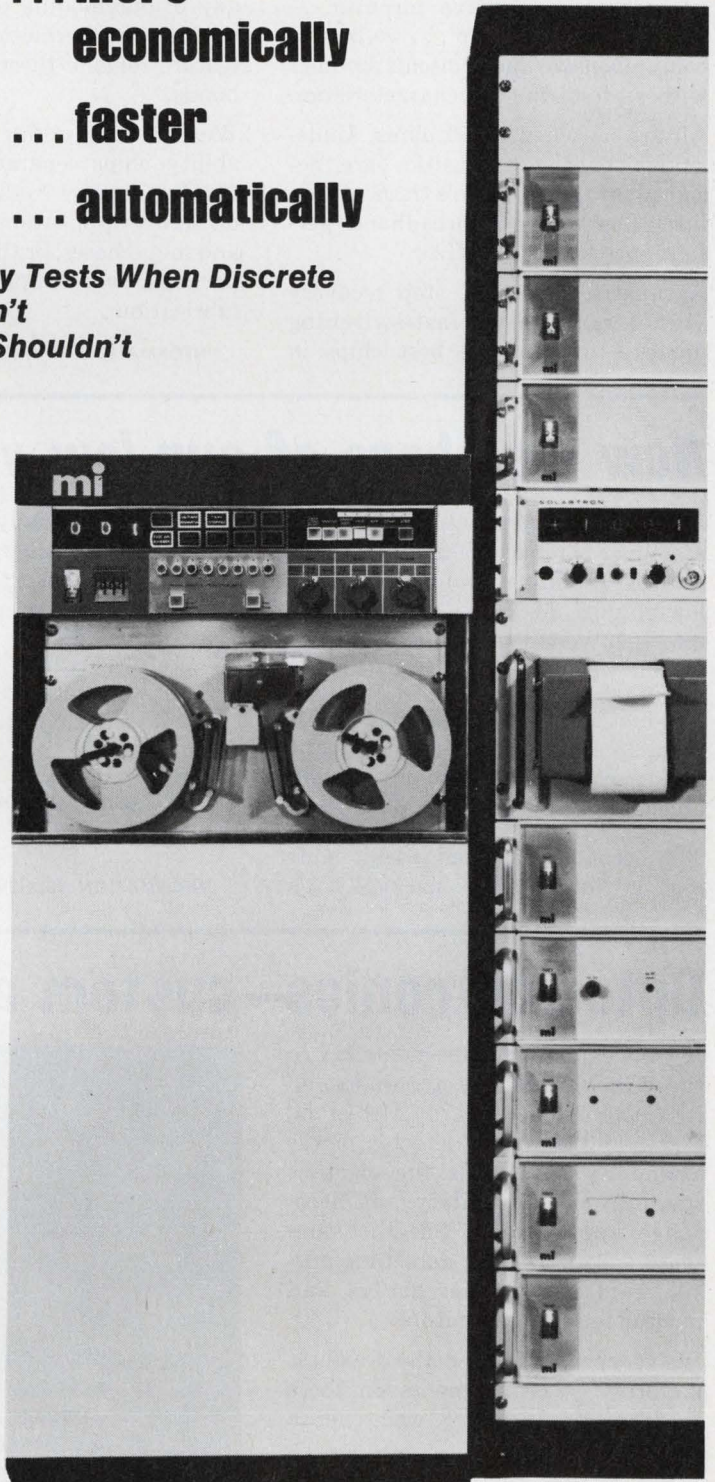

# microtopics

## New broadband integrated modules for stripline or microstrip.

For any route you're taking to next generation microwave circuits... stripline or microstrip... we have a comprehensive line of circuit modules with state-of-the-art characteristics.

All are matched to 50 ohms. Undesirable package parasitics are designed into the module's transmission line. The result is broadband performance up to 18 GHz.

As mixers, detectors, step recovery varactors, PIN or fast-switching diodes—ours are the best chips in

the business. We can put any chip in any of our module packages. Philco modules are hermetically sealed and feature reliable thermal-compression bonds.

We can supply the same high-reliability chips separately, for use in MIC's. They're configured for shunt or series applications. Flying leads and metal bases, or the standard LID package, will simplify your circuit fabrication.

INFORMATION RETRIEVAL NUMBER 161

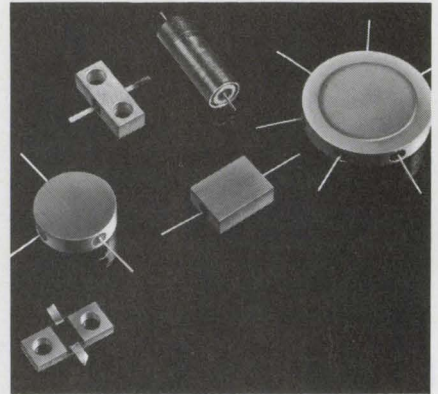

## New members of our low-voltage MOS family.

Like new parents, we're proud to announce three of the first of a series of new products coming from our low-voltage MOS process. All are +5, -12 volt devices, directly compatible with T<sup>2</sup>L or DTL logic.

The first is a 2560-bit dynamic ROM, in a 28 lead, metal-base, hermetic DIP package. It will soon be available also in a 24-lead cerdip package.

The second is a quad 64-bit shift register in a cerdip package. It's

configured especially for electronic calculators, containing separate dual 64-bit, dual 60-, and dual 4-bit register—all on the same chip.

The third is a 64-bit dynamic shift register, configured 60-bits plus 4-bits. It is also ideal for electronic calculators.

Soon to come: silicon gate low-voltage MOS.

INFORMATION RETRIEVAL NUMBER 162

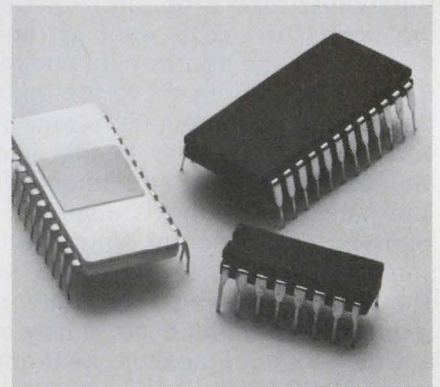

## Optoelectronics—custom and standard.

If your detector requirements fall in the .4 to 30 micron range, we can do it. Custom or standard. Detectors, arrays and complete detector/dewar assemblies that meet the rigorous specifications of military and aerospace applications. Satellite sun sensors, star-tracking detectors, missile guidance system arrays and nuclear radiation monitors.

We've been satisfying the toughest performance requirements on these kinds of products for well over a decade.

INFORMATION RETRIEVAL NUMBER 163

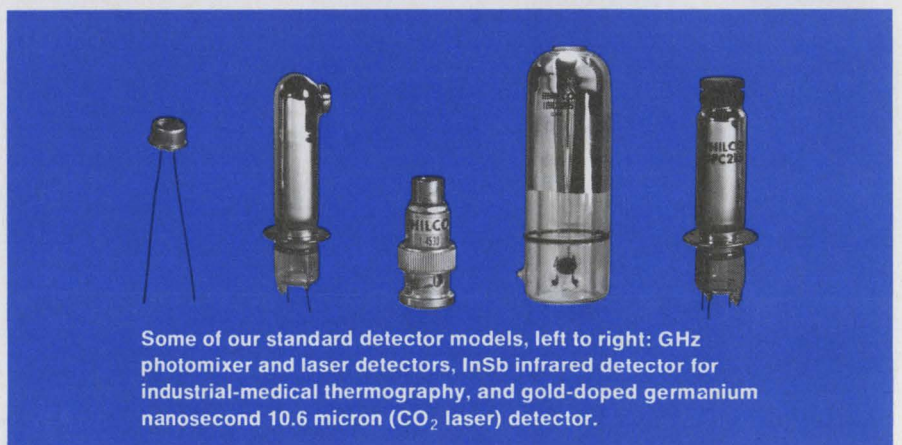

Some of our standard detector models, left to right: GHz photomixer and laser detectors, InSb infrared detector for industrial-medical thermography, and gold-doped germanium nanosecond 10.6 micron (CO<sub>2</sub> laser) detector.

## PSG passivation makes our MOS extra reliable.

PSG passivation lets us put MOS in cerdip—the low-cost hermetic packaging that meets all the environmental requirements of MIL-STD-883.

In our process, we apply a unique phosphosilicate glass over the entire surface of the chip—not just over the metallization. This gives us yields that are double the industry average, and produces the most reliable, trouble-free MOS you can buy.

Our PSG process ends surface ion migration and eliminates field inversion voltage effects—the “Fahrenheit freakout” that can cause all sorts of logic errors when chips get hot. The process also prevents corrosion, scratched metallization, and bridging

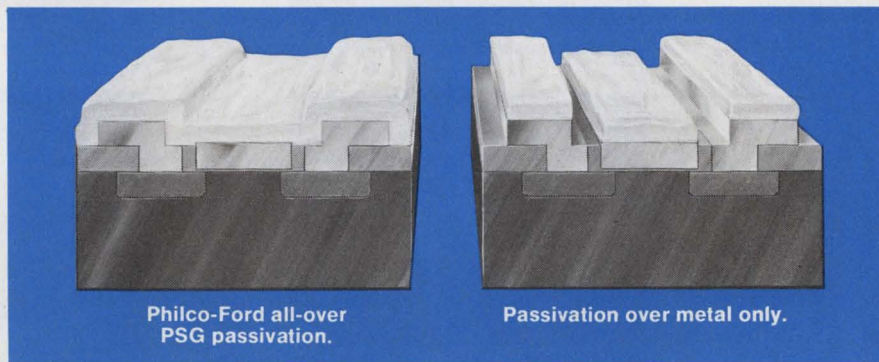

of metal lines by stray conductive particles.

We also have MOSAB, a patented input device that insures *permanent* over-voltage protection at every input on every circuit.

PSG, cerdip, MOSAB—they all add up to yields that are double the industry average . . . from a plant that can make up to a million perfect chips per week.

INFORMATION RETRIEVAL NUMBER 164

## Linear MSI...the new approach to AM, FM and stereo receiver design.

All active semiconductor circuitry for a complete AM-FM stereo receiver is contained on six MSI linear IC chips. Of special interest are the AM and FM front-end chips.

The AM chip contains the RF amplifier, frequency converter, IF amplifier and automatic gain control amplifier stages. Add an audio amplifier, and you have a complete AM radio.

The FM chip is particularly significant, because it combines high frequency, high performance front end characteristics with the complexity of linear MSI circuitry. It contains the RF amplifier, mixer, first IF amplifier and local oscillator.

These front end chips can drastically reduce package count, minimizing

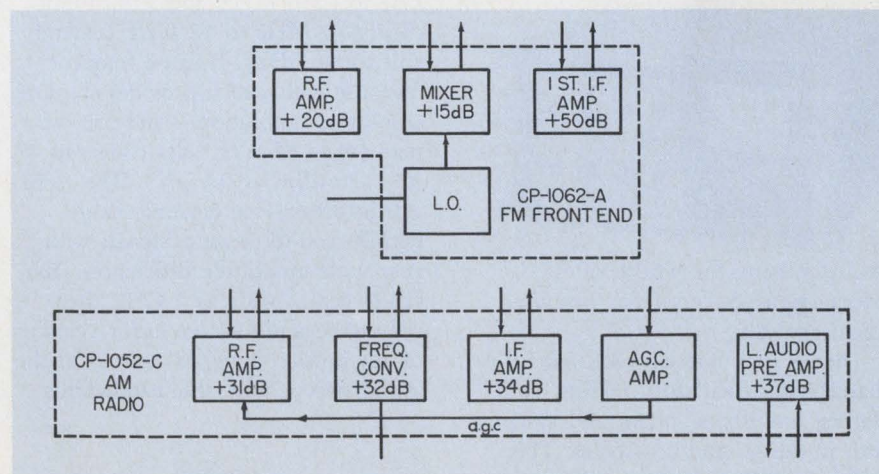

the total cost of a receiver. And that's not all. We're also developing chips for FM multiplex, FM amplifiers and limiting functions. For additional in-

formation on all these developments, check the reader service card.

INFORMATION RETRIEVAL NUMBER 165

# If you only see this

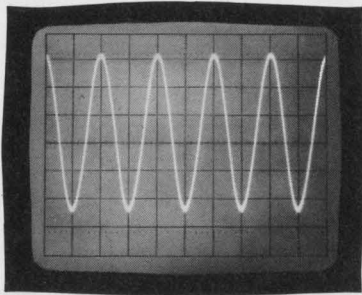

Conventional scope display of 5 MHz signal appears undistorted →

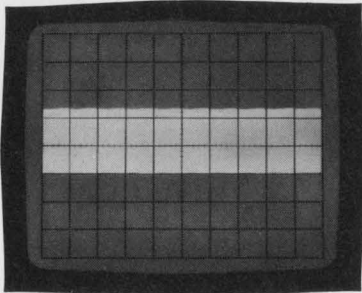

Conventional scope display barely shows 10 kHz AM of 30 MHz carrier →

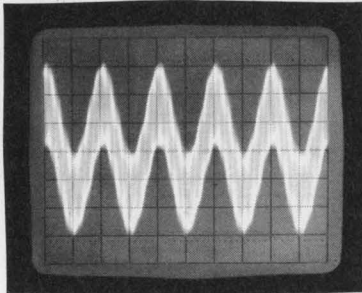

Conventional scope display merely shows "fuzzy" sine wave →

# look what you're missing.

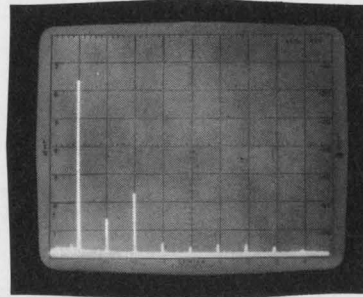

but spectrum analyzer display shows 2nd harmonic 50dB down and 3rd at -40 dB.

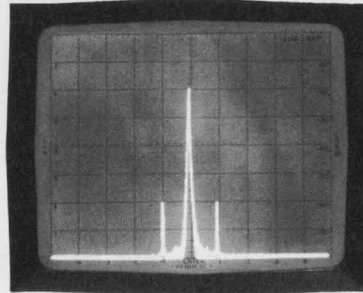

but spectrum analyzer shows sidebands 40 dB down; i.e., 2% AM.

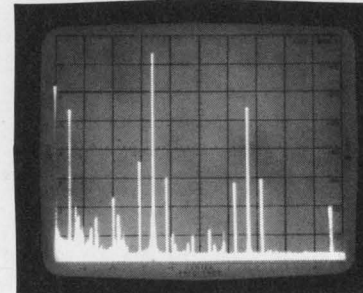

but spectrum analyzer identifies parasitic oscillations.

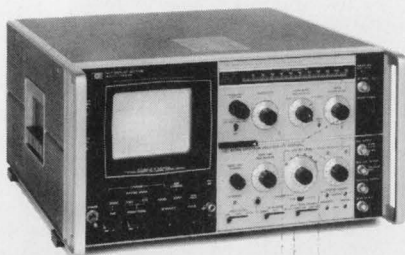

You're missing the wealth of information you need for *complete* signal analysis.

There's only one lab tool that fully characterizes oscillators, mixers, modulators, amplifiers, filters and systems, both in design and test stages. This tool is an HP spectrum analyzer, the oscilloscope that operates in the frequency domain.

One of the analyzers covers 1 kHz to 110 MHz, another goes from 500

kHz to 1250 MHz, and a third unit covers 10 MHz to 18 GHz (extendable to 40 GHz). Because frequency response is flat, each provides absolute amplitude calibration — and you can read out in dBm or volts (down to  $< -120$  dBm or  $0.1 \mu\text{V}$ ). The  $>70$  dB distortion-free dynamic range permits you to measure signals with very wide amplitude differences. You can sweep as wide as 2 GHz, then reduce the scan to zoom in for a closeup of any portion down to 0.001% of the initial sweep. Selectable bandwidths

04102

**HEWLETT *hp* PACKARD**

**SIGNAL ANALYZERS**

INFORMATION RETRIEVAL NUMBER 33

provide resolution as high as 10 Hz at RF, 100 Hz at microwave frequencies.

So why struggle with half the picture when evaluating signal characteristics?

With one of these RF sections:

8553B (1 kHz-110 MHz), \$2200

8554L (500 kHz-1250 MHz), \$3500

8555A (10 MHz-18 GHz), \$5975

plus either of these IF sections:

8552B (highest resolution), \$2850

8552A \$2150

and a 141T Display Section:

with variable persistence CRT, \$1700

— you'll be all set for fast, accurate and thorough signal analysis.

For complete information on this universal measurement tool — or a demonstration — contact your HP field engineer. Or write to Hewlett-Packard, Palo Alto, California 94304; Europe: 1217 Meyrin-Geneva, Switzerland.

# Speed up synchronous counters

by eliminating logic-gate delays in the front end and restricting gates to slowly changing signals.

The maximum speed of a synchronous counter is frequently less than the toggle frequency of the flip-flops that are used to make it. This reduction in speed is caused by the propagation delay in external gates that are required to implement the design of the counter.

There are several ways in which this propagation delay can be minimized. One is to restrict all external logic to a single level, thus reducing the delay to that of a single gate, but in this approach gate count cannot be minimized.

A better method is simply to eliminate gating of the signals that are changing most rapidly, while permitting the slower signals to be gated. More reliable synchronous counters of higher speed can be built by carefully integrating gate design with clock frequency. The final speed limitation, the propagation delay of the flip-flops, is one restraint that cannot be overcome.

## Binary counter is basic

An n-stage synchronous binary counter, because of its familiarity, is a good circuit on

**Edward G. Linde**, Engineer, Harris Semiconductor, Div. of Harris-Intertype Corp., Melbourne, Fla. 32901.

which to illustrate the use of the suggested gating technique. The condition for switching the nth stage of this counter, if J-K flip-flops are used, is

$$\text{Switch } FF_n = (FF_{n-1})(FF_{n-2}) \dots (FF_1)(\text{Clock}). \quad (1)$$

An implication of this equation is that the AND gate at the input to the nth flip-flop either must have n-1 inputs or it must have a logic tree to reduce the number of inputs. The second alternative is the usual solution, even though it introduces an additional delay for each level in the logic tree.

Consider, for example, a J-K flip-flop with AND inputs. (SUHL II/SF200 has three J, three K and one clock input.) The data to be entered must be present at the J and K terminals before the clock goes high. If the clock frequency is a 25-MHz square wave, its period is 40 ns. Thus the clock is low for only 20 ns. The worst-case propagation delay of the SF200 flip-flop is 15 ns, which leaves 5 ns for the gating operation.

Since the worst-case delay for a SUHL II gate is 11 ns, 6 ns more than is available, it is obvious that the logic tree approach cannot be used or the clock must be slowed. Neither alternative is particularly attractive.

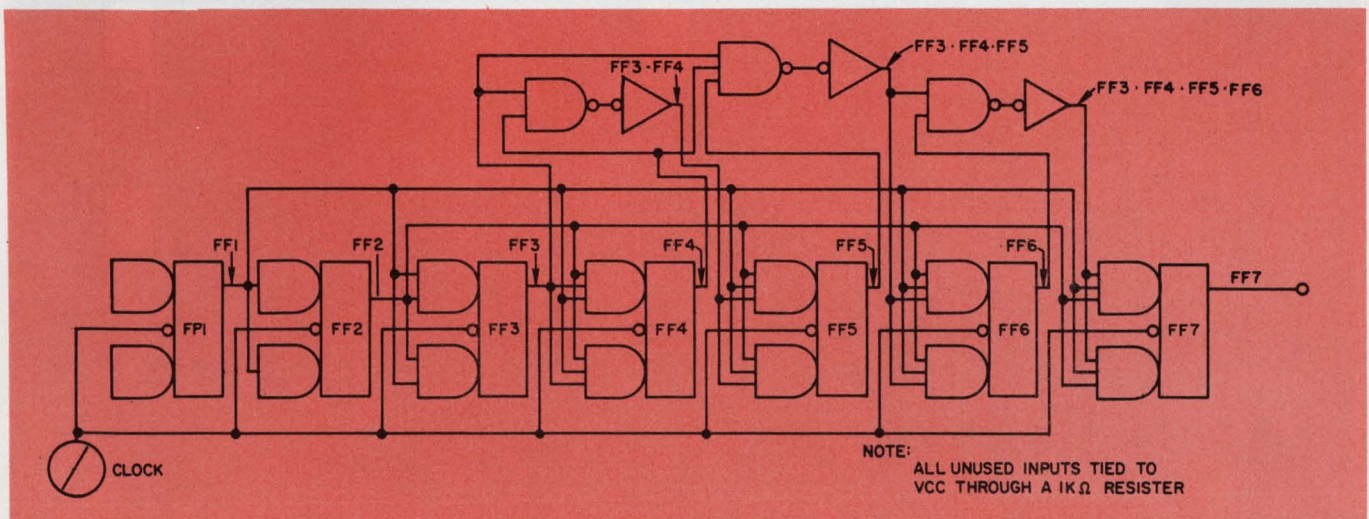

1. This seven-stage binary counter has logic gating only at the inputs to the third and subsequent flip-flops.

Elimination of gating at the least significant stages raises speed by removing gate delays.

## Resolve the impasse

As a first step in clearing this impasse, re-group Eq. 1 as follows:

Switch  $FF_n =$

$$[FF_{n-1} \cdot FF_{n-2} \cdot \dots \cdot FF_3] [FF_2 \cdot FF_1 \cdot \text{Clock}]$$

Now form the AND of  $FF_2$ ,  $FF_1$  and the clock at the inputs of  $FF_3$  through  $FF_n$  as shown in Fig. 1. The effective clock rate to these stages of more significant bits is the clock frequency divided by  $2^2$  or, in this case, 6.25 MHz.

The effective clock, which is the logic product of clock  $FF_2$  and  $FF_1$ , is not a square wave (see Fig. 2). Rather, it is high for one half of the clock period (20 ns) and low for the remainder of  $2^2$  clock periods, which is  $(4 \times 40) - 20$  or 140 ns.

Since the worst-case propagation delay is 15

ns, 140–15 or 125 ns are available for delay in the gates. Assuming an 11-ns gate delay, as many as 11 levels of logic can be used and 4 ns are still left over. The timing diagram in Fig. 2 graphically illustrates this process.

The seven-stage synchronous binary counter of Fig. 1 has been built and tested. An input clock frequency as high as 33.3 MHz was divided by  $2^7$  (128), and satisfactory operation was then obtained.

## Divide by 100

A second application of selective gating is a divide-by-100 counter that consists of two cascaded synchronous decade counters (Fig. 3). Each decade counted has a divide-by-five and a divide-by-two stage.

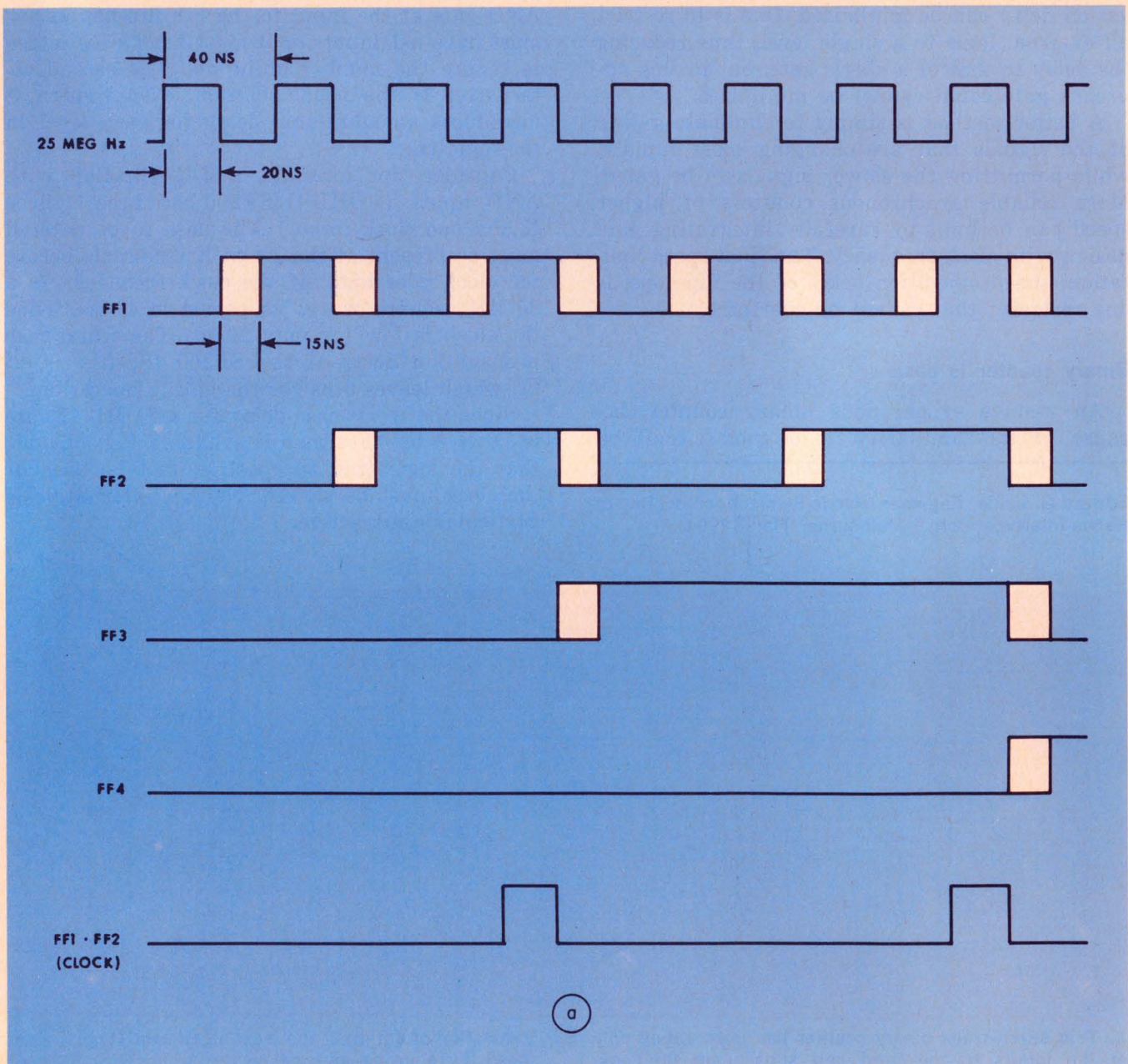

The progression of the count in each decade counter is listed in the decade-counter sequence table. The least significant bit (LSB) is generated in FF<sub>1</sub>, while the most significant bit (MSB) is generated in FF<sub>4</sub>.

The accompanying box describes the derivation of the flip-flop equations of the divide-by-five stage. These equations,

$$J_{FF1} = FF_2' \cdot FF_3'; K_{FF1} = FF_2,$$

$$J_{FF2} = FF_1; K_{FF2} = FF_1',$$

and

$$J_{FF3} = FF_1' \cdot FF_2; K_{FF3} = FF_2'$$

are implemented in the first three stages of the divide-by-100 counter of Fig. 3.

The output of FF<sub>3</sub> is fed directly to the inputs of FF<sub>4</sub>, along with the clock. This is the equiva-

Decade counter sequence table

CNT	FF1	FF2	FF3	FF4
0	0	0	0	0
1	1	0	0	0
2	1	1	0	0
3	0	1	0	0
4	0	0	1	0
5	0	0	0	1
6	1	0	0	1
7	1	1	0	1
8	0	1	0	1
9	0	0	1	1

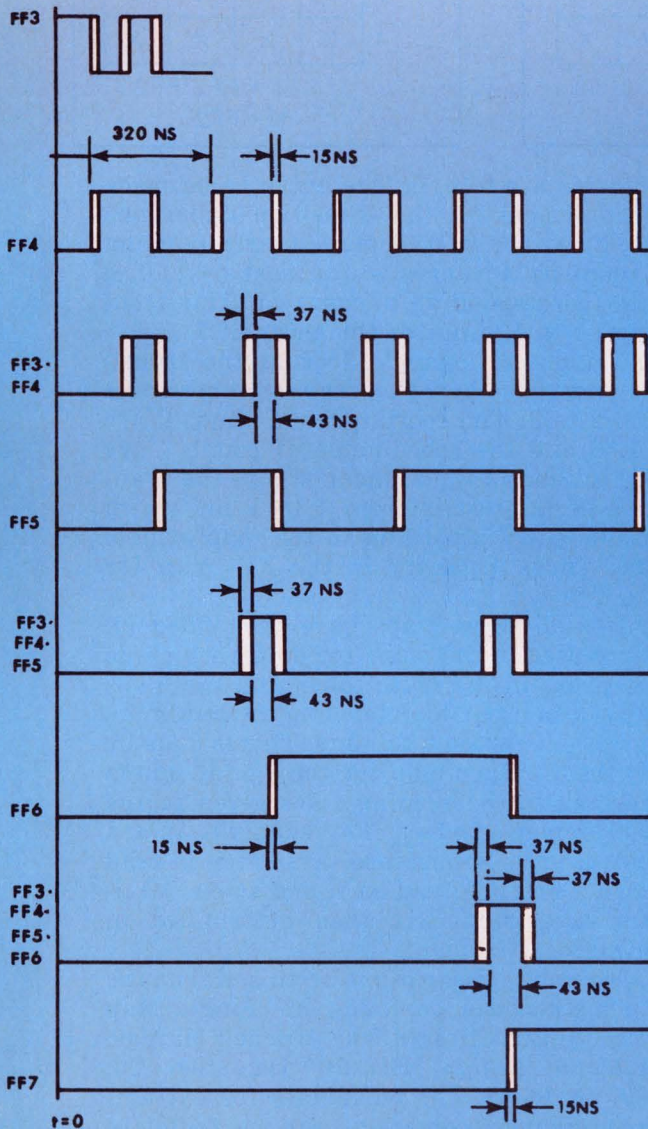

(b)

2. A worst-case timing diagram for the binary counter of Fig. 1 shows the relationship between areas of uncertainty (shaded) and the actual pulse width. The uncertainty arises from worst-case propagation delay of the flip-flops. Because it is operating with the shortest period, FF<sub>1</sub> has least time available for gating after the propagation delays has been subtracted from its pulse. Since all gating must be accomplished during this interval, it is obviously advantageous to relieve FF<sub>1</sub> of as much gating as possible if a high-speed counter is to be built.

# Divide-by-five derivation

**Truth table**

Count	FF1	FF2	FF3
0	0	0	0
1	1	0	0
2	1	1	0
3	0	1	0
4	0	0	1
0	0	0	0

**Map symbols**

Transition	Enter Map	Read Map	
		J	K
0 to 0	0	0	X
0 to 1	1	1	X
1 to 0	0	X	1
1 to 1	1	X	0
Optional	X	X	X

## Karnaugh maps

		FF1, FF2			
		00	01	11	10
FF3	0	1	0	0	1
	1	0	X	X	X

J = FF2'·FF3'  
FF1 : K = FF2

		FF1, FF2			
		00	01	11	10
FF3	0	0	0	1	1
	1	0	X	X	X

J = FF1  
FF2 : K = FF1'

		FF1, FF2			
		00	01	11	10
FF3	0	0	1	0	0
	1	0	X	X	X

J = FF1'·FF2  
FF3 : K = FF2'

In order to divide by a given integer, n, a counter must provide n unique states. If n=5 as in this case, at least three flip-flops (scale of eight) must be used. A truth table, such as the one in this box, then defines each state or count in terms of the outputs of each flip-flop. For example, at count 0 each of the flip-flops, FF<sub>1</sub>, FF<sub>2</sub> and FF<sub>3</sub>, are set to ZERO. This can be abbreviated as 0, 0, 0 and is the equivalent of count 0.

At count 1, FF<sub>1</sub> goes to 1 while FF<sub>2</sub> and FF<sub>3</sub> remain unchanged. Count 1 thus corresponds to 1, 0, 0. In the transition from count 0 to count 1, only FF<sub>1</sub> changed its state from 0 to 1. As can be seen in the transition from count 1 to count 2 in the accompanying truth table, FF<sub>1</sub> remains at 1, FF<sub>2</sub> changes from 0 to 1 and FF<sub>3</sub> remains at 0. The remaining counts entail similar changes of state of the flip-flop outputs.

The truth table can be translated into a set of Karnaugh maps in which each flip-flop has its own unique map. The coordinates of the entries in a given map are all of the possible flip-flop states. In this case there are eight entries. The coordinates across the top of each map are the states of FF<sub>1</sub> and FF<sub>2</sub>, respectively, and on the left side are the states of FF<sub>3</sub>. Each entry thus corresponds to one of the eight possible states. However, since only five counts are being considered, three of the possible states have no relation to the truth table.

A set of rules is given in the table of map symbols for making entries in the Karnaugh maps. As an example, consider the top left entry in the FF<sub>1</sub> map for which the co-

ordinates are 0, 0, 0. The entry to be made is the symbol for the transition undergone by FF<sub>1</sub> as the 0, 0, 0 state (corresponding to count 0) advances to the next or 1, 0, 0 state (corresponding to count 1). This transition, 0 to 1, requires the entry of 1.

As a second example, look at the transition undergone by FF<sub>2</sub> as the count advances from 2 to 3. The coordinates of count 2 are 1, 1, 0 and the coordinates of count 3 are 0, 1, 0. Since FF<sub>2</sub> is under study, the transition of interest is from 1 to 1 for which 1 is the entry according to the map symbol table. Thus, the entry in the FF<sub>2</sub> map for 1, 1, 0 is 1.

After all three maps have been filled in, Xs are used in the maps for states which do not appear in the truth table, and the maps are read in order to determine the minimum expressions for each flip-flop. This is done by first reading each map for the J or K inputs according to the reading rules given in the table of map symbols. For example, if a J input is to be determined, a 0 entry is read as 0, a 1 entry is read as 1, and so on. Minimum expressions are then determined in conventional fashion.

A complete description of this Karnaugh map method can be found in "Single Map Method Speeds Design," by Mitchell Marcus, *Electronic Design*, ED 26, December 20, 1969, pp. 66-68. The techniques for extracting minimum expressions can be found in any standard text on Boolean algebra, such as "Introduction to Switching Circuit Theory," by Donald D. Givone, McGraw-Hill Book Co., New York, N. Y., 1970.



lent of forming the AND of  $FF_4$  with the clock frequency. Since  $FF_4$  sees the clock only once in each five clock cycles, it toggles at one-tenth of the clock rate.

Two of the three available inputs of each stage of the second decade counter are used to synthesize the effective clock, and this leaves only one input to implement the design equations. However, since the effective clock is one-tenth of the input clock, the time to propagate signals has increased from 20 ns, if a 25-MHz square-wave clock is used, to  $(10)(40) - 20 - 15 = 365$  ns. The effective clock is high for 20 ns, and the worst-case propagation delay of the flip-flop is 15 ns. With this large increase in allowable gate propagation delay, many levels of external gating can be used to implement the second decade counter.

### Approach suitable for high bit rates

This design approach, feeding the most rapidly changing signals directly to the flip-flops while the slower signals are gated, has proved to be a

highly satisfactory way of implementing Boolean logic at high bit rates. Rates approaching those limited only by the propagation delay of the logic device are attainable. ■■

### Test your retention

*Here are questions based on the main points of this article. Their purpose is to help you make sure you have not overlooked any important ideas. You'll find the answers in the article.*

1. How many inputs are needed for the  $N$ th stage of a binary counter?
2. Is the most significant bit generated in the slowest or fastest stage of a counter?
3. What is the relationship between clock frequency and propagation delay in flip-flops? In logic gates?

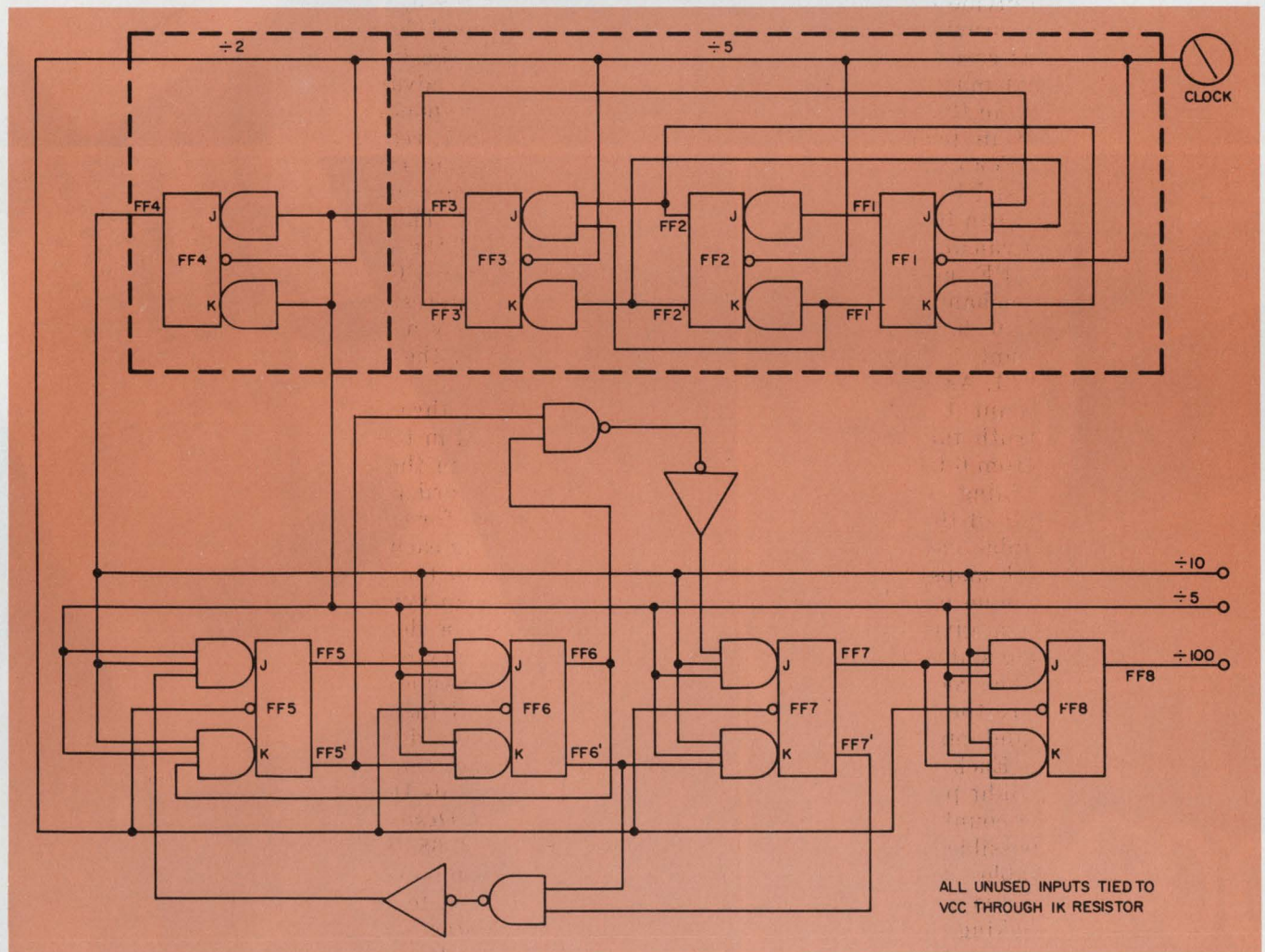

3. Division by 100 is accomplished by this cascade of decade counters. Logic gating is restricted to the second

decade to speed operation. Each decade contains a divide-by-five and divide-by-two stage.

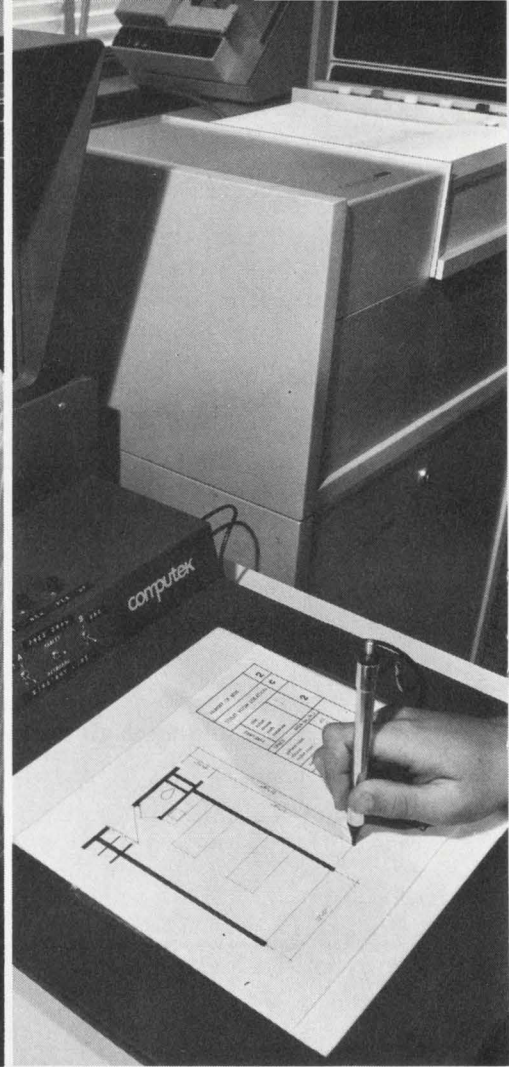

# Gould 4800 meets architects' demanding requirements for hardcopy alphanumerics and graphics.

A Boston-based architectural firm, specializing in institutional projects, has made a high speed interactive computer system an integral part of their architectural design process. And to take full advantage of this capability, they use a Gould 4800 electrostatic printer to provide hardcopy alphanumerics and graphics.

The Gould 4800 provides printout for feasibility studies, area diagrams, alternate plans, perspectives, detail drawings, specifications and managerial reports. Where a plotter would take up to 30 minutes to produce a drawing, the Gould 4800 delivers one in seconds.

And where a dry-silver photographic process would produce muddy copies that can't be traced or used directly, Gould 4800 copy is sharp, clean and fully acceptable for client presentations.

The computer system, called the ARK/TWO was developed by Perry, Dean and Stewart Architects and Planners and programmed by Design Systems, Inc.

It includes an Autrotrol digitizer, a DEC PDP 15/20 (16K), 500K Disk, two Computek CRT's with a keyboard and tablet. Ultimately, it's felt this advanced system will reduce the critical path in large construction projects by 4 to 6 months. All kinds of companies are using the Gould 4800 to meet all kinds of hardcopy requirements. This smooth, quiet unit delivers up to 4800 lines per minute on an 8½" or 11" format. It has an optional character generator. Software and interfaces for major computers are available. And while the Gould 4800 has relatively few moving parts and little need for maintenance, there are service facilities nationwide.

**Find out what the Gould 4800 can do for you.**

**Give us a call. Or write:** Graphics Division, Gould Inc., 3631 Perkins Avenue, Cleveland, Ohio 44114.



# Don't minimize noise figure to optimize the noise performance of your operational amplifier. Concentrate instead on maximizing the output S/N ratio.

While noise figure is excellent for comparing amplifiers, it is not necessarily the appropriate indicator for optimizing the noise performance of an amplifier circuit.

In designing op-amp circuits, for example, best noise performance—that is, highest output S/N ratio—is not usually obtained under the same circuit conditions that minimize the noise figure.

The problem comes about because noise figure (NF) is defined as the ratio of an amplifier's input S/N to its output S/N (Eq. a in the box). The NF can therefore be reduced by increasing the amount of noise at the input—hardly the way to improve the amplifier's noise performance.

The mistaken idea that minimum noise figure equals best noise performance comes from the days when noise figure was almost exclusively used in the design of transformer-coupled rf amplifiers. In that application, adjusting the source resistance by varying the transformer turns ratio yields the best noise performance when the noise figure is minimized. This result applies only to transformer-coupled circuits because a transformer scales the source resistance proportional to the square of its turns ratio while scaling the input signal voltage proportional to the turns ratio itself.

## Total amplifier noise is a better idea

A better indicator of amplifier noise performance is the total equivalent amplifier input noise voltage,  $e_{nit}$  (see box). Both this quantity and the noise voltage of the source,  $e_{ng}$ , are functions of the source resistance. They should, therefore, both be studied as functions of this variable.

To see how  $e_{nit}$  varies with source resistance, consider the standard inverting op-amp configuration of Fig. 1. In this circuit, it is assumed that the two input noise current sources are essentially equal (in a statistical sense).

Generally, to minimize thermal drifts, the

source resistances presented to the two amplifier inputs are made equal. Since both the feedback and summing resistors in Fig. 1 are returned to low-impedance points, the resistance seen by the inverting input is essentially the parallel combination of  $R_1$  and  $R_2$ . Thus, standard practice would be to choose  $R_g = R_1 || R_2$ .

Under these conditions, the expression for total amplifier input noise voltage (Eq. d in the box) simplifies to

$$e_{nit} = \sqrt{e_{ni}^2 + 2R_g^2 i_{ni}^2}. \quad (1)$$

In this form, the noise produced by the op amp can be compared directly with input signal levels to evaluate the S/N ratio regardless of the function to be performed by the op amp.

The noise voltage of the source,  $e_{ng}$ , is generally accounted for by the thermal noise of the source resistance. The thermal noise of the combined source resistance,  $2R_g$ , is given by

$$e_{ng} = \sqrt{8KT \Delta f R_g} \quad (2)$$

where  $K$  is Boltzmann's constant

( $1.38 \times 10^{-23}$  joules/°K),

$T$  is the absolute temperature and

$\Delta f$  is the bandwidth in hertz.

Plugging Eqs. 1 and 2 into Eq. f (in the box) yields an expression for noise figure as a function of source resistance:

$$NF = 10 \log_{10} \left[ 1 + \frac{e_{ni}^2 + 2R_g^2 i_{ni}^2}{8KT \Delta f R_g} \right]. \quad (3)$$

Eqs. 1, 2 and 3 are plotted in Fig. 2 to show how misleading noise-figure measurements can be, especially for low values of  $R_g$ .

The noise contributed by the op amp is essentially constant for low  $R_g$  where the effects of current noise are small compared with those due to voltage noise. The thermal noise of the source resistance is a linear function of  $R_g$  and can exceed the total amplifier noise over some range of resistance.

The noise figure hits a minimum when the ratio of amplifier noise to source noise is smallest, leading to the common recommendation that  $R_g$  be adjusted to minimize NF. Unfortunately, this does not lead to optimum noise performance.

Jerald Graeme, Manager, Monolithic Engineering, Burr-Brown Research Corp., International Airport Industrial Park, Tucson, Ariz. 85706.

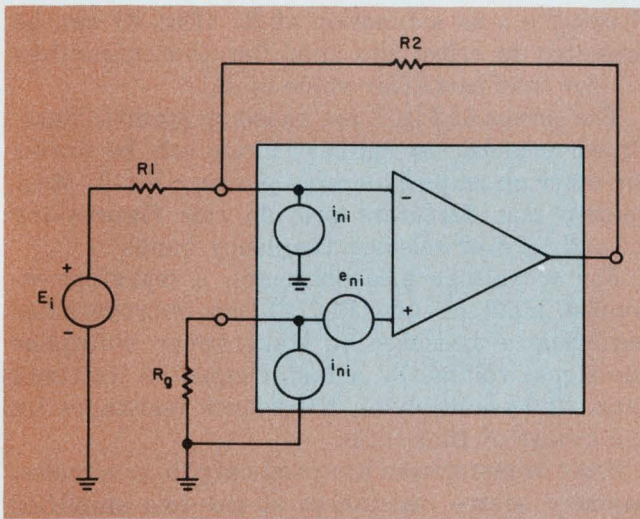

1. Amplifier noise increases as the resistances go up because of the increased contributions from the noise-current sources. The voltage contribution is constant.

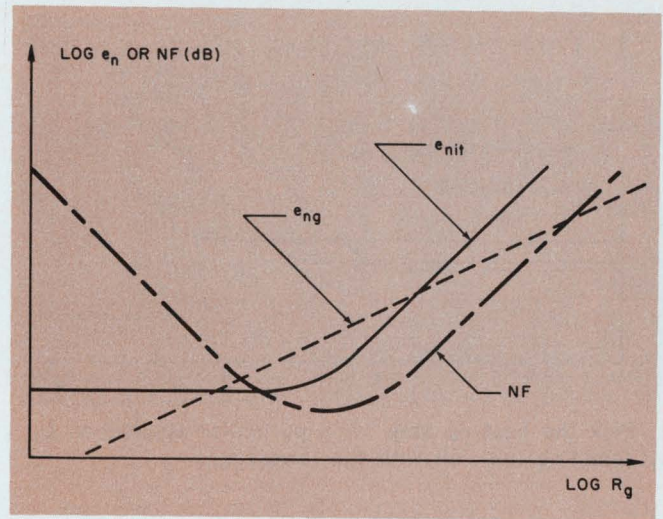

2. Noise figure is minimized when the ratio of amplifier noise to source noise is smallest. This does not correspond to optimum noise performance.

## What is the noise figure of an op amp?

Noise figure is defined as the power S/N ratio at the input of an amplifier divided by the same quantity measured at the amplifier's output. In decibels, it is given by

$$NF \text{ (dB)} = 10 \log_{10} [(S/N)_i / (S/N)_o]. \quad (a)$$

To see how the noise figure and the output S/N ratio are affected by external circuitry, it is convenient to rewrite Eq. a in terms of noise voltages and currents. The resulting expression is

$$NF = 10 \log_{10} \left[ \frac{(E_i^2/R_i) / (\overline{e_{ng}^2}/R_i)}{(E_o^2/R_o) / (\overline{e_{no}^2}/R_o)} \right] \quad (b)$$

where  $E_i$  is the input signal voltage,  $E_o$  is the output signal voltage,  $\overline{e_{ng}^2}$  is the mean-square noise voltage of the source,  $\overline{e_{no}^2}$  is the mean-square noise voltage at the output,

$R_i$  is the input resistance and

$R_o$  is the load resistance.

For a gain,  $A = E_o/E_i$ , Eq. b can be simplified to

$$NF = 10 \log_{10} [\overline{e_{no}^2} / A^2 \overline{e_{ng}^2}]. \quad (c)$$

This relationship makes clear the fact that increasing the level of input noise can reduce an amplifier's noise figure while worsening its noise performance.

To relate the standard definition of noise figure to an operational amplifier, it is useful to represent the op amp as an ideal noiseless amplifier preceded by equivalent input noise voltage and current sources (see diagram).

The equivalent noise sources are uncorrelated and without polarity. They therefore add in a mean-square sense, and the total mean-square

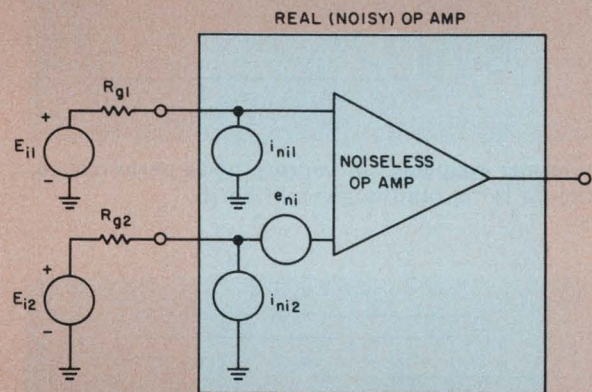

amplifier noise voltage presented to the noiseless amplifier is

$$e_{nit}^2 = \overline{e_{ni}^2} + \overline{i_{ni1}^2} R_{g1}^2 + \overline{i_{ni2}^2} R_{g2}^2 \quad (d)$$

where it is assumed that the input resistance of the amplifier is much larger than  $R_{g1}$  and  $R_{g2}$ .

If we make the assumption that the noise from the signal sources is not correlated with the amplifier noise, then it will add in a mean-square sense yielding a total mean-square output noise

$$\overline{e_{no}^2} = A^2 (\overline{e_{ng}^2} + \overline{e_{nit}^2}). \quad (e)$$

Plugging this expression into Eq. c yields an expression for noise figure in terms of the op-amp noise parameters:

$$NF = 10 \log_{10} [1 + \overline{e_{nit}^2} / \overline{e_{ng}^2}]. \quad (f)$$

In this form, the noise figure is related to the ratio of noise generated by the amplifier to that generated by the source. Since the comparison reference is arbitrarily set by the source, the noise figure serves only as a common, arbitrary reference from which a comparison can be made between amplifiers under fixed conditions.

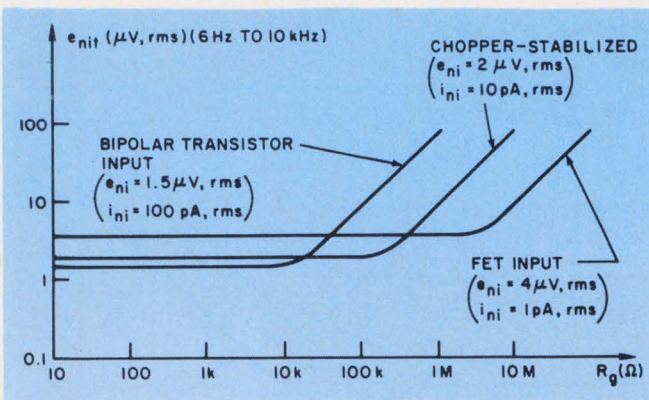

3. Pick the best op amp for a particular application by selecting the unit with the lowest  $e_{nit}$ .

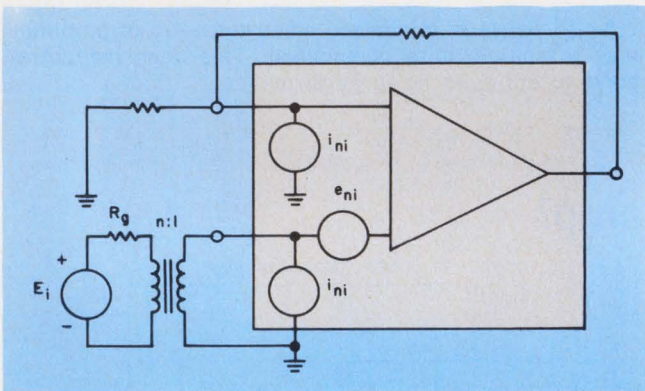

4. Transformer coupling can improve noise performance. The optimum turns ratio is given in Eq. 5.

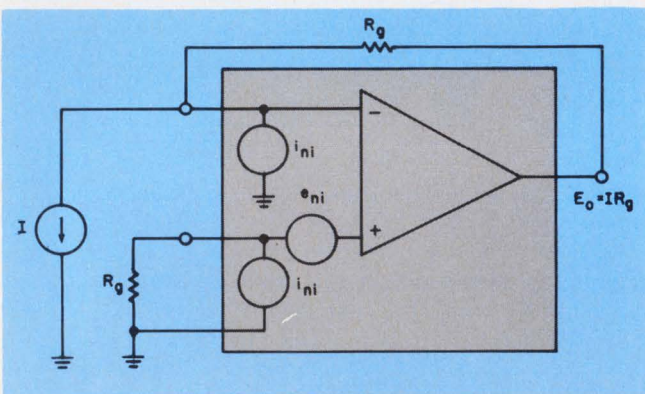

5. The S/N ratio of this current measuring circuit is maximized for very large  $R_g$ .  $(S/N)_{max} = I/2i_{ni}$ .

In fact, the best S/N ratio is obtained when  $R_g = 0$ —a condition for which the noise figure becomes infinite, demonstrating that high NF does not, in itself, indicate poor noise performance.

### Match the amplifier to the circuit

It is clear that noise performance is optimized when  $e_{nit}$  is minimized. How can this be done?

For the very common case of dc voltage amplifiers, Eq. 1 indicates that  $R_g$  should be made as small as possible. Once  $R_g$  is specified, a graph

showing  $e_{nit}$  as a function of  $R_g$  (Fig. 3) can be consulted to select the amplifier that minimizes  $e_{nit}$  for that particular value of  $R_g$ .

The curves of Fig. 3 are based on specific Burr-Brown models, but similar curves can be drawn for other op amps by simply plotting Eq. 1. Most op-amp manufacturers provide rms figures for  $e_{ni}$  and  $i_{ni}$  over selected frequency bands.

For ac voltage measurements, a transformer-coupled input circuit (Fig. 4) can improve noise performance because the transformer multiplies the signal voltage by a factor equal to its turns ratio while multiplying the source resistance by the square of that ratio.

Since transformers are used only in ac circuits, balanced source resistances at the two amplifier inputs are not needed to ensure the cancellation of the dc voltages caused by input bias currents. Instead, the feedback and summing resistances are minimized to make the noise contribution of the noise-current source at the inverting input small enough to be considered negligible.

As a result, the current  $i_{ni1}$  and the resistance  $R_{g1}$  (see box illustration) are assumed to be zero, and the S/N ratio of the circuit is given by

$$S/N = \frac{E_i/n}{\sqrt{e_{ni}^2 + R_g^2 i_{ni}^2/n^4 + 4KT\Delta f R_g/n^2}} \quad (4)$$

where  $n$  is the turns ratio of the transformer.

To find the turns ratio resulting in maximum S/N ratio, the derivative of S/N with respect to  $n$  is equated to zero, yielding

$$n_{opt} = \sqrt{i_{ni} R_g / e_{ni}} \quad (5)$$

If the input signal is a current, rather than a voltage, an analysis of the standard current-measuring circuit (Fig. 5) will show that the S/N ratio increases as  $R_g$  is increased. ■■

### Test your retention

Here are questions based on the main points of this article. Their purpose is to help you make sure you have not overlooked any important ideas. You'll find the answers in the article.

1. Under which condition is a noise figure measurement likely to be most misleading: low source resistance or high source resistance?

2. For dc voltage measurements, what condition will maximize the S/N ratio? What is the noise figure under this condition?

3. How can a transformer be used to maximize the S/N ratio of an ac amplifier?

**Major advances** in IC performance are obtained by combining advanced processing techniques with complete mastery of advanced circuit design. One manufacturer does that: Analog Devices . . . *Circuit Specialists*.

**A perfect example: the AD503**, an FET-input op amp with 5 pA bias current, and a slewing rate of 6V/μsec. To put it bluntly, the AD503 outperforms every other FET/IC design, in every significant parameter, by wide margins.

The spec summary we've shown stacks the AD503 against the best conventional FET/IC op amp. You'll see why we made the AD503 pin-interchangeable with the μA740 (and 741). We expect to cure a lot of your nagging design headaches — simply by saying: "Retrofit with the AD503!"

**Here's how we do it:** the AD503 is a dual-chip IC, combining a monolithic dual FET chip with a specially designed monolithic amplifier chip. This permits independent optimization of both chips, since they are processed independently, each with the most favorable starting materials and doping profiles for its function. Consequently, the yield is high, the cost is low, and the performance is superb. The AD503, in other words, is not limited by the processing constraints inherent in single-chip FET op-amp designs.

**Coming soon:** specially optimized versions of the AD503 . . . one with 1 pA bias current . . . an externally compensated version with 40V/μsec slew rate . . . and one in which we use laser trimming to internally reduce the offset voltage to less than 1 mV.

The AD503, like all of our new fourth-generation devices, was created by the most experienced team of linear circuit and processing engineers ever assembled. And it is manufactured in one of the few microcircuit facilities that is currently capable of large-volume fourth-generation processing.

# The "C" in IC's stands for Circuits

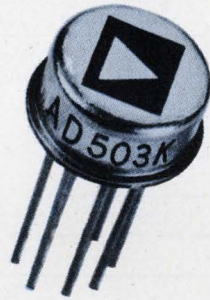

—therefore the AD503

...a 5pA FET Op Amp in a TO-99 Can

For complete and explicit data on the AD503 and six more extraordinary new IC devices, get our new 20-page Engineering Brochure on *fourth-generation IC's* from ANALOG DEVICES, INC., 221 Fifth St., Cambridge, Mass. 02142.

*Evaluation units? Certainly! Immediately! Call Stan Harris at: (617) 492-6000; TWX: (701) 320-0326; and he'll send up to 5 —at the 100-piece price!*

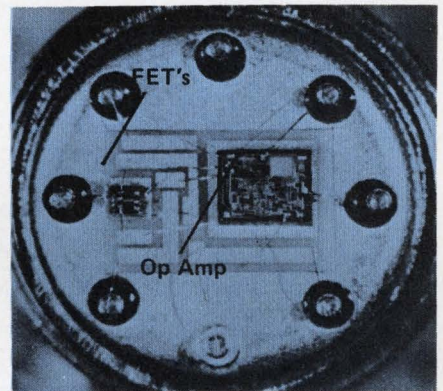

Parameter	AD503J	μA 740C	AD503K	μA 740
Max $V_{OS}$ (mV)	50	no max spec*	20	20
Max $I_B$ (pA)	25	2000	10	200
Max $\Delta V/\Delta T$ ( $\mu V/^\circ C$ )	75	no max spec*	25	no max spec*
Min Gain	20K	no min spec*	50K	50K
Min CMRR (dB)	70	no min spec*	70	64
Min Slew Rate (V/μsec)	4	no min spec*	4	no min spec*

\*Manufacturer gives this parameter as typical value only. (Note that only the AD503 is completely min and max specified; the μA 740C is almost completely unspecified.)

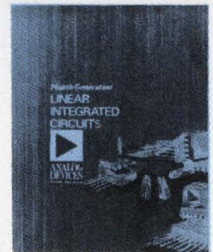

**ANALOG  
DEVICES**  
*Circuit Specialists*

INFORMATION RETRIEVAL NUMBER 35

## High energy silicon for the 70's

# The new tough breed from the Kokomoans



Circle No.	Transistor	V <sub>CEX</sub> Voltage	Continuous I <sub>c</sub>	V <sub>CEO</sub> (sus)	Maximum Power Dissipation	Typical Applications
121	DTS 103	80V	15A	60V	125W	Voltage regulators, power amplifiers, high efficiency switching circuits.
122	DTS 104	80V	15A	60V	125W	
123	DTS 105	100V	15A	75V	125W	
124	DTS 106	110V	15A	80V	125W	
125	DTS 107	120V	15A	85V	125W	*I <sub>c</sub> Peak = 5A Vertical magnetic CRT deflection, has good gain linearity.
126	DTS 401	400V	2A*	300V		
127	DTS 402	700V	3.5A*	325V		*I <sub>c</sub> Peak = 10A Horizontal magnetic CRT deflection, features fast switching time, high reliability under horizontal sweep fault condition.
128	DTS 410	200V	3.5A	200V	80W	
129	DTS 411	300V	3.5A	300V	100W	Voltage regulator, switching regulator, DC to DC converter, class A audio amplifiers.
130	DTS 413	400V	2.0A	325V	75W	
131	DTS 423	400V	3.5A*	325V	100W	*I <sub>c</sub> Peak = 10A High V <sub>CB0</sub> and V <sub>CEO</sub> ratings make it practical to operate directly from rectifier 117V or 220V AC line.
132	DTS 424	700V	3.5A*	350V	100W	
133	DTS 425	700V	3.5A	400V	100W	*I <sub>c</sub> Peak = 10A High V <sub>CB0</sub> , V <sub>CEO</sub> (sus) ratings make them ideal for use in deflection circuits, switching regulators and line operating amplifiers.
134	DTS 430	400V	5A	300V	125W	
135	DTS 431	400V	5A	325V	125W	Voltage regulators, power amplifiers, high voltage switching.
136	DTS 701	800V	1A	600V	50W	
137	DTS 702	1200V	3A	750V	50W	Vertical magnetic CRT deflection circuits.
138	DTS 704	1400V	3A	800V	50W	
139	DTS 721	1000V	3A	800V	50W	Horizontal magnetic CRT deflection circuits operating off-line.
140	DTS 723	1200V	3A	750V	50W	
141	DTS 801	1000V	2A	700V	100W	High voltage DC regulators.
142	DTS 802	1200V	5A	750V	100W	
143	DTS 804	1400V	5A	800V	100W	Very high voltage industrial and commercial switching.
144	2N3902†	700V	3.5A*	325V	100W	
145	2N5157	700V	3.5A*	400V	100W	Color vertical magnetic CRT deflection circuits.
146	2N5241	400V	5A	325V	125W	
147	2N2580	400V	10A	325V	150W	Color horizontal magnetic CRT deflection circuits.
148	2N2581	400V	10A	325V	150W	
149	2N2582	500V	10A	325V	150W	*I <sub>c</sub> Peak = 10A Ideal for switching applications. Can be operated from rectified 117 or 220 volt AC line.
150	2N2583	500V	10A	325V	150W	
151	2N3079	200V	10A	200V		
152	2N3080	300V	10A	300V		

†Mil. qualified units available.

Transistors are NPN triple diffused.



# Now available from these distributors in production quantities.

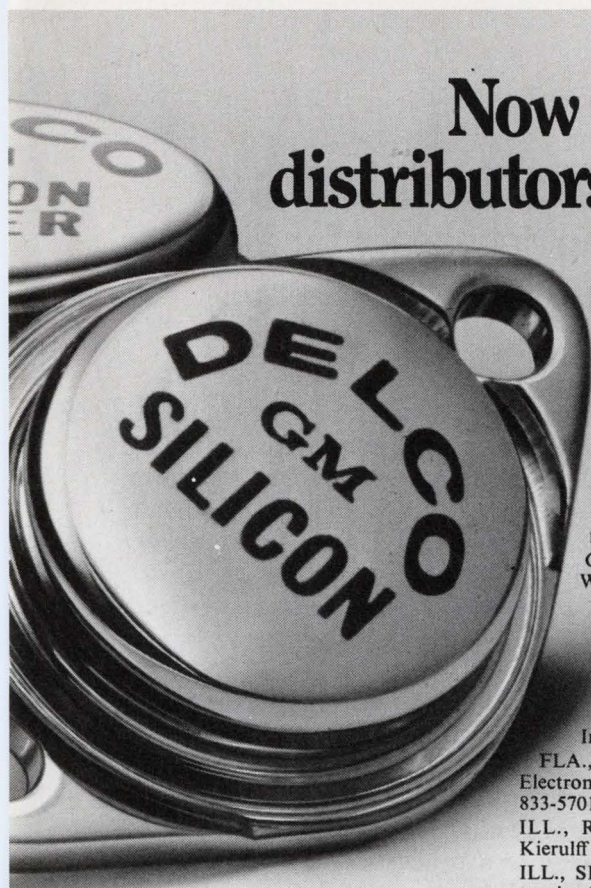

- ALA., BIRMINGHAM • Forbes Distributing Co., Inc. (205)-251-4104
- ARIZ., PHOENIX • Cramer/Arizona (602)-263-1112 • Sterling Electronics (602)-258-4531
- CAL., LOS ANGELES • Kierulff Electronics, Inc. (213)-685-5511 • Radio Products Sales, Inc. (213)-748-1271
- CAL., PALO ALTO • Kierulff Electronics, Inc. (415)-968-6292
- CAL., SAN DIEGO • Milo of California, Inc. (714)-232-8951
- COLO., COLORADO SPRINGS • Walker Electronics (303)-636-1661
- COLO., DENVER • Cramer/Denver (303)-758-2100 • Denver Walker Electronics (305)-935-2406
- FLA., MIAMI • Mountain Electronics, Subsidiary of Avnet, Inc. (305)-634-4556
- FLA., WEST PALM BEACH • Mountain Electronics, Subsidiary of Avnet, Inc. (305)-833-5701
- ILL., ROSEMONT (Chicago) • F-J-R/Kierulff (312)-678-8560
- ILL., SKOKIE (Chicago) • Merquip Electronics (312)-282-5400
- IND., INDIANAPOLIS • Graham Electronics Supply, Inc. (317)-634-8486
- MD., BALTIMORE • Radio Electric Service Co. (301)-823-0070
- MASS., NEWTON • The Greene-Shaw Co., Inc. (617)-969-8900
- MICH., ROMULUS • Harvey/Detroit (313)-729-5500
- MINN., MINNEAPOLIS • Stark Electronics Supply Co. (612)-332-1325
- MO., KANSAS CITY • Walters Radio Supply, Inc. (816)-531-7015
- MO., NO. KANSAS CITY • ECI Semiconductors, Inc. (816)-221-2400
- MO., ST. LOUIS • Electronic Components for Industry Co. (314)-647-5505
- N.J., CLIFTON • Eastern Radio Corporation (201)-471-6600
- N.M., ALBUQUERQUE • Cramer/New Mexico (505)-265-5767 • Sterling Electronics (505)-247-2486
- N.Y., BINGHAMTON • Harvey/Federal (607)-748-8211
- N.Y., NEW YORK • Harvey/New York (212)-582-2590
- N.Y., WOODBURY • Harvey/New York (516)-921-8700
- OHIO, CINCINNATI • United Radio, Inc. (513)-761-4030
- OHIO, CLEVELAND • Pattison Supply (216)-441-3000
- OHIO, DAYTON • F-J-R/Kierulff (513)-278-9411
- OKLA., OKLAHOMA CITY • Radio, Inc. (405)-235-1551
- OKLA., TULSA • Radio, Inc. (918)-587-9123
- PENN., PHILADELPHIA • Almo Electronics (215)-676-6000
- PENN., PITTSBURGH • RPC Electronics (412)-782-3770
- S.C., COLUMBIA • Dixie Radio Supply Co., Inc. (803)-253-5333
- TEXAS, DALLAS • Adleta Electronics Company (214)-742-8257
- TEXAS, FORT WORTH • Adleta Electronics Co. (817)-336-7446
- TEXAS, HOUSTON • Harrison Equipment Co., Inc. (713)-224-9131
- UTAH, SALT LAKE CITY • Cramer/Utah (801)-487-3681
- VA., RICHMOND • Meridian Electronics, Inc., a Sterling Electronics Company (703)-353-6648
- WASH., SEATTLE • Kierulff Electronics, Inc. (206)-763-1550
- WASH., TACOMA • C & G Electronics Co. (206)-272-3181
- CANADA, ONT., SCARBOROUGH • Lake Engineering Co., Ltd. (416)-751-5980
- All Overseas Inquiries:  
General Motors Overseas Operations  
Power and Industrial Products Dept.  
767 Fifth Avenue, New York, N.Y.  
10022. Phone: (212)-486-3723.

**Best for Your Systems of the 70's. Here's Why:** Delco silicon power transistors have earned a reputation for survival in the most rugged applications. Their proved performance in solid state deflection circuits for the new large screen color TV sets is but one example. This new breed of silicon power is built to handle the high energy found in inductive switching or in circuits normally subject to fault conditions or transients.

Their high voltage capability permits the design of simpler circuits, eliminating the extra weight, bulk, and complexity associated with low voltage, higher current systems. Their energy capability is backed by the surest rating in the business—Peak Energy Testing. Solid copper TO-3 and TO-36 packages assure maximum thermal conductivity. All in all this is the silicon power for the equipment of the 70's.

When you specify Delco you can count on consistent quality and on-time delivery, too. These are assured because our semiconductor production and quality controls are geared to our own high volume output of automobile radios and electronic systems.

Call the Kokomoans or your Delco distributor for more information on the New Tough Breed.



**Delco Electronics**

DIVISION OF GENERAL MOTORS CORPORATION  
KOKOMO, INDIANA

Kokomoan's Regional Headquarters. Union, New Jersey\* 07083, Box 1018 Chestnut Station, (201)-687-3770 ■ El Segundo, Calif. 90245, 354 Coral Circle, (213)-772-5181 ■ Chicago, Illinois\* 60656, 5151 N. Harlem Avenue, (312)-775-5411 ■ Kokomo, Ind. 46901, 700 E. Firmin, (317)-459-2175 Home Office ■ \*Office includes field lab and resident engineer for application assistance.



## Firm name games are serious business.

Companies spend more time and money than necessary for a name; examples show need for flexibility to avoid duplications.

Have you ever wondered how a company gets its name, and what it signifies? If you're an engineer or a manager, thinking about starting your own company one day, chances are you'll find what follows informative and entertaining. Included are the legal steps required for selecting a corporate name, and a few of the more interesting stories behind the selection of some of the more unique names in the electronics industry.

Getting a company name is a lot more work than meets the eye. Because of the growing number of new businesses each year, the choice of a company name is often determined by what's available, rather than what's wanted. Gene Rogers, one of the founders of the Intellex Corp., a California-based venture capital and management firm, advises:

"A simple guideline for choosing a name is this: don't choose a name that's likely to be confused with a firm already in the same business. The name probably won't get approved and, even more important, will tend to confuse your customers and do more harm than good."

Another important point to remember in the game of naming is how the company name will fit a logo, which is the graphic symbol of the company name. In this age of mass media, the logo is an important tool of recognition for a firm. So a logo should be chosen carefully. Many companies are chagrined when they discover that, after using their logo successfully in their home state, they run into a conflict when making their first out-of-state shipment. If they want interstate business they must re-do all their literature and art work. This kind of mistake can be very costly, and anyone forming a new company should do the necessary research to avoid it.

### Company names come in three flavors

A company is named in one of three different ways: after its founder (namesake); to tell the world what it does and/or what its market is (descriptive); or simply to attract attention (invented).

---

**Frank J. Burge**, Vice President Marketing, Data Technology Corp., Palo Alto, Calif. 94303.

For many firms, the selection of a company name seemed an easy job. Sherman Fairchild called one of his companies *Fairchild Camera*, Dr. Arnold Beckman tagged his enterprise *Beckman Instruments*, Seymour Schweber, *Schweber Electronics*, Howard Hughes, *Hughes Aircraft*. Then there's *McDonnell Douglas*, *Hewlett-Packard*, *Varian Associates*, *Philbrick*, *Julie Research*, *John Fluke* and on and on.

In today's "down" market, many companies have found that their markets have dried up, or in some cases leveled off. Two of today's industry leaders found themselves with an even more ominous future at the end of World War II when the switch was made to a peacetime economy. A few days after AMPEX took a day off to celebrate the end of the war, it had all of its contracts canceled, and Haloid (later Xerox) found its

## Steps required for selecting a corporate name

A corporate name is required in order to complete incorporation procedures. The requirements for incorporation are generally the same in most states, and the secretary of each state can usually provide a corporation check list that details the requirements of that particular state.

In general, to be as certain as possible that another electronics company hasn't taken your name, check all electronic indexes, i.e., trade press; EEM; Thomas Register; Buyer's Guide; Instrument Databook, etc., and, of course, check with the Patent Office in Washington, D.C. Also check on registered company names in those states or countries that represent your major markets. Your attorney will arrange for a trade name and corporate name check. The fee ranges from \$50 to over \$400, depending on how extensive you want the search to be.

A corporate name must be submitted and approved before incorporation can be completed. The rules (Corporation Check List State of California) applying to corporate names in California, for example, are as follows:

1. Check with the office of the Secretary of

markets were shrinking rapidly. Something drastic had to happen, and it did.

Dr. John H. Dessauer and Joseph C. Wilson of Xerox visited Batelle Memorial Institute and started negotiations on what was later to be known as xerography, and made Xerox a household word. The generic word, xerography was coined from the Greek words "xeros" (dry) and "graphein" to write.

On the other hand, Alexander M. Poniatoff and Harold Lindsay of AMPEX decided to take a chance and develop a high-fidelity tape recorder for broadcast applications. This was the beginning of an entire new industry and one of the biggest success stories in American industry.

*Four-Phase Systems*, a new LSI minicomputer company, derived its name from the use of four-phase logic design throughout its general-purpose computer.

*Intel* founders Dr. Robert Noyce and Dr. Gordon Moore (also founders of Fairchild Semiconductor) started their company with an interim name, NM Electronics, until they were able to get a name cleared and registered. They tried to register 12 names before they came up with Intel, which is an abbreviated form of Integrated Electronics. As it turned out, there's an Intel in Ohio that's in the hotel business.

Sid Klein, executive vice president of *QED Systems*, explains his company's name this way:



State as to the availability of your proposed name before drafting your Articles of Incorporation. In requesting a name check, explain what the principal business will be and where it will be conducted.

2. Obtain two or three alternate names, but do not submit more than four names at one time. Due to the great number of corporations on file, the similarity of names is becoming a problem.

3. Since names cannot be checked out properly during the telephone call, make your request for a name availability check by telegram, letter or postcard. There is no fee for a name check.

4. If you desire to reserve a name prior to the incorporation, you can do so by requesting a reservation by letter and by enclosing the reservation fee of \$4. This reserves the company name for 60 days. Name reservations cannot be made for consecutive reservation periods to the same applicant or for that party's benefit.

5. A name is not acceptable if it is likely to mislead the public or if it is the same as, or resembles another so closely as to tend to deceive (like the name of a domestic corporation, such as a computer company called IBN); or if it is the name of a foreign corporation that is qualified in California; or if it is a name under

reservation for another corporation.

6. The words "bank," "trust," "trustee," or related words, may not be a part of the corporate name unless the certificate of approval of the Superintendent of Banks is attached to the Articles of Incorporation.

7. Generally speaking, the word "co-operative," or any abbreviation thereof or word similar thereto *may not* be a part of a corporate name.

8. The words "Olympic" or "Olympiad" should not be a part of the corporate name.

9. The name of a person may not be used as a corporate name without the addition thereto of a corporate ending or some other word or words which show that the name is not that of the individual alone.

The Small Business Administration has published a number of aids, (including "Steps to Incorporating a Business") for the small businessmen. Although small firms are sometimes incorporated without the help of an attorney, the information offered is not intended as a substitute for professional advice. Professional legal help will usually result in a better corporate charter and in the long run will save the company time and money.

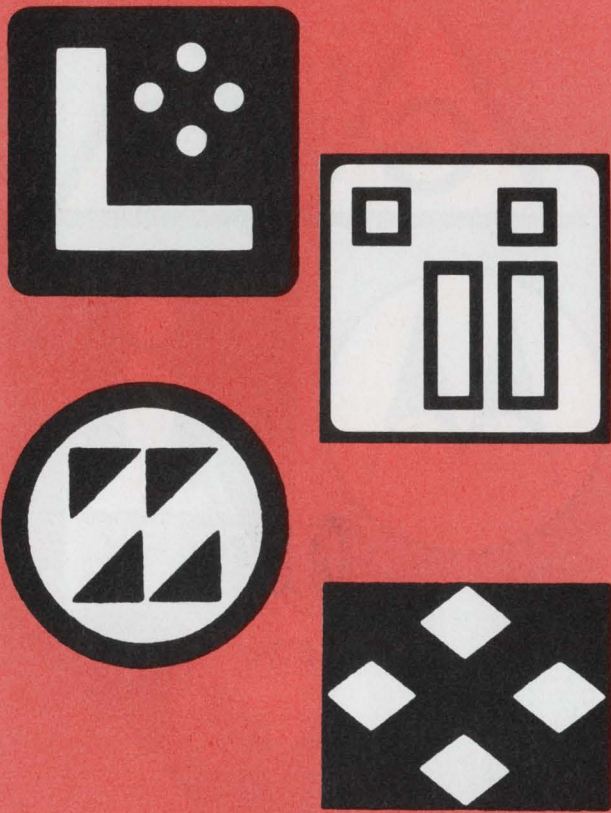

“QED is a familiar expression in engineering text books and is derived from the Latin ‘quod erat demonstrandum,’ which means ‘that which can be demonstrated.’ All of us have had a great deal of experience in the systems business and can therefore demonstrate performance.”

*Genesys Systems* started out as General Systems, but because of conflicts with that choice, settled on Genesys (*General Systems*) and then tacked on Systems to describe the business.

*Intersil* is a shortened form of International Silicon and was so named because the founder, Dr. Jean Hoerni, had an eye on the international microcircuit market. Dr. Hoerni was also one of the founders of several other northern California semiconductor firms, including Fairchild Semiconductor.

Burton R. Cohn, president of *XYNETICS* relates, “The name is a precise description of the business in which we are engaged, the manufacture of X Y positioning devices. X and Y represent the Cartesian coordinates and ‘netics’ is from the Greek ‘kinetikos’ which has the dual meaning of both ‘to move’ and ‘to command’. Our only difficulties to date have been a series of misspellings and inevitable mispronunciations.

Our consolation is that a few years ago ‘Xerox 914’ was thought to be an incomplete telephone number.”

The word *Kodak* was first registered as a trademark in 1888, having been adopted the year before as the name of a camera that was to make photography everybody’s hobby. This first Kodak camera sold for \$25 already loaded with film; and after 100 exposures, it was returned to the factory for the developing and printing of the pictures and the insertion of another roll of film.

There has been some fanciful speculation on how the name was originated. But the plain truth is: George Eastman invented it out of thin air!

“I devised the name myself . . . the letter ‘K’ had been a favorite of mine—it seems a strong, incisive sort of letter . . . It became a question of trying out a great number of combinations of letters that made words starting and ending with ‘K.’ The word ‘Kodak’ is the result.”

*Lectrion*, one of the few companies headquartered on an island (Whidbey Island, near Seattle), coined its name from the word “electronics” but with a twist that is decidedly different.

Frederick Van Veen, *Teradyne* Publicity Manager, explains that the company name has no particular meaning other than to suggest a highly dynamic company. He claims some people refer to them as the Japanese branch of *Tele-dyne*, but they just shrug that off.

“The *Teradyne* subsidiary that owns all of the buildings we occupy,” he says, “is called *Terrafirma Inc.*—so you see we have had our own fun with our name.”

Then there’s the story behind *Zehntel* as told by Bill Martin, president and founder.

“We had decided to form a company, and were asked by a friend to bid with him on a job involving a digital system. We asked that he give us a day or two to get incorporated. We called our attorney and gave him six space-age type of names we thought fitted our type of activity. He called back and said that he hadn’t been able to incorporate us because three of the names were too similar to other companies’ names, one was on reserve, and the other two were already taken.

“We couldn’t bid this new job without being incorporated, and we couldn’t incorporate without a name. The name we wanted was something related to digital or small systems. After hours of searching we came across the German word ‘*zehntel*,’ which, according to the German dictionary, stood for ‘decimal.’ The next day we were incorporated under the name ‘*Zehntel*,’ using the anglicized pronunciation.

“The postscript to the story is that later we discovered that the preferred meaning of ‘*zehntel*’ is ‘one-tenth.’ It took us a few weeks to make a psychological adjustment to the new meaning, but to my knowledge it hasn’t been a problem.”

In 1946, there was a small Northwest company called Tekrad, that stood for Technical/Radio, but a few months after incorporation, the firm ran into troubles because a small receiver-tube manufacturer on the East Coast had copyrighted the name Tekrad. The name was then changed to *Tektronix*, a phonetic spelling of a coined word for technical and electronics.

*AMPEX* is coined from the initials of the Company's founder; Alexander M. Poniatoff—AMP—plus EX, which stands for excellence.

D. G. C. Hare sold his DGC Hare company to Sangamo in 1956 and in 1958 moved to Grass Valley, Calif. to set up an R&D Lab for Sangamo. In 1959 he started another company on a shoestring, and on the day of incorporation decided to call his company *The Grass Valley Group*, for no good reason at all.

"About the only problem has been that some people think we are a medical or insurance group . . . but in the Television Industry, we are pretty well known as 'The Group.'"

F. Douglas Van Sicklen, president of *XYZ Corp.*, Newton, Mass., tells us why this unusual name was chosen.

"For years people have referred to the 'XYZ Company,' so we decided to capitalize on this mythical company's notoriety. We're a rather unusual organization of engineers and entrepreneurs. Our business is putting other companies in business. We have 25 to 30 products already developed that we use to start new companies. We provide the seed capital, get the people and management team, and get additional financing when needed. Next time a would-be entrepreneur thinks of starting an XYZ company, we hope he'll think of us and let us help him get started."

*Intech* founders selected their name since it sounded like a technology-based company. The name cleared registration—so they stuck with it.

*Itron*, like *Intech*, is a name that doesn't mean anything in particular. *Itron* was picked because it gave the impression that the company was in electronics, and yet was not restrictive to any specific area, since product line diversification was planned.

Harold E. Eden, president of *IOMEC*, manufacturer of computer peripherals, explains, "IOMEC actually had a logotype before we had a name. We had settled on 'Informec Inc.,' but the name was not available because another company had a similar name. We didn't want to lose the logotype, so we had to come up with another name beginning with 'I.' We merely dropped the 'nf' from the 'Infomec' to get 'Iomec.' Now we're delighted with both the name and the logotype."

As you can see, selecting a name is not as easy as it first appears. There is almost no foolproof way to insure that your company name or logo

GALVIN MFG. CORPORATION

*Motorola*

*Motorola*

*Motorola Inc.*

*Motorola Inc.*

**Motorola**

**MOTOROLA**

"Motorola" became a trademark of the Galvin Manufacturing Corp. in 1930 to identify a line of radios for motor cars. In 1947 it became the corporate name, and the present logotype (bottom) was introduced in 1955.

is not in conflict with another previously registered corporate name or trade mark. The best you can do is check to see if your proposed name is in conflict with an existing corporation—then register the name in your state and keep your fingers crossed.

#### What's in a name tag?

Corporate names, of course, are neither good nor bad in themselves. If the corporation is successful, the name will be good. If it flops, the name will be lousy. "Xerox" is a beautiful example. Who would ever have thought of choosing a funny Greek word that most people couldn't spell or pronounce? Except for its brevity, it's a bad choice by all the usual criteria. Yet the success of the company has made it one of the great corporate names. ■■

The logos represent the following companies: Inter-sil; 'Lectrion; Iomec; Motorola; Four Phase Systems; Grass Valley Group; Zehntel; and Xynetics.

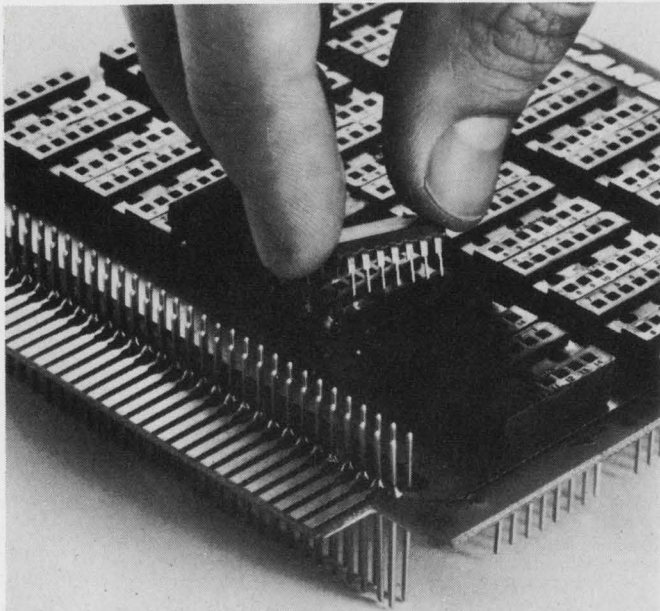

## use our wire-wrap\* cambi-cards to keep your ic's in line

Matter of fact, we'll help you package whole IC sub-systems. Start with our 4.5 x 4.5 inch or 4.5 x 9.25 inch Cambi-Card® printed circuit boards with 70-pin input/output edge connectors, containing Wire-Wrap sockets for 14, 16 or 24-pin dual in-line IC's. Then our precision fabricated card files with 13 or 26 positions. Next our 13 or 26 position power planes.

And if you need 'em, our card extenders, Wire-Wrap card connectors, blank Cambi-Cards for discretes, pluggable/patchable breadboards for 16, 32 or 64 DIPS, patch cord kits . . . even our super fast, economical wire-wrapping service.

For details, call us or write for Catalog 92, the latest word on IC accessories and wire-wrapping. Cambridge Thermionic Corporation, 445 Concord Avenue, Cambridge, Mass. 02138. Phone: (617) 491-5400. In Los Angeles, 8703 La Tijera Boulevard 90045. Phone: (213) 776-0472.

\*Registered Mark of Gardner-Denver Co.

Standardize on

# CAMBION®

The Guaranteed Electronic Components

INFORMATION RETRIEVAL NUMBER 36

## Standard Logic Symbol Templates for Digital Processing

**RAPIDESIGN®**

Saves time and improves accuracy. MIL-STD-806 plus Y32.14. Available in five sizes: full size, three-quarter, half, three-eighths, and one-quarter. Like all RapiDesign templates, has a 1/4" pencil allowance to assure uniformity and accuracy. Packed with new RapiDesign TempLift for no-smear inking. Available almost everywhere that engineering supplies are sold. For detailed information on nearly 200 Professional Drafting Templates, send today for your free copy of the 1971 RapiDesign Catalog.

RAPIDESIGN INC., P.O. BOX 6039, BURBANK, CALIF 91505  
A SUBSIDIARY OF BEROL CORPORATION

**BEROL®**

INFORMATION RETRIEVAL NUMBER 37

# FREE

## BUTTite SPACERS®

# SAMPLES

from tremendous stocks  
of over

### 1000 DIFFERENT STANDARDS!

**IMMEDIATE  
DELIVERY!**

#4 bolt size to 1" diameter  
3/16" to 4" in length

Square ends, burr-free edges!

Send for literature and free  
samples . . .

## CEM COMPANY, INC.

50 SCHOOL STREET, DANIELSON, CONN. 06239  
INFORMATION RETRIEVAL NUMBER 38

ELECTRONIC DESIGN 2, January 21, 1971

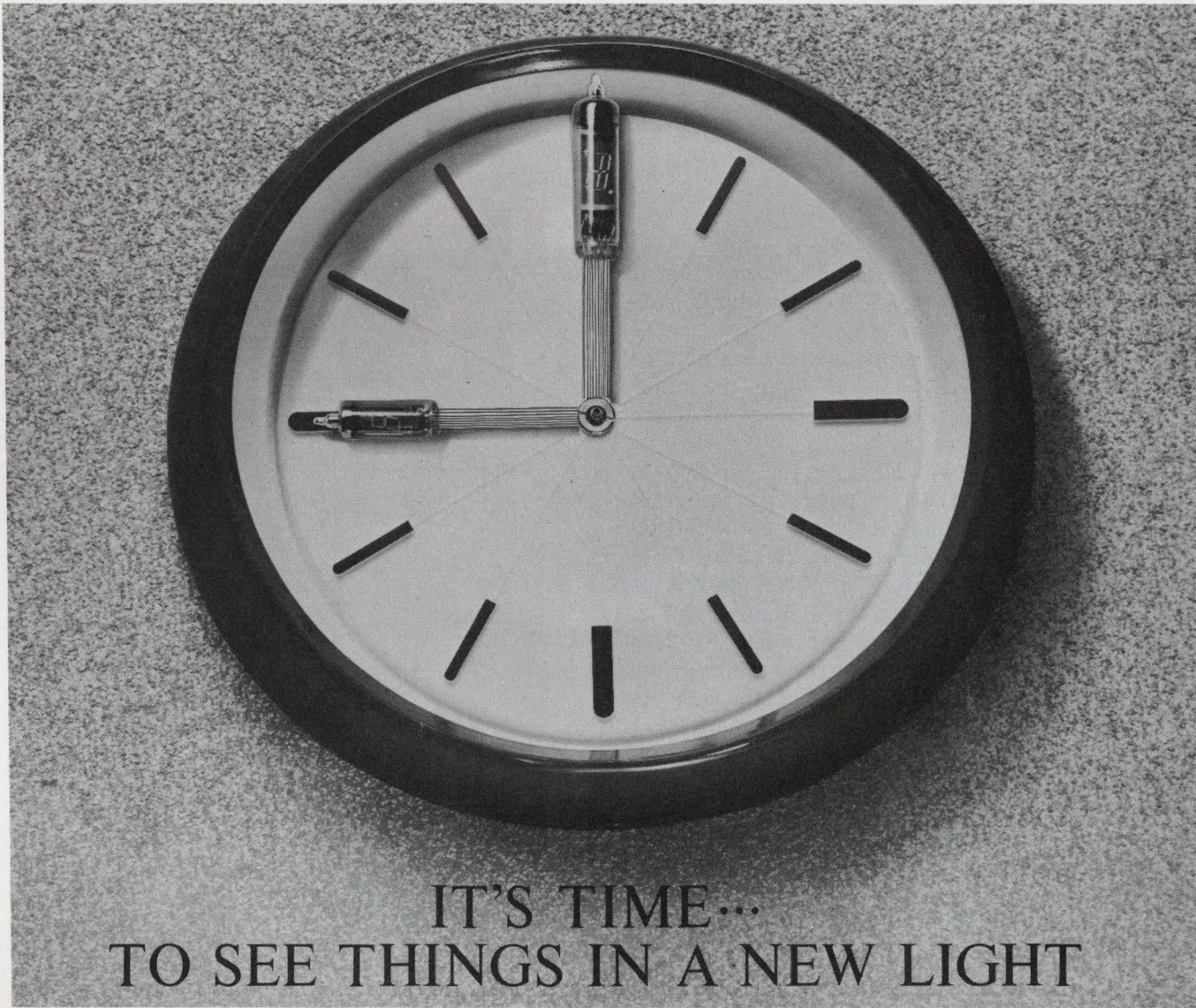

## IT'S TIME... TO SEE THINGS IN A NEW LIGHT

When multi-faceted display problems dictate 9 to 9 work days, it's high time you saw things in a new light, on a single plane with no "dancing" digits and with no eye strain.

Legi DG 12C numerical indicator tube segments are an eye-easy phosphor green for a readout as bright and clear as day, legible at distances over 35 feet.

These tubes offer low-voltage, low current drain, and high stability advantages so definitive and pack a performance punch so large, you can't afford not to afford to examine full particulars. They fit to the "T" perfectly portable and circuit-board mounting applications and are available at mass production prices. Look at these important particulars, then write for comprehensive data

that show display tube performance in an entirely new light:

### LEGI DG 12C

- Filament voltage at 95 mA ..... 0.85 volts  $\pm$  10%
- Phosphor segments & control grid ..... 20 Vdc
- Brightness ..... 80 foot -lamberts
- Operating temperature .....  $-10^{\circ}$  to  $+70^{\circ}$  C
- \* Dynamic life expectancy ..... 200,000 hrs.

U.S. PATENT 3508101

*Legi* Sole U.S. Distributor:

### Legi Electronics Corporation

3118 West Jefferson Blvd. Los Angeles, California 90018 U.S.A.  
Phone: RE 3-4508, 733-9105



Manufacturer:

### Ise Electronics Corporation

P.O. Box 46, Ise City Mie Pref., Japan Phone: Mie (059627) -26

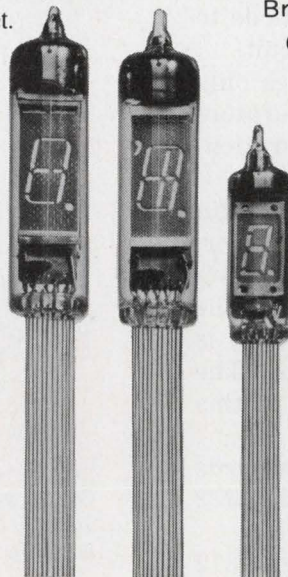

DG 12H

DG 10A

INFORMATION RETRIEVAL NUMBER 39

# ideas for design

## Set and reset flip-flops with separate pulses

In computer interfacing and control timing, it is often necessary to set and reset a flip-flop on the trailing edges of two separate pulses, where the pulses may be asynchronous and each may be at either ONE or ZERO level when the other occurs. This action can be accomplished by using a dual J-K flip-flop IC.

In the circuit shown, FF-1 is the flip-flop to be set and reset by the two pulses. In the reset condition both FF-1 and FF-2 are in the ZERO state. On the trailing edge of a set pulse, FF-1 toggles to the ONE state. The ONE output of FF-1 is then high, enabling the J input of FF-2. On the trailing edge of a reset pulse FF-2 is then set to the ONE state, and the resulting low ZERO output of FF-2 resets FF-1 through its direct reset input. The low ONE output of FF-1 resets FF-2 through its direct input, and the circuit is now ready for the next cycle.

In the case of a series of set pulses between reset pulses or vice versa, the circuit responds to only the first pulse of the series. The circuit is compatible with almost any line of logic commercially available. The width of the set and reset pulses can vary from 50 ns to several seconds.

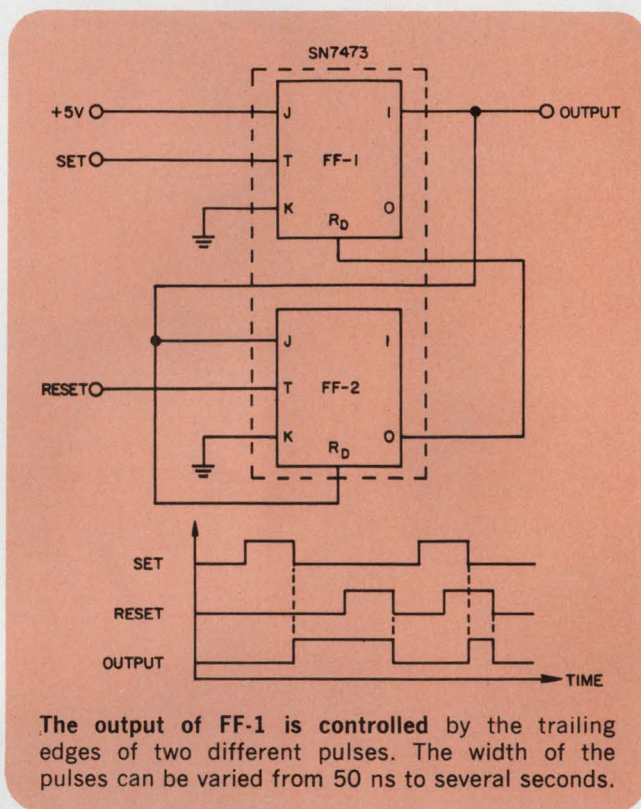

The output of FF-1 is controlled by the trailing edges of two different pulses. The width of the pulses can be varied from 50 ns to several seconds.

Edward S. Peltzman, Engineering Specialist, Tridea Electronics, 11581 Federal Drive, El Monte, Calif. 91731.

VOTE FOR 311

## Digital hysteresis amplifier cleans up noisy signals

Noisy or slowly varying input signals can create unwanted oscillations at the outputs of digital logic elements. The digital hysteresis amplifier shown eliminates the oscillations by using the forward voltage drop across a diode to increase the hysteresis of a switching circuit.

In addition to the diode, the circuit uses only one quad or triple-gate IC. Unlike comparators and op amps used in a hysteresis configuration, this circuit needs only a single 5-V dc source.

There is no loss in the input low-level margin as might be expected (see waveforms); however, precautions must be taken to ensure that the sum of the diode forward voltage drop,  $V_f$ , and the low-voltage value of the input signal,  $V_{i(LOW)}$ , is below the switching threshold of gate  $G_2$ . The diode will tend to compensate for changes of this threshold with temperature.

R. C. Nybo, Principal Engineer, Standards Engineering, Univac, Federal Systems Div., 322 N. 21 St. West, Salt Lake City, Utah 84116.

VOTE FOR 312

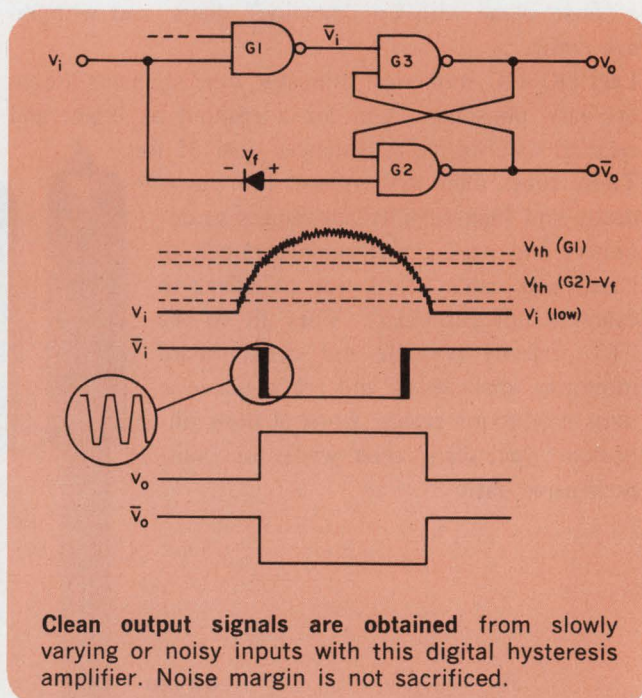

Clean output signals are obtained from slowly varying or noisy inputs with this digital hysteresis amplifier. Noise margin is not sacrificed.



# MICROWAVE DOUBLE-BALANCED MIXERS



Model M1G  
Inputs (L&R): 1-4.2 GHz  
Output (I): DC-1 GHz



Model M1H  
Inputs (L&R): 1.8-4.2 GHz  
Output (I): DC-2.0 GHz

## Lower noise figure . . . more isolation . . . wider bandwidth

You can now improve your microwave designs with double-balanced mixers that have a new plateau of performance—a performance previously available only in RELCOM's lower frequency mixers. The table below shows the improved mixer performance available with the new RELCOM M1G and M1H:

NOW from RELCOM	Previously available
30 dB isolation	20 dB
6 dB noise figure	8 dB
1 to 4.2 GHz input	Octave bands
DC to 2 GHz IF range	? to 1 GHz
Guaranteed MIL environments	Lab environments only
Delivery from stock	?
\$199 each	>\$300 each

With these new microwave mixers you get better suppression of IMD products, less LO leakage, better system sensitivity, and a wide frequency range—all at a much lower price and with RELCOM's high reliability.

And remember that RELCOM's proven reliability and unmatched performance are *guaranteed even after our mixers are put to MIL-STD-202C environmental stress.*

Compare our microwave performance for yourself. Circle our Reader Inquiry Number or call our factory sales engineer for additional data.

Better yet, requisition your own evaluation unit from our stock. It's easy—just call us.

2329 Charleston Road • Mountain View • California 94040  
Telephone (415) 961-6265 • TWX (910) 379-6979

**RELCOM**  
Reliable signal-processing components

## Adding three components cuts regulator ripple

Simple regulator circuits provide two paths through which ripple and input variations can reach the error amplifier—and thus the output. One is through  $R_1$  to the base of  $Q_2$ ; the other is through  $R_2$  to the collector of  $Q_1$  (dashed portion of the illustration).

The first path can be easily eliminated by providing a constant-current source for the zener diode. The second path is removed by replacing the dashed circuitry with two resistors and a transistor as shown in color in the diagram.

To see how this arrangement works, assume that an error signal at the base of  $Q_1$  has caused a change in  $I_{c1}$  of  $\Delta I$ . This, in turn, will cause  $I_{c2}$  to change by  $\Delta I$ , resulting in a change in the voltage drop across  $R_7$  and, hence, a change in the bias of  $Q_4$ . This in turn, will change the current through  $R_8$  by an amount  $\Delta I(R_7/R_8)$ .

The change in current through the base of  $Q_3$  will thus be equal to  $\Delta I(1+R_7/R_8)$ . If  $R_7 = R_8$ , the change will be  $2\Delta I$ . If  $R_8$  is chosen equal to  $R_7$  and  $R_8$ , current will be equally shared between  $Q_1$  and  $Q_2$ . Changes in the input signal will appear across both  $R_7$  and  $R_8$  and not across the output.

Because of the very high gain of the circuit, it may be necessary to connect a small capacitor—

about 1.0 nF—between the collectors of  $Q_1$  and  $Q_2$  to eliminate high-frequency oscillations.

The components shown in the diagram will provide a 12-V output at up to 100 mA for inputs of 18 to 30 V. The 2N3019 should be fitted to a suitable heat sink.

*A. Johnstone, Chief Engineer, Electronic Consultants, P.O. Box 27, Stoke-on-Trent, England.*

VOTE FOR 313

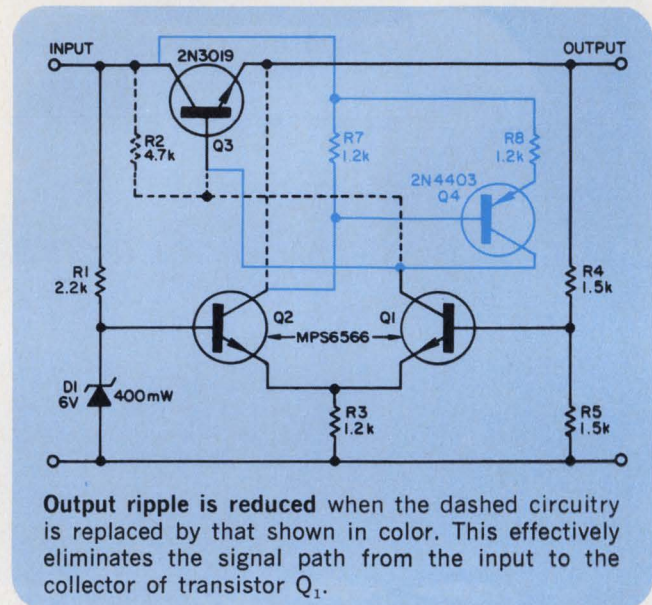

## Get longer time delays with TTL ICs

Some pulse detector or limiter applications require time delays longer than is normally possible with TTL ICs. Delays of 1.5 ms/ $\mu$ F can be obtained by using the open collector versions shown

in Fig. 1. The output is delayed by a specified time after the input is applied.

A further application of this delay method is shown in Fig. 2. With this configuration, an out-

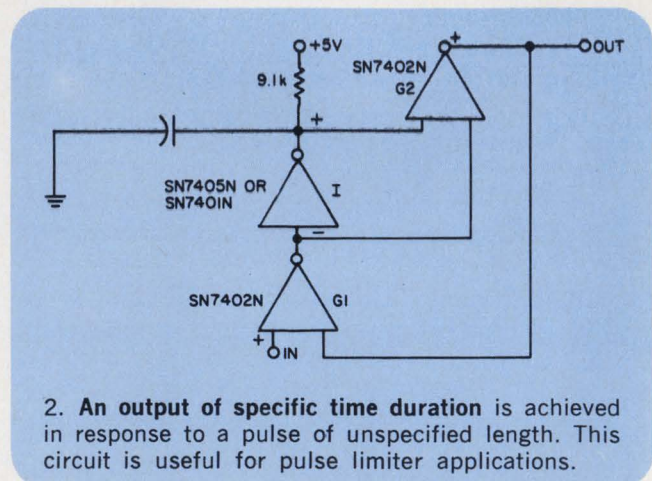
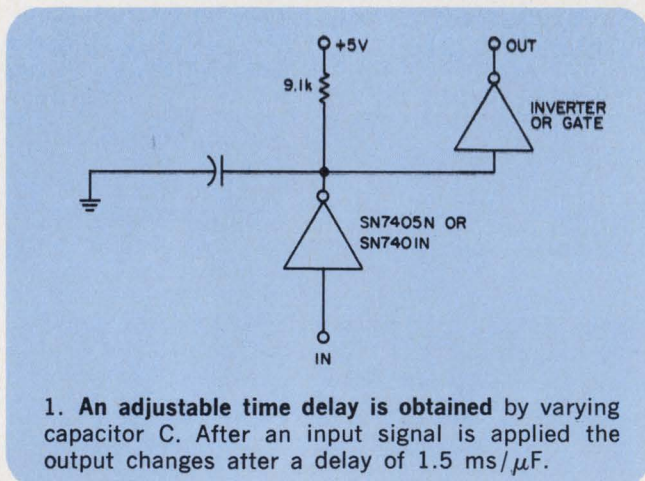

# If a thousand solid-state low-level switches won't turn you on, how about \$80 a switch?

You may not have 1024 signals at 2.5 millivolts that you want to run at 15kHz, but you can control that many if you want to by hooking eight of our solid-state differential multiplexer units together.

What's probably more important to you is that, even if you need only 128 switch channels, it'll still cost you less than \$110 per channel, including a 12-bit A-to-D converter, power supply, all multiplexer control circuitry, 13 levels of programmed gain and interconnecting cabling — all ready to interface with your computer.

Actually, the incremental price per

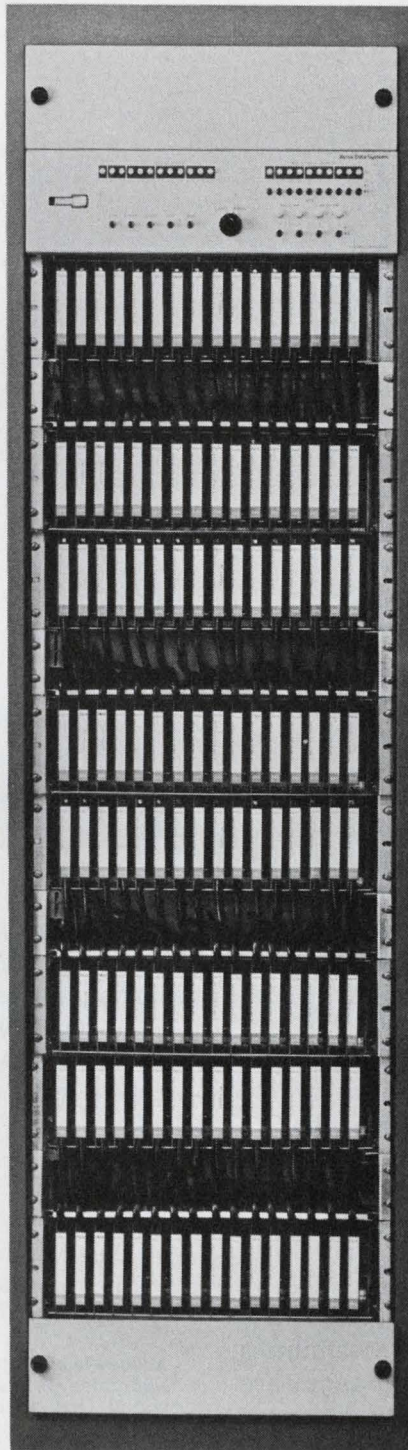

switch is only \$50. The other goodies make up the difference.

You'll also be relieved to know that our low-level multiplexer works. Over 40 systems are operating in the field with high reliability. User testimonials furnished on request.

If you're interested in low cost, flexibility and reliability in proven units that are available now, you ought to call us at (213) 679-4511, ext. 1139 or 3392.

If you're not in a hurry, write Xerox Data Systems, Dept. A, 701 South Aviation Blvd., El Segundo, Calif. 90245

**XDS**  
Xerox Data Systems  
El Segundo, California

put of specific time duration is achieved in response to an input pulse of unspecified length.

Gate  $G_1$  produces a ZERO output when a positive pulse is applied. This causes the outputs of gate  $G_2$  to switch to the ONE state. The output of  $G_2$  also latches  $G_1$ . At the same time the inverter switches to the ONE state, but not fast enough to affect the other input to  $G_2$ .

After the delay period, this second input to  $G_2$

becomes positive, switching  $G_2$  back to its normal ZERO state. The output of  $G_1$  then becomes positive when both inputs are ZERO. The ZERO output of  $G_1$  holds  $G_2$  in the ZERO state.

*W. M. Muehter, Engineering Consultant, American District Telegraph Co., 155 Sixth Ave., New York, N. Y. 10013.*

VOTE FOR 314

## Switch improves accuracy of op-amp comparator

The usual op-amp comparator with hysteresis (Fig. 1a), has input switching points that are functions of the output voltage,  $E_o$ . Since the two stable-point voltages of  $E_o$  are typically specified rather loosely, the switching-point accuracy is low.

The equation for the switching points is given by

$$E_i = \frac{E_o R_2 / R_f}{1 + (R_2 / R_f) + (R_2 / R_1)} + \frac{E_b R_2 / R}{1 + (R_2 / R_f) + (R_2 / R_1)}$$

where  $E_i$  is the input switching-point voltage and  $E_b$  is the bias voltage. Since the output voltage can assume two values, depending upon the state of the comparator, the equation gives two values for  $E_i$ .

To build a comparator with a higher degree of accuracy, a designer can use a controlled switch in the op-amp circuit (Fig. 1b). The switch, which is controlled by the output voltage,  $E_o$ , can be a saturating transistor or a FET. Since  $E_o$  is not fed back to the op amp's input, it does not affect the switching-point accuracy. Instead, the switching points are determined by the bias voltages  $E_{b1}$  and  $E_{b2}$  and by the quality of the switch. If the bias voltages are chosen so that

$$|E_{b1}| > |E_{b2}|,$$

then the comparator will exhibit hysteresis. If, however,

$$|E_{b1}| < |E_{b2}|,$$

the circuit will oscillate at a rate determined by the circuit's time constants.

A whole new world of application possibilities opens up if one or both of the bias voltages are allowed to vary and if a time delay is introduced between the comparator output and the switch. For example, the complex feedback networks used in some a/d converters and delta modulators consist of comparators, feedback step or ramp

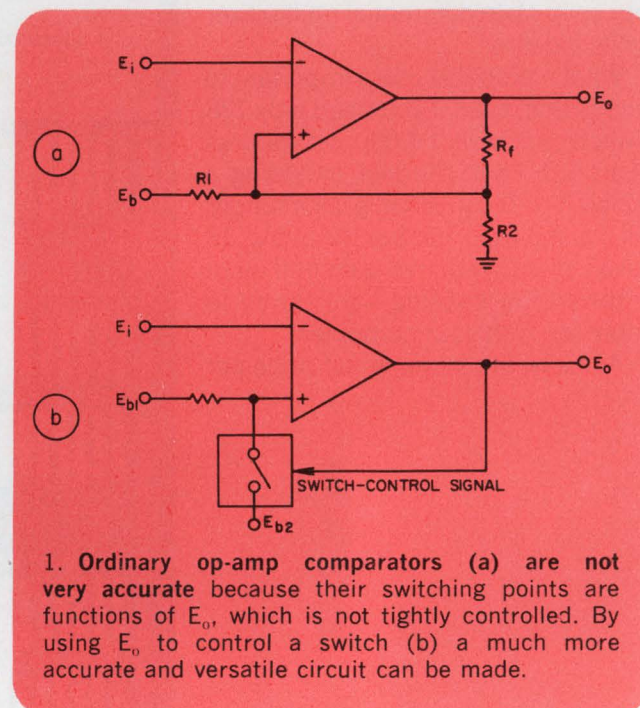

1. Ordinary op-amp comparators (a) are not very accurate because their switching points are functions of  $E_o$ , which is not tightly controlled. By using  $E_o$  to control a switch (b) a much more accurate and versatile circuit can be made.

generators and timed or delayed switches. Simpler configurations can be used to make single-pulse generators and gated oscillators.

To consider just one simple application of the circuit of Fig. 1b, it can be used to generate a square wave of period  $2T$  if three conditions are met:

1.  $|E_{b2}| > |E_i|_{\max}$
2.  $\text{sgn } E_{b2} = \text{sgn } E_i$

3. A delay of duration  $T$  is placed in the path of the switch-control signal.

The oscillations will be present as long as  $|E_i| > |E_{b1}|$ .

**Acknowledgment:** This research was performed at the Ordnance Research Laboratory under contract with the Naval Ordnance Systems Command.

*Ralph M. Seeley, Ordnance Research Laboratory, Pennsylvania State University, P. O. Box 30, State College, Pa. 16801.*

VOTE FOR 315

**"Bigger and better...this  
engineer's bible..."**

**—ELECTRONICS MAGAZINE**

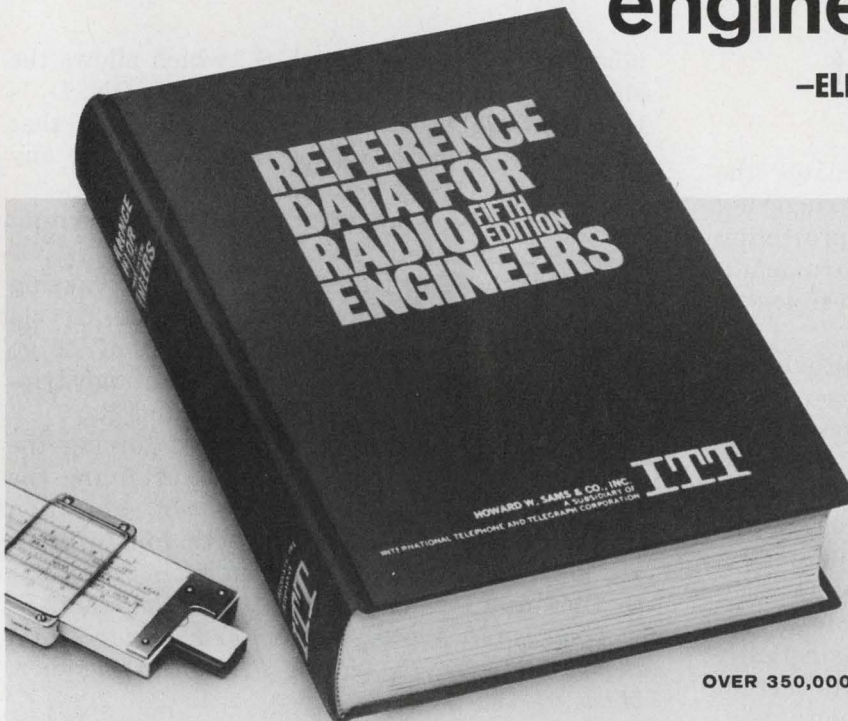

**5th EDITION of a  
world-famous reference**

Now contains 50% MORE DATA to include major information developed over the past 12 years. Prepared by an outstanding group of practicing engineers, professors, and industry and government experts, under the direction of the International Telephone and Telegraph Corporation staff.

**OVER 350,000 COPIES SOLD IN PRIOR EDITIONS**

# Reference Data for Radio Engineers

## CHAPTER CONTENTS

Frequency Data	Transmission Lines
*International Telecommunication Recommendations	Waveguides and Resonators
Units, Constants, and Conversion Factors	Scattering Matrices
Properties of Materials	Antennas
Components or Parts	Electromagnetic-Wave Propagation
Fundamentals of Networks	Radio Noise and Interference
Filters, Image-Parameter Design	Broadcasting and Recording
Filters, Modern-Network-Theory Design	Radar Fundamentals
Filters, Simple Bandpass Design	Wire Transmission
Attenuators	*Switching Networks and Traffic Concepts
Bridges and Impedance Measurements	Digital Computers
Magnetic-Core Transformers and Reactors	*Navigation Aids
Rectifiers and Filters	*Space Communications
Magnetic Amplifiers	Electroacoustics
Feedback Control Systems	Nuclear Physics
Electron Tubes	*Quantum Electronics
Electron-Tube Circuits	Information Theory
Semiconductors and Transistors	Probability and Statistics
Transistor Circuits	*Reliability and Life Testing
*Microminiature Electronics	Miscellaneous Data
Modulation	Fourier Waveform Analysis
	Maxwell's Equations
	Mathematical Equations
	Mathematical Tables

\*New chapters on subjects not covered in 4th Edition

**1196 PAGES • 1350 ILLUSTRATIONS**  
plus 41 page index

The FIFTH EDITION of this widely used reference work has been completely revised and updated. It provides in a single volume comprehensive data on all basic phases of electronics, including tables, formulas, standards, and circuit information—*PLUS*—all-new data on microminiature electronics, space communications, navigation aids, reliability and life testing, international telecommunication recommendations, switching networks and traffic concepts, and quantum electronics. Includes over 1300 charts, nomographs, diagrams, tables, and illustrations. 45 data-packed chapters. 1196 pages of invaluable information for practicing radio and electronics engineers.

## 10-Day Free Examination

**HOWARD W. SAMS & CO., INC.**, Dept. ED-011  
A Subsidiary of International Telephone & Telegraph Corporation  
**4300 West 62nd Street, Indianapolis, Ind. 46268**

- Send me REFERENCE DATA FOR RADIO ENGINEERS for 10-day examination, without cost or obligation. If I decide to keep the volume, I will send \$20.00 (plus postage) in 10 days; otherwise, I will return the book within 10 days.
- \$20 payment enclosed. Send my copy postpaid with full 10-day refund privilege. (Include sales tax where applicable.)

Name \_\_\_\_\_

Company \_\_\_\_\_

Address \_\_\_\_\_

City \_\_\_\_\_

State \_\_\_\_\_

Zip \_\_\_\_\_

## Semiconductor trip circuit protects delicate circuitry

A semiconductor trip circuit eliminates the conventional-fuse problems of slow triggering and high resistance, thus effectively protecting semiconductor circuitry or sensitive instrumentation. Figure 1 shows a transistorized version of such a circuit.

The transistor  $Q_1$  is saturated and provides a low and practically constant impedance path to ground for the network requiring protection. Transistor  $Q_2$  is biased OFF through diode  $D_1$ . Saturation base current is supplied to  $Q_1$  by the trip-adjust resistors  $R_2$  through  $R_4$ . Resistor  $R_3$  provides selection of the desired trip current.

When a short occurs, the collector of  $Q_1$  rises above its saturation voltage because of the demand of unavailable current, and  $R_1$  instantly saturates  $Q_2$ . Transistor  $Q_2$  further limits current to  $Q_1$ , thus providing network protection.

The trip circuit can be restored by pressing the

normally closed reset switch  $S_1$ , which allows the slight bias on the base of  $Q_1$  to turn it ON.  $D_1$  is then forward-biased and  $Q_2$  turns OFF. Note that the protected network can be powered by any positive voltage that is compatible with  $Q_1$ .

Figure 2 shows another way of implementing the trip circuit using an integrated circuit NAND gate. Switch  $S_1$  activates the circuit by causing a logic 0 to be temporarily applied to  $G_1$  via capacitor  $C_1$ . This causes the output of  $G_1$  to go high.  $G_1$  turns  $Q_1$  ON to saturation through trip-point current-limiting resistors  $R_4$  and  $R_5$ .

Diode  $D_1$  is now forward biased, forcing the second input to  $G_1$  to go low and sustaining the base bias to  $Q_1$ . If  $Q_1$  is pulled out of saturation by excessive current demand, both inputs to  $G_1$  are high, causing the low output from  $G_1$  to bias  $Q_1$  OFF and terminating the output current.

*Alphonse H. Marsh, Jr., Senior Engineer, Raytheon Company, 111 Horse Pond Rd., Sudbury, Mass. 01776.*

VOTE FOR 316

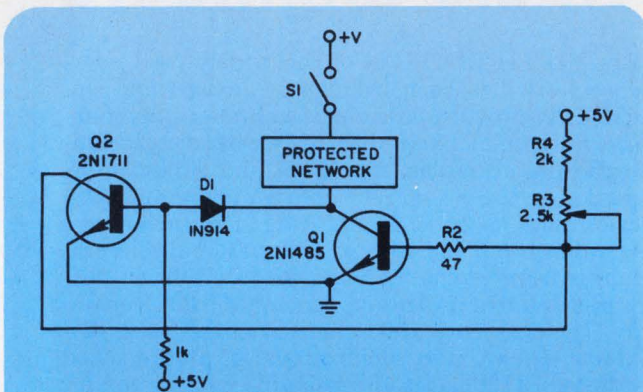

1. Transistorized trip circuit protects semiconductor networks without the speed and impedance drawbacks of conventional-fuse techniques.

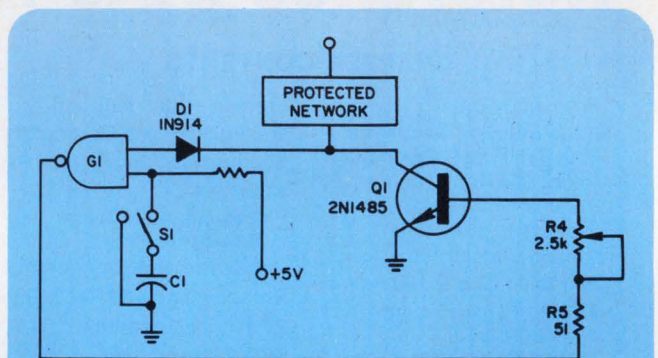

2. An integrated circuit NAND gate can also be used to implement the high-speed trip circuit. The trip-point control resistors are  $R_4$  and  $R_5$ .

### IFD Winner for September 27, 1970

Davis E. Wilson, Supervisor, Support Systems, Lockheed Missiles & Space Co., P. O. Box 4097, Patrick AFB, Fla. His idea "Tunable Low-Cost LC Oscillator Has Excellent Stability" has been voted the Most Valuable of Issue award.

Vote for the Best Idea in this Issue.

**VOTE!** Go through all Idea-for-Design entries, select the best, and circle the appropriate number on the Reader-Service-Card.

**SEND US YOUR IDEAS FOR DESIGN.** You may win a grand total of \$1050 (cash)! Here's how. Submit your IFD describing a new or important circuit or design technique, the clever use of a new component or test equipment, packaging tips, cost-saving ideas to our Ideas-for-Design editor. You will receive \$20 for each accepted idea, \$30 more if it is voted best-of-issue by our readers. The best-of-issue winners become eligible for the Idea Of the Year award of \$1000.

# Our new OEM series is the best power supply you can buy for applications that don't need the best power supply you can buy.

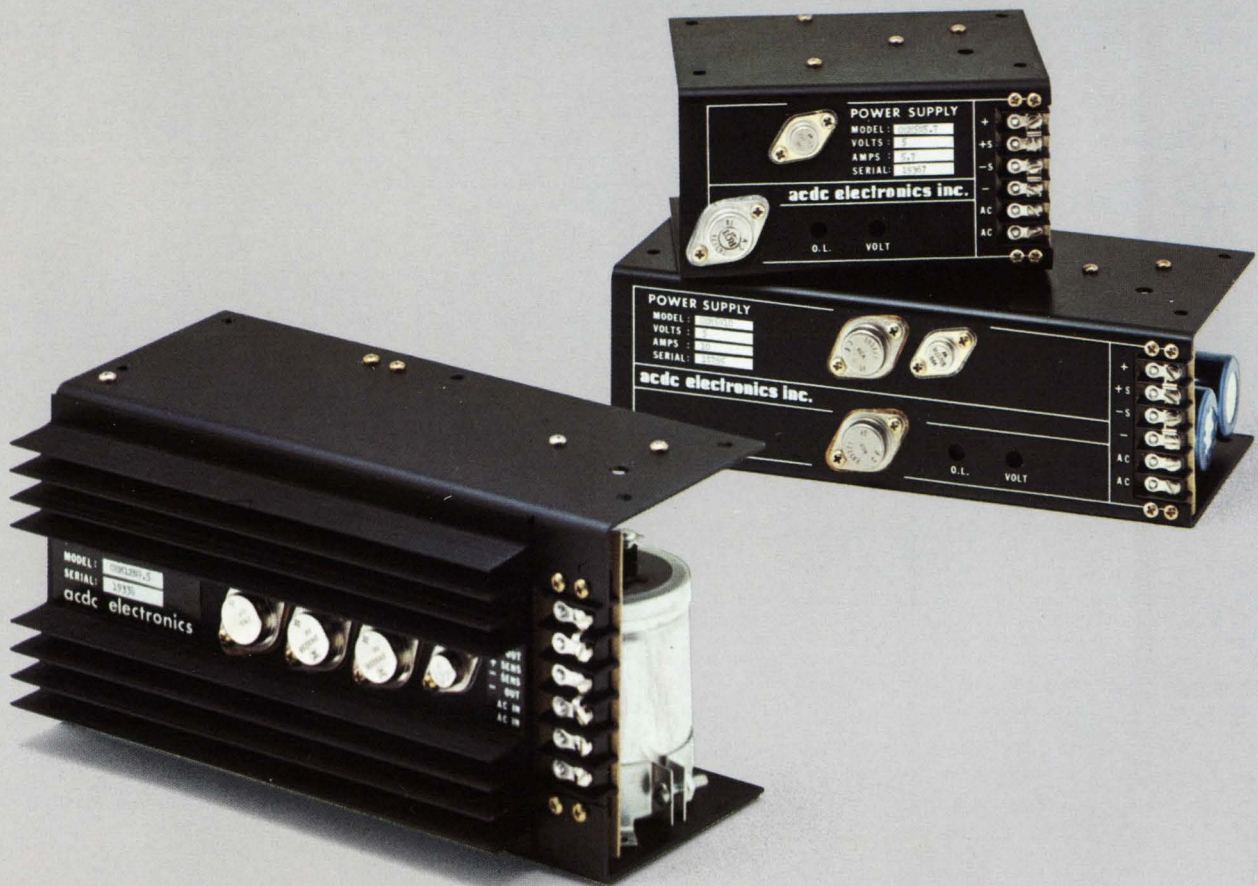

Most OEM applications don't need all the special features we build into our best line of power supplies. And most OEM power supply users just won't pay for features they don't need. That's why we've introduced a new power supply designed especially for the OEM user.

We call it our OEM Series power supply.

There are 51 models in this new series from 4 to 32 volts and in current ranges from 0.9 to 18 amps. The OEM series offers 0.1% regulation instead of our usual 0.01% and

comes with open frame construction instead of our usual closed black box. Aside from that, you might never notice any other difference. The OEM series features the same excellent stability, same dependable overload protection, same versatile mounting capability, same "guaranteed forever" performance and same off-the-shelf delivery. The only conspicuous difference is in the price.

So now, when you don't need the best power supply that we sell, we can sell you the best power supply that you need.

**acdc electronics inc.**

Oceanside Industrial Center, Oceanside, California 92054, (714) 757-1880

Input	105-125 VAC, 47-63 Hz (Useable also at 400 Hz; consult factory for derating.)
Output	See table. Output is floating; either positive or negative output terminal may be grounded. Zero to full load current ratings as shown in table.
Regulation	0.1% +5 mV NL-FL, ±0.1% ±5mV for 10% Input change.
Ripple	2mV RMS max., 20 mV P-P max.
Stability	Typically 10mV for eight hour period after initial warmup.
Temp. Coeff.	0.02%/°C max.
Output Impedance	DC-1KHz: 0.001 R <sub>L</sub> or 0.005 ohm max. 1KHz-100KHz: 0.005R <sub>L</sub> or 0.03 ohm max. (R <sub>L</sub> is the rated load)
Transient Response	Output voltage returns to within regulation limits within 50 μsec in response to a 50% load step.
Remote Sensing	Terminals are provided to maintain regulation at the load, compensating for the DC voltage drop in the load cable.
Remote Voltage Adjustment	Output voltage may be remotely adjusted over a limited range by insertion of a variable resistor in the positive sensing line.
Overload Protection	Inherently protected against overload and short circuit by a foldback type characteristic.
Overvoltage Protection (Optional)	Any model can be furnished with overvoltage protection which crowbars the output in the event of a rise in the output voltage of between 1 to 2 Volts or 10-20% (whichever is larger). This protection circuit is completely independent of the supply and is adjustable. The addition of overvoltage protection does not add to the outline dimensions of the supply.
Ambient Temperature	Operating: 0 to 71 °C Storage: - 50 to 85 °C
Construction	Integral aluminum chassis and heatsink. Printed circuit regulator board may be removed for servicing. Three sides are open to allow unobstructed ventilation, easy inspection and accessibility.
Mounting	Units may be mounted on five surfaces for unusual mechanical versatility. Self-locking mounting hardware for all mounting variations supplied with each unit.
Connector	Barrier strip.
Dimensions	See Table Below.

DIMENSIONS				
Case Size	H	W	L	Weight Approx. (Lbs.)
R1	3 <sup>3</sup> / <sub>16</sub>	4 <sup>15</sup> / <sub>16</sub>	6 <sup>1</sup> / <sub>4</sub>	4 <sup>1</sup> / <sub>2</sub>
R2	3 <sup>3</sup> / <sub>16</sub>	4 <sup>15</sup> / <sub>16</sub>	10	7 <sup>1</sup> / <sub>2</sub>
R3	4 <sup>15</sup> / <sub>16</sub>	4 <sup>15</sup> / <sub>16</sub>	10	12

Obtain ACDC outline drawing for design and mounting details.

① NOMINAL OUTPUT VOLTAGE	ADJ. RANGE ±V	MAXIMUM CURRENT RATING (AMPS)			CASE SIZE	MODEL NUMBER (add -1 for OVP)	PRICE <sup>②</sup> 10-24 PIECES (Add \$10 for OVP)
		40 °C	55 °C	71 °C			
4	.25	6.0	5.1	3.9	R1	OEM4N6	59.00
		11	9.3	7.1	R2	OEM4N11	84.00
		18	15.3	11.7	R3	OEM4N18	128.00
⑤	.25	5.7	4.8	3.7	R1	OEM5N5.7	59.00
		10	8.5	6.5	R2	OEM5N10	84.00
		17	14.5	11.0	R3	OEM5N17	128.00
6	.25	5.2	4.4	3.4	R1	OEM6N5.2	59.00
		9.5	8.1	6.2	R2	OEM6N9.5	84.00
		15	12.7	9.7	R3	OEM6N15	128.00
8	.25	4.2	3.6	2.7	R1	OEM8N4.2	59.00
		7.5	6.4	4.9	R2	OEM8N7.5	84.00
		12	10.2	7.8	R3	OEM8N12	128.00
10	.5	3.5	3.0	2.3	R1	OEM10N3.5	59.00
		6.5	5.5	4.2	R2	OEM10N6.5	84.00
		10.2	8.6	6.6	R3	OEM10N10.2	128.00
⑫	.5	3.2	2.7	2.1	R1	OEM12N3.2	57.00
		5.8	4.9	3.8	R2	OEM12N5.8	76.00
		9.5	8.1	6.2	R3	OEM12N9.5	119.00
14	.5	2.8	2.4	1.8	R1	OEM14N2.8	57.00
		5.2	4.4	3.4	R2	OEM14N5.2	76.00
		8.7	7.4	5.6	R3	OEM14N8.7	119.00
⑮	.5	2.7	2.3	1.7	R1	OEM15N2.7	57.00
		5.0	4.2	3.2	R2	OEM15N5	76.00
		8.2	7.0	5.3	R3	OEM15N8.2	119.00
16	.5	2.6	2.2	1.7	R1	OEM16N2.6	57.00
		4.7	4.0	3.0	R2	OEM16N4.7	76.00
		7.7	6.5	5.0	R3	OEM16N7.7	119.00
18	.5	2.3	1.9	1.5	R1	OEM18N2.3	57.00
		4.2	3.6	2.7	R2	OEM18N4.2	76.00
		6.9	5.9	4.5	R3	OEM18N6.9	119.00
20	1	2.1	1.8	1.4	R1	OEM20N2.1	57.00
		3.8	3.2	2.5	R2	OEM20N3.8	76.00
		6.2	5.3	4.0	R3	OEM20N6.2	119.00
22	1	1.9	1.6	1.2	R1	OEM22N1.9	57.00
		3.6	3.1	2.3	R2	OEM22N3.6	76.00
		5.9	5.0	3.8	R3	OEM22N5.9	119.00
⑳	1	1.8	1.5	1.2	R1	OEM24N1.8	57.00
		3.3	2.8	2.1	R2	OEM24N3.3	76.00
		5.4	4.6	3.5	R3	OEM24N5.4	115.00
26	1	1.7	1.4	1.1	R1	OEM26N1.7	57.00
		3.1	2.6	2.0	R2	OEM26N3.1	76.00
		5.0	4.2	3.2	R3	OEM26N5.0	115.00
㉑	1	1.6	1.4	1.0	R1	OEM28N1.6	57.00
		2.9	2.5	1.9	R2	OEM28N2.9	76.00
		4.7	4.0	3.1	R3	OEM28N4.7	115.00
30	1	1.5	1.3	1.0	R1	OEM30N1.5	57.00
		2.7	2.3	1.8	R2	OEM30N2.7	76.00
		4.5	3.8	2.9	R3	OEM30N4.5	115.00
32	1	1.4	1.2	0.9	R1	OEM32N1.4	57.00
		2.5	2.1	1.6	R2	OEM32N2.5	76.00
		4.3	3.6	2.8	R3	OEM32N4.3	115.00

① Contact ACDC for any voltage not listed

② In stock at ACDC (others available in 3 weeks)

③ 1-4 pcs: Add \$25

5-9 pcs: Add \$15

Contact ACDC or your local ACDC representative for higher quantity prices.



# OUR ANGLE: four frequency phase angle voltmeters

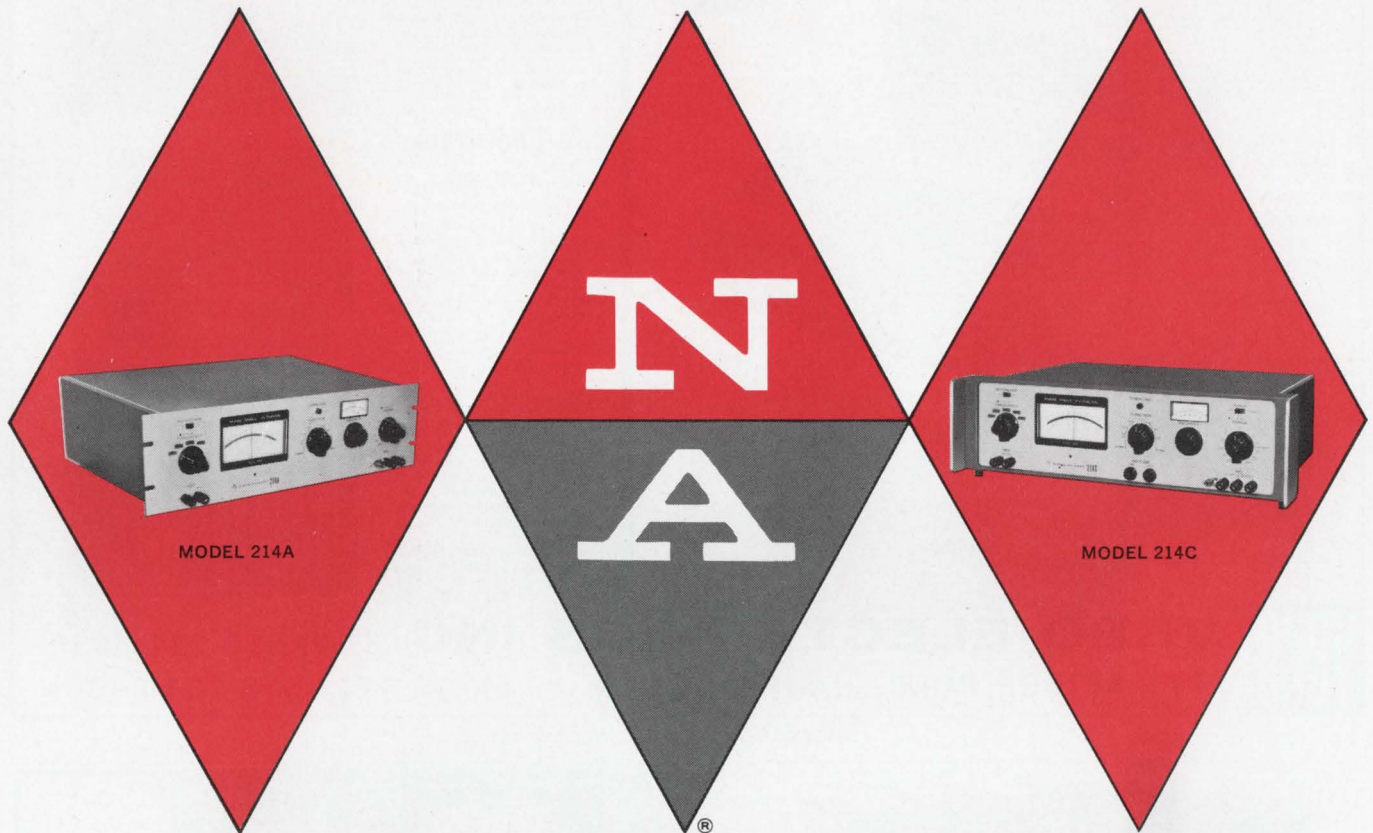

## CAN YOU THINK OF A BETTER ANGLE TO AVOID OBSOLESCENCE?

North Atlantic's 214 FOUR-FREQUENCY PHASE ANGLE VOLTMETER introduces a new flexibility in AC voltage measurements. It enables direct reading of null balance, total voltage, fundamental voltage, in-phase voltage, quadrature voltage, and phase angle.

It's also pre-wired to handle four operating frequencies from 30Hz to 20kHz, which means extended longevity and broader application. Even if you only need one frequency, there are three extra spots to add other frequencies later. Frequency changes can be made rapidly and conveniently in the field with plug-in modules. The 214 can be completely recalibrated at the installation site by a single rear-panel adjustment.

Harmonic rejection and high signal overload design of the unit screens out conventional distortion and errors in measurement and calibration. The all solid-state Model 214 offers full accuracy over  $\pm 5\%$  bandwidth,  $1^\circ$  phase measurement, adjustable meter scaling for go/no-go testing, and  $300 \mu\text{V}$  full-scale sensitivity. Priced from \$1215.00.

Options? Other models offer  $0.25^\circ$  phase accuracy, lower-cost single frequency operation, broadband phase-sensitive performance from 10Hz to 100kHz.

Whether your AC measurements are large or small, contact your North Atlantic sales engineering representative today. He'll show you a new angle to your AC voltage measurements.

**NORTH ATLANTIC**  
*industries, inc.*

200 TERMINAL DRIVE, PLAINVIEW, NEW YORK 11803  
cable: noatlantic / twx: 510-221-1879 / phone: (516) 681-8600

INFORMATION RETRIEVAL NUMBER 43

# COMPLETE PACKAGING CAPABILITY

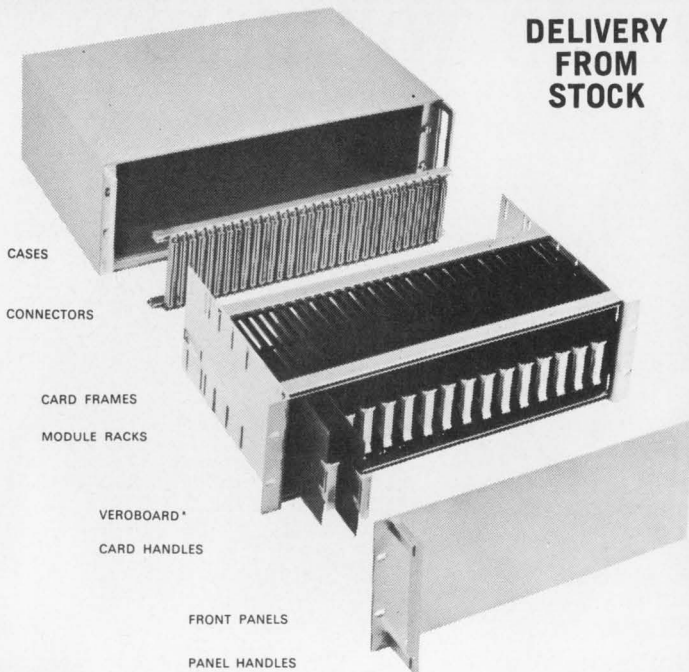

**DELIVERY  
FROM  
STOCK**

## VEROBOARD\*

THE UNIVERSAL PRINTED WIRING BOARD

- Hole Patterns—.1 x .1, .150 x .150, .156 x .1, .2 x .2, .2 x .1.
- Over 200 Standard Sizes — Single and Double Sided x-y pattern.
- Material — Epoxy Glass or Phenolic

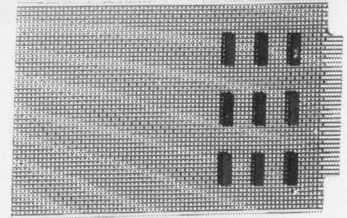

## VERO FINGER-BOARD

EPOXY GLASS WITH .1 x .1 HOLE PATTERN

- Dual In-Line Sockets plug in
- 1/16 Epoxy Glass
- Gold plated connector fingers with .1 and .156 spacing
- .052 holes accept Vero terminal pins and new clip #2147
- Matching connectors in stock

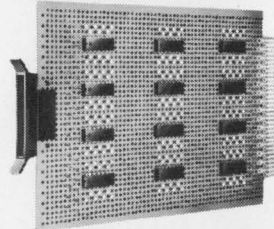

## VERO D.I.P. BOARD

FOR DUAL IN-LINE I.C. PACKAGES

- Accepts D.I.P. socket or direct I.C. plug in
- Gold plated contacts with connectors to match
- Boards available in epoxy glass 1/16 thick or low cost paper
- Complete versatility with continuous isolated pads on .1 centers holds 20 D.I.P.s on 4.5 x 6.5 board

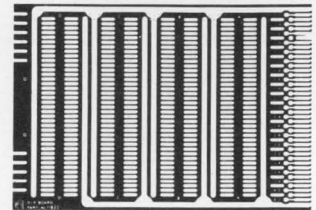

\*Patented

**vero**

**VERO ELECTRONICS INC.** TWX510-227-8890  
171 BRIDGE ROAD, HAUPPAUGE, N. Y. 11787 TEL: 516-234-0400

INFORMATION RETRIEVAL NUMBER 44

**NEW  
from CIE!**

Your chance to take  
**one giant step UP!**

**NEW home-study course in  
Electronics Engineering:**

- For the experienced electronics technician who wants to qualify for positions normally filled by college-graduate engineers.
- For the career engineer who feels he needs to update his electronics knowledge.

Send coupon below for complete information, or write:  
Cleveland Institute of Electronics, 1776 E. 17th St., Cleveland, Ohio 44114

**CIE** Cleveland Institute  
of Electronics

1776 East 17th Street, Cleveland, Ohio 44114

I'm interested. Please send me your 44-page catalog with details about CIE's new advanced course in Electronics Engineering.

Name \_\_\_\_\_ (please print)

Address \_\_\_\_\_

City \_\_\_\_\_ State \_\_\_\_\_ Zip \_\_\_\_\_

**Veterans & Servicemen:** check here for G.I. Bill information.  
Accredited Member National Home Study Council.

ES-1

INFORMATION RETRIEVAL NUMBER 45

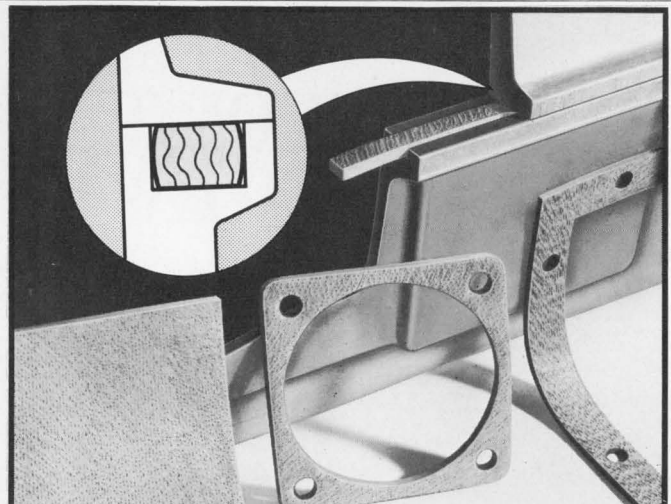

## EMI/RFI GASKETING SILICONE/CONVOLUTED WIRE

ELASTOMET • Composite silicone elastomer containing independent convoluted wire • Over 900 contact points/square inch • Excellent environmental sealing • High Total Shielding Effectiveness • Operating Temperatures: -65° F. to +450° F. • Compressible under low closing forces • Available in sheets, strips, and gaskets • Write for data #820.

**TECKNIT**®

TECHNICAL WIRE PRODUCTS, INC.

East Division • 129 Dermody St., Cranford, N.J. 07016 (201) 272-5500  
West Division • 427 Olive St., Santa Barbara, Calif. 93101 (805) 963-1867

INFORMATION RETRIEVAL NUMBER 46

ELECTRONIC DESIGN 2, January 21, 1971

# new products

## Flexible scope system with 9 plug-ins allows economical measurements

Tektronix, Inc., P. O. Box 500, Beaverton, Ore. Phone: (503) 644-0161. P&A: see text; stock to 2 months.

Offering the user flexibility and the ability to economically choose a professional measurement system compatible with his needs, a new dc-to-2-MHz low-cost modular oscilloscope system includes four interchangeable displays for single and dual-beam storage and non-storage applications, six amplifier and three time-base plug-ins for high-gain and delayed-sweep measurements, one to four-trace capability, X-Y or Y-T operation and the mobility of changing from a bench-top to a rack-mount system.

The new system includes the \$220 5103N mainframe which contains a power supply/amplifier module with three plug-in compartments; the single-beam \$320 D10 and dual-beam \$650 D12 non-storage display modules, each with a 6-1/2-in. CRT; the single-beam \$800 D11 and dual-beam \$1150 D13 storage units, each also with a 6-1/2-in. CRT.

The \$115 5A15N and \$265 5A18N are single and dual-trace 2-MHz 1-mV/division amplifier plug-ins; The \$165 5A20N is a 1-MHz 50- $\mu$ V/division single-trace differential plug-in and the \$185 5A21N is a 1-MHz 50- $\mu$ V/division and 0.5-mA/division single-trace differential plug-in for voltage and current measurements. The \$65 5A23N is a 10-mV/division single-trace 1-MHz plug-in and the \$25 5A24N is a 50-mV/division single-trace plug-in.

Rounding out the system are the single sweep \$175 5B10N and the single and dual-sweep \$550 5B12N time-base units with normal and delayed-sweep features, respectively. The former operates over a sweep-rate range of 1  $\mu$ s/division to 5 s/division and the latter over a sweep rate of 100 ns/division to 5 s/division. The \$85 5B13N single-sweep unit operates over 5  $\mu$ s/divi-

sion to 0.5 s/division.

The 5103N mainframe module contains the low-voltage power supplies, the vertical and horizontal amplifiers and the electronic switching and logic circuitry for dual-trace or dual-beam operation. Chopped and alternate modes are selected from the time-base plug-ins. The mainframe also contains all the interconnections for interchanging the display modules.

The four display modules feature CRTs with 8  $\times$  10 divisions at 1/2 in./division. All have internal

graticules. P31 phosphor is standard for the non-storage units and a phosphor similar to P1 phosphor is standard for the storage units.

The display modules include the power switch, a voltage-current time calibrator, a beam finder, related CRT display controls and a dc-coupled Z-axis input.

The D11 single-beam storage display unit has a bi-stable split-screen storage CRT with increased light output, particularly in the stored mode. A brightness control allows the user to vary the stored brightness level. By adjusting this level, the CRT retains the information for as long as several hours. The stored brightness control in conjunction with other storage controls also increases the effective CRT writing rate.

The D13 storage display has all the storage features of the D11 storage display and differs only in that it is a dual-beam unit. The D12 dual-beam non-storage display is the same as the D10 single-beam non-storage display except that its CRT has two writing guns and two pairs of vertical deflection plates.

A new improved scale-factor readout is provided by backlighted skirted knobs which automatically switch to the correct reading when using the recommended 10X

(Continued on page 84)

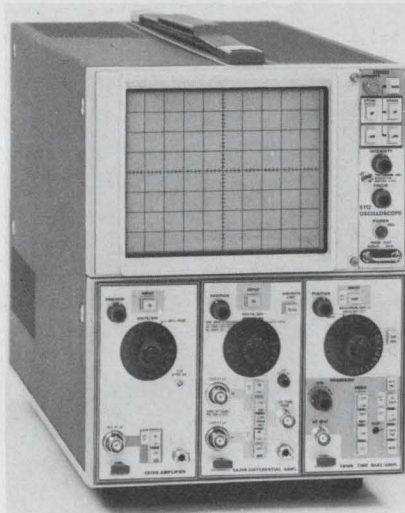

New oscilloscope system shows bench-top version with two amplifier and one time-base plug-in.

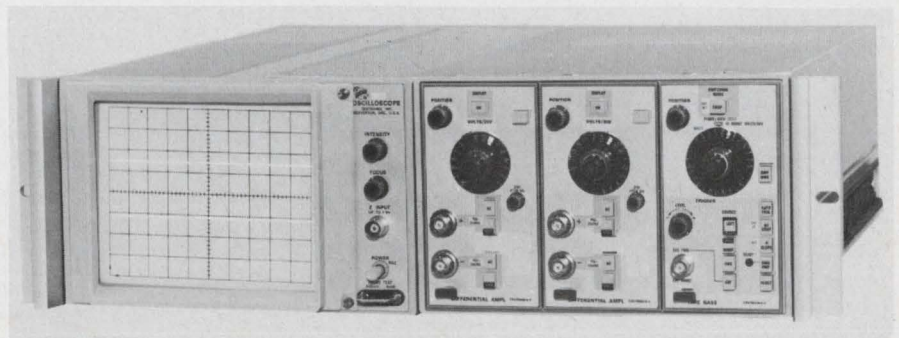

Versatile oscilloscope system converts easily into a rack-mount version with the display unit alongside two amplifier and one time-base plug-in.

(Continued from page 83)

probes and X10 magnifier. The readout goes off when a plug-in is not used and remains off until a plug-in or a channel is placed into operation.

Up to four simultaneous traces can be selected with the amplifier plug-ins, while a chopped or alternate display mode is selected on the time base. Pressing the display pushbutton on the amplifiers places the left, center or both plug-ins into use.

The ability to simultaneously use different types of amplifier plug-ins such as high-gain-differential and dual-trace plug-ins expands performance by removing the limitation imposed by only switching between channels on a dual-trace amplifier.

By using the amplifier input of the time base or inserting a vertical amplifier plug-in into the horizontal plug-in compartment, the system converts into an X-Y oscilloscope. A time-base plug-in into the left amplifier compartment solves applications requiring a vertically oriented sweep. Channel switching between left and center plug-ins is accomplished in the mainframe with logic commands generated in the plug-ins.

The 5B10N single-sweep time-base plug-in includes full-frequency triggering, 10-times magnification and a calibrated compensated amplifier with inputs of 50 and 500 mV/division for X-Y operation. The 5B12N has dual delaying sweeps with independent sweeps for simultaneous time measurements at different sweep rates. The dual sweep operates in an alternate or chopped mode.

When two vertical amplifiers are used with the 5B12N in the dual-sweep mode, the A and B sweeps are slaved to the left and center plug-ins, respectively. The 5B12N also operates as a high-performance delaying sweep plug-in.

All plug-ins in the 5103N system stress simplicity of design and operating ease. Logical grouping of controls and the use of color-coded panel markings by function is used throughout. For conversion from bench-top to rack-mount systems, a kit is available.

CIRCLE NO. 250

## Battery-powered scope responds to 35 MHz

Hewlett-Packard Co., 1501 Page Mill Rd., Palo Alto, Calif. Phone: (415) 326-7000. P&A: \$1850 (plus \$200 for battery pack); January, 1971.

The new model 1701A dual-trace oscilloscope with delayed sweep, a 6 by 10-cm display and a frequency range of dc to 35 MHz operates from a rechargeable battery pack which draws only 18 W of power for up to 6 h of operation on a single charge. The new scope weighs only 35 lbs and also operates from 115/230 V ac.

CIRCLE NO. 251

## Table-top analyzer diagnoses digital ICs

Signetics Corp. Measurement Data, 341 Moffet Blvd., Mountain View, Calif. Phone: (415) 961-9384. P&A: \$450; 60 days.

Complete analysis of failure causes in digital ICs can be made with the new table-top Function Analyzer. The instrument diagnoses specific digital IC malfunctions by operating as an accessory to the model 1110 digital IC tester. Indicators on the Function Analyzer's front panel show the type, mode and state of IC failure.

CIRCLE NO. 252

## Programmable sources enhance interfacing

John Fluke Mfg. Co., Inc., P. O. Box 7428, Seattle, Wash. Phone: (206) 774-2211. Price: \$895, \$1195, \$895, \$1195.

Four new programmable sources interface digital and analog circuits. The 4210A and 4250A have 0 to  $\pm 10$ -V outputs in 1-mV increments at 100 mA and 1 A, respectively. The latter also has a 0 to  $\pm 50$ -V 10-mV-increment output. The 4216A and 4265A have 0 to  $\pm 16.383$ -V outputs in 1-mV increments at 100 mA and 1A, respectively. The latter also have a 0 to  $\pm 65.532$ -V 4-mV-increment output.

CIRCLE NO. 253

## 500-MHz counter has a \$1445 price



Atec, Inc., 1125 Lumpkin St., Houston, Tex. Phone: (713) 468-7971. P&A: \$1445; stock.

Spanning the frequency range of 10 Hz to 500 MHz, the 4058 seven-digit low-cost frequency counter with an input sensitivity of 100 mV rms and an input impedance of 50  $\Omega$  at 500 MHz and 1 M $\Omega$  shunted by 50 pF at 5 MHz features a price of only \$1445.

Its solid-state construction insures instant-on operation and it uses a highly stable 1-MHz crystal oscillator with a stability of  $\pm 4$  parts per  $10^7$  per month for all combinations of aging, temperature variations of  $\pm 10^\circ\text{C}$  at room temperature and power-supply voltage variations of  $\pm 10\%$  at 115 V ac.

Another important feature of the 4058 counter is a maximum input voltage of 5 V rms. In the event that the 5-V amplitude is inadvertently exceeded, a lamp indication is given on the front panel of the counter.

Three selectable readout resolutions of 1, 10 and 100 Hz are provided for the high-frequency channel and 0.1, 1 and 10 Hz for the low-frequency channel. Accuracy for either channel is  $\pm 1$  count  $\pm$  the time-base accuracy.

Display time is continuously adjustable from 0.2 to approximately 5 s. A hold provision allows infinite display time until the counter is manually reset.

The 4058 counter is available in a half-rack configuration and measures 3-1/2 by 8-1/2 by 12 in. Its total weight including its instrument stand and a carrying strap is only 6 lbs.

For an additional price of \$35, optional BCD output is available in 1-2-4-8 formats.

CIRCLE NO. 254

# Plastic Cheaper Than Gold?

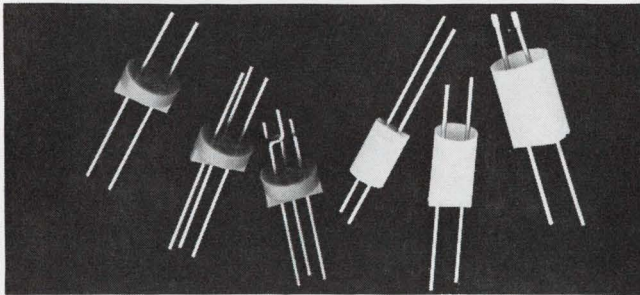

Lots cheaper. That's why you can encapsulate LEDs and photo cells on GE plastic headers for up to 25% less than gold plated, solder sealed cans. Reliable enough to replace many hermetically sealed devices in non-critical applications, standard headers are available off-the-shelf for \$10 per M and lower. Design and production capability for your own special types too. Plug-in or solder to circuit boards. Bipin bases shown on right ideal for photo cells. Headers (left) come with several options on twist, form, and number of lead wires. Write today or call today for more information.

**General Electric Company, Lamp Metals and Components Department, 21800 Tungsten Road, Cleveland, Ohio 44117 Telephone: (216) 266-3942**

**GENERAL  ELECTRIC**

INFORMATION RETRIEVAL NUMBER 47

**ALCO LITE OFFERS MORE**

**MINIATURE INCANDESCENT LAMP ASSEMBLIES HAVE 5V 60 ma. rating, and 100,000-hr. life. Its sealed plastic assembly contains a T-1 #680 lamp. Mounting ring is included. Choice of 5 colors, pins or leads.**

**PANEL INDICATORS**

6" INSULATED LEADS  
MC-680  
PIN CONTACTS  
ME-680

**ALCO** ELECTRONIC PRODUCTS, LAWRENCE, MASS.

INFORMATION RETRIEVAL NUMBER 48

**THINK DIGITAL**

**NEON READOUT DRIVER MODULE**

USES ELFIN\* 7-SEGMENT DISPLAY TUBE

Factory assembled Elfin readout modules with built-in decoder-drivers are ready to plug into your systems. Choice of decoder-drivers or with memory, counter. Model DM-17G-721

**13.62**  
IN 500 LOTS

**ALCO**  
LAWRENCE, MASS.

\* Manufactured Under a License By Burroughs Corp.

INFORMATION RETRIEVAL NUMBER 49

**Good News:  
Your "Make or Buy" Problems  
are solved!**

## Custom Miniaturized Sub-Systems

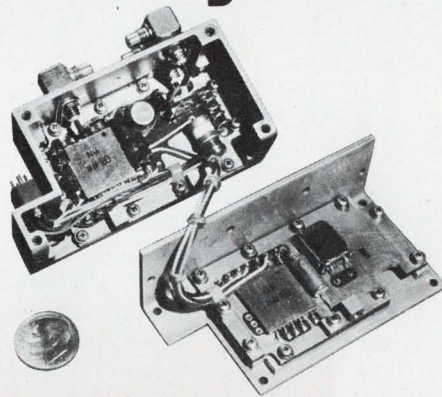

**Give CTI your Black Box Function and QC Requirements. Then relax!**

CTI will do the whole job for you. Completely. Right from the beginning. Right the first time.

With the complete sub-system designed, miniaturized, packaged, tested, ready to go to work. And delivered, as promised, on time.

Is it expensive to go this route? Not at all. You'll be amazed how inexpensive it is compared to making it in-house. In fact, it is the only way to go these days if you're going to remain competitive!

How does CTI do it? By using a unique combination of talents. • Top circuit engineering • Established-quality micro-circuit production (to MIL Std 883) • Innovative packaging capability, with the optimum combination of thick-film, monolithic and discrete components for maximum economy and performance • Quick turn-around.

**Custom Hybrid + Hybrid + Hybrid = SubSystems**

See how great it is to do business with the Leader!

On the East Coast, call: Mel Spitz (516) 293-8686.

In the Mid-West, call: Bryan Geyer (502) 425-5434.

On the Pacific Coast, call: Syl Cole (213) 372-8419.

**CIRCUIT TECHNOLOGY INCORPORATED**

160 Smith St., Farmingdale, N.Y. 11735

INFORMATION RETRIEVAL NUMBER 50

# We're putting our reputation on the line every time a Sorensen power supply goes into service.

## Maybe that's why we have such a great reputation.

Sorensen was the first commercial firm to manufacture and market precision electronic voltage regulators and power supplies.

Today we have the most extensive power supply line available from stock. Sixteen complete series, hundreds of individual models. Standard designs for almost any application. Custom designs for the rest. We have regulated and unregulated dc bench, rack, and modular supplies, dc high voltage and high power types, dc systems. DC isolated power supplies, dc/ac inverters, dc/dc and ac/ac converters. AC voltage regulators and line conditioners.

Our new plant is equipped to manufacture to any specification or standard. Everything is done in one plant, incoming material inspection to final equipment test, with rigidly controlled quality checking at each step.

Sorensen means built-in reliability assurance. Write for our complete catalog, with prices, today, or contact any of the sales reps listed on the facing page. Raytheon Company, Sorensen Power Supplies, 676 Island Pond Road, Manchester, N.H. 03103. Tel: (603) 668-1600.

**Sorensen**  
POWER SUPPLIES

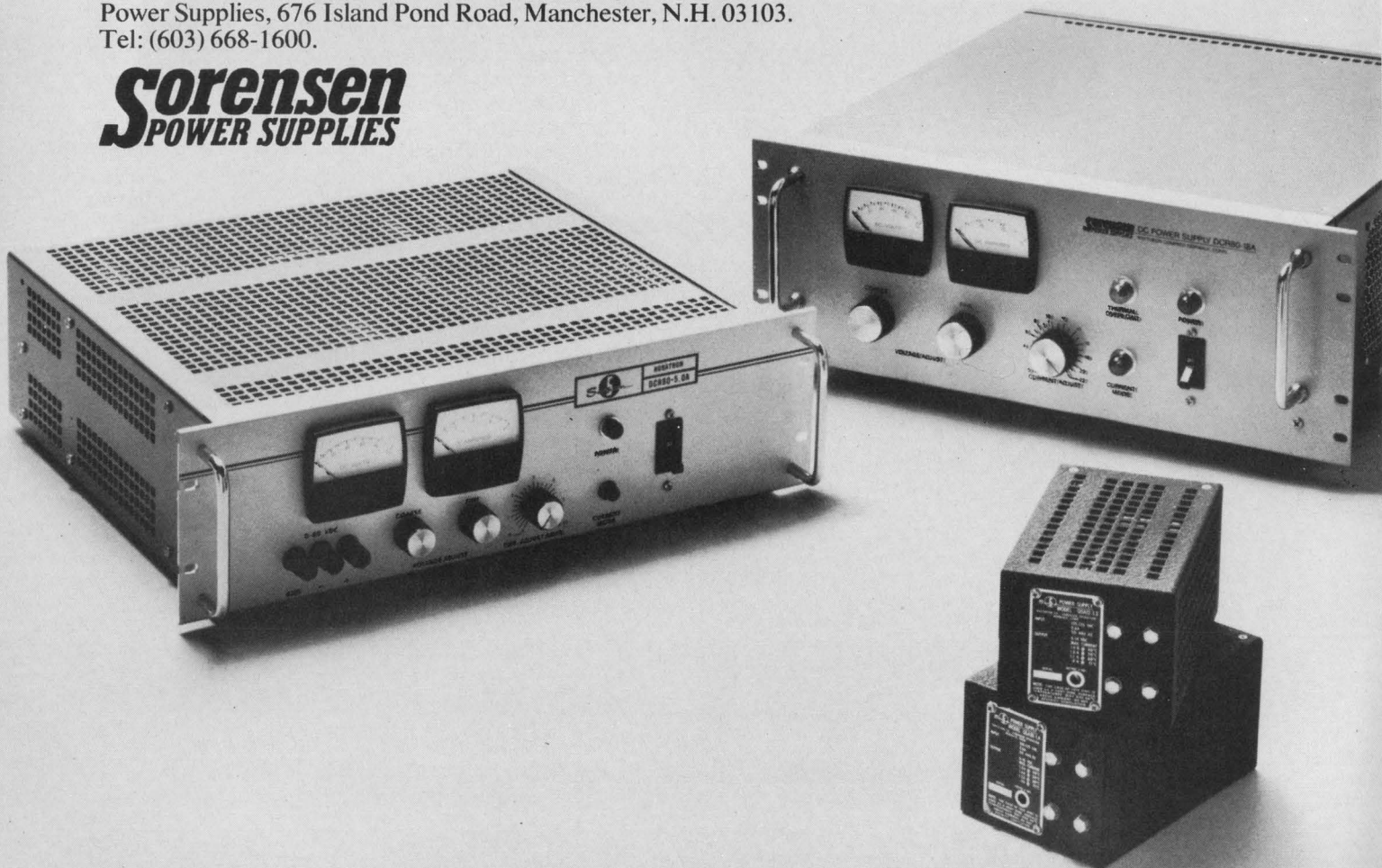

# Fast complementary switch handles +10-V analog signals

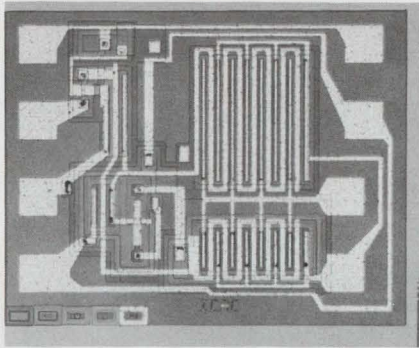

Siliconix, Inc., 2201 Laurelwood Rd., Santa Clara, Calif. Phone: (408) 246-8000. P&A: \$5.10, \$3.50 (for 100-unit quantities); stock.

Featuring a switching time of 50 to 80 ns, a complementary metal oxide silicon (CMOS) switch can handle an analog signal range of  $\pm 10$  V equal to the supply voltage range and exhibits only 60  $\Omega$  of ON resistance at a signal modulation of 20%.

The G150 switch, which has low feedthrough capacitance and micro-watt power dissipation, incorporates both n and p-channel MOS transistors on the same substrate.

The n and p-channel transistors are used in a parallel combination.

Since they turn ON with opposite-polarity signals, varying the analog voltage increases the drive to one transistor while decreasing it to the other. Thus one of the paralleled transistors is always ON, even though the analog voltage reaches the supply voltage level.

The use of n and p-channel transistors also reduces the modulation of ON resistance as the analog signal is varied. This reduction occurs because the ON resistance of one transistor increases while the ON resistance of the other transistor decreases, leaving the parallel combination nearly constant.

The switch includes a built-in inverter to provide opposite-polarity signals to the n and p-channel devices which are used in such a way that only one of the two devices is conducting in either quiescent state.

Two models are available: the G150AA for the temperature range of  $-55$  to  $+125^\circ\text{C}$  and the G150DA for the temperature range of  $-55$  to  $+85^\circ\text{C}$ . Future models are expected to have the capability of handling  $\pm 15$  V analog signals.

CIRCLE NO. 255

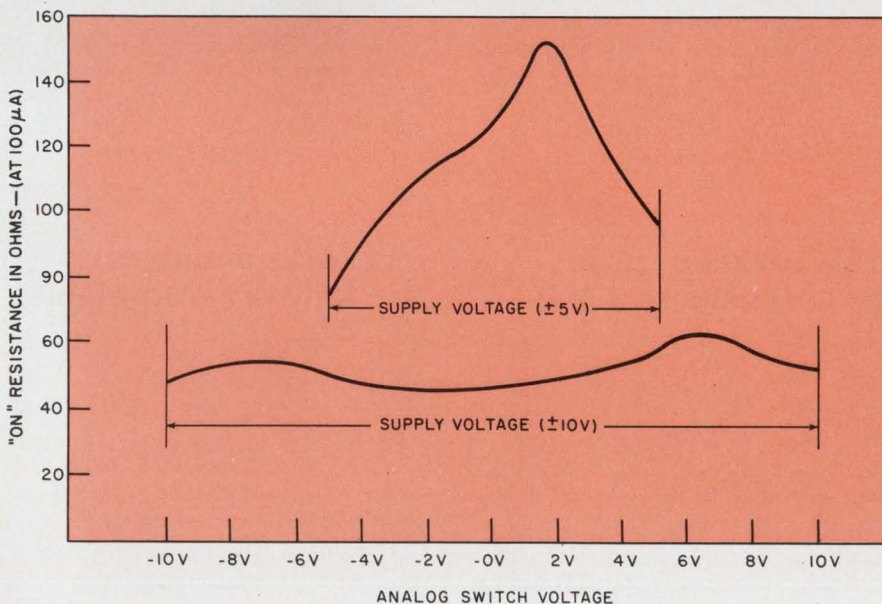

Typical switch ON resistance as a function of the applied analog voltage for the  $\pm 10$ -V range (lower curve) and the  $\pm 5$ -V range (upper curve).

## We're putting our reputation on the line, too!

**ARVA, Inc.**  
Seattle, Washington  
Tel: 206-622-0177

**Barnhill Associates**  
Denver, Colorado  
Tel: 303-934-5505, 6, 7  
Phoenix, Arizona  
Tel: 602-263-1250  
Albuquerque, New Mexico  
Tel: 505-299-7658  
Houston, Texas  
Tel: 713-621-0040  
Richardson, Texas  
Tel: 214-231-2573  
Salt Lake City, Utah  
Tel: 801-487-1327

**BCS Associates, Inc.**  
Huntsville, Alabama  
Tel: 205-881-6220  
Orlando, Florida  
Tel: 305-843-1510  
Greensboro, North Carolina  
Tel: 919-273-1918

**Earl Associates, Inc.**  
Honolulu, Hawaii  
Tel: 808-949-6953

**Instrument Associates, Inc.**  
Bedford, Massachusetts  
Tel: 617-275-0700  
Hartford, Connecticut  
Tel: 203-525-9367

**Instrument Specialists, Inc.**  
Glendale, California  
Tel: 213-245-9404  
San Diego, California  
Tel: 714-453-1833  
Santa Clara, California  
Tel: 408-244-1505

**Pivan Engineering Company**  
Chicago, Illinois  
Tel: 312-539-4838  
Indianapolis, Indiana  
Tel: 317-253-1681  
Mission, Kansas  
Tel: 913-722-1030  
Minneapolis, Minnesota  
Tel: 612-537-4501  
St. Louis, Missouri  
Tel: 314-872-8424  
Brookfield, Wisconsin  
Tel: 414-786-1940

**SBM Associates, Inc.**  
Union, New Jersey  
Tel: 201-687-8737  
Pleasantville, New York  
Tel: 914-769-1811  
Rochester, New York  
Tel: 716-266-1400

**Sonco**  
King of Prussia, Penna.  
Tel: 215-265-3250  
Washington, D.C.  
Tel: 301-654-5226

**S. Sterling Company**  
Detroit, Michigan  
Tel: 313-255-1970  
Cleveland, Ohio  
Tel: 216-442-8080  
Dayton, Ohio  
Tel: 513-298-7573  
Pittsburgh, Penna.  
Tel: 412-922-5720

**CANADA**  
**Allan Crawford Associates, Ltd.**  
Malton, Ontario, Canada  
Tel: 416-678-1500  
Montreal, 379, P.Q., Canada  
Tel: 514-747-9849  
New Westminster, B.C. Canada  
Tel: 604-524-1161  
Ottawa, Ontario, Canada  
Tel: 613-725-3354

**Sorensen**  
POWER SUPPLIES

# NEW

## from BULOVA...

### DC Servo Amps

### 2.5w to 2,500w

Here's a line of servo amps packaged for flexibility and priced for system saving. It's another example of Bulova's unique capability in producing quality servo products at a price lower than you can make or buy.

Available from 2.5 w to 2.5 Kw —  
StyLED in flat pack, modular or  
rack mount — to meet industrial  
or mil-spec — able to operate from  
AC or DC — to include power supply  
when required.

#### FEATURES:

- Adjustable Gain
- Current Limiting
- Voltage or Current Feedback
- Wide Bandwidth
- Low Cost



DCA Series

#### DESIGNED TO DRIVE:

- DC Torque Motors
- Low Inertia Motors
- DC Servo Motors
- Servo Valves
- Deflection Coils

DCAR Series



Don't miss out on this Bulova Servo Special. For new applications or old . . . for help in planning new servo systems . . . for the lowest price on DC Servo Amps . . . Look to Bulova!

Call (212) 335-6000, or write —



Electronic Division of Bulova Watch Company, Inc.  
61-20 Woodside Avenue  
Woodside, N. Y. 11377 (212) 335-6000

Bulova also offers a complete line of AC servo products, including servo amplifiers, modulators and demodulators, plus a line of power supplies.

INFORMATION RETRIEVAL NUMBER 52

## ICs & SEMICONDUCTORS

### 14-lead flatpacks have three 741 op amps

Mini-Systems, Inc., Washington Park, N. Attleboro, Mass. Phone: (617) 695-0206.

Providing circuit designers with multiple-amplification functions out of a tiny package, a new 1/4-in. hermetic flatpack comes complete with three  $\mu$ A741 operational amplifiers in the same case. The case is a TO-86 14-lead flatpack.

CIRCLE NO. 256

### Field-effect transistors cost just one dollar

General Instrument Corp., 600 W John St., Hicksville, N. Y. Phone: (516) 733-3333. Price: \$1, \$1.10.

Two new low-cost FETs, the NEM655 and the NEM614, retail in 100-unit quantities at \$1 and \$1.10 each, respectively. The former is designed for use in TV and FM tuners and i-f, SSB and wide-band amplifiers. The latter is also for use in wideband amplifiers.

CIRCLE NO. 257

### Compensated op amp comes on a film-strip

General Electric, Integrated Circuit Products Dept., Electronics Park, Syracuse, N. Y. Phone: (315) 456-0123. P&A: \$2.25 (100 to 999); stock.

The GEL 1741 is an internally compensated operational amplifier that is available in the new mini-Mod film-strip package. The package is formed by attaching a silicon IC pellet to a film-strip lead frame.

CIRCLE NO. 258

### JAN varactor diodes have Q values of 350

Teledyne Crystalonics, 147 Sherman St., Cambridge, Mass. Phone: (617) 491-1670. P&A: \$5.60 (1 to 99), \$3.75 (100 to 999); stock.

A new line of JAN-approved voltage-variable capacitance diodes features Q values (at -4 V) as high as 350. Designated as the Varactron series JAN IN5139A to IN5148A, they also feature ratings of 60 V dc and low leakage.

CIRCLE NO. 259

### 256-bit bipolar PROM has 25-ns delay time

Harris Semiconductor, Melbourne, Fla. Phone: (305) 727-5412. P&A: \$30.75; \$23.50; stock.

A new 256-bit bipolar programmable read-only memory features a worst-case address-to-output propagation delay of 50 ns, and 25 ns when using the chip enable. The HROM-1256 is fully decoded on the chip.

CIRCLE NO. 260

### Power transistors handle 50 amperes

Solitron Devices, Inc., 1177 Blue Heron Blvd., Riviera Beach, Fla. Phone: (305) 848-4311. Availability: 2 to 4 wks.

The SDT2205 (MT23 case) and SDT2305 (TO-68 case) germanium transistors feature typical collector-to-emitter voltages (sat.) as low as 0.075 V and collector currents up to 50 A. Typical common-emitter forward current gain is 120.

CIRCLE NO. 261

### IC Schmitt trigger drives 50-mA loads

Amperex Electronic Corp., Integrated Circuits Div., Cranston, R. I. Phone: (401) 737-3200. Price: 40¢ (25,000-unit quantities).

A new silicon monolithic IC Schmitt trigger provides up to 50 mA of output current to drive large loads without further amplification. TAA560 consists of a Darlington input that operates as a low-current Schmitt trigger.

CIRCLE NO. 262

### TTL/MSI counters are fully programmable

Texas Instruments, Inc., 13500 N. Central Expressway, Dallas, Tex. Phone: (214) 238-2011. P&A: from \$3.24; stock.

Two new TTL/MSI asynchronous counters are the dc-coupled SN54/74196 decade counter and SN54/74197 binary counter which are fully programmable. Both are guaranteed to count input frequencies of 0 to 50 MHz.

CIRCLE NO. 263



**Tape cassette transport operates at 30 in./s**

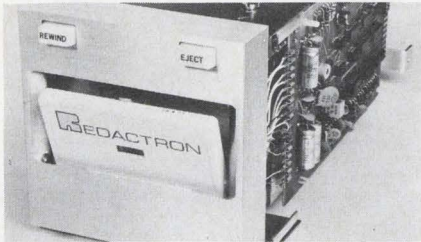

*Redactron Corp., 100 Parkway Dr. S., Hauppauge, N. Y. Phone (516) 543-8700.*

A new magnetic-tape cassette transport for data capture operates at 30-in./s when reading, writing, rewinding and searching. It is a read-after-write unit with a write gap that is 10% greater than the full width of the tape. The instantaneous transfer rate is 1800 characters/s and the average transfer rate with 110-character blocks is 1000 characters/s.

CIRCLE NO. 264

**16-bit data coupler converts BCD to ASCII**

*Beckman Instruments, Inc., 2500 Harbor Blvd., Fullerton, Calif. Phone: (714) 871-4848.*

The Auto-Pro 3109 Intercoupler converts 16-bit digital BCD inputs into ASCII formats. It is suitable for operation with ASR Teletype-writers and provides an output in a direct-entry format for most data processors. Two types of controls are available: front-panel pushbuttons and remote-control through external contact closures to ground.

CIRCLE NO. 265

**Read/write memory interchanges ROM**

*Unicom, Inc., 1275 Bloomfield Ave., Fairfield, N. J. Phone: (201) 228-1696.*

The UI-1011 is a read/write memory that is interchangeable with a read-only memory. This interchangeability allows the user to write and debug his program using the UI-1011 read/write memory. When satisfied that his program is correct, he can have a read-only memory made with the correct memory contents.

CIRCLE NO. 266

# We've added a little something\* to the world's biggest RF inductor line

\* ACTUAL SIZE

## New Pee Dee Ductor world's smallest unshielded RF inductor

Nytronics' newest unshielded microminiature RF inductor for hybrid circuit applications — Pee Dee Ductor — is the smallest in the world. Measuring a wee .140" end to end, it has a diameter of .075", and meets the requirements of MIL-C-15305 Grade 2, Class 5. Minimum Q values at RF frequencies range from 21 to 55. Epoxy encapsulated, it is available in values from 0.1 uH to 1000 uH, with current capabilities ranging from 30 to 600mA. Standard inductance tolerance is  $\pm 10\%$ , and Pee Dee Ductor meets operating temperatures of  $-55^{\circ}\text{C}$  to  $+125^{\circ}\text{C}$ . Its axial leads will withstand a minimum pull of 3 pounds.

So Nytronics not only has the biggest RF inductor line available anywhere. It has the smallest. Write for a free sample and the rest of the story. Available off-the-shelf at all Nytronics distributors.



**Nytronics, Inc.**

THE QUALITY LINE OF STANDARD COMPONENTS

ORANGE STREET, DARLINGTON, S. C. 29532 • (803) 393-5421 • TWX 810-665-2182  
INFORMATION RETRIEVAL NUMBER 53

# NEW! AUTOMATIC RESET TIMING



SERIES  
400

## ...with independent AC or DC clutch control

Deltrol Controls' NEW Series 400 Fixed Time Cycle Automatic Reset Timer incorporates features which give the designer advanced engineering excellence and higher value per dollar spent. Check these features yourself:

- ✓ Clutch control is independent of timer motor and may be operated on either AC or DC voltage while timer motor is operated on AC.
- ✓ Remains in timed-out position without the use of an external relay or without stalling the timer motor. At end of time-cycle, motor is turned off while clutch holds switch position.
- ✓ Reset time is not a function of total time cycle. Reset time is 25 milliseconds maximum.
- ✓ Standard fixed time cycles of 5, 10, 15, 20, 30, 60 seconds; 5, 10, 15, 20, 30, 60 minutes. Other time cycles on request.
- ✓ Recognized under the Components Program of Underwriters Laboratories, Inc. (File No. E19033).
- ✓ Lower cost...more value per dollar. Interchangeable with higher priced units.

Write for complete specifications & prices

## DEL TROL CONTROLS

1461

2745 So. 19th St. Milwaukee, Wis. 53215  
Phone (414) 671-6800 Telex 2-6871

## MODULES & SUBASSEMBLIES

### Solid-state displays mount on PC boards

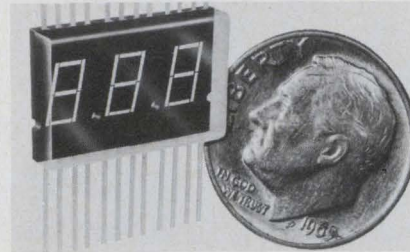

Bowmar/Canada Ltd., div. of Bowmar Instrument Corp., 1257 Algonoma Rd., Ottawa, Ontario, Canada. Phone: (613) 746-3100.

Either 0.11 or 0.19 in. in height, two new solid-state displays come in flatpack configurations, making them ideally suited for printed circuit mounting. Models R7M-111 and R7M-191 are totally monolithic seven-segment semiconductor read-outs with decimal point included. They light with an output illumination of 100 ft-L per segment at 10 mA.

CIRCLE NO. 267

### Power op amps put forth 300 W

Analog Devices, Inc., 221 Fifth St., Cambridge, Mass. Phone: (617) 492-6000. P&A: \$176, \$122; stock.

Two new power operational amplifiers, designated models 408 and 409, develop 110 and 300 W of output power, respectively, and can internally dissipate 50 and 400 W, respectively. Both amplifiers measure 4.7 by 2.8 by 0.75 in. and feature electrically insulated integral heat sinks. Model 408 develops an output of  $\pm 22$  V at 5 A while model 409 produces  $\pm 20$  V at 15 A.

CIRCLE NO. 268

### 15-bit a/d converter has 0.01% accuracy

Analogic Corp., Audubon Rd., Wakefield, Mass. Phone: (617) 246-0300. P&A: \$2000; 4 to 8 wks.

Measuring 48 in.<sup>3</sup>, the AN2715M 15-bit a/d converter offers 0.01% absolute accuracy and linearity to 0.002%. Conversion speed is user-adjustable from 0.5 to 1.1  $\mu$ s/bit. The AN2715M is available with inputs of +10 V or  $\pm 10$  V.

CIRCLE NO. 269

### Programmable supply provides 3 HV outputs

Bertran Assoc., Inc., 15 Newton Rd., Plainview, N. Y. Phone: (516) 293-3340. P&A: \$685; stock.

The model 620 is a triple-output precision programmable high-voltage power supply that provides an anode supply of up to 20 kV dc, a focus supply which is remotely programmable to 5 kV dc and a grid supply of up to 500 V dc. All three supplies are highly regulated for line and load conditions and feature stability and low ripple. Programming is accomplished at low-voltage levels.

CIRCLE NO. 270

### Sample/hold module is $\pm 0.025\%$ accurate

Varadyne Systems, 1020 Turnpike St., Canton, Mass. Phone: (617) 828-6395. P&A: \$110; stock.

Model SHM-1 sample-and-hold module is a 1 by 2 by 0.4-in. device capable of tracking a full-scale  $\pm 10$ -V analog input in less than 5  $\mu$ s to within an accuracy of  $\pm 0.025\%$  of the full-scale output. Other features include frequency response of 200 kHz, aperture uncertainty of less than 50 ns and hold-delay time of 1 ms for 1 mV. Input impedance is 100 M $\Omega$  and temperature coefficient is  $\pm 20$  ppm/ $^{\circ}$ C.

CIRCLE NO. 271

### Fast 60-W op amp slews at 25 V/ $\mu$ s

Torque Systems, Inc., 225 Crescent St., Waltham, Mass. Phone: (617) 891-0230. P&A: \$85; stock.

A new high-speed 60-W class-B operational amplifier for driving CRT sweeps features a slew rate of 25 V/ $\mu$ s. The model PA-131 includes output currents to  $\pm 3$  A at voltages to  $\pm 20$  V, built-in current limiting and short-circuit protection. It also features high open-loop gain of up to 20,000 permitting full-load compensation capability. The new operational amplifier is packaged in a sealed 1.8 by 3.5 by 0.47-in. case.

CIRCLE NO. 272

## Unitized switches form 150 stations

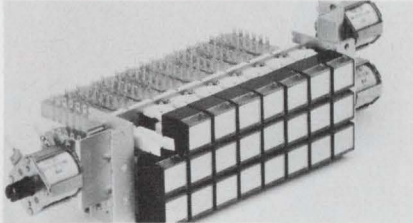

International Electro Exchange Corp., 6851 Oxford St., Minneapolis, Minn. Phone: (612) 929-7875.

A new unitized switch design permits construction of versatile pushbutton switches with up to 150 stations. The switches are totally enclosed contact modules with up to 8pdt contacts. Any combination of individual switch functions is available. Shorting or non-shorting 2-A bifurcated contacts are included. A printed-circuit connector is available for rear wiring.

CIRCLE NO. 273

## 60-V/ $\mu$ s FET op-amp settles in 1 $\mu$ s

Burr-Brown Research Corp., International Airport Industrial Park, Tucson, Ariz. Phone: (602) 294-1431. P&A: \$37; stock.

Model 3402 fast-settling FET operational amplifier settles in 1  $\mu$ s to final value  $\pm 0.01\%$  and slews at a minimum rate of 60 V/ $\mu$ s. The 3402 is packaged in a 1.12 by 1.12 by 0.4-in. case and has a 20-mA output current rating. Open-loop response rolls off at 6 dB/octave and open-loop gain is 100 dB. Unity-gain bandwidth is 10 MHz.

CIRCLE NO. 274

## Three hybrid op amps cut bias to 2 x 10<sup>-15</sup> A

Bell & Howell Control Products Div., 706 Bostwick Ave., Bridgeport, Conn. Phone: (203) 368-6751. Price: \$25, \$50, \$13.

Three new hybrid operational amplifiers are the F-318 with an input bias current of 200 femtoamps, the C-238 with a slew rate of 80 V/ $\mu$ s and settling time to 0.01% of 1  $\mu$ s, and the low-cost C-118 with 5 pA of bias current.

CIRCLE NO. 275

# NEED A 10,000 VOLT ZENER DIODE?

Corotron 3000V actual size: Photo-multiplier power supply, showing Corotron location,  $\frac{2}{3}$  size.

You could string together several hundred zeners. Or you could specify *one* Victoreen Corotron. It is the gaseous equivalent of the zener with all the advantages of an *ideal* HV zener diode.

For space research and other rugged applications requiring absolute power supply stability, GV3S Series, shown, provide the ideal reference voltage anywhere in the range of 400 to 3000 volts. They enable circuitry to maintain constant high voltage regardless of battery source voltage or load current variations. Cubage and weight (GV3S Corotron weighs only 4 gm.) are important considerations. So is temperature variation (Corotrons operate from 200°C down to -65°C). Ruggedized versions withstand shock to 2000 G, vibration 10 to 2000 cps.

If you're trying to simplify circuits . . . to cut cost, size and weight . . . to upgrade performance—you need Corotron high voltage regulators. Models are available now from 400 to 30,000 volts. A consultation with our Applications Engineering Dept. will speed up the countdown.

DMA 525



**VICTOREEN INSTRUMENT DIV. of VLN**  
10101 WOODLAND AVENUE • CLEVELAND, OHIO 44104

## SOLID-LITE

# SOLID STATE NUMERIC INDICATORS AND LAMPS

New Solid-Lite display devices use gallium phosphide, the most efficient visible light emitting semiconductor. You get bright light at low current.



### SOLID-LITE Solid State Numeric Indicators

- Large (.33" x .21") bright numerals are pleasing to the eye
- Standard 14-pin dual-in-line package
- Low voltage operation at less than ¼ watt total power
- Compatible with TTL and DTL IC's
- Single-plane wide-angle viewing
- High reliability – long life
- Excellent shock and vibration resistance
- Low cost

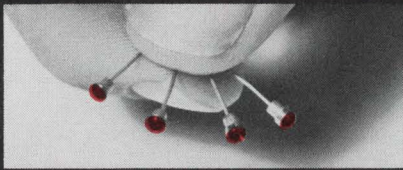

### SOLID-LITE Solid State Lamps

- 2 millicandelas luminous intensity at 15 mA and 2.1 V
- Area light source – not a pinpoint
- Easy wide-angle viewing
- IC compatible
- Excellent shock and vibration resistance
- High reliability – long life
- Low cost

For technical literature or applications assistance, write or call OPCOA, Inc., 330 Talmadge Road, Edison, New Jersey 08817; phone (201) 287-0355.

# OPCOA

## PACKAGING & MATERIALS

### Flatpack connectors ignore soldering/drilling

*Teledyne Kinetics, 410 S. Cedras Ave., Solana Beach, Calif. Phone: (714) 755-1181.*

Flatpacks can now be installed on PC boards without soldering or hole drilling by using the new Becon Carrier connectors. They can mount and connect seven 10-lead or five 14-lead flatpacks (or a mixture of both) to PC boards of any thickness. Individual flatpacks can be changed without de-soldering, or the entire connector removed to a new board at any time.

CIRCLE NO. 276

### Cassette wiring unit displays instructions

*Monitron, Inc., Concord Airport, Concord, N. H. Phone: (603) 225-6625. P&A: \$1000; 30 days.*

The MI105 instruction display unit provides a cassette-tape-to-alphanumeric presentation of a sequence of instruction to aid assembly and wiring. Wiring data is digitally recorded on magnetic tape in cassette form and displayed in sequence as required by the operator. Each wire instruction is independently presented and the operator output is counted and displayed.

CIRCLE NO. 277

### Fast wafer sectioner has 10<sup>-6</sup>-in. tolerance

*PhilTec Instrument Co., 620 Carpenter Lane, Philadelphia, Pa. Phone: (215) VE-6-5133. P&A: \$1275; 2 wks.*

The model 2015 Gaugemetic wafer sectioning system provides all necessary functions for measurement of deposited layers at any stage of wafer processing within 2 minutes of operator time and down to a repeatable tolerance of  $\pm 10^{-6}$  in. The system features an instant-loading chuck, uses no vacuum or bonding agents, has mechanical clamping and sections wafers from 5/16 to 2 in.

CIRCLE NO. 278

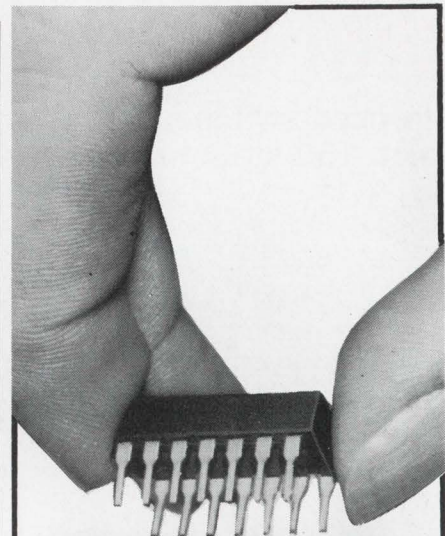

# THIS IS A RELAY

### A MERCURY-WETTED RELAY THAT OPERATES IN ANY POSITION

Don't be fooled by the dual-in-line package. It's a Logcell® mercury-film relay that is completely compatible with DTL/TTL power driver IC's. It operates in any mounting position without contact bounce. And you can mount it into DIP-drilled printed circuit boards or DIP sockets without special handling. Other features include:

- Long life – tested to billions of cycles
- 2.5 millisecond speed
- Thermal noise less than 1 microvolt
- AC noise below instrumentation levels
- 10<sup>-6</sup> to 1 ampere load switching range
- Open circuit resistance in excess of 10,000 megohms
- 0.05 ohms maximum contact resistance
- Available in bi-stable or mono-stable configurations

Logcell DIP relays open new vistas of switching system operation and packaging. For more information, write Fifth Dimension Inc., Box 483, Princeton, New Jersey 08540 or call (609) 924-5990.

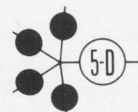

FIFTH DIMENSION INC.

INFORMATION RETRIEVAL NUMBER 57  
ELECTRONIC DESIGN 2, January 21, 1971

**6-GHz oscillator diode pulses out 100 W**

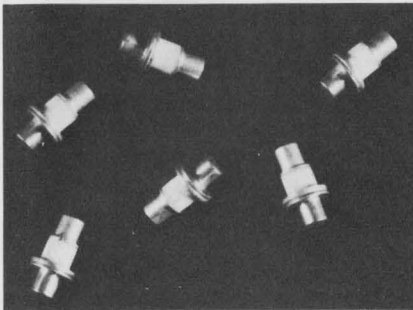

*Microwave Diode Corp., 467 Merri-mac St., Newburyport, Mass. Phone: (617) 462-7462. P&A: \$67.50; stock.*

The MD632 is a self-pulsing oscillator diode using the trapatt mode of oscillation with a dc current bias of 1 to 2 ma applied in the reverse direction for outputs of 50 to 100 W of pulsed power. Due to its low input power requirement, no special heat sinking is required. PIV is 250 V and the range of oscillations is from 200 MHz to 6 GHz. Capacitance at no reverse voltage is 8 pF.

CIRCLE NO. 279

**Tiny 75-Ω T pad works 0 to 300 MHz**

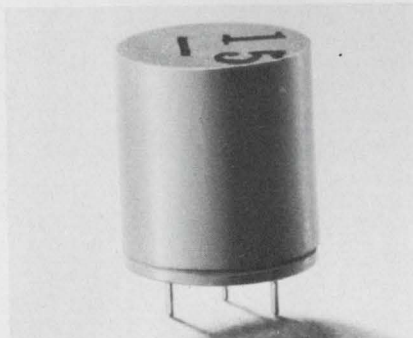

*Aerovox Corp., 740 Belleville Ave., New Bedford, Mass. Phone: (617) 994-9661.*

Distortion-free ac signals over 0 to 300 MHz for CATV or audio-distribution systems are now provided by a new 75-Ω plug-in T pad only 0.375-in. in dia and 0.473-in. high. Incorporating a thick-film cermet resistive element, it provides minimum inductance with improved stability. It is available in a range of 11 values from 0 to 15 dB. Tolerances are ±0.05 to ±1 dB.

CIRCLE NO. 280

# Measure True RMS

$$E_{RMS} = \sqrt{\frac{1}{T} \int_0^T [E_1(t)]^2 dt}$$

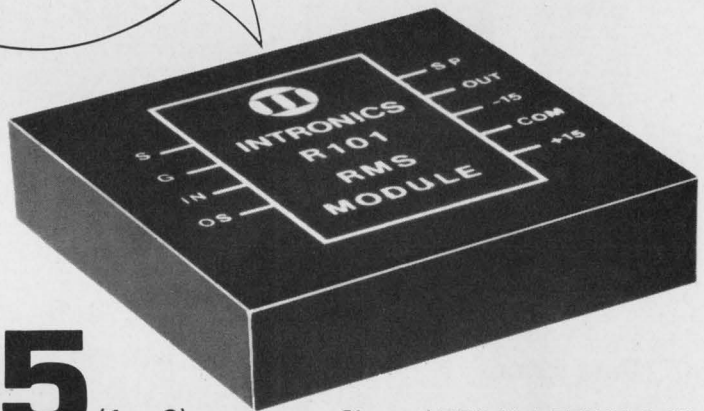

**\$85** (1 - 9)

Size: 1.75" X 1.75" X 0.4"

## INTRONICS' MODEL R101 CONVERTER

Intronics' new R101 converter measures true RMS of complex wave forms with 0.1% accuracy packaged in a 1.25 cubic inch module. The new converter accepts most wave forms, allowing measurement of random noise, pulse trains, distorted sine waves and SCR outputs. With externally adjustable time constant, the R101 provides maximum flexibility and the ideal solution to system design problems.

**FEATURES:**

- 0.1% accuracy
- 1 MHz @ 7 VRMS (sine wave)
- Variable time constant
- Only two adjustments required (gain and offset)
- Measures RMS value of most wave forms



57 CHAPEL STREET, NEWTON, MASS. 02158 • (617) 332-7350 (TWX 710-335-6835)  
INFORMATION RETRIEVAL NUMBER 58

# WE'RE

# #1

**One-Stop Shopping  
from  
THE #1 COMPANY  
in  
Small PC Mount  
DC POWER  
SUPPLIES**



- Best Prices**
- Best Performance**
- Most Voltage/  
Current  
Combinations  
(3.6 to 180 V DC)**
- Single & Dual Output**
- 50/60 to 400 Hz  
Operation Available  
in ALL Models**
- One-Day Shipment**

**CALL:** 305-933-5561  
**WRITE:** P.O. Box 23849  
Ft. Lauderdale, Fla. 33307



**COMPUTER  
PRODUCTS®**

FORT LAUDERDALE

## COMPONENTS

### Fiber-optic readout has large characters

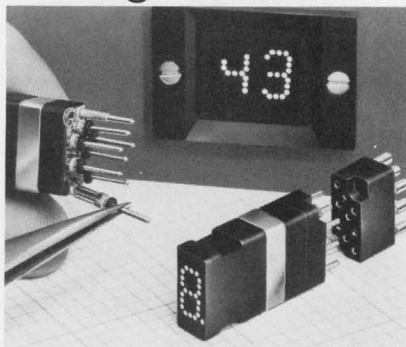

*Master Specialties Co., 1640 Monrovia, Costa Mesa, Calif. Phone: (714) 642-2427. P&A: approx. \$20; 3 wks.*

A new miniature plug-in 7-segment readout utilizes 30-mil-dia optical fibers to transmit light to a 0.32-in.-high by 0.19-in.-wide character pattern. The 903 readout has a low power requirement of 5 V at 20 mA per segment and produces sharp and bright character patterns at more than 100 foot lamberts. Push-pin connector blocks are available for pre-wiring ease.

CIRCLE NO. 281

### Wire-wound resistor dissipates 1000 W

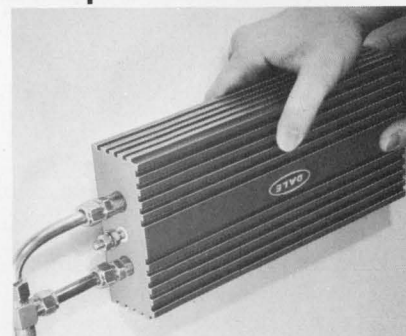

*Dale Electronics, Inc., Box 609, Columbus, Neb. Phone: (402) 364-3131.*

The SPR-574 wire-wound resistor can be internally water cooled to dissipate up to 1000 W. Without water cooling it will dissipate up to 500 watts at 25°C ambient. It is designed for use as a shunt or dummy load and ranges in tolerance from  $\pm 0.05\%$  to  $+5\%$ . Available resistances cover 0.1  $\Omega$  to 500 k $\Omega$ . Temperature coefficient is  $\pm 20$  ppm for standard units and  $+5$  ppm for special units.

CIRCLE NO. 282

## There is a difference in Heath Dynamics' Quartz Crystal Filters!

Heath Dynamics specializes in the design and manufacture of the highest quality Quartz Crystal Filters and Discriminators for the Communications Industry.

Our facility is completely new, inside and out, fully staffed and equipped with the most modern mechanical and electronic test measuring devices.

We employ the assistance of one of the largest time sharing computers available.

Heath Dynamics' area of specialization includes the manufacture of miniature and sub-miniature filters in the range of 10 thru 32 Mhz. Bandwidths may be from .025% thru .35% in the smallest packages and may range up to 2.0% in the larger ones.

*We manufacture direct replacement filters for all the current monolithic designs using our half lattice configuration which yield lower insertion loss, lower ripple and greater ultimate rejection. Yet our filters cost less and faster delivery is guaranteed!*

All Heath Dynamics' crystal filters designed and manufactured to your particular specifications meet Mil F. 18327.

In short, we want your business and we'll act like it. Do us both a favor and send us your print or specification for a quote. If you have any questions just write or call us...we're here to serve you.



**heath  
dynamics, inc.**

6050 n. 52nd avenue  
glendale, arizona 85301  
(602) 934-5234

subsidiary of  
Heath International, Inc., Richmond, Mich.

## GaAsP panel lights snap-in with clips

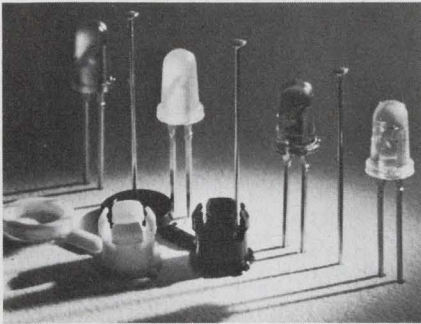

Monsanto Electronic Special Products, 10131 Bubb Rd., Cupertino, Calif. Phone: (408) 257-2140. P&A: \$1.65; stock.

The MV5020 series of low-cost GaAsP panel lights with an operational lifetime of  $10^6$  h easily mount in 1/16 to 1/8-in. thick panels with only plastic snap-in clips and require no extra mounting hardware. Four models are distinguished by their lenses: clear, diffused, clear red and diffused red. Output is 750 foot-lamberts at 2 V and 20 mA.

CIRCLE NO. 283

## Match-box-size units are component decades

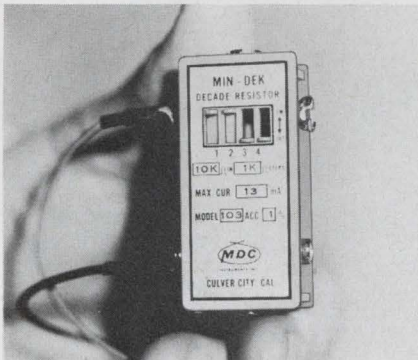

MDC Instruments, Inc., 11822 W. Jefferson Blvd., Culver City, Calif. Phone: (213) 391-8308. Price: \$9.50 to \$18.

Called Min-Deks, a new line of match-box-size decade components include switch-selectable resistors, capacitors, potentiometers, attenuators, four-terminal shunts and transistor substitution units. Measuring 2 by 1 by 1/2 in., Min-Deks may be connected in series, in parallel or in branching networks by simply snapping them together.

CIRCLE NO. 284

# LED

## New low cost LED Vactrol photon isolator

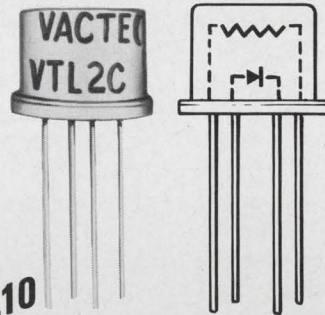

\$3.10

as low as ~~\$4.20~~ each in 1,000 quantities

- all solid state
- 4 types of photoconductors combined with LEDs
- hermetically sealed TO-5 enclosure
- unlimited life—no filaments
- ideal for environments where shock and vibration are a problem
- applications include photochoppers, linear isolators, noiseless switching, SCR and triac turn-on, audio level controls, etc.

Part Number	LED	PHOTOCELL		
	Current (ma) (1.65v typ.)	Max. Cell Resistance	Typical Rise Time (ms)*	Decay
VTL2C1	40	10 K $\Omega$	.5	3.5 ms **
VTL2C2	40	500 $\Omega$	3.5	500 ms †
VTL2C3	40	2 K $\Omega$	2.5	35 ms †
VTL2C4	40	100 $\Omega$	6.0	1.5 sec †

\* To 63% conductance

\*\* To 1 meg

† To 100 K $\Omega$

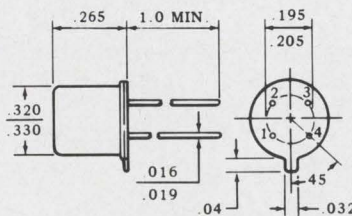

1-3 PHOTOCELL  
2-4 LED

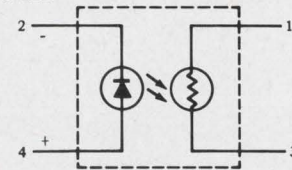

Write for Bulletin VTL2C. Also a complete line of neon and incandescent Vactrol photon isolators.

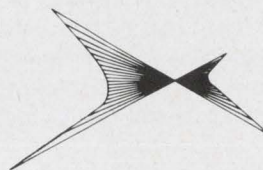

## VACTEC, INC.

2423 Northline Ind. Blvd.  
Maryland Heights, Mo. 63043  
Phone: (314) 872-8300

Specializing in standard Cds, Cdse, and Se sells; custom engineering for every photocell need.  
Listed in EBG under "Semi-Conductors" and in EEM Sec. 3700.

INFORMATION RETRIEVAL NUMBER 61

# evaluation samples

## PC-card handles

A series of three attractive plastic printed-circuit card handles are available in a variety of colors to suit the requirements of most equipment. Two of the handles, models 10035 and 10037 have a specially designed clip-on feature which enables them to be assembled into a PC board without any mounting hardware since they snap into pre-drilled holes on the PC board. The former is used with PC boards mounted at a minimum pitch of 0.25 in. while the latter is used with boards at a minimum pitch of 0.4 in. The third series is the model 10035 which attaches to PC boards by means of two screws or bolts. It is used with PC boards mounted at a minimum pitch of 0.35 in. All three handles have card-identification provisions. Free samples are available. Vero Electronics, Inc.

CIRCLE NO. 285

## Harness mount

The new SCMS-P swivel clip-on mount fits on a harness band by attaching clips to lightening holes and on edges of sheet metal to hold the harness away from sharp edges. The mount is used with any miniature, intermediate or standard cross-section cable ties. The mount may be swiveled in any direction. Panduit Corp.

CIRCLE NO. 286

## Magnetic materials

A new Alnico permanent-magnet material with a higher energy product than any currently available Alnico 8 is available in evaluation samples. New high-energy Alnico 8HE offers a typical energy product of 6 million, which results in a flux 10% greater than Alnico 8 materials. It is particularly suitable for applications requiring the magnet material to operate at or above the knee of the magnetizing curve. Indiana General.

CIRCLE NO. 287

# design aids

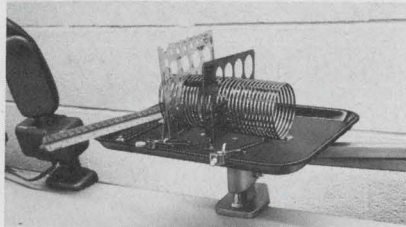

## Drafting aid

A new caddy permits art or drafting tools to be always within easy reach of a draftsman without covering or being covered by work on the drafting table. The Caddy consists of a tray on a folding arm which permits organizing of drafting implements and positioning them within a 30-in. radius of the caddy's mounting position. The device fits any table from  $-1$  to  $+15$  degrees. The caddy's tray measures 10 by 13 in. and supports up to 10 pounds of equipment. It sells for \$28. McElroy Mfg., Inc.

CIRCLE NO. 288

## Core design chart

A comprehensive tape-wound core design chart provides, at a glance, all the pertinent data an engineer needs to design with cores. Presented is information on gross core area, mean path length, core size, gross core weight, case size (for both plastic and metal) as well as turns/V at 10,000 gauss (60 and 400 Hz). Also given is data on  $\mu\text{H}/\text{turn}$ , core saturation, and the product of window area times the core area. Also provided is a complete wire table. Magnetic Metals Co.

CIRCLE NO. 289

## Microwave ICs

A new wall chart for microwave integrated circuits and discrete devices is available. Measuring 17 by 22 in., the chart covers transistors, diodes, beam-lead diodes and capacitors, and microwave integrated circuits. Applications, product specifications, and package types for each device are listed. Texas Instruments Inc.

CIRCLE NO. 290

# application notes

## D/a converters

Written expressly to improve user understanding of d/a converters so that one may better anticipate device performance, the "Designer's Guide: D/A Converters" goes into considerable detail to define critical d/a converter specifications and operating mechanics and to explain their influence upon over-all system performance. Analogic.

CIRCLE NO. 293

## Snap-action switches

A new pamphlet provides a simple step-by-step approach in showing what design factors should be considered when selecting the proper snap-action switch for an application. It points out that the designer need only prepare a composite switch sketch and then take into consideration four key switch parameters: lever movement, lever force, space and load. Diagrams and sketches are also given. Cherry Electrical Products Corp.

CIRCLE NO. 294

## Photon equipment

A four-page illustrated catalog describes a wide range of digital synchronous computers, amplifier discriminators, data converter consoles, power supply consoles and photomultiplier tube housings. SSR Instruments Co.

CIRCLE NO. 295

## Maintenance concepts

Three technical papers on maintenance philosophies and concepts discuss the problem of growing module failure and the increasing need for effective repair of electronic assemblies. Included in the papers are suggestions for setting up a repair program and realistic decision criteria for throwing away vs repairing of modules. Pace, Inc.

CIRCLE NO. 296



**JUST SNAP THEM IN PLACE!**

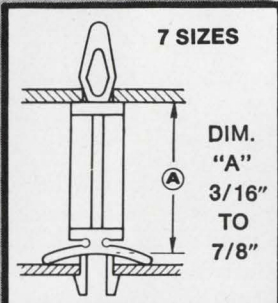
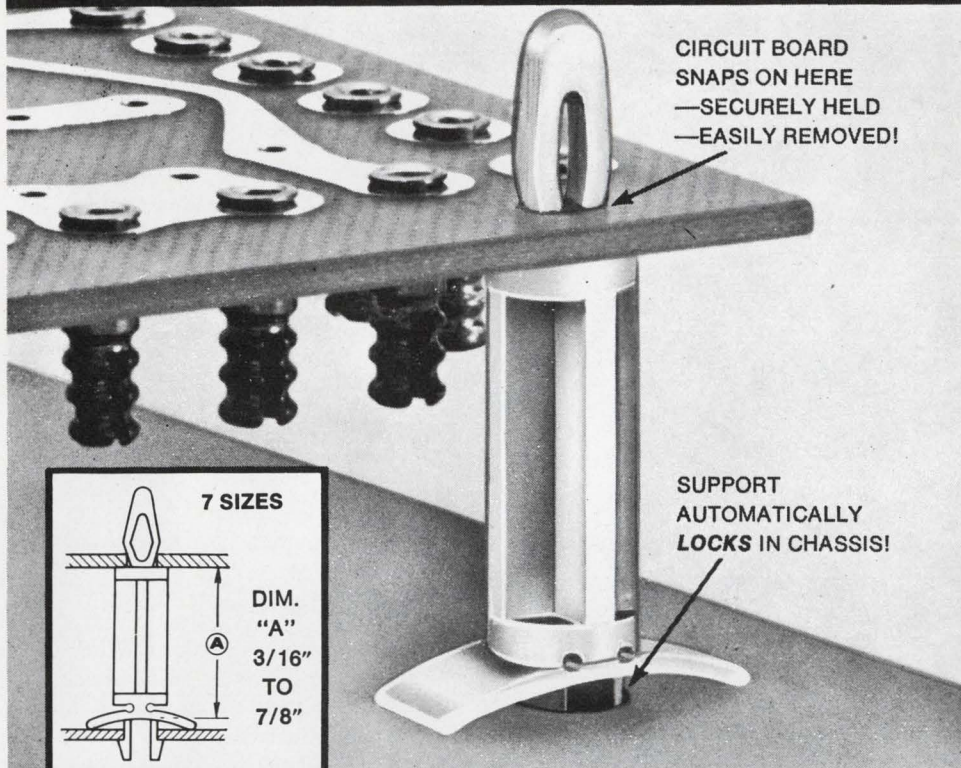

# RICHLOK CIRCUIT BOARD SUPPORTS!

CUT ASSEMBLY COSTS SUBSTANTIALLY!

STRONG, TOUGH NYLON WITH HIGH DIELECTRIC STRENGTH!

ALSO AVAILABLE IN FLAME RETARDANT MATERIAL

Write For Free Samples!

**RICHLOK CORPORATION** 5825 No. Tripp Ave., Chicago, Ill. 60646

INFORMATION RETRIEVAL NUMBER 62

## ON THE MOST WANTED LIST

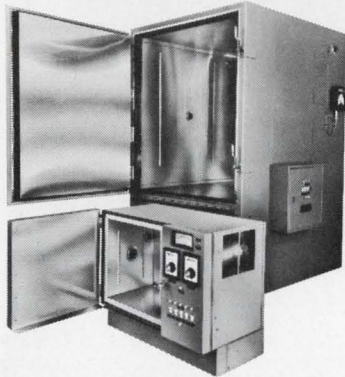

### ALIAS MINI & MAXI

Real names: **TH-Jr. and TH-65**. Smallest and largest members of the "Tenney Gang" of reach-in, temperature-humidity chambers. Easily identified by the Tenney Vapor-Flo® humidity generation system and the fully hermetic, all-welded Hermeticool® refrigeration system.

Known to cover a temperature range of 0°F to 200°F and a humidity range of 20% to 95% RH. Noted for responsive performance. Praised for ease of operation and high reliability.

Can be found serving in evaluation or manufacturing of products sensitive to temperature and humidity environments. For details on Mini, Maxi and all the Gang in-between, call or write today:



1090 Springfield Rd., Union, New Jersey 07083 • (201) 686-7870  
Western Division: 15721 Texaco St., Paramount, Calif. 90723



## The WANG 700 Series

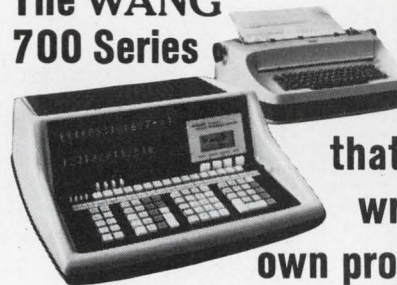

Now a calculator that lets you write your own programs

and store them on a tape cassette

It's easy to store, enter or change programs with a 700 Series and there are no language problems. You already have the knowledge in the math steps you're now using to solve your problems.

With the Wang 700 you'll have more than a calculator. There are 16 special function keys that make it personally yours - you can determine the function each performs. And a choice of typewriter or printer/plotter output turns the 700 Series into a fully programmable calculating system.

And to make it even easier, Wang offers a library of pre-programmed cassettes for the many standard needs. Want a demonstration? Call Mr. Courtney collect at 617-851-7211 or send us the coupon.

Wang Laboratories, Inc. Dept. ED-1  
836 North Street, Tewksbury, Mass. 01876

I'd like a 700 demonstration as soon as possible. Call me at \_\_\_\_\_ for a date.

(Phone number)

Name \_\_\_\_\_

Company \_\_\_\_\_

Street \_\_\_\_\_

City \_\_\_\_\_

State \_\_\_\_\_

Zip \_\_\_\_\_

INFORMATION RETRIEVAL NUMBER 63

ELECTRONIC DESIGN 2, January 21, 1971

INFORMATION RETRIEVAL NUMBER 64

97

# new literature

## TV equipment

An extensive catalog features 144 pages of a large selection of new and used TV cameras and associated equipment. Denson Electronic Corp.

CIRCLE NO. 297

## SCRs

A new eight-page brochure covers the features, applications and performance characteristics of two series of SCRs. Westinghouse.

CIRCLE NO. 298

## Reed relays

A new series of economy reed relays are described in a data sheet. Guardian Electric Manufacturing Co. of California.

CIRCLE NO. 299

## Pollution instruments

Direct-reading colorimeters for water and pollution testing are the subject of a new brochure. Hach Chemical Co.

CIRCLE NO. 300

## Insulating compounds

Three new electrical insulating compounds are described in a new technical bulletin. Richardson Co.

CIRCLE NO. 301

## PC card guides

A catalog covers PC card guides, brackets and card racks. Calabro Plastics, Inc., Unitrack Div.

CIRCLE NO. 302

## Vises

An eight-page brochure has detailed illustrations of high-precision vises. Karl A. Neise, Inc.

CIRCLE NO. 303

## Driving and perception

A summary of research on the importance of visual perception in driving has been published in a pamphlet by the Highway Users Federation for Safety and Mobility. Highway Users Federation for Safety and Mobility.

CIRCLE NO. 304

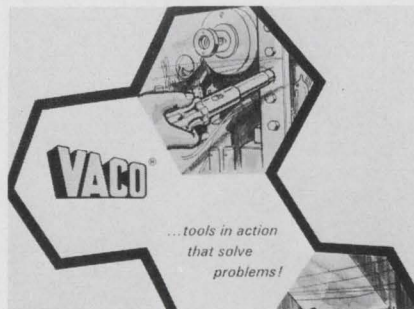

## New tools

A new 40-page tool catalog illustrates in full color screw drivers, nut drivers, pliers, wrenches, crimping tools, riveters, steel tapes and other specialty tools. Vaco Products Co.

CIRCLE NO. 305

## Function modules

A comprehensive 28-page catalog contains detailed electrical and mechanical information on a line of miniature a/d and d/a converters, sample-and-hold modules, multiplexers and miniature PC power supplies. Varadyne Systems.

CIRCLE NO. 306

## Interconnection systems

An eight-page brochure describes a complete line of self-locking electrical connector systems, modular card edge plates, quick-connect receptacles, solderless terminals, flat cable connectors, PC card guides, rack-and-panel connectors and other interconnection systems. Malco Manufacturing Co., Inc.

CIRCLE NO. 307

## Power supplies

A new 64-page power supply handbook and catalog contains power supplies and power modules for systems, laboratory and OEM applications. Trygon Electronics, Inc.

CIRCLE NO. 308

## Memory products

An eight-page illustrated brochure covers digital memory modules, delay lines, analog video delay line modules and analog delay lines. Corning Glass Works.

CIRCLE NO. 309

## Lacing tapes

Introduction to a complete line of braided lacing tapes, cords, and twines for electronic and electrical harnessing is contained in a buyers guide. Western Filament, Inc.

CIRCLE NO. 321

## IC dynamic testing

A new eight-page brochure describes a computer-operated dynamic test system for integrated circuits. Teradyne

CIRCLE NO. 322

## Digital displays

A full-color 12-page catalog contains photographs and specifications of a line of digital displays. Wagner Electric Corp.

CIRCLE NO. 323

## Standby power

A comprehensive 12-page folder describes standby electric power systems for emergency electric power applications. Onan Corp.

CIRCLE NO. 324

## Miniature lamps

A new four-page catalog describes a complete line of subminiature lamps. Inter-Market Inc.

CIRCLE NO. 325

## Scientific instruments

More than 3000 laboratory and scientific products are presented in a 400-page general catalog of selected equipment, instruments and appliances for industrial research, the health sciences, chemistry, agriculture and biology. Cole-Parmer Instrument Co.

CIRCLE NO. 326

## Noise control services

A four-page brochure describes consulting acoustical engineering services that include noise control, environmental noise, architectural, psychological and physical acoustics and project management. Donley, Miller & Nowikas

CIRCLE NO. 327

**YOU SET THE STOPS  
TO SUIT YOUR  
CIRCUIT**

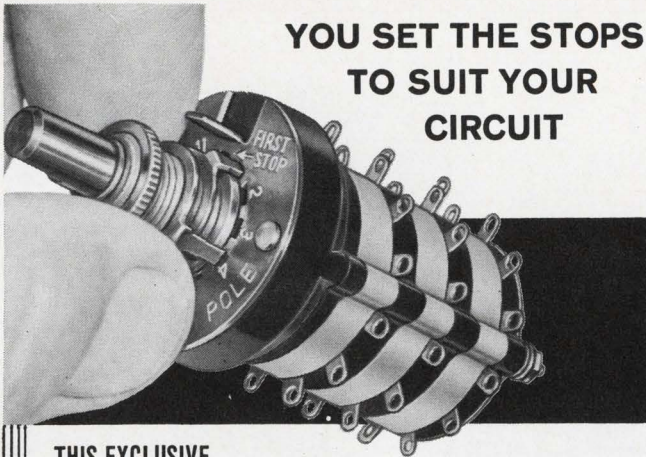

**THIS EXCLUSIVE  
GRAYHILL ADJUSTABLE STOP FEATURE**

simplifies switch selection for prototype and small production run.

- 1 to 4 Poles Per Deck
- 2 to 12 Positions Per Pole
- 1 to 12 Decks
- Shorting Or Non-shorting Contacts
- 30°, 36°, 45° or 60° Angle Of Throw
- Concentric Shaft Switch And Potentiometer Styles Available
- Explosion Proof Design

For your Grayhill Engineering Catalog offering complete technical data—contact



565 Hillgrove Avenue  
LaGrange, Illinois 60525  
Area Code 312, Phone 354-1040

... the Difference Between Excellent and Adequate

INFORMATION RETRIEVAL NUMBER 65

**TOGGLE SWITCH MINIATURES**

Accident-proof mini switches have toggles locking in position to guard against human errors. Interchangeable colored toggles. 1-2-3-4 poles in many configurations. 6A @ 125 VAC.



**ALCOSWITCH®**

DIV. OF ALCO ELECTRONIC PRODUCTS, INC., LAWRENCE, MASS.

INFORMATION RETRIEVAL NUMBER 66

**PUSH BUTTON MINIATURES**

MSPN SERIES

Lighted snap-action DPDT models handle 6A @ 125 VAC & features separate connections to T-1 3/4 lamp. 1/2", 3/8", 3/4" round or square buttons; transparent or translucent colors. P.C. side terminals.

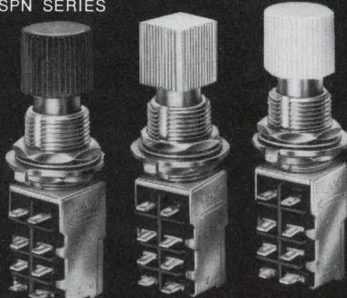

**ALCOSWITCH®**

ILLUMINATED

DIV. OF ALCO ELECTRONIC PRODUCTS, INC., LAWRENCE, MASS.

INFORMATION RETRIEVAL NUMBER 67

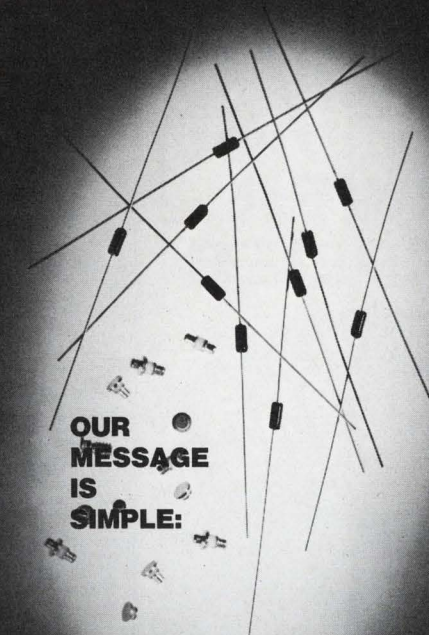

**OUR MESSAGE IS SIMPLE:**

**“our high performance glass PIN diodes cost under \$5.\*”**

\*unit cost per 100 quantity

APPLICATION	MINIMUM V <sub>BR</sub> (Volts)	MAXIMUM C <sub>VR</sub> (pF)	MAXIMUM R <sub>S</sub> (ohms)	TYPICAL τ (ns)	TYPE NUMBER
UNIVERSAL SWITCH	150	0.3	1.2	200	A5S301
UNIVERSAL SWITCH	200	0.25	1.0	200	A5S302
LOW COST SWITCH	100	0.3	1.5	200	A5S339
FAST SWITCH	70	0.4	1.0	15	A5S342

NOTE: These devices are also available in ceramic case styles.

For further information on these devices or other semiconductors, contact your local Aertech representative, or write us directly.



825 STEWART DR. • SUNNYVALE • CALIF. 94086  
(408) 732-0880 • TWX 910-339-9207

INFORMATION RETRIEVAL NUMBER 68

**DELIVERY FROM STOCK**

*a series of*  
**DUAL OUTPUT  
POWER  
SUPPLIES**

FROM  
**\$49.00**



MODEL OS15-0.3D

**for OP AMPS and IC'S**

An exceptional value, the new Deltron OS/PS Series are Independent Dual Output Power Supplies for use with operational amplifiers, integrated circuits and digital logic. Check these features—

- 0.02% regulation
- 500 microvolts ripple and noise
- 10 microsecond recovery time
- Master-slave series and parallel
- Built to top quality standards . . . MIL P-13949 & MIL A-8625
- Plug/wire in — compact design
- All Silicon . . . 71°C operation

**OS/PS SERIES—RATINGS AND PRICES**

MODEL	Each Output		Price
	Volts	Amps	
OS6-0.2D	5-6	0.2	\$49.
PS6-0.2D	5-6	0.2	\$69.
OS6-0.6D	5-6	0.6	\$69.
PS6-0.6D	5-6	0.6	\$89.
OS15-0.1D	8-15	0.1	\$49.
PS15-0.1D	8-15	0.1	\$69.
OS15-0.3D	8-15	0.3	\$69.
PS15-0.3D	8-15	0.3	\$89.

WRITE FOR TECHNICAL BULLETIN



WISSAHICKON AVE., NORTH WALES, PA. 19454  
PHONE: (215) 699-9261 TWX: (510) 661-8061

D 117

INFORMATION RETRIEVAL NUMBER 69

**bulletin  
board**

of product news  
and developments

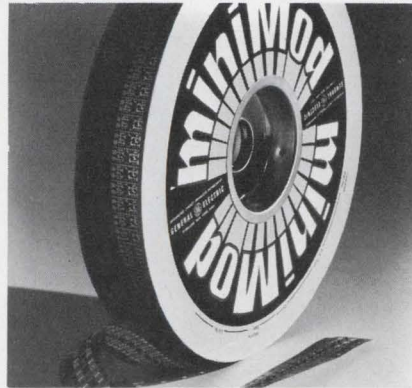

General Electric's Integrated Circuit Products Dept. of Syracuse, N. Y. has announced a new packaging process for ICs that uses a plastic film strip. The process known as the Multibond lead attachment process uses a film strip made of polyimide plastic which comes in continuous lengths and is perforated with indexing holes for mechanized testing and processing. Holes in the film strip accept silicon pellets and provide access to the IC substrate's copper leads.

CIRCLE NO. 328

Five new CMOS ICs have been introduced by Hughes Aircraft Co., Los Angeles, Calif. They are a 16-bit memory, a four-bit adder, two hexadecimal buffers and a shift register.

CIRCLE NO. 329

Electronic Graphics, Inc., Garland, Tex., has a new computerized design analysis service for use by logic circuit designers. Designated Logic Network System, it performs a wide range of load analysis, simulation, packaging, timing and miscellaneous error checks on logic network descriptions at any desired level of complexity. It reveals any unused inputs and outputs, automatically completes all power and ground connections, and determines that allowable loading is not exceeded on any circuit. The program is written in FORTRAN.

CIRCLE NO. 330

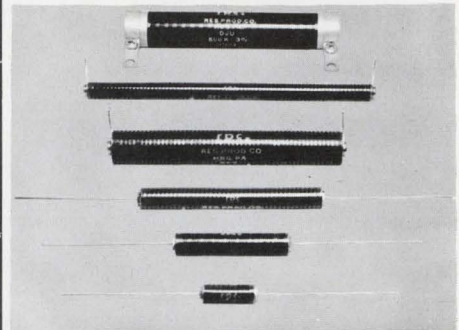

**high voltage  
high ohmic  
carbon film resistors**

15 basic styles available from stock

- WATTS: .25 to 100w.
- RESISTANCE: 10 to 10<sup>14</sup>Ω
- TOLERANCE: to ±1%
- STAND. SIZES: .563" L x .1" dia. to 19.687" L x 2" dia.

**RPC Resistance Products Co.**

914 South 13th Street  
Harrisburg, Pa. 17104 • (717) 236-5081

INFORMATION RETRIEVAL NUMBER 70

**A mouse has  
already been saved  
from leukemia.**

**Help us save a man.**

For years, you've been giving people with leukemia your sympathy. But sympathy can't cure leukemia. Money can. Give us enough of that, and maybe we'll be able to do for a man what has already been done for a mouse.



American Cancer Society

# advertiser's index

Advertiser	Page
ACDC Electronics, Inc.	80A-B
Aertech Industries	99
Alco Electronic Products, Inc.	85, 99
Allen-Bradley Co.	4, 5
Amperex Electronic Corporation	11
Analog Devices, Inc.	65
Associated Testing Laboratories, Inc.	50
Automatic Electric Company	16B, 16C
Bourns, Inc.	12
Bulova Servo Products	88
CEM Company, Inc.	72
Cambridge Thermionic Corporation	72
Circuit Technology Incorporated	85
Cleveland Institute of Electronics	82
Cober Electronics	101
Computer Products	94
Cutler-Hammer	1
Dale Electronics, Inc.	Cover III
Decitek Div. of Jamesbury	104
Delco Electronics	66, 67
Deltrol Controls	90
Deltron, Inc.	100
Digilin, Inc.	103
Ex-Cell-O Corporation	44
Federal Scientific Corporation	102
Fifth Dimension, Inc.	92
Fluke Mfg. Co., Inc., John	17
Garrett Micro-Circuits Corporation	8, 9
General Electric Company	85
Gould, Inc., Graphics Division	60, 61
Grayhill, Inc.	99
Hayden Book Company, Inc.	16D, 102
Heath Dynamics, Inc.	94
Heinemann Electric Company	29
Hewlett-Packard	Cover II, 16A, 54
ISE Electronics Corporation	73
Intronics, Incorporated	93
Johanson Manufacturing Corp.	36
Keithley Instruments, Inc.	6
Keystone Electronics Corp.	103
Lear Siegler, Inc., Cimron Division	33
Lockheed Electronics Company	42, 43
Marconi Instruments	51
Molex, Incorporated	23
Mostek Corporation	16
Motorola Semiconductor	10, 34, 35
National Semiconductor Corporation	24
North Atlantic Industries, Inc.	81
Nytronics, Inc.	89
OPCOA, Inc.	92
Philco-Ford Corporation	52, 53
Philips Electronic Components	80 D-E
Power/Mate Corp.	13
Potter & Brumfield	20
Radio Switch Corporation	101
Rapidesign, Inc.	72
Raytheon Company	86, 87
RCA Electronic Components	Cover IV
Relcom	75
Resistance Products Company	100
Richlok Corporation	97
Rotron, Incorporated	31
Sams & Co., Inc., Howard W.	79
Schauer Manufacturing Corp.	7
Siemens Corporation	38
Signetics Corporation	27, 37
Simpson Electric Company	14, 15
Sprague Electric Company	18
TRW Semiconductor	2
Technical Wire Products, Inc.	82
Tektronix, Inc.	41
Tenney Engineering, Inc.	97
Trio Laboratories, Inc.	102
Vactec Inc.	95
Vero Electronics, Inc.	82
Victoreen Instrument Division	91
Wang Laboratories, Inc.	97
Xerox Data Systems	77

## A complete line of CUSTOMIZED ROTARY CERAMIC SWITCHES ...

For RF and POWER APPLICATIONS

RSC switches are available in a variety of switching models. RSC high precision, quality built units are designed for applications requiring long life maintenance-free service. Types include shorting and non-shorting, single and multi-deck, up to 18 pole positions. Features include, 10 to 100 amp current carrying capacity, 20° to 90° detents, 2000 to 24000 volts flashover and corrosion-proof construction.

Write for catalog no. 960  
and complete information.

**RADIO SWITCH CORPORATION**

Rt. 79, Marlboro, N. J. 07746

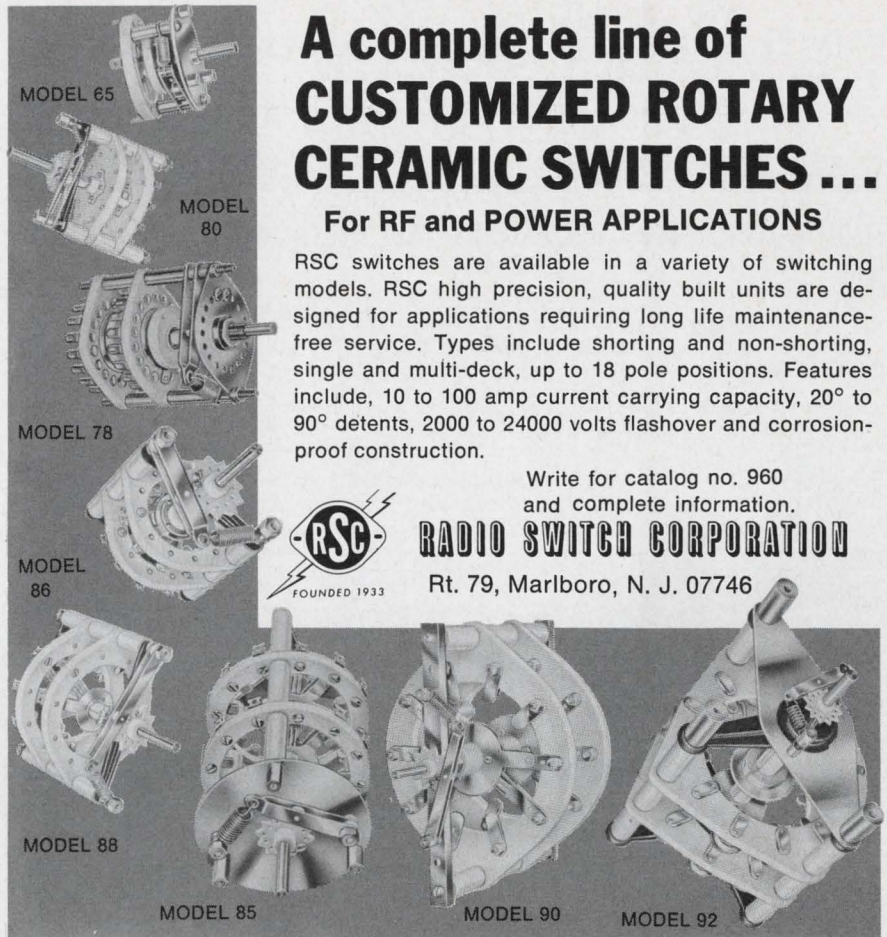

INFORMATION RETRIEVAL NUMBER 71

## High Power PULSE GENERATOR



Ideal for driving —

- LSA DEVICES • GUNN DIODES
- MICROWAVE TUBES
- POCKEL CELLS • KERR CELLS

- Delivers 24Kw (2200V at 11A)
- Fast 20ns Rise Time
- Wide Pulse Range 50ns to 5ms
- Single Shot to 1MHz Repetition Rate and Both Polarities
- It all adds up to a highly versatile general purpose test instrument. Other voltages and currents available.

For Model 605P data, send Coupon:

**COBER**  
ELECTRONICS  
*The High-Power People*

Power supplies, pulse modulators, micro-wave test equipment, transmitters

7 Gleason Avenue  
Stamford, Conn. 06902  
Phone: (203) 327-0003

Name \_\_\_\_\_ Title \_\_\_\_\_

Firm & Dept. \_\_\_\_\_

Address \_\_\_\_\_

City \_\_\_\_\_ State \_\_\_\_\_ Zip \_\_\_\_\_

INFORMATION RETRIEVAL NUMBER 72

## Mini-Computer Mated with Real-Time Analyzer for Automatic Testing



Complete Spectrum Processing System SP-6-1 automatically scales, equalizes, processes underwater acoustic data and noise/vibration signatures for production testing. Monitors on-line signals (nuclear reactor noise, heart sounds, machine tool vibration), recognizes aberrations, gives alarm. Setup conditions are entered via teletype unit as requested by computer. System prints out all spectral data or only frequency amplitude above preset levels. Data also pre-recordable on tape, played back often faster than real time. Analysis over frequency bands as wide as 40 kHz are possible. Many options. **CIRCLE NO. 171**

### Federal Scientific Corporation

a subsidiary of Elgin National Industries, Inc.  
615 West 131st Street, New York, N. Y. 10027.

## WORLD'S SMALLEST 5VDC/100 AMP POWER SUPPLY

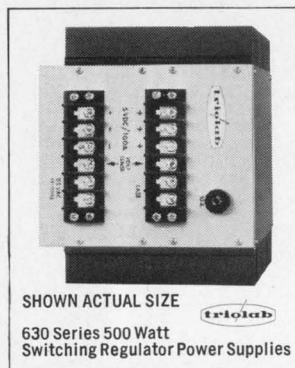

Now you can squeeze your power supply down to fit your microcircuitry with our complete line of off-the-shelf 100 watt to 500 watt supplies. All offer small size, lightweight, high efficiency, cool operation, low cost.

630 Series 5V/100 Amp supply has volume under 500 cubic inches! (8½" x 6¾" x 8¾"); weighs under 20 lbs; 65% efficiency even with light load conditions; no forced air or external cooling for full rated output to 55°C; priced lower than large conventional supplies.

The 100 watt series come in single, dual, triple outputs; 5VDC to 30VDC; commercial, Military, and export models available. **CIRCLE NO. 172**

### Trio Laboratories, Inc.

80 Dupont Street  
Plainview, Long Island, N. Y. 11803

## FUNDAMENTALS OF INTEGRATED CIRCUITS

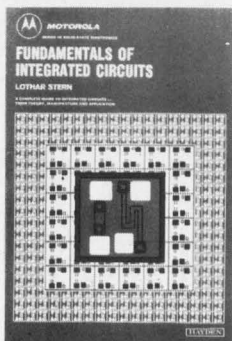

A practical guide to integrated circuits, their theory, manufacture, and applications. This new guide by Lothar Stern offers complete, highly readable coverage of the various techniques of circuit fabrication, and their effect on circuit design and performance. As to marketing considerations, it compares the characteristics of the numerous IC structures devised to date in terms of economics and logistics. A volume in the Motorola Series in Solid-State Electronics. 198 pages, 7 x 10, illustrated. \$8.95, clothbound. Circle the reader-service number below for 15-day examination copies. **CIRCLE NO. 173**

### Hayden Book Company, Inc.

116 West 14th Street  
New York, N.Y. 10011

# Electronic Design

ELECTRONIC DESIGN's function is:

- To aid progress in the electronics manufacturing industry by promoting good design.
- To give the electronic design engineer concepts and ideas that make his job easier and more productive.
- To provide a central source of timely electronics information.
- To promote two-way communication between manufacturer and engineer.

**Want a subscription?** ELECTRONIC DESIGN is sent free to qualified engineers and engineering managers doing design work, supervising design or setting standards in the United States and Western Europe. For a free subscription, use the postfree application form inside the back cover. If none is included, write to us direct for an application form.

If you do not qualify, you may take out a paid subscription for \$25 a year in the U.S.A., \$35 a year elsewhere. Single copies are \$1.50 each.

**If you change your address,** send us an old mailing label and your new address; there is generally a prepaid postcard for this inside the back cover. You will have to requalify to continue receiving ELECTRONIC DESIGN free.

**The accuracy policy of ELECTRONIC DESIGN is:**

- To make reasonable efforts to ensure the accuracy of editorial matter.
- To publish prompt corrections whenever inaccuracies are brought to our attention. Corrections appear at the end of the Letters column.
- To refuse any advertisement deemed to be misleading or fraudulent.

Microfilm copies are available of complete volumes of ELECTRONIC DESIGN at \$19.00 per volume, beginning with Volume 9, 1961. Work is now in process to complete the microfilm edition of Volumes 1-8. Reprints of individual articles may be obtained for \$2.00 each, prepaid (\$.50 for each additional copy of the same article) no matter how long the article. For further details and to place orders, contact the Customer Services Department, University Microfilms, 300 North Zeeb Road, Ann Arbor, Michigan 48106; telephone (313) 761-4700.

**Want to contact us?** If you have any comments or wish to submit a manuscript or article outline, address your correspondence to:

Editor  
ELECTRONIC DESIGN,  
850 Third Avenue,  
New York, N.Y. 10022.

# Electronic Design

Advertising Sales Staff  
Keith Aldrich  
Sales Manager

## New York 10022

Robert W. Gascoigne  
Samuel M. Deitch  
Daniel J. Rowland  
850 Third Avenue  
(212) Plaza 1-5530  
TWX: 710-581-2874

## Philadelphia 19025

Mort Sullivan  
P.O. Box 126  
Dresher, Pa.  
(215) 884-6880

## Boston 02154

Joseph F. Palmer  
1268 Main Street  
Waltham, Mass.  
(617) 894-2700

## Chicago 60611

Thomas P. Kavooras  
Berry Conner, Jr.  
200 East Ontario  
(312) 337-0588

## Cleveland

Thomas P. Kavooras  
(Chicago)  
(312) 337-0588  
(call collect)

## Los Angeles 90303

Stanley I. Ehrenclou  
Jerry D. Latta  
2930 Imperial Highway  
Inglewood, Calif.  
(213) 757-0183

## San Francisco 94022

Arthur R. Shields, Jr.  
95 Main Street  
Los Altos, Calif.  
(415) 941-3084

## London W. 1

For United Kingdom and Holland  
Brayton C. Nichols  
44 Conduit Street  
Tel: REGent 4714

## Verviers, Belgium

For Continental Europe  
Andre Jamar  
1, Rue Mallar, 1  
087) 253.83 Telex 41563

## Tokyo

Haruki Hirayama  
Electronic Media Service  
5th Floor, Lila Bldg.,  
4-9-8 Roppongi  
Minato-ku  
Phone: 402-4556  
Cable: Electronicmedia, Tokyo



# No room for a digital panel meter?

Actual size.  
Cut out and  
use as a  
template.

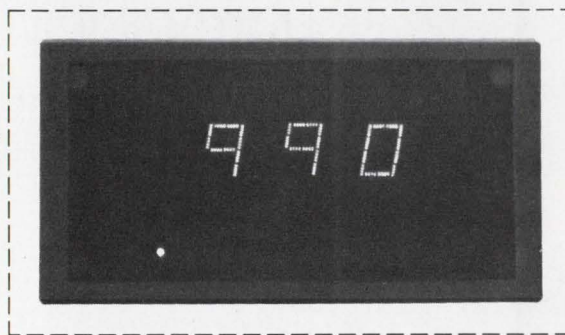

## Try the Digilin 3330 on for size

If you've got space for a commemorative stamp, you've got room for our new 3½-digit light-emitting diode meter, the world's smallest digital panel meter. It's all-solid-state — an industry first — and reliability and ruggedness are practically MIL-spec so it's perfect for aircraft instrument panels and mobile units. Brilliant red numbers make it easier to read — even

in direct sunlight. A dream for portable applications because of its small size, light weight and 5 volt power requirement. True floating differential input. Standard TTL-compatible BCD output. Digilin auto-zero and constant high input impedance features are included, of course. Get all the details today. Digilin, Inc., 1007 Air Way, Glendale, Calif. 91201 • (213) 240-1200.

**digilin**  
DIGITAL INSTRUMENTS

INFORMATION RETRIEVAL NUMBER 73

**READI-MADE terminal boards FROM STOCK**

Submit drawings for special fabrications

Manufacturers of Standardized Hardware  
**NEW FREE CATALOG ON REQUEST**



**KEYSTONE**  
ELECTRONICS CORP.

49 Bleecker St., New York, N.Y. 10012

INFORMATION RETRIEVAL NUMBER 74



## The "no maintenance" PUNCHED TAPE READER

**No edge guides  
No capstans, pinch  
rolls or brakes  
No lenses  
No lubrication  
No adjustments**

You may have to  
replace this bulb  
after 25,000 hours.



New DECITEK Punched Tape Readers give greater accuracy, freedom from maintenance and longer tape life. With 20% to 30% fewer parts than units of comparable performance, they start, stop and hold tape accurately through a stepping motor/dual sprocket bi-directional drive. Tests at 300 cps for more than a quarter-million cycles showed insignificant sprocket hole wear. DECITEK Readers interchangeably read 5, 6, 7 or 8-level paper, paper-polyester or metallized polyester tapes at 60 to 600 cps. Fiber optic elements illuminated by a single, easily replaced bulb eliminate cross-talk and partial or bit failure. Photo-transistor sensing delivers high signal-to-noise ratio outputs. Input-outputs are TTL or DTL compatible. For technical brochure, write DECITEK, 16 Sagamore Rd., Worcester, Mass. 01605. Call (617) 757-4577.

**DECITEK**  
A DIVISION OF JAMESBURY CORP.

INFORMATION RETRIEVAL NUMBER 75

# product index

**Information Retrieval Service.** New Products, Evaluation Samples (ES), Design Aids (DA), Application Notes (AN), and New Literature (NL) in this issue are listed here with page and Information Retrieval numbers. Reader requests will be promptly processed by computer and mailed to the manufacturer within three days.

Category	Page	IRN	Category	Page	IRN
<b>Components</b>			<b>Packaging &amp; Materials</b>		
decade components	95	284	compounds (NL)	98	301
DIPS, plastic (AN)	96	295	connectors, carrier	92	276
lamps, miniature (NL)	98	325	cores, magnetic (DA)	96	289
lights, GaAsP	95	283	DIPS, plastic (AN)	96	295
readout, 7-segment	94	281	handles, PC card (ES)	96	285
relays, reed (NL)	98	299	harness mount (ES)	96	286
resistor, wire-wound	94	282	instruction display	92	277
switches (AN)	96	294	interconnections (NL)	98	307
tools (NL)	98	305	magnetic materials (ES)	96	287
			noise control (NL)	98	327
<b>Data Processing</b>			PC card guides (NL)	98	302
coupler, BCD/ASCII	89	265	sectioner, wafer	92	278
memory, read/write	89	266	tapes, lacing (NL)	98	321
memory products (NL)	98	309	tools (NL)	98	305
transport, tape	89	264	vises (NL)	98	303
<b>ICs &amp; Semiconductors</b>			<b>new literature</b>		
counters, TTL/MSI	88	263	compounds, insulating	98	301
diodes, varactor	88	259	displays, digital	98	323
FETs	88	257	driving and perception	98	304
flatpacks, op amp	88	256	dynamic testing	98	322
ICs, microwave (DA)	96	290	function modules	98	306
memory, programmable	88	260	instruments	98	326
op amp	88	258	interconnections	98	307
SCRs (NL)	98	298	lamps, miniature	98	325
switch, analog	87	255	memory products	98	309
transistors, power	88	261	noise-control services	98	327
trigger, IC Schmitt	88	262	PC card guides	98	302
			pollution instruments	98	300
<b>Instrumentation</b>			power supplies	98	308
analyzer, digital IC	84	252	relays, reed	98	299
counter, 500-MHz	84	254	SCRs	98	298
dynamic testing (NL)	98	322	standby power	98	324
instruments (NL)	98	300	tapes, lacing	98	321
instruments (NL)	98	326	tools	98	305
oscilloscope, 3-MHz	84	251	TV equipment	98	297
oscilloscope system	83	250	vises	98	303
sources, programmable	84	253			
			<b>application notes</b>		
<b>Microwaves &amp; Lasers</b>			converters, d/a	96	293
diodes, oscillator	93	279	DIPs, plastic	96	295
ICs, microwave (DA)	96	290	maintenance concepts	96	296
T pad	93	280	switches	96	294
TV equipment (NL)	98	297			
			<b>design aids</b>		
<b>Modules &amp; Subassemblies</b>			core-design chart	96	289
converters, a/d	90	269	drafting aid	96	288
converters, d/a (AN)	96	293	ICs, microwave	96	290
displays (NL)	98	323			
module repair (AN)	96	296	<b>evaluation samples</b>		
modules, function (NL)	98	306	handles, PC card	96	285
op amp, FET	91	274	harness mount	96	286
op amp, high-speed	90	272	magnetic materials	96	287
op amps, hybrid	91	275			
op amps, power	90	268			
power supplies (NL)	98	308			
readouts, solid-state	90	267			
sample/hold modules	90	271			
standby power	98	324			
supply, HV	90	270			
switches, unitized	91	273			



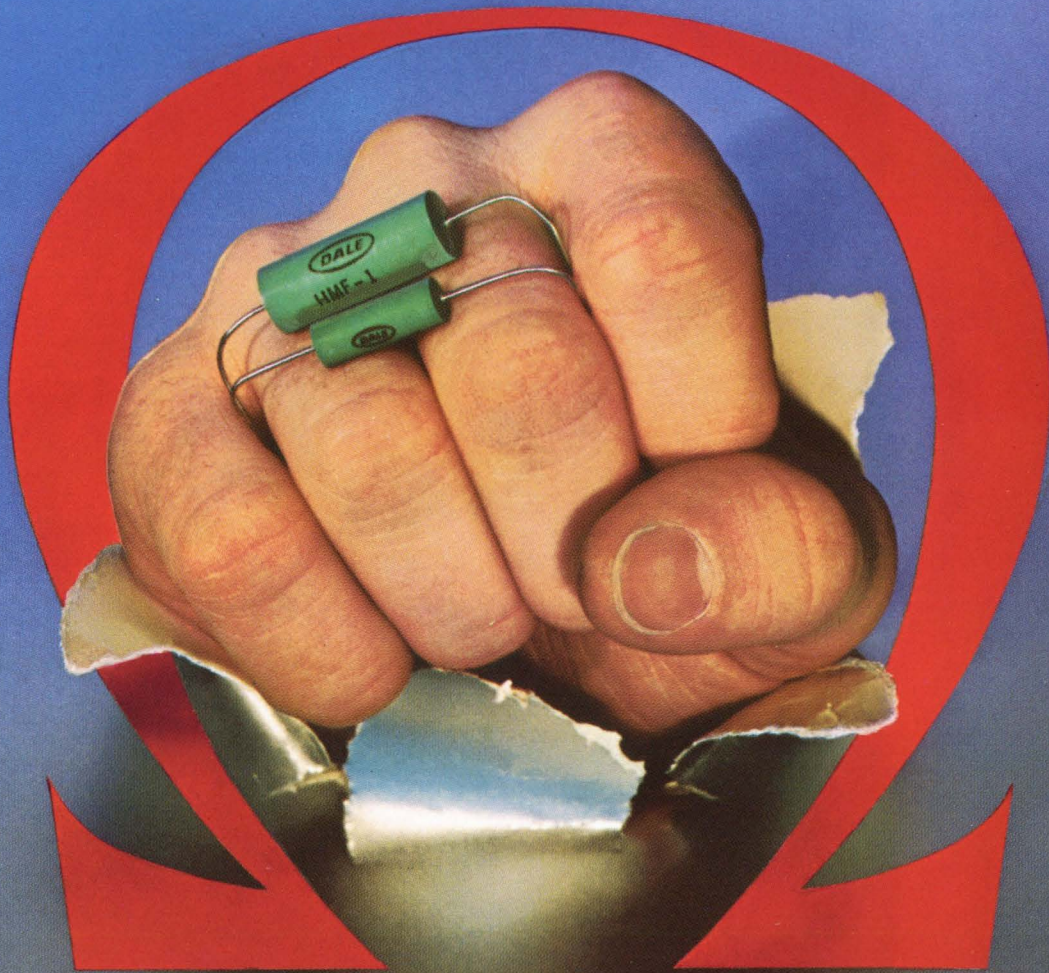

# Dale breaks metal film value barriers

**Exclusive new  
LMF/HMF Resistors  
go as low as 1 Ohm...  
and as high as 50 Megohms!**

Now you can use low-priced Dale Metal Film Resistors in more applications than ever. New LMF and HMF Series let you extend the use of high stability metal film parts to your lowest and highest resistance requirements. This Dale breakthrough gives you design and performance uniformity you've never had before. T.C.'s are no longer a problem — packaging is easier, too. The price: Competitive with the non-precision carbon film parts you previously had to use in low and high value situations. Check the specifications at right, then ask Dale for details on the industry's broadest and most useful line of metal film resistors.

Phone 402-564-3131 today  
or write:

**DALE ELECTRONICS, INC.**

1300 28th Avenue  
Columbus, Nebraska 68601  
In Canada: Dale Electronics Canada, Ltd.  
A subsidiary of The Lionel Corporation



## SPECIFICATIONS

RESISTANCE		T.C.		
LMF	1-9.9 ohms	HMF	100K-50M	150 PPM
	5-30 ohms		100K-50M	100 PPM
	10-30 ohms		100K-30M	50 PPM
	15-30 ohms		100K-5M	25 PPM

**Tolerance:** 1% standard. Special tolerances and T.C.'s available.

**Applicable Mil Specifications:** MIL-R-10509 (Char. C, D, E), MIL-R-22684 (RL-07, RL-20).

### Power Rating:

LMF — 1/10, 1/8, 1/4, 1/2 watt.

HMF — 1/20, 1/10, 1/8, 1/4, 1/2, 3/4, 1 watt.

Per Char. C & E 125° C rating, MIL-R-10509.

## FLAME RETARDANT COATINGS

are standard on all Dale 1/10 thru 1/2 watt conformally-coated metal film resistors.

These resistors have excellent color stability when subjected to short time overloads and prolonged high temperature operation. They have withstood 100 times rated power for as long as 10 minutes without exhibiting flame.



# RCA Announces the Industry's First Power Transistor Thermal-Cycling Ratings.

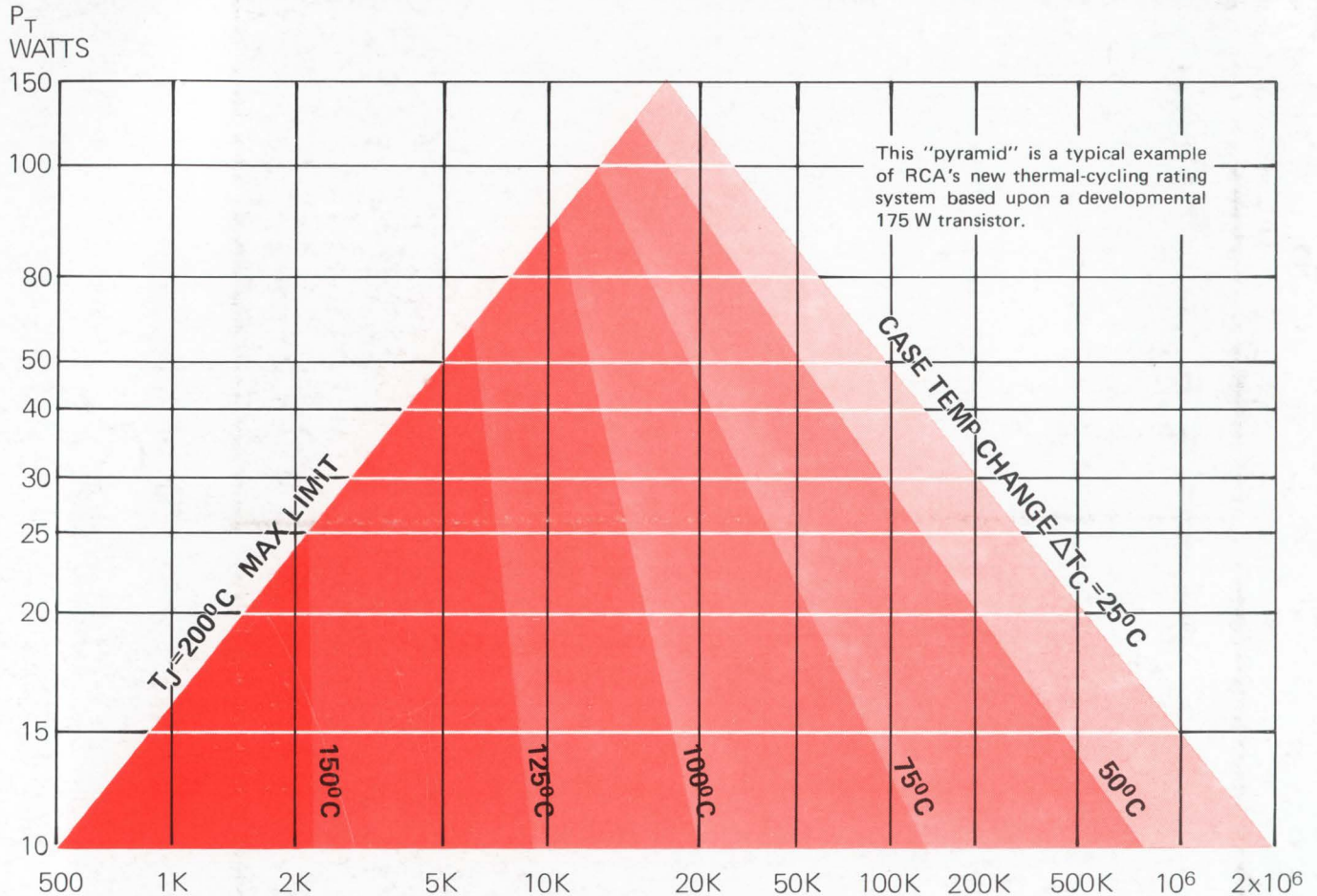

## The Rating "Pyramid" – built with the help of RCA's Controlled Solder Process.

RCA, the industry leader in over-all silicon resources, introduces a totally new concept in thermal-cycling ratings to help you establish and extend equipment life.

Using these new thermal-cycling ratings, you can tell at a glance the life expectancy of any given RCA power transistor in terms of number of cycles, power dissipation, and case temperature change. A rating chart is being developed for each family of RCA power transistors, and will be included in data sheets as they are completed. RCA's Controlled Solder Process (CSP) has made possible these ratings – the only such ratings in the industry.

Controlled Solder Process is an RCA development. With it, RCA can control the effects of thermal stress between the pellet and mounting base, and thereby extend the number of times a transistor can be cycled thermally. CSP increases the device thermal-cycling capability from five to 20 times. The RCA "pyramid" is the only rating chart yet devised to help you avoid thermal-fatigue failure in the field.

This announcement of thermal-cycling ratings on power transistors is made in the same spirit as RCA's pioneering disclosure in 1964 on Second Breakdown capability. The philosophy, simply, is to continue to provide power transistor users with the best possible tools to achieve the optimum interface between the capabilities of RCA devices and the needs of their applications.

For more information on RCA's new thermal-cycling ratings, consult your local RCA Representative or your RCA Distributor or write:  
RCA, Commercial Engineering, Section 57A-21/UT16, Harrison, N.J. 07029.  
International: RCA, 2-4 rue du Lièvre, 1227 Geneva, Switzerland, or P.O. Box 112, Hong Kong.