

Electronic Design 26

VOL. 20 NO.

FOR ENGINEERS AND ENGINEERING MANAGERS

DEC. 21, 1972

Just arrived: an amp with clout. It's the highest-power, tubeless, class-A rf amp yet, delivering 100 W in the frequency range of 0.25 to 105 MHz. The unit

replaces bulkier, heavier, more costly tube types with far higher dissipation. And you can safely hook up any load from short to open circuit. More on P. 71.



Do you face a make or buy decision on power supplies?

BUY LAMBDA LX SERIES

Now 47 models in 8 package sizes...
single, dual & triple outputs.

new single and dual output models in "EE" package



NEW "EE" PACKAGE
SINGLE OUTPUT
LXS-EE-5-OV

\$425

5 VOLTS 45 AMPS

(with O.V.)

NEW "EE" PACKAGE
DUAL OUTPUT
LXD-EE-152

\$435

±15 TO ±12 VOLTS 12.5 AMPS

all listed in Underwriters'
Recognized Components Index*

all designed to meet MIL
environmental specifications

all in stock for 1-day delivery

all guaranteed 5 years

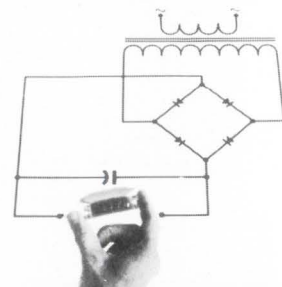

**WHETHER
YOU MAKE
OR BUY...**

LAMBDA
ELECTRONICS CORP.
A Veeco Company

*LX-EE models presently undergoing qualifying tests.

MELVILLE, NEW YORK 11746 515 Broad Hollow Road Tel. 516-694-4200 ARLINGTON HEIGHTS, (CHICAGO) ILL. 60005 2420 East Oakton St., Unit Q Tel. 312-593-2550
NORTH HOLLYWOOD, CALIF. 91605 7316 Varna Ave. Tel. 213-875-2744 MONTREAL, QUEBEC 100C Hymus Blvd., Pointe-Claire, Quebec-730 Tel. 514-697-6520

INFORMATION RETRIEVAL NUMBER 242

XR-210 IC MODEM BECAUSE...

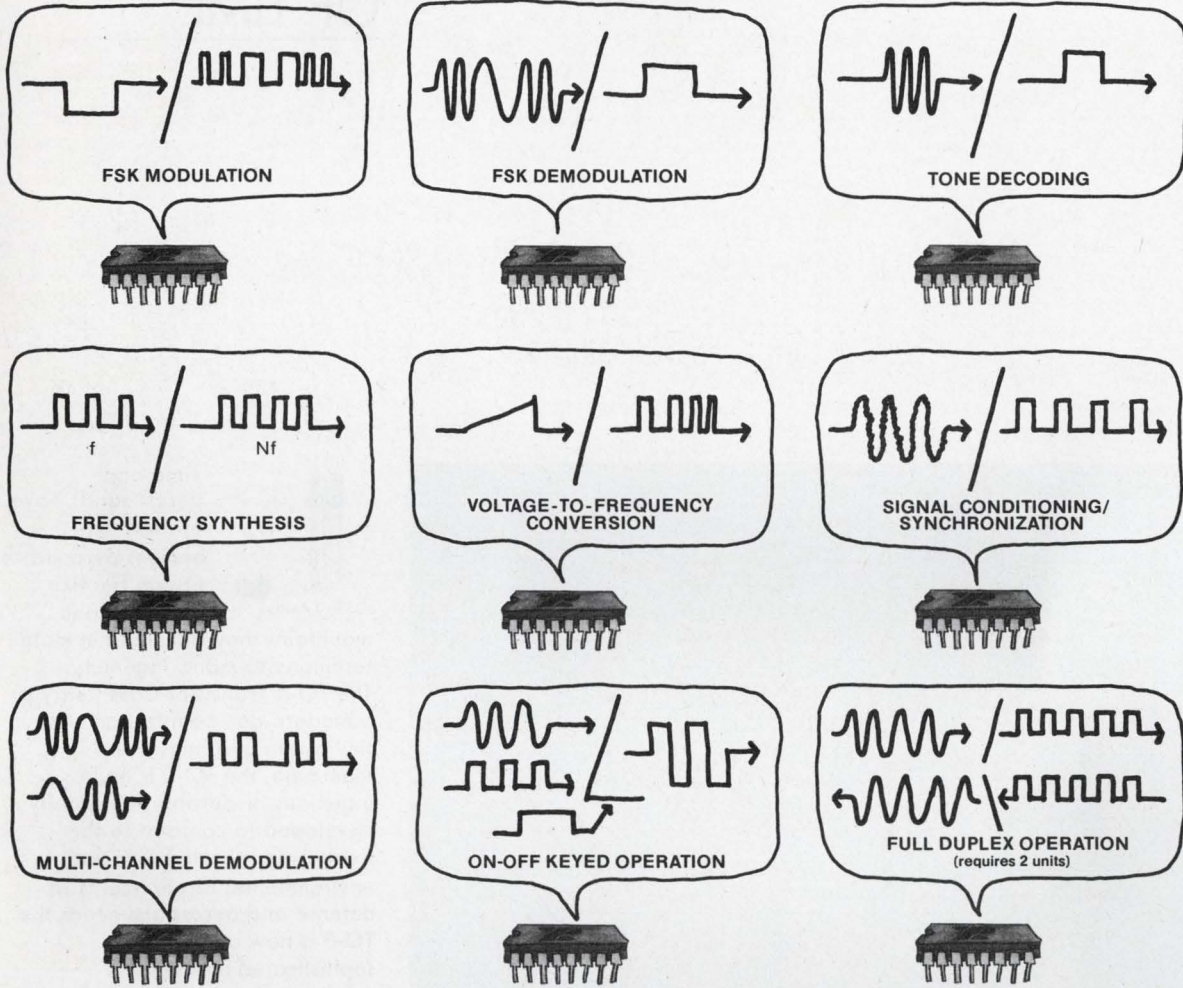

If you're a systems or circuit designer interested in Modems, we think you'll want to listen to our new XR-210 integrated FSK Modulator/Demodulator.

The XR-210 brings you the highest level of component and functional integration in any Modem circuit on the market. It has an internal phase detector, voltage controlled oscillator, high-speed comparator and an RS-232C compatible output driver. The integration of these functions allows you to cut two-thirds to four-fifths of the components you'd otherwise use in a discrete Modem design.

As a designer, you get less complicated systems, improved device matching and better overall performance, and promise of a fairly painless way to prototype your Modems.

Manufacturing people like this circuit because it reduces component count. Reliability is enhanced because of the XR-210's integration of many components onto a single silicon chip. And Exar gives off-the-shelf delivery.

The XR-210 uses an internal Phase-Locked Loop system and operates at 5 to 26 volts at 0.5 Hz to 20 MHz. It's especially well suited for 103 (300 Baud) and 202 (1800 Baud) type data sets.

You can get single XR-210's for \$10 each. Parts in 25-99 quantities are \$8.50 and 100-up \$6.50.

EXAR SPEAKS YOUR LANGUAGE



EXAR INTEGRATED SYSTEMS

750 Palomar Sunnyvale, California 94086 (408) 732-7970 TWX 910-339-9233

EXAR SALES REPRESENTATIVES Alabama, Georgia, Mississippi, North Carolina, South Carolina and Tennessee: K&E Associates, Kennesaw, Georgia (404) 974-4264
Arkansas, Louisiana, Oklahoma and Texas: Evans-McDowell, Dallas, Texas (214) 238-7157 California: De Angelo, Rothman and Co., Whittier (213) 398-6239, Logan Sales
Co., Redwood City (415) 369-6726 Connecticut, Maine, Massachusetts, New Hampshire, Rhode Island and Vermont: Com-Sale, Waltham, Massachusetts (617) 890-0011
Indiana, Kentucky and Ohio: McFadden Sales, Columbus, Ohio (614) 221-3363 Idaho, Oregon and Washington: SD-R² Products & Sales, Bellevue, Washington (206)
747-9424 Illinois and Wisconsin: Mar-Con Associates, Inc., Skokie, Illinois (312) 675-6450 Iowa, Kansas and Missouri: Nevco, Inc., Kansas City, Missouri (816) 421-1751
Maryland, Virginia and Washington, D.C.: Rep-tron, Inc., Silver Spring, Maryland (301) 593-4844 New Jersey (North) and Pennsylvania: Harvard Electronic Sales, Willow
Grove, Pennsylvania (215) 657-2213 New Jersey (South) and New York: MOS Associates, Floral Park, New York (516) 694-5923 Canada: Harvard Electronic Sales,
Laval, Quebec (514) 681-1400 **EXAR DISTRIBUTORS** California: Intermark Electronics, San Carlos (415) 592-1641, San Diego (714) 279-5200, Van Nuys (213) 782-0362
Colorado: Intermark Electronics, Denver (303) 936-8284 Massachusetts: Gerber Electronics, Dedham (617) 329-2400 Washington: Intermark Electronics, Seattle (206) 767-3160

INFORMATION RETRIEVAL NUMBER 2

THINGS THAT STAND THE TEST OF TIME



Time and desert sands have eroded the ancient pyramids of Egypt, but like massive stone

mountains they still stand in mute testimony to man's ingenuity. The TO-5 Transistor Case Relay is a modern-day counterpart. As tiny as the pyramids are mammoth, the TO-5 is no less ingenious or durable. Originally developed to conform to the extraordinary reliability and environmental requirements of defense and aerospace needs, the TO-5 is now available for sophisticated industrial applications.

The same pioneering spirit at Teledyne that created the TO-5 Relay is breaking new ground in the field of Solid State switching devices. This advanced family of Solid State relays will also stand the test of time. Send us your requirements.

3155 West El Segundo Boulevard
Hawthorne, California 90250
Telephone (213) 679-2205



**TELEDYNE
RELAYS**

Electronic Design 26

VOL. 20 NO.

FOR ENGINEERS AND ENGINEERING MANAGERS

DEC. 21, 1972

NEWS

- 23 **News Scope**
- 26 **New thin-film incandescent display** could outperform LEDs in cost, power dissipation, brightness and character size.
- 28 **'Printed-circuit' TWT** challenges transistor as a microwave amplifier.
- 30 **A BIFET developed**, and it could lead to a faster, more dense IC.
- 32 **World's most potent comsat** to test new concepts for future satellites.
- 36 **1-kW, 170-lb battery**, developed for extra-long space missions.
- 38 **Technology Abroad**
- 41 **Washington Report**

TECHNOLOGY

- 48 **Planning to use high-speed logic?** Problems with layouts overshadow those of logic design. Controlled transmission lines must replace conventional wiring.
- 54 **Improve your Karnaugh mapping skills.** Use of variables allows you to simplify maps and design circuits for latching or sequential-signal gating.
- 58 **Watch out for traps in hybrid IC tests.** If you don't take precautions, you may wind up doing more harm than good. Here are three pitfalls to avoid.
- 62 **Ideas for Design:** Circuit reduces the gates needed in TTL comparator for 16-bit words . . . Transformerless voltage doubler has good output regulation . . . Zero-crossing detector avoids hysteresis problem with complementary dual comparator . . . Self-stabilized zener insures constant current in op-amp voltage reference . . . overflow detector uses counter-output display.

PRODUCTS

- 71 **Microwaves & Lasers:** Linear rf amp challenges tubes with 100-W output.
- 75 **Components:** Noninductive resistors made with serpentine film pattern.
- 78 **Modules & Subassemblies:** 4-bit analog-to-digital unit converts at 100-MHz rate.
- 82 **ICs & Semiconductors:** 2048-bit PROM matches chip area of 1024-bit counterpart.
- 86 Instrumentation
- 87 Data Processing

Departments

- 45 **Editorial:** What we don't print—Should we?
- 7 Across the Desk
- 88 Evaluation Samples
- 89 Application Notes
- 90 New Literature
- 93 Bulletin Board
- 96 Advertisers' Index
- 98 Product Index
- 98 Information Retrieval Card

Cover: Photo by Len Rosenberg, courtesy of Electronic Navigation Industries, Inc.

ELECTRONIC DESIGN is published biweekly by Hayden Publishing Company, Inc., 50 Essex St., Rochelle Park, N. J. 07662. James S. Mulholland, Jr., President. Printed at Brown Printing Co., Inc., Waseca, Minn. Controlled circulation postage paid at Waseca, Minn., and New York, N. Y., postage pending Rochelle Park, N. Y. Copyright © 1972, Hayden Publishing Company, Inc. 84,392 copies this issue.

If you feel we've been too commercial

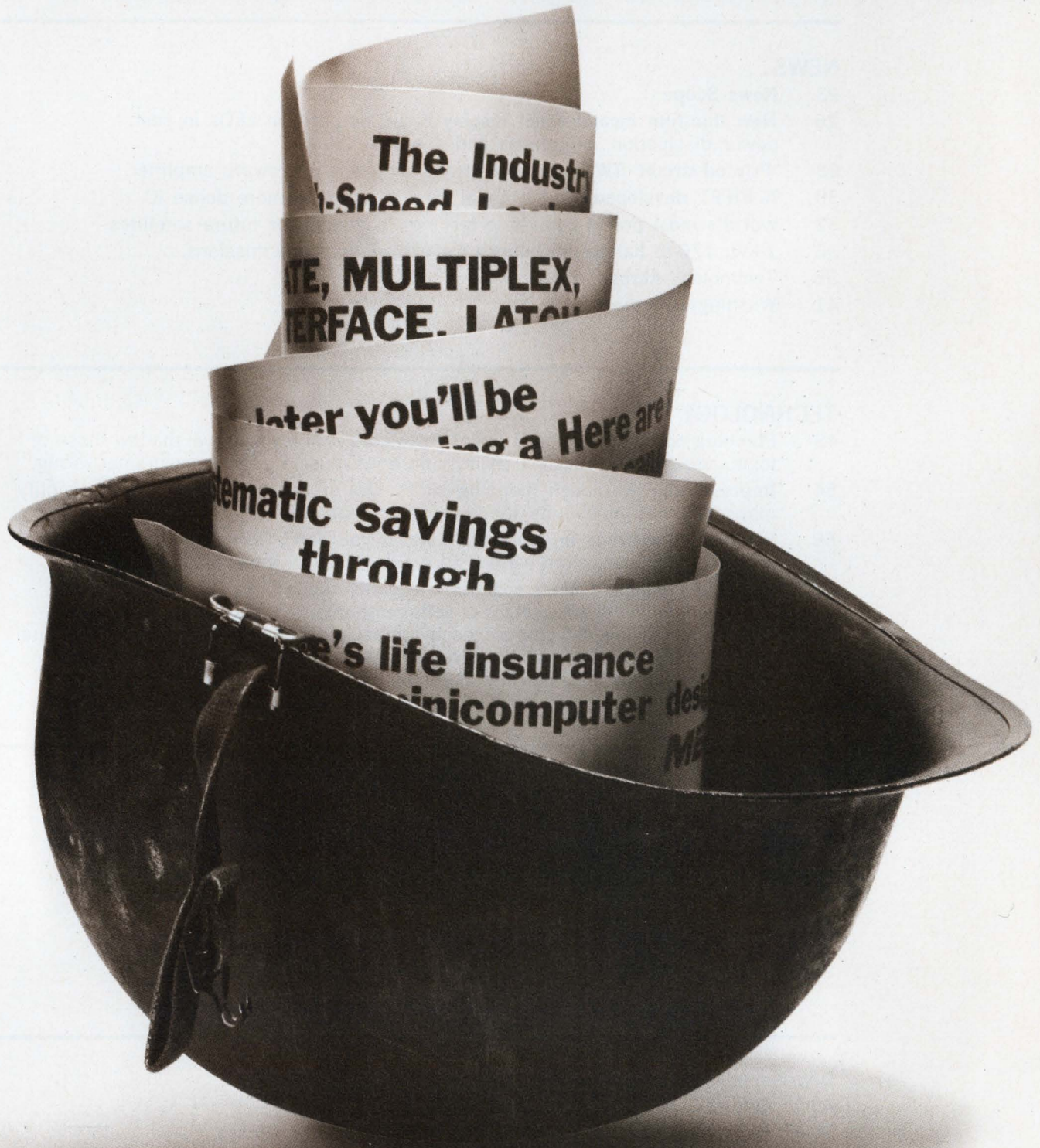

...MECL 10,000 goes military.

MECL 10,000*—the industry's fastest growing high-speed logic family — is now available in the MIL-TEMP range of -55°C to $+125^{\circ}\text{C}$. The FULL-MIL circuits are pin and function-compatible with commercial (-30°C to $+85^{\circ}\text{C}$) MECL 10,000 products. However, the FULL-MIL parts are specified to drive 100 OHM (min) transmission lines rather than the 50 OHM (min) capability of commercial range devices. Higher impedance loads may be used.

Two new subsets, MC105XX and MC106XX identify the new additions which are as follows:

MIL-TEMP (-55°C to $+125^{\circ}\text{C}$) Part #	Function	Commercial (-30°C to $+85^{\circ}\text{C}$) Part #
MC10501	Quad OR/NOR Gate with Strobe	MC10101
MC10502	Quad NOR Gate	MC10102
MC10505	Triple 2-3-2 OR/NOR Gate	MC10105
MC10506	Triple 4-3-3 NOR Gate	MC10106
MC10507	Triple Exclusive OR/NOR Gate	MC10107
MC10509	Dual 4-5 OR/NOR Gate	MC10109
MC10515	Quad Line Receiver	MC10115
MC10516	Triple Line Receiver	MC10116
MC10517	Dual 2-Wide OR-AND/OR-AND-INVERT Gate	MC10117
MC10518	Dual 2-Wide OR/AND Gate	MC10118
MC10519	4-Wide OR-AND Gate	MC10119
MC10521	4-Wide OR-AND/OR-AND-INVERT Gate	MC10121
MC10531	Dual D Flip-Flop (160 MHz Typ.)	MC10131
MC10533	Quad Latch with Output Enable	MC10133
MC10574	Dual 4-Line Multiplexer	MC10174
MC10581	4-Bit Arithmetic Logic Unit	MC10181
MC10631	Dual D Flip-Flop (225 MHz Typ.)	MC10231

Additional MECL 10,000 functions will be added to the military subset in the near future. And, a program has begun to qualify MECL 10,000 devices under MIL-M-38510.

Your nearby Motorola distributor now has MIL-TEMP MECL 10,000 available for evaluation. Packaging is in the hermetic 16-pin black-ceramic dual in-line package. Whatever your requirements, commercial or military, MECL 10,000 gets the job done . . . faster.

MECL 10,000 eliminates the alternatives. Evaluate and compare!

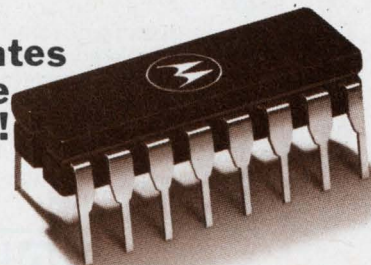

*MECL and MECL 10,000 are trademarks of Motorola Inc.

 **MOTOROLA MECL**
... for faster computers & systems

INFORMATION RETRIEVAL NUMBER 4

One "no" and your power supply doesn't go.

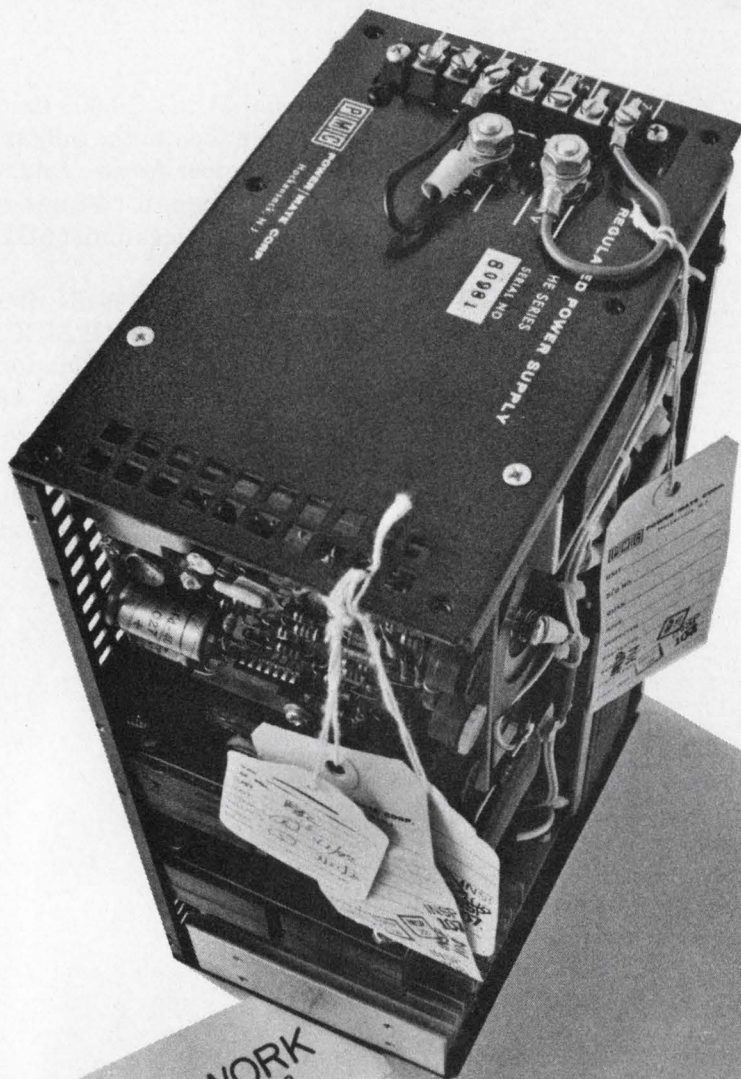

Did you know that each and every Power/Mate power supply gets 42 separate inspections? A "no" in any one means that your power supply doesn't go out the door. That's the insistence and emphasis that the new Power/Mate puts on quality. Sure, it costs us more, but that's how Power/Mate makes friends . . . and why Power/Mate is the world's largest producer of quality power supplies. Send for the Power/Mate catalog . . . 32,500 models . . . most available for same-day shipment.

THE NEW **P/M/C**
POWER/MATE CORP.

514 S. River Street, Hackensack, N. J. 07601/Phone (201) 343-6294
TWX 710-990-5023

Vice President, Publisher

Peter Coley

Editors

Editorial Offices
50 Essex St.
Rochelle Park, N.J. 07662
(201) 843-0550
TWX: 710-990 5071
Cable: Haydenpubs Rochellepark

Editor-in-Chief: George Rostky

Managing Editors:

Ralph Dobriner
Michael Elphick

Associate Editors:

Jules H. Gilder
Richard Lee Goldberg
Morris Grossman
Seymour T. Levine
John F. Mason
Stanley Runyon
Edward A. Torrero
Richard L. Turmail

Contributing Editor:

Peter N. Budzilovich

Editorial Field Offices

East

Jim McDermott, Eastern Editor
P.O. Box 272
Easthampton, Mass. 01027
(413) 527-3632

West

David N. Kaye, Senior Western Editor
2930 West Imperial Highway
Inglewood, Calif. 90303
(213) 757-0183

Washington

Heather David
2506 Eye St., N.W.
Washington, D.C. 20037
(202) 338-3470

Editorial Production

Marjorie A. Duffy

Art

Art Director, William Kelly

Richard Luce
Anthony J. Fischetto

Production

Manager, Dollie S. Viebig

Helen De Polo
Maxine Correal
Anne Molfetas

Circulation

Manager, Nancy L. Merritt
Ron Deramo

Information Retrieval

Peggy Long

Promotion

Manager, Jeffrey A. Weiner
Karen Kerrigan

across the desk

U.S. export controls called a bottleneck

Recently a Capital Capsule in "Washington Report" said that "procedures for clearing exports have been simplified."

Whom are you kidding? Export controls are still the biggest stumbling block to the export of electronic parts and instruments. While companies in England, France and Japan export lustily to Europe, American exporters have to fight for export licenses.

Our company is still waiting for an export license for a spectrum analyzer, to be sold to West Germany. It is readily available elsewhere.

I. Steiner

Meriam, Inc.
P.O. Box 2134
Hammond, Ind. 46323.

Uhf TV-tuner market alive and competitive

"FCC Remains Firm on TV-Tuner Accuracy Requirements," published in "Washington Report" in the Sept. 28 issue (ED 20, pp. 49-50), contains an inaccuracy. It says that "electronic companies are waiting anxiously to see if the single producer of 70-position TV tuners can meet FCC standards for accuracy." The article then discusses problems that Sarkes-Tarzian has in meeting accuracy specifications.

The article is misleading in its implication that there is a sole industry source for 70-position uhf tuners and that the source is Sarkes-Tarzian.

The F.W. Sickles Div. of the

General Instrument Corp. is the largest supplier of uhf tuners in the United States, as well as the largest producer of 70-position TV tuners in the world. General Instrument tuners have, from initial production, continually met the FCC accuracy specifications of ± 3 MHz to all customers without exception. General Instrument has additionally advised the FCC and the TV industry of the significant progress being made to achieve accuracies of greater than 3 MHz to meet the proposed July, 1975, FCC requirements.

Eli Cohen

Vice President of Engineering
F.W. Sickles Div.
General Instrument
P.O. Box 330
Chicopee, Mass. 01014.

Ed Note: The news item should have stated: "... the single manufacturer of 70-position uhf tuners for a large portion of the U.S. TV production line this year."

Watch your language on time-delay relays

I was glad to see that the Focus article on time-delay relays pointed out that where operational times are involved, the correct (preferred) terminology is "operate time" and "release time" (see Focus on Time-Delay Relays," ED 21, Oct. 12, 1972, p. 62).

Having gone this far, the article might well have pointed out that the other associated preferred terms that are largely ignored by NARM members, despite NARM's "Engineers' Relay Handbook," are

(continued on page 10)

Electronic Design welcomes the opinions of its readers on the issues raised in the magazine's editorial columns. Address letters to Managing Editor, Electronic Design, 50 Essex St. Rochelle Park, N. J. 07662. Try to keep letters under 200 words. Letters must be signed. Names will be withheld on request.

giga-trim capacitors for microcircuit designers

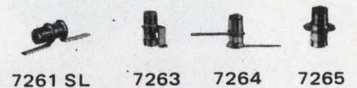
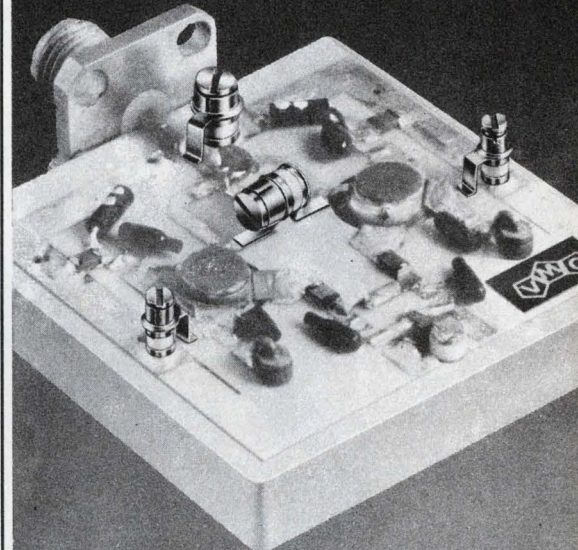

Giga-Trim® (gigahertz-trimmers) are tiny variable capacitors which provide a beautifully straight forward technique to fine tune RF hybrid circuits and MIC's into proper behavior. They replace time consuming cut-and-try adjustment techniques and trimming by interchange of fixed capacitors.

Applications include impedance matching of GHz transistor circuits, series or shunt "gap-trimming" of microstrips, external tweaking of cavities, and fine tuning of crystal oscillators.

Johanson

MANUFACTURING CORPORATION

BOONTON, NEW JERSEY 07005
201 / 334-2676

**NOW
WE MAKE
95K AND
10K ECL**



The ECL you want is now made in Fairchild: Voltage-compensated 10K. Our fully-compensated 95K. And they all cost the same!

10K for today's designs, 95K for tomorrow's designs today. That's our philosophy.

With this in mind we're now making 10K ECL. But 10K ECL with a plus. Ours is voltage-compensated. And *fully* compatible with existing 10,000 series ECL. So if you want to upgrade your present 10K system and get rid of some of the noise margin problems, we've now got the parts to help you.

On the other hand, if you're starting to plan a new ECL system, consider our 95K series. Voltage compensated. And temperature compensated. And, to complete the system, our high-speed ECL memories, fully compatible with 95K logic.

Some day all ECL will be fully compensated. Our 95K is today. Why wait?

Whether you want production for your present 10K system, or want to launch a new system with tomorrow's ECL logic, or if you'd just like to talk over your ECL problems, write us. Or call us on our special Hot Line: (415) 962-3333. We've got the ECL parts. And the ECL smarts. Whatever's right.

Temperature & voltage compensated 95K ECL

- Typical Propagation Delay of 2 Nanoseconds
- Broad Range of MSI and SSI Functions
- Unloaded Gates less than 25 mW/Gate
- Voltage and Temperature Compensated over greater than 3 volts and 75°C
- Pinouts compatible with F 10,000 series

Available 1972

- F95002 Dual 4-Input OR/NOR Gate
- F95003 Triple 2-Input OR/NOR Gate
- F95004 Quad 2-Input NOR Gate
- F95029 JK Master/Slave FF
- F95101 Quad OR/NOR Gate with Common Enable
- F95102 Quad 2-Input NOR Gate
- F95106 Triple 4-3-3 Input OR Gate
- F95109 Dual 4-5 Input OR/NOR Gate
- F95110 Dual 3-Input/3-Output OR Gate
- F95111 Dual 3-Input/3-Output NOR Gate
- F95115 Quad Line Receiver
- F95231 High Speed Dual D Flip-Flop

Available 1st Quarter 1973

- F95000 Four-Bit Universal Shift Register
- F95010 BCD Decade Counter
- F95016 Four-Bit Binary Counter
- F95105 Triple 2-3-2 Input OR/NOR Gate
- F95107 Triple Exclusive OR/NOR Gate
- F95116 Triple Differential Line Receiver
- F95117 Dual 2-Wide 2-3-Input OR-AND/OR-AND-INVERT Gate
- F95118 Dual 2-Wide 3-3-Input OR-AND Gate
- F95119 4-Wide 4-3-3-3-Input OR-AND Gate
- F95121 4-Wide 3-3-3-3-Input OR-AND/OR-AND-INVERT Gate
- F95124 Quad TTL to ECL Level Converter
- F95125 Quad ECL to TTL Level Converter
- F95130 Dual Latch
- F95160 12-Bit Parity Generator/Checker
- F95161 1 of 8 Demultiplexer/Decoder (low output)
- F95162 1 of 8 Demultiplexer/Decoder (high output)
- F95164 Eight Input Multiplexer
- F95170 9+2-Input Parity Circuit
- F95179 Look Ahead Carry
- F95181 Four-Bit Arithmetic Logic Unit/Function Generator

Voltage-compensated 10K ECL

- Typical Propagation Delay of 2 Nanoseconds
- Broad Range of MSI and SSI Functions
- Unloaded Gates less than 25 mW/Gate
- Voltage Compensated
- Plug in replacement for any 10K series device

Available 1972

- F10101 Quad OR/NOR Gate with Common Enable
- F10102 Quad 2-Input NOR Gate
- F10106 Triple 4-3-3 Input NOR Gate
- F10109 Dual 4-5 Input OR/NOR Gate
- F10110 Dual 3-Input/3-Output OR Gate
- F10111 Dual 3-Input/3-Output NOR Gate
- F10115 Quad Line Receiver

Available 1st Quarter 1973

- F10105 Triple 2-3-2 Input OR/NOR Gate
- F10107 Triple Exclusive OR/NOR Gate
- F10116 Triple Differential Line Receiver
- F10117 Dual 2-Wide 2-3-Input OR-AND/OR-AND-INVERT Gate
- F10118 Dual 2-Wide 3-3-Input OR-AND Gate
- F10119 4-Wide 4-3-3-3-Input OR-AND Gate
- F10121 4-Wide 3-3-3-3-Input OR-AND/OR-AND-INVERT Gate
- F10124 Quad TTL to ECL Level Converter
- F10125 Quad ECL to TTL Level Converter
- F10130 Dual Latch
- F10131 Dual D Flip-Flop
- F10160 12-Bit Parity Generator/Checker
- F10161 1 of 8 Demultiplexer/Decoder (low output)
- F10162 1 of 8 Demultiplexer/Decoder (high output)
- F10164 Eight Input Multiplexer
- F10170 9+2-Input Parity Circuit
- F10179 Look Ahead Carry
- F10181 4-Bit Arithmetic Logic Unit/Function Generator
- F10231 High Speed Dual D Flip-Flop

**MADE IN
FAIRCHILD**

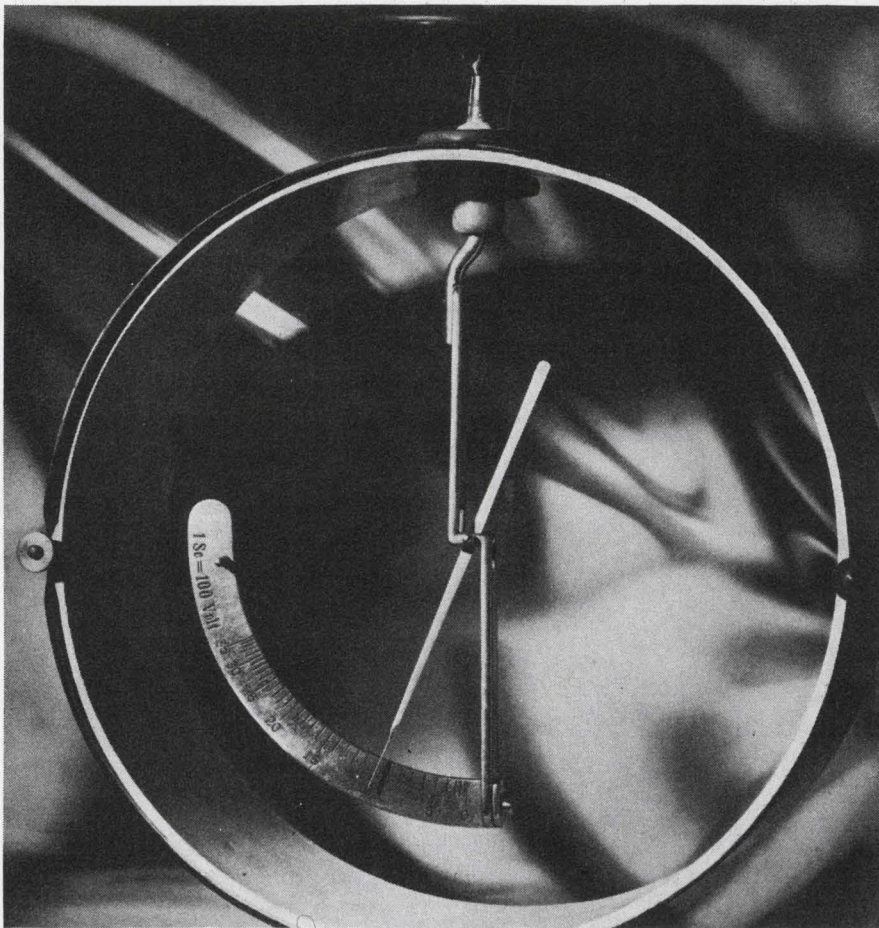

How would you get a measureable signal from only 6,000 electrons per second?

Most people do it Victoreen's way

With just 6,000 electrons, our 10^{12} RX-1 will give you a good clean one millivolt signal . . .

We've been making hi-meg resistors for over 30 years, making it possible for engineers like you to make big things out of little things. And with Victoreen RX-1 resistors, hi resistance is just one of the nice things you get . . . how about accuracy to $\pm 1\%$, good stability, and ranges from 10^7 to 10^{14} ohms . . .

Victoreen . . . where else can you get so many accurate ohms for your money?



VICTOREEN
INSTRUMENT DIVISION
10101 Woodland Avenue
Cleveland, Ohio 44104

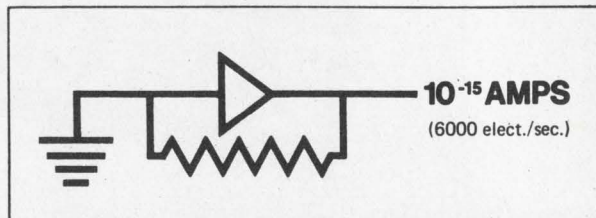

DMA 722

INFORMATION RETRIEVAL NUMBER 8

ACROSS THE DESK

(continued from page 7)

"pickup" and not "pull-in," as well as "dropout" and not "release" where time is not considered. By the same token, the article should have used "pickup" and not "pull-in" throughout.

To the three references should have been added ANSI (American National Standards Institute) C83.16 (1971) "Definitions and Terminology for Relays for Electronic Equipment," which shows the same preference in terms as the "Engineers' Relay Handbook" but is more authoritative.

While on the subject of time delays, the article might have listed the military specifications:

"MIL-R-19648 Relays, Time Delay, Thermal, General specifications for, and."

"MIL-R-83726 Relays, Time Delay, Electric and Electronic, General specification."

E. U. Thomas
Chairman

SAE A-2R Relay Committee
Grumman Aerospace Corp.
Syosset, N.Y. 11791.

Semis take a bath

During takeoff a TWA cargo jet, carrying mostly strawberries and mail, crashed into San Francisco Bay on Sept. 13. Later, when the sales manager of a semiconductor company was asked if he had anything on that plane, he replied: "Ah, yes. Every single delinquent order."

Correction

Several sharp-eyed readers spotted four incorrect Boolean expressions in the article "Use the Wired-AND/and Implied-OR" (ED 20, Sept. 28, 1972, p. 76). The correct expressions are:

1. Fig. 1a: $a \oplus b$.
2. Fig. 1b: c' and d' should be \bar{c} and \bar{d} . The output expression is then correct.
3. Equation at bottom of page 76: $f = a + b + (c + d)$.

4. Fig. 4b: $f = (\overline{abc}) (\overline{abc}) = (\bar{a} + \bar{b} + \bar{c}) (a + b + c)$.

Thanks to Akavia Kaniel, the first to spot the errors, and to the other readers who wrote in.

At Littelfuse we don't just meet your needs —we anticipate them.



But that should come as no surprise. Littelfuse has long been known throughout the industry as a leader in innovative design. Our research and development engineers are constantly designing and testing to create tomorrow's products—more advanced, more streamlined, more versatile . . . like these four new fuseholders, developed exclusively by Littelfuse.

P.C. BOARD FUSEHOLDER—281007

A low-profile, plug-in fuseholder accommodating Littelfuse picofuses and microfuses. Edge-mounted, the holder permits easy and rapid fuse removal and replacement. Rated at 5 amps to 125 volts.

TWIN MICROFUSE HOLDER—280021

A twin circuit or single circuit and spare fuseholder for spacetight applications. Accepts two microfuses or a combination of micro and picofuse. Rated at 5 amps to 125 volts.

IN-LINE FUSEHOLDER—155100

A low-cost holder with "twist lock" allowing easy fuse extraction and replacement. Accepts all $\frac{1}{4}$ " x $1\frac{1}{4}$ " fuses and SFE fuses to 20 amps. Standard color is black; special colors can be supplied to order.

LOW PROFILE FUSEHOLDER—348(000) Series

Square cap fuseholder snaps into chassis, eliminating need for mounting hardware. The cap snaps open for quick and easy fuse insertion and removal. Aesthetically styled to complement modern instrument panels, the holder is available in several color combinations.

For detailed information on our complete line of fuses, fuseholders, circuit breakers, switches, and relays, write for Catalog #17. Or contact our representative or authorized Littelfuse distributor in your area. He will be glad to help you determine your immediate needs—and to help you plan for tomorrow's.

Littelfuse Inc.

Subsidiary of Tracor, Inc.

800 EAST NORTHWEST HIGHWAY • DES PLAINES, ILLINOIS 60016 • PHONE: (312) 824-1188

WOULD YOU LIKE A CAREFREE WEEK FOR TWO IN THE BLUE CARIBBEAN?

Relax or lend a hand, swim, scuba dive, or just put your feet on the rail. Visit exotic tropical islands and foreign ports. It's the vacation for thinking people with a spirit of adventure. Sail in air conditioned comfort on big, safe windjammers. Choice of Bahamas, Virgin Islands, Windward or Leeward islands cruises. Pick your own departure dates. It's a trip you'll always remember. AND it's only part of the big first prize offered this year.



PLUS: \$1,000 IN CASH!

Everyone can use some extra money—especially on a cruise. Use it for babysitters, tropical clothes, shop the free ports, bank it or spend it. It goes along as an extra bonus to the lucky first prize winner who picks the Top Ten ads in the January 4 issue.



LAST YEAR'S TOP PRIZE WINNERS TELL HOW TO DO IT

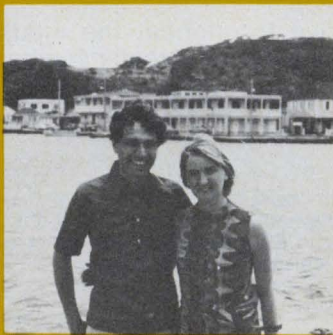

Ronald S. Newbower
Bio Engineering Division
Harvard Anesthesia Center
Massachusetts General Hospital

Dr. Newbower looked through the contest issue with particular attention to general interest advertisements. He assumed that those ads with appeal to a large fraction of readers would place in the Top Ten. He also tended to choose ads for products that were (a) new (and of general interest), or (b) had their logos emphasized. The result: Dr. Newbower sailed off with first prize. He and his wife enjoyed their windjammer cruise; sent *Electronic Design* an enthusiastic note from the Caribbean island of Saint Lucia.



William R. Austin
Senior Engineer
Singer, Simulated Products Division
Binghamton, New York

Mr. Austin selected 37 ads which he considered potential winners. Then he made a chart, assigning points to each ad for esthetic appeal, copy approach, usefulness, etc.—six rating categories in all. The final results were then modified using a purely subjective approach. His system must be a good one. Two or three hours of work paid off with second prize.



Arthur L. Moorcroft
E.E.
Naval Underwater Systems Center
New London, Connecticut

Mr. Moorcroft first selected the 15 to 20 ads that he considered exceptional. Then culled them to pick the Top Ten. He leaned heavily toward new advertisements, new products, or new features in making his choices. The system worked well enough to make him one of the three big reader winners in last year's contest.

Electronic

1973 SUPER TOP

LOOK FOR COMPLETE INFORMATION—LIST OF PRIZES—

AND: FREE JET TRANSPORTATION

This really makes the 1st prize complete. Think about it! The cruise . . . the \$1,000 in cash, AND free round-trip tickets for two on



regularly scheduled jets to the cruise's point of departure. It all adds up to the vacation of a lifetime. AND, you can be the lucky winner!

AND: YOU CAN WIN VALUES UP TO \$4,500—OR MORE— FOR YOUR COMPANY

Another big feature of the Top Ten Contest is the free advertising you can win for your company. Here's what your company can win if it has an ad in the January 4 issue:

A FREE RERUN . . . for each of the ads that are voted in the Top Ten by *Electronic Design's* readers.

A FREE RERUN . . . if one of your company's engineers wins any one of the first 3 prizes — whether or not your ad placed in the top ten.

A FREE RERUN . . . if one of your company's advertising or marketing people, or your advertising agency, wins any of the first 3 prizes.

Suppose you are one of the first three prize winners. If your company has a full page, 2-color ad in the January 4 issue, your company will receive a free rerun worth \$2,165. But suppose it is a 4-color spread. You've just racked up space worth \$4,500 for your top brass.

Be sure to alert your advertising or marketing manager to these possibilities. Urge him to schedule your company's ad in the January 4 issue . . . It's an opportunity no company can afford to miss.

Design

TEN CONTEST

RULES—ENTRY BLANKS IN THE JANUARY 4 ISSUE

PLUS 99 OTHER VALUABLE PRIZES

There are two separate Top Ten Contests, one for *Electronic Design's* engineer-readers, and one for advertisers and their advertising agencies.

PRIZES (Reader Contest)

- 1st Prize: Windjammer cruise for two.
Jet transportation for two.
\$1,000 cash.
Free ad rerun.
- 2nd Prize: Portable color TV.
Free ad rerun.
- 3rd, 4th & 5th Prizes: Bulova timepieces.
Free ad rerun (3rd Prize only).
- 6th thru 100th Prizes: Technical books.
(Title to be announced.)

PRIZES (Advertiser Contest)

- 1st Prize: Windjammer cruise for two.
Jet transportation for two.
\$1,000 cash.
Free ad rerun.
- 2nd Prize: Portable color TV.
Free ad rerun.
- 3rd Prize: Bulova timepiece.
Free ad rerun.

NO STRINGS, NO GIMMICKS ... HERE'S ALL YOU HAVE TO DO TO ENTER

- (1) Read the January 4th issue of *Electronic Design* with extra care.
- (2) Select the ten advertisements that you think will be best remembered by your 78,300 fellow engineer readers.
- (3) Identify the advertisements by company name and *Information Retrieval Number* (Reader Service Number) on the entry blanks bound in the issue. Mail before midnight February 15.



MARK JANUARY 4 ON YOUR CALENDAR NOW

Try for the Top Ten. Contest judges will compare your selections with "Percent Recall Seen" scores on Reader Recall—*Electronic Design's* method of rating readership. Complete information, rules, and entry blanks will appear in the January 4 issue.

**GENERAL
AUTOMATION
SAYS
BUY DEC**

If you're shopping the minicomputer market for raw hardware at rock bottom cost, it's hard to know where to stop. With more than two dozen price lists to choose from, it can get confusing. And time consuming.

We're here to make it easy for you.
Buy DEC.

When you cut through all the claims, DEC's priced as low as anyone else. And they have built a business fulfilling the needs of the low-end iron buyer.

We make low cost hardware too. And if you're price shopping, you'll find us competitive. But raw iron is not our primary business.

The cheapest machine vs. the cheapest solution:

Sure, our goal is to save you money too. But our long suit is squeezing these savings out of your total systems cost rather than off of our price list. So if you need more from the machine or the company that sells it to you, we recommend us. General Automation.

Take *the world's most powerful minicomputer*, for instance.

The General Automation SPC-16.

The SPC-16 possesses the most powerful instruction set you can buy in a minicomputer today. Think about that. The *most* powerful. As a result, the SPC-16 does more things in less time. It will actually reduce the total cost of your system.

Depending on your specific needs, you can choose from six different models in the SPC-16 family. Each backed by the best software and peripheral capability in the business. There's another very important reason why you should buy from us.

It's called involvement.

All the other big mini manufacturers

today are touting the fact that they're "end-user oriented" or that they're now "in the systems business."

We've been doing exactly that for more than five years now. And it's nice to see that others have begun to recognize our leadership.

We learned a long time ago that the only way to really help our customers in solving their systems problems was to fully understand those problems.

So we got involved with our customers. Both end-users and OEMs. Listened attentively. Learned a lot. Got answers. And wound up building systems to solve some very tough, very complex problems.

Emissions analysis and electrical test systems for the nation's largest automobile manufacturers.

Production machine control systems for some of the biggest companies in the machine tool business.

Telecommunications and message switching systems for the world's leading communications companies, to name just a few.

In short, we've built our company and our reputation by offering answers, not just iron.

Who's it gonna be?

Actually, we've made your choice fairly simple.

If all you need is raw minicomputer hardware at a "rock bottom" price, we recommend DEC.

If you'd like something more—from a mini with more oomph to the total solution of a complex systems problem—we recommend us.

General Automation.

Our phone number is (714) 778-4800.

Or write:

1055 South East St., Anaheim, Calif. 92805

General Automation

INFORMATION RETRIEVAL NUMBER 12



Perhaps an etchable glass display panel will turn you on ...Corning makes it

FOTOFORM® glass is uniquely suited for use in flat alpha-numeric display devices. Because it's etchable. We precision-etch panels with up to 10,000 holes per square inch. Holes of any shape. Holes as small as .005". In panels .010" to .105" thick.

Call Don Van Wagner for information about FOTOFORM glass. And FOTOCERAM® parts. And other Corning products for plasma discharge and liquid crystal displays.

Corning also makes CRT bulbs for display devices in standard sizes from one to 27 inches, plus custom bulbs to meet your specific requirements.

Call Al Baer for details about Corning CRT bulbs. To turn on, call Don or Al, via our direct BUZZ LINE. Phone (607) 962-6836.

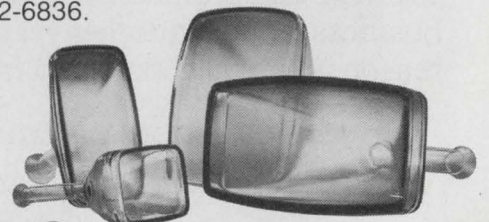

Electronic Materials
Department

CORNING
CORNING GLASS WORKS
Corning, New York 14830

INFORMATION RETRIEVAL NUMBER 13

ELECTRONIC DESIGN 26, December 21, 1972

A \$500 message for the engineer who buys digital IC's but not in sufficient number to warrant the investment of thousands of dollars in automatic testing gear.

That's it. The Model 1248 IC Functional Tester from Electro Scientific Industries. This little \$500 box will tell you exactly what you want to know most about your incoming ICs — all those in TTL, DTL, and CMOS families in DIP, TO-5, and flat configurations — which is whether or not their inputs and outputs are functioning in the expected manner. And it will give you this information in absolute terms, right now, *before* you install them on a PC board. (The Model 1248 makes more than 1 million tests on a device in a few seconds at the touch of a button.) No comparisons with a "good" IC are necessary.

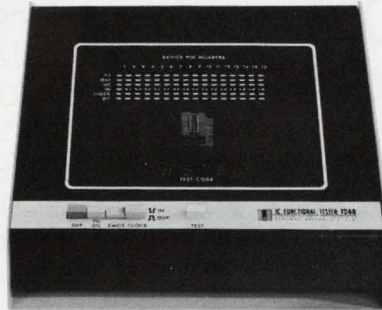

THE MESSAGE

What it won't do, and you shouldn't care less at the price, is make measurements of propagation delays, threshold voltages, the effects of output loading, or the magnitudes of input currents under various logic or temperature conditions. It isn't meant to. It *is* meant to test one IC at a time and tell you immediately if that device has developed an input

or an output malfunction. And this it does, every time, and we guarantee it.

Write or call us for the complete story on this ingenious little IC tester, and ask about our free trial program.

Electro Scientific Industries
13900 N.W. Science Park Dr.
Portland, Oregon 97229
Telephone: (503) 646-4141
Telex: 36-0273

e|s|i



INFORMATION RETRIEVAL NUMBER 121

Harris' New

Our new Poly-planar™ technology did it. Produced the densest PROM on the market today, with twice the memory capacity of 1024's on the same size chip.

Poly-planar. What is it?

Poly-planar is a Harris developed technology designed to eliminate the area consumed by conventional isolation techniques by replacing

the P⁺ diffusion with polycrystalline silicon.

As a result, "P-type" isolation and depletion region-spread are eliminated, permitting a packing density of up to 4/1 over chips utilizing conventional isolation diffusion. In addition, the Poly-planar process provides a level surface structure, which is highly desirable for multi-level interconnections. Poly-planar is flexible, too; it can be utilized with either Bipolar or MOS technology and can be used for fabricating digital or linear circuits. End result: high-density, high-yield, low-cost devices, providing improved speed/power performance and high reliability.

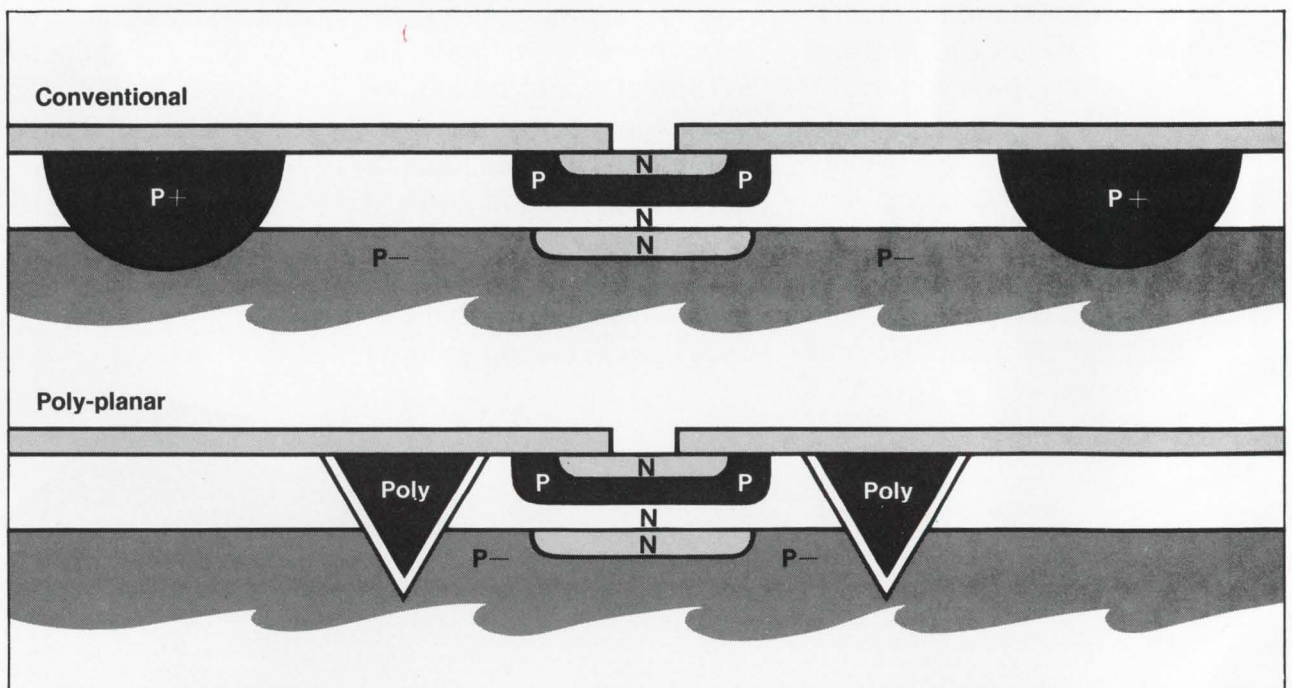

Poly-planar makes it denser. Compare the two diagrams shown here. The one at the top represents a cross-section of a chip fabricated through use of the conventional isolation diffusion process. The diagram above represents a chip manufactured with our Poly-planar process, demonstrating a packing density twice as great as in the conventional device.

2048 PROM™

HPROM-2048/2048A—512 words/ four bits per word. Easily interchangeable with all other 1024's. We were first with the PROM concept, first to establish its reliability and first to deliver in volume. Now to all this experience, performance

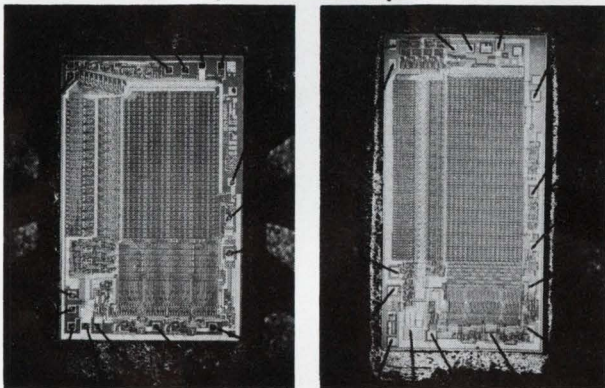

Twice the memory capacity at no increase in chip area. At left is a photo blow-up showing the circuit density of a typical Harris 1024 PROM. At right is our new HPROM-2048, fabricated through use of our Poly-planar process, demonstrating isolation to isolation spacings half that of conventional devices and yielding a 4/1 improvement in density.

and dependability we've added the advantages of our new Poly-planar process to bring you this significant addition to the industry's most complete PROM line. PROM reliability has been documented by more than 232,000,000 fuseable link life test hours data. The HPROM-2048 is available now for off-the-shelf delivery.

Because of its capacity (512 words/four bits per word) the HPROM-2048 provided additional application possibilities for designing and producing economical

memories. By changing one address pin on any 1024 ROM socket, you can use the HPROM-2048 to double your memory system capacity or reduce power dissipation by one half on your existing system. In addition the HPROM-2048 is programmed in the same manner as the Harris 1024 PROM. Available with either 3-state (HPROM-2048) or open collector (HPROM-2048A) outputs. For details see your Harris representative or distributor.

Features:

512 words/4 bits per word

Fully decoded

DTL/TTL compatible

50ns typical access time

Power dissipation of 0.25 mW/bit

Expandable—"Wired-OR" outputs with chip select input

Available in military and commercial temperature ranges

HPROM-2048

HPROM-2048A

Bipolar

512 x 4

100-999 units
0°C to +75°C —55°C to +125°C

\$65.00 \$98.00



**HARRIS
SEMICONDUCTOR**

A DIVISION OF HARRIS-INTERTYPE CORPORATION

P.O. Box 883, Melbourne, Florida 32901
(305) 727-5430

WHERE TO BUY THEM: ARIZONA: Phoenix—Liberty, Weatherford; Scottsdale—HAR (602) 946-3556 CALIFORNIA: Anaheim—Weatherford; El Segundo—Liberty; Glendale—Weatherford; Long Beach—HAR (213) 426-7687; Mountain View—Elmar; Palo Alto—Weatherford, HAR (415) 321-2280; Pomona—Weatherford; San Diego—Weatherford, Western COLORADO: Denver—Elmar, Weatherford WASHINGTON, D.C.: HAR (202) 337-3170 FLORIDA: Hollywood—Schweber; Melbourne—HAR (305) 727-5430 GEORGIA: Atlanta—Schweber ILLINOIS: Chicago—Semi-Specs, Schweber; Palos Heights—HAR (312) 597-7510 INDIANA: Indianapolis—Semi-Specs MARYLAND: Rockville—Schweber MASSACHUSETTS: Lexington—R&D; Waltham—Schweber; Wellesley—HAR (617) 237-5430 MICHIGAN: Detroit—Semi-Specs MINNESOTA: Minneapolis—Semi-Specs MISSOURI: Kansas City—Semi-Specs; St. Louis—Semi-Specs NEW MEXICO: Albuquerque—Weatherford NEW YORK: Melville—HAR (516) 249-4500; Syracuse—HAR (315) 463-3373; Rochester—Schweber; Westbury—Schweber OHIO: Beachwood—Schweber, Dayton—Semi-Specs PENNSYLVANIA: Pittsburgh—Semi-Specs; Wayne—HAR (215) 687-6680 TEXAS: Dallas—Weatherford, Semi-Specs, HAR (214) 231-9031 WASHINGTON: Seattle—Liberty, Weatherford WISCONSIN: Wauwatosa—Semi-Specs.

LEGEND FOR HARRIS SALES OFFICES & DISTRIBUTORS: Harris Semiconductor (HAR); Elmar Electronics (Elmar); Harvey/R&D Electronics (R&D); Liberty Electronics (Liberty); Schweber Electronics (Schweber); Semiconductor Specialists, Inc. (Semi-Specs); R. V. Weatherford Co. (Weatherford); Western Radio (Western).

INFORMATION RETRIEVAL NUMBER 122

Does he...or doesn't he? Only BPA knows for sure.



Qualify, that is. Qualify as being in the kind of business, kind of job, that makes him important to the buyer of advertising. That's why more than 650 business newspaper publishers have their circulations audited by BPA.

BPA member publishers require qualification of all recipients — whether they pay for the magazine or get it free. They must qualify as to business or industry; they must qualify as to title or function. BPA audits the qualification records.

BPA member publishers re-qualify all recipients on a regular basis. BPA has

rules regarding the frequency and manner of such re-qualification, and renews the original audit accordingly.

Businessmen move about, as we well know. When you advertise in a publication that's BPA-audited, you can be sure that — except for the *most recent* moves — all the circulation you've been promised is *there*.

BPA

Business Publications Audit of Circulation
360 Park Avenue So., New York, N.Y. 10010

This symbol means:
edited for businessmen, *audited* for advertisers

Dunk this page into a cup of coffee.

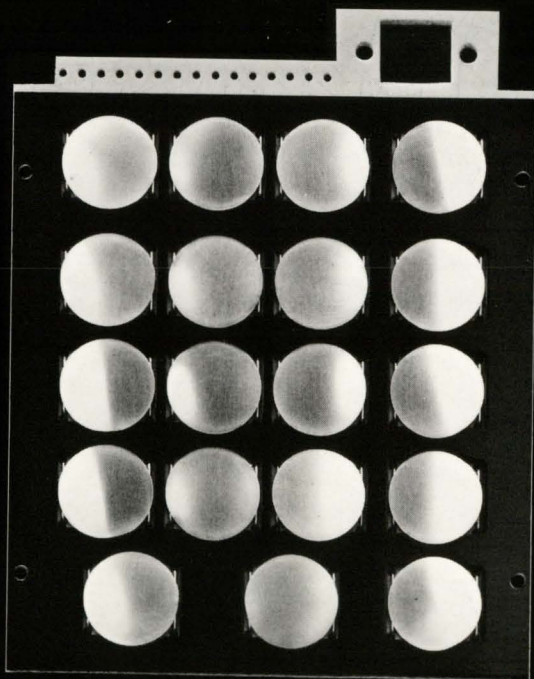

What happened to the paper? Nothing. Because this page is protected with a plastic film. A film similar to the Mylar™ that protects the heart of our Klixon® keyboard. The keyboard that is used by more pocket calculator manufacturers than any other type. Protects it from dust, lint, and accidents like coffee spills that would put ordinary calculators out of commission.

We've got a new brochure that tells how reliable it is (10,000,000 proven life cycles), how inexpensive it is, and about the company that stands behind it. For your copy, fill out the coupon on the reverse side.

TEXAS INSTRUMENTS
INCORPORATED

CONTROL PRODUCTS DIVISION • ATTLEBORO, MASSACHUSETTS 02703

Texas Instruments Incorporated
Keyboard Products Marketing
MS 12-33/DE
Attleboro, Mass. 02703

Name _____ Title _____

Company _____

Address _____ City _____ State _____ Zip _____

Keyboard application: Pocket Calculator Computer Terminal Desk-top Calculator

Credit Card Verifier Personal use Other _____

Application is new or existing Approximate annual usage _____ units

Application requires: Basic 1KS keyboard array Complete 6KS keyboard assembly

Please send additional information on:

TI optoelectronic displays TI calculator integrated circuitry

Please have a TI Sales Engineer call



Now read about the exclusive gold disc keyboards from Texas Instruments.

Brushed stainless steel escutcheon for appearance and durability.

Double-shot molded keytops provide quality feel and appearance.

TI capability to furnish complete keyboard reduces customer tooling costs.

Switching array Mylar sealed for protection against dust, lint, and accidents like coffee spills.

Low-profile. Complete 6KS keyboard assembly only .320 inches thick.

Snap-action Klixon disc gives positive tactile feedback and error-free data entry.

1KS keyboard array only .150 inches thick.

All contacts are gold-surfaced for high reliability.

Keyboard arrays can be provided to interconnect with most popular logic circuits. Available in a choice of formats, allowing variations in the number and spacing of keys.

Last Call!

Electronic Design's Nov. 23 issue

The age of the transistor

Order your copy now!

A collector's item celebrating the 20th anniversary of Electronic Design with the 25th anniversary of the transistor. This issue is a compendium of major milestones in design -- a quarter century of design activity in such areas as consumer electronics, packaging and materials, computers, communications, components and instrumentation. This special issue is must reading for every designer. No engineer should be without it. Order extra copies now, for yourself and your associates, by filling in the order blank below.

**The complete issue
for only \$2.00**

Electronic Design 24

FOR ENGINEERS AND ENGINEERING MANAGERS

VOL. 20 NO. NOV. 23, 1972

Electronic Design celebrates its 20th anniversary by saluting the transistor. Its 25th anniversary marks a quarter century of rapid progress. In all areas--consumer electronics to space, packaging to instrumentation--the transistor and its solid-state descendants have left their indelible marks. Highlights begin on page 66.

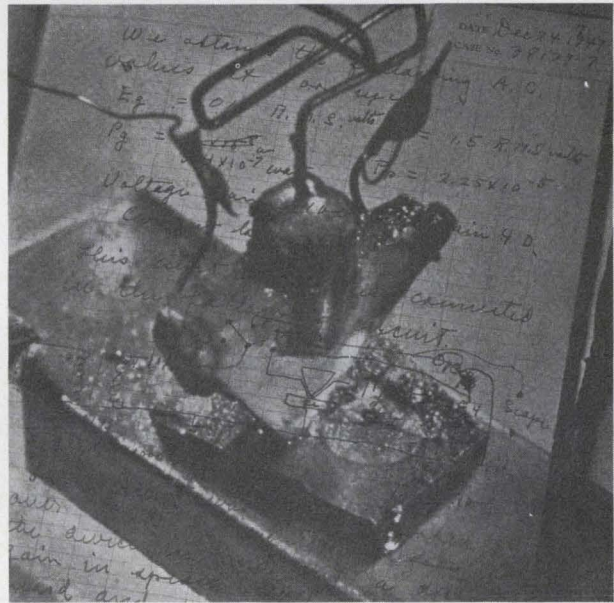

William H. Smith, Electronic Design Magazine,
50 Essex Street, Rochelle Park, N. J. 07662

Please send me _____ copies of
Electronic Design's anniversary issue.

I enclose \$2.00 for each copy, including
handling and postage.

- check
 money order

Checks or money orders only, please.

Name _____

Firm _____

Street _____

City _____

State/Zip _____

sure it works,
but can you work with it



Belden makes all kinds of wire and cable: Ultrafine magnet wire to the most complex multi-conductor cable designs. Cables that resist heat, cold, abrasion, moisture, chemical attack and fit many other environmental needs. Configurations that can help you cope with numerous codes, specs, industry standards plus nitty-gritty electrical/electronic design parameters.

We also make it as easy as possible to work with.

An important benefit if you consider that cable usually costs far less per foot than the time of the hands making the installation.

A more workable wire involves many things: type of termination; method of

stripping; insulating, jacketing and shielding materials; conductor design. Your Belden wire specialist can help you get the best buy. He can tell you if a standard or special is called for. The tradeoffs. Modifications that might be made, and the costs.

He might not be able to give you a cable as strippable as a banana, but can deliver a complete package tailored to meet your job requirements. The kind of cable that can save you time and money all down the line.

If you have a wire problem right now, call (317) 966-6681. If you don't have a copy of the Belden Electronic Wire and Cable Catalog, write: Belden Electronic Division, P.O. Box 1100, Richmond, Indiana 47374.

8-6-2

INFORMATION RETRIEVAL NUMBER 234



We want your cable business and are out to prove... Belden covers wire with performance, service and ingenuity



specify the
BETTER 3/4" LONG

10-TURN PRECISION POTENTIOMETER

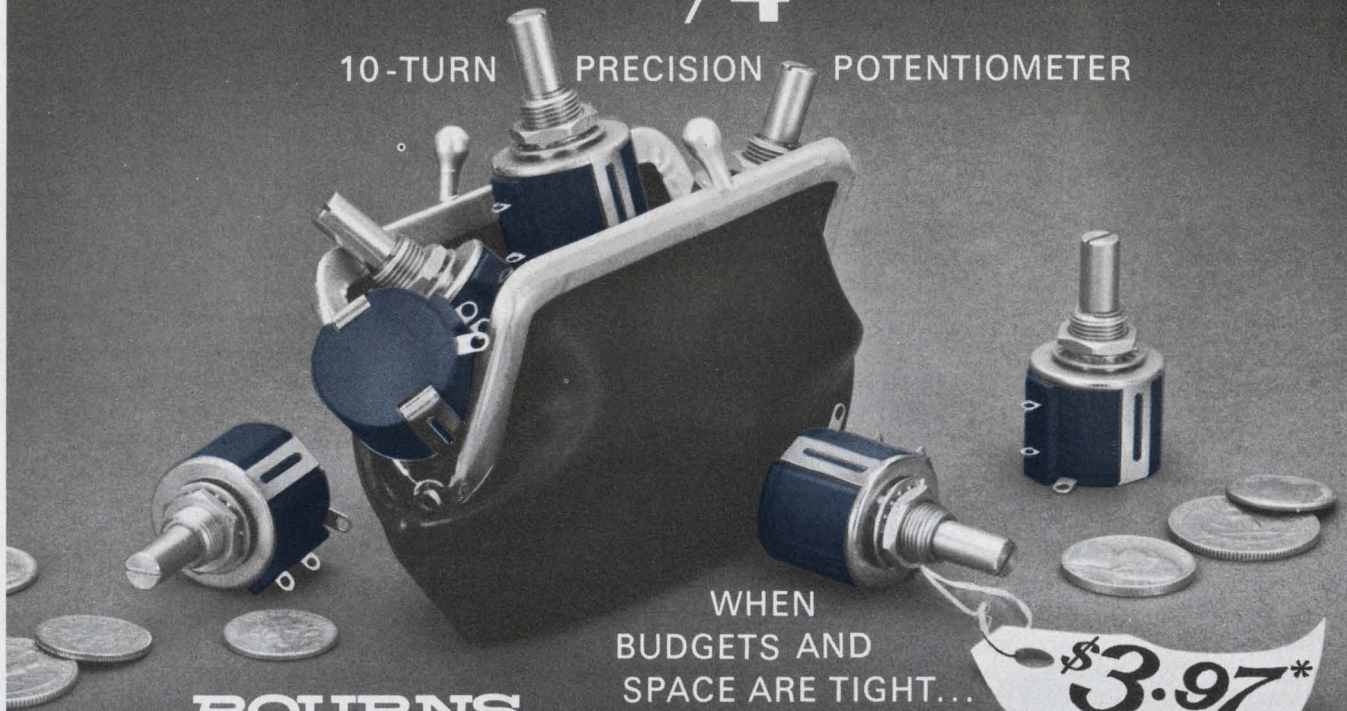

WHEN
BUDGETS AND
SPACE ARE TIGHT...

\$3.97*

* 1000-1999 quantity
U.S. Dollars, F.O.B., U.S.A.

BOURNS
NEW MODEL
3540

*MODEL 3540 IS RUGGED, TOO!
CHECK THE EXCLUSIVE CONSTRUCTION FEATURES.*

- SILVERWELD® UNITIZED TERMINATION — Why settle for multi-joint, terminal-to-element connection? Get the direct element-to-terminal connection method that guards against catastrophic failures
- MOLDED-IN, SHAFT-TO-ROTOR CONSTRUCTION — This Bourns feature optimizes stop-strength and minimizes accidental rotor/shaft displacement and slippage
- NON-CEMENTED, ALL-MECHANICAL ASSEMBLY. Snap-on straps provide all-mechanical assembly. No cemented joints, heat-forming, or ultrasonic welding

LOOK AT THE SIGNIFICANT SPECS!

- LINEARITY: 0.25%
- TEMPERATURE RANGE: -55 to +125°C
- RESISTANCE RANGE: 100 ohms to 100K ohms

FOR COMPLETE DETAILS AND PRICES...CONTACT YOUR LOCAL BOURNS REPRESENTATIVE, FIELD SALES OFFICE, OR THE FACTORY DIRECT.



BOURNS, INC., TRIMPOT PRODUCTS DIVISION • 1200 COLUMBIA AVE., RIVERSIDE, CALIF. 92507

New, bigger in-line tubes touching off TV color battle

A new battle is looming among color-television manufacturers. Nineteen-inch, in-line (one-gun, three-beam) picture tubes are now ready for mass production, and producers of these simple, slim-line units are out for mass sales.

Developed more than a decade ago and put into a 10-inch commercial unit by General Electric in 1965, the in-line tube was at first limited to small sizes because it did not use convergence controls; it depended solely on the precision of the tube's manufacture for a clear picture.

Since 1965 precision has progressed, and GE has built 14-inch and 16-inch portable units. Now, by introducing four convergence controls that will do the job of the conventional tube's 12, GE is building a 19-inch tube, and has plans for a 25-inch set. This will move the in-line tube from the patio or beach to the big console in the family room.

Meanwhile RCA has been designing its own tube, stressing precision to the extent that it plans to go to a 19-inch tube without any convergence controls. It will also put on the market 15-inch and 17-inch in-line tubes. Hence the major battle lines are drawn between GE and RCA.

Which tube will set manufacturers choose? Neither 19-inch tube will be produced until spring, and although some set manufacturers are said to be signing up for one or the other, no one is publicizing details.

The difference in cost is negligible, says GE's Ronald Borick, manager of marketing for the TV Components Products Dept. in Syracuse, N. Y. And the set manufacturer is not going to be locked in forever Borick agrees, noting:

"If he decides to buy RCA one year and switch to GE the next,

he has only to add the dynamic convergence circuitry. If he switches from GE to RCA he takes it out."

Some extra cost would be involved in doing this, of course, and set manufacturers are hoping to make the right choice from the start.

The simplicity of the in-line tube comes from its use of one gun to fire its three electron beams, rather than three guns, as the conventional tube does. The resulting advantages are numerous. The set is shortened by about two inches and is two to four pounds lighter. The new tubes are more reliable, because there's less to go wrong. Maintenance is less of a problem.

Another advantage is the high degree of deflection that is possible with the in-line tube. The 19-inch tubes will offer 90-degree deflection, and 110-degree tubes are not far away. GE has already announced its intention of going to 110 degrees in later 19-inch units and in its 25-inch tube.

Also available are in-line units from Japan. Sony has sets with tubes that measure 9, 12, 15, and 17 inches. And Tokyo Shibaura Electric is marketing a nine-inch, in-line set through the Sharp Corp. and plans to introduce a 13-inch set under its own name next year.

4-k RAMs slated to make debut

The race among semiconductor memory manufacturers to introduce 4-k, n-channel random-access memories appears to have narrowed to two manufacturers—Microsystems International Ltd. of Ottawa, Canada, and Standard Microsystems of Sunnyvale, Calif. Both companies expect to offer a 4096-bit RAM next month.

However, the initial availability of the Microsystems International chip will be restricted to a memory system that uses the RAM as a building block. The memory chip will have three transistors in its basic memory cell. Termed the 7112, the new Canadian memory features an access time (from a stable address) of 300 ns max. A read/write cycle can be accomplished in 540 ns max. and a read-only cycle takes 450 ns max.

Total refresh time of the 7112 is 8.6 μ s, corresponding to only 16 read/write cycles. Operating power requirements are 130 μ W/bit, with standby power drain (all clocks decoded) at 600 mW/bit.

The Standard Microsystems 4412 RAM is an n-channel, silicon-gate device. Microsystems International is making a comparable device, the 7112, but the 4412 makes use of a Coplamos process, which reportedly offers density/speed advantages over standard n-channel processes. These advantages are said to be achieved by the minimization of field-inversion and parasitic push-through problems normally found in n-channel ICs.

Preliminary data for the 4412 list an access time of 180 ns.

Power feeder built for 300-mph trains

After some skepticism among railroad specialists, a practical technique has been reported developed for feeding third-rail electric power to 300-mph ground vehicles.

Under a contract from the Transportation Dept.'s Federal Railroad Administration, the Garrett Corp. in Torrance, Calif., has developed a technique that, it reports, has already transferred 17 MW of 8250-V, 3-phase, 60-Hz power to a test vehicle going over 300 mph.

Charles Weinstein, program manager at Garrett, says the power collector is a stabilized assembly consisting of six sets of carbon graphite brushes. The assembly rides between, and in contact with, three fixed rails. Each rail carries one phase of the three-phase power system. Each set of brushes is composed of both heavily loaded brushes, which condition the rail for power transfer and maintain dy-

dynamic stability of the collector assembly, and lightly loaded brushes, which accept current from the rail for transfer to the vehicle. The concept is similar to a cleaning brush riding in the groove of a record ahead of the phonograph pickup stylus.

Power from the brush assembly is transferred to the speeding vehicle through a flexible umbilical. According to Weinstein, "The design should be good to at least 400 mph."

In other high-speed power collection systems the major problem has been that the brushes jump off the rail. Weinstein points out that the combination of both heavily and lightly loaded brushes is the key to success in the Garrett system. It is possible, he says, that communications could also be fed to the vehicle through the same set of rails, owing to the high trackability of the collector. This has not yet been tried.

Weinstein concedes that the problem of brush wear on the heavily loaded brushes still requires more materials development. The power collector will be tested next at the Transportation Dept.'s test track in Pueblo, Colo. The vehicle will be a tracked-air-cushion type, driven by a linear induction motor. The technique will also have application with magnetically levitated high-speed vehicles.

\$1.4-billion market seen for traffic-control units

An electronics market of \$1.4 billion for street and highway traffic control equipment between now and 1980 has been forecast in a recent study, "Automotive Traffic Controls, Surveillance and Communications Markets." Published by Frost & Sullivan of New York City, the study is based on information from traffic-control administrators in principal cities of the United States and from manufacturers of equipment.

The principal markets forecast are as follows:

- Computer controls—\$580-million.
- Street signal systems—\$581-million.
- Pedestrian signal systems—\$100-million.

■ Surveillance equipment, such as TV for monitoring highway exit and entry ramps—\$120-million.

■ Miscellaneous equipment—\$19-million.

The principal systems, according to the study, will be computer-controlled networks designed to speed traffic flow in critical areas.

A typical system that will reduce the average traffic delay by about 10% in a city of 200,000 population will cost about \$3-million the report says. For this system, traffic sensors will be installed at each intersection, with their outputs fed to a large central processor that evaluates and directly controls traffic flow.

Miniature computer traps road speeders

A low-cost hand-held computer for clocking motor-vehicle speeds has been developed as the result of a space engineer's concern for ground-travel safety. Devised by Peter H. Broussard Jr., chief of the sensors branch in the Astrionics Laboratory of the Marshall Space Flight Center, Huntsville, Ala., the elapsed-time computer costs about \$200—one-tenth that of a radar doing the same thing.

Broussard, who is a volunteer auxiliary state trooper who works weekends with the Alabama Dept. of Public Safety, says that the computer operates with two roadside markers installed on the route being observed. The computer has an adjustable distance input that is set to the number of feet between the markers.

The observer places himself so that both markers are visible. When a vehicle passes the first marker, he turns on a timing switch. As the car reaches the sec-

ond marker, he flips the switch off. The elapsed time thus measured is fed into the computing section to solve the equation: velocity equals time multiplied by distance.

The unit is about the size of a thick textbook and weighs only three pounds. Its power requirements are small: It can be supplied from a cigarette lighter outlet in a vehicle or from a battery pack on the operator's belt.

The accuracy of the new system has been compared with that of conventional radar units, and it is good enough so that it has already been accepted as valid evidence in speed-violation cases before the Huntsville traffic court.

Over 100,000 computers in U.S., census reveals

A total of 100,420 computers were installed in the United States by mid-1972, according to a computer census conducted by the Diebold Group, a computer research organization in New York City. While this represents a 22.5% increase over the installations counted as of June 30, 1971, the census indicates the increase was accounted for by a 63.2% boost in the number of minicomputers in use.

Minicomputers now account for 54% of the total number of computers installed in the U.S., compared with 40% in 1971; according to the Diebold Group.

The census revealed that if the minicomputers were excluded from the total, there would be a decline of about 5% in the number of installed computers. This decrease, according to Diebold, is a result of "an accelerating trend in hardware consolidation."

News Briefs

Ionarc/TAFA has established a new Automated Systems Div. in Bow, N.H. The division will specialize in the custom design of digital precision positioning and measuring systems for industrial applications, particularly for the electronics packaging business.



Conversion of naval sonar into a medical diagnostic tool for prolonged or repetitive studies of the

heart has been proposed by Dr. Raymond Gramiak, Robert C. Waag and William Simon, radiological and biomedical engineering researchers at the University of Rochester, New York. The method would use ultrasound to produce motion pictures of the heart's movements, thus providing an indication of the condition of the organ without danger to the patient.

GENERAL ELECTRIC

OPTOELECTRONIC

DETECTOR LINEUP

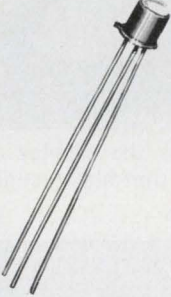
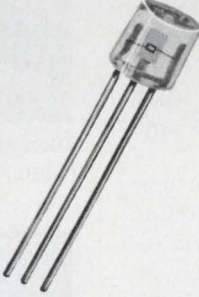
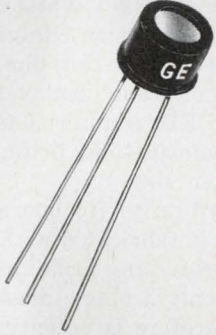
				
<p>L15A SERIES</p> <ul style="list-style-type: none"> ● hermetic phototransistor ● packaged for printed circuit board mounting 	<p>L15E SERIES</p> <ul style="list-style-type: none"> ● hermetic phototransistor ● sensitive, fast switching ● for detector arrays 	<p>L14A SERIES</p> <ul style="list-style-type: none"> ● hermetic phototransistor ● 3 μsec turn on, turn off <p>L14F SERIES</p> <ul style="list-style-type: none"> ● hermetic photodarlington ● high sensitivity <p>L1V SERIES</p> <ul style="list-style-type: none"> ● hermetic "SCS" 	<p>L14D SERIES</p> <ul style="list-style-type: none"> ● photodarlington configuration ● high sensitivity <p>L14E SERIES</p> <ul style="list-style-type: none"> ● phototransistor ● typical 3 μsec turn on <p>L14T SERIES</p> <ul style="list-style-type: none"> ● PNP photo switch 	<p>L8, L9 SERIES</p> <ul style="list-style-type: none"> ● hermetic photosensitive SCR ● switches 1.6 amp

OUR NO. 1 GOAL:
TO MAKE
GENERAL ELECTRIC
YOUR BEST BUY



AVAILABLE NOW FROM
YOUR AUTHORIZED
GENERAL ELECTRIC
DISTRIBUTOR

AT THE INTERNATIONAL ELECTRON DEVICES MEETING

Thin-film incandescent display outshines LEDs in key areas

Light-emitting diode displays may be in for tough competition if laboratory work at International Business Machines is any indication of things to come. In a paper presented earlier this month at the International Electron Devices Meeting in Washington, D.C., Dr. Fred Hochberg, a research staff member at IBM's Watson Research Center, Yorktown Heights, N.Y., described a new thin-film, integrated incandescent display that could outdo LED counterparts in cost, power dissipation, brightness and character size.

According to Hochberg, the new display is fabricated with thin-film, batch-processing techniques and requires only a single mask. The device therefore is potentially cheaper than LEDs to produce.

IBM's new display consists of a ceramic substrate covered with a thick layer of glass. Filament support posts are produced by making holes in the glass and filling them with metal. A thin layer of refractory material—such as tungsten—is then deposited on the glass. The filaments are formed by etching away the metal and glass, leaving only the filaments attached to the metal posts. When completed, the device is sealed in a vacuum in a glass package.

The resultant display, says Hochberg, dissipates only 30 mW of power per segment—20 by 20 mils, or comparable with the dissipation of LEDs. If the width of the filament is decreased, it is possible to reduce this to 10 mW or possibly less, Hochberg notes.

As for the brightness and efficiency of the device, the IBM re-

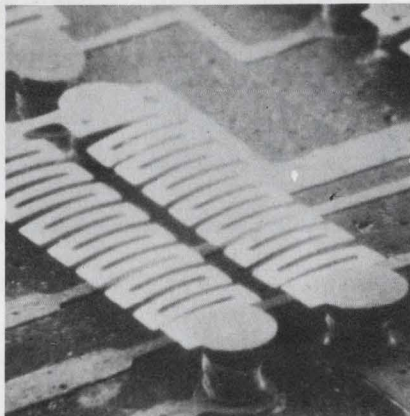

Filaments for the display are fabricated using thin-film techniques.

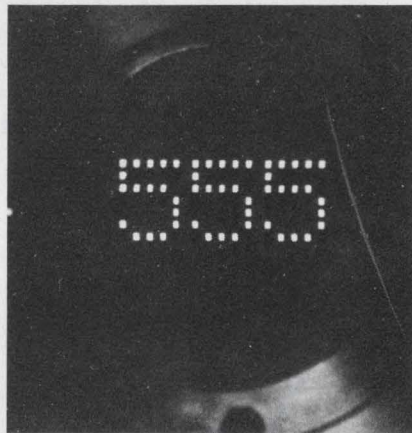

Incandescent display developed by IBM is brighter than LEDs at the same power consumption.

searcher says that it is better than that of LEDs. The color is straw yellow, and the device can be used in high ambient light because of its high brightness. Like plain incandescent lamps, various colors can be achieved simply by the placement of filters in front of the display. The filaments of the display operate at 1200 C and are more efficient than most LEDs, Hochberg reports. If the operating

temperature is raised, efficiency is also increased.

Another plus for the integrated incandescent display, Hochberg says, is that one-inch-high characters can be fabricated relatively inexpensively. Such large displays are not practical with LEDs, because the semiconducting material is very expensive.

Circuit design simplified

Designing with the new display turns out to be a little simpler, too, according to Hochberg. Because it uses a tungsten filament, a current-limiting resistor—such as is used with LED displays—is not needed. This cuts the number of components needed and also decreases power dissipation.

Even though the display generates heat, this is not expected to be a major problem. In explaining why, Hochberg points out that IC chips can be mounted on the back of the ceramic substrate and maintained at 50 C. Thus the trend towards integrated decoder displays appears to be applicable to this new device.

While the new display appears to have many advantages over LED equivalents, it is nevertheless still an incandescent lamp and susceptible to problems peculiar to these devices. For example, the lifetime is expected to be less than that for LEDs, although final testing has not yet been completed. Another problem, although probably not major, is that the incandescent display exhibits thermal inertia and produces relatively large surge currents when it is switched on.

Applications for the new display appear at first glance to include all those currently covered by LEDs plus some where LEDs are

it's both **who**
and **what**

...with **SLOAN'S**
FRONT RELAMPABLES

Who makes a product is almost as important as the product itself. That's why at Sloan we like to think of our product as us. Our sub-miniature series of incandescent lampholders, the Model 855 Front Relampable Indicator Lights, are no exception. We've combined all of our years of experience and reputation for superior indicator lights into every Model 855 we make.

Specifically designed for use with the T-1 $\frac{3}{4}$ Midget Flange Based Bulbs, the 855 series' outstanding features include: • Small mounting size • Front bulb servicing • Interchangeable lens assemblies • Insulation for two-terminal application and single terminal non-insulated models • Coding collars (at rear of body) in choice of E. I. A. colors • Contact pressure maintained by silicone rubber pressure pad • Pressure pad to seal out moisture front-to-back. You can be sure that both the "who" and "what" of it are always there in the Sloan Front Relampables.



THE SLOAN CO.

7704 San Fernando Rd., Sun Valley, Calif.
Phone: (213) 875-1123 / TWX 910-498-2250

INFORMATION RETRIEVAL NUMBER 18

not now used, such as high ambient and multicolored applications. A big market could be in the calculator industry, where LEDs now have a strong foothold.

Hochberg would not indicate ex-

actly what IBM's interest was in the device, other than to say that the company was investigating low character-count displays.

When questioned as to when the device might become commercially

available, he said it was too early to tell, since the display was still in the laboratory stage. He added, the fabrication of the device was well within the present state of the art. ■■

Next in tubes: the 'printed circuit' TWT

Every now and then transistor manufacturers come up with an advance in semiconductor technology that looks as if it will vanquish the vacuum tube once and for all. Then rising to the challenge, the tube designers knuckle down and come out with a new technique that keeps the tube alive. This happened in the 50s. And it is happening again today.

Just as transistors are getting a foothold in microwave amplifier applications, tube manufacturers have come up with a new device that promises to give the microwave transistor stiff competition. Borrowing processing techniques from microwave integrated-circuit technology, Varian Associates of Palo Alto, Calif., has developed a device that it calls a "printed-circuit" traveling-wave tube.

Developed with the support of the Army Electronics Command, the new tube is smaller than the conventional TWT, offers an order-of-magnitude reduction in manufacturing costs and eliminates the fragile helical structure in conventional tubes. Just how these advantages were achieved was described by Allan W. Scott, manager of advanced development for Varian's TWT Div. at the International Electron Devices Meeting.

Design approach is radical

In a session on low-power microwave amplifiers, Scott described a radical design approach. All the tube elements—including the electron beam-forming electrodes, the microwave interaction structure, the collector and all electrical and microwave connections—are printed on a pair of ceramic sheets. The sheets are used to form the vacuum envelope of the tube.

Scott described the operation of the tube this way: An rf wave passes through it and is slowed. In conventional TWTs this is done by means of a helical structure. In the Varian unit, this is accomplished by a meander line. Microwave power is generated when an electron beam is passed between the ceramic sheets. The beam is

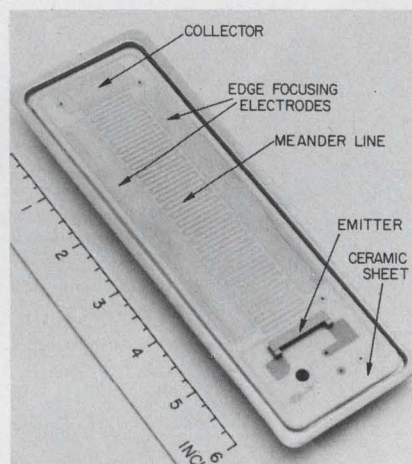

All the elements of the new Varian TWT are printed on the inside surface of the ceramic substrate except the cathode.

focused by a pair of sheet magnets mounted on the outer surface of the ceramic sheets.

At present the printed-circuit TWT is only a laboratory device, but, according to Scott, commercial devices should be available in about six months.

The Varian official points out that the new tube can handle higher power levels than microwave transistors—2 kW at S band—and might be potentially cheaper (about \$100 in quantity). He believes that printed-circuit tubes will be able to replace a large majority of conventional TWTs.

But Scott also notes that transistors are better suited for certain applications. Although printed-circuit TWTs are about half the size of conventional TWTs, they are still bigger than transistors. And the TWTs need a high-voltage power supply to operate.

With the advent of microwave transistors, Scott notes, many designers thought phased-array radar would become economically feasible. But this is not necessarily true, he contends, particularly with high-power systems. A system that

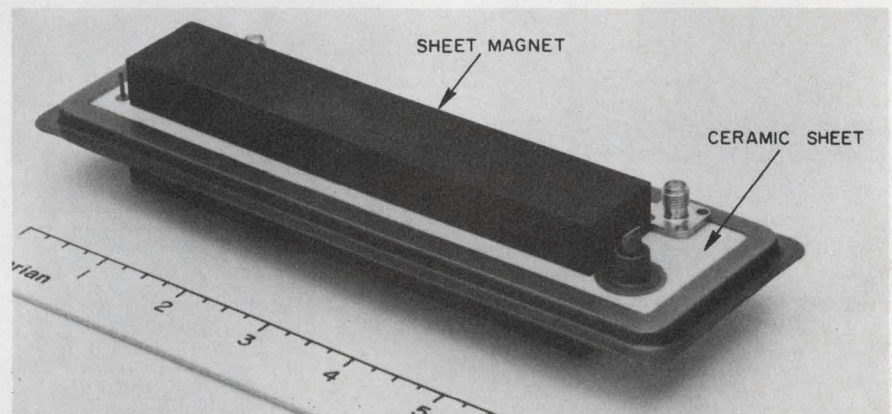

The ceramic sheets of the printed-circuit TWT form the vacuum envelope for the tube. Sheet magnets are used for focusing.

Are you getting static?

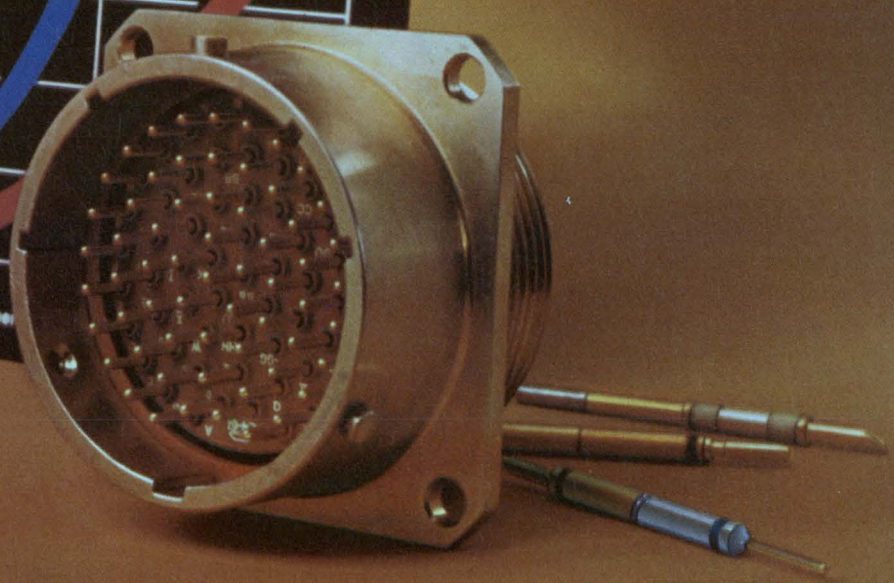
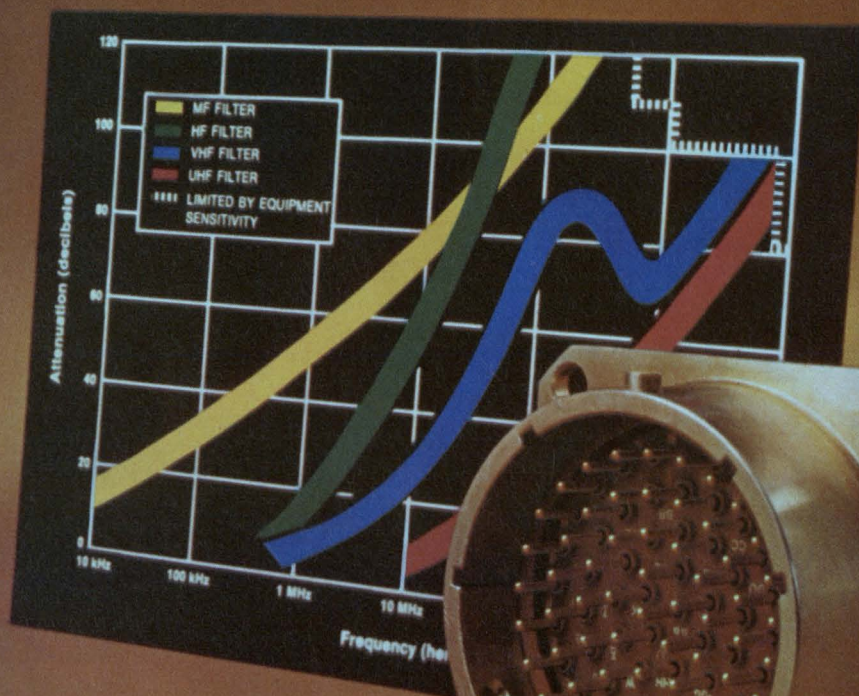

Our filter connectors are designed to eliminate interference from your circuits. See those attenuation curves? They are just a part of our selection. We can mix and match filters to solve your low pass filtering requirements. Small wonder Bendix filter connectors are first choice in the fight against electronic noise pollution.

Bendix filters come packaged in connectors intermateable with MIL-C-26482, MIL-C-83723, MIL-C-38999 and

MIL-C-5015 connectors. In addition, filter contacts can be packaged to mate with other popular connector types including rectangular in military, industrial and commercial applications. There's sure to be one to meet your attenuation and frequency requirements.

You'll like the price, too.

Delivery? We won't give you any static there, either. Write for our brochure. The Bendix Corporation, Electrical Components Division, Sidney, New York 13838.

Bendix

Varian is working on, he says, will have a 1-MW capability. It will use 5000 printed-circuit tubes, each capable of handling 2 kW of power. About 50,000 transistors would be needed to do the job, Scott says, and this approach would cost much more than the one Varian is using.

Other applications that Varian envisions for the new tube include their use in expendable jammers, beacon transponders, microwave relay systems, miniaturized airborne phased-array jamming equipment and CATV.

The company is developing four

different printed-circuit TWTs. One is a 20-W continuous unit that operates at L band. The second averages 200 W—a 2-kW peak device that operates at S band. The third is a 20-W, continuous S-band unit, and the last is a 100-W, X-band device. ■■

BIFET promises faster and denser ICs

A bipolar-MOSFET structure developed by International Business Machines may make the speed-density race between bipolar and MOS integrated circuits a thing of the past before long. The new structure was described in a paper at the International Electron Devices Meeting by Madhu B. Vora, a senior engineer in IBM's Components Div., Hopewell Junction, N.Y. The developer of the technique, he spoke in a session on junction devices in integrated circuits.

Called a BIFET, the new structure combines both an npn bipolar transistor and an n-channel MOSFET on the same silicon chip. According to Vora, the BIFET could lead to integrated circuits that have the advantages of both bipolar and MOS devices. By using this structure to develop logic cells for semiconductor memories, he believes it will be possible to fabricate memories that have both the high density of MOS and the high speed of bipolar.

New isolation technique used

The BIFET is made possible by a self-isolation scheme developed by Vora last year. With this method it is possible to create an n/n⁺ pocket in p⁻ silicon, thus eliminating the need for isolation diffusion. This technique also allows fabrication of an npn transistor on a p type of substrate instead of the normal n type, explains Vora. And it is this feature that makes it possible to combine these two devices on one chip, he continues.

Another advantage of the self-isolation technique, Vora notes, is

that it permits a two to three-fold increase in density.

Fabrication of the BIFET device, he says, is simple and requires only three diffusions and one thin-oxide growth step. Processing is further simplified by forming the source-drain diffusion for the MOSFET at the same time

that the emitter diffusion is made.

According to Vora, experimental devices have been made and tested. He points out that n⁺ arsenic was used for the emitters rather than the more common phosphorus, for these three reasons: (1) It has a slower rate of diffusion, which allows for better control of the base width; (2) It has lower sheet resistivity, which makes possible much narrower channel lengths; and (3) It can withstand the 1000-C temperature cycle that occurs during processing. Phosphorus, says Vora would punch through the base.

Another important feature of the BIFET structure is that the n-channel MOSFETs are formed on epitaxy material and thus offer tighter control of the doping.

Uses for the BIFET structure are not limited to semiconductor memories alone, Vora says. It could make possible more complex functions in a single package. As an example of how this could be done, Vora cites a decoder-driver for 35 LED displays. He notes that the use of FETs alone would make for a difficult design, because large-area devices would have to be fabricated to handle the required current. If the bipolar approach were chosen, he continues, once again the chip would have to be extremely large, and there would also be serious yield problems.

By use of the BIFET, however, the decoding—which would require about 1000 devices—could be done by small-area FETs, Vora notes, while the driving could be done by 35 bipolar devices. The chip needed for such an application would be of reasonable size and would have reasonable yields, he contends. ■■

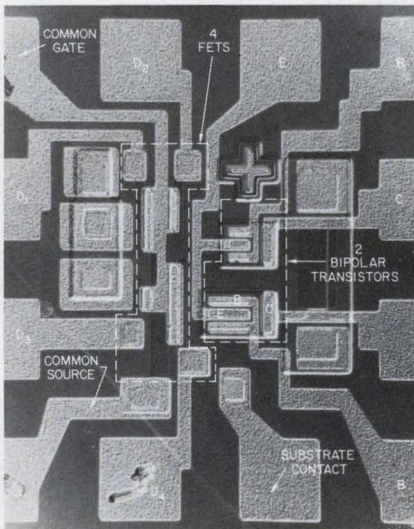

A chip developed by IBM contains FETs and bipolar transistors.

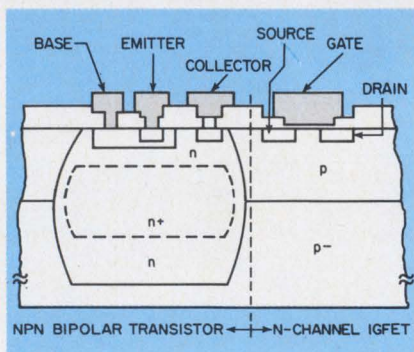

The key to the BIFET structure is the self-isolated bipolar transistor.

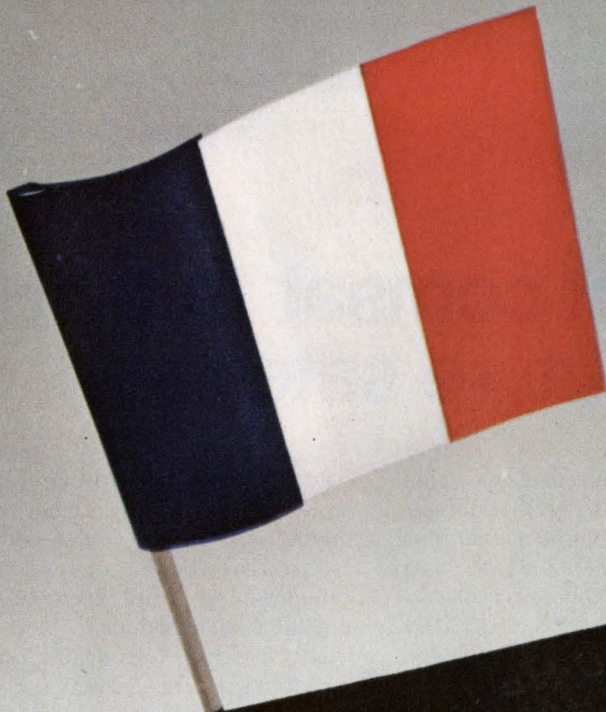

Voilà

Amphenol brings you a whole new line of fans. Etri, from France. A complete, established line of axial fans. With solid design advantages that make them the most widely accepted fan in Europe. Built to last longer by design.

Ball Bearings, Not Bushings

Ball bearing shaft assembly is designed to reduce the friction that wears out conventional bushing-design fans before their time has come.

Standard models can handle almost any job be it an industrial, military, or space application. Customized designs take over where the standard line leaves off. We welcome special ventilation problems.

Etri is not new. Etri backed by Amphenol is new. It's one of the first products from our Alliance Marketing Service. Amphenol's AMS selects the best components on a world-wide

Aluminum Frame, Not Plastic

Non-deforming aluminum body designed to conduct and dissipate motor heat, protecting bearings and sensitive motor parts from premature burn-out and wear-out.

A Lightweight Rotor, Not a Heavy One

Designed to place less stress on the bearing assembly. Laminations and windings are stationary. Fan blades are lightweight self-extinguishing plastic or aluminum alloy.

basis and brings them to you. You get a broader component selection and increased design options. For more information, contact: Alliance Marketing Service, Amphenol Sales Division, 2875 South 25th Avenue, Broadview, Illinois 60153. (312) 345-4260.

**BUNKER
RAMO**

AMPHENOL

World's most potent comsat to test new concepts for future satellites

A Canadian team has finished designing the most powerful communications satellite in the world and plans to begin building it next year. Experiments to be conducted with the station are expected to influence satellite communications design for years to come.

The sophisticated relay station, called the Communications Technology Satellite, is to be launched in late 1975 from Cape Kennedy, Fla., into a stationary orbit. For two years it will hover over the equator at 116° west longitude, carrying out tests with ground stations in Canada and the United States.

Of immediate interest to the public, especially inhabitants of remote areas, will be the degree of success that the powerful transmitter and sensitive receiver

achieve in relaying color television to small, low-cost ground terminals—some using antennas as small as eight feet in diameter. These tests will be made over the newly allocated broadcast frequency of 12 GHz from the satellite to the ground terminals and over 14 GHz from transportable ground facilities to the satellite.

High-powered TWT relays telecast

To reach the small ground antennas on the downward link, a new, high-powered traveling-wave tube designed by NASA will be used in the satellite transmitter. The tube is designed to have greater than 50% efficiency at a power output of 200 W when operating at 12 GHz.

The color telecasts will be made from Ottawa to the satellite, which will then relay them to remote terminals. Telecasts will also be made from remote terminals to the satel-

lite and down to Ottawa for network retransmission. Other experiments will include two-way voice communications, one-way sound broadcast to small terminals and digital transmissions.

Responsible for designing and building the spacecraft is Canada's Communications Research Center in Ottawa. NASA's Lewis Research Center in Cleveland has project management responsibility for the launch vehicle, the high-power TWT amplifier and its power conditioner, the environmental test support and the launch and operation support.

The high-power transmitter, described as an "electronics nightmare" by an engineer working on the project, consists of two major components: One is the TWT, with 10 collectors at depressed levels and 10 different high-voltage outputs; it is to be capable of producing a maximum output of 200 W rf.

John F. Mason
Associate Editor

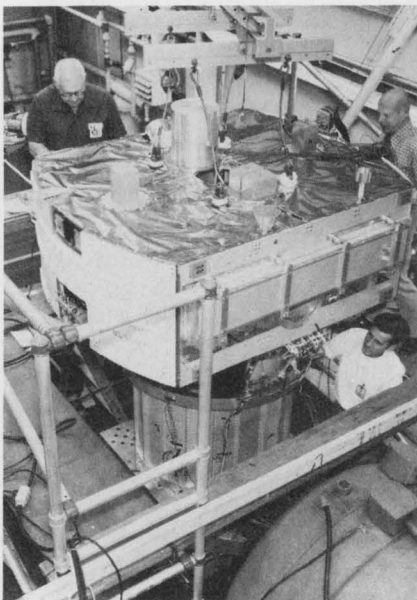

Satellite model gets vibration tests at NASA's Lewis Research Center.

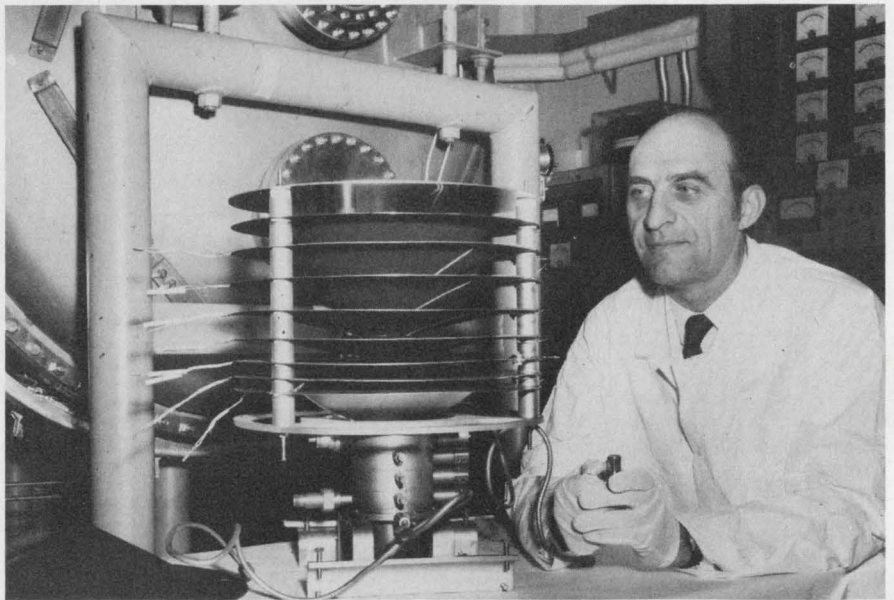

A half-size version of this high-power TWT will fly in the Communications Technology Satellite in 1975. NASA's Henry Kosmahl (above) developed it.

APPLY TODAY

Suggest a use for the 555 IC timer, and get one FREE to work with.

Think. What could you do with this flexible, low-cost, exceptionally simple-to-use circuit? The first – and only – standard IC timer in production today. That functions interchangeably as a time delay, oscillator, pulse detector or power modulator. With resettable timing from microseconds through one hour.

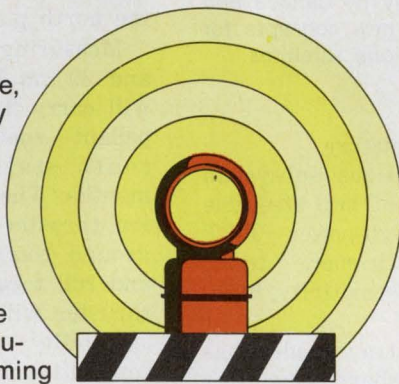

Think. And get much more than a penny for your thoughts. Originate a specific use for the 555, and we'll rush you a timer to experiment with. FREE.

Applications almost limitless. Over the broadest range of industries. This exclusive device easily wires into just about anything made today requiring generation of a frequency or time delay.

Anything. Anywhere.

Anything you can think of for the home. From appliance and cooking timers... to house-light timers, sprinkler system regulation. Or how about security systems, with all their intricate mechanizations? Anything in the automotive line. Like anti-skid braking controls, windshield wiper speed regulators, tachometers. Fuel injection and emission control systems.



Sports: electronic stopwatches. Entertainment: vending and concession machines. Business: office intercoms, time-release locks, teletypes, telephones. Biomedical: stimuli control.

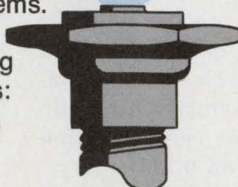

And of course, anything in the electronics/computer fields – right back where it all started.

Specs for the versatile 555 timer include 200mA output drive capability; flexibility in supply voltage 5 to 15 volts; unique temperature stability 0.005% per °C. Free run or latch in adjustable duty cycles, externally triggered.

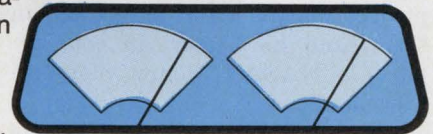

And the incredible ease-in-use (requires only a resistor and capacitor) is matched only by our incredible low cost. The 8-pin dual-inline circuit comes to you off the shelf from your distributor for only 75¢, from 100-up.



Signetics/Linear
811 East Arques Avenue
Sunnyvale, California 94086

- Attached is my application suggestion for the 555 universal timer. Please send my FREE part immediately.
- Rush me all specs and data for the 555 timer.

Name

Title

Company

Address

City

State

Zip

Telephone

Signetics Corporation. A subsidiary of Corning Glass Works.

signetics

INFORMATION RETRIEVAL NUMBER 21

The other component is the power processor, or conditioner, which, in addition to supplying power at appropriate voltages to the tube, will also give command and closed-loop control and protection.

The multistage depressed collector concepts used in designing the TWT permit a major improvement in its electrical efficiency, according to Dr. Henry Kosmahl, designer of the tube at the Lewis Research Center.

The collector, resembling concave plates, retrieves the excess energy passing through the tube and cycles it back to the power supply. This process saves substantial amounts of energy, giving the tube a working efficiency of more than 50%, Kosmahl says.

"Such an improvement could have great significance in the design of high-power communications satellites," says Colin A. Franklin at Ottawa's Communications Research Center. Franklin is project manager for the Canadian team, and his American counterpart is NASA's Henry Slone in Cleveland.

The NASA-developed TWT is being built competitively by Hughes Aircraft's Electron Dynamics Div. in Torrance, Calif., and by Litton Systems Inc.'s Electron Tube Div. in San Carlos, Calif. In April one of the companies will be selected to proceed with production.

The finished tube will be turned over to TRW Systems in Redondo Beach, Calif. TRW is building the transmitter's power conditioner and will integrate the TWT into the transmitter system.

The CTS is a flying test bed

A number of characteristics of the transmitter package will be watched closely once the satellite is in orbit. They include these:

- The efficiencies of the collector, the over-all TWT and the power processor at different rf power levels.

- The TWT gain, bandwidth and frequency stability under space environment conditions for a period of two years.

- The system noise loading.

- The effects of distortion noise and intermodulation on the quality

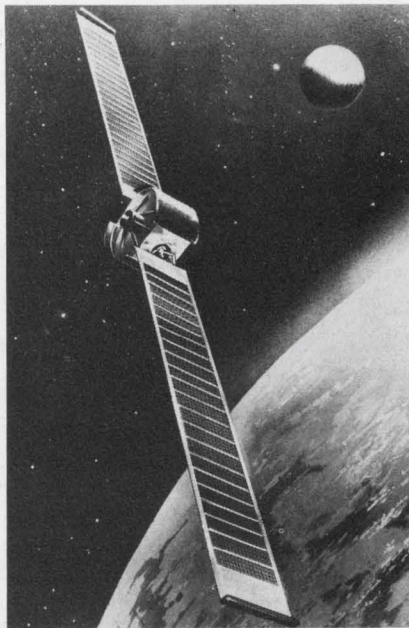

Communications Technology Satellite, designed jointly by Canada and the U.S., will test new concepts for future communications satellites.

of the television picture.

The communications subsystem consists basically of two steerable antennas, the high-power TWT and power conditioner, driver TWTs and a high-sensitivity, high-gain receiver.

The satellite's transponder has four 85-MHz passbands—two for transmitting in the 11.7-to-12.2-GHz band and two for receiving in the 14-to-14.3-GHz band.

Probably the second most important experiment on the satellite will be an extendible solar array, which will consist of two sails, each 244 inches long and 51 inches wide. They will carry 26,250 solar cells. The initial power output of the array will be 1260 W, and after two years it will be 1000 W.

The two sails will rotate about the spacecraft's pitch axis. Sensors mounted on the sails will automatically control the drive mechanism, so that the solar-cell side of the sails will always face the sun.

Dc currents from the solar cells and from strain gauges will be transferred from each sail via a 46-channel, wet-lubricated, gold-on-gold slip-ring assembly. The slip rings will rotate at one revolution per day in steps of 0.125°.

Liquid-metal slip rings made of gallium will be carried along as an experiment and not a functional part of the satellite's operations.

Gallium's good points include these: It has a low vapor pressure, produces virtually no electrical noise, has high-current capability (200-amp rings have been demonstrated), has high-voltage capability (20 kV between rings) and makes possible the reduction of debris generation. Gallium also has an indefinite life (there's no known wearout in a vacuum), has very little power loss, eliminates friction and is small and light.

On the other hand, gallium oxidizes rapidly when exposed to oxygen, has a large supercooling range and has a melting point of +30 C.

Another major advance in spacecraft design that will receive careful attention is the north-south station-keeping device—a 0.4-millipound thrust, 5-cm mercury bombardment ion engine mounted on the north platform of the satellite.

Measuring 13 cm in diameter and 30 cm long, the ion thruster will carry 2.7 kg of mercury propellant—enough to perform north-south station-keeping for six months. The thrust vector of the ion thruster will be controlled by ground command to provide yaw and roll torques. Operation of the thruster will also demonstrate the storability and multiple restart capability characteristics that are important for long space missions.

Compatibility will be studied

Of particular interest, Franklin points out, is the thruster's compatibility with the spaceborne communications systems, particularly as regards electromagnetic interference and contamination.

After the satellite arrives on station, it must be three-axis-stabilized and the solar array must be extended. Roll and pitch information required for keeping the platform facing the earth will be acquired from a static infrared earth sensor installed on the forward platform. Yaw information will be provided for two 8-1/2-hour periods in each 24-hour orbit by sun sensors on the east and west panels. The goal is to maintain antenna-boresight pointing accuracy to +0.2° in pitch and roll and ±1° in yaw.

In orbit, the satellite is to weigh 800 pounds and measure 71 by 62 by 70 inches. ■■

Press here to save on lighted pushbutton switches.



**buys all
the switch
you need.**

Oak's Series 300 gives you good looks and a small price-tag in lighted pushbutton switches. Plenty of switching performance for most jobs, without paying a premium. Even the Series 300 Split-Legend/4 Lamp Switch is less than \$1.60 (normal latch, 2P2T, glass alkyl insulation, no engraving, less lamps.)

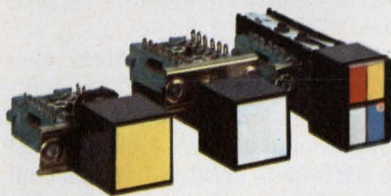

Three versions with switching up to 4P2T.

Choose from single, dual, or four lamp display as well as non-lighted type. One to twelve station, momentary, interlock, alternate action, or any combination available on the same switch bank. Lockout feature available for all types. Power Module 3A125VAC. Lighted indicators are identical in size and appearance, but without switching.

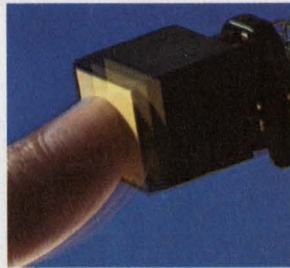

Built to take it.

Series 300 is built for reliable performance and long life. Applications galore — bank terminals, calculators, and copy equipment.

Gang them up by the dozen.

Order up to 12 switching stations on a single channel, any switching mix, with convenient panel-mounting studs. Color selection: white, lunar white, yellow, amber, orange, red, green, blue. Choose silk-screened, hot-stamped, or engraved-and-filled legends. Split-legend switches can be specified with any two, three, or four colors on insertable legend plates.

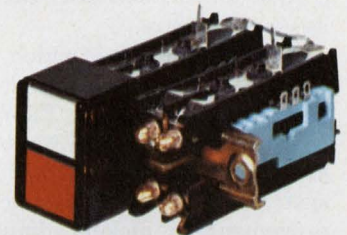

Modular design.

Single-legend/single-lamp, split-legend/4-lamp, and single-legend/redundant lamp switches have snap-on lamp holders. Plus replaceable legend plates, lens caps, and button assemblies. Front-panel relamping, too, without special tools on all types.

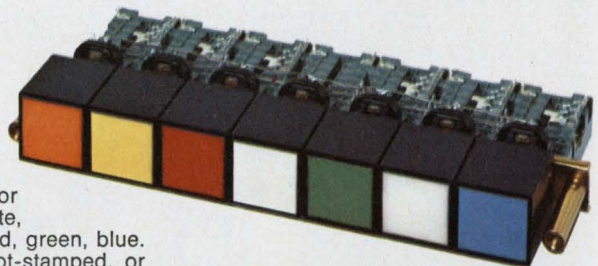

Write for our Series 300 Brochure

OAK Industries Inc.

SWITCH DIVISION / CRYSTAL LAKE, ILLINOIS 60014
TELEPHONE: 815 • 459 • 5000 ■ TWX: 910 • 634-3353 ■ TELEX: 72 • 2447

INFORMATION RETRIEVAL NUMBER 22

1-kW, 170-lb battery developed for extra-long space missions

The largest and most powerful spacecraft battery ever built—a 1-kW, 170-pound, nickel-cadmium unit—is undergoing simulated flight tests. It is believed to be twice as powerful as any battery so far put into space.

Developed by the TRW Systems Group, Redondo Beach, Calif., for the Air Force Aero Propulsion Laboratory, Wright-Patterson Air Force Base, Ohio, the prototype battery is designed to power synchronous-orbit satellites for as long as seven years.

A 2-kW battery, which weighs about 320 pounds, is also in the early design stage at TRW.

According to David Stager, TRW project manager, the 1-kW battery system represents a significant improvement in nickel-cadmium battery technology in terms of higher power, longer lifetime, greater energy density, higher reliability and radiation hardening.

Design specs for typical state-of-the-art spacecraft battery systems

and those for the 1 kW, battery prototype are shown in the table.

The battery consists of 24 high-capacity cells connected in series, individual cell bypass electronics, an active thermal control system and a power-conditioning unit.

The system is designed to operate between 24 and 33 Vdc bus voltage and to function with an internal spacecraft temperature of 30 to 100 F. Seven to eight watt-hours per pound are provided, compared with about four watt-hours

per pound for conventional batteries.

Each cell produces 60 ampere hours—twice the total of conventional battery cells.

Protective circuit provided

A bilateral bypass circuit protects each cell from power reversal, high pressure and excessive overcharging. If a cell degrades or failure occurs, this circuit bypasses the inoperative cell to deliver sufficient power from those remaining. Each cell is protected from damaging overpressure by means of a third oxygen sensing electrode. Upon reaching full charge, the electrode signal causes the upper voltage to be reduced to a point where voltage limiting and bypassing occur.

Third-electrode schemes such as this have been used for several years by Gulton Industries and General Electric in small NiCd batteries.

The 24 cells in the battery system are divided into four individual packs, consisting of six cells with associated bypass electronics. The battery is designed to meet all objectives, Stager says, with only 22 cells remaining operational at the end of seven years.

Battery temperature is maintained at 30 F by the shifting of excess heat from the battery pack to an external heat-rejection radiator, made of gas-loaded (variable-conductance) heat pipes.

The entire battery, including cells, electronics and thermal controls is housed in a single, lightweight structure. Shielding and baffling for radiation protection are integral with the battery. ■■

Battery specs compared

Parameter	State of the art	Development
Power Level	200-500 W	1000-2000 W
Lifetime	5 Years	7 Years
Reliability	0.90	0.95
Energy Density	4 Wh/lb	7 Wh/lb (1 kW) and 8 Wh/lb (2 kW)
Volume	2 ft ³ /kW-hr	1.5 ft ³ /kW-hr
Radiation Hardening	Partially	Fully

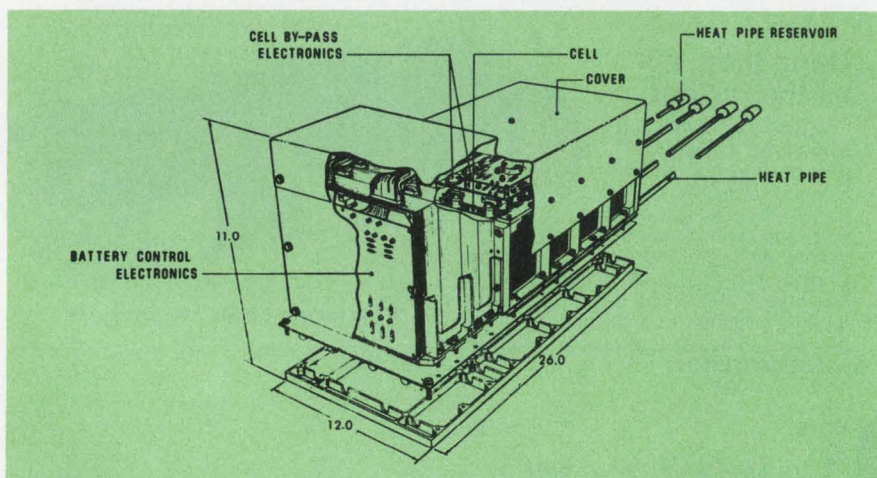

1 kW battery system for use on future satellites weighs about one hundred seventy pounds, including heat pipes and associated electronics.

Putting innovation to work.

**One
GaAsLITE,
two
colors.**

Think what you can do with our new bi-color and AC GaAsLITEs:

We've taken two light-emitting diodes and put them in one pop-in panel mounting package. Result? A tri-state device (*red, green, and off*) that is a nifty nulling circuit all by itself. Or a battery charge-discharge indicator. Or a self-contained polarity meter. Or whathaveyou.

ON DISTRIBUTORS' SHELVES:

MV 5094
AC RED 0.8 mcd @ 20 mA (typ.)

MV 5491
RED/GREEN
1.5 mcd @ 20 mA (typ.) RED
0.5 mcd @ 20 mA (typ.) GREEN

AVAILABLE ON FACTORY ORDER:

MV 5591
RED/YELLOW

MV 5691
YELLOW/GREEN

MV 5291
AC GREEN

MV 5391
AC YELLOW

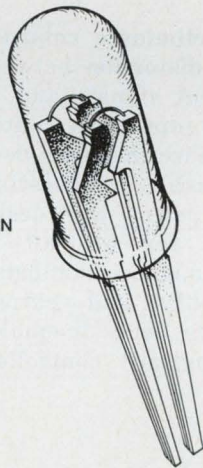

AC GaAsLITEs

By putting two red, green or yellow chips in the package, we give you the world's first line of AC light-emitting diodes. Run them with up to 110 V and a simple resistor. No flicker. Prices start at 99¢ (1,000's).

So call your distributor for your first quantities or the data sheet.

Monsanto Commercial Products Co.
Electronic Special Products
10131 Bubb Road
Cupertino, California 95014
Phone: (408) 257-2140

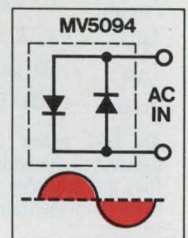

Distributed by: Alta Electronics, Elmar Electronics, Hammond Electronics, Kierulff Electronics, Kierulff/Schley, Liberty Electronics, Schweber Electronics, Semiconductor Specialists, Wesco Electronics, Western Radio; Canada: Canadian Dynamics, Ltd., Cescio Electronics, Ltd.

Monsanto

INFORMATION RETRIEVAL NUMBER 23

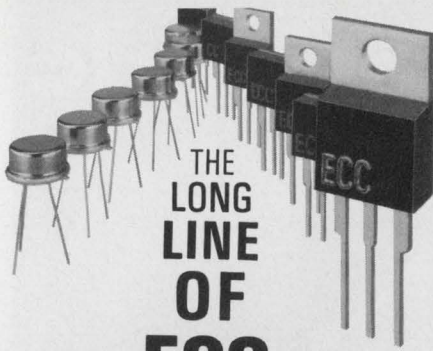

THE
LONG
LINE
OF
ECC

SENSITIVE and STANDARD GATE
TRIACS

World's leading triac producer offers fast delivery, electrical isolation and competitive pricing.

SENSITIVE GATE TRIACS

TO-5 Metal and Plastic; THERMOPAK® and THERMOTAB® Packages

$I_{T(RMS)}$	0.8 - 3 amps
I_{gt}	3 & 10 ma (all 4 quadrants)
I_{TSM}	20 amps
V_{DROM}	200 - 400 volts

STANDARD GATE TRIACS

THERMOTAB and THERMOPAK Packages (13 other packages available up to 40 amps)

$I_{T(RMS)}$	0.8 - 40 amps
I_{gt}	25 & 50 ma max.
I_{TSM}	20 - 300 amps
V_{DROM}	200 - 800 volts

All ECC triacs feature heavily glass passivated junctions for high reliability. They are available from your nearest ECC Sales Representative or Authorized Distributor.

New Condensed Catalog contains technical data on these and other ECC semiconductors. To receive your copy, circle No. 246.

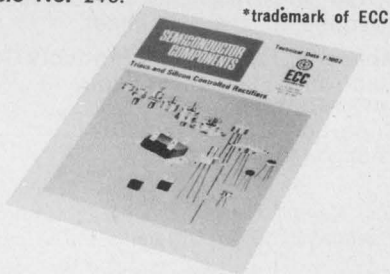

ECC
CORPORATION

P.O. Box 669 • Euless, Texas 76039
817/267-2601

**technology
abroad**

A telephone transatlantic cable between England and Canada—the Cantat II—is scheduled to be laid in 1973. The cable to cost some \$75-million will incorporate the latest techniques in cable laying and cable communications. The British CS Mercury, a cable laying ship belonging to Cable and Wireless Ltd. in London, will have an advanced navigation system developed originally for the Royal Navy. The system employs an Elliott 905 minicomputer and it takes positional data from the U.S. Navy Navigation Satellites. A visual display permits the navigator to pinpoint the ship's position to within 300 feet. Transistors with a design life of twenty-five years are used in the repeaters. A manned midget submarine will lay the cable in trenches formed by underwater jets. The cables will be covered using the same technique.

CIRCLE NO. 441

To eliminate color-television signal distortion between the studio output signals and the transmitter input, an automatic video equalizer has been developed by the British Broadcasting Co. The equipment was designed to correct for over-all signal level, chrominance/luminance gain inequality and chrominance/luminance delay inequality. The unit is digitally controlled.

CIRCLE NO. 442

A simple, low-cost method of growing special crystals that can double laser frequencies—for example, infrared doubled produces a green-light laser beam—has been developed by Siemens of West Germany. The new crystals are said to be extremely stable and to permit new frequencies to be extracted from a given laser

beam without loss of monochromaticity. The new beams have a high intensity and a collimation like that of the original beam. While Siemens will not disclose the crystal material, the company says the process starts with an inorganic gel that contains a combination of the raw materials required to grow the crystal. Small crystals develop in a few days. Siemens is confident that larger crystals will be grown through improvement of the method.

CIRCLE NO. 443

To measure stress, pressure and ship motion in various sea conditions, the 34,447-ton container ship Nihon is being fitted with transducers and associated electronic equipment. The research is a collaborative effort of Lloyds Register of Shipping (London) and the Swedish Ship Research Foundation. Shipboard measurements will be compared with sea-state measurements made by similar sensors on doughnut-shaped pitch-and-roll buoys. The buoys will be 1.5 m in diameter and tethered to the ship at the end of a 300-m cable. Information from the buoys will be telemetered to the ship on 27.030 MHz, then recorded and processed to give wave-height information.

CIRCLE NO. 444

Comprehensive electronics are being installed on 10 new ships being built for Shell Tankers of Britain in Danish, French and Japanese yards. The equipment, being supplied by Marconi Marine in England, includes an 1800-W main communications system, emergency communications, short-range vhf fathometers, visual depth indicators, radio-direction finders, facsimile receiver/printers and AM/FM antenna systems.

CIRCLE NO. 445

For built-in reliability, design with "Scotchflex" Flat Cable/Connector Systems.

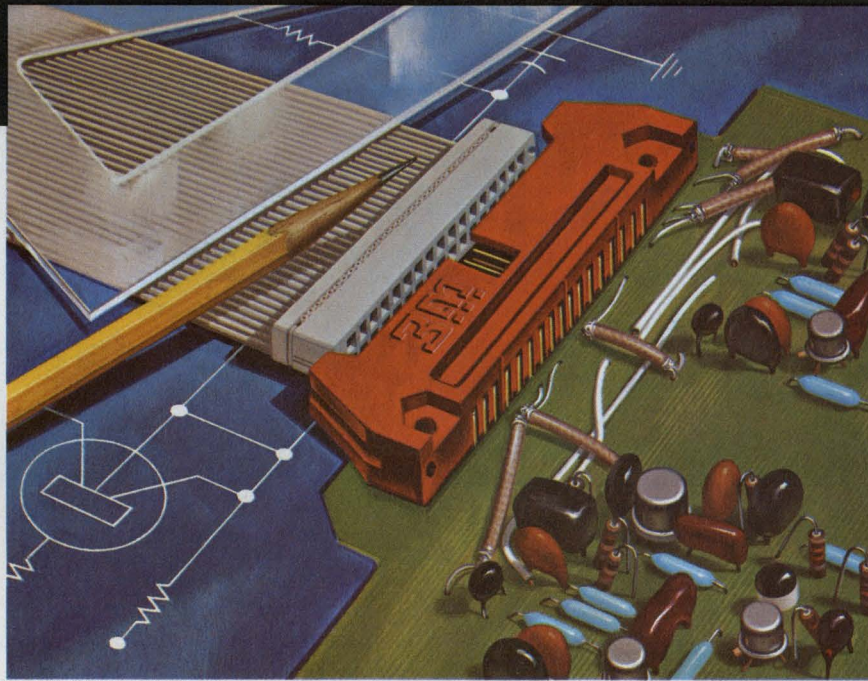

"SCOTCHFLEX" IS A REGISTERED TRADEMARK OF 3M CO.

"Scotchflex" Flat Cable and Connectors can offer you trouble-free packaging for your next generation equipment.

There's built-in reliability for your circuit inter-connects. Our flat, flexible PVC Cable has up to 50 precisely spaced conductors. The gold plated U-contacts are set into a plastic body to provide positive alignment. They strip through the insulation, capture the conductor, and provide a gas-tight pressure connection.

Assembly cost reductions are built-in, too. "Scotchflex" Connectors make up to 50 simultaneous connections without stripping or soldering. No special training or

costly assembly equipment is needed.

Off-the-shelf stock offers you flat cable in a choice of lengths and number of conductors from 14 to 50. Connector models interface with standard DIP sockets, wrap posts on .100 x .100 in. grid, or printed circuit boards. Headers are available to provide a de-pluggable inter-connection between cable jumpers and printed circuit boards (as shown). Custom assemblies are also available on request.

For full information on the "Scotchflex" systems approach to circuitry, write to Dept. EAH-1, 3M Center, St. Paul, Minn. 55101.



STARK*

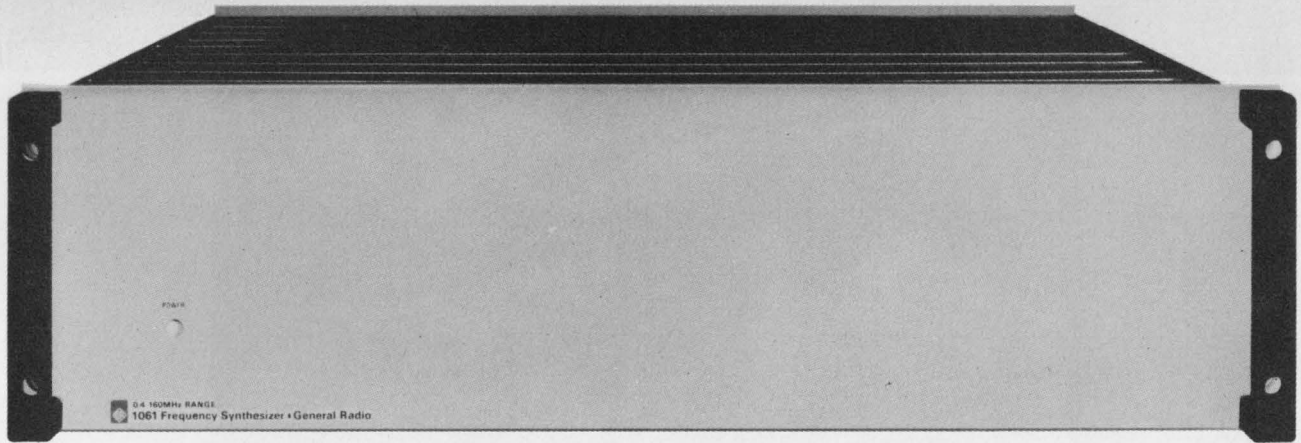

... but bristling with performance — total performance that is unexcelled by any other frequency synthesizer:

	GR 1061	Runner-up A	Runner-up B
Frequency	dc to 160 MHz	1 MHz to 160 MHz	10 kHz to 110 MHz
Switching Speed	< 100 μ s	1 ms	5 to 100 ms
Output Level	+ 20 dBm	+ 13 dBm	+ 13 dBm
Spurious	-80 dB	-70 to -100 dB	-80 dB
Phase Noise	-63 dB	-60 dB	-50 dB
A-M, FM Capability	standard	no	optional
Search-Sweep	standard	no	optional

Data current as of August, 1972



General Radio

NEW YORK (N.Y.) 212-964-2722, (N.J.) 201-791-9990 • BOSTON 617-646-0550
 CHICAGO 312-992-0800 • WASHINGTON, D.C. 301-881-5333 • LOS ANGELES 714-540-9830
 TORONTO 416-252-3395 • ZURICH (01) 55 24 20

GR COMPANIES • GRASON-STADLER • TIME/DATA • TECHWARE COMPUTING CORP.
 GR ASSOCIATE • MICRONETIC SYSTEMS INC.

* *stark* \stärk\ *adj* ... STRONG, ROBUST ... having few or no ornaments,

For computer-controlled systems or in applications that require special controls, often remote from the instrument, who needs a panel full of knobs? In systems that already include a standard reference oscillator, why buy another one? Where a resolution of only 5 digits is required, why pay for 10?

Of course one man's ornament may be another man's necessity, so we offer an array of options to tailor the 1061 to **your** needs: a full control panel, two different internal reference oscillators, resolution to 10 digits, and phase-modulation capability. We don't offer, as options, search-sweep, a-m and fm capability, wide frequency range, fast switching speed, complete programmability, high output, and low spurious and phase-noise levels — they're all standard, starting at \$4700.

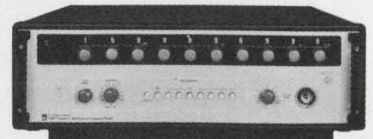

washington report

The software patent issue: It's up to Congress

The Senate Judiciary Patent Subcommittee will ask computer companies and other parties interested in patenting software to submit recommendations on how the matter should be acted upon by Congress. Committee sources say, however, that the question is so complex that there probably will be no action to amend the Patent Law during the next session of Congress. The Supreme Court has ruled that Bell Telephone Laboratories is not entitled to a patent for digital computer software that converts binary code to pure binary. Such a patent, the Court has held, would in effect be a patent on the algorithm itself. However, the High Court did not rule out the possibility that some software could be patented, and it suggested that Congress look into the problem.

A nuclear communications satellite considered

NASA is moving toward the use of nuclear electric power for a high-power communications satellite and is looking for industry sources with both communications satellite and nuclear experience to conduct a feasibility study. Nuclear electric units have been used to power the Navy's Transit and Navigation satellites and as backup power on the Nimbus meteorological satellites. This would be the first use of nuclear power for an extremely high-power communications satellite.

Meanwhile, the Coast Guard is the latest agency to enter the proliferating communications satellite field. It is issuing requests for proposals for a study of space telecommunications services. In other developments the Air Force is looking for R&D sources to study multi-use terminal designs that would accommodate signals from satellites, troposcatter systems and serve as a relay station for signals to and from remotely piloted vehicles. The Navy wants contractors for the design, fabrication, testing and installation of a real-time telemetry display system for spacecraft.

U.S. looking at magnetic rail systems

The Dept. of Transportation will issue reports for proposals in the next two months for work on two types of electronically controlled high-speed transit systems. The first will involve high-speed sled testing of a vehicle using magnetic-attraction principles. The second will deal with magnetic levitation and the use of super-cooled magnets. The department and Stanford Research Institute are testing the latter principle after a successful first run with a prototype vehicle. Magnetic levitation uses

the principle of opposite poles to lift the vehicle. Liquid helium renders the magnetic coils resistant to electric current, permitting a current to build up and remain indefinitely without further power.

After further study and testing of the two concepts, Federal Railroad Administration officials say, a single contract will be issued to build a large test vehicle of the best design.

Breakthrough extends communications spectrum

Bell Telephone Laboratories and the U. S. Dept. of Defense are expressing great interest in a recent breakthrough by the National Bureau of Standards in measuring the speed of light. The achievement, according to Dr. Ken Evenson of the bureau's Boulder, Colo., center, allows use of regular radio-frequency techniques in previously unused portions of the spectrum extending almost to frequencies of visible light.

Dr. Evenson is one of the bureau's scientists who used highly stabilized lasers to refine the accuracy figure for the velocity of light by two decimal points, or a factor of 100. The new figure is 299,792.4562 kilometers per second. The result is that communications bands up to 88 terahertz—1000 times higher than frequencies now in use—can now be allocated accurately.

Interest in pollution monitoring mounts

Environmental Protection Agency efforts to combat pollution are resulting in a search for precision monitoring instruments. The Coast Guard is planning to contract for development of sensor systems to detect and positively identify oil spills and other water pollutants. The detection would be done remotely by infrared-reflectivity, ultraviolet-reflectivity or laser-fluorescence techniques, or on the scene by mechanical, optical, acoustic or chemical-detection methods. NASA meanwhile is testing a telescope-mounted laser for the remote detection of gases from industrial smokestacks, and it is flight-testing a number of atmospheric-monitoring instruments for eventual use on high-flying aircraft.

Capital Capsules: Opponents of the supersonic transport aircraft are girding for an expected attempt by the Administration to revive the SST project next year. A Capitol Hill office has been set up by a group of environmentalists and consumer interests to "educate" new members of Congress in January. . . . Proposals for a "space tug" are under scrutiny at NASA's Marshall Space Flight Center. Three companies will be chosen from bidders on the study project. . . . Westinghouse Electric Corp. has been chosen principal contractor for the nation's first large scale, fast-breeder nuclear electric-power plant. It nosed out General Electric Co. and North American Rockwell, Inc., which are expected to participate as subcontractors in the program. . . . The General Accounting Office, Congress' own watchdog, has accused the FCC of being ineffective in regulating use of the radio spectrum. The GAO says the FCC doesn't have the technical capability to monitor the entire spectrum. It suggests transferring some responsibilities elsewhere. . . . The Army has issued requests for proposals for a new helicopter to replace the canceled Cheyenne.

*going in circles
with your measurements?*



put them all together with...



You don't need to jump from display to indicator, from meter to control any more, because your measurement power is all together . . . in a TEKTRONIX 7000-Series Integrated Test System.

TEK's 7000-Series Integrated-Test-System concept brings you the convenience of one compact system for easier and faster measurement solutions. By focusing your attention on one integrated display, you save time by looking at only one spot for your answers. TEK's unique CRT READOUT labels the display with important parameters, increasing your measurement accuracy and confidence.

Put your system together from a selection of 17 scope mainframes, 32 plug-ins and a complete line of accessories. The 7000-Series scopes offer bandwidths from DC to 50, 100, 250 or 500 MHz, and there are Conventional, Storage, Ruggedized, Cabinet and Rackmount models. The Plug-ins include: Amplifiers, Time Bases, Curve Tracer, Samplers, TDR, Spectrum Analyzer, Digital Counters, DMM, Digital Delay, Optical Spectrometer and more coming.

Call your local Tektronix Field Engineer today, and ask to see TEK's 7000 Series; or write: Tektronix, Inc., P.O. Box 500, Beaverton, Oregon 97005. In Europe write: Tektronix Ltd., P. O. Box 36, St. Peter Port, Guernsey, Channel Islands.

Tektronix, Inc.

***Offering sales, after-sales support
and service . . . worldwide***

Here's a versatile new IC for
portable or battery-powered instrumentation

150 μ Watts powers Triple Op Amp

The Siliconix L144 is a *low-power* monolithic IC with three complete op amps and a common bias network on the same substrate. The circuit operates over a power supply range of ± 1.5 to ± 15 V, with a supply current set by an external bias resistor. With a ± 1.5 V battery, only $50 \mu\text{A}$ is required for all three op amps!

Other features:

- Internal compensation provides stable operation for any feedback circuit—including capacitive loads >1000 pF
- 80 dB gain with $20\text{K}\Omega$ load
- Typical slew rate $0.4 \text{ V}/\mu\text{sec}$
- Military or commercial versions available

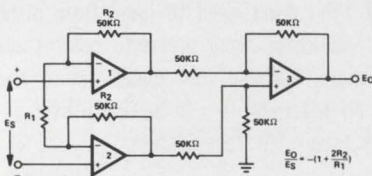

Instrumentation amplifier for high input impedance with differential operation.

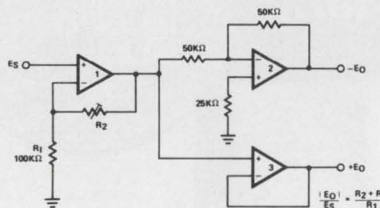

Precision phase splitter with good gain, high input impedance, low output impedance.

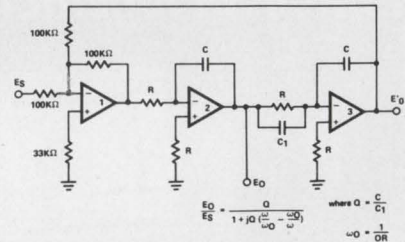

Active filter with high Q and excellent stability.

Applications? Above are three suggestions. There are more: Low-drift sample-and-hold, inverting amplifiers, voltage comparators, and so on. Call us if you have a specific design problem.

write for data

Applications Engineering: (408) 246-8905



Siliconix incorporated

2201 Laurelwood Road, Santa Clara, California 95054

INFORMATION RETRIEVAL NUMBER 28

What we don't print— Should we?

Despite persistent pressure from vendors, there's a kind of article we continue to refuse to publish. We keep rejecting articles in which a manufacturer touts his own products or capabilities—articles that say, in essence, "Here's a blow-by-blow report on how we designed our dandy new counter," or "Here's an A-to-Z description of our zippy new IC."

We've always felt that such articles are more self-serving for the manufacturer than useful to the reader. We're probably biased against such articles anyway, because they're so easy to obtain; manufacturers repeatedly bang on our doors with such offerings, all of them "interesting." But we've always insisted that every article we publish must be *useful* to electronics engineers—not merely interesting.

At issue here is not so much the information itself, but rather, who dispenses it. If a company develops a new technology or a new product, ED's staff will write about it. We'll show its advantages and limitations, its strengths and weaknesses. We'll highlight its significance and show how it stacks up against competing technologies and products. But we don't feel it's right for the manufacturer to write these articles. We feel it's inevitable that he'll be biased and that his attempts at objectivity most often will merely yield yawn-inspiring prose that's still biased.

We don't accept an article that tells how to design with an advanced product that's available only from the author's company. But we welcome articles on how to design with an advanced product that's available from several sources.

Maybe we're wrong. Maybe we're too doctrinaire. Perhaps we shouldn't be deterred by the fact that an article is easy to get or by the fact that it tends to favor the author's company. We're so close to this question that we begin to wonder about our own judgment.

How do *you* feel about it? Use some space on the Information Retrieval card to give us your view or send us a note. We'd welcome your opinion.



A handwritten signature in cursive script that reads "George Rostky".

GEORGE ROSTKY
Editor-in-Chief

New and recent Spartan Books . . .

Introduction to Defense Radar Systems Engineering

JAMES N. CONSTANT, *President, RCS Associates, Inc.*

Just Published! The first book to bring together all aspects of radar systems and integrate them in a systematic and logical pattern offers all the background needed to specify a system for a given application. Each chapter presents analyses and equations in engineering terms. Among this comprehensive volume's many unique features are: the most extensive treatment of the effects of Electronic Counter Measures (ECM); coverage of the theory of trajectory predictions and array theory; and an in-depth treatment of data processing in radar systems. 260 pp., 6 x 9, *illus.*, #9194, cloth, \$20.00

Checklists for Management, Engineering, Manufacturing, and Product Assurance

W. B. ROSSNAGEL, *Rossnagel and Associates*

Technically accurate and ready to be applied, these checklists are an excellent means to ensure that a given specification, contract, design, etc., is complete in every respect.

Volume I, Management Checklists

22 checklists cover computers, engineering, finance, labor relations, manufacturing, marketing, personnel, product assurance, proposals, publications, small business, and other subjects. 192 pp., 6 x 9, *illus.*, #9178, cloth, \$14.00

Volume II, Electrical and Electronic Checklists

22 detailed lists encompass cables and connectors, communication radios, multi-coders, lasers, microelectronics, integrated circuits, and much more. 192 pp., 6 x 9, *illus.*, #9181, cloth, \$14.00

Vibration and Acoustic Measurement Handbook

MICHAEL P. BLAKE, *Development Engineer, and*
WILLIAM S. MITCHELL, *Vibration and Acoustical Consultant, both of Lovejoy, Inc.*

This original 700-page illustrated guide closes the great technological gap between theory and operations in the field. Developed through years of practical testing, it demonstrates the value of vibration and acoustic measurement in terms of actual situations and machine problems. It clearly shows how these measurements can give warning months in advance of 90 percent of equipment problems, allowing time to take corrective action before trouble starts. The net-result: less production stoppage, fewer lost man-hours, better quality control, and lower maintenance costs. 656 pp., 6 x 9, *illus.*, #9195, cloth, \$30.00

Analysis of Plates

D. E. McFARLAND, B. L. SMITH, *and*
W. D. BERNHART, *Wichita State University*

This comprehensive text presents both classical and computer-oriented solutions for the analysis of thin plates for stresses, strains, and lateral deflections. The coverage includes orthotropic plates, continuous plates, various shapes, plates on elastic foundations, large deflections, and laminated plates. The authors add new insight to the variational approach to plate theory, including many illustrative examples. Although intended as a text in mechanical engineering, the book should be of great interest to engineers in industry. 296 pp., 6 x 9, *illus.*, #9191, cloth, \$18.50

Control Theory, Volume 1

Elements of Modern Control Theory

ARTHUR L. GREENSITE, *Convair Division of General Dynamics*

The first of these two volumes on flight control provides the practicing engineer and advanced student with a comprehensive, modern, and up-to-date exposition of all facets of modern control theory. Based on a series of monographs written for NASA, it is recommended as a primary or supplementary reference text. Extensive sample problems and exercises included. 896 pp., 6 x 9, *illus.*, #9154, \$29.95

Control Theory, Volume 2

Analysis and Design of Space Flight Vehicle Control Systems

The companion volume treats applications to aerospace vehicles in detail. It examines techniques and methods for the design of launch vehicle control systems, and presents an analytical framework for the study of the performance of satellite attitude control systems. 752 pp., 6 x 9, *illus.*, #9163, cloth, \$29.95

Modeling of Thinking and the Mind

N. M. AMOSOV, *Academy of Medical Science, U.S.S.R.*

An exciting work on the theory and techniques of simulating the functions of the human intellect by one of the Soviet Union's leading cyberneticists and Lenin Prize winner. Presenting his original hypothesis concerning programs of man's psychic functions, the author outlines methods for modeling these on the computer. 208 pp., 6 x 9, *illus.*, #9147, cloth, \$12.00

SPARTAN BOOKS / HAYDEN BOOK COMPANY, Inc., New York

... now available from Hayden

Pattern Recognition

M. BONGARD, *Translated from the Russian by T. Cheron;*
Edited by J. K. Hawkins, Robot Research

Although primarily directed toward specialists in computers and artificial intelligence, this volume is of importance to engineers and others attempting to understand such brain functions as the ability to "find similarity," "create abstract ideas," and "act by intuition." The Soviet scientist clarifies the meaning of pattern recognition and problem solving. 256 pp., 6 x 9, illus., #9195, cloth, \$12.95

The Future of Science

MORRIS GORAN, *Roosevelt University*

A provocative, well documented investigation of the scientists' relationships with society, government, and money. It examines three current problems of the scientists: communication, education, and financing. Throughout, discussions are supported by facts rather than moralistic statements. 168 pp., 6 x 9, #9190, cloth, \$8.50

Technology Gap in Perspective

Strategy of International Technology Transfer

DANIEL LLOYD SPENCER, *Morgan State College*

An original strategy for visualizing and coping with the technological variants of the modern world. Presenting a novel systems vision, the author deals with the problems of incessant waves of technological impact, and holds that we must view them as a world technology system. 192 pp., 6 x 9, illus., #9180, cloth, \$10.00

Character Readers and Pattern Recognition

Edited by V. A. KOVALEVSKY, *Institute of Cybernetics, Kiev, U.S.S.R.*

This collection of articles focuses on problems of pattern recognition and computer simulation of various algorithms

and recognition systems. All methods discussed and all work examined are based on procedures used in the development of actual equipment at the Institute of Cybernetics. 280 pp., 6 x 9, illus., #9150, cloth, \$12.00

Durability and Reliability in Engineering Design

GILBERT KIVENSON

This thought-provoking work places at your disposal highly relevant findings from a variety of technical areas. It examines materials properties, breakdown mechanisms and phenomena, and failure modes along with steps to counter them; provides a capsule course in reliability theory; relates design considerations to the user's needs. 200 pp., 6 x 9, illus., #5851-9, cloth, \$9.95

Materials Science and Technology for Design Engineers

Edited by ALEX E. JAVITZ

The fundamentals of materials integrated with the hard facts of day-to-day engineering practice. The coverage offered you ranges from basic structure and behavior through new materials and applications, to environmental effects, reliability concepts, and cost effectiveness. 560 pp., 6 x 9, illus., #5640-0, cloth, \$23.95

The Successful Engineer-Manager

A Practical Guide to Management Skills for Engineers and Scientists

Edited by ROBERT C. HAAVIND and RICHARD L. TURMAIL

A well-organized, realistic guide to the critical areas of technical management — career, decisions, people, projects, finances, and communications. Articles carefully chosen from *Electronic Design* offer you valuable pointers on financial analysis, person-to-person dealings, project scheduling, promoting new ideas, and much more. 176 pp., 7 1/8 x 9 3/4, illus., #5879-9, cloth, \$8.95

15-DAY FREE EXAMINATION

Please send the book(s) circled on 15-day free examination. At the end of that time, I will remit payment, plus postage, or return the book(s) with no further obligation.

9194	9195	9163	9150	5851-9
9178	9191	9147	9190	5640-0
9181	9154	9195	9180	5879-9

Save Money!

Payment Enclosed. Publisher will pay all shipping and handling charges — same 15-day guarantee.

Name _____

Firm _____

Address _____

City/State _____ Zip _____

\$10.00 minimum for free exam orders. Because of higher billing and collection costs, we must ask for payment in full with any order for less than \$10.00. Same 15-day guarantee.



HAYDEN BOOK COMPANY, INC., 50 ESSEX STREET, ROCHELLE PARK, N.J. 07662

ISBN Prefix 0-8104

72-87

Planning to use high-speed logic? Problems with layouts overshadow those of logic design. Controlled transmission lines must replace conventional wiring.

High-speed logic is a two-edged sword. It allows the system designer to increase system speed, but it also creates packaging and layout problems. The problems can be solved, if the designer obeys certain rules of high-frequency interconnection and if he uses the new packaging materials now available.

The two main problem areas are interconnections between logic devices and heat removal from the logic devices.

As you increase the speeds of logic devices, the propagation delay of the interconnections starts to limit system performance. With clock-time intervals below 10 ns, the propagation delays of interconnections must be around 1 ns or less. But delays of approximately 2 ns/ft are common even for high-frequency microstrip-line configurations.

Also, as the rate of change of the signal current increases—with faster rise and fall times of pulses—spiking, because of wiring inductance, becomes an important factor. With a current rate of change of 20×10^6 A/sec—a 20-mA change in 1 ns is common—1-V spikes are generated by a tiny inductance of only 50 nH. And it takes only 1.5 in. of No. 22 gauge wire to create this much inductance.

Obviously the usual method of interconnection won't do. Controlled transmission-line characteristics are needed. Strip-line or microstrip, multilayer printed-circuit boards provide the answer.

The heat-removal problem is also twofold. High-speed logic devices usually require more power than their slower relatives. And propagation delays and inductive spiking dictate that parts be crowded together as closely as possible. This tends to concentrate the heat sources, and heat sinking becomes more difficult.

While ordinary multilayer printed-circuit boards provide good interconnections, good heat removal is not usually one of the prime considerations in multilayer design. Some companies have developed improved packaging techniques, one example being Bunker-Ramo's Planar Coax (Fig. 1). The objective is a good compromise between

controlled transmission-line characteristics, good heat-sinking qualities and easy fabrication. For a 150-MHz system, Planar Coax limits each board to a maximum of 20 devices as the best tradeoff between lead length and good heat dissipation.

High-speed logic requires careful layout

Motorola's MECL III series of high-speed logic devices, introduced in 1968, appears ideal to many designers. After all, an emitter-coupled logic family with subnanosecond propagation delays can mean much higher system speeds. But there are potential headaches.

Consider a microwave frequency synthesizer for an ECM system that requires a programmable counter operating from 25 to 125 MHz. For such speed, the MECL III family is an obvious choice.

When you're working with a clock duration of only 8 ns, you have to lay out the components very carefully to complete a logic decision in less than one clock period. With flip-flops responding in as little time as 1.8 ns, you can't afford the luxury of long connecting leads. Further, tight packaging and the inherently high-heat dissipation of MECL III circuits—they have an average power dissipation of 55 mW per gate—raises the problem of how to get rid of all the heat, in addition to aggravating the usual problems.

Contrary to expectations, the logic part of the programmable counter's design did not present any unusual problems.

Packaging a high-speed logic circuit

Optimal solutions to packaging take time to develop. But there are some general rules that go a long way toward solving layout problems:

1. *Determine the maximum number of device delays that can be included within a clock period.* For instance, at 125 MHz, the clock period is 8 ns, but any clock-inhibit signal should be generated at least 4 ns ahead of the next clock edge. A MECL-III gate delay is 1.1 ns, and the flip-flop delay is 1.8 ns. If the logic circuit is designed so that no more than one gate and one flip-flop are exercised in tandem during each half clock period—thus taking 2.9 ns—only 1.1 ns is left for line

Stanley R. Hall, Director of Systems Development, Electronic Systems Div., Bunker-Ramo Corp., Westlake Village, Calif. 91360.

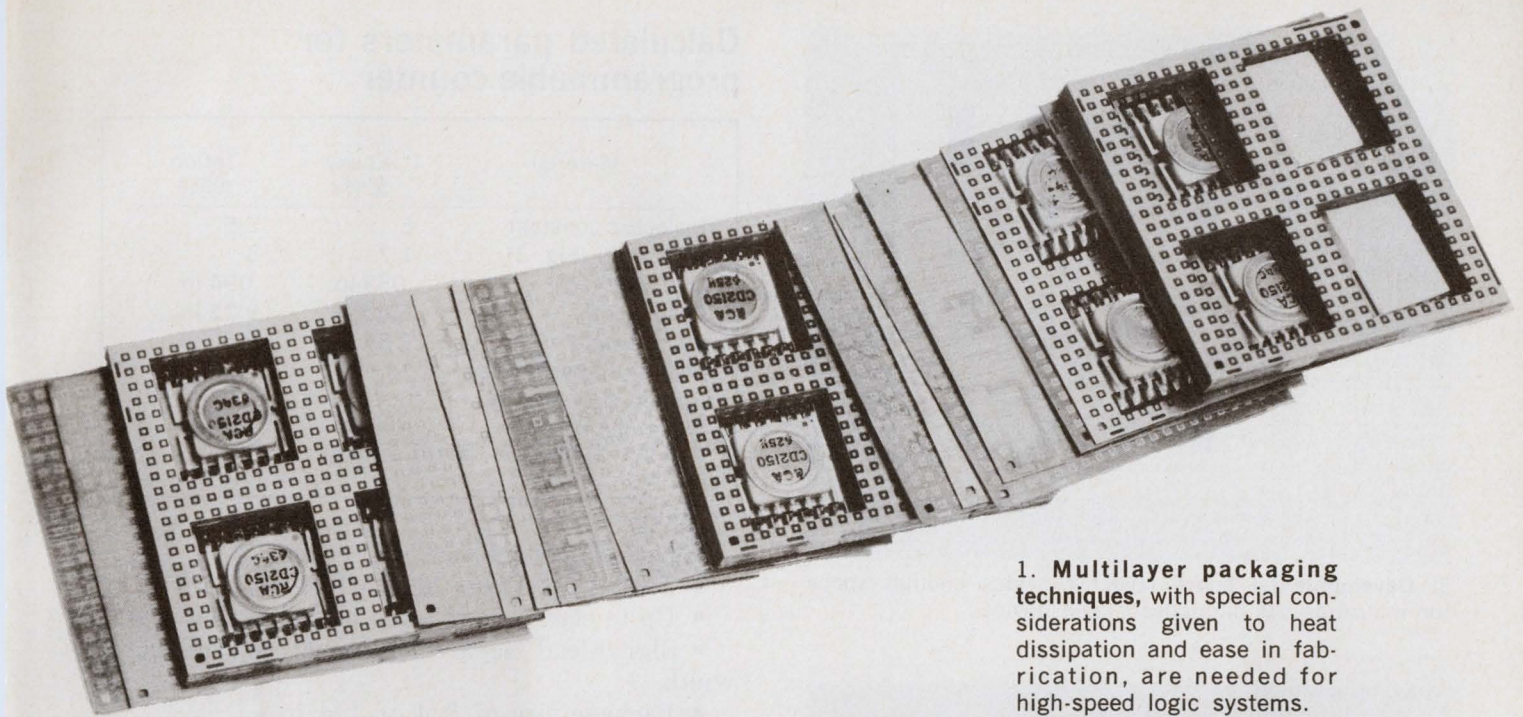

1. Multilayer packaging techniques, with special considerations given to heat dissipation and ease in fabrication, are needed for high-speed logic systems.

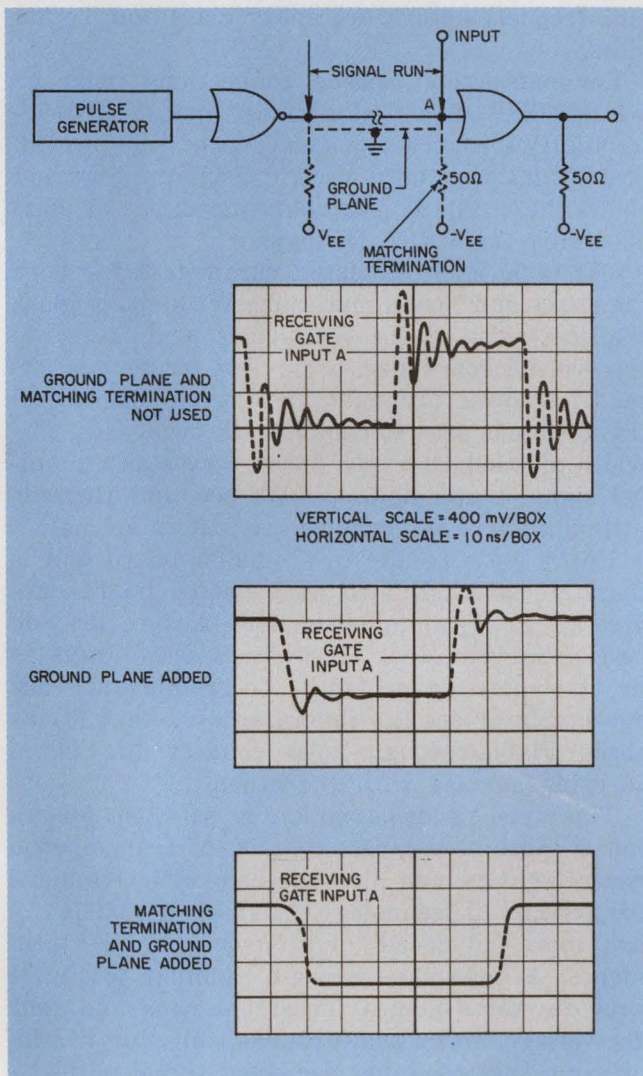

2. Terminating the transmission-line signal run in a matching resistor prevents ringing.

propagation and a suitable safety margin.

2. *Determine the critical circuit functions and signal runs.* Group the critical logic elements for minimal lead length. Logic elements that are signal sources should be centrally positioned. Group the receivers of these signals around and close to these sources. In general, avoid long leads, otherwise a propagation time well in excess of the allowable 1.1 ns can easily result.

3. *Consider the relative propagation distance of signals that are to be combined.* Such signals should travel similar distances. In this way the timing of the two signals will still coincide at the combining element.

4. *Avoid branching.* This disrupts the impedance matching of a transmission line. The layout should be arranged so that the source end of a signal run is at one extreme and all loads are in one direction from the source. A single transmission line running from the source can then supply high-impedance taps along the run.

5. *Terminate lines in a matching impedance.* Impedance matching avoids reflections, ringing and spurious, improperly timed signals (Fig. 2). With a 50 Ω impedance, unterminated lines for MECL III should be no longer than 1.6 in. for driver circuits with a fanout capability of one. Units with a fanout of eight, should be limited to 0.6 in. These values are based upon an overshoot of about 15%.

The programmable counter chosen for our example, is a subsystem of average complexity and it adequately illustrates the steps required to lay out a high-speed logic package.

As a first step write down the constraints for the layout design (Fig. 3).

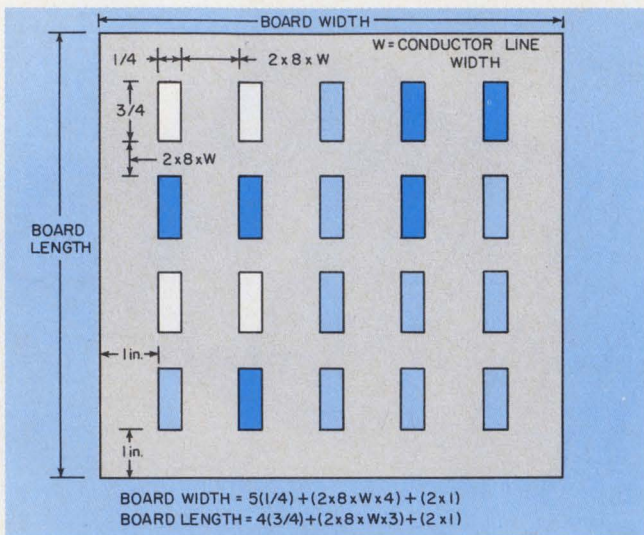

3. Developmental board layout provides enough space for mounting 20 high-speed logic devices.

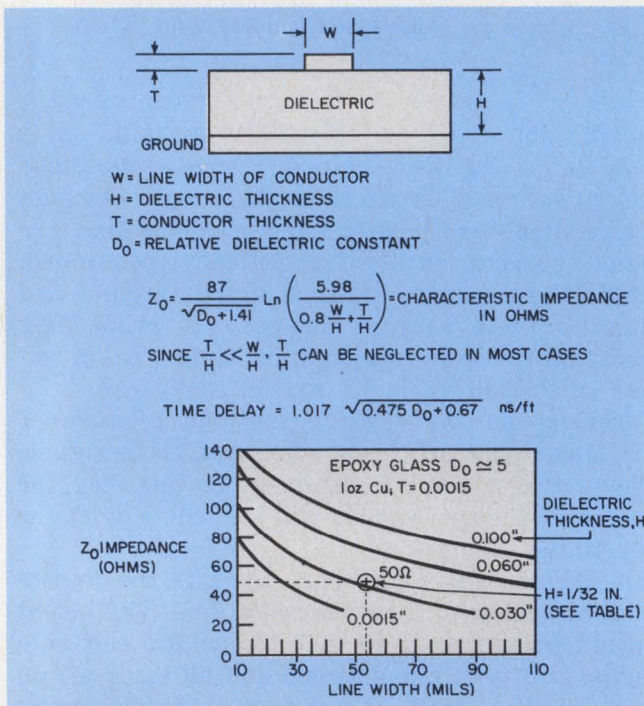

4. Characteristic impedance and propagation time delay depend mainly on the dielectric constant of the board insulation material.

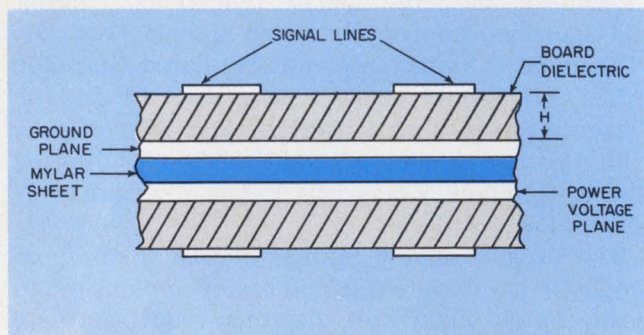

5. Two glass-epoxy microstrip double-sided boards, mounted back-to-back and separated by a Mylar sheet, are used in packaging a prototype.

Calculated parameters for programmable counter

Material	Epoxy glass	Teflon glass
Dielectric constant	5	2.5
W/H ratio (Fig. 3)	1.7	3
Line width (W)	.053 in.	.094 in.
Board width	6.65 in.	9.25 in.
Board length	7.54 in.	9.50 in.
Comparison signal run*	14.19 in.	18.75 in.
Propagation velocity	6.2 in./ns	7.9 in./ns
Signal-run time*	2.3 ns	2.4 ns
* board width + board length		

- Dielectric thickness of 1/32 in.
- Twenty packages arrayed in a 4 × 5 grid.
- Up to eight signal leads between packages.
- Signal-lead separation equal to conductor width.
- Package size of 3/4 × 1/4 in.
- Borderwidth of 1 in.

The two most common board materials for high-frequency work are epoxy glass and Teflon glass.

For nanosecond speeds connections must be treated like transmission lines. Specific characteristic impedances depend upon line width, board thickness and dielectric constant. Figure 4 shows these relationships. An impedance of 50 Ω is suitable for MECL-III logic.

The table lists calculated parameters for both the epoxy and Teflon materials. With epoxy glass the line width of the conductors, and therefore the over-all board size, is smaller, but this is offset by a lower propagation velocity. The signal travel time is used to compare the two cases. The width plus length of the board serves as a nominal signal travel distance. We see that there is little difference in these values, 2.3 vs 2.4 ns.

Epoxy glass results in a smaller board and is therefore selected. Two double-sided boards are used (Fig. 5), mounted back-to-back to provide two signal surfaces. This allows more ways to provide short signal runs. The ground and voltage-supply planes are separated by a thin Mylar sheet. Plated-through holes connect one signal carrying surface with the other.

This type of construction is selected for an initial design because controlled transmission characteristics can be obtained with standard printed-circuit technology. Production models can use more advanced multilayer bonding techniques. A multiplane structure similar to Fig. 1 provides three planes for signal runs and four for voltage, and signal grounds, thus further increasing the possibility for short signal paths. A copper plate, to which all logic units are fastened, serves as a heat sink. ■■

Another Exclusive From HP— Self Test!

Examine HP's new low-cost multimeter 3490A. It's a full 5-digit instrument that's priced \$300 less than two other major manufacturer's units—yet its low price includes Self Test.

Self Test is the built-in bonus you get because the circuits within the 3490A perform double-duty. Design scrutiny coupled with unique signal routing let us include Self Test without adding more circuits, and without raising the price.

Always Ready—Need to use your DMM? Simply flip the switch and Self Test tells you that 3490A is ready to perform. With a 3490A, you'll never be in doubt concerning your DMM's readiness.

Programmable—For systems work, 3490A's Self Test is remotely programmable, which lets your computer determine its operational capability *before* you start to measure data. You'll have assurance that your DMM is ready to tackle its assigned tasks.

Cuts Equipment Costs—Because calibration is aided by Self Test, the time needed to calibrate your 3490A is trimmed significantly, while the need for costly calibration equipment is reduced. And, if problems ever should occur in your 3490A, Self Test will assist your technician in isolating the fault.

Price for the 3490A is just \$1650 which includes AC, DC, Ohms, and Self Test functions. (Systems features—isolated BCD output and isolated remote control are low-cost options.) For further information on the 3490A, contact your local HP field engineer, or write Hewlett-Packard, Palo Alto, California 94304. In Europe: 1217 Meyrin-Geneva, Switzerland.

HEWLETT  PACKARD
DIGITAL MULTIMETERS

AO92/3



INFORMATION RETRIEVAL NUMBER 30

Increase life expectancy with Dow Corning silicones.

Silicone materials increase the life, reliability and safety of microcircuitry. They battle adverse environments, especially high temperatures, as no other material can. This module may give you an idea or two about the use of silicones to add efficiency and life to your next consumer, industrial or military design:

Silicone encapsulated ICs (1) perform with reliability approaching that of hermetics. Similar performance is obtained with silicone-packaged **resistors (2)** and **power transistors (3)**. Flame-retardant thermosetting molding compounds from Dow Corning opened the door to this advance in low-cost, transfer-molded plastic packaging. Years of service, and device life tests in the millions, record the superior moisture and mechanical shock resistance, thermal life and dimensional stability of silicones over all other plastics.

Silicone heat-sink compound (4) helps maintain device efficiency, guards against premature device failure. Bridging the gap between devices and the heat sink, this compound ensures high thermal conductivity and high-temperature stability.

Flame-retardant silicone elastomer (5), encapsulating the module, adds safety, protects circuitry from moisture, dirty atmospheres, mechanical shock and vibration. This pourable material cures to a tough, flexible rubber without exotherm or corrosive byproducts.

Want more silicone reliability ideas? Write for our Silicones for Electronics brochure. Dow Corning, Dept. A-2206, Midland, Michigan 48640. Circle Information Retrieval Number 151.

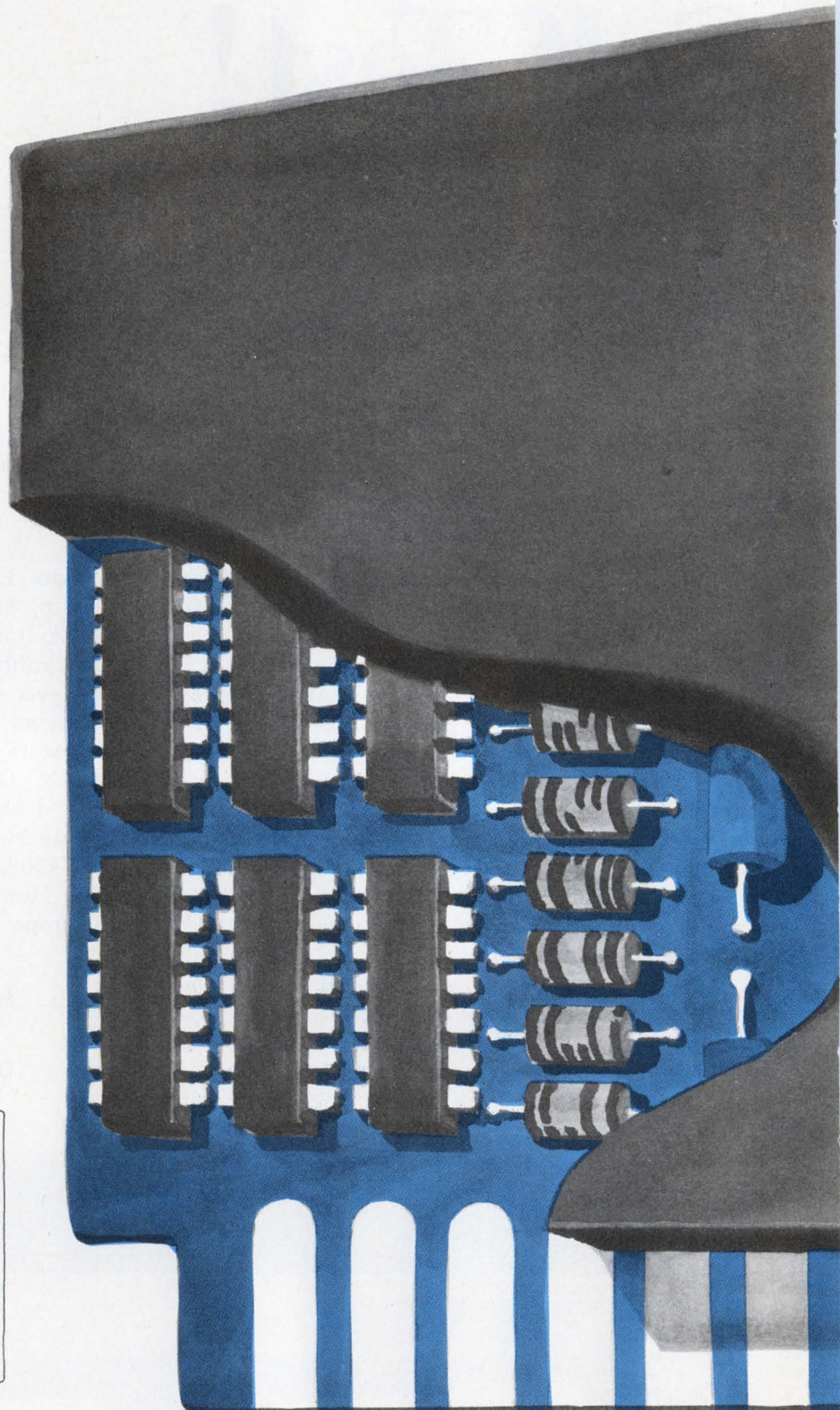
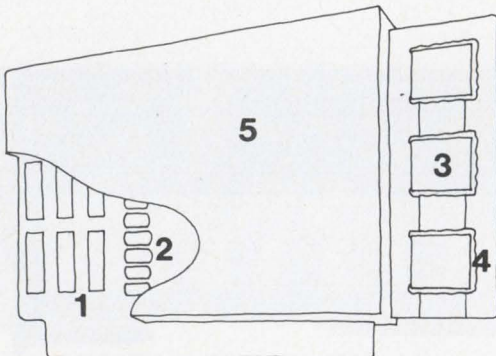

Electrical/electronic materials
from

DOW CORNING

DOW CORNING

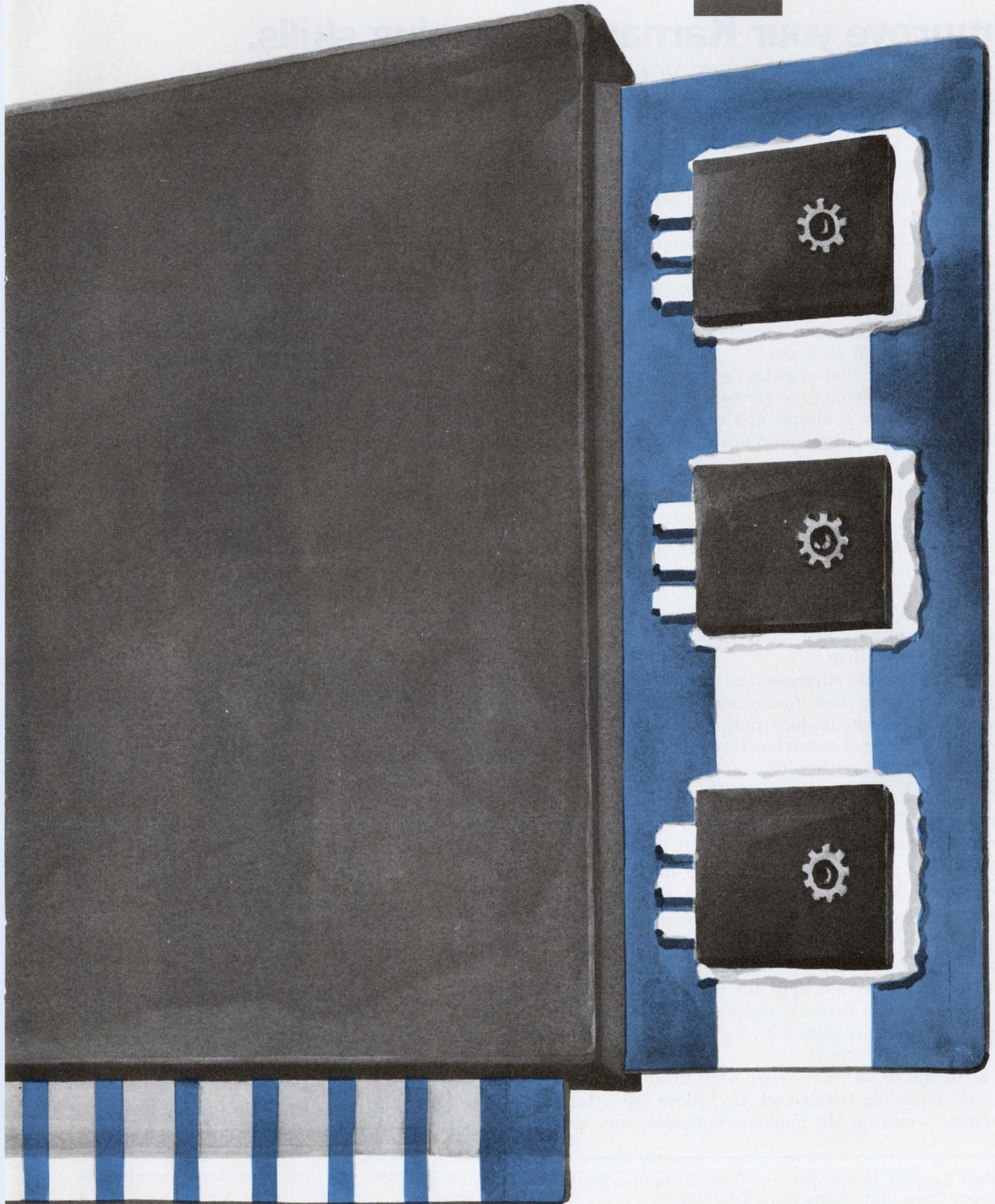

Improve your Karnaugh mapping skills.

Use of variables allows you to simplify maps and design circuits for latching or sequential-signal gating.

Most digital-design engineers are familiar with Karnaugh maps that have the logic values ONE, ZERO and X (don't care) in the body of the map. Not so well known is a powerful extension of this technique to incorporate letter-name variables into the map along with the ONES, ZEROS and Xs. This technique permits:

- Reduction of map size.
- The configuring of gates for complex signals.
- Design of latch-type circuits.

The technique is simple and can be readily applied, as illustrated in the following examples.

Reducing a map to four variables

A Karnaugh map with four input variables is quite straightforward. With five or more input variables, however, the map becomes awkward to use; the groupings for a minimum Boolean expression are no longer obvious. Nevertheless a logic problem with five inputs can be solved with a four-variable map.

For illustrative purposes, the five variables are divided between two four-variable maps (Fig. 1a). This division is done only to make it easy to see the changes resulting from the fifth input variable, E. Note that the only differences between the $E = 0$ map and the $E = 1$ map lie in the states for inputs $\overline{A}BC\overline{D}$ and $AB\overline{C}\overline{D}$, which are shaded. When $E = 0$, the outputs for both $\overline{A}BC\overline{D}$ and $AB\overline{C}\overline{D}$ are ZEROS. Likewise when $E = 1$, these outputs are ONES. It follows then that a four-variable map with E in the positions $\overline{A}BC\overline{D}$ and $AB\overline{C}\overline{D}$ (Fig. 1b) is directly equivalent to the two maps of Fig. 1a.

The procedure then calls for reducing the map to a minimized Boolean expression and implementing the expression with logic elements. This is done in three steps:

1. In the usual way, group only those Boolean terms employing ONES and Xs. Ignore the letter variable terms for the moment, but make sure all

ONES are accounted for (Fig. 2a).

2. Group the variable(s) (only E in this case) with convenient ONES and Xs. Write the resulting term(s) in the normal manner and OR them with the variable(s) from the first step (Fig. 2b).

3. Implement the resulting Boolean expression. Fig. 2c shows a circuit configured with NAND gates.

Although for simplicity, this illustrates a reduction of only one variable, the technique can also be applied to reduction by two or more variables. When reducing by several variables, choose variables for reduction that operate independently of one another—that is, variables that will not appear together in the same output term. Such a choice insures no more than one reduced variable per square.

The following more generalized steps permit handling a logic problem with five or more input variables:

- Inspect the logic requirements. Are there more than four input variables? If yes, are some of them independent of each other and do they occur in "few" of the combinations. A four-variable map has 16 unique possible combinations. The term "few" combinations can be loosely applied to those variables that appear in four or fewer of the 16 combinations, but this is not a hard and fast rule. Are there sufficient numbers of such independent variables so that only four others, dependent or independent, remain? If the answer is yes, keep four of the variables, set aside the excess independent ones for now, and proceed with the next step.

- Draw a standard, four-variable Karnaugh map with the four retained input variables. Map all their combination states with ONES, ZEROS and Xs, as required. Now insert the set-aside variables, designating them by their letter name—E, F, G, etc.

- Write the Boolean equation for the map.

- Derive a logic implementation from the Boolean expressions.

As an example of this procedure, consider a logic problem with six input variables. Input

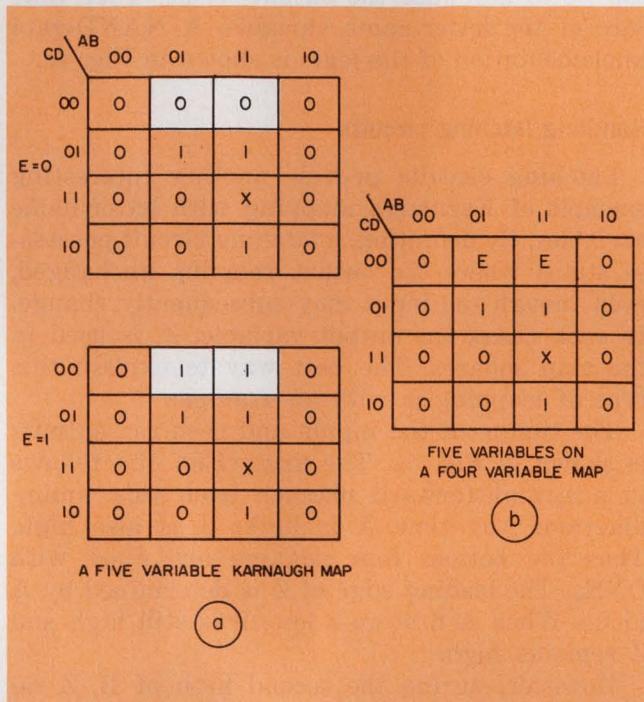

1. Combinational logic with five or more variables can be reduced to a convenient four-variable map.

variables A, B, C, D are from outside sensors and E and F from local control circuitry. The output, Z, drives a warning light.

The conditions for lighting the warning light are as follows:

- If all outside sensors (A, B, C, D) are high, the light should be on ($Z = 1$), provided E is high.
- If all outside sensors (A, B, C, D) are low, the light should be on, but only if F is low.
- The light is on any time B, C are high (except state ABCD).
- The light is off if A and B are low (except state $\overline{A}\overline{B}\overline{C}\overline{D}$).

Other combinations are don't cares.

Of the six input variables, only E and F are independent of each other. In addition both appear on the map (Fig. 3a) in only two places. The map is filled in directly from the statement of the logic problem, as before. The first two con-

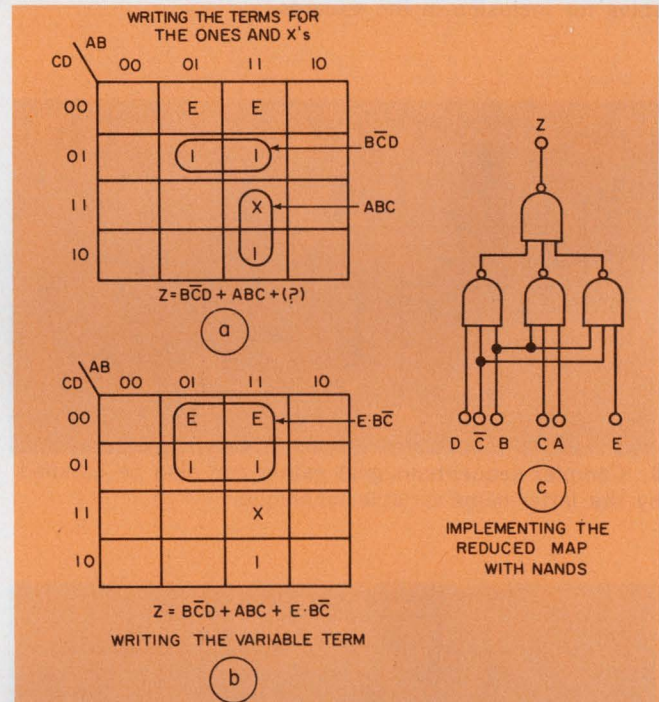

2. Karnaugh maps with letter-name variables in the squares are solved in three simple steps.

ditions determine the positions of the variables E and F. The ONES and ZEROS follow from the rest of the conditions. The last statement permits all other positions to be Xs.

First, combine the map entries as shown, making sure that every ONE appears in at least one group not containing a letter variable. Then work on the letter variables to include them into appropriate groups of ONES and Xs. The reduced Boolean expression can now be written as

$$Z = \overline{A}\overline{B} + \overline{A}\overline{D} + BE + \overline{C}\overline{D}\overline{F}$$

Fig. 3b shows this expression implemented with NAND gates, thus completing the solution of the problem.

Gating complex signals

Complex sequential signals that require control gating can also be handled by including letter-name-variables in the squares of the map.

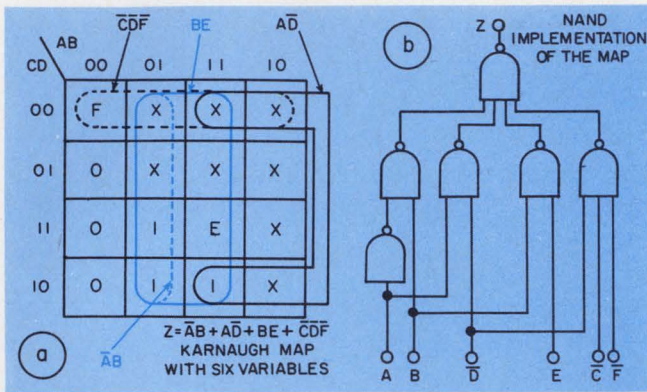

3. Select the independent, infrequently occurring variables for inclusion in the squares.

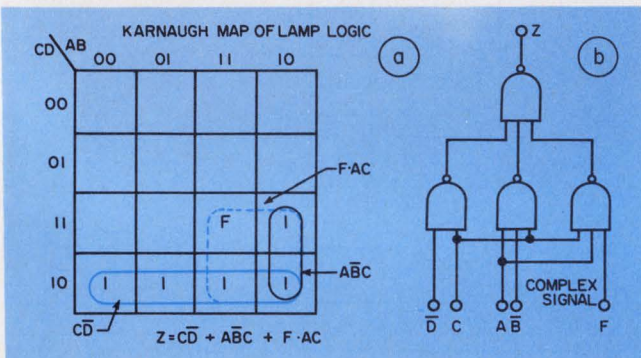

4. Complex-sequential-signal gating can also be handled by the letter-name-variable technique.

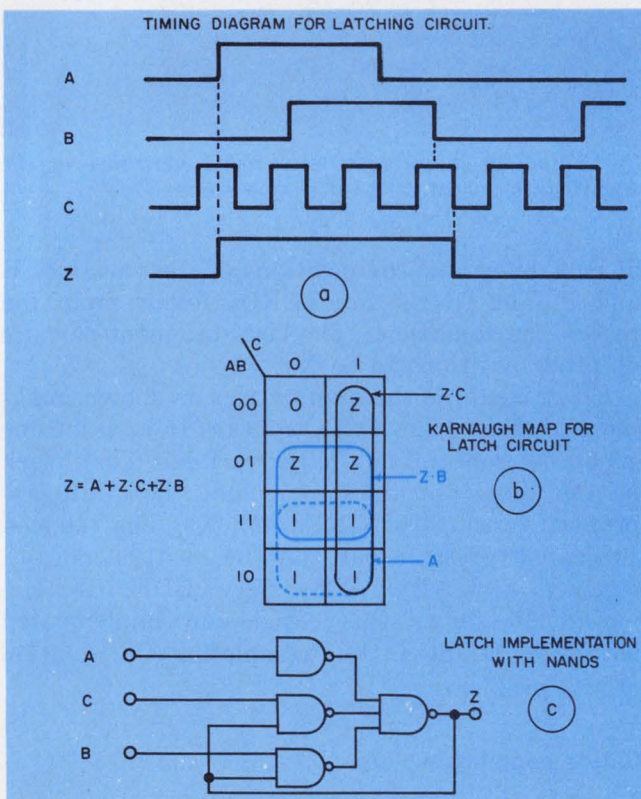

5. Latching circuits use the output variable, Z, in those squares for states that can be either a ONE or ZERO, depending on the prior history of the inputs.

Consider a system that requires a lamp to be either on, off or flashing. The logic output to the lamp can be designated as ONE, ZERO or F, where F represents the signal for flashing the lamp. Four other variables—A, B, C, and D—are the control inputs to the lamp logic. As before, draw a four-variable map and fill in the ONEs and ZEROs for the outputs.

However, one case is special. For control-input state ABCD, the output is F, the flashing signal, and it is mapped accordingly in Fig. 4a. The Boolean equation is obtained as before: First, group the terms, including all the ONEs and use the Xs to minimize the output terms. Then take care of the letter-name variable. A NAND-gate implementation of the logic is shown in Fig. 4c.

Handling latching circuits

Latching circuits provide another interesting example of Karnaugh mapping with letter-name variables. By definition, a latching circuit possesses states where the output remains unchanged, even though the input may subsequently change. In such cases, the output variable, Z, is used in the map squares. The best way to explain this type of mapping is with an example.

The timing of the inputs and required outputs is shown in Fig. 5a. The map (Fig. 5b) follows in a straightforward manner from this timing diagram. Any time A is high; Z is also high. Thus the bottom four squares are filled with ONEs. The leading edge of Z is determined by A alone. When A first goes low, B is still high and Z remains high.

However, during the second high of B, Z remains low. Mapping a ONE or a ZERO for the two \overline{AB} conditions just won't do. Instead, for these conditions, enter a Z into the map in the second row (Fig. 5b).

Output Z returns to its low state only when A and B are low and C goes low, too. Thus we put a ZERO in the top lefthand square. A possible two-state condition also occurs when A and B are low but C is high. The output under these conditions is high only right after the first negative-going transition of B, but it is low for all other \overline{ABC} conditions. Again, we see that a variable Z must be placed in the square corresponding to this \overline{ABC} condition—the top righthand square.

As in the other examples, the Boolean expression is obtained in the usual way. A NAND configuration of the expression is shown in Fig. 5c.

Note the feedback arrangement to use Z as an input. Observe one caution, however. Indiscriminate use of feedback in digital circuits can cause race conditions and instability. Just as in analog circuits, a feedback circuit needs careful analysis of the time delays and possible oscillatory conditions. ■■

CTS puts the squeeze on space wasters

CTS Cermet "Saver Pac" Resistor Networks Increase Circuit Density ... At Economical Prices

Space comes *high!* So you'll like how much a CTS 750 Series "SAVER PAC" network can save you, and your circuit. Less space ... fewer components ... greater system reliability ... quicker, easier installation ... reduced handling costs ... and faster inspection. Consolidate up to 13 discrete resistors into one compact in-line resistor module. CTS can do it easily

with twenty standard packages ... available in .100", .125", or .150" lead centers. High power capabilities to 4.3 watts @ 70°C per module.

CTS 750 series cermet thick-film resistors assure proven performance—ultra high stability and reliability—backed by over 700,000,000 hours of test data. Hand install or use automatic assembly equipment...they're designed for either. Pick a SAVER PAC today. Large or small orders welcome. CTS of Berne, Inc., 406 Parr Road, Berne, Indiana 46711. Phone: (219) 589-3111.

INFORMATION RETRIEVAL NUMBER 31



CTS CORPORATION
A world leader in cermet resistor technology.

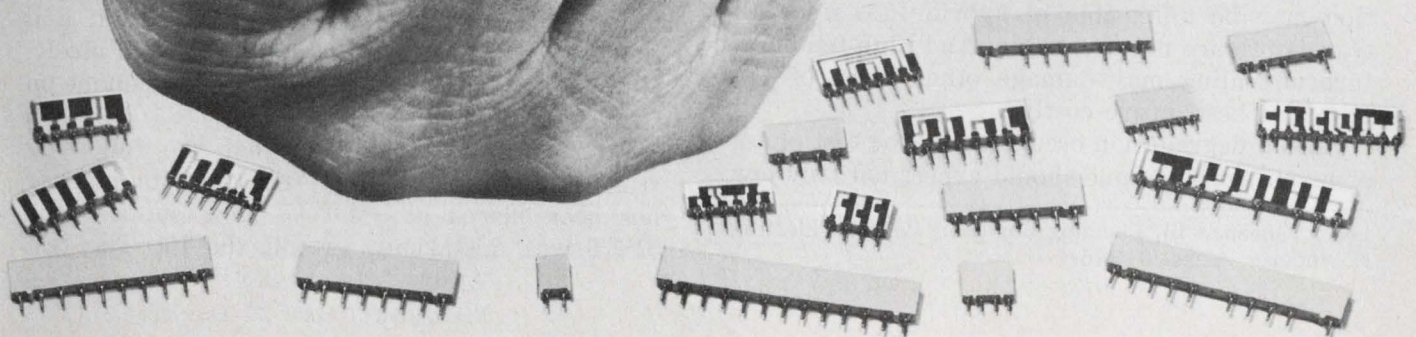

Watch out for traps in hybrid IC tests.

If you don't take precautions, you may end up doing more harm than good. Here are three pitfalls to avoid.

Partitioned hybrid integrated circuits should be diagnostically tested with caution. Here are three good reasons why:

1. Devices mounted on the hybrid IC are often more susceptible to test damage than discrete components.

2. Nonfunctional leads—that is, leads created through circuit partitioning for use as test points—are not always protected from potential transient damage.

3. Test-equipment manufacturers do not always disclose that their equipment produces potentially damaging test transients.

The test engineer must be aware of improper biasing conditions that result from incomplete assembly, improper specification or transients induced by the test set. Reverse biasing of a transistor's base-emitter junction can result in total failure or in degraded performance. Of the two possibilities, degradation is perhaps the more harassing, because it may not be readily noticed. For example, any of the following may result:

- An increase in $1/f$ noise: A reverse current of 1 mA for a period of one second can increase transistor noise current by a factor of two or more.

- Reduced low-current hfe. A reverse current of 1 mA for a period of one second can reduce transistor current gain by 20% or more.

- An increase in reverse-bias current leakage. A reverse current of just a few milliamperes for 15 seconds can increase transistor-base leakage current by a factor of two to five.

Damage like this is not irreversible. The transistor may be restored to nearly original condition by several hours of annealing at a 250 C oven temperature or by a continuous forward current of 500 mA. But the forward current solution may be unfeasible in hybrid ICs, since all transistors are not accessible. And high-temperature annealing may damage other parts of the IC or, at best, prove costly.

Should degradation occur during the test phase of manufacturing, one should expect not only low

Leo J. Sheehan III, Planning Engineer, Western Electric, N. Andover, Mass. 01845.

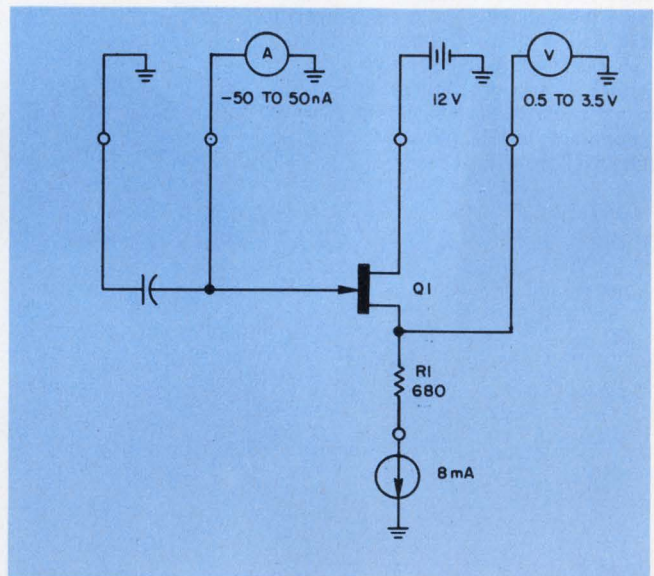

1. Gate leakage of an isolated FET can be measured by "forcing" voltage and current and observing gate draw.

yields but a need for greater repair. Thus, in a marginally performing circuit, a degraded transistor may be replaced by a new one. However, a retest of the circuit may again cause a defect. The process may be repeated until, eventually, a transistor is selected that is capable of surviving the test strain. Thus there are tradeoffs between thorough electrical testing of circuits and the destruction or degradation that may occur as a result of those tests.

Three tests that can cause trouble

Let's consider three tests that degrade hybrid ICs. Figure 1 shows what might be a reasonable approach to measuring the gate leakage of a junction FET. The forced voltage and current, and the observed current draw, will do the job nicely. However, the FET is not the only component on the IC (Fig. 2).

To reduce the possibility that the following transistor, Q_2 , will affect the test, its emitter has been placed at +4.0 V. Now suppose the JFET was mistakenly left off the IC. The test

will fail, of course, but let's see what else occurs.

In an attempt to maintain its draw, the current source will pull 8 mA of reverse current through the base of Q_2 —and the damage is done. To make matters worse, the test operator will halt the test when an error is indicated, in an attempt to find the problem. Eventually, the operator discovers that the JFET has not been assembled on the IC and sends the chip off for repair. But the "repaired" unit may still be inoperative because of the damage to Q_2 .

If this is not bad enough, consider this possi-

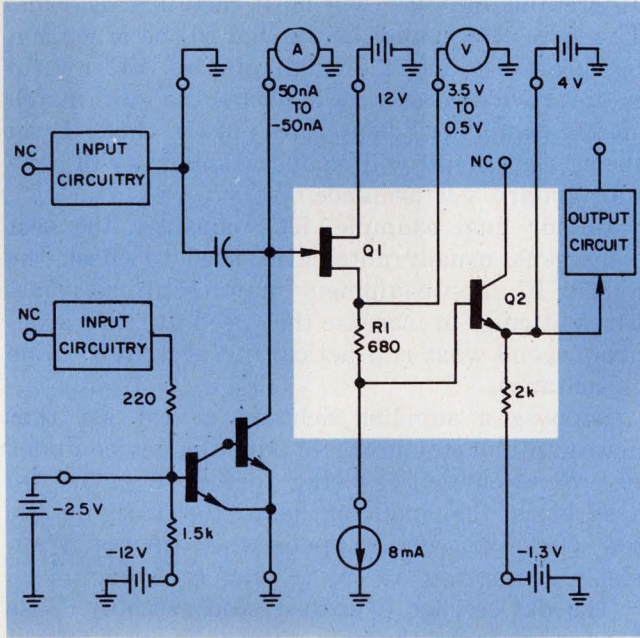

2. Forcing current can be dangerous: Q_2 can burn out if Q_1 is inadvertently left off the IC chip.

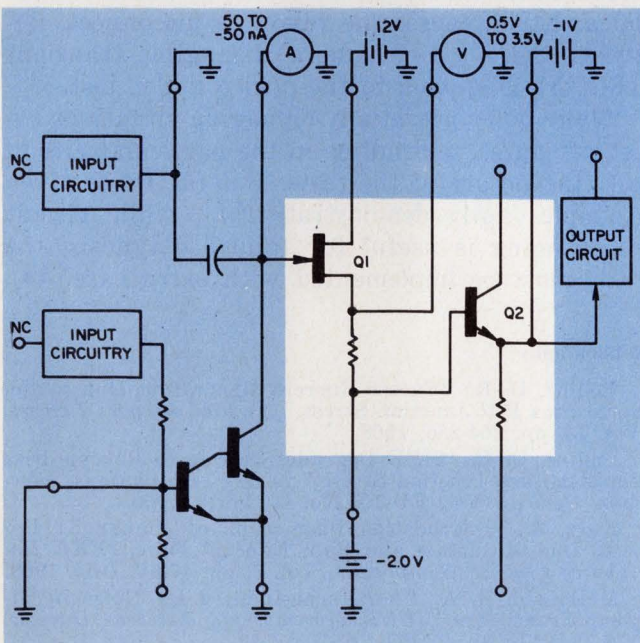

3. Gate leakage current of Q_1 can be determined with less risk by removing the current source.

bility: Even if the JFET were mounted on the IC and operating within specification, Q_2 may still be degraded. The current forced through R_1 , and the associated voltage drop, can reverse-bias Q_2 in excess of its 4-V spec. All in all, it would be better if the test were dropped. Figure 3 shows a modified test that may be used with far less risk.

Case No. 2: The Darlington transistor pair of Fig. 4 is to be reversed-biased at a potential of 9 V. This is specified to verify that either or both junctions are not shorted. To test for this condi-

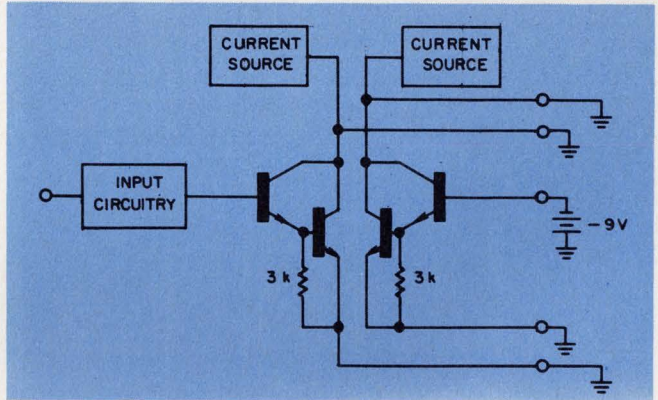

4. An attempt to find shorted junctions with a reverse voltage can result in avalanche and degradation of β .

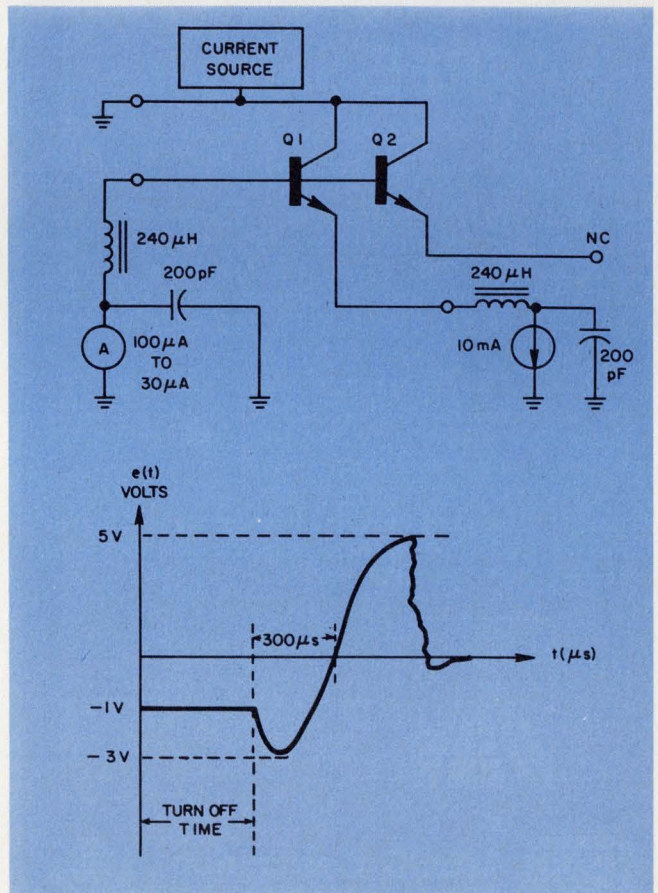

5. Test equipment used to produce forcing functions (top), can also produce damaging transients (bottom).

MONO-KAPSTM

Unique in
Availability,
Price and Quality

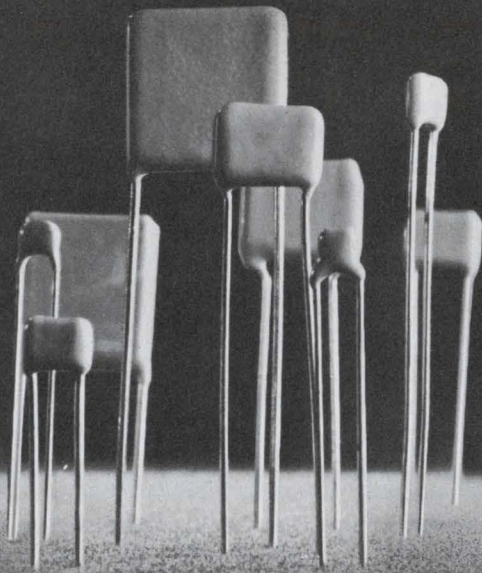

* FREE Samples

USCC/Centralab Mono-Kap Ceramic Capacitors have availability, price and quality inherent in every part.

AVAILABILITY. Immediately available from over 150 distributors are stock units in six sizes from .100 x .100 to .500 x .500. Our four dielectrics are NPO, W5R, Z5U and Y5V, with capacitance values from 4.7 pF to 10 Mfd in 50, 100 and 200 VDC ratings.

PRICE. \$.09 average in production quantities. This low price is due to USCC's development of highly automated assembly techniques resulting in large volume production of Mono-Kaps.

QUALITY. USCC is currently under contract to produce chip capacitors (the heart of Mono-Kaps) at the rate of 25,000 per hour, with a failure rate level of only .001% per 1000 hrs.



*Want FREE evaluation samples? Write on company letterhead to USCC/Centralab. For complete technical data on MONO-KAPS and other quality USCC components, circle the information retrieval number below.

USCC

USCC/Centralab

Electronics Division • Globe-Union, Inc.

2151 North Lincoln Street • Burbank, California 91504
(213) 843-4222 • TWX: 910-498-2222



INFORMATION RETRIEVAL NUMBER 32

tion on a current-gain basis is difficult, because of the low current levels involved. Further, to maintain the balance of the differential amplifier, both Darlington pairs must have similar gains.

But the 9-V reverse can cause trouble. Even though leakage current is small in this circuit, the current through one transistor of the Darlington pair may differ from that through the other by a factor of 9. The voltage across the transistor with the lower leakage will be 90% of 9 V. This is high enough to cause avalanche in some cases.

Usually one transistor will avalanche, and then the other. The over-all Beta of this leg of the differential amplifier will most certainly degrade. The same test cannot be applied to the other leg, because there aren't enough pins on the hybrid IC to provide access. As a result, the gain match of the amplifier disappears in testing. Even though the circuit will be operational, it will have substandard performance.

In our final example, let's consider the test equipment, usually automatic, used to check the hybrid IC. Test-equipment manufacturers sometimes attempt to increase the speed of their products beyond what is practical in the light of cable capacitance.

Suppose a supplier delivers a test set that places an inductor in series with the device under test while current is being forced (Fig. 5). On a dc basis, this inductor has little effect on the test. However, what happens when turn-off transients are applied to the IC under test?

The devices are degraded stochastically. This happens because the collectors of Q_1 and Q_2 are grounded through a relay while the test current is forced. When the test is finished, the automatic test set first commands the current source to shut off and then causes the relays to disconnect. Between these two events a damaging transient (Fig. 5) is applied to the device under test.

Many other potentially-damaging situations exist, of course, depending on the particular circuit and the nature of the tests. But the three given examples aptly demonstrate that, while circuit partitioning is useful for failure diagnosis, the tests must be implemented with extra care. ■■

Bibliography

Collins, D. R., "Excess Current Generation Due to Reverse Bias P-N Junction Stress," *Applied Physics Letters*, Vol. 13, pp. 264-266, 1968.

Collins, D. R., "HFE Degradation Due to Reverse-Bias Emitter-Base Junction Stress," *IEEE Transactions, Electron Devices*, Vol. ED-16, No. 4, April, 1969.

Kurz, B., "Degradation Phenomena of Planar S1 Devices Due to Surface and Bulk Effects," *Proc. IEEE Reliability Physics, Symposium*, Vol. 6, pp. 47-65, Dec., 1968.

McDonald, B. A., "Avalanche-Induced 1/f Noise in Bipolar Transistors," *IEEE Transactions, Electron Devices*, Vol. ED-17, No. 2, Feb., 1970.

Motchenbacher, C. D., "Protect Your Transistors Against Turn-On or Testing Transient Damage," *Electronics*, Vol. 44, No. 25, Dec. 6, 1971.

**MORE
VALUE
IN**

TELEQUIPMENT 

**DUAL-TRACE
OSCILLOSCOPES**

\$975

D67 25 MHz, 10 mV/cm, 200 ns/cm

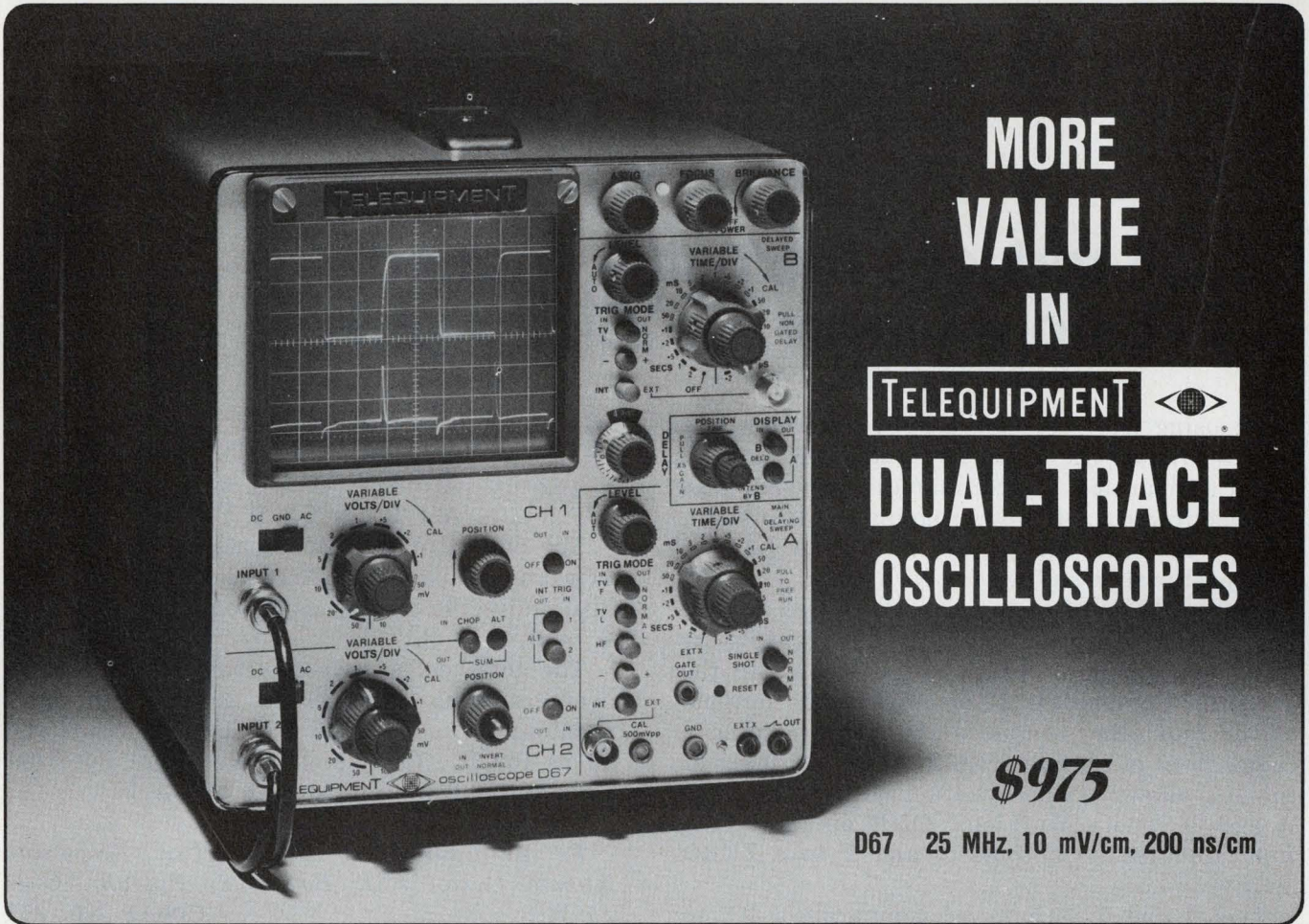

D66 25 MHz, 10 mV/cm, 100 ns/cm \$795

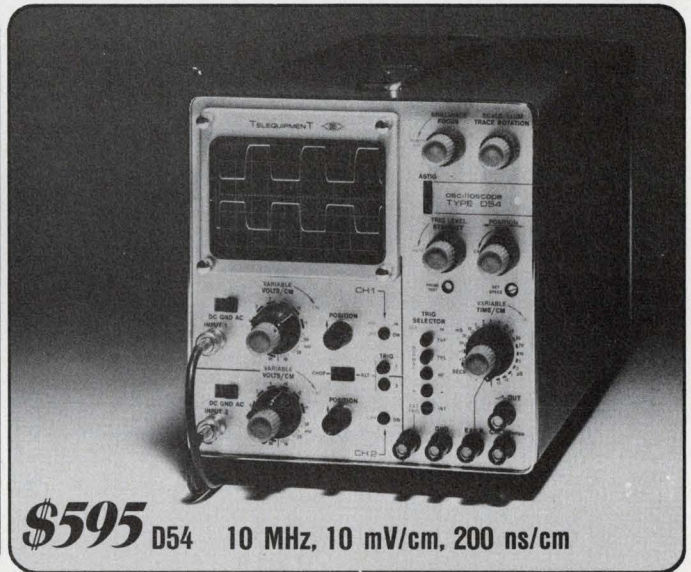

\$595 D54 10 MHz, 10 mV/cm, 200 ns/cm

Part of the Telequipment line from Tektronix, Inc.

The Telequipment line is growing . . . and offers you a greater selection for your next dual-trace scope. Take the new **D66** . . . it offers a choice of alternate or chopped dual-trace display and convenient single-button X-Y operation. The **D67** offers laboratory performance with delayed sweep, regulated power supplies, and 3% accuracy. The **D54** offers dual-trace convenience at lowest cost. All have triggered sweeps.

All are backed with the same warranty as other TEKTRONIX products, and are marketed and supported in the U.S. through the Tektronix network of 58 Field Offices and 34 Service Centers. Call your nearest office or write Tektronix, Inc., P.O. Box 500, Beaverton, Oregon 97005.

U.S. Sales Prices FOB Beaverton, Oregon

INFORMATION RETRIEVAL NUMBER 33

Circuit reduces the gates needed in TTL comparator for 16-bit words

By using five four-bit digital-comparator ICs, you can reduce the number of gates needed for a 16-bit comparator. The technique shown simplifies the required circuitry by grouping the two 16-bit input words into blocks of four bits. A four-bit comparator then suffices for each block.

If the 16 bits of each word are labeled according to their binary weights, 2^0 to 2^{15} , the inputs to comparators IC_1 to IC_4 are as shown in the diagram. Comparator IC_5 compares the outputs of the four other comparators, thus providing a comparison of all bits from 2^0 to 2^{15} . Strobing of the ICs allows synchronization with the parallel A and B inputs. Any logic ONE on the strobe input thus resets outputs X and Y to a ZERO level.

The X and Y outputs of comparators IC_1 to

IC_5 can be defined as follows:

$$A > B \quad X = 1, Y = 0.$$

$$A = B \quad X = Y = 1.$$

$$A < B \quad X = 0, Y = 1.$$

The output of IC_5 represents the comparison of words A and B for all 16 bits. Gates G_1 to G_3 distinguish the three possible outcomes: $A > B$, $A = B$, $A < B$.

The total delay in completing a comparison averages 40 ns. This includes 20 ns for the comparators IC_1 to IC_4 (the first level of logic) and 20 ns for IC_5 (the second level), but does not include the delay for gates G_1 to G_3 .

P. M. Callihan, Technical Div., Goodyear Atomic Corp., P.O. Box 628, Piketon, Ohio 45661.

CIRCLE NO. 311

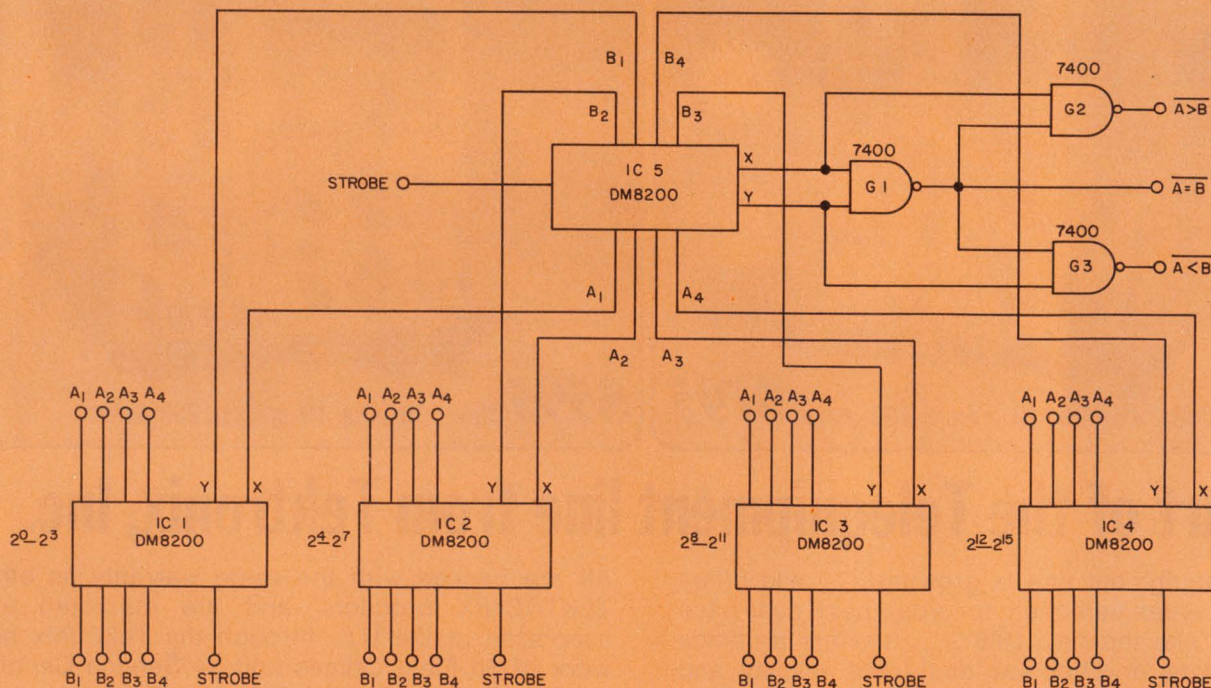

Four-bit comparators IC_1 to IC_4 handle two 16-bit words, which are separated into four blocks of four

bits each. The second level of logic, comparator IC_5 , compares the four block outputs.

START YOUR OWN BUG COLLECTION...

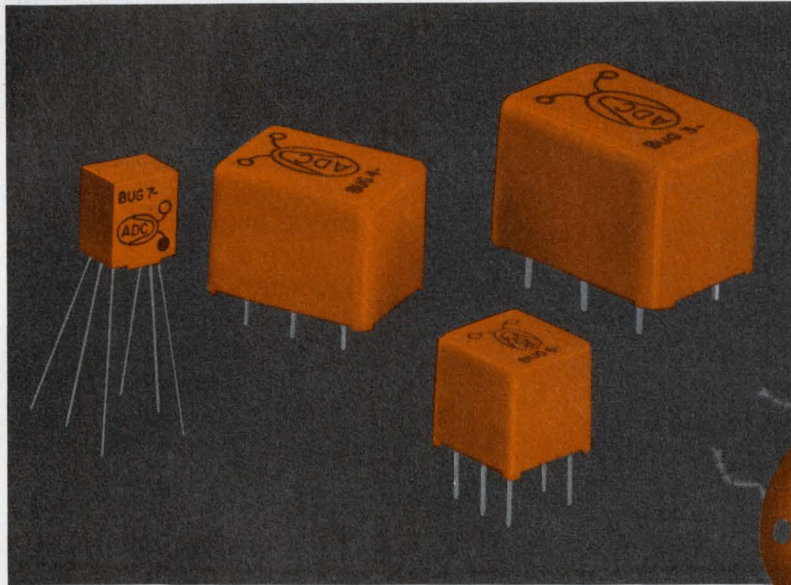

WITH A FREE LADY BUG FROM ADC!

If you've been thinking that most commercial transformers are pretty much alike, these new ADC Lady Bugs will change your mind.

We've engineered Lady Bugs to provide the kind of reliability you've come to associate only with transformers meeting military specifications. More than that, we've made sure these ADC Transformers offer something you haven't seen in a while: economy. So, beginning now, you can have the transformer performance you've always wanted, and still keep costs in line.

ADC Lady Bugs come in 46 different electrical configurations with power ratings from 50 mw to 2 watts. There are four different case sizes, with the smallest being approximately one-third cubic inch.

We don't want to bug you, but if you have a real need for miniature transformers, we will send you an evaluation sample free — no strings attached. Just tell us what your requirements are on the coupon and send it back to us. Or, if you just want more information, please circle the number on the Reader Service card.

ADC PRODUCTS

4900 West 78th Street
Minneapolis, Minnesota 55435

Yes, I would like an evaluation sample of the new Lady Bug transformer. Here's my application: _____

We anticipate using _____ units/year.

My needs are for _____ 30 days

_____ 60-120 days _____ Future

Division of Magnetic Controls Company
4900 West 78th Street
Minneapolis, Minnesota 55435
TEL: (612) 835-6800 TWX: 910-576-2832 TELEX: 29-0321

NAME _____

COMPANY _____

ADDRESS _____

CITY _____ STATE _____ ZIP _____

TELEPHONE _____



Transformerless voltage doubler has good output regulation

The use of symmetrical positive and negative power supplies can often simplify circuit design. But unfortunately this also increases the size and weight of portable or mobile equipment because of the need for extra batteries. The voltage doubler shown overcomes this problem and provides better regulation than conventional cascade voltage doublers.¹

Transistors Q_1 and Q_2 act as a multivibrator.

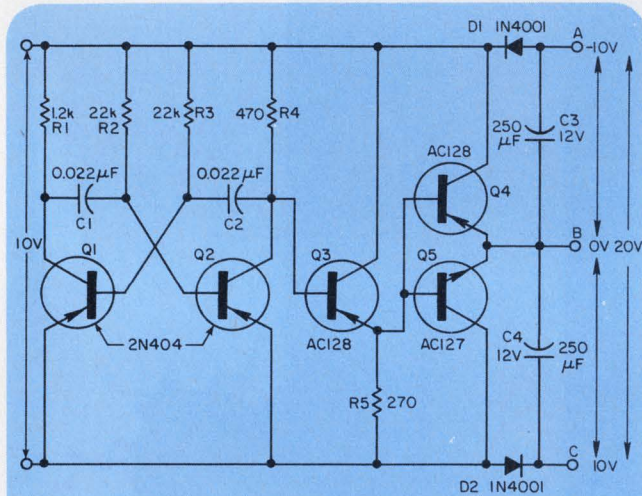

Switching-mode operation of the voltage-doubler output stage, composed of transistors Q_4 and Q_5 , provides a load regulation of 5.4%.

Q_3 matches the multivibrator to the low input impedance of the complementary-symmetry output stage, Q_4 and Q_5 , which operates in the class-B switching mode. This improves the efficiency² and regulation.

Any one of the three terminals—A, B, or C—can be used as a common output to provide the following respective output voltage: +20, ±10 or -20 V.

The output resistance of this circuit is 10 Ω . The output voltages are 18.25 and 17.25 V for continuous load currents of 100 and 200 mA, respectively. At no-load the output voltage is 19.25 V, and an input current of 33 mA is drawn from the 10 V source.

A wider range of output voltages and currents can be obtained by varying the supply voltage, the type of transistor used and the multivibrator frequency.

Reference:

1. Kauffman, Ray, "Transformerless Converter Yields Plus/Minus Voltages," *ELECTRONIC DESIGN* 15, July 19, 1970, p. 106.
2. Hnatek, Eugene, "Cut Noise in Switching Regulator by Using Simple Filters," *ELECTRONIC DESIGN* 22, Oct. 28, 1971, p. 49.

K. N. Pal, Assistant Research Engineer, Research and Development Div., TISCO, Jamshedpur, India.

CIRCLE No. 312

Zero-crossing detector avoids hysteresis problem with complementary dual comparator

A dual integrated differential voltage comparator avoids the inherent hysteresis problem in a zero-crossing detector. The hysteresis—which still exists—delays the output pulses. But the duration of the delay is constant, regardless of the amount of hysteresis.

Dual comparator A_1 (Fig. 1) is connected as a complementary differential detector. Since both comparators are fabricated on the same chip, their turn-on thresholds are matched. But their turn-on thresholds can differ from the turn-off thresholds, depending on the hysteresis effect and the variations of the rise and fall slopes. These threshold variations, however, do not affect the position of the output pulses, which depend only

on the turn-on thresholds.

Resistors R_3 and R_4 pull sink current as recommended by the comparator manufacturer. Retriggerable one-shot FF_1 has its negative input tied to ground. It generates a positive pulse of duration T , as determined by the R_5C_1 and R_6C_2 time constants on each input that has a positive-going edge.

NOR gate G_1 combines the two pulse strings. Their leading edges contain the zero-crossing information.

With component values shown, the circuit detects frequency-modulated analog signals with high-frequency components up to 5 MHz. The frequency response is dictated by the recovery time

“Hycom’s new data products offer the OEM improved systems performance and lower costs.

Better yet, they give his new product even greater advantages.”

Dave Redick, Hycom’s director of marketing



When an OEM brings his product to market, he’s got to come on strong with price and performance.

Hycom can help him, right from technical conception through mass production.

We design and build MOS/LSI products, like the first reverse channel, MOS/LSI high speed modem for use over switched networks. Then our link with a \$500-million electronics manufacturer brings all the economies of large-scale production.

In partnership with the OEM, we can give the end user better systems, with increased capacity, while

reducing operating and total costs. And our OEMs also profit by getting new products on-stream much faster.

We’d like to work with you on future projects and quote on your current needs. To find out how high-quality, high-performance Hycom components fit into your systems, contact the Marketing Department at Hycom, 1641 McGaw Ave., Santa Ana, CA 92705; phone (714) 557-5252.

HYCOM

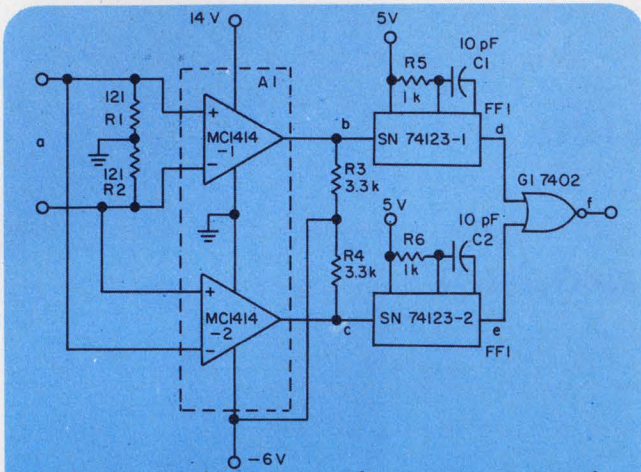

1. Dual complementary voltage comparator A_1 minimizes hysteresis problems in this zero-crossing detector.

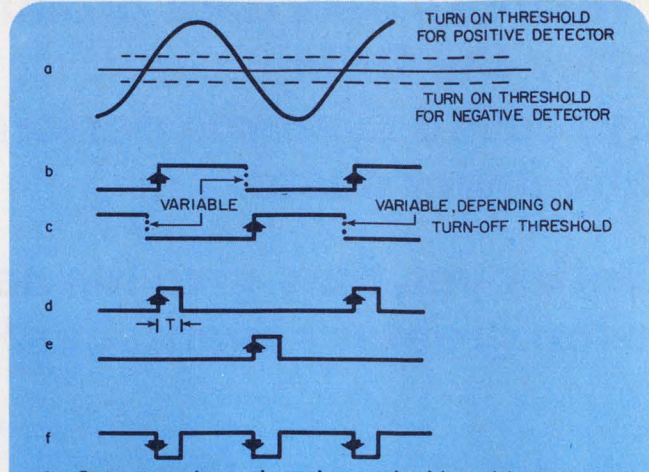

2. Output pulses d and e coincide with turn-on waveforms b and c of comparators A_1 . Pulse train f is delayed from the zero-crossing.

of op amp A_1 . The op amp also solely determines the over-all sensitivity, which is ± 6.5 mV over a 0-to-75-C temperature range. With $R_5 = R_6 = R = 1$ k Ω and $C_1 = C_2 = C = 10$ pF, FF_1 provides a 50 ns pulse width, as determined by the formula

$$t_o = 0.28 RC \left(1 + \frac{0.7}{R} \right)$$

where

R is in k Ω , C in pF, and t_o in ns.

Fig. 2 gives the waveforms describing circuit operation at the nodes labeled in Fig. 1.

Chao S. Chi, *Peripheral Engineering, Digital Equipment Corp., 146 Main St., Maynard, Mass. 01754.*

CIRCLE No. 313

Self-stabilized zener insures constant current in op-amp voltage reference

An op-amp voltage-reference circuit uses the voltage across a zener diode to determine and stabilize the current through the diode. This approach avoids the need to trim the zener current manually. The power-supply rejection-ratio of op amp A_1 guarantees that the zener current remains stable during power-supply fluctuations.

Zener voltage V_z is buffered by the op amp. The voltage fed back through resistor R_c is calculated to provide the specified zener current of 7.5 mA. The voltage V_c across R_c is given by:

$$V_c = 1.1 V_z - V_z = 0.1 V_z = 0.62 \text{ V.}$$

Then
$$R_c = \frac{0.1 V_z}{-7.5 \text{ mA}} = 82.6 \Omega .$$

Resistor R_s together with supply voltage V act as a current source of several milliamps since most 741 op amps supply only 5 mA, and the zener requires 7.5 mA. Resistor R_b equalizes the impedance at each input of the op amp, eliminating drift due to bias-current variations.

When using the component values shown, one can approach the specified voltage stability of the zener itself. The circuit operates with a power-supply range of 10 to 36 V. Use of the 741 op

amp typically introduces less than 1 mV of output-voltage variation over a temperature range of 0 to 100 C. Moderately-priced, premium-grade amplifiers, such as the Sprague 2151D, can reduce output variations to about 150 μ V over the same temperature range.

Leonard Accardi, 66-30 54th Ave., Maspeth, N.Y. 11378.

CIRCLE No. 314

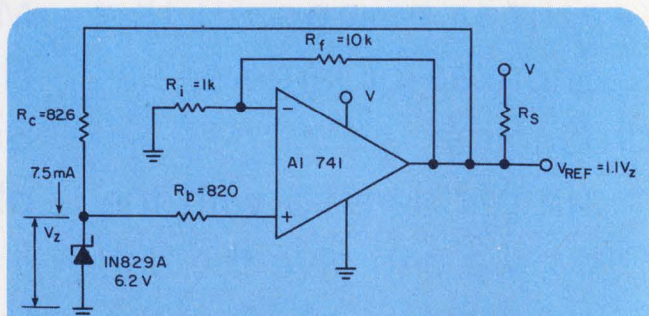

Combination of positive and negative feedback from op amp A_1 enables zener voltage V_z to stabilize the zener current.

Ours is one of the broadest 54/74 TTL lines in the world

In the past 18 months we've developed 151 new IC's and put them into production. 53 of them were 54/74 series types. Our total in the standard family (not including the H, L or S series) is now 95 types, each of which is available in two temperature ranges and your choice of dual-in-line or flat package.

We're doers, not talkers!

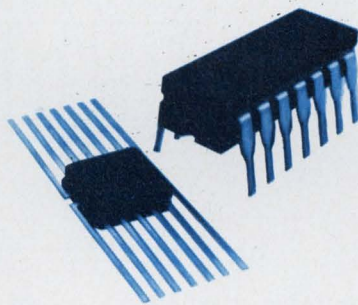

semiconductors

ITT Semiconductors is a division of International Telephone and Telegraph Corporation, 3301 Electronics Way, West Palm Beach, Florida 33407. Phone 305/842-2411. Factories in West Palm Beach, Florida • Lawrence, Massachusetts • Footscray, England • Colmar, France • Freiburg, Germany • Cascais, Portugal • Sydney, Australia.

ITT

Overflow detector uses counter-output display

An overrange detector, for a frequency counter or other instrument with a digital display, eliminates an additional overflow lamp and its driving circuit by using the counter display itself to indicate overflow. The circuit shown detects the overflow condition and forces the seven-segment display to indicate a series of dashes.

When a count of 999 is exceeded, flip-flop FF₁ changes state. The flip-flop thus stores the fact that overrange has occurred. This forces the open-collector outputs of inverters G₁ to G₆ to the LOW state.

Inverters G₁ to G₃ connected to the Blanking

Input/Ripple Blanking Output (RI/RBO) terminals of the SN 7446 decoder drivers, cause the displays to blank. All display segments, A to G, are thus inactivated. Inverters G₄ to G₆, are connected to and activate the center segments (segment G on the MAN 1 display). Each display now indicates a dash.

The added circuitry (FF₁ and G₁ to G₆) does not interfere with the normal ripple blanking operation of the SN 7446 decoder.

H. R. Durrett, EMR Telemetry, Box 3041, Sarasota, Fla. 33578. CIRCLE No. 315

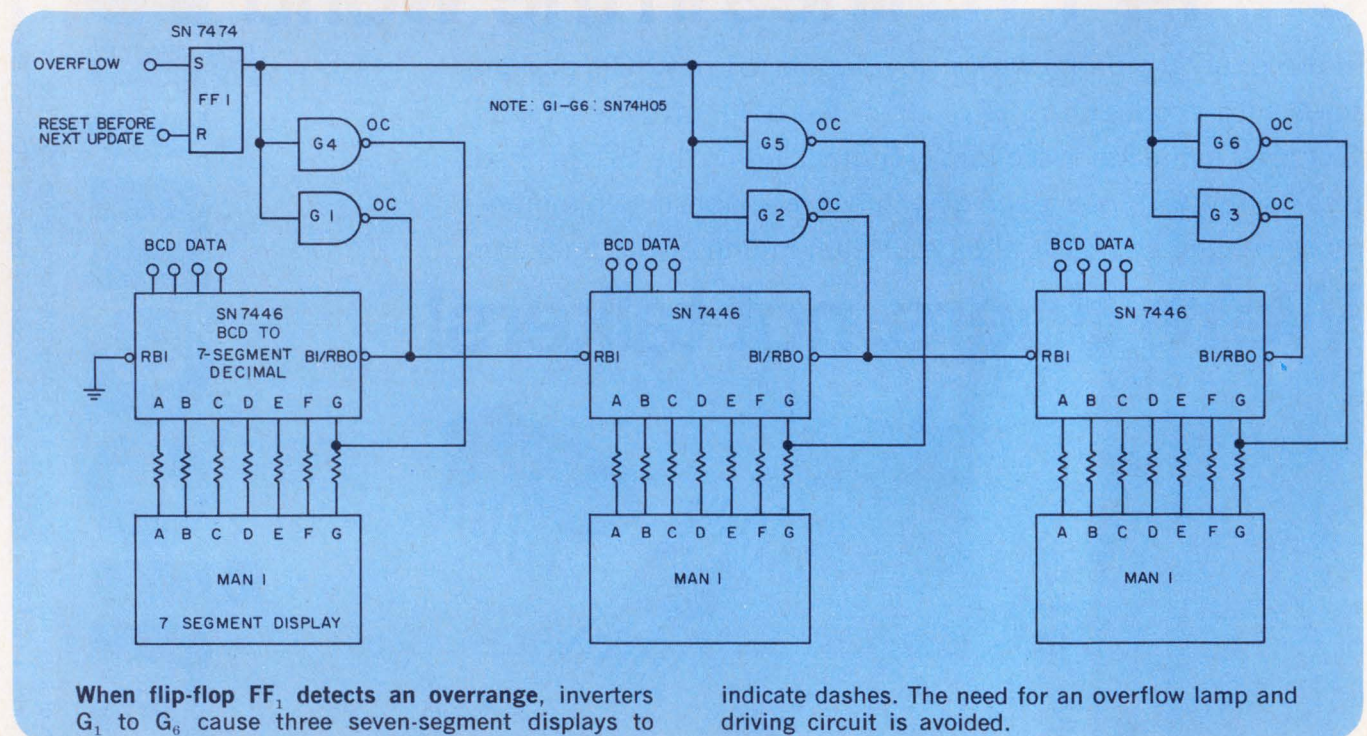

IFD Winner of August 17, 1972

Ury Priel, National Semiconductor Corp., 2900 Semiconductor Dr., Santa Clara, Calif. 95050. His idea "To decode counter state, use a NOR gate instead of an AND" has been voted the Most Valuable of Issue Award.

Vote for the Best Idea in this issue by circling the number for your selection on the Information Retrieval Card at the back of this issue.

SEND US YOUR IDEAS FOR DESIGN. You may win a grand total of \$1050 (cash)! Here's how. Submit your IFD describing a new or important circuit or design technique, the clever use of a new component or test equipment, packaging tips, cost-saving ideas to our Ideas for Design editor. Ideas can only be considered for publication if they are submitted exclusively to ELECTRONIC DESIGN. You will receive \$20 for each published idea, \$30 more if it is voted best of issue by our readers. The best-of-issue winners become eligible for the Idea of the Year award of \$1000.

ELECTRONIC DESIGN cannot assume responsibility for circuits shown nor represent freedom from patent infringement.

One part in 10 million from 0° to 55°C. Without an oven.

Unlike an oven oscillator, it's smaller, more reliable, uses less power, needs no warm-up time, and it's not as expensive. The K1098A TXCO has TTL compatible output, $\pm 1 \times 10^{-9}$ /sec. rms short term stability, operates from 5 and 12VDC. Prototype quantities available at 10MHz for immediate delivery. Full details from Motorola Component Products Dept., 4545 W. Augusta Blvd., Chicago, Ill. 60651.  **MOTOROLA**

INFORMATION RETRIEVAL NUMBER 37



**INTRODUCING
THE EA 1502 BIPOLAR
COMPATIBLE 1024-BIT RAM**

The EA 1502 is another new addition to the growing line of N-Channel silicon gate products from EA. The EA 1502 accepts TTL inputs without external level shifting and sinks 1.6 mA on the output. It has an access time of typically 130 nanoseconds and dissipates only 115 mW (typical). In fact, in a systems configuration the EA 1502 outperforms the so-called high performance versions of the 1103, with lower power, bipolar compatibility, automatic refresh and low cost to boot! Oh yes, there's no address cycling requirements either. A single write pulse refreshes all data independent of the state of the address and chip enable inputs. Place your order early, everyone else is. \$27.50 in 100 quantities.

To make it easier for you to evaluate our EA 1500 series RAM's, we have an evaluation P.C. board available which contains all of the necessary interconnections for building a 2K by 4 memory. Ask about it!

**MORE FROM THE
VERY SAME FOLKS
WHO BROUGHT YOU
N-CHANNEL
SILICON GATE.**

INFORMATION RETRIEVAL NUMBER 67



**electronic
arrays,
inc.**

501 ELLIS STREET
MOUNTAIN VIEW, CALIFORNIA 94040
(415) 964-4321 TWX: 910-379-6985

Stocking distributors: Burstein-Applebee Company,
Computer Components,
Cramer.



**ROGAN'S NEW
500 SERIES**



**VERSATILITY
IN CONTROL
KNOBS**

How can a control knob be versatile? By being available in four sizes in both plain and aluminum-skirted styles. By being available with round shaft hole and set screw or with threaded female insert or with threaded stud.

Achieve a unified front panel appearance by specifying the versatile "500 Series" by Rogan. Write for our complete catalog.

Rogan

3455 Woodhead Drive • Northbrook, Ill. 60062
(312) 498-2300 TWX 910-686-0008

INFORMATION RETRIEVAL NUMBER 68

**Your choice package
for easier, less
expensive
circuit design**

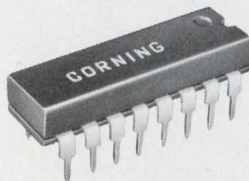

CORDIP™ COMPONENT NETWORKS

CORNING Electronics offers combinations of resistors, capacitors and diodes in standard dual in-line packages. With these CORDIP networks you can design circuit combinations of up to 20 components in a 14-pin DIP and up to 23 in a 16-pin DIP. They offer higher component densities, less complex circuit boards, reduced inventory of discretes, and significant savings in handling costs. Prototypes available in three weeks, production quantities in approximately eight weeks.

Send for our new brochure containing complete information on CORDIP component networks. Or call us. Corning Glass Works, Electronic Products Division, Corning, New York 14830. (607) 962-4444, Ext. 8684.

CORNING
ELECTRONICS

INFORMATION RETRIEVAL NUMBER 69

HALEX, INC.

**Second sourcing.
Immediate delivery on:**

- 0007 Clock Driver
- 0009 Dual Clock Driver
- 0032 FET Operational Amplifier
- 0033 High Speed Buffer
- 0034 Level Shifter

Coming in 1973:

- 0002 Buffer Amplifier
- 0013 Dual Clock Driver
- 0021 High Power Operational Amplifier
- 0041 High Power Operational Amplifier

For prices and data sheets on these and other high-quality thin-film microcircuits and resistor networks, please call or write:

HALEX, INC.

Box 2940
Torrance, California 90509
(213) 772-4461, 542-3555

INFORMATION RETRIEVAL NUMBER 70

new products

Linear rf amp challenges tubes with 100-W output

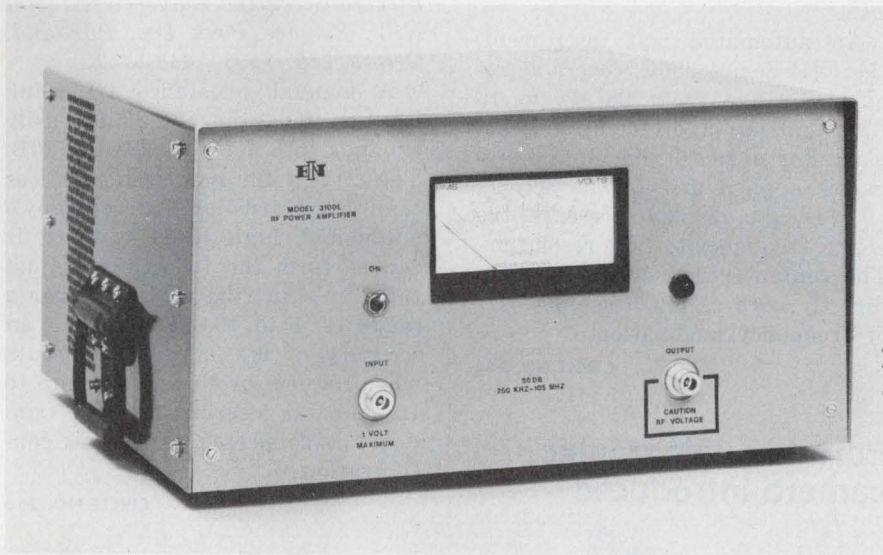

Electronic Navigation Industries, Inc., 3000 Winton Rd. South, Rochester, N.Y. 14623. (716) 473-6900. \$5690; 60 days.

Obtaining 100 W of linear power over the frequency range of a few hundred kilohertz to more than 100 MHz used to call for a tube amplifier. Now a solid-state rf amplifier can do the job. And the manufacturer reports that the new unit weighs far less and is more compact than tube units, while costs and power dissipation are significantly reduced. The mean time between failure (MTBF) is reported greater than 10,000 hours.

Called the ENI Model 3100L, the Electronic Navigation Industries amplifier can provide more than 100 W of linear class A power and up to 180 W of pulse power over the frequency range of 250 kHz to 105 MHz. More than 50 W can be obtained below this range (from 120 to 250 kHz) and above it (from 105 to 120 MHz). Gain is specified at 50 dB over the full 120-kHz-to-120-MHz range, with a variation of ± 1.5 maximum over the 250-kHz-to-105-MHz range.

Input/output impedance ratings are listed at 50 Ω . For an output load of this value, maximum power will be transmitted to the load. However, any load—from a short to an open circuit—can be connected to the output without causing amplifier failure or oscillation, the company says. Reflected power due to load mismatch is absorbed within the amplifier.

The unit is reported to withstand up to 13 dB of overdrive (input signal of 1 V rms) for all output load conditions, including short and open-circuit loads. Any signal generator, synthesizer or sweeper can be hooked up to the input terminal to amplify AM, FM, SSB, TV or pulse signals.

Distortion is listed as low, too. All odd harmonics are more than 25 dB below signal level at 75-W output. All even harmonics are more than 30 dB below signal level at 100-W output.

Other features include input VSWR under 1.5:1 and output VSWR of less than 2:1 (typical). The noise figure is held to less than 10 dB.

The 3100L operates over the temperature range of 0 to 40 C, weighs 70 lbs and measures 8-3/4 \times 17 \times 17 inches. The unit's extraordinary power output, bandwidth and compactness results, according to the manufacturer, from the following: the use of state-of-the-art rf power transistors, a low-loss hybrid matrix network that combines the outputs of 32 power transistors, and a cooling system that maintains transistor case temperature to within 18 C of the outside air.

The rf transistors used in the 3100L are said to be the largest class-A chip devices available. The high-power custom chips use nichrome resistors built into the emitter sites to minimize hot-spotting and to even out the current distribution. The manufacturer reports a full power burn-in of 100 hours for each device.

The hybrid matrix uses a special nickel-zinc ferrite material that has a maximum of 0.2-dB loss at 105 MHz. The transformer hybrids using the special ferrite cores are connected to form a 32-way summing network. The over-all maximum insertion loss of the matrix network is only 1 dB, or 25% of the power generated.

Maximum heat dissipation—a total of 1100 W, with 450 W in the rf transistor alone—occurs under zero-signal conditions. To dissipate this power, the amplifier modules are mounted on 0.25-inch, low-thermal-resistance aluminum plates. A cooling fan and corrugated fins extending from the heat-bearing plates combine to wash cool outside air over the modules continuously. A very small thermal rise (for the 1100 W dissipated) enables the rf transistors to deliver high output power.

CIRCLE NO. 250

Doubly balanced mixer comes in low cost DIP

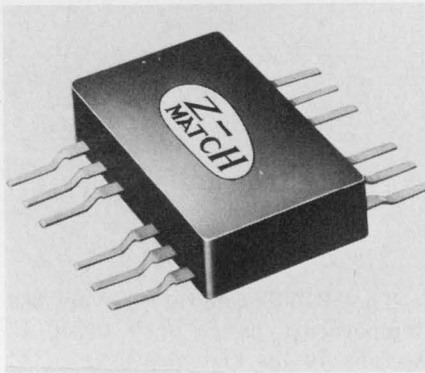

Vari-L Co., 3883 Monaco Pkwy., Denver, Colo. 80207. (303) 321-1511. P: See below.

The Z-Match-DBM-166 mixer, for general purpose use in communication equipment, is available in a DIP at the low cost of \$6.95 (100-999). Conversion loss is typically 6 dB and interport isolations of 40 dB are typical up to 100 MHz. Over-all frequency range is 0.2 to 500 MHz.

CIRCLE NO. 252

1-to-2 GHz amp offers 30-dB gain, 1-W output



Hughes Electron Dynamics Div., 3100 W. Lomita Blvd., Torrance, Calif. 90509. (213) 534-2121. \$2495; stock.

The Model 1403H solid-state instrumentation amplifier, covering the 1-to-2-GHz frequency band, can be used as a direct replacement for 1-W instrumentation TWTs. It provides 1 W minimum power output at saturation and 30-dB gain over its entire frequency range. The amplifier includes an ac-to-dc regulated power supply. Stable rf device operation is achieved through a combination of bias voltage and current regulators; no forced air cooling is required.

CIRCLE NO. 253

Automated tester covers 20 Hz to 18 GHz range



EIP Inc., 3130 Alfred St., Santa Clara, Calif. 95050. (408) 244-7975. 350C: \$4250; 351C: \$4850; 3-4 wks.

An automated test instrument, the EIP Series 350C, covers a frequency range from 20 Hz to 18 GHz and has a direct digital display. For a measurement, the signal is applied and in one second, an 11-digit display presents the signal frequency to 1-Hz resolution. The center frequency can be read directly with as much as 130 MHz of frequency modulation.

CIRCLE NO. 254

Portable holographic camera introduced

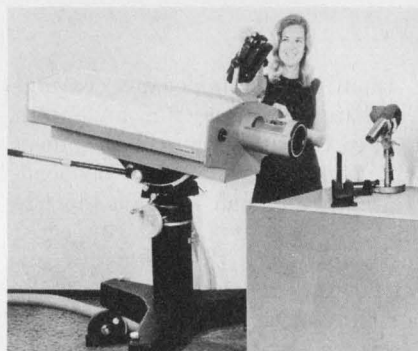

Union Carbide Corp., 2520 Colorado Ave., Santa Monica, Calif. 90406. (213) 829-3377.

A laser holographic camera, designated the KHC1, is said to be the first unit featuring complete portability. Moreover, the system's ease of operation enables semi-skilled personnel to conduct interferometric and non-destructive holographic tests in industrial environments. Exposure time is 20 ns, enabling the "freezing" of moving (as well as stationary) objects on a permanent hologram. Optional photographic film systems are capable of a dry-to-dry development time as fast as 20 seconds. The KHC1 can holograph fringe-free depths up to 2 meters.

CIRCLE NO. 255

Manual trimmer easily automated

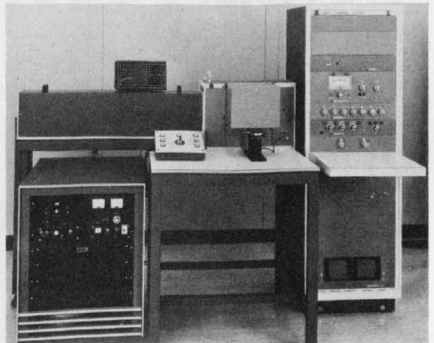

Electro Scientific Industries, 13900 N.W. Science Park Dr., Portland, Ore. 97229. (503) 646-4141.

A manual resistance trimming laser system, the SP 3723, easily expands into a Model 20A or 20B. The cost of the new system is less than two-thirds of the company's automated, high speed systems. It can perform the following: adjust thick or thin film resistors over a range of 1 to 10 MΩ, trim to an accuracy of 0.1%, perform L-cuts when needed, probe and scan up to 12 resistors per circuit, and trim resistors connected in network configuration.

CIRCLE NO. 256

Wideband amp permits easy field repairs

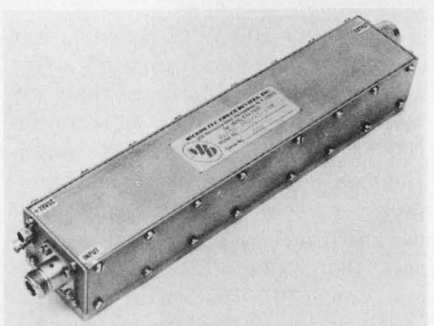

Microwave Power Devices, Inc., Adams Ct., Plainview, N.Y. 11803. (516) 433-1400. \$3200; 60 days.

The Model PWA 7598, a 755-to-985 MHz solid-state amplifier built with 50-Ω prealigned modules, allows for easy field repairs since defective modules can be replaced simply. Other features include a power output of 15 W min, a power input of 10 mW and a gain ripple of 1 dB monotonic. Also, harmonics are greater than -30 dB, input VSWR is 1.25:1 and input voltage is 28 V dc.

CIRCLE NO. 257

350 MHz

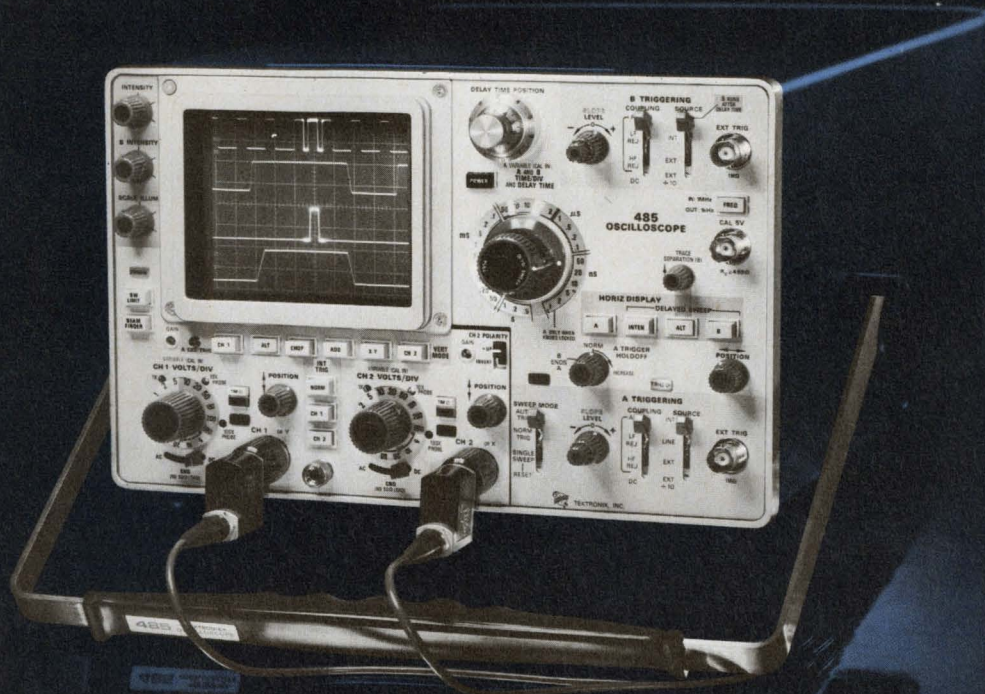

in a *portable* laboratory oscilloscope
that weighs only 23 pounds.

The dual-trace, 350-MHz TEKTRONIX 485 Oscilloscope is the newest addition to the world's most widely used portable family. Many features of earlier TEKTRONIX portables are retained, many others are expanded and a lot of new ones are added. The result is a new product which significantly expands the performance spectrum of portable scopes. Following are some of the features of the 485, an oscilloscope which measures with laboratory precision and carries with small-package ease.

350-MHz Bandwidth at 5 mV/Div—More dual-trace high frequency measurement capability at 5 mV/Div than any other laboratory-quality scope—portable or cabinet.

1-M Ω and 50- Ω Selectable Inputs—Scope circuitry automatically disconnects the 50- Ω inputs when signals exceed 5 V RMS or 0.5 watts to protect your equipment.

Time Resolution to 1 ns/Div—More time resolution than any other portable. And it's direct reading.

A-External Trigger—Just press this button to display the external trigger signal and quickly verify your trigger source or check timing reference.

Alternate Sweep Switching—View intensified waveforms and delayed waveforms at the same time. When you move the intensified zone you always know precisely where you are, and still see the delayed waveform. It saves time and adds operation convenience.

Weight without accessories, just 20½ lb (23 lb with accessories). As much as 30% lighter than other portables which have only 150-MHz bandwidth.

For complete information or to arrange a demonstration, contact any TEKTRONIX Field Office. Our offices are located in or near major cities and industrial centers—worldwide. If you prefer, write Tektronix, Inc., P.O. Box 500, Beaverton, Oregon 97005. In Europe, write Tektronix Ltd., P.O. Box 36, St. Peter Port, Guernsey, C.I., U.K.

485 Oscilloscope \$4200
U.S. Sales Price FOB Beaverton, Oregon



TEKTRONIX®

committed to
technical excellence

Centralab Rotary Switches... in line with your design requirements



Write
Centralab
for
Bulletin
No. 1101S(R)3

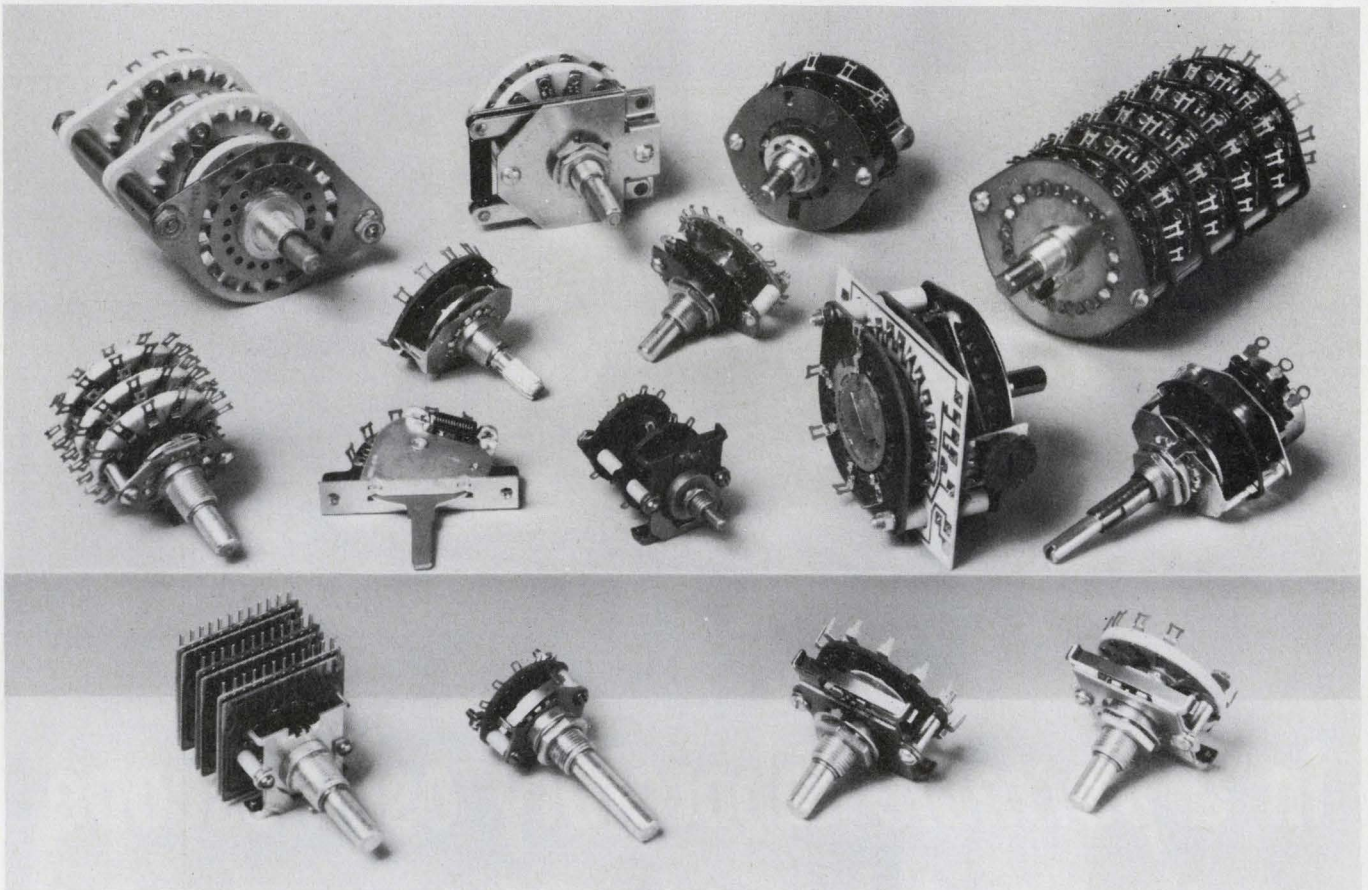

Do you identify with this group?

The group is Centralab's rotary switch line—preferred by over half of today's design engineers. In unbiased product preference studies conducted annually by several leading electronics magazines, design engineers identified Centralab rotary switches as their first choice by a 2 to 1 margin.

And for good reason, too! Because most of you came to Centralab for a special rotary switch capability. And you got it.

Over 35 years of experience in solving switching problems is the reason Centralab can offer you a most extensive and growing line of standard switches. Now, for example, you can select from four new series of miniature and subminiature switches that feature a dual-ball sidethrust mechanism

for top index performance and exceptionally good torque and feel. Adjustable stop models require no disassembly or removal of stop tabs. You can easily change stops by varying the placement of one or two stop rings in the front plate. For torque adjustment you just change index springs on an otherwise completed switch. You can choose from a wide variety of section materials too, including diallyl phthalate for the highest insulation resistance.

When you come to Centralab you widen your choice of rotary switches—types, sizes, configurations, ratings and other options. You get the right switch at the right price. If you're not in that group, find out how the other half lives. Write Rotary Switch Sales Manager, Centralab.

GET CENTRALAB THE "IN" LINE FOR YOUR DESIGN

Hybrid Microcircuits
Pushbutton & Rotary Switches
Capacitors
Potentiometers
Technical Ceramics
Ceramic Packages
Semiconductor Devices



CENTRALAB

Electronics Division
GLOBE-UNION INC.

5757 NORTH GREEN BAY AVENUE
MILWAUKEE, WISCONSIN 53201

INFORMATION RETRIEVAL NUMBER 40

Centralab distributors identify with your switch requirements

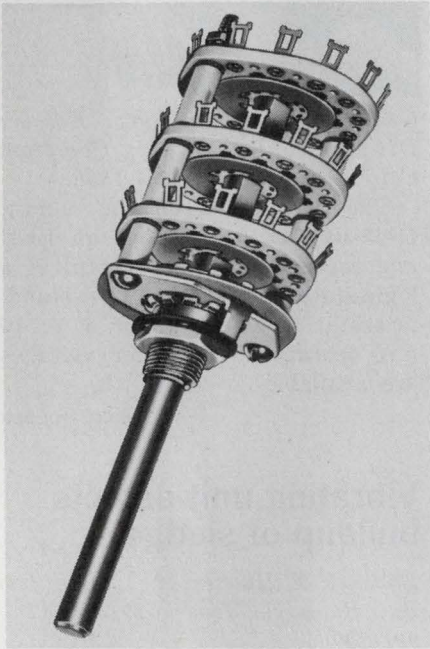

Centralab Distributors are your number one source for the number one line of standard rotary switches. You can select the switch you need — off the shelf — from all sizes and types, in prototype or small production quantities with immediate delivery. It's this kind of availability that lets you obtain the right switch for your design requirements every time. And, it's been that way for over 35 years.

Centralab Distributors also carry component switch parts in kit form for convenient field repair and economical prototype switch assembly.

When you need a rotary switch, look to your Centralab Distributor first. For a complete catalog of Centralab switches and switch kits, see your distributor or write Centralab Distributor Products, Dept. RS-1.

DISTRIBUTOR PRODUCTS



INFORMATION RETRIEVAL NUMBER 41

ELECTRONIC DESIGN 26, December 21, 1972

COMPONENTS

Noninductive resistors made from serpentine film pattern

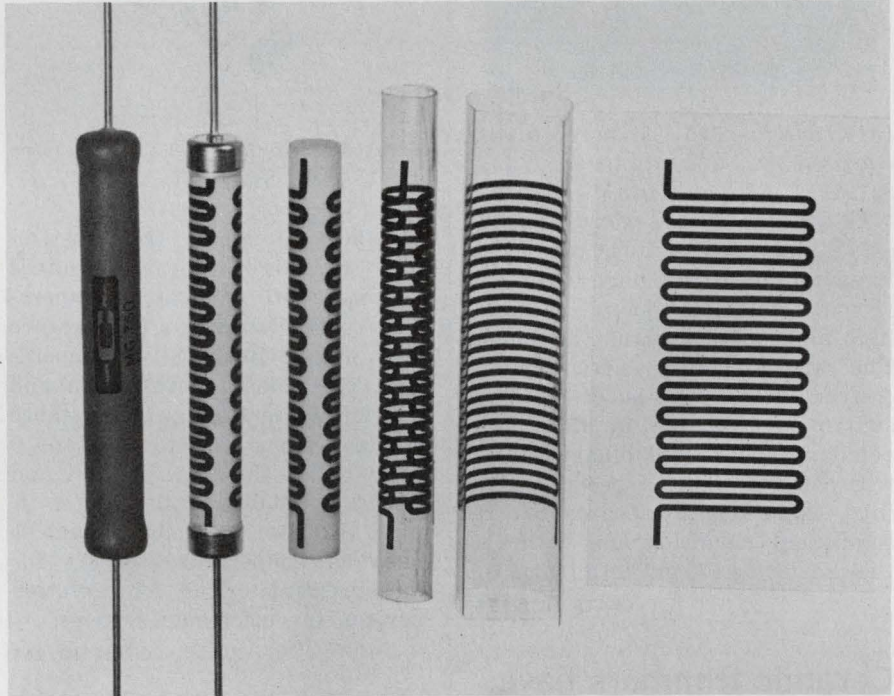

Caddock Electronics, 3127 Chicago Ave., Riverside, Calif. 92507. (714) 683-5361. MSN220, 2 W, $\pm 1\%$; \$1; MGN721, \$100 M Ω , $\pm 1\%$; \$2.97 (1000 up); 3-4 wks.

Precision thick-film resistors with virtually no inductance are fabricated by a new technique that uses a serpentine resistive pattern on a supporting insulator. These resistors are packaged in a rugged axial-lead configuration like Caddock's older MG, MH, MM and MS series.

Until now, axial-lead resistors have been fabricated with the resistive material in a helical pattern. But a helix is a high-inductance configuration that can cause problems at high frequencies. With the serpentine pattern, opposite flux fields are generated by the adjacent current paths, and the fields tend to cancel each other. Therefore the resistors are only about as inductive as a straight piece of wire the length of the resistor body.

The new resistors are thus suited to high-frequency applications or circuits where fast response times are critical. In addition the

axial-lead package is mechanically stronger and easier to handle than the noninductive resistors previously fabricated on flat substrates.

High-resistance, noninductive resistors are available in a range from 1 k Ω to 2000 M Ω with standard tolerances of $\pm 1\%$. Tolerances to 0.2% are also available. A precision 10-W power resistor, is available in values from 10 Ω to 20 M Ω with standard tolerances of $\pm 1\%$. Tolerances to 0.1% are available on special order.

Caddock intends to phase this noninductive, serpentine resistance element into its older, axial-lead resistors in the next two years at no increase in price. Until the phase-in is completed, an N should be added to the model numbers to indicate the noninductive type.

The serpentine elements appear to provide the same power ratings, temperature characteristics, working voltages and precision as the older styles plus the added advantage of a noninductive design.

Engineering samples can be obtained in one to two weeks.

CIRCLE NO. 258

Thumbwheel switch is claimed world's smallest

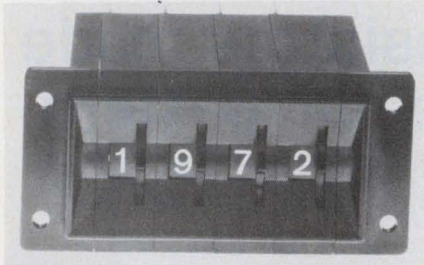

Interswitch, 770 Airport Blvd., Burlingame, Calif. 94010. (415) 347-8217. \$3 (unit qty).

Claimed to be the world's smallest thumbwheel switch, the Type L switch measures only 0.315 in. (8-mm) wide and 0.71 in. (18-mm) high and mounts behind the panel. The rated switching current is 0.1 A from 0 to 50 V, ac or dc. The switch is available in the most popular decimal and binary codes, with colored wheels, special markings, extra-long PC boards to aid component mounting and with either solder or PC pin terminations.

CIRCLE NO. 259

Ceramic trimmers have large ΔC in small size



JFD Electronics Corp., 15th Ave. at 62nd St., Brooklyn, N.Y. 11219. (212) 837-2510.

Two new microminiature, ultra-thin ceramic trimmer capacitors provide a large adjustable capacity for their small size. The DVJ5014 trimmer, only 0.070 in. above the mounting surface and 0.245-in. D is claimed to match the electrical performance of other capacitors many times this size. The trimmers feature a slotted adjustment head. The DVJ5009 series has a height of only 0.045 in. above the mounting surface and features a flush adjustment head. The below-the-mounting surface section of both units is only 0.040 in. Both types are available in the 3-10, 3.5-15, 4-20, 5-30 F capacitance ranges.

CIRCLE NO. 260

Thermistor provides linear response

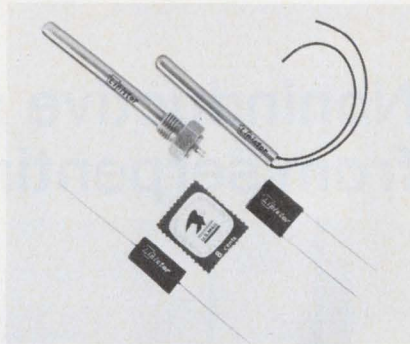

Keystone Carbon Co., Thermistor Div., 1935 State St., St. Mary's, Pa. 15857. (814) 781-1591.

Called Linistors, these assemblies provide a linear resistance response with a negative temperature coefficient over a temperature span of 0 to 100 C. Seven temperature coefficients between 20 and 400 $\Omega/^{\circ}\text{C}$ are standard. Resistance changes from 3392 to 1392 for 0 to 100 C in the 20 $\Omega/^{\circ}\text{C}$ unit and 64,693 to 24,693 in the 400 $\Omega/^{\circ}\text{C}$ unit. Linistor assemblies can be used as temperature sensors for measurement or as compensation devices for electronic systems.

CIRCLE NO. 261

LEDs directly replace incandescent bulbs

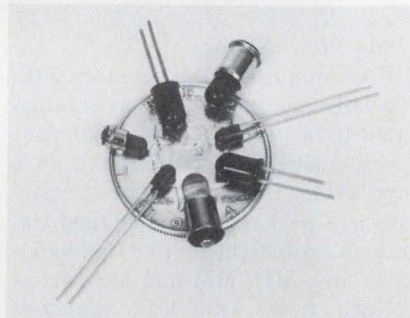

Lamps, Inc., 19220 S. Normandie Ave., Torrance, Calif. 90502. (213) 323-7578.

Manufacturers and users of T-1 and T-1-3/4 incandescent lamps can switch over to solid-state, LED types without making circuit or receptacle changes. Required resistors are incorporated within the lamp body. This is seen as a significant development when considering the small size of some lamps. Resistors may be specified within limits to allow correct lamp current for a given circuit voltage. Various bases and lens colors are available.

CIRCLE NO. 262

LED status indicator packaged in DIP

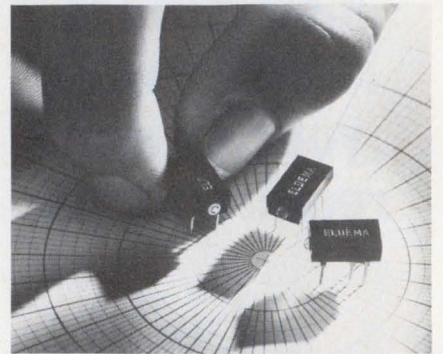

Genisco Technology Corp., Eldema Div., 18435 Susana Rd., Compton, Calif. 90221. (213) 774-1850.

The Genisco indicator unit, ID45-RCB-0510, provides an LED and resistor in a DIP useful as a logic-status indicator. The standard unit is designed for 5 V, 10 mA operation, but other voltages are available.

CIRCLE NO. 263

Vibrating unit detects buildup of sludge

Endress & Hauser Inc., 38 Cabot St., Beverly, Mass. 01915. (617) 927-3996.

Activated at its resonant frequency, the tines of this sludge or slurry detector unit, called the Vibratrol, work totally submerged. Contact with solids in the mixture (10% or greater) deactivates the tines to signal a sludge buildup. The unit is insensitive to variations in the liquid level.

CIRCLE NO. 264

Wire-wound resistor acts as a fuse

RCL Electronics, Inc., 700 S. 21st St., Irvington, N. J. 07111. (201) 374-3311.

The F500 fuse resistor acts as both a wire-wound resistor and as a fusing device. The resistors are designed to protect semiconductor devices and to prevent circuit board damage. A resistance range of 0.2 to 200 Ω with a tolerance of 10% is standard. Tolerances of 5% and 2% are also available. Over-all length is 0.400 in. maximum, and units are provided with No. 24 gauge leads. Blowout times range from 10 ms to 10 s.

CIRCLE NO. 265

MCL cavities 10 to 6000 MHz all power levels

From milliwatts to megawatts, from HF to C band, MCL cavities deliver state-of-the-art performance in your RF systems. Maximum efficiency and extended tube life are possible through MCL high-reliability approach to cavity design.

MCL can assist you in developing the most advanced microwave systems available today. Our new applications guide covers important system parameters, trade-offs, cooling and power supply requirements.

Relationships between pulse width and duty factor, tube life, and other important factors are included to help you get maximum performance from latest tube developments.

MCL engineers will also work with you directly in evaluating your application. And we will supply a fast quotation for price and delivery of the cavity that meets your needs.

For your copy of our applications guide or for assistance in meeting your requirements, call (312) 354-4350 or write: MCL, Inc., 10 North Beach Avenue, LaGrange, Illinois 60525.

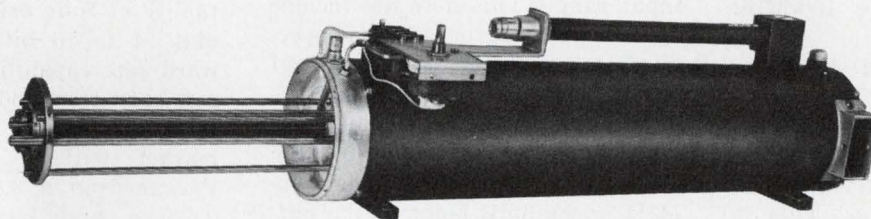
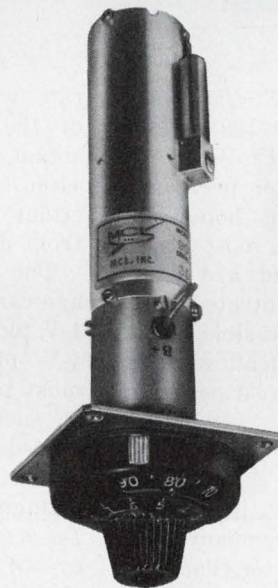

MCL
INC

*Opportunities developing now for RF engineers at MCL, Inc.
—an equal opportunity employer.*

INFORMATION RETRIEVAL NUMBER 42

4-bit analog-to-digital unit converts at 100-MHz rate

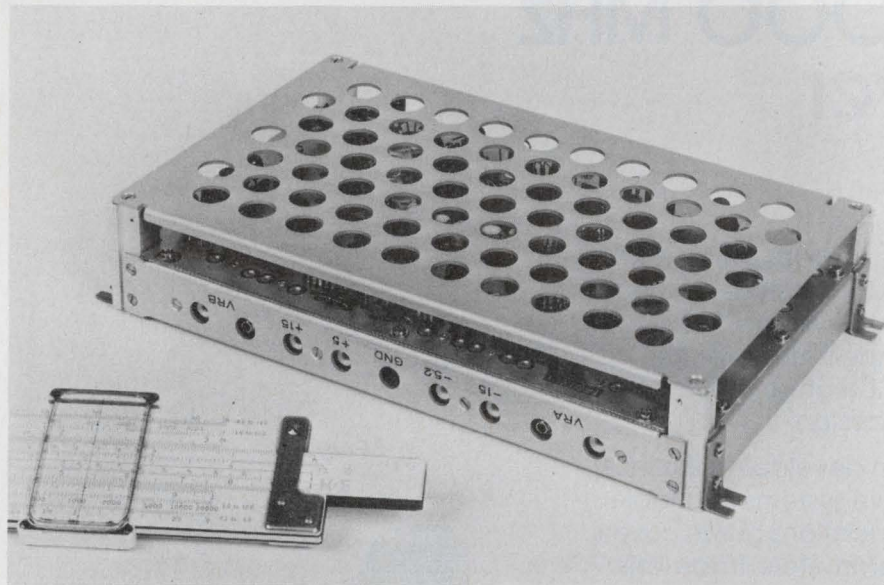

Computer Labs, 1109 S. Chapman St., Greensboro, N.C. 27403. (919) 292-6427. \$2000; 6-8 wks. ARO.

In the race for better performance combinations and hopefully a bigger market share, most manufacturers of packaged a/d converters have concentrated on squeezing the largest possible number of bits into the smallest possible package at the lowest possible price.

But Computer Labs has taken another tack. Realizing that a market exists for low-resolution, high-speed converters, the company has produced an a/d converter that can transform a signal to a four-bit word at an impressive 100-MHz rate.

Designated the MOD-4100, the converter achieves the fast word conversion rate by using an all-parallel processing technique. Conversion time of the new unit is also fast: 30 ns \pm 2 ns. This is the time between the leading edge of the encode command—the external signal that initiates encoding—and the trailing edge of the data ready pulse—the pulse that signals a completed conversion.

Conversion time should not be confused with word conversion

rate, which is really the frequency of the external encode command signal. In the case of the MOD-4100, the conversion rate can vary either periodically or at random, from dc to 100 MHz.

The full-scale analog input voltage can range from a minimum of 1-V pk-pk to a maximum of about 4-V pk-pk but the latter value must be centered about zero—that is, such that neither peak voltage exceeds 2 V. Internal potentiometers are provided to adjust the voltage range of the converter. Dc accuracy—or, rather, inaccuracy—of the MOD-4100 is specified at 10 mV \pm 1/2 LSB over the listed input range. This does not include aperture time error, which is specified separately at a maximum of \pm 400 ps.

The full accuracy applies for large input signals up to 50 MHz. However, inputs up to the 100-MHz upper 3-dB point of the buffer amplifier can be converted at reduced accuracy. And the converter will settle to \pm 1/2 LSB within 10 ns, for a full scale input step. Input impedance can be either 50, 75 or 93 Ω , at the choice of the purchaser.

The MOD-4100 will operate from

0 to 50 C with a tempco of only 0.02%/°C over this temperature range. Monotonicity is guaranteed over the temperature range and up to 50 MHz.

The four parallel output bits are in nonreturn-to-zero (NRZ) format and, because output storage is provided, time skew is held to less than 1.5 ns. Outputs are ECL-compatible: logic ONE equals -0.8 V and ZERO equals -1.7 V.

Each bit can drive 10 feet of RG/174-B/U, terminated in 100 Ω line-to-line. Codes are straight or offset binary or, optionally, twos complement for bipolar input only.

Size of the MOD-4100 is 5-1/2 \times 9 \times 1-3/4-in. and weight is 2 pounds. The unit can be mounted vertically or flat on a subchassis. All input/output signals are via only two connectors, including power. The latter is \pm 15 V at 35 mA, +5 V at 275 mA and -5.2 V at 2.2 A.

CIRCLE NO. 266

D/a module converts at 20-MHz word rate

Optical Electronics, Inc., P.O. Box 1140, Tucson, Ariz. 85706. (602) 624-8358. \$231 to \$304; stock.

Optical Electronics, Inc., offers a family of four d/a converter modules (4 to 10 bits) with 20-MHz word rate capability. The 7560 series converter modules are believed to be the fastest available on the market with a voltage output. Packaged in a 3.125 \times 2.625 \times 0.625-in. high module, the family features: \pm 5 V output, all models; inputs compatible with Schottky TTL and CMOS logic families; \pm 15 V operation; 810 mW max power dissipation—all models; -55 to $+100$ C operating temperature range—all models.

CIRCLE NO. 267

**Silicone breakthrough:
Noncorrosive
adhesive/sealant
at general-purpose
prices.**

The protective advantages of bonding and sealing with a noncorrosive silicone can now be extended to a wider variety of products. New Silastic® 738 RTV adhesive/sealant is offered at prices competitive to conventional silicone sealants and even to many organic materials. It will not corrode sensitive metals because it has a curing system different from that of regular silicone sealants. Also, there is no objectionable odor during cure.

Silastic 738 is a ready-to-use, durable sealant that will guard your products with all the superior resistive properties inherent in silicones.

For a free trial sample, fill out coupon:

Encapsulants and sealants from
DOW CORNING

DOW CORNING

Dow Corning Corporation
Dept. A-2318, Midland, Michigan 48640
Send me a free trial sample of
Silastic 738.

Name _____

Title _____

Company _____

Address _____

City _____

State _____

Zip _____

Phone _____

Offer expires March 31, 1973.

INFORMATION RETRIEVAL NUMBER 43

16-bit d/a converter is highly linear

Lancer Electronics Corp., P.O. Box 925, Malvern, Pa. 19355. (215) 539-4410. \$650; 30 days.

The 333 16-bit d/a converter offers linearities of approximately $\pm 0.0005\%$, and a settling time of $8 \mu s$ (full-scale step). The unit is available in a $2 \times 4 \times 0.6$ -in. potted module or on a PC board with buffering and logic. Other features of the Model 333 include standard input of binary 2s complement, TTL/DTL-compatible, internal reference tempo of ± 5 ppm/ $^{\circ}C$, output of 0 to +1 mA, output impedance of 10 k Ω , 96-dB dynamic range, and a power requirement of 15 V at 75 mA.

CIRCLE NO. 268

TV voltage triplers deliver 25-kV output

Varo Semiconductor, Inc., P.O. Box 676, Garland, Tex. 75040. (214) 272-4551.

MH919 and 920 Series of voltage triplers are for solid-state and vacuum-tube color television receivers. These multipliers have a nominal output of 25 kV, with 8 kV pk-pk maintained. The MH919 series contains five diodes and five capacitors with focus tap, and is designed for pulse-input solid-state television receivers. The MH920 Series contains six diodes and six capacitors, with focus tap, for sine wave input with any solid-state or vacuum tube color-television receiver. Operating temperature capability is 75 C, T_A.

CIRCLE NO. 269

Hybrid dividers work in two quadrants



GPS Corp., 14 Burr St., Framingham, Mass. 01701. (617) 875-0607. \$54 to \$152 (100 up); stock.

Series 5000 two-quadrant dividers feature discrete performance in hybrid size. They are miniature (1/2 cubic in. and less than 1 oz.) encapsulated, plug-in modules. They require no external amplifiers or adjustments. GPS Series 5000 dividers come in five models.

CIRCLE NO. 270

Interference filters operate at 250-V ac

Sprague Electric Co., 347 Marshall St., N. Adams, Mass. 01247. (413) 664-4411.

A series of general-purpose interference filters for use where leakage current is limited to 5 mA because of safety requirements is now available from the Sprague Electric Co. The new dual-circuit, low-leakage filters come in 3, 5, and 10 A ratings for use with 125 or 250-V, 60-Hz circuits. The filters are hermetically sealed in corrosion-resistant steel cases with glass-to-metal terminals.

CIRCLE NO. 271

Hybrid power amps yield up to 100 W

Electronic Associates, Inc., 185 Monmouth Pk., W. Long Branch, N.J. 07764. (201) 229-1100.

These hybrid audio power amplifiers yield 15 to 100 W continuous output power for audio, servo drive and general low-frequency (< 50 kHz) applications. The 15 W operates from a single 30-V supply while the 30, 60 and 100 W amplifiers run on split supplies ranging from ± 15 to ± 50 V. All drive output loads vary from 3 to 8 Ω at full power, with distortion less than 0.1% typical. Amplifiers with 30 W output and above are equipped with overload protection as standard. Input voltage is 500 mV rms max., and frequency response is flat from 25 Hz to 50 kHz, at full power output, for the standard configuration.

CIRCLE NO. 272

Power supplies offer ratings to 30 kV

Spellman High Voltage Electronics Corp., 1930 Adee Ave., Bronx, N.Y. 10469. (212) 671-0300. From \$145; stock to 30 days.

RM miniature, high-voltage power supplies are now available in 1.5 W, 3 W and 6 W models and feature fully enclosed, shielded metal cases, encapsulated for environmental protection. The expanded RM line offers improved regulation of 0.1% per watt load regulation for full load variations and improved ripple of 0.1% peak-to-peak for all load conditions. Ratings to 30 kV dc are available.

CIRCLE NO. 273



ANALOGY:
FOR THAT EXTRA KICK IN HIGH VOLTAGE REQUIREMENTS, USE THE A-302, FET INPUT, ± 150 VOP AMP. IT SUPPLIES A LOT OF ZAP (+20MA) WHILE INPUT BIAS CURRENT IS LESS THAN 10pA. LET ANA TURN YOU ON, WRITE.

intech INCORPORATED
(408) 244-0500
1720 COLEMAN, SANTA CLARA CA 95050

Power supply kits give choice of regulation

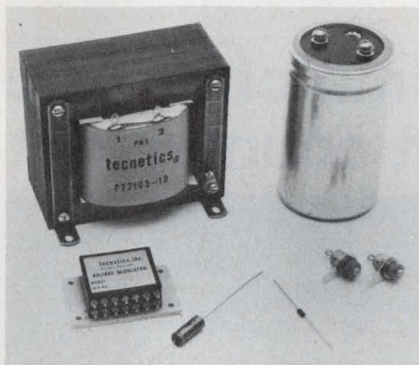

Tecnetics Inc., Boulder Industrial Park, Boulder, Colo. 80302. (303) 442-3837. Start at \$13; stock.

Tecnetics offers power supply kits with matched components. Unregulated, regulated, or highly-regulated kits are available. Unregulated kits range from 5 to 48 V dc at 1, 5, and 10 A. Regulated kits range from 5 to ± 15 V dc at 2, 5, and 10 A with 0.15% line and 0.2% load regulation. Highly regulated kits range from 5 to ± 18 V dc at 0.25, 0.5, 1, 5, and 10 A with 0.01% +1 mV line and 0.01% +1 mV load regulation.

CIRCLE NO. 274

DIP holds photo detector preamp & video amp

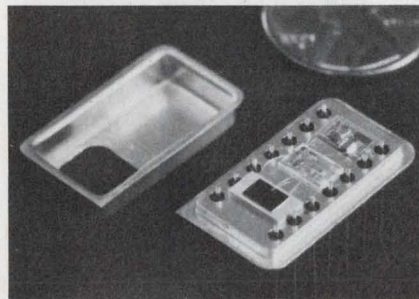

Meret Inc., 1815 24th St., Santa Monica, Calif. 90404. (213) 828-7496. \$190; 2 wks. ARO.

The DDV325 is an integral photo-detector, low-noise preamplifier and video amplifier in a DIP. The unit has just 3 pins (B+, ground and output). Radiant power of 10 nW at 905 nm incident on the 4.5-mm² area silicon photodiode gives an output of 10 mV over a 10-MHz bw. Rms noise voltage is less than 5 mV over the bandwidth of the device. Rise time response to pulsed radiation is less than 40 ns. Operating voltage range extends from +6 to +15 V.

CIRCLE NO. 275

Waveform recording doesn't have to be all that complicated.

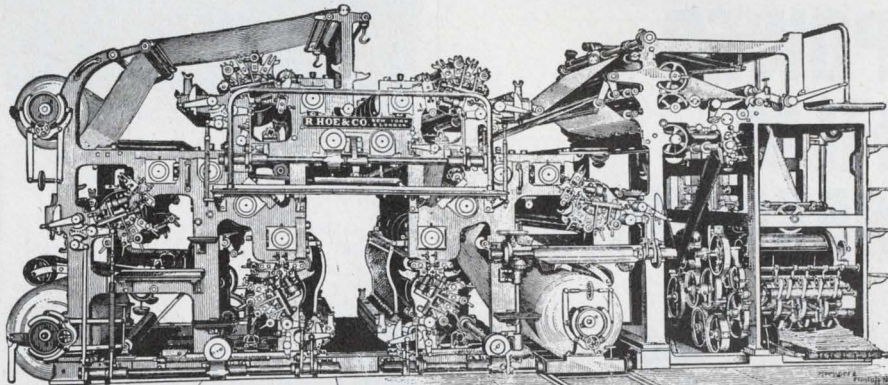

Tape deck, strip chart, conventional scope and camera — the old ways die hard.

But why make transient waveform recording all that complicated? Now you can easily stop, record, observe, and process fast, single-shot (or repetitive) signals or pulses without all the old-fashioned, time-consuming apparatus.

For example, you can stop any non-recurring signal — like a nuclear pulse, sonic boom, or power line transient — and store it digitally at analog-to-digital conversion rates up to 100 MHz per sample with 8 bit resolution.

You can even record the data preceding your trigger signal so that you can study conditions leading up to the trigger point.

Then you can transfer recorded data digitally to a computer or to other digital processors or peripherals; whatever is most convenient for you. Or, you can present the analog equivalent on a CRT display. Or make a permanent record on a strip chart or Y-T recorder.

This kind of data acquisition is priceless — especially in such convenient, easy-to-use form. You can measure explosion shock waves, for example. Shock tube studies, T-jump, stop-flow and other reaction kinetic chemistry, Plasma physics, Fluorescent decay studies, Automatic test systems for component testing. Lidar and other optics systems. Pulsed NMR work. Biomedical signal analysis — you name it.

We have the broadest line of waveform recorders in the world. Choose one that fits your application, regardless of A/D speed, A/D resolution, memory length, or price. For full information, write or call Biomation, 1070 East Meadow Circle, Palo Alto, California 94303. (415) 321-9710.

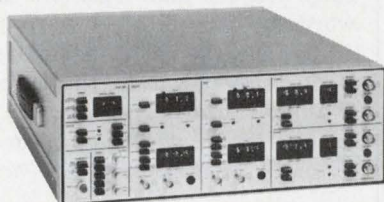

biomation
Always a trace ahead.

INFORMATION RETRIEVAL NUMBER 45

UNIQUE PRECISION POWER FILM RESISTORS

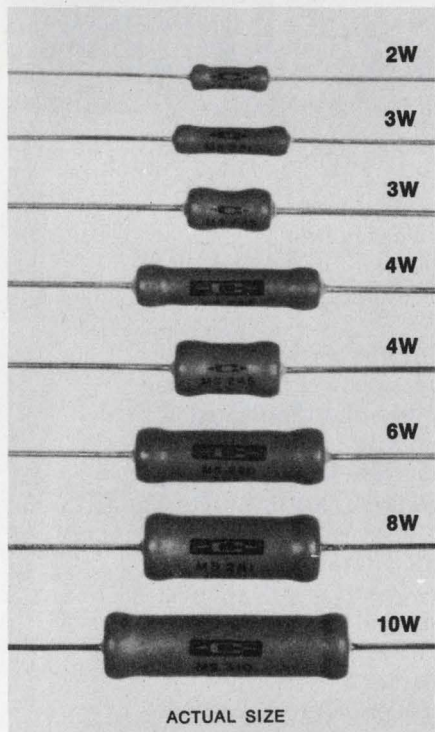

- Power ratings up to 10 watts, derated from 25°C.
- Resistances up to 2 Megohms without derating.
- Temperature coefficient 50 PPM/°C from -15°C to 105°C (special TC: 50 PPM/°C @ 275°C available).
- Resistance ranges from 10 ohms to 20 Megohms.
- Silicone conformal coating.

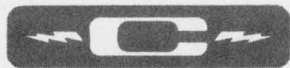

**CADDOCK
ELECTRONICS**

3127 Chicago Ave., Riverside, CA 92507
Tel: (714) 683-5361 • TWX: 910-332-6108

INFORMATION RETRIEVAL NUMBER 46

ICs & SEMICONDUCTORS

2048-bit PROM matches chip area of 1024-bit counterpart

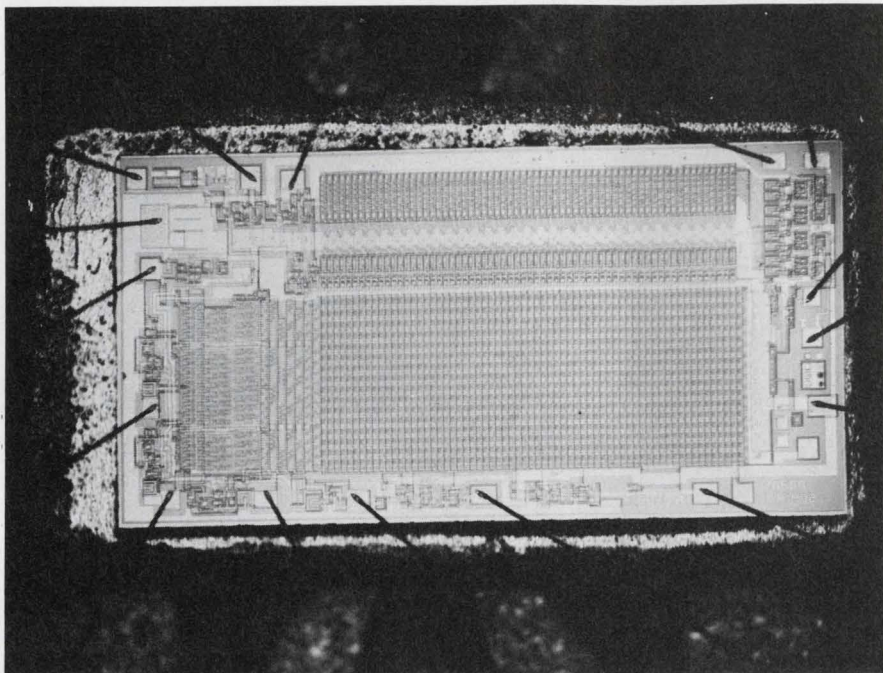

Harris Semiconductor, P.O. Box 883, Melbourne, Fla. 32901. (305) 727-5407. P&A: See below.

The manufacturer that introduced PROMS—Harris Semiconductor—now has a 2048-bit version with a chip area equal to Harris' popular 1024-bit PROM (Model H PROM-1024). Called the H PROM 2048, the new memory has the same nichrome fusible link design of the 1024 but achieves the higher density through the use of Harris' Poly-planar process, an oxide isolation technique.

Pin-for-pin compatible with other commercially available 2048-bit bipolar ROMs, the H PROM-2048 can also be used in existing 1024 ROM sockets by converting one chip select pin on the 1024 to an address pin for the 2048.

The 2048 is available with either three-state or open collector (suffix A) outputs. Both versions are fully decoded and organized as 512 words by four bits per word.

Because the 2048 dissipates the same total power as the currently available 1024-bit devices, the power per bit is effectively decreased by one half in comparison—to 0.25 mW/bit.

Other key features of the 2048 are DTL/TTL compatibility, typical access times of 50 ns and low input address current of 0.25 mA maximum. The 2048 devices are packaged in 16-pin DIPs.

Similar to other PROMs, 2048 devices are supplied with output bits HIGH. LOW levels are obtained by addressing the word to be programmed, applying 11 V to the appropriate output pin, and applying a 25 V pulse to the chip select input.

In this manner, the user can program the 2048 to any custom pattern needed.

The 2048 devices have one chip enable that offers an additional level of decoding for memory expansion in the word dimension. Word expansion is also facilitated by the three-state and open collector outputs that allow the corresponding bits of different devices to be tied together directly in a wire-OR configuration.

In 100 to 999 quantities, the 2048 devices are priced at \$98 for the military-temperature-range version and \$65 for the commercial version.

CIRCLE NO. 251

Sense amp/data register has ± 2 -mV sensitivity

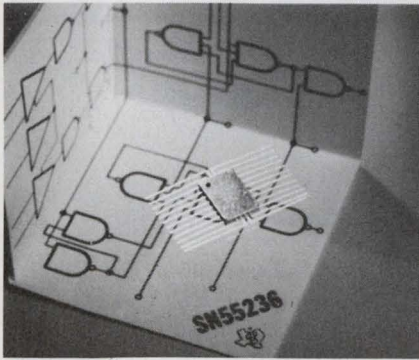

Texas Instruments Inc., P.O. Box 5012, M/S 308, Dallas, Tex. 75222. (214) 238-3741. \$23.17 (100 up); 8 wks.

A dual sense amp/data register IC features ± 2 mV threshold sensitivity over the -55 to 125 C temperature range. Termed the SN55236 and believed to be the first MSI sense amp, the IC offers a two-times improvement in threshold sensitivity over that previously announced. Designed for high-speed core memory systems, the new IC detects bipolar differential input signals from the memory and provides the interface between the memory and logic section.

CIRCLE NO. 276

Fast rectifiers go to 20 A, 600 V

RCA Solid State Div., Route 202, Somerville, N.J. 08876. (201) 722-3200. TA8411, TA8411R: \$1.49; TA8415; TA8415R: \$2.00; TA8419, TA8419R: \$2.80 (1000 up); stock.

Twelve 100 to 600-V fast-recovery silicon rectifiers, available in forward and reverse-polarity versions, have current ratings of 6, 12 and 20 A. Series TA8411 through TA8414 are 6-A, forward-polarity types (cathode connected to stud), while Series TA8415 through TA8418 are rated at 12 A. The Series TA8419 through TA8422 covers 20-A applications. Repetitive peak reverse voltage ratings are 100 V for TA8411, 15 and 19; 200 V for TA8412, 16 and 20; 300 V for TA8413, 17 and 21; and 600 V for TA8414, 18 and 22. All twelve devices have reverse-polarity versions (like numbered with suffix R) that are anode connected to stud.

CIRCLE NO. 277

For 25 years, Sage gave you the finest resistors possible.

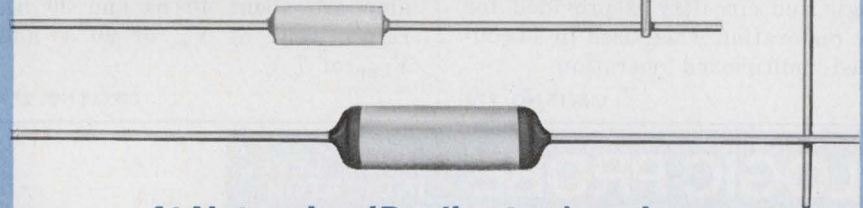

At Nytronics (Darlington), we're accomplishing the impossible.

For the past quarter-century, Sage precision and power resistors have been the accepted industry standard for quality and dependability.

Today, these fine quality components are being produced, along with famous precision-crafted Nytronics inductors and capacitors, in Nytronics' huge 250,000 square foot facility in Darlington, S.C. — with one important difference — we believe we're making them even better than before:

Tighter tolerances, more rigid quality control, in-

creased reliability, simplified specifying and immediate availability from an ever-expanding network of full-line Nytronics distributors.

Check the "impossible" new Sage precision, power wirewound and thin film microwave resistors yourself. And while you're at it, put Nytronics super-quality inductors and capacitors through their paces too. We'll be pleased to send you literature and off-the-shelf samples for your most critical applications. Simply write:



Nytronics, Inc.

Sage Electronics Corp.

Orange St., Darlington, S.C. 29532 (803) 393-5421 TWX-810-665-2182

Display driver breaks down at 160 V

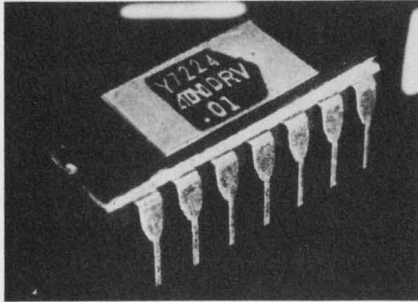

Precision Monolithics Inc., 1500 Space Park Dr., Santa Clara, Calif. 95050. (408) 246-9225. \$2.95 (100-249); stock.

The mono DRV-01, a high voltage display driver, exhibits a breakdown voltage of 160 V—the highest yet attained by a conventional linear processing technique, according to PMI. The device is designed to drive the cathode segments of high voltage gas discharge displays. The device's input levels are compatible with MOS logic and circuitry is provided for dc restoration when used in ac-coupled multiplexed operation.

CIRCLE NO. 278

Driver/amp/converter good for TMS4062 RAM

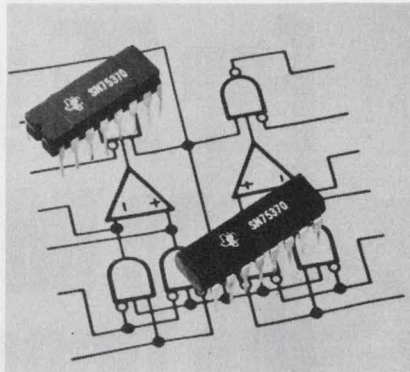

Texas Instruments Inc., P.O. Box 5012, M/S 308, Dallas, Tex. 75222. (214) 238-3741. \$5.40 in plastic (100 up); stock.

The SN75370, a high-speed dual-bit driver/sense amp/converter IC, interfaces the TMS4062 (AMS-6002) MOS RAM with standard TTL/DTL levels. Output of this interface circuit can be paralled with other packages to perform the wire-AND function. Propagation delays for the bit driver and sense amp are about 40 ns and 30 ns, respectively, at V_{SS} of 20 V and V_{REF} of 7 V.

CIRCLE NO. 279

Phototransistor comes micro-packaged



Shigoto Industries Ltd., Empire State Bldg., 350 Fifth Ave., New York, N.Y. 10001. (212) 695-0200.

A micro-packaged silicon planar npn phototransistor, the Sharp PT-100, is designed for array installation in printed-board circuits. It has a low and stable dark current and measures 0.059" in diameter with an over-all length of 0.098". Other features include: maximum 50-V collector-emitter voltage, maximum 6-V emitter-collector voltage, operating temperature range of -30 to +125 C and peak spectral response at 800 mu wave length. The symmetrical domed lens phototransistor has a relative directional sensitivity of 85 to 100% over a viewing angle of 20°.

CIRCLE NO. 280

LOGIC PROBE A HANDY "LEVEL" INDICATOR

Helps diagnose digital circuit malfunctions by indicating logic level. High input impedance and low drain LED does not affect circuit under test. Comfortable, lightweight and rugged. Only \$24.95 Post Paid.

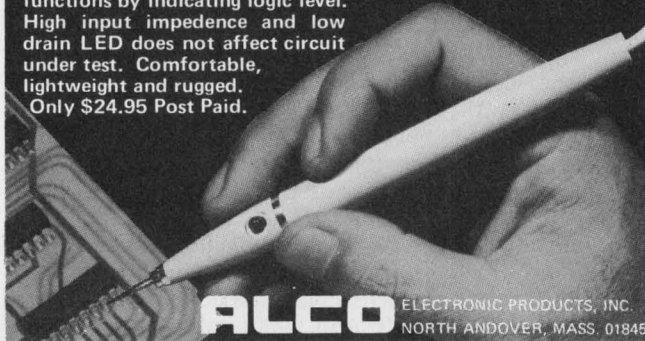

ALCO ELECTRONIC PRODUCTS, INC.
NORTH ANDOVER, MASS. 01845

INFORMATION RETRIEVAL NUMBER 48

NEW LED LOGIC CHECKER

Displays logic state of most 14 or 16 pin IC's with no external controls. Simply clip over DIP package and appropriate LED will light to indicate a high logic state at each associated lead. For use on popular 5V systems. Completely portable for shop, lab, or field use—fully guaranteed. Detailed instructions and handy carry case supplied. Free set of 24 logic templates included. Post paid — \$99.95.



ALCO ELECTRONIC PRODUCTS, NORTH ANDOVER, MASS.

INFORMATION RETRIEVAL NUMBER 49

bounce to the ounce(r)

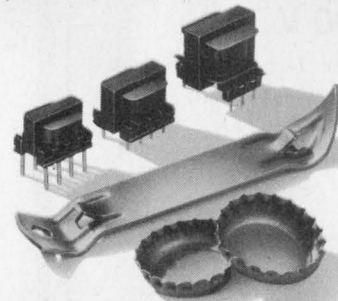

TRW/UTC Ouncers, Subouncers and Sub-subouncers can open up some refreshing solutions to PC board audio transformer problems. These units have been the quality standards for years. Now they're the cost-saving standards, too, available in plug-in versions, with leads compatible with wave soldering.

These plug-in units offer all the quality, reliability and utility of the famous UTC Ouncer line with insulated leads. Nothing has been compromised. This line couples highest performance and reliability with plug-in economy and the shortest delivery cycles. Write for catalog data. TRW/UTC Transformers, an Operation of TRW Electronic Components, 150 Varick Street, New York, N. Y. 10013. Tel: (212) 255-3500.

TRW
UTC TRANSFORMERS

INFORMATION RETRIEVAL NUMBER 50

ELECTRONIC DESIGN 26, December 21, 1972

Precision preamp boosts op amp accuracy

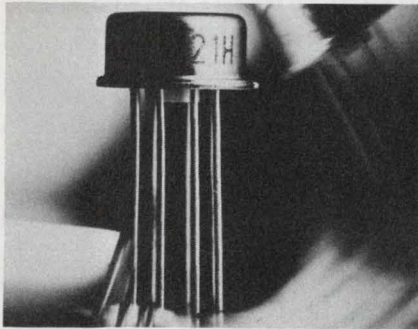

National Semiconductor Corp., 2900 Semiconductor Dr., Santa Clara, Calif. 95051. (408) 732-5000. Stock.

The LM121/LM121A series precision preamplifier, for use with an op amp to greatly increase dc accuracy, boasts chopper-stabilized drift performance. When LM121 offset is nulled, drift is guaranteed to be less than $1 \mu\text{V}/^\circ\text{C}$. The LM121A is a factor of five or better, according to National, and guarantees less than $0.2 \mu\text{V}/^\circ\text{C}$ drift, which is said to be even better drift than some chopper-stabilized amps. The internal operating current is programmable from $5 \mu\text{A}$ to $200 \mu\text{A}$, so bias current, gain or noise can be optimized to the application while retaining low drift.

INQUIRE DIRECT

MECL 10,000 subsets answer military needs

Motorola Semiconductor Products Inc., P.O. Box 20924, Phoenix, Ariz. 85036. (602) 273-3466.

MECL 10,000 logic functions are now available for use over the full military temperature range, -55 to $+125$ C, in MC105XX and MC106XX subset lines. Nine standard speed MECL 10,000 devices and one higher-speed device are included in the first group of military-rated parts. Logic circuits in the new subsets are pin and function-compatible with existing MECL 10,000 products. One difference is that the military temperature range devices are specified for driving $100\text{-}\Omega$ loads at their outputs. Higher impedance loads may be used. Packaging of the military temperature range devices is in the hermetic 16-pin black-ceramic DIP.

CIRCLE NO. 281

10 amps of switching in a 1" cube!

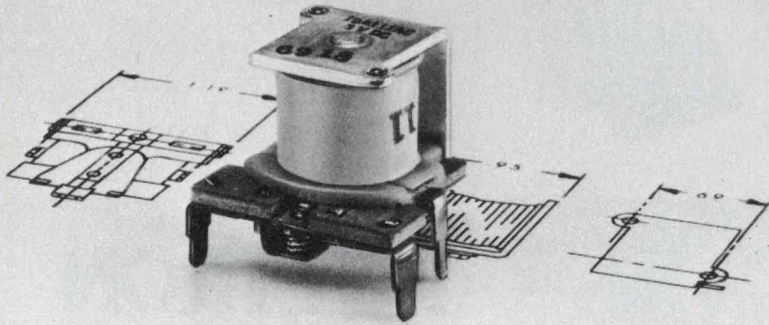

We call it our Series 19 Relay. You'll call it one of the most compact and reliable packages you've ever used.

Remarkable 10 amp Series 19 relay is low in cost, too — less than \$1.00 each in quantity. But price is only part of the story. The Series 19 also offers the advantages of miniaturization and the capacity to handle heavy switching loads. Result: more performance in a smaller overall package. Contact arrangement is SPDT. Rated 10 amps at 28 vdc or 115 v, 60 hz. Coil voltages available range from 3 to 24 vdc. The Series 19 is an ideal choice for a multitude of low level to 10 amp switching applications, including remote control, alarm systems and many other industrial and commercial uses. Equally important, the Series 19 is part of a whole family of interrelated low-cost relays which will lend themselves to multiple usage in the same system. Included are:

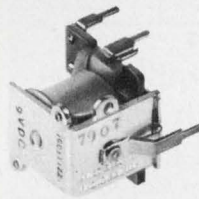

wide range of industrial and commer-

Series 10.

Sensitive, low cost, highly reliable SPDT relay rated at 3 amps, 28 vdc. Coil voltages 3-24 vdc. Can be used for a

cial control functions and alarm systems.

Series 28. Same as Series 10, but furnished with a dust cover for use in appliance controls, remote TV tuning, industrial process controls and similar functions.

Series 38. DPDT, 3 amp 28 vdc contacts. Coil ratings 3-24 vdc. Applications include business machine controls, antenna rotor controls, industrial process controls, etc.

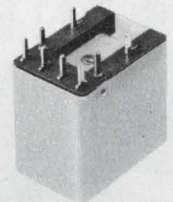
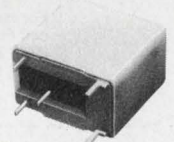

GP. A miniature general purpose relay with 2, 4, or 6 PDT contacts, rated 1, 2 or 5 amps, 28 vdc or 115 v, 60 hz. Coil voltages: 6-115 vdc. Consider the GP for copiers, business machines, control or alarm systems, etc. Available with single or bifurcated contacts.

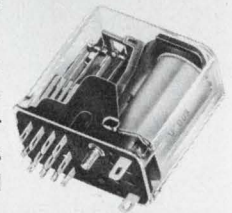

Send for information. Complete technical data on NAPCC relays available on request. Write today.

PRICE ELECTRIC RELAYS

NORTH AMERICAN PHILIPS CONTROLS CORP.

A NORTH AMERICAN PHILIPS COMPANY
E. Church & 2nd St. • Frederick, Md. 21701 • (301) 663-5141

INFORMATION RETRIEVAL NUMBER 51

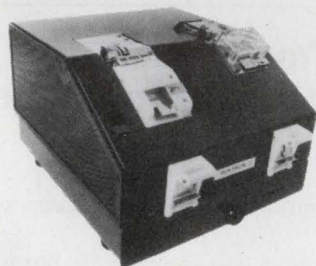
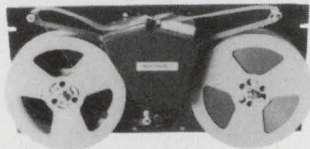
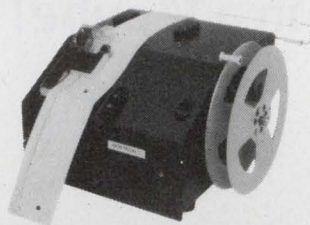

if you're going to use punched paper tape and edge punched cards... use

ROYTRON

the most reliable paper tape and edge punched card punches and readers in the industry for over a decade.

For more information call Frank Misiewicz
OEM Products
(201) 935-2200



OEM PRODUCTS DIVISION
LITTON ABS
Automated Business Systems
600 Washington Avenue, Carlstadt, N. J. 07072

INFORMATION RETRIEVAL NUMBER 52

VIDEO STORAGE



Simple, low cost way to give your displays stop-action and four other competitive advantages—all in one small package.

Introducing the Hughes Model 639 video storage unit. A complete electronic image memory system. With all the circuitry, power and controls built-in to make your displays versatile exhibitions.

It stores alphanumeric, graphic, and pictorial data. With high resolution, high-speed writing capability, selective updating and fast erasure. It converts slow-scan and x-y information to TV format.

It integrates signals (automatically enhancing weak or low light images). It speedily processes and

stores input signals for conversion into TV displays for the medical, management, law enforcement, and many other applications.

If you need close-up images, there's a zoom control, with a positioning joystick. And because it's flexible, it can be customized to star in any graphic display system.

Write for new brochure:
2020 Oceanside Blvd., Oceanside, CA 92054.

Or call:
(714)
757-1200.



INFORMATION RETRIEVAL NUMBER 53

INSTRUMENTATION

Scope plug-in offers time delays to 100 ns

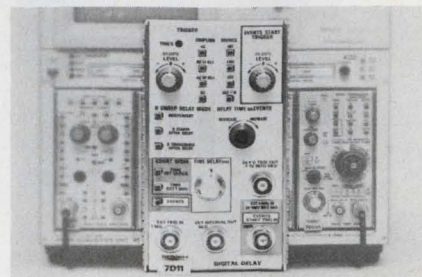

Tektronix, Inc., P.O. Box 500, Beaverton, Ore. 97005. (503) 644-0161. \$1475.

Accurate, stable delays are provided by the 7D11 Series scope plug-in. The unit offers both time delays and delay by a number of events. Delay-by-Time: Following a trigger and after a preselected time, this unit will give a delayed trigger output. The delay time is indicated on the scope CRT READ-OUT and is displayed along with the measured signal. Delay-by-Events: Following a selectable number of events after a master sync or index pulse, the unit provides a low jitter delayed trigger. Accuracy is 0.5 ppm \pm 2 ns and jitter is less than 2.2 ns. Delay times are 100 ns to 1 s with resolution to 1 ns.

CIRCLE NO. 301

Digital test set displays error rate

Tau-Tron Inc., 685 Lawrence St., Lowell, Mass. 01852. (617) 458-6871. \$14,600; 2-4 wks.

The System 1000A/1100A Digital Communications Test Set has a bit-rate testing capability from dc through uhf. The transmitter produces a 127 or 32,767-bit pseudonoise code when clocked from an external source. The receiver generates a local version of the transmitted code. Synchronization is automatic and independent of length of transmission time. The receiver makes bit-by-bit comparisons between the received and the locally generated code. Errors may be counted and displayed, accumulated or may be counted versus the number of bits. The latter provides direct-reading bit error rate.

CIRCLE NO. 302

Test set for phone lines covers broad spectrum

Marconi Instruments Ltd., St. Albans, Hertfordshire, England.

A heterodyne oscillator and a calibrated superheterodyne receiver provide the means for evaluating communication lines in the frequency range of 10 kHz to 20 MHz. The OA 2350/2 system consists of oscillator TF 2351/2 and level-measuring set TF 2352/2. The latter may be used separately or with the oscillator following the receiver. Oscillator output, into a 75 Ω line, is adjustable in 10-dB and 1-dB steps from -71 dBm to +11 dBm. Frequency is adjustable in increments of 100 kHz or may be continuously tuned to within a 1-kHz scale calibration. The measurement range of Model TF 2352/2 is -111 dBm to +1 dBm with selectable bandwidths of 200 Hz to 4 kHz. Provision is made for pen-recorder and headphone output.

CIRCLE NO. 303

ROM programmer replaces wired units

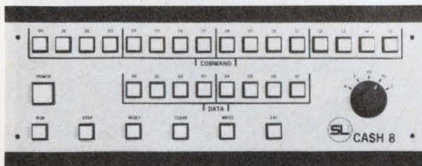

Standard Logic Inc., 1630 S. Lyon St., Santa Ana, Calif. 92705. (714) 835-5466. \$595; 30 days.

The CASH-8 is designed to replace hard-wired controllers for peripheral interfacing and other dedicated applications. Two plug-in cards contain the processor and up to 512 words of TTL ROM for the stored program. Extra cards can be used to extend the program memory to 65-k words. The unit communicates with the controlled devices via a multiplexed I/O bus. Execution time of the computer-like instructions can be as short as 200 ns. A total of 16 programmable registers handle bit manipulation, indexing and I/O. Read/write memory can be tied to the I/O bus to have the CASH-8 act as a data controller or custom minicomputer.

CIRCLE NO. 304

Data terminals use cassettes

Texas Instruments Inc., P.O. Box 1444, Houston, Tex. 77001. (713) 494-5115. \$2750, \$1500; 120 days.

Model 733 is an automatic send/receive type data terminal offering data-transmission rates of 10, 15, 30 and 120 char/s. Data transmission can occur concurrently with off-line data preparation. Other functions provided are off-line block or character editing, tape duplication, selectable record/playback on each cassette and automatic record location. The unit is said to be quiet enough for office use even when printing at the maximum rate of 30 char/s.

CIRCLE NO. 305

300 Mbit/s recorder stores 25-billion bits

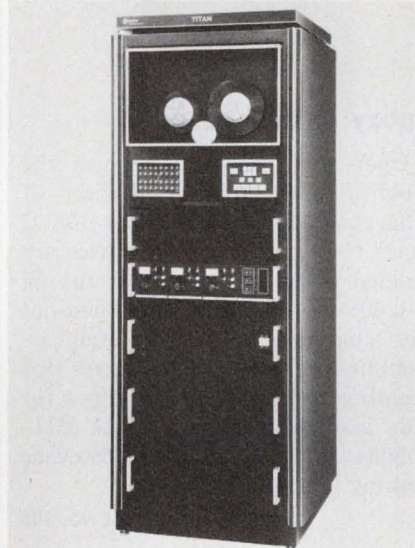

Orion Products Co., Inc., 155 San Lazaro Ave., Sunnyvale, Calif. 94086. (408) 245-4479.

This data recorder stores the equivalent of 68 reels of computer tape. Model GW300 records 16,700 bits/in. on thirty tracks at 10 Mbit/s per track. The combined acquisition rate is 300 Mbit/s, using a recording speed of 600 in/s Video in the form of 20 Hz to 4 MHz FM signals as well as pulse code modulation channels can be combined with the digital data. The unit reads in both directions and can slave its input and output data rates to external clocks. Any recording format can be used including externally generated data headers and error-correcting codes.

CIRCLE NO. 306

Noise Immunity—All solid state MOS circuitry provides higher noise immunity than other electronic counters. **Output Options**—Pulse or latching relay output, selectable by rear terminal connections. Automatic recycling feature works without loss of counts even up to 5,000 cps. **Two 10 amp Outputs**—The counter is preset to the desired number. Upon reaching zero an output signal is provided. In addition, a factory set warning or presignal is available at any number between 9998 and 1. Both output contacts are rated for 10 amps. **LED Display**—Seven segment LEDs provide easy readability and long life. A unique built-in display test circuit is standard. **12 Models**—Counters are available in 2, 3 or 4 digit models, each with or without display and with or without presignal.

Typical applications for the AO 611 are in high speed numerical control, weighing, blending, batching, packaging and cut-to-length operations.

The Hecon Electronic Counter is available from the factory or a distributor near you.

For additional information write or call **Hecon Corporation, P.O. Box 247, Eatontown, N.J. 07724, (201) 542-9200.** In Canada: Hecon of Canada, Ltd., 80 Galaxy Boulevard, Rexdale, Ontario, (416) 678-2441.

electronic predetermining counter has a lot to offer



For five cents, I'd start something.

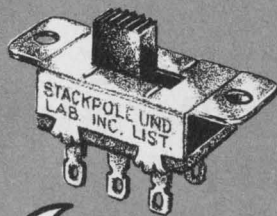
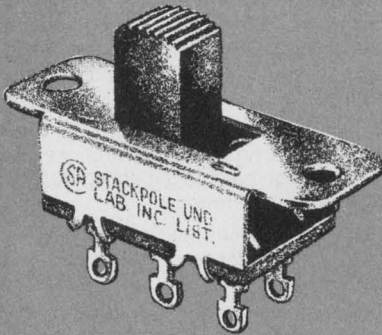

me too.

Turn on with a Stackpole slide switch. Prices start at 5¢ for this field proven standard of the industry. Available in two sizes, Regular and the new 50% smaller Miniature Series. Fully UL and CSA approved. Rated from 1 to 10 amps @ 125 and 250 volts (Miniature Series rated at 3 amps @ 125 V). Over 23 basic types, 7960 variations of slide and rocker switch adaptations. For complete details, send for Bulletin 78/79-100.

STACKPOLE
COMPONENTS COMPANY
Raleigh, N. C. 27610

INFORMATION RETRIEVAL NUMBER 55

evaluation samples

PC and module connectors

An interconnecting system for PC board and chassis use is able to accommodate almost any board-to-board, board-to-component and chassis-to-board application. The connector terminals have bifurcated contacting surfaces and are designed to be used with companion header units with 0.045-in. round, 0.045-in. square and 0.031 × 0.062-in. pins. Both the connector terminals and the companion header pins are located on 0.156-in. centers. Methode Manufacturing Corp.

CIRCLE NO. 307

Epoxy circuit cases

Open stock tooling permits the molding of thousands of sizes of fiberglass laminated epoxy 155 C cases for hybrid circuits. Cases are molded in 18-in. lengths of tubing—0.005-in. thick and up—then cut into channels for potting strip assemblies of circuits, matrixes for molding flat packs or envelopes for side loading. Material meets MIL-C-9084 and MIL-R-9300. Stevens Tubing Corp.

CIRCLE NO. 308

Transistor sockets

Two sockets are designed to enable TO3 and TO66 transistors to be readily mounted on, or removed from, heat sinks, chassis, etc., without soldering the transistor leads. The transistor is simply plugged into the socket and secured by means of two screws, which also connect the transistor case to a solder lug. The socket contacts are silver plated phosphor bronze and terminate in solder lugs. The socket bodies are molded in black phenolic thermosetting plastic and are suitable for continuous operation to 150 C. Jermyn.

CIRCLE NO. 309

Switch on **NOISE**,
Switch off **NOISE**,
Switch on **NOISE**,
Switch off **NOISE**.

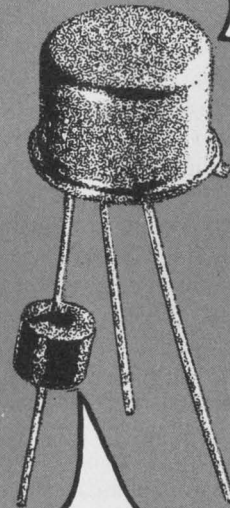

Quiet!

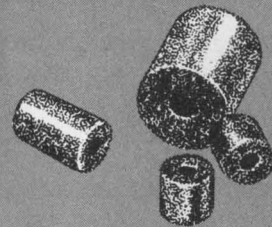

Ceramag® ferrite beads provide a simple, inexpensive means of obtaining RF decoupling, shielding and parasitic suppression without sacrificing low frequency power or signal level. Install beads by slipping one (or more) over appropriate conductor(s) for desired effect. Sizes from .020" ID - .038" OD - .050" L. Beads available with leads for PC boards. Send for samples.

STACKPOLE
Electronic Components Division
St. Marys, Pa. 15857

INFORMATION RETRIEVAL NUMBER 56

ELECTRONIC DESIGN 26, December 21, 1972

Cut and formed leads reduce assembly costs.

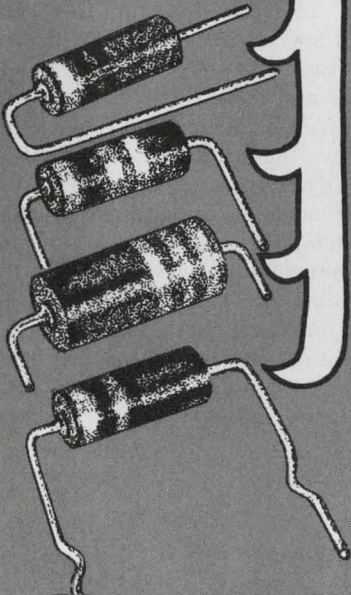

Now that's a nice twist.

Pre-shaped and trimmed resistor leads significantly reduce installation time. All Stackpole carbon composition resistors, 2, 1, 1/2, and 1/4 watts are available with cut and formed leads, to your specifications. Leads are coated for easy soldering. All resistors are 100% tested. Samples available. Send for Bulletin 80-100.



STACKPOLE

Electronic Components Division

Kane, Pa. 16735

application notes

Thyristor firing

Tech Tips 4-2 explains the one correct way and the two incorrect ways of causing a thyristor to turn on and conduct current in the forward direction. Illustrations help give a better understanding of how firing occurs. Westinghouse Electric Corp., Semiconductor Div., Youngwood, Pa.

CIRCLE NO. 320

Phase contrast vs Normarski

An eight-page reprint describes and illustrates through high-quality photomicrographs and charts the difference between phase contrast and Normarski as used in transmitted and reflected light. The paper explains the tremendous advantages of the relatively new Normarski-Interference-Contrast technique. It also credits the merits of conventional phase contrast in transmitted-light microscopy where this optical staining technique has been used successfully for decades. Carl Zeiss, Inc., New York, N.Y.

CIRCLE NO. 321

Telecommunication control

"A Management Guide to Telecommunications Control" describes the requirements for communications control and information handling systems that can accommodate both teleprinting and teleprocessing requirements. Tele-switcher Corp., Dallas, Tex.

CIRCLE NO. 322

Coaxial cable

An application note covers fundamentals of coaxial cables. The note, written in an easy-to-read question and answer style, explains some of the old mysteries of coaxial cables. The paper covers such items as how to figure dB losses in a line and how to determine the optimum impedance of a cable. These and other questions are answered with very little math. Tektronix, Inc., Beaverton, Ore.

CIRCLE NO. 323

You're a penny-pinching, up-tight, li'l switch with no spark.

True.

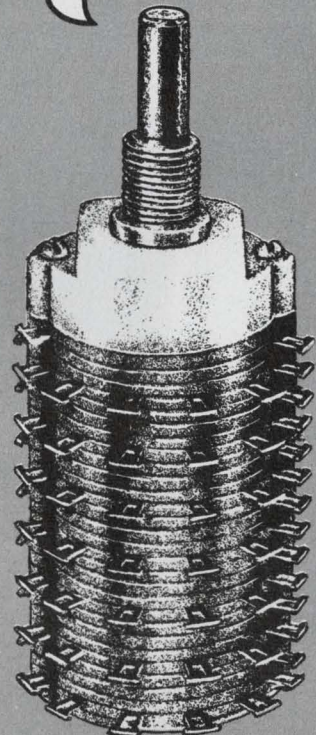

There's no better value than a Stackpole rotary switch. Fast delivery and quality features, but at a price you can afford. Unique design achieves a totally enclosed rotary, without sacrificing complex switching capability. Rigid construction and molded terminals produce a switch so tight it's explosion proof. Samples immediately. Production quantities in 1 to 2 weeks. Including switches with PC mounting. For details, send for Bulletin 73-103.



STACKPOLE

COMPONENTS COMPANY

Raleigh, N. C. 27610

see better...

with
Eldema/Genisco's
new high visibility
IC compatible
L.E.D. indicators.

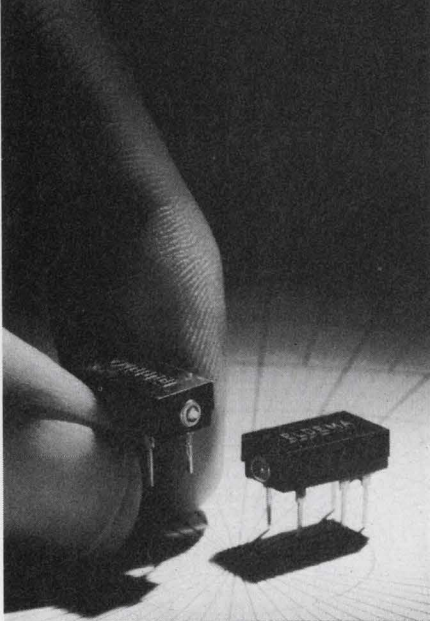

We've got what it takes to lighten your indicator design problems. The new ID series of dual-inline packaged LED's. They mount directly on your PC boards, anywhere that's convenient. And you don't need any special connectors. Their wide viewing angle (160°, or more) and high light output from low-power sources, like IC logic levels, are sure to satisfy the most discriminating requirement. All this and a practically infinite lifetime (nobody's lived long enough to see a LED burn-out)! We also provide the same kind of LEDs in other popular packages such as our low-cost miniature B-Lite series, our subminiature J-Lites, our plug-in cartridge C-Lites and our rugged E-Lites. So contact us and "see better".



Eldema Div., Genisco
Technology Corp.,
18435 Susana Rd.,
Compton, CA 90221
(213) 537-4750.

**25 years of
Technological
Know-How.**

new literature

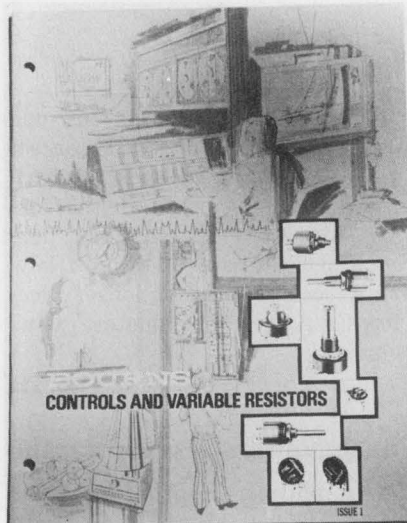

Variable resistors

The Controls and Variable Resistor brochure contains detailed data on the entire product line presented in a format designed for quick, easy reference. A one-page digest provides model numbers, technical data and prices on all models. Bourns, Inc., Riverside, Calif.

CIRCLE NO. 324

Transformers

Industrial control transformers for use in machine tools and in industrial machinery and equipment are featured in a 28-page brochure. The brochure presents comprehensive data on the line of standard products as well as information on the company's capabilities in saturable reactors, chokes and special-purpose transformers. TDC, Inc., Littleton, Mass.

CIRCLE NO. 325

Wiring analyzer

A 16-page brochure details characteristics of the Flexible Automatic Circuit Tester (FACT) system. The brochure illustrates how the FACT wiring analyzer and various functional interconnection methods may be adapted to provide efficient and economical solutions to large volume, exacting test procedures for a wide variety of electronic systems and equipment. Hughes Fact Systems, Los Angeles, Calif.

CIRCLE NO. 326

Pin and socket connectors

A 52-page catalog describes a complete line of pin and socket interconnecting devices for industrial or commercial electronic applications. Full information on the expanded pin socket contact line with quick selection charts for easy visual specifications is provided. A wide range of sizes, dielectric materials and mounting arrangements are offered. Included in the catalog are the electrical, mechanical, and environmental characteristics, specifications, line drawings and product photos of the pin and socket connectors. A five-page section describes all of the company's termination equipment, including crimping, insertion and withdrawal tools for all connectors. Amphenol Industrial Div., Chicago, Ill.

CIRCLE NO. 327

IC sockets

A 16-page, two-color catalog describes sockets for testing and packaging ICs and components. Specifications, schematics, dimensions and photos are included. Augat, Attleboro, Mass.

CIRCLE NO. 328

Technical briefs

"Tech Briefs," a brochure of new aerospace technology, has been published jointly by NASA and the Small Business Administration. "A Current Index of Technical Briefs" lists technology advances in computer programs, electronics and electrical devices, instrumentation, industrial management, plastics, pollution control and detection, safety engineering and seals. "Measurements Technology" contains 35 abstracts dealing with new developments in the field, including surface measurement, alignments and orientation of bodies, fluid measurement, linear and angular measurements and measurement of force. Small Business Administration, Washington, D.C.

CIRCLE NO. 329

Fluoropolymer film

Performance and property data on a fluoropolymer film are contained in a series of publications. The thermoplastic film was developed for rugged service in mechanical, electrical and chemical applications. Du Pont Co., Wilmington, Del.

CIRCLE NO. 330

Resistor networks

Four standard Cordip resistor networks available off-the-shelf are described in a two-page illustrated data sheet. Resistance values are listed and electrical and environmental performance data are given. Corning Glass Works, Corning, N.Y.

CIRCLE NO. 331

Thumbwheel switch

Features of the Type M, H and P thumbwheel switches are described in a 16-page, short-form catalog. The brochure also introduces what is claimed to be the smallest thumbwheel switch—the Type L switch that measures only 0.71 inch (18-mm) high and 0.315 inch (8-mm) wide. Included are electrical, mechanical and environmental specifications and a complete description of options available and their applications. Also included is ordering terminology. The brochure lists complete mounting dimensions and panel cutout requirements. Interswitch, Burlingame, Calif.

CIRCLE NO. 332

NBS Electricity Div.

A brochure describes the Electricity Div. of the National Bureau of Standards. The division conducts a major research program to improve measurement capabilities on a broad front, and disseminates these capabilities through calibration services, seminars, cooperative research programs and publications. The research often involves the application of new techniques to old problems, such as the maintenance of the legal volt by means of the ac Josephson effect. National Bureau of Standards, Washington, D.C.

CIRCLE NO. 333

PC connectors

Over 14 product families containing nearly 1000 individual components are described in a 64-page catalog. Complete specifications, plus application and dimensional data are included for: two-piece connectors, card-edge connectors, single-lead connectors, flexible flat cable connectors and a variety of other types for printed circuit applications. Complete packaging concepts are explained. Hand tools for maintenance and production of interconnection systems for printed circuitry, as well as automatic and semiautomatic machinery are also described. AMP, Inc., Harrisburg, Pa.

CIRCLE NO. 334

Panel, edge-reading meters

A complete description, application information and specifications for over 20 panel, edge-reading and control meter models in more than 70 standard ranges are covered in a 20-page catalog. High-density Miniscan systems and monitoring control meter relays are also included. Airpax Electronics/Controls Div., Fort Lauderdale, Fla.

CIRCLE NO. 335

A/d-d/a converters

A 36-page catalog contains detailed electrical and mechanical information on a line of ultra-miniature a/d and d/a converters, plus accessory operational amplifiers, sample-and-hold amplifiers, analog multiplexers, miniature dc power supplies, and a line of modular and rack mount data acquisition systems. Hardware described in the catalog forms the basic building blocks for many forms of data acquisition, data analysis, data reproducing and graphic display equipment. Datel Systems, Inc., Canton, Mass.

CIRCLE NO. 336

Switches

Miniature switch packages, joystick and push-button switches are described in a 10-page catalog. Features, operation and electrical data are included as well as typical applications and characteristics. Machine Components Corp., Plainview, L.I., N.Y.

CIRCLE NO. 337

POWER SPLITTERS-COMBINERS

Great Value at

\$7⁹⁵
500 piece quantities.

\$9.95 in 6-piece quantities.

0.1-400MHz
0.5dB insertion loss
40dB isolation
EMI shielded case

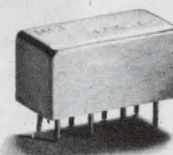

A breakthrough in technology and high production volume enables Mini-Circuits Laboratory to offer these new products at an unprecedented low price.

In today's tough competitive market can you afford not to use these remarkably low priced and high performance units?

Ruggedness and durability are built in the PSC2-1. Packaged within an EMI shielded metal enclosure and hermetically sealed header. This new unit uses a broadband hybrid junction and uniquely designed matched transmission line transformers.

We invite you to convince yourself. Place your order now and check our delivery, product performance and reliability.

Mini-Circuits Laboratory

2913 Quentin Rd., Brooklyn, N.Y. 11229
(212) 252-5252, Int'l Telex 620156
A Division Scientific Components Corp.

FRANCE: S.C.I.E., *31, rue George-Sand, Palaiseau 91, France. GERMANY, AUSTRIA, SWITZERLAND: Industrial Electronics GMBH, *Klüberstrasse 14, 6000 Frankfurt/Main, Germany *UNITS IN STOCK

INFORMATION RETRIEVAL NUMBER 60

NEW SHORTER CASE! SCHAUER 1-WATT ZENERS

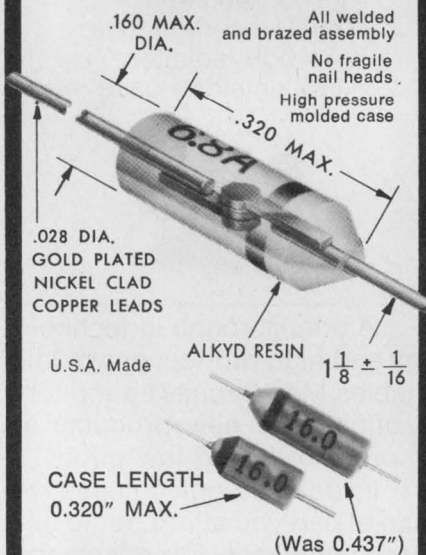

**SAME LOW PRICES FOR
1% TOLERANCE ZENERS
ANY VOLTAGE
FROM 2.0 TO 18.0**

Quantity	Price Each
1-99	\$1.07
100-499	.97
500-999	.91
1000-4999	.86
5000 up	.82

IMMEDIATE SHIPMENT
Send for rating data and
20%, 10%, 5% and 2%
tolerance prices.

Semiconductor Division

SCHAUER

MANUFACTURING CORP.

4511 Alpine Ave., Cincinnati, Ohio 45242
Telephone 513/791-3030

NEW LITERATURE

PHOTOELECTRIC PUNCHED TAPE READERS

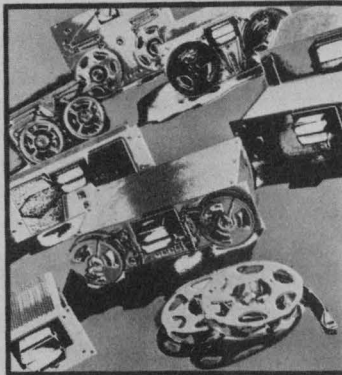

E.E.C.O. ELECTRONIC ENGINEERING
COMPANY OF CALIFORNIA

Punched tape readers

A broad line of photoelectric punched tape readers for commercial, industrial and ruggedized military applications are covered in a 56-page catalog. Electronic Engineering Company of California, Santa Ana, Calif.

CIRCLE NO. 338

Proximity switch

Product Sheet 10FL describes the low-cost, self-contained, solid-state proximity switch. The illustrated brochure lists features and applications of the all-metals-sensitive unit, along with electrical specifications, mounting dimensions, a mass-sensitivity table, wiring schematic and ordering instructions. Micro Switch, a div. of Honeywell, Inc., Freeport, Ill.

CIRCLE NO. 339

Data entry system

The CMC 5 KeyProcessing System, for computer-controlled data entry, is described in an eight-page, four-color illustrated brochure. The brochure summarizes the unit's major features and functions. Software capabilities are described as are the system's hardware elements. The system also includes an ASR 33 teleprinter and, optionally, an 80-column or a 132-column line printer. Computer Machinery Corp., Los Angeles, Calif.

CIRCLE NO. 340

Terminal block guide

A compact, six-page brochure makes use of convenient tables and charts to present information on terminal blocks, relay socket assemblies and standard control assemblies. Terminal blocks are presented in order of capacity from the high-current blocks for power circuits to control circuit blocks and low-capacity blocks for electronic circuitry. All pertinent dimensions and other data required for the selection of a component for a specific application are included. Curtis Development and Manufacturing Co., Inc., Milwaukee, Wis.

CIRCLE NO. 341

Disc-type thyristors

Four technical data sheets give full rating information, curves and order instructions on four versions of the company's Pow-R-Disc thyristors, a silicon-controlled rectifier supplied in disc form with double-sided cooling. Typical applications of these three devices are motor control circuits and transformer primary circuits in power supplies. Westinghouse Electric Corp., Semiconductor Div., Youngwood, Pa.

CIRCLE NO. 342

Replacement components

The 32-page Commercial Products Catalog contains details on a wide range of products from replacement components for home entertainment and industrial electronic equipment to components for hobbyists. Components for home entertainment equipment include transistors, ICs, rectifiers, diodes, solid-state tube replacements and electrolytic capacitors. Among the components for industrial electronics are SCRs, selenium stacks and voltage transient protectors. Solar cells, fiber optics, knobs, PC board material, relays, switches, heat exchangers, project and engineering handbooks and semiconductors are featured. Photographs, case diagrams of the devices and price information are included. International Rectifier Corp., Semiconductor Div., El Segundo, Calif.

CIRCLE NO. 343

bulletin board

A report covering the recent electronics communications trade mission to the Soviet Union and Poland has been published by the Communications and Electronics Div., Electronic Industries Association. The report offers comments on the state-of-the-art of communications technology, covers highlights of the trade mission and lists key government agencies in the two countries which have responsibility for the development and purchase of communications equipment.

CIRCLE NO. 344

Price reductions

Hewlett-Packard has announced reductions of over 20% in core memory prices and new OEM and volume user discount schedules.

CIRCLE NO. 345

The Tylan Corp. has announced a reduction in price from \$1100 to \$900 for its FCS-100 mass flow controllers in quantities from one to nine. OEM and quantity pricing are correspondingly reduced.

CIRCLE NO. 346

Milgo Electronic Corp.'s subsidiary, International Communications Corp., has announced reductions ranging from 2% to 17% in the selling price and 14% to 50% in the lease price of its high-speed modems.

CIRCLE NO. 347

Data Technology Corp. has announced a 20% reduction for its Model 370 five-digit multimeter and options. The basic price is \$1195 down from \$1450. The price with options: \$1195 with millivolt ranges, \$1395 with five or six resistance ranges and \$1795 with ohms and ac.

CIRCLE NO. 348

Another Sprague Breakthrough!

PRODUCTION-ORIENTED SOLID TANTALUM CAPACITORS

Solid flame-retardant epoxy with precise dimensions for automatic insertion. Completely shock and vibration resistant.

Flat surface permits clear easy-to-read marking.

No rundown to interfere with seating of capacitors on printed wiring board.

Rugged 0.025" dia. tinned leads maintain alignment. 0.100" lead spacing for standard PWB grids.

Top flat for easy identification of positive lead either visually or by touch.

Standoff feet on base to eliminate moisture entrapment and facilitate cleaning of wiring boards.

Formed leads with either 0.200" or 0.250" spacing to permit interchangeability with dipped capacitors.

ACTUAL SIZE

Type 198D Low-cost Econoline* Tantalum Capacitors Lead in Performance!

When it comes to low-cost solid tantalum capacitors, the new Sprague Type 198D Econoline Capacitors outperform all other designs. Here are some additional advantages:

- Low d-c leakage
- Low dissipation factor
- Wide voltage range, 4 to 50 VDC
- Capacitance range from 0.1 to 100 μ F
- Withstand severe temperature cycling and temperature shock over -55 C to +85 C
- Speedier handling for insertion
- Easier-to-read markings

The new Sprague Type 198D epoxy-encased Econoline Capacitor is tooled for mass production and priced competitively with imported dipped units. Investigate this new Sprague breakthrough without delay.

Call your nearest Sprague district office or sales representative, or write for Engineering Bulletin 3546 to: Technical Literature Service, Sprague Electric Co., 347 Marshall Street, North Adams, Mass. 01247.

*Trademark

THE BROAD-LINE PRODUCER OF ELECTRONIC PARTS



INFORMATION RETRIEVAL NUMBER 62

ELECTRONIC DESIGN's function is:

- To aid progress in the electronics manufacturing industry by promoting good design.
- To give the electronic design engineer concepts and ideas that make his job easier and more productive.
- To provide a central source of timely electronics information.
- To promote communication among members of the electronics engineering community.

Want a subscription? ELECTRONIC DESIGN is sent free to qualified engineers and engineering managers doing design work, supervising design or setting standards in the United States and Western Europe. For a free subscription, use the application form bound in the magazine. If none is included, write to us direct for an application form.

If you do not qualify, you may take out a paid subscription for \$30 a year in the U.S.A., \$40 a year elsewhere. Single copies are \$1.50 each.

If you change your address, send us an old mailing label and your new address; there is generally a postcard for this bound in the magazine. You will have to requalify to continue receiving ELECTRONIC DESIGN free.

The accuracy policy of ELECTRONIC DESIGN is:

- To make diligent efforts to ensure the accuracy of editorial matter.
- To publish prompt corrections whenever inaccuracies are brought to our attention. Corrections appear in "Across the Desk."
- To encourage our readers as responsible members of our business community to report to us misleading or fraudulent advertising.
- To refuse any advertisement deemed to be misleading or fraudulent.

Microfilm copies are available of complete volumes of ELECTRONIC DESIGN at \$19.00 per volume, beginning with Volume 9, 1961. Work is now in process to complete the microfilm edition of Volumes 1-8. Reprints of individual articles may be obtained for \$2.00 each, prepaid (\$.50 for each additional copy of the same article) no matter how long the article. For further details and to place orders, contact the Customer Services Department, University Microfilms, 300 North Zeeb Road, Ann Arbor, Michigan 48106 telephone (313) 761-4700.

Want to contact us? If you have any comments or wish to submit a manuscript or article outline, address your correspondence to:

Editor
ELECTRONIC DESIGN
50 Essex Street
Rochelle Park, N.J. 07662

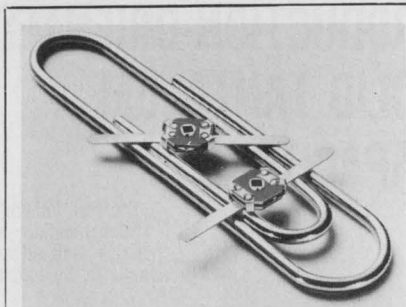

Thin-Trim® variable capacitors are designed to replace fixed tuning techniques. Applications include crystal oscillators, CATV amplifiers, communication and test equipment. Series 9410 has high Q's with five capacitance ranges from 1.0 - 4.5 pf to 10.0 - 50.0 pf. Johanson Manufacturing Corporation, Boonton, N. J. (201) 223-2676

INFORMATION RETRIEVAL NUMBER 181

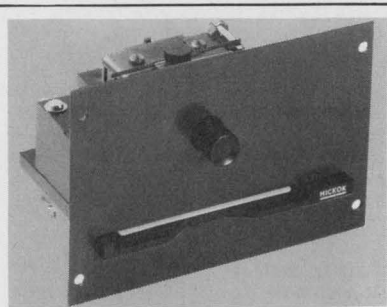

264-bit Badge Reader is designed for data collection, identification and simplified system programming. TTL-compatible electronic interfaces are available to scan punched information and present it in character serial format. Single unit, \$175. Hickok Electrical Instrument Co., 10514 Dupont Avenue, Cleveland, Ohio 44108. (216) 541-8060.

INFORMATION RETRIEVAL NUMBER 182

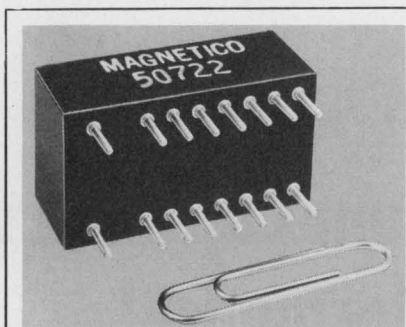

Scott-T-Transformers — Miniature size 13/16 x 1-1/2 x 5/8, input 90 or 11.8 volts, line to line, 400 Hz, output sine and cosine, 60 secs. accuracy, cost \$19. in quantity. Write for standard literature. Synchro to resolver & resolver to synchro. Magnetic, Inc., East Northport, N.Y. 11731. (516)-261-4502.

INFORMATION RETRIEVAL NUMBER 183

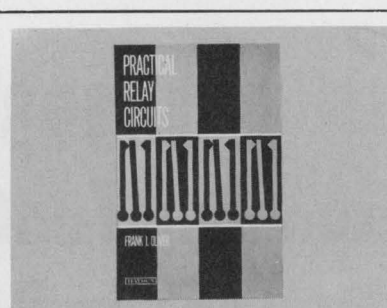

Practical Relay Circuits, by Frank J. Oliver. Time-saving guide classifies relays by function, presenting a rapid overview of the circuits that can solve the problem at hand. 384 pp., illus., cloth, \$14.95. Circle below for 15-day examination copies. Hayden Book Co., New York, N.Y. 10011.

INFORMATION RETRIEVAL NUMBER 184

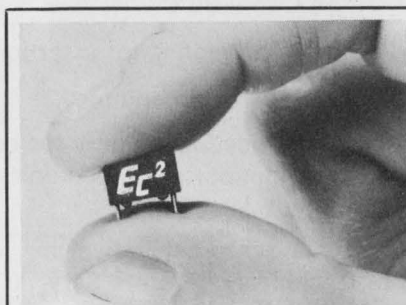

EC² offers nearly 100 capacitance values in its new line of 100-Volt Flat-Pak, Axial and Radial-Lead Metallized-Polypropylene Capacitors. Capacitors are epoxy encapsulated in Diallyl Phthalate. Stand-off feet are provided on both Flat-Pak and Radial Lead units. Engineered Components Co., 2134 W. Rosecrans Ave., Gardena, Cal. 90249. (213) 321-6565.

INFORMATION RETRIEVAL NUMBER 185

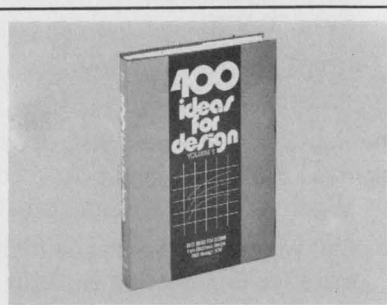

400 Ideas for Design, Vol. 2, Edited by Frank Egan. Ready to borrow, modify, or adapt, the top recent contributions to Electronic Design's popular "Ideas for Design" column range from amplifiers to switching circuits. 288 pp., illus., cloth, \$11.95. Circle below for 15-day examination copies. Hayden Book Co., New York, N.Y. 10011.

INFORMATION RETRIEVAL NUMBER 186

Electronic Design

Advertising Sales Staff

Bryce Gray
Sales Manager

Rochelle Park, N.J. 07662

Robert W. Gascoigne
Daniel J. Rowland
50 Essex Street
(201) 843-0550
TWX: 710-990-5071

Philadelphia

Thomas P. Barth
50 Essex Street
Rochelle Park, N. J. 07662
(201) 843-0550

Boston 02116

Richard L. Green
20 Columbus Avenue
Boston, Mass.
(617) 482-7989

Chicago 60611

Thomas P. Kavooras
Berry Conner, Jr.
200 East Ontario
(312) 337-0588

Cleveland

Thomas P. Kavooras
(Chicago)
(312) 337-0588
(call collect)

Los Angeles 90303

Stanley I. Ehrenclou
Burt Underwood
2930 Imperial Highway
Inglewood, Calif
(213) 757-0183

San Francisco 94022

Jerry D. Latta
P.O. Box 1248
Los Altos, Calif.
(415) 965-2636

London W. 1

For United Kingdom and Holland
Brayton C. Nichols

For Eastern Europe
Peter Kehr

The American Magazine Group
9 Warwick Street
London, W. 1, England
Phone: 437 5462
Cable: Ammagnic, London

4800 Verviers, Belgium

For Continental Europe
Andre Jamar
Rue Mallar, 1
(087) 253.85 Telex 41563

Tokyo

Haruki Hirayama
Electronic Media Service
5th Floor, Lila Bldg.,
4-9-8 Roppongi
Minato-ku
Phone: 402-4556
Cable: Electronicmedia, Tokyo



Design Data from Manufacturers

Advertisements of booklets, brochures, catalogs and data sheets. To order use Reader-Service Card.
(Advertisement)

LOW COST MAGNETIC SHIELDS IN MINUTES



Quickly cut AD-MU high & low permeability foils to your exact shape for time saving, convenient, economical magnetic shielding. No waiting. In many applications, foils can eliminate costs of designing and manufacturing pre-fabricated shields. Also useful for those hard-to-get-at places. Furthermore, they permit more compact assemblies, accomplished by placing magnetically reacting components closer together without performance degradation. Delivery from stock. Ask about our free sample policy.

CIRCLE NO. 171

Ad-vance Magnetics, Inc.

The Magnetic Shielding Specialists
226 E. Seventh St., Rochester, Indiana 46975. (219) 223-3158

Free Wallchart Of Waveform Comparisons

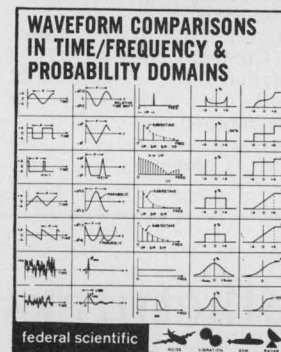

For analyzing random data such as noise, vibration, shock, underwater acoustic signals, and radar, this unique new engineering tool is a convenient picture-reminder of how 10 different basic waveforms look in terms of 5 different processing domains. The waveforms consist of 5 examples of repetitive waveshapes & 5 different random signals. The typical functions shown are: time, auto-correlation, averaged frequency spectrum (PSD), probability density, & cumulative distribution. Printed on heavy glossy stock, the 10" x 12" wallchart is free by writing directly to Federal Scientific, originators of the Ubiquitous® brand of real-time spectrum analysis equipment.

CIRCLE NO. 172

FEDERAL SCIENTIFIC CORP.

615 West 131st Street, New York, N.Y. 10027

Circuit Zaps® for Instant PC Boards



Circuit Zaps® are 1 ounce copper circuit component patterns, pads, and conductor paths, precision-etched on 5 mil (.005") glass epoxy base material, backed by a special pressure-sensitive adhesive. Circuit Zaps® completely eliminate the artwork, photography, photoprinting, touch up, etching, stripping, and other time-consuming steps in PC board development.

Write today for the FREE TECHNICAL BULLETIN 1003 with FREE SAMPLE.

CIRCLE NO. 173

Bishop Graphics, Inc.

7300 Radford Avenue (ED)
North Hollywood, California 91605
(213) 982-2000 Telex 674672

advertiser's index

Advertiser	Page	Advertiser	Page	Advertiser	Page
ADC Products, Inc., A Division of Magnetic Controls Company.....	63	ECC Corporation	38	ITT Semiconductors, A Division of International Telephone and Telegraph Corporation	67
Ad-Vance Magnetics, Inc.	95	Electro Scientific Industries	16A	Intech, Incorporated	80
Alco Electronic Products, Inc.	84	Electronic Arrays, Inc.	70	Integrated Microwave Systems, Inc... ..	97
Amphenol Alliance Marketing Service	31	Electronic Design	12, 13, 19, 97		
		Engineered Electronics Company	94		
		Exar Integrated Systems	1		
Belden Corporation	20, 21	Fairchild Semiconductor, A Division Fairchild Camera and Instrument Corporation	8, 9	Johanson Manufacturing Corp.....	7, 94
Bendix Corporation, The, Electrical Components Division.....	29	Federal Scientific Corporation.....	95		
Biomation, Inc.	81			Lambda Electronics Corp.	Cover II
Bishop Graphics, Inc.	95	General Automation, Inc.....	14, 15	Littlefuse, Inc.	11
Bourns, Inc., Trimpot Products Division	22	General Electric Company, Semiconductor Products Department	25	Litton Industries OEM Products Division	86
Business Publications Audit of Circulation	16D	General Radio Company.....	40		
By-Buk Company	96	Genisco Technology Corporation, Eldema Div.	90	MCL, Inc.	77
				3M Company	39
CTS Corporation	57	Halex, Inc.	70	Magneto, Inc.	94
Caddock Electronics	82	Harris Semiconductor, A Division of Harris Intertype Corporation	16B-C	Mini-Circuits Laboratory, A Division of Scientific Components Co.	91
Centralab, the Electronics Division of Globe-Union, Inc.	74, 75	Hayden Book Company, Inc. 46, 47, 94		Molex, Incorporated	Cover III
Control Data Corporation, Magnetic Components Division	97	Hecon Corporation	87	Monsanto Commercial Products Co. 37	
Corning Glass Works.....	70	Hewlett-Packard	51	Motorola Component Products Dept. 69	
Corning Glass Works, Electronic Materials Department	16	Hickok Instrumentation and Controls Division	94	Motorola Semiconductor Products, Inc.	4, 5
		Hughes Aircraft Company.....	86		
Dow Corning Corporation	52, 53, 79	Hycomp	65	North American Philips Controls.....	85
				Nytronics, Inc.	83

Design Data from Manufacturers

Advertisements of booklets, brochures, catalogs and data sheets. To order use Reader-Service Card.
(Advertisement)

PC Drafting Aids Catalog

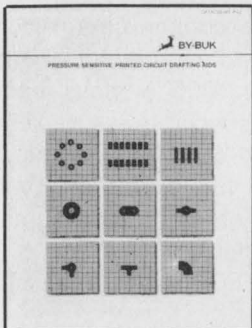

Thousands of time saving, cost saving artwork ideas are found in the By-Buk P-50 catalog of pressure sensitive printed circuit drafting aids. With the most practical artwork patterns for: TO cans, multi-pads, dual-inlines and flat packs featured. Donuts, connector strips, teardrops, ovals, tapes, tees, elbows, etc., by the hundreds are included in the most comprehensive list of sizes. Opaque black, transparent red and transparent blue materials for one and two-sided board designs. For a free copy and samples, write today.

CIRCLE NO. 174

By-Buk Company

Subsidiary of Webtek Corp., 4326 W. Pico Blvd.
Los Angeles, California 90019 (213) 937-3511

Oak Industries, Inc.35

Power/Mate Corp. 6

RCA Solid State DivisionCover IV

Rogan Brothers, Inc. 70

Schauer Manufacturing Corp. 92

Signetics Corporation

33

Siliconix Incorporated

44

Sloan Co., The

27

Sprague Electric Company

93

Stackpole Carbon Company

88, 89

Stackpole Components Company.....

88, 89

Summit Engineering Corporation.....

97

TRW/UTC Transformers, an
Operation of TRW Electronic
Components

84

Tektronix, Inc.43, 61, 73

Teledyne Relays, A Teledyne
Company

2

Texas Instruments Incorporated.....

17, 18

USCC Centralab, Electronics
Division, Globe-Union Inc.....

60

Vectron Laboratories, Inc. 98

Victoreen Instrument Division

10

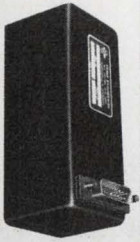

A Unique Servo Package? IF YOU CAN DEFINE IT ...CEDAR CAN PROBABLY PRODUCE IT!

Unique, exclusive "leadership experience" for over 20 years gives Cedar an edge over other suppliers—an edge that can mean higher performance and lowest-cost-to-the-user for the life of your product!

Cedar can put it all together to meet your most unusual servo-package performance specs. Military-grade components—synchronizers, converters, integrators, error detectors, gear trains, switches and all the rest—plus Cedar's innovative design talent, can deliver the servo-package that delivers to your satisfaction.

SERVO PACKAGES BROCHURE, yours for the asking, details a typical cross-section of Cedar's truly imaginative packages.

Send for your copy today!



CEDAR AVIONICS from:

MAGNETIC COMPONENTS DIVISION

CONTROL DATA CORPORATION

7801 Computer Ave. So., Minneapolis, Minn. 55435
(612) 920-8600 TWX 910-576-2978

INFORMATION RETRIEVAL NUMBER 63

WANTED

THE NEWEST
MEMBER OF THE

SUMMIT GANG

Schottky B. Diode alias: "HOT CARRIER"

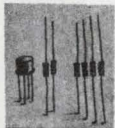

5600

The 5600 family of identical twins and quadruplets (pairs & quads) have recently joined other notorious members of the SUMMIT gang on the MOST WANTED LIST. Their precision computer matched characteristics of less than .05 pf and 5 millivolts over the 60 microamps to 20 milliampere dynamic range, make any pair or quad of the 5600 family easily recognizable. They are known to frequent the highest quality instruments and communications equipment pulling the most critical jobs under extreme conditions.

CAUTION: Some of the SUMMIT pairs and quads are known to conceal themselves as TO-5 Assemblies. They are RFI shielded and have accurate thermal tracking with ultrafast switching capabilities.

NOTICE: The SUMMIT gang is offering their precision computer matching and/or sorting services to other gangs.

REWARD!

PRODUCTION \$\$\$ SAVINGS!!

IF YOU DON'T KNOW HIS WHEREABOUTS :

CONTACT **SUMMIT engineering corporation**
Box 938 Bozeman, Montana 59715 Ph.(406)587-0636 twx(910)975-1950

INFORMATION RETRIEVAL NUMBER 64

When you take the most creative engineering and production people you can find . . . People who grew up in semiconductor technology . . . Develop the best thick-film operation in the industry . . . Complete with such refinements as in-house computer-controlled laser resistor trimming . . . And construct a large volume production capability . . . And offer complete custom services . . . and more . . . you have

INTEGRATED MICROSYSTEMS INCORPORATED

16845 Hicks Road
Los Gatos, California 95030
(408) 268-2410

THE
HYBRID
PROFESSIONALS

INFORMATION RETRIEVAL NUMBER 65

We need a SENIOR ELECTRONICS ENGINEER



**whose ideas
and talent
can move us
into new
product
areas.**

Vectron Labs is a leading producer of Crystal Oscillators and Frequency Standards, with a reputation for technical excellence. We are looking for a creative electronics engineer, who can lead us into other non-military oriented products. If you possess that rare combination of product creativity and circuit design expertise, Vectron can offer you a real opportunity. Please write in full confidence to the attention of Alfred Camhi, President. Your reply should indicate general ideas for new Vectron product areas.



**VECTRON
LABORATORIES, INC.**

121 Water Street
Norwalk, Conn. 06854
203/853-4433

4600

INFORMATION RETRIEVAL NUMBER 900

product index

Information Retrieval Service. New Products, Evaluation Samples (ES), Design Aids (DA), Application Notes (AN), and New Literature (NL) in this issue are listed here with page and Information Retrieval numbers. Reader requests will be promptly processed by computer and mailed to the manufacturer within three days.

Category	Page	IRN	Category	Page	IRN
Components			d/a converter	80	268
capacitor trimmers	76	260	dividers	80	270
data entry system (NL)	92	340	filters	80	271
LED indicator	76	263	PROM	82	251
LED lamps	76	262	photodetector	81	275
photodetector	81	275	power supply	80	273
phototransistor	84	280	power supply	81	274
proximity switches (NL)	92	339	voltage tripler	80	269
resistor fuse	76	265	Packaging & Materials		
resistors, noninductive	76	258	coaxial cable (AN)	89	323
resistors, variable (NL)	90	324	epoxy circuit cases (ES)	88	308
sludge detector	76	264	fluoropolymer film (NL)	91	330
switches (NL)	91	337	pin and socket		
thermistor probe	76	261	connectors (NL)	90	327
thumbwheel switch	76	259	terminal blocks guide		
transformers (NL)	90	325	(NL)	92	341
Data Processing			transistor sockets (ES)	88	309
a/d converter	78	266	new literature		
d/a converter	78	267	a/d-d/a converters	91	336
d/a converter	80	268	components	92	343
data terminal	87	305	data entry system	92	340
delay, digital	86	301	disc-type thyristors	92	342
programmer, digital	87	304	fluoropolymer film	91	330
recorder, digital	87	306	IC sockets	90	328
tape readers (NL)	92	338	NBS standards	91	332
telecommunications (NL)	89	322	PC connectors	91	334
test set for telephone	87	303	panel meters, edge reading	91	335
ICs & Semiconductors			pin and socket		
disc-type thyristors (NL)	92	342	connectors	90	327
display driver	84	278	proximity switches	92	339
driver/amp/converter	84	279	resistor networks	91	331
LED indicator	76	263	resistors, variable	90	324
LED lamps	76	262	switches	91	337
MECL subsets	85	281	tape readers	92	338
PROM	82	251	technical briefs	90	329
phototransistor	84	280	terminal blocks guide	92	341
rectifiers	83	277	thumbwheel switch	91	332
sense amp/data register	83	276	transformers	90	325
thyristors (AN)	89	320	application notes		
Instrumentation			coaxial cable	89	323
delay, digital	86	301	microscopy	89	321
digital tester	86	302	telecommunications	89	322
recorder, digital	87	306	thyristors	89	320
test set for telephone	87	303	evaluation samples		
wiring analyzer (NL)	87	303	connectors	88	307
Microwaves & Lasers			epoxy circuit cases	88	308
amp, wideband	72	257	transistor sockets	88	309
holographic camera	72	255			
instrumentation amp	72	253			
mixer	72	252			
rf amplifier	71	250			
tester	72	254			
trimmer, manual	72	256			
Modules & Subassemblies					
a/d converter	78	266			
amplifier	80	272			
d/a converter	78	267			

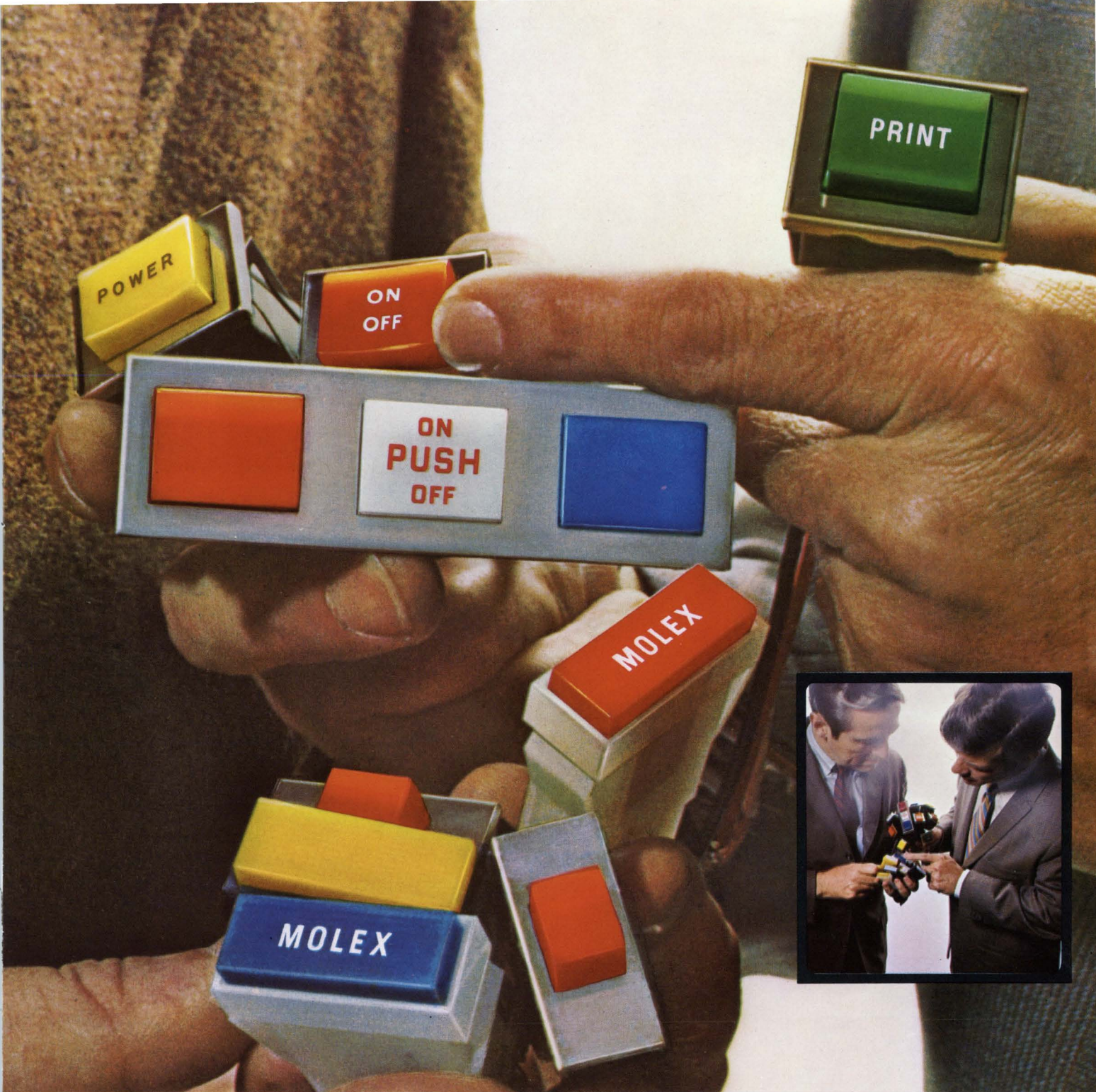

HERE ARE TWO EASY WAYS TO SOLVE LIGHTED PUSH BUTTON SWITCH PROBLEMS. Economically. Reliably. Fast. The Molex 1175 snap mounts. Offers spade or wire terminals for fast, easy assembly. A choice of nine colors, 500 variations. And look at the Molex 1820. You can use one, or a gang of them, for an infinite variety of applications. Lighted push button can be wired to light independently of the switch. And it's available in colors galore. Best of all . . . both switches are priced considerably under one

dollar in quantity. ■ These components are good examples of the Molex creative approach to design problems. And we have the ability to design reliability and ease of assembly into a product without letting costs run wild due to over-engineering. ■ If this makes sense, and you would like a *free sample* of either the 1175 or 1820 switch, write: Molex Incorporated, Lisle, Illinois 60532. Or phone (312) 969-4550.

...creating components that simplify circuitry



This is no time for popcorn noise...

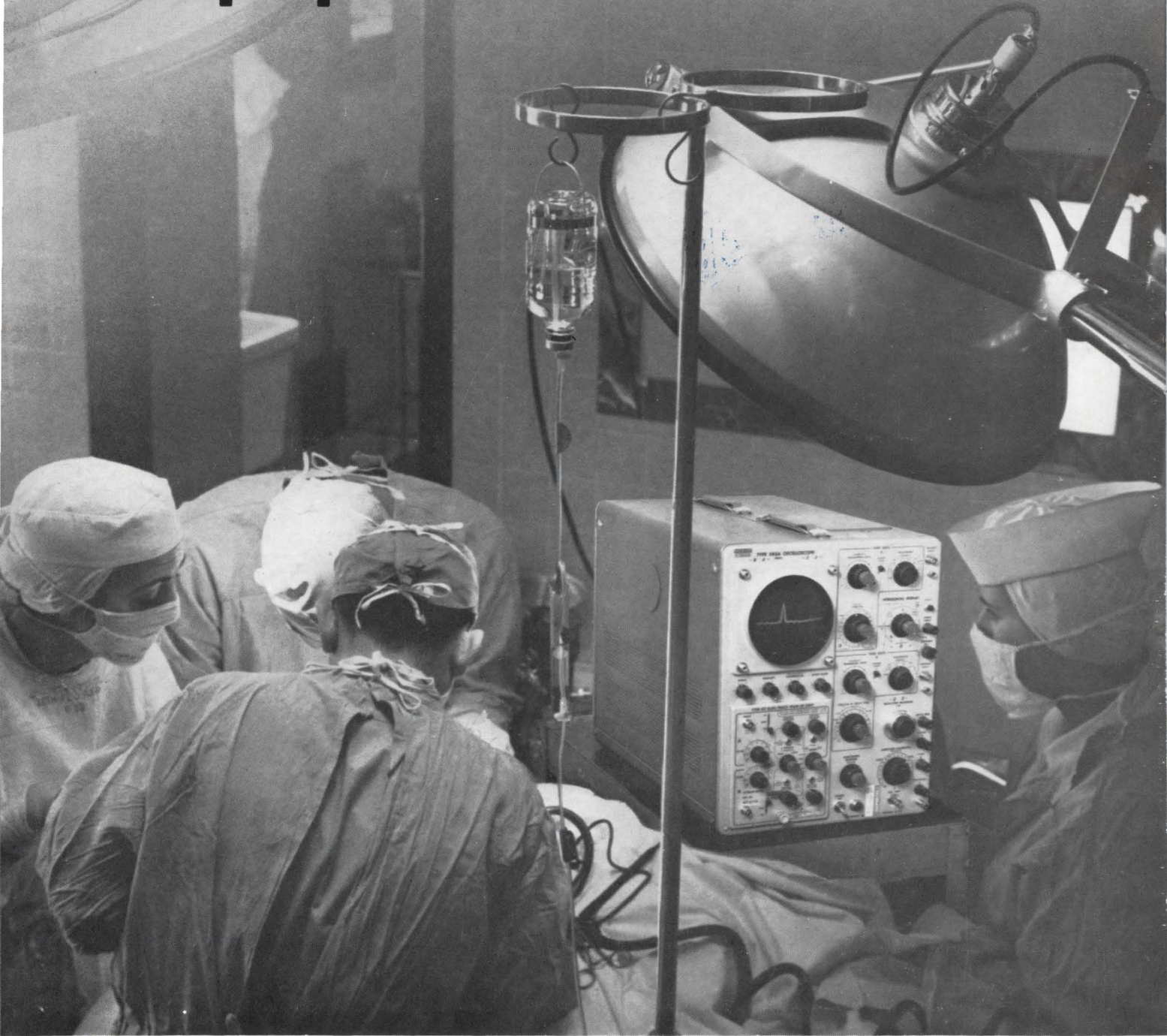

In fact, no time is acceptable for Popcorn (burst) noise, if you're designing a system to handle extremely small signals.

So RCA is announcing a new micropower, low noise operational amplifier. It's a designer's dream.

Our unique process gives you a monolithic silicon op amp that not only exhibits low burst noise but operates from a single 1.5-volt cell with a power consumption of 1.5 microwatts.

How low is the noise? Every CA6078AT op amp that leaves RCA must operate with equivalent

input burst noise less than 20 μ V (peak) at $R_s=200,000$ ohms.

That's not all, the CA6078AT features output short-circuit protection through built-in output resistors, input voltage range (± 15 V max. for ± 15 V supply) wide dif-mode range (± 6 V), and low offset-voltage nulling capability.

So go ahead! Design the CA6078AT into your system... and relax. Because you can be certain that with the new RCA micropower op amp, no time is acceptable for popcorn (burst) noise.

Want more data on the

CA6078AT or CA3078AT (the low cost version of the CA6078AT for less critical applications) or the CA6741T, RCA's low-burst-noise 741? See your RCA Representative or Distributor and ask for Technical Bulletins, File No. 530 and 592 and Application Note ICAN-6732. Or write RCA Solid State, Box 3200, Somerville, N.J. 08876. Phone (201) 722-3200.

RCA Solid State

products that make products pay off