

# Electronic Design 19

VOL. 24 NO

FOR ENGINEERS AND ENGINEERING MANAGERS

SEPT. 13, 1976

See  $\mu$ P memory accesses in unique formats. A new kind of analyzer not only catches data, it displays information in four ways. Use the memory mode to

get the big picture of read-write activity. Then go into the page mode to look at details. Thumb through program listings or word sequences. Sort it out: p.129.

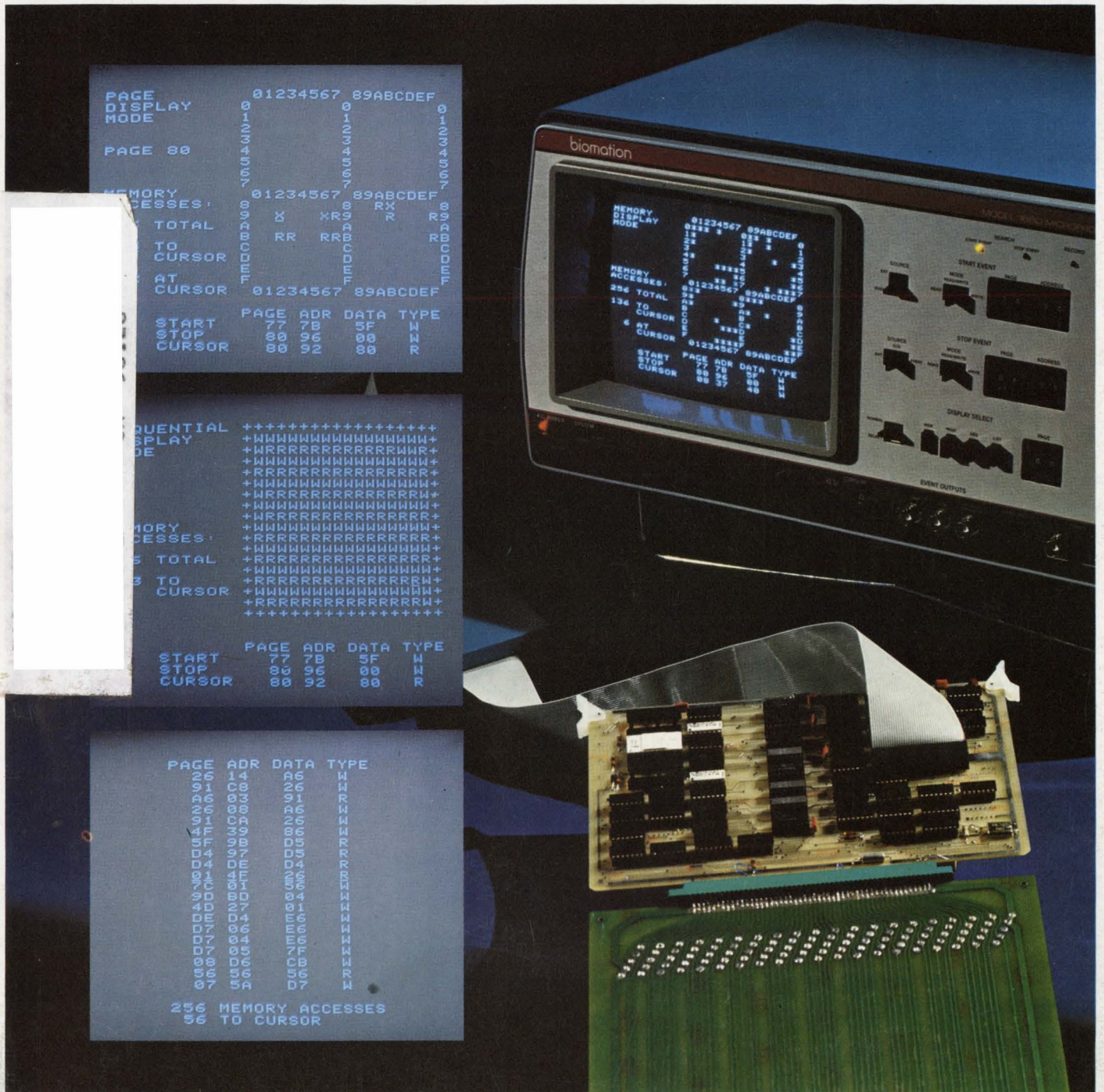

# Swage-Bond™ ... a revolution in trimmer reliability!

## ... here today at no extra cost in every Trimpot® Potentiometer

Historically, pin-to-element termination problems have been one of the primary causes of trimmer failure . . . especially during handling and PC board process operations. Bourns exclusive Swage-Bond™ process virtually eliminates pin termination failure . . . truly a revolution in trimmer reliability. Furthermore, Swage-Bonding results in a marked improvement in temperature coefficient consistency.

Other trimmer manufacturers utilize a simple clip-on termination. Some solder this connection, some rely on tension pressure alone. In the Swage-Bond process, the P.C. pins are secured **through** the substrate, with a high-pressure compression swage on both top and bottom sides. The pressure of the swage locks the pin solidly into the element, and thoroughly bonds it to the thick-film termination material.

Swage-Bond™ eliminates pin termination failure, provides more reliable tempco. Microphotograph shows trimmer element magnified 20X.



### The seal that seals . . . without springback

Bourns trimmers stay sealed when others fail. We know. We've tested them all. Bourns uses a chevron-type sealing technique, that seals without O-rings . . . eliminating the windup and springback that frequently occurs with such seals. The result is faster and more precise adjustability . . . with a seal that really works.



### Wrap-around wiper for better setting stability

Bourns multi-fingered, wrap-around wiper delivers more consistent, more reliable performance. The unique design significantly reduces CRV fluctuations and open circuit problems due to thermal and mechanical shock . . . by maintaining a constant wiper pressure on the element. Compare the ruggedness of Bourns design with the common "heat-staked" wiper designs. Compare performance. Specify Bourns.

### HERE'S PROOF:

Send for a copy of our new engineering report on TRIMMER PERFORMANCE. Tell us about your application, and we'll provide qualification samples that best suit your needs.

Bourns reliability is available at ordinary prices . . . off-the-shelf from nearly 100 local distributor inventories . . . plus our largest-ever factory stock. TRIMMER PRODUCTS, TRIMPOT PRODUCTS DIVISION, BOURNS, INC., 1200 Columbia Avenue, Riverside, California 92507. Telephone 714 781-5320 — TWX 910 332-1252.

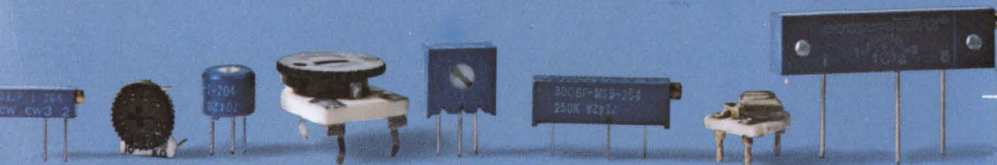

International: HQ Switzerland, 042/23 22 42 • Belgium 02/218 2005 • France 01/2039633 • Germany 0711/24 29 36 • Italy 02/32 56 88 • Netherlands 070/88 93 18 • United Kingdom 01/572 6531 • Japan 075 92 1121 • Australia 86 9410 • Brazil 257-3535 • India 373 544

CIRCLE NUMBER 236

# SURPRISE!

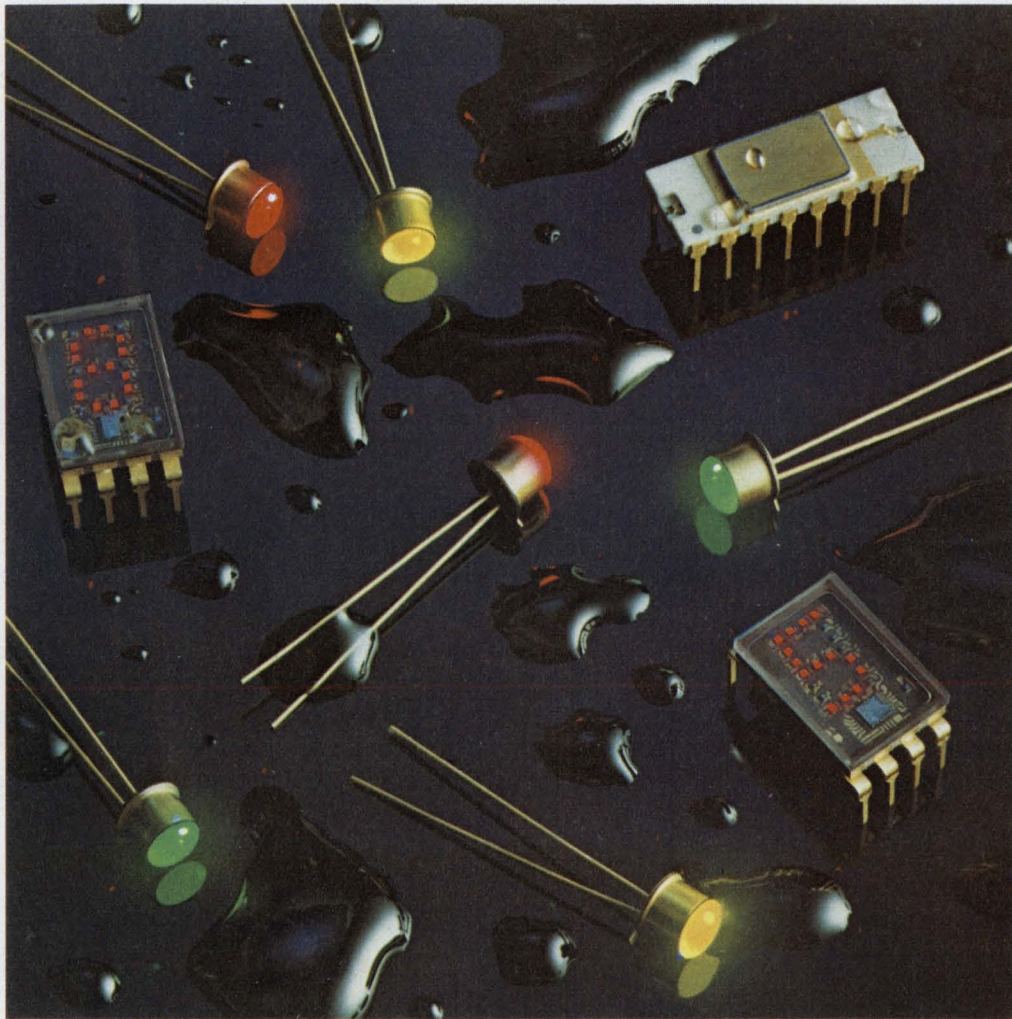

## High Reliability Optoelectronic Products!

Hermetic lamps, displays and isolators from Hewlett-Packard. That's our family of high-reliability optoelectronic products. These devices are ideal for ground, airborne and shipboard equipment, medical instrumentation, fire-control and space flight systems. Lamps are available in high-efficiency red, yellow and green.

Our isolators offer high speed.

And displays come with a built-in decoder, driver and memory.

In the U.S., contact Hall-Mark, Schweber, Wilshire or the Wyle Distribution Group (Liberty/Elmer) for immediate delivery.

In Canada, contact Bowtek Electronics Co., Ltd., Schweber Electronics or Zentronics, Ltd.

**HEWLETT  PACKARD**

Sales and service from 172 offices in 65 countries.  
1507 Page Mill Road, Palo Alto, California 94304

## TO-5 RELAY UPDATE

# The world's smallest RF relay

Inherently low inter-contact capacitance and contact circuit losses have established the Teledyne TO-5 relay as an excellent subminiature RF switch for frequencies up through UHF. Typical RF performance: 45db isolation and 0.1db insertion loss at 100MHz.

Added to this, our TO-5 relay requires very low coil power compared to other miniature relays — as much as 75% less than a half crystal can relay.

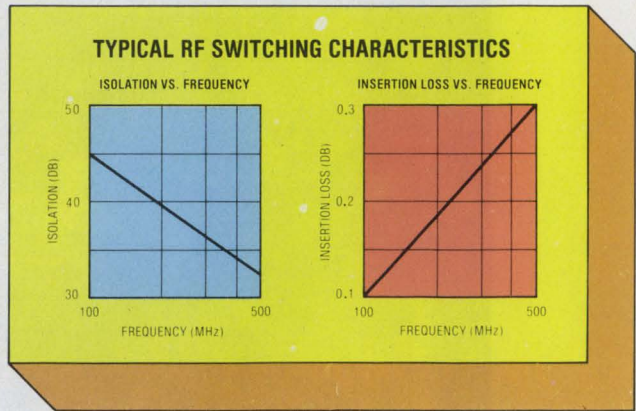

For hand held radio transceivers, for example, where battery power drain as well as good RF performance are key factors, Teledyne's TO-5 relay is the logical choice for T-R switching.

Our complete line of TO-5 relays includes military and commercial/industrial types, with virtually all military versions qualified to established reliability MIL specs. For complete data, contact Teledyne Relays — the people who pioneered the TO-5 relay.

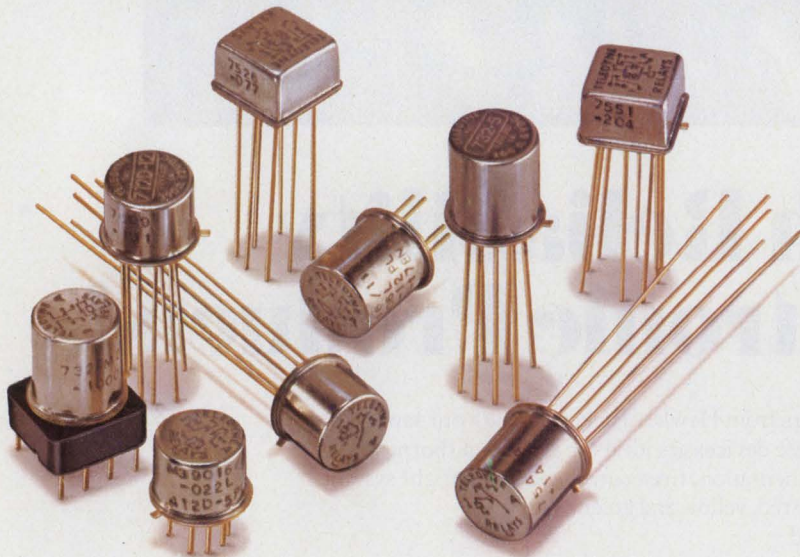

- **Hybrid "T" Series**  
SPDT & DPDT types with internal transistor driver and suppression diode. Military and commercial/industrial versions.
- **"D" and "DD" Series**  
With internal suppression and steering diodes. Military and commercial/industrial versions.
- **Maglatch Series**  
SPDT, DPDT, and 4PST magnetic latching types. Military and commercial/industrial versions.
- **Centigrad® Series**  
World's smallest relay—only .225" (5.72mm) high x .370" (9.40mm) square. DPDT, with optional internal suppression and steering diodes.
- **Hi-Rel Series**  
Screened versions for space flight applications (NASA qualified)
- **High Environment Series**  
Hi-temperature, Hi-shock, and Hi-vibration types

 **TELEDYNE RELAYS**

3155 West El Segundo Boulevard, Hawthorne, California 90250  
Telephone (213) 973-4545

CIRCLE NUMBER 3

ELECTRONIC DESIGN 19, September 13, 1976

---

## NEWS

- 21 **News Scope**
- 26 **Charge transfer technology** used in sonic imager and signal correlator.
- 28 **Semis invade medical transducers;**  $\mu$ Ps monitor EKG and blood pressure.
- 30 **Fingerprint identification systems** are beginning to go commercial.
- 34 **Satellite tracking system** keeps tabs on polar bear movements.
- 45 **Washington Report**

---

## TECHNOLOGY

- 53 **MICROPROCESSOR DESIGN**
- 68 **FOCUS on Data Converters:** To select the right converter you should carefully examine key analog specs such as accuracy and slew rate, as well as key digital terms like resolution and conversion rate.
- 82 **Design single-action delay equalizers** rapidly with normalized tables and graphs. Circuits provide parabolic and negative or positive-slope equalization.
- 90 **90-degree phase-difference networks are simply designed** with a program in Basic. Only a few parameters need be known to start; the rest are calculated.
- 98 **Use transconductance amplifiers** to make programmable active filters. The OTAs offer a 10-octave tuning range by using predictable  $V_{BE}$ -vs- $I_C$  relationships.
- 104 **Get around op amp limitations** in active filter design. Simple derived expressions show how to compensate the amplifier and explain second-order effects.
- 110 **Use slew-rate filtering** to discriminate against noise spikes. Pass the desired signals without phase or amplitude distortion.
- 114 **Floyd Kvamme of National Semiconductor** speaks on stimulating your engineers.
- 120 **Ideas for Design:**
  - Age reference zeners to achieve long-term performance.
  - Handle 100-V analog signals with 10-V ICs by using a divide/multiply technique.
  - Use an IC voltage reference to control crystal-oven temperature accurately.
  - Build a voltage-controlled oscillator with only one TTL-inverter package.

---

## PRODUCTS

- 129 **Instrumentation:** Microprocessor analyzer rearranges captured data into unusual displays.
- 138 **Modules & Subassemblies:** Digital encoder/decoders enhance audio system.
- 140 **Modules & Subassemblies:** Cut size, weight and cost with hybrid s/d converters.
- 152 **Data Processing:** Flexible CRT terminals have many data handling features.
- 162 **Integrated Circuits:** Floppy-disc control and format circuit comes on single chip.
- 170 **Packaging & Materials:** Underwater connectors mate with the power on.
- 148 Components
- 157 Discrete Semiconductors
- 166 Power Sources
- 174 Microwaves & Lasers

---

## DEPARTMENTS

- 63 **Editorial:** Doing the wrong job right.
- 7 Across the Desk
- 175 New Literature
- 178 Design Aids
- 178 Bulletin Board
- 182 Advertisers' Index
- 184 Product Index
- 184 Information Retrieval Card

**Cover:** Photo by Robert Fernandez, courtesy of Biomation

# Introducing SpinGuard<sup>®</sup>

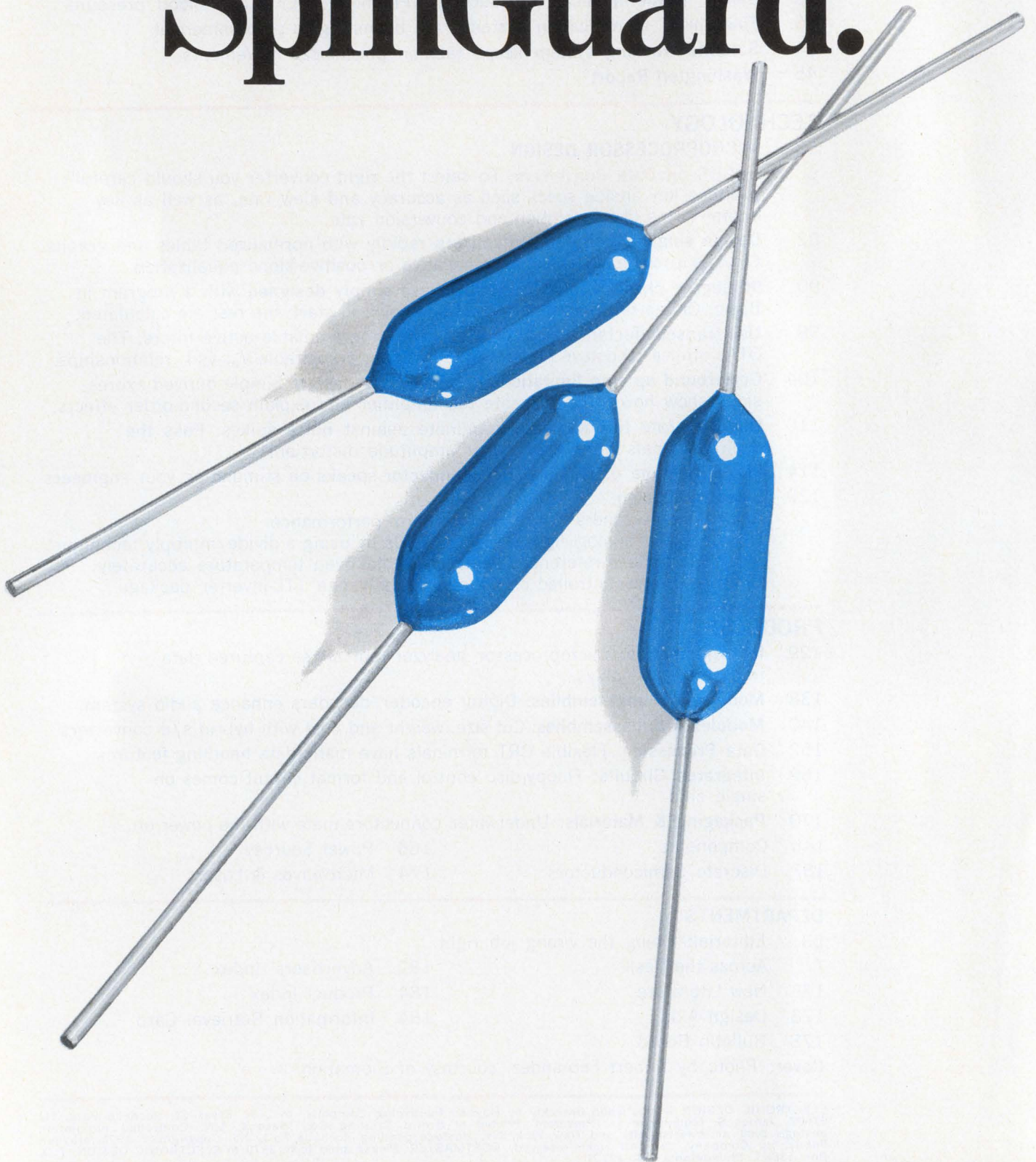

# A new case for AVX quality.

SpinGuard is AVX's new multi-layer ceramic capacitor in an economical epoxy case. Axial leaded to make it perfect for automatic insertion.

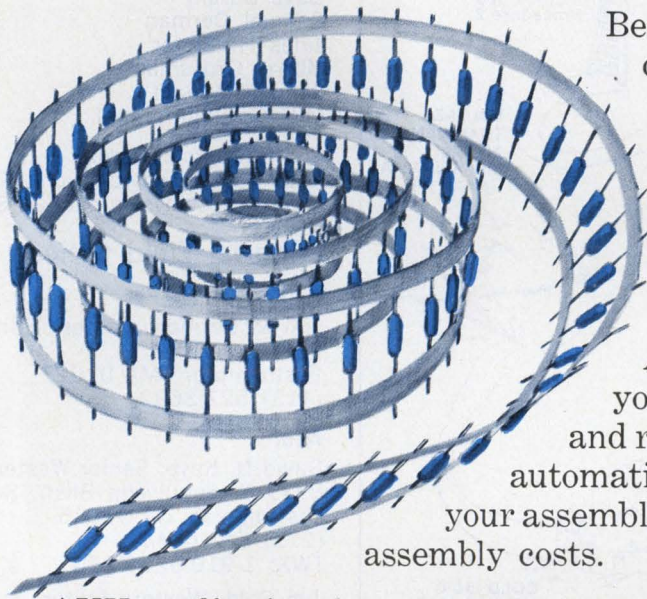

Because it comes from AVX, you can be sure of its quality. Quality designed in, built in and demonstrated by exhaustive testing. To guarantee you greater reliability, exact adherence to temperature and tolerance specifications.

And because it's axial leaded, you can order SpinGuards taped and reeled to run trouble free on your automatic insertion equipment. Cutting your assembly time. Reducing your assembly costs.

AVX quality in a low cost component, designed for low-cost assembly. That's quite a case for switching to SpinGuard.

**Free sample**

Mail this coupon today. We'll send you a SpinGuard sample, plus information on how to get more samples in your specific applications ratings. Mail coupon to AVX Ceramics, P.O. Box 867, Myrtle Beach, SC 29577

Name \_\_\_\_\_

Title \_\_\_\_\_

Company \_\_\_\_\_

Address \_\_\_\_\_

Tel. \_\_\_\_\_ Zip \_\_\_\_\_

## **AVX:** The Insiders

AVX Ceramics, P.O. Box 867, Myrtle Beach, SC 29577 (803) 448-3191 TWX: 810-661-2252  
Olean, NY (716) 372-6611 TWX: 510-245-2815

# CAN YOUR POWER SUPPLY RUN THE GAUNTLET?

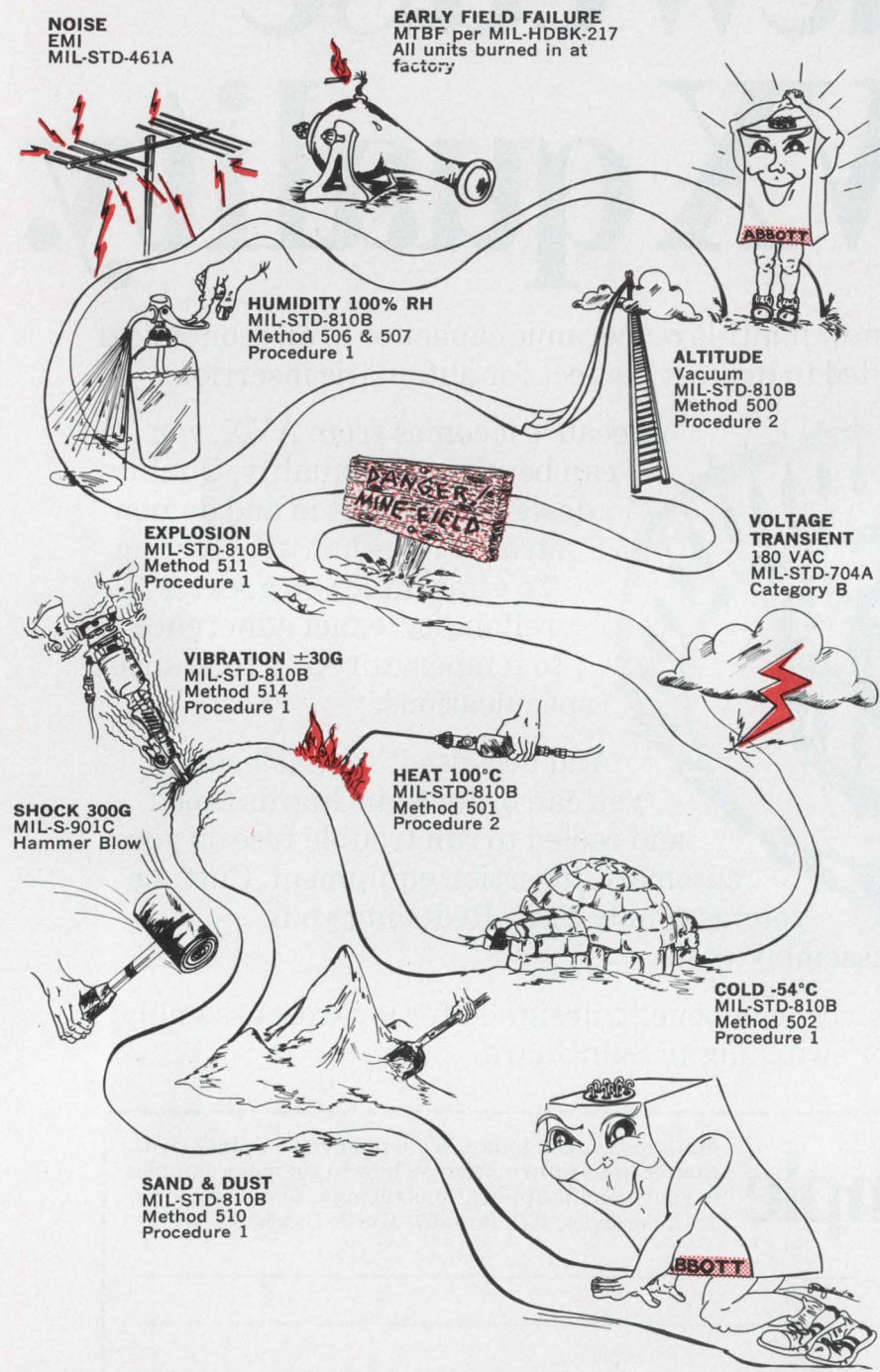

Abbott's hermetically sealed power supplies have run this gauntlet many times. Each and every unit is subjected to rigid quality control procedures and extensive testing at our factory to insure that it will pass the most important test — your gauntlet.

Please see pages 1836-1848 of your 1976-77 EEM (ELECTRON ENGINEERS MASTER Catalog) or pages 676-682 Volume 2 of your 1976-77 GOLD BOOK for information on Abbott Modules.

Send for our new 60 page catalog

**abbott transistor**  
LABORATORIES, INCORPORATED

GENERAL OFFICES  
5200 W. Jefferson Blvd.  
Los Angeles, CA. 90016  
(213) 936-8185  
Telex 69-1398

EASTERN OFFICES  
1224 Anderson Ave.  
Fort Lee, N.J. 07024  
(201) 224-6900  
Telex 13-5332

SEE US AT WESCON/76 SHOW IN LOS ANGELES, BOOTH NO. 1057.  
CIRCLE NUMBER 5

Sr. Vice President, Publisher  
Peter Coley

## Editors

Editorial Offices  
50 Essex St.  
Rochelle Park, NJ 07662  
(201) 843-0550  
TWX: 710-990-5071  
Cable: Haydenpubs Rochellepark

Editor-in-Chief George Rostky

## Managing Editors:

Ralph Dobriner  
Michael Elphick

## Senior Associate Editor:

Stanley Runyon

## Associate Editors:

Sid Adlerstein  
Dave Bursky  
Samuel Derman  
Jules H. Gilder  
Morris Grossman  
John F. Mason  
Michael Shunfenthal

## Contributing Editors:

Peter N. Budzilovich, John Kessler  
Alberto Socolovsky, Nathan Sussman

## Editorial Field Offices

### East

Jim McDermott, Eastern Editor  
P.O. Box 272  
Easthampton, MA 01027  
(413) 527-3632

### West

David N. Kaye, Senior Western Editor  
8939 S. Sepulveda Blvd., Suite 510  
Los Angeles, CA 90045  
(213) 641-6544  
TWX: 1-910-328-7240

Jim Gold, Western Editor  
1537 Shasta Ave.  
San Jose, CA 95128  
(408) 279-8588

## Editorial Production

Marjorie A. Duffy, Production Editor  
James Keane, Copy Editor

## Art

Art Director, William Kelly  
Richard Luce, Anthony J. Fischetto

## Production

Manager, Dollie S. Viebig  
Helen De Polo, Anne Molfetas

## Circulation

Director, Barbara Freundlich  
Trish Edelmann

## Information Retrieval

Peggy Long

## Advertising Promotion

Susan G. Apolant



# Across the Desk

## A funny thing happened to us at the printer

Somehow the wrong photo got attached to a story. Which wouldn't have been so bad if that photo hadn't already received its due in the right story. So if that "pulse generator" on page 161 of *ELECTRONIC DESIGN* Vol. 24, No. 15, July 19, 1976 looks strange, you're right. It's a power supply, not a pulse generator. Sorry HP 8080.



This is a power supply.



This is a pulse generator.

## Parasitic oscillation may have a simple cure

Regarding your article on parasitic oscillation in emitter followers (*ED* No. 13, June 21, 1976, p. 110), I have often observed such

problems with modern transistors, but for different reasons. Such oscillations can occur with simple resistive-emitter loads. In that case, one should check the path, however devious, from base to collector.

If it is some inches in length and has no unbypassed resistors or inductors, there is sufficient lead inductance for a respectable tank circuit somewhere in the frequency range mentioned in your article. The capacitors to complete the equivalent of a Colpits oscillator are formed from the transistor's base-emitter and collector-emitter capacities.

There were even oscillators made intentionally this way in the vacuum tube days; I think they were called "ultra audion." This form of parasitic oscillation is not much affected by adding emitter resistance, but a resistor in either base or collector spoils the Q of the lead-formed inductor. The longer the path from base to collector, the larger the resistor that will be needed.

*John O. G. Darrow*  
Westinghouse Air Brake Co.  
Pittsburgh, PA 15218

## Random Thoughts

Your editorial sounds like my last job and my reasons for leaving.—*R. B. White, Kaiser Aerospace, San Jose, CA.* (Editorial: "Using Resources," *ED* 5, Mar. 1, 1976).

This is about the third time you described our company president. You mean there's more than one? —*Name withheld, Austin, TX.*

*(continued on page 10)*

Electronic Design welcomes the opinions of its readers on the issues raised in the magazine's editorial columns. Address letters to Managing Editor, Electronic Design, 50 Essex St. Rochelle Park, N.J. 07662. Try to keep letters under 200 words. Letters must be signed. Names will be withheld on request.



## OPTICALLY COUPLED INTERRUPTER MODULES

OPTRON OFFERS IMMEDIATE DELIVERY OF NEW, LOW COST SERIES

OPTRON's new, low cost optically coupled interrupter module series combines non-contact switching and solid state reliability for applications requiring sensing of position or motion of an opaque object such as motion limit, paper edge or shaft encoding.

The new OPB 813, OPB 814 and OPB 815 consist of a gallium arsenide infrared LED coupled with a silicon phototransistor in an economical molded plastic housing. With a LED input of 20 mA, the OPB 813 and OPB 815 have typical unblocked current outputs of 2.0 mA and 3.0 mA, respectively. Typical output of the OPB 814 is 3.0 mA with a 10 mA input. The entire series is available from stock.

Background illumination noise is eliminated by a built-in infrared transmitting filter and dust cover in each device type. The OPB 813 also is available with a 0.010 inch aperture for high resolution applications.

New OPTRON optically coupled interrupter modules are interchangeable with similar products as follows:

OPTRON	GE
OPB 813	H13A1
OPB 813	H13A2
OPB 814	H13B1
OPB 814	H13B2

Detailed technical information on these and other OPTRON standard interrupter and reflective modules, as well as versions for specific applications is available on request.



**OPTRON, INC.**

1201 Tappan Circle  
Carrollton, Texas 75006, U.S.A.  
214/242-6571 • TELEX-73-0701  
TWX-910-860-5958

Must you always obtain new application tooling when you develop a new design?

Not always. You can use AMP Multimate.

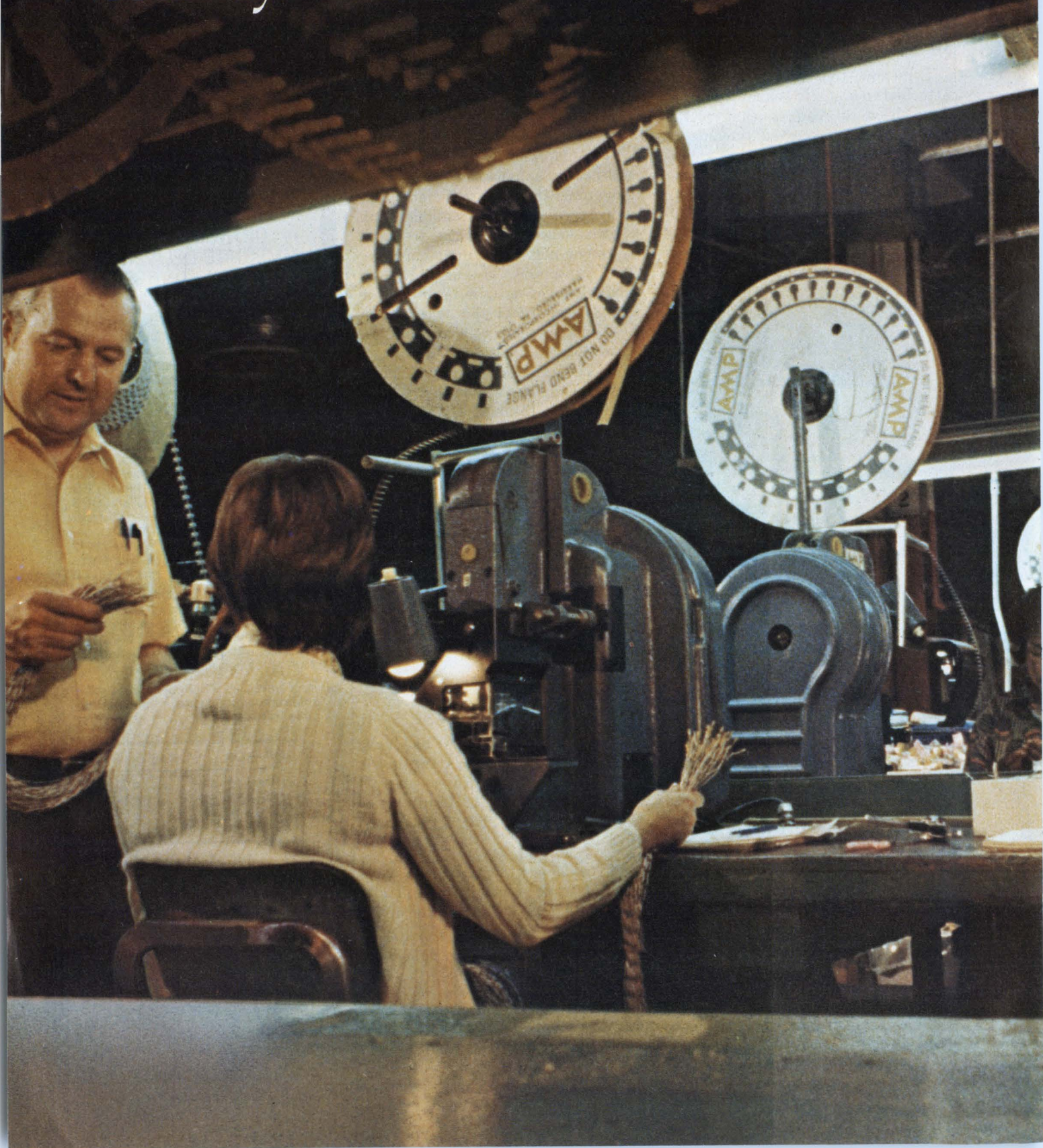

You asked for a way to produce new I/O cable or internal harness designs without always having to obtain new connector application tooling.

AMP answers with the Multimate concept.

For example.

A choice of three, size 16 contacts. A screw machine contact, and 1 or 2-piece precision formed contacts. All interchangeable and intermateable plus AMP Subminiature Coaxial contacts fit in the same cavities when needed.

Then specify AMP Connector housings from many proven styles and sizes.

The rugged, economical Circular Plastic Connector, or those versatile M Series connectors widely used for commercial and military applications; or the AMP MI Connectors, designed to international standards. Additionally there is a cast shell rack and panel range as well as metal-shelled modular connectors.

If you have AMP application tooling for the Multimate contacts, you can produce these connector assemblies. And that can save inventory and allows for larger piece part volume purchases. Further savings can be made in the field because fewer service tools are needed.

Here at AMP, answering your problems is our business.

So when you work with Multimate, you can expect the kind of service and backup for which AMP is famous.

We have district sales offices around the country; they are there for one purpose only. To serve you.

With Multimate, you not only get real contact-connector flexibility, you have AMP behind your design innovations.

For information on Multimate, write or call AMP Incorporated, Harrisburg, PA 17105. (717) 564-0100.

SEE US AT  
LJUBLJANA ELECTRONICS  
SHOW

# AMP

INCORPORATED

CIRCLE NUMBER 7

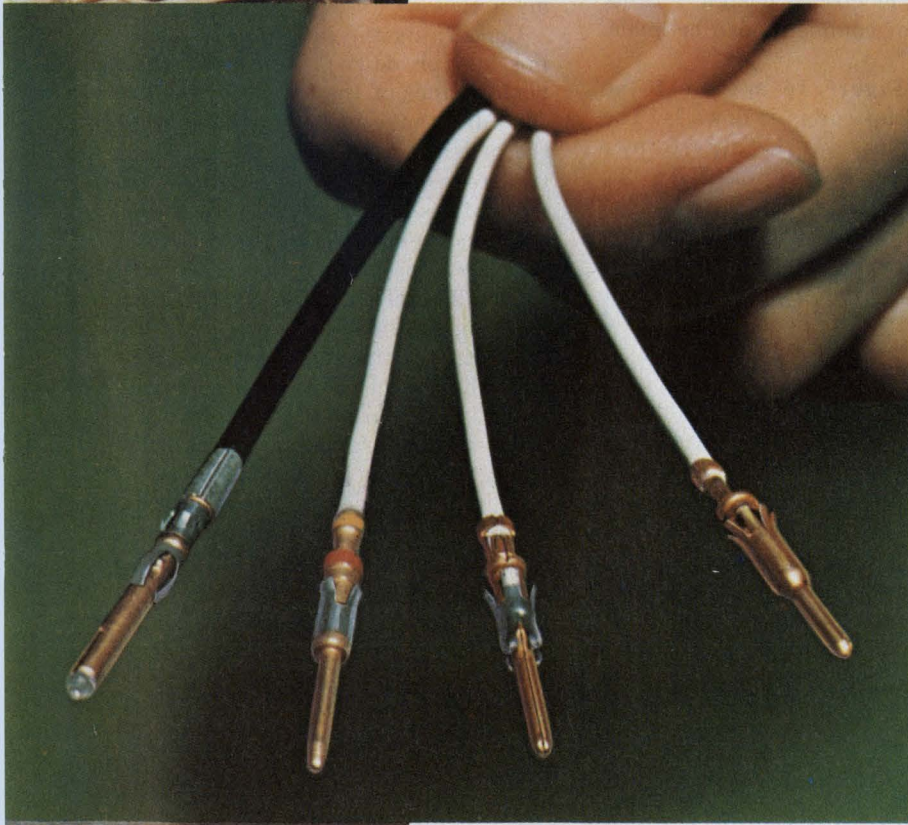

## ACROSS THE DESK

(continued from page 7)

(Editorial: "The Star," ED 12, June 7, 1976).

Perhaps Teitaro Hiraga of TDK will come and speak to my boss.—*Name withheld, Haifa, Israel.* (Challenges to the Engineer who Manages, ED 9, April 26, 1976).

## Misplaced Caption Dept.



I'll never work overtime again.

Sorry. That's Jan Vermeer van Delft's "Young Women Reading a Letter," which hangs in the Rijksmuseum in Amsterdam.

## Here's Tuit

We are deeply grateful to Walter Skowron of Hewlett-Packard for his most useful gift, pictured here. This gift should prove invaluable in helping us with those thousands of jobs we were going to complete as soon as we got a round tuit.

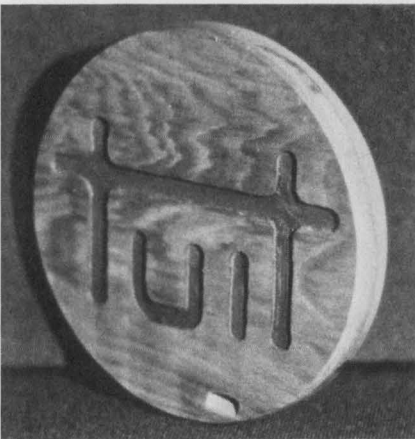

## 'My Crime' not serious enough for businessmen

I read your editorial of June 21st with some interest. The whole subject of business ethics is certainly high in everybody's mind these days.

I'm not sure that your "tongue-in-cheek" approach to the subject, if I understand your editorial, goes far enough in really bringing the message of the importance of honesty and integrity in business dealings.

In my mind, it is an extremely serious subject that needs straightforward talk and complete communication to all of the employees of a business enterprise.

*William E. Terry*  
Vice-president  
Instrument Group

Hewlett-Packard Co.  
1501 Page Mill Road  
Palo Alto, CA 94304

## Wideband rf design raises some questions

I found Mr. Nagle's article on wideband rf transformers (ED No. 3) quite worthwhile. The information presented is generally not widely publicized and is often very useful in rf circuit design. I think a couple of comments can be made, however.

First, Figure 16 appears to be all fouled up (or is it down?). The insertion loss of the transformer is shown to rise below 1 MHz, but above 100 MHz it is shown to go down from the -19.5-dB reference. That's strange, because the insertion loss of the transformers that I've build goes up at either band limit.

Second, the equation for finding the required primary inductance to obtain the lower 3-dB frequency desired was over-simplified. His equation is accurate only if the signal source is a current source and no parallel resistance shunts the primary (i.e., a high Q core). Ferrites are usually low-Q materials, which makes them useful for filter beads. And rf circuits typically employ broadband transformers with matched primary and secondary.

For the more general case, the

equation for insertion loss in dB is

$$10 \log \left( 1 + \frac{(R/N^2 X_p)^2}{(1 + R_L/2N^2 R_p)^2} \right)$$

where

$X_p$  = inductive reactance of one turn at frequency of interest

$R_p$  = parallel resistance of one turn at frequency of interest

$R_L$  = load resistance

$N$  = total number of turns from  $R_L$  to ground

and

$$R = \frac{1}{2/R_L + 1/N^2 R_p}$$

Although this equation is considerably more involved, it provides accurate results and is easily programmed on a programmable pocket calculator. With this form of the equation, the effect of changing the number of turns is quickly evaluated. The values of  $X_p$  and  $R_p$  are often given by the manufacturer of the core. For those cores specified with  $A_L$  and  $Q$ , or  $A_L$  and loss factor, similar equations can be written.

*Ken Wetzel*

Naval Weapons Center  
China Lake, CA 93555

## The author replies

I appreciate Mr. Wetzel's taking the time and trouble to write about my article.

Concerning the insertion loss being up (or down): I ascribe the performance of the transformers to the fact that, at low frequencies, the primary reactance falls—so the transformer becomes more and more of a short circuit. At the high frequency end, the voltage rise is due to resonance.

Mr. Wetzel is quite correct in pointing out that my equation for the primary inductance considers only the effect of the load resistance. However, the transformer losses and generator impedance will shunt the transformed load impedance, thereby lowering the required primary inductance. Therefore, use of my equation will usually result in a conservative design. While ferrites generally yield low  $A$ , compared with other core materials, the energy loss in a well-designed ferrite core should still be low compared to the energy dissipated in the load.

(continued on page 15)

# SORENSEN IS THE SOURCE.

## FOR A COMPLETE LINE OF HIGH QUALITY POWER SUPPLIES

... that are priced right, immediately available, conservatively designed and rated, and covered by Sorensen's full warranties.

Sorensen. For a complete line of modules, lab supplies, assemblies, AC regulators, open frame, encapsulated and D/A programmers.

Sorensen Company,  
676 Island Pond Rd.,  
Manchester, N.H.  
03103.  
(603) 668-4500.

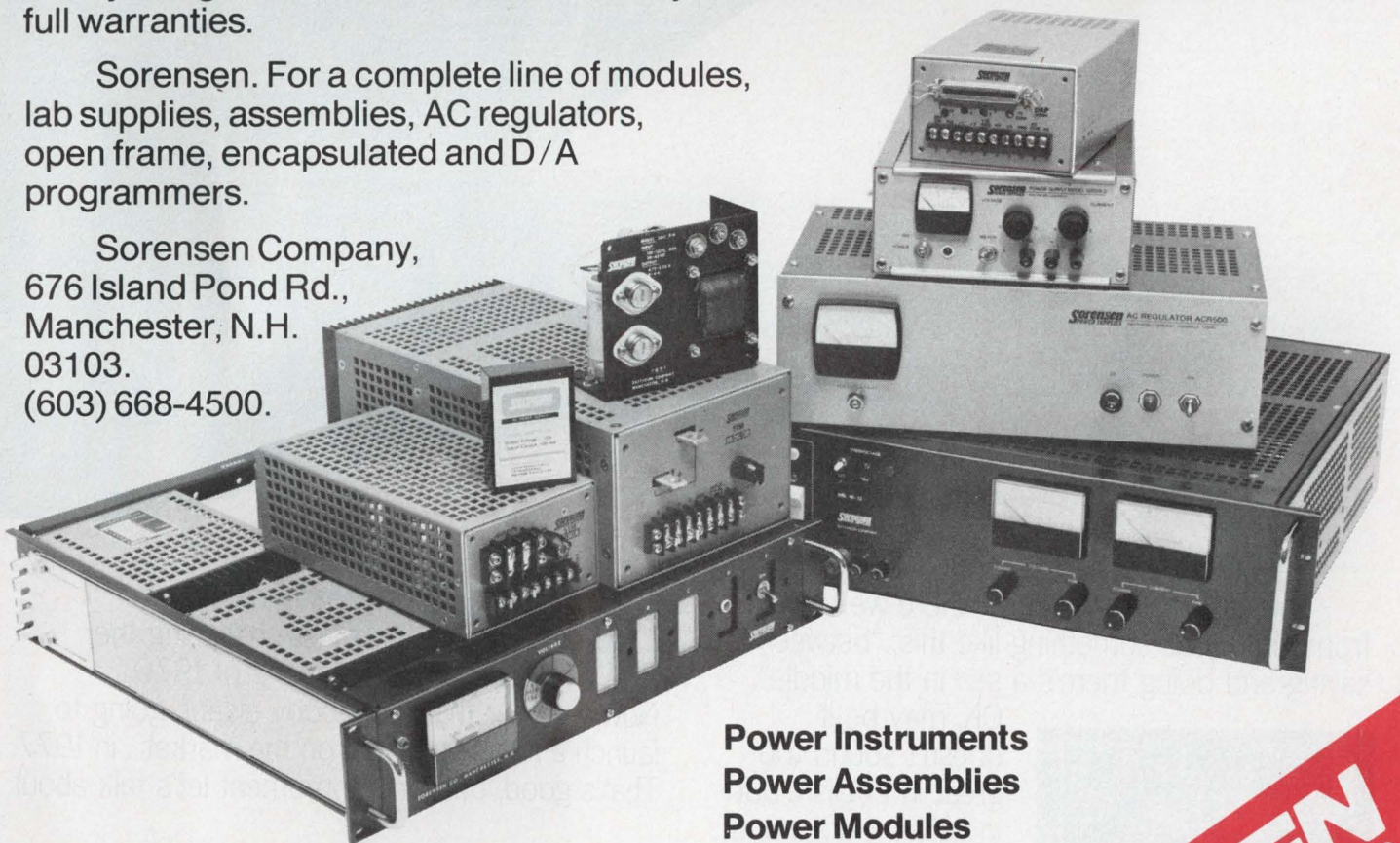

Power Instruments  
Power Assemblies  
Power Modules

See us at Booth  
#765-767  
Wescon '76  
Los Angeles, Sept. 14-17

**SORENSEN**  
POWER SUPPLIES

A Raytheon Company  
CIRCLE NUMBER 9

# TDA 2002

We have  
They say



There's a saying in Italy, where we come from, that goes something like this: "between saying and doing there's a sea in the middle".

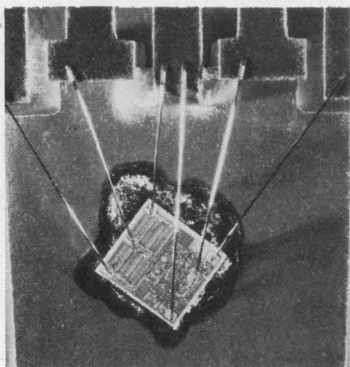

The TDA 2002 chip on its Pentawatt® frame.

OK, may be it doesn't sound too great in English, but in Italian it does and it rhymes as well!

Now, the particular "sea" in our case is just this: TDA 2002 was invented and patented by SGS-ATES; we were the first to

produce it and we're already delivering it - in fact, we've been mass-producing the TDA 2002 since the beginning of 1976. Now we hear that somebody else is going to launch a similar product on the market... in 1977. That's good, but for the moment let's talk about

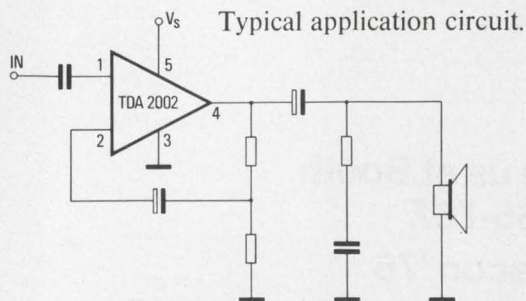

# 2002

## ive it. they do.

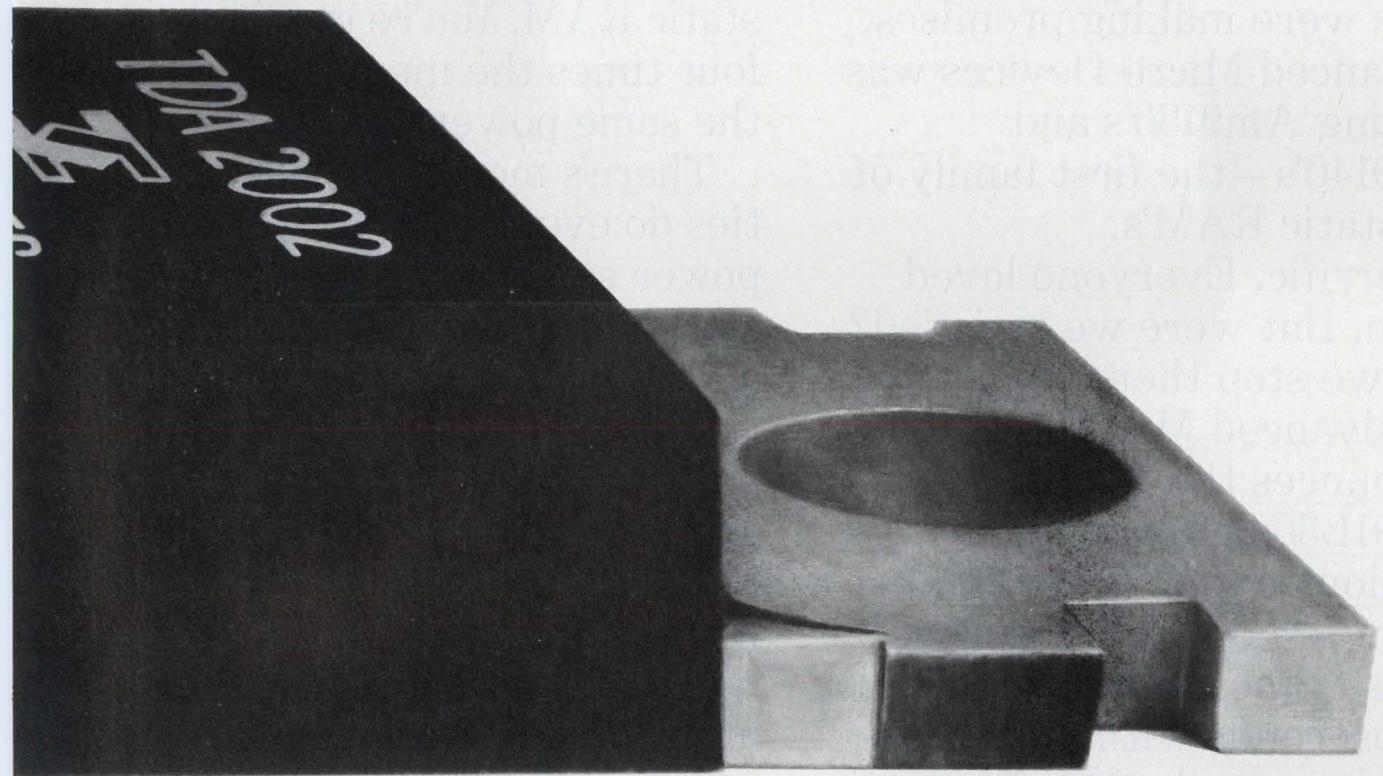

TDA 2002: 8W integrated audio amplifier.

our TDA 2002, since it's the only one...

Worldwide patents for both the circuit and the package have been granted, or have been applied for. All of SGS-ATES' years of experience in the design and production of power linears are behind this product.

The package (Pentawatt®) and type of assembly guarantee more than 10,000 cycles of thermal fatigue with  $\Delta T_C = 100^\circ$ , and that means long life. What's more, it's highly protected against short circuits; thermal over-range; supply overvoltages, including spikes; open ground; polarity inversion - which ensure the same trouble free, long life, even under exceptional conditions.

With a 14.4 V supply it gives 8 W on  $2\ \Omega$ . It is ideal for car radios and CB transceivers: it saves 50% on external components and even more on space.

## And that's why



SGS-ATES SEMICONDUCTOR CORPORATION  
Newtonville Avenue, Newtonville, Mass.  
tel.: 617-9691610

# Some people just can't leave well enough alone.

Last March, while the other guys were making promises, Advanced Micro Devices was making Am9130's and Am9140's—the first family of 4K static RAM's.

Terrific. Everyone loved them. But were we satisfied? Did we stop there? No.

Advanced Micro Devices announces the 1Kx4/4Kx1 Am91L30/L40, low-power versions of our Am9130/40.

These new circuits provide access times down to 250 nanoseconds with power dissipation of only 367mW. That's half the power of the original. (And that's the same power

as the industry standard 1K static RAM. You're getting four times the memory for the same power. Wow!)

There's more. These beauties do everything on a 5-volt power supply. The logic levels are identical to TTL. You get all the features of the original, including full military temperature range availability and, as always, MIL-STD-883 for free. Plus: a freshly minted set of application notes and data sheets awaiting your call, wire or letter.

Some people just can't leave well enough alone.

## Advanced MOS/LSI

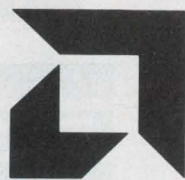

Advanced Micro Devices • 901 Thompson Place, Sunnyvale, California 94086 • Telephone (408) 732-2400 •  
Distributed nationally by Hamilton/Avnet, Cramer and Schweber Electronics.



**Tek map found faulty**

Though I have never been there, I have in my mind's eye a vision of the Tektronix facility in Wilsonville, OR. So I feel that the map on page 31 of your June 7, 1976 issue omits some important landmarks.

For example, I recall the lovely olde church nearby, the Fielde Mission. And a vegetable farmer, Planck, had a cornstand nearby.

In the bit stream, I recall see-some half waves and there was a conTROLL gate just on the other side of the Wheatstone bridge. And I recall, with some annoyance, that in a lovely wooded area of the grounds, some careless workmen had left a light pipe. Or was it a heavy pipe?

*Dan Sheingold*

Analog Devices  
Norwood, MA 02062

**More connectors  
—and a note on radio**

Ordinarily I don't take the time to write to editors of magazines. My business of servicing CB transceivers keeps me pretty busy, but I had to take time to make a couple of small corrections.

1. In your article on connectors ("Focus on Connectors," ED No. 11, May 24, 1976, p. 60.) I noted that Automatic Connector, Inc., of Commack, NY was not mentioned and they make a very nice connector, one much easier to install in the field than others. They deserve a mention, at least.

2. In response to the letter in the same issue by H. E. Fairman (p. 11), I would suggest that he look up the call sign of W2XMN Alpine, NJ and I think that he will find that it was issued to Maj. E. H. Armstrong. "K" call-signs were generally issued WEST of the Mississippi River. It was on W2XMN that I heard of the attack on Pearl Harbor!!

*Alfred Kohlberg Jr.*

5706 84 Ave.  
New Carrollton, MD 20784

**Our newest  
air variable capacitor's  
biggest feature:**

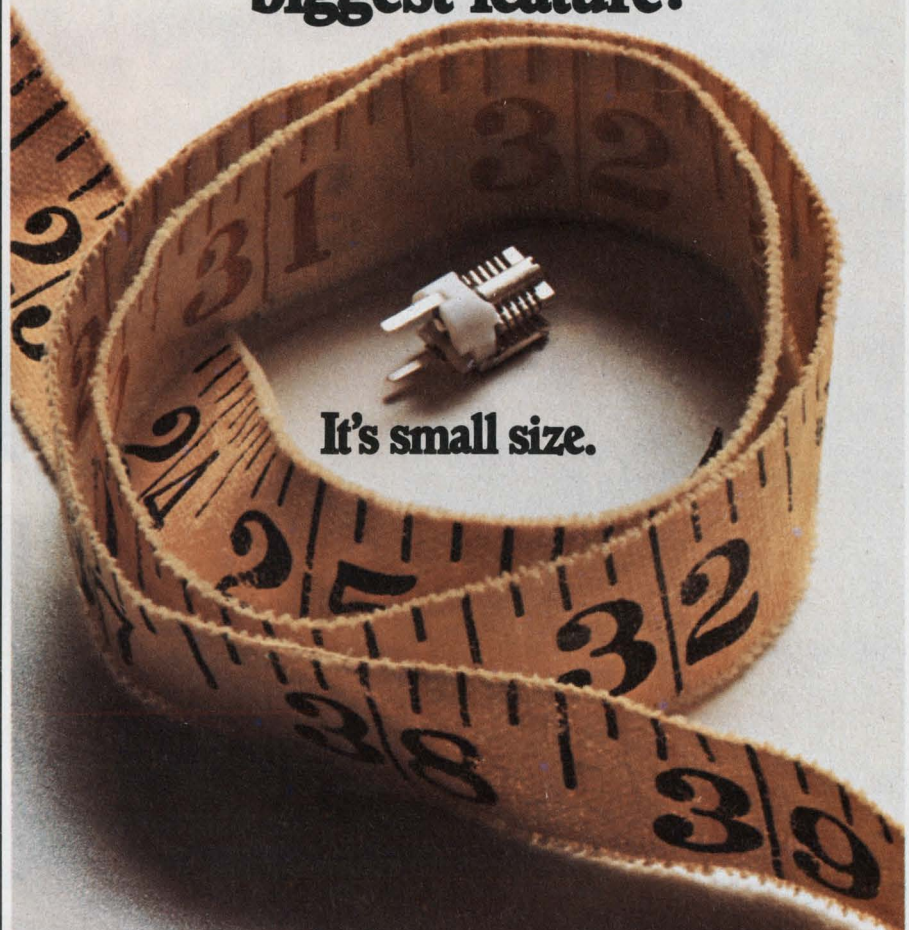

**It's small size.**

As you can plainly see, our new air variable capacitor is nearly as small as many sub-miniature ceramic trimmers. It also features the same mounting configuration which means you can use it in many of the same applications

But small size isn't the only reason for buying our new Micro T™ capacitor. Because it's air variable, it offers you

great stability. Q is typically 1000 at 100 MHz. TC is +45 ±45 PPM/°C. And it's available in maximum capacities of 3, 6.5, 12.7, and 19.0 pF in either vertical or horizontal tuning PC and stripline mounting versions. What's more, it gives you all this for a very small price.

E. F. Johnson Company/Dept. E.D., Waseca, MN 56093

Please send me technical information on sub-miniature air variable capacitors.

Please send me samples. You can call me at \_\_\_\_\_

Name \_\_\_\_\_

Firm \_\_\_\_\_

Address \_\_\_\_\_

City \_\_\_\_\_ State \_\_\_\_\_

Zip \_\_\_\_\_

For fast service, contact your local Johnson Distributor.



**JOHNSON**  
®

CIRCLE NUMBER 12

# More and more major companies The future

More than 200  
deep discharge  
cycles.

Great versatility  
in charging methods.

Wide temperature range  
from  $-40^{\circ}\text{C}$  to  
 $+50^{\circ}\text{C}$ .

More packaging  
flexibility than  
you might  
have thought possible.

Easy  
recharge,  
plus a wide  
range of  
discharge rates.



# use Gates. in energy cells.

Fewer design problems,  
fewer operating problems.

A watt-hour  
per dollar value  
that would warm  
a comptroller's heart.

Thermal  
runaway problems  
are a memory.

Tough,  
sealed construction  
for rugged, safe  
performance.

## FREE!

I would like to know a  
lot more about Gates' energy  
cells. Please send your **FREE**,  
no-obligation brochure containing  
battery features, application information,  
ratings and specifications.

ED-46

Name \_\_\_\_\_

Title \_\_\_\_\_

Company \_\_\_\_\_

Address \_\_\_\_\_

City/State/Zip \_\_\_\_\_

Please mail coupon to: Gates Energy Products, Inc.,  
1050 S. Broadway, Denver, CO 80217.

CIRCLE NUMBER 13



**Energy Products**

# How does our broad line of discrete semiconductors fit your growing line of switching power supplies?

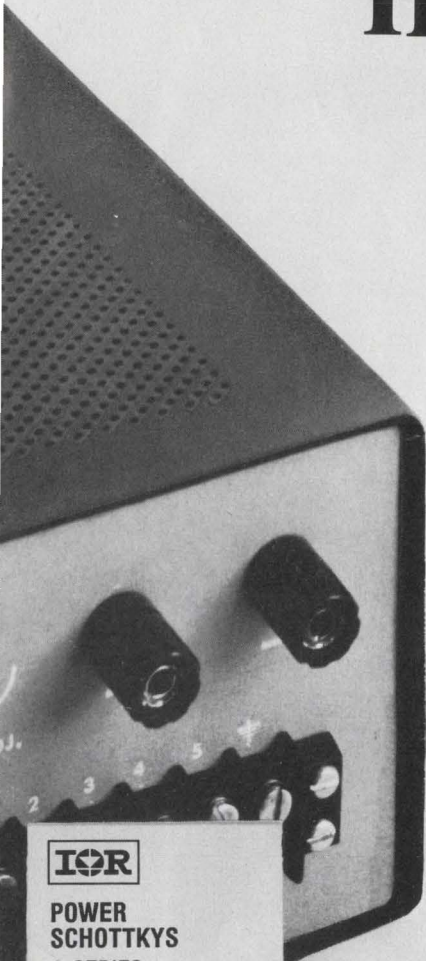

**IOR**

**POWER SCHOTTKYS**  
6 SERIES

20-50 Amps  
10-50 Volts  
150°C  
Junction  
Temp

**IOR**

**FAST RECOVERY RECTIFIERS**  
8 SERIES

6-12 Amps  
50-1000 Volts

**IOR**

**RECTIFIERS**  
28 SERIES

1-40 Amps  
50-1000 Volts

**IOR**

**ZENERS**  
26 SERIES

250mW-50W  
2.4-280 Volts

**IOR**

**TEMP. COMP. VOLTAGE REFERENCES**  
16 SERIES

250mW-1.6W  
5.9-49.6 Volts

**IOR**

**INVERTER SCR's.**  
4 SERIES

35 Amps (RMS)  
20-400 Volts

**IOR**

**SCR's**  
22 SERIES

4-70 Amps (RMS)  
15-1200 Volts

**IOR**

**POWER TRANSISTORS**  
34 High Gain Types  
1-10 AMPS

15 Fast Switching Types  
5-15 AMPS

**IOR**

**HIGH VOLTAGE POWER DARLINGTONS**  
25 High Gain Types  
10-20 AMPS  
9 Fast Switching Types  
10-20 AMPS



# Beautifully.

When you're breaking new ground in switching power supplies you need a vendor who can solve most of your problems.

In discrete semiconductors, only a broad-line supplier like International Rectifier can help you in so many ways. Both in design and later in production.

**Design Tradeoffs.** Like your own circuits, each of our discrete semiconductors has its own limitations as well as advantages. If a part number you've previously specified doesn't seem to do the job, we can probably suggest one that will. We can also select standard devices with the special parameters you need, or start fresh with a new design.

If you need a capability trade-off between different types of discretes, no one has more knowledge to assist you with than IR.

**Applications Assistance.** We know it takes more than data sheets and application notes to keep your design and production running smoothly. No matter what your questions, if it has to do with discrete semiconductors we can help.

And we do help. Our application engineers will come when you call.

**High, and consistent quality.** For 28 years we have been specializing in discrete semiconductors. They have earned a reputation for consistently high quality, ruggedness, dependability, and good performance. Our manufacturing, test and QC procedures are sound, and painstakingly adhered to.

One source.

We save you design time.

We keep your production running smoothly.

We deliver the kind of performance that increases your sales.

For information, just give us a call. At the factory (213) 322-3331, at our 30 local sales offices, or at any of our nationwide distributors. Write to International Rectifier, 233 Kansas Street, El Segundo, CA 90245.

# International Rectifier

... the innovative semiconductor people



CIRCLE NUMBER 14



## SEMICONDUCTOR HEAT EXCHANGERS

12 Types  
readily available.



## SEMICONDUCTOR FUSES

130 and 250 Volts  
5-800 AMPS (RMS)

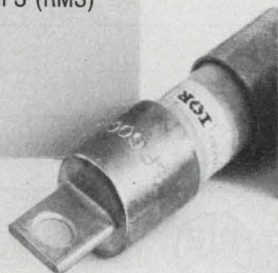

## DIODE BRIDGES

1.8 to 25 Amps  
50-1000 Volts

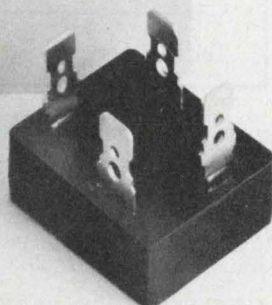

**You can buy  
this Spectrum Analyzer  
and take a big chunk  
out of your budget.**



**You can rent  
this Spectrum Analyzer  
and get more  
equipment out of  
your budget.**



Even the best equipment budget can only go so far. And at the price you pay for electronic test equipment nowadays, that's not very far at all.

Unless you rent your equipment from REI.

When you rent from us, there's no large cash outlay. You pay only for the time you have your instruments, and you return them when you're through. So you never have to spend your money on idle equipment.

Getting more for your money is just one reason for renting from REI. Immediate delivery is another. We have over \$10 million in inventory in fully stocked centers around the country. And, when you have short-term needs, you can rent equipment for just as long as you need it, and make it pay for itself.

REI stocks over 8,000 fully checked-out test instruments, and they're ready whenever you are. For the full story on renting, as well as our low prices, send in the coupon for prompt delivery of our free illustrated catalog... or call us now for your immediate requirements.

Rental Electronics, Inc.  
99 Hartwell Avenue, Lexington, Mass. 02173  
Please send me your free instrument rental catalog:

Name \_\_\_\_\_ Title \_\_\_\_\_

Company \_\_\_\_\_

Address \_\_\_\_\_

City \_\_\_\_\_ State \_\_\_\_\_ Zip \_\_\_\_\_

Tel. Number \_\_\_\_\_

**Rental Electronics, Inc.** 

A PEPSICO LEASING COMPANY

Burlington, MA (617) 273-2770 • Gaithersburg, MD (301) 948-0620 • Oakland, NJ (201) 337-3757 • Ft. Lauderdale, FL (305) 771-3500  
• Des Plaines, IL (312) 827-6670 • Dallas, TX (214) 661-8082 • Mountain View, CA (415) 968-8845 • Anaheim, CA (714) 879-0561  
• Rexdale, Ontario (PLC Leasing Ltd.) (416) 677-7513

SEE US AT WESCON/76 IN L.A., SEPTEMBER 14-17, BOOTH #493

CIRCLE NUMBER 15

## GM laser crystals make better pollution monitors

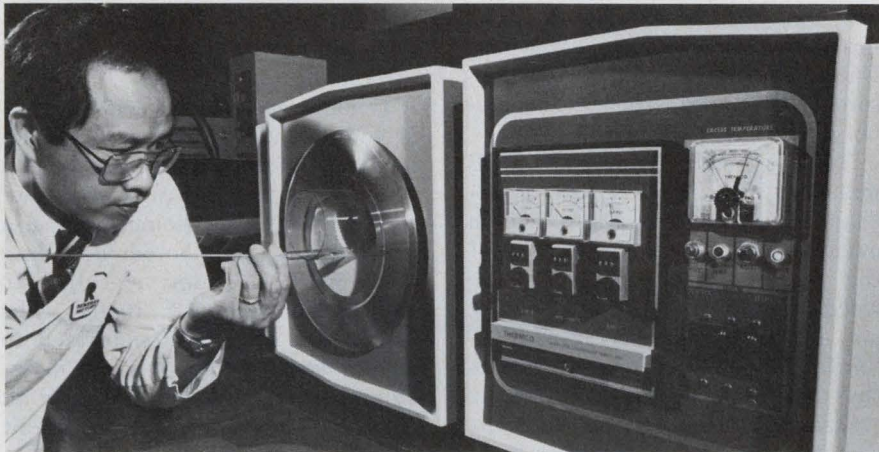

Laser crystals made of lead-tin-telluride are being grown at General Motors for use in pollution monitoring systems.

Large, lead-tin-telluride laser crystals that will contribute to improved identification and measurement of air pollutants have been grown, for the first time, by researchers at the General Motors Research Laboratories, Warren, MI.

These crystals are used to make semiconductor-diode lasers that emit IR radiation in the 8-to-9- $\mu\text{m}$  wavelength range, a spectrum important to air pollution research. The lead-tin-telluride laser diodes will be incorporated in pollution-monitoring equipment also under development at GM.

The GM crystals produce a laser output of 750  $\mu\text{W}$ , in contrast to only 10  $\mu\text{W}$  produced by the best of the previously grown semiconductor lasers in the same wavelength range.

The lead-tin-telluride crystals ( $\text{Pb}_{1-x}\text{Sn}_x\text{Te}_{0.06 \text{ to } 0.08}$ ) were grown by Dr. Wayne Lo, senior research engineer at the Laboratories, by nucleating them on a source ingot enriched with 0.01% tellurium. The ingot was sealed in an ampoule 15-cm long and maintained at a critical temperature of 825 C for sev-

eral days. This temperature markedly reduced crystal defects.

While conventional IR spectrometers and monochromators are available for pollutant monitoring, the broad spectrum emitted by their IR sources makes it difficult to distinguish pollutant molecules that have absorption bands close to each other.

The telluride laser, on the other hand, is much better suited for observing hydrocarbons present in exhaust gases and air, according to Dr. John C. Hill, senior research physicist at the Laboratories. The GM laser, Hill points out, has a resolution bandwidth  $10^4$  times narrower than that of regular IR equipment. In addition, the GM laser power-per-unit bandwidth is about  $10^8$  times higher than that of conventional IR instrumentation.

## Fuel-cell power plant to generate 27 MW . . .

A \$40-million project to develop a pollution-free, fuel-cell power plant for electric utilities is under

way at United Technologies, South Windsor, CT. The company, which is funding the project jointly with the Energy Research and Development Administration (ERDA) and the Electric Power Research Institute, is developing a 4.8-MW fuel-cell module that can be applied in multiples to produce up to 27.8 MW of power for a single installation.

Fuel for the cell will be hydrogen. An inverter plus a line transformer will be included in the module to convert the cell's dc output of ac power.

Development of the first module is expected to take two years, and the full program is expected to eventually produce 56 27-MW units. Thirty-two units have already been contracted for by utility companies.

## . . . while sodium-sulfur battery stores 10 MWh

Special hollow glass fibers that can conduct sodium ions are the key elements of a sodium-sulfur cell being developed by Dow Chemical for use in two different batteries: a 10-MWh battery for storing utility power during off-peak-demand hours, and a 60 kWh battery for powering electric vehicles.

The Dow cell uses molten sodium for its positive electrode and molten sulfur for the negative, says William Brown, associate scientist at the Western Division in Walnut Creek, CA, where the cell is being developed. The temperature of the cell (which is about one-eighth the size and weight of its lead-acid equivalent) is maintained at 300 C, largely by the heat of the cell produced during the charge-discharge cycles.

Efficiency of the charge and discharge at high rates—95% for voltage and 100% for current—is high compared to that of the conventional lead-acid battery. Voltage across a fully charged cell is 2.08 V.

Banks of 5-Ah laboratory cells have successfully undergone more than 2000 rapid-charge, deep-discharge cycles, more cycles than would be encountered in over three years of energy-storage use.

The hollow glass fibers of the sodium-sulfur battery—fiber diam-

eter is 0.003 in., and wall thickness 0.0005 in.—are filled with hot liquid sodium. The outside of the fibers is surrounded by the molten sulfur solute.

As the cell charges and discharges, the sodium remains chemically unchanged. But the sulfur is converted back and forth from sulfur to sodium sulfide ( $\text{NaS}_x$ ) as the sodium ions migrate away from the back to the interior of the hollow fiber during charge-discharge cycles.

The ultimate energy storage configuration for kilowatt and megawatt capacity will consist of banks of hundreds of series and parallel-connected cells.

## Race is on to convert 23-channel CBs to 40

On January 1, 1977, the Federal Communications Commission (FCC) will permit users of citizens band radios to operate on 40 channels instead of on the currently allowed, but already overcrowded, 23.

This announcement has touched off the beginning of a scramble among CB radio manufacturers to come up with an inexpensive (and government-acceptable) means of modifying existing sets to accommodate the additional channels. These sets include not only those transceivers already in the hands of consumers, but also the large number stored in warehouses.

The impetus behind this rush of activity is readily apparent in view of the enormous increase in sales of these two-way communications units over the past few years. More than 10 million CB 23-channel sets are already in use throughout the nation, with 4.2 million units produced and sold in 1975 alone. The estimated market for 1976 is 10 million sets.

For \$25, Hy-Gain Electronics Corp., Lincoln, NE, will remanufacture any of its present 23-channel CB sets into 40-channel units, says Andrew Andros, Hy-Gain's chief executive officer. Hy-Gain's sets contain Phase-Locked Loop (PLL) oscillator circuits which can be programmed for "virtually any number of channels." The remanufacture process consists of reprogramming the PLL oscillator and replacing the 23-channel

selector with a 40-channel switch. Andros cautions, however, that this remanufacture procedure is applicable only to CB sets operating on the PLL principle, and cannot be applied to older, crystal-synthesizer-type sets.

In addition to PLL reprogramming for 40-channel operation, an antenna filter might have to be added to conform to the new FCC specifications on harmonic radiation Andros adds.

Remanufacturing CB transceivers from 23 to 40 channels may not be all that simple, warns Ted Danhouser, Sales Manager of Motorola Communications, Schaumburg, IL.

The FCC will not allow the CB manufacturers to retrofit a 23-channel set with simple add-on devices—hence, the significance of the word "remanufacture." The word implies, for example, meeting not only the more stringent FCC limitations on spurious harmonics that may be radiated from the transmitter, but also on spurious radiation from the receiver. Such radiation—which can cause interference to television reception—can originate in the local oscillator of the CB receiver.

## Holographic ROM stores 200 Mb on microfiche

A 4 × 6-in. piece of microfiche can be used to store up to 200 Mb of data in a holographic memory

system designed by TRW Systems, Redondo Beach, CA, for Holofile Industries of Woodland Hills, CA.

The microfiche (renamed holofiche) contains data stored in an array of 2 × 2-mm holograms. Each laser-written hologram contains 2500 bits of data. Since all of the data in a hologram can be read by illuminating any single point on the hologram, the data are virtually indestructible. In fact, should most of a given hologram be destroyed by, for example, punching a hole through the holofiche, all of the data can be reconstructed.

Holofile has produced a relatively inexpensive (under \$500) reader for holofiche. The reader uses a 2-mW Spectra-Physics He-Ne laser to illuminate the holofiche and a self-scanning, Si-photodiode array from Reticon, Sunnyvale, CA, to detect the resulting image. The reader can be either connected to a computer terminal as a mass-storage peripheral or used with an embossed card reader as a credit verification terminal.

When the reader is used with a computer terminal, an address is fed to the reader, and the laser is positioned to illuminate the proper hologram. Because of the mechanical positioning, the access time is from 1 to 10 s. Data can be read out, however, at up to 5 MHz.

"The reader is about 6 months to one year away from commercial availability," says James Case, vice president of operations at Holofile.

## News Briefs

**UOP Inc. of Des Plaines, IL, is developing an oxygen sensor based on electrolyte technology to measure the concentration of oxygen in aircraft fuel tanks.** The program is sponsored by the Air Force Aero Propulsion Laboratory as part of a safety system to measure explosive fuel-air mixtures in tanks.

**A General Accounting Office review of the Navy F-14 fighter, which figured in two fatal crashes near San Diego earlier this year, has cited low avionics reliability as a possible cause of the fighter's poor performance.** Reliability of some major flight systems

ranged from 6-to-14% of the desired objective. The Air Force Avionics Laboratory is seeking industry sources to do research on laser communications at data rates of 2-10 gigabits per second. Primary applications are in space.

**The Navy plans to buy 204 Light Airborne Multi-Purpose System (LAMPS) helicopters—plus six prototypes—with production to begin in 1981.** These heavy-on-electronics helicopters will be used for anti-submarine warfare. A contractor will be selected next spring; Boeing and United Technologies Corp. are considered the leading contenders.



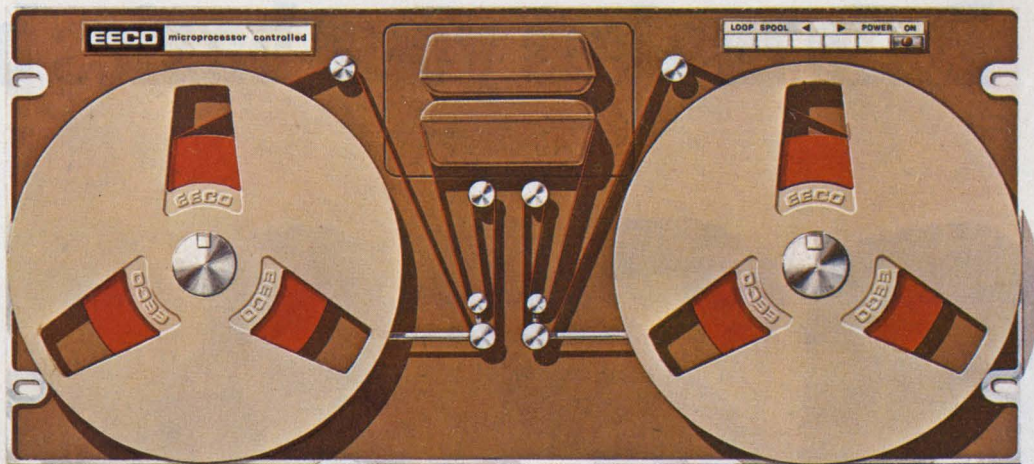

# This new microprocessor controlled

reader/spooler will read 1000 characters per second, and still provide *stop on character*. All of its reader/spooler functions, such as starting, stopping, rewind speed (1500 c/s), data output, and interface timing are controlled by a program stored in its microprocessor memory. Its other advantages lie in the areas of reading reliability, high speed stopping, programmed soft stopping, the spooler system, and equipment reliability. It also includes step and slew modes, and

a priority interrupt mode. And like other EECO readers it boasts LED and phototransistor optoelectronics, a step motor drive, a full tape-width barrel sprocket, handshake interface logic, and TTL and DTL compatible electronics. But wait, we can't sell you one now, because it won't be shippable until after the National Computer Conference.\* We're telling you now just so you can make plans. The best is yet to come.

\*First public showing.

**EEECO**  
READERS/PACKAGING/SWITCHES

1441 East Chestnut Avenue, Santa Ana, California 92701 Phone 714/835-6000

# Dale makes your basics better.



## More muscle in your resistors

Wirewound, metal film, carbon film, tin oxide... Dale's resistor line is stronger than ever. To match expanded capacity, we've installed a network of computer terminals to speed shipments and aid you in production planning. In addition, we've upgraded our quality assurance programs so that one out of every 10 Dale employees is directly involved with quality control. As a result, the Dale resistors you order are the best we've ever made... and the most efficient for you to buy.

CIRCLE NO. 351

## More stretch in your connectors

Don't let the costs of tooling a special connector scrap your design. Dale's innovative ED line gives you dual readout .050" and .100" edgeboards that expand in length and number of contacts without tooling charges. This "stretchability" is also available in a line of digital display connectors. In addition, Dale can provide a variety of .156" edgeboards plus dip solder and rack and panel models. To find out more about the advantages of Dale connectors, circle the reply number or call 605-665-9301 today.

CIRCLE NO. 352

## More punch in your trimmers

A trimmer's power rating should give you leeway to derate for assured long-term stability. Dale trimmers do. Our low profile 700 Series provides 1 watt at 70°C in both wirewound and cermet models and cermet models give you 1% CRV in the bargain. In single-turn square trimmers Dale's 3/8" 100 Series gives you a half watt clear up to 85°C in a choice of 5 top adjust and 3 side adjust models. Compare. We're the new source you've been looking for.

CIRCLE NO. 353



## Higher Q in your inductors

Dale is steadily growing as a source for a wide range of inductors including: Flame retardant coated chokes with performance and durability comparable to molded models at a much lower price; filter inductors with a wide selection of Q vs frequency; trigger transformers interchangeable with 11Z types. In addition, we offer a versatile line of transformers including low power, converter and pulse models. Get complete price and delivery information by calling 605-665-9301 today.

CIRCLE NO. 354

## More versatility in your networks

Dual-in-line, single-in-line standard or special circuits... Dale has what you need in thick film resistor networks. For custom circuits our SDP and SSP Series offer two ceramics with space for up to 28 resistors. New low profile SIP models and machine insertable DIP's solve packaging problems. We were the first to qualify to MIL-R-83401 and now offer 10 models meeting this spec. For network help, call 402-371-0080 today.

CIRCLE NO. 355



*Your man from Dale has a lot of ways to help you ...call him today.*

DALE ELECTRONICS, INC.  
1300 28th Avenue,  
Columbus, Nebraska 68601  
A subsidiary of The Lionel Corporation  
In Canada: Dale Electronics Canada Ltd.  
In Europe: Dale Electronics GmbH,  
8 Munchen 60, Falkweg 51, West Germany

*Our complete product line can be found in Electronic Design's GOLD BOOK.*

## At Wescon/76

# Charge transfer technology used in sonic imager and signal correlator

A basic review of charge-transfer device technology and a look at some new applications for it will be featured in Session 19, "Application of Charge Transfer Devices to Sampled-Data Signal Processing."

Employing charge-coupled device (CCD) as a lens for ultrasonic imaging applications will be described by Roger D. Melen, a researcher at Stanford University's Electronics Laboratory, Stanford, CA. According to Melen, the CCD lens promises to reduce the weight, volume, power consumption and cost of ultrasonic imaging systems by as much as an order of magnitude. In addition, the CCD lens permits improvements in system resolution, field of view, range and frame rate.

Reviewing past efforts in ultrasonic imaging systems, Melen notes that developing electronic focusing techniques has always been a problem due to the need for a high performance, low-cost, electronically variable, analog delay line. With CCDs, this variable delay is now possible.

## Standard processing used

The cascade charge-coupled device (C3D) is an array of CCD delay lines interconnected on a single IC substrate. According to Melen, the array can be fabricated with present-day MOS manufacturing techniques on a 120-by-120-mil chip.

The delay lines of the lens consist of multiple sections, each clocked by independent clocks of differing frequencies. When these separately clocked sections are combined with multiple-input taps, the result is a device that can perform the high-speed Fourier and

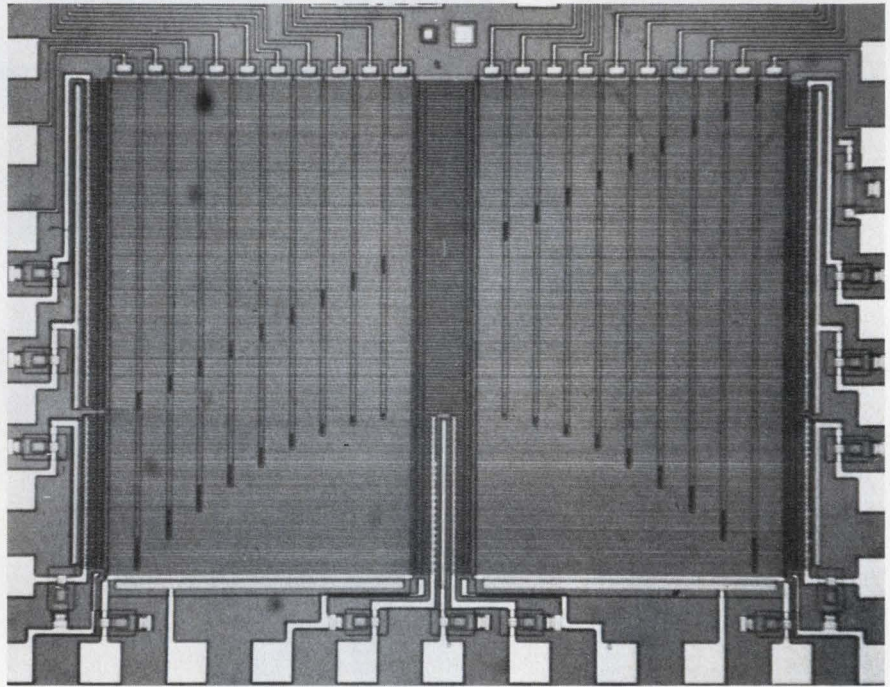

An ultrasonic lens composed of a CCD chip can reduce the size and power needed by ultrasonic imaging systems. It is described in Session 19.

Fresnel transformations required for the imaging task.

The CCD lens is the equivalent of an optical, wedge-shaped lens cascaded with a quadratically shaped lens. Unlike the optical counterpart, however, the thickness of the CCD lens is electronically variable so that the imaging system can be focused and steered to different targets.

A large-scale integrated circuit that can perform binary-analog correlation will be described in "A Programmable Binary-Analog Correlator," by Udo Strasilla of Reticon Corp., Sunnyvale, CA.

According to Strasilla, a 32-stage, bucket-brigade, tapped delay line is used to perform correlation or convolution between an analog

signal and a programmable binary function. The new correlator duplicates the complex signal-processing task normally handled by digital computers. The digital method involves a/d conversion, storage in memory, a multitude of multiplications and a d/a conversion. With the BBD correlator, however, all these operations are replaced by a sequence of sample, store, shift and multiply functions, that are performed by a single IC chip.

Explaining how it works, Strasilla notes that discrete-time samples of the analog signal are shifted into the BBD register. After every clock period, the temporarily stored analog samples are multiplied with a binary pattern residing in a static shift register. ■■

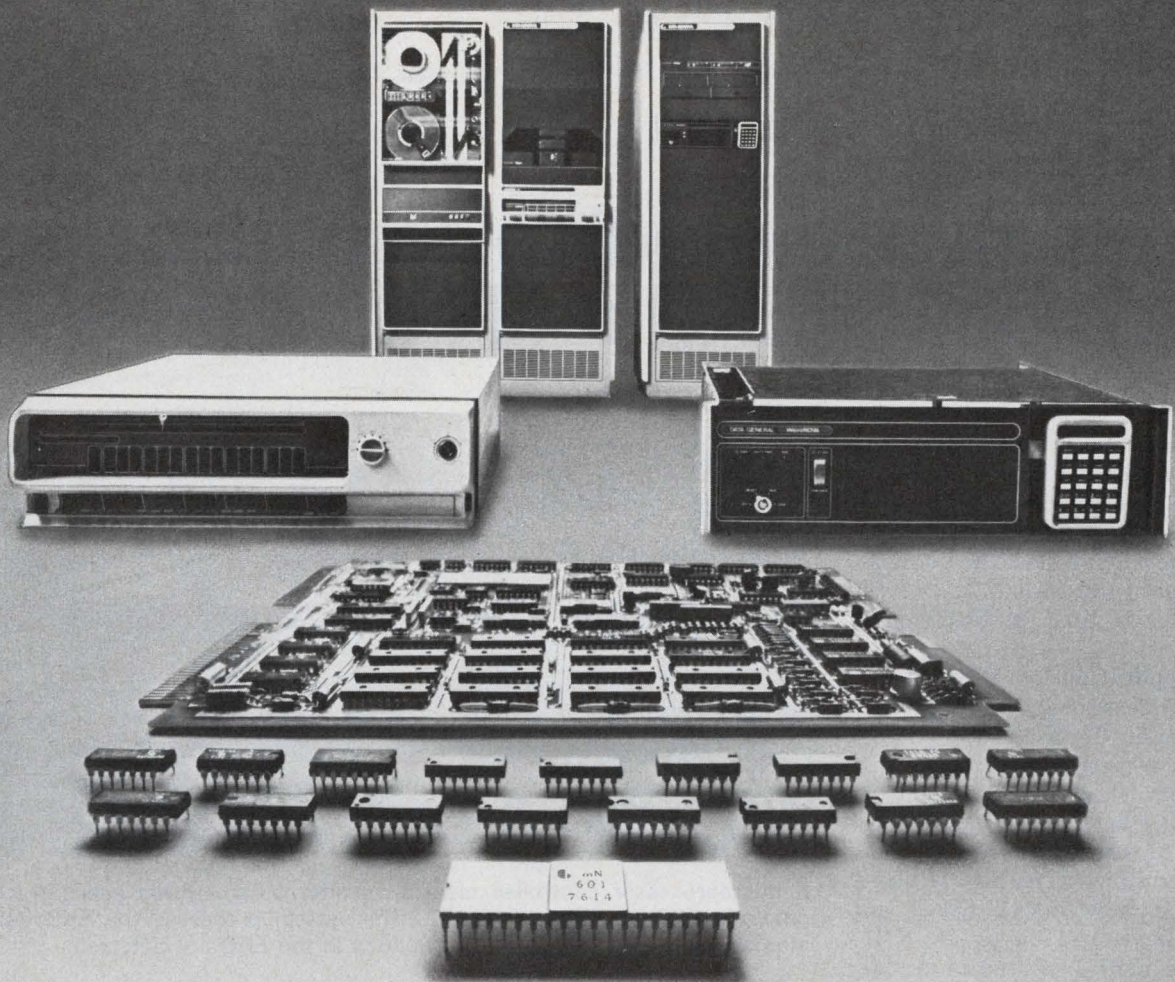

# With a line of minis and micros like ours, we don't have to push any one of them.

With other companies, you might set out to buy a microprocessor chip and end up with the whole chassis. Or get a box when all you need is a board.

But Data General doesn't work that way. We don't have to push you into buying something you weren't really looking for. Because we can let you choose from microprocessor chip sets, microcomputer boards, completely packaged MOS minis and full-blown NOVA 3 systems. All four are compatible. And they give you a range of performance with a range of prices.

So, if you're a component user, there are both high-performance microNOVA chip sets and microcomputer boards that feature Data General's mN601 microprocessor. The mN601 is a full 16-bit NOVA-on-a-chip. And the microcomputer is a full 4K-word computer-on-a-board. You package them yourself, for greatest economy. (Speaking of economy, the board costs only \$589 in OEM quantities of 100.)

And if you're not ready for components yet, there's our fully-packaged microNOVA MOS minicomputer. It's available with up to 32K words of MOS memory and peripherals like

our diskette subsystem. And it's supported by our Real-Time Operating System and diskette-based Disc Operating System. You can get our mini with 4K words of MOS memory for only \$1995. Or as a complete development system with the diskette.

If you need bigger systems capabilities, take a look at our NOVA 3 computer. It's compatible with our microNOVA family. And it runs with high-performance peripherals, sophisticated software like Real-Time Disc Operating System, high-level languages like FORTRAN 5 and BASIC, and memory expansion to a full 128K words.

We've got it all. But we won't try to sell it all. Unless it's what you really need. If you don't believe that line, call us. Dial 800-225-9497 (in Massachusetts, 1-617-485-9100, extension 2509) and ask for information on microNOVA and on the free half-day microNOVA seminars that happen this fall all over the country.

Or write for our microNOVA and NOVA 3 brochures. And see for yourself.

## DataGeneral

Data General, Route 9, Southboro, Mass. 01772 (617) 485-9100. Data General (Canada) Ltd., Ontario.  
Data General Europe, 15 Rue Le Sueur, Paris 75116, France. Data General Australia, Melbourne (03) 82-1361  
NOVA is a registered trademark of Data General Corp.

## At Wescon/76

Semis invade medical transducers;  
 $\mu$ Ps monitor EKG and blood pressure

Field-effect transistors as physiological transducers and microprocessors as electrocardiograph and blood-pressure monitors are two of the new developments to be discussed at Wescon in Session 22, "Needs and Trends in Medical Electronics—1976."

In "Application of FET Semiconductor Technology to Biochemically Specific Transducers," Stanley Moss, a researcher at the University of Utah's Department of Bioengineering, will describe the invasion of semis into the physiological transducer area and will report on a new device called an ISFET. Developed under an NIH grant, the ISFET is used in miniaturized transducers that produce an output when exposed to a specific type of ion.

The ISFET, says Moss, is basically a MOSFET that has either a bare gate or a polymer ion-selective gate membrane. Because the membrane is in direct contact with the gate insulator of the FET, the voltage (Nernst Potential) developed at the membrane solution interface is transmitted to the gate.

When the chip is used as a transducer, notes Moss, the part containing the ISFET gate is exposed to the electrolyte solution, while the rest of the device is covered with epoxy. To date, transducers sensitive to calcium, potassium and hydrogen ions have been fabricated.

The transducer has an anion liquid ion exchanger immobilized in a matrix material. As a cation approaches the membrane, it becomes attracted to the membrane. The positive charge of the cation adds to the already existing charge on the membrane, thereby changing its value. This change is then reflected as a change in gate charge.

Moss predicts that FET tech-

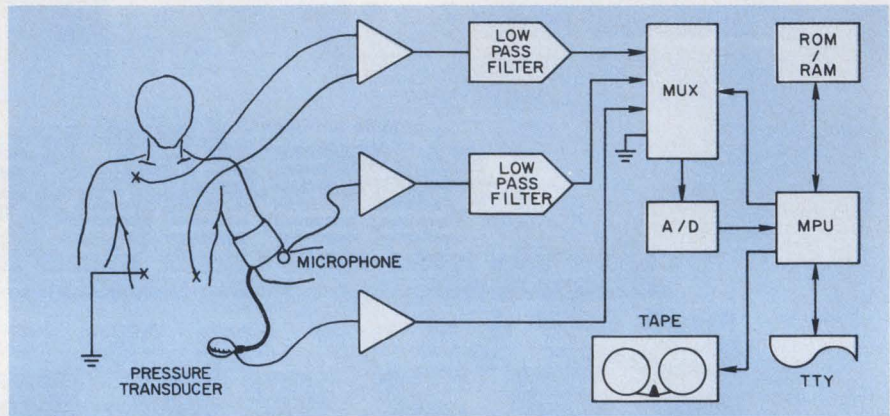

**A microprocessor controlled medical monitor** automatically keeps track of a patient's EKG and blood pressure. The system processes the EKG data and stores it only when significant deviations in the EKG are detected.

nology will also be used to develop transducers sensitive to enzyme reactions as well as to immunological reactions. During the latter reactions, an antigen—a substance that stimulates the body's defense mechanism to produce antibodies—is covalently bonded to a surface connected to the gate of a FET. The antigen and the antibody with which it reacts have specific charges associated with them. When these two combine, they produce a third charge. Like the charges of the ion transducers, this new charge will affect the amount of charge under the gate of the FET.

#### $\mu$ P checks EKG and pressure

A portable electrocardiogram and blood pressure signal monitor will be described at the same session by Martin Graham, professor of electrical engineering of the University of California at Berkeley. According to Graham, the system provides a day-long analysis of EKG signals and periodic recordings of blood pressure. He further notes that rather than record sig-

nals all the time, the system processes the information and reduces it, extracting and storing data only when it detects deviations.

To minimize the amount of memory needed, the micro-based monitor waits for an irregular or premature heartbeat and then records it and several subsequent beats. The EKG part of the system is similar to commercially available EKG recorders, notes Graham, but smarter. It can distinguish and store abnormal behavior separately.

Blood pressure measurements can be taken and recorded throughout the day or upon request. A measurement algorithm uses a Fast Fourier Transform to detect shifts in the spectral content of the Korotkov sounds characterizing the systolic and diastolic pressures. Comparing the frequency spectrum of sounds associated with previous heart beats to the spectrum of the current beat can determine the blood pressure. The systolic and diastolic points can be identified by a change in specific-frequency components that exceed a fixed threshold. ■■

# Unmatched Performance and Selection in High Speed Data Acquisition

Ultra-high speed ADC's and DAC's, sample-holds, multiplexers, and super-fast op amps. Individually, they're outstanding — many without peer. Collectively, they are carefully matched to provide the fastest data acquisition systems available. Anywhere.

Ultra-High Speed ADC's	Resolution	Conv Time	Gtd Throughput Rate with 4855S/H*	Add a 4550 Multiplexer Time per Channel	Throughput
4130	8-bits	0.75 $\mu$ s	1.25 MHz	1.10 $\mu$ s	909 kHz
4131	10-bits	1.00 $\mu$ s	940 kHz	2.12 $\mu$ s	471 kHz
4133	12-bits	2.50 $\mu$ s	377 kHz	3.30 $\mu$ s	303 kHz

\*Model 4855 features 250 nsec acquisition time to 0.01% and an aperture time of 2 nsec max.

**For high speed MIL-applications**, our 4058, a true 12-bit microcircuit DAC, features ultra-fast, ultra-stable operation from  $-55^{\circ}\text{C}$  to  $+125^{\circ}\text{C}$  with 100% screening available to MIL-STD-883.

**Settling at 200 nsec to 0.01% max** and providing 10 V @ 50mA output, our 1430 IC op amp is still the performance leader. Combine it with 4058: without question the fastest 12-bit hybrid voltage DAC. Anywhere.

**The industry's fastest MDAC's** — that's our 4070 series. 8, 10, or 12-bit resolution, 500 nsec settling to 0.1%, and inputs up to 7 MHz.

**High Speed Current DAC's** — our 4060 series give you a competitive and compatible selection, with a guaranteed settling of 85 nsec to  $\pm 0.1\%$ .

Radar pulse digitizing, video digitizing, FFT, simultaneous sample-hold systems, CRT displays, and waveform synthesis — applications where only Teledyne Philbrick can give you the complete high speed solution. And, a new series of Application Bulletins will facilitate your high speed design. Just write for them.

Teledyne Philbrick, Allied Drive, Dedham, MA 02026 — Telephone (617) 329-1600. In Europe, Telephone 673.99.88, Telex 25881, or write 181 Chaussee De La Hulpe, 1170 Brussels.

**TELEDYNE PHILBRICK**

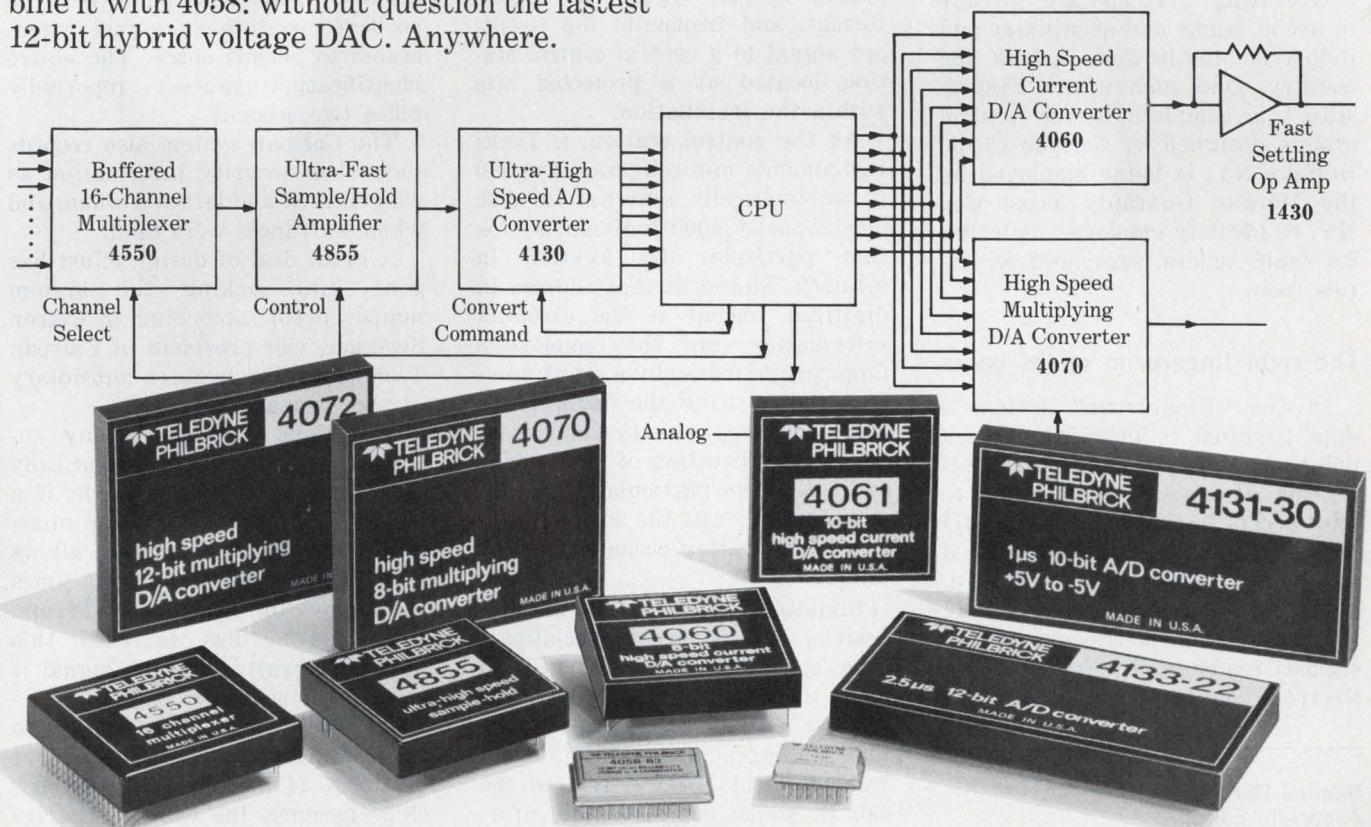

CIRCLE NUMBER 19

# Electronic fingerprints compete with ID cards for access control

For years, law enforcers have identified people by their fingerprints—personal “signatures” that can neither be duplicated or forged.

Now, private industry has become interested in putting this identification technique to use, especially in light of the proliferation of stolen and forged identification cards.

The most common use of fingerprint identification outside law enforcement agencies is screening entries into restricted areas. Benefits of screening by fingerprint include:

- Positive identification (rather than by a potentially misleading photograph).
- Cost reduction (machines are generally cheaper than guards).
- Automatic recording of entry and exit times.

Operating systems are already in use at banks and at military and industrial institutions across the country. One such unit, “Fingerscan,” a complete access control system designed by Calspan Corp., Buffalo, NY, is being employed by the Morgan Guaranty Trust Co., NY, to identify employees entering its vault, tellers’ area, and securities room:

## The right fingerprint opens doors

In the “Fingerscan” system a data terminal is installed at each point of entry to a restricted building or area. Anyone wishing to gain access to the area keys his ID number (or any other pre-assigned code) into the terminal keyboard. Upon receipt of a return signal, the person then places one (pre-assigned) finger on a glass plate. An electromechanical photosensor scans

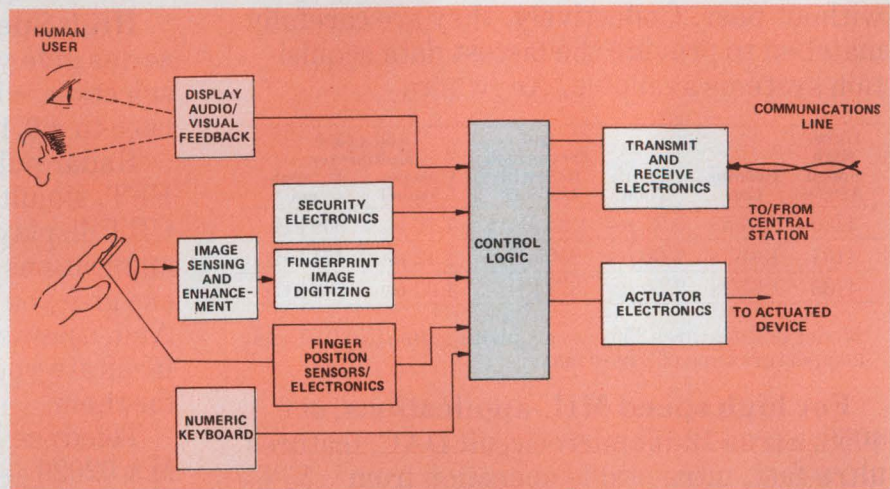

Calspan's Fingerscan terminal accepts an individual's ID number and fingerprint for transmission to a central computer. After comparison against its stored-data file, the computer decides whether or not to grant access.

the finger's surface, converts the analog optical signals to digital format, and transmits the resultant signal to a central control station located at a protected site within the installation.

At the control station, a Texas Instruments minicomputer, the 980 B, automatically searches its disc file (capacity 4000 individuals) for that particular ID location in memory. Stored at that address in digitized format is the essential information on the employee's fingerprint—basically a set of numbers representing the fingerprint's ridge endings, in particular, the location and direction of these ridge endings. These particular data, called minutiae, are the key to positive identification because they are unique.

Simultaneously with the disc file search, a hard-wired special-purpose computer examines, in real time, the fingerprint of the person seeking entry, selects the important fingerprint minutiae and transmits this information to the 980 B, which compares the infor-

mation to the data stored in the disc-file memory. Should there be positive correlation, a signal is generated to permit entry. The entire identification process reportedly takes two seconds.

The Calspan system also records such vital security information as who entered and left and when, and which entrances were used.

A great deal of design effort has gone into making the system tamper proof, according to Claron Swonger, vice president of Calspan Technology Products (a subsidiary of the Calspan Corp.)

Suspicious activity at any entrance or exit will automatically set off an alarm. For example, if a person attempts to key in an unassigned number, the system allows him to try a fixed number of times—to allow for any honest errors. But once he has exceeded this number, a warning alarm signal is sent to the security office.

Similarly, the system will try to read a fingerprint a fixed number of times. If unsuccessful, the machine assumes the worst and trig-



# The right DVM Decision means >1 ppm resolution, HP-IB, and math... all for \$3200.\*

Introducing HP's 3455A DVM—a microprocessor controlled DVM with high resolution and computational capability for the lab plus high speed and good noise rejection for systems use...complete with true r.m.s. ac to 1MHz, dc and ohms for \$3,200\*. HP's new high-speed microprocessor gives the lab user:

**5½ or 6½ digit resolution.** Choose from the normal 5½ digit mode or the High Resolution 6½ digit mode for >1 part per million resolution...ideal for trimming, matching and balancing in the Standards lab. Wide bandwidth ac readings are always displayed with 5½ digit resolution.

**Math capability.** Enter constants into memory and you can offset readings, take ratios or scale a measurement to give direct readout in engineering units. Or, display percent error from a standard value in memory to speed calibration and inspection tasks.

But the microprocessor is also control oriented to give the systems user:

**Fast reading.** Read at rates up to 24/sec on dc ranges, up to 12/sec in the fast ac mode and up to 12/sec on ohms ranges. You get this high dc speed with >60 db normal mode noise rejection at line related frequencies.

**Easy programming.** Program by pushing front-panel buttons. That's right, program-code knowledge is not required. In the Binary Program Mode, the HP-IB (HP's implementation of IEEE's 488-75) compatible 3455A

automatically monitors front-panel control settings and reports their status to the controller, speeding and simplifying instrument programming. Front-panel indicators give complete instrument status at all times.

**Removable reference and automatic calibration.** Calibrate your 3455A on the spot. Now your DVM needn't go to the lab for dc and ohms calibration. Simply keep an extra reference on hand. Then, to calibrate, just pull one out...slip another in...and with HP's Auto Cal you're ready to go again in seconds.

And for both lab and systems:

**Microvolt sensitivity and high accuracy.** Read directly from thermocouples and other low-level sources...with >140 dB CMR. On dc you have 1 µV sensitivity, 10 µV on ac. and HP's Auto Cal provides dc accuracy of ±0.005% of reading + 1 digit for 90 days by automatically measuring reference constants and digitally correcting readings. A test function signals out of tolerance constants and identifies the constant for rapid repair.

**Plus convenient features and options.** Choose either 2-wire k Ω or 4-wire k Ω measurements. Switch select 50 or 60Hz operation...front or rear panel inputs. And for \$200 less (\$3,000) you can substitute an average ac converter for the r.m.s. converter. Once you see the 3455A, you'll know it's the right system or lab DVM decision. Ask your local HP field engineer for all the details.

\*Domestic U.S.A. price only.

**HP DVM's—  
the right decision**

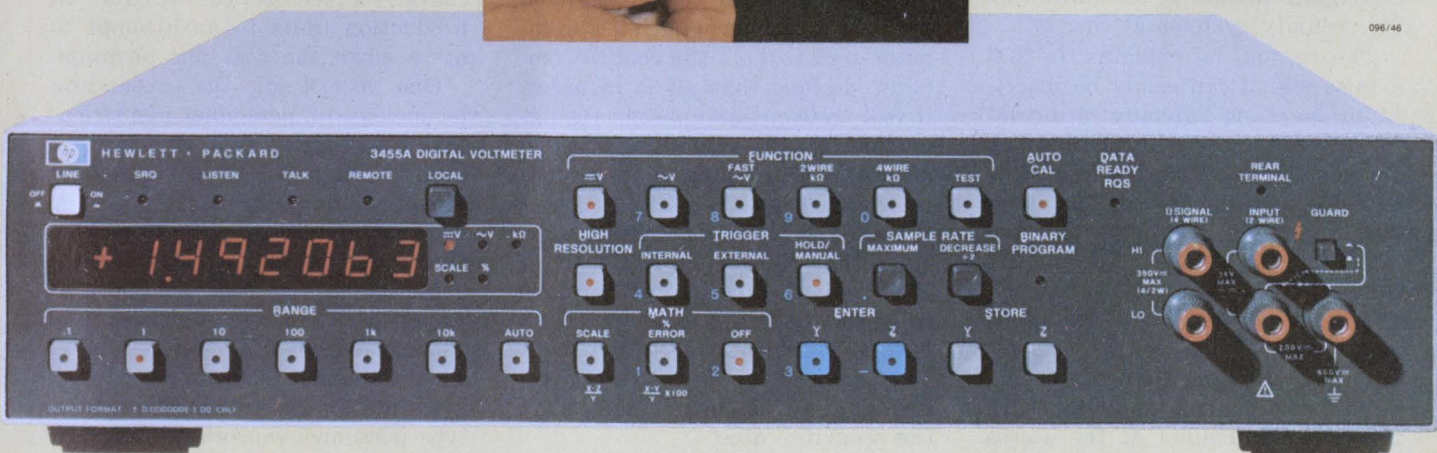
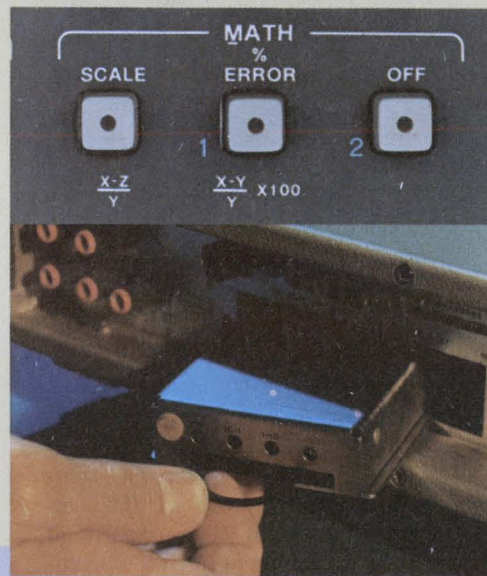

**HEWLETT *hp* PACKARD**

Sales and service from 172 offices in 65 countries.  
1507 Page Mill Road, Palo Alto, California 94304

For assistance call: Washington (301) 948-6370, Chicago (312) 677-0400,  
Atlanta (404) 434-4000, Los Angeles (213) 677-1282, Toronto (416) 678-9430

CIRCLE NUMBER 20

gers an alarm. Fingerscan will also "view with suspicion" an employee's ID number showing up at different entrances, all within a short time.

Swonger points out that the system can deal with many other possibilities, such as:

- Persons tampering with the terminal.
- Persons keying in invalid (nonexistent) ID numbers.
- Failure of a file storage device.
- Injury to the designated finger of an individual.
- Attempts to "forge" a fingerprint.
- Data communication errors.

On occasion, the Fingerscan will err by either accepting an individual who should be rejected or rejecting an individual with valid credentials. The error rate for both cases, according to Swonger, is approximately 1%.

### Another one will use TV

Currently in the final design stages at Sperry Rand Corp., Great Neck, NY, is a similar access-control fingerprint identification system. Using a TV-like scanning technique, the Sperry system samples thousands of bits of information from a single finger, encodes them, and compares them with similar fingerprint information previously taken from that employee and stored in a computer.

"For a high security device, more than just a simple 'yes' or 'no' signal is wanted (at the entrance or gate)," says Thomas Garrigan, manager of marketing for security systems at Sperry.

The reason, he explains, is that a false signal can easily be inserted by someone entering or breaking the line and feeding in a string of "yes" signals. That is, if all the signal processing is done at a central computer, and only the final result, a "yes" or "no" signal is returned to the terminal at the entrance gate, then this signal can possibly be duplicated.

For this reason, the information linking the central computer with the remote terminal at the access point is sent in complex form. A microprocessor at the remote terminal decodes this information to provide the necessary signals for the person seeking entry.

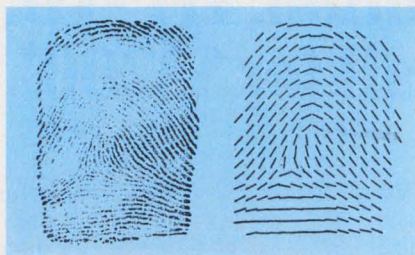

A single fingerprint is scanned to provide data on positions and angles of discrete points. These are matched against a similar set stored in memory. Verification is granted at a certain degree of match.



Rockwell's Printrak 250 verifies identity of a person based on a fingerprint read directly from a finger.

An access control module in the Sperry system provides an additional "surprise" to anyone tampering with the system. An employee keys in an ID number and supplies a fingerprint at a computer terminal. If the central computer decides that all is in order, it will transmit an appropriate signal to open the second door, which permits the employee to enter the restricted area.

Should the computer sense, however, that something is wrong at the terminal, it will not only refuse to open the inner door, but will also automatically lock the first door behind the unsuspecting individual. An alarm will then alert the security force.

The system's error rates for anyone keying in a valid ID or personnel code number are approximately 0.1% for false acceptances and 1% for false rejections.

Sperry's system, expected to be available in product form in approximately six months, will be able to replace up to 50 guards.

### More units on the way

Printrak 250, a direct-fingerprint reader developed by the Autonetics group of Rockwell International, Anaheim, CA, will soon be on the market, too. Like the Calspan and Sperry systems, the Rockwell system requires the print of only one finger.

"A prototype has already been built," reports Richard Snyder, director of ID systems at Autonetics. The first versions of this system will be aimed at the banking industry for automatic deposits and withdrawals but other applications envisaged include immigration control as well as a variety of areas where credit cards are now in use.

Ultimately, the over-all impact of fingerprint ID schemes on banking and credit card operations will depend on the cost. Present applications are limited to individual banks, single buildings, or single installations where the number of personnel involved is at most in the thousands.

Expansion of such systems to large-scale credit card replacement or to national banking systems would require an enormous increase in computer storage, coupled with a corresponding large increase in the number of input fingerprint-reading terminals.

Autonetics' engineers are seriously considering the use of charge-coupled devices (CCDs) in production units in an attempt to drive down the cost per terminal.

One aspect of the expanding technology of personnel identification via fingerprints that cannot be overlooked is the psychological consideration. Some individuals, or groups, for one reason or another, object to a record of their fingerprints (even one finger) being permanently stored in some remote and inaccessible computer file. This objection has prompted the investigation of other biometric-type personnel sensors.

### Hand reader used, too

Identimat Corp. of New York City has developed one solution—



Only one finger is scanned for its fingerprint at a terminal of Calspan's Fingerscan. The system uniquely identifies an individual.

the measurement of certain parameters of the entire hand. The Identimat system measures hand geometry parameters, such as finger length, curvature of finger tip, and translucency. The combination of these measurements is unique to any one individual, according to Chet Cohen, Identimat's vice president.

Three hundred such devices are now in operation in a variety of installations ranging from schools to financial institutions. "Unions won't touch fingerprint machines," says Cohen, "and a large number of other organizations also object to this method of personnel identification."

Garrigan of Sperry Rand, who has encountered few objections to the fingerprint method, disagrees. Fingerprint devices that are used expressly for access control do not record an actual fingerprint. What they record are digital data on certain discrete characteristics (the minutiae) of a fingertip pattern. The entire print is not available.

The controversy over whether fingerprint access control machines do or do not invade personal privacy has yet to be resolved. Nevertheless, with the costs for maintaining staffs of guards, keeping accurate entry records, and attempting to outwit forgers, ever rising, while at the same time the costs of technology go down, biometric security devices of nearly all forms would seem to have a secure future. ■■

# if you really need the smallest 10-bit synchro-to-digital converter...

...then you really need  
DDC's model  
HSDC-10.



The smallest synchro-to-digital 10-bit converter available is here now from the leader in data conversion devices. It's the Model HSDC-10 offering you a 36-pin double D.I.P. hermetically sealed can measuring only 0.78 by 1.9 by 0.21 inches.

Besides small size, the HSDC-10 offers you a whole range of outstanding features:

- Excellent dynamics — true type II servo tracking ( $K_a=200,000$ )
- Low power — 200 ma
- High reliability — MIL-STD-883 level C processing (Level B optional)
- Low cost

If you really need a converter whose ratiometric conversion technique makes it insensitive to voltage and frequency variations . . . then you really need the HSDC-10. Also . . . its unique circuit design eliminates the need for the usual —15VDC supply. With the all-new HSDC-10 only +15 volts and a logic supply (+4.5V to +15VDC) are required.

The unit is fully transient-protected and is available with or without transformer isolation.

The HSDC-10 accepts all standard inputs, synchro or resolver, and can be easily provided in a Navy Standard Electronic Module (SEM) Configuration.

Let us send you full details and technical specifications.

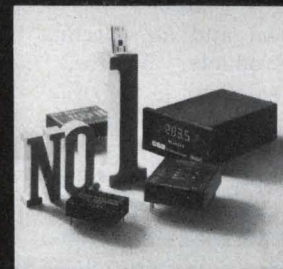

We're Number One in High Performance Data Conversions



**ILC DATA DEVICE CORPORATION**

A Wholly Owned Subsidiary of ILC Industries, Inc.

AIRPORT INTERNATIONAL PLAZA BOHEMIA, LONG ISLAND, N.Y. 11716 (516) 567-5600

APPLICATIONS AND SERVICE CENTERS

CALIFORNIA: 7337 Greenbush Ave.,  
No. Hollywood 91605 (213) 982-6454

EUROPE: England: The Sanctuary,  
Oakhill Grove, Surbiton, Surrey, Tel.: 01-399-7262

Interested engineers, write or call Harry Lewis or send for our 164-page product line catalog.

# Satellite enables scientists to track the movements of bears

Two hundred miles north of Point Barrow, Alaska, a 500-pound female polar bear has been outfitted with a battery pack on her chest and a 1-watt radio transmitter on her back. To advise the Nimbus 6/RAM satellite of her whereabouts, she transmits 15 bursts of energy—once a minute for 15 minutes when the satellite is overhead. To conserve battery power, the transmitter shuts down for four-day intervals.

Nimbus receives the signals, measures their rf frequency for Doppler shift, decodes the data and sends the information to earth.

## Bear's movements monitored

The purpose of this invasion of the privacy of polar bears, being carried out by the Dept. of Fish and Wildlife, is to determine if, and how, the pipeline now under construction is interfering with the hibernation patterns of Arctic bears.

The equipment being used includes a transmitter built by Handar Co., Santa Clara, CA, which was originally designed for use on buoys at sea, and an antenna by Transco Products, Venice, CA. Since the satellite is "visible" to the bear for 15 to 20 minutes of each orbit, the biologists have 15 to 20 data points from which to determine Doppler shift, and consequently, the bear's movement.

"NASA knows exactly where the satellite is at any given moment, so any Doppler shift is due to movements of the telemetry unit on the bear," says Hank Fallek, president of Handar, who went to Alaska himself to put the transmitter on the bear. So far, Fallek says, the bear's recorded location has been accurate to 1 km.

The battery pack, worn on the



**A miniaturized telemetry package** that is strapped on to polar bears in Alaska relays a bear's location to researchers via the Nimbus weather satellite. Scientists are studying the effect of the Alaskan pipeline on hibernation patterns.

bear's chest, is a 3.2-pound unit made with organic lithium. With its energy capacity of nearly 1 kW hour, Fallek expects the charge to last about 18 months.

## Miniature antenna used

Transmitter size was kept down by Transco's small, circularly-polarized antenna. "The operating frequency of 401.2 MHz corresponds to a wavelength of 29.4 inches," observes Dr. John Greiser, director of engineering at Transco. "But we made use of a high dielectric constant material and coplanar stripline to produce an antenna with only a 6-inch square radiating aperture."

The antenna is built on an epoxy-fiberglass board, which has cutouts from Emerson and Cuming High-K material. Greiser explains why: "The stripline gap is filled

with this material, which has a dielectric constant of about 10, resulting in dramatic size reduction." The telemetry unit on the bear measures  $8.5 \times 12 \times 3$  in.

The antenna is placed in the lid of the Lexan transmitter package and heat-welded in place. Hemispherical patterns are produced with a peak gain of +4 dBic.

The designer feels that the antenna can be made even smaller by loading the gaps with titanium dioxide. The powdered chemical, which is used in the manufacture of paint, is mixed with a resin and applied as a paste. Depending on the mix, the dielectric constant can range from 10 to 20.

Handar's Fallek is confident that Transco's work will enable him to reduce the size of the telemetry unit to  $5 \times 5 \times 2$  in. "Future programs may include dolphins," he explains. ■■

## Problem:

You need more than a card frame.

## Solution:

See Bud's new system. It not only provides card carrying capacity, but also affords modular packaging.

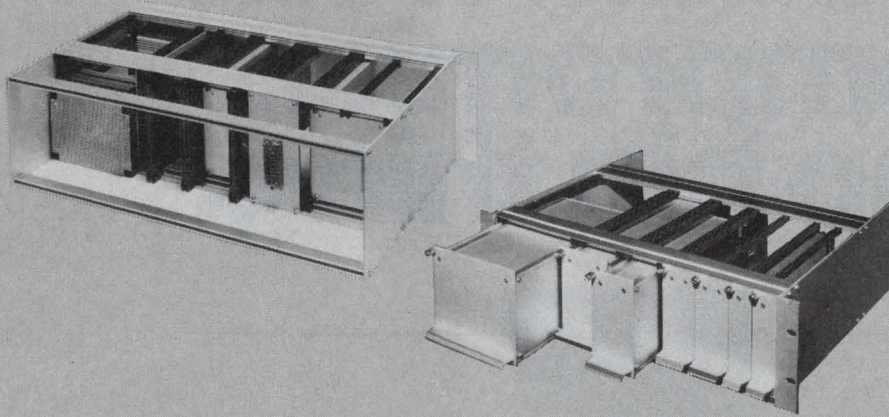

Our new modular packaging system is the most versatile on the market. We know you'll agree when you see it. Eight sizes take 44 different size modules. Yet, the design is simple. Components are easily assembled, easily modified. Your Bud representative will demonstrate it anytime. **YOUR PROBLEM IS SOLVED!**

## Call toll free:

(800) 321-1764 for more facts. In Ohio, (800) 362-2265.

# BUD

BUD RADIO, INC.  
Willoughby, Ohio 44094

### Now in stock at your Bud distributor.

### Call for a demonstration today!

#### ALABAMA

Birmingham -  
James W. Clary Co.  
205-322-2486

#### ARKANSAS

Little Rock -  
Carlton Bates Co.  
501-562-9100

#### CALIFORNIA

Chatsworth -  
Westates Electronics Corp.  
213-341-4411  
Los Angeles -  
Radio Product Sales, Inc.  
213-748-1271  
Mountainview -  
Elmar Electronics, Inc.  
415-961-3611  
Riverside -  
Electronic Supply  
714-787-9220

#### COLORADO

Denver -  
Electronic Parts Co.  
303-744-1992  
Newark Electronics  
303-757-3351

#### FLORIDA

Orlando -  
Hammond Electronics, Inc.  
305-849-6060

#### GEORGIA

Atlanta -  
Lykes Electronics  
404-355-2223

#### ILLINOIS

Chicago -  
Newark Electronics  
312-638-4411

Palatine -  
Ohm Electronics  
312-359-5500  
Peoria -  
Klaus Radio, Inc.  
309-691-4840

#### INDIANA

Indianapolis -  
Graham Electronics  
Supply, Inc.  
317-634-8486  
Ra-Dis-Co., Inc.  
317-637-5571

#### KANSAS

Wichita -  
Radio Supply Co., Inc.  
316-267-5213

#### LOUISIANA

Lafayette -  
Ralphs of Lafayette, Inc.  
318-234-4507

#### MARYLAND

Gaithersburg -  
Pioneer/Washington  
Electronics, Inc.  
301-948-0710  
Rockville -  
Capitol Radio  
Wholesalers, Inc.  
301-881-2270

#### MASSACHUSETTS

Dedham -  
Gerber Electronics, Inc.  
617-329-2400  
West Newton -  
A. W. Mayer Co.  
617-277-3577

#### MICHIGAN

Ann Arbor -  
Wedemeyer  
Electronic Supply  
313-665-8611  
Detroit -  
RS Electronics  
313-491-1000  
Livonia -  
Pioneer/Michigan  
313-525-1800

#### MINNESOTA

St. Paul -  
Gopher Electronics Co.  
612-645-0241

#### MISSOURI

Kansas City -  
Walters Radio Supply, Inc.  
816-531-7015

#### NEW MEXICO

Albuquerque -  
Walker Radio Co.  
505-247-2288

#### NEW YORK

Binghamton -  
Harvey Federal  
Electronics  
607-748-8211  
E. Farmingdale -  
Harrison Electronics  
516-293-7990  
Lynbrook, L.I. -  
Peerless Radio Corp.  
516-593-2121

#### NORTH CAROLINA

Winston-Salem -  
Kirkman Electronics, Inc.  
919-722-9131

#### OHIO

Cleveland -  
Pioneer/Cleveland  
216-587-3600  
Cincinnati -  
Hughes-Peters, Inc.  
513-351-2000  
Columbus -  
Hughes-Peters, Inc.  
614-294-5351  
Dayton -  
Pioneer/Dayton  
513-236-9900  
Solon -  
Radio & Electronic  
Parts Corp.  
216-248-8900

#### OKLAHOMA

Tulsa -  
Oil Capitol  
Electronics Corp.  
918-836-2541

#### PENNSYLVANIA

Allentown -  
A. A. Peters, Inc.  
215-434-5237  
Montgomeryville -  
Pyttronic Industries, Inc.  
301-792-7000  
Philadelphia -  
Almo Electronics Corp.  
215-698-4000  
Pittsburgh -  
Cam/RPC Electronics  
412-782-3770  
Pioneer/Pittsburgh  
412-782-2300

#### SOUTH CAROLINA

Columbia -  
Dixie Radio  
Supply Co., Inc.  
803-779-5332

#### TENNESSEE

Memphis -  
Bluff City Electronics  
901-725-9500  
Nashville -  
Electra Distributing Co.  
615-329-3971

#### TEXAS

Dallas -  
Wholesale  
Electronic Supply  
214-824-3001  
Ft. Worth -  
Swieco, Inc.  
817-335-6521  
Houston -  
Harrison Equipment Co.  
713-652-4750  
San Antonio -  
Sherman Electronics  
Supply, Inc.  
512-224-1001  
UTAH  
Salt Lake City -  
Standard Supply Co., Inc.  
801-466-3371

#### VIRGINIA

Charlottesville -  
Virginia Radio  
Supply Co., Inc.  
804-296-4184

#### WASHINGTON

Seattle -  
Almac/Stroom  
Electronics, Inc.  
206-763-2300

# Now freedom from compromise is no big thing.

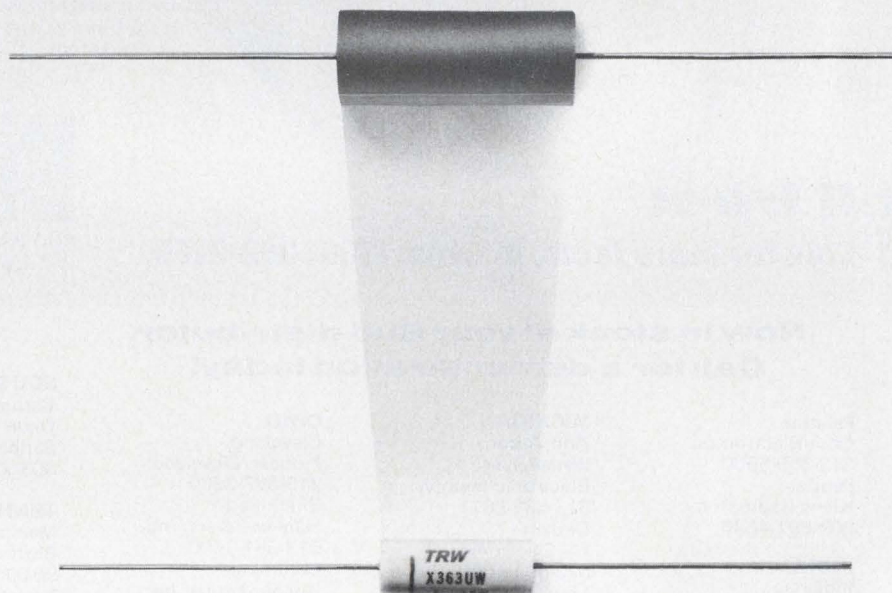

## Introducing the metallized polypropylene X363UW capacitor.

Now, circuit designers have a new freedom in applications where trade-offs were always necessary.

And, our new capacitor is no big thing. It's small where it should be, in physical size. But large in capabilities.

Capabilities such as low dielectric absorption (even better than polystyrene). Outstanding stability. High insulation resistance equal to polystyrene. And a low dissipation factor (High Q).

The result: the X363UW is an excellent all-purpose capacitor ideal for many applications including time base generators, integrators, filters and low level RF circuitry.

Tired of compromising? Tired of trade-offs? Write for complete specs. TRW Capacitors, an Electronic Components Division of TRW Inc., Box 1000, Ogallala, Neb. 69153.

## **TRW** CAPACITORS

ANOTHER PRODUCT OF A COMPANY CALLED TRW



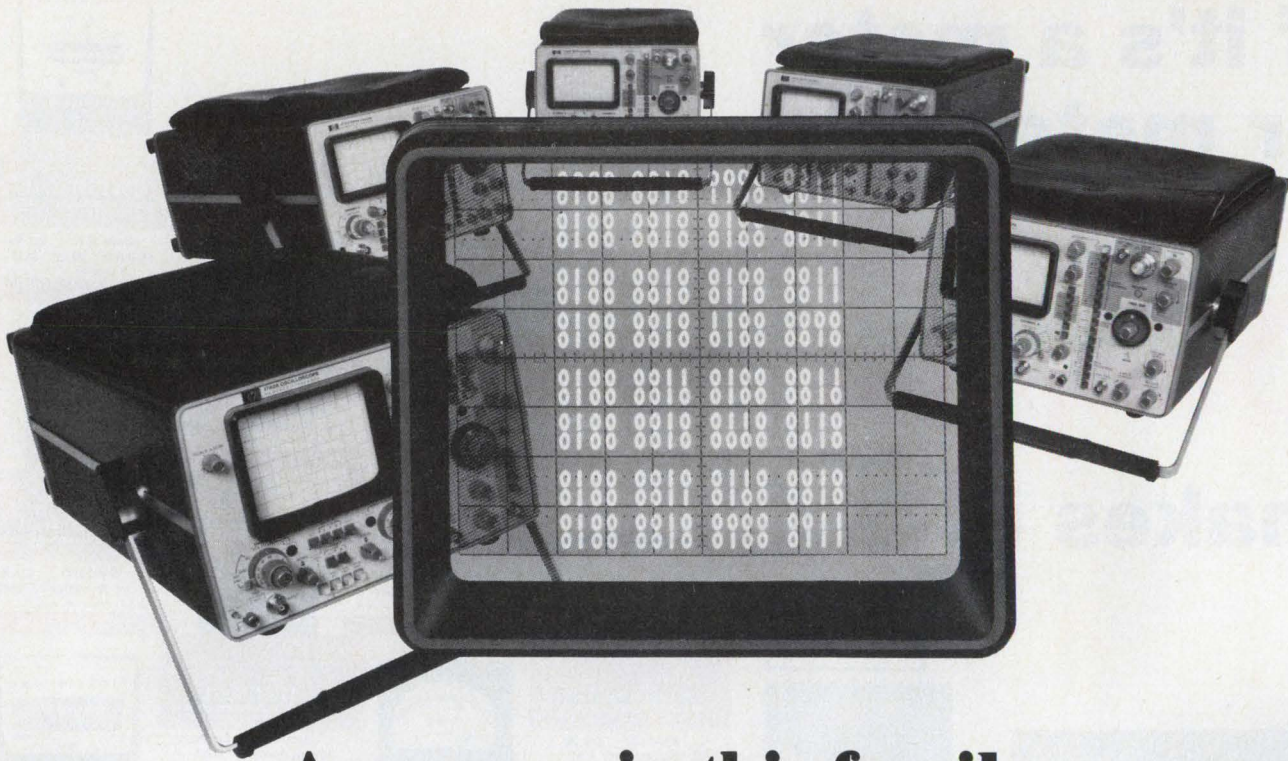

## Any scope in this family gets you started in the data domain.

Pick any one of these HP scopes. With the optional Logic State Switch, and the 1607A Logic State Analyzer, you have an economical and convenient way to time-share the display between traditional time-domain measurements and the new data domain. Select the data domain and your scope's CRT displays the results of your measurements in 1's and 0's. Select time domain and you have a display of electrical waveforms. It gives you a digital test setup that lets you perform both functional and electrical measurements with the same instrument. You'll have:

**Data Domain PLUS third-channel trigger view in the 100 MHz 1740A.** This scope lets you see the trigger signal along with the other two channels so you can make accurate timing measurements from the trigger signal to events on either or both channels and see the trigger point. Large display, 1 mV

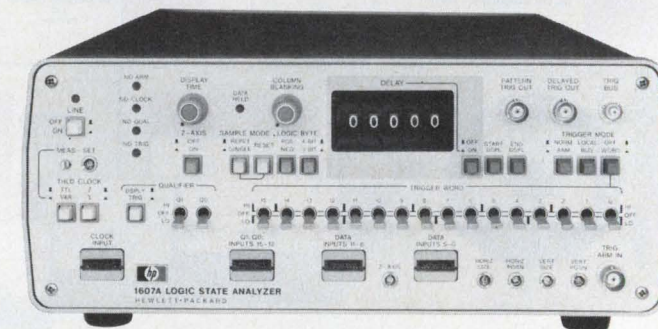

sensitivity to 40 MHz on both channels...and it's only \$1,995\* (plus \$105\* for the Logic State Switch).

**Data Domain PLUS Dual-Delayed Sweep, microprocessor and digital readout in the 275 MHz 1722A.** Put this scope in your lab and you have a partner that takes care of dial settings and calculations. It gives you a direct digital readout of time, frequency, voltage, and percent. This plus Dual-Delayed Sweep for rapid, accurate timing

measurements. Price is \$4,750\* (plus \$150\* for the Logic State Switch).

**Data Domain PLUS Dual-Delayed Sweep and 200 MHz in the 1712A.** This low-cost high-frequency scope gives you the measurement convenience and accuracy of Dual-Delayed Sweep, and scaled voltage output for direct readout of time intervals on your DVM. And it's priced at just \$2,950\* (plus \$150\* for the Logic State Switch).

**Data Domain PLUS 275 MHz in the 1720A.** Here's real bandwidth value in a dual-channel scope. It has exceptionally stable triggering and it's priced at just \$3,500\* (plus \$150\* for the Logic State Switch).

**Data Domain PLUS general purpose in the 200 MHz 1710B.** Here's another scope with real bandwidth value. It gives 200 MHz bandwidth at \$2,900\* (plus \$150\* for the Logic State Switch).

Pick the scope with the Logic State Switch (option 101) that best fits your needs and your budget. Then add the 1607A (priced at \$2,750\*) and you're ready to begin tackling problems in both the time and data domain. Contact your local HP field engineer for all the details.

\*Domestic U.S.A. prices only.

**Data/Time Domain Oscilloscopes**



Sales and service from 172 offices in 65 countries.  
1507 Page Mill Road, Palo Alto, California 94304

CIRCLE NUMBER 24



# There's so much good news about the Amphenol<sup>®</sup> SMA line, we almost ran out of ad.



But there's  
enough  
room to talk  
about our  
bigger-than-ever  
line. And our  
competitive prices.

What do you need in SMA's? Now you can get it in our expanded line of Amphenol stainless steel SMA's. And you'll get premium quality, too, at very competitive prices in all these configurations (shown above, left to right):

**Amphenol SMA cable assemblies:** For semi-rigid 0.141" and 0.085" diameter metal-jacketed cable and all flexible coaxial cables. Fitted with SMA or other RF connectors to your specs.

**Amphenol 'Spark Plug' SMA's:** For Microwave Integrated Circuit (MIC) packages. One-piece, screw-in, with hermetic seal. No gaskets, brazing, or soldering. Get a better seal for less cost. Superior RF performance, too.

**Amphenol phase-adjustable SMA's:** Just turn the nut to change phase up to 180° at 18 GHz and get phase-matched cable assemblies. No more repeated cable trimming operations are required to achieve precise electrical length. In-line adapters also available.

**Amphenol SMA connectors:** For all microwave frequencies up to 24 GHz. Comply with MIL-C-39012. All shell and body parts are gold-plated stainless steel. Dielectric is solid TFE. Amphenol SMA straight and angle plugs, jacks, receptacles, between-series adapters—the works.

**Something extra-special in SMA's?** We can help there, too. With unique designs that'll satisfy your needs. Just ask us.

**They're all easy to get—from your Amphenol Industrial Distributor.** He's in your neighborhood. For off-the-shelf service on our SMA line, give him a call. And phone or write us for more information. Amphenol Connector Systems, Bunker Ramo Corporation, 33 East Franklin Street, Danbury, Connecticut 06810. (203) 743-9272.

*When you can connect it  
and forget it...that's quality.*

Amphenol Connector Systems

**BUNKER  
RAMO**

CIRCLE NUMBER 25

DAIK

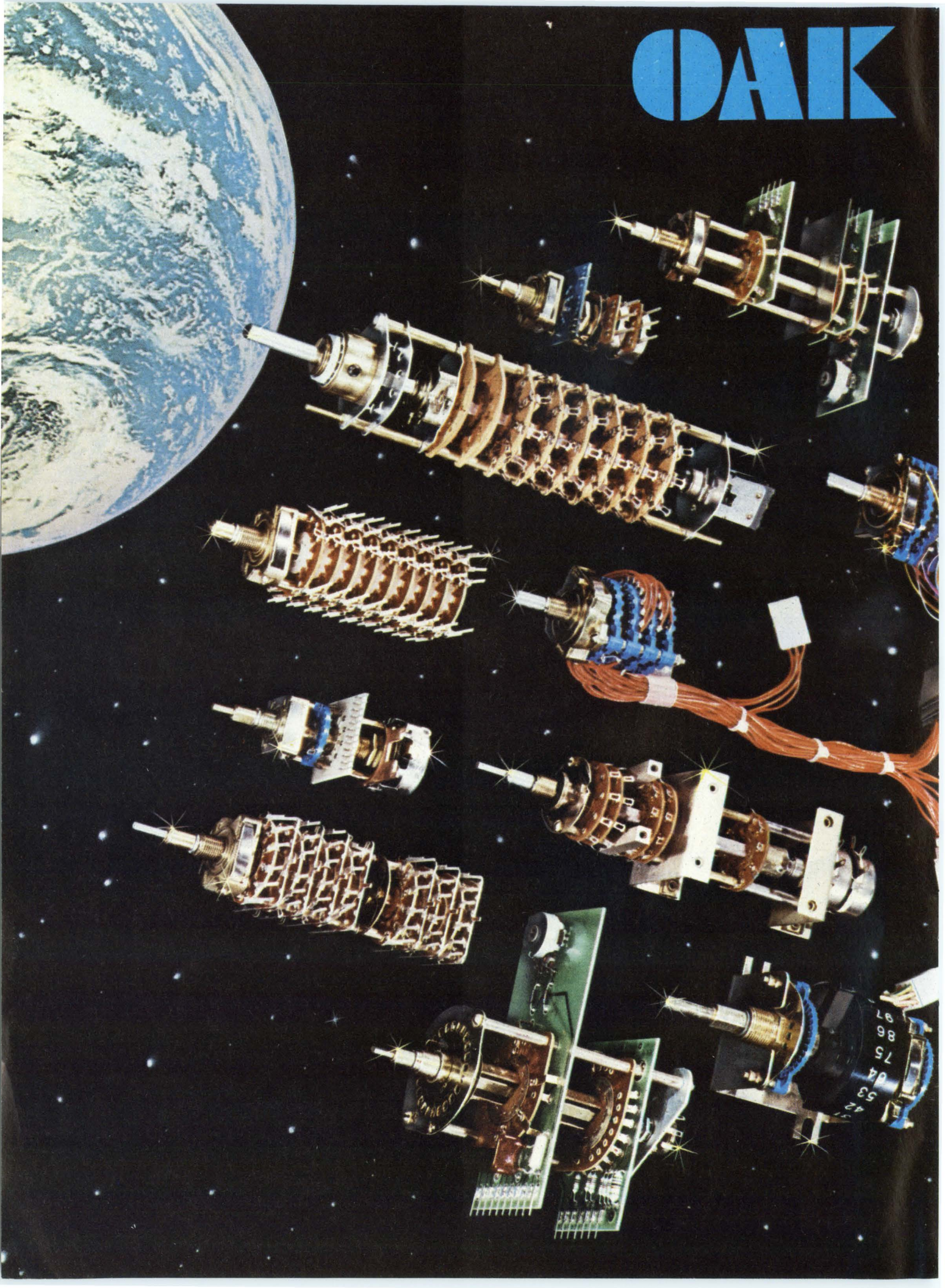

# does more than provide the industry's most complete line of rotary switches

Supplying any rotary switch—from the simplest single wafer to complex multiple section types isn't enough.

We will build our switches into almost any mechanical or printed circuit sub-assembly that you specify—with parts fabrication and special testing performed in-house.

Oak has internal metal-working facilities for all metal-forming, machining and attachment operations. Of course, we'll incorporate and/or terminate any components that are required—either supplied by you or purchased by us.

Some typical examples are described below. If your requirements are not represented... call us, (815)-459-5000—or provide prints—for a prompt quotation.

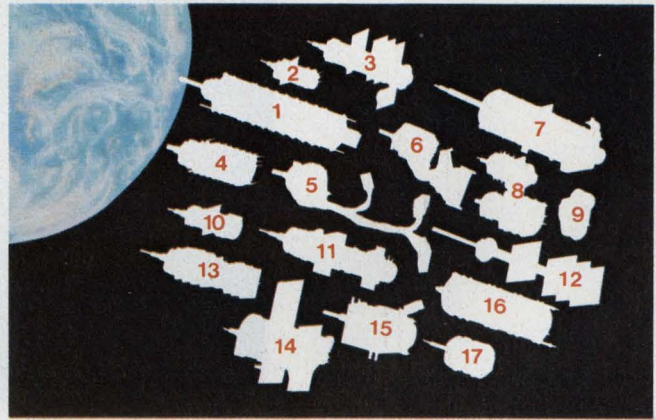

**1.** Combination push-button/rotary switch. Rotation can occur only after shaft is pushed in to activate push-button. Special hardware designed and built by Oak.

**2.** PC Board assembly with Unidex detent concentric shaft and PC switch section, with two variable resistors controlled from center shaft.

**3.** Test equipment assembly, combining phenolic switch sections, resistors and capacitors attached to PC boards, with concentric shafts, brackets and potentiometer.

**4.** Nine section Unidex switch with PC terminals at opposite sides for attachment to parallel PC boards.

**5.** Connector and harness assembly attached to four section, 24 position Multidex switch.

**6.** Five section Multidex switch wired and terminated with customer supplied connectors.

**7.** Triple concentric shaft with dual detent, with potentiometer on inner shaft, rear bank of 3 sections on center shaft and 4 front sections on outer shaft.

**8.** Switch assembly for electronic test equipment assembled by Oak. Includes six switch sections, gear system, potentiometer and special brackets.

**9.** Compact assembly controlling four 7.5A, 32V snap switches.

**10.** For PC board insertion, this Unidex dual concentric switch combines a PC board switch section, standard switch section and shielded variable resistor.

**11.** Stamped and machined mounting brackets and shielding hardware on multi-section switch with variable resistors controlled by center shaft.

**12.** Glass epoxy PC board switch sections with added components, solder terminals, special brackets and shielding for hi-fi equipment.

**13.** Seven section dual concentric Unidex switch with PC board terminals and shielding between sections.

**14.** Printed circuit section switch with additional wiring and components; for attachment to PC mother board.

**15.** Dual concentric switch with bracket and special counting dials, wired sections and attached connector.

**16.** Dual-concentric, 7 section switch, with shielding and special locking mechanism for use in test equipment.

**17.** Three 18-position sections, dual concentric switch with counting gear mechanism used for airborne equipment. Special brackets and gears assembled at Oak to customer's specifications.

**OAK Industries Inc.**

SWITCH DIVISION/CRYSTAL LAKE, ILLINOIS 60014  
TELEPHONE: 815-459-5000 TWX: 910-3353 TELEX: 72-244

CIRCLE NUMBER 27

K-601

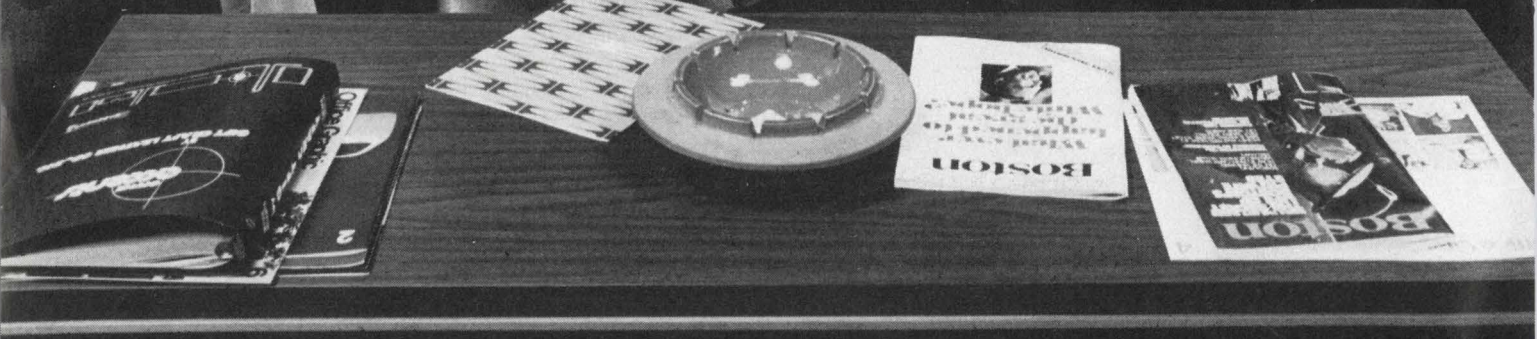
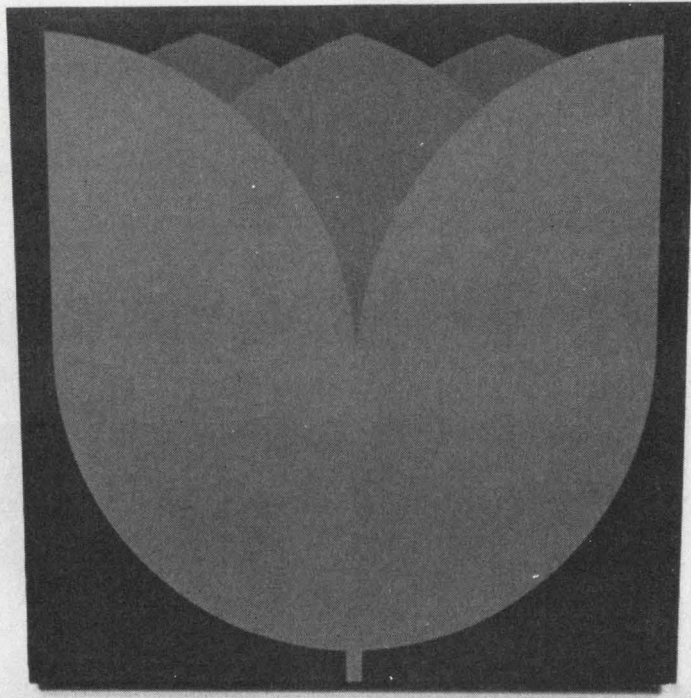

# Five tough questions to ask our 8080A competitors.

1. Do you have an 8K Electrically Erasable PROM? You know, like NEC Microcomputer's  $\mu$ PD458 that's compatible with 2708's but can be erased in 1 minute, programmed in 80 seconds, only needs two voltages for reading and programming, has conventional packaging, a guaranteed data retention time of 10 years, and an access time of 450/650ns, making it the first practical non-volatile RAM storage.

2. Do you have a Universal Synchronous Receiver/Transmitter Data Communications Controller? You know, like NEC's  $\mu$ PD379 with SDLC capacity up to 50K baud.

3. Do you have a 450ns 16K ROM? You know, like NEC's  $\mu$ PD2316A that's pin compatible with other 2316As but has the speed to match the 8080A.

4. Do you have a Floppy Disk

Controller? You know, like NEC's  $\mu$ PD372 that can control up to four IBM 3740-compatible drives.

5. Do you have a Tape Cassette Controller? You know, like NEC's  $\mu$ PD371 that can control up to two cassette drives with International Standard Data Format.

Go ahead, ask any competitor you like. What you'll find is that if you want these super 8080A peripherals, you'll simply have to come to NEC.

And when you do, you'll also be dealing with an 8080A supplier with complete applications support — plus the full range of 8080A products listed.

Any more tough questions?

Your NEC rep or distributor is waiting to put you at ease.

NEC Microcomputers, Inc.,  
Five Militia Drive, Lexington, MA  
02173. 617-862-6410.

$\mu$ PD8080A	2.0 MHz MPU
$\mu$ PD8080A-E	1.25 MHz MPU
$\mu$ PD8080A-2	2.5 MHz MPU
$\mu$ PD8080A-1	3.0 MHz MPU
$\mu$ PD411	4K DYN-RAM
$\mu$ PD5101-E	1K STATIC RAM
$\mu$ PD2101AL	1K STATIC RAM
$\mu$ PD2102AL	1K STATIC RAM
$\mu$ PD454	2K EE PROM
$\mu$ PD2308	8K Mask ROM
$\mu$ PD369	UART
$\mu$ PD758	Sieko Printer Controller
$\mu$ PB8212	I/O Port
$\mu$ PB8214	Priority Interrupt Controller
$\mu$ PB8216	Bus Driver
$\mu$ PB8224	Clock
$\mu$ PB8228	Generator/Driver
$\mu$ PB8251	System Controller
	Prog. Comm. Interface
$\mu$ PD8255	Peripheral Interface

## NEC microcomputers, inc.

**REPS:** East — C & D Sales 301-296-4306, Contact Sales 617-273-1520, Trionic Assoc. 516-466-2300; South — Merino Sales 214-233-6002, Perrott Assoc. 305-275-1132, 305-792-2211, 813-585-3327, Wolffs Sales Serv. 919-781-0164; Midwest — Electronic Innovators 612-884-7471, K-MAR Eng. & Sales 314-567-1829, 816-763-5385, McFadden Sales 614-221-3363, R.C. Nordstrom 313-559-7373, 616-429-8560, R.F. Specialists 312-698-2044; West — Mike Duffy Assoc. 303-934-7392, Electronic Component Mktg. 213-340-1745, 714-295-6122, 714-524-9899, Summit Sales 602-994-4587, Trident Assoc. 408-734-5900, Tri-Tronix 505-265-8409; Canada — R.F.Q. Ltd. 416-626-1445, 514-626-8324

**DISTRIBUTORS:** Century Electronics (Albuquerque, Denver, Salt Lake City) Diplomat (Chicago, Chicopee Falls, Clearwater, Dayton, Detroit, Little Falls, Minneapolis, Mount Laurel, Newport Beach, St. Louis, Salt Lake City, Sunnyvale, Woodbury) Harvey Electronics (Boston, Fairfield, Norwalk, Woodbury) Intermark Electronics (San Diego, Santa Ana, Seattle, Sunnyvale) Lionex Corp. (Boston) G.S. Marshall (Sunnyvale) Mirco Electronics (Phoenix) R-M Electronic (Detroit) Semiconductor Specialists (Boston, Chicago, Dallas, Dayton, Detroit, Indianapolis, Kansas City, Los Angeles, Milwaukee, Minneapolis, Pittsburgh, St. Louis; Malton, Canada) Technico, Inc. (Baltimore)



# KEPCO

## PRM

### 180 watts of the most reliable power supply you can buy

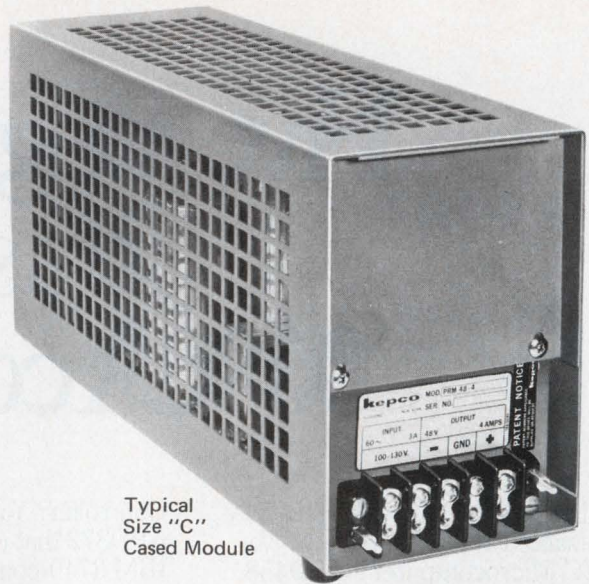

Typical  
Size "C"  
Cased Module

Recognized by Underwriters' Lab under their component recognition program, UL478 and UL114. 180 watts of the most reliable power supply you can buy. We really mean it. Reliability bears a simple inverse relationship to the number of parts likely to fail. Kepeco's Size "A" PRM design uses *exactly 10 components*: 4 diodes, 2 capacitors, 1 transformer, 1 resistor, 1 terminal strip, and 1 chassis. . . . That's it, period.

Compare parts population to some of the competitive SCR-regulators, high-frequency switching supplies and transistor feedback stabilizers. But, the PRM isn't an unstabilized brute; it's a rather elegant power supply with a number of attractive features:

1. Automatic (inherent) overcurrent limiting—at approximately 150% of rated current.
2. Automatic (inherent) overvoltage protection. There's no crowbar—there's no need for one.
3. Good source isolation, a 100–130V a-c line change brings less than 2% output effect. Line noise is attenuated by more than -120 dB at 1 MHz.
4. Low output impedance for minimal load effect, typically less than 0.1 ohm.
5. Ripple on the order of 30–300 millivolts (depending on model) and as little as 3 millivolts for the double filter models.
6. Operation in environments up to +55°C with no derating whatever.
7. A choice of several power ratings for the standard output voltages: 5.2V, 6.3V, 12V, 18V, 24V, 38V, 36V, 48V, 60V, and 120V. The size "D" models offer 85 different volt/ampere combinations from 4.2 volts at 12 amperes to 260 volts at 0.23 amperes.
8. Custom volt/ampere combinations available to your order.

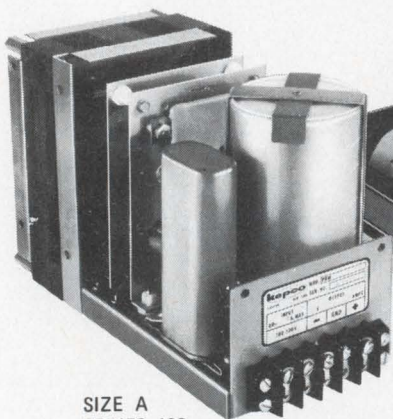

SIZE A  
SERIES 180

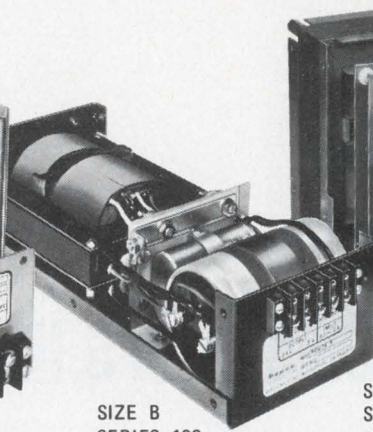

SIZE B  
SERIES 120

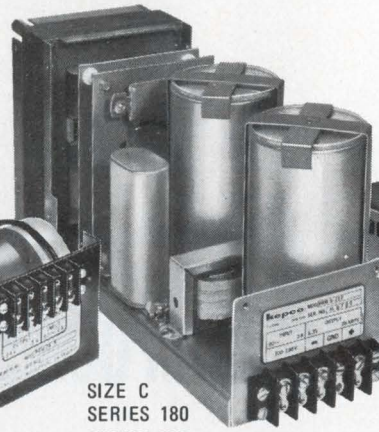

SIZE C  
SERIES 180  
SERIES 300



SIZE D  
SERIES 60

For complete specifications,  
write Dept. O-05

# KEPCO

KEPCO, INC. • 131-38 SANFORD AVENUE • FLUSHING, N.Y. 11352 • (212) 461-7000  
TWX #710-582-2631 • Cable: KEPCOPOWER NEWYORK

# Washington Report

## **New legislation aimed at overseas bribes**

Moving to curb the recent scandals in overseas arms sales, the Administration has submitted to Congress legislation that would require U.S. citizens to report payments made to foreign government officials. Known as the Foreign Payments Disclosure Act, the proposal would require disclosures of payments made to a foreign official in connection with an official action of his government or in connection with sales to, or contracts with, a foreign government.

The reports would be submitted initially to the Commerce Dept., then transmitted to the Departments of Justice and State, the Internal Revenue Service and the Securities and Exchange Commission. After a year, they would be made public. Penalties for failing to report, or for making false reports, would carry fines up to \$100,000 and prison terms up to three years.

The proposal follows recent revelations that such U.S. firms as Grumman and Lockheed paid questionable commissions to foreign sales agents on transactions involving aircraft exports.

## **Army field radio contract to E-Systems criticized**

The Army "apparently steered an \$11-million contract for mobile field radios to a favored company, E-Systems Inc. . . . despite lower bids from a competitor (Bristol Electronics Inc.)," according to a staff report by the House Government Operations Committee.

E-Systems won the contract after it was underbid three times by Bristol, the report noted. On the fourth submission, E-Systems had the low bid of \$528 per unit, but, the report added, "through contract modifications (the firm) was permitted to supply 10,030 additional radios at unit costs ranging from \$780 to \$934." The radios were intended for foreign military sales.

The report also criticized Congress's own General Accounting Office for its role in the procurement. After a protest by Bristol, GAO first declared the contract improperly awarded but later reversed itself when asked by the Army to reconsider. The committee urged that GAO hereafter stick by its original decision in a contract dispute unless "gross error or clear damage to the public interest is shown."

## **EIA, WEMA oppose tariff legislation**

The two major trade associations representing the electronics industry, the Electronic Industries Assn. and WEMA, have testified against proposed tariff legislation during hearings conducted by the House Ways and Means Committee.

The committee is considering a bill, H.R. 9220 (also known as the Customs Modernization Act), that would streamline the existing tariff regulations. As part of the process, the committee is considering changes to Section 592, which permits the government to assess penalties against an importer for the entire value of a shipment rather than for the actual revenue loss to the government.

Both associations focused their opposition on Section 592. WEMA called it an outmoded and poorly written law that causes honest U.S. businessmen to be treated like criminals. EIA urged the committee to amend the Section to establish grades of penalties for fraud, negligence and error; to postpone any penalty or seizure of goods, until the penalty is agreed upon; and to establish the right of any importer facing a penalty to seek judicial review of his own action.

WEMA, which represents many semiconductor producers, also complained that the existing tariff law hits particularly hard at firms that depend on overseas assembly. WEMA suggested that the law be changed to permit firms that think they may have made a mistake to come forward voluntarily and pay up any duties owed without being exposed to criminal penalties.

## **Hughes, Westinghouse divide airborne radar market**

Hughes and Westinghouse, the two traditional rivals in the military airborne radar business, appear to be dividing up the market for the new generation of tactical fighters.

In the latest competition between the two, Hughes has been selected by McDonnell Douglas to subcontract the radar on the Navy's new F-18 fighter. The contract not only calls for Hughes to supply three engineering and 16 pre-production model radars under a \$63.9-million development agreement, but also contains options to permit the firm to supply radars to all 800 aircraft in the proposed Navy procurement. At a reported production price of \$325,000 each, plus development costs, that works out to nearly \$300-million's worth of new business.

Earlier, Westinghouse was selected by General Dynamics to produce a somewhat smaller radar (approximately \$250,000 each in production) for the Air Force's new F-16. The Air Force plans to buy 650 of these aircraft. Westinghouse will also co-produce with European firms the radars for the 348 F-16s ordered by NATO. Westinghouse even has a chance to supply the radars for an export version of the F-18, known as the F-18L, being developed by Northrop and McDonnell Douglas.

The F-16 and F-18 radars are similar in that they operate at X-band for air-to-air applications and up in the K-band region for higher resolutions in air-to-ground missions. The more powerful F-18 radar puts out 400-450 watts, compared to 150-250 watts by the F-16 radar.

**Capital Capsules:** The Federal Aviation Administration is replacing the 100-words-per-minute teletypewriters used for the past two decades at its flight-service stations with cathode-ray tube displays that can operate up to 3000 wpm. Applied Devices Corp., Hauppauge, NY, is supplying 325  $\mu$ P-based terminal controller units, 800 keyboard/displays and 400 high-speed printers. . . . The Air Force Avionics Laboratory is seeking industry sources to do research on laser communications at data rates of 2 to 10 gigabits per second. Primary applications are in space.



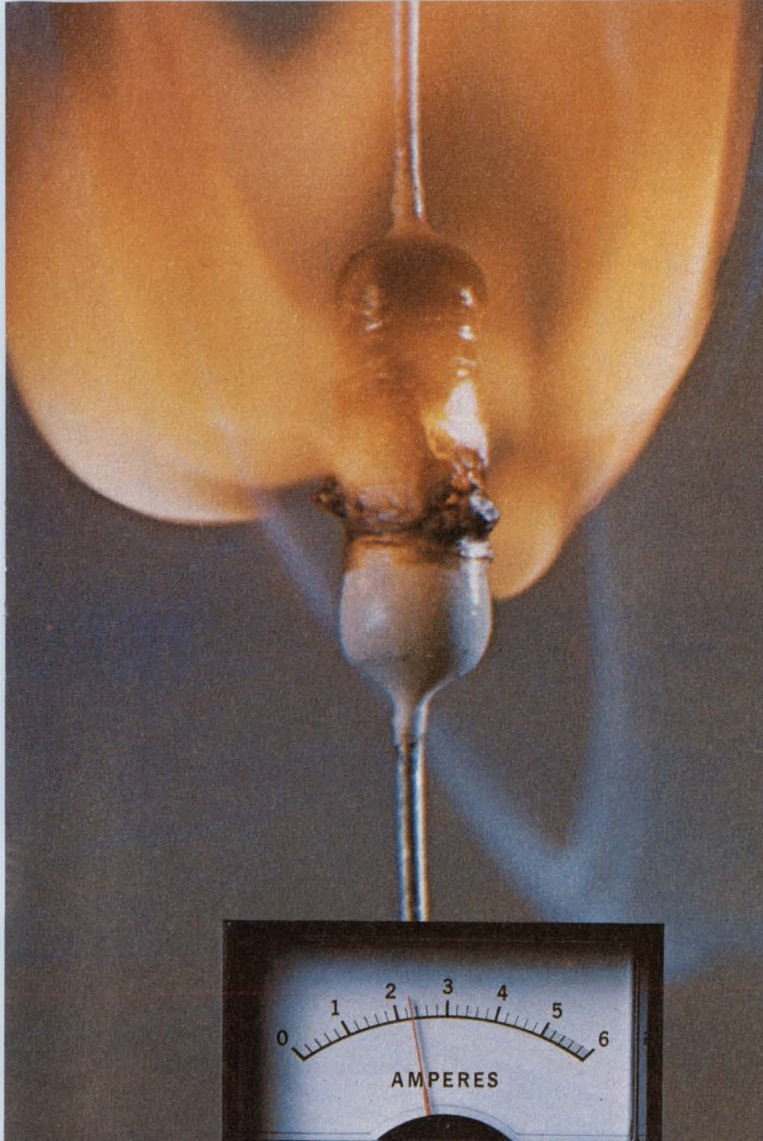

**The failure.** A 16 W overload causes this 1/2 W carbon film resistor to burst into flame. The initial failure mode is a short circuit, causing even more current to be drawn as shown on the meter.

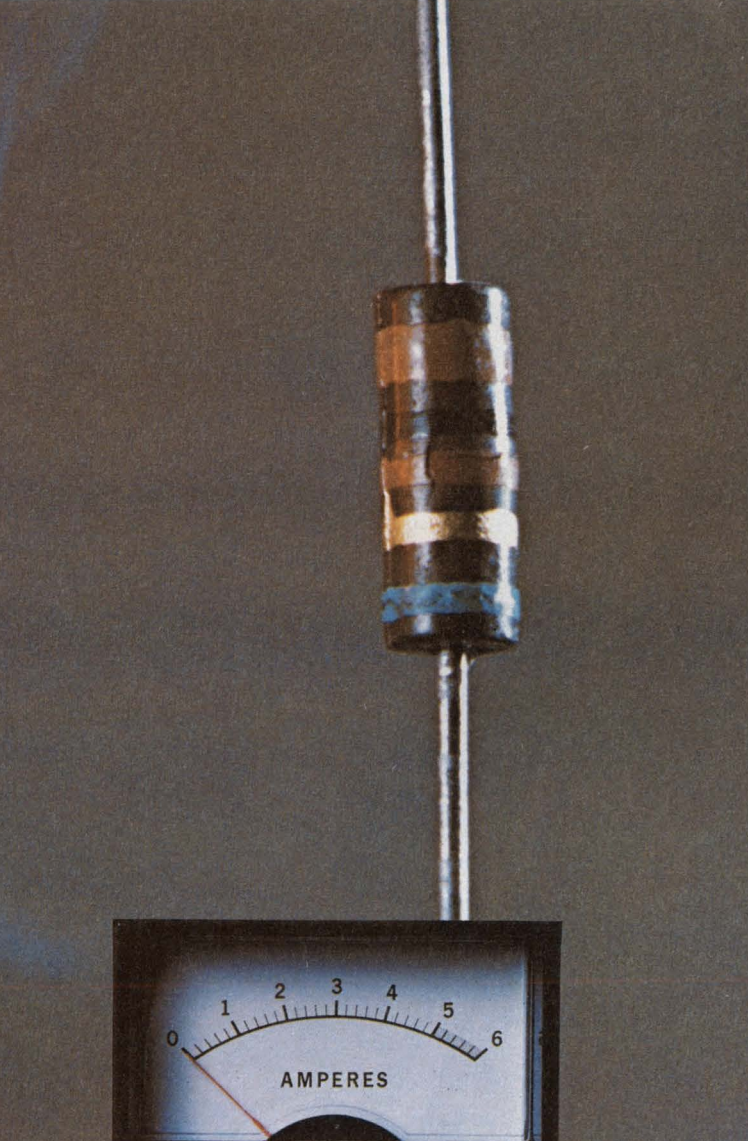

**The successful failure.** The TRW 1 W rated BW-20F (1/2 W size) stays cool and fuses quickly and safely under identical power surge conditions. The failure mode, as shown, is an open circuit.

# A failure your circuit can live with.

**Failsafe, Fusible, Wirewounds Offer Built-In Circuit Protection.**

Cool wirewounds like our BW failsafe series have a dual personality.

They provide stable resistance to normal operating current. But at specific overloads, they open circuit like a good fuse. So, as shown above, they'll protect your circuit from excess heat and fire in places where severe fault conditions are encountered.

The BW failsafe series, UL listed per Document 492.2, can save cost by eliminating the need for both resistor

and fuse. Save space, too, because they're about half the size of standard 1 and 2 W devices.

Depending on your specific circuit parameters, other TRW film and wirewound resistors can be engineered to meet your requirements.

For more information on resistors your circuit can live with, contact TRW/IRC Resistors, an Electronic Components Division of TRW, Inc., 401 N. Broad St., Phila., Pa. 19108. Tel. 215-922-8900. Telex: 710-670-2286.

**TRW IRC RESISTORS**  
ANOTHER PRODUCT OF A COMPANY CALLED TRW  
CIRCLE NUMBER 31



**When you're  
designing microprocessors  
into your products...  
our 990 computer products  
can give you a head start.**

# TEXAS INSTRUMENTS.

Start with the TMS 9900 microprocessor.

It delivers surprising power, speed and flexibility in a low-cost, single-chip 16-bit package. Its repertoire of versatile instructions and high-speed interrupt capabilities provide computing power usually associated with a 16-bit TTL minicomputer.

Hardware multiply and divide is standard and the software you develop for the TMS 9900 is upward compatible with any other member of the 990 computer family.

When your application calls for a microcomputer—start with the 990/4 microcomputer on a board.

It offers all the advantages of the TMS 9900, plus flexible memory and CPU options ideally suited to manufacturers' applications: up to 8K bytes of dynamic RAM memory, up to 2K bytes of RAM and/or PROM, real-time clock input, eight vectored interrupts, expansion interface and optional ROM utilities. It's our off-the-shelf answer for many production needs.

The 990/4 microcomputer is also available in a low-cost three-slot OEM chassis... or housed in a 6- or 13-slot rack-mount chassis with programmer's panel... or in a 6-slot



tabletop chassis. And, the 990/4 is available as a complete computer system supported by your choice of performance options and peripherals.

For applications requiring greater speed, we offer the most powerful member of the 990 computer family... the 990/10 minicomputer. It uses a TTL implementation of the 990 architecture and features TILINE\*, an asynchronous, high-speed 16-bit parallel I/O data bus which links the CPU, memory, and high-speed peripheral devices.



Rack-Mount 990 Computer

And to help you get on line faster and surer, there's a prototyping system using 990 computer hardware and software packages.

In addition, the 990 family is well supported by a substantial library of software development packages.

Whatever your needs... the TMS 9900 microprocessor, the 990/4 microcomputer, or the 990/10 minicomputer... you'll be working with some of the most attractive



990/9900 Prototyping System

computer component values on the OEM market. Price/performance leadership you expect from Texas Instruments.

You can start today by getting more information on the entire 990 computer family. Contact your nearest TI sales office, or phone (512) 258-5121, Computer Equipment Marketing, for your local distributor. Write Texas Instruments Incorporated, P.O. Box 1444, M/S 784, Houston, Texas 77001.



\*Trademark of Texas Instruments Incorporated

**TEXAS INSTRUMENTS**

INCORPORATED  
CIRCLE NUMBER 33

# We made them first. To last.

Available now from Singer: Size 8 and 11 Bu/weps synchros designed to meet the latest requirements of MIL-S-20708C specifications.



Kearfott, the first to design Bu/weps size 5, 8 and 11 synchros, has over the years constantly made them better. These units are used in fire control systems, radar, navigation, missile functions and other applications requiring a high level of precision, endurance and reliability.

These Kearfott synchros operate over the entire temperature range of  $-55^{\circ}\text{C}$  to  $+125^{\circ}\text{C}$ . They are DOD qualified and listed in the QPL.

(They can also meet reasonable cost requirements in computers, electronics and other types of business equipment.)

CIRCLE NUMBER 34

You can get these synchros in the following Bu/weps types:

Size 8	Size 11
26V 08CX4c	26V 11CX4c
26V 08CDX4c	11CX4e
26V 08CT4c	26V 11TX4c
	26V 11CDX4c
	11CDX4b
	26V 11CT4d
	11CT4E

We'll be happy to send you drawings and technical details on request. Also for Kearfott Size 5 Bu/weps CX, CDX and CT units, and Size 11 and 15 resolvers. Units with the same characteristics but different Bu/weps shaft variations are also available. Write for information to the Singer Company, Kearfott Division, 1150 McBride Avenue, Little Falls, N.J. 07424.

**SINGER**  
AEROSPACE & MARINE SYSTEMS

# to sell you on our new 70 amp and 100 amp high current power transistors...



## WE'LL SEND YOU ONE FREE!

We're introducing Solitron's new 70A and 100A industrial NPN silicon power devices. They are derived from the same generic family as the popular JAN 2N5250 and designed for power supply and motor driver applications or as SCR replacements. We've manufactured these transistors with a single planar chip. They feature low saturation voltages at high current levels.

We know they're a great buy for the money... less than \$12 each in 100 quantity orders. To prove it, Solitron will send you a free sample. Just select one from the specification chart, fill out the coupon and return it to us.

TYPE NO.	CASE	V <sub>CEO</sub>	V <sub>EBO</sub>	V <sub>CE(sat)</sub>	I <sub>C(max)</sub>	h <sub>fe</sub>	f <sub>t(typ)</sub>
SDT 96301	TO-3	60V	10V	1.8V max @ 70A, 7A	120A	10 min. @ 70A, 5V	10 MHZ
SDT 96302	TO-3	100V	10V	1.8V max @ 70A, 7A	120A	10 min. @ 70A, 5V	10 MHZ
SDT 96303	TO-3	140V	10V	1.8V max @ 70A, 7A	120A	10 min. @ 70A, 5V	10 MHZ
SDT 96304	TO-3	200V	10V	2.0V max @ 40A, 8A	70A	8-40 @ 40A, 10V	10 MHZ
SDT 96305	TO-3	250V	10V	2.0V max @ 40A, 8A	70A	8-40 @ 40A, 10V	10 MHZ
SDT 96306	TO-3	300V	10V	2.0V max @ 40A, 8A	70A	8-40 @ 40A, 10V	10 MHZ

MAIL THIS  
COUPON  
TODAY  
FOR YOUR  
FREE POWER  
TRANSISTOR

Please send free the following Industrial,  
High Current Series No. as indicated:

\_\_\_\_\_

I'm presently using the following high  
current power transistors:

\_\_\_\_\_

\_\_\_\_\_

**Solitron**  
DEVICES, INC.

1177 Blue Heron Boulevard  
Riviera Beach, Florida 33404

NAME \_\_\_\_\_ TITLE \_\_\_\_\_

COMPANY \_\_\_\_\_

ADDRESS \_\_\_\_\_

CITY \_\_\_\_\_ STATE \_\_\_\_\_ ZIP \_\_\_\_\_

## Save Space. Save Weight. Increase Reliability.

Paralleling transistors doesn't pay —not when an inherently rugged single device can do the job far more reliably, using much less space, weight, and at lower total system cost. That's why PowerTech's unique single-chip NPN silicon high-power transistor is the *one* way to go.

Used alone, our space-saving single-chip device eliminates multiple failure sources while reducing the environmental testing costs inherent in parallel arrays. Because of their simplicity they're available off-the-shelf—pre-rated, pre-tested and inventoried to meet virtually any hi-rel JAN and JAN-TX hi-current requirements without custom prices and long

custom waits. For information, application assistance, and free design guide call Sales Engineering, PowerTech, Inc., 9 Baker Court, Clifton, N.J. 07011; (201) 478-6205.

Type #	(pk.) $I_c$	$V_{ce0}$	( $h_{fe} = 10$ ) $V_{ce} (sat) @ I_c$
JAN-TX 2N5926	90A	120V	0.6V @ 50A
PT-7511	90A	200V	0.6V @ 50A
JAN-TX 2N5927	120A	120V	0.6V @ 70A
PT-6502	200A	80V	0.7V @ 100A
PT-9502*	500A	80V	0.5V @ 300A

350 Watt Power Rating  
\*625 Watt Power Rating  
Guaranteed SOAR

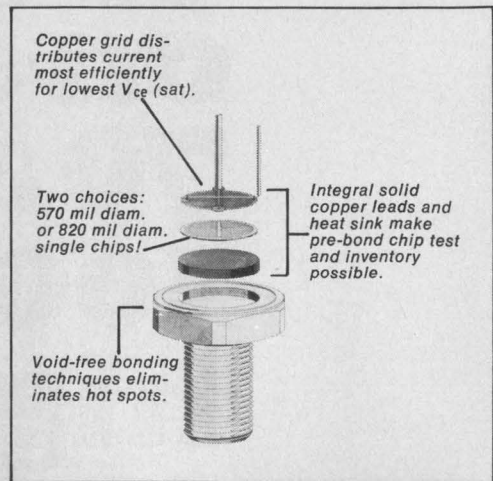

# TO UNPARALLEL IS TO SAVE:

Silicon transistors  
to 500 amps with  
lowest  $V_{CE} (sat)$



**PowerTech, Inc.**  
"BIG IDEAS IN  
BIG POWER"

# Microprocessor Design

## 1977 automobile to conserve fuel with a $\mu$ P-based ignition system

While everyone has been talking about microprocessors not being installed in cars before 1979 or later, General Motors has scooped the industry by installing a  $\mu$ P-based system in their 1977 Toronado. The lucky micro maker who will be supplying the automotive brain is Rockwell International, Anaheim, CA.

That system will be used to control engine spark advance and it will increase the mpg by 10 percent. While that's only a limited use of micros in a limited number of cars, the GM application promises to be the first of many.

"I don't know of anything else in the automobile that has as much effect on improving fuel economy while simultaneously lowering emissions," says Frank Jaumont of GM's Delco Electronics Div.

Once a  $\mu$ P system doing this task has proven itself, other possibilities include control of fuel injection, car cruising speed, automatic transmission, anti-skid braking and chassis suspension. It can also provide a digital read-out of car speed, total mileage and trip mileage while monitoring possible failure conditions. It can even prevent an intoxicated driver from starting his car.

### Why will they be used?

Microprocessors are going to be used in cars for several pressing reasons. Both stringent

DELCO-REMY MISAR\* SYSTEM

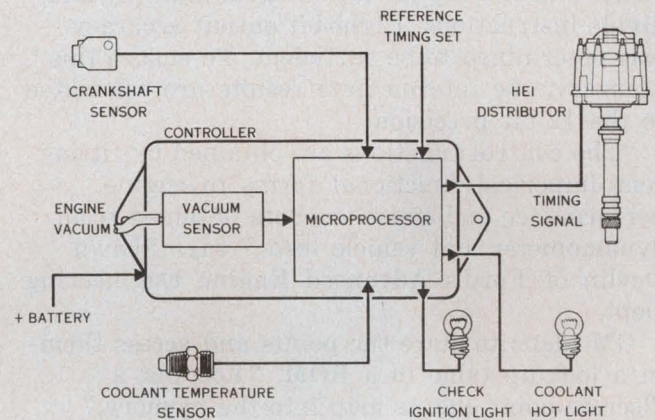

\*GENERAL MOTORS REGISTERED TRADEMARK

Federal laws and public pressure have called for greater fuel economy. Environmental considerations have additionally mandated low pollutant emissions. Simultaneously, microprocessor and related electronic hardware costs have come down.

The American automobile manufacturers have designed their systems differently. The first task of a microprocessor system will be control of spark advance and fuel injection. The necessary algorithms and equations have already been developed by each of the auto makers.

*(continued on page 54)*

## $\mu$ C card uses EA9002 $\mu$ P; no RAM is needed for small systems

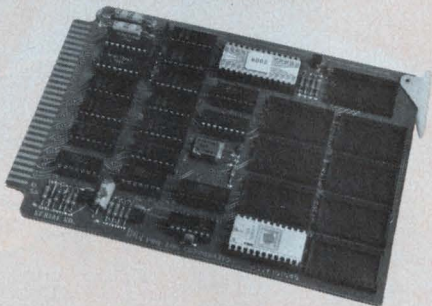

A single printed card, called the PLS-891, uses the Electronic Arrays 9002 microprocessor. Because the  $\mu$ P contains 64 bytes of scratchpad RAM, no separate RAM chips need be added. The card, manufactured by Pro-Log, contains to the  $\mu$ P, sockets for 2 k of PROM and 2 k of ROM, and several I/O ports.

The I/O consists of three latched 8-bit output ports and two 8-bit input ports. Output drive is 10 TTL loads and input loading is one TTL load. The  $\mu$ P has instruction execution times of 3.2  $\mu$ s for one-byte and 6.4  $\mu$ s for two-byte instructions, with the clock on the card.

Power requirements are 5 V at 1.8 A, and -10 V at 0.5 A.

Pro-Log Corp., 2411A Garden Rd., Monterey, CA 93940, (408) 372-4593.

CIRCLE NO. 224

## MICROPROCESSOR DESIGN

Controlling both spark advance and fuel requires measuring such variables as starting condition, engine speed, intake manifold vacuum, engine and coolant temperature, and flywheel angle. These must be digitized and fed to the  $\mu P$ . In contrast, a conventional nonelectronic ignition system responds only to engine speed and manifold vacuum, and all other variables must be compromised.

Ford's approach to the control problem uses a 12-bit NMOS chip having integral multiply and divide instructions. Eight-bit output accuracy was determined to be sufficient. To ensure this accuracy, the intermediate results are calculated to the 12-bit precision.

"The control functions are obtained by fitting semi-empirical functional forms to engine performance and emissions data obtained from dynamometer and vehicle tests," says Shawn Devlin of Ford's Advanced Engine Engineering Dept.

GM plans to store the points and access them in a look-up table in a ROM. "You put a discrete-point engine map into the memory," Jaumot says, "then, between these points you interpolate with additional factors to find the actual control point. If the temperature is rising, for example, you might want to interpolate up. Otherwise, you will interpolate down."

Earl Meyer of Chrysler Corp. says, "We have produced a spark computer that works pretty much the same as our analog system, and we are satisfied with it. We are working with Texas Instruments and RCA in a program that will develop both spark and fuel systems.

"Our philosophy in design is to minimize hardware and maximize software control of

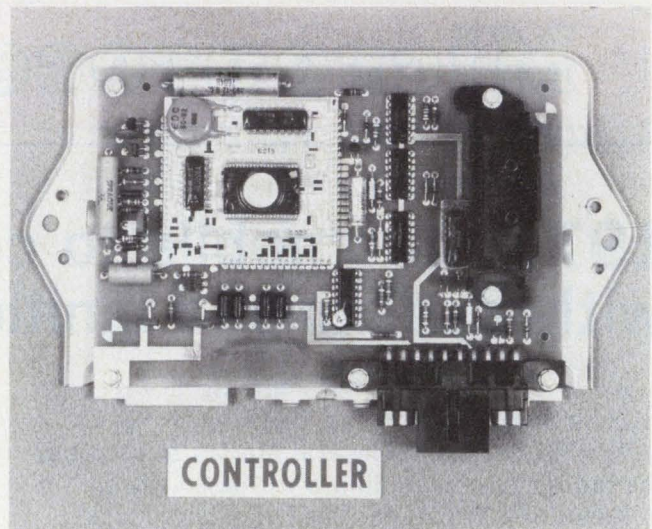

engine functions. That way control can be adjusted from year to year and model to model, and we won't have to retool a custom circuit each time."

### What about the sensors?

Since these systems monitor so many variables, there is a wide range of sensor types. The GM system contains a solid-state manifold-vacuum sensor mounted right inside the controller. An input and output vacuum line is connected to it. Such sensors might be thermistors for temperature sensing or coils with ferrite cores for position information. Bimetallic switches are also used for go/no-go-temperature indication.

### Where will it be mounted?

The physical location of the electronics involves a tradeoff. The  $\mu P$  system can be

*(continued on page 56)*

## A MODEL TO TAKE HOME TO MOTHER.

### HIGH-RELIABILITY, SUPERIOR EFFICIENCY AND A 5 YEAR WARRANTY AT \$145. (1-99)

ETATECH's patented "UNIVERTECH"™ pulse width modulated power conversion circuit is combined with practical packaging techniques to provide a low cost line of fully regulated Series "B" power modules. Compactly designed with fewer component parts, these units are ideally suited for microprocessor systems, digital instrumentation, portable test equipment and military or high quality commercial electronics. Call or write for our complete technical data file.



### LOW COST 50-60 WATT DC-DC CONVERTERS

- 70% min. efficiency @ 5V, 10A (Model B5D10, \$165., 1-99 pcs.)
- Std. inputs 28 and 48 VDC; specials from 20-180 VDC avail.
- 70K hrs. MTBF (@80°C. baseplate) in compact size (4 7/8" x 7" x 1 3/4").

### 50-60 Watt AC-DC Series "B" Modules

Features 75% min. efficiency @ 5V, 10A (Model B5S10, \$145., 1-99 pcs.). Std. outputs 12, 15, 28 and 48 VDC. Specials 2-48 VDC avail.



ETATECH, INC.  
187-M W. Orangethorpe  
Placentia, CA 92670  
(714) 996-0981

# ETATECH

 ... HIGH DENSITY POWER MODULES



**HUGHES**

HUGHES AIRCRAFT COMPANY  
CONNECTING DEVICES DIV.

Today we  
supply the spark  
for America's  
defense.

Connections were much simpler 200 years ago. Torch the fuse and the cannon fired.

Supplying the vital spark that makes a modern weapon system do its job is a lot more complicated.

That's where we come in. For many years, primes and OEMs for military and aerospace products have depended on us to provide the vital links in their electronic systems—flat cable, etched circuitry, connectors, and total interconnection systems.

Our high-rel connections have to be the best. They're used in systems like Phoenix, Maverick, Lance, Minuteman, AWACS, F-14, F-15, Space Shuttle, Viking, Sonobuoy, F-4, A-7, Condor, Standard Missile, F-18, AAH, Cruise Missile, F-8, Trident, Hobo, Sprint and many more.

To learn how we can serve your interconnection needs, contact Jack Maranto or Dave Cianciulli: Hughes Connecting Devices, 17150 Von Karman Ave., Irvine, CA 92714.

Or call (714) 549-5701.

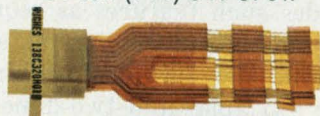

**Hughes  
Connecting Devices**

CIRCLE NUMBER 38

mounted in the passenger compartment, where the temperature and vibration is not severe. Or it may be mounted under the hood, close to the sensors and actuators.

If the unit is mounted too far from the engine, the signal wires pick up and radiate noise, because production line economies dictate the use of unshielded wire. Noise is, of course, a more severe problem in a digital system than in an analog system.

GM's controller is mounted in the passenger area near the glove compartment. The wires must go from one end of the engine compartment, through the firewall and across the instrument panel. Despite this wire length, "most of our filtering and noise suppression is taken care of in the basic design," comments Charles Dusenberg of GM. "We have also had no

problem with digital signals radiating into the car radio."

On the other hand, when the electronics is mounted in the engine compartment the package must withstand engine-generated heat, plus dust and vibration that are not present in the passenger compartment.

The Chrysler digital system, for example, will be mounted the same way as their present analog system. That unit is located in a plastic encapsulated enclosure on the air cleaner.

Engine compartment temperature can reach 121 C on a hot day. The operating temperature rise of the Chrysler analog spark-control computer is limited to 17 C by means of cool air reaching it from the outside. Thus, even on a hot day, the spark computer operates at just 49 C.

---

## Microcomputer accessory board combines memory and interfaces



The MI accessory board can easily expand E&L Instruments MMD-1 microcomputer breadboarding system (see ELECTRONIC DESIGN, No. 14, July 5, 1976, Vol. 24, p. 37). On the 6 × 12-in. MI board is enough room for 2-k bytes of RAM workspace (1-k byte supplied), a teletypewriter interface, a paper-tape-reader control and an audio-cassette interface.

If you have an MMD-1, the MI board mounts directly onto the main circuit board, connects to the I/O port and can be powered by the main unit's supply. The MI board,

though, can work with any 8080-based system and require 5 V at 1 A, +12 V at 100 mA and -12 V at 250 mA. Only 1-k byte of RAM is supplied on the board but there are additional sockets to hold another 1-k of RAM and 1-k byte of PROM or ROM.

The ROM sockets can hold memories that contain the bootstrap load program for the cassette interface or a special debug program that provides an interactive interface between the microcomputer and a teletypewriter.

For the cassette interface a listing of the bootstrap loader program is supplied, or you can optionally purchase a ROM that holds the program. You must write your own software to control the paper-tape or TTY inputs. With the Debug program you can set breakpoints, examine, and modify registers.

The fully assembled and tested accessory board costs \$200, but if you want it in kit form you'll pay only \$150. The set of ROMs holding the Debug program cost \$150, but a paper-tape listing is also available for \$50.

*E & L Instruments, 61 First St., Derby, CT 06418. (203) 735-8874.*

Booth No. 714-716

CIRCLE NO. 225

---

## Two software packages available for 8080 processor

A disc operating system and a compiled Basic language system for the 8080 micro are being offered by Intelligent Computer Systems. Included in the software are debug capability, an assembler, text editor, a Basic compiler and a Basic interpreter.

The software package includes such features as sequential and random-access file manipulation, print editing, assembly-routine linking, subroutine linking and program chaining through console control. Also included are binary and logic operations, 7-digit variables, 255 character string variables and two-dimensional arrays.

*Intelligent Computer Systems, 777 Middlefield Rd., Suite 40, Mountain View, CA 94043. (415) 961-8941.*

CIRCLE NO. 226

# New snap-in rockers with Cutler-Hammer reliability.

Here's a completely new line of snap-ins, each engineered with the kind of solid dependability you expect in Cutler-Hammer Rockette® switches. Bright metal bezels, illuminated and non-illuminated, A-c and D-c capabilities up to 20 amps.

Sub-panel rockers in a variety of colors, rocker or paddle designs in standard, special, or proprietary models.

Switches snap in and stay in permanently. Speed up assembly time, cut costs.

Flush-mounted rockers in the same wide range of designer-oriented colors and styles. One- and two-pole models.

Illuminated single-pole rockers. Choice of red, green, amber, white, or clear. Hot-stamped legends indicate switch functions.

For more information, call your Cutler-Hammer Sales Office or Switch Distributor.

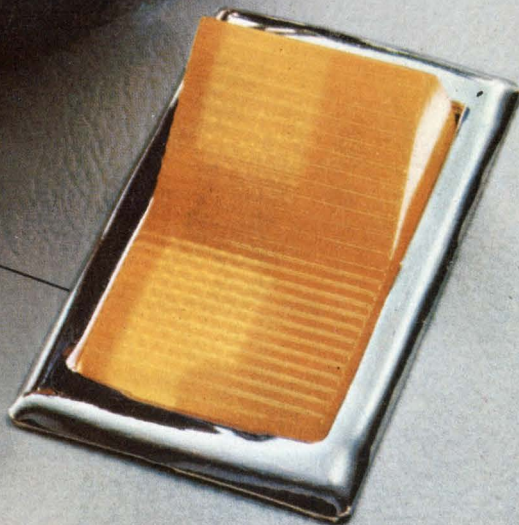
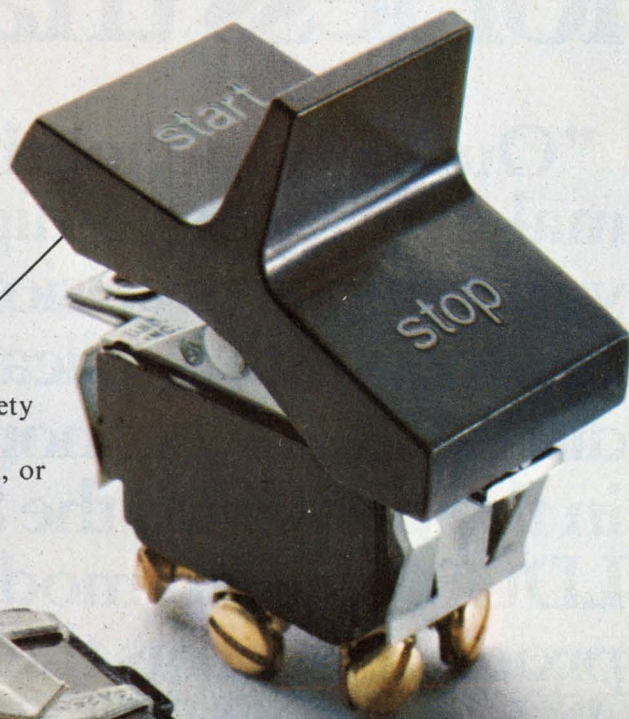

**CUTLER-HAMMER**  
SPECIALTY PRODUCTS DIVISION, Milwaukee, Wis. 53201

 **Switch to No.1**

# "Now you can build a for less than the cost of

"Our new monolithic CMOS A/D converter makes low-cost, 3-digit DVMs a reality. With it you can put precision digital readouts into applications that did not make economic sense in the past. With the Siliconix LD130, you can modernize products such as thermometers, dashboards, test consoles, industrial meters and controls at a cost competitive with ordinary analog meters."

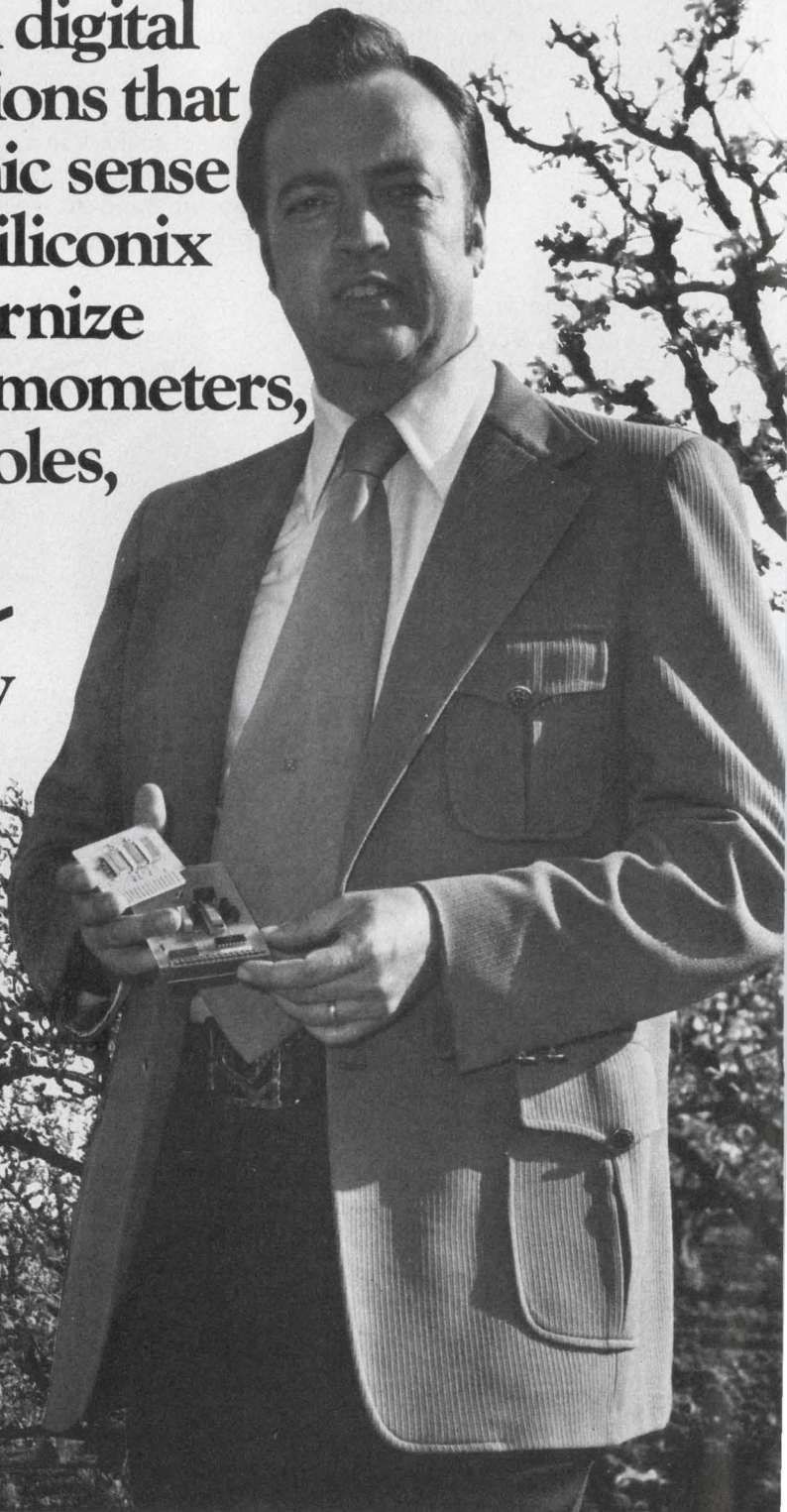

# quality digital meter a cheap analog meter."

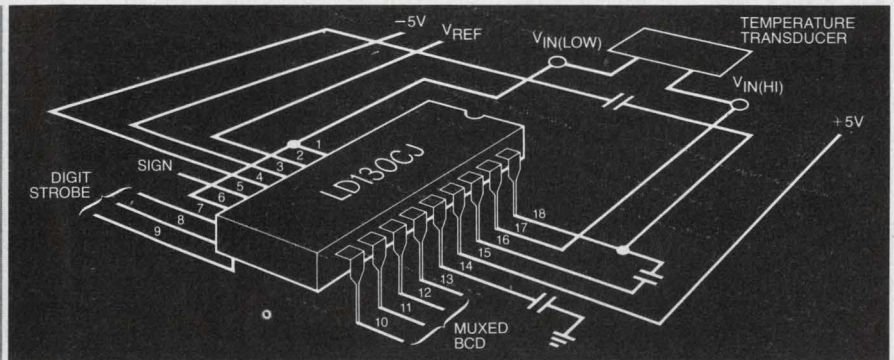
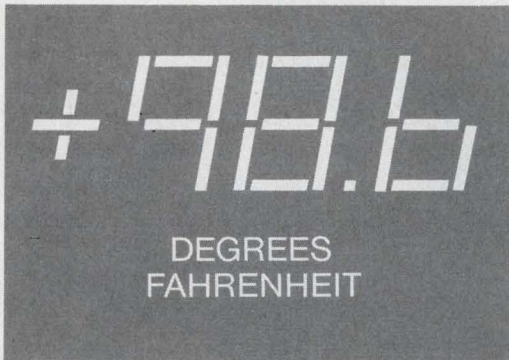

"At Siliconix, we call the LD130 'everyman's digital voltmeter chip'.

"Almost any high volume product that requires a meter can be made more attractive and useful with this sophisticated, low power, 3-digit DVM chip. In addition to the visibility and style of digital readout, the LD130 provides 10 to 20 times the accuracy and much higher resolution than analog meters.

"Moreover, the LD130 imposes none of the design restrictions of 'cheap' analog meters. Its full 3-digit range of  $\pm 999$  allows almost any variable, such as very high and very low temperatures, to be measured. In contrast, a person can at best resolve one part in 100 using an inexpensive analog meter.

"Automatic zeroing, automatic polarity outputs, and auto-ranging outputs eliminate zero adjust potentiometers, switch the  $\pm$  sign, and allow automatic control of decimal points and range scaling resistors.

" $\pm 5V$  CMOS construction enables the LD130 to operate efficiently with any standard CMOS or TTL logic. The multiplexed BCD outputs are easily interfaced with 'intelligent' microprocessor-based systems. This format is also ideal for the widest range of digital displays.

"Accuracy is  $\pm 0.1\%$  of reading  $\pm 1$  count. Accuracy is maintained automatically by Siliconix' exclusive quantized feedback design (patent applied for) which continuously corrects for zero drift. This same feature has made the Siliconix  $\pm 3\text{-}1/2$  digit LD110/LD111 DVM set the most widely used by designers of professional instruments and control systems.

"Just as important, the LD130 is easy and inexpensive to use. Unlike most DVMs, it requires no precision resistors and capacitors, no external temperature compensation, no dual tracking references, no operational amplifiers or input buffers. These have been eliminated by state-of-the-art chip design.

"Since only low-cost components are needed with the 18-pin LD130, it allows complete meter/display subsystems to be built into products for less than \$15 (1K quantities).

"The LD130 is your opportunity to create new products and upgrade your present ones. Now you can build a quality digital meter for your system at a cost you can afford."

To order the LD130CJ (\$8.75 at 100 lot), contact our franchised distributors: Components Plus, Elmar, Hamilton/Avnet, Pioneer, Quality Components, Semiconductor Specialists, or R. A. E. For more details, call or write Siliconix, 2201 Laurelwood Road, Santa Clara, California 95054, (408) 246-8000.

**Siliconix incorporated**

# Ask CONTROL DATA for the Floppy Disk Drive more major OEM's specify.

## We have it.

One major OEM after another tested our Floppy Disk Drives. Ran them through rigorous evaluations. Compared them with competition. And chose ours. Either our Model 9400; or our Model 9404 with **double-density capability**.

Both have true IBM compatibility, with the write-current switched at track 43. Both offer ceramic heads; and hard and soft-sector capability. The 9400 has a star interface; the 9404 a daisy chain interface plus power reduction, write-protect option, and double-density capability.

Whether large OEM or small, we invite you to make your own tests and comparisons. Let us demonstrate our Floppy Disk Drives, right in your facility. Evaluate them, just as many major OEM's did. We know you'll make the same choice.

Two configurations available. Choose Model 9400 for single; Model 9404 for multiple drive applications. Model 9404 also offers double-density capability.

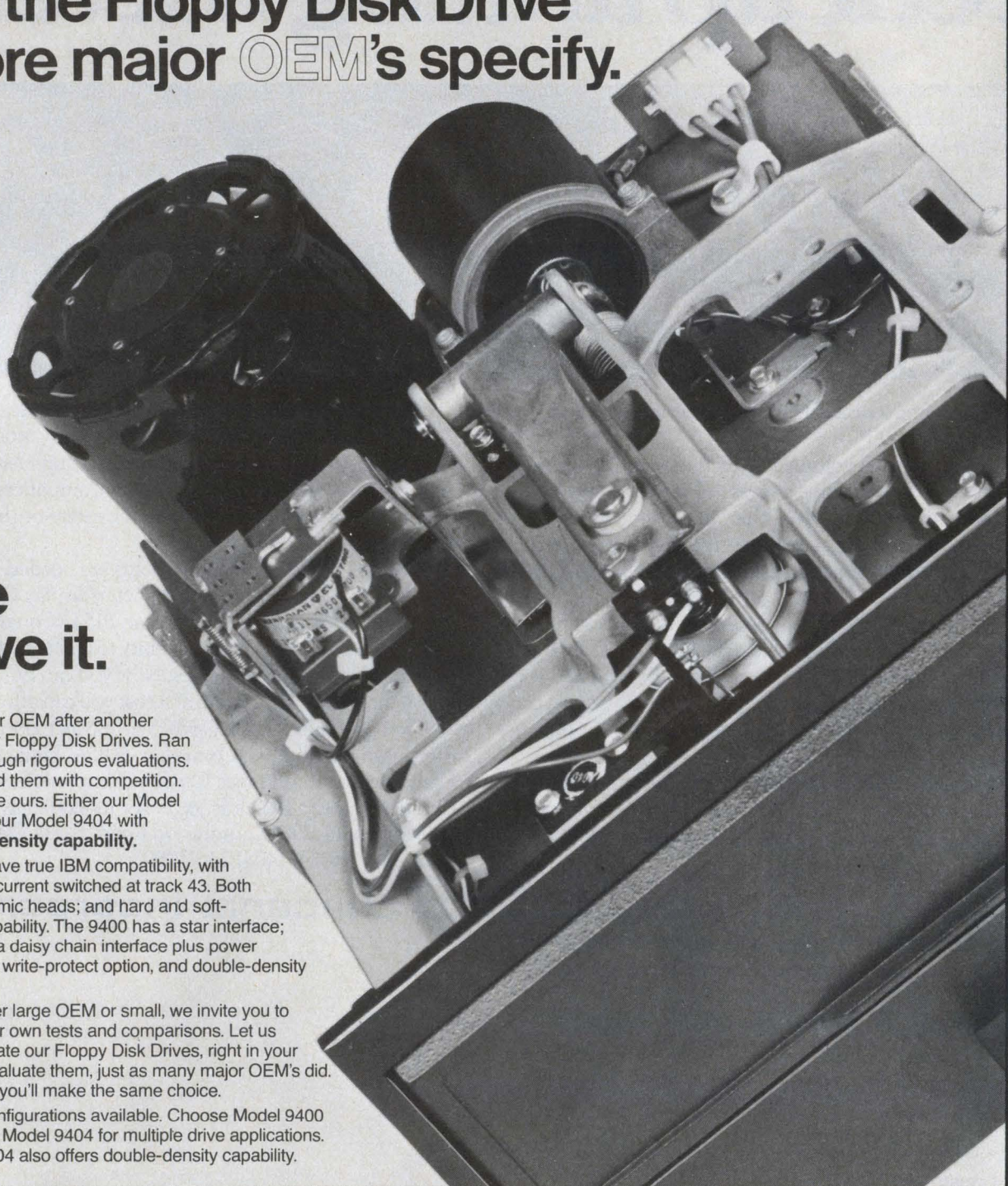

Ask the CDC OEM people

**GD** CONTROL DATA CORPORATION

Call (405) 946-5421 or return coupon to: Terry J. Hardie, Control Data Corporation, 4000 NW 39th Street, Oklahoma City, OK 73112.

Please have your salesman bring me a Floppy Disk Drive for evaluation.  Tell me more about your OEM Floppy Disk Drives.

NAME \_\_\_\_\_ TITLE \_\_\_\_\_

COMPANY \_\_\_\_\_ ADDRESS \_\_\_\_\_

CITY \_\_\_\_\_ STATE \_\_\_\_\_ ZIP \_\_\_\_\_ AREA CODE \_\_\_\_\_ PHONE \_\_\_\_\_

CIRCLE NUMBER 42

# The smallest graphic recording system is also the biggest in flexibility and convenience.

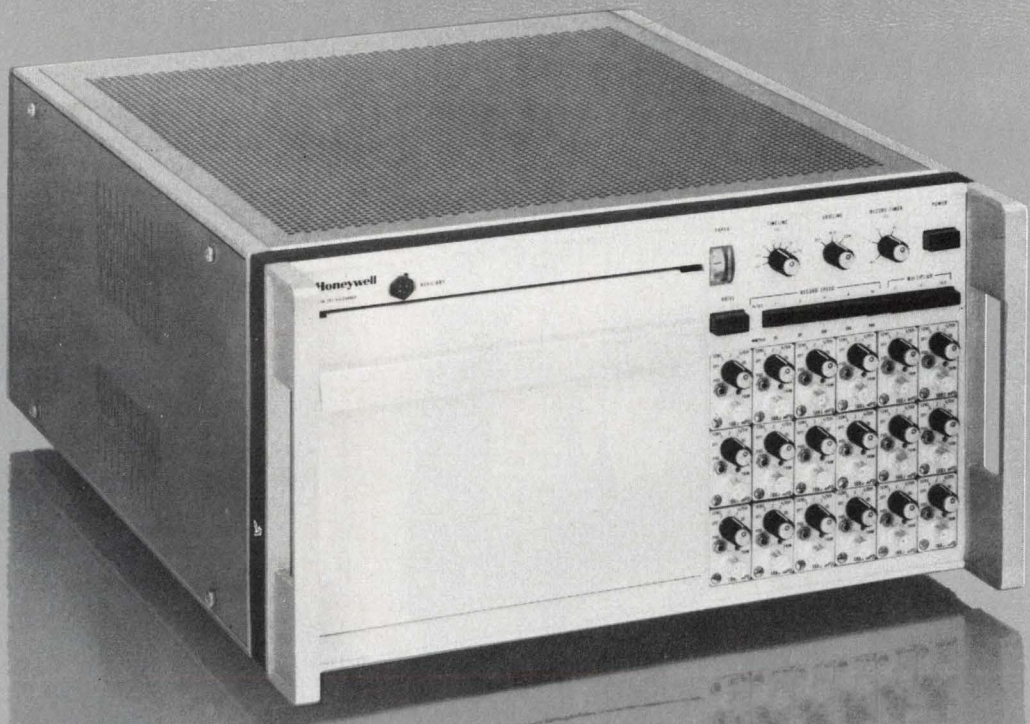

## Honeywell Model 1858 Data Acquisition System

### **Most compact.**

The Honeywell Model 1858 Oscillograph is an unbelievable 8¾ inches short, including plug-in signal conditioning and internal paper take-up. The 65-pound-light 1858 is easy to take anywhere as well; it can be used in a rack, on a table, on the seat of a car or plane.

### **Most flexible.**

You get up to 18 channels (expandable to 32), each with dc to 5,000 Hz response, and a choice of 42 discrete paper speeds . . . up to 120 inch/sec. You also get a choice of seven plug-in signal conditioning modules, each of which was designed to perform a specific function. Taken together, these modules cover a wide range of input signals, including those from transducer sources. Its new 14-channel add-on housing permits up to 32-channel capacity, but adds only 5¼ inches to height. And our new 1887 plug-in signal conditioning module (one of seven)

provides simultaneous input signal conditioning for magnetic tape recording and the Model 1858, or serial record and playback from tape to the Model 1858.

### **Most convenient.**

Because the Model 1858 uses a cathode ray tube and plug-in signal conditioning modules, it is easier to use and set up than any other graphic recorder. You never have to waste time with pens . . . there are no inks, chemicals or toners to worry about. Also, our signal conditioning is calibrated in volts/division and have both trace position and trace-off controls, so that you can position any trace at any point across the record. The trace, if desired, may traverse the full record width even at maximum frequency. All these features add up to making the 1858 the most in graphic recording.

For complete technical specifications, call or write Lloyd Moyer, Honeywell Test Instruments Division, P.O. Box 5227, Denver, CO 80217, (303) 771-4700.

# Honeywell

# "I'll tell you why this OEM picked PDP-8. It's good engineering and it's good business."

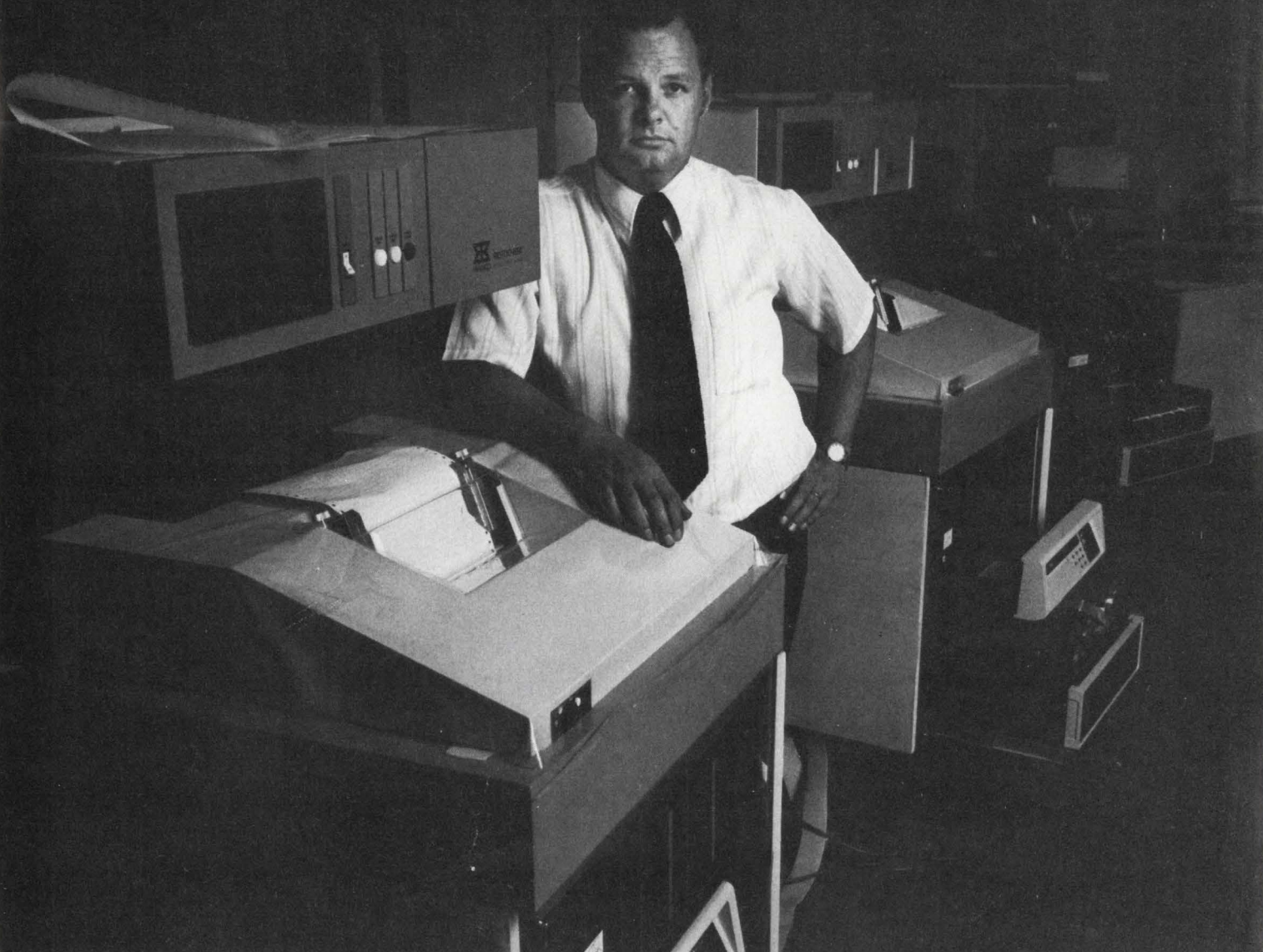

The man in the picture is Dr. David Kemper, biochemist and product manager in charge of development, production, installation and field support for an amazing analytical device called Rotochem IIa, from American Instrument Co.

The computer inside his product is a PDP-8A from Digital. Dr. Kemper is buying scores of them. Why?

"They're inexpensive in a market that's cost sensitive. They're incredibly reliable in a

market that's reliability oriented. And our customers can get service anywhere in the world. The PDP-8A gives us the performance we need at a price we can't beat. We can offer the capability to run 50 tests on each of 250 patients."

Sensitive but tough. High in performance, low in cost. "Good engineering. Good business." It's the same story you hear from OEMs around the world. And that's why PDP-8's the most

successful minicomputer ever.

Digital Equipment Corporation, Parker Street, Maynard, MA 01754. (617) 897-5111.

European headquarters: 81 route de l'Aire, 1211 Geneva 26. Tel: 42 79 50. In Canada: Digital Equipment of Canada, Ltd.

**PDP-8  
The Most  
Successful  
Minicomputer  
Ever!**

**digital**

**50,000 computers saving managers millions.**



## Doing the wrong job right

A computerized supermarket system in Tokyo had just everything. It made life easier for the shopper, for the checkout clerks and for supermarket management. And it saved time and money.

A shopper could stroll down the aisles and use a magnetic card to select products displayed behind glass windows. A computer would keep a running tally of her purchases and instantly provide a totaled receipt after she brought her goods to the checkout counter.

Beautiful. The concept was great and the system worked just as it was supposed to work.

The supermarket manager must have been thrilled with the crowds of shoppers who took advantage of this super-modern system. Briefly. Then, after the novelty wore off, they left in droves. The system had to be scrapped and the supermarket was forced to return to the "old-fashioned way."

The system designer obviously tackled some important shopping problems. He saw shoppers handle, damage and misplace merchandise. He saw them wait on long checkout lines as clerks packed each item, checked the price and punched cash registers. And the designer overcame most of the problems. But the system was a failure. It neglected some key points.

Shoppers wanted to touch the merchandise. They wanted to examine labels. They wanted to compare one can of food with another. But the system didn't let them. Once they selected something it was theirs, and they were charged for it unless they went through an annoying procedure to return it. Further, shopping was a social occasion—not to be rushed. People wanted to chat and socialize. And the new system interfered with those pleasures.

So it was a great idea, but a failure—like many of the things we do. Too often, we design what it pleases us to design, rather than what's needed in the marketplace. We get a brilliant idea for solving some design problem; we devote time and effort to that problem; and we win. But nobody needed that problem solved. Lab shelves throughout the world are littered with prototypes of brilliantly conceived products that customers didn't need. Their designers did a job right. But they did the wrong job.



RECOGNIZED BY  
AMERICAN REVOLUTION  
BICENTENNIAL  
ADMINISTRATION

ELECTRONIC DESIGN is deeply honored to have received official recognition as a participant in the American Revolution Bicentennial Celebration, with authority to display the Bicentennial Symbol.

GEORGE ROSTKY  
Editor-in-Chief

new!  
unique!  
versatile!

# Series "R"<sup>TM</sup> electronic switch input components

SCHADOW

## SERIES REK

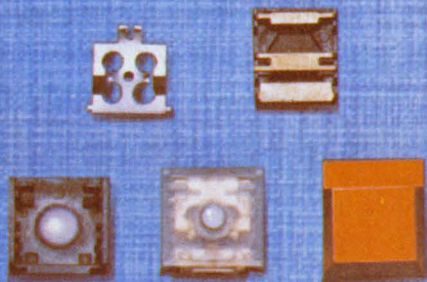

## SERIES RE

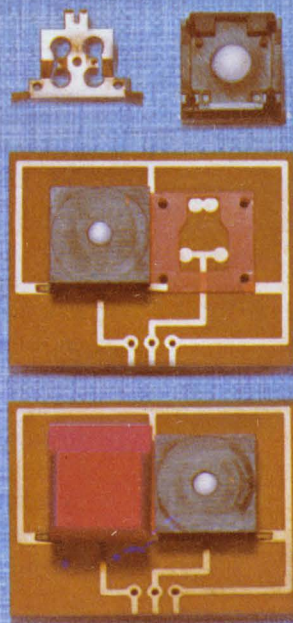

Series R is the economical answer for an electronic switch input component to use with standard dual-in-line packages (DIP's), ideally designed for incorporation into a broad variety of electronic devices including advanced micro-processor controlled equipment. Series R is compatible with TTL, CMOS Logic. Redundant contacts insure required reliability.

### UNIQUE!

Schadow's RE Series offers both SPST and SPDT contact arrangements in an extremely compact design. Available with or without buttons, and can be mounted on PC boards.

A crisp, consistent tactile feel is achieved due to the constant tension of the formed inner contact arrangement.

### VERSATILE!

A wide variety of button colors is standard: black, white, blue, green, orange (graphics available upon request); or actuating method can be custom designed.

Series RE contacts are installed on a customer-designed printed circuit board (edge connections or pin connections). Because of the modular, low profile design, you can place the series RE at any location on the PC board that best suits your custom application.

### SERIES R SPECIFICATIONS:

Wattage Capacity	.....200mW
Voltage	.....20 V.
Current	.....10mA
Contacts	.....Silver or Gold
Contact Resistance	.....100mΩ -1Ω (Series REK) .....300mΩ -1Ω (Series RE)
Contact Bounce	.....1 Milisec. Max.
Operating Force	.....100 Grams
Travel	......03 in.
Life	.....10 <sup>6</sup> Cycles @ 10mA

CIRCLE NUMBER 45



**IEE / SCHADOW inc**  
A SUBSIDIARY OF ITT

8081 Wallace Road, Eden Prairie, MN 55343  
612/944-1820. TWX 910-576-2469  
Manufacturing facilities in Minneapolis, Minnesota,  
Einbeck, W. Germany and W. Berlin

# Now, Intel delivers memory for PDP-11/04 and PDP-11/34.

Intel is now shipping high speed, low cost memory for two of the hottest new minicomputers, DEC's PDP-11/04 and PDP-11/34.

That means you can get 30-day delivery and 30 to 50% savings by specifying Intel, the largest independent manufacturer of semiconductor memory.

We can give you add-in memory and add-on memory, both totally compatible with PDP-11 hardware and software. Our in-4711 is an add-in memory for the PDP-11 family and slides into an available memory slot, without modifications. For add-on memory capacity, simply attach the in-4011 memory system. You can add memory in 16K x 16 bit increments, up to 128K words.

Built with the proven Intel 2107B 4K RAM, the in-4711 memory is fully transparent to the CPU, with greater processing speed. For maximum throughput you can interleave two memories.

The in-4711's lower power consumption permits wider operating margins on the main

frame power supply and results in a cooler running, more reliable system.

If you've picked DEC to be your computer supplier, go with the best for memory, too. Intel delivers a complete line of add-in and add-on memory for the entire PDP-11 family.

That puts two good names together. Add a third — yours — with the coupon.

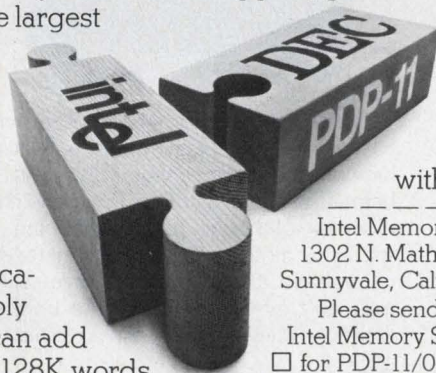

Intel Memory Systems  
1302 N. Mathilda Avenue  
Sunnyvale, California 94086

Please send me information on the following  
Intel Memory Systems:  
 for PDP-11/04, 11/34     for PDP-11/05, 11/35  
 for PDP-11/\_\_\_\_\_

Name/Title \_\_\_\_\_  
Company \_\_\_\_\_ Mail Station \_\_\_\_\_  
Address \_\_\_\_\_ Phone \_\_\_\_\_  
City/State/Zip \_\_\_\_\_

**intel memory systems**  
A DIVISION OF INTEL CORPORATION

CIRCLE NUMBER 46

# We guarantee our crystal oscillators for one full year. Which is a year longer than any of our major competitors will guarantee theirs.

If you're in the business of making or marketing computers and information systems, you know how important a guarantee is. It's your way of letting your customer know you're so confident about your product's performance that, for a specified amount of time, you will assume full responsibility for that performance.

Well, at MF Electronics, we feel the same way about our products. Especially the crystal clock oscillators that are our specialty. We make them the best way we—or anyone—know how. So we're able to guarantee them for a full year.

## The difference between oscillators.

What separates good oscillators from bad is space. Space is one thing there shouldn't be any of inside an oscillator. But the way most oscillators are made, space is one thing you can count on.

## The hollow truth about crystal oscillators.

Look at this oscillator. The fact that we can lift the cap to show you what's wrong with it shows you what's wrong with it.

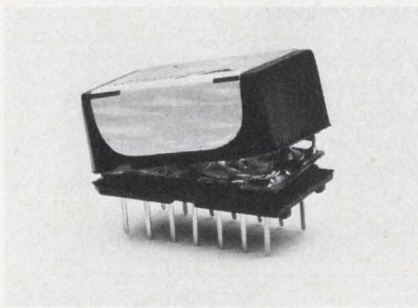

After the crystal and other parts are attached to the base, the cap is glued on, creating a bond that's tenuous at best.

Air seeps through this bond, allowing dirt and moisture to collect. You've got a leaky oscillator, one that's prone to loose parts and electrical shorting. That's how deadly a breath of fresh air can be to the inside of an oscillator.

## The un-holely oscillator: It's molded. What a blessing.

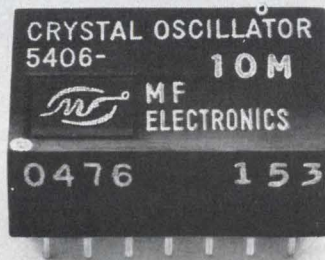

A molded oscillator, on the other hand, has no holes, no open spaces, nothing to hide and nowhere to hide it. Its crystal is hermetically sealed and set in a monolithic block of solid black plastic. There are no spaces for air to penetrate, no room for dirt or moisture to accumulate. Wave soldering can't even deteriorate the unit, so there's no danger of loose pins or joints.

## A test that rings true.

One of our customers, who is also one of the country's largest users of crystal clock oscillators, tested the performance of

various oscillators. He found that MF's molded oscillator lasted 3000 hours in an 85°C/85% relative humidity test. If you've ever done any oscillator testing yourself you know how remarkable that is.

## Two more solid reasons to use MF Crystal Oscillators.

3rd overtone crystals are used in MF's molded oscillators to provide greater electrical and mechanical stability in frequencies exceeding and including 20 MHz.

And an MF molded oscillator is the only one made that meets the UL oxygen index guideline of 28%.

## Because we're solid, your product is more solid.

So when you use MF molded crystal oscillators, you're giving your product a more efficient component, a heart that will beat longer. And your customers will be giving you fewer complaints and service calls.

MF Electronics is the only company that makes molded crystal oscillators. We invented them.

We make what we think are the best crystal oscillators you can buy. And we guarantee them, so your product can be "the best you can buy."

And that's the solid truth.

## THE MF GUARANTEE

MF Electronics warrants this molded crystal oscillator to be free from defects for one year from date of purchase.

Any oscillator found to be defective during this period may be returned to the factory, postage paid, for repair or, at our option, replacement without charge.

MF Electronics limits its liability to the repair and/or replacement of the returned MF oscillator.

# MF ELECTRONICS CORP.

118 E. 25th St., New York, N.Y. 10010 (212) 674-5360 TWX: 710-581-4109

# The Ansley "D" Connector...

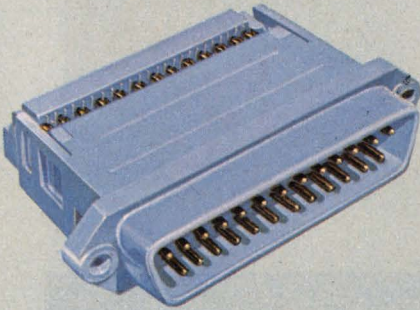

Our new series of male and female "D" connectors offer you a cost effective external mass termination cable and connector system second to none. Its uniqueness begins with a one-piece "D" connector package that meets industry standards for size, pin spacing, and contact reliability. With no loose parts to match up, positive cable-to-contact alignment is assured. Conductors are mass terminated in seconds with our standard BLUE MACS™ hand or bench tools. The results? Faster installation, higher reliability.

Contact pins are spaced on .054" centers — a perfect fit for any standard inter-cabinet "D" type connector application. Our new "D" connectors are designed to mate with standard 50 mil pitch flat cable as well as our new, improved jacketed cable — the only flexible flat cable engineered specifically for out-of-cabinet use.

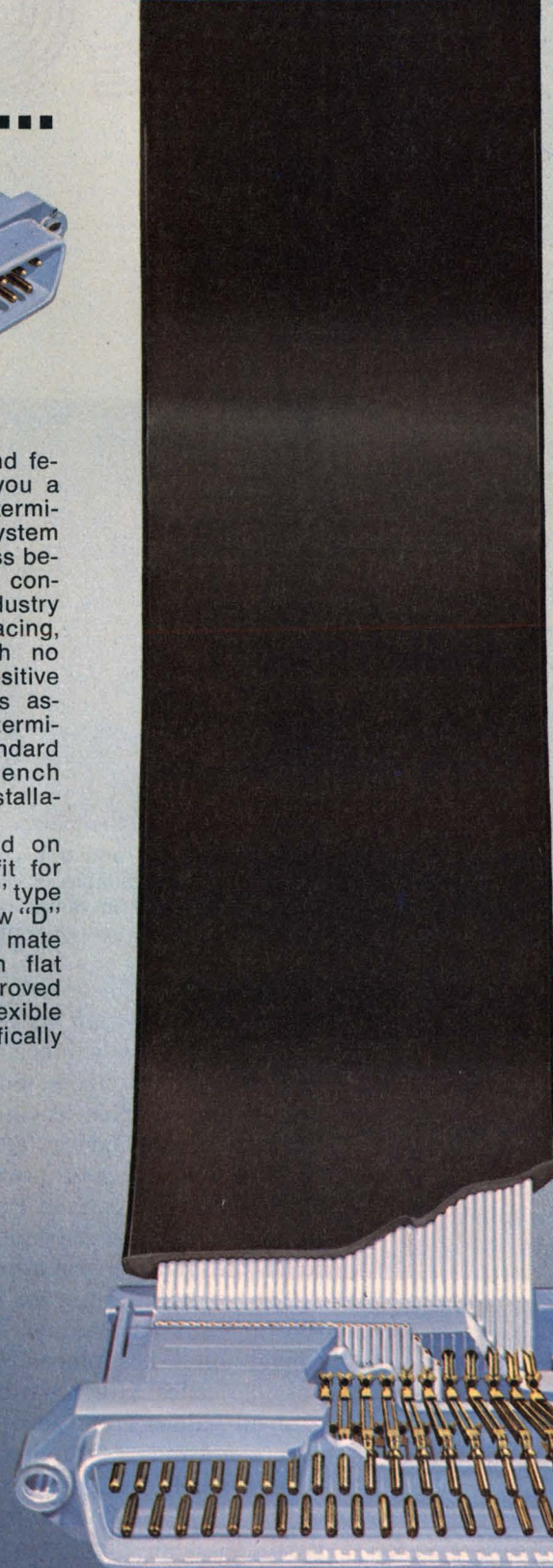
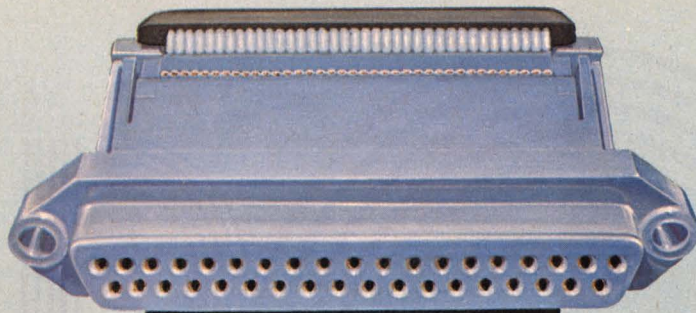

# a new meaning to cost effectiveness.

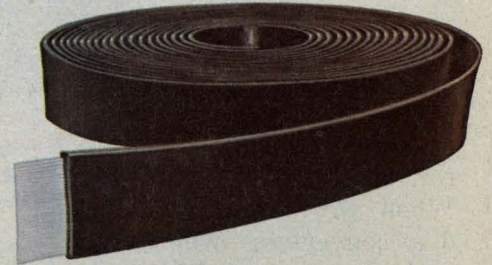

The Ansley BLUE MACS™ jacketed cable is U.L. listed for external interconnection of electronic equipment. Electrically, it outperforms standard jacketed twisted pairs in typical I/O applications. And there's no special zipper lock tubing required — reducing the need for an extra cable accessory. Installation is faster, easier. And like all Ansley connectors, you can daisy chain our "D" types anywhere in the cable — along with our DIP socket, card edge, or pc board connectors.

Cable alignment and high contact reliability is assured — because both cable and connector are grooved for absolute alignment. Our patented TULIP™ 4-point insulation-displacing contacts are permanently fixed and sealed-in to provide a reliable, gas-tight, corrosion-free mass termination.

For the full reliability/cost effectiveness story and technical data, call or write:

**T&B / Ansley**

The mass termination company.

**T&B/Ansley Corporation • Subsidiary  
of Thomas & Betts Corporation**  
3208 Humboldt St. • Los Angeles, CA  
90031 • Tel. (213) 223-2331 •  
TWX 910-321-3938

**Available through authorized  
Ansley distributors**

In Canada: T&B/Ansley, Ltd.  
700 Thomas Ave.,  
Industrial Park  
Iverville, P.Q.

SEE US AT WESCON '76 BOOTH 690

CIRCLE NUMBER 48

# Focus on Data Converters

Working with either analog or digital specs can be quite a hassle. When you select a/d or d/a converters—which span both worlds—expect double the trouble.

Also, a lack of standard definitions for the specs multiplies the problems. Common converter specs such as accuracy, resolution, linearity, temperature coefficients, settling time and conversion speed are often defined to make a vendor's product look good, not necessarily to help you.

Even worse, each of the converter families—the analog-to-digital, voltage-to-frequency and resolver (synchro)-to-digital, along with their opposites—has unique specifications that cause additional headaches.

## Don't confuse accuracy with resolution

When you compare converter specs from various manufacturers, you'll find that accuracy and resolution are often used interchangeably. However, these two specs are only loosely related. Resolution defines the size of the smallest output increment (sometimes referred to as step size), while accuracy tells you how exact the output level is, in terms of a known reference.

Most converters have their resolution stated in bits—6, 8, 10 or more. But that really doesn't define the smallest increment. To get the resolution in millivolts or milliamps, you must first take the full-scale output and divide it by  $2^n$ , where  $n$  is the resolution in bits.

When you compute a converter's resolution, carefully separate the terms "full-scale range," "full-scale voltage" and "full scale." In bipolar units that handle, say a  $\pm 10$ -V signal, the "full-scale range" is 20 V, the "full-scale voltage" is 10 V and "full scale" is whatever the manufac-

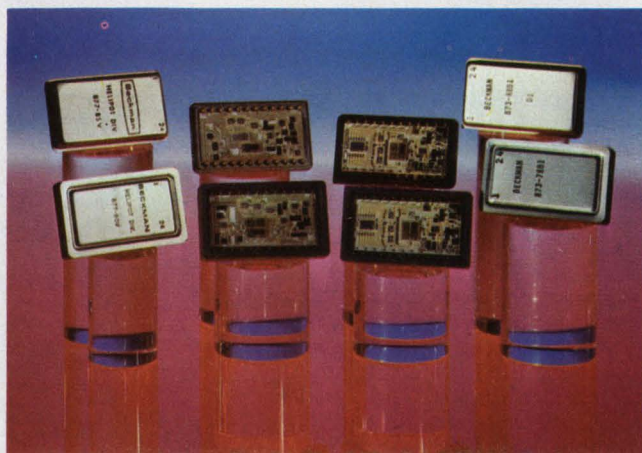

These recent a/d and d/a converter additions to Beckman's line are available in glass-epoxy packages for as little as \$20 and in metal hermetic packages for only \$70 (both in 100-unit quantities).

turer decides to put on the data sheet.

Accuracy (really inaccuracy) is a combination of many error sources. Some of the more important error sources include: quantization, non-linearity, scale factor (gain), offsets, temperature coefficients and power-supply changes. Of these, some are defined in terms of LSBs, others in percentages—and vendors often leave it to you to fit the numbers together.

The quantization error of a converter specifies the inherent uncertainty that occurs each time a conversion takes place. Since there are only  $2^n$  possible codes (for an  $n$ -bit converter) to represent all values from zero to full scale, each code covers a range of analog values that is 1 LSB wide. Usually each code represents the midpoint of the step and thus uncertainty of the value is 0.5 LSB. And, this error is over and above any other errors that contribute to the inaccuracy of

the data converter.

If the manufacturer gives the converter accuracy with respect to a known standard, preferably one traceable to the National Bureau of Standards, the figure is usually called the absolute accuracy.

In many cases, though, all the vendor supplies is the relative accuracy—the maximum deviation of the output from a straight line drawn between the zero and full-scale output points. Some vendors call this deviation the linearity error, but other manufacturers object because it includes the additional error caused by offset.

True linearity is determined by measuring the maximum deviation from a straight line drawn between the value of the converter's offset and the full-scale value.

Often omitted from data sheets is the differential-linearity error. When available, it tells you the maximum variation the step size can have

monotonicity only at room temperature—though this temperature limitation may be buried in a footnote.

Heat, of course, is the scourge of most electronic circuits, and converters are no exception. The effects of drifts in component values show up as increased nonlinearity, decreased accuracy, decreased resolution, loss of monotonicity and more.

Few data sheets give all converter tempcos. In fact, you'll be lucky if the vendor gives you the most important three: those for linearity, offset and scale factor. Most companies supply tempcos in percent per degree centigrade, while others make it harder for you by giving the tempcos in parts per million per degree centigrade. Converting from ppm/°C to %/°C is easy enough, but trying to add up several terms with mixed units can raise your temperature.

Because many vendors only guarantee specifi-

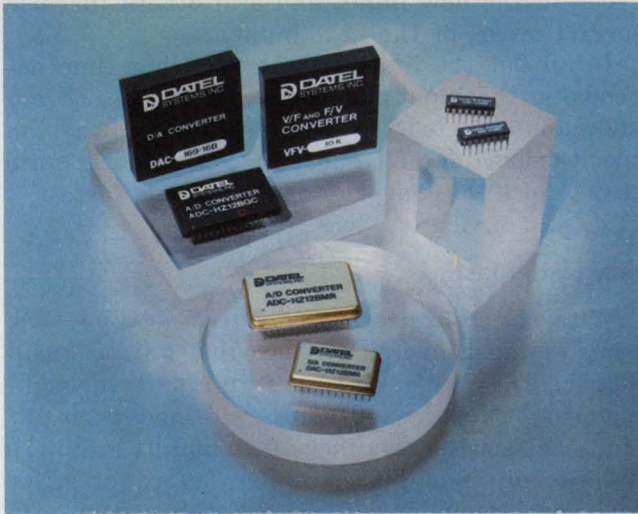

The wide variety of modular, hybrid and monolithic converters available from Datel can fill almost any a/d or d/a converter need. A universal voltage-to-frequency/frequency-to-voltage converter is also available.

for an incremental code change. Ideally, the differential-linearity error will be zero—but imperfections in resistor networks and active components create an error that can usually be held to within  $\pm 0.5$  LSB.

If the error increases beyond 0.5 LSB, the converter could skip a code and become non-monotonic. When a converter is monotonic, its output will change in proportion to every input change—increasing when the input increases, and vice-versa.

### Temperature changes ruin every spec

Some vendors can't maintain, over a wide operating-temperature range, an error of less than 0.5 LSB. As a result, they guarantee the converter's



High-speed modular a/d and d/a converters as well as a wide selection of v/f and f/v converters are available from Teledyne-Philbrick. MIL-temperature-range performance and 883 level-B processing are available.

cations at 25 C, make sure the converter can still meet the demands of your application when the tempcos are added in.

Find out how the vendor derived his tempco values. Does he take just a couple of endpoint values and average them over the entire range, or are several points over the range tested to check for changes in direction of the curve and to make sure that the rate of change doesn't vary too drastically?

Another point to check is the way the tempco errors are summed, if at all. Many vendors use an rms summation that "averages" all the drifts so one high number gets buried with several low ones.

Although a worst-case arithmetic drift summation might be an ideal spec to get, it's not too realistic. Very rarely do all the tempcos change

in the same direction. Manufacturers don't like to give you this spec either—in most cases it makes their converters look much worse than they really are.

You can often trim converter offset voltages to zero at room temperature with external potentiometers. But don't forget to add the extra tempco of the trimmers to the overall tempco of the converter. And remember, the manufacturer won't be responsible for the tempco after you've added external components—his specs were for the converter as it was shipped.

### Settle the argument about settling time

When you start to look at the dynamic performance specs, you'll run into a lot of different definitions for output settling time. Often you'll find it defined as the time required for the converter output to arrive at and stay within 1 LSB of its new stable state.

For d/a converters, vendors may give you only the settling time for a minor transition (a change of only 1 bit). Don't accept it. Settling times for most 1-bit changes are very short.

You'll be better off if you get one of the more-critical bit-change conditions specified: zero to full scale, minus full scale to plus full scale, or the major carry. The major carry, of course, occurs when the maximum number of bit changes takes place for a single bit increment—for instance, when 011 . . . 1 changes to 100 . . . 0.

Other factors that affect the settling time include the type of load and whether the converter delivers a voltage or a current.

Current-output units usually settle much faster than voltage-output converters. And, of the different loads, resistive types have the least effect on settling time. Reactive loads—such as coaxial cables, motors and cathode-ray tubes—can cause ringing and thus increase the settling time. Get

your vendor to spell out the settling time for your expected load.

D/a and d/r converters have glitches on their outputs—a major problem. Glitches are very narrow transient pulses that are generated whenever digital inputs change. The largest glitch occurs at the major carry or borrow, when all the switches are changing.

If you're planning to use a d/a converter for CRT display generation, a glitch spec on the data sheet is an absolute must. Make sure you get both the amplitude and width of the glitch. Either—by itself—tells you nothing since, for most applications must know the total energy of the glitch.

F/v converters don't have glitches, but they do have settling-time problems when their input frequencies change. Settling time can be defined in several ways. Some vendors spec it in milliseconds, others list several milliseconds plus several cycles of the new input, and still others just use several cycles of the new input.

In all but the first case, the settling time depends on the input frequency. Of course, if you know the expected frequency range, the way the spec's defined doesn't matter too much; it's quite easy to pick the converter that responds fastest.

### How fast is fast?

With a/d converters, instead of settling time you get the conversion time. But a nice small number doesn't necessarily mean a high throughput rate. Most manufacturers "inadvertently" omit the fact that another 10 to 500 ns might be needed for logic housekeeping before or after each conversion. Thus the actual throughput of a unit with a 1- $\mu$ s conversion time may be only 800,000 words per second, instead of the expected one million.

For a d/a converter, throughput depends on

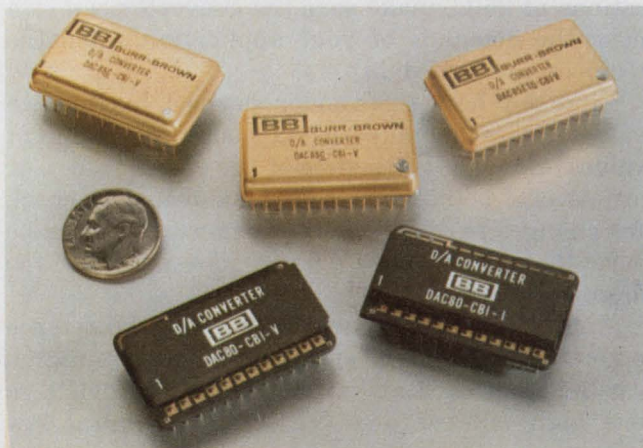

Commercial and MIL-grade d/a converters, in both voltage and current-output models, as well as a/d converters, are made by Burr-Brown. Prices for the DAC-80 series start at \$20 in hundreds for glass-package units.

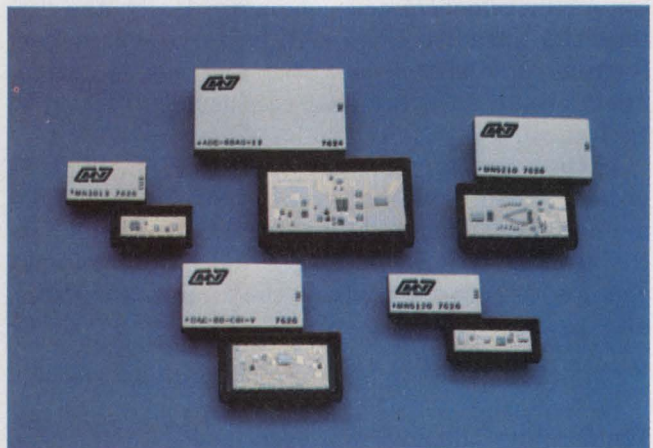

Precision hybrid a/d converters like the MN5210—with guaranteed performance over the MIL temp range—and low-cost hybrid d/a converters like the MN3013 are off-the-shelf products from Micro Networks.



both settling and slew times. Sometimes the converter settles to its new value rapidly, but it may require a long time to reach the vicinity of the new level. Not all settling specs include the slew time.

R/d and d/r converters have a step-response spec that gives a worst-case conversion time to an arbitrary accuracy (in most cases 1 LSB). But the worst-case step responses would be for a 0 to 179-degree angular change—the maximum deviation the converter could theoretically face. Fortunately, such abrupt transitions rarely occur in resolver applications. Slewing is usually the major problem.

Instead of having a slew-rate spec, angular converters are usually characterized in terms of their tracking-rate, in degrees/second. If the listed rate is exceeded, internal counters in the converter can't keep up with the resolver (synchro) position.

Commonly omitted from a tracking-converter's spec sheet is the maximum acceleration rate and the error at this acceleration. Of course, the faster the acceleration, the greater the error.

### Resolution and noise don't mix

As converters deliver more precise outputs, the distinction between a signal and accompanying noise gets harder to make. Output noise stems from two major sources: internally generated, caused by active and passive components; and externally generated, from power and signal sources.

Internal noise you really can't do much about; just make sure the manufacturer tells you how much there is and how it affects the converter output. For analog outputs, manufacturers often spec the noise as an rms voltage, measured over an arbitrary bandwidth. In this way, large spikes and high-frequency components can easily be camouflaged from your scrutiny.

Peak values of some spikes can exceed the rms rating by 10 times or more so get the manufacturer to define the noise in peak or peak-to-peak terms, and over the widest bandwidth possible. Also, have the vendor specify the input conditions at which the noise was measured. You can get a low, but misleading, noise figure for a zero input, but a very high noise figure once the internal circuits start to operate.

Noise often shows up as an instability of the digital word, for a/d converters, or as a slight shift of frequency for v/f converters.

External noise coming in on the signal or power lines causes false triggering of internal circuits and results in output errors. Take a hard look at those exceptional performance specs some manufacturers provide. You'll find most vendors assume zero input noise—a condition

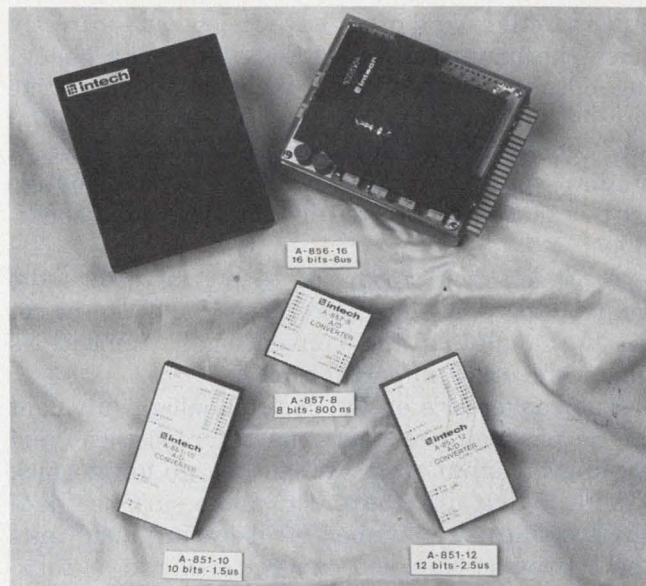

These speedy a/d converter modules, from an 8-bit, 800-ns unit to a 16-bit, 8- $\mu$ s unit, complement Intech's line of d/a, v/f and f/v converter modules.



MIL-quality converters, such as this DAC-347 hybrid d/a converter, have been added to the line of modules already available from Hybrid Systems.

almost impossible to meet.

Some manufacturers include extra bypass capacitors on the power pins to help eliminate the incoming supply noise. (A good power-supply rejection spec will also help.) Other vendors separate the analog and digital grounds to improve isolation and reduce noise feedthrough. In most cases, though, the manufacturer leaves it up to you to minimize power-supply effects.

The power-supply specs for converters are often vague. You'll usually find a statement like "supplies are  $\pm 15$  and  $+5$  V, nominal," along with some specified range of variation. For a dual supply, the spec normally assumes the voltages track. But what happens when they don't? Asymmetrical supply operation is often needed, so get the vendor to spec it.

Most d/a converters are available with either current or voltage-output options. For current-

output units, you'll often have to pry out—directly from the manufacturers—the effects of a changing output voltage. Few converters have a true current output that is unaffected by changing load conditions. Voltage output units have a similar spec problem; few have a true voltage output that is unaffected by changing load conditions.

A specialized form of d/a converter—the multiplying d/a—has no reference, but can be set up to handle all the conventional applications plus some other important ones.

The converter's output is the analog equivalent of the product of an external reference level and the digital input word. When you go out to pick a multiplying d/a converter, make sure the data sheet defines the number of operating quadrants the converter has; you can get one, two or four-quadrant operation.

Signal feedthrough in multiplying converters can also keep you going in circles. When the digital input or reference is zero, you want a zero output; this is rarely the case. If either the signal or the reference input changes rapidly, capacitive leakage paths, especially in IC products, may let part of the input signal get through to the output.

Vendors play a lot of tricks with the feedthrough spec if you don't watch them carefully. For instance, they may define feedthrough only for low frequencies—where capacitive leakage is insignificant. Check the frequency over which feedthrough applies; a good maximum frequency should be at least 10 kHz, with many companies now giving you numbers closer to 100 kHz.

Another problem with feedthrough specs is the way the vendors define the amount of feed-

through. Some will give you the value in LSBs at a specific frequency, others may give you a maximum voltage and still others will give it to you as a percentage. A maximum voltage would be the ideal definition, but the conditions that exist when that number is given should also be specified—for example, temperature, frequency and input conditions.

### A/d converter specs abound

Whether you build or buy an a/d converter, the first decision you have to make is a tough one—which conversion method to use? Parallel conversion offers the highest speed, but is the most expensive approach. Ramp-comparison and multiple-slope methods are the slowest (conversion times of milliseconds or more) but can be made very accurate. The multiple-slope technique also offers noise immunity to line frequencies if the integration period is made equal to  $1/f$ . Successive-approximation a/d converters offer a good combination of all features—they're fairly fast (800 ns for 8 bits) and are reasonably priced (\$25 and up).

Interface requirements and logic compatibility are two major areas that manufacturers have been lax in defining. Until recently, converters have had TTL and DTL-compatible inputs and outputs, but newer converters have CMOS and even three-state control and data lines.

Some of these circuits claim TTL compatibility, but beware. Often, these circuits have a very limited fanout—typically one or two normalized TTL loads—instead of the large fanouts that are typical of TTL circuits. Vendors often bury the drive restrictions in one of the footnotes.

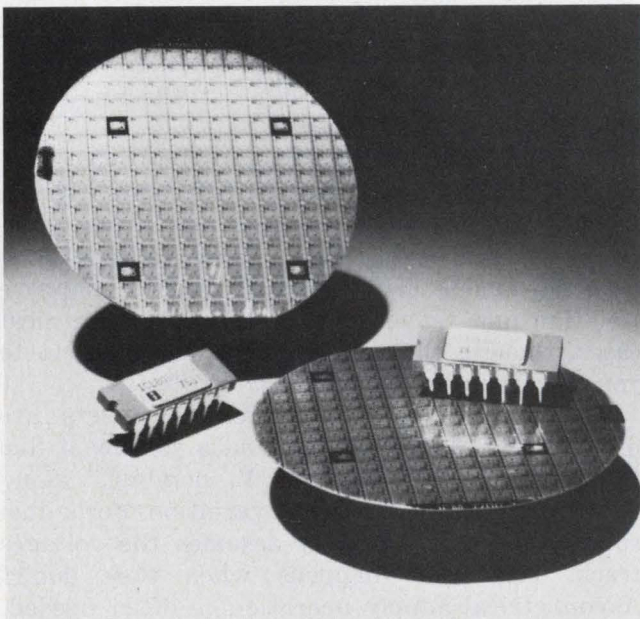

**Two-chip a/d converters** that use multiple-slope techniques help keep the cost of instruments low by providing BCD outputs. The 8052/53A is from Intersil.

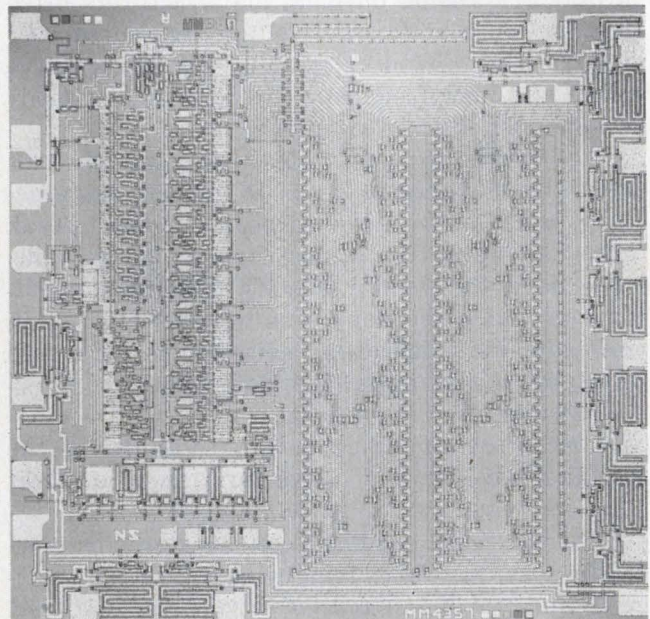

**A speedy successive-approximation a/d converter** developed by National Semiconductor—the MM4357—delivers an 8-bit word in 20  $\mu$ s. It costs \$7.95 in hundreds.

A/d converter input conditions are usually vaguely defined on data sheets. Input impedance may not be specified. If it isn't, you'll usually find an input current listed. From the input current you can find the input impedance. But why do it the hard way? The manufacturer should spell it out.

When an a/d converts a ramp input, you may find it skips several codes. This occurs if the codes on either side of the missing one get too close together (a large differential nonlinearity). As the converter tries to pick a representative code, it sees only two choices instead of three.

Many multiple-slope converters are used in instruments that deliver numerical readouts and BCD data. The converters are designed to provide outputs in BCD form, usually specified as 2-1/2, 3-1/2, or 4-1/2 digits, with maximum counts of 199, 1999 or 19999. However this is not always the case.

Not all manufacturers agree about the definition of the half digit. Many use 1 as the maximum reading for the extra (first) digit. But several others use a 2 and some even use a 4 and call it a 3/4 digit. Make sure you understand what the vendor really means.

Some integrating units also come with an auto-zero capability. If the one you pick does, check out the amount of external support circuitry needed to make it function. Also, make sure the auto-zero will work for your particular circuit layout; sometimes voltage pickup and offsets can wipe out its advantage.

Monolithic multiple-slope converters present a complex problem for interfacing with a processor. You'll have to come up with a software routine or some specialized hardware to demultiplex the BCD-coded lines.

#### For high accuracy consider v/f converters

The v/f converter can form a slow, but very accurate a/d converter. And it can transmit data over a two-wire serial-data link. But, with most v/f converters the output frequencies are not very exact. They're fine when you have a matching set—a v/f and f/v converter—or when you go directly to a counter, but when you compare two v/f or f/v converter outputs, don't expect an exact match.

What is the shape of the output signal from the v/f converter? Most manufacturers don't tell you if its a square wave, a pulse, a sine wave or a triangle wave. If they tell you it's square or pulsed, do you also know its duration? How about the on/off ratio or the output levels? There are many gaps the vendors can leave on the data sheet; don't get caught in them.

V/f converter linearity, probably the most important spec for this family, appears on data

sheets in several forms. Some vendors define linearity as a percentage of full scale, others as a percentage of full scale plus a percentage of signal. Still others provide just a percentage of signal. Whichever looks better on the data sheet is what you will be given. If you know the signal range, a converter with its nonlinearity based on signal might prove easier to specify.

F/v units suffer many of the same problems as v/f's, but you must give extra care to their input parameters. For instance: What pulse widths are acceptable, what pulse separations are permissible, how much noise can be tolerated and what rise times can be handled? Many manufacturers leave these questions unanswered; don't let them.

You can often adjust (scale) the output ranges of v/f and f/v converters so that when the signals feed into a display or processor you don't have to readjust the units being measured. Find out how much of an adjustment range is permissible—and what happens to the other converter specs when the converter is readjusted?

#### Synchro converters present unique specs

Once past their input circuitry, electronic resolver and synchro-to-digital converters look pretty much alike. This is also true for the outputs of digital-to-resolver (synchro) converters. These circuits use Scott-T transformers to con-

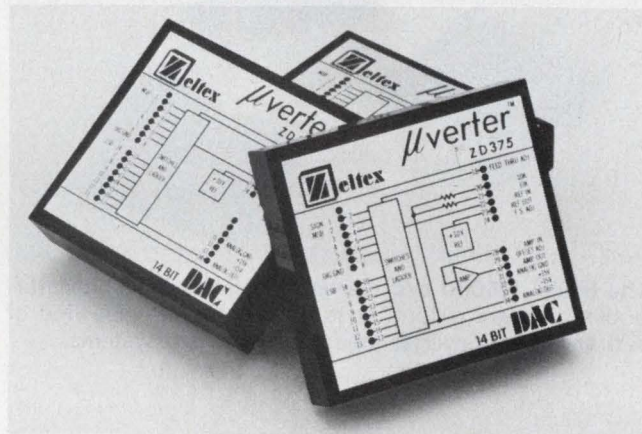

Voltage and current-output d/a converters are available from Zeltex with resolution from 8 to 14 bits. A/d converters with comparable resolution are also available.

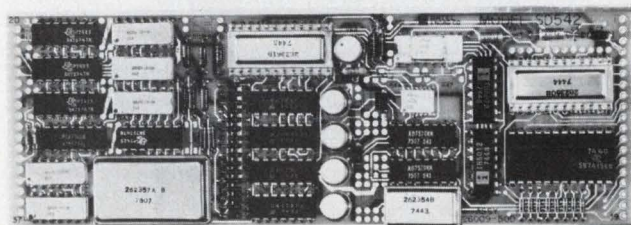

Packaging 15-bit resolution on a circuit card that's 0.3 in. high, Natel's tracking s/d converter—Model SD542—can handle input velocities of up to 3600°/s.

vert the 3-wire synchro signals into 4-wire resolver equivalents and vice-versa. But the Scott-T does not necessarily have to be a transformer; some companies offer an electronic equivalent, which offers small size but sacrifices high-voltage isolation.

The sampling and tracking r/d converters form the two basic families. Sampling units take a sample of their sinusoidal inputs and digitize the signals into a binary or BCD-coded angle. Tracking units do one complete conversion when they're turned on, and then continuously change their value as the input signals change. Multi-channel systems use sampling converters because a completely new conversion must be done each time a channel is sampled.

Most r/d systems operate on 60 or 400-Hz references, so response times are usually in tens of milliseconds. However, if the mechanical input angle changes by 180° a tracking converter can lose its count and require up to 300 ms to recover. Manufacturers are loath to tell you this, and in many cases omit the step response for a

180 degree change.

If resolvers change angles faster than the unit can track, the r/d converter will have a lag error as part of its dynamic response characteristic. Sampling converters are also prone to this error because they require several milliseconds to do a conversion. The conversion delay makes possible errors of 40 to 50 arc-seconds.

Converter accuracy specs are often given in arc minutes plus an LSB. This can let the manufacturer imply better accuracy than is really available. Get the vendor to state accuracy in absolute terms.

### Power output is important for d/r converters

Digital-to-resolver converters often have underspecified output capabilities. Many converters are protected from overload only for short periods of time, say 2 to 5 minutes, and can burn out their power amplifiers. Data sheets don't care if the bearing got stuck in the motor mount, so make sure you have a rating for continuous overload protection. Also, load ratings should be given for reactive loads—not resistive. Synchros and resolvers are inductive loads, with typical power-factor angles of 70 to 80 degrees.

Inductosyn-to-digital converters, a special class of r/d developed by Farrand, offer some rather unique problems. These converters use two air-coupled moveable linear windings to form a high-resolution control transformer. They usually work in an industrial environment (with plenty of electromagnetic and radio-frequency interference). Therefore, susceptibility to switching and radiated noise should be specified.

Even though vendors claim Inductosyns will work with carrier frequencies ranging from 2 to 10 kHz, if you choose too low a frequency, the carrier won't be coupled efficiently from the primary to secondary. And, with too high a frequency, leakage capacitances cause interference and signal loss.

Inductosyn resolution can be influenced by two factors usually not listed on data sheets.

- The precision to which the induced voltages in the two windings follow the sine and cosine laws with angle.
- The degree of control smoothness required. The more precise the resolution, the harder to meet the maximum velocity and acceleration requirements.

### Monolithic converters: a growing field

Monolithic d/a converters such as those developed by Precision Monolithics, Analog Devices and Motorola, have already found their way into many applications. Their low cost—typically \$2 to \$10 for commercial temperature range prod-

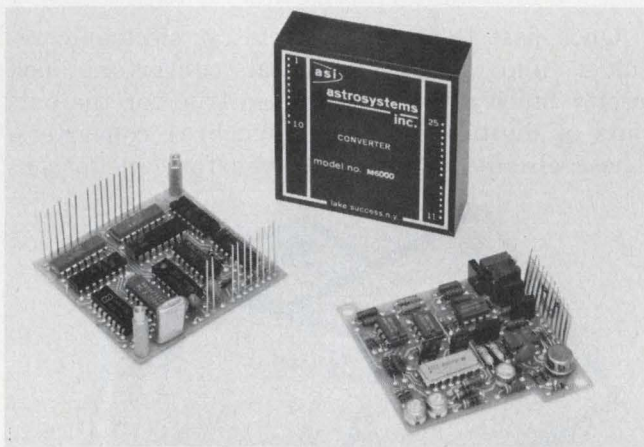

The Model M6000 s/d converter delivers a 12-bit natural-binary angle output. It is only one of a wide line of s/d and d/s converter modules from Astrosystems.

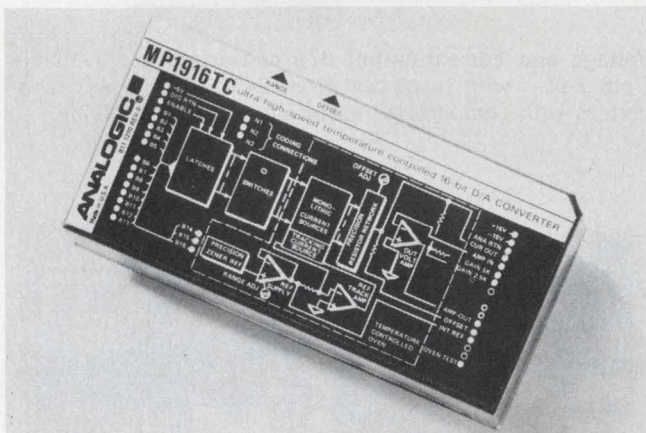

You can get true 16-bit performance from the MP1916TC d/a converter designed by Analogic. Built into it are data latches and a temperature-controlled oven.

ucts—opens many doors. But beware of low-cost “bargains.” Many vendors achieve the low cost by omitting the reference and sometimes the output amplifier too.

Until now, monolithic d/a's have been able to resolve up to 12 bits with relative accuracies to 0.01%. Recent developments are boosting performance still further.

The most accurate, highest-resolution monolithic d/a converter will soon be available from Intersil. The 6202 will accept a 16-bit digital input and resolve the analog output to a true 16-bit accuracy of 30  $\mu$ V. The converter, built with CMOS technology, uses an all-digital scheme of time-division multiplying to do the conversion. This unusual scheme eliminates the precision resistors and switches normally needed.

However, only 30 conversions per second are possible. And, the slow speed may restrict the 6202 to low-frequency-measurement, display and controls applications.

Recently announced by Precision Monolithics is an 8-bit companding d/a converter (DAC-76). It

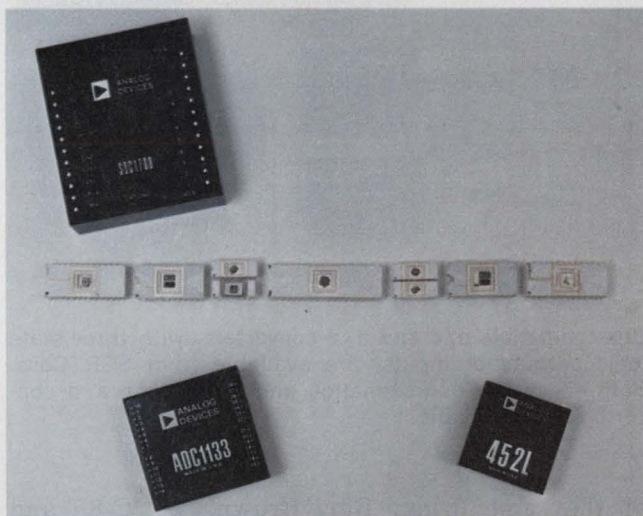

**Monolithic and modular a/d and d/a converters** as well as r/d and d/r converters are available from Analog Devices with resolutions from 8 to 16 bits.

has either logarithmic or antilog weighting that is logic-level selectable. The log compression or expansion gives the converter the small-signal relative accuracy of a 12-bit converter—at a cost of \$19 in hundreds. The DAC-76 can also be used as a multiplying d/a converter. (See story ED Vol. 24, No. 9, April 26, 1976, p. 111.)

Analog Devices has a new monolithic d/a converter—the AD7522—that accepts 10-bit data words and has two sets of input-data latches on the same chip as all the other circuitry. The extra latches simplify interface requirements for microprocessor-based systems and eliminate the outboard latches normally required. Intersil also

offers the AD7522 as a second-source product.

Just out of Motorola's ovens are the MC3510/3410, 10-bit d/a converters. These laser-trimmed multiplying converters have a maximum error of 0.05% (relative to full-scale output current). Also coming from Motorola is an ECL-compatible converter that accepts 8 bits and settles in 20 ns.

Several other companies—including Advanced Micro Devices, National Semiconductor, RCA and Signetics—are jumping onto the d/a converter bandwagon with both second-source and proprietary products.

### You can't get a monolithic a/d converter

There really aren't any monolithic a/d converters available that include all the necessary circuitry. At the very least you'll have to add a reference source and several scaling resistors. And, for some models you'll even have to add a comparator or clock. Two of the most complete monolithics, though, are the 8702 from Teledyne Semiconductor and the MM4357 from National Semiconductor. Both of these just need a reference and a couple of resistors.

The 8702 a/d converter delivers 12 bits and has a relative accuracy of  $\pm 0.5$  LSB. It uses a change-balancing integration technique to convert signals and can thus deliver a word only every 20 ms. National's unit delivers an 8-bit word every 80  $\mu$ s (maximum) with its successive-approximation circuitry. Its full-scale error is  $\pm 2$  LSB for the lowest cost model (\$7.95 in hundreds) and  $\pm 1$  LSB for higher accuracy versions. Three-state outputs simplify interface requirements.

TRW and Precision Monolithics have recently announced monolithic 8-bit and larger successive-approximation a/d converters. The TRW units use ECL technology and have conversion times of 140 ns for 8 bits, 200 ns for 10 bits and 500 ns for 12 bits. PMI's 8-bit converter should be available by the end of the year and is expected to have a conversion time of under 10  $\mu$ s.

Most a/d converters are one or two-chip integrating units that require external comparators or resistor-capacitor networks. Some popular manufacturers of monolithic a/d's are Analog Devices, Integrated Photomatrix, Intersil, Motorola and Siliconix.

The AD7550 made by Analog Devices uses a four-slope integration technique and delivers a 13-bit data word. It is a CMOS circuit and requires a reference and an external R-C network, and can deliver about 40 words per second. Three-state outputs permit it to be connected directly to data busses.

Analogic has had a single-chip integrating unit available for about a year, the MN2301, that delivers 3-1/2 BCD digits (1999 max count) and can do 10 conversions per second. It costs about

\$24 in 100-unit lots.

Siliconix has also announced a single-chip CMOS unit with a 3-digit BCD output—the LD-130. Just add a reference and a few capacitors and it's ready to go. It costs \$8.75 in 100-unit lots.

Two-chip, multiple-slope converters with 3-1/2 digit, 4-1/2 digit and up to 16-bit binary outputs are available from Integrated Photomatrix, Intersil, Motorola and Siliconix, with prices ranging from about \$12.50 per set in 100-piece lots.

Monolithic v/f or f/v converters are few and far between, unless you include "function-generator" chips such as the 8038, or phase-locked loops. The only three "monolithic" v/f (or f/v) units are available from Raytheon (the RM4151), Intech/FMI (the A-8400) and Analog Devices (the AD537). A single-supply version of the A-8400 (the A-8402) will be available from Intech, shortly.

Both the Raytheon and Intech units can be used as either a v/f or f/v converter, just by simple external pin connections but need from 4 to 15 external components. They can operate at frequencies of up to 10 kHz. The AD537 from Analog Devices operates only as a v/f converter and delivers frequencies of up to 100 kHz.

There are currently no monolithic r/d or d/r converters available at any price, however hybrid circuits are now starting to fill the need.

### Hybrids: the best of two worlds

Hybrid microelectronic converters combine the best of the monolithic and discrete-component worlds whenever space is at a premium. D/r and r/d converters have always been pretty bulky—in modular form a 2.5 × 4 × 0.8 in. package is common—but in many of the new all digital systems much of the bulk can be eliminated.

ILC Data Device has developed a complete 10-bit s/d converter in a 36-pin double DIP that costs just \$345 in single-unit quantities. It has a ±30 minute worst-case error and can track at speeds of up to 100 rps for a 400 Hz reference (see story p. 140 of this issue). Aside from this unit, ILC Data Device offers two series—the H and HMSDC—of hybrid s/d and r/d converters and has a 14-bit hybrid unit in development.

Most activity in hybrids comes from manufacturers of a/d and d/a converters. Some of the manufacturers—Beckman, Burr-Brown, Dattel, Hybrid Systems, ILC Data Device, Micro Networks and Teledyne Philbrick—offer hybrid converters with resolutions ranging from 8 to 16 bits at speeds as short as 50 ns for d/a's and several hundred nanoseconds for a/d's.

A low-cost d/a converter like the DAC-80 12-bit unit introduced by Burr-Brown and second sourced by Micro Networks and others costs less than \$20 when purchased in quantities of 100 or

more. The converters come in 24-pin DIPs and have either binary or BCD input coding. Both current or voltage-output models are available, with settling times of 300 ns or 3 μs, respectively, for a full-scale input change.

Beckman has just announced a series of low-cost d/a units. The 877-80 and 877-85 12-bit units cost \$20 and \$40 respectively in 100-up quantities. They operate over a 0 to 85 or -25 to +85-C range, have a linearity error of ±1/2 LSB and settle in 300 ns (for the current output models and a 100-Ω load).

Dattel and Hybrid Systems also offer hybrid units with up to 12-bit resolution and accuracy. Dattel's units, the DAC-HZ series, are pin-compatible with the DAC-85 series from Burr-Brown and the 877-85 units from Beckman. They have prices starting at \$49 in singles and require only ±15-V instead of ±15-V and +5-V supplies.

Inexpensive a/d's are also available from many

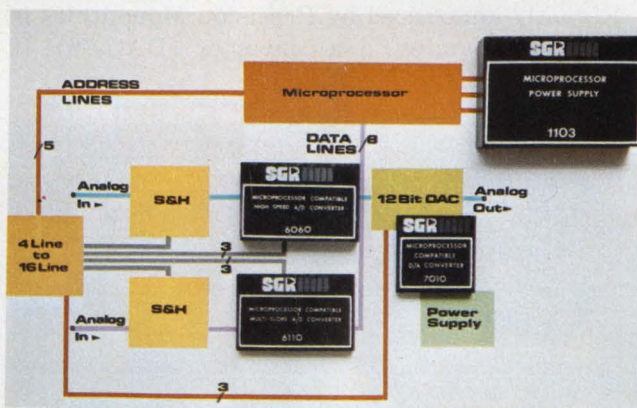

Bus-compatible a/d and d/a converters, with three-state logic outputs or inputs, are available from SGR Corp. Both successive-approximation and multi-slope a/d converters are available.

of the same firms; Burr-Brown's ADC-85 and ADC-80 series units have been second-sourced by Beckman, Dattel and Micro Networks. These converters come in 32-pin packages and include a clock, comparator and reference. The ADC-85 also has an input-buffer amplifier. Conversion times are 25 μs for ADC80 and 10 μs for the 85. Prices start at under \$50 in 100-unit quantities.

ILC Data Device offers some ECL-compatible d/a and a/d converters in its ADH series that are about the best you can get in hybrid form. The ADH-030 12-bit d/a converter settles in under 50 ns for a full-scale change, has an internal reference and a linearity of 0.05%.

The a/d converter, Model ADH-010 requires several hybrid packages, because of power dissipation restrictions, but can be mounted on a single circuit board. It can deliver ECL-compatible 10-bit words at a 1 MHz rate. Prices for these speedy units start at \$295 for the ADH-030

and go to \$895 for the ADH-010. A 12-bit version of the a/d will be available shortly.

Single-package hybrid converters with full MIL-temperature-range performance and hermetic packages are available from companies like Burr-Brown, Datel, Micro Networks and Teledyne Philbrick. Teledyne's units—such as its 4058-83 12-bit d/a which has a settling time of 200 ns (current output)—are some of the fastest available with TTL output levels. They are screened to MIL-STD-883, Level B.

### Modular and rack converters offer the tops

As the space you have available increases, or the performance requirements become more exacting, modular and rack-mounted converters can fill most needs. For very-high-speed applications, companies like Computer Labs, Datel, ILC Data Device, Intech, M. S. Kennedy and Teledyne-Philbrick offer a/d converters with conversion times of under 1  $\mu$ s for 8, 10 and 12-bit units.

The fastest include the VADC 8/17 from ILC Data Device, which delivers 8-bit words at a 17-MHz word rate; the MOD-4100 from Computer Labs that operates at a 100-MHz word rate and delivers 4-bit data and the ADC-UH8B from Datel, an 8-bit unit with a 10 MHz sampling rate. The DDC unit is made up of three circuit cards and costs \$4350. The MOD-4100 costs \$2120 and is an open-frame converter and the Datel unit costs \$995 and is a 3  $\times$  5  $\times$  1.15-in. module.

At slightly slower speeds the field opens up to over a hundred module manufacturers and about half as many manufacturers of rack-mounted circuits. Some of the well-known manufacturers of off-the-shelf modules include Analog Devices, Analogic, Burr-Brown, Datel, Dynamic Measurements, Hybrid Systems, ILC Data Device Corp., Intech, Phoenix Data, Teledyne-Philbrick and Zeltex. Rack units for very high precision (12-bit resolution and tighter) are available from companies such as Phoenix Data, Preston Scientific, Princeton Applied Research and Tustin Electronics.

Prices for modular converters range from under \$15 for simple 8-bit current-output versions to over \$1000 for high-speed, high-precision a/d converters such as the MP8016 series of 14, 15 or 16-bit units from Analogic. They have conversion times of 0.6 to 2.5  $\mu$ s per bit. SGR Corp. has recently announced a line of microprocessor-compatible converters—double-buffered d/a converters and a/d converters with three-state outputs.

Modular v/f and f/v converters are available from about a dozen manufacturers with full scale frequency ranges of 10 kHz, 100 kHz and 1 MHz commonly offered. Teledyne-Philbrick has topped even those ranges with its 4707, 5-MHz voltage-

to frequency converter.

Many interface options—from differential or instrumentation-amplifier front ends, to optically-coupled inputs and outputs—are available from most vendors. Intech even offers a "super" unit with a built-in crystal to improve frequency stability. Wide ranges of performance specs are available from companies like Analog Devices, Datel, Dynamic Measurements, Intech and Teledyne-Philbrick. Basic f/v and v/f prices start at \$25 for units with nonlinearities of under 1%.

Another group of converters that use a delta-sigma technique are somewhere in between the a/d and v/f converter (or d/a and f/v). Hybrid Systems offers these converters under the trade name of Deltaversers. Just released circuits include the DV620 encoder and DV621 decoder that can be used at frequencies of up to 20 kHz and cost only \$59 each in singles. (See story p. 138 this issue.)

The angular-converter area has about a dozen

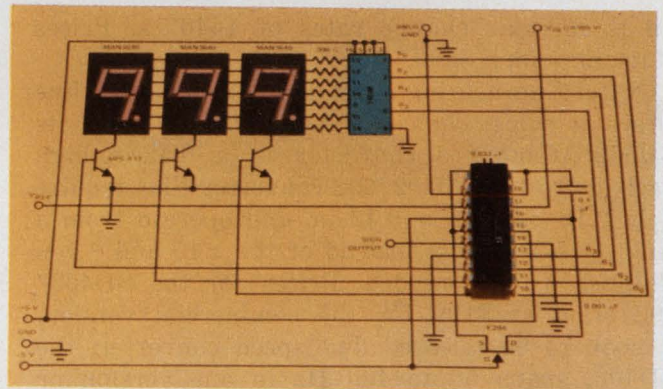

A simple 3-digit voltmeter can be built using the LD130 single-chip integrating a/d converter made by Siliconix. In addition to the chip all you need is a display driver, display, four transistors, some resistors and a capacitor.

manufacturers vying for the market. Some of the largest include Analog Devices, Astrosystems, Computer Conversions, Control Science, ILC Data Device, Natel, North Atlantic Industries and Transmagnetics. Both Analog Devices and ILC Data Device have introduced Inductosyn-to-digital converters—the IDC 1701, 1703 and IDC-101, 102, respectively. One version from each company delivers a count of 4000 per pitch cycle and the other a count of 4096. The units from Analog Devices come without the input amplifiers necessary to sense the Inductosyn output and cost \$350. The DDC units include the amplifiers and isolation transformers and cost \$495.

Within the last year, North Atlantic Industries has developed a custom LSI circuit for use within its LSI/85 and LSI/90 series of s/d converters. The circuit permits a 35% reduction in module size and an increase in reliability. Accuracy of the LSI/85 units is better than  $\pm 3$  minutes

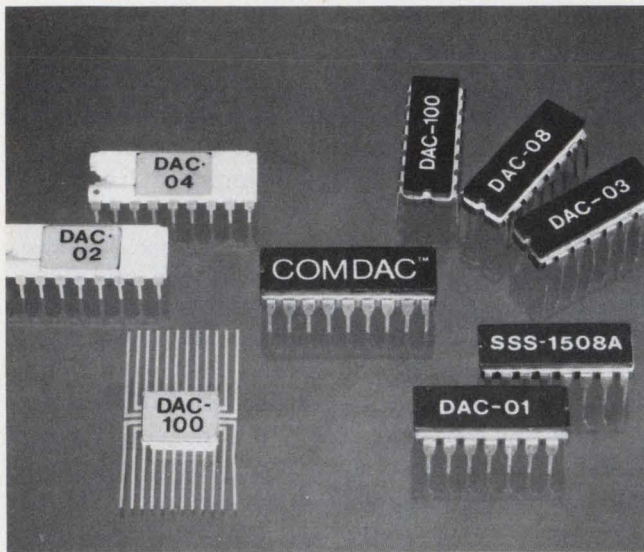

Monolithic d/a converters, ranging from 4 to 12-bit units, are the prime product line from Precision Monolithics. Its newest unit is the Comdac, a companding 8-bit d/a.

up to angular change rates of 1440°/s. Prices start at under \$500.

Natel Engineering's r/d and d/r converter line offers a wide choice of capabilities—from its SD552 16-bit r/d converter in a 0.42-in.-high package to the SD402/602 converter that require only 2.13 × 2.13 × 0.42 in. and operate from a single +5-V supply instead of the ±15 and +5-V supplies usually needed. Prices for the SD402/602 start at \$199 for the commercial version. A soon to be released dual-speed converter, the SD402, spans 50 to 400 Hz in one version or 400 Hz and up in another. It has 16-bit resolution, 0.01% accuracy and fits into about 7 cubic inches. The converter runs from a +5-V supply and costs \$995 or \$1095, depending upon the frequency selected.

High power-drive d/s converters that can power up to three size-11 torque receivers have been introduced by Computer Conversions. The units accept a 14-bit input and can deliver 90 or 11.8-V, rms, line-to-line at 60 or 400 Hz. Prices for these units are under \$500.

Converters from Astrosystems use tapped toroidal transformers that are said to make the converters insensitive to temperature and aging. S/d converters from Astrosystems have an infinite range of scale factors just by a simple change in an RC time constant. Full scale is determined by the ratio between the integrator's time constant and a digital clock frequency.

Transmagnetics and Control Sciences both offer high-speed tracking s/d converters with rates of 5760°/s and 3600°/s for their 14-bit units. For fast tracking you'll pay dearly, though. The Transmagnetics unit (Model 1651), for instance, costs \$640 in singles. ■■

## Need more information?

For manufacturers' literature, detailed specs and other information helpful in selecting and applying converters this list of major OEM suppliers is provided. Code letters A, B and C indicate whether the vendor offers a/d or d/a converters, f/v or v/f converters, or r(s)/d or d/r(s) converters, respectively. For additional manufacturers' listings see ELECTRONIC DESIGN'S GOLD BOOK.

- Acromag Inc., 30765 Wixom Rd., Wixom, MI 40896. (313) 624-1541. (S. Kresch). B **Circle No. 381**
- Action Instruments Co., Inc., 7969 Engineer Rd., San Diego, CA 92111. (714) 279-5726. (R. Britton). B **Circle No. 382**
- ADAC Corp., 118 Cummings Park, Woburn, MA 01801. (617) 935-6668. A **Circle No. 383**
- AD Data Systems, 830 Linden Ave., Rochester, NY 14625. (716) 381-2370. (H. Turner). A **Circle No. 384**
- American Astrionics, 291 Kalmus Dr., Costa Mesa, CA 92626. (714) 540-4330. A, C **Circle No. 385**
- American Electronic Labs., Inc., P.O. Box 552, Lansdale, PA 19446. (215) 822-2929. (T. Keffer). A **Circle No. 386**
- American Vector Inc., 50 Culver Rd., Dayton, NJ 08810. (201) 329-4683. (T. Gordon). A **Circle No. 387**
- Anadex Instruments Inc., 7833 Haskell Ave., Van Nuys, CA 91046. (213) 782-9527. (K. Mathews). B **Circle No. 388**
- Analog Devices, Inc., P.O. Box 280, Norwood, MA 02062. (617) 329-4700. (L. Wickersham). A, B, C **Circle No. 389**
- Analogic Corp., 1 Audubon Rd., Wakefield, MA 01880. (617) 246-0300. (D. Chase). A **Circle No. 390**
- Astrosystems Inc., 6 Nevada Dr., Lake Success, NY 11040. (516) 328-1600. (G. Steinberg). C **Circle No. 391**
- Automated Industrial Measurements, P.O. Box 125, Wayland, MA 01778. (617) 653-8602. (E. Hilton). B **Circle No. 392**
- Aydin Vector Div., P.O. Box 328, Friends Lane, Newton, MA 18940. (215) 968-4271. (J. Thomason). A **Circle No. 393**
- Baldwin Elecs. Inc., 1101 McAlmont St., Little Rock, AR 72203. (501) 375-7351. (S. Berg). A **Circle No. 394**
- Barber-Colman Co., Industrial Instruments Div., 1317 Rock St., Rockford, IL 61101. (815) 877-0241. (W. Paetz). A **Circle No. 395**
- Base Ten Systems Inc., 3828 Quakerbridge Rd., Trenton, NJ 08619. (609) 586-7010. (W. Errickson). A **Circle No. 396**
- Beckman Instruments, 2500 Harbor Blvd., Fullerton, CA 92634. (714) 871-4848. (D. Snyder). A **Circle No. 397**
- Bell & Howell Control Prods. Div., 706 Bostwick Ave., Bridgeport, CT 06605. (203) 368-6751. (S. Rose). B **Circle No. 398**
- Biomatic, 10411 Bubb Rd., Cupertino, CA 95014. (408) 255-9500. (D. Blecki). A **Circle No. 399**
- Burr-Brown Research Corp., 6730 S. Tucson Blvd., Tucson, AZ 85734. (602) 294-1431. (J. Santen). A, B **Circle No. 406**
- Cal Tek Engineering, 29 Pemberton Rd., Wayland, MA 01778. (617) 653-0355. (D. Sheehan). B **Circle No. 407**
- Cambridge Thermionic, 445 Concord Ave., Cambridge, MA 02138. (617) 491-5400. (L. Wilkes). A **Circle No. 408**
- Canberra Ind., 45 Gracey Ave., Meridan, CT 06450. (203) 238-2351. (B. Compo). A **Circle No. 409**
- C & A Products Inc., 37-12 58 St., Woodside, NY 11377. (212) 779-4303. (R. Bogen). A, C **Circle No. 410**
- Clifton Precision, Div. Litton Systems Inc., Marple At Broadway, Clifton Heights, PA 19018. (215) 622-1000. (W. Runiewicz). C **Circle No. 411**
- CMP Ind. Inc., 23660 Research Dr., Farmington Hills, MI 48024. (313) 477-1750. (A. Carter). A **Circle No. 412**
- Coded Communications Corp., 1620 Linda Vista Dr., San Marcos, CA 92069. (714) 744-3710. (J. Tyler). A **Circle No. 413**
- Computer Central, P.O. Box 804, Gaithersburg, MD 20760. (301) 948-5557. (A. O'Hara). A, C **Circle No. 414**
- Computer Conversions Corp., 6 Dunton Ct. E., Northport, NY 11731. (516) 261-3300. (S. Renard). C **Circle No. 415**
- Computer Labs Inc., 505 Edwardia Dr., Greensboro, NC 27409. (919) 292-6427. (J. Poitras). A **Circle No. 416**
- Conrac Corp., NJ Div., 32 Fairfield Pl. W., Caldwell, NJ 07006. (201) 575-8000. (P. Daro). A, C **Circle No. 417**
- Control Sciences Inc., 8399 Topanga Canyon Blvd., Suite 303, Canoga Park, CA 91304. (213) 887-7344. (H. Ericsson). C **Circle No. 418**
- Coulbourn Instruments Inc., P.O. Box 2551, Lehigh Valley, PA 18100. (215) 395-3771. (P. Johnson). B **Circle No. 419**
- Cycon Inc., 1080 E. Duane Ave., Sunnyvale, CA 94086. (408) 732-8311. A **Circle No. 420**
- Data General Corp., Rte. 9, Southboro, MA 01772. (617) 485-9100. (H. Richman). A **Circle No. 421**
- Data Tech, 2700 S. Fairview Rd., Santa Ana, CA 92704. (714) 546-7160. (W. Miller). A **Circle No. 422**
- Data Translation Inc., 109 Concord St., Framington, MA 01701. (617) 879-3595. (F. Molinari). A **Circle No. 423**



- Datawest Corp., 7333 E. Helm Dr., Scottsdale, AZ 85260. (602) 948-3280. (D. Bozich). A, C **Circle No. 424**
- Datel Systems Inc., 1020 Turnpike St., Canton, MA 02021. (617) 828-8000. (E. Zuch). A, B **Circle No. 425**
- Datex Div., Conrac Corp., 1600 S. Mountain Ave., Duarte, CA 91010. (213) 359-9141. (W. Shevell). A **Circle No. 426**
- Datum Inc., 1363 State College Blvd., Anaheim, CA 92806. (714) 533-6333. (N. Dawirs). A **Circle No. 427**
- Digital Equipment Corp., 146 Main St., Maynard, MA 01754. (617) 897-5111. (T. Johnson). A **Circle No. 428**
- Dynamic Measurements, 6 Lowell Ave., Winchester, MA 01890. (617) 729-7870. (J. Gendreau). A, B **Circle No. 429**
- Elographics, Inc., P.O. Box 388, Oak Ridge, TN (615) 482-4039. (R. Evans). A **Circle No. 431**
- EPSCO Inc., 411 Providence Hwy., Westwood, MA 02090. (617) 329-1500. (H. Gershanoff). A, C **Circle No. 432**
- E-Systems Inc., P.O. Box 6030, Dallas, TX 75222. (214) 742-9471. (D. Dirks). A **Circle No. 433**
- Farrand Controls Inc., 99 Wall St., Valhalla, NY 10595. (914) 761-2600. (C. Farrand Jr.). A, C **Circle No. 434**
- Fluidyne Instrumentation, 1631 San Pablo Ave., Oakland, CA 94612. (415) 444-2376. (R. Jennings). A **Circle No. 435**
- FX Systems Co., 5070 Kings Hwy., Saugerties, NY 12477. (914) 246-9571. (W. Landell). A **Circle No. 436**
- Gap Instrument Corp., 110 Marcus Blvd., Hauppauge, NY 11787. (516) 273-0909. (W. Soboleski). A, C **Circle No. 437**
- General Atronics Corp., 1201 E. Mermaid Lane, Philadelphia, PA 19118. (215) 248-3700. (W. Lutz). A **Circle No. 438**
- General Instrument Corp., 600 W. John St., Hicksville, NY 11802. (516) 733-3333. (G. Cacavio). A, B, C **Circle No. 439**
- Hewlett-Packard, 175 Wyman St., Waltham, MA 02154. (617) 890-6300. (R. Hanna). A **Circle No. 440**
- Hybrid Systems Corp., 22 Third Ave., Burlington, MA 01803. (617) 272-1522. (D. Misno). A **Circle No. 441**
- Hy Comp Inc., 146 Main St., Maynard, MA 01754. (617) 897-4578. (N. Palazzini). A **Circle No. 442**
- ILC Data Device Corp., 105 Wilbur Pl., Bohemia, NY 11716. (516) 567-5600. (A. Carbone). A, C **Circle No. 443**
- Intech Inc., 1220 Coleman Ave., Santa Clara, CA 95050. (408) 244-0500. (P. Pinter). A, B **Circle No. 444**
- Integrated Photomatrix, Inc., 1101 Bristol Rd., Mountainside, NJ 07092. (201) 233-6010. (P. Noble). A **Circle No. 445**
- Inter-Computer Electronics Inc., P.O. Box 507, Lansdale, PA 19446. (215) 855-0922. (A. Rosset). A **Circle No. 446**
- Interface Engineering Inc., 386 Lindelof Ave., Stoughton, MA 02072. (617) 344-7383. (R. Eastman). C **Circle No. 447**
- Intersil, 10900 N. Tantau Ave., Cupertino, CA 95014. (408) 257-5450. (J. Corser). A **Circle No. 448**
- Intronics Inc., 57 Chapel St., Newton, MA 02158. (617) 332-7350. (A. Pfaelzer). A, B **Circle No. 449**
- Jorway Corp., 27 Bond St., Westbury, NY 11590. (516) 997-8120. (T. Radway). A **Circle No. 450**
- Kennedy, M.S., Pickard Dr., Syracuse, NY 13211. (315) 455-7077. (B. Lesjack). A **Circle No. 451**
- Kinometrics Inc., 336 Agostino Rd., San Gabriel, CA 91776. (213) 287-9731. (H. Halverson). A **Circle No. 452**
- Kinetic Systems Corp., Maryknoll Dr., Lockport, IL 60441. (815) 838-0005. (L. Klaisner). A **Circle No. 453**
- Lancer Elecs. Corp., 3950 German Town Pike, Collegeville, PA 19426. (215) 489-2265. (Mr. Amstey). A **Circle No. 454**
- LRC Inc., 101 Digital Dr., Hudson, NH 03051. (603) 883-8001. (F. Solla). A **Circle No. 455**
- Macrodyne Inc., 1900 Maxon Rd., Schenectady, NY 12301. (518) 372-5619. (D. Antos). A **Circle No. 456**
- Martin-Decker Co., 1928 S. Grand Ave., Santa Ana, CA 92705. (714) 540-9220. (J. Knowlton). A **Circle No. 457**
- Media III, 2259 A Via Burton, Anaheim, CA 92806. (714) 870-7660. (G. Salley). A **Circle No. 458**
- Metric Systems Corp., 736 N. Beal St., Fort Walton Beach, FL 32548. (904) 242-2111. (R. Zlata). A **Circle No. 459**
- Micro Networks Corp., 324 Clark St., Worcester, MA 01606. (617) 852-5400. (R. Jay). A **Circle No. 460**
- Motorola Semiconductor Products, 5005 E. McDowell Rd., Phoenix, AZ 85008. (602) 962-2994. (S. Faulkner). A **Circle No. 461**
- Natel Engineering Co., Inc., 8954 Mason Ave., Canoga Park, CA 91036. (213) 882-9620. (J. Naster). C **Circle No. 462**
- National Semiconductor Corp., 2900 Semiconductor Dr., Santa Clara, CA 95051. (408) 732-5000. (D. Coleman). A **Circle No. 463**
- Nationwide Elec. Systems Inc., 1536 Brandy Pkwy., Streamwood, IL 60103. (312) 289-8820. (H. Hanson). A **Circle No. 464**
- Newport Labs, 630 E. Young St., Santa Ana, CA 92705. (714) 540-4914. (C. Hasley). A **Circle No. 430**
- Non-Linear Systems Inc., Box N, Del Mar, CA 92014. (714) 755-1134. (H. Lesser). A **Circle No. 465**
- North Atlantic Industries, 200 Terminal Dr., Plainview, NY 11803. (516) 681-8600. (K. Salz). C **Circle No. 466**
- North Hills Elecs. Inc. Alexander Pl., Glen Cove, NY 11542. (516) 671-5700. (H. Marx). B **Circle No. 467**
- Nuclear Data Inc., Golf & Meacham Rd., Schaumburg, IL 60196. (312) 884-3621. (J. Heraty). A **Circle No. 468**
- Optical Elecs. Inc., Box 11140, Tucson, AZ 85734. (602) 624-8358. (R. Gerdes). A, B **Circle No. 469**
- Orbit Instrument, 131 Eileen Way, Syosset, NY 11791. (516) 921-6310. (J. Kilkenny). A **Circle No. 470**
- Ortec Inc., 100 Midland Rd., Oak Ridge, TN 37830. (615) 482-4411. (R. Welch). A **Circle No. 471**
- Pacific Electro Dynamics, 14220 Sunset Hwy., Bellevue, WA 98007. (206) 747-7400. (W. Maesner). C **Circle No. 472**
- Perkin-Elmer Corp., Main Ave., Norwalk, CT 06856. (203) 762-4786. (P. Hutchinson). A, C **Circle No. 473**
- Phoenix Data, Inc., 3384 W. Osborn Rd., Phoenix, AZ 85017. (602) 278-8528. (J. Hartigan). A **Circle No. 474**
- Pioneer Magnetics Inc., 1745 Berkeley St., Santa Monica, CA 90404. (213) 829-3305. (G. Held). B **Circle No. 475**
- Plessey Environmental Systems, 3939 Ruffin Rd., San Diego, CA 92123. (714) 278-6500. (G. Clausen). A **Circle No. 476**
- Precision Monolithics, 1500 Space Park Dr., Santa Clara, CA 95050. (408) 246-9222. (D. Soderquist). A **Circle No. 477**
- Preston Scientific, 805 E. Cerritos, Anaheim, CA 92805. (714) 776-6400. (B. Spear). A **Circle No. 478**
- Prime Computer Inc., 145 Pennsylvania Ave., Framingham, MA 01701. (617) 879-2960. (N. Stover). A **Circle No. 479**
- Princeton Applied Research Co., P.O. Box 2565, Princeton, NJ 08540. (609) 452-2111. (S. Letzler). A **Circle No. 480**
- Process Computers Systems Inc., 5467 Hill 23 Dr., Flint, MI 48507. (313) 744-0225. (G. Johnson). A **Circle No. 481**
- Quindar Elecs., 60 Fadem Rd., Springfield, NJ 07081. (201) 379-7400. (J. Tennant). B **Circle No. 482**
- Radar Technology Inc., 91 Merrimack St., Haverhill, MA 01830. (617) 372-8504. (T. Jarron). A **Circle No. 483**
- Ragen Data Systems Inc., 125 Schmitt Blvd., Farmingdale, NY 11735. (516) 293-1333. (M. Richardson). A **Circle No. 484**
- Renco Corp., 26 Coromar Dr., P.O. Box 246, Goleta, CA 93017. (805) 968-1525. (R. Hotchin). A **Circle No. 485**
- RFL Ind. Inc., Coms Div., Powerville Rd. 23, Boonton, NJ 07005. (201) 334-3100. (R. Gilman). B **Circle No. 486**
- Richard-Lee Co., Box 724, New Providence, NJ 07974. (201) 665-1333. (L. Gintella). B **Circle No. 487**
- Scanivalve Inc., P.O. Box 20005, San Diego, CA 92120. (714) 283-0010. (H. Hunt). A **Circle No. 488**
- Sea Data Corp., 153 California St., Newton, MA 02138. (617) 244-3216. (W. Hill). A **Circle No. 489**
- SGR Corp., Neponset Valley Industrial Park, P.O. Box 391, Canton, MA 02021. (617) 828-7773. (S. Radler). A, B **Circle No. 490**
- Signetics, 811 E. Arques Ave., Sunnyvale, CA 94086. (408) 739-7700. (P. Guest). A **Circle No. 491**
- Siliconix Inc., 2201 Laurelwood Rd., Santa Clara, CA 95054. (408) 246-8000. (S. Bolger). A **Circle No. 492**
- Singer Co., Kearfott Div., 1150 McBride Ave., Little Falls, NJ 07424. (201) 256-4000. (C. Wheatley). A, C **Circle No. 493**
- Singer Instrumentation, 5340 Alla Rd., Los Angeles, CA 90066. (213) 822-3061. (W. Becher). C **Circle No. 494**
- Solid State Elecs., 15321 Rayen St., Sepulveda, CA 91343. (213) 894-2271. (E. Politi). A, B **Circle No. 495**
- Spacetac Inc., Crosby Dr., Bedford, MA 01730. (617) 275-1710. (R. Reed). A **Circle No. 496**
- Tauber-Dreyer Corp., 10533 Topeka Dr., Northridge, CA 91324. (213) 368-4011. C **Circle No. 497**
- Teledyne Geotech, 3401 Shiloh Rd., Garland, TX 75041. (214) 271-2561. (J. Whalen). A **Circle No. 498**
- Teledyne-Philbrick, Allied Dr. at Rte. 128, Dedham, MA 02026. (617) 329-1600. (F. Goodenough). A, B **Circle No. 499**
- Tennelec Inc., 601 Oak Ridge Tpke., Oak Ridge, TN 37830. (615) 483-8404. (B. Hebenstreit). A **Circle No. 500**
- Theta Instrument Corp., 24 Dwight Pl., Fairfield, NJ 07006. (201) 227-1700. (T. Villano). C **Circle No. 501**
- Three Rivers Computer Corp., P.O. Box 235, Pittsburgh, PA 15213. (412) 621-6250. (B. Rosen). A **Circle No. 502**
- Transmagnetics Inc., 210 Adams Blvd., Farmingdale, NY 11735. (516) 293-3100. (A. Talbot). C **Circle No. 503**
- TRW Defense and Space Systems Group, 1 Space Park, Redondo Beach, CA 90278. (213) 536-1977. (H. DiMondi). A **INQUIRE DIRECT**
- Tucker Elecs. Co., P.O. Box 1050, Garland, TX 75040. (214) 348-8800. (J. Schrengohst). A **Circle No. 504**
- Tustin Elecs. Co., 1431 E. St. Andrews Pl., Santa Ana, CA 92705. (714) 549-0391. (W. Buchanan). A **Circle No. 505**
- Varian Assoc., 611 Hansen Way, Palo Alto, CA 94303. (415) 493-4000. (J. Heldack). A **Circle No. 506**
- Vega Precision Labs Inc., 800 Follin Lane, Vienna, VA 22180. (703) 938-6300. (W. Howells). A, B, C **Circle No. 507**
- Vernitech Div., Vernitron Corp., 300 Marcus Blvd., Deer Park, NY 11729. (516) 586-5100. (J. Moonelis). C **Circle No. 508**
- Xincom Corp., 8944 Mason Ave., Box 648, Chatsworth, CA 91311. (213) 341-5040. (B. Sear). A **Circle No. 509**
- Zeltex Inc., 940 Detroit Ave., Concord, CA 94518. (415) 686-6660. (W. Peacock). A **Circle No. 510**

New 32D permanent magnet fhp motors and 32D-5F right angle gearmotors join the growing Bodine PM family.

Perfectly matched with Bodine's PM controls, 32's offer the same performance characteristics as the 42's—in a smaller package. Only 3.55" in diameter. Built for high starting torque, low speed opera-

tion, and a high degree of control, the new systems have continuous duty motor ratings of 1/12, 1/10 and 1/8 Hp at 2500 Rpm. New right angle gearmotors are available in six standard ratios.

All PM systems have grounding provisions for safe operation. Bodine PM motors are totally-enclosed, nonventilated and reversible.

Optional "L" bracket mounting kits, terminal endshield kits, and other accessories are available. Bodine also offers D-C motors for use with your own controls. See your Bodine Distributor or write for Catalog CDC-PM.

Contact Bodine Electric Company, 2500 W. Bradley Pl., Chicago, IL 60618. Phone (312) 478-3515.

# *Bodine's PM drive systems family is growing...smaller.*

We've added 2 new 32-frames

**42D-E Parallel Shaft Control Gearmotors**  
Torques through 350 Lb-in.

**DPM Controls—**  
Encased type.

**DPM Controls—**  
Chassis type.

**42D Control Motors**  
1/8 through 1/4 Hp at 2500 Rpm.

**32D Control Motors**  
1/12 through 1/8 Hp at 2500 Rpm.

**32D-5F Right Angle Control Gearmotors**  
Torques through 55 Lb-in.

ADE (After Delivery Economies) make Bodine a better fhp buy

**BODINE  
ELECTRIC  
COMPANY**

BODINE MOTORS  
GEARMOTORS  
SPEED CONTROLS

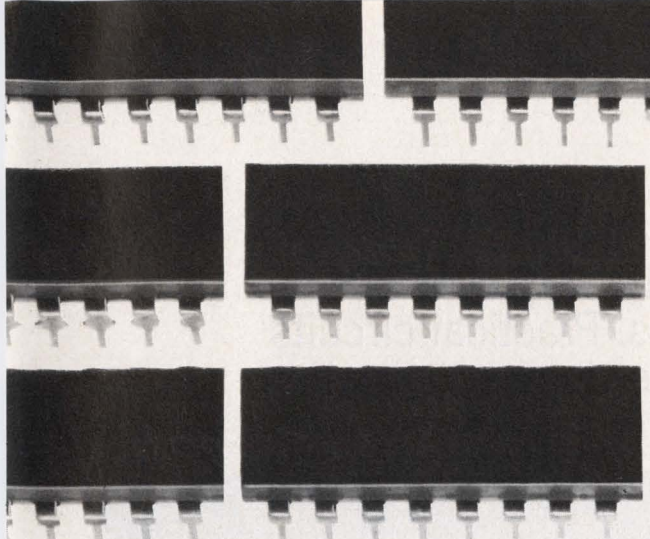

## STANDARD DIP NETWORKS

14 and 16 pin... hundreds  
of values... stock items:  
22 ohms to 100k.

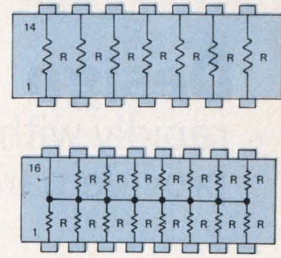

## THICK FILM RESISTOR

# DIP'S

## CUSTOM DIP NETWORKS

Our computer controlled laser has solved thou-  
sands of custom designed dip and sip networks  
... use it to solve your's!

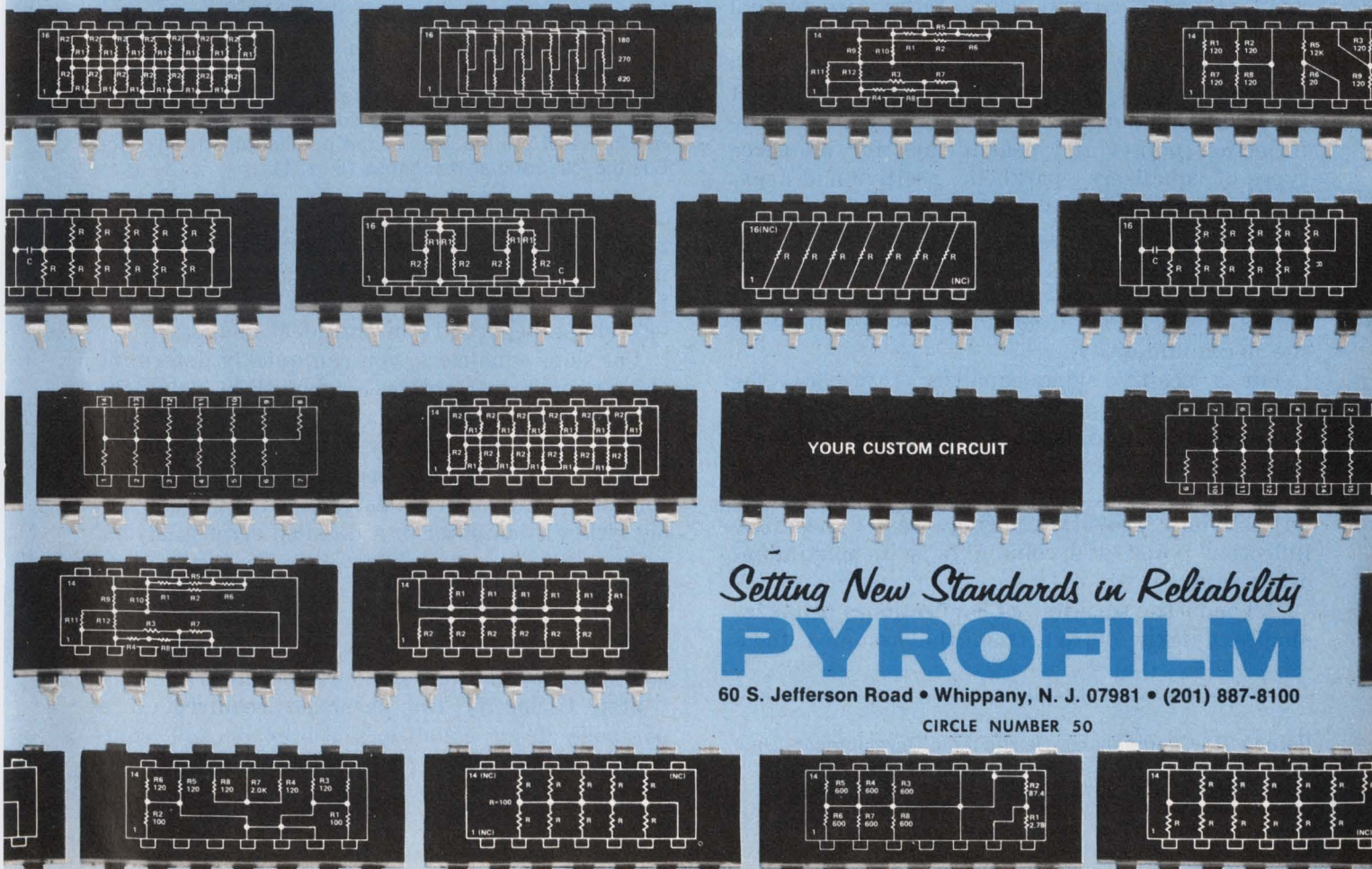

YOUR CUSTOM CIRCUIT

*Setting New Standards in Reliability*  
**PYROFILM**

60 S. Jefferson Road • Whippany, N. J. 07981 • (201) 887-8100

CIRCLE NUMBER 50

## Design single-section delay equalizers rapidly with normalized tables and graphs. Practical circuits provide parabolic and negative or positive-slope equalization.

In spite of the impact of computers on design work, normalized tables for designing such often-used networks as delay equalizers, still remain one of the most useful and powerful of engineering aids. However, tables for delay-equalizer design have lagged behind those for other networks, such as filters and attenuators, largely because of the large number of possible and desirable variations. Nevertheless, if we restrict our interest to single-section all-pass equalizers, which command wide usage, the number of different versions falls to practical limits.

Some published delay-equalizer tables<sup>1</sup> are fairly widely used, but they are directly applicable only to parabolic equalizers. Also, they offer little insight into the equalizer's delay shape when the bandwidth is normalized. In addition, these published tables are not applicable where the shape factor ( $d$  value, Figs. 1 and 2 and related value,  $\theta$ ) is very small, and where equivalent bridged-T circuits (Fig. 1) require mutual inductance.

The new normalized table (Table 1) overcomes these handicaps. In addition to shape factors, it provides the normalized frequencies,  $X$ , of the inflection points and peak delays for all three types of equalizers—parabolic, positive and negative—shown in Figs. 3b, 3c and 3d.

For a parabolic equalizer (Fig. 3b) the table's columns A and C contain the  $X$  values corresponding to positive and negative-slope inflection points, respectively. Column B provides the  $X$  of the maximum-delay.

For a positive-slope equalizer (Fig. 3c), the same column A provides the frequency of its single inflection point, and column B provides its maximum-delay point.

Similarly, for a negative-slope equalizer (Fig. 3d) column C provides the frequency of the single inflection point, and column B is its maximum-delay point.

Beyond the points of inflection, equalizer shapes quickly depart from the assumed theo-

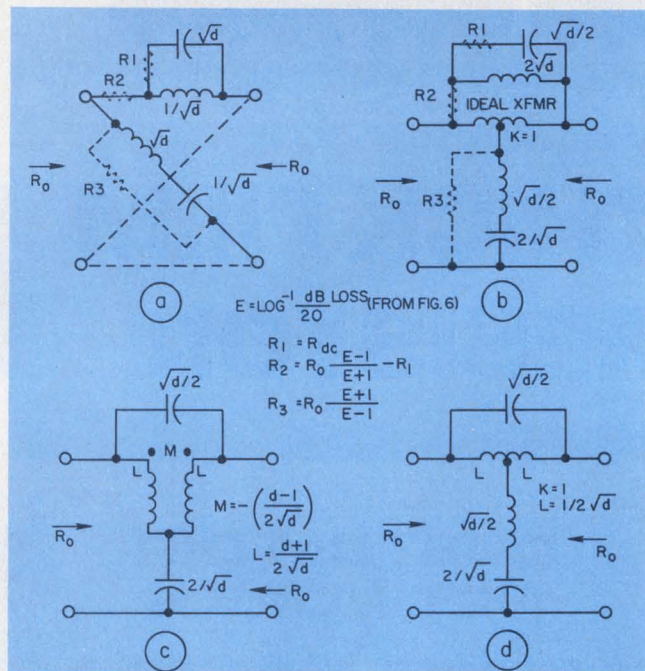

1. Delay-equalizer circuits with components normalized as a function of the shape-factor,  $d$ , from Table 1 may be predistorted (to compensate for dissipation losses) by the inclusion of the dotted components.  $R_{dc}$  is the dc resistance of the inductor in the parallel-tuned tank, and  $E$  is the loss ratio at resonance ( $E > 1$ ).

retical shapes. For parabolic equalizers, you can use the peak-delay frequency and the inflection points to estimate quickly how much the equalizer's shape departs from the ideal shape.

For slope equalizers, you can quickly determine the maximum percentage bandwidth by using the frequency of the peak delay taken from column B as one band edge, and by using the point of inflection as the center frequency. Thus the performance limits can be determined rapidly without either a computer or a detailed error analysis.

### Steps for using the tables

Using the table to design delay equalizers is a straightforward, step-by-step procedure.

**Step 1. Specify the passband required.** If a parabolic delay equalizer's center doesn't coincide with the center of the desired passband, use

Vernon R. Cunningham, Design and Development Engineer, Collins Radio Co., Richardson, TX 75207.

**Step 3. Calculate a quantity, M, from the appropriate equation.**

$$\text{Parabolic Delay:} \quad M = \frac{T\Delta f_c}{B^2}$$

$$\text{Slope Delay:} \quad M = \frac{T\Delta f_c}{B}$$

$T\Delta$  = differential delay (seconds)

$f_c$  = center frequency of bandwidth specified in Step 1 (Hz)

$B$  = ratio of the bandwidth to  $f_c$

For the example in Step 1

$$M = \frac{(4 \times 10^{-9})(65 \times 10^6)}{\left(\frac{30}{65}\right)^2} = 1.22$$

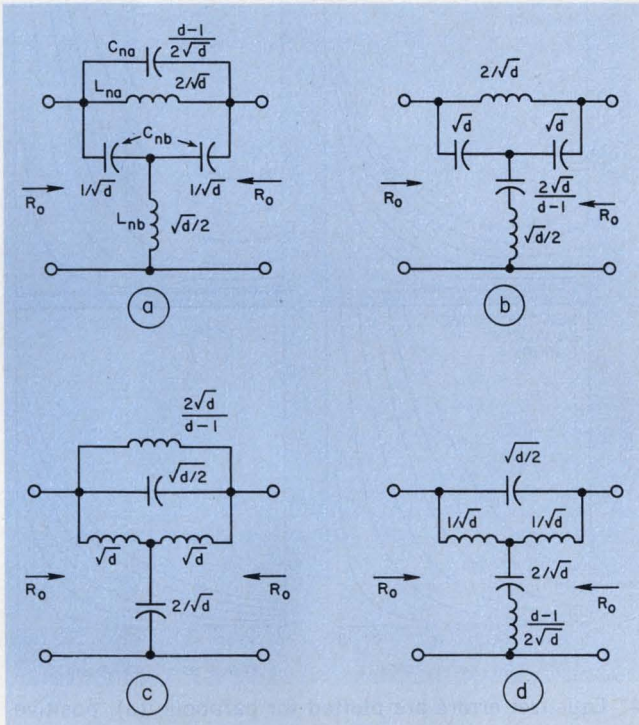

2. **Bridged-T circuits** such as these can be used when  $d > 1$  ( $\theta > 60^\circ$ ). They have the advantage that they require no transformers or mutual inductances. If  $d < 1$ , one of the components must have a negative value.

a passband value that is twice the distance from the center of the parabola to the furthest band edge.

For example, suppose you wish to equalize an off-centered parabola that has 4 ns of delay at 80 MHz, and whose center is at  $f_c = 65$  MHz when the actual bandwidth of interest is 60 to 80 MHz. Then the "new" bandwidth to be used for design purposes is  $2(80 - 65) = 30$  MHz—instead of 20 MHz—and it is centered around 65 MHz.

**Step 2. Establish the amount of differential delay to be equalized.** For a slope delay equalizer, the differential delay is the difference in delay between one band edge and the other. For a parabolic equalizer, it's the difference in delay between the value of the delay that occurs at the frequency of the peak delay and the delay that occurs at the band edge furthest from the peak frequency.

**Step 4. Look up the values of d and X in Table 1.** With the value M, look up the normalized-frequency variable, X, in the column appropriate for the desired equalizer type and also obtain the value of the shape factor, d. The relationships between the shape factor, d, and the other shape factor,  $\theta$ , are explained later. In the previous example (Step 1), the closest value in the table to M is 1.212, and

$$\begin{aligned} d &= 1.80 \\ X_c &= 0.925 \\ \theta &= 68.12^\circ \end{aligned}$$

Also, the columns labeled Positive slope and Negative slope provide the inflection points.

$$\begin{aligned} X_{neg} &= 1.142 \\ X_{pos} &= 0.715 \end{aligned}$$

Note: The terms positive and negative slope refer to the slope of the equalizer's delay, not to the delay of the circuit to be corrected. Interpolation may be used to establish the values for d, X and  $\theta$ .

**Step 5. Determine the normalized component values.** Choose an equalizer circuit from Figs. 1 or 2 and calculate the normalized component values using the value of d obtained in Step 4.

**Step 6. Calculate the actual circuit values.** Introduce the desired impedance and frequency into the relationships

$$\begin{aligned} C &= C_n \frac{X}{R_o \omega_c} \\ L &= L_n \frac{X R_o}{\omega_c} \end{aligned}$$

where the subscript n identifies the normalized values (from Step 5) and

- $R_o$  = terminating impedance (ohms)
- $\omega_c$  = center frequency of the equalized bandwidth (in radians)
- $X = \omega/\omega_o$ , the normalized-frequency variable from the table in Step 4.

Note: Normalized-component circuits resonate at the normalized frequency,  $X = 1$ . However, the frequency of peak delay occurs at  $X = 1$  only for  $\theta = 90^\circ$  (Fig. 3a).

Let's equalize a system having a negative-delay slope of 5 ns and a 60-to-80 MHz passband.

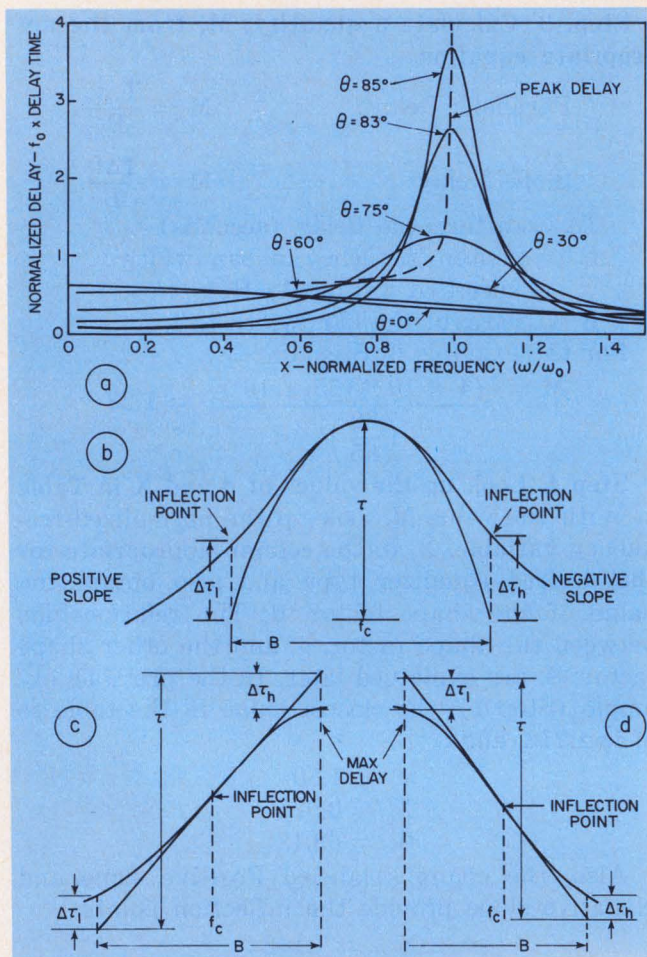

3. Normalized delay when plotted against normalized frequency,  $X$ , for different shape factors,  $\theta$ , provide a quick overview of an equalizer's characteristics (a). The tables for both parabolic and positive or negative sloping equalizers, because of approximations, include the errors plotted in Fig. 4. These errors increase with increasing bandwidth.

First calculate

$$M = \frac{T\Delta f_c}{B} = \frac{(5 \times 10^{-9})(70 \times 10^6)}{\left(\frac{20}{70}\right)} = 1.225.$$

Because the system's delay has a negative slope—one that decreases delay as frequency increases—we must use a positive-slope equalizer. We find the nearest value,  $M = 1.235$ , in Table 1, where

$$\begin{aligned} X &= 0.77 \\ \theta &= 71.80^\circ \\ d &= 2.56. \end{aligned}$$

If you select the circuit shown in Fig. 2a, calculation of the normalized component values yields

$$\begin{aligned} C_{na} &= \frac{d-1}{2\sqrt{d}} = \frac{2.56-1}{2\sqrt{2.56}} = 0.4875 \\ C_{nb} &= \frac{1}{\sqrt{d}} = \frac{1}{\sqrt{2.56}} = 0.6250 \\ L_{na} &= \frac{2}{\sqrt{d}} = \frac{2}{\sqrt{2.56}} = 1.250 \end{aligned}$$

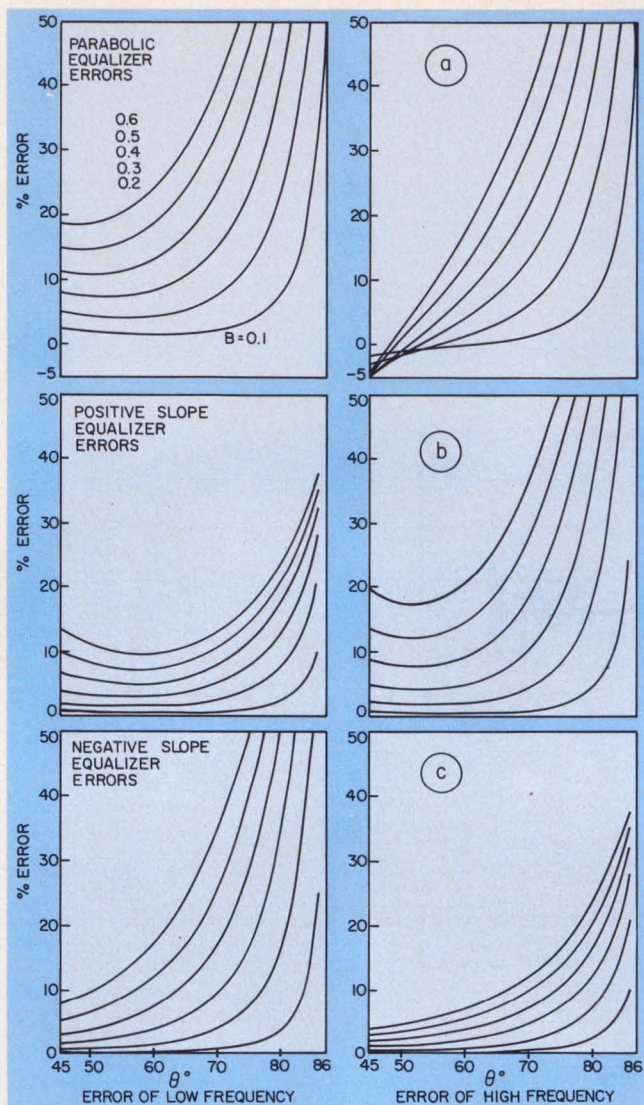

4. Equalizer errors are plotted for parabolic (a), positive-slope (b) and negative-slope (c) equalizers.

$$L_{nb} = \frac{\sqrt{d}}{2} = \frac{\sqrt{2.56}}{2} = 0.800.$$

For a terminating impedance of  $75 \Omega$ , the actual values are

$$\begin{aligned} C_A &= \frac{(0.4775)(0.770)}{(2\pi)(75)(70 \times 10^6)} = 11.38 \text{ pF} \\ C_B &= \frac{(0.6250)(0.770)}{(2\pi)(75)(70 \times 10^6)} = 14.59 \text{ pF} \\ L_A &= \frac{(1.250)(75)(0.770)}{(2\pi)(70 \times 10^6)} = 0.164 \text{ } \mu\text{H} \\ L_B &= \frac{(0.800)(75)(0.770)}{(2\pi)(70 \times 10^6)} = 0.105 \text{ } \mu\text{H} \end{aligned}$$

#### Determining the errors

Because of approximations employed in deriving the tables, the design procedure introduces some errors (Figs. 3b, 3c and 3d). Figs. 4a, 4b and 4c are plots of these errors. In the previous example, we would go to Fig. 4b for a positive-slope equalizer. With a  $\theta = 71.8$  and a  $B$  equal to  $0.256$  the error at the lower-band edge ( $60 \text{ MHz}$ ) is



**Table 2. Equations for dissipative losses**

	Loss in inductors only ( $Q_c = \infty$ ) Loss in capacitors only ( $Q_l = \infty$ )	Loss in both inductors and capacitors	
		$Q_l = Q_c$	$Q_l \neq Q_c$
Solution at $\omega = \omega_0$ , if $Q \gg 1$	$\approx 20 \text{ Log} \left[ \frac{\cos \theta - \frac{1}{2Q}}{\cos \theta + \frac{1}{2Q}} \right]$	$\approx 20 \text{ Log} \left[ \frac{\cos \theta - \frac{1}{Q}}{\cos \theta + \frac{1}{Q}} \right]$	$\approx 20 \text{ Log} \left[ \frac{\cos \theta - \frac{1}{Q_l} - \frac{1}{Q_c}}{\cos \theta + \frac{1}{Q_l} + \frac{1}{Q_c}} \right]$
Exact solution at $\omega = \omega_0$	$= 10 \text{ Log} \left[ \frac{Q^2 + Q^2 \left( 1 - \frac{1}{2 \cos^2 \theta} \right) + \frac{1}{16 \cos^4 \theta}}{\left( Q^2 + \frac{Q}{\cos \theta} + \frac{1}{4 \cos^2 \theta} \right) \left( Q^2 + \frac{Q}{\cos \theta} + \frac{1}{4 \cos^2 \theta} + 1 \right)} \right]$	$= 10 \text{ Log} \left[ \frac{Q^2 - \frac{2Q+1}{\cos \theta} + \frac{4 + \frac{1}{Q^2}}{4 \cos^2 \theta} + 1}{Q^2 + \frac{2Q+1}{\cos \theta} + \frac{1 + \frac{1}{Q^2}}{4 \cos^2 \theta} + 1} \right]$	Unwieldy
General solution	$= 10 \text{ Log} \left[ \frac{A^2 + B^2}{C^2 + D^2} \right]$ where: $A = X^4(\epsilon^2 - \delta^2) - 2X^2\epsilon(1 - 2 \cos^2 \theta) + 1$ $B = 2X^4\epsilon\delta - 2X^2\delta(1 - 2 \cos^2 \theta)$ $C = X^4(\epsilon^2 - \delta^2) - 2X^2\delta(2 + \epsilon)\cos \theta - 2X^2\epsilon(1 + 2 \cos^2 \theta) + 2X\delta \cos \theta + 1$ $D = 2X^4\epsilon\delta + 2X^2(2\epsilon - \delta^2)\cos \theta - 2\delta X^2(1 + 2 \cos^2 \theta) - 4X \cos \theta$ $X = \frac{\omega}{\omega_0}$ $\epsilon = 1 - \frac{1}{Q_l Q_c}$ $\delta = \frac{1}{Q_l} + \frac{1}{Q_c}$	$Q_l = \frac{\omega L}{R}$ (Series L-R) $Q_c = \omega RC$ (Parallel R-C)	

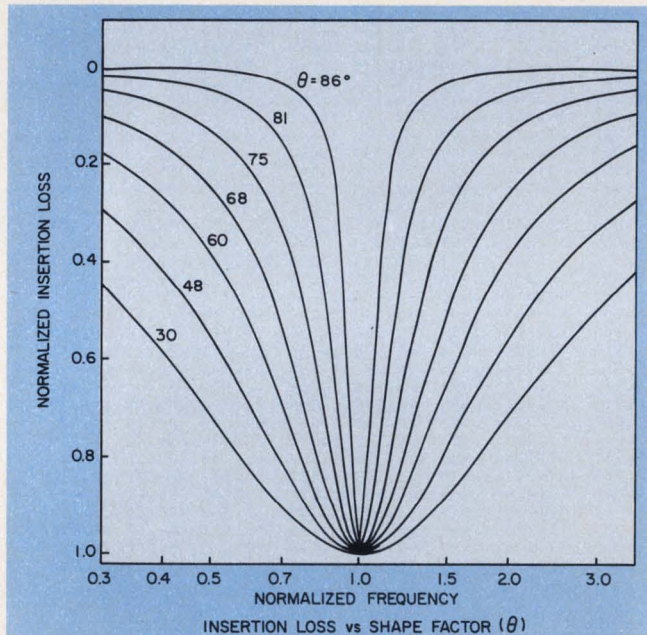

5. Normalized insertion loss is plotted as a function of  $\omega/\omega_0$  for an inductor  $Q$  of 100 (capacitor  $Q = \infty$ ). However, a change of  $Q$  from 10 to 1000 has little effect.

loss at 80 MHz of about 0.83, since the normalized high-end frequency is

$$\frac{80 \times 10^6}{70 \times 10^6} \times 0.77 = 0.88$$

At the low end the normalized loss is about 0.34, since the low-end normalized frequency is

$$\frac{60 \times 10^6}{70 \times 10^6} \times 0.77 = 0.66$$

To obtain the losses in dB use Fig. 6. For a  $Q$  of, say, 100, the denormalization factor is found to be 0.28. This makes the losses

$$0.28 \times 0.83 = 0.23\text{-dB loss at 80 MHz, and } 0.28 \times 0.34 = 0.095\text{-dB at 60 MHz.}$$

**Tables are derived from prior work**

The procedure to transform the general circuit equations for Figs. 1 and 2, so that Table 1 could be compiled, was published by Skwirzynski and Dunlop in 1964.<sup>2</sup> In compiling the table, approximations were required. The region near the peak-delay frequency is assumed to be parabolic, and the region near the inflection points is assumed to be linear (Figs. 3b, 3c and 3d).

Errors that result from these approximations increase with increasing bandwidth. However, for the value of  $\theta$  and for bandwidths normally encountered, the error is not usually a serious problem. Skwirzynski and Dunlop also treated these errors in detail. Modified curves are presented graphically in Fig. 4.

Where  $\theta$  is related to  $d$  by

$$d = 1/4 \cos^2 \theta$$

$\omega_0$  = resonant frequency of the network

$X = \omega/\omega_0$  (normalized frequency variable)

The absolute delay of the all-pass delay-correcting networks is

$$T = \frac{\frac{4 \cos \theta}{\omega_0} (X^2 + 1)}{X^4 - 2X^2 (1 - 2 \cos^2 \theta) + 1,}$$



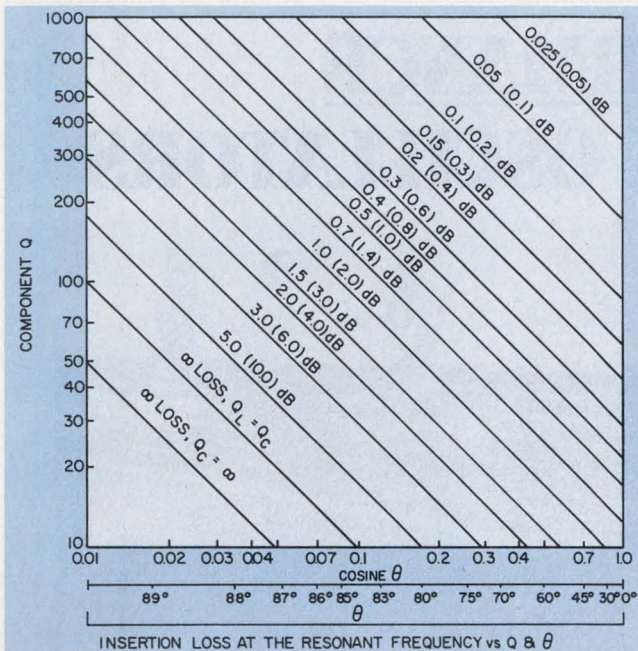

6. This set of curves is used to denormalize the equalizer loss. If inductor and capacitor Qs are equal, use the dB values in the parentheses; when the Qs are very different (the usual case) use the first values listed. Note that infinite loss can occur for some values of Q and θ.

and the slope of the delay curve is

$$S = \frac{dT}{dX} = \frac{2X [(3 - 4 \cos^2 \theta) - 2X^2 - X^4]}{[X^4 - 2(1 - 2 \cos^2 \theta)X^2 + 1]^2}$$

The inflection points are the real positive roots of the equation

$$3X^8 + 4(3 - \cos^2 \theta)X^6 - 6(5 - 6 \cos^2 \theta)X^4 + 12(1 - 5 \cos^2 \theta + 4 \cos^4 \theta)X^2 + (3 - 4 \cos^2 \theta) = 0.$$

And the peak-delay frequency is

$$\omega_p = \omega_0 \sqrt{2 \sin^2 \theta - 1}.$$

The problem of response deviation due to dissipative losses in circuit elements, has been treated by several authors,<sup>3-6</sup> but usually only at the resonant frequency, and often only for special conditions.

Table 2 lists the applicable equations for loss calculations. Usually, losses result from the inductor Qs; capacitor loss is insignificant. For Qs much larger than 1, the usual case, the simplified forms in row 1 of Table 2 may be used. ■■

#### References

1. Cunningham, V. R., "Pick a Delay Equalizer," *Electronic Design*, May 24, 1966, p. 62.
2. Skwirzynski, J. K., and Dunlop, E.J.C.B., "Group Delay Equalization of Bandpass Filters at Intermediate Frequencies," *The Marconi Review*, Fourth Quarter, 1964.
3. Geffe, P. R., "Simplified Modern Filter Design," Hayden Book Co., Inc., Rochelle Park, NJ, 1963, p. 75.
4. Rosenfield, S. and Juels, R.J., "Group Delay Equalization in Communications Systems," *Applications/Data Bulletin 175*, Comstron-SEG, Richmond Hill, NY
5. Kurzrok, R. M., "Start Bridged-T Equalizer Designs Easily," *Electronic Design*, December 9, 1971, p. 66.
6. Guillemin, *Communications Networks*, Vol. II, p. 447.
7. Turvey, E. J., "A Graphical Method of Equalizing Envelope Delay," unpublished Report for M.S. degree in Electrical Engineering, Southern Methodist University, 1963.

# If we haven't made the mechanical filter you need yet, we can.



## Call Collins.

The worldwide reputation of Collins' standard mechanical filters is the same today as it has been for the past two decades: high quality and reliability. Their excellent rejection of unwanted signals has been demonstrated in applications ranging from CB transceivers to missile guidance systems.

Today, as a direct result of our years of experience in these diverse applications, we have a cost-effective solution to your filtering problems readily available.

Moreover, we have the engineering know-how to create an original design concept for your custom requirements.

For information call or write: Mechanical Filters Marketing, Collins Radio Group, Rockwell International, 4311 Jamboree Road, Newport Beach, California 92663. Phone: 714/833-4632.



**Rockwell International**

...where science gets down to business

CIRCLE NUMBER 51

# PROVEN PERFORMANCE CRYSTAL CLOCK OSCILLATORS

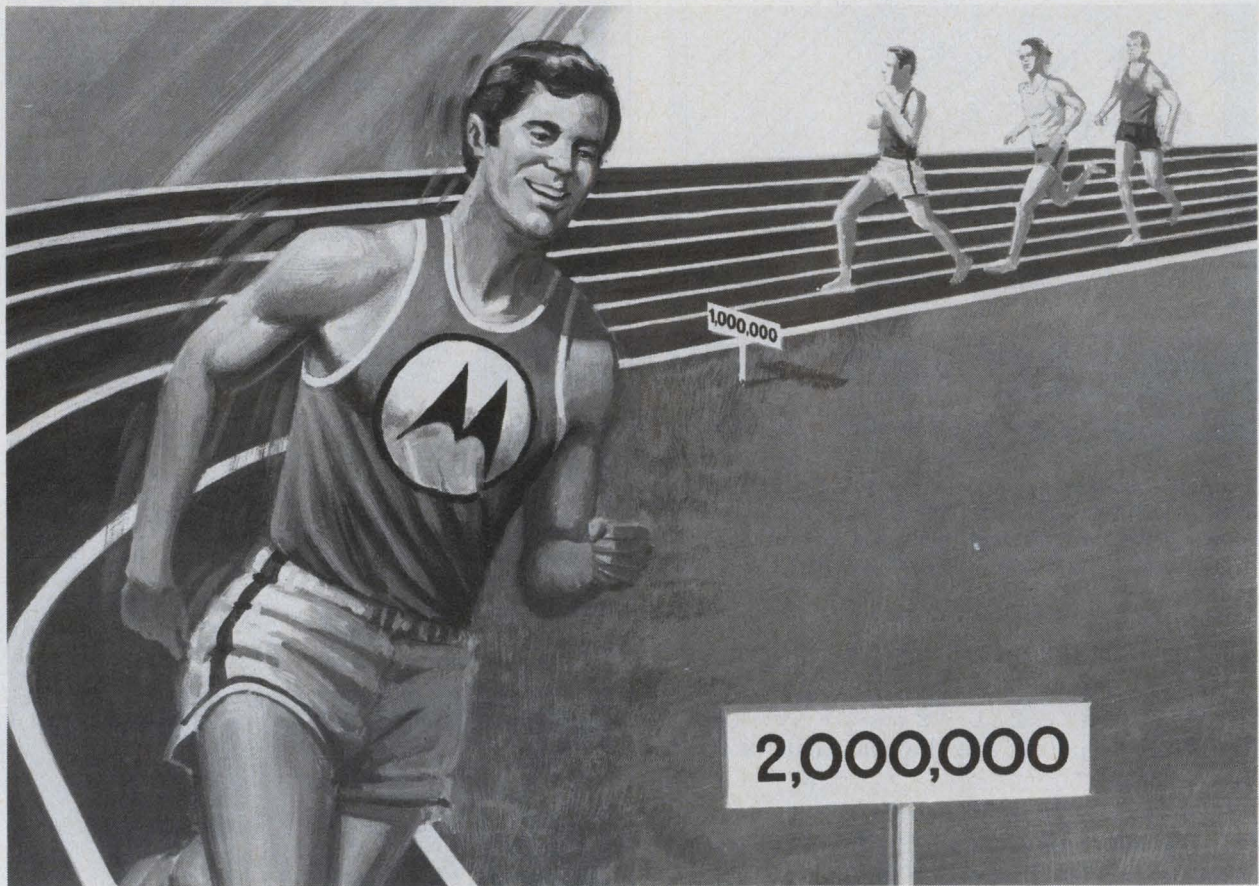

Motorola's K1100A leads the industry with a crystal clock oscillator that has a proven track record of more than one million units. That's right . . . over one million oscillators are in use by satisfied, repeat customers. That's not all . . . we feature fast deliveries.

How versatile is the K1100A? With over 1200 frequencies already designed, and same day shipment for standard stock frequencies of 4, 4.9152, 5, 10, and 20 MHz . . . you make the decision.

Oscillators are available from 250 kHz to 32 MHz, +0.01% stability from 0°C to 70°C, TTL compatible, and standard +5V dc input.

For full specifications and prices on the oscillator that design engineers trust, write Motorola, Component Products Department, 2553 N. Edgington, Franklin Park, Illinois 60131. Or call (312) 451-1000, ext. 4183.



**MOTOROLA**  
Communications and Electronics Inc.

# All aerosols are not alike.

The constant progression of sophistication in electronics has demanded a parallel progression in standards of purity. Industrial cleaning is one very vital link in maintaining component and system purity and reliability.

Let's look at eight important criteria and compare Miller-Stephenson products to the general aerosol industrial cleaner industry.

## SOLVENTS:

Miller-Stephenson — Most of our aerosols contain 80% Active Ingredient, 20% Propellant.

Other Aerosol Cleaners — Active Ingredient averages 70-75%.

Miller-Stephenson — Uses only Certified Virgin Solvent.

Other Aerosol Cleaners — Some utilize reclaimed solvents. Though lower in cost, reclaimed solvents usually contain foreign substances.

## PROPELLANTS:

Miller-Stephenson — Uses only the highest purity, safest propellants. They are nonflammable - TWA 1000 ppm.

Other Aerosol Cleaners — Many use cheap, sometimes flammable, sometimes higher order of toxicity propellants.



## FILTERING:

Miller-Stephenson — We double filter "Freon" solvent and propellant — first with a 0.5 micron filter, then with a Millipore 0.2 absolute filter.

Other Aerosol Cleaners — Some use no filters; others only a 0.5 micron filter.

## LOADING LINES:

Miller-Stephenson — All loading lines are dedicated to the individual ingredients used.

Other Aerosol Cleaners — Loading lines are often used for multiple products and if not thoroughly flushed, contamination will occur.

## LOADING ENVIRONMENT:

Miller-Stephenson — Class 100 Clean Room conditions.  
Other Aerosol Cleaners — Normally uncontrolled — environmental contamination can occur.

## VOLUME PRODUCTION:

Miller-Stephenson — Our principal raw materials come direct from Du Pont tankers into our 5500 gallon storage tanks through a closed system direct to container.  
Other Aerosol Cleaners — Low volume suppliers often load from open 55-gallon drums thereby introducing possibility of contamination.

## CONTAINER:

Miller-Stephenson — Our new seamless cans further reduce the possibility of contamination.  
Other Aerosol Cleaners — Cans with soldered seams may introduce residual contaminants.

## SAFETY IN SHIPPING:

Miller-Stephenson — Most of our "Freon" aerosol solvents are non-regulated items, exempt from all Federal Regulations "Restricted Articles". May be Shipped Air Transport.

Other Aerosol Cleaners — Do not meet Air Transport Regulations.

**MS aerosol solvents have the lowest residual contamination in the industry — some approaching 5-7 ppm. The general range for the industry is 50-130 ppm.**

\*Freon® is Du Pont's registered trademark for its fluorocarbon compounds.

## miller-stephenson

Danbury, Connecticut 06810 (203) 743-4447

- Enclosed is \$2.00, please send my "Trial Unit" of MS-180.  
 Enclosed is \$5.00, please send my "Trial Units" of MS-180 & Cobra Brush.  
 Please send FREE literature and prices.

Intended Use \_\_\_\_\_

Name \_\_\_\_\_ Dept./Title \_\_\_\_\_

Company \_\_\_\_\_

Address \_\_\_\_\_

LOS ANGELES • CHICAGO • DANBURY, CT. • TORONTO

CIRCLE NUMBER 53

ED-9U



**MS-226 "COBRA"™**  
Solvent Spray  
Brush

Scrubbing action dislodges hard-to-remove residue. Fits all Miller-Stephenson aerosol solvents and cleaners.

# 90-degree phase-difference networks are simply designed with a program in Basic. Only a few parameters need to be known to start; the rest are calculated.

A simple calculator program can overcome one of the major problems in designing 90-degree phase-difference networks. Because the calculator rapidly performs many iterations of the problem, you can slash the time required for trial and error calculations, if some parameters are unknown.

These networks are used in single-sideband modulators, frequency-shift keying systems, and display generators of CRTs. The networks split a sinusoidal voltage, usually in the audio-frequency range, into two outputs with a nearly constant phase difference; in this article, 90 degrees.

The major stumbling block is calculating the network zero/pole frequencies from a given set of performance specifications (Figs. 1 and 2).

## Older solutions proved cumbersome

The mathematical solution used here requires solving elliptic functions that have no closed-form. That is, results cannot be obtained by substitution of variables, such as center frequency and number of poles, into a finite set of equations.

Published solutions have taken the form of tables and graphs, approximations, and, for special cases, exact solutions. Tabular and graphic solutions<sup>1,2</sup> tend to be inexact, and often require awkward and time-consuming interpolation.

Some of the input parameters that are needed for the design of these networks: the total number of poles (N); the ratio of the low to high frequency points, called range (R); the center frequency (FO), and the phase-difference tolerance over the frequency band (TOL). Table 1 shows the complete list.

The closed-form approximation routine for one design of these networks applies only where the required number of poles equals an integer power of two.<sup>5,6</sup> Another technique works well for small

values of N and R, but diverges widely for larger values.<sup>4</sup>

The program given here works for any number of poles from one to 30. I've called it Glory-poles—for "Glory-osky Zero, I've got the pole frequencies!" The name is appropriate, because the pole frequencies are needed in the design equations of any network to get the circuit values<sup>9</sup> (Fig. 5).

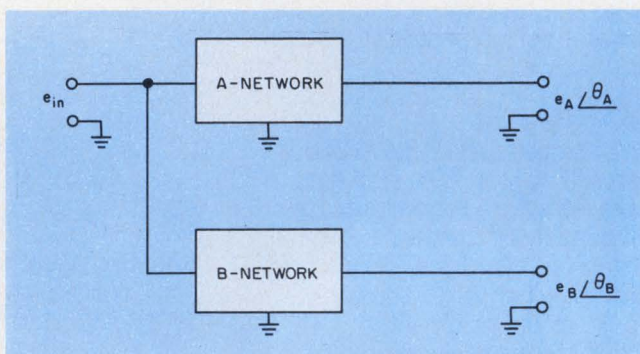

1. Phase-difference networks are constructed from two separate networks. The relative phase difference of the outputs will be 90 degrees over a given frequency band. The output-voltage difference is ignored.

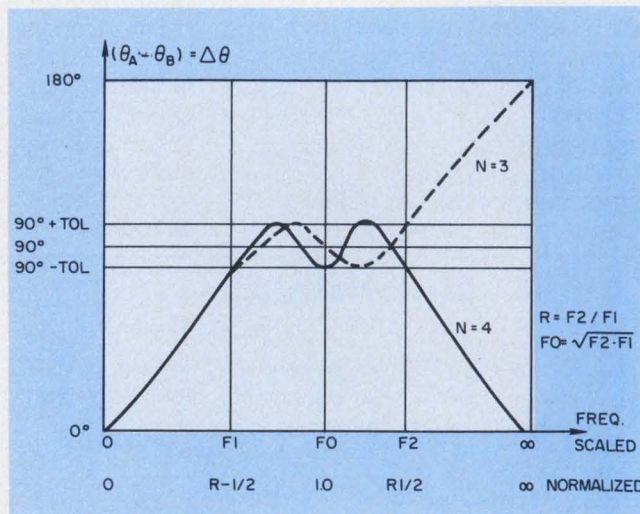

2. For a 90 degree phase-difference network having three or four zero/pole pairs, the phase difference ( $\Delta\theta$ ) oscillates around the designed phase difference with a total amplitude of twice the tolerance.

Allan G. Lloyd, Engineering Specialist, Magnavox Electro-Optical Systems, Advanced Products Division, 91 Mckee Drive, Mahwah, NJ 07430.

While Glorypoles is written HP Basic, you can use the program listing to modify it for other calculators. It may be necessary to change some of the logic statements for use on other computers. For instance, in line 100, "If A and B" means "If ( $A \neq 0$ ) and ( $B \neq 0$ )" in another language.

Table 1, together with Fig. 2, defines the input variables and symbols. The program solves for all possible relations between the first seven listed variables, both forward and inverse.

This forward-backward mode of solution is useful as a preliminary design aid when nothing

the input "0" in a branching test since no variable ever has an actual value of zero.

All variables are entered via one or two INPUT statements (Fig. 4 and Table 2). The three variables, F1, F2 and N, are sufficient for a complete design. The remaining variables are then calculated and printed out. If one or more of F1, F2 or N is entered as a "0," it is taken as an unknown, and branching occurs—to an auxiliary input-statement (lines 110 and 820).

The program now needs four (or two) more inputs; each is either specified, or entered as a

**Table 1. Variable symbols and definitions used in Glorypoles program**

Variable Symbols		Input Priority	Definition	Units	Equals
External	Internal				
F1	A <sup>‡</sup>	1	Low freq. limit	Hz	
F2	B <sup>‡</sup>	2	Hi freq. limit	Hz	
N	N	3	Combined poles	—	
R	R	4	Range	—	F2/F1
FO	F	5	Center freq.	Hz	$(F1 \cdot F2)^{1/2}$
TOL	T	6	Phase tolerance	Deg.	
DB	D	7	Sideband supression	DB	(Fig. 3)
—	P(J)	—	Normalized poles	—	(J = 1 to N)
—	W(J)	—	Scaled poles	Hz	FO · P(J)

‡ Do not confuse the internal program variable A and B with the A and B network labels of Fig. 1.

is known in advance concerning expected performance or the required degree of network complexity.

### See how the program runs

First, Glorypoles calculates a satisfactory set of parameters from the first set of inputs. Then, the program calculates and prints A and B-network pole frequencies.

The program accepts all 128 possible combinations of the seven variables F1, F2, N, R, FO, TOL and dB as inputs, known or unknown. Computational priority is assigned in this order. If you try to specify inconsistent or unnecessary values, those values will be ignored, and consistent values will be calculated and printed out as replacements. A variable is specified by inputting its value. If it is unknown, a "0" (zero) must be entered in its place. The program uses

"0." Glorypoles calculates and prints out the remaining unknowns, using the combined data from both input statements. Program-error messages are "INSUFFICIENT INPUT DATA," "OUT OF RANGE" (lines 200 and 600) or "IMPROPER FREQ DATA" (line 540) after which the program restarts to input statement 1.

After these preliminary calculations, the user is presented with a five-way branch DO = ? (line 1100), which calls for the input of one of the following digits (or S for stop).

- 1 — complete restart at F1, F2, N
- 2 — partial restart at R, FO, TOL, DB
- 3 — continue, print scaled poles in Hz.
- 4 — continue, print normalized poles
- 5 — continue, print both 3 & 4.

The program yields normalized poles in addition to those scaled in frequency for the specific application. Poles are first calculated in normalized form (lines 1160 through 1300) and then

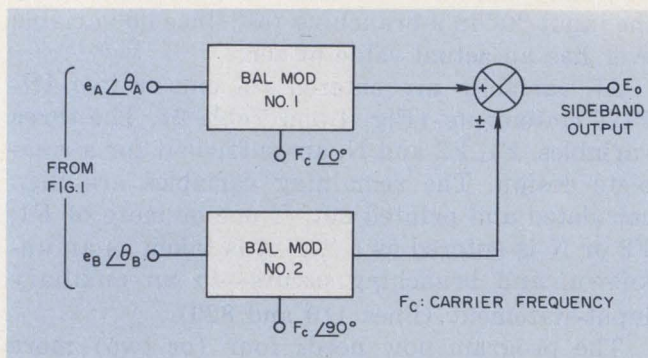

3. Single-sideband modulation of a carrier frequency,  $f_c$ , uses a 90-degree phase difference network of Fig. 1 to split the modulating input for two balanced modulators.

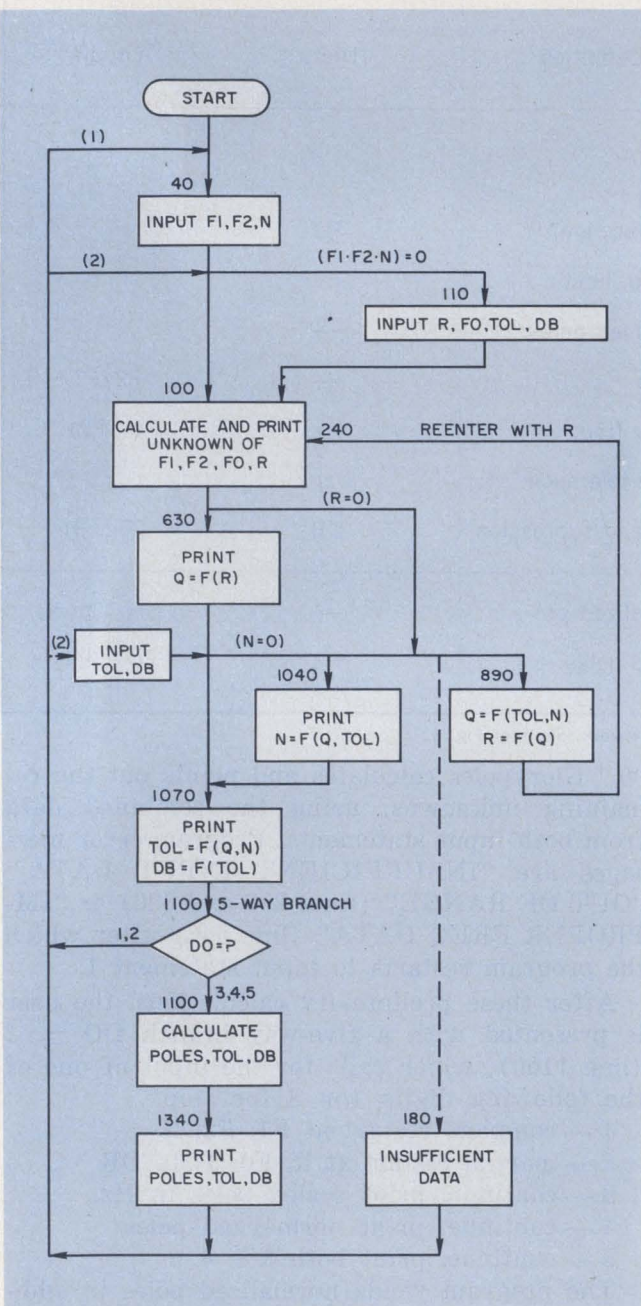

4. A simplified flow chart for the Gloripoles program shows how input data are entered and how the unknowns are calculated.

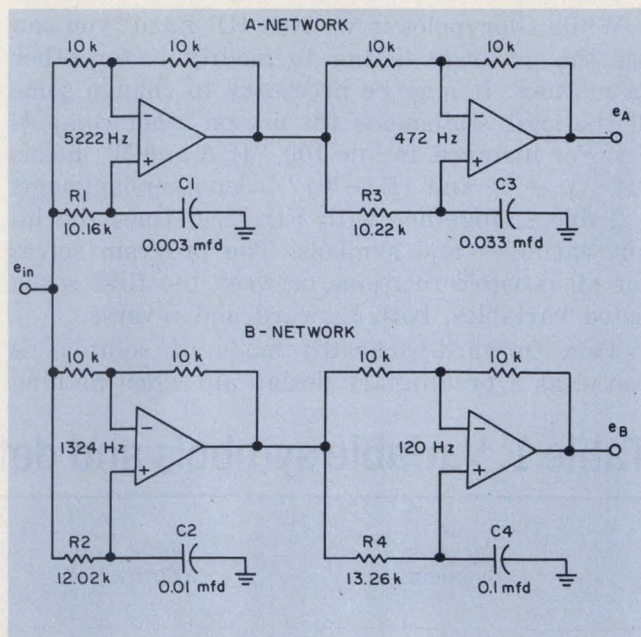

5. Circuits can be designed directly from the program outputs once zero/pole pairs are known.

multiplied by  $F_0$  (line 1290) to yield the scaled values.

When the calculator prints the normalized values, the column headed by " $P(1) \times P(N)$ " is also printed. Mathematically, normalized poles  $P(J)$  are reciprocally related such that  $P(1) \times P(N) = 1$ ,  $P(2) \times P(N-1) = 1$ , etc. For odd numbers of poles the middle pole,  $P_C$ , will equal one. All poles are actually computed independently, and not by reciprocals, so that their paired product, which should be unity, gives a running check on computer accuracy.

Using Gloripoles, the A and B networks can be designed directly from the bandwidth and sideband-suppression specification, in dB, for an SSB transmitter/receiver (Fig. 3).

Sideband rejection in dB is given by:

Minimum rejection =

$$20 \log_{10} \left[ \tan \left( \frac{\pi \times \text{TOL}}{360} \right) \right], \text{ dB.}$$

Table 3 shows printout for the following runs:

1. For the case of  $F_1 = 250$ ,  $F_2 = 2500$ , and  $N = 4$  (Fig. 5).<sup>8</sup>

2. For the trivial (but useful) case,  $N = 1$ . Here the B network becomes unity and  $E_b = E_{in}$ .

3. For the case of  $N = 5$  (= odd). The A network has three poles, and the B network has two. The starting frequency,  $F_1$ , is specified and the other frequencies are calculated from  $N$  and  $TOL$ .

4. For the case of a 100-Hz to 10-kHz network having a specified 40 dB of SSB suppression. Since the program quantizes the calculated value of  $N$  to the next higher integer value ( $N = 7$ ), the resulting final value of -44 dB is more than the specified 40 dB.

5. The same as No. 4, except that  $N$  and  $DB$

# Table 2. Glorypoles program listing

```

10 DIM Z(30),P(30),W(30)
20 PRINT
30 PRINT "AT DC=? 1-2-REPEAT, 3-PRINT HZ, 4-NORMALIZED, 5-BOTH"
40 PRINT
50 PRINT
60 LET F=R=T=D=N=C1=0
70 PRINT "1-INPUT: F1,F2,N ";
80 INPUT A,B,N
90 LET N=INT(ABS(N)+.5)
100 IF A AND B THEN 530
110 PRINT "2-INPUT: R, FC, TOL, DB";
120 INPUT R,F,T,D
130 LET C1=1
140 LET D=-ABS(D)
150 IF R THEN 200
160 IF F THEN 300
170 IF N THEN 850
180 PRINT "INSUFFICIENT INPUT DATA"
190 GOTO 50
230 IF R>1 AND R<1.00001E+09 THEN 240
210 PRINT "OUT OF RANGE"
220 PRINT
230 GOTO 110
240 IF A THEN 280
250 IF B THEN 310
260 IF F THEN 340
270 GOTO 630
280 LET B=R/A
290 PRINT "F2=";B;
300 GOTO 580
310 LET A=B/D
320 PRINT "F1=";A;
330 GOTO 560
340 LET A=F/SQR(P)
350 LET B=F/SQR(R)
360 PRINT "F1=";A;"F2=";B;
370 GOTO 630
380 IF A THEN 410
390 IF B THEN 480
400 GOTO 170
410 IF A<F THEN 430
420 GOTO 540
430 LET B=F/R/A
440 PRINT "FC=";B;
450 LET R=B/A
460 PRINT "R=";R;
470 GOTO 630
480 IF D>F THEN 500
490 GOTO 540
500 LET A=F/R/B
510 PRINT "F1=";A;
520 GOTO 450
530 IF A<B THEN 560
540 PRINT "IMPROPER FREQ DATA"
550 GOTO 50
560 LET R=B/A
570 PRINT "R=";R;
580 LET F=SQR(A*B)
590 PRINT "FC=";F;
600 IF R<1.00001E+09 THEN 630
610 PRINT "OUT OF RANGE"
620 GOTO 40
630 LET K1=1/P
640 LET K4=K1+2
650 IF K1>.7 THEN 740
660 LET Y=0
670 FOR J=12 TO 1 STEP -1
680 LET Y=(J-1.25)*K4*(1+Y)/J
690 NEXT J
700 LET L=Y/(4+2*Y)
710 IF L>1.00000E-06 THEN 760
720 LET Q1=L
730 GOTO 780
740 LET K2=(1-K4)/(1/4)
750 LET L=.5*(1-K2)/(1+K2)
760 LET M=L+4
770 LET Q1=L*(1+M*(2+15*M))
780 LET Q=EXP(9.8696/LOG(Q1))
790 PRINT "Q=";Q
800 IF N THEN 1070
810 IF C1 THEN 850
820 PRINT "2-INPUT: TOL, DB ";
830 INPUT T,D
840 LET D=-ABS(D)
850 IF T THEN 880
860 IF D THEN 1020
870 GOTO 180
880 IF R THEN 1240
890 LET C=(T/229.183)/(1/N)
900 LET Y3=Y4=.5
910 LET C=0
920 FOR J=1 TO 20
930 LET C=C+2*J-1
940 LET E=C+C
950 LET Y3=Y3+E
960 LET Y4=Y4+E*(-1)^J
970 IF E<1.00000E-07*Y4 THEN 990
980 NEXT J
990 LET B=(Y3/Y4)+2
1000 PRINT "D=";B;
1010 GOTO 240
1020 LET T=114.592*ATN(EXP(D/8.68589))
1030 GOTO 880
1040 LET N1=LOG(Q1)*LOG(T/229.183)/9.8696
1050 LET N=INT(N1+.999999)
1060 PRINT "N=";N;"(N1=";N1;")";
1070 LET T=229.183*Q/N
1080 LET D=8.68589*LOG(TAN(2*Q/N))
1090 PRINT "TOL=";T;"DB=";D;
1100 PRINT "DC=";
1110 INPUT X
1120 PRINT
1130 IF X=1 THEN 60
1140 IF X=2 AND C1 THEN 110
1150 IF X=2 AND C1=0 THEN 820
1160 LET S=1.5708
1170 FOR J=1 TO N
1180 LET U=0
1190 LET Z(J)=(-1)^(J-1)*3.14159*(2*J-1)/(4*N)
1200 FOR K=0 TO 20
1210 LET W=(Q*(K+1))^K
1220 IF W<1.00000E-20 THEN 1260
1230 LET U=U+W*COS((2*K+1)*Z(J))
1240 LET V=V+(-1)^K*W*SIN((2*K+1)*Z(J))
1250 NEXT K
1260 LET P(J)=(-1)^N*U/V
1270 LET S=S+2*ATN(SQR(K1)/P(J))
1280 LET P(J)=ABS(P(J))
1290 LET W(J)=F*P(J)
1300 NEXT J
1310 LET T=57.2958*S
1320 LET D=8.68589*LOG(TAN(S/2))
1330 PRINT
1340 IF F=0 OR X=4 THEN 1370
1350 PRINT "A-NETWORK-HZ","B-NETWORK-HZ",
1360 IF X=3 THEN 1390
1370 PRINT "A=NORMALIZED","B=NORMALIZED","P(1)*P(N)"
1380 GOTO 1400
1390 PRINT
1400 PRINT
1410 FOR J=1 TO N STEP 2
1420 IF F=0 OR X=4 THEN 1480
1430 IF J=N THEN 1460
1440 PRINT W(J),W(J+1),
1450 GOTO 1470
1460 PRINT W(J)," "
1470 IF X=3 THEN 1530
1480 IF J=N THEN 1510
1490 PRINT P(J),P(J+1),P((J+1)/2)*P(N-(J+1)/2)
1500 GOTO 1540
1510 PRINT P(J)
1520 GOTO 1540
1530 PRINT
1540 NEXT J
1550 PRINT
1560 PRINT "TOL=";T;"DB=";D;"DONE"
1570 PRINT
1580 PRINT
1590 PRINT
1600 GOTO 40
1610 END

```

Line	Value	Formula
780	9.8696	$(\pi)^2$
890	229.183	$720/\pi$
1020	114.592	$360/\pi$
1020	8.68589	$20/\ln(10)$
1160	1.5708	$\pi/2$
1190	3.14159	$\pi$
1220	1E - 20	(Arbitrary) - Prevents Underflow
1310	57.2958	$180/\pi$

are specified, and R is calculated.

6. The same as Reference.<sup>9</sup> Note the slight difference in pole frequencies and TOL values.

7. For the maximum allowable  $N = 30$  and  $R = 1E9$ . Note that  $P(1) \times P(N)$  is starting to diverge, and the final TOL calculation is off by 0.38 degrees. Since the TOL is calculated as the sum and difference of 30 arctan calculations, an error is generated. The program is accurate enough for most practical problems.

**'Q' means something else**

Program 'Q' (line 790) is the elliptic function "nome" and has nothing to do with the usual circuit quality factor, Q. It is calculated for  $K1 >$

### Table 3. Problems run on Glorypoles

```

RUN
AT DO=? 1,2-REPEAT, 3-PRINT HZ, 4-NORMALIZED, 5-BOTH

1-INPUT: F1,F2,N ? 250, 2500, 4
R= 10 FO= 790.569 Q= .262196
TOL= 1.08315 DB=-40.489 DO=? 3

A-NETWORK-HZ B-NETWORK-HZ
5221.92 1324.19
471.988 119.688

TOL= 1.08354 DB=-40.4859 DONE

(1)

1-INPUT: F1,F2,N ? 0, 0, 1
2-INPUT: R, FO, TOL, DB? 0, 1000, 10, 0
R= 1.419
F1= 839.477 F2= 1191.22 Q= 4.36333E-02
TOL= 10 DB=-21.161 DO=? 3

A-NETWORK-HZ B-NETWORK-HZ
1000.

TOL= 9.97494 DB=-21.1829 DONE

(2)

1-INPUT: F1,F2,N ? 100, 0, 5
2-INPUT: R, FO, TOL, DB? 0, 0, 2, 0
R= 45.5043
F2= 4550.43 FO= 674.569 Q= .387409
TOL= 2.00001 DB=-35.1615 DO=? 3

A-NETWORK-HZ B-NETWORK-HZ
8360.29 1996.67
674.57 227.902
54.4295

TOL= 2.00021 DB=-35.1607 DONE

(3)

1-INPUT: F1,F2,N ? 100, 10000, 0
R= 100 FO= 1000 Q= .43883
2-INPUT: TOL, DB ? 0, 40
N= 7 ( 6.4327 ) TOL= .718224 DB=-44.0577 DO=? 1

(4)

1-INPUT: F1,F2,N ? 0, 0, 7
2-INPUT: R, FO, TOL, DB? 0, 1000, 0, 40
R= 169.595
F1= 76.7881 F2= 13022.9 Q= .469116
TOL= 1.14589 DB=-39.9999 DO=? 1

(5)

1-INPUT: F1,F2,N ? 100, 10000, 6
R= 100 FO= 1000 Q= .43883
TOL= 1.63668 DB=-36.9032 DO=? 3

A-NETWORK-HZ B-NETWORK-HZ
19219.4 4706.9
1657.28 603.402
212.455 52.0311

TOL= 1.63698 DB=-36.9016 DONE

(6)

1-INPUT: F1,F2,N ? 1, 1E9, 30
R= 1.00000E+09 FO= 31622.8 Q= .799957
TOL= .283255 DB=-52.1395 DO=? 4

A=NORMALIZED B=NORMALIZED P(1)*P(N)
83919.7 23505. 1.00975
10281. 4822.44 .997819
2297.88 1098.45 .998267
525.571 251.492 1.00055
120.352 57.5945 1.00033
27.5619 13.19 .999976
6.31213 3.02069 1.00011
1.44557 .591781 1.
.331055 .158428 1.00002
7.58169E-02 3.62823E-02 1.00001
1.73629E-02 8.30910E-03 1.00001
3.97628E-03 1.90290E-03 1.00002
9.10352E-04 4.35329E-04 1.00001
2.07478E-04 9.70987E-05 1.00001
4.24514E-05 1.20323E-05 1.00002

TOL= .664851 DB=-44.7285 DONE

(7)

```

0.7 (lines 740-780), or approximated by Horner's method (lines 660-730) for  $K1 \leq 0.7$ .

The two methods give the same value of Q to 10 places at the branching value of  $K1 = 0.7$  (line 650). Q really serves no useful purpose as output; it remains solely for program analysis.

Normalized poles were left in as an optional output because they can still be calculated where there is not enough input data to frequency scale them—for example, when inputting N and R only. The program outputs two values each for TOL and dB. The first is calculated from a theoretical value,

$$TOL = 720 Q^N / \pi \text{ degrees (line 1070)}$$

The second TOL output is obtained by summing the individual-pole phase shifts at F1 over the entire network after all the pole frequencies are calculated<sup>6</sup>. This provides another check on computer accuracy because these two values should agree. The theoretical, non-integer value of N is output (when N is not specified) in parentheses to show what the nearest integer value actually is. The program assumes the next higher integer value for N and continues calculations.

There are some "idiot" lines (90, 410, 480, 530) that check for improper input format. The entire sequence from lines 80 to 620 is computationally simple and could easily be done on a hand calculator, but at a loss of convenience.

The pole-calculating algorithm at 1160 through 1300 stores the poles in arrays P(J) and W(J). The inside K-loop (1200-1250) uses a maximum of 20 terms of lines 1230 and 1240 to calculate each pole, except that the program usually jumps from line 1220 to 1260 much sooner.

Program length could be reduced by using a higher level language and leaving out the frills, but the routine runs very nicely with 8 k of core in HP minicomputers. ■■

#### References

1. Bedrosian, S. D., "Normalized Design of 90° Phase-Difference Networks," *IRE transactions on Circuit Theory*, June, 1960, pp. 128-136.
2. Saraga, W., "The Design of Wide-Band Phase Splitting Networks," *Proceedings of the IRE*, July, 1950, pp. 754-770.
3. Darlington, S., "Realization of a Constant Phase Difference," *Bell System Technical Journal*, January, 1950, pp. 94-104.
4. Weaver, D., "Design of RC Wide-Band 90 Degree Phase Difference Network," *Proceedings of the IRE*, April, 1954, pp. 671-676.
5. Albersheim, W., and Shirley, F., "Computation Methods for Broad-Band 90° Phase Difference Networks," *IEEE Transactions on Circuit Theory*, Vol. CT-16 No. 2, May, 1969, pp. 189-195.
6. Shirley, F., "Shift Phase Independent of Frequency," *Electronic Design* No. 18, Sept. 1, 1970, pp. 62-66.
7. Whittaker, E., and Watson, G., *A Course of Modern Analysis*, MacMillan, 1947, pp. 485-486.
8. Lloyd, A., "Here's a Better Way to Design a 90° Phase-Difference Network," *Electronic Design* No. 15, July 22, 1971, p. 78.
9. Dickey, R., "Outputs of Op-Amp Networks Have Fixed Phase Difference," *Electronics*, Aug. 21, 1975, pp. 82-83.



# 116 reasons why *only* Buchanan® PC Board Connectors provide **Lowest Total Applied Cost!**

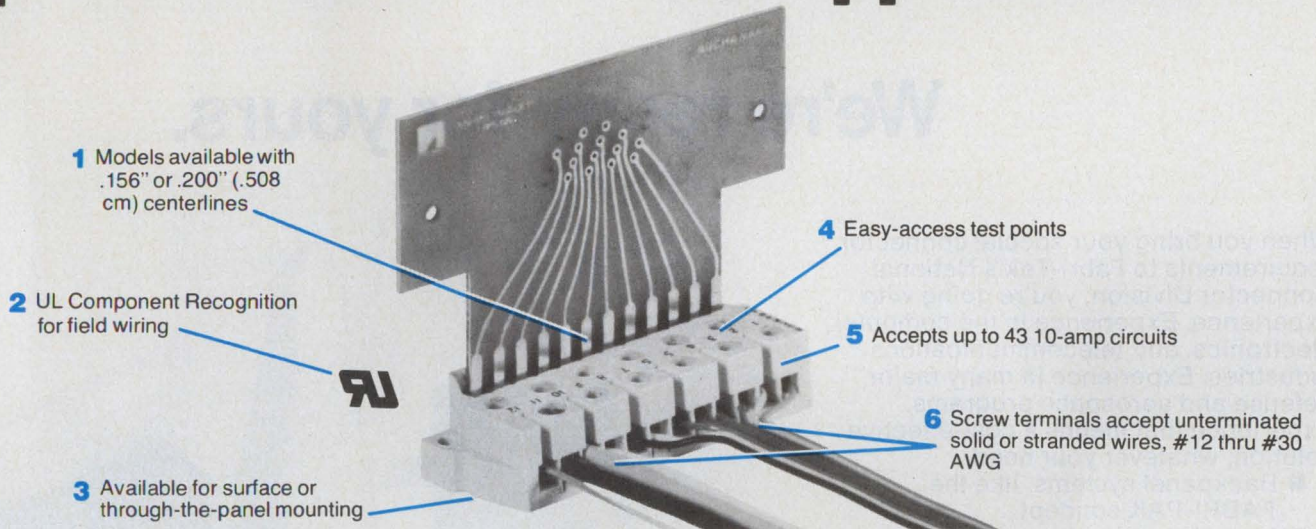

## And here are 110 more—the 110 connections you eliminate!

Here's how to achieve significant Lower Total Applied Cost when building control panels or other equipment using printed circuit boards.

Simply specify the new Buchanan Connector that eliminates hybrid interfaces between electronic circuitry and electrical connections. It replaces multiple terminal strips and costly interwiring; actually saves up to 5 separate connection points—potential trouble spots—per circuit!

Models are available for just about every standard requirement. For complete engineering and ordering information, use the Reader Service Card. Or, call one of our Factory Regional Offices shown below. They'll also be happy to talk to you about special configurations.

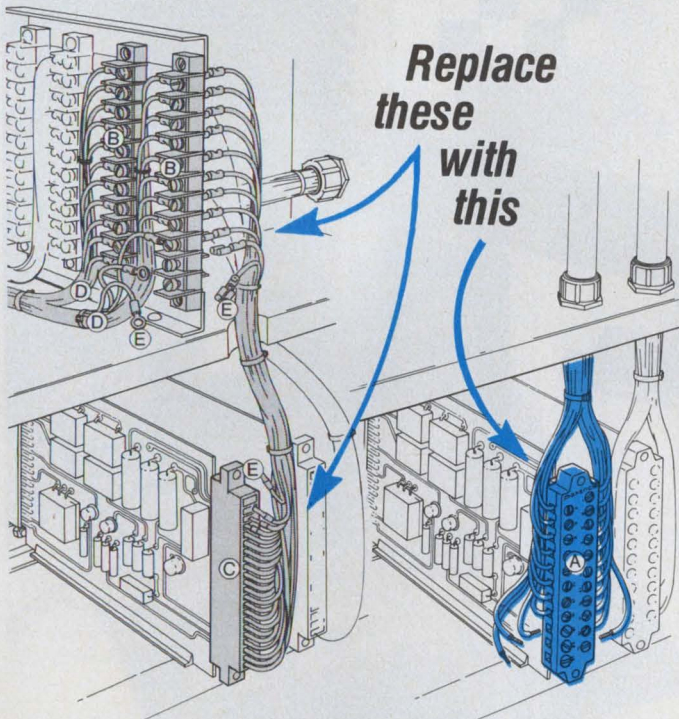

Just one Buchanan Printed Circuit Board Connector (A) replaces the two terminal strips (B), the edge card connector (C), the double wiring (D), and the 110 costly terminations (E) shown at left. Result: LTAC (Lower Total Applied Cost)!

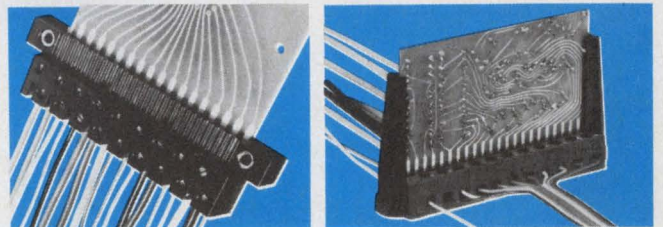

Models available for surface or through-the-panel mounting, with or without card guides and keys.



**CONTROL PRODUCTS  
DIVISION**

Amerace Corporation  
Control Products Division  
2330 Vauxhall Road  
Union, N. J. 07083, U.S.A.  
Telex 138-978

21

Atlanta—(404) 261-1224 • Cleveland—(216) 333-8540 • Chicago—(312) 437-8354 • New York Metro.—(201) 355-7770 • Los Angeles—(213) 863-5753

CIRCLE NUMBER 54

# We've been solving interconnection problems for 20 years.

## We're ready for yours.

When you bring your special connector requirements to Fabri-Tek's National Connector Division, you're going with experience. Experience in the computer, electronics, and telecommunications industries. Experience in many major defense and aerospace programs. Experience that means a cost-effective solution, whatever your need:

- Backpanel systems, like the FABRI-PAK concept
- Metal backplanes and plate connectors
- Special molded connectors
- Card cages, I/O connectors

We'll supply a system with the exact dimensions, spacings, materials, and finishes you need. And, since we're one of the few connector companies with complete in-house capability, we can handle jobs from the engineering, artwork, and tooling-up stages right through to final production and assembly. It's your guarantee of strict quality control and on-time delivery.

Now that we've told you, you tell us. Let's tackle your problem together. Call Peter Van Wyngaeren at (612) 533-3533.

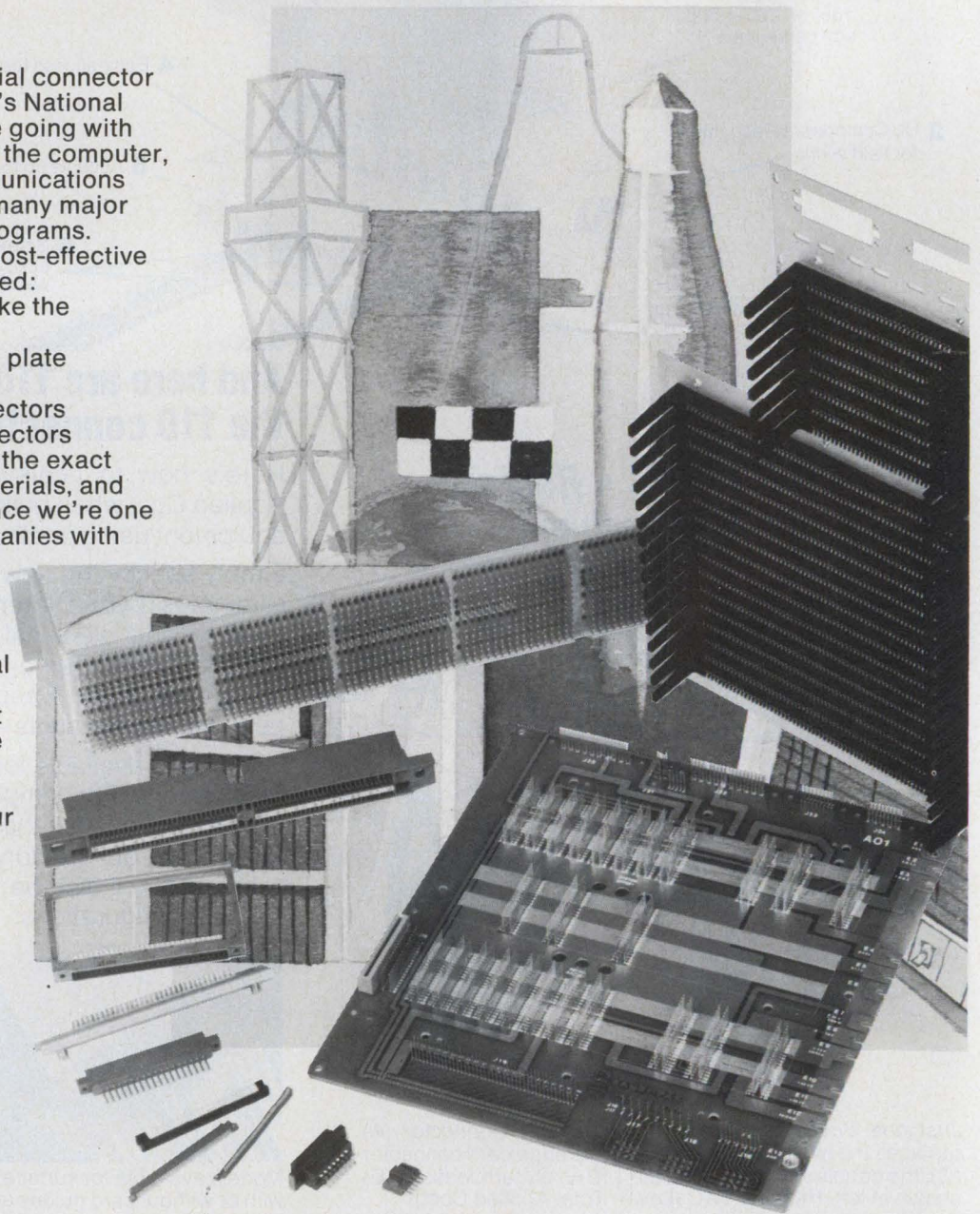

Single and Multi-layer P.C. Backpanels #241  
Aluminum Backpanels #242  
Edge Card Connectors #243  
Special Molded Connectors #244  
Commercial #245  
Military #246



**FABRI-TEK** INC.  
NATIONAL CONNECTOR DIVISION

9210 Science Ctr. Drive Minneapolis, MN 55428 (612) 533-3533

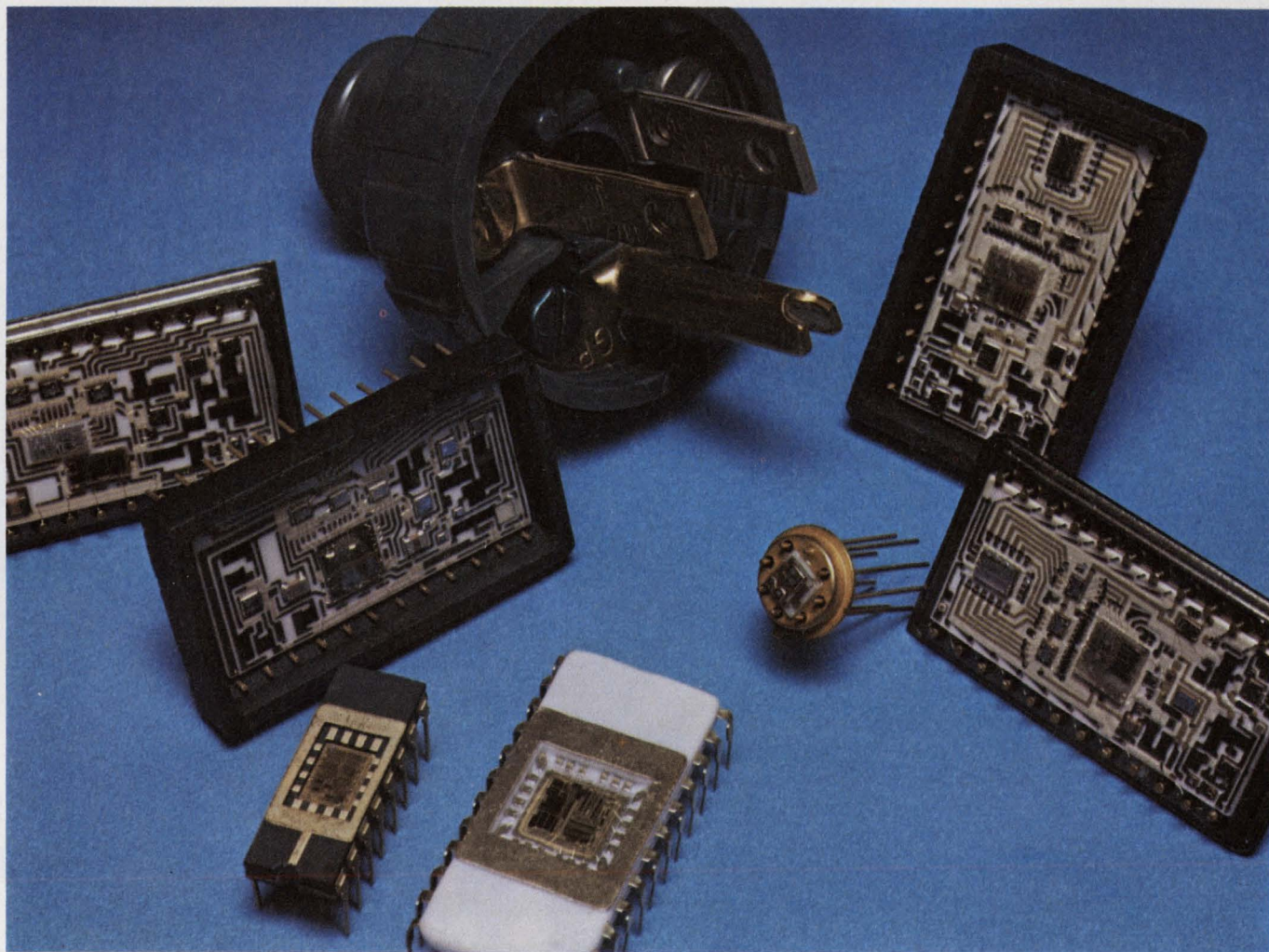

# Our new low-cost industrial converter products are standard, too.

Standards, like that plug, make life less complicated.

That's why we're leading the campaign to standardize converter products.

And the group you see here is just part of a growing family that starts as low as \$19.50 in the 100-piece quantity.

They're on-the-shelf, for quick delivery. A new line of DAC's and ADC's for designers who can use standard functions. Plus thin-film ladder networks and a precision voltage reference to give exceptional design flexibility.

These competitively priced, industry-standard converter products can save you engineering, manufacturing, and inventory time and money. And you have a wide selection of package types and temperature ranges to fit your exact applications.

Learn more about Beckman-quality, Beckman-backed hybrids. They'll make your life easier, too.

For data, write or call Helipot Division, Beckman Instruments, Inc., 2500 Harbor Blvd., Fullerton, CA 92634. Phone: (714) 871-4848, Ext. 1776.

## BECKMAN®

HELIPOT DIVISION

If you need hybrids, you should know about Beckman.

CIRCLE NUMBER 171

**You're looking at less than 5 percent of Omron's control components line.**

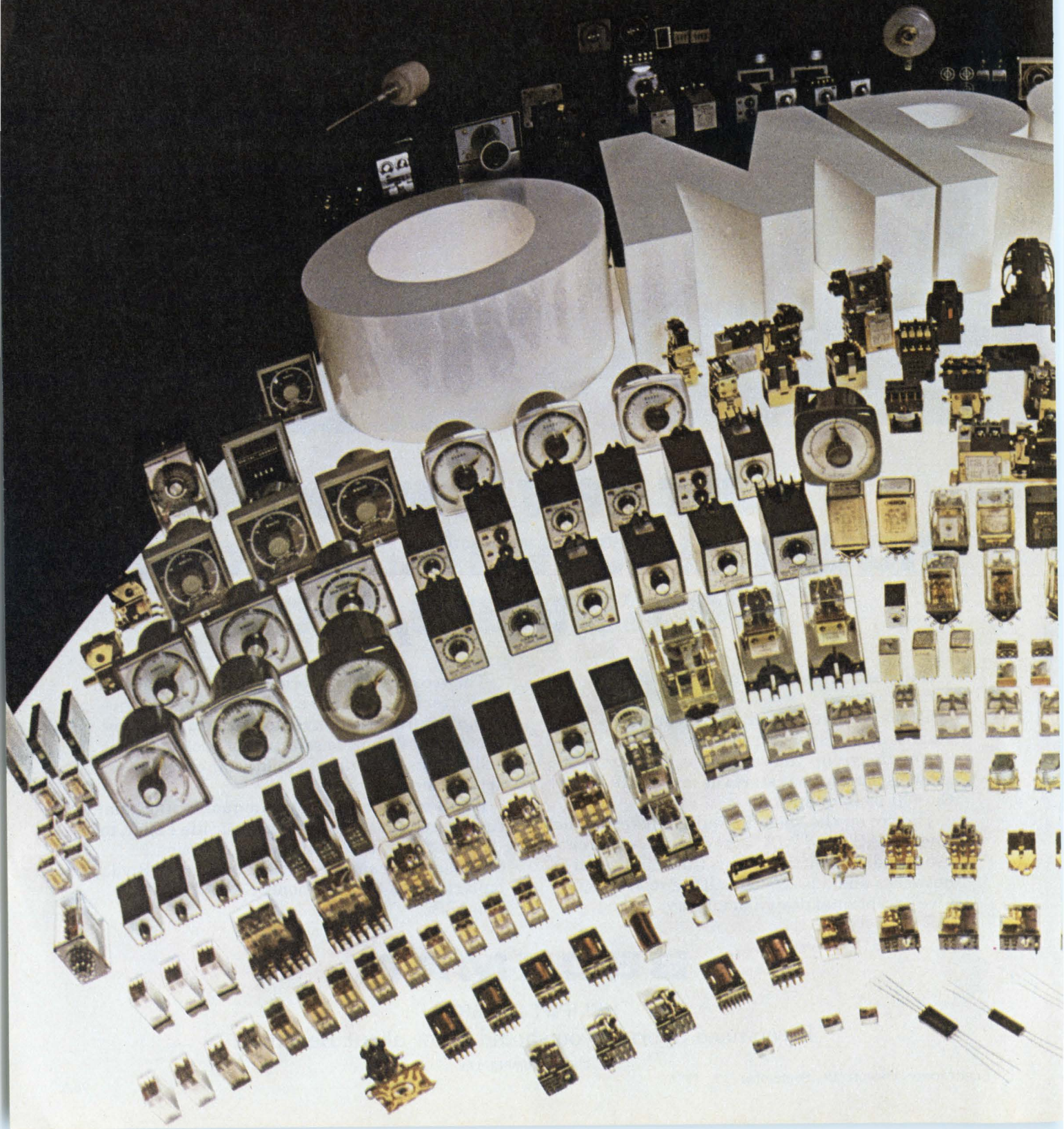

If you don't see the control component you need, maybe it's because we didn't have room for it in the photograph. Omron manufactures what is probably the largest selection of relays, switches, and timers in the world, and to show them all we'd need a 40-page ad.

What does this mean to you? It simply means that we may already have the "unique" component you need in stock. If we

do, you'll get it fast, thanks to our expanded distributor network. You'll also know you're getting a quality product: Omron has been a world leader in control components for 43 years, and our growth over the decades has been based on excellence in engineering, manufacturing, marketing, and—above all—in serving you, the Omron customer.

To find out what Omron can do for you, contact your nearest Omron distributor. Or give us a call at (312) 885-9500.



*a world leader  
in electronics  
since 1933*

Omron Corporation of America  
Corporate Headquarters  
Sears Tower, Chicago, Illinois

Sales and Service  
1051 State Parkway  
Schaumburg, Illinois 60172  
Phone: (312) 885-9500

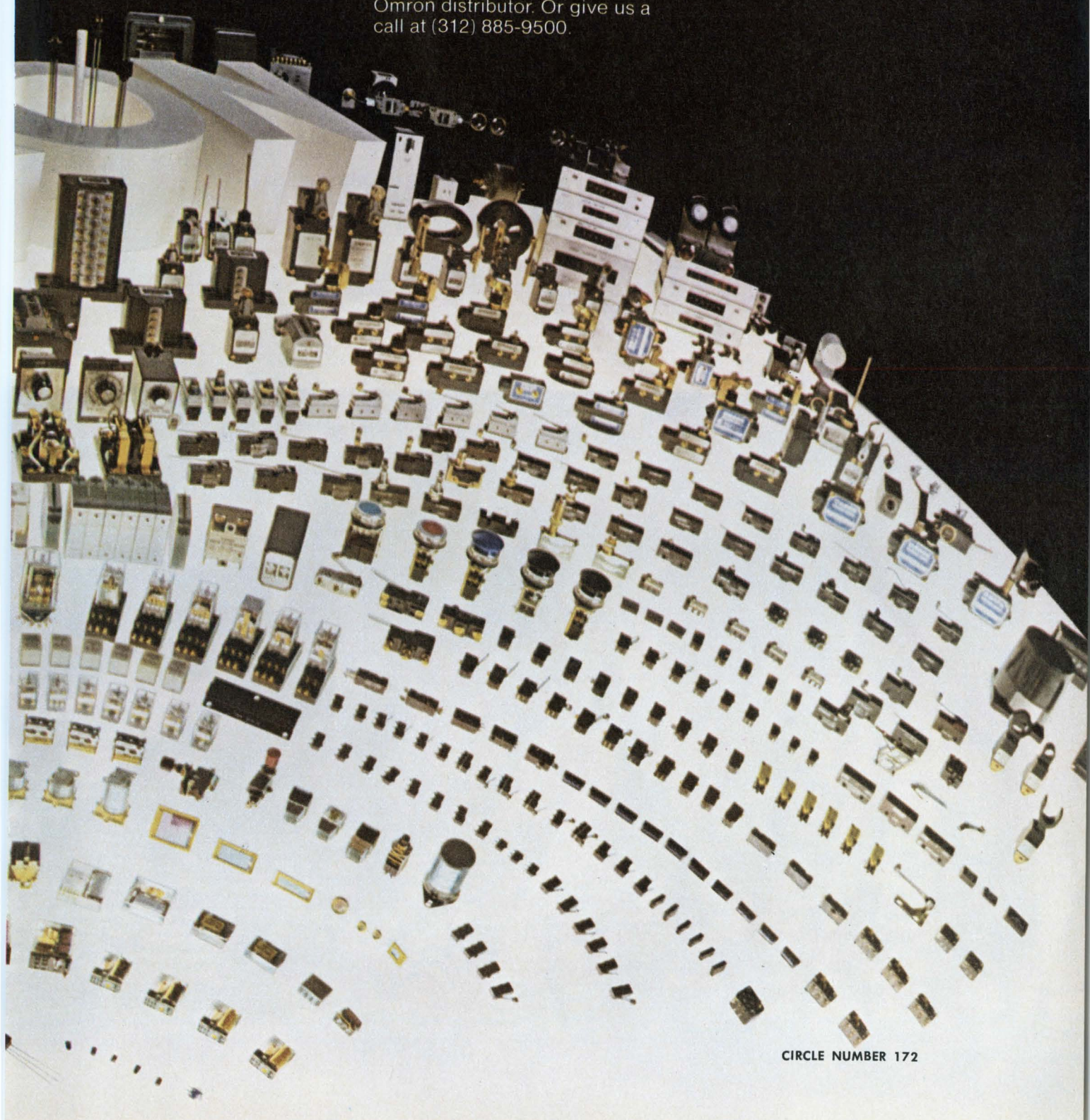

CIRCLE NUMBER 172

# **Allen-Bradley Trimmers:**

**We have what  
you need.**

**Our distributors have  
them when your  
need is now.**

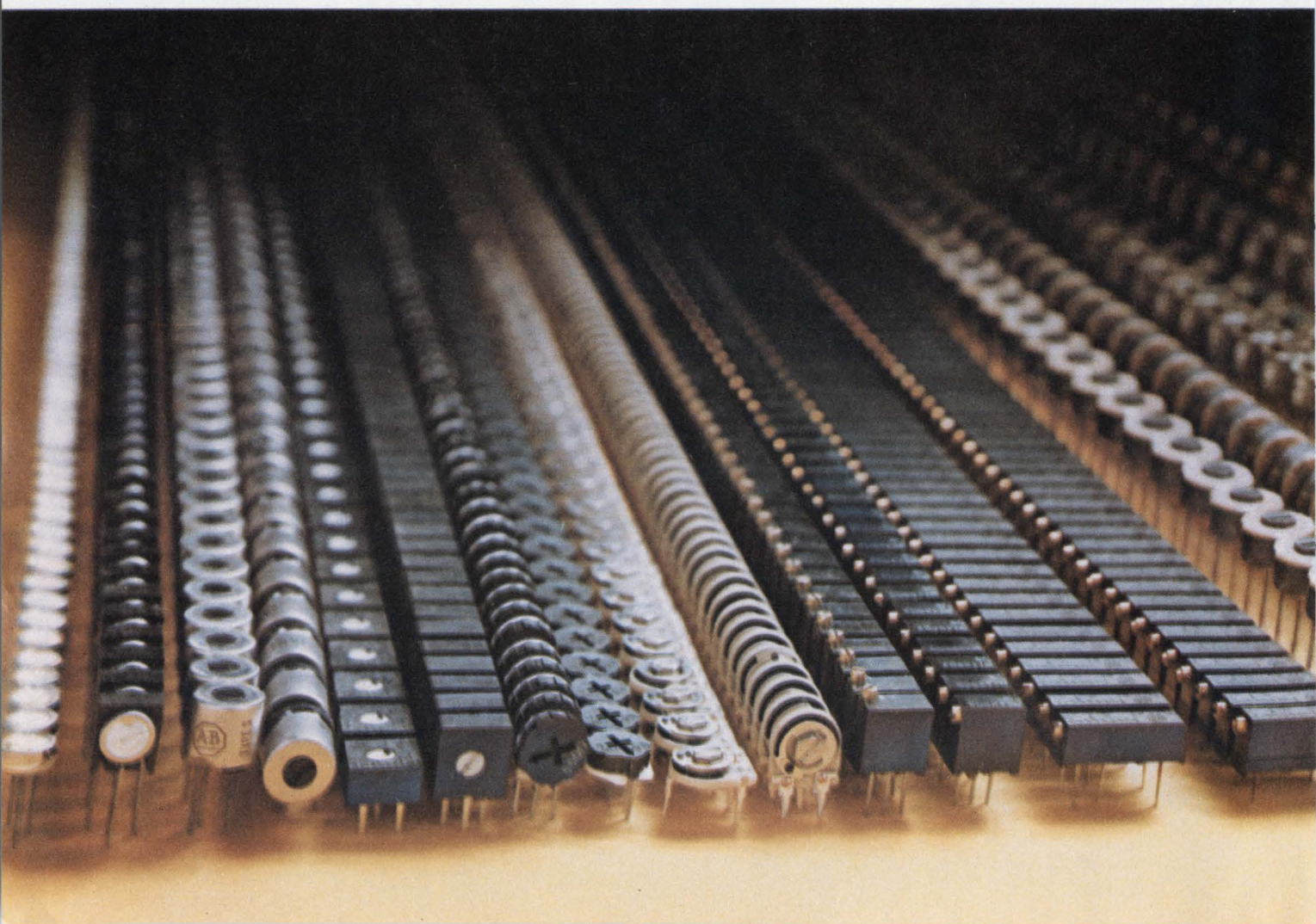

### CERMET TRIMMERS



**Type A:** ¼" diameter, single turn, 10 ohms to 2 megs ±10%, 0.5W at 85°C, immersion sealed, 3 terminal options, Publication 5238. **1000 piece price \$1.12 to 1.68.**



**Type S:** ⅜" dia., single turn, 50 ohms to 1 meg ±10%, 0.5W at 85°C, immersion sealed, top or side adjust, Publication 5208. **1000 piece price \$1.15 or 1.40.**



**Type E:** ⅜" square, single turn, 10 ohms to 2 megs ±10%, 0.5W at 70°C, immersion sealed, 13 terminal options, Publication 5219. **1000 piece price \$0.49.**



**Type D:** ⅜" diameter, single turn, 10 ohms to 2 megs ±20%, 0.5W at 70°C, dust cover, 6 terminal options, Publication 5240. **1000 piece price \$0.42.**



**Type 90:** Approx. ⅞" square, single turn, 100 ohms to 2 megs ±20%, 0.5W at 70°C, open frame, 2 terminal options, Publication 5242. **1000 piece price \$0.55.**



**Type MT:** ⅜" square, 20 turn, 10 ohms to 2 megs ±10%, 0.5W at 70°C, immersion sealed, 3 terminal options, Publication 5241. **1000 piece price \$1.18.**



**Type RT:** ¼" long, 20 turn, 10 ohms to 2 megs ±10%, 0.75W at 70°C, immersion sealed, 3 terminal options, Publication 5237. **1000 piece price \$0.65 or 0.93.**

### CARBON COMPOSITION TRIMMERS



**Type Y:** ½" dia., single turn, 100 ohms to 5 megs ±10% or 20%, 0.25W at 50°C, dust/splash resistant, 5 styles, non-linear tapers, Pub. 5209. **1000 piece price \$0.90 to 1.59.**



**Type F:** ½" dia., single turn, 100 ohms to 5 megs ±10% or 20%, 0.25W at 70°C, immersion sealed, 6 styles, non-linear tapers, Pub. 5234. **1000 piece price \$1.00 to 1.62.**



**Type O:** ½" dia., single turn, 100 ohms to 5 megs ±10% or 20%, 0.40W at 70°C, immersion sealed, 4 styles, non-linear tapers, Pub. 5235. **1000 piece price \$1.20 to 1.58.**



**Type FD:** ½" dia., 2 sec., 1 turn, 100 ohms to 5 megs ±10% or 20%, 0.25W at 70°C, immersion sealed, 5 styles, 5 tapers, 2 atten. Pub. 5231. **1000 piece price \$2.65 to 4.10.**



**Type BT:** ½" dia., 2 section, 1 turn, for 75 ohm Bridged-T pad applications, dust/splash resistant, side and top adjust versions. Pub. 5236. **1000 piece price \$2.49.**



**Type N:** 1¼" long, 25 turn, 100 ohms to 2.5 megs ±10% or 20%, 0.33W at 50°C, immersion sealed, Publication 5206. **1000 piece price \$2.50 or 2.65.**



**Type R:** 1¼" long, 25 turn, 100 ohms to 2.5 megs ±10% or 20%, 0.25W at 70°C, immersion sealed, bushing mount option, Pub. 5205. **1000 piece price \$2.87 to 3.73.**

# Quality in the best tradition.



**ALLEN-BRADLEY**

Milwaukee, Wisconsin 53204

CIRCLE NUMBER 173

EC120

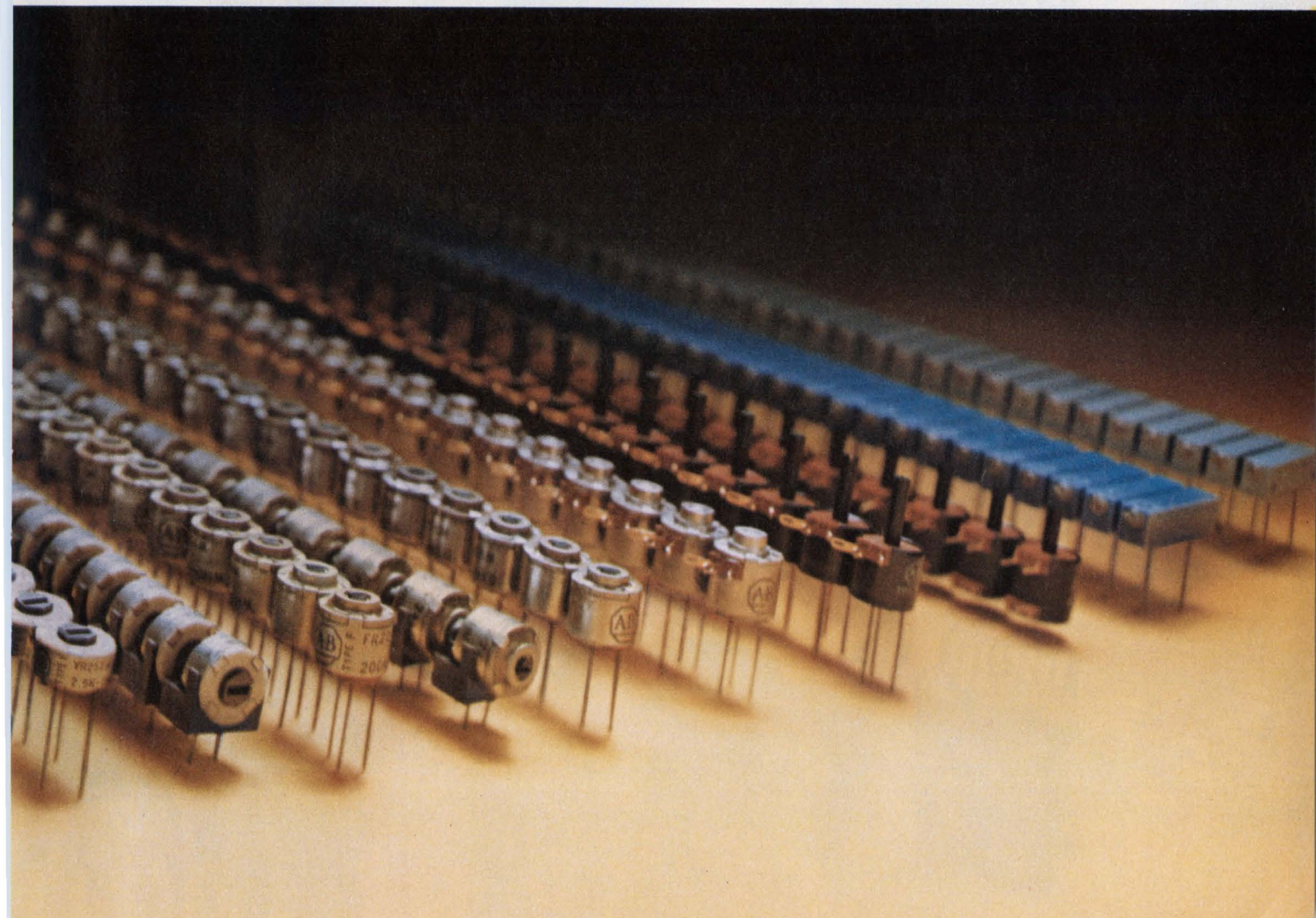

# HIGH RELIABILITY

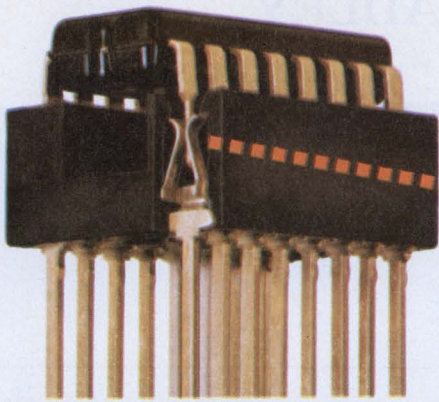

Get the **high reliability** that eliminates trouble. RNDIP sockets make contact with the wide, flat sides of your IC leads. This provides **100% greater surface contact** for positive electrical connection.

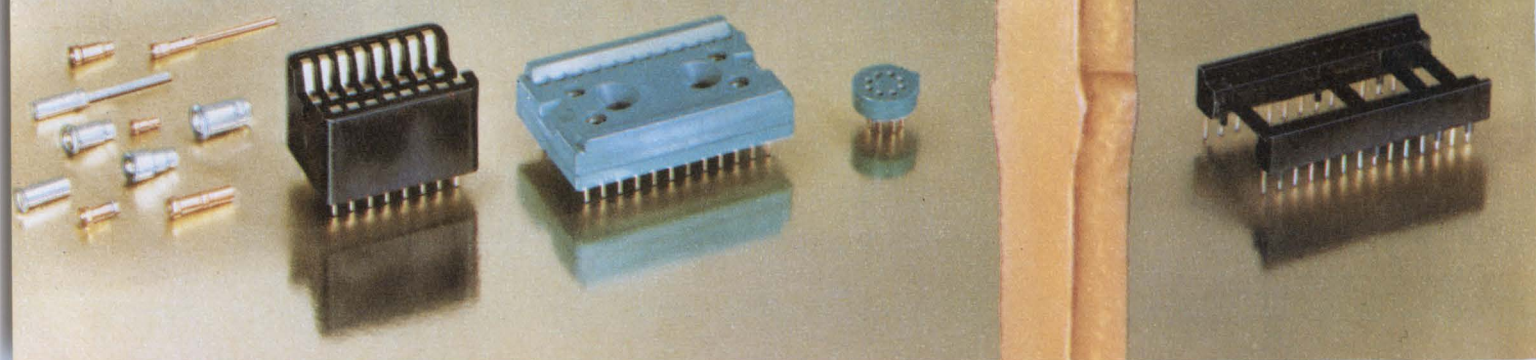



# DIP SOCKETS **for the price you're paying for junk!**

**Robinson Nugent "side-wipe" DIP sockets make 100% greater contact than any edge-bearing socket on the market.**

This 100% greater contact with the wide, flat surface of your IC leads is your guarantee of unmatched reliability. This RN "side-wipe" contact provides constant low contact resistance. No edge-bearing contact can possibly deliver this long term dependability. This designed-in reliability of RN DIP sockets is your assurance of trouble-free IC interconnects—yet they cost no more than ordinary sockets.

**Put an end to troublesome junk sockets!** Write today for catalog and informative book, "What to Look for in IC Interconnects." It's free from RN—the people who make more kinds of high reliability IC sockets than anyone.

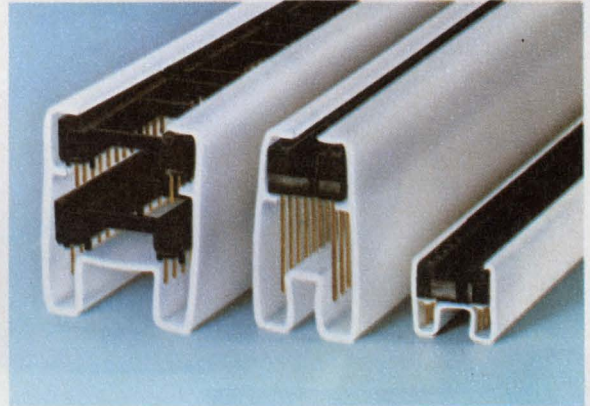

**They're even packaged for high reliability.**

"Protecto-pak"® packaging delivers consistently perfect RN sockets to your production line—for automated or manual assembly.

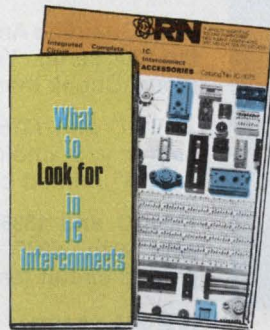

# **RN ROBINSON NUGENT, INC.**

800 East Eighth Street • New Albany, Indiana 47150 • Phone: (812) 945-0211  
CIRCLE NUMBER 174

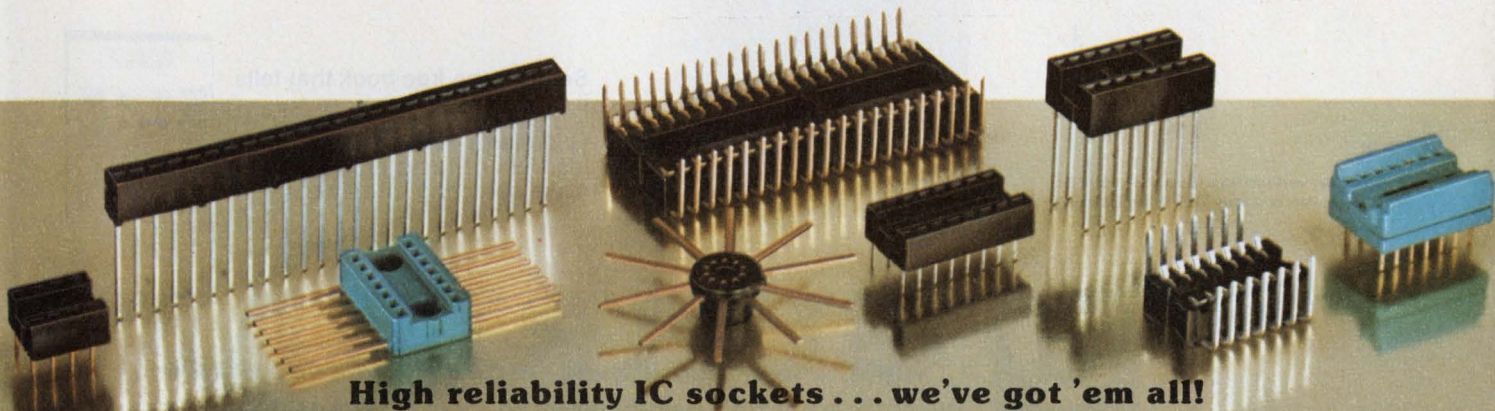

**High reliability IC sockets . . . we've got 'em all!**

# THIRTEEN JUST BECAME YOUR LUCKY NUMBER



**NEW!** 1390 and 1395 DPDT



Two new 1300 series relays give you the most complete line of miniature enclosed relays to meet your most exacting specifications.

Your Guardian Angel calls these relays the 1300 series. You'll call them miraculous. Check these specs for proof:

**1310 AC and 1315 DC relays, 4 PDT, 5 amp** in your choice of .107" solder lug or .059" printed circuit termination.

**1330AC and 1335DC relays, DPDT, 5 amp** with .098" solder lug or .059" printed circuit termination.

**NEW!** 1345DC relay, SPST-NO, SPST-NC, or SPDT, 10 amp. Termination is standard .055" x .030" printed circuit. Just over a cubic inch small, yet specifically designed for low cost, high reliability.

**NEW!** 1390AC and 1395DC relays, DPDT, 13 amp. Dual type .187" or solder lug termination. Space saving, compact. Give large control capacity in about half the size of competitive relays that do the same job. Small price, too.

**1360AC and 1365DC relays, DPDT, 5 amp** with .060" diameter, 13/64" long terminal pins on .1" grid spacing for PC board. Also available in SPST and SPDT up to 50 amps.

**Mounting sockets and hardware.** A complete line of solder lug, PC and wire wrap sockets. Plus, side mounting/permanent stud hardware that allows you to mount these relays in any position.

**NEW!** 1345 SPST-NO, SPST-NC, SPDT



Send for the free book that tells it all:

Guardian's 48 page relays catalog. Full of facts and specs to make selecting a relay a snap.



This mark indicates recognition under the component program of Underwriters Laboratories, Inc.



# GUARDIAN®

GUARDIAN ELECTRIC MANUFACTURING CO. • 1572 W. Carroll Ave., Chicago, Ill. 60607

CIRCLE NUMBER 175

**Who provides the  
industry's broadest  
line of electronic  
packaging hardware  
... including  
Card Files?**

SAE does! In either kit form or fully assembled, VARIFILE's® exclusive snap-together construction lets you assemble a card file in just minutes—without tedious component stringing.

Designed on a modular basis, SAE card files contain only five basic parts: end plates; support bars; card guides; nylon snap locking tabs; and connector mounting feet. Also available is a complete line of accessories including identification tabs, card pullers, circuit card ejectors, circuit card ejector/retainers, printed circuit board edge connectors, and cable connector hoods.

Stanford Applied Engineering has the complete capability for the design and production of special card files in both New York and California that will accommodate mixed cards and connectors with such features as front/rear panels, divider plates, front panel hinges, chassis slides, etc. Your request for quotation will receive immediate attention!

Our new 128 page packaging handbook gives complete details, and also describes our entire line of electronic packaging and interconnection hardware.

® Stanford Applied Engineering, Inc.



**Stanford Applied Engineering, Inc.**

340 Martin Ave., Santa Clara, CA 95050  
(408) 243-9200 TWX 910-338-0132

CIRCLE NUMBER 56

For an immediate reply, call the following toll-free  
"ZIP QUOTE" number at the factory ... 800-538-6843



## Use transconductance amplifiers to make programmable active filters. The OTAs offer a 10-octave tuning range by using predictable $V_{BE}$ -versus- $I_C$ relationships.

Operational transconductance amplifiers (OTAs) can provide control of many active filter parameters over a 60-dB dynamic range. Ranges this wide are possible because the controlling signals are currents and not voltages. And currents can represent filter variables—such as corner frequency, center frequency,  $Q$  or bandwidth—better than a voltage, since the relationship between the collector current and the base-to-emitter voltage drop of a silicon transistor is predictable over extremely wide ranges.

Over the last few years state-variable and biquad active filter circuits have been adopted by many companies as universal filter building blocks. Analog multipliers scale the impedance elements of these filters, thereby achieving parameter control.<sup>1</sup> Commercially available multipliers, however, are limited when it comes to voltage range, temperature drift and linearity. Because of these drawbacks, programmable filters based on analog voltage multipliers are generally restricted to operation over a 3-to-6-octave range. But by exploiting the transistor's  $V_{BE}$  vs  $I_C$  relationship in an OTA, you can use current signals to provide filter control over many decades.

The operational transconductance amplifier consists of a matched pair of npn transistors, connected as a variable transconductance multiplier, and a matched pair of pnp transistors, connected as a current mirror (Fig. 1). The small-signal relationship between the collector difference currents  $i_1 - i_2$  and the base-emitter difference voltages  $v_1 - v_2$  can be expressed by

$$i_1 - i_2 = (i_E/2V_T) (v_1 - v_2),$$

in which  $V_T$  is the thermal voltage and is typically 26 mV at room temperature, and  $i_E$  is the combined emitter current.

Due to the current-mirror action of the pnp pair, the collector current of  $Q_4$  equals  $i_1$ , the collector current of  $Q_1$ . The difference current,  $i_1 - i_2$ —shown as  $i_o$ —is proportional to the product of the emitter current and the differential voltage applied to the npn pair. This product

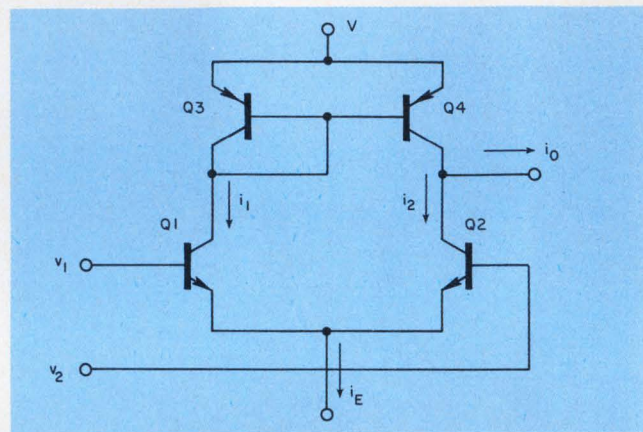

1. The basic operational transconductance amplifier uses two pnp transistors and two npn's to provide a linear conversion of voltage to current.

holds up over a very wide range of common-emitter current values—a property that makes the OTA very powerful in programmable filter synthesis and wide-range gain control.<sup>2,3</sup> Let's see how this can be put to use by examining an integrator—the basic building block of active filters.

### Programmable integrators from OTAs

A programmable integrator can be built with an op amp and a transistor array (Fig. 2). To ensure the validity of a small-signal approximation for  $Q_1$  and  $Q_2$ , the differential input signal is scaled down with resistors  $R_1$  and  $R_2$ . For the values given in Fig. 2, the difference voltage becomes

$$\begin{aligned} v_1 - v_2 &= (V^- - V^+) R_2 / (R_1 + R_2) \\ &= 3.2 \times 10^{-3} (V^- - V^+). \end{aligned}$$

Thus an input signal of  $\pm 5$  V, pk-pk, is attenuated into a  $\pm 16$ -mV swing at the bases of  $Q_1$  and  $Q_2$ . Transistor  $Q_5$ , connected in diode form, provides emitter bias for the current-mirror transistors, while the 100-k $\Omega$  potentiometer compensates for the over-all voltage offset of the OTA. The pot should be adjusted so that the difference current is zero for  $V^- = V^+ = 0$ .

The transfer function of the circuit can easily be found if you use Laplace transforms:

$$V_o = -I_o/sC = (i_E/2V_T) (v_2 - v_1)/sC,$$

Dr. Sergio Franco, Via Battisti, 18, 34070 Capriva del Friuli (Gorizia), Italy

which can be simplified to

$$V_o = (V^+ - V^-) / s\tau,$$

where

$$\tau = [2 V_T C (R_1 + R_2) / R_2] / i_E.$$

These equations show that the circuit integrates the differential input signal and that the constant of integration,  $\tau$ , is inversely proportional to  $i_E$ . The constant,  $\tau$ , can be programmed externally if  $i_E$  is controlled with a variable current generator. When this is all put together, you have a programmable differential integrator.

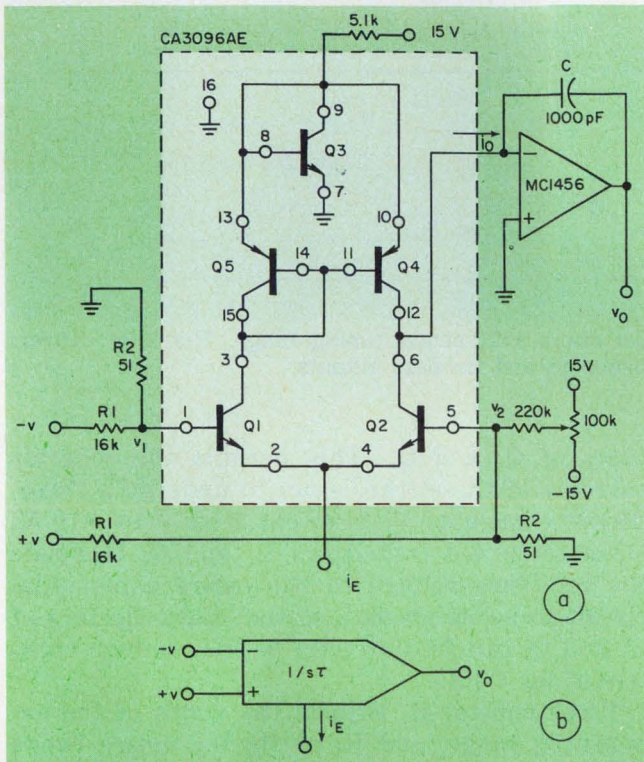

2. To build a programmable integrator, the OTA can be combined with an op amp and some resistors to form the basic building block of an active filter.

Of course, if one input is grounded, the circuit is an inverting or noninverting integrator. To minimize any error introduced by the op amp at low current levels, an op amp with very low input bias current, such as one with a FET input or super-beta transistor input, should be used.

### Combined integrators make a filter

Two integrators can be combined to make a programmable filter that exhibits simultaneous second-order, low-pass and bandpass responses (Fig. 3). To build a circuit using this block diagram, you also need a dual-output current generator to control both integrators. The actual circuit is shown in Fig. 4 (offset-adjustment pots have not been included, for the sake of simplicity). Now let's see how it works.

If we start with the block diagram of Fig. 3 and use Laplace transforms to find the bandpass and low-pass outputs, we get:

$$V_{BP} = (V_i - V_{LP} - V_{BP}/Q) / s\tau \quad \text{and} \\ V_{LP} = V_{BP} / s\tau,$$

where  $1/Q$  represents the fraction of  $V_{BP}$  fed back to the input of the first integrator. After combining these equations and rearranging terms, we get:

$$V_{BP}/V_i = s\omega_c / (s^2 + s\omega_c/Q + \omega_c^2) \quad \text{and} \\ V_{LP}/V_i = \omega_c^2 / (s^2 + s\omega_c/Q + \omega_c^2),$$

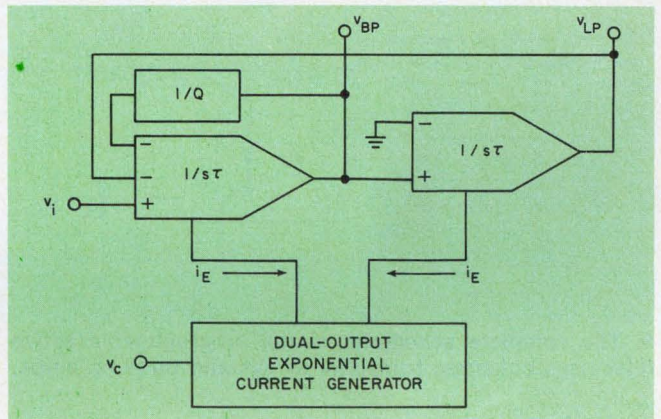

3. This block diagram of a second-order integrator shows how you can obtain both bandpass and low-pass outputs from a single programmable filter.

where

$$\omega_c = 1/\tau \approx 62 \times 10^6 (i_E).$$

The center frequency of the bandpass can now be calculated:

$$f_c = \omega_c / 2\pi \approx 10^7 (i_E).$$

This shows that  $f_c$  is directly proportional to the common-emitter current that feeds the OTAs. Thus if  $i_E$  changes from  $1 \mu\text{A}$  to  $1 \text{mA}$ ,  $f_c$  varies accordingly from  $10 \text{Hz}$  to  $10 \text{kHz}$ —a three-decade or 10-octave range.

When you have ranges this wide, exponential parameter control is usually more convenient than linear control, since changes can then be expressed in decibels rather than linear steps. The exponential control over a 10-Hz-to-10-kHz range can be accomplished by use of a dual-output exponential current generator. Let's specify the circuit parameters so that a 1-V increment in the control voltage,  $V_c$ , results in a one-octave change in  $i_E$  and hence in  $f_c$ . The relationship between  $f_c$  and  $V_c$  can then be written as

$$f_c = 10 \times 2^{V_c} \text{ Hz } (0 \leq V_c \leq 10).$$

The circuit of Fig. 4 provides this wide range. Its  $Q$  factor is set by  $R_1$  and can range from 0.5 to several hundred. As the  $Q$  increases, the circuit will eventually break into oscillation at a frequency of  $f_c$ . When used in this mode, the circuit can operate as a voltage-controlled quadrature oscillator, since the low-pass output lags the

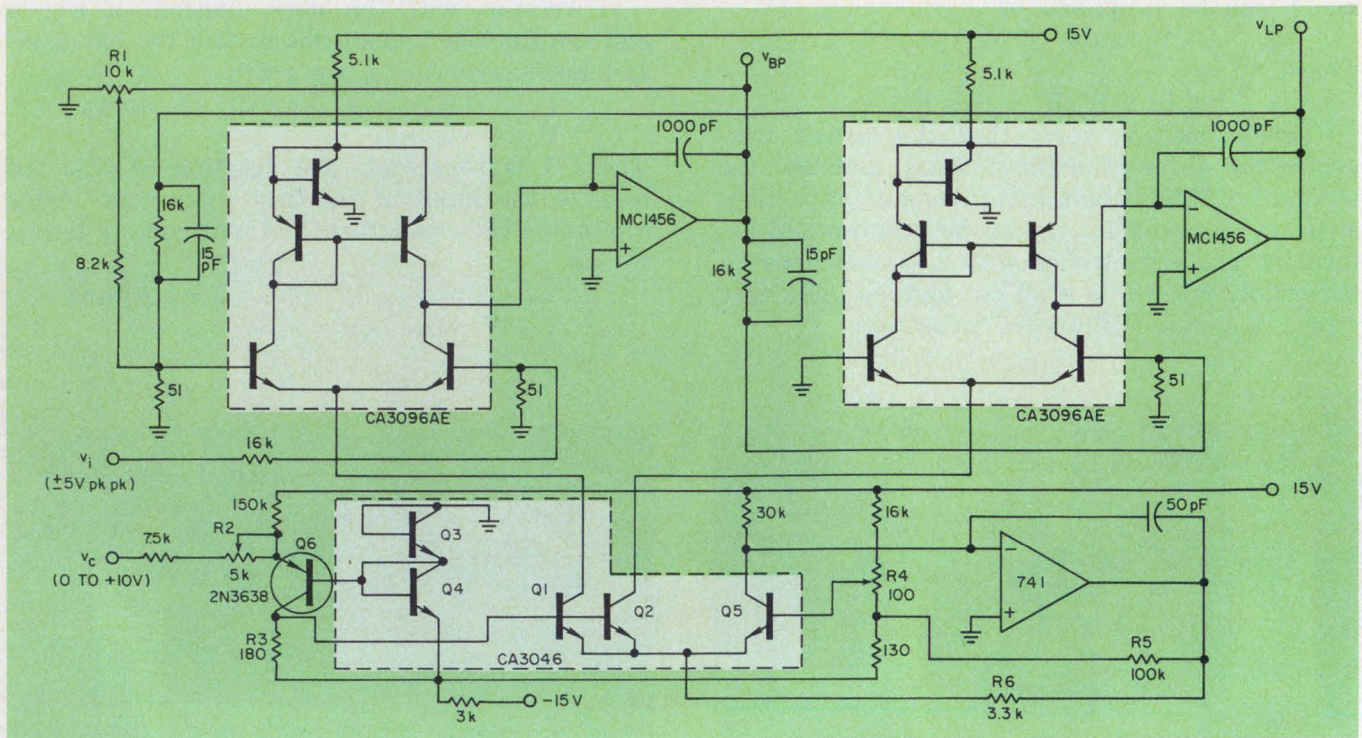

4. The complete schematic of the programmable active filter uses but three transistor arrays and three op amps,

yet offers a 10-octave tuning range. The filter delivers bandpass and low-pass outputs.

bandpass output by  $90^\circ$ . For good sine purity, though, a nonlinear limiting element should be added in the feedback loop to ensure output amplitude stabilization. As an added bonus, the  $Q$  and  $f_c$  are totally independent, and any adjustment of either has no effect on the other.

#### The circuit works like this . . .

A common problem with state-variable circuits is the so-called  $Q$  enhancement at high frequencies, which results from the phase lag of finite bandwidth op amps. This effect can be reduced if you use high-speed op amps and counteract the phase lag of the amps with some intentionally inserted phase lead in the interstage coupling circuitry. This is exactly what the 15-pF capacitors do when connected in parallel with 16-k $\Omega$  coupling resistors.

Since the amount of phase lag is likely to vary from one op-amp type to another, the capacitor values shown in Fig. 4 are only indicative of the order of magnitude involved. The optimum capacitor values can be determined experimentally.

The dual-output current generator used in Fig. 4 consists of three matched transistors,  $Q_1$ ,  $Q_2$  and  $Q_5$ , a level shifter,  $Q_6$ , and a regulator op amp. The op amp keeps the current through  $Q_5$  constant, and thus develops a temperature-tracking reference voltage at the emitter of  $Q_5$  for the emitters of  $Q_1$  and  $Q_2$ .

Level shifter  $Q_6$  scales the input voltage range into a nominal swing of 180 mV at the common

bases of  $Q_1$  and  $Q_2$ . This permits the collector currents of these transistors to undergo a three-decade change as  $V_C$  is swept from 0 to +10 V. Diode-connected transistors  $Q_3$  and  $Q_4$  translate the reference voltage of the entire exponential circuit to below ground, so that the collectors of  $Q_1$  and  $Q_2$  can feed directly to the common emitters of the OTAs.

Potentiometer  $R_2$  adjusts the width of the exponential range, and  $R_4$  shifts the entire range up or down and, in turn, controls the scale factor of the exponential function. The 50-pF capacitor in the feedback circuit of the regulator, together with  $R_6$ , prevents high-frequency oscillation of the op amp. Resistor  $R_5$  compensates for any error introduced by the emitter bulk resistances,  $r_E$ , of  $Q_1$  and  $Q_2$ . These resistances could cause the relationship between the collector current and the base-emitter voltage drop to be no longer exponential in the upper current range. The value of  $R_5$  is calculated by the formula:

$$R_5 \approx 2 \times 130 \Omega \times R_6 / r_E.$$

Since  $r_E$  is only about 10  $\Omega$  or so, the value of  $R_5$  easily compensates for the bulk-resistance error.

Nonperfect matching between  $Q_1$  and  $Q_2$  means that the collector currents of these transistors are likely to differ, and this will affect both  $f_c$  and  $Q$ . However, this doesn't create a problem, since the mismatch is automatically compensated for during the initial calibration adjustments of  $R_1$ ,  $R_2$  and  $R_4$ . The performance of the filter for a  $Q$  setting of about 50 is shown in Fig. 5.

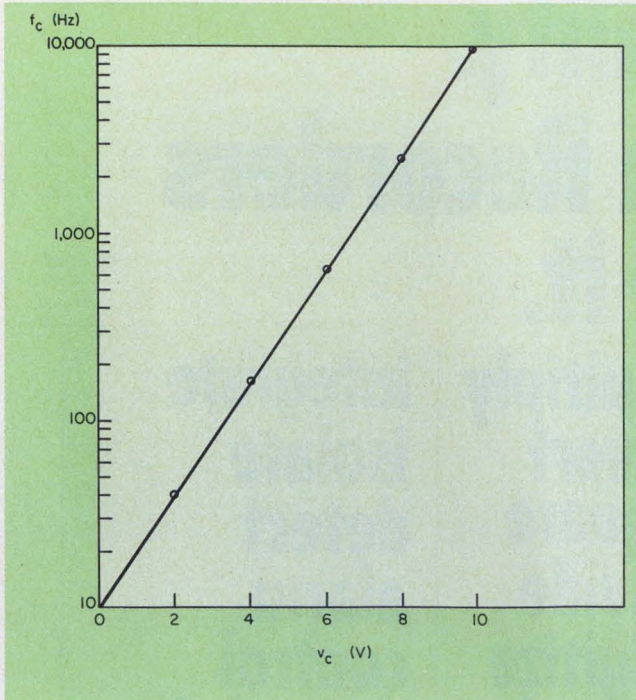

5. The response of the programmable filter is linear (in decibels) over a 10-V tuning range. It has a corner or center frequency within a 10-Hz-to-10-kHz range.

The transfer characteristics of the OTAs, as well as those of the dual-output current generator, depend on  $V_T$ , the thermal voltage. The filter thus has a certain amount of temperature sensitivity, and for applications where this is critical, you can minimize it. All you have to do is replace the 51- $\Omega$  input resistors ( $R_2$  in Fig. 2) and the 180- $\Omega$  current-generator input resistor ( $R_3$  in Fig. 4) with thermistor elements that have compensating characteristics.

#### Automatic Q control for the filter

In the circuit of Fig. 4, Q is determined by the setting of  $R_1$ . However, the Q can also be made programmable if you add a transconductance multiplier and associated current generator. This modification is shown in Fig. 6, where, for clarity, only the circuit components directly involved in the change are shown schematically; the rest of the circuit is shown in block diagram form. For optimum performance, make provisions to zero the voltage offset between  $Q_1$  and  $Q_2$ .

The response of this circuit to input-signal levels is the same as for the circuit shown in Fig. 4, except that the value of Q is now determined by a control voltage,  $V_Q$ . The gain of the circuit at  $f_c$  equals Q, and this may be a problem for large values of Q. This is because the amplifiers in the filter will saturate for large voltage inputs, unless the input is intentionally maintained below a predetermined value. To eliminate this possible saturation problem, an additional input to the

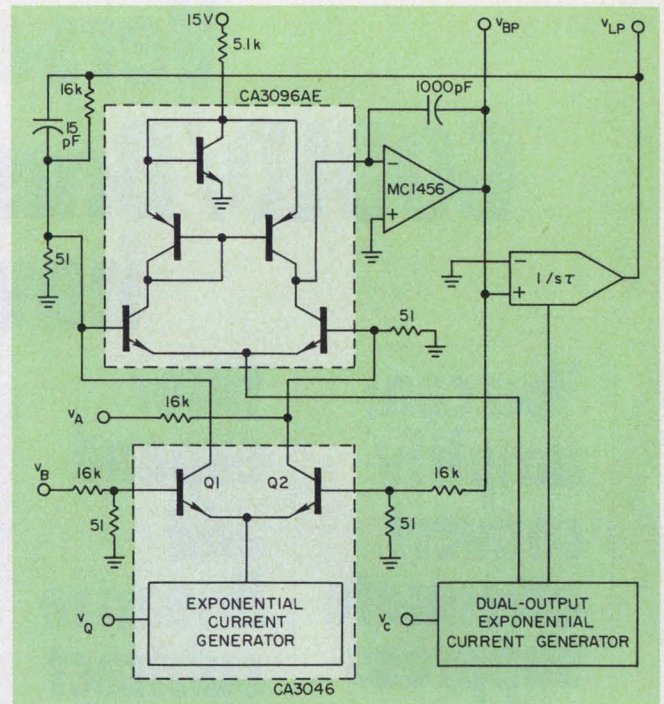

6. You can program the Q of the tunable filter by adding a transconductance multiplier in the input stage and an exponential current generator to control it.

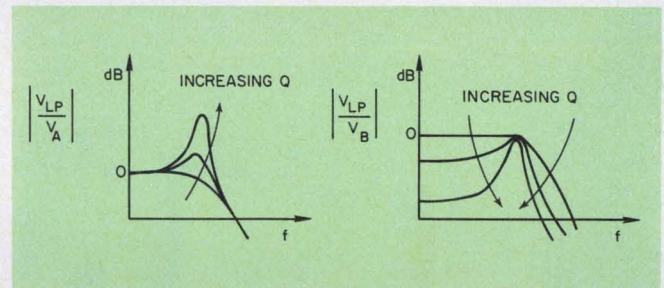

7. The low-pass response for the modified circuit of Fig. 6 shows that for the  $v_a$  input, gains will reach values higher than one (a), while for the  $v_b$  input, gains are adjusted for a maximum of one (b).

filter,  $V_B$ , can be designed in.

Since the signal  $V_B$  is applied to the filter through the multiplier that controls the Q, it undergoes some attenuation. This attenuation is inversely proportional to the value of Q. Thus the gain of the filter at  $f_c$  is unity, regardless of the value of Q. The typical low-pass responses to the two input lines are shown in Fig. 7. ■■

#### References

1. Sparkes, R. G. and Sedra, A. S., "Programmable Active Filters," *IEEE Journal of Solid-State Circuits*, Vol. SC-8, February, 1973, pp. 93-95.
2. Jung, W. G., "Get Gain Control of 80 to 100 dB," *Electronic Design* No. 13, June 21, 1974, pp. 94-99.
3. Franco, "Hardware Design of a Real-Time Musical System," Department of Computer Science Technical Report, University of Illinois, October, 1974.

# Versatility. GOULD/Brush Recorders have it.

**You can:  
amplify  
convert  
attenuate  
suppress  
reject**

**filter  
expand  
add  
linearize  
subtract  
display**

**multiply  
invert  
square  
divide  
digitize  
record**

**integrate  
isolate  
detect  
alarm  
control  
demodulate**

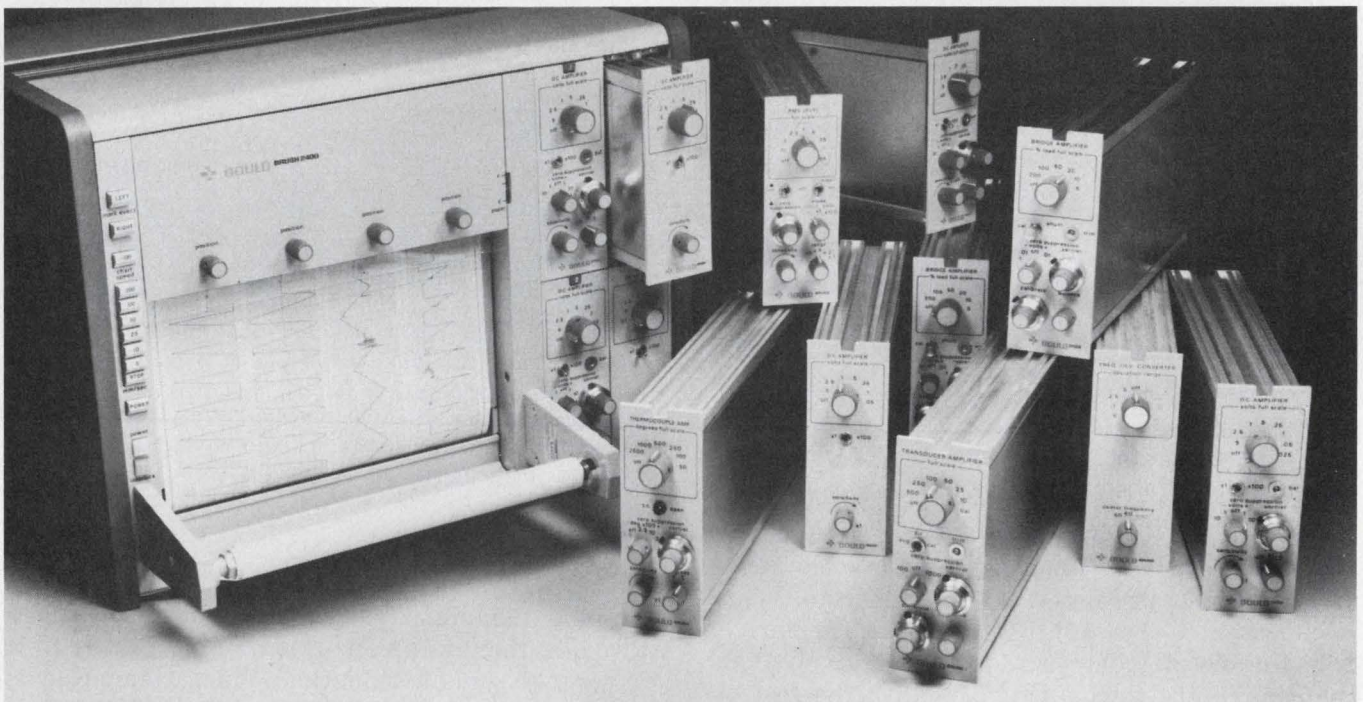

## The plug-in signal conditioners do it.

Its modular design and interchangeable signal conditioners mean you get a recorder system "customized" to your needs with the ability to change input parameters at will through the

addition of appropriate plug-in conditioners. Let us tell you more. Write Gould Inc., Instrument Systems Division, 3631 Perkins Ave., Cleveland, Ohio 44114. Or Gould Allco

S.A., 57 rue St. Sauveur, 91160 Ballainvilliers, France. Or for a brochure, call Gould toll-free at (800) 325-6400, Ext. 77. In Missouri: (800) 342-6600.

Wescon/76 Booth 556

 **GOULD**  
The product development company

CIRCLE NUMBER 57

ELECTRONIC DESIGN 19, September 13, 1976



# Switch to the LICON® LPB line...a spur to your imagination!

Your design ideas really *will* track better when you keep Licon LPB's in mind. With Licon's vast array of choices and options you're sure to find the switch you need quickly, save design time, and avoid frustration.

Take our Series 05 LPB's for example. These economical lighted or non-lighted low-level switching devices are available in seven lens cap colors, plus clear. Centrally-located red, yellow or green LED display, too. Excellent illumination with LED's or inexpensive T 1 $\frac{3}{4}$  wedge base lamps. Fits .625 panel cutout. Single or double pole versions. Unitized housing and mounting latches. Bifurcated contacts with long wipe. Good tactile feedback. U.L. listed. Wide application range. Ideal

for low energy digital electronics switching.

Our Series 06 LPB's feature Licon's ultra-reliable double-break Butterfly® switches. One or two-lamp illumination. Over 200 display options. One light full screen. Two-light vertical split, horizontal split, or full-screen illumination. Solid color, projected color, insertable legend or hidden display. Use standard T 1 $\frac{3}{4}$  flange base lamps. Fits .70 x .920 panel cutout. U.L. listed, C.S.A. certified, and meets 3 mm terminal spacing requirements. Wide

application range. Both Series 05 and 06 LPB's have standard PC or .110 quick-connect terminals.

Many other brilliant choices available in our amazing array of lighted and unlighted switches. Switch to us for best answers. Call or write for our Licon Switch Catalog: Licon, 6615 West Irving Park Road, Chicago, Illinois 60634. Phone (312) 282-4040. TWX 910-221-0275.



## LICON

A DIVISION OF ILLINOIS TOOL WORKS INC.

CIRCLE NUMBER 58



# Get around op amp limitations in active filter design. Simple derived expressions show how to compensate the amplifier and explain second-order effects.

Avoid the problems caused by limited op amp gain-bandwidth products in active filter designs. You can obtain near-ideal response by modifying the filter's quality factor and natural frequency.

The limited gain-bandwidth product of the amplifier creates several problems in second-order filter responses:

- Increased gain near the natural frequency of the filter.
- A downshift of the natural frequency due to the excess phase shift of the amplifier.
- A maximized Q at low frequencies due to the finite amplifier gain.

To analyze the problems, and compensate the circuit for them, let's use one of the most common filter forms, the state-variable active filter, as a model (Fig. 1).<sup>1,2</sup> This filter circuit has a low-sensitivity to component variations, an adjustable circuit Q, and adjustable natural frequency.<sup>3,4</sup> It provides simultaneous low-pass, bandpass and high-pass responses.

## Start with the filter transfer function

Before we derive the filter transfer function, let's model the amplifiers used inside. This first-order model should be sufficient for the forthcoming analysis:

$$a(s) = a_0 / (1 + s/\omega_a) = RGB / (s + \omega_a), \quad (1)$$

where the radian gain bandwidth, RGB, equals  $a_0\omega_a$ . Now the transfer function for the entire filter can be written as:

$$V_o/V_s = (s + X) (G_sRGB/G_T(RC)^2) \times [s^4 + s^3(\omega_a + X) + s^2(\omega_a X + Y + G_2RGB/C_i) + s(XY) + G_1RGB/C_i(RC)^2]^{-1}, \quad (2)$$

where  $C_i$  is the input capacitance,

$$X = (G_1 + G_2)/C_i, \quad Y = G_FRGB/G_TRC$$

and  $G_T = G_F + G_s + G_2$ .

For the ideal amplifier and zero input capacitance, Eq. 2 reduces to:

$$V_o/V_s = G(0) \omega_n^2 / (s^2 + \omega_n s/Q + \omega_n^2), \quad (3)$$

where  $\omega_n^2 = G_1/G_2(RC)^2 = R_2/R_1(RC)^2$ ,

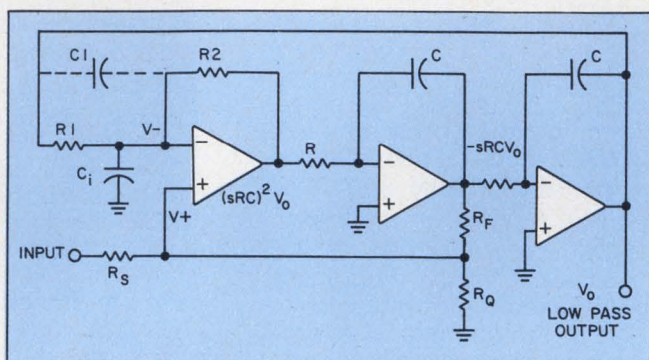

1. A minimum of three op amps are needed to build the state-variable active filter. This filter delivers simultaneous low-pass, bandpass and high-pass outputs.

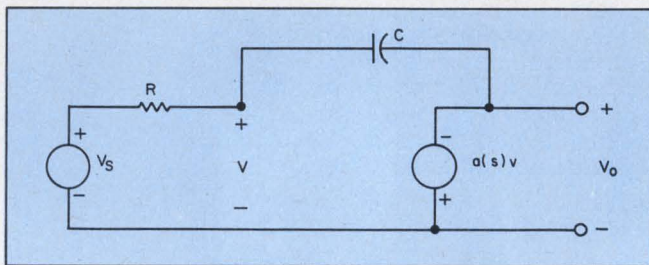

2. The integrator stage of the state variable filter can be modeled by this simple circuit. Each filter has two integrator stages.

$$\omega_n/Q = G_F(G_1 + G_2)/G_TG_2RC$$

$$\text{and } G(0) = G_s(G_1 + G_2)/G_TG_1.$$

In these equations  $\omega_n$  is the natural frequency in radians, Q the quality factor and G(0) the dc gain.

The definitions of  $\omega_n$  and Q can be written accurately if you work back from the ideal transfer function and substitute frequency values into Eq. 2. For example, in Eq. 3, when  $s = j\omega_n$ , the gain magnitude is Q and the phase is  $-90^\circ$ . Likewise from Eq. 2, when  $s = j\omega'_n$ , the gain magnitude is Q' and the phase is  $-90^\circ$ . (The primed variables denote modification from the ideal.)

The transmission zero in Eq. 2 is much greater than  $\omega_n$ . Thus, if we set  $s = j\omega'_n$  in Eq. 2 we can compute the gain:

$$G(j\omega'_n) \cong WXZ [\omega_n'^4 - \omega_n'^2(\omega_a X + G_2RGB/C_i) + \omega_n G_FRGB \sqrt{R_1/R_2}/G_T] + Z \omega_n/C_i + j\omega_n XY - \omega_n'^2(\omega_a + X)]^{-1}, \quad (4)$$

Gerald T. Volpe, formerly consultant for General Instrument Corp., Hicksville, NY 11802; presently Associate Professor of Electrical Engineering, The Cooper Union, Cooper Square, New York, NY 10003.

where X and Y are the same as noted in Eq. 2 and  $W = G_s \omega_n / G_T G_1$  and  $Z = RGB \omega_n G_2$ .

By setting the real part of the denominator equal to zero you can find the natural frequency of the filter,  $\omega'_n \approx \omega_n$ , and the gain

$$G(j\omega'_n) = (WZX) \{j\omega'_n [Z/QC_1 - \omega_n^2(\omega_n + X)]\}^{-1} \quad (5)$$

where W, X and Z are defined in Eq. 3 and 4.

From this result and  $\omega'_n \approx \omega_n$  you will find that Eq. 5 becomes

$$G(j\omega'_n) \approx [G_s (G_1 + G_2) / G_T G_1] Q \angle -90^\circ$$

causes a decrease in natural frequency. Let's examine the frequency change by use of the idealized transfer function of Eq. 3, modified as follows:

$$G(s) = G(0) / [1 + \omega_n/sQ + (\omega_n/s)^2]. \quad (8)$$

The middle coefficient of  $s^{-1}$  in the denominator of this equation represents the left-most integrator in the inner Q loop of Fig. 1. In the last term of the denominator, the  $s^{-2}$  coefficient represents the cascade combination of both integrators in the outer  $\omega_n$  loop. Let's look at the effect of these

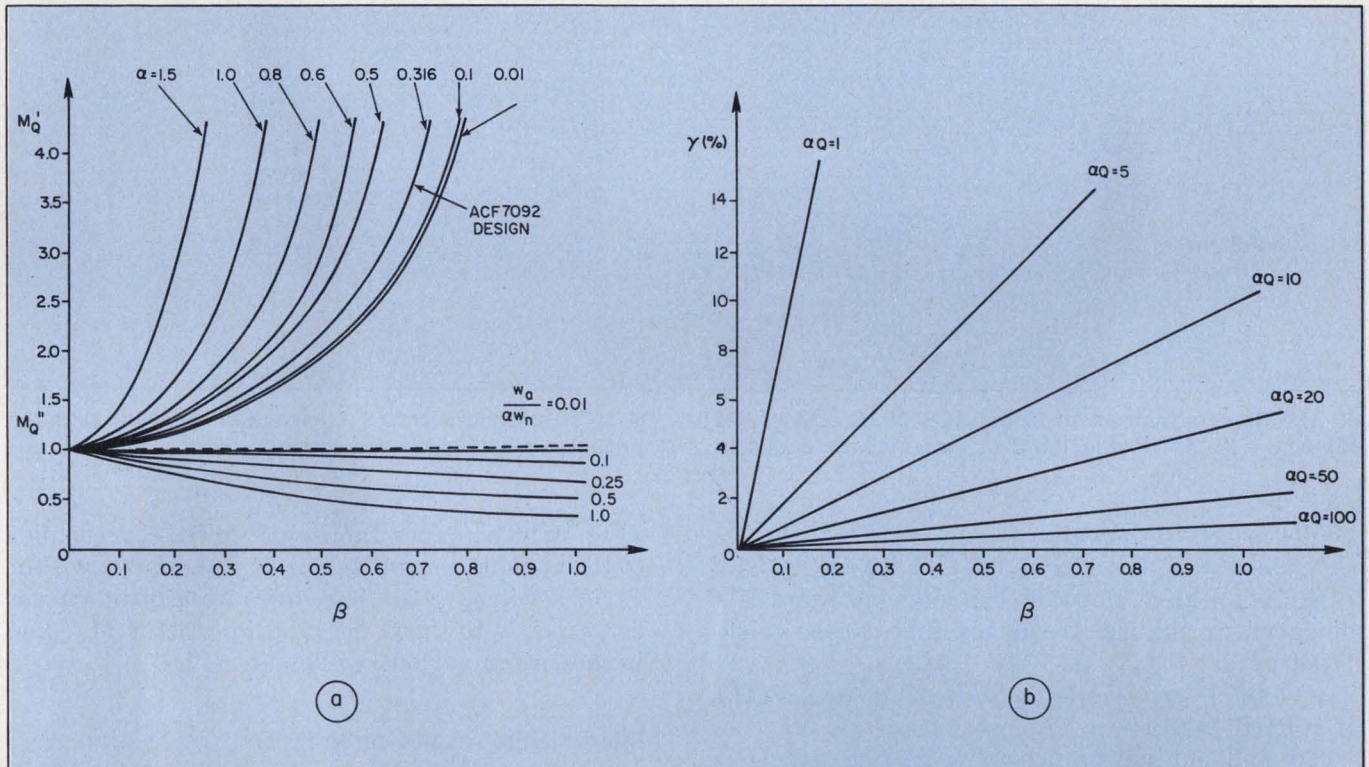

3. The plot of Q multiplicative factors versus normalized  $f_n Q$  product (a) and of percent natural frequency down-

shift versus normalized  $f_n Q$  product (b) can be used to interpret the derived results of the equations.

$$\times [1 - \omega_n Q (1 + R_2/R_1) / RGB]^{-1} \quad (6)$$

$$= G(0) Q' \angle -90^\circ,$$

for  $\omega_n C_1 \ll G_1 + G_2$ .

The effective Q, or  $Q'$ , is therefore enhanced above the ideal Q by the factor

$$M_{Q'} = [1 - \omega_n Q (1 + R_2/R_1) / RGB]^{-1} \quad (7)$$

$$= [1 - (1 + \alpha^2) \beta]^{-1},$$

where  $\alpha = \sqrt{R_2/R_1}$  and  $\beta = \omega_n Q / RGB$ .

Thus, when you design the filter, don't use the desired Q. Use a lower value,  $Q' = Q / M_{Q'}$ . Alternately, you can add a small lead-compensation capacitor, C, in parallel with R, to offset Q enhancement.

#### Downshift in frequency also compensates

While the gain-bandwidth limitation of the difference amplifier causes Q enhancement (peaking), the integrator's gain-bandwidth limitation

integrators on the filter's frequency response by using the simplified integrator model of Fig. 2.<sup>5,6</sup>

Finite input and output impedances have been omitted from the model for clarity, but can be included without significantly changing the results. The gain expression for the integrator model is then:

$$V_o/V_s = -a(s) / [1 + sRC (1 + a(s))] \quad (9)$$

As  $a(s)$  goes to  $\infty$  this equation reduces to  $-1/s\tau$ , where  $\tau = RC$ . This indicates that the integrator sets the filter's frequency. For a more accurate frequency determination, Eq. 9 can be expressed as

$$V_o/V_s = -a(s) / [1 + s\tau a(s)]$$

$$= -[s(\tau + 1/RGB)]^{-1} \quad (10)$$

$$= -1/s\tau' \text{ (for } \omega_n \ll \omega),$$

where  $\tau' = \tau + 1/RGB$  is the modified time constant. Since the time constant has increased, it follows that the modified natural frequency will

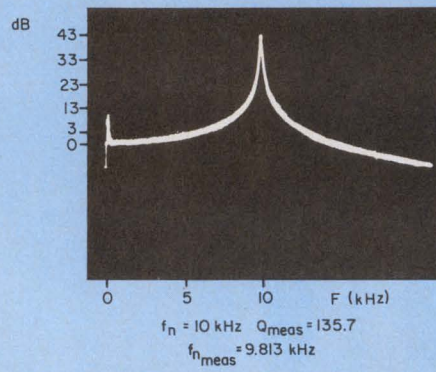
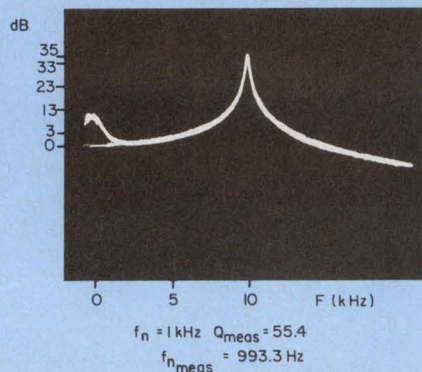
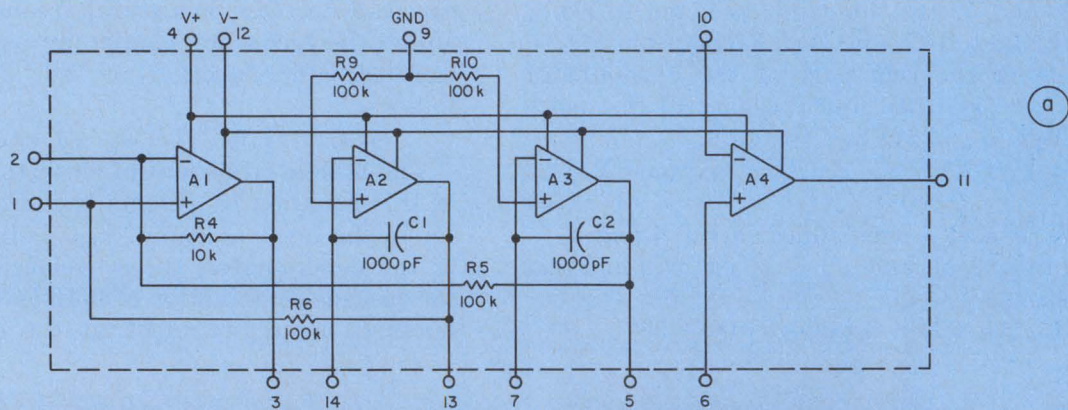

4. The General Instrument Model ACF7092C active filter (a) when tested on the low-pass output with a design

Q of 50 produces output curves that coincide with the predicted results from the equation (b).

be decreased to the value

$$\omega_n'' = \alpha/\tau' = \alpha/(\tau + 1/RGB) = \omega_n \tau / (\tau + 1/RGB).$$

Since the time constant has changed there is a deviation in natural frequency that can be calculated by:

$$\gamma = (\omega_n - \omega_n'')/\omega_n \cong 1/RGB \tau = \beta/\alpha Q, \quad (11)$$

if  $\tau RGB \gg 1$

To find out how much of a decrease in Q is caused by the change in frequency, substitute the amplifier gain from Eq. 1 into Eq. 10. The resulting equation becomes:

$$\begin{aligned} V_o/V_s &= - [RGB/(s + \omega_n)] / \\ & [1 + s \tau RGB/(s + \omega_n)] \\ &= -1/\tau s' \quad (\text{for } RGB \gg 1/\tau) \end{aligned} \quad (12)$$

where  $s' = s + \omega_n/\tau RGB = s + \beta\omega_n/\alpha Q$ .

Eq. 12 implies that the finite gain of the integrators creates a frequency shift in s that causes the real part of the second-order pole-pair to be increased by  $\beta\omega_n/\alpha Q$ . This increase is equivalent to lowering Q to Q'', and is found from the increase in the real part of the complex pole-pair:

$$\begin{aligned} \omega_n/2Q'' &= \omega_n + \beta\omega_n/\alpha Q \\ &= (\omega_n/2Q) (1 + 2\beta\omega_n/\alpha \omega_n). \end{aligned}$$

Now Q'' can be written as  $M_Q''Q$  where

$$\begin{aligned} M_Q'' &= 1/(1 + 2\beta\omega_n/\alpha \omega_n) \\ &= 1/(1 + 2Q/\alpha a_n), \end{aligned} \quad (13)$$

the Q multiplicative factor.

A plot of the Q multiplicative factor  $M_Q'$  and  $M_Q''$  versus the normalized  $f_n Q$  product or  $\beta$  can help interpret the results we've just derived

(Fig. 3). The upper family of curves corresponds to the Q-enhancement factor  $M_Q'$  and is shown for various values of  $\alpha$ . The lower family of curves corresponds to the Q-degradation factor  $M_Q''$  and is shown for various values of  $\omega_n/\alpha \omega_n$ .

#### Interpret the results carefully

From these graphs you can see that decreasing values of  $\alpha$  imply a reduced  $M_Q'$  (Q enhancement) because as  $R_2$  is made less than  $R_1$  more open-loop gain-bandwidth is obtained from the difference amplifier. And, for  $\beta > 0.2Q$ , enhancement rapidly becomes excessive. Thus when you select op amps for a filter, make sure their gain-bandwidth products are at least 10 times the  $f_n Q$  product to minimize Q sensitivity.

The  $M_Q''$  curves show that Q degradation is only important when  $\omega_n < 0.1 \omega_n/\alpha$ . Typical op amps have an  $f_n$  of 10 Hz, and thus Q degradation will only be significant below 10 Hz when  $\alpha \cong 0.1$ . In general, Q enhancement should be considered for frequencies above 1 kHz when Q is greater than 100.

Fig. 3b shows the percentage of frequency downshift versus  $\beta$ , for different values of  $\alpha Q$ . You can see that circuits with higher Qs can be designed more accurately for natural frequency than can low-Q circuits.

To verify these results, a commercially avail-

## Comparison of measured and calculated natural frequency and Q

Case	Idealized design values $f_n$ in kHz	Calculated values		Measured values
		(GB = 1 MHz) (Typical)	(GB = 875 kHz) (Actual)	
1	$f_n = 1$ $Q = 50$	996.84 Hz 52.91	996.39 Hz 53.35	993.3 Hz 56.43
2	$f_n = 2.5$ $Q = 40$	2.480 kHz 44.94	2.477 kHz 45.75	2.477 kHz 48.53
3	$f_n = 5$ $Q = 40$	4.921 kHz 51.28	4.910 kHz 53.44	4.935 kHz 58.21
4	$f_n = 10$ $Q = 30$	9.683 kHz 44.78	9.639 kHz 48.17	9.807 kHz 50.87
5	$f_n = 10$ $Q = 40$	9.684 kHz 71.43	9.639 kHz 80.46	9.809 kHz 81.66
6	$f_n = 10$ $Q = 50$	9.684 kHz 111.11	9.639 kHz 134.62	9.813 kHz 135.67

able filter, the ACF-7092C manufactured by General Instrument, was selected for testing (Fig. 4a). Typical responses for a Q of 50 at an  $f_n$  equal to 1 and 10 kHz were measured and displayed on a scope (Figs. 4b and 4c). Q enhancement at 10 kHz increased above its value at 1 kHz, as can easily be seen. Some of the points shown on the scope traces are tabulated in the table and also compare favorably with the calculated results. ■■

### Acknowledgement

The author wishes to thank the Hybrid Microelectronics Division of General Instrument Corp. for the resources to perform this work, and Mr. Greg Verity, a technician at GI, for his help in obtaining the data necessary to substantiate the mathematical predictions.

### References

1. Sedra, A. S., and Espinoza, J. L., "Sensitivity and Frequency Limitations of Biquadratic Active Filters," *IEEE Transactions on Circuits and Systems*, Vol. 2, February, 1975, pp. 122-129.
2. Bruton, L. T., and Salama, A. I. A., "Frequency Limitations of Coupled Biquadratic Active Ladder Structures," *IEEE Journal of Solid State Circuits*, Vol. 2, April, 1974, pp. 70-72.
3. Huelsman, L. P., *Active Filters; Lumped, Distributed, Integrated, Digital and Parametric*, McGraw-Hill, New York, 1970, pp. 52-56.
4. Mitra, S. K., *Analysis and Synthesis of Linear Active Networks*, John Wiley, New York, 1968, pp. 489-495.
5. Graeme, J. G., Tobey, G. E., and Huelsman, L. P., *Operational Amplifiers-Design and Applications*, McGraw-Hill, New York, 1971, Ch. 8.
6. Moschytz, G. S., "Inductorless Filters—A Survey," *IEEE Spectrum*, August/September, 1970, pp. 30-36.

# QUIK STRIP

## SOLDERLESS BUS CONNECTOR

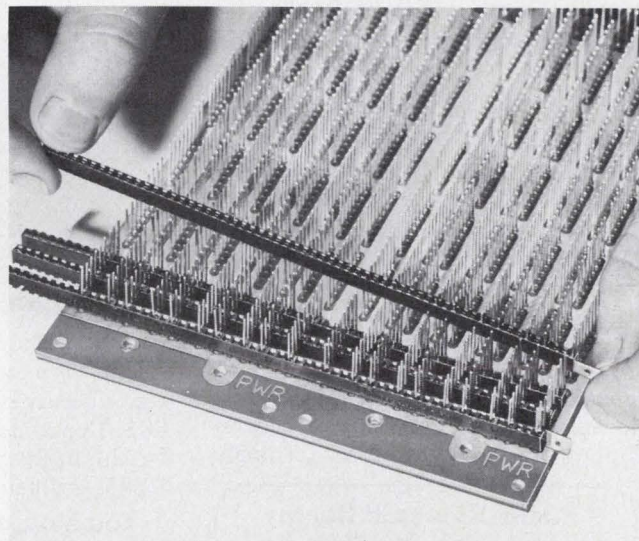

for fast, low cost connection of in-line pins on DIP socket boards and connector arrays.

- low installed cost\*
- fully insulated contacts
- extremely reliable — shock and vibration resistant
- 18 gauge current capacity
- strips can be stacked for increased capacity

\* Installed cost runs between 2.5¢ and 11¢ per connection.

Write on company letterhead for free sample.  
For more information, contact product specialist.



**ROGERS CORPORATION**  
Chandler, AZ 85224  
Phone: (602) 963-4584

EUROPE: Mektron NV, Ghent, Belgium. JAPAN: Nippon Mektron, Tokyo.

CIRCLE NUMBER 59

# Lower wages and no taxes can add up to higher profits with a plant in Puerto Rico

Puerto Rico's absolutely unique combination of manufacturing incentives has made electronics one of the largest and fastest-growing industries in this U.S. Commonwealth.

Already, 150 plants employ more than 10,000 workers, with more plants on the way.

RCA, Motorola, Digital Equipment, Centronics, and Technicon are just a few of the leaders in the electronics industry with plants in Puerto Rico.

Last year they shipped a total of almost \$300 million in electrical and electronic products from this U.S. island. And for good reasons.

## You pay zero taxes

Puerto Rico is the only manufacturing location in the U.S. where Federal corporate income taxes do not apply.

## Puerto Rico's CB Boom

When CB became hot, manufacturers knew they needed to move fast to make a profit from this marketing phenomenon.

Since 1971, three companies in the CB business have been operating 7 production facilities in Puerto Rico.

Now, there are seven companies: Hy-Gain, The Allen Group, Hallcrafters, Motorola, Tenna CB, REC Communications, Kraines. And ten new plants or expansions are in the works—further proof that CB manufacturers turn to Puerto Rico for worker know-how.

When these plants are in full production, almost 4,000 people in Puerto Rico will be busy producing CB radios, antennas, circuit boards and components for the CB market.

Your income is also 100% exempt from local taxes for up to 30 years.

No other U.S. plant site can promise you that the profit you make

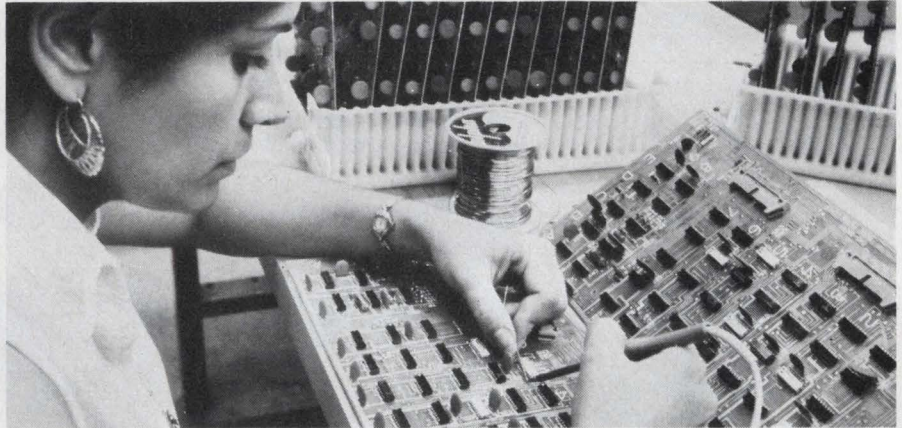

The average hourly wage for electrical and electronics workers in Puerto Rico is \$2.83, compared to \$4.66 on the U.S. mainland.

will be the profit you keep. Not just some of it, but *all* of it.

## You save on wages

On the U.S. mainland, the average hourly wage for production workers in your industry is \$4.66 according to the U.S. Department of Labor.

In Puerto Rico, that average is \$2.83—a differential of \$1.83 an hour.

## You have dedicated workers

Worker productivity in Puerto Rico is among the highest of any U.S. plant location. Dedicated production workers are the rule, not the exception.

Centronics President, Robert Howard, says, "Our Dorado plant was in full production in less than 60 days. This remarkable performance owes a great deal to the sheer hustle and enthusiasm of our Puerto Rican workers."

## We smooth the way

We make it our business to help you succeed—more profits for you mean more jobs for Puerto Rico.

That's why the specialists in our Economic Development Administration's Department of Industrial Services are at your disposal to expedite plant start-up.

Need help selecting a plant site? Estimating utility needs? Importing machinery? Locating and screening

workers? Whatever your needs, we've got facts and figures to help make your move to the island a lot easier.

## Send for free report

Mail the coupon below for all the latest facts and figures behind the electronics industry's outstanding performance in Puerto Rico. And we'll mail you a copy of our new, 52-page industry report.

**See us at Wescon '76 Show  
September 14, 15, 16, 17  
Booth #1157.**

Commonwealth of Puerto Rico  
Economic Development Administration  
Dept. F D-3, 1290 Ave. of the Americas  
New York, New York 10019

I want more details on the incentives that have made electronics one of the largest industries in Puerto Rico.

Please send my free copy of "Profile of Puerto Rico's Electrical, Electronic and Measuring, Analyzing and Controlling Instruments Industries." Plus "Fast Facts About Profits & Puerto Rico."

The electronic products I might be interested in making in Puerto Rico are:

Name \_\_\_\_\_  
Title \_\_\_\_\_  
Company \_\_\_\_\_  
Address \_\_\_\_\_  
City \_\_\_\_\_  
State \_\_\_\_\_ Zip \_\_\_\_\_

©1976 Commonwealth of Puerto Rico

**You're in good company in Puerto Rico, U.S.A.** GENERAL ELECTRIC COMPANY • WESTINGHOUSE ELECTRIC • GTE SYLVANIA • APPLIED MAGNETICS CORP • MOTOROLA • AMP • ECONOMICS LABORATORY • COIN ACCEPTORS DIGITAL EQUIPMENT CORP • DYNAMIC INSTRUMENT CORP • KELVIN ELECTRIC CO • MATSUSHITA ELECTRIC • TRACOR, INC POTTER INSTRUMENTS • RCA CORP • COMMUNICATIONS TECHNOLOGY CORP

CIRCLE NUMBER 60

# PMI-Variety Store for DACs.

When you go shopping for D/A Converters, please swing by PMI. Ever since we opened our doors six years ago, we've been working hard to spice up our distributors' shelves with the widest line of monolithic DACs in the industry. 6-, 7-, 8-, 9-, and 10-bit DACs. Current or voltage outputs. Internal or external references. Routine MIL-STD 883A Level B processing, with Level A available. Guaranteed specs over full MIL Temp range. PMI pioneered monolithic DACs. It's only natural to find more here than anywhere.

And if DACs are new to you, lean on PMI's experience. We've helped designers and project managers put dependable PMI monolithic DACs to work in the most unusual spots. How can we help you?

Also, our price list, DAC data sheets and Ap. Notes are yours for the asking. Ask your distributor or call us at our store.



Precision Monolithics Incorporated  
1500 Space Park Drive, Santa Clara, CA 95050  
(408) 246-9222. TWX 910-338-0528.  
Cable MONO.

CIRCLE NUMBER 61

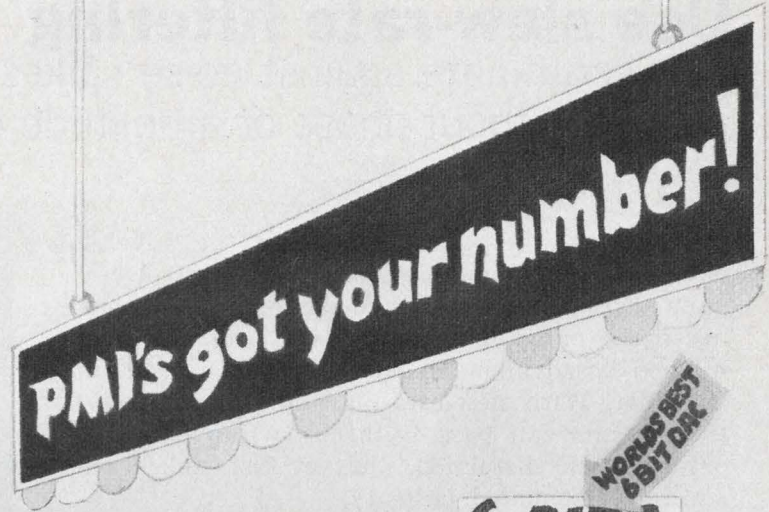

WORLD'S BEST  
6 BIT DAC

**6 BITS** Vout  
INTERNAL REF.  
from \$9.25

**10 BITS** Vout  
INTERNAL/EXTERNAL  
REF. FROM  
**\$10.00**

**8 BITS** Vout  
INTERNAL/EXTERNAL  
REF  
from **\$10.00**

**8 BITS** I out  
EXTERNAL REF.  
from **\$3.95**

**8 BITS**  
I OUT  
INTERNAL REF.  
FROM  
**\$9.95**

more  
**SOLD!**  
MORE MONOLITHIC  
DAC's SOLD THAN  
BIG MAC's (almost)



DAC-02's from \$15.00  
7 BITS  
8 BITS  
9 BITS

# Use slew-rate filtering

to discriminate against noise spikes. Pass the desired signals without phase or amplitude distortion.

The usual methods of reducing the adverse effects of noise spikes in electronic control circuits also disturb the desired signals. At best they are inadequate. One solution is to use a filtering method based upon limiting the slew rate of an amplifier. With slew-rate limiting "normal" control signals can pass faithfully without timing or amplitude distortion, and yet fast spikes are severely attenuated (Fig. 1).

Amplitude-limiting techniques clip the top of an interfering spike, but the rest of the spike remains. Worse, the signal of interest might be clipped too.

Although a low-pass RC filter can reduce the amplitude of noise strikes, the filter then takes several RC time constants to recover. And the desired signal is considerably altered in amplitude and phase, even without noise spikes.

Both of these common methods cause trouble, particularly with amplitude comparators for detecting signal levels: amplitude limiters set high to avoid distorting the desired signal can't keep noise spikes from triggering comparators; and phase delay in low-pass filters, delays the operation of comparators.

## Slew-rate limiting to the rescue

Limit the slew rate of an op amp, and the output from the circuit can still faithfully follow the desired input-control signals. But noise spikes, because they require a very high slew rate to reproduce, are severely discriminated against. The circuit's output can slew only at a predetermined maximum rate; only a small triangular pip results from a formidably high fast spike. Slower, normal signals pass through unaffected.

The slew rate of an op amp can be controlled as in Fig. 2a. Output voltage fed back to the op amp's inverting terminal tends to keep the voltage between inverting and noninverting inputs near zero, because of the op amp's very-high open-loop gain.

**M. J. Wright**, Electronic Circuit Dept., Joseph Lucas Ltd., Group Research Center, Shirley Solihull, West Midlands B90 4JJ, England.

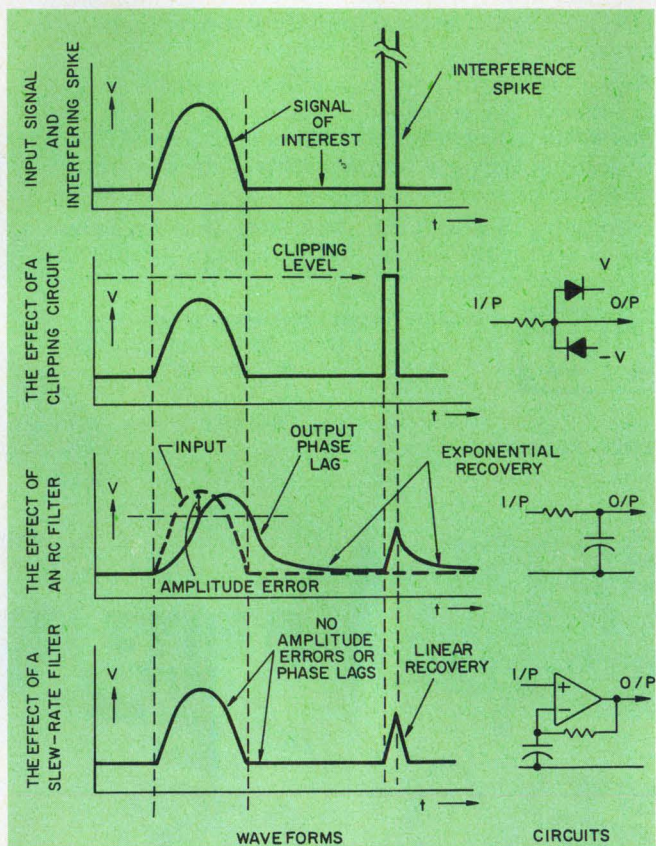

1. A slew-rate filter can pass the desired signal without phase or amplitude distortion, but it will severely attenuate sharp noise spikes.

For the rates of change ( $dV/dt$ ) in the usual control signal, the output of the op amp readily provides enough charge into  $C_1$  through  $R_1$  to closely follow the input signal. However, for signals with high steeply rising wavefronts, the op-amp output saturates and limits the output slew rate of the circuit; the maximum rate of charge is limited to  $I_c = V_{cc}/R_1$ .

When driven into such a current-limited mode, the circuit changes from a voltage follower with a gain of one to a constant-slew-rate filter. The circuit limits the output voltage's rate of change until the input signal's  $dV/dt$  falls below the circuit's slew-rate limit, and until the circuit's maximum negative slew rate can restore the capacitor voltage to correspond to the input signal.



The circuit's slew-rate (SR) capability is

$$SR = (dV/dt)_{\max} = \pm I_C / C_1 \\ = \pm V_{CC} / R_1 C_1.$$

For the components shown in Fig. 2a

$$SR = \pm 15 / (30 \times 10^3 \times 10^{-6}) \\ = \pm 500 \text{ V/s.}$$

Resistor  $R_2$  provides some decoupling between the input and output, and helps stabilize the circuit. As a rule of thumb, the ratio of  $R_1/R_2$  is made equal to 300; thus,

$$R_2 = 30 \times 10^3 / 300 = 100 \Omega.$$

In practice, set the slew rate to about twice the maximum rate of change you expect in the signal of interest. This 2:1 ratio ensures rapid circuit recovery following a disturbance.

In one application, a proportionate voltage represents the instantaneous value of current flowing in a dc traction motor. A thyristor controls the power input to the motor by alternately connecting and disconnecting the motor from the traction battery. Motor current ramps in the positive direction during the on period, and falls during the off period. The maximum rate at which the current rises or falls is given by

$$L \cdot \frac{dI_m}{dt} = \pm E,$$

where

- $I_m$  = motor current,
- $E$  = 200 V (traction battery),
- $L$  = 4 mH (motor inductance).

Therefore,

$$\frac{dI_m}{dt} = \pm 50 \times 10^3 \text{ A/s.}$$

The proportionate voltage that represent a motor current of 400 A has a maximum value of  $\pm 2$  V. Therefore, the maximum rate of signal-voltage change is

$$\frac{dV_m}{dt} = \frac{dI_m}{dt} \times \frac{2}{400} = \pm 250 \text{ V/s.}$$

Thus the values of  $R_1$  and  $C_1$  in Fig. 2a, which provide  $SR = 500$  V/s, should be able to adequately handle these motor-control signals, in accordance with the 2:1 criterion.

Small variations in the basic op-amp slew-limiting circuit can provide improved noise-pulse discrimination.

(continued on next page)

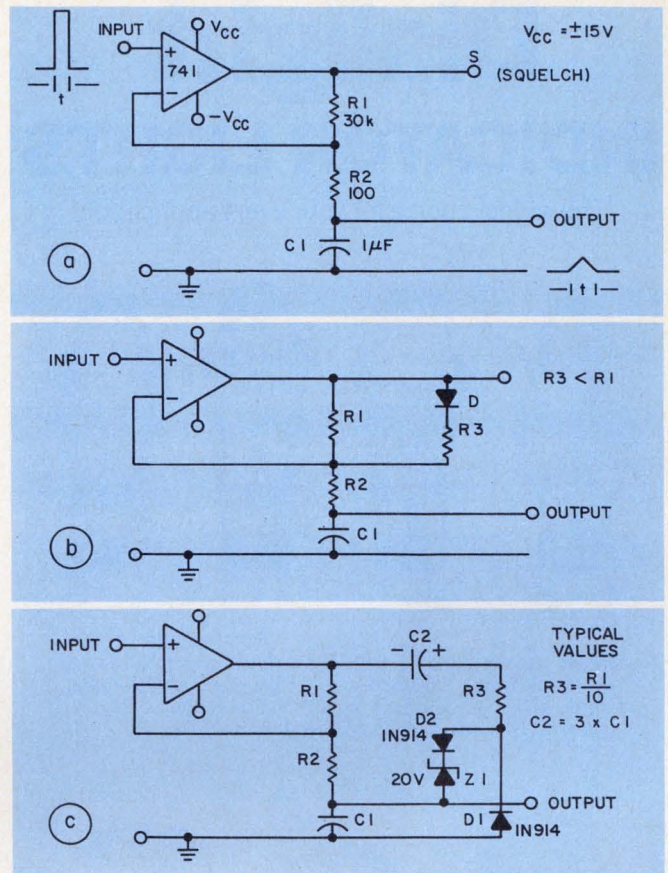

2. The basic circuit of the slew-rate filter (a) can be improved to provide increased discrimination against noise spikes for specific spike polarities (b), or with a few additional parts provide fast recovery following negative spikes or transients (c).

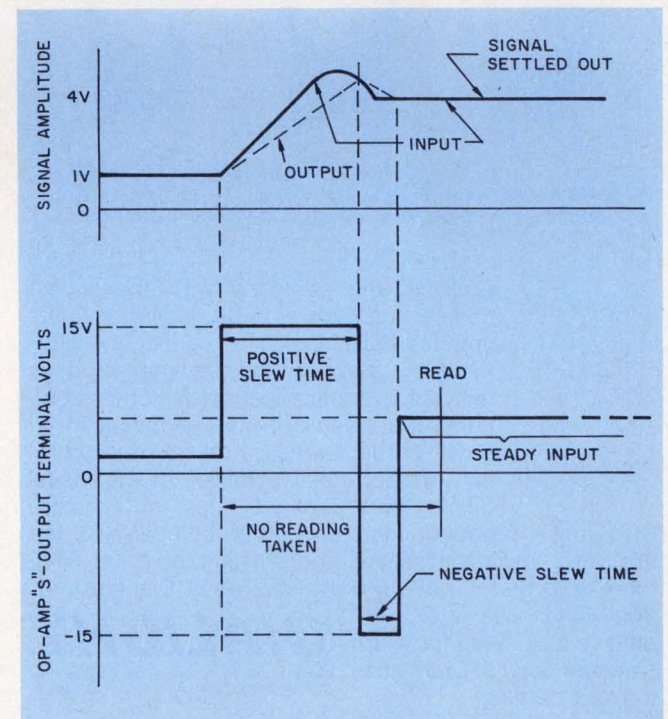

3. A squelch output can be taken from the output terminal (S in Fig. 2) of the op amp to cut off data reading when the signal's rate of change rises above a desired level.

# Dialight INDICATOR LIGHTS

The widest choice for your every application.

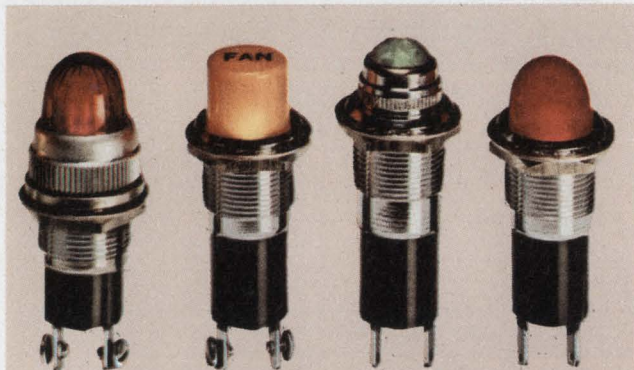

**MINIATURE INCANDESCENT OR NEON INDICATORS**—1,500,000 varieties to choose from. MIL-L-3661 and UL approved. Red, green, amber, blue, white, yellow or colorless lenses in wide range of shapes, legends, finishes. Stocked by local distributors.

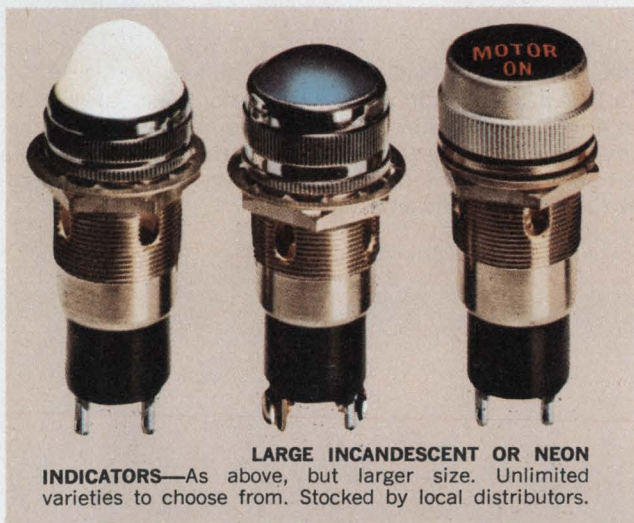

**LARGE INCANDESCENT OR NEON INDICATORS**—As above, but larger size. Unlimited varieties to choose from. Stocked by local distributors.



Dialight, the company with the widest choice in switches, LEDs, indicator lights and readouts, looks for needs . . . your needs . . . and then they develop solutions for your every application. No other company offers you one-stop shopping in all these product areas. And no other company has more experience in the visual display field. Dialight helps you do more

with these products than any other company in the business, because we are specialists that have done more with them. Talk to the specialists at Dialight first. You won't have to talk to anyone else. Send for your free new copy of Dialight's current catalog.

**DIALIGHT**

Dialight, A North American Philips Company  
203 Harrison Place, Brooklyn, N. Y. 11237  
(212) 497-7600

# See Dialight.

CIRCLE NUMBER 62

Where the interfering transients have a single known polarity, the circuit in Fig. 2b can provide different slew rates to produce more effective signal interference discrimination than the circuit in Fig. 2a. With  $R_3 < R_1$ , positive-going signals of higher rates of change can pass unaffected and negative-going spikes receive a heavier filtering action in the ratio of  $R_1/(R_3 \parallel R_1)$ . Reversal of the diode causes positive spikes to receive the heavier filtering.

Fig. 2c features normal operation for positive-going transients, but gives a very fast recovery following a negative transient. During negative transients, while the amplifier output, limited by the current  $V_{CC}/R_1$ , charges  $C_1$  negatively, capacitor  $C_2$  rapidly charges via the lower-valued  $R_3$  and diode  $D_1$  to  $V_{CC}$  (15 V). Resistor  $R_3$  is usually selected to be about  $0.1 \cdot R_1$ ;  $C_2$  is usually  $3 \cdot C_1$ .

After the input transient returns to zero, the amplifier output in series with the 15-V stored in  $C_2$  is sufficient to cause the 20-V zener to conduct and force a high current into  $C_1$  to help the circuit recover rapidly. A transient-free input signal, of course, doesn't call  $C_2$  into action.

But a word of caution: For most applications, all the circuits in Fig. 2 should be coupled to the load with a voltage-follower buffer. No more than about  $5 \mu A$  should be drawn from  $C_1$ . Also, for accurate slew-rate limiting, signal amplitudes should be small compared with the supply-rail voltages.

## There are other applications too

Applications of the circuits, other than for noise suppression, include use in high-speed data-logging and power-control systems. In high-speed data logging, the circuit can be used to prevent taking readings during signal disturbances. The normal output of the circuit (across  $C_1$  in Fig. 2) is used to limit the maximum signal-change rate that can be passed on to the measuring circuit (Fig. 3). In addition, a squelch output taken from the output terminal of the op amp (point S in Fig. 2) can be used to indicate the presence of disturbances. This squelch-control can be arranged to prevent taking readings whenever its value exceeds  $\pm 10$  V.

In power-control systems, the slew-rate filter circuit can be used to limit the rate with which power output is allowed to change. Placing the slew-rate circuit in the control-signal path ahead of the power stage introduces no delays for signals of normal rate change, unlike an RC-smoothing circuit. Signals with excessively high rates of change are automatically limited to a safe value.

The circuit in Fig. 2b is particularly suitable, since it could allow a slow increase but fast reduction of power, or vice versa. ■■

## **NOW!** SINGLE IN-LINE RESISTOR NETWORKS WITH IMPROVED PERFORMANCE

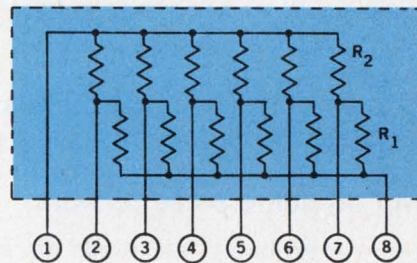
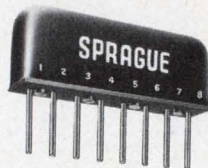
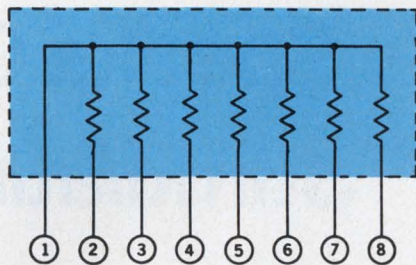

# BOARDABLE AND AFFORDABLE

### **Low Cost and High Density Configuration**

are only two of the features of Sprague Type 216C Metanet® Resistor Networks. Now, you can also enjoy the benefits of improved power dissipation, better temperature coefficient of resistance, and closer standard resistance tolerance.

**Save Board Space.** Single in-line design permits vertical installation, which allows more units to be seated in less space. This mounting style also results in improved high-frequency performance and significant in-place cost reduction.

**Better TCR.** Typical temperature coefficient of resistance is within  $\pm 200$  ppm/°C, cutting previous allowable limit almost in half.

**Up-graded Power Dissipation.** Individual terminating, pull-up/pull-down, and interface networks are capable of dissipating 250 mW per resistor at 70°C, an increase of 100% over previous designs.

**Closer Resistance Tolerance.** Standard resistance tolerance for each resistor is  $\pm 2\%$ , with other tolerances between  $\pm 1\%$  and  $\pm 5\%$  available on special order.

**Proven Product Line.** Sprague has more than fifteen years of experience in the development and manufacture of precision thick-film resistor networks, which include individual terminating, pull-up/pull-down, interface, and dual terminating designs.

For complete technical data, write for Engineering Bulletin 7041A to:  
Technical Literature Service, Sprague Electric Co.,  
347 Marshall Street, North Adams, Mass. 01247.

**THE BROAD-LINE PRODUCER OF ELECTRONIC PARTS**



**W**hen an engineer works on a job it should be a real job. The fruit of his work, if he is successful, should be brought to the marketplace.

I've spoken to many engineers who have worked in the laboratory and found that nothing ever gets to the marketplace. They can't point to something and say, "I did that." And that's the most frustrating thing in the world.

**You've got to realize that there's a bit of an engineer's personality in any product you see. An engineer wants to see his stamp on some piece of work.**

There are probably all kinds of reasons for this, but it relates to the fact that productive activity is a basic human trait. If you're a manager, you must pay attention to that.

Let me give you a personal example. My dad was a builder and I can remember riding through San Francisco with him. He would point to a house or a store and say, "I built that."

Well, I worked with my father sometimes. I had the job of assigning the location of the Westlake Market. My role was insignificant but I relate to that market, even now. There's a piece of me there.

I had similar experiences in my days as a salesman with Fairchild. I never designed any of the Apollo equipment but I did the application engineering for many parts that went into Apollo. So I identified with that program.

Our guys who design, say, the MOS LSI chips that go into a calculator feel they're part of that product. They get warm feelings whenever they see it in a shop window, whether the calculator is marketed by National or by a customer.

If a company is not committed to marketing a product, it should not get an engineer working on that product. Sure, you're going to make mistakes. X percent of the time you're going to decide later that you ought to have rejected one project in favor of another. You have to examine such things on a regular basis.

But a company basically should be prepared to follow through with what it starts. That sounds like a basic thing. Every company, you would think, wants its projects to fly. But that's not always true.

You find companies who start six projects, then kill five and select one for the market. Or you get: "We have to dabble in this in case there's something there. Competition is talking about something in this area so we had better assign a couple of guys to follow it." I think that's a bad idea.

**If you're going to get into a thing, define the technology you want to use, then assign it to a product.**

# Floyd Kvamme of Speaks On Stimulating Your Engineers

There's a good example in I<sup>2</sup>L. People started discussing integrated injection logic about two years ago. When we looked at it, we said, "Hey, that looks interesting. Maybe we ought to do something in that area." So we got some guys together and said "OK, where is its greatest chance of being competitive in the marketplace?"

We concluded that the best home for I<sup>2</sup>L was in watch circuits. It had several things going for it—on-chip drivers, very low power consumption, and smaller chips than needed with CMOS.

So we gave some guys the job of developing I<sup>2</sup>L technology and a circuit technique—applied to a watch circuit. In other words, our mission was not to explore I<sup>2</sup>L, but rather, to explore I<sup>2</sup>L watch circuits. We wanted to tie our research to a product so that, if the guys were successful, we could take something to the marketplace.

There's an interesting fallout to that I<sup>2</sup>L project. We had been building a lot of watch circuits before we developed I<sup>2</sup>L circuits. We had been very successful with CMOS. Well, our CMOS guys, recognizing the benefits of the on-chip driver, finally developed on-chip drivers in CMOS circuits. That seemed impossible a year earlier.

Now you may wonder if we're neglecting research in favor of development. That depends on your definition; the line between them becomes very fuzzy.

At the extremes it's easy to distinguish research and development. The fellow who developed the first MOS circuit was surely conducting research. And the fellow who made a minor modification of an old process was doing development. But someplace between these two, there's something hard to define.

What's really important is that you must con-

# National Semiconductor

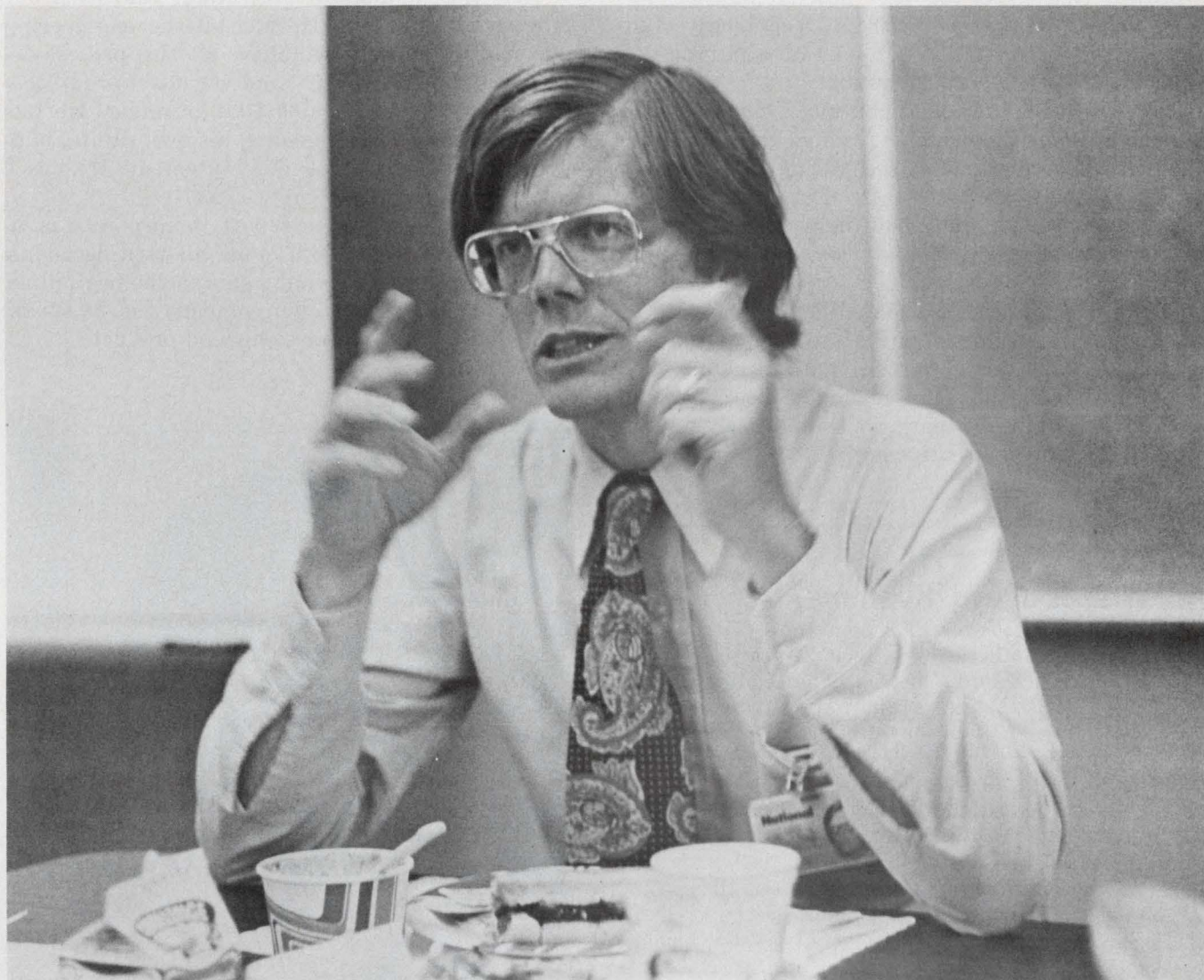

tinue to push that forefront of technology, whether you call it research or development. Pushing that forefront makes it possible to do something you couldn't do before. You can't exist in this business without that.

Now basic research is certainly necessary in many areas. But in the semiconductor field, we have not begun to tap what research has put into our hands. And we have a responsibility to tap what's already there.

I think that research for the sake of research itself can be frustrating to people who work in the real world. We want to use any technology we're using as extensively as possible. But we also want to bring something to the party. We want to add something so that next time we work

in that technology we'll have a broader base of knowledge to work with.

**You can't just be a me-too manufacturer. You may use 90 or 95% of old knowledge on a new product, but you must plumb another 5% or so of new depths. And that's exciting.**

This approach to real-product design has an added benefit. You can give useful work to the new engineer. Too often, when industry hires an engineer out of school, he's not used productively for a long time. He's given make-work projects. We turn him into a leaf-raker or gopher. You know. "Go for this, go for that." So we waste

the company's money while we demoralize the young engineer.

But with a real-product philosophy, we put a new engineer to work immediately. We can give him a project that involves perhaps 99% of existing technology, and he plumbs 1% of new territory. The more experienced engineer can take a project that looks for 40% new technology. In both cases, you start with a technology you haven't fully exploited. Yet a part of what you do should become a new contribution.

To maximize your contributions you have to remove barriers that prevent things from getting done. Engineers want to see things accomplished. They don't want to goof off all day. They want to work. It's our job to help them do that. We try to remove things that prevent their being creative.

It's unfortunate that so much of business runs on paperwork. It really bothers me when a guy needs five signatures to get something done. It's very important that the manager clear things out of the engineer's path so that he can spend most of his time in creative activity.

## Who is Floyd Kvamme?

When he took his BEE from the University of California at Berkeley in 1959, 21-year-old Floyd Kvamme had never met an engineer and didn't know what engineers did for a living. So he worked as an engineer with Electronic Systems Development Corp. in Ventura, CA before going to Syracuse. There he worked for GE (and wrote seven chapters of the GE Transistor Manual) and studied at Syracuse University, where he earned his Master's in EE in 1962.

After returning to California, he did post-Master's work in semiconductor electronics and computer design at the University of California at Los Angeles while working at Space Technology Laboratories. There he learned that military circuit design held little fascination. He had been bitten by the semiconductor bug.

So he eagerly accepted an offer from Mel Phelps of a job in custom-microcircuit marketing for Fairchild in 1964. In February, 1967 he left the position of Microcircuit Marketing Manager to join Charlie Sporeck at National Semiconductor. And in 1974 he was appointed vice-president and general manager of the Semiconductor Division.

It's a job he loves because he finds tremendous challenge in the semiconductor business. He loves the excitement of a wild new application of semiconductors, and loves the fact that there are always 20 things going on at the same time.

He's an ardent tennis player, and he skis often with his wife, Jean, and their three sons, Mark,

**There's something else you can do to stimulate your engineers; give them as much responsibility as possible.**

We do that by dividing our company into some 15 smaller businesses. The fellow in charge of each is like a president of his own company.

Take the example of Jeff Kalb, who runs our memory components. He has all the engineering and marketing responsibility, all the process-development responsibility, and he has his fabrication lines. He really runs that business. He has his own capital requirements, his own capital budget, his own profit-and-loss statement. He has a P&L center, not just a cost center.

Of course Jeff has to report to corporate management. But we let him make his own decisions. And this ties back to what I said in the beginning. By giving a man his own company, so to speak, we're putting him closer to his end product.

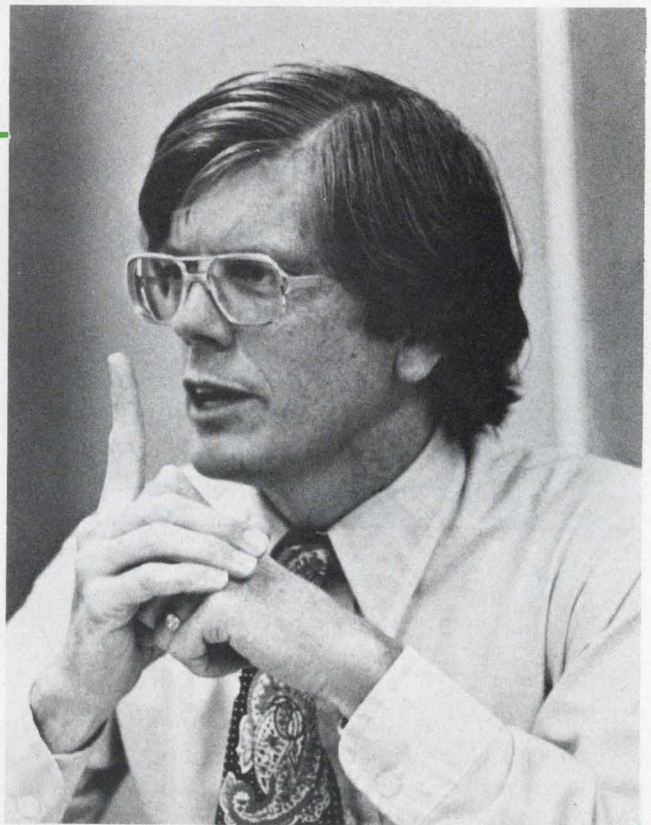

Damon and Todd. He enjoys languages, too. He once boasted that he could say "thank you" in 20 languages.

He reads a great deal, especially philosophy and history. His reading is often related to his strong belief in the bible and its messages. This belief is at the heart of his deep involvement in a small fellowship of people who believe that religion should not be merely a Sunday morning exercise. Kvamme tries to live his beliefs.

This also help us attract top people. Look at all our people who used to be presidents or senior executives of their own companies—Bob Lloyd, Dick Baeder, Marty Oudewaal—and others.

This is the reverse of what you usually find. As companies get larger in our industry, they tend to lose their entrepreneurial individuals. In our case, despite our size—and we're operating at an annual rate of about \$300 million—we're attracting entrepreneurs. We try to make the entrepreneur feel comfortable.

Of course, we do have some centralized function. We have a single advertising department, for example, and a single advertising budget. The entrepreneurs compete for the ad manager's time and budget, just as they compete for our salesmen's time.

At some point you must bring some decisions to a higher management level. A higher official would make decisions, for example, on how to apportion the advertising budget. He would decide how much to devote to discretions, to LEDs, to memories, and so on.

There are other cases where corporate people might have to step in. I had to intervene recently and tell one guy to hire more engineers and spend more money on R&D. You must make sure people invest adequately in the future.

You also have to make sure that your entrepreneurs participate in the growth of the entire corporation. It's bad to set up a situation where they don't care about other groups. You want to encourage people to make suggestions that can help other parts of the company.

**Encouraging people is important for many reasons, so you sometimes have to take special steps to get people to talk.**

We have an open-door policy because we want people to come in and tell us things like, "Hey, something ain't working." As a manager you can make extremely dumb moves if you have people who are afraid to tell you things.

But an open-door policy is easier said than done. You need sensitivity. If I see a guy walk by my office three or four times and glance at me, I must be sensitive to the fact that he may be looking for an opening. He may be nervous. He wants to say something but it's not convenient. In such a case, I've got to push myself and say, "Hey, let's have a cup of coffee." I've got to help that man open my door.

Unfortunately, people who are good at expressing themselves aren't always good listeners. It's important to learn to listen. I used to have a motto in my office that said: "Listen to learn, and learn to listen." That's a key to good management. ■■

# There's a Hoffman enclosure for almost every corrosive environment you can think of.

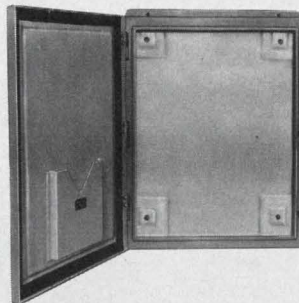

## Fiberglass enclosures

available in 12 different sizes, to house critical controls and instruments in corrosive atmospheres.

## Fiberglass junction boxes

molded to give you corrosion protection in small sizes (8 different), for use as electrical junction boxes, terminal wiring boxes, and small instrument, or electrical control housings.

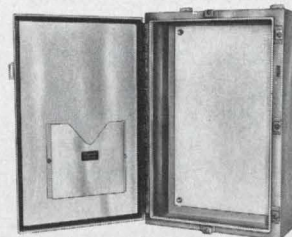

## Stainless Steel NEMA Type 4X enclosures

designed for use in corrosive environments, areas that are regularly washed down, or otherwise very wet; they're made of 14-gauge stainless, in 19 ready-to-use sizes.

## Aluminum NEMA Type 12 enclosures

designed both to combat corrosion problems and for lightweight use, 24 standard sizes also feature complete oil-tight and dust tight integrity.

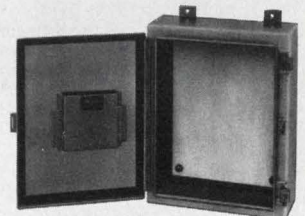

These, along with epoxy-coated and galvanized enclosures, and our Vapor Phase Corrosion Inhibitor, are just some of the corrosion-resistant components of a 1700-product Hoffman line. All are available off the shelf. Let Hoffman help solve your enclosure needs in corrosive areas.

For complete data write:

HOFFMAN ENGINEERING COMPANY  
Division of Federal Cartridge Corporation  
DEPT. ED681, ANOKA, MN 55303

**Hoffman**<sup>®</sup>  
ELECTRICAL ENCLOSURES  
CIRCLE NUMBER 64

# We deliver more bipolar PROM than:

**Texas Instruments  
Intel  
Fairchild  
National  
and Motorola,  
all put together!**

That makes us No. 1 in bipolar PROM and then some. We got there by having the most reliable PROMs, the best selection, a complete line of mil. temp. devices, the fastest access times, the best delivery, and the best prices. Look at our product line. See if we shouldn't be your PROM supplier.

For more information call,  
TWX or write:

**United States**  
Monolithic Memories, Inc.  
1165 East Arques Avenue  
Sunnyvale, CA 94086  
Tel: (408) 739-3535  
TWX: 910-339-9229

**Europe**  
Monolithic Memories, GmbH  
8000 Munich 80  
Mauerkircherstr. 4  
West Germany  
Tel: (089) 982601, 02, 03, 04  
Telex: (841) 524385

**Far East**  
MMI Japan, K.K.  
2-2, Sendagaya 4-chome,  
Shibuya-ku,  
Tokyo 151, Japan  
Tel: (03) 403-9061  
Telex: J26364

## MONOLITHIC MEMORIES PROMS

MEMORY SIZE	ORGANIZATION	DEVICE	OUTPUTS	PINS	OPERATING RANGE	MAX* ACCESS TIME (ns)	100-999 PRICE
256	32 x 8	6330/1-1	OC/TS	16	com	50	\$ 2.55
		5330/1-1	OC/TS	16	mil	60	5.00
1024	256 x 4	10149	OE	16	com	30	17.50
1024	256 x 4	6300/1-1	OC/TS	16	com	55	3.25
		5300/1-1	OC/TS	16	mil	75	7.90
2048	256 x 8	**6308/9-1	OC/TS	20	com	65	15.95
		**5308/9-1	OC/TS	20	mil	85	33.50
2048	512 x 4	6305/6-1	OC/TS	16	com	60	7.00
		5305/6-1	OC/TS	16	mil	75	15.95
4096	512 x 8	**6348/9-1	OC/TS	20	com	65	15.95
		**5348/9-1	OC/TS	20	mil	85	33.50
4096	512 x 8	6340/1-1	OC/TS	24	com	90	15.95
		5340/1-1	OC/TS	24	mil	120	33.50
4096	1024 x 4	6350/1-1	OC/TS	18	com	60	15.95
		5350/1-1	OC/TS	18	mil	75	33.50
4096	1024 x 4	6352/3-1	OC/TS	18	com	60	15.95
		5352/3-1	OC/TS	18	mil	75	33.50
8192	1024 x 8	**6386/7-1	OC/TS	22	com	90	Consult Factory
		**5386/7-1	OC/TS	22	mil	125	Consult Factory
8192	1024 x 8	**6380/1-1	OC/TS	24	com	90	Consult Factory
		**5380/1-1	OC/TS	24	mil	125	Consult Factory

\*max access time is guaranteed over the complete voltage and temperature variation.  
\*\*available October 1976.

# Monolithic Memories

CIRCLE NUMBER 65



# Introducing Model 9300

## Quality that's Quick & Quiet

Model 9300 Vacuum Column digital tape transport has characteristics common to all Kennedy recorders — and a few new ones. It's quick (125ips); quiet (noise level of less than 70db), and it has the built-in quality of all Kennedy products.

Utilizing side-by-side vacuum columns and a capacitive tape-location detector for improved tape life; air bearings and Tribaloy coated read-after-write heads to reduce tape wear and improve data integrity, Model 9300 is ideal for minicomputer and data collection applications requiring complete reliability at high tape speeds.

Model 9300 comes complete with all the operational features of the 9000 Series. Performance is guaranteed by crystal controlled timing, read threshold scanning, our

read-after-write shortened skew gage and other exclusive Kennedy features. Operation is simplified by such operator-oriented features as a front-accessible test panel, quick-release hubs and simplified tape loading.

Model 9300 has a standard tape speed of 125ips, with data densities of 200/556cpi or 556/800 on the 7-track unit and 800cpi, 1600cpi or 800/1600cpi on the 9-track transport. The format is NRZI/PE.

Model 9300 is not only quick and quiet — it's very competitive. That's quite a lot, considering the Kennedy quality.

**KENNEDY CO.**

540 W. WOODBURY RD., ALTADENA, CALIF. 91001  
(213) 798-0953



**KENNEDY · QUALITY · COUNT ON IT**

## Age reference zeners to achieve stable long-term performance

Compensated zener diodes having voltage temperature coefficients (TC) better than 50 ppm/°C and voltage time stabilities better than 500 ppm/1000 h are classified as voltage-reference diodes. But commercially available very stable reference diodes (2 ppm/°C and 10 ppm/1000 h) are expensive.

A measuring and aging technique makes it possible to improve both the TC and the voltage-time stability of standard low-performance reference zeners and achieve TCs as low as 2 ppm/°C and long-term stabilities of about 20 ppm/1000 h. Thus a \$40 precision reference zener may be replaced by a \$1.35 diode and about \$1.40 worth of testing.

A curve typical of the change in temperature coefficient with respect to operating current ( $I_z$ ) is shown in Fig. 1. From the curve, it is apparent that the TC can be either negative or positive, and that at a particular bias current, the TC passes through the zero value.

The data for a graph like Fig. 1 may be generated by operating a diode at several bias currents and a given temperature, say 25 C, and recording the diode voltage at each current. Then, if you raise the temperature a given amount, say 10 C, the voltage changes for the same bias currents are obtained as follows:

$$\Delta V/^\circ\text{C} = \frac{V_{35\text{C}} - V_{25\text{C}}}{10\text{C}} \quad (\text{at a given } I_z)$$

Straight-line approximations may be made for interpolating between currents.

From the plot, determine the bias current of the zero-TC point of the diode. To age the diode, bias it at this current and place it in an oven at an elevated temperature of about 70 C.

Fig. 2 is a plot of the accelerated aging characteristic of a typical zener diode. The zener diode was placed in an oven at  $70 \pm 1$  C for seven weeks. Once each week the diode was allowed to cool to room temperature ( $25 \pm 0.1$  C) and its voltage measured at the previously established "zero-TC" current.

Fig. 2 shows that most of the voltage drift takes place during the first 168 h (1 week). If a baseline is drawn starting after the first 168 h (heavy line), the excursions of  $\Delta V$  are seen to

be much smaller than the initial change. Another baseline drawn starting after 336 h (dotted line) shows an improvement that is not nearly as pronounced as the initial change.

In general, aging the diode for 1 week results in about 2-to-1 improvement in voltage drift with time. After aging, operation of the diode at or near its zero-TC point can provide a 10:1 improvement over operation elsewhere.

*Kenneth E. Panck, Electrical Design Engineer, Lab Instrument Div., Tektronix Inc., P.O. Box 500, MS 39-135, Beaverton, OR 97077.*

CIRCLE No. 311

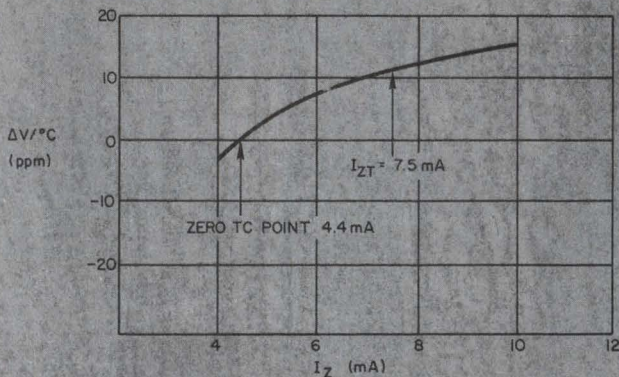

1. A plot of  $\Delta V$  vs  $I_z$  for a standard zener diode shows that the TC value goes through zero at a particular bias current. Operation at this point is recommended when using the diode as a reference.

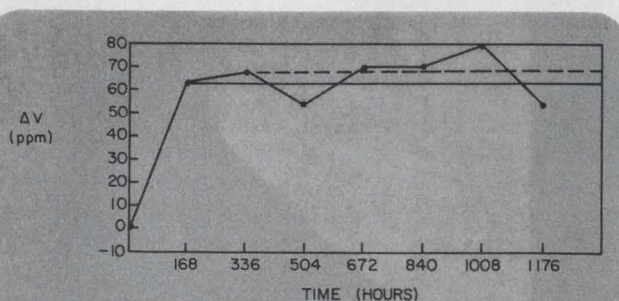

2. A plot of a zener diode's aging characteristics demonstrates improved voltage drift after 1 week of accelerated aging.

# The only **FET-VOLT-OHMMETER** that is drop-proof...burnout proof...the new **Super Safe Triplett Model 64.**

The Triplett Model 64 FET-Volt-Ohmmeter is brand new and ready for safe fast in-circuit resistance and continuity testing of diodes, IC's or transistors. Six LP  $\Omega$ ™ ranges have only 90mV open circuit voltage that won't bias or destroy sensitive circuitry. And, no other FET can match these exclusive features:

1. **Drop-Proof...Burnout-proof...Super Safe** solid state Volt-Ohmmeter.
2. **Low-Power Ohms—LP  $\Omega$ ™**—6 ranges with 90mV power source for in-circuit measurements plus junction test circuit.
3. **Exclusive Triplett MicroPower—TMP™** permits continuous operation with carbon battery life in excess of one year.

Designed for tough use in labs, QC or inspection departments, field servicing and vocational or trade schools, the new Model 64 easily withstands 90% of costly misuses of VOM's.

Call your Triplett distributor for a demonstration.

## only **\$130**

**TTT** **TRIPLETT**  
BLUFFTON, OHIO 45817  
WESCON BOOTH #604-606

### RANGES

#### 8 DC Volts

0-0.3-1-3-10-30-  
100-300-1000 11.12  
Megohm input  
resistance

#### 8 AC VOLTS

0-0.3-1-3-10-30-100-300-  
1000 10 Megohm input  
impedance.

#### 7 OHMS

Low Power (LP  $\Omega$ ™)

0-1k-10k-100k-1M $\Omega$ -10M $\Omega$ -  
100 M $\Omega$ , Conventional  
(HP  $\Omega$ ) 0-1000M  $\Omega$

#### JUNCTION TEST

Short-germanium-silicon-open

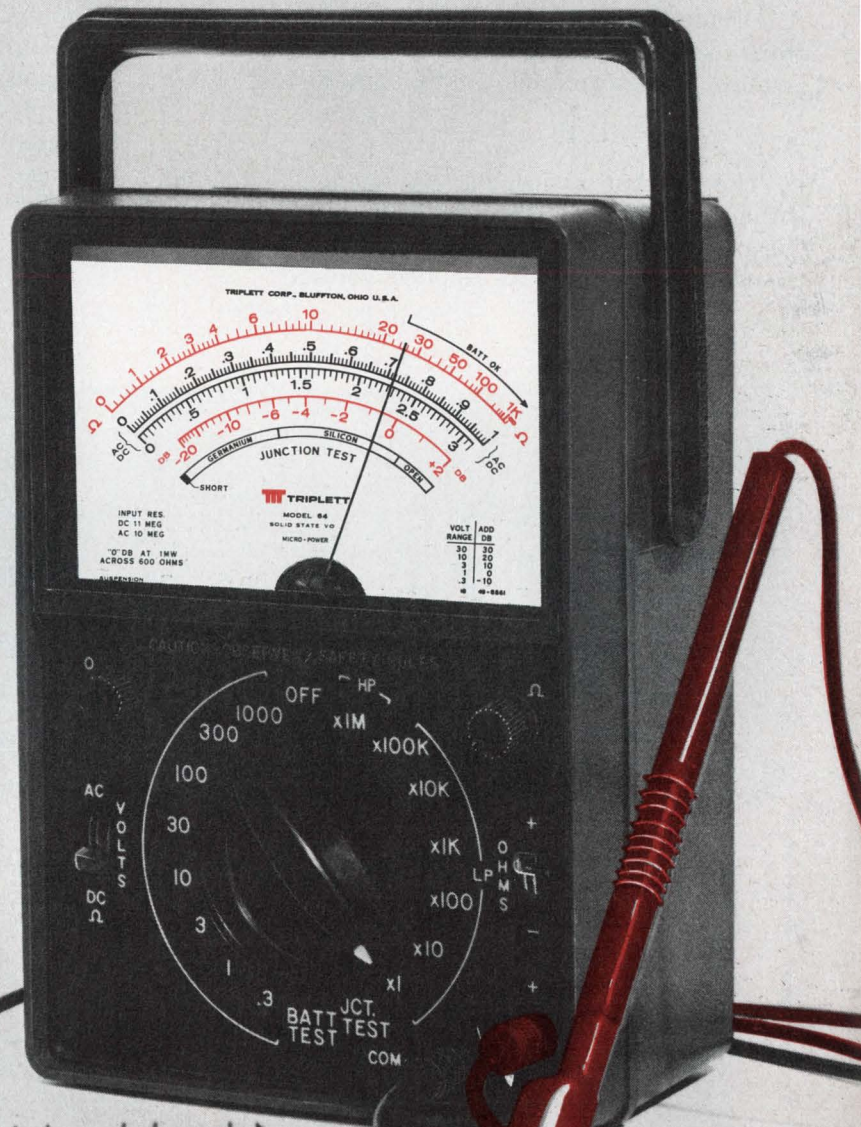

*Super-Safe*

**Triplett. The easy readers.**

# Handle 100-V analog signals with 10-V ICs by using a divide/multiply technique

Linear-IC building blocks that are low in cost, reliable and small usually can't handle linear voltage swings greater than  $\pm 10$  V.

However, a simple level-changing technique allows the handling of high signal levels to 145 V (Fig. 1) with such readily available 10-V ICs as multiplexers, op amps, multiplying digital-to-analog converters, analog multipliers and solid-state switches.

The method employs a precision divide-by-ten amplifier followed by a precision multiply-by-ten amplifier at the system's input and output, respectively. The signal processing is performed between these amplifiers at 10-V levels.

Divide-down and multiply-up precision resistors used in the amplifiers have the same ohmic values, as determined by the equation

$$\frac{e_{IN}}{e_1} = 10 = \frac{e_o}{e_2} = \left(1 + \frac{R_1}{R_2}\right).$$

The resistor ratios may be changed to handle other signal levels. Resistor  $R_1$  must be physically large to avoid internal self-heating, and hence, resistance change with applied voltage.

Performance achieved with  $e_1$  connected directly to  $e_2$  includes a bandwidth of over 1 MHz, a dc gain error of less than 0.01%, a zero-error offset adjustable to closer than  $\pm 200 \mu\text{V}$  and temperature coefficient of less than  $\pm 150 \mu\text{V}/10^\circ\text{C}$ .

The output of the system uses a 15-mA,  $\pm 100$ -V output op amp. The modified Burr-Brown BB 3582, for example, together with its feedback network, provides a precise gain of 10. The amplifier is compensated for optimum gain-bandwidth product at a gain of 10 with an external RC network to shape its open-loop gain-vs-frequency characteristics. The BB 3582 also includes thermal protection and current limiting and is housed in a TO-3 case.

Unfortunately, the divide/multiply system's signal-to-noise ratio is poorer than in a system employing only 100-V signal levels. Although the signal is attenuated by the input-divider circuit, noise and dc drift are not.

Ronald W. Embley, Staff Engineer, Electronic Associates, Inc., West Long Branch, NJ 07764.

CIRCLE No. 312

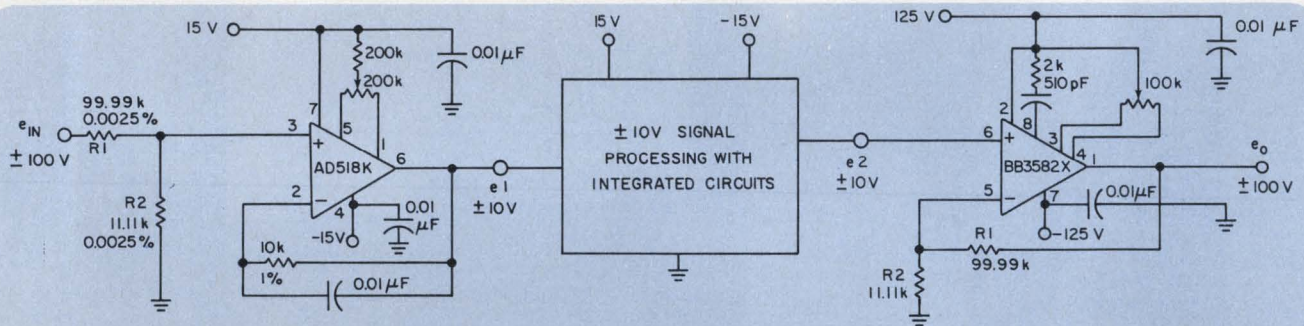

1. A precise divide-by-10 followed by a matching multiply-by-10 op amp allows the use of readily

available 10-V processing ICs to handle input signals of 100 V.

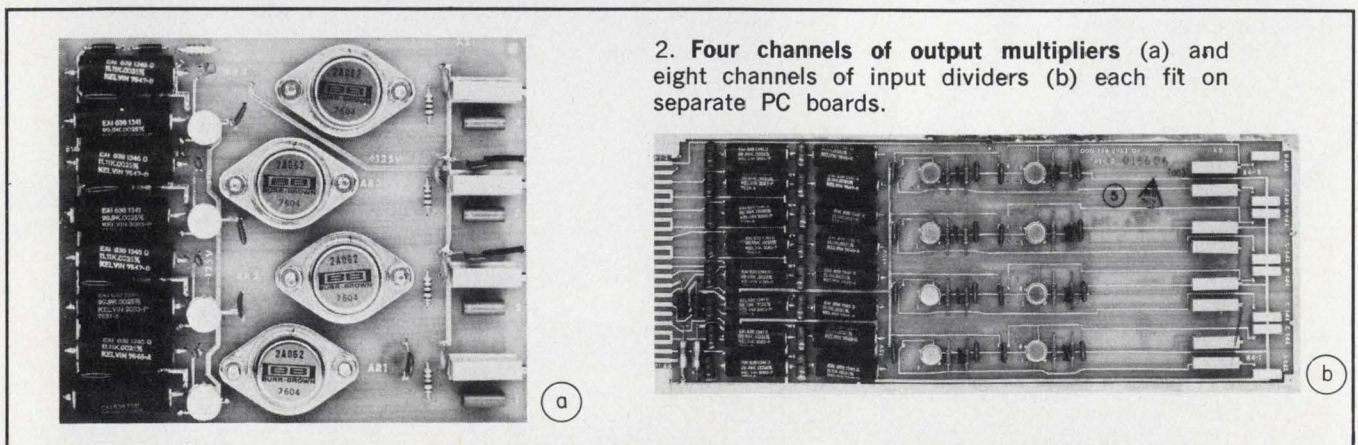

2. Four channels of output multipliers (a) and eight channels of input dividers (b) each fit on separate PC boards.

# PMI's Universal DAC.

**The stuff  
dreams are  
made of.**

The DAC-08 is more than the world's fastest monolithic DAC (settling in 85 nsec. typ.); it is a true current output device . . . a *digitally controlled current source*. And it features true 8-bit accuracy:  $\frac{1}{2}$ LSB max. over temp.

It can deliver wide output voltage swings without loss of linearity, since its impedance approaches infinity.

The DAC-08 is universal in its applications because its logic threshold is universal. It accepts TTL, CMOS, P- and N-MOS—any digital input. It's right at home in  $\mu$ P designs. And if you're interested in 4-quadrant multiplication, you'll want to know that you can do it with only two DAC-08's.

## Free Sample

If you just want the data sheet, circle the number below. But if you would like to run some tests on a DAC-08, write us on your letterhead and tell us what your application is. We'll get a sample to you fast, along with appropriate Application Notes.



Precision Monolithics, Inc.  
1500 Space Park Drive,  
Santa Clara, CA 95050  
(408) 246-9222, TWX: 910-338-0528  
Cable MONO.

CIRCLE NUMBER 68

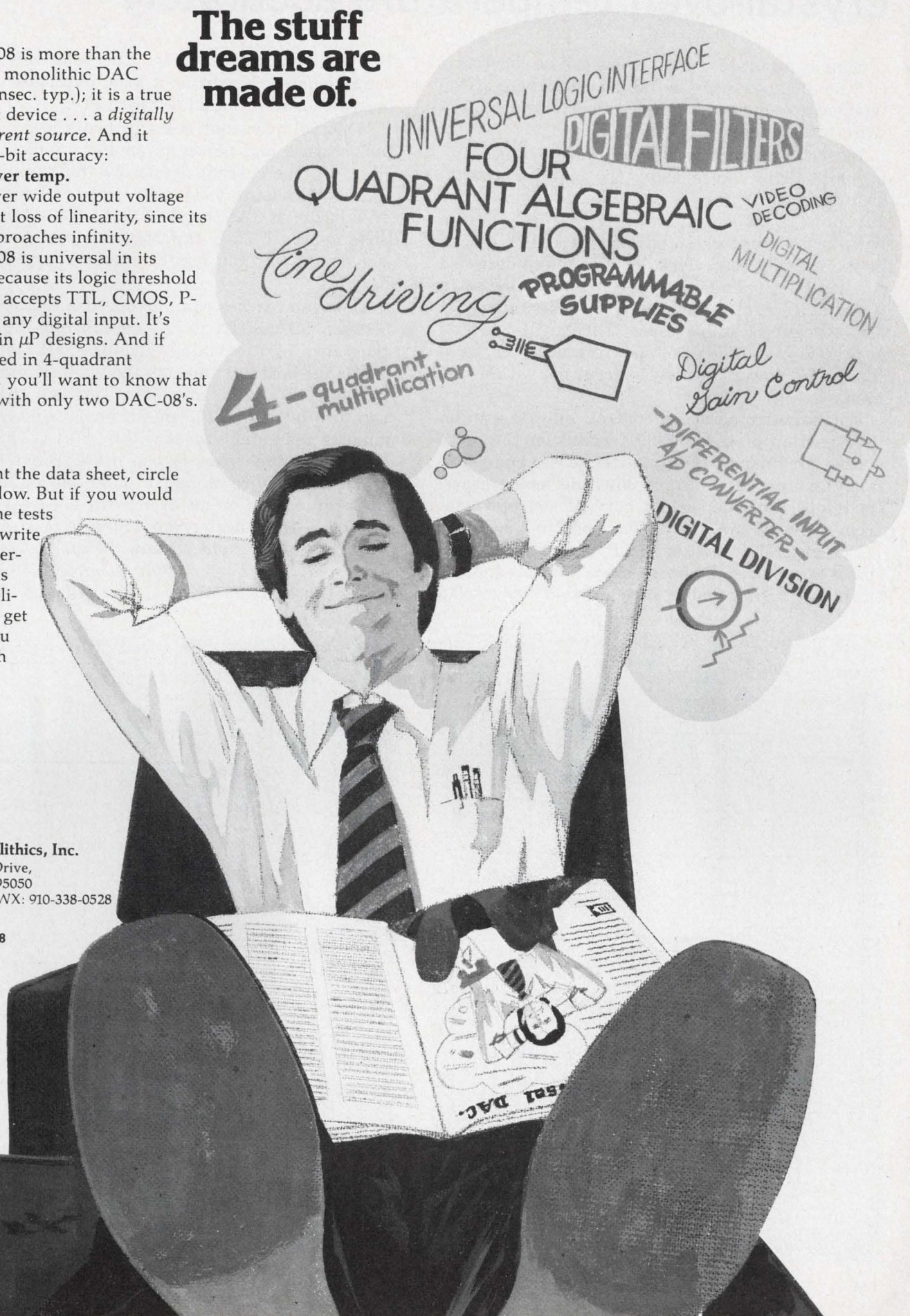

UNIVERSAL LOGIC INTERFACE  
DIGITAL FILTERS  
FOUR QUADRANT ALGEBRAIC FUNCTIONS  
VIDEO DECODING  
DIGITAL MULTIPLICATION  
PROGRAMMABLE SUPPLIES  
Digital Gain Control  
DIFFERENTIAL INPUT A/D CONVERTER  
DIGITAL DIVISION  
4-quadrant multiplication  
line driving

# Use an IC voltage reference to control crystal-oven temperature accurately

Simple, accurate crystal ovens can be constructed very inexpensively by taking advantage of the temperature-dependent characteristics of a forward-biased silicon junction.

Discrete transistors can be used to sense and regulate temperature using the drift of a transistor-junction's  $V_{BE}-I_C$  curve with temperature (about 2.2 mV/°C). However, an IC with a built-in temperature stabilizer, the LM399H, can be more easily used. This device, though designed for use as a voltage reference, can be altered to sense and regulate an external temperature. It also contains a stable zener that can be used as a precise noise-free voltage reference, or as a source to power low-level circuitry within the oven.

For oven-temperature control, only the stabilizer portion of the LM399H precision reference is used. Ordinarily, the stabilizer senses and maintains an internal constant 85-C die temperature. Its temperature-dependent current source varies from about 20 mA at 25 C to 1 or 2 mA at 85 C.

For crystal-oven use, the IC's plastic thermal shield is removed, and the device is firmly mounted to a heat sink that is attached to a copper-clad

PC board within the oven. The relatively large copper surface serves as a good averager of the oven's over-all internal temperature.

When all oven-control components are at room temperature and power is applied to the circuit (Fig. 1), the current drawn by the stabilizer is sufficient to saturate  $Q_1$  and apply full power to oven heater  $R_1$ . As the oven and LM399H temperatures approach 85 C (approximately), the stabilizer draws less and less current through  $Q_1$  and  $R_1$ .

The oven reaches equilibrium at a temperature between 82 and 84 C. At equilibrium the heat generated by combining stabilizer,  $R_1$ , and  $Q_1$  equals the heat lost through the walls of the oven. Between 12 and 15 min after turn-on, the temperature is within 1% of its final value. A few minutes more stabilizes it within  $\pm 0.1$  C (Fig. 2).

In a prototype oven,  $R_1$  was made from a length of nichrome wire wound around the outside of the oven core. For an oven with a core volume of 3 in<sup>3</sup>, a 10-W heater was found to be sufficient.

*Forrest Sass and Brent Welling, National Semiconductor Corp., 2900 Semiconductor Dr., Santa Clara, CA 95051.* CIRCLE NO. 313

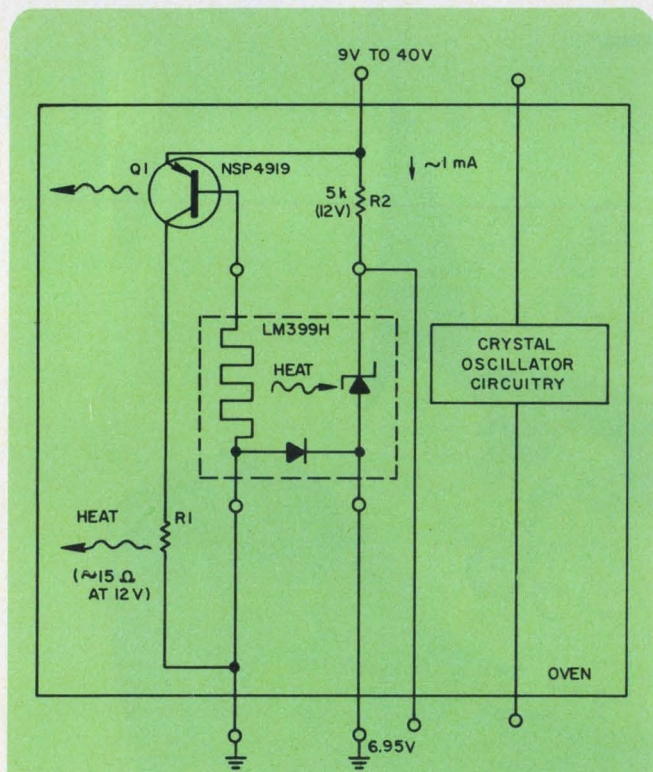

1. An IC can sense temperature and regulate the current in a heater resistor to maintain the temperature of a crystal oven within  $\pm 0.1\%$  at some temperature between 82 and 84 C.

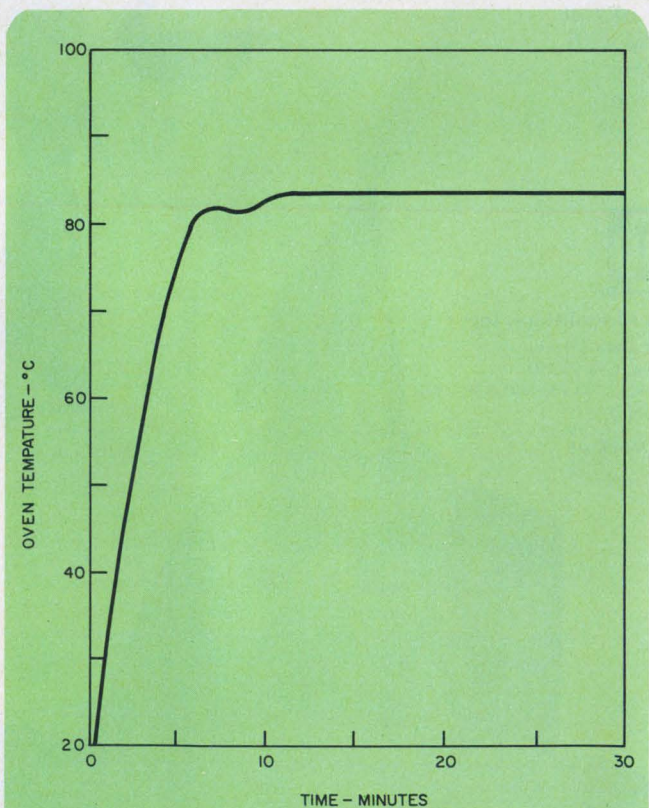

2. In 10 to 15 minutes after turn-on, the temperature reaches about 1% of its final value.

# ONLY VISHAY GIVES YOU ALL SIX TOP SPECS IN RESISTOR PRECISION.

## TCR

No other precision resistor comes even close to our  $0 \pm 1 \text{ ppm} / ^\circ\text{C}$  throughout the temperature range  $0^\circ\text{C}$  to  $+60^\circ\text{C}$ .

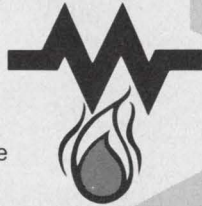

## HIGH-FREQUENCY CAPABILITY

Our Bulk Metal<sup>®</sup> resistive elements are inherently non-inductive, with rise and settling times as low as 1 nsec (no ringing)—necessary characteristics in pulsed-data and high-frequency applications.

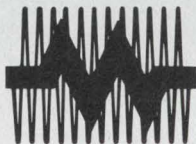

## STABILITY

After documented 10,000-hr load-life testing, our new S444 mil-spec resistor showed  $\Delta R$ 's of no more than 0.02% (200 ppm).

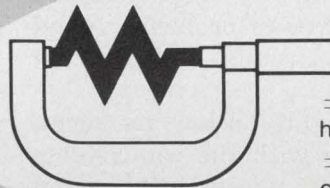

## TOLERANCE

$\pm .01\%$  is easy, and our hermetics even go to  $\pm .001\%$ . While wirewounds can trim this tight too, can your circuits tolerate their inductance, ringing, and higher TCR?

## TC TRACKING

So close that all the resistors we've ever made will still track each other within  $3 \text{ ppm} / ^\circ\text{C}$ , and we can also match and track resistors to within  $1/2 \text{ ppm} / ^\circ\text{C}$ , regardless of resistance value and tolerance—good to know for ladder networks and bridge circuits.

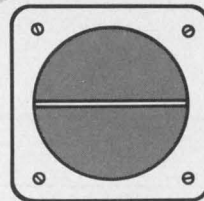

## NO NOISE

—at least none that can be detected by the best noise-measuring equipment on the market ( $-40\text{dB}$  low-end resolution).

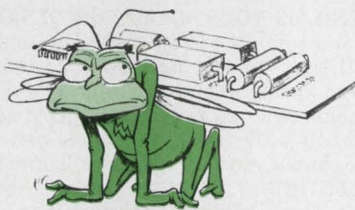

**GET THAT BUG  
OUT OF YOUR EQUIPMENT**

Learn to make custom precision resistors in your prototype design lab, or even for production in your plant. Call or write for information on our popular training program. Vishay Resistive Systems Group, 63 Lincoln Highway, Malvern, PA 19355; phone (215) 644-1300; TWX 510-688-8944.



# Build a voltage-controlled oscillator with only one TTL-inverter package

A low-cost (about \$15 for parts) voltage-controlled crystal oscillator (VCXO) can be built with only one TTL inverter logic package. Although not highly linear or extremely stable, the configuration is easily adapted to many applications, including phase-lock loops.

Three inverters ( $G_1$ ,  $G_2$  and  $G_3$ ) connected in a series loop form an unstable logic configuration that ensures oscillator start-up; the small-signal ac gain of a TTL gate is greater than one in the frequency range of interest. The consistency of this circuit's start-up characteristics contrasts strongly with start-up problems found in many other oscillator circuits built around TTL gates and inverters.

The crystal operates slightly below its series resonance, which, together with the components in the loop, provides a  $360^\circ$  phase shift around the loop. An input control voltage of 0 to 5 V can vary the capacitances of the varactors,  $CR_1$  and  $CR_2$ , to provide a small frequency change.

The values of  $R_1$  and  $R_2$  and the capacitances of  $CR_1$  and  $CR_2$  are not critical. They are selected so that the circuit oscillates at between 70 and 90% of the crystal frequency, without the crystal in place. Setting the "natural" frequency of the circuit in this manner prevents spurious operation of the oscillator at its higher harmonics.

The usable center-frequency range of the VCXO, is approximately 1 to 20 MHz. Of course, the frequency depends on the crystal and the type of TTL inverter used. A low-power 54L04 is useful for 1-to-2-MHz operation; a standard 5404 can cover 2 to 6 MHz; a high-speed unit, such as the 54H04 or 54S04, is required for higher frequencies.

A useful amount of frequency control can be achieved within the TTL-supply range of 0 to +5 V. Actual test results at 25 C for a 6-MHz crystal using a 54S04 TTL inverter and 1N54-63A varactors provided the following results:

Control Voltage	Frequency
0 V	5,993,810 Hz
1	5,999,508
2	5,999,591
3	5,999,620
4	5,999,652
5	5,999,667

*J. E. Buchanan, Westinghouse Electric Corp., Defense & Electronics Systems Center, Friendship International Airport, P.O. Box 746, Baltimore, MD 21203.*

CIRCLE NO. 314

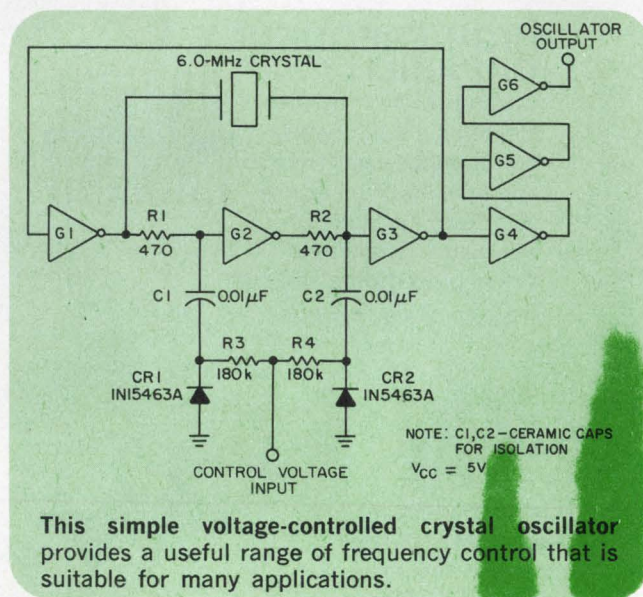

## IFD Winner of May 10, 1976

**Gordon L. Wong**, Project Engineer, Data Tech, Div. of Penril Corp., 2700 S. Fairview Ave., Santa Ana, CA 92704. His idea "CMOS Analog Switches Can Precisely Control An Op Amp's Gain" has been voted the Most Valuable of Issue Award.

**Vote for the Best Idea in this issue** by circling the number for your selection on the Reader Service Card at the back of this issue.

**SEND US YOUR IDEAS FOR DESIGN.** You may win a grand total of \$1050 (cash)! Here's how. Submit your IFD describing a new or important circuit or design technique, the clever use of a new component or test equipment, packaging tips, cost-saving ideas to our Ideas for Design editor. Ideas can only be considered for publication if they are submitted exclusively to ELECTRONIC DESIGN. You will receive \$20 for each published idea, \$30 more if it is voted best of issue by our readers. The best-of-issue winners become eligible for the Idea of the Year award of \$1000.



# To be precise about it, you need a wide choice of ultra precision resistors.



#### MAR Non-inductive Metal Film

Resistance range 20-1 meg $\Omega$  in 4 molded, axial lead sizes. All the advantages of evaporated metal film resistors with precision tolerances to .01% and temperature coefficients to 5 PPM/ $^{\circ}$ C.

The inherent low inductance and low capacitance of this design make it ideally suited to high-speed applications requiring a high degree of stability.



#### AR-90 High Range

Designed to satisfy critical design requirements where resistance values between 1 meg $\Omega$  and 10 meg $\Omega$  are required. Temperature coefficients to 5 PPM/ $^{\circ}$ C and tolerances to .05% are standard.

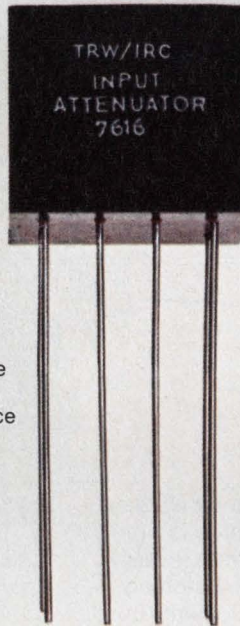

#### AR Resistor Networks

Provide the best performance and maximum flexibility where multiple, interdependent resistors are required. Resistance ranges from 20 $\Omega$  to 10 meg $\Omega$ . TC and tolerance matching to  $\pm 1$  PPM/ $^{\circ}$ C and  $\pm .01\%$  respectively.



#### AR-40 Metal Film

Designed to satisfy critical design requirements where minimum T.C., stability and absolute accuracy are needed. Temperature coefficients as low as  $\pm 1$  PPM/ $^{\circ}$ C and purchase tolerances to .01% are standard.



#### TaFilm Resistor Networks

These feature inherent passivation, ratio tolerances to .05% and TCR tracking to 3ppm. Standard packages are DIP sandwich from 4 pins to 20 pins and flatpack from 10 to 24 pins. Standard products include R-2R ladders in both package types, in R values from 2K $\Omega$  to 50K $\Omega$  and resolution from 8 Bits to 12 Bits. Other standard and custom networks also available.

For more technical information on these products call 319-754-8491. Or, for the broadest choice in resistors for all types of applications, write or call TRW/IRC Resistors, an Electronic Components Division of TRW Inc., 401 N. Broad St., Phila., Pa. 19108. Tel. 215-922-8900.

**TRW** IRC RESISTORS  
ANOTHER PRODUCT OF A COMPANY CALLED TRW

CIRCLE NUMBER 70

# We've improved our Mini-Mag magnetic circuit breakers.

## Broader line. Improved design. Easier to order. And more available.

New code designations,  
easy to understand  
and use in specifying  
and ordering.

New broader line of  
standard models.

New positive latching  
mechanism, greater  
repeatability, more  
positive feeling  
toggle action.

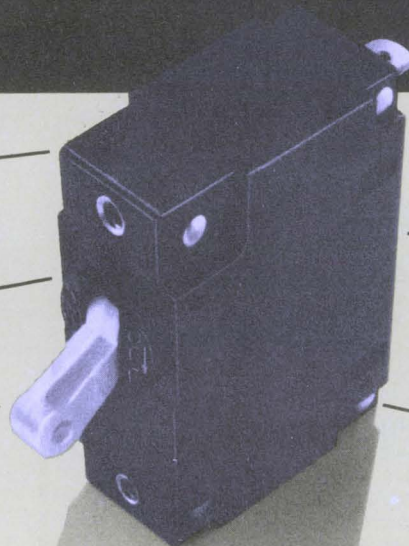

Stocked nationally by  
leading electronic  
parts distributors.

Completely  
interchangeable,  
electrically and  
physically, with  
industry models.

Mini-Mag yesterday and Mini-Mag today look alike outside. We wouldn't want to change that. Inside is where the big difference is; design changes provide greater dependability and improved performance. Latching, repeatability and toggle action have all been improved for reliable, low cost circuit protection.

And, don't overlook the intriguing possibilities for protecting semiconductor devices. Mini-Mag circuit breakers may be used to protect solid-state switches such as SCRs, triacs, power diodes, power transistors, and solid state relays. Circuit clearing time is as fast as 10 milliseconds.

Did we say the Mini-Mag is more available? You bet! One hundred authorized distributors stock Wood Electric Mini-Mag circuit breakers nationally. Sound good? Works out even better when you set up a local stocking program for delivery of exactly what

you need on a pre-arranged schedule.

Mini-Mag circuit breakers, UL and CSA Recognized, can now be specified in 330 standard distributor stock models, thousands more when you order direct from the factory.

Best of all, our new code designators give you an easier-to-use, more error free part numbering system for specifying and ordering improved Mini-Mag circuit breakers.

Contact your Potter & Brumfield sales representative, or call or write Potter & Brumfield Division AMF, Incorporated, Princeton, Indiana 47671. 812 385 5251.

*European address: Electrical Products Group,  
AMF International Limited, AMF House, Whitby Road,  
Bristol BS4 4AZ, England. Telephone: (0272) 778383,  
Telex: 449481, AMMAFOCO, BRISTL.*

**AMF**

**Potter & Brumfield**

CIRCLE NUMBER 71

# New Products

## Microprocessor analyzer rearranges captured data into unusual displays

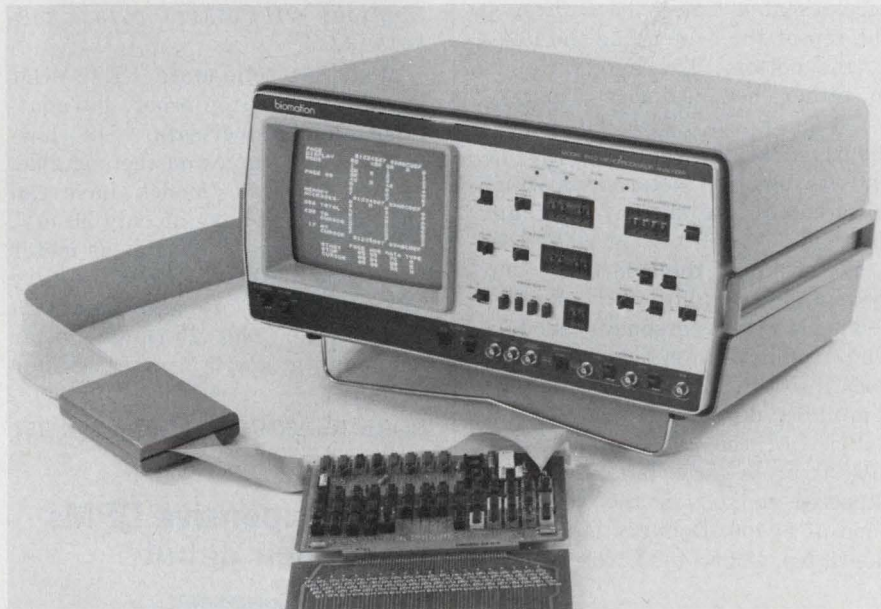

Biomation Corp., 10411 Bubb Rd., Cupertino, CA 95014. (408) 255-9500. See text.

Biomation's 168-D  $\mu$ P analyzer is the first to rearrange captured memory transactions into various display formats. The unit digests up to 256 memory accesses, beginning and ending with specified start and stop events, then spits the information out on its CRT in one of four possible arrangements.

Two of the formats can be termed memory maps, and the other two called time listings (see display photos at upper right). With a moveable cursor and the panel controls, you can transfer one display to another and examine any desired data.

In the top photo, showing the Memory Display Mode, four blocks form the data field of the CRT, with each block composed of an  $8 \times 8$  hexadecimal matrix. This mode shows the "big" picture of system activity—that is, in memory mode, the most significant eight

bits (pages) of a 16-bit address word are mapped on the CRT field.

In the top photo, asterisks show that pages  $\phi 3$  and  $\phi C$  were accessed. Alphanumeric readouts indicate that a total of 256 accesses were recorded, and that the blinking cursor (the line under  $\phi C$ ) is positioned at memory location 239. The notation, "215 AT CURSOR," indicates that 215 accesses on page  $\phi C$  were recorded.

You can look at all 215 accesses by decrementing the cursor position. Other readouts show the start and stop events and the information at the cursor position.

In the second display mode, the Page Mode (center photo), you can take a more detailed look at the recorded data. The cursor position remains constant when you switch from one mode to the next, so that you look at the same access from mode to mode.

In the Page Mode, the data field maps the least significant eight bits of the address. Select which

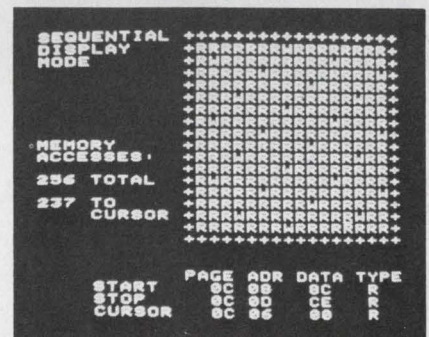
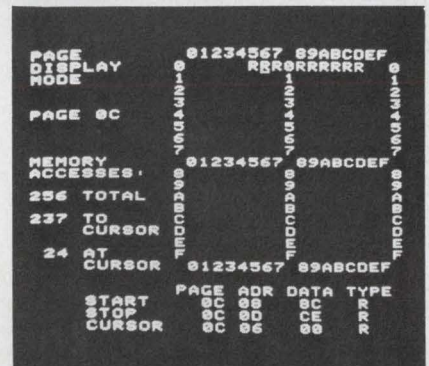
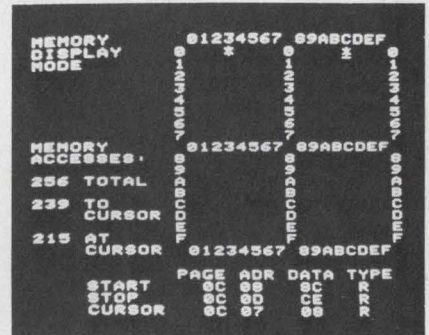

page you want to view, and all addresses associated with that page are mapped.

Thus, in the center photo, page  $\phi C$  was selected, the cursor is at address  $\phi 6$ , and 24 accesses occurred at  $\phi C \phi 6$ . The cursor displays the data at the 24th access. To look at others, you just decrement the cursor.

The bottom photo shows the

(continued on page 130)

# RF power

We've made the most of it...  
You can, too!!

All wrapped up in a neat little package, our Model 510L is an ultra-wideband RF power amplifier whose wide range of frequency coverage and power output provide the user with the ultimate in flexibility and versatility in a laboratory instrument. Easily mated with any signal generator, this completely solid state unit amplifies AM, FM, SSB, TV, pulse and other complex modulations with a minimum of distortion.

Constant forward power is continuously available regardless of the output load impedance match making the 510L ideal for driving highly reactive loads.

Unconditional stability and instantaneous fail-safe provisions in the unit provide absolute protection from damage due to transients and overloads.

This outstanding unit covers the frequency range of 1.7 to 500 MHz with a linear power output of more than 9.5 watts and there is no tuning.

For further information or a demonstration, contact ENI, 3000 Winton Road South, Rochester, New York 14623. Call 716-473-6900 or TELEX 97-8283 ENI ROC

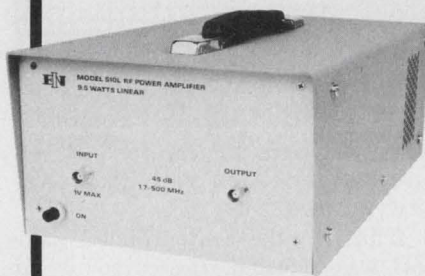

## ENI

The world's leader  
in solid state power amplifiers

SEE  
Electronic Design's  
**GOLD BOOK**  
FOR COMPLETE  
PURCHASING  
INFORMATION

CIRCLE NUMBER 72

## INSTRUMENTATION

(continued from page 129)

168-D's Sequential Display Mode, Here, 256 data-field locations—each representing a memory location—are displayed with the accesses arranged according to time. The letters R and W indicate whether memory activity was a read or write. Note that the cursor again occupies position 237.

Not shown is the Biomation unit's List Mode, which shows 20 accesses at a time—the earliest at the top of the screen and the latest at the bottom. The listing can be in either hexadecimal or binary, as you wish. The cursor is displayed at the center of the list and its position determines which 20 accesses are displayed at any one time.

To hook up the 168-D to your system, you unplug your  $\mu P$ , then replug it into a personality module. The module's interface plug then goes into the  $\mu P$  socket in the system under development.

Price of the 168-D wasn't definite at press time, but the unit is expected to sell in the neighborhood of \$5400. Delivery is 60 days. **Booth No. 483 to 489 Circle No. 305**

## Unit computes digital averages



Monitor Labs Inc., 4202 Sorrento Valley Blvd., San Diego, CA 92121. (714) 453-6260. \$750.

With the Model 8640 signal averager, the output of a single-pen strip-chart recorder can be used to display true digital averages for any time period from 1 to 99 min. The averager has a time shared output that allows the operator to preserve the original instantaneous output trace. During the averaging period, the strip chart displays the current reading as usual.

CIRCLE NO. 250

## Bang it or zap it— it's a goof-proof VOM



Triplett Corp., 286 Harmon Rd., Bluffton, OH 45817. (419) 358-5015. \$130.

Model 64 solid-state FET VOM is said to be drop-proof, burnout-proof and super-safe. Six low-power ohms ranges on the portable, battery-operated model have an open circuit voltage of only 90 mV. Circuitry permits continuous meter operation with a carbon battery life in excess of one year even with long usage. The 29-range tester has only a single range selector switch.

**Booth No. 604-606 Circle No. 251**

## Two inexpensive DPMs make their debut



Simpson Electric, 853 Dundee Ave., Elgin, IL 60120. (312) 697-2260. See text.

Two new 3-1/2-digit DPMs, Models 2860 and 2861, sell for under \$80. The 2860 (120/220-V ac line operation) is priced at \$79.00 and the 2861 (5-V dc operation) is priced at \$69.00. Readout is on 7-segment 0.43-in.-high red LEDs with automatic polarity and out-of-range indication, and fixed decimal. Accuracy is  $\pm(0.1\%$  of reading +1 digit). Stock ranges include 200 mV to 200 V, 20  $\mu A$  to 200 mA, with special ranges to order. Case dimensions are 3.9  $\times$  1.93  $\times$  4.27 in. Panel cut out is 3.622  $\times$  1.680 in.

**Booth No. 476-478 Circle No. 252**



Three times actual size.

## New high ripple performance THF capacitors. One replaces up to four CSR types.

Here's a family of small, solid-tantalum capacitors with a per-unit substitution factor as high as one for four. To give you savings all the way in space, weight and cost.

Mallory THFs are specially designed for low impedance to ripple current at frequencies above 1kHz through 100kHz. Which makes them ideal for high-frequency power supply switching, or for regulator switching. Or for bypassing or filtering unwanted ripple currents.

ESR is low, so power losses are low. With the solid electrolyte and hermetic seal, long life is inherent. And electrical characteristics are very stable over a temperature range of  $-80^{\circ}\text{C}$  through  $125^{\circ}\text{C}$ .

Mallory THF Spirit of '76 Capacitors come in a wide range of ratings; 5.6 to  $330\mu\text{F}$ , 6 to 50VDC. They're the result of our engineering program that's producing new high-performance types at less cost to you. Just ask your Mallory representative.

**MALLORY**

**MALLORY CAPACITOR COMPANY**

a division of P. R. MALLORY & CO. INC.

Box 372, Indianapolis, Indiana 46206; Telephone: 317-636-5353

Electrical and Electronic Components • Timing Devices and Motors • Metallurgical Products • Batteries

CIRCLE NUMBER 73

## Blend your own digital patterns & timing signals

Interface Technology, 852 N. Cummings Rd., Covina, CA 91724. (213) 966-1718. Basic unit, \$5985; 10-12 weeks.

With microprocessor-controlled data and timing generator, Model RS-432, you can generate unique

digital patterns and special control timing signals simultaneously. Formats include serial or parallel data of specified output period; data from selected blocks of the word memory; data contingent upon special inputs such as levels, pulses or sense switches, as well as generation of data continuously or single shot.

Booth No. 873 Circle No. 253

## Low-cost pulse gen delivers 5-MHz signal



Continental Specialties, 44 Kendall St., Box 1942, New Haven, CT 06509. (203) 624-3103. \$124.95.

Design Mate 4 pulse generator costs just \$124.95 and generates symmetrical and unsymmetrical pulses from 0.5 Hz to 5 MHz. The positive output ranges from 100 mV to 10 V, with a rise and fall time of less than 30 ns. The unit offers an independently controlled pulse width and spacing from 100 ns to 1 s in seven overlapping ranges, as well as independent variable amplitude CMOS, and fixed amplitude TTL outputs.

CIRCLE NO. 254

## DMM lets you set nulls with analog meter



Viz Test Instruments Group, 335 E. Price St., Philadelphia, PA 19144. (215) 844-2626. \$267 (dealer optional).

The WD-750A offers such features as a 3-1/2-digit, 3/4-in. LED display, and a built-in analog meter. The unit is powered by either 120 V or by its own built-in rechargeable nickel-cadmium battery. The multimeter has six dc and six ac voltage ranges covering 1 mV to 1200 V (rms for ac). There are five current ranges from 1  $\mu$ A to 1 A and six resistance ranges from 1  $\Omega$  to 10 M $\Omega$ .

CIRCLE NO. 255

# THIS digital data printer does the most \$495 FOR

Newport built the Model 810 Printer with you in mind...with maximum interface potential, reliability and performance characteristics. We invite you to take a look inside and compare these outstanding features before you buy another printer.

- 9 columns, Std: expandable to 18
- Small size 4 1/2" H x 8 1/2" W
- Programmable two-color printing
- Fixed or floating decimal point
- Standard adding machine paper fan-fold or roll
- Spare IC gates available to user for interfacing
- Remote paper advance
- Convenient paper and ribbon loading
- Internal formatting patchboard
- 3 million operations MTBF
- Last record viewed without paper advance
- Print mechanism available separately

### OPTIONS INCLUDE:

- Internal data storage
- Sequence counter to 99999 counts
- Digital clock (days,hr.,min.,sec.)
- Universal breadboard card

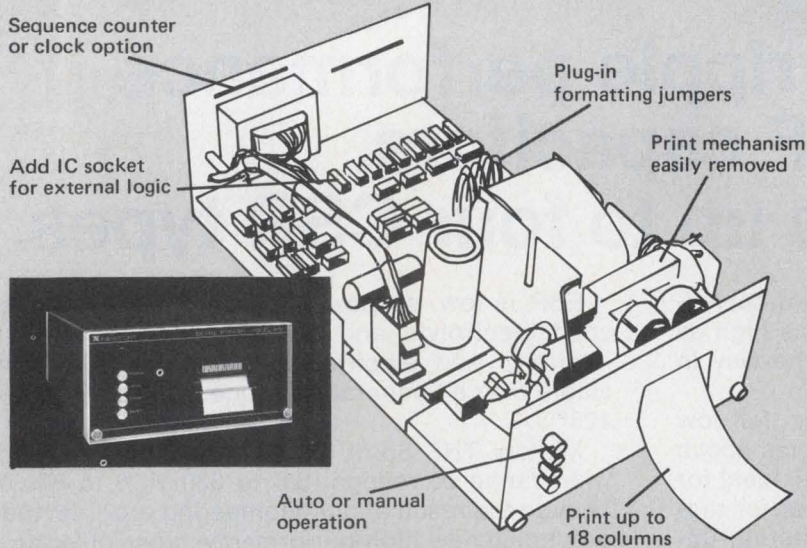

Newport Laboratories, Inc.  
630 E. Young St.  
Santa Ana, CA 92705  
Call Collect: (714) 540-4686  
In Netherlands, Call:  
Amsterdam (20) 45-20-52

# NEWPORT

SEE US AT WESCON BOOTH NO. 582

CIRCLE NUMBER 74

# Announcing the 1740A... a new 100MHz scope with fresh measurement ideas.

**In the time domain**—Push the third channel trigger display button, release, and you have a simultaneous display of the trigger waveform *plus* channel A and B traces. Now you can make accurate timing measurements from the trigger signal to events on either or both channels.

A X5 vertical magnifier provides 1 mV/div sensitivity on both channels to 40 MHz, without cascading, so you can monitor low-level signals directly. Signals such as the output of read/write heads of disc or mag tape units, low-level ripple on power supplies, or medical sensor and electro-mechanical transducer outputs.

**In the data domain**—You can combine the 1740A with HP's 1607A Logic State Analyzer and use the analyzer's pattern trigger or delayed trigger output for external scope triggering. Add the "Gold Button" (an optional logic-state push-button in lieu of A versus B) for just \$128\* and (with the 1607A) you have the convenience of logic-flow display or real-time display at the push of a button.

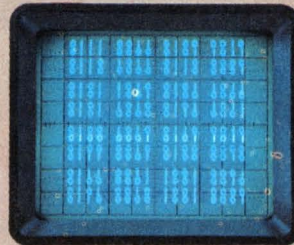

That means you can view the logic states of operational circuitry directly for pinpointing a program problem. Then—with a push of a button—take a look at the waveforms you've selected at that specific point in time.

Add to all this, features such as selectable input impedance (1 megohm or 50 ohms) and the time-tested 8 x 10 cm CRT used in our 180 System lab scopes for bright, easy-to-read displays. Priced at just \$2,095\*, the 1740A with its new ideas, simplifies both

real-time and data-domain measurements. When

you get your hands on this scope—you'll know you're working with a quality instrument. Give your local HP field engineer a call today.

\*Domestic U.S.A. price only.

**Data/Time Domain  
Oscilloscopes**

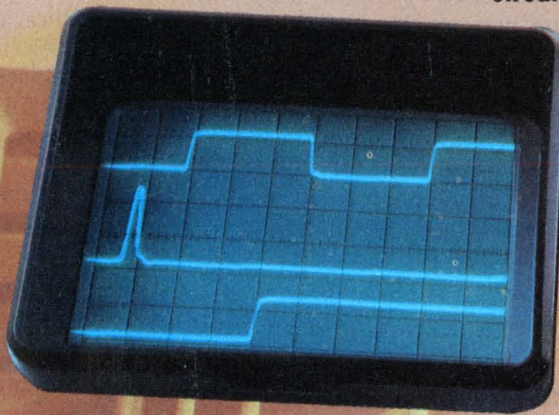

STATE  
DSPL

TRIG  
VIEW

HEWLETT  PACKARD

Sales and service from 172 offices in 65 countries.

1507 Page Mill Road, Palo Alto, California 94304

CIRCLE NUMBER 75

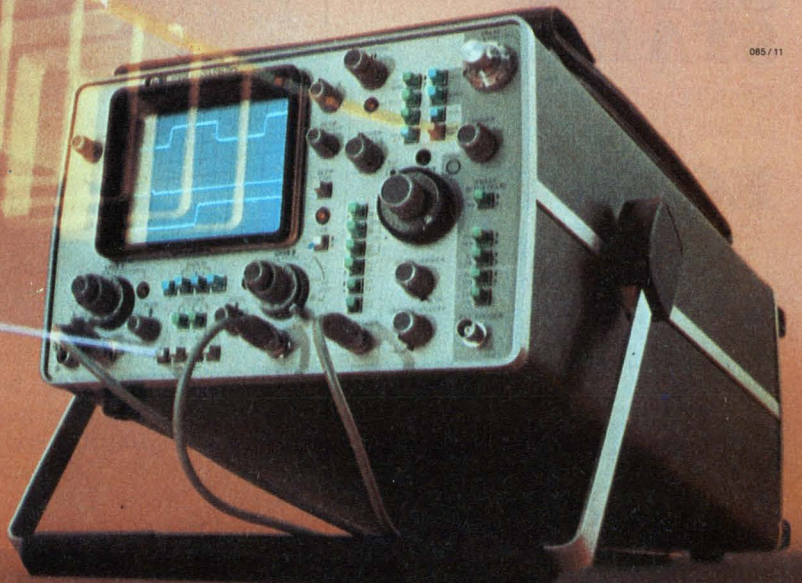

# the NAKED\* ADC

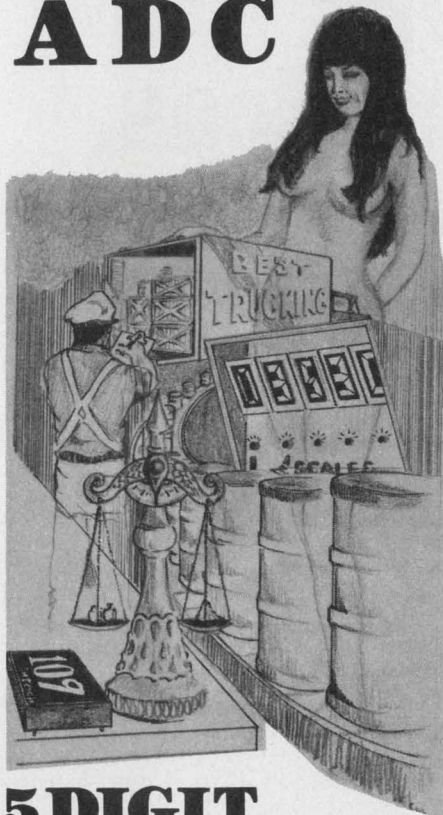

## 5 DIGIT ACCURACY

The Model 109 yields linearity better than  $\pm 0.0025\%$ . With gain and offset errors trimmed out, the absolute accuracy of the Model 109 makes it compatible with resolutions of  $\pm 16$  bits binary or  $\pm 5\frac{1}{2}$  digits BCD.

## SUPER STABLE

Gain TC  $< \pm 1$  ppm/ $^{\circ}$ C  
Offset TC  $< \pm 0.2$  ppm/ $^{\circ}$ C

## ECONOMIC

**\$99.<sup>00</sup>**  
(100's)

\*Requires external counter and clock.

**intech**

**function modules**

282 Brokaw Rd., Santa Clara, CA 95050  
Tel. (408) 244-0500, TWX 910 338-0254

CIRCLE NUMBER 76

## INSTRUMENTATION

### IEEE-488 interface controls counter-timer



John Fluke, P.O. Box 43210,  
Mountlake Terrace, WA 98043.  
(206) 774-2211. 1953A with -15,  
\$1595; 120 days.

An internal IEEE-488 bus interface option (-15) is now available for Model 1953A universal counter/timers. The interface, available as a factory-installed option at time of purchase, permits interconnection between the 1953A and other compatible instruments. Option 15 uses the recommended ASCII code format and permits full remote operation of range and function selection, control of the A and B trigger slopes, ac-dc coupling, attenuation selection and the separate-common input status between channels A and B.

CIRCLE NO. 256

### Sig gens offer improved specs



Boonton Electronics, Parsippany,  
NJ 07054. (201) 887-5110. 102C,  
\$3575; 102D, \$4295; 4 wks.

Two new FM-AM signal generators offer an extended frequency coverage from 450 kHz to 520 MHz, as well as harmonic distortion reduced to less than 0.5% for 100-kHz deviation in the FM band, lower residual FM, and a typical SSB broadband noise floor of 135 dB/Hz. Model 102D provides a phase-locked digital display of frequency with 100-Hz resolution and a stability of 0.5 ppm/h after warmup. Model 102C is identical to the 102D but has no phase lock.

CIRCLE NO. 257

### 10-MHz dual-trace scope carries \$595 price tag



Tektronix, P.O. Box 500, Beaverton,  
OR 97077. (503) 644-0161.  
\$595.

The D61a dual-trace oscilloscope attains bandwidths to 10 MHz. Fully transistorized, it weighs only 15 lbs. Operation is simplified by automatic selection of chopped and alternate modes and fully automatic triggering. In the TV trigger position, it automatically selects line or frame displays. With external X capabilities, this scope can be used in the X-Y mode. Vertical sensitivity is 10 mV/div at bandwidth, and the  $8 \times 10$ -cm CRT provides high-contrast displays.

CIRCLE NO. 258

### Ac powered DPMs cost \$60 in quantity



Gralex Industries, 155 Marine St.,  
Farmingdale, NY 11735. (516)  
694-3607. \$94 (ac version).

Model 38 DPMs use LSI circuits and the latest in LED display technology. Available in both ac line and 5-V dc powered versions, Model 38 features 3-1/2 digits, bipolar operation with automatic minus display, 0.5-in digit display and the proposed NEMA standard DPM case. The ac-line version is also pin compatible with most ac DPMs now in popular use.

CIRCLE NO. 259



# Rose enclosures. New. Beautiful. Quality. Standards.

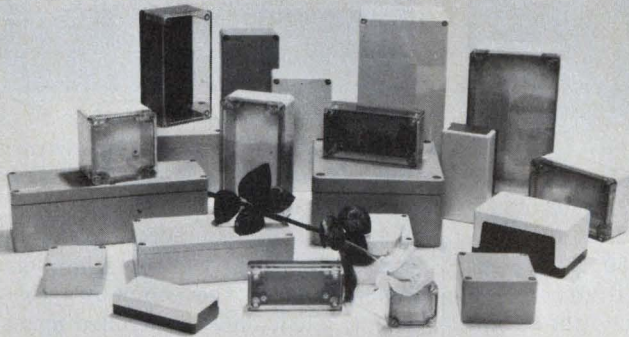

Rose Enclosures, made specifically for electronic use, culminate years of design, engineering and production experience. Extra high quality, precision-finished units provide functional protection, easy access, excellent esthetics. Available materials: Lexan, Aluminum, Polyester and ABS. Clear plastic covers with Lexan and ABS. A competitively-priced stock of Rose Enclosures is maintained in Belding, Mich. for immediate shipment. Contact us at (616) 794-0700.

**STAHLIN**  
BROTHERS, INC.  
Belding, Michigan 48809

Visit Booth 653 — ISA-76 International Conference and Exhibit - Houston

CIRCLE NUMBER 77

## Power Terminal Blocks Unlimited —A Full Selection From Our Stock

Reduce capital tie-up. Save storage space. Draw on our inventory to get the block you want when you want it. Full range of capacities, sizes and types for both copper and aluminum conductors. Most are UL recognized and CSA certified.

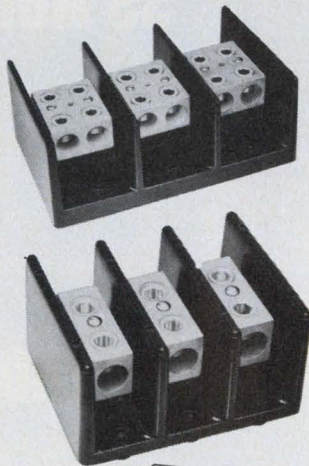

Request bulletin. If you have a special requirement, give us the specs. We'll design a block specifically for your needs.

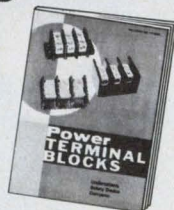

**Underwriters Safety Device** an **Eltra** company

7300 W. Wilson Ave., Chicago, Ill. 60656 • 312-867-4600

CIRCLE NUMBER 78

ELECTRONIC DESIGN 19, September 13, 1976

## BergStik™ Straight and Right-Angle Headers... for production line or prototype.

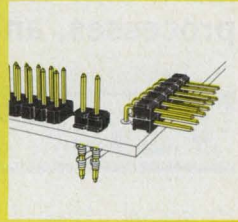
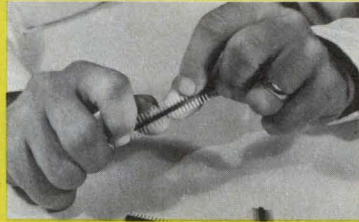

Here's an inexpensive method of inserting .025" square pins in boards for wire-wrapping or input/output usage. Header consists of drawn wire pins (3/4-hard phosphor bronze) molded in position in glass-filled nylon carriers. Result: A stronger pin with no rough edges. Headers are available on .100", .125" and .150" centers. Carriers are notched to allow the user to break to length for any desired number of pins. BergStik Headers also have tongue-and-groove design to facilitate side-by-side stacking. Headers can be loaded like components and do not interrupt flow on the assembly line. Just plug 'em in! (Write for Bulletin 140)

**DU PONT**  
REG. U. S. PAT. OFF.

**BERG ELECTRONICS**  
Division E. I. du Pont de Nemours & Co. (Inc.)

New Cumberland, Pa. 17070 Phone: (717) 938-6711

CIRCLE NUMBER 79

## Minisert™ Low-Profile P.C. Socket... provides repeated pluggability for I.C.'s, DIP's, etc.

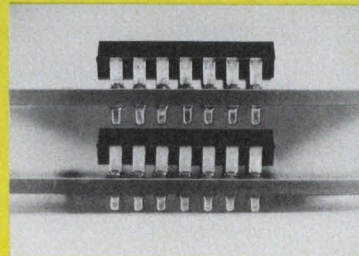

For use where space is restricted . . . extends just .030" above and .088" below board . . . allows .400" board-to-board spacing. One size Minisert\* socket fits wide range of hole sizes . . . .050" to .058" in diameter . . . and accepts round or flat leads of DIP's, LED's and LSI's. Elastomeric seal keeps foreign matter out of socket. Free standing design can be used in any socket pattern. Semi-automatic machine inserts at rates up to 2000 per hour. Write for Bulletin 120 or call.

\*Sockets sell for \$20.00 to \$30.00 per thousand in volume quantities.

**DU PONT**  
REG. U. S. PAT. OFF.

**BERG ELECTRONICS**  
Division E. I. du Pont de Nemours & Co. (Inc.)

New Cumberland, Pa. 17070 Phone: (717) 938-6711

CIRCLE NUMBER 80

## INSTRUMENTATION

### Multi-unit stores, processes, analyzes



Princeton Applied Research, Box 2565, Princeton, NJ 08540. (609) 452-2111. \$2750.

Model 4101 scan recorder accommodates the varied requirements of recording, storing, displaying and transferring of analog data. It can serve as a digital X-Y, strip-chart or transient recorder. Analog input signals are digitized to 10-bit accuracy and stored in 1024 words of memory or in two 512-banks. The curves in memory are continuously available for scope display or hard-copy recording by conventional plotters. A front panel, 3-1/2-digit display under cursor control allows readout of word amplitude and address.

CIRCLE NO. 260

### Portable scope combines high bw and sensitivity

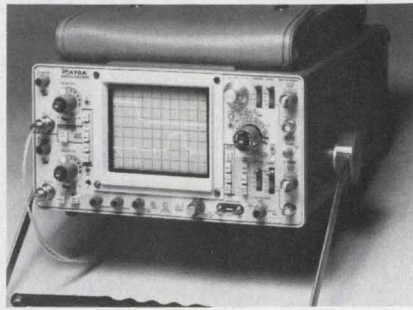

Tektronix, Inc., P.O. Box 500, Beaverton, OR 97077. (503) 644-0161. \$3300; 4 wks.

A bandwidth of 250 MHz combined with a sensitivity of 5 mV/div characterizes the company's latest portable scope. The 250-MHz bandwidth is specified at the probe tip. Sweep rate is to 1 ns/div on an 8 x 10-cm CRT. Other features: delayed sweep, variable trigger holdoff, trigger view, automatic scale-factor readout, and availability of clip-on battery power. The 475A also offers (as an option) direct numerical readout of displayed time intervals and a precision built-in DMM.

CIRCLE NO. 261

### Scanner handles up to 100 channels



Keithley Instruments, 28775 Aurora Rd., Cleveland, OH 44139. (216) 248-0400. \$1995.

Model 703 scanner mainframe can switch up to 100 channels. When used in the company's System 1, a calculator-controlled measuring system, the 703 can be remotely controlled to select one or more of 100 channels on a single mainframe. The 703 permits selection of multiple active channels simultaneously. Remote control of channels can be accomplished in any order. A three-digit readout on the front panel displays the most recently switched channel. The display also provides two "error" indicators.

CIRCLE NO. 262

## NEW LOW COST REED RELAY ROCK HARD EPOXY COATED

\$1.85 to 49¢

Depending on coil voltage, contact level and volume.

### Blue Boy Reed Relays offer:

- Protection from handling, solvents, tough environments
- 1 pole normally open contacts up to 10 watts
- General purpose or logic level contacts
- Coil voltages 5 through 48 VDC; .35" H x 1" L

Available from distributors.

26477 Golden Valley Road • Saugus, California 91350  
(805) 252-8330 • (213) 788-7292 • TWX 910-336-1556

## ELEC-TROL, INC.

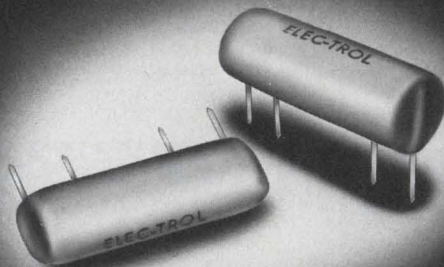

CIRCLE NUMBER 81

## DIP REED RELAYS 35 MODELS

Your choice of:

- SPST, DPST & SPDT dry reed contacts, 3 to 10 watts.
- SPST mercury wetted reed contacts, 28 watts.
- 5 to 24 VDC coils. 4, 8, or 14 terminals. TTL compatible.
- Optional clamping diodes and electrostatic shielding.

Available from distributors. Or contact us today.

26477 N. Golden Valley Road • Saugus, Calif. 91350  
(805) 252-8330 • (213) 788-7292 • TWX 910-336-1556

## ELEC-TROL, INC.

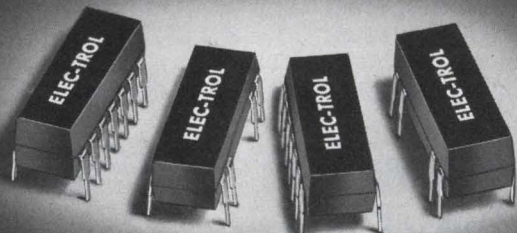

eem

CIRCLE NUMBER 82  
ELECTRONIC DESIGN 19, September 13, 1976

# Introduce Your Microcomputer to the Analog World— the Easy Way.

We can help you interface your microcomputer systems to the real world. From development through finished product, Burr-Brown has analog input and output systems that are totally hardware and software compatible with your microcomputer system.

Using an Intel SBC80/10 (8080), Intellec® MDS800 (8080, 3000), Motorola EXORciser® (M6800)? We now have analog I/O systems that are mechanically and plug compatible with each of these microcomputer systems, as well as the I/O system we recently introduced for Intel's Intellec® 8.

Our I/O systems can be configured to meet your exact needs, too. Choose 8-channel differential input, 16-channel single ended input, high-level or low-level. The standard models have DC/DC converters which require only +5V power. In OEM applications where the necessary  $\pm 15V$  are available, Burr-Brown analog Input/Output systems can be ordered without power supply, cable and connector. This brings the price down to just \$295 each, in hundreds.

Since each input or output system is addressed by the microprocessor as memory, software implementation is extremely simple, and there is virtually no limit to the number of analog systems you can use. All you need to do is plug into the bus, and you're ready to operate.

With famous Burr-Brown quality, 12-bit resolution, throughput accuracies of  $\pm 0.025\%$  full scale on input systems and  $\pm 0.0125\%$  full scale on output systems, don't you think it's about time you introduced your microcomputer to the analog world—the easy way?

Contact us today for full details. Burr-Brown, International Airport Industrial Park, Tucson, Arizona 85734. Telephone (602) 294-1431.

Intellec® is a registered trademark of Intel Corp.  
EXORciser® is a registered trademark of Motorola Semiconductor Products, Inc.

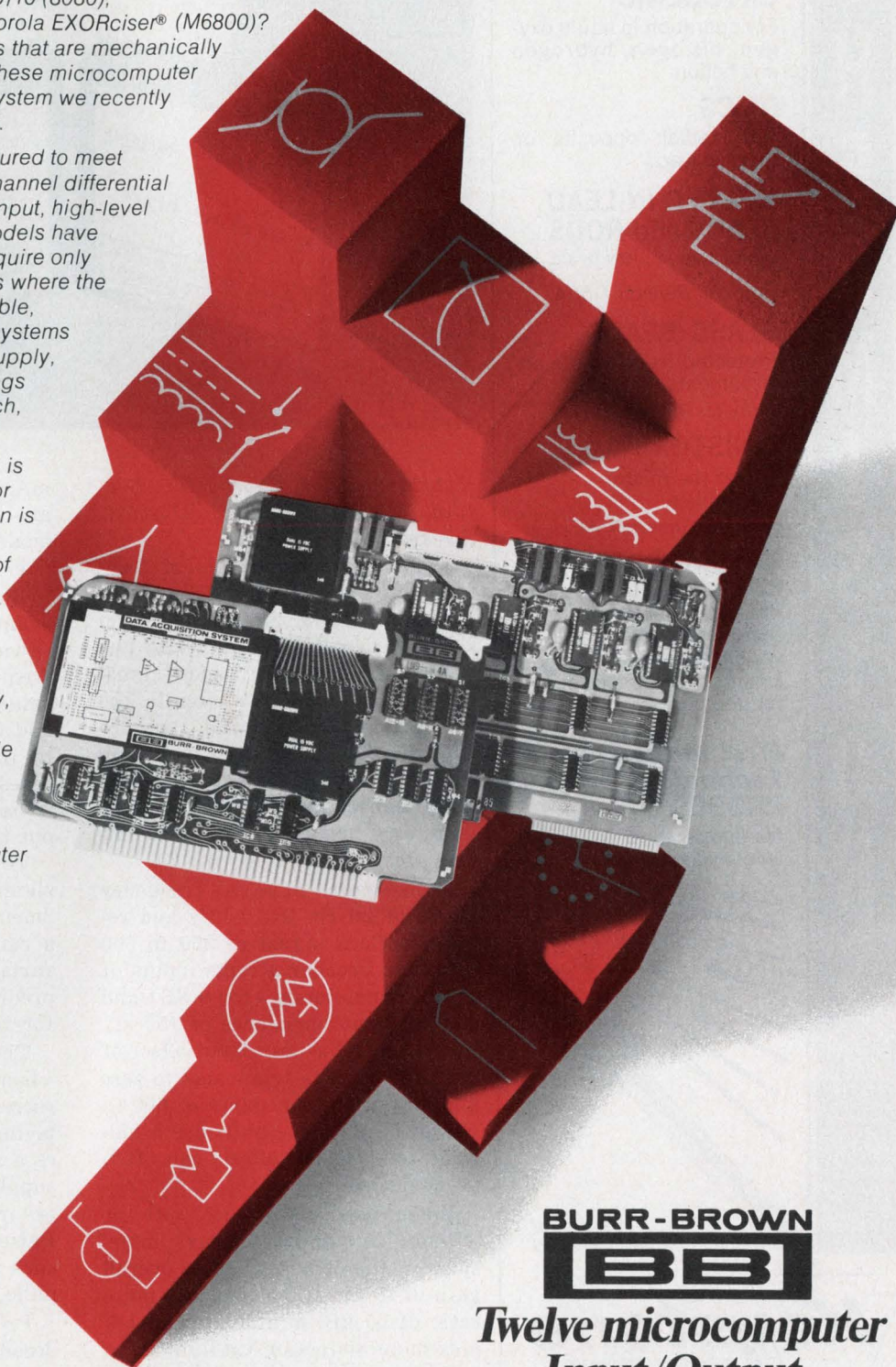

**BURR-BROWN**  
**BB**

**Twelve microcomputer  
Input/Output  
Systems**

**Fast Response,  
Low-Cost  
Thermistors****RODS**

Low / medium and high temperature coefficients

**LOW-COEFFICIENT**

Discs or rectangular rods

**CRYOGENIC**

For operation in liquid oxygen, nitrogen, hydrogen and helium

**DISCS**

With radial, opposite or crossed leads

**MOLDED-IN-LEAD  
BEADS and RODS**

Small size . . . low price

Write for Bulletin T-504

**GLASS BEADS**

Protected from hostile environments

Write for Bulletin T-610

**LINISTORS™**

Linear thermistor assemblies

Write for Bulletin L-601

**SPECIALS**

Keystone also produces a line of close tolerance thermistors as well as a variety of special configurations to meet certain requirements.

**First in Creative  
Technology with  
PROBES**

for temperature and liquid level measurement

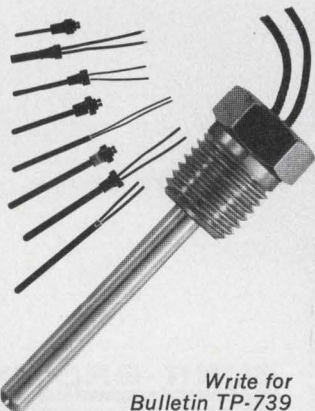

Write for  
Bulletin TP-739

**Keystone**  
CARBON COMPANY

Thermistor Division  
St. Marys, PA 15857  
814/781-1591 • Telex 91-4517

CIRCLE NUMBER 84

## MODULES &amp; SUBASSEMBLIES

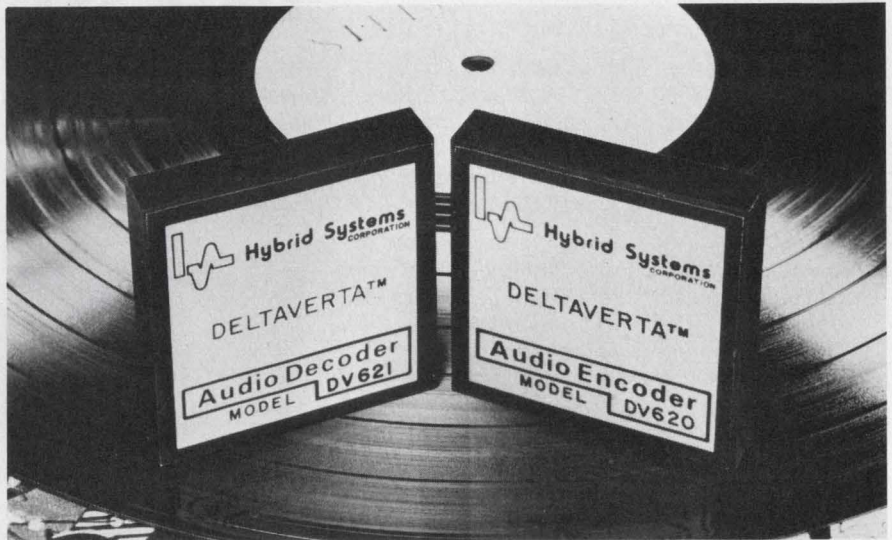
**Digital encoder/decoders  
enhance audio system sound**

Hybrid Systems, Crosby Dr., Bedford, MA 01730. (617) 275-1570. See text.

Using a novel conversion technique based on the delta-sigma process, Hybrid Systems has developed encoding and decoding circuits optimized for audio-signal manipulation. The two circuits, the DV620 analog-to-digital encoder and the DV621 digital to analog decoder, can be used to digitally delay and manipulate audio signals in a way not previously economically feasible.

Both units have a frequency range of 20 Hz to 10 kHz and require a clock signal of 250 to 500 kHz. The encoder accepts inputs of 1 V rms maximum (for 0 dB) and has an input impedance of 150 k $\Omega$ . The decoder has an output offset of  $\pm 50$  mV that is trimmable to zero and an output impedance of 500  $\Omega$ . However, since the units are usually ac coupled, the offsets can often be neglected.

When used as a set, with or without a digital delay interspersed, the 620/621 has an overall gain of  $0 \pm 2$  dB; a signal-to-noise ratio of 65 dB, minimum; and 1% maximum distortion (at 0 dB).

Each circuit is housed in a  $2 \times 2 \times 0.4$ -in. module and requires +15 at 30 mA and -15 V at 15

mA. All digital inputs and outputs are CMOS compatible, and the analog output of the 621 can deliver about 5 mA.

Basically, the encoder circuit samples the input at about 4- $\mu$ s intervals (depending upon the clock frequency) and encodes the analog value into digital pulses whose rate and width are directly proportional to input amplitudes. The decoder takes the pulse train and converts it back to analog form, smoothing out the jagged areas with a filter.

To improve on the basic delta-sigma process, the modules use a "memory" circuit that maintains a running tally of the audio-signal variations and makes an educated prediction of the waveform slope for the next clock period.

The DV620 and DV621 modules, when used with shift registers, can recreate concert-hall realism by delaying the sound output that reaches a set of rear speakers. (The set supplements the main front speakers in a stereo system.) The Audio-Pulse Div. of Hybrid Systems has such a unit available for the audiophile, the Model 1.

Price for either the encoder or decoder circuit is \$59 for single unit purchases and delivery is from stock.

CIRCLE NO. 309



## Down to earth economy from CTS

Overall cermet resistor network economy is what CTS has been putting into modern systems for well over a decade. For example, Series 760 DIP cermet networks, purchased in quantity, can cost less than 30¢ each.

And on the PC board, they offer still more economy by saving valuable space. Quick, automatic installation lets you cut handling costs and inspection time. You eliminate many separate components. And CTS production methods assure not only the highest quality product, but the fastest delivery, too.

Where one of our more than 210 standard off-the-shelf 14-pin and 16-pin DIP cermet resistor networks won't meet your circuit requirements, we'll custom design the network you need in either

8, 14, 16 or 18 pin package configuration.

CTS Series 760 DIPs' stability and reliability are remarkable. Over 900 million hours of test data on CTS cermet resistor networks prove CTS reliability with an established failure rate of only 0.00051% per 1000 hours @ 95% confidence level — considerably superior to military failure level S of established reliability specs. With failure so low, you enjoy the ultimate in long-range system economy.

See for yourself the many ways CTS reliable, economical DIPs can benefit you. Write for your copy of our reliability report and complete 12-page cermet resistor network catalog. **CTS OF BERNE, INC.**, 406 Parr Road, Berne, Indiana 46711. Phone (219) 589-3111.

**CTS CORPORATION**

Elkhart, Indiana

A world leader in cermet and variable resistor technology.



**Grayhill's  
value  
leader**

**switches  
from logic levels  
up to  
1/4 amp**

**1/2" diameter  
enclosed construction rotaries  
priced lower than many  
"open wafers"**

- contamination-free construction, gold plated contact system, dially phthalate insulation, molded-in terminals.
- up to 12 positions, 30° or 36° angle of throw, up to 6 poles per deck, up to 12 decks
- fixed or adjustable stops, solder lug or PC terminals, 1/8", 1/4", or 4 mm shaft diameters, concentric shafts also available.

You have never seen so much switching versatility and quality in a compact switch at any price... yet Grayhill has engineered its Series 71 to reflect state-of-the-art capabilities and state-of-the-economy pricing. Review the many available features and options... and see why this switch family is revolutionizing switch specification standards throughout the industry. For complete information, consult EEM or ask Grayhill for Series 71 Rotary Switch data.



561 Hillgrove Avenue • La Grange, Illinois 60525  
Phone (312) 354-1040

CIRCLE NUMBER 86

**MODULES & SUBASSEMBLIES**

**Cut size, weight and cost  
with hybrid s/d converters**

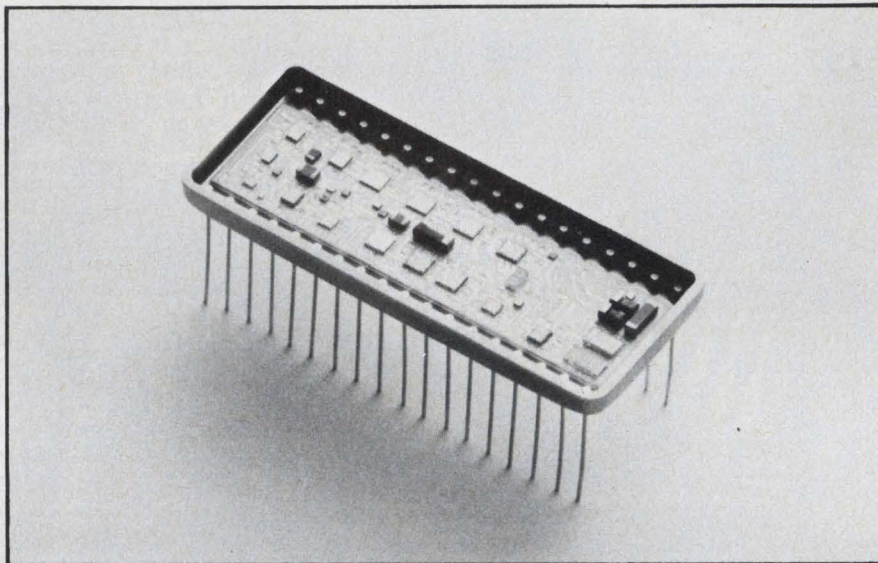

*ILC Data Device Corp., Airport International Plaza, Bohemia, NY 11716. (516) 567-5600. See text.*

Whenever a manufacturer claims he can do a job in one-hundredth the volume, one-tenth the weight and at a lower cost than his closest competitors we usually say bull. Not so with the HSDC-10 hybrid synchro-to-digital converter made by ILC Data Device Corp. Its 10-bit converters measure only  $0.8 \times 1.9 \times 0.21$  in. and offer performance equal to or better than the Model SDC1603 from Analog Devices (Norwood, MA), the LSI 90 from North Atlantic Industries (Plainview, NY) or the Model SDC410 from Computer Conversions (East Northport, NY).

The tracking rate of DDC's unit is 100 rps—more than five times that of the Analog Devices' and Computer Conversions' units. Even more important, the high acceleration constant ( $K_a = 200,000$  for 400 Hz) of the HSDC-10 means that the acceleration lag will be less than 1 LSB for speeds of up to  $70,000^\circ/s^2$ . This compares with only  $3500^\circ/s^2$  for the LSI 90 from North Atlantic.

Converter settling time for a  $179^\circ$  step (to within 1 LSB) is a speed 25 ms—eight times faster

than previously available. The fast settling of the HSDC-10 permits it to be used in systems with reference frequencies of up to 3000 Hz.

All of the three competing units require +5 and  $\pm 15$  V and dissipate more than 2 W. In comparison, the DDC unit needs only two supplies—a +15 V and a second +3 to +15 V supply. The converter dissipates only 0.2 W and when set to handle TTL can drive two standard TTL loads.

The HSDC-10 comes in all standard synchro and resolver formats and is fully transient protected. Transformer isolation can be obtained as an option. Operating temperature ranges of 0 to 70 and  $-55$  to  $+125$  C are available. All units are manufactured and processed at MIL-STD-883 Level C, with Level B processing available.

All three competing units do have built-in transformer isolation and cost from \$100 to \$200 more than the \$345 single-unit price of the HSDC-10. Delivery for the HSDC-10 is from stock.

For DDC	CIRCLE NO. 301
Analog Devices	CIRCLE NO. 302
Computer Conversions	
	CIRCLE NO. 303
North Atlantic	CIRCLE NO. 304

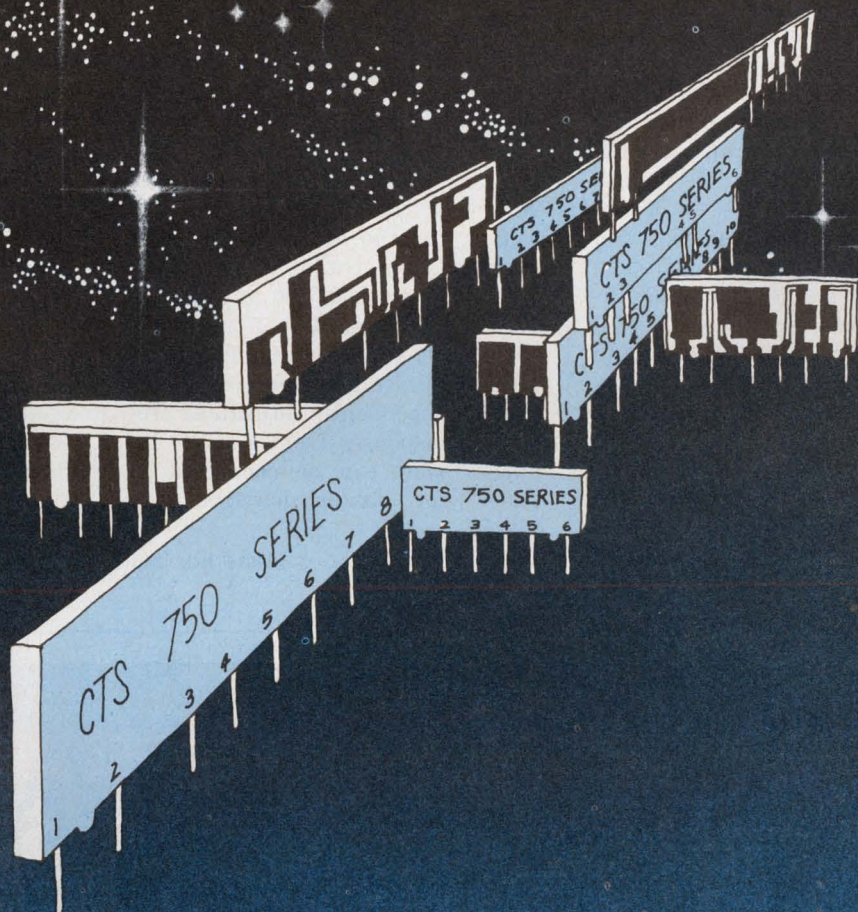

# CTS conquers space.

And has for *well over a decade* with space saving Series 750 SIP cermet resistor networks. And with space a very important commodity in modern systems, you'll want to make CTS a very special source for your network needs.

You conserve valuable PCB space, enjoy greater system reliability, use fewer components, install easier—automatically, cut handling costs and derive faster inspection. CTS experience, technology and production capacity insure the highest quality, fastest delivery available.

Where one of our more than 130 *standard* off-the-shelf SIP's won't meet your circuit require-

ments, we'll custom design the resistor network you need in either conventional or low profile package configurations.

Be assured of ultra-high stability and reliability. Over 900 million hours of test data prove CTS reliability with an established failure rate of only 0.00051% per 1000 hours @ 95% confidence level—considerably superior to military failure level S of established reliability specs.

For your copy of our reliability report or complete resistor network data, write: **CTS OF BERNE, INC.**, 406 Parr Road, Berne, Indiana 46711. Phone (219) 589-3111.

**CTS CORPORATION**  
Elkhart, Indiana

A world leader in cermet variable resistor technology.



CIRCLE NUMBER 87

### Signal conditioner ckt has internal reference

*Calex Mfg., 3305 Vincent Rd., Pleasant Hill, CA 94523. (415) 932-3911. From \$84; stock to 2 wks.*

A complete signal-conditioner, the Model 165 bridgesensor, comes in a single 2 × 2 × 0.6 in. package. It's more than just an instrumentation amplifier since it also contains an internal reference circuit, a bridge supply and a comparator. The 165A operates from a single +15-V supply and the Model 165B operates from unregulated +28 V dc. With single-supply operation, the instrumentation amplifier output has a range of +50 mV to +10 V. With the inputs shorted together, the amplifier section can be connected for an output of either +50 mV or +5 V. With a dual supply the instrumentation amplifier can also be connected for an output of ±10 V.

CIRCLE NO. 263

### Triple active filter has switchable cutoffs

*Fogg System Company, Box 22226, Denver, CO 80222. (303) 758-2979. From \$196 (unit qty.); stock.*

A triple high-pass filter, the Model 127, can be frequency programmed via switches built onto its circuit card. Each high-pass filter section consists of an active two-pole Butterworth filter whose low-frequency 3-dB point is user programmed with a DIP switch. The high-frequency 3-dB point is greater than 20 kHz for all units. The triple filter is housed on a 5.4 × 4.55 × 0.7 in. PC card. Four versions, that provide different ranges for the low-frequency cutoff point, are available. They are: 1 to 16; 10 to 160, 100 to 1600 and 500 to 8000 Hz. Roll-off is 40 dB per decade for all units. The three filters can also be combined to give three independently adjustable frequency responses from a single input or they can be connected in series for faster low-frequency roll-off.

CIRCLE NO. 264

### Reference junction takes 10 input channels

*San Diego Instrument Laboratory, 7969 Engineer Rd., San Diego, CA 92111. (714) 292-0646. \$180 (5-up); stock.*

The SL100, a 10-channel reference junction, receives 10 thermocouple wire pairs with guards and provides transition of the wires to copper conductors. It also electronically compensates the selected pair relative to 0 Celsius. Compensation for any wire type (types J, K, T, E, R, S, and B are standard) is available, as well as any reference temperature. The unit measures 6 × 3.14 × 1.06 in. and comes with a choice of 0.04-in. diameter solder pins or a ribbon-cable edge connector. Oversize truss-head screws and large binding posts can accommodate up to No. 14 AWG thermocouple wire. An outer metal cover, indicator light, and zero adjustment are also provided. Compensation is within 0.025 C/°C with a long-term stability of 0.002 C/°C/year.

CIRCLE NO. 265

# 8 Bit A to D/D to A Converter - the first priced at only \$4.50\*

The Ferranti Model ZN425E—an 8 bit dual mode analog to digital/digital to analog converter features:

- Single chip monolithic construction
- Typical settling time 1.0 μs for 1 L.S.B. step
- 8 bit binary counter, R-2R ladder network and switches
- On-chip precision voltage reference
- Self-contained, precision ramp generator
- TTL and CMOS compatible

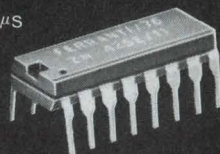

better by design

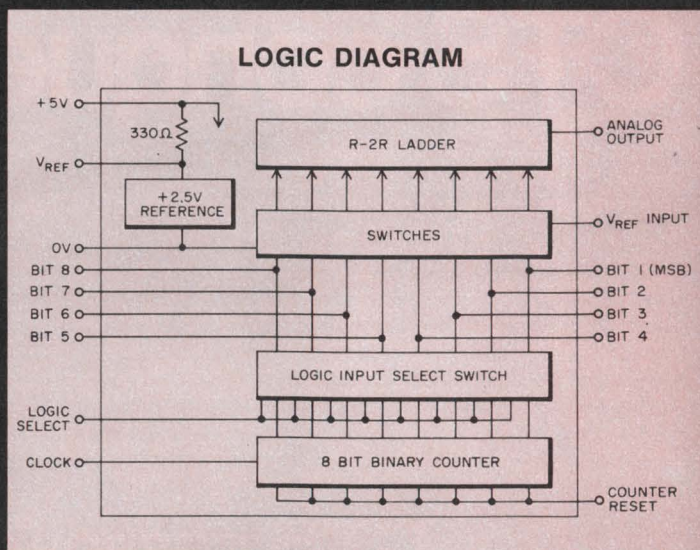

\*1000 piece price

FOR COMPLETE SPECIFICATIONS, CONTACT: FERRANTI ELECTRIC, INC. / SEMICONDUCTOR PRODUCTS EAST BETHPAGE ROAD, PLAINVIEW, NEW YORK 11803 PHONE: (516) 293-8383 / TWX: 510-224-6483



## Temperature controller spans -50 to 550 F

PSG Industries, 1225 Tunnel Rd., Perkasie, PA 18944. (215) 257-3621. \$10.95 (2500-up); stock.

The TC-series of solid-state temperature controllers will control temperatures over a range of -50 to 550 F. They can handle a current load of 1 A at 115 V ac and use zero crossover switching. Available features of the controllers include failsafe protection, 0.2 C differential or better and adjustable temperature control.

CIRCLE NO. 266

## Data-acquisition system handles $\pm 10$ mV inputs

Burr-Brown, International Airport Industrial Park, Tucson, AZ 85706. (602) 294-1431. \$170 (100-up); stock.

The SDM853 eight or 16-channel data-acquisition system can convert analog signals ranging from  $\pm 10$  mV to  $\pm 10$  V into 12-bit digital words. Inside the system is a low drift, unity-to-60-dB gain instrumentation amplifier, a 16-channel multiplexer, a sample/hold amplifier and a 12-bit a/d converter. All blocks are not internally connected so the data acquisition system can be very flexible. The amplifier has a gain range from 1 to 1000, and an offset voltage drift of  $2 \mu\text{V}/^\circ\text{C}$  at  $G = 1000$ . Overall the unit's accuracy is  $\pm 0.025\%$  of full-scale reading, with a maximum nonlinearity of  $\pm 1/2$  LSB. Gain error and offset error are both adjustable to zero. System accuracy drift with temperature is 30 ppm/ $^\circ\text{C}$  of reading. The differential amplifier CMRR is 74-dB down at 1 kHz and 65 dB down at 3 kHz. Channel cross-talk is 80 dB down at 2 kHz (OFF channel to ON channel). The modular data-acquisition has a 33 kHz max throughput rate. Maximum input voltage is  $\pm 16$  V, and the complementary output coding can be unipolar straight binary, bipolar offset, or binary two's complement. Input impedance is 100 M $\Omega$ , shunted by 10 pF (OFF channel); 100 M $\Omega$ , 100 pF (ON channel). The SDM-853 operates from  $\pm 15$ -V supplies over a 0 to 70 C range and measures  $4.6 \times 3 \times 0.375$  in.

Booth No. 503-505 Circle No. 267

**N**ow, a single integrated circuit, our TAD-32 (Tapped Analog Delay), can provide filtering with passband-to-stopband ratios of 40 DB or more per device. Simple variation of the clock sampling rates over 5 decades will accordingly shift a given filter characteristic. Transversal or recursive filters can be constructed with over 60DB dynamic range and linear phase. Tapped delays up to several hundred milliseconds are possible.

Discrete time analog signal processing using charge transfer devices is a reality at RETICON.

The TAD-32 is just one device in this growing family.

**We don't just talk about them, we make them.**

## THIS DIP DOES IT ALL.

TAPPED DELAYS  
MATCHED FILTERS  
CORRELATION  
CONVOLUTION



## RETICON®

910 Benicia Avenue, Sunnyvale, California 94086  
PHONE: (408) 738-4266 TWX: 910-339-9343

CIRCLE NUMBER 89

## Digital-to-resolver ckt has $\pm 6$ -min accuracy

Singer, Kearfott Div., 1150 McBride Ave., Little Falls, NJ 07424. (201) 256-4000. \$225 (100-up); 30 days.

A digital-to-resolver converter (part number C70 4773 514) is suited for use in servo loops, CRT

displays, and other low power applications. The resolver output is derived from a reference voltage and digital inputs at sufficient power levels to drive loads as low as 2000  $\Omega$ . The unit measures 2.565  $\times$  2.565  $\times$  0.42 in. and has an accuracy of  $\pm 6$  minutes over the operating temperature range of  $-55$  to  $+85$  C.

CIRCLE NO. 268

## A/d and d/a converters span wide range

Beckman, 2500 Harbor Blvd., Fullerton, CA 92634. (714) 871-4848. From \$20 (100-up); stock.

The first four in a series of converter products include two a/d and two d/a converters that can be used in commercial and rugged industrial applications. Both d/a converters accept 12-bit binary inputs and have external connection options for bipolar and unipolar outputs of  $\pm 2.5$ ,  $\pm 5$ ,  $\pm 10$ ,  $+5$  and  $+10$ -V full scale. Current output options are also available. The Model 877-80 d/a converter has an accuracy of  $\pm 1/2$  LSB, operates over 0 to 70 C and comes housed in a 24-pin glass DIP. The Model 877-85 is similar, but operates over a  $-25$ -to- $85$ -C range and is housed in a 24-pin metal DIP. It may also be screened to MIL-STD-883A for a  $-25$ -to- $125$ -C range. Both a/d converters use a successive approximation technique, have a conversion accuracy of  $\pm 1/2$  LSB and have full scale voltages of  $+10$ ,  $\pm 5$  and  $\pm 10$  V. The Model 873-78 a/d converter comes in a 24-pin glass DIP and operates over a 0-to-70-C range. The 873-88 is an industrial grade version of the 873-78 operating over  $-25$  to  $+85$  C and housed in a 24-pin metal DIP. You can get the 873-88 screened to 883A for an operating range of  $-55$  to  $+125$  C.

CIRCLE NO. 269

## D/s converters have 4-arc-minute accuracies

Natel Engineering, 8954 Mason Ave., Canoga Park, CA 91306. (213) 882-9620. From \$495; stock to 45 days.

Inputs of 14-bits are changed into synchro signals with 4-arc-minute accuracies by the DSC5012 digital-to-synchro converter. The converter is housed in a 3.1  $\times$  2.6  $\times$  0.8-in. module and delivers 2 W of drive. Included in the module are the signal and reference transformers, sine and cosine multipliers and power amplifiers. Accuracy is maintained over temperature ranges of 0 to  $+70$  C for the "C" version, and  $-55$  to  $+125$  C for the "M" version.

CIRCLE NO. 270

BAUSCH & LOMB

## StereoZoom<sup>®</sup> 5 microscope

### Meet the new MORE and LESS microscope

MORE in optics . . . MORE in mechanics . . . LESS in price.

This new StereoZoom 5 completes the royal family of world-leading Bausch & Lomb Stereomicroscopes. Fills the need in electronics for a middle zoom range of 0.8X-4.0X (5:1 ratio) with higher resolving power for accurate inspection and quality control of micro-circuits.

**More in optics.** Higher resolution . . . 200 lines/mm at 4X. Better color correction. Less distortion. Flatter fields . . . no refocusing to see detail at edge of wide field. Zooming is fast with image continuously in focus through full range, while maintaining full working distance of 4". Workers see more, faster, easier, more accurately.

**More in mechanics.** Tighter precision tolerances for better alignment, smoother operation. Eye-pieces can be locked in to prevent theft or tampering, but they are still rotatable.

StereoZoom 5 is directly interchangeable with other Bausch & Lomb pods, and can be used with many of the existing StereoZoom modules and accessories. Attractive new modern styling and professional black and white finish.

**Less in price.** Priced lower than other stereomicroscopes with equivalent features.

**More . . . There's more to the new StereoZoom 5 story. Discover this exciting new instrument by arranging for a free, no-obligation demonstration. Catalog 31-2436 is also available just for the asking.**

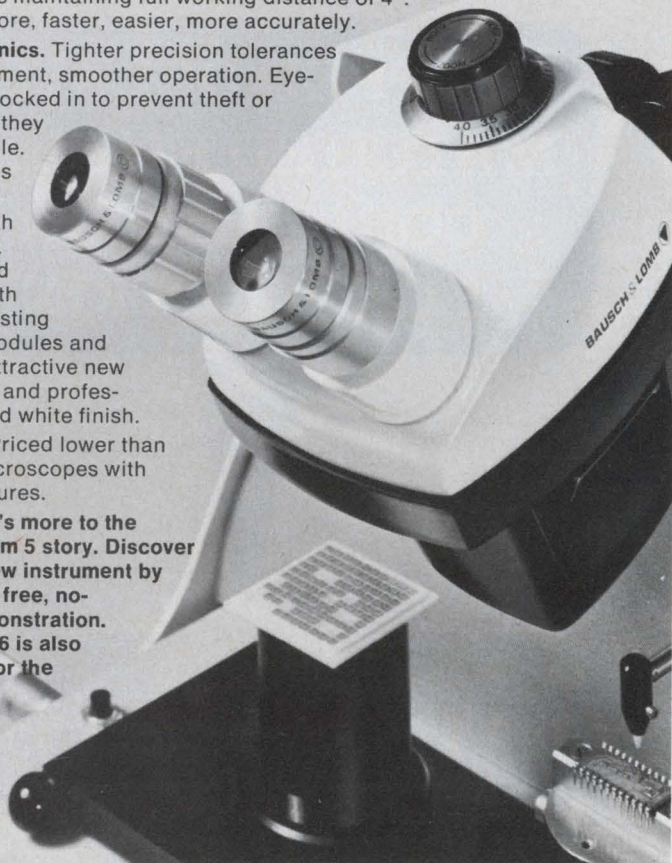

Bausch & Lomb, Scientific Optical Products Division 91509 N. Goodman St., Rochester, N.Y. 14602  
In Canada: Bausch & Lomb, Scientific Optical Products Division, 2001 Leslie St., Don Mills, Ont. M3B 2M3

CIRCLE NUMBER 90

# Q

WHICH OF THE  
ANNUALS DO  
ELECTRONICS ENGINEERS  
CONSULT MOST?

# A

■ **Electronic Design's**  
■ **GOLD BOOK**

# 83%

OF THE ENGINEERS WHO RESPONDED TO  
A TECHNICAL TRENDS ANALYSTS SURVEY SAY  
THEY CONSULTED THE GOLD BOOK  
WITHIN THE PAST MONTH

(Survey date: February, 1976)

***IF IT'S ELECTRONIC... IT'S IN THE***  
**GOLD BOOK**

(91,000 copies of the 1976/77 edition are now off the presses  
and are being used throughout the U.S.A. and overseas!)

# NEW!

## LED Illuminated LOW PROFILE KEYBOARD

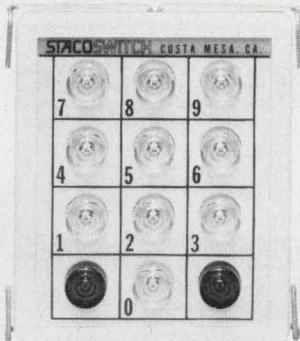

12 Station LED Keyboard

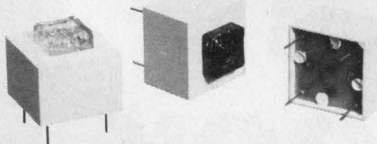

Single Station LED Keybutton

Other STACO Company products: Custom Transformers, STACO, INCORPORATED, Richmond, Indiana; Variable Transformers, STACO, INCORPORATED, Dayton, Ohio.

High performance LEDs mounted in keybutton give visual indication of function process or data acceptance. Standard 10 and 12 station keyboards and single station keybuttons easily mounted from front of panel or on mother-board from rear of panel. In-line connector pins fit standard strip connectors. Compact design saves panel space. Keyboards measure 2½" x 3" and extend only .380" below panel. Keybuttons mount on .70" centers.

Legend decal offers low cost custom character design and color co-ordination with machine. Long key life... 5,000,000 cycles plus... and unique patented design assure reliable momentary contact. Unlighted keyboards and keybutton offer same design features and advantages.

Proven dependability... we've produced hundreds of thousands of keyboards for the electronic calculator industry. Get full details. Write for our new Low Profile Keyboard brochure.



a STACO, INC. company  
1139 BAKER STREET, COSTA MESA, CALIF. 92626  
(714) 549-3041 TWX: 910/595-1507

CIRCLE NUMBER 92

# Better... ...across the board.



Our PLP-550 logic probe is internally programmed to select C-MOS, HTL, TTL/DTL logic.

Stretch memory catches single, short pulses you can't see. Unique three lamp system gives you duty cycle information you'd otherwise need a scope to see. Next time out, take the Kurz-Kasch PLP-550 with you... and leave your scope back at the shop. Soon to be available are single and dual family probes in the same rugged, functionally designed package.

Call or write.....



**Kurz-Kasch, Inc.**  
Electronics Division,

1501 Webster Street, P.O. Box 1246, Dayton, Ohio 45401 (513) 223-8161

CIRCLE NUMBER 93

## MODULES & SUBASSEMBLIES

### Compact s/d converters have 10 or 14-bit inputs

North Atlantic Industries, Terminal Dr., Plainview, NY 11803. (516) 681-8600.

The LSI/90 synchro-to-digital converter measures only 2.12 x 2.56 x 0.82 in. It uses the company's LSI Trig/Logic processor chip to reduce the size. The s/d converter is TTL compatible and can also be used in MOS interfaces without modification. Both 14 and 10-bit resolution versions are available. The standard operating range is 0 to 70 C, and an optional "HT" version that operates between -55 and +105 C is also available. Accuracy of the converter is ±3 minutes up to speeds of 1440°/s. The LSI/90 converter series is electrically identical to the company's LSI/85 series.

Booth No. 495 Circle No. 271

### Hybrid converter series contains 18 models

Datel Systems, 1020 Turnpike St., Canton, MA 02021. (617) 828-8000. See text; 6 to 8 wks.

The HX and HZ series of 12-bit hybrid data converters contain 12 different d/a converter models and six different a/d converter models. The models span operating ranges of 0 to 70, -25 to +85, -55 to +100, and -55 to +125 C. The converters are available in both glass or metal, hermetically sealed DIPs. There are two basic a/d converter lines with three models each: the ADC-HX series units have a conversion time of 20 μs and cost from \$119 to \$185; and the ADC-HZ series units have a conversion time of 8 μs and cost from \$149 to \$215. All have five programmable input ranges, 20 ppm/°C maximum tempo, and 1/2 LSB maximum nonlinearity. The 12 DAC-HZ converters have output settling times of 3 μs and cost from \$49 to \$175. The d/a converters have five programmable voltage output ranges, 20 ppm/°C maximum tempo, and 1/2 LSB maximum nonlinearity. Two models in the series have a tempo of 10 ppm/°C maximum.

CIRCLE NO. 272

## Sample/hold amplifier locks signal in 500 ns

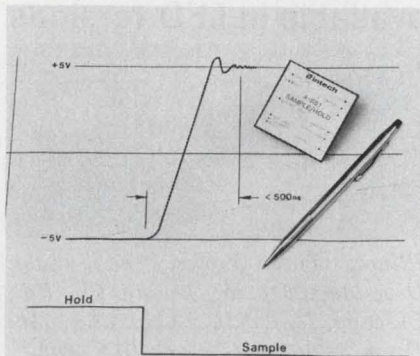

Intech, 282 Brokaw Rd., Santa Clara, CA 95050. (408) 244-0500. \$180 (unit qty.); stock.

The A-881 high speed sample/hold amplifier has a 500 ns maximum acquisition time to 0.01%. Its maximum aperture is 5 ns and the circuit can acquire a 4 kHz input signal to within a 1/2 LSB uncertainty for 12-bit applications. Nonlinearity of the output is 0.005% maximum and the dielectric absorption of the circuit is less than 0.01% over a 5  $\mu$ s hold time. The A-881 comes in a 2  $\times$  2  $\times$  0.5 in. module and requires  $\pm$ 15 V supplies. An operating range of 0 to 60 C is guaranteed and if derated specs can be tolerated, a range of -25 to 85 C is possible.

CIRCLE NO. 273

## Data-acquisition system does 30,000 samples/s

Analog Devices, P.O. Box 280, Route 1 Industrial Park, Norwood, MA 02062. (617) 329-4700. See text; stock.

A complete 12-bit data-acquisition system is available in a 3  $\times$  4.6  $\times$  0.375 in. (76.2  $\times$  116.8  $\times$  9.5 mm) module. The system is a pin-compatible alternative to several popular competitive models and costs only \$295 in single quantities. The DAS1128 includes a 15- $\mu$ s, 12-bit a/d converter, sample-and-hold amplifier, precision reference, high-stability buffer amplifier, and a 16-channel multiplexer. System features include a 2.5 ppm/ $^{\circ}$ C non-linearity tempo, an 8 ppm/ $^{\circ}$ C gain tempo,  $\pm$ 0.12% of FSR relative accuracy at a 33 kHz throughput rate. The DAS1128 requires 15 V at 40 mA, -15 V at 70 mA, and 5 V at 250 mA.

CIRCLE NO. 274

# MEET OUR FAMILY OF ELECTRONIC TEST ACCESSORIES

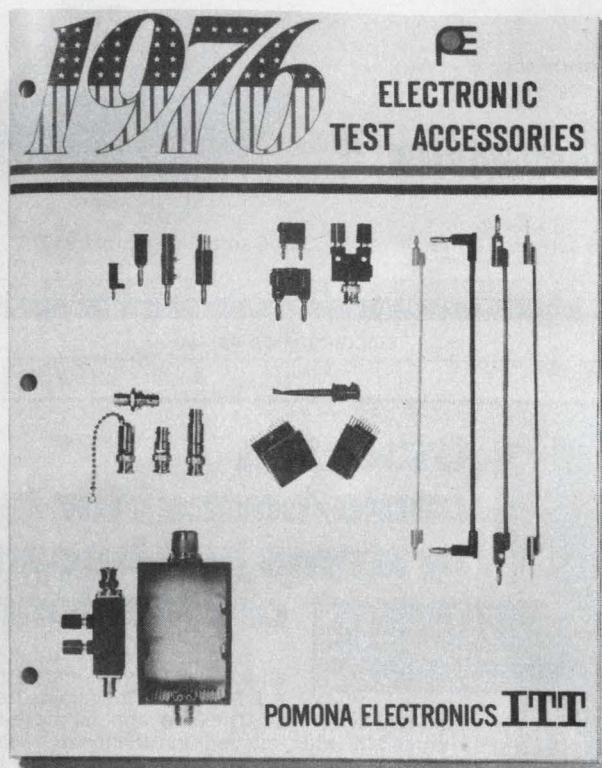

This new General Catalog is our latest family portrait. In the past twenty-five years (1976 is our Silver Anniversary year) it has grown from a handful of items to almost 500 products for the electronics industry.

Our catalog has grown to 76 pages for 1976, and we are introducing 65 new items this year. It describes and illustrates every member of our family. You're bound to find the solution to your testing problem with one or more of these quality products.

For your free copy, circle the reader service number listed below, or write:

## ITT POMONA ELECTRONICS

1500 East Ninth St., Pomona, Calif. 91766  
Telephone (714) 623-3463, TWX: 910-581-3822



Booth 722 Wescon

CIRCLE NUMBER 94

# Parallel Entry Printer

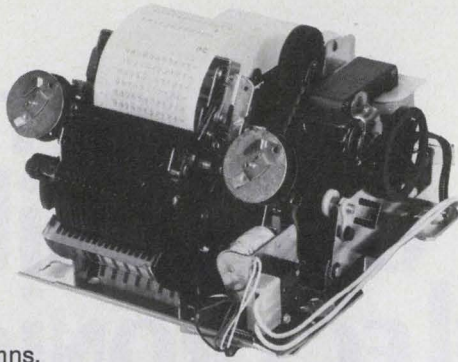

Prints 3 lines per second, 11 character locations per column with a capacity up to 16 columns. Print mechanism is small (5¼" x 10" x 8").

**Options available:** Serial or parallel BDC interface  
Power supply                      Attractive case

With the addition of calculator logic, it becomes our "Intelligent Printer".

Write for catalog of Addmaster computer peripherals.



416 Junipero Serra Drive • San Gabriel, California 91776

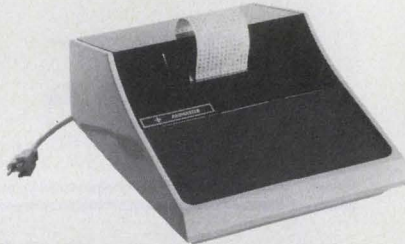

CIRCLE NUMBER 95

## COMPONENTS

### Lighted pushbuttons available in LED versions

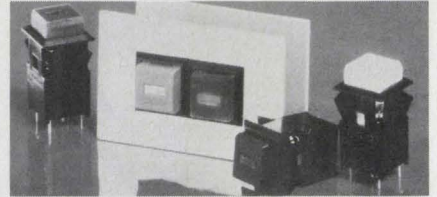

Illinois Tool Works, Inc., Licon Division, 6615 W. Irving Pk. Rd., Chicago, IL 60634. (312) 282-4040. From \$3.90; list; stock to 8 wks.

The new LED version of Licon's 05 lighted-pushbutton series is offered in seven different background button color with red, yellow and green LEDs. Centered in a 1/2-in. button, a 0.1 x 0.25-in. window displays the LED over a 150° viewing angle. LEDs remain fixed during switch operation, which improves reliability. Life of the switch is two-million cycles at logic-level loads. Bifurcated contacts are used, and options of 1 or 2-pole NO momentary switching or indicator only is available. A maintained-latching logic circuit is also available.

Booth No. 504-506 Circle No. 275

## Other flat cable/connector systems just became old fashioned.

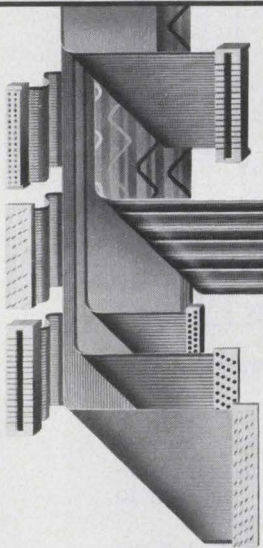

Meet the new Great Jumpers™ and Great Daisy Jumpers™ from A P Products. They come from our factory fully pre-assembled and fully pre-tested, complete with molded-on connectors featuring integral strain relief and complete line-by-line probeability, yet can cost half as much as the jumpers you're using now.

Just name your jump and watch us hop to it. We offer the three most popular connectors, the five most popular flat cable widths, solid or stranded Electric Pink or rainbow cable, single ended, double ended or daisy chained. And Great Jumpers are directly-interchangeable replacements for the jumpers you're using now.

Connect with the A P rep nearest you.

(203) 868-7748	(219) 447-9623	(314) 434-6242	(512) 443-9687	(617) 272-8163
(206) 822-8223	(301) 484-5400	(315) 437-8343	(513) 433-0966	(713) 691-3961
(212) 682-5844	(303) 420-4646	(414) 421-2300	(602) 946-4437	(714) 560-6266
(214) 238-0408	(305) 894-3351	(415) 328-3232	(602) 949-8424	(714) 833-1802
(215) 923-5195	(312) 298-4830	(416) 638-1322	(609) 429-4013	(816) 765-2998
(216) 333-4120	(313) 356-2161	(503) 223-3374	(612) 922-7011	

Faster and easier is what we're all about.



**A P PRODUCTS INCORPORATED**

Box 110-F Painesville, OH 44077 (216) 354-2101 TWX: 810-425-2250

CIRCLE NUMBER 96

### Semiconductors provide overvoltage protection

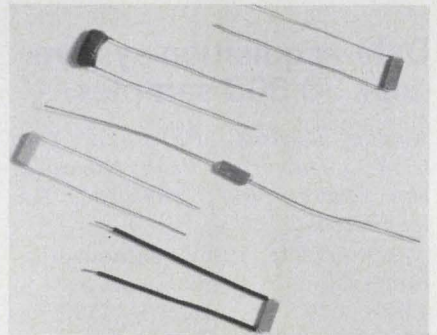

Midwest Components, Inc., 1981 Port City Blvd., Muskegon, MI 49443. (616) 777-2605.

These semiconductor devices can provide low-cost, recyclable protection against overvoltages applied to ohms scale of digital meters. Under normal operation, the devices maintain a low resistance until a high voltage causes a sharp rise in resistance, which switches the voltage source out of the circuit. Maximum applied voltages ranging up to 1000 vdc can be handled.

Booth No. 1024 Circle No. 276

## Cermet trimmer mounts on PC boards

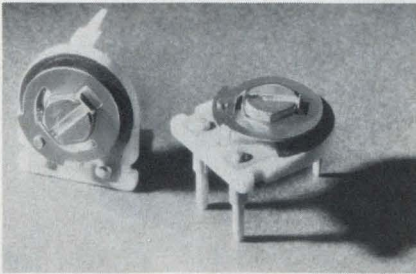

Allen-Bradley, 1201 S. Second St., Milwaukee, WI 53204. (414) 671-2000. \$0.55 (1000 up); 4 to 6 wks.

The new Type 90, single-turn 1/2-W cermet trimming potentiometer has terminals spaced on a 0.1-in. grid for PC-board mounting. The trimmer has a resistance range of 100  $\Omega$  to 2 M $\Omega$ , and it features a metal actuator and sturdy terminals. It's offered in two versions: Type 90V for top adjustment and 90H for side adjustment.

CIRCLE NO. 277

## Ceramic cap trimmer covers audio to 500 MHz

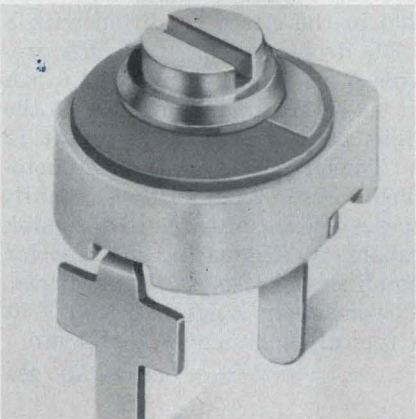

Johanson Manufacturing Corp., 400 Rockaway Valley Rd., Boonton, NJ 07005. (201) 334-2676. \$0.75 (1000 up); stock.

The new 9371 series of ceramic trimmer capacitors are 50% smaller than most other trimmers of this type, but still provide high capacitance values, according to Johanson. They are available in four capacitance ranges from 1.5 to 4, 3.0 to 10, 3.5 to 18 and 5.0 to 25 pf with  $Q_s > 300$  at 10 MHz. All units meet or exceed MIL-C-81. They have an over-all diameter of 0.225 in. with a 0.215-in. above-board height. The 9371 series are designed for audio-to-500 MHz use.

Booth No. 1003 Circle No. 278

## CMOS logic drives sensitive relays

Electrodyne, Inc., 1404 21st St., Milwaukie, OR 97222. (503) 654-0711. \$6 (1000 up).

Electrodyne's DPDT sensitive (30 mW) electromechanical DIP Series 10 relays can be switched directly by many IC devices, such as CMOS logic. Elimination of the need for interfacing reduces design cost and saves board space.

Also, no heat sinking is required. These rotary balanced-armature, environmentally sealed relays don't incorporate glass-capsule reed switches commonly used. The terminal grid spacing of 0.1  $\times$  0.3 in. allows plugging directly into DIP sockets. The relay can be used to switch dry circuits to 2-A, 28-V-dc loads. Low capacitance (0.3 pF max) provides excellent rf-switching capabilities.

CIRCLE NO. 279

# Anyone can make Lighted Pushbutton Switches



Unimax makes them Status Symbols.

Single lamp, dual lamp or 4-lamp lighting. Momentary or alternate switching. Ratings from dry circuit to 10 amps. Unsealed or oil-tight. Each one is a Status Symbol. To see which one is right for you, call or write: Unimax Switch Corp., Ives Rd., Wallingford, Conn. 06492. Phone (203) 269-8701.

**Unimax**  **Switch**

CIRCLE NUMBER 97

# RAPID SYN

... the broad flexible line of

## STEPPERS

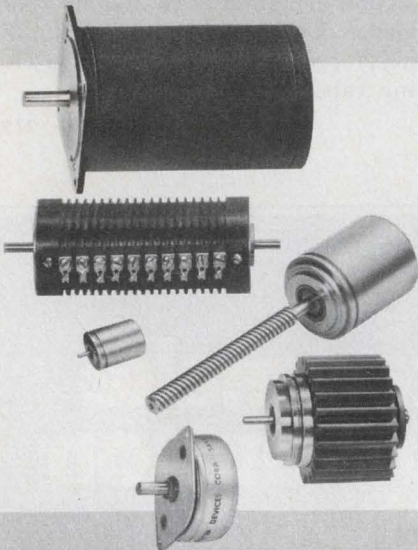

## Your special may be one of our standards

Computer Devices gives you more step angles, more sizes and more types of stepper motors. Make your choice from the broad, flexible line that the majors are switching to in ever-increasing numbers.

Standard RAPID-SYN steppers include 2, 3, 4, & 5 phase units, frame sizes of 3/4" and up with stepping angles of 1.8°, 2.25°, 5°, 7.5°, 11.25°, 45° and 90°—all designed to operate from a wide variety of solid state logics offered from stock.

RAPID-SYN Synchronous 72, 200, 300 & 450 RPM motors are also stock items. These low speed, high torque motors eliminate the need for gear reducers, clutches and brakes and are rated for 110 VAC, 60 Hz.

Chances are your special motor requirements and drivers are already in stock at Computer Devices. If not, you can be assured that your needs get extra-prompt attention.

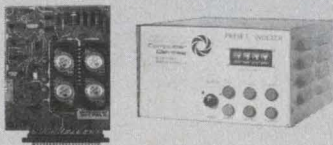

Call or wire for free catalog

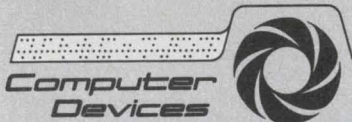

**COMPUTER DEVICES OF CALIFORNIA**  
11901 Burke St., Santa Fe Springs, Calif. 90670  
(213) 696-2595 - TELEX: 69-6352  
For local offices see EEM 74-1

CIRCLE NUMBER 98

## COMPONENTS

### Solid-state relay has random turn on

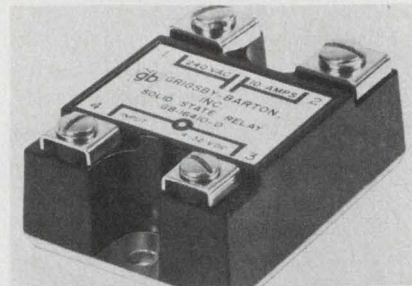

Gordos/Grigsby-Barton, Inc., 1000 North Second St., Rogers, AR 72756. \$11.27 (1000 up); 2 to 3 wks.

A new series of random-turn-on, all-solid-state photocoupled relays, the Series 6B 16000, can control resistive, capacitive or inductive loads. Standard features include reverse-input-polarity protection, current-limited input and an RC-suppression network. Housed in molded packages, the UL-recognized units include output ratings of 2.5 to 25 A at 24 to 280 V ac, 50/60 Hz. Their 4-to-32-V-dc input is TTL-compatible. A constant-current feature provides improved LED life characteristics over the full input-voltage range. The relays are particularly well suited for control of loads with large voltage/current phase shifts, or where zero-voltage turn-on is not required.

CIRCLE NO. 280

### DIP ceramic capacitors feature low inductances

Sprague Electric Co., 347 Marshall St., North Adams, MA 01247. (413) 664-4411.

Layer-built ceramic capacitors in four-pin bantam DIPs, Type 935C Monolithic, feature low inductance and low impedance with a very high self-resonant frequency. They offer a typical inductance of less than 4 nH, when used in the four-terminal mode. Alternate layers of ceramic dielectric material and metallic electrodes are fired into a rugged homogeneous block. Available with COG (NPO) and X7R temperature characteristics, these capacitors have preferred ratings of 0.01, 0.022, 0.047, and 0.1  $\mu$ F at 100 V dc.

CIRCLE NO. 281

### Optical limit switch is bounceless



Optron, Inc., 1201 Tappan Circle, Carrollton, TX 75006. (214) 242-6571. \$2.75: OPS-200 (1000 up); stock.

The OPS-200 and OPS-200A solid-state switches feature a shutter, controlled by a snap-action mechanism, which interrupts a light path between a gallium-arsenide infrared LED and a silicon photosensor. There is no contact bounce or contact contamination. The switches interface high-speed logic circuitry without the buffering required with conventional switches. Operated at rated currents, the OPS 200 and OPS 200A still meet specifications after 100,000-h of operation. The OPS 200 in the closed condition with a LED drive current of 30 mA provide a minimum output of 1.6 mA at 0.4 V. Maximum output with the light path blocked is 20  $\mu$ A at 12 V. The OPS 200A contains a photodiode sensor followed by a Schmitt trigger with 140-mA output sink capability, eliminating the need for amplifiers in most applications. Power supply range is 5 to 9 V at a typical supply current of 4 mA.

CIRCLE NO. 282

### Metal proximity switch senses to 40-k pulses/s

Electro Corp., 1845 57th St., Sarasota, FL 33580. (813) 355-8411. \$55 (unit qty); stock to 4 wks.

Three new noncontact metal-sensing proximity switches, for 5, 12 and 24-V-dc operation, are designated Models 55527, 55525 and 55526, respectively. They are designed to provide a stable and fixed sensing distance, typically 0.375 in. for 4130-steel and 0.175 in. for aluminum target. Switching speeds are 0-to-40,000 impulses-per-second. Output current is 10 mA dc for 5 V, 100 mA dc for 12 V and 500 mA dc for 24-V models.

CIRCLE NO. 283



## Watch crystals made in tuning-fork form

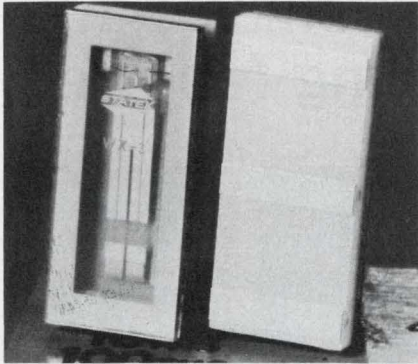

Statek Corp., 1233 Alvarez Ave., Orange, CA 92668. (714) 639-7810. \$1.50 (100,000 up).

A new package for watch crystals, Model WX-35, is the smallest and lowest-cost watch crystal in the industry, according to Statek. The crystal is a microminiature tuning fork made of quartz—a major departure from the XY-bar crystal usually employed by other US manufacturers. The crystal is 0.325-in. long by 0.15-in. wide and 0.054-in. thick. The thin leadless ceramic package allows watch module manufacturers to design thinner and smaller watches. Customers who are now using the WX-2CF are planning to phase in the new WX-3.

CIRCLE NO. 284

## Delay line to 255 ns programmed digitally

Engineered Components Co., 3580 Sacramento Dr., San Luis Obispo, CA 93401. (805) 544-3800. \$30 to \$50 (OEM qty); stock to 6 wks.

A T<sup>2</sup>L-compatible programmable-logic delay line allows for final delay adjustment during or after installation in a circuit. No additional external components are needed to obtain the desired delay. The delay line is offered in 15 models with time delays to a maximum of 255 ns and step resolutions of 1, 2, 3, 5, 10 or 16 ns. Rise time for all modules is 4 ns maximum. The lines are digitally programmable in 16 delay steps with four digital inputs. Programming may be accomplished by remote switching, permanent termination of the appropriate programming pins to ground or automatically by computer-generated data.

CIRCLE NO. 285

# Stay current with small lamp data from General Electric. It's free.

## Check these 6 halogen cycle lamps GE has added to its low-voltage line.

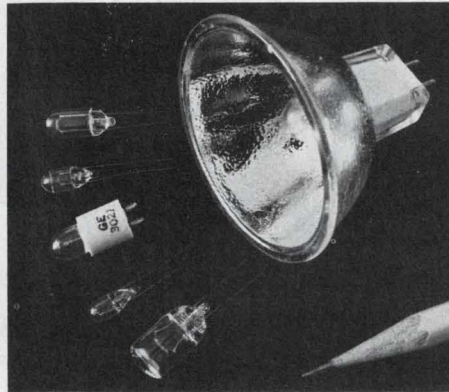

General Electric now offers over 27 halogen cycle lamps that pack high light output in small packages. (In addition, GE offers 8 sealed beam halogen lamps primarily for aircraft applications.) Bulb diameters range from 3/16" to 1/2". Lengths from .520" to 2.25". Voltages from 3.5 to 28. O.V. And candlepower from 2.15 cd up to 250 cd.

They're ideal for you if you're designing applications such as optical systems, instrumentation, illuminators, fiber optics, card readers, displays and aircraft navigation. A variety of terminals are offered.

For updated technical information circle the number below or write GE for Bulletin #3-5357.

## These GE wedge base miniature lamps offer you savings in time, money and space.

These lamps are ideal for applications such as indicators, markers and general illumination where space is at a premium. Their wedge-based construction makes them easy to insert and remove. They don't require bulky, complicated sockets. And because the filament is always positioned the same in relation to the base, you get consistent illumination from lamp to lamp.

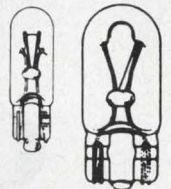

You can choose from over 25 types of GE wedge base lamps. Voltages range from 6.3 V to 28 V. Candlepower from 0.03 to 12 cd. Bulb sizes range from subminiature at 6mm to a heavy-duty bulb at 15mm.

To send for updated wedge base lamp technical information, circle number below or write GE for Bulletin #3-5259.

## These three free GE catalogs include important data changes that could affect your present design. Send for yours today.



#3-5169

June '75 Miniature lamp catalog features 40 pages and 500 data changes for complete 500-lamp line.



#3-6252R1

Feb. '75 Sub-miniature lamp catalog features 24 pages and 91 changes for more than 210 lamps.

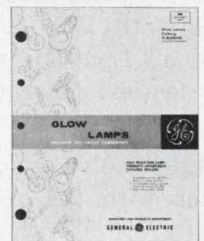

#3-6254R

Dec. '74 Glow Lamp catalog features 8 pages and 50 changes for 83 Glow Lamp Indicator and Circuit Component lamps.

For up-to-date technical information on any of these items write: General Electric Company, Miniature Lamp Products Department #3382-L, Nela Park, Cleveland, Ohio 44112.

GENERAL  ELECTRIC

CIRCLE NUMBER 99

## V/F-F/V CONVERTERS

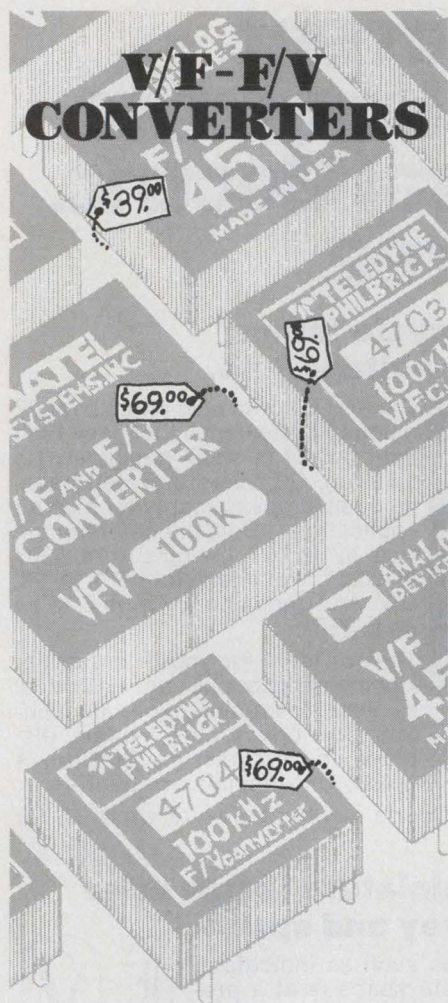

# OR



The A-8400 is the world's first monolithic V/F/V with 12 bit accuracy, 100 kHz bandwidth and does both V/F & F/V functions all in a 14-pin DIP which gives you the easiest buying decision in years.

**NOW** we've made things even easier with the A-8402; a single supply V/F/V with 11 bit accuracy, 100 kHz bandwidth and a supply range from +4V to +18V all in a 14-pin DIP for **\$895**

## intech

**function modules**

282 Brokaw Rd., Santa Clara, CA 95050  
Tel. (408) 244-0500, TWX 910 338-0254

CIRCLE NUMBER 102

## Flexible CRT terminals have many data handling features



Hewlett-Packard, 1501 Page Mill Road, Palo Alto, CA 94304. (415) 493-1501. P&A: See text.

Combining the advantages of the company's earlier 2640B and 2644A display terminals, the 2645A developed by Hewlett-Packard offers a wide range of data communications features. The 8080-based CRT terminal operates in both local and distributed computing networks at switch-selectable data-transmission speeds from 110 to 9600 baud.

An optional capability of the terminal permits asynchronous or synchronous (BISYNC) multipoint polling of up to 32 terminals on the same line. The terminal has eight special-function keys. Each key can be set to issue a user-defined string of up to 80 characters or a control sequence, which can be stored in the terminal RAM.

The 2645A permits off-line data preparation and editing,  $\mu$ P-controlled memory allocation, self testing and both page and character-mode operation. Also included are: character wraparound to simplify text insertion, adjustable margins, back tab, memory lock, automatic data logging and field protection.

The CRT has a high-resolution  $5 \times 10$  in. display area that can show 24 lines of 80 characters. Up to 12,000 bytes of multipage dis-

play memory can be included in the terminal; 4000 bytes come as standard equipment. Information can be retrieved from the unit by scrolling forward or backward a line or page at a time.

There are four 128-character sets—switchable on a character-by-character basis—that can be used concurrently. Among the available sets are a Roman set with displayable control codes for program debugging, a line drawing set for forms, a mathematics set with frequently used symbols and a Greek-character set. Each character has a size of  $0.097 \times 0.125$  in., but can be expanded to triple that size.

Two mini-3-M tape-cartridge transports are available as a built-in option. They provide up to 110,000 bytes each of mass data storage. This storage permits the 2645A to batch information and to perform many operations on a stand-alone basis. An RS-232C interface is standard, but a 20 mA current loop can be ordered.

Special color-coded prefix keys provide access to the multiple data paths and permit information to be moved between the different peripherals available—display and keyboard, built-in cartridges, or external units such as a printer.

The 2645A can display either white-on-black or black-on-white

characters and has a blinking underline cursor. It can operate over a 5-to-40-C range with a relative humidity of 5 to 95% (noncondensing). Over-all dimensions of the display are 17.5 × 18 × 13.5 in. and the plug-in keyboard is 17.5 × 8.5 × 3.5 in. The unit requires 85 W and weighs a total of 50 lb.

The earlier 2640B and 2644A terminals are based on the 8008 microprocessor and can communicate at rate of up to 2400 baud. The 2640 comes with only 1-k words of memory and cannot be modified for the tape storage option. The 2644A comes with 4-k of memory but cannot be expanded any further. It does, though, have the dual mini tape drives built in for bulk storage. Prices for the 2640B start at \$2600 for a unit with 1-k words and the additional 3-k increases the price to \$2900. The 2644A costs \$5000.

Prices for the 2645 start at \$3500 for the basic model with 4-k words of RAM, and increase to \$5100 for the unit with dual tape transports. Other accessories and options range from \$50 to \$500 each. Delivery is from stock.

Booth No. 449-458 Circle No. 307

## Alter formats on a floppy-disc system

*Remex, 1733 Alton St., Santa Ana, CA 92705. (714) 557-6860. \$2400, dual drive (OEM qty); 90 days.*

The Model RFS 7500 floppy disc system features user-selectable sector size. By changing a DIP switch on the formatter PC board, the user can select a 1, 2, 4, 8, 16, 26 or 32 sector format. This formatting employs a soft "sectoring" technique similar to the IBM 3740 format, so the user can increase data capacity by decreasing sectors without changing software. The system incorporates formatter electronics, power supply and from one to four flexible disc drives—all enclosed in a 19 in. rack-mountable chassis. The formatter is  $\mu$ P based, performing many functions within the system which normally require main computer control.

CIRCLE NO. 286

# AIRPAX™

## UPG Delay 66 Circuit Protector



## Problem Solver!

### Problem:

Customer had a 1/3 hp, 115 volt single phase capacitor-run 3450 rpm motor. Running current was 4.6 amperes and starting current was 28 amperes with a start-up time of 1.6 seconds.

He needed overload protection that was faster than that supplied by the internal sensors and a fairly quick dropout in case of a jammed load or stalled rotor.

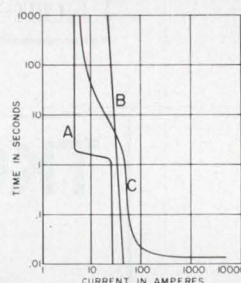

Time vs Current  
A — Motor Characteristics  
B — 15A Fuse  
C — UPG Delay 66, 5A

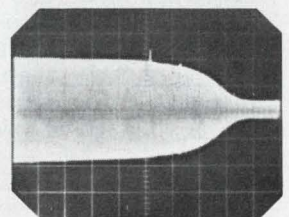

Start-up Current Envelope  
Vertical 7.5 amps rms/div.  
Horizontal .2 sec./div.

In order to start the motor without blowing a fuse, he was forced to use a 15 ampere rating. This gave him stalled rotor protection at about 10 seconds, but no overload protection. The standard long delay magnetic protector required a 7½ amp rating to be able to turn his motor on reliably. This gave him his stalled rotor protection at about 5 seconds, and overload protection at 200%. Still not good enough.

### Solution:

The Airpax UPG Delay 66, at 5 amp rating eliminated this problem with turn on . . . locked rotor protection at about 4½ seconds . . . and overload protection at about 150% on nameplate in approximately 400 seconds. This allowed short periods of overload without nuisance tripping. His problem was solved. (Delay 66 is also available in larger Airpax Type 219 and 229 Molded Case units up through 100 amperes.)

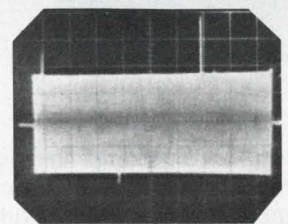

Stalled Rotor Trip Out  
Vertical 7.5 amps rms/div.  
Horizontal .5 sec./div.

If you have an application with a special protection problem, call Airpax Electronics at Cambridge, Maryland (301-228-4600) or write for literature on Airpax Circuit Protectors and Circuit Breakers.

# AIRPAX™

**AIRPAX ELECTRONICS  
CAMBRIDGE DIVISION**

Cambridge, Maryland 21613 • Telex 8-7715 • TWX: 710-865-9655

Other Airpax Divisions:  
CONTROLS DIVISION, Ft. Lauderdale, Florida  
Instruments for Industry  
AMERICAN DATA, Huntsville, Alabama  
TV Products

CIRCLE NUMBER 103

**A new  
International  
Power.  
(switch, that is.)**



C&K Components, Inc.

C&K's new Model 9201 miniature DPDT *power switch* meets all international electrical and dimensional specifications. It has an electrical life of 25,000 cycles at full load, a contact rating of 6 amps, and a dielectric strength rating of 1500 rms @ sea level. For more info on C&K's international power switch, write or call today!

103 Morse St., Watertown,

MA 02172 Tel: (617) 926-0800 TWX: 710-327-0460

Telex: 92-2546

A FREE engineering sample is available on request.  
Echantillon pour expertise gratuit sur demande.  
Kostenloses Ingenieurmuster bei Anfrage.  
Sono disponibili su richiesta saggi gratis d'ingegneria.

See C&K at Wescon Booth 928-930  
CIRCLE NUMBER 104

**Low cost, high  
performance  
3A SPDT relay  
really saves  
PC board space**

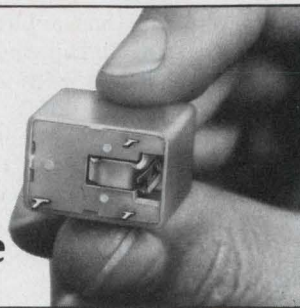

**Mounts on .69" centers...  
satisfies thousands of application needs**

Where size and space are important, the Series 27 relay can be just the low cost answer you've been looking for. It provides 3 amps of switching in a 0.526" cube and mounts on .69" centers, assuring high density PC board mounting. The cost is \$1.05 each in 1,000 piece lots for 3, 6 and 12V dc units ...slightly higher for 24V dc.

You'll find the Series 27 relay suitable for hundreds of control applications. For instance: timing controls; gas pilot light controls; anti-theft devices for CB radios; automotive controls; emergency lighting equipment; and medical equipment, to name a few.

The relay has a 450 mW pick-up sensitivity (180 mW available). Contact rating is 3A res @ 28V dc. 120V ac. Contact resistance is 0.10 ohm.

**Write for information today!**

**NORTH AMERICAN PHILIPS CONTROLS CORP.**

Frederick, Md. 21701 • (301) 663-5141

CIRCLE NUMBER 107

**MaX-Y line-up**

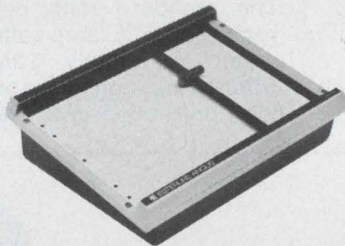
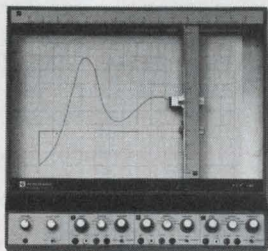

Esterline Angus has the newest and best in X-Y recorders, many models from high speed 2 pen to new stripped down OEM. Maximize your choices: rugged XYY' Model 540 zips along at up to 30 ips on each axis. Plots 2 independent variables against time or 3rd variable. Multirange with vernier on all axes. One millivolt/in. sensitivity.

OEM Model 575 contains a unique Y-axis pen shuttle with throwaway fiber-tip pen and pen lift in a single assembly. Slew speeds of 50 ips! Single ranges from 1 mV to 10 V/in. Add-on multirange module available for lab use. Full X-Y catalog: Esterline Angus Instrument Corporation, Box 24000, Indianapolis, Indiana 46224. Telephone 317/244-7611.

**ESTERLINE ANGUS**  
AN ESTERLINE COMPANY

CIRCLE NUMBER 105

**TKC® STACKING CONNECTORS**

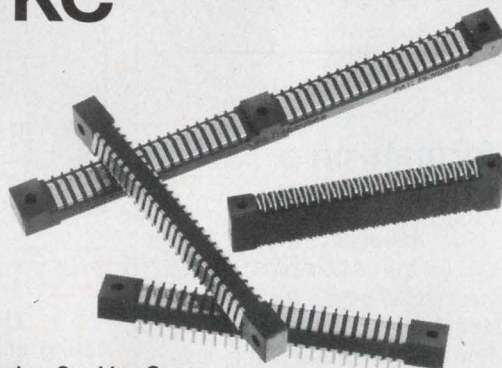

**Solderless Stacking Connectors**

Connectors available with through holes and threaded inserts... various contact platings... and the number of contacts and spacing to match requirements. (Also: solder pins for thru-board mounting.)

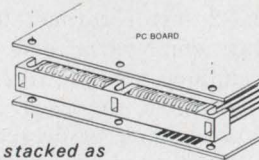
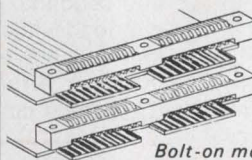

*Bolt-on models can be stacked as deep as required to hold PC boards rigidly parallel.*

**FEATURES**

- Easy mounting...low assembly costs
- CONE-POINT® contacts for positive connection
- Gold or tin-plated special alloy contacts
- Two mounting methods: bolt-on or solder-post
- Rugged, glass-filled phenolic body
- CUSTOM DESIGN AT OFF-SHELF PRICES

**TELEDYNE  
KINETICS**

410 S. Cedros Ave.  
Solana Beach, CA 92075 • (714) 755-1181  
TWX (910) 322-1135

CIRCLE NUMBER 108  
ELECTRONIC DESIGN 19, September 13, 1976

## DATA PROCESSING

### Microcomputer card has fully buffered lines

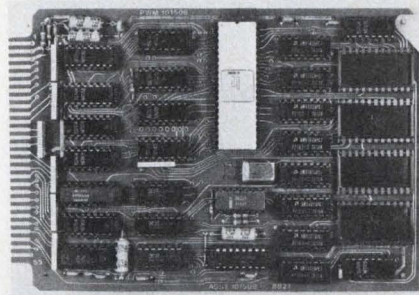

Pro-Log Corp., 2411 Garden Rd., Monterey, CA 93940. (408) 372-4593. \$350 (single qty); stock.

The Model 8821 PC card contains an 8080A  $\mu$ P with TTL buffering of address and data lines. The card has address and memory control for DMA, a crystal clock, a power-on and external reset, 1-k bytes of RAM, capacity for 4-k bytes of ROM, and external memory and I/O control. A separate I/O card is usually necessary to build a complete system. The 8821 card measures 4.5  $\times$  6.5 in. with a 56-pin card-edge connector and fits into standard card racks. All parts used in card production are second sourced.

Booth No. 853, 855 Circle No. 287

### Digitizer connects to computers, calculators

Talos Systems, Inc., 7419 East Helm Dr., Scottsdale, AZ 85260. (602) 948-6540. See text.

A series of three PC boards connects the manufacturer's graphic digitizing tablets to a wide range of minicomputers and intelligent terminals. The Sequential model (\$350 single qty) allows you to connect directly to the PDP-11. The GPIB module (\$450 single qty) connects directly to the Tektronix 4051 smart terminal and most HP instruments. The Programmable module (\$450 single qty) allows you to connect via an RS-232 port, to a teletypewriter. Also it provides several other formats for interfacing Tektronix, Monroe or Wang Calculators, modems, computers or recorders. These interfaces are in addition to the standard parallel-binary or BCD outputs. The appropriate board plugs into the digitizer's electronics box.

CIRCLE NO. 288

### Low-cost disc systems fit on DG's Nova CPUs

Tri-Star Computer Systems, Inc., 304 Harper Dr., Moorestown, NJ 08057. (609) 234-6661. \$17,000 (80 Mbyte).

Three disc subsystems for Data General's Nova minicomputers store 40, 80 or 300 Mbyte. The TDS series of subsystems allow Data General's Nova users to add large-file disc storage to their mini-computer systems at lower cost than similar equipment from Data General. The disc subsystems include the controller, drives, power supply, interface, and all the necessary cables and mounting hardware. The systems feature 30-ms average access time, 603-kHz word transfer rate and 8.33-ms average latency.

CIRCLE NO. 289

### Computer driven TV display is inexpensive

Grinnell Systems Corp., 2986 Scott Blvd., Santa Clara, CA 95050. (408) 988-2100. See text.

The GP-26, a graphic television imaging system, sells for about half the price of other systems. The system generates and displays complex line drawings and/or picture images on standard TV monitors. Users can choose black and white, grey scale, color, multilevel color in any combination. The system also generates alphanumeric characters, symbols and vectors. The GMR-26 interfaces to most popular computers, and any point on the display may be accessed in 3.2  $\mu$ s. Other capabilities of the GMR-26 include line by line, up or down image scrolling, automatic incrementing of display entities and generation and display of a blinking cursor. Three resolutions are available: 512  $\times$  512 elements, 256  $\times$  512 elements and 256  $\times$  256 elements. The GMR-26 consists of a controller and one or more display channels. The controller includes the control logic, a power supply, a 19-in. rack-mount chassis and a standard 16-bit interface. Other interfaces can be furnished. A GMR-26 controller and two display channels with 256  $\times$  256 element resolution costs \$5700.

CIRCLE NO. 290

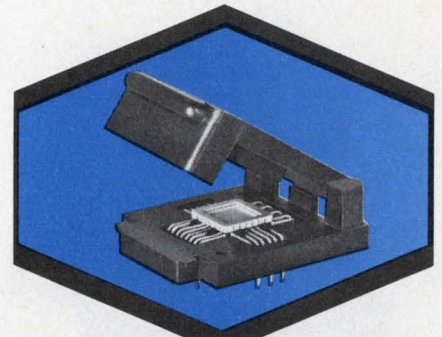

NEW

### "CHIP CARRIER" TEST SOCKETS

VERSATILE TEXTOOL SERIES ACCEPTS VIRTUALLY ALL "CHIP CARRIERS"

The versatile new TEXTOOL "chip carrier" test socket series includes models capable of accepting all "carriers" with from 14 to 48 leads and body sizes up to and including .500 inch square.

In addition, only minor tooling changes allow the socket to also accept plastic "leaded" packages less than .500 inch square with two or four side, straight or formed leads.

A positive locking system enables loading and unloading literally with the fingers. Different pressure pad thicknesses may be specified for the socket lid to adjust for those applications where packages are "too thick" or "too thin."

Other significant features of TEXTOOL's new "chip carrier" sockets include a lid design that eliminates shorting against contacts or P.C. board and which will not separate from the socket body under normal usage, integral mounting holes and minimum lid overhang at the back of the socket to permit maximum P.C. board mounting density.

All TEXTOOL "chip carrier" sockets are ideally suited for both test and burn-in applications and are available in a wide variety of materials to meet specific test requirements.

Detailed information on these and other products from TEXTOOL . . . IC, MSI and LSI sockets and carriers, power semiconductor test sockets, and custom versions . . . is available from your nearest TEXTOOL sales representative or the factory direct.

NEW TEXTOOL CONDENSED CATALOG AVAILABLE!



PRODUCTS, INC.

1410 W. Pioneer Drive • Irving, Texas 75061  
214/259-2676

CIRCLE NUMBER 109

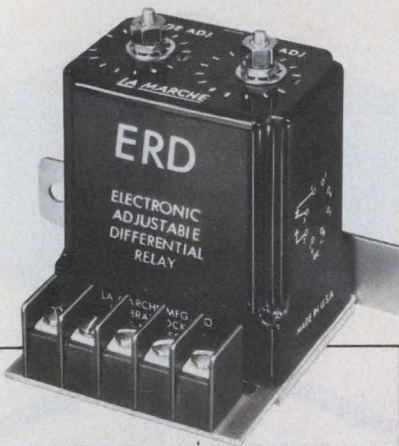

## New LaMarche solid state relays provide split second actuation in supervisory control circuits.

These new relays are offered in two basic versions. Model ERD has fast-acting, dc-voltage-sensing circuit with independently adjustable pull-in voltage and differential. High-reliability, zener-diode-referenced, electronic-time-gated switch drives relay. Model ERT is dc-voltage-sensing unit having time-delayed operation on either "make" or "break", with independently adjustable "make" voltage and differential. Both types of relay have a nominal voltage of 6-250 vdc and repeat accuracy of 0.1% over a temperature range of 0-60 C. Maximum reset time is 50 msec, and all models are field adjustable.

Typical applications include the operation of electromechanical relays in control systems for food and packaging machinery, machine tools, and a wide variety of manufacturing processes. They are also used to command valves, solenoids, protection devices and a variety of other resistive loads.

These units are offered in three enclosed-housing configurations, plus an open board version. Ac relay models also available. For full details, call your local LaMarche Sales Office, or contact factory on special applications.

**LaMARCHE**  
MANUFACTURING COMPANY  
106 Bradrock Drive  
Des Plaines, Illinois 60018  
Phone: 312/299-1188

CIRCLE NUMBER 110

## DATA PROCESSING

### A telephone self-dials a predetermined number

Warren G-V Communications, 101 Okner Pkwy., Livingston, NJ 07039. (201) 992-6200.

A telephone dials a programmed number of up to 11 digits, automatically, when the handset is lifted. Called the Courtesy Phone, the unit does this over the public switched network, not over leased or dedicated lines as previous systems did. The Courtesy Phone is self-contained and in a standard telephone assembly. The number to be dialed is determined by internal wire straps, and can be changed after installation. The circuitry is solid state and is powered by the central office line; no battery or other power source is required.

CIRCLE NO. 295

### Terminal has flexible data transmission

Omron Corp., Information Products Div., 440 East Middlefield Rd., Mountain View, CA 94043. (415) 964-2266; 30-60 days.

The 8025C communications display terminal has an expanded data transmission capability. The terminal is controlled by a microprocessor and designed for stand-alone or on-line data entry. The 8025C will operate in both a normal and in a protected field mode. Protected fields cannot be altered by the terminal operator; only variable data may be inserted in specified areas of the display. The terminal permits identification of the beginning and end of data fields by transmission of control characters embedded in the protected field. This feature provides increased flexibility and control of data flow and improves data reliability. The 8025C features a 15-in. diagonal, 1920-character display. A full range of scrolling and editing features are included. In addition, the terminal will support RS-232 compatible peripheral devices. The unit is TTY compatible (ASR and KSR modes) with transmission rates to 2,400 baud asynchronous in full or half-duplex mode.

CIRCLE NO. 296

## Hand-held calculator works with fractions

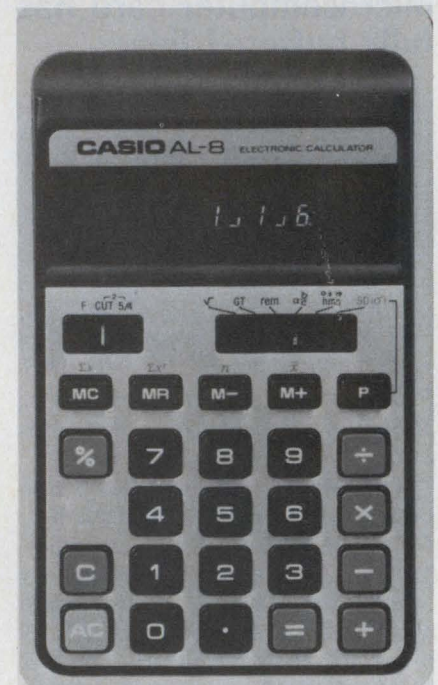

Casio, Inc., Consumer Products Div., 15 Gardner Rd., Fairfield, NJ 07006. (201) 575-7400. \$24.95.

The AL-8, 8-digit calculator adds, subtracts, multiplies and divides numbers expressed as fractions. The function-selector slide switch also selects the following instructions: to generate the remainder of a division between two numbers; to calculate standard deviation of a group of numbers; and to deal with numbers expressed as hours, minutes and seconds. The calculator comes with a one-year warranty on parts and labor. It operates on regular penlight batteries, included in the calculator price.

CIRCLE NO. 297

### Disc drives add memory to a desktop calculator

Hewlett-Packard, 1501 Page Mill Rd., Palo Alto, CA 94304. (415) 493-1501. 9885M: \$3900; 9885S: \$2500.

Two flexible-disc drives connect to the manufacturer's 9825 programmable desktop calculator. The drives, the 9885M (master) and 9885S (slave), have a memory capacity of 468-k bytes per diskette. The 9825 calculator can direct up to eight 9885M units. Each 9885M, with its built-in controller, can in turn manage three 9885S units.

CIRCLE NO. 298

## DISCRETE SEMICONDUCTORS

### Thyristor/rectifiers operate at TV voltages

RCA/Solid State Div., Route 202, Somerville, NJ 08876. (201) 685-6423. \$2.58 to \$3.22 (100 up); stock.

Eight integrated thyristor/rectifiers, the S3900 and S3901 series for color TV and the S3902DF and S3903MF for monochrome TV, can drive horizontal deflection circuits. They are all-diffused monolithic circuits incorporating a silicon-controlled rectifier and a silicon rectifier on a common pellet. The S3900-series and S3902DF types are used as bipolar switches in television circuits to control horizontal yoke current during the beam-trace interval; the S3901-series and S3903 MF types are used as commutating switches to initiate trace-retrace switching. Devices in the S3900 series can supply 8 mJ of stored energy to the deflection yoke; this is sufficient for 29 and 35-mm-neck color picture tubes operated at a nominal supply voltage of 31 kV. The S3902DF is capable of supplying 3 mJ of stored energy to the deflection yoke; this is sufficient for 29-mm-neck black-and-white tubes operated at a nominal value of 19 kV.

CIRCLE NO. 299

### Optical sensor contains hybrid output circuit

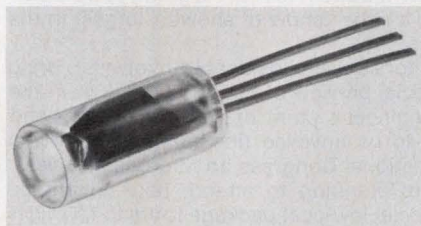

HEI, Inc., Chaska, MN 55318, (612) 448-3510. \$7.39 (1000 up); stock.

A new single-point sensor, the HEI-115 solid-state optoelectronic assembly, contains a silicon phototransistor and waveshaping hybrid circuitry. This combination provides the user with a square-wave output that is TTL-compatible. The device has a broad-band spectral response, and an output capability of 10 standard TTL gates.

CIRCLE NO. 300

### Tuning-diode Q values increased two times

Alpha Industries, Inc., 20 Sylvan Rd., Woburn, MA 01801. (617) 935-5150. See text; stock.

Typical Q values of the DKV-6520 and the DKV-6530 series of hyperabrupt tuning diodes have been increased to over twice previous catalog values, according to Alpha. Guaranteed minimum Qs are 150 to 190% of previous mini-

mum values. There is no increase in cost. The DKV-6520 series, designed for hf to vhf applications, offers  $C_{T_1}$  capacities of 20 to 200 pF with typical Q values of 420 to 125. For uhf applications, the DKV-6530 series offers  $C_{T_3}$  capacities of 11.5 and 28 pF with typical Q values of 700 and 400. Both series offer tuning ratios of over 5:1 from 4 to 20 V, and exceptionally linear-frequency-vs-voltage tuning.

CIRCLE NO. 310



**OptimaDesk...  
the data console  
with the one thing you've  
been waiting for.**

**Everything.**

Every feature you'll ever conceivably want, including the ones that cost extra in other data consoles (rolled front edge, chrome legs and the like.) Every color from Burnt Orange to Sky Blue to Black; fourteen standard colors in all. Standard widths are 24", 45" and 66", each in a choice of keyboard or desk heights. And the two styles you see here are just the beginning.

Above all, the OptimaDesk is the finest quality furniture ever built for electronic instruments. And the price is right. The 45" model is around \$239, for instance.

Write to us for complete information.

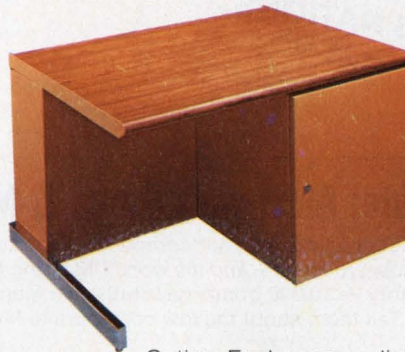

**OPTIMA®**

Optima Enclosures, a division of Scientific-Atlanta, Inc. 2166 Mountain Industrial Blvd., Tucker, Georgia 30084 or call (404) 939-6340

CIRCLE NUMBER 111

# Electronic Design in cooperation with ~ electronica 76

announces a special Oct. 25 preview issue of

**the World's Largest  
Electronics Show — EVER!**



**MUNICH**  
GERMANY. NOV. 25 — DEC. 1, 1976  
20 EXHIBITION HALLS PACKED  
WITH 1,600 EXHIBITS AND STANDS  
FROM OVER 2,500 ELECTRONICS  
FIRMS FROM 23 NATIONS.

This year's ELECTRONICA is going to be a stellar event. It's the "show of shows," largest in the world.

Our editors are already deeply involved to bring you a special preview of ELECTRONICA from the design engineer's point of view...the news and products to be unveiled (including those at the 7th International Congress on Microelectronics).

If you're planning to attend, take advantage of our special low-cost package tours to MUNICH — see right. If you're staying home, watch for ELECTRONICA 76 PREVIEW — October 25 in *Electronic Design*.

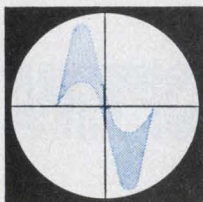

## Note: Alert your Sales & Marketing People

October 25 can be your company's opportunity to *sell* at ELECTRONICA, in Europe, to the U.S. and the world! It's going to have the largest circulation in our history — 10,000 bonus distribution at Munich, 24,000 international, 103,500 in all. Tell them about the low cost tours to Munich, too. They can save a bundle!

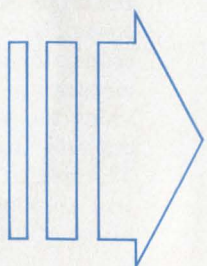



# Electronic Design in cooperation with

# electronica 76 announces 1976

# Travel Tours to Munich

departing from New York, Boston or Chicago



A FULL WEEK OR TWO-WEEK STAY FOR ONLY SLIGHTLY MORE THAN REGULAR AIR FARE ALONE

## 8 DAYS/7 NIGHTS

Included: **Air travel**, economy class via Swissair regularly scheduled flights with complimentary meal service aloft.

**Transfer** by deluxe motor coach from airport to hotel, and return, including baggage handling.

**First class hotel accommodations** (double occupancy) at Eden Hotel Wolff — one of Munich's finest — within walking distance of the fair grounds; all rooms with bath, breakfast and service.

**Champagne reception** co-sponsored by *Electronic Design* and ELECTRONICA 76 management.

**Admission** to the ELECTRONICA Exhibition.

**Tour** accompanied by U.S. representative of the Munich Fair Authority.

## 14 DAYS/13 NIGHTS

Included: All features of shorter tour except accompaniment by U.S. rep. Half-day sightseeing tour of Munich.

All tours are predicated on 10 or more participants; air fares are subject to change. All participants must depart and return with the group to qualify for this low group airfare. Regular airfare for less than 14 days is \$748.00!

NAME \_\_\_\_\_  
 TITLE \_\_\_\_\_  
 COMPANY \_\_\_\_\_  
 ADDRESS \_\_\_\_\_  
 CITY, STATE, ZIP \_\_\_\_\_  
 PHONE \_\_\_\_\_ DEPART FROM: NEW YORK  BOSTON  CHICAGO

Specify ELECTRONIC DESIGN/ELECTRONICA 1976 TOUR TO MUNICH. Make checks payable to "Kallman Associates" (U.S. Electronica representatives). Tel: 201-653-3304. Mail to: Kallman Associates, 30 Journal Square, Jersey City, New Jersey 07306.

### 8-DAY PACKAGE

**\$698<sup>00</sup>**

From N.Y.  
or Boston

(\$819 from Chicago.)  
Subject to change.

DEPART: NOV. 24, 1976

RETURN: DEC. 2, 1976

Rates based on double occupancy.  
Single supplement: \$40.

### 14-DAY PACKAGE

**\$938<sup>00</sup>**

From N.Y.  
or Boston

(\$1059 from Chicago.)  
Subject to change.

DEPART: NOV. 19, 1976

RETURN: DEC. 3, 1976

Rates based on double occupancy.  
Single supplement: \$90.

### RESERVE NOW DEPOSIT REQUIRED

**\$100<sup>00</sup>**

Returnable before  
October 1, if cancelled.

DEADLINE FOR FINAL  
PAYMENT:

**OCT. 30**

(for both tours)

# Electronic Cabinets & Cases by PREMIER METAL PRODUCTS CO.

381 Canal Place, Bronx, N.Y. 10451/(212) 993-9200  
OVER 1300 ITEMS IN OUR CATALOG



CIRCLE NUMBER 112

## COLOR DISPLAY DRIVER

- Alphanumerics
- Programmable Character Definition
- Graphics
- Color or Grey Scale
- Raster Scan
- Standard T.V. Monitor
- 2048 Characters
- Self-contained Refresh Memory
- Conforms to IEEE Standard 583 Modular Instrumentation and Digital Interface System (CAMAC)
- Use with virtually any computer

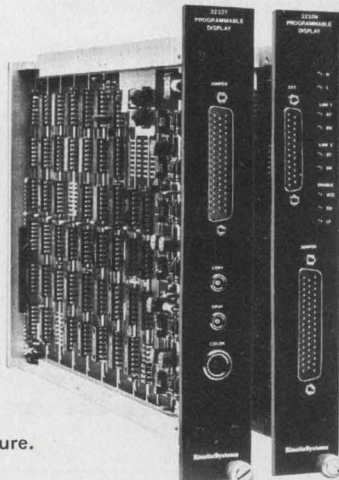

Circle number for a copy of our color brochure.

KineticSystems Corporation Lockport, Illinois 60441 815 838 0005  
TWX 910 638 2831

 **KineticSystems Corporation**  
CAMAC Process Control Systems for Science and Industry

CIRCLE NUMBER 113

## DISCRETE SEMICONDUCTORS

### FET chips provide low noise at 10 GHz

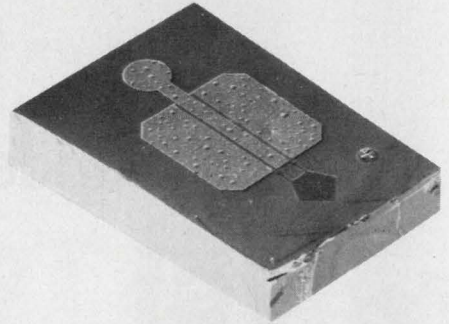

*Aertech Industries, 825 Stewart Dr., Sunnyvale, CA 94086. (408) 732-0880. \$95 (10-49); stock.*

One-micron-gate GaAs FET chips, the AFT2000, are now available for low-noise applications to 15 GHz. Maximum available gain at 10 GHz is 10 to 12 dB and typical noise figure at 10 GHz is 3.5 dB. They offer freedom from short-term drift. The AFT2000 require little or no circuit redesign when replacing similar competitive devices.

CIRCLE NO. 320

### JFETs available in low-noise versions

*National Semiconductor Corp., 2900 Semiconductor Dr., Santa Clara, CA 95051. (408) 732-5000. \$0.95 to \$2.50 (100 up); stock.*

Ultra-low-noise JFETs are now available as standard parts. You no longer have to select them. The new series includes three TO-72 metal-can devices and three epoxy-B, TO-92 devices, respectively identified as NF5101, NF5102 and NF5103 and PF-5101, PF5102 and PF5103. Key specifications for the new JFETs include an equivalent short-circuit input noise of 5 nV/ $\sqrt{\text{Hz}}$ , which is typical with a drain current of 0.5 mA at 10 Hz; the common-source transconductance is 4000  $\mu\text{mho}$  (minimum). An important feature of the new series is tight control of the gate-source cut-off voltage. The  $V_{GS}$  (OFF) of the NF/PF5101 ranges from 0.5 to 1 V; the NF/PF5102, from 0.8 to 1.4 V; and the NF/PF5103, from 1.3 to 2.5 V.

CIRCLE NO. 321

## LEDs replace incandescent lamps



Data Display Products, P.O. Box 91072, Los Angeles, CA 90009. (213) 641-1232. \$1.59 (100 up); to 5 wks.

Model 2SBL LEDs are replacements for incandescent lamps in all popular sizes, including a special version of base #2. The extended-length unit is designed to replace both the incandescent lamp as well as the lens on the front panel, thereby using the most of light output from the LED. Three colors are offered: red, amber and green. At 20 mA, typical, brightness is 50, 32 and 20 mcd, respectively, with clear tinted encapsulation. Diffused versions are also available and are best suited where the LED is viewed without a secondary lens or panel. All types are available with built-in resistors for all popular voltages through 48 V. For ac operation over 6 V, a built-in rectifier also is available. Optimum current is 20 mA for maximum life and efficiency. The cathode is identified with a green dot. However, units with built-in resistors are not damaged if installed momentarily in the wrong direction. On most models, an integral secondary Fresnel lens is available for front panel applications.

CIRCLE NO. 322

## Power transistors rated 125 W at 400 V

International Rectifier, Semiconductor Div., 233 Kansas St., El Segundo, CA 90245. (213) 678-6281. \$11.41 (100-999); stock.

A new series of power transistors rated for 400-V operation features a power-dissipation rating of 125 W. Designated 2N5241, the transistors employ hard-glass passivation of the silicon chip to provide stability at high operating junction temperatures. Collector current is rated at 5 A continuous, and dc-current gain is 35 max.

CIRCLE NO. 323

## Optoisolators have JEDEC registration

Optron, Inc., 120 Tappan Circle, Carrollton, TX 75006. (214) 242-6571. \$3.25:3N243, \$4.31:3N244, \$5.83:3N245 (1000 up); stock.

A new series of optically coupled isolators has the JEDEC registration 3N243, 3N244 and 3N245. When used as replacements for pulse transformers or mechanical relays, these isolators solve such problems as common-mode noise re-

jection, ground loops and voltage-level translation. The devices consist of gallium-arsenide infrared emitters coupled with silicon phototransistors. They are similar to Optron's OPI 140 standard isolator, and they are available in a hermetically sealed TO-18 package. Guaranteed minimum current transfer ratios are 15% for the 3N243, 30% for the 3N244 and 60% for the 3N245. All devices feature 1-kV isolation.

CIRCLE NO. 324

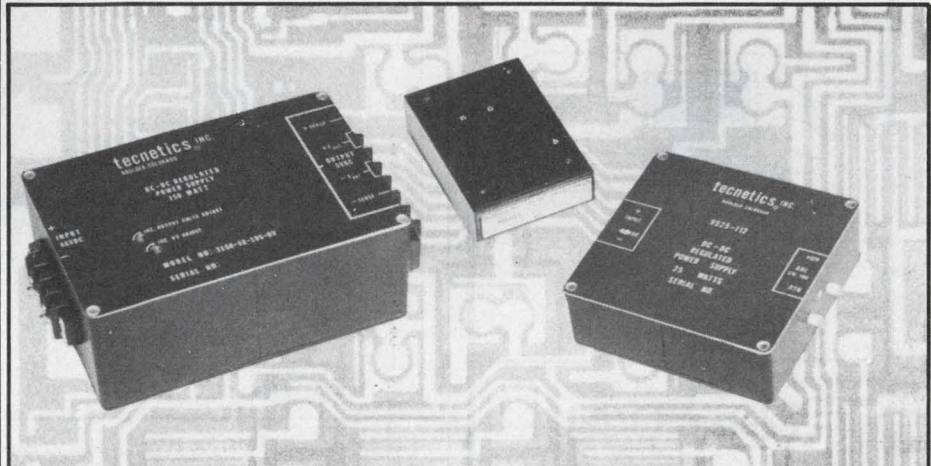

## Designing solid state telecommunication equipment? Let Tecnetics convert your 48VDC power source.

Tecnetics high efficiency power converters are the reliable and cost effective way to convert 48VDC power sources into usable power for solid state devices.

Tecnetics offers a wide range of 48VDC input power converters with outputs ranging between 5 and 48VDC and power up to 150 watts. All are super reliable, too, because Tecnetics is a high technology company that has been supplying the telecommunications industry with converters since 1958.

We pioneered numerous technological advances including pulse width modulation techniques which enable us to achieve extremely high efficiency in our power supplies.

Features of our 48VDC power supplies include full input/output isolation, overload protection, remote error sensing and input filters to reduce conducted EMI.

For full specifications on these and over 300 other power supplies, write for our new 1976 catalog.

### 48VDC POWER SUPPLIES FROM TECNETICS

SERIES	POWER Watts	SINGLE (S) DOUBLE (D) TRIPLE (T)	VOLTAGE VDC	EFFICIENCY	DIMENSIONS			PRICE RANGE U.S. \$ 1 to 9
					L IN.	W IN.	H IN.	
3150-48	150	S	5-48	High	6	4	2.25	500
3100-48	100	S	5-48	High	6	4	2.25	450
3050-48	50	S	5-48	High	4	4	2.25	425
3025-48	25	S	5-48	High	4	4	2	395
9525-48	25	S,D,T	5-24	Std.	4	4	1.5	250,295,365
1000	10	S,D,T	5-24	Std.	3.5	2.5	0.96	115,125,140
1600	6	S,D,T	5-24	Std.	3.5	2.5	0.96	89,99,109
1300	3	S,D,T	5-24	Std.	2.35	2.125	0.84	79,89,99
1100	1	S,D	5-24	Std.	1.75	1.50	0.65	49.55

**tecnetics®** The Power Conversion Specialists P.O. Box 910, 1625 Range Street, Boulder, Colorado 80302 (303) 442-3837 TWX 910-940-3246

CIRCLE NUMBER 114

We squeeze time

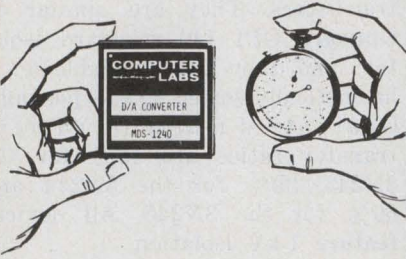

...in our new...

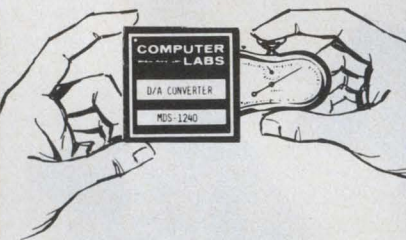

12-bit D/A!

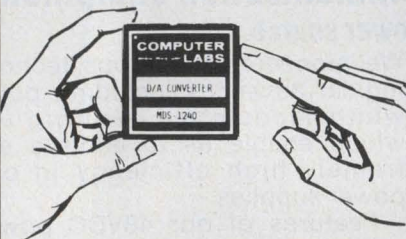

**MDS-1240**  
**D/A CONVERTER**

12-Bits, 40NS

**\$149**

**COMPUTER LABS**

505 EDWARDIA DRIVE  
GREENSBORO, N. C. 27409  
(919) 292-6427

CIRCLE NUMBER 115

INTEGRATED CIRCUITS

# Floppy-disc control & format circuit comes on single chip

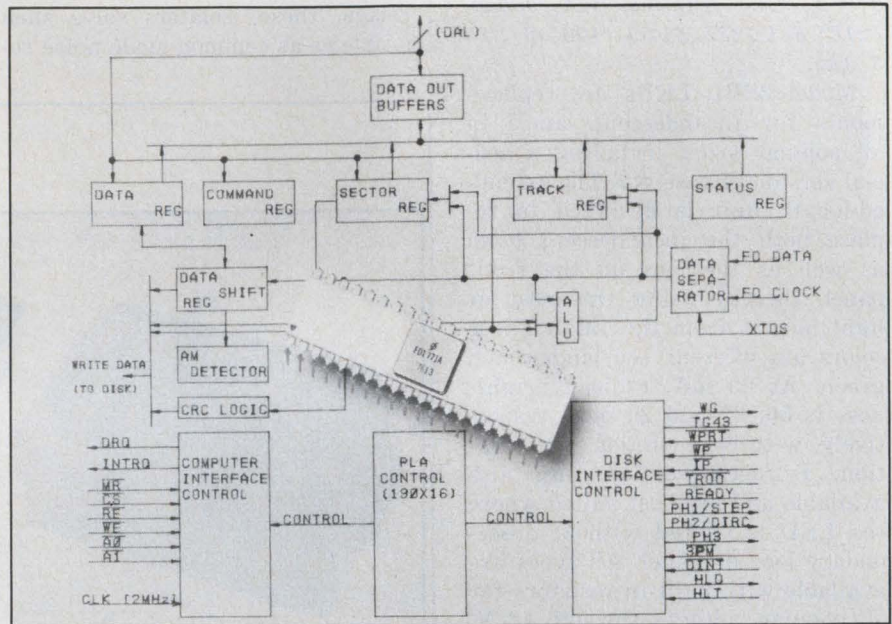

Western Digital, 3128 Red Hill Ave., Box 2180, Newport Beach, CA 92663. (714) 557-3550. P&A: See text.

Building a controller or formatter to interface your computer to a floppy-disc drive need no longer be a complex design task.

The Western Digital FD1771 formatter/controller chip contains all the circuitry necessary to control a floppy-disc drive and format the data. It can replace about 100 to 150 assorted TTL circuits normally needed to do the job.

On the computer-interface side of the circuit, the processor can access and alter five on-chip 8-bit registers—the command, status, data, sector and track registers—and sense the data request and interrupt signals.

The disc-interface side of the FD1771 provides write-gate and data outputs, a head-load output, stepping-motor outputs and a low-current output. Inputs to the circuit include separated data and check lines, as well as lines for index, mark, track-0, write-protect, format-protect and write-fault.

As a formatter, the circuit can

arrange data in IBM 3740 format with 128, 256, 512 or 1-k byte sectors. In a non-IBM mode, sector lengths of up to 4-k bytes are possible.

The FD1771 accepts and executes 11 commands and has 8-bit bidirectional busses for data, status and control registers. Also included on the chip is a circuit that generates a cyclic redundancy check to minimize data errors. A free-running 2 MHz clock with a  $\pm 1\%$  maximum variation is required to do the internal timing.

Both three-phase or step-and-direction control of a drive motor is possible, so either type of disc drive can be used with the chip. Stepping rates of 10, 8 or 6 ms are possible.

The FD1771 operates over a 0-to-70-C range and requires +12 and  $\pm 5$  V. All input-output lines are TTL-compatible and can handle one 1.6-mA load. The circuit is housed in a 40-pin DIP.

Single-unit price of the controller/formatter is \$80, including a full documentation package. Delivery is from stock.

CIRCLE NO. 308

## Contemporary Classics in Electronics Design...

### COMPUTER-AIDED ANALYSIS OF ELECTRONICS CIRCUITS: Algorithms and Computational Techniques

Leon O. Chua—University of California, Berkeley;  
Pen-Min Lin—Purdue University

Comprehensive coverage of topological and computational techniques used in computer-aided circuit analysis. Up-to-date, flexible text topics range from elementary to advanced, with numerous examples, problems and illustrations. Solutions Manual, Fortran Source Programs and Large General Circuit Analysis Programs are available to instructors.

1975 737 pp. Cloth \$24.50

### COMPUTER SYSTEM ARCHITECTURE

M. Morris Mano—California State College

Introduces over 30 integrated circuit MSI and LSI digital functions, then explains their internal and external characteristics. Employs an easy-to-use register transfer language to clearly present basic concepts of computer organization and design. A Solutions Manual is available for the instructor.

1976 478 pp. Cloth \$17.95

For further information and to order your examination copies of the above texts, please write to: Robert Jordan, Prentice-Hall, Inc., Dept. J-570, Englewood Cliffs, New Jersey 07632.

# Prentice-Hall

CIRCLE NUMBER 116

## RIGHT-ANGLE PC TOGGLE



The ultimate in submini-toggle switches which are designed expressly for PC applications. Terminals and mounts fit 0.1" hole centers on X and Y axis. Gold or silver contacts are optional. Plain or threaded bushing. Custom PC terminals, too!

Write or call for our Product Selection Guide, technical information, prices & free samples.

CIRCLE NUMBER 151

## SUBMINIATURE PUSHBUTTON



This compact pushbutton switch series features snap-action contacts for a 3 amp 125 VAC rating. One piece bushing and case in aluminum with DAP base. Available as SPDT in either momentary or alternate action. Mounts in 1/4" diameter hole and is supplied with decorative hardware.

Call today for sample and additional information on this and other ALCOSWITCH products.

CIRCLE NUMBER 152

**ALCO** ELECTRONIC PRODUCTS, INC.  
1551 OSGOOD STREET, NORTH ANDOVER, MA. 01845 U.S.A.

Tel: (617) 685-4371

TWX: 710 342-0552

A SUBSIDIARY OF

**AUGAT** INC.

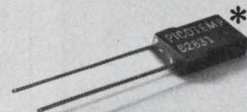

## Small Wonder

\* It's **PICOTEMP**® thermal cutoff  
New from Micro Devices

(Actual Size)

PICOTEMP® thermal cutoffs. Fit tight spaces — and limited budgets. Same accuracy and similar capabilities as the widely used MICROTEMP® safety thermal cutoffs...but smaller in size. Weighs just 1/48th of an ounce. Installed costs are less, too.

Use PICOTEMP thermal cutoffs when installation or space restrictions rule out MICROTEMP. At present, motors and transformers are two leading applications.

But, wherever you use PICOTEMP thermal cutoffs, you're assured of positive, low cost protection against overheating caused by malfunctions in electrical circuits and components.

The PICOTEMP thermal cutoff is completely sealed

against atmosphere. Because of its unique design and construction, it won't derate. And it is unaffected by age or extended use.

Here are some other things you'll want to know:

- current capacity—to 5 amps. at 120 VAC. Will hold this rating up to and including 240 VAC.
- temperature tolerance +0° C.—3.3° C.
- temperature ratings—63° C.—150° C. (146° to 300° F.)
- leads are 26 gauge silver plated wire.

Recognized under the Component Program of Underwriters' Laboratories, Inc. UL File #E40667A. MITI approved.



# MICRO DEVICES



DIVISION OF EMERSON ELECTRIC CO.  
1881 SOUTHTOWN BLVD.  
DAYTON OH 45439 513-294-0581

CIRCLE NUMBER 118

# FIRST CHOICE of INDUSTRY

## Phoenix Data's ENCASED EDAC Series 3000 Converters

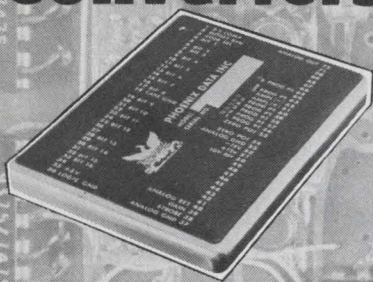

Time-proven reliability and ease of application in a wide range of products have made Phoenix Data's encased digital to analog converters a first choice with commercial and industrial equipment designers everywhere. Reasons why:

- 20 different models.
- 12 to 16 bit resolution.
- Straight binary, offset binary, or 2's complement input.
- Programmable output range selection.
- Bipolar or unipolar output.
- Precision internal voltage reference.
- Pre-calibrated for specified temperature range.
- RFI and EMI shielded.
- Conversion times to 1  $\mu$ sec. for 13 bits, 3  $\mu$ sec. for 16 bits.
- Accuracy to 0.003% of FSR.
- Optional temperature ranges from  $-55^{\circ}\text{C}$  to  $90^{\circ}\text{C}$ .
- TTL compatible input holding register.
- Convenient printed circuit board mounting.

All of the EDAC modules are available to meet military specifications.

If it's stability, accuracy, speed, or all-around quality you need in Data Conversion, contact Ron Brunnemer, director of marketing, or your area representative.



### PHOENIX DATA, INC.

3384 W. Osborn Rd. Phoenix, AZ 85017  
Ph. (602) 278-8528, TWX 910-951-1364

CIRCLE NUMBER 119

## INTEGRATED CIRCUITS

### Low-cost a/d converter delivers words in 20 $\mu$ s

National Semiconductor, 2900 Semiconductor Dr., Santa Clara, CA 95051. (408) 732-5000. See text; stock.

An 8-bit a/d converter, the MM-5357, costs only \$7.95 each in quantities of 100. The converter has a linearity of  $\pm 0.5$  LSB, an input impedance of 100 M $\Omega$  and a conversion speed of 20  $\mu$ s. The MM5357 operates from +5 and  $-12$ -V supplies, dissipates about 170 mW and is housed in an 18-pin epoxy DIP. The converter contains a chain of 256 identical resistors connected in series, 255 analog switches, a high-impedance-input comparator, output latches and control logic all on a single chip. A 10-V reference applied across the resistor chain sets 256 precision voltages against which the unknown input voltage is compared by the analog switches under control of the on-chip logic.

CIRCLE NO. 325

### CMOS master slices hold up to 2000 CMOS pairs

International Microcircuits, 3000 Lawrence Expressway, Santa Clara, CA 95051. (408) 735-9370. See text.

Two additions to the Master MOS family of CMOS master slice chips have been announced. The largest of the new chips, called MasterMOS-XXL, contains over 2000 pairs of CMOS transistors, 64 output buffers and 88 interface pads. Typical development charges for a custom circuit using MasterMOS-XXL are less than \$30,000 and typical production prices are less than \$75 each for 1000 units. The other new chip called MasterMOS-XL, contains over 1000 pairs of CMOS transistors, 52 output buffers, and 66 interface pads. Typical development charges are less than \$15,000, and typical product costs are less than \$35 each for 1000 units. Both chips are fully compatible with the company's three existing MasterMOS chips. Typical development schedules are eight to 12 weeks from logic drawing to IC production.

CIRCLE NO. 326

### Count extender widens range by factor of eight

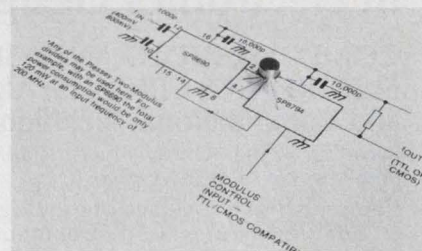

Plessey Semiconductors, 1674 McGaw Ave., Irvine, CA 92714. (714) 540-9945. From \$7.10 (100-up); stock.

The SP8794, a  $\div 8$  count extender increases the minimum division ratio of a 2-modulus counter while retaining the same difference in division ratios. For instance, with the SP8794, a  $\div 10$  or 11 counter becomes a  $\div 80$  or 81 counter, a  $\div 5$  or 6 counter becomes a  $\div 40$  or 41 counter. The SP8794 dissipates 40 mW and operates at frequencies from 0 to 120 MHz (minimum). Three operating temperature ranges are available: 0 to  $+70^{\circ}\text{C}$  (SP8794B);  $-40$  to  $+85^{\circ}\text{C}$  (SP8794M); and  $-55$  to  $+125^{\circ}\text{C}$  (SP8794A).

CIRCLE NO. 327

### IC comparator/counter is programmable

Motorola, 3501 Ed Bluestein Blvd., Austin, TX 78721. (512) 928-2600. \$2.61 (100-up); stock.

The MC14568B CMOS IC contains a phase comparator, a programmable reference divider (divide by 4, 16, 64 or 100) and a presettable 4-bit counter (divide by 1 to 15). The device is designed for phase-locked-loop circuits. In synthesizer schemes, the circuit's 4-bit counter can be used in the feedback loop by itself or cascaded with other binary or BCD counters such as the MC14569B, MC14522B, and/or the MC14526B to increase the length of the count. The comparator/counter circuit has a 3 to 18-V operating supply range. The MC14568B is available in two temperature range versions:  $-55$  to  $+125^{\circ}\text{C}$  ("AL" suffix in ceramic package) and  $-40$  to  $+85^{\circ}\text{C}$  ("CL" and "CP" suffix in ceramic or plastic, respectively). In addition to the two 16-pin DIP versions, the circuit is available as tested die.

CIRCLE NO. 328

## Digital voltmeter chip drives 4-1/2 digits

EFICS, 85X 38041 Grenoble Cedex, France. 100 francs (500-up); stock.

The CAF p-channel, MOS digital voltmeter chip provides a 4-1/2 digit readout. It delivers both multiplexed BCD outputs (4-bit parallel, in 5 serial blocks) and multiplexed seven-segment outputs that can directly drive liquid crystal displays. When connected with two op amps, a reference and a comparator, the CAF requires 160 ms to complete a reading. An external crystal controls the on-chip oscillator, which, in turn, controls all timing including automatic reset. The circuit requires +9 and -12 V supplies for a total operating power of 250 mW.

CIRCLE NO. 329

## Serial/parallel register completes filter set

Advanced Micro Devices, 901 Thompson Pl., Sunnyvale, CA 94086. (408) 732-2400. From \$4.60 (100-up); stock.

The Am25LS22 8-bit serial/parallel register includes a sign extend function. It is designed for use with the Am25LS14 multiplier and the Am25LS15 quad serial adder/subtractor. All three chips can be used to form a rudimentary digital filter. These circuits are available in molded or hermetic DIP packages and are specified for operation over the commercial or military temperature ranges.

CIRCLE NO. 330

## Speedy static RAM organized as 1 k x 4

Electronic Memories & Magnetics, 12621 Chadron Ave., Hawthorne, CA 90250. (213) 644-9881. \$18.75 (100-up); stock.

The SEMI 4104A static RAM offers an access time of 200 ns and a cycle time of 350 ns. It is organized as 1024 x 4. The 350 ns cycle time, or selected faster cycle times, permits application in data communications buffer memories. The SEMI 4104A has the same low standby power and "brownout" protection as the SEMI 4200 (4 k x 1) static RAM.

CIRCLE NO. 331

from Electronic Measurements . . .

# SCR 1Ø & 3Ø DC Power Supplies

We are pleased to report that we now produce the industry's largest selection of SCR phase-controlled power supplies.

How did we do it?

Slowly.

We didn't acquire the largest selection without selling a lot of power supplies along the way. Our way, for 35 years, has been giving the user what he wants; and in a watts/dollar ratio that gives him no choice but E/M.



Type	SINGLE PHASE				THREE PHASE			
Watts	500	800	1600	2400	2500	5000	10 KW	To 60 KW
Volts	0 to 7.5 V up to 600 V DC							
Amperes	0 to 0.75 A up to 3000 A DC							
Height (in.)	3.50	3.50	5.25	7.00	7.00	8.75	12.25	To 4'
Price (\$)	450 to 500	575 to 650	800 to 895	1000 to 1100	1200 to 1600	1500 to 2300	2300 to 2900	To 9500

Over 100 standard models. Thousands of optional combinations.

To order, or for any technical information, call

**TOLL FREE (800) 631-4298**



**ELECTRONIC MEASUREMENTS INC.**

405 Essex Road, Neptune, N.J. 07753

Phone (New Jersey) 201-922-9300 (Toll free) 800-631-4298

Specialists in Power Conversion Equipment

CIRCLE NUMBER 120



# MINIATURE PRECISION MOTORS

featuring

economy simplicity

volume production

low power input

efficient



integral gear reduction

extremely fast response

For more information and application data send for HSI catalog on Precision Motors.



**HAYDON SWITCH & INSTRUMENT, INC.**

1500 Meriden Road, Waterbury, Conn. 06705  
(203) 756-7441

CIRCLE NUMBER 121

## Two-Tone SSB RF Test Set

Model 315 combines two Model 925 RF Signal Generators having "Signallock" with a Model 210 Signal Combiner, resulting in a two-tone test set with unsurpassed stability from 50 kHz to 80 MHz. Signal level of each tone or combined tones is adjustable from 0.1  $\mu$ V to 2 volts with  $\pm 10$  Hz stability. Signal spacing is from 100 Hz to almost 80 MHz. Intermodulation distortion is 60 dB down at full output; better at lower outputs. Write or call today for complete specifications and pricing.

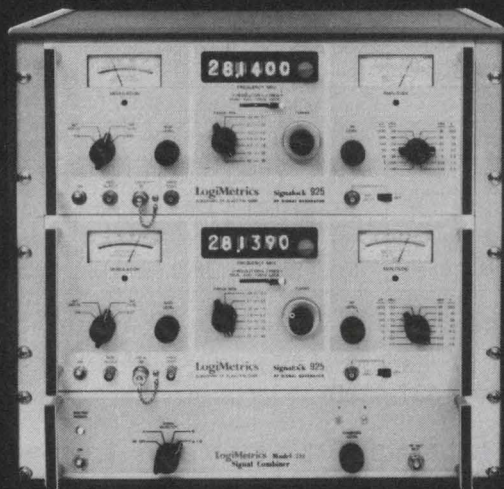

**LogiMetrics**

121-03 Dupont Street, Plainville, New York, 11803, (516) 681-4700/TWX: 510-221-1833  
RF Signal Generators, Frequency Synthesizers, Traveling Wave Tube Amplifiers

CIRCLE NUMBER 122

## POWER SOURCES

Portable dc standard offers  $\pm 0.05\%$  accuracy



Yokogawa Corp. of America, 5 Westchester Plaza, Elmsford, NY 10523. (914) 592-6767. \$995; stock.

A portable dc voltage and current standard operates from its internal battery for three hours under full load. It can also operate from the 115-V-ac line. Features of the unit include:  $\pm 0.05\%$  accuracy from 0 to 12 V or 0 to 120 mA, and resolution of 1  $\mu$ V and 0.1  $\mu$ A. The unit provides front-panel display and selection of voltage or current: five decades for voltage (10 mV through 100 V), three decades for current (1 through 100 mA). Overvoltage and overcurrent protection and polarity selection are included. The internal battery charger repowers the batteries in three hours. The unit weighs 8 lb.

Booth No. 274 Circle No. 332

## Pulse-width modulation UPS efficiency upped

Cyberex, Inc., 7171 Industrial Park Blvd., Mentor, OH 44060. (216) 946-1783. \$350/kVA; 20 wk.

The Delta-Y uninterruptible power system's (UPS) overall efficiency has been increased almost 10%. In addition, reflected power-line distortions have been essentially eliminated and the system now presents almost unity power-factor, thereby reducing kVA demand. Using pulse-width modulation, the Delta-Y is said to provide 25% greater reliability (MTBF) and more than 275% short-circuit current than step-wave designs. It is a three-phase solid-state system which can handle non-linear loads; and when operating with 100% phase-load imbalance, it still delivers balanced voltage. Single units pass from 15 to 250 kVA. Multiple units can operate in parallel, or redundantly.

CIRCLE NO. 333



## UPS protects self and load provides printout

General Electric, General Purpose Control Dept., P.O. Box 2913, Bloomington, IL 61701. Or call (203) 357-4088.

An uninterruptible power system (UPS) from GE is designed for operation in the 100 kVA-and-up range. It features a solid-state annunciator that provides a printout of status and sequential events pertinent to automatic system operation. UPS multimodule systems have an intermodule datalink to coordinate individual control operation. An internal monitor and an output detector eliminate any possible common mode-control failures. This provides sustained power output even if one datalink is lost. A logiccenter in each power module contains a self-diagnosing annunciator, which produces a time-stamped printout of status and sequential events of the automatic system operation. Indications are provided for more than 220 monitored items. Each power module has built-in "early warning" detectors that can be triggered by a module malfunction. The detectors are simultaneously linked to the sequential, self-diagnosing annunciator. The printout of sequential events aids servicing. The logiccenter continuously monitors and analyzes battery conditions. These "battery protector" functions are designed to prevent unnecessary battery cell stress and discharge.

CIRCLE NO. 334

## Rechargeable solid gel battery delivers 4 A-h

Elpower Corp., 2117 S. Anne St., Santa Ana, CA 92704. (714) 540-6155. \$6.67 (100-up); last quarter, 76.

The Model EP640 solid-gel rechargeable batteries are the same physical size as common dry cells. They are fully rechargeable for as many as 150 cycles. The batteries are available with two different terminal configurations: the common spring terminal, with part number EP640-21, and a spade lug terminal, with part number EP-640-8. The 6-V, 4-Ah battery has an improved lead-acid design. It uses a fully gelled lead-electrolyte. Booth No. 922 Circle No. 335

## Two supplies targeted for 8080 $\mu$ Ps and RAMs

Semiconductor Circuits, 306 River St., Haverhill, MA 01830. (617) 373-9104. LCD5808, \$43 (10); CM-5808, \$47.50 (10).

Two line-operated, encapsulated modular power supplies (LCD5808, CM5808) are designed to power 8080  $\mu$ Ps and several popular families of RAMs. Delivering short-

circuit protected output of +12 V dc at 300 mA and -5 V dc at -200 mA with 0.2% line and load regulation, the sources are electrically identical. But each is configured differently to accommodate a variety of power distribution techniques. Both models feature MTBFs in excess of 150,000 h at high line and full load and require no derating from -25 to +71 C.

CIRCLE NO. 336

## Our Standard Power Supplies Don't Always Come In Standard Packages!

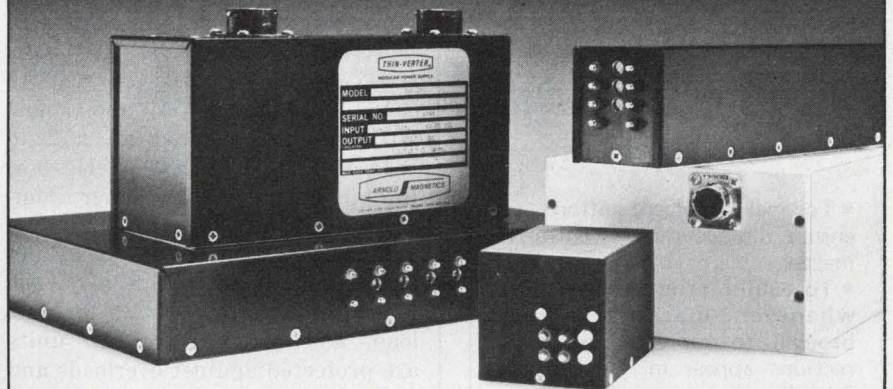

For special electrical and/or mechanical power supply needs, Arnold Magnetics is hard to beat. Our unique modular concept allows us to mix our standard modules with specials to meet custom design requirements. The result is reduced engineering costs, fast deliveries and proven performance. And with over 1200 possible standard configurations a special from someone else may be just another standard for us.

- Single or dual inputs: 115 VAC, 47-500 Hz, 12, 28, 48, 115, 150 VDC.
- Multiple isolated and regulated DC outputs from 4.2 to 300 VDC.
- Line & load regulation to 0.1%.
- Up to 400 watts per output.
- Efficiencies to 85%.
- Completed units provided in tested and encapsulated, conduction cooled packages.

Call or write for more information today!



**ARNOLD MAGNETICS CORPORATION**

11520 W. Jefferson Blvd., Culver City, CA 90230 • (213) 870-7014

CIRCLE NUMBER 123

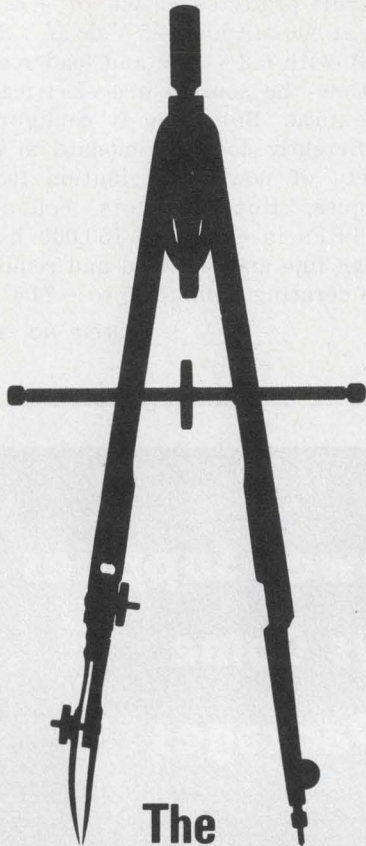

## The Accuracy Policy of Electronic Design Is:

- To make diligent efforts to ensure the accuracy of editorial matter.
- To publish prompt corrections whenever inaccuracies are brought to our attention. Corrections appear in "Across the Desk."
- To encourage our readers as responsible members of our business community to report to us misleading or fraudulent advertising.
- To refuse any advertisement deemed to be misleading or fraudulent.

This statement of accuracy has appeared in every issue of *Electronic Design*, from the very first one. Staff members are imbued with it, from their very first day.

### Electronic Design

50 Essex Street  
Rochelle Park, New Jersey 07662  
(201) 843-0550

## POWER SOURCES

### Dual-output models join supply line

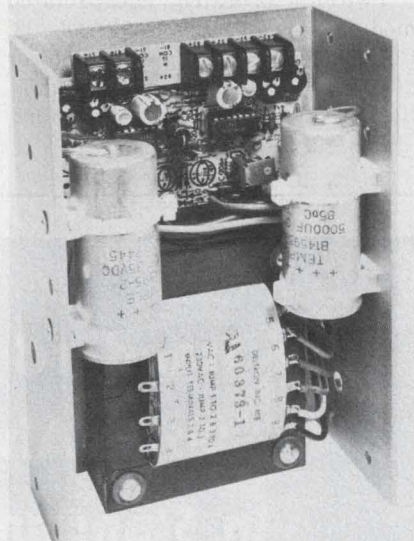

*Deltron Inc., Wissahickon Ave., North Wales, PA 19454. (215) 699-9261. \$35 to \$79; stock.*

The "QD" Series of dual-output sources consists of three models. Model QD12/15-0.6 is rated at  $\pm 12$  to  $\pm 15$  V dc at 0.6 A, Model QD12/15-1.7 is rated at  $\pm 12$  to  $\pm 15$  V dc at 1.7 A, and Model QD12/15-3.0 is rated at  $\pm 12$  to  $\pm 15$  V dc at 3.0 A. The series are interchangeable with other competitive units. Specs include line and load regulation of 0.1%, and ripple and noise of 1.5 mV rms. Tracking accuracy is 0.2% for line, load, and temperature. All units are protected against overloads and short circuits.

CIRCLE NO. 337

### 60-W dc/dc converters feature high MTBF

*Etatech Inc., 187-MW Orange-thorpe, Placentia, CA 92670. (714) 996-0981. \$165.*

The company's "B" Series of power modules now includes 28 V-input dc/dc converters. A fully regulated 5-V, 10-A module (Model B5D10) features a 70,000-h MTBF at 80-C baseplate, 70% min efficiency, size of 4-7/8  $\times$  1-3/4 in., remote sensing, and complete overload/short circuit and overvoltage protection, all with automatic recovery.

CIRCLE NO. 338

### Switching supplies work over wide input range

*ACDC Electronics, 401 Jones Rd., Oceanside, CA 92054. (714) 757-1880. \$595; stock to 4 wks.*

The JP series of six switching-dc supplies operate from an input of 90 to 132 or 180 to 264 V ac, 48 to 63 Hz, single-phase. Standard outputs are: 2 V at 100 A, 5 V at 100 A, 6 V at 100 A, 12 V at 43 A, 15 V at 35 A and 24 V at 23 A. The output is floating—either the positive or negative terminal can be grounded. Additional features are: 70% efficiency; overload, overvoltage, reverse-voltage and thermal protection; remote-sensing; remote-shutdown; remote-control; and parallel-operation. All units are 5  $\times$  7  $\times$  15 in. and weigh less than 20 lb. UL 478 recognition is pending.

CIRCLE NO. 339

### Micro-based controller cuts electric power cost

*Westinghouse Electric, Control Div., Tuscarawas Rd., Beaver, PA 15009. (412) 255-3693. From \$3800.*

The Numa-Logic 600 is a programmable energy controller (PEC), which controls both demand and energy consumption. It is a microprocessor based system with capability for up to 16 electrical loads. The PEC contains a reprogrammable microcomputer which continuously monitors ongoing consumption of electricity and predicts energy demand for a given period of time. The controller automatically regulates, reduces and schedules the amount of power drawn from a utility company to reduce consumption and eliminate power peaks. No tie-in with utilities demand measuring equipment is needed. Its 16 individual electric loads include capacity for lighting, air conditioning, refrigeration equipment and most other electrical equipment. Information such as maximum kilowatt demand, time-of-day scheduling and minimum on/off times is entered by the user. The information is stored in the PEC's memory. The PEC is intended for small and medium-sized industrial plants, supermarkets, department stores, schools, hospitals, office and apartment buildings and hotels and motels.

CIRCLE NO. 340

## Calibrator simulates motion transducers

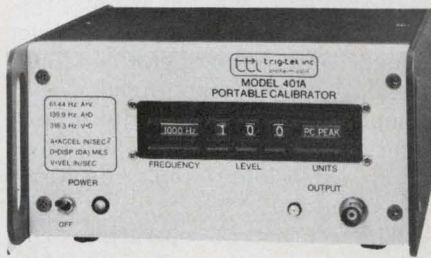

Trig-Tek Inc., 423 S. Brookhurst St., Anaheim, CA 92804. (714) 956-3593. \$425; stock.

The portable calibrator allows you to simulate the output of any accelerometer using the picocoulomb output, and any velocity pick-up using the millivolt output. Picocoulomb outputs are in rms and peak from 000 to 999. Ac millivolt outputs are in rms and peak from 000 to 999 with five precise frequencies of 100 Hz, 1000 Hz and the three frequencies associated with motion: 61.4 Hz where acceleration equals velocity; 139.9 Hz where acceleration equals displacement; and 318.9 Hz where velocity equals displacement. Dc millivolt outputs are available for checking tape recorders, strip chart or x-y recorders and oscilloscopes. The unit is operated by rechargeable batteries, is 3-1/2 by 7 by 8 in., and weighs 3 lb.

CIRCLE NO. 341

## Variable-dual, set-single outputs from small unit

Instant Instruments, Inc., 306 River St., Haverhill, MA 01830. (617) 373-9260. \$96-\$137; stock.

The LT series of miniature laboratory-supplies delivers variable-dual tracking-voltages from  $\pm 9$  to  $\pm 18$ -V dc and a preset 5-V dc at currents from 100 to 1000 mA. Other voltage and current outputs may be obtained by special order. The power sources are cased in an unbreakable-epoxy enclosure and all components are American-made. A color-coded solid-aluminum knob and ring-reference gives visual voltage-control resolution to within 2% accuracy. Regulation is 0.05% for line, and 0.01% for load, ripple (PARD) is less than 1-mV rms, and the preset-voltage accuracy is 1%.

CIRCLE NO. 342

# Our carry-in recorder/reproducer will carry on for 32.8 hours!

The 70-lb. Sabre VI: It's a giant leap beyond any other small, high performance IRIG analog tape recorder/reproducer.

Records at 8 electrically selectable speeds: 120 ips through 15/16 ips; reproduces at any 3 electrically selectable speeds; records from 15.3 minutes at the highest speed to 32.8 hours at the slowest on 14" reels. Remote speed selection and LED footage counter. LED bar data monitor. Let us give you full details.



## SANGAMO RECORDERS

THE INNOVATORS IN TAPE INSTRUMENTATION

Sangamo Electric Company

Data Systems

P.O. Box 3347 • Springfield, Illinois 62714

(217) 544-6411

CIRCLE NUMBER 125

# Underwater connectors mate with the power on

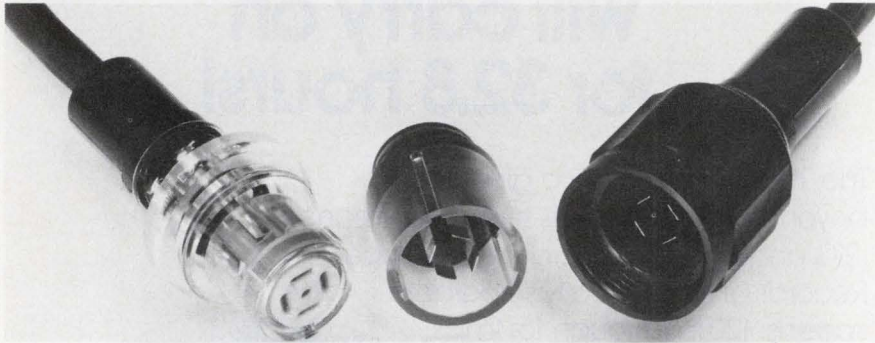

Viking Industries, 9324 Topanga Canyon Blvd., Chatsworth, CA 91311 (213) 882-6275. P&A: see text; 30 days.

Connecting and disconnecting cables underwater with the power on has not been possible until now. But Pisces connectors from Viking Industries can be used with up to 600-V ac, at 20 A, on the pins—either underwater or in an explosive atmosphere.

Pisces can accomplish these feats because the pins mate in a chamber full of a dielectric fluid. The fluid squelches arcing and provides electrical insulation between the outside world and the mated or unmated connector pins.

To enter the receptacle, the pins on the plug pass through a flexible diaphragm that seals the dielectric fluid in its chamber. The diaphragm also ensures that pres-

sure differences between the outside and the fluid chamber are equalized. Then the connector can be mated and unmated at any pressure without contamination from outside, or loss of dielectric fluid. Because of the diaphragm's rapid compliance, fast changes in atmospheric pressure—such as those from explosions—won't damage the connector.

The connector's operating temperature range is -40 to +125 C and its insulation resistance is a good 5000 MΩ. It withstands up to 20,000 lb/in<sup>2</sup> of hydrostatic pressure, and has a dielectric withstanding voltage of 2 kV ac, regardless of pressure.

A thermoplastic is used for the shells and coupling nut; the insulator (plug) is polychloroprene. The shells will also be available in stainless steel or titanium.

Available pin configurations will range from 1 to 14 pins. The first version has four pins and sells for \$125 per mated pair, in single quantities. At the 100-unit level, the mated pair price comes down to \$85.

CIRCLE NO. 306

## shigoto-cables and cord sets

... we go to any lengths.  
... we go to any ends.

That's why Shigoto can help make your ends meet. From hundreds of standard combinations to unusual characteristics that meet your own requirements. Even U.L. and C.S.A. approved. Our volume production for O.E.M.'s in electronics, communications, automotive, appliances, and practically every other industry, takes all the variables out of price-performance differences. Shigoto's ability to consistently produce top quality assemblies, when combined with large quantities, always brings in the prices you need. Unmatched quality has become our standard, our reliability and delivery schedules will become yours. Call, write, or wire your specs. At Shigoto, you'll find we'll go to any ends, to any lengths, to satisfy you.

**Shigoto Industries Ltd.**  
350 Fifth Ave., N.Y., N.Y. 10001/(212) 695-0200/Telex 224219  
One of the World's Largest Manufacturing Importers

CIRCLE NUMBER 126

## We started a counter revolution

... in 1964, when we introduced the Hecon line ... every kind of electro-mechanical, electronic and pneumatic/fluidic counter imaginable, from totalizing to predetermining to batching ... every single one tested before it leaves our plant.

Find out for yourself. Contact us for free catalog today.

**HECON CORPORATION**  
P.O. Box 247  
Tinton Falls, N.J. 07724  
Phone (201) 542-9200

**HECON CANADA INC.**  
80 Galaxy Blvd.  
Rexdale, Ontario M9W-4Y8  
Phone: (416) 678-2441

**G0411** Periodic Output 6 digits 10, 25 cps

**G0414** Totalizing 4, 6, 7, 8 digits 10, 25, 40, 50 cps

**G0441** Predetermining 4 digits, subtractive Optional Presignal 10, 24 cps

**G0860** Predetermining heavy duty 5 digits

**G0431** Bi-Directional 4 and 6 digits 10, 20 cps

**G0422** Predetermining 6 digits, additive 10, 25 cps

31B

CIRCLE NUMBER 127  
ELECTRONIC DESIGN 19, September 13, 1976

## A snap-in PC board guide resists flames

*Bivar, Inc., 1617 Edinger Ave., Santa Ana, CA 92705. (714) 547-5832. FR-650, 6.5-in. length; 18¢ (1000-up).*

Printed-circuit board card guides are manufactured from 94 V-0, a UL-rated material with fire retardant additives. Called Temp-O-Gides, they are brownish red, and rigid. They snap into 11/64 in. holes drilled into plates or channels that are from 0.47 to 0.090 in. thick. The card guides hold 1/16-in. thick PC boards. Temp-O-Gides are stocked in 24 standard lengths from 2-1/2 through 14 in.

Booth No. 306 Circle No. 343

## Rf connector crimps onto cable

*Kings Electronics Co., Inc., 40 Marbledale Rd., Tuckahoe, NY 10707. (914) 793-5000. \$18 (1-24).*

Two crimp-type, push-on plugs are designed to mate with G-R leaf-spring coaxial cable receptacles. The rf connectors can be assembled to the cable with standard crimping tools. The No. 1935-1 plug fits on RG/U 58, 141, 142, 223, 303 and 400. The No. 1935-2 is for use with RG/U 8, 9, 213 and 214. Both are supplied with neoprene boots.

CIRCLE NO. 344

## Clear one-piece unit mounts LEDs to panels

*Visual Communications Co., Box 986, El Segundo, CA 90245. 10¢ (high qty); stock-2 wk.*

A LED mount called Cliplite improves LED viewing angle and brightness, and simplifies installation. Cliplite increases the angle of visibility and the brightness of standard LED displays by using striated lines and Fresnel rings in transparent butyrate plastic. It is a one-piece unit that mounts on a panel without tools; it snaps into a 1/4-in. hole with finger pressure. The unit eliminates the grommet normally used to panel-mount LEDs. Cliplite is said to provide six-times the brilliance with a 180-degree viewing angle, using any standard narrow beam T-1 3/4 LED.

CIRCLE NO. 345

## Terminals secure wire leads to a PC board

*Molex Inc., 2222 Wellington Ct., Lisle, IL 60532. (312) 969-4550. 2.35¢ (1000-up).*

The 4706 series of terminals secures wire leads to a PC board prior to soldering. The terminals prevent the leads from falling out of the board holes during compo-

nent insertion and handling before wave soldering. Because the terminal fills the printed circuit board hole, solder voiding is minimized. The 4706 series terminals are inserted into the boards with a low insertion force, so adjacent components don't pop out of the PC board. After soldering, the insulation crimp creates a strain relief.

CIRCLE NO. 346

**You know our Capacitors,  
but have you seen our...**

# EMI FILTERS

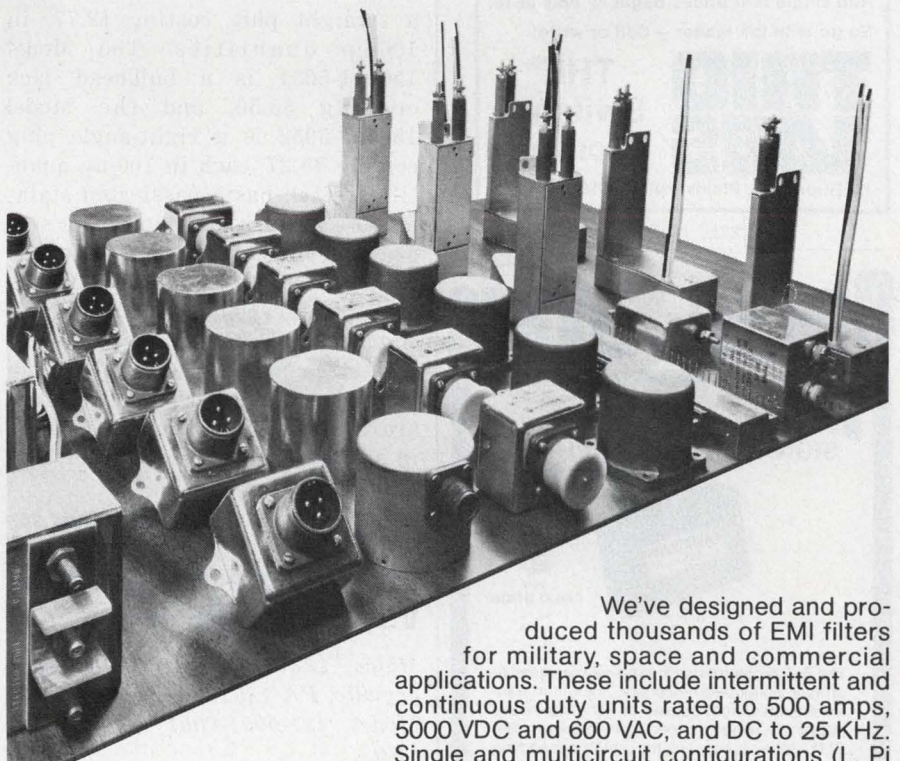

We've designed and produced thousands of EMI filters for military, space and commercial applications. These include intermittent and continuous duty units rated to 500 amps, 5000 VDC and 600 VAC, and DC to 25 KHz. Single and multicircuit configurations (L, Pi and T) are offered as low pass, electrical noise, line, screen room and heavy duty filters. Send us your circuit requirements—our extensive file of existing designs can probably provide the benefits of standardization to meet your non-standard needs. Get complete information today on our EMI Filters; write Electrocube, 1710 So. Del Mar Ave., San Gabriel, CA 91776; (213) 573-3300.

 **electrocube**

CIRCLE NUMBER 128

# MOPS\* for your MPU

Trio Labs Model 674/675 \*Multi-Output (Switching Regulator) Power Supplies will provide all your MPU power needs in one box for less than you could do it yourself!



Up to 4 outputs — 475 watts. A main 2 or 5 VDC rail @ 50 or 70 amps. A second rail @ up to 10 amps. Two additional outputs @ up to 4 amps ea.

Internal Cooling — Overvoltage, Overload and Overtemperature Protection, Remote Sense—Independent V adj.—U.L. rec.—just some of the features of Trio's 674/675.

And single unit prices begin @ only \$635.

So go with the leader — Call or write:

**TRIO LABS** THE®  
Switcher  
Source

80 Dupont St. Plainview NY (516) 681-0400

CIRCLE NUMBER 146

# Circuit Savers

**NEW**  
SIGNAL/DATA/TELEPHONE  
PROTECTION



The SLP protectors were expressly designed to protect signal/data/telephone lines from transient overvoltages caused by lightning, heavy machinery, elevator motors, generators, etc. The SLP interfaces between the signal lines and the sensitive circuit to provide a sophisticated blend of high speed (nanoseconds) voltage limiting and brute force protection. The SLP's recover automatically to standby when the need for protection has passed.

Output Clamp Voltage Level  $\pm 5V$  to  $\pm 200V$   
Input Voltage Level (max) to  $\pm 35KV$  (10 US)  
Energy Handling to 50 joules and higher

## BULLETIN 301

Full line of protection modules for every hi-lo voltage/current requirement. Write or call for data.

279 Skidmore Rd., Deer Park, N. Y. 11729  
Telephone: 516-586-5125

# MCG Electronics

CIRCLE NUMBER 147

## PACKAGING & MATERIALS

### SMA-connectors require no soldering

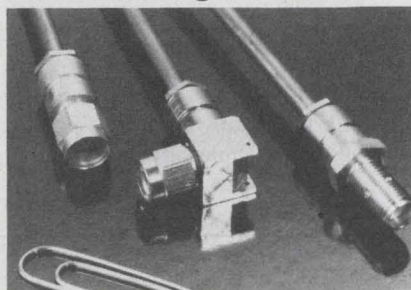

ITT, Cannon Electric Div., 666 E. Dyer Rd., Box 929, Santa Ana, CA 92702. (714) 557-4700. See text; 6 wks.

Three solderless SMA connectors for 0.141-in. semi-rigid cables require no soldering of the center or outer conductors. The three versions are the Model 150500-5052, a straight plug costing \$2.77, in 100-up quantities. The Model 150511-5051 is a bulkhead jack costing \$5.56, and the Model 150526-5052 is a right-angle plug costing \$5.27, each in 100-up quantities. Each has a passivated stainless-steel finish and features a separate, completely captivated female center contact that accepts the cable center conductor. The cable clamping mechanism is reusable and is capable of withstanding a pull test of 100 lb. The connectors are available with gold-plating or in stainless steel, and in other configurations.

CIRCLE NO. 347

### Coax connector provides VSWR of 1.08:1

Malco, 12 Progress Dr., Montgomeryville, PA 18936. (213) 799-9171. Model 141-0001-0001 jack, \$4.05 (1-9).

A microminiature coaxial connector is said to have the lowest voltage standing wave ratio in the connector industry. Lepra/Con coax connectors have a VSWR of only 1.08:1 at a frequency of 1 GHz. The connector is available in 180 different styles. Designed for RG178 and RG196, Lepra/Con also comes with an optional locking interface, which permits the user to lock the coaxial plug, when mated to its receptacle. This prevents any axial rotation.

CIRCLE NO. 348

### Instrument cases are made for portability

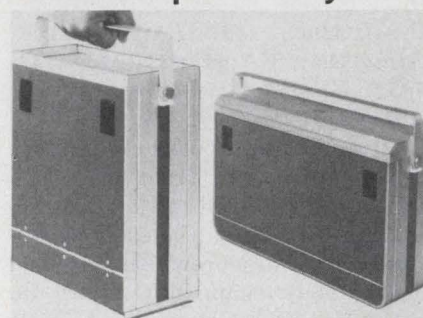

Buckeye Stamping Co., 555 Marion Rd., Columbus, OH 43207. (614) 445-8433. \$32.75 to \$99.50 (25-40); 2 wks.

Portable instrument cases, made of extruded aluminum shapes and aluminum panels, are designed for rugged applications. Dimensions are either 3-1/2 or 5-1/4 in. high, and 8-1/2, 11-1/4 or 17 in. wide. The panels and feature stripes are either painted with a suede-type color finish or are vinyl-clad in blue, black or woodgrain. The cases include a dust cover on 5.25 in. high units to protect controls and meters. All sizes have a top with a flip-top piano-hinge at the back, and held securely with flush-mounted slide locks. Silk-screening and custom piercing on front panels are also available.

CIRCLE NO. 349

### AC-line plug listed by UL as hospital grade

Pacific Electriccord Co., Div. of Leviton Mfg. Co., P.O. Box 10, Gardena, CA 90247. (213) 532-6600. Model C4700-010-GY 10-ft. cord, \$3 to \$3.50 ea. (1000-up).

A power-supply cord comes with a molded-on plug that is listed by Underwriters Laboratories as "hospital grade." Internal components are locked-in electrically, mechanically and physically. The construction restricts access and withstands cord pull out. The plug features a strain relief and blade assembly encapsulated in a PVC body. The assemblies are 100% tested for electrical integrity. In addition, torque, crush, drop, twist, and X-ray examination tests are performed on a statistical sampling basis. The standard color is light gray, and other wire sizes and jacket colors are available upon request.

CIRCLE NO. 350

semiconductor  
overload  
protection...  
**murata's  
posistors®  
make it simple**

Murata's PTH487A Posistors are designed to sense the case temperature of high power semiconductors and appropriately reduce power dissipation when dangerous power and/or current limits are approached. No other components are required, recycling is automatic and reliability is outstanding. Write for complete specifications.

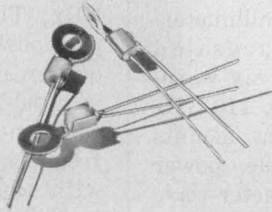

**muRata**  
CORPORATION OF AMERICA  
Rockmart Industrial Park, Rockmart, Georgia 30153  
Phone: 404-684-7821/Telex: 54-2999/TWX: 810-766-1340

CIRCLE NUMBER 129

**LOOKING FOR  
A  
DISTRIBUTOR  
NEAR YOU?**

Electronic Design's GOLD BOOK lists 5,700 distributors with access both **alphabetic**, by distributor name, and **geographic** by location.

When you need  
information . . .

**Electronic Design's  
GOLD BOOK  
IS THE PLACE  
TO LOOK**

ELECTRONIC DESIGN 19, September 13, 1976

New from Standard Grigsby . . .

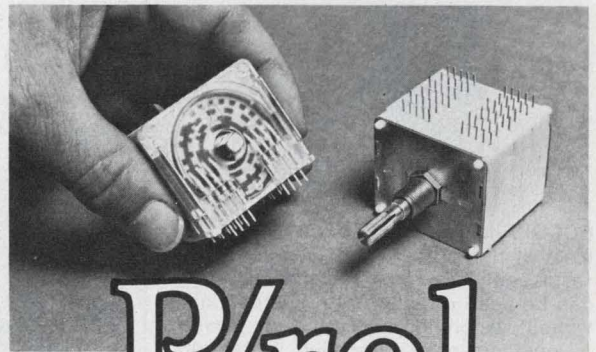

**P/rel** T.M.

**the switch with a mind  
of its own**

An economical alternative to conventional rotaries in the manual switching of complex binary codes.

Up to 60 detent positions are achieved with our Dual Flex™ detent which features a dual ball, starwheel drive and a single C spring.

20 contact terminals provide a large number of programming possibilities for the most complex codes. And, the use of concentric shafts allows up to 120 detent positions from a single switch.

So send for the P/rel 700 brochure today.

**A smart move for a smart switch!**



**standard grigsby, inc.**

920 Rathbone Avenue, Aurora, Illinois 60507, Phone (312) 897-8417

CIRCLE NUMBER 130

**COST - CUTTING  
WESTON  
BREAKTHROUGH!**

**3/8" MULTITURN  
CERMET TRIMMER**

**FOR ONLY 99¢**

(1,000-Pc. Price)

850-W



**Same High Weston Quality  
At A Real Savings In Price!**

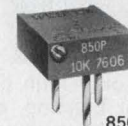

850-P



850-X

Weston has done it with the new #850! We took this widely used square multiturn trimmer, and by radically improving manufacturing techniques have been able to trim the price without sacrificing quality, performance or uniformity. It can give you an important new competitive edge.

WRITE FOR SPECS AND DETAILED  
PRICE INFORMATION.

**WESTON**

**Schlumberger**

Weston Components  
Archbald, Pa. 18403  
Tel. (717) 876-1500  
TWX 510 656-2902  
Telex 83-7443

CIRCLE NUMBER 131

173

## NEW LITERATURE ON ONE-PART EPOXY SYSTEMS



ECCOPRIME one-part products provide most of the properties of standard E&C resins, adhesives, and coatings, and they can be used directly from the container, without weighing, measuring, or mixing. A new four-page illustrated folder lets you select from up to sixteen systems. Each offers improved convenience, accuracy, and speed when you use epoxies for casting, potting, bonding, sealing, or coating. Send for a free copy.

CIRCLE NO. 161

## NEW PRESENTATION DIELECTRIC MATERIALS CHART

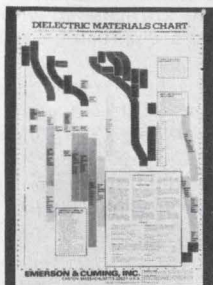

This colorful chart is a standard reference for electronic engineers. Shows Dielectric Constant ( $\kappa'$ ) and Loss Tangent ( $\tan \sigma$ ) for many E&C products and common materials plotted on 11" x 16½" graph. For notebook or wall mounting.

CIRCLE NO. 162

## ELECTRICALLY CONDUCTIVE ADHESIVES AND COATINGS



ECCOAMP products offer high performance and savings for bonding, coating, sealing electrical/electronic components with conductive plastic. They include "cold" solders, anti-static, reflective and absorptive coatings. Some have electrical and thermal conductivity equivalent to metals.

CIRCLE NO. 163

## Emerson & Cuming, Inc.



CANTON, MASS.  
GARDENA, CALIF.  
NORTHBROOK, ILL.  
Sales Offices  
in Principal Cities

EMERSON & CUMING EUROPE N.V., Oevel, Belgium

## MICROWAVES & LASERS

### Thermistor mounts work in mm range

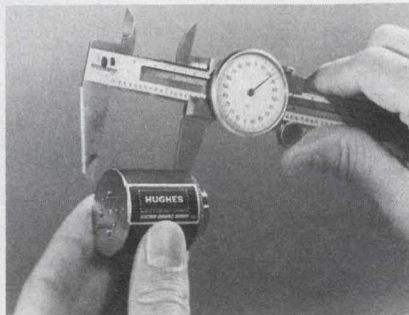

Hughes Electron Dynamics Div., 3100 West Lomita Blvd., Torrance, CA 90509. (213) 534-2121. \$600 to \$1525.

A new series of millimeter-wave, temperature-compensated thermistor mounts cover six waveguide bands in the 26.5 to 110-GHz frequency range. The new mounts are designed to provide power measurements at millimeter-wave frequencies with the same convenience as those made in the lower microwave bands. All but the highest frequency range (W-band) provide full waveguide bandwidth coverage. Each mount consists of an RF and compensating thermistor matched for tempo before being paired in the waveguide mount.

CIRCLE NO. 356

### Directional couplers need less space

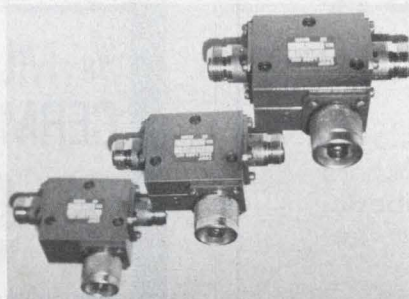

Sage Laboratories, 3 Huron Dr., Natick, MA 01760. (617) 653-0844. \$250; 30 days.

Model FC1991 coaxial directional coupler covers the 3.7-to-4.2-GHz communications band. Typical performance features are  $50 \pm 0.2$  dB nominal coupling, 0.25-dB pk-pk coupling variation from 3.7 to 4.2 GHz, 22-dB directivity, and 1.05:1 main line VSWR. Model FC1991 measures only 1-3/4 x 1-1/2 x 1-1/8 in., excluding the connectors.

CIRCLE NO. 357

### 4-12 GHz detector has flat response

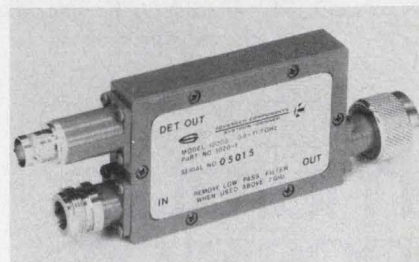

Syston-Donner, Advanced Component Div., 735 Palomar Ave., Sunnyvale, CA 94086. (408) 735-9660. \$1050; stock.

A calibrated directional detector is designed for use with microwave radio test sets in the common-carrier bands from 3.6 to 11.7 GHz. The Model 1020-1 offers a previously unobtainable flat frequency response of  $\pm 0.02$  dB over any 30-MHz window within the common-carrier bands. Over-all frequency response is  $\pm 0.5$  dB with 15-dB directivity. Sensitivity is 10 mV per mW up to +13 dBm.

CIRCLE NO. 358

### Modulators feature low insertion loss

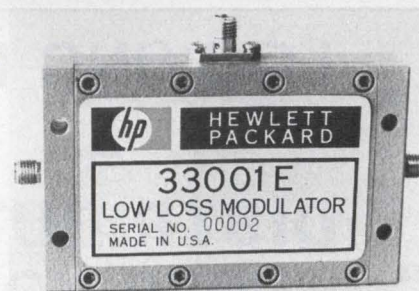

Hewlett-Packard, 1501 Page Mill Rd., Palo Alto, CA 94304. (415) 493-1501. \$495 to \$730; stock-8 wks.

Three new absorptive modulators for the frequency range 3.7 to 18 GHz feature at least 0.5-dB lower insertion loss from 12 to 15 GHz, units. Models 33001E, 33001F and 33008E are matched ( $Z_0 = 50 \Omega$ ) at all attenuation levels. Each device covers more than one octave. The 33001E is a 45-dB isolation modulator with insertion loss of 2.5 dB from 8 to 12 GHz, 3.0-dB insertion loss from 12 to 15 GHz, and 3.5-dB loss from 15 to 18 GHz. The 33001F is an 80-dB isolation modulator, and the 33008E provides 45-dB isolation from 3.7 to 8 GHz.

CIRCLE NO. 359



## New Literature

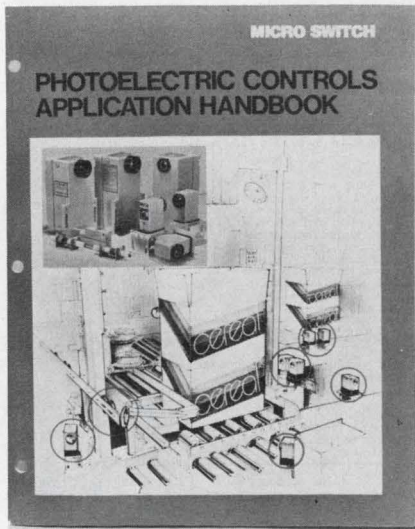

### Photoelectric controls

Dozens of photoelectric applications for production and material-handling control are described in a 48-page handbook. A glossary, as well as three appendices on control response time, wiring and selection of arc-suppression components, complete the publication. Micro Switch, Freedport, IL

CIRCLE NO. 360

### Electrode station hardware

A variety of electrode mounting station hardware for on-stream pH-measuring requirements is described in a 12-page booklet. Beckman Instruments, Fullerton, CA

CIRCLE NO. 361

### Circuit technology

Application notes for a 13-bit monolithic CMOS A/D converter, and new product descriptions for other devices are included in Vol. 10, No. 1 of Analog Dialogue. Analog Devices, Norwood, MA

CIRCLE NO. 362

### LSI test systems

Multi-user, multi-usage LSI test systems are described in a color brochure that includes a block diagram and descriptions of several software packages. Macrodata Corp., Woodland Hills, CA

CIRCLE NO. 363

### If we're Number 1, it's your fault.

Computer Products, Inc., is the world's leading manufacturer of encapsulated power supplies. And we owe it all to you, for recognizing the value of:

- "Triple-testing" before delivery to insure reliable performance
- Internal short circuit protection
- 24 month warranty
- Flexibility... single and dual outputs from 3.6V to 28V with output currents from 65mA to 2,000mA.

- Low cost and fast delivery.

With 49 models to choose from, chances are we can fill your every need. Like to find out more? Just circle our number on the Reader Service Card, and we'll send you our new Power Supplies catalog. If you just can't wait, give Bill Ford a call at 305-974-5500. He can't wait to send it to you.

 Computer Products, inc.



1400 NW 70 Street, Fort Lauderdale, Florida 33309 (305) 974-5500, TWX (510) 956-9895.

CIRCLE NUMBER 135

# Mu IQ. #2 Quiz

## Prototype Magnetic Shields

1	2	3	4	5	6
Who gives you 4-day prototype service—the fastest in the industry?	How do you determine optimum shield design and specs in advance?	Who will fabricate a number of prototypes, in different thicknesses, so you can determine exactly how much shielding you really need?	Who tests every prototype shield, using Helmholtz coils, to ASTM standards, and gives you guaranteed attenuation data?	Who's the leader in custom-designed magnetic shields?	What magnetic shield application is growing fastest?

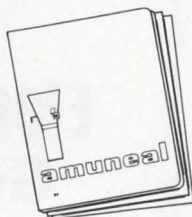

**Answers:** 1. Amuneal; 2. You don't have to, Amuneal will do it for you—or work to your print if you prefer; 3. Amuneal; 4. Amuneal guarantees that production shields will meet the same high standards of our prototype; 5. Amuneal is the biggest in the industry; 6. Shields for CRT terminals. Nobody wants wiggling displays.

For all the answers on custom and standard shields, send today for your free Magnetic Shield Source Book.

**amuneal**  
MANUFACTURING CORP.

4737 Darrah St., Philadelphia, Pa. 19124, Telephone: 215-535-3000

CIRCLE NUMBER 136

# Power Supplies

# Do-it-yourself dc motor with Pancake armature.

No coupling. No bearings. No shaft. No front housing.

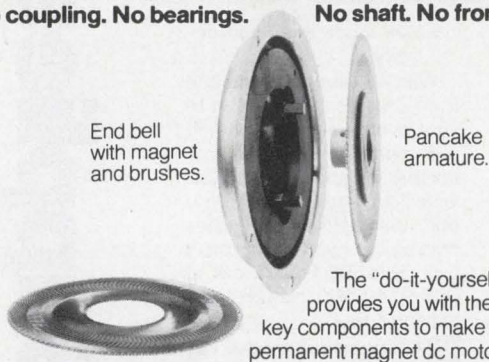

End bell with magnet and brushes.

Pancake armature.

The "do-it-yourself" motor provides you with the minimum key components to make a permanent magnet dc motor an integral part of your product. You save the cost of couplings, motor shaft and bearings, mounting plate and motor enclosure parts, while reducing assembly and alignment costs.

We supply the unique Pancake armature to mount on your shaft and an end bell with magnet and brushes. Your load bearings serve as motor bearings. Your housing can be the flux return path. These motors are thinner than any other, so you can design more compactly than before.

Pulse torque capability is very high, typically 10 times continuous-duty ratings. With low armature inertia, response is extremely fast with smooth torque at speeds ranging from 0 to over 3000 rpm. Brush life up to 10,000 hours. Ratings: 1/25, 1/13 and 1/8 hp.

PMI offers dc motors up to 4 hp as prime movers, gear-motors and high-performance servos. For information call PMI Customer Service at (516) 448-1234. Or write us.

## PMI Division

Kollmorgen Corporation, Glen Cove, New York 11542

CIRCLE NUMBER 141

# PHOTO ETCH<sup>TM</sup> PRINTED CIRCUIT KIT

Makes circuits **THREE** WAYS

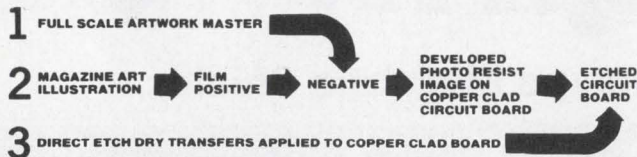

**NO** CAMERA DARKROOM FILM CUTTING TRACING

**USES DATAK'S POS-NEG<sup>TM</sup> PROCESS**  
The revolutionary photographic way that makes **PERFECT** printed circuits from original art or a printed page.

KIT CONTAINS: 5" x 6" steel printing frame, 4 sheets 5" x 6" photocopy film, yellow filter, chemicals for 1 pint film developer and 1 pint film fixer, 5" x 6" copper clad board, 3" x 4" copper clad board, spray can of photo etch resist, 1 pint resist developer, 2 sheets 8 1/2" x 11" layout film, 1 roll 1/16" printed circuit tape, 1 roll 1/32" printed circuit tape, 8 sheets dry transfer direct etch PC patterns, including pads, transistors, round can and flat pack ICs, DIP ICs, edge card connectors, lines, circles, jogs, etc. 1/2 lb anhydrous ferric chloride to make 1 pint etchant. Instructions.

ER-4 COMPLETE PHOTO ETCH SET	.....	\$26.95
ER-2 PC patterns and tapes - refill	.....	3.95
ER-3 1/4 pound dry etchant - refill	.....	1.49
ER-5 6 sheets photocopy film - refill	.....	3.95
ER-6 Film process chemicals - refill	.....	1.95
ER-7 Photo resist spray, 2.5 oz. - refill	.....	2.95
ER-8 Resist developer, 16 oz. can - refill	.....	2.95

AT YOUR DISTRIBUTOR OR DIRECT

the **DATAK** corp.  
65 71st St. • Guttenberg, N. J. 07093

CIRCLE NUMBER 142

## POLY PAKS "Inflation Fighters"



**\$888**  
Only 4-11/16" sq. x 1 1/2" deep!

Now anyone can afford these neat Muffin and Centaur Fans by Rotron. Used extensively for hi-fi eqpt because of low-cost, dependable cooling, as well as flushing computers, power supplies, office equipment, light projectors, transmitters, receivers & more! Weighs only 1-lb. **LOW NOISE LEVEL!** Humidity & moisture resistant, motor. **REVERSIBLE AIR FLOW!** Impedance protected. Suitable for -40° to +160° F. Both 115 VAC, 3200 rpm, 15 watts, .16 amps. Hi-impact, flame retardant polycarbonate propellers in a reinforced phenolic venturi block. **Blow away high prices with our Muffin and Centaur fans!** Removed from new equipment.

- 3-blade "Muffin"
- 9D 3108 "Muffin"
- #2" 5-blade "
- 9D 3109 "Centaur"
- 6-blade "
- 9D 3110 "Centaur"

### ECC INDUSTRIAL SPEED CONTROL

Repeat of a sellout! A \$30 item, made by ECC famous for semiconductors, designed and built this speed control for XEROX. Controls home, shop and industrial lighting too. Rated at 1200 watts. A very elaborate circuit for controlling many electrical and electronic devices. Easily controls speeds of electric drills, brush type motors, etc. Built with heavy duty aluminum framing. Complete with external 50K pot, for variable speed control, and series resistor. Heavy duty colored wires for 115VAC 60 cycles, and item to be controlled. 10/32 mounting stud. Outperforms our previous sell-out. With hookup diagram. Use as temperature controller too. Wt. 2 lbs. **Cat. No. 9D 3392**



### DELTROL TUBULAR SOLENOID

**Cat. No. 9D 3394**  
It's new! Different! 1st Time we've seen these popular tubular solenoids at this price. Designed for maximum FULL, in minimum space. Features 12VDC @ 450 mils, 32 ohm coil, continuous duty, only 3/4 x 3/4", with 1/2" threaded bushing for panel mtg, 1/8" stroke up to 17 oz. pull. All metal frame, black slotted plunger, with pointed end for precision smooth recoil action. With wire connections. Wt. 3 ozs.



### The Revolutionary PowerDIP

**SOLID STATE 5V DC RELAYS**  
**3 FOR \$18**  
**\$6.50**

- Operates directly from CMOS (µa control-sensitivity)
- TTL/DTL Compatible (7 milliamp control current)
- Switches up to 4 amps without heat sinking



Terms: Add postage. Rated: net 30  
Phone: Wakefield, Mass. (617) 245-3829  
Retail: 16-18 Del Carmine St. Wakefield.  
**MINIMUM ORDER — \$6.00**  
**POLY PAKS**  
P.O. BOX 942D LYNNFIELD, MASS. 01940  
C.O.D.'s MAY BE PHONED  
Send for FREE Fall-Winter CATALOG

© Poly Paks Inc., Wakefield, Mass., U.S.A. 1976.

CIRCLE NUMBER 143

# WHO MAKES WHAT & WHERE TO FIND IT

Volume 1 of **Electronic Design's GOLD BOOK** tells all. And, when you look up an item in its **PRODUCT DIRECTORY** you'll find each manufacturer listed **COMPLETE WITH STREET ADDRESS, CITY, STATE, ZIP AND PHONE.** Save time. There's no need to refer elsewhere to find missing information.

**IT'S ALL THERE**  
in  
**Electronic Design  
GOLD BOOK**

## NEW LITERATURE

### Filter catalog

More than 550 RFI/EMC filters and feedthrough capacitors are described in a 28-page booklet published by RF Interionics, Bay Shore, NY.

CIRCLE NO. 364

### High-voltage supplies

A complete product line description of high-voltage power supplies, photomultiplier tube housings, photon-counting and current-measuring instrumentation is contained in a new catalog. Pacific Photometric Instruments, Emeryville, CA

CIRCLE NO. 365

### Test instruments

A 40-page catalog describing new test instruments has just been released. New instruments described for the first time includes 5, 15 and 30 MHz scopes and a 3.5-digit voltmeter. B & K Precision, Chicago, IL

CIRCLE NO. 366

### Mini reed relays

Bulletin MR-14.1 describes a new series of micromini reed relays—including what the company feels is the smallest form 2A contact model on the market. Coto-Coil, Providence, RI

CIRCLE NO. 367

### Soldering and brazing

A comprehensive report on a modular approach to soldering and brazing systems is described—including case histories and data sheets—in a bulletin from Lucas-Milhaupt Div., Cudahy, WI.

CIRCLE NO. 368

### Pump-fluid recycling

Diffusion pump fluids can be cleaned and reused. Several methods are described in a new booklet from CVC Products, Rochester, NY

CIRCLE NO. 369

### Linear thermistors

A bulletin on linear thermistor networks is available for those who would like to investigate this alternative to thermocouples. Fenwal Electronics, Framingham, MA

CIRCLE NO. 370

### Coaxial connectors

A 64-page catalogue offering information on SMA, TM, TNC, and n-type rf connectors is available. Solitron/Microwave, Port Salerno, FL

CIRCLE NO. 371

### Magnetic cores

A 24-page catalog of tape-wound magnetic cores, including nine types of magnetic material is available. It features a list of 140 standard cores, their specs and magnetic path lengths. SGL Electronics, Westville, NJ

CIRCLE NO. 372

### Specialty tubing

Small-diameter tubing for industrial instrumentation is discussed in a new booklet from the Superior Tube Co., Norristown, PA.

CIRCLE NO. 373

### ICs for measuring control

A guide to a/d and d/a converters, to amplifiers and other all-IC devices, is available. Analog Devices, Norwood, MA.

CIRCLE NO. 374

### Function generator

A brochure that describes product features, specs, and 13 instrument configurations is available on the FG 504 40-MHz function generator. Tektronix, Beaverton, OR

CIRCLE NO. 375

### Hybrid microcircuits

A 30-page Hybrid Microcircuit Short Form Catalog that details new telephone tone receiver products, converters, power amplifiers and other devices is available from Beckman Instruments, Fullerton, CA.

CIRCLE NO. 376

### Pushbutton switches

Electrical and mechanical specifications, dimensional drawings, wiring diagrams and installation tips for standard pushbutton switches are found in a 16-page catalog. Centralab Distributor Products, Milwaukee, WI

CIRCLE NO. 377

**Q.** How do you resolve two signals spaced 1 Hz apart at 2 MHz?

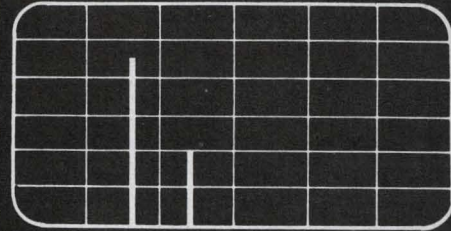

**A.** With EMR's new Model 1520 Digital Spectrum Translator and Model 1510-03 Digital Real-Time Spectrum Analyzer.

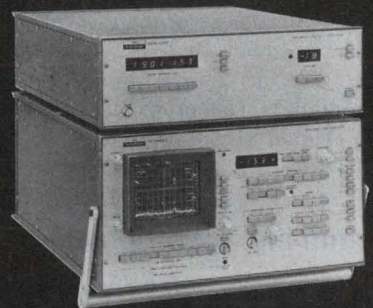

Why go partway in analyzing data? Get the resolution/performance edge of our Model 1510-03 Digital Real-Time Spectrum Analyzer, then go it one better. Enhance frequency resolution still more by adding the Model 1520 Digital Spectrum Translator to concentrate the full resolution of the Analyzer about a selectable point of interest in the spectrum. For that matter, why stop there? Step up from 25.6 kHz to a full 2 MHz upper frequency limit by adding the optional Model 1521 Range Extension Module, too!

Other features of the unequalled 1520 Translator: nine translatable frequency ranges from 25.6 Hz to 10.24 kHz; center frequency selectable in 1-Hz steps and automatic gain ranging — each with an easy-to-read LED display; plus, an automatic frequency sweep. Full-scale out-of-band signal to minimum-detectable in-band signal exceeds 100 dB.

**EMR** Schlumberger

EMR Telemetry  
Weston Instruments, Inc.  
Box 3041, Sarasota, Florida 33578  
(813) 371-0811

## Design Aids

### Steatite ceramics

Everything from water absorption through to power and loss factors are charted in a "Property Chart" of steatite, ceramic and lava insulators for electrical, electronic and chemical applications. Superior Steatite & Ceramic Corp.

CIRCLE NO. 211

### IC interconnects

Design guidelines and application data for production sockets, burn-in and test sockets as well as plugs, cables and headers are given in a four-page selection guide. Robinson-Nugent.

CIRCLE NO. 212

### Microelectronic compounds

A microelectronic compounds selector chart provides a guide to the use of epoxy and urethane compounds for microelectronic applications. Hysol Div.

CIRCLE NO. 213

### Trimming potentiometers

A guide to MIL Spec trimmer potentiometers provides a handy reference to military spec numbers along with the equivalent type designations as well as MIL code resistance values. Weston Components.

CIRCLE NO. 214

### Display slide rules

Conrac's slide rule, useful for CRT display design, features a sine-wave MTF calculator on one side and a contrast ratio calculator on the other. The rule measures 9-1/4 x 4 in. SSD.

CIRCLE NO. 215

### Buzz words

An expanded edition of "Sherry's Guide to Data Communication Buzz Words" is available from International Communications, Miami, FL

CIRCLE NO. 216

## Bulletin Board

Owens-Illinois has established a technical assistance program for customers of Digivue **display panels**, which can now be purchased without the driving electronics.

CIRCLE NO. 217

Hewlett-Packard has cut prices 18% on its Model 5451B **digital Fourier analysis system**. There is also a new and less expensive **a/d converter** with 2 channels, 12 bits and a 100 KHz maximum sampling rate.

CIRCLE NO. 218

EMI Gencom has acquired the **vacuum photodiodes** formerly manufactured by Tung Sol Division of Wagner Electric Co. The devices are used in analytical instruments such as turbidity meters and UV monitors. They are low voltage (typically 9 V) and fully compatible with solid-state circuitry, and can be battery operated.

CIRCLE NO. 219

Philips plans 94 different **LOC-MOS 400 digital ICs** by the end of the year, of which over 70 are available now. They have a wide supply voltage range from 3 to 15 V and are pin compatible with other 4000 types.

CIRCLE NO. 220

Chomerics has developed a very **low cost technique** for the fabrication of **printed circuit boards**. Circuits made through this process can be molded to form 3-D features.

CIRCLE NO. 221

Fairchild Camera and Instruments has introduced **5 and 6-kV couplers** as direct replacements for most standard types of single-channel couplers.

CIRCLE NO. 222

Honeywell has enhanced its 60/62 small **computer systems** by doubling main memory and adding new data-management and communications features, among other changes.

CIRCLE NO. 223

## Electronic Design

ELECTRONIC DESIGN's function is:

- To aid progress in the electronics manufacturing industry by promoting good design.
- To give the electronic design engineer concepts and ideas that make his job easier and more productive.
- To provide a central source of timely electronics information.
- To promote communication among members of the electronics engineering community.

**Want a subscription?** ELECTRONIC DESIGN is sent free to qualified engineers and engineering managers doing design work, supervising design or setting standards in the United States and Western Europe. For a free subscription, use the application form bound in the magazine. If none is included, write to us direct for an application form.

If you do not qualify, paid subscription rates are as follows: \$30.00 per year (26 issues) U.S., \$40.00 per year (26 issues) all other countries. Single copies are \$2.00 U.S., \$3.00 all other countries. The Gold Book (27th issue) may be purchased for \$30.00 U.S. and \$40.00 all other countries.

**If you change your address**, send us an old mailing label and your new address; there is generally a postcard for this bound in the magazine. You will have to requalify to continue receiving ELECTRONIC DESIGN free.

**The accuracy policy** of ELECTRONIC DESIGN is:

- To make diligent efforts to ensure the accuracy of editorial matter.
- To publish prompt corrections whenever inaccuracies are brought to our attention. Corrections appear in "Across the Desk."
- To encourage our readers as responsible members of our business community to report to us misleading or fraudulent advertising.
- To refuse any advertisement deemed to be misleading or fraudulent.

Microfilm copies are available of complete volumes of ELECTRONIC DESIGN at \$19 per volume, beginning with Volume 1, 1952 through Volume 20. Reprints of individual articles may be obtained for \$3.00 each, prepaid (\$.50 for each additional copy of the same article) no matter how long the article. For further details and to place orders, contact the Customer Services Department, University Microfilms, 300 North Zeeb Road, Ann Arbor, Michigan 48106 telephone (313) 761-4700.

**Want to contact us?** If you have any comments or wish to submit a manuscript or article outline, address your correspondence to:

Editor  
ELECTRONIC DESIGN  
50 Essex Street  
Rochelle Park, N.J. 07662

# Electronic Design

## Advertising Sales Staff

Tom W. Carr, Sales Director  
Jean Bunfield, Sales Coordinator

## Rochelle Park, NJ 07662

Robert W. Gascoigne  
Daniel J. Rowland  
Thomas P. Barth  
50 Essex St.  
(201) 843-0550  
TWX: 710-990-5071

## Philadelphia

Thomas P. Barth  
(201) 843-0550

## Boston 02178

Gene Pritchard  
P.O. Box 379  
Belmont, MA 02178  
(617) 489-2340

## Chicago 60611

Thomas P. Kavooras  
Berry Conner, Jr.  
200 East Ontario  
(312) 337-0588

## Cleveland

Thomas P. Kavooras  
(312) 337-0588

## Los Angeles 90045

Stanley I. Ehrenclou  
Burt Underwood  
8939 Sepulveda Blvd.  
(213) 641-6544

## Texas

Burt Underwood  
(213) 641-6544

## San Francisco

Robert A. Lukas  
3579 Cambridge Lane  
Mountain View, CA 94040  
(415) 965-2636

## London

Constance McKinley  
50 Essex St.  
Rochelle Park, N.J. 07662  
Phone: (201) 843-0550

## Amsterdam, Tokyo, Seoul

Sanders, W. J. M.  
Raadhuisstraat 24  
Graft-De Ryp, Holland  
Phone: 02997-1303  
Telegrams: Euradteam-Amsterdam

Haruki Hirayama  
Electronic Media Service  
5th Floor, Lila Bldg.,  
4-9-8 Roppongi  
Minato-ku, Tokyo, Japan  
Phone: 402-4556  
Cable: Electronicmedia, Tokyo

Mr. O-kyu Park, President  
Dongbo Intl Corp.—  
World Marketing  
C.P.O. Box 4010  
Seoul, Korea  
Tel. 76-3910/3911  
Cable: DONGBO SEOUL  
Telex: EBKOREA K27286

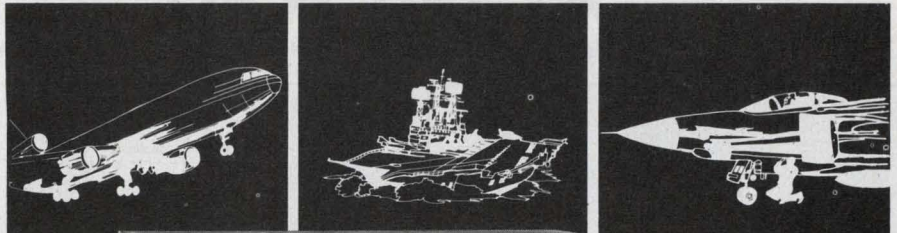

## Invertron® AC POWER SOURCES ARE FIRST IN AVIONICS TESTING

For your 400 Hz/800 Hz power requirements you can rely on Invertron® single or three phase fully **isolated** power output with variable voltage and frequency to meet all Avionics Power Specifications. Invertron® features reliability and flexibility which is unsurpassed for today's use or tomorrow. For other frequencies and power to 30 KVA, 21 models of Plug-in oscillators and 16 models of amplifiers are available. Learn more about the oldest and most respected name in AC Power.

FOR FREE AVIONICS BROCHURE WRITE:

California Instruments,  
5150 Convoy Street, San Diego, California 92111  
Phone: (714) 279-8620 Telex: 695047  
See EEM Pgs. 1.1164, 1.1165

**Aiken Industries**  
California Instruments  
Division

CIRCLE NUMBER 138

## IF YOU WANT MORE IN $\mu$ C DATA ACQUISITION MODULES, YOU'LL JUST HAVE TO SPEND LESS MONEY.

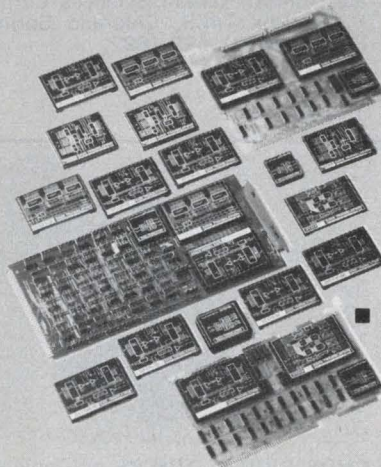

■ **Widest Selection**  
Lowest Cost...\$120-\$750  
Widest Resolution Range...8-12 Bit  
Fastest Throughput...20KHz-125KHz

■ **Complete interfaces for Intel, Motorola, National, Computer Automation**

■ **All Models in Stock**  
...5 Day Delivery: **GUARANTEED**

■ **100% Computer Testing on All Models**

CALL the Company dedicated to your needs for Microcomputer Analog I/O Systems at (617) 655-5300. A Complete set of Applications Data is available.

# DATA TRANSLATION INC

23 Strathmore Rd., Natick, MA 01760/(617) 655-5300 Telex 948474

CIRCLE NUMBER 139

ABP

BPA

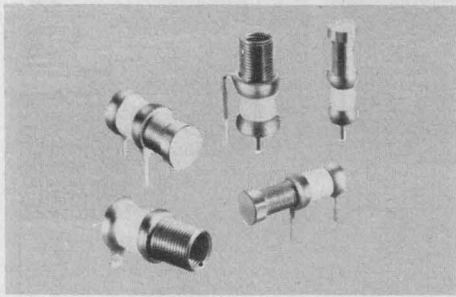

**MINIATURE LOW INDUCTANCE CAPACITORS**, 50% more capacity in the same size is now available in these Johanson extended range capacitors. Beautiful for microwave, VHF and UHF applications, they offer fine tuning, ultra high Q, low temperature coefficients and "sizes" for hybrid and microcircuit as well as standard applications. Featured are capacitance range .5 to 5.0 pf,  $Q > 10,000$  @ 100 MHz, and extra fine tuning. Johanson Manufacturing Corporation, Rockaway Valley Road, Boonton, NJ 07005 (201) 334-2676.

MINIATURE CAPACITORS

181

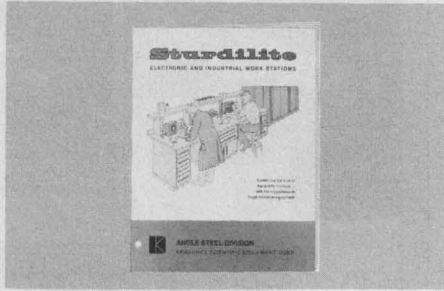

**STURDILITE ELECTRONIC WORK STATIONS** designed to meet exacting requirements for electronic testing, production and assembly. Electrical outlets available in almost any quantity and in convenient locations. Free catalog. Also, free planning service is available. Angle Steel Div., Kewaunee Scientific Equipment Corporation, Plainwell, Mich. 49080 Phone (616) 685-6831

TECHNICAL WORK STATIONS

184

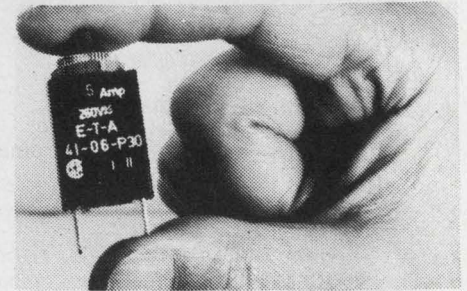

**Overcurrent Protector**, manual reset eliminates fuse replacement. Convenient panel mounting. 19 fractional ratings from 0.1 to 5 amp. Other models up to 400 amp. Trip-free and fool-proof, UL and CSA approved. High quality, low cost \$1.33 ea. in 1000 lots. E-T-A Products Co. of America, 7400 N. Crounse Rd., Chicago, Ill. 60648. Tel: (312) 647-8303. Telex: 253780.

CIRCUIT BREAKER

187

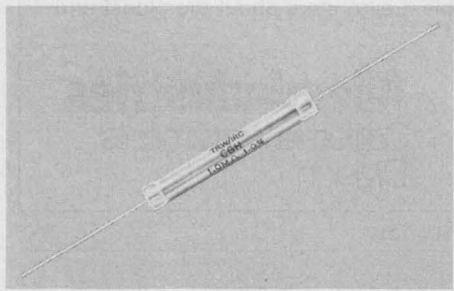

**CGH Metal Glaze Resistors** from TRW operate in high ambient temperatures with excellent high voltage load stability. These thick film resistors are particularly suited for precision high voltage and high impedance applications such as voltage multipliers, X-ray equipment, and high voltage power supplies where precision tolerances and TCs are required. TRW/IRC Resistors, an operation of TRW Electronic Components, 401 N. Broad St., Phila., Pa. 19108. (215) 922-8900.

CGH HIGH VOLTAGE

182

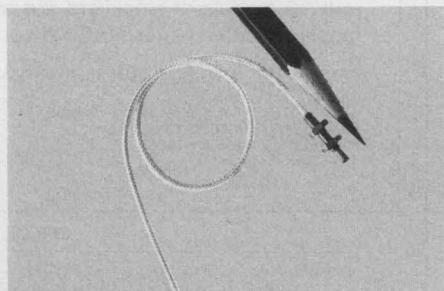

**World's Smallest Displacement Transducer.** Make precision, noncontacting displacement measurements at points never before possible. This new transducer, 0.080" OD, gives accuracy of  $< 100 \mu\text{in.}$  in a range up to 0.020". Temperature stable. Repeatability and resolution is better than  $10 \mu\text{in.}$  Price \$485, including associated electronics. Kaman Sciences Corporation, P. O. Box 7463, Colorado Springs, CO 80933. (303) 599-1892.

TRANSDUCER

185

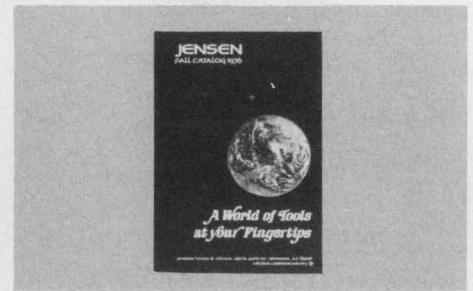

**FREE TOOL CATALOG**—128 pages of hard-to-find precision tools—pliers, tweezers, tool kits, etc. Contains more than 2,800 items. Also includes ten pages of useful "Tool Tips" to aid in tool selection. Jensen Tools and Alloys, 4117 No. 44th St., Phoenix, AZ 85018 (602) 959-2210.

PRECISION TOOL CATALOG

188



**PACE BENCH-TOP REPAIR CENTERS** for simplified Rework/Repair of electronic assemblies. Permits: controlled desoldering for solder joint removal . . . abrading, milling, drilling, grinding and cutting for circuit board repair . . . removal of conformal coatings . . . reflow soldering . . . accurate component forming . . . component salvage . . . repair of damaged plated-thru holes and terminals . . . replating of damaged/worn connectors or contacts. From \$895. PACE INC., 9329 Fraser St., Silver Springs, Md. 20910 (301) 587-1696

REPAIR CENTERS

183



**CMOS DIGITAL TIMERS** by General Time. Low prices enable their use in lieu of both low and high accuracy analog timers and many electromechanical timers.  $\pm 0.5\%$  typical repeat accuracy. On-delay, off-delay, and interval modes available in four different packages; AC and DC. Short reset, recycle and abort times; fast startup. From the industrial control specialists at Industrial Controls Division, General Time, Main Street, Thomaston, CT. 06787. Tel. (203) 283-5881. Telex 96-2445. Helpful literature available on request.

CMOS DIGITAL TIMERS

186

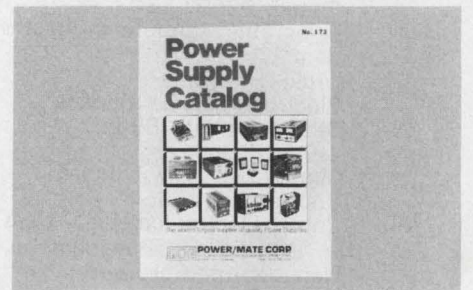

**Free New '76 catalog** contains over 34,-500 quality power supplies from the world's largest manufacturer, Power/Mate Corp. Power Supplies for every application including submodulars, open frame, vari-rated, encapsulated, laboratory & system. All units UL approved and meet most military and commercial specs for industrial and computer uses. Power/Mate Corp., 514 S. River St., Hackensack, NJ 07601 (201) 343-6294

POWER SUPPLIES

189

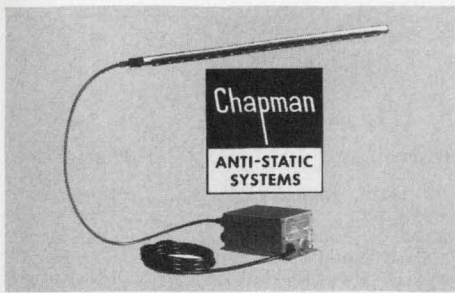

**ANTI-STATIC SYSTEMS FOR PRINTERS, OCR COM and other machines.** Static causes rapidly moving paper and film to jam. . . cause arc tracks on undeveloped film. . . attract and hold dust to photographic negatives causing imperfections on printed circuit boards. Numerous products, of interest to both OEM and user, are detailed in new 32 page catalog to solve these problems quickly, reliably and economically. Chapman Anti-Static Div., Portland Co., 58 Fore St., Bx 427, Portland, ME 04112. (207) 773-4726

ANTI-STATIC SYSTEMS

190



**Cramolin - Antioxidizing lubricant** for all metal contacts and connections exposed to corrosive atmospheres, stationary or moving. Reduce contact resistance. Preserve the metal surface and help improve electronic system performance without change of design shape of connections. Improve service life, safe on plastics. Excellent on P.C. boards placed in storage as well as in use. Liquid form or aerosol. Used by Military, standard labs. Tech-Data available. Caig Labs., Inc., P.O. Box 64, Escondido, Ca., 92025. Tel: 714-743-7143

ANTIOXIDIZING LUBRICANT

193

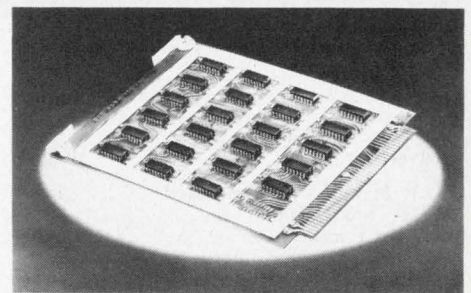

**T2L Power Distribution**—Noise attenuation and highest packaging density for P.C. boards with T2L logic are yours with Mini/Bus®, the Rogers way to eliminate the cost of multilayer boards by off-board power distribution. Rogers Corporation, Chandler, AZ 85224. Phone (602) 963-4584. (EUROPE: Mektron NV, Ghent, Belgium; JAPAN: Nippon Mektron, Tokyo)

PC POWER DISTRIBUTION

196

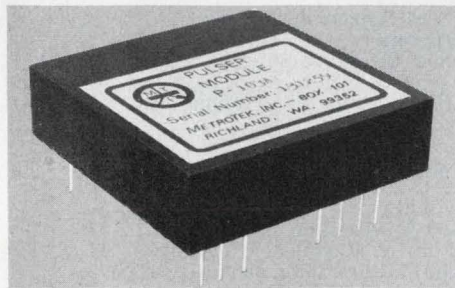

**P100A Series Ultrasonic Pulsers** are designed to drive piezoelectric transducers. Their small size and convenience simplifies ultrasonic system design. The broad-band negative spike output pulse typically has a 10 nsec risetime. Outputs to -380 volts into 50 ohms are available. The pulser repetition rate is variable from 100 Hz to over 5 kHz. TTL-compatible sync outputs and external trigger inputs are provided. METROTEK, INC., P. O. Box 101, Richland, WA 99352 (509) 946-4778

ULTRASONIC PULSER MODULE

191

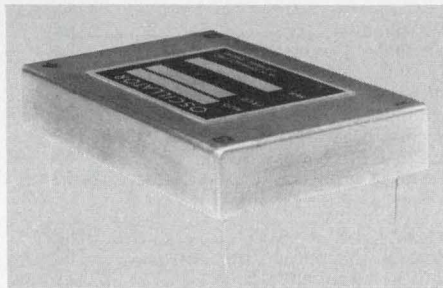

**Model TCX0152, crystal oscillator** with two stability options:  $\pm 1$ PPM over  $0^{\circ}\text{C}$  to  $+50^{\circ}\text{C}$  or  $\pm 1$ PPM over  $-40^{\circ}\text{C}$  to  $+70^{\circ}\text{C}$ . C/MOS output with TTL options. Available at any frequency from 200Hz to 10MHz. Many other models available from .0005Hz to 75MHz. W. H. Ferwalt, Inc., Lapwai, Idaho 83540. Phone: (208) 843-2281

CRYSTAL OSCILLATOR

194

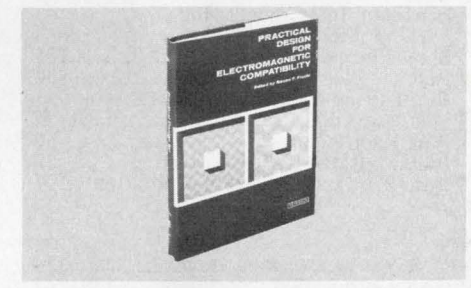

**PRACTICAL DESIGN FOR ELECTROMAGNETIC COMPATIBILITY**, ed. by R. Ficchi. A complete guide to elec. compatibility for electronic systems and equipment, including semiconductor, microelectronic, and digital computer equipment. Numerous charts, graphs, and nomographs. #5685-0, 272 pages, \$17.20. Circle the Info Retrieval Number to order 15-day exam copy. When billed, remit or return book with no obligation. Hayden Book Co., 50 Essex Street, Rochelle Park, N.J. 07662.

DESIGN GUIDE

197

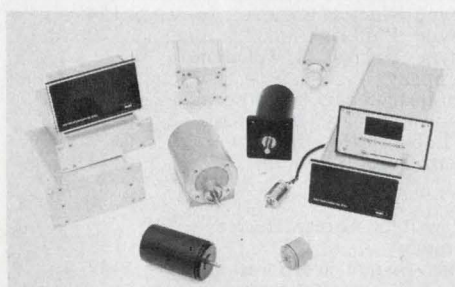

**ENCODING SYSTEMS, (ELECTROMAGNETIC ABSOLUTE)** rugged, completely-passive magnetic transducers providing absolute position information, with a unique output for each position. Correct information is retained even when power is removed. Readings are not affected by electrical noise. Systems offered in a range of full-scale counts from 360 to 10,000 in binary or BCD outputs. All associated electronics provided. Astrosystems, Inc., 6 Nevada Drive, Lake Success, New York 11040. (516) 328-1600

ENCODING SYSTEMS

192

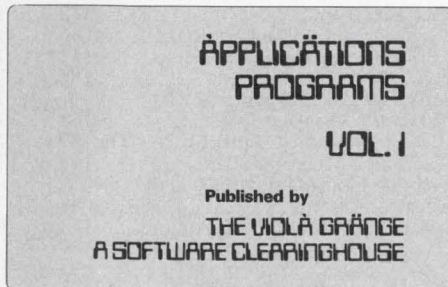

**FOR POCKET CALCULATORS**, 13 exceptional programs from EE, math, and statistics. 26 pages including text, programs and examples. HP-25 coding is used for standardization, but the documentation and stating the equations and algorithms explicitly makes *Applications Programs* calculator independent. A useful and interesting volume that will further your professional development. \$6. We invite your material for publication. The Viola Grange, Rt 2, Box 965, Estacada, Oregon 97023

APPLICATIONS PROGRAMS

195

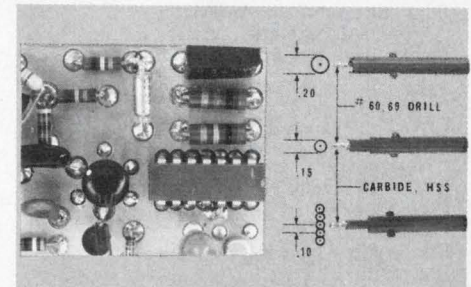

**NO ETCH BREADBOARDS . . . WIRE-WRAP BREADBOARDS** with isolated pad drill-mill construction. Quickly duplicate any etched board; build circuits from full-size artwork. Add components to and/or change circuitry of previously etched boards. Complete freedom in wire-wrap design/layout. Ideal for high frequency ground plane construction. A kit of three IP6003C with #60 carbide drills, \$27.50. A.F. Stahler Company, P.O. 354, Cupertino, CA 95014 (408) 252-4219.

NO ETCH BREADBOARDS

198





**SOMETHING NEW for the  
Efficient World of High Frequency Power Switching!**

# OK, you Power Schottkys, the heat's on. Talk!

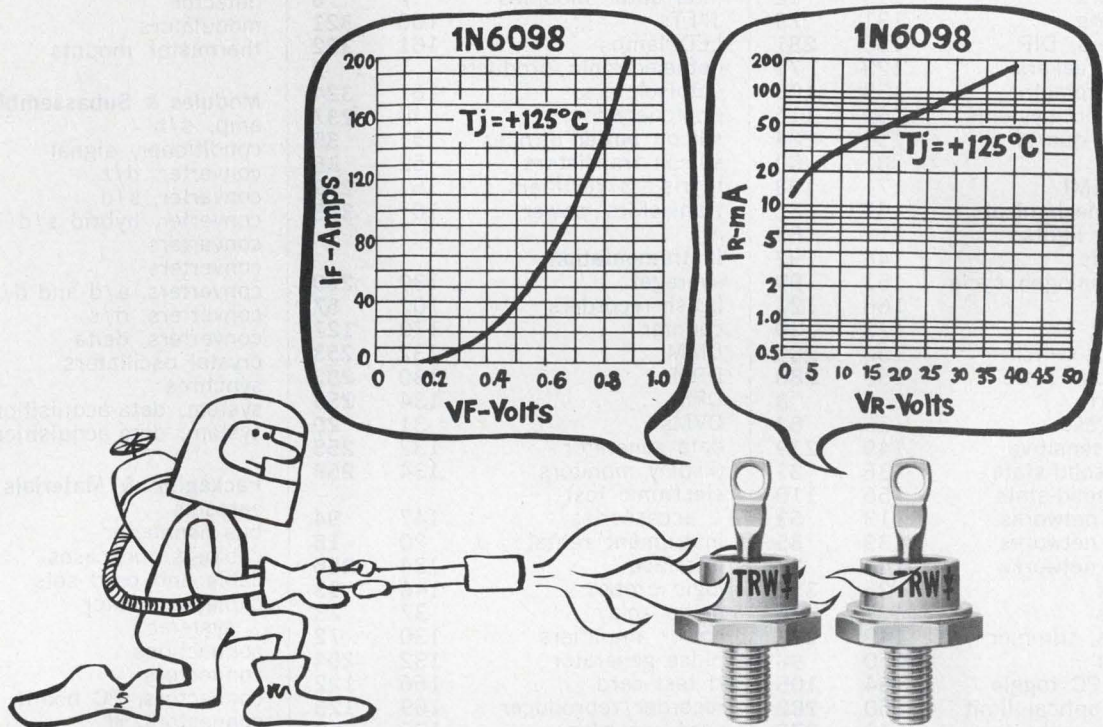

These new TRW Power Schottkys have quite a story to tell and it starts with the fact that they're JEDEC registered. Then they'll tell you that they let you maintain 50 Amps—typically 0.55 Volt forward drop at a  $T_j$  of 125° C. The highest operating junction temperatures, lowest reverse leakage typically less than 200mA @ 40V, 125° C, and highest voltages on the market today. (Yet, for all that, they're competitively priced.)

Yes, TRW's Schottky Diodes are now 1N registered. And they're about to be JAN and JANTX qualified.

Let these new Power Schottkys take your heat, try one in your present circuit or in the circuit you're working on, you'll find out they're not just talk.

1N6095	25 AMP	30V	DO-4
1N6096	25 AMP	40V	DO-4
1N6097	50 AMP	30V	DO-5
1N6098	50 AMP	40V	DO-5

If you'd like to hear more about how TRW's Power Schottkys can help you in the design of low-voltage, high-current power supplies, call John Power at (213) 679-4561. Or use the coupon. (These components are available from stock from our distributors.)

#### TRW Power Semiconductors

An Electronic Components Division of TRW, Inc.,  
14520 Aviation Boulevard, Lawndale, California 90260

- Please send me data sheets on TRW's Power Schottky Diodes
- Have a salesman get in touch with me

Name \_\_\_\_\_

Company Name \_\_\_\_\_

Position \_\_\_\_\_

Address \_\_\_\_\_

City \_\_\_\_\_

State \_\_\_\_\_

Zip \_\_\_\_\_

## TRW POWER SEMICONDUCTORS

ANOTHER PRODUCT OF A COMPANY CALLED TRW

# Product Index

**Information Retrieval Service.** New Products, Evaluation Samples (ES), Design Aids (DA), Application Notes (AN), and New Literature (NL) in this issue are listed here with page and Information Retrieval numbers. Reader requests will be promptly processed by computer and mailed to the manufacturer within three days.

Category	Page	IRN	Category	Page	IRN	Category	Page	IRN
<b>Components</b>			<b>Discrete Semiconductors</b>			microcomputer systems	53	224
capacitor, trimmer	149	278	diodes, tuning	157	310	<b>Microwaves &amp; Lasers</b>		
capacitors	10	8	FET chips, 10-GHz	160	320	detector	174	358
capacitors	15	12	interrupter modules	7	6	modulators	174	359
capacitors	131	73	JFETs	160	321	thermistor mounts	174	356
capacitors, DIP	150	281	LED lamps	161	322	<b>Modules &amp; Subassemblies</b>		
circuit breakers	128	71	optoelectronic products	1	2	amp, s/h	147	273
circuit protector	153	103	optoisolators	161	324	conditioner, signal	142	263
connection systems	162	115	photodetectors	III	237	converter, d/r	144	268
crystals, quartz	151	284	silicon power devices	51	35	converter, s/d	146	271
DIPs	81	50	silicon transistors	52	36	converter, hybrid s/d	140	304
filters, EMI	171	128	thyristors/rectifiers	157	299	converters	144	269
filters, mechanical	87	51	transistors, power	161	323	converters	164	119
indicator lights	112	62	<b>Instrumentation</b>			converters, a/d and d/a	146	272
keyboards	146	92	averager	130	250	converters, d/s	144	270
lamps, halogen cycle	151	99	brush recorders	102	57	converters, delta	138	309
motors	166	121	counter	170	127	crystal oscillators	66	47
posistors	173	129	DMM	132	253	synchros	50	34
proximity switch	150	283	DPM	130	252	system, data-acquisition	143	267
relay, solid state	150	280	DPM	134	259	system, data-acquisition	147	274
relays, rf	2	3	DVMs	31	20	<b>Packaging &amp; Materials</b>		
relays, reed	136	82	data generator	132	255	aerosols	89	53
relays, sensitive	149	279	display monitors	134	258	bus connector	107	59
relays, solid-state	136	81	electronic test			cabinets and cases	160	112
relays, solid-state	156	110	accessories	147	94	cable and cord sets	170	126
resistor networks	113	63	instrument rental	20	15	cable/connector		
resistor networks	139	85	interface	134	256	systems	148	96
resistor networks	141	87	logic probe	146	93	connections	55	38
resistors	25	351	meter relay	37	23	connectors	96	55
resistors	127	70	power amplifiers	130	72	connectors, PC board	95	54
resistors, trimmer	149	277	pulse generator	132	254	connectors, rf	172	347
steppers	150	98	rf test card	166	122	connectors, power	170	306
switch, PC toggle	154	105	recorder/reproducer	169	125	data console	157	111
switch, optical limit	150	282	scan recorder	136	260	enclosures	117	64
switch, pushbutton	148	275	scanner	136	262	enclosures	135	77
switch, subminiature	154	106	scope	38	24	headers	135	79
switches	103	58	scope	136	261	magnetic shields	175	136
switches	140	86	scope, 100-MHz	133	75	PC sockets	135	80
switches	173	130	signal generators	134	257	packaging hardware	97	56
switches, PB	149	97	telecommunication			reader/spooler	23	16
switches, rocker	57	39	equip.	161	114	stacking connectors	154	107
thermal cutoff	163	118	$\mu$ P analyzer	129	305	test sockets	155	109
thermistors	138	84	VOM	130	251	wire terminals	171	346
trimmers	173	131	VOMs	121	248	<b>Power Sources</b>		
wirewounds	47	31	X-Y recorders	163	117	battery, rechargeable	167	335
						controller, energy	168	340
<b>Data Processing</b>			<b>Integrated Circuits</b>			dc/dc converters	168	338
calculator, fraction	156	297	analog delays	143	89	energy cells	17	13
color display driver	160	113	audio amplifier	13	10	modular supplies	167	336
computer products	49	33	comparator/counter, IC	164	328	open-frame sources	168	337
data-acquisition system	61	239	controller, disc	162	308	power sources, ac	179	138
data-acquisition system	137	83	converter, a/d	164	325	power supplies	11	9
data terminal	156	296	chip, DVM	165	329	power supplies	44	202
digital data printer	132	74	d/a converters	109	61	power supplies	165	120
disc drives	156	298	d/a converters	123	68	power supplies	167	123
disc system	155	289	extender, count	164	327	power supplies	175	135
floppy-disc system	153	286	master slices, CMOS	164	326	power supply	168	339
floppy discs	60	42	memory	65	46	power supply	169	342
interface, digitizer	155	288	memory, random-access	165	331	power supply, ac UPS	167	334
microcomputer card	155	287	PROM, bipolar	118	65	simulator, xducer	169	341
microcomputer systems	53	224	PROM, erasable	43	29	standard, dc-I/E	166	332
minis and micros	27	18	RAMs, 4-k static	14	11	switching regulator	179	140
printer	148	95	register, 8-bit	165	330	UPS	166	333
TV display, computer	155	290	<b>Microprocessor Design</b>					
tape transport	119	66	board, accessory	56	225			
telephone, self-dial	156	295	computer software	56	226			
terminal, CRT	152	307						

# VACTEC Photodetectors

The Industry's Broadest Line Provides More Semiconductor Detectors for More Design Applications

Vactec serves manufacturers of a wide range of modern electronic products. Pictured are a few examples. All these devices are both made and sold by Vactec, including complete lines of LDR's (photoconductive cells, CdS and CdSe); silicon solar cells, as well as silicon high speed and blue enhanced cells; NPN phototransistors and darlington's; opto-couplers (LED/LDR, lamp/LDR and neon/LDR); selenium photovoltaic cells; silicon photodiodes, blue enhanced and PIN; and custom C-MOS and bi-polar IC's. Write for technical bulletins on the types that suit your requirements. Or send your application, and Vactec will recommend the right cell for the job.

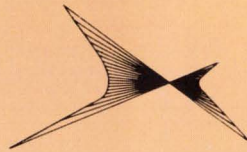

## Vactec, Inc.

2423 Northline Industrial Blvd.  
Maryland Heights, Mo. 63043  
(314) 872-8300

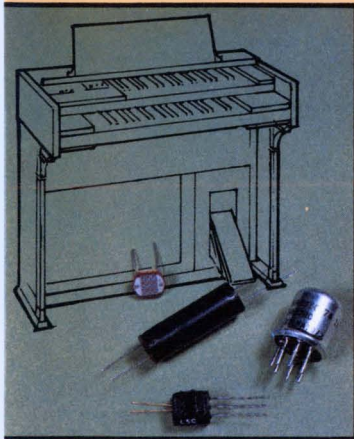

### Electronic Organs

LED or lamp/LDR Vactrols for audio, and CdS cells for swell pedal controls.

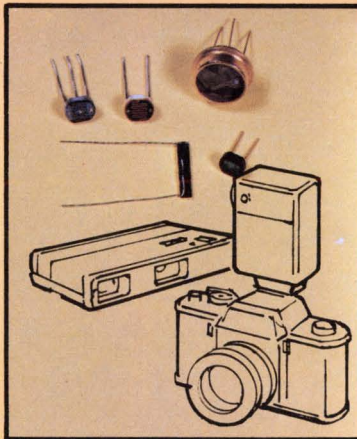

### Cameras and Projectors

CdS or blue enhanced silicon photodiodes for automatic shutter timing, aperture servo systems for automatic projector focus; and slave flash controls.

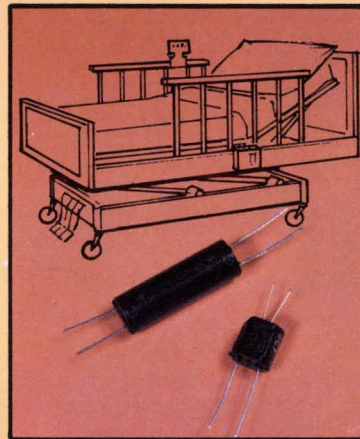

### Triac Motor Controls

A special Vactrol gates a triac for forward and reverse motor operation as in hospital beds.

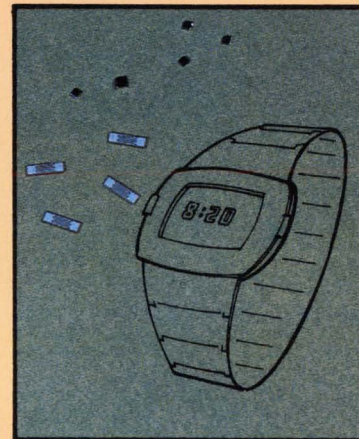

### LED Watches

Photoconductive or phototransistor chip controls LED brightness.

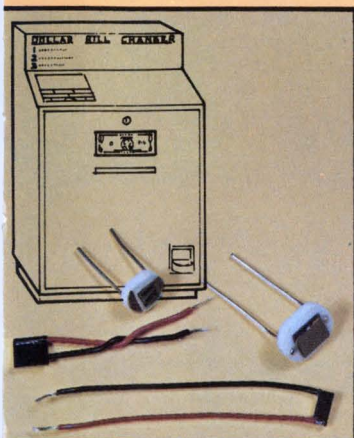

### Dollar Bill Changers

Silicon photovoltaic cells analyze optical characteristics.

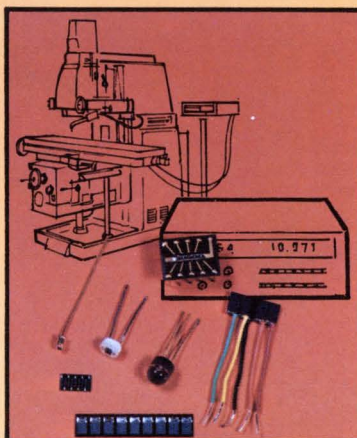

### Machine Tool Controls

High-speed photovoltaic cells or transistor arrays help computer control repetitive operations, non-contact sensing, and counting and weighing.

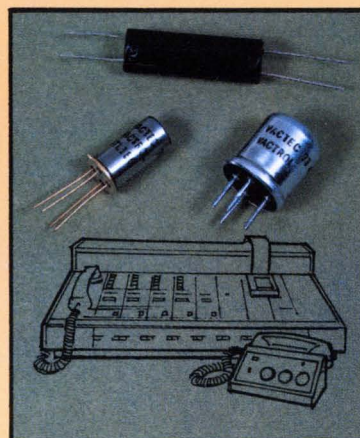

### Telephone Equipment

Neon/LDR Vactrols sense ringing. Direct a-c coupling, slow LDR response isolates electronics from noise.

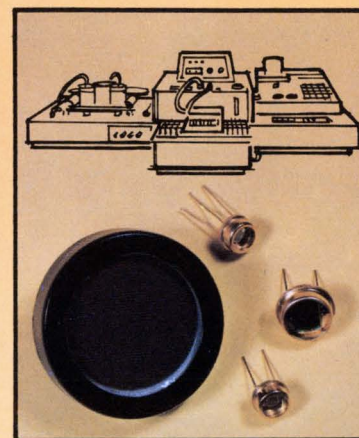

### Scientific Instruments

Blue enhanced silicon or selenium photovoltaic cells detect solutions densitometrically for precise blood chemistry and other analyses.

What's new in solid state ...

# RCA races on with popular memory types: 14 now, 10 coming up.

From a virtual standing start in 1974, we've already introduced 14 of the most popular RAMs and ROMs. By year's end there will be 24—a comprehensive lineup of devices that are directly interchangeable or pin compatible with 62 types from 19 manufacturers of industry standards ... often with improved performance as a dividend.

RCA memories span NMOS, CMOS, and SOS technologies. Organizations range from 4 words x 8 bits up to 512 words x 8 bits, with emphasis on standard 1K and 4K arrangements. And these products are now available in volume from several facilities including our newest, most highly automated plant, designed and equipped to produce with a high degree of uniformity.

All of which shows RCA is totally committed to winning your confidence as a front-running, wide-range memory supplier. To help you program RCA memory products into your design we've put together a pocket-size Memory Interchangeability Guide. Ask for it at your local RCA Solid State distributor. Or contact RCA.

<b>1974</b>			
NMOS	MW7001ID	CMOS	CD4039AD
CMOS	CD4036AD	CMOS	CD4061AD
<b>1975</b>			
SOS	MWS5001D	SOS	MWS5501D
SOS	MWS5040D	SOS	MWS5540D
Now ...		<b>1976</b>	
NMOS	MW4050D	NMOS	MW4060D
NMOS	MW4050DVI	NMOS	MW4060DVI
NMOS	MW4050DV2	NMOS	MW4060DV2
Coming ...		SOS	MWS5001A
NMOS	MW4051	SOS	MWS5580
NMOS	MW4101	CMOS	CD40024
NMOS	MW4104	CMOS	CD40032
NMOS	MW4111	CMOS	CD40061
NMOS	MW4112		

Write: RCA Solid State, Box 3200, Somerville, N.J. 08876; Ste. Anne de Bellevue H9X 3L3, Canada; Sunbury-on-Thames, U.K.; Fuji Bldg., Tokyo, Japan.

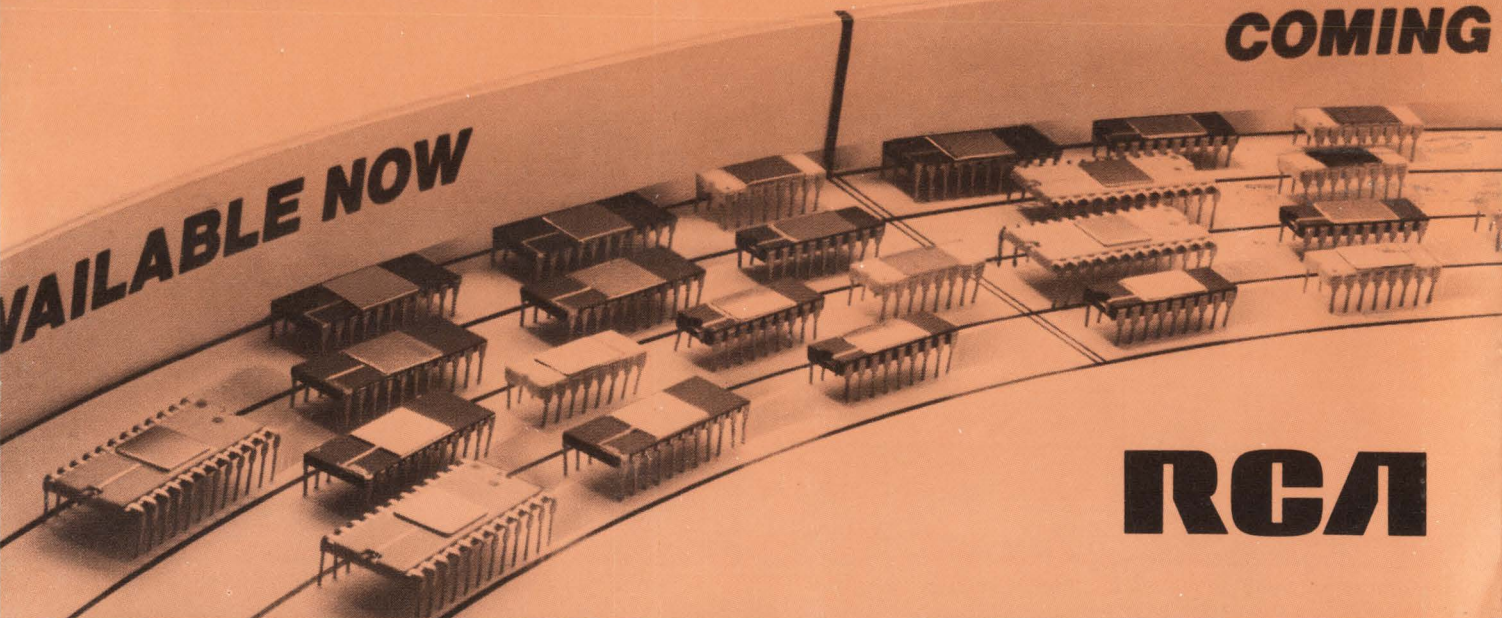

RCA. Fastest moving house in memory.