

Electronic Design. 5

VOL. 26 NO.

FOR ENGINEERS AND ENGINEERING MANAGERS — WORLDWIDE

MARCH 1, 1978

Pick a calculator, any calculator. More computing power is packed into all machines. Displays are easier to read, and reliability is better. But problems persist. Poor

keyboard designs still give false entries. Live NiCd batteries play dead. And complex features of programmables make selection tougher than ever. See p. 40.



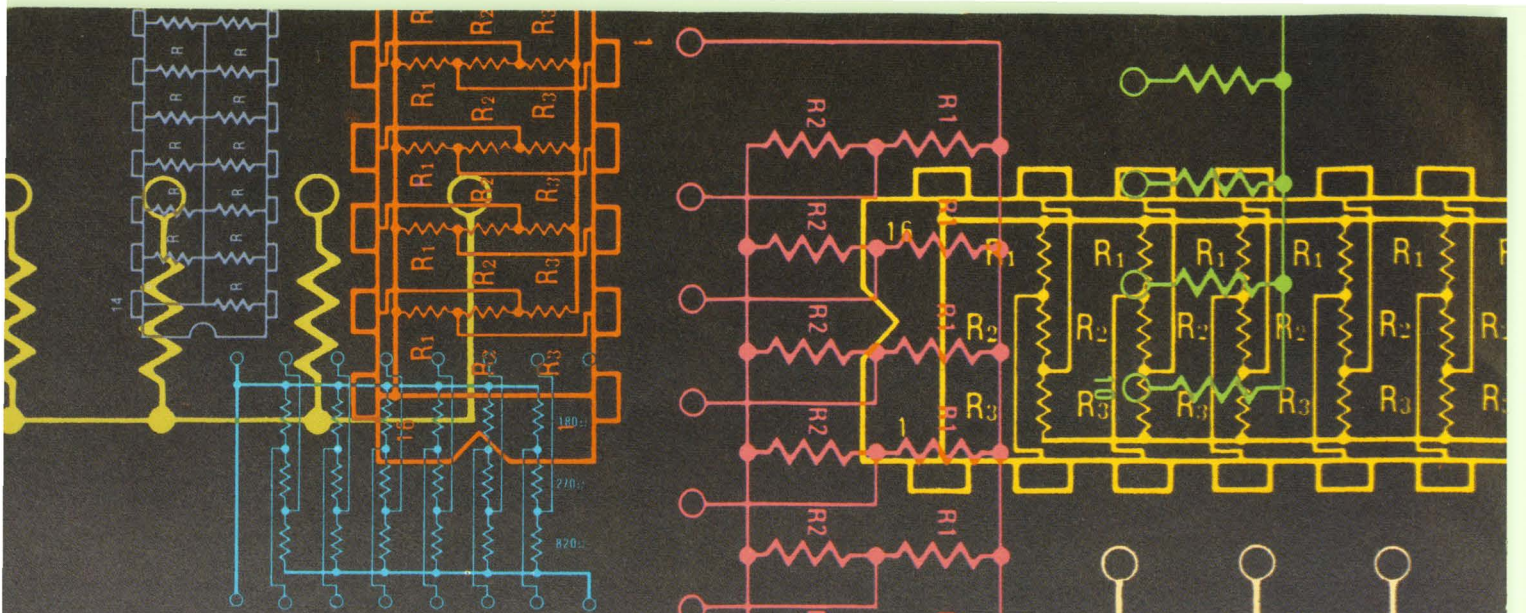

Bourns resistor networks

... for the "discreet" design engineer.

Sure, you've already made a smart decision, choosing networks over discrete resistors. After all, the cost per resistor in a network package can be 40% less; they require only 10-15% of the P.C. board space needed by discrettes; and component count is reduced as much as 95% with resistor networks.

But, when choosing a network supplier, you should also consider these points:

1. Bourns has the broadest network product line in the industry — over 1000 part numbers in all. And our standard DIP circuits range from simple pull-up configurations to Thevinin-equivalent ECL terminators and memory interface circuits.
2. Bourns Krimp-Joint™ offers both a mechanical and electrical bond that lap or butt joint construction doesn't provide. The lead is crimped onto the network element and a high-temp, reflow-resistant solder is used to prevent failure during wave soldering and in circuit thermal cycling and vibration.
3. Bourns was the first manufacturer to offer a complete line of off-the-shelf, super low profile SIPs with demonstrated automatic insertion capability.

These are the facts. So, now you can be even more "discreet". We're sure you'll specify Bourns Resistor Networks — direct or through your local distributor.

Send today for our new 1977 Resistor Networks Catalog.

TRIMPOT PRODUCTS DIVISION, BOURNS, INC., 1200 Columbia Avenue, Riverside, CA 92507, Telephone 714 781-5415 — TWX 910 332-1252.

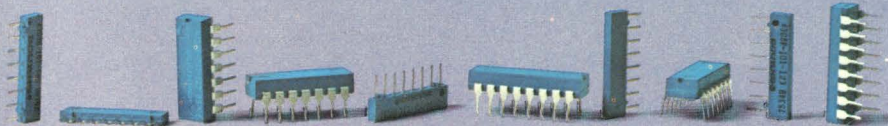

International Marketing Offices: European Headquarters — Switzerland 042/23 22 42 • Belgium 02/218 2005 • France 01/2039633 • Germany 0711/24 29 36 • Italy 02/32 56 88 • Netherlands 70/87 44 00 • United Kingdom 01/572 6531 • Norway 2/71 18 72 • Sweden 764/20 110 • Japan 075/921 9111 • Australia 02/55-0411 03/95-9566 • Israel 77 71 15/6/7

For Immediate Application — Circle 130
For Future Application — Circle 230

SURPRISE!



Sundial courtesy of Franks Antique Clock Shop, San Jose, California.

The World's First LED Displays You Can View in Bright Sunlight.

Now available from Hewlett-Packard are displays designed for high ambient conditions. These seven-segment displays optimize the contrast between the digit segments and the background. A specially designed P-N junction and larger top contact metallization permit operation at high peak currents. This feature enhances display light output and permits strobed operation of long display strings. Combined with proper filtering these displays can be used under high ambient lighting as bright as 10,000 footcandles!!!

Available in High Efficiency Red and Yellow, the HDSP-3530/4030 series are designed for use in outdoor terminals, gas pumps, airplane cockpits, instruments, weighing scales, agricultural instrumentation and point-of-sale terminals.

The High Efficiency Red (HDSP-3530/3730 Series) displays are priced at \$2.05* (7.6mm/0.3") and the Yellow (HDSP-4030/4130 Series) displays are \$2.25* (10.9mm/0.43") in quantities of 1000.

For immediate delivery, call any franchised HP distributor. In the U.S. contact Hall-Mark, Hamilton/Avnet, Pioneer-Standard, Schweber, Wilshire or the Wyle Distribution Group (Liberty-Elmar). In Canada, call Hamilton/Avnet or Zentronics, Ltd.

01803

*U.S. Domestic Prices Only.

CIRCLE NUMBER 2

HEWLETT  **PACKARD**

1507 Page Mill Road, Palo Alto, California 94304

For assistance call: Washington (301) 948-6370, Chicago (312) 255-9800, Atlanta (404) 955-1500, Los Angeles (213) 877-1282

MIL-
 And
 from

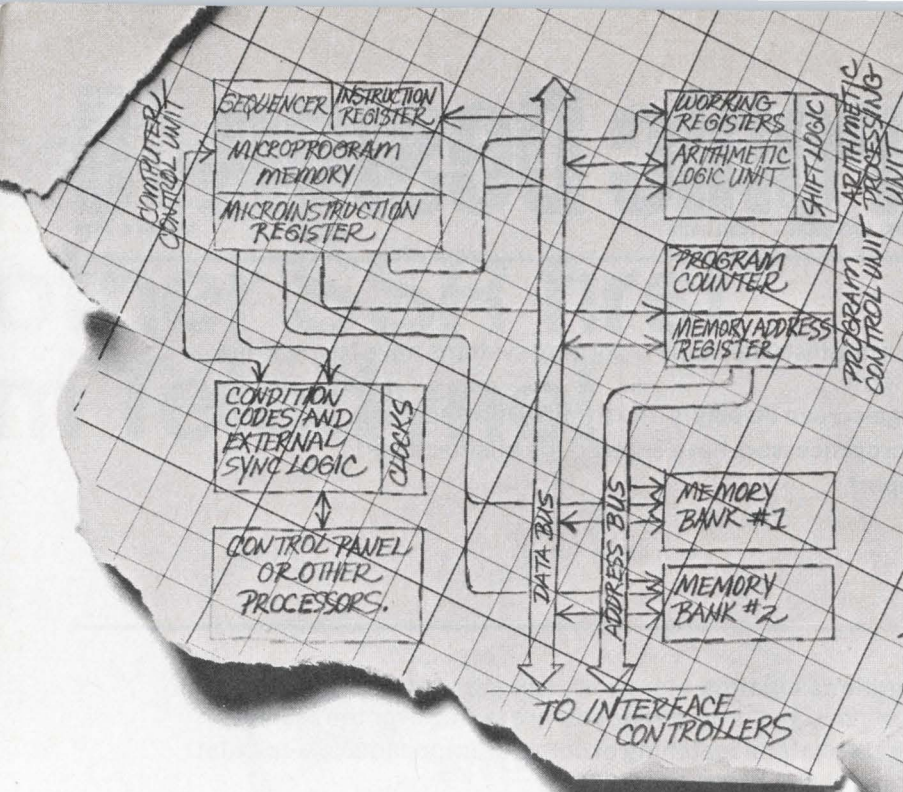

THE MACHINE CONTAINS AN ARITHMETIC PROCESSOR, A PROGRAM-CONTROL UNIT, DMA, INTERRUPT AND OTHER CIRCUITS. THE CONTROL LINES FOR ALL THOSE CIRCUITS COME FROM A BIPOLAR MEMORY WHICH IS PART OF THE COMPUTER CONTROL UNIT. EACH WORD IS ~~ONE~~ A MICROINSTRUCTION, THEY ARE SELECTED FROM THE MEMORY BY A SEQUENCER, THEN DEPOSITED IN A REGISTER. FROM THERE, THEY CONTROL ALL THE SYSTEM'S PARTS, INCLUDING THE SELECTION OF THE NEXT MICROINSTRUCTION TO BE EXECUTED.

FIGURE 1. GENERALIZED COMPUTER ARCHITECTURE

Advanced Micro Devices announces an advanced course in microprogrammable microprocessing.

Step by step, function by function, month by month, we'll build a fast, powerful, micro-programmed machine.

And on December 31, 1978, you'll know what we know. As it turns out, that's quite a lot.

Experience, state relay to milestone with solid state re MIL-R-28750:

- M2E
- M2E
- M2E

These SSI reliability record switching ap support equi

BUILD A MICROCOMPUTER THIS YEAR.



31
 T

CHAPTER ONE: COMPUTER ARCHITECTURE.

Modern digital processors are built using one of two techniques: A fixed-instruction MOS processor, such as the 8080A or 8085, or a microprogrammed TTL design. Because of the extremely low cost and small size of the microcomputer built around a fixed-instruction microprocessor, this approach is dominant.

But, not all problems can be solved with an 8080A or 8085. They may not be fast enough. And, applications requiring more than 8 bits of precision, substantial amounts of arithmetic processing, adherence to a pre-defined instruction set or blazing speed need something more than MOS has to offer. You need microprogramming capability. You need bipolar LSI.

During the year, you'll be meeting several new members of the Am2900 Family, a series of low-power Schottky LSI devices specifically designed for microprogrammed machines.

Your microcomputer can have instruction execution as short as 100 nanoseconds, multiplication as fast as 4 microseconds and division in just 8 microseconds.

So clear some space. In your office. In your home. In your brain.

BUILD YOUR LIBRARY, TOO.

Each of these messages is backed by a ton of theory and applications information. Send in this coupon, and we'll send you Chapter One and tell you how to get the whole book.

| | |
|--|-----------------------|
| Advanced Micro Devices | 3/78-ED |
| 901 Thompson Place | |
| Sunnyvale, California 94086 | |
| I want to build a microcomputer this year. Sign me up. | |
| Name _____ | |
| Title _____ | Mail Stop _____ |
| Company _____ | |
| Address _____ | |
| City _____ | State _____ Zip _____ |

Advanced Micro Devices



Multiple technologies. One product: excellence.
901 Thompson Place, Sunnyvale, California 94086
Telephone (408) 732-2400

Next month, Chapter Two: Microprogrammed Control.●

I want to show you our reliable system for removing flux

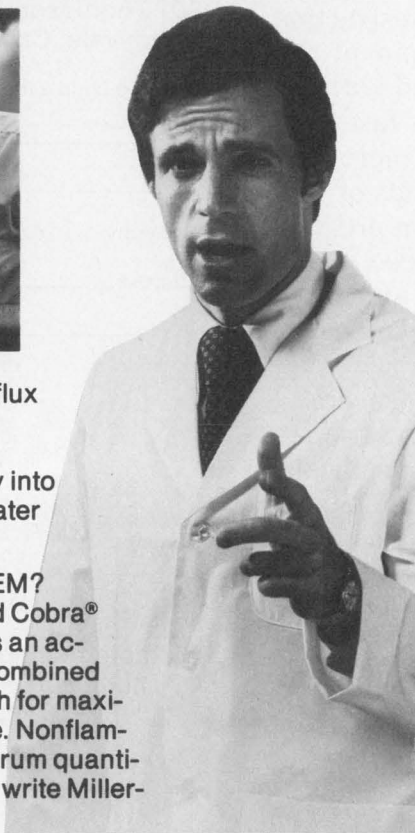
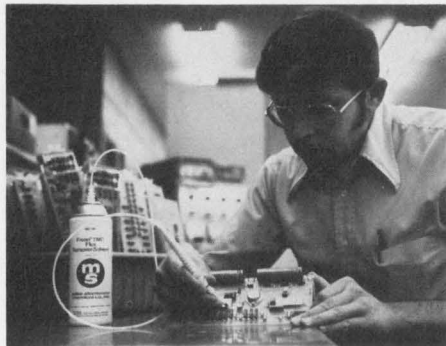

MS-190 and MS-190HD removes flux quickly, efficiently, economically without harm to components. Flux does not migrate by etching its way into critical parts causing failures at a later date.

WHAT'S NEW ABOUT THE SYSTEM?

The M-S system utilizes a patented Cobra® Solvent Spray Brush, the solvent is an accurately directed, metered spray combined with a scrubbing action of the brush for maximum cleaning with minimum waste. Nonflammable. Available in gal., 5 gal and drum quantities. For further information, call or write Miller-Stephenson.

**m s miller-stephenson
chemical co., inc.**
Danbury, Connecticut 06810 (203) 743-4447

miller-stephenson chemical company, inc.
Danbury, Connecticut 06810, (203) 743-4447

_____ Write our Technical Director for application information of MS-190, MS-190HD and MS-226 Cobra Solvent Spray Brush.

_____ Enclosed is \$5 for Trial Pack —
MS-190/MS-190HD/MS-226 Cobra Brush

_____ Send Literature and prices.

Name _____ Title/Dept. _____

Company _____

Address _____

City _____ State _____ Zip _____

*Registered trademark.

For Industrial Use Only. Trial Units must be sent to Company address.

LOS ANGELES • CHICAGO • DANBURY, CONN. • TORONTO

CIRCLE NUMBER 4

Publisher
William Maass

Editors
Editorial Offices
50 Essex St.
Rochelle Park, NJ 07662
(201) 843-0550
TWX: 710-990-5071
(HAYDENPUB ROPK)
Cable: Haydenpubs Rochellepark

Editor-in-Chief George Rostky

Managing Editors:
Ralph Dobriner
Michael Elphick

Senior Associate Editor
Stanley Runyon

Associate Editors:
Sid Adlerstein
Nicholas Bodley
Dave Bursky
Morris Grossman
Gene Heftman
Andy Santoni
Max Schindler

Contributing Editors:
Peter N. Budzilovich, Jules H. Gilder,
Sidney Moskowitz, Nathan Sussman

Editorial Field Offices
East

Jim McDermott, Eastern Editor
P.O. Box 272
Easthampton, MA 01027
(413) 527-3632

West

Dick Hackmeister, Western Editor
8939 S. Sepulveda Blvd., Suite 414
Los Angeles, CA 90045
(213) 641-6544
TWX-1-910-328-7240

Dave Barnes, Western Editor
465 S. Mathilda, Suite 302
Sunnyvale, CA 94086
(408) 736-6667

Editorial Production

Marjorie A. Duffy, Production Editor
James Keane, Copy Editor

Art

Art Director, William Kelly
Richard Luce, Anthony J. Fischetto

Business Manager

Thomas E. Vachon

Production

Manager, Dollie S. Viebig
Nancy Hurey

Circulation

Director, Barbara Freundlich
Senior Assistant, Gail Stone

Information Retrieval

Paula Greenleaf

Advertising Promotion

Judith Nappo

Reprints

Maxine Sassano

ELECTRONIC DESIGN 5, March 1, 1978

Across the desk

Putting the brakes to radar brake control

Your article on automobile radar systems in the U.S. for brake control (ED No. 23, Nov. 8, 1977, p. 30) indicates that noticeable progress has been made in the U.S., but I remember the Japanese reporting approximately this much success at a conference in Detroit around 1972. It appears from your article, though, that the most serious questions raised in 1972 haven't been solved by the approaches you describe, including:

- Inability to determine a real threat. An oak tree or a bridge abutment is a threat. An empty trash can is not, but it has a beautiful radar cross-section.

- Water splash or heavy rainfall problems. Ironically, these bad conditions can occur when braking help might be most needed.

- The braking systems don't know what you're thinking. For example, if you pull out to pass with a car coming on, the systems in your article could brake you just before you turn back into your lane, leaving you in a rather bad position.

- EMI and reliability. The danger from some stray signal is very serious. Likewise, the over-all reliability of the electronics will have to be several orders of magnitude better than anything of this general level of complexity ever built. It will be hard to prove that the units save a life, but rather obvious when it causes a serious accident.

There is nothing wrong with using radar to warn a driver, but taking control raises serious questions. I, for one, would not want the system(s) you describe to control my car.

W.T. Walton

38 Windward Dr.
Severna Park, MD 21146

A few changes

The article, "Exploit Existing NOVA Software by Designing computer Systems Around the Micro NOVA" (ED

No. 19, Sept., 13, 1977, p. 54), contained several inaccuracies.

The last two sentences of p. 56 should read: "During a Refresh operation, the CPU specifies a group *equivalent to 1/64 of all the* memory locations to be refreshed, but transfers no data. *The refresh address is* selected by a 6-bit refresh address register placed on the lower six address lines."

Also, Fig. 8a on p. 63 should be corrected as indicated.

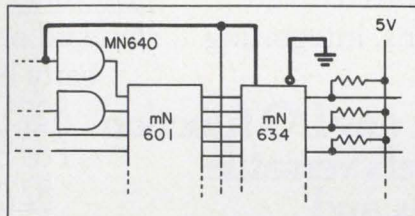

Daniel Falkoff
Design Engineer

Data General
Route 9
Westboro, MA 01581

Misplaced Caption Dept.



Our engineers react positively to design reviews. Our younger engineers, in particular, look forward to these inputs.

Sorry. That's "Massacre of the Barbarians," from the Column of Marcus Aurelius located in Rome.

Electronic Design welcomes the opinions of its readers on the issues raised in the magazine's editorial columns. Address letters to Managing Editor, Electronic Design, 50 Essex St., Rochelle Park, NJ 07662. Try to keep letters under 200 words. Letters must be signed. Names will be withheld upon request.



OPTRON OPTICALLY COUPLED ISOLATORS

NEW JAN 4N22A SERIES
OFFERS
HIGHEST RELIABILITY

You can't buy a more reliable optically coupled isolator than one of OPTRON's new JAN 4N22A series. The popular JAN 4N22A, 4N23A and 4N24A all feature fully qualified JANTX and JANTXV ratings.

These new OPTRON isolators consist of a high efficiency, solution grown gallium arsenide LED and a silicon N-P-N phototransistor in a hermetically sealed 6-pin TO-5 package. Minimum input-to-output isolation voltage for the series is 1000 volts and minimum current transfer ratios range from 25% for the 4N22A to 100% for the 4N24A.

New "A" version OPTRON isolators are a significant improvement over the older 4N22 series since the case is isolated from the sensor and LED to eliminate the need for an insulating spacer in many applications.

OPTRON also offers a new JEDEC registered series of high reliability isolators in a 4-pin TO-18 package. The 3N243 series includes three devices with the same reliability and similar characteristics as the JAN 4N22A TO-5 series, yet in a smaller package.



3N243

In addition, OPTRON's complete line of optically coupled isolators includes other immediately available standard devices in high-rel metal cans and low cost DIP and other plastic configurations for almost every application.

Detailed technical information on optically coupled isolators and other OPTRON optoelectronic products... chips, discrete components, limit switches, reflective transducers, and interrupter assemblies... is available from your nearest OPTRON sales representative or the factory direct.



OPTRON, INC.

1201 Tappan Circle
Carrollton, Texas 75006, U.S.A.
TWX-910-860-5958
214/242-6571

Intel delivers the micro components designers

There's no more efficient way to solve your interface and control requirements for microcomputer-based systems than our peripheral components.

They're single-chip solutions to even the most complicated operations, integrating

"I can accomplish almost any I/O function with one chip using Intel's versatile peripheral interfaces and dedicated device controllers."



up to 22,000 transistors per chip to replace circuit boards full of discrete logic with a single component. Result: you cut parts cost, reduce package count and board space, and simplify both development and operating software.

We've designed each of these peripheral chips to be an intelligent, programmable component in your system and to perform most functions with minimal cpu supervision. The resulting decrease in cpu overhead provides your system with higher performance and increased throughput.

The dedicated function components below are available now, with more on the way. Here's a brief description of their versatility.

8271 Programmable Floppy Disk Controller. Provides full control of up to four standard or minifloppy drives. (Available early 1978.)

8273 SDLC/HDLC Protocol Controller. For SDLC and HDLC communications.

8275 Programmable CRT Controller. Provides fully buffered interface and control of almost any raster scan CRT display.

8278/8279 Programmable Keyboard/Display Interfaces. Keyboard/sensor array input scan, and output scan for LED, incandescent and other displays. 128-key or 64-key input.

8251A Programmable Communications Interface. Industry standard USART for synchronous or asynchronous serial data

transmission, including bisync.

8253 Programmable Interval Timer. Contains three independent 16-bit counters, programmable modes from dc to 2MHz.

8255A Programmable Peripheral Interface. General purpose I/O interface with 24 individually programmable I/O pins.

8257 Programmable DMA Controller. Provides four-channel, high speed direct memory access independent of CPU.

8259 Programmable Interrupt Controller. Handles eight levels of vectored priority interrupt. Expandable to 64 levels.

computer peripheral are talking about.

UPI-41™ is Intel's Universal Peripheral Interface, bringing distributed intelligence to microcomputer systems for the first time.

Actually a highly integrated, user-programmable microcomputer, UPI-41 is a new solution that obsoletes custom LSI and specialized discrete designs for interfacing most low and medium speed peripherals with an MCS-80,™ MCS-85™ or MCS-48™ microcomputer.

Intel delivers UPI-41 in two versions that make it easy for you to implement your own designs. The 8741 includes an erasable and reprogrammable 1K-byte EPROM, for development, testing and low volume production. Then the 8041, with masked ROM, provides maximum economy in high volume.

We've taken the UPI-41 concept a step further with the 8278, described at left. The 8278 is the first of several preprogrammed 8041's that we've adapted to specialized applications.

Because UPI-41 is a microcomputer, we've given it the same high level of support we give all our microcomputers. UPI-41 is supported by our

Prompt™ 48 Design Aid, the Intellec® microcomputer development system with resident UPI-41/MCS-48 Macro Assembler. Plus appli-

"And, for my special I/O requirements, Intel's UPI-41 Universal Peripheral Interface is user programmable to control nearly any other peripheral device."

cations assistance worldwide, full documentation, training classes, design seminars and a rapidly expanding users' software library.

Intel's peripheral components, and the MCS-80, -85 and -48 microcomputers they support, are available through:

Almac/Stroum, Component Specialties, Cramer, Hamilton/Avnet, Harvey Electronics, Industrial Components, Pioneer, Sheridan, L.A. Varah, Wyle/Elmar-Liberty and Zen-tronics. For your copy of our Peripheral Data Handbook use the reader service card or write: Intel Corporation, 3065 Bowers Ave., Santa Clara, CA 95051. Telephone: (408) 987-8080.

intel® delivers.

CIRCLE NUMBER 6

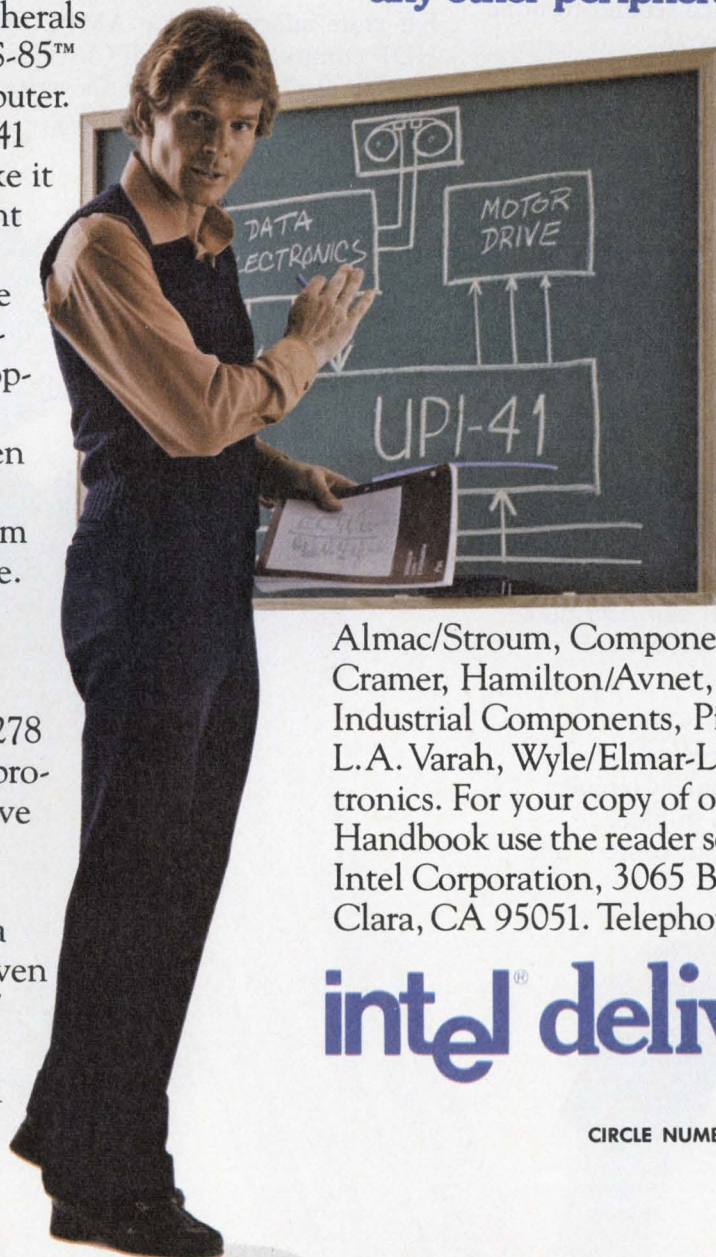

“We can use anybody’s .050” centerline cable with AMPLIMITE HDF connectors.

And get mass termination efficiency.”

And there are no exceptions. AMPLIMITE High Density Flexible connectors work with all .050" centerline 28-30 AWG round conductor ribbon cable. You get an axial cable-to-connector interface second to none in strength and ruggedness.

AMPLIMITE HDF connectors provide complete packaging flexibility. They are available in 15-, 25- and 37-position sizes, and have through-cable capability for “daisy chain” applications. They intermate with other D-type connectors, including AMPLIMITE all-plastic right-angle headers. HDF connectors are at work in computer peripherals, modems, instrumentation, industrial controls, and word processing systems. They are completely compatible with transmission specification RS-232.

AMPLIMITE HDF connectors give you another plus. AMP technical assistance and support. It’s thorough, complete, professional aid you can call on even during project planning. It can help make sure your design will be efficient and effective right from the start.

There are more advantages with AMPLIMITE HDF connectors:

- Probe-ability for convenient circuit testing with connectors in place.
- Compatibility with “dead center” and “dead edge” designs.

- Matched application tooling assures highest production rates and lowest applied cost.
- Integrated cable strain relief.

For more information on AMPLIMITE HDF connectors, just call Customer Service at (717) 564-0100. Or write AMP Incorporated, Harrisburg, PA 17105.



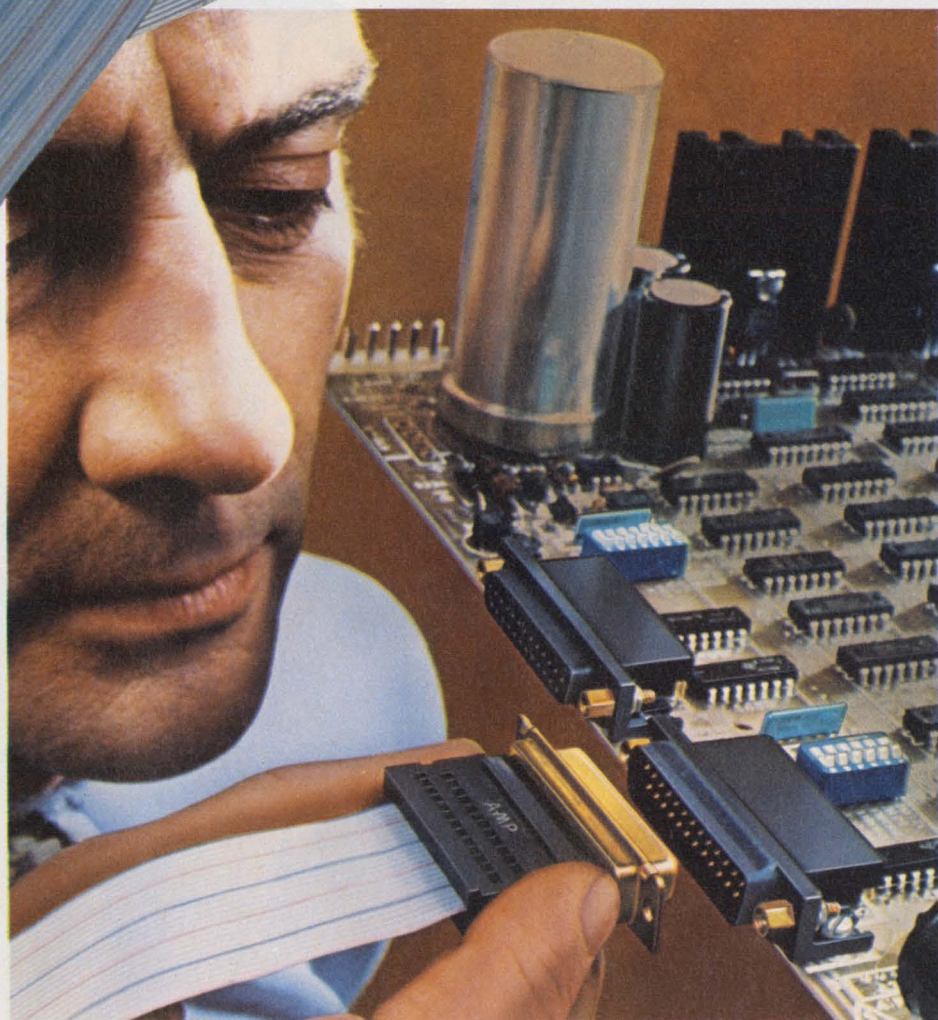
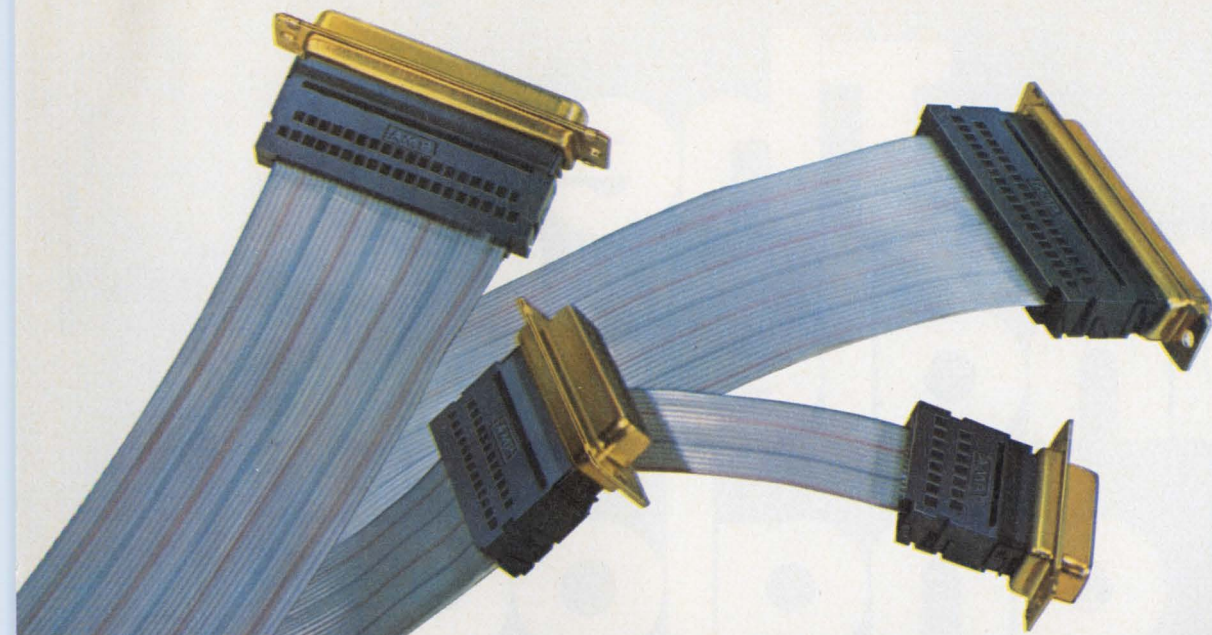

**AMP has a better way
... Mass Termination.**

AMP pioneered the concept and today is the acknowledged leader with the industry's widest range of application experience. We have mass termination connectors for discrete wire and virtually any type of cable: ribbon coaxial, flat etched, twisted pair, round conductor, flat flexible. All have preassembled contacts, eliminate costly wire preparation and offer productivity savings and benefits never before possible. If you would like details on any of our other mass termination ideas, call Customer Service at (717) 564-0100.

AMP & AMPLIMITE are trademarks of AMP Incorporated.

SEE US AT
NEPCON SOUTHEAST, ORLANDO

CIRCLE NUMBER 7

AMP
INCORPORATED

The single chip analog computer.

A versatile, new
computational IC that's
accurate and easy
to use,

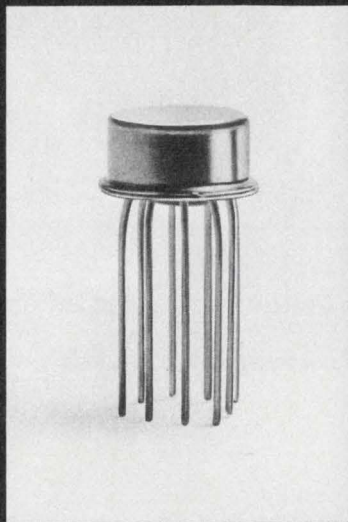

The AD534 Analog Multiplier,
from \$16 in 100s.

The Analog Devices' AD534 Analog Multiplier. A new, monolithic, laser-trimmed, four-quadrant analog multiplier destined to smash the myth that analog multipliers are more complex than the computing function they solve.

The AD534 has a guaranteed maximum multiplication error of $\pm 0.25\%$ without external trims of any kind. This level of accuracy you'd normally expect to find only in expensive hybrids or bulky discrete modules. Excellent supply rejection, low temperature coefficients and long-term stability of the on-chip thin film resistors and buried zener reference preserve the AD534's accuracy even under the most adverse conditions.

The AD534 is the first general purpose, high performance analog multiplier to offer fully differential high impedance operation on all inputs. And that's what gives the AD534 its amazing flexibility and ease of use.

The AD534 is a completely self-contained, self-sufficient multiplier which can generate complex transfer functions very close to theoretical. Our active laser trimming of thin film resistors on the chip to adjust scale factor, feedthrough and offset allow you to plug in the AD534 and run it virtually without adjustment.

In addition to straightforward implementation of standard MDSSR functions (multiplication, division, squaring and square rooting), the AD534 simplifies analog computation (ratio determination, vector addition, RMS conversion); signal processing (amplitude modulation, frequency multiplication, voltage controlled filters); complex measurements (wattmeters, phasemeters, flowmeters) and function linearization (transducers, bridge outputs, etc.) You can set up the AD534 to perform complex calculations by using various feedback arrangements to manipulate the AD534 transfer function of $(X_1 - X_2)(Y_1 - Y_2) = 10(Z_1 - Z_2)$.

and use,

In Frequency Multiplication.

Nonlinear circuits which accept sinusoidal inputs and generate sinusoidal outputs at two, three, four, five or more times the input frequency make use of trigonometric identities which can be implemented quite easily with the AD534 as shown. For this frequency doubling circuit the output should be AC-coupled to remove the DC offset resulting from the trigonometric manipulation.

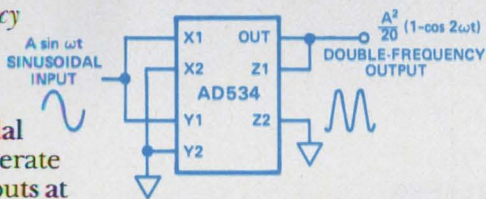

In Ratio Computing. The percentage deviation function is of practical value for many applications in measurement, testing and control. The AD534 is shown in a circuit that computes the percentage deviation between its two inputs. The scale factor in this arrangement is 1% per volt although other scale factors are obtainable by altering the resistor ratios.

and use,

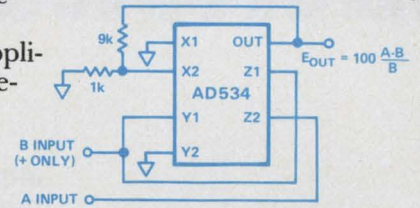

The AD534 is shown in a circuit that computes the percentage deviation between its two inputs. The scale factor in this arrangement is 1% per volt although other scale factors are obtainable by altering the resistor ratios.

and use,

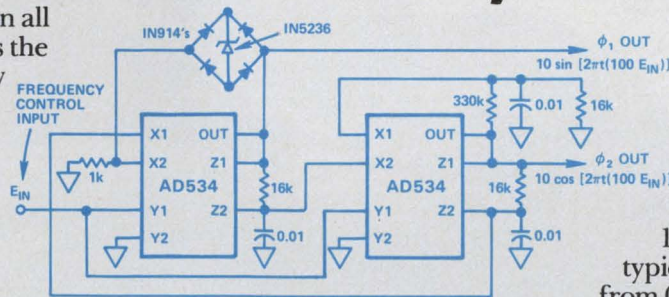

In Sine Wave Function Generation.

The voltage controlled 2-phase oscillator uses two AD534's for integration with controllable time constants in a feedback loop. The frequency control input, E_{IN} , varies the integrator gains, with a sensitivity of 100Hz/V and frequency error typically less than 0.1% of full scale from 0.1V to 10V.

In a Voltage Controlled Filter.

The output voltage, which should be unloaded by a follower, responds as though E_s were applied directly to the RC filter but with the filter break frequency proportional to the input control voltage (i.e. $f_0 = \frac{E_c}{20\pi RC}$). The frequency response has a break at f_0 and a 6dB/octave rolloff.

These uses of our new Single Chip Analog Computer, the AD534, are only the beginning. For the big picture call Doug Grant at (617) 935-5565. Or write for a copy of our new Multiplier Application Guide and the data sheet on the AD534.

and use.

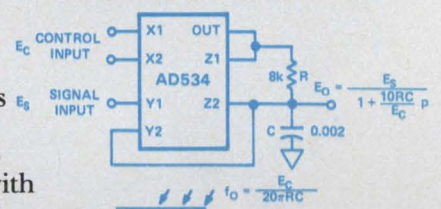

ANALOG DEVICES

The real company in analog computation.

MICRONOVA. ALL THE INGRED

HIGHER LEVEL LANGUAGES

Fortran IV
Basic-single/multiuser
Business BASIC

RUN TIME I/O SOFTWARE SUPPORT

Communications Access Manager (CAM)
Sensor Access Manager (SAM)
RJE/80 (2780,3780), HASP II
DG/L Programming Language

MICRONOVA PROCESSOR

Single chip 16-bit NOVA computer,
Integral MUL/DIV,
RTC, DMA, hardware stack, and
memory refresh
Available as a chip, board microcomputer
or packaged minicomputer

INTERFACING/PACKAGING

Card Cage/Power Supply
General Purpose Interface
High Speed DMA
Cabling
Prom Programmer

COMMUNICATIONS

Synchronous with CRC
Asynchronous
4-line Asynchronous Mux

SENSOR I/O

A/D, D/A, Digital I/O
DG/DAC Sensor I/O Subsystem

IMPROVEMENTS TO MAKE YOU A HERO.

OPERATING SYSTEMS

Diskette Operating System (DOS)
Real-Time Operating System (RTOS)
Extensive Program Development Utilities

SYSTEM PERIPHERALS

Dasher Displays and Printer Terminals
Single and Dual-Diskette Subsystems
Line Printers, Paper Tape

AVAILABLE MEMORIES

Expansion to 64K bytes with:
8KB and 16KB RAM
4KB and 8KB PROM



Our microNOVA line is now of heroic proportions. 17 new enhancements make it the broadest line of 16-bit microcomputer products available. Here are all the basics so the design engineer can bite into the real challenge. Without having to waste time developing the tools he needs. Call 800-225-7282. Or write for free brochure.

 **Data General**

We make computers that make sense.

New Type FM resistor. Tight on tolerance. Tight on TC.

Meet the newest member on the board. Allen-Bradley's Type FM. It features the accuracy and stability of metal film technology. It provides you with the tight tolerance, tight temperature coefficient and stable performance you may need for precision applications. Approved to MIL-R-10509, Style RN55, Characteristic E, all tolerances. This high quality metal film resistor adds another dimension to Allen-Bradley's line of hot-molded carbon composition and cermet film fixed resistors of high reliability. We have what you need. Write for Publication EC 54.

Tolerances

$\pm 1\%$, $\pm 0.5\%$, $\pm 0.25\%$
 $\pm 0.1\%$ and $\pm 0.05\%$

Temperature coefficient

± 25 , ± 15 , ± 10 PPM/ $^{\circ}\text{C}$

Power rating

0.25 watt at 70°C
0.1 watt at 125°C

Temperature range

-65°C to $+175^{\circ}\text{C}$

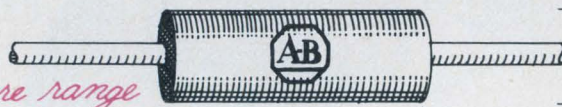

.281" max.
(7.14 mm max.)

.098" max.
(2.49 mm max.)

Uniform molded body

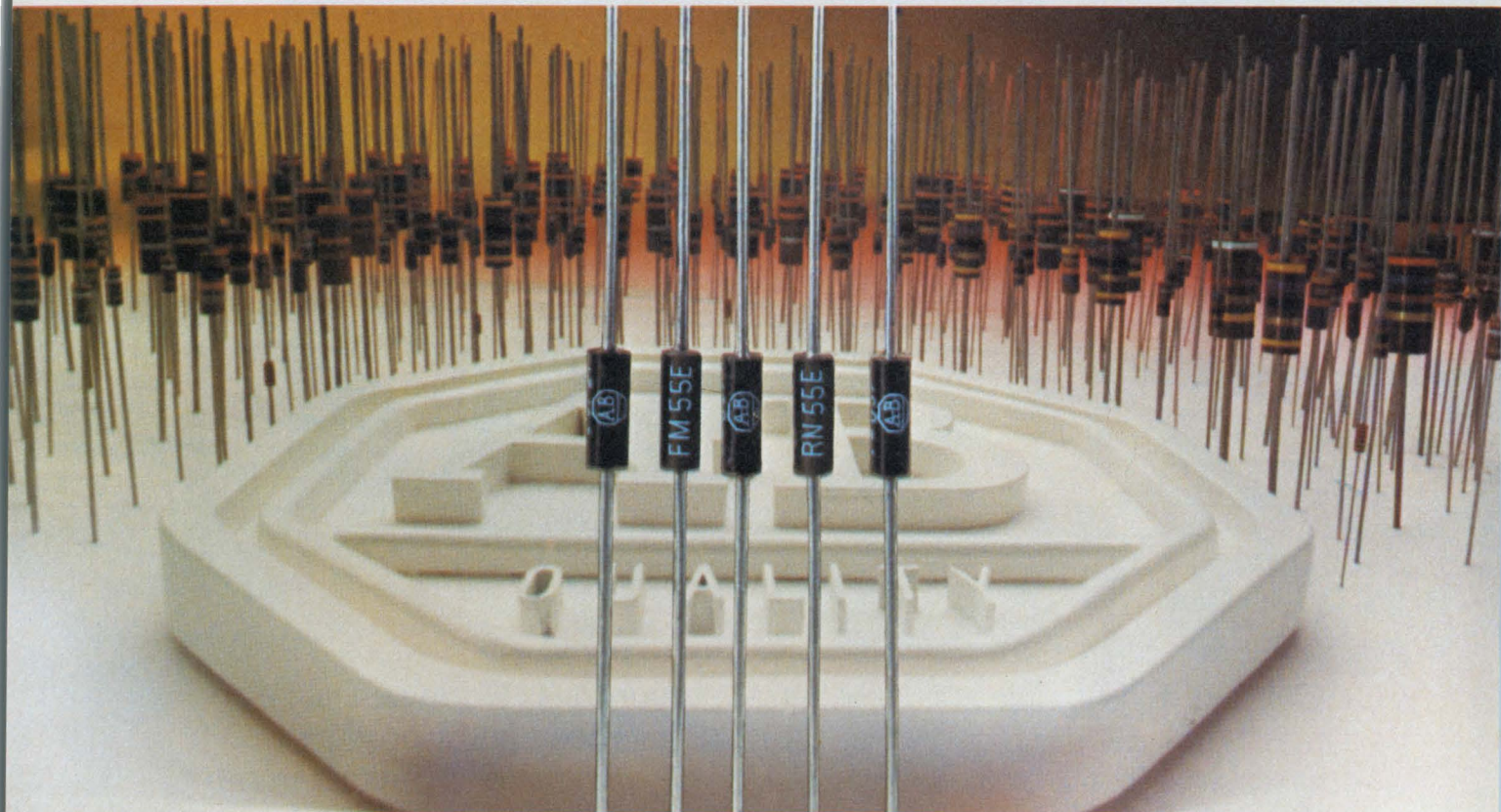

Quality in the best tradition.



ALLEN-BRADLEY
Milwaukee, Wisconsin 53204

CIRCLE NUMBER 11

PEOPLE WHO KNOW RELAYS COUNT ON STRUTHERS-DUNN FOR TIME DELAY

New Design Concept

1

The Struthers-Dunn line of standard tdrs was achieved by combining a proven hybrid solid state timing module with the entire line of standard general purpose relays. In most cases the module fits within the existing relay cover, and therefore does not affect unit size or ease of mounting.

Broad Selection

2

Imagine, more than 6000 combinations of timing, voltage, contact arrangement and mounting. New concept permits any standard general purpose relay to be equipped with built-in time delay function. Standard off-the-shelf models are U.L. recognized. Hermetically sealed models meet the requirements of MIL-R-83726. It adds up to the most complete line available anywhere.

Design Flexibility

3

The versatility of these timing modules offers a wide variety of alternatives when the control circuit must include time delay. Instead of searching for a timer to fit the circuit, simply choose the type of relay you want with the assurance that it is available with time delay capability.

Reduce Costs

4

The new tdrs will cut costs in many applications. If, for example, a system now uses a conventional electromechanical timer and a separate relay as many circuits do, the designer may substitute a single tdr and cut his component cost in half. Cost of mounting and wiring the component is also reduced.

Standard Voltages & Sockets

5

Forget previous voltage limitations. Our tdrs are available for all standard voltages from 12 VAC to 240 VAC and from 12 VDC to 125 VDC. Plug-in models available for most common sockets: Octal, square base, miniature or 12 pin rectangular plugs with quick connect, solder, printed circuit or front connect terminals.

Timing & Setting Range

6

Standard off-the-shelf models offer seven different timing ranges with adjustable setting: 0.1-1 second, 0.2-2, 1-10, 3-30, 6-60, 18-180 and 30 to 300 seconds. Settings are available three ways: Fixed (factory preset), knob adjustable or remote adjustable from a central control panel.

Reliability

7

These tdrs incorporate two time-tested components—electromechanical relays and solid state timing modules. Thus there is no weak link to cause premature failure. Repeatability of $\pm 3\%$ at 20 to 25°C and $\pm 10\%$ accuracy within voltage and temperature range is assured. Life expectancy is 50 million mechanical operations or 500,000 operations minimum at full load.

Transient & Polarity Protection

8

Time delay operation is protected for transient voltages as long as 5ms duration with exponential slope from 0 volts to 20 microsecond peaks of ± 2000 volts. DC models are inverse polarity protected. Tdrs will not operate with polarity reversed, but will function normally once wiring is corrected.

False Contact Protection

9

Another added operational protection. With our on-delay relays, false transfer of contacts is prevented should the voltage be interrupted during timing cycle. With off-delay relays, if control switch closes during delay period, timing resets to zero and contacts do not transfer. Full timing is assured when control switch opens again.

Total Relay Capability

10

Dependability and know-how, that's what you get from more than 50 years experience. You, too, can count on a relay line-up with unmatched diversification. We provide solutions to control problems with ten key relay functions: General Purpose, Latch Sequence, Sensitive, Reed, Solid State & Hybrid, Motor Control, Military, Special Assemblies and, of course, Time Delay.

...we're in TOTAL CONTROL

STRUTHERS-DUNN, INC.

PITMAN, NEW JERSEY 08071

Manufacturers of Relays and Solid State Controls

Telephone: 609-589-7500 TWX: 510-686-7510



CIRCLE NUMBER 12



NEWCOM'78

Las Vegas Convention Center, May 2, 3, 4
See our diversified line of relays at Booth G31

Available Through 140 Stocking Distributors
Canada: Struthers-Dunn Relay Div., Renfrew Electronic Marketing, Ltd.

Dual Density DUEL

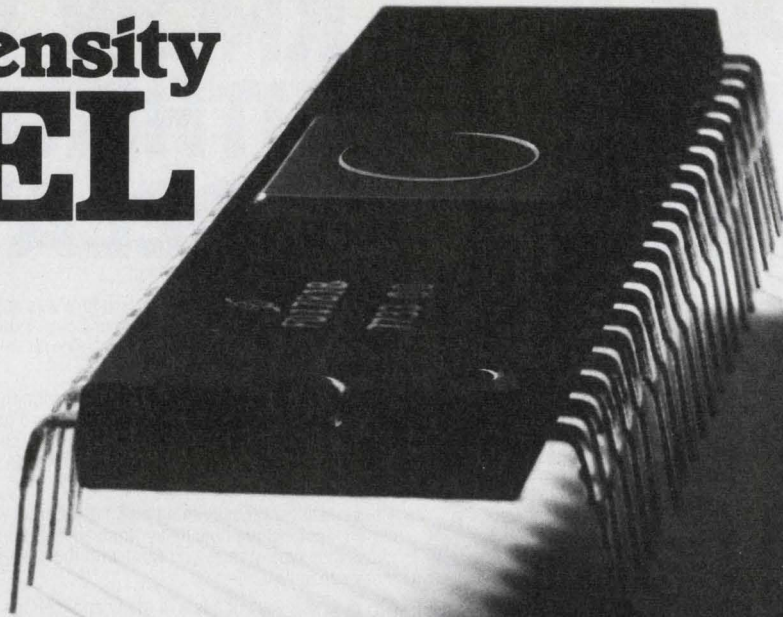

We've challenged other manufacturers to a duel... you can win.

All they have to do is produce a floppy disk formatter/controller comparable to our FD 1781 in performance and cost.

The catch is, it's got to be capable of dual density operation, be available right now, and cost even less than the original price for FD 1771, the industry standard for single density versions.

Furthermore, it's loaded with extras.

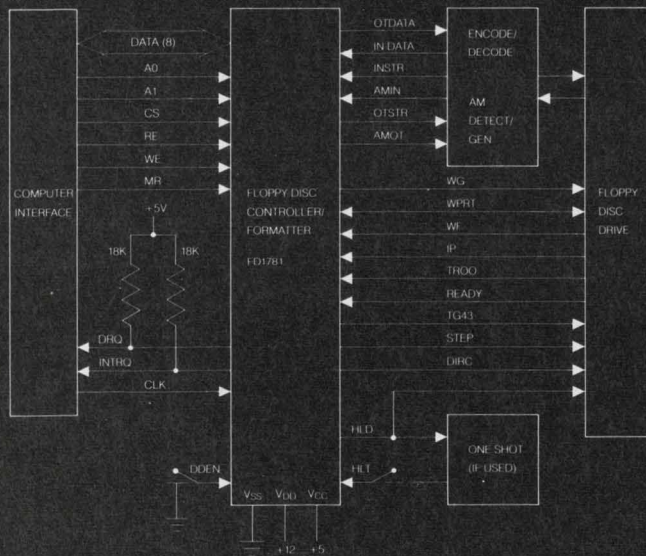

And its flexible interface organization easily accommodates most drives.

What's more, it will be second sourced for added convenience.

So, check out the features below, then call us.

We're out to set another industry standard, and you're going to be the winner.

Western Digital Corporation, 3128 Red Hill Ave., Box 2180, Newport Beach, CA 92663. (714) 557-3550. TWX 910-595-1139.

Features

- Dual density capability
- Automatic track seek with verification
- Read mode
 - Record read with automatic sector search or entire track
 - Read
 - Selectable 128 byte or variable length record
- Write mode
 - Record write with automatic sector search
 - Entire track write for diskette initialization
- Programmable controls
 - Selectable track to track stepping, head settling and head engage times
 - Step and direction and head positioning motor controls
- System compatibility
 - Double buffering of data 8 bit bi-directional bus for data, control and status
 - DMA or programmed data transfers
 - All inputs and outputs are TTL compatible
- Provides NRZ data, data strobe and address mark outputs for writing data
- Accepts NRZ data, data strobe and address mark input for reading data
- Will accommodate MFM, M²FM, group coding or other double density encoding methods
- Software compatible with FD 1771
- +5v + 12v operation

WESTERN DIGITAL

C O R P O R A T I O N

Clara, CA, firm's 2147 4-k static RAM. The processor addresses memory logically as a linear sequence of 8-bit bytes, but speeds access with a 16-bit-wide physical path to memory.

Speed is also increased by internal pipelining and overlapped instruction fetch and execution.

The 8086 can use programs written for the 8080, but only after they've been recompiled or translated and reassembled. Intel's 8080-to-8086 translator, the CONV86, converts most source programs, including macros, controls, and source text. But the translator, which runs on the firm's development systems, doesn't support instruction-set dependencies such as timing, size and encoding, nor can it handle self-modifying code or interrupt sequences.

But the 8086 does offer features beyond those of the old 8-bit model. It can address up to 1 Mbyte of memory over a 20-bit bus; handle bit, byte, word, and block operations; and perform floating-point and integer arithmetic. Moreover, the 8086 provides for signed or unsigned arithmetic operations as well as 16-bit multiply and divide.

Incorporating the 8086 into multi-processor systems is simplified by a locked-exchange or "test-and-set-lock" mechanism. A 1-byte prefix may precede any instruction and cause the processor to assert its bus-lock signal for the duration of the operation caused by that instruction. External hardware should be designed so that other bus masters are disengaged during the period of assertion.

CIRCLE NO. 319

Carter's to blame for energy crisis, says NSPE

The Carter administration is not handling the energy crisis effectively, according to 90% of the engineers surveyed by the National Society of Professional Engineers. Not only that, but almost half the respondents blame the U.S. government for causing the problem.

The responses came from a special energy survey conducted during the NSPE's Winter Meeting in New Orleans, which was attended by 500 elected delegates representing 54 state and territorial regions. The Society sponsored the survey to determine what the nation's leading engineers, representing all major disciplines, con-

sider the critical issues in the energy crisis.

Almost everyone surveyed felt that there indeed is an energy crisis. But opinion was almost evenly divided as to the nature of the problem. Production and distribution got 51% of the vote, while resource shortage garnered 49%.

Who's to blame? The lion's share went to U.S. government policies (48%), while the country's energy consumption habits got most of the rest (38%). Interestingly, only 7% of the respondents blamed foreign energy sources, and just 6% felt the energy industry was the culprit.

As a matter of fact, more than six of every 10 respondents considered the energy industry a more reliable source of information than the U.S. government. And seven of every 10 didn't think the public had been given enough information to form a realistic judgment about the energy crisis.

The economic outlook didn't look very promising to most of the respondents. While 39% felt that by 1985 energy costs would rise by 50%, 43% predicted that by 1985 the energy they consume would cost 100% more than it does today.

Geothermal logger to read temp, pressure, flow rate

An electronic geothermal well-logging tool that simultaneously reads temperature, pressure and flow rate is being developed at Sandia Laboratories, Albuquerque, NM. An early model, which reads only temperature, has been successfully tested recently in a New Mexico geothermal well.

There is great interest in geothermal energy, says Tony Veneruso, supervisor of Sandia's Drilling Technology Div., which conducts tests of the new logging tool. He points to the new power-generating plants being constructed at the Geysers site (north of San Francisco), where geothermal electricity has been produced since the mid-1920s. This site now produces 500 MW of electricity at reasonable rates.

But conventional oil and gas logging tools aren't reliable in the unusual rock formations and high temperatures of geothermal wells, Veneruso adds. Early tests indicate that Sandia's geothermal logging tool will operate for hundreds of hours over a continuous range from room temperature to more than 300 C (575 F). It uses a combination of commercially available hybrid thick-

film circuits and junction field-effect transistors, with JFETs in all active circuit devices.

A 3-in.-long platinum thermometer at the tip of the electronics package provides temperature readings. A magnetic sensor keeps track of well depth by counting the number of steel casing pipes the tool has passed. The entire package, which weighs about 5 lbs in its present form, slips into a 4-ft-long, 1-1/2-in.-diameter housing.

We won't forget how to make microwave tubes

Microwave tubes won't disappear in the 1980s and 1990s, thanks to a special program supported by the Air Force, Stanford University, and a number of microwave tube companies.

Tubes are anything but old-fashioned in the microwave field, because solid-state devices do not yet approach their high power and wide bandwidth—particularly at the higher frequencies. Yet university-level teaching and research on microwave tubes dried up in the late 1960s. Worse still, the average age of microwave-tube engineers is over 45, and many are close to retirement.

When this situation was recognized, a number of people organized the Air Force Thermionic Engineering Research Program. Stanford University was chosen to provide the teaching because it is near the greatest concentration of tube companies.

Varian, Watkins-Johnson, Litton, Teledyne Microwave, Raytheon, and Hughes are sponsoring one student apiece. Each student receives \$4500 from his sponsoring company for schooling, as well as a salary of \$10,000 from the Air Force.

The courses combine standard applicable graduate courses with special courses on tubes, the latter taught by Dr. Marvin Chodorow, professor of applied physics and electrical engineering. His lectures are being videotaped, and currently the tapes are air-expressed to the students on the east coast. But, that won't be necessary for much longer.

The first transcontinental satellite instructional-TV link will soon provide two-way communication between the Stanford Instructional Television Network in Palo Alto, CA and Varian's plant in Beverly, MA. Interestingly, Dr. Chodorow's lectures on microwave tubes will be carried via microwave tubes.

Available as JAN, JAN TX & JAN TXV to MIL-S-19500/503 (EL)

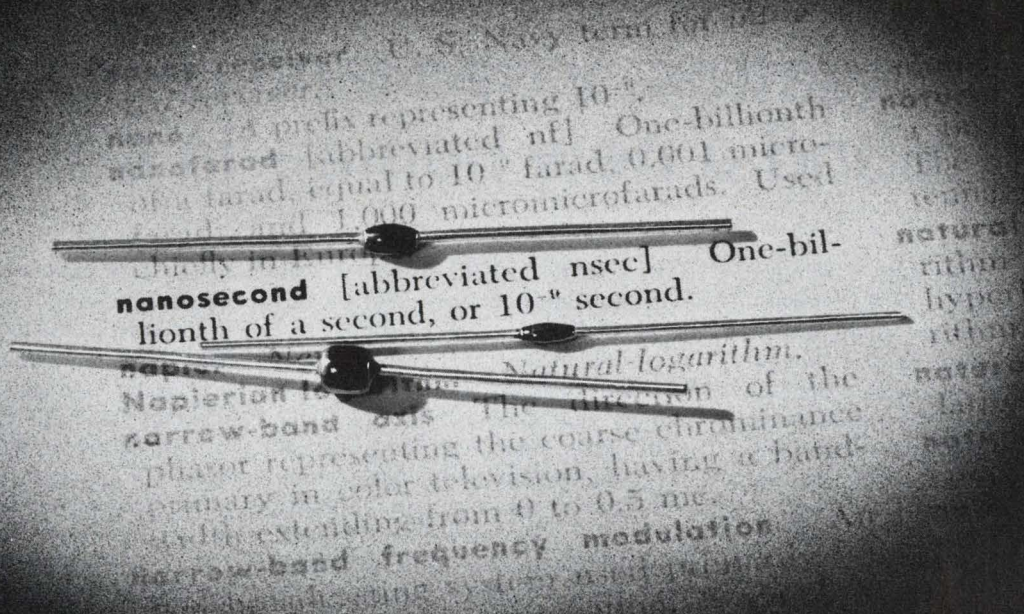

SUPER-FAST LO-V_F

METOXILITE SILICON RECTIFIERS

Featuring 30 nanoseconds Reverse Recovery Time

A breakthrough in junction technology makes Super-Fast silicon rectifiers possible. These new high speed silicon rectifiers feature low forward voltage drop at higher operating currents and reverse recovery time better than 30 nanoseconds. In addition, these devices have extremely low reverse leakage and high surge ratings. Super-Fast rectifiers use Semtech's proven Metoxilite non-cavity monolithic high temperature construction. Designed for high frequency applications, such as high speed switching regulators and converter circuits. Semtech's Super-Fast silicon rectifiers are stocked for immediate delivery.

Types: 1N6073, 74 & 75 (T_{rr} 30ns)
PIV: 50, 100 & 150V
Reverse Current (Max.): 1 μ A DC @ 25°C
Instantaneous Forward Voltage @ 1.5A:
1.0V @ 100°C
Capacitance @ 12V DC (Max.): 24 pF
Single Cycle Surge Current: 35A
Dimensions (Max.): Body .070" D x .165" L
Leads .029" D x 1.25" L

Types: 1N6076, 77 & 78 (T_{rr} 30ns)
PIV: 50, 100 & 150V
Reverse Current (Max.): 5 μ A DC @ 25°C
Instantaneous Forward Voltage @ 3.0A:
1.0V @ 100°C
Capacitance @ 12V DC (Max.): 58 pF
Single Cycle Surge Current: 75A
Dimensions (Max.): Body .110" D x .165" L
Leads .038" D x 1.10" L

Types: 1N6079, 80 & 81 (T_{rr} 30ns)
PIV: 50, 100 & 150V
Reverse Current (Max.): @ 25°C 10 μ A DC
Instantaneous Forward Voltage @ 5.0A:
.8V @ 100°C
Capacitance @ 12V DC (Max.): 230 pF
Single Cycle Surge Current: 175A
Dimensions (Max.): Body .165" D x .165" L
Leads .038" D x 1.10" L

1975 NATIONAL SBA SUBCONTRACTOR OF THE YEAR



652 Mitchell Road, Newbury Park, California 91320
(805) 498-2111 • (213) 628-5392 • TWX: 910-336-1264
CHICAGO: (312) 352-3227 • DALLAS: (214) 234-6523
DAYTON: (513) 274-8356 • FLORIDA: (305) 644-5404
MARYLAND: (301) 937-0070 • NEW YORK/NEW JERSEY: (201) 964-9305
SAN FRANCISCO: (415) 494-0113 • SEATTLE: (206) 455-4807
CANADIAN SALES: Avotronics, Ltd. (416) 493-9711
EUROPEAN SALES: Bourns AG Zug, Switzerland (042) 232-242

With cassettes, video tape recorders have found a new home—in the home

After nearly two decades of technical advancements—and false starts—video tape recorders are finally finding a place in the home. What's brought them home is a packaging technique borrowed from audio recorders—tape cassettes. Consumers are much more interested in video recorders now that they can just pop in a cassette containing 1/2-in. wide tape instead of having to thread tape carefully by hand through a maze of guideposts.

A fistful of suppliers - all of them Japanese—is now selling home VTRs under more than a dozen brand names.

Unfortunately, videocassettes developed by Sony Corp., Sanyo Electric, Victor Co. of Japan Ltd. (JVC) and Quasar Electronics (both JVC and Quasar are subsidiaries of Matsushita Electric Industrial Co. Ltd. of Osaka) are incompatible with each other. But Sanyo has now introduced a second machine that is compatible with the Sony Betamax system, and Quasar has introduced a JVC-compatible video home system (VHS) recorder. Along with Quasar and JVC, Matsushita is in the VHS camp with a recorder bearing its own Panasonic trade name, and is building VHS recorders for such marketers as GE, Magnavox, and RCA. But with firms like Zenith and Toshiba in the Betamax lineup, Betamax joins VHS in dominating the VCR field.

Playing time increases

The major battle between VHS and Betamax is finding new ways to stretch the playing time—though not the dimensions—of a tape cassette that can cost \$25. Sony's original Betamax machine could record and play up to an hour on a cassette, and the first VHS recorder, introduced shortly afterwards by JVC, had a two-hour limit.

Now, four-hour VHS machines and two-hour Betamax recorders are the norm, with a three-hour Betamax expected from Sony this year. In addition, Sony has an optional \$100 tape changer that doubles recording time.

In both systems, recording time is increased by eliminating the Guard-band spacing between tracks. According to the video recording standard developed by the Electronic Industries Association of Japan (EIAJ), the guard band is 63 μm wide and the video track 110 μm wide. So nearly a third of the tape is unused.

The guard band has been eliminated by actually taking advantage of a basic problem of magnetic tape recording: The signal that can be picked up from the tape drops off quickly if the playback head gap is even slightly off parallel with the recorded signal. Since video tape recorders paint and retrace alternate lines with two different heads, each can be slightly off perpendicular to tape travel, yet pick up its own signal properly. If the offset is

in opposite directions, the difference between azimuth angles for the two heads is twice the offset. The offset in VHS is 6°, and in Betamax it is 7°, drastically reducing crosstalk and making guard bands unnecessary.

Azimuth recording, most effective at higher frequencies, is less valuable at lower frequencies. Since chrominance (color) signals are recorded at lower frequencies (688 kHz for Betamax and 629 kHz for VHS) than are luminance (black and white) signals, crosstalk attenuation on a color signal is inadequate even with azimuth recording. Color flicker and color distortion result, which explains why slanted azimuth recording was not used for years after its development.

Changing phase cuts noise

To cut crosstalk even in a lower frequency chrominance signal, both Betamax and VHS recorders use phase inversions, though in somewhat different forms. In a VHS machine, the signal fed to one recording head is advanced in-phase by 90° every horizontal picture-scanning line; the signal fed to the other head is delayed by 90° every line.

In playing back through the first head, the signal is delayed by 90° every line, so that signals from the tape that were recorded with this head come out in-phase. Signals from the second channel that appear as crosstalk in the first channel are delayed 180°. All signals are then fed through a one-line delay circuit, then the original and delayed versions of the signal are added. Since each scanning line is about the same as the last, the desired signal component is almost doubled, and the unwanted crosstalk is almost eliminated.

In the Betamax system, signals to one head don't change, while signals to the other get delayed 180° on alternate scans. Again, a delay-line filter cuts



Compact, \$1000 video recorders using plug-in cassettes are finding a niche in consumers' homes.

crosstalk on playback.

The VHS system suppresses noise further in the black-and-white part of the video signal with a double-limiter playback circuit. The signal is separated into lower and higher frequency components, which are limited separately. If they were limited together, high-amplitude, low-frequency signals would so saturate the limiter that lower-amplitude, high-frequency signals wouldn't be amplified enough to bring them out of the noise.

The color signal on a VHS recorder comes in for further processing, too, to improve signal-to-noise ratio. The burst signal that is in every color transmission to guarantee sync between the broadcast signal and the playback signal is doubled before recording, then halved on playback. This raises the signal-to-noise ratio to 43 dB, the highest of any 1/2-in. home VCR and about 3 dB better than other systems, says Tom Shinozaki, assistant national service manager at JVC in Maspeth, N.Y.

Player size cut

As a result of all these noise-cutting tricks, the drum that holds the heads in a Betamax machine is only 74.5 mm in diameter, and the VHS drum is only 52 mm. Without the noise reducers, a larger head drum, like the 115.8-mm drum of the EIAJ standard, would be needed to achieve acceptable s/n at the low tape speeds of these VCRs.

The smaller head drums help reduce the size of the over-all package. The JVC Vidstar unit, for example, is less than 18 x 6 x 15 in. and weighs less than 30 pounds.

This diminutive package also results from a tape-threading mechanism JVC calls "M-loading." Tape is pulled out of the cassette by two parallel arms, one on either side of the head drum, so that the final tape path is in the shape of an M.

In Betamax sets, on the other hand, tape is pulled from the cassette at one point by a rod that swings around the drum. As a result, loading takes more time and the size of the tape-transport mechanism is bigger than in a VHS set. However, this "U-loading" is more reliable than M-loading since the tape goes through fewer bends, says Yasuo Ohkura, consumer video product planner at Sony in New York.

In either case, the tape touches slightly more than 180° of the drum, which means that tape is always in contact with one or the other head—

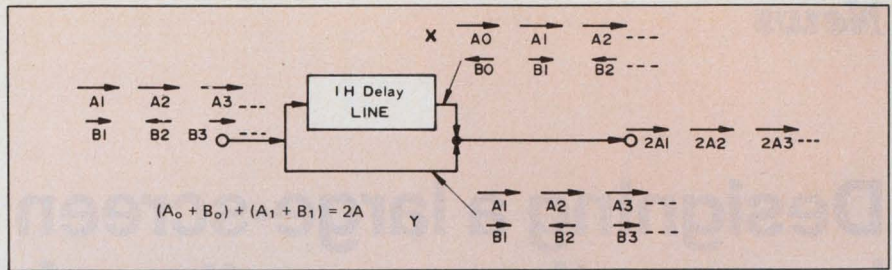

Phase inversions and a delay line help cut distortion in VHS tape recorders. Crosstalk components end up cancelling each other out, while desired signals are boosted, in a summing network. Betamax machines use a similar technique.

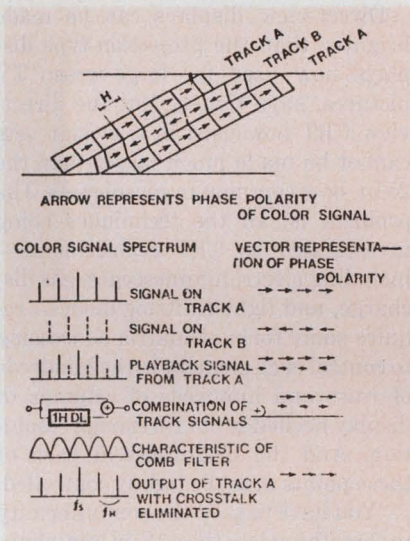

Only one signal is phase-inverted in the Betamax system to eliminate crosstalk. As in VHS, Betamax has no guard bands between tape tracks to keep signals from spilling over.

hence the tape-path description "omega wrap."

Along with basic record and playback functions and longer playing time, all VCR manufacturers are looking to add features that will separate their machine from the rest of the pack. For those machines that don't have one built in, accessory timers permit unattended recording of broadcasts while the viewer is asleep or away. In most Betamax machines, the timer sits atop the player. VHS machines have timers that are built-in or, in the case of JVC's Vidstar, plug into the unit's front panel as an option.

But with four-hour unattended recording now possible, and six-hour capacity coming soon, a simple on/off timer won't be enough. The next generation of timers will include programmable station selectors so that the recorder can store broadcasts on different stations sequentially. Almost all timers today simply turn the machine

on at a specified time and shut it off at the end of the tape.

In addition, future Videocassette recorders will feature freeze-frame and slow-motion playback. Even more interesting than that, JVC is working on a double-speed playback machine with automatic audio-frequency correction to eliminate the "Donald Duck" distortion of higher-speed playback. This will allow higher-speed scanning of programs and make a precise point on a long tape much easier to locate.

The price future is down

But even as VCR's of the future promise more and advanced performance, increasing sales volume is expected to bring prices down. Basic VCR's here today cost around \$1000, better than 30% below the price for a Betamax when it was introduced two years ago. Open-reel home video tape recorders on the market a decade ago also sold for \$1000, but the dollar was much more valuable then.

The price decline will be dramatic, though not as sharp as the drop for other consumer products like calculators and watches. After all, much of the cost of a videocassette recorder is in mechanical, not electronic, parts.

The future of videocassette recorders is far from clear, however. One small cloud is the video disk, which some consumers may favor over tape. After all, a fair amount of interest in VCRs is for playing back prerecorded material, not in taping new programs. And if movies and television shows become available in low-cost, stamped-out plastic discs, consumers may choose to bypass the more-expensive tape medium. That's been true of audio recordings, for example.

At any rate VCRs seem to have caught the consumer's fancy. The only question is whether their popularity will continue, or if they will turn out to be a fad like simple video games and CB radios. ■

Designing a large-screen display is more than a matter of size

Making the picture of a large-screen TV display acceptable to the average viewer may be even more difficult than you think. That's the conclusion of researchers at RCA Laboratories in Princeton, NJ. In fact, one aspect of display quality—brightness uniformity—has been analyzed thoroughly enough to determine that the kinds of large-screen TV displays now under development will have to be 200 times better than present television CRTs, says Roger W. Cohen, a group head in the display systems lab at RCA. Cohen's group is studying perception to advise other RCA lab groups that are working not only to develop the best large-screen, direct-view TV displays at the lowest cost, but also to improve aircraft and shipboard displays used by the military. Some of the research has been done for the Navy.

Direct-view displays can be made brighter than the projection-type displays now used for large-screen TV pictures, says Cohen. But the direct-view CRT now used in television sets cannot be made much larger than the 25 in. now common in console sets. The problem is, all the techniques being investigated as CRT replacements—including electroluminescence, gas discharge, and light-emitting diodes—require some form of matrix addressing to control each element in the hundreds of rows and hundreds of columns of display needed to obtain enough resolution. And the brightness at each of these points must be tightly controlled.

"You have to keep the nonuniformity to something less than 1% in luminance fluctuations," says Cohen, adding that current color televisions have center-to-edge brightness variations that can

approach a factor of two. The gradual drop-off in brightness from the center of the screen to the edges isn't noticeable to most observers, Cohen notes, but even small differences from one point to the next would be disturbing.

Pictures break into frequencies

High uniformity is essential because when an observer looks at a scene, the eye and brain break up the picture into spatial frequencies, much as electrical signals are broken into distinct frequencies through Fourier analysis, explains Cohen. This leads to simplified mathematical analysis of images, he notes, and makes it possible to describe display quality quantitatively.

Unfortunately, such an analysis

Sometimes, measurements don't tell the whole story

The eye and brain form a complicated system for interpreting images, so simple measurements like brightness and contrast can't always determine if a picture is good.

Here, the image at the left was made by taking the average brightness of the original, analog image in each pixel, or picture element. The image at the right is

made by taking the minimum brightness within each pixel.

Most observers agree that the left-hand picture looks sharper and has better contrast than the right-hand picture, yet the right-hand picture looks more "natural." There is no quantitative method for describing why most observers would choose the right-hand picture to, for example, identify a mugshot.

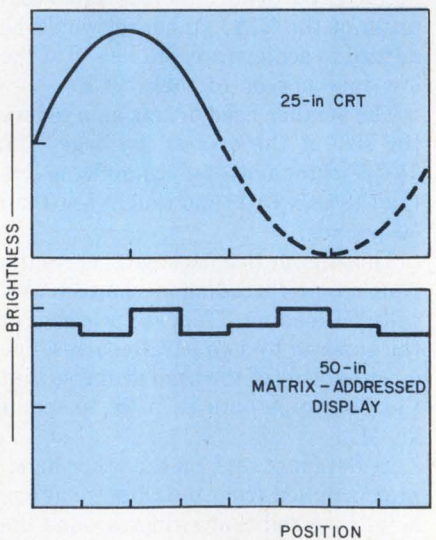
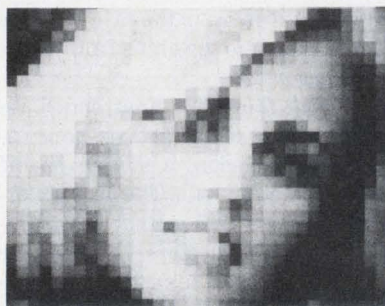
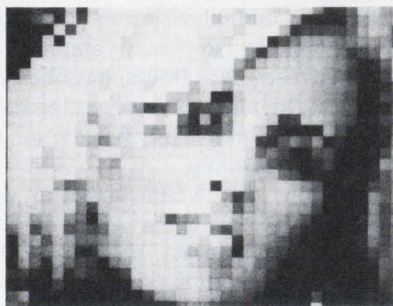

Matrix-addressed displays have to be better than standard CRTs for their images to be perceived just as well. With CRTs, the eye sees the gradual change in brightness as a low spatial frequency (that of the sine wave shown by a dotted line), where perception is tolerant to brightness variations. But the abrupt changes in brightness of a matrix display are seen as high frequency signals, where the eye is more sensitive.

More muscle for your microprocessor: Now there's a simpler way to trigger a triac, drive a digit, or light up a lamp.

One of our new addressable drivers can control up to eight peripheral devices in any bus-oriented system.

Next time you put a microprocessor to work, it may have more to manipulate than data. Real-world μ P applications often require the kind of muscle that our new NE590/591 Addressable Peripheral Drivers can provide—simpler and less expensively than the usual combination of discrete power transistors and resistors. **Another First From Signetics.** Either of these new devices can give you a powerful alternative way to address and drive as many as eight different peripherals, using bits extracted directly from a bus. Each of the 8 latched Darlington outputs can drive a 250-mA load current, subject to power dissipation limitations. That's plenty of muscle for turning on (or off) LEDs, SCRs, stepping motors and a host of other commonly used peripheral components.

Most applications can be handled by the 16-pin NE590, which has 8 open-collector (current sinking) outputs. The NE591 is an 18-pin version with open-emitter (current sourcing) outputs. **Simpler Designs at Lower Costs.** A quick parts count and cost evaluation will demonstrate the device's dollar savings. The NE590N costs only \$1.95 in

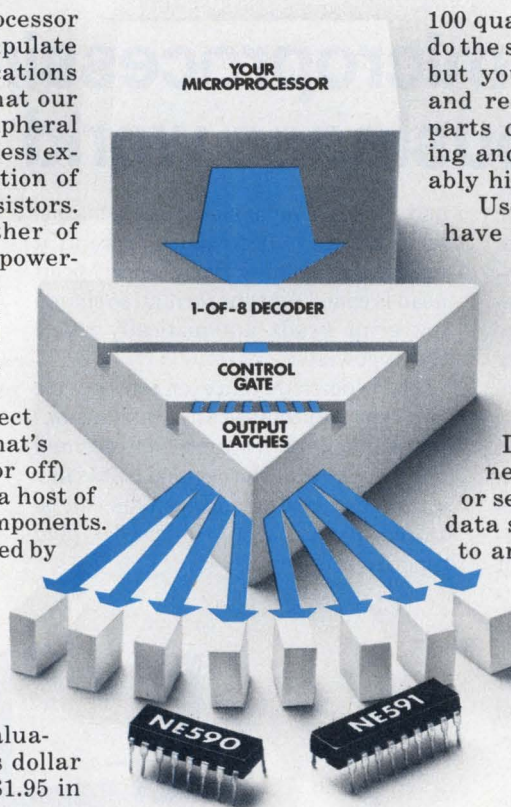

100 quantity, the NE591N, \$2.45. You can do the same job with an addressable latch, but you'll need extra driver transistors and resistors that will bring your total parts cost—exclusive of assembly, testing and related expenses—to a considerably higher price.

Use NE590 or NE591 whenever you have multiple high-current peripherals to drive in any bus-oriented system. You'll simplify your design, improve reliability, reduce component and assembly costs. In short, you'll get more muscle for your money.

Addressable Peripheral Drivers. Available only from Signetics. Call your nearest distributor or send the coupon to us today for your data sheet, a sample, or quick attention to any application questions you have.

signetics

a subsidiary of U.S. Philips Corporation

Signetics Corporation
811 East Arques Avenue
Sunnyvale, California 94086
Telephone 408/739-7700

OTHER SIGNETICS DRIVERS

| Part No. | Description | Output Current | No. of Drivers |
|----------------|----------------------------|----------------|----------------|
| NE582 | LED digit drivers | 400mA | 6 |
| ULN2001 series | Power drivers | 500mA | 7 |
| NE5501 series | High-voltage power drivers | 500mA | 7 |
| DS3611 series | Peripheral drivers | 300mA | 2 |
| UDN5711 series | Peripheral drivers | 300mA | 2 |

To: Signetics Information Services, 811 E. Arques Ave.
P.O. Box 9052, MS 27, Sunnyvale, CA 94086

- Send me your NE590/591 Data Sheet
 Send me a sample of the NE590 for evaluation.
 I need data on these other devices shown in the table:

- I have an urgent requirement. Please have an applications specialist phone me at once: () _____

Name _____ Title _____

Company _____ Division _____

Address _____ MS _____

City _____ State _____ Zip _____

(Note: For faster response, clip coupon to letterhead.) ED 31

CIRCLE NUMBER 15

shows that the dissection of images into separate frequencies makes today's matrix-addressed displays inadequate for large-screen viewing. A curve plotting brightness as a function of position across the screen of a matrix-addressed display is a series of straight lines, each at a slightly different level. Using Fourier analysis to break up such a step-function curve into single frequencies yields a large number of high-order terms, and the human eye and brain are very sensitive to these frequencies. Even the small

brightness variations are disturbing.

In present CRTs, on the other hand, the gradual increase then drop-off in brightness from one end of the screen to the other can be plotted as a single, fairly low-frequency sinewave. The eye is relatively insensitive to brightness variations at low spatial frequencies. According to Cohen, the eye's sensitivity to brightness variations ranges from as little as 0.01% at some frequencies to nearly 100% before the difference is noticeable at other frequencies where the eye is least sensitive.

Another area that can benefit from improved displays is medical imaging: x-rays, ultrasound, and computerized tomography. Here, one unresolved question, is whether the eye can better detect differences when an image is printed in white on a black background or vice versa. Given the same contrast between black and white, the eye sometimes distinguishes shapes better when the picture is displayed in one mode and sometimes in the other, says Cohen. So, which mode is better? No one can say for sure yet. ■■

Distributed microprocessing enters the business world

The first electronic typewriter makes it easier for businesses to move toward distributed processing—decentralized computer power. And the typewriter itself uses distributed *micro*-processing—a master Z-80 controller and a pair of F-8 chips—to handle drive motors.

In its basic form, the typewriter, developed by the Qyx Division of Exxon Enterprises Inc., Lionville, PA, does far more than a standard office typewriter. Yet it goes for just \$1390—not much higher than the nearest comparable mechanical machine (about \$900).

The Qyx typewriter has 70% fewer moving parts than electromechanical typewriters, says Dan Matthias, general manager of Qyx. Microprocessors controlling linear motors replace conventional cables, pulleys, and gears.

The Z-80 microprocessor, from Zilog Corp. (another Exxon Enterprises affiliate), Cupertino, CA, handles overall system control and memory operations. A pair of F-8 microprocessors from Fairchild Semiconductor, Mountain View, CA, controls the linear motors that position the carriage and the rotary print head.

The Qyx typewriter can be expanded beyond its basic functions by adding plug-in boards and changing keyboards—without sending the machine back to the factory and without expanding the size of the typewriter itself.

Typewriter built in blocks

The Qyx Level 1 features dual pitch (either 10 or 12 characters to an inch)

and proportional spacing (each character takes up only as much space as it needs). The rotary “daisy wheel” print head is coded for type format, so changing print heads automatically resets the typewriter.

The typewriter can even center a line of type automatically and automatically type columns of decimal numbers so that the decimal points line up. Stock phrases and formats can be stored and called up to speed typing repetitive forms.

In addition, the basic typewriter has automatic erase backspace. A lift-off tape, like that used in the IBM Correcting Selectric, pulls an erroneous character off the paper so that a correction can be typed. According to Matthias, Qyx has developed the first daisy-wheel printer that can position its print head accurately enough for this function. This is accomplished by building the rotor of the linear print head-drive motor into the \$25 print head itself and by feeding-back position information



The first electronic typewriter, from the Qyx Division of Exxon Enterprises, distributes computer-aided typing throughout an office while itself taking advantage of multiple processors—three μ Ps.

**Now you
can specify
Spectronics
opto couplers for
every isolation
requirement.**

Spectronics offers industry's broadest choice of optically coupled isolators. Available in popular 6- and 8-pin dual in-line versions, they are completely interchangeable with standard industrial types. The complete Spectronics line includes high-speed, high-gain circuits in IC, phototransistor, photodarlington and photo SCR versions. Check the Spectronics isolator for your application:

□ **200V SCR**

When switching an SCR or TRIAC, specify our 200V SCR rated at 300 mA. The SCS11C1-11C3 also features 5000 VDC isolation and 11mA I_{GT} .

□ **1 or 5 or 10mA Controlled Gain**

You specify the input current at 1 or 5 or 10 mA, and we'll provide controlled gain. SPX 7110, 7130 and 7150 provide 10-50%, 30-80% and 50-125% CTR at 1 mA. The SPX 7530, 7550 and 7590 have 30-75%; 50-125% and 90-200% CTR at 5 mA. The SPX 7270-7273 series offers controlled gain at 10mA: 10-50%, 45-90%, 75-150%, 125-250%.

□ **TTL Compatible**

Choose the SPX 74A1 for TTL interface with guaranteed logic level/compatibility, over the full 0°C to 70°C range. Use it as an ideal transistor coupler for eliminating current loops. Our standard isolation voltage is 4000V rms.

□ **1 MBIT/SEC**

For high-speed data transmission,

try our 6N135 and 6N136 with up to .8 μ s rise and fall at 19% CTR, or the 6N138 and 6N139 with up to 1.0, μ s t_{PHL} at 500% CTR. You can drive them with as little as .5 mA.

□ **4N25 to 4N38**

We provide the industry's standard work horses, off the shelf. Outputs include transistors and darlington.

Your critical requirement may be BV_{cex} , I_c , CTR, T_r , T_f or isolation. You won't find one coupler to fill all your needs, but one company can. Only Spectronics has all the design choices!

For more details and delivery information, call us *today* at 214-234-4271. Or write: Commercial Component Division, 830 E. Arapaho Rd., Richardson, Texas 75081.



Spectronics
INCORPORATED

UP TO 4000V RMS ISOLATION

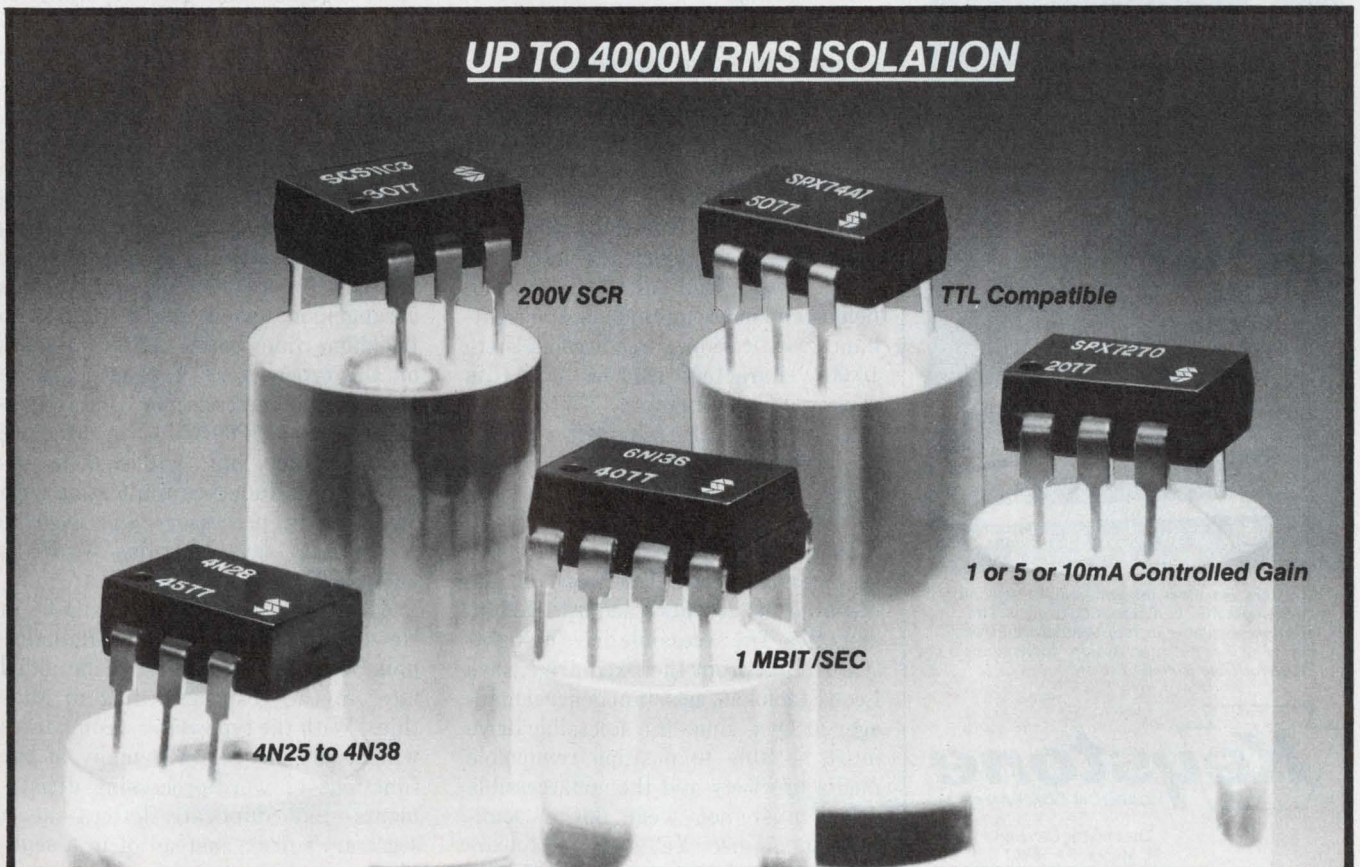

CIRCLE NUMBER 16

NOW!

LINISTORS™

sensitive linear
negative temperature
coefficient thermistor
assemblies

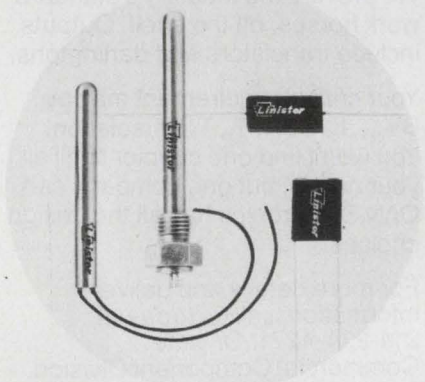

Linistor assemblies will provide you with an accurate straight line resistance/temperature plot from 0°C to 100°C.

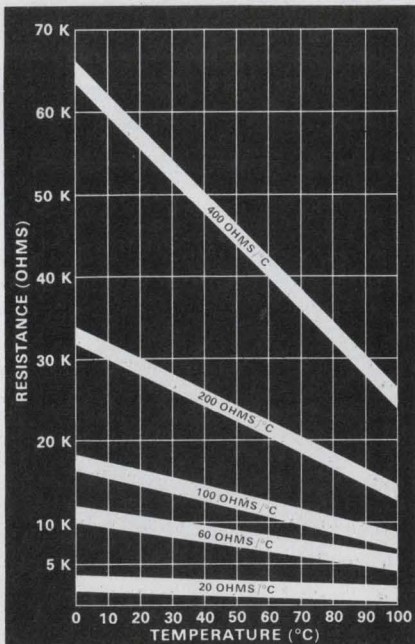

Linistors are ideal for temperature sensing and temperature compensating devices. They are now available in four standard encasements to satisfy most design applications. Write for Data Bulletin L-601.

Keystone

CARBON COMPANY

Thermistor Division
St. Marys, PA 15857
814/781-1591 • Telex 91-4517

CIRCLE NUMBER 17

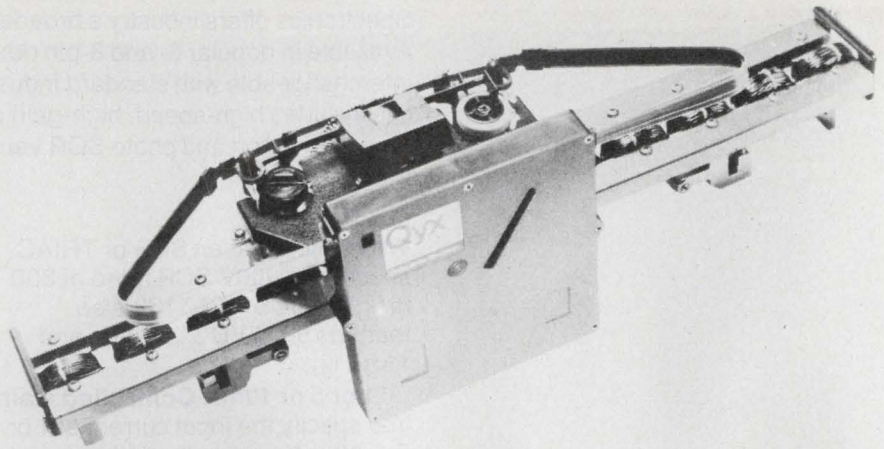

A linear stepper motor controls the position of the Qyx carriage, while a microprocessor controls the motor. The ribbon cartridge is mounted on the typewriter's case, instead of on the carriage, and flexible guides lead the ribbon to the lightweight carriage.

through a light-emitting diode and photodetector sensor.

With an optional \$850 display module, a typist can read a line of copy as it is entered, then have it printed after it has been typed correctly. The red LEDs read out upper and lower-case characters in a 5 × 7 dot matrix format.

The carriage itself rides on a linear motor that is controlled by one of the F-8 microprocessors. Instead of a rotary motor and a series of pulleys and gears, the linear motor can move and position the carriage correctly for character spacing.

Expand to word processor

By adding plug-in boards and modules for data storage, the Qyx typewriter can expand to perform most of the functions of a word-processing system, yet retain its physical dimensions.

An advanced model, the Qyx Level 2, adds store and edit features; add, delete, and move commands; and right-hand justification, when needed. Up to 10,000 characters can be stored in random-access memory.

The Qyx Level 3 typewriter adds a buried-media diskette drive to the Level 2 machine. This drive can store up to 60,000 characters.

In the Qyx Level 4, the diskette drive is accessible from the front of the machine and accepts standard 5-1/4-in. diskettes. The accessible drive is slightly different from the fixed drive, says Leon Staciokas, assistant general manager at Qyx, since the accessible drive must be able to position removable media precisely and the nonaccessible drive must not wear out a semi-permanent disc. Yet both use linear-induction drive motors and linear

stepper motors to position the read/write head.

The diskette drives are about half as thick as commercially available diskette drives so that they can fit within the typewriter case. Qyx has no plans to offer the drive as a separate OEM product, according to Matthias.

Change a phrase everywhere

The top-of-the-line Qyx Level 5, priced at \$7750, includes two diskette 120,000 characters of storage, and features "global change." A word or phrase that appears throughout a manuscript can, with but one correction, be changed throughout the typescript each time it appears.

Any Qyx typewriter can communicate with another Qyx typewriter over standard telephone lines with the addition of a \$500 communications module. The module incorporates the features of a modem and a data-access arrangement, so it can be tied to a telephone line directly. The numbers on the typewriter's keyboard can be used to dial the call, and communications moves at 1200 baud. The interface is proprietary, but "will soon be expanded to include communication with Vydec word processors and even to computers," says Matthias. Vydec is another Exxon affiliate.

All typewriters will be available in New York, Washington, and Philadelphia first, and other cities will be added later in the year, according to Matthias. With the typewriters, companies will be able to perform many of the functions of word-processing departments—like duplicate letters—at a secretary's desk, instead of in a separate operation. ■■



'SWITCHER' OUTPUT FILTER CAPACITORS THAT REALLY PUT OUT

If you're working with switching-type power supplies, you'll want to know about new electrolytic capacitors featuring low equivalent series resistance (for example, 3 m Ω @ 57,000 μ F/7.5V) and low internal inductance. Type 622D EXTRALYTIC® Capacitors are the first of their type to meet the power supply designer's need to know, for worst case design, the maximum and minimum ESR of a capacitor, as well as the need to hold the nominal ESR to a tolerance of \pm 30% at 20 kHz. To simplify calculations for the



equipment designer, Type 622D capacitors have a symmetrical capacitance tolerance of a tight \pm 20% instead of the wide asymmetrical tolerance customarily associated with low-voltage electrolytic capacitors. These new capacitors are designed for operation over the wide

temperature range of -55°C to $+85^{\circ}\text{C}$. They are furnished in a 1 $\frac{3}{8}$ " diameter case with lengths ranging from 2 $\frac{1}{8}$ " to 5 $\frac{5}{8}$ ". Capacitance values from 2,800 to 67,000 μ F are available as standard, and voltage ratings range from 5 to 55 WVDC.

For complete technical data, write for Engineering Bulletin 3459 to: Technical Literature Service, Sprague Electric Company, 347 Marshall Street, North Adams, Mass. 01247.

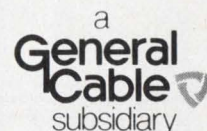

THE BROAD-LINE PRODUCER OF ELECTRONIC PARTS

CIRCLE NUMBER 18

think SMALL SMALL SMALL

If you think switching power supplies useful only above 300 Watts, we have some good news...switch-mode power supplies in the 30 to 300 Watt class.

**SMALL
SWITCHING
POWER
SUPPLIES**
from
KEPCO/TDK

In the popular 5 Volt design, for example, you can choose models ranging from 6 to 60 Amperes. The littlest one is only 40.5 cubic inches, (1-3/8" x 5-1/8" x 5-3/4"). It weighs a mere 19-1/4 oz. You can get them in most voltages, ranging up to 28 Volts d-c output.

We also have some nice, small, triple-output models: 5 Volts, combined with $\pm 12V$, $\pm 15V$ etc., as well as single-output d-c to d-c converters.

When your design needs a small high efficiency switching power supply, look to **KEPCO/TDK** and **THINK SMALL.**

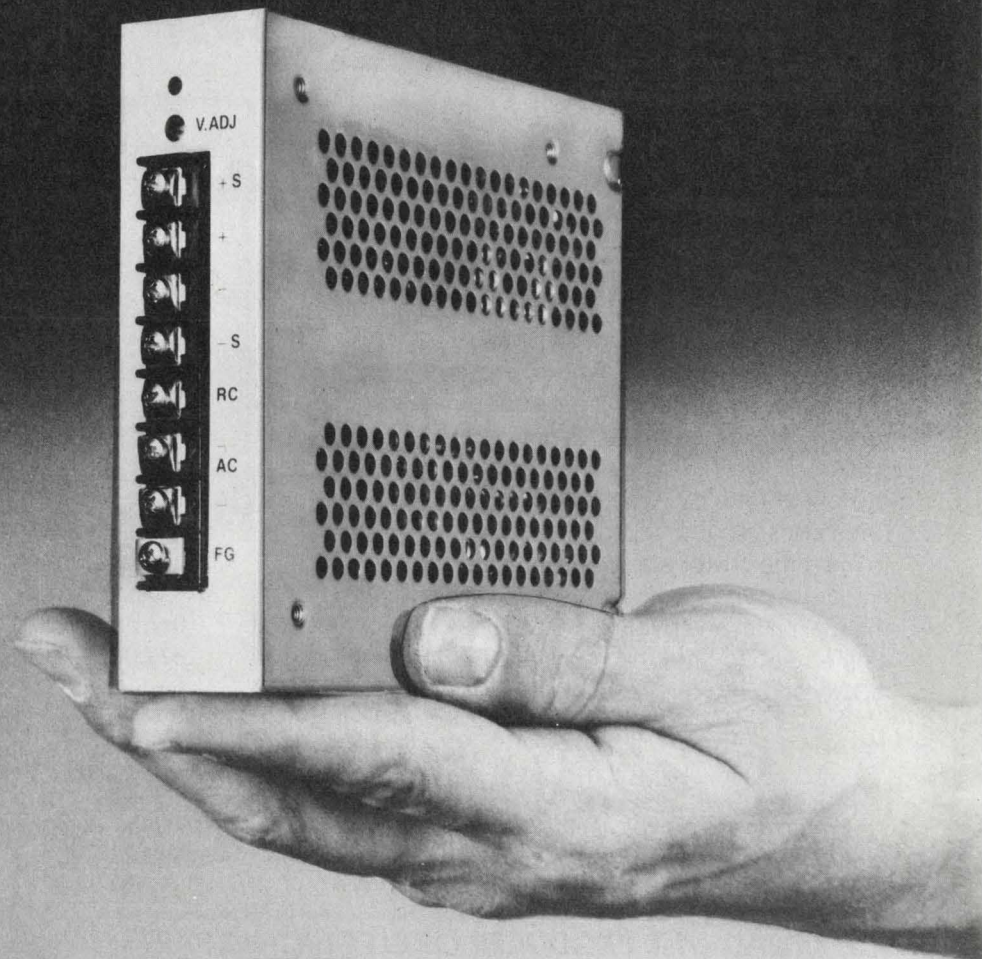

KEPCO® For complete specs, write Dept. BTF-05.

CIRCLE NUMBER 19

KEPCO, INC. • 131-38 SANFORD AVENUE • FLUSHING, N.Y. 11352 U.S.A. • (212) 461-7000 • TWX # 710-582-2631 • Cable: KEPCOPOWER NEWYORK

NASA seeks fifth Shuttle, warns of costly delays

Further delays in deciding on a fifth Space Shuttle orbiting spacecraft will increase its cost to \$600-million, a top space agency official told the House Science subcommittee.

President Carter approved four Shuttle spacecraft when he reviewed the fiscal 1979 budget for the National Aeronautics and Space Administration, but deferred a decision on the fifth for another two years. Now, NASA Associate Administrator John F. Yardley says the fifth spacecraft is needed and would cost \$365-million if procurement were to begin in fiscal 1979.

The other \$235-million will stem from a more inefficient production rate and the higher cost of purchasing smaller quantities of parts from subcontractors, according to Yardley. In the past NASA has estimated the additional cost of waiting for another two years at \$100-million to \$200-million.

Yardley bases his case on the belief that the Space Shuttle will be used extensively during the 1980s and that five of the reusable spacecraft will be needed in case of unforeseen delays in ground operations or in case one of the craft is lost in an accident. NASA has predicted 560 Shuttle flights during the 1980 to 1991 period, but critics have doubted that the Shuttle will be that popular.

Both the Air Force and NASA plan to launch almost all their satellites from the Shuttle during that period. Under the present plan NASA will get two, the Air Force one, and the two organizations will have to share the fourth orbiter. But if the fifth spacecraft is approved, NASA will be assured of three and the Air Force of two.

U-2 spy plane slated to return

Next year the Air Force plans to reopen production of the U-2, the famous spy plane of the 1950s. A new version of the aircraft, designated the TR-1, will be produced at Lockheed Aircraft Corp.'s "Skunk Works" in Burbank, CA.

Unlike its predecessor, which conducted strategic reconnaissance from high altitudes and thus became obsolete with the development of spy satellites, the new aircraft is intended to support Army and Air Force tactical units under battlefield conditions.

The Pentagon has attempted to keep the program under wraps, but Defense Secretary Harold Brown told the House Armed Services Committee that the aircraft would be able to provide continuous standoff surveillance of a battle area, including such activity as nighttime operations, and even during bad weather. The TR-1's complement of electronic sensors will include long-range, side-looking radar for covering ground targets from outside enemy airspace.

Since Lockheed halted U-2 production more than a decade ago, the company has been experimenting with what has been called a "stealth aircraft" under

the sponsorship of the Defense Advanced Research Projects Agency. Techniques developed for that aircraft, such as new types of paint and new electronic countermeasures to make the aircraft less visible to optical and radar detection, are expected to be adapted for the TR-1.

The Air Force is requesting \$10.2-million to begin procurement of the TR-1 next year, but defense officials won't say how many they plan to buy or what they expect the planes to cost.

Laser weapons eyed to protect air bases

The Air Force has become interested in high-energy laser weapons to protect its European bases against enemy cruise missiles.

Studies will be sponsored by the Air Force's Armament Development and Test Center at Eglin Air Force Base, FL, which has asked interested companies to submit proposals. These are expected to be strictly paper studies aimed at figuring out the best ways to protect the bases from 1985 to 1995.

In addition to laser weapons, the studies may also cover guns, surface-to-air missiles and missiles launched by aircraft. The European bases are considered particularly vulnerable to a variety of weapons, including cruise missiles, standoff missiles launched by aircraft, and TV-guided glide bombs.

Computer data entered via voice system

The Defense Mapping Agency is now using a voice-input system to put hydrographic data on ocean-depth measurements into its computer at Suitland, Maryland.

The voice system was developed by the Air Force's Rome (New York) Air Development Center in conjunction with Threshold Technology of Delran, NJ, and is based on the analysis of voice-frequency patterns. Operators at the DMA's Hydrographic Center have trained the system to recognize 14 words and numbers.

As the numbers are read-in for each depth entry, a visual display gives an immediate feedback to allow the operator to correct any errors. Each operator's speech patterns are prerecorded to create an individual speech program, which the system converts into a digital format. This is done by repeating the word to be added to the program 10 times. Speech patterns are averaged out, and a general pattern for each word is established.

Capital Capsules: The National Bureau of Standards is planning a major increase in its program to develop new federal data-processing standards, as required by Public Law 89-306—the so-called Brooks Act named after its sponsor, Rep. Jack Brooks (D-TX). Funding would nearly triple from \$6.4-million this year to \$21-million in the new budget. The over-all NBS budget would go from \$71.5-million to \$94.3-million, the largest jump in the organization's history—if Congress approves. . . . **The first of 19 passive tactical reconnaissance systems will be delivered by Litton Industries Amecon Div. (College Park, MD)** late next year to the Air Force for installation on RF-4C aircraft. The firm won a \$30-million production contract late last year after a successful development program it began in 1971. The reconnaissance system is designed to spot enemy radar systems around surface-to-air missile (SAM) sites. The company previously installed similar passive detection systems on the Navy's E-2C aircraft.

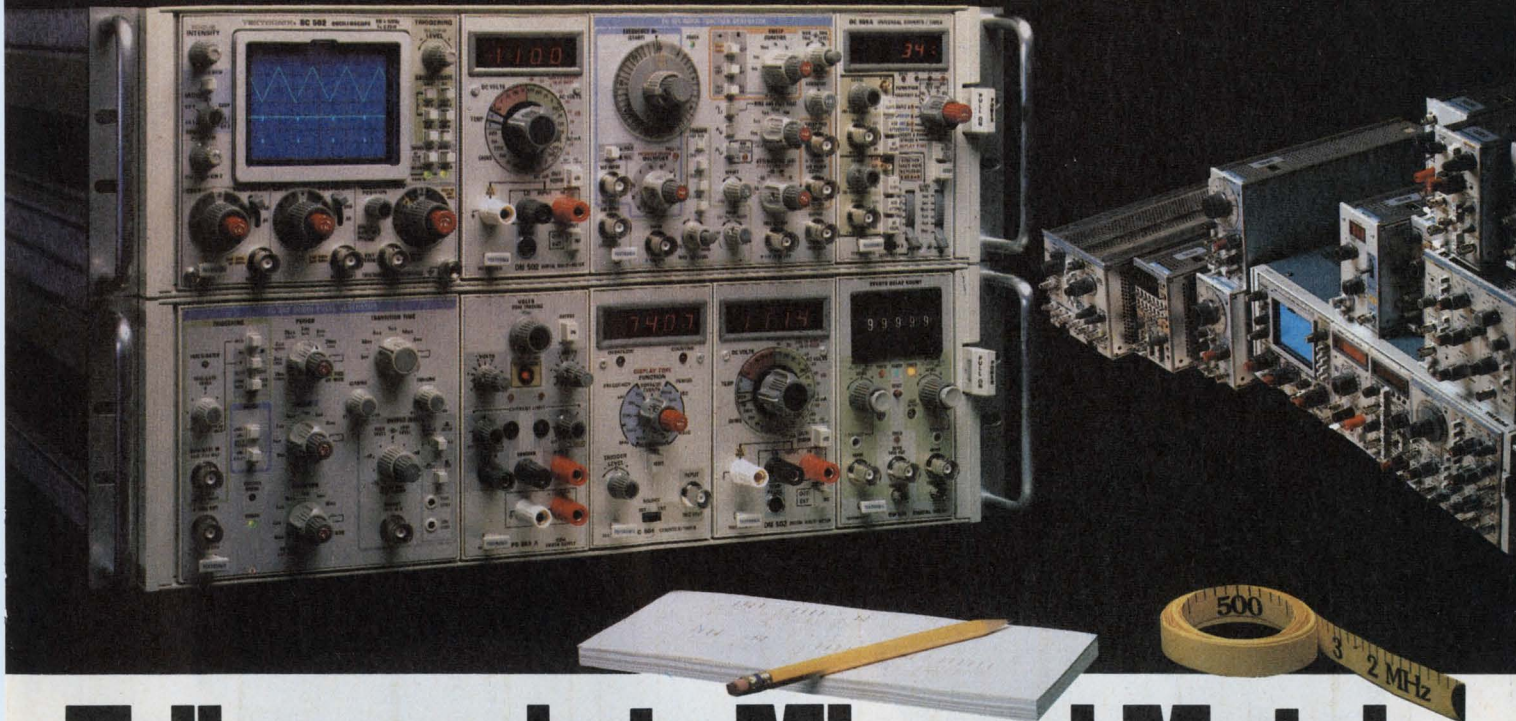

Tailor-made to Mix and Match.

If your rack is bulging at the seams with monolithics, maybe it's time to have it fitted with a trim set of TM 500 instruments from Tektronix.

TM 500 is the family name for nearly 40 configurable instruments:

| | |
|------------|------------------|
| DMMs | Power Supplies |
| Counters | Oscilloscopes |
| Generators | Logic Analyzers |
| Amplifiers | Word Recognizers |
| | Custom Plug-ins |

They all interface electrically through a common mainframe with a built-in "mother board." A TM 500 system gives you performance that's compact, convenient and flexible.

TM 500 mainframes come in six different versions, portable or stationary. You can load an RTM 506 Rackmount Mainframe, for instance, with up to six different plug-ins, all interchangeable. You can mix and match combinations of instruments with ease, without pulling plugs. Pull out a pulse generator and slide in an oscilloscope, just like that.

The RTM 506 Rackmount Mainframe comes equipped with a high-powered fan designed to take on the high ambient temperatures of enclosed racks or console environments without any sweat. Grab hold of its strong lateral grips and slip the mainframe, instruments and all, from your stationary rack into a TEK Model 7 Rack Cart. It puts your test and



measurement station on wheels, complete with desk top and storage.

TM 500 can help you stretch your budget, too, since TM 500 instruments share the mainframe's common power supply. You won't be paying for an unnecessary power component each time you need a new instrument. You'll be able to update your system's performance or add on new capabilities without starting from scratch or bucking the budget.

Wherever your rack might be, in aircraft, in a van, a ship or a submarine, TM 500 can help trim your space requirements and save valuable dollars. Every extra inch consumed by monolithic racks on a crowded production floor or in a specially equipped van costs hundreds, even thousands of dollars. When figuring your rack cost, extra size and weight can really add up to mean extra dollars. Because of its convenient, compact size more of TM 500 fits into less rack space.

And because TM 500 mainframes, plug-ins and accessories are designed and manufactured by Tektronix, you can get technical assistance, parts and service all across the U.S.A. and in 50 other countries around the world.

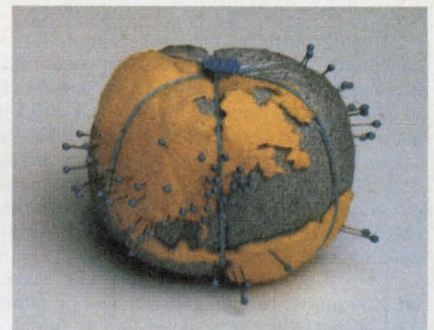

Ask your Tektronix Field Engineer about TM 500. He can tailor a TM 500 system that fits your application, your budget and your rack space requirements.

TM 500 Designed for Configurability

If you would like more information about TM 500 configurability write for a copy of our TM 500 concepts brochure. Tektronix, Inc., P.O. Box 500, Beaverton, Oregon 97077, (503) 644-0161, Ext. 5283. In Europe: Tektronix Limited, P.O. Box 36, St. Peter Port, Guernsey, Channel Islands.

Tektronix
COMMITTED TO EXCELLENCE

30 MGO_e

We don't hand out our new REC (rare earth cobalt) magnets to just anybody. Only to those manufacturers who want to make their magnetic circuits smaller, for instance. And to those who are only satisfied with the best possible temperature characteristics and overall performance from the smallest possible magnet sizes.

Just like with people, looks can be deceptive. You probably wouldn't guess that these magnets pack a residual flux density (Br) of 11 k-gauss, a coercive force (iHc) of 6.5 kOe and a maximum energy product of 30 MGO_e. These features make them worth a second look especially if you've got problems in magnetic circuits and other applications where ordinary cast magnets and ferrite magnets are just not good enough.

Even though they're so small, REC magnets are guaranteed to retain their magnetic punch. And because they're made of hard materials, they can be processed to a very high degree of precision. You can slim them down and give them any number of poles, too.

Whether you want them now or later, take a hard look at TDK's REC magnets. After all, you'll agree that when it comes to any race for the highest energy product, they'll win hands-down with 30 MGO_e.

•REC magnets are just another top-performing creation from TDK. They're what you would expect from one of the world's top producers of ferrite magnets.

Our magnets earn their living and reputation for quality in motors, speakers, chucks and a host more products. Their shapes, materials and specifications meet even the strictest requirements.

Our ferrite magnets, for instance, can be molded into any shape and mass produced. Our plant in Mexico knows all our production secrets. It's our ferrite magnet specialist.

So if you've got questions about magnets, contact us. You'll get the answers firsthand.



Our REC magnets win hands-down.

 **TDK**

TDK CORPORATION OF AMERICA

2041 Rosecrans Avenue, Suite 365, El Segundo, California 90245 U.S.A. Phone: (213) 644-8625

CHICAGO BRANCH 2906 West Peterson Avenue, Chicago, Illinois 60659 U.S.A. Phone: (312) 973-1222

NEW YORK BRANCH 755 Eastgate Blvd., Garden City, N.Y. 11530 U.S.A. Phone: (516) 248-5230

EL PASO BRANCH 3501 Frutas Street, El Paso, Texas 79905 U.S.A. Phone: (915) 533-5799

TDK DE MEXICO S.A. de C.V.

Carr. Juárez-Parvenir, Parque Ind. A.J. Bermúdez, Cd. Juárez, Chín, Mexico Phone: 3-88-27

TDK ELECTRONICS CO., LTD. Tokyo Japan

CIRCLE NUMBER 22

Fast Relief for the "Typical Spec" Headache

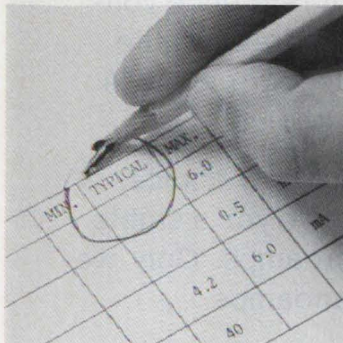

"Typical Specs" Are a Pain

The next time you're searching through component spec sheets for a characteristic best suited to your design, the word to watch out for is "TYPICAL."

Typical specifications can be devilish creatures. Ask any design engineer who has ever believed in them. When you need answers in black and white, they turn gray and disappear in the fog. Until you determine what the MIN., MAX, or typical value really is, you've got headaches. Headaches not just for you, but for everyone on down the reliability line —from QC to your field service people.

Curve Tracer A Quick Cure

There's an age-old cure for the headaches caused by typically elusive specifications. It's called a Curve Tracer. TEKTRONIX Curve Tracers aren't new. We introduced our first one in the days of vacuum tubes.

Since then Curve Tracers have performed wonders for semiconductor manufacturers, component evaluators, incoming QC inspectors and reliability engineers.

We prescribe them for design engineers because the earlier you can diagnose a problem, the less of a problem it will be.



A Picture of Health

If you need to examine a component, it's a good idea to start with its vital signs — current and voltage. And we all know that the best way to understand the voltage/current relationship is to look at a graph.

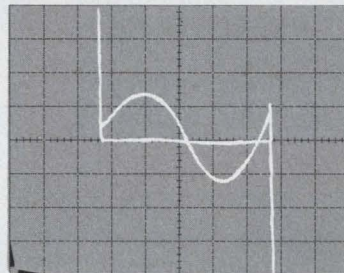

Two Op Amp gain curves at different sensitivities in the storage mode.

TEKTRONIX Curve Tracers graph voltage vs. current in digital and linear ICs, 2- and 3-terminal devices...transistors, diodes, rectifiers, thyristors, optoisolators and more.

At a glance, you can pinpoint parameters such as an Op Amp's offset drift at various loads, or zero in on the *actual* breakdown voltage in a power transistor.

With a Curve Tracer, you can assign *proven* values to several components and select the one that *you know* performs best in the environment you've created. Just think of it as a little preventive medicine to help you and your organization avoid headaches in the future.

Why Prolong Suffering

Fast relief can be on its way. For detailed information — application notes, specifications, a demonstration and the prices of our Curve Tracers and their Test Fixtures simply call your Tektronix Field Engineer. Or, write:

Tektronix, Inc.
P.O. Box 500
Beaverton, OR 97077
In Europe: Tektronix, Limited,
P.O. Box 36, St. Peter Port,
Guernsey, Channel Islands.

CAUTION
TEKTRONIX Curve Tracers
are mildly habit-forming.
Once you use one, you'll wonder
how you ever survived
without it.

Tektronix
COMMITTED TO EXCELLENCE

So put down those aspirins and take one Curve Tracer.

At 100 nanoamps...

Our knee makes their knee look sick

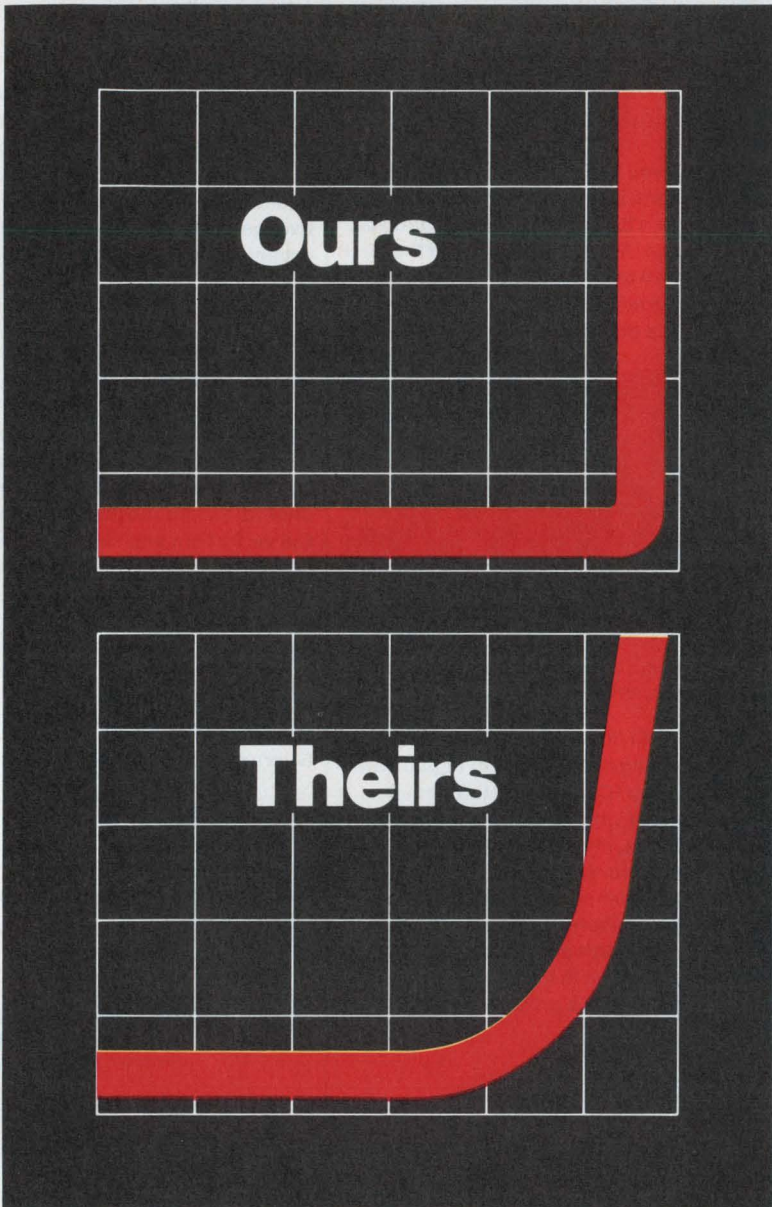

If your logic circuit needs an extremely constant reference voltage, but you want to draw as little current as possible, *our new LVA zener is your only choice.*

That's right. Your only choice. Other zeners can give you a stable voltage at 50 microamps. Only we can do it at 100 nanoamps.

Teledyne low voltage avalanche zeners are available in a range of voltages from 4.7V to 10V at your tolerance requirement. Let us know what you need, and we'll give you exact specs. And the most pleasant surprise of all may be the price.

For complete information and/or evaluation samples, contact Jerry Kramer at (415) 968-9241.

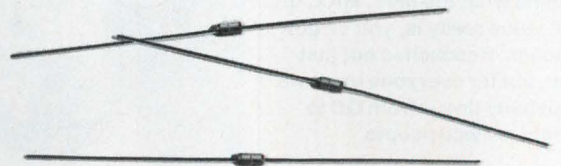

TELEDYNE SEMICONDUCTOR

1300 Terra Bella Avenue, Mountain View, California 94043 • (415) 968-9241

SALES OFFICES: DOMESTIC: Salem, N.H. (603) 893-9551; Stony Brook, N.Y. (516) 751-5640;
Des Plaines, IL (312) 299-6196; Los Angeles, CA (213) 826-6639; Mountain View, CA (415) 968-9241
INTERNATIONAL: Hounslow, Middlesex, England (44) 01-897-2503; Tiengen, West Germany 7741-5066;
Kowloon, Hong Kong 3-240122; Tokyo, Japan 03-403-8141

CIRCLE NUMBER 25

The typewriter

Charlie's new job as chief engineer brought with it a large corner office. Charlie liked it. He didn't spend an inordinate amount of time at it, but he did take a few hours, with his secretary, to furnish the office more to his tastes and comforts. He got a few plants, pictures and souvenirs and sprinkled them around the place. After all, he would be spending lots of hours there.

But something was lacking, and Charlie couldn't work effectively. Ah—a typewriter. So he sent a requisition for a typewriter, indicating that any old typewriter would do. He didn't object to a good electric, but a 20-year-old manual would be fine. And then came the trouble. The head of the Office Services Department asked if his secretary wasn't suitable. "Oh sure, she's fine," he responded. Then, in the course of the next few days, a small army of people came to ask mysterious questions relating to this typewriter until, finally, Charlie's boss gave him some avuncular advice.

"Charlie," he said, "you aren't entitled to a typewriter. You are Management Code Level 7. You're suppose to be issued a pencil and a pad. Your secretary is supposed to type for you. Nobody above Code 4 ever gets a typewriter."

"But that's ridiculous," Charlie told him. "My handwriting is atrocious. Even I can't read it. And while I certainly use my secretary a lot, I do a lot of my thinking at the typewriter, I make quick notes to myself, to you and to my people on the typewriter. I brew up ideas at the machine. When I have an idea, I want to put it on paper right away, and if I did it in handwriting, we'd need a Sanskrit expert to decipher it. Hell, if we can't manage it through channels, I'll buy my own typewriter."

Well, Charlie won. And for weeks he was the talk of the office, as people would wander by and point with amazement at the executive with the typewriter—a man at Management Code Level 7, no less.

In time, Charlie hopes to break down a lot of other organizational structures that get in the way of getting things done.

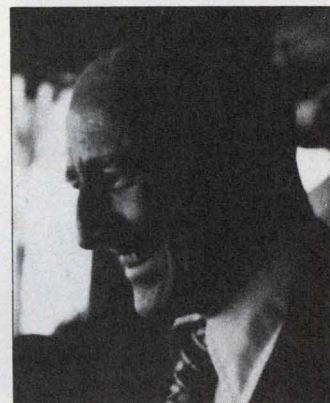

GEORGE ROSTKY
Editor-in-Chief



Choice!

New Dale MSP Networks let you match profile, power and package to meet your resistance needs.

Dale's new MSP single-in-line networks are the shape of things to come in resistance. Rugged. Machine insertable. And available in your choice of profiles: .350" with up to .3 watts per resistor or .195" (.19 watts) to meet critical board spacing requirements. Both are molded for extra protection. Both give you the kind of quality assurance we developed for Dale's SDM—the first network to meet MIL-R-83401. Sample the MSP now. It's available fast in quantity from stock... and it's only part of Dale's complete line of SIP and DIP networks.

Contact your Dale Representative or phone 402-371-0080

DALE ELECTRONICS, INC.
Box 74, Norfolk, Nebraska 68701
In Canada: Dale Electronics Canada Ltd.
In Europe: Dale Electronics GmbH,
8 Munchen 60, Falkweg 51, West Germany
A subsidiary of The Lionel Corporation.

CIRCLE NUMBER 351

AVAILABLE FAST: .350" model (MSPXXXC) available in 1 week from factory or from distributor stock. 6, 8 or 10 pin models (-01 circuit) in 49 standard values. Consult factory for fast delivery times on other configurations and schematics.

APPLICATIONS: Standard circuit (-01) has 5, 7 or 9 resistors with 1 pin common. Typical applications include "wired OR" pull-up, power gate pull-up, MOS/ROM pull-up/pull-down, open collector pull-up, TTL input pull-down, TTL unused gate pull-up.

SPECIFICATIONS: *Power:* .350" model=.3 watts max. per resistor; .195" model=.19 watts max. per resistor. *Resistance:* 33Ω to 1 Meg. standard. *Tolerance:* ±2% standard. T.C. ±100 PPM/°C. T.C. Tracking: 50 PPM/°C. *Operating Temperature:* -55°C to +125°C.

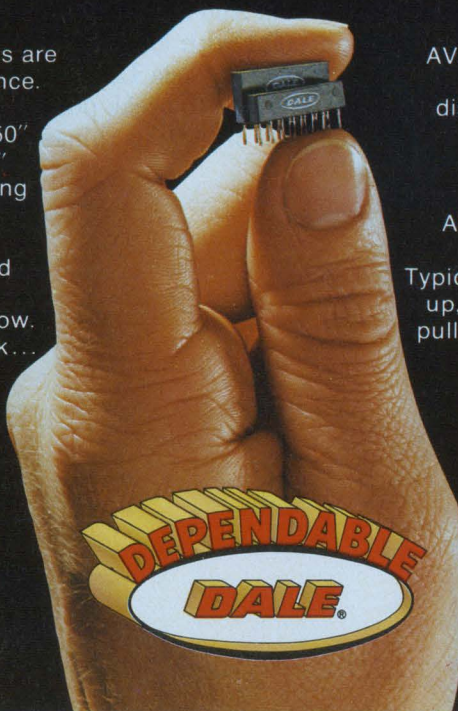



Choice!

Dale DIP Resistor Networks meet your industrial and military requirements—from stock!

If you're using, or designing-in, thick film resistor networks—talk to Dale. Our DIP team features the MDP, a rugged new molded package ideal for low-cost industrial applications plus our SDM, the first dual-in-line network to be qualified for MIL-R-83401. Both give you time-saving availability from distributor or factory stock in 14 and 16 pin packages with a choice of two popular schematics. Write for sample of the MDP. It's machine insertable...interchangeable...and very competitively priced.

Contact your Dale Representative or phone 402-371-0080.

DALE ELECTRONICS, INC.
Box 74, Norfolk, Nebraska 68701
In Canada: Dale Electronics Canada Ltd.
In Europe: Dale Electronics GmbH,
8 München 60, Falkweg 51, West Germany
A subsidiary of The Lionel Corporation

CIRCLE NUMBER 352

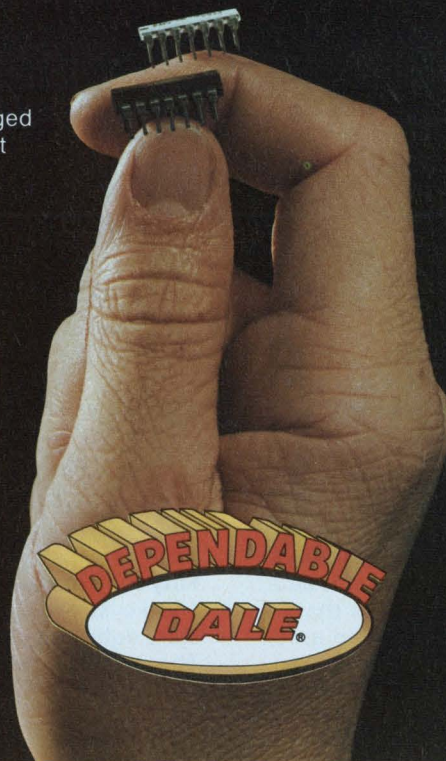

AVAILABLE FAST: Both MDP (molded) and SDM (MIL-R-83401) immediately available from factory or distributor stock in 14 and 16 pin models. MDP available in 49 stock values from 33Ω to 1 Megohm, 2% tolerance, 100 PPM/ $^{\circ}$ C. SDM available in 18 stock values from 100Ω to $100K\Omega$ (2% tolerance, "M" or "K" levels).

STANDARD SCHEMATICS: 01 = 7 or 8 isolated resistors. 02 = 13 or 15 resistors with one pin common. Applications include: pull-up, pull-down, impedance balancing and current limiting. Other schematics also available.

For SIP resistor networks, ask about Dale's MSP. Available from stock in 6, 8, 10 pin models.

FOCUS

on Scientific Calculators

Picking a scientific calculator is getting tougher all the time, despite the fact that the number of calculators to choose from—and manufacturers—has gone down rapidly over the last three years. But what the industry has lost in numbers, it has more than gained in calculating features and computing power. Keyboards have been improved. LED and fluorescent-display technologies have been refined. And more computing power has been packed into all machines, with top programmable calculators beginning to take over for computer terminals. Re-

liability has been upgraded—and so has service availability.

Unfortunately, increased machine complexity is making it harder to compare units. And a fast-growing generation of powerful user-programmable calculators is further confusing the picture.

Three years ago, you could get only one hand-held programmable, the \$795 HP-65—today there are more than 15 new ones. They range from a \$35 Sinclair unit with 36 program steps to a \$300 Texas Instruments TI-59 with several hundred program steps to a \$750 Hewlett-Packard HP-97 with a 224-step program and

Jim McDermott
Eastern Editor

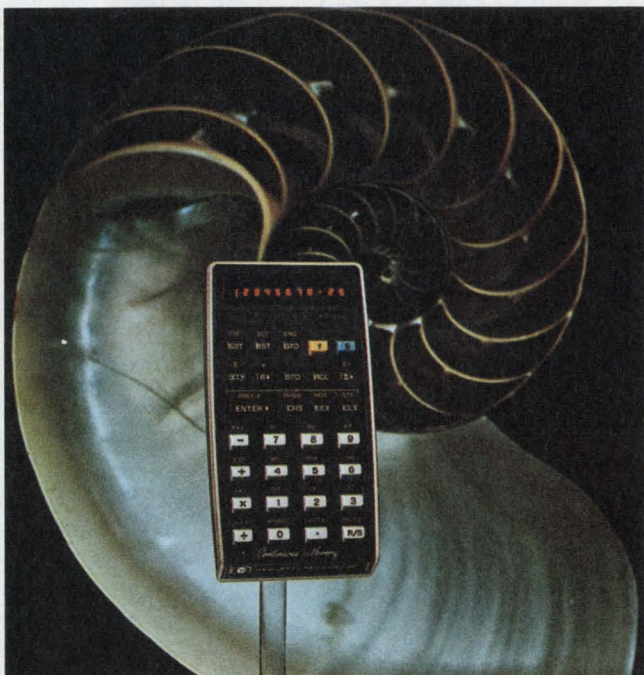

The continuous CMOS memory of the HP-25C retains data stored in its 49-step program memory as well as that in eight addressable registers. Special functions often used, but not preprogrammed in the machine, can be stored.

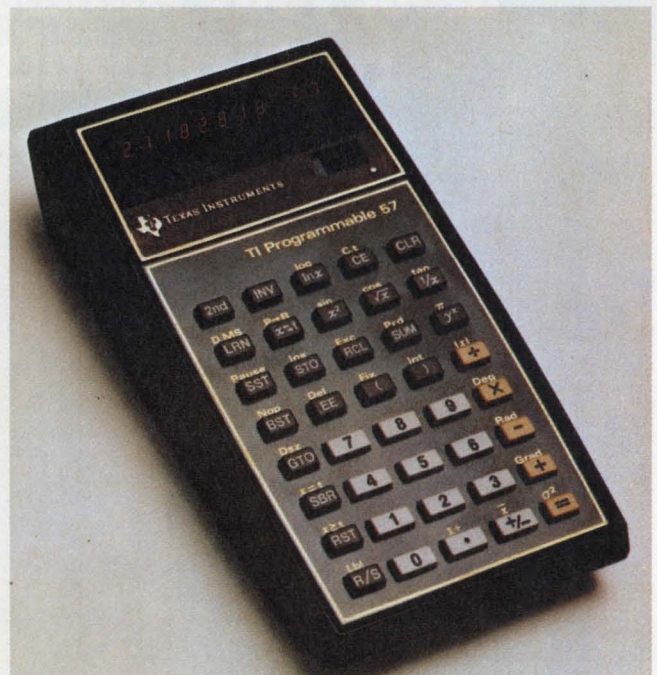

Fifty fully merged program steps of the TI-57 store up to 150 keystrokes. Eight multi-use, addressable memories store data, calculation results, and intermediate answers. The machine has full editing capabilities.

a printer.

Specifying a calculator, no matter what type, is not as straightforward as specifying components or hardware, because the specs aren't generally comparable. That is, purely personal factors, like experience and habit, play a major role in your choice. For example, it's up to you to decide how readable a display is, and how the keys feel when you enter data. And the type of arithmetic operation you choose—algebraic or reverse-Polish notation—may be the one you have become most comfortable with.

And finally, with the growing preponderance of

programmables come many new considerations—not only machine architectures and programming features, but also the availability and quality of software and programming-teaching materials.

Where do you start?

If you use a calculator just to do some simple math once or twice a week, you'll have no problem picking one. Several suitable machines selling from \$30 to \$50 have powerful preprogrammed trigonometric, logarithmic and other math functions. Scientific notation

Table 1. Calculator keyboard functions.

| Instructions to calculator | Scientific functions |
|--|---|
| <p>CE or CLX Clears entry (previous entry and memory unaffected)</p> <p>CLR Clears calculator</p> <p>ENTER or ENT or ↑ Enters number into stack*</p> <p>R↓ rolls stack to review contents</p> <p>= Completes pending operation+</p> <p>(and) Parentheses+</p> <p>X ↔ Y Exchanges x and y register contents</p> <p>Last X Recalls last x entry*</p> <p>CHS or +/- Changes sign</p> <p>EEX or EE Enters exponent (for scientific notation)</p> <p>FIX Fixed notation</p> <p>SCI Scientific notation</p> <p>ENG Engineering notation ($n \times 10^{3,6,9,\dots}$)</p> <p>*RPN only +Algebraic only</p> | <p>DEG Sets angular functions in degrees mode</p> <p>RAD Sets angular functions in radians mode</p> <p>GRD Sets angular functions in grads mode</p> <p>tan or tan⁻¹ Computes tangent or arc tangent</p> <p>sin or sin⁻¹ Computes sine or arc sine</p> <p>cos or cos⁻¹ Computes cosine or arc cosine</p> <p>tanh Computes hyperbolic tangent</p> <p>sinh Computes hyperbolic sine</p> <p>cosh Computes hyperbolic cosine</p> <p>π Displays pi (3.14159...)</p> <p>→H.MS or D.MS Converts displayed decimal hours (or degrees) to hours/min./sec. format</p> <p>→H or D.MS⁻¹ Converts displayed hours/min./sec. to decimal hours (or degrees)</p> <p>→R or P/R⁻¹ Rectangular coordinate conversion</p> <p>→P or P/R Polar coordinate conversion</p> |
| Mathematical functions | Statistical functions |
| <p>+ Addition</p> <p>- Subtraction</p> <p>x Multiplication</p> <p>÷ Division</p> <p>1/x Computes reciprocal of displayed number</p> <p>% Computes x percent of y</p> <p>x² Squares displayed number</p> <p>√x Extracts square root of displayed number</p> <p>y^x Raises number in y register to power in display</p> <p>x√y Extracts xth root of previously entered number</p> <p>log Computes common log of number</p> <p>10^x Raises 10 to the power in display</p> <p>ln Computes natural log of number in display</p> <p>e^x Raises e (2.718...) to the power in display</p> <p>x! Computes factorial (1 x 2 x 3...x n)</p> | <p>Σ + Summations</p> <p>Σ - Negative summation (for deleting data)</p> <p>S Standard deviation</p> <p>x̄ Mean (arithmetic average)</p> <p>LR or TL Linear regression</p> <p>ŷ Linear estimate</p> <p>VAR Variants</p> <p>r Correlation coefficient</p> <p>N.D. Normal distribution</p> <p>POISS Poisson distribution</p> <p>GAUSS Gaussian distribution</p> <p>BINOM Binomial distribution</p> |

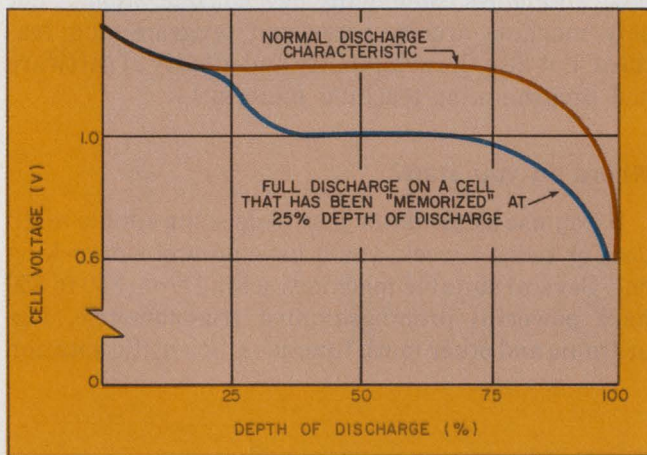

1. A "memory" effect in NiCd rechargeable cells results in an apparent loss of capacity with repetitive charge-discharge cycles. This effect is reversible and can be cured by giving the cell a deep discharge and a recharge.

as well as 12 digits—10 mantissa and 2 exponent—are now found in low-cost units.

For once-in-a-while use, get one of the low-cost LED or fluorescent-display units that runs on AA dry cells. Keeping nickel-cadmium batteries recharged when a calculator is idle most of the time is a nuisance. Or buy an LCD model, and forget the batteries for a year.

But if you're going to make serious, professional use of a calculator, you're going to have to look long at several key features:

- The kind of arithmetic programmed into the machine. It may be ordinary algebra, algebra with a

hierarchy, or reverse-Polish notation.

- Keyboard design and accessibility.
- Display types and viewability, the number of digits and special display features.
- Care and feeding of batteries.
- Power of preprogrammed math, trigonometric, statistical and other functions.
- Use of floating point, scientific and engineering notations.
- Accuracy.
- Basic programmable features.
- Printer applications.
- Programmable machine features.
- Software and its availability.

Which arithmetic?

You'll probably feel most at home using a calculator with the math system you've grown up with—say, ordinary algebra. But two other math systems, algebra with a hierarchy and reverse-Polish notation, may be better in the long run because they are more efficient (use less keystrokes) and can solve complex problems easier and faster.

Ordinary algebra, the simplest and most straightforward, is found in all scientific calculators except those of Texas Instruments and Hewlett-Packard. TI's calculators use algebra with a special hierarchy while HP's line incorporates reverse-Polish notation.

Ordinary algebraic operations are, for the most part, executed in the sequence you enter them. For example:

$$2 + 3 \times 4 = 20.$$

For long strings of calculations, make sure that your machine has at least two levels of nested parentheses, but preferably more—as well as a one or two-register memory. Canon's F-7 calculator, for one, has seven levels of parentheses and two registers.

An algebraic-entry system with hierarchy, together with a pair of parentheses keys, makes up what TI calls its Algebraic Operation System (AOS). Its problem-solving capabilities are comparable to those of HP's reverse-Polish (RPN), but for most problems AOS requires more keystrokes.

If you were brought up on ordinary algebra, AOS may be somewhat confusing at first. Where a calculator using ordinary algebra obeys you and performs the arithmetic in the entering order, an AOS calculator grabs your key entries, both function and digit, sorts out the data in the order it wants, and performs the calculations in its own sequence. The TI-59, for example, defies you to set up an equation any other



With a 36-step program capacity, this vest-pocket Sinclair programmable calculator handles frequently used programs in math, physics and engineering. For \$35 the machine and a library of 290 programs are supplied.

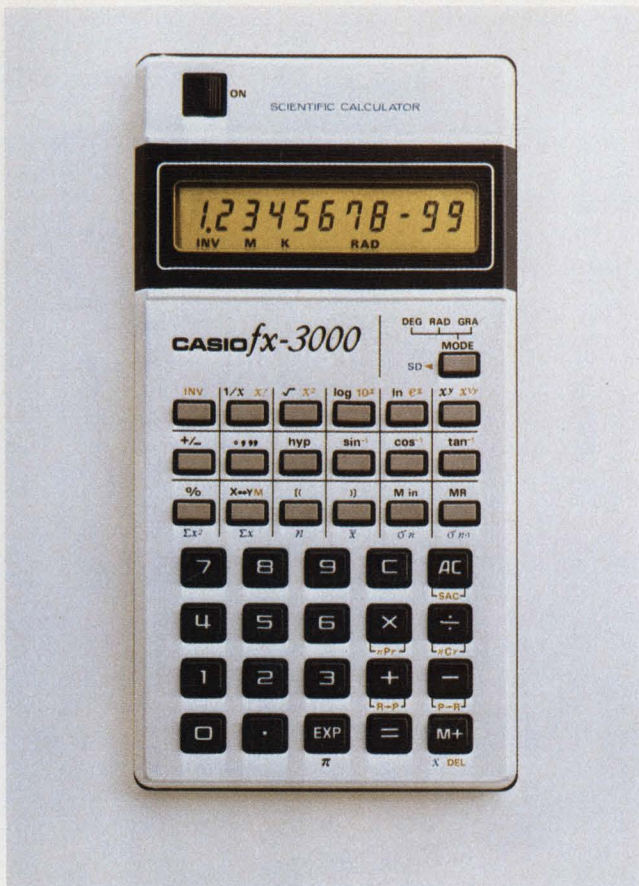

Silver-oxide cells provide 700 hours of use for this Casio fx-3000 calculator with a liquid-crystal display. This type display permits packaging the power of a 38-function, 10-digit machine in a slim billfold case.

way than the machine wants it. Computations are always performed in the following order:

1. Special single-function key entries, such as those for trig and log functions, and squares, square roots, reciprocals and conversions.
2. Powers and other roots.
3. Multiplications and divisions.
4. Additions and subtractions.

In other words, if you were to key in the previous equation, the answer wouldn't be 20:

$$2 + 3 \times 4 = 14$$

With AOS the 3 and 4 are first multiplied, and 2 is then added.

The battle of keystrokes

But is AOS more efficient than RPN? This continuing controversy has been joined by calculator users on both sides. Examples have been created that "prove" one or the other to be more efficient. This, of course, can be done by selecting problems specially suited to one calculator architecture and not the other.

But the pros and cons of the efficiency of one arithmetic system over another become more or less academic, because TI concedes that RPN is somewhat more efficient than AOS architecture. However, Rich-

ard Cuthbert, applications manager for TI's professional calculators, points out that the general need for more keystrokes per program by TI machine users is intentional.

"It's intrinsic that you use more space with the AOS architecture," Cuthbert says. "But we have deliberately taken this approach to make it easier for the user to program. Our AOS, like higher-level languages in large computers, takes more room than assembly language. But assembly language is a lot tougher for the neophyte. While our approach imposes additional overhead, we have a lot more storage in the machine."

RPN does save a few keystrokes. But there's much more to choosing a calculator language than counting keystrokes. The machine itself should be adaptable to the user's background and needs. A survey of HP and TI users has shown that, by and large, those who have learned to operate programmable machines of one type or another become "addicted" to the machine they learned on. As a matter of fact, over 2000 calculator owners belong to an HP Users Club and 500 to a TI Users Club, both of which are unaffiliated with the manufacturers.

Graduating from an algebraic calculator to an RPN can be a problem because data in the RPN system are entered and manipulated differently. The RPN procedure is a lot like the entry of data into computers.

With algebraic entry, the arithmetic functions of plus, minus, times, or divide by are placed between the numbers of a two-number operation. But with RPN entry the arithmetic function is placed after both members of a two-number operation.

In other words, for problems having two numbers and one arithmetic operator, the first number is keyed in and saved in a stack register by pressing an ENTER key. The second number is keyed in and followed by the arithmetic operator. An expression like $(3 \times 4) + (5 \times 7)$ would be evaluated in an RPN machine by the following steps:

3 ENTER 4 \times (12.00 is displayed),

5 ENTER 7 \times (35.00 is displayed)

+ (47.00 is displayed).

While RPN, like AOS, is at first awkward for those accustomed to working with algebraic system entry, users experienced with both AOS and RPN say that with frequent use, they become either as proficient or more proficient at using RPN.

Keyboards are growing

Unfortunately, the amount of keystrokes isn't determined simply by the math language you choose. Because of the abundance of functions preprogrammed into all of today's advanced scientific calculators, keyboards have two, and in some cases, three functions assigned to one key. The more functions per

key, the more keystrokes it takes to solve a problem. Try to pick a calculator with more single-function keys for faster and more accurate keyboard operation.

Some calculators signify data entry with keys that snap or click when they are depressed, so you don't have to verify each entry visually. One Sharp calculator even has keys that "beep." But other calculators have keys with a very light touch and no positive feel, which means that you've got to watch the display to make sure a number or function is entered. That type of key is more prone to unintentional multiple-digit entry on low-quality keyboards. Not surprisingly, most users prefer the more reliable snap action keys and their tactile feedback.

Keys should be far enough apart so that you can operate them without accidentally depressing an adjacent key. One indication of a good keyboard is that the number keys are somewhat larger or spaced farther apart than the rest of the keys.

A frequently neglected but important consideration is to make sure that your calculator has a moisture barrier under the keyboard to keep liquids like coffee from getting into the keyswitch or into the calculator circuitry.

Check off your functions

Finally, inspect the keyboard markings to verify whether or not a calculator has all the key-addressable functions you'll need—arithmetic, trigonometric, statistical or whatever. One calculator specialist suggests that you draw up a list of the formulas and equations on the basis of those you regularly use, those employed occasionally, and those encountered infrequently.

Check your list against the Table, which contains key-addressable functions that will be needed for a wide range of problems. Not all of these come on all calculators. And whether the machine is costly or inexpensive doesn't necessarily have any bearing on whether certain functions are contained.

For example, anyone who wants to work hyperbolic problems won't find the special keys on the high-priced HP-67 or HP-97. But solutions are included in HP's \$35 Math Pac I software.

Texas Instruments doesn't do any better with its TI-58 or -59, which have no hyperbolics on the keyboard. The company recommends the formulas in a standard math handbook.

What's happened is this: The hyperbolic keys and functions have been sacrificed in most programmable calculators (the APF MK 90 is an exception) to make room for other programming keys and functions. The point is, compare your math-function list carefully with the keyboards you look at. Other functions may have been omitted, too.

Another thing: You may be able to calculate the values of a function only through extra keystrokes. For example, with most calculators you determine the value of an inverse function by striking an "F" or

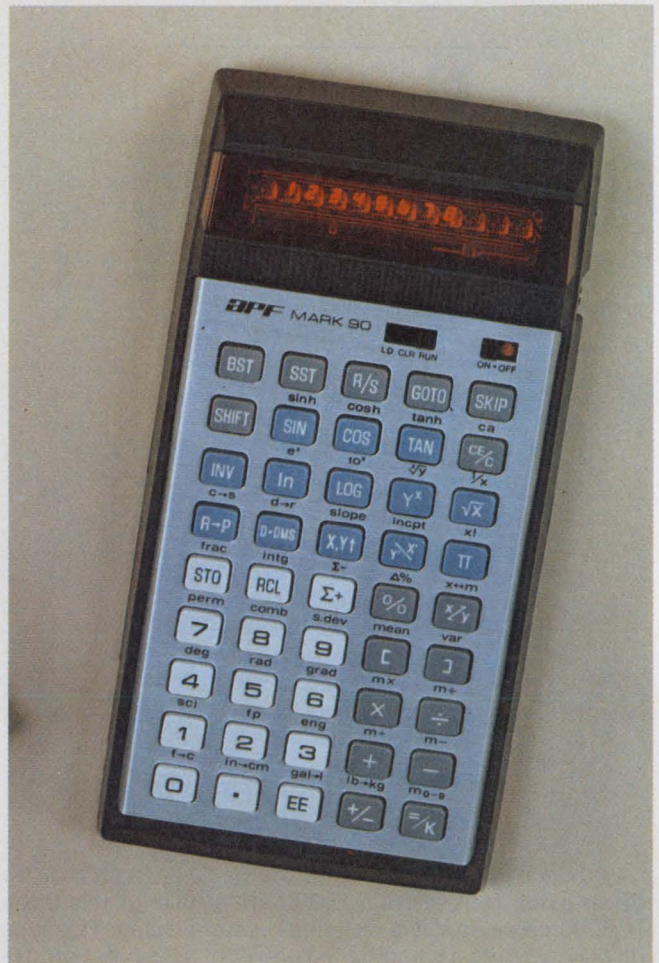

Over 70 preprogrammed functions are available in this 72-step programmable calculator, the MK 90 by APF Electronics. Five keys control program loading or running. Data are stored in 10 registers. Full editing features are provided for program debugging.

transfer key to access that function on a second key. But TI has packed so much computing into the TI-58 and TI-59 that it takes an added keystroke to get at the inverse sine. But this is a trade-off you can probably live with.

Today's engineering calculators display very large or very small numbers in scientific notation. On some machines when the displayed numbers exceed a certain maximum value or drop to less than a specified minimum, the display automatically switches to this notation. On others, you do the switching.

Scientific notation consists of a mantissa that carries the significant digits of a number, and a two digit exponent, which in most cases ranges from 10^{-99} to 10^{99} . The mantissa commonly consists of 8 or 10 displayed digits, with two or three undisplayed digits carried in the machine.

Engineering notation—a form of scientific notation in which the exponent is a multiple of 3, is also common. It is particularly desirable for problems in the electronics field. Many machines offer a special key (EE or ENG) for converting floating-point into engineering notation.

Another desirable feature to look for in advanced calculators is a fixed-point key (FIX), which allows you to select the number of digits to be displayed after a decimal point. If the digits in the calculated result or the original entry exceeds the number selected with the FIX key, the calculator automatically rounds the least-significant digit displayed, while continuing to perform all calculations.

Look at displays

Having gone over keyboards, you should literally look at displays. Your eyes are the best judge, for a display should be easy and comfortable to read. The two most common displays for scientific calculators are red LEDs and the blue-green electrofluorescent units. Unfortunately they both demand a relatively high battery current. But liquid-crystal displays, which substantially reduce battery current and boost battery life a thousand hours or so, are emerging in slim preprogrammed calculators, such as APF Electronics' MK 8602, Casio's fx-3000, Commodore's LC63SR and Sharp's EL-5806.

LED displays vary in quality. Watch out for the display that enlarges tiny digits with plastic bubble-type lenses. Its field-of-view is narrow, and the calculator must be positioned exactly right for decent viewing—which literally can give you a pain in the neck.

In addition to showing data, a display indicates errors, entry of false data, overflow, underflow, data in memories and a low battery. Unfortunately, the low-battery indication generally is as effective as idiot lights on automobiles. When it flashes, pull over and stop calculating until you plug in a new battery pack or put the charger on.

Does your calculator lie?

Assuming now that you've made a tentative selection of a calculator, the next question is: "Can I trust it?"

The answer is: "Most of the time, yes. But not exactly all of the time." For example, try the following exercise on your machine: Enter 2, and take its square root 20 times. Now hit the square key 20 times. The answer should be exactly 2. But it won't be. An HP-97 will give you 1.999897829. A TI-59 will give you 1.99999681. And a National Semiconductor 4660 will give you 1.99993871.

Take another example: Subtract two functions that are mathematically equal. The answer should be zero. But the calculator may not display that. For instance, take a TI-59 and subtract the cos of 45° (0.7071067812) from the sin of 45° (0.7071067812). A remainder of $-7. -13$ is displayed, showing that there is a discrepancy in the 13th digit.

Irregularities like these occur because designers have to fit algorithms into digit strings of a given length—and at a specified cost. The designer may have



The program memory in this 128-step programmable PC-1201 calculator by Sharp can be partitioned into 13 separate programs; or it can hold 12 subroutines. A CMOS memory powered by silver-oxide cells hold a program for a year, which is equal to silver-cell life.

decided to chop off guard digits, additional digits used in calculators to preserve the accuracy of results. For example, the TI-59 displays 10 digits, but actually uses 13 for most operations. For some functions the 13th digit is chopped off. More accurate results would be obtained if the 13th digit were first rounded off by adding 5, then chopped.

Anomalies in equations used to fit functions within a machine's architecture may sometimes be unknown even to the designer. They will be found only when the calculator gets into the field.

So what do you do about it? Where can you find out whether or not there may be some unexpected errors associated with the functions and numerical ranges you'll be most concerned with?

That's not easy to answer. Some Owners Manuals list the expected accuracies of various functions within stated calculation boundaries. They frequently point out that "accuracy is low around singular and deflection points." But how low? How do you find out? Other manuals ignore the problem entirely.

Don't try to get inside information from the manufacturers. Many of the errors are the result of discontinuities in proprietary machine algorithms. To openly identify critical data regions could give the competition useful insight into a calculator's architecture.

Discrepancies uncovered by calculator users have been reported to two private groups—the HP-65 Users Club, and the SR-52 Users Club.

Excellent information on calculator inaccuracies appears in reports by Dr. William Kahan, professor

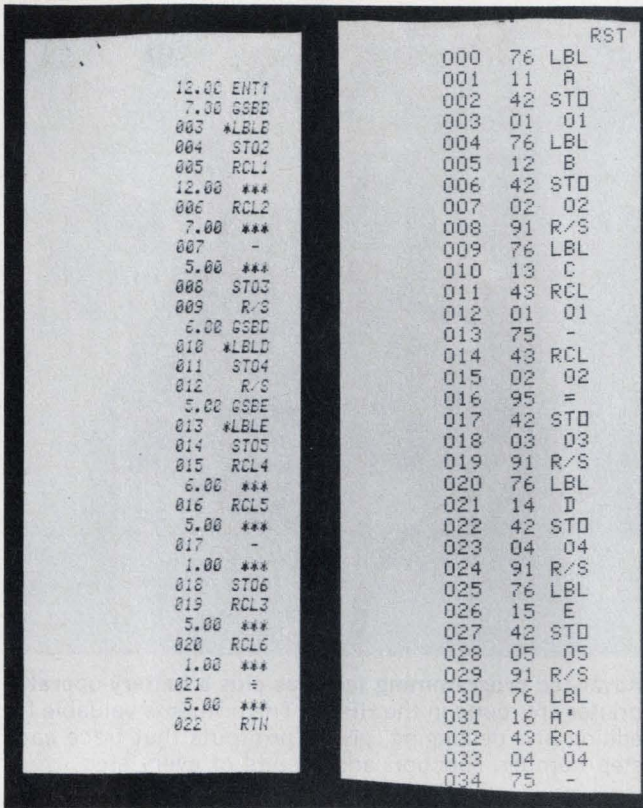

Thermal-printer tapes show a trace listing of a simple program executed on an HP-97 (left) and a verification listing of program steps (right) produced by a TI PC-100A printer controlled by a TI-59 in the printer cradle.

of Mathematics and Computer Science at the University of California at Berkeley. Kahan specializes in numerical error analysis and has conducted independent studies and reported them in "Can You Count on Your Calculator?" and "And Now for Something Completely Different, the Texas Instruments SR-52."

One simple way to find out if and where your calculator has errors is to perform a forward-function calculation and then an inverse calculation with functions and values in the region of suspected inaccuracies. The displayed answer should be identical to the original entry. If not, there is an error in the forward-function or the inverse, or both.

For example, take the cos of 0.05°. Then press the inverse-function (cos⁻¹) key. The answer probably won't be 0.05. Try the same approach on the sine and tangent functions.

You can use the forward-inverse method on other functions, such as natural logs and antilogs. The natural log of zero, or of a negative number, should indicate ERROR. Make this check in the vicinity of 2, say, from 1.99 to 2.04, and in the vicinity of 1. Use the following table to verify your results:

| Number | ln |
|--------|-------------------------------------|
| 1.1 | 9.53101798043247 × 10 ⁻² |
| 1.01 | 9.95033085316808 × 10 ⁻³ |
| 1.001 | 9.99500333083532 × 10 ⁻⁴ |
| 1.0001 | 9.99950003333083 × 10 ⁻⁵ |

| STEP | KEY | KEY CODE | STEP | KEY | KEY CODE | |
|------|----------------|------------------|-------|-----|----------|---------|
| 0 | C | x→M: 0 | 55 00 | 32 | = | 84 |
| 1 | | F HLT | F 12 | 33 | ‡ | 45 |
| 2 | L | x→M: 1 | 55 01 | 34 | RM 5 | 65 05 |
| 3 | | F HLT | F 12 | 35 | ‡ | 45 |
| 4 | R _s | x→M: 2 | 55 02 | 36 | F →rθ | F 64 |
| 5 | | F HLT | F 12 | 37 | x→M: 6 | 55 06 |
| 6 | R _p | x→M: 3 | 55 03 | 38 | ‡ | 45 |
| 7 | | F HLT | F 12 | 39 | x→M: 7 | 55 07 |
| 8 | | x→M: 4 | 55 04 | 40 | RM 2 | 65 02 |
| 9 | | x | 54 41 | | + | 74 |
| 10 | | 2 | 54 42 | | RM 3 | 65 03 |
| 11 | | x | 54 43 | | x | 54 |
| 12 | | F π | F 41 | 44 | RM 0 | 65 00 |
| 13 | | = | 84 45 | | = | 84 |
| 14 | | x→M: 4 | 55 04 | 46 | ‡ | 45 |
| 15 | | F x ² | F 44 | 47 | RM 5 | 65 05 |
| 16 | | x | 54 48 | | ‡ | 45 |
| 17 | | RM 0 | 65 00 | 49 | F →rθ | F 64 |
| 18 | | x | 54 50 | | ‡ | 45 |
| 19 | | RM 1 | 65 01 | 51 | +/- | 82 |
| 20 | | - | 64 52 | | M+ | 7 75 07 |
| 21 | | 1 | 01 53 | | ‡ | 45 |
| 22 | | = | 84 54 | | ÷ | 44 |
| 23 | | +/- | 82 55 | | RM 6 | 65 06 |
| 24 | | x→M: 5 | 55 05 | 56 | ‡ | 45 |
| 25 | | RM 4 | 65 04 | 57 | = | 84 |
| 26 | | x | 54 58 | | ‡ | 45 |
| 27 | | RM 0 | 65 00 | 59 | RM 7 | 65 07 |
| 28 | | = | 84 60 | | F →xy | F 74 |
| 29 | | x→M: 0 | 55 00 | 61 | ‡ | 45 |
| 30 | | x | 54 62 | | x→M: 7 | 55 07 |
| 31 | | RM 2 | 65 02 | 63 | ‡ | 45 |

| MEMORY | | | LABEL | | |
|--------|----------------|-----------------------------------|-------|---|--|
| s | 4 | f → 2πf | s | 4 | |
| t | 5 | 1 - ω ² LC | t | 5 | |
| 0 | C → ωC | 6 R ₁ /R ₂ | 0 | 6 | |
| 1 | L | 7 θ ₁ - θ ₂ | 1 | 7 | |
| 2 | R _s | 8 | 2 | 8 | |
| 3 | R _p | 9 | 3 | 9 | |

2. Program lists, like this one for solving series-resonant circuit problems, are found in Sharp's PC-1201 software manual. Each program is supplied with a sample problem and step-by-step directions for its execution.

| | |
|---------|--------------------------------------|
| 1.00001 | 9.99995000033333 × 10 ⁻⁶ |
| 0.99999 | -1.00000500003333 × 10 ⁻⁵ |
| 0.9999 | -1.00005000333358 × 10 ⁻⁴ |
| 0.999 | -1.00050033358353 × 10 ⁻³ |
| 0.99 | -1.00503358535014 × 10 ⁻² |
| 0.9 | -1.05360515657826 × 10 ⁻¹ |

Another check is to add mathematically equal functions of opposite sign, or subtract equal functions of the same sign:

$$\tan 89.99^\circ + \tan 90.01^\circ = ?$$

$$\sin 45^\circ - \cos 45^\circ = ?$$

The answer should be zero.

Can I count on my battery?

Having determined whether or not your calculator can be trusted, don't forget to check the batteries. Nickel-cadmium rechargeable batteries are the work-

horses that power the vast majority of scientific calculators. But they're sensitive to heat and to cold. Not only that, a perfectly good cell may stubbornly resist taking a charge. And continuous overcharge will cut capacity. And continuous deep discharge will do worse.

To get maximum, continuous useful life and dependability from NiCd batteries, you'd better know their properties and characteristics. Unfortunately, calculator manufacturers offer little help. For example, take the following statement from a "Battery Care" section of an otherwise excellent 300-page User Manual. The manual defines the point of battery discharge as follows: "If the calculator fails to turn on you should substitute a charged battery pack, if available, for the one in the calculator."

A typical NiCd battery pack consists of two or three AA-sized, sealed cells, each with a nominal voltage of about 1.25 V. Pressure-relief seals are designed into the cells so that when internal pressure builds up, it can be relieved.

Most calculators use what are termed "slow-charge" batteries that are designed to be fully charged in "14 to 16 hours, or overnight." One reason is that these batteries are not harmed by a continuous overcharge. However, a sustained overcharge does lower the discharge voltage.

Note that nickel-cadmium batteries apparently lose capacity from repetitive use patterns. This phenomenon, known as "memory," acts like this: If you charge your battery fully each night, and discharge it by 25% during each working day, after a while the battery develops a memory that makes it think it has only 25% of its original capacity (see Fig. 1): It acts like a battery that is only one-fourth its actual size. So whereas the calculator should normally operate off the battery for, say, four hours, it will now last less than one.

Fortunately, "memory" is only temporary and can be corrected easily: Subject the battery to a deep discharge, then recharge it to restore it to its original performance. One calculator manufacturer suggests that a battery occasionally be discharged by leaving the calculator on until the display digits go out, then recharging it fully. To avoid the situation in the first place, all you have to do is make your charge-discharge patterns random.

Attention: Don't subject the battery to extended deep discharges, such as those caused by neglecting to turn the calculator off for a day or two. Two bad things will happen. First, since the two or three cells in the battery packs don't have identical charge capacities, one usually discharges to 0 V before the others. It is then reverse-charged by the voltage in the other cell or cells, and hydrogen gas is generated internally. The resultant pressure rise may then vent through the pressure-relief seal, with a loss of battery moisture.

Second, a deeply discharged cell is more likely to short internally than one that is fully charged. That's



Advanced programming features plus a battery-operated printer are found in the HP-97. The printer is valuable for editing and debugging, giving printouts that trace each step number, function and results of every step.

because a fully charged cell has sufficient energy to vaporize, or clear, the shorted path. A near-dead cell won't have enough energy to do so.

Nickel-cadmium batteries are designed to live in an ambient of 20 C (68 F) room temperature. Charging them at greater than, or much less than 20 C shortens their life. Don't make a practice of charging your calculator batteries in a cold room. Or in a hothouse.

Fully charged NiCd batteries, standing idle at 20 C, lose about 1% of their charge per day because of chemical self-discharge. So in about a month or so, the battery will have lost about half its capacity, which calls for a recharge.

Hint: To keep idle batteries charged for extended periods, wrap them in a moisture-proof bag and store them in the food—not freezer—compartment of your refrigerator. The ≈ 40 F temperature reduces the normal self-discharge to one-fourth, and extends the 50% discharge time to over six months. Caution: Be sure the batteries are warmed to room temperature before recharging.

So far, you've been trying to select a scientific calculator in general. But a new breed—calculators you can program—is fast emerging, and you'd better be ready for them.

The year of the programmables

As 1975 was the year of the preprogrammed scientific calculator—more than 40 kinds were available then—1978 is the year of the programmables. Five out of eight of HP's scientific machines can be programmed, as can three out of five of TI's new line. Programmables are also appearing from APF Electronics, Casio, Commodore, Sharp and Sinclair.

Programmable calculators are "grown-up" preprogrammed machines that tell you, in effect, "Leave the driving to us." They can learn a sequence of keyed-in instructions and automatically execute that sequence on command. They store constants and other data. The program sequence, or list, is stored in a program memory while the data are stored in registers that can be accessed by the program.

To teach a programmable calculator a program, you switch to a PRGM or LEARN mode and enter a problem in a sequence of keystrokes dictated by the calculator's program list. The needed software may be prepared by the calculator manufacturer, or you can write it as an original program.

To execute the program, you switch the machine to a RUN mode, key-in initial problem values and let the program take over. You'll save a substantial amount of time when you have to solve similar problems over and over: You can use the same program, instead of going through single-key entry of every step. Great? Sure. But wait.

Turn the calculator off. Then turn it back on and try to run the program. Chances are, you can't, because the program was wiped out when the power went off. Now you have one important yardstick for comparing programmables: In one class of machines, the program must be keyed in again when the power is turned back on. So if your problems involve 100 or 200 program steps, get to work early. Or leave your calculator plugged into the charger and turned on as long as you want to keep the program in. However, when you do so, you'll be trading inconvenience for potential battery trouble.

One way to retain the program is to use low-power CMOS memories, which, with an auxiliary battery, keep the program and its data for months after a calculator is shut off. Such memories are designed into the \$160 HP-25C, \$195 HP-19C and the \$345 printer-equipped HP-19C. Sharp's \$90 PC-1201 has a standby CMOS memory, powered by two silver-oxide cells, that will hold program information for about a year.

Magnetic cards also keep programs. Machines like the \$300 TI-59 come with a magnetic-card handler and can store programs on the cards and read them back at any time. Magnetic cards are also used in the \$450 HP-67 and \$750 HP-97. In addition, libraries of pre-recorded or "canned" programs are available in HP's Engineering Application Pacs.

The newest approach to programs that won't vanish when the machine is turned off is the Solid-State Software ROM modules that plug into the TI-58 and 59. The Master Library module, which corresponds to HP's Standard Pac of magnetic cards for the 67 and 97, has some 5000 program steps that provide 25 different programs in mathematics, geometry, statistics, engineering conversions, finances and games. Each of the programs can be loaded into the program memory and data registers with a few keystrokes, and run independently. Or the program can be called in by the machine to run as a subroutine

of a larger program.

A universal and frequently vexing problem with programmables is how to debug a program you have written. For most programmables, debugging is a time-consuming operation that requires you to single-step through the entire program listing, comparing the program step numbers and associated key codes (two-digit numbers that tell which keys were depressed to enter the program) that appear in the display against your master list. If a mistake has been made, you may have to delete or back step, or add steps, moving other portions of the program forward or backward. And you must repeat the single-step check of the program until the listing is correct.

The answer to a programmer's prayer for aid in debugging is found in printers that can be called on to list or trace through a portion of or an entire program. Such printers are incorporated into HP's 19C and 97. And TI has produced a free-standing print/security cradle, the PC-100A, in which the SR-52, SR-56, TI-58 and TI-59 can be mounted and locked in place. Locking-in helps solve another problem—theft.

HP's printer machines have a limited alphanumeric capability that identifies the kind of program step entered as well as other functions keyed into the program, for instance, ENT (enter), ST01 (store data in register 1), SIN, TAN, etc. TI, however, has taken a giant stride with its \$200 PC-100A printer, which, when used with the TI-58 and TI-59, can produce full alphanumerics plus 29 other useful symbols.

Not only can users of PC-100A list and trace program steps, but program headings and user-prompting phrases (up to 20 characters wide) such as "ENTER INDUCTANCE" can be printed. In addition, you can make simple plots of data, such as sine curves, directly from the keyboard or automatically under program control.

Both HP and TI printers use nonimpact, thermal print heads. "Whisper-quiet operation" is claimed for both. After listening for a while, though, you may feel that the sound is more like a stage whisper.

Programmable benchmarks

The power and performance of most programmable calculators generally can be described by the following criteria:

- The number of program steps that can be held.
- The number of data registers.
- The ability to manipulate program steps to edit a program.
- The presence, or absence, of user-definable LABEL keys or other keys that identify a program or program segment simply by pressing the defined key.

Comparing some of the lower-cost calculators, you find that Sinclair's 18-key Cambridge Programmable—the world's smallest programmable—has a 36-step program memory. APF's 45-key, \$70 MK 90 has 72

program steps and 10 user-accessible data memories. Advanced program-editing features include single-step, forward and backward program verification as well as jump commands.

Sharp's \$90 PC-1201, with a permanent CMOS program memory, has 40 keys, 128 program steps, 12 data registers and 1 test register. It also has 12 user-addressable labels and can hold up to 12 subroutines. Conditional and unconditional subroutine jumps are possible, and full editing keys are included. As an added attraction, the entry of each program step is verified by a "beep."

An unusual calculator, the Sharp EL-5001, as six "most-used" engineering programs hard-wired into a program memory. These programs are selected by a six-position thumbwheel switch. They are equivalent to keyed-in programs ranging from 30 to over 150 program steps. For electronic designers, the machine has programs, impedance calculations, vector analysis, quadratic stability analysis, polynomial integration, and statistics. For more details, see Table 2 and News Scope, ED 3, Feb. 1, 1978, p. 21.

All these programmables use an ordinary algebraic language. You can, by studying manuals and looking at the machines, make reasonable comparisons.

Comparisons May Be Different

But you'll have a hard time comparing the performance of powerful machines like the HP-67/97 and the TI-58/59. First of all, data are entered and processed differently in each. And while the two architectures produce essentially the same results, they don't go about it in the same way. In fact, directly comparing the features of some of these machines may give only part of the story.

For example, TI's brochure on the 57/58/59 compares the 224-step program memory of the HP-67/97 with the TI-59's maximum number of program steps (960). Looks like TI is ahead, right? But not if you look at the TI-59 architecture.

When the TI-59 is turned on, the program memory is configured with 480 steps, and there are 60 associated data registers, each able to store eight program steps. The TI-59 architecture permits you to allocate the data registers to program steps or the program memory to data. But if the machine is in the 960 program-step configuration, it can't store data, and you've got problems.

Using the 960 steps as your basis for comparison obscures the fact that the exceptionally versatile TI-59 can allocate nearly all the registers to data to handle a short program with many numbers, or allocate those registers to program steps for a long program with many operations, but few variables.

Meanwhile, HP contends that to get the 67/97's true capability, you should multiply 224 by 3. So-called "fully merged" codes are used in the HP architecture, which means that three keystrokes may be combined and executed as just one program step.



An independent printer that can be used with TI's SR-52, SR-56, TI-58 and TI-59, the PC-100A has a full line of alphanumeric plus 29 other useful symbols. A worthwhile feature is a lock that secures the calculator in place.

Some comparisons start out as direct, but end up giving you more to consider. For example, both the TI-59 and the HP-67/97 have magnetic card read/write units, with TI claiming a capacity of 480 steps per card, against 224 for HP. But HP counters with the intelligence built into its "smart" card reader. When you load a card into an HP machine, its reader knows which side of the card carries the first 112 steps and which carries the second. And it also knows if a step contains data or a program. And you don't need to tell the 67/97 the status and flags.

With the 67/97, you can also write a program that turns the card reader on automatically and pulls a card through—calculating all the while. With this technique, program cards can be chained together to give, at least theoretically, an infinite number of program steps. The TI-59's reader has this feature.

You can keep comparing calculator features, but it will all boil down to this: No single programmable has all of the most desirable features. Because so much processing and memory and control and computing powers are packed into the advanced hand-held marvels, it's tough to make meaningful comparisons from spec sheets and brochures.

Veterans of the programmable "wars" will tell you to beg or borrow a programmable from a friend; or get one on a trial basis. Working with a calculator, you will learn in a few days what you may not learn even after months of second-hand research and study.

The power of any programmable calculator is only as good as the programs that run it. But program development is expensive, and you pay more for machines supplied with program libraries. But the cost goes down when you consider the many hours you'd spend generating just a few of your own pro-

grams. And with ready-made programs, you can start out immediately.

One good thing about writing your own, however, is that as you develop a personal approach, your store-bought programs may not seem as good as they should be. You may want to rewrite them to make them shorter, easier to keep track of, or simply more comfortable to work with.

A major software benchmark when considering a programmable is the quality and depth of the machine's documentation. Check that the Owners Handbook or Owners Manual is comprehensive, and thoroughly describes the programming keys and their functions. And be sure there are plenty of clear sample programs with step-by-step explanations.

With the lower-cost machines, the Owners Manual will usually provide just a few programming examples. One exception is Sharp's PC-1201 programmable. Its instruction manual contains clear descriptions of the programming functions of the machine, along with a good sampling of test programs. But the bonus is a 266-page Application Manual listing 92 programs for math, statistics, electronics, engineering and other problems (See Fig. 2).

Preceding each program listing is its basic formula, a sample problem, and key-by-key directions for executing the program. Also, the program can be stored indefinitely in its special CMOS memory.

Software and documentation for HP and TI machines are ahead of the rest of the competition. And both companies continue to improve and enlarge their sizable libraries and Owners Manuals to capture a larger share of the programmable-calculator market.

In addition to their own software, both companies support in-house User Libraries of programs submitted by calculator owners. In line with this, newsletters from both manufacturers pass on program hints and announcements contributed by subscribers. HP's newsletter is "HP Key Notes" and TI's is the "PPX Exchange Newsletter."

For the new TI-58 and TI-59 machines, TI's Solid-State Software library modules include the Master Library, which comes with the calculator, and Applied Statistics, Aviation, Marine Navigation, Surveying and Real Estate/Investment. No EE library is available, and at the time of writing there hasn't been any indication that one will be. For TI-programmable-calculator users, another source of software news is the SR-52 Users Club in Dayton, OH, which reports on all TI models.

Software for HP's 67/97 machines is available in two forms. One is a 40-book series of \$10 "User Library Solutions," each containing 10 to 15 programs. Purchased separately they would cost \$35 to \$45. One book covers electrical engineering. Four books handle mathematics and three more have programs for chemistry, optics and physics. For these calculators, \$35 magnetic-card Application Pacs are also available.

One independent source of HP program information and news is the HP Users' Club in Santa Ana, CA.

The 2000-member club swaps programming techniques, applications and programs in its newsletter.

What about your old software?

Suppose you already have a programmable and want to step up to a new machine. You ask plaintively, "What do I do with the software that I've already spent a bundle on? Can I transfer my programs, say, from an SR-52 to a TI-59, or from an HP-65 to an HP-67?"

Yes you can. And HP and TI newsletters have run articles telling how. But an ELECTRONIC DESIGN survey of long-term users of both kinds of machines elicits the following advice: Transfer programs from old libraries directly, and you'll lose efficiency in the translation. The best and quickest approach is to rewrite them according to the new machine's rules.

The thousands of HP and TI programmables now in use have also created a demand for software not available from the manufacturers. To satisfy this demand, calculator-software houses are appearing. One is the International Software Clearinghouse in Estacada, OR, and another is Horizons Technology, Inc., in San Diego. ■■

Want more information?

Readers interested in learning more about the calculators mentioned in this article and of similar machines available may contact the manufacturers listed below or consult ELECTRONIC DESIGN'S GOLD BOOK. Types of calculators produced are indicated by the letters following the listing: P—preprogrammed; K—key programmable; M—magnetic-card programmable; S—solid-state-module programmable.

For readers who wish to learn more about the activities and services of the private calculator User's Clubs and of the software houses, the addresses are included below.

APF Electronics, Inc., 444 Madison Ave., New York, NY 10022. (212) 758-7550.
P. K. Circle No. 501
Canon, Inc., 10 Nevada Dr., Lake Success, NY 11040. (516) 488-6700. P.
Circle No. 502
Casio, Inc., 15 Gardner Rd., Fairfield, NJ 07006. (201) 575-7400. P. K.
Circle No. 503
Commodore Business Machines, 901 California Ave., Palo Alto, CA 94306.
(415) 326-4000. P. K. Circle No. 504
Hewlett-Packard, 1000 N.E. Circle Blvd., Corvallis, OR 97370. (503) 757-2000.
P. K. M. Circle No. 505
Kingspoint Corp., 104 Harbor Dr., Jersey City, NJ 07305. (201) 432-7707. P.
Circle No. 506
National Semiconductor, 1177 Kern Ave., Sunnyvale, CA 94086. (408)
732-5000. P. K. Circle No. 507
Sharp Electronics Corp., P.O. Box 588, Paramus, NJ 07652. (201) 265-5600.
P. K. Circle No. 508
Sinclair Radionics, Inc., 115 E. 57th St., New York, NY 10022. (212) 355-5005.
P. K. Circle No. 509
Texas Instruments, P.O. Box 53, MS 5842, Lubbock, TX 79408. (806) 747-3737.
P. K. M. S. Circle No. 510

Software clubs and houses:

HP Users Club, Richard J. Nelson, 2541 W. Camden Pl., Santa Ana, CA 92704.
(714) 639-7810.
SR-52 Users Club, Richard C. Vanderburgh, 9459 Taylorsville Rd., Dayton, OH
45424. (513) 255-6502.
International Software Clearinghouse, Route 2, Box 965, Estacada, OR 97023.
(503) 631-2214.
Horizons Technology, Inc., 8333 Clairemont Mesa Blvd., San Diego, CA 92111.
(714) 292-8331.

PRECISION SIGNALS

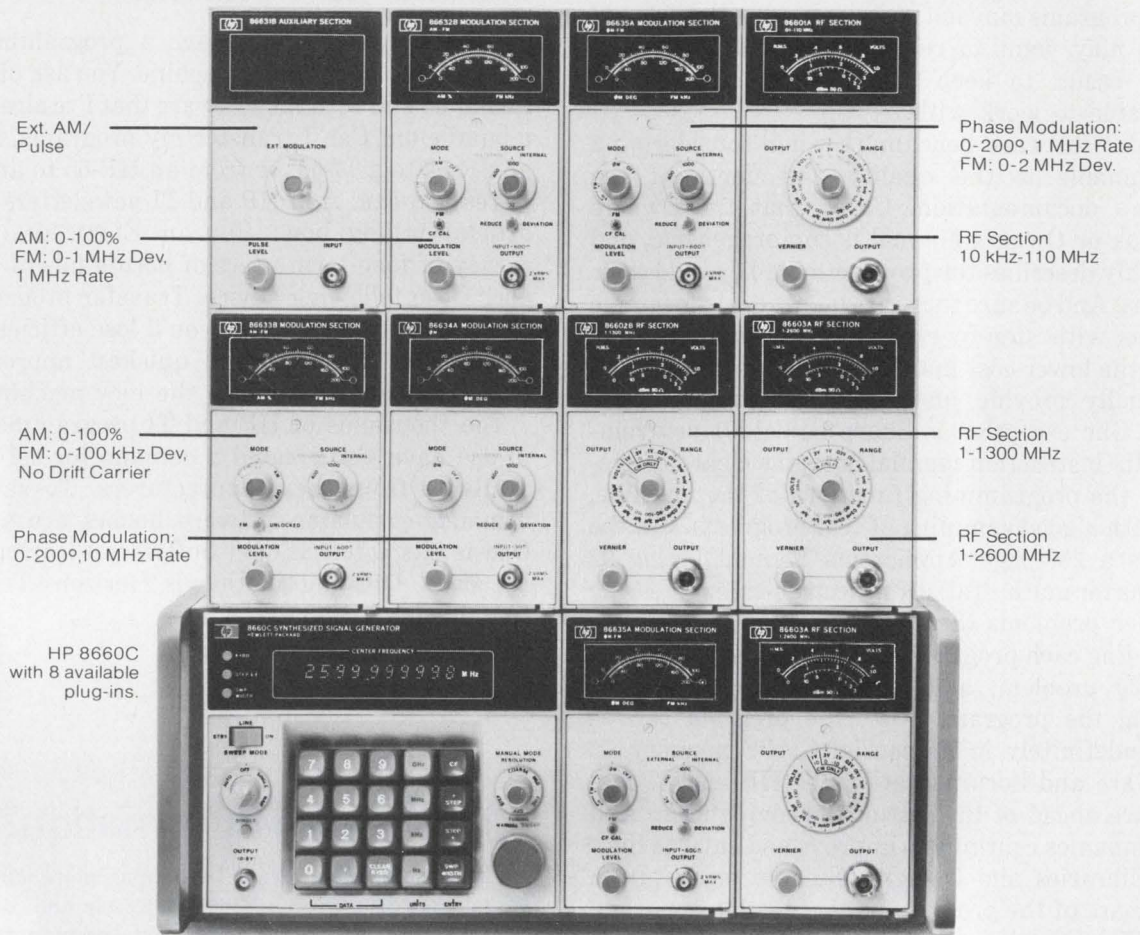

FROM 10 kHz TO 2600 MHz.

Your broadest selection of precision signals.

Choose a modulation capability for your exact frequency range. You can get the precise combination for the signals you need. And you won't

find a broader selection of modulation and output capabilities on the synthesizer market.

For manual operation, choose the HP 8660C mainframe. It features keyboard entry, digital readout, 1 or 2 Hz resolution, digital sweep, good signal purity and the operating convenience you need.

For systems operation, the HP 8660A mainframe features thumbswitch entry.

Both mainframes are completely programmable with the HP Interface Bus (IEEE 488) or BCD.

Complete systems start at \$10,350* and a typical keyboard mainframe with 1300 MHz output and AM-FM modulation is \$19,875*.

For our 20 page brochure describing HP's synthesized signal generator call your nearby HP field sales office, or write.

*Domestic U.S. prices only.



1507 Page Mill Road, Palo Alto, California 94304

For assistance call: Washington (301) 948-6370, Chicago (312) 256-9800, Atlanta (404) 955-1500, Los Angeles (213) 877-1282

CIRCLE NUMBER 65

HYBRID



IN A MARKET FULL OF DROPOUTS, OUR NEW REGULATORS ARE PHI BETA KAPPA.

Fairchild is introducing two new Linear regulators that are a study in efficiency. Our μ A78HO5ASC 5-amp positive voltage regulator. And our μ A78PO5SC 10-amp positive voltage regulator.

They're designed to provide extremely low dropout voltage — typically 2 volts at 5 amps on the μ A78HO5ASC and 2.2 volts at 10 amps on the μ A78PO5SC. And as any student of regulators knows, dropout like this just isn't available with monolithic designs.

STRAIGHT "A" PERFORMANCE.

Since lower dropout voltage provides more efficient power supply designs, these regulators, like all Fairchild voltage regulators, require fewer components than traditional designs. And that reduces design time considerably.

Features include short-circuit and safe-area protection, thermal shutdown and hermetically sealed TO-3 packages. And all this at the same price you'd expect to be paying for regulators that graduate at the bottom of their class. In fact, you can start designing in our new regulators for as little as \$5.00 in quantities of 100 (μ A78HO5ASC).

IF YOU HAVE QUESTIONS, PLEASE RAISE YOUR HAND.

For more details on our new enhanced voltage regulators, or information on our other Hybrid products, contact your Fairchild distributor or representative. Or, for immediate results, call your nearest Fairchild sales office.

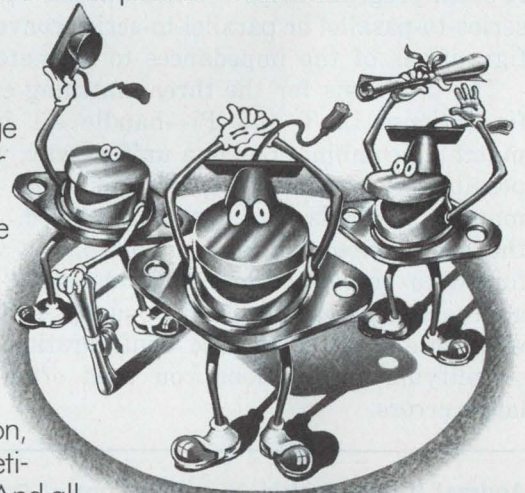

FAIRCHILD

CALL US ON IT.

France: Fairchild Camera & Instrument S.A., 121 Ave. d'Italie, 750013 — Paris. Tel: 00331 584 55 66. Telex: 0042 200614. Italy: Fairchild Semiconduttori S.P.A., Via Rosellini, 12, 20124 Milano. Tel: 02 6887451. Telex: 36522. Germany: Fairchild Camera & Instrument (Deutschland) GmbH, 8046 Garching Hockbruck Daimlerstr. 15, Munchen. Tel: 089 320031. Telex: 52 4831 fair d. England: Fairchild Camera & Instrument (UK) Ltd., 230 High St., Potters Bar, Hertfordshire EN6 5BU. Tel: 0707 51111. Telex: 0051 262835. Sweden: Fairchild Semiconductor AB, Svartengsgatan 6, S-11620 Stockholm. Tel: 8-449255. Telex: 17759.

Simplify conjugate bilateral matching

of complex impedances. A unified approach provides practical L, Pi or T solutions with a low-cost programmable calculator.

Matching complex impedances is an everyday but tedious circuit-design problem, especially in rf work. Now you can save time and reduce errors with five programs for an HP-25 that quickly and easily calculate L, Pi or T-circuit solutions for conjugate bilateral matching of a load to a source. One program solves L circuits, and the Pi and T circuits each need two. A sixth program helps the calculations by providing series-to-parallel or parallel-to-series conversion configurations of the impedances to be matched.

The programs for the three matching circuit configurations—L, T and Pi—handle all impedance-matching combinations in a unified way, which isn't possible with most other methods. With the many manual methods you may have used, to reduce the large amount of labor involved, you were often forced to employ widely differing and "ingenious" approaches for each problem. Usually, each approach was limited to a specific configuration. And the simplifying assumptions you used often produced large errors.

Andrzej B. Przedpelski, Vice President of Development, A.R.F. Products Inc., 2559 75th St., Boulder, CO 80301.

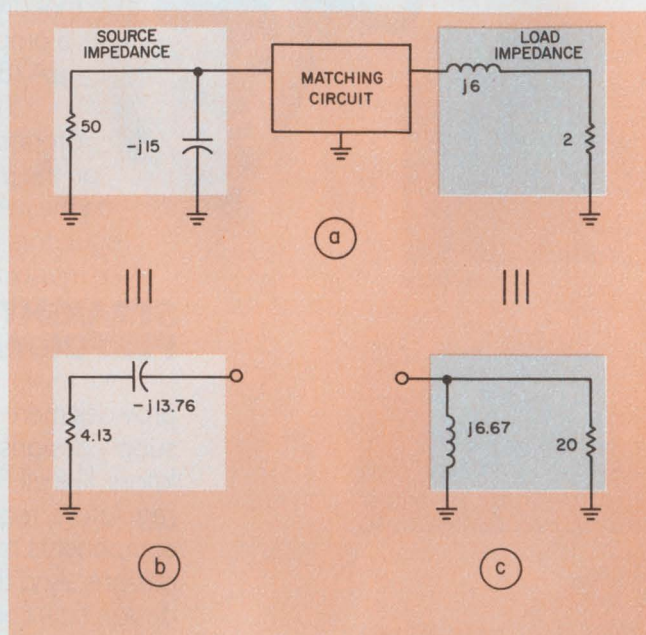

1. The first step in matching impedances is to convert the source and load impedances (a) into the most convenient form for doing the subsequent calculations. Parallel configurations (b) can be converted to series, and vice versa (c), depending upon use of an L, T or Pi.

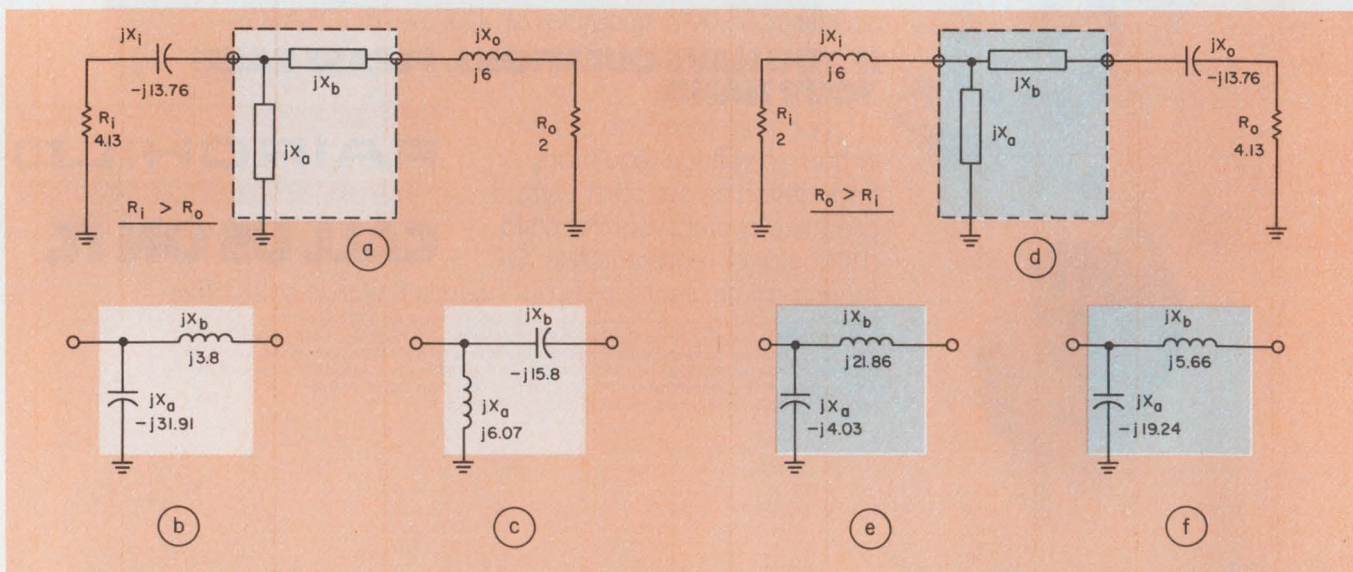

2. An L-section matching circuit (a) can have two solutions—a low (b) and high-pass form (c)—when $R_i > R_o$.

However, by reorienting the L matcher (d) so that $R_o < R_i$, you can often obtain two more solutions (e and f).

Table 1. Parallel/Series/Parallel/Transformations

| Display | | Key Entry | Remarks | Registers |
|---------|-------|-----------|----------------|-------------------------------|
| Line | Code | | | |
| 00 | | | | R ₀ |
| 01 | 24 02 | RCL 2 | | |
| 02 | 15 71 | (g) x=0 | | |
| 03 | 13 15 | GTO 15 | | R ₁ R _p |
| 04 | 15 22 | (g) 1/x | | |
| 05 | 24 01 | RCL 1 | | |
| 06 | 15 22 | (g) 1/x | | R ₂ X _p |
| 07 | 15 09 | (g) →P | | |
| 08 | 15 22 | (g) 1/x | | |
| 09 | 14 09 | (f) →R | | R ₃ R _s |
| 10 | 23 03 | STO 3 | R _s | |
| 11 | 74 | R/S | | |
| 12 | 21 | xzy | | R ₄ |
| 13 | 23 04 | STO 4 | X _s | |
| 14 | 74 | R/S | | |
| 15 | 24 04 | RCL 4 | | R ₅ |
| 16 | 24 03 | RCL 3 | | |
| 17 | 15 09 | (g) →P | | |
| 18 | 15 22 | (g) 1/x | | R ₆ |
| 19 | 14 09 | (f) →R | | |
| 20 | 15 22 | (g) 1/x | | |
| 21 | 23 01 | STO 1 | R _p | R ₇ |
| 22 | 74 | R/S | | |
| 23 | 21 | xzy | | |
| 24 | 15 22 | (g) 1/x | | |
| 25 | 23 02 | STO 2 | X _p | |
| 26 | 13 00 | GTO 00 | | |

| Step | Instructions | Input Data/Units | Keys | Output Data/Units |
|------|-------------------|------------------|----------------|----------------------------------|
| 1 | STORE | R _p | STO 1 | |
| | | X _p | STO 2 | |
| | | O | STO 3 | |
| | | O | STO 4 | |
| 2 | CALCULATE | O | STO 1 | |
| | | O | STO 2 | |
| | | R _s | STO 3 | |
| | | X _s | STO 4 | |
| 3 | RECALL (TO CHECK) | | R/S | R _s or R _p |
| | | | R/S | X _s or X _p |
| | | | RCL 1 | R _p |
| | | | RCL 2 | X _p |
| | | RCL 3 | R _s | |
| | | RCL 4 | X _s | |

The HP-25 fits the bill because it has just the amount of memory needed. Although the programs aren't the shortest possible, they have been written so that they can be converted easily for use on an algebraic-type calculator. A calculator without the programming feature also can be used; however, some flexibility is lost and errors will increase.

While the HP-25 programs don't provide the optimum matching solution automatically, they allow you to perform rapid "trials" of the three matching-circuit configurations with all possible solutions of each.

Your choice of configuration is usually dictated by:

- Whether you desire a low or a high-pass circuit.
- The effect of including stray and coupled-circuit reactances as part of the matching circuit's components.
- How much bandwidth the matching circuit should have. Unfortunately, the programs can't work directly with bandwidth: They employ the matching circuit's Q. As a matching network's Q goes up, the circuit's bandwidth goes down. Also, the greater the difference between the real parts of the matched impedances, the less bandwidth the matching circuit will have.

But before you start the calculations, you may have to convert the forms of the load and source impedances into series or parallel forms.

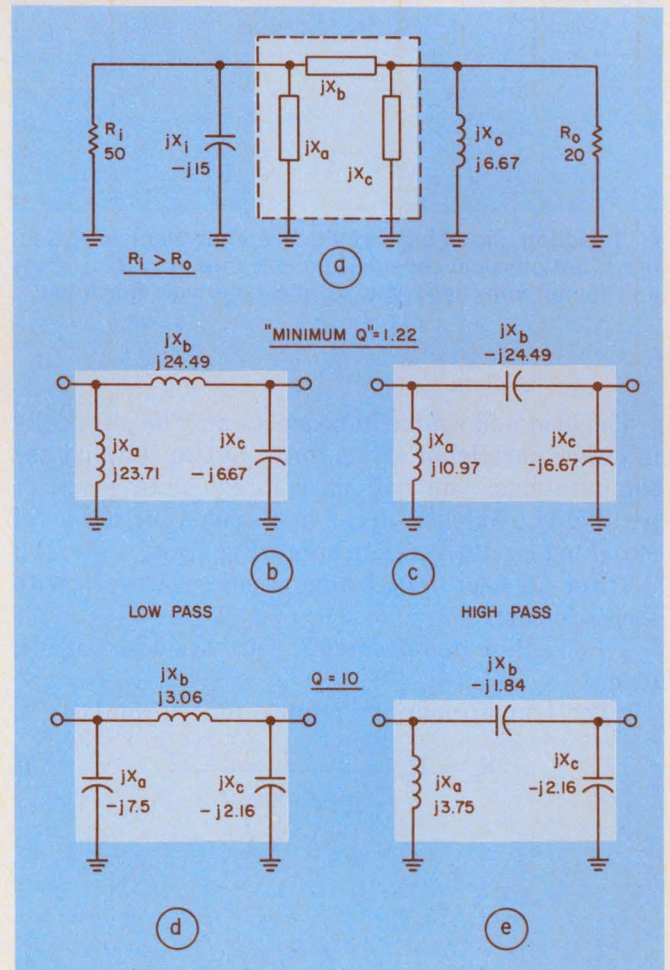

3. Pi-section matching circuits (a) allow you to choose circuit Q. Wideband matching is obtained with "minimum-Q" solutions (b and c); more selective circuits (d and e) are solved with Q = 10.

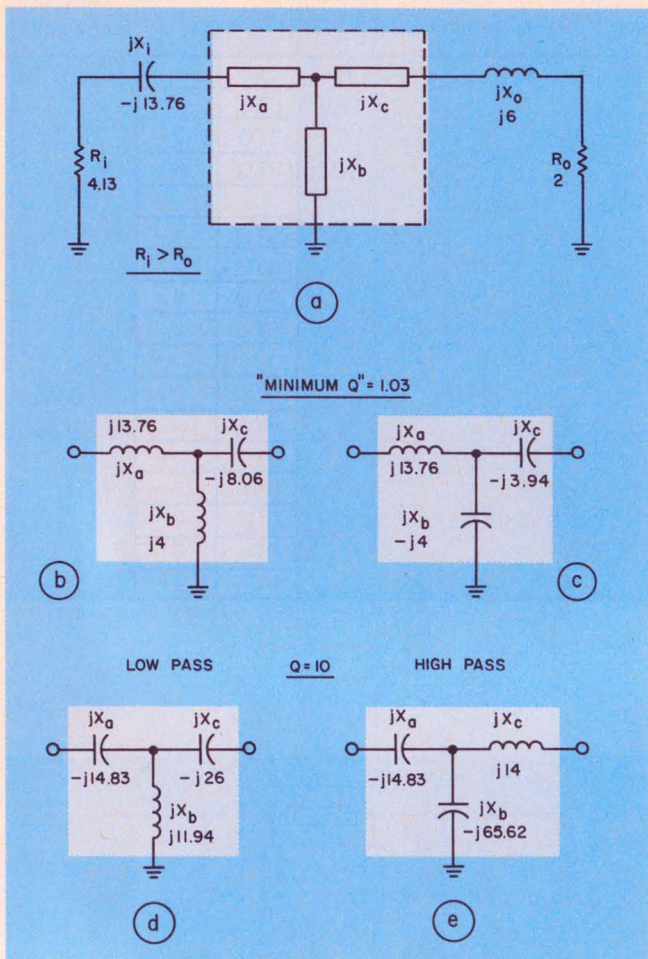

4. T-section matching circuits are equivalent to Pi-sections, but physical considerations, component size, costs and layout may lead you to one type over the other.

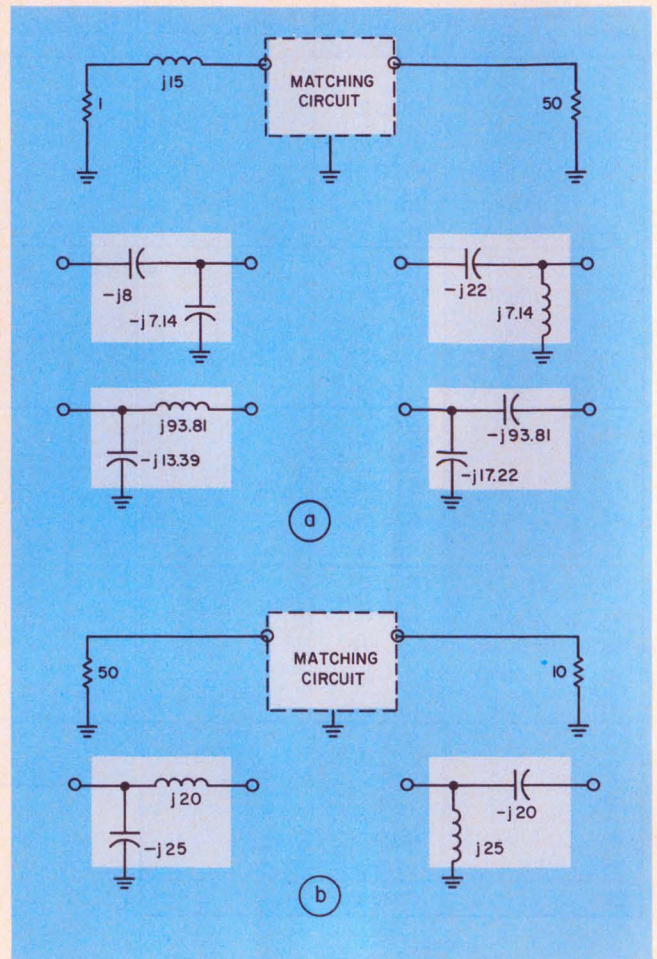

5. The load may have no reactive impedance (a) or both source and load may have no reactive impedance (b), but the programs can handle either case.

The load and source impedances may be physically in either parallel or series form. But to simplify the computations, you will have to calculate series or parallel equivalents, depending upon your choice of matching-circuit configuration (Fig. 1a):

- For an L or T matching circuit, you work with series forms.
- For a Pi matching circuit, you work with parallel forms.

The transformations require four formulas:

$$R_s = R_p \frac{1}{1 + \left(\frac{R_p}{X_p}\right)^2}, \quad (1)$$

$$X_s = X_p \frac{\left(\frac{R_p}{X_p}\right)^2}{1 + \left(\frac{R_p}{X_p}\right)^2}, \quad (2)$$

$$R_p = R_s \left[1 + \left(\frac{X_s}{R_s}\right)^2 \right], \quad (3)$$

$$X_p = X_s \frac{1 + \left(\frac{X_s}{R_s}\right)^2}{\left(\frac{X_s}{R_s}\right)^2}. \quad (4)$$

Subscripts "p" denote parallel resistances and reactances and subscripts "s" denote series.

The program that performs these transformations (Table 1) uses polar coordinates, because polars need fewer steps. Parallel values stored in registers [R₁] and [R₂] are transformed to series values and stored in registers [R₃] and [R₄], or series stored in [R₃] and [R₄] are transformed to [R₁] and [R₂]. But before you enter data always remember to clear the two registers not used to enter data.

Note: The program's R/S steps (11, 14 and 22) can be deleted, but then the answers won't be displayed,

Table 2. L Section matching

| Display | | Key Entry | Remarks | Registers |
|---------|-------|--------------------|----------------|-------------------------------|
| Line | Code | | | |
| 00 | | | | R ₀ Q |
| 01 | 24 02 | RCL 2 | | |
| 02 | 24 01 | RCL 1 | | |
| 03 | 15 09 | (g)→P | | R ₁ R _i |
| 04 | 15 22 | (g) 1/x | | |
| 05 | 14 09 | (f)→R | | |
| 06 | 15 22 | (g) 1/x | | R ₂ X _i |
| 07 | 24 03 | RCL 3 | | |
| 08 | 71 | ÷ | | |
| 09 | 01 | 1 | | R ₃ R _o |
| 10 | 41 | — | | |
| 11 | 14 02 | (f)/x | Q | |
| 12 | 23 00 | STO 0 | | R ₄ X _o |
| 13 | 74 | R/S | | |
| 14 | 24 03 | RCL 3 | | |
| 15 | 61 | X | | R ₅ X _a |
| 16 | 24 04 | RCL 4 | | |
| 17 | 41 | — | | |
| 18 | 23 06 | STO 6 | X _b | R ₆ X _b |
| 19 | 74 | R/S | | |
| 20 | 24 01 | RCL 1 | | |
| 21 | 15 02 | (g) x ² | | R ₇ |
| 22 | 24 02 | RCL 2 | | |
| 23 | 15 02 | (g) x ² | | |
| 24 | 51 | + | | |
| 25 | 24 00 | RCL 0 | | |
| 26 | 24 01 | RCL 1 | | |
| 27 | 61 | X | | |
| 28 | 24 02 | RCL 2 | | |
| 29 | 51 | + | | |
| 30 | 71 | ÷ | | |
| 31 | 32 | CHS | | |
| 32 | 23 05 | STO 5 | X _a | |
| 33 | 74 | R/S | | |
| 34 | 24 00 | RCL 0 | | |
| 35 | 32 | CHS | | |
| 36 | 13 12 | GTO 12 | | |

| Step | Instructions | Input Data/Units | Keys | Output Data/Units |
|------|--|------------------|-------|-------------------|
| 1 | STORE | R _i | STO 1 | |
| | | X _i | STO 2 | |
| | | R _o | STC 3 | |
| | | X _o | STO 4 | |
| 2 | CALCULATE LOWPASS CONFIGURATION | | R/S | Q |
| | | | R/S | X _b |
| | | | R/S | X _a |
| 3 | RECALL (TO CHECK LOWPASS) | | RCL 1 | R _i |
| | | | RCL 2 | X _i |
| | | | RCL 3 | R _o |
| | | | RCL 4 | X _o |
| | | | RCL 5 | X _a |
| | | | RCL 6 | X _b |
| 4 | CALCULATE HIGHPASS CONFIGURATION | | R/S | -Q |
| | | | R/S | X _b |
| | | | R/S | X _a |
| 5 | RECALL (TO CHECK HIGHPASS) | | RCL 1 | R _i |
| | | | RCL 2 | X _i |
| | | | RCL 3 | R _o |
| | | | RCL 4 | X _o |
| | | | RCL 5 | X _a |
| | | | RCL 6 | X _b |

just stored. Delete the store steps (10, 13, 21 and 25), and the answers will be displayed only.

The complex source and load impedances shown in Fig. 1a will be used throughout to illustrate application of the programs. The parallel source impedance was transformed into serial form (Fig. 1b) and the series load impedance into parallel (Fig. 1c) with the program in Table 1. In solving matching problems, you use the appropriate form depending upon the matching circuit.

Using L matching circuits

If the impedances to be matched happen to be in series form, a simple L matching circuit is a good first

approach to solving the matching problem (Fig. 2a). The applicable equations for obtaining the impedances of a matching L are

$$X_a = \frac{R_i^2 + X_i^2}{QR_i + X_i} \tag{5}$$

and

$$X_b = QR_o - X_o, \tag{6}$$

where Q is defined as

$$Q = \pm \sqrt{\left(\frac{R_i \left[1 + \left(\frac{X_i}{R_i} \right)^2 \right]}{R_o} - 1 \right)} \tag{7}$$

And the program for solving these equations is in Table 2.

Note that since Q can be positive or negative, X_a and X_b can have a low or a high-pass configuration. (Figs. 2b or 2c). Most other methods for matching with an L consider only the low-pass solution. While such an approach always gives a valid answer, your application might be better served with a high-pass matching circuit.

Furthermore, note in Fig. 2a that X_a is attached to the port facing the external network with the highest resistance, since R_i > R_o. Again, while other methods

Table 3. Pi Section matching (Lowest Q)

| Display | | Key Entry | Remarks | Registers | |
|---------|-------|-----------|----------------|----------------|----------------|
| Line | Code | | | | |
| 00 | | | | R ₀ | Q |
| 01 | 24 04 | RCL 4 | | | |
| 02 | 32 | CHS | | | |
| 03 | 23 07 | STO 7 | X _c | R ₁ | R _i |
| 04 | 74 | R/S | | | |
| 05 | 24 01 | RCL 1 | | | |
| 06 | 24 03 | RCL 3 | | R ₂ | X _i |
| 07 | 71 | ÷ | | | |
| 08 | 01 | 1 | | | |
| 09 | 41 | — | | R ₃ | R _o |
| 10 | 14 02 | (f)√x | | | |
| 11 | 23 00 | STO 0 | Q | | |
| 12 | 74 | R/S | | R ₄ | X _o |
| 13 | 24 03 | RCL 3 | | | |
| 14 | 61 | X | | | |
| 15 | 23 06 | STO 6 | X _b | R ₅ | X _a |
| 16 | 74 | R/S | | | |
| 17 | 24 00 | RCL 0 | | | |
| 18 | 24 01 | RCL 1 | | R ₆ | X _b |
| 19 | 15 22 | (g) 1/x | | | |
| 20 | 61 | X | | | |
| 21 | 24 02 | RCL 2 | | R ₇ | X _c |
| 22 | 15 22 | (g) 1/x | | | |
| 23 | 51 | + | | | |
| 24 | 15 22 | (g) 1/x | | | |
| 25 | 32 | CHS | | | |
| 26 | 23 05 | STO 5 | X _a | | |
| 27 | 74 | R/S | | | |
| 28 | 24 00 | RCL 0 | | | |
| 29 | 32 | CHS | | | |
| 30 | 13 11 | GTO 11 | | | |

| Step | Instructions | Input Data/Units | Keys | Output Data/Units |
|------|--|------------------|-------|-------------------|
| 1 | STORE | R _i | STO 1 | |
| | | X _i | STO 2 | |
| | | R _o | STO 3 | |
| | | X _o | STO 4 | |
| 2 | CALCULATE LOWPASS CONFIGURATION | | R/S | X _c |
| | | | R/S | Q |
| | | | R/S | X _b |
| | | | R/S | X _a |
| 3 | RECALL (TO CHECK LOWPASS) | | RCL 0 | Q |
| | | | RCL 1 | R _i |
| | | | RCL 2 | X _i |
| | | | RCL 3 | R _o |
| | | | RCL 4 | X _o |
| | | | RCL 5 | X _a |
| | | | RCL 6 | X _b |
| 4 | CALCULATE HIGHPASS CONFIGURATION | | R/S | -Q |
| | | | R/S | X _b |
| | | | R/S | X _a |
| 5 | RECALL (TO CHECK HIGHPASS) | | RCL 0 | -Q |
| | | | RCL 1 | R _i |
| | | | RCL 2 | X _i |
| | | | RCL 3 | R _o |
| | | | RCL 4 | X _o |
| | | | RCL 5 | X _a |
| | | | RCL 6 | X _b |
| | RCL 7 | X _c | | |

usually limit the configuration to this orientation and thus you are assured of valid solutions, you often can get two more solutions by turning the L circuit around.

In Fig. 2d, the input and output circuits are interchanged, so that R_o > R_i. Both new solutions, Figs. 2e and 2f, have low-pass configurations.

It's wise to explore all possibilities for the most convenient or economical component selections. If you prefer a low-pass solution, Fig. 2f might be a better compromise of inductor-vs-capacitor sizes than Figs. 2a or 2e. But if you want a high-pass matching circuit, your only choice is Fig. 2c.

However, with the R_o > R_i arrangement, you don't always get a viable solution—the value of Q could come out imaginary. For example, if X_i in Fig. 2d is reduced from j6 to j2, the answer is unusable. In such a case, the program will provide automatically an "error" indication in step 11 to show that Q is imaginary.

Matching with a Pi or T circuit

But if you want to be assured of the widest possible bandwidth you must use a Pi or T matching circuit.

A Pi or T matching circuit uses one more component than the L, but gives you more flexibility in choosing bandwidth. To get the maximum possible bandwidth, you must use a so-called "minimum-Q" solution, which also provides the lowest insertion loss for components having the same Q value.

For a Pi matcher, the parallel forms of the input and output circuits of Fig. 1a are used (Fig. 3a) and the applicable equations are

$$X_c = -X_o, \tag{8}$$

$$X_b = R_o Q_{min}, \tag{9}$$

$$X_a = \frac{-1}{\frac{1}{X_i} + \frac{Q_{min}}{R_i}}, \tag{10}$$

where the minimum Q is

$$Q_{min} = \pm \sqrt{\frac{R_i}{R_o} - 1}. \tag{11}$$

The program in Table 3 gives a low-pass and a high-pass configuration for the positive and negative values of Q_{min}. Calculated matching sections for these two cases are shown in Figs. 3b and 3c.

Table 4. T Section matching (Lowest Q)

| Display | | Key Entry | Remarks | Registers |
|---------|-------|-----------|----------------|-------------------------------|
| Line | Code | | | |
| 00 | | | | R ₀ Q |
| 01 | 24 01 | RCL 1 | | |
| 02 | 24 03 | RCL 3 | | |
| 03 | 71 | ÷ | | R ₁ R _i |
| 04 | 01 | 1 | | |
| 05 | 41 | — | | |
| 06 | 14 02 | (f) √x | | R ₂ X _i |
| 07 | 24 00 | STO 0 | Q | |
| 08 | 74 | R/S | | |
| 09 | 24 02 | RCL 2 | | R ₃ R ₀ |
| 10 | 32 | CHS | | |
| 11 | 23 05 | STO 5 | X _a | |
| 12 | 74 | R/S | | R ₄ X ₀ |
| 13 | 24 01 | RCL 1 | | |
| 14 | 24 00 | RCL 0 | | |
| 15 | 71 | ÷ | | R ₅ X _a |
| 16 | 23 06 | STO 6 | X _b | |
| 17 | 74 | R/S | | |
| 18 | 24 03 | RCL 3 | | R ₆ X _b |
| 19 | 24 00 | RCL 0 | | |
| 20 | 61 | X | | |
| 21 | 24 04 | RCL 4 | | R ₇ X _c |
| 22 | 51 | + | | |
| 23 | 32 | CHS | | |
| 24 | 23 07 | STO 7 | X _c | |
| 25 | 74 | R/S | | |
| 26 | 24 00 | RCL 0 | | |
| 27 | 32 | CHS | | |
| 28 | 13 07 | GTO 07 | | |

| Step | Instructions | Input Data/Units | Keys | Output Data/Units |
|------|--|------------------|-------|-------------------|
| 1 | STORE | R _i | STO 1 | |
| | | X _i | STO 2 | |
| | | R ₀ | STO 3 | |
| | | X ₀ | STO 4 | |
| 2 | CALCULATE LOWPASS CONFIGURATION | | R/S | Q |
| | | | R/S | X _a |
| | | | R/S | X _b |
| | | | R/S | X _c |
| 3 | RECALL (TO CHECK LOWPASS) | | RCL 0 | Q |
| | | | RCL 1 | R _i |
| | | | RCL 2 | X _i |
| | | | RCL 3 | R ₀ |
| | | | RCL 4 | X ₀ |
| | | | RCL 5 | X _a |
| | | | RCL 6 | X _b |
| 4 | CALCULATE HIGHPASS CONFIGURATION | | R/S | -Q |
| | | | R/S | X _a |
| | | | R/S | X _b |
| | | | R/S | X _c |
| 5 | RECALL (TO CHECK HIGHPASS) | | RCL 0 | -Q |
| | | | RCL 1 | R _i |
| | | | RCL 2 | X _i |
| | | | RCL 3 | R ₀ |
| | | | RCL 4 | X ₀ |
| | | | RCL 5 | X _a |
| | | | RCL 6 | X _b |
| | RCL 7 | X _c | | |

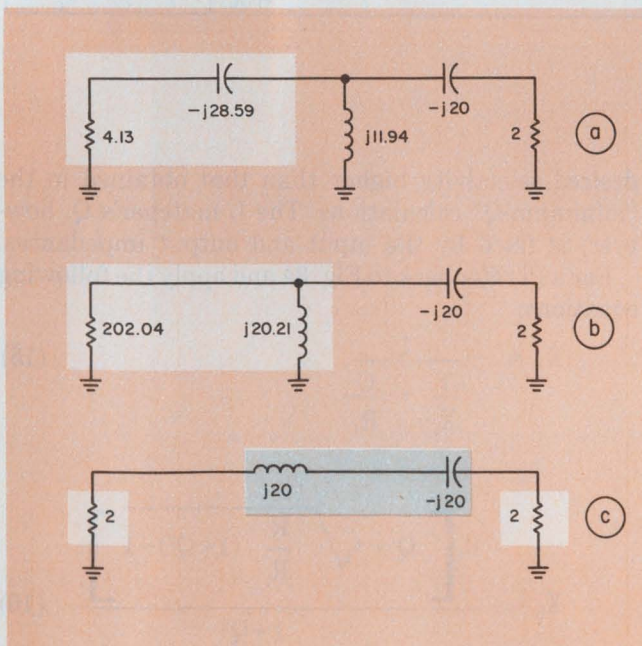

6. To check a solution such as the T section in Fig 4d, you add the source side's series configuration to the left series impedance of the T (a). Then the left-side capacitor and resistor, converted to a parallel form, are combined (b). Finally, reconverting the left side to series shows that the reactances cancel and real parts are equal (c).

Note the following precautions for the program:

- If you have no X_i or X₀ value, store the number 10⁹⁹ (infinity) in its place.
- Orient the Pi so that R_i is always larger than R₀.

Also note that reactance X_c is the same in both low and high-pass solutions.

Similarly, a T matching circuit with characteristics like the Pi can be used for wideband work. Now, the series form of the input and output circuits is used (Fig. 4a), and the applicable equations are

$$X_a = -X_i, \quad (12)$$

$$X_b = \frac{R_i}{Q_{\min}}, \quad (13)$$

$$X_c = -(X_0 + R_0 Q_{\min}), \quad (14)$$

where Q_{min} is defined as in Eq. 11 for Pi matchers, and also, only where R_i > R₀. Table 4 contains the program for solving these equations. Figs. 4b and 4c show the solutions.

Table 5. Pi Section matching (Higher selectivity)

| Display | | Key Entry | Remarks | Registers |
|---------|-------|--------------------|----------------|-------------------------------|
| Line | Code | | | |
| 00 | | | | R ₀ Q |
| 01 | 24 00 | RCL 0 | | |
| 02 | 24 01 | RCL 1 | | |
| 03 | 71 | ÷ | | R ₁ R _i |
| 04 | 24 02 | RCL 2 | | |
| 05 | 15 22 | (g) 1/x | | |
| 06 | 51 | + | | R ₂ X _i |
| 07 | 15 22 | (g) 1/x | | |
| 08 | 32 | CHS | | |
| 09 | 23 05 | STO 5 | X _a | R ₃ R ₀ |
| 10 | 74 | R/S | | |
| 11 | 24 00 | RCL 0 | | |
| 12 | 15 02 | (g) x ² | | R ₄ X ₀ |
| 13 | 01 | 1 | | |
| 14 | 51 | + | | |
| 15 | 23 06 | STO 6 | | R ₅ X _a |
| 16 | 24 03 | RCL 3 | | |
| 17 | 61 | X | | |
| 18 | 24 01 | RCL 1 | | R ₆ X _b |
| 19 | 71 | ÷ | | |
| 20 | 01 | 1 | | |
| 21 | 41 | - | | R ₇ X _c |
| 22 | 14 02 | (f) √x | | |
| 23 | 23 07 | STO 7 | | |
| 24 | 24 00 | RCL 0 | | |
| 25 | 51 | + | | |
| 26 | 24 01 | RCL 1 | | |
| 27 | 61 | X | | |
| 28 | 24 06 | RCL 6 | | |
| 29 | 71 | ÷ | | |
| 30 | 23 06 | STO 6 | X _b | |
| 31 | 74 | R/S | | |
| 32 | 24 07 | RCL 7 | | |
| 33 | 24 03 | RCL 3 | | |
| 34 | 71 | ÷ | | |
| 35 | 24 04 | RCL 4 | | |
| 36 | 15 22 | (g) 1/x | | |
| 37 | 51 | + | | |
| 38 | 15 22 | (g) 1/x | | |
| 39 | 32 | CHS | | |
| 40 | 23 07 | STO 7 | X _c | |
| 41 | 74 | R/S | | |
| 42 | 24 00 | RCL 0 | | |
| 43 | 32 | CHS | | |
| 44 | 23 00 | STO 0 | | |
| 45 | 13 02 | GTO 02 | | |

| Step | Instructions | Input Data/Units | Keys | Output Data/Units |
|------|--|------------------|-------|-------------------|
| 1 | STORE | Q | STO 0 | |
| | | R _i | STO 1 | |
| | | X _i | STO 2 | |
| | | R ₀ | STO 3 | |
| | | X ₀ | STO 4 | |
| 2 | CALCULATE LOWPASS CONFIGURATION | | R/S | X _a |
| | | | R/S | X _b |
| | | | R/S | X _c |
| 3 | RECALL (TO CHECK LOWPASS) | | RCL 0 | Q |
| | | | RCL 1 | R _i |
| | | | RCL 2 | X _i |
| | | | RCL 3 | R ₀ |
| | | | RCL 4 | X ₀ |
| | | | RCL 5 | X _a |
| | | | RCL 6 | X _b |
| 4 | CALCULATE HIGHPASS CONFIGURATION | | R/S | X _a |
| | | | R/S | X _b |
| | | | R/S | X _c |
| 5 | RECALL (TO CHECK HIGHPASS) | | RCL 0 | -Q |
| | | | RCL 1 | R _i |
| | | | RCL 2 | X _i |
| | | | RCL 3 | R ₀ |
| | | | RCL 4 | X ₀ |
| | | | RCL 5 | X _a |
| | | | RCL 6 | X _b |
| | RCL 7 | X _c | | |

desired selectivity higher than that obtained in the "minimum-Q" calculations. The L matcher's Q, however, is fixed by the input and output impedances.

For a Pi refer back to Fig. 3a and apply the following equations:

$$X_a = - \frac{1}{\frac{1}{X_i} + \frac{Q}{R_i}} \quad (15)$$

$$X_b = \frac{R_i \left[Q + \sqrt{\frac{R_0}{R_i} (1+Q^2) - 1} \right]}{1+Q^2} \quad (16)$$

$$X_c = \frac{1}{\frac{1}{R_0} \sqrt{\frac{R_0}{R_i} (1+Q^2) - 1} + \frac{1}{X_0}} \quad (17)$$

However, additional solutions are possible with Pi and T matching circuits with larger Qs. Where an L matcher has at most four solutions, both Pi and T matchers can have almost unlimited numbers, depending on your choice of Q.

You can design Pi and T circuits for almost any

Table 6. T Section matching (Higher selectivity)

| Display | | Key Entry | Remarks | Registers |
|---------|-------|--------------------|----------------|-------------------------------|
| Line | Code | | | |
| 00 | | | | R ₀ Q |
| 01 | 24 00 | RCL 0 | | |
| 02 | 24 03 | RCL 3 | | |
| 03 | 61 | X | | R ₁ R _i |
| 04 | 24 04 | RCL 4 | | |
| 05 | 51 | + | | |
| 06 | 32 | CHS | | R ₂ X _i |
| 07 | 23 07 | STO 7 | X _c | |
| 08 | 74 | R/S | | |
| 09 | 24 00 | RCL 0 | | R ₃ R _o |
| 10 | 15 02 | (g) X ² | | |
| 11 | 01 | 1 | | |
| 12 | 51 | + | | R ₄ X _o |
| 13 | 24 03 | RCL 3 | | |
| 14 | 61 | X | | |
| 15 | 23 06 | STO 6 | | R ₅ X _a |
| 16 | 24 01 | RCL 1 | | |
| 17 | 71 | ÷ | | |
| 18 | 01 | 1 | | R ₆ X _b |
| 19 | 41 | - | | |
| 20 | 14 02 | (f) √x | | |
| 21 | 24 01 | RCL 1 | | R ₇ X _c |
| 22 | 61 | X | | |
| 23 | 32 | CHS | | |
| 24 | 24 02 | RCL 2 | | |
| 25 | 41 | - | | |
| 26 | 23 05 | STO 5 | X _a | |
| 27 | 74 | R/S | | |
| 28 | 24 06 | RCL 6 | | |
| 29 | 24 06 | RCL 6 | | |
| 30 | 24 01 | RCL 1 | | |
| 31 | 71 | ÷ | | |
| 32 | 01 | 1 | | |
| 33 | 41 | - | | |
| 34 | 14 02 | (f) √x | | |
| 35 | 24 00 | RCL 0 | | |
| 36 | 51 | + | | |
| 37 | 71 | ÷ | | |
| 38 | 23 06 | STO 6 | X _b | |
| 39 | 74 | R/S | | |
| 40 | 24 00 | RCL 0 | | |
| 41 | 32 | CHS | | |
| 42 | 23 00 | STO 0 | | |
| 43 | 13 02 | GTO 02 | | |

| Step | Instructions | Input Data/Units | Keys | Output Data/Units |
|------|--|---|----------------|-------------------|
| 1 | STORE | Q R _i X _i R _o X _o | STO 0 | |
| | | | STO 1 | |
| | | | STO 2 | |
| | | | STO 3 | |
| | | | STO 4 | |
| 2 | CALCULATE LOWPASS CONFIGURATION | | R/S | X _c |
| | | | R/S | X _a |
| | | | R/S | X _b |
| | | | | |
| 3 | RECALL (TO CHECK LOWPASS) | | RCL 0 | Q |
| | | | RCL 1 | R _i |
| | | | RCL 2 | X _i |
| | | | RCL 3 | R _o |
| | | | RCL 4 | X _o |
| | | | RCL 5 | X _a |
| | | | RCL 6 | X _b |
| 4 | CALCULATE HIGHPASS CONFIGURATION | | R/S | X _c |
| | | | R/S | X _a |
| | | | R/S | X _b |
| 5 | RECALL (TO CHECK HIGHPASS) | | RCL 0 | -Q |
| | | | RCL 1 | R _i |
| | | | RCL 2 | X _i |
| | | | RCL 3 | R _o |
| | | | RCL 4 | X _o |
| | | | RCL 5 | X _a |
| | | | RCL 6 | X _b |
| | | RCL 7 | X _c | |

$$Q = -\frac{R_i}{X_i} \quad (18)$$

An "error" indication in step 7 of Table 5 signifies this condition. Actually, Eq. 18 is a legitimate value for Q. Such a Q makes X_a equal to infinity (an open circuit), which reduces the Pi to an L configuration.

If, for example, you choose Q = 10, which is larger than the "minimum Q" of 1.22 obtained in Figs. 3b and 3c, you get the solutions in Figs. 3d and 3e.

Similarly, for a T configuration, refer again to Fig. 4a where now, the following equations apply:

$$X_c = (-X_o + R_o Q) \quad (19)$$

$$X_a = -R_i \sqrt{\frac{R_o}{R_i} (1+Q^2) - 1} - X_i \quad (20)$$

$$X_b = \frac{R_o(1+Q^2)}{Q + \sqrt{\frac{R_o}{R_i} (1+Q^2) - 1}} \quad (21)$$

But now Q can be almost any value higher than the "minimum Q" obtained from Eq. 11 (or in step 11 of Table 3). The program to solve Eqs. 15, 16 and 17 is in Table 5. If you try to use a value of Q lower than the "minimum Q," the program provides an "error" indication in step 22. Above the minimum Q, only one value of Q is impossible:

Design it for safety!

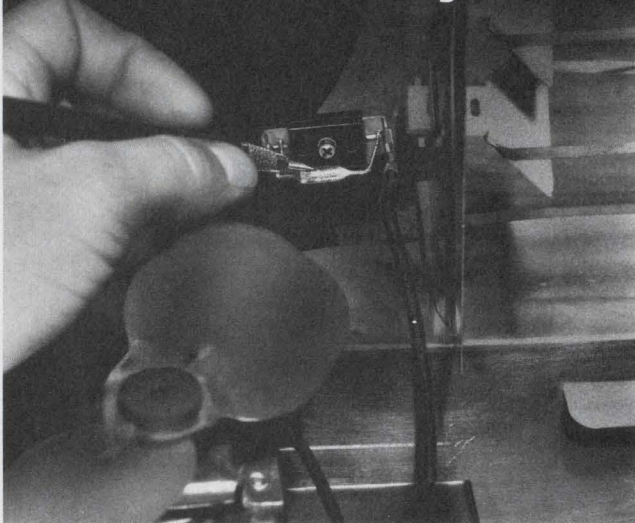

4000 Series MICROTEMP®
thermal cutoff in electric space heater

Guard your products and profits with MICROTEMP® thermal cutoffs

This electric space heater is designed for safety ... using the low-cost, yet precise 4000 Series MICROTEMP® thermal cutoff. It not only protects those who use the heater, but also the good name of those who make and sell it.

If the heater's thermostat fails—or if the unit overheats for any reason—the MICROTEMP® promptly cuts off the power. Before the appliance can be used again, the fault must be corrected and the MICROTEMP® replaced.

The MICROTEMP® thermal cutoff is available for a wide range of design applications with cut-

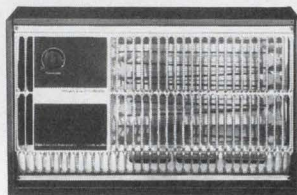

off ratings from 136 to 468°F (60 to 240°C) and operating accuracy within ± 0 -4°C.

Millions of our MICROTEMP® thermal cutoffs are now protecting hundreds of successful products.

We offer assorted terminations, mounting packages, and insulation to suit your design and production needs. Write or call us for your test samples and data.



MICRO DEVICES



DIVISION OF EMERSON ELECTRIC CO.
1881 SOUTHTOWN BLVD.
DAYTON OH 45439 513-294-0581

CIRCLE NUMBER 27

And the program for their solution is in Table 6.

As in the case of a Pi, the value of Q can be any value higher than that obtained in program-step 7 of Table 4 for a "minimum-Q" T.

If you again choose Q = 10, as was done for the Pi, which is larger than the "minimum Q" of 1.03 obtained for the solutions in Figs. 4b and 4c, you get the solutions in Figs. 4d and 4e.

For values of Q smaller than the "minimum Q," the program provides an "error" indication in step 20. Note that for $Q = X_o/R_o$, X_c becomes zero, and the T configuration becomes a simple L, as was the case with the Pi configuration under the conditions of Eq. 18.

Handling special cases

All sources and loads, however, don't necessarily contain reactive components. When either the input or output impedances, or both, have no capacitance or inductance, the number of possible matching solutions is reduced. Fig. 5a is an example of no reactive component in the output circuit and the four L solutions you can get for it. But if you attempt to obtain Pi and T "minimum-Q" solutions for the matching circuits, they will come out identical to the four L solutions.

For larger Qs (higher selectivity), the number of Pi and T solutions is virtually unlimited. But with no reactances in both the source and load, only two L solutions are obtained (Fig. 5b).

Verify with parallel/series transformations

Finally, you can easily verify that your matching circuit has no errors. You merely use the series/parallel transformations several times and add the resultant reactances. The input and output resistances should become equal, and all reactances should cancel.

As an example, insert Fig. 4d into Fig. 4a and add the series reactances. You get Fig. 6a. Convert either side, say, the left side, to a parallel configuration and combine the two parallel reactances to get Fig. 6b. Now convert the left-side parallel configuration of Fig. 6b to series and you get Fig. 6c, which shows that you have satisfied the conjugate bilateral matching requirements—the reactances cancel and resistances match.■

Bibliography

Charest, C. N., "Impedance Matching Can Be Easy," *EDN*, Jan. 1, 1969, pp. 48-51.

Henning, H. B., "Impedance Matching by Graphical Techniques," *Microwave Journal*, June, 1977, pp. 112-114.

Johnson, R., "Do Complex Impedance Matching in Seven Easy Steps," *EDN*, March 20, 1974, pp. 73-75.

Nardin, R., "Impedance Matching Made Easy: a 3-Step Uncomplicated Method," *Electronic Design*, Aug. 16, 1975, pp. 76-78.

Acknowledgement

The author wishes to thank Mr. James R. Jackson for stimulating and constructive discussions on the above subject.

Here's your golden opportunity to meet our better half.

Texas Instruments Incorporated
Mail Station 2-16, Attleboro, MA 02703

I'd like to meet TI's better half. Please send information on your new H4 Series .156" x .200" Edgeboard Connector.

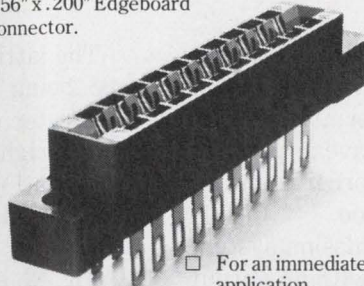

- For an immediate application.
 Please contact me directly.
 For reference.

Name _____

Title _____

Company _____

Area code _____ Phone _____ Ext _____

Address _____ Mail Station _____

City _____ State _____ Zip _____

ED

Our better half.

TI's new H4 Series edgeboard connector half of a PC board/edgeboard connector system. It's today's best connector value because we made it better in so many ways.

Better functional and dimensional interchangeability, better design and construction, better porosity and wear characteristics, and better price and delivery advantages.

But we've done ourselves even one better. Specifically, our better half uses more gold to

get more performance and reliability. And yet there is a substantial cost savings. The reason is our proprietary clad metal technology.

Cladding permits gold to be concentrated only where it is needed—at the contact mating surface—the area critical to contact reliability.

Therefore, significant cost savings can be realized in terms of labor and precious metal consumption. This savings is being passed on to you in the form of a lower price. Or if you prefer, a bigger value.

After all, TI pioneered gold inlay. And we also make extremely high performance connectors. So it was only natural to put them together in our better half.

If you haven't met our better half yet, don't miss out on this truly golden opportunity. Return the coupon above or call Texas Instruments Connector Systems Marketing today. (617) 222-2800, Extension 268 or 269.



TEXAS INSTRUMENTS
INCORPORATED

Predict noise in digital systems

caused by transmission-line reflections. All you need is a programmable calculator to solve the lattice diagram.

Reflections on transmission lines are a major source of noise in digital systems, but you can predict them easily with a lattice diagram. To determine the reflective voltages for the diagram, you have to perform numerous calculations. But with a programmable calculator like the SR52 that's easy too.

Fig. 1a which shows a digital transmission system contains a step generator of voltage E with an output impedance, Z_S , an interconnecting transmission line of characteristic impedance Z_0 , and a line termination, Z_L . Fig. 1b shows the lattice diagram for the circuit of Fig. 1a, and the equations that must be solved to determine the voltage at every step.

A. R. Campbell, Senior Member, Engineering Staff, RCA Government and Commercial Systems, Moorestown, NJ 08057

The lattice diagram graphically represents the signal being reflected back and forth between signal generator and load (see box). The voltages traveling left to right are identified as V_S (send-side), and right to left as V_R (receive-side). The incident and reflected voltages at points A and B combine to form successively smaller steps (Fig. 1c).

Fig. 2 shows the flow chart for a program to calculate these voltages. Execute the program on an SR52 calculator with the following steps:

1. Clear all registers and flags by pressing user-defined key "E."
2. Enter circuit parameters (Z_0 , Z_S , Z_R , E) into registers R_{00} through R_{03} as follows:

| Register | Content |
|----------|---------|
| R_{00} | Z_0 |
| R_{01} | Z_S |

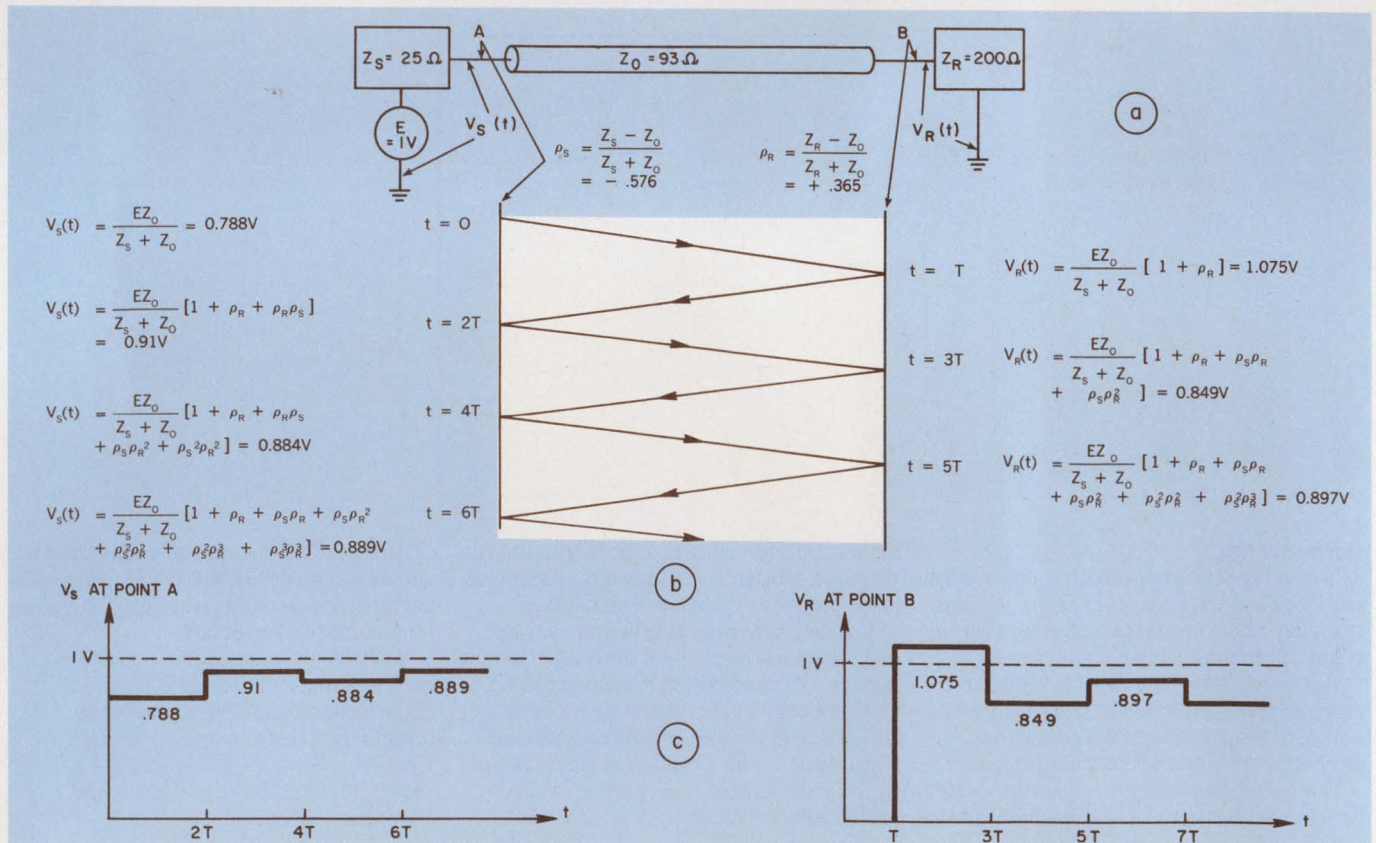

1. A step voltage from generator E travels down a transmission line until it hits a load (a). If both the generator and the load are not properly matched, a diminishing part of

the wave is reflected back and forth, as represented by the lattice diagram (b). At points A and B the waves add up to form the total voltage (c).

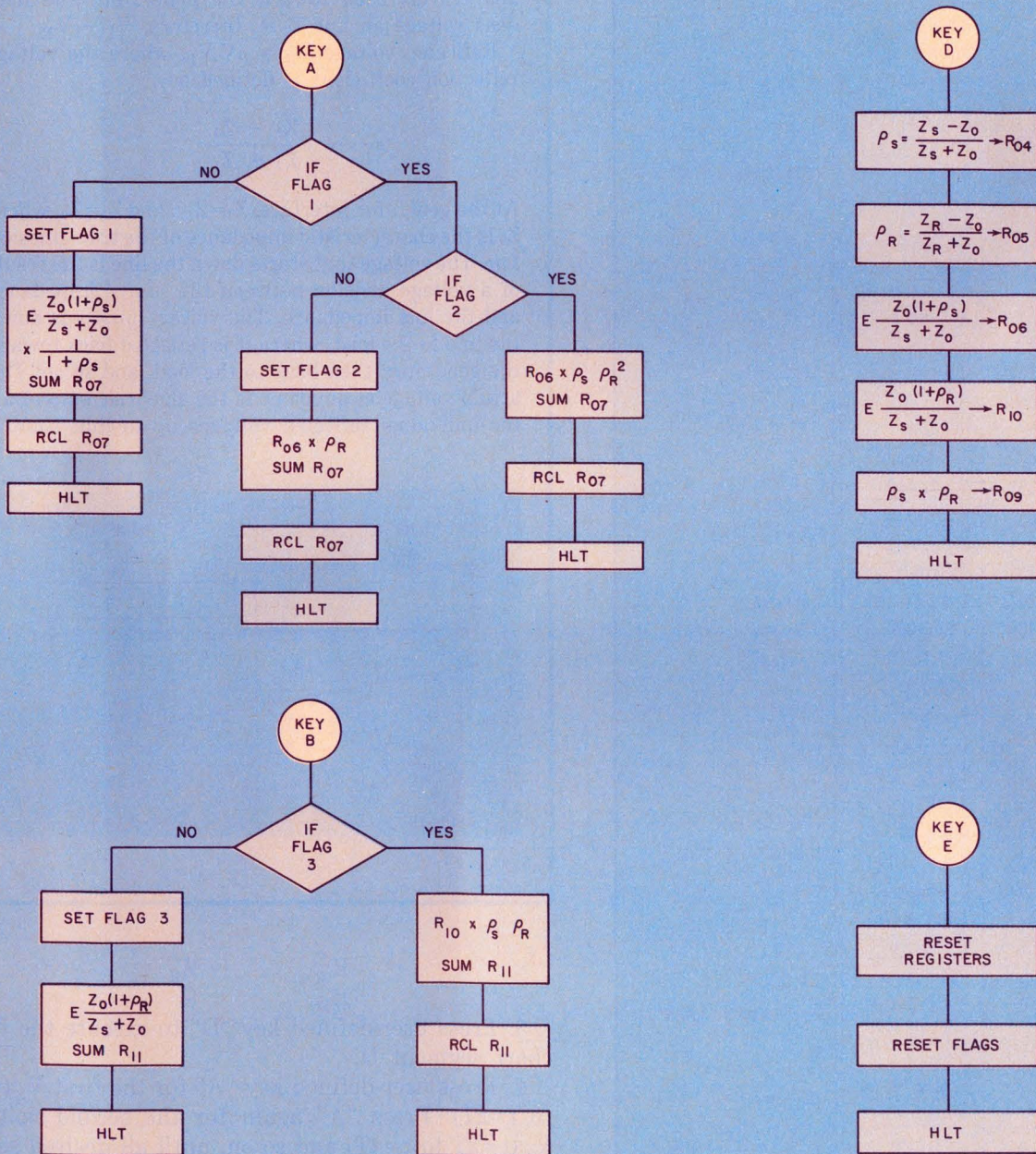

2. The flow chart for calculating a lattice diagram consists of four segments. The user-defined keys determine which

will be executed: clear flags (E) calculate common factors (D), calculate send (A) and receive (B) voltages.

3. The SR52-program requires 219 entries.

| LOCATIONS | CODES | KEYS | COMMENTS |
|-----------|----------------|------------------|---|
| 000 002 | 81 46 15 | HLT *LBL E | RESET REGS. |
| 003 004 | 47 86 | *CMs *rset | RESET FLAGS. |
| 005 007 | 46 14 53 | *LBL D (| |
| 008 010 | 43 00 01 | RCL 0 1 | |
| 011 014 | 75 43 00 00 | — RCL 0 0 | CALCULATE |
| 015 018 | 54 55 53 43 |) ÷ (RCL | $\rho_S = \frac{Z_S - Z_0}{Z_S + Z_0} \rightarrow R_{04}$ |
| 019 022 | 00 01 85 43 | 0 1 + RCL | |
| 023 026 | 00 00 54 95 | 0 0) = | |
| 027 029 | 42 00 04 | STO 0 4 | |
| 030 033 | 53 43 00 02 | (RCL 0 2 | |
| 034 037 | 75 43 00 00 | — RCL 0 0 | CALCULATE |
| 038 041 | 54 55 53 43 |) ÷ (RCL | $\rho_R = \frac{Z_R - Z_0}{Z_R + Z_0} \rightarrow R_{05}$ |
| 042 045 | 00 02 85 43 | 0 2 — RCL | |
| 046 049 | 00 00 54 95 | 0 0) = | |
| 050 052 | 42 00 05 | STO 0 5 | |
| 053 056 | 43 00 00 65 | RCL 0 0 × | |
| 057 060 | 43 00 03 65 | RCL 0 3 × | |
| 061 064 | 53 01 85 43 | (1 + RCL | |
| 065 068 | 00 04 54 55 | 0 4) ÷ | CALCULATE |
| 069 072 | 53 43 00 00 | (RCL 0 0 | $E \frac{Z_0 (1 + \rho_S)}{Z_S + Z_0} \rightarrow R_{06}$ |
| 073 075 | 85 43 00 | + RCL 0 | |
| 076 078 | 01 54 95 | 1) = | |
| 079 081 | 42 00 06 | STO 0 6 | |
| 082 085 | 43 00 06 65 | RCL 0 6 X | |
| 086 089 | 53 01 85 43 | (1 + RCL | |
| 090 093 | 00 05 54 95 | 0 5) = | CALCULATE |
| 094 097 | 55 53 01 85 | ÷ (1 + | $E \frac{Z_0 (1 + \rho_R)}{Z_S + Z_0} \rightarrow R_{10}$ |
| 098 101 | 43 00 04 54 | RCL 0 4) | |
| 102 105 | 95 42 01 00 | = STO 1 0 | |
| 106 109 | 43 00 04 65 | RCL 0 4 × | |
| 110 113 | 43 00 05 95 | RCL 0 5 = | CALCULATE |
| 114 117 | 42 00 09 81 | STO 0 9 HLT | $\rho_R \times \rho_S \rightarrow R_{09}$ |
| 118 121 | 46 11 60 01 | *LBL A *if flg 1 | |
| 122 125 | 01 04 03 50 | 1 4 3 *st flg | CALCULATE |
| 126 129 | 01 43 00 06 | 1 RCL 0 6 | $E \frac{Z_0 (1 + \rho_S)}{Z_S + Z_0}$ |
| 130 133 | 55 53 01 85 | ÷ (1 + | |
| 134 136 | 43 00 04 | RCL 0 4 | |
| 137 139 | 54 95 44 |) = SUM | |
| 140 142 | 00 07 81 | 0 7 HLT | $\times \frac{1}{1 + \rho_S} \rightarrow \text{SUM } R_{07}$ |
| 143 146 | 60 02 01 06 | *if flg 2 1 6 | |
| 147 150 | 08 50 02 43 | 8 *st flg 2 RCL | |
| 151 154 | 00 06 65 43 | 0 6 × RCL | CALCULATE |
| 155 158 | 00 05 95 42 | 0 5 = STO | $R_{06} \times \rho_R \rightarrow \text{SUM } R_{07}$ |
| 159 162 | 00 08 44 00 | 0 8 SUM 0 | |
| 163 167 | 07 43 00 07 81 | 7 RCL 0 7 HLT | |
| 168 171 | 43 00 08 65 | RCL 0 8 × | |
| 172 175 | 43 00 09 95 | RCL 0 9 = | CALCULATE |
| 176 179 | 42 00 08 44 | STO 0 8 SUM | $R_{06} \times \rho_S \rho_R^2 \rightarrow \text{SUM } R_{07}$ |
| 180 182 | 00 07 43 | 0 7 RCL | |
| 183 185 | 00 07 81 | 0 7 HLT | |
| 186 189 | 46 12 60 03 | *LBL B *if flg 3 | |
| 190 193 | 02 00 02 50 | 2 0 2 *st flg | CALCULATE |
| 194 197 | 03 43 01 00 | 3 RCL 1 0 | $E \frac{Z_0 (1 + \rho_R)}{Z_S + Z_0} \rightarrow \text{SUM } R_{11}$ |
| 198 201 | 44 01 01 81 | SUM 1 1 HLT | |
| 202 205 | 43 00 09 65 | RCL 0 9 × | |
| 206 209 | 43 01 00 95 | RCL 1 0 = | |
| 210 213 | 42 01 00 44 | STO 1 0 SUM | CALCULATE |
| 214 216 | 01 01 43 | 1 1 RCL | $R_{10} \times \rho_S \rho_R \rightarrow \text{SUM } R_{11}$ |
| 217 219 | 01 01 81 | 1 1 HLT | |

*denotes the second key function

Transmission line reflections

Signal reflections on transmission lines occur whenever a wave encounters an impedance different from that of the original line. Such a discontinuity can stem from a change in the transmission line. In the general case, an incident voltage (V_I) and incident current (I_I) wave travel along a transmission line with impedance Z_1 . When they encounter a discontinuity of impedance Z_2 , a reflected voltage V_R originates at the discontinuity and travels back toward the generator. The incident voltage on line B is, therefore, $V_I + V_R$.

Reflected voltage $V_R = \rho_V V_I$, where the voltage reflection coefficient is defined as

$$\rho_V = \frac{Z_2 - Z_1}{Z_2 + Z_1}$$

At the generator interface, $Z_1 = Z_G$, and $Z_2 = Z_0$, where Z_0 is the characteristic impedance of the transmission line. The voltage that starts down the line is the result of a voltage division between the source impedance and the line impedance. The voltage proceeds down the line to the load, where it is reflected back toward the generator, then back to the load, and so on. The actual voltage at any time is the algebraic sum of all the individual reflected voltages up to that time.

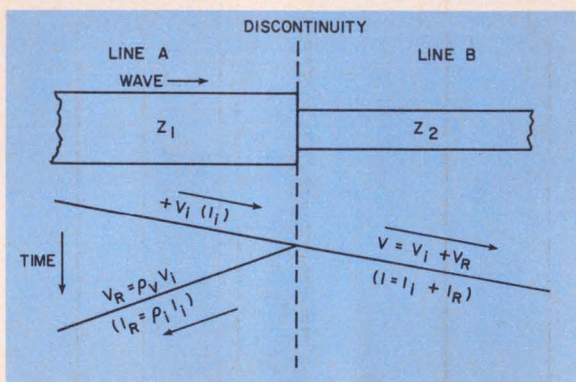

$$\frac{R_{02}}{R_{03}} \quad \frac{Z_R}{E}$$

3. Press user-defined key "D" to execute the flow chart segment D.

4. Press user-defined key "A" for the first V_S ($t=0$ to $t=2T$). Press "A" again for the second voltage V_S ($t=2T$ to $t=4T$) and so on, until all desired send-voltages are calculated.

5. Press user-defined key "B" for the first V_R ($t=T$ to $t=3T$), then repeat for the second V_R ($t=3T$ to $t=5T$) and so on.

Programming your SR52 calculator requires 220 keystrokes. They are listed in Fig. 3, in groups of two to four instructions. ■

TAKE A CLOSE LOOK AT THESE BURROUGHS PLASMA DISPLAY BREAKTHROUGHS.

Easier to read

Greater brightness

Improved contrast

Larger matrix dot

Broader horizontal
viewing angle

Lower power
requirements

Cost effective
design

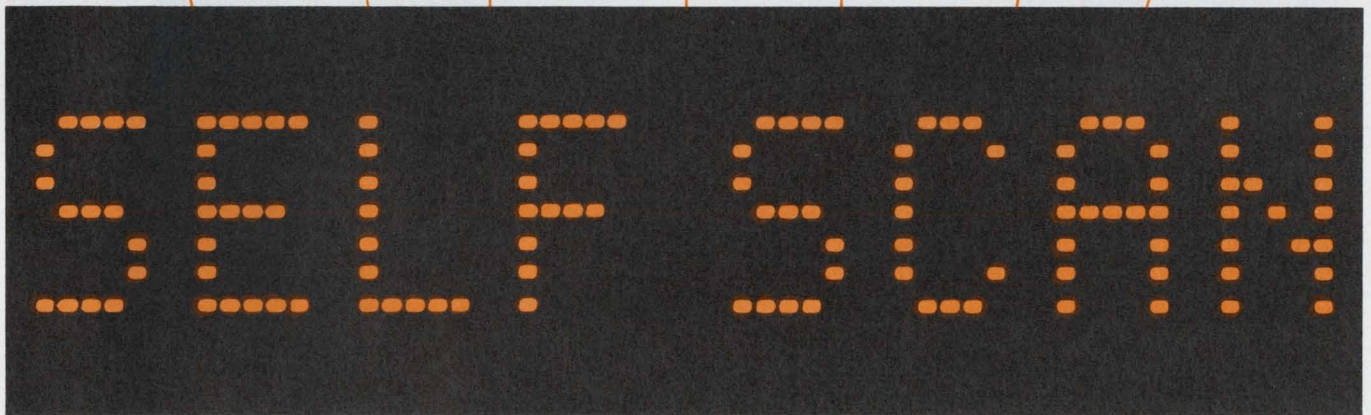

The new Burroughs SELF-SCAN® II single register gas plasma panels are breakthroughs in visibility and readability, making them ideal for all types of applications — from audience information displays to instrumentation applications. They are digitally addressed to interface

easily with microprocessors and computers. Only 15 connections are required. These new units complement Burroughs' standard line of single register 16 and 32 character plasma displays.

The Burroughs SELF-SCAN II 1 x 20 and 1 x 40 displays. Certainly worth looking into.

Burroughs ECD International, 11-15 Betterton Street, Drury Lane, London, England. Telephone (01) 240-1479.

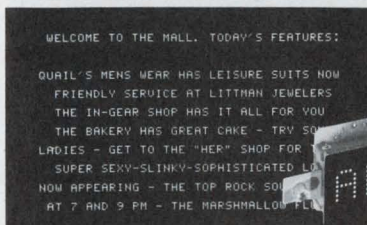

New 1 x 20 panel can be stacked and butted together to give a contiguous large audience information display of any number of characters.

New 1 x 40 panel for instrumentation, data terminals, computers and hundreds of other applications.



You can see the difference

Burroughs



SELF-SCAN is a registered trademark of Burroughs Corporation.

CIRCLE NUMBER 163 FOR GENERAL INFORMATION
CIRCLE NUMBER 170 FOR DETAILED SPECIFICATIONS

Reduce sampling errors by adding an RC network to your sample-and-hold

Include an RC network in a high-speed sample-and-hold circuit, and you can restore an otherwise lost charge to the holding capacitor.

Sampling errors are caused when the drain-to-gate capacitance of a sample-and-hold's switching FET draws off charge from the holding capacitor. In Fig. 1, R_3 and C_c form a network for controlling the amount of charge injected into holding capacitor C_H . Of course, small values of C_H are required to allow a full charge to accumulate during the sampling period.

But small holding capacitors are affected by the FET's drain-to-gate capacitance, C_{DG} . The value of C_c is selected to be larger than the FET's expected C_{DG} . When the FET's gate voltage switches from high to low, C_c 's voltage goes from low to high, which provides a charge pulse equal and opposite to that of the FET's capacitance.

To understand the RC network's effect, examine a sampling-circuit model without the network (Fig. 2) and see what happens. The step voltage on the FET's gate causes C_{DG} to take a charge, which comes from holding capacitor C_H . Assume that C_H is charged to 1 V and C_{DG} of the dual MOSFET is 2 pF. Then the

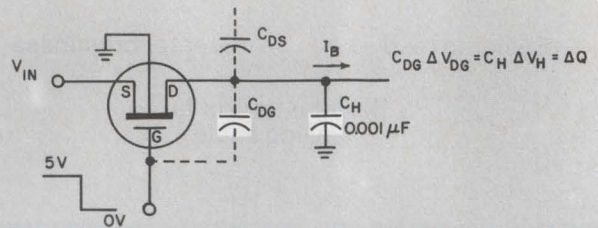

2. Drain-to-gate capacitance of a sample-and-hold's switching FET causes charge to be drawn off holding capacitor C_H . If charge isn't restored, the result is sampling errors.

charge on C_{DG} is:

$$Q = C_{DG} (\Delta V),$$

where $\Delta V = 15 - 1$, or 14 V.

Therefore:

$$Q = 2 \times 10^{-12} (14) = 28 \times 10^{-12} \text{ coulombs.}$$

The effect on C_H is:

$$V = \frac{\Delta Q}{C_H} = \frac{28 \times 10^{-12}}{1 \times 10^{-9}} = 28 \text{ mV.}$$

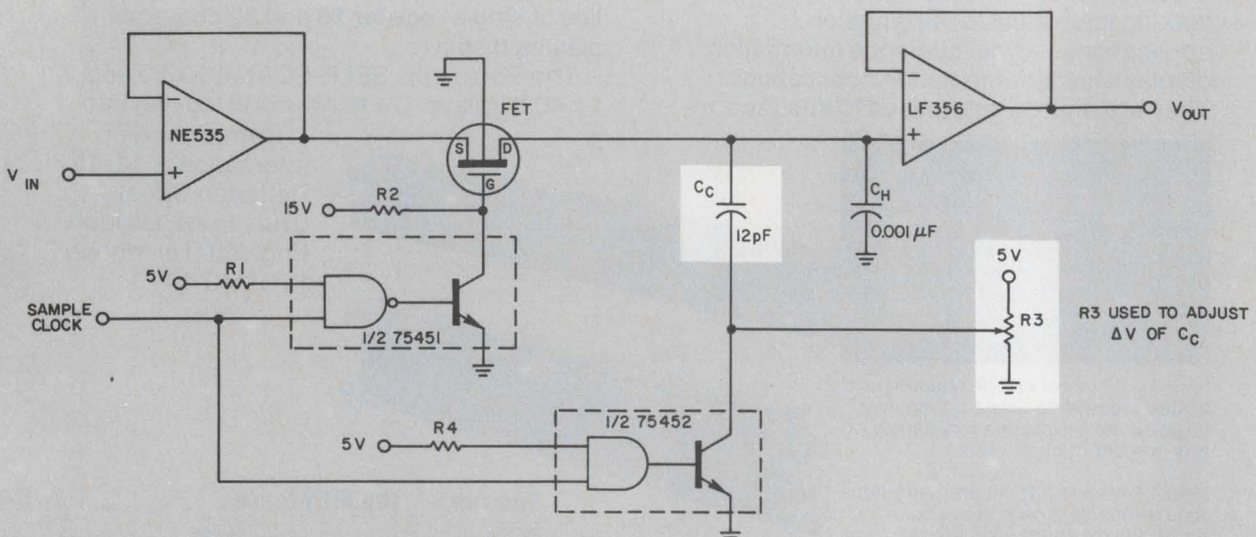

1. Lost charge can be restored to holding capacitor C_H by adding the R_3 , C_c compensation network to

a fast sample-and-hold circuit. The network controls the amount of charge injected into C_H .

How to tell a Super-VOM from just the everyday garden-variety Brand X.

ONLY THE SUPER-VOM (Triplet's New 60) HAS ALL THESE FEATURES:

X'TRA RUGGED CONSTRUCTION
(For an accidental drop up to a five-foot height)

BUILT-IN "CONFIDENCE-TEST"
for periodic meter reassurance checks after overload/drops.

OVERLOAD PROTECTED
(All ranges; 3-fuse arrangement including diodes and 2 Amp/1000 V protection fuse)

SINGLE-RANGE SELECTOR SWITCH
(Most VOM's have 2 or more. Single switch minimizes range selection errors)

SAFETY DESIGNED FOR YOU
(Completely insulated; new Safety Leads; prevents explosive arcs from high energy circuits up to 20 KW)

48" SAFETY ENGINEERED TEST LEADS
(Especially designed recessed safety connectors and heavily insulated alligator clips)

ONLY 2 RECESSED INPUT JACKS
(Makes lead changes unnecessary - Some VOM's have as many as seven)

DETENTED HANDLE POSITION



\$102

Nobody else offers these features in a VOM at any price. So for only \$102, the Model 60 is the safest, most versatile, most honestly priced quality VOM you can buy. And, for just \$8 more, you can have the Model 60-A that has 1 1/2% DC accuracy, plus a mirrored scale.

That's the kind of Triplet one-upmanship appreciated the world over by value conscious users in industrial production and maintenance. TV - Radio - Hi-Fi shops, vocational training and hobbyists, airconditioning, appliance and automotive service, R & D, and application engineering . . . anyone who wants to be more productive with the latest in VOM technology. Model 60 Type 2 Approved by MESA, Approval 2G-2880.

Drop in on your nearest Triplet distributor or Mod Center and drop the new Model 60. Ask for a no-obligation demonstration of every feature. Compare it with any other VOM. You'll know why Triplet Models 60 and 60-A eliminate over 90% of the costly repairs from VOM misuses. Cultivate a profitable habit for selecting Triplet design-firsts.

TTT TRIPLETT

BLUFFTON, OHIO 45817

Circle # 29 For Information

Circle # 30 for FREE Demonstration

Triplet. The easy readers

Ideas for design

Without an RC network, the uncompensated voltage appears as in Fig. 3a, where the step error is ΔV . In fact, the step error can even exceed the total sag, dv/dt , of the hold circuit. You can get a smaller error by reducing the FET's gate voltage, but the resulting increase in on-resistance causes other problems. Choosing C_c as 12 pF (Fig. 1) with a C_{DG} of 2 pF limits the step error as shown in Fig. 3b. Fig. 3c and 3d show output error for other values of C_c .

Unfortunately, FET capacitance varies with drain-to-gate voltage, so the injected charge can be completely canceled only at one potential. If you know what voltage range to expect on C_H , you can compensate for errors by adjusting R_3 .

Bob Marshall, Jr., Applications Engineer, Signetics Corp., 811 E. Arques Ave., Sunnyvale, CA 94086.

CIRCLE NO. 311

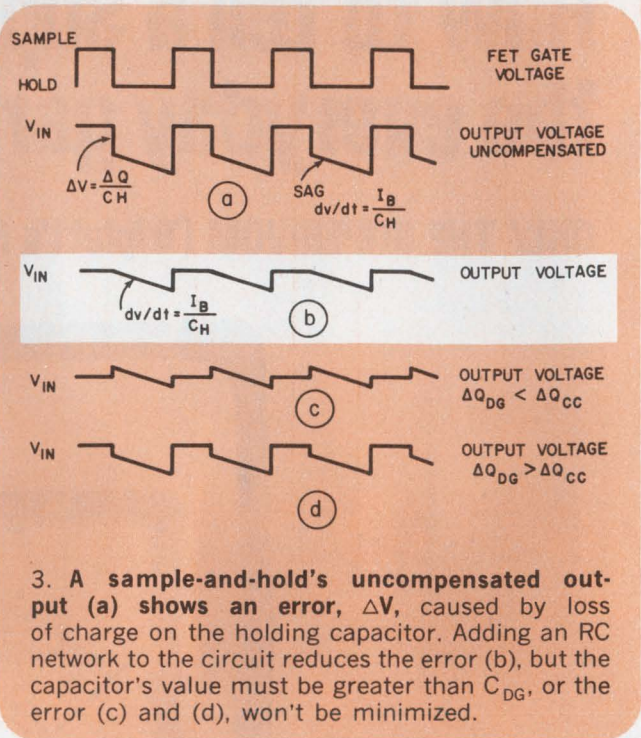

A simple level shifter lets an IC modulator accept a unipolar input signal

With a single transistor and resistor acting as a controlled current source (see figure), you can shift the operating point of an IC modulator to accept a positive-going modulating signal. The IC, a CA3080E transconductance amplifier (RCA), has its g_m input (pin 5) internally clamped near the negative-supply potential. A signal applied through Q_1 and R_3 to pin 5 produces a modulated envelope at the output. Its amplitude is directly proportional to current flowing into the g_m input, and the value of R_3 determines that current. Since the collector and emitter currents of Q_1 are equal, current into g_m is simply E_m/R_3 .

When E_m is at any value below the base-emitter breakdown voltage of Q_1 , no current is delivered to pin 5, and the output is zero. In a typical modulation application, however, a positive-going modulating signal must produce an output whose carrier amplitude is near zero only when the modulating voltage is zero. So to eliminate this small offset, you can bias Q_1 's base slightly negative, instead of grounding it as in the figure.

For Q_1 , choose a general purpose pnp type having a low I_{cbo} . The carrier should be about 1-V pk-pk at the amplifier input. And the network formed by C_1 , R_1 and R_2 is designed to interface with CMOS for

coupling a high-level signal to the amplifier input.

Dale Hileman, Engineering Services Manager, Sphymetrics, Inc., Woodland Hills, CA 90290.

CIRCLE NO. 312

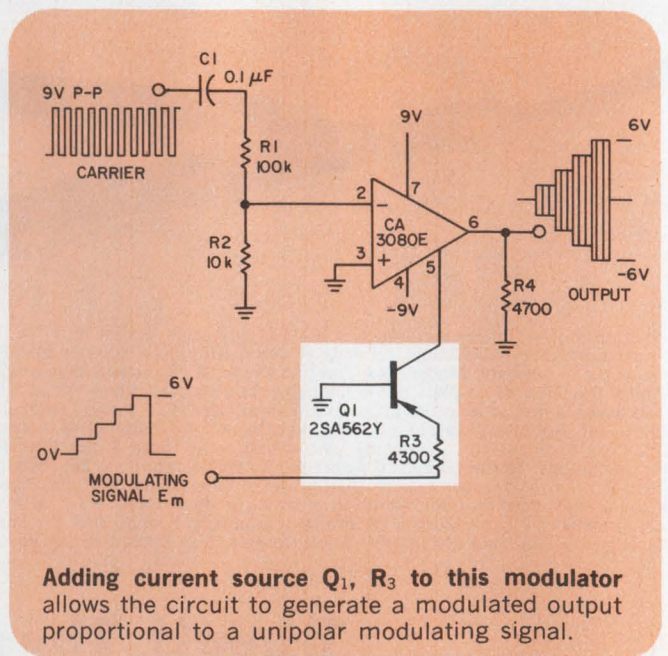

The 8080 A/D & D/A Advantage

super-software supplied • fast, on-card DMA logic • 80 (to 256) channel expansion from just 2 cards

Datel's SineTrac 800 has it. SineTrac 800 slide-in A/D and D/A cards provide a complete analog "front-end" inside your Intel MDS-800 or SBC-80/10/20 microcomputers.

SineTrac 800 is ideal for industrial data logging, process loops, and high speed data acquisition systems.

The A/D card contains 32 single-ended or 16 differential channels with 12-bit resolution. An A/D Expander card offers 48 additional channels. Thus, two cards give 80 single-ended or 64 differential channels! Card addressing allows expansion to 256 channels. Throughput is 20 microseconds with rates up to 36,000 samples/second in DMA mode.

SineTrac D/A cards contain either 8 channels or 4 channels.

More SineTrac system advantages include on-card start and final address register/counters to save time and CPU housekeeping, and an adjustable IC scan clock with interrupt-flagged scan markers for event-triggered or internal scan starts.

The paper tape diagnostic test programs, supplied, allow channel calibration and a multi-scan accuracy test with decimal printout. The programs diagnose error conditions, give a descriptive TTY printout between selected channels, and continuously loop for scope or logic analyzer troubleshooting.

A/D or D/A cards are \$650* (singles). Write today for complete details.

*U.S.A. domestic prices only.

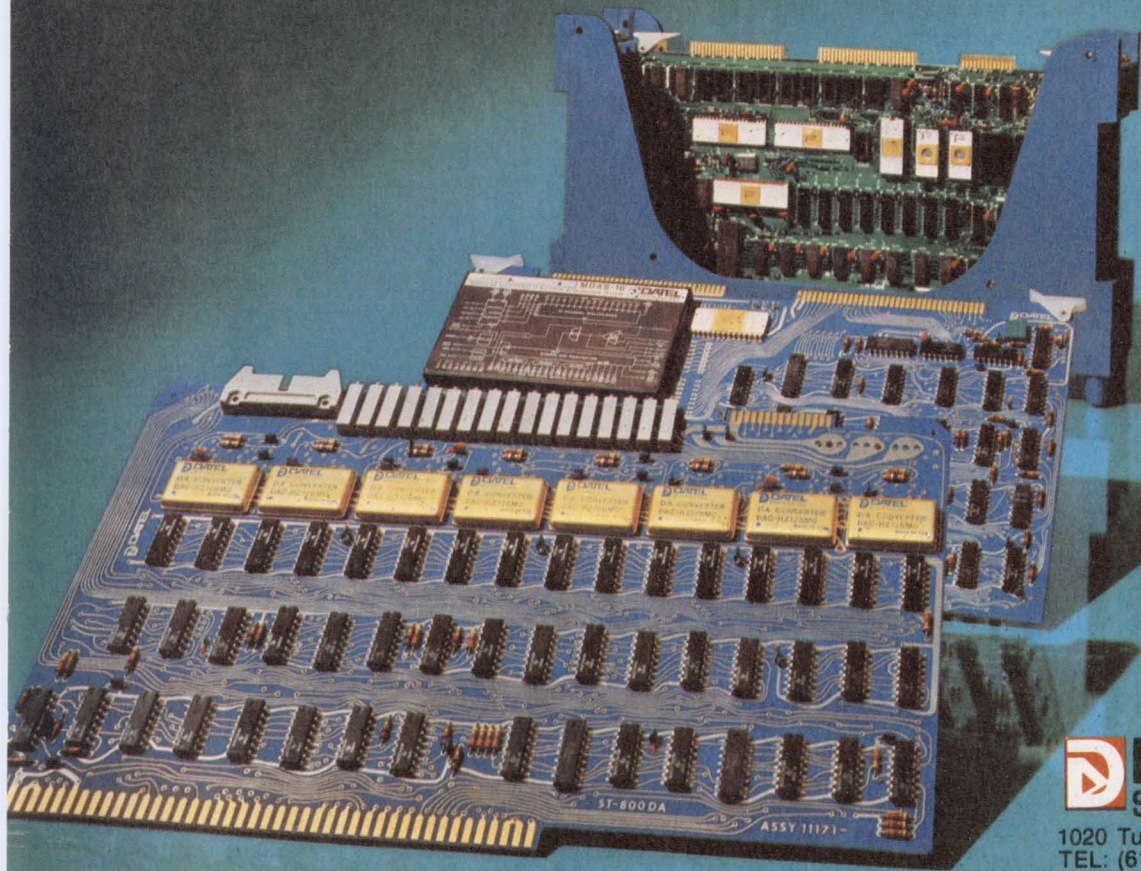

DATEL
SYSTEMS, INC.

1020 Turnpike Street, Canton, MA 02021
TEL: (617) 828-8000 TWX: 710-348-0135

Ideas for design

Inexpensive circuit monitors voltage conditions in battery-operated equipment

For about a buck, you can build a circuit that lights a warning LED when battery voltage in portable equipment falls outside of design limits. Not only does the circuit (Fig. 1) eliminate expensive and bulky meters; it uses only one IC, an LM2905/3905 precision timer from National (about \$0.60 apiece for a 3905) and three stable 1/4-W resistors, in addition to the LED.

A 3905, which operates over the range of 4.5 to 40 V, contains a floating transistor (pins 6 and 7), which can pull a load to ground or supply referenced loads of up to 40 V and 50 mA. Also built-in is a 3.15-V regulator with a 2-V divider, which establishes a trip point between reference and ground. The relationship between the LED activating voltage and external resistors is found from the following equation:

$$\frac{R_b(V)}{R_a + R_b} = 2,$$

where V is the activating voltage.

Assume that the battery in Fig. 1 is a 9-V transistor type whose voltage must fall to 5 V to light the LED. You can choose a value for either R_a or R_b , and solve for the unselected resistor using the equation. Resistor R_c is a LED current limiter. Simply by changing the external wiring of the 3905, you can use the same circuit to detect an overvoltage condition (Fig. 2). Note that pin 8 of the IC, grounded in Fig. 1, is tied to pins 1 and 2 in the overvoltage circuit.

Michael Bozoian, Consultant, Consulting Service in Electronics, 702 Fifth St., Ann Arbor, MI 48103.

CIRCLE NO. 313

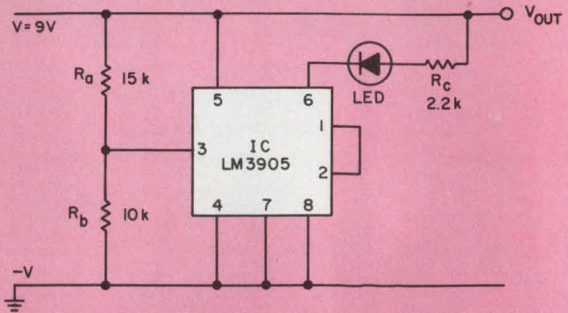

1. This inexpensive circuit detects low voltage conditions in battery-operated equipment, and eliminates the need for expensive and bulky meters.

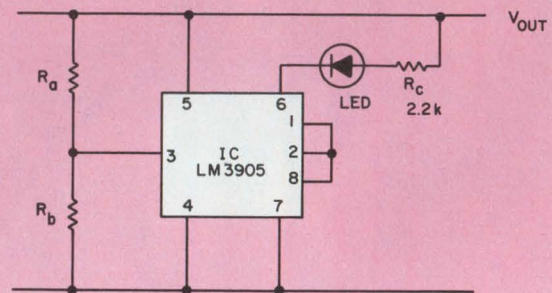

2. If you rewire pin 8 of the IC, the circuit of Fig. 1 is able to detect an overvoltage condition.

IFD Winner of October 25, 1977

Tom Gross, T. A. O. Gross & Associates, Lincoln, MA 01773. His idea "Flyback-Inverter Efficiency Increases when the Transformer Is Loaded Properly" has been voted the Most Valuable of Issue Award.

Vote for the Best Idea in this issue by circling the number of your selection on the Reader Service Card at the back of this issue.

SEND US YOUR IDEAS FOR DESIGN. You may win a grand total of \$1050 (cash)! Here's how. Submit your IFD describing a new and important circuit or design technique, the clever use of a new component or test equipment, packaging tips, cost-saving ideas to our Ideas for Design editor. Ideas can only be considered for publication if they are submitted exclusively to ELECTRONIC DESIGN. You will receive \$20 for each published idea, \$30 more if it is voted best of issue by our readers. The best-of-issue winners become eligible for the Idea of the Year award of \$1000.

Portable Weather Station

Rain or shine, arctic or desert,
-20°C to +70°C



Geophysical Monitor

Event-triggered recording to save tape,
batteries and for fast computer data-spotting



Traffic or Noise Level Logger

Accepts analog or digital
(event counter) inputs



Oceanographer's Probe

No outside power needed,
runs on internal batteries



Log your Analog Data on Digital Tape Cassettes...



Biomedical Data Recorder

Optional 5 mV
differential amplifier
for low level detectors.

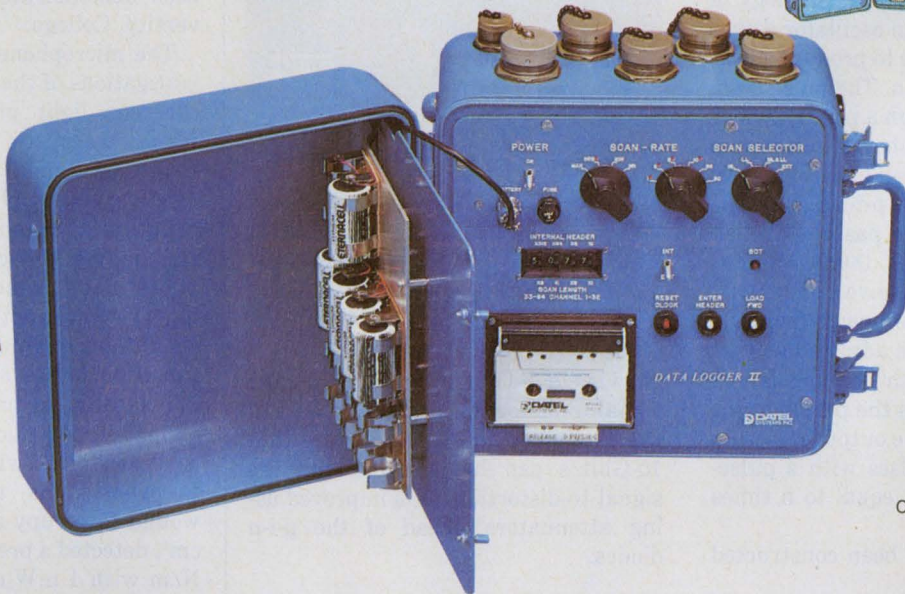

Pollution and Environmental Logger

Crystal CMOS clock
can command different
scan periods

DATEL'S DL-2 DATA LOGGER

An Important New Tool-- Choose Datel's DL-2 Cassette Data Logger for unattended standby recording of multi-channel, slowly-varying analog samples. The DL-2 samples up to 64 high level or low level analog channels, digitizes them to 12-bit binary coding and records them on a cassette at 5 samples per second. Also recorded are a one year calendar clock with one second resolution produced by an internal CMOS crystal oscillator. And external digital samples (up to 36 bits) may be recorded at any time. Analog scans are started automatically from a preset front panel scan timer with intervals from one second up to 30 hours.

The all-CMOS electronics of the DL-2 and stepper-motor transport consume only one watt while recording and microwatts while powered-down between scans. A set of batteries in the front cover will power the DL-2 for a year or longer, recording up to 120,000 samples.

Or external +12VDC or AC power may be used.

The DL-2 features a high-quality instrumentation amplifier (down to $\pm 5\text{mV}$ full scale input) and weather-proof housing and connectors suitable for -10°C to $+60^\circ\text{C}$ environments. (-40°C optional)

A companion DL-2R Cassette Reader offers a convenient playback front end to a minicomputer, microprocessor, TTY, CRT terminal or modem telephone coupler.



1020 Turnpike Street, Canton, MA 02021
TEL: (617) 828-8000 TWX: 710-348-0135

Multiplexer does big job with simple components

A new multiplexer with a pulse repetition rate of 5 Gbit/s is made of simple components—yet it can be used in high-capacity fiber-optic communications systems in place of complex optical multiplexing techniques currently being developed.

In the multiplexer, developed at the Chalmers University of Technology in Goteborg, Sweden, an oscillator drives a step-recovery diode to produce a low-duty-cycle pulse train. The pulse train is then passed through a power divider and split into a number of microstrip lines, each of which can be individually switched on and off by p-i-n diodes. The switched outputs are passed through microstrip delay lines, then combined by an OR gate (a passive circuit that is the inverse of the power divider).

The delay lines are adjusted so that the delay for the n th channel is $t_n - (n-1)t_p/n$ where t_p is the period of the input-pulse train. The output is a train of evenly spaced pulses with a pulse-repetition frequency equal to n times the input PRF.

Multiplexers have been constructed

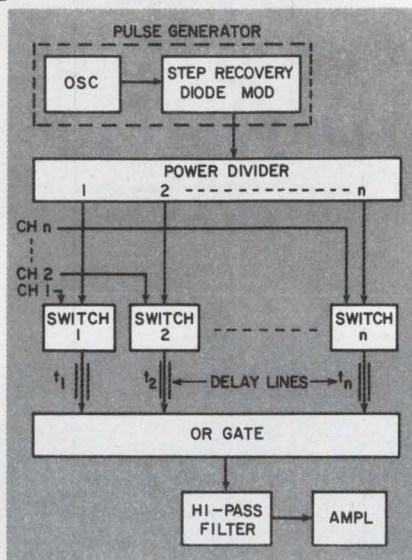

showing a 5-Gbit/s output PRF and signal-to-distortion ratio of 12 dB. But the Chalmers developers believe that 10-Gbit/s can be achieved and the signal-to-distortion ratio improved using attenuators ahead of the p-i-n diodes.

has not yet been measured. But careful polishing of the end faces may achieve coupling efficiencies of 70 to 90%.

Fiber-optic microphone has wide dynamic range

Optical fibers have been used almost exclusively for data-communications applications. But a fiber-optic microphone with a wide dynamic range has been demonstrated at London's University College.

The microphone is the result of investigations of the interaction between coherent light propagating along a fiber and acoustic waves incident on it. In a fiber, small changes in the refractive index phase-modulate light being sent through it. An acoustic wave striking the fiber causes pressure variations that then modulate its refractive index. Because optical wavelengths are small, appreciable phase shifts can be caused by low levels of acoustic power.

Typically, the pressure sensitivity of a single-mode silica or glass fiber is 6×10^{-5} rad/Nm² where N is in Newtons. In experiments, a fiber 1 km long, wound to occupy a volume of only 10 cm³, detected a pressure change of 10^{-6} N/m with 1 mW optical power at the detector converting phase modulation to audio signals. This is some 26 dB below the weakest sound that can be perceived by the human ear. The linear dynamic range is about 180 dB for a 1-m length of optical fiber.

The microphone's sensitivity is increased by increasing the optical power carried by the fiber. With 1W of optical power, the limit for currently available fibers, acoustic powers below the threshold of hearing can be detected by only 30 m of fiber.

Inverter problem solved

Size and weight problems of the isolating transformer used in high power inverters is said to have been overcome by the use of high-frequency transformers in a technique developed by ERA Ltd. in England.

Backward laser radiation is detectable and usable

The backwards-emitted light of a semiconductor is useful as a signal for the AGC circuitry that stabilizes a laser's output power. But commercial laser diodes are usually packaged so that the backwards-emitted laser light can't be detected by an axially positioned fiber. Now a simple technique, developed by R. Bosch GmbH Geschäftsbereich Fernsehanlagen in Darmstadt, W. German, allows the backward laser radiation to be picked up and fed to the AGC system.

A 45° face is formed at the end of a fiber, which is positioned with its axis perpendicular to the laser light, and its sloping end facing away from the laser.

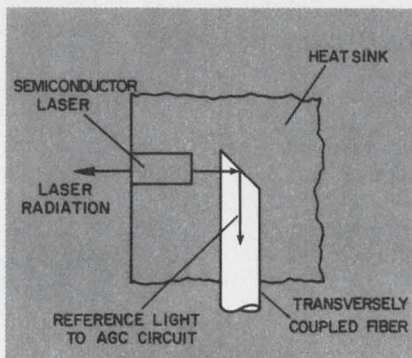

A 10% coupling efficiency, adequate for AGC applications, can be achieved by cutting a plastic fiber with a blade. The coupling efficiency of silica fibers

Complete, 12-Bit Microcircuit Data Acquisition System

Datel has it...

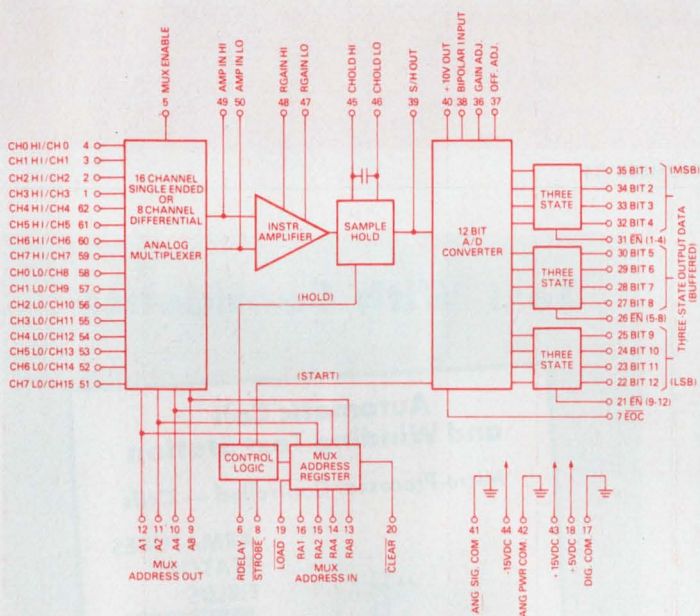

HDAS-16 & HDAS-8

- ▶ 16 Channels, Single-Ended (HDAS-16)
- ▶ 8 Channels, Differential (HDAS-8)
- ▶ 12 Bits Resolution
- ▶ 50kHz Throughput Rate
- ▶ Internal Instrumentation Amplifier
- ▶ Three-State Data Outputs
- ▶ Military and Commercial Temperature Range available
- ▶ 62-pin Miniature Package
- ▶ Priced at \$295.00* (1-9)

*U.S.A. domestic prices only

Datel's HDAS — the first complete 12-bit data acquisition system in a single, miniature package. Using thin-film hybrid fabrication, it challenges modular data acquisition systems on performance and price. Its excellent performance and reliability are also available in versions for full MIL-Spec operation over -55 to $+125^{\circ}\text{C}$. The HDAS 62-pin package measures only 2.3 x 1.4 x 0.24 inches (58 x 36 x 6 mm).

DATEL
SYSTEMS, INC.

1020 TURNPIKE STREET, CANTON, MASS. 02021
TEL. (617) 828-8000 / TWX: 710-348-0135 / TELEX: 924461

Santa Ana (714) 835-2751, (L.A.) (213) 933-7256 • Sunnysvale, CA (408) 733-2424 • Gaithersburg, MD (301) 840-9490 • Houston, (713) 932-1130 • Irving, TX (214) 256-4444
OVERSEAS: DATEL (UK) LTD—TEL: ANDOVER (0264) 51055 • DATEL SYSTEMS SARL 620-06-74 • DATELEK SYSTEMS GmbH (089) 77-60-95

CIRCLE NUMBER 33

Salon international des Composants Electroniques 3-8 avril 78 - Paris

All electronic components + measuring instruments, material and products + equipment and methods specific to the manufacture and installation of electronic components.



Further particulars and free entrance cards on request: International Trade Shows
1350 Avenue of the Americas,
New York, N.Y. 10019
(212) 582.4960 - Tx 237 757 Fren Ur

Don't miss it, others won't.

CIRCLE NUMBER 34

INTRODUCING **THE STRIPPER**

Saves time and will improve your profits! Sleek. Well-proportioned. Fits easily in your hand. Fast, automatic action. Precise, clean cutting and stripping. **ONE TOOL DOES IT ALL!** No muscle power, no extra cutting tools needed. Unbreakable, lifetime body. Lightweight, too. **A REMARKABLE VALUE!**

- Guaranteed to cut and strip multiple-shielded and conductor cable!

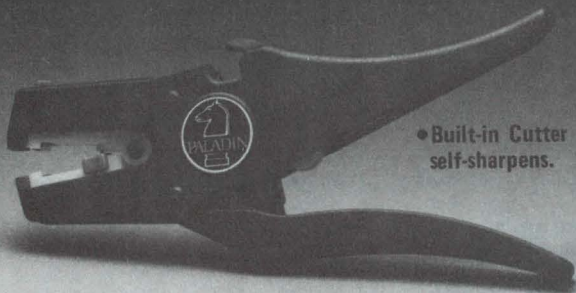

- Built-in Cutter self-sharpens.

Appealing? Return the Reader Service Card for information, or see us at Booth 5066 at the NEPCON West Show February 28 - March 2.

 PALADIN CORPORATION
2680 VALENCIA CIRCLE
THOUSAND OAKS, CA 91360
(805)-492-2853

CIRCLE NUMBER 35

Test With Confidence

Automatic Coil and Winding Test Station

Micro-Processor Controlled — Coils

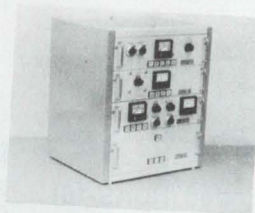

**ARMATURES
STATORS
FIELDS**

Series
720

**TEST RATES TO
1000 PARTS
PER HOUR**

READY-TO-GO PACKAGE HANDLES 90% OF COIL WINDING TEST APPLICATIONS — QUICK CHANGE TEST FIXTURES — FULLY AUTOMATIC GO/NO-GO CYCLE.

MANUFACTURERS OF INSULATION TESTERS
CABLE & HARNESS TESTERS ... MEGOHMMETERS
STROBOSCOPES ... COIL & WINDING TESTERS
& BATTERY TESTERS

SLAUGHTER COMPANY

MOORE & HAILEY STS
Tele: 405-223-4773

ARDMORE, OKLAHOMA 73401
TWX: 910-830-6972

CIRCLE NUMBER 36

ELECTRONIC DESIGN 5, March 1, 1978

New products

Schottky power diodes run at high junction temperatures

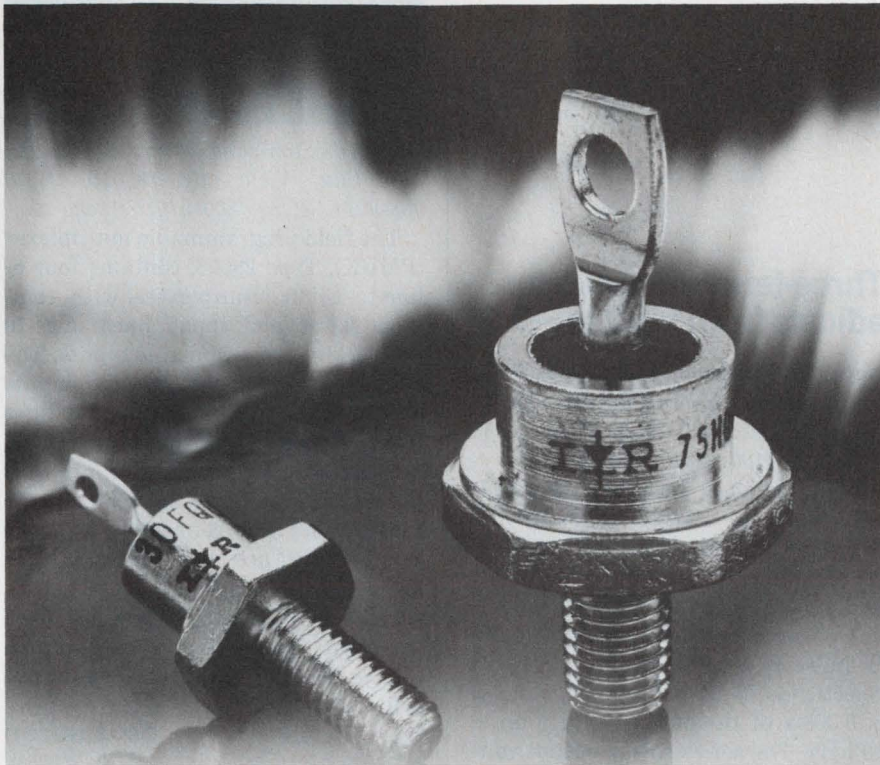

International Rectifier, 233 Kansas Street, El Segundo, CA 90245. Bob Del Vecchio (213) 322-3331. P & A: See text.

Pushing the operating temperatures up and reducing the reverse currents, International Rectifier's families of extended-range Schottky diodes pack more punch into power-supply designs. The diodes can operate at up to 175 C—a 25-C increase over available devices. As a result, you get either more current-handling capability or less heat-sink area.

Typical of the new devices is the 75HQ family, 75-A diodes with reverse-voltage capabilities of 30 or 45 V. Reverse currents for the diodes range from 15 mA at a junction temperature of 100 C to 150 mA at a T_j of 150 C. The maximum forward voltage drop for the diodes is as high as 0.9 V at 25 C and a forward current of 150 A (peak), and as low as 0.74 V at 175 C and 150 A (peak).

The Schottky diodes, since they operate at junction temperatures up to 175 C, permit the ambient temperature of

the power supply they are used in to rise—typically from 40 to 70 C. Or, ratings can be kept the same but the heat-sink area reduced—by 20 to 40%, according to estimates.

Not only are the 75HQ diodes able to handle the high continuous currents, but they are also sturdy. The maximum peak one-cycle nonrepetitive surge current is 1000 A and the maximum I^2t for fusing is 4150 A²S for 5 to 8.3 ms and 2275 A²S for 1.5 ms.

Housed in stud-mount DO-203AB cases (formerly called DO-5), the diodes have a case-to-sink thermal resistance of 0.25 C/W. Mounting torque for the 1-oz devices is 30 lb-in., maximum. All diodes have an operating junction temperature range of -65 to 175 C.

Also available is a 30-A series of high-temperature diodes, the 30HQ family. Reverse currents are less than half those of the 75HQ devices and forward-voltage drops are about the same as the 75HQ units.

Compared to other high-current

Schottky diodes, the 75HQ series offers 80% less reverse leakage current than its closest competitor, the MBR75 made by Motorola (Phoenix, AZ). The lower leakage minimizes the problem of thermal runaway—one of the major causes of Schottky diode failures.

Another competing diode series, the SD51, is available from TRW (Lawn-dale, CA). Every diode in this group also handles 75-A loads, but has higher reverse currents and a lower maximum operating junction temperature.

Prices for International Rectifier's 30HQ and 75HQ diodes start at \$4.48 for the 30-A, 30-V device and range up to \$7.08 for the 75-A, 45-V diode, both in 100-unit quantities. Delivery of samples is from stock, and production quantities require four weeks.

International Rectifier **CIRCLE NO. 302**
Motorola **CIRCLE NO. 303**
TRW **CIRCLE NO. 304**

Speedy power transistors take high voltage

General Semiconductor Industries, P.O. Box 3078, Tempe, AZ 85281. Jim Williams (602) 968-3101. \$4.95 to \$6.00 (100 qty); stock.

Models XGSR7530, XGSR7535 and XGSR7540 feature a V_{CEO} of 300, 350 and 400 V. Each is both current-gain and saturation-voltage rated at 7.5 A. Peak collector current is 15 A. Collector saturation voltage is typically 0.3 V and switching speed is less than 1 μ s. Packaging is the TO-3 metal case.

CIRCLE NO. 305

Bridge rectifiers rate 27.5 A, 3-phase

Electronic Devices, 21 Gray Oaks Ave., Yonkers, NY 10710. Dennis Dean (914) 965-4400. Free samples.

A line of 3-phase, full-wave bridge rectifiers is rated at 27.5 A. Peak reverse voltage ratings are 50, 100, 200, 400, 600, 800 and 1000 V. Maximum surge current is 300 A. The bridges are 1.5 x 2 x 0.406 in. and can be mounted on a heat sink or chassis.

CIRCLE NO. 306

Bipolar a/d converter delivers 10-bit output

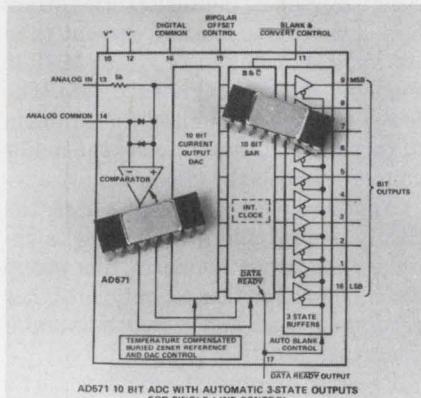

Analog Devices, Route 1 Industrial Park, P.O. Box 280, Norwood, MA 02062. Jeff Riskin (617) 329-4700. Stock.

Built using I²L technology, the AD571 is a complete, 10-bit analog/digital converter. On a single chip is a d/a converter, voltage reference, clock, comparator, successive approximation register and output buffer. The AD571 performs a complete conversion to 10-bit accuracy $\pm 1/2$ LSB with no missing codes in 25 μ s. There are three versions available; the J suffix for fully guaranteed 10-bit performance at 25 C (9 bits from 0 to 70 C), the K suffix for a full 10 bits over 0 to 70 C, or the S suffix for -55 to +125 C operation. The guaranteed full-scale temperature coefficients of 88, 44, and 40 ppm for each version, respectively, are the total TC errors of all the components in the circuit.

CIRCLE NO. 307

Transistors switch 1 A and are MIL qualified

Silicon Transistor, Katrina Rd., Chelmsford, MA 01824. Bill Schromm (617) 256-3321. \$3.38/\$4.30; bonded stock.

JAN-2N3740 and JAN-2N3741 silicon power transistors are qualified to MIL-S-19500/441A. They are rated for a V_{CEO} of 60 and 80 V, respectively, and continuous collector current of 1 A. The dc gain is 30 to 100 at an I_C of 250 mA, and the collector-emitter saturation voltage is specified at 0.6 V at 1 A. The devices are in TO-66 cases.

CIRCLE NO. 308

High-speed op amp has 15-MHz bandwidth

Texas Instruments, P.O. Box 5012, M/S 308 (Attn: LM318), Dallas, TX 75222. Dale Pippenger (214) 238-3527. \$1.64 to \$10.08 (100 qty); stock.

The LM318 high-speed operational amplifier has a typical small-signal bandwidth of 15 MHz and a slew rate of 50 V/ μ s min. The op amp has internal unity-gain frequency compensation. External compensation may be added for optimum performance. Supply voltage can range from ± 5 V to ± 20 V.

CIRCLE NO. 309

Three-terminal regulator adjusts from -1.2 to -37V

National Semiconductor, 2900 Semiconductor Dr., Santa Clara, CA 95051. Dave Whetstone (408) 737-5856. \$2.80 to \$13.60 (100 qty); stock to 4 wks.

Negative three-terminal adjustable regulators, the LM137 series, are 1.5-A devices. The regulators have internal current limiting, thermal shutdown and safe-area compensation. The output voltage shifts 0.2% max when a 10-W pulse is applied for 10 ms. Ripple rejection is 75 dB and rms output noise is 0.003% of the output voltage up to 10 kHz. The series covers output voltage from -1.2 to -37 V in TO-3, TO-5, TO-220 and TO-202 cases.

CIRCLE NO. 310

Dual op-amps have high input impedance

RCA Solid State, Route 202, Somerville, NJ 08876. (201) 685-6423. \$0.55 (chip) to \$1.73 (100 qty); stock.

The CA3240 and CA3240A dual op amps have gate-protected MOSFET transistors in the input circuit for high input impedance ($1.5 \times 10^{12} \Omega$), low input current (10 pA at ± 15 V) and high-speed. The op amps have, respectively: max input offset voltages of 15 mV and 5 mV, input offset currents of 30 pA and 20 pA and max input currents of 50 pA and 40 pA. The dc supply voltage can range from 4 to 36 V and the common-mode input voltage can swing to 0.5 V below the negative supply rail. Package options are 8-lead or 14-lead plastic DIPs.

CIRCLE NO. 320

Programmable circuit multiplexes 8 lines

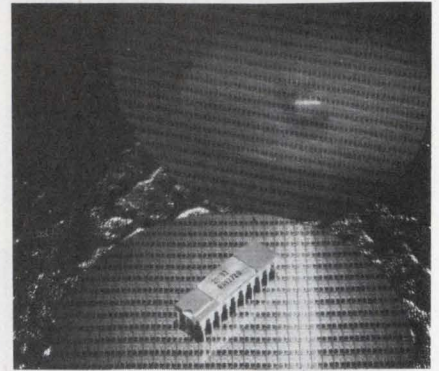

Raytheon Semiconductor, 350 Ellis St., Mountain View, CA 94040. (415) 968-9211. \$4.25 (100 qty); stock.

The field programmable multiplexer (PMUX), Type 29693, contains four 8-line-to-1-line multiplexers with common select and input lines and 10 electrically programmable inputs. The 20-pin device has 10 buffered inputs and four outputs. The 10 input lines form a matrix with 32-bit lines. At each junction of the horizontal inputs with the vertical bit lines, there is a diode-fuse combination connecting the two. The bit lines are then routed to four one-of-eight multiplexers controlled by three "select" inputs. The select lines determine which multiplexer inputs are connected to the three-state output drivers.

CIRCLE NO. 321

64-k ROM features 200-ns access time

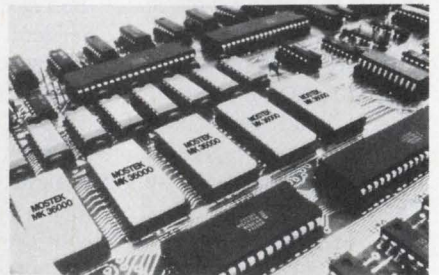

Mostek, 1215 W. Crosby Rd., Carrollton, TX 75006. Derrell Coker (214) 242-0444. See text; 6 wks.

The MK 36000 64-k ROM operates at a 200-ns access time and requires only 200-mW active power (max) and 25-mW standby power. The device operates from a single +5-V power supply with 10% tolerance. Other system features include full TTL-compatible inputs and outputs. The three-state output can drive two TTL loads and 100 pF. The price for the plastic package is \$49.00 in 500 quantity with a \$1000 refundable masking charge.

CIRCLE NO. 322

Don't waste money and ruin PROMs. Move up to a first-rate programmer.

What defines a first-rate programmer?

A first-rate programmer is easy to use, safe (U.L. listed), reliable, backed with a long-term warranty, and flexible enough to handle advances in PROM technology, a combination you get only with a Pro-Log programmer.

Our systems take the mistakes out of programming.

Our Series 90 PROM Programmer walks you through the programming process so there's less chance for misprogramming. Separate sockets for master and copy PROMs make it impossible to accidentally destroy a valuable master.

Vendor-approved programming, full portability, free 2-year warranty.

Using vendor-approved PROM personality modules, Pro-Log's field-proven programmers program every major MOS and bipolar PROM. They also program generic PROM families and do gang programming.

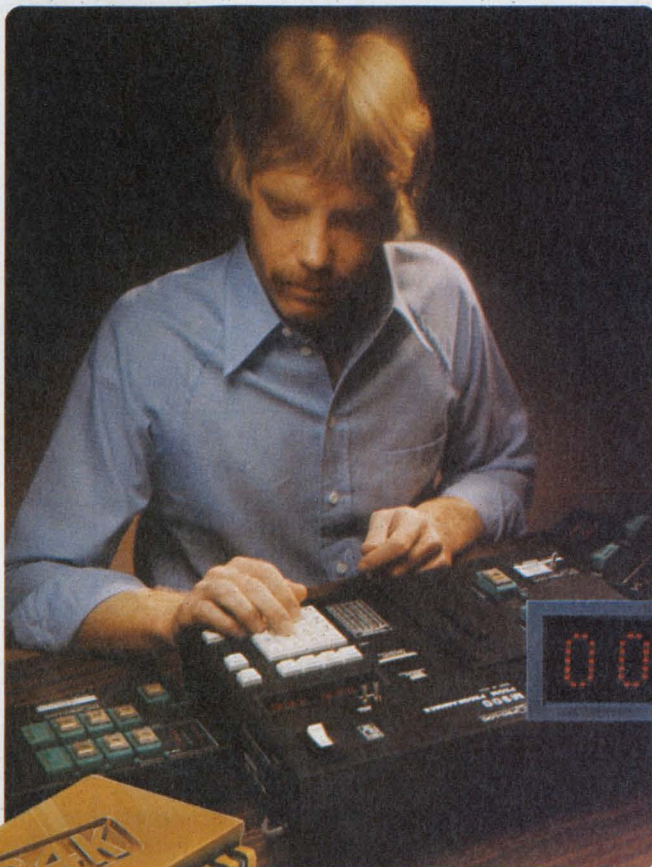

They weigh less than 20 pounds so they go where you need them. And they're backed by the longest warranty in the industry, 2 full years parts and labor.

A first-rate programmer is economical, too.

A complete Series 90 consists of a master control unit, a PROM personality module, and options. An M900 master control unit costs only \$1,800. An M920 PROM Duplicator master control unit costs only \$1,145. Single PROM personality modules cost from \$325 to \$450. Generic modules start at \$350. Gang modules which program 8 PROMs simultaneously are \$895. All modules come U.L. listed and fit both the M900 and the M920. Options include CMOS RAM buffer (to 4K bytes), RS-232 (terminal or modem) interface, TTY, parallel interfaces, paper tape reader,

U.L. listed erase light, checksum option, and Auto-baud.*

Find out what else a truly first-rate programmer has to offer.

Call or write for a free pamphlet giving you comparison checkpoints. Pro-Log Corporation, 2411 Garden Road, Monterey, CA 93940. Phone (408) 372-4593.

*Trademark, Pro-Log Corporation.



 **PRO-LOG**
CORPORATION

Microprocessors at your fingertips.

System monitor keeps track of microcomputer performance

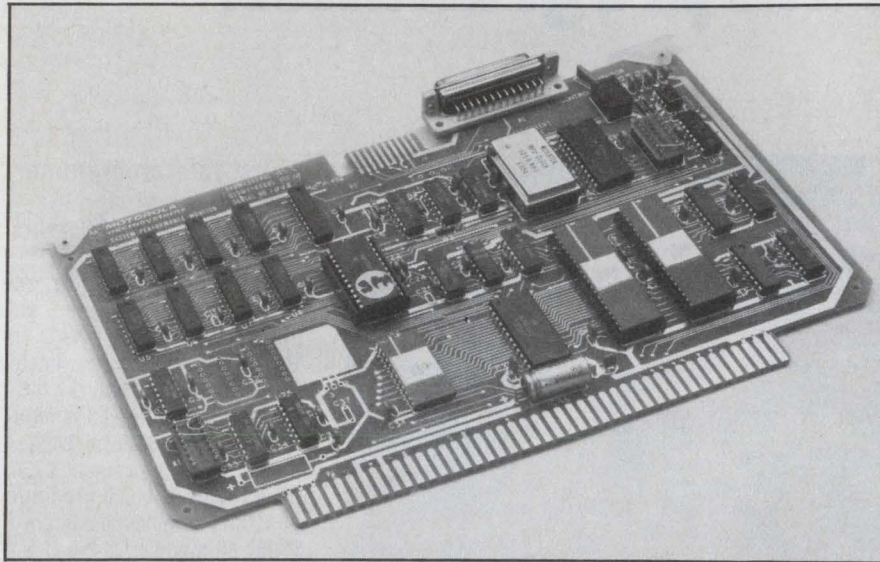

Motorola Microsystems, 3102 N. 56th St., Phoenix, AZ 85018. Wes Patterson (602) 244-6815. P&A: See text.

Although system monitors are routinely used to analyze the performance of large computer systems, they cost too much for most microcomputer applications. But for just \$1045 Motorola's System Performance Monitor gives the micro user the monitoring capability of units costing several thousand dollars.

Connecting directly to a microcomputer's address bus, the SPM periodically samples the μ C system's address lines, and accumulates the results to produce a map of memory addresses with corresponding frequencies of reference. Samples collected in the program-storage region may be used to correlate processor activity with specific program segments. One result is that software bottlenecks can be identified and quantitative information provided about the performance limits they impose. Or, critical program segments may be identified for reorganization or optimization. Or, if a high-level language is being used for software development, certain sub-routines may be identified for recoding in assembly language.

An autonomous single-board microcomputer system, the SPM measures 5.75 x 9.75 in. and is physically and logically bus-compatible with Motoro-

la's EXORciser μ P development system and the Micromodule series of OEM microcomputer boards. Jumpers enable the SPM to adapt logically to other microcomputer bus structures, with physical adaptation left to the user.

As seen from the bus, the SPM is a passive device; it doesn't disturb the measured system. During operation, 12 address bits from the monitored bus are latched and sampled by the SPM approximately 6000 times per second. Data from each sample accumulate in one of 256 4-byte counters. Bus observations may be run for almost a week without losing data. Samples may be collected within a specified memory region of 4, 16 or 64 kbytes. Experiments over smaller regions produce greater detail in the results.

Samples collected in the data-storage region of memory may provide such additional useful information as the efficiency of a particular buffer-management algorithm. Since I/O in the M6800 μ P is memory-mapped, the SPM can also collect information about I/O activity. In addition, processor utilization may be derived from bus-utilization information collected by the SPM. This can be used to project maximum system capacity, or to quantify improvements over previous measurements.

(continued on page 84)

Call your nearest ISC sales representative

- Alabama (also Mississippi):**
W. A. Brown Inst. Inc.
Huntsville 205/883-8660
- Arizona (also Nevada):**
The Thorson Co.
Phoenix 602/956-5300
- California:**
The Thorson Co.
Los Angeles 213/476-1241
Goleta 805/964-8751
Mountain View 415/964-9300
San Diego 714/292-8525
Irvine 714/557-4460
- Colorado (also Utah, Wyoming):**
The Thorson Co.
Denver 303/759-0809
- Florida:**
W. A. Brown Inst. Inc.
Ft. Lauderdale 305/776-4800
Melbourne 305/723-0766
Orlando 305/425-5505
Valparaiso 904/678-7932
- Georgia:** W. A. Brown Inst. Inc.
Atlanta 404/939-1674
- Illinois (N.) (also Indiana, Wisconsin):**
Resource Data Sys.
Northbrook 312/564-5440
- Kansas (also W. Missouri, Nebraska):**
Inland Assoc.
Shawnee Mission 913/362-2366
- Louisiana:** W. A. Brown Inst. Inc.
Mandeville 504/626-9701
- Maryland (also D.C., Virginia):**
Bartlett Assoc.
Bethesda 301/656-3061
- Massachusetts (also Maine, N. Hampshire, Rhode Island, Vermont):**
Bartlett Assoc.
Framingham 617/879-7530
- Michigan:** WKM Assoc.
Madison Heights 313/588-2300
- Minnesota:** Cost Reduction Services
Minneapolis 612/822-2119
- Missouri (E.) (also S. Illinois, Iowa):**
Inland Assoc.
St. Louis 314/821-3742
- New Mexico:** The Thorson Co.
Albuquerque 505/265-5655
- New York (also Connecticut, New Jersey):**
Bartlett Assoc.
White Plains 914/949-6476
- North Carolina:** W. A. Brown Inst. Inc.
Durham 919/682-2383
- Ohio (also Kentucky):** WKM Assoc.
Cleveland 216/267-0445
Dayton 513/434-7500
- Oklahoma:** Data Marketing Assoc.
Oklahoma City 405/528-6071
- Pennsylvania (E.) (also Delaware):**
Bartlett Assoc.
Wayne 215/688-7325
- Pennsylvania (W.) (also West Virginia):**
WKM Assoc.
Pittsburgh 412/892-2953
- South Carolina:** W. A. Brown Inst. Inc.
Columbia 803/798-3297
- Tennessee:** McCain Elec. Equip. Co.
Knoxville 615/588-2417
- Texas (also Arkansas):**
Data Marketing Assoc.
Austin 512/451-5174
Dallas 214/661-0300
Houston 713/780-2511
San Antonio 512/828-0937
- Washington (also Idaho, Montana, Oregon):**
The Thorson Co.
Bellevue 206/455-9180
- European Export Sales:** Techexport, Inc.
Cambridge, MA 617/661-9424
- England:** Techex, Ltd.
Bournemouth 0202-293-115
- France:** Peritex
Rueil 749-40-37
- Switzerland:** Intertest, AG
Bern 031-224481
- West Germany:** COT GmbH
Altheim 6691-255
- Australia:** Anderson Digital Equip.
Mt. Waverly, Victoria 03-543-2077
- Canada:**
Cantec Rep., Inc.
Milton, Ont. 416/624-9696
Ottawa, Ont. 613/255-0363
Pierrefonds, Que. 514/620-3121
- Canada:** Datamex, Ltd. (Distributor)
Dorval, Que. 514/636-9774
Toronto, Ont. 416/787-1208
Vancouver, B.C. 604/684-6750
- Far East:** Computers International
Los Angeles, CA 213/382-1107



Intelligent Systems Corp.

\$1925

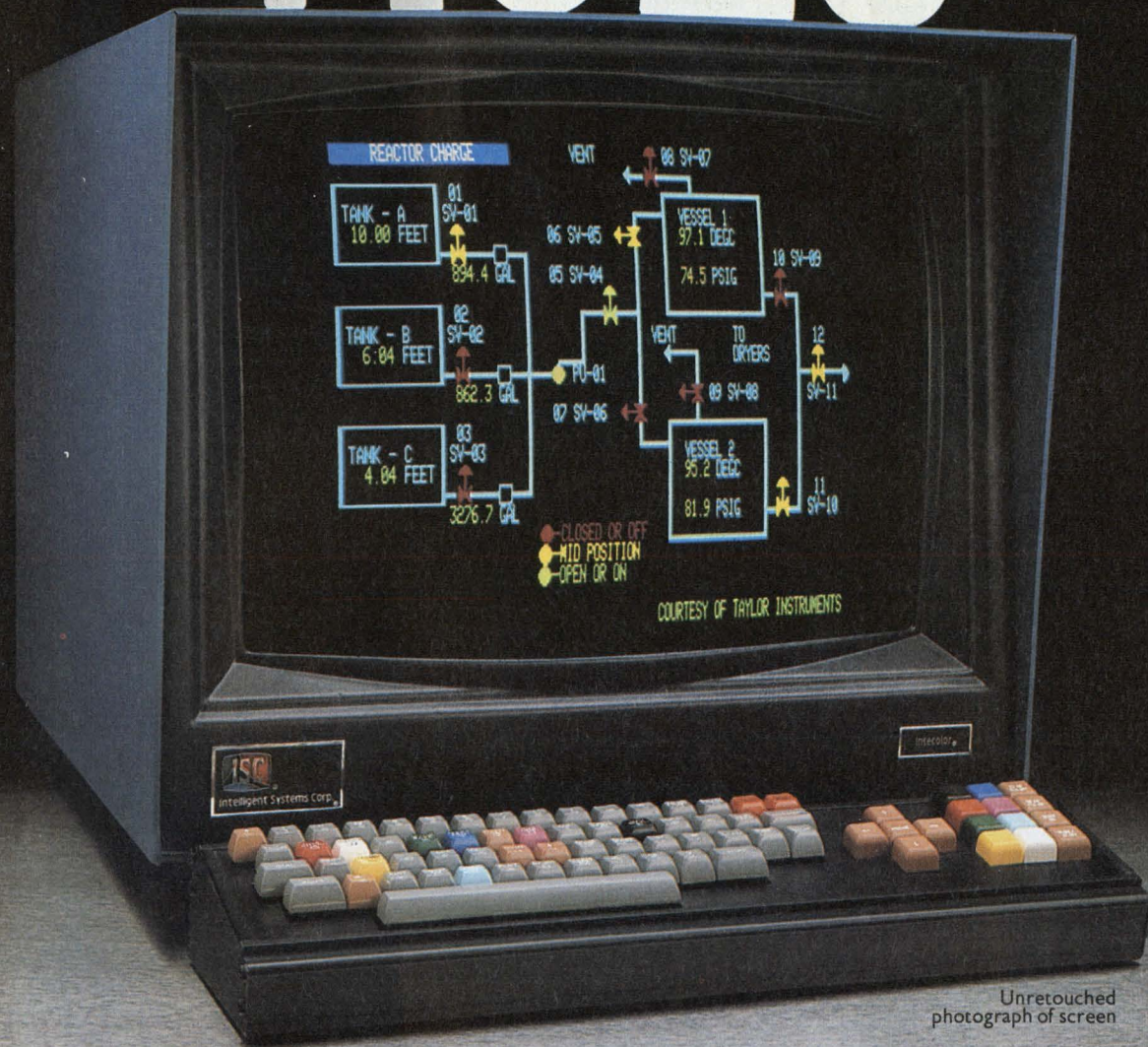

Unretouched photograph of screen

There isn't a process control system in the industry that our Intecolor 8001G can't improve, because color communicates faster.

Bailey Meter, Taylor Instruments, Dow Chemical, International Paper, ACCO Bristol, PPG Industries come from a long list of industry leaders who have integrated our Intecolor 8001 color data terminal into their systems — sophisticated systems that demand critical control. Now we can bring you the Intecolor 8001G, the same precision terminal with a special color graphics package as a standard feature, at con-

siderable savings over the separate option cost. Look at some of the advanced Intecolor 8001G features:

- Expanded hardware and software graphics
- 48 lines by 80 characters with two different character heights
- Eight foreground colors, plus eight background colors for additional definition
- Character and line insert and delete
- Page roll-up
- 64 Standard Instrument Society of America characters
- Plotting capability on a 160 by 192 matrix
- Expanded keyboard with cursor and color controls
- 19" display

A 25" unit with the same standard features is available at slightly extra cost.

We guarantee delivery of your Intecolor 8001G evaluation unit for

\$1,925* (cash-with-order) within 30 days or your money back. The same \$1,925 price goes for orders of 100 units or more. Get the jump on your competition without outspending your competition. Get the Intecolor 8001G.



Intelligent Systems Corp.

5965 Peachtree Corners East
Norcross, Georgia 30071
Telephone 404-449-5961 TWX 810-766-1581

Color communicates faster.

*U.S. domestic price.

THE CENTRALAB EDGE in disc capacitors

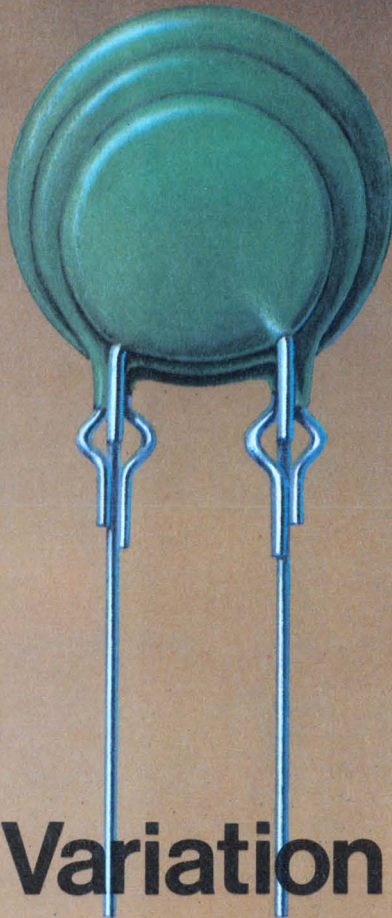

Any Lead Variation You Need

At Centralab we are concerned with the same things you are – performance, reliability, on-time delivery. But any ceramic disc capacitor supplier can say that. We go that critical step further; we give you a choice of leads to help you cut your manufacturing costs.

Our standard leads include stand-off types to prevent solder damage; snap-in types to avoid fall-out during assembly; short leads for low profile; long leads for those hard-to-reach placements.

We'll go even further. On minimum OEM order, we'll make any lead configuration (under 3½") you need. Just tell us your manufacturing problem; we'll give you a cost-effective answer.

And don't forget our tape-and-reel packaging for automatic insertion.

Cost savings *in use*. That's the competitive edge you get from Centralab. The Centralab Edge.

Products you need from people who care.



CENTRALAB / USCC
Electronics • GLOBE-UNION INC.

7158 Merchant Ave., El Paso, TX 79915 (915) 779-3961

CIRCLE NUMBER 8

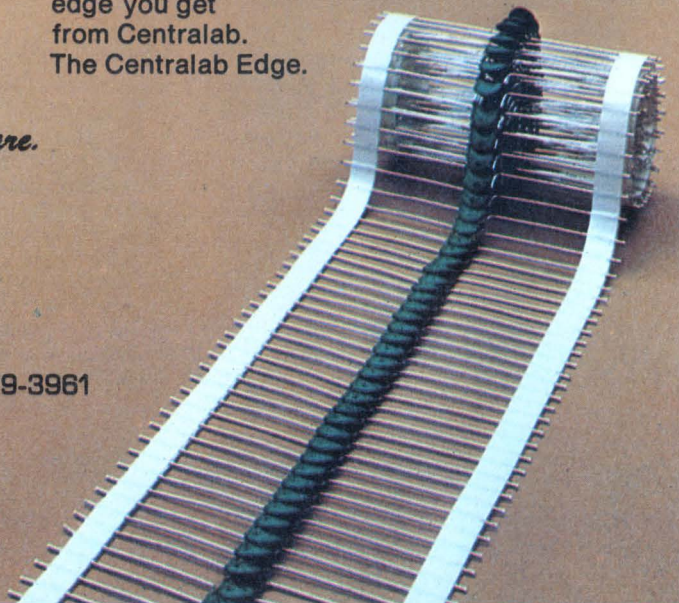

PMI announces two



monolithic 10-bit DAC's.



Good news! Two new ten-bit digital-to-analog converters from the folks who know how to make them monolithically. And each is completely "complete." Includes internal reference and output op amp. They are fast (1.5 μ sec settling time), with voltage outputs, yet consume only 350mW (max) over the entire military temp range (-55°C to $+125^{\circ}\text{C}$).

DAC-05: Sign-magnitude coding (sign-plus-ten-bits).

DAC-06: Two's complement coding.

Both DACs are available now specified over the full temp range. Off the shelf to MIL STD-883A Level B. Reliability is enhanced by 100% burn-in, hermetic packaging for all parts, PMI's famous triple passivation, low noise process and no laser trimming.

Data sheets are ready. Parts are on the shelf. Write, wire or phone. Precision Monolithics, Inc., 1500 Space Park Drive, Santa Clara, CA 95050. (408) 246-9222. TWX: 910-338-0528.



CIRCLE NUMBER 9

OPTICAL SWITCHES

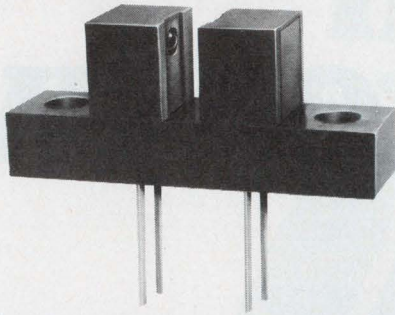

**Designing-in switches? Call Spectronics.
We can show you a better way.**

All Spectronics optical switches are manufactured using our high-technology infrared process, assuring highest reliability. Our broad line is increasingly utilized for such applications as speed control, position and level sensing, and card reading, replacing traditional mechanical switches for these important functions. Interchangeability is no problem — our switches are direct replacements for such popular devices as the H13A1, A2; H13B1, B2; MCA 8, 81 and MCT 8 and 81. Spectronics optical switches are TTL compatible and feature switching speeds ranging from 10 to 750 μ secs.

For more details and delivery information, contact Commercial Component Division, 830 E. Arapaho Road, Richardson, Texas 75081, (214) 234-4271.



The
Quality
Leader

CIRCLE NUMBER 41

MICRO/MINI COMPUTING (continued from page 80)

A control-console keyboard is used to initialize the starting memory address and memory block size for each measurement experiment. Results are retrieved via console printer or CRT and reported both as a percentage of samples occurring in each memory segment within the measured region and as a histogram. Bus utilization is reported as busy bus cycles, which are sampled as a percentage of the total cycles sampled.

Since the console isn't needed except to initialize the SPM and to retrieve results, the EXORciser console device may be shared for this function. A serial RS-232 interface is included with the SPM, and a current-loop interface adapter is available as an option.

Delivery of the board is from stock.

CIRCLE NO. 301

Thrifty disc drive holds 143 kbytes

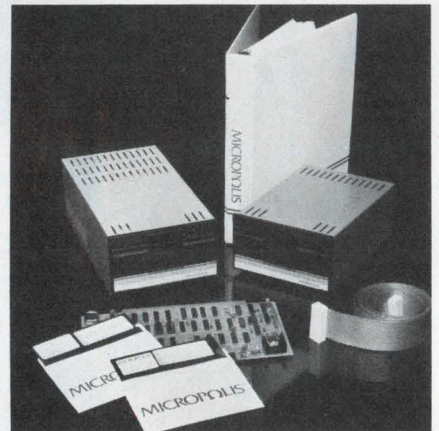

Micropolis, 7959 Deering Ave., Canoga Park, CA 91304. (213) 703-1121. \$695.

The 1041 series of disc drives includes software, S-100 bus compatible controller and 143-kbyte capacity. Model 1041 packages a drive, enclosure, cabling and connectors, disc operating system and disc-extended Basic for integration into any 8080A or Z80 microcomputer. Model 1042 adds a power supply and dc regulators for desktop use. The drives are hard-sectored into 16 sectors, each 256 bytes long; total tracks per surface is 35. Both offer transfer rates of 250 kbits/s at an average rotational latency time of 100 ms. Access time, track to track, is 30 ms and recording density is 5162 bits/in.

CIRCLE NO. 323

monolithic filters say NUTS TO NOISE!

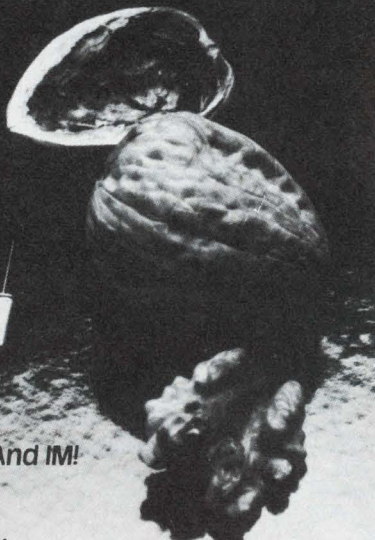

Nuts to Noise! And Interference! And IM!

We're putting out the widest and best selection of stock model monolithic filters you'll find at any radio get-together. From 5 to 180 MHz. Over 60 tasty models at 10.7 and 21.4 MHz. Plus two can't-put-them-down monolithic crystal discriminators. *Nuts to high prices too! We'll give you macadamia quality at peanut prices.*

NUTS TO NOISE!

Pti

Piezo Technology Inc.
2525 Shader Road, Orlando, FL 32804
(305) 298-2000

The standard in monolithic crystal filters

CIRCLE NUMBER 37

Full-function computer fits on desk top



IBM, P.O. Box C-1645, Atlanta, GA 30301. Bill Shaffer (404) 231-3201. \$9875 to \$32,925.

The IBM 5110 is a desktop computer that houses a central processing unit, a typewriter-like keyboard with a 10-key calculator pad and a 1024-character display screen. Main memory holds 16 k, 32 k, 48 k or 64 kbytes of data, depending on the unit selected. The computer is available in two models. Offering either magnetic tape or diskette storage, the Model 1 stores 204 kbytes per tape cartridge or 1.2 Mbytes on a single diskette. The Model 2 allows diskette storage only. Up to two IBM 5114 diskette units, each housing a maximum of two diskette drives, can be attached to the 5110 for an on-line diskette capacity of 4.8 Mbytes.

CIRCLE NO. 324

Memory module contains more than 1 Mbyte

EMM Commercial Memory Products, 12621 Chadron Ave., Hawthorne, CA 90250 (213) 644-9881. \$0.10/bit

The Megabyte Module memory is configured as 1,114,112 × 8 (8,912,896 bits), which is 524,288 bits in excess of 1 Mbyte. The additional 64-kbyte capacity allows the use of various error checking methods while maintaining a 1-Mbyte capacity for data. The memory is a random-access, two-wire, 1-1/2D core memory, packaged on a single pluggable PC card. An available chassis can take up to four modules, two I/O cards, and a power supply within 17-1/2 in. of vertical rack space. The memory module operates at 2 μs in the read/restore and clear/write modes with an access time of 1.2 μs.

CIRCLE NO. 325

Your Reasons For Moving ...

You probably already have a lot of good reasons for moving your plant or expanding your operation. And they're all great reasons for moving to Palm Coast Industrial Park.

LOCATION — Florida's growing Northeast coast just one hour South of Jacksonville.

SAVINGS — Lower state and local taxes, including a total tax on industrial property of 10.887 mills. Lower housing and labor cost, too.

LABOR — A population of 725,000 within a reasonable commuting distance.

TRANSPORTATION — I-95 and US 1 cross the property with available access to air, rail and trucking.

CORPORATE COMMITMENT — ITT Community Development Corporation is ready to assist you in every step of your move.

LIFESTYLE — The bright, warm Florida climate.

There's even more good reasons. Write us and we'll send you all the details, or call Dave Irving toll free at 1-800-874-1828 (in Florida 1-904-445-3411 collect).

Are Great Reasons For Moving Here.

ITT Community Development Corporation

Palm Coast INDUSTRIAL PARK

ED 3/78

For more information write Mr. David Irving, ITT Community Development Corporation, Executive Offices, Palm Coast, FL 32037 or call toll free at 1-800-874-1828 (in Florida 1-904-445-3411 collect).

PLEASE SEND ME MORE GREAT REASONS FOR MOVING TO PALM COAST.

My company is engaged in manufacturing, distribution, other, and we are moving, expanding.

NAME _____ TITLE _____

COMPANY NAME _____

ADDRESS _____ CITY _____ ZIP _____

MICRO/MINI COMPUTING

Low-end computer uses PDP-8 processor

Digital Equipment, Maynard, MA 01754. Joe Nahil (603) 884-5101. \$12,600; 8 wks.

The Datasystem 308 uses a PDP-8 video data processor and is for data processing that requires a single termi-

nal. A typical system consists of a video data processor with 32 kbytes of memory, dual floppy-disc file system, and a minidesk. The 308 uses the COS-310 operating system whose program includes DIBOL, a business-oriented language. COS-310 files and the DIBOL language permit the user to transfer programs and data to larger systems by appropriate media.

CIRCLE NO. 326

Bulk magnetic eraser is hand held

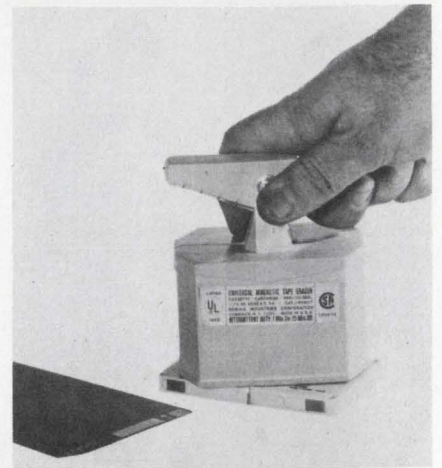

Printcraft Systems, 11-17 Beach St., New York, NY 10013. Don Hubbinett (212) 966-0001. \$22.50.

The UL-approved hand-held bulk tape/card eraser electronically restores magnetic cards, cassettes, discs and reel-to-reel recording tapes to "like new" blank recording condition. The process can be performed off line in quantity for either general reuse or for information security. The eraser guards against one program from running into a previously recorded program should a stop code be missed.

CIRCLE NO. 327

Personal computer uses Z80 CPU



Realistic Controls, 404 W. 35 St., Davenport, IA 52086. (800) 553-1863. \$2495.

REX, a total microcomputer system, is fully assembled with a Z80 CPU, 24-k RAM, video output, keyboard, microfloppy-disc drive, cabinet, power supply and optional extended-disc Basic and ANSI Fortran IV. The system includes an S-100 motherboard, up to 64 k of RAM (24 k standard), bootstrap and monitor PROM and power-fail and vectored-interrupt circuitry.

CIRCLE NO. 328

yes Standard Grigsby's rotary switches have printed circuit and solderless terminals that will not bend or twist

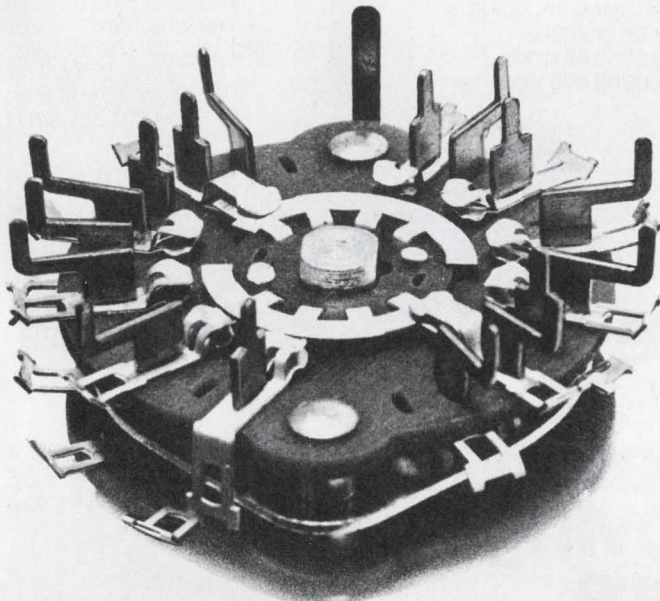

our exclusive rigid construction provides you with savings by eliminating costly assembly operations

"YES" - Save the valuable time wasted on straightening the P.C. terminals of rotary switches!

Our exclusive printed circuit "T" terminals are ruggedly designed to allow EASY insertion of our rotary switches into any P.C. board pattern.

If you wire your rotary switches with wire-wrap or other solderless techniques, try a terminal that won't bend or twist... Standard Grigsby's NEW solderless "T" terminal.

Send for Free "Yes" button and literature.



standard grigsby, inc.

920 Rathbone Avenue • Aurora, Illinois 60507
(312) 844-4300

CIRCLE NUMBER 43

Intel delivers a better 22-pin 4K RAM for people who are never quite satisfied.

For some people "good enough" is never quite good enough. In 1972 we introduced the industry's first 22-pin 4K RAM, the 2107. But we weren't content to stop there. So we followed with the 2107A. Then in 1975 the 2107B. Now, introducing the 2107C. Compare it with any 4K dynamic RAM. The results are sure to put a smile on your face.

The 2107C delivers a new standard of performance. Access time: 150 ns. Power consumption: 40% lower than the TMS 4060 or our own 2107B. Current spikes: significantly lower than competitor's parts means less system noise with the 2107C. Supply tolerance: $\pm 10\%$ in all power supplies gives you the widest system operating margins available anywhere.

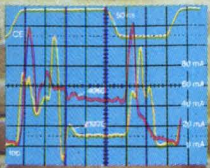

Best of all, the 2107C is already in volume production and available in both hermetic and plastic packages. Plan now to upgrade your systems now using our 2107B or any of its second sources. For a complimentary P2107C evaluation sample and data sheet,

| | 2107C-1 | 2107C-2 | 2107C |
|---------------------------------|------------|------------|------------|
| Maximum Access Time | 150 ns | 200 ns | 250 ns |
| Maximum Read/Write Cycle | 380 ns | 400 ns | 430 ns |
| Maximum I _{DD} Average | 35 mA | 33 mA | 30 mA |
| Power Supply Tolerance | $\pm 10\%$ | $\pm 10\%$ | $\pm 10\%$ |

contact your Intel sales office. To order, contact Almac/Stroum, Component Specialties, Cramer, Hamilton/Avnet, Harvey Electronics, Industrial Components, Pioneer, Sheridan, Wyle/Elmar, Wyle/Liberty, L.A. Varah, Zentronics. Or write us. Intel Corporation, 3065 Bowers Avenue, Santa Clara, CA 95051.

In Europe, Telex 24814, Brussels.
In Japan, Telex 28426, Tokyo.

CIRCLE NUMBER 44



intel delivers.

COMPONENTS

Solid-state chopper comes in TO-5 case

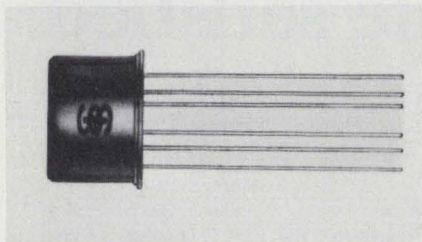

Solid State Electronics, 15321 Rayen St., Sepulveda, CA 91343. Ed Politi (213) 894-2271. \$89 (100 qty); 1 to 3 wks.

The NS8000A is a transformer-isolated solid-state chopper built with stabilized integrated silicon semiconductors in a TO-5 type enclosure. The max chopped current is 10 mA and the total device dissipation in free air is 0.5 W (2 W at 25-C case temp). The chopping frequency (limited by an internal transformer) ranges from 50 kHz to 1.5 MHz.

CIRCLE NO. 329

Large indicator lights are attention grabbers



Industrial Devices, 7 Hudson Ave., Edgewater, NJ 07020. (201) 224-4700. Free samples.

Large attention-getting panel indicator lights, Omni-Glow 2600, have built-in, round metal bezels that retain a lens. High dome-shaped, or low-profile flat or rounded lenses can be used. The indicators fit into a 7/8-in. diameter panel opening or in a keyed D-mounting hole. Either snap-fit or speednut mounting may be used. Lamps for the indicators are either standard or high-brightness neons or rugged wire-lead incandescents.

CIRCLE NO. 330

Low-profile heat sink fits TO-3 and TO-66

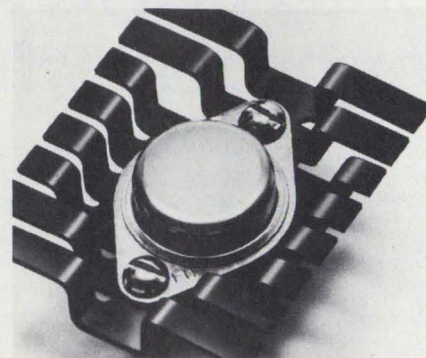

Aavid Engineering, 30 Cook Court, Laconia, NH 03246. (603) 524-4443. Free samples.

Heat sinks that feature a universal hole pattern, part numbers 5060 and 5061, also accommodate TO-3 and TO-66 case-style devices. The heat sinks are 0.375-in. high and fit PC boards spaced 0.5-in. between board centers. Both types come with black anodized finish.

CIRCLE NO. 331

VICTORY SELECTIVITY

THERMISTORS

Selectivity, not just a word but a reality at VECCO. SensiChips[®] thick films, beads and probes in a wide variety of sizes and resistances. Try us, you'll like VECCO quality and prices.



VICTORY ENGINEERING CORP.
Victory Rd., Springfield, N. J. 07081
TWX: 710-983-4430 Tel: 201-379-5900

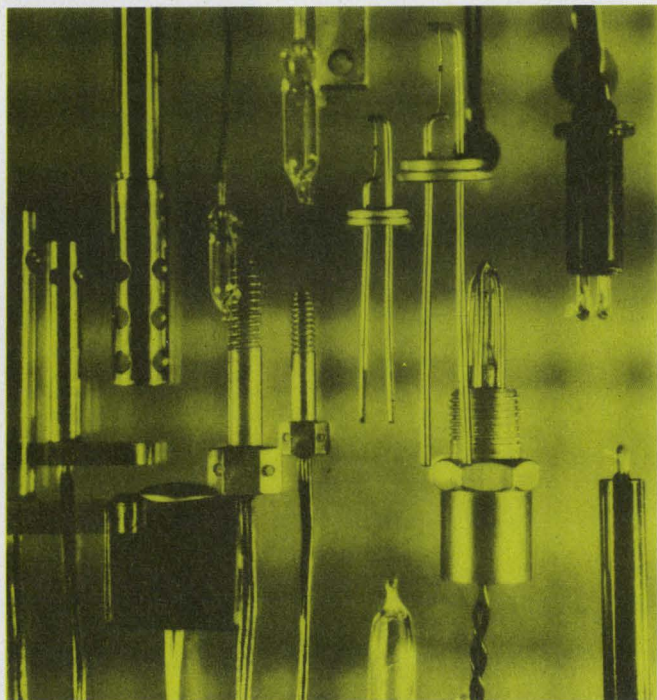

CIRCLE NUMBER 45

Rogan knobs look better and are built better,



and we'll prove it with a free sample.

After you receive our catalog, send us a note outlining your specific requirement and the quantity involved.

Or furnish us with our competitor's part number and we will cross-reference it.

Our samples and quotation will be returned promptly.



3455 Woodhead Drive, Northbrook, Illinois 60062 (312) 498-2300

CIRCLE NUMBER 46

Intel delivers the only 16-pin 4K RAM that's sure to keep you smiling.

You may or may not think of your memory system as a masterpiece. But one thing is certain, once you've reached volume production you're going to be reluctant to make major changes. That's why it is so frustrating to find that a supplier has painted you into a corner by deciding to stop delivering the part you want. Or by trying to switch you to a newer, non-compatible part.

Smile. Our 2104A 16-pin 4K RAM is the answer. It's a direct replacement for both the older 4096 metal gate and newer 4027 silicon gate parts. The 2104A keeps your production line moving without expensive re-design. Plug it in and you're ready to go.

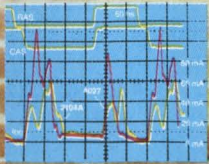

The 2104A is best for your new designs, too. We've been delivering this part in volume since July, 1976. So you can count on Intel to deliver the quantity you need, when you need it.

Delivery is not the only reason to specify the 2104A. There's not a 16-pin 4K RAM anywhere with lower power consumption. And because the 2104A has significantly lower current spikes

than other 16-pin 4K RAMs, there's less system noise. What it all means is that when you design your next system, it makes sense to design it using our 2104A.

| | Maximum Access Time | Maximum Read/Write Cycle | Maximum I _{DD} Average |
|----------------|---------------------|--------------------------|---------------------------------|
| 2104A-1 | 150 ns | 320 ns | 35 mA |
| 2104A-2 | 200 ns | 320 ns | 32 mA |
| 2104A-3 | 250 ns | 375 ns | 30 mA |
| 2104A-4 | 300 ns | 425 ns | 30 mA |
| 2104A | 350 ns | 500 ns | 30 mA |

You can order the 2104A from distributor stock. Contact: Almac/Strom, Component Specialties, Cramer, Hamilton/Avnet, Harvey Electronics, Industrial Components, Pioneer, Sheridan, Wyle/Elmar, Wyle/Liberty, L.A. Varah, Zentronics. Or write Intel Corp., 3065 Bowers Ave., Santa Clara, CA 95051.

In Europe, Telex 24814, Brussels.
In Japan, Telex 28426, Tokyo.



intel delivers.

Our newest air variable capacitor's biggest feature:



It's small size.

As you can plainly see, our new air variable capacitor is nearly as small as many sub-miniature ceramic trimmers. It also features the same mounting configuration which means you can use it in many of the same applications.

But small size isn't the only reason for buying our new Micro T™ capacitor. Because it's air variable, it offers you

great stability. Q is typically 1000 at 100 MHz. TC is $+45 \pm 45$ PPM/°C. And it's available in maximum capacities of 3, 6.5, 12.7, and 19.0 pF in either vertical or horizontal tuning PC and stripline mounting versions. What's more, it gives you all this for a very small price.

E. F. Johnson Company/Dept. E.D., Waseca, MN 56093

Please send me technical information on sub-miniature air variable capacitors.

Please send me samples. You can call me at _____

Name _____

Firm _____

Address _____

City _____ State _____

Zip _____

For fast service, contact your local Johnson Distributor.



JOHNSON

CIRCLE NUMBER 48

COMPONENTS

Thermistor in glass bulb is indirectly heated

Fenwall Electronics, 63 Fountain St., Framingham, MA 01701. (617) 872-8841.

Thermistor K365 has a heating element and thermistor bead enclosed in a glass bulb. It is unaffected by changes in ambient conditions. When power is applied directly to the thermistor bead, temperature increases 1 C/0.015 W. Power of 0.04 mW to the heater indirectly heats the thermistor bead 1 C and changes the thermistor resistance, typically, from 50 to 15 k Ω .

CIRCLE NO. 332

RCD networks save board space

TRW Capacitors, 301 West "O" St., Ogallala, NE 69153. (308) 284-3611. 8 to 10 wks.

Resistor-capacitor-diode (RCD) networks save both circuit-board space and design time. The networks come packaged in axial-lead molded-plastic cases. Diodes have reverse-breakdown voltages of 1000 V with less than 50 mA of leakage current and max forward-voltages of 1.1 V at 1 A. Resistors, rated from 1/4 to 1/2 W, have values from 100 to 800 Ω . And metallized-Mylar capacitors have voltage ratings from 100 to 400 V and capacitances from 0.22 μ F to 1 μ F.

CIRCLE NO. 333

Slim DPM features 3-1/2 digit display

Fairchild Instruments & Controls, 1725 Technology Dr., San Jose, CA 95110. John Hatch (415) 962-2521. \$33.

Model 30 3-1/2-digit DPM is a flat pack that operates on only 0.75 W at 5 V dc. With the display blanked, power is reduced to 0.05 W. The meter is available in a full-scale range of ± 1.999 V with a resolution of 0.0005%. Higher ranges are obtained by the use of external resistor-divider networks. Accuracy is $\pm 0.1\%$ of reading, ± 1 digit. The display is 0.5 in. high. The unit fits NEMA and DIN standard 0.44 \times 3.59-in. panel cuts.

CIRCLE NO. 334

MODULES & SUBASSEMBLIES

Cassette transport has accurate speed

MFE, Keewaydin Dr., Salem, NH 03079. Jim Saret (603) 893-1921. \$560; 4 to 6 wks.

The Model 450B digital-cassette transport has a speed-control system that provides long-term speed accuracy at the heads without the use of a pre-recorded digital clock track. The transport is fully ANSI/ECMA compatible, allowing full interchange of cassette tapes with any other compatible system. Two data tracks are available allowing data storage up to 5.9 Mbits (720 kbytes) per cassette. Read/write speeds from 10 to 40 in/s are available providing data transfer rates up to 32 kbits/s using the bi-phase level encoding standard. Search speeds up to 80 in/s can be used.

CIRCLE NO. 335

Dual line amp has equalizer option

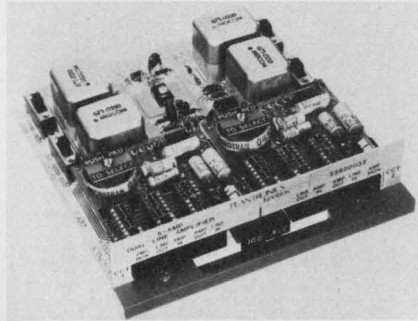

Plantronics Kentrox, 14335 N.W. Science Park Dr., Portland, OR 97229. (503) 643-1681. \$155 (amplifier), \$47 (equalizer); stock.

The Model 3300 dual line amplifier takes an optional line-amplitude equalizer that provides transmit and receive equalization in four-wire applications with DIP switches to select equalization. The amplifier has a power regulator and 70-dB power-supply-noise rejection. Simplex leads are provided. A switch selects 150, 600 and 1200-Ω input and output impedances. A visual indication of gain is provided.

CIRCLE NO. 336

Analog interface board handles many functions

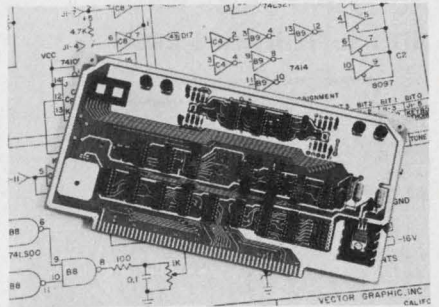

Vector Graphic, 790 Hampshire Rd., Westlake Village, CA 91361. Lore Harp (805) 497-6853. \$115; stock.

The multifunction analog interface board interfaces a μP with potentiometers, joysticks or voltage sources. An 8-bit digital port with latch strobe is used as a keyboard-input port. Tone-pulse generators also can be used to produce sounds for games or keyboard audio feedback. Also included are four a/d inputs, MWRITE logic and power-on jump capability for computers lacking a front panel.

CIRCLE NO. 337

Pancake Resolvers

Custom-designed for complex applications.



Our special-design resolvers are today performing on missiles, aircraft, submarines, radar and satellite systems.

Our pancakes, in sizes 16 through 134 and in single and dual speed configurations, are among the most reliable and accurate resolvers available. As are our standard resolvers.

We deal in difficult, custom applications, using engineer-to-engineer contact with detailed technical interchanges to assure smooth production, delivery and absolute performance.

As a result, American Electronics, Inc. has been, for over 15 years, one of the leading suppliers of custom resolvers.

Call or write for our free data package with complete 20-page technical work on resolvers, including outline and performance details.

AEI AMERICAN ELECTRONICS, INC.
ELECTRO-MECHANICAL INSTRUMENTS DIVISION
1600 VALENCIA DRIVE, FULLERTON, CA 92631 TELEPHONE (714) 871-3020

CIRCLE NUMBER 49

ELECTRONIC DESIGN 5, March 1, 1978

Buzzzzz. (Write for new catalog.)



Solid state electronic MICRO-BUZZER from CITIZEN: High reliability, competitively priced with immediate delivery.

A complete range: SMB 1.5, 6, 12, 24, VDC
RMB 3, 6, 12, 24, VDC
IMB (Intermittent) 6, 12, VDC

CITIZEN

CITIZEN AMERICA CORPORATION
1710 - 22nd St.
Santa Monica,
CA 90404

Toll Free (800) 421-6516
In Calif. (213) 829-3541
TWX: (910) 343-6450

Name _____
Company _____
Address _____
City _____ State _____
Zip _____ Phone _____

CIRCLE NUMBER 50

Adhesive tacks wires and terminates coils



Loctite, N. Mountain Rd., Newington, CT 06111. (203) 278-1280.

A wire-tacking adhesive system called the Tak Pak simplifies circuit-board engineering changes and lowers coil production costs with its instant-curing adhesive. Wires are tacked to circuit boards by first priming the bond area with wire-tacking accelerator. A drop of clear, thick wire-tacking adhesive is then applied to the wire. The material cures within 15 s. When terminating coil wires, adhesive is first applied to the wire. The accelerator is then applied and the drop cures in less than 5 s.

CIRCLE NO. 338

Flat sockets offer 42 to 62 pins for DIPs

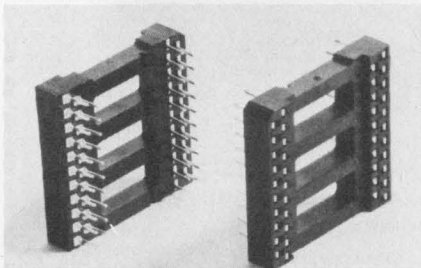

Circuit Assembly, 3169 Red Hill Ave., Costa Mesa, CA 92626. Dick Foringer (714) 540-5490.

DIP sockets with 42, 52 and 64 pins fit calculator and microprocessor chips. The sockets provide four staggered rows of pins on 0.5-in. centers. A low-profile, open-design insulator body reduces component height.

CIRCLE NO. 339

DIP sockets provide up to 64 pins

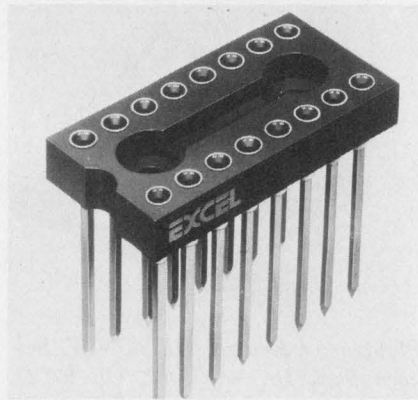

Excel Products, 401 Joyce Kilmer Ave., New Brunswick, NJ 08903. (201) 249-6600.

Low-profile 800 Series DIP sockets include from 4 to 64 pins per socket. The bodies are Valox or FR4 glass epoxy, UL recognized and 94V-0 rated. With a height of 0.116 in., the sockets' pins come with 1, 2 or 3-level wrapped-wire posts, PC posts or bifurcated pins. Pins are plated with gold over nickel or tin plate, all to MIL specs.

CIRCLE NO. 340

Thick-film kit screens resistors and conductors



Methode Development, 7447 W. Wilson Ave., Chicago, IL 60656. (312) 867-9600. \$200; stock.

A polymer thick-film evaluation kit permits experimentation with screen-printing resistors and conductors on PC boards. The technology eliminates many discrete components and can be used for multilayer or crossover conductors, or to eliminate circuit soldering or plating. Twelve 2-oz samples of resistor, conductor, insulator and solvent compounds, plus several samples of circuits and PC boards are included in the kit. One ounce of material will cover up to 500 in.².

CIRCLE NO. 341

Solderless wire terminal gives firm tool grip

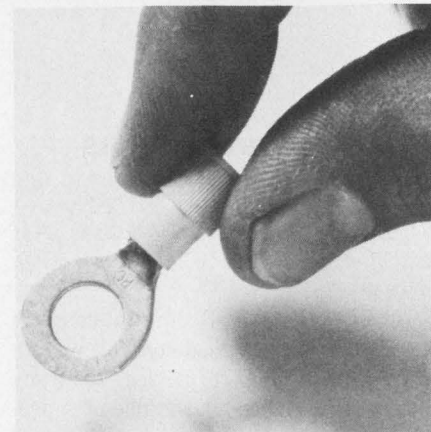

Teledyne Ansonia, 1 Riverside Dr., Ansonia, CT 06410. Bob Sobolewski (203) 735-9311. Free samples.

Funnel-Crimp wire terminals have knurled barrels that give positive grips for holding when crimping and handling. An internal funnel guides the wire into the barrel and positions stripped wire for crimping. A built-in tool stop (sharp shoulder) eliminates mis-crimping. Tongue type terminals include rings, spades, flanged spades, locking spades, hooks and male/female disconnects. Color coding in red, blue and yellow identifies wire capacities from 22 to 10 AWG.

CIRCLE NO. 342

PC connectors designed for wave soldering

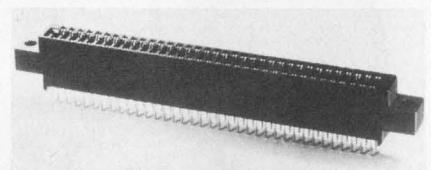

Viking Industries, 21001 Nordhoff St., Chatsworth, CA 91311. (213) 341-4330. See text; stock to 6 wks.

Type NK and NL PC connectors, for wave soldering, have round-contact tails instead of the square tails commonly used for wrapping. The round tails fit into smaller holes than the square tails and allow for more uniform solder joints. Contacts come on 0.1, 0.125 and 0.156-in. centers with two tail lengths. For standard wave soldering, a 0.2-in. tail is used. For the Raychem Solderpak system, a 0.25-in. tail is available. Pricing for a standard 40-position connector (3VH40/9JNK5) is \$3.63 in 500 to 999 quantity.

CIRCLE NO. 343

Aluminum heat sink mounts vertically

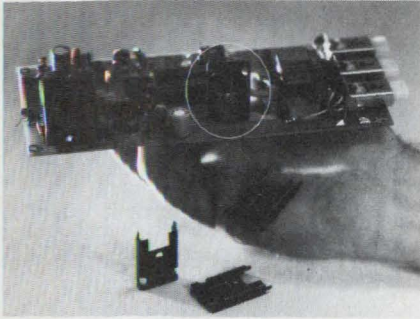

Tran-Tec, P.O. Box 1044, Columbus, NE 68601. Cliff Schroeder (402) 564-2748. \$0.095; 5 wks.

The Series M1110 aluminum heat sink is for vertical mounting where space is limited. Dimensions above the circuit board are 1.25 high, 0.84 wide and 0.235-in. thick. Transistors mount by the use of a 0.14-in. diameter hole or a push-on clip. The heat sink takes plastic encapsulated transistors with TO-220, TO-202 or A2 cases.

CIRCLE NO. 344

Strain relief installs without tools

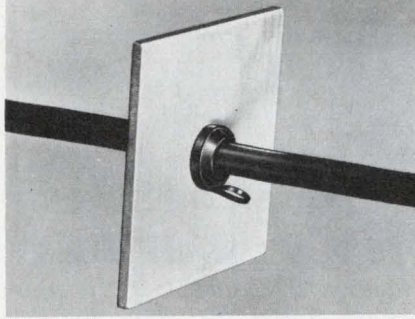

Weckesser, 4444 W. Irving Park Rd., Chicago, IL 60641. (312) 282-8626.

Nylon Straincheck bushings don't crimp or torture wire or cable and it can be installed without tools. The cable is laid in the bushing section, the bushing and cable inserted into the chassis and the locking member is pushed in over the cable into the open portion of the hole until it locks. The bushings fit type SC-J cable in 18/2, 16/2, 18/3 and 16/3 gauges.

CIRCLE NO. 345

Alarm prevents theft or removal of equipment

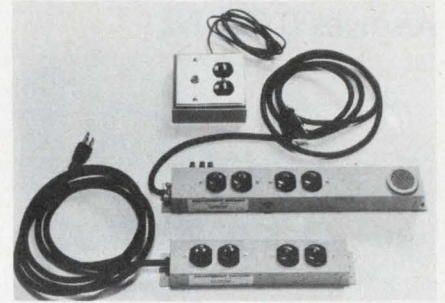

Stajer, P.O.Box 1171, Lowell, MA 01853. (617) 458-3871. From \$48.

Equipment Guard alarm systems protect all types of electrical equipment against theft or removal by detecting a cut or unplugged line cord. Slave units enable the user to expand the system. The alarm is useful in laboratories to ensure that important experiments are not interrupted by the unauthorized removal of test equipment.

CIRCLE NO. 346

VARIETY

ESSEX/SUFLEX has a wide selection of Astratite[®] heat shrinkable tubing to insulate and protect circuits, wiring harnesses, fuses, diodes, capacitors, terminals and junctions.

Polyolefin very flexible, flexible or semi-rigid . . . lower cost Polyvinyl Chloride tubings (cross-linked and non cross-linked) standard wall or thin wall . . . greater or lesser than 2:1 recovery ratio. All from one source — Essex/Suflex. And most of these Astratite versions are UL listed.

Samples, property data and prices available from 29 Essex/IWI Warehouse/Sales Centers and many independent distributors — or contact:

Essex Magnet Wire & Insulation Division, Essex/Suflex, Newmarket, N.H. 03857, Phone: 603/659-5555.

ESSEX GROUP



Subsidiary of
UNITED TECHNOLOGIES

INSTRUMENTATION

Frequency synthesizer resolves 0.001-Hz

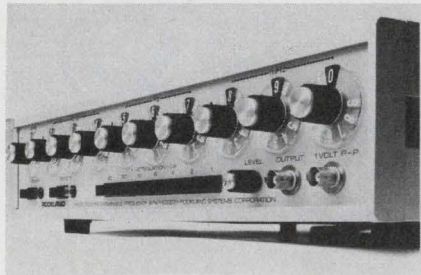

Rockland Systems, 230 W. Nyack Rd., West Nyack, NY 10994. David Kohn (914) 623-6666. \$3440; 4 to 6 wks.

The Model 5100-13 frequency synthesizer has a frequency range from dc to 3 MHz with 0.001-Hz resolution across the entire range. The instrument provides absolute phase continuity in switching, fast switching (1.5- μ s max programming delay), short-term stability of $\pm 1 \times 10^{-6}/^{\circ}\text{C}$ and spectral purity of -70 dB spurious, -55 dB harmonic.

CIRCLE NO. 347

XY recorders use capacitance feedback

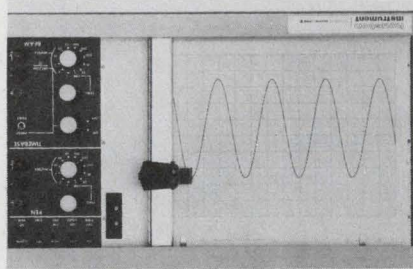

Houston Instrument, 1 Houston Square, Austin, TX 78753. Jim Bell (512) 837-2820. \$895 to \$1275.

The Type 100 Omnigraphic XY recorders use capacitance feedback transducers rather than slidewires or potentiometers in the servo positions. Specifications include an accuracy of $\pm 0.2\%$, linearity of $\pm 0.1\%$, slew speed of 20 in./s, common-mode noise rejection of 140 dB, critical damping and sensitivity of 1 mV/in. The general-purpose versions include a switch for change from English to metric scaling, 11-position attenuators for the X and Y inputs and a zero check.

CIRCLE NO. 348

Multimeters feature LCD readouts

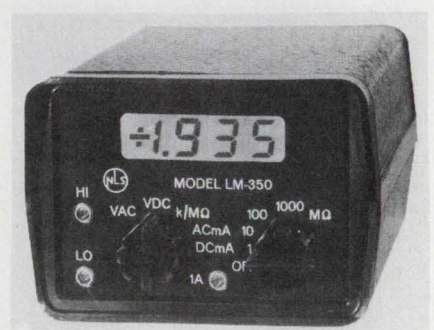

Non Linear Systems, P.O. Box N, Del Mar, CA 92014. (714) 755-1134. \$99.50/\$125.

Two digital multimeters, LM-300 (3-digits) and LM-350 (3½-digits) provide LCD numeric readouts for best viewing in bright sunlight. The meters measure ac and dc voltage, resistance, and ac and dc current. Options include a leather carrying case, a tilt stand case, a panel-mount flange, a 45-kV probe, an rms probe, rechargeable batteries and charger unit.

CIRCLE NO. 349

NOW! BREAKAWAY WIRING DUCT

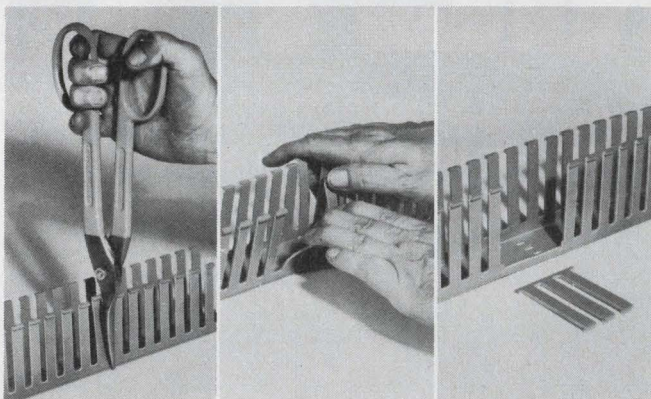

Recognized under the Components Program of Underwriters' Laboratories, Inc.

MEETS ALL I.C. STANDARDS

Approved

Pat. Pend.

Exclusive "breakaway" sidewalls set a new mark in wiring duct utility. Interior scoring along the bottoms of both sidewalls facilitates removal of wall segments for junctioning, etc.—with no reduction of bending strength in the critical direction toward the duct centerline. No awkward cuts required. Snip. Snip. Pop! Available in all standard styles and sizes.

Write for free samples.



TAYLOR ELECTRIC, INC.

DIV. OF TAYLOR INDUSTRIES, INC.
P.O. BOX 729 MARBLE FALLS, TEXAS 78654

CIRCLE NUMBER 52

THE ORIGINAL AND BEST!



Sealectro "Press-Fit" Teflon Terminals

The standard of the industry...one-piece Teflon insulated terminals, completely assembled and ready to install. Biggest selection of feed-thrus, standoffs, receptacles, jacks, probes, plugs available anywhere...and available in all EIA colors. Virgin Teflon bushings and precision machined lugs for high shock and vibration resistance, temperature range, and high electrical and mechanical performance. Simply center terminal over prepared chassis hole...Press-Fit...that's it! Available from nationwide network of stocking distributors. Send for new catalog.



CIRCUIT COMPONENTS DIVISION

SEALECTRO CORPORATION
MAMARONECK, N.Y. 10543

PHONE: 914 698-5600 TWX: 710-566-1110

Sealectro West:

14011 Ventura Blvd., Suite 215, Sherman Oaks, Ca. 91423, (213) 990-8131
1901 Old Middlefield Way, Suite 19, Mountain View, Ca. 94043 (415) 965-1212

Sealectro Ltd., Portsmouth, Hants, England

Sealectro S.A., Zone Industrielle Toulon Est, 83087 Toulon Cedex, France

CIRCUIT COMPONENTS ■ R.F. COMPONENTS ■ PROGRAMMING DEVICES

CIRCLE NUMBER 53

ELECTRONIC DESIGN 5, March 1, 1978

Bodine's PM drive family grows-

New 32D permanent magnet Control Motors and 32D-5F right angle gearmotors, perfectly matched with Bodine speed/torque controls. Continuous duty ratings of 1/12, 1/10 and 1/8 Hp at 2500 Rpm. See your Bodine Distributor or write for Cat. CDC-PM.

*New 32-frame
PM motors and
garmotors!*



**BODINE
ELECTRIC
COMPANY**

ADE (After Delivery Economies)
make Bodine a better fhp buy

Bodine Electric Company, 2500 W. Bradley Place, Chicago, IL 60618.

CIRCLE NUMBER 54

**You've been looking
for a more reliable
solid-state relay.**

Just look at this one.

A unique combination of dv/dt snubber, fusible-link protection in the trigger circuit, plus an oversized triac—all combine to protect against catastrophic system failure should the triac fail to turn on.

Either zero-voltage or non-zero-voltage switching, both types rated for maximum ac load currents of 5A or 10A. Any control voltage from 3 to 32V dc; all models compatible with TTL, DTL, CMOS logic. Solder-pin, quick-on, or screw terminals.

Call (609-882-4800) or write for further information. Heinemann Electric Company, Brunswick Pike, Trenton, NJ 08602.

HEINEMANN

We keep you out
of trouble.

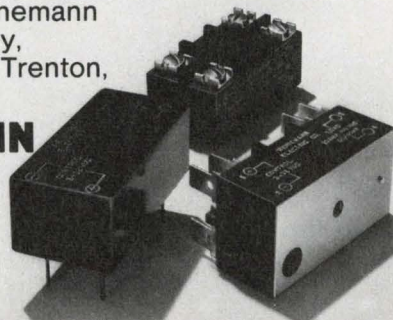

© Heinemann
6961

CIRCLE NUMBER 55

CIRCLE NUMBER 56 ▶

DELTROL'S HIGH CURRENT PRINTED CIRCUIT RELAYS

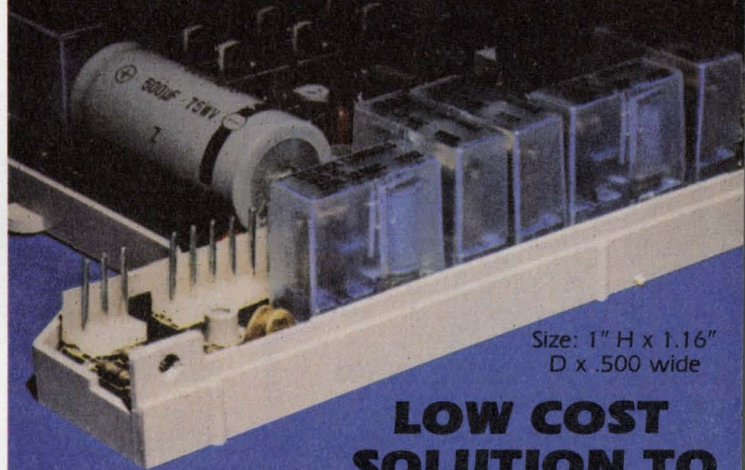

Size: 1" H x 1.16"
D x .500 wide

**LOW COST
SOLUTION TO
CONTROL
SWITCHING
PROBLEMS**

Specification Data

| Series Model AMP Rating | Contact Configuration | Coil Voltage DC | OHMS Resistance | Pull-In Voltage-DC (Max.) |
|----------------------------------|----------------------------|-----------------|-----------------|---------------------------|
| 404 (2 AMP) 405 (6 AMP) | SPDT SPST-NC SPST-NO | 3 | 16 | 2.2 |
| | | 4.5 | 32 | 3.1 |
| | | 6 | 75 | 5 |
| | | 12 | 280 | 9.6 |
| 406 (2 AMP) 407 (6 AMP) | DPDT DPST-NC DPST-NO | 24 | 1100 | 22.1 |
| | | 48 | 3500 | 35.4 |
| | | 3 | 11 | 2.2 |
| | | 4.5 | 25 | 3.1 |
| 406 (2 AMP) 407 (6 AMP) | DPDT DPST-NC DPST-NO | 6 | 45 | 5 |
| | | 12 | 170 | 9.6 |
| | | 24 | 740 | 22.1 |
| | | 48 | 2800 | 35.4 |

WT: 1/2 oz. — Op. Time: 10 Milliseconds — Release Time: 8 Milliseconds. Recognized Under the Components Program of Underwriter's Laboratories, Inc. File No. E37006.

See Your Local Distributor or
Send For Free Engineering Literature.

DELTROL
controls

Division Of Deltron Corp.

2745 S. 19th Street, Milwaukee, WI 53215
Phone (414) 671-6800, Telex 2-6871



Advanced Circuitry introduces...

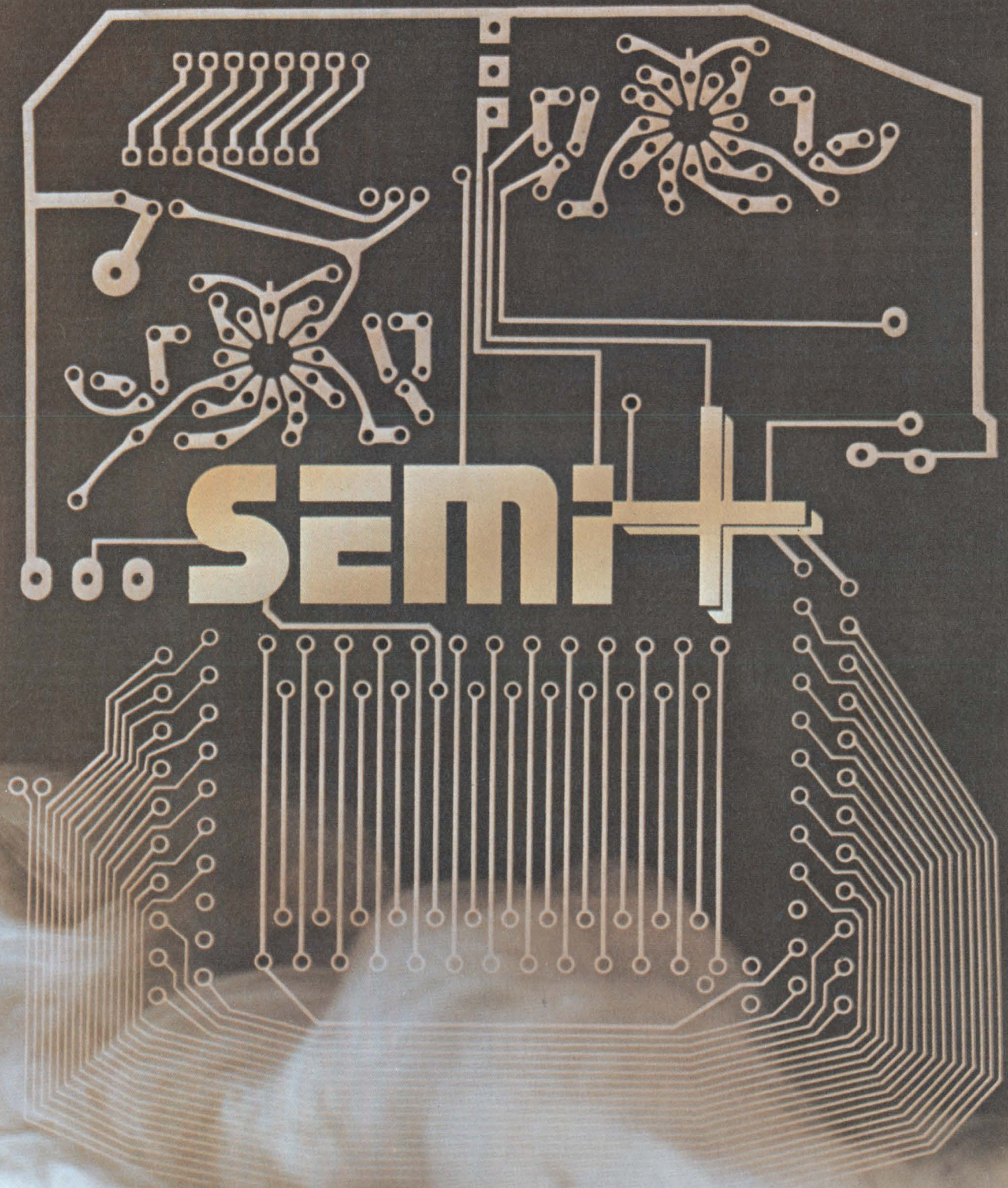

the new standard in additive process circuit boards.



**gives you the best of both
subtractive and additive.**

You know, and we know, that additive and subtractive processes each have their strengths and their weaknesses. So Advanced Circuitry went back to the beginning. We took the best of both subtractive and additive circuit board processing. By integrating these two technologies, we came up with the **SEMI +** Process for plated-thru-hole boards.

It's a first in the printed circuit industry. You see, **SEMI +** combines the efficiencies and eliminates the typical problems found in the other two processes. As a partially *additive* process, **SEMI +** offers a high-yield product for the total range of circuit densities. As a partially *subtractive* process, it permits these circuits to be electroplated rather than chemically deposited as with additive. Use of ductile copper in this plating process yields the greatest single advantage of **SEMI +** when compared with fully additive processing — plated-thru-holes which are free of cracks following thermal cycling.



| | SEMI+ | Additive | Subtractive |
|---|--------------|----------|-------------|
| Thermal shock failures | No | Yes | No |
| Undercut | No | No | Yes |
| Sliver free | Yes | Yes | No |
| Superior peel strength | Yes | No | No |
| Superior line definition | Yes | Yes | No |
| Many overplate combinations | Yes | No | Yes |
| Thick copper deposits economically feasible | Yes | No | Yes |

The chart above outlines some of the other advantages of Advanced Circuitry's **SEMI +** Process. No undercut. No slivers and shorting. Superior peel strength. Superior line definition. Many overplate combinations. Thick, economical copper deposition.



All these features are possible due to selective electroplating without the degradation of conventional etching. This sounds simple enough, but you can be sure it has taken extensive development, prototyping, and design of separate

facilities to bring **SEMI +** to its current level of performance. **SEMI +** has been tested at a major independent testing laboratory and meets or exceeds all requirements for MIL-P-55110. Just ask and we'll send you a copy of the report.

To explore the design possibilities and the cost efficiencies of **SEMI +** in your own operation, call us. Our sales engineers are prepared to answer your questions and study your requirements. With a quote in your hand, you can best consider the total benefits provided by Advanced Circuitry's **SEMI +** Process.



**Another first from
The State of the Art Company.**



ADVANCED CIRCUITRY

4811 West Kearney • Springfield, Missouri 65803 • Telephone 417-862-0751 • TWX 910-775-4705

TOTAL CAPABILITY • Conventional and Semi-Additive Plated-Thru-Hole • Multilayer • Backpanels • Print and Etch

CIRCLE NUMBER 57

DATA PROCESSING

Dumb terminal is CRT/printer combo



Lear Siegler/EID, 714 N. Brookhurst St., Anaheim, CA 92803. John Pagliaro (800) 854-3805. \$3890.

The Dumb Connection peripheral package (ADM-3A video terminal, the Model 210 ballistic printer and interconnecting cable) gives the user the flexibility of both a video terminal and a 180-char/s receive-only serial printer. The ADM-3A has 59 data entry keys, a 24-line, 12-in. screen and 1920 char. Switches offer a choice of eleven baud rates (975 to 19,200 baud) and an RS-232 or 20-mA current-loop interface. The Model 210 prints bidirectionally at rates of 75 lines/min for 132 characters or 120 lines/min for 80-char lines.

CIRCLE NO. 356

Data modems operate at 2400 bits/s



Racal-Milgo, 8600 N.W. 41 St., Miami, FL 33166. R. Nathanson (305) 592-8600. \$1092 to \$1275; 2 wks.

The 24-LSI Mark II modem operates at 2400 bits/s and provides pushbutton test features. Included are internal error test, receive test, and analog and digital loopback tests. Nine LEDs provide continuous indication of key EIA interface signals and modem status. The modems are compatible with ICC 2200/24 and 24-LSI modems, and Western Electric 201B and 201C data sets. The modems allow full-duplex operation over four-wire point-to-point and multipoint dedicated lines, and direct operation over two-wire dial-up lines.

CIRCLE NO. 357

Paper-tape reader/punch is whisper-quiet

Data Specialties, 3455 Commercial, Northbrook, IL 60062. (312) 564-1800. \$2335; 6 wks.

The SRP-3075 whisper-quiet paper-tape reader/punch with parallel or serial interface punches at speeds up to 75 char/s, and reads up to 300 char/s. The unit punches Mylar, Mylar laminates, oiled, unoled, rolled and folded tapes without readjustment or modification.

CIRCLE NO. 358

Data terminal uses gas-discharge display

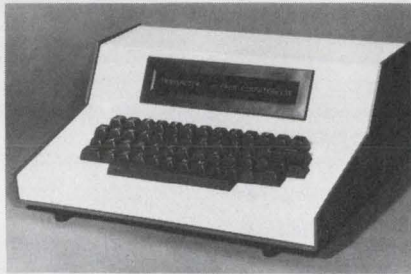

Computerwise, 4006 E. 137 Terrace, Grandview, MO 64030. (816) 765-3330. \$995; stock.

The Transactor III data terminal includes a single-line 32-char gas-discharge display and a 53-key TTY-style keyboard. The terminal connects to any computer with an RS-232 or 20-mA current-loop interface or to a communications line through a modem. Switches select the operating mode, including 110 to 9600 baud speeds, full or half duplex, even/odd/no parity, and the station address. The standard unit supports ASCII-coded data. EBCDIC is available as an option.

CIRCLE NO. 359

Video display divides into separate areas

Human Designed Systems, 3700 Market St., Philadelphia, PA 19104. (215) 382-5000. \$1260 (50 qty).

The Concept 100 CRT terminal handles several different functions simultaneously by allowing the user to divide the display memory into any number of separate rectangular "windows," which can be treated as separate displays. The terminal handles forms control, text editing, line-drawing graphics, multiple pages of display memory and multiple character sets. Up to 19 user-programmable function keys are provided.

CIRCLE NO. 360

Video terminal displays 1920 char/page



Datamedia, 7300 N. Crescent Blvd., Pennsauken, NJ 08110. Bob Sullivan (609) 665-2382. \$1520 (100 qty).

The Elite 3025A is a buffered TTY-compatible CRT terminal with a single-page video memory that displays 1920 alphanumeric characters in a 24-line, 80-char format. Operating modes include local edit, batch, batch modified and transparent. The terminal is asynchronous and compatible with 103 and 202-type modems. Fifteen baud rates, up to 9600, are keyboard selectable.

CIRCLE NO. 361

Small plasma display mounts on desk

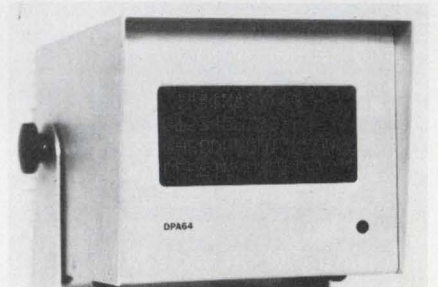

Pichler Associates, 410 Great Rd., Littleton, MA 01460. Pete Martin (617) 486-8948. \$1450; stock to 12 wks.

The DPA64 alphanumeric plasma display is a small desk-mountable, PROM-operated unit that is easy to read in high ambient light over a 120° viewing angle. Plug-compatible with most minicomputers and modems through a 20-mA current-loop or RS232C interface, the UL-listed unit handles up to 9600 baud. A self-refreshing RAM buffers up to 128 char. Changing the PROM produces code and character-font changes. The unit displays up to four 16-char lines of 0.3-in. high 5 × 7 dot matrix characters. The DPA64 measures 6.5 × 7.5 × 8.5 in.

CIRCLE NO. 362

ELECTRONIC DESIGN 5, March 1, 1978

POWER SOURCES

Rack-mounting supplies adjust over wide range

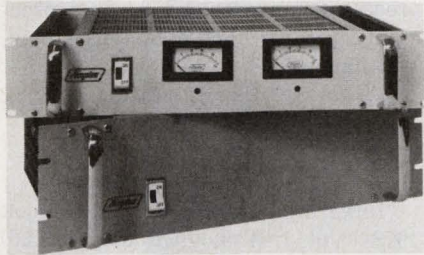

Acopian, Easton, PA 18042. Tom Skopal (215) 258-5441. \$300 to \$370; 1 wk.

Rack-mounting power supplies provide output-voltage ranges between 0 to 6 and 0 to 50 V dc and output current to 16 A. The output voltage and current limit-point adjusts continuously from zero to maximum ratings, either by means of the built-in controls or with external programming resistances. Options include metering, overvoltage protection and 210 to 250-V-ac input. Line and load regulations are $\pm 0.005\%$ or 2 mV and ripple is 0.25 mV rms. Height of the units are 3.5 and 5.25-in.

CIRCLE NO. 363

UL-recognized switchers have one to seven outputs

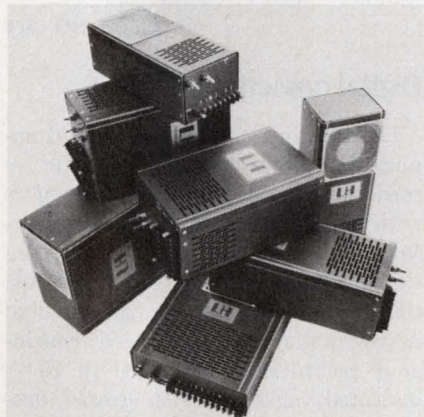

LH Research, 1821 Langley Ave., Irvine, CA 92714. Wally Nusslock (714) 546-5279. \$0.65/W.

Eight single and multiple-output switching-power-supply models in the MM Series are recognized under UL 478. The number of outputs produced by various units ranges from one through seven. Total power for all outputs is either 375 or 750-W, depending on the model.

CIRCLE NO. 364

Switcher models get UL recognition

ACDC Electronics, 401 Jones Rd., Oceanside, CA 92054. (714) 757-1880. \$620 to \$720; stock.

The JF Series of fan-cooled switching-regulated power supplies boast UL component recognition under standard 478 for electronic data-processing equipment. The switchers generate almost 2 W per in³. Three ver-

sions are available: JF120 (5 V, 120 A); JF150 (5 V, 150 A); JF102 (either 5.2 V, 16 to 80 A or 2.2 V, 0 to 50 A). Regulation of all models is $0.1\% \pm 5$ mV for either a no-load to full-load change or for a $\pm 10\%$ input-voltage change. Ripple is 10-mV rms max or 50-mV pk-pk max. Output voltage returns to within 1% in less than 100 μ s following a 50% load step. The package for all three units is $5 \times 8 \times 10\frac{1}{2}$ in.

CIRCLE NO. 365

**±12V
DAC80's
and ADC80's!**

In 1974, We Set The Standards For ± 15 V A/D - D/A Converters. Now We've Set Them Again!

± 15 V supplies were common in 1974 when we designed and named the industry standard DAC80 and ADC80. Since then we've offered more models and built more of these popular converters than any other source.

Now, MOS memories and μ P's demand ± 12 V supplies! To simplify your design problems we've set the standard once again - with DAC80Z and ADC80Z models that cover the ± 11.4 to ± 16.0 V and +5V supply range.

Everything else stays the same:

± 12 V DAC80: 12-bit resolution, $\pm 1/2$ LSB max linearity, ± 30 ppm/ $^{\circ}$ C max gain drift and 300 nsec settling time to $+0.01\%$ FSR. Price: (100's) \$19.50.

± 12 V ADC80: 10 and 12 bits, 25 μ sec max conversion time, $\pm 1/2$ LSB non-linearity, internal reference, clock and comparator. Price: (100's) \$49.50.

Call-write for specs on a full line of data conversion products, including 8 to 16-bit hybrid DAC's. BURR-BROWN, P.O. Box 11400, International Airport Industrial Park, Tucson, Arizona 85734, Phone: (602) 746-1111.

BURR-BROWN



Putting Technology
To Work For You

CIRCLE NUMBER 58

New literature



1/20 and 1/10 hp motors

Specifications and schematics on a series of motors and gear motors with input horsepower ranging from 1/50 to 1/10 are shown in a brochure. Molon Motor & Coil, Rolling Meadows, IL

CIRCLE NO. 366

Circuit breakers

Photographs, dimensional drawings, delay curves, specifications of a snap-action magnetic circuit breaker are given in a four-page bulletin. Airpax Electronics, Cambridge, MD

CIRCLE NO. 367

Industrial control μ C

The IP300 industrial-control-micro-computer system is described in a brochure. The publication discusses operational advantages, hardware features and system software of the IP300. The pamphlet contains a configuration summary listing standard systems, options, and both digital and analog I/O modules. Digital Equipment Corp., Communication Services, Northboro, MA

CIRCLE NO. 368

Silicon photodetectors

A 24-page electro-optic-components catalog reviews the physical and electrical properties of silicon photodetectors, providing basic information on structure, response, sensitivity limits, temperature effects and equivalent operating circuits. Centronic, Mountainside, NJ

CIRCLE NO. 369

PC board laminates

Copper-clad laminates for printed-circuit boards are described in a fold-out brochure. The illustrated six-page brochure contains a comprehensive, easy-to-read table that lists applications and technical specifications for each of the many laminate grades and compositions available. Westinghouse Electric, Micarta Div., Hampton, SC

CIRCLE NO. 370

Op amps

Data sheets on 18 operational amplifiers and 22 fast analog-function modules plus a microcomputer are included in a 92-page catalog. A selection guide indexes op-amp modules by slewing rate, by gain-bandwidth at $\times 100$, and by settling time to 0.1%. Optical Electronics, Tucson, AZ

CIRCLE NO. 371

Pressure transducers

Two bulletins describe 0 to 5-V-dc isolated-output signal, bonded strain-gauge pressure transducers. Teledyne Taber, North Tonawanda, NY

CIRCLE NO. 372

UL standards

"Catalog of Standards for Safety" is an easy and quick reference guide to UL's 396 published standards. Underwriters Laboratories, Northbrook, IL

CIRCLE NO. 373

Magnetics

The use of custom magnetics in modern circuits and application information on wideband, rectifier, and pulse transformers and inductors are discussed in a 14-page booklet. Polyphase Instrument, Bridgeport, PA

CIRCLE NO. 374

GP and power relays

Specifications, characteristics, wiring diagrams and dimensional drawings for more than 1200 stock and special relays are included, as well as socket information, in a 56-page catalog. A relay selection chart guides the user to the proper relay class which fits his particular requirements. Magnecraft, Chicago, IL

CIRCLE NO. 375

Signal processors

A brochure describing the new SPS-61 and SPS-81 programmable digital signal processors features a unique set of comparisons that clearly explain the difference between array processing and real-time signal processing. Signal Processing Systems, Waltham MA

CIRCLE NO. 376

Semiconductors

"Integrated Circuits Reference Book 1978," Vol. 1: Analog Circuits (\$29.50) and Vol. 2: Digital Circuits (\$29.50) lists details of all ICs, with a PRO ELECTRON type number, which are available on the market. It is an up-to-date reference source of ICs made in Western Europe. "Semiconductor Reference Book 1978" (\$35.00) is a revised and updated Fifth Edition listing the technical characteristics of every semiconductor device made in Western Europe with a PRO ELECTRON type number, which is on the market. Both books include an explanation of the PRO ELECTRON code, a list of the symbols used and a glossary in English, French and German. Scholium International, Flushing, NY

CIRCLE NO. 377

Rf coaxial connectors

A 36-page catalog features the SMA series of rf coaxial connectors. ITT Cannon Electric, Santa Ana, CA

CIRCLE NO. 378

Digital cassette recorders

Descriptions, specifications and application information on low-power recorders for data logging, data loggers with crystal-controlled clocks, universal readers, incremental and continuous read/write cassette systems, OEM incremental transports and ANSI-compatible high-speed continuous recorders are covered in 16 illustrated pages. Block diagrams, outline drawings and timing sequences are also included. Memodyne, Newton Upper Falls, MA

CIRCLE NO. 379

Connectors

Cinch Nu-Lok environment-resistant coaxial cable connectors that meet MIL-C-25516 are fully described in a 16-page catalog. TRW Cinch Connectors, Elk Grove Village, IL

CIRCLE NO. 380

Bulletin board

Raytheon Data Systems Co. has doubled the main memory of its **PTS-100 programmable terminal systems** and increased the number of operator stations those systems can support.

CIRCLE NO. 381

Longer shelf life, high reliability, and no degradation in power output over operating life are among the advantages of a new hard seal construction technique now being offered on **Hughes Aircraft Co.'s line of helium-neon lasers.**

CIRCLE NO. 382

Intel's Microcomputer Components Div.'s **6-MHz 8748 single-chip microcomputer**, which was priced at \$275 in single-unit quantity and \$150 in 100-unit quantity, is now priced at \$75 and \$48, respectively.

CIRCLE NO. 383

Blank cards for programming Hewlett-Packard's HP-67 and 97 calculators are now available at a reduced price—\$195 (1000 qty).

CIRCLE NO. 384

Data General has added comprehensive **data communications capabilities to its microNOVA family**, giving users the ability to implement asynchronous and synchronous protocols and run Data General's RJE80 (IBM 2780/3780) and IBM HASP II emulation packages on a microcomputer system.

CIRCLE NO. 385

Elco's Series 6307, 6064, 6007 and 6308 card-edge connectors are now U.L. approved.

CIRCLE NO. 386

Opcoa's OP 004 series stud-mount GaP LED panel lamps come with 6-in. insulated leads and provide a variety of indicator functions in equipment requiring LEDs with long lead lengths. The typical luminous intensity at a forward current of 15 mA is 2 mcd with viewing angles of 60° and 120°. These units come in red, green, and yellow.

CIRCLE NO. 387

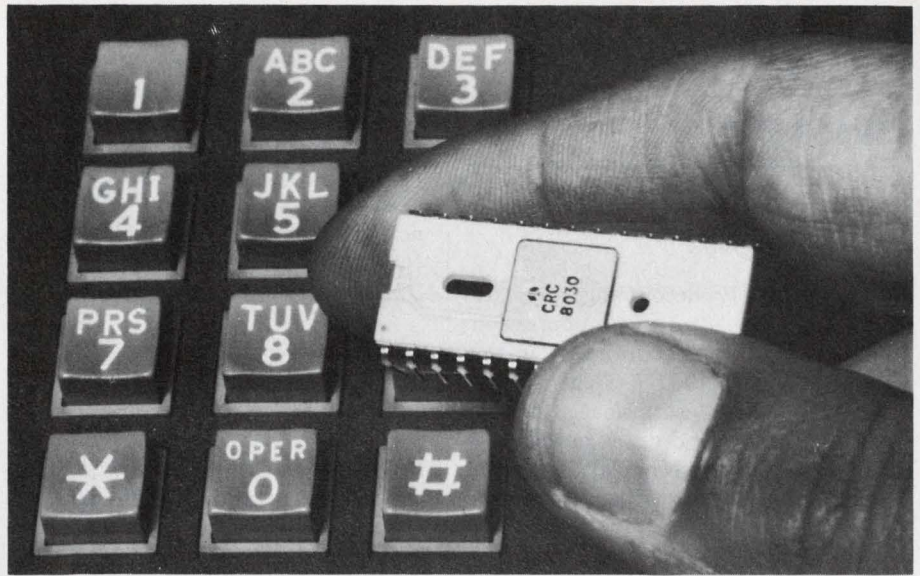

Rockwell MOS/LSI Touch Tone® detection can get you into more products.

CRC-8030, Rockwell's MOS/LSI digital Touch Tone® detector, can open up new markets for your products by providing a low cost, high performance solution for dual tone multi-frequency (DTMF) detection.

A product of Collins high-technology telecommunications experience coupled with Rockwell's extensive MOS/LSI production capability, CRC-8030 has been in quantity production for over a year. Besides traditional telephony systems, it can be used in a growing number of applications including computer signaling and control systems.

CRC-8030 reduces costs versus conventional systems (in some cases as much as one fifth the cost) and offers the size and reliability benefits of MOS/LSI. You get: detection in 22-39 MS; on-chip oscillator operating at 3.579545 MHz color burst crystal frequency; binary or 2-of-8 coded outputs; operation with single or dual power supply.

The CRC-8030 performs the key critical functions of DTMF detection. To implement a complete DTMF receiver, a number of front-end band-split filters are available. And, if you need DTMF-to-dial pulse conversion, use the CRC-8030 in conjunction with Rockwell's MOS/LSI Binary-to-Dial Pulse Dialer, the CRC-8001.

For more information on telecommunications devices and applications services, contact your nearest Hamilton/Avnet distributor. Or use the coupon below.

Touch Tone is a registered trademark of AT & T.

Get the full story.

ED-3/1

Microelectronic Devices
Rockwell International
P.O. Box 3669, Anaheim, CA 92803
Attn: Marketing Services D/727 RC55 · (714) 632-3698

I want information on CRC-8030 CRC-8001
 Send it by mail Have a salesman call me.

Name _____ Title _____

Company _____

Address _____ City _____

State _____ Zip Code _____ Telephone _____



Rockwell International

...where science gets down to business

New and current products
for the electronic designer
presented by their manufacturers.

Electronic Design

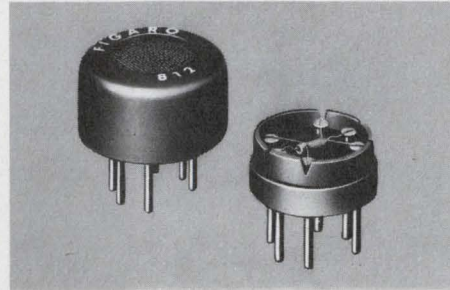
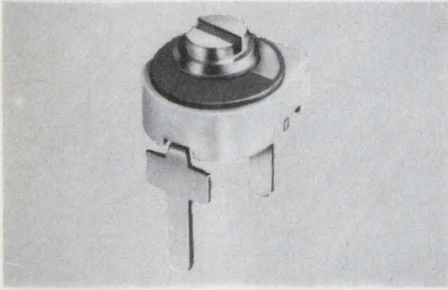

MINIATURE CERAMIC TRIMMER CAPACITORS 9371 series of ceramic trimmer capacitors are compact, economical and rugged. They are 50% smaller than other trimmers of this type yet provide high capacitance values. Available in 4 capacitance ranges, 1.5 to 4, 3.0 to 10, 3.5 to 18 and 5.0 to 25 pf with Q's > 300 at 10 MHz. They have an overall diameter of .225" with .215" above board height. JOHANSON MANUFACTURING CORPORATION, Rockaway Valley Road, Boonton, N.J. 07005 201-334-2676

FIGARO GAS SENSOR TGS is a gas sensitive semiconductor. When combustible gas is absorbed on the sensor surface, a marked decrease of electrical resistance occurs. Major features of the sensor include high sensitivity, long term reliability and low cost. The applications are: GAS-LEAK ALARM, AUTOMATIC FAN CONTROL, FIRE ALARM, ALCOHOL DETECTOR, etc. Figaro Engineering Inc., North America Office-3303 Habor Boulevard, Suite D-8, Costa Mesa, Calif. 92626 Tel: (714) 751-4103 Telex: 678396

TRIMMER CAPACITORS

181

GAS SENSOR

184

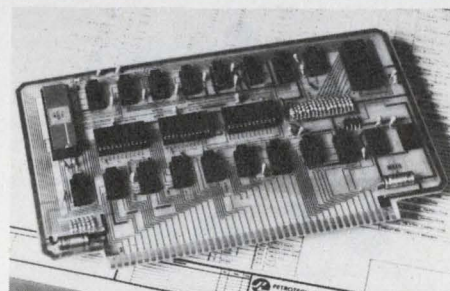

YOU'LL GET IT THE DAY BEFORE YOU ORDER IT as soon as we perfect a time-travel machine. Meanwhile 3 working days is typical turn-around for rack-mounting chassis units, card cages, desk-top & floor-standing cabinets, mini-consoles, subassembly housings. Circle our number or phone Techmar, 213-478-0046, and stand away from the door!

HARDWARE MATHBOARD—RAM SAVER!! performs logarithmic & trigonometric functions, e^x , y^x , multiply, add, divide, subtract, etc., etc., 8 digit mantissa, 2 digit exponent, very fast (comparable with in-system software) Compatible with M-6800 Microprocessor KITS AVAILABLE AT \$72.80, \$252, \$555. A - Board, software, full instructions B - 'A' and all components, unassembled C - Assembled, inst. manual, sftwr. pkg. WOODTRON LTD., P.O. BOX 4067, STATION "C", CALGARY, ALBERTA, CANADA.

ENCLOSURES

182

HARDWARE MATHBOARD

185

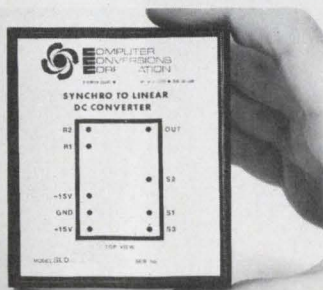

Synchro to Linear DC Converter: Infinite Resolution. Full ($\pm 180^\circ$) or Limited Angle DC Output ($\pm 90^\circ$), ± 6 or ± 15 minute accuracy at input rates up to $1440^\circ/\text{sec.}$, 60 or 400 Hz input. Custom Output scaling available. Module 2.6" x 3.1" x .82" H. Price from \$350 in quantity. Other CCC Products are Synchro to Digital, Digital or DC to Synchro, Solid State C.T.'s or CDX's, and Absolute Encoders. Send for Free Catalog & Application Notes. Computer Conversions Corp., East Northport, N.Y. 11731—(516-261-3300).

Ultrasonic Pulse Generators drive piezoelectric transducers. The plug-in modules simplify ultrasonic system design. High energy outputs available up to 350 volts into 50 ohms, with 10 nsec risetime. Modules contain pulse rep rate clock variable to 10 kHz, or the output pulse may be triggered externally. External sync output pulse coincident with main bang. Trigger, sync TTL-compatible. MetroTek, Inc. (509) 946-0684

SYNCHRO TO LINEAR DC

183

ULTRASONIC PULSE MODULES

186

ELECTRONIC DESIGN's function is:

- To aid progress in the electronics manufacturing industry by promoting good design.
- To give the electronic design engineer concepts and ideas that make his job easier and more productive.
- To provide a central source of timely electronics information.
- To promote communication among members of the electronics engineering community.

Want a subscription? ELECTRONIC DESIGN is circulated free of charge to those individuals in the United States and Western Europe who function in design and development engineering in companies that incorporate electronics in their end product and government or military agencies involved in electronics activities. For a free subscription, use the application form bound in the magazine or write for an application form.

If you do not qualify, paid subscription rates are as follows: \$30.00 per year (26 issues) U.S./Canada/Mexico, \$40.00 per year (26 issues) all other countries. Single copies are \$2.50 U.S. and all other countries. The Gold Book (27th issue) may be purchased for \$30.00 U.S./Canada/Mexico, and \$40.00 all other countries.

If you change your address, send us an old mailing label and your new address; there is generally a postcard for this in the magazine. You will have to requalify to continue receiving ELECTRONIC DESIGN free.

The accuracy policy of ELECTRONIC DESIGN is:

- To make diligent efforts to ensure the accuracy of editorial matter.
- To publish prompt corrections whenever inaccuracies are brought to our attention. Corrections appear in "Across the Desk."
- To encourage our readers as responsible members of our business community to report to us misleading or fraudulent advertising.
- To refuse any advertisement deemed to be misleading or fraudulent.

Individual article reprints and microfilm copies of complete annual volumes are available. Reprints cost \$6.00 each, prepaid (\$5.00 for each additional copy of the same article), no matter how long the article. Microfilmed volumes cost \$23 for 1976 (Vol. 24); \$30 for 1973-75 (Vols. 21-23), varied prices for 1952-72 (Vols. 1-20). Prices may change. For further details and to place orders, contact Customer Services Dept. University Microfilms, 300 N. Zeeb Rd., Ann Arbor, MI 48106. (313) 761-4700.

Want to contact us? If you have any comments or wish to submit a manuscript or article outline, address your correspondence to:

Editor
ELECTRONIC DESIGN
50 Essex St.
Rochelle Park, NJ 07662



Free New catalog contains over 34,500 quality power supplies from the world's largest manufacturer, Power/Mate Corp. Power Supplies for every application including submodulars, open frame, variorated, encapsulated, laboratory & system. All units UL approved and meet most military and commercial specs for industrial and computer uses. Power/Mate Corp., 514 S. River St., Hackensack, NJ 07601 (201) 343-6294

POWER SUPPLIES

187

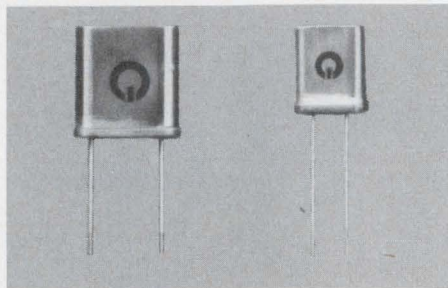

HIGH STABILITY LOW COST QUARTZ CRYSTAL for μ -processor and clock oscillator. Accuracy is $\pm 0.002\%$ at 25°C , Frequency change over -10 to $+55^\circ\text{C}$ is within $\pm 20\text{ppm}$. 1.000, 1.8432, 2.000, 2.097152, 2.4576, 3.2768, 4.0000, 5.0000, 5.0688, 5.1850, 5.7143, 6.5536, 10.0000, 18.0000, 18.4320, 20.0000, 22.1184 Immed. Divy. \$1.85 ea. 10 MHz up in HC-18/u; (Min. 100 pcs.) Q-MATIC CORP., 3194-D Airport Loop Dr., Costa Mesa, CA 92626, (714) 545-8233, Telex 678389

CRYSTAL

190

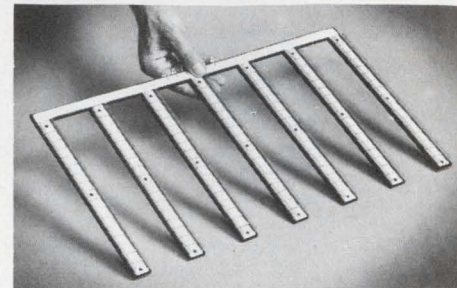

METHODE BUS BARS REPLACE MAZE OF COSTLY CABLE HARNESES in computer, communications, industrial control systems. Fifteen years custom design experience, plus innovations like extra-strength staked and soldered .025" pins, puts METHODE first in bus bar designs for both military and commercial applications . . . FREE Design Guide or call our Customer Engineering Service Dept., Methode Manufacturing Corp., 1700 Hicks Road, Rolling Meadows, IL. 60008. (312) 392-3500.

BUS BARS

193



Paladin Corporation introduces the first truly easy-to-use, efficient, coaxial wire stripper. The Paladin Coaxial Stripper will strip every coax wire with an O.D. between .14 & .30 inches. Its compact body (3.5 in.) and light weight (1 Oz.) allow for use in areas which previously prevented post-stripping coax wires. The tool has removable cassette blades which are rated for up to 10,000 strips. PALADIN CORP., 2680 Valencia Circle, Thousand Oaks, CA 91360, (805) 492-2853

COAXIAL WIRE STRIPPER

188



MAGNETIC SHIELDING Take advantage of Eagle's 23-year background in shield design and production. Custom and standard models. Full service includes design, engineering, fabrication, heat treating, finishing, testing. Also wide selection of sheet and foil so you can form your own shields. For helpful design and cost data, request Bulletin E-77. Eagle Magnetic Co., Inc., Box 24283, Indianapolis, IN 46224, 317-297-1030.

MAGNETIC SHIELDING

191



VARIAC® AUTOTRANSFORMERS There are hundreds of Variac continuously adjustable autotransformer models for smooth control of ac voltage to regulate light, heat, power, current, motion and speed. Metered, ganged, motor-driven, remote-controlled, high frequency single and three-phase models with optional overload protection, ball-bearings and microswitches. Ask us about your special application requirements. GenRad, 300 Baker Ave., Concord, MA 01742, 617-369-8770.

GENRAD

194

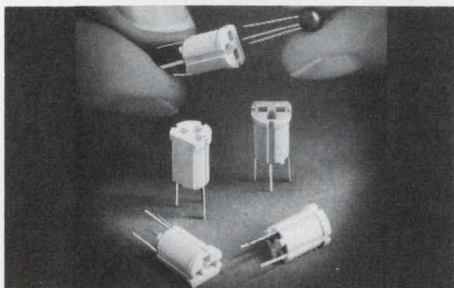

NEW 3-LEAD TRANSISTOR SOCKETS from Methode have an extended funnel-shaped lead-in which eliminates the need for transistor lead preforming or trimming. Also, ideally suited for automatic insertion of transistors into the socket. Contacts are reliable dual leaf cantilever type of phosphor bronze with tin plating. Insulation is flame retardant polyester rated 94V0. Methode Electronics, Inc., 1700 Hicks Rd., Rolling Meadows, IL 60008. (312) 392-3500.

3-LEAD TRANSISTOR SOCKETS

189

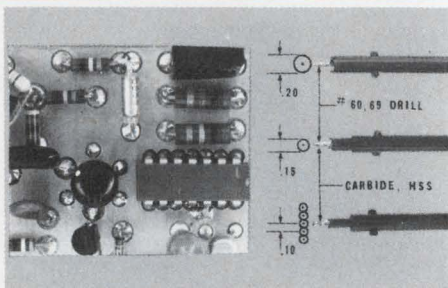

NO ETCH BREADBOARDS . . . WIRE-WRAP BREADBOARDS with isolated pad drill-mill construction. Quickly duplicate any etched board; build circuits from full-size artwork. Add components to and/or change circuitry of previously etched boards. Complete freedom in wire-wrap design/layout. Ideal for high frequency ground plane construction. A kit of three IP6003C with #60 carbide drills, \$30.00 (\$12.50 ea.). A. F. Stahler Company, P.O. 354, Cupertino, CA 95014 (408) 252-4219.

NO ETCH BREADBOARDS

192

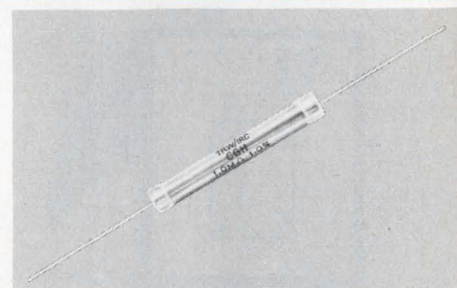

CGH Metal Glaze Resistors from TRW operate in high ambient temperatures with excellent high voltage load stability. These thick film resistors are particularly suited for precision high voltage and high impedance applications such as voltage multipliers, X-ray equipment, and high voltage power supplies where precision tolerances and TCs are required. TRW/IRC Resistors, an operation of TRW Electronic Components, 401 N. Broad St., Phila., Pa. 19108. (215) 922-8900.

CGH HIGH VOLTAGE

195

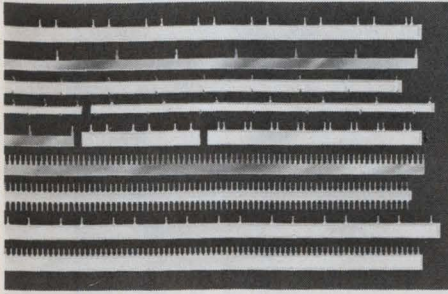

MINI/BUS® BY ROGERS, low-cost, low-inductance, high capacitance printed circuit board bus bars for noise reducing voltage distribution, are available in a variety of ready-to-ship designs. Prototype kits are also available from stock. Call or write Mini/Bus product specialist for a complete list. Rogers Corporation, Chandler, AZ 85224. Phone: (602) 963-4584. (EUROPE: Mektron NV, Gent, Belgium; JAPAN: Nippon Mektron, Tokyo.)

BUS BARS

196



DORMEYER COACH'S NEW 12-PAGE CATALOG ON COMMERCIAL USE TRANSFORMERS offers quick reference application help. A wide variety of channel frame and bracket mount open coil 120/30 VAC transformers; Universal Mount control units with 5, 10, 12, 20, 40 and 55 VA ratings are described. Electrical data, load curves and mounting data is given on these U/L and CSA listed or recognized transformers. Dormeyer Industries, Dept. QA 3418 N. Milwaukee Avenue, Chicago, IL 60641, (312) 283-4000.

TRANSFORMER CATALOG

201

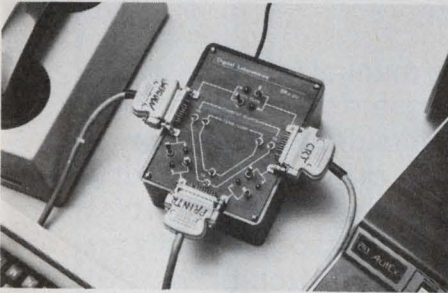

UNIVERSAL JUNCTION UNIT . . . for three devices, RS232C or current loop.

. . . Six switches provide all 63 interconnects that are possible between three I/O devices. LED's indicate data flow. . . . Designed to provide circuit compatibility and easy data routing between different manufacturer's devices. . . . \$350 (1-4) from DIGITAL LABORATORIES, 600 Pleasant St., Watertown, MA 02172 (617) 924-1680

3 PORT RS232 & 20 MA LOOP

197



Free 16 Page Catalog from Timeco, Inc. describes line of Time Delay Relays and other timing devices. Included are On Delay, Off Delay, Interval (one-shot) and Repeat Cycle units. Units are available for DC Voltage from 12 to 120 and AC from 12 to 220. Also AC/DC units as well as 50 Cycles. Time Ranges from .02 Seconds to 16 Minutes. All Units are Guaranteed for 1 Year and over 150,000 are in service.

TIME DELAY RELAY CATALOG

202

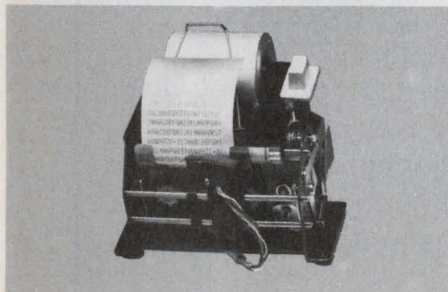

FAST, RELIABLE DISCHARGE PRINTER DC-1606B/DC-2106D prints 16 or 21 column alphanumerics in a 5 x 7 dot matrix format. Its MTBF is 5.5 million lines on a 2.25" paper costing less than a half a cent a foot. 3.8" H x 5.4" W x 5.5" D, it is as low as \$99 in 100 quantity. Interface electronics and power supply available. HYCOM, 16841 Armstrong Ave, Irvine, CA 92714 714/557-5252.

DISCHARGE PRINTER

200

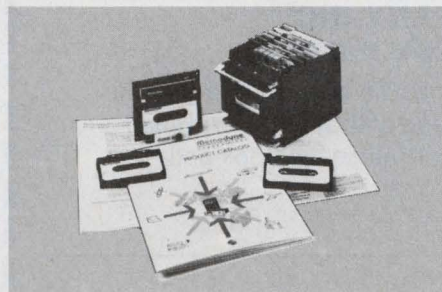

Free 1978 Catalog of Recorder Products. Complete description of all Memodyne incremental and continuous digital cassette recorders, data loggers, transports, universal readers and high speed recording system with illustrations, block diagrams, mechanical dimensions and timing sequences are contained in this new catalog. Accessories, supplies, cassettes and a price list are also included. Write for your free copy! Memodyne Corporation, 385 Elliot Street, Newton Upper Falls, MA 02164 (617) 527-6600

FREE RECORDER CATALOG

203

Electronic Design

Advertising Sales Staff

Susan G. Apolant
Sales Coordinator

Rochelle Park, NJ 07662

Robert W. Gascoigne
Thomas P. Barth
Stan Tessler
Constance McKinley
50 Essex St.
(201) 843-0550
TWX: 710-990-5071
(HAYDENPUB ROPK)

Philadelphia

Thomas P. Barth
(201) 843-0550

Boston 02178

Gene Pritchard
P.O. Box 379
Belmont, MA 02178
(617) 489-2340

Chicago 60611

Thomas P. Kavooras
Berry Conner, Jr.
200 East Ontario
(312) 337-0588

Cleveland

Thomas P. Kavooras
(312) 337-0588

Los Angeles 90045

Stanley I. Ehrenclou
Burt Underwood
8939 Sepulveda Blvd.
(213) 641-6544

Texas

Burt Underwood
(213) 641-6544

San Francisco

Robert A. Lukas
465 S. Mathilda, Suite 302
Sunnyvale, CA 94086
(408) 736-6667

England

Constance McKinley
50 Essex St.
Rochelle Park, N.J. 07662
Phone: (201) 843-0550

Europe

Sanders, W. J. M.
Raadhuisstraat 24
Graft-De Ryp, Holland
Phone: 02997-1303
Telegrams: Euradteam-Amsterdam
Telex: 13039-SIPAS

G. Nebut

Promotion Presse Internationale
7 ter Cour des Petites Ecuries
75010 Paris, France
Telephone: 5231917, 1918, 1919

Dieter Wollenberg

Erikastrasse 8
D-8011 Baldham/Muenchen
Germany
Telephone: 0 8106/4541

Tokyo

Haruki Hirayama
EMS, Inc.
5th Floor, Lila Bldg.,
4-9-8 Roppongi
Minato-ku, Tokyo, Japan
Phone: 402-4556
Cable: EMSINCPERIOD, Tokyo

★ABP

BPA

Due to popular demand
**MICROPROCESSOR
DATA MANUAL**
is now in book form!

**ALL THE INFORMATION
ON MICROPROCESSOR
SELECTION AND
SOFTWARE IN ONE
CONVENIENT SOURCE!**

- First appeared in **Electronic Design Magazine!**
- Over 30 manufacturers represented!

**MICROPROCESSOR
DATA MANUAL**
Edited by Dave Bursky

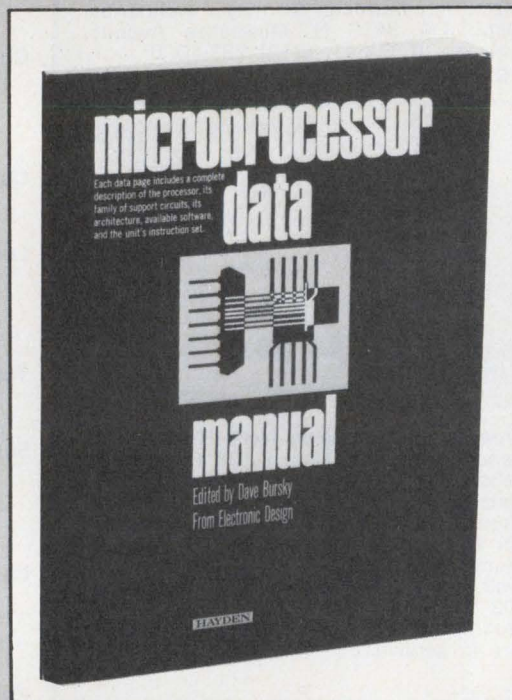

The manual includes a complete data page for each microprocessor or family of processors, with a complete description of the processor, its family of support circuits, architecture, available software, and the unit's instruction set.

Other sections include:

- the pitfalls to avoid when choosing a specific model;
- micro fundamentals and a glossary of terms;
- a report on floppy-disc drives;
- background information on micro selection and software.

Send to: **HAYDEN BOOK COMPANY, INC.**

50 Essex Street, Rochelle Park, N.J. 07662

Please send me MICROPROCESSOR DATA MANUAL (#5114-X, \$7.95) on 15-day examination. At the end of that time, I will send payment, plus postage and handling, or return the book and owe nothing.

Name _____

Firm _____

Address _____

City/State/Zip _____

78-009

SAVE MONEY! If you send cash with order, publisher pays postage and handling. Same return guarantee. Price subject to change without notice. Offer good in U.S.A. and Canada only.

**Make your micro
decisions easier! Order
your copy today!**



Electronic Design

recruitment and classified ads

PLACE YOUR AD AT ONLY \$55 PER COLUMN INCH IN

Electronic Design

— GET A REPEAT AD FREE!

With our 2 for 1 plan, your net cost in *Electronic Design* is only \$27.50 per column inch, lowest among all the national newspapers and electronics media. You get a total of 165,418 exposures to E OEM engineers and engineering managers (not counting 11,668 more among general or corporate managers) at only 33¢ per thousand! You can't beat the price. You can't beat the coverage and you can't beat the quality.

YOU REACH ENGINEERS WITH TITLES LIKE THESE:

- Chief Engineer
- Development Engineer
- Design Engineer
- Project Engineer
- Electronic Engineer
- Engineer-Supervisor
- Section Leader
- Staff Engineer
- Systems Engineer
- Test Engineer
- Standards Engineer
- Master Engineer

Electronic Design RECRUITMENT ADVERTISING RATES

15% commission to recognized agencies supplying offset film negatives. 2% 10 days, net 30 days. Four column makeup. Column width 1-3/4" x 10".

| SPACE | DIMENSIONS | | COST |
|----------------------|--------------------|------|---------|
| | Wide | Deep | |
| One column inch | 1-3/4" x 1" | | \$55. |
| 2 col. in. | 1-3/4" x 2" | | \$110. |
| 1/16 page (1/4 col.) | 1-3/4" x 2-1/2" | | \$130. |
| 1/8 page (1/2 col.) | 1-3/4" x 5" | | \$275. |
| 1/4 page (1 col.) | 1-3/4" x 10" Vert. | | \$550. |
| | 3-1/2" x 5" Hor. | | |
| 1/2 page (2 cols.) | 3-1/2" x 10" Vert. | | \$1100. |
| | 7" x 5" Hor. | | |
| 3/4 page (3 cols.) | 5-1/4" x 10" | | \$1650. |
| 1 page | 7" x 10" | | \$2200. |

NOTE: EACH RECRUITMENT AD YOU PLACE WILL BE REPEATED FREE OF CHARGE!

LATE CLOSING DATES

Electronic Design is mailed every two weeks. Because of its timeliness, personnel recruitment advertising closes only two weeks before each issue's mailing date.

| Issue Date | Recruitment Closing Date | Mailing Date |
|------------|--------------------------|--------------|
| Mar. 15 | Feb. 17 | Mar. 3 |
| Mar. 29 | Mar. 3 | Mar. 17 |
| Apr. 12 | Mar. 17 | Mar. 31 |
| Apr. 26 | Mar. 31 | Apr. 14 |
| May 10 | Apr. 14 | Apr. 28 |
| May 24 | Apr. 28 | May 12 |
| June 7 | May 12 | May 26 |



HOW TO PLACE YOUR AD

CALL THE RECRUITMENT HOT LINE 201-843-0550

Camera-ready film (right reading negatives, emulsion side down) or camera-ready mechanicals must be received by deadline. Or, if you wish us to set your ad (typesetting is free) simply pick up the phone and call our RECRUITMENT HOT LINE — (201) 843-0550. Ask for:

Constance McKinley
RECRUITMENT ADVERTISING MANAGER
ELECTRONIC DESIGN

50 Essex Street, Rochelle Park, New Jersey 07662

ELECTRICAL ENGINEERS

ANALOG

Engineers to design test stands and associated electrical/electronic controls and data acquisition systems. Experience in solid state closed loop analog control systems.

DIGITAL

Engineers to design the hardware and software of digital computer based equipment used in the testing of high speed rotating machinery and mechanical actuating equipment. Experience in Assembly and Fortran programming of mini-computers is required.

ANALOG/DIGITAL

Engineers to design control circuits for turbine systems and other high speed machinery. Must have experience in both analog and digital control circuit design.

Sundstrand Corporation's Advanced Technology Group designs, manufactures and markets a variety of aircraft accessory products. Sundstrand offers an excellent benefits package including an extensive medical and dental plan.

We are located in Rockford, Illinois, providing for easy access to Chicago and to the recreational areas of southern Wisconsin.

Send resumes to:

SUNDSTRAND CORPORATION

Peter L. Arthurs
4751 Harrison Avenue
Rockford, IL 61101

An Equal Opportunity Employer. M/F

MANAGER
APPLICATIONS ENGINEERING
 to \$25,000

Our client is a leader in the commercial electronics field and one of the most dynamic and successful among the 1000 largest industrial corporations.

They seek a marketing minded multi-project, state of the art engineer to direct an application engineering group. This is an exceptional career opportunity for a BSEE to broaden an engineering career through association with sales marketing and project management responsibilities.

Our client is an equal opportunity employer-M/F and pays all employment expenses. Reply in confidence to P. Luttinger.

W.J.W. Willard Associates, Inc.
(agency)

One Lincoln Center Syracuse, New York 13202 (315) 422-5111

POWER SUPPLY
ENGINEERS

Junior and Senior Level

Relocation to Dallas, Texas Area

Heavy experience with DC to DC, linear, and high frequency switchers. Openings on all levels with a rapidly growing high technology company. Send resume or contact

REACOR, INC.

718 Lingco Drive, Richardson, Tex. 75081
 or call (214) 231-7218

SYSTEMS
PROGRAMMERS

- Assembler Language
- New Systems development
- Business applications
- Requires 1-4 years' experience with major operating systems
- Competitive salaries, benefits
- Maryland countryside location

Principals only, please. All inquiries confidential.

Mr. W.T. Myers
 Director of Personnel Management
 Executive Plaza IV
 Hunt Valley, Maryland 21031
 301/667-9211

An Equal Opportunity Employer M/F

in*sight
 DISPLAY DATA CORPORATION



SYSTEMS ENGINEERING:
FIRST IN TRUE 32-BIT MINIS
FIRST IN REAL TIME SOLUTIONS
FIRST IN CAREER OPPORTUNITY
ALL IN FORT LAUDERDALE

We're putting more bytes to work in a real time environment than anyone else in the industry. For almost 2 decades, we've bred a family of pacesetter systems, culminating in the first true 32-bit super mini... not a bridge-the-gap system from 16 bit architecture, but a true 32-bit machine with richer instruction sets and larger directly addressable memory.

This kind of presence means opportunity is here... now... along with the resources to really make a name for yourself. If being on the cutting edge of technology, surrounded by year round warmth and swaying palms sounds inviting, consider the many ways available for you to grow at Systems Engineering.

We welcome the professional who is highly motivated in the direction of creativity, fresh conceptualization, and imaginative problem-solving in state-of-the-art design and software development of small to medium real time systems.

CONTRACT ADMINISTRATOR Senior Level, With Program Management Capability. We require experience, ability and effectiveness at all levels of management in negotiating, drafting, enforcing, and administering fixed-price government and industrial contracts and knowledge of ASPR, and computer systems. Background is essential in either legal, business, or engineering areas. Some travel.

PROJECT ENGINEERS BSEE and experience with job costing of custom computer systems.

PROJECT LEADER BSEE and minimum of four years experience as Group Leader involved in job costing for custom computer systems.

MICROPROGRAMMER Minimum of one year design experience in FIRMWARE design. Work involves state-of-the-art advanced concepts.

SENIOR ENGINEERS (DIGITAL) Four years experience in LOGIC DESIGN. Microprocessor or CPU experience highly desirable. Work involves Custom Systems Group.

SOFTWARE TECHNICAL INSTRUCTOR Two or more years teaching computer software courses in industry or academia. Must have knowledge of ASSEMBLY and FORTRAN language.

MTS PROGRAMMER (DISTRIBUTIVE SYSTEMS) Must have thorough knowledge of Assembly language programming and some background in FORTRAN. Real Time and inter-CPU COMMUNICATIONS and Data Base experience preferred.

MTS PROGRAMMER (DATA BASE DESIGN) D/B Generation software experience for data acquisition and applications programs. Assemblers and FORTRAN required.

MTS PROGRAMMER (CUSTOMER SERVICE) Minimum of three years in ASSEMBLY and FORTRAN LANGUAGE. Programming background in Real-time and applications environments. Customer contact experience desired. Some travel.

TECHNICIANS DIGITAL I/O and CPU experience desirable. Will work closely with digital design engineers. Two years experience in troubleshooting and testing preferred.

DESIGNER Three to ten years experience in electro-mechanical design for a computer manufacturer.

SYSTEMS offers top starting salaries, relocation to beautiful Fort Lauderdale, a full-range benefits program including dental insurance, savings/retirement plan and 100% tuition refund, and the opportunity to work and advance your career in a stable and stimulating professional environment. For immediate and confidential consideration, please forward resume or detailed letter of information, including current annual compensation to:

MR. FRED BRILLANTE, Dept. ED

SYSTEMS

ENGINEERING LABORATORIES

6901 West Sunrise Blvd., Fort Lauderdale, Florida 33313

Equal Opportunity Employer Male/Female



HOW TO PLACE YOUR AD
CALL THE RECRUITMENT
HOT LINE 201-843-0550

Constance McKinley
 RECRUITMENT ADVERTISING MANAGER
 ELECTRONIC DESIGN
 50 Essex Street, Rochelle Park, New Jersey 07662

Come join me at Hughes and be part of the new world of electronics.

It's a good feeling to be in the vanguard of technology with employment stability through dynamic growth and diversification!

For Immediate Openings In:

Circuit Design Engineers

Experienced in RF, IF, Video, and A/D circuit design for use in Signal Processing in both airborne and space applications.

Digital Logic Design Engineers

Experienced in design and development of digital circuits using TTL, STTL, ECL and CMOS technologies.

Software Development Engineers

Experienced in the development of software for special purpose digital processors. Digital hardware background experience desired.

Product Design Engineers

Experienced in extremely high density physical and thermal designs for airborne and spaceborne signal processing.

Project Engineers

Experienced in the management of all aspects of a project including management of subcontracts and remote manufacturing facilities.

Digital Module Test Engineer

Experienced in developing software for automatically testing digital modules.

Digital Associate Engineer (Non MTS)

Having good rapport with digital logic design, logic schematics and the conversion of these to a computerized interconnect data base.

Actual Hughes Scientific and Engineering Manpower Growth Curve
This chart indicates the Company's extraordinary record of growth with stability in the dynamic electronic technology industry.

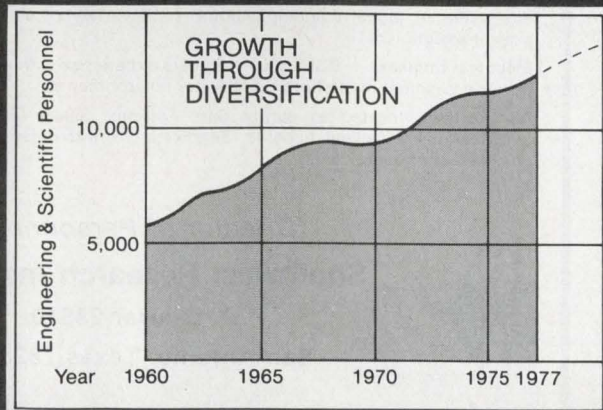

Call now—*call collect*: Richard Fachtmann, Assistant Manager, Signal Processing Laboratory, (213) 391-0711, Ext. 3904. Or send *resume* (referencing this ad) to: Professional Employment C, Aerospace Groups, 11940 W. Jefferson Blvd., Culver City, Ca 90230.

HUGHES

HUGHES AIRCRAFT COMPANY
AEROSPACE GROUPS

U.S. citizenship required. Equal opportunity M/F/HC employer

have a gripe?



let us know about it!

We'll help you put pressure on any company that makes promises in its ads . . . then fails to deliver.

Electronic Design refuses to run advertisements deemed to be misleading or fraudulent.

ACCURACY is everybody's business. So if you have a gripe about a misstatement or inaccuracy in either editorial or advertising material in *Electronic Design* . . . tell us about it. We'll do everything we can to find out what happened and see that it's corrected. Notify . . .

George Rostky

Editor-in-Chief

Electronic Design

50 Essex Street
Rochelle Park, New Jersey 07662



How Much Are You Worth?

INCOME \geq OUTGO

In most parts of the country the climate has not been good this winter but the climate has never been better for Engineers, Technical, Scientific and Manufacturing people desiring a change. Do you want more money, better location or better growth potential?

If you are looking for a change, look to IPA to assist you. One hundred and thirty-five agencies with offices from coast to coast are at your disposal.

All positions are Employer Fee Paid. No cost to you ever!

If you are looking for more than your present position offers, send your resume, salary requirements, position objectives and relocation preference to:



Inter-City Personnel Associates, Inc.
P.O. Box 1296
Charlotte, N.C. 28231

"The buck doesn't stop here; it starts here"

Research Engineers

Leading Southwest research and development organization has immediate openings for:

Senior Instrumentation Engineer — MSEE plus 5 yrs. experience in design and development of analog and digital solid state circuitry and systems. Desirable prior experience should include project supervision, minicomputer interface design, microprocessors and instrumentation development.

Senior Electronics Engineer — MSEE or Ph.D. plus 5 yrs. experience in digital communication systems design and testing. Assignments will involve point-of-sale terminal polling strategies and equipment, simulation of digital communication network and systems and error rate prediction.

Senior Electronics Engineer — BSEE plus 7 yrs. experience in automatic test equipment using minicomputers and microprocessors. Assignments will include development of automatic test equipment for machinery and electronics.

Electronic Engineers — BSEE plus education background or experience in microprocessors systems design, automatic test equipment or digital communications. Wide variety of challenging project assignment.

Electrical Engineer — BSEE plus 3-5 years experience with electrical power equipment in offshore/underwater environments.

All positions located in sunny San Antonio. Salary based on qualifications. Excellent benefits. Send resume, with references, in complete confidence to:

Director of Personnel

Southwest Research Institute

P.O. Drawer 28510

San Antonio, Texas 78284



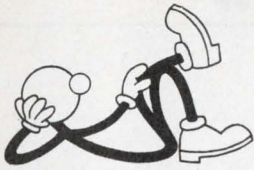

EFFORTLESS . . .

If you're ready to move on with your career, it can be a lot easier than you expect.

We are the members of



who work extensively with electronics industry leaders. The companies we service have many openings and pay for us to search you out.

Send your resume to the office nearest you. Then sit back and relax while we do the work.

BURTON PERSONNEL SERVICE

300 Walker Building
120 Boylston Street
Boston, Massachusetts 02116
(617) 482-1950

ANDERSON-TAYLOR

P.O. Box 21
Exton, Pennsylvania 19341
(215) 363-1600

PETER A. KECHIK & ASSOCIATES, INC.

1420 Renaissance Drive
Park Ridge, Illinois 60068
(312) 298-1148

STAFF DYNAMICS, U.E.

26 Sixth Street
Stamford, Connecticut 06905
(203) 324-6191

CAREER SPECIALISTS, INC.

4600 El Camino Real, Suite 206
Los Altos, California 94022
(415) 941-3200

BRENTWOOD PERSONNEL ASSOCIATES

Electronics Division
1280 Route 46
Parsippany, New Jersey 07054
(201) 335-8700

190 associates internationally

Power Supply Designers

Explore the rewards and satisfaction of working on new and exciting communications and experimental satellite programs.

GOES — NASA's Weather/Environmental Satellite Program

GMS-2 — Japan's Newest Weather Satellite Program

SBS — Privately Owned U.S. Commercial System

ANIK-C — Canada's Latest National Communications System

Join the Hughes team of Space & Communications Engineers who are designing high voltage (5 to 10 KV), space qualified high efficiency power supplies for TWTs. Operations with multiple collector TWTs (as loads) present interesting design challenges.

Experience with series and switching regulators, TWM converters and DC-DC converters and BS or MS in EE are desired.

For immediate consideration please call (collect): Mr. G. Kemanis, Asst. Mgr. Communications Labs, at (213) 648-8731 or send your resume to: Professional Employment, Dept. 41-20, P.O. Box 92919, Los Angeles, CA 90009.

HUGHES

HUGHES AIRCRAFT COMPANY

U.S. citizenship required • Equal opportunity M F HC employer

Engineering Specialists

"A Professional Approach to Your Career Growth"

Are you at a career impasse? Are your abilities being stretched to the fullest? If not, take a positive approach and talk to the specialists at Gray Kimball Associates. Our nationwide roster of blue-chip clients have come to rely on us in recruiting top-echelon engineering talent. All fees/expenses paid by our clients.

Challenging positions available nationwide include:

RF Engineers

Signal Processing
Phase Lock Loop
Spread Spectrum Analysis
Secure Communication

Software Engrs/ Programmers

Real-Time
Mini-Computer

Digital/Analog Engineers

Microprocessors
Display Systems
EW Systems

Reliability/ Maintainability Engineers

Now is the time to arrange a confidential interview with

Lou Basso (516) 799-5400

or send your resume in confidence to:

GRAY KIMBALL ASSOCIATES INC.

660 Bway, Massapequa, N.Y. 11758

Our clients are equal opportunity employers

ENGINEERS SYSTEMS ANALYSTS/ PROGRAMMERS

Nationwide Professional Fee Paid Positions. Salary Range to 35K. Call Collect or send resume to K. Schargus or S. Nemer for immediate attention.

Software/Hardware Analog/Digital
Weapon Systems Microprocessors
Sonar/Radar Instrumentation
Electro optics Test Engineering
Electronic Design Mechanical Design

AMERICAN PERSONNEL SERVICE

240 State Street
New London, Conn. 06320
203-442-0395

KEEP

Electronic Design's GOLD BOOK

HANDY When

You Call

semi CUSTOM CMOS LSI

- Reduce Your Circuit to a Single Chip with One of Our 14 Master-slices.
- Fast Turn Around - Prototypes in 4 to 6 Weeks.
- Development Cost - As Low As \$ 2,150.
- Quantities from 200 to 200,000 Pieces with Volume Prices as Low as \$1.50 Each.

Call

Orhan Tozun or Joe Puhich
(408) 735-9370

Or Send for New Brochure:
International Microcircuits, Inc.
3004 Lawrence Expressway
Santa Clara, CA. 95051

CIRCLE NUMBER 61

Save on Calculators

HEWLETT-PACKARD

| Model | Your Cost | Model | Your Cost |
|-------------------------------------|-----------|-----------------------------------|-----------|
| HP 67 224 step programming | \$379.95 | HP 97 224 Program Step/Printer | \$596.95 |
| HP 10C Comb. betw. HP25C/HP67/ptr | 274.95 | HP 29C Comb. bet. HP25C/HP67 | 154.95 |
| HP 52 Bond Trader-Finance-Printer | 996.95 | HP 25C Scient. retains memory | 127.95 |
| HP 25 Scient. programmable | 99.50 | HP 27 Comb Bus-Science-Stat | 138.95 |
| SR 51-2 Super Slide Rule-Calcv | 224.95 | HP 91 Printer Scient.-HP 45 specs | 259.95 |
| HP 21 Scient. slide rule | 63.95 | HP 10 hand held Ptr-mem, small | 139.95 |
| HP user lib. solut. books (40) each | 9.50 | HP 22 R/E Business-Finance | 99.50 |

HP accessories at discount prices
Between 2/1/78 and 3/31/78, buy one HP-47 or 97, get \$105 worth of software free. Buy one HP-19C or 23C, get \$37.50 of software free.

We are an HP franchised dealer. Each unit comes complete with charger, batteries, case, manuals. One year guarantee by Hewlett-Packard. We will beat any deal. Try us.

TEXAS INSTRUMENTS

| Model | Your Cost | Model | Your Cost |
|---------------------------------------|-----------|---------------------------------------|-----------|
| TI 59 960 prog step-100 mems | \$214.95 | TI 30 Scient. slide rule, parentheses | \$17.95 |
| PC 100A printer for TI 59-58-56-52 | 148.95 | Money Manager for R/E and Finance | 18.95 |
| SR 40 Scient. slide rule, parentheses | 24.95 | TI 1750 Thin, wall. LCD 2M Hrs. mem. | 17.95 |
| Bus. Analyst R/E and Finance | 28.95 | MBA Business-Finance-Stats. | 64.95 |
| SR 51-2 Super Slide Rule-Calcv | 48.95 | Little Prof. for kids 5 yr./up | 12.95 |
| Data Clip pencil thin, LCD 1000 Hrs. | 48.95 | Data-Man (Big Prof) educ. | 21.95 |
| TI 1680 Instant Replay calcs. | 25.95 | TI 5015 Printer-Grand Total-Percent | 64.95 |
| TI 2550-3 Business-Memory | 25.95 | TI 5100 Desk-Digital, mem.-percent | 43.95 |
| TI 5000 Printer-Display-Memory | 98.95 | TI 1025 Memory-Percent-+- | 10.95 |
| TI 1050 Mem. printer-square root | 83.95 | TI 5015 Printer-Grand Total-Percent | 9.95 |
| Libraries for TI 59 and TI 58 | 12.95 | TI Digital watches all models incl | |
| TI 58 480 step prog.-60 memories | 97.95 | Star Wars LED-LCD-Ladies-Men's | |
| TI 57 150 step prog.-replaces SR56 | 63.95 | All styles | 9.95 up |

We are a TI franchised dealer and carry TI accessories at discount prices. We will beat any deal. Try us. All TI calculators are guaranteed by Texas Instruments, Inc.

SPECIALS

| Model | Your Cost | Model | Your Cost |
|-----------------------------------|-----------|-----------------------------------|-----------|
| Norelco #185 Dictating unit | 99.95 | Sony KV-2141R Color Remote 21" | 619.95 |
| Norelco #88 Dictating unit | 242.00 | Sony Betamax | 879.95 |
| Norelco #186 Transcribe unit | 245.00 | Zenith Video Recorder | 859.95 |
| Norelco #NT-1 new dictating unit | 164.00 | RCA Selectavision | 819.95 |
| Norelco #97 dictating or transcr. | 298.00 | 3M dry photocopy machine #149 | 79.95 |
| Norelco #98 dictating or transcr. | 409.00 | Hughes calculator watch | 119.95 |
| Norelco Mini Cassettes | 2.95 | LCD calculator watch | 199.95 |
| Craig # 2625 elect. notebook | 149.00 | Atari comput TV game/27 war games | 159.95 |
| Craig #2765A dictating/transcr. | 189.00 | Phone Mate-Code A Phone- | |
| Sony KV-1204 Color Trinitron 12" | 309.95 | Record A Call-Ans. Systems | call us |
| Sony KV-1512 Color Trinitron 15" | 359.95 | Chessmaster II, comput. | 199.95 |
| Sony KV-1541R Color Remote 15" | 409.95 | Gammomaster adv. comput. | 199.95 |
| Sony KV-1741R Color Remote 17" | 469.95 | Royal, APF-Lloyd, Victor, Div. | call us |
| Sony KV-1921 Color Trinitron 19" | 449.95 | Unitrex, etc. print calcs. | call us |
| Sony KV-1941R Color Remote 19" | 529.95 | Atari pinball TV game | 74.95 |
| Sony KV-2101 Color Trinitron 21" | 559.95 | | |

We carry: Royal-Divette-Smith Corona-Amana-Litton-Commodore-APF-Unitrex-Canon-Casio-Sharp-Panasonic-Sanyo-Bally-JVC-HY Gain-Kosmos-Victor-Sinclair-Pearlcoorder-Midex alarm-3M-Microma-Lloyds-Bosche-Rockwell-Sentry Sales-Walton Gym equip.-RCA-Zenith-Sony-Atari-Phone Mate Record A Call-Code A Phone and many more. Over 20,000 units. (Try COFFEE PLUS at \$1.79 per one pound can by the case of 24 cans. Freight prepaid. Good seller.)

Prices are f.a.b. LA. Goods subject to availability. Ask for our famous catalog. We will beat any prices if the competition has the goods on hand. Add \$3.00 for shipping hand held calculators. CA residents add 6% sales tax.

OLYMPIC SALES COMPANY, INC.
216 South Oxford Ave. • P.O. Box 74545
Los Angeles, CA 90004 • (213) 381-3911 • Telex 67-3477

CIRCLE NUMBER 62

Advertiser's index

AFS Precision Tools..... 104
AMP, Incorporated..... 10,11
Advanced Micro Devices..... 4,5
Allen Bradley Co..... 16
American Electronics..... 91
Analog Devices, Inc..... 12,13

Bodine Co., The..... 95
Bourns, Inc., Trimpot Products
Division..... Cover II
Burr-Brown Research Corporation..... 99
Burroughs Corporation..... 67

Capitol Machine & Switch Co.,
Inc., The..... 102
Centralab/USCC..... 82
Citizen America Corporation..... 91
Computer Conversions Corp..... 103
Continental Specialties Corpor-
ation..... Cover III

Dale Electronics, Inc..... 38,39
Data General Corporation..... 14,15
Data I/O Corporation..... 18
Datel Systems, Inc..... 71,73,75
Deltrol Controls..... 95
Digital Laboratories..... 105
Dormeyer Industries, Inc..... 105

Eagle Magnetics, Inc..... 104
*Electronic Design..... 95,96
Essex Group, Sub. of United Tech-
nologies..... 93

Fairchild Semiconductor, Components
Group..... 53
Fairchild Systems Technology,
A Division of Fairchild
Camera and Instrument Corpor-
ation..... 16A-B
Figaro Engineering, Inc..... 103

GenRad..... 104
*Gold Book, The..... 97

Hayden Book Co..... 106
Heinemann Electric Company..... 95
Hewlett-Packard..... 1,52
Hycom..... 105

ITT Community Development Corp... 85
Intel Corporation..... 8,9
Intel Memory Systems..... 87,89
Intelligent Systems, Inc..... 80,81
International Microcircuits, Inc..... 112

Johanson Manufacturing Corp..... 103
Johnson Company, E.F..... 90

Keppo, Inc..... 30
Keystone Carbon Company..... 28

Litton Advanced Circuitry..... 96,97

*Mektron..... 16

Memodyne Corporation..... 105
Methode Manufacturing Co..... 104
MetroTek, Inc..... 103
Micro Devices Div. of
Emerson Electronic..... 62
Miller-Stephenson Chemical Co., The... 6
Murata..... 102

Olympia Sales Company, Inc..... 112
Optron, Inc..... 7

Paladin Corporation..... 76,104
*Philips Electronic Components and
Materials..... 93
Piezo Technology, Inc..... 84
Power/Mate Corp..... 104
Precision Monolithics, Incorporated... 83
Pro-Log Corporation..... 79

Q-Matic Corporation..... 104

RCA Solid State Division..... Cover IV
Rockwell International..... 101
Rogan Corporation..... 88
Rogers Corporation..... 105

Salon International des Composants
Electroniques..... 76
Sealectro Corporation..... 94
Semtech Corporation..... 21
*Sfernice..... 92
Signetics Corporation..... 25
Slaughter Co..... 76
Spectronics, Incorporated..... 27,84
Sprague Electric Company..... 29
Standard Grigsby, Inc..... 86
Struthers-Dunn, Inc..... 17

TDK Electronics..... 34
TRW/IRC Resistors, an operation of
TRW Electronic Components..... 104
Taylor Industries, Inc..... 94
Techmar Omniclosure..... 103
Tektronix, Inc..... 33,35
Teledyne Relays, A Teledyne
Company..... 2
Teledyne Semiconductor..... 36
Texas Instruments, Incorporated..... 63
Timeco, Inc..... 105
Triplett Corporation..... 69

Victory Engineering Corp..... 88

Western Digital Corporation..... 18
Woodtron, Ltd..... 103

*Advertisers in non-U.S. edition

RECRUITMENT

Display Data..... 108
Gray, Kimball Associates..... 111
Hughes..... 109, 111
Intercity..... 110
National Personnel Associates..... 111
Southwest Research Institute..... 110
Sunstrand..... 107
Systems Engineering Labs..... 108

SAVE UP TO 50% ON PARTS.

Hobbyist or professional, there are probably a lot of circuits you build just for the fun of it. And a lot you'd *like* to build, but never get around to.

One reason is the cost of parts. Parts you buy for one project, but can't re-use... because you haven't time to take them carefully apart. Or because of heat and mechanical damage that occur when you do.

Now, there's an easier way that can save you big money on parts *and hours on every project*, as well: *Proto-Board® Solderless Breadboards*.

Now, assembling, testing and modifying circuits is as easy as pushing in—or pulling out—a lead. IC's, LED's, transistors, resistors, capacitors... virtually every kind of component... connect and inter-connect instantly via long-life, nickel-silver contacts. No special patch cords or jumpers needed—just

| MODEL | NO. OF TIE-POINTS | 14-PIN DIP CAPACITY | SUGG. LIST * | OTHER FEATURES |
|---------|-------------------|---------------------|--------------|--|
| PB-6 | 630 | 6 | \$15.95 | Kit—10-minute assembly |
| PB-100 | 760 | 10 | 19.95 | Kit—with larger capacity |
| PB-101 | 940 | 10 | 29.95 | 8 distribution buses, higher capacity |
| PB-102 | 1240 | 12 | 39.95 | Large capacity, moderate price |
| PB-103 | 2250 | 24 | 59.95 | Even larger capacity; only 2.7¢ per tie-point |
| PB-104 | 3060 | 32 | 79.95 | Largest capacity; lowest price per tie-point |
| PB-203 | 2250 | 24 | 80.00 | Built-in 1%-regulated 5V, 1A low-ripple power supply |
| PB-203A | 2250 | 24 | 129.95 | As above plus separate ½-amp +15V and -15V internally adjustable regulated outputs |

*Manufacturer's suggested list
Prices and specifications subject to change without notice.

lengths of ordinary #22-30 AWG solid hookup wire.

Circuits go together as quickly as you can think them up. And parts are re-usable, so as your "junk box" builds, you build more and more projects for less and less money.

Before you invest in your next project, invest in a CSC breadboard.

Order today. Call 203-624-3103 (East Coast) or 415-421-8872 (West Coast): 9 a.m.-5 p.m. local time. Major credit cards accepted. Or see your CSC dealer. Prices slightly higher outside USA.

CONTINENTAL SPECIALTIES CORPORATION

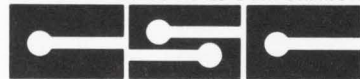

70 Fulton Terrace, Box 1942, New Haven, CT 06509
203-624-3103 TWX 710-465-1227
WEST COAST: 351 California St., San Francisco, CA 94104,
415-421-8872 TWX 910-372-7992
GREAT BRITAIN: CSC UK LTD,
Spur Road, North Feltham Trading Estate,
Feltham, Middlesex, England.
01-890-8782 Int'l Telex: 851-881-3669

© 1978, Continental Specialties Corporation

CIRCLE NUMBER 231



RCA first in CMOS.

Ready with megarad CMOS to new MIL38510 specs.

RCA will take orders for 23 megarad-hard CMOS circuits to MIL-M-38510 Class S specifications. We're ready to deliver 10^6 radiation hardness because we've had so much experience in supplying CMOS hardened to 10^5 .

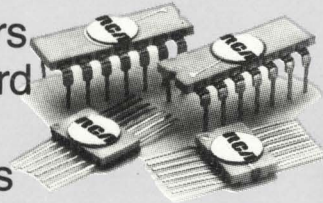

| | | | |
|-------|-------|-------|-------|
| 0520 | 05204 | 05205 | 05301 |
| 05206 | 05102 | 05103 | 05504 |
| 05701 | 05702 | 05703 | 05207 |
| 05208 | 05209 | 05601 | 05210 |
| 05211 | 05212 | 05603 | 05301 |
| 05213 | 05102 | 05704 | 05501 |
| 05214 | 05705 | 05604 | 05502 |
| 05215 | 05503 | 05003 | 05001 |
| 05216 | 05504 | 05605 | 05002 |
| 05217 | 05201 | 05204 | 05101 |
| 05218 | 05202 | 05102 | 05702 |
| 05219 | 05203 | 05705 | 05703 |
| 05220 | 05204 | 05501 | 05601 |
| 05221 | 05205 | 05502 | 05602 |
| 05222 | 05701 | 05603 | 05603 |
| 05223 | 05601 | 05102 | 05704 |
| 05224 | 05602 | 05705 | 05604 |

After shipping hundreds of thousands of parts to 10^5 Rads, megarad was a natural step up for us. Many of our Rad-Hard CMOS circuits are now in satellites. Voyagers 1 and 2, for example, which are well into space.

When you use RCA Rad-Hard CMOS, you can have added confidence because every single wafer processed for Rad-Hard is sample tested on one of our two in-house cobalt sources.

In addition to the 23 MIL types, we can produce any RCA COS/MOS logic circuits processed to megarad hardness.

Let us send you "Radiation Guidelines" plus two other papers on test results and recent advances in Rad-Hard CMOS. For immediate information, call (201) 685-6625.

Or write RCA Solid State headquarters in Somerville, NJ; Sunbury-on-Thames, Middlesex, England; Quickborn 2085, W. Germany; Ste. Anne-de-Bellevue, Quebec, Canada; Sao Paulo, Brazil; Tokyo, Japan.

When you say CMOS, say RCA first.