

**CHIP SET EXPANDS IMAGE-COMPRESSION CHOICES
DESIGN A SECONDARY CACHE FOR AN 80486**

FOR ENGINEERS AND ENGINEERING MANAGERS — WORLDWIDE

ELECTRONIC DESIGN

A PENTON PUBLICATION U.S. \$5.00

SEPTEMBER 27, 1990



**DESIGN A PC/AT
WITH A SINGLE-CHIP
'MOTHERBOARD'**

- **SPECIAL REPORT: GRAPHICS CHIPS**
- **PIPS: POWER, INTERCONNECTS, PASSIVES, SWITCHES/RELAYS**

QUICKLOOK
PAGE 97

Twice the Power:

PCB III

PC Board Layout
on your PC

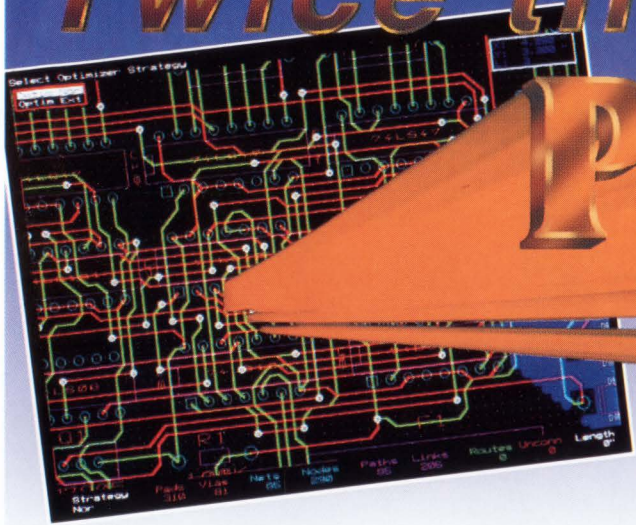

OrCAD Systems Corporation, the world's largest marketer of PC-based CAE software, has completely upgraded its popular printed circuit board layout software. Now you can have all the power features you need for your board designs on the PC you already own.

Twice the capacity

OrCAD/PCB II has over double the capacity using a flexible, user-definable memory allocation system. The product now supports over 270 14-pin IC equivalent designs, 6000+ pads, 16,000+ equivalent track segments.

Twice the options

OrCAD/PCB II comes with over 50 different printer drivers including most popular dot matrix and laser printers, over a dozen plotter drivers and over 50 display drivers. We conform to your system better than anyone.

Twice the features

- Improved autorouting strategies means a faster route with more completions.
- Design Rule Check available as OrCAD/PCB II runs. Parameters are user configurable.
- Via and Track Optimization. Minimize vias and improve routing automatically.

OR8944

- On-Line module browsing and reading. Call up modules and browse through their graphic descriptions.
- Gerber Viewer generates screen version of Gerber file to check output.

Twice the value

OrCAD's commitment to you is that all of our powerful software will give you workstation performance without extra hardware, all handled within 640k RAM.

And the price? The package comes complete with autorouter, printer and plotter support, excellent documentation and more for only \$

1495

The price also includes one year of technical support, free product updates and access to our 24 hour BBS.

Curious? Try it yourself with our free demo disk.

Call for our free demonstration disk and information packet. You'll see why more designers look to OrCAD for their design solutions.

OrCAD 
Systems Corporation

3175 N.W. Alcock Drive
Hillsboro, Oregon 97124
(503) 690-9881

If you would like more information about this or any other OrCAD product, contact your local OrCAD representative.



- | | |
|--|--|
| 1. WA, OR, MT, ID, AK
Seltech, Inc.
(206)746-7970 | 9. IN, OH, KY, WV, W. PA
Frank J. Campisano
(513)574-7111 |
| 2. N. CA, Reno NV
Elcor Associates Inc.
(408)980-8868 | 10. VA, TN, NC, SC
Tingen Technical Sales
(919)870-6670 |
| 3. So. CA
A D G
(714)897-0319 | 11. FL
High Tech Support
(813)920-7564 |
| 4. Las Vegas, UT, AZ, NM, CO
Tusar Corporation
(602)998-3688 | 12. MS, AL, GA
Electro-Cadd
(404)446-7523 |
| 5. ND, SD, MN, W. WI
Comstrand, Inc.
(612)788-9234 | 13. DE, MD, DC, E. PA, NJ, NY
Beta Lambda, Inc.
(201)446-1100 |
| 6. NE, KS, IA, MO
Walker Engineering
(913)888-0089 | 14. CT, RI, MA, VT, NH, ME
DGA Associates
(617)935-3001 |
| 7. TX, OK, AR, LA
Abcor, Inc.
(713)486-9251 | 15. BC, AB, SK, MB
Interworld Electronics, Ltd.
(604) 984-4171 |
| 8. MI, E. WI, IL
MacKellar Associates
(313)335-4440 | 16. ON, PQ & Maritimes
Electralert, LTD.
(416)475-6730 |

Call today for your FREE demo disk

BELL
2000 pts 50 kHz
Sample Rate

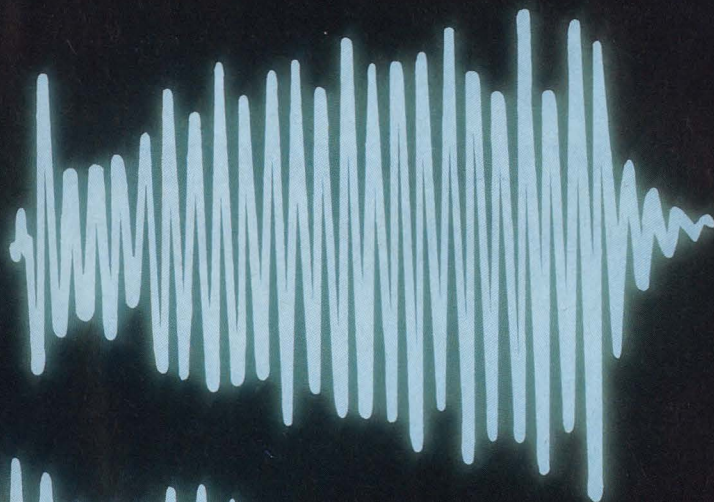

WHISTLE
2000 pts 50 kHz
Sample Rate

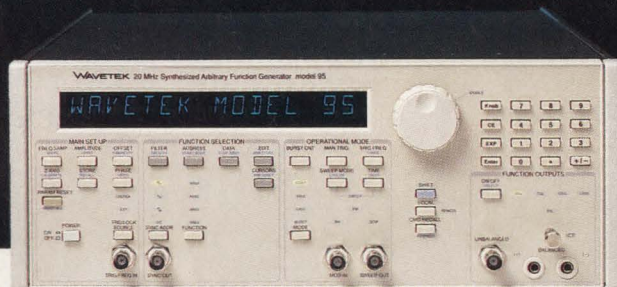
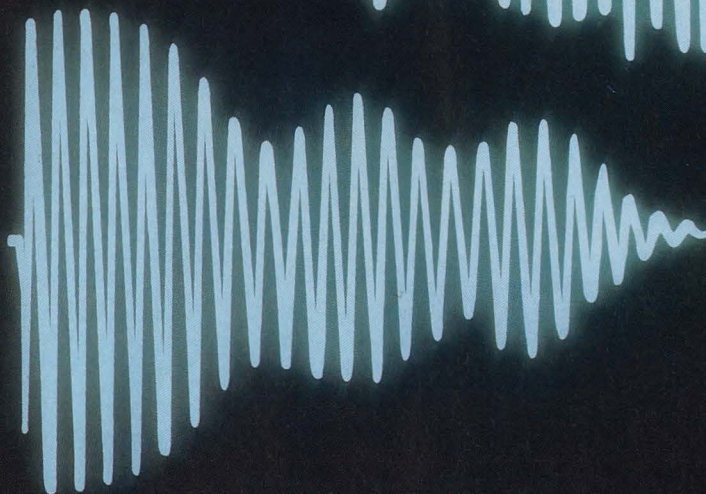

Our new function generator has all the bells and whistles.

In fact, it has any kind of waveform you can imagine. Because the Model 95 combines a high performance function generator with a powerful arbitrary generator.

As a function generator, Model 95 produces remarkably pure square waves, triangles and sines, from 1 mHz to 20 MHz with synthesized accuracy up to 0.001%. It has

the power to output 15 Vp-p into 50 Ω , and includes sweep, pulse and modulation modes plus four user-selectable output impedances. There's even an internal trigger generator for trigger, gate and burst.

If you'd rather be arbitrary, Model 95 gives you up to 128k of waveform memory to work with, and a sample rate of 20 MHz. Four different editing

modes help you produce even the most complicated wave shapes quickly and accurately, while analog and digital filters allow you to create the purest output possible.

For information about all the other bells and whistles you'll find on the Model 95, call Wavetek San Diego, Toll Free at 1-800-874-4835 today.

Our new pulse generators will test what you have.



High Speed Bi-polar

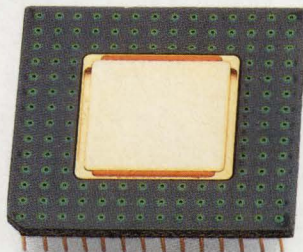

BICMOS



ECL



ECLips

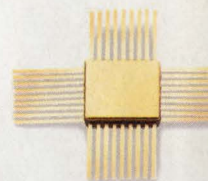

GaAs

That's a big statement. But these are powerful new programmable pulse generators. Combined, they deliver top speed, high resolution and pulse-parameter flexibility. So you get accurate testing of your present and future high-speed designs, whether they're ICs, PCBs, or components.

Put the new 500 MHz HP 8131A to work on your hot-



HP 8130A Pulse Generator



HP 8131A Pulse Generator

test new devices. With a transition time of <200 ps, plus pulse widths down to 500 ps with 10 ps timing resolution, you get the stimulus you've needed for accurate testing of your fastest designs.

For the most complete testing of your high-speed devices, choose the new HP 8130A. It has the features you've wanted in a 300 MHz pulse generator,

And what you have in mind.

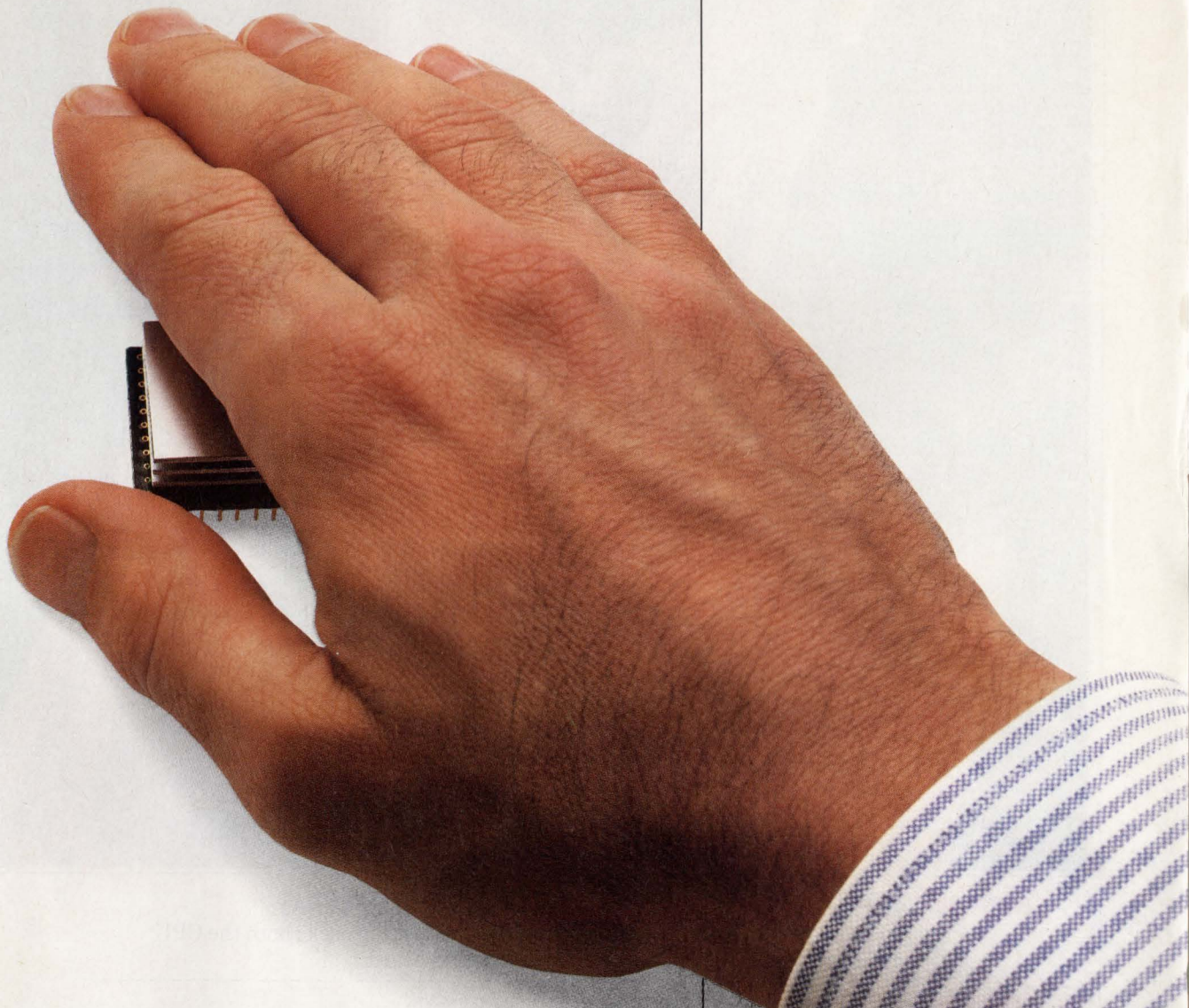

© 1990 Hewlett-Packard Co. TMBID957A/ED

including variable transition times down to 1 ns, and 10 ps timing resolution. Which means you not only have the flexibility for high-speed parametric testing of digital devices, but for analog device testing as well.

So call **1-800-752-0900** today. Ask for **Ext. 217X** to get data sheets and application information. Then get the program-

mable pulse generators you need for the fast devices you have in hand and mind.

There is a better way.



**HEWLETT
PACKARD**

CIRCLE 123

ELECTRONIC DESIGN



COVER FEATURE **40 THE ONE-CHIP PC MAKES BUILDING SYSTEMS A SNAP**
Approaching the limit of integration for a PC, one chip packs both the CPU and the logic needed to build a complete motherboard.

ELECTRONIC DESIGN REPORT **51 COLORFUL GRAPHICS FOR THE DESKTOP**
New chips deliver higher resolution and more colors.

DESIGN APPLICATIONS **67 DESIGN A SECONDARY CACHE FOR INTEL'S i486 PROCESSOR**
Because an i486 easily outpaces the main memory bus, an external cache steps in to boost system throughput.

85 SIMULATION SORTS SYSTEM SCHEMES BY SURVEYING TRADE-OFFS
A hardware modeler helps to accurately predict the performance of a micro-processor-based board.

PRODUCT INNOVATION **173 CHIP SET BROADENS OPTIONS FOR IMAGE COMPRESSION**
Programmable functions lead to cost-effective transmission of video and photo-quality stills.

14 EDITORIAL

16 TECHNOLOGY BRIEFING

The customer is always right

23 TECHNOLOGY NEWSLETTER

- InP HEMT sets record, operates at 260 GHz
- Conductive epoxies seen as solder substitute
- CAE and database companies form partnership
- Silicon-on-insulator process builds diodes
- High-power lasers make efficient X-ray source
- Synthesis acquisition fills out ASIC toolset
- Window comparator responds in just 5 ns
- High-power switches and neural nets advance

31 TECHNOLOGY ADVANCES

- 90-GHz AlInAs/GaInAs bipolar transistors build dc to 33-GHz amp with 8.6-dB gain
- Redundant buses, parity, and radial control boost reliability

97 QUICK LOOK

105 IDEAS FOR DESIGN

- Vary filter's passband gain
- Convert waveform period to voltage
- Add variable wait states



Certificate of Merit
Winner, 1988
Jesse H. Neal Editorial
Achievement Awards

Cover photo: Jook Leung

PIPS SPECIAL EDITORIAL SECTION

- 115 Use power bypassing and busing for high-performance circuits
- 125 Resistors
- 133 Capacitors
- 141 Inductors
- 147 Crystals & Oscillators
- 152 Optoelectronics
- 156 Power, Interconnects, and Switches & Relays
- 158 New Literature

164 PEASE PORRIDGE

What's all this noise stuff, anyhow? (Part I)

171 PRODUCTS NEWSLETTER

- Ultra-thin packages house DRAMs and SRAMs
- 200-V-CMV differential-amp now in 8-pin SOIC
- Nonvolatile memories leave their mark
- Standard palette DAC becomes standard cell
- IC DIP op amps move into 8/14-pin SOICs

NEW PRODUCTS

- 179 Computer-Aided Engineering
PLD and FPGA tools take a system-level approach to design
- 184 Instruments
- 189 Digital ICs
FIR filters and direct digital synthesizers tackle tough applications
- 191 Digital ICs
Enhanced RISC processor packs floating-point unit and graphics commands
- 194 Analog
- 196 Power
- 202 Packaging & Production
- 205 Computers & Peripherals

210 INDEX OF ADVERTISERS

213 READER SERVICE CARD

COMING NEXT ISSUE

- Special Report: Selecting design tools for PLD-based systems
- Career Special: Results and analysis of Electronic Design's annual salary survey
- Avoiding system pitfalls in PLD-based systems
- Understanding EISA bus-cycle translations
- Designing embedded controllers with new 386-based modules
- Pease Porridge: What's all this noise stuff, anyhow? (Part II)
- A new image-processing chip set offers expanded options
- A preview of the Buscon East show

ELECTRONIC DESIGN (USPS 172-080; ISSN 0013-4872) is published semi monthly by Penton Publishing Inc., 1100 Superior Ave., Cleveland, OH 44114. Paid rates for a one year subscription are as follows: \$75 U.S., \$140 Canada, \$230 International. Second-class postage paid at Cleveland, OH, and additional mailing offices. Editorial and advertising addresses: ELECTRONIC DESIGN, 611 Route #46 West, Hasbrouck Heights, NJ 07604. Telephone (201) 393-6060. Facsimile (201) 393-0204.

Printed in U.S.A. Title registered in U.S. Patent Office. Copyright © 1990 by Penton Publishing Inc. All rights reserved. The contents of this publication may not be reproduced in whole or in part without the consent of the copyright owner.

Permission is granted to users registered with the Copyright Clearance Center Inc. (CCC) to photocopy any article, with the exception of those for which separate copyright ownership is indicated on the first page of the article, provided that a base fee of \$1 per copy of the article plus \$.50 per page is paid directly to the CCC, 27 Congress St., Salem, MA 01970 (Code No. 0013-4872/90 \$1.00 + .50). Copying done for other than personal or internal reference use without the express permission of Penton Publishing, Inc. is prohibited. Requests for special permission or bulk orders should be addressed to the editor.

For subscriber change of address and subscription inquiries, call (216) 696-7000.

POSTMASTER: Please send change of address to ELECTRONIC DESIGN, Penton Publishing Inc., 1100 Superior Ave., Cleveland, OH 44114.



MAKING THE SWITCH TO HIGH PERFORMANCE? OUR 68331 PUTS YOU ON THE RIGHT TRACK.

Considering a move up in power? Now you can switch to the 32-bit performance track that's parallel with all your future needs. Thanks to Motorola's new, surprisingly affordable 68331 microcontroller.



OUR NEW 68331 IS MORE THAN A MICROCONTROLLER. IT'S A MILESTONE.

The 68331 features the same powerful 32-bit CPU, System Integration Module, and Queued Serial Module used in our unsurpassed 68332.

Not to mention a powerful General Purpose Timer. Modular design. The support of Motorola's huge 68000 Family software base. And access to the most sophisticated development systems in the industry.

All at a price that's considerably less than you'd expect to pay for 32-bit power.

IF YOU'RE HEADED FOR HIGH PERFORMANCE, YOU'RE ON THE RIGHT PATH.

With Motorola, your path to power is virtually a straight shot, thanks to the families of

microcontrollers we've mapped out to take you from here to high performance. Without unnecessary changes in software and architectures along the way.

The newest point on this revolutionary route is Motorola's 68331.

There will be many others in the months to come, all of which demonstrate one thing.

For well-planned migration to high performance, travel with the leader. Motorola.

To receive a Technical Product Preview for the 68331, plus more news to come on our high performance migration path, please complete and return this coupon to:

Motorola, Inc.
P.O. Box 1466
Austin, Texas 78767

ED9/27/90

Name _____
Company _____
Title _____
Address _____
City _____
State _____ Zip _____ Phone _____

THE PATHWAY TO PERFORMANCE.



MOTOROLA

Analog Designers... COMTRAN[®] Is Now On The 386[™]

Automatic optimization adjusts selected component values of your topology to make its response fit your arbitrary target curves in magnitude, phase, Z_{in} , Z_{out} , or any combination. Multiple passes allow standard value capacitors in precision filters or other networks.

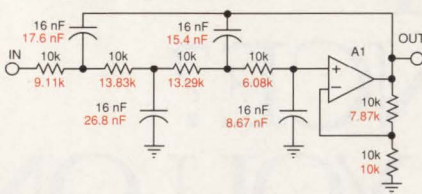

- COMTRAN[®] is fast. Each plot here was generated on screen in 6 seconds. Optimization took less than 3 minutes using a 25 MHz 386/387 (or an HP 310).
- COMTRAN[®] is an interactive, intuitive AC circuit analysis program that handles component entry, editing, analysis, optimization, and user scaled Linear/Log graphics in one program.
- COMTRAN[®]'s tolerance mode graphically shows the effect of real world components. Impedance mode plots impedance at ANY node in your circuit.

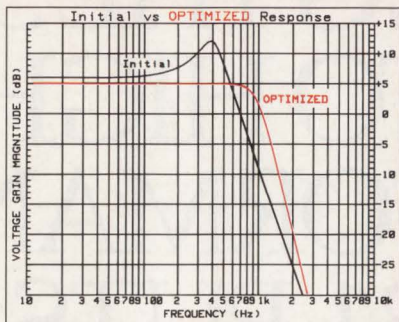

Actual Plotted Output of COMTRAN (Reduced Size)

- COMTRAN[®] can create, capture and analyze time domain data, then use it to stimulate your circuit and plot the result in either time or frequency domain.
- COMTRAN[®] has over 10 years of field experience on HP computers. Now it runs on 386[™] machines, too. And it still drives HPGL plotters.
- COMTRAN[®] is modular—buy only what you need today. Ready-to-use packages start at under \$1000.

COMTRAN[®] Integrated Software

A Division of Jensen Transformers, Inc.

10735 BURBANK BOULEVARD, N. HOLLYWOOD, CA 91601
FAX (818) 763-4574 PHONE (213) 876-0059

COMTRAN is a registered trademark of Jensen Transformers, Inc. 386 is a trademark of Intel Corporation.

CIRCLE 212

ELECTRONIC DESIGN

Editor-in-Chief: Stephen E. Scrupski

Executive Editor: Roger Allan

Managing Editor: Bob Milne

Senior Editors: Frank Goodenough,
Milt Leonard, John Novellino

Technology Editors:

Analog & Power: Frank Goodenough

Communications & Industrial:

Milt Leonard (San Jose)

Components & Packaging: David Maliniak

Computer-Aided Engineering:

Lisa Maliniak

Computer Systems: Richard Nass

Semiconductors: Dave Bursky (San Jose)

Test & Measurement: John Novellino

News Editor: Sherrie Van Tyle

New Products Editor: Susan Nordyck

Field Bureaus:

West Coast Executive Editor:

Dave Bursky (San Jose)

Boston: Lawrence Curran

Dallas: Jon Campbell

Frankfurt: John Gosch

London: Peter Fletcher

Chief Copy Editor: Roger Engelke, Jr.

Editorial Production Manager:

Lisa Iarkowski

Administrative Assistant: Janis Kunkel

Editorial Support Supervisor: Mary James

Editorial Assistant: Ann Kunzweiler

Editorial Secretary: Bradie Guerrero

Editorial Offices: (201) 393-6272

Advertising Production:

(201) 393-6093 or FAX (201) 393-0410

Production Manager: Michael McCabe

Production Assistants:

Donna Marie Bright, Doris Carter,

Eileen Slavinsky

Circulation Manager: Elaine Brown

Subscription Inquiries:

Mary Lou Allerton (216) 696-7000

Promotion Manager: Clifford Meth

Reprints: Helen Ryan (201) 423-3600

Group Art Director: Peter K. Jeziorski

Computer Systems Administrator:

Anne Gilio Turtoro

Published by Penton Publishing

Vice President-Editorial: Perry Pascarella

Group Editorial Director: Leland Teschler

Publisher: Paul C. Mazzacano

New!
The HPR 1XX Series

Single In-Line Package
DC/DC Converter

- Uses Less than 0.2inch² Board Space
- High Isolation - 750 VDC
- 750mW of Unregulated Output Power
- High Efficiency - 80%
- No External Components Required

Reduced Parts Count
Surface Mount Technologies
Premium Performance at Low Cost

CALL 1-800-548-6132 ext. 529
Fax 1-602-741-3895
Write P.O. Box 11400 - Tucson, Arizona 85734

\$6.85
OEM

BURR-BROWN[®]
BB

Your Partner in Quality

CIRCLE 217

PERFORMANCE

means the FASTEST 64K SCRAMS

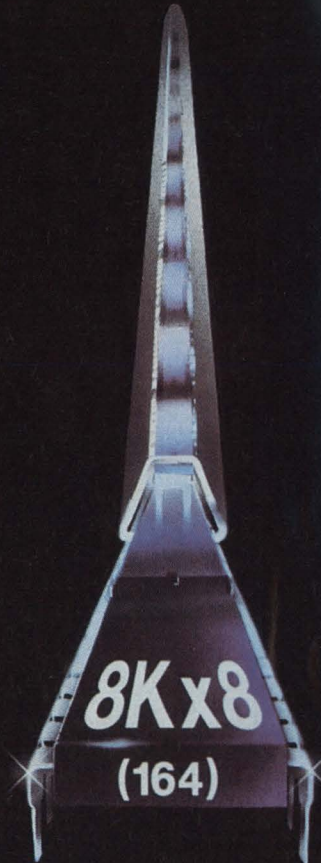
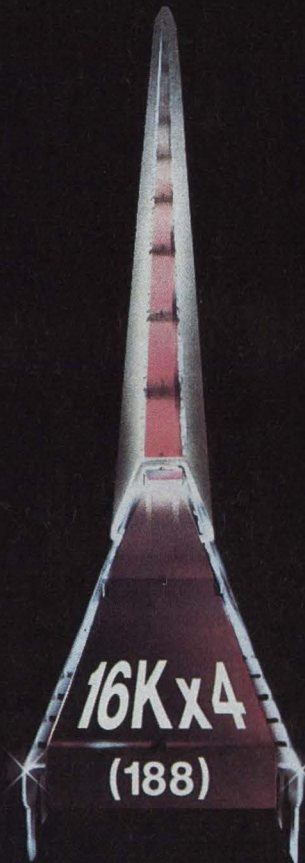
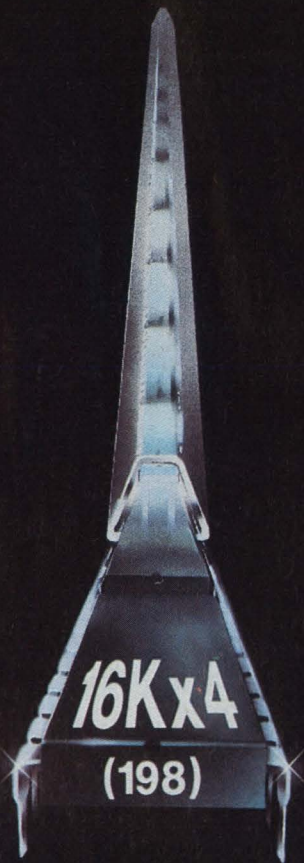
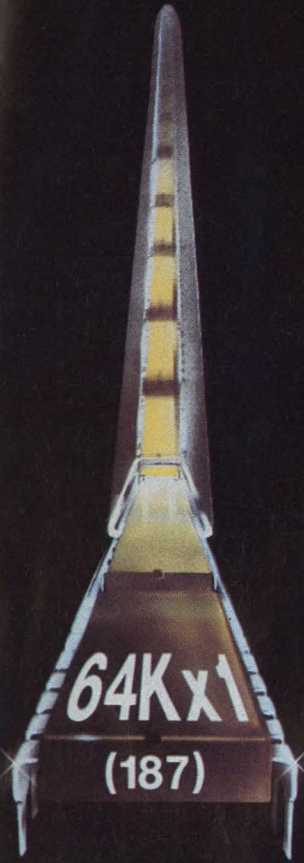

10ns (x1)
12ns (x4)
15ns (x8)

Performance's CMOS 64K SCRAMs (Static CMOS Random Access Memories) are the industry's fastest — as fast as 10ns for x1, 12ns for x4, and 15ns for x8 configurations.

These SCRAMs are ideal for data-bus-intensive RISC and CISC processors. They have extremely fast output enable times to permit fast data bus turnaround for high system throughput. *Also available are x4 SCRAMs with separate I/O.*

At Performance, SCRAMs are manufactured in a six-inch Class 1 fabrication facility using PACE II (0.7 micron gate length) technology which has set the standard for memory speed.

All Performance 64K SCRAMs are available now in DIP, SOJ, and LCC packages.

64K SCRAMS AVAILABLE NOW

PART	CONFIGURATION	SPEED
P4C187	64Kx1	10ns
P4C188	16Kx4	12ns
P4C198	16Kx4 W/OE	12ns
P4C164	8Kx8 W/OE	15ns

FAST, COOL & AFFORDABLE

To get Performance's Data Book, more information, or to order 64K SCRAMs, call or write:



Performance Semiconductor

610 E. Weddell Drive, Sunnyvale, Ca 94089

Telephone: 408 734-9000

FAX: 408 734-0258

CIRCLE 154

PERFORMANCE
SEMICONDUCTOR CORPORATION

10BASE-T. Turnkey.

You've Got Better Things
To Do With Your Design
Time (And Money) Than
Learning The Mysteries
Of Twisted Pair Ethernet.
Let Us Help.

No other chip supplier knows its way around networks like Advanced Micro Devices: Backbones, LANs, WANs, you name it.

Just ask our chipset development partners at HP® and SynOptics™

AMD is a major, major maker of 10BASE-T transceivers. We sell the most cost-effective solution. Our silicon is CMOS, so we'll save you energy as well as time. And you can trust that we're compliant. (We helped write the standard.)

Are you starting development soon? How about now? Call (800) 222-9323.

Advanced Micro Devices 

901 Thompson Place, P.O. Box 3453, Sunnyvale, CA 94088.

CIRCLE 166

From Star Wars



to Price Wars

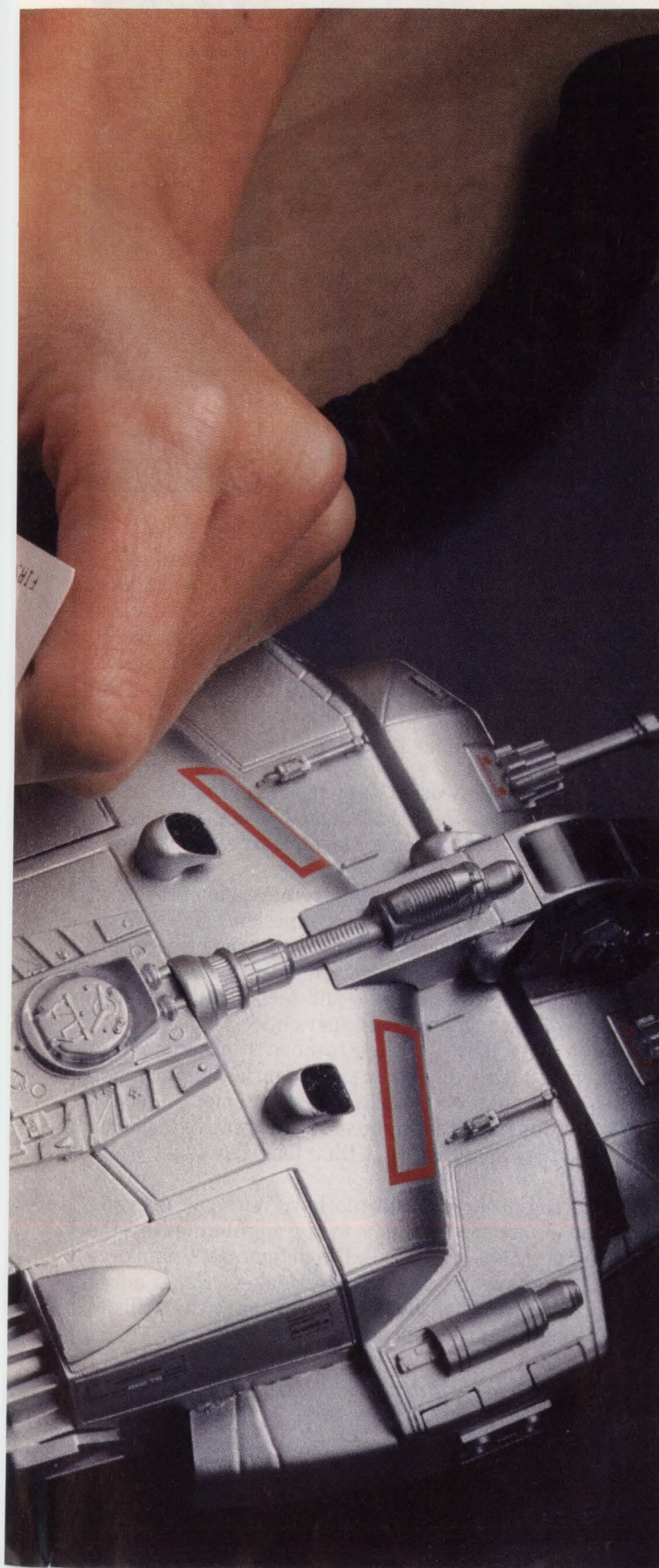

Our High Rel/Aerospace linear array experience is paying off for companies with high-volume, low-cost applications.

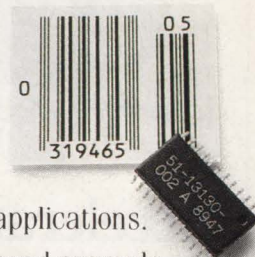

Symbol Technologies is a good example. A tiny Raytheon instrumentation amplifier helped them combine both bar code scanner and decoder in a single, lightweight, handheld unit—that's tough enough to take a five foot drop onto concrete.

Symbol also took advantage of our *Win-Win* program. It let them get to market quickly with a semicustom array, then shift to full custom as sales volumes increased.

Win-Win is fast, flexible, and makes good business sense because it eliminates the risk of getting into a full custom array before you're really ready.

Raytheon is committed to analog technology. From our design kits and engineering support to our fab and plastic assembly facility. We have the experience it takes to help you develop creative, cost effective solutions.

Find out how. Call 1-800 722-7074 for our new analog brochure.

Raytheon Company, Semiconductor Division.
350 Ellis St., Mountain View, CA 94039.

CIRCLE 196

Raytheon

Where quality starts with fundamentals



New CY545

Only \$75 each
(\$25/1000s)

**Accelerate your
Stepper Motor
to 27,000
Steps/second!
Travel 16
Million Steps
and back!**

Is your motor earthbound by sluggish controllers that can't give you the performance you need? Look at what you get with the new CY545 single chip stepper motor controller:



- 40-pin, CMOS, +5v chip
- Speeds up to 27K Steps/sec
- 16 Million steps per motion
- Programmable start rate, accel/decel, slew rate
- Pulse and Direction Output
- Separate Limit Switches
- Jog operation
- Home seek command
- ASCII or binary commands
- Parallel or Serial interface
- 8 General Purpose I/O lines
- External memory control
- LCD & LED Display interface
- Thumbwheel Switch interface

Break the single chip *speed* barrier and the high performance *price* barrier. You can't afford to pass up this latest innovation from the company that, ten years ago, brought you the first stepper motor controller on a single chip! Order by Fax or phone or call today for free info.



Cybernetic Micro Systems

PO Box 3000 • San Gregorio CA 94074
Ph: (415) 726-3000 • Fax: (415) 726-3003

CIRCLE 144

EDITORIAL



LET'S RAISE THE CEILING

In our October 11 issue, we will publish the results of our annual reader survey on EE salaries. Don't miss it, we're sure that you'll find it makes for interesting reading. Some findings sparked our interest: We found that the average salary among the 350 or so readers who responded to our survey is \$51,646, and the average reader has about 14 years of engineering experience. What's intriguing, however, is that many responses confirm the generally held belief that engineers face a definite salary ceiling. Averaging the numbers cited by the respondents, we find that the ceiling resides at about \$59,500.

\$59,500 isn't a bad salary in today's world. Many people in the U.S. raise families on salaries topping out at one-third that much. Nevertheless, many other professionals have earnings at much higher levels. First-year lawyers, for example, can easily command that salary level.

These numbers clearly illustrate the heavy salary compression present in today's engineering world: Engineers with 14 years experience are earning about \$51,600, while engineers with many more years of experience earn only about \$8000 more. But does that salary carry enough incentive to motivate engineers to continue honing their design skills and technical knowledge while they put in their years of gaining practical experience?

One way to break through that \$59,500 barrier is to move from engineering into marketing or management. It's true that both the marketing and management functions in today's complex electronics industry demand a technical background. But why continue to force engineers with creative technical talent into such roles just so they might improve their long-term salary outlook?

Salaries for experienced engineers are still too low. With the growing emphasis on quality in the electronics industry today, highlighted by the growing respect for, and importance of, the U.S. Department of Commerce Malcolm Baldrige Awards, perhaps one angle is overlooked: Experienced engineers, more than any other group within a company, have the skills to achieve total quality. And they should be paid accordingly.

Stephen E. Scrupski
Editor-in-Chief

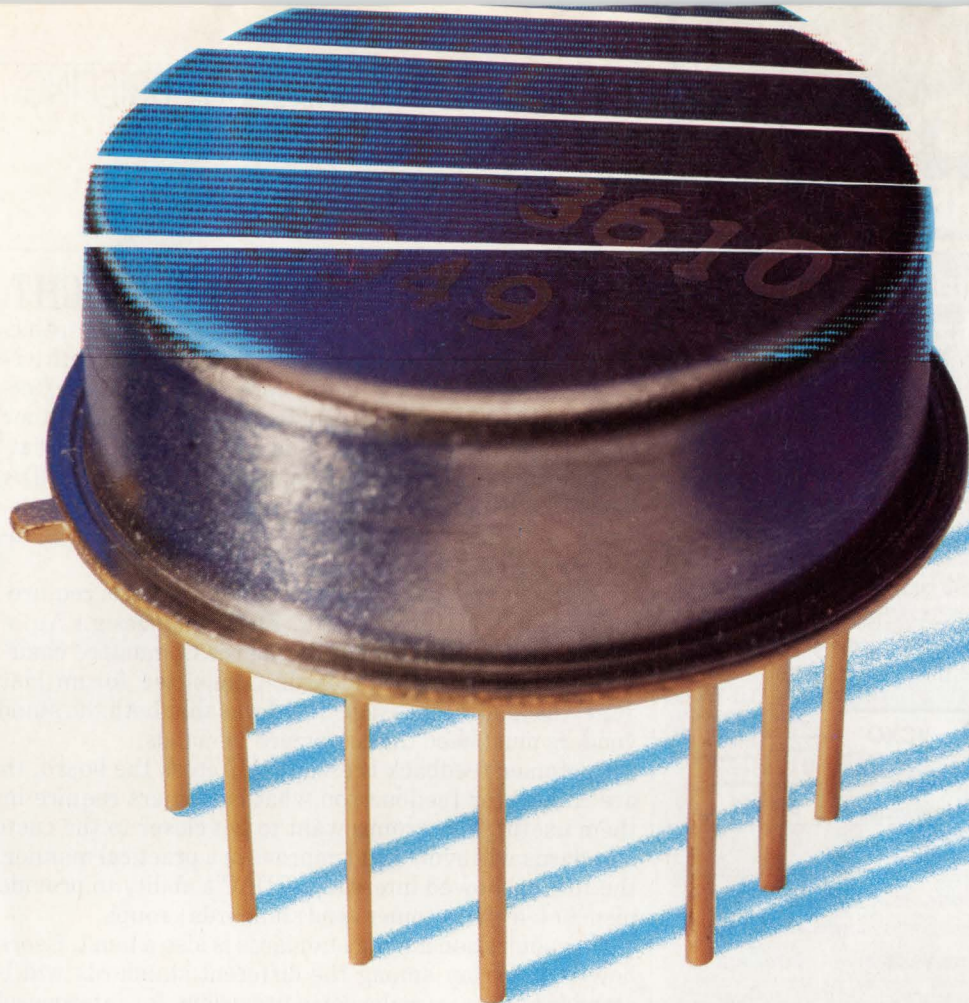

PRECISION TTL-CONTROLLED ATTENUATORS

up to 35dB
10 to 1000MHz
only **\$5995**

TOAT-R512 Accuracy (dB) (+/-dB)		TOAT-124 Accuracy (dB) (+/-dB)		TOAT-3610 Accuracy (dB) (+/-dB)		TOAT-51020 Accuracy (dB) (+/-dB)	
0.5	0.12	1.0	0.2	3.0	0.3	5.0	0.3
1.0	0.2	2.0	0.2	6.0	0.3	10.0	0.3
1.5	0.32	3.0	0.4	9.0	0.6	15.0	0.6
2.0	0.2	4.0	0.3	10.0	0.3	20.0	0.4
2.5	0.32	5.0	0.5	13.0	0.6	25.0	0.7
3.0	0.4	6.0	0.5	16.0	0.6	30.0	0.7
3.5	0.52	7.0	0.7	19.0	0.9	35.0	1.0

bold faced values are individual elements in the units

Now...precision TTL-controlled attenuators accurate over 10 to 1000MHz and -55 to +100°C. Four models are available in the new TOAT-series, each with 3 discrete attenuators switchable to provide 7 discrete and accurate attenuation levels (see chart). Cascade all four models for up to 64.5dB control in 0.5dB steps. Custom values available on request.

The 50-ohm TOAT-series performs with 6μsec switching speed and can handle power levels up to 0dBm. Units are housed in a rugged hermetically-sealed TO-8 package to withstand the shock, vibration, and temperature stresses of MIL-STD-883. Connector versions are available.

Take advantage of the \$59.95 (1-9 qty) price breakthrough to stimulate new applications as you implement present designs and plan future systems.

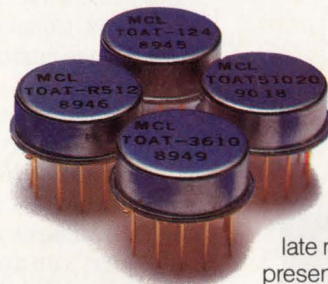

finding new ways ...
setting higher standards

Mini-Circuits

CIRCLE 170

WE ACCEPT AMERICAN EXPRESS

P.O. Box 350166, Brooklyn, New York 11235-0003 (718) 934-4500 Fax (718) 332-4661 Domestic and International Telexes: 6852844 or 620156

VCXO's and

PHASE-LOCKED-LOOP-VCXO

VCXO's Series M2000 1MHz to 67 Mhz



These VCXO's are used to replace a distorted incoming reference signal (e.g. 1.544 MHz, T1), with a stable crystal-controlled signal of the same or any multiple frequency, from 1 to 67 MHz.

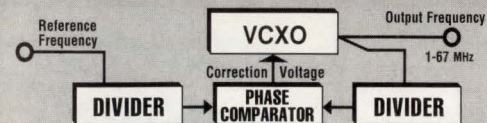

With MF VCXO's, since the specification is computer-tested over the full operating temperatures, you can be assured that the specified frequency- deviation is what you get for capture range.

	Control Voltage	Deviation
M 2001	0.3 to 10V	±175 ppm
M 2002	0.3 to 4V	± 75 ppm
M 2003	0.3 to 10V	±175-300 ppm
M 2004	0.3 to 4V	±125 ppm
M 2005	1.0 to 4V	± 75-300 ppm
M 2006	0 to 5V	±150 ppm
M 2007	0.5 to 4.5V	±125-250 ppm

PHASE-LOCKED LOOP-VCXO'S

Series M2010, M2015

This is the complete loop, including the phase-comparator and the VCXO, in just one package. Add the dividers to match the frequencies. Oscillators from 10 to 30MHz.

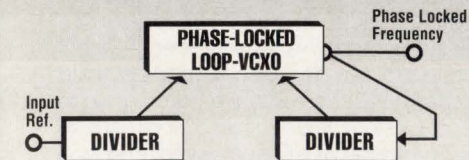

	Frequency Range
M 2010	±125 ppm
M 2015	±150 ppm



Headquarters and manufacturing plant: 36,000 sq. feet

THE CUSTOMER IS ALWAYS RIGHT

There's no doubt that customers want electronic-design-automation tool standards. Competitive-ness is making users more dependent on effective design tools. And for tools to work together effectively, there must be standards. In addition, creating and adopting these standards must be quicker. EDA tools are changing rapidly, as are hardware platforms. Therefore, the standards must keep pace with the advances in EDA technology.



LISA MALINIAK
CAE EDITOR

"Nothing speaks louder than the customer's requirements," states Mitch Weaver, Electronic Design Automation Companies (EDAC) Standards Committee chairman. At the EDAC Standards Committee forum last June, the loudest message heard was that both the standards bodies and the vendors must heed the customers' demands.

Customer feedback is essential: Across the board, the standards groups are calling for feedback on what customers require in standards to make them useful. The groups want to get closer to the customer to ensure that standards will evolve and improve in a practical manner. Moreover, those at the forum showed interest in EDAC's ability to provide a feedback mechanism between customers and standards groups.

Harmonization among standards is also a must. Users are concerned over how the overlap among the different standards will be reconciled. While standards groups make some provisions for interoperability between standards, no one entity exists that's responsible for overall harmonization. Again, those at the forum showed an interest in seeing EDAC play a role in facilitating overall harmonization.

The EDAC forum consisted of standards bodies, vendors, and users. Among the standards represented were the CAD Framework Initiative (CFI), Electronic Design Interchange Format (EDIF), VHSIC hardware description language (VHDL), and Initial Graphics Exchange Specification (IGES) and Product Data Exchange Specification (PDES).

EDAC plans to act on its findings from the 1990 forum. It foresees creating a document that would represent customer requirements. The document would state, for each standards organization, what's needed to speed the adoption of its standard. This document would be written from the customers' perspective, not from EDAC's view.

EDAC must know how it can improve the rate of adopting standards. First, a better method of educating users on the importance of each different standard is required. All members agree that standards are important, but many don't know the difference between the standards.

Significant progress has been made within the last year, especially with EDIF and VHDL. It resulted from the failures in the marketplace in terms of standards. Customers have complained about their failings due to a lack of standards. Consequently, the standard creation-adoption process has accelerated since customers got involved.

A key element that's missing among standards organizations is communication with the customers. None of the standards bodies have an access to customers. The role of a trade association, such as EDAC, isn't only to educate, but also to influence. EDAC feels it can influence the standards associations by voicing customer requirements. It can also affect the user base as to where standards are and aren't appropriate. Lastly, it can influence vendors as to what's an appropriate model of business.

Another EDAC Standards Committee forum will be held in 1991. A couple of hours, however, isn't enough time to cover every problem concerning design-automation tool standards. Therefore, next year's forum will probably focus on specific topics.

DON'T TOUCH THAT DIAL...

Unlike mechanical potentiometers, our DS1267 Dual Digital Potentiometer Chip doesn't have to leave the circuit board surface and come up to a dial. Our pot is software-controlled, so you can make calibration settings to pots on the board without ever opening the enclosure. Dials become obsolete; you change settings from the keyboard.

No more tearing apart the system to get at the pots. No more getting in there with a teeny tiny little screwdriver to make minute adjustments.

Digitally calibrate gain and offset of an op amp for tight, closed-loop control.

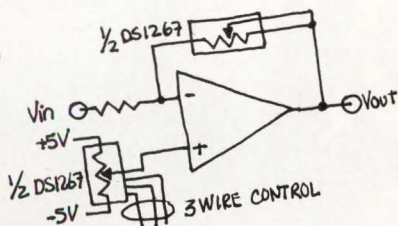

EXACTITUDE

Ever try to repeat the setting of a 10 turn pot? For all the trouble you put into those excruciating adjustments, you can't read the wiper position directly. So maybe you make the same change again. And again. Until you get it right.

If it has to be right the first time, try setting *our* pot. You write two 8-bit words through a serial port to an on-chip register. That number is stored in a read/write memory and the setting is read electronically. Which means the setting is what you want it to be. Exactly.

In fact, we are so exact we have 512 settings. Or you can divide those in half and create two independent 256-position pots. An unlimited number of potentiometers can be controlled by daisy-chaining using only three signal wires.

QUICK AND QUIET

Just how quiet is the Digital Pot? We spec'd it quieter than -120 dB. Our customers have measured it at less than -137 dB -- about the thermal noise of a transistor.

How did we do this? First, the Digital Pot doesn't have to stop at every setting along the way -- it can hop directly to the desired resistance. Once the setting has been made, there is no activity in the chip to cause noise.

Second, because all electronics remain on the card, you don't have to run wires out to dials on the surface of the equipment, which eliminates that source of noise.

And as if all this isn't enough, our pot withstands the high temperatures and cleaning fluids required for surface mount assembly. Subject your mechanical pot to those temperatures and see what happens.

The Digital Pot is available in 10K, 50K, and 100K ohms. If you're ready to throw away your screwdriver, give us a call.

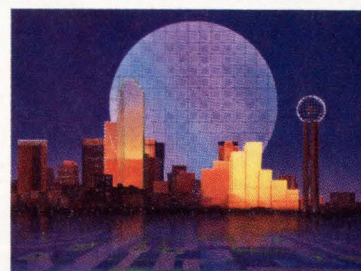

DALLAS SEMICONDUCTOR

4401 SOUTH BELTWOOD PARKWAY
DALLAS, TEXAS 75244-3292
TELEPHONE: 214-450-0448
FAX: 214-450-0470

FILTERS



dc to 3GHz from \$11.45

lowpass, highpass, bandpass, narrowband IF

- less than 1dB insertion loss • greater than 40dB stopband rejection
- 5-section, 30dB/octave rolloff • VSWR less than 1.7 (typ) • meets MIL-STD-202 tests
- rugged hermetically-sealed pin models • BNC, Type N; SMA available
- surface-mount • over 100 off-the-shelf models • immediate delivery

low pass dc to 1200MHz

MODEL NO.	PASSBAND, MHz (loss <1dB)		f _{co} , MHz (loss 3db)	STOP BAND, MHz (loss >20dB) (loss >40dB)		VSWR pass-band typ.	stop-band typ.	PRICE \$ Qty. (1-9)
	Min.	Nom.		Max.	Max.			
PLP-10.7	DC-11	14	19	24	200	1.7	18	11.45
PLP-21.4	DC-22	24.5	32	41	200	1.7	18	11.45
PLP-30	DC-32	35	47	61	200	1.7	18	11.45
PLP-50	DC-48	55	70	90	200	1.7	18	11.45
PLP-70	DC-60	67	90	117	300	1.7	18	11.45
PLP-100	DC-98	108	146	189	400	1.7	18	11.45
PLP-150	DC-140	155	210	300	600	1.7	18	11.45
PLP-200	DC-190	210	290	390	800	1.7	18	11.45
PLP-250	DC-225	250	320	400	1200	1.7	18	11.45
PLP-300	DC-270	297	410	550	1200	1.7	18	11.45
PLP-450	DC-400	440	580	750	1800	1.7	18	11.45
PLP-550	DC-520	570	750	920	2000	1.7	18	11.45
PLP-600	DC-580	640	840	1120	2000	1.7	18	11.45
PLP-750	DC-700	770	1000	1300	2000	1.7	18	11.45
PLP-800	DC-720	800	1080	1400	2000	1.7	18	11.45
PLP-850	DC-780	850	1100	1400	2000	1.7	18	11.45
PLP-1000	DC-900	990	1340	1750	2000	1.7	18	11.45
PLP-1200	DC-1000	1200	1620	2100	2500	1.7	18	11.45

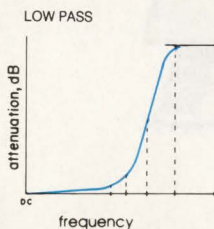

high pass dc to 2500MHz

MODEL NO.	PASSBAND, MHz (loss <1dB)		f _{co} , MHz (loss 3db)	STOP BAND, MHz (loss >20dB) (loss >40dB)		VSWR pass-band typ.	stop-band typ.	PRICE \$ Qty. (1-9)
	Min.	Min.		Min.	Min.			
PHP-50	41	200	37	26	20	1.5	17	14.95
PHP-100	90	400	82	55	40	1.5	17	14.95
PHP-150	133	600	120	95	70	1.8	17	14.95
PHP-175	160	800	140	105	70	1.5	17	14.95
PHP-200	185	800	164	116	90	1.6	17	14.95
PHP-250	225	1200	205	150	100	1.3	17	14.95
PHP-300	290	1200	245	190	145	1.7	17	14.95
PHP-400	395	1600	360	290	210	1.7	17	14.95
PHP-500	500	1600	454	365	280	1.9	17	14.95
PHP-600	600	1600	545	440	350	2.0	17	14.95
PHP-700	700	1800	640	520	400	1.6	17	14.95
PHP-800	780	2000	710	570	445	2.1	17	14.95
PHP-900	910	2100	820	660	520	1.8	17	14.95
PHP-1000	1000	2200	900	720	550	1.9	17	14.95

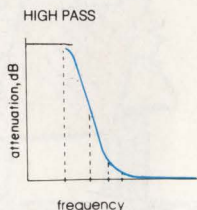

bandpass 20 to 70MHz

MODEL NO.	CENTER FREQ. MHz F0	PASS BAND, MHz (loss <1dB)		STOP BAND, MHz (loss > 10 dB) (loss > 20 dB)				VSWR 1.3:1 typ. total band MHz	PRICE \$ Qty. (1-9)
		Max. F1	Min. F2	Min. F3	Max. F4	Min. F5	Max. F6		
PIF-21.4	21.4	18	25	4.9	85	1.3	150	DC-220	14.95
PIF-30	30	25	35	7	120	1.9	210	DC-330	14.95
PIF-40	42	35	49	10	168	2.6	300	DC-400	14.95
PIF-50	50	41	58	11.5	200	3.1	350	DC-440	14.95
PIF-60	60	50	70	14	240	3.8	400	DC-500	14.95
PIF-70	70	58	82	16	280	4.4	490	DC-550	14.95

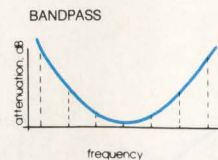

narrowband IF

MODEL NO.	CENTER FREQ. MHz F0	PASS BAND, MHz I.L. 1.5dB max. F1-F2	STOP BAND, MHz I.L. >20dB		STOP BAND, MHz I.L. >35dB		PASS-BAND VSWR Max.	PRICE \$ Qty. (1-9)
			F5	F6	F7	F8-F9		
PBP-10.7	10.7	9.5-11.5	7.5	15	0.6	50-1000	1.7	18.95
PBP-21.4	21.4	19.2-23.6	15.5	29	3.0	80-1000	1.7	18.95
PBP-30	30.0	27.0-33.0	22	40	3.2	99-1000	1.7	18.95
PBP-60	60.0	55.0-67.0	44	79	4.6	190-1000	1.7	18.95
PBP-70	70.0	63.0-77.0	51	94	6	193-1000	1.7	18.95

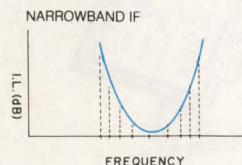

Mini-Circuits

P.O. BOX 350166, Brooklyn, New York 11235-0003 (718) 934-4500 FAX (718) 332-4661 TELEX 6852844 or 620156 WE ACCEPT AMERICAN EXPRESS

CIRCLE 167

F132-2 REV. ORIG.

SAMSUNG
NOW

OUR MEMORY CAN GET

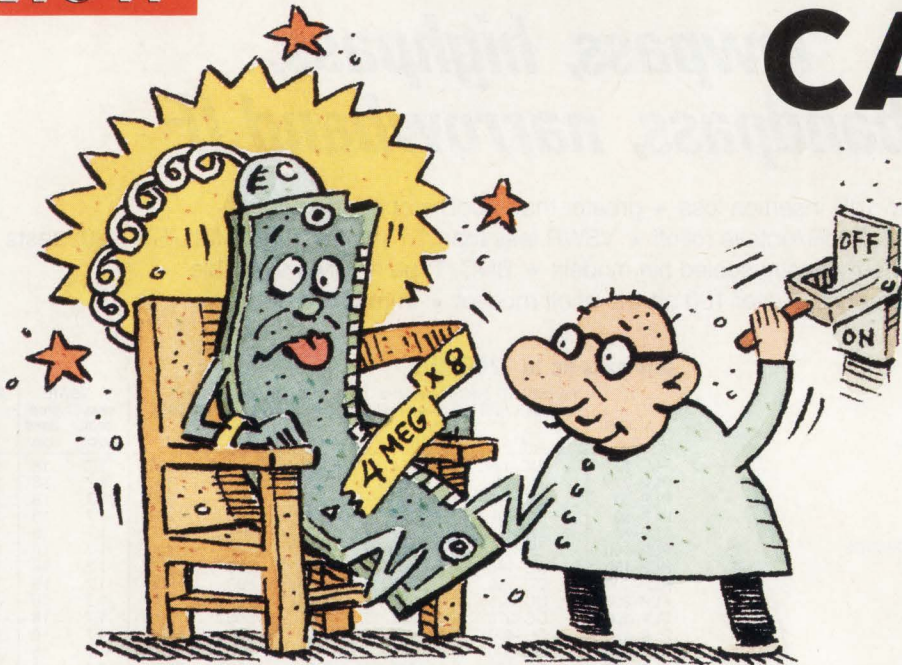

ELECTROSTATIC DISCHARGE

Unlike typical modules, Samsung memory modules—including those using our 4-meg DRAMs—are thoroughly tested for all the important characteristics. And although the people who do this are nice, kind folks—well, when it comes to quality control they can get testy. To guarantee specs on electrostatic discharge, for instance, they test to assure each pin will withstand a minimum of 2000 volts.

FLAMMABILITY

On flammability, our module people take great pains to assure that our products meet standards. As a result, we guarantee that every Samsung memory module meets or exceeds the 94V-0 Underwriters Laboratory flame classification.

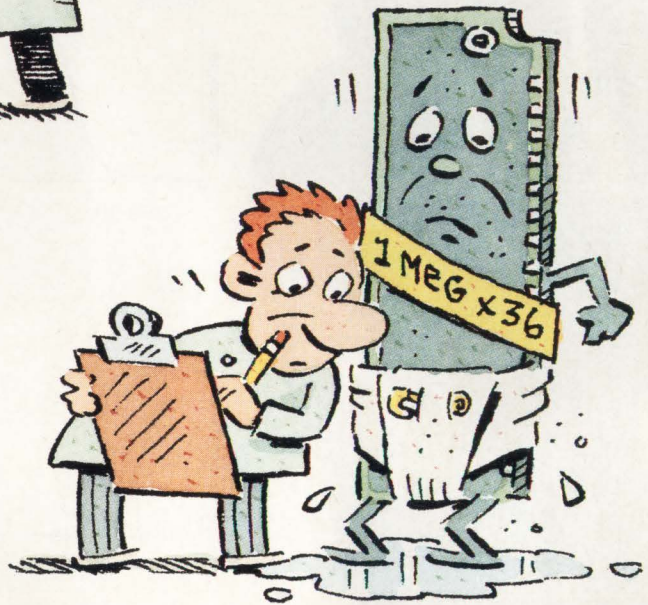
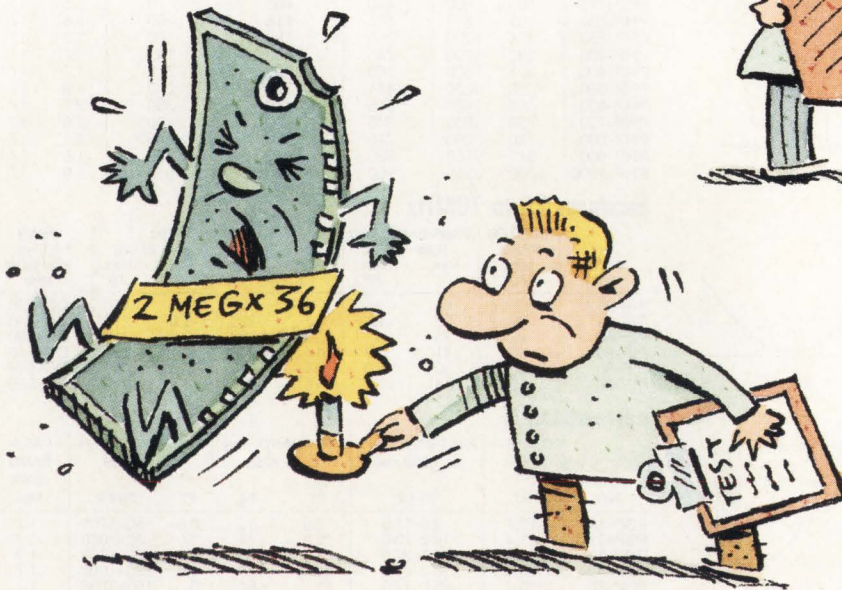

LEAKAGE

Even in the era of the 4-meg DRAM, there's still such a thing as a module with leaky pins. Many manufacturers just don't inspect for leakage. You guessed it, our team does comprehensive tests. All pins on all modules are 100% tested to the data sheet leakage specification.

MODULE PEOPLE A BIT TESTY.

POWER CONSUMPTION

In this day and age there are enough power-hungry things without your memory modules getting that way. You want them to consume what they say they will. Ours are thoroughly tested not to exceed the spec.



DIMENSIONAL CONTROL

A too-big or too-small module isn't good for much. Samsung modules are tested to perfectly match JEDEC standard dimensions, including 50 ± 3 mil thickness. Since they are, and are also tested on all the other features detailed here, we can't see why you'd ever buy from anyone else. For information on modules with our 4-meg DRAMs, or the rest of our line, write to the testy people at Memory Module Marketing, Samsung Semiconductor, 3725 North First Street, San Jose, CA 95134. Or call 1-800-669-5400, or 408-954 7229.



High-Speed Amplifiers

WB05

CURRENT
BUFFER

- ▶ 10,000 V/ μ s Slew Rate
- ▶ 1 Amp Output (1.5 A Pulse)
- ▶ ± 5 to ± 15 Supply
- ▶ 70 MHz Full Power Bandwidth
- ▶ Up To 15 Watts Dissipation

WA01

TRANSIMPEDANCE
AMPLIFIER

- ▶ 4,000 V/ μ s Slew Rate
- ▶ 400 mA Output
- ▶ ± 12 to ± 15 Supply
- ▶ 40 MHz Full Power Bandwidth
- ▶ Up To 10 Watts Dissipation

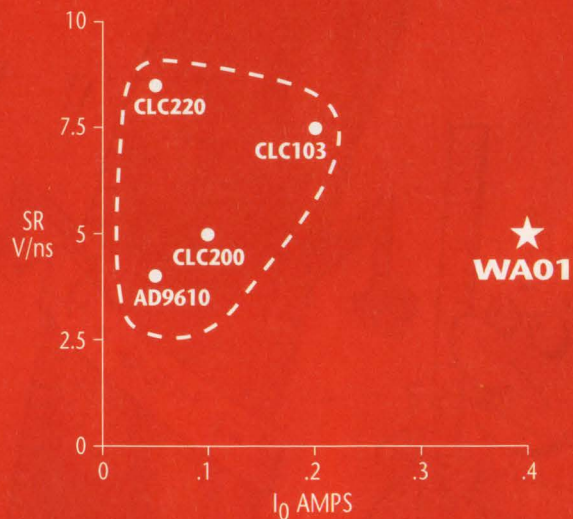
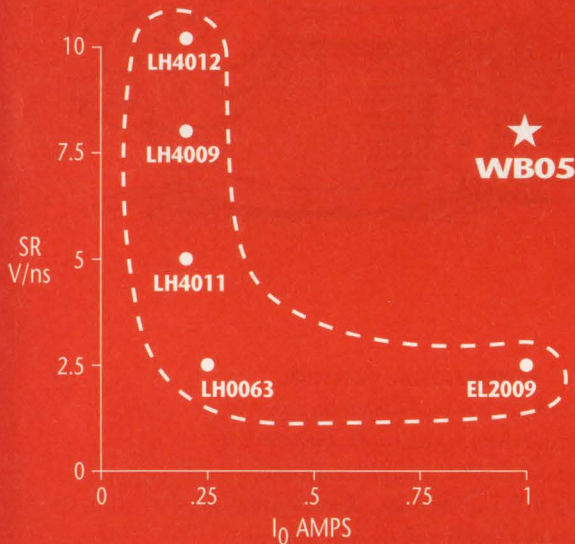

APPLICATIONS

LASER DIODE DRIVERS
SONAR TRANSDUCER DRIVERS
PIN DRIVER

LASER DIODE DRIVERS
VIDEO AMPLIFIERS
WAVEFORM GENERATORS

To Place An Order Call
602-742-8601

For Applications
Assistance Call
1-800-421-1865

APEX[®]
μtech

DEDICATED TO EXCELLENCE

APEX
MICROTECHNOLOGY
CORPORATION



To receive
your copy of our
High Performance
Amplifier Handbook
please call toll free
1-800-448-1025

**INP HEMT SETS RECORD,
OPERATES AT 260 GHZ**

The fastest high-electron mobility transistor (HEMT) to date, with an operating frequency of 260 GHz at room temperature, has been crafted in indium-phosphide. The device, created with electron-beam lithography and Varian's molecular-beam epitaxy system, hails from Varian Associates Inc. research laboratories, Palo Alto, Calif. The InP HEMTs have gate widths of less than 0.1 μm , which are formed in lattice-matched indium-aluminum arsenide and indium-gallium-arsenide epitaxial layers on a semi-insulating InP substrate. The actual transistor structure is based on a low-conductance drain that the company conceptually described in research papers at this past year's IEEE Indium Phosphide and Related Materials Conference and at the 48th Device Research Conference. Because the transistor is based on InP, a popular material for laser diodes, photo detectors, and many other opto-electronic applications, the merger of optical elements and HEMT circuitry will most likely follow. *DB*

**CONDUCTIVE EPOXIES SEEN
AS SOLDER SUBSTITUTE**

Isotropic conductive epoxies hold promise as a fluxless, low-temperature interconnection material for chip attachment. The epoxies hurdle many of the limitations of tin-lead solder for surface-mounted assemblies. These include package cracking from high-temperature reflow, potential contamination from fluxes, environmental difficulties with CFCs, solder bridging, and fatigue failures. In a paper presented at this year's Society for Advancement of Materials and Process Engineering Conference, Art Burkhart of Dexter Electronic Materials, Industry, Calif., suggests that isotropic conductive epoxies can greatly simplify process technology by eliminating up to 50% of the steps in chip attachment. *DM*

**CAE, DATABASE COMPANIES
FORM PARTNERSHIP**

Digital Equipment Corp., Maynard, Mass., and Objectivity Inc., Menlo Park, Calif., have established a joint development and marketing partnership for Objectivity/DB, an object-oriented database-management system. As part of the agreement, Digital will sublicense and distribute Objectivity/DB to end users. According to Digital, the object-oriented database is a complementary solution to VAX Rdb/VMS, the company's relational-database product. Digital chose the Objectivity database because of the product's broad platform coverage and its open architecture. Both companies have committed to working together within standards organizations to advance evolving standards for object-oriented systems. Digital is a member of the Object Management Group (OMG), an international group of software and hardware companies focused on developing standards and guidelines for using an object-oriented database. *LM*

**SILICON-ON-INSULATOR
PROCESS BUILDS DIODES**

Silicon-on-insulator (SOI) processes, which offer minimum-size ICs with galvanic-isolation and radiation-hardness properties, have been long on talk and short on practical applications. Now, however, Silicon General, Garden Grove, Calif., uses an SOI process to create a pair of arrays holding 7 and 8 silicon diodes. Each diode (anode and cathode) is completely isolated from its companions with silicon-dioxide rated at 400 V. The oxide is part of the original wafer, sandwiched between the silicon substrate and a layer of monocrystalline silicon in which the diodes are diffused. Each diode in the 7-diode SG6100 and the 8-diode SG6101 is rated at 75 V and 100 mA. Earlier versions of these devices were built using air-bridge techniques to obtain the isolation. Forward and reverse recovery times run 15 and 5 ns maximum, respectively. The arrays, rated for military temperatures, come in 14- and 16-pin ceramic DIPs and flat packs. High-volume pricing starts at \$20.25 for each array. For additional information, call (714) 898-8121. *FG*

**HIGH-POWER LASERS MAKE
EFFICIENT X-RAY SOURCE**

Using high-efficiency, diode-pumped solid-state lasers as a source of X-rays for a deep submicron lithography system promises to improve lithography-system performance and throughput. The work is part of a joint development between Hampshire Instruments Inc., Rochester, N.Y. and McDonnell Douglas, St. Louis, Mo. It will focus on adapting McDonnell Douglas' high-power lasers developed for military applications to Hampshire Instrument's commercial X-ray lithography system. The diode-pumped laser increases efficiency and power by about 250% over a standard neodymium solid-

state laser pumped by arrays of flash lamps. Higher laser power translates into a stronger X-ray source, and thus a shorter exposure time per wafer and a higher overall wafer throughput. Though the agreement runs for five years, Hampshire expects to have prototypes ready sooner. *DB*

SYNTHESIS ACQUISITION FILLS OUT ASIC TOOLSET

With the procurement of logic-synthesis technology, the completion of GenRad Inc.'s ASIC toolset has been realized. The Concord, Mass.-based company bought the technology from Aptor S.A., Grenoble, France. GenRad will mesh the logic-synthesis tool with its System HILO simulation tools for a top-down design environment. Plans for the synthesis software, which will be announced later this year, include support for both the GenRad hardware description language (GHDL) and the VHSIC hardware description language (VHDL). *LM*

WINDOW COMPARATOR RESPONDS IN JUST 5 NS

Designers at Burr-Brown Corp., Tucson, Ariz., have succeeded in building a comparator IC—which takes a common-mode voltage (CMV) of ± 12 V running off ± 5 -V rails—that responds in just 5 ns with 100 mV of overdrive. It was done by adding attenuators to the signal input and the two reference inputs of a typical high-speed window comparator. By limiting the supply voltage, the designers were able to build the comparator on a high-speed complementary linear process that could handle 12 V maximum between the rails. The input attenuator is RC-tuned (like an oscilloscope probe) to handle fast-rising waveforms, but the reference inputs are not. A buffer amplifier connects each attenuator to the comparators' inputs. Though designed for test-equipment pin-electronics, the IC can fill the bill on a wide range of threshold-detector, window-comparator applications previously limited by CMV restrictions. Each comparator provides complementary ECL outputs. In addition, latch-enable inputs permit sampling-type operation. In 16-pin DIPs and SOICs, pricing starts at \$23.20 each in 100s. For additional information, call John Conlan, 1-(800) 548-6132. *FG*

HIGH-POWER SWITCHES, NEURAL NETS ADVANCE

A pair of developments from Sandia National Laboratories, Albuquerque, N.M., promise to improve machine vision and accelerate the speed of optical power switches. Both developments could eventually simplify some tough industrial and military control tasks. To enhance machine vision, one research group developed a neural network that can detect target objects placed at different angles or positions when mixed in among other objects. The network can process a camera image within seconds—an impossibility with previous neural networks. Most earlier systems typically focused on analyzing and identifying target features, such as a line or box, and thus could only handle rotations in two dimensions. The improved software and hardware enable the neural network to be both shift- and perspective-invariant so that the object's physical position and rotation make no difference during the recognition process. To teach the system, researchers use multiple training sets that contain the desired target viewed from different perspectives. When the system gives a wrong answer, the correct answer is supplied by the "teacher." The neural network can then compare the right and wrong answers in a process called back propagation to adjust itself in favor of the correct answer. The recognition software on the neural network requires about four seconds to identify the image. Similar software on a Sun 3 required about four hours.

In experiments to switch large amounts of electrical power under the control of an optical signal, another group of Sandia researchers developed a gallium arsenide photoconductive switch. The device, activated by light from an 850-W laser-diode array, could switch 8.5 MW. The switch also held off 55 kV until it was activated and delivered 470 A to a 38- Ω load. The optical pulse used to turn on the switch was just 21-ns wide. However, the fast switch required just 3.5 ns for the current pulse to reach its maximum value. The switch itself is built from a 1-in. disk of undoped GaAs. In the dark, the material is an insulator; but when exposed to intense light from the 850-W laser array, the disk rapidly becomes a conductor. Such a fast-acting switch could be a key element in such applications as ultra-wideband impulse radar, optically activated firesets for triggering explosives, pulsed power systems to supply energy to compact high-power accelerators, or as a fast-rise-time switch in electromagnetic-pulse testing. For details on the neural net, contact Mary Moya (505) 844-7031; for the optical switch, call Fred Zutavern (505) 845-9128. *DB*

VGA

Get On Board.

Introducing VGA that fits your motherboard and your budget.

To put VGA graphics on your motherboard, you need a cost-efficient, highly integrated, powerful solution that uses minimal board space. You need the new CL-GD5320 Enhanced VGA-Compatible Graphics Chip from Cirrus Logic.

Use it to incorporate full 16-bit or 8-bit VGA into low-cost personal computers. You only need two industry standard 256K x 4 DRAMs and as few as five other ICs. Whatever memory speed you select — 80ns, 100ns, or 120ns — you'll get a complete VGA display system with greater performance than systems using a more expensive solution with 64K x 4 DRAMs.

You don't sacrifice features. You get 16-bit and 8-bit support for the VGA graphics standard, and full, register-level backwards compatibility. For maximum performance, it has an 8/16-bit CPU interface, independent video and DRAM clocks,

internal FIFOs, and page mode DRAM access. And it will interface to both analog (PS/2 and multi-sync) and TTL monitors.

You can also pick a ready-to-use solution that's right for you. Anything from a chip with full BIOS, drivers, utilities, user's manual, and documentation — to a complete manufacturing kit including everything you need to quickly move into high-volume production.

Make your PC more competitive and save time, space, and money. Call Cirrus Logic today.

Get on board. Call today for more information on our motherboard VGA solutions. Call 1-800-952-6300. Ask for dept. LM32.

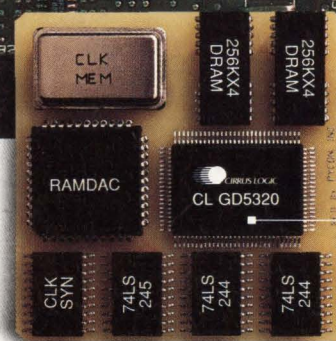

This full 16-bit CL-GD5320 lets you implement 16-bit or 8-bit VGA capabilities on your motherboard with as few as 5 other chips and two 256K x 4 DRAMs. Get a complete solution that saves time, space, power, and expense. You still get all the speed, features and flexibility you're looking for.



CIRRUS LOGIC

C L O S I N G T H E G A P



Signetics. Because into making

WITH OUR FULL FAMILY

To design successful new systems, you need an IC vendor who understands your ever-changing needs. A partner who can match the right device to your application.

That's exactly what you get from Philips Components-Signetics.

As the design world changes, Signetics changes. We're listening to your needs. And designing and enhancing our devices to meet those needs.

Like the growing need for personal communication devices and for ICs in desktop and portable computing. As well as devices for computer networking with compatibility across platforms. And for ICs that meet the need for robotics and automation in manufacturing.

We're also drawing from nearly a century of Philips innovation to apply our consumer technologies to the business world. Including digital video and high-density compact disc storage.

In fact, wherever your design needs take you, Signetics will be there with complete families of devices to meet emerging computing, communications and control needs.

© 1990 NAPC

Philips Components

you've put so much it perfect.

OF ICs, YOU GET OUT OF IT WHAT YOU PUT INTO IT.

COMPUTING		COMMUNICATIONS		CONTROL	
APPLICATION	PRODUCT	APPLICATION	PRODUCT	APPLICATION	PRODUCT
Workstations	<ul style="list-style-type: none"> ● Advanced BiCMOS Logic ● High Speed ASICs ● Futurebus Chip Set ● High Speed PAL[®]-type Devices ● High Performance MCUs ● SRAMs 	Cellular Communications	<ul style="list-style-type: none"> ● Cellular Chip Set ● Frequency Synthesizers 	Automotive Control Systems	<ul style="list-style-type: none"> ● 8-bit 80C51-based MCUs ● OTP EPROMs ● Linear/Digital/Mixed Mode ASICs
Personal Computers	<ul style="list-style-type: none"> ● High Density ASICs/PLDs ● DRAM Controllers ● OTP EPROMs ● FLASH Memory 	Mobile Telephony	<ul style="list-style-type: none"> ● Paging ICs ● Frequency Synthesizers 	Consumer Appliances and Entertainment	<ul style="list-style-type: none"> ● A/D MCUs ● LCD Displays ● Audio Circuitry ● Dolby Noise Reduction ● Frequency Synthesizers
Desk Top Video	<ul style="list-style-type: none"> ● A/D Converters ● Digital Color Decoders 	FAX/Modems/Features Phones	<ul style="list-style-type: none"> ● 8-bit 80C51-based MCUs ● E²PROM ● LCD Drivers ● Dialers ● Speech Circuits ● RF Chip Set 	Industrial Control & Robotics	<ul style="list-style-type: none"> ● Advanced BiCMOS Logic ● UV/OTP EPROM MCUs ● Real-Time Bus Communications Controller
Peripheral Products	<ul style="list-style-type: none"> ● 8-bit 80C51-based MCUs ● Zero Power PLDs ● Programmable Sequencers ● 3-State ECL Transceivers 	DataComm LANs	<ul style="list-style-type: none"> ● Ethernet Chip Set ● 100-Mbit Fiber ● High Speed PLDs ● Advanced BiCMOS Logic 	Portable Instrumentation	<ul style="list-style-type: none"> ● Low Voltage/Power MCUs ● Advanced CMOS Logic ● LCD Drivers
		Multi-Protocol	<ul style="list-style-type: none"> ● Dual Universal Serial Controller ● UARTs and DUARTs 		

As illustrated above, we're listening to customer needs and developing products in three focused areas: computing, communications and control.

This includes products based on our advanced BiCMOS technology, QUBiC. Developed from our strength in bipolar technology and fully integrated with our sub-micron CMOS technology, QUBiC gives you nearly twice the speed of previous-generation bipolar ICs. With CMOS power savings. We're incorporating QUBiC into all our product families, creating a new class of high-performance devices.

Philips Components-Signetics is committed to the military market, with over 80% of our ICs meeting MIL-SPEC certification. This commitment is evident in our Class S domestic assembly plant and DESC-certified wafer fabs.

To learn how Philips Components-Signetics helps you make the perfect design, call today for more information: 800-227-1817, ext. 711C.

PAL is a trademark of AMD/MMI

Signetics

EXTENDING THE DIMENSIONS OF PERFORMANCE



PHILIPS



IN 1990, WE'RE FINA JOE, BOB, BEN AND FRAN

Nowadays it's called "Concurrent Engineering". Back then it was simply the way the job got done. A small group of people in constant communication. From flowchart changes to thermal problems. From concept to manufacturing.

Did it work? You bet. It gave us things we now use every day. Like

television. Radio. And computers.

But time passed, the technology got more complex, and the people became departments. "Over the wall" engineering carried the day. Unfortunately, a lot was lost in the process. Projects began to control people, instead of people controlling projects.

Now there's a way to regain the human dimension that makes concurrent engineering such a powerful competitive weapon. It's called the Concurrent Design Environment.™

No matter how many engineers, no matter how complex the technology, no matter how many design disciplines involved, the Concurrent



GO BACK TO WHAT WE WERE DOING IN 1963.

Design Environment binds your engineering force into a highly interactive team. Its Falcon Framework™ combines state of the art design tools with unprecedented engineering management capacity. For virtually all electronics technologies and engineering disciplines. With tools from any source, includ-

ing third party and in-house.

So let us show you how to turn back the clock by moving your engineering forward. For a free videotape about the Concurrent Design Environment, call **1-800-547-7390.**

 **Mentor
Graphics®**
Changing The Way The World Designs. Together.

The FS700 LORAN-C frequency standard

10 MHz cesium stability

\$4950

Cesium long term stability at a fraction of the cost

Better long-term stability than rubidium

Not dependent on ionosphere position changes, unlike WWV

Complete northern hemisphere coverage, unlike GPS.

The FS700 LORAN-C frequency standard provides the optimum, cost-effective solution for frequency management and calibration applications. Four 10 MHz outputs from built-in distribution amplifiers provide cesium standard long-term stability of 10^{-12} , with short-term stability of 10^{-10} (10^{-11} optional). Reception is guaranteed in North America, Europe and Asia.

Since the FS700 receives the ground wave from the LORAN transmitter, reception is unaffected by atmospheric changes, with no possibility of missing cycles, a common occurrence with WWV due to discontinuous changes in the position of the ionosphere layer. Cesium and rubidium standards, in addition to being expensive initially, require periodic refurbishment, another costly item.

The FS700 system includes a remote active 8-foot whip antenna, capable of driving up to 1000 feet of cable. The receiver contains six adjustable notch filters and a frequency output which may be set from 0.01 Hz to 10 MHz in a 1-2-5 sequence. A Phase detector is used to measure the phase shift between this output and another front panel input, allowing quick calibration of other timebases. An analog output with a range of ± 360 degrees, provides a voltage proportional to this phase difference for driving strip chart recorders, thus permitting continuous monitoring of long-term frequency stability or phase locking of other sources.



FS700: The optimum frequency management system



STANFORD RESEARCH SYSTEMS

1290 D Reamwood Avenue ■ Sunnyvale, CA 94089 ■ Telephone: (408) 744-9040
FAX: 4087449049 ■ Telex: 706891 SRS UD

CIRCLE 153

90-GHZ ALINAS/GAINAS BIPOLAR TRANSISTORS BUILD DC TO 33-GHZ AMP WITH 8.6-DB GAIN

The world's widest-bandwidth dc amplifier with a 3-dB bandwidth of 33 GHz and a gain of 8.6 dB has been developed by Hughes Aircraft Co.'s Research Laboratories, Malibu, Calif. The circuit was described by Hughes' Joe Jensen at the recent Bipolar Circuits and Technology Meeting (BCTM) in Minneapolis (Sept. 17-18). The "true IC" is built with heterojunction bipolar transistors (HBTs) that feature an f_t (unity-gain or cutoff frequency) of 90 GHz and an f_{MAX} (maximum frequency of oscillation) of 70 GHz. The AlInAs/GaINAs (aluminum indium arsenide/gallium indium arsenide) transistors were grown on a semi-insulating GaP (gallium phosphide) substrate, using a molecular-beam-epitaxial (MBE) process.

The final circuit's development by Jensen and his associates at Hughes, as well as Mark Rodwell of the University of Calif. at Santa Barbara, shows that basic analog-circuit design still applies at millimeter wavelengths. The team started with a simple one-transistor common-emitter circuit employing both collector-to-base and emitter-circuit negative feedback with resistors R_f and R_e , respectively (see the figure, part a). (Similar feedback was used throughout the amplifier's design.) It achieved a gain of 9.3 dB and a bandwidth of 14.4 GHz.

With a Darlington circuit, the bandwidth can go to 26 GHz at 10-dB gain (see the figure, part b). The

Darlington circuit supplies a low-impedance drive for the capacitive load that's represented by the base of the output transistor Q_2 . In both the common-emitter and Darlington circuits, the Miller-multiplied collector-base capacitance represents the major factor limiting bandwidth.

Moving to a cascode circuit reduces Miller multiplication and raises simulated bandwidth to 32 GHz (see the figure, part c). This assumes the base of the upper transistor of the cascode (Q_2) can be at (bypassed to) ac ground. Because the process didn't provide the needed capaci-

tors, the collector-base capacitance of an array of large transistors (represented by Q_3) was employed. However, its 0.35-pF capacitance was insufficient, and the resulting bandwidth was a mere 18.4 GHz.

The final circuit achieves the 33-GHz bandwidth with active biasing (see the figure, part d). The bias-source buffer Q_3 reduces the source impedance that drives the base of Q_2 , and the 0.35 pF supplied by Q_4 does the bypassing job. The amplifier output is biased at 4 V, the transistors in the cascode operate at 16 mA, and output power is

about 5 dBm at the 1-dB gain-compression point (the point at which the output power ceases to increase linearly with input power).

The amplifier offers potential savings in cost, size, and weight over present techniques that use matched-impedance circuits with GaAs FETs whose transmission lines can occupy over 90% of the die. While such amplifiers achieve smaller bandwidths for a given transistor f_{MAX} , they take less die area and offer well-controlled performance that's set by internal feedback elements.

For more information, call Joe Jensen at (213) 317-5250.

FRANK GOODENOUGH

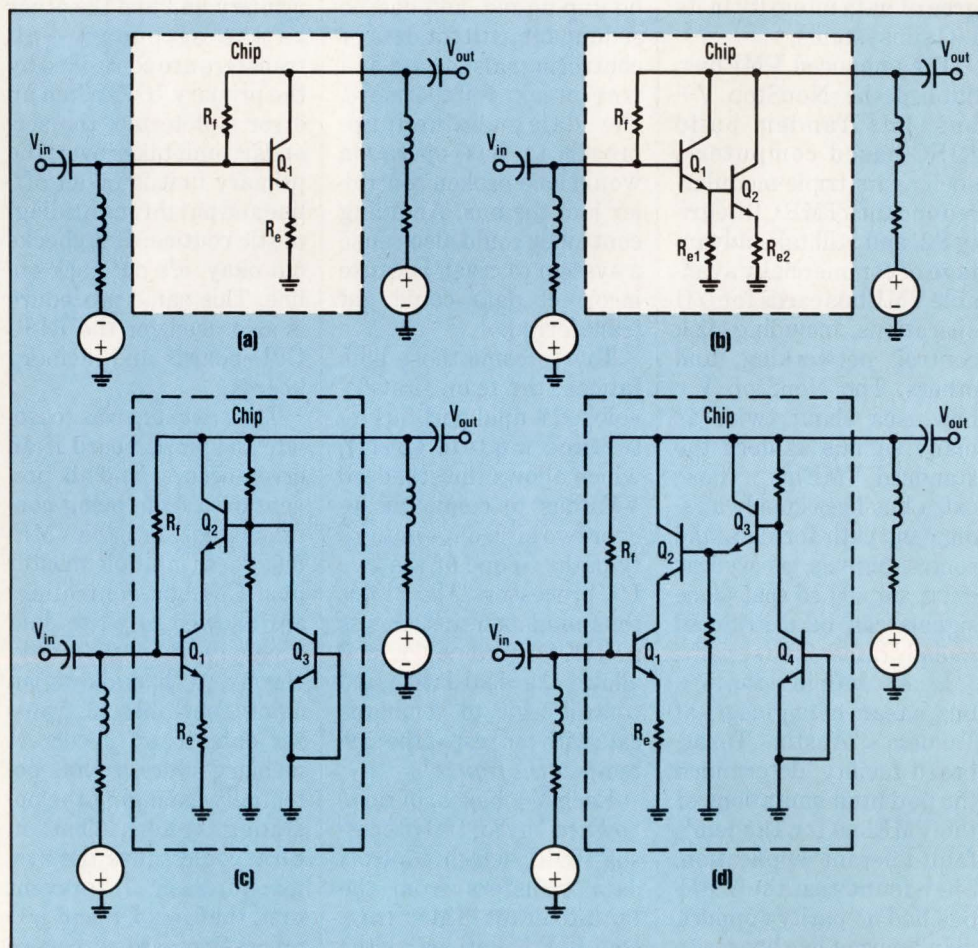

REDUNDANT BUSES, PARITY, RADIAL CONTROL BOOST RELIABILITY

Although such industrial system buses as VMEbus and Multibus offer reliable and sufficiently high performance for most applications, they're limited for applications that require non-stop operation should a board or part of the bus fail. There's no commercially available bus that can hold up under catastrophic system failures. That's why Tandem Computers Inc., Cupertino, Calif., developed an enhanced version of the VMEbus for its Integrity S2, a non-stop, fault-tolerant system. Integrity S2 enhances the VMEbus with redundancy and extra signals to add a high degree of data integrity in its I/O subsystems.

The enhanced VMEbus, dubbed the NonStop V+ bus, lets Tandem build RISC-based computers, such as its triple-modular-redundant (TMR) Integrity S2, and still take advantage of commercially available VMEbus cards for I/O operations, including disk control, networking, and others. The NonStop V+ bus uses about twice as many signals as does the standard VMEbus. Those extra bus lines supply a redundant path for data and control signals, as well as extra signals so that some signals can be distributed radially rather than serially.

When defining the V+ bus, a team of engineers at Tandem's Austin, Texas-based facility, determined the potential limitations of the VMEbus for Tandem's fault-tolerant application. They found that the VMEbus had no parity support, didn't permit live boards to

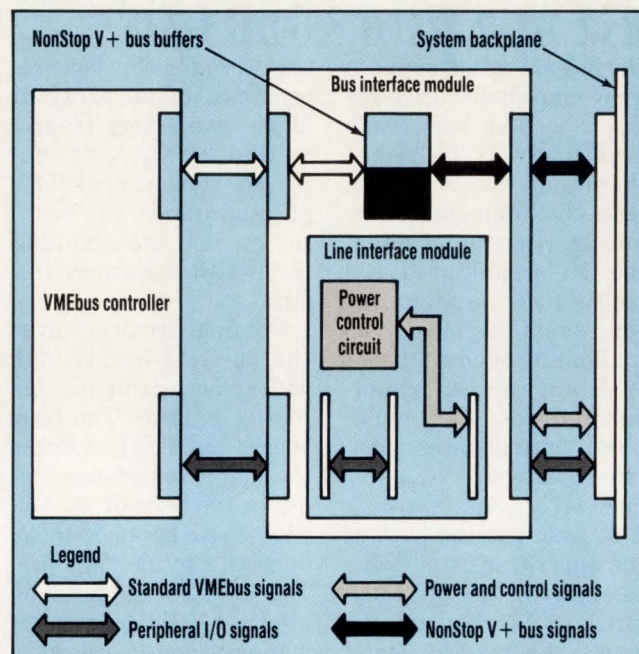

be unplugged, and had no redundant path for data or control signals in case of a wire break. Furthermore, the daisy-chained approach to bus operation would let a broken controller jam the bus. An ailing controller could also cause a system to crash because incorrect data could get transferred.

To overcome those limitations, the team first developed a dual-port bus interface module (BIM), which allows the standard VMEbus to communicate over two high-data-integrity paths to one of the two I/O processors. The BIM is thus an adapter that accepts a VME card on one side, and allows the dual buses and control logic to communicate with the rest of the system (see the figure).

Each V+ bus is, in turn, "owned" by an I/O processor (IOP), which controls data transfers from the fault-tolerant TMR core. One IOP is defined as the

primary unit and the other as the secondary—all transfers are controlled by the primary IOP. When an error is detected, the secondary unit takes over; the primary unit is taken offline and put through a diagnostic routine. If it checks out okay, it's put back online. This same procedure is also used for the RISC CPU boards and memory boards.

The next step was to isolate the VME board if an error occurs, and to prevent data from being contaminated. Since the VMEbus is a multiple-master bus, VMEbus controllers are allowed to write data directly into memory. However, that allows an ailing controller to transfer data to an incorrect memory address, thus potentially damaging the operating system. That, in turn, could cause the system to crash. To prevent that, the Unix OS and I/O processing hardware were

enhanced to limit memory access of the VMEbus controllers to preauthorized areas.

Furthermore, to avoid the possible problem with daisy-chained Bus Request/Grant operations, the V+ bus uses a radial request scheme employing multiple request lines. The same approach was taken for the Interrupt line. Each BIM has its own "private" Request/Grant, Interrupt, and Reset lines.

Including a private reset line for each controller was a critical factor because the Integrity S2 must run without stopping. Consequently, it can't have one reset line controlling all boards—each board in the system must be controllable individually. Parity lines were also added to all data and address buses and to a number of control lines, especially those that control bus timing.

To allow hot removal of the boards, designers made the ground pins on the BIM substantially longer than the power pins. Upon insertion, ground contact will always be made before power reaches the card. And during card removal, power will be removed before the ground connection breaks. An inhibit circuit in the power-supply sense circuits on the BIM detects the board removal or insertion, and can quickly remove power from the card circuits on the supply. Furthermore, power to each of the VME cards is controllable on a slot-by-slot basis from both IOPs (both IOPs must agree to shut power to a card).

DAVE BURSKY

Break Through 7ns

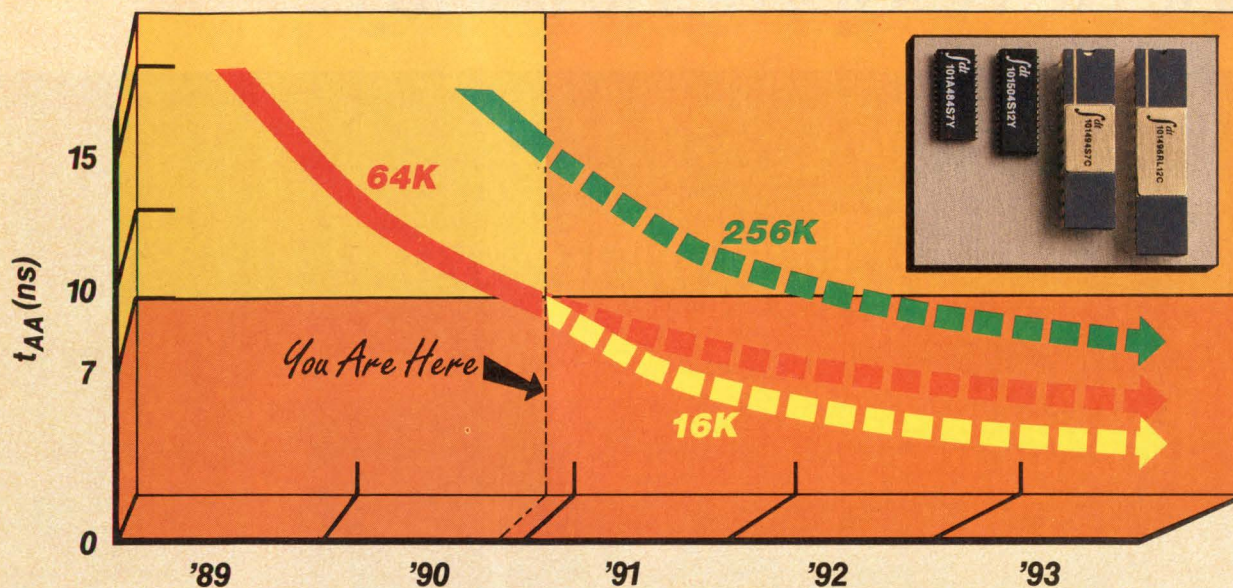

with BiCEMOS™ ECL

Speed Leadership

Design tomorrow's fastest systems today. Our IDT10484 (4K × 4) will be the fastest high-density BiCMOS memory to run primary caches in ECL systems. At 7 ns, the IDT10494 (16K × 4) is the fastest BiCEMOS 64K ECL SRAM available in volume production today.

In addition, we offer the densest BiCEMOS ECL RAM, the IDT10504 (64K × 4), at 12 ns. And our new 12 ns IDT10496RL (16K × 4) synchronous self-timed SRAM (STRAM)

offers registered inputs, latched outputs, and self-timed write for easier system design.

Each of our ECL SRAMs is available today in 10K, 100K, and 101K configurations in 300 mil SOJ and 400 mil Sidebrazed DIP packages.

Technology for the '90s

We engineered BiCEMOS technology to offer the best of both worlds: the low power consumption of CMOS with the high speed of bipolar technology.

Count on our BiCEMOS ECL to take you through the 7 ns speed barrier for 64K densities. We believe our BiCEMOS ECL will achieve speed increases of 20% a year every year for the next five years, making BiCEMOS the technology for the '90s.

Samples Available

Call or FAX us today for samples and a copy of the new *BiCEMOS ECL Product Information* booklet with information on designing with BiCEMOS ECL for ultra-high-speed systems.

BiCEMOS ECL SRAM Family

Part No.	Description	Max. Speed (ns)	Typ. Power (mW)
IDT10484	16K (4K × 4) 10K ECL	7	700
IDT100484	16K (4K × 4) 100K ECL	7	500
IDT101484	16K (4K × 4) 101K ECL	7	700
IDT10490	64K (64K × 1) 10K ECL	8	420
IDT100490	64K (64K × 1) 100K ECL	8	320
IDT101490	64K (64K × 1) 101K ECL	8	420
IDT10494	64K (16K × 4) 10K ECL	7	700
IDT100494	64K (16K × 4) 100K ECL	7	500
IDT101494	64K (16K × 4) 101K ECL	7	700
IDT10496RL	64K (16K × 4) 10K STRAM	12	1000
IDT100496RL	64K (16K × 4) 100K STRAM	12	800
IDT101496RL	64K (16K × 4) 101K STRAM	12	1000
IDT10504	256K (64K × 4) 10K ECL	12	800
IDT100504	256K (64K × 4) 100K ECL	12	600
IDT101504	256K (64K × 4) 101K ECL	12	800

IDT Corporate Marketing
P.O. Box 58015
3236 Scott Blvd.
Santa Clara, CA 95052-8015

(800) 345-7015
FAX: 408-492-8454



When cost-effective performance counts

Integrated Device Technology

Test development today:

The write way

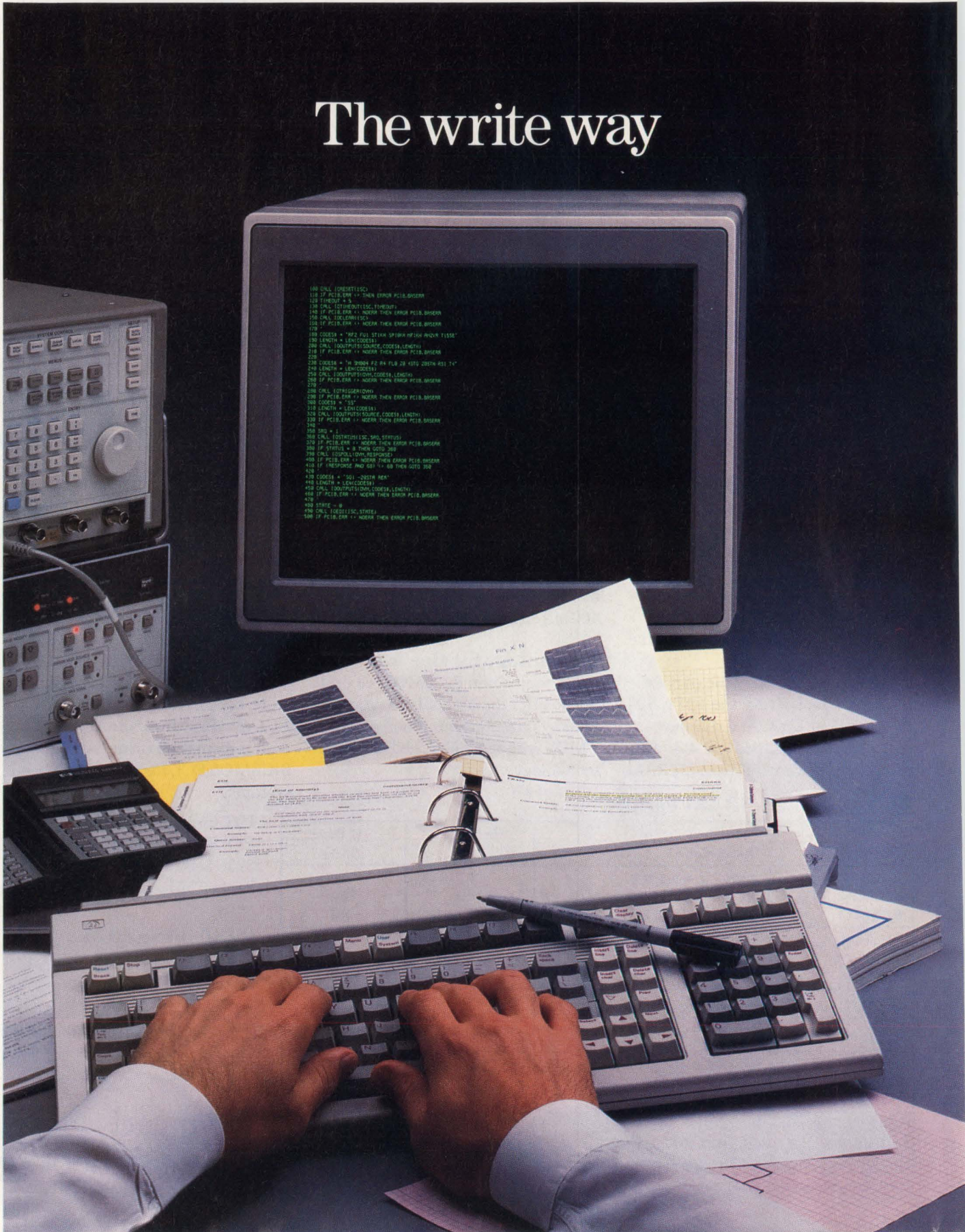

Now on DOS!

The right way



Now, HP's **Interactive Test Generator** delivers faster, easier test development on PCs, too.

If the task of writing code is taking you away from test engineering and turning you into a full-time programmer, you'll welcome a faster, easier method of test development...the HP Interactive Test Generator (ITG) software.

Of course ITG is already the preferred programmer's tool if you're using HP BASIC on an HP workstation or BASIC Language Processor. And now, there's an HP ITG for DOS package for PC users who rely on Microsoft QuickC, C or QuickBASIC.

Either ITG package gives you an easy-to-use interface and automatically writes complex code for your test systems. Simple mouse-controlled instrument panels and menu-driven commands make test development intuitive. No need for manuals when programming new or unfamiliar instruments. HP ITG chooses the right command and sends it...automatically.

With HP ITG, you'll cut development time dramatically. And you'll find it easy to integrate the ITG-developed test programs with your other test software.

So whether you're using an HP workstation or a PC, call **1-800-752-0900*** today. Ask for **Ext. 1430** and we'll send details on doing test development the right way.

*In Canada, call 1-800-387-3867, Dept. 412.

There is a better way.



"Did you know that new 1Mb Video RAMs increase throughput

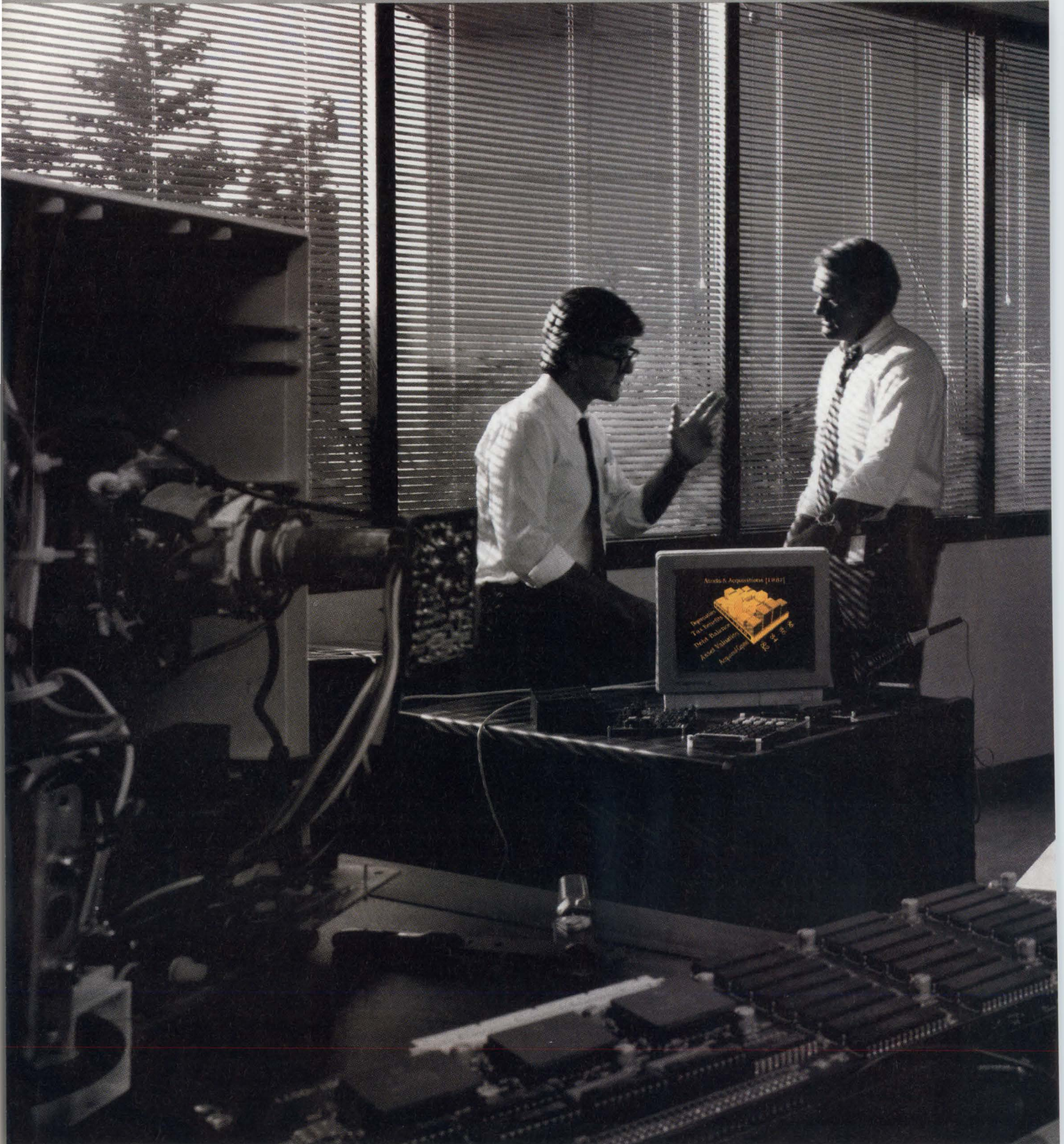

Toshiba semiconductor products are available from a distributor near you. You can reach the distributor of your choice by calling one of the central numbers: Active Electronics, **1-800-388-8731**; Cronin Electronics, Inc., **1-800-5CRONIN**; General Components, Inc., **1-800-524-1463**; Gould Electronics, **1-800-323-6639**; Insight Electronics, **1-800-677-7716**; Itt Multicomponents Corp., **1-800-387-3687**;

by over 100%?"

SERVICE IS OUR KEY COMPONENT

"1Mb Video RAM?"

"Yeah. With the fancy new Flash Write, Block Write and Split Transfer functions to improve performance"

"Not bad?"

"And greater density for high resolution color graphics?"

"Come on. We need something we can use today."

"Toshiba's got 'em. In quantity."

First the good news. Toshiba, the leader in 1Mb DRAMs, introduces a new high density 1Mb Video RAM for today's high resolution color graphic applications. Now the great news. It's available in volume production, giving you access to the quantities you need. Today. With capabilities that'll take you into tomorrow.

Toshiba's high density, 256K x 4bit and 128K x 8bit Video RAM supports next generation video board or graphic terminal applications by allowing you to store, manipulate and transmit more information than ever before.

A multi-port feature combining RAM and SAM gives you easy and fast access to data. Bit Masking is achieved through the Write Per Bit feature.

	ORGANIZATION		SPECIAL FEATURES				PACKAGE	
	X4	X8	Fast Page Mode	Flash Write	Block Write	Split Transfer	SOJ	ZIP
TC524256A	X		X				X	X
TC524258A	X		X	X	X	X	X	X
TC528126A		X	X				X	
TC528128A		X	X	X	X	X	X	

With this feature, selected planes of data can be modified using just a Write cycle instead of a Read-Modify-Write cycle.

Use the Block Write feature to write four times faster and simplify high speed window clear/fill. Use the Flash Write feature to accomplish high speed clear of selected planes without using the SAM register.

To speed things along even more, RAM read/write cycle times have been improved through fast page mode. A split SAM register provides the best method to simplify SAM to RAM and RAM to SAM transfer timing in the system.

TC524256A/8A & TC528126A/8A	-10	-12
RAS ACCESS TIME (MAX)	100NS	120NS
COLUMN ADDRESS ACCESS TIME (MAX)	30NS	35NS
FAST PAGE MODE CYCLE TIME (MIN)	60NS	70NS
SERIAL ACCESS TIME (MAX)	25NS	35NS
SERIAL CYCLE TIME (MIN)	30NS	40NS

Want more good news? Toshiba's service is every bit as good as their new Video RAM. With the people and the design specification information you need to get the job done. Call for your complete data sheet today. (1-800-888-0848 ext. 517).

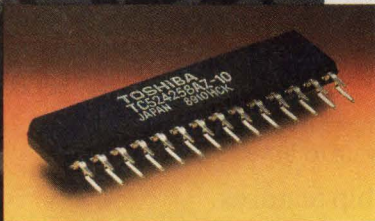
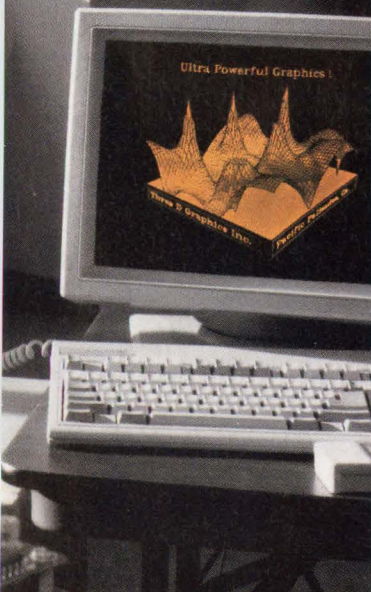

© 1989 Toshiba America, Inc.

MST-88-009

In Touch with Tomorrow
TOSHIBA

TOSHIBA AMERICA ELECTRONIC COMPONENTS, INC.

Merit Electronics, Inc., 1-408-434-0800; Marshall Electronics Group, 1-800-522-0084; Milgray Electronics, Inc., 1-800-MILGRAY; Marsh Electronics, Inc., 1-800-558-1238; Repron Electronics, Inc., 1-800-282-1360; Rome Electronics, 1-800-366-7663; Nu Horizons Electronics Corp., 1-800-726-7575; Sterling Electronics, 1-713-623-6600; Western Microtechnology, Inc., 1-800-338-1600;



S-MOS MICROCOMPUTERS
TAKE THE PRESSURE
OFF YOU
AND YOUR SYSTEM.
.....

Extend battery life up to 10 years

Now that's a hot subject.

Fortunately, our S-MOS 4-bit SMC6200 Microcomputers (MCU) are a cool alternative for today's power-hungry designs. S-MOS MCU's offer the world's lowest current consumption— $0.9 \mu\text{A}^{\dagger}$ —enabling you to extend the life of your battery up to 10 years.

On-chip features

Even the most pressured designers will find relief with all the SMC6200 Series options. On chip Battery Level

[†]Typical



Detect (BLD) circuits signal a low battery to your display. Software selectable twin clocks let you optimize your power consumption. A wide range of on-chip ROM and RAM, I/O ports and on-chip LCD drivers. As well as many other high performance peripherals. Plus, S-MOS offers powerful, easy-to-use PC-based development tools and add-on hardware that help you develop applications quickly.

S-MOS 4-Bit Microcomputers

Part Number	Memory (bits)		LCD Drivers		Features
	ROM	RAM	Common	Segment	
SMC6214	4096 x 12	208 x 4	3 or 4	32	*AC, **BLD, Timer Twin Clock
SMC6215		488 x 4		50	
***SMC6232	2048 x 12	144 x 4	3 or 4	38	AC, Counter, BLD
***SMC6235	4096 x 12	574 x 4	3 or 4	48	Sound Generator Counter, BLD, AC
SMC6246	6144 x 12	640 x 4	8 or 16	40	Sound Generator Twin Clock, BLD
SMC6266	6144 x 12	1024 x 4	N/A	N/A	2 Channel AC Counter, Twin Clock
***SMC6281	1024 x 12	96 x 4	3 or 4	26	Melody Generator BLD, AC

*Analog Comparator (AC) **Battery Level Detect (BLD) *** Microcomputers running as low as 0.9V

Take the pressure off now. For a Free "Create the Future" Mouse Pad and our S-MOS Microcomputer Technical Guide, just call 1-800-888-1967 ext. 123. And move full-steam ahead.

**ASICs, Microcomputers,
Memories & ChipSets**

S-MOS
SYSTEMS

A Seiko Epson Affiliate

CIRCLE 193

APPROACHING THE LIMIT OF INTEGRATION FOR A PC, ONE CHIP PACKS BOTH THE CPU AND THE LOGIC NEEDED TO BUILD A COMPLETE MOTHERBOARD.

THE ONE-CHIP PC MAKES BUILDING SYSTEMS A SNAP

DAVE BURSKY

Ever since the IBM PC was introduced, designers have searched for ways to cost-reduce and shrink the size of the PC. Chip sets have reduced motherboard complexity, but without access to micro-processor designs, chip-set manufacturers reached their limit. They've compressed the chip sets down to a single support IC with all the essential motherboard logic. However, Advanced Micro Devices, one of a few companies owning access to the 80286 design, has now integrated the CPU chip with all the base motherboard logic functions for PC/AT class 80286-based computers

The new processor, the AM286ZX, is targeted for motherboards in low-cost desktop systems. Its 286LX cousin, with on-chip power management logic, targets low-power, battery-operated applications, such as laptop and notebook computers, portable instruments, and so on. Both will be available in 12- and 16-MHz versions.

Besides the CPU core, the 286ZX has dynamic-memory control logic, peripheral-control and bus-clocking control circuits, and LIM EMS 4.0 memory-management logic to extend the available memory. It also has two DMA controllers, three counter-timers, two interrupt controllers, and a real-time clock (*Fig. 1*). All of these functions are housed in a 28-by-28-mm 216-lead quad-sided flat package designed around the TapePak format defined by National Semiconductor. A plastic ring around the perimeter of the fine-pitch leads secures and protects the leads.



The ZX or LX replaces about 175 ICs originally used to build the first AT motherboard. To implement the full PC/AT equivalent system, dynamic-RAM (DRAM) and BIOS memories along with a keyboard controller are required, and optionally, a floating-point coprocessor can be used (*Fig. 2*). The chip can directly drive two banks of DRAMs for a total of 16 Mbytes (using 4-Mbit chips), or 4 Mbytes (with 1-Mbit chips) and two AT-bus

THE ULTIMATE SINGLE-CHIP PC

slots. Thus bus buffers are no longer required if only limited expansion is needed. Buffers can be added if more memory or more expansion slots are desired.

The chip can also serve in embedded PC applications, furnishing PC compatibility to an instrument, appliance, machine tool, or any other intelligent piece of hardware. For power-critical embedded applications, the LX's power management allows the chip to shut down the CPU, put the processor into a standby mode, and perform staggered or slow refresh of the DRAM array.

The CPU core is a complete 80C286 processor, functionally identical to the 80C286 that AMD sells as a standalone CPU. The on-chip DMA controllers are compatible with the 9517A/8327A controllers and support all seven PC/AT DMA channels. Similarly, the interrupt-control logic is compatible with the standard 8259A and has connections for the timer, keyboard, math coprocessor, real-time clock, and other PC/AT interrupts. The three-channel counter-timer is the same as the 8254 and provides the same configuration functions as in the AT—system heartbeat, speaker tone, and DRAM refresh request.

The real-time clock subsection has 114 bytes of low-power CMOS static RAM—64 bytes more than the AT standard 146818 real-time clock chip, for extra storage of extended-configuration data. The clock section in the LX version also includes a low-power oscillator that eliminates some external circuitry. The real-time clock includes complete time-of-day with alarm, a 100-year calendar, and the ability to generate programmable periodic interrupts.

The 286 core's fully static CMOS design allows the system to stop operation by reducing the clock to 0 Hz (dc), cutting power consumption to near zero. Or the application program can slow down the system's clock to conserve power when little activity is occurring, and speed up the processor for maximum throughput. The CPU retains data even with the clock stopped, and continues from where it left off when the clock

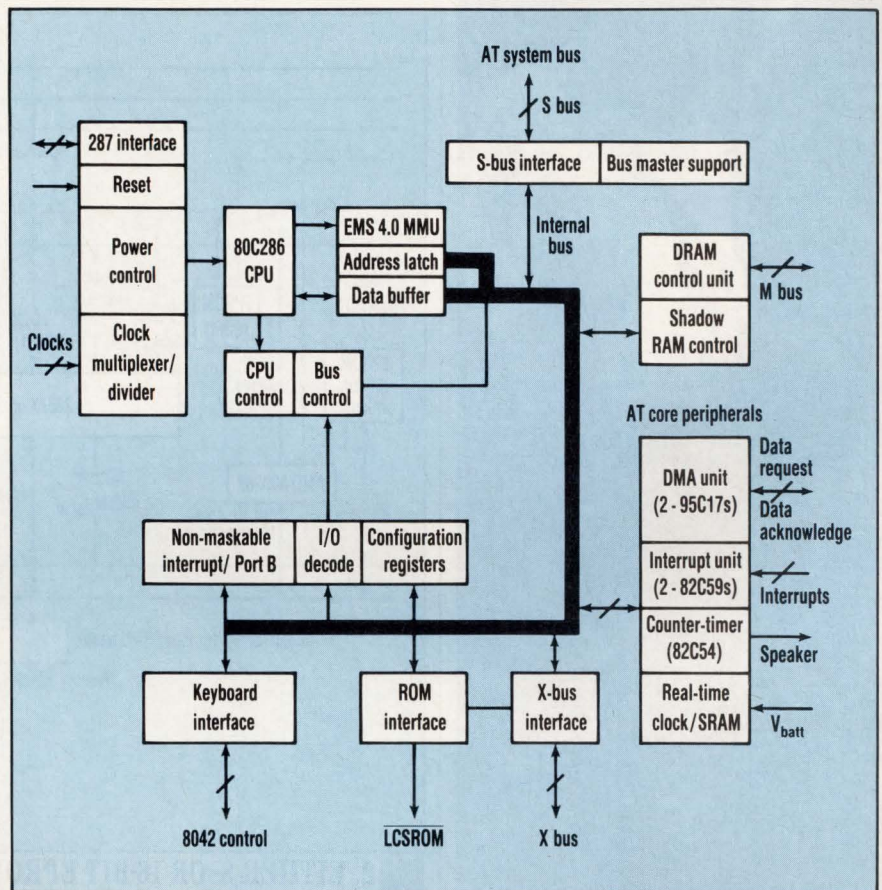

1. IF IT WASN'T A SINGLE-CHIP PC, designers would swear the 286ZX or LX was a basic PC/AT compatible motherboard. On one chip, AMD packed the CPU, EMS 4.0 control circuits, dual DMA controllers, three counter-timers, a pair of interrupt controllers, a real-time clock, DRAM refresh circuits, and an enhanced bus controller.

signal returns.

The CPU stop-clock mode causes a gate to stop the incoming clock from reaching the CPU logic until an interrupt arrives, thus saving system power. At the same time, the rest of the system is kept active so that the keyboard, display, and other sections can still respond. The system-standby mode stops all system clocks not essential for DRAM refresh. This mode could be used with slow-refreshing DRAMs that retain data with minimal power, and is handy if a system user had to temporarily stop work and then return to it later and not want to reload the computer's memory with the application program or data. This capability is often referred to as a "bookmark."

The chip includes an enhanced bus controller and clock-generation block with the features of the 82284

and 82288. An on-chip controller permits non-paged support, page-mode, or combined page/interleave operation with 2- or 4-way interleaving.

Furthermore, the EMS control block includes two sets of 64 address translation registers (main and alternate). This makes it possible for high-performance execution of such programs as Microsoft's Windows or Deskview. By supplying two sets of registers, the CPU enables the EMS software to switch rapidly between the two translated regions, improving the system's ability to handle multitasking applications.

With the internal system-timing circuits of the 286ZX or LX, designers can program various timing options for the CPU clock, the AT-bus clock, keyboard clock, and the math coprocessor clock. Internal configuration registers on the CPU chip hold



Wise In Years. Young At Heart. Great American Investor.

If you stop for gas at Wally Bonfield's service station, be prepared to fill up on a few good stories. One of his favorites is how he built his retirement nestegg—with U.S. Savings Bonds, the Great American Investment. "Bonds have always been there for me," he says proudly. Become the next Great American Investor. Call us to find out more.

U.S. SAVINGS BONDS



THE GREAT AMERICAN INVESTMENT

1-800-US-BONDS

A public service of this publication.

THE ULTIMATE SINGLE-CHIP PC

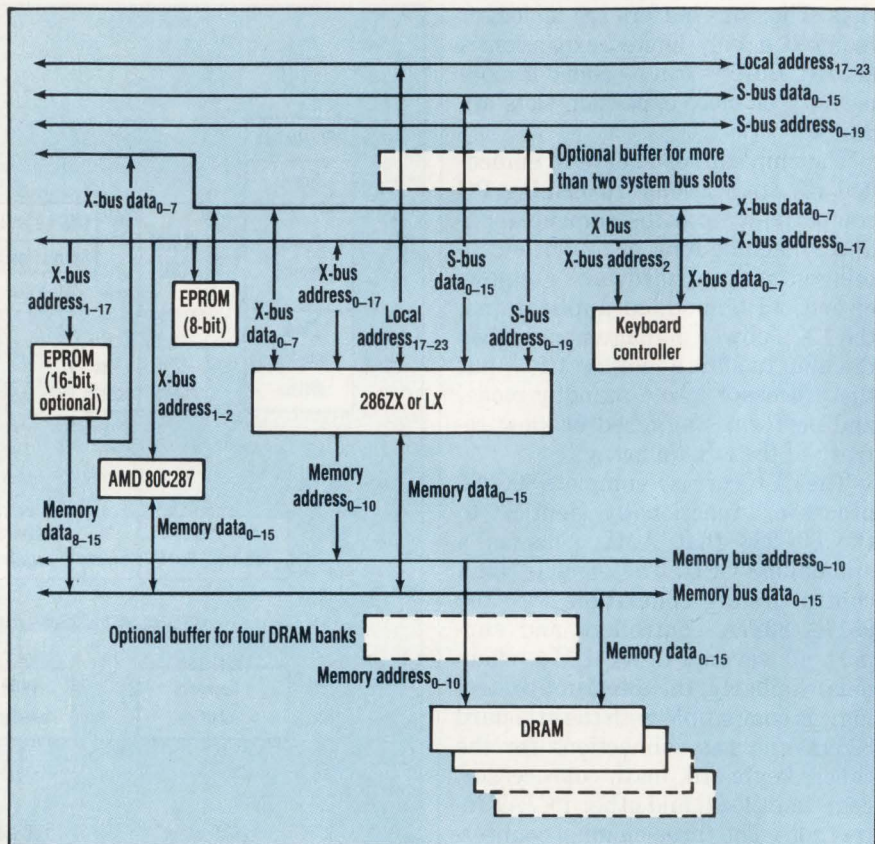

2. EITHER 8- OR 16-BIT EPROMS can be used with the highly integrated 286ZX/LX which stores the contents in shadow RAM for high-speed execution. All that's needed to complete the basic AT motherboard are a keyboard controller, the DRAM, and the optional math coprocessor. For large systems, optional bus buffers must be added.

the set-up information.

In addition to delivering the functionality of the 82284 and 288, the bus controller's dual state-machine design gives users a high-speed CPU synchronous state machine for DRAM control and internal register accesses. The other state machine handles system-bus control and operates either synchronously or asynchronously with respect to the CPU. Furthermore, the controller offers AT-compatible high-byte routing and word-to-byte transaction conversion for bus transfers to 8-bit peripherals. That bus subsection also controls all of the address and data routing and buffer control for all possible data transfers—CPU, DRAM refresh, and bus mastering.

A complete mini PC/AT motherboard with four card slots can be built with the chip on a card in just a 4.6-in.² area.

In addition, by using the shadow-

RAM feature that's part of the ZX memory control circuits, one low-cost 8-bit EPROM can be used to hold the BIOS. Phoenix Technologies Inc., Norwood, Mass., has developed BIOS and EMS drivers, and Hewlett-Packard Co., Palo Alto, Calif., is developing an in-circuit emulator. □

PRICE AND AVAILABILITY

Samples of the 286ZX or LX will be available in the late fourth quarter in either 12- or 16-MHz speed grades; production quantities will be ready in the second quarter of 1991. Prices for the TapePak version in 1000-unit quantities are \$69.00 and \$85.50, respectively, for the two ZX speed grades. The LX versions go for \$76.50 and \$89.00.

Advanced Micro Devices Inc., 5204 E. Ben White Blvd., MS-522, Austin, TX 78741; Rajesh Tanna, (512) 462-4700. CIRCLE 511

HOW VALUABLE?

HIGHLY
MODERATELY
SLIGHTLY

CIRCLE

529
530
531

Analog Devices
delivers mixed-
signal technology
that meets today's
most demanding
specifications.



Faster.



ADSP-2101 – Talk about fast – this DSP microcomputer executes a 1024-point FFT in only 2.26 ms. That's faster than other DSPs that operate at almost twice the clock rate. And since our entire ADSP-2100 family is code compatible, your code will run fast on all of our DSPs.



AD9617 – The fastest slewing and settling op amp around slews at 1400 V/ μ s and settles to 0.02% in just 14 ns. And with a closed loop bandwidth of 200 MHz and harmonic distortion at 20 MHz of -59 dBc (max), it makes driving A/D converters easier than ever.



AD9712 – The only 12-bit, 100 MHz D/A converter on the market. Ideal for high-speed video and direct digital synthesis, its low glitch and low harmonics combine to deliver a spectrally pure output waveform.

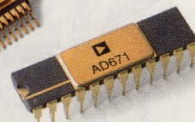

AD9060 & AD671 – The fastest 10-bit and 12-bit monolithic A/D converters, respectively. The **AD9060** guarantees encode rates up to 75 MSPS for unparalleled dynamic performance. The **AD671** is twice as fast as any other 12-bit monolithic, converting in under 0.5 μ s, thanks to our high-speed mixed-signal ABCMOS process.

Our Spectrum CAD Tool is 100 times faster than traditional SPICE programs, so it makes quick work of mixed-signal ASIC design cycle time.



Perfect on-time delivery – it's our goal and at 97% we're getting close, thanks to our continuous improvement process based on Total Quality Management. Over 150 TQM teams make the customer and quality improvement the focus of our entire organization. A focus that gets translated into not just catchy slogans, but real action.



Tap into 25 years of experience at our high-speed and mixed-signal design seminars. You'll learn new techniques that'll get your applications to work more quickly, and you'll get design manuals that put all this information right at your fingertips.

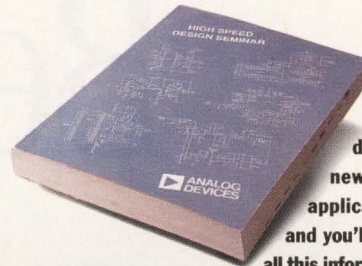

In the disk drive market, you've got to be fast – in both performance and time-to-market. That's why seven of the top 10 disk manufacturers rely on Analog Devices for mixed-signal components.

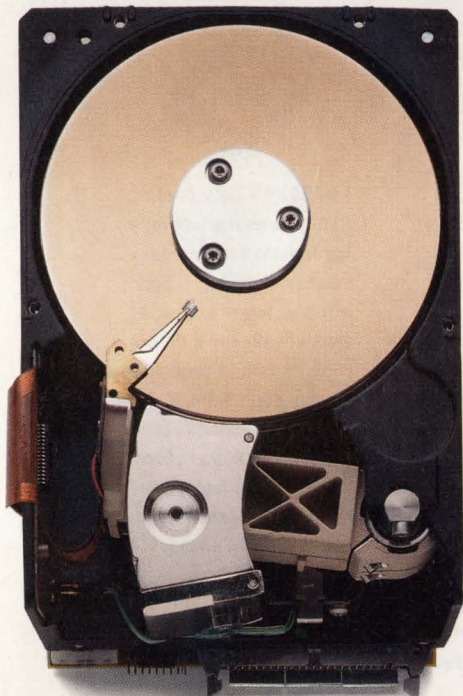

Our high-speed D/A converters will have eavesdroppers hopping mad. In direct digital synthesis applications, they allow communications receivers to hop frequencies 100 times faster than traditional analog techniques.



Faster development time means faster time-to-market. And that's what you get with our EZ-KIT, a complete design tool with a demonstration/evaluation board, DSP textbooks, and powerful, yet easy-to-use software.

Today, Analog Devices offers more high-performance mixed-signal components than anyone else. And we get them to you fast. So if you want mixed-signal ICs that'll help you design faster performing products, from a company that'll help you get your product to market faster, call us at 1-800-262-5643.



Better.

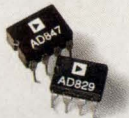

AD820/AD840 Series – If you're looking for the best in high-speed op amps, here they are – a whole family of components with the right combination of features to deliver high speed, precision, low noise, low input bias currents, low offset voltage and low drift performance. Our Complementary Bipolar process delivers gain-bandwidth products in excess of 750 MHz and slew rates in excess of 2000 V/ μ s.



ADV7141 – Our new Continuous Edge Graphics RAM-DAC gives users of standard low-end color monitors better graphics on their PCs. Graphics that are virtually the same as those produced on expensive engineering and scientific workstations. It does this by eliminating jagged edges, providing photo-realistic colors and shading, and displaying text comparable to a 300-dpi laser printer.



ADSP-2111 – Better integration on the best architecture in the industry. Adds an 8/16-bit host port to the two serial ports, timer, hardware companding and memory already on the ADSP-2101. And like all our DSPs, it's got fast, flexible arithmetic, wide dynamic range and a single cycle fetch of two operands (on- or off-chip). Plus it's code-compatible with the rest of our DSP family, so what's written today will be useful tomorrow.

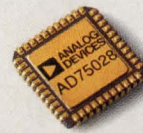

AD75028 – This custom ASIC passes the test for a top automatic test equipment manufacturer. Serving the function of 21 separate 12- and 8-bit D/A converters and providing on-chip static RAM, it also has seven channels of level setting (other monolithics only have four), and can automatically remove gain and offset errors.



We're your best source for linear, digital and mixed-signal information. Annually, we publish over 20 books and newsletters, and scores of applications notes. And our *Analog Dialogue* enjoys a worldwide readership of over 100,000 design engineers.

'Try, try again' is a costly way for manufacturers to find the best design solution. So to help our customers find answers to tricky problems the first time around, technical application engineers are just a phone call away. In some instances, they're even located right on the customer's premises.

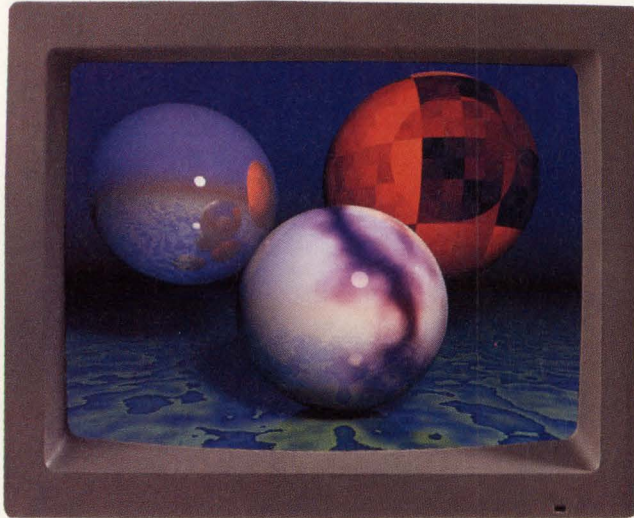

Picture this – a PC monitor that offers the same color and clarity as a high-end engineering workstation costing as much as 20 times more. Our pin-compatible RAM-DAC is literally redefining the low end of the PC monitor market.



After analyzing semiconductor suppliers, many of the leading oscilloscope and spectrum analyzer manufacturers chose Analog Devices for their mixed-signal components. One reason is our ability to deliver high performance at high levels of integration – for example, our AD640, which replaces a chain of discrete log-amps for higher accuracy.



With our motion control ICs, several major aircraft companies are staying right on course. High reliability and accuracy are hallmarks of our 2S80, AD598 and the rest of our nearly 400 defense-qualified products.



People are hearing a lot better, thanks to our fully integrated baseband processing subsystem, which controls, conditions and converts I and Q channels in both the data transmit and receive paths.

Today, Analog Devices offers a better line of high-performance mixed-signal components than anyone else. And no one has a better record for reliability, or more experience in analog, DSP and mixed-signal ICs. If you want mixed-signal components that'll help you design better products, the best thing to do is to call us at 1-800-262-5643.



Cheaper.



ADSP-2105—High performance DSP at an incredibly low price. So low, in fact, you can now consider DSP in a host of new applications. And since it's pin-compatible with the ADSP-2101, and code-compatible with all of our other DSP processors, upgrading is easy and inexpensive.



AD712—If you're working in professional audio and compact disc applications, you'll like the sound of this—an IC that combines two high-performance op amps in one compact package. You get low offset voltage and low input bias currents coupled with superb transient response, ambience, clarity and dynamic range.

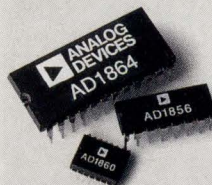

SOUNDPORT DACs—We've made these DACs cost-efficient by making them complete with output amplifier, reference and digital logic interface. Perfect for high-fidelity digital audio and multimedia applications, these mixed-signal ICs achieve SNRs as high as 108 dB and THDs as low as 0.0025%.



AD22001—One way to make a car less expensive is to make it with less parts. This component replaces a whole board of discrete analog and digital circuitry. It continuously monitors up to five automotive bulbs or indicators, along with the associated in-line fuse, and provides a digital status output.



More gadgets for less money, and make it work better—that's the only way to survive in consumer electronics, the most competitive market there is. That's why three of the top five Japanese electronics firms rely on us to meet their mixed-signal needs in applications ranging from CD players to video cameras.

We've got the phone lines buzzing. Via our CMOS and Bipolar processes, we're helping modem makers turn out products that cost less yet perform better. We got the call because we have the broadest portfolio of process technology for signal processing. A portfolio that includes not only CMOS and Bipolar, but BiCMOS, Complementary Bipolar, Flash and many others.



We're far from your local component boutique. Over half of our \$540 million in revenues comes from international sales. And with manufacturing and stocking facilities on just about every continent, getting products to you quickly is a snap. Plus multiple manufacturing facilities allow us to take advantage of the right talent and processes for the job at hand.

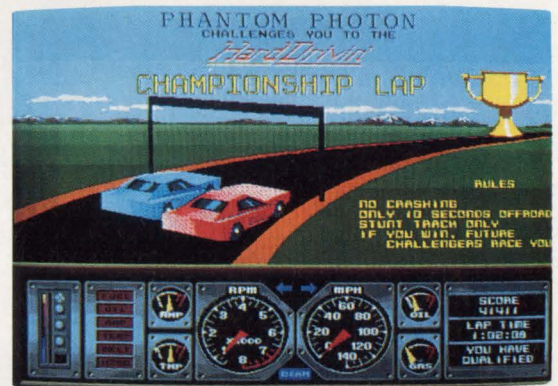

With billions of dollars in annual sales at stake, the video game market is anything but child's play. One leader in this market found that with our DSP they could create more realistic and interactive games. As a result, they're driving away with a bigger share of the market.

Automakers certainly understand that manufacturing efficiency is a critical key to lowering production costs. That's why we've developed high-performance ICs for several car companies around the world, as well as companies making DAT equipment, disk drives, digital mobile phones, modems, and HDTV.



Today, Analog Devices offers more cost-effective solutions to your high-performance mixed-signal needs than anyone else. Solutions that are surprisingly affordable, whether they're available off the shelf or developed for a specific application. To find out more about how we can help you develop products more efficiently, or for a free copy of our recent Mixed-Signal Technology white paper, call us at 1-800-262-5643.



The F80 Programmable Filter

Another exciting episode of mission impossible.



Many said it was impossible. Create a truly programmable filter that lets you skip over do-it-yourself passive-filter design and do away with many external components.

Well, they were wrong. Our F80 Series of Programmable Low Pass Filters do it dramatically. It's a real breakthrough that lets you program channel bandwidth from 5-13 MHz. Continuously. And easily. It lets you program on the fly and fully realize the potential of constant density

recording.

It's here. The F8011. One of a family of customizable filters designed for a variety of custom applications. It requires only a +5V power supply and reduces the costs and time associated with what had been one of the most engineering-intensive tasks in electronics design.

Whether you're designing hard disk drives, LANs, cellular telephone systems, radar systems or whatever, your next mission is to contact your nearest

CIRCLE 120 FOR PRODUCT INFO.
CIRCLE 121 FOR CAREER INFO.

Silicon Systems representative or distributor. Or call us for literature package SPD-4.

Silicon Systems, Inc.

14351 Myford Road, Tustin, CA 92680
Ph 1-800-624-8999, ext. 151 Fax (714) 669-8814
European Hdq. U.K. Ph (44) 79-881-2331
Fax (44) 79-881-2117

silicon systems[®]

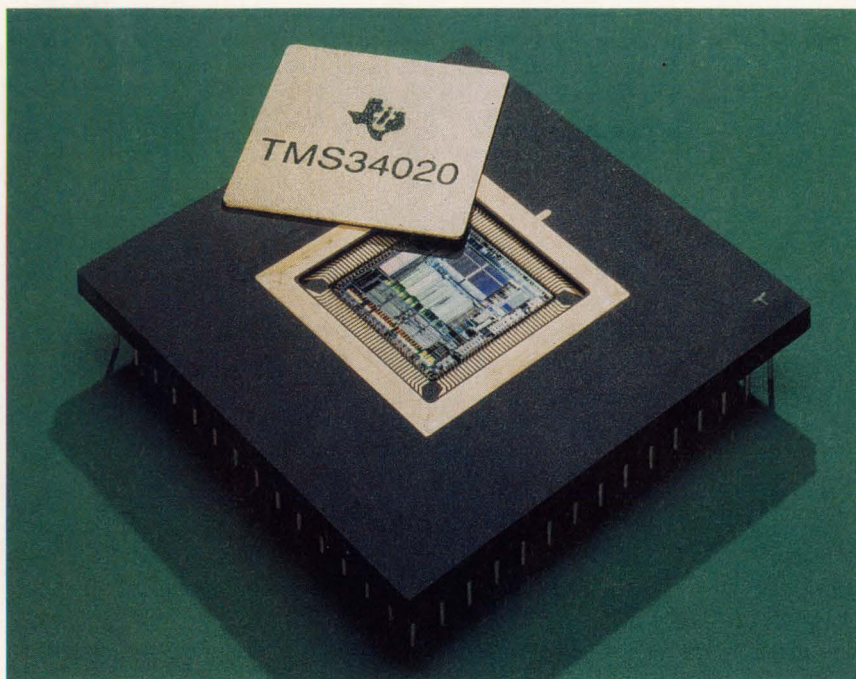

DAVE BURSKY

NEW CHIPS DELIVER HIGHER RESOLUTION AND MORE COLORS.

screens, more colors, and improved screen drawing speeds.

For graphics acceleration in any system, off-the-shelf floating-point digital signal processors or integer reduced-instruction-set computer (RISC)

COLORFUL GRAPHICS FOR THE DESKTOP

Without question, the onslaught of windowed operating systems, graphical user interfaces, and multimedia applications is causing a performance bottleneck in many video subsystems. Previous PC video standards, such as IBM's VGA and EGA controllers and their predecessors, lack the resolution and color variety required by advanced applications. These requirements as well as faster drawing speeds are demanded by both users and application developers.

Apple's Macintosh computers, whose basic 8-bit graphics subsystems can be upgraded to 24 bits for true-color capability, are indicative of this trend. Furthermore, accelerators for the company's QuickDraw graphics interface—developed by Apple as well as by add-in card vendors—allow larger

processors can either supplement or replace the controller. Such circuits can be used to accelerate the operations associated with repositioning an image (bit-block transfers or bitBLTs), or calculate shading or reflections. Such circuits will be discussed in a future report.

The myriad of choices offered to designers to create graphics subsystems delivers a kaleidoscope of resolutions, colors, and performance levels (see "Manufacturers of graphics chips," p. 63). Dedicated commercial chips sparkle where standards exist, giving designers many alternatives from which to build controllers. When performance or speed levels can't be met by off-the-shelf chips, advanced programmable processors can either replace or supplement the video controllers. And where no hardware standards exist, semicustom or full-custom chips can be defined to do the job.

GETTING PERSONAL

The 640-by-480-pixel resolution and 16 colors offered by the IBM VGA standard has become the de-facto minimum standard for most PCs. Almost all of the dozen or so VGA chip manufacturers, though, offer chips that duplicate the full set of features included in IBM's controller and provide enhanced operating modes that offer more colors and more than twice the resolution—peaking at 1024-by-768 pixels and 256 colors.

IBM's 8514/A graphics adapter, defined before the super-VGA capabilities were added to VGA chips, initially offered more than double the number of VGA pixels with up to 1024-by-768-pixel resolution and 256 simultaneous colors. Although such resolution matches the extreme high-end of the super VGA, the 8514/A chips perform their opera-

tions faster. That's because many of the time-critical graphics operations are integrated into the circuits on the chip instead of executed as firmware, as they are in the VGA cards.

The so-called "super-VGA" operating modes, however, aren't standardized and each VGA chip maker offers their own selected superset of video features. This confusion creates much duplicated software effort because each video card or chip maker must develop custom software drivers for each application program. Without the drivers, the application software couldn't take advantage of the enhanced video capabilities unless the application developer created the driver for a specific video chip or card. (see "Extending the standards," p. 62).

CHIP SUPPLIERS

About a half-dozen chip suppliers account for more than 80% of the non-IBM super-VGA controllers. Perhaps another six account for the remaining 20% or so of the add-in business. Chips and Technologies, Cirrus Logic, Headland Technology, Trident Microsystems, Tseng Labs, and Western Digital are the top six suppliers. Those fighting for the remaining 20% include Intel, NCR, Oak Technology, S-MOS Systems, United Microelectronics, Yamaha Systems, Zymos, and others.

Although all of the chips offered by the suppliers meet the basic VGA requirements, each slightly differs from the other when it comes to superset features. A few also include the ability to drive monochrome or color liquid-crystal, plasma, or electroluminescent display panels. In addition, several companies have more than one version of a VGA controller to cater to designers who want to offer systems at various price and performance levels.

For example, Chips and Technologies offers three VGA controllers: the 82C450, the C451 and the just-released C452A, an upgrade to the earlier C452. Another chip, to be released the last quarter of this year, is being developed.

The C450 is a low-cost controller chip. It offers a simple solution in a

compact 100-lead plastic quad flat pack (PQFP) for designers that want to include super-VGA graphics on the motherboard. It supports 1024-by-768 16-color interlaced displays with just four dynamic RAMs (DRAMs) and a RAMDAC color palette. The C451 is the simplest chip, with extensions that include 800-by-600 pixels with 16 colors and a 132-column text mode. Released early this year, the C452 added the ability to drive noninterlaced monitors with 1024-by-768-pixel resolution and 16 colors. The controller uses the fast-page-mode DRAMs to operate at a 65-MHz clock frequency.

The C452A supports 16-bit-wide DRAMs and drives both interlaced and noninterlaced monitors. Housed in a 144-lead PQFP, it has a 32-bit-wide interface to the video memory to accelerate data transfers.

The chip includes support for both analog and digital monitors, and has a dual-bus architecture to tie into industry-standard-architecture (ISA), extended-ISA (EISA), or Micro Channel Adapter (MCA) buses. A controller aimed at high-end super-VGA performance is now being developed. It will include some graphics-support functions for windows or cursor acceleration.

Tseng Labs, which offers a trio of chips to suit various display needs, has two versions of its ET3000 and one version of the just-released ET4000. The ET3000A operates with up to a 65-MHz dot clock and includes support for nearly all super-VGA modes up to 1024-by-768 pixels with 16 colors, and 800-by-600 pixels with 256 colors, on interlaced monitors.

Unique features of the 100-lead PQFP chip include hardware zooming to view and alter individual pixels and the ability to simultaneously display up to eight character fonts. The chip also has a split-screen capability that permits up to three simultaneous windows with mixed graphics and text in each, and a two-color 1600-by-1280-pixel high-resolution mode with an externally supplied 180-MHz ECL clock. The 3000B offers a subset of features in a low-cost 84-lead plastic leaded chip carrier (PLCC). It only extends the VGA ca-

pability to 800-by-600 pixels with 16 colors and can only display two fonts concurrently.

For higher performance, the Tseng ET4000 adds support for video RAMs and provides 1024-by-768-pixel displays with 256 colors, or 800-by-600-pixel displays with 65,000 simultaneous colors. The 160-lead controller can drive either interlaced or noninterlaced monitors and can improve display speed up to 17-fold over the 3000A when video RAMs are used.

Some of that speed improvement is due to a small cache on the bus interface front end, and multiple first-in/first-out buffers on the CRT interface back end. By using the cache and FIFO registers, data transfers on either end are independent of true data-transfer speed. As with the ET3000, the new chip operates at 65 MHz, has the two-color high-resolution mode, and performs both vertical and horizontal panning and scrolling in both text and graphics modes.

Headland has three super-VGA chips to choose from—the HT205, which supports only 800-by-600-pixel extensions with either video or standard DRAMs, and the newer HT208 and 209. The HT208 supports only DRAMs but can display 1024-by-768 pixels with 16 colors on either interlaced or noninterlaced monitors.

An upgraded version, the HT209, will soon be released—it will display 256 colors on a 1024-by-768-, 800-by-600-, or 640-by-480-pixel image. It supports 65-MHz noninterlaced monitors as well as video or DRAMs (including 128k-by-8 devices), and includes hardware cursor support to improve display response time in window environments. The controller also packs an IBM 3270-compatible text mode and handles bit-mapped fonts with dithered fills for smooth character outlines. Compared to a 16-bit AT-bus super-VGA card, the HT209 can run about 15% faster with DRAMs and about 50% faster when equipped with video RAMs. The chip also has a 1-Mbyte remappable linear address space. This enables software drivers to reside in upper memory without the

page boundaries encountered in video memory.

Two of a trio of controllers from Western Digital's Imaging division that have similar capabilities—the WD90C00 and 90C10—aim at desktop systems. The third, the 90C20, is targeted for portable systems. The 90C10 is a superset of the 90C00 and was released about 18 months ago. The 90C00, which delivers 16 colors for displays of 800-by-600 and 1024-by-768 pixels, and 256 colors for 640-by-400 and 640-by-480 pixels, operates with a 45-MHz dot clock. FIFO buffers on the video output allow the 100-lead chip to buffer video data to ease some of the DRAM timing requirements. Special text modes make it possible to display 132 columns with 25, 43, or 50 rows.

The more-integrated C10 operates with a 64-MHz maximum dot clock, and ties directly into two 256k-by-4 DRAMs and an 18-bit color palette. Two other extensions to the C10 are available. The C11 controls up to four DRAMs and displays up to 256 colors in the 800-by-600-pixel mode with either interlaced or noninterlaced monitors. Also available is the C12, which integrates the RAMDAC into the controller chip, greatly minimizing board space.

The 90C20 supports all functions of the 90C00 when in the CRT mode, and delivers 640-by-480-pixel resolution with 8-, 16-, or 32-shade gray-scale mapping. Consequently, the controller can drive either monochrome or color LCD or plasma panels. To keep system requirements low, the 132-lead PQFP-housed chip includes the 18-bit-wide color palette and the triple DACs to drive the CRT display. On-chip intelligent power-management logic reduces standby power for the display subsystem. Only four chips are needed to form an entire video subsystem—the 90C20 controller, two 64k-by-16 DRAMs, and the 90C61 clock IC.

FLAT-PANELS ARE HOT

Several contenders are competing with the 90C20 to get a share of the high-growth laptop market. One challenger is the V6388 versatile panel-display controller from Ya-

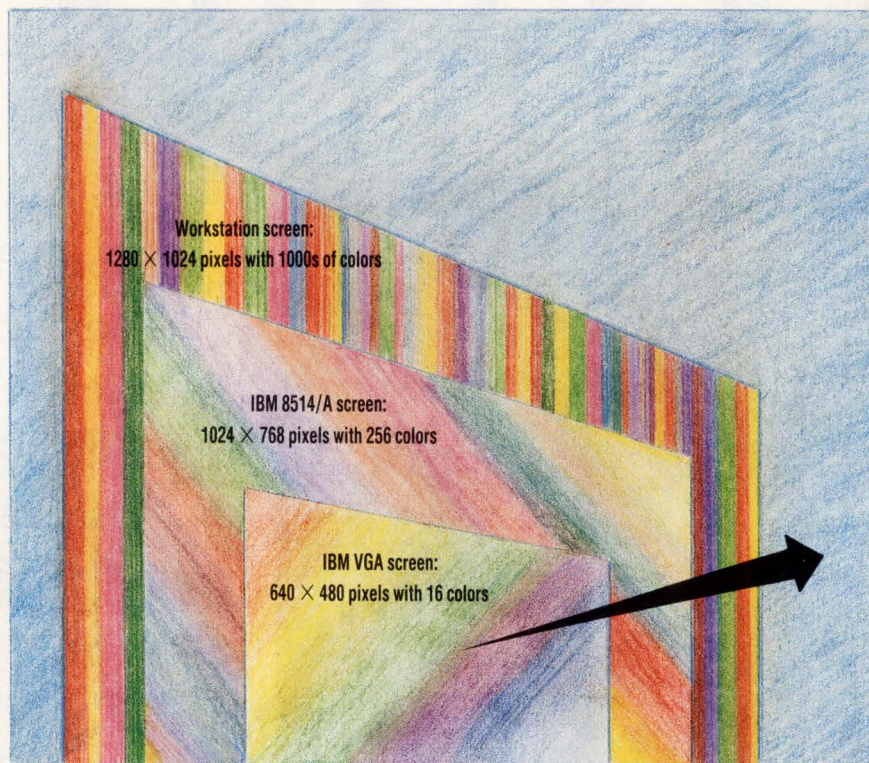

ALTHOUGH THE STANDARD VGA SCREEN offers what seems to be sufficient display area and resolution for most users, it's dwarfed when compared to the typical workstation screen. A typical megapixel workstation screen provides four times as many pixels and thousands of simultaneously displayable colors. In between the workstation and IBM VGA display lies IBM's 8514/A standard, which with 256 displayable colors and 1024-by-768-pixel resolution supplies more than twice the number of pixels over the VGA screen. That's slightly over half the pixels that a workstation's screen might deliver.

maha Integrated Systems. The 128-lead V6388 can control LCD, plasma, and EL panels with resolutions ranging from 320-by-200 to 640-by-480 pixels. Up to 16 colors or gray scales can be displayed at maximum resolution. A built-in RAMDAC holds the color mapping data and supplies analog or digital outputs for CRTs. External DRAMs or static RAMs can hold the video data.

Yamaha is also developing an advanced VGA-compatible controller two-chip set—the 128-lead AVCC advanced video CRT controller and the 80-lead AVPC advanced video panel controller. The chips support extended 800-by-600-pixel resolution with 16 colors on either flat panels or CRTs, and up to 1024-by-768 pixels with 16 colors only on CRTs. They can use 16-, 8-, or 4-bit-wide DRAMs, and static or pseudo-static RAMs for the video memory. They provide up

to 64 gray scales with monochrome displays, and up to 4096 colors with a color LCD panel.

Cirrus Logic's CL-610/620 and Chips and Technologies' 82C455 are designed for flat-panel control. The Cirrus chips don't have direct support for 16-bit-wide DRAMs and the internal RAMDAC, but can support 256-color modes and map those modes to 32 shades of gray. The CL-610/620 also include power-management logic and a hardware-assisted cursor. They can scale both text and graphics to fit flat-panel resolution.

Cirrus' CL-DG6340 supplements the 610/620 to improve the image quality of color LCD panels. The chip can take a standard 8-color LCD panel and make it appear as if it had 256 simultaneous colors (ELECTRONIC DESIGN, July 28, p. 43).

For non-flat-panel applications, Cirrus also offers the CL-510A/520A

Speed or size.

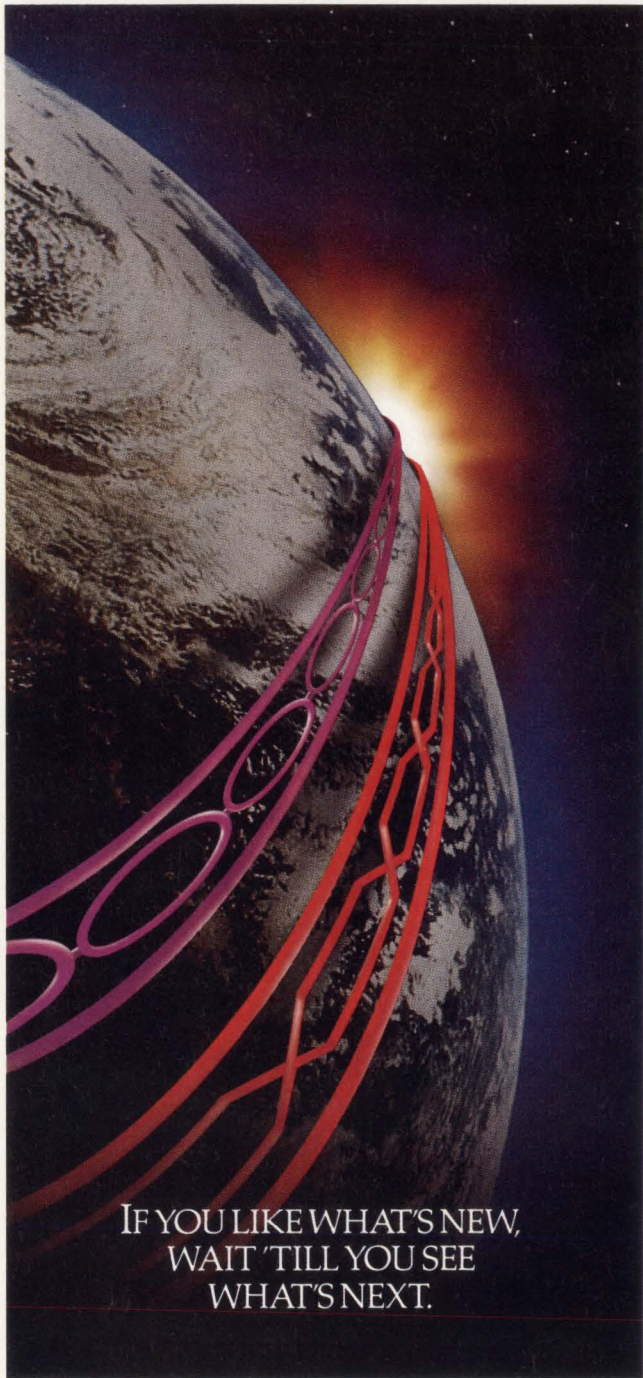

IF YOU LIKE WHAT'S NEW,
WAIT 'TILL YOU SEE
WHAT'S NEXT.

Get true no-wait-state performance in a 256K Fast Static RAM, with the famous reliability and performance that comes from Motorola's pure CMOS technology.

To squeeze 15ns access times out of a 256K Fast Static, we had to go to the drawing board and rethink Fast Static design from the start. First, we eliminated the need for shortcut measures like Address Transition Detection (ATD). We replaced them in a design that incorporates several new memory innovations.

LOOK WHAT'S NEW.

As part of our redesigned Fast Static architecture, we radically increased the array subdivisions to 32 blocks (with 128 rows and 64 columns per block). We then added small signal techniques, pre-amps,

Pick any two.

and current regulation throughout. The result is a 256K, pure CMOS Fast Static that keeps up with even the fastest 32-bit microprocessors.

Four versions of our 256Ks are available. The 64K x 4s and 256K x 1s are available with 15ns access times. The 32K x 8s and 32K x 9s both offer 17ns.

JUST TWO MORE OF MANY.

These new Fast Statics are just two of the many exciting products in Motorola's complete line of memories—which includes Fast Static RAMs, one and four-megabit Dynamic RAMs, 256K and one-meg Slow Statics, and modules. For more information, complete and return the coupon, or contact your local Motorola sales office, or call us toll-free at 1-800-521-6274.

MOTOROLA CMOS FAST STATIC RAMS				
256K x 1	MCM6207	15, 20, 25ns	PDIP, PSOJ	A
64K x 4	MCM6208	15, 20, 25ns	PDIP, PSOJ	
64K x 4 OE	MCM6209	15, 20, 25ns	PDIP, PSOJ	
32K x 8	MCM6206	17, 20, *25, †30, 35	PDIP, PSOJ	
32K x 9	MCM6205†	17, 20, 25ns	PDIP, PSOJ	
64K x 1	MCM6287	12, 15, 20, 25	PDIP, PSOJ	B
16K x 4	MCM6288	12, 15, 20, 25	PDIP	
16K x 4 OE	MCM6290	12, 15, 20, 25	PDIP, PSOJ	
8K x 8	MCM6264	15, 20, 25, 35	PDIP, PSOJ	
8K x 9	MCM6265	15, 20, 25, 35ns	PDIP, PSOJ	
4K x 4	MCM6268	20, 25, 35, 45	PDIP	C
4K x 4 CS	MCM6269	20, 25, 35ns	PDIP	
4K x 4 OE	MCM6270	20, 25, 35ns	PDIP, PSOJ	
Cache Tag RAM Comparators				
4K x 4	MCM4180	18, 20, 25ns	PDIP, PSOJ	C
4K x 4	MCM62350	20, 25ns	PDIP, PSOJ	D
4K x 4	MCM62351	20, 25ns	PDIP	
Synchronous Fast Static RAMs				
64K x 4	MCM62980/2	15, 20ns	PSOJ	E
4 x 64K x 1	MCM62981/3	15, 20ns	PSOJ	F
16K x 16	MCM62990†	20, 25ns	PLCC	G
16K x 4	MCM6293/4/5	20, 25, 30ns	PDIP, PSOJ	H
4K x 12	MCM62973/4/5	20, 25, 30ns	PLCC	
DSPRAM™				
8K x 24	MCM56824	25, 35ns	PLCC	J
Latched Fast Static RAMs				
8K x 20	MCM62820†	23, 30ns	PLCC	K
16K x 16	MCM62995†	17, 20, 25ns	PLCC	
BurstRAM™				
32K x 9*	MCM62940 (68040)	50, 40, 33 MHz	PLCC	M
32K x 9*	MCM62486 (i486)	50, 40, 33 MHz	PLCC	N
32K x 9*	MCM62960 (SPARC)	50, 40, 33 MHz	PLCC	O
Fast Static RAM Modules				
64K x 32	MCM3264†	20, 25ns	64 ZIP	P
256K x 8	MCM8256†	20, 25ns	60 ZIP	Q
2 x 64K x 24	MCM2464†	20, 25ns	58 ZIP	R

† Samples now, introduction in 3Q90. * Samples in 4Q90, introduction in 1Q91

To: Motorola Semiconductor Products, Inc.
P.O. Box 20912, Phoenix, AZ 85036

To get more information on Motorola FSRAMs, circle the letters in the shaded area that correspond with the devices you select.

440ED092790

Name _____
Title _____
Company _____
Address _____
City _____
State _____ Zip _____
Call me (_____) _____



MOTOROLA

chip set, which delivers 800-by-600-pixel resolution with 256 colors. Similar to the 610/620, the chips include a hardware-assisted cursor and a 32-bit-wide video memory interface.

Another recent addition, the CL-GD5320, integrates the functions of the 510 and 520 into one chip and includes some of the glue logic. The 100-lead IC permits a full VGA subsystem with a 800-by-600-pixel, 16-color display that's compatible with the Video Electronics Standards Association (VESA) standard to be constructed with a minimum of seven ICs. The chip—like Tseng Labs' ET4000—employs multiple internal FIFO buffers and a small CPU-to-memory read-write cache to make the DRAM and video-subsystem timing requirements independent of each other.

CRT AND LCD CHIPS

Three chips that control both CRTs and LCD panels form the Dragon chip set developed by S-MOS Systems. The SPC8000 controller handles the VGA operations, the SPC8010 or 8011 controls the LCD interface, and the SEA6461 RAMDAC ties the SPC8000 into a CRT subsystem. The LCD controller can convert color-palette information into 16 or 64 gray scales. For color LCD panels, S-MOS replaces the RAMDAC with another version, the SEA6462, and the LCD controller with an additional unit, the SPC8030. The 8030 can display up to 64 colors with resolutions reaching 800-by-600 pixels.

Trident's TVGA 8900A super-VGA controller, which slims down the designer's choice to one chip, has been available for about a year. With an interlaced or noninterlaced monitor, it can display up to 256 colors with resolutions of up to 1024-by-768 pixels. Similar to the Tseng Labs ET4000 and the Cirrus CL-GD5320, the TVGA 8900A includes a front-end cache to buffer data transfers for flicker-free display control. The chip can also drive plasma displays with resolutions reaching 640-by-480 pixels and 16 gray scales.

To handle complex character sets, such as Chinese or Japanese, Trident is developing the TBC8900. The chip

can handle character font cells up to 24-by-24 pixels in the graphics mode, and 16-by-16 pixels in the text mode.

One little-seen supplier for VGA products, NCR, just unveiled a high-performance controller, the 77C22. The company claims it can deliver up to 10 times the drawing speed of standard VGA controllers. The chip incorporates a smart host interface with a deep 32-word by 16-bit FIFO buffer and other logic that improves system throughput. Also available is an enhanced version dubbed the 77C22E, which offers short-cycle data-transfer rates of 75 ns—faster than AT-buses can handle.

The 160-lead chip also has clock-generator support, a bit-mapped cursor and hardware control, and expanded DRAM control to handle the 64k-by-16 memories. Dot-clock rates of up to 65 MHz are possible with the 77C22. Font widths of 4 or 7 to 16 pixels can be displayed on screens with resolutions of 1024-by-768 or 800-by-600 pixels and 16 colors or 640-by-480 with 256 colors. Up to 4 Mbytes of frame-buffer RAM can be addressed, allowing the chip to handle multitasking video, extended-display modes, and animation.

Delivering 800-by-600 displays with 16 or 256 colors and 1024-by-768 images with 16 colors (interlaced), the Poach 52 VGA controller from Zymos boils a super-VGA subsystem down to just five chips plus memory. The controller includes a FIFO buffer to lessen bus-transfer-rate dependence. As a result, 100-ns DRAMs can be used—even with all of the enhanced modes. Using 4- or 16-bit-wide DRAMs, the controller enables a minimal-space VGA subsystem to be included on a system motherboard or occupy a small portion of an add-in card.

Also offering similar operating modes is the OTI-067, a super-VGA controller from Oak Technology. The 144-lead chip displays up to 256 colors in 800-by-600-pixel images, 16 colors in 1024-by-768-pixel screens, and offers a unique portrait mode with 4 colors and a 768-by-1024-pixel format. Both interlaced and noninterlaced monitors can be driven with a 65-MHz dot clock.

For simpler super-VGA systems, the company also offers the OTI-037. This chip has an 800-by-600-pixel 16-color extension and is in a 100-lead PQFP. Competing with the OTI-037 is the UM587 controller from United Microelectronics. The chip supports the 800-by-600-pixel 16-color extension as well as 132-column text modes. It also supplies basic VGA functionality in a 100-lead PQFP.

THE NEXT LEVEL

Beyond the VGA, IBM's 8514/A graphics standard has become the goal for many PC chip and board manufacturers. Although its resolution is the same as that of the highest end of VGA—1024-by-768 pixels—the controller's performance and intelligence is much higher. The higher performance comes from the controller implementing some operations in hardware rather than software. The operations integrated in silicon include bitBLT, line drawing, color mixing, polygon filling, pattern filling, and scissoring (post clipping).

The complex circuitry of the controller chip, though, makes developing functionally compatible silicon rather difficult. This challenge is further exacerbated because IBM released only its adapter interface (AI) definition, rather than a hardware register specification. By releasing only the AI, IBM hoped that all software developers would create their programs using the calls rather than relying on specific hardware features. If that was done, then the underlying hardware could be updated with no change to the software.

The 8514/A specification doesn't define a separate text mode in hardware. Rather, text is supported in the graphics mode, thus enabling characters to be any size. However, the AI does define three standard text modes for the 1024-by-768-pixel resolution option: mode 0 with 85 characters on 38 lines with a 12-by-20-pixel character cell; mode 2 with 128 characters on 54 lines and an 8-by-14 character cell; and mode 3 with 146 characters by 51 lines and a 7-by-15 character cell. With a 640-by-480-pixel screen, the AI also supports an 80-character-by-34-line screen (8-by-

JUST KEEP ADDING CHANNELS.



Analytek 2000—the only Waveform Sampling System that expands in 4, 8, or 16-channel modules up to 196 channels.

We started out right. We built the Analytek 2000 Waveform Sampling System using VME/VXI architecture. A smart move for you. You're not stuck with just a few channels like one competing system. Nor do you have to buy an additional base system each time you add another four channels, like you

do with another competitor.

Our modular design allows the Analytek 2000 to expand all the way up to 196 channels with the same sampling, timing and processor cards.

Every time you add channels, you can do so without facing a programming nightmare.

And mixing and matching sampling modules allows you to trade channel count for sampling

speed and record length as your needs change.

You can also incorporate *any* add-ons from other manufacturers that tie into the VME/VXI bus—memory cards, disk drive controllers, instruments, you name it.

Remarkable specs.

Easy to use.

The Analytek 2000 offers the best specs of any waveform sampling system: 2 GS/s sampling speed, 12-bit digitizing resolution, greater than 60 dB dynamic range. It's extremely easy to use; every operation is mouse driven via on-screen menus.

And there's the extraordinary price, as low as \$1,200 per channel.

Grow now; grow later. The Analytek 2000 is the high-performance waveform sampling system optimized for expansion. Call your local Tektronix sales engineer or call Analytek at **(800) 366-5060**. FAX (408) 745-1894. 365 San Aleso Drive, Sunnyvale, CA 94086.

	Le Croy 6880B	HP 54111D	Analytek Series 2000
Maximum Channels per Chassis	6 @ 1.3 GS/s	1 @ 2 GS/s 2 @ 1 GS/s	12 @ 2 GS/s 24 @ 1 GS/s 48 @ 500 MS/s 96 @ 250 MS/s 192 @ 125 MS/s
Sampling Speed	1.3 GS/s Fixed	Up to 2 GS/s Programmable	Up to 2 GS/s Programmable
Dynamic Range	Not Specified	Not Specified	>60 dB
Vertical Resolution	.1%	1.56%	.05%

*Let us show you
what you've been missing.*



CIRCLE 143

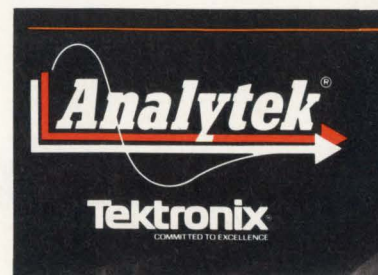

The IBM RISC System/ Designing on any other workstation



Whatever you're creating, you'll sail into a whole new age with any of the four POWERstations in the RISC System/6000 family. Because POWER (Performance Optimization With Enhanced RISC) processing can give you performance you've probably only dreamed about:

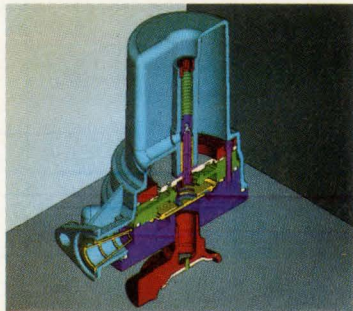

up to four instructions per machine cycle, 42 MIPS and 13 MFLOPS. Suddenly, complex designs don't take eons anymore.

The four RISC System/6000 POWERstations feature a range of graphics processors from grayscale to Supergraphics to satisfy any graphics demand. Great news for Power Seekers working on animation, scientific visualization, medical imaging and engineering solutions like CADAM™, CAEDS™ and CATIA™. And for electrical design automation, there's IBM's all new CBDS™ and an arsenal of over 60 EDA appli-

6000™ family. will seem downright primitive.

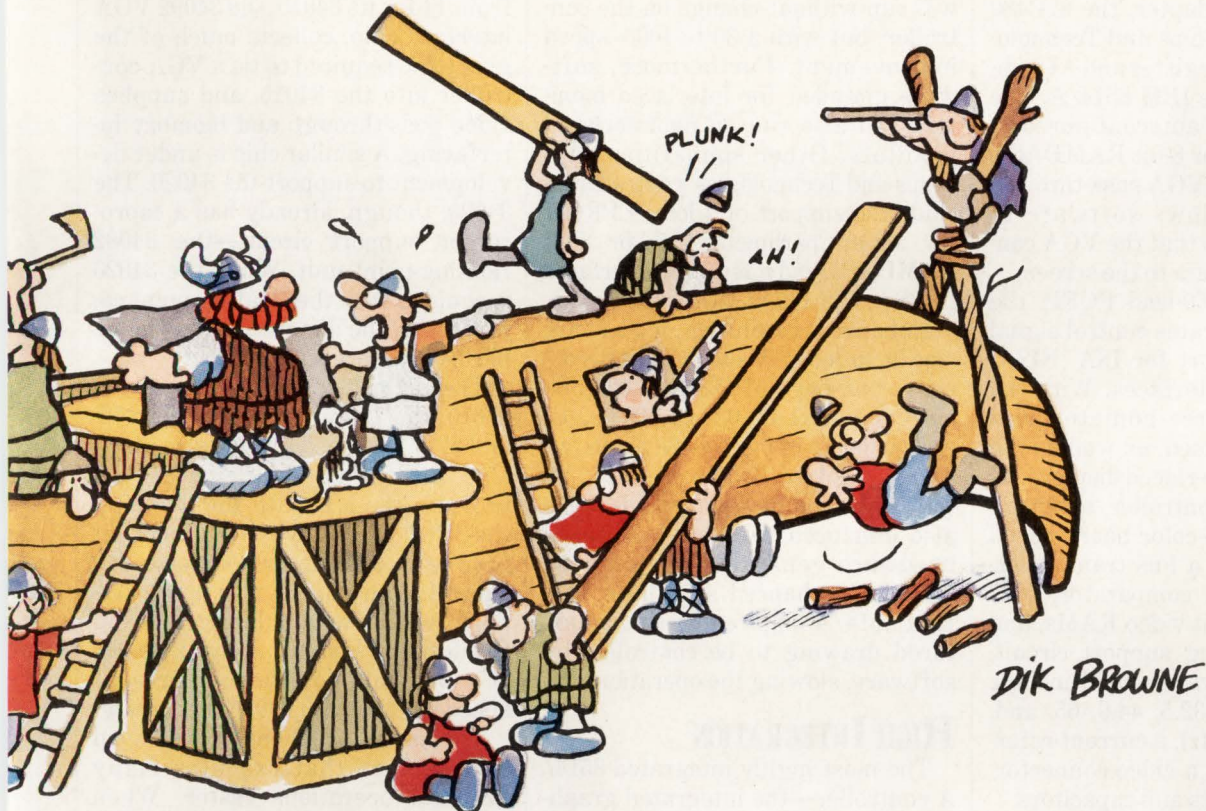

cations from more than a dozen vendors.

With every POWERstation, you can get an almost unimaginable palette of 16 million colors, which gives you 3D images so realistic, they fairly leap off the screen, with super sharp resolution of 1,280x1,024 pixels. And when it's time to call in the heavy artillery, the POWERstation 730 draws nearly one million 3D vectors per second. Like all POWERstations, it can come complete with its own graphics processor, freeing the POWER processor to rapidly create and analyze your designs. All at prices that won't sink anybody's budget.

So if you're tired of paddling upstream with yesterday's performance, call your IBM marketing representative or Business Partner to find out more about the RISC System/6000 family. For literature, call 1 800 IBM-6676, ext. 991.

Civilization never looked so good.



For the Power Seeker.

14-pixel character cell).

Up to now, only three companies have released dedicated chips or chip sets to implement the 8514/A standard—Chips and Technologies, Western Digital's Imaging Products division, and Integrated Information Technology. Boiling down the number of chips to just nine to build a complete basic adapter, the 82C480 controller from Chips and Technologies offers both register and AI compatibility with the IBM 8514/A. The controller can be autoconfigured to tie into either 6- or 8-bit RAMDACs. Also included is a VGA pass-through mode, which allows software to switch the chip so that the VGA controller can send data to the screen.

Housed in a 160-lead PQFP, the chip also incorporates control-signal and timing support for ISA, EISA, and MCA bus interfaces. With the circuit, flicker-free noninterlaced displays can be used, as well as the IBM standard interlaced displays. In addition to the controller, all that's required for a 16-color board based on the 82C480 is a bus transeiver, the RAMDAC, a comparator, four 256-kword-by-4-bit video RAMs, and the 82B484 timing support circuit. Additional hardware would include crystals (25.175, 32.5, 44.9, 65, and, optionally, 80 MHz), a current reference and a diode, a video connector, and a few resistors and capacitors.

With 512 kbytes of display memory, the chip provides 16 or 256 displayable colors in the 640-by-480-pixel mode, and 16 colors in the 1024-by-768-pixel mode. By doubling the display memory (four additional 256k-by-4 video RAMs), 256 colors can be delivered in the 1024-by-768-pixel mode. An EPROM for power-on self-test code storage can be added as an option. The chip can check for the ROM automatically and execute the code when it's turned on. Furthermore, the controller can also support resolutions of up to 2540-by-2048 pixels, interlaced or noninterlaced, with video data rates of up to 300 MHz.

Implementing similar 8514/A functionality on a pair of chips, Western Digital's personal-workstation graphics-array (PWGA1) chip

set divides the control task into a pixel address manager and pixel data manager, both housed in 132-lead fine-pitch PQFPs. Independent video and data clocks enable designers to optimize system timing.

As with the Chips and Technologies 8514/A controller, all software written for the IBM 8514/A adapter will run without change on the controller, but with a 30 to 100% speed improvement. Furthermore, software intended for interlaced monitors will also run on noninterlaced monitors. Other similarities with Chips and Technologies' controller include the support of a local EPROM for set-up parameters, 6- or 8-bit RAMDACs, and integrated interfaces for ISA, EISA, and MCA buses.

Enhanced resolution modes are also included in Western Digital's design—one page of 1280-by-1024 pixels, two pages of 1024-by-768 pixels, or two pages of 640-by-480 pixels, all with 256 colors, can be displayed by the chip. Graphics commands were also enhanced to allow high-speed hardware generation of textured lines and enhanced solid lines. The IBM 8514/A chip requires such textured drawing to be controlled by software, slowing the operation.

HIGH INTEGRATION

The most highly integrated 8514/A controller—the integrated graphics adapter (IGA) from Integrated Information Technology—combines both the 8514/A controller and the VGA controller on one chip. As a result, the company eliminates the VGA display card typically required for VGA-pass-through when both VGA and 8514/A software must display data. Housed in a 144-lead PQFP, the controller supports interlaced or noninterlaced displays, runs with dot-clock rates of up to 65 MHz, and can be used with standard DRAM to implement a single frame buffer for the video memory. Displays with 256 colors and resolutions of 640-by-480, 800-by-600, and 1024-by-768 pixels can be created.

Alternatively, the 8514/A standard can be implemented with a general-purpose off-the-shelf graphics processor, such as the TMS34010 or

34020 from Texas Instruments. More than a dozen board-level manufacturers have done just that: By employing either of the two processors, they implemented either AT, EISA, or MCA-compatible graphics cards as well as cards for such systems as VME or Multibus backplanes.

A recently released support chip from TI for its 34010, the 34092 VGA interface chip, collects much of the glue logic required to tie a VGA controller into the 34010, and supplies video pass-through and memory interfacing. A similar chip is under development to support the 34020. The 34020, though, already has a coprocessor support circuit—the 34082 floating-point unit. When the 34020 is coupled with the floating-point coprocessor, the duo makes a formidable 3D graphics engine.

The highest-speed version of the 34010 runs at up to 60 MHz, with 40- and 50-MHz speed grades also available. Although a 16-bit external bus provides the I/O path for the data, the 34010 internally contains a 32-bit processor core optimized for video control. The chip can support displays with up to 16 million colors and resolutions reaching 4k-by-4k pixels. It's possible to draw images at speeds of about 50,000 2D vectors/s.

The newer 34020 has an improved architecture that executes many graphics operations faster. When running at 40 MHz, the 34020 would be equivalent to an 80-MHz 34010, which at 40 MHz give the 34020 a throughput of about 10 MIPS and a drawing speed of about 200,000 vectors/s. Some operations were accelerated by as much as 50-fold over those in the 34010. To get the speed, TI included a full 32-bit wide external bus structure, a 512-byte instruction cache, enhanced instructions, direct support of special features included in the latest megabit video RAMs, and a coprocessor interface for a floating-point accelerator.

The companion floating-point processor delivers 32 MFLOPS of single-precision calculations when running at 32 MHz and 40 MFLOPS at 40 MHz. TI is now sampling only the 32-MHz version. Multiple floating-point units can be included in a graphics

OPEN A NEW CHAPTER IN BOBBIN HISTORY... WITH ASPECT® TPPE.

If your objective is the efficient production of quality bobbins, look into Aspect® TPPE.

This Application Specific Plastic from Phillips 66 is stiff enough for high-speed winding. And tough enough to thrive on the assembly line. It comes glass fiber reinforced in natural and flame-retardant grades.

Above all, Aspect TPPE offers ease of processing you never thought possible in a thermoplastic polyester.

From now on, demand:

- *Smooth processing.* The secret is

the flow. Aspect TPPE fills the most intricate parts precisely—even at low injection pressure. Aspect TPPE releases smoothly, too.

- *High-temperature endurance.* With a 264 psi heat distortion temperature over 210°C, Aspect TPPE can take the heat. Long term. After 17 weeks at 220°C, Aspect TPPE still retains over 50% tensile strength.
- *Back up for your designs.* The Phillips 66 Plastics Technical Center can help you design, mold, and evaluate tomorrow's bobbins. Before full-scale production. With computer-aided design. Prototyping and testing. And expert analysis—by engineers who know a winner when they see one.

Along with Aspect TPPE, Phillips 66 offers Ryton® PPS, the resin that sets the standard for high-temperature performance in electrical/electronic applications. And with all Application Specific Plastics, you can count on statistically controlled quality, plus personal support, from concept through the production epilogue. To learn more about Aspect TPPE, call **1-800-53-RESIN.**

The next chapter is yours.

ASPECT®

TPPE

©MCMXC Phillips 66 Company

**PLASTICS WITH
POWER TO WIN®**



SIEMENS

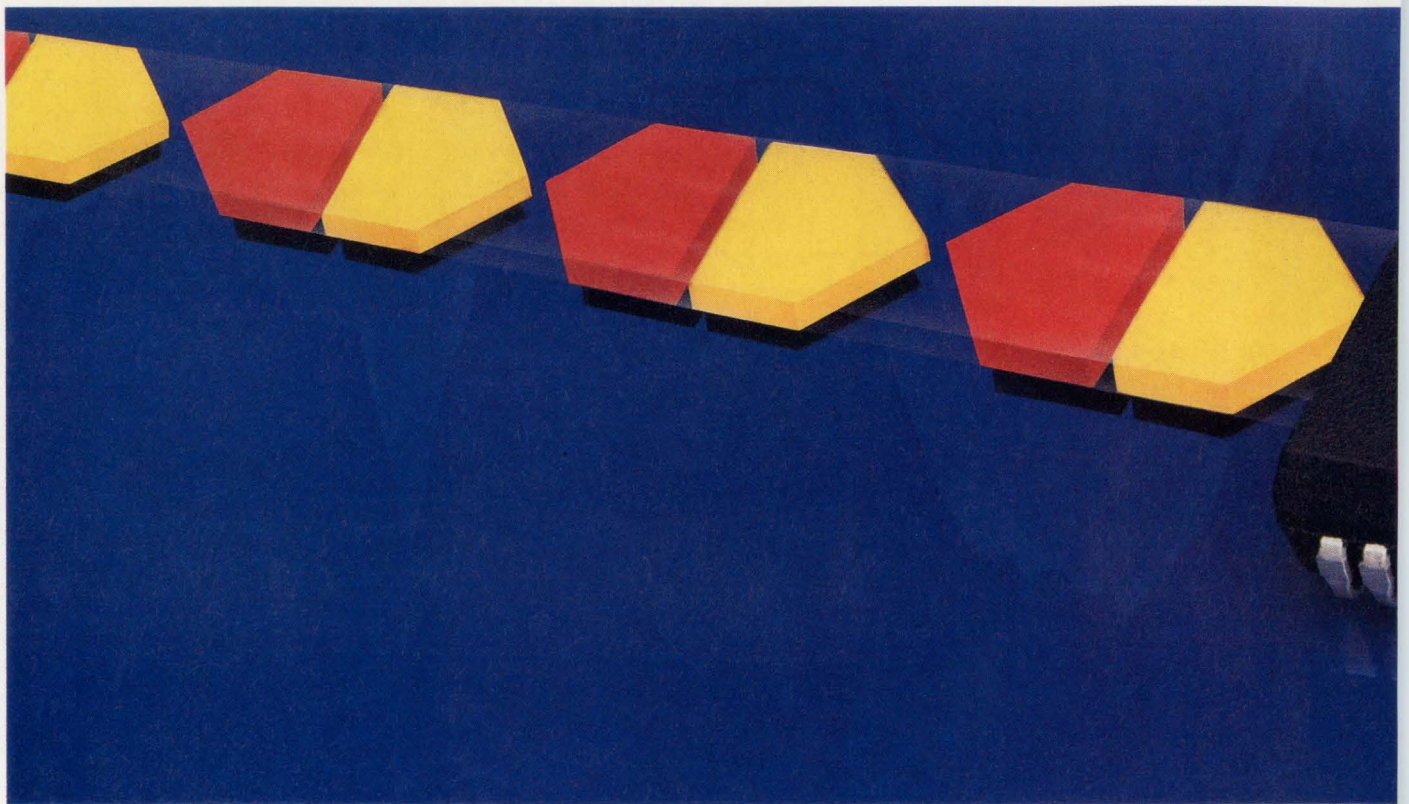

Sound Strategy.

Siemens announces a single-chip echo cancellation U-interface device for ISDN networks of all sizes. From switching to transmission, a clearly superior solution. Berlin to Iselin.

Siemens has won another sound victory in communications technology by developing the industry's first single-chip solution in CMOS for echo cancellation circuit functions in ISDN. It's a clear example of the innovative thinking which has made Siemens a leader in ISDN technology.

From its single-chip design to its ease of integration, the Siemens PEB 2091 ISDN Echo Cancellation Circuit (IEC-Q) represents a milestone in ISDN realization. This device can double the traffic-handling capability in existing telephone lines, and is ideal for appli-

The best address for Siemens Semiconductors:

(A) Wien, Tel. (0222) 71711-5661 (AUS) Melbourne, Vic. 3121, Tel. (03) 4 20 7111 (B) Bruxelles, Tel. (02) 5 36-2111 (BR) Sao Paulo-SP, Tel. (011) 8 33-2211 (CDN) Mississauga L5T 1P2, Tel. (416) 564-1995 (CH) Zurich, Tel. (01) 4 95-3111 (D) Berlin 10, Tel. (0 30) 3939-1; Duesseldorf 1, Tel. (0211) 3 99-0; Frankfurt 1, Tel. (0 69) 7 97-0; Hamburg 1, Tel. (0 40) 28 89-0; Hannover 81, Tel. (0511) 8 77-0; Muenchen 80, Tel. (0 89) 92 21-43 80; Nuernberg 1, Tel. (09 11) 6 54-0; Stuttgart 1, Tel. (07 11) 20 76-0 (DK) Ballerup, Tel. (44) 77 44 77 (E) Madrid, Tel. (01) 555 4062 (F) Paris, Tel. (1) 49 22-3810 (GB) Sunbury on Thames, Tel. (09 32) 75 2615 (GR) Amaroussio, Tel. (01) 68 64-111 (HK) Hongkong, Tel. 5-833 02 22 (I) Milano, Tel. (02) 67 66-42 41 (IND) Bombay 400018, Tel. 4 93 87 86

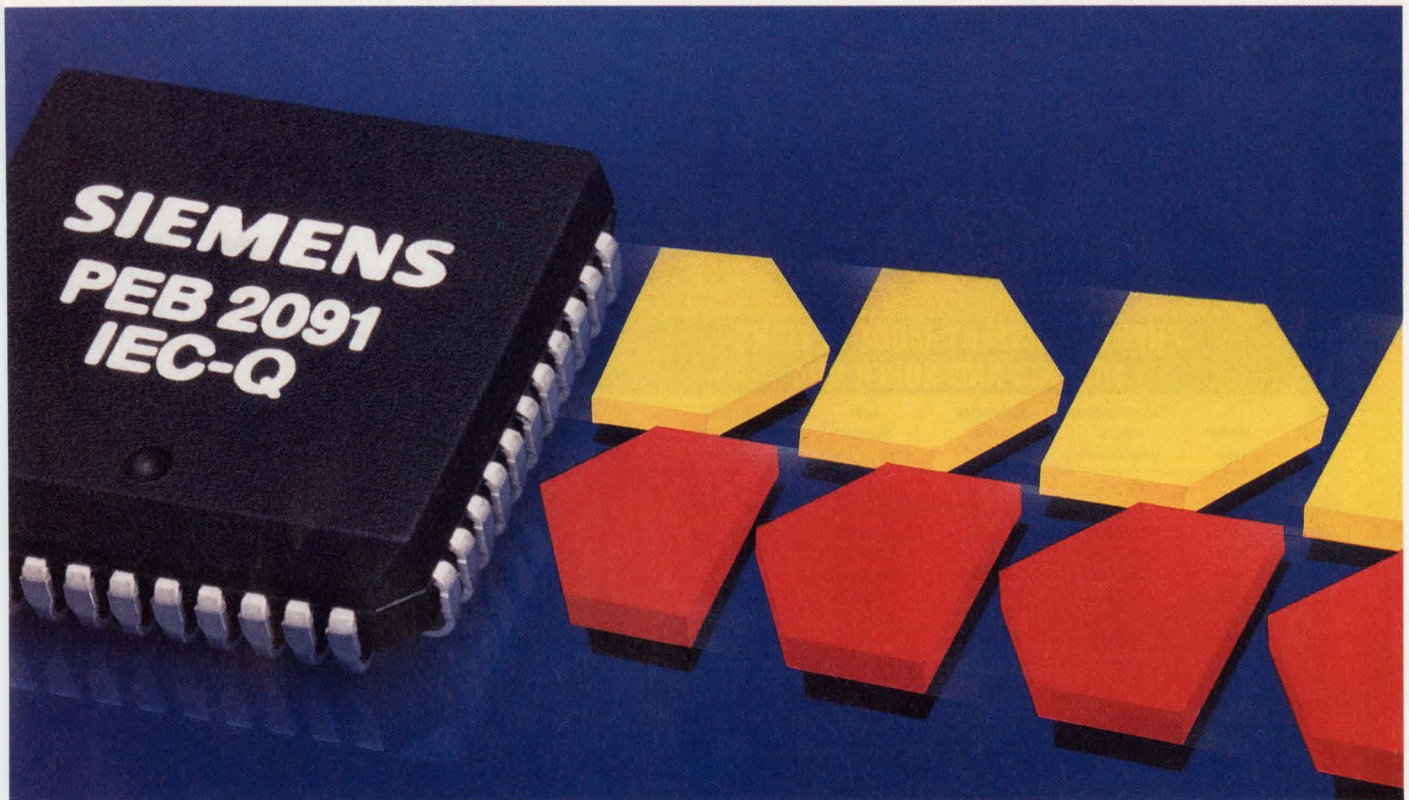

cations in transmission systems such as digital added main line, pair gain systems and intelligent channel banks.

Through its single-chip design and CMOS technology, the advanced PEB 2091 reduces space requirements and software overhead, and has lower power consumption requirements than any other design. And it supports ISDN Oriented Modular (IOM) architecture, the de facto standard for ISDN, which makes installation simple, and enables it to work in tandem with the most advanced ICs available.

Building upon the most comprehensive line of ISDN ICs in the industry, the PEB 2091 sends a clear signal that Siemens is continuing to take

great strides in telecommunications. Siemens was the first company to design a two-chip U-interface trans-

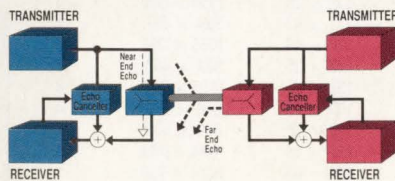

Siemens uses CMOS technology to provide a superior echo cancellation solution with the lowest power consumption requirements.

ceiver for the 4B3T block code used in Europe, and developed the first single-chip device for the 2B1Q code established in North America. And the PEB 2091 meets the requirements of the American National Standard for Telecommunication.

Our unsurpassed line of ISDN ICs are complemented by a wide array of microprocessors, microcontrollers, DRAMs, optoelectronic devices, and more. So you can count on Siemens to provide the best solution for all of your IC applications, and telecommunication products which reflect the sound thinking that has made Siemens a leader in ISDN.

For more information on our advanced products, call (800) 456-9229.

Or write:

Siemens Components, Inc.
2191 Laurelwood Road
Santa Clara, CA 95054-1514.
Ask for literature package M12A006.

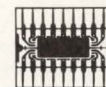

Siemens
Practical Solutions By Design.

(IRL) Dublin, Tel. (01) 30 28 55 (J) Tokyo 100, Tel. (03) 2 01-24 01 (N) Oslo 5, Tel. (02) 63 30 00 (NL) Den Haag, Tel. (0 70) 3 33 33 33
(P) Alfragide, Tel. (01) 4 18 33 11 (RA) Buenos Aires, Tel. (01) 30 04 11 (RC) Taipei, Tel. (02) 5 23 47 00 (ROK) Seoul, Tel. (02) 2 75-61 11
(S) Stockholm, Tel. (08) 7 28 10 00 (SF) Helsinki, Tel. (9) 05 10 51 (SGP) Singapore 0513, Tel. 7 76 00 44
(TR) Istanbul, Tel. (01) 1 51 09 00 (USA) Santa Clara, Tel. (408) 980-4500 (ZA) Johannesburg, Tel. (0 11) 4 07-41 11

© 1990 Siemens Components, Inc. M12A006

EXTENDING THE STANDARDS

In the world of IBM-compatible PCs, visual output is usually defined by an alphabet soup of progressive standards. These standards started with the monochrome display adapter and its 320-by-200-pixel resolution, and have improved gradually since then. Today's latest offering, the video graphics adapter (VGA), includes almost all previous PC display standards plus numerous enhanced modes by offering over a dozen program-able display resolution and color

options (see the table).

The basic VGA display options, defined by the mode settings, include previous color-graphics-adapter (CGA), and enhanced-graphics-adapter (EGA) modes for backwards compatibility. The best of the pre-VGA standard modes is the EGA standard with its 640-by-400-pixel and 16-color resolution. Many companies also extended the EGA standard to achieve VGA-level resolution, but the popularity of "Super EGA" was short-lived due to the rapid

acceptance of VGA.

However, never content to accept just the VGA standard, many manufacturers extended the standard to add 800-by-600- and 1024-by-768-pixel resolution modes, and expanded the color options from 16 to 256. However, each chip or board maker selected or implemented the superset of features with their own twists that often makes their version incompatible with a similar resolution unit from another company. Most recently, several novel modes, such as a two-color 1280-by-1024, or a four-color 768-by-1024-pixel portrait mode have appeared (not listed in the table).

In turn, each video card manufacturer must provide a library of video driver software so users can take advantage of the extended-display modes. Such a large software undertaking results in a poor use of technical resources. It would be much more efficient if the application software developer could include a "universal" driver, which would check to see if a mode was available.

To get some degree of standardization, many chip, card, and monitor suppliers created an organization that will try to set up extended-mode standards for graphic adapters, monitor scan rates, signal timing relationships, and other aspects of video subsystems. The Video Electronics Standards Association (VESA) has over 50 members. It obtained agreement for an 800-by-600-pixel, 16-color standard (VS900602) that defines a common software interface to the VGA BIOS.

The committee is working on standards that define a common range of ROM addresses and register names for 8514/A-compatible boards in an AT bus (VS890802-1 and VP900308-1).

To contact VESA, call Jan Shepard, executive director, (408) 971-7525; 1330 South Bascom Ave., Suite D, San Jose, CA 95128.

POPULAR DISPLAY-MODE OPTIONS FOR VGA AND SUPER VGA

Mode number (hex)	Mode type	Simultaneous colors/palette size	Character matrix (pixels)	A/N format (row × col.)	Display resolution (pixels)	Maximum pages
0,1	A/N	16/256k	8 × 8	40 × 25	300 × 200	8
0,1 ¹	A/N	16/256k	8 × 14	40 × 25	320 × 350	8
0,1 ²	A/N	16/256k	9 × 16	40 × 25	360 × 400	8
2,3 ³	A/N	16/256k	8 × 8	80 × 25	640 × 200	8
2,3	A/N	16/256k	8 × 14	80 × 25	640 × 350	8
2,3	A/N	16/256k	8 × 16	80 × 25	720 × 400	8
4,5	APA	4/256k	8 × 8	40 × 25	320 × 200	1
6	APA	2/256k	8 × 8	80 × 25	640 × 200	1
7	A/N	—	9 × 14	80 × 25	720 × 350	8
7 ²	A/N	—	9 × 16	80 × 25	720 × 400	8
8 through C RESERVED						
D	A/N	16/256k	8 × 8	40 × 25	320 × 200	8
E	APA	16/256k	8 × 8	80 × 25	640 × 200	4
F	APA	—	8 × 14	80 × 25	640 × 350	2
10	APA	16/256k	8 × 14	80 × 25	640 × 350	2
11	APA	2/256k	8 × 16	80 × 30	640 × 480	1
12	APA	16/256k	8 × 16	80 × 30	640 × 480	1
13	APA	256/256k	8 × 8	40 × 250	320 × 280	1
54 ³	A/N	16/256k	7 × 9	132 × 43	924 × 387	2
54 ⁴	A/N	16/256k	8 × 9	132 × 43	1056 × 387	2
55 ³	A/N	16/256k	7 × 16	132 × 25	924 × 400	4
55 ⁴	A/N	16/256k	8 × 16	132 × 25	1056 × 400	4
56 ³	A/N	4/mono	7 × 9	132 × 43	924 × 387	2
56 ⁴	A/N	4/mono	8 × 9	132 × 43	1056 × 387	2
57 ³	A/N	4/mono	7 × 16	132 × 25	924 × 400	4
57 ⁴	A/N	4/mono	8 × 16	132 × 25	1056 × 400	4
58 ⁴	APA	16/256k	8 × 8	100 × 75	800 × 600	1
59 ⁴	APA	2/mono	8 × 8	100 × 75	800 × 600	1
5A	APA	2/256k	8 × 16	128 × 48	1024 × 768	1
5B	APA	4/256k	8 × 16	128 × 48	1024 × 768	1
5C	APA	256/256k	8 × 8	100 × 75	800 × 600	1
5D	APA	16/256k	8 × 16	128 × 48	1024 × 768	1
5E	APA	256/256k	8 × 16	80 × 25	640 × 400	1
5F	APA	256/256k	8 × 16	80 × 30	640 × 480	1

Notes: A/N = Alphanumeric APA = all points addressable

¹ EGA enhanced text modes (350 scan lines)

² Enhanced text modes (400 scan lines)

³ Fixed-frequency monitor setting. The character font must be loaded by the software application or driver.

⁴ Multifrequency monitor setting. The monitor setting is DIP-switch selectable and can be determined by reading PR register 3CFH.

General comments: Chart includes all backwards-compatible EGA, CGA, Hercules modes.

Mode 5F can only be set if 512 kbytes of video memory exist.

³ is the power-on default mode for a color monitor.

⁷ is the power-on default mode for a monochrome monitor.

Cursor is not displayed in the all-points-addressable modes.

TEXAS INSTRUMENTS

A PERSPECTIVE ON DESIGN ISSUES:

Creating systems with an analog edge

IN THE ERA OF

MegaChip

TECHNOLOGIES



Advanced Linear can help you raise system performance levels.

A leadership family of analog circuits from Texas Instruments is helping designers meet difficult design challenges.

The evidence is strong. Throughout the design community, systems using the new breed of Advanced Linear functions from Texas Instruments are achieving the keener performance edges that can spell marketplace success.

TI's new analog devices are enabling design engineers to link digital brains to analog worlds more effectively and efficiently than ever before. Some offer new standards of accuracy or speed while others are highly integrated devices combining analog and digital functions on a single chip. The result is superior system performance and design flexibility.

These Advanced Linear functions are the result of leadership process technologies that we at TI firmly believe are the key to the advanced analog devices your future applications will demand.

Intelligent power for automobiles

Designers in the automotive industry face a tough challenge: Handle high reverse voltages and achieve rapid load turnoff while providing fault protection, detection, and reporting and efficient load management. To provide the needed intelligent power devices, we developed one of our newest process technologies, Multi-EPI Bipolar. It is unique because it can combine rugged power transistors with intelligent control functions.

The resulting circuits are now providing reliable, cost-efficient control of solenoids and valves in such automotive applications as antiskid braking systems, electronic transmission controls, and active suspension systems.

Other industry segments are also benefiting from TI's Advanced Linear process technologies. Here are a few of the winning designs to which we have helped add an analog edge:

Toledo Scale

Challenge: Improve the accuracy of point-of-purchase scales by eliminating drift over time and temperature.

Solution: The TI TLC2654 Chopper op amp. Our Advanced LinCMOS™ process makes possible chopping frequencies as high as 10 kHz, reducing noise to the lowest in the industry.



Pulsecom

Challenge: Develop a linecard capable of driving low-impedance loads with greater precision.

Solution: Our TLE206X family of JFET-input, low-power, precision operational amplifiers. These devices offer outstanding output drive capability, low power consumption, excellent dc precision, and wide bandwidth. Fabricated in our Excalibur process, they remain stable over time and temperature.

Leitch Video

Challenge: Design a compact, cost-efficient direct broadcast satellite TV descrambler for consumer use.

Solution: TI's TLC5602 8-bit Video DAC. Our LinEPIC™ process combines one-micron CMOS with precision analog to satisfy the demands of the application for video speeds and low-power operation.

U.S. Robotics

Challenge: Build a modem for high-speed data transmission between computers; allow flexible operation and minimize data errors.

Solution: Our TLC32040 Analog Interface Circuit (AIC). A product of our Advanced LinCMOS process, the AIC combines programmable filtering, equalization, and 14-bit A/D and D/A converters with such digital functions as control circuitry, program registers, and a DSP interface.

Xerox

Challenge: Cut component count and cost of copier systems while boosting reliability.

Solution: Our TPIC2406, a top-performance peripheral driver in a standard DIP package that is capable of driving heavy loads. It is fabricated using our Power BiDfET™ process which permits greater circuit density and incorporates CMOS technology for low total power dissipation.

Mr. Coffee

Challenge: Design an intelligent coffee maker that brews faster, maintains optimum temperature, shuts off automatically, and has a built-in cleaning cycle.

Solution: Our LinASIC™/LinBiCMOS™ capability permits us to combine both analog and digital library cells with custom analog cells. This results in cost-efficient integration of temperature monitoring, timing, and high-current outputs on a single control chip.

All of these examples point to one conclusion: TI's Advanced Linear functions are adding an analog edge to many system designs. They are contributing significantly to the enhanced system performance that marks a market winner.



WORLDWIDE MERCHANT IC MARKET

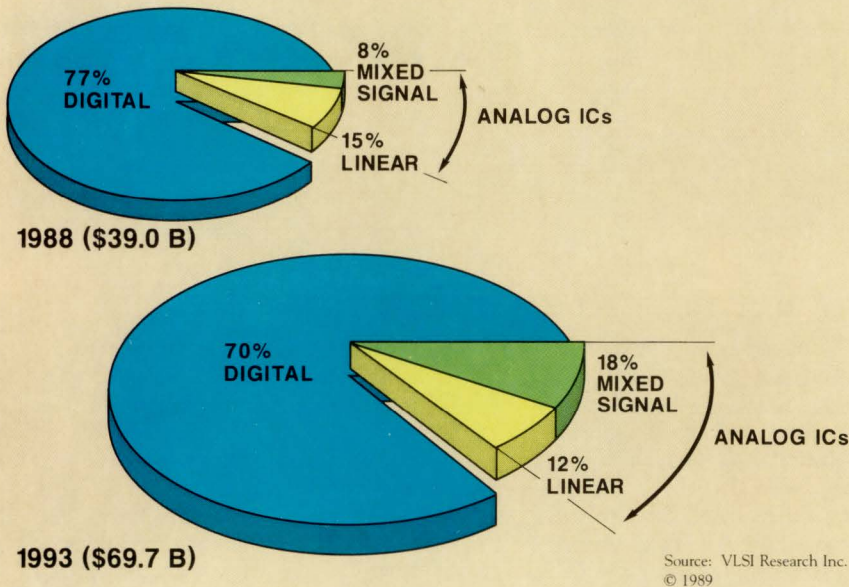

TI's Leadership Analog Processing Technologies

LinBiCMOS — Combines Advanced LinCMOS, digital ASIC CMOS, and up to 30-V bipolar technologies to allow the integration of digital and analog standard cells and handcrafted analog components on a monolithic chip.

LinEPIC — One-micron CMOS double-level metal, double-level polysilicon technology, which adds highly integrated, high-speed analog devices to the high-performance digital EPIC process.

Advanced LinCMOS — An N-well, silicon-gate, double-level polysilicon process featuring improved resistor and capacitor structures and having three-micron minimum feature sizes.

Power BIDEFET — Merges standard linear bipolar, CMOS, and DMOS processes and allows integration of digital control circuitry and high-power outputs on one chip. Primarily used for circuits handling more than 100 V at currents up to 10 A.

Multi-EPI Bipolar — A very cost-effective technology that utilizes multiple epitaxial layers instead of multiple diffusion steps to reduce mask steps by more than 40%. Used to produce intelligent power devices that can handle loads as high as 20 A and voltages in excess of 100 V.

Excalibur — A true, single-level poly, single-level metal, junction-isolated, complementary bipolar process developed for high-speed, high-precision analog circuits providing the most stable op amp performance available today.

If you would like a more detailed explanation of our Advanced Linear process technologies, please call 1-800-336-5236, ext. 3423. Ask for a copy of our *Advanced Linear Circuits* brochure.

™ Trademark of Texas Instruments Incorporated ©1990 TI 08-0082



Helping you implement your designs in a changing world.

An increasing share of the total analog market is being captured by mixed-signal devices. As they gain more widespread acceptance, they are driving the expansion of the overall analog market (see above).

Changes such as this are the order of the day in the IC marketplace. Texas Instruments continues to provide not only the high-performance circuits you need but also the depth of experience, support, and service fundamental to successful completion of your designs.

**Experience:
Building on three decades in ICs**

We at TI can successfully meet your requirements for mixed-signal devices because we have acquired the necessary knowledge from 30 years of experience in developing both analog and digital functions. We have also drawn upon our digital ASIC strengths in developing our LinASIC capabilities.

**Support:
Speeding our chips to you**

The faster we move new products through our design cycles, the faster you can get through yours.

We employ a wide variety of design-automation tools and sophisticated software to speed our development process.

**Service:
Providing a surety of supply**

However advanced our circuits may be, they are of little value if they are inaccessible to you. TI operates on the principle of global coverage, local service. We manufacture semiconductors in 13 countries and operate support centers in 22. We have product and applications specialists, designers, and technicians around the world. They are linked by one of the world's largest privately owned communications networks so that we can bring you our best — circuits and support — from wherever they may be to wherever you are.

Keeping our communications open

The relationship between you as customer and us as vendor is vital: You are our chief source for firsthand information that can help guide us in developing the circuits you will need for your future designs. We at TI welcome your comments and your suggestions.

GRAPHICS CHIPS

accelerator to improve the drawing speed.

Close to two dozen cards offered by nearly as many manufacturers employ either TI's 34010 or 020. One example consists of the Info IGX and SGX from Nissei Sangyo America. The IGX card is based on the 34010. It provides a 1280-by-1024-pixel display and emulates 8514/A, VGA, and CGA controllers. Higher-performance SGX cards use the 10 MIPS 34020 and deliver either 1280-by-1024- or 1600-by-1280-pixel displays with VGA and 8514/A emulation modes. All three cards can display 256 colors simultaneously from a pal-

ette of 16.7 million.

Some of the other PC card suppliers using the TI chip include Artist Graphics, Compaq Computer, Dell Computer, Matrox Electronic Systems, NEC Technologies, Number Nine Computer, Renaissance GRX (now owned by Zymos), and Vermont Microsystems. One alternative to the TI chips is the HD63484, a graphics processor offered by Hitachi America. Only Artist Graphics offers an 8514/A-compatible card with that chip.

In addition to PC add-in graphics cards, the 340X0 chips are widely used in other graphics applications:

on VME cards for industrial systems, in X-window terminals as a graphics controller, laser printers, and other non-PC systems. One other controller, the Hitachi HD63484 can also be found in industrial systems. Although it hasn't become widely accepted, the controller does offer dedicated graphics operations considerably faster than software-controlled drawing operations.

Similarly, Apple has established a minimum performance level in the Macintosh world. This is done through its color and monochrome graphics adapters and its first accelerator—a RISC-based card employing the Am29000 from Advanced Micro Devices that speeds up the QuickDraw operations.

Also applying RISC to a Macintosh graphics card, Radius used the 6-MIPS Acorn processor manufactured by VLSI Technology to create its QuickColor graphics engine. The Nubus graphics card delivers about six times the performance of the Macintosh QuickDraw processor.

Combining both a 24-bit color video display capability and full-motion video, a board from RasterOPs gets its power from custom logic. The card can be used in multimedia applications, and brightness, contrast, or sound can be controlled from the keyboard. With a companion board—the Video Expander—Macintosh graphics can be sent to a video recorder.

Relying on custom circuits, two accelerator cards developed by SuperMac Technology also offer close to a six-fold performance increase. The custom chips implement many of the QuickDraw commands in hardware, significantly reducing the time for each operation to execute. The ColorCard/24 delivers 640-by-480-pixel resolution to drive the 12- or 13-in. Apple monitors, while the other product, the Spectrum/24, delivers 1024-by-768-pixel resolution for 19-in. monitors. □

MANUFACTURERS OF GRAPHICS CHIPS

Advanced Micro Devices Inc.

Austin, Texas
(512) 385-8542
CIRCLE 541

Apple Computer Corp.

Cupertino, Calif.
(408) 996-1010
CIRCLE 542

Artist Graphics Inc.

St. Paul, Minn.
(612) 631-7800
CIRCLE 543

Chips and Technologies Inc.

San Jose, Calif.
(408) 434-0600
CIRCLE 544

Cirrus Logic Inc.

Milpitas, Calif.
(408) 945-8300
CIRCLE 545

Compaq Computer Corp.

Houston, Texas
(713) 370-0607
CIRCLE 546

Dell Computer Corp.

Austin, Texas
(512) 338-4400
CIRCLE 547

Edsun Laboratories

Waltham, Mass.
(617) 647-9300
CIRCLE 549

Genoa Systems Inc.

San Jose, Calif.
(408) 432-9090
CIRCLE 550

Headland (G2)

Fremont, Calif.
(415) 683-6234
CIRCLE 551

Hitachi America Ltd.

Brisbane, Calif.
(415) 589-8300
CIRCLE 552

Integrated Information

Technology Inc.
Santa Clara, Calif.
(408) 727-1885
CIRCLE 553

Intel Corp.

Folsom, Calif.
(916) 351-8080
CIRCLE 554

Matrox Electronics

Quebec, Canada
(514) 685-2630
CIRCLE 555

NCR Microelectronics Corp.

Colorado Springs, Colo.
(719) 596-5795
CIRCLE 556

NEC Technologies Inc.

Dale, Ill.
(312) 860-9500
CIRCLE 557

Nissei Sangyo America

Waltham, Mass.
(617) 893-5700
CIRCLE 558

Number Nine Computer Corp.

Cambridge, Mass.
(617) 492-0999
CIRCLE 559

Oak Technology Inc.

Sunnyvale, Calif.
(408) 737-0888
CIRCLE 560

Radius Inc.

San Jose, Calif.
(404) 434-1010
CIRCLE 561

RasterOps Corp.

Santa Clara, Calif.
(408) 562-4033
CIRCLE 562

S-MOS Systems Inc.

San Jose, Calif.
(408) 922-0200
CIRCLE 563

SuperMac Technology

Sunnyvale, Calif.
(408) 773-4456
CIRCLE 564

Texas Instruments Inc.

Houston, Texas
(713) 274-2517
CIRCLE 565

Trident Microsystems Inc.

Sunnyvale, Calif.
(408) 738-3194
CIRCLE 566

Tseng Laboratories Inc.

Newtown, Pa.
(215) 968-0502
CIRCLE 567

United Microelectronics

Corp.
Santa Clara, Calif.
(408) 727-9306
CIRCLE 568

Vermont Microsystems Inc.

Winooski, Vt.
(802) 655-2860
CIRCLE 569

VLSI Technology Inc.

Tempe, Ariz.
(602) 752-6222
CIRCLE 570

Western Digital Corp.

Imaging Products Div.
Mountain View, Calif.
(415) 960-3360
CIRCLE 571

Yamaha Integrated

Systems Inc.
San Jose, Calif.
(408) 437-3133
CIRCLE 572

Zymos Inc. (including Renaissance GRX Inc.)

Sunnyvale, Calif.
(408) 730-5400
CIRCLE 573

Consider this a guide rather than a definitive list.

HOW VALUABLE?	CIRCLE
HIGHLY	526
MODERATELY	527
SLIGHTLY	528

Inova gives you a whole new way of looking at SRAMs

Look at the leader in SRAM density

This graph illustrates why you should look at Inova when you're looking for SRAMs. You can upgrade to the next generation of density without waiting for the next generation of process technology. While our competitors must wait for 0.5-micron technology, we can volume-produce our 4-megabit monolithic SRAM designs with 0.8-micron process technology. That puts us – and you – a generation ahead for all the generations to come.

Look at the leader in monolithic 1-meg SRAMs

Inova was the first to ship 1-megabit monolithic SRAMs, and we've been shipping them since 1988. We've established a reputation for on-time delivery — even during the memory crunch of 1988 and '89. Our high-speed, high-density monolithic devices are getting faster all the time. Inova has 55ns and 45ns devices in stock now, with 35ns and 25ns devices available this quarter.

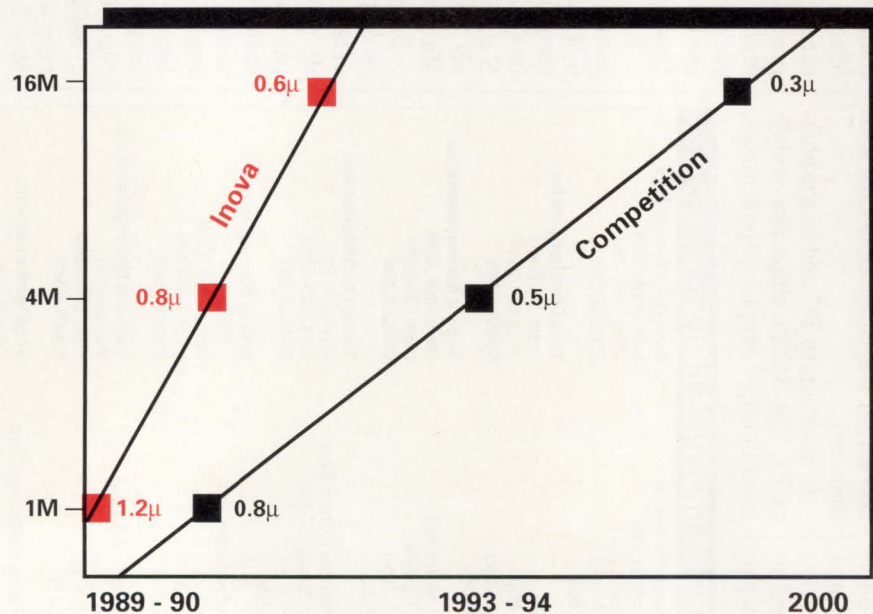

Look at the industry's only DESC-certified monolithic 1-meg SRAMs

Inova makes the only monolithic 1-megabit SRAM specified on DESC drawing #5962-89598. That says even more about our reliability and quality. Both our 1-megabit and 256K devices are DESC listed. All our military grade devices are MIL-STD-883C compliant.

Look at the first and only 64Kx16 monolithic SRAM

This year Inova introduced the industry's first 64Kx16 monolithic 1-megabit SRAM. At 45ns, these devices complement our family of 45ns 128Kx8 SRAMs. They feature our proven 4-transistor cell CMOS process with high-speed access and low active and standby power characteristics. And they're listed on DESC drawing #5962-90858.

Look at Inova for your high-speed, high-density SRAM solutions

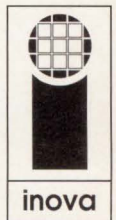

Call for a free copy of our new SRAM databook: 408-980-0730

inova microelectronics corporation
2220 Martin Ave. Santa Clara, CA 95050

BECAUSE AN i486 EASILY OUTPACES THE MAIN MEMORY BUS, AN EXTERNAL CACHE STEPS IN TO BOOST SYSTEM THROUGHPUT.

DESIGN A SECONDARY CACHE FOR INTEL'S i486 PROCESSOR

Intel's i486 microprocessor, with its internal cache, can solve computational problems at blinding speeds. Thanks to the number of transistors on the i486 chip, functions once performed off the 386 CPU can be incorporated on chip for faster operation. The i486 CPU not only contains the cache memory and floating-point math unit, but many of the CPU's instructions have been streamlined with increased parallelism.

The i486 CPU's internal 8-kbyte, four-way set associative cache would seem to eliminate using an external cache. Current 386 benchmarks reportedly can run up to three or four times faster on the i486. Some of this can be attributed to these benchmarks, which are small enough to be completely contained within the i486's internal cache. However, real-world programs are often quite large or may operate on huge data sets. In that case, they would not fit within the i486's cache at all.

Without an external or secondary cache, the true speed of the i486 CPU can't be realized. This is because bus transactions are still limited by the speed of the system backplane and the economical dynamic memory used for program storage. In other words, any time the CPU pins can wiggle at a much faster rate than the signals on the main memory bus, a cache can step in to boost the system's throughput.

Backplane response time is limited by many factors: the time to refresh dynamic RAMs (DRAMs), buffers (with their associated propagation delays) within the bus timing's critical paths to route DMA or multiprocessing data paths, and the meeting of protocols for bus arbitration at the expense of timing delays. Even the time to travel along the backplane must be considered. To absorb the difference in speed between the CPU's irregular high-speed, data-transaction needs and the backplane's slower response, a cache is needed to buffer the data in either direction and to match CPU timing to backplane timing, much as a FIFO buffer would. Most current i486 system designs incorporate a simple external secondary cache.

Without a secondary cache and write buffer, all write cycles would require wait states, as would all of the read cycles that produced internal cache "misses." Intel suggests that, even with the internal cache of the i486, about 10% of all CPU read cycles must go external to the chip's 8-kbyte cache. This doesn't sound like a large number until designers consider 200-ns DRAM access time—through all of the bus buffers and refresh circuitry. A 200-ns access time

JIM HANDY

Integrated Device Technology Inc., 3236 Scott Blvd., P. O. Box 58015,
Santa Clara, CA 95052-8015; (408) 727-6116.

SECONDARY CACHE FOR THE i486

is equivalent to one normal cycle, plus four 40-ns wait states (on a 25-MHz CPU). As a result, if 10% of all I/O cycles incur four wait states, the system operates at an average of 0.4 wait states. Needless to say, this sort of system will never win a benchmark war.

Even if economy were ignored and a static-RAM-only system were designed, the signal buffering needs would still require that CPU wait states be inserted at any clock rate. Here's why: A static RAM (SRAM) would need to have an access time of at least 53 ns to support the slowest 25-MHz i486 I/O transaction (a derivation of this figure will be shown later). At first flush, this requirement doesn't seem too tough for an SRAM-based system. However, most systems use buffers on both the address and data buses to keep VLSI devices, such as the CPU, from driving large capacitive loads. Assuming that only one buffer is used between the SRAMs and the CPU on the address bus and one buffer is used on the data bus, a 10-ns buffer would cost the design 20 ns. Now the static RAMs would need to have a 33-ns access time to support 25 MHz.

Unfortunately, most fast SRAMs are too small to handle much of the software written for Intel's processors. If system cost is no object, a 25-ns 64k-by-4-bit RAM is readily available, but this size device holds little code. This means that chip-select decoding must be used to expand the RAM's depth. Another problem is that chip-select access time on these devices is equivalent to their address access time. As a result, if a 25-ns SRAM was used in a system requiring a 33-ns SRAM access, only 8 ns would be left to decode addresses. Even discounting such real-world problems as skew and capacitive loading, an 8-ns decoding time is difficult to achieve.

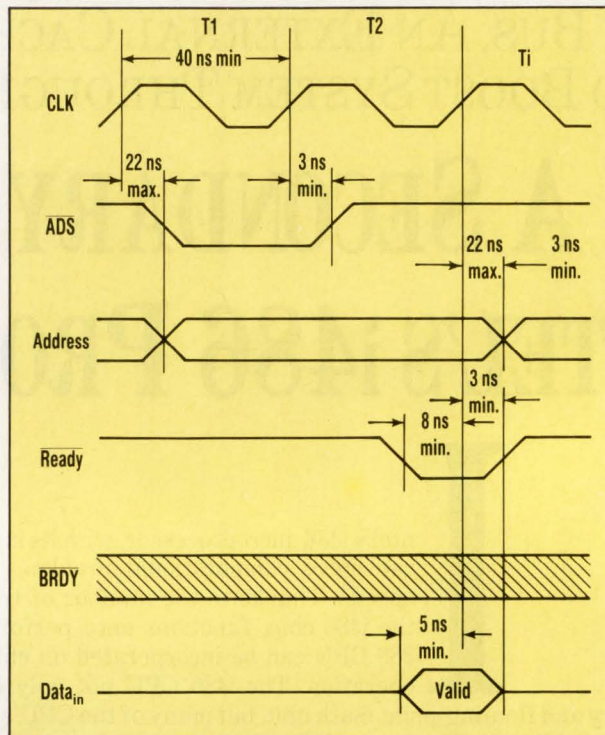

1. FOR A 25-MHz i486 with a basic bus and single-read cycle, the addresses become valid during the first cycle. The address isn't guaranteed to become valid until 22 ns after the beginning of the first cycle. To support a zero-wait read, data must be valid at least 5 ns before the clock's rising edge at the end of the second cycle.

All of this timing is based on the slowest cycle of the slowest speed grade i486—a 25-MHz CPU doing single reads. The i486 can also execute burst reads, where four reads are performed in five cycles, and clock speeds are specified up to 33 MHz. Imagine what this would do to the timing of the example SRAM-only system.

A secondary cache placed between the CPU and the system bus can enhance throughput immensely in any i486-based system. With a cache memory, a small number of SRAMs can be attached directly to the CPU's Address and Data pins without requiring intervening buffers. If cache depth and policies are chosen judiciously, the cache can be accessed instead of main memory for most CPU data I/O cycles, enabling the CPU to run at near-zero average wait states.

Another cache-design concern is minimizing board space. As a general rule, less-dense SRAMs are con-

siderably faster than their denser counterparts. This implies that all speed requirements could be met by using many less-dense SRAMs. Some designers have committed half of a PC-style motherboard to the cache alone. Because most system designers would not want the cache to force them to remove other important functions from their boards, designing caches in minimal board space should be considered.

i486 BUS TIMING

The i486 I/O bus is a drastic departure from the buses of its predecessors. Unlike the 386, 286, and earlier Intel CPUs that use asynchronous buses, the i486 uses a synchronous bus. This means that the output signals are levels instead of pulses. And these levels must be strobed into peripheral circuitry on the rising edge of the system clock. Consequently, the timing diagrams have been clarified

by omitting the write/not-read (W/R) output. The W/R signal follows the most-significant address bit timing. This simplifies the timing of critical-path signals, such as write pulses, and reduces ill effects of bounce and noise on level transitions. Unfortunately, peripheral devices (for example, standard SRAMs) require asynchronous input signals. It's challenging to derive these signals from the i486's synchronous interface.

In the basic-bus, single-read cycle for the 25-MHz i486—the slowest zero-wait cycle on Intel's slowest i486—the addresses become valid during the first cycle, while the data is sampled into the CPU at the end of the second cycle (Fig. 1). The address isn't guaranteed to become valid until 22 ns after the first cycle starts. To support a zero-wait read, data must be valid at least 5 ns before the clock rising edge at the end of second cycle. Any requirement for wait

NEW
ABEL-4
 with SmartPart™
 intelligent device selection



Knock-your-socks-off PLD software on a shoestring budget.

Who says you can't afford the world's best PLD development tools? Data I/O's industry-standard design software and programming solutions are more powerful—and more affordable—than ever before. So now the best tools on the market are also the best value.

NEW ABEL™-4 marks a major milestone in PLD software. The leader in device support, ABEL-4 automatically identifies which PLDs match your design needs with new SmartPart™ intelligent device selection. New optional device fitters automatically assign pins and

configure macrocells for complex device architectures. And an all-new user interface speeds the entire PLD design process.

A major new version of the leading schematic capture software, **NEW FutureNet®-5**, redefines "ease-of-use" with pop-up menus, extensive dialog boxes and a fast symbol browsing feature.

To make designing for testability practical, choose **NEW PLDgrade™**. This inexpensive fault grading software helps you optimize your design for testability before production.

And the affordable **NEW 2900 Programming System** brings the cost of high-performance programming down to earth. Its innovative technology makes programming any PLD—even surface-mount devices—fast and easy.

CALL TODAY for your **FREE** tutorial on designing with PLDs—a \$12.95 value.



1-800-247-5700

The Personal Silicon Experts

DATA I/O
 Corporation

Data I/O Corporation 10525 Willows Road N.E., P.O. Box 97046, Redmond, WA 98073-9746, U.S.A. (206) 881-6444/1-800-247-5700
Data I/O Canada 6725 Airport Road, Suite 302, Mississauga, Ontario L4V 1V2 (416) 678-0761
Data I/O Europe World Trade Center, Strawinskylaan 633, 1077 XX Amsterdam, The Netherlands +31 (0)20-6622866/Telex 16616 DATIO NL
Data I/O Instrumentic Electronic Systems Vertrieb GmbH Lochthamer Schlag 5A, 8032 Graefelfing, W. Germany, +49 (0)89-858580
Data I/O Japan Sumitomoseimei Higashishinbashi Bldg., 8F, 2-1-7, Higashi-Shinbashi, Minato-Ku, Tokyo 105, Japan
 (03) 432-6991/Telex 2522685 DATAIO J

© 1990 Data I/O Corporation

CIRCLE 159

SECONDARY CACHE FOR THE i486

states is indicated by the system taking the $\overline{\text{Ready}}$ input invalid (high) at least 8 ns before the clock rising edge of the second and subsequent cycles. Because the clock cycle time of the 25-MHz processor is 40 ns, the total time from a valid address to valid data is 53 ns ($2 \times 40 - 22 - 5 = 53$).

Another difference between the i486 and previous Intel CPUs is the use of a burst-mode transfer to refill cache lines. The i486 has a cache line size of 16 bytes, or 4 long words. The entire line must be replaced whenever a cache miss occurs. A burst sequence fetches four long words residing at adjacent memory locations into the i486's internal cache. Typical zero-wait, burst-read cycles are five clock cycles long (*Fig. 2*).

As in the single read just described, the first cycle outputs the address to the system. During the second and following cycles (assuming no wait-states are used), data is input to the CPU, and the $\overline{\text{BRDY}}$ input is asserted to inform the CPU that the data transaction was finished accurately. The same sequence is followed for cycles three through five, except that the CPU changes its output address within the same cycle that the data is required.

The timing on burst-read cycles and no-burst write cycles is somewhat tricky. On a 25-MHz i486, address outputs are guaranteed to be valid no sooner than 22 ns after the rising edge of the system clock. For data to be captured correctly, it must be presented to the CPU at least 5 ns before the clock rising edge. With the CPU's 40-ns minimum cycle time, this means that the cache memory would need to be designed to output burst data to the CPU in $40 - 22 - 5 = 13$ ns. At 33 MHz, this number drops to 9 ns, even without considering derating. Obviously, this speed requirement will keep designers from implementing a cache of an effective size by using standard SRAMs that are connected between the i486's address and data buses.

Fortunately, two things work in the cache designer's favor. First, all burst addresses share the same upper address bits. Only the lower two bits change during the burst trans-

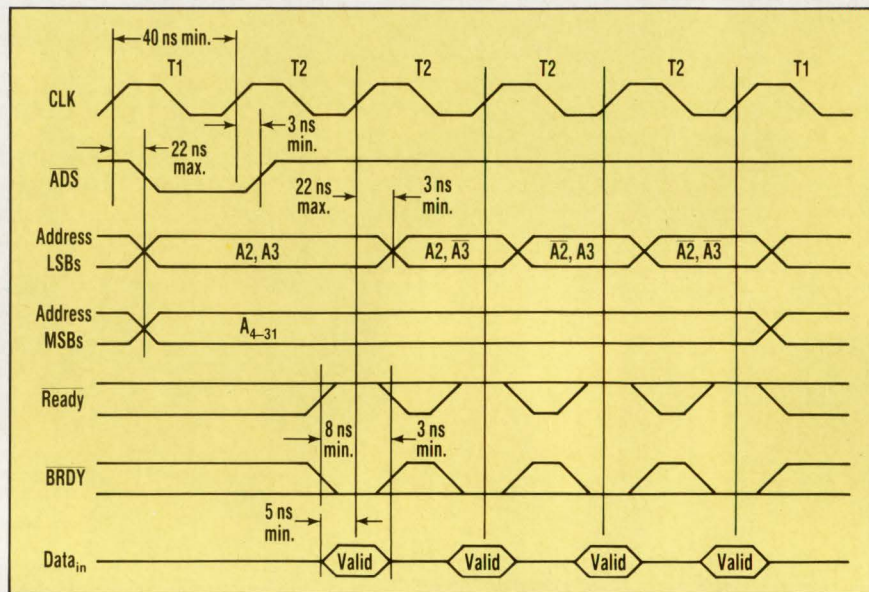

2. FIVE CLOCK CYCLES make up typical zero-wait, burst-read cycles. In the first cycle, the address is output to the system, and during the second and following cycles (assuming no wait-states are used), data is input to the CPU. The $\overline{\text{BRDY}}$ input is asserted to inform the CPU that the data transaction was finished accurately. The same sequence is followed for cycles three through five, except that the CPU changes its output address within the same cycle that the data is required.

fer. Second, the initial cycle, during which the i486 outputs its first address, isn't the same cycle where data is first requested. This means that the 13 ns calculated can be added to an entire cycle time to get an initial access time of 53 ns in a zero-wait cache design. The initial access requirement matches what was mentioned previously for one read cycle.

Most designers take three routes when designing fast memories to support the i486. All three count on the extra time afforded by the first cycle to ease RAM timing requirements. The first method is to design the cache with a wide bus, which delivers all 16 bytes of the line simultaneously within the 53-ns window. Then, a simple multiplexer selects which long word will be routed to the CPU every cycle. Although this approach is simple and uses inexpensive, slower (35- to 45-ns) SRAMs, a typical version requires about 30 devices to implement. In fact, some designs consume half of a typical PC motherboard.

The second method requires no cache but adds wait states to the first cycle of a burst. As with the preced-

ing example, the design uses a 16-byte word width and multiplexes the data to the CPU once it arrives. The difference is that this wide word is used as a main-memory bus, and the main memory's DRAMs are the weak link in the timing chain. As a result, the system should use very fast DRAMs to reduce the initial wait-states. A dedicated bus must be employed to support the wide word required by this approach. This makes such a design incompatible with most existing system bus architectures.

At this point, system designers experienced in working with nibble-mode DRAMs may wonder why these devices' sequential-addressing capabilities can't be harnessed to burst 32-bit data into the CPU once the burst cycle begins. One of the unique aspects of the i486 CPU is its peculiar bursting sequence. The sequence follows nibble-mode DRAMs only when the starting address is an even number. However, on odd-numbered addresses, the i486 counts down or even down, then up and down again. This means that nibble-mode DRAMs would not work in a



SURPRISING FACTS KEEP POPPING UP

**Free
MAXI/PC
Demo
Disk**

When we first compared the facts about MAXI/PC vs. OrCAD®/PCB II, the differences surprised a lot of people. Especially OrCAD. So they ran ads claiming more "technical support" and "proven commitment." The simple fact is, MAXI/PC comes with toll-free hotline support. OrCAD/PCB II doesn't. And we'll stack our support engineers up against anyone's.

OrCAD/PCB II is *still* surprising engineers who find out it's missing important functions that any competent layout software should have. Here's a partial list of the unpleasant surprises:

- No automatic component placement
- No automatic gate and pin swapping
- No on-screen design rule error notification

- No automatic component or part replacement
- No partial editing of existing routes
- No automatic component renaming

MAXI/PC has every one of these functions, and a lot more. And while OrCAD charges \$1,495 for PCB II (doesn't include schematics which costs another \$495), MAXI/PC costs just \$995 including schematics, placement, routing, and manufacturing output.

If You Have OrCAD Schematics...

OrCAD's schematics package outputs directly to MAXI/PC's layout and routing software. So if you were going to buy PCB II because you thought you were locked in, you can move up to MAXI/PC instead.

You don't need unpleasant surprises when you invest time and money in PCB software. You need performance. Call today for the details and a free MAXI/PC demo disk. Have boards waiting? Order MAXI/PC and get them started now. Our 30 day, money-back guarantee makes it risk-free.

(508) 692-4900

MAXI/PC
PCB CAD SOFTWARE

RACAL-REDAC

238 Littleton Road, P.O. Box 365
Westford, MA 01886-9984, USA
Fax: (508) 692-4725

RACAL

Performance comparison based on OrCAD PCB II as of 1/1/90.

CIRCLE 157

SECONDARY CACHE FOR THE i486

general enough manner to be usable in i486 burst cycles.

The third and most popular method of designing fast memories for the i486 is to build a cache with burst-count logic and a limited number of very fast SRAMs. This results in an effective cache size at a reasonable cost within a reasonable board space. Several existing designs employ fast 16k-by-4-bit static RAMs and implement a fast burst-address sequencer externally from the CPU in a very fast PLA. Such a design can be made to work because the i486 microprocessor has a predictable, if unusual, bursting sequence.

An i486-style counter can be implemented in discrete logic (*Fig. 3*). The design is pipelined, where addresses are computed during the cycle before they're used. All of the cache addresses are latched into a 74FCT823A 10-bit noninverting register by the system clock during the cycle in which $\overline{\text{ADS}}$ first becomes active. The conditioned $\overline{\text{ADS}}$ signal also resets the 74FCT163T synchro-

nous binary counter. In addition, the signal tells the 74FCT157T two-input multiplexer when to route addresses directly from the processor to the 74FCT374A octal-D flip flop, and when to take them from the burst address counter. The 74FCT163T counter outputs are exclusive-ORed with the original addresses to mimic the i486 burst sequence. The modified versions of the addresses are latched into the 74FCT374A latch on subsequent clock cycles.

If the PLA implementing this discrete logic can change addresses within 7.5 ns of a clock input and knowing that the CPU requires data 5 ns before the clock's next rising edge, a 25-MHz CPU could be supported with RAMs as slow as $40 - 7.5 - 5 = 27.5$ ns, and a 33-MHz CPU would require 17.5-ns RAMs. In the future, as faster CPUs become available, this design becomes less attractive. Assuming that a 50-MHz CPU is used with a 5-ns PLA, it would still need SRAMs that boast an address access of only 10 ns, less derating.

This clearly will push or even exceed the state of the art within the next year or two.

One simple alternative is to use a high-speed SRAM, into which an i486-style counter is absorbed. A counter can be implemented at the cost of only about 1 ns to the RAM's address access time by avoiding the need to translate internal logic signals to valid TTL levels and back again and by removing the requirement of driving highly capacitive DIP pins and interconnections. The IDT71589 32k-by-9-bit cache RAM is an example of such an SRAM. It supports a clock-to-data access time of as little as 15 ns.

WRITE-CYCLE TIMING

Another possible problem area on the i486 concerns write-cycle timing. About 50% of the I/O cycles of a typical i486 program are write cycles, because most of the device's read cycles will be absorbed by the internal cache. This means that cache designers need to focus as much attention

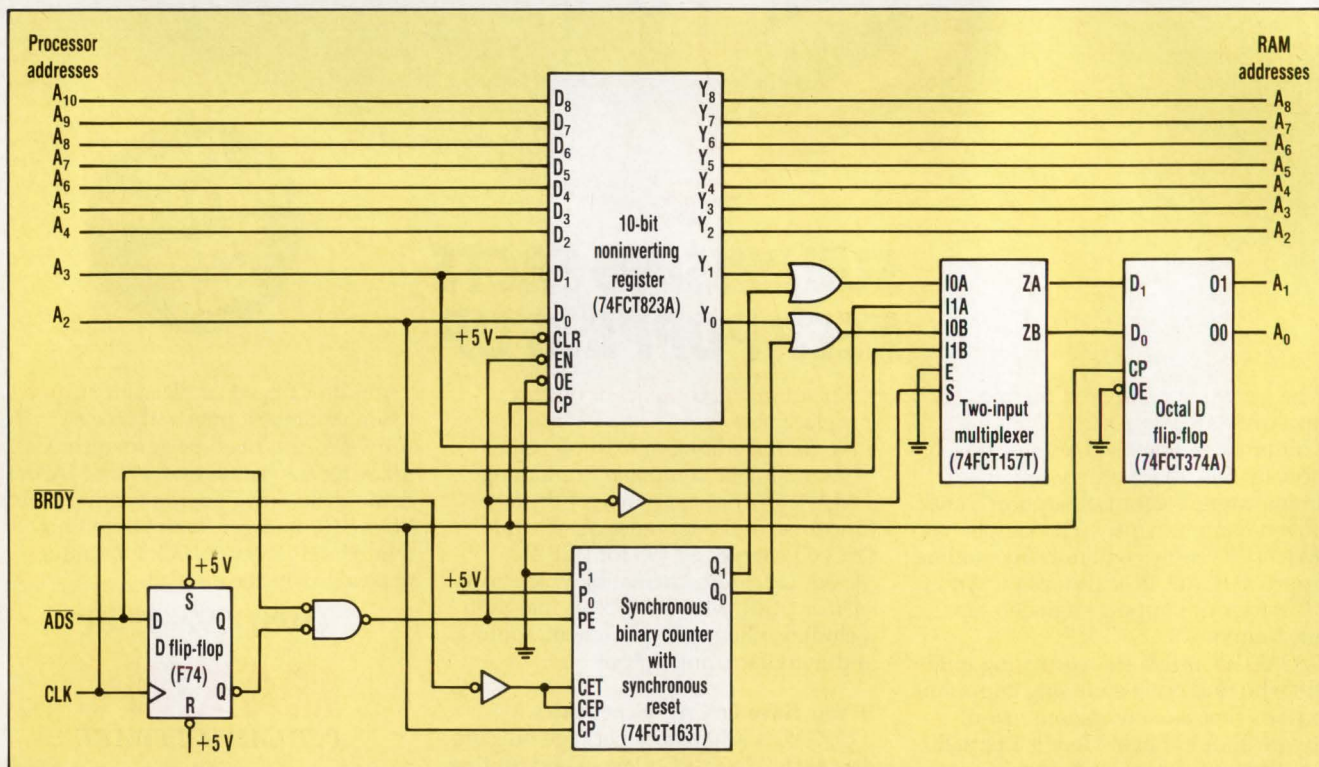

3. An i486-STYLE COUNTER can be built in discrete logic. The design is pipelined, where addresses are computed during the cycle before they're used. All of the cache addresses are latched into a 74FCT823A 10-bit noninverting register by the system clock during the cycle in which $\overline{\text{ADS}}$ first becomes active. The conditioned $\overline{\text{ADS}}$ signal also resets the 74FCT163T synchronous binary counter and tells the 74FCT157T multiplexer when to route addresses directly from the processor to the 74FCT374A, and when to take them from the exclusive ORs.

WE APPROACH THE MEMORY BUSINESS FROM ONE POINT OF VIEW... YOURS.

At Micron Technology, we offer a full line of leading-edge RAM components in speeds and packages for virtually any application.

But the memory business is more than just parts — it's people.

That's why we offer a total commitment to

service and support, and a team of engineers and technical support personnel that are the most experienced memory professionals in the industry.

Because in the memory business there's only one point of view that counts. Yours.

Component Product Family	Memory Size (Total)	Org. (Bits)	Speed (ns)	Package						Special Features	Availability	Military Qualified
				DIP	ZIP	SOJ	PLCC	TSOP	PQFP			
SRAMs	1MEG	x1, x4, x8	25-45	X		X				x4 option: OE	Now	2H90
	256K	x1, x4, x8	20-45	X	X	X				x4 option: OE	Now	X
	64K	x1, x4, x8	12-45	X		X				x4 options: Separate I/O, OE	Now	X
	16K	x1, x4, x8	12-45	X		X				x4 options: Separate I/O, OE	Now	X
Cache Data SRAMs	288K	x9	14-34				X			486 Compatible, Self-timed write, Fast toe 7ns, 486 Burst and extended burst support	Samp: 1H91, Prod: 2H91	
	144K	x18	20-35				X	X		386/486 Compatible, Fast toe 8ns, Auto write completion, Parity bits	Now	
	128K	x16	20-35				X	X		386 Compatible, Fast toe 8ns	Now	
Synchronous SRAMs	288K	x18	15-25				X			Registered address, chip enables and write control; Data latch, Fast toe 6ns, Byte write capability	Samp: 2H90, Prod: 1H91	Samp: 1H91
	256K	x16	15-25				X					
SRAMs with Address Latch	288K	x18	15-35				X			Address, data and chip enable latches; Byte write capability, Fast toe 6ns, 3.0 Volt output buffer option	Samp: 2H90, Prod: 1H91	Samp: 1H91
	256K	x16	15-35				X					
	16K	x8	100	X		X				Intel 8051 and 8096 compatible	Now	X
	16K	x8	15-35	X		X				Compatible with high end micro controllers	Now	X
FIFOs	18K	2Kx9	15-35	X			X			Family options:	Samp: 1H91	2H91
	9K	1Kx9	15-35	X			X			300 mil DIP package, Programmable flags	Samp: 1H91	2H91
	4.5K	512x9	15-35	X			X				Samp: 1H91	2H91
DRAMs	4MEG	x1, x4, x8, x16	60-100	X	X	X		X		x4, x8 options: Write per bit x16 options: 2WE/1CAS; 1WE/2CAS and 1WE/1CAS with write per bit	x1, x4 Samp: Now, Prod: 1H91; x8, x16 Samp: 1H91	Samp: 1H91
	1MEG	x1, x4, x16	70-120	X	X	X		X			Now	X
	256K	x1, x4	100-120	X	X	X	X				Now	X
	64K	x1	100-150	X				X			Now	X
Quad CAS DRAMs	4MEG	x4	60-100				X			Separate CAS control for each DQ input/output, Enhanced write per bit capabilities	Samp: 1991	
	1MEG	x4	70-100				X				Now	
Pseudo Static DRAM	1MEG	x8	80-120	X			X			Unmultiplexed addresses, Simple refresh control	Samp: 2H90, Prod: 1H91	
Dual Port DRAMs (VRAMs)	1MEG	x4, x8	80-120		X	X				CMOS, Fully static SAM, Serial input, Split read transfer	Now	Samp: 1H91
	256K	x4	100-120	X	X					CMOS, Fully static SAM, Serial input	Now	X
Triple Port DRAMs	1MEG	x4, x8	80-120				X	X		CMOS, Two fully static SAMs, Transfer mask, Split Transfers, Functional superset of 1MEG VRAM	Samp: Now, Prod: 2H90	
Module Product Family*	Word Size (Words)	Org. (Bits)	Speed (ns)	Package			Special Features		Availability	Military Qualified		
DRAM Modules	2MEG, 1MEG, 512K, 256K	x36	70-120		X		X			Industry standard pin-out	256K, 512K: Now; 1MEG, 2MEG Samp: 2H90	
	4MEG, 1MEG, 256K	x9	70-120			X	X			Industry standard pin-out	256K, 1MEG: Now; 4MEG Samp: 2H90	
	4MEG, 1MEG, 256K	x8	70-120			X	X			Industry standard pin-out	256K, 1MEG: Now; 4MEG Samp: 2H90	
SRAM Modules	256K, 128K, 64K, 16K	x32	15-45		X					Industry standard pin-out with OE	16K, 64K: Now; 128K, 256K: 2H90	1H91
	64K, 32K	x16	30-45	X						Industry standard pin-out with OE	Now	1H91
	128K	x8	30-45	X						Compatible with 1MEG monolithic	Now	1H91

* Custom module and board-level product manufacturing services available.

MICRON

TECHNOLOGY, INC.

2805 E. Columbia Rd., Boise, ID 83706 (208) 368-3900

CIRCLE 132

SECONDARY CACHE FOR THE i486

on the cache's write-cycle performance as on the read-cycle performance to maximize the cache's benefits. However, designing an i486 cache for zero-wait write cycles isn't as simple as it sounds.

The i486's zero-wait write cycle is similar to the zero-wait read, except that data is output from, rather than input to, the CPU. The W/R signal, which follows the timing of the address outputs, is held high for the entire write cycle (Fig. 4).

For the cache-data RAM to support zero-wait write cycles, it must perform a write cycle within the tight constraints of the i486's timing. Here's an example based upon the 25-MHz i486 CPU: Because a 1x clock is used, most system designs would try to generate a write pulse from the system clock. The only question is whether to use the clock-high or the clock-low time to generate the write pulse.

Assuming that the clock-high time is used, the tag's output would be combined in a PLA or other fast logic element to produce a write pulse, which would be active for the first 20 ns or so of the second clock cycle. Unfortunately, the data isn't guaranteed to be stable out of the CPU until 22 ns after the rising edge of that clock cycle. This means that the data would not even be valid during the RAM's write pulse, unless the design supported a clock duty cycle other than 50%. Even if the minimum

clock-low time of 14 ns were used (at the minimum clock period of 40 ns), there would be only 4 ns of overlap between the longer clock-high time and the data from the CPU. It's true that logic delays would cause the generated write pulse to overlap the data by more than 4 ns. But the minimum data setup time required by even a 12-ns RAM is 8 ns. Nonetheless, it would be difficult to absolutely guarantee that logic delays would consistently generate 4 ns of addi-

tional delay.

Thus ruling out the use of the clock-high time, the clock-low time should be explored. Now the address and data hold times become a problem. The i486 specification for this parameter is a minimum of 3 ns. If the write pulse is generated by gating the clock with any logic, the write pulse should stay valid after the i486's address and data stop being valid. Most fast SRAMs have a 0-ns data-and-address hold time. This figure would need to be a negative num-

inappropriate for i486 designs. Only the IDT71589 chip has its pinout and timing matched to the i486—therefore it's the easiest to design into this kind of system.

CACHE SPECIFICATIONS

Let's assume that the cache design will be implemented at a reasonable price and will consume little board space. Target operation requires all secondary cache "hits" to consume few, and preferably no, wait states. Naturally, every effort will be made to maintain the fastest allowable clock speeds by reducing capacitive loading wherever possible.

One rule of thumb in cache design is that an effective secondary cache must be about an order of magnitude larger than the primary cache. For the i486, the processor's internal 8-kbyte cache should be augmented with a secondary cache of about 80 kbytes. Two choices exist in this realm—64-kbyte and 128-kbyte caches. Using the previous example, a 64-kbyte cache could be designed with eight fast 16k-by-4 bits (nine, if parity were supported) plus a fast PLA (for the burst counter). Synchronous devices must be used to allow zero-wait write cycles. Should a synchronous 16k-by-4 be employed, this size cache could be built using about the same number of parts. It would be simpler and would consume less board space to design a 128-

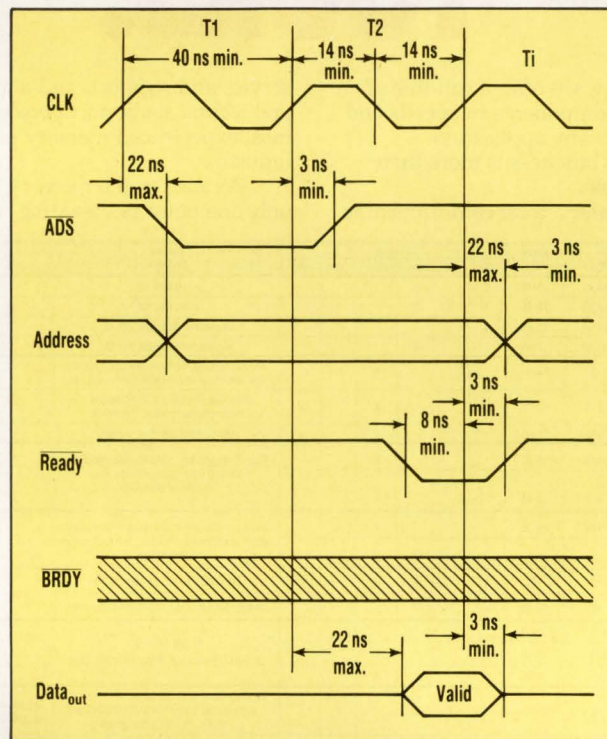

4. THE ZERO-WAIT WRITE CYCLE for the i486 resembles the CPU's zero-wait read. Data, however, is output from, rather than input to, the CPU. Furthermore, the W/R signal, which follows the timing of the address outputs, is held high for the entire write cycle.

ber to support a write pulse generated from a gated version of the clock-low cycle.

From this example, it's clear that a synchronous RAM is needed in the design of zero-wait caches for the i486's synchronous bus. Few synchronous RAMs with TTL-compatible outputs are currently available. Most are offered only with ECL-compatible inputs and outputs. Of those with TTL I/O, certain timing and interface anomalies make most parts

kbyte cache with the IDT71589 32k-by-9-bit device. This is because only four of these devices would be necessary even in a system with parity support, and synchronous writes would be offered.

It's generally accepted that an n-way set-associative cache offers a higher hit rate than a direct-mapped cache of the same size. However, there are three key reasons to avoid implementing an n-way cache.

The first reason is cost. An n-way

MEGABIT MEMORIES

As Big As Your Imagination

The first time your designs start having density or space problems, we should be talking. Whether you need a few megabits of SRAM in a 32-pin DIP, or 64-Megabits of Flash PROM in a 2" x 2" flatpack, we can help.

Our newest models, for example, are a series of 4-Megabit (512Kx8) CMOS SRAMs in a rugged 1.6" x 0.6" ceramic 32-pin DIP with JEDEC standard pinouts. They offer read access times from 45nSec to 120nSec, and three temperature ranges. They also feature a typical operating current of just 37mA, and data retention with voltages as low as 2.0 volts. Data retention current at 25°C is typically 10ua. Just right for

those low-power battery-backed applications. As with all our products, Screening and burn in to Military standards are available options. White is certified to MIL-STD-1772.

If 4-Megabit isn't enough, we have a new 34-pin 8-Megabit Flash PROM module that measures just 1.93" x 1.14". At 0.41in² it's probably the smallest package available holding that much non-volatile memory. Organized as 1 Megabyte x 8, its eight pages of one megabits each can be erased a page at a time without affecting the other pages. Access time is 150nSec. Programming typically takes just 10uSec/byte and 2

seconds/page. Chip erase also takes 2 seconds/page. We also have a 2" x 2" 64-Megabit Flash PROM flatpack in test now, and still larger capacities to follow.

We have all the building blocks for your tiny systems, the memory and density for your terabit

dreams, and the products to help you anywhere in between. If it's only a 2-Megabit SRAM or EEPROM in a miniature package, or a shoebox-size supercomputer array, we have the technology and the expertise to respond. Your imagination or ours, we'll make it happen.

White Technology, Inc.

A wholly owned subsidiary of Bowmar Instrument Corporation
4246 E. Wood St. • Phoenix, Arizona 85040 • (602) 437-1520
FAX 602-437-9120 • TWX 910-951-4203

CIRCLE 148

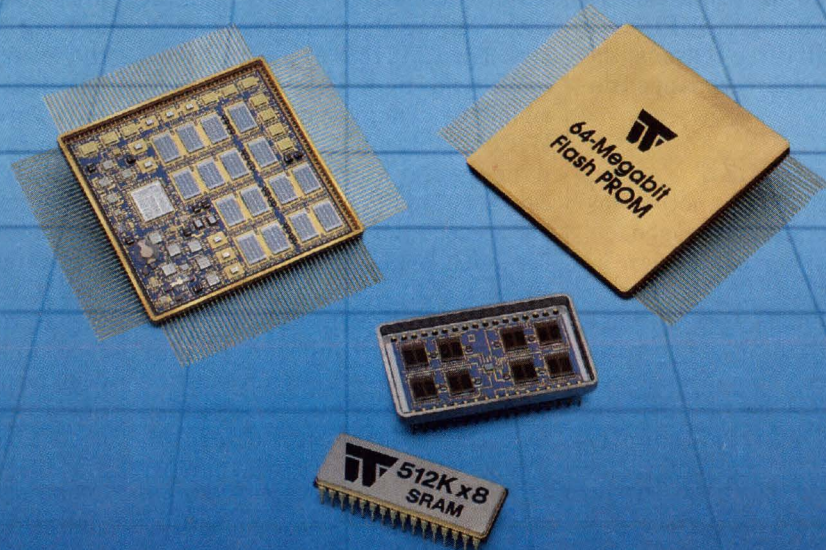

CERTIFIED AND
QUALIFIED TO
MIL-STD-1772

SECONDARY CACHE FOR THE i486

cache must start every cache cycle with the cache-data RAMs' outputs disabled. Only after the tags decide which RAM contains the appropriate data can the outputs be enabled for one of the data RAMs. The address-to-data critical path of the cache runs from the tag, through logic, and through the data RAMs' Output Enable pins. This requires a fast cache-tag RAM, which is usually costly. In a direct-mapped cache, the data RAMs' outputs are enabled onto the data bus as a default and are disabled only after a cache miss. The critical path in this system runs from the cache-tag RAM, through logic, and allows the cache-tag to be around 10 ns slower. Subsequently, it's much less expensive than in the n-way design.

The second reason is board space. A typical n-way cache design requires n cache-tag RAMs and n sets of data RAM, which typically doubles cache chip count for two-way and quadruples it for four-way. The cost in board space is obvious. The third reason is address loading. All cache-tag RAMs and cache-data RAMs must be either tied directly to the CPU's lower order address output pins or specified about 10 ns faster and tied to the bus through a buffer. Because of this, designers must either use even faster tags or find a way around the derating delays caused by overloading the CPU's address bus. For all three reasons, the example cache is a direct-mapped design (Fig. 5).

SELECTING LINE SIZE

Line-size selection is another important consideration in cache design. To keep the cache design as simple as possible, the secondary cache in this example uses the same size line as the i486 (Fig. 5, again). With this choice, a copy-back implementation can use the fact that the Cache RAM's internal counter wraps around and counts again after completing its count sequence. Clever designers use this feature to off-load a "dirty" cache line to a write buffer while priming the system bus for a read cycle. When the bus finally responds, data can be written imme-

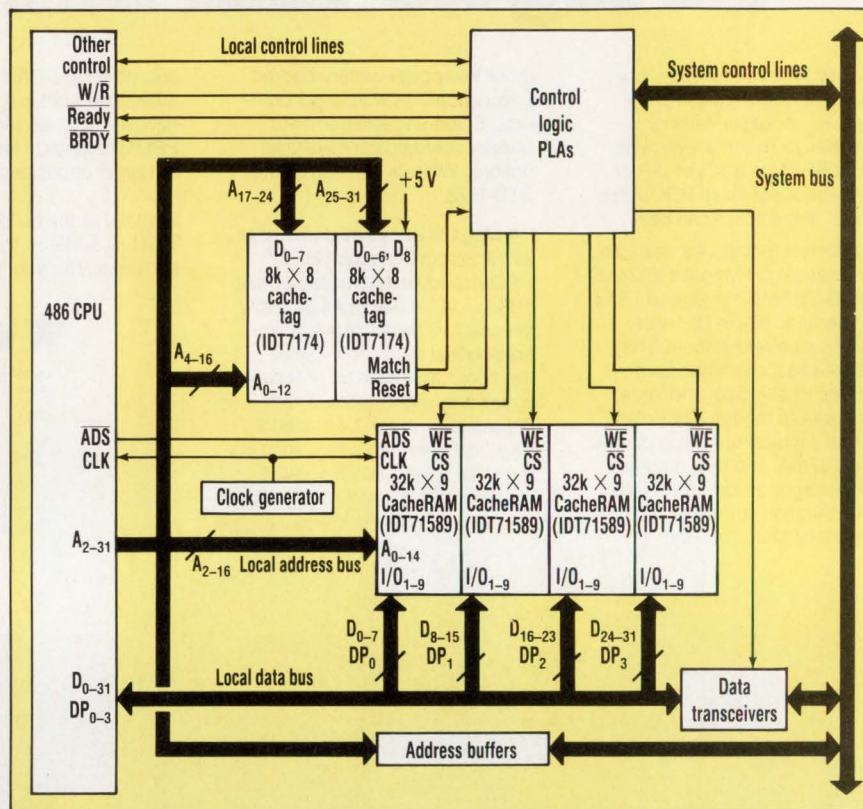

5. CPU ADDRESS OUTPUTS A_{2-16} are tied to Cache RAM address inputs A_{0-14} , because the CPU's address outputs A_0 and A_1 are used only for byte and word manipulation during 8- and 16-bit accesses. Since this cache supports 32-bit transfers, A_0 and A_1 aren't needed. The cache-tag RAM observes only address bits A_{4-31} because each tag is responsible for a four-doubleword (16-byte) cache line. The most significant bit of the cache-tag data input is tied high as a "valid" bit. After the tag is reset at power-on or during a cache flush, this input is compared with a 0 in the corresponding RAM bit to cause a cache miss.

diately to both the CPU and the cache during the following four cycles. The IDT71589 can move from a burst-read to a burst-write mode simply by changing the state of the Write Enable input. Even in simpler write-through caches, the internal counter simplifies line refills by using a cache line of the same length for both primary and secondary caches.

Line size directly influences the cache-tag depth chosen for the cache. The cache-tag RAM must be deep enough to contain one location for every line in the cache-data RAM. Some systems minimize the number of tag-RAM bits by having tag address bits only for every fourth or eighth line and a separate valid bit for each line. With the cache-tag RAMs currently on the market, it's simpler and actually costs less in ad-

dress loading and chip count to use one tag location for every line. For the example (Fig. 5, again), with a 32k-deep cache-data RAM and a four-word-long line size, the appropriate cache-tag RAM would be 8k locations deep.

The tag width must account for any remaining address bits used by the system, plus a valid bit for each line. It's rare for a system to support the entire 4-Gbyte address range offered to i486-system users, so many designs discard some of the address bits. In this sort of design, there's no need for the cache-tag to examine bits that won't be referenced anywhere else in the system. Of the 30 address outputs used when addressing long words in a system, the lower two define the long word within the line and won't be used as inputs to the cache-tag RAM. The 8-k-deep

The ten years battery that offers you even more capacity.

Modern micro-electronics now have a clear pace setter where high capacity Lithium Cells are concerned - the Varta CR Cylindrical Cell specially developed for the specific demands of the computer age.

For long life and high reliability.

With capacities second to none worldwide:

2.0 Ah for the AA, 1.4 Ah for the 2/3 AA,

1.0 Ah for the 1/2 AA and 360 mAh for the

1/4 AA, the smallest type in the range.

Laser welding and a self-discharge of less than 1% per year means that the

Varta Lithium cells achieve a lifetime of 10 years. They can be wave-soldered without any additional precautions.

If the needs of your memory backup is for an environmentally friendlier cell with a high energy density, then it is time to start thinking about an improved product for the future. Just call us for your free samples.



Lithium

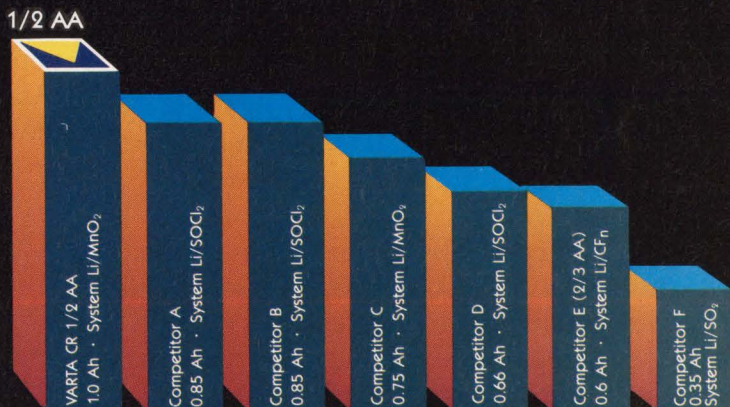

CIRCLE 110



VARTA

Varta Batterie AG · Daimlerstr. 1 D-7090 Ellwangen - Jagst · W.- Germany · Tel. (07961) 831
Varta Batteries Inc. 300 Executive Boulevard Elmsford · N.Y. 10523-1202 USA · Tel. (0914) 59 22 500
Varta Batteries Pte. Ltd. · P.O.Box 55 · Bedok North Post Office · Singapore 9146 · Tel. (02 41) 26 33

BIG CHANGE.

FOR THOSE WHO KNOW THE WORLD IS HEADED FOR HIGH PERFORMANCE, MORE POWER TO YOU.

If you're among the leading-edge designers on a power trip to the future, consider this. Motorola's Microcontroller Division just cut your travel costs with an offer too good to miss:

*Act between September 4 and October 12, and you can get a computer-based learning program and a development kit for our 32-bit microcontrollers for just \$332. Plus, you could win a supercharged Macintosh® IIfx.**

This offer is the perfect way to learn about Motorola's 68332. The one microcontroller that delivers the 32-bit performance and integration you will need to be competitive in tomorrow's world. And it's available from Motorola today.

THE 68332. A BIG PART OF THE FUTURE.

The 68332 is simply the world's most powerful microcontroller. It contains a full 32-bit HCMOS CPU surrounded by smart, modular on-chip peripherals, including a RISC-based Time Processor Unit.

The 68332 is backed by the unsurpassed 32-bit software base of our 68000 microprocessors. And its modular architecture will keep your product designs evolving right along with our expanding portfolio of microcontroller peripherals.



BIG NEWS. NEW LOW COST.

Thanks to Motorola's aggressive production ramps, the price of power will be less than you might expect. To find out just how low prices will be by the time your applications reach volume production, check with your Motorola representative.

BIGGER NEWS. FOR JUST \$332, YOU CAN EXPLORE THE WORLD OF 32-BIT TODAY.

No matter where you are on your move toward higher performance, our 32-bit learning tools can be invaluable.

If you're at the 16/32-bit decision point, use them as a basis for immediate comparison. Or use them to prepare for future migration when you're ready to step up to 32-bit performance. (As you make your move up, be sure to mail in the attached coupon for details on our soon-to-be-announced compatible 16-bit Family.)

START OUT SMALL. END UP WITH BIG RESULTS.

This \$332 introductory offer, *available only through your Motorola distributor*, includes our \$32 68332CLP computer-based learning

SMALL CHANGE.

FOR THOSE WHO WANT TO KNOW MORE,
OUR 32-BIT LEARNING TOOLS ARE NOW JUST \$332.

program. As well as the \$300 68332KIT.

The 68332CLP learning program alone is the equivalent of a full-day instructional seminar. It features a MS-DOS® programmed learning disk and a complete set of manuals that teach you how to design the 68332 into your next system.

The 68332KIT development package has everything you need to learn hands-on operation of the 68332, including a Business Card Computer (BCC). With a surface mount 68332, 128K bytes of EPROM, 64K bytes of RAM, and a RS232 port, the BCC provides stand-alone evaluation of the 68332 on a board the size of a business card.

The 68332KIT also features a Platform Board for mounting the BCC in expanded development operations. As well as assembler software. And a variety of support literature.

Perform the exercise included in your 68332KIT or 68332CLP and send us your completed entry form by December 31, 1990. If you performed the exercise correctly, you become eligible for a drawing to win one of five Mac IIxs. (The Mac IIx can be awarded to you, your company, or your favorite charity.)

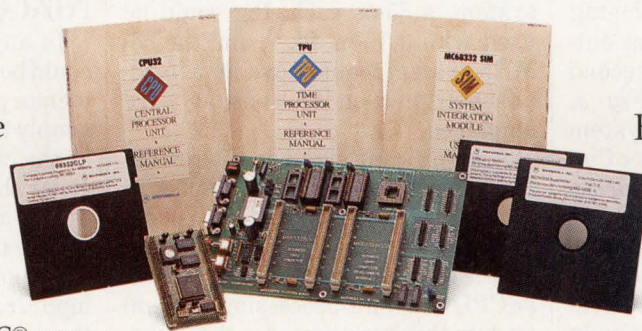

HURRY. WHILE THE
POSSIBILITIES ARE
ENDLESS, THIS
OFFER IS NOT.

Our \$332 special offer is the perfect chance to consider making a big change in power and performance for small change. To order, call your Motorola distributor today.

But hurry. Quantities are limited.** And this great price is good only through October 12.

All prices are manufacturer's suggested retail price.

**No purchase necessary. For entry details, write: Motorola, Inc., Dept. OE39/332 Promo, 6501 William Cannon Drive West, Austin, Texas 78735-8598*

***While supplies last. Limit 3 per customer.*

*Macintosh is a registered trademark of Apple Computer, Inc.
MS-DOS is a registered trademark of Microsoft Corporation.*

To receive a Technical Data Sheet for the 68332, plus news on our other 68300 Family products and our upcoming 16-bit high performance products, please complete and return this coupon to:

Motorola, Inc.
P.O. Box 1466
Austin, Texas 78767

ED9/13/90

Name _____
Company _____
Title _____
Address _____
City _____
State _____ Zip _____ Phone _____

THE PATHWAY TO PERFORMANCE.



MOTOROLA

SECONDARY CACHE FOR THE i486

cache-tag described in the preceding paragraph uses the next 13 address bits on its address input pins. One readily available cache-tag that matches this depth requirement is the IDT7174, an 8k-by-8 resettable tag RAM, which currently runs as fast as 30 ns.

If one of the IDT7174's data pins is used as a valid bit, with the seven remaining bits tied to the next more-significant address outputs, a 16-Mbyte main memory address range can be supported with one cache-tag chip. Eight more i486 address outputs could be supported by a second IDT7174, as in this design (*Fig. 5, again*). This would allow the system to support main memory sizes of up to the CPU's full 4-Gbyte address range. Although other tag-RAM configurations are available, they're all less dense than the IDT7174. Subsequently, they present the processor's address bus with a drastically higher load to support the same number of tag bits. This usually means that the cache-tag RAM's address inputs would need to be buffered, at a cost of 5 to 10 ns. Designers using future i486 speed grades would be forced to use much faster cache-tag RAMs at a much higher cost. The IDT7174 offers the lowest board-space consumption and capacitive loading of any cache-tag RAM currently available.

SNOOPING THE BUS

Speed requirements of a cache-tag RAM in a direct-mapped cache are easy to calculate if self-timed cache-data RAMs are used. The equation is straightforward. First, a zero-wait cache must tell the i486 in two cycles that its data is available. During the first cycle, the CPU outputs the address, and in the second cycle, the cache must respond. From these two clock cycles, the clock to address delay must be subtracted, as well as the BRDY setup to clock time. Finally, the PLA's propagation delay is subtracted to show the required access time of the cache-tag to be used.

Fortunately, on the IDT71589 CacheRAM, the Write-Enable input sports timing identical to the timing of the i486's BRDY and Ready input

pins. Therefore, no additional restrictions need to be put on the cache-tag's timing to accelerate write hit cycles, as would be required with the use of asynchronous RAMs. Assuming that designers use 7-ns PLAs downstream of a cache-tag to drive the BRDY, Ready, and Write Enable pins of the i486 and IDT71589, respectively, cache-tag requirements will be $(40 \times 2) - 22 - 6 - 7.5 = 44.5$ ns at 25 MHz. At 33 MHz, it's $(30 \times 2) - 16 - 5 - 7.5 = 31.5$ ns. In the 25-MHz system, a 35-ns cache-tag could be used with a 10-ns PLA, and the 33-MHz system would have an affordable margin even if a 30-ns tag were employed.

A significant side benefit results from using an external cache to "snoop" on the system bus. Snooping ensures that there aren't any writes from a DMA device (or another CPU in a multiprocessing system) on data that's replicated in the cache. On a snoop-hit, cache data should be either invalidated or updated. The i486 serves this need by either allowing the external system to flush the on-chip cache or to stop the CPU and drive addresses into the CPU to invalidate a single line in the on-chip cache.

Naturally, a cache flush bogs down the CPU from the time it's invoked until the cache can again be refilled from external memory. But if the CPU was stopped for a line invalidate every time a DMA device performed a main memory write, the CPU could be stopped often enough to seriously degrade system performance. The secondary cache's tag RAM can be set up to screen invalidate cycles to the CPU by using the principle of inclusion. This allows the CPU to be stopped for invalidation only at those addresses when it's probable that the address being written actually exists within the i486's internal cache.

The principle of inclusion requires that the external cache attempt to invalidate a corresponding line in the i486's internal cache every time a line is invalidated in the secondary cache. By performing this simple trick, the external cache-tag always contains a superset of the addresses in the in-

ternal cache-tag. Now, if the external cache-tag is used during idle cycles to monitor the write-cycle traffic on the system bus, it flags only those writes that could require a primary cache invalidation. Those bus writes cause an invalidation on the secondary cache, and a subsequent attempted invalidation on the primary cache. Coherence will be maintained with minimal impact on the CPU's performance.

NONCACHEABLE ADDRESSES

In any cache design, I/O devices could be mapped into the CPU's main memory space. This can be dealt with simply by blocking the match output of the cache-tag with an address decoder that recognizes the addresses of the memory-mapped I/O devices before the cache has an opportunity to respond. This can be handled by an input from an I/O address decoder to the logic between the tag and the CPU's Ready and BRDY inputs.

Although the final cache design consumes only four SRAMs, two cache tags, and various PLAs and random logic, it is a full, 128-kbyte, direct-mapped, zero-wait design. Either a write-through or a copy-back cache can be implemented with this basic design: The only difference is the sophistication of the PLA-based cache-controller state machine and the addition of an 8k-by-1 "dirty-bit" RAM (not shown) to express the status of each line in the cache. The low chip count keeps capacitive loading to a minimum and derating is avoided. Both the tag and the data RAMs come in narrow J-lead, SOIC packages, so board space for the entire cache is only a few square inches. □

Jim Handy, strategic marketing manager for Integrated Device Technology, received a bachelor's degree in electrical engineering from Georgia Institute of Technology and an MBA from the University of Phoenix.

HOW VALUABLE?	CIRCLE
HIGHLY	535
MODERATELY	536
SLIGHTLY	537



When you're the first and fastest, what do you do for an encore?

Whatever it is, it better be good.

After all, our EL 3200 was the first 68020/030 development system with 33 MHz speed.

So, while others were just getting into the act, Applied Microsystems upped the ante.

We made the EL 3200 a more powerful performer. So you get an



advanced event system for easier tracing and debugging of complex 32-bit designs. Support for the memory management unit, floating point, cache burst and synchronous cycles. And a graphical interface to set breakpoints more quickly and a powerful macro language to simplify lengthy routines.

All this comes with full Ethernet

network support to maximize your investment in workstations and PCs. Plus installation, training and application assistance to help you finish your designs faster.

For a free demonstration, call Telemarketing at 1-800-343-3659 (in WA, 206-882-2000).

Because folks, it's show time.



**Applied
Microsystems
Corporation**

© 1990 Applied Microsystems Corporation, P.O. Box 97002, Redmond, WA 98073-9702 USA. All rights reserved. AMC-17. Other names indicated by ® are registered trademarks of their respective holders. For the name of your nearest distributor in Europe, call 44-(0)-296-625462. Europe Fax 44-296-623460. Or contact Applied Microsystems Corporation, Ltd., Chiltern Court, High Street, Wendover, Aylesbury, Bucks, HP22 6EP, England. In Japan, call 03-493-0770. Japan Fax 03-493-7270. Or contact Applied Microsystems Japan, Ltd., Nihon Seimei, Nishi-Gotanda Building, 7-24-5 Nishi-Gotanda, Shinagawa-KU, Tokyo T141, Japan.

Here's one reason that over half of all SCSI devices sold are NCR.

We created the market... and we still lead the way.

Meet NCR's SCSI development team. In 1983, they gave the computer industry its first SCSI device. By providing easy connectability and significantly reducing time to market, a new product era was born.

Since then needs have changed. By combining our system skills, high-performance standard cell methodology, and in-house manufacturing, NCR has maintained its leadership role with innovative new ideas

like the 53C700 product family. And the joint development of LADDR — a new architecture aimed at cutting the development time of OS/2 device drivers by 90%.

Today SCSI is becoming the leading I/O standard — adopted by industry giants like Apple, IBM, HP, and DEC. And no one is selling more SCSI chip level products than NCR. In fact, no one even comes close.



Part of the NCR SCSI Development Team: (left to right)
Jerry Armstrong, Sr. Software Engineer; **Harry Mason**, Strategic Marketing Manager; **John Lohmeyer**, NCR Sr. Consulting Engineer and Chairman of the ANSI X3T9.2 Committee and **Dave Skinner**, SCSI Product Manager.



Worldwide Sales Headquarters
3130 De La Cruz Boulevard, Suite 209
Santa Clara, California 95054
1-800-334-5454

New Product
Announcement!

Here's another.

The NCR 53C700 SCSI I/O Processor...
So good, *Electronic Design* named it the
product of the year.

"You can't tell a good SCSI chip just by looking at it..." and according to *Electronic Design*, NCR's 53C700 is the best there is.

The only third generation SCSI device on the market today, it concentrates all the functions of an intelligent SCSI adapter board on a single, smart and extremely fast, chip... for about 15% of the cost.

As the first SCSI I/O processor on a chip, the 53C700 allows your CPU to work at maximum speed while initiating I/O operations up to thousands of times faster than any non-intelligent host adapter. DMA controllers can burst data at speeds of up to 50 Mbytes/s. This new chip cuts down system time hookup to a fraction of what it has been.

Those are just a few of the reasons *Electronic Design's* "Best of the Digital IC's" award went to NCR's 53C700 last year.

And now the NCR 53C710!

For the complete story on the NCR SCSI product line featuring the new 53C710, as well as the upcoming SCSI seminars with the NCR SCSI Development Team, please call:

1-800-334-5454



NCR

Creating value

CIRCLE 114

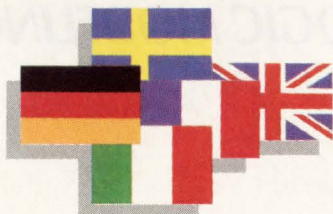

European Sales Headquarters
Gustav-Heinemann-Ring 133
8000 Munchen 83
West Germany
49 89 632202



Asia/Pacific Sales Headquarters
2501 Vicwood Plaza
199 Des Voeux Road
Central Hong Kong
852 859 6044

H111 Hawaii ハワイ

HI GANG!

PARADISE SURE BEATS
DEBUGGING ANOTHER
BOARD REV. I KNEW
WE COULD GET IT
RIGHT THE FIRST
TIME!

SEE YOU IN A MONTH,
Steve



ENGINEERING, M/S198

ADVANCED PROCESSOR

4027 BRIGHTON CIR.

SAN LUCAS, CA

93954

LM-1000® makes it happen

By eliminating extra board revisions, this vacationing engineer beat his aggressive development schedule—and beat the competition.

Steve knew he could get it right by simulating the entire design. But to simulate, he needed models.

That's why he chose the LM-1000 hardware modeler. With the LM-1000 he could get all the models he couldn't find anywhere else.

Any model, any simulator

The LM-1000's Logic Model Library™ offers the largest selection of complex standard components, including all of the latest microprocessors. And the LM-1000 lets you model ASICs and proprietary devices quickly and accurately.

The LM-1000 works with all major simulators and hardware platforms. It fits right in with the environment you choose, even if you use multiple simulators.

Call for your free handbook

Make your first board revision your final revision. Call or fax today for your Handbook of Hardware Modeling, including a complete Logic Model Library catalog.

Phone: (800) 445-1888

Fax: (408) 945-9181

LOGIC MODELING

1520 McCandless Drive,
Milpitas, CA 95035 (408) 957-5200

SIMULATION SORTS OUT SYSTEM SCHEMES BY SURVEYING TRADE-OFFS

A HARDWARE MODELER
HELPS TO ACCURATELY
PREDICT THE
PERFORMANCE OF
A MICROPROCESSOR-
BASED BOARD.

DAVID A. VASKO AND DAN WEYER
Allen-Bradley Co. Inc.,
Industrial Computer and Communication Group,
747 Alpha Dr., Highland Heights, OH 44143;
(216) 449-6700.

In a microprocessor-based system design, engineers strive to reach the best balance between performance, cost, design time, reliability, and board space. However, the data needed to accurately predict a microprocessor's performance in a design is usually unavailable. For design optimization, engineers need a way to calculate the trade-offs between various microprocessors and memory structures over a wide range of parameters.

Formerly, breadboarding the prospective designs was considered the only real alternative. However, breadboarding is difficult, expensive, and time-consuming. These cost and time factors can limit experimentation to only one or two design ideas.

Simulation, which has been used successfully for post-design verification, also holds promise for pre-design evaluation. Ideally, engineers would prefer to run actual code or a suitable benchmark on a wide variety of system models—many more variations than would be practical to evaluate on a breadboard. However, simulation wasn't used for this application because of the prohibitive amount of time required to execute code on a simulated system. But if engineers choose and refine appropriate test code, and focus on exploring specific design questions rather than attempt a full-system implementation, simulation can yield valuable data. It can also cost-effectively quantify architectural trade-offs for many design ideas.

A design team at Allen-Bradley Co. used simulation to evaluate the Motorola 68020 and 68030 microprocessor

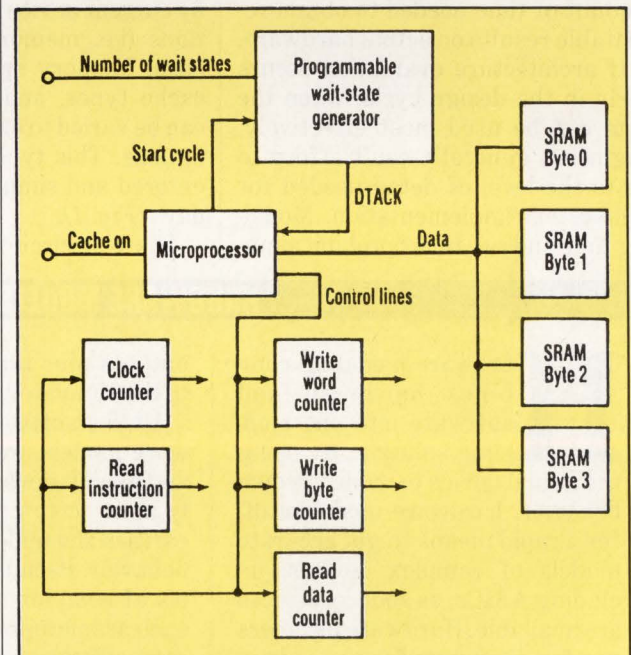

1. THE SRAM SHOWN in the block diagram of the test circuit stores test code. This circuit model can be configured during simulation to represent different designs.

EVALUATING DESIGN TRADE-OFFS WITH SIMULATION

architectures for a specific application. This pre-design evaluation was performed in a matter of days, and produced critical information for making design trade-offs.

The Allen-Bradley design project involved a 68020-based board. The team wanted to evaluate whether upgrading from a 68020 to a 68030 would improve the price/performance ratio. The areas of interest were microprocessor speed and memory-architecture efficiency. The Dhrystone 2.1 benchmark was one of the tests chosen to evaluate relative system performance.

The key to getting accurate results from simulation is the timing resolution. The simulator is accurate to a fraction of a microprocessor clock cycle, whereas an actual system requires averaging results to compensate for the system clock's inaccuracies (50 to 60 ms). In this case, simulation results matched the test code results produced on the actual system to within 1%. Each configuration's simulation runs in about 20 min. because of intelligent design of the test circuit, test-code compaction, and using the inherent accuracy of simulation to limit run times. Twenty minutes is about the same amount of time needed to obtain repeatable results on actual hardware.

If architecture evaluation occurs early in the design cycle, when the data can be used most effectively, engineers generally can't afford to go to the level of detail needed for full-system implementation. Modeling time and run times prohibit simu-

TABLE 1. ONE-PASS TEST SEQUENCE						
68020 Internal caches on, cold start, 1 pass						
Wait states	0	1	2	4	8	16
Clock cycles/Dhrystone	4888	5665	6512	8143	11759	19470
Read cycles	698	686	726	726	726	726
Instruction reads	376	364	404	404	404	404
Data reads	322	322	322	322	322	322
Longword writes	138	138	138	138	138	138
Byte or word writes	102	102	102	102	102	102

lating full systems. The most convenient option is to create a test circuit simplified to evaluate the design problems that are of most interest to engineers.

In the Allen-Bradley case, a test-circuit model was designed to evaluate the relationship between the microprocessor and the memory scheme. This circuit model has only a few schematic pages, and uses library models created by the company's engineers. It was designed for maximum flexibility, giving the engineers a way to vary architectures through the simulator without changing the circuit model itself. When simulating this circuit, the engineers could vary parameters quickly without being constrained by current device and process limitations (i.e. memory speed, memory size). Memory speeds, cache sizes, cache types, and processor speeds can be varied to explore many design options. This type of design can be entered and simulated in just a few days (*Fig. 1*).

The test circuit contains a micro-

processor, 1-Mbyte of static RAM (SRAM) to store the test code, a series of counters, and a programmable wait-state generator. The microprocessor is a hardware model, which incorporates the actual device into simulation. The rest of the circuit elements are simulation library models created by the engineers with schematic editing tools from Valid Logic Systems, San Jose, Calif.

The simulation ran on a Sun 3/60 workstation configured with 8 Mbytes of local memory, connected via Ethernet to the LM-1000 hardware modeling system from Logic Modeling Systems Inc., Milpitas, Calif. Allen-Bradley engineers employed Valid Logic's ValidSim 3.15 simulator, and entered schematics through the ValidGED design editor. Designing the test-circuit model, creating library parts, modifying test code, and entering the schematics took about six engineer-days.

No model-development time was needed because the microprocessor hardware models were obtained from Logic Modeling. The hardware

HARDWARE MODELS ENSURE ACCURACY

Hardware modeling combines hardware and software into one modeling solution. By using the actual device to model its own behavior, hardware modelers offer a rapid means to get accurate models of complex devices, including ASICs, as soon as devices are available. Hardware modelers can format inputs from the simulator, evaluate device behavior, and return the resulting device

outputs plus timing information, to the simulator.

Unlike software models, hardware models are fully functional and exhibit device behavior exactly as it occurs, including nonlinearities and undocumented device behavior. Because hardware models of complex standard devices, such as microprocessors, can execute software, they're a logical choice for running benchmarks or for performing hardware-soft-

ware integration.

A hardware model library of over 600 VLSI components is available from Logic Modeling Systems Inc., Milpitas, Calif., for the LM-1000 universal hardware modeler. The LM-1000 (which was used in this example) operates with a wide range of standard logic simulators. Therefore, engineers can share hardware models among the various simulators used by a design group.

EVALUATING DESIGN TRADE-OFFS WITH SIMULATION

models executed the test code accurately (see "Hardware models ensure accuracy," p. 86).

Rather than create a different design for each variation in architecture, engineers use a generalized circuit model that can be configured dynamically. With no wait states imposed, the test circuit represents the fastest memory scheme under consideration. The programmable wait-state generator model enables engineers to alter memory architectures by adding the wait states that are typical of each architecture. This is done by changing input-signal values only. Then the simulation script file, which controls the simulation, can alter the design automatically, without recompiling the circuit. This allows engineers to model variations in memory speed, cache size, and bus width. By varying these architectures, the performance of each microprocessor for various memory designs can be viewed.

The microprocessor in the test circuit activates the programmable wait-state generator when it begins a bus operation. This generator produces wait states requested by the engineer in the simulation script, and then sends an acknowledge signal to the microprocessor. In the Allen-Bradley project, the acknowledge is sent through the DTACK pin. The microprocessor then continues its operation, accessing the test code stored in the SRAMs. The counters monitor the control lines from the microprocessor and record the number of clock cycles and memory cycles.

Designs are configured dynamically with a specially designed 24-bit multiplexed shift register in the programmable wait-state generator block. This can supply a different number of wait states for read, longword write, and non-longword write operations.

Within the simulation script (a list of commands to the simulator), engineers specify the desired combination of wait states to the programmable-wait-state generator, and indicate whether a particular test should be done with the microprocessor's internal cache on or off. The combination of wait states produces the ap-

propriate speed for each memory scheme. In this example, as many as 26 designs, each with different wait-state combinations, are simulated in one session.

Dynamically configured wait states can also be used when evaluating different types of memory—SRAM, dynamic RAM (DRAM), and ECC DRAM (error-correcting memory)—for a given microprocessor design. SRAM is used as the base case. Then it's made to resemble dynamic memory by changing the acknowledge delays and including a timer to disable access to memory during the refresh cycles required by DRAM. This variation's simple implementation shows how a programmable-wait-state test circuit can be used in various evaluation procedures.

FINE-GRAIN TOOLS

Performance statistics depend heavily on the system in which the microprocessor resides. The statistics are rarely given for anything but the most optimal design case. The average number of clock cycles per memory fetch is seldom reported even though it's one of the most important parameters that an engineer considers when designing a memory interface to a microprocessor.

Measurement tools for the microprocessor test circuit were modeled to count clock cycles; read instructions; and non-byte-write, byte-write, and read data operations. The counters are started and stopped with the simulation script file. Counter data characterizes the rate and type of fetches per cycle. The resulting data, in turn, is used to compute internal cache hit rates and the memory bandwidth. The cache hit rate tells engineers how often external memory access is required. The memory bandwidth is the amount of information traveling across the memory bus per second. Both of these quantities aid engineers in creating the best memory design for an application.

When selecting test code, its size and complexity should be scrutinized. Ideally, actual system code should be used in the system comparison to give engineers an accurate

measurement of system performance for that specific application. However, large, complex applications require too much simulation time. Therefore, running system code, such as an operating system, may be impractical.

Standard benchmarks can be used to measure system performance. The Dhrystone benchmark is a synthetic benchmark. It was chosen as one of the benchmarks used to compare 68020 and 68030 performance because this benchmark can be simplified for simulation, and is well known to most engineers.

Preparing test code calls for reducing the code to the minimum length possible without lowering the accuracy of the results. For the Dhrystone benchmark, minutes of CPU time are typically required to achieve an accurate result on a typical workstation. On the system under consideration, 3 million passes of the Dhrystone code were needed to achieve a repeatable result. Allen-Bradley engineers used two main strategies to reduce run times: eliminating unnecessary code and limiting test-code iterations.

The test code was compacted by eliminating non-critical code. To trim code and preserve the accuracy of the test results, only code residing outside the actual testing section was eliminated.

The setup phase of the Dhrystone benchmark was reduced by removing the C language function calls—scanf and printf—that required large C libraries and a large amount of memory. Hard-coding the number of tests to be run also reduced the setup phase. While this changed how the hard-coded value was stored in memory, the overall execution time was hardly affected because this value was accessed only once per iteration. The extensive pre- and post-test reporting and printing operations usually performed during this benchmark were purged in favor of extracting the desired information from the simulator's results. The compacted benchmark is roughly 80% smaller than the original code.

The key to running test code on a simulator is to utilize the simulator's

For 17 years you've been better look at your

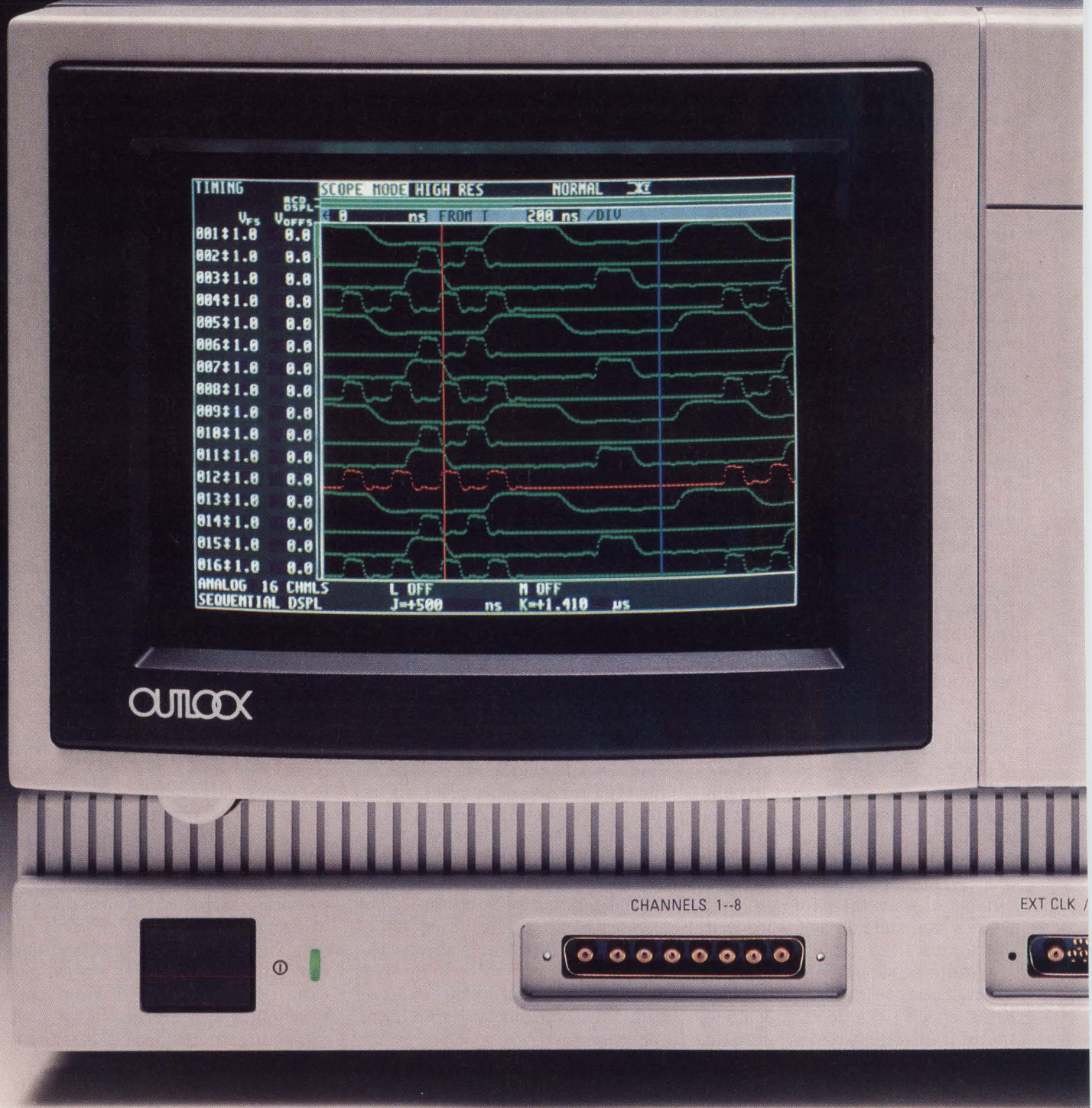

trying to get a logic signals.

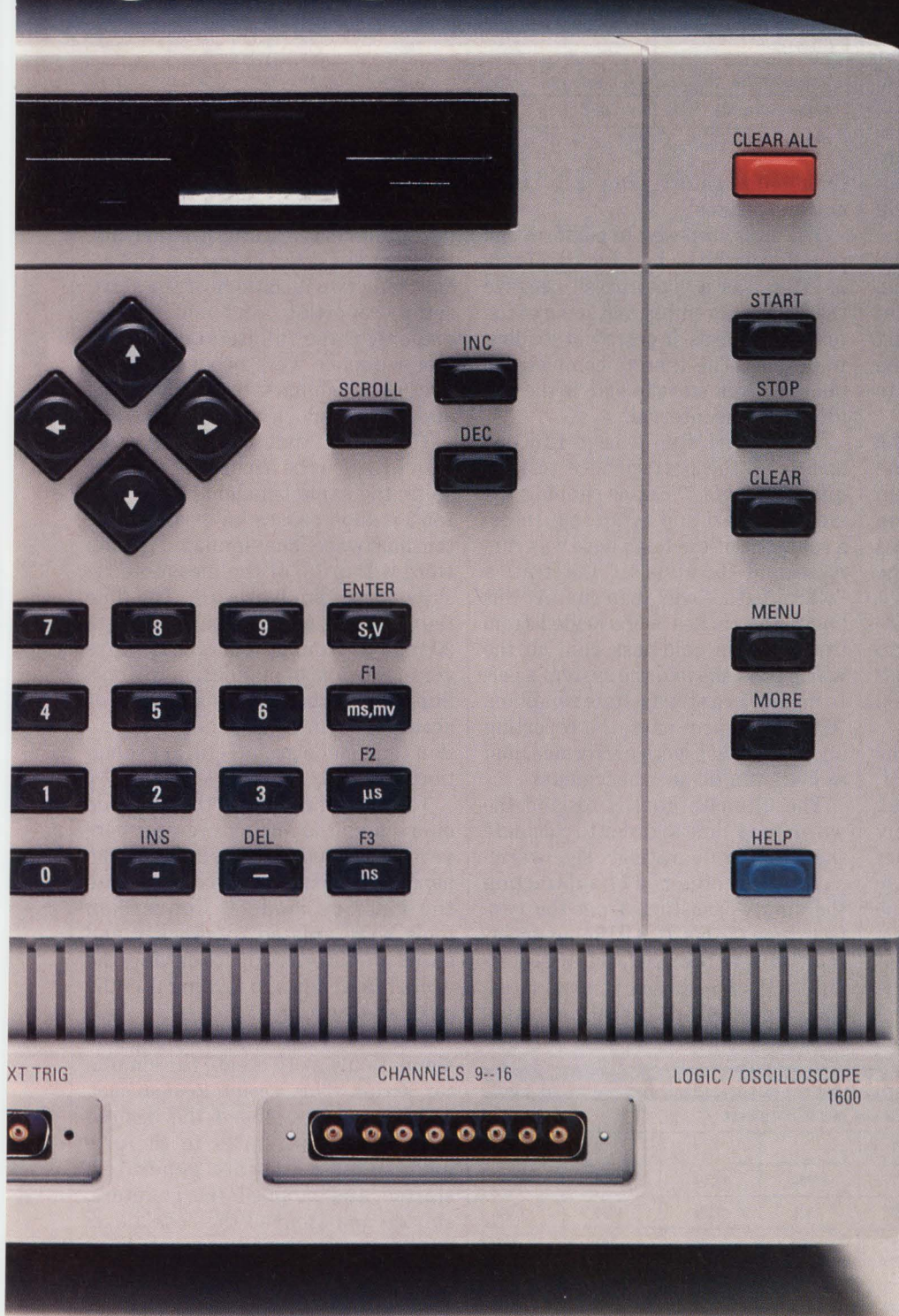

Sorry you had to wait so long.
**Introducing the Model 1600
Logic/Oscilloscope**

Now you can clearly see logic timing problems in analog form across as many as 160 channels—with logic analyzer triggering.

Look at both time alignment and signal fidelity simultaneously on lots of channels, and solve all kinds of measurement problems. Bus monitoring, for computers and peripherals. Termination problems. Ringing. Overshoot. Rise and fall times. Set-up and hold times.

And now, finally, you can test and time-align high channel-count test equipment. Calibration labs can now test and verify their ATE systems and ASIC verification systems.

The Logic/Oscilloscope lets you see it all, in exactly the format you want, with one machine. One screen. One group of parameters. One set of probes.

Display any channel, any place, relative to any other channel you want. Overlap two or more waveforms for easy comparison, and differentiate them in eight colors.

Easy-to-understand screens, prompted functions and a "Help" key make it easy to set up and take measurements without ever opening the manual.

Call (408) 374-2990 now and find out how to get a good look at the new Model 1600 Logic/Oscilloscope from Outlook.

You've waited long enough.

CIRCLE 177

OUTLOOK

Outlook Technology, Inc.
200 E. Hacienda Avenue, Campbell, CA 95008
Telephone (408) 374-2990 FAX (408) 374-9273

EVALUATING DESIGN TRADE-OFFS WITH SIMULATION

inherent accuracy to minimize the simulation time required to perform the system evaluation. Long run times are essential because of the limited timing accuracy of actual systems. Counters within actual systems rely on the system clock, which is typically restricted in accuracy to 1/60th of a second. Engineers must run iterative benchmarks repetitively until the uncertainty due to the system clock is negligible. In this example, the test code may typically have to run on an actual system thousands of times before a reasonable degree of accuracy is reached.

A simulator can determine time down to a fraction of a clock cycle, therefore it's not limited by the accuracy of a system clock. If exact start and stop times are known, only one iteration is needed to obtain accurate test-code execution times.

In the Allen-Bradley example, the number of passes of the Dhrystone benchmark test were reduced from the thousands ordinarily required on an actual system to only three passes run on the simulator. As a result, the benchmark simulated in less than 1 ms of actual CPU time. The simulator could run in a time comparable to the time required to achieve repeatable results (3 million iterations) on an actual system.

The benchmark's execution can be divided into five main phases: start, set up, test, reporting, and end. These phases are common to many types of benchmarks. If the exact start and stop times of each phase were known, only one pass would be needed to determine performance. However, these times can't be determined precisely. The problem was avoided in the Allen-Bradley example by eliminating the uncertainty in

68020 Internal caches on, warm pass (cold 2 pass - cold 1 pass)						
Wait states	0	1	2	4	8	16
Clock cycles/Dhrystone	3765	4406	5108	6451	9307	15370
Read cycles	572	560	600	600	600	600
Instruction reads	330	318	358	358	358	358
Data reads	242	242	242	242	242	242
Longword writes	119	119	119	119	119	119
Byte or word writes	40	40	40	40	40	40

timing of the start, setup, reporting, and end phases.

The first step was to perform one pass through the benchmark (*Table 1*). This was a "cold pass" because the cache was empty and some of the test's time was invested in loading the cache. The time to complete all phases, from start to end, is the single-pass time interval.

The second step was to run two passes of the performance test sequence (*Table 2*). After running the identical start and setup sequences, a cold pass of the test phase was run. A second iteration of the test, a "warm pass," was then run. At this point, the caches were loaded from the previous cold-pass run, so the warm pass showed the system's performance in a steady-state condition. After the warm pass, the reporting and end phases were performed, just as in the single-pass benchmark.

The ultimate goal is to land the warm-pass time in order to calculate the Dhrystone rating. The warm-pass time is obtained by subtracting the single-pass time from the two-pass time (*Table 3*). All timing uncertainty due to the start, setup, reporting, and end phases is eliminated. The cold-pass time is also eliminated because this test code is usually run

through thousands of iterations, making the cold-pass time of the first iteration insignificant. In the end, the warm-pass time remains. As a result, only two iterations of the start, setup, reporting, and end phases, and only three full iterations of the test sequence were needed. The resulting benchmark test code ran in about 12,000 clock cycles.

To ensure that this compaction didn't reduce the accuracy of the results, the same benchmark was run for 3 million passes on existing system hardware. The simulated results were within 1% of the measured results on system hardware. The time required was also comparable: 15 to 20 min. of running actual hardware versus 20 min. of simulation run on a Sun-3/60. Achieving this degree of accuracy with a reasonable execution time made architectural evaluation practical.

The procedure to run the test code on a simulated design requires converting the code into a simulator-dependent format, then loading it into the memory models. Conversion tools were created to simplify and speed the process of modifying the executable code and loading it in the simulated system.

The first step in performing the simulation was to create the simulator script. This script loaded code into memory, supplied the desired number of wait states to the programmable-wait-state generator, started and stopped the counters, started and stopped the code's execution in simulation, recorded results and elapsed time, and restarted the procedure using a different number of wait states. After the C source code for the test code was compiled

TABLE 2. TWO-PASS TEST SEQUENCE

68020 Internal caches on, cold start, 2 passes						
Wait states	0	1	2	4	8	16
Clock cycles/Dhrystone	8653	10071	11620	14594	21066	34840
Read cycles	1270	1246	1326	1326	1326	1326
Instruction reads	706	682	762	762	762	762
Data reads	564	564	564	564	564	564
Longword writes	257	257	257	257	257	257
Byte or word writes	142	142	142	142	142	142

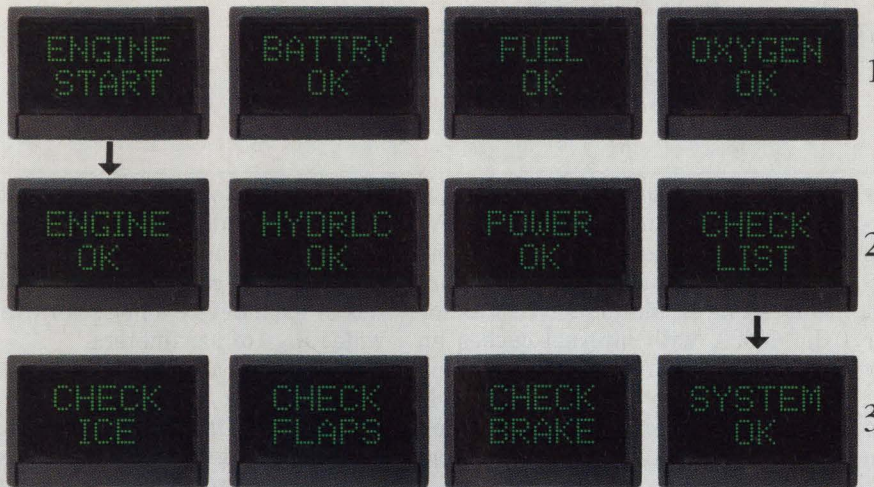

AN APPLICATIONS EXAMPLE.
While the following example is for aircraft, it could apply to any air, land, sea or space system.

SEQUENCE ONE: The four-pushbutton display reads "ENGINE START," "BATTERY OK," "FUEL OK," "OXYGEN OK." The operator selects "ENGINE START."

SEQUENCE TWO: The four-pushbutton display now changes to read "ENGINE OK," "HYDRIC OK," "POWER OK," "CHECK LIST." The operator selects "CHECK LIST."

SEQUENCE THREE: The four-pushbutton display now reads "CHECK ICE," "CHECK FLAPS," "CHECK BRAKE," "SYSTEM OK." In this manner, the designer can program in as many sequences as required.

Design flexibility: The programmable display system.

Vivisun Series 2000, now the leading programmable display pushbutton system, interfaces the operator with the host computer. The user-friendly LED dot-matrix displays can display any graphics or alpha-numerics and are available in green, red or amber. They can efficiently guide the operator through any complex sequence with no errors and no wasted time.

They also simplify operator training as well as control panel design. One Vivisun Series 2000

programmable display system can do the work of 50 or more dedicated switches. In short, Vivisun Series 2000 gives the design engineer more control over the design.

Contact us today.



AEROSPACE OPTICS INC.

3201 Sandy Lane, Fort Worth, Texas 76112
(817) 451-1141 • Telex 75-8461 • Fax (817) 654-3405

*Vivisun Series 2000
programmable displays. The intelligent
communications system.*

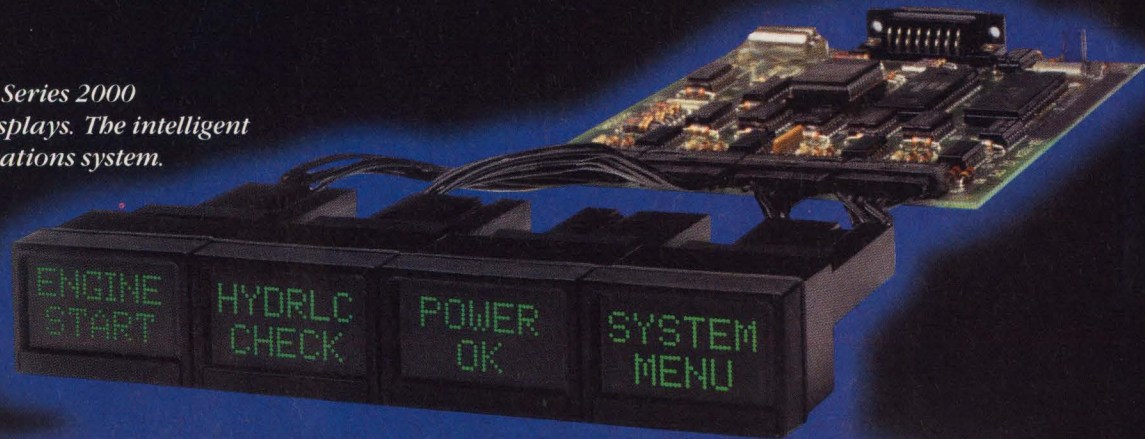

SERIES

VIVISUN 2000™

EVALUATING DESIGN TRADE-OFFS WITH SIMULATION

and linked, the executable file was converted to a downloadable Motorola S-records format. This file was then divided into four parts, transformed into a hexadecimal format file and loaded through a simulator routine into the four SRAM memory models.

The Dhrystone program was compiled and tested on the workstation before downloading to the simulation system. With translation utilities, changes were made in the source code and simulation began with the new executable code inside of 5 min. Each evaluation required about 20 min. to perform. For the 68020, engineers could evaluate 0 to 16 wait states in 6 hours and 18 min. For a 68030, the same evaluations required 5 hours and 35 min. As a result, simulation for architectural evaluation required less than one day per processor. The results enabled engineers to select the appropriate architecture for the design.

REVEALING RESULTS

Ideally, comparisons between the internal architectures of the 68020 and 68030 should be made at all available clock rates and desired wait states. Tests were run on the 68020 with 0 to 16 asynchronous wait states for memory access, and on the 68030 with 0 to 16 asynchronous and synchronous wait states. These tests confirmed that the 68030's asynchronous wait states are one wait state longer than the synchronous wait states. All of these tests were performed with the microprocessor's internal cache enabled and, in different runs, disabled to determine the cache hit rate. Tests were also performed with compiler register-optimization enabled and disabled.

Using hardware models of the microprocessors yielded

highly accurate results (*Table 3, again*). The simulation results revealed subtle variations in device behavior. For example, warm-start Dhrystone 2.1 simulation results for the 68020, with internal caches on and with registers, show an unexpected increase in instruction reads with two wait states. This variation in device behavior stemmed from

prefetching operands while the 68020 executed a forward branch instruction. By using hardware models, engineers could learn the subtleties of each device's behavior over a wide range of parameters.

The warm-pass time holds the key to calculating the design's Dhrystone rating. One Dhrystone equals the time the design requires to execute one test pass. When the Dhrystone benchmark is run on an actual system, only the first pass is a "cold pass." If the first pass is also assumed to be a warm pass, the margin of error is only:

$$\frac{\text{Cold pass time} - \text{Warm pass time}}{\text{Number of Passes}}$$

Determining the number of Dhrystones the design can execute per second from the warm pass time is trivial.

This benchmark is run independently of clock speed, so the effects of clock speed on performance must be calculated to attain performance-comparison graphs (*Fig. 2*). To calculate the expected Dhrystone rating for a design, divide the clock frequency by the number of clock cycles per Dhrystone, which is determined during the benchmark. Repeat the calculation for different wait states by dividing each clock frequency by the clock cycle total for the given number of wait states.

For example, consider a 68020 system with 0 wait states and register optimization enabled. During simulation, this processor and memory configuration required 3765 clock cycles per Dhrystone. To determine the Dhrystone rating for each speed of the 68020 processor, divide each speed by 3765:

$$\begin{aligned} 50 \text{ MHz} \div 3765 \text{ cycles per Dhrystone} \\ = 13280 \text{ Dhrystones/s} \end{aligned}$$

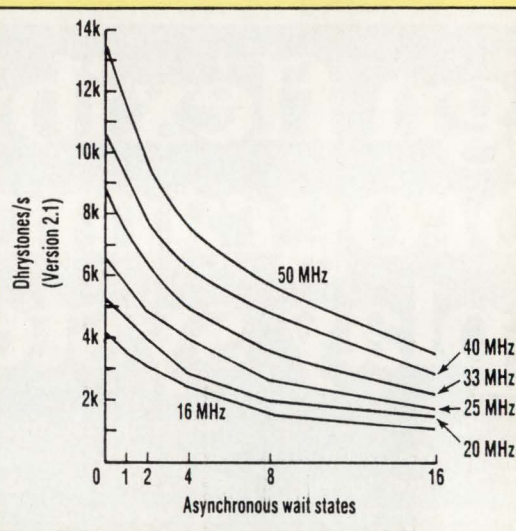

(a)

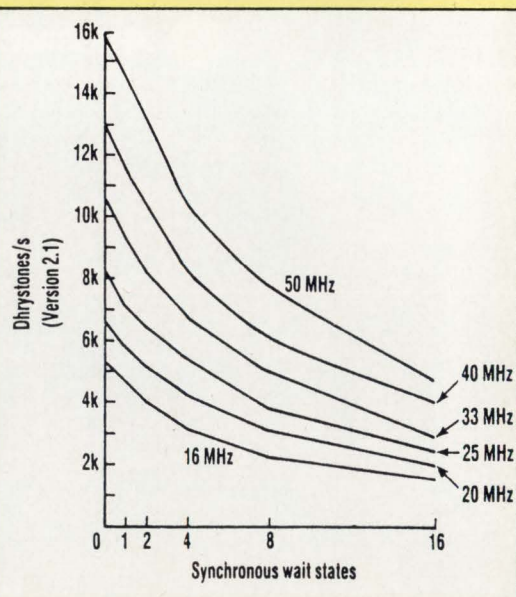

(b)

2. PERFORMANCE-COMPARISON GRAPHS

show the number of Dhrystones/s calculated for the 68020 (a) and for the 68030 (b). The horizontal axis represents the memory speed given as the number of wait states.

EVALUATING DESIGN TRADE-OFFS WITH SIMULATION

TABLE 4. CALCULATED CACHE HIT RATES

Dhrystone 2.1 registered (warm start behavior)		
68020	Internal cache read cycle hit rate:	32%
	Internal instruction cache read cycle hit rate:	45%
68030	Internal cache read cycle hit rate:	57%
	Internal instruction cache read cycle hit rate:	46%
	Internal data cache read cycle hit rate:	86%

40 MHz ÷ 3765 cycles per Dhrystone
= 10,624 Dhrystones/s

33 MHz ÷ 3765 cycles per Dhrystone
= 8765 Dhrystones/s

25 MHz ÷ 3765 cycles per Dhrystone
= 6640 Dhrystones/s

20 MHz ÷ 3765 cycles per Dhrystone
= 5312 Dhrystones/s

16 MHz ÷ 3765 cycles per Dhrystone
= 4249 Dhrystones/s

Because the clock cycle measurement is independent of microprocessor speed, this method makes it possible for engineers to rate microprocessors that aren't yet available, as shown in the previous chart.

Internal cache-hit rates can be determined with the read cycle counts by using the following formula:

$$1 - \left(\frac{\text{Read cycles with cache on}}{\text{Read cycles with cache off}} \right)$$

Large cache-hit percentages for the relatively small 68030 internal cache might indicate that this benchmark produced optimistic results for this particular processor design. Moreover, the cache-hit rates would probably be considerably less in an actual system (Table 4).

In the graph of the 68020 and the 68030's performance operating within the test system, the horizontal axis represents the memory speed given as the number of wait states (Fig. 2, again). The wait states are asynchronous for the 68020 and synchronous for the 68030. The vertical axis represents performance, given in Dhrystones/s as calculated with the aforementioned formulas.

Graphing data in this manner enables engineers to quickly determine the architecture options available for a given performance specification, and to ascertain the effects of design changes on performance. For

example, the graphs show that there are four practical options for a 68030-based system to perform at 8k Dhrystones/s. Four curves—25 MHz, 33 MHz, 40 MHz, and 50 MHz—cross the 8k Dhrystone mark. Knowing these options, engineers can determine the best solution based on the relative cost and availability of the memory and processor components, as well as the difficulty of implementation.

In the Allen-Bradley example, the 68030 was compared to a 68020. These test results show an unexpected similarity in performance for the two microprocessors. For the asynchronous memory interface under consideration, the 68030 executed the test code only about 10% faster than the 68020. This difference can probably be attributed to the data cache in the 68030. Note that the 68030's asynchronous wait states are one wait state longer than the synchronous wait states.

For this application, the engineers found that a faster version of the 68020 offered the best price/performance ratio. If a memory management unit (MMU) or a synchronous bus was used in the test system, however, the difference in performance between a 68030 and a 68020 would be more pronounced. These results underscore the importance of modeling a test system that's as close as possible to the actual hardware, with test code that's as close as possible to the actual system code.

In particular, engineers should be careful when using benchmarks to compare different microprocessors. If different compilers are used to compare two different microprocessor families, the benchmark results might reveal more information about the compiler's efficiency than about the performance of the microprocessors being rated. Benchmarks typically test one aspect of perfor-

mance, such as processor-to-memory interface, interrupt latency, or disk I/O transfers. The best way to compare different microprocessor families is to simulate with the compiler and code chosen to run in the final system. If this isn't possible, engineers should try to pick several benchmarks that most closely approximate how the final system will be used.

By simulating a test circuit model, designers can evaluate new processors over a wide range of design parameters with a minimum of effort. A test circuit model using full-function hardware models can reduce modeling time and run the test code accurately during simulation. This test circuit can be configured dynamically to deliver a wide range of architectures and measure system performance. To make the simulation most efficient, engineers can take advantage of the simulator's accuracy to reduce run time.

By evaluating a range of designs early in the design process, designers choose wisely and accurately predict the result of the final product. With the large number of new and increasingly complex microprocessors introduced each year, evaluating system architecture efficiently during simulation will help system designers realize the full benefit of these advances. □

David A. Vasko, senior hardware engineer in the Industrial Computer and Communication Group of Allen-Bradley Co. Inc., received a BEET degree from the Ohio Institute of Technology, Columbus. He is currently completing his MSCE at Case Western Reserve University, Cleveland.

Dan Weyer is a senior CAE engineer in the Industrial Computer and Communication Group of Allen-Bradley Co. Inc. Dan holds a BSET degree from Cleveland State University.

HOW VALUABLE?	CIRCLE
HIGHLY	532
MODERATELY	533
SLIGHTLY	534

For Designs That Demand a Lot of Memory,

When it comes to PCs, workstations, printers, and other computer-related products, end-users want smaller systems, maximum memory storage, and minimum power consumption. And they want it now. Which creates several problems for you. How do you reduce system size *and* power consumption yet increase memory capacity? *And* be first to market with your product? Oki offers some flexible solutions.

To begin with, our pin-for-pin compatible 4-Megs provide 4X the memory storage of a 1-Meg — without increasing space. Plus our 4-Megs have the lowest power consumption of any 4-Meg, making them ideal for laptops and other memory-intensive, power-hungry

systems. Choose from a variety of packages too: DIP, SOJ, ZIP — and, later in 1990, an ultrathin TSOP, for even more space-saving advantages.

For higher density applications, select from Oki's package-efficient family of SIMMs: 4-Megx8s, 4-Megx9s, and 1-Megx36s. Or we'll work with you to design a custom SIMM that meets your unique specifications. All our 4-Megs and SIMMs are available *now*, so we're ready to help accelerate your design time and your product's time-to-market.

Call Oki today for qualification samples. See why so many companies are demanding Oki's low-power, space-saving 4-Megs and SIMMs — and getting their leading-edge computer products to market so quickly.

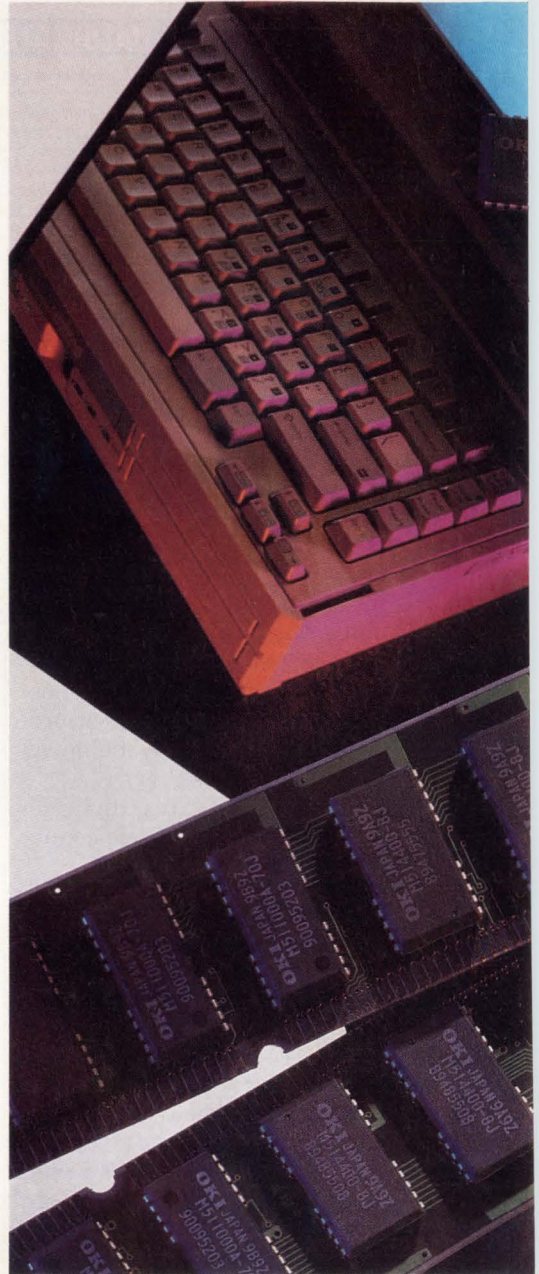

Transforming technology into customer solutions

Demand Oki 4-Megs and SIMMs



Oki's 4-Meg Product Line-Up

Device	Organization	Access Mode
MSM514100-XXYY	4M x 1	Fast Page
MSM514101-XXYY	4M x 1	Nibble
MSM514102-XXYY	4M x 1	Static Column
MSM514400-XXYY	1M x 4	Fast Page
MSM514402-XXYY	1M x 4	Static Column

Speed Options (XX) Include:
 70 = 70ns (°RAC)
 80 = 80ns (°RAC) 20ns (°CAC)
 8A = 80ns (°RAC) 25ns (°CAC)
 10 = 100ns (°RAC) 25ns (°CAC)

Packaging Options (YY) Include:
 JS = 350 mil SOJ
 RS = 400mil DIP
 ZS = 400mil ZIP

SIMMs

MSC2341-XXYS8	4M x 8	Fast Page
MSC2340-XXYS9	4M x 9	Fast Page
MSC2350-XXYS12	1M x 36	Fast Page

Speed Options (XX) Include:
 70 = 70ns (°RAC)
 80 = 80ns (°RAC) 20ns (°CAC)
 10 = 100ns (°RAC) 25ns (°CAC)



OKI
Semiconductor

CA Irvine 714/752-1843, Tarzana 818/774-9091, San Jose 408/244-9666 FL Boca Raton 407/394-6099
 GA Norcross 404/448-7111 IL Rolling Meadows 708/870-1400 MA Stoneham 617/279-0293 MI Livonia 313/464-7200
 NC Morrisville 919/469-2395 NY Poughkeepsie 914/473-8044 PA Horsham 215/674-9511 TX Richardson 214/690-6868

~~a~~
“expensive”

The Multibus II product line has changed.

We've dramatically reduced your costs and added dozens of products. And that's great news when your designs call for more than a PC.

Today, our Multibus II system with a 386™ CPU, disk, tape, and 4MB of RAM is priced at just \$9,995.

And the costs of our Multibus II single board computers are down as much as 47%.

Now you can build the Multibus II discipline right into your system for the price of VME or EISA. Multibus II's new MPI bus interface chip is perfect for building simple analog, digital, or serial interface boards. It costs just \$40 in quantities over 100.

The Multibus II product line has expanded, too. In the last year alone, we've added over a

dozen I/O and CPU board products. And you can choose from the more than 500 Multibus II products on the market, including 150 full-size Multibus II boards.

Need help migrating from VME? Our single-slot VME-to-Multibus II adapters will give you a jump on switching your custom VME boards to Multibus II.

To view the entire expanse of Multibus II products — from over 100 vendors — call Intel at (800) 548-4725, Dept. AA60. Ask for a free copy of the *1990 Multibus II Product Directory*.

So don't delay. Call now, and start a change for the better.

intel®

OFFERS YOU CAN'T REFUSE

A free evaluation package demonstrates Accel's Tango PLD software for designing programmable logic devices. Tango PLD combines in one program a design compiler, logic minimizer and simulation. The program's list price is \$495. The evaluation package consists of a 60-page illustrated tutorial and an evaluation version of Tango-PLD. To order the package, designers may call (800) 433-7801.

Non-PC applications show a growing need for special-purpose DOS. Makers of pc-boards find that one-third or more of their products work their way into industrial or non-PC applications. To fill that need, ROM-DOS is available for as little as \$6 per copy in quantities of 5,000. The operating system, which operates like MS-DOS 3.2, works within ROM or boots from a floppy or hard disk. Because it resides in ROM and uses only minimal RAM during operation, ROM-DOS is frugal with memory. It takes up 34k of ROM and 14k of RAM. For more information, contact Datalight, 17505-68th Ave. NE, Suite 304, Bothell, WA 98011; (206) 486-8086.

Five free application notes describe developing microprocessor-based designs. The notes are written by Applied Microsystems Corp.'s field engineers.

Selecting the Correct Development Tools serves as a checklist for engineers choosing development and debugging tools. *What to Look for in an In-Circuit Emulator* covers how the emulator will work with the target and looks at basic emulator features, software considerations, and support issues.

Statistical Performance Analysis gives real-life examples of how statistical performance analysis helps improve code performance. The article also has C source code for a PC program, which stands alone or works with an Applied Microsystems' ES 1800 emulator. *Comparison of Source-Level Debug Tools for Intel 16-bit Microprocessors* describes features of the Validate/Soft-Scope, Validate/Unison, and GeneProbe debuggers.

Emulation in a Multiprocessor Environment: An 8051-68302 LAN explains a simple 68302-8051 local-area network and discusses using emulation and other tools to debug the design. Copies of the notes are available by calling (800) 343-3659.

K M E T S K O R N E R

...Perspectives on Time-to-Market

BY RON KMETOVICZ

President, Time to Market Associates Inc.
Cupertino, Calif.; (408) 446-4458



Imagination is more important than information.

Albert Einstein

Several trends stand out as the '90s open—the move toward a global peacetime economy, the opening of the European Common Market, the emergence of an Eastern European market, and changing environmental patterns. These will alter the product and service mix of many businesses while stimulating new opportunity. Defense companies in the U. S. are struggling with some of the most dramatic market changes since the late '40s. Participation in Europe's economic unification will affect many companies' bottom lines. Countertrade (barter) seems to offer a way to do business with cash-poor Eastern Bloc countries. Add to these items the difficulties of meeting tougher environmental and safety requirements.

Information on these issues, along with data on other significant items of national, local, and corporate interest, profoundly affects developing new products. Believable, accessible, voluminous, and conflicting information is producing a decision crisis. Only creative management and imaginative use of time-perishable information keeps the definition phase of the new-product development process from extending to infinity.

Developing a quality business definition and product definitions that align with the business definition isn't a single-step process done by an individual in a vacuum. It is a complex horizontal and vertical team effort that can touch just about everyone involved in the new-product development process. Top management, middle management, and individuals with the talent and the time for doing front-end work from R&D, marketing, manufacturing, and support become actively involved in coming up with business and product definitions. The accuracy of these definitions and the performance of new-product development teams to convert the ideas they contain into product reality forms the foundation for business success. To make the definition process more visible and therefore measurable, I've developed a Definition Matrix model. The two-by-six matrix establishes a recommended path to generate a stable product definition. The two columns are labeled business and product. The six rows are titled vision, big picture, market information, alternative synthesis, alternative analysis, and output. Each of the 12 cells identifies the production of refined information that leads to quality business and product definitions based on facts and verified assumptions. The results that managers and product development people produce within each cell are measurable. For example, you can tell if your business vision (row 1, column 1) is of high quality if:

- Everyone, from line worker to executive, understands the vision statement.
- It is short, bold, and optimistic.
- It was made by the right person, a leader in a position of power.
- It stimulates creative thinking.
- It doesn't speak of products and services.
- It places constraints on market focus.
- It lies beyond next quarter's earnings or this month's production schedule. It looks well into the future.

Likewise, a product definition is complete (row 6, column 2) when:

- A prototype or simulation of the final product exists for manipulation, measurement, and inspection.
- The complexity of work to be done within each functional area is quantized.
- The expected productivity for each functional group is understood.
- Estimates of resource availability are known.
- Information on complexity, productivity, and resource availability is used to estimate project time to market.

Space doesn't permit me to describe fully each cell of the Definition Matrix. But I've given you the basic structure. Next I'll describe an organizational model to further develop product-definition skills.

T I P S O N

WRITING . . .

In their memos, letters, and periodic progress reports, engineers typically write about how they solved a technical problem. But since the writer of the report solved the problem, he may have difficulty seeing the forest for the trees. This form of tunnel vision is perhaps the biggest pitfall in engineers' writing—getting bogged down in details and not putting the problem and its solution in perspective. Perhaps the writer assumes that "every one knows all that already."

Another common problem is digression. A writer trails off into side discussions that may be interesting technologically but aren't directly related to the subject at hand.

Remember—even if you know your subject cold, it is what's on the paper that counts—that's all that anyone else has at hand to learn about your project. Accept that your report may not say what you think you've said.

One helpful technique is to ask a colleague to read your first draft and give you feedback. If you do this, you'll have to swallow your writer's pride. But note that professional writers submit their writing to an editor's scrutiny every day. Everyone can use a second pair of eyes on his writing.

If you write on a PC, use one of the many spelling- and grammar-checking programs, besides the desktop standbys, a dictionary and a thesaurus. If you'd like to explore writing and grammatical topics in some depth, take a look at William Zinsser's *On Writing Well*, just out in a third edition.

D I D Y O U K N O W ?

. . . that one-third of engineers and scientists doing research and development work are employed by the U. S. Department of Defense or by companies with DOD defense contracts? IEEE

. . . that hard disk drives came to be known as Winchester after the familiar .30-30 rifle: The first drive held 30 Mbytes on each of its two spindles.

IBM *Directions*, Summer 1990

. . . that only 6% of working engineers are women. And just 16.5% of undergraduates currently majoring in engineering are women—a percentage that hasn't budged much in the past five years. Other fields are a different story, however. Women make up 40% of the enrollment in law schools and 35% of the enrollment in medical schools.

The New York Times

1-M I N U T E O P I N I O N S

Should the U.S. government directly support U.S. electronic manufacturers, who face increasing international competition?

No. The problem is much more fundamental. The governmental system is already overloaded. **Herbert Heller**, *Pittsburgh, Pa.*

Yes. Everybody else does. Stop arguing about it, and *do it*. **James D. Traill**, *Tokyo, Japan*

The U. S. government should supply more tax benefits toward R&D investments as a means of combating foreign competition. **Ken Smetana**, *San Diego, Calif.*

The government seems to support other industries that can't support themselves (i. e., farming, railroads, welfare career specialists, etc.). What difference would one more make? **Mark A. Long**, *Bluffton, Ohio*

No! Absolutely not! The last thing we need in this country is the government subsidizing another important industry, especially the one I'm in.

All such subsidies do is isolate the beneficiaries from the market, ensuring that they will have no rock-hard stimulus to efficiency and leadership. Eventually the moribund companies lose their subsidies, and then they die, leaving the country with no means of catching up with the (foreign) companies that have had the benefit of exposure to the real world and its harsh lessons. I'd much rather see a bunch of unsubsidized gazelles than a whole lot of subsidized dinosaurs, and I wouldn't work for the latter. **Kenneth H. Fleischer**, *Los Angeles, Calif.*

No. I am against all attempts at manipulating free enterprise and all attempts to corrupt the free market. If a company or country cannot produce goods that are of sufficient quality at a reasonable price, then they should be allowed to go under. It is well and good to say "Why not? The Japanese have been doing it for years." But that only makes you as bad as them and doesn't even begin to address the problem.

It's also how things like wars get started. **Paul Harper**, *London, England*

It is not a proper function of democratic governments in free-market economies to support underproductive industries. It is time for us to be done with corporate bailouts!

Government handouts and the restrictions accompanying them squelch necessity-motivated industriousness and creativity. The demoralizing and debilitating effects of government welfare for individuals are well known to political conservatives and liberals alike. The system, altruistic as it is, has produced multiplying generations of indolents and unemployables. Welfare recipients are soon entrapped by a bureaucratic, dehumanizing system. We can not afford to create a welfare system for corporations that will be equally counterproductive.

The parallel between individual welfare and government support of industry may seem obscure but it will become painfully clear to corporate recipients after the trap has been sprung. Whatever the government supports, it controls. Whatever the government controls, it corrupts. Government support and control aren't needed, but enlightened management is. Foreign competitors are beating us at our own game not because they are unfair but because we have tried to short-circuit the rules. The rules, originally made in America, are flexibility, individual initiative, productivity, and business decisions that promote long-term development vs. short-term greed. **Earl Pomeroy**, *Grand Rapids, Mich.*

What's your opinion on the design skills of today's EE graduates? How do their skills stack up against those of young engineers of the past? Or how important do you think analog design skills are for engineers? Send us your opinions on these questions to our Reader Opinions fax: (201) 393-0637. Or mail your responses to *Electronic Design*, Reader Opinions, 611 Route 46 W., Hasbrouck Heights, NJ 07604.

PARTNERS IN DESIGN

COTO WABASH

REED RELAYS

"Our Customers depend on Teradyne to deliver our Automatic Test Equipment to the highest standards of quality and reliability. To meet these requirements we depend on our suppliers to deliver their components to these same standards. Coto has delivered and is working with us to insure our continued success."

Tom Felding, Teradyne Operations Manager

"Coto is the first relay manufacturer to meet our tough ship-to-stock requirements. In a business as complicated and fast-paced as ours, getting quality parts on time makes a big difference."

Kevin Cawley, Teradyne Manager, Component Engineering

"What really impresses us is Coto's willingness to work with Teradyne to help solve problems. Their people are always professional and detailed. Together, we make a great team."

Don Murphy, Teradyne Component Engineer

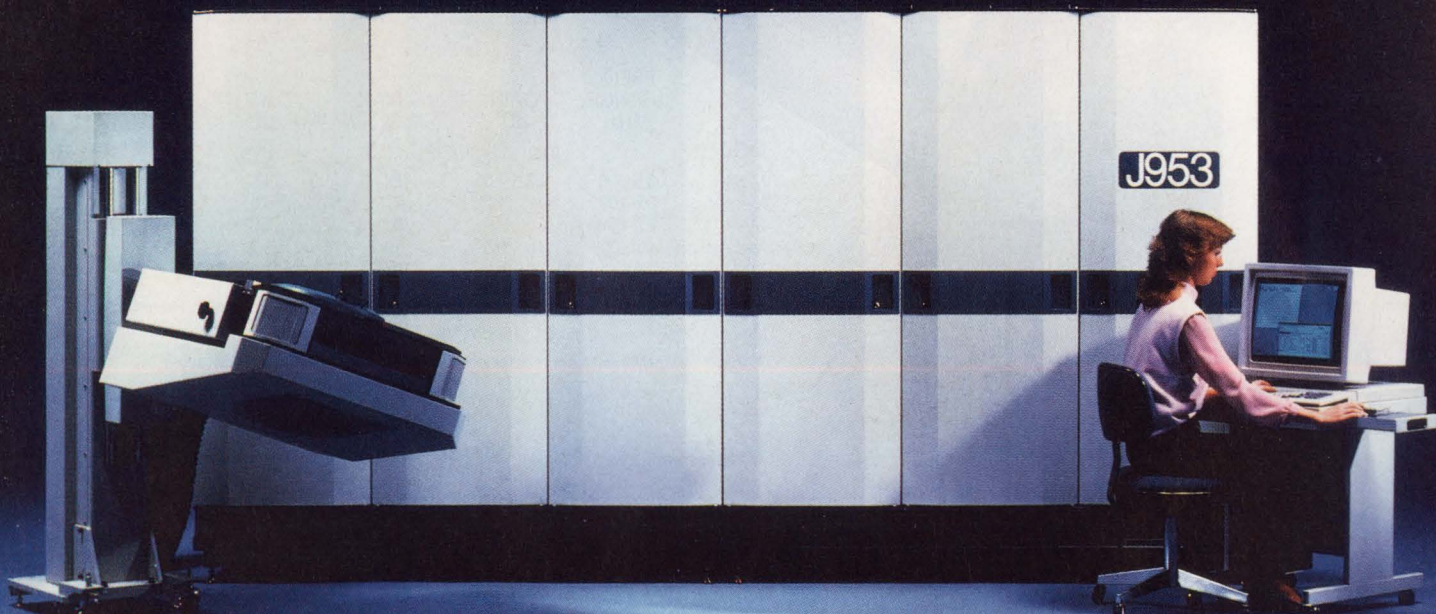

55 Dupont Drive, Providence, RI 02907 • (401) 943-2686 • FAX (401) 942-0920

CIRCLE 214

rugged plug-in amplifiers

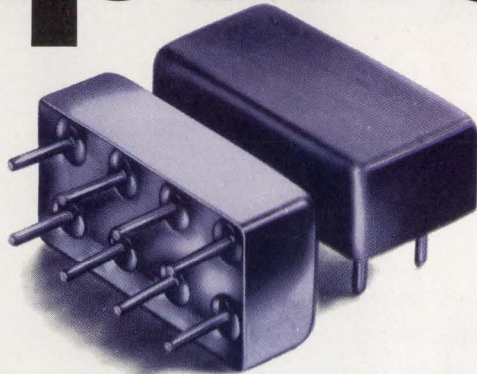

0.5 to 1000/MHz from \$13⁹⁵ (10 to 24 qty)

Tough enough to meet full MIL-specs, capable of operating over a wide -55° to $+100^{\circ}\text{C}$ temperature range, in a rugged package... that's Mini-Circuits' new MAN-amplifier series. The MAN-amplifier's tiny package (only 0.4 by 0.8 by 0.25 in.) requires about the same pc board area as a TO-8 and can take tougher punishment with leads that won't break off. Models are unconditionally stable and available covering frequency ranges 0.5 to 1000MHz, NF as low as 2.8dB, and power output as high as +15dBm. Prices start at only \$13.95, including screening, thermal shock -55°C to $+100^{\circ}\text{C}$, fine and gross leak, and burn-in for 96 hours at 100°C under normal operating voltage and current.

Internally the MAN amplifiers consist of two stages, including coupling capacitors. A designer's delight, with all components self-contained. Just connect to a dc supply voltage and you are ready to go.

The new MAN-amplifiers series...
another Mini-Circuits' price/performance breakthrough.

MODEL	FREQ. RANGE (MHz)	GAIN dB		MAX. OUT/PWR†	NF dB	DC PWR 12V, mA	PRICE \$ ea.
	f_L to f_U	min	flatness††	dBm	(typ)		(10-24)
MAN-1	0.5-500	28	1.0	8	4.5	60	13.95
MAN-2	0.5-1000	19	1.5	7	6.0	85	15.95
MAN-1LN	0.5-500	28	1.0	8	2.8	60	15.95
◇MAN-1HLN	10-500	10	0.8	15	3.7	70	15.95
*MAN-1AD	5.500	16	0.5	6	7.2	85	24.95

††Midband $10f_L$ to $f_{U/2}$, $\pm 0.5\text{dB}$ †dB Gain Compression ◇Case Height 0.3 In.
Max input power (no damage)+15dBm; VSWR in/out 1.8:1 max.

*Active Directivity (difference between reverse and forward gain) 30 dB typ.

finding new ways...
setting higher standards

Mini-Circuits

A Division of Scientific Components Corporation
P.O. Box 350166, Brooklyn, New York 11235-0003 (718) 934-4500
Fax (718) 332-4661 Domestic and International Telexes: 6852844 or 620156

CIRCLE 521 VARY FILTER'S PASSBAND GAIN

ALEKSANDER NIEMAND

Harris Semiconductor, P.O. Box 976,
Sollentuna, Sweden 19129; 46 8 623 5229.

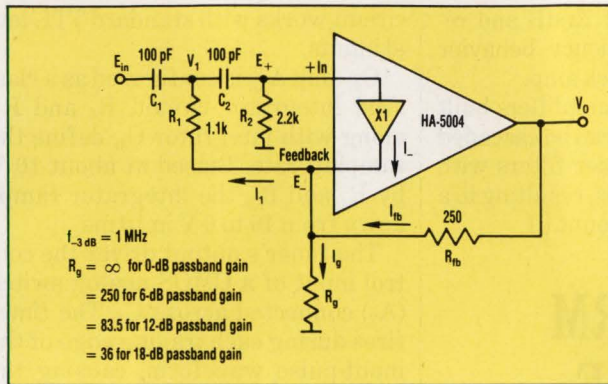

1. BY USING the input buffer as the active element in the filter, the variable passband gain is set by the resistive feedback around the amplifier.

Standard op amps are widely used as building blocks in various active-filter configurations. One of the more popular is the Sallen-Key second-order high- or low-pass filter due to its straightforward design. However, while the filter simplifies second- or higher-order filter implementation, its passband gains can't be varied independently of other filter parameters. This limitation can be removed easily by using the new breed of current-feedback amplifiers as active elements in the filter design.

The main difference between a

standard op amp and this type of amplifier lies in the input-stage topology. In the current-feedback amp, there's a high-impedance buffer between the noninverting and feedback inputs. Also, output voltage is a function of current in the buffer's output.

This current-feedback amp can be implemented in an active filter with a passband gain that's independently variable of other filter parameters. The filter itself is built using the input buffer as the active element while passband gain is set by resistive feedback around the amp (Fig. 1).

The following equations can be derived from the circuit:

$$\text{Output voltage: } V_o = A(s) \times I_-$$

$$\text{Input buffer: } E_- = E_+$$

$$\text{Current summing: } I_- + I_{fb} = I_g + I_1$$

$$\text{Kirchhoff: } I_{fb} = (V_o - E_-)/R_{fb}$$

$$I_g = E_-/R_g$$

$$I_1 = (E_- - V_1)/R_1$$

$$(E_{in} - V_1) \times sC_1 + I_1 = E_+/R_2$$

$$E_+ = V_1 \times sR_2C_2 / (1 + sR_2C_2)$$

Rearranging the equations and performing basic algebraic operations results in the following transfer function for the circuit:

$$V_o(s)/E_{in} = \frac{1}{(s^2R_1R_2C_1C_2)[1+sR_1(C_1+C_2)] + s^2R_1R_2C_1C_2}$$

$$\times (1 + [R_{fb}/R_g] - [R_{fb}/sR_1R_2C_2])$$

The first term is readily recognized as the second-order high-pass filter transfer function. The gain expression at the end of the equation contains a frequency-dependent term $[R_{fb}/(sR_1R_2C_2)]$ that produces a notch in the filter's stopband. With the proper dimensioning of components, this notch can occur at a sufficient low frequency so that its effect on the passband and the roll-off characteristics will be negligible. A prototype circuit was built using selected filter-component values to produce high-pass Butterworth characteristics that have a -3-dB frequency at 1 MHz.

A comparison was made between

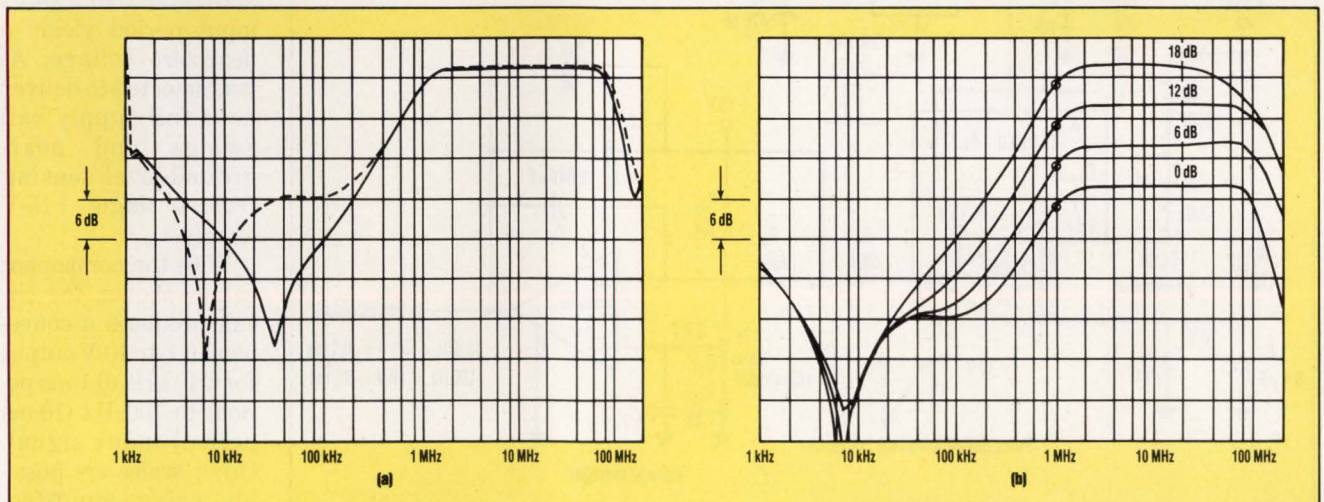

2. THE 1-MHZ HIGH-PASS FILTER RESPONSES are compared using a standard Sallen-Key topology (solid line) versus one with the current-feedback amplifier's input buffer as the active element (dashed line) (a). The gain settings from 1 kHz to 200 MHz are plotted as the passband gain is varied from 0 to 18 dB (b).

filter response with standard topology and the proposed design. As evidenced by the frequency-response plots, a notch appears in the stopband for both topologies (Fig. 2a). In a standard configuration, the notch results from leakages and input stray capacitances. If the capacitances were taken into account in the analysis, similar parasitic terms in the transfer function would have been produced.

Passband gain in the new design was then varied between 0 and 18 dB by adjusting the value of R_g between infinity and 36Ω . Afterwards, fre-

quency response was plotted for each gain setting between 1 kHz and 200 MHz. The plot shows that the cutoff frequency remains constant throughout the gain range, while roll-off is maintained at -20 dB/decade down to 100 kHz (Fig. 2b). The upper bandwidth limit remains constant up to a gain of 12-dB and reflects the high-frequency behavior of the current feedback amp.

A number of filter amplifiers built with this technology can be cascaded to produce higher-order filters with higher passband gains, resulting in a reduced component count. □

figured as a $5\text{-}\mu\text{s}$ one shot. Resistors R_1 and R_2 bias the timer's input at about 3 V above the triggering threshold. Because the timer fires only on the trailing edge of the input waveform, the signal doesn't need a symmetrical 50% duty cycle. However, it does require a fast fall time. The circuit works with standard TTL-level inputs.

Op amp A_{3A} is configured as a classical integrator circuit. R_6 and R_7 , along with integrator C_4 , define the ramping rate. Biased at about 10 V by R_4 and R_5 , the integrator ramps down from 10 to 0 V in 10 ms.

The timer's output drives the control input of a CMOS analog switch (A_2) connected across C_4 . The timer fires during each trailing edge of the input-pulse waveform, causing the switch to reset the integrator back to 10 V.

The average of the sawtooth waveform voltage produced at the integrator's output is directly proportional to the time between the incoming pulses. R_7 adjusts the conversion scale and compensates for component tolerances.

The sawtooth waveform is aver-

aged using an inverting low-pass filter (A_{3B}). The filter components are selected for a gain of 2 and a 5-Hz knee. R_{11} sets the zero reference voltage (6.67 V) so that a short input period yields a near-zero voltage. A_3 was selected to deliver near-full-supply rail swings and near-ground-level sensing from a single +15-V supply.

With the component values shown, the circuit produces a convenient 0.1- to 10-V output for a 10 kHz (0.1-ms period) to 100 Hz (10-ms period) input signal. Other scales are possible using input-frequency dividers or different integrator ramping times. □

CIRCLE 522 CONVERT WAVEFORM PERIOD TO VOLTAGE

DAVID JOHNSON

10198 W. Berry Dr., Littleton, CO 80127; (303) 973-8408.

On special occasions, a design may call for the monitoring of a signal's period rather than its frequency. This period-to-voltage circuit performs such a function. The circuit's 0.1- to 10-V

output corresponds to an input period of 10 to 0.1 ms. The design is made of simple components, and requires just a single +15-V supply (see the figure).

A CMOS 555 timer IC (A_1) is con-

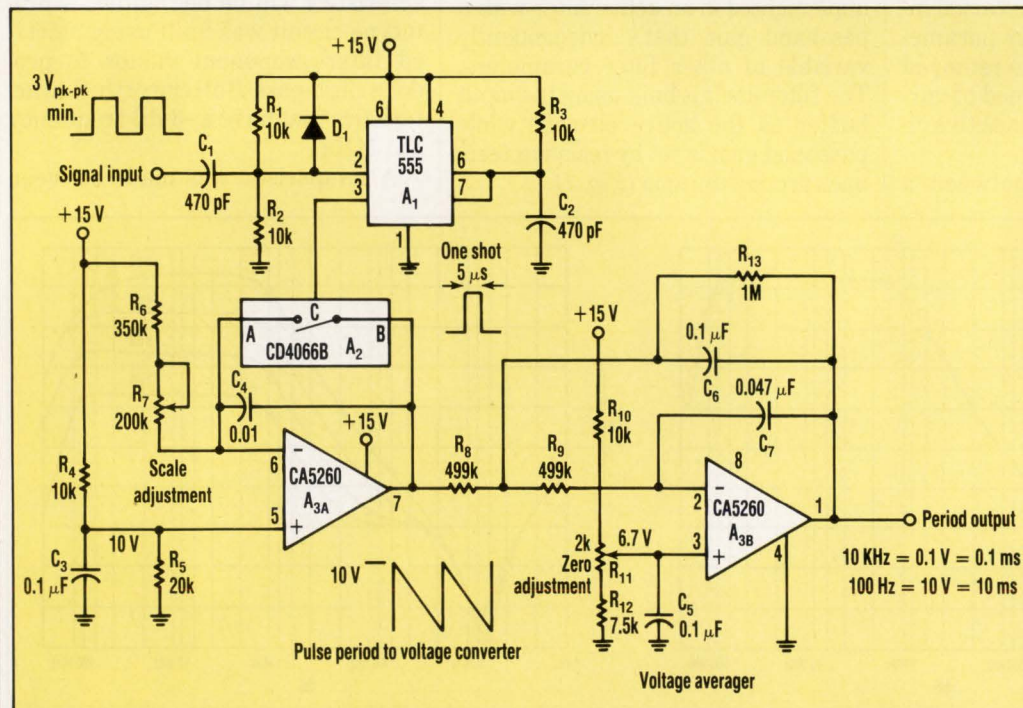

USING A SINGLE +15-V SUPPLY and a few simple components, this circuit converts the period of a waveform to a voltage. Integrator A_{3A} produces a 10-ms ramp that determines the low-frequency limit of 100 Hz.

The Highest Density, Fastest, VME-Compatible Memory

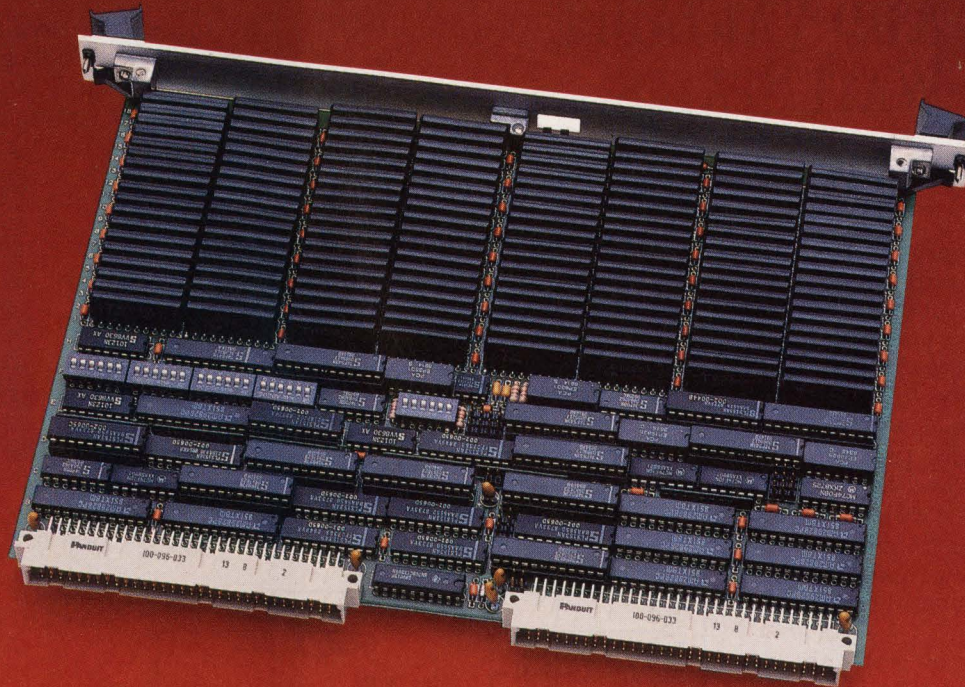

Clearpoint, of course!

Advanced Chip Technology and Design

Get up to 64 MB of fast, VME-compatible memory in a single slot. Designed with state-of-the-art 4 Mb DRAM technology, Clearpoint's VMERAM-FP1 assures higher reliability through lower component count. Each of Clearpoint's VME-compatible boards supports all VMEbus addressing and data transfer types—block mode (BLT), unaligned (UAT), and address only (ADO).

The Fastest Byte Parity

The VMERAM-FP1, available in 4 to 64 MB, provides the fastest sustained block transfer timing available. Typical operating speeds boast 100 ns read and 74 ns write.

Our company-wide pledge to deliver reliability and performance.



Clearpoint is a registered trademark of Clearpoint Research Corporation.

Error Detection and Correction Options

Clearpoint offers several EDC boards for the VMEbus and the VSB subsystem bus. Our proprietary second generation EDC chip set with "extra bit" automatically replaces a bad DRAM and re-maps the array to include the new location.

- VMERAM-EC1: EDC with 64-bit cache and Clearpoint's exclusive "extra bit" technology, the VMERAM-EC1 includes 24- and 32-bit addressing, 8-, 16-, and 32-bit data transfers, and is available in 2 to 64 MB densities.
- VMERAM: The VMERAM is the low-cost alternative for EDC memory, with pricing comparable to parity memory. The VMERAM is available in 2 to 16 MB densities.
- VSB RAM-EC1: Features include "extra-bit" EDC and dual 64-bit caches for simultaneous transfer capabilities. Dual-ported for the VMEbus and VSB subsystem bus, the VSB RAM-EC1 is available in 2 to 64 MB densities.

The Clearpoint Difference

Clearpoint is a leading vendor in the VME marketplace, with the most comprehensive service program available. All Clearpoint memory products are covered by a lifetime warranty and a toll-free technical support hotline. Dedicated inventory in multiple locations worldwide support our 24-hour replacement program.

Call or write to receive the facts:

- Product/Services Catalog
- Designer's Guide
- Spec Sheets
- Newsletter
- Applications Video
- Quality Assurance Information



CLEARPOINT

Clearpoint Research Corporation
35 Parkwood Drive
Hopkinton, MA 01748
1-800-CLEARPT
(1-800-253-2778)

CIRCLE 523 ADD VARIABLE WAIT STATES

JOHN DUNN

Bertan Associates Inc., 121 New South Rd., Hicksville, NY 11801; (516) 433-3110.

Any microprocessor system may require a fixed number of wait states. For the 8085A, the prescribed method of generating them uses a 74LS74 dual D flip-flop (Fig. 1a). During system development, however, temporarily having more than one wait state per machine cycle could be useful. In such cases, a variable number of wait states can be generated by using the 74LS74 with a 74LS123 retriggerable monostable vibrator (Fig. 1b).

The additional wait states are added by introducing a delay in the feedback path to the Clear input of the D flip-flop (74LS74). By making that delay adjustable with R_3 , a variable number of wait states per machine cycle can be generated. Any portion of the target system that can't work quickly enough at normal speed may become operational when the system is slowed down by the additional wait states.

If the circuit's pinouts are followed for the basic wait-state generator, and if the flip-flop is put in a 14-

pin socket, the circuit can be constructed with a ribbon cable ending in a 14-pin plug (Fig. 2). To get the variable wait states, simply unplug the flip-flop and plug in the circuit board. □

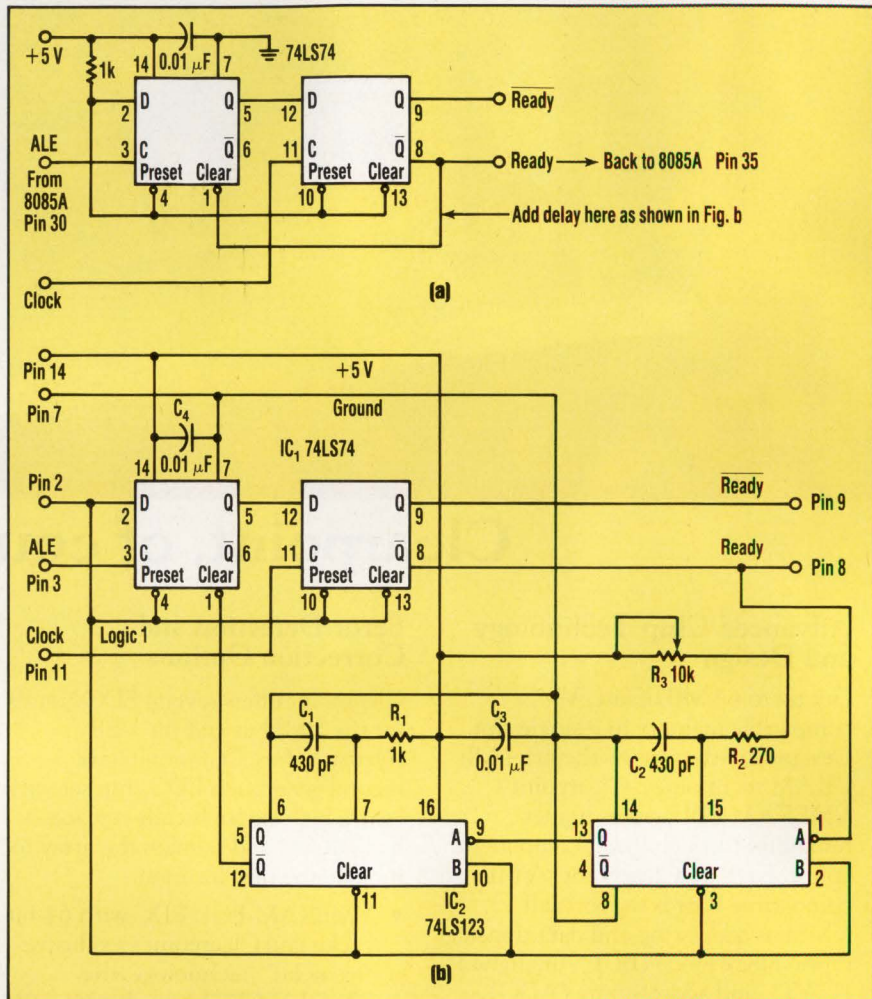

1. THIS CIRCUIT ILLUSTRATES the prescribed method for generating wait states for an 8085A microprocessor (a). During system development, a circuit that generates a variable number of wait states per machine cycle is often useful (b).

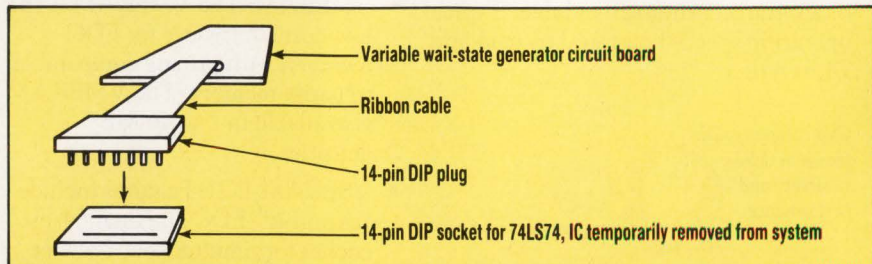

2. THE VARIABLE WAIT-STATE GENERATOR is plugged into the socket normally occupied by the 74LS74 used to generate wait states. A ribbon cable and 14-pin DIP plug simplify the job.

IFD WINNERS

IFD Winners for May 10, 1990

Gary Multer, Sen Majumber, and Raj Pisupati, Digital Equipment Corp., 20 Hampden St., Boston, MA 02119; (617) 569-0284. Their idea: "Drive Stepper Motor, Cut Cost."

VOTE!

Read the Ideas for Design in this issue, select your favorite, and circle the appropriate number on the Reader Service Card. The winner receives a \$150 Best-of-Issue award and becomes eligible for a \$1,500 Idea-of-the-Year award.

Looking
for some
straight answers
on twisted pair?

The newest tw

Finally, a plug and play 10BASE-T network.

With our new ML4650 family of Single Chip 10BASE-T transceivers, you're covered all across the LAN. Because we have single chip twisted pair solutions for both ends, hub to node. Available now. In quantity. Giving you a fast, no hassle 10BASE-T solution.

On the PC side, the ML4651 and ML4652 transceivers incorporate AUI interfaces designed for both Ethernet adapter cards and external MAUs. On the hub side, the ML4654 is tailor-made for a hub design with TTL or ECL outputs. All are highly integrated single chip solutions, minimizing

the number of external components required. So your design-in process is much easier. And faster.

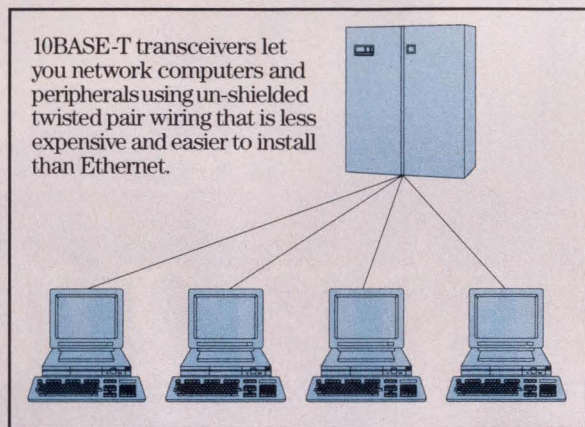

On-chip current driven transmitters are less sensitive to noise and power supply variations. So you get superior jitter performance and low noise outputs that help you easily pass FCC requirements. And the receiver includes an intelligent squelch that rejects cross-talk noise commonly found coupling from the phone wires into the LAN. There's no external crystal oscillator required either, and devices use 5 volts only power supplies.

Parts are available in 20- and

Micro Linear
10BASE-T products
are available in both
adapter card and
external MAU configurations.

ist in 10BASE-T.

24-pin skinny DIPs and 28-pin PLCCs. There's even an ML4621 Fiber Optic Inter-Repeater Link (FOIRL) receiver available to satisfy 10 Mbps fiber optic Ethernet requirements.

And, unlike much of the technology you've been hearing about, these are products of experience. We've been shipping twisted pair transceivers since 1987, as part of Synoptics' LattisNet network.

Semi-standard options.

We're one of the first to market for one simple reason. Our 10BASE-T family is based on our standard FB3651 bipolar tile array. So we were able to quickly modify our "standard" product to satisfy the rapidly-emerging IEEE 802 standards.

And, for the same reason, they can be easily modified with semi-standard capability to give you proprietary product advantages. Like

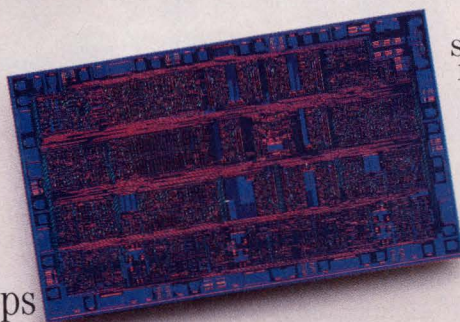

Semi-standard options of the standard 10BASE-T circuits are possible simply by modifying the metal mask on the FB3651 tile array.

functional or performance modifications. Or special screening packaging or reliability

levels to meet your specific network requirements. Whether it's an on-board AUI device. Or a multi-port repeater (MPR) designed to achieve that critical time-to-market advantage you've been looking for.

Call us on it.

If you'd like to turn your 10BASE-T idea into a deliverable product, just call Charles Yager today at (408) 433-5200 and ask him for the complete story on our ML4650 family of single chip 10BASE-T transceivers. Or ask for a free sample. It could add a whole new twist to your networking scheme.

Micro Linear, 2092 Concourse Drive,
San Jose, CA 95131



Micro Linear

©1990 Micro Linear Corporation. LattisNet is a registered trademark of SynOptics Corp.

Why settle for anything less?

Before you begin your next data comm transceiver design, there are a lot of things we think you should consider.

Should it be a standard, off-the-shelf transceiver? A semi-standard transceiver? Or even a USIC (User Specific) transceiver?

With us, the decision is yours. Because we can satisfy the whole spectrum. From high performance standard data comm transceivers like 10BASE-T and Fiber Optic IEEE 802.3, 802.4 and 802.5 networks. To proprietary semi-standard solutions. To sophisticated, ASIC-based designs. Or any combination.

Since 1983 we've pioneered the use of analog ASIC methodologies to produce high-performance, high reliability analog products for a wide range of commercial and military applications including computer peripherals, instrumentation, telecommunications and data communications. Yours could be next.

To find out, simply send us your data comm transceiver design problem with all the critical performance parameters. Our application engineers will quickly analyze your problem, evaluate the alterna-

tives and give you our best recommendation.

We'll even give you a number of development cost options—ranging anywhere from a one-time NRE charge to waiving it in exchange for the rights to eventually offer your design as one of our standard products.

Write to Micro Linear, 2092 Concourse Drive, San Jose, CA 95131. Or send in the coupon below. Better yet, call Charles Yager at (408) 433-5200 and give him all the facts. The answers he'll give you are anything but standard.

CIRCLE 125

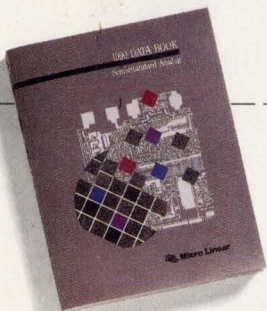

- Yes, I'd like to know more about your data comm transceivers and Semi-Standard Analog. Please send me your 1990 Data Book.
- Please have a Micro Linear sales engineer call me. I have an immediate requirement.

Name: _____ Title: _____

Company: _____

Address: _____

City: _____ State: _____ Zip: _____

Phone: () _____

Send to: Micro Linear, 2092 Concourse Drive, San Jose, CA 95131.



A SPECIAL EDITORIAL FEATURE

PIPS

POWER • INTERCONNECTIONS • PASSIVES • SWITCHES • RELAYS

ELECTRONIC DESIGN

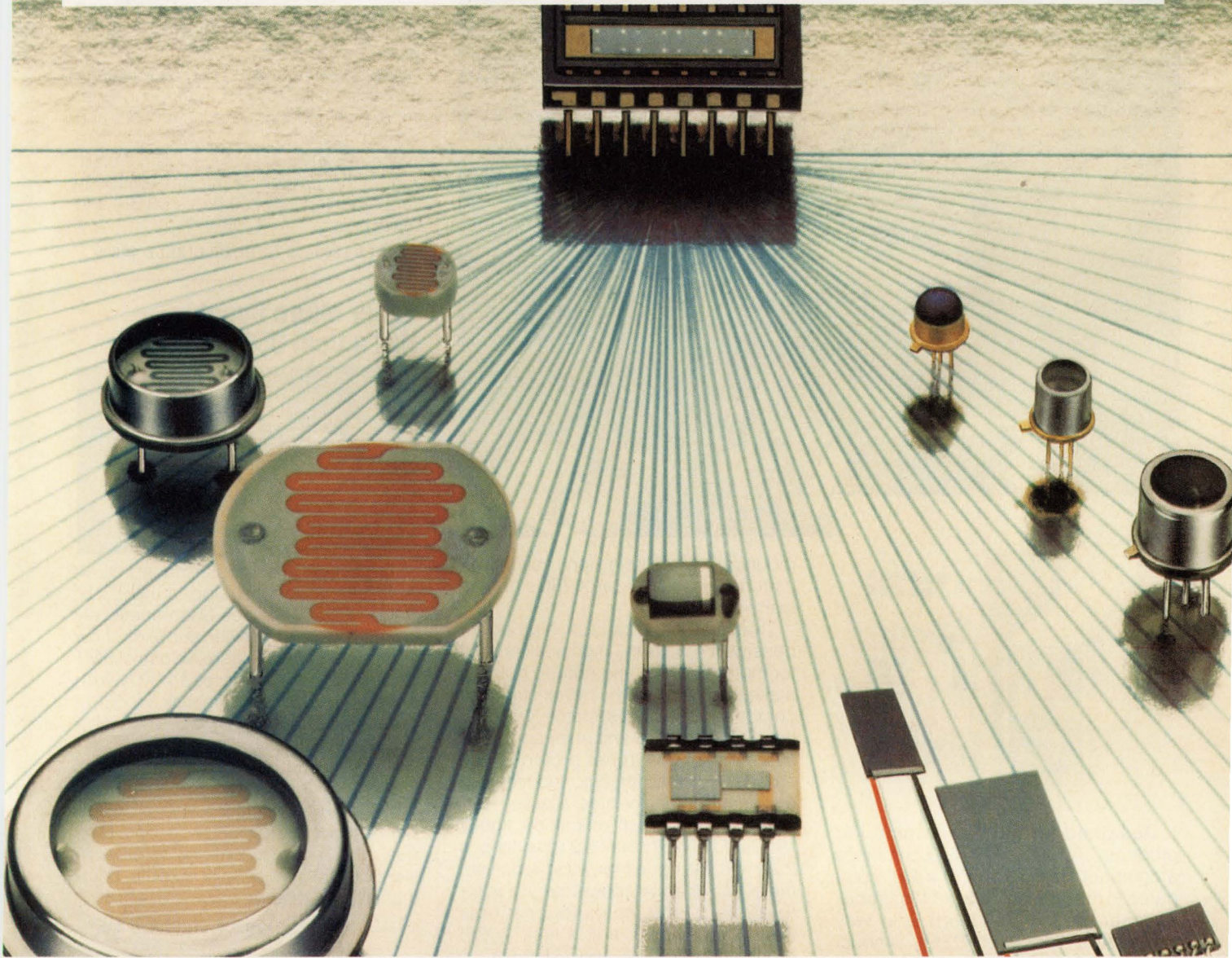

“Specialists in the design, manufacture and marketing of CdS photocells, silicon photodiodes and opto assemblies.”

For new or established optoelectronic applications Silonex has your component.

Call us today



331 Cornelia St., Plattsburgh, N.Y. 12901 Tel. (518) 561-3160
2150 Ward St., Montreal, Que. H4M 1T7 Tel. (514) 744-5507 Fax. (514) 747-3906
Northwich, Cheshire, CW9 7TN Tel. (0606) 41999 Fax. (0606) 49706

Power Source Up-Date

**Single Board Construction Shrinks 750W Size and Cost:
58% Smaller, 30% Cost Savings**

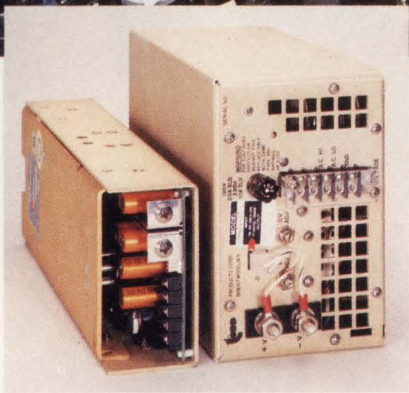
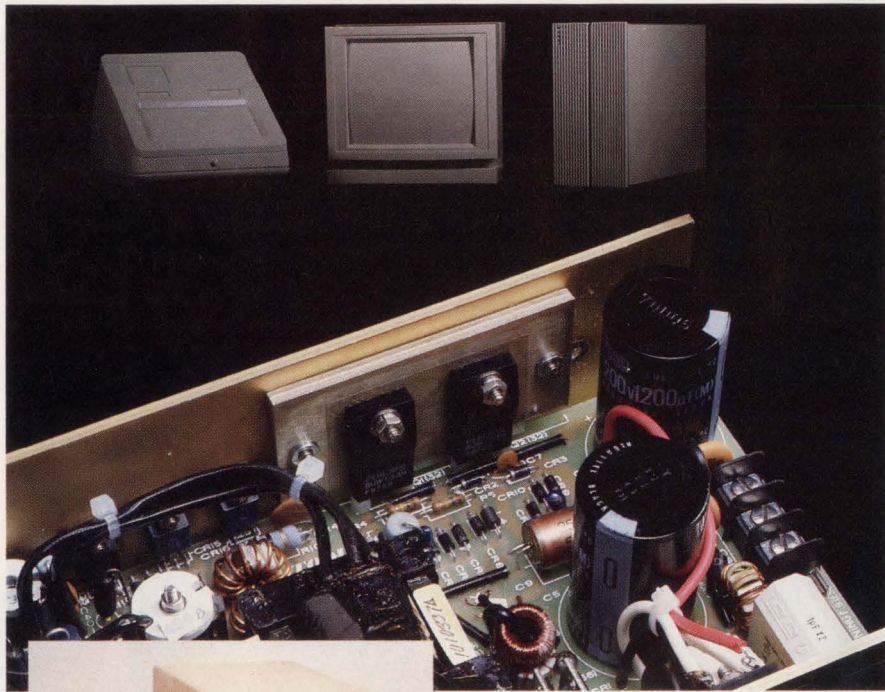

Designed for high-end computer products, TODD's MAX-750 combines a compact size, 13.5" x 5" x 2.6" compared to the typical 5" x 8" x 11" shoebox switcher (see photo insert), and very competitive pricing. OEM product designers can reduce product size with a MAX-750 or build in power supply

redundancy, replacing one "shoebox" switcher with two MAX-750's in the same space.

The small package size, high power density of 4 watts/in., high peak current for motor starting, and cooling options, make the MAX-750 the power supply of choice for VMEbus systems, workstations, file servers and mini-computer systems. The switcher provides 120 amps of +5 volts for logic and memory, and features up to three auxiliary outputs providing high efficiency, tightly regulated 12 volts or -5.2 volts at up to 20 amps. Designed for world wide use, the series offers AC power fail, AC auto-line select, and meets International Safety standards and Class A RFI requirements of FCC and VDE 0871.

CALL 1-800-223-TODD, OR CIRCLE #203

High Efficiency DC Converters Fit AC To DC Footprint

TODD's DC to DC converters provide up to 350 watts from 48 volts DC input. Designed as companion units to TODD's standard line of AC input power supplies, they are fit, form, and function compatible with the MAX-350, MTC-250, MTC-350, and certain single output

SC series products.

Available in a 250 watt "DC" single output series and a 350 watt multi output "DCX" series these power supplies have up to 50 amp main output of tightly regulated 5V power, two fully regulated, high-efficiency, post-regulated mag-amp outputs and one low-power three-terminal regulated output.

CALL 1-800-223-TODD, OR CIRCLE #204

New Technology Shrinks 500 Watt Power Supply

TODD's MAX-500 switchers pack 25% more power into TODD's 400 watt package size (11.5" x 5" x 2.5"). The series incorporates a new SMT circuit, newly-available components, improvements to TODD's VERI-DRIVE current-fed inverter topology, monocoque construction, and a high efficiency FLUX-GATE switching mag-amp auxiliary post regulation. Result: higher performance, higher reliability (approaching 100,000 hours MTBF) and lower cost.

CALL 1-800-223-TODD, OR CIRCLE #205

Super Micro Supply Has a Cool 350 Watts



Targeting the computer-based OEM, TODD engineers developed the 9" x 5" x 2.5" MAX-350 series of competitively priced switching power supplies. Low component count, extensive use of SMT and raising efficiencies to 80% with attendant reduction of heat sink requirements results in MTBF approaching 100,000 hours.

The series features up to 50 amps of +5 volts for logic and memory and fully regulated high efficiency mag-amp outputs to power up to four disc drives. Auxiliary outputs power common peripherals like ECL monitors, RS232 outputs, communications drivers, etc.

CALL 1-800-223-TODD, OR CIRCLE #206

More information on these and the full line of TODD Switching Power Supplies can be obtained in EEM File 4000, by circling the response card numbers, or by contacting:

TODD

PRODUCTS CORP.

50 Emjay Boulevard
Brentwood, New York 11717
(516) 231-3366 or 1-800-223-TODD
FAX (516) 231-3473

Use Power Bypassing and Busing for High-Performance Circuits

Taking A Sensible Approach To Decoupling Capacitors Can Mean Better Designs

BY MICHAEL SCOTT HYSLOP

Rogers Corporation, Circuit Components Division, 2400 S. Roosevelt St., Tempe, AZ 85282; (602) 967-0624.

Advances in IC design and packaging are making bypassing more difficult than ever. Circuits containing high-performance ICs operate unpredictably unless the power-supply network is properly bypassed and distributed. Even a design that's thoroughly simulated and whose components are individually tested may fail to operate when the first board-level prototype is built. Signal rise times in the picosecond range can easily produce ground bounce and V_{CC} voltage-drop problems, particularly with large numbers of gates switching simultaneously. High-density packages, such as chip carriers with hundreds of closely spaced pins, worsen the problem.

These IC-driven advances create other problems, including noise generation within the pc-board environment, increased electromagnetic-interference (emi) and radio-frequency-interference (rfi) emission, and increased susceptibility to emi and rfi. As IC designs migrate from 5-V to low-voltage (3-V) operation, noise margins shrink, which makes bypassing even more critical. For most electronic systems, the primary sources of radiated emissions are the pc boards contained within that system. With their long trace runs carrying transient currents with sizable high-frequency spectral content, pc boards radiate emi efficiently.

A power-distribution system would not radiate at all if only dc currents flowed. But ICs draw large amounts of instantaneous current during logic switching.

1. In a typical IC-decoupling-circuit model, the decoupling capacitor (C) is a local energy source that supplies current to the chip during gate switching. The essence of good bypassing is to minimize the total decoupling-loop inductance by keeping the equivalent series inductance and resistance to a minimum.

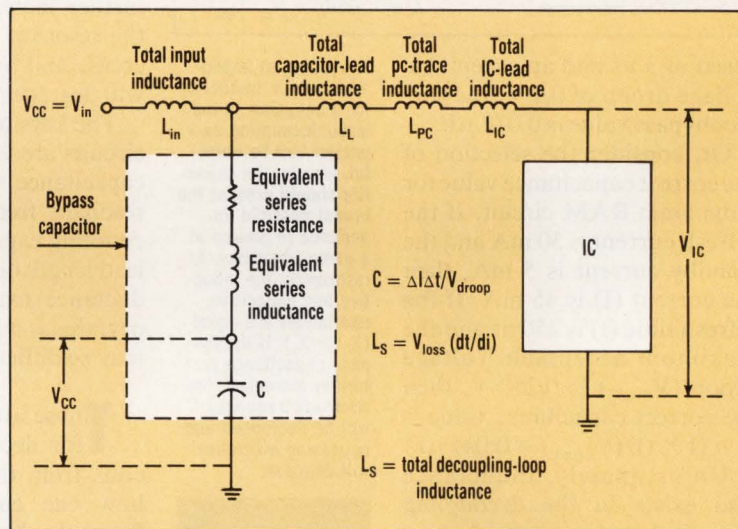

These current pulses rise and fall quickly, and therefore have significant spectral content between 30 MHz and 1 GHz. The faster the IC, the larger the portion of the spectrum falling within that band. But because system speed is critical, reducing emi by increasing rise and fall times isn't an answer.

This article suggests a number of power-bypassing and bussing options, some of which are novel and others that are often overlooked by system designers. Techniques to select the best bypassing and bussing options will also be presented.

Designers often attempt to decouple every IC in a system by liberally sprinkling bypass capacitors throughout the system. In doing so, little attention is paid to the correct capacitance values and their associated inductance. The capacitance values are chosen using empirical rules of thumb. It's better to

optimize the capacitance value for the particular circuit with simple analytic techniques.

In any IC-decoupling circuit, the capacitor is essentially a local energy source that supplies current to the chip during gate switching. Without bypassing, the impedance of the pc traces causes a droop on the supply line. A typical IC-decoupling circuit can be easily modeled (Fig. 1). Depending on the frequency, the typical unbypassed dynamic impedance of the V_{CC} line is about 50 to 100 Ω . That's high enough to produce a considerable V_{CC} droop unless a bypass capacitor is used.

Consider, for instance, the case of an octal buffer. Assume that each buffer output sees a 50- Ω dynamic load and that the output-voltage swing is 2.5 V. The current swing for the buffer is therefore 50 mA. If all eight buffers operate simultaneously, the maximum current swing is 400 mA. Assuming a switching

POWER BYPASSING AND BUSING

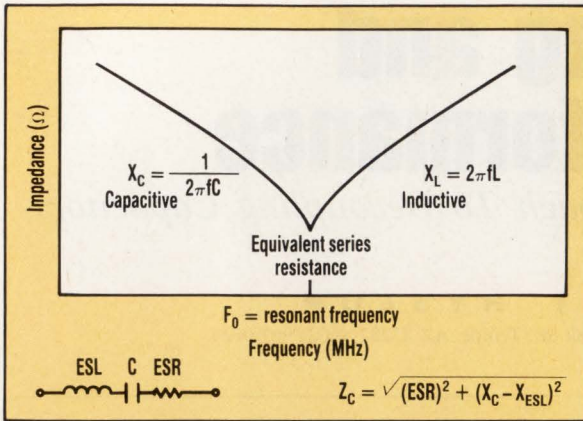

speed of 3 ns and an acceptable voltage droop of 0.1 V, the correct bypass value is 0.012 μF .

Or, consider the selection of the correct capacitance value for a dynamic-RAM circuit. If the refresh current is 50 mA and the standby current is 5 mA, then the current (I) is 45 mA. If the refresh time (t) is 250 ns and the maximum acceptable voltage droop (V_{droop}) is 0.250 V, then the correct capacitance value is $C = (I \times t) / (V_{\text{droop}}) = 0.045 \mu\text{F}$.

Unfortunately, inductance also exists in the decoupling loop. If the edge rate (t) is 3 ns, the current change (I) is 45 mA, and the acceptable voltage loss (V_{loss}) is 0.250 V, then the maximum permissible decoupling-loop inductance is $LS = V_{\text{loss}} \times (t/I) = 17 \text{ nH}$.

These capacitance values are the minimum that will keep voltage droop and loss within acceptable bounds. So why not choose a larger capacitance value "just to be safe?" The answer is related to the resonant frequency of the decoupling capacitor. Ideally, the decoupling capacitor should present the low-

est possible impedance to ground at the frequency of concern. The decoupling capacitor is modeled as an equivalent series inductance (ESL) in series with an ideal capacitance (C) and an equivalent series resistance (ESR), which comprises both the dielectric losses and ohmic lead resistance. At resonance, the inductive and capacitive reactances are equal ($X_C = X_L$). If the bypass capacitance is further increased, the resonant frequency will be decreased and bypassing efficiency will degrade.

Looking at impedance versus frequency for a capacitor, a too-large decoupling capacitor can be harmful. Ideally, the capacitor should present the lowest possible impedance to ground at a given frequency. At resonance, the inductive and capacitive reactances are equal ($X_C = X_L$). If the bypass capacitance is further increased, the resonant frequency will be decreased and bypassing efficiency will degrade.

est possible impedance to ground at the frequency of concern. The decoupling capacitor is modeled as an equivalent series inductance (ESL) in series with an ideal capacitance (C) and an equivalent series resistance (ESR), which comprises both the dielectric losses and ohmic lead resistance. At resonance, the inductive and capacitive reactances are equal ($X_C = X_L$). If the bypass capacitance is further increased as suggested, the resonant frequency will decrease and bypassing efficiency will degrade (Fig. 2).

The keys to decoupling noisy circuits are to select the correct capacitance value, to note the resonant frequency of the decoupling capacitor, and to keep lead length (and thereby lead inductance) to a minimum. In theory, this is well understood, but may be difficult to achieve.

Those are some techniques for decoupling noisy circuits from the power bus. But how can emi that's radiated from the board traces be reduced? The best way is to contain the interfering high-frequency pulses in the smallest closed-loop area possible. That's because emi is a function of loop geometry and frequency. Such containment is accomplished by using a local decoupling capacitor for charge storage and short interconnects to the IC. As long as the impedance of the coupling loop is much lower than that of the rest of the power-distribution system, the high-frequency components of the circuit will remain almost entirely within

this loop, minimizing emi. When the loop's impedance is no longer much lower than that of the rest of the system, some fraction of the high-frequency component will be carried on the larger loop formed by the power-distribution traces. This results in higher emission levels.

The key, then, is to minimize the impedance of the capacitor and the interconnects. Ideally, the capacitor should have no lead inductance, low loss and stable capacitance, and be as close to the IC as possible. Such a capacitor would have very low impedance and an excellent ability to deliver current in the desired band of rejection.

Unfortunately, real capacitors are often far from the ideal. Most decoupling capacitors are Z5U-grade barium-titanate-ceramic capacitors. Barium titanate is used because of its high dielectric constant, which allows small capacitors to have relatively large capacitance values. Depending upon the formulation and packaging, such ceramics perform extremely well—both in terms of losses and capacitance—at resonances that vary from less than 1 MHz to nearly 20 MHz. Above resonance, it becomes lossy and the capacitance begins to fall. This generally limits the effectiveness of a good Z5U capacitor to the 1-to-50-MHz frequency range.

Other dielectrics, such as strontium titanate, NPO, and some polymers, have better high-frequency performance but a lower dielectric constant. This can make them unsuitable for low-frequency (dc-to-10-

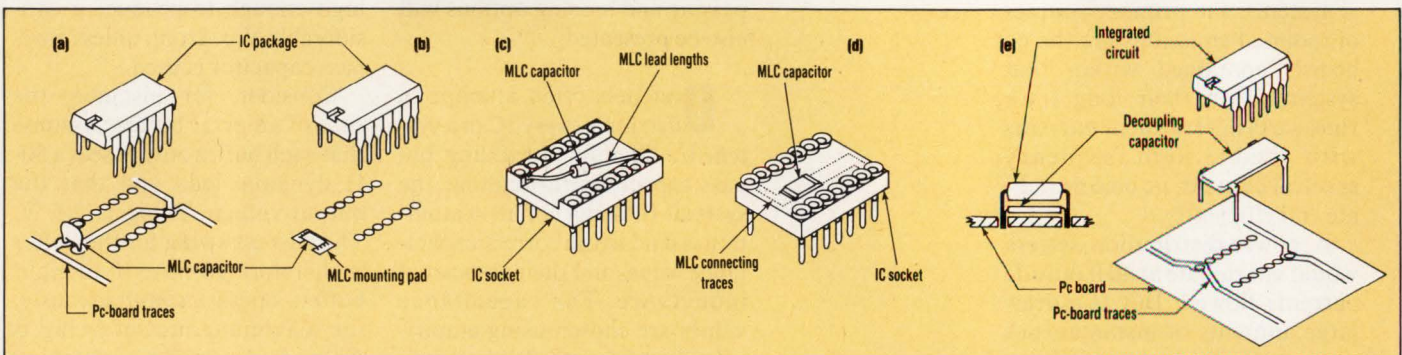

POWER BYPASSING AND BUSING

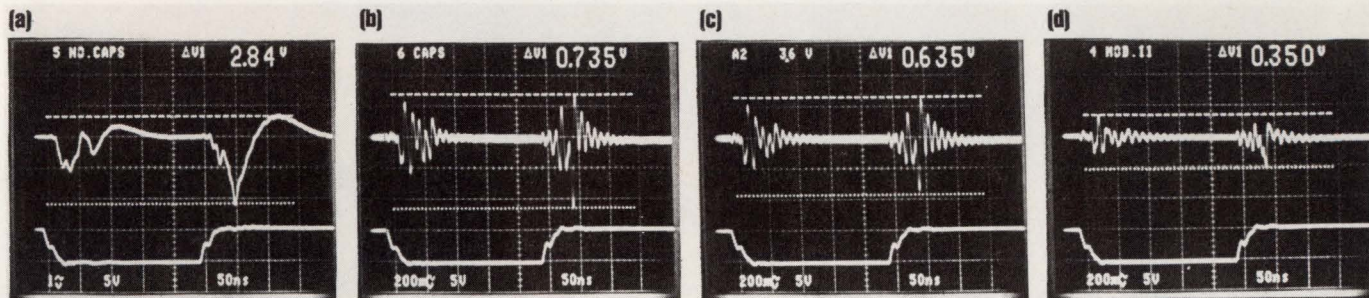

MHz) decoupling. As a result, there is a trade-off of high-capacitance and low-frequency decoupling against low losses and stable capacitance for good high-frequency decoupling.

If the pc board works well with high levels of low-frequency noise that were only slightly attenuated by low-valued local decoupling capacitors, then low-valued capacitors may be used. Remember that low-valued bypasses reduce emissions more effectively than most high-valued decoupling capacitors. However, if this isn't the case, then a mix of the two types could be employed. It's best to have the resonant frequency of the decoupling loop at or near the troublesome frequency because the loop's impedance is lowest at that point.

The two types of capacitors should not be next to each other when being mixed. The high-dielectric-constant capacitor can dampen the resonance of the more frequency-stable, low-dielectric-constant capacitor. In cases where the emi problem is below 50 MHz, the best choice is a good, low-inductance Z5U (or equivalent) capacitor. This is because it combines excellent low-frequency decoupling with reductions in radiated emissions up to that frequency.

In theory, then, techniques to decouple noise from the power bus and minimize emi are known. But how is this achieved in practice? Bypass capacitors are often placed on the pc board as an afterthought. A typical capacitor placement has long asymmetrical capacitor leads and long pc-board traces (Fig.

3a). But placement can be improved by using internal parallel power and ground planes, resulting in inherently lower bypass-loop inductance (Fig. 3b). However, the relatively long pc-board traces to the IC's voltage and ground pins introduce inductive effects and limit the capacitor's effectiveness at high frequencies. Moreover, the capacitors take up board space, which often is tight.

Another possibility is to integrate the decoupling capacitor into the IC socket itself (Figs. 3c and 3d). Although they're effective in some cases, such decoupling schemes add to the board's cost. In addition, this tactic can be ineffective at high frequencies because of inductive effects resulting from overly-long capacitor and socket pins and from the mounting configuration of the capacitor within the socket.

A more elegant and efficient solution involves a decoupling capacitor consisting of a single-layer ceramic dielectric sandwiched between two parallel-plate electrodes (Fig. 3e). This decoupling capacitor offers two advantages over the others mentioned. First, it's positioned under the DIP, which increases board density. In addition, it has parallel-plate construction and shares pc-board holes with the IC, which yields the lowest possible inductance in the decoupling loop.

These "under-the-DIP" flat capacitors are available with values ranging from 450 to 3000 pF for decoupling in the 50-to-70-MHz range, and from 0.02 to 0.16 μ F for the 1-to-30-MHz range. They use X7R, Z5V, and P3J dielectrics, and are available

4. Various tests show the total noise resulting from various decoupling techniques for a memory array. The first scope photo shows the result with no decoupling in the memory array (a). The results of decoupling the array follow, with a 0.33- μ F discrete multilayer-chip capacitor mounted at the end of every RAM (b), a 0.33- μ F decoupled socket mounted under every RAM (c), and a 0.30- μ F "under-the-DIP" flat decoupling capacitor (manufactured by Rogers Corp.) mounted under every RAM (d). The flat, under-chip capacitor held total noise the lowest.

in standard 14-to-40-pin DIPs and in non-standard pinouts.

To verify the performance gains achieved by paying close attention to bypassing, characteristic impedance analysis was performed on alternative decoupling schemes. Under-the-DIP flat decoupling capacitors were analyzed for two dielectric materials (Z5V and X7R), and then compared to a conventional capacitor and to a decoupled socket of roughly equal capacitance. The test consisted of connecting each decoupling device to the test fixture in a manner that simulated actual use on a pc board. This included any circuit traces that might be used to connect the decoupling capacitor to the IC voltage and ground pins. The impedance analyzer's frequency was then swept from 1 to 500 MHz in logarithmic increments.

The net impedance of a decoupling capacitor and its associated leads is almost entirely inductive at frequencies above its resonant frequency. Typical values of inductance were calculated for each decoupling method at a frequency approximately one decade above resonance (see the table). Note that the lowest value of inductance, 11.0 nH, is associated with the under-the-DIP capacitor. In addition, its resonant frequency is 50% higher (3 MHz compared with 2 MHz). This results from eliminating lead and pc-board traces.

To compare the three devices (an under-the-DIP flat capacitor, a socket with an integrated decoupling capacitor, and a ceramic monolithic capacitor) in an actual circuit, a memory ar-



DOUBLE

“...  for

AMP TBC (Twin-Beam Contact) Connectors steal the show for high-density, high-pin-count affordability. Three- and four-row versions deliver compelling performances in 32 to 540 position roles.

The twin-beam receptacle at

the heart of the TBC Connector represents the very best of AMP engineering—the greatest economy of material consistent with design excellence. It provides two-point contact (with gold-over-nickel plating), and the BeCu base assures high normal forces of 50 grams/contact (end of life minimum) for solid dependability.

There's more here than economy, though. Tightly controlled, short point-of-contact geometry allows two levels

of mating for make-first break-last sequencing of power and ground pins. The same design reduces insertion

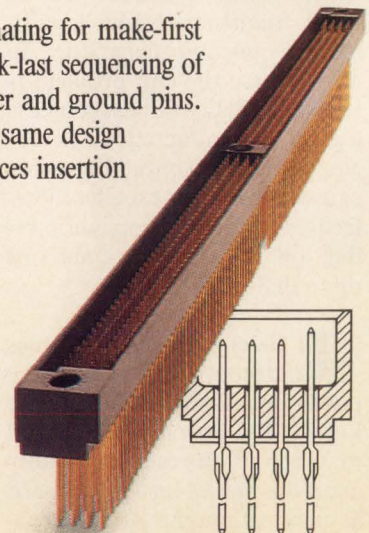

Two levels of sequenced mating allow "hot" connect/disconnect. Compliant pin option for solderless pcb insertion.

FEATURE

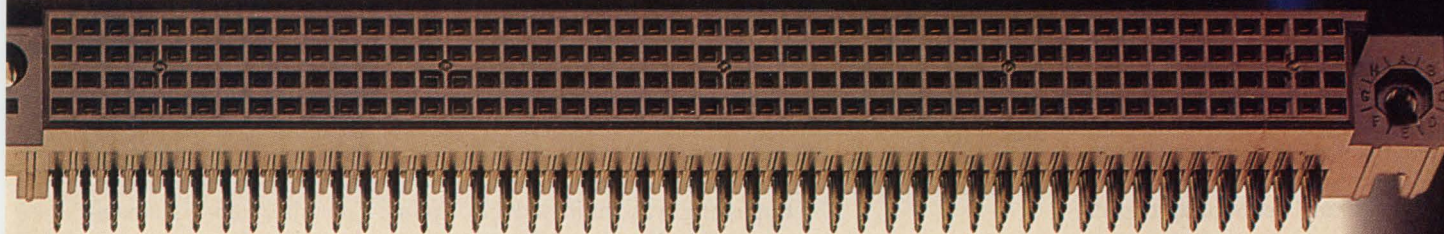

cost reduction.”

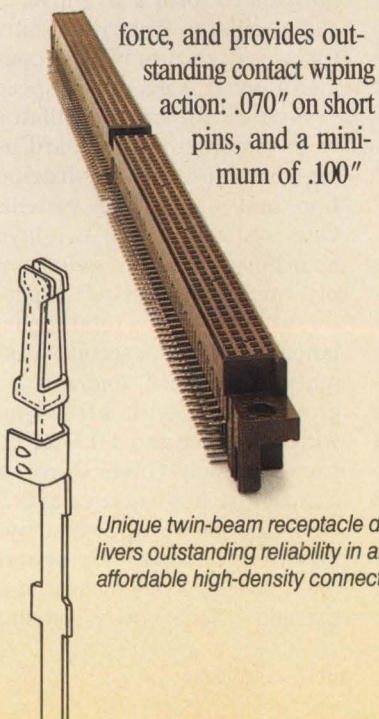

force, and provides outstanding contact wiping action: .070" on short pins, and a minimum of .100"

Unique twin-beam receptacle delivers outstanding reliability in an affordable high-density connector.

on long. (Coming soon: TBC Plus Connectors, with six rows of contacts and three levels of sequencing.)

AMP TBC Connectors are fully polarized, with closed-entry design to eliminate stubbing, and they come in high-temp materials ready for vapor-phase and IR reflow soldering.

And TBC receptacle assemblies intermate with our popular AMP-HDI pin header assemblies, to give you immediate daughter card cost-reduction, without redesign.

Call 1-800-522-6752 and ask about the AMP TBC Connector Series. AMP Incorporated, Harrisburg, PA 17105-3608.

AMP Interconnecting ideas

POWER BYPASSING AND BUSING

ray consisting of 32 Fujitsu MB81256-15 256-kbit dynamic RAMs (150-ns access time) was assembled on a Robinson Nugent VQC pc board. The DRAMs were connected to a counter, which provided row-address sequencing for refresh. Refresh waveforms following Fujitsu's recommendations were created by a waveform generator. All 32 DRAMs were refreshed simultaneously.

In the test, all like decoupling devices were attached on the board in their respective decoupling schemes. In addition, the ac-voltage noise was measured across V_{CC} and ground of the "noisiest" 256-kbit RAM for each set of decoupling devices. Measurements were also made without any decoupling capacitors in place. In all test cases, a 100- μ F bulk decoupling capacitor was mounted at the test board's power-input pins.

The test results can be depicted graphically (Fig. 4). In each display, the row-address-sequencing signal is shown as a reference (the bottom trace). The vertical and horizontal scales are found at the bottom of each figure. The decoupling method using the under-the-DIP flat capacitor resulted in the least amount of total noise, 350 mV, as compared to the total noise of 735 mV and 635 mV associated with the discrete multilayer-chip capacitors (MLCs) and decoupled sockets, respectively.

The memory-array example shows how bypassing minimizes the transmission of switching noise to a board's power bus. But how does bypassing affect the emi radiated by the board? A simple pc board was created to determine the effects of IC decoupling upon the radiated emissions of an electronic system. The board, which contained an Intel 8049 micro-computer IC, a clock circuit, and several driver transistors, executed a video-game program stored in ROM. Most radiated

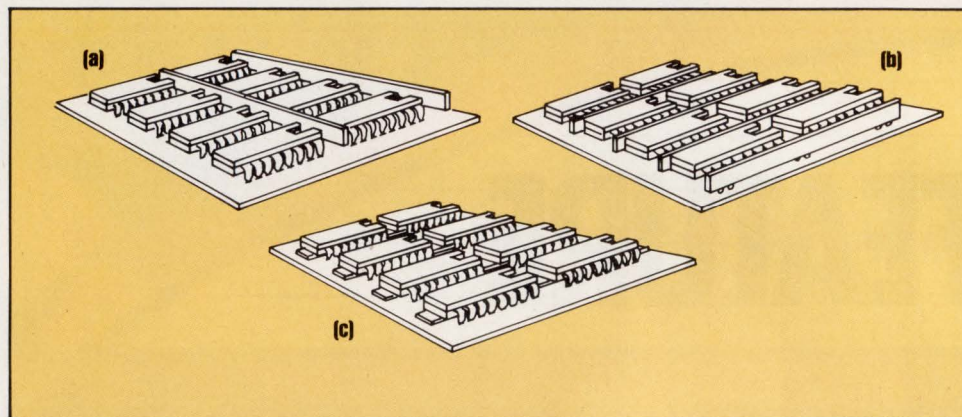

5. Capacitive bus bars can be mounted vertically across IC rows (a), vertically between IC columns (b), or horizontally under IC columns (c).

emissions from such a self-contained system can be attributed to the power-distribution system. A horizontally polarized antenna was positioned on-axis 90 cm above the board, operating in a shielded chamber.

Bypassing was improved incrementally. First, the board was run without any decoupling capacitors. Next, for bulk decoupling, a 22- μ F tantalum capacitor was connected 13 cm from the 8049 chip. Reducing the decoupling loop by this small amount diminished emissions up to 10 dB. Bypassing was further improved by placing a 0.1- μ F MLC Z5U capacitor as close to the 8049 IC as possible. This further reduced emissions below 50 MHz.

The next incremental bypassing gain was achieved by replacing the 0.1- μ F capacitor with an under-the-DIP 0.03- μ F flat capacitor. By eliminating the field associated with the traces and cutting lead inductance, emissions were further reduced by nearly 5 dB below 70 MHz and 2 dB above 70 MHz.

A key to building low-noise pc boards using high-speed logic, beyond optimizing local capacitive decoupling, is to minimize inductance. Two common methods are increasing the width of the supply traces and building additional planes into the board. The first method can't be used on pc boards with moderate-to-high package density. The second method—a multilayer pc board—is expen-

sive compared with a two-sided board, though it does offer increased density. An alternative method combines multilayer performance with the cost advantages of two-sided pc boards, while providing excellent decoupling. That alternative is capacitive pc-board bus bars.

Such bus bars use wide, thick conductors with supply and return lines in close proximity. An example is Rogers Corp.'s Q/PAC bus bars. Their integral decoupling capacitors offer one of the lowest inductance power-distribution systems available.

To demonstrate the relative merits of combining decoupling with power distribution, hex inverters of the 74XX, 74LSXX, and 74SXX logic families were tested. The hex-inverter packages were connected with short jumpers to form a five-inverter ring oscillator. The ring oscillators were free-running and operated at the IC's maximum speed.

Five of the ring oscillators were soldered onto a board using one of three power-distribution and decoupling systems. One system was a two-layer board using 0.070-in.-wide supply traces with 0.1- μ F capacitors at each IC for a total capacitance of 0.6 μ F. A second was a multilayer board, including a ground plane, with a 0.030-in.-wide V_{CC} trace and a 0.1- μ F capacitor at each IC. The third was a capacitive bus bar rated at 0.28 μ F. All three were powered by a low-noise supply. The operating-noise level was measured at the end of the power-distribu-

When it comes to evaluating quality, we ask the toughest judge in the world. YOU!

"Thank you for your recent order to Equipto Electronics Corporation,"

Bob Goltz, President

At Equipto Electronics Corp., we want to be sure our quality control and service programs are meeting your needs...and you can help us.

By answering the following questions and mailing this postage-paid card back to us, you will help identify areas where we can become a better supplier to your company.

1. Your primary responsibility:
 Purchasing Engineering
 Other (please state area of responsibility) _____
2. Equipto Electronics engineering support was:
 Not required Excellent Good
 Poor Not available
3. Equipto Electronics customer service support was:
 Not required Excellent Good/
 Poor Not available
4. Quality of our products:
 Excellent Good Poor
 Remarks: _____
5. Equipto Electronics delivery was:
 As promised Late

Q-88

6. Was there freight damage on this order?
 No Yes If "yes" Carrier Damaged
 Improperly Packed

7. In what state is your plant or office where this order was received? MISSOURI

If you have suggestions on how we can better serve your company's needs or other comments, please provide them in the space below.

Optional Information:

Name DAVID C. MAINER SR

Title DESIGN ENGINEER

Company Mc DONNELL DOUGLAS

Address PO Box 516, D257/MC. 1021111

City ST LOUIS State MO Zip 63166

Telephone (314) 234-9010

Please fold this card over and tape it closed so our address shows on the outside, and mail—no postage is necessary. Thank you.

Used with permission of David C. Mainer, Sr. and the McDonnell Douglas Corporation

After each order of Equipto Electronics enclosures is delivered, we ask the customer to rate our quality and performance in five important areas. Here's how customers indicated we scored over a recent nine-month period:

CATEGORY	SUMMARY
Product Quality	100.00% Excellent or Good
Engineering Support	99.938% Excellent or Good
Customer Service	99.875% Excellent or Good
On-Time Delivery	99.562% "As Promised"
Quality of Packing	99.938% Damage Free Packing

We know our reputation is on the line every time you specify and buy Equipto Electronics enclosures. You can't afford alibis and excuses. Neither can your company. Neither can we. That's why everyone at Equipto Electronics is specially trained to understand, respect and carry out the principles of quality manufacturing and service.

We invite you to see our Quality Control Program in operation. Call us to arrange an inspection of our facility. Or, request a copy of our "Quality Control and Inspection Manual" which also lists the military specifications we meet.

Our customer surveys indicate we're delivering products and performance you can count on time after time after time. We ask you to think about this the next time you order electronic enclosures.



Committed to Excellence Since 1960

EQUIPTO
 Electronics Corporation®

©Equipto Electronics Corporation, 1990

Equipto Electronics Corporation
 351 Woodlawn Avenue • Aurora, Illinois 60506-9988

Phone (708) 897-4691 • FAX (708) 897-5314

CIRCLE 99

POWER BYPASSING AND BUSING

tion system and displayed on a spectrum analyzer.

In all operating-noise-level tests, the capacitive bus bar was 25 to 35 dBm quieter than a standard two-layer board using equal or greater decoupling capacitance. Such a reduction in operating-noise level will improve the emi/rfi characteristics of most pc boards. The capacitive bus bar was 5 to 10 dBm quieter than multilayer boards from resonance to 150 MHz and approximately equivalent at higher frequencies. Its noise-attenuation characteristics were 10 to 20 dBm better than typical supply traces and external decoupling capacitors.

Now that ZIP memories enable extremely dense memory arrays to be designed on boards with severely limited form factors, very high capacitance-per-inch bus bars are offered that provide up to 3.0 $\mu\text{F}/\text{in}$. Incidentally, in the 8049 video-game example, using the capacitive pc-board bus bar gave at least the same performance level and, in most cases, an additional 1-to-3-dB emi-noise reduction. That's because it eliminated nearly all of the power and ground traces on the pc board.

Each circuit design has different requirements that can affect the way power-distribution and decoupling components are mounted. Factors such as board size, number and types of ICs, component-height requirements, and personal preferences play roles in determining which mounting style is best. Horizontal mounting allows maximum packaging density and the low-

6. Flat decoupling capacitors for pin-grid arrays, such as Rogers Corp.'s Micro/Q 3000 decoupling capacitor, fit the inside area of the array. It's the dimension of the inside perimeter of pins that sets the size limit, not the number of PGA pins.

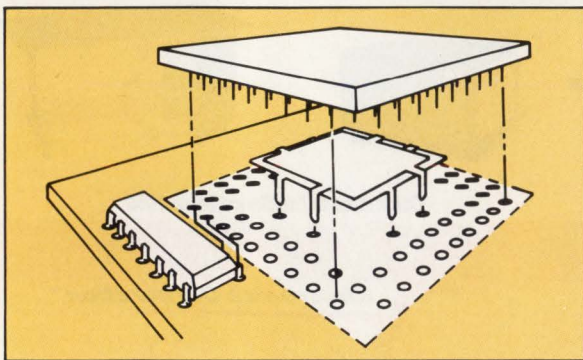

IMPEDANCE-ANALYSIS-DATA SUMMARY FOR VARIOUS DECOUPLING METHODS						
Decoupling Method	Capacitance ⁽²⁾ (μF)	ESR (Ω)	f_0 (MHz)	$f_1^{(3)}$ (MHz)	$ Z_1 ^{(4)}$ (Ω)	L_{calc} (nH)
Decoupled Socket Discrete ⁽¹⁾	0.333	.038	2.1	20.8	2.39	18.3
MLC chip	0.330	.119	2.1	20.8	2.56	19.6
Under-the-DIP flat decoupling capacitor	0.300	.068	3.1	31.6	2.18	11.0

(1) This includes approximately 1.1 in (27.94 mm) of total pc-board traces. Trace width = 0.1 in (2.54 mm).
 (2) Measured at 1.0 kHz, 1.0 V rms and 25°C
 (3) Frequency used for inductance calculation
 (4) Impedance magnitude at f_1

est operating-noise levels while vertical mounting stiffens the board and eases assembly. Once the decision is made to incorporate either style, the designer can proceed with the board layout (Fig. 5).

Even though there are application-specific ICs, not one decoupling-capacitor configuration exists that suits all needs. The under-the-DIP bypass capacitors are available in enough different sizes and pin-outs to decouple virtually any DIP. These would include such devices as Zilog's Z80, Advanced Micro Devices' 2910, Texas Instruments' TMS32010, and center-pinout DIPs, as well as other MPUs and logic devices with non-standard corner power and ground pins.

One packaging innovation that makes bypassing a thorny problem is pin-grid-array (PGA) packages. These devices include 16- and 32-bit microprocessors, digital-signal processors, graphic-signal processors, gate arrays, standard cells, and ASICs. Very-low-inductance decoupling capacitors specifically designed to be through-hole-mounted under PGAs, PGA sockets, and plastic-leaded chip carriers are now available (Fig. 6).

These flat capacitors to be used with pin-grid arrays consist of one capacitor with multiple leads. For example, an eight-pin have four pins that are common to each capacitor plate. By hav-

ing power and ground on each side of the capacitor, the distance between the power pins of the PGA IC and those of the capacitor is minimized.

The capacitor must be sized to fit the inside area of the PGA. The dimension of the inside perimeter of pins sets the limit on size, not the number of PGA pins (Fig. 6, again). This inside perimeter, or gap, is typically square. Inserting the flat capacitor into a pc board requires additional board holes for the appropriate gap size. As long as the gap is taken into consideration, one capacitor configuration can decouple various PGA packages with the same gap, regardless of pin locations.

With these new decoupling and power-distribution options, designers are more assured that their systems will operate as intended and without unexpected noise or stability problems. New systems will benefit from a more rational approach to decoupling.

Michael Scott Hyslop, applications-engineering manager at the Circuit Components Division of Rogers Corp., received a BSEE from Arizona State University, Tempe.

HOW VALUABLE?

HIGHLY	CIRCLE 538
MODERATELY	CIRCLE 539
SLIGHTLY	CIRCLE 540

0.99 Power Factor Corrected Switcher With Universal Input



1000 watt single and multiple output switchmode power supplies operate from 120 VAC 15 Amp service, or as Universal Input from 90 to 264 VAC line without strapping. Units meet IEC 555-2 harmonic distortion and UL, CSA, VDE, EN, and FCC safety and EMI specifications. Other models operate from 48 VDC or 120/230 VAC.

Contact: **Qualidyne** (619) 575-1100

Qualidyne ▶ CIRCLE 641

Compact, Modular Switchmode Supply Meets Class B EMI



Compact power supplies can provide up to 400 watts with hundreds of volt/amp combinations of from 1 to 7 DC outputs. Units are available with in-line or side-mount I/O terminals and operate from 120/230 VAC. Options include Auto Current-Sharing with a isolated Power Supply Fail signal, ideal for N+1 use.

Contact: **Qualidyne** (619) 575-1100

Qualidyne ▶ CIRCLE 642

Low Profile/Low Cost Supplies Are Only 2" to 3" High



Compact switchers feature robust, high-current main and auxiliary outputs to suit OEM needs. Single and multiple output models provide from 250 to 1000 watts. Wide user-adjustment ranges, auto AC line select, integral fan-cooling, margining, and inhibit are among the features and available options.

Contact: **Qualidyne** (619) 575-1100

Qualidyne ▶ CIRCLE 643

Modular 5" x 5" & 5" x 8" AC-DC Switchers & DC-DC Converters

Hundreds of models with up to 9 independent outputs can be easily configured to meet custom requirements without delays. Providing 800 to 3000 watts, units operate from 48 VDC or 120/230 VAC. All meet EMI and safety specs from UL, CSA, EN, FCC and VDE. Wide adjustable and current sharing outputs available.

Contact: **Qualidyne** (619) 575-1100

Qualidyne ▶ CIRCLE 644

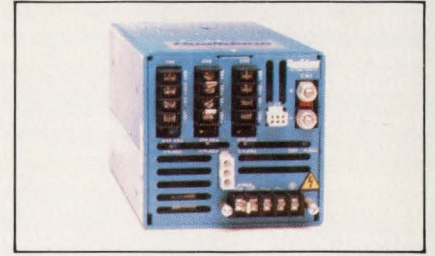

1990-91 CATALOG
SWITCHMODE POWER SUPPLIES
■ AC-DC ■ DC-DC CONVERTERS ■ 0.99 POWER FACTOR

- Low Cost
 - Low Profile Case
 - 250 to 600 Watts
 - 1 to 4 Outputs



- User-Configurable
 - 1 to 9 Outputs
 - Quick Customized Supplies
 - Modular Construction

- Feature-Intensive
 - Low Profile Cases
 - 1 to 9 Outputs
 - 500 to 1000 Watts



- Wide Adjustment Ranges
 - 600 to 1000 Watts
 - 2V to 56VDC Outputs
 - 1 to 7 Outputs

- 1KW to 3KW
 - 1 to 9 Outputs
 - N + 1 Redundancy



Qualidyne
Lambda Group of Unitech plc



FREE NEW 66-PAGE CATALOG/BINDER

CALL OR WRITE: QUALIDYNE

3055 DEL SOL BLVD.

SAN DIEGO, CA 92154

PHONE: (619) 575-1100

FAX: (619) 429-1011

▶ CIRCLE 645

It seems that every custom power supply project starts with inflexible performance specifications, impractical space limitations, and unrealistic completion schedules.

That is why Lorain custom power supplies start with Lorain Megahertz Power Modules. These compact, field proven modules contain a patented megahertz technology that provides exceptional power density, extremely high operating efficiency, quiet operation, and agency compliance. There are over 170 master and booster modules to accurately meet your system requirements.

To these, we add custom circuitry to match your input and output specifications; design-in visuals, forced load sharing, and other peripheral components; even allow for future expansion capabilities with additional plug-in booster modules.

If you are looking for a custom power solution that cuts turnaround time dramatically, practically eliminates debugging, and conserves space, call the Lorain Power Team. We are ready for your problem.

The Flexible, Practical, Realistic solution to custom power

Custom Lorain® Megahertz Power™ Supplies

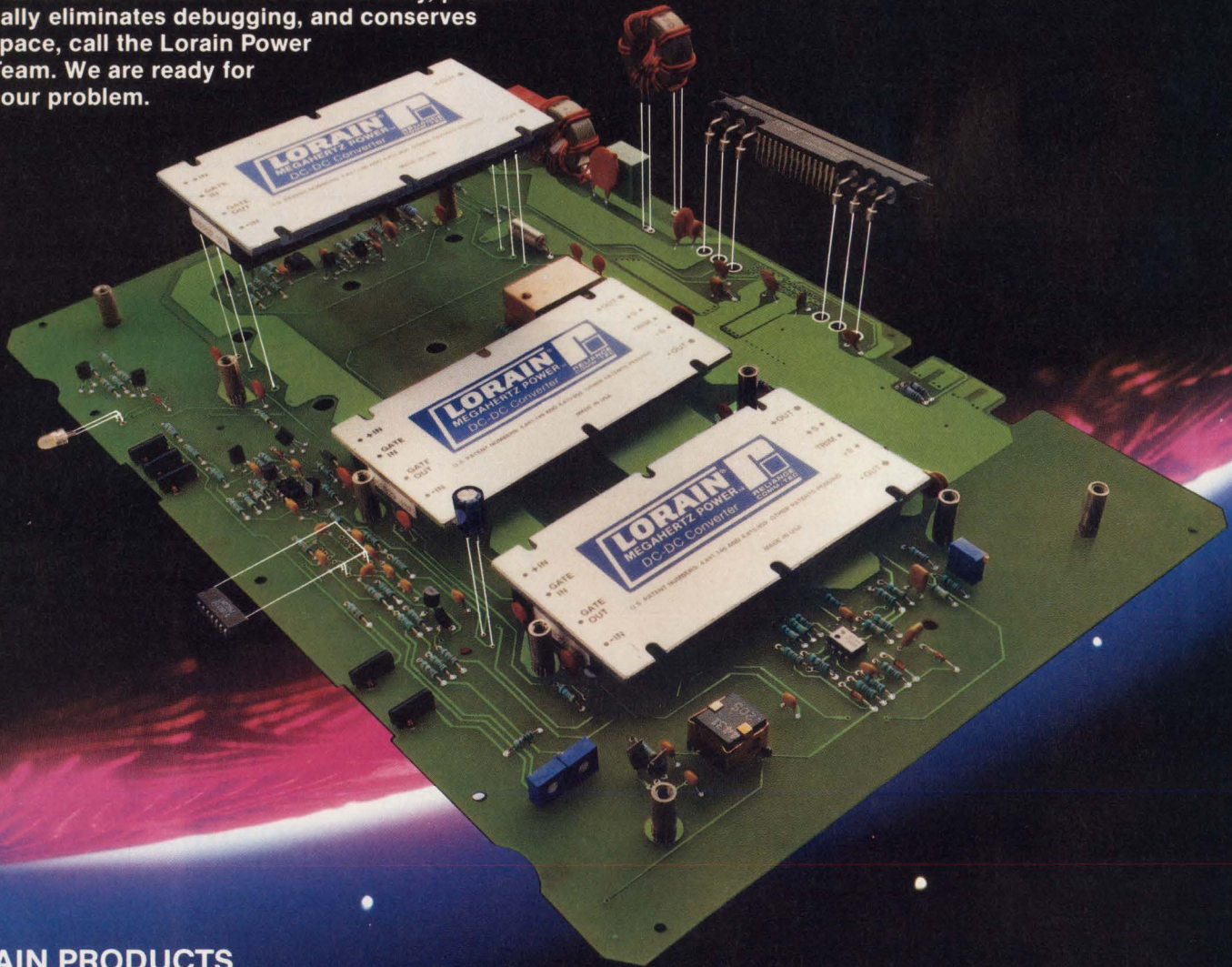

LORAIN PRODUCTS

1122 F Street, Lorain, OH 44052-2293, (216) 288-1122

RELIANCE COMM/TEC, CANADA

St. Thomas, ONT., (519) 631-0780

CIRCLE 133

RELIANCE
COMM/TEC

MANUFACTURERS LISTING

RESISTOR MANUFACTURERS

AVX Corp.
A Kyocera Group Co.
Box 867
Myrtle Beach, SC 29577
(803) 448-9411
(TF) (CH) (TR) (RN)
CIRCLE 300

Allen-Bradley Co.
Electronic Comp. Div.
1414 Allen-Bradley Dr.
El Paso, TX 79936-6415
(915) 592-4888
(CC)
CIRCLE 301

Allen-Bradley Co.
Div. of Rockwell Int'l.
Corp.
1201 S. Second St.
Milwaukee, WI 53204
(414) 382-2000
(CC)
CIRCLE 302

Beckman Industrial Corp.
4141 Palm St.
Fullerton, CA 92635
(714) 447-2345
(TF) (TH) (ST) (MT) (CE)
CIRCLE 303

Bourns Inc.
1200 Columbia Ave.
Riverside, CA 92507
(714) 781-5071
(CE) (TF) (WW) (CH) (ST)
(MT) (TR) (RN)
CIRCLE 304

Bradford Electronics Inc.
550 High St.
Bradford, PA 16701-9520
(814) 362-5635
(CF) (CE) (MN) (TF) (TH) (GL)
(HR) (MO) (WW) (CH)
CIRCLE 305

Brel Int'l. Components
1621 University Pkwy.
Sarasota, FL 34243
(813) 355-9791
(CF) (CE) (MN) (TF) (HR)
(MO) (WW) (CH) (CO) (ST)
(MT)
CIRCLE 306

CTS Corp.
Frequency Control Div.
400 Reimann Ave.
Sandwich, IL 60548
(815) 786-8411
(CC) (CE) (TF) (TH) (WW)
(CO) (ST) (MT) (TR) (RN)
CIRCLE 307

CTS Corp.
Resistor Network Div.
406 Parr Rd.
Berne, IN 46711
(219) 589-3111
(CE) (TF) (CF) (CO)
CIRCLE 308

Caddock Electronics Inc.
1717 Chicago Ave.
Riverside, CA 92507
(714) 788-1700
(MN) (TF) (HR) (MO) (RN)
CIRCLE 309

Capar
8243 Jericho Tpke.

Woodbury, NY 11797
(516) 367-7676
(CF) (MN) (MO) (CH)
CIRCLE 310

The Carborundum Co.
345 Third St.
Niagara Falls, NY 14302
(716) 278-3940
(CR)
CIRCLE 311

Cermetek Microelectronics Inc.
1308 Borregas Ave.
Sunnyvale, CA 94088-3565
(408) 752-5000
(CF) (TF) (TH)
CIRCLE 312

Clarostat Mfg. Co.
1 Washington St.
Dover, NH 03820
(603) 742-1120
(AU) (CC) (CE) (MN) (TF)
(HR) (WW) (CO) (ST) (MT)
(TR)
CIRCLE 313

D1 Products Inc.
95 E. Main St.
Huntington, NY 11743
(516) 673-6866
(CC) (CF) (MN) (MO) (WW)
(ST) (MT)
CIRCLE 314

Dale Electronics Inc.
2064 12th Ave., Box 609
Columbus, NE 68601
(402) 564-3131
(CF) (CE) (MN) (TF) (TH) (GL)
(HR) (MO) (WW) (CH) (CO)
(ST) (MT) (TR) (RN)
CIRCLE 315

Dale Electronics Inc.
Tempe Div.
1155 W. 23rd. St.
Tempe, AZ 85282
(602) 967-7874
(CE) (ST) (MT)
CIRCLE 316

Electro-Films Inc.
111 Gilbane St.
Warwick, RI 02886
(401) 738-9150
(TH) (CH)
CIRCLE 317

Electronic Components Int'l.
121 Sheldon St.
El Segundo, CA 90245
(213) 322-7205
(CF) (CO)
CIRCLE 318

Electronic Precision Components
519 S. Fifth Ave.
Mt. Vernon, NY 10550
(914) 664-2333
(WW)
CIRCLE 319

Ericsson Components Inc.
Box 853904
Richardson, TX 75085-3904
(214) 480-8300
(TF)
CIRCLE 320

Hipotronics Inc.
P.O. Drawer A
Brewster, NY 10509
(914) 279-8091
(WW)
CIRCLE 321

Hycomp Inc.
165 Cedar Hill St.
Marlborough, MA 01752
(508) 485-6300
(TH) (CH)
CIRCLE 322

IRC Inc.
Greenway Rd., Box 1860
Boone, NC 28607
(800) 255-4472
(CE) (CO) (CC) (CF) (MN)
(TF) (TH) (GL) (HR) (MO)
(WW) (CH)
CIRCLE 323

International Mfg. Services
50 Schoolhouse Lane
Portsmouth, RI 02871-2418
(401) 683-9700
(TF)
CIRCLE 324

Iskra Electronics Inc.
222 Sherwood Ave.
Farmingdale, NY 11735
(800) 862-2101
(CF) (CE) (ST) (MT) (CF) (CE)
CIRCLE 325

KCK America Inc.
A Mitsubishi Co.
930 Remington Rd.
Schaumburg, IL 60173-4516
(312) 884-8688
(TF) (CH)
CIRCLE 326

KOA Speer Electronics Inc.
Box 547
Bradford, PA 16701
(814) 362-5536
(CF) (MN) (TF) (MO) (CH)
CIRCLE 327

Litton Systems Inc.
Potentiometer Div.
750 S. Fulton St.
Mount Vernon, NY 10550
(914) 664-7733
(CF) (CO) (ST) (MT)
CIRCLE 328

(continued on p. 126)

KEY

Resistors
(AU) Audio
(CC) Carbon composition
(CF) Carbon film
(CE) Cermet
(MN) Metal/non-metal film
(TF) Thick film
(TH) Thin film
(GL) Glass
(HR) High resistance
(MO) Metal oxide
(WW) Wire-wound
(CH) Chip
(CO) Conductive plastic
(ST) Single-turn pot
(MT) Multi-turn pot
(TR) Trimmers
(RN) Resistor networks
(CR) Ceramics

PICO POWER INDUCTORS

PLUG-IN SURFACE MOUNT AXIAL INDUCTORS TOROIDAL INSULATED LEADS

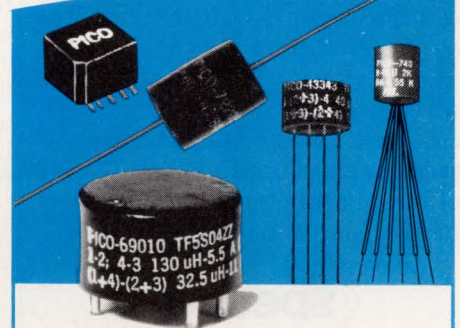

PICO's Ultra-Miniature Power Inductors are ideal for Noise, Spike and Power Filtering Applications in Power Supplies, DC-DC Converters and Switching Regulators.

- QPL standards available MIL-T-27/356
- Temperature range - 55°C to +130°C
- All units are magnetically shielded
- All units meet the requirements of MIL-T-27 (TF5S04ZZ)
- Minimum possible size
- Split windings
- Inductance values to 20mH with DC currents to 23 amps

PICO manufactures complete lines of Transformers, Inductors, DC-DC Converters and AC-DC Power Supplies

Delivery—
stock to
one week

SEE EEM,
OR SEND DIRECT FOR
FREE PICO CATALOG

PICO Electronics, Inc.

453 N. MacQuisten Pkwy. Mt. Vernon, N.Y. 10552

Call Toll Free **800-431-1064**
IN NEW YORK CALL **914-699-5514**

CIRCLE 97

Multi-Turn Cermet Trimmer Measures Only 3/8" Square

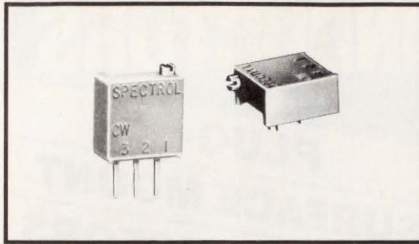

Spectrol's 3/8" square multi-turn cermet trimmer, the Model 64, offers five package/terminal styles to choose from. The unit is available in three side-adjust and two top-adjust versions, with pin configurations to suit any standard PCB application. This low cost space saver is available in resistance ranges from 10 ohms to 2 megohms with a $\pm 10\%$ resistance tolerance. It also features solder plated terminals, an integral multi-finger wiper contact, superior setability and stability, a TEMPCO of ± 100 PPM/ $^{\circ}\text{C}$, a CRV of 3%, and is sealed for solvent and aqueous cleaning. Power rating 0.5 W at 85 $^{\circ}\text{C}$.

Spectrol[®]

Spectrol Electronics Corporation
P.O. Box 1220, La Puente, CA 91749
Phone: (818) 964-6565 Fax: (818) 810-1093

CIRCLE 222

Spectrol Offers Low Cost Single-Turn Precision Pots

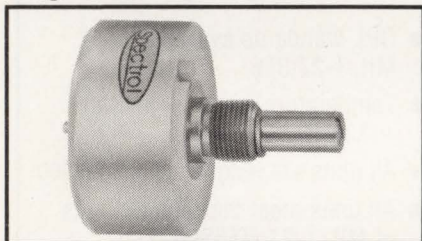

Spectrol offers single-turn precision potentiometers for position sensing and panel control applications. These rugged, low cost 1-5/16 inch diameter pots offer a choice of resistive elements and are well suited for industrial usage where reliable service and long life are essential. The Model 132 features a low noise wirewound element. The Model 138 and Model 139 feature infinite resolution with conductive plastic and cermet resistive elements, respectively. Other specifications include a resistance range of 5 Ω to 2M Ω , standard linearity of 0.5%, operating temperature of -55°C to $+125^{\circ}\text{C}$ and the choice of center taps, continuous rotation or mechanical stops.

Spectrol[®]

Spectrol Electronics Corporation
P.O. Box 1220, La Puente, CA 91749
Phone: (818) 964-6565 Fax: (818) 810-1093

CIRCLE 223

RESISTORS

▼ TINY CHIP RESISTOR NOW IN PRODUCTION

The industry's smallest surface-mountable chip resistor has an external package about the size of a pin-head. Measuring just 1 by 0.5 mm, Rohm's MCR 01 occupies 60% less board space than the company's earlier midget, its MCR 03. The new chip also weighs 75% less than its predecessor. Rated voltage for the MCR 01 is 0.032 W at 70 $^{\circ}\text{C}$ with a maximum operating voltage of 25 W. The resistance range is from 5.6 Ω to 1.5 M Ω with tolerance of $\pm 5\%$. The part operates from -55 to $+125^{\circ}\text{C}$. The MCR 01 costs \$35 per 1000 pieces. It's available in 5000-piece reels of 8-mm paper tape. Delivery is in 12 weeks from receipt of order.

Rohm Corp.
Electronics Division
8 Whatney
Irvine, CA 92718
(714) 855-2131.

► CIRCLE 653

▼ WIREWOUND RESISTORS FOR TRIMMING TASKS

Two types of microminiature wirewound resistors are available for temperature-compensating and trimming applications. Type 401 comes in three models that range in value from 500 Ω to 30 k Ω and handle a maximum voltage of 75 V dc. All are rated for 0.05 W at 70 $^{\circ}\text{C}$. Tolerances are from 0.05% to 20%. Type D-100 also comes in three models and range in value from 10 Ω to 25 k Ω . A flat surface on the device facilitates bonding for excellent response time. They're also rated for 0.05 W and come in tolerances from 1% to 20%. All feature wirewound epoxy construction, excellent repeatability, and rapid response time. Call for pricing and availability.

Micro-Ohm Corp.
1088 Hamilton Rd.
Duarte, CA 91010
(818) 357-5377

► CIRCLE 495

RESISTOR MANUFACTURERS

Mecpocal Co.
11468 Sorrento Valley Rd.
San Diego, CA 92121
(619) 453-0332
(CE) (WW) (ST) (MT)
CIRCLE 329

Micro Ohm Corp.
1088 Hamilton Rd.
Duarte, CA 91010
(818) 357-5377
(CF) (MN) (HR) (MO) (WW)
CIRCLE 330

Milwaukee Resistor Corp.
700 West Virginia St.
Milwaukee, WI 53204-0219
(414) 271-9900
(WW)
CIRCLE 331

Mini-Systems Inc.
Thick/Thin-Film Div.
20 David Rd.
North Attleboro, MA 02760
(508) 695-0203
(CE) (TF) (TH) (HR) (CH)
(RN)
CIRCLE 332

**Murata Erie
North America Inc.**
2200 Lake Park Dr.
Smyrna, GA 30080
(404) 436-1300
(HR) (CH)
CIRCLE 333

NTE Electronics Inc.
44 Farrand St.
Bloomfield, NJ 07003
(201) 748-5089
(MN) (MO) (WW)
CIRCLE 334

Noble U.S.A. Inc.
5450 Meadowbrook Ind. Ct.
Rolling Meadows, IL 60008
(708) 364-6038
(CF) (CE) (GL) (HR) (MO)
(WW) (ST) (TR)
CIRCLE 335

Nytronics Inc.
700 Orange St.
Darlington, SC 29532
(803) 393-5421
(WW)
CIRCLE 336

Ohmite Mfg. Co.
Div. of North American
Philips
3601 Howard
Skokie, IL 60076
(312) 675-2600
(CC) (CF) (MN) (HR) (WW)
CIRCLE 337

Ohmtek Inc.
2160 Liberty Dr.
Niagara Falls, NY 14304
(716) 283-4025
(TF) (TH) (HR) (CH)
CIRCLE 338

PCA Electronics Inc.
16799 Schoenborn St.
Sepulveda, CA 91343
(818) 892-0761
(TH)
CIRCLE 339

**Panasonic Industrial Co.
Electronic Comp. Div.**
Two Panasonic Way
Secaucus, NJ 07094
(201) 348-5244
(AU) (CC) (CE) (CO) (ST)
(MT) (TR)
CIRCLE 340

**Philips Components
Discrete Products Div.**
2001 W. Blue Heron Blvd.
Riviera Beach, FL 33404
(407) 881-3308
(CE) (TF) (TH) (ST) (TR) (RN)
CIRCLE 341

Piher International Corp.
903 Feehanville Dr.
Mount Prospect, IL 60056
(708) 390-6680
(CC) (CF) (CE) (MN) (MO)
(WW) (CH) (ST) (MY) (TR)
(RN)
CIRCLE 342

Preh Electronic Industries
470 E. Main St.
Lake Zurich, IL 60047-2578
(708) 438-4000
(CF) (CE) (TF) (TR)
CIRCLE 343

(continued on p. 129)

KEY

Resistors
(AU) Audio
(CC) Carbon composition
(CF) Carbon film
(CE) Cermet
(MN) Metal/non-metal film
(TF) Thick film
(TH) Thin film
(GL) Glass
(HR) High resistance
(MO) Metal oxide
(WW) Wire-wound
(CH) Chip
(CO) Conductive plastic
(ST) Single-turn pot
(MT) Multi-turn pot
(TR) Trimmers
(RN) Resistor networks
(CR) Ceramics

New

Type MS Precision Power Film Resistors

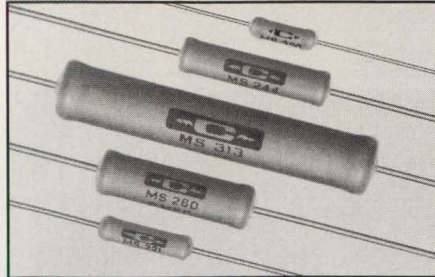

- Power Rating up to 15 Watts**
- **Non-Inductive Design** with power ratings from 2 Watts to 15 Watts
 - Select from 17 Models
 - Voltage ratings from 200 V to 6 KV
 - Resistance Range 20 Ω to 30 Meg
 - Tolerance of 1% (available to 0.1%)
 - Max. Operating Temperature of 275°C

For Type MS data, circle number 90

Type MV Low Resistance Power Film Resistors

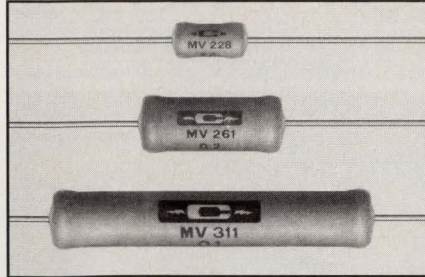

- Resistance Range of 0.1 Ω to 50 Ω**
- **Non-Inductive Design** with power ratings from 1.5 Watts to 10 Watts
 - Select from 5 Models
 - Tolerance of 1%, 2%, 5% or 10%
 - Max. Operating Temperature of 275°C

For Type MV data, circle number 91

Type MP Kool-Tab® Power Film Resistors

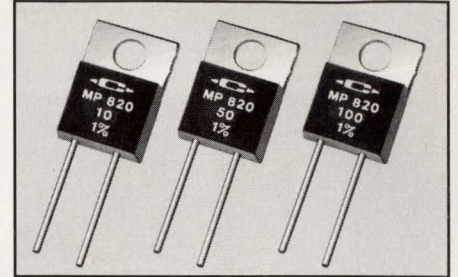

- 20 Watts in the TO-220 Package**
- **Non-Inductive Design**
 - Resistance Range 1 Ω to 10 K
 - 20 Watts at 25°C Case Temperature
 - Tolerance of 1%, 2%, 5% or 10%

For Type MP data, circle number 92

CADDOCK® Resistor Technology

High Performance Power Resistors and High Voltage Resistors with a 25 year record for solving problems across the board!

New

Type MG Precision High Voltage Resistors

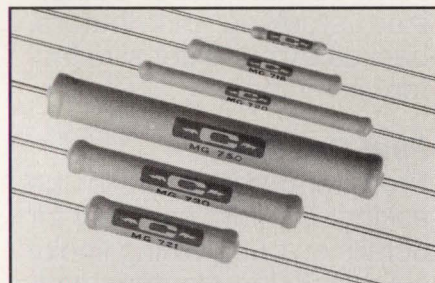

- Voltage Ratings from 600V to 48KV**
- 80 ppm/°C, -15°C to 105°C, ref. 25°C
 - Resistance Range up to 10,000 Meg
 - Select from 23 Models
 - Tolerance of 1% (available to 0.1%)
 - Stability of 0.5% per 1,000 hours

For Type MG data, circle number 93

Type TG Low TC Precision High Voltage Resistors

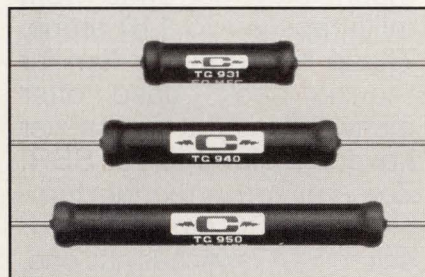

- TC of 25 ppm/°C, -55°C to +125°C**
- Resistance Range 1 Meg to 1,000 Meg
 - 7 Models with Voltage Ratings from 4 KV to 48 KV
 - Voltage Divider Match Sets with **Ratio TC to as tight as 10 ppm/°C**
 - Tolerance of 1% (available to 0.1%)
 - Stability of 0.25% per 1,000 hours

For Type TG data, circle number 94

Type MX Lab Grade High Voltage Resistors



- New Cost Efficient Design**
- 80 ppm/°C, 0°C to 70°C, ref. 25°C
 - Resistance Range 1 Meg to 2,000 Meg
 - 7 Models with Voltage Ratings from 7.5 KV to 48 KV
 - Tolerance of 1%, 2%, 5% or 10% (available to 0.1%)
 - Stability of 0.5% per 1,000 hours

For Type MX data, circle number 95

More high performance resistor products from

CADDOCK

ELECTRONICS, INCORPORATED

These products are manufactured with Caddock's exclusive Micronox® or Tetrinox® Resistance Film Technologies. For your copy of the Caddock General Catalog call or write:

Applications Engineering
Caddock Electronics, Inc.
1717 Chicago Avenue
Riverside, California 92507
(714) 788-1700

The Caddock General Catalog includes specifications on over 200 models of high performance resistor products.

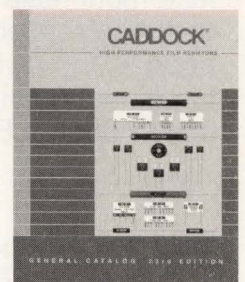

Potter & Brumfield offers the solid state I/O module and relay options you need.

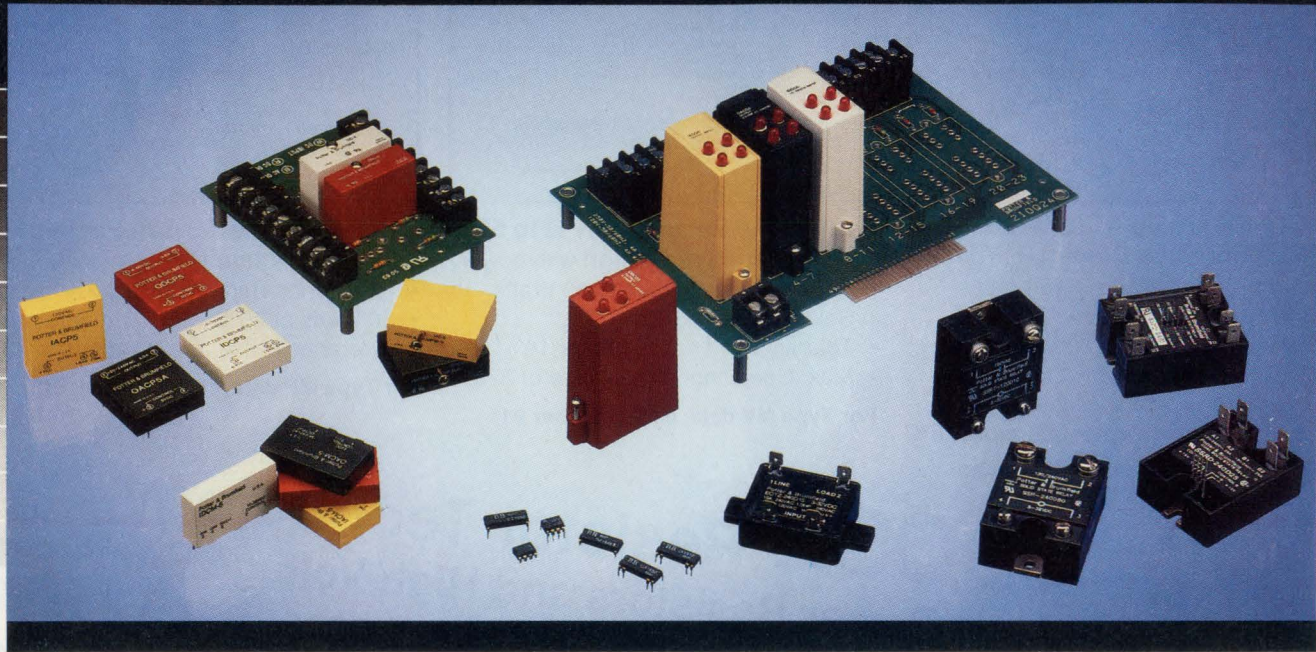

Expanded Offering

New product additions to Potter & Brumfield's already-broad line provide you an even greater variety of solid state products, unmatched in the industry. Now you can select solid state input/output modules and relays with the package style, performance and features just right for your application.

Input/Output Modules

Why force your design to fit around one or two standard configurations? P&B offers six different package styles for design flexibility. From plug-in quad modules to surface-mountable DIP units, our optically-isolated I/O modules provide the options and the traditional quality you expect from Potter & Brumfield.

Solid State Relays

Our new family of chassis mount relays can switch from milliamps up to 110 amps. These relays in our familiar "hockey-puck" case offer many options you might never have imagined in an SSR. Zero-voltage or random turn-on. AC or DC input. Triac or paired-SCR switches and one, two or even four outputs help open the door to your creative design. At the other end of the spectrum, DIP solid state relays put reliable P&B solid state switching of loads up to 1 amp right on your printed circuit board. And you have a choice of conventional or surface mount terminals.

Stock Availability

Most models are available from stock through our nationwide network of authorized stocking distributors, backed by our extensive factory inventory.

Find Out More

Free literature is yours for the asking. Contact us today for details on our growing line of solid state input/output modules and relays. Potter & Brumfield, A Siemens Company, 200 South Richland Creek Drive, Princeton, Indiana 47671-0001.

Call toll-free 1-800-255-2550 for the P&B authorized distributor, sales representative or regional sales office serving your area.

Potter & Brumfield A Siemens Company

RESISTOR MANUFACTURERS

RCD Components Inc.
520 E. Industrial Park Dr.
Manchester, NH 03103
(603) 669-0054
(CC) (CF) (CE) (MN) (TF)
(TH) (GL) (HR) (MO) (WW)
(CH)
CIRCLE 344

Robert G. Allen Co.
7267 Coldwater Canyon
North Hollywood, CA 91605
(818) 765-8300
(AU) (CC) (CF) (CE) (MN)
(TF) (TH) (GL) (HR) (MO)
(WW) (CH) (CO) (RN)
CIRCLE 345

Rohm Corp.
Rohm Electronics Div.
8 Whatney
Irvine, CA 92718
(714) 855-2131
(CF) (MN) (TF) (MO) (CH)
(ST) (MT) (RN)
CIRCLE 346

Shokai Far East Ltd.
280 N. Central Ave.
Hartsdale, NY 10530
(914) 681-0700
(CC) (CF) (CE) (MN) (MO)
(WW)
CIRCLE 347

Silicon Sensors Inc.
Old Hwy. 18 East
Dodgeville, WI 53533
(608) 935-2707
(CE)
CIRCLE 348

Solitron Devices Inc.
Semiconductor Div.
1177 Blue Heron Blvd., #1
Riviera Beach, FL 33404
(407) 848-4311
(CE) (MN) (TH) (CH) (TR)
(RN)
CIRCLE 349

Spectrol Electronics Corp.
Box 1220
La Puente, CA 91749
(818) 964-6565
(ST) (MT)
CIRCLE 350

Sprague Electric Co.
Aluminum Capacitor Div.
Box 9102
Mansfield, MA 02048
(800) 777-7575
(TF)
CIRCLE 351

Stackpole Carbon Co.
Stackpole St.
St. Marys, PA 15857
(814) 781-1234

(HR)
CIRCLE 352
State of the Art Inc.
2470 Fox Hill Rd.
State College, PA 16803-1797
(814) 355-8004
(TF) (TH) (HR)
CIRCLE 353

TDK Corporation
of America
1600 Feehanville Dr.
Mount Prospect, IL 60056
(708) 803-6100
(RN)
CIRCLE 354

Taiyo Yuden (USA), Inc.
714 W. Algonquin Rd.
Arlington Heights, IL 60005
(708) 364-6104
(RN)
CIRCLE 355

Ultronix Inc.
Box 1090
Grand Junction, CO 81502
(303) 242-0810
(WW) (CH) (CE) (ST) (MT)
CIRCLE 356

United Chemi-Con Inc.
9801 W. Higgins Rd.
Rosemont, IL 60018
(312) 696-2000
(TH)
CIRCLE 357

Vishay Resistive Systems
Group
63 Lincoln Hwy.
Malvern, PA 19355
(215) 644-1300
(MN) (TF) (YH) (GL) (WW)
(CH) (ST) (MT)
CIRCLE 358

Voltronics Corp.
Box 476
East Hanover, NJ 07936
(201) 887-1517
(CC) (CF) (TF) (HR) (CO) (ST)
CIRCLE 359

Zenith Electronics Corp.
1000 Milwaukee Ave.
Glenview, IL 60025
(312) 391-7733
(TF) (CH)
CIRCLE 360

KEY

Resistors

- (AU)** Audio
- (CC)** Carbon composition
- (CF)** Carbon film
- (CE)** Cermet
- (MN)** Metal/non-metal film
- (TF)** Thick film
- (TH)** Thin film
- (GL)** Glass
- (HR)** High resistance
- (MO)** Metal oxide
- (WW)** Wire-wound
- (CH)** Chip
- (CO)** Conductive plastic
- (ST)** Single-turn pot
- (MT)** Multi-turn pot
- (TR)** Trimmers
- (RN)** Resistor networks
- (CR)** Ceramics

YOUR FULL HOUSE TRANSFORMER COMPANY



BASLER ELECTRIC HOLDS THE CARDS

Beat the competition with a "Full House." Dry Type Transformers, 5 VA - 2500 KVA, designed to meet UL, CSA, VDE, and other world-wide standards. Basler backs its hand with 50 years of experience in Engineering Design and Automated SPC Monitored Manufacturing Facilities. **LET US DEAL YOU IN!**

B Basler Electric
MAGNETIC PRODUCT GROUP

Rt 143, Box 269, Highland, IL 62249
Phone 618/654-2341 • FAX 618/654-2351

CIRCLE 190

ic[®] MPH/MPL

Metalized Polypropylene Film Capacitors

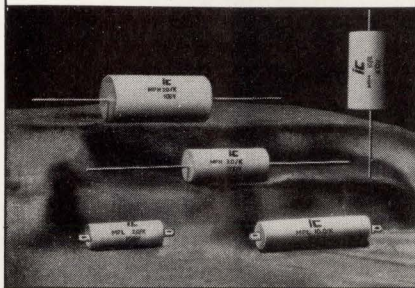

Proven High Reliability
... 100% Burn-In Tested

Non-Inductive High Frequency
Self-Healing High Current Design

- 1.0 Mfd. to 30 Mfd.
- 100 WVDC to 400 WVDC
- > 200 KHz Operation
- -55°C to +105°C
- ±10% Std. (±5% (J) Opt., ±20% (M) Opt.)
- Low ESR, Low ESL, Low Impedance
- High Current Construction

ic[®] TECH TIPS

Type MPH and MPL axial lead High Current capacitors feature flame retardant wrapped and filled construction and meet the specifications of MIL Std. C-55514/9. Type MPL is designed with tinned lug terminals for high current (30A) applications. Offering superior environmental performance up to +105°C without voltage derating, Type MPH and Type MPL are excellent replacements for polycarbonate dielectric capacitors. The self-healing design provides excellent transient and surge protection. Non-inductive extended foil metallized windings are electronically welded to lead wire terminations, providing high ripple current and dV/dt ratings for pulse circuits along with rugged mechanical performance. Designed for operation at 20 to 100KHz min. with rated RMS ripple current. They are perfect for modern SMPS designs.

©1988 ILLINOIS CAPACITOR, INC.

The source for Quality.
Performance and Delivery.

ic[®] ILLINOIS CAPACITOR, INC.

3757 West Touhy Avenue
Lincolnwood, Illinois 60645
(708) 675-1760
Fax (708) 673-2850

CIRCLE 191

RESISTORS

▼ CHIP RESISTOR IS SURFACE MOUNTABLE

Rated for 100 mW at 70°C, the TNPW0805 international-standard-sized 0805 (2.0 mm by 1.25 mm) thin-film resistor chip comes in values from 10 Ω to 100 kΩ with ±0.5% tolerance. Tolerances of ±0.1% are also available with a short lead time. The standard thermal constant is ±25

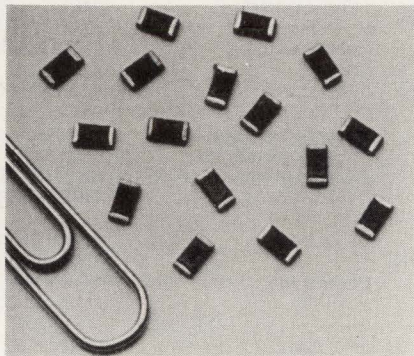

ppm/°C for values of 100 Ω and higher and ±50 ppm/°C under 100 Ω. The TNPW0805 is a companion to the older TNPW1206, a 125-mW thin-film chip resistor that ranges between 49.9 Ω to 1 MΩ at 0.1% tolerance. Both feature solder-coated, nickel-barrier, wrap-around terminations that are compatible with surface-mounting assembly techniques such as vapor-phase and infrared soldering. The resistors come on tape and reel with 500 pieces per reel or in bulk. The typical cost for a 1-kΩ TNPW0805 with a ±0.5% tolerance and temperature coefficient of ±25 ppm/°C is \$0.105 each in quantities of 10,000. Delivery is from stock in four weeks.

Dale Electronics Inc.
1122 23rd St.
Columbus, NE 68601-3647
(402) 644-4244
► CIRCLE 493

▼ TINY ST-4 TRIMMERS NOW MADE HERE

The ST-4 trimmer resistor, at 4.5 by 5 by 2.3 mm, is still the smallest and thinnest sealed single-turn unit available for surface mounting. Mepcopal now makes the trimmers in the U.S. The device withstands dip or reflow soldering temperatures up to 260°C for 10 s, and manual-soldering temperatures up to 350°C for 3 s. The operating-temperature range is -55 to 125°C, the resistance range is 10 Ω to 2 MΩ, and the resolution is infi-

nite. The trimmer can handle input voltages up to 200 V dc at 0.25 W and 70°C, derated to zero watts at 125°C. Rotational life is 100 cycles with a maximum shaft torque of 100 gcm. With a metal-alloy brush wiper and 1% maximum CRV, the ST-4 withstands thermal shock of -65 to 125°C, mechanical shock of 100 G, and vibration of 20 G at 10 to 200 Hz. Sealed with an O-ring, the trimmer passes the Flourinert leak test at 85°C and withstands high-temperature exposure of 125°C for 250 hrs. Reeled tape packaging provides 12-mm tape width, 8-mm part pitch, and 178-mm reel diameter for automatic placement. In 500-piece quantities, they cost \$1.05 each. Prototypes are available immediately; production quantities take eight to 12 weeks.

Mepcopal Co.
11468 Sorrento Valley Rd.
San Diego, CA 92121
(619) 453-0332

► CIRCLE 494

▼ SEALED TRIMMER IS SIDE ADJUSTABLE

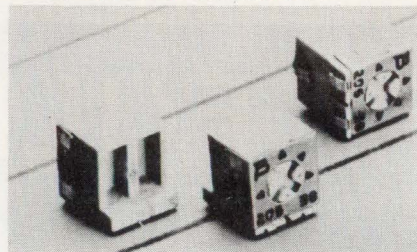

A side-adjustable, 4-mm sealed trimmer is surface-mounted on the edge of a circuit board for easy access from outside the housing of the end product. The 3314S is the latest addition to the 3314 family of trimmers, which includes top-adjusting and through-hole models. Applications include instrumentation and test and measurement systems, pagers, cellular phones, oscilloscopes, power supplies, video cameras, security alarms, factory automation, and process controls. Packaging specifications for 7-in. reels of 200 units, 13-in. reels of 100 units, and tubes of 100 units meet EIA standards. When packaged in tubes, the cost is \$1.70 per trimmer.

Bourns Inc.
1200 Columbia Ave.
Riverside, CA 92507
(714) 781-5500

► CIRCLE 636

RESISTORS

▼ LADDER NETWORKS HOLD VALUE OVER TEMPERATURE

Both 8- and 10-bit versions are available of thick-film ladder networks from Beckman Industrial. The models 898-8X and 899-10 networks are accurate to $\pm 1/2$ LSB (8 bits) and ± 1 LSB (10 bits), respectively, and their

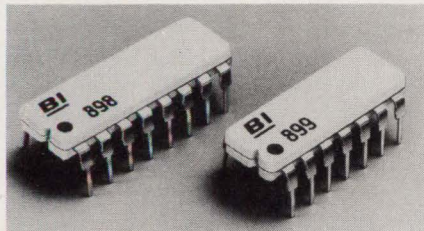

accuracies are maintained over the zero-to-70°C temperature range. Standard ladder impedances are 10k Ω /20k Ω , 25k Ω /50k Ω , 50k Ω /100k Ω , and 100k Ω /200k Ω . The 899 and 898 series are packaged in 14- and 16-pin ceramic DIPs, respectively. Call for pricing and availability.

Beckman Industrial Corp.

4141 Palm St.
Fullerton, CA 92635
(714) 447-2345

► CIRCLE 646

▼ 3-MM SMT TRIMMER FITS IN TIGHT SPACES

The model 3363 surface-mounted trimmer features what the company calls the industry's smallest 3-mm design. The device meets both EIA and EIAJ standards. Features include superior termination-pad ge-

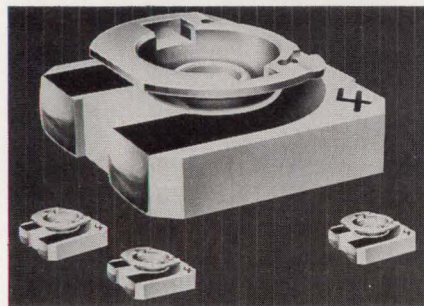

ometry for improved solderability. The trimmer comes in an 8-mm embossed tape and carries values from 100 Ω to 1 M Ω with 5% maximum contact-resistance variation. In low volumes, the 3363 trimmer starts at \$.395.

Bourns Inc.

1200 Columbia Ave.
Riverside, CA 92507
(714) 781-5500.

► CIRCLE 647

SURFACE MOUNT THIN-FILM RESISTOR NETWORKS

On The Surface,
Nobody Gives You Tighter Tolerances
and Long-Term Stability
In So Many Packages



Hermetic chip carrier.

Electro-Films gives you more options for mounting a network...with utmost confidence...than any company in the business.

Our surface mount packages include SOIC's, SOT-23's and PLCC's; hermetic LCC's and Flat Packs; leadless SLRC's and wrap-around chip resistors. Each is available in a wide variety of lead configurations for industrial and military applications.

Ratio tolerances of 0.01%, and

TCR ratio tracking of 0.5 PPM/°C are offered. Typical ratio stability is 28 PPM/1000 hrs. at 125°C.



Chip resistors and capacitors.

Call or write us with your tolerance, stability and

packaging requirements. We'll get back to you with data, pricing and application help. We'll also send you our new Product Guide and Capabilities Brochure. Contact: Electro-Films, Inc, 111 Gilbane Street, Warwick, Rhode Island 02886. (401) 738-9150 FAX (401) 738-4389



Molded SOIC network.



SLRC surface-mount network.

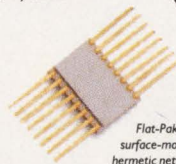

Flat-Pak surface-mount hermetic network.

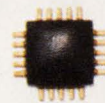

Versa-Chip leaded surface-mount network.



Electro-Films Inc.
The Creative Force in Thin-Film Technology

CIRCLE 200

WORLD CLASS

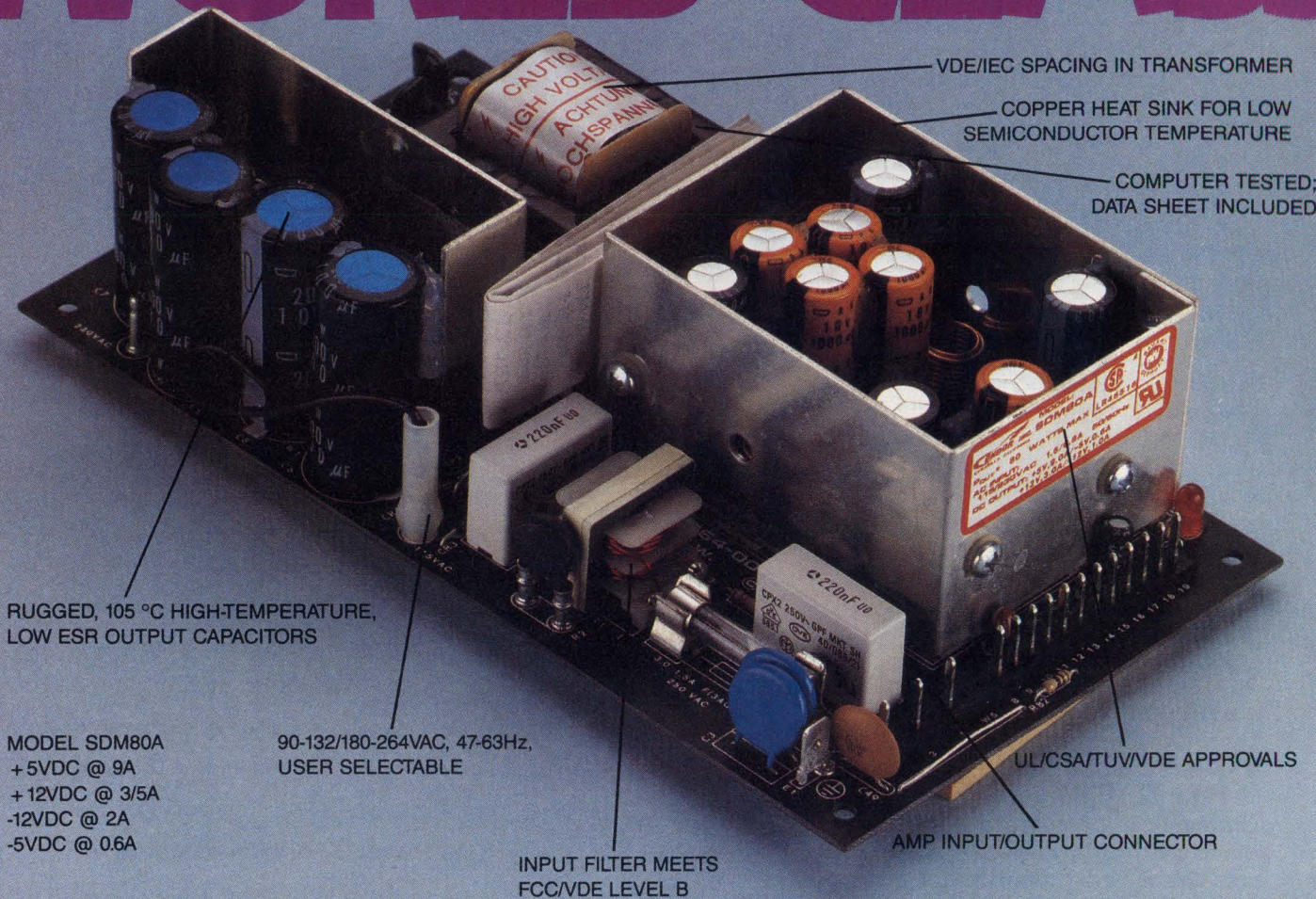

RUGGED, 105 °C HIGH-TEMPERATURE, LOW ESR OUTPUT CAPACITORS

MODEL SDM80A
+5VDC @ 9A
+12VDC @ 3/5A
-12VDC @ 2A
-5VDC @ 0.6A

90-132/180-264VAC, 47-63HZ,
USER SELECTABLE

INPUT FILTER MEETS
FCC/VDE LEVEL B

VDE/IEC SPACING IN TRANSFORMER

COPPER HEAT SINK FOR LOW
SEMICONDUCTOR TEMPERATURE

COMPUTER TESTED;
DATA SHEET INCLUDED

UL/CSA/TUV/VDE APPROVALS

AMP INPUT/OUTPUT CONNECTOR

Condor's SDS and SDM Series power supplies meet FCC/VDE Level B and have agency safety approvals!

Want a tough, versatile, well-designed power supply for your next application? Try a single (SDS) or multiple (SDM) output model from Condor!

Every Condor SDS or SDM power supply meets the toughest domestic and international safety requirements, and is UL, CSA and TUV/VDE certified. All units also meet FCC 20870 Level B and VDE 0871 Class B above 150KHz.

SDS/SDM Series features:

- 5 power levels — 45 to 200 watts
- 20 single and 29 multiple-output models

- (up to 5 outputs)
- Clean, low-cost, open-frame design
- Fully protected — adjustable current limit, built-in OVP and reverse voltage protection
- Full load burn-in and 2-year warranty
- LED "on" indicator
- Powerfail signal and logic inhibit on 140 and 200W levels
- High peak current disk drive outputs plus closely regulated 3-terminal-type outputs
- Extremely versatile output configurations for tough applications
- Very high value for your purchasing dollar
- Isolated outputs can be used for positive or negative sources or in series with other outputs
- Pass vibration and shock per MIL-STD 810D

Call us today and find out how a Condor SDS or SDM world-class power supply can meet your most demanding design requirements!

Send for our free catalog!



250 power supplies!
Switchers and linears!
Open frame and enclosed!
Custom capability!

CONDOR INC.
DC POWER SUPPLIES

2311 Statham Parkway, Oxnard, CA 93030
(805) 486-4565 • TWX: 910-333-0681
FAX: (805) 487-8911
CALL TOLL-FREE: 1-800-235-5929 (outside CA)

CAPACITOR MANUFACTURERS

ASC
21541 Blythe St.
Canoga Park, CA 91304
(818) 710-8555
(FL) (FP) (FY) (FT) (FF) (CN)
CIRCLE 361

AVX Corp.
A Kyocera Group Co.
Box 867
Myrtle Beach, SC 29577
(803) 448-9411
(CM) (ED) (CG) (CP) (CN)
CIRCLE 362

Aerovox Inc.
740 Belleville Ave.
New Bedford, MA 02745
(508) 994-9661
(FY)
CIRCLE 363

American Precision Industries
Delevan Div.
270 Quaker Rd.
East Aurora, NY 14052
(716) 652-3600
(CM) (CP)
CIRCLE 364

Arco Electronics Inc.
9822 Independence Ave.
Chatsworth, CA 91311
(818) 882-8707
(CM) (EA) (ED) (FP) (MI) (CP)
CIRCLE 365

Bourns Inc.
1200 Columbia Ave.
Riverside, CA 92507
(714) 781-5071
(CN)
CIRCLE 366

Brel Int'l. Components
1621 University Pkwy.
Sarasota, FL 34243
(813) 355-9791
(CD) (CM) (EA) (ED) (EW) (FL) (FP) (FY) (FT) (CN) (CP)
CIRCLE 367

Capar
8243 Jericho Tpke.
Woodbury, NY 11797
(516) 367-7676
(CD) (CM) (EA) (ED) (FP) (FY) (MI) (CP)
CIRCLE 368

Component Research Co. Inc.
1655 26th St.
Santa Monica, CA 90404
(213) 829-3615
(FL) (FP) (FY) (FT) (FF) (TE) (CN)
CIRCLE 369

Cornell-Dubilier Sangamo Comp. Div.
1605 E. Rodney French Blvd.
New Bedford, MA 02744
(508) 996-8561
(EA) (EW) (FL) (FP) (FY) (MI)
CIRCLE 370

D1 Products Inc.
95 E. Main St.
Huntington, NY 11743
(516) 673-6866
(AI) (CD) (CM) (EA) (FL) (FP)

(FY) (FT)
CIRCLE 371

Eldre Corp.
1500 Jefferson Rd.
Rochester, NY 14623
(716) 427-7280
(CD)
CIRCLE 372

Electro-Films Inc.
111 Gilbane St.
Warwick, RI 02886
(401) 738-9150
(CN)
CIRCLE 373

Electronic Components Int'l.
121 Sheldon St.
El Segundo, CA 90245
(213) 322-7205
(CD) (CM) (EA) (FP) (FY) (FT)
CIRCLE 374

GTE Corp.
Elec. Components and Materials
2401 Reach Rd.
Williamsport, PA 17701
(717) 326-6591
(CN) (CP)
CIRCLE 375

Globtek Inc.
7700 Marine Rd.
North Bergen, NJ 07047
(201) 861-0246
(EA) (FP) (FY)
CIRCLE 376

Hipotronics Inc.
P.O. Drawer A
Brewster, NY 10509
(914) 279-8091
(CN)
CIRCLE 377

Horizon Capacitor Corp.
2012 W. St. Paul Ave.
Chicago, IL 60647
(312) 252-2211
(FL) (FP) (FY) (FT) (FF) (TE) (CN)
CIRCLE 378

ITT Components
1201 E. McFadden
Santa Ana, CA 92705
(714) 836-0351
(ED) (FL) (FP)
CIRCLE 379

ITW Paktron
1205 McConville Rd.
Lynchburg, VA 24502
(804) 239-6941
(FP) (FT) (CP) (CN)
CIRCLE 380

Illinois Capacitor Inc.
3757 W. Touhy Ave.
Lincolnwood, IL 60645
(708) 675-1760
(CD) (EA) (FL) (FP) (FY)
CIRCLE 381

Iskra Electronics Inc.
222 Sherwood Ave.
Farmingdale, NY 11735
(800) 862-2101
(FL) (FP) (FY) (FT)
CIRCLE 382

Johanson Dielectrics Inc.
Box 6456
Burbank, CA 91510
(818) 848-4465
(CD) (CM) (OP)
CIRCLE 383

Johanson Mfg. Corp.
400 Rockaway Valley Rd.
Boonton, NJ 07005
(201) 334-2676
(AI) (CD)
CIRCLE 384

KCK America Inc.
A Mitsubishi Co.
930 Remington Rd.
Schaumburg, IL 60173-4516
(312) 884-8688
(CD) (CM) (EA) (ED) (FL) (FP) (FY) (FT) (CN) (OP)
CIRCLE 385

KEMET Electronics Corp.
Box 5928
Greenville, SC 29606
(803) 963-6621
(CM) (EA) (FL) (CP)
CIRCLE 386

KOA Speer Electronics Inc.
Box 547
Bradford, PA 16701
(814) 362-5536
(ED)
CIRCLE 387

Mallory Capacitor Co.
4760 Kentucky Ave.
Indianapolis, IN 46291
(317) 856-2430
(CD) (CM) (EA) (ED) (EW) (PF) (FY) (FT) (CP)
CIRCLE 388

Marcon America Corp.
Toshiba Group
998 Forest Edge Dr.
Vernon Hills, IL 60061
(708) 913-9980
(CM) (EA) (ED) (EW) (FP) (FY) (CP) (CN)
CIRCLE 389

(continued on p. 134)

KEY

- Capacitors**
(AI) Air
(CD) Ceramic/disk
(CM) Ceramic/multilayer
(EA) Electrolytic/aluminum
(ED) Electrolytic/tantalum dry slug
(EW) Electrolytic/tantalum wet
(FL) Film/polycarbonate
(FP) Film/polyester
(FY) Film/polypropylene
(FT) Film/polystyrene
(FF) Film/polysulfone
(CG) Glass
(MI) Mica
(TE) Teflon
(VA) Vacuum
(CP) Chip
(CN) Capacitor networks
(CR) Ceramics

MILITARY CAPACITORS FEATURE LOW ESR/ESL

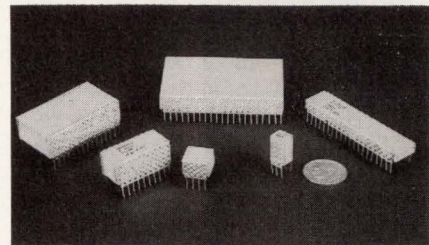

Used for switchmode power supplies, the KMP multi-pack capacitors offer the low ESR and ESL values necessary for output filtering of high-speed switchers. They are approved to DESC drawings 87106 and 88011, are built with a full-height lead frame, and use M123-qualified dielectrics. Fabricated in a clean-room multilayer-ceramic chip-fabrication facility, the capacitors employ solderless construction (cofired technology), undergo statistical process control, and the chips are parametrically screened and are burned in. Extra high-reliability processing and screening is available as is M123 screening.

Kemet Electronics Corp.
Box 5928
Greenville, SC 29606
(803) 963-6608
► **CIRCLE 496**

METAL-FILM CAPACITORS SERVE POWER SYSTEMS

A line of metallized-polypropylene capacitors is qualified to MIL-C-84321/2, failure rate S for switchmode power supplies. The C15 series of hermetically sealed devices covers the range of 0.056 μ F to 20 μ F with voltage ratings of 60, 120, and 240 V rms. Special values are also available on request. The ac ratings are specified for frequencies of 400 to 100 Hz within a temperature range of -55 to 105°C. All capacitors are burned in with rated currents at 85°C for 24 hrs. A typical specification for a 20- μ F, 100-V dc capacitor is 60 V rms at 400 Hz, 15 A at 25°C. Maximum ESR at 100 kHz is a very low-loss 9 m Ω . Delivery of small quantities is from stock.

Component Research Co.
1655 26th St.
Santa Monica, CA 90404
(213) 829-3615
► **CIRCLE 497**

CAPACITORS

▼ TRIMMER CAPACITORS SPORT NEW STYLES

Two new configurations—top and bottom tuning—have been added to the GKG series of 4-by-4.5-mm ceramic trimmer capacitors. Both reverse-leaded types have snap-in spring leads on 5-mm (0.197-in.) mounting-hole centers. The bottom-

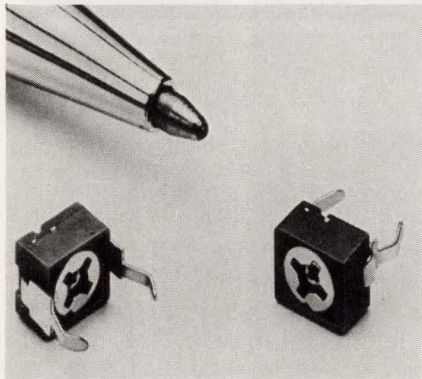

tuning models are designated GKGXXX72 when supplied with a membrane seal for the adjust cavity and GKGXXX22 when left unsealed. The top-tuned models are named GKGXXX74 when sealed and

GKGXXX24 in unsealed versions. Their molded-plastic housings are color-coded to indicate each model's capacitance range. Seven capacitance ranges in each series go from 1.7 to 3 pF to 15 to 50 pF. All models operate from -25 to 85°C and have a voltage rating of 100 V dc. Top-tuning models are available in magazine packs for auto insertion.

Sprague-Goodman Electronics
134 Fulton Ave.
Garden City Park, NY 11040
(516) 746-1385

► CIRCLE 498

▼ SURFACE-MOUNTED CAPS FIT UNDER PLCCs

With its very low profile of 0.027 in., Rogers' Micro/Q 3500SM decoupling capacitor fits underneath 68-pin, 84-pin, and larger plastic leaded chip carriers. The capacitors don't develop microscopic cracks during soldering as do multilayer ceramic chips, and have very low equivalent series inductance of 1.6 nH. Two dielectrics are available: the Z5V dielectric offers capacitances of 0.10 and 0.22 μ F,

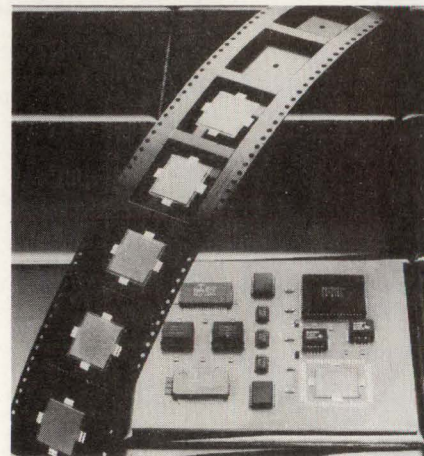

while the X7R dielectric offers a value of 0.075 μ F. The capacitors come on 32-mm-wide tape at a 28-mm pitch. Pricing is \$.83 each in lots of 10,000. Delivery is in six to eight weeks after receipt of order. Samples are available now.

Rogers Corp.
Circuit Components Div.
2400 S. Roosevelt St.
Tempe, AZ 85282
(602) 967-0624

► CIRCLE 499

CAPACITOR MANUFACTURERS

Mini-Systems Inc.
Thick/Thin-Film Div.
20 David Rd.
North Attleboro, MA 02760
(508) 695-0203
(CP)
CIRCLE 390

Murata Erie
North America Inc.
2200 Lake Park Dr.
Smyrna, GA 30080
(404) 436-1300
(AI) (CD) (CM) (VA) (CN)
(OP)
CIRCLE 391

NEC Electronics Inc.
401 Ellis St., Box 7241
Mountain View, CA 94039
(415) 960-6000
(CM) (ED) (EW) (CP)
CIRCLE 392

NIC Component Corp.
6000 New Horizons Blvd.
North Amityville, NY 11701
(516) 226-7500
(CD) (CM) (EA) (ED)
CIRCLE 393

NTE Electronics Inc.
44 Farrand St.
Bloomfield, NJ 07003
(201) 748-5089
(CD) (EA) (ED)
CIRCLE 394

Nichicon (America) Corp.
927 E. State Pkwy.
Schaumburg, IL 60173

(312) 843-7500
(EA) (FP) (FY)
CIRCLE 395

Noble U.S.A. Inc.
5450 Meadowbrook Ind. Ct.
Rolling Meadows, IL 60008
(708) 364-6038
(FY) (FT)
CIRCLE 396

Nytronics Inc.
700 Orange St.
Darlington, SC 29532
(803) 393-5421
(FL) (FP) (FY) (FT)
CIRCLE 397

Philips Components
Discrete Products Div.
2001 W. Blue Heron Blvd.
Riviera Beach, FL 33404
(407) 881-3308
(CM) (CP)
CIRCLE 398

Piher International Corp.
903 Feehanville Dr.
Mount Prospect, IL 60056
(708) 390-6680
(CM)
CIRCLE 399

Robert G. Allen Co.
7267 Coldwater Canyon
North Hollywood, CA 91605
(818) 765-8300
(AI) (CD) (CM) (EA) (ED)
(EW) (FL) (FP) (FY) (FT) (FF)
(CG) (MI) (TE) (VA) (CP) (CN)
CIRCLE 400

Roederstein Electronics Inc.
Box 5588
Statesville, NC 28677
(704) 872-8101
CIRCLE 401

Rogers Corp.
Circuit Components Div.
2400 S. Roosevelt St.
Tempe, AZ 85282
(602) 967-0624
(CD) (CM)
CIRCLE 402

Seacor Inc.
Box 541, 123 Woodland Ave.
Westwood, NJ 07675
(201) 666-5600
(CM) (FL) (FP) (FY) (FT) (CN)
CIRCLE 403

Shokai Far East Ltd.
280 N. Central Ave.
Hartsdale, NY 10530
(914) 681-0700
(CD) (EA) (FL) (FP) (FY) (FT)
(FF)
CIRCLE 404

Siemens Components Inc.
186 Wood Ave. South
Iselin, NJ 08830
(201) 906-4376
(FL) (FP) (FY) (CP)
CIRCLE 405

Spectrum Control Inc.
2185 W. Eighth St.
Erie, PA 16505
(814) 455-0966
(CD) (CM) (CP) (CN)
CIRCLE 406

Sprague Electric Co.
Aluminum Capacitor Div.
Box 9102
Mansfield, MA 02048
(800) 777-7575
(CD) (CM) (EA) (ED) (EW)
(FL) (FP) (CN) (CP)
CIRCLE 407

Sprague-Goodman
Electronics
134 Fulton Ave.
Garden City Park, NY 11040
(516) 746-1385
(AI) (FL) (FY) (CG) (MI) (TE)
CIRCLE 408

TDK Corporation
of America
1600 Feehanville Dr.
Mount Prospect, IL 60056
(708) 803-6100
(CD) (CM) (CP) (CN)
CIRCLE 409

Taiyo Yuden (USA), Inc.
714 W. Algonquin Rd.
Arlington Heights, IL 60005
(708) 364-6104
(CD) (CM) (CP) (CN)
CIRCLE 410

Thomson Passive
Components Corp.
Box 4051, 6203 Variel Ave.
Woodland Hills, CA 91367
(818) 887-1010
(CD) (CM) (ED) (FP) (FY) (FT)
(CN) (CP)
CIRCLE 411

United Chemi-Con Inc.
9801 W. Higgins Rd.
Rosemont, IL 60018
(312) 696-2000
(EA) (CP)
CIRCLE 412

Voltronics Corp.
Box 476
East Hanover, NJ 07936
(201) 887-1517
(AI) (CG) (TE)
CIRCLE 413

World Products Inc.
19654 8th St. East
Sonoma, CA 95476
(707) 996-5201
(FP)

For codes, see pg. 133

CAPACITORS

▼ SMT TRIMMER CAPS HANDLE OVER 5 GHz

Surface-mounted trimmer capacitors come in three choices of dielectrics: sapphire, usable to over 5 GHz in 1.1-, 2.5-, 4.5-, and 8-pF values; air, usable to over 1.2 GHz in 10- and 14-pF values; and glass, usable to over 200 MHz in many values to 60 pF. All versions are sealed with O rings to meet stringent washing require-



ments. They have nonrotating pistons that provide linear tuning, long life, positive stops, and high Q. The capacitors are modified versions of a proven MIL-C-14409 design.

Voltronics Corp.

Box 476

East Hanover, NJ 07936

(201) 887-1517

► CIRCLE 637

▼ MULTILAYER CAPACITORS MOUNT LOW ON BOARDS

A line of multilayer ceramic capacitors was developed for applications that call for very thin, surface-mounted capacitors. With their maximum thickness of 0.020 in., the devices fit under a plastic leaded chip

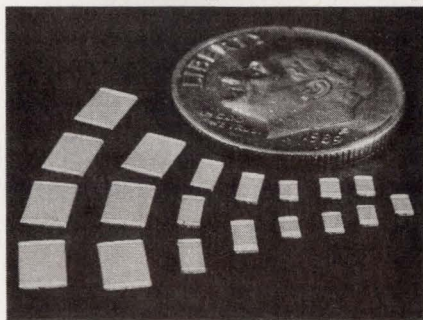

carrier. They also can be used on multichip modules. Four EIA sizes are available: 1206, 1210, and 1812. Values range from 0.01 to 0.3 μ F. Typical pricing is \$.15 each in OEM lots. Delivery is from stock to eight weeks.

Rogers Corp.

Circuit Components Div.

2400 S. Roosevelt St.

Tempe, AZ 85282

(602) 967-0624

► CIRCLE 638

Who says nobody loves trimmer capacitors?

When it comes to small size,
low cost and SMT requirements,
engineers are flowery in their praise of
Sprague-Goodman's Ceramic Dielectric Trimmers.

It's no wonder. Our ceramics have a way of making everything look rosy. They come in a broad variety of sizes, shapes and capacitance ranges, including Surtrim® SMT, and sealed models. All are of the highest quality, sensibly priced and readily available.

For more information, call or write for Engineering Bulletin SG-305A, plus data on other trimmer capacitors for virtually every requirement.

CIRCLE 127

**SPRAGUE
GOODMAN**

The World's Broadest Line Of Trimmer Capacitors
134 FULTON AVENUE, GARDEN CITY PARK, NY 11040-5395
TEL: 516-746-1385 • FAX: 516-746-1396 • TELEX: 14-4533



A SLEEPING GIANT IS WAKING UP.

GS BATTERY (JAPAN STORAGE BATTERY CO., LTD.) supplies energy sources worldwide for thousands of electronics, security, computer and communications needs. Until recently, we've been content to sell our products through private marketing channels. Now, GS BATTERY—"THE QUIET GIANT"—is waking up and wants you to get to know us better.

Our wide range of PORTALAC sealed lead acid batteries provides state-of-the-art performance for a myriad of applications. Position insensitive, they may be used in series or in parallel for maximum design flexibility. GS BATTERIES feature the highest power-to-volume ratio available in the industry. Their maintenance-free design,

low self-discharge rate, and high energy density are some of the reasons why more of today's cost-conscious, performance-oriented engineers specify GS BATTERIES for their most demanding applications.

For detailed specifications, call, write or fax us today and tell us about your requirements. Find out how a quiet giant called GS BATTERY can go to work for you.



GS BATTERY (USA), INC.
17253 Chestnut Street
City of Industry, CA 91748
Tel: (818) 964-8348 Fax: (714) 598-5872

CIRCLE 146

JAGUAR™

The ultimate enclosure with sleek, sophisticated styling,
computer-aided, high-tech design and functionality
and Bud's legendary built-in quality.



The new Jaguar Cabinet offers the contoured elegance of a modern classic in perfect harmony with advanced engineering and inspired technical innovation. Beneath the graceful curves of its removable top cover, you'll discover a rugged steel frame engineered to be incredibly strong and stable. The sophisticated, functional design provides a precise environment for today's, and tomorrow's, high-tech equipment.

Utilizing Bud's standard option packages and our engineer-assisted custom capabilities, we can create a unique Jaguar Cabinet to meet your specific technical requirements.

Bud East, Inc.
4605 East 355th Street
P.O. Box 431
Willoughby, Ohio 44094
(216) 946-3200
FAX: 216-951-4015

BUD
Bud Industries, Inc.

Bud West, Inc.
7733 West Olive Avenue
P.O. Box 1029
Peoria, Arizona 85345-0350
(602) 979-0300
FAX: 602-878-5371

BUD...Your Single Source Enclosure Company.

CIRCLE 136

▼ **METALLIZED CAPS
SUIT PULSE CIRCUITS**

Two non-inductive metallized-film capacitors feature high reliability and a self-healing nature. The radial types 2114 and 914 offer pulse properties, low losses, and low ESR. Type 2114 is a metallized polypropylene device that ranges from 0.01 to 2.2 μF with tolerances of ± 5 , ± 10 , and $\pm 20\%$. Standard voltages are 250,

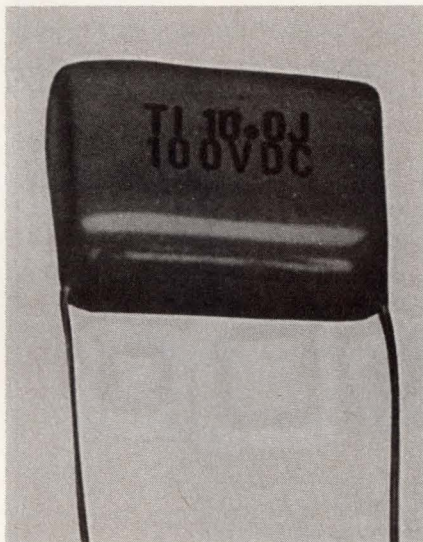

400, and 630 V dc. The metallized polyester type 914 ranges in value from 0.01 to 6.8 μF and adds a $\pm 2\%$ version. In lots of 1000, the 2114 starts at \$.08 each and the 914 at \$.07 each. Delivery for both is from stock to eight weeks.

Tecate Industries Inc.
Box 711509
Santee, CA 92072
(619) 448-4811
► **CIRCLE 648**

▼ **HIGH-CURRENT CAPACITORS
SUIT POWER CONVERTERS**

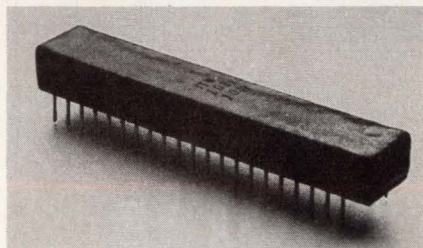

Applications for ITW Paktron's type CS Capstick capacitors can be found in the input and output filter circuits of high-frequency switchmode power supplies and dc-dc converters. They're useful where conventional capacitors are too high in impedance

because of dielectric losses or where they display high inductive reactance because of their size and shape. The high-current, high-capacitance devices are multilayer, metallized polyester-film types with multiple leads on a 0.1-in. grid. Their dissipation factor is stable in low-frequency applications. Standard capacitance values are available up

to 25 μF at 50 V dc with 100- and 250-V dc ratings depending on value. In lots of 100, a 25- μF , 50-V dc capacitor goes for \$.60. Delivery is in five to six weeks after receipt of order.

ITW Paktron
1205 McConville Rd.
Lynchburg, VA 24502
(804) 239-6941.
► **CIRCLE 649**

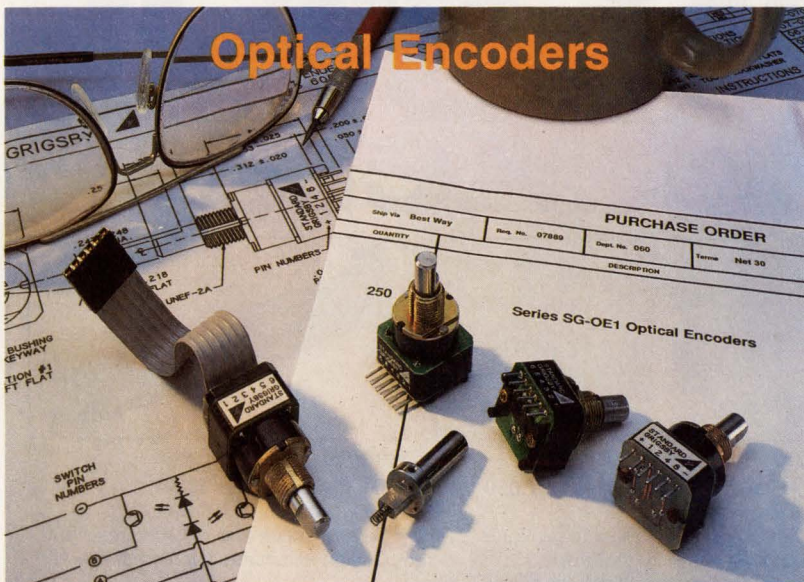

**Specify THE Standard In Optical Switching...
Standard Grigsby!**

Quality Is Standard At Standard Grigsby...

- Vibration-resistant interlock design
- Long life
- Reliable LED optical switching source
- Low power consumption

Customer Satisfaction Is Standard, Too!

- Binary, gray, or custom codes
- High res, 128-152 position option
- Ribbon cable or connectors
- 16, 24, 32, 64 positions
- P.C. lugs and right angle mounts available
- Priced at under \$20 in lots of 100

Raise your switching standards! Call us today for our complete **Optical Encoder** product catalog. 708/556-4200

STANDARD GRIGSBY

88 N. Dugan Road/P.O. Box 890, Sugar Grove, IL 60554-0890
708/556-4200 FAX 708/556-4216

CIRCLE 199

You need 'em. We got 'em. Let's talk sockets.

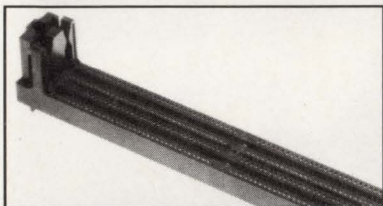

.050 Pitch SIMM Sockets

- Accepts SIMM modules with .010" thickness range
- IR compatible high temp insulator
- Audible "snap in" feature
- User friendly insertion/withdrawal

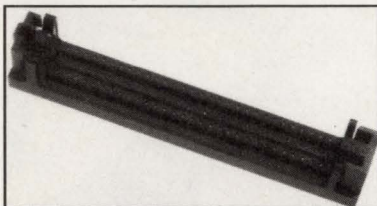

Rugged SIMM Sockets

- For larger, heavier SIMM's
- 100 cycle minimum durability
- Severe shock and vibration resistant
- Design eliminates latch breakage

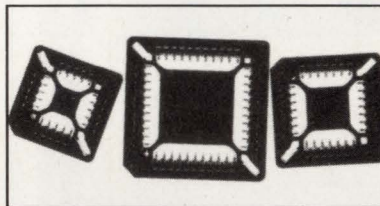

Low Profile SMT PLCC

- Easy visual inspection
- Footprint same as device
- Tape and reel packaging
- Shock and vibration resistant

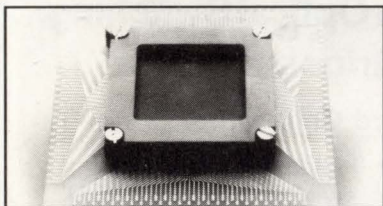

Solderless SMT .025" PQFP Socket

- Made for bumpered PQFP's
- Designed for high speed applications
- Footprint matches device
- Eliminates typical socket inductance

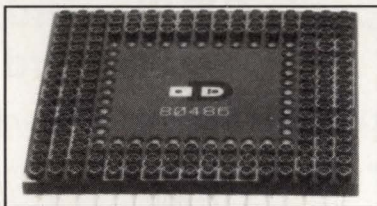

Customized PGA Sockets

- High density .050" interstitial
- For high speed microprocessors
- Reduced crosstalk
- Integral decoupling capacitor

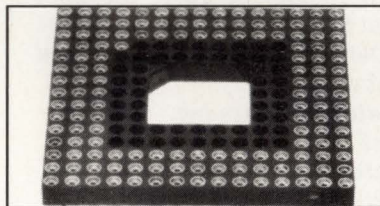

Ultra Low Force PGA Sockets

Contact Type	Insertion/Withdrawal Total (Based on 68 Pins)
Robinson Nugent Ultra-Low	7.5/5.5 lb
2-finger Tulip (Stamped & Formed)	10.3/6.7 lb
6-finger Staggered	14.8/8.7 lb

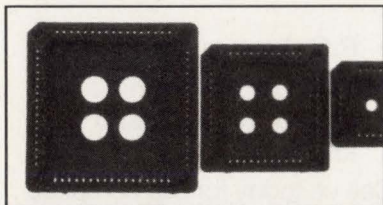

High Temp .050" PLCC Sockets

- Shock and vibration resistant
- 20 through 100 positions
- Closed bottom design
- Extraction tool common for all sizes

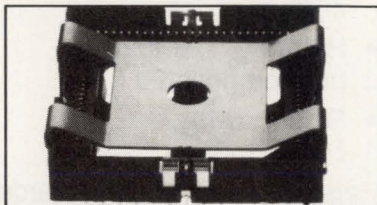

Motorola SLAM PAK .050" Socket

- Custom design DSP socket
- Shock and vibration resistant
- Anti-wicking bottom cover

**The
Call is
on Us.**

800-338-8152

**Robinson
Nugent**

P.O. Box 1208 New Albany, IN 47150-1208
800/338-8152 • FAX 812/945-0804

6 Rue St. Georges, CH 2800 Delémont
(41) 66-22-9822 • FAX (41) 66-22-9813

▼ **MULTILAYER CHIP FORMS INDUCTOR**

Unlike conventional coils, the LMCL multilayer chip inductor is built up of alternate layers of ferrite and conductor paste that form a perfectly closed magnetic circuit. They come in three of the smallest possible sizes for high-density applications and

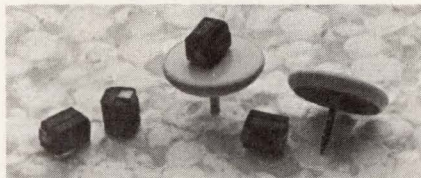

cover a range of 0.047 to 220 μ H. Highly heat resistant, the inductors withstand flow and reflow soldering and present no shelf-life problems over long years of storage. They are suitable for use in camcorders, disk drives, automobiles, and more.

Inductor Supply Inc.
1849 W. Sequoia Ave.
Orange, CA 92668
(800) 854-1881

► CIRCLE 500

▼ **COMMON-MODE CHOKES WORK IN ISDN CIRCUITS**

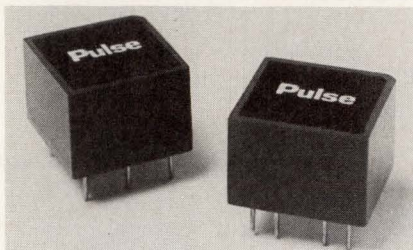

Specifically designed for ISDN four-wire S-interface circuits is a line of common-mode filter chokes. The chokes can be used in the transmit and receive lines and reduce common-mode noise. Two models are available with inductances of 1 and 6 mH and common-mode impedances up to 5 k Ω and 20 k Ω at 1 MHz. The packages are board-mountable and are a maximum of 0.4 in. tall.

Pulse Engineering Inc.
Telecom Group
Box 12235
San Diego, CA 92112
(619) 268-2400

► CIRCLE 501

▼ **SMD INDUCTORS SPORT WIDE RANGE OF VALUES**

Believed to be the first line of surface-mounted inductors to offer high Q and dc-resistance values, Dale's IS-22 inductors come in a wide range of standard inductance values. Models are available with values of 200, 1000, 10,000, and 25,000 μ H. Minimum Q values range from 50 to 80 and dc-resistance values range from

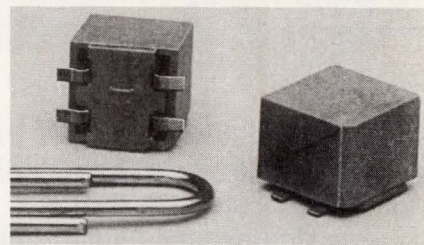

0.2 to 8 Ω . Standard tolerance is \pm 40% over a temperature range of -20 to +105°C.

Dale Electronics Inc.
East Hwy. 50
Yankton, SD 57078
(605) 665-9301.

► CIRCLE 502

INDUCTOR, COIL, AND CHOKES MANUFACTURERS

AVA Electronics Corp.
4000 Bridge St.
Drexel Hill, PA 19026
(800) 331-8838
(PF)
CIRCLE 405

Allen Avionics Inc.
224 E. Second St.
Mineola, NY 11501
(516) 248-8080
(PL) (PF)
CIRCLE 406

American Precision Industries Delevan Div.
270 Quaker Rd.
East Aurora, NY 14052
(716) 652-3600
(AF) (RF) (SU)
CIRCLE 407

Andersen Laboratories
1280 Blue Hills Ave.
Bloomfield, CT 06002
(203) 242-0761
(PL) (PF)
CIRCLE 408

Automatic Coil
3545 N.W. 71st St.
Miami, FL 33147
(305) 696-6660
(AF) (IF) (RF)
CIRCLE 409

Coilcraft
1102 Silver Lake Rd.
Cary, IL 60013
(708) 639-2361
(IF) (RF) (SU) (PF)
CIRCLE 410

Cramer Coil & Transformer
Box 200, 401 Progress Dr.
Saukville, WI 53080
(800) 972-9594
(AF) (IF) (RF) (SU)
CIRCLE 411

Curtis Industries
Box 19910
Milwaukee, WI 53219
(414) 649-4200
(PF)
CIRCLE 412

Dale Electronics Inc.
2064 12th Ave., Box 609
Columbus, NE 68601
(402) 564-3131
(AF) (IF) (RF) (SU)
CIRCLE 413

Data Delay Devices Inc.
3 Mt. Prospect Ave.
Clifton, NJ 07013
(201) 773-2299
(PL)
CIRCLE 414

Datatronics Inc.
28151 Hwy. 74
Romoland, CA 92380
(714) 928-7700
(PL)
CIRCLE 415

ESC Electronics Corp.
534 Bergen Blvd.
Palisades Park, NY 07650
(800) 631-0853
(AF) (RF) (SU)
CIRCLE 416

Ecliptek Corp.
18430 Bandolier Circle
Fountain Valley, CA 92708
(714) 963-4009
(AF) (IF) (RF) (SU)
CIRCLE 417

Engineered Components Co.
Box 8121
San Luis Obispo, CA 93403
(805) 544-3800
(PD)
CIRCLE 418

FDK America Inc.
Fuji Electrochemical Co.
17326 Edwards Rd., Ste.
A130
Cerritos, CA 90701
(213) 404-1770
(RF)
CIRCLE 419

Ferroxcube Div. of Ampere Electronics
5083 Kings Hwy.
Saugerties, NY 12477
(914) 246-2811
(IF) (RF)
CIRCLE 420

Frequency Devices Inc.
25 Locust St.
Haverhill, MA 01830
(617) 374-0761
(PF)
CIRCLE 421

General Instruments Corp. Optoelectronics Div.
3400 Hillview Ave.
Palo Alto, CA 94304
(415) 493-0400
CIRCLE 422

Gowanda Electronics Corp.
1 Industrial Pl.
Gowanda, NY 14070
(716) 532-2234
(IF) (RF) (SU) (PO)
CIRCLE 423

ICS Manufacturing Inc.
621 S. Manchester Ave.
Anaheim, CA 92802
(800) 642-2645
(AF) (IF) (RF) (SU)
CIRCLE 424

Inductor Supply Inc.
1849 W. Sequoia Ave.
Orange, CA 92668-1017
(714) 978-2277
(AF) (IF) (RF) (SU)
CIRCLE 425

Kappa Networks Inc.
1443 Pinewood St.
Rahway, NJ 07065
(800) 223-0603
(AF) (IF) (SU)
CIRCLE 426

Microwave Filter Co.
6743 Kinne St.
East Syracuse, NY 13057
(800) 448-1666
(PF)
CIRCLE 427

Mini-Circuits
Box 350166
Brooklyn, NY 11235-0003
(718) 934-4500
(PF)
CIRCLE 428

Murata Erie North America Inc.
2200 Lake Park Dr.
Smyrna, GA 30080
(404) 436-1300
(IF) (RF) (SU)
CIRCLE 429

Nytronics Inc.
700 Orange St.
Darlington, SC 29532
(803) 393-5421
(RF) (PL)
CIRCLE 430

Opt Industries Inc.
300 Red School Lane
Phillipsburg, NJ 08865
(201) 454-2600
(AF) (IF) (RF)
CIRCLE 431

(continued on p. 142)

KEY

- Inductors, coils, and chokes**
- (AF) Audio frequency
- (IF) Intermediate frequency
- (RF) Radio frequency
- (SU) Surface-mounted
- (PL) Passive delay lines
- (PF) Passive filters

Active Airborne ECM Power Management

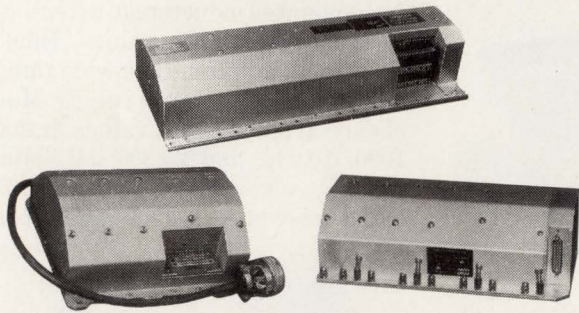

- Multibeam Mini TWT (HVPS)
- Signal Processor (LVPS)
- RF Processor (LVPS)
- Uninhabited Fighter Application

Ferranti Venus

399 SMITH STREET, FARMINGDALE, N.Y. 11735
(516) 293-4100 • TWX: 510-224-6492 • FAX: 516-752-7976

CIRCLE 186

NEED QUICK-TURN P.C. BOARDS?

IT SAYS YOU WERE
3 WEEKS LATE WITH YOUR
PROTOTYPE... DON'T YOU
KNOW ABOUT
AVANTI CIRCUITS
ONE DAY SERVICE?



Avanti Circuits...
your quick-turn P.C.B. specialist.

Single/Double sided: One day
Multi-layer: Two days
Phone Quotes: 5 minutes

Call 1-800-234-1556

AVANTI
CIRCUITS
INC. 
17650 North 25th Avenue
Phoenix, Arizona 85023
(602) 863-7729/(602) 234-1556
FAX: 1-800-234-7731
MODEM/BBS#: 1-602-234-1737

Need help in designing
the most cost-efficient
PCB? Call our DESIGN
ASSISTANCE Hot Line
now... 1-800-234-1556

CIRCLE 83

MANUFACTURERS LISTING

INDUCTOR, COIL, AND CHOKE MANUFACTURERS

PCA Electronics Inc.
16799 Schoenborn St.
Sepulveda, CA 91343
(818) 892-0761
(RF)
CIRCLE 432

Pacific Coil Co.
Div. of Inductor Supply
Inc.
430 E. 19th St.
Bakersfield, CA 93305-5495
(800) 332-2645
(AF) (IF) (RF) (SU)
CIRCLE 433

Polara Engineering Inc.
4115 Artesia Ave.
Fullerton, CA 92633
(714) 521-0900
(AF) (IF) (RF) (SU)
CIRCLE 434

Prem Magnetics Inc.
3521 N. Chapel Hill Rd.
Mc Henry, IL 60050
(815) 385-2700
(AF) (RF)
CIRCLE 435

Pulse Engineering
Box 12235
San Diego, CA 92112
(619) 268-2544
(IF)
CIRCLE 436

RCD Components Inc.
520 E. Industrial Park Dr.
Manchester, NH 03103
(603) 669-0054
(RF) (SU)
CIRCLE 437

Renco Electronics Inc.
60 Jefryn Blvd.
East Deer Park, NY 11729
(516) 586-5566
(AF) (IF) (RF) (SU)
CIRCLE 438

Robert G. Allen Co.
7267 Coldwater Canyon
North Hollywood, CA 91605
(818) 765-8300
(SU)
CIRCLE 439

Saronix
4010 Transport
at San Antonio
Palo Alto, CA 94303
(415) 856-6900
(SU)
CIRCLE 440

Schaffner EMC Inc.
825 Lehigh Ave.
Union, NJ 07083
(201) 851-0644
(PF)
CIRCLE 441

Shokai Far East Ltd.
280 N. Central Ave.
Hartsdale, NY 10530
(914) 681-0700
(IF) (RF)
CIRCLE 442

Sprague Electric Co.
Aluminum Capacitor Div.
Box 9102
Mansfield, MA 02048
(800) 777-7575
(RF) (SU)
CIRCLE 443

**Sprague-Goodman
Electronics**
134 Fulton Ave.
Garden City Park, NY 11040
(516) 746-1385
(RF) (SU)
CIRCLE 444

State of the Art Inc.
2470 Fox Hill Rd.
State College, PA 16803-1797
(814) 355-8004
(SU)
CIRCLE 445

**TDK Corporation
of America**
1600 Feehanville Dr.
Mount Prospect, IL 60056
(708) 803-6100
(SU) (PL) (PF)
CIRCLE 446

Taiyo Yuden (USA), Inc.
714 W. Algonquin Rd.
Arlington Heights, IL 60005
(708) 364-6104
(AF) (IF) (RF) (SU) (PF)
CIRCLE 447

Thermometrics Inc.
808 U.S. Hwy. 1
Edison, NJ 08817
(201) 287-2870
(SU)
CIRCLE 448

Toko America Inc.
1250 Feehanville Dr.
Mount Prospect, IL 60056
(312) 297-0070
(AF) (IF) (RF) (SU)
CIRCLE 449

World Products Inc.
19654 8th St. East
Sonoma, CA 95476
(707) 996-5201
(RF)
CIRCLE 450

KEY

Inductors, coils, and chokes
(AF) Audio frequency
(IF) Intermediate frequency
(RF) Radio frequency
(SU) Surface-mounted
(PL) Passive delay lines
(PF) Passive filters

When It Comes To High-Speed, State-Of-The-Art Interconnection Technology, No One Can Touch Us.

HIGH SPEED FLEXIBLE CIRCUITS WITH GOLD-DOT INTERCONNECTIONS

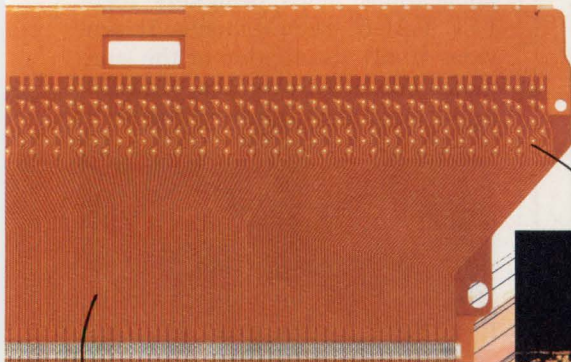

Gold-Dot magnification: 80X

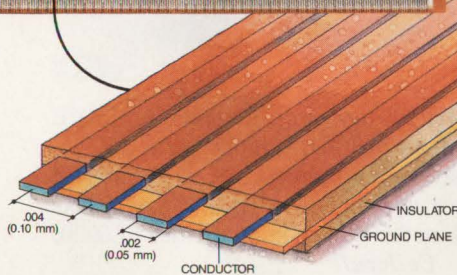

GOLD-DOT INTERCONNECTION SYSTEM

Hughes pioneered Gold-Dot.* Simple, but revolutionary, Gold-Dot is a precision gold bump, integral with a flexible circuit, that mates with a pad on a PC board or another flexible circuit. Offering unparalleled size, weight, and reliability advantages, Gold-Dot answers high performance electronics needs that exceed the limitations of the pin and socket connector.

Gold-Dot, our solution for tomorrow's board-to-board, or multichip module-to-board interconnections, today!

CONTROLLED IMPEDANCE TRANSMISSION LINES

Solving high density transmission problems is our business. Are high data clock rates and propagation delay limiting your system performance? Your solution lies in our ability to produce and test controlled impedance flexible circuits in line widths and spacing of .002.

Every day thousands of our controlled impedance flexible circuits are in use in commercial and military high frequency, multichip module and automatic test interconnect applications.

Hughes research in action. Why not put it to work for you?

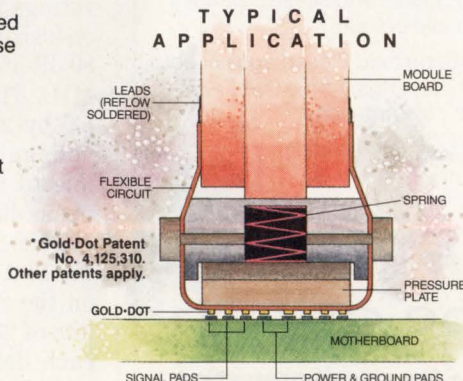

* Gold-Dot Patent No. 4,125,310. Other patents apply.

HIGH DENSITY PRINTED CIRCUIT CONNECTORS WITH DIGITAL, POWER AND FIBER OPTIC CONTACTS

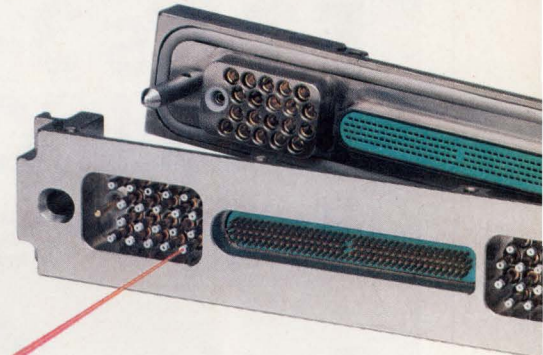

APPLICATION

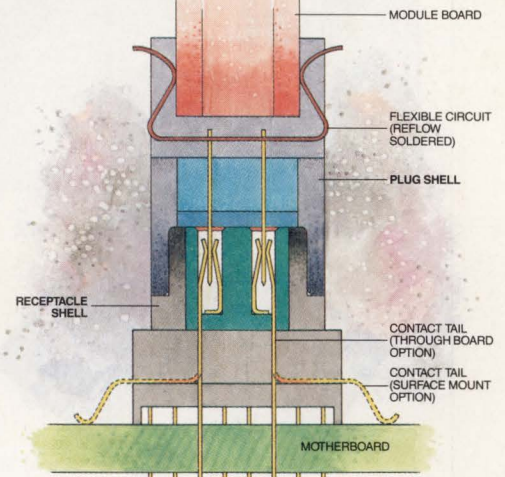

Our rugged, high density HDPC Series offers you a High-Rel connector that meets current state-of-the-art packaging requirements.

Contacts on .050 centers have leads on .025 centers, ready for reflow soldering — surface mount or through board termination. Features: Multiple sizes; EMI shielding; Environmental seal; Digital, power and fiber optic contacts; And more.

FIBER OPTICS Interconnections are available for single or multimode fibers. A unique alignment system guarantees consistent performance in multichannel applications. Low losses are achieved with our standard QPL termini, and ultra low losses with the new ceramic termini.

Direct Line to Product Managers

Flexible Circuits and Gold-Dot: Alex Torres (714) 660-5830
High Density Connectors: Bill Hunter (714) 660-5703
Fiber Optics: Jack Maranto (714) 660-5759
In Europe: Hugh McInally (901144) 592-754311

Hughes Aircraft Company
Connecting Devices Division
17150 Von Karman Avenue
Irvine, California 92714

HUGHES

Subsidiary of GM Hughes Electronics

INDUCTORS

▼ ANALOG DELAY LINE IS PROGRAMMABLE

Housed in a 14-pin DIP, the DIP series of programmable analog delay lines (PADL) is of hybrid construction using both IC and discrete-component techniques. The MTBF of these units is over 1.6 million hours as calculated by MIL-HDBK-217 for a 50°C ground-fixed environment.

The delay lines are digitally programmable by TTL signals from remote switch setting or by a computer in eight steps. Analog input signals are specified to be between -5 and 5 V and input impedance is 100 Ω ±10 Ω. Supply voltage is nominally 5 V at less than 1 mA. Typical set-up time is 24 ns. The device is available in 10 models in maximum delays

from 4.5 ns to 36 ns. The 36-ns PADL offers a maximum deviation of ±1 ns, a delay change per step of 5 ±0.5 ns, and 3-dB bandwidth of 10 MHz.

Engineered Components Co.

3580 Sacramento Dr., Box 8121
San Luis Obispo, CA 93403-8121
(805) 544-3800

► CIRCLE 650

▼ FILTER QUIETS TIP-AND-RING CIRCUITS

The TRF-4000 filter for tip-and-ring applications helps designers meet FCC Part 68 requirements. It provides 20-dB attenuation of the common-mode noise over the 30-to-250-

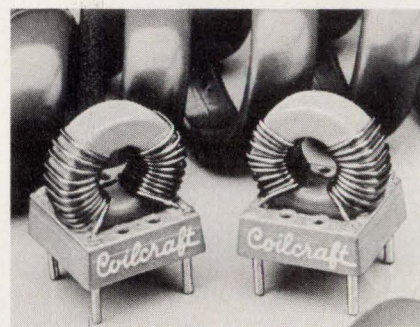

MHz range, and attenuates 15 dB out to 300 MHz. Isolation is 1500 V between windings and dc resistance per winding is 65 mΩ. Cost is less than \$2.00 each in quantities of 5000.

Coilcraft

1102 Silver Lake Rd.
Cary, IL 60013
(708) 639-6400

► CIRCLE 651

▼ THREE-PHASE EMI FILTER OPERATES TO 400 HZ

The FN 356 series of three-phase EMI filters is available in current ratings from 16 to 50 A at 45°C. The chassis-mounted filters provide over 80 dB of differential attenuation at 1 MHz. The 16-A model measures only 5.9 by 2.0 by 4.0 in. The operating-voltage rating is 250 V from phase line to neutral and 440 V between phase lines at a frequency of dc to 400 Hz. Solder-lug connections serve the 16-A size and UNC 8-32 studs are on the 25-, 36-, and 50-A models. In lots of 25, the 16-A unit costs \$109.59 each; delivery is in four to ten weeks.

Schaffner EMC Inc.

825 Lehigh Ave.
Union, NJ 07083
(800) 367-5566

► CIRCLE 652

E-T-A's 3-in-1 Switch/Circuit Breakers

Proof
That
Simpler
Is Better.

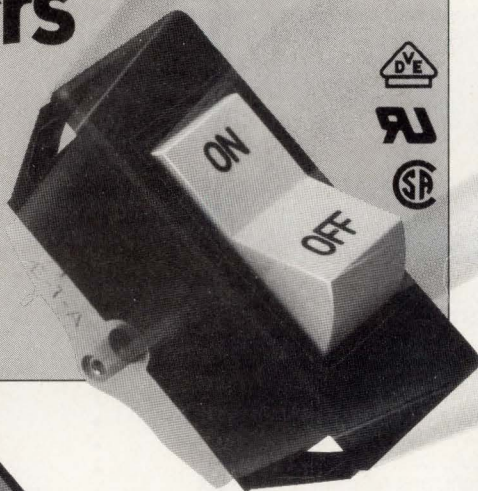

E-T-A's combination switch, circuit breaker, and indicator lamp means you only have to buy, stock, mount and wire *one* component. It simplifies wiring, saving installation time and space. Both double and single pole units fit the same small panel cutout.

Units are trip free, cannot be held closed against an overload. Available in current ratings from 0.05A to 25A at 250VAC, and offered with many optional configurations.

E-T-A's 3-in-1 switch/breaker... a singularly simple solution to dependable overload protection.

E-T-A[®]

CIRCUIT BREAKERS GROUP

setting the pace for circuit protection

7400 N. Croname Rd., Chicago, IL 60648 Phone: (708) 647-8303 Fax: (708) 647-7494

© 1990 E-T-A Circuit Breakers

Circle Reader Service
Number to receive our
FREE Catalog.



CIRCLE 128

ELECTRONIC DESIGN ■ PIPS SPECIAL EDITORIAL FEATURE ■ SEPTEMBER 27, 1990

SAMTEC SLASHES SHIPMENTS TO 5 DAYS

MON	TUE	WED	THU	FRI
1	2	3	4	5

On orders of up to 1000 connectors.

With Samtec "Super Service" we'll ship up to 1000 of just about everything in our catalog in just 5 days. This includes *all* machined strip, DIP and PGA interconnects, *all* .025" square post headers and sockets, *all* board stackers, *all* low profile interconnects, *all* .050" centerline micro interconnects... virtually everything in over 100 pages of interconnect solutions.

The only excluded items are cable assemblies and other custom interconnects.

For common connectors shipped from stock, in two days guaranteed, or nearly anything else shipped in just five, experience Samtec Sudden Service today.

Call: 1-800-SAMTEC-9

Until 7:00 pm EST

**SUPER
SERVICE**

1000
CONNECTORS
SHIPPED IN
5 DAYS



samtec



IS SUDDEN SERVICE

CIRCLE 171

New Albany, Indiana USA • Sacramento, California USA • Cumbernauld, Scotland UK • Singapore

SAMTEC, INC. P.O. Box 1147 • New Albany, IN 47151-1147 USA • Phone 812-944-6733 • Fax 812-948-5047 • TWX 810-540-4095 • Telex 333-918

ALMAC



CARSTEN

CHELSEA



Hamilton Avnet

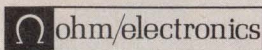
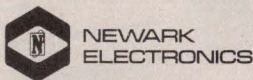

**Bourns Surface Mount
Trimmer Design Kit
Available From These Distributors**

COPYRIGHT © 1990, BOURNS, INC. 7/90

BOURNS

**“IT'S YOUR
CHOICE”**

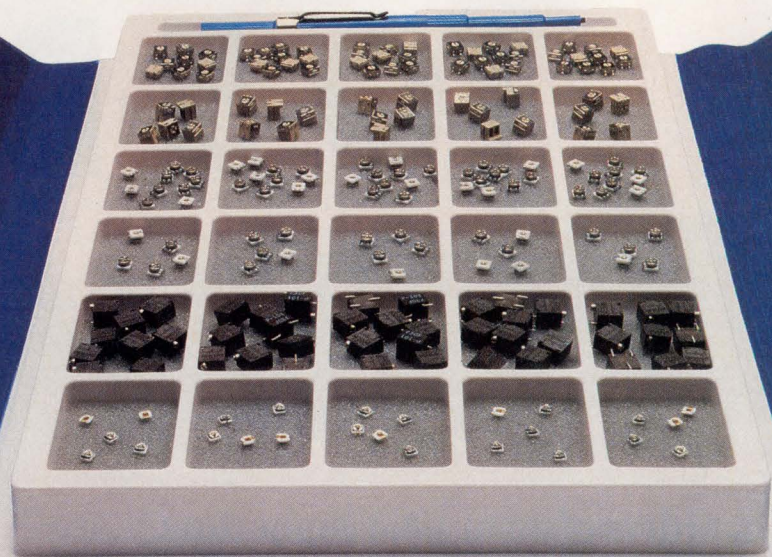

Which surface mount trimmer is right for your job?

To be sure, you need working samples. Complete specifications. Application details. So Bourns Trimpot makes it easy with its new Surface Mount Trimmer Design Kit.

Everything you need to prototype and test is in one place. Pick from over 200 surface mount trimmers in the most popular sizes, styles and resistance values. Check the specs. Verify the soldering process. All with one convenient kit . . . the industry's first.

Order your kit today from your Bourns distributor. It's the right choice.

**Send Me My Free
Surface Mount Design Kit Brochure**

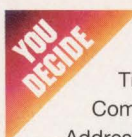

Name: _____
Title: _____
Company: _____
Address: _____
City: _____ State: _____ Zip: _____

Send to: Bourns, Inc., M/S ADV,
1200 Columbia Ave., Riverside, CA 92507



BOURNS TRIMPOT

Bourns, Inc., 1200 Columbia Avenue, Riverside, CA 92507; (714) 781-5500;
European Headquarters: Zugerstrasse 74, 6340 Baar, Switzerland: 042-333333;
Benelux: 070-3874400; France: 01-40033604; Germany: 0711-22930; Ireland: 021-357001; United Kingdom: 0276-692392;
Asia Pacific Headquarters: 510 Thomson Road, Unit D9-01A SLF Building, Singapore 1130; (65) 353 4118; Hong Kong: (852) 5702171;
Korea: (62) 2-556-3619; Japan Headquarters: Nichibei Time 24 Building, 35 Tansu-Cho, Shinjuku-Ku, Tokyo, 162, Japan: (81) 3-260-1411

CIRCLE 224 "CALL ME"

CIRCLE 179 "SEND LITERATURE"

CRYSTALS & OSCILLATORS

CRYSTAL AND OSCILLATOR MANUFACTURERS

AT&T Microelectronics
555 Union Blvd.
Allentown, PA 18103
(800) 372-2447
(CO)
CIRCLE 451

AVX Corp.
A Kyocera Group Co.
Box 867
Myrtle Beach, SC 29577
(803) 448-9411
(QC) (CO) (TC) (VC) (CK)
(SO)
CIRCLE 452

Billey Electric Co.
2545 W. Grandview Blvd.
Erie, PA 16508
(814) 838-3571
(MC) (QC) (SC) (CO) (TC)
(VC) (CK)
CIRCLE 453

Brel Int'l. Components
1621 University Pkwy.
Sarasota, FL 34243
(813) 355-9791
(MC) (QC) (CO)
CIRCLE 454

CTS Corp.
Frequency Control Div.
400 Reimann Ave.
Sandwich, IL 60548
(815) 786-8411
(MC) (QC) (SC) (CO) (TC)
(VC) (CK) (SO)
CIRCLE 455

Connor-Winfield Corp.
1865 Selmarten Rd.
Aurora, IL 60505-1335
(312) 851-4722
(CO) (TC) (VC) (CK) (SO)
CIRCLE 456

Crystek Corp.
Div. of Whitehall Co.
Box 6135
Ft. Myers, FL 33906
(813) 936-2109
CIRCLE 457

Dale Electronics Inc.
2064 12th Ave., Box 609
Columbus, NE 68601
(402) 564-3131
(CO) (SO)
CIRCLE 458

Dale Electronics Inc.
Tempe Div.
1155 W. 23rd. St.
Tempe, AZ 85282
(602) 967-7874
(CO) (SO)
CIRCLE 459

Damon Corp.
Electronics Div.
80 Wilson Way
Westwood, MA 02090
(800) 348-0028
(CF) (TC) (VC)
CIRCLE 460

Data Delay Devices Inc.
3 Mt. Prospect Ave.
Clifton, NJ 07013
(201) 773-2299
(CK)
CIRCLE 461

Ecliptek Corp.
18430 Bandler Circle
Fountain Valley, CA 92708
(714) 963-4009
(MC) (QC) (SC) (CL) (CO)
(TC) (VC) (SO)
CIRCLE 462

Fox Electronics
5842 Corporation Circle
Fort Myers, FL 33905
(813) 693-0099
(MC) (QC) (SC) (CL) (CO)
(TC) (VC) (SO)
CIRCLE 463

Frequency Electronics Inc.
55 Charles Lindbergh Blvd.
Mitchell Field, NY 11553
(516) 794-4500
(QC) (CL) (CO) (TC)
CIRCLE 464

GTE Corp.
Elec. Components
and Materials
2401 Reach Rd.
Williamsport, PA 17701
(717) 326-6591
(QC)
CIRCLE 465

ITT Components
1201 E. McFadden
Santa Ana, CA 92705
(714) 836-0351
(MC) (QC) (CO)
CIRCLE 466

KCK America Inc.
A Mitsubishi Co.
930 Remington Rd.
Schaumburg, IL 60173-4516
(312) 884-8688
(MC) (QC) (SC) (CL) (CO)
CIRCLE 467

M-Tron Industries Inc.
Box 630
Yankton, SD 57078
(605) 665-9321
(SC)
CIRCLE 468

MF Electronics Corp.
10 Commerce Dr.
New Rochelle, NY 10801
(800) 331-1236
(CO) (VC) (SO)
CIRCLE 469

Matec Corp.
Valpey-Fisher
75 South St.
Hopkinton, MA 01748
(508) 435-6831
(MC) (QC) (SC) (CO) (TC)
(VC) (CK) (SO)
CIRCLE 470

McCoy Electronics Co.
Box B, 100 Watts St.
Mount Holly Springs, PA
17065
(717) 486-3411
(QC) (SC) (CL) (CO)
CIRCLE 471

Micro Crystal Div./SMH
35 E. 21st St.
New York, NY 10010
(212) 505-5340
(MC) (QC) (CO)
CIRCLE 472

Murata Erie
North America Inc.
2200 Lake Park Dr.
Smyrna, GA 30080
(404) 436-1300
(CL) (CO)
CIRCLE 473

NDK America Inc.
20300 Stevens Creek Blvd.
Cupertino, CA 95014
(408) 255-0831
(MC) (QC) (SC) (CO) (TC)
(VC)
CIRCLE 474

NEL Frequency Controls
357 Beloit St.
Burlington, WI 53105
(414) 763-3591
(MC) (QC) (SC) (CL) (CO)
(TC) (VC) (CK) (SO)
CIRCLE 475

NTE Electronics Inc.
44 Farrand St.
Bloomfield, NJ 07003
(201) 748-5089
(MC) (QC)
CIRCLE 476

Piezo Crystal Co.
100 K St., Box 619
Carlisle, PA 17013
(717) 249-2151
(MC) (QC) (SC) (CO) (TC)
(VC)
CIRCLE 477

Piezo Technology Inc.
Box 547859
Orlando, FL 32854
(407) 298-2000
(SC) (CL) (CO) (TC) (VC)
(CK) (SO)
CIRCLE 478

Pietronics Inc.
9026 Roosevelt Way N.E.
Seattle, WA 98115
(206) 523-9395
(MC) (QC) (SC) (CO) (CK)
(SO)
CIRCLE 479

Q-Tech Corp.
4010 W. Jefferson Blvd.
Culver City, CA 90232-3510
(213) 836-7900
(QC) (SC) (CO) (TC) (VC)
(SO)
CIRCLE 480

Saronix
4010 Transpourt
at San Antonio
Palo Alto, CA 94303
(415) 856-6900
(MC) (QC) (SC) (CO)
CIRCLE 481

(continued on p. 148)

For codes, see pg. 148

CRYSTAL OSCILLATORS SERVE FIBER OPTICS

A family of four crystal oscillators for use with fiber-optic-transmission lines deliver ± 20 ppm accuracy over operating temperature ranges of -40 to 85°C or zero to 70°C . The devices oscillate at 51.840 MHz (HV54/64) or 155.520 MHz (EO1-453/463), and are designed for Sonet STS1 and STS3,

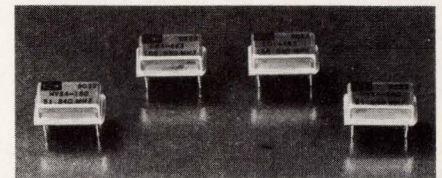

respectively. Prototypes are available in six to eight weeks and cost \$87.95 (HV54/64) and \$82.70 (EO1-456/463). Both prices are for lots of 10.

The Connor-Winfield Corp.
1865 Selmarten Rd.
Aurora, IL 60505
(708) 851-5040
► CIRCLE 502

CRYSTAL OSCILLATORS BOAST HIGH STABILITY

A frequency stability of ± 1 ppm from -30 to 80°C is featured in the TCXO digitally compensated crystal oscillators from Toyocom USA Inc. The oscillators require no warmup,

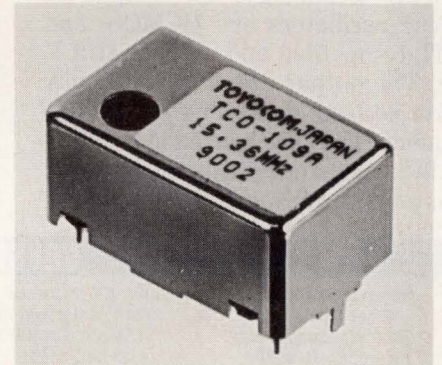

and their small size (0.1 in.³) makes them well suited for fixed or portable applications. The oscillators are available with frequencies of 15.36, 16.8, or 12.8 MHz. Their output is 1 V pk-pk minimum. Pricing, depending on model, ranges from \$105 to \$117 for samples and from \$30 to \$35 each in lots of 5000.

Toyocom U.S.A. Inc.
617 E. Golf Rd., Suite 112
Arlington Heights, IL 60005
(800) 869-6266
► CIRCLE 503

CRYSTALS & OSCILLATORS

▼ CLOCK OSCILLATOR REACHES TO 40 MHz

With output frequencies available from 500 kHz to 40 MHz, Pletronics' three-state, SQ 3300 series clock oscillator includes an enable/disable control input. When in the enable condition, operation is normal. When in the disable condition, the output presents a high impedance and the clock oscillator is ready for connection to alternate circuits or to test signals. The operating temperature range is from zero to 70°C. Frequency stabilities from 0.005 to 0.1% are

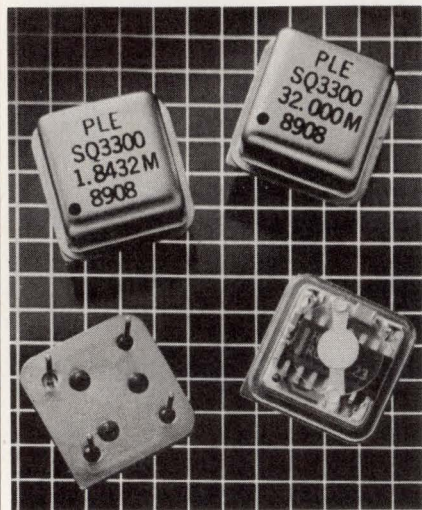

available. Built with high-speed CMOS technology, the output of these oscillators are HCMOS- and TTL-compatible and operate at 5 V dc. The output draws 10 to 60 mA with no load, depending on the frequency. They are housed in hermetically sealed, four-pin metal mini-DIP containers. Pricing is \$3.40 in quanti-

ties of 1000.

Pletronics Inc.
9026 Roosevelt Way N.E.
Seattle, WA 98115
(206) 525-2350

► CIRCLE 504

▼ TTL-COMPATIBLE CLOCKS IN 26 FREQUENCIES

An off-the-shelf line of TTL-compatible clock oscillators comes in 26 standard frequencies. CTS Corp.'s MXO55L line of oscillators offers frequencies ranging from 2.4576 to 70 MHz. All are capable of driving up to 10 standard TTL loads. With many applications in personal computers, facsimile machines, and telecommunications equipment, the MXO55L oscillators come in an all-metal, hermetically sealed 14-pin DIP. Stability for standard frequencies is ± 100 ppm over an operating-temperature range of zero to 70°C. Call for pricing and availability.

CTS Corp.
Frequency Control Div.
400 Reimann Ave.
Sandwich, IL 60548
(815) 786-8411

► CIRCLE 505

▼ HIGH STABILITY ANCHORS OSCILLATOR

With high stability and low noise, the type CO-705SL2 crystal oscillator provides a noise floor of just -168 dBc/Hz. The oscillator warms up to within 10^{-8} of the output frequency in 4 minutes after turn on. Aging is 5×10^{-10} per day and 10^{-7} per year, and temperature stability is $\pm 10^{-9}$ from zero to 50°C and $\pm 5 \times 10^{-9}$ from -55 to



75°C. Standard output frequencies are 5 MHz and 10 MHz, and any frequency from 4 MHz to 12.5 MHz is available. The standard output is +7 dBm into a 50- Ω load. A +13-dBm or HCMOS/TTL output is optional. The frequency can be adjusted either mechanically or by means of an externally injected voltage. The unit is packaged in a 1.5-by-1.5-by-2-in. case. Delivery is in from 10 to 16 weeks, depending on the frequency requested.

Vectron Laboratories Inc.
166 Glover Ave.
Norwalk, CT 06850
(203) 853-4433

► CIRCLE 506

CRYSTAL AND OSCILLATOR MANUFACTURERS

Seiko Instruments U.S.A.
Fiber Optic Comp. Div.
2990 W. Lomita Blvd.
Torrance, CA 90505
(213) 517-7841
(QC) (CO) (TC)
CIRCLE 482

Shokai Far East Ltd.
280 N. Central Ave.
Hartsdale, NY 10530
(914) 681-0700
(MC) (QC) (SC) (CL)
CIRCLE 483

Spectrum Technology Inc.
Box 948
Goleta, CA 93116
(805) 964-7791
(QC) (SC) (CO) (TC) (VC)
CIRCLE 484

Standard Crystal Corp.
9940 E. Baldwin Pl.
El Monte, CA 91731
(818) 443-2121
(MC) (QC) (SC) (CO) (VC)
(CK)
CIRCLE 485

Statek Corp.
512 N. Main St.
Orange, CA 92668
(714) 639-7810
(QC) (SC) (CO) (CK) (SO)
CIRCLE 486

TDK Corporation of America
1600 Feehanville Dr.
Mount Prospect, IL 60056
(708) 803-6100
(VC)
CIRCLE 487

Taiyo Yuden (USA), Inc.
714 W. Algonquin Rd.
Arlington Heights, IL 60005
(708) 364-6104
(VC)
CIRCLE 488

Time & Frequency Ltd.
55 Charles Lindbergh Blvd.
Mitchell Field, NY 11553
(516) 794-4500
(MC) (QC) (CL) (CO) (TC)
(VC)
CIRCLE 489

Toyocom U.S.A. Inc.
617 E. Gold Rd., Suite 112
Arlington Heights, IL 60005
(708) 593-8780
(MC) (QC) (SC) (CL) (CO)
(TC) (VC) (CK) (SO)
CIRCLE 490

Valpey-Fisher Corp.
75 South St.
Hopkinton, MA 01748
(800) 982-5737
(MC) (QC) (SC) (CO) (TC)
(VC) (SO)
CIRCLE 491

Vectron Laboratories Inc.
166 Glover Ave.
Norwalk, CT 06850
(203) 853-4433
(CO) (TC) (VC) (CK) (SO)
CIRCLE 492

KEY

Crystals and oscillators

- (MC) Microprocessor crystals
- (QC) Quartz crystals
- (SC) Surface-mounted crystals
- (CL) Crystal filters
- (CO) Crystal oscillators
- (TC) Temperature-controlled oscillators
- (VC) Voltage-controlled oscillators
- (CK) Clock oscillators
- (SO) Surface-mounted oscillators

RELIABILITY YOU CAN DEPEND ON!

MILITARY DC-DC CONVERTERS

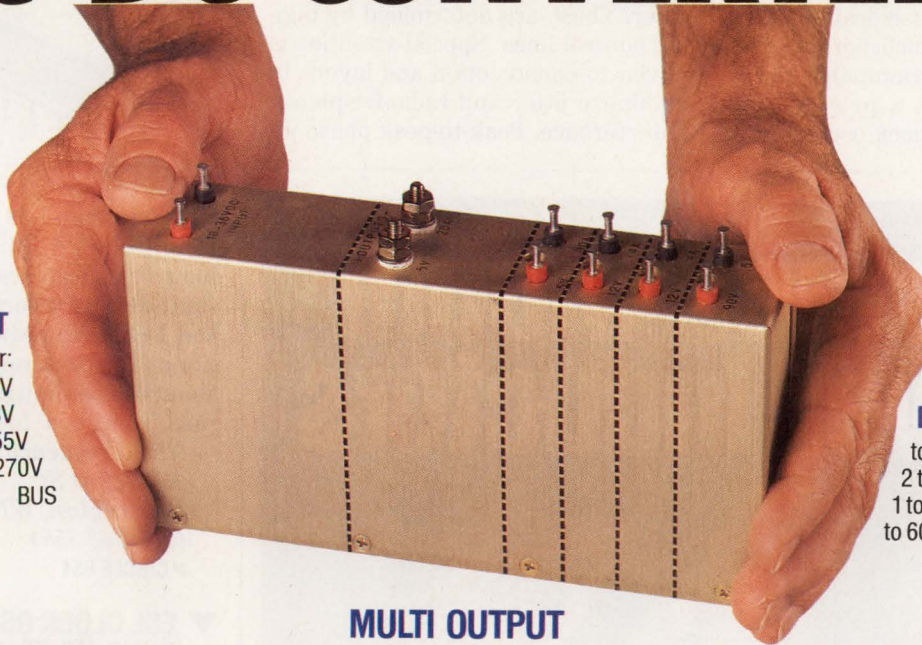

DC INPUT

18-300V for:
28V
48V
155V
270V
BUS

DC OUTPUT

to 110A
2 to 300V
1 to 8 outputs
to 600 watts

MULTI OUTPUT
EL2000 SERIES

WE PUT IT ALL TOGETHER

CONDITIONED INPUTS FOR LAND, SEA & AIR

- Surge and spike protection to input requirements of Mil-Std-1275A and Mil-Std-704D.

- Operation to Mil-Std-810D environments.

- High density designs to 24 watts/in.³.

- Efficiencies to 80%+.

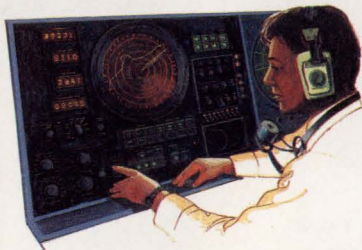

Mil-Std-1275A

Mil-E-16400,
Mil-E-4158E and
Mil-Std-454J.

- Design and derating to NAVMAT P4855-1.

- Extended MTBF to >500,000 hours.
- Low EMI/RFI options available.

- Meets applicable requirements of Mil-E-5400T,



Mil-Std-704D

- Mil-I-45208A facilities and systems.
- Standard products for custom applications without NRE.
- Short lead times...deliveries in weeks not months.

For complete brochure and applications assistance please call **Toll Free 1-800-421-8181** (in CA 805/484-4221)

ARNOLD  MAGNETICS

ARNOLD MAGNETICS CORPORATION

4000 Via Pescador, Camarillo, California 93012 • Phone: (805) 484-4221 • FAX: (805) 484-4113

CRYSTALS & OSCILLATORS

▼ PROGRAMMABLE CLOCK GENERATES UP TO 200 MHz

The HF-5700 series programmable clock can generate from 781.25 kHz to 200 MHz for applications where jitter and RFI considerations are critical. The unit incorporates the NSC DP8431 programmable-clock-generator IC with a proprietary ASIC TTL/CMOS clock oscillator, a

quartz crystal, and a loop filter in one 18-pin DIP. The outputs from the device provide programmable pixel (PCLK) and system (SCLK, LCLK, and GCLK) clocks as required by the user. These are determined by digital control lines. Special attention is given to construction and layout to minimize jitter and radio-frequency interference. Peak-to-peak phase jit-

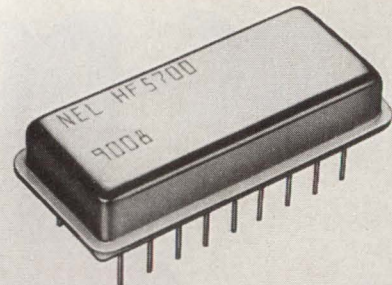

ter is less than 1 ns under worst-case conditions. Applications include computer graphics, disk-drive constant-density recording, fiber optics, and local-area-network communications. Production quantities cost about \$40 per unit; standard delivery runs from stock to 14 weeks.

NEL Frequency Controls Inc.
357 Beloit St.
Burlington, WI 53105
(414) 763-3591

► CIRCLE 654

▼ ECL CLOCK OSCILLATOR RUNS UP TO 700 MHz

Complementary sub-nanosecond ECL-compatible outputs can be specified for any frequency from 150 to 700 MHz in the CO-233KEQ clock oscillator from Vectron Labs. The output is derived from either a 100K

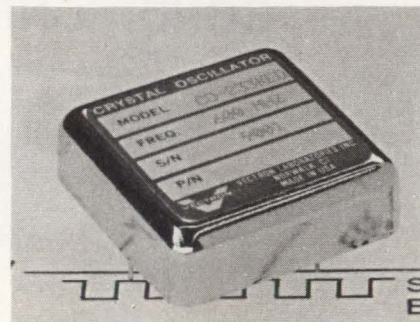

ECL or ECLiPS gate, depending on output frequency. The oscillator operates from -4.5 V dc, with -5.2 V dc operation optional. The device is factory-set to within $\pm 0.001\%$ of the specified frequency. A frequency adjustment for setting to within $\pm 0.0001\%$ is also available as an option. Delivery is from five to 10 weeks after receipt of order. Call company for pricing.

Vectron Laboratories Inc.
166 Glover Ave.
Norwalk, CT 06850
(203) 853-4433

► CIRCLE 655

NEW Surface Mount Power Inductors

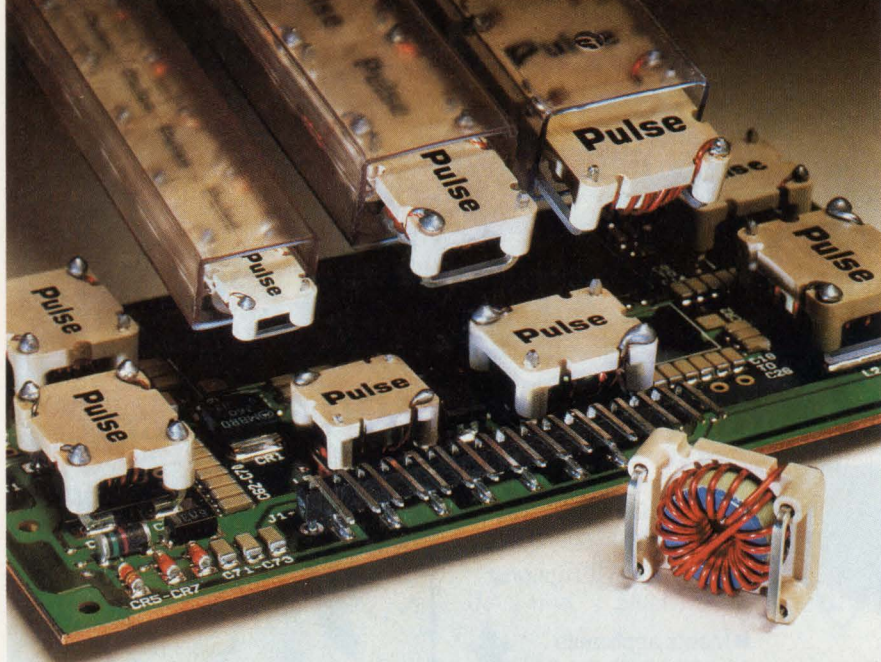

- Power Filter Applications to 6.4 Amps
- Pick & Place Handling
- IR or Vapor Phase Reflow Soldering
- Frequency Range to 1 MHz

Range of Standard Models

Size	Inductance (μ H)	Current (Amps)
SM1	0.6-6	1.0-4.0
SM2	2.2-17	1.6-6.4
SM3	3.7-28	1.6-6.4
SM4	6.9-46	1.6-6.4

Eliminate hand assembly from your ripple filter circuits with Pulse Engineering's unique surface mount inductors. Low-loss core materials make these inductors especially suited for high frequency applications. All materials meet UL 94VO rating.

There are 16 off-the-shelf models in 4 sizes, with a wide range of inductance ratings and current capacity. Call us today for a data sheet with all the details.

 **Pulse**

Pulse Engineering, Inc.

P.O. Box 12235, San Diego, CA 92112
(619) 268-2400

CIRCLE 197

ELECTRONIC DESIGN ■ PIPS SPECIAL EDITORIAL FEATURE ■ SEPTEMBER 27, 1990

Oak puts a leader's performance in lighted products.

As the primary physical link between your product and your customers, lighted pushbutton switches and indicators are components too important to receive anything less than your full attention. That's why it's just as important to look to the leadership of Oak Switch Systems Inc. for lighted products you can depend on.

Oak has been serving the industry with a full range of lighted products for almost 50 years. Whether your application requires military qualified products or the aesthetics of commercial components, we deliver the features, selections and quality that you demand. UL recognized components are also available.

Choose from a wide range of pushbutton switches and

indicators to fit your specific requirements. Expect documented performance too. Our Marcoflex® 650 series, for example, provides wiping action, multiple point contact, true snap action, tactile feel, and high contact force—all in a standard 0.625 in. square panel opening. Add to that a demonstrated life of better than 1 million actuations, even in demanding low level switching applications.

Lighted pushbutton switches and indicators, however simple their function, still are critical components. So it makes sense to get them from a leader. Oak's 50 years of performance will make you glad you did.

Call or write us today. You can't afford not to call Oak!

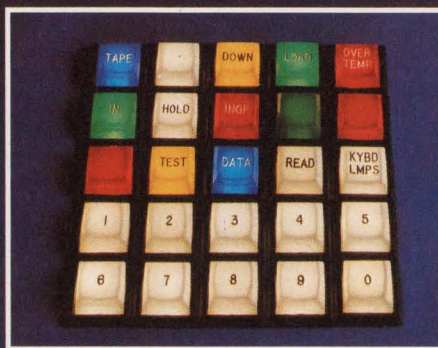

OAK Switch Systems Inc.

The Power of Imagination

P.O. Box 517 • Crystal Lake, IL 60014 • (815) 459-5000 • FAX (815) 459-5011

OPTOELECTRONICS MANUFACTURERS

3M Fiber Optic Products
10 Industrial Way East
Eatontown, NJ 07724
(201) 544-9119
(FC) (ON) (EM)
CIRCLE 575

AC Interface Inc.
15560 Rockfield Blvd., #1E
Irvine, CA 92718
(714) 472-9524
(FC) (ON) (EM) (IE) (IS) (LL)
(LI) (OS) (OI) (PH) (PD) (PT)
(PR) (UV)
CIRCLE 576

AEG Corp.
3140 Rt. 22, Box 3800
Somerville, NJ 08876-1269
(201) 231-8300
(EM) (IE) (IS) (LL) (LI) (OS)
(OI) (PD) (PT) (RR)
CIRCLE 577

AMP Inc.
Box 3608
Harrisburg, PA 17105-3608
(800) 522-6752
(FC) (ON) (EM) (OS)
CIRCLE 578

AND
W. J. Purdy Co.
770 Airport Blvd.
Burlingame, CA 94010
(415) 347-9916
(LL)
CIRCLE 579

AT&T Microelectronics
555 Union Blvd.
Allentown, PA 18103
(800) 372-2447
(OI) (PT)
CIRCLE 580

Amperex Electronic Co.
Optoelectronics
Business Group
George Washington Hwy.
Smithfield, RI 02917
(401) 232-0500
(LL) (LI) (OI) (PD) (PT) (PR)
CIRCLE 581

Clairex Electronics
560 S. Third Ave.
Mt. Vernon, NY 10550
(914) 664-6602
(IE) (IS) (LL) (LI) (OS) (OI)
(PH) (PC) (PD) (PT) (PR) (UV)
CIRCLE 582

Cree Research Inc.
2810 Meridian Pkwy.
Durham, NC 27713
(919) 361-5709
(LL)
CIRCLE 583

D1 Products Inc.
95 E. Main St.
Huntington, NY 11743
(516) 673-6866
(LL) (LI) (OS) (OI)
CIRCLE 584

Data Display Products
445 S. Douglas St.
El Segundo, CA 90245-4630
(213) 640-0442
(LL)
CIRCLE 585

Dialight Corp.
1913 Atlantic Ave.
Manasquan, NJ 08736
(201) 223-9400
(LL)
CIRCLE 586

EG&G Reticon
345 Potrero Ave.
Sunnyvale, CA 94086
(408) 738-4266
(IS) (UV)
CIRCLE 587

EG&G Vactec
10900 Page Blvd.
St. Louis, MO 63132
(314) 423-4900
(IE) (IS) (LI) (OS) (OI) (PH)
(PC) (PD) (PT) (PR) (UV)
CIRCLE 588

Epitaxx Inc.
3490 U.S. Route 1
Princeton, NJ 08540
(609) 452-1188
(EM) (IE) (IS) (LL)
CIRCLE 589

Fotec Inc.
529 Main St.
Boston, MA 02129
(617) 241-7810
(FC) (ON)
CIRCLE 590

Gilway Technical Lamp
800 W. Cummings Park
Woburn, MA 01801
(617) 935-4442
(EM) (LL) (LI)
CIRCLE 591

Hewlett-Packard Co.
Components Div.
370 W. Trimble Rd.
San Jose, CA 95131
(408) 435-7400
(FC) (ON) (EM) (LL) (OS) (OI)
(PT) (PR)
CIRCLE 592

Hirose Electric (U.S.A.) Inc.
2685-C Park Center Dr.
Simi Valley, CA 93065
(805) 522-7958
(ON)
CIRCLE 593

Hitachi America Ltd.
Semiconductor & IC Div.
2000 Sierra Pt. Pkwy.
Brisbane, CA 94005
(415) 244-7286
(EM) (IE) (LL) (PT)
CIRCLE 594

Honeywell Optoelectronics
830 Arapaho Rd.
Richardson, TX 75081
(214) 470-4271
(EM) (IE) (IS) (LI) (OS) (OI)
(PD) (PT) (PR)
CIRCLE 595

IDEA Inc.
1300 Pioneer St., Suite B
Brea, CA 92621
(213) 697-IDEA
(LL) (LI)
CIRCLE 596

Industrial Devices Inc.
260 Railroad Ave.
Hackensack, NJ 07601
(201) 489-8989
(LL)
CIRCLE 597

Industrial Electronic
Engineers
7740 Lemona Ave.
Van Nuys, CA 91405
(818) 787-0311
(LL)
CIRCLE 598

KCK America Inc.
A Mitsubishi Co.
930 Remington Rd.
Schaumburg, IL 60173-4516
(312) 884-8688
(LL)
CIRCLE 599

Ledtronics Inc.
4009 Pacific Coast Hwy.
Torrance, CA 90505
(213) 549-9995
(LL)
CIRCLE 600

Lemo USA
335 Tesconi Circle
Santa Rosa, CA 95401
(707) 578-8811
(ON)
CIRCLE 601

Marktech International
Corp.
5 Hemlock St.
Latham, NY 12110
(518) 786-6591
(IE) (LL)
CIRCLE 602

Matec Corp.
Valpey-Fisher
75 South St.
Hopkinton, MA 01748
(508) 435-6831
(FC)
CIRCLE 603

Matec Fiberoptics
56 Hudson St.
Northboro, MA 01532
(508) 393-3753
(FC)
CIRCLE 604

(continued on p. 153)

KEY

Optoelectronics
(FC) Fiber-optic cables
(ON) Fiber-optic connectors
(EM) Fiber-optic emitters/
detectors
(IE) Infrared emitters
(IS) Infrared sensors
(LL) LEDs, light-emitting
(LI) LEDs, IR-emitting
(OS) Optical switches
(OI) Optocouplers/isolators
(PH) Photocells
(PC) Photoconductive cells
(PD) Photodarlingtons
(PT) Photodiodes and ar-
rays
(PR) Phototransistors
(UV) UV sensors

▼ FIBER-OPTIC COUPLERS SPLIT OR JOIN PATHS

A family of single- and multi-mode couplers can combine or split light from fiber to fiber to create optical systems that transcend simple point-to-point interconnections. Standard input-output configurations for single-mode couplers are 1-by-2 and 2-by-2 arrangements. Units can be cascaded or combined to form single-mode tree or star couplers in configurations such as 1-by-8 or 8-by-8. Multi-mode couplers come in standard input-output configurations ranging from simple 1-by-2 arrangements to 32-by-32 star couplers. All

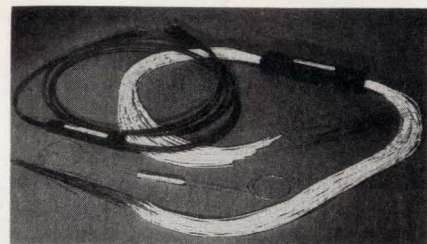

couplers are available in light-duty miniaturized, medium, or heavy-duty pigtailed packages. Delivery of single-mode units is in three weeks after receipt of order; multi-mode units are custom designed, which determines price and availability.

AMP Inc.
Box 3608
Harrisburg, PA 17105-3608
(717) 564-0100
► CIRCLE 507

▼ BRIGHT BLUE LEDs COMPLETE SPECTRUM

With the availability of bright blue LEDs from Cree Research, designers can now combine blue, red, and green LEDs in a single package to achieve any color light in the visible spectrum, including solid-state white. Fabricated in silicon carbide, the blue chips emit an intense color at a peak wavelength of 470 nm. They generate up to 35 mcd in a T-1-3/4 LED package. Typical optical power output is 8 mW at 20 mA. Pricing for the blue LEDs ranges from \$.75 each for volume quantities of unpackaged die to \$15 for sample quantities of packaged parts.

Cree Research Inc.
2810 Meridian Pkwy., Suite 176
Durham, N.C. 27713
(919) 361-5709
► CIRCLE 508

NEW. Open frame, "N" Range switch mode power supplies from Farnell Advance.

The Farnell "N" Range of open frame, 50 to 500-watt, switch mode power supplies offers electronic designers a wide choice of single and multiple output units, featuring technically superior designs and the highest standards of production quality. Refer to the listing of available standard models and contact Farnell Advance, 32111 Aurora Rd., Solon, OH 44139 for specifications. **PHONE: (216) 349-0755.** **FAX: (216) 349-0142.**

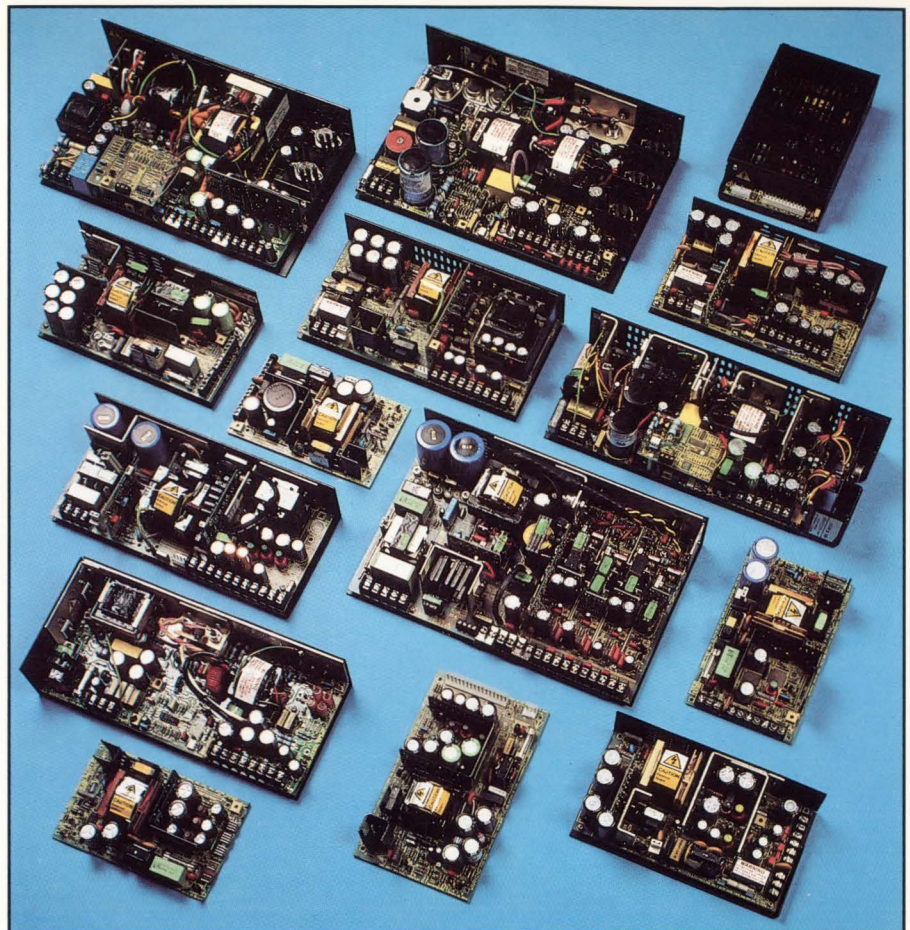

FCC



Output Power	Output 1	Output 2	Output 3	Output 4	Output 5	Package Options	Dimensions including covers	Model No.	
50 watts multi output	+5V 6A	+12V 1A	+24V 1A	-5V 1A	-12V 1A	2,3	*a	N50R110	
	+5V 6A	+15V 1A	+24V 1A	-5V 1A	-15V 1A	2,3	*a	N50R201	
55 watts single output	5V 11A	—	—	—	—	1,3,4	b	NS055005	
	12V 4.6A	—	—	—	—	1,3,4	b	NS055012	
	15V 3.7A	—	—	—	—	1,3,4	b	NS055015	
	24V 2.3A	—	—	—	—	1,3,4	b	NS055024	
	30V 1.8A	—	—	—	—	1,3,4	b	NS055030	
	48V 1.15A	—	—	—	—	1,3,4	b	NS055048	
	56V 1A	—	—	—	—	1,3,4	b	NS055056	
55 watts multi output	100V 0.55A	—	—	—	—	1,3,4	b	NS055100	
	+5V 3.5A	+12V 3A(S)	-12V 1A(S)‡	—	—	1,3,4	b	NA055P300	
	+5V 3.5A	+12V 3A(S)	+24V 1A(S)‡	—	—	1,3,4	b	NA055P301	
	+5V 3.5A	+15V 3A(S)	-15V 1A(S)‡	—	—	1,3,4	b	NA055P302	
	+5V 6A	+12V 3A(S)	F12V 2A(S)	F24V 1A(S)	—	1,3,4	c	NA055P400	
	+5V 6A	+12V 3A(S)	F12V 2A(S)	F5V 1A(S)	—	1,3,4	c	NA055P401	
	+5V 6A	+15V 3A(S)	F15V 2A(S)	F24V 1A(S)	—	1,3,4	c	NA055P403	
	+5V 6A	+12V 3A(S)	F12V 1A	F12V 1A	—	1,3,4	c	NA055P413	
	75 watts single output	5V 15A	—	—	—	—	1,3,4	*d	NS075005
		12V 6.25A	—	—	—	—	1,3,4	*d	NS075012
15V 5A		—	—	—	—	1,3,4	*d	NS075015	
24V 3.2A		—	—	—	—	1,3,4	*d	NS075024	
30V 2.5A		—	—	—	—	1,3,4	*d	NS075030	
48V 1.6A		—	—	—	—	1,3,4	*d	NS075048	
56V 1.4A		—	—	—	—	1,3,4	*d	NS075056	
75 watts multi output	+5V 8A	+12V 3A(S)	F12V 2A(S)	—	—	1,3,4	e	NA075P300	
	+5V 8A	+12V 3A(S)	F12V 2A(S)	F24V 1A	—	1,3,4	e	NA075P400	
	+5V 8A	+12V 3A(S)	F12V 2A(S)	F5V 1A	—	1,3,4	e	NA075P401	
	+5V 8A	+12V 3A(S)	+12V 2A(S)‡	-12V 0.5A‡	—	1,3,4	e	NA075P402	
	+5V 8A	+15V 3A(S)	F15V 2A(S)	F24V 1A	—	1,3,4	e	NA075P403	
	+5V 8A	+12V 3A(S)	-12V 1A‡	-5V 1A‡	—	1,3,4	e	NA075P414	
	90 watts multi output	+5V 10A	+12V 5A	-12V 2A	-5V 1A	+24V 1A	2,3	*f	N90R109
+5V 10A		+15V 5A	-15V 2A	-5V 1A	+24V 1A	2,3	*f	N90R132	

FARNELL ADVANCE OPEN-FRAME SWITCH MODE POWER SUPPLIES

Output Power	Output 1	Output 2	Output 3	Output 4	Output 5	Package Options	Dimensions including covers	Model No.	
110 watts single output	5V 22A or 30A(FC)	—	—	—	—	2,3,4	*g	NS110005	
	12V 9.2A or 12.5A(FC)	—	—	—	—	2,3,4	*g	NS110012	
	15V 7.5A or 10A(FC)	—	—	—	—	2,3,4	*g	NS110015	
	24V 4.6A or 6.25A(FC)	—	—	—	—	2,3,4	*g	NS110024	
	30V 3.7A or 5A(FC)	—	—	—	—	2,3,4	*g	NS110030	
	48V 2.3A or 3A(FC)	—	—	—	—	2,3,4	*g	NS110048	
110 watts multi output	56V 2A or 2.6A(FC)	—	—	—	—	2,3,4	*g	NS110056	
	+5V 12A	+12V 6A(S)	-12V 3A(S)##	—	—	2,3,4	h	NA110P300	
	+5V 12A	+15V 6A(S)	-15V 3A(S)##	—	—	2,3,4	h	NA110P302	
	+5V 10A	+12V 1.5A(S)##	+12V 3.5A(S)	-12V 0.7A(S)##	—	2,3,4	h	NA110P400	
	+5V 12A	+12V 5A(S)	-12V 2A(S)##	—	+24V 2A(S)‡	2,3,4	*i	NA110P400	
	+5V 12A	+12V 5A(S)	-12V 2A(S)##	-5V 1A##	—	2,3,4	*i	NA110P401	
	+5V 12A	+12V 5A(S)	+12V 3A(S)##	—	-12V 2A(S)‡	2,3,4	*i	NA110P402	
	+5V 12A	+15V 5A(S)	-15V 2A(S)##	—	+24V 2A(S)‡	2,3,4	*i	NA110P403	
	+5V 12A	+12V 5A(S)	-12V 2A(S)##	-5V 1A##	+24V 2A(S)‡	2,3,4	*i	NA110P500	
	+5V 12A	+12V 5A(S)	-12V 2A(S)##	-5V 1A##	+12V 2A(S)‡	2,3,4	*i	NA110P501	
140 watts single output	+5V 12A	+15V 5A(S)	-15V 2A(S)##	-5V 1A##	+24V 2A(S)‡	2,3,4	*i	NA110P503	
	5V 28A	—	—	—	—	2,3,4	*g	NS140005	
	12V 12A	—	—	—	—	2,3,4	*g	NS140012	
	15V 10A	—	—	—	—	2,3,4	*g	NS140015	
	24V 6A	—	—	—	—	2,3,4	*g	NS140024	
	30V 5A	—	—	—	—	2,3,4	*g	NS140030	
	48V 3A	—	—	—	—	2,3,4	*g	NS140048	
	56V 2.5A	—	—	—	—	2,3,4	*g	NS140056	
	140 watts multi output	+5V 17A	+12V 7A(Q)	F12V 3A(Q)	—	—	2,3,4	*j	NA140P300
		+5V 17A	+12V 5A(Q)	F12V 3A(Q)	F24V 3A(Q)	—	2,3,4	*j	NA140P400
+5V 17A		+12V 5A(Q)	F12V 3A(Q)	—	F5V 1.5A	2,3,4	*j	NA140P401	
+5V 17A		+12V 5A(Q)	F12V 3A(Q)	F12V 1.5A	—	2,3,4	*j	NA140P402	
+5V 17A		+12V 5A(Q)	F12V 3A(Q)	F24V 3A(Q)	F5V 1A	2,3,4	*j	NA140P500	
+5V 17A		+12V 5A(Q)	F12V 3A(Q)	F12V 1.5A	F5V 1A	2,3,4	*j	NA140P501	
+5V 17A		+15V 5A(Q)	F15V 3A(Q)	F24V 3A(Q)	F5V 1A	2,3,4	*j	NA140P503	
180 watts multi output and 48 volt D.C. input		+5V 20A	+12V 5A(S)	-12V 5A(S)	+24V 2A(S)	-5V 1A(S)	2,3,4	*k	ND180P500
	+5V 25A	+15V 1A	-15V 1A	—	—	2,3,4	*k	ND180P810	
200 watts multi output	+5V 30A	+12V 7A(Q)	F12V 5A(Q)	—	—	2,3,4	*l	NA200P300	
	+5V 30A	+12V 7A(Q)	F12V 5A(Q)	F24V 3A(Q)	—	2,3,4	*l	NA200P400	
	+5V 30A	+12V 7A(Q)	F12V 5A(Q)	—	F5V 1A	2,3,4	*l	NA200P401	
	+5V 30A	+12V 7A(Q)	F12V 5A(Q)	F12V 1.5A	—	2,3,4	*l	NA200P402	
	+5V 30A	+12V 7A(Q)	F12V 5A(Q)	F24V 3A(Q)	F5V 1A	2,3,4	*l	NA200P500	
	+5V 30A	+12V 7A(Q)	F12V 5A(Q)	F12V 5A(Q)	F5V 1A	2,3,4	*l	NA200P501	
	+5V 30A	+12V 7A(Q)	F12V 5A(Q)	F12V 5A(Q)	F5V 5A(Q)	2,3,4	*l	NA200P502	
	+5V 30A	+15V 7A(Q)	F15V 5A(Q)	F24V 3A(Q)	F5V 1A	2,3,4	*l	NA200P503	
	F5V 30A	F12V 5A	F12V 5A	—	—	2,3,4	*l	NA200R300	
	F5V 30A	F12V 5A	F24V 3A	—	—	2,3,4	*l	NA200R301	
	F5V 30A	F15V 4.5A	F15V 4.5A	—	—	2,3,4	*l	NA200R303	
	F5V 30A	F24V 3A	F24V 3A	—	—	2,3,4	*l	NA200R304	
	240 watts single output	5V 48A	—	—	—	—	2,3,4	*m	NS240005
12V 20A		—	—	—	—	2,3,4	*m	NS240012	
15V 16A		—	—	—	—	2,3,4	*m	NS240015	
24V 10A		—	—	—	—	2,3,4	*m	NS240024	
30V 8A		—	—	—	—	2,3,4	*m	NS240030	
48V 5A		—	—	—	—	2,3,4	*m	NS240048	
300 watts multi output (FC)	56V 4.5A	—	—	—	—	2,3,4	*m	NS240056	
	+5V 40A	+12V 5A	-12V 5A	+24V 5A	-5V 1A	2,3,4	*n	N300R113U	
	+5V 40A	+15V 5A	-15V 5A	+24V 5A	-5V 1A	2,3,4	*n	N300R135U	
	F5V 40A	F12-24V 6A(8Apk)	F12-16V 6A(8Apk)	F12-16V 6A(8Apk)	F5-15V 4A(5Apk)	2,3,4	*o	NF300R500	
	F5V 40A	F12-16V 6A(8Apk)	F48-56V 5A	F12-16V 6A(8Apk)	F5-15V 4A(5Apk)	2,3,4	*o	NF300R505	
	300 watts multi output and 48 volt D.C. input (FC)	+5V 40A	+12V 5A	-12V 5A	+24V 5A	-5V 1A	2,3,4	*n	ND300R801
		+5V 40A	+12V 5A	-12V 5A	-50V 5A	-5V 1A	2,3,4	*n	ND300R505
	500 watts multi output (FC)	F5V 60A	F12-24V 6A(8Apk)	F12-16V 10A (12Apk)	F12-16V 6A(8Apk)	F5-15V 4A(5Apk)	2,3,4,5	*o+	NF500R500
		F5V 60A	F12-16V 6A(8Apk)	F48-56V 5A	F12-16V 6A(8Apk)	F5-15V 4A(5Apk)	2,3,4,5	*o+	NF500R505

CODES (S) = Semi regulated (otherwise output is fully regulated)
See specification sheets for further detail.
(Q) = Quasi regulated (otherwise output is fully regulated)
See specification sheets for further detail.
F = Output is supplied floating
= Can be supplied in opposite polarity to special order.
‡ = Floating or in opposite polarity to special order.
* = Localized areas may exceed these dimensions (eg terminal cover). Consult full outline drawings.
(FC) = Forced air Cooling at 1 meter/sec is required.
1 = PCB only.
2 = Mounted on L chassis.
3 = Fully cased (add suffix 'M' to end of model number).
4 = Customized enclosure to special order.
5 = Fully cased with integral fan.

DIMENSIONS (in inches)

LENGTH	WIDTH	HEIGHT
a 7.19	4.32	2.00
b 6.50	4.15	2.13
c 7.19	4.41	2.13
d 7.19	4.41	2.41
e 7.98	4.72	2.41
f 10.53	4.63	2.36
g 8.30	4.53	2.36
h 7.99	4.43	2.36
i 8.28	4.53	2.36
j 9.74	5.00	2.36
k 10.91	4.93	2.83
l 10.49	4.79	2.76
m 9.76	5.91	2.61
n 12.02	7.59	2.95
o 11.81	7.48	2.56
O+ if integral fan is required		4.06

Unless noted by "(FC)", power ratings are with convection cooling. Forced Cooling will increase output capacity by 25% on the average.



Advance Power Supplies, Inc.
32111 Aurora Road
Solon, Ohio 44139
PHONE (216) 349-0755.
FAX: (216) 349-0142.

▼ **FOUR-ELEMENT LED OPERATES ON 2 MA**

A very efficient four-element LED for low-current 2-mA operation has been added to the Series 551 Quad-LED family of arrays for high-density circuit-board applications. In their compact T-1 3-mm-sized envelopes, they are suited for duty as logic-status indicators, binary-data displays, other types of circuit-board indicators, and even panel illumination.

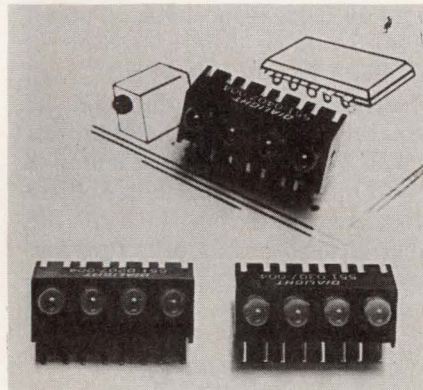

The operating temperature is from -55 to 100°C, and standoffs can provide right-angle viewing. The units, which come in a black housing for increased visibility, are available in standard or custom combinations of green, yellow, and red. Depending on the color combination, prices start at \$1.25 each in lots of 1000. Deliveries are from stock to four weeks.

Dialight Corp.
1913 Atlantic Ave.
Manasquan, NJ 08736
(201) 223-9400

► **CIRCLE 509**

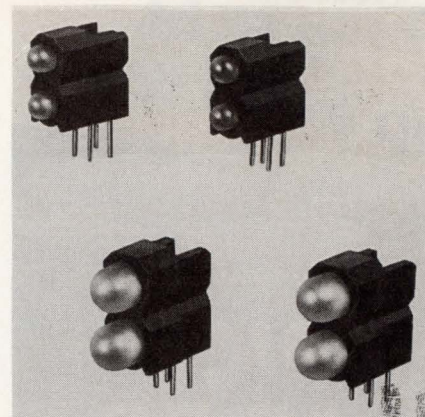

are also available. Luminous intensities up to 1000 mcd and a high-contrast black-nylon housing make viewing easier. The LEDs are priced from \$.38 each in bulk quantities. Free samples are available.

Industrial Devices Inc.
260 Railroad Ave.
Hackensack, NJ 07601
(201) 489-8989

► **CIRCLE 510**

▼ **DUAL-LED ASSEMBLY GOES PIGGYBACK**

Two series of dual-LED piggybacked assemblies save board space. The units are available in T-1-3/4 (Series 5670H) and T-1 (Series 5680F) sizes in 2-to-12-V, 1-to-50-mA models. Built-in resistors are included. Two-color units in each of the two LEDs, allowing up to four-color indication,

OPTOELECTRONICS MANUFACTURERS

Meret Inc.
1815 24th St.
Santa Monica, CA 90404
(213) 828-7496
(FC) (ON) (EM) (IE) (IS) (LL) (OI) (PT)
CIRCLE 605

Micro Switch
Div. of Honeywell
11 W. Spring St.
Freeport, IL 61032
(815) 235-6600
(EM) (IE) (LI) (OS) (OI) (PH) (PR)
CIRCLE 606

Mitsubishi Rayon
America Inc.
520 Madison Ave.
New York, NY 10022
(212) 605-2392
(FC)
CIRCLE 607

Motorola Semiconductor
Opto, Sensor, Comm
Prods. Sector
5005 E. McDowell Rd.
Phoenix, AZ 85008
(602) 244-3955
(ON) (EM) (IE) (IS) (LI) (OS) (OI) (PD) (PR)
CIRCLE 608

NEC Electronics Inc.
401 Ellis St., Box 7241
Mountain View, CA 94039
(415) 960-6000
(ON) (LL) (OI) (PC) (PT) (PR)
CIRCLE 609

NSG America
28 Worlds Fair Dr.
Somerset, NJ 08873

(201) 469-9650
(FC) (ON) (EM) (IE) (OS) (OI)
CIRCLE 610

NTE Electronics Inc.
44 Farrand St.
Bloomfield, NJ 07003
(201) 748-5089
(IE) (IS) (LL) (LI) (OI) (PD) (PT) (PR)
CIRCLE 611

Optek Technology Inc.
1215 W. Crosby Rd.
Carrollton, TX 75006
(214) 323-2200
(EM) (IE) (IS) (LI) (OS) (OI) (PD) (PT) (PR)
CIRCLE 612

Opto Diode Corp.
750 Mitchell Rd.
Newbury Park, CA 91320
(805) 499-0335
(LI)
CIRCLE 613

Rohm Corp.
Rohm Electronics Div.
8 Whatney
Irvine, CA 92718
(714) 855-2131
(IE) (IS) (LL) (LI)
CIRCLE 614

SI Tech
Box 609
Geneva, IL 60134
(312) 232-8640
(FC) (ON) (EM)
CIRCLE 615

Seiko Instruments U.S.A.
Fiber Optic Comp. Div.
2990 W. Lomita Blvd.

Torrance, CA 90505
(213) 517-7841
(FC) (ON) (EM) (LL)
CIRCLE 616

Sharp Electronics Corp.
Electronic Comp. Div.
Sharp Plaza, Box 650
Mahwah, NJ 07430
(201) 529-8757
(FC) (EM) (IE) (IS) (LL) (LT) (OS) (OI) (PH) (PC) (PD) (PT) (PR) (UV)
CIRCLE 617

Shelly Associates
14811 Myford Rd.
Tustin, CA 92680
(714) 669-9850
(LL)
CIRCLE 618

Shogyo International Corp.
287 Northern Blvd.
Great Neck, NY 11021-4799
(516) 466-0911
(LL) (LI)
CIRCLE 619

Shokai Far East Ltd.
280 N. Central Ave.
Hartsdale, NY 10530
(914) 681-0700
(IE) (IS) (LL) (LT)
CIRCLE 620

Siecor Electro-Optic
Products
Box 13625
Research Triangle Park, NC 27709
(919) 481-5100
(FC) (ON)
CIRCLE 621

Siemens Components Inc.
Optoelectronics Div.
19000 Homestead Rd.
Cupertino, CA 95014
(408) 257-7910
(LL) (OI)
CIRCLE 622

Silicon Detector Corp.
1240 Avenida Acaso
Camarillo, CA 93012
(805) 484-2884
(EM) (IE) (IS) (LL) (LI) (PH) (PC) (PT) (PR) (UV)
CIRCLE 623

Silicon Sensors Inc.
Old Hwy. 18 East
Dodgeville, WI 53533
(608) 935-2707
(IE) (IS) (LL) (LT) (OS) (OI) (PH) (PC) (PD) (PT) (PR) (UV)
CIRCLE 624

Sprague Electric Co.
Aluminum Capacitor Div.
Box 9102
Mansfield, MA 02048
(800) 777-7575
(OS) (PT)
CIRCLE 625

TDK Corporation
of America
1600 Feehanville Dr.
Mount Prospect, IL 60056
(708) 803-6100
CIRCLE 626

Texas Instruments
Semiconductor Group
Box 809066
Dallas, TX 75380-9066
(214) 995-6611

(EM) (IE) (IS) (LL) (LT) (OS) (OI) (PH) (PC) (PT) (PR) (UV)
CIRCLE 627

Theta-J Corp.
107 Audubon Rd.
Wakefield, MA 01880
(617) 246-4000
(OS) (OI) (PD) (PT) (PR)
CIRCLE 628

Toshiba America Inc.
Semiconductor Operation
9775 Toledo Way
Irvine, CA 92718
(714) 455-2000
(LL) (OS) (OI) (PD) (PT) (PR)
CIRCLE 629

KEY

- Optoelectronics**
- (FC)** Fiber-optic cables
- (ON)** Fiber-optic connectors
- (EM)** Fiber-optic emitters/detectors
- (IE)** Infrared emitters
- (IS)** Infrared sensors
- (LL)** LEDs, light-emitting
- (LI)** LEDs, IR-emitting
- (OS)** Optical switches
- (OI)** Optocouplers/isolators
- (PH)** Photocells
- (PC)** Photoconductive cells
- (PD)** Photodarlington
- (PT)** Photodiodes and arrays
- (PR)** Phototransistors
- (UV)** UV sensors

Lowest Profile
0.5" ht.,
up to 55 Watts



PICO AC-DC Power Supplies

- Input Voltage 90 to 130 VAC (47/440Hz)
- Single, Dual, Triple Outputs
- 1200V Rms Isolation
- Low Isolation Capacity Available
- Continuous Short Circuit Protection
- High Efficiency
- Fully Regulated Voltage Outputs
- Operating Temperature -25°C. to +70°C. with No Heat Sink or Electrical Derating Required
- Expanded Operating Temperature Available (-55°C. to +85°C. ambient)
- Optional Environmental Screening Available

PICO manufactures complete lines of Transformers, Inductors, DC-DC Converters and AC-DC Power Supplies

Delivery—
 stock to
 one week

SEE EEM,
 THOMAS REGISTER
 OR SEND DIRECT FOR
 FREE PICO CATALOG

PICO
Electronics, Inc.

453 N. MacQuesten Pkwy. Mt. Vernon, N.Y. 10552

Call Toll Free **800-431-1064**

IN NEW YORK CALL **914-699-5514**

OPTOELECTRONICS

▼ LED DISPLAYS GET BRIGHTER

With their luminous-intensity ratings of 1000, 2000, or 3000 mcd, the 200K-R1K GaAlAs LEDs boast a luminous intensity that's 15 times brighter than standard water-clear units. That makes them well suited for outdoor applications. They come in a T-1-3/4 size snap-in or panel-mounting package as well as any 200-size package from the PCB line.

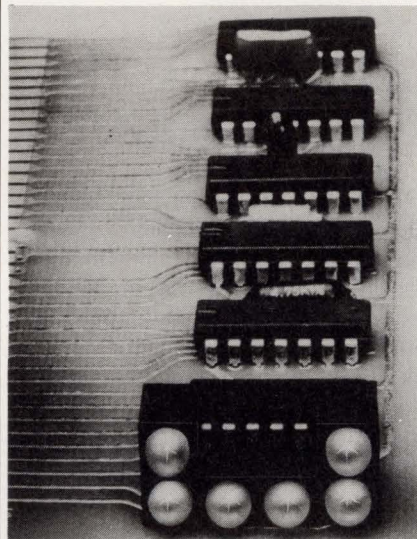

The panel-mount package can be manufactured in a tight-water version. The LEDs produce a red output with a peak wavelength of 660 nm. The 3000-mcd LED operates on a typical forward voltage of 1.8 V and offers a viewing angle of 35°. Prices begin at \$.58 per unit in quantities of 1000. Delivery is in six weeks after receipt of order.

Data Display Products

445 S. Douglas St.
 El Segundo, CA 90245-4630
 (203) 640-0442

► CIRCLE 666

▼ BLUE LEDS LIGHT UP MEDICAL PANELS

Low-cost blue-light LEDs are now available in production quantities as discretely or in clusters housed in most industry-standard package styles. The 470-nm true-blue-peaked LEDs can replace incandescent filament lamps with blue filters and the older high-cost blue LEDs. The color blue is specified for critical status indicators in medical instruments and other control panels. The rugged LED lasts about 100,000 hrs compared with only about 4000 hrs for an



incandescent lamp. The LED chip operates on 20 mA and uses 170 mW, while a higher-powered 50-mA version uses 200 mW, with intensities of 5 and 10 mcd, respectively. Typical forward-voltage drop is between 3 and 3.7 V. Viewing angle is 12° with water-clear encapsulation, and 30° with translucent white. In quantities of 1000, the blue LEDs cost from \$12 to \$15 in standard packages. Clusters of seven run from \$60 to \$70. Delivery is four to six weeks for standard packages and eight to 12 weeks for clusters.

Ledtronics Inc.

4009 Pacific Coast Hwy.
 Torrance, CA 90505
 (213) 549-9995

► CIRCLE 667

▼ LED LASERS DELIVER VISIBLE LIGHT

For applications such as bar-code readers, optical-alignment systems, and target markers, the CQL80/D emits 5 mW of a typical peak wavelength of 675 nm, a red light easily visible to the eye. Its life is anticipated at about 250,000 hrs under 3-mW continuous-wave operation at ambient temperature. Mounted in a 9-mm encapsulation, the device includes a monitor diode optically coupled to the rear facet of the laser to control the optical-output level. The low-power CQL90/D, a light-emitting collimating pen, has a power output of 1 mW at 675 nm. Encapsulated in a nonhermetic, circular stainless-steel enclosure, the pen is 11 mm in diameter with an accuracy between +0 and -11 μm. Unit pricing is \$48 for the CQL80/D and \$135 for the CQL90/D in lots of 5000. Delivery is up to eight to 12 weeks, respectively, depending on quantity.

Philips Components

Discrete Products Div.
 2001 W. Blue Heron Blvd.
 Riviera Beach, FL 33404
 (407) 881-3308

► CIRCLE 668



The Emerging Standard in 574 Family 12-Bit A/D's

- **Monolithic construction**
- **Lowest power in the industry — 110mW**
- **No -15V power required**
- **25 μ s maximum conversion; 15 μ s maximum for 674**
- **Complete ADC — on-board SAMPLE/HOLD, reference, clock and tri-state output**
- **Available in surface-mount J-lead LCC and LCC**
- **Delivery from stock**

For a data sheet, pricing or samples, call **Sipex** direct at **1-800-272-1772**.



Sipex

Sipex Corporation
6 Fortune Drive
Billerica, MA 01821
800-272-1772
508-663-9691
FAX: 508-670-9001

POWER, INTERCONNECTS, AND SWITCHES & RELAYS

▼ POWER MOSFETS ARE SEALED TIGHT

A line of MOSFET and Schottky power devices targeted for military and aerospace applications is now available in hermetically sealed TO-220 packages (TO-254, TO-258, etc.), as well as in multipin high-power flat packs. The devices feature one-piece copper construction instead of the

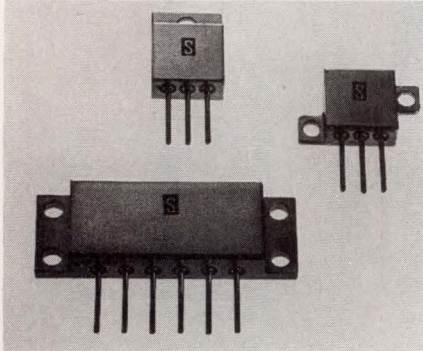

usual baseplate with a brazed-ring frame. Particularly important to high-reliability users are the packages' rugged ceramic feed-through seals, which eliminate the problem of cracking when glass seals are used. Pricing begins at \$20 in 100-piece quantities with eight-to-10-week delivery.

Solitron Devices Inc.
1177 Blue Heron Blvd.
Riviera Beach, FL 33404
(800) 888-8763

► CIRCLE 669

▼ ISOLATED DIODE RECOVERS IN 200 NS

An isolated diode module from Marconi features an ultrafast reverse recovery time of 200 ns. The IMP110 module is intended for use with high-frequency devices such as IGBT and FET inverters and switching-power-supply freewheel and snubber diodes. Electrically isolated to 2500 V, the diode can handle over 100 A at 1200 V. The reverse-recovery charge is less than 20 μC at 40 A and a di/dt of 100 A/ μs . The module measures 3.62-by-1.38-by-0.91 in. and has industry-standard mounting centers of 80 mm. Prices for the IMP110 start at \$49 for one to nine pieces; delivery is six to eight weeks.

Marconi Circuit Technology
160 Smith St.
Farmingdale, NY 11735
(516) 293-8686 Ext. 432

► CIRCLE 670

▼ DIN CONNECTOR SIMPLIFIES ASSEMBLY

Designed to simplify assembly, a series of circular DIN connectors provides easy snap-in seating of the pin-and-wafer assembly into the low-profile one-piece metal shell, which gives it a streamlined appearance and EMI/RFI shielding. An available assembly tool guarantees a perfect hex-crimp strain-relief around the cable, thereby preventing molding compound from entering the connector. In addition to a standard male plug, the company offers a locking (30° twist) version in three-to-eight-pin configurations. Connector shells are of nickel-plated stamped steel. Pricing ranges from \$0.70 to \$1.50, and all versions are available from stock.

Preh Electronic Industries Inc.
470 E. Main St.
Lake Zurich, IL 60047-2578
(312) 438-4000

► CIRCLE 671

▼ MORE PINS ADDED TO LCD DISPLAYS

A technique that increases the number of pin terminals that can be affixed to a liquid-crystal display allows more information to be accessed by small LCDs. The pin pattern of terminals are on 0.075-in. centers. This feature complements the complex and dense information-display demands of many LCD applications and eliminates the need for alternate connector methods. The terminals can be supplied in all popu-

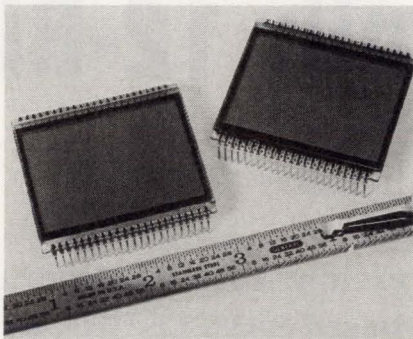

lar pin lengths from 0.120 through 0.350 in. long. Call for pricing and availability.

Standish Industries Inc.
Hamlin LCD Div.
W7514 Highway V
Lake Mills, WI 52551
(414) 648-1000

► CIRCLE 672

▼ EURO-STYLED SWITCHES FIT STANDARD OPENINGS

For designs with a European look, a family of oval-shaped rocker switches fits standard rectangular openings and can often be used without retooling. Applications include business machines, appliances, furni-

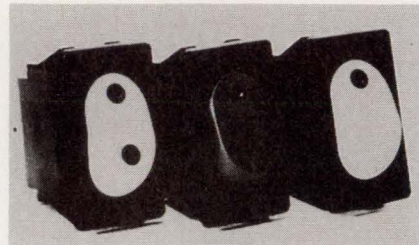

ture, marine panels, and many others. Available in one-light, two-light, and unlighted models, the Euro-Switch is UL-listed and CSA-approved for 3-A, 277-V ac; 6-A, 125-V ac; and 1/4-to-3/4-hp, 125-to-277-V ac ratings. The switch comes in both single- and double-pole styles and can be easily matched with a gasket for added moisture resistance.

McGill Manufacturing Inc.
1002 N. Campbell St.
Valparaiso, IN 46383
(219) 465-2200

► CIRCLE 673

▼ RELAY SWITCHES LOW SIGNAL LEVELS

Primarily for telecommunications applications, the NA relay has double-pole, double-throw bifurcated crossbar contacts rated at 1 A. The relay meets FCC Part 68, Bellcore, UL, and CSA specifications and has a minimum electrical life of 500,000 operations. The dielectric with open contacts can withstand 1000 V ac. Coil voltages range from 4.5 to 48 V dc, and the nominal power consumption is 140 mW. The ambient operating temperature ranges from -40°C to 85°C. Backfilled with nitrogen gas and permanently sealed, the maximum package dimensions of the relay are 0.55 in. long, 0.30 in. wide, and 0.37 in. high. Other applications include security systems, instruments, and portable devices. In quantities of 1000 pieces, pricing starts at \$3.06 each. Lead time is 10 to 12 weeks.

ITT Components
5 Jenner St.
Irvine, CA 92718
(714) 727-3001

► CIRCLE 674

Who interrupted the uninterruptible power system?



Did somebody push the wrong switch?

Was it faulty design?

Not at all. The uninterruptible power system turned out to be highly interruptible because a battery died. Scary, isn't it? You get a power system failure followed by a power backup system failure and—presto—you're plunged into darkness. Of course, while you'll recover, your computers won't. Their memories will be gone for good.

Well, it wouldn't have happened had that battery been a Yuasa. With Yuasa, sudden death is a virtual impossibility. Its failure rate is an almost non-existent .001.

The fact is that Yuasa is used by more UPS manufacturers than any other battery made today. No other sealed lead acid battery is more dependable or lasts longer.

Our point is simple. The next time you're designing an uninterruptible power system, make sure it stays uninterruptible.

Specify the battery that doesn't die on the job.

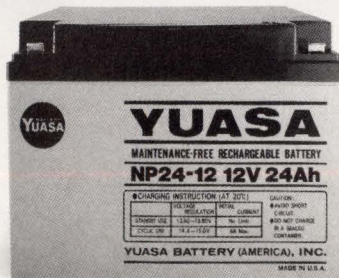

YUASA

The World Leader In Back-Up Energy.

Yuasa Battery (America), Inc. 9728 Alburdis Avenue Santa Fe Springs, CA 90670 (213) 949-4266 or (800) 423-4667
Eastern Regional Office 131 Industrial Ave. Hasbrouck Heights, N.J. 07604 (201) 641-5900 or (800) 962-1287

NEW LITERATURE

▼ CHOOSE CARBON, CERMET OPEN-FRAME TRIMMERS

The 3300 family of single-turn open-frame trimmer resistors are low-cost components for circuit adjustments. Although carbon-resistance elements are usually the designer's first choice for economy, the cermet-resistance types should also be considered, according to the 12-page bulletin from Bourns. For industrial use, the cermet elements have better load stability, a superior temperature coefficient, improved moisture resistance, and higher power ratings than corresponding carbon units. Carbon units may give the lowest absolute cost, but cermet units can give the best performance per dollar. The bulletin will help designers compare performance factors and select the trimmer suited for the application.

Bourns Inc.
1200 Columbia Ave.
Riverside, CA 92507
(714) 781-5500

► CIRCLE 675

▼ CARBON-COMPOSITION RESISTORS FILL BILL

Hot-molded, carbon-composition fixed resistors are still vital components in modern electronic circuitry. A comprehensive 45-page guide provides in-depth data on Allen-Bradley's complete line from 1/8-to-4-W sizes. The first and second pages contain a selection guide to help make initial design decisions. Following are charts of detailed performance characteristics, temperature, derating, and other environmental specifications, packaging information, testing and reliability data. Six pages of power nomographs reflect years of experience and testing. The last page expands into a handy color chart explaining the MIL and EIA resistor color-band coding.

Allen-Bradley
Electronic Component Div.
1414 Allen-Bradley Dr.
El Paso, TX 79936-6415
(800) 592-4888

► CIRCLE 676

▼ FILM CAPACITORS BOAST HIGH RELIABILITY

Hermetically sealed high-reliability plastic-film capacitors that meet MIL-C-83421/39022-9/87217 military specifications are described in this 44-page booklet. The company's quality-control system, which is maintained in a complete military-approved environmental testing laboratory, is approved to MIL-Q-9858 and MIL-STD-790 standards. Also, its calibration laboratory complies with MIL-STD-45662 specifications. The catalog includes sections on the various available dielectrics: metallized-polycarbonate, metallized-polypropylene, polyphenylene-sulfide, metallized-teflon, and polystyrene. Specifications listed include full case dimensions, ac ratings, and life-test data.

Component Research Co.
1655 26th St.
Santa Monica, CA 90404
(213) 829-3615

► CIRCLE 677

One Switch gives you all these options

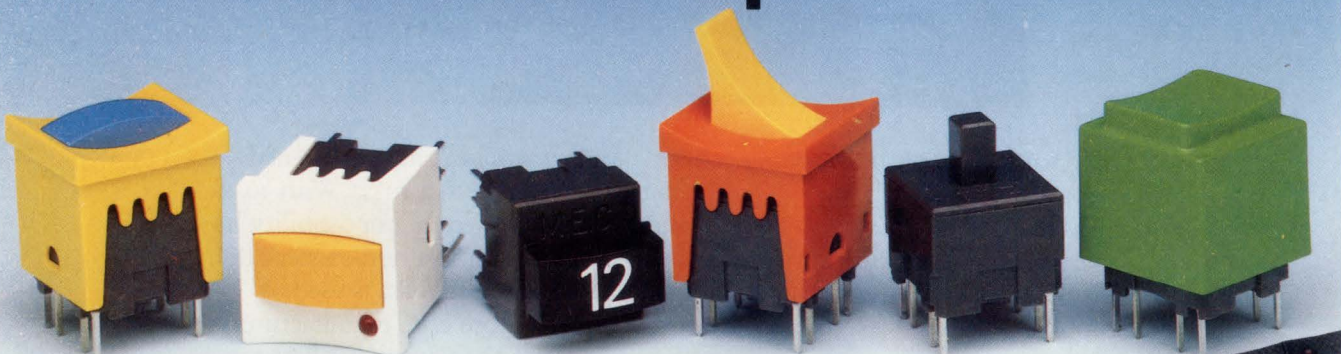

One switch. But look what it can become.

A pushbutton. A toggle. A keypanel. A designer's delight. Add a variety of bezels, keycaps, LEDs and standard legends to produce hundreds of highly colourful configurations. Momentary or latching versions, silver or gold contacts. Each one completely interchangeable with another thanks to its modular design. Each one a master of action. And of disguise.

Full details
of the MEC Modular Switches
on request.

SOLiCo/mec
Sorenson Lighted Controls, Inc.

75 Locust Street
Hartford, CT 06114

Tel: (203) 527-3092 Fax: (800) 331-1184

CIRCLE 138

ELECTRONIC DESIGN ■ PIPS SPECIAL EDITORIAL FEATURE ■ SEPTEMBER 27, 1990

Watt's Up™ from Semiconductor Circuits, Inc.

New DC/DC Converter Delivers 4.5 Watts in Half the Space at a Fraction of the Cost

The pioneering technology leader in encapsulated power converter modules, Semiconductor Circuits, Inc. introduces the QA series for space critical applications. For pin-for-pin replacement of 2" x 2" converters, the QA series offers 4.5 watts in a low profile case measuring just 1.0" x 2.0" x 0.4". And it offers all that performance at a significantly reduced price.

With the QA series, you also don't need to sacrifice a wide input range to

Key Features

Power	4.5 watts
Inputs	5.0 Vdc; 9.0 - 36.0 Vdc; 20.0 - 72.0 Vdc
Short Circuit Protection	Continuous with auto restart
Package Size	1.0" x 2.0" x 0.4"
Isolation	500 Vdc
Efficiency	75% (typical)



have linear features such as low ripple and tight power regulation. The QA gives you both.

To achieve these price/performance breakthroughs, the QA series incorporates our extensive MOSFET and surface mount technology. These features also allow us to achieve higher power density and higher reliability.

With an input/output isolation of 500 Vdc, an operating temperature range of -25°C to +71°C, with no derating, efficiencies of 75% (typical), continuous short circuit protection and output voltage tracking providing protection for power sensitive devices requiring \pm voltages. The QA series is ideal for

many board-level power conversion applications. Including cellular and portable telecommunications, process control, ATE, CAD/CAM, and other space critical applications.

For more information on how to put the QA series to work for you, please contact your nearest Semiconductor Circuits, Inc. distributor or representative. Or contact us direct in New Hampshire, (603) 893-2330 or FAX: (603) 893-6280. And be sure to ask for the latest edition of our Quick Selection Guide to Power Converters.



**SEMICONDUCTOR
CIRCUITS, INC.**

SUBSIDIARY OF ASTEC AMERICA, INC.

CIRCLE 149



surface temperature sensor



High-Reliability, Military, Spacecraft Applications:

- Surface Sensors designed to meet or exceed: Performance requirements of MIL-T-23648, Component test methods of MIL-STD-202, Environmental Test Methods of MIL-STD-810, Other specifications as required.
- Temperature ranges from -80°C minimum to +200°C maximum.
- Nominal resistances at 25°C from 500 ohms to 100 kilohms.
- Interchangeability: $\pm 1\%$, $\pm 2\%$, $\pm 5\%$ over temperature spans of up to 200°C.
- Accuracy
- Repeatability
- Stability

More detailed information on the various surface temperature sensor types may be obtained in the Thermometrics, Inc. "Thermistor Sensor Handbook." Detailed information on the electrical and mechanical properties of various thermistor types may be obtained in the Thermometrics, Inc. "Thermistor Catalog."

Contact Thermometrics, Inc. to request the Catalog, Sensor Handbook and/or to discuss your specific application requirements today.

THE THERMOMETRICS
The Source of Thermistor Expertise
808 U.S. HIGHWAY 1, EDISON, N.J. 08817
(201) 287-2870

CIRCLE 100

NEW LITERATURE

▼ QUARTZ CRYSTALS OPERATE AT 800 HZ

Very-low-frequency quartz crystals, from 800-Hz J-series types to high-frequency AT-cut units ranging to 300 MHz, as well as the DT-cut series operating from 80 to 500 kHz, are specified in this eight-page design guide. The guide includes dimensionally detailed illustrations of many standard crystal holders, design data, and typical oscillator circuits.

Standard Crystal Corp.

9940 E. Baldwin Pl.

El Monte, CA 91731

(818) 443-2121

► CIRCLE 678

▼ SMALL INDUCTORS ARE SURFACE MOUNTED

In eight pages, ISI covers its line of surface-mountable inductors ranging in value from 0.047 to 1000 μ H. Photos, dimensional outlines, graphs, and charts fully describe their characteristics and describe applications for the various inductor designs: multilayer chip, molded shielded, shielded-chip beads, and multilayered-chip beads. Impedance-versus-frequency graphs of the units' characteristics give users a better idea of how they will behave in a circuit than can single nominal values from charts.

Inductor Supply Inc.

1849 W. Sequoia Ave.

Orange, CA 92668-1017

(714) 978-2277

► CIRCLE 679

▼ CUT LOSSES WITH FIBER-OPTIC LINKS

To accurately transmit a great amount of information over long distances, fiber-optic technology offers many advantages compared with copper-wire systems. The advantages include wide bandwidth, EMI immunity, low signal losses, small size, light weight, security, safety, and electrical isolation. The AMP Optimate catalog, a hefty 88-page volume, covers cable, connectors, splicing and repair kits, test equipment, couplers, optical switches, tools and other accessories. Seven pages summarize fiber-optic technology.

AMP Inc.

Harrisburg, PA 17105

(717) 564-0100

► CIRCLE 680

▼ RESISTOR, CAPACITOR DATA PRESENTED

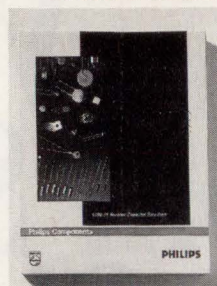

A massive 700-page data book covers aluminum-electrolytic, ceramic, tantalum, film, and variable capacitors. In addition, the catalog provides full details

on fixed, trimmer, and nonlinear resistors. Each section begins with a quick-reference index of all products. A complete competitor cross-reference section is featured.

Philips Components

Discrete Products Div.

2001 W. Blue Heron Blvd.

Riviera Beach, FL 33404

(800) 447-3762

► CIRCLE 681

▼ QUARTZ OSCILLATORS WORK AT 0.0006 HZ

A four-page short-form catalog describes Statek's line of quartz crystals and quartz-crystal oscillators that operate from 0.0006 Hz to 2 MHz in DIP and TO-5 housings. For example, the CX series crystals consist of miniature quartz resonators hermetically sealed in rugged ceramic packages. They're available in two case sizes. An LXO series oscillator comes in a 4-pin metal case centered on a 14-pin DIP footprint.

Statek Corp.

512 N. Main

Orange, CA 92668

(714) 639-7810

► CIRCLE 682

▼ VARIED RESISTORS IN SHORT FORM

Resistors of many descriptions, from metal-film types to carbon-film devices to temperature-sensing resistors, can be found in a 28-page short-form catalog. The book includes taping and packing specifications as well as conversion tables and a handy color-code chart. Information is included on scores of resistors in 14 different types with full electrical and dimensional specifications.

Robert G. Allen Co. Inc.

7267 Coldwater Canyon

North Hollywood, CA 91605

(800) 423-3186

► CIRCLE 683

Design Help From KEMET



Solid Tantalum



Multilayer Ceramic

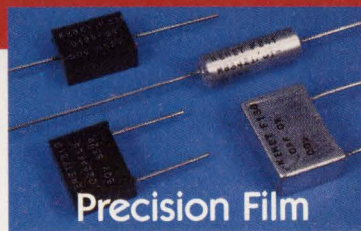

Precision Film

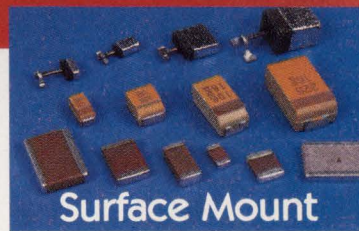

Surface Mount

From constant product testing and analysis to a steady offering of engineering bulletins and applications assistance, KEMET's know-how is working for you!

Before we could offer you a fully tested more crack-resistant ceramic chip dielectric, we spent years in the lab, using new analysis tools, trying new processes, modifying basic materials.

We provide a whole series of bulletins dealing with surface mount caps: reflow and wave soldering techniques, repair, mounting pad considerations. Producing high-performance components is just half our job at KEMET. Giving you the industry's best technical support is the other half. And always KEMET makes it easy to buy, worldwide.

Tell Me More, KEMET...

- Send me your general catalog.
- Have a sales representative call me.

I'm interested in:

- Ceramics
- Mil-Spec
- Customs
- Tantalums
- Surface Mount
- Film

NAME _____
 COMPANY _____
 ADDRESS _____
 CITY _____ STATE _____ ZIP _____
 PHONE _____

P.O. Box 5928
 Greenville, SC 29606
 803/963-6348



U.S.A., Newport Beach, CA, Phone: (714) 640-9320, FAX: (714) 720-9807; Irving, TX, Phone: (214) 556-0009, FAX: (214) 401-0254; Schaumburg, IL, Phone: (708) 517-1030, FAX: (708) 517-1037; Stoneham, MA, Phone: (617) 279-0400, FAX: (617) 279-0406; Greenville, SC, Phone: (803) 242-5789, FAX: (803) 242-5795; EUROPE, Switzerland, Phone: 41-22-738-4244, FAX: 41-22-738-3918; Germany, Phone: 49-89-46-30-01, FAX: 49-89-46-04-117; France, Phone: 33-1-46-87-70-95, FAX: 33-1-49-78-06-63; United Kingdom, Phone: 44-278-757-343, FAX: 44-278-757-188; ASIA, Hong Kong, Phone: 852-770-5633, FAX: 852-770-5656; Singapore, Phone: 65-567-7677, FAX: 65-567-1585; Taiwan ROC, Phone: 886-2-752-8585, FAX: 886-2-721-3129; Korea, Phone: 82-02-599-7131, FAX: 82-02-533-8089

286 DESIGNER'S TOOLKIT

AT MOTHERBOARD
CORE LOGIC CHIP SET
40MB IDE DRIVE
ORCAD SCHEMATIC DISKETTES
AND DESIGNER'S MANUAL
WD USER'S MANUALS
AND MORE

 WESTERN DIGITAL

Would you rather have what's in Box Number One or Box Number Two?

The Western Digital Designer Kit gives you everything you need to start and complete your next design. All in one handy box.

A box that lets you avoid a lot of headaches and hassles. Such as all the begging, pleading, and conniving necessary to get the parts that are necessary.

The designer kit gives you a Western Digital 286 Motherboard, the WD286-LPM16. You also get a 4-chip FE3600 AT Core Logic Set. The WD16C452 Serial/Parallel Controller.

The WD37C65 Floppy Disk Controller. The WDPVGA1A VGA Controller. The WD93044-A 40Mb IDE Drive. 512K RAM. All the cables you'll need for the drive and the keyboard. An expansion slot riser card. LPM Utilities Diskettes. ORCAD Schematic Diskettes and Designer's Manual. Complete data sheets for all the Western Digital chips. And a Western Digital User's Manual.

The entire Western Digital Designer Kit costs just \$999. Obviously, rounding up all the parts by yourself would take far more money. And far more time.

All you need to supply is a little brain power. And before you know it, your next great idea will be off the drawing board and into production.

The Western Digital Designer Kit is available for a limited time. And in limited quantities. So call your favorite Western Digital distributor now.

And let's make a deal.

Almac Electronics at 206-643-9992.
Anthem Electronics at 408-453-1200.
Hall-Mark Electronics at 214-553-2171.

Pioneer-Standard Electronics at 800-874-6633.
Pioneer Technologies Group at 800-227-1693.
Wyle EMG at 408-727-2500.

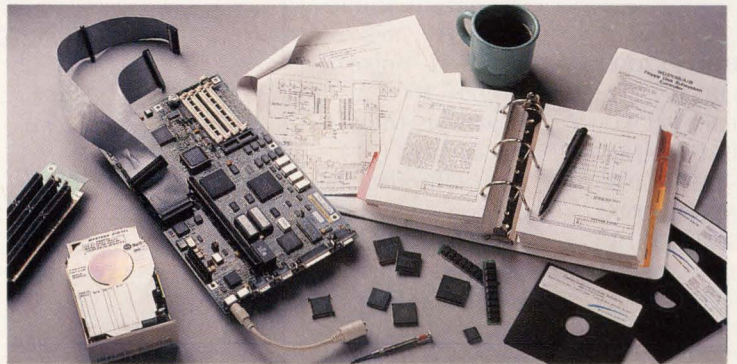

Matched sets, unmatched performance.

 **WESTERN DIGITAL**

CIRCLE 184

WHAT'S ALL THIS NOISE STUFF, ANYHOW? (PART I)

Recently I was invited to a meeting to see the results of a new high-performance, low-noise transistor project. I looked at the technical report. The new transistors were indeed quieter than the old ones. In fact, they were 2 to 4 orders of magnitude quieter than the conventional ones. I was suspicious. What was the test method? Oh, here is the test circuit (see the figure).

Now, I asked, were the betas high or low? I was told they were pretty low, but they can be brought up later. I explained that when the betas get low, if they're not very well matched, the test circuit's output can peg—right up to the + or - rail. Then, of course, the apparent output noise gets rather small. (Ohhhhhh!)

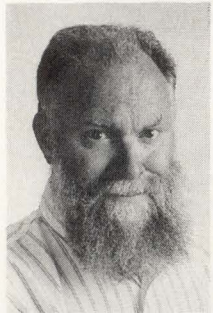

BOB PEASE
OBTAINED A BSEE FROM MIT IN 1961 AND IS STAFF SCIENTIST AT NATIONAL SEMICONDUCTOR CORP., SANTA CLARA, CALIF.

When this circuit is running okay, the current noise is amplified by a big resistance: $1\text{ M}\Omega \times (N+1)$, where N is the closed loop gain, (R_F/R_1) . So, the output will include: $(I^+$ noise of Q_{1A}) + $(I^-$ noise of $Q_{1B}) \times 1000\text{ M}\Omega$. However, the offset current $(I^+ - I^-)$ will also be magnified by $1000\text{ M}\Omega$. So even 9 nA of offset current will cause the op amp's output to try to go to $+9\text{ V}$.

If the power supply won't let the output get to a fair balance, the output will peg. Naturally the output becomes very quiet—the circuit has stopped amplifying the noise.

I also pointed out that ideally the circuit could measure the base-cur-

rent noise of the transistor, or device under test (DUT). But the layout of the circuit is quite critical. Just 1 pF of capacitance (C_F) from the output to the base of Q_{1B} will cause a lag in the response: $1000\text{ M}\Omega \times 1\text{ pF} = 1\text{ ms}$, so the noise will roll off above 160 Hz . You can make a layout with less than 0.1 pF , but you have to think about it and engineer it.

When we checked the test box, it was laid out very neatly: The output wire was bused alongside the sum-

ming-point (base of Q_{1B}) wire, and the bandwidth was indeed less than 100 Hz . In a future column, I will talk about what a picofarad looks like and the harm it can do to you. So, even if the output wasn't pegged and you looked for the noise at 1 or 10 kHz , this test circuit would give an answer that's considerably quieter than the theoretical minimum for the transistor. Now here's a good place for a sanity check.

It's not impossible to measure the noise of a transistor's base current, but you must have a suitable circuit. I wrote a paper back in 1968, and as I look at it today, the only things that changed are the names of the op amps. You can't buy any of those old discrete-transistor, potted-module op amps any more, but the testing

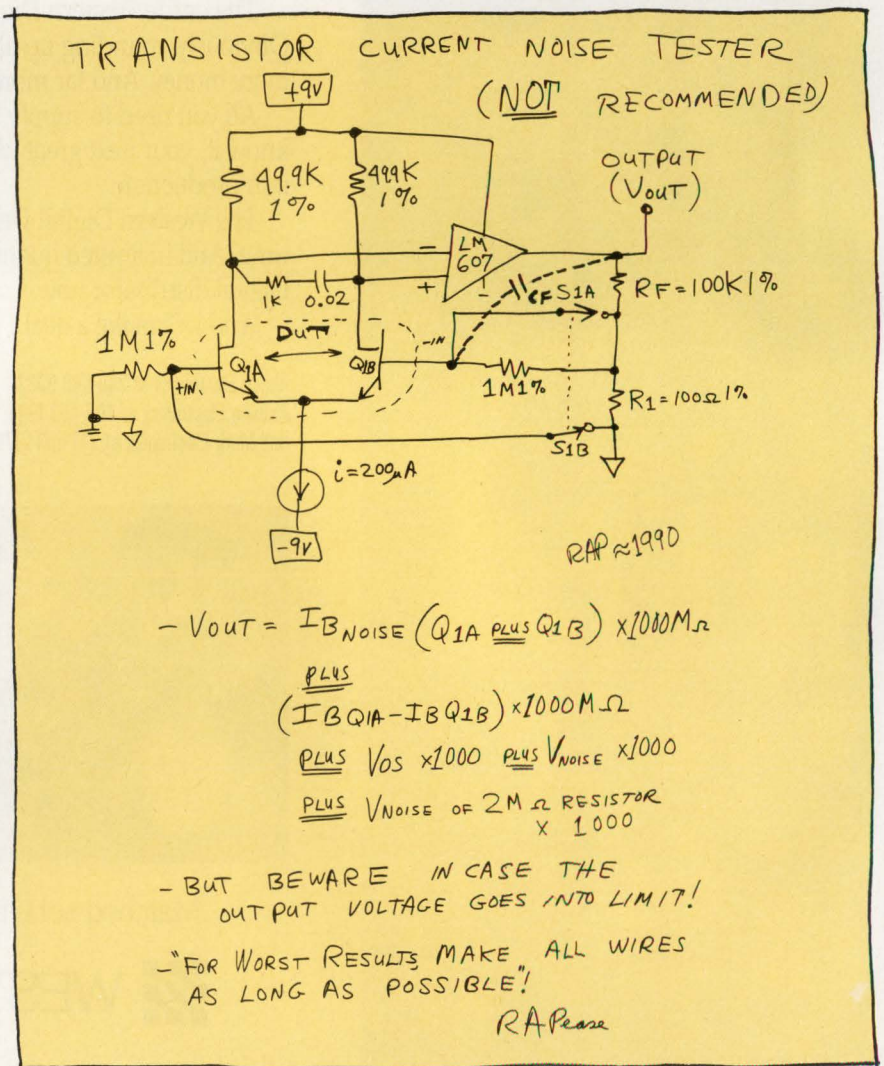

SPACE QUALIFIED, RAD-HARD CUSTOM CIRCUIT, 14 WEEK DESIGN.

WAS **SECRET** CRAZY OR WHAT?

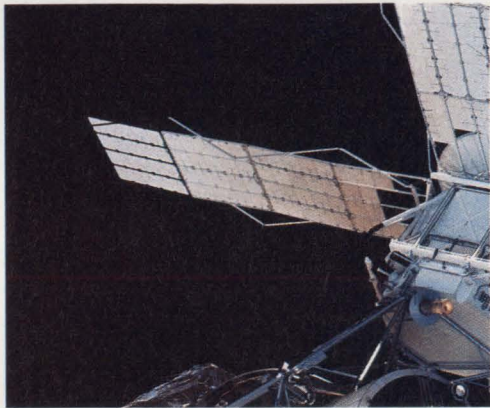

Some stories can't be told.

We're going to try anyway and still respect confidentiality.

A major aerospace company wanted a RAD-HARD, space-qualified stepper-driver for positioning the solar array of a highly sensitive military satellite. They wanted fail-safe performance plus adherence to a set of intimidating specs.

And they wanted it fast. "We're in a bit of a hurry," they said.

That was enough for the incumbent. They stepped out of the picture.

Which is just when we stepped in.

You see, few companies in the U.S. can build custom circuits like Silicon General can—quickly, reliably and profitably. That's because in over 20 years of solving problems in silicon, our files are bulging with thousands of IC solutions. We've developed an encyclopedia of circuit design and manufacturing solutions that lead us around the problems and pitfalls that plague less experienced vendors.

We work in partnership with your engineering department through every stage of design and manufacturing and will often assign a full-time project manager to oversee your job, as we did with this customer.

In the case of the stepper-driver, our drop-in replacement not only met form, fit and function, our specs gave the customer a little more latitude to meet his own price/performance requirements.

And to cap it off, we even delivered ahead of schedule.

If you need a partner to design and manufacture power IC's, someone who can meet "impossible" specs and deadlines, remember, nothing is as crazy as it sounds.

Not when you call in the General.

To hear more, contact Silicon General,
11861 Western Avenue, Garden Grove,
CA 92641. TWX: 910-596-1804.
FAX: (714) 893-2570. Phone
(714) 898-8121.



*Solutions...
that's the general idea.*

POWER-ONE D.C. POWER SUPPLIES

Not Only The Best...The Best Selection, Too

SWITCHERS

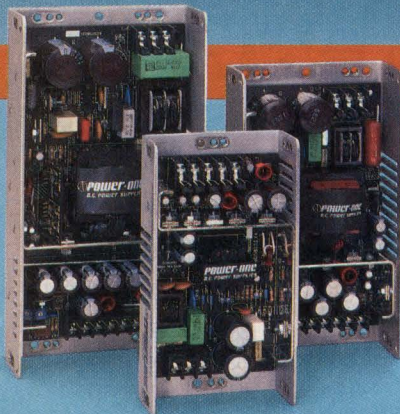

POWER-ONE'S International Switcher Series incorporates the latest state-of-the-art switching technology while providing POWER-ONE's traditional high quality at low prices. With certification to the world's toughest safety agency requirements, the series is especially suited for products sold not only domestically, but internationally as well. • 85 models... 40 watts to 400 watts • Efficient... reliable... economical • VDE construction • Up to 5 fully regulated outputs • Full international safety and EMI approvals

LINEARS

POWER-ONE'S International Linear Series is the world's undisputed leader in versatile, cost-effective linear power supply products. A long-time favorite of designers and engineers worldwide, the series is the most widely purchased power supply line through distribution in the industry. The most popular voltage and current combinations are available in a wide variety of off-the-shelf standard models. • Popular industry standard packages • 77 models... 6 watts to 280 watts • $\pm 0.05\%$ regulation • Up to 4 fully regulated outputs • Worldwide safety approvals

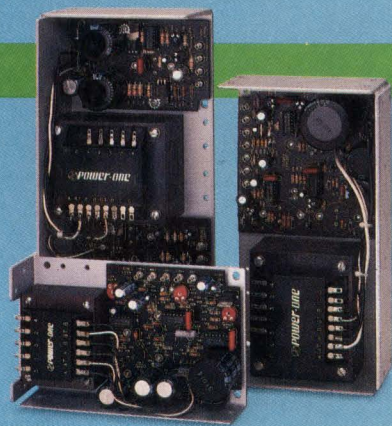

HIGH POWER

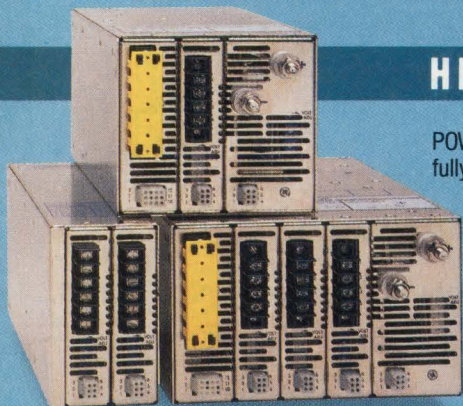

POWER-ONE'S International High Power Series is the industry's only true fully-modular high power product line. Specify a power system that meets your exact requirements from a wide selection of single, dual and triple output plug-in power modules. Virtually any combination of output voltage and current rating can be delivered from stock. • 500 watts to 1500 watts • Fully modular construction • Up to 15 fully regulated outputs • UPS battery backup option • Parallelable outputs with current sharing

**TOLL-FREE
LITERATURE
HOT-LINE:
(800) 235-5943
In California:
(800) 421-3439**



POWER-ONE offers one of the largest selections of switcher, linear, and high power standard models in the world. So, whatever your D.C. power supply requirement calls for, make POWER-ONE your first choice and be sure you're getting the best—not only in quality, but selection and value as well. Call today for our new 1990 catalogs.

"Innovators in Power Supply Technology"
1 POWER-ONE
D.C. POWER SUPPLIES

POWER-ONE, INC.
740 Calle Plano • Camarillo, CA 93010-8583
Phone: (805) 987-8741 • (805) 987-3891
TWX: 910-336-1297 • FAX: (805) 388-0476



PEASE PORRIDGE

approaches are just as valid. Maybe I'll write an updated version. In this case, the problem was that a 1-M Ω resistor and a noise gain of 100 or 1000 (provided by R_F and R₁) wasn't a good idea. The stray capacitances and the noise of the 1-M Ω resistor are detrimental to accuracy. It's better to use a real 100-M Ω or 1000-M Ω resistor.

In fact, a 20-M Ω or 5-M Ω resistor is justified because it will still give plenty of signal-to-noise ratio, and a lot more bandwidth. More on how to do this in the next issue.

All for now. / Comments invited! /
RAP / Robert A. Pease / Engineer

ADDRESS:

Mail Stop C2500A
National Semiconductor
P.O. Box 58090
Santa Clara, CA 95052-8090

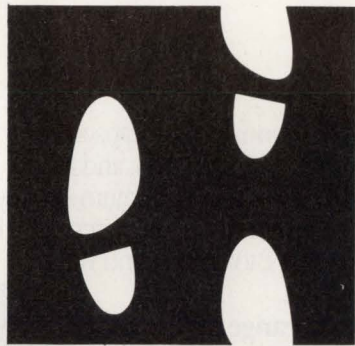

Make Tracks...

... to your nearest mailbox and send for the latest copy of the **free** Consumer Information Catalog. It lists about 200 free or low-cost government publications on topics like health, nutrition, careers, money management, and federal benefits. Just send your name and address to:

**Consumer Information Center
Department MT
Pueblo, Colorado 81009**

U.S. General Services Administration



**Our CODE switches
stand out in a crowd.**

Industry's Largest CODE Switch Selection

- Rotary DIP & Pushwheel switches
- Hundreds of code, actuation and termination combinations
- Largest choice of PC terminations for pushwheels
- PC or wire lug card edge connectors

AUGAT/ALCOSWITCH offers a full product line including...



Relays



Toggles, Rockers, Pushbuttons



Industrial Controls

For your free catalog, product samples, applications help, or a quotation, call or write AUGAT/ALCOSWITCH, 1551 Osgood Street, No. Andover, MA 01845 USA.

Tel: (508) 685-4371, TLX: 275423, FAX: (508) 686-9545

AUGAT[®] ALCOSWITCH[®]

Quality and Innovation

AUGAT INTERNATIONAL SALES OFFICES

AUGAT LIMITED - ENGLAND	(011) 4490676655
AUGAT SA - FRANCE	(011) 33146683090
AUGAT GMBH - WEST GERMANY	(011) 49896129090
AUGAT AB - SWEDEN	(011) 468960270
AUGAT SRL - ITALY	(011) 3939654100
AUGAT ISRAEL	(011) 9723492173
AUGAT ELECTRONICS INC. - CANADA	(1) 4166771500
AUGAT RTY LTD. - AUSTRALIA	(011) 6129050533
AUGAT KK - JAPAN	(011) 810550897911

CIRCLE 194

A World-Sized Commitment To Leaded And Surface Mount Passives, Summed Up In World-Sized Data Books.

Call For Your Copies: 1-800-447-3762.



In 856 pages, our data books cover our world-sized scope of passive products:

A full range of SMD[®] tantalum chip capacitors that includes two MIL-approved devices — CWR06 and CWR11 — plus special low ESR,

high-frequency products designed for switcher power supply and computer memory applications. Also available: the industry's broadest line of axial leaded hermetic solid and wet tantalums.

A complete selection of SMD[®] ceramic chips and leaded ceramic capacitors, including



Mono-Axial[™] conformal coated capacitors for high-density automatic insertion, and Mono-Kap[®] multilayer radials for maximum stability. Choose C0G, X7R or Z5U dielectrics in a wide range of case sizes, tolerances and voltage ratings.

A broad range of film capacitors for general purpose, precision, low power and motor run applications from 47 pF to 75 μ F, in several dielectrics and package configurations.

A complete line of AC and DC aluminum electrolytic capacitors for



Philips Components

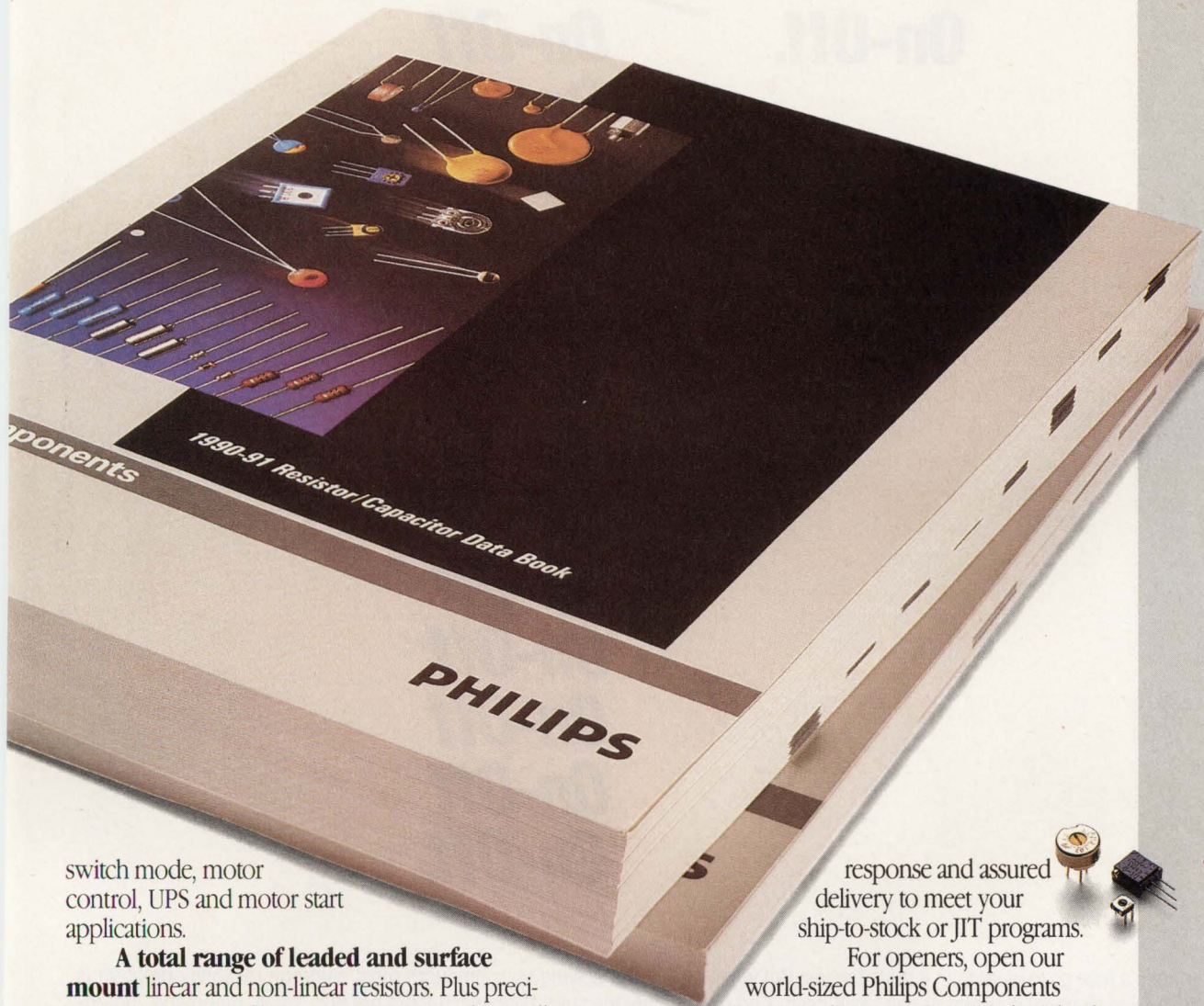

switch mode, motor control, UPS and motor start applications.

A total range of leaded and surface mount linear and non-linear resistors. Plus precision film power resistors—the smaller, more economical alternative to wirewounds—with tolerances to $\pm .05\%$ and TCs to ± 20 ppm.



And more. High-performance cermet trimmers. Temperature and humidity sensors. Plus quick

response and assured delivery to meet your ship-to-stock or JIT programs.

For openers, open our world-sized Philips Components Capacitors/Resistors Data Books. They're free! So is the phone call.



**Philips Components
Discrete Products Division**
2001 W. Blue Heron Boulevard
P.O. Box 10330
Riviera Beach, FL 33404

1-800-447-3762

More Products. More Solutions.



PHILIPS

CIRCLE 162



On-Off.



On-Off
On-Off
On-Off
On-Off
On-Off
On-Off
On-Off
On-Off
On-Off
On-Off
On-Off
On-Off
On-Off

No sooner does a fuse go to work than it quits forever. But when a PolySwitch® device stops overcurrent, it can reset itself. And go on protecting your product again and again.

Think of it: self-resetting protection for motors, speakers, solenoids, power supplies, even batteries. For computers, printers, modems, and LANs. For PBXs, FAX machines, key telephone systems, telecom central office equipment, security and alarm systems, and more. Much more.

PolySwitch circuit protectors do it with technology so elegant it makes other approaches look burnt out. When a current overload hits its conductive polymer compounds, the PolySwitch PTC (positive temperature coefficient) device heats up and turns nonconductive. Lower the current and the device's conductivity resumes. Along with your product's reputation for reliability.

PolySwitch PTCs accomplish all this without manual resetting or replacement. Thereby eliminating any chance of going from a bad fuse to something worse—the wrong fuse.

But solving your product's most common reliability problem is only the start. PolySwitch PTCs are also small, monolithic, board-mountable, and testable. And they're available in hundreds of optimized designs—for everything from rechargeable batteries to telephones to stereo speakers.

Finally, PolySwitch PTCs are from Raychem. Which means they're reliable, and backed by experience and support that never shuts down.

Call for a free sample and more information. Because this one time your product can clearly benefit from on-again, off-again performance.



Raychem

Raychem Corporation
PolySwitch Division
300 Constitution Drive
Menlo Park, CA 94025-1164
(415) 361-6900

CIRCLE 213

**ULTRA-THIN PACKAGES
HOUSE DRAMS, SRAMS**

Adding the ultra-thin plastic small-outline package (SOP) to its list of packaging options, Hitachi America Ltd., Brisbane, Calif., gives designers another choice for 1- and 4-Mbit dynamic RAMs, and 1-Mbit static RAMs. The ultra-thin packages are just 0.047-in. (1.2-mm) thick—one-third the height of standard small-outline J-leaded packages. Their lead pitch is about 40% that of the SOJ—just 0.5 mm. The TSOP's small size means more chips on a circuit board, and the low profile means better cooling airflows. The 1-Mword-by-1-bit and 256-k-by-4 megabit DRAMs, the 4-M-by-1 and 1-M-by-4 4-Mbit chips, and the standard and low-power 128-k-by-8 SRAMs will all be included in the TSOP. The 1-Mbit DRAM TSOP is 6 by 16 mm, while the 4-Mbit DRAM and 1 Mbit SRAM TSOP are 8 by 20 mm. The TSOP option will also be offered for pseudostatic RAMs, EPROMs, EEPROMs, and mask ROMs. In 10,000-unit lots, the 1-Mbit DRAM (80 ns) in the TSOP sells for \$9. The 4-Mbit DRAM sells for \$48.75 and the 1-Mbit SRAM (100 ns) costs \$25.50 in 5000-unit lots. Call Sally Withers for the 1-Mbit DRAM, Carrie Shulman for the 4-Mbit DRAM, and Victor Zilinskas for the 1-Mbit SRAM, (415) 244-7146, 7131, and 7183, respectively. *DB* **CIRCLE 631**

**200-V-CMV DIFF-AMP
NOW IN 8-PIN SOIC**

A differential amplifier from Burr-Brown—the INA117—can now easily handle 200 V of common-mode voltage (CMV) in an 8-pin SOIC package. That's in addition to its original 8-pin TO-99 and miniDIP packages. The IC makes it possible to process millivolt signals riding on CMVs of more than ± 15 V, with devices running off ± 15 -V rails. The precision IC op amp, which includes a thin-film resistor network, provides a fixed, differential-in to single-ended-out gain of unity while attenuating the CMV by a factor of ten. It's ideal for monitoring the current in the hot side of a high-voltage (up to 200 V) power supply. Gain accuracy at 25°C is 0.02% maximum and gain drift runs 10 ppm/°C. Full-power bandwidth is a minimum of 30 kHz. As a result, the device isn't limited to just dc levels. In quantities of 100, the amplifier costs \$4.85 each. Call Bruce Trump at (602) 746-7347 or 1-(800) 548-6132, or their bulletin board at (602) 741-3978. *FG* **CIRCLE 632**

**NONVOLATILE MEMORIES
LEAVE THEIR MARK**

With its latest nonvolatile-memory offerings, the nonvolatile division of Hitachi America Ltd., Brisbane, Calif., has covered almost every design need. The offerings include fast 4- and 1-Mbit EPROMs, a 1-Mbit flash EEPROM, a medium-speed 256-kbit full-function EEPROM, and a 4-Mbit masked ROM. Thanks to a fine-line 0.8- μ m process, the EPROMs can access in as little as 100 ns. They're organized as a 256-kword-by-16-bit (HN27C4096) or as 128-k-by-8-bit (27C101A) memories. The megabit flash chip (HN29C101) is also organized as a 128-k-by-8-bit array and can endure more than 100 erase cycles. The chip's access time is 120 or 150 ns, and can be reprogrammed by applying a 12-V signal. The companion EEPROM, the HN58C256, is a basic EEPROM memory chip with an access time of 200 ns. The 4-Mbit ROM offers a 100-ns access time, and mounts in a multichip configuration to achieve 8- and 16-Mbit storage arrays in a 48-lead package. Chip prices start at \$7 in volume for the ROM; \$13 and \$35, respectively, for the EEPROM and flash EPROM; \$53 for the 4-Mbit UV EPROM; and \$6 to \$8 for the 1-Mbit UV EPROM. *DB* **CIRCLE 633**

**STANDARD PALETTE DAC
BECOMES STANDARD CELL**

Joining the growing ranks of 8-bit triple-palette DAC suppliers for IBM PCs and clones, Sierra Semiconductor of San Jose, Calif., is offering the device both as a standard product and as a cell in their 1.5- μ m mixed-signal CMOS library. Four speed versions of the product—the SC11478—are available between 35 and 80 MHz. Use of the VDAC78 cell (identical to the SC11478) in Sierra's library gives designers flexibility in creating proprietary solutions to CRT displays. The chip (and cell) also holds an anti-sparkle circuit that maintains prior output-color data on the three DAC outputs. At the same time, it transfers data between the lookup table RAMs and the RGB color registers. Housed in a 44-pin PLCC, the SC11478 costs between \$3 and \$5 each in 10,000-unit quantities, depending on speed. Call Zaheer Hassan, (408) 263-9300. *FG* **CIRCLE 634**

**IC DIP OP AMPS MOVE
INTO 8/14-PIN SOICs**

Following the strong demand for ICs in surface-mounted packages, Harris Semiconductor, Melbourne, Fla., is producing 16 standard and proprietary amplifiers available in narrow-body SOICs. Heading the list are four high-speed op amps: the HA-5195, HA-2539, HA-2540 and HA-2544. It also includes the HA-5002 and HA-5033 video buffers and the HA-5141/42/43 low-power op amps. All nine devices are made on the Harris dielectrically isolated (DI) bipolar process. Low-noise op amps in these packages include the HA-5101/5111, the HA-5102/5112, and the HA-5104/5114. Also on the list is the general-purpose HA-4741. Call 1-(800)-427-7747. *FG* **CIRCLE 635**

TURN A FEW DOLLARS INTO A COOL 18 MILLION.



*SPARC
Embedded RISC.
18 MIPS.*

Embedded control challenge of the 90s:
Applications are increasingly burdened with the overhead of friendliness. Even so, users expect everything to happen immediately, if not sooner.

As a result, applications with embedded microprocessors need more computing power than ever. Our CY7C611 SPARC RISC controller gives you the power to create, at a price that fits your application.

It performs. At 25 MHz, our CY7611 delivers 18 sustained MIPS.

It handles interrupts brilliantly. Asynchronous and synchronous traps let you jump to trap routines with 200 ns worst case response. 16 prioritized interrupt levels let you tailor your application. You get 136 32-bit registers that you can divide into register banks for fast context switching.

It has hooks. Connect our CY7C602 concurrent floating point unit for 5 MFLOPS. Use our CY7C157 Cache SRAM for a zero wait state memory system.

Use our CY7C289 512K PROM for glueless, virtually waitless program storage.

It is extendable. You get a large address space, and support for multitasking and multiprocessing.

It is affordable. We're talking a few dollars per MIPS.

And it is SPARC. You can choose from a multitude of SPARC platforms to operate as native development platforms. You work with the world's most popular RISC architecture. You can expect faster evolutions, to keep your design current well after it is designed.

The whole story – from data sheet to User's Guide – is yours for a fast, free phone call.

**Free SPARC RISC User's Guide.
Hotline: 1-800-952-6300*.
Ask for Dept. C3K.**



**CYPRESS
SEMICONDUCTOR**

*1-(800) 387-7599 in Canada. (32) 2-672-2220 in Europe. ©1990 Cypress Semiconductor, 3901 North First Street, San Jose, CA 95134. Phone: (408) 943-2600, Telex: 821032 CYPRESS SNJ UD, TWX: 910-997-0753. Trademarks: SPARC-Sun Microsystems, Inc.

PROGRAMMABLE FUNCTIONS LEAD TO
COST-EFFECTIVE TRANSMISSION OF VIDEO AND
PHOTO-QUALITY STILLS.

CHIP SET BROADENS OPTIONS FOR IMAGE COMPRESSION

MILT LEONARD

A surging trend in information handling is the merging of text, still images, and full-motion video pictures in computer terminals and workstations. Forcing this trend are rapid advances in data reduction and compression techniques, which reduce the amount of memory required to store data, as well as the bandwidth needed to transmit the data. And, with advances in VLSI, large arrays of digital signal processors are no longer required to handle the intense computations involved.

For example, LSI Logic has developed a new image-compression CMOS chip set which, when interconnected to form an image-processing pipeline, offers user-selectable image-compression ratios for both still and video images. Moreover, the chip set allows designers to take a building-block architectural approach—for maximum flexibility—in the face of a still-evolving standards environment.

The 40-MHz chip set consists of the L64760 interframe processor, L64730 discrete cosine transform (DCT) processor, L64740 DCT quantization processor, and the L64720 video motion-estimation processor (*Fig. 1*). It also includes the L64750 variable-length encoder, and L64715 error-correcting encoder-decoder. The chip set's programmable features not only afford a substantial amount of application flexibility, but also make it possible for designers to track the emerging standards. These include the CCITT (International Consulta-

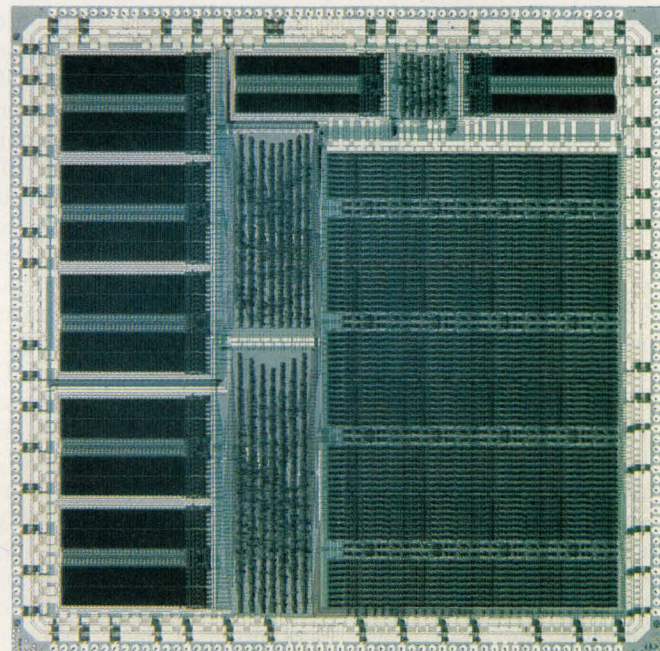

1. A KEY PLAYER for compressing video images, the L64720 motion-estimation processor uses an array of 32 ALUs (right side) to detect relative motion between successive video frames. Static RAM (left and top) functions as input buffers to store the data block and search window, and to store computational results. Circuitry between the memory and ALU array provide control.

tive Committee for Telegraphy and Telephony) H.261 standard for video conferencing (specifying VHS/VCR-type broadcast quality, which is about half that of broadcast television operating at 27 Mpixels/s), the JPEG (Joint Photographic Experts Group) standard for still-picture transmission, and the MPEG (Motion Pictures Experts Group) standard. The latter, which is a combination of JPEG and H.261,

IMAGE-COMPRESSION CHIPSET

is expected to become an ISO (International Standards Organization) standard.

The functional partitioning scheme also supplies access to the bus architectures to allow further design differentiation. For example, although the image-compression algorithms are embedded in firmware, users can apply proprietary algorithms by connecting memory devices and additional logic to the buses. Using the building blocks, designers can construct an image-compression subsystem for low-volume production, with an option for higher-level integration in the future. Considering the downward cost trend of such I/O devices as video monitors, cameras, scanners, and facsimile machines, the chip set is more in stride with target system costs than, say, a \$50,000 video-codec solution for data compression.

All chips are used to compress images of full-motion video (Fig. 2a). The 64760 interframe processor's input signal is rasterized image data, coming from a scanner, video camera, or frame memory. Depending on the data source, users must insert logic between the 64760 and the signal source to implement the required signal conversion (for example, a video camera's analog signal would require analog-to-digital conversion).

For H.261 operation, the 64760 reformats the input image data into

block form for subsequent processing by other chip-set members. Image data (luminance and chrominance) is formatted in 8-by-8 data blocks, with each block containing 8-by-8 pixels and each pixel defined by 8 bits. The 64760 sends this data in raster-scanned order to the L64720 motion-estimation processor, which generates a motion vector for each block. This is done by searching corresponding blocks in the current and previous frames for translational differences. As a result, once the initial frame is stored in memory, ensuing frames can be formed just by adding translational differences to the previous frame.

The L64730 DCT is a time-to-frequency converter that contributes to the image-compression process by changing the 64760's time-domain, motion-compensated output to the frequency domain. The DCT processor computes both the forward and inverse DCT over 8-by-8-bit data blocks, and can have up to 12-bit data precision at the input and output data terminals. Depending on a control pin's logic level, the device can also round off the output to 9 or 12 bits. In effect, this conversion changes the average value of a pixel block into a gray scale with a wide range of pixel values. Because the human eye is insensitive to minute changes in hue and brightness, many of these values can be stripped out

without noticeable picture-quality degradation.

A "binning" operation on the DCT's output, performed by the L64740 quantization processor, sorts DCT coefficients according to value. Quantization step size, and thus compression ratio, is user-selectable. Although the result is an approximation of the image, the lost precision at the receiving end can't be seen.

The L64750 coder performs additional data reduction by encoding each quantized DCT coefficient in one cycle, using short code words for the predominant pixel block values and longer code words for lesser-used values. Combined with motion compensation, the overall result is a minimum number of bits needed to define a series of video frames.

Output data is packed into 24-bit words and multiplexed and coded according to the proposed CCITT H.261 standard. The compressed signal can now be transmitted to an I/O device, such as a video telephone or teleconferencing system.

For I/O devices lacking error-correction capability, the L64715 error-correcting encoder-decoder can follow the L64750. Containing both an encoder and decoder for full-duplex operation, the device processes blocks of 512 bits and corrects up to two errors per code word. This is acceptable for image-compression applications. The 64715 also performs

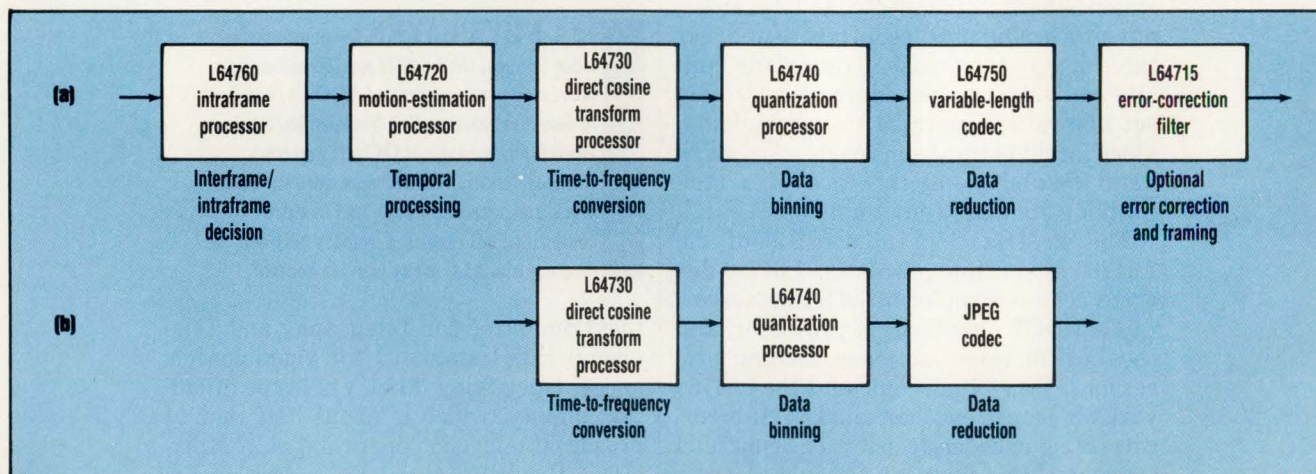

2. A VIDEO CODEC for broadcast-quality images requires all or part of LSI Logic's chip family (a). The optional L64715 error-correcting device isn't needed for communication with an I/O device having error-correcting capability. Still-image encoding is implemented with only the DCT processor and the quantization processor (b). JPEG encoding can be implemented with standard MSI devices. Signal paths are reversed to receive encoded still and motion pictures in the decoding mode. The L64760 and L64720 aren't required to decode video signals.

NEED BROAD-BAND COAXIAL RELAYS? FROM 2 TO 24 THROW, MATRIX HAS THE ANSWER

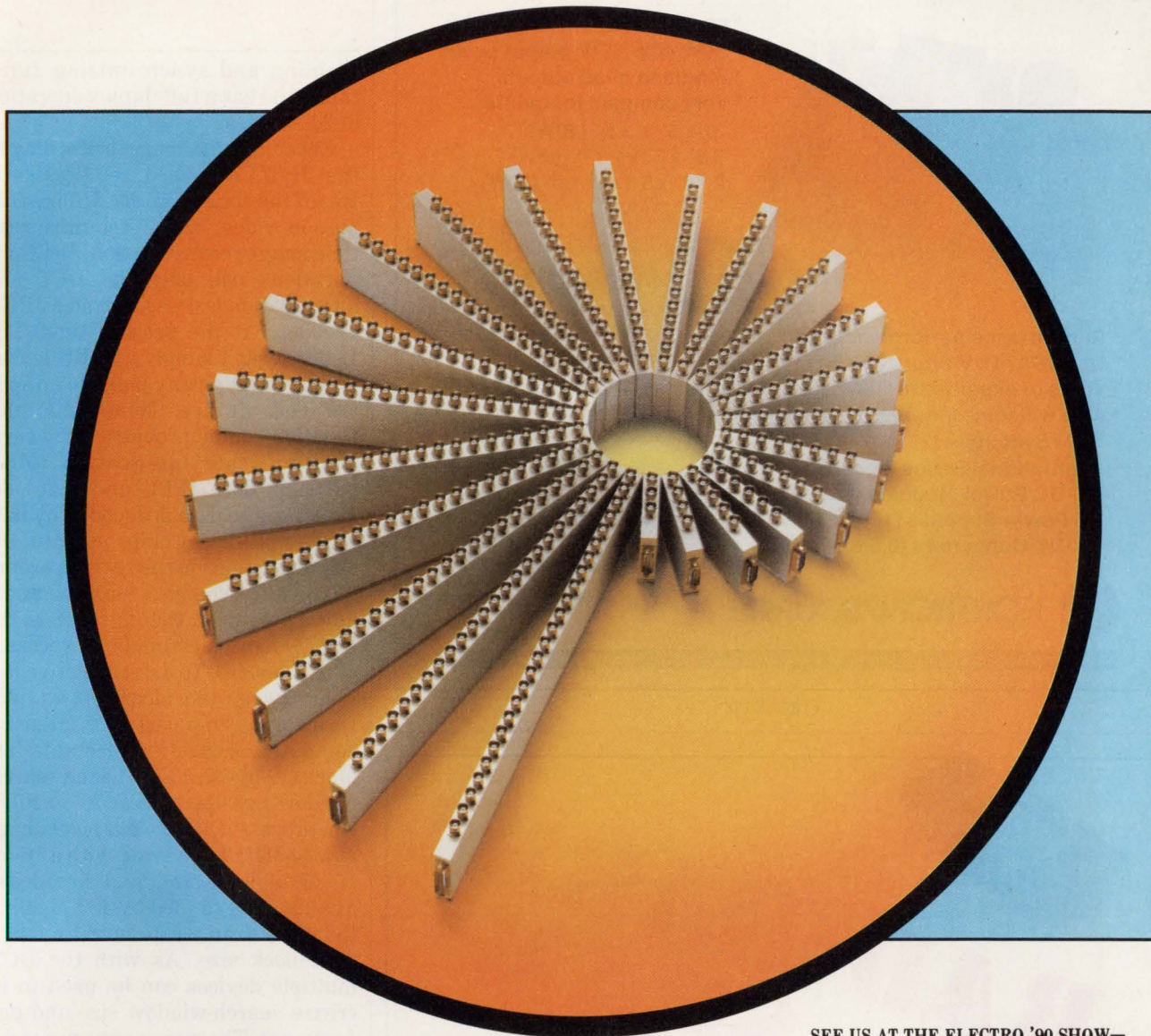

Our versatile 7000 series of coaxial relays have band-widths from DC up to 800 MHz. They're available from 2 to 24 throw. And by using our 9000 series cross-straps, switching matrices of any size can be configured.

Why have Matrix broad-band relays become the industry standard? Because we construct them of precision machined anodized aluminum alloy, all signal shield paths are silver plated, and basic switch elements are hermetically sealed in nitrogen filled gas envelopes with rhodium plated contacts to insure non-stick operation.

The end result is extremely low crosstalk, EMI and VSWR. Another plus, all switchpoints are individually field replaceable.

The units are plug compatible with Matrix 6100A and 1600 Series Logic Modules for compatibility with RS-232, RS-422 and IEEE-488 Interface busses as well as 16 bit parallel.

Non-blocking Matrix configuration may be easily assembled

SEE US AT THE ELECTRO '90 SHOW—
HYNES CONVENTION CENTER, BOOTH #1734

using our self-terminating relays and 5100A series power dividers. Built-in Video/RF amplifiers allow zero insertion loss designs.

So if you're looking for broad-band relays, it pays to deal with Matrix. After all, we've been designing state-of-the-art reed relay and semiconductor switching systems for over 18 years.

Our customers include government agencies, defense contractors, the TV industry, ATE and telecommunications companies—and more.

Phone: 818-992-6776

TWX: 910-494-4975

FAX: 818-992-8521

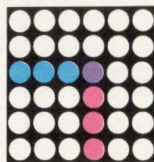

MATRIX
SYSTEMS CORPORATION

5177 NORTH DOUGLAS FIR ROAD
CALABASAS, CALIFORNIA 91302

CIRCLE 113

**UNIVERSAL INPUT IS NOT THE ONLY ENTREE,
IT'S THE BEGINNING.** And the whole menu are:

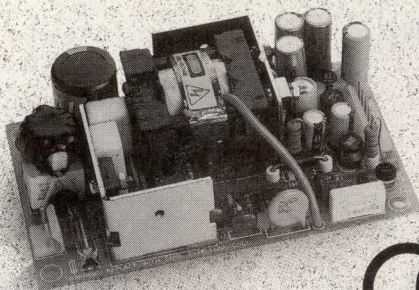

- * 85 - 264 VAC universal input
- * 30W/40W/65W output power
- * Single to quad outputs
- * Very compact footprints:
3" x 5" x 1.5" (40W)
3.5" x 6" x 1.77" (65W)
2.76" x 5.12" x 1.5" (30W)



Nov 13-15 Anaheim, CA Booth # 1698

- * Superb price/performance ratio
- * UL/CSA/TUV approvals in process
- * Years of expertise in OEMs, distributors, and private labels.
- * Also welcome inquiries on other product lineups:
OEM Switchers (20 to 300W)
International Series Linears (6 to 112W)
AC-DC Power Modules (15 & 25W)
PC Power Supplies (150 to 375W)
DC-DC Converters (0.5 to 45W)

Call: 1-800-821-9771

ATTN: MONICA/JENNIFER



6818-G Patterson Pass Road, Livermore CA 94550 Tel:(415)373-1008 Fax:(415)373-1168 Tlx: 559291

CIRCLE 176

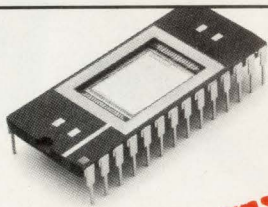

**RAD-HARD
55NS SRAM**

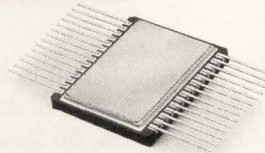

UTMC is delivering 64K SRAMs with solid guarantees: address access time of 55ns, SEU to 1.0E-10 (tested to 1.0E-15) errors/bit-day over full military temperature range. Built on the industry's hardest production-proven CMOS process, UTMC's SRAM is qualified to 883C Levels B and S and backed by our RAD-SPECSM program for off-the-shelf delivery and pricing. Call today for radiation test data.
1575 Garden of the Gods Rd.
Colorado Springs, CO 80907

1-800-MIL-UTMC



**UNITED
TECHNOLOGIES
MICROELECTRONICS
CENTER**

DEDICATED TO MILITARY AND AEROSPACE

CIRCLE 101

IMAGE-COMPRESSION CHIPSET

framing and synchronizing functions, and has a full-duplex operation at 20 Mb/s.

Encoding still images according to the JPEG standard requires only two of the chips (Fig. 2b). Unlike full-motion video, which requires real-time image reconstruction, JPEG applications use only the DCT and quantization processors and a JPEG encoder. At the present time, LSI Logic doesn't supply a JPEG encoder, but the company plans to do so in the near future. Meanwhile, this function can be provided by several medium-scale integration (MSI) parts. In both JPEG and H.261 designs, image data is decoded by having the processor chips perform the same functions in the reverse order.

The most complex member and a key element of the chip set is the L64720 motion-estimation processor (Fig. 1 again). To detect relative motion between data blocks in two video frames, the chip performs intensive computations using a selectable data block (16-by-16 or 8-by-8) and search-window size (32-by-32 or 16-by-16). It can process a 352-by-288-pixel image at a 30-MHz frame rate with a 16-by-16 data-block size, and broadcast-quality images (600-by-480 pixel) at the same frame rate with an 8-by-8 data-block size. As with the DCT, multiple devices can be used to increase search-window size and performance. The main-memory access-time requirements for computing N^2 errors for an $N \times N$ data-block size ranges from 229 cycles for $N = 8$ at 40 MHz, to 2237 cycles for $N = 16$ at 30 MHz. □

PRICE AND AVAILABILITY

Available now in plastic packages, unit prices for 100-lot quantities are \$93.50 for the L64715, \$137.50 for the L64720 and L64730, and \$151.25 for the L64740. The L64750 and L64760 will be available in November.

LSI Logic Corp., 1525 McCarthy Blvd., Milpitas, CA 95035; Simon Dolan, (408) 433-8000.

CIRCLE 512

HOW VALUABLE?

HOW VALUABLE?	CIRCLE
HIGHLY	518
MODERATELY	519
SLIGHTLY	520

SOLID STATE RELAY

Our FB Series military solid-state relay features high speed and low off-state leakage.



ACTUAL SIZE

Here's what you get:

- Availability to pending DESC drawing 89116 with screening to "W" and "Y" levels of MIL-R-28750.
- High-voltage output
- Very-low leakage current (200 nA)
- DC or bi-directional power FET output (see wiring diagrams)
- Ideal for ATE applications
- Optical isolation
- Fast switching speed
- Adjustable turn-on times
- Low profile 6-pin mini-DIP
- Cost efficiency

Review the electrical characteristics below and call us for immediate application assistance.*

INPUT ELECTRICAL CHARACTERISTICS (-55° to +105° unless otherwise noted)				
	Min	Max	Units	
Continuous Input Current (I_{IN})	10	50	mA_{DC}	
Input Current (Guaranteed On)	10		mA_{DC}	
Input Current (Guaranteed Off)		100	μA_{DC}	
Input Voltage Drop at (I_{IN}) = 25mA		3.25	V_{DC}	
OUTPUT ELECTRICAL CHARACTERISTICS (-55° to +105° unless otherwise noted)				
Part Number	FB00CD	FB00FC	FB00KB	Units
Bidirectional Load Current (I_{LOAD})	± 1.0	± 0.50	± 0.25	A_{DC}/A_{PK}
DC Load Current (I_{LOAD})	2.0	1.0	0.5	A_{DC}
Bidirectional Load Voltage (V_{LOAD})	± 80	± 180	± 350	V_{DC}/V_{PK}
DC Load Voltage (V_{LOAD})	80	180	350	V_{DC}
ON-Resistance (R_{ON}) at (I_{LOAD}) max.	0.72	1.8	12.9	Ohms
Turn-On Time (T_{ON})	800	800	500	μs
Turn-Off Time (T_{OFF})	300	600	500	μs

Notes: 1. A series resistor is required to limit continuous input current to 50mA (peak current can be higher).
 2. Rated input current is 25mA for all tests.
 3. Loads may be connected to any output terminal.
 4. ON resistance shown is for the bidirectional configuration. The DC ON resistance is 1/4 of these values.

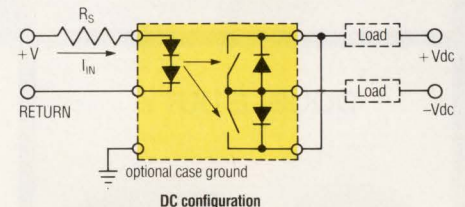
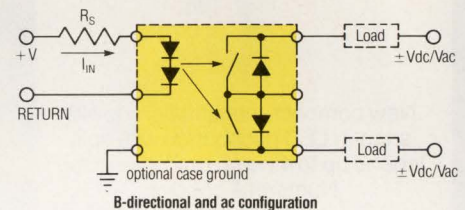

"CREATING THE STANDARD OF THE FUTURE"

TELEDYNE SOLID STATE
A Division of Teledyne Relays

*For immediate application assistance call 1-800-284-7007.

Teledyne Solid State, 12525 Daphne Avenue, Hawthorne, California 90250.

BEST OF THE '90s

NKK can show you exactly where the switch industry is headed because we're already there. We have over 917,000 different ways to improve your products' reliability and functionality — starting with the just-released break-through switch ideas on this page. Send for our free 400-page catalog.

Contact
NKK Switches,
7850 E. Gelding Dr.,
Scottsdale, AZ 85260.
Phone (602) 991-0942.

NKK switches

WORLD'S SMALLEST



NKK introduces the surface mount G3T with patented STC contacts, gull-wing terminals. VPS or infrared reflow solderable.

EASY DOES IT

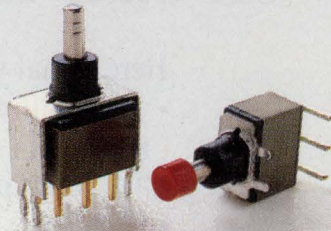

Washable M2B subminiature pushbuttons feature very-light-touch, snap-acting contacts. Straight, right angle, vertical PC terminals.

ULTRA-MINI



New ND switch is half the size of ordinary binary coded DIP rotaries. Washable and universal footprint pattern.

LEGENDARY



New compact, industrial-grade NB snap-in LED pushbutton with split legend up to 4 ways. Built-in resistor. Numerous options.

40TH YEAR of Innovation

WORTH A MILLION

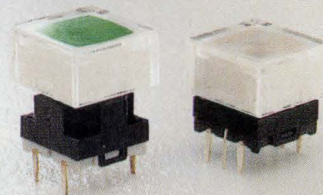

Million operations from unique LED illuminated JB keypad switch. Red, green or yellow LED options.

DOUBLE DUTY

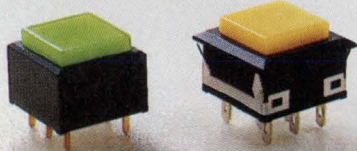

Logic-level for PCB or power rating for snap-in panel mounting, from very low-profile UB pushbuttons with full-face LED illumination.

TURNING POINT

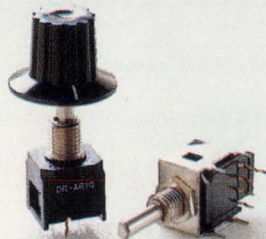

Washable Binary Coded DIP rotary DR-A switch can be PC or panel mounted. Crisp operation. Right angle or straight terminals.

100,000 CHOICES

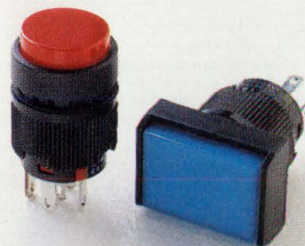

YB pushbutton yields literally 100,000+ part numbers with variations in mounting, illumination, circuitry and color.

PLD AND FPGA TOOLS TAKE A SYSTEM-LEVEL APPROACH TO DESIGN

LISA MALINIAK

To make complex designs manageable, engineers need to take a system-level approach. Most programmable-logic design tools, however, don't facilitate system-level approaches. Two new design tools from Valid Logic Systems called SystemPLD and SystemPGA solve this problem. Using the Valid software, engineers can mix logic types throughout system schematics, perform system simulation before device selection, and automatically combine or re-target programmable logic without design-description changes. In addition, an automatic schematic redraw capability smooths the integration with physical design, packaging, and back-annotation.

The products are a result of the combined technologies of Minc Inc., Colorado Springs, Colo., and Valid Logic Systems Inc. Valid incorporated its Logic Workbench framework with Minc's synthesis capabilities.

With SystemPLD and SystemPGA, engineers choose the most efficient method for describing specific parts of their design. These methods include ValidGED schematics, hardware description languages (HDLs), waveform descriptions, state machines, truth tables, and Boolean equations. Unlike many of today's systems, these methods can be combined hierarchically in the same schematic without selecting a target device or technology.

The tools then synthesize functional simulation models. The system can be verified through simulation with Valid's RapidSim digital simulator. By simulating the programmable logic device (PLD) or field-programmable gate array (FPGA) within the target system early in the design cycle, problems can be detected and corrected with minimum impact on the design schedule. Earlier methods of design required that the engineer go back through the entire design process and re-simulate.

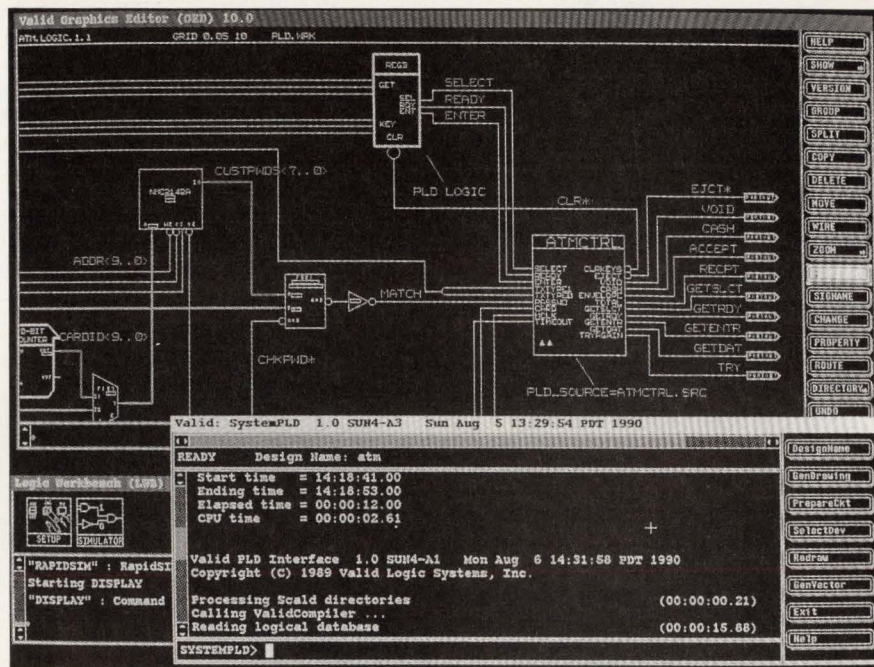

Designing with SystemPLD and SystemPGA is technology-independent. As a result, the design can be re-targeted from one technology or vendor to another. In addition, users can migrate from PLDs to higher-density FPGAs transparently.

Device selection is simplified because users can specify such constraints as manufacturer, specific PLD type, speed, cost, power, and logic family. The engineer can include those constraints in the schematic to drive device selection and partitioning from the beginning of the design cycle. Users can also select devices manually. After part selection, the design is automatically fit into the device. For large designs that need more than one device, the tools automatically partition the design across multiple devices.

When the design is functionally correct, the logic is implemented with any of over 3000 devices in the Minc PLD and FPGA libraries. The libraries support nearly all PLD vendors and architectures, and have PGA support for Actel ACT, Altera MAX, AMD Mach, and Xilinx LCA

families.

Full-timing models are synthesized once devices have been selected. Therefore, after device selection and fitting, the engineer can perform full-timing simulation. SystemPLD and SystemPGA automatically redraw the fully-annotated schematic containing the newly selected devices. After full-timing simulation, the target system with the actual devices is packaged for physical layout with Allegro, Valid's PCB layout system.

SystemPLD includes the tools for PLD logic synthesis and optimization design as well as the Minc library of devices. It is available now starting at \$13,500. SystemPGA contains all the SystemPLD features, plus added capabilities and the Minc FPGA library. It is also available now, starting at \$19,500. SystemPLD users can add SystemPGA functionality through an upgrade that costs \$6000. Both products run on DEC, IBM, and Sun workstations.

Valid Logic Systems Inc., 2820 Orchard Pkwy., San Jose, CA 95134; (408) 432-9400. CIRCLE 630

IEEE-488



Control any IEEE-488 (HP-IB, GP-IB) device with our cards, cables, and software for the PC/AT/386, EISA, MicroChannel, and NuBus.

SOFTWARE SYNTHESIZES AND PARTITIONS LOGIC

PL Partition is a computer-aided-engineering tool that lets engineers synthesize and partition their programmable logic designs into a convenient number of segments. Each segment can then be individually optimized for device cost, propagation delay, power consumption, and number and size of program-

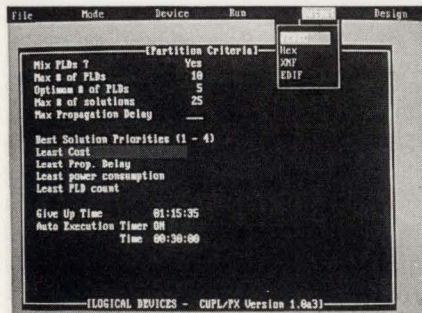

mable logic devices (PLDs). The least-to-most or most-to-least feature lets engineers begin designing with the maximum or minimum number of PLDs. The split-product-terms feature gives flexibility during layout. If propagation delay is not critical for a particular signal, engineers can cross device boundaries during layout to allow for the use of smaller, less costly devices. In addition, engineers can designate the percentage of device capacity to be used to allow for future expansion and modification. Also, graphic representations of how the devices are to be connected offer engineers a preview of how the devices can be arranged on a pc board. PL Partition, which is shipping now, costs \$995.

Logical Devices Inc., 1201 NW 65th Pl., Fort Lauderdale, FL 33309; (305) 974-0967 or (408) 970-0504. CIRCLE 690

NEW PRODUCTS

COMPUTER-AIDED ENGINEERING

ANALOG DESIGN TOOLS INCREASE YIELDS

An analog design system called CLIO takes steps during the design phase to maximize yields in the manufacturing phase. The tools' capabilities include circuit optimization to match performance targets, yield analysis and design centering to increase manufacturing yield, schematic capture, design specification entry, circuit simulation and analysis, and results processing and presentation. Design centering involves choosing values to minimize the unwanted effects of component toler-

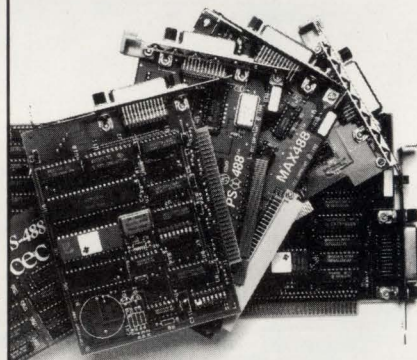

You get fast hardware and software support for all the popular languages. A software library and time saving utilities are included that make instrument control easier than ever before. Ask about our no risk guarantee.

ances. CLIO is available now for \$18,750 in a network configuration of four seats. It runs on HP/Apollo and Sun workstations.

Electrical Engineering Software Inc., 4675 Stevens Creek Blvd., Suite 200, Santa Clara, CA 95051; (408) 296-7563. CIRCLE 691

RULES CHECKER KILLS REDUNDANT ERRORS

A hierarchical layout-rules checker called the LRC 2000 removes the redundant errors common in non-hierarchical systems. The errors are eliminated because each LRC 2000 run generates a hierarchical database that mimics the original layout database. In addition, the error-identification software works within the database hierarchy, allowing engineers to obtain immediate feedback on design errors simply by click-

ing on the error vectors. After each run, the software creates a log file listing the number and location of all errors. LRC 2000 runs on most 80386- and 80486-based computers, and on Apollo, Sony, and Sun workstations. It is shipping now for \$20,000.

Integrated Silicon Systems Inc., P.O. Box 13665, Research Triangle Park, NC 27709; (919) 361-5814. CIRCLE 692

TIMING SOFTWARE SAVES SIGNAL INTEGRITY

SigDelay is a new signal-integrity tool from Valid Logic that analyzes high-speed pc-board signal transmissions for timing effects of logic transitions. With SigDelay, engineers can identify and correct high-speed timing problems before the prototype stage. It works with Valid's Signal Noise Analysis tool, which lets users analyze many different high-speed board characteristics. For signal-delay analysis, SigDelay uses the transmission-line simulation results provided by Signal Noise Analysis and applies heuristics to analyze the speed and smoothness of the signal. It then verifies length and delay constraints on the signal, and extracts the minimum and maximum pin-to-pin wire delay data for post-layout timing simulation. SigDelay will be available in January on DEC, IBM, and Sun workstations. Depending on configuration, it will cost between \$12,500 and \$50,000.

Valid Logic Systems Inc., 2820 Orchard Pkwy., San Jose, CA 95134; (408) 432-9400. CIRCLE 693



Free:
Informative catalog 800-234-4232
Applications help (617) 273-1818



**Capital Equipment Corp.
Burlington, MA. 01803**

CIRCLE 85

From OC-3 to OC-12...

Regenerate your SONET signals with our PLL clock and data recovery IC.



If you are designing a fiber optic receiver subsystem for applications requiring data rates from 100 to 625 Mbit/s NRZ, you should find out more about our PLL-based 16G041-H clock and data regenerator. It's a three terminal (data in, clock and data out) device in a compact 1.25 inch x 1.25 inch flatpack package.

The 16G041-H synchronizes an internal VCO directly to an incoming data stream and simultaneously retimes and regenerates the data, unlike SAW filter clock recovery circuits which first filter the clock signal from incoming data and then retime it. Moreover, the 16G041-H

generates a clock output in the absence of incoming data. The SAW filter does not.

To find out more about our PLL clock and data recovery circuit as well as the other members of our complete high speed fiber optic communications chip family including 16x16 crosspoint switch, limiting amplifier, transimpedance amplifiers, laser diode driver, LED driver, MUX and DEMUX, call us today. United States and Canada: (805) 499-0610, FAX (805) 499-2751; Europe: GIGA, at +45 4343 1588, FAX +45 4343 5967.

GBL GigaBit Logic

CIRCLE 163 FOR MORE INFORMATION
CIRCLE 207 FOR REPRESENTATIVE CONTACT

NEW PRODUCTS

COMPUTER-AIDED ENGINEERING

SIMPLIFY AND SPEED UP AUTOCAD 386

Soft Engine/386 is a display-list software driver that's used with AutoCAD 386. The software increases displays speeds by up to 1000%. It adds an enhanced user interface that makes AutoCAD zooms and pans easier to execute

and avoids unnecessary regenerations. It also allows the user to choose between using this direct interface or using AutoCAD's own display commands. By running in the 80386 processor's protected mode, Soft Engine/386 takes full advantage of the 32-bit processor's power. AutoCAD's virtual-memory manager is effectively utilized

by Soft Engine/386 so that extended memory is maximized. System requirements include AutoCAD 386, an 80386SX- or higher-based system with math coprocessor, a minimum of 2 Mbytes of RAM (4 Mbytes recommended), a hard disk drive, DOS 3.3 or higher, and an EGA, VGA, or super VGA display. The software sells for \$295 and is available immediately.

Vibrant Graphics Ltd., 10622 Burnet Rd., Austin, TX 78758; (800) 937-1711 or (512) 832-1711. CIRCLE 686



Free Demo

You can start your debugging with this **FREE** demo simulator. You can load up to 512 bytes of code, assembler, C, or PL/M and do full debugging/simulation in assembly and source level. A great way to get started for **FREE**. Fantastic for schools! Just call and we'll send it!

Full Simulator

The full-blown simulator is an extension of the DEMO. You can load up to 64K of code and use 64K of XDATA space. You can program an "external environment" to interact with your code to simulate your target system. The emulator is the hardware extension of the simulator!

In-Circuit Emulation

The 24MHz real-time emulator has been the industry standard for years. With its complex breakpoint logic and advanced trace, nobody can beat it for performance. Plug-in or RS-232 configuration. All 8051 derivatives are supported!

NOHAU
CORPORATION

51 E. Campbell Avenue, Campbell, CA 95008
(408) 866-1820 • FAX (408) 378-7869

Australia (02) 654 1873, Austria (0222) 38 76 38, Benelux +31 1858-16133, Canada (514) 689-5889, Denmark (42) 65 11 11, Finland 90-452 1255, France (01)-69 41 28 01, Great Britain 0962-73 31 40, Israel (03) 48 48 32, Italy (011) 771 00 10, Korea (02) 784 784 1, New Zealand (09) 392-464, Portugal (01) 81 50 454, Sweden, Norway (040) 92 24 25, Singapore (065) 284-6077, Spain (93) 217 2340, Switzerland (01) 740 41 05, Taiwan (02) 7640215, Thailand (02) 281-9596, West Germany 08131-1687.

CIRCLE 135

AUTOROUTER PERFORMS SUBMICRON LAYOUTS

The newest release of the Omnicards design system from Task Technologies will layout analog and digital circuits to submicron resolution. Omnicards Release 4.2 incorporates many enhancements, including a 32-bit database that

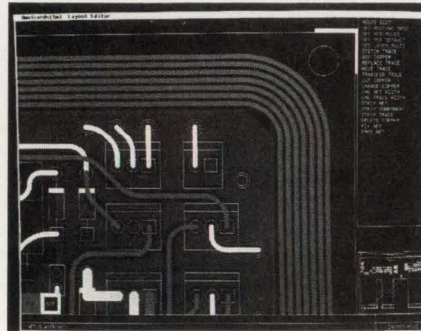

lets users work in metric units, english units, or both. An interactive autorouter quickly makes trace connections, and will also re-route component traces when components must be moved. For analog circuit design, the release adds curve-trace capabilities and automatic copper-area creation with auto-clearing and auto-fill. A trace-length odometer calculates the total trace length of a net as the user enters that trace. The automatic step-and-repeat feature lets users specify a cell, or several cells, to be copied to a user-designated location. The copied cells maintain proper electrical connectivity data for back annotation. The complete Omnicards design system includes a schematic editor, a 3000-part library, interactive placement and routing, and outputs for manufacturing. Omnicards 4.2 runs on HP/Apollo and Sun workstations, and is shipping now. A complete system costs \$24,000. The design software without the router costs \$12,000.

Task Technologies Inc., 6 North Main St., Suite 235, Fairport, NY 14450; (716) 377-1060. CIRCLE 687

TELECOM DC/DC CONVERTERS

VICOR PROVIDES THE POWER FOR TELECOM APPLICATIONS

Central Office



Customer Premises Equipment

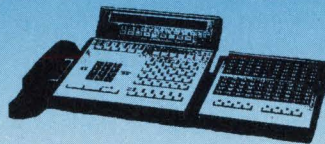

Remote Cell Site

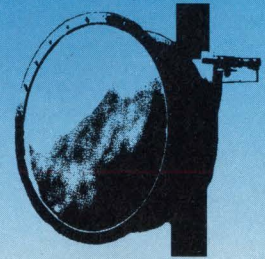

VI-J00

- ▶ 2.28" x 2.4" x 0.5"
- ▶ 25-100 Watts

VI-200

- ▶ 4.6" x 2.4" x 0.5"
- ▶ 50-200 Watts

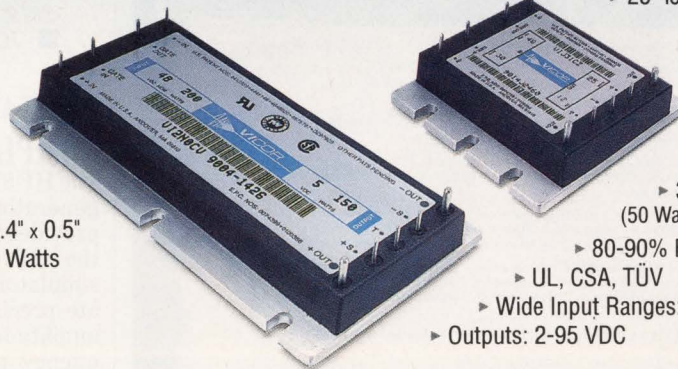

Family features

- ▶ 36 Watts/in³
(50 Watts/in³—SlimMod™ option)
- ▶ 80-90% Efficiency
- ▶ UL, CSA, TÜV
- ▶ Wide Input Ranges: 36 to 76 VDC
21 to 56 VDC
- ▶ Outputs: 2-95 VDC 18 to 36 VDC

From remote sites in Alaska and desert sites in Egypt to central offices in Oklahoma, agency approved Vicor converters have consistently demonstrated the ability to meet rigorous demands (Bellcore or British telecom) at competitive prices.

For immediate delivery of converters or for additional information call **VICOR EXPRESS** today at 1-800-735-6200

Component Solutions For Your Power System

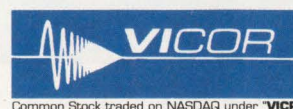

CIRCLE 192

Common Stock traded on NASDAQ under "VICR"

NEW PRODUCTS

INSTRUMENTS

WAVEFORM GENERATOR BOASTS 16-BIT RESOLUTION

With its 16-bit resolution and 2-MHz sampling rate, the model 2201A arbitrary waveform generator is well-suited to high-precision, low-frequency test ap-

plications. The unit comes with interactive waveform creation and editing software that doesn't require an external PC.

Each of the three phase-coherent outputs has 64 kwords of battery-



backed static RAM for waveform memory. In addition, users can store setup and waveform data on a 32-kbyte battery-backed static RAM card that plugs into the front panel. When the outputs are used independently, phase between them can be programmed with a resolution of 0.0055 deg.

The 2201A includes a pseudo-random noise generator with a 150-kHz bandwidth. Its output can be used separately or displayed on channel one. Operating modes include continuous, triggered, gated, toggled, burst, hold, step, and return-to-start. The unit produces standard sine, square, triangle, and ramp waveforms. Typical sinewave total harmonic distortion at 1 kHz is -86 dB. IEEE-488.2 and RS-232-C interfaces are standard.

A 2-line by 40-character backlit LCD screen displays the setup parameters, which can be entered or changed. The model 2201A costs \$9985 and is available immediately.

Pragmatic Instruments Inc., 7313 Carroll Rd., San Diego, CA 92121-2319; (619) 271-6770. **CIRCLE 688**

■ **JOHN NOVELLINO**

THE PERFECT STRATEGY FOR ANALOG & DIGITAL PCB DESIGN



- ☐ YOU want powerful, automated analog design features
- ☐ YOU use power planes
- ☐ YOU want lots of other automated features
- ☐ YOU want an affordable upgrade path
- ☐ And don't forget schematic capture...
- ☐ YOU want to find out more
- ☐ ULTIboard's new Version 4.1 let's you use curved or any angle traces. Also, you specify automatic fill patterns for copper areas of any shape. Polygons are assigned to nets while traces of other nets are automatically ploughed through filled areas.
- ☐ With ULTIboard, power and ground planes with thermal relief pads are created automatically.
- ☐ Real-time DRC, trace shove, reroute-while-move, round tracing and board outlines, .DXF output, automatic component renumbering, and more are standard in all ULTIboard systems.
- ☐ ULTIboard's got a smooth upgrade path with a system in every price range, running under DOS or extended memory. Choose a system to design a small board of 50 equivalent IC's, up to our 32-bit 386 version with unlimited design capabilities.
- ☐ ULTIcap schematic capture featuring automatic guided wiring, automatic junctions, auto rewire after block moves, and on-line symbol creation are just some of ULTIcap's easy-to-use automated features. Or, use your own schematic package with ULTIboard's backannotation.
- ☐ Call ULTIimate Technology today for a **free demo disk**, and the name of the dealer nearest you.

ULTIboard Professional 386 is a **true 32 bit** Design System; approx. 2x faster than 16 bit versions.

Model	Price	Nr. of 16 pins equiv. IC's	Memory required
Select your ULTIboard system from this table:			
Entry Level	\$ 995	35 - 50	640 K
Advanced Level	\$ 2,475	140 - 200	640 K + 1 Mb
Professional 286	\$ 5,950	unlimited	640 K + 2 Mb ¹
Professional 386	\$ 7,900	unlimited	640 K + 2 Mb ²

USA/Canada Headquarters
ULTIimate Technology Corp.
269 ML Hermon Road.
Suite 105
Scotts Valley, CA 95066
Tel. (+08) 439-8944
Fax (+08) 439-8966

UK/Ireland Sales Office
ULTIimate Technology (UK) Ltd.
2 Rachus House Calvea Park
Aldermaston
Berkshire RG7 4QW
Tel. (0734) 812030
Fax (0734) 815323

Germany Sales Office
ULTIimate Technology GmbH
Stangenstrasse 1
D-7022 L-Echterdingen 2
Tel. (0711) 796057
Fax (0711) 791939

Belgium Sales Office
ULTIimate Technology
Kardinaal Mercierplein 1
B 2800 Mechelen
Tel. (015) 401895
Fax (015) 401879

Europe Intl. Headquarters
ULTIimate Technology by
Energiestraat 36
4111 UT Nardien, Netherlands
Tel. (+31) 2159-44424
Fax (+31) 2159-43345
Telex: 73415

CIRCLE 208

PACKAGE GENERATES COMPLEX MODULATION

The HP 8791 Model 100 precision signal generator is a software package that provides an interactive work screen for the HP 8791 frequency-agile signal simulator. The package lets users create precise and complex signals with amplitude modulation (to 20 MHz), frequency modulation (to 20-MHz deviation), phase modulation (to 20-MHz rates), or with frequency-hop speeds of less than 250 ns. All modulations can be used simultaneously, along with other user-defined formats. The HP 8791 covers 10 MHz to 3 GHz with upconverters available to 40 GHz. The HP 8791 Model 100 costs \$6000 and is available 4 to 6 weeks after receipt of an order.

Hewlett-Packard Co., (800) 752-0900. **CIRCLE 689**

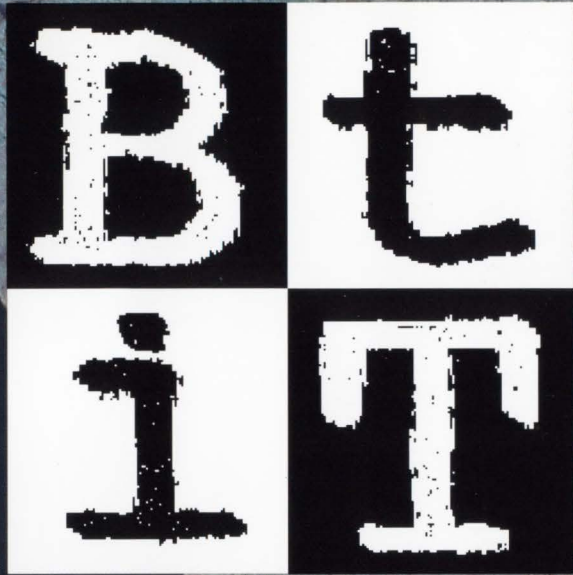

BROOKTREE'S

I M A G E

TECHNOLOGIES

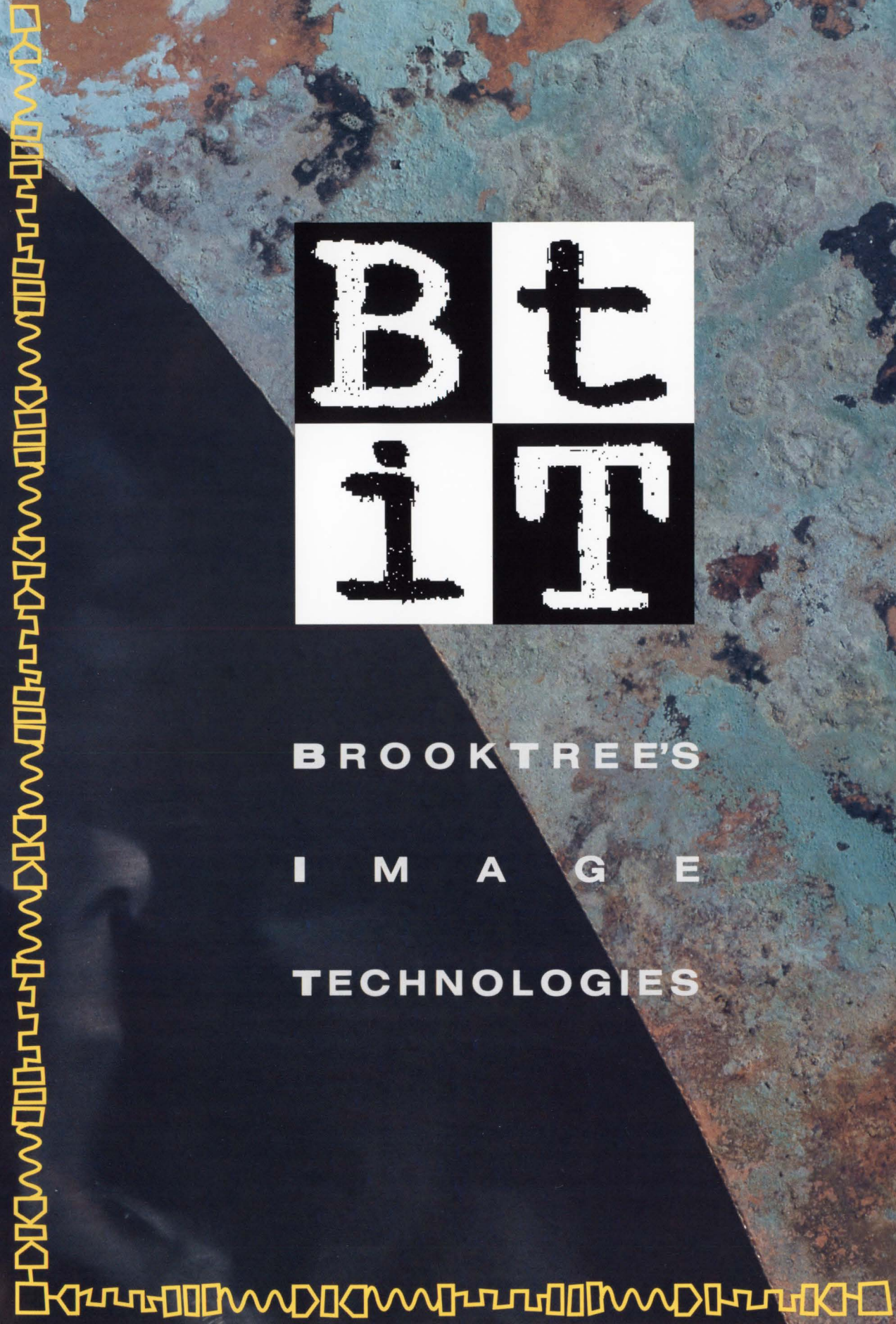



Capture it

Change it

Capture an image, manipulate it, transmit it, display it—and do it all with Brooktree's Image Technologies. They'll give your system a visual edge in competitive markets.

In fact, Image Technologies can be the key differentiator in today's look-a-like world. At Brooktree, we're dedicated to creating the highly integrated devices designers need to set their systems apart with exciting imaging and graphics capabilities.

IMAGE ACQUISITION

Image Acquisition starts with our Bt251 Gray-Scale or Bt253 Color Image Digitizer chips. They're the easy, economical way to add image capture to your system, with flexible architectures and standard MPU interfaces.

And they link up to our new Bt261 30 MHz Line Lock Controller. It will change the way you bring video images into your system. It's flexible and fully programmable.

Program it to strip horizontal and vertical sync information from any incoming video signal it encounters. Program its sync noise gating to cope with noisy signals and to enable locking to horizontal sync.

In fact, you won't find a more flexible solution to the timing control section of your design. Or a better way to assure your Image Acquisition system is programmed for success.

IMAGE MANIPULATION

Once you capture an image, change it.

That's easy with our Bt281 real-time Color Space Converter/Color Corrector chip. It's programmable and lets you convert from any color space to any other, including YIQ, YUV, RGB and Y, R-Y, B-Y, while capturing or displaying the image.

So now you can optimize the color space of your frame buffer for image processing independent of the video signal you're digitizing and the CRT's RGB needs. The Bt281 handles everything.

Since the Bt281 has programmable matrix coefficients and input look-up RAMs you can also use it for gamma correction, color correction or other image restoration techniques.

And if you think that's hot, you should see the Image Manipulation chips we'll be introducing this winter. Here's a hint: It will scale new heights.

IMAGE TRANSMISSION

How can you send your image from here to there? Digitally? In real time?

Enter two more pieces of Brooktree's Image Technologies story: The Bt291 and Bt294 VideoNet™ point-to-point Video Interfaces.

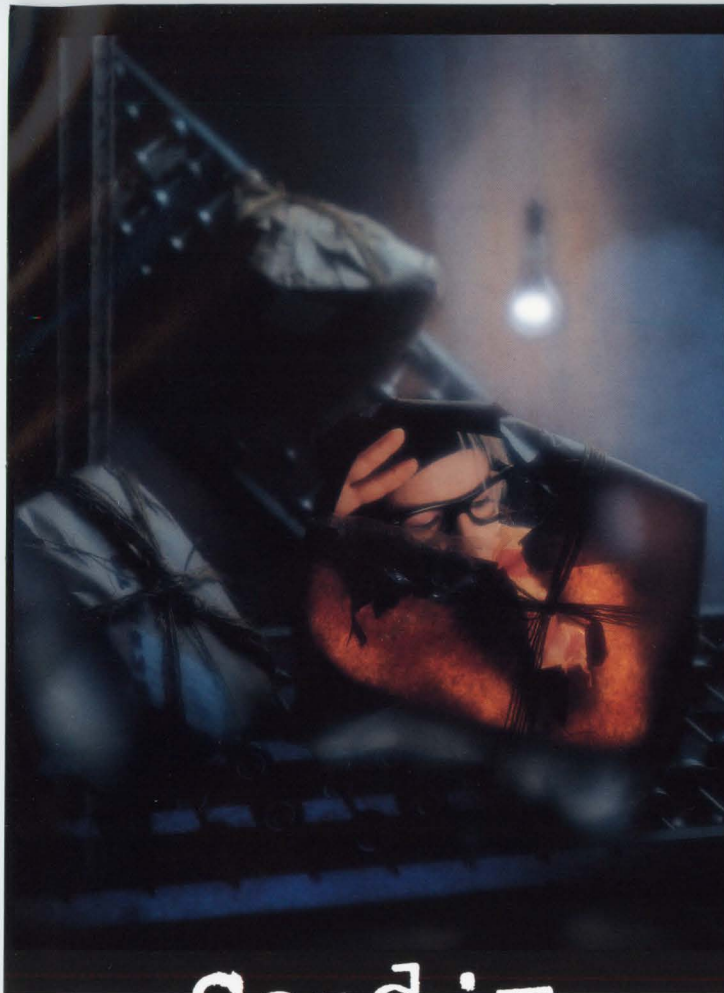

Send it

Display it

Simply put, the Bt291 and Bt294 let you ship and receive live color digital video using an 8-bit interface.

Which means you can replace about a square foot of board real estate with two highly integrated devices. And take the rest of the week off.

The two devices have, respectively, input or output look-up table RAMs to simplify the interface to the frame buffer and to add or remove gamma correction and scale signal levels.

So if you're working with CCIR601, SMPTE RP125, EBU 3246-E or other digital video standards, we've done our parts. You take it from here.

IMAGE PRESENTATION
When it comes to display technology, our true colors really shine. We invented RAMDACs. We understand the special needs of graphics systems designers. And we've never stopped innovating.

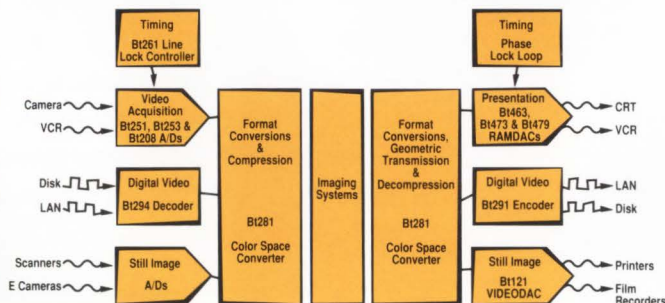

A perfect example is our Bt473, designed specifically for VGA true-color graphics. It has three 256x8 color look-up tables with 8-bit video D/A converters to support 24-bit true-color operation. And it can also support 8-bit pseudo-color, 8-bit true-color and 15-bit true-color operations. That makes it a perfect match for the Bt253 supporting the same formats.

Now our new TrueVu™ RAMDAC, the Bt463 is what's hot for designers of next-generation workstations eager to add windows capability, and delighted to do virtually everything with a single device. The Bt463 is the first monolithic true-color RAMDAC. That means it supports multiple

display modes—both True Color and Pseudo Color—simultaneously. And with multiple windows, you get multiple colormaps, avoiding conflicts. Bt463 supports multiple plane depth, too, so a window can be 24, 16, 12 or 8 planes deep. And for a little frosting on the cake, it's flexible and easy to design in.

Dive into Image Technologies with

Brooktree. We've got the growing family of

highly integrated chips you need to handle

graphics and imaging requirements in lead-

ing edge systems. Check these specs

to see how easy we make it to capture,

manipulate, transmit and display really neat

visual stuff. Or call 1-800-VIDEO IC for com-

plete product details.

Get With it

A C Q U I S I T I O N

Bt208: 8-Bit Flash A/D Converter, 18 MSPS, External Zero and Clamp Control, On-Chip Voltage Reference, Overflow Output, No Video Amplifier Required, 28-Pin PLCC or 24-Pin DIP Package.

Bt251: 8-Bit Single Channel Image Digitizer, 18 MSPS, 4:1 Multiplexed Video Inputs, 256X8 Look-up Table RAM, MPU Adjustable Gain and Offset, Sync Detection, No Video Amplifier Required, 44-Pin PLCC Package.

Bt253: 8-Bit Triple Channel Image Digitizer, 18 MSPS, 2:1 Multiplexed Video Inputs, Output Format Logic, MPU Adjustable Gain and Offset, Sync Detection, No Video Amplifier Required, 84-Pin PLCC Package.

Bt261: HSYNC Line Lock Controller, 30 MHz Pixel Clock Generation, MPU Programmable Video Timing, Programmable Noise Gating, Generate HSYNC, Recovers VSYNC and FIELD, External VCO or High Speed Crystal Oscillator Clock Generation, 28-Pin PLCC Package.

M A N I P U L A T I O N

Bt281: Color Space Converter, Three 256X8 Input Look-up Table, Programmable Matrix Coefficients, Optional Input Interpolation/Output Decimation, Standard MPU Interface, 36 MHz, 84-Pin Package.

T R A N S M I S S I O N

Bt291: RGB to CCIR 601/SMPTE RP125 Encoder, RGB Input Look-up Tables, RGB to YCrCb Conversion, Flexible Digital Filtering of YCrCb, 16-Bit YCrCb I/O Bus, Ancillary Input Port, Handles Video Timing Control, 100-Pin PLCC Package.

Bt294: YCrCb to CCIR 601/SMPTE RP125 Decoder, Handles Video Timing Recovery, Ancillary Output Port, Error Checking, 16-Bit YCrCb I/O Bus, YCrCb to RGB Output Look-up Tables, 100-Pin PLCC Package.

P R E S E N T A T I O N

Bt463: TrueVu RAMDAC, 4:1, 2:1 MUX's, Switch on a Pixel Basis Between True Color and Pseudo Color of Multiple Plane Depths with Multiple Colormaps, Two 8 Plane Overlay Cursors, Variable Palette Size, Reconfigurable Pixel Port, Advanced Diagnostics including JTAG Port, 170, 135 and 110 MHz Operation, 169-Pin PGA.

Bt473: True-Color RAMDAC VGA Compatible, Compatible with Bt253 Output Formats—24-Bit, 15-Bit and 8-Bit True-Color, 6/8-Bit Pseudo-Color, Programmable Setup (0 or 7.5 IRE), Internal/External Voltage Reference, RS-343A/RS-170 Compatible Outputs, 80, 66, 50 and 35 MHz Operation, 68-Pin PLCC Package.

Brooktree Corporation
9950 Barnes Canyon Rd.
San Diego, CA 92121
1-800-VIDEO IC. FAX 1-619-452-7294

Brooktree®

FIR FILTERS AND DIRECT DIGITAL SYNTHESIZERS TACKLE TOUGH APPLICATIONS

DAVE BURSKY

Aimed at demanding applications such as digital receivers for sonar, radar and electronic warfare, as well as secure communications systems, digital filter chips and an amplitude-and-phase-modulator chip operate at sampling rates of up to 20 MHz. The Plessey PDSP16256 is a programmable, variable-length finite-impulse-response filter that packs 16 16-by-12-bit multiplier-accumulators on a single chip. By multicycling the chip, from 16 to 128 stages of digital filtering can be created (with sample rates of 20 MHz, a 16-stage filter is possible at 2.5 MHz, 128 stages of filtering can be done). The other chip, the PDSP16350, is a direct digital synthesizer. It's the first chip to include an on-chip I/Q splitter to obtain the in-phase and quadrature components of an analog waveform.

The FIR filter chip accepts 16-bit data and coefficient values and accumulates results with 32-bit resolution. The chips, which come in 144-lead pin-grid array packages, can be cascaded to form filters of any length, limited only by the degradation caused by accumulator overflow. Intermediate 32-bit results are passed between devices without any intermediate scaling to minimize any deterioration of the precision. Two configuration modes are possible: the chip can be set up as one long filter or as two separate filters, with half the number of taps in each. Both organizations can have independent inputs and outputs. A decimate-by-2 mode is also available. It permits the chip to apparently double the number of filter stages at a given sample rate, but at an output rate that's one-half the input rate.

Filter coefficients can be stored in an off-chip byte-wide EPROM or down-loaded from a host system. If stored in the EPROM, an auto-boot loader in the filter chip can automatically transfer up to 128 coefficients from the EPROM to the filter chip's coefficient memory.

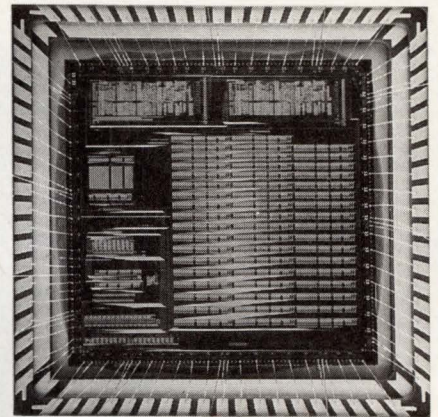
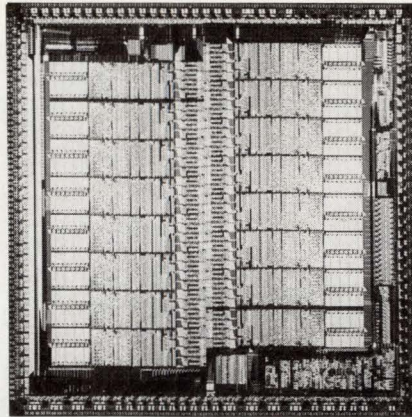

To support algorithm development, a behavioral model of the chip is available as part of the Signal Processing Worksystem from Comdisco Inc., Foster City, CA. Plessey offers a PC-AT hosted custom-filter-design-and-coefficient-optimization package at no charge to customers.

Providing the first integrated solution to obtain accurate, digitized, sine and cosine waveforms, the PDSP16350 produces both simultaneously with 16-bit-amplitude accuracy. The signals are synthesized with a 34-bit phase accumulator, with the most-significant bits (the upper 16-bits) providing the 16 bits of phase accuracy required for the sine and cosine lookup tables. Some typical applications for the chip include numerically controlled oscillators, quadrature signal generators, am/fm or pm modulators and constellation generators.

When driven with a 20-MHz clock, the circuit can synthesize waveforms that have 10-MHz maximum frequencies with 0.001-Hz resolution. If frequency modulation is required with no discontinuities, the phase-increment value can be changed linearly on every clock cycle. Furthermore, absolute phase jumps can be made to any phase value. Dual output multipliers on the chip allow the sine and cosine waveforms to be amplitude-modulated with a 16-bit value presented at the input port. That 16-bit value can also

be used by the on-chip cordic processor to generate the in-phase and quadrature components from an incoming signal. An 84-lead PGA package houses the splitter.

Additionally, an AT-compatible card developed by ERA Technology contains both the PDSP 16256 and 16350 as well as either a 12-bit, 1-MHz ADC or an 8-bit 20-MHz DAC. Plessey expects to offer the board, but its price has not yet been set.

In addition to the two application-focused DSP chips, Plessey has also developed an upgraded version of its PDSP16116 complex multiplier. The new version, the 16116A, is still housed in a 144-lead PGA but runs at double the speed—20-MHz. The chip can multiply two complex 16-bit words every 50 ns and deliver the complete 32- + 32-bit result every cycle. On the chip are four 16-by-16-bit multipliers, two 32-bit adder-subtractors, and control logic.

All chips are fabricated in CMOS and consume about 1.5, 2, and 0.5 W, respectively, for the 16256, 16350, and 16116A. The price for either the 16256 or 16350 is the same—\$395 in lots of 1000, and delivery of either is from stock. The industrial-temperature grade 16116A complex multiplier sells for \$439.36 in 100-unit lots and is also available from stock.

Plessey Semiconductors Corp., 1500 Green Hills Rd., Scotts Valley, CA 95066; Steve Brightfield, (408) 438-2900.

CIRCLE 684

Can your Bipolar do this?

Can your IGBT do this?

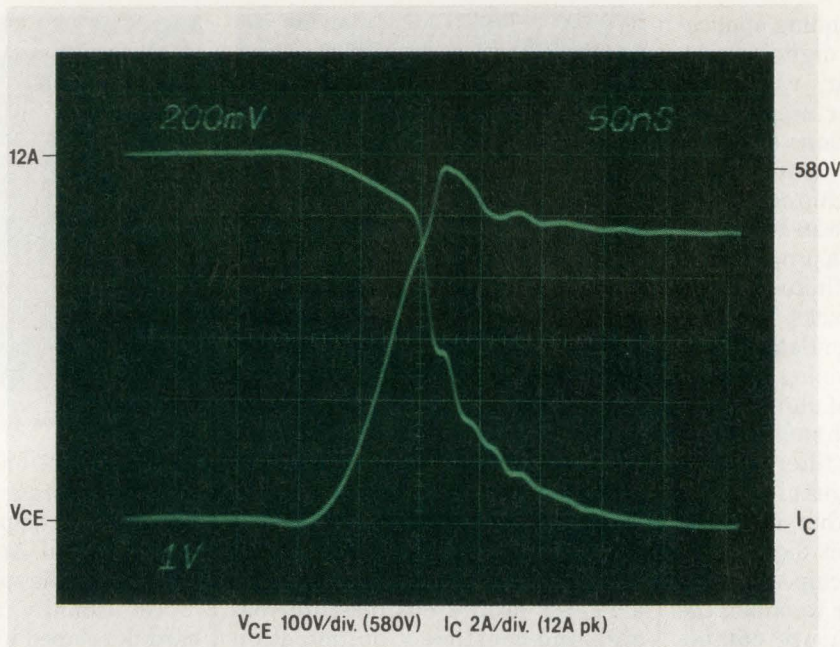

Turn-off characteristics of a single-ended forward converter with 300Vdc input. International Rectifier's IRGBC30U switches 12A at 50 kHz. Easily. (Actual unretouched photo.)

We didn't think so.

Introducing the UltraFast IGBT.
A quantum leap in power transistors!

...only from

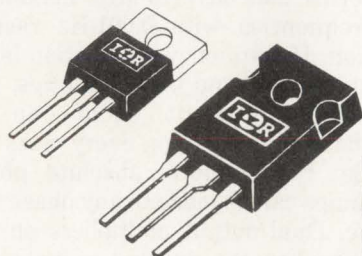

**International
IR Rectifier**

Electronic Products Division

WORLD HEADQUARTERS: 233 KANSAS ST., EL SEGUNDO, CA 90245, U.S.A. (213) 772-2000, FAX (213) 772-9028
EUROPEAN HEADQUARTERS: HURST GREEN, OXTED, SURREY, RH8 9BB, ENGLAND, TELEPHONE (0883) 713215, FAX (0883) 714234

ENHANCED RISC PROCESSOR PACKS FLOATING-POINT UNIT AND GRAPHICS COMMANDS

DAVE BURSKY

With a high percentage of applications for its Am29000 RISC processor family in graphics-related subsystems, Advanced Micro Devices has developed an enhanced member of the family optimized for such compute-intensive requirements. Having a single-precision floating-point math unit on the same chip as the CPU allows the Am29050 to deliver three to four times the floating-point throughput of the previous 29000-family processors. And improvements in the integer unit boost the throughput of the integer portion of the processor by 20% over the standard 29000 RISC processor.

The 29050 delivers a sustained throughput of up to 32 MIPS and 36 MFLOPS (80 MFLOPS peak) when running at 40 MHz. In comparison, the original 29000 was rated at just 17 MIPS. Yet the 29050 still maintains pin- and code-compatibility with AMD's original 29000 processor family.

Basic improvements include a reduction of the average load latency and branch latency, and a simplification of the debug capabilities so that supervisor or user code can be debugged by hardware or software tools. Special hardware was added to permit the data load address to be issued early, thereby shortening about half of all load operations by one clock cycle. A larger branch target cache that can be configured as either a 64-entry by 4-word-deep or 128-entry by 2-word-deep array reduces the branching delay. Furthermore, to aid in imaging applications, the thrashing done by the memory-management unit on large libraries and data arrays has been reduced. Additionally, the integer multiplication time has been reduced. To reduce the thrashing, two new mapping registers augment the translation look-aside buffer to ease the processor's access to large data structures.



On-chip hardware on the 29050 speeds up 2- and 3-D window clipping and orthogonal rotations. The on-chip floating-point unit can execute single- or double-precision calculations with minimal latency. A single-precision computation requires 3 to 4 cycles. Operations can be transparently pipelined such that a new single-precision operation can be issued every cycle. The floating-point section fully supports the IEEE floating-point standard, including gradual underflow, rounding, and exception handling.

Floating-point operations possible by the new block include addition, subtraction, multiplication, division, comparisons, conversions, classifications, multiplication-accumulation, multiplication-summation, and square-root. Integer multiplications (32-bit) can also be done in the floating-point unit with a three-cycle latency before a 64-bit result is delivered.

Because the 29050 is pin-compatible with the 29000, almost all already-available development tools can be used for software and hardware development. These include the EB29K, a PC-AT add-in card containing the 25-MHz Am29000 and socket for the 29027 floating-point unit, Native C-compiler toolkit, HighC29K that runs on the EB29K to remove the 640-kbyte memory constraint of the PC, and assembly code monitor and debug software.

AMD has also created a developer's support organization called Fu-

sion29K, which works with software and hardware developers to help define software standards, facilitate the development of high-quality tools and products, and disseminate information. Several standards already defined include a common object-file format for code portability across different development tools, a host interface for simple operating-system services, and a universal debugger interface to allow different debuggers to work with many target systems.

Supporting the 29050, JMI Software Consultants, Inc., Spring House, Penn., has enhanced and qualified its C Executive operating systems for the new processor. The software provides a real-time multi-tasking operating system for embedded control applications. Optional additions to the new version of the C Executive include CE-DOSFILE, a file system that replicates the DOS 8086 file structure on external media, and CE-View, a system debugger.

Samples of the Am29050 will be housed in 169-lead ceramic pin-grid-array packages. The 20-MHz version sells for \$255 in 1000-unit quantities; the 40-MHz version for \$410 in similar quantities. Intermediate 25- and 33-MHz grades will also be available. Samples will be available in the mid fourth quarter.

Advanced Micro Devices Inc., 5204 E. Ben White Blvd., Austin, TX 78741; Subodh Toprani, (512) 385-8542.

CIRCLE 685

EMPLOYMENT OPPORTUNITIES

RELIABILITY ENGINEER

MKS is the leading manufacturer of electronic instrumentation used to measure and control vacuum, pressure and the flow of gases. Our products are sold throughout the world to control processes in a variety of marketplaces including the petrochemical and food processing industry, the R&D community and the semiconductor market.

We currently have an opening in our Andover headquarters for a Reliability Engineer. This individual will be responsible for formalizing and maintaining an in-depth reliability system at MKS. This will include reliability analysis from the design stage throughout the manufacturing process. This position requires a BSEE, a minimum of 5 years in reliability/quality experience, and familiarity with Mil-Std-217. This individual must possess excellent written and oral communication skills, be able to easily interface with both Engineering and Manufacturing disciplines, and possess the ability to work under limited supervision.

The above position offers competitive starting salary and excellent benefits including profit sharing, 401K, tuition reimbursement and dental insurance. Interested applicants should send their resume with salary requirements to MKS Instruments, Inc., 6 Shattuck Road, Andover, MA 01810, Attn: Jean Flanagan.



An Equal Opportunity Employer M/F

HOW TO PLACE YOUR AD



**CALL THE RECRUITMENT HOT LINE
216-696-7000
X 2520**

80387-COMPATIBLE COPROCESSOR PUMPS OUT FIVE TIMES THE PERFORMANCE

Delivering up to five times the application performance of the Intel 80387 coprocessor, the FasMath EMC87 math processor from Cyrix Corp., works with all 80386/387 programs without modification and guarantees fully-compatible numeric results. The chip fits in the standard 121-pin extended math coprocessor (EMC) socket found in most 386-based PCs.

Applications written to maximize the potential of the EMC87 are simplified using various programming and application tools serving the CAD market. These include Intusoft's Spice and Evolution Computing's FastCAD 3D.

The performance improvements result from implementing its floating-point primitive operations in hardware and by using proprietary algorithms for computing math functions. This lets the chip perform floating-point operations in fewer clock cycles than traditional coprocessors.

The processor implements a full extended double-precision IEEE-754-1985 architecture with parallel adder, multiplier, and exponent units. Also, the EMC87 automatically selects one of the two interface modes in response to the instruction being executed. The EMC87 either emulates 80387 style execution, or, for maximum speed, executes in EMC mode using its parallel command-data interface. The chip's 1.0- μ m gate length, double-layer metal process permit clock rates of 20, 25, and 33 MHz. Electrostatic-discharge protection and latch-up-prevention circuits are built into the chip's 121-pin grid-

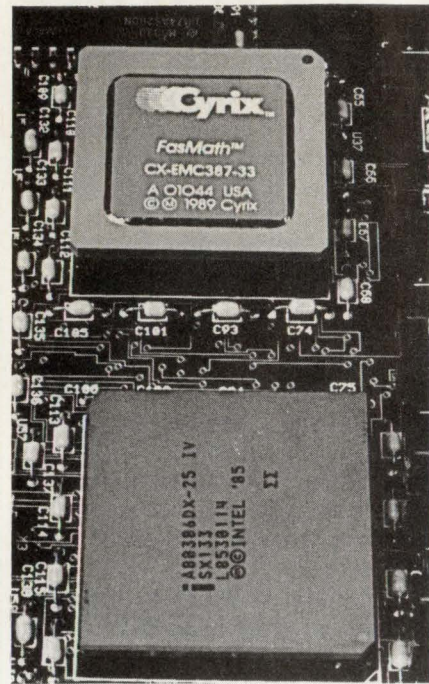

ray package.

Prices for 20-, 25-, and 33-MHz parts are \$774, \$865, and \$994, respectively, and all are available now. The prices include a reference and installation manual and a utility disk containing test programs, demos, and utilities for the programmer to assist in tuning applications using the advanced parallel command-data interface.

Cyrix Corp., 1850 N. Greenville 184, Richardson, TX 75081; (214) 234-8387. CIRCLE 695

■ RICHARD NASS

CMOS PLDS RUN AT 80 MHZ, CONSUME LITTLE

Designed to balance the demands of two contradictory specifications—low power and high speed—the 85C224 and 85C060 programmable logic devices can operate at clock frequencies as high as 80- and 66-MHz, respectively. In addition, they consume only one quarter the power of their closest bipolar counterparts.

The 85C224 is a 24-pin PLD with t_{pd} 's of 10 ns, maximum. It has eight programmable macrocells and up to 22 inputs (14 dedicated and 8 programmable as inputs or outputs). When running at 25 MHz, the chip consumes 35 mA from its 5-V supply.

The 85C060 is a pin-compatible upgrade of Intel's previously available 24-pin 5C060, which was an alternate source to the EP600 from Altera Corp. The new chip has t_{pd} 's of 12 ns, maximum, 16 I/O macrocells, and draws a supply current of 80 mA when running at 66 MHz.

Both the 85C224 and 85C060 PLDs are fabricated with a CMOS process and come in either reprogrammable windowed CerDIP or one-time programmable plastic packages. In quantities of 1000, the plastic-DIP versions of the 85C224 and 85C060 sell for \$9.65 and \$13.65, respectively.

Intel Corp., 3065 Bowers Ave., P.O. Box 58065, Santa Clara, CA 95052-8065; (408) 987-8080. CIRCLE 696

PLUG-IN MASTERY

THE ONLY ANALYZER TO HOLD 5 INTERFACE UNITS AT ONCE

Data communications applications and traffic grow faster every year, spurred on by the increased availability of multimedia networks. Managing this diversity requires the versatility of Anritsu's new Data Transmission Analyzer MD6420A—the only one on the market that can hold up to 5 different plug-in interface or extension units at the same time.

But that's not all. There's no more worry about losing valuable online data and time when a power failure occurs, because the MD6420A saves test data in battery-protected memory. It also measures clock slips, for greater accuracy in any location. A new option even displays the histogram data automatically, freeing you from time-consuming graph plotting.

The MD6420A naturally conforms to the new CCITT G821, and offers an extensive variety of plug-in units to handle all types of interfaces, including digital lines from 50bps to 10Mbps. The printer is built in, and remote control via GPIB or serial interface is possible.

Plug into the new Anritsu MD6420A, where the best performance is backstage.

DATA TRANSMISSION ANALYZER MD6420A

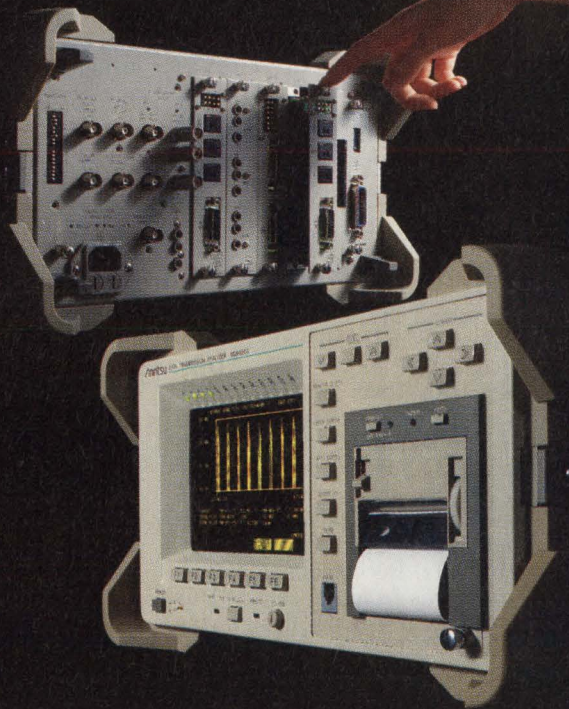

Anritsu

ANRITSU CORPORATION 10-27, Minamiazabu 5-chome, Minato-ku, Tokyo 106, Japan Tel. 03-446-1111
U.S.A. ANRITSU AMERICA, INC. 15 Thornton Road, Oakland, N.J. 07436 Tel. 201-337-1111 Sales & Service 1-800-255-7234
U.K. ANRITSU EUROPE LIMITED Capability Green, Luton, Bedfordshire LU1 3LU Tel. (STD0582) 418853
F.R. Germany ANRITSU ELEKTRONIK GmbH Grafenberger Allee 54-56, 4000 Düsseldorf 1 Tel. 0211-679760
Italy ANRITSU ITALIA S.p.A. Centro Direzionale Colleoni, Via Paracelso N.14, 20041 Agrate Brianza (MI) Italy Tel. 039-639411
Brazil ANRITSU ELETRONICA S.A. Av. Passos, 91-Sobrelas 203/205-Centro, 20051-Rio de Janeiro-RJ Tel. 021-221-6086

• **Argentina** IGTA S.A. Tel. 432-8459 • **Australia** STANDARD TELEPHONES AND CABLES PTY. LTD. Tel. 03-615-6677 • **Austria** WIEN SCHALL GmbH Tel. 01-81155140 • **Belgium** C.N. ROOD S.A. Tel. 02-4668199 • **Bulgaria** ELSINCO GmbH Tel. 222-871751 • **Canada** ATECO INC. Tel. 416-479-8590 • **Chile** PARKER Y CIA. Tel. 231-9976 • **Colombia** RADIOCOM S.A. Tel. 218-2054/218-4606 • **Costa Rica** ELECTRONIC ENGINEERING S.A. Tel. 250394, 258793 • **Cyprus** CHRIS RADIOVISION LTD. Tel. 02-466121 • **Czechoslovakia** ELSINCO GmbH Tel. 222-871751 • **Denmark** INSTRUTEK A/S Tel. 05-611100 • **Egypt** GIZA SYSTEMS ENGINEERING CO. Tel. 3490140 • **Finland** INTO OY Tel. 0-755 7711 • **France** SALIES S.A. Tel. 1-69.20.40.10 • **Greece** KOSTAS KARAYANNIS Tel. 3230303, 3237731 • **Guatemala** ELECTRONICA OSRO Tel. 314966, 61552 • **Hong Kong** SCHMIDT & CO., (H.K.) LTD. Tel. 5-8330222 • **Hungary** ELSINCO GmbH Tel. 222-871751 • **Iceland** GEORG AMUNDASON & CO. Tel. 687820, 681180 • **India** PHOTOPHONE LTD. Tel. 582493, 582498 • **Indonesia** PT. SUBUR SAKTI PUTERA Tel. 359163 • **Korea** HAN-IL COMMERCE & COMPANY Tel. 783-6391 ~5 UTO TRADING COMPANY Tel. 765-180001 • **Malaysia** RANK O'CONNOR'S (M) SDN. BHD. Tel. 7566599 • **Mexico** ELECTRONICA 2000 S.A. DE CV. Tel. 548-5049/548-0630 • **Netherlands** C.N. ROOD BV. Tel. 070-996360 • **New Zealand** WM SCOLLAY & CO. LTD. Tel. 4-722-961 • **Norway** TELEINSTRUMENT AS Tel. 02-901190 • **Pakistan** ASSOCIATED ELECTRIC TRADING CORP. Tel. 042-563516/6635 • **Papua New Guinea** STANDARD TELEPHONES AND CABLES PTY. LTD. Tel. 2569333 • **Peru** ESTEMAC PERUANA S.A. Tel. 45-5530 • **Poland** ELSINCO GmbH Tel. 222-871751 • **Portugal** OMNITECNICA Tel. 905517, 905617 • **Saudi Arabia** ELECTRONIC EQUIPMENT MARKETING CO. Tel. 477650 • **Singapore** RANK O'CONNOR'S (PTE) LTD. Tel. 473-7944 • **Spain** UNITRONICS, S.A. Tel. 2425204, 4480162 • **Sri Lanka** INFOTECHS LTD. Tel. 580088, 500817 • **Sweden** TELEINSTRUMENT AB Tel. 08-380370 • **Switzerland** GMP S.A. Tel. 021-6348181 • **Taiwan** CHA WEI ELECTRIC TRADING CO., LTD. Tel. 522-1295 • **Thailand** P&P TELECOM CO., LTD. Tel. 2712397, 2710057 • **Turkey** burc ELECTRONICS AND MACHINERY INDUSTRY AND TRADE CORP. Tel. (4) 1250300, 1250302, 1259044 • **Uruguay** GTE TELECOMUNICATIONS INC. Tel. 91-1289/98-3788 • **Yugoslavia** ELSINCO GmbH Tel. 222-871751

IC SAMPLE-AND-HOLD AMPLIFIER GRABS SIGNALS AT 100 MHz

As computers have upped their ability to perform real-time processing on faster signals, the demand for fast—yet accurate—ADCs to provide their digital data has likewise grown. And the ADCs in turn demand fast and accurate sampling amplifiers of reasonable cost, size and power. To meet that latter demand, Acculin has developed the AL1210 monolithic sampling amplifier. It grabs 2-V pk-pk waveforms, to within 1, 0.1 and 0.01% accuracy, in just 8, 9 and 14 ns maximum, respectively.

While completely specified for classic data-acquisition-type applications (nonlinearity error over temperature is a maximum of 0.03%), dynamic performance, which is more important for many of today's applications such as driving flash ADCs, is also well specified. For example, sampling a 2-V pk-pk 43.75-MHz sine wave at 100 MHz results in total harmonic distortion (THD)

of -61 dB (typical) and maximum THD over temperature of -55 dB (between 8 and 9 bits). Sampling an 18.75-MHz sine wave at 50 MHz provides a typical THD of -70 dB (about 11 bits). Similarly, maximum THD over temperature runs -64dB (about 10 bits).

The chip also lends itself well to undersampling applications (sampling frequencies greater than Nyquist, or more than half the sampling rate) as its 3-dB full-power bandwidth at the on-chip hold-capacitor is a minimum of 270 MHz (over temperature), and aperture jitter similarly is just 2 ps rms. The amplifier comes in a 16-pin narrow-body plastic SOIC and draws just 40 mA from ± 5 -V rails. In quantities of 100, the AL1210 goes for \$95 each, a price that's significantly less than that for large, power-hungry hybrids.

Acculin Inc. Suite 204, 214 N. Main St. Natick, MA 01760; Barry Hilton (508) 650-1012. **CIRCLE 711**

■ FRANK GOODENOUGH

IC OP AMPS SETTLE TO 14-BIT SPEC IN 32 NS

The CLC402 and CLC502 current-feedback op amps from Comlinear are basically designed to drive flash ADCs. However, with their minimum full-power (5-V pk-pk output) 3-dB bandwidth of 50 MHz, and guaranteed settling times to 14-bits (0.0025%) for a 2-V step of 32 ns, they're useful with virtually any wideband precision analog signal. Bandwidth (3-dB) for a 0.5-V output is 120 MHz. Recommended closed-loop gain ranges from ± 1 to ± 8 . Due to their current-feedback design, the CLC402 and CLC502 IC op amps feature ac performance that's virtually identical—regardless of gain. All of these specifications are over temperature and while driving a load of 250 Ω . The CLC502 op amp is similar to the CLC402 op amp except that the user can externally set the value of internal positive and negative clamp voltages that limit the output voltage when driving a flash ADC. Most such ADCs have well-defined safe, maximum and minimum, input voltages. The CLC402 AND CLC502 op amps are available in 8-pin DIPs and SOICs. In hundreds, prices start at \$9.56 for the 402, and \$10.45 for its cohort.

Comlinear Corp. 4800 Wheaton Dr. Fort Collins CO., Wayne Lownowski (303) 226-0500. **CIRCLE 712**

SYNTHESISE 1 HZ TO 500-MHz WAVEFORMS

A direct digital-to-analog waveform synthesiser from Plessey Semiconductors, the SP2002, generates square, triangle and sine waves, both in-phase and quadrature, from 1 Hz to over 400 MHz, with 1-Hz resolution. The device's square-wave outputs are from logic gates, and sine and triangle outputs from a pair of 8-bit digital-to-analog converters. The inputs are 32-bit parallel digital words to set the frequency, and a clock which can be as great as 1.6 GHz. The high clock rate permits switching between frequencies in just 10 ns, about 1000 times faster than the phase-locked loops commonly used. Applications range from commercial, multi-function radio (VHF, FM, AM, SSB and OPSK) as well as cellular-radio and satellite data links to military communications, radar and countermeasures systems.

The quadruple outputs are ideal for carrier recovery loops in MPSK modems while the fine frequency resolution and fast switching lend it to frequency-hopping (spread-spectrum) systems. The SP2002 comes in a 68-pin grid array and goes for a mere \$1,400 each in hundreds.

Plessey Semiconductors Corp., 1500 Green Hills Rd., Scotts Valley, CA; Ashi Majid (408) 438-2900. **CIRCLE 713**

PRECISION DUAL OP AMP RUNS OFF BATTERIES

Needing just 500 μ A per amplifier, a dual precision op amp from Burr-Brown aims at portable/remote industrial and medical applications which must run off batteries or other limited power sources. However, with a minimum open-loop gain over temperature of 120 dB and a maximum offset voltage of 350 μ V, under similar conditions, the OPA1013 gives up nothing in performance. Moreover, with its pnp input transistors, its common-mode voltage includes ground. The op amp is completely specified operating from ± 15 -V rails and a single 5-V supply. It can put 12 V across 2000 Ω and 3.3 V across 600 Ω (with a single 5-V supply). From 0.1 to 10 Hz, 1/f noise typically runs 0.55 μ V pk-pk. While basically for dc applications, slew rate is a minimum of 0.2 V/ μ s. In its 8-pin DIP or TO-99 metal can, it goes for \$2.30 each in 100s.

Burr-Brown Corp., P.O. Box, 11400, Tucson, AZ 85734; John Conlon (800) 548-6132. **CIRCLE 714**

ISOLATION AMP WORKS FROM -55° TO +125°C



The AD203SN is one of the first isolation amplifiers to be tested and specified over the full military temperature range of -55° to +125°C. It can tolerate up to 1500 V rms of common mode voltage. Full power bandwidth is 10 kHz, accommodating high-frequency signals from ac-excited bridge transducers. The amplifier has low 0.012% (0.025% maximum) nonlinearity. Maximum offset voltage is $\pm(5 + 25/G)$ mV ($G = \text{gain}$), and typical offset voltage drift is $\pm(6 + 100/G)$ μ V/°C. Typical gain temperature coefficient averages 50 ppm/°C over the full temperature range. The AD203SN is housed in a plastic 2.23-by-0.83-by-0.6-in. DIP. It costs \$58 in lots of 100 units and is delivered from stock.

Analog Devices Inc., One Technology Way, P.O. Box 9106, Norwood, MA 02062; (617) 461-4065.

CIRCLE 715

First the TQ and now . . .



the T-Series.

Only from Aromat!

NEW! TN Relay
Vertical TQ...
the Ultimate Space Saver.

Again, Aromat breaks through in technology, with new relays that are ideal extensions of the TQ, for a wider variety of demanding applications.

First, the TQ2, introduced in 1986 as "the world's smallest polarized relays."

Second, the TQ-4, a 4-pole version of the TQ, ideal for special applications and critical board layouts.

Third, the TF, the highly sensitive version of the TQ, offering 80mW nominal power consumption, direct drive possible by TTL or CMOS logic, available for use with 48V coil.

Fourth, the TF-SMD, a surface mount configuration of the TF, with all the features plus surface mount capability.

CIRCLE 139 CALL ME I'M INTERESTED
CIRCLE 140 SEND LITERATURE

Micro-Balance Armature Design, the secret behind the T-Series.

- Excellent in vibration/shock resistance
Destructive shock — 100G
Destructive vibration — 30G
- Capable of high density board mounting without affecting the adjacent relays' operating characteristics.
- High speed performance is due to the low mass and small size of the moving components
Operate Time: 2mSec
Release Time: 1mSec
- Special hinge construction of the Armature block reduces friction. Consistent movement offers minimal variation in operating characteristics.

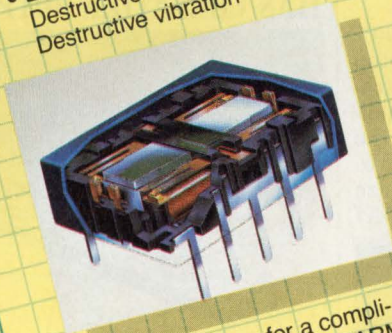

Call or write today for a complimentary copy of the 1987 NARM's Charles Schneider Best Paper Award (1st Place Prize) on the TQ relay's micro-balanced armature design.



Advanced switching technology.

For further information, contact your nearest Aromat sales office:

Marlboro, MA
Tel: (508) 481-1995

Orlando, FL
Tel: (407) 855-1075

Elk Grove Village, IL
Tel: (708) 593-8535

Richardson, TX
Tel: (214) 235-0415

San Jose, CA
Tel: (408) 433-0466



Aromat
Member of Matsushita Group

Garden Grove, CA
Tel: (714) 895-7707

Aromat Canada Inc.
Mississauga, Ontario
Tel: (416) 624-3777

POWER LOW-DROP-OUT REGULATOR SOURCES 125 MA AT 4.5 TO 36 V

Not only can Linear Technology's LT1120 regulate up to 125 mA while operating with just 0.65 V across it (its drop-out voltage) but it also has a free-collector on the same chip that you can put feedback around and compensate, and so use as an op amp. The comparator's output handles 10 mA and the regulator's 2.5 V band-gap reference output can source and sink 2 mA. The latter feature lets it be used as a supply-splitter. One additional chip-input pin of the miniDIP lets a 5 V, logic-high turn off the regulator, for example to save battery power. Used to monitor the regulator's 4.5 to 36 V source, the comparator can turn the chip off if the input voltage gets too high or too low.

Drop-out voltage ranges from 0.65 V (maximum) while passing 125 mA to 50 mV while regulating 100 μ A. Likewise, the current needed to run the IC ranges from 100 μ A to 20 mA. Line and load regulation run maximums of 0.05%/V and 0.5% respectively over an input voltage range of 6 to 36 V and an out-

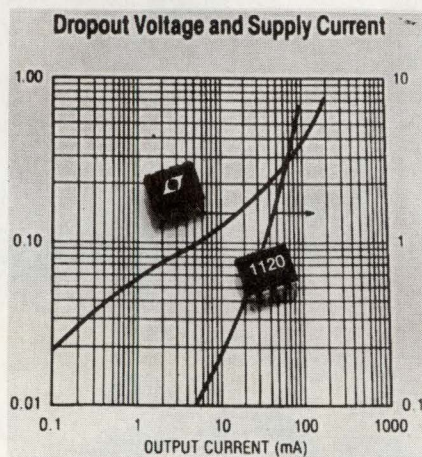

put current of 100 μ A to 125 mA. The LT1120 comes in 8-pin plastic DIPs and TO-5 cans. In quantities of 100, the former go for \$2.40 each.

Linear Technology Corp., 1630 McCarthy Blvd., Milpitas, CA 95035-7487; Bob Scott, (408) 432-1900.

CIRCLE 701

FRANK GOODENOUGH

BATTERIES FOR LAPTOPS BOOST HIGH CAPACITY

Run times of as much as 50% to 70% higher for cellular phones and laptop computers are promised by the Ultramax line of rechargeable nickel-cadmium batteries. Four of the cells in the line (AA, Cs, CsC, and C) are claimed to have the highest capacity for their size in the world, while two others (4/5A/



and D) match the highest capacities now offered. All cells, when used with proper charge-termination techniques, can accept three-to-five-hour and one-hour fast charging. Production quantities of all sizes will ship by the second quarter of 1991. Samples are available now. Call for pricing.

Gates Energy Products Inc., P.O. Box 861, Gainesville, FL 32602; (904) 462-3911. CIRCLE 702

FIVE-OUTPUT SWITCHER HAS VERSATILE OUTPUT

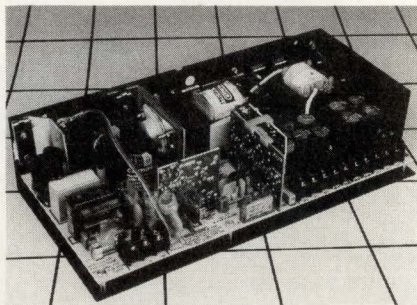

Measuring just 10.5-in. long, the SA200 switching-power-supply series offers users five outputs in a 200-W package. The supply lets users internally connect two outputs in either series or parallel to create new voltage or current levels. Other standard features include built-in filtering, international safety approvals, dual input-voltage selection, and overload protection. The five outputs are between +5 V and +24 V with the main output being 5 V at 20 A with 2% line and load regulation. The supply costs \$207 in lots of 100. Delivery is from stock to eight weeks.

Astec America Inc., 401 Jones Rd., Oceanside, CA 92054-1216; (619) 439-4280. CIRCLE 703

DESIGN YOUR OWN SWITCHED-CAP FILTER IC

A metal-mask programmable array allows designers to develop their own 12-pole, switched capacitor filter (SCF) ICs in a 16-pin DIP. The LMF120 lends itself to many applications, from mobile phones and anti-aliasing, to control systems and real-time audio analyzers. It can realize all common filter types: low, high, band and all-pass and notch, as well as all common responses including Butterworth, Chebyshev, Bessel and elliptic. The chip can hold the equivalent of three independent MF10 or MF100 filters in one package. Center or cutoff frequencies range from 0.1 Hz to 100 kHz, offset voltage is below 70 mV and they need 100 mW from ± 5 V rails. An evaluation chip contains three 4th-order Chebyshev bandpass filters with center frequencies spaced 1/3 octave apart. Non-recoverable engineering (NRE) charges run \$5000 per design, with a minimum order quantity of 5000 pieces.

National Semiconductor Corp. 2900 Semiconductor Dr., Santa Clara, CA 95052-8090; Andy Jenkins, (408) 721-2273. CIRCLE 704

PLANAR TRANSFORMER DRIVES OFF-LINE SOURCES

A high-frequency planar transformer is now available for off-line power supplies. The MTT-125-AC units are claimed to be the first of their kind to meet UL, VDE, CSA, and IEC safety standards. Standing just 0.5 in. tall, the transformer is designed for 100-kHz-to-1-MHz operation in pulse-width-modulated and resonant-topology converters. It can deliver 200 W from one to three outputs with typical efficiency

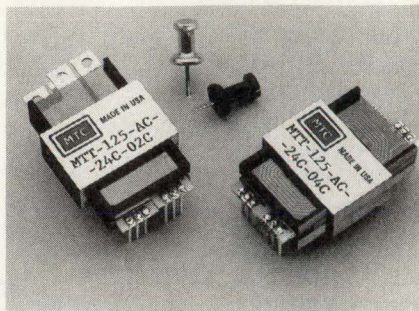

of 98% and low leakage inductance. Prototypes cost \$100 each, and production lots cost \$10 each in quantities of 1000. Delivery of small quantities is from stock.

Multisource Technology Corp., 393 Totten Pond Rd., Waltham, MA 02154; (617) 890-1787. CIRCLE 705

NEW PRODUCTS

POWER

QUAD HIGH-SIDE SWITCHES PASS 1 A—CONTINUOUSLY—AND 3 A PEAK

The jury is still out on whether the high-side solid-state switch will find a home outside the automobile. However the latest device in the genre has already attracted interest in applications as diverse as non-military avionics, and hotel electronic door-locks. It contains four switches, each rated at 28 V, a continuous current of 1 A, and peak currents of 3 A. The quad high-side switch comes from International Rectifier and National Semiconductor, the IR8400 and LMD18400, respectively.

Basically, these switches control dc power to small lamps, motors, solenoids and power supplies under the aegis of host processors, an activity that's becoming as common in appliances, toys, machine tools, copiers and computer peripherals as it is in cars. To meet automotive needs, these chips offer a number of features equally applicable to other applications. A circuit protects the switch from burn-out by sensing instantaneous switch voltage and current, calculating the power, and limit-

ing the current if power exceeds 15 W. This action limits in-rush current in lamp loads raising lamp life. If the die temperature exceeds 170°C, all four switches turn off and a flag notifies the host.

A serial data port provides additional diagnostics to the host, including whether the load is open, shorted or okay. An early-warning feature tells the host when the die temperature exceeds 145°C, permitting the host to turn off some of the switches, in lieu of all four. Additionally, under- and over-voltage sensing are also provided. The switch survives 80-V transients. In its 20-pin DIP and in quantities of 100, the IR8400 goes for \$6.19 each; the LMD18400 for \$6.50 each.

International Rectifier Corp., 233 Kansas St., El Segundo CA 90245; Arnold Alderman (213) 607-8899.

CIRCLE 716

National Semiconductor Corp., 2900 Semiconductor Dr. Santa Clara, CA 95052-8090; Al Kelsch (408) 721-6937.

CIRCLE 717

■ FRANK GOODENOUGH

100-V, 4-A, DMOSFET NOW HERE IN A TO-92

Now you can get 100-V power MOSFETs in a plastic TO-92 package with an on-resistance of just 0.35 Ω , while putting 10 V between the gate and source. Drain current is 4 A. From Supertex, the VN2210N3 is the first 100-V die with only 0.35 Ω on-resistance that's small enough to fit in a TO-92. The high cell density of the company's DMOS III process made possible this performance. Drive the MOSFET's gate with just 5 V—for example with a 5-V logic signal—and on-resistance is still a low 0.5 Ω . The transistor's 2.5-V gate threshold voltage, also a function of the process, insures this performance. A second device, the VN2206N3 is rated at 60 V. Applications for these transistors include driving small motors, solenoids, and lamps, as well as solid-state relays, high-voltage linear circuits such as op amps, and low-on-resistance signal (rather than power) switches. In quantities of 1000, the 100-V device goes for \$0.88 each; its cohort for a penny less.

Supertex Inc., 1225 Bordeaux Dr., Sunnyvale CA; Dilip Kapur, (408) 744-0100.

CIRCLE 718

POWER SWITCHER NEEDS NO LOOP COMPENSATION

Now you can build a low-cost step-up, step-down or inverting, 15-W switching regulator without worrying about keeping a dominant-pole feedback loop stable. Motorola's MC34163 replaces typical PWM circuits with what's called the "fixed on-time, variable off-time, voltage-mode ripple topology". Operating in what might be called a bang-bang servo mode, somewhat analogous to a capacitor charge-pump, the chip's 3-A switch is continuously gated on by a 50-kHz clock and turned off by the feedback comparator which compares the output voltage to a stable reference. Regardless of the configuration, a typical circuit takes a small inductor (180 μ H), a Schottky rectifier, a 300- to 3000- μ F capacitor, and a handful of additional resistors and capacitors. Efficiencies run 80 to 90% and line and load regulation from 0.01% to 0.1%. Features include cycle-by-cycle current limiting, thermal shutdown and a "low-output-voltage" flag. In quantities of 100, the MC34163 runs \$1.59.

Motorola Semiconductor, Bipolar Analog IC Div. 7402 South Price Rd., Tempe, AZ; (602) 897-3615.

CIRCLE 719

SUPPLIES PERFORM CONSTANT-VOLT CHARGING

A series of 11 switching power supplies is intended for constant-voltage-charging applications in 24-V dc battery systems, such as for emergency equipment, or as a general source in 28-V systems. The PLB series comes in 19-in.

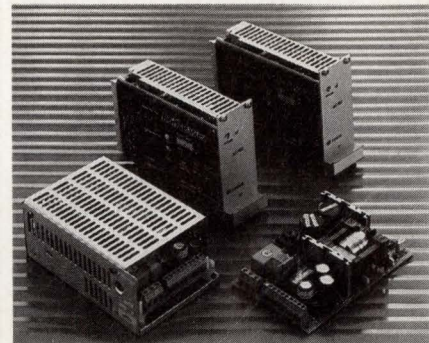

and open-frame mechanical versions. Output power is 100 W and hold-up time is 30 ms. Efficiency for the supplies is more than 87%. Two supplies can be connected in series to charge a 48-V battery system. Depending on mechanical model, pricing starts at \$141 for lots of 100. Delivery is from stock.

Ericsson Components Inc., 403 International Pkwy., Suite 500, Richardson, TX 75081; (214) 669-9900.

CIRCLE 720

100-A, 50-V DMOSFET NOW IN A 5-PIN TO-218

By using a 5-pin, TO-218 package for a basic three-terminal power MOSFET, Harris has broken the barrier set by lead resistance and built the highest-current—100-A—lowest on-resistance—10 m Ω —power MOSFETs in a low-profile package. Two extra leads provide Kelvin connections directly to the die's drain and source bond pads. This permits internal sensing of FET voltages. Thus, FET current can be determined (and thus controlled) by measuring the voltage drop across the bond wire between die and lead (the voltage between the source lead and the source Kelvin lead). In addition, these are "logic-level" FETs that can be turned on hard with just 5 V. And they're rugged—they're rated for a single-pulse avalanche energy of 800 mJ. And like all DMOSFETs, the RFA100N05 FETs are fast, turning on and off in just 60 and 100 ns maximum, respectively. In quantities of 1000, they go for just \$7.97 each.

Harris Semiconductor Corp., P.O. Box 883, Melbourne, FL 32901; 1-(800) 427-7747.

CIRCLE 721

LASER TAPE-AUTOMATED BONDER QUICKLY, RELIABLY BONDS COMPLEX ICs

A faster, gentler, non-contact approach to tape-automated bonding (TAB) of complex ICs is now available in the model 7100 laser-TAB system from Electro Scientific Industries. The system bonds up to 65 leads per second and produces metal-

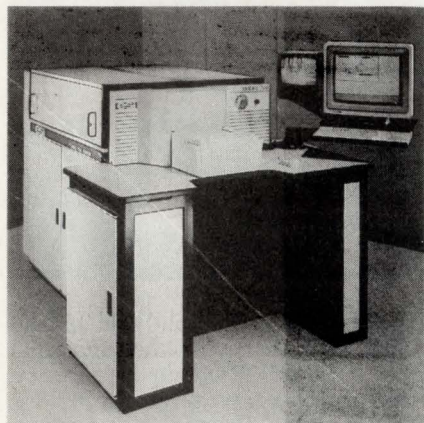

lurgical bonds with consistent high quality without subjecting the IC to extreme mechanical and thermal stress.

In operation, a technician aligns the die using a mouse and video monitor, positions the focused laser beam over the first lead, pulses the laser once, and moves on to the next lead. The operation is repeated until all leads are bonded. The ability to bond leads on a tight

pitch especially suits the model 7100 bonder to modern ICs. With laser TAB, bond pitch is limited only by the laser-beam diameter. This is in contrast with the tool-size limitations of single-point bonders or the maximum-pressure limitations of gang bonders.

Because laser bonding is a non-contact methodology, the bond pressure is extremely low—about 2 grams/lead. In addition, die temperature is minimal at about 22°C.

Another advantage of laser TAB is the system's ability to change over from one die size to another in seconds by means of software control. In gang bonding, a thermode changeover can take up to an hour.

To meet the specific needs of laser TAB, the company developed its pseudo-pulsed Nd:YAG laser, which operates at a 1064-nm wavelength. The laser gives operators more precise control over laser energy, which means consistent repeatable bonding and flexibility for bonding different types of ICs.

Configurations of the model 7100 laser-TAB system start at \$245,000. Call for system availability.

*Electro Scientific Industries Inc.,
13900 N.W. Science Park Dr., Port-
land, OR 97229-5497; (503) 641-
4141. **CIRCLE 697***

■ DAVID MALINIAC

MULTILAYER PACKAGE STACKS 16 LAYERS

Cofired, multilayer ceramic modules are now available from CTS Corp. using DuPont Electronics' Green Tape technology. The substrate system combines the best features of thick-film and high-temperature cofired ceramic packaging technologies. Sixteen or more separate substrate layers can be stacked with screened conductive patterns on each layer. Also, cavities can be built so that discrete components can be recessed into the layers. The substrate material can be fired in one pass at a low 850°C. The process also makes possible higher print resolutions. Samples are available in four to six weeks after receiving customer specifications.

*CTS Corp., Microelectronics Division,
1201 Cumberland Ave., West Lafay-
ette, IN 47906; (317) 463-2565.*

CIRCLE 698

DATACOM GANG JACKS LINK EIGHT DEVICES

Dual-through octagon gang jacks are available in both right-angle and perpendicular versions. Triple, quadruple, and quintuple jacks are also offered.

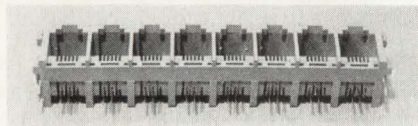

Six position openings with up to six contacts in any combination can be specified. Metal locking brackets allow for quick, easy pc-board insertion. The contact material is phosphor-bronze with selective gold plating, and the current rating is 1.5 A. In lots of 1000, prices range from \$0.85 for a dual jack to \$4.52 for an octagon jack. Delivery is in six to eight weeks.

*Kycon Cable & Connector Inc., 1772
Little Orchard St., San Jose, CA 95125;
(408) 295-1110. **CIRCLE 699***

■ DAVID MALINIAC

TWO-METAL TAB TAPE INCLUDES GROUND PLANE

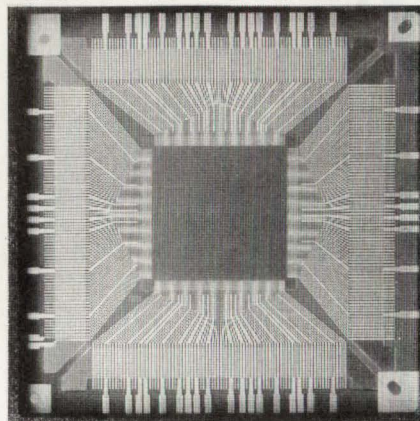

The sub-300-ps rise times of today's ECL devices can be problematic, making even short tape-automated-bonding (TAB) leads look like impedance discontinuities. That adversely affects the devices' performance. But the advanced packaging requirements of high-lead-count, high-speed digital devices are taken into account by Rogers Corp.'s two-metal-layer TAB circuits. The second layer makes up a ground plane that delivers controlled impedance and reduced crosstalk right up to the die.

Rogers's advanced TAB circuits are based on a proprietary process that combines additive plating and dimensionally stable material systems. Circuits are manufactured in panel form, which makes for greater flexibility in part size and configuration.

In the test area, it's becoming more critical that full or partial functional testing, as well as burn-in of the chip, be done in TAB form. This is especially true in multichip modules or tape-on-board applications. The double-metal-layer tape makes such testing possible at or close to speed.

The additive process makes possible fine-line densities and high-lead-count circuits. Current production products have 360 or more leads with 0.002-in. lines and spaces. Prototype parts are in the 700-lead-plus range with lines and spaces measuring 0.0015 in.

Price and availability depends on the complexity and size of the circuits.

*Rogers Corp., Micro-Interconnec-
tions Div., 2001 W. Chandler Blvd.,
Chandler, AZ 85244; (602) 963-
4584. **CIRCLE 700***

■ DAVID MALINIAC

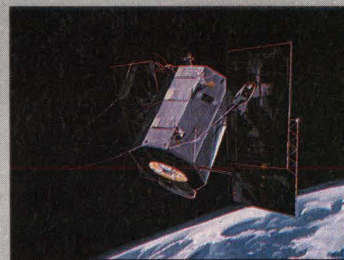
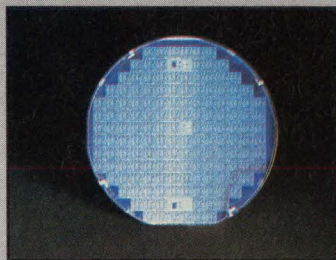
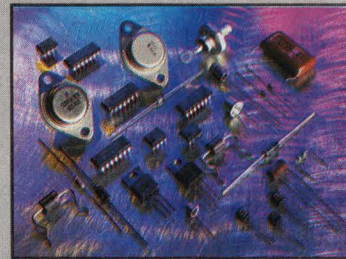
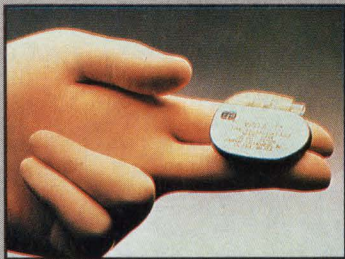
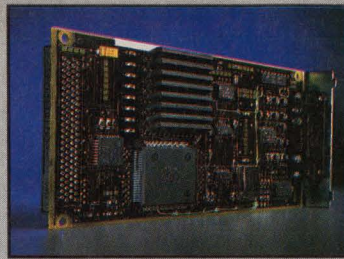
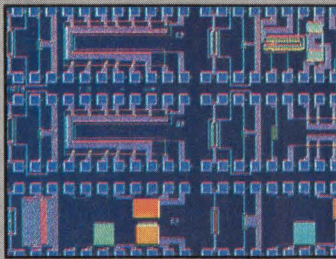

HSPICE: From Concept to Creation

The competition is tough in today's marketplace. Innovative companies need to bring their products to market just as the demand ripens. HSPICE is the optimizing circuit simulator which brings concepts to reality.

Why HSPICE?

■ HSPICE is proven in the marketplace. Engineers have depended on HSPICE for over ten years to provide the circuit simulation solution they demand.

■ HSPICE addresses all electronic industry segments, including mixed signal ASICs, custom IC design, PCB/backplane design, cell characterization, RF and microwave designs, and discrete power applications. No matter what your speciality, HSPICE provides the answers.

■ HSPICE is continually enhanced and improved to stay ahead of your creative processes. When your design is ready to be simulated, HSPICE will be there with the tools you need for accurate results. Transmission lines and submicron MOS models are already part of HSPICE. So is the built-in optimizer.

■ The HSPICE Instrumentation Interface, ATEM, along with a custom MetaTestchip™ automates HSPICE model creation. Meta-Software also maintains a semiconductor measurements lab for research and development efforts and user model generation. Meta-Software compares results to the silicon itself, not to other simulators. You don't get a comparable answer, you get the right answer.

Engineers designing analog and mixed signal circuits turn to Meta-Software's HSPICE for their simulation solution. Yesterday, today and tomorrow — we're there to give you the competitive advantage.



META-SOFTWARE

THE CIRCUIT DESIGN ADVANTAGE!

1300 White Oaks Road • Campbell, CA 95008
Phone (408) 371-5100 • Toll Free (800) 346-5953
FAX (408) 371-5638 • Telex 910-350-4928

Maximum IEEE-488.2 Performance... and the Foundation for the Future

NEW FEATURES

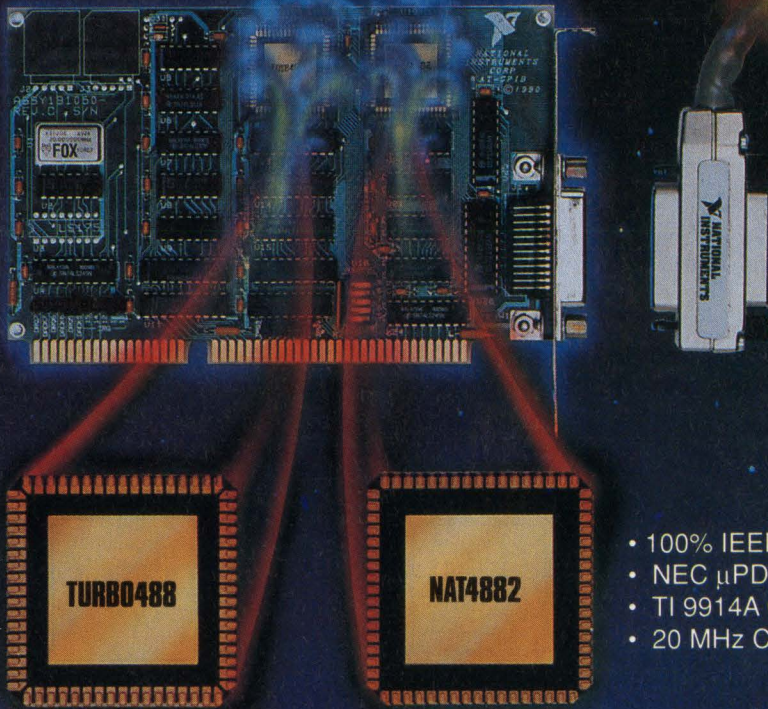

- FIFO Buffers
- Last-Byte Handling
- Byte/Word Packing
- 1 Mbytes/sec Rates

- 100% IEEE-488.2
- NEC μ PD7210 Compatible
- TI 9914A Compatible
- 20 MHz Clock Input

The AT-GPIB

Custom Chips – Bringing state-of-the-art technology to you is why we've been the leader in the IEEE-488 (GPIB) market for over 14 years. Our latest AT-GPIB board for the PC/AT computer combines the functionality of our new IEEE-488.2 controller chip, the NAT4882™, and the performance enhancements of our Turbo488™ ASIC to provide 100% IEEE-488.2 compatibility, 1Mbytes/sec read and write data rates, and significantly reduced software overhead.

Enhanced Software – The performance and functionality of our NI-488 software has made it the *de facto* industry standard. The new NI-488.2 is compatible with NI-488 when using either Hewlett-Packard commands or high-level functions with popular compiled languages. A complete 488.2 controller command set, dynamic configuration, and compatibility with extended memory are but a few of the enhancements.

IEEE-488.2 and SCPI – IEEE-488.2 is the foundation of the new Standard Commands for Programmable Instrumentation (SCPI) and of the new generation of GPIB test systems. The NAT4882, AT-GPIB, and our enhanced NI-488.2 software are the tools of the 90's. But the NAT4882 is also completely compatible with both the NEC μ PD7210 and TI 9914A chips of the 80's.

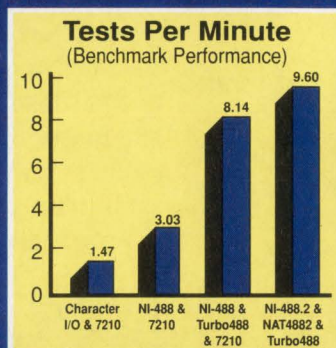

A Sound Investment – You can still run your existing NI-488 programs yet automatically take advantage of the NAT4882, Turbo488, and the streamlined NI-488.2 driver. The state-of-the-art technology of the AT-GPIB with its maximum specified data rates for both reads and writes and its complete 488.2 compatibility ensures that your GPIB investment will not be obsolete because of the new instrumentation standards.

Take advantage of these technologies and standards to make your IEEE-488 control problems a thing of the past.

Nihon National Instruments K.K. (Japan) (3) 788-1922 • National Instruments of France (1) 4865-3370
National Instruments of Italy (2) 4830-1892 • National Instruments United Kingdom (06) 355-23-545

Call for **FREE** Catalog
(800) IEEE-488 (U.S. and Canada)
(512) 794-0100

NATIONAL INSTRUMENTS
The Software is the Instrument[®]
6504 Bridge Point Parkway
Austin, TX 78730-5039

NEW PRODUCTS

COMPUTERS & PERIPHERALS

LOW-COST WORKSTATION PUSHES 15.8 MIPS

Coming in below \$10,000, Sun Microsystems' SparcStation IPC is a compact color workstation that performs 15.8 MIPS. It comes with a 16-in. color monitor, 8 to 24 Mbytes of RAM, and two S-bus expansion slots. An Ethernet port enables the workstation to be

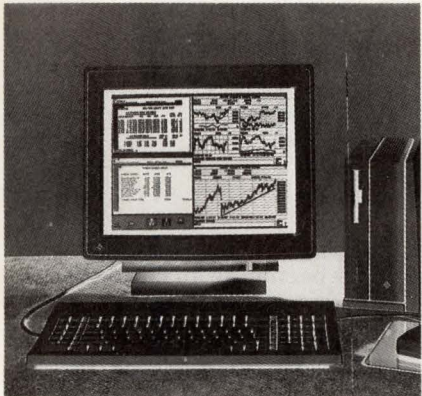

networked. The 9.5-by-10.25-by-4-in. package contains a 3.5-in. floppy drive and a 207-Mbyte hard drive. By incorporating Sun's Open Look graphical user interface, the IPC becomes as easy to use as a Macintosh. According to Sun, the IPC costs about half of what a PC with similar features would cost, and it runs faster, has more storage, and has a larger, higher-resolution monitor. In addition, more than 2100 software applications are now available for the Sparc architecture. These include Lotus 1-2-3, WordPerfect, FrameMaker, and Ventura Publisher. The SparcStation sells for \$9995 (\$8995 for the disk-less version) and is available now.

Sun Microsystems Inc., 2550 Garcia Ave., Mountain View, CA 94043; (415) 960-1300. CIRCLE 706

COLOR PC/AT MONITORS DISPLAY 3D IMAGES

Combining a color CRT with a proprietary liquid-crystal shutter, Tektronix Inc.'s three SGS (Stereoscopic Graphics Adapter) series monitors boast passive 3D viewing using simple, nontethered polarizing glasses. The three IBM PC/AT-compatible monitors, the 431, 630, and 635, come with an SGA card that offloads low-level graphics functions from the PC. The card supports all common 2D primitives such as move, line, polygon, and area fill. Applications that require 1280-by-1024-pixel, stereo 3D viewing include molecular modeling, mechanical CAD, cartography, photogrammetry, remote

sensing, and medical imaging. Sizes of the 431, 630, and 635 (multimode) monitors are 16, 19, and 19 in., respectively. The 431 sells for \$9800, the 630 for \$13,300, and the 635 for \$13,800. Quantity discounts are available. All the monitors come equipped with cables, polarizing glasses, SGA card, and a graphics subroutine library.

Tektronix Inc., P.O. Box 500, M/S 46-943, Beaverton, OR 97077; (503) 627-5000. CIRCLE 707

SUN PLATFORM LINKS TO RT VME FRONT END

The Solar System, from Matrix Corp., transparently links Sun Microsystems' Unix platforms with a real-time (RT) operating system, VxWorks, from Wind River Systems. While configured as an integrated VME target, the system is networked directly to a Sun SparcStation. By linking the system over an Ethernet network, development time is cut. Alternatively, the system can operate as a stand-alone VME

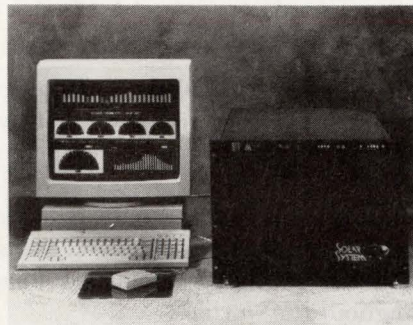

real-time target. Users can also choose from a variety of 68020/30/40 real-time VMEbus target processors with a wide range of available I/O modules. A key feature of the Solar System is that it separates the Unix environment from the real-time VMEbus subsystem. By maintaining the separate, yet linked, subsystems, neither system is compromised. Prices for a typical target system start at \$7995, while prices for a development system start at \$27,595.

Matrix Corp., 1203 New Hope Rd., Raleigh, NC 27610; (919) 231-8000. CIRCLE 708

ADAPTER ADDS SERIAL AND PARALLEL I/O TO SCSI

The limited expansion capability of low-cost workstations no longer need be a limiting aspect of the system thanks to the SLAT-1. The SCSI local-area network adapter connects to the SCSI port that is typically available on all Unix workstations. It adds either one bidirec-

tional parallel port, four serial ports and one parallel port, or up to eight serial and one parallel port to the workstation. Serial data rates of up to 150 kbits/s and full dial-in and dial-out modem capabilities, as well as hardware flow-control signals are available. The parallel port can operate at either 30 or 250 kbytes/s, depending on the adapter version. Prices for the 4-by-9-by-10-in. SLAT-1 adapter start at \$575 for the parallel-only version plus a \$100 site-license fee for the control software. The versions with 4 or 8 serial ports sell for \$900 and \$1595, respectively.

Uninet Peripherals Inc., 1209 Warner Ave., Santa Ana, CA 92705; (714) 546-1100, Paul Hammond. CIRCLE 709

UNITS GIVE DSP CARDS HIGH-SPEED ANALOG I/O

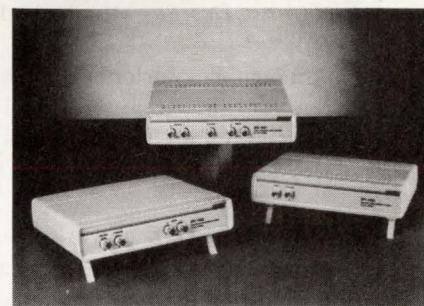

A family of analog I/O systems allows continuous real-time digital signal processing in PC environments. The systems are for use with Burr-Brown's DSPeed processing cards, which employ either the 16- or 25-MHz version of AT&T's WE DSP32 floating-point digital signal processor or the 50-MHz DSP32C. They enable the processor cards and the company's DSP development software, DSPlay XL, to obtain real-world signals with higher resolution than most other systems currently available. Used as development and interface systems, they can also speed the integration and testing of Burr-Brown's ultra-high-performance PCM78, ADC603, and ADC701 analog-to-digital converters.

The ZPD1001 offers 16-bit analog I/O and sampling rates to 150 kHz. The ZPD1002 features single or dual analog input with 12-bit, 10-MHz analog-to-digital conversion. Single analog input with 16-bit, 500-kHz resolution is achieved with the ZPD1003. Prices start at \$1249, \$2495, and \$2295 for the ZPD1001, 1002, and 1003, respectively. All three systems are delivered from stock to four weeks.

Burr-Brown Corp., P.O. Box 11400, Tucson, AZ 85734; (800) 548-6132. CIRCLE 710

WANTED:

ENGINEERS INTERESTED IN COVERING THE INDUSTRY'S MOST SIGNIFICANT DEVELOPMENTS

ELECTRONIC DESIGN IS EXPANDING ITS EDITORIAL STAFF

Thinking of a career change? You can leverage your engineering expertise by becoming an editor of *Electronic Design*—the fastest growing industry publication.

Engineering experience is highly valued at *Electronic Design* and your technical knowledge is directly transferable to an editorial career—as *Electronic Design's* engineers-turned-editors will readily attest to. In fact, to keep up with the rapid pace of technological advances, you will have to use everything you have ever learned as an electronics engineer.

Electronic Design editors deal with the top electronics technologists in the world to keep other engineers up-to-date on where technology is heading. Consequently, you must have an aptitude for quickly grasping new concepts and for clearly communicating technical information.

At *Electronic Design*, you will learn of major developments in advance and will be exposed to a far broader range of technologies than possible in a working engineering environment. And you will gain the satisfaction of communicating the technical essence of those developments to more than 200,000 fellow EEs working throughout the world.

Educational requirements: Bachelor's degree in electrical engineering. Candidates with computer science degrees or physics degrees would also be considered. Published by Penton Publishing, *Electronic Design* offers editorial salaries that are commensurate with engineering salaries.

Send your resume (in an envelope marked "resume enclosed") to:

Stephen E. Scrupski
Editor-in-Chief
Electronic Design
611 Route 46 West
Hasbrouck Heights, NJ 07604



Electronic Design is an equal opportunity employer M/F/H/V

ELECTRONIC DESIGN

DIRECT CONNECTION ADS

New Products/Services Presented By The Manufacturer.
To Advertise, Call JEANIE GRIFFIN At 201/393-6080

HIGH FREQUENCY NOISE PROBLEMS?

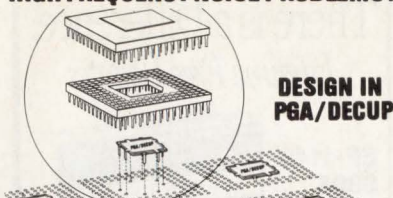

DESIGN IN
PGA/DECUP

PGA/DECUP Capacitors provide superior noise reduction to pin grid array (PGA) devices like 32-bit micro processors, and ASIC's that must operate in today's high frequency, low inductance applications. The inherent low inductance and rapid delivery of the charge allow PGA/DECUP capacitors to suppress high speed switching transients with superior results. PGA/DECUP Capacitors fit under PGA packages and LCC sockets, delivering high efficiency decoupling without using any valuable board space.

ELDRE CORPORATION
1500 Jefferson Rd., Rochester, N.Y. 14623
TEL: 716-427-7280 Fax: 716-272-0018

ELDRE CIRCLE 252

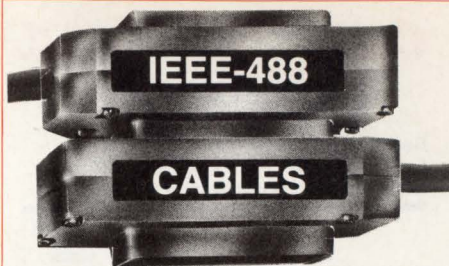

IEEE-488, (GP-IB, HP-IB) CABLES

- Reliable gold plated contacts.
- Durable metal connectors.
- High strength strain reliefs.
- Two shields for high noise immunity.
- Custom lengths at low prices.

cec Capital Equipment Corp.
Burlington, MA. 01803

Informative catalog 800-234-4232
Applications help (617) 273-1818

CAPITAL EQUIPMENT CIRCLE 253



PORTABLE DISC DRIVE CONNECTOR

L Series Rack & Panel Connectors provide in excess of 100,000 cycles with excellent electrical repeatability. The rugged blind matable float design and low insertion force contacts provides the performance needed in removable disc drives. Crimp and solder style contacts for 8, 15, 25, and 50 amp use are available. Meets performance requirements of MIL-C-28748A.

HYPERTRONICS CORPORATION
16 Brent Drive, Hudson, MA 01749
Telephone: (508) 568-0451

HYPERTRONICS CIRCLE 254



NEW EPROM PROGRAMMER

At \$495, Wintek's Universal EPROM Programmer is a low-cost and versatile tool for programming most industry-standard EPROMs (2716-27256). Since it can operate with an IBM PC, as well as stand-alone, the Programmer is ideal for use with PC-based microcomputer development software. Credit cards are welcome.

WINTEK CORPORATION
1801 South St., Lafayette, IN 47904
(800) 742-6809 or (317) 742-8428

WINTEK CIRCLE 255

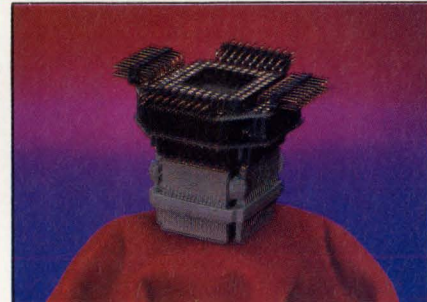

PLCC Package Adapter Clips

- QuadClip™ turns your surface-mounted PLCC package into an accessible, pin-grid package for easy emulation.
- Makes it possible to test chips on production boards without un-soldering your PLCC packages.
- Can be attached to packages with up to 84 pins, including the 68000 series chips and 8031-51 chip.
- Custom orders get immediate attention and quick turn-around. For a free catalog, contact:

Emulation Technology, Inc.
2368-B Walsh Ave. Santa Clara, CA 95051
Phone: 408-982-0660 FAX: 408-982-0664
EMULATION TECHNOLOGY



CIRCLE 256

Don't Get Zapped!

High inrush current can **destroy** your sensitive VAX CPUs and peripherals in less time than it takes to flip a switch.

THE SOLUTION?
Power up with Z-LINE TPC 115-10 MTD™ the **smallest** power distribution and control system available.
POWER UP WITH ——— **Z-LINE™**

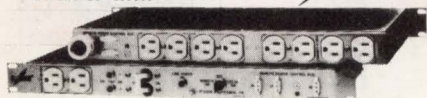

Our proprietary Multiple Time Delay™ circuitry sequences your power-up to protect your systems from the spikes and surges, EMI & RFI, that **destroy your hardware and erase your data.** And our remote on/off and emergency shutdown gives the power control back to you.

All Pulizzi Engineering MTD™ controllers are compatible with DEC and UPS systems.
PRICES FROM \$453 TO \$317

DON'T WAIT UNTIL IT HAPPENS, CALL TODAY!
PULIZZI ENGINEERING INC.
3260 S. Susan Street, Santa Ana, CA 92704-6865
(714) 540-4229 FAX (714) 641-9062

PULIZZI ENGINEERING CIRCLE 257

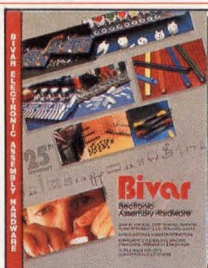

ELECTRONIC ASSEMBLY CATALOG

A 25th anniversary edition of the Bivar catalog of hardware for electronics features several new product lines, including clips and rings for mounting LEDs, connector cutout covers, and a greatly expanded line of mounts and spacers to military specifications. The 38-page, applications-based catalog offers over 5000 cost-saving products for printed circuit board packaging and component installation. The products are carefully designed and manufactured to assist engineers in the reduction of work and reject and inspection problems.

BIVAR, INC.
4 Thomas, Irvine, CA 92718
Phone: (714) 951-8808 Fax: (714) 951-3974
BIVAR

CIRCLE 258

NEW NEW NEW NEW NEW Telecom Design!

INTEGRATED CMOS DTMF RECEIVER

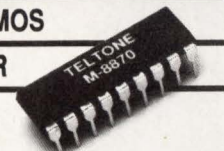

M-8870 is a full DTMF receiver that integrates bandsplit filter and digital decoder on one 18-pin CMOS DIP.

- Low power consumption (35 mW max.)
- On-chip differential amplifier, clock generator, and latched 3-state bus
- 5 volt power, 3.58 MHz TV crystal
- Low cost

For more info call: **1-800-426-3926**

TELSTONE®

10801-120th Avenue NE, Kirkland, WA 98033
Phone: 206-827-9626 Fax: 206-827-6050

TELSTONE CIRCLE 259



C for the 8051 Compare:

Benchmark Results—Sample program: Eratosthenes Sieve Program from BYTE (1/83), expanded with I/O and interrupt handling.

	FRANKLIN SOFTWARE C-51 v2.1	MCC51 v1.2	Archimedes ICC51 v2.20A
Linkage time	6 sec	9	29
Execution time	0.88 sec	9.00	11.45
Total code size	1726 bytes	3798	5318
Compilation time	17 sec	18	12
Sieve module size	541 bytes	1021	736

Call now for your free DEMO disk.



888 Saratoga Ave. #2 • San Jose, CA 95129
(408) 296-8051 • FAX (408) 296-8061

FRANKLIN SOFTWARE

CIRCLE 260

There is a Difference. Lifetime Free Updates

EP-1140
\$895



A programmer is not just another programmer. That is why BP Microsystems is committed to bringing our customers the highest quality programmers at an affordable price. This commitment is evident in our EP-1140 E/EPROM programmer supporting thousands of 24-, 28-, 32- and 40 pin devices. A 32-pin model, EP-1132, is available also for \$695. And, all of our programmers include future chip support at no charge and an unconditional money back guarantee.

BP MICROSYSTEMS
1-800-225-2102
(713) 461-9430

BP MICROSYSTEMS

CIRCLE 261

QUALITY & DEPENDABLE EPROM/MICRO PROGRAMMER

- Fast PC Interface via Standard Parallel Port
- Field Upgradable From One Model To Another

"GET IT FROM
A REPUTABLE
COMPANY"

Made in
USA

408-243-7000
800-627-2456
FAX 408-736-2503

(* = Field Upgradable)

	24, 28-pin EPROMs	32-pin EPROMs	40-pin EPROMs	874X	875X
PILOT-145 \$995	YES	YES	YES	YES	YES
PILOT-144 \$795	YES	YES	YES	*	*
PILOT-143 \$595	YES	YES	*	*	*
PILOT-142 \$495	YES	*	*	*	*
PILOT-S51 \$495	*	*	*	*	YES
PILOT-S48 \$495	*	*	*	YES	*



ADVIN SYSTEMS INC.
1050-L East Duane Avenue • Sunnyvale, CA 94086

ADVIN SYSTEMS

CIRCLE 262

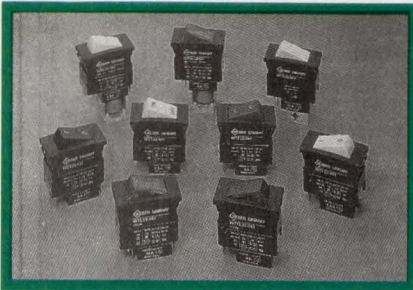

WEBER W22 CIRCUIT BREAKER FOR EQUIPMENT

Swiss precision, double pole on/off switch, thermal circuit breaker with thermal protection in one or both poles. Compact snap-in. Illuminated rocker. UL/CSA/VDE approved up to 60 Vdc and 240 Vac and current ratings from 0.05 to 20 amps. Options include low voltage release coil, relay trip coil, and mechanical safety release. Contact

INMARK CORPORATION, 4 Byington Place, Norwalk, CT 06850. Tel. 203-866-8474 or Fax. 203--866-0918

INMARK

CIRCLE 263

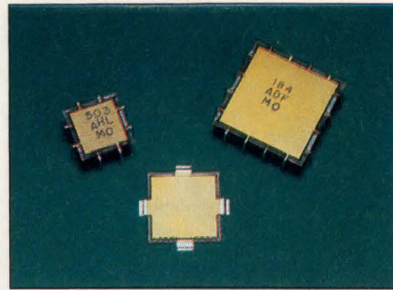

CUT PGA/PLCC NOISE

MICRO/Q® 3000 capacitors reduce noise associated with PGA and PLCC devices. Designed to be mounted under the device, take no extra board space. Can be used under MPUs, Gate Arrays, and ASICs. Choose from Z5V, X7R, and P3J dielectrics. Available in both thru-hole and surface mount versions. Several sizes available to fit all devices.

ROGERS CORP.
2400 South Roosevelt St., Tempe, AZ 85282
Telephone: (602) 967-0624

ROGERS CORP.

CIRCLE 264

RELIABILITY PREDICTION SOFTWARE

ARE YOUR PRODUCTS RELIABLE?

The RelCalc 2 Software Package predicts the reliability of your system using the part stress procedure of MIL-HDBK-217E, and runs on the IBM PC and full compatibles. Say goodbye to tedious, time consuming, and error prone manual methods! RelCalc 2 is very easy to use, and features menu windows, library functions, global editing for what-if? trials, and clear report formats. Try our Demo Package for \$25.

T-CUBED SYSTEMS, 31220 La Baya Drive # 110, Westlake Village, CA 91362. (818) 991-0057 • FAX: (818) 991-1281

T-CUBED SYSTEMS

CIRCLE 265

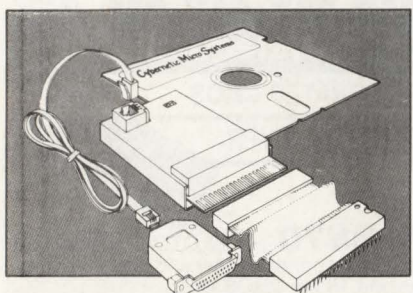

8051 Emulator - \$1250

d²ICE is a low cost, Full Speed, real time 8051 Emulator.. Powerful user interface for Hi-level multi-window source code debugging. Uses IBM-PC COM1/2. No Slots! Portable, fits in shirt pocket. Assembler and test bed included.



Cybernetic Micro Systems

PO Box 3000 • San Gregorio CA 94074
Ph: (415) 726-3000 • Fax: (415) 726-3003

CYBERNETIC MICRO SYSTEMS

CIRCLE 267

Design:

Industry-standard
language for PLDs



With new ABEL-PLD at just \$895*.

- 150 PLD architectures supported (over 4000 devices).
- Uses ABEL™ Hardware Description Language (AHDL).
- Intelligent synthesis and optimization.
- Upgradable to full-featured ABEL.

Call for your FREE ABEL-PLD demonstration diskette.
1-800-247-5700

*U.S. list price only.

DATA I/O
Corporation

DATA I/O

CIRCLE 268

Program:

16L8, 20V8, 22V10,
27C020, and 450
other CMOS devices



PLDs and memories with the low-cost 212.

- Memory cards for easy updates.
- Extensive editing capabilities.
- Compatible with JEDEC standard programming files.

Call for your FREE 15-day trial AND ABEL-PLD demonstration diskette.
1-800-247-5700

DATA I/O
Corporation

DATA I/O

CIRCLE 269

Tango-Schematic Series II.™ It simply works better.

We listened to your suggestions and built the best in PC-based schematic capture. More versatile than OrCAD.™ More features than Schema.™ Easier to use than DASH.™ Thanks to our streamlined interface and integrated approach, Tango-Schematic makes creating complex schematics simple. Compare for yourself.

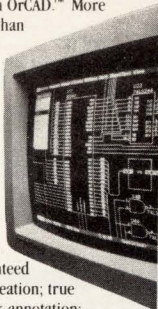

Tango™

Tango-Schematic features SEDCO™ libraries, with over 8,000 parts guaranteed for accuracy; integrated component creation; true ANSI/IEEE support; forward- and back-annotation; PostScript and DXF output; free tech support; and much more. It's all there for just \$495—guaranteed.



FREE EVALUATION PACKAGE

800 433-7801 619 554-1000 619 554-1019 Fax

ACCEL™ Technologies ■ 6825 Flanders Drive ■ San Diego, CA 92121 USA
International prices may vary. Contact us for the distributor nearest you.
ACCEL TECHNOLOGIES **CIRCLE 270**

PC Communications Coprocessors

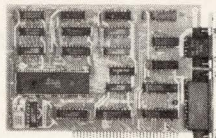

Our communications coprocessors offload serial and parallel communications tasks from PC's used in dedicated applications. RS232 and RS485 style communications. Easily programmed using C. A memory mapped interface to the host PC allows high speed data transfer and simple buffer schemes. From 64k to 512k of memory local to the coprocessor but accessible from the host PC. Used in many industrial and business systems to dramatically improve performance compared to standard PC serial port implementations.

Z-World Engineering

1340 Covell Blvd., Davis, CA 95616
(916) 753-3722
Fax: (916) 753-5141

Z-WORLD ENGINEERING

CIRCLE 271

LOW COST Data Acquisition Cards for PC/XT/AT



12 Bit A/D & D/A [PCL711S] \$295

- A/D converter: 8 single-ended channels; Uses AD574 device; Conversion time less than 25µsec; Built-in programmable pacer; Input range: ±5V; Software Trigger Mode only.
- D/A converter: 1 channel; 12 bit resolution; 0 to +5/10V Output Range.
- Digital I/O: 16 In/Out (TTL compatible); External Wiring Terminal Board incl.
- Utility Routines and Demo/Sample Programs for BASIC and Quick-BASIC.

12 Bit A/D & D/A [PCL812] \$395

- A/D converter: 16 single ended inputs; Uses AD574; Conversion time less than 25µsec; Built-in programmable pacer; Input Ranges: ±10V, ±5V, ±1V.
- D/A converter: 2 channels; 12 bit resolution; Output Range 0-5V.
- Digital I/O: 16In/Out (TTL compatible); Programmable Counter/Timer (8254).
- DMA and interrupt capability. Utility software and sample program in BASIC.

Fast 12 Bit A/D/A [PCL718] \$795

- A/D converter: 16 single ended or 8 differential channels; 12 bit resolution; Programmable scan rate; Built-in Interrupt and DMA control circuitry; Conversion speed 60,000 samples/sec (standard), 100,000 samples/sec (optional).
- Input Ranges: Bipolar: ±10V, ±5V, ±2.5V, ±1V, ±0.5V; Unipolar: 10, 5, 2, 1V.
- D/A converter: 2 channels; Resolution: 12 bits; Settling time: 5µsec; ±5V.
- Digital I/O: 16In/Out (TTL compatible); Programmable Counter/Timer (8254).
- Software: Utility software for BASIC & QuickBASIC included. Sample prgm. Supported by LabDAS, ASSYST, LABTECH, UnkeScope.

6 Channel 12 bit D/A [PCL726] \$495

- Output Ranges: 0 to +5V, 0 to +10V, ±5V, ±10V, or sink 4-20mA.
- Settling time: 70µs. Linearity: ±1/2bit. Voltage output drive capacity: ±5mA.
- Digital I/O: 16 digital input and 16 digital outputs (TTL compatible).



B&C MICROSYSTEMS INC.

750 N. Pastoria Ave, Sunnyvale, CA 94086 USA
TEL: (408) 730-5511 FAX: (408) 730-5521

B&C MICROSYSTEMS

CIRCLE 272

DASP100

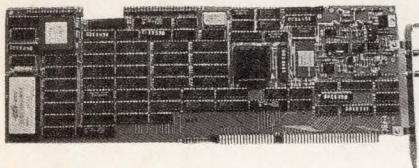

100MHZ

DATA ACQUISITION & SIGNAL PROCESSING

- ★ 100 MILLION SAMPLES PER SECOND
- ★ 256K SIGNAL MEMORY (EXPAND TO 2 MB)
- ★ 10 MIPS DSP (320C25)
- ★ EXTENSIVE HARDWARE & SOFTWARE SUPPORT
- ★ 3 DATA ACQUISITION MODES
- ★ MULTI-CHANNEL CAPABILITY

ALSO ASK ABOUT OUR NEW DASP25!

357 N. Sheridan St. #119
CORONA, CA 91720
(714) 734-3001
FAX: (714) 734-4356

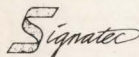

SIGNATEC

CIRCLE 273

Cross-Assemblers from \$50.00 Simulators from \$100.00

Cross-Disassemblers from \$100.00 Developer Packages from \$200.00 (a \$50.00 Savings)

Make Programming Easy

Our Macro Cross-assemblers are easy to use. With powerful conditional assembly and unlimited include files.

Get It Debugged—FAST

Don't wait until the hardware is finished. Debug your software with our Simulators.

Recover Lost Source!

Our line of disassemblers can help you re-create the original assembly language source.

Thousands Of Satisfied Customers Worldwide

PseudoCorp has been providing quality solutions for microprocessor problems since 1985.

Processors

Intel 8048	RCA 1802.05	Intel 8051	Intel 8096, 196kc
Motorola 6800	Motorola 6801	Motorola 68HC11	Motorola 6805
Hitachi 6301	Motorola 6809	MOS Tech 6502	WDC 65C02
Rockwell 65C02	Intel 8080, 85	Zilog Z80	NSC 800
Hitachi HD64180	Mot. 68k 8, 10	Zilog Z8	Zilog Super 8

• All products require an IBM PC or compatible.

For Information Or To Order Call:

PseudoCorp

716 Thimble Shoals Blvd, Suite E
Newport News, VA 23606

(804) 873-1947

FAX: (804) 873-2154

PSEUDOCORP.

CIRCLE 274

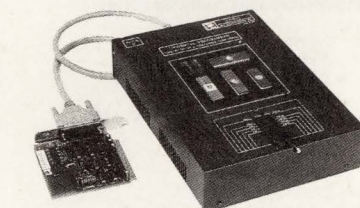

PC BASED UNIVERSAL DEVICE PROGRAMMER

\$695/895

- Programs EE/EPROMs, PALs, GALs, EPLDs, MICROs, BIPOLARS, PEELs.
- Software driven pin drivers. D/A generated programming voltages (8 bit DACs) used to generate voltages from 5-25V with 0.1V resolution for all 40 pins
- Upgradable for virtually any future programmable devices up to 40 pins.
- Self substituent operation. No additional modules or plug-in adapters required.
- Includes user friendly MEMORY BUFFER FULL SCREEN EDITOR.
- Commands include: Fill, Move, Insert, Delete, Search, ASCII or HEX entry.
- Friendly Menu-Driven interface. Device selection by P/N and manufacturer.
- Supports 8/16/32 bit data word formats.
- Programming algorithm: Normal, Intelligent I&H, Quick Pulse Programming.
- Verify operation performed at normal & worst case operating voltage
- Functional test: JEDEC standard functional testing for logic devices.
- TTL Logic functional test for 74xx/54xx series devices.
- File formats accepted: JEDEC (full), JEDEC (kernel), Straight Hex, MOS Technology, Motorola Hex, Intel Hex, Tektronix Hex.
- Customer support via voice line, fax & dedicated BBS. Full 1 year warranty.
- Base price \$695 includes interface card, cable, Memory/Micro/Bipolar library and 1 year free updates. \$895 with additional Logic Device Library.
- Library updates can be received via floppy or Customer Support BBS.

MC / VISA / AMEX

Call today for datasheets!



B&C MICROSYSTEMS INC.

750 N. Pastoria Ave, Sunnyvale, CA 94086 USA
TEL: (408) 730-5511 FAX: (408) 730-5521

B&C MICROSYSTEMS

CIRCLE 275

1553 B INTERFACE

- Dual-Redundant
- Commercial & Militarized Versions
- IBM PC/XT/AT/386 Half Card
- Powerful Software With Window-driven User Interface



ponson
CORPORATION

7720 Arjons Drive
San Diego, California 92126
(619) 271-6309 • Fax (619) 271-6341 • BBS (619) 271-6342

PONSOR ENTERPRISES

CIRCLE 276

The Best GANGSITE™ Money Can Buy!

GANG/SET MULTIPROGRAMMER

The only SET Programmer for \$995.00
that supports 32-pin (E)EPROMs.



★ Made in USA. 1-800-523-1565

- 8 32-pin sockets (optional 16).
- 3 key standalone Gang/Set operations.
- 40 character LCD. • Easy to use.
- 2Meg RAM expandable to 32Meg.
- RS-232 Remote Control.
- Options for 40-pin devices.

BYTEK

FL: 407/994-3520
Fax: 407/994-3615
CA: 408/437-2414

BYTEK

CIRCLE 277

How to take custom transformers for granted.

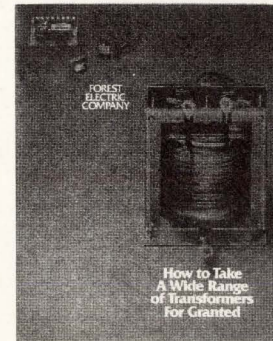

- First read our free guide.
- Then work with our CAD design team for sub-minis to 50KVA.
- 100% testing.
- 2-year warranty.

FOREST ELECTRIC COMPANY

1001 North 25th Ave.
Melrose Park, IL 60160 • (708) 681-0180
1-800-282-0180

FOREST ELECTRIC

CIRCLE 278

INDEX OF ADVERTISERS

ELECTRONIC DESIGN

Chairman and CEO: Sal F. Marino
President and COO: Daniel J. Ramella
Senior Vice President: James D. Atherton
Group Vice President: James W. Zarembo
Advertising Sales Staff

Publisher: Paul C. Mazzacano
 Hasbrouck Heights, NJ; (201) 393-6060
 San Jose, CA; (408) 441-0550

National Sales Manager:
 Andrew M. Dellins
 San Jose, CA; (408) 441-0550

Hasbrouck Heights:
 Judith L. Miller, Robert Zarembo
Sales Support Supervisor: Betsy Tapp
 611 Route # 46 West
 Hasbrouck Heights, NJ 07604; (201) 393-6060
 TWX: 710-990-5071

Boston: Ric Wasley
 400 Fifth Ave.
 Waltham, MA 02154; (617) 890-0891
 FAX: (617) 890-6131

Colorado: Lou Demeter (408) 441-0550

Chicago/Midwest: Russell Gerches
Sales Assistant: Susan Johnson
 2 Illinois Center Bldg., Suite 1300
 Chicago, IL 60601; (312) 861-0880
 FAX: (312) 861-0874

Arizona: James Theriault (408) 441-0550

Los Angeles/Orange County/San Diego:
 Ian Hill
Sales Coordinator: Debi Neal
 16255 Ventura Blvd., Suite 300
 Encino, CA 91436; (818) 990-9000
 FAX: (818) 905-1206

Pacific Northwest: Bill Giller (408) 441-0550

San Jose:
 Lou Demeter (408) 441-0550
 Bill Giller (408) 441-0550
 James Theriault (408) 441-0550
Sales Administrator: Amber Hancock
 2025 Gateway Pl., Suite 354
 San Jose, CA 95110; (408) 441-0550
 FAX: (408) 441-6052 or (408) 441-7336

Texas/Southeast: Bill Yarborough
 12201 Merritt Dr., Suite 220
 Dallas, TX 75251; (214) 661-5576
 FAX: (214) 661-5573

Direct Connection Ad & DAC Sales Representative:

Jeanie Griffin (201) 393-6080

Canada: Tony Chisholm
 Action Communications
 135 Spy Court
 Markham, Ontario L3R 5H6
 Phone: 416-477-3222
 FAX: 416-477-4320

Holland: W.J.M. Sanders, S.I.P.A.S.
 Oosterpark 6-P.O. Box 25
 1483 DePyp, Holland
 Phone: 02997-1303
 Telex: 13039 SIPAS NL
 Telefax: (02997)-1500

Austria, Belgium, Germany, Switzerland:

Friedrich Anacker
 InterMedia Partners GmbH
 Katernberger Strasse 247
 5600 Wuppertal 1
 West Germany
 Phone: 02-02-711-091/92

Japan: Hirokazu Morita
 Japan Advertising Communications
 New Gunza Buiding 3-13
 Gunza 7-chome
 Chuo-Ku, Tokyo 104 Japan
 FAX: 011-81-3-511-8710

Korea: Young Sang Jo
 Business Communications Inc.
 K.P.O. Box 1916
 Midopa Building 146
 Dangju-Dong, Chongu-Ku
 Seoul, Korea
 Phone: 011-82-2-739-7840
 FAX: 011-82-2-732-3662

Taiwan: Tomung Lai
 United Pacific International
 No. 311 Nanking E. Rd., Sec. 3
 Taipei, Taiwan R.O.C.
 Phone: 011-886-27-150-751
 FAX: 011-886-27-169-493

United Kingdom/Scandinavia/Israel:

John Maycock
 Huttons Buildings
 146 West St.
 Sheffield, England S1 4ES
 Phone: 742-759186

A	
ACCEL Technologies	209
Advance Power	152A-B
Advin Systems	208
Aerospace Optics	91
AMD	10-11
AMP	118-119
Analog Devices	43-49
Analytek	57
Anritsu	193
Apex Microtechnology	22
Applied Microsystems	81
Arnold Magnetics	149
Aromat	195
Augat Alcoswith	167
Avanti Circuits	142
B	
Basler Electric	129
B&C Microsystems	209
Bivar, Inc.	207
Bourns Trimpot	146
BP Microsystems	208
Brooktree	185-188
Bud Industries	138
Burr-Brown	8
Bytek Corp.	209
C	
Caddock Electronics	127
Capital Equipment Corp.	180, 207
Cirrus Logic	25
Clearpoint Research	107
Comtran® Integrated Software	8
Condor	132
Coto Wabash	178
Cybernetic Micro Systems	14, 208
Cypress Semiconductor	172
D	
Dallas Semiconductor	17
Data I/O	69, 208
E	
Eldre	207
Electro Films	131
Emulation Technology	207
Equipto	121
E-T-A® Circuit Breakers	144
F	
Farnell Advance Power	152A-B
Ferranti Venus	142
Forest Electric Co.	209
Fortron/Source	176
Franklin Software	208
G	
GigaBit Logic	181
GS Battery	137
H	
Hewlett-Packard Co.	2-3, 34-35
Hughes Aircraft	143
Hypertronics	207
I	
IBM	58-59
Illinois Capacitor	130
Inmark Corp.	208
Inova Microelectronics	66
Integrated Device Technology	33
Intel	96
International Rectifier	190
IOtech	135-136
K	
Kemet Electronics	161
L	
Lambda Electronics	197-200
Linear Technology	Cover IV
Logic Modeling	84
Lorain Products	124
M	
Matrix Systems	175
Mentor Graphics	28-29
Meta-Software	203
MF Electronics	16

Micro Linear	109-112
Micron Technology	73
Mini-Circuits Laboratory, a Div. of Scientific Components Corp.	15, 18-19, 104, Cover III
Motorola Computer Group	98-100
Motorola Semiconductor Products 6-7, 54-55, 78-79	
N	
National Instruments	204
NCR Microelectronics	82-83
NKK Switches	178
Nohau Corp.	182
O	
Oak Switch Systems	151
OKI Semiconductor	94-95
OrCAD Systems	Cover II
Outlook Technologies	88-89
P	
Performance Semiconductor	9
Philips Components	168-169
Philips Components-Signetics	26-27
Philips 66 Company	61
Pico Electronics, Inc.	125, 154
Ponsor Enterprises	209
Potter & Brumfield	128
Power-One	166
PseudoCorp	209
Pulizzi Engineering	207
Pulse Engineering	150
Q	
Qualidyne	123
R	
Racal Redac	71
Raychem	170
Raytheon	12-13
Robinson Nugent	140
Rogers Corp.	208, 212
Rohm	211
S	
Samsung Semiconductor	20-21
Samtec	145
Semiconductor Circuits	159
Siemens Components	62-63
Signatec	209
Silicon General	165
Silicon Systems	50
Sipex	155
S-MOS	38-39
SoLiCo	158
Spectrol	126
Sprague Goodman	137
Standard Grigsby	139
Stanford Research	30
T	
T-Cubed Systems	208
Teledyne Solid State	177
Teltone	207
Texas Instruments	64A-D
Thermometrics	160
Todd Products	114
Toshiba America	36-37
U	
Ultimate Technology	184
UTMC	176
V	
Varta Batterie	77
Vicor	183
W	
Wavetek	1
Western Digital	162-163
White Technology	75
Wintek Corp.	207
Y	
YUASA Battery	157
Z	
Z-World Engineering	209

The advertisers index is prepared as an extra service. Electronic Design does not assume any liability for omissions or errors.

Real help.



When you're looking for solutions that work *today*, call us. We have products that'll give you some real help.

See, we're a lot like you. Working hard—often late into the night—to make reliable products that meet real needs.

ROHM makes a great line of components—monolithic and hybrid ICs, LEDs, displays, LCDs, discretes, passives, printheads and more. In fact, we're among the world's top 25 semiconductor companies.

Dual Digital Transistors

Take our digital transistor series. These combine up to four resistors and two transistors in a SOT-36—a neat little package we developed so we could put more stuff into the same space as the good old SOT-23. And save you a lot of real estate on the circuit board.

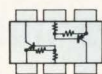
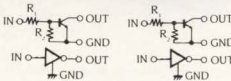
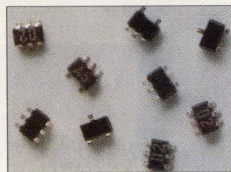

You can get V_{ce} ratings from 11 to 120 volts, and current ranges from 30 to 100 mA. Whichever configuration you choose, they're

all the same size, which sure helps simplify your layout. And their surface-mount packaging makes them popular with the manufacturing folks, too.

If you want to know more, call Sharon Whitmore, who's shown in the photo below. In addition to having answers to your questions and real solutions to meet your transistor requirements, Sharon is easily the best-looking of the group. And easy to talk to.

E²PROMs

Maybe you need a PROM with low power consumption and high reprogrammability. If so, take a look at our new CMOS 1024-bit EEPROM, the best alternative to traditional NMOS we know of.

In addition to all the standard features you'd expect, the BR93CS46 operates at a low 2.7 volts, drawing only 20 μ A. And

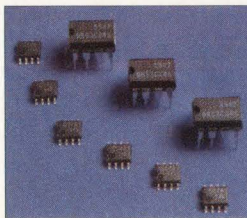

you can even run it at a full 1 MHz.

The BR93CS46 gives you external read/write memory in sixty-four 16-bit registers, and interfaces with standard microprocessors like Intel's 8048/49/51/96, National's COP4XX, Motorola's 6801/05, TI's TMS1000, and Zilog's Z8. Seven 9-bit instructions control everything.

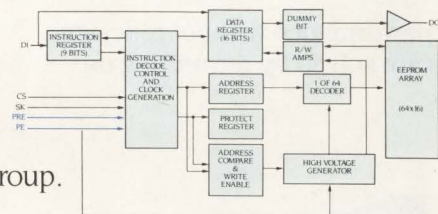

For more details, call Warren Schoals, the studious guy standing in the

back. (Warren's also known as Mr. Whiteshirt when he's not out in his pick-up.)

Next time you're trying to figure out a solution that works today—or tonight—FAX us an S.O.S. Thank-you.

Then turn off the light and go home. Your family will thank you, too.

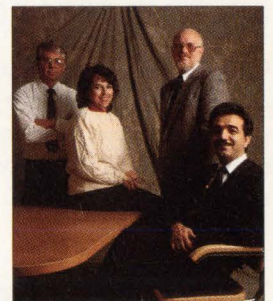

ROHM
ELECTRONICS

ROHM Electronics ■ 8 Whatney ■ Irvine, CA 92718 ■ (714) 855-2131 ■ FAX (714) 855-1669

CIRCLE 226

©Copyright 1990, ROHM Corporation.

KILL THE NOISE WITH

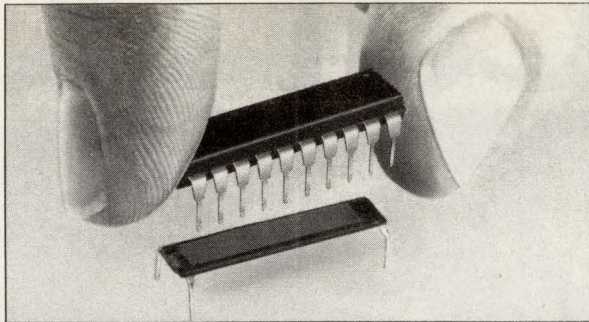

MICRO/Q® CAPACITORS

Reduce voltage noise spikes in ICs by as much as a factor of 10. Without redesign. Without using additional space.

With Micro/Q® decoupling capacitors from Rogers. Micro/Q capacitors mount under the IC. Share mounting holes. To improve noise suppression where it's most effective—at the source.

Best of all, Micro/Q capacitors kill the noise without killing a lot of valuable time.

CIRCLE 104

Micro/Q® is a registered trademark of Rogers Corporation. Another MEKTRON® Interconnection Product.

For all the facts, including the Micro/Q capacitor track record for noise-reduction in dynamic RAMs, EPROMs, static RAMs and boards that need EMI/RFI fix, call a Rogers' Product Specialist today at (602) 967-0624 (Fax 602-967-9385). And ask for a free sample.

Technology for tomorrow built on TQC today.



ROGERS

Rogers Corporation
Circuit Components Division
2400 S. Roosevelt Street
Tempe, AZ 85282

DISTRIBUTION: Europe, Japan, Taiwan, Singapore, Hong Kong, Korea, Brazil, Australia

MICRO/Q 1000 STANDARD CAPACITORS

Improve board performance without redesign. Noise problems are solved by retrofitting on existing boards.

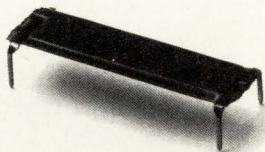

CIRCLE 105

MICRO/Q 1000 CUSTOM CAPACITORS

Special pinouts are available to address the wide variety of specialty DIPs such as analog devices, op-amps, and the center pinout advanced CMOS devices. Applications include: decoupling, EMI/RFI filtering, and compensation.

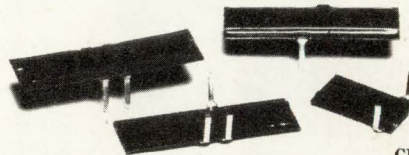

CIRCLE 106

MICRO/Q 2000 CAPACITORS

Capacitance levels from 0.01 μF to 0.3 μF in Z5V and X7R temperature stable dielectrics. The unique molded construction provides for maximum environmental protection. Suitable for use in both commercial and military applications.

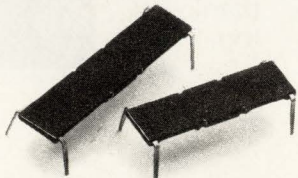

CIRCLE 107

MICRO/Q 3000 CAPACITORS

Reduces noise associated with the use of PGA and PLCC devices. Several part sizes are available to address a variety of package sizes, Micro/Q 3000 is designed to be used with all 16/32-bit MPUs, DSPs, GSPs, FPPs, gate arrays, standard cells, and fully custom ASICs.

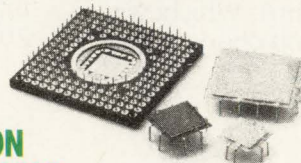

**SMT VERSION
NOW AVAILABLE**

CIRCLE 108

SPDT & SP4T SWITCHES

WITH BUILT-IN DRIVERS

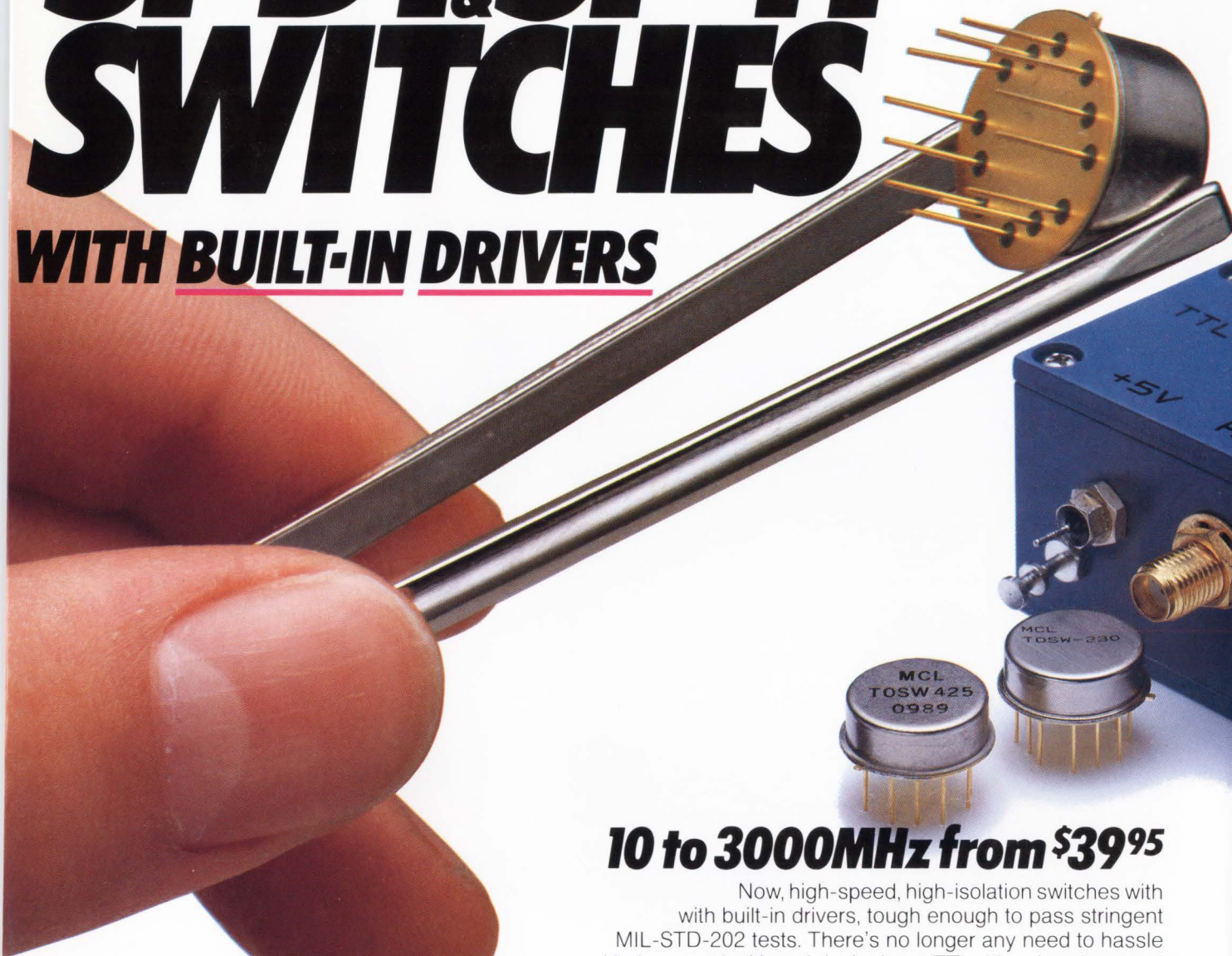

10 to 3000MHz from \$39⁹⁵

Now, high-speed, high-isolation switches with built-in drivers, tough enough to pass stringent MIL-STD-202 tests. There's no longer any need to hassle with the complexities of designing a TTL driver interface and then adding yet another component to your subsystem... it's already included in a rugged, low-cost, compact assembly.

Available in the popular hermetically-sealed TO-8 package or a small EMI-shielded metal connectorized case, these tiny PIN-diode reflective switches, complete with driver, can operate over a 10 to 3000MHz span with a fast 2μsec switching speed.

Despite their small size, these units offer isolation as high as 40dB(typ), insertion loss of only 1.1dB(typ), and a 1dB compression point of +27dBm over most of the frequency range. All models are TTL-compatible and operate from a dc supply voltage of 4.5 to 5.5 V with 1.8mA quiescent current.

Switch to Mini-Circuits for highest quality innovative products... and leave the driving to us.

finding new ways ...
setting higher standards

Mini-Circuits

A Division of Scientific Components Corporation
P.O. Box 350166, Brooklyn, New York 11235-0003 (718) 934-4500
Fax (718) 332-4661 Domestic and International Telexes: 6852844 or 620156

WE ACCEPT AMERICAN EXPRESS

SPECIFICATIONS

	TOSW-230 ZFSW-230DR		TOSW-425 ZFSW-425DR	
	10-3000		10-2500	
Freq. Range(MHz)				
Insert. Loss (dB)	typ.	max.	typ.	max.
10-100MHz	1.3	1.9	1.3	1.7
100-1500MHz	1.1	1.9	1.1	1.7
1500-3000MHz	1.8	2.7	1.8	2.5
Isolation(dB)	typ.	min.	typ.	min.
10-100MHz	60	40	60	40
100-1500MHz	40	28	40	30
1500-3000MHz	35	22	35	22
1dB Compression(dBm)	typ.	min.	typ.	min.
10-100MHz	17	6	17	6
100-1500MHz	27	19	27	19
1500-3000MHz	30	28	30	28
VSWR(ON)	typ.	max.	typ.	max.
	1.3	1.6	1.3	1.6
Switching Time (μsec) (from 50% TTL to 90% RF)	typ.	max.	typ.	max.
	2.0	4.0	2.0	4.0
Oper. Temp.(°C)	-55 to +100		-55 to +100	
Stor. Temp.(°C)	-55 to +100		-55 to +100	
Price (10-24)	\$39.95		\$59.95	
(1-9)	\$89.95		\$109.95	

500 μ A RS485 is here

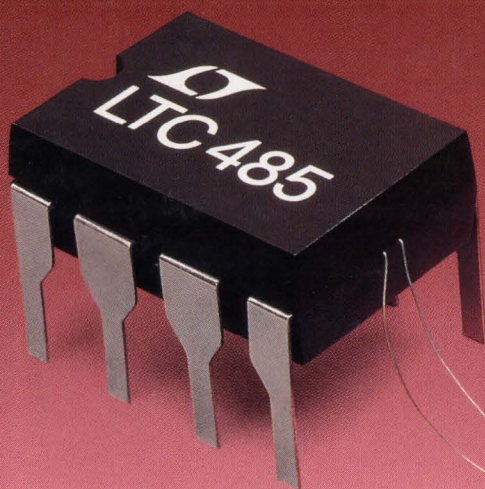

60x Less Power.

Linear introduces the industry's first CMOS/Schottky low power RS485 transceiver—the LTC485. This rugged new part meets the RS485 interface standard and is pin compatible (DIP and SOIC) with the industry standard 75176 bipolar device—but the LTC485 consumes 60 times less power. With an innovative new technology that combines CMOS transistors and Schottky diodes, Linear's new LTC485 withstands drive voltages above and below the power supply rails without latch up. Its supply current is 300 microam-

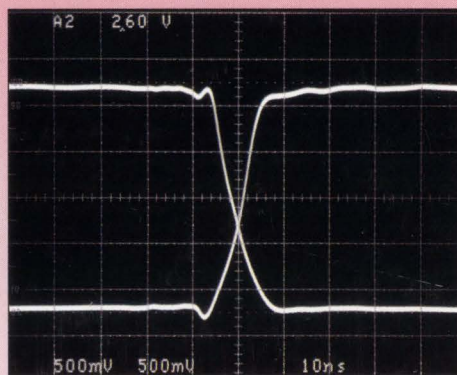

LTC485 differential driver output.

peres typical and 500 microamperes maximum. The LTC485 driver output skew is a very low 5nS. During power up and power down, the outputs remain glitch free. The LTC485 is available in 8 lead DIP and SOIC packages. Commercial, industrial and military temperature grades are available. Pricing in 100-up quantity in plastic DIP is \$1.35 and samples are available now. For a free sample and a datasheet contact: Linear Technology Corporation, 1630 McCarthy Blvd., Milpitas, CA 95035. Or call 800-637-5545.



TOUGH PRODUCTS
FOR TOUGH APPLICATIONS.

CIRCLE 156