

Electronics®

Designing high-power varactor multipliers: page 42

A survey of superpower microwave tubes: page 48

Light-emitting diodes for circuit design: page 61

July 13, 1964

75 cents

A McGraw-Hill Publication

Below: electronic explorer
probes ocean depths, page 70

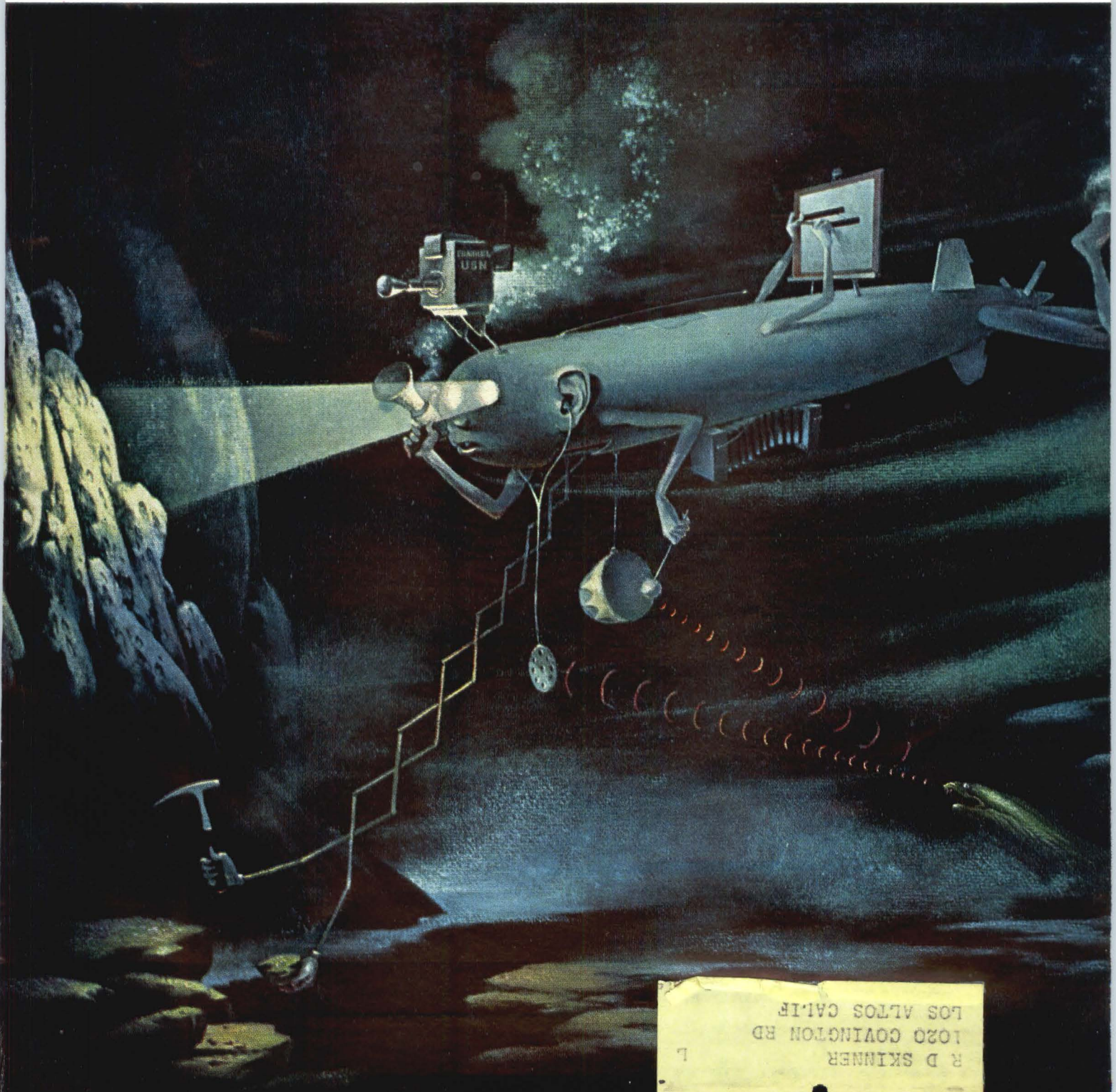

R D SKINNER
1020 GOVINGTON RD
LOS ALTOS CALIF

NEW



Ruggedized 5 Mc Standard-Frequency Oscillator

Excellent Long-Term Stability, Short-Term Stability, Spectral Purity, and with Minimal Temperature Loading and Line-Voltage Effects

Outputs: 5Mc 1Mc 100Kc

Short-Term Stability Standard Deviation (Sigma) is less than:

50×10^{-11} for 1 msec averaging time • 10×10^{-11} for 10 msec
 1.5×10^{-11} for 0.1 sec • 1.0×10^{-11} for 1 sec and for 10 secs.

Spectral Purity Spectral line width is less than 0.25 cps at 10 Gc.

Noise pedestal is $-150 \text{ db} / \sqrt{\text{cps}}$ referred to 5-Mc output.

Aging rate is less than 5×10^{-10} per day after 30 days

— less than 10^{-10} per day after one year.

Incremental-frequency control over 2700×10^{-10} range

provided by a varactor diode — resolution is such that the oscillator can be set to within 2×10^{-11} of any frequency inside the range.

Frequency can be controlled remotely with a dc voltage, if desired.

Essentially independent of line and load transients

Open- to short-circuit load change causes less than $\pm 2 \times 10^{-11}$ deviation.

All silicon solid-state circuits

Crystal Oscillator and AGC circuits housed in proportional control oven. Oven holds temperature to within 10 millidegrees C.

Built-in emergency battery supply will provide up to 35 hours continuous operation — uses explosion-proof nickel-cadmium battery.

Ruggedized Construction — meets MIL STD 167 for vibration and will withstand 30-g shocks of 11-millisecond duration.

Negligible RFI — Exceeds MIL I 26600 requirements.

Uses either ac or dc power —

ac, 90-130 or 180-260 volts, 40 to 2000 cps;
dc, 22-35 volts, 4 watts at 24 volts.



**Type 1115-B
Standard Frequency Oscillator**

... \$2050 in U.S.A.

Write for complete data — including an account of techniques used for measurements on high-stability crystal oscillators.

GENERAL RADIO COMPANY

WEST CONCORD, MASSACHUSETTS

IN CANADA: Toronto 247-2171, Montreal (Mt. Royal) 737-3673
IN EUROPE: Zurich, Switzerland — London, England

NEW YORK, N. Y., 964-2722
(Ridgefield, N. J.) 943-3140

CHICAGO
(Oak Park) 848-9400

PHILADELPHIA, 424-7419
(Abington) 887-8486

WASHINGTON, D. C.
(Rockville, Md.) 946-1600

SYRACUSE
454-9323

DALLAS
FL 7-4031

SAN FRANCISCO
(Los Altos) 948-8233

LOS ANGELES
469-6201

ORLANDO, FLA.
425-4671

CLEVELAND
886-0150

Circle 900 on reader service card

get speed and data density of magnetic tape...

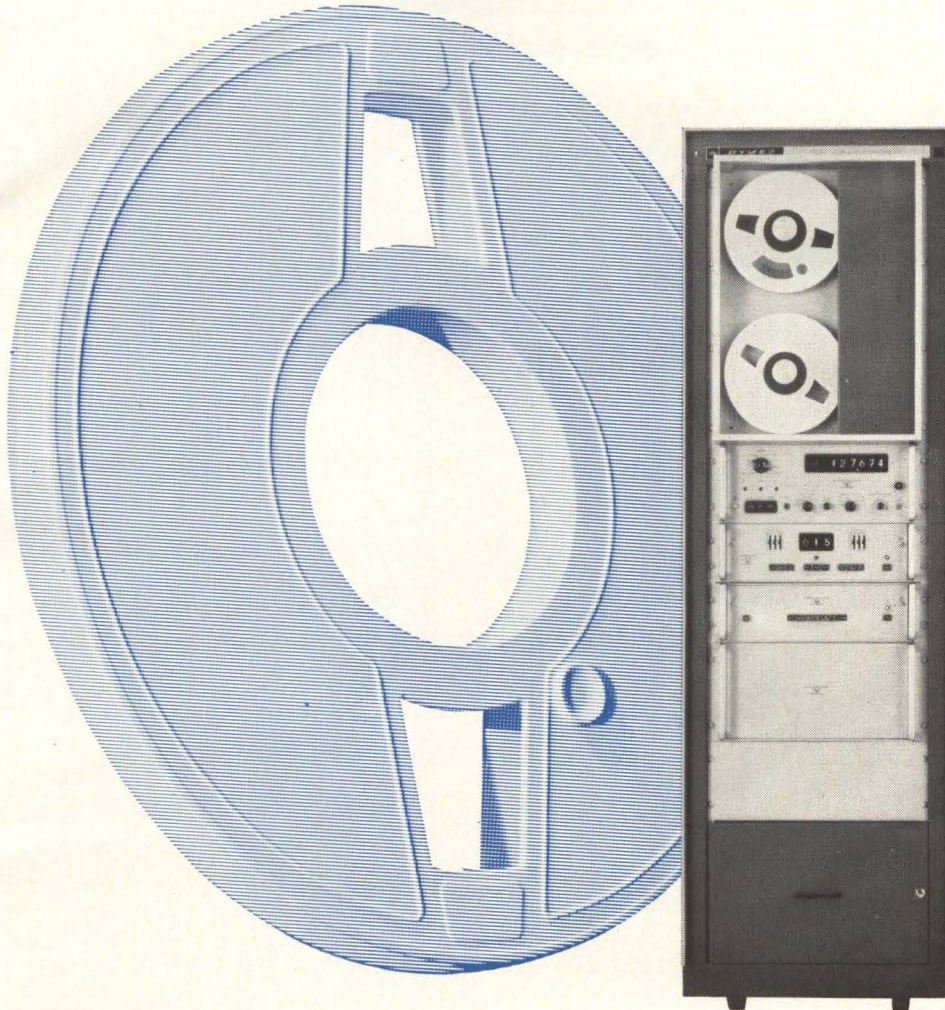

—with new standard digital data acquisition systems!

ADD: The advantages of standard systems—complete system specifications, immediate delivery, proven reliability, low cost **TO:** The benefits of magnetic tape recording and data processing **AND GET:** Fast automatic measurement of dc volts, low-level dc, ac volts, resistance and frequency recorded on an incremental recorder in computer compatible format—as fast as 10 channels per second—with up to 440,000 unattended measurements and recordings.

Heart of these magnetic tape systems, as of other Dymec 2010 Data Acquisition Systems, is the DY-2401B Integrating Digital Voltmeter, a floated and guarded instrument which lets you measure extremely low-level signals even in the presence of severe common mode and superimposed noise. The 2401B measures dc voltages to 1000 volts with 300% overranging on the lower ranges. It also measures frequency 10 cps to 300 kc, and you can add an optional converter to measure ac and resistance.

The newest of Dymec's standard systems comes in two models, the 2010J and the 2010H, which differ only in scanning capability. With the 2010J you can measure up to 200 3-wire channels, or measure up to 100 channels with the 2010H System.

Now from nine standard systems you can select a wide variety of input capabilities and recorded output, including printed paper tape, punched tape, punched cards ...and magnetic tape. Prices of the newest systems: DY-2010H, \$15,365; DY-2010J, \$17,415.

Data subject to change without notice. Prices f.o.b. factory.

DYMEC

A DIVISION OF HEWLETT-PACKARD COMPANY



DEPT. E-7, 395 PAGE MILL ROAD, PALO ALTO, CALIF. • PHONE (415) 326-1755 TWX 415-492-9363

now measure frequency to

3000 mc

with counter
ease and accuracy

The new Hewlett-Packard 5254A Frequency Converter, \$825, extends the measurement range of the 5245L Counter to 3000 mc, with full counter accuracy and performance. It's the newest example of the plug-in versatility of the counter, which offers a basic maximum counting rate of 50 mc, with 8-digit resolution.

The new converter operates on the heterodyne principle, subtracting a selected multiple of 50 mc from the

input signal. Direct measurement is simple, with the measured frequency equaling the sum of the counter reading and the value indicated by the 5254A dial. Input signal level is 50 mv rms to 1 v rms. Spurious signals have been virtually eliminated. Smooth, backlash-free tuning and a level indication meter enable untrained personnel to make quick, easy measurements to full counter accuracy.

Here's a brief summary of the features
delivered with the basic
5245L Counter for \$3250:

Time base stability better than $3/10^6$ /day

Display storage for continuous display

Automatic display of measurement units

Four-line BCD output for systems, recorders

Compact modular cabinet only 5 1/4" high

Call your Hewlett-Packard field engineer for details and a demonstration, or write Hewlett-Packard Company, Palo Alto, California 94304, Tel. (415) 326-7000; Europe: 54 Route des Acacias, Geneva; Canada: 8270 Mayrand Street, Montreal.

Data subject to change without notice. Prices f.o.b. factory.

THESE PLUG-INS AVAILABLE TODAY.... MORE TO COME!

- 5253B Frequency Converter to 500 mc, \$500
- 5254A Frequency Converter 300 mc to 3000 mc, \$825
- 5261A Video Amplifier for 1 mv rms sensitivity, \$325
- 5262A Time Interval Unit, 1 μ sec to 10^8 sec, \$300
- 5264A Preset Unit—for measuring N x frequency, period, ratio, time N events, divides input by N, with N = 1 to 100,000 selectable, \$650
- 5265A DVM plug-in—six-digit measurement of dc, 10, 100 or 1000 v full scale, accuracy 0.1% of reading, \$575

HEWLETT
PACKARD 

An extra measure of quality

Electronics

Page 4	Readers comment
8	People
10	Meetings ahead
15	Editorial
17	Electronics newsletter
35	Washington newsletter
97	New products
116	New literature
117	New books
118	Technical abstracts

In this issue

Solid State	42	Charge storage varactors boost harmonic power New varactor can handle power to 50 watts at 150 Mc in uhf and microwave applications Gerald Schaffner, Motorola, Inc.
Microwave	48	Superpower tubes: capabilities and limitations This survey examines the design features that impart high power performance, and compares tubes Lester F. Eastman, Cornell University
Circuit design	55	Four-layer diodes form staircase generator A simple circuit uses fewer components than do conventional designs H.W. Wieder, U.S. Naval Ordnance Laboratory
Circuit design	58	Designers casebook Interrogator circuit tells good data from bad; basic uhf circuit forms amplifiers and multipliers
Advanced technology	61	P-n junctions as radiation sources High-efficiency radiation from semi-conductor diodes may one day light buildings and spacecraft M.F. Lamorte and R.B. Liebert, RCA
Communications	66	II. Applications Pocket-size transmitter Solid-state transmitter for emergencies is kept on frequency by human body heat James G. Arnold, RCA
Oceanography	70	Frontier of the deep Underwater electronics is competing against conventional mechanical and electromechanical instruments John M. Carroll and Harold C. Hood

Electronics review

Page 25	Simplified servos	28	Character builder
25	Readout in living color	28	Getting the message
25	Crystal gazers	28	Wanted: circuit breakers
26	Now it's SAID	30	Inside a diode
26	1604-A where are you?	32	Optical aligner
27	Human servos	32	Transistors for color tv
27	Detecting hemorrhages		

Probing the news

87	Commuter and computer
90	Machines that think like people
94	Electronics at the Cow Palace

Technical articles

I. Design

II. Applications

Electronics

Editor: Lewis H. Young

Managing editor: John M. Carroll

Senior editors

Technical: Samuel Weber

News: George Sideris

Senior associate editors: John F. Mason

Department editors

Advanced technology: George V. Novotny

Avionics: W.J. Evezia

Circuit design: Jerome Eimbinder

Communications: Alexander A. McKenzie

Components: Michael F. Tomaino

Computers: Stephen B. Gray

Consumer electronics: V.S. Acunto

Industrial electronics: Louis S. Gomolak

Instrumentation: George J. Flynn

Military electronics: John F. Mason

New products: William P. O'Brien

Solid state: G.G. Tirellis

Space electronics: Joel A. Strasser

Staff writers: Leon H. Dulberger, Peggy Jackson

Regional editors

Boston: Thomas Maguire, editor; Susan Turner

Chicago: Cletus M. Wiley, editor

Los Angeles: Harold C. Hood, editor

San Francisco: Laurence D. Shergalis, editor; Mary Jo Jadin

London: Derek Barlow, editor

Copy editors

Howard Rausch, Sally Powell

Illustration

Art director: Howard R. Berry

Assistant art director: John C. Wright, Jr.

Editorial production: Ann Mella, Sandra A. LeMond

Editorial secretaries: Claire Benell, Lynn Emery,
Kay Fontana, Lorraine Rossi, Lorraine Werner

McGraw-Hill news service

Director: John Wilhelm; **Atlanta:** Fran Ridgeway; **Chicago:** Bruce Cross;

Cleveland: Arthur Zimmerman; **Dallas:** Marvin Reid;

Detroit: Donald MacDonald; **Los Angeles:** Kemp Anderson, Michael Murphy,

Ron Lovell; **San Francisco:** Margaret Ralston, Ed. Addeo;

Seattle: Ray Bloomberg; **Washington:** George Bryant Jr., Glen Bayless,
Charles Gardner

McGraw-Hill world news service

Bonn: Richard Mikton; **Brussels:** Arthur Erikson; **London:** John Shinn;

Mexico City: Wesley Perry; **Milan:** Bruce Bendow;

Moscow: Donald Winston; **Paris:** Dan Smith;

Rio de Janeiro: Leslie Warren; **Tokyo:** Richard Halloran, Charles Cohen

Circulation manager: Hugh Quinn

Reprints: T.M. Egan

Publisher: C.C. Randolph

Electronics: July 13, 1964, Vol. 37, No. 20

Printed at 99 North Broadway, Albany, N.Y.
Second class postage paid at Albany, N.Y.

Subscriptions are solicited only from those actively engaged in the field of the publication. Position and company connection must be indicated on orders. Subscription prices: United States and Possessions and Canada, \$6.00 one year, \$9.00 two years, \$12.00 three years. All other countries \$20.00 one year. Single copies, United States and Possessions and Canada 75¢. Single copies all other countries \$1.50.

Published every other Monday by McGraw-Hill Inc. 330 West 42nd Street, New York, N.Y. 10036. Founder: James H. McGraw, 1860-1948.

Subscribers: The Publisher, upon written request to our New York office from any subscriber, agrees to refund that part of the subscription price applying to copies not yet mailed. Please send change of address notices, subscription orders or complaints to Fulfillment Manager, Electronics, at the address below. Change of address notices should provide old as well as new address, including postal zone number if any. If possible, attach address label from recent issue. Allow one month for change to become effective.

Postmaster: Please send Form 3579 to Fulfillment Manager, Electronics, P.O. Box 430, Hightstown, New Jersey 08520

Readers Comment

Magnetic logic

The article, The Case for Magnetic Logic [June 1, 1964, p. 40], was very good to see. It seems to me that this is a somewhat neglected area, there appearing all too few papers in this important field of electronics. As a result, many engineers are effectively denied the special knowledge of the potential of magnetic circuitry for simplicity and reliability covering a very broad range of circuit functions.

This well-organized and informative article will hopefully be followed by others.

A. Kelly Hooks
Sprague Electric Co.
North Adams, Mass.

■ See our 24-page special report on magnetics in the June 29 issue, page 61.

Diversification

Your "Challenge of Change" editorial of June 15 [p. 15] hits close to home. You and I suppose that a large defense electronics firm would be interested in making a move toward diversification into consumer electronics, particularly with a new product.

To quote you: "Now the big payoff will come to the man who can devise the inexpensive, ingenious product for a big-volume market that is independent of giant government projects." Certainly that should be the case, but I'm afraid it isn't.

My firm has developed Color-sound, a modern electronic approach to the age-old color organ, a device to control color from sound. Experimenters have played with this type of thing for years, but our company has spent over \$100,000 developing, testing and marketing Colorsound as a consumer product. The public likes it, is willing to buy it, and we have "the inexpensive, ingenious product for a big-volume market."

Recently we approached several defense electronics firms, thinking that they should be interested in acquiring a consumer product for the reasons expressed in your ed-

(ADVERTISEMENT)

Extreme Size Reduction, Unusual Capacitance Stability Achieved with Filmite® 'K' Polycarbonate Film Capacitors

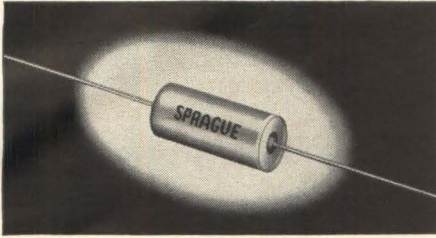

New Filmite 'K' Polycarbonate Film Capacitors are more than 13 times smaller than paper capacitors of equivalent capacitance value and voltage rating.

Designed and developed by the Sprague Electric Company, their polycarbonate film dielectric provides exceptionally high capacitance stability over the entire temperature range, due to the inherently low coefficient of expansion of polycarbonate film and a dielectric constant which is nearly independent of temperature.

Filmitite 'K' Capacitors exhibit almost no capacitance change with temperature — dramatically better than polyester-film types, they even surpass polystyrene capacitors. The low dissipation factor (high Q) makes these capacitors extremely desirable where high current capabilities are required, as in SCR commutating capacitor applications.

Low dielectric absorption, considerably lower than that of many other commonly-used film dielectrics, over a broad frequency/temperature spectrum makes Filmitite 'K' Capacitors ideal for timing and integrating.

Type 260P Filmitite 'K' Capacitors are metallized, utilizing non-inductive construction. They feature special self-healing characteristics in the rare event of dielectric breakdown. Designed for operation at temperatures from -55 C to +105 C, these metal-clad capacitors are hermetically sealed and are available in a variety of mounting styles. Types 237P and 238P are of high-purity foil construction, and are hermetically sealed in metal cases. Their operating temperature range is -55 C to +125 C.

For complete technical data on Type 260P and on Type 237P and 238P Capacitors, write for Engineering Bulletins 2705 and 2700, respectively, to Technical Literature Service, Sprague Electric Co., 35 Marshall St., North Adams, Mass.

45C-4143

Availability from Sprague!

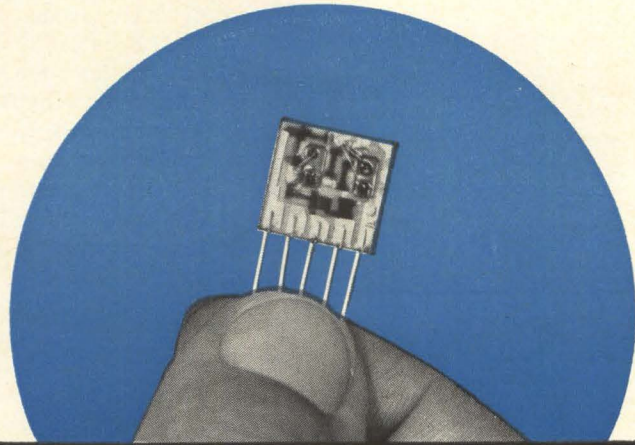

CERACIRCUIT* THIN-FILM MICROCIRCUITS

NOW IN VOLUME PRODUCTION

Alert design engineers everywhere are discovering that Sprague thin-film microcircuits allow great flexibility and design freedom. Chopping size, weight, and cost, while boosting reliability and power utilization, these ceramic-base circuits are remarkably easy to work with. Containing familiar elements such as capacitors, inductors, resistors, diodes, and transistors, Sprague thin-film microcircuits utilize precision components with a wide choice of tight parameters.

If you have a genuine interest in knowing how these customized circuits can save you time, space, and money while actually increasing the reliability of your equipment, a Sprague microcircuit specialist will be glad to explain how you can take full advantage of Sprague's proven capabilities and production facilities. For complete information, write to Microcircuits Marketing, Sprague Electric Company, 35 Marshall Street, North Adams, Massachusetts.

*Trademark

SPRAGUE COMPONENTS

MICROCIRCUITS
CAPACITORS
RESISTORS
TRANSISTORS
INTERFERENCE FILTERS
PIEZOELECTRIC CERAMICS

PACKAGED COMPONENT ASSEMBLIES
FUNCTIONAL DIGITAL CIRCUITS
MAGNETIC COMPONENTS
PULSE TRANSFORMERS
CERAMIC-BASE PRINTED NETWORKS
PULSE-FORMING NETWORKS

45M-101-04

SPRAGUE®
THE MARK OF RELIABILITY

from Sprague, of course!

SEPT[®]

**SILICON
PLANAR
EPITAXIAL
TRANSISTORS**

**Conforming to
ALL requirements of**

**MIL-S-19500/251A(EL)
2N2219**

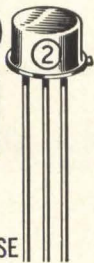

and

TO-5 CASE

**MIL-S-19500/255A(EL)
2N2222**



TO-18 CASE

For complete technical data, write to:
TECHNICAL LITERATURE SERVICE
SPRAGUE ELECTRIC COMPANY,
35 MARSHALL ST.
NORTH ADAMS, MASS.

45T-4126

SPRAGUE[®]
THE MARK OF RELIABILITY

'Sprague' and '®' are registered trademarks of the Sprague Electric Co.

itorial. We have the product, and went to them looking for financial and managerial backing. Without exception we were told, "Sorry, but consumer products are not compatible with our present plans. We don't have a sales organization ready to sell them."

That's just the point of your editorial, and that's why they're going to be in trouble. So we're left with a fine product and a problem. You said: "Getting electronics defense contractors moving again will take more than sympathy. It will take hard, careful planning; it will take a radical change by management; it will take thorough studies of engineering, production and marketing; it will take ingenuity; it will take hard work; and it will take aggressiveness."

I join you in asking: "What are the affected companies waiting for?"

Pierre Sundborg

Colorsound, Inc.
Covina, Calif.

Mail sorting

This is in reference to the article on Scanning the Mails [June 15, p. 115]. I would like to offer a possible solution to a portion of the problem, facing the Post Office Dept. in its attempt to automate mail sorting and routing.

The Post Office Dept. could issue pre-coded and pre-stamped envelopes, at reduced postal rates, to those who desire to stock and use them, utilizing existing recognition equipment, such as magnetic ink readers, adapted to this usage. Such envelopes could be stamped on both sides of all four corners with area or distribution-center codes, so that special positioning equipment could be eliminated. Envelopes could be of one or more colors, differentiating the mail classification automatically; that is, first, second, third class, air mail, special delivery, etc.

The above-mentioned would seem to me to be a much simpler method, utilizing much less equipment and involving less complexity, a system less subject to error and failure than the character-recognition system mentioned in the article.

I believe that a study, concerning all present methods of ap-

proach to these solutions, should be conducted before going into more complex and possibly less reliable areas to achieve the same result.

S. Hamilton McNeill

President
Guarantee Engineering
Enterprizes, Inc.
Addison, Ill.

In your June 15 issue [p. 115], you state that Richard Hessinger, the Post Office's director of research, estimates that if just the location of the address on the envelope could be standardized, as much as 25% to 50% of the research and development costs could be eliminated.

Here's my solution: Make a stamp and addressing label combination that has this form:

	
NAME	
STREET	
CITY	
STATE	

At one stroke, by selling this stamp-label, or "stabel," you at once can make everyone conform and thus standardize the location of address.

Allan Kiron

Washington

Micropower amplifier

Your article, How to design micropower transistor amplifiers [May 18, p. 73], is very interesting, but there seem to be discrepancies in the section on design procedures on page 76. Equations 2 and 3 equate currents to voltages in both instances.

In the complementary amplifier item on page 92, resistor R₄ is shorted out.

Hubert Scholz

Arvada, Colo.

▪ The voltage terms in equations 2 and 3 should be enclosed in brackets on page 76. On page 93, remove the junction dot just to the right of capacitor C₁.

TRW CAPACITORS STAY PUT



14-59

How do we build stability into our close tolerance capacitors? ■ By selecting the finest basic materials ■ By manufacturing in a highly specialized facility ■ By control-processing to precise values ■ By inspection-testing to prove top reliability ■ By really caring.

Result? *Stability*. The kind that won't quit. The kind you need for all exacting circuits requiring $\pm 1\%$ tolerance with built-in "stay-put-ability."

These are typical of the stabilized close tolerance types now available:

Type	Dielectric	Case	Voltage Range
663UW	mylar	tape-wrapped	100-1000v
X663F	metallized mylar	tape-wrapped	100-1000v
863	polystyrene	tape-wrapped	100-600v
683	mylar (MIL-C-19978) (CQ)	hermetically sealed	50-600v
643UW	mylar (MIL-C-27287) (CTM)	tape-wrapped	100-600v

What the TRW Close Tolerance Program Means to You . . .

TRW Capacitor Division (formerly Good-All) has an outstanding history as a close tolerance capacitor supplier. A specific facility and team of specialists are assigned to development and manufacturing in this product area. Coordinated action yields quick delivery . . . in any quantity range.

Good-All's precision processing is fully applicable to sub-miniature designs in tape-wrapped, dipped or hermetically sealed construction. Reliability and stability are proved by data from millions of test hours.

The Close Tolerance Program is a continuing one, aimed at delivering a better product in less time. As part of this program, Good-All offers close tolerance capacitors using new dielectrics and combinations of dielectrics.

For complete technical information, contact our field salesman in your area, or write:



TRW CAPACITOR DIVISION
THOMPSON RAMO WOOLDRIDGE INC.
112 WEST FIRST STREET, OGALLALA, NEBRASKA
PHONE: 308 284-3611 • TWX: 309 526 7816

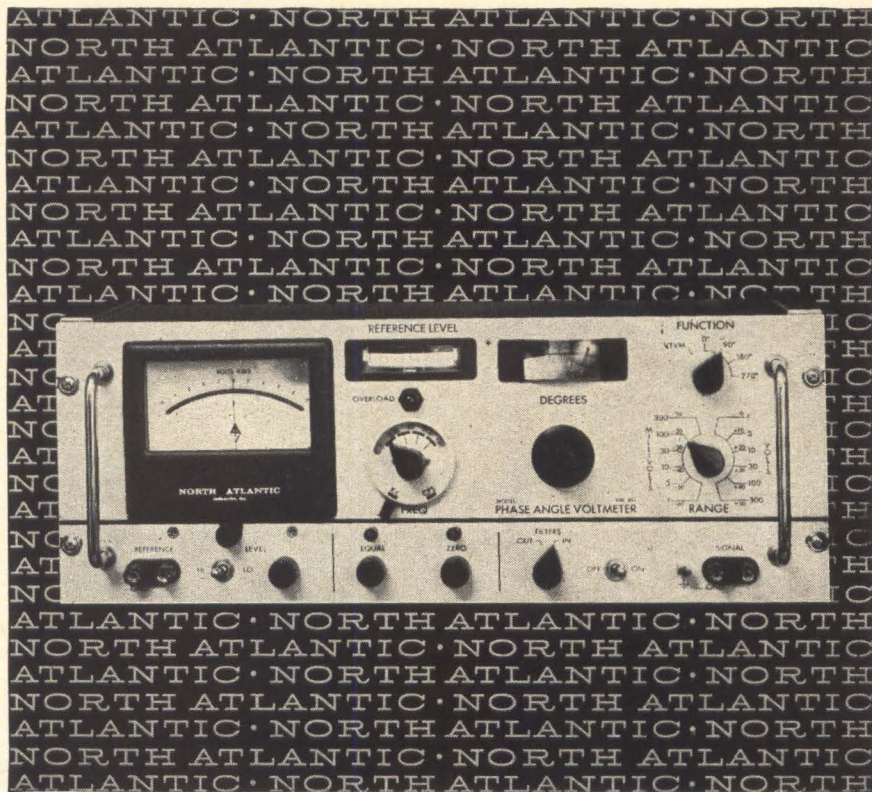

how to measure in-phase, quadrature and angle while sweeping frequency to 100 kc

North Atlantic's latest addition to the PAV line of Phase Angle Voltmeters* enables you to make measurements while frequency is varying over half-decades without recalibration. The VM-301 Broadband Phase Angle Voltmeter* provides complete coverage from 10 cps to 100 kc, and incorporates plug-in filters to reduce the effects of harmonics in the range of 50 cps to 10 kc with only 16 sets of filters. Vibration analysis and servo analysis are only two of the many applications for this unit. Abridged specifications are listed below:

Voltage Range.....	1 mv to 300 volts full scale
Voltage Accuracy.....	2% full scale
Phase Dial Range.....	0° to 90° with 0.1° resolution (plus 4 quadrants)
Phase Accuracy.....	0.25°
Input Impedance.....	10 megohms, 30μf for all ranges (signal and reference inputs)
Reference Level Range.....	0.15 to 130 volts
Harmonic Rejection.....	50 db
Nulling Sensitivity.....	less than 2 microvolts
Size.....	19" x 7" x 10" deep
Price.....	\$1990.00 plus \$160.00 per set of filters

North Atlantic's sales representative in your area can tell you all about this unit as well as other Phase Angle Voltmeters* for both production test and ground support applications. Send for our data sheet today.



NORTH ATLANTIC industries, inc.
 TERMINAL DRIVE, PLAINVIEW, L. I., NEW YORK • OVerbrook 1-8600

*Trademark

People

Michel Levit says his vacuum-tube business is doing very well, thank you, despite the universal swing to transistors. He specializes in finding tubes for obsolete equipment.



A visitor to his office high above Park Avenue South, in New York, would not be inclined to doubt the success of the Metropolitan Supply Co., of which the silver-haired Belgian is president. The plush suite is appointed in rosewood and decorated with imported reproductions of Renaissance art.

His stock in trade consists of 1,600 different types of tubes, a knowledge of where to find 2,400 other kinds at prices from 50 cents to \$11,000, and an up-to-date international cross-reference. The file enables Metropolitan to replace a burned-out tube anywhere in the world, regardless of its age or of the multiplicity of tube designations among manufacturers and governments.

He has found a United States manufacturer's equivalent of a World War II British Army tube, and a replacement for a tube in a foreign airline's flagship. A few weeks ago he helped a disabled ship resume her voyage by air-freighting a crucial klystron tube to Hamburg, Germany—at a cost \$900 below the tube's original price.

Metropolitan, a tube-distributing concern, stocks tubes that may have been discontinued 25 years ago. Sometimes manufacturers buy their own tubes from Levit, finding this cheaper than retooling for an out-of-production model.

Do tubes spoil during years of storage? No, except for magnets, Levit replies. "Tubes are not tomatoes, you know," he explains. "Some types actually improve with age, like wine."

Levit, a debonair gentleman with a French accent, left his native Belgium in 1940, a step ahead of the invading Germans. His only baggage was a raincoat.

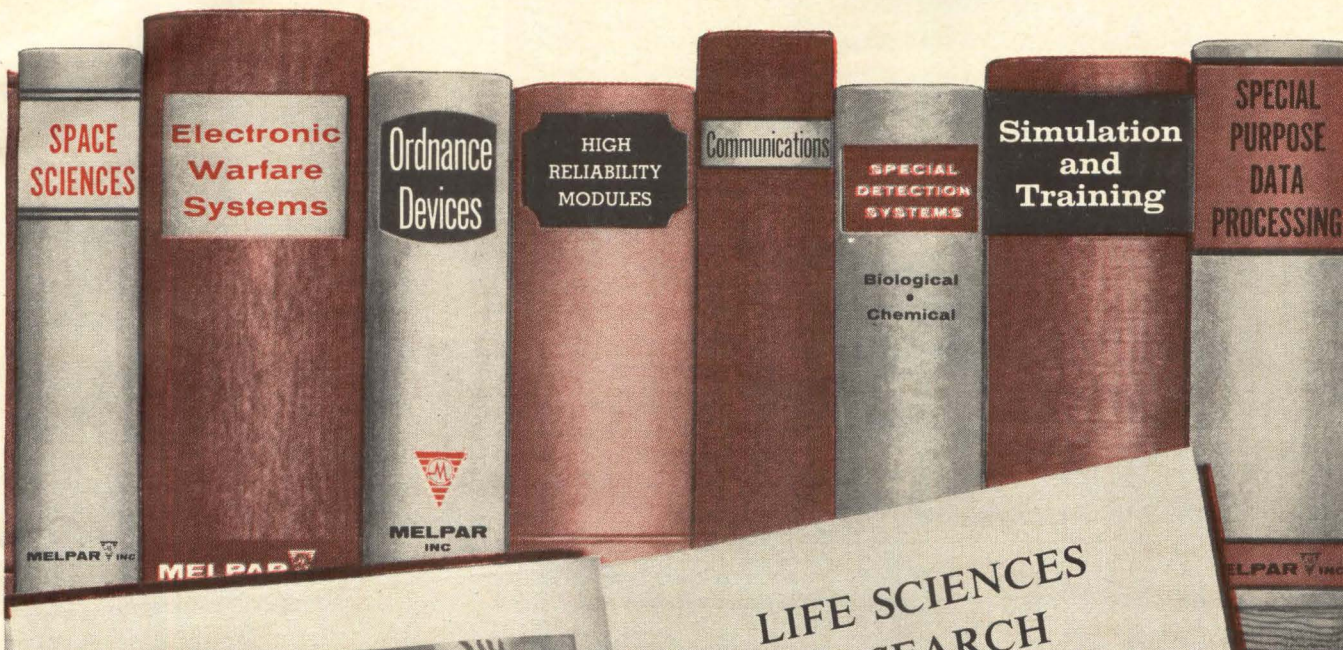

LIFE SCIENCES RESEARCH and TECHNOLOGY

- Advanced Bacteria and Virus Detection Methods
- Extraterrestrial Life Detection
- Enzymatic Detection and Identification
- Space Biology and Biophysics
- Biological Energy Conversion
- Bioinstrumentation
- Biological Surface Phenomena
- Rapid Identification of Airborne Pathogenic Microorganisms
- Virus-Cell Interaction Studies
- Biochemical Gas Phase Chromatography
- Psychotropic Compounds
- Automated Tissue Culture Techniques
- Adaption of Terrestrial Organisms to Extraterrestrial Conditions
- Lipid Phase Transitions in Biological Membranes
- Microbiological Fuel Contamination
- Life Support

Continued investigations in all these areas have created a continuing need for highly qualified, highly creative life scientists and bio-engineers. If you feel that you can contribute to Melpar's programs in the life sciences we'd like to hear from you. Write: Manager, Professional Placement.

MELPAR INC

A SUBSIDIARY OF WESTINGHOUSE AIR BRAKE CO.

3000 Arlington Boulevard, Falls Church, Va.

IN HISTORIC FAIRFAX COUNTY,
ONLY 10 MILES FROM WASHINGTON, D. C.

an equal opportunity employer

4th of a Series

NOW . . .

THE FAMOUS

JERROLD 900-B SWEEP SIGNAL GENERATOR



OFFERS CENTER FREQUENCIES FROM 500 kc to 2,400 mc without plug-ins

The versatile Jerrold Model 900-B Sweep Signal Generator now extends its useful frequency range all the way up to 2,400 mc, with sweep widths ranging from 10 kc to 800 mc. A diode frequency doubler, priced at only \$115, increases the usefulness of the 900-B without the need for plug-ins.

Frequency Doubler Specifications

Input Frequency..... 500-1,200 mc
Output Frequency..... 1,000-2,400 mc
Conversion loss at 0.5 volt RMS
... less than 12 db to 2,000 mc
... less than 13 db to 2,400 mc

Output component, other than harmonic of input..... 20 db or more below
Maximum Input..... 1 volt RMS
Connectors..... 50 ohm, BNC

The diode frequency doubler can also be used with the economical Jerrold 900-A Sweep Generator.

Model 900-B..... \$1,980
Model 900-A..... \$1,260
Frequency Doubler..... \$ 115

Write for complete technical data.
Jerrold Electronics Corporation, 15th & Lehigh Ave., Philadelphia 32, Pa.

**JERROLD
ELECTRONICS**

A subsidiary of THE JERROLD CORPORATION

Meetings

Rochester Conference on Data Acquisition and Processing in Medicine and Biology, University of Rochester, Rochester, N.Y., July 13-15.

Special Technical Conference on Nuclear Radiation Effects, IEEE PTG-NS, Radiation Effects Committee; University of Washington, Seattle, Wash., July 20-24.

Research Conference on Instrumentation Science, ISA; William Smith College, Geneva, N.Y., Aug. 3-7.

UAIDE Annual Meeting, Users of Automatic Information Display Equipment; International Hotel, Sepulveda and Century Blvds., Los Angeles, Aug. 12-14.

Quantification of Human Performance Symposium and Workshop, University of New Mexico, EIA M-5.7, Subcommittee on Human Factors; University of New Mexico, Albuquerque, N.M., Aug. 17-19.

Symposium on Ultra Low Frequency Electromagnetic Fields, NBS Central Radio Propagation Lab. and National Center of Atmospheric Research; Boulder Laboratories, Boulder, Colo., Aug. 17-20.

Electronic Packaging International Symposium, University of Colorado Cahners Publishing Co.; University of Colorado, Boulder, Colo., Aug. 19-21.

Distributor-Manufacturer-Representative Conference, WESCON; Ambassador Hotel, Los Angeles, Aug. 24.

Association for Computing Machinery Annual Conference, ACM; Sheraton Hotel, Philadelphia, Aug. 25-27.

WESCON 1964, 6th Region IEEE and Western Electronic Manufacturers Assoc.; Los Angeles Sports Arena and Hollywood Park, Los Angeles, Aug. 25-28.

International Conference on Microwaves, Circuit Theory and Information Theory, Inst. Electrical Comm. Engrs. of Japan; Akasaka Prince Hotel, Tokyo, Sept. 7-11.

International Exhibition of Industrial Electronics, Swiss Industries Fair; Basel, Switzerland, Sept. 7-11.

International Convention on Military Electronics (MIL-S-CON-8), IEEE; Shoreham Hotel, Washington, Sept. 14-16.

Ceramic-To-Metal Session, American Ceramic Society, Philadelphia, Sept. 17.

Annual Northwest Computing Conference, Northwest Computing Association, University of Washington, Computing Center; University of Washington, Seattle, Wash., Sept. 17-18.

Engineering Management Annual Conference, IEEE-AME; Pick-Carter Hotel, Cleveland, Sept. 17-18.

AIAA Military Aircraft Systems and Technology Meeting (Secret), AIAA, USAF, and BuWeps; NASA-Langley Research Center, Va., Sept. 21-23.

Third Canadian IEEE Communications Symposium, Canadian Region IEEE; Queen Elizabeth Hotel, Montreal, Sept. 25-26.

Society of Motion Picture and Television Engineers Technical Conference, SMPTE, Inc.; Commodore Hotel, New York, Sept. 27-Oct. 2.

Physics of Failure in Electronics Annual Symposium, Rome Air Development Center, IIT Research Institute; IIT Research Institute, Chicago, Sept. 29-Oct. 1.

Call for papers

Symposium on General Systems Knowledge, Society for General Systems Research, IEEE; American Association for the Advancement of Science, Montreal, Dec. 26-31. **September 15** is deadline for submitting a 500 word abstract in triplicate to Omar Wing, Columbia University, Dept. of Electrical Engineering, New York, N.Y. 10027.

Solid-State Circuits International Conference, University of Pennsylvania, IEEE; University of Pennsylvania and Sheraton Hotel, Philadelphia, February 17-19. Deadline is **October 26** for submitting both a 300-500 word summary and a 35-word abstract to B.J. Lechner, RCA Laboratories, Princeton, N.J. 08540. Papers are invited in the areas of integrated circuits, design and test techniques, linear signal processing by digital means, redundancy practice, solid-state techniques for microwave signal amplification, oscillation, conversion and control, new devices and device characterization, optoelectronics, micropower circuits and design limitations, and cryoelectronics.

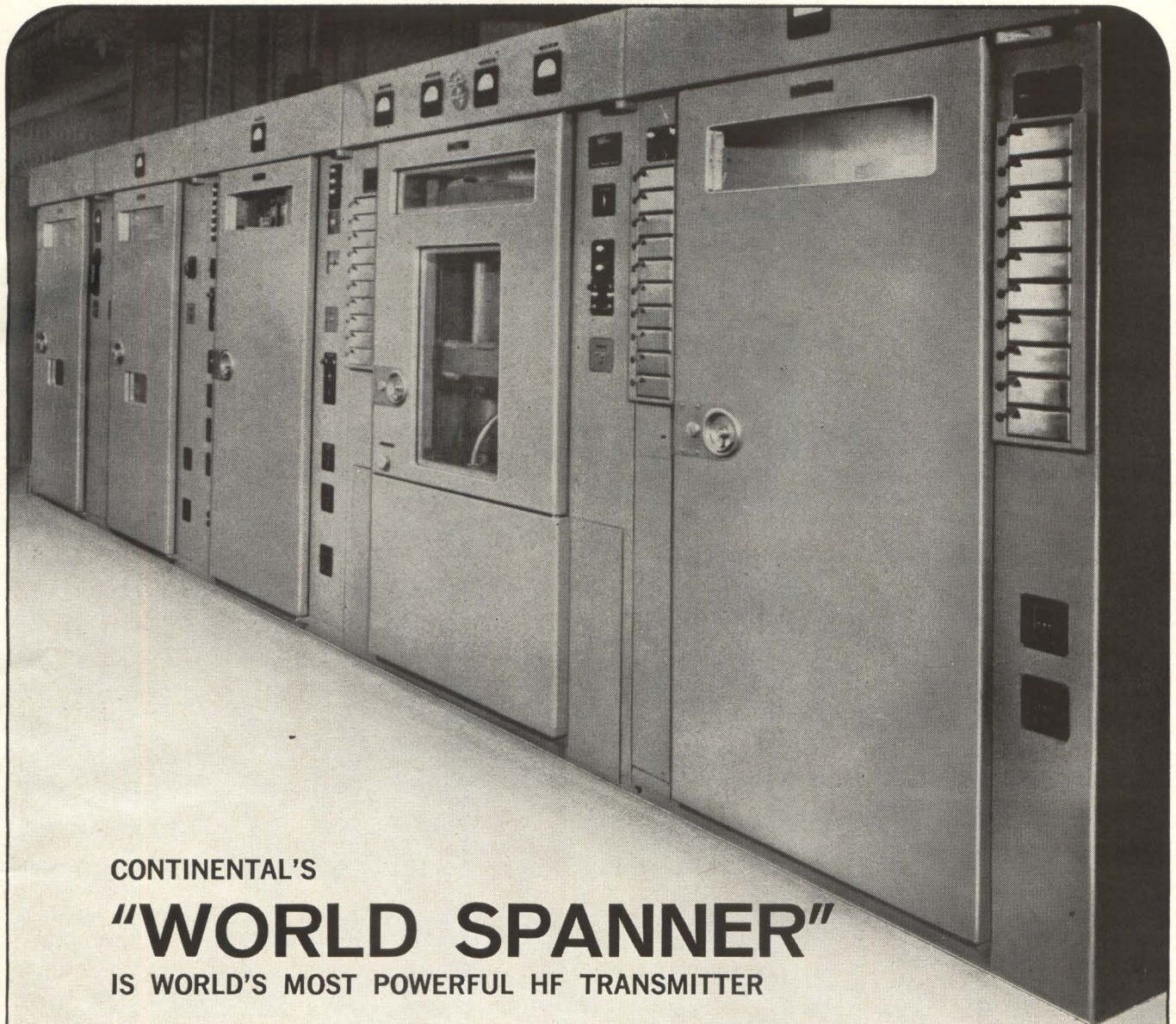

CONTINENTAL'S

"WORLD SPANNER"

IS WORLD'S MOST POWERFUL HF TRANSMITTER

Generating 600,000 watts peak, 300,000 watts average RF power, Continental's Type 621A Amplifier Group is currently being used by the U. S. Air Force, Army, and Navy in communication and research applications. Powerful enough to override natural disturbances and enemy jamming attempts, it beams messages anywhere on earth. Originally developed under an Army Signal Corps contract, and installed for operation as part of the AN/FRT-33 in

1958, it provides continuous range servo tuning of all circuit elements between 4 and 30 megacycles with the capability of presetting 10 channels. A linear amplifier, it can be used for various modes of output such as AM, FM, SSB, ISB, FSK, pulse or any other complex wave shape within the average and peak power capabilities of the equipment. Continental's AN/FRT-32 provides identical capabilities in the 20 to 65 megacycle range.

for information on this and other super power communication/radar and system experience, write dept. 35

LTV *Continental Electronics Division* 
CONTINENTAL ELECTRONICS MANUFACTURING CO.
MAILING ADDRESS: BOX 5024 / DALLAS, TEXAS 75222 / TELEX CEPCO
THE SPECIALISTS IN SUPER POWER RADAR & RADIO TRANSMITTERS

TOUCH AND READ:

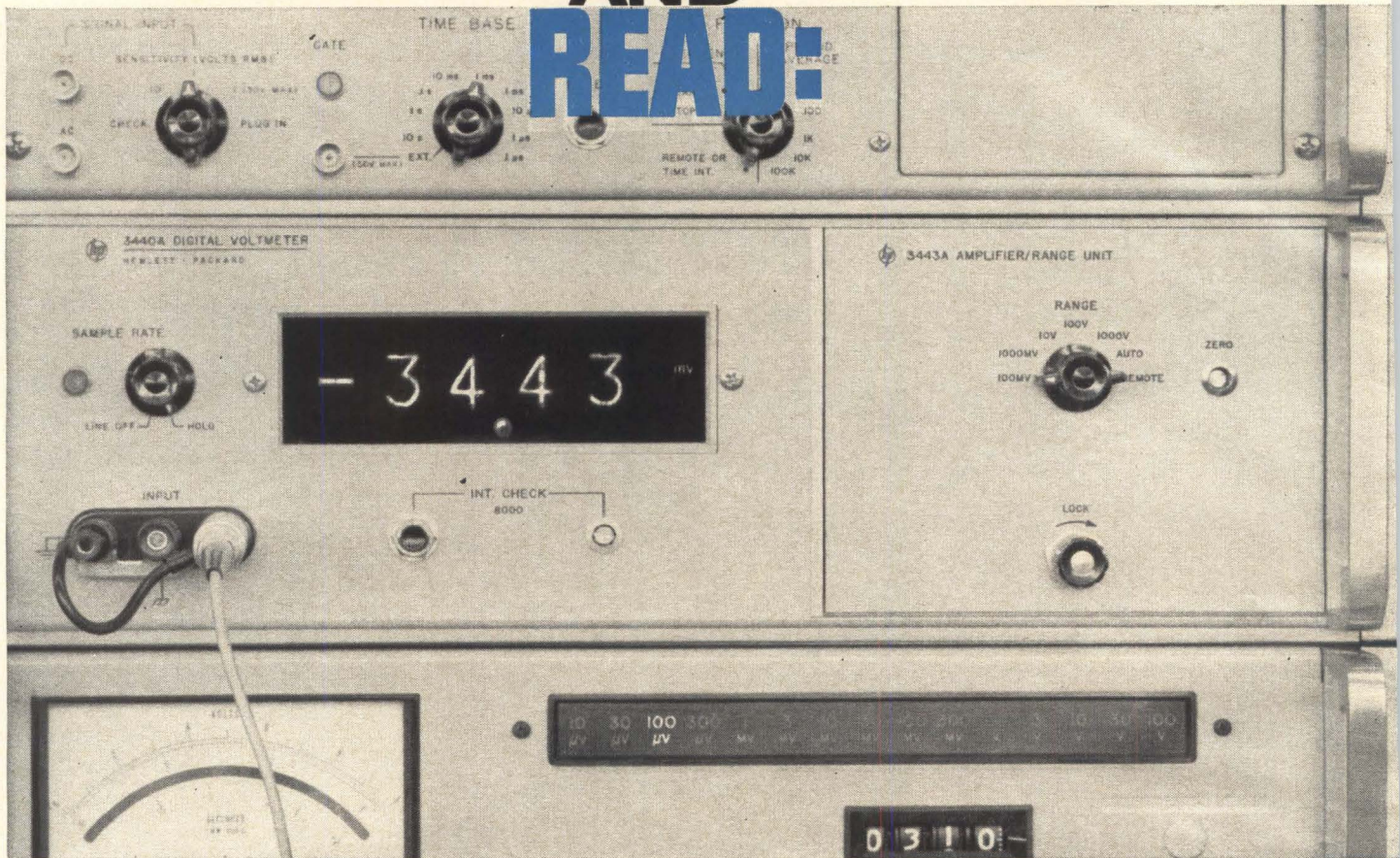

10 μ v resolution, 5 readings/second, accuracy 0.05% of reading—in a Hewlett-Packard plug-in digital voltmeter for only \$1610!

With the new 3443A High Gain/Auto Range Plug-in, the hp 3440A Digital Voltmeter permits automatic and remotely controlled measurement from 100 mv to 1000 v full scale. Constant input impedance on all ranges prevents circuit loading. Ideal for most low-level applications, such as drift measurements, transducer readout, amplifier testing, physiological responses. A front-panel offset control permits compensation for thermocouple voltages of external connections. The plug-in is priced at only \$450.

The 3440A Voltmeter, now with three plug-ins, offers inherent flexibility, and new functions will be offered with introductions of future plug-ins. For maximum economy, the 3441A Range Selector, \$40, offers range-switch selection of full-scale measurements of 9.999, 99.99 or 999.9 volts. The 3442A Automatic Range Selector, \$135, retains the manual range selection capability, plus the 5-reading-per-second speed of the accurate DVM. The 3440A and its plug-ins are priced right for quantity use, too. Ideal for systems use...or

for accurate measurement even by non-technical personnel. Also available from Hewlett-Packard: The 405BR (\$890) and 405CR (\$960, for systems use) Automatic Digital Voltmeters, with 3-digit resolution, 0.001 to 999 v dc, accuracy $\pm 0.2\%$ (of reading) ± 1 count. Or select the Dymec DY-2401B Integrating Digital Voltmeter (\$3950), for 140 db effective common mode rejection at all frequencies, including dc, with floated and guarded circuitry, and measures 100 mv to 1000 v. The DY-2401B adds an optional sixth digit to take advantage of the instrument's built-in 300% overranging. Automatic ranging optional at extra cost.

Call your Hewlett-Packard field engineer for full information on how the right DVM can solve your measuring problems. He'll be glad to provide a demonstration of the 3440A or the hp DVM of your choice. Or write: Hewlett-Packard Company, Palo Alto, California 94304, Telephone (415) 326-7000; Europe: 54 Route des Acacias, Geneva; Canada: 8270 Mayrand Street, Montreal.

Here's what the top-value 3440A offers:

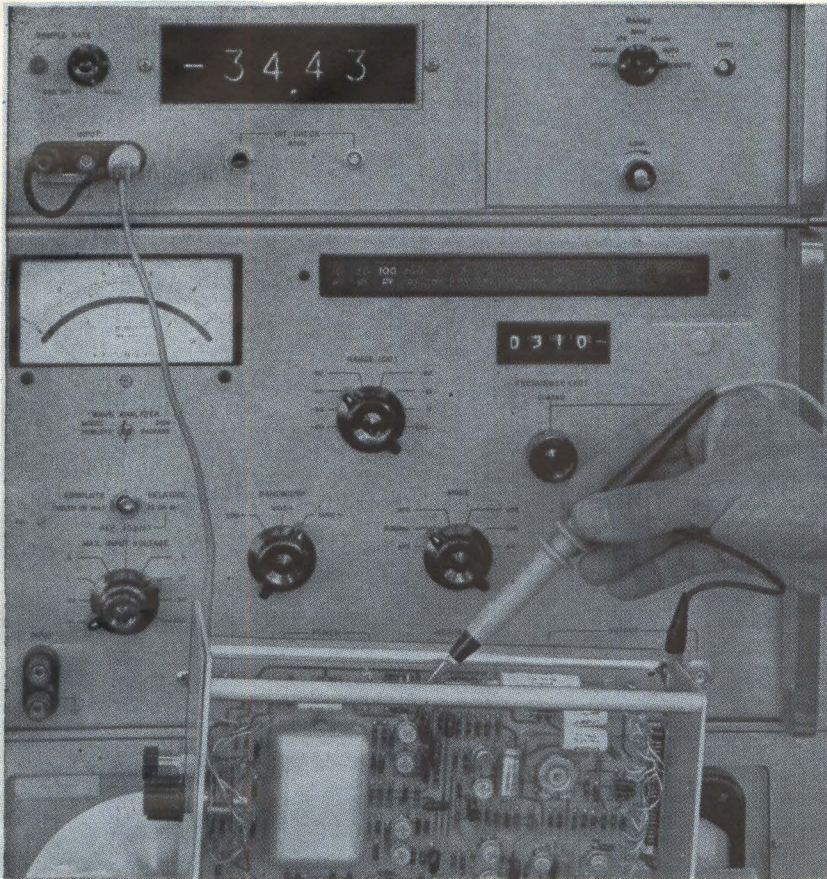

Automatic measurement with readout to 4 significant figures, up to 5 readings/sec

Total error of less than $\pm 0.05\%$ of reading ± 1 digit for 10, 100, 1000 v ranges, $\pm 0.1\%$ of reading ± 1 digit for 100, 1000 mv ranges

Automatic decimal and polarity indication

BCD recorder output in the 1-2-2-4 weighted code

Constant 10.2-megohm input impedance

Floating input, up to 500 v above chassis ground

Display storage for rapid non-blinking readings on easy-to-read rectangular display tubes

All solid state basic measuring circuitry, plug-in reed-relay ranging logic

Compact size, 5 $\frac{1}{4}$ " panel height, bench and rack instrument in one

SPECIFICATIONS hp 3440A DVM

Voltage range:	4-digit presentation, 9.999 to 999.9 v full scale, 5% overrange, plus overrange indicator; with the 3443A, 99.99 mv to 999.9 v full scale, 5 ranges, same overranging indicator	Input impedance:	10.2 megohms (to dc) all ranges; floating
Accuracy:	$\pm 0.05\%$ of reading ± 1 digit for 10, 100, 1000 v ranges, $\pm 0.1\%$ of reading ± 1 digit for 100, 1000 mv ranges, with line voltage variations of $\pm 10\%$ and temperature between $+15^{\circ}\text{C}$ and $+40^{\circ}\text{C}$	Input filter ac rejection:	30 db at 60 cps increasing at 12 db/octave
Sample rate:	5 samples per sec to 1 per 5 sec; storage between samples	Common mode rejection:	60 db at 60 cps (90 db at dc)
Range selection:	with 3441A, Manual with 3442A, Manual, Automatic and Remote: Automatic (max.) achieves accurate reading in less than 1 sec after new voltage is applied; Remote (max.) will change range within 40 msec with 3443A, Manual, Automatic and Remote: Automatic (max.) achieves accurate reading in less than 1.5 sec after new voltage applied; Remote (max.) will change range within 40 msec	Polarity:	automatic indication
		DC isolation:	signal pair may be operated up to 500 v dc from chassis ground
		BCD output:	6 columns consisting of 4 digits, polarity and decimal point of four-line BCD with weighting of 1-2-2-4; "0" is -24 v and "1" is -1 v, with 100 k output impedance
		Size:	5 $\frac{1}{4}$ " high, 16 $\frac{3}{4}$ " wide, 11 $\frac{1}{2}$ " deep, 15 lbs. net with plug-in
		Price:	\$1160 without plug-ins

Data subject to change without notice. Prices f.o.b. factory.

**HEWLETT
PACKARD**



An extra measure of quality

9379

Why Motorola uses capacitors of Mylar® in its TV line

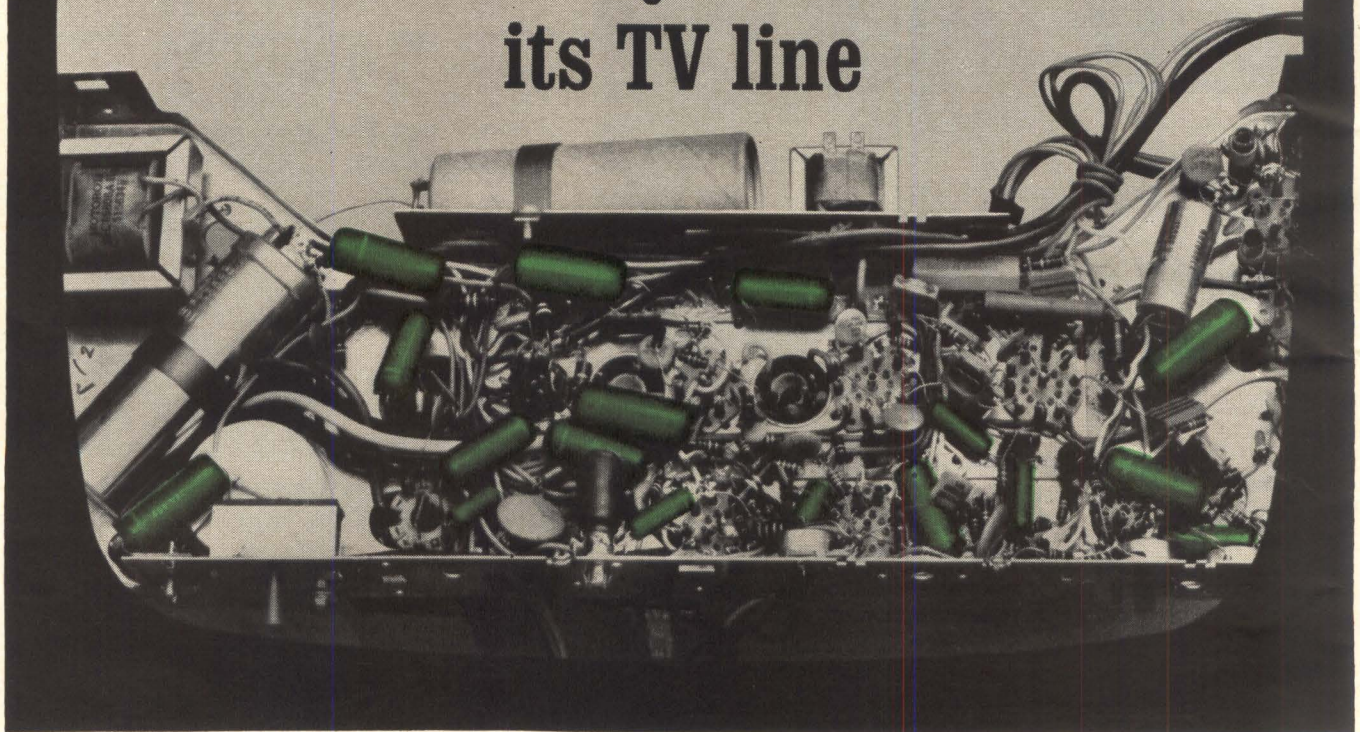

Chassis KTS-586-A00

“RELIABILITY!”

says Dick Kraft, Assistant Chief Engineer—TV Design

Under its exacting Golden M program, Motorola is placing emphasis squarely on reliability. Every tube and part in every color and black-and-white set in its complete line is guaranteed for a full year. It's no wonder that in the chassis shown (used for a group of portables) Motorola specified 17 tubular capacitors of “Mylar”.*

“With the reliability of ‘Mylar’ available to us, we simply couldn't afford to use paper,” says design engineer Kraft. Capacitors of “Mylar” also offer these advantages for

home entertainment and similar circuits: reduced size, high IR, thermal stability, moisture resistance and AC/DC compatibility... all at a price about the same as paper!

For complete data on the performance of capacitors of “Mylar” and how they can help you in your design problems, write: Du Pont Co., Film Department B-22, Wilmington, Delaware 19898.

DU PONT
BETTER THINGS FOR BETTER LIVING
... through Chemistry

only DU PONT makes
MYLAR
POLYESTER FILM

*Du Pont registered trademark for its polyester film

No time for Mittyism

One of James Thurber's heroes, Walter Mitty, is a frustrated little man who repeatedly escapes from the harsh realities of everyday life to the pleasant fantasies of daydreams. Unhappily, we've discovered the electronics industry is full of Walter Mittys.

As the industry suffers the pains of change, a lot of executives who should know better want to ignore what's happening. Military markets are shrinking, engineers are being laid off, and a revolution has hit the components field. Still, the electronic Walter Mittys tell you that everything will be fine next year. "Let's ignore this now," they tell you, "and maybe it will all go away."

Last month we watched a neat Walter Mitty act performed by the Electronics Industries Association. While the group held its annual convention in Chicago, an EIA press release headlined "Electronics Industry Least Affected by Military Cutbacks." The mimeographed release quoted EIA president Charles F. Horne, a senior vice president of the General Dynamics Corp., this way: "The impact of (defense) cuts on the electronics industry will probably be the lightest among all the major defense industries."

It's bad enough that this statement is untrue. But what makes EIA's Walter Mittyism even worse is that Horne didn't make the statement in his speech. A General Dynamics aide of Horne's explained: "Things aren't good enough at our company for him to say anything like that."

Then, at the annual meeting of the American Institute of Aeronautics and Astronautics, Eugene G. Fubini, the Defense Department's deputy chief of research, pulled a dream sack over his head. He told the session he was fed up with gloomy predictions. He even refused recently to participate in a symposium on converting defense companies to civilian production.

The men who want to ignore the industry's current problems are supposedly intelligent and sophisticated. There must be a reason why they think military electronics will fare better next year. There is, and it's Walter Mitty at his best.

The "in-boys" confide that political pressure is building up on President Johnson from politicians, company executives and from unemployed engineers and production workers. They tell you he has never resisted that kind of pressure from voters in his career and won't now. That means, they continue, Johnson will find big projects for the industry, whether Defense Secretary McNamara wants them or not, or whether the country needs them or not. When Johnson's projects start awarding contracts, prosperity will abound again.

We think it is quite likely that Lyndon Johnson will succumb to the pressure exerted by politicians in states hardest hit, particularly populous California, New York and Massachusetts. Observers in Washington tell us that Fubini was not really daydreaming at the AIAA session. His blast was calculated. The White House is upset about conditions in military electronics and wants to hide them if it can't help them until after the November election. Johnson is likely to try to ease the dent soon.

But we feel very strongly that make-work projects like this cannot build a firm foundation for the electronics industry. Experience shows they tend to breed inefficiency. And a lot of talented people are going to be hurt. Make-work government projects never seem to be awarded on the basis of capability; they go where political wheels squeak the loudest.

As we've said many times before on this page, the industry's answer lies in honest realization of its problems. Calling a story about engineer unemployment rubbish doesn't put a single unemployed engineer back to work. Diversification will. So will aggressive, straight-forward engineering, ingenious product planning, economic manufacturing and knowledgeable marketing.

Never has the need been greater for hard-nosed, practical management. There's no place for Walter Mitty among electronics executives today.

ES Product of the month: DC TO 12 GC STRIPLINE SWITCH

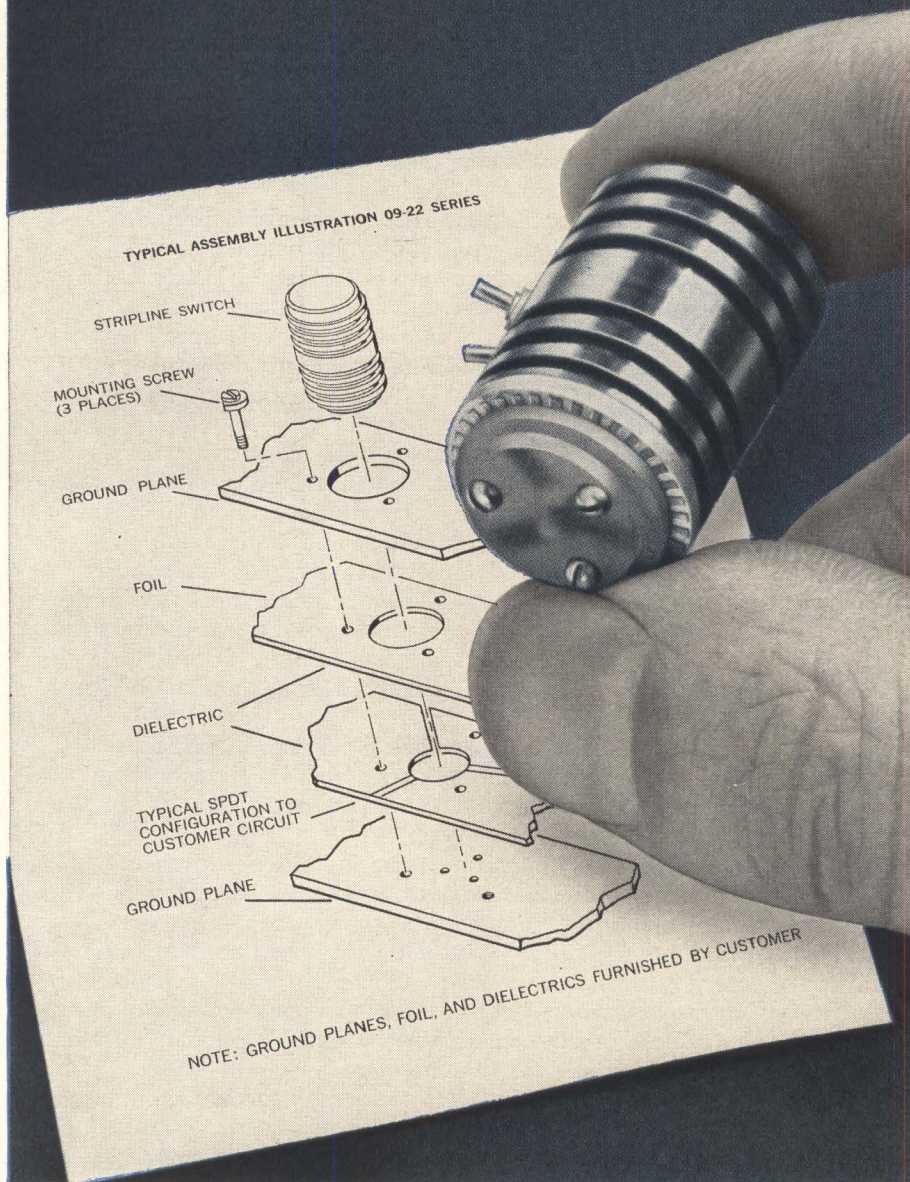

Designed and developed by Electronic Specialty for an advanced missile program, the unique stripline switch eliminates the need for coax switches and transitions in all stripline applications. Installation of the rugged, light weight, miniature switch is simple; no soldering is necessary. Now available in four types (SPST, SPDT, DP Transfer, SP Transfer), the units can be manufactured to fit any dielectric material, center conductor strip width and thickness to meet specific requirements.

This highly reliable switch possesses these outstanding characteristics: light weight, 1.5 oz. max.; small size, .73 in. dia. x .99 in. nom.; broad frequency range, DC to 12 GC; low VSWR, 1.2:1 max.; insertion loss, .2 DB; isolation, DC to 6 GC—40 DB min., 6 GC to 12 GC—20 DB min.; duty cycle, continuous; connectors, none—fits directly into stripline circuit. For complete information on the stripline switch write to William Marcy, Director of Marketing, at the address shown below.

ES is a diversified, dynamic, multi-divisional organization serving defense and industry over a broad range of vital areas with advanced systems, sub-systems, and state-of-the-art components. Major contributions are currently being made in the following:

ELECTRONIC AND ELECTROMECHANICAL CONTROLS:

gyroscopes, relays, static switching devices, sensors, flashers, regulators, converters, rotary and linear actuators, motors, generators, weapon and camera controls, electromechanical assemblies for aerospace applications.

COMMUNICATIONS:

antennas, flexible and rigid waveguides, coaxial switches, diplexers, power dividers, filters, radio telescopes, solar furnaces, matching networks, antenna drive motors and controls.

POWER:

precise power systems, dynamotors, computer power sources, motor - generators, actuators, starter generators, power conversion systems, transmission towers for public utilities.

SPACE CONDITIONING:

electronically programmed environmental controls and systems for industrial, commercial, and military applications.

SYSTEMS:

Systems Laboratories conduct research, development and study programs in reconnaissance, electronic countermeasures, interferometer phased array systems, and total energy packages; integrating divisional components, sub-systems, and specialized technical skills.

For information concerning the corporate systems capability, product line, or research and development programs, write to the Director of Marketing, address below.



ELECTRONIC SPECIALTY CO.

5121 San Fernando Road • Los Angeles 39, California

Electronics Newsletter

July 13, 1964

Integrated-circuit patent tangle

On June 23, the U. S. Patent Office granted Texas Instruments Incorporated two patents that are said to cover basic processes for producing integrated circuits.

Since then, the industry has just shrugged its shoulders. A number of integrated-circuit producers think that the patents may produce a new round of cross-licensing and the payment of some nominal royalty fees. Others don't expect TI to press for licensing, because that would only complicate an already tangled patent situation in the industry—almost every producer is said to be wilfully or inadvertently infringing on somebody else's patents.

Texas Instruments won't say whether it intends to press for licenses and royalties, only that the matter is in the hands of its patent attorneys. "We know of no semiconductor integrated circuit devices now being made or proposed that are not covered by the TI patents," says S. M. Mims, the company's patent counsel.

The patents "apply to the incorporation of both active and passive circuit components into a semiconductor bar" and "hybrid integrated circuitry with active components formed within the bar and passive components deposited on it."

A spokesman for one company says that the monolithic p-n junction approach covered by the patents will soon be of "only historic interest" because of the development of dielectric isolation methods [Electronics, April 6, 1964, p. 29, and June 1, 1964, p. 23].

Several companies believe that the TI patents are no more basic than the planar process patent held by Fairchild Camera & Instrument Corp.

TI's claims did strike a nerve at Fairchild. Fairchild says that the structure described in the patents is impractical and that the rival company can't produce integrated circuits without using the planar process. Fairchild and Texas Instruments may resolve the question of who has a basic patent for integrated circuitry through an over-all licensing agreement now being negotiated by the two companies.

Airborne controls for Minuteman

The next big step in the Minuteman intercontinental ballistic missile program will be a system enabling the missiles to be launched by controls in aircraft. The Department of Defense is expected to issue requests for proposals soon. Industry interest in the preliminary stages indicates that the competition will be keen.

The Department of Defense is placing heavy emphasis, in its systems planning and development, upon communications-command capability after a nuclear attack. An Air Launch Control system would enable Minuteman to take off even if ground systems were wiped out.

New drop seen in engineer jobs

Electronics engineers' job problems [Electronics, May 18, 1964, p. 105] are common to engineers in general, according to a report by the Engineering Manpower Commission of the Engineers Joint Council.

The report indicates that employers plan to recruit 11% fewer experienced engineers this year after a similar decrease in 1963. The hiring of new engineering graduates dropped only 6% in 1963, however, and

Electronics Newsletter

recruiting goals for 1964 are practically unchanged.

"When hiring experienced engineers," the commission said, "employers will probably concentrate on obtaining only high-quality men with training in the field specifically related to particular openings."

The survey estimated a 26% gain in engineering employment by 1973, considerably lower than the 67% increase recently forecast by the Department of Labor.

The report is based on information supplied by 543 companies and government agencies that employ a total of more than 250,000 engineers.

More price cuts on integrated circuits

The swing to low-priced integrated circuits for commercial computers, controls and instruments was emphasized during the last week of June when two of the largest producers, Signetics Corp. and Motorola Inc. announced low-cost lines of circuits. The moves bore out predictions of a round of price cuts in the wake of the price slash two months earlier by the Fairchild Camera & Instrument Corp. [Electronics, May 18, 1964, p. 17].

Motorola Semiconductor Products will sell 10 circuits in the MECL current-mode-logic configuration. Prices range from \$1.95 for a bias driver to \$7.60 for a J-K flip-flop (a complex circuit which defines changes in state). Signetics has three circuits, two gates and a J-K flip-flop, priced from \$6.40 to \$10.50. Both lines have a narrower temperature range than military circuits—0° to 75° C for Motorola's and 0° to 70° for Signetics'.

Signetics is predicting that its prices will tumble to a range of \$1.50 to \$5 for volume buyers within a year. Asked why it hasn't yet cut prices as much as other producers, Signetics said "because these are new circuits, not fall-off from an existing line" of military circuits. The circuits are reported to be specially designed for commercial use. The narrower temperature range and lowered power consumption provides a higher production yield than possible for military circuits made by the same processes.

Profit forecast by Honeywell unit

Paul B. Wishart, chairman of Honeywell, Inc., expects the company's electronic data-processing division to be operating at a profit near the end of the year. He also predicts that Honeywell's computer deliveries, which he said were the fifth largest in the industry last year, would climb to third place this year and to second in 1965. The International Business Machines Corp. leads by far in computer sales, but the other computer companies don't agree on the ranking further down the line.

Wishart made his predictions during the introduction on June 30 of a large-scale computer. Besides its size and speed (one microsecond memory cycle), the H-2200 features a design that makes its program compatible with five competing systems, all made by IBM.

A-M freeze ends

The Federal Communications Commission will, on July 13, thaw the "freeze" on new a-m radio broadcasting stations. License applications will be accepted, subject to new rules eliminating overlap, or interference, between a-m stations and duplication of programming by a-m/f-m station licensees.

AN OPEN LETTER TO THE PRESIDENT OF THE UNITED STATES

April 14, 1964

President Lyndon B. Johnson
The White House
Washington 25, D.C.

Dear Mr. President:

We applaud your efforts to reduce government expenditures. We respectfully suggest this for your consideration:

Ten thousand pounds of lobsters fly from Boston to Los Angeles for \$1700.

Ten thousand pounds of airmail from Boston to Los Angeles on the same airplane pays \$4200.

Now, lobsters are very delicate to ship. They require special handling. They must get through. If they are delayed, they die. So, why don't we label airmail "lobsters" and save \$70,000,000 this year?

Of course, we can't do that. But you could ask the Post Office and the Civil Aeronautics Board to get their heads together and get as good a deal for the government as lobsters get.

We are one of your airmail contractors. We have been trying for six years to reduce our charges for airmail, to no avail. Now we appeal to you.

Respectfully,

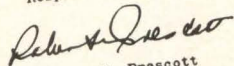

Robert W. Prescott
President
The Flying Tiger Line Inc.
Lockheed Air Terminal
Burbank, California

AN OPEN LETTER TO JOHN A. GRONOUSKI, POSTMASTER GENERAL OF THE UNITED STATES

April 7, 1964

The Honorable John A. Gronouski
Postmaster General
Post Office Department
Washington, D.C. 20025

Dear Mr. Postmaster General:

We are one of your airmail contractors. We fly your mail between Boston, Hartford, New York, Binghamton, Philadelphia, Cleveland, Detroit, Chicago, Los Angeles, San Francisco, Portland and Seattle.

We are sure we are charging you too much. In 1958 we filed an offer with the Civil Aeronautics Board to cut our rate by almost 50%. This still has not been acted upon.

In the interest of the President's desire to cut government expenses, won't you please petition the Civil Aeronautics Board to investigate our exorbitantly high airmail rate?

Respectfully yours,

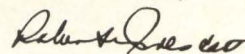

Robert W. Prescott,
President
The Flying Tiger Line Inc.
Lockheed Air Terminal
Burbank, California

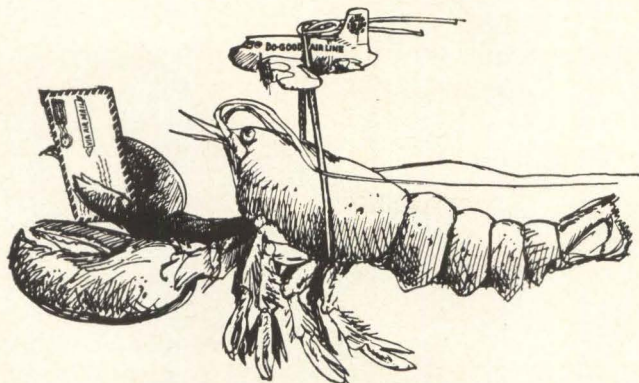

WHY DID WE WRITE THEM?

Because we don't like to see money wasted—yours, ours or anyone else's. The Flying Tiger Line was the first air carrier in history to ask the government for a cut in airmail rates—a 50% cut! The passenger carriers may need exorbitant profits from excessively high airmail rates to subsidize their cargo operations, but we don't!

We will keep moving your airfreight at low cost

so that you can make a profit on the cargo you ship by air. We will continue to improve our service and to pioneer new and better airfreight handling methods. Without competition from us, the passenger carriers could write their own ticket on both service and price. YOUR PROFITS WOULD BE THEIR LAST CONSIDERATION. Write to us today for more details. And for efficient, reasonable and reliable airfreight service, ship on the line that operates in your best interests, THE FLYING TIGER LINE.

the airfreight specialist

FLYING TIGER LINE



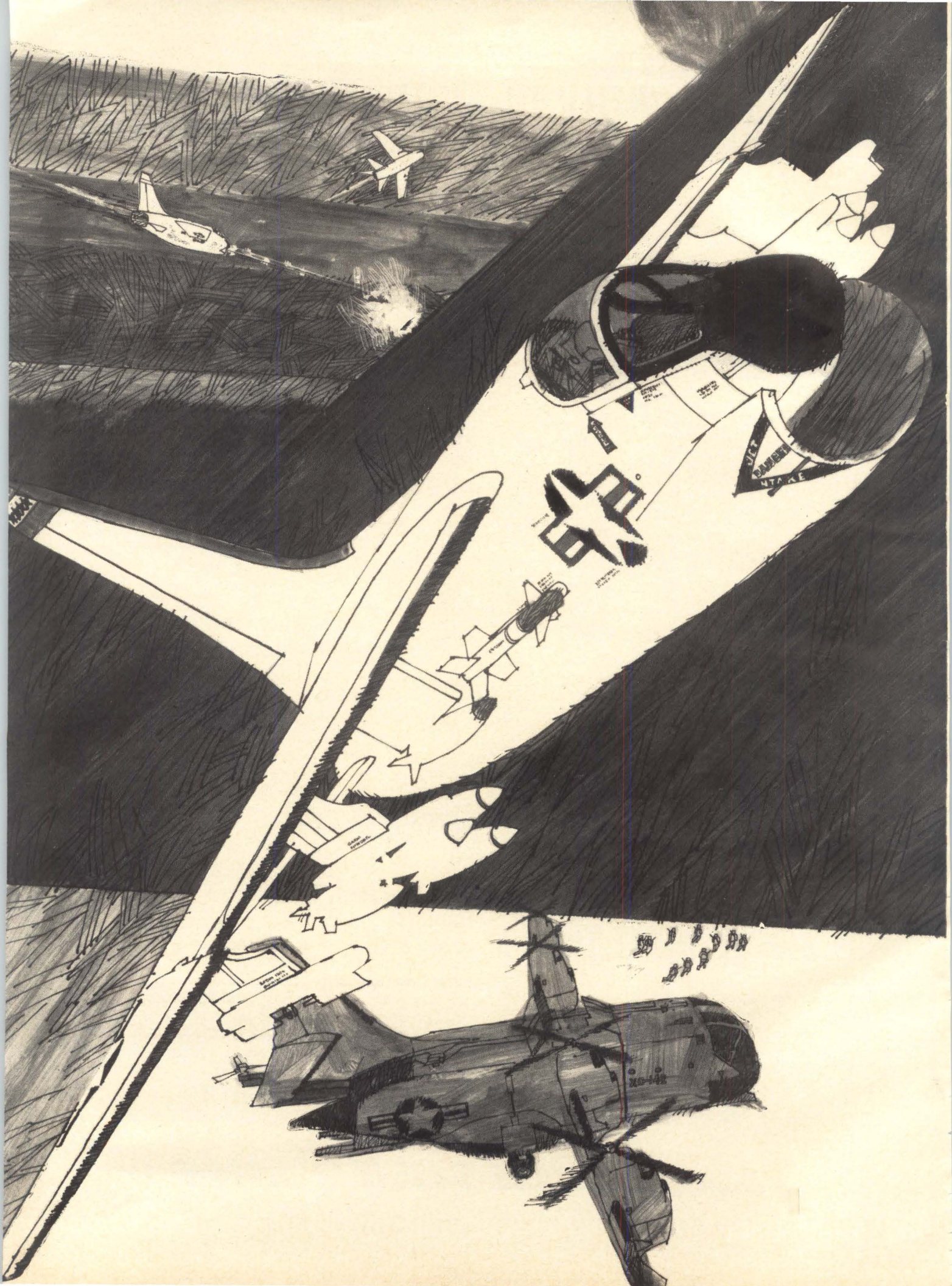

FROM BRAIN POWER TO SYSTEMS...TO AIR POWER

The modern military mission calls for air power that will closely support the man on the front lines, intercept enemy aircraft and attack. LTV Vought Aeronautics Division is "up front" in the development and production of this air power.

LTV recently was awarded a contract to build the Navy's A-7A light attack aircraft for attack missions plus close support of fighting men. It is a direct descendant of the F-8 Crusader, supersonic all-weather fighter-interceptor that has been a mainstay of the Navy's air arsenal for almost 10 years.

Scheduled for its maiden flight early this summer is LTV's tri-service XC-142A, America's first vertical/short-takeoff-and-landing transport, designed for troop support in remote and unprepared landing areas, submarine search missions and other applications. A company project that looks toward the future in V/STOL aircraft is Adam II (air deflection and modulation).

To delve into the air vehicles of tomorrow, LTV has aerophysics research and development capabilities that are unexcelled in the industry, plus basic and applied research in human engineering, mechanics and materials. Such a vehicle of the future is the Air Force LASV (low altitude supersonic vehicle) for which LTV is researching the vehicle and the ramjet propulsion system. Using nuclear heat for its propulsion energy, the LASV would have global range at sea level and speeds up to Mach 3. The Atomic Energy Commission has now completed highly successful full power tests of its Tory II-C nuclear reactor simulating flight conditions.

The ability to produce airborne weapons systems for modern defense is another example of the versatile store of scientific and engineering brain power at LTV, leader in aircraft, missiles, space, mobile ground vehicles, ground and airborne communications, electronics and range services. Ling-Temco-Vought, Inc., Dallas, Texas.

Divisions and subsidiaries: LTV Altec • LTV Astronautics • LTV Continental Electronics • LTV Ling Electronics • LTV Michigan • LTV Military Electronics
LTV Range Systems • LTV Research Center • LTV Temco Aerosystems • LTV University • LTV Vought Aeronautics • Kentron Hawaii, Ltd.

Circle 21 on reader service card

LTV
LING-TEMCO-VOUGHT, INC.

Today, the F-8 Crusader flies from Navy bases at land and sea around the world.

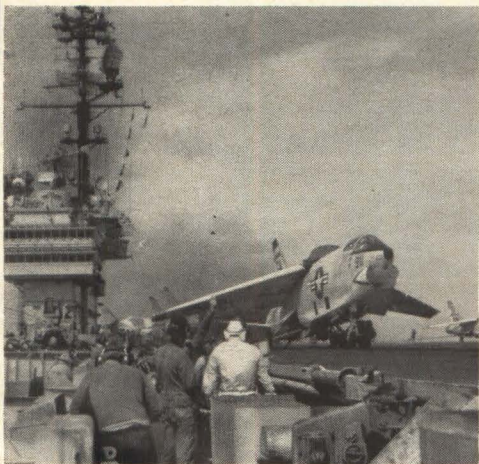

In 1966, the A-7A light attack aircraft (artist's concept here) will join the fleet.



Pioneering research in nuclear powered flight is tied to successful Tory II-C reactor tests.

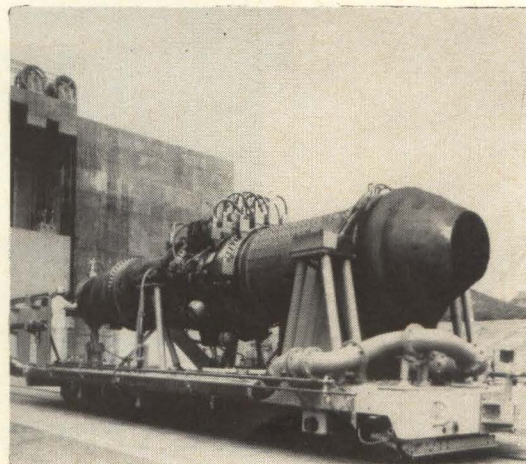

The first tri-service XC-142A V/STOL transport is rolled out of the LTV plant.



LTV looks toward the future in V/STOL with Adam II concept.

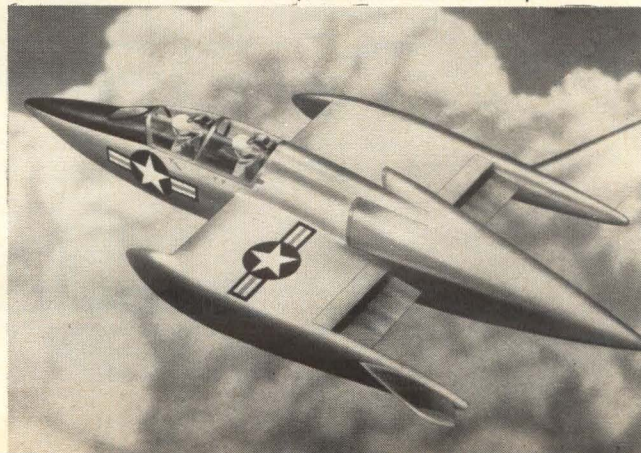

TIME BASE CORRECTION

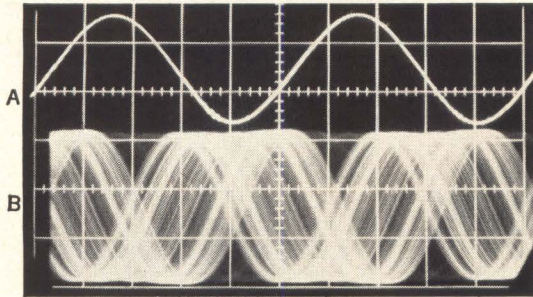

CONVENTIONAL

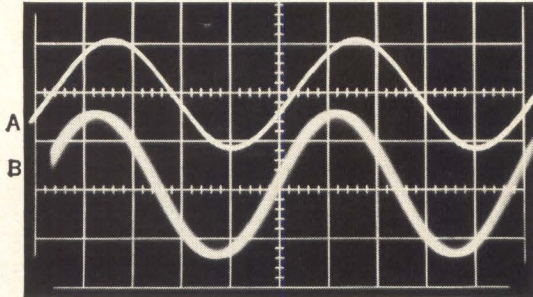

TICOR II

TRACE A: 100-kc oscillator reference signal
 TRACE B: 100-kc line driver output, track 13
 One-inch tape, speed 60 ips. Sweep rate: 2.0 μ sec/cm.
 Photo exposure: 1/25 sec.

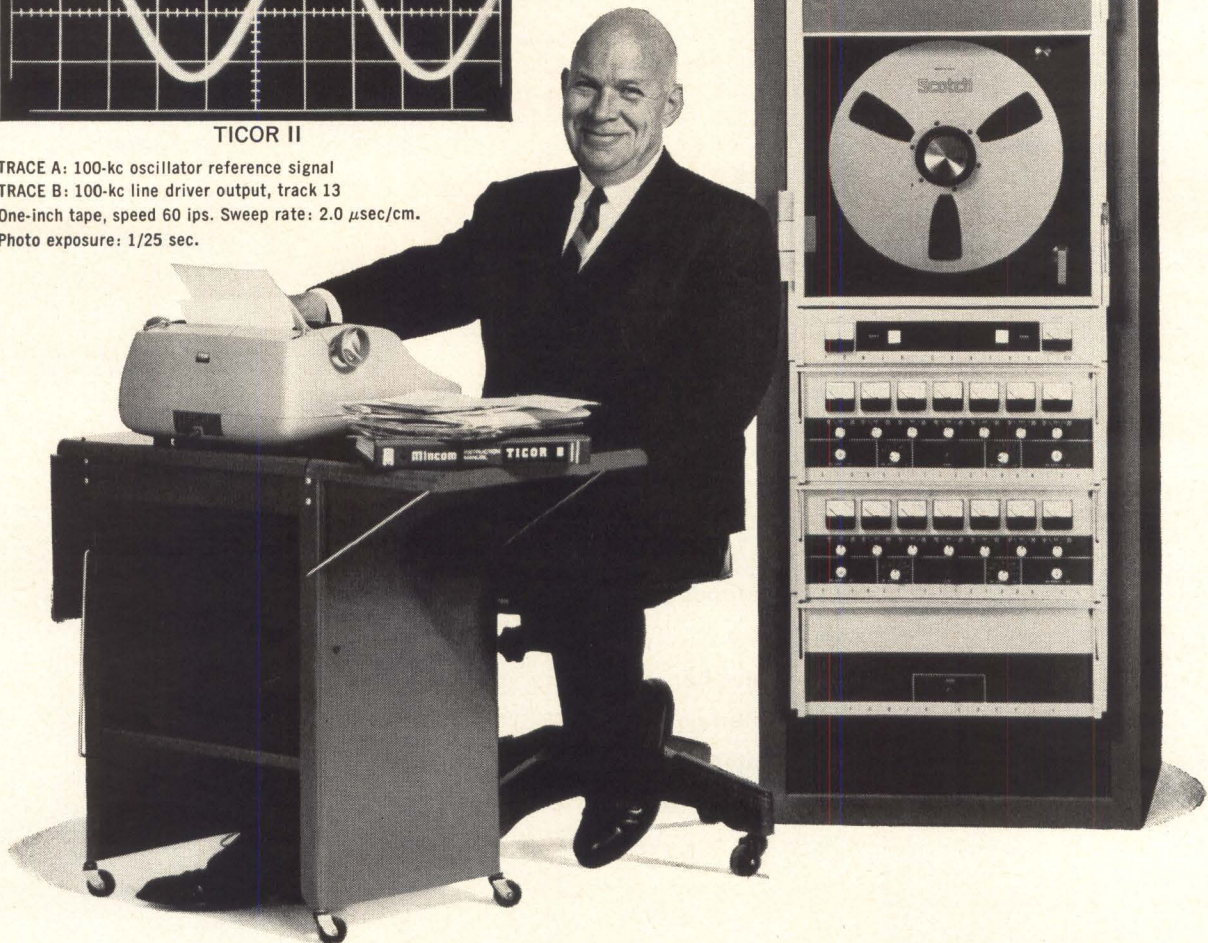

EXCLUSIVE STORY ON MINCOM'S NEW 1.5-mc TICOR II

On playback, lock in your tape reference track to TICOR II's reference oscillator signal—the traces above demonstrate a time-base correlation between events holding well within $\pm 0.5 \mu$ sec, continuously anywhere on the tape. This unique and exclusive Mincom 1.5-mc recorder/reproducer immediately updates any existing data reduction center. It opens new doors to data analysis in radar recording, single sideband, serial PCM and other systems dependent on precise time-base stability. Flutter components below 200 cps are essentially removed. Rapidly convertible from 1/2-inch to 1-inch tape, all solid state, one equipment rack, RFI-shielded. Write for specifications.

Mincom Division **3M**
COMPANY

300 South Lewis Road, Camarillo, California • 320 Shaw Road, South San Francisco, California • 529 Pennsylvania Building, 425 13th Street, N.W., Washington, D.C. • 135 West 50th Street, New York, New York • Post Office Box 272, Fairborn, Ohio • 1230 Orange Avenue, Winter Park, Florida • 2121 Santa Anna Avenue, Dallas, Texas • Eltron Engineering Sales, Inc., 246 Walnut Street, Newtonville, Massachusetts

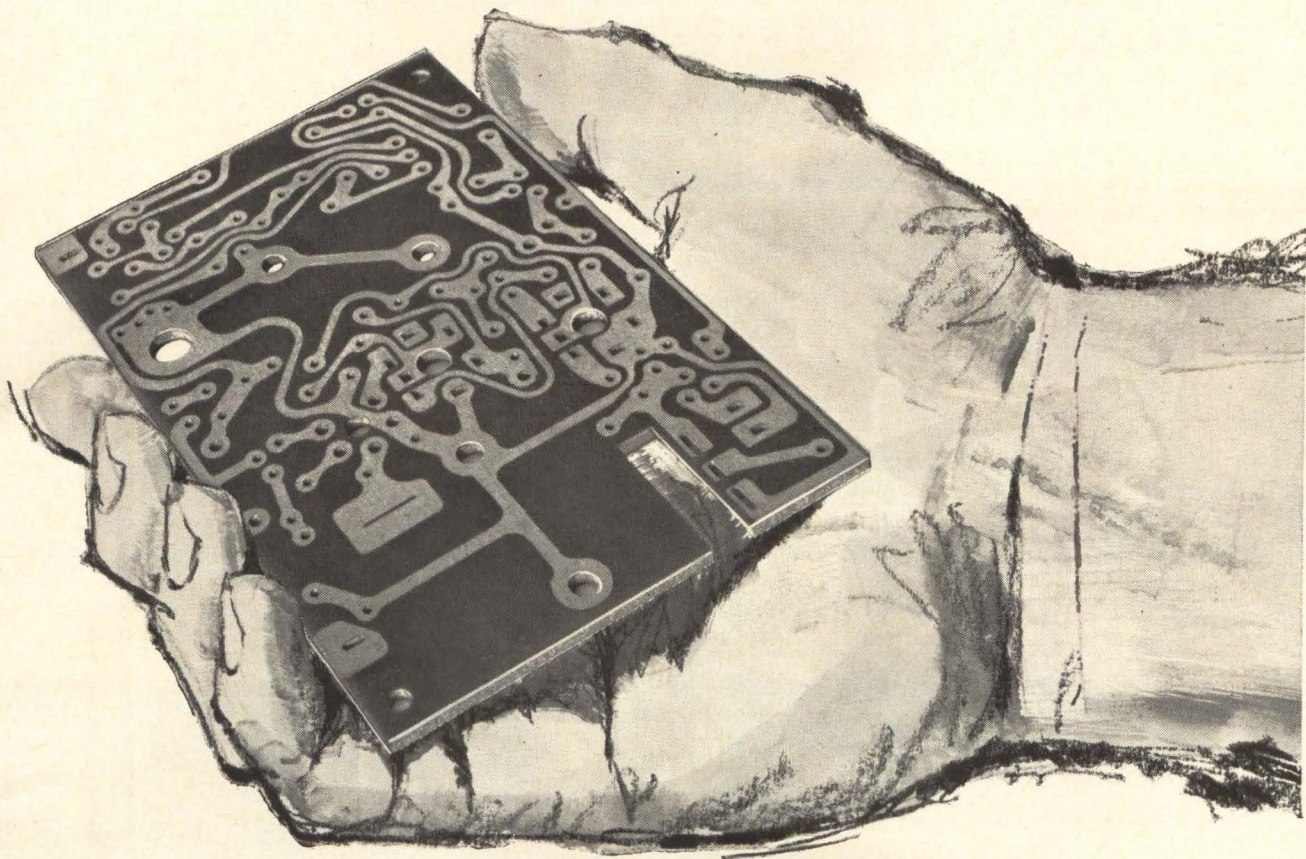

Copper clad

10 different copper clad laminates are available from Formica . . . paper-phenolics, paper-epoxies, nylon-phenolics, glass-epoxies. Flame retardant materials—FR-2, FR-3, FR-4 . . . three grades accepted by UL for support of current-carrying parts at temperatures up to 105°C. Grades with MIL spec properties, NEMA properties . . . property combinations to meet any need.

WRITE FOR DATA ON:

- Copper clad laminates
- Electrical /electronic grades
- Mechanical grades
- Engraving stock

FORMICA CORPORATION
DEPT. I-424, CINCINNATI 32, OHIO

subsidiary of  **CYANAMID**



industrial plastics

Formica presents The World's Fair House to introduce the newest and best in carefree, contemporary living.

ANOTHER EXAMPLE OF "TOTAL VALUE" ASSURANCE...

CANNON

HAS A PLUG FOR EVERY KNOWN ENVIRONMENT

Cannon has plugs built to withstand the various conditions of temperature, moisture, altitude and other environmental hazards encountered in high-performance applications, whether your environmental need is earthbound or in outer space.

Over the past four decades, CANNON® Plugs have provided reliable operation for both military and

industrial users in more than 56,000 designs. If your application or environment requires the most exacting demands, look to Cannon, the world's largest and most experienced manufacturer of electrical connectors. For information, write to ITT Cannon Electric Inc., 3208 Humboldt Street, Los Angeles 31, California.



Our 50th Year



CANNON ELECTRIC INC.

3208 Humboldt Street, Los Angeles 31, California

A SUBSIDIARY OF INTERNATIONAL TELEPHONE AND TELEGRAPH CORPORATION

© "CANNON" IS A TRADEMARK REGISTERED IN U.S. PAT. OFF. AND IN FOREIGN COUNTRIES BY ITT CANNON ELECTRIC INC. ©1964 ITT CANNON ELECTRIC INC.



Instrumentation

Simplified servos

Among many problems faced by designers of the Gemini space capsule was that of displaying information to the astronauts. Panel meters were chosen to furnish information on fuel supply, battery voltage, oxygen supply, etc. Ordinary permanent-magnet moving coil instruments were just barely able to meet vibration specifications by special shock mounting and special oil-bath damping. Servo-driven instruments could meet the vibration requirements, but the required power—seven to ten continuous watts—would generate enough heat to place an intolerable load on the cooling system of more advanced space vehicles.

Engineers at Honeywell, Inc., took a hard look at the servo-driven meter and came to some embarrassing conclusions. Neither the usual two-phase servomotor, with its continuously excited reference winding, nor the power-eating gear train that drives the pointer and the feedback potentiometer were necessary.

Honeywell eliminated the gear train by using a d-c torque motor instead of a two-phase servomotor to drive the pointer which, in turn, drives the wiper of the feedback potentiometer. Any difference between the input signal voltage and the feedback voltage from the potentiometer is fed to a differential d-c amplifier and then to the torque motor. Matched transistors are used in the amplifier input to keep d-c drift under control.

Better and cheaper. The result is still a servometer but with several significant differences. Power consumption is one-third watt instead of seven or ten. There are only 24 parts instead of 71. Mean time between failure is as high as 25,000 hours as compared with 12,500

hours for a typical servometer. Total weight, including sensors, is reduced by about 30%. Volume is reduced by about 35%. Battery operation is entirely feasible and the price of the new meters is about half that of servometers.

Honeywell says the new meters—which they call Servometric—are accurate at acceleration of up to 25 g's in any axis. When power is removed, the pointer is held at its last position by the friction of the potentiometer.

Servometric indicator (left) withstands vibrations that set conventional meter movements dancing. At right, Honeywell engineer uses a simplified servometer to measure the amount of liquid in a container.

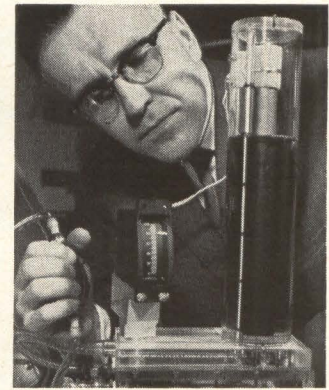
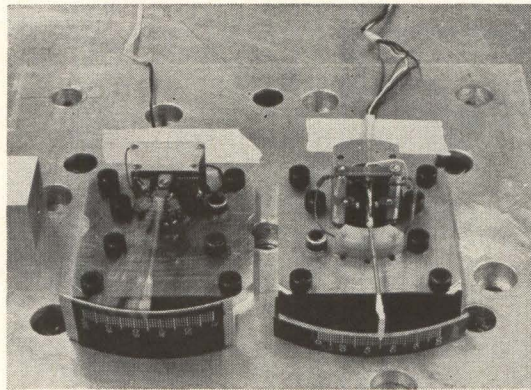

Readout in living color

An inkless data-logging system, producing 36 readout channels in as many as seven colors on a single strip-chart, is cutting costs, \$25,000 a year—or 60%—below conventional methods, according to the Lockheed Missiles & Space Co., a division of the Lockheed Aircraft Corp.

Conventional light-beam galvanometers, fitted with color filters, produce colored light beams in a multichannel oscillograph mix. The light is projected onto photo-sensitive paper, producing a trace of the same color as the light. Color allows a signal to be identified easily even if several traces criss-cross on paper.

Less paper used. The special paper costs twice as much as standard oscillograph paper, but only about one-fourth as much is needed.

Developed by the Eastman Kodak Co. and the Consolidated Elec-

trodynamics Corp., the system is used at Lockheed's plant in Sunnyvale, Calif., to record temperature, pressure, vibration, thrust, stress and other forces.

Previously, Lockheed needed several oscillographs, with a maximum of four channels per chart, to produce complete recordings 24 hours after test firings or laboratory simulations. With the new color system, the company can use a single oscillograph to record 36 parameters, and can remove the paper from the machine for processing immediately after the test run.

Advanced technology

Crystal gazers

At the Air Force's Cambridge Research Laboratory in Bedford, Mass., a crop of crystals is being



High-intensity x-ray tube will watch crystals form.

formed and scientists are "watching" every stage of their development. The watching is done with an x-ray system designed by physicist Abraham Taylor—a pioneer in developing rotating anode x-ray apparatus—for the Westinghouse Electric Corp. who developed and installed the device.

The system includes an x-ray tube that can operate continuously at beam currents of up to 200 milliamperes (about 10 kilowatts of power). Conventional x-ray tubes operate for periods of a millisecond at beam currents of 10-15 milliamperes.

Continuous record. Scientists at the Cambridge facility will study structural changes that occur when crystalline materials are subjected to very high temperatures and pressures—such as those occurring in the creation of man-made diamonds. A scintillation counter will record the x-ray spectrum of a group of atoms and provide data on changes as they take place. Until now, scientists have been able to study crystal structure at various stages with a photographic system, but they have not been able to maintain a continuous record of changes taking place.

The x-ray tube was built by

Barogenics, Inc., of New York City. It is designed to fit in a press which can exert pressures of up to 1.5 million pounds per square inch at temperatures in excess of 2,000 degrees centigrade. At these temperatures and pressures, graphite can be changed into artificial diamonds.

Computers

Now it's SAID

Teaching students to speak the language like a native is one of the goals of an experimental computer-based system of speech instruction under development at the University of Michigan. SAID—short for Speech Auto-Instructional Device—was designed by two researchers at Michigan to teach the prosodic features of speech—pitch, loudness and rhythm—essential in mastering foreign languages.

A recorded phrase is played simultaneously to a student in a booth and to a computer that stores the phrase in its memory core. As the student repeats the recorded word or phrase the system measures his imitation against measurements stored in the computer. The student can see the degree of his accuracy on a dial that shows both the magnitude and the direction of his error. If the error is greater than a certain permissible limit, the tape is rewound and the lesson is repeated. When the student masters pitch, for example, the system moves on to the next feature, loudness, and then to rhythm.

Relative pitch. Since the pitch of a co-ed's voice differs significantly from that of her male classmate's, or should, the system is designed to compare pitch ratios at various points in the phrase instead of absolute pitch.

The computer used in the system is the Digital Equipment Corp.'s PDP-4. It takes only 4.5 milliseconds for the computer to compare a student's pronunciation at each point in a phrase with the stored correct version. A pitch

extractor and an amplitude extractor process the information from the tape recorder and microphone and feed it to the computer through a two-channel multiplexed analog-to-digital converter. The computer's output is handled by three digital-to-analog converters.

The \$75,000 cost of the computer was covered by grants from the Language Development Section of the U. S. Office of Education.

So far SAID has been used only for simple non-speech patterns and for short English phrases ("an ice man" as compared to "a nice man" and "he had to" versus "he had two"), but university researchers expect to use it in foreign language instruction within a year.

1604-A: where are you?

The Navy has received a \$15 million data-processing system, the biggest in the service's history. But don't ask where it is or exactly what it does—that information is classified. The Navy will use it in command-and-control activities.

One central control console operates nine general-purpose computers, which are connected to an array of peripheral devices through a unique switching network. Four Control Data Corp. 1604-A computers perform the major information processing and computing tasks; five CDC 160-A computers perform smaller data-processing operations and provide centralized systems control. Control Data also made the peripheral equipment.

Flexible switching. The switching network is controlled by a computer program and permits any computer to be connected with any other computer or with peripheral equipment automatically. The switching permits rapid, automatic organization of subsystems so that several specific tasks of differing complexity but equal priority can be processed at the same time.

The switching flexibility also permits the problem analyst to design computer programs for the most efficient equipment configuration. Rather than having to fit the program to a fixed system, he can se-

lect subsystems to meet his specific requirements for data handling and computation.

Medical electronics

Human servomechanisms

Researchers are using feedback servo control techniques to study symptoms of Parkinson's disease in patients at the National Institute of Health in Bethesda, Md., to measure eye movements of patients in the Massachusetts General Hospital and to help premature infants to breathe.

The program is part of a trend by engineers and doctors to regard the human body as a series of servomechanisms and apply electronic solutions to physiological problems.

Doctors at the National Institutes of Health are using a computer at the Massachusetts Institute of Technology—500 miles away—for remote analysis of the dynamics of neurophysiological ailments. They are particularly interested in the effects of surgery on instabilities of the muscular coordination system, such as those occurring in Parkinson's disease.

Eye tremors. Several laboratories of the Massachusetts General Hospital are also connected with the MIT computer. At the neurosurgical laboratory, for example, a pupillometer makes eye movement measurements which are fed into the remote computer for real-time analysis. Investigators consider the pupil of the eye as a servomechanism and regard involuntary tremors as oscillations in the pupil servosystem.

In both cases, the researcher at the hospital must control the system. The Boston area hospitals are connected with the computer's analog-to-digital converter through d-c paired telephone lines. The National Institutes of Health use f-m transmission.

Infant breathing. In another human servomechanism study, doctors are developing an electronic respirator to ease the breathing

of premature infants. Pressure changes inside the infant's chest cavity are transmitted to an electronic transducer which converts the mechanical breathing to electrical signals. These are amplified, fed through a differentiator, and used to control pressure cycling within the respirator chamber. The triggering circuit opens and closes pressure valves to follow the pace of the infant's own breathing and, by this synchronization, makes breathing easier.

Detecting hemorrhages

A technique long used to find leaks in underground pipes has been put to work for the medical profession in the form of a miniaturized device that can locate and measure gastrointestinal bleeding. The first of these probes, developed by the EON Corp., Brooklyn, has been delivered to the Columbia Presbyterian Medical Center in New York.

A series of tiny geiger counters are spaced at four to six-inch intervals along the length of a plastic "swallow" tube that is connected to a multichannel ratemeter recorder. The long tube is inserted in the patient's nose. No surgery is required; the tube descends to the intestinal tract through peristalsis.

EON researchers developed a special plastic tube material that was medically acceptable and that wouldn't be damaged by digestive fluids. The tube remains in the patient during the test, which can continue for several days.

Red cells. Harmless radioactive isotopes are injected into the blood. The P^{32} - phosphorus - labelled red cells give off signals when blood escapes and hits the plastic sheath surrounding the detector. The location of the bleeding and an indication of the size of the wound is indicated on the recorder.

Each counter has a maximum outside diameter of 0.1 inch and is less than an inch long. The outputs of the individual detectors are fed into electronic circuits such as pulse shapers, limiters and cross-talk arresting networks. This cir-

cuitry is necessary because the detectors produce pulses of large amplitude and short rise time. Each detector's reading must be isolated from the others. The detectors require an operating voltage of 300 to 400 volts, and a stable power supply.

The radioactive P^{32} has a half-life of 21 days. When the tube is left in the body for long periods, the readings must be adjusted to compensate for the decayed strength of the phosphorus.

Previously developed scanning systems worked from outside the body. They were unable to yield clear readings on deep-seated ruptures of veins—such as those occurring in the stomach of a heavy drinker.

The cost of the detection systems will range from \$10,000 to \$50,000 depending upon the number of detectors required and the volumes manufactured.

The device could also be used, according to the company, to study blood flow and the digestive system and to detect intestinal cancer.

Communications

Character builder

An alphanumeric display generator that takes a message off a teletypewriter circuit and prints it clearly on the screen of a regular television set has been developed for the Air Force, to display weather data. But it might also provide a readout for on-line process control computers.

A digital method of synthesizing the characters from strokes or line segments provides exceptionally high resolution, according to the developer, the Norden division of the United Aircraft Corp.

In fact, says Newton D. Bartle II, the project engineer, the video character generator "provides higher resolution than other techniques used with alphanumeric displays compatible with standard commercial tv monitors and receivers. Better character form and

stability are attained than with other techniques, such as the dot matrix or Lissajous."

Conversion to video. The system accepts information in the form of teletypewriter signals with formatting data. The information is then stored in a recirculating memory (see diagram), converted to video signals and modulated on standard tv carriers. It is then transmitted for display on tv receivers at remote locations.

The alphabet, 10 numerals and 16 punctuation and weather symbols are generated. To produce these 52 characters, a series of 54 strokes are generated. Then, 52 OR gates combine the strokes into the characters.

The catalog of strokes is synthesized by programing delays and pulse widths in pulse generators. Separate generators form the horizontal, vertical, curved and slanted strokes.

Horizontal strokes are made by selecting and gating appropriate scan lines. Pulse generators, triggered by clock pulses at the start of each character space, produce the vertical strokes. Slanted strokes result from pulses that are linearly delayed as a function of line count. And pulse generators, programed for both delay and width as a function of line count, produce curved segments.

The position and width of all pulses are adjusted to smooth the curved and slanted lines. Seen all

together on the tv screen, the pulses form the characters.

Microcircuit shortcut. The display generator is an assembly of integrated-circuit modules except for the power supply and modulators. The recirculating memory units are magnetostrictive delay lines. Direct-coupled-transistor logic is used throughout.

Bartle says that the use of integrated circuits cut the cost of designing the system. Once the logic design was worked out, it was translated to hardware by interconnecting modules, eliminating the intermediate steps required in work with conventional circuitry.

Getting the message

Field men and executives roving about the 123-acre plant of the American Potash and Chemical Corp. at Trona, California, are carrying pocket receivers that enable them to hear telephone messages from outside callers—but they can't talk back.

A solid-state device, developed by the General Electric Co. and believed to be the first of its kind, connects the company's telephone switching system with a radio transmitter. To reach a man in the field, the caller dials a special number and hears a well-defined ringing signal, indicating that the call is in progress. The paging terminal answers the telephone auto-

matically, stops the ringing and feeds back a second, distinctive dial tone. The caller then dials a three-digit number for the person desired. The three sets of dial impulses are picked up by the sensitive equipment as clicks, since the regular telephone line circuits are locked in the answering position. The impulses, converted into coded tones, are stored until the radio transmitter signals that it is ready to send. Then the tones are released in timed bursts and the caller gives his message.

One-minute limit. The man in the field hears a beep signal from his pocket receiver, pushes a button, and hears the voice message. No message can be longer than one minute—the length of time the transmitter operates before it is shut off. Previously-developed systems could call men in the field to a telephone by sounding a buzzer, but this is the first that actually transmits the voice of the caller.

The three-digit number can be dialed from any telephone in the plant. Impulses from the radio transmitter trigger the paging receiver that corresponds to a dialed number. To satisfy Federal Communications Commission requirements, an automatic station identifier announces station call letters.

Components

Wanted: circuit breakers

Burn-out of transistors in integrated circuits because of short circuits or overloads is now a major problem. Designers are searching for circuit breakers small enough and fast enough for use with integrated circuits.

As one exasperated engineer from the Autonetics division of North American Aviation, Inc., put it, "We're getting tired of having the integrated circuits in our airborne and space-borne computers used as high-priced fuses."

Autonetics reportedly is considering building circuit breakers into an all-IC inertial navigation computer. One of its developers

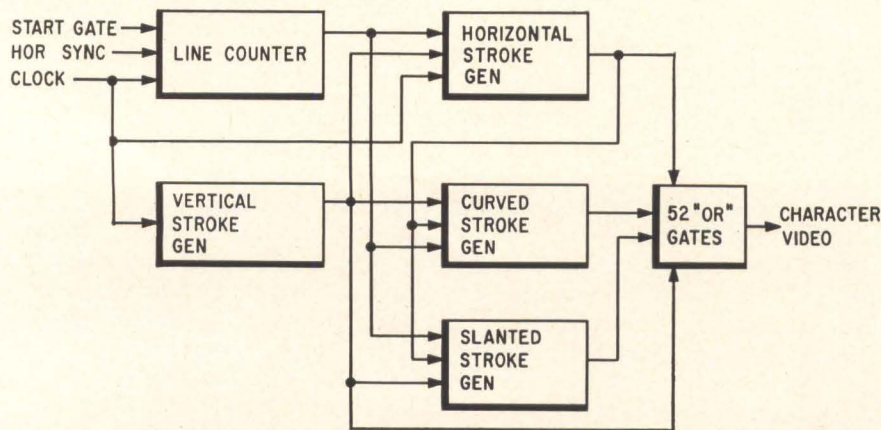

Alphanumeric display generator uses parallel recirculating memories, one at the tv field rate of 60 cps, the other at the line rate of 15,750 cps. This provides the high data rate needed to generate character video. Four stroke generators (above) are used in synthesizing 52 characters.

**“Who makes that sharp
new line of
telemetry and surveillance
receivers?”**

“Astro Communication Laboratory”

**“What makes them
the greatest?”**

*“All solid-state design, all modular
construction, superior specs, long MTBF,
unmatched versatility and
flexibility... and that just scratches
the surface!”*

Indeed it does. Look at the four equipments here—members of the large and still-growing ACL family.

All three surveillance receivers (identified by the “S” in their model numbers) provide Pulse reception in addition to AM, FM, and CW.

The SR-209, a high-performance receiving system, covers the 30-2000 mc range with 5 plug-in tuning heads. Its solid state design means low power requirements and light weight, and a rechargeable plug-in battery pack makes it both portable and self-sufficient.

The SR-202 (VHF) and SR-207 (UHF) also can be battery operated in the field. They draw only 15 watts each. Again, credit solid state design ingenuity.

Or consider what the TR-104 VHF/UHF telemetry receiving system has to offer: AM, FM, and PM reception across 55-2300 mc, 8 plug-



SR-209
VHF/UHF Surveillance Receiving System



SR-202
VHF Surveillance Receiver



SR-207
UHF Surveillance Receiver

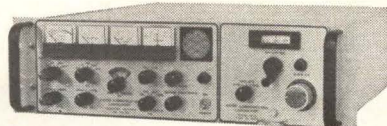

TR-104
VHF/UHF Telemetry Receiving System

in heads, 4 meters, 10 available IF bandwidths (4 bandwidth amplifiers and matching demodulators may be installed at once). Hundreds of ACL telemetry receiving systems have been purchased since their introduction at WESCON last summer.

There is still more to the story, including the bonus of competitive prices. It's all yours for the asking. Write, wire or phone today for complete information about the family of surveillance and telemetry receiving equipment designed and produced by Astro Communication Laboratory.

**ASTRO
COMMUNICATION
LABORATORY**

DIVISION OF AERO GEO ASTRO CORPORATION
801 Gaither Road • Gaithersburg, Maryland
Phone 301-948-5210 • TWX 703-354-0334
WU Telex 089-435

“RF Equipment for the Systems Engineer”

explains: "When an overload in current or voltage hits a group of IC's, it's frequently very difficult to determine which circuit has blown." Occasionally the entire IC board must be replaced.

Roving 'black box.' Sometimes, on the production lines, a careless screwdriver across the wrong terminals can cause a short. Designers are considering sending a detachable "black box" containing many high-speed circuit breaking devices down the line with the computer.

This would be an interim step until fuse elements are built into circuit boards. For that, Autonetics needs breakers that will kick out at 10 and 30 milliamperes. One device being evaluated is the Hypersensor, produced by the Qualtronic Corp., Fullerton, Calif.

The Hypersensor is a low-cost (\$4 to \$7) single-component, resettable circuit breaker described as a majority-carrier tunneling device. It operates in nanoseconds on either a-c or d-c.

Don't understand it. The phenomenon behind its functioning is not completely understood. "We're about where transistor theorists were in '48, '49." Qualtronic explains the Hypersensor operation this way:

The multivalent dielectric on either side of the center metal (see diagram) may assume two states. In the conducting state, it has very low impedance (about 10 ohms), and in the nonconducting state, very high impedance (10^8 to 10^{10} ohms). An overload causes elec-

trons to accelerate through tunnels believed to exist axially through its layers. Magnetic pinching closes the tunnels, causing the device to be an insulator. Heating the device above 100°C also pinches off the tunnels, providing heat protection as well as overload protection. The high-frequency reset pulse, typically 1 megacycle, is believed to reform the tunnels. The Hypersensor can be reset with 12 volts.

Cautious optimism. An engineer-executive at Lear-Siegler, Inc. is cautiously optimistic about the new device: "It functions faster than anything I know of . . . in nanoseconds." The Jet Propulsion Laboratory of the California Institute of Technology has set aside several thousand dollars to evaluate the device. "It looks promising," one Ranger scientist commented. "In case of trouble in a space probe, for example, it can be reset remotely."

Litton Industries, Inc., Systems division, Thompson Ramo Wooldridge, Inc. and General Dynamics Corp. are among other West Coast companies interested in the device. Said a TRW circuit designer, "At first we were concerned about reported drifting upwards of the trip current, after reset, on Hypersensors rated at less than 50 ma. We worried, too, about the down-drift of these levels on the models rated above 100 ma. But about 80 percent of our needs for circuit protection is in the 50 to 100 ma range, and in this area the devices appear quite stable."

Solid state

Inside a diode

A fine beam of electrons can disclose the internal structure of semiconductor p-n junctions at depths of from three to five microns, scientists with Bell Telephone Laboratories have found. The technique is nondestructive and is expected to become an important tool in semiconductor studies.

The dark lines in the photos (magnification is about 500 times)

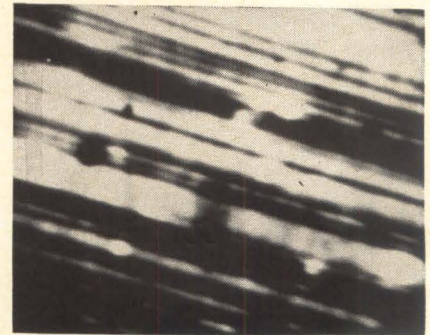
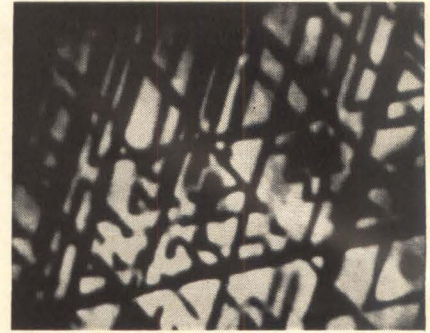

Internal views of crystal imperfections in a silicon diode.

are crystal defects in an acceptable silicon diode as seen from three perpendicular views. The views are of different amounts of material.

Current formed. Electrons in the probing beam generate hole-electron pairs along the beam's path through the material. The hole-electron pairs that are formed near the p-n junction are separated by the junction's characteristic electric field into positive and negative charges. The separated charges form a current that flows through the diode and any external load.

Pairs formed far enough from the influence of the junction's electric field recombine and produce practically no current. Even near or at a p-n junction, however, defects in

OHMIC CONTACT
DIELECTRIC
MULTIVALENT DIELECTRIC
METAL
MULTIVALENT DIELECTRIC
DIELECTRIC
OHMIC CONTACT

Hypersensor is bilaterally symmetrical. Metal midsection is primarily aluminum.

ELECTRO INSTRUMENTS ANNOUNCES

NEW LINE

OF LOW COST DIGITAL INSTRUMENTS

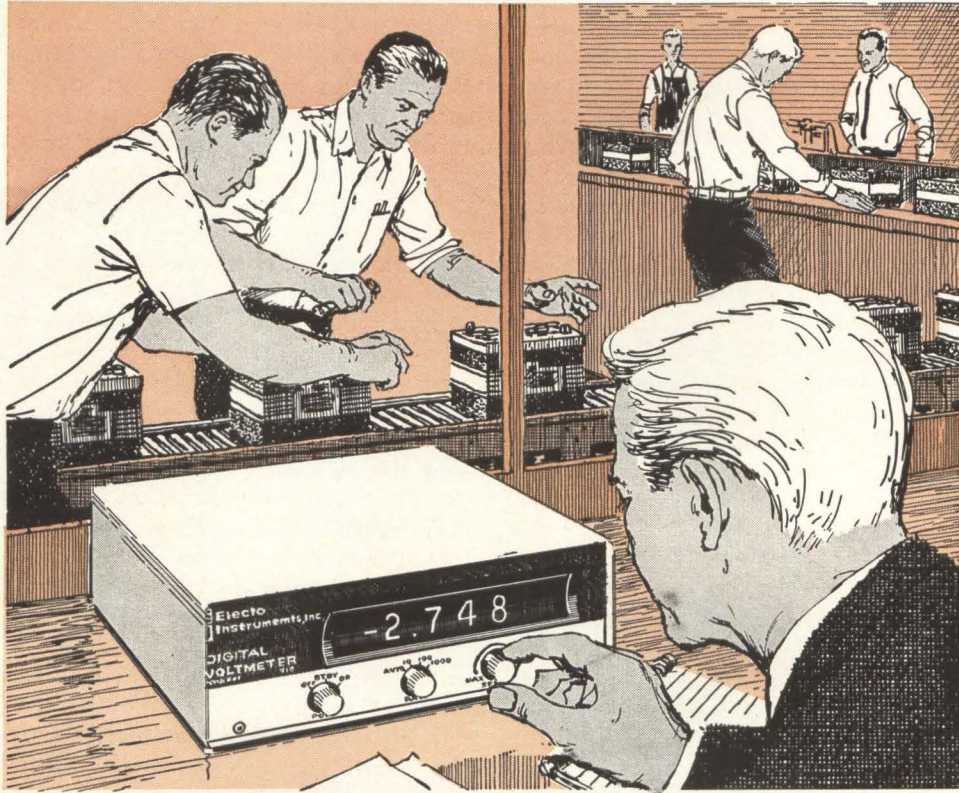

FOURTEEN PRECISION INDUSTRIAL MODELS—
THE UNIQUE ADVANTAGE OF TOTAL MEASURING

By Dr. Walter East
President, Electro Instruments, Inc.

Many a production line is still tied to the slow speeds and accuracy shortcomings of old-fashioned, pointer type measuring meters.

Today's widespread use of high-speed, ultra-precise electronic instruments in industries such as aerospace is common management knowledge.

But factory managements, generally, have balked at making a similar instrument change-over. Under no compulsion to work within tolerances as

infinitesimal as aerospace's, there was no incentive for making a substantial investment in equipment that was both expensive and, in many cases, a bit too sophisticated for production line use.

For these managements, I have news of great importance.

Expressly For Industry

Our new Series 900 Digital Measuring Instruments are the first ever offered that have been expressly designed for industrial measuring uses.

They are priced within the reach of the smallest company. They are highly precise, yet characterized by extreme operational simplicity. They are com-

pact, portable, require an absolute minimum of maintenance. They are capable of *total measurement*—monitoring, computing, functioning as an integral part of control systems.

Many Ways to Use—Save!

The Series 900 Digital Instruments can bring about user savings worth many times their initial cost . . . on the production line . . . in the laboratory . . . in the field.

It was inevitable that superior digital measuring instruments would one day be made available for production line use. That "day" is here. An EI Sales Engineer will gladly give you details!



Electro Instruments, Inc.

8611 Balboa Avenue • San Diego 12, California

EI SALES, SAN DIEGO, CALIF. • ELECTRO INTERNATIONAL, INC., ANNAPOLIS, MD. • TRANSFORMER ENGINEERS, SAN GABRIEL, CALIF.

the crystal structure inhibit the separation of the hole-electron pairs into positive and negative charges. The resulting increase in recombination reduces the current generated in these regions.

Tv readout. As the beam is moved across the semiconductor, the output current rises and falls in accordance with the internal structure. Current from the scanned area is amplified and used to modulate a cathode-ray-tube beam. Since the tube's deflection plates are driven by the same waveforms that position the electron beam, the resulting readout is essentially a televised cross-section of the semiconductor.

In recent studies, beam diameter has been about one micron; beam currents have ranged from 4×10^{-9} to 10^{-6} ampere, and beam energies from 4,000 to 50,000 electron volts. The greater the energy of the beam, the greater is the penetration into the semiconductor. Two basic types of crystal defects have been recognized so far by the probing technique: arrays of impurities and sets of dislocations called slip planes.

The cross-sections shown are of diodes made by shallow diffusion of phosphorous into p-type silicon. The difference in size between the phosphorous and silicon atoms introduce stresses in the silicon host material that lead in turn to the crystal defects.

Manufacturing

Optical aligner

Just about the knottiest mechanical problem in building a big dish antenna is making sure that the reflector surface is true, so that the transmitted radio beam will not be distorted.

North American Aviation, Inc., is using an unusual optical system to check on deflection of the 120-foot-diameter Haystack antenna system it is building for the Air Force near Tyngsboro, Mass. The quarter-acre surface of the antenna cannot vary more than 0.075 inch.

The surface of the antenna is painted with 800 targets consisting of black lines on a white background. If the antenna surface is deflected or distorted during static-load tests, the lines will shift position and indicate the distortion. Alignment fixtures built into the antenna can then be adjusted to correct the deflection.

Periscope. But because the Haystack antenna is so huge, the engineers needed a special optical system to look at the targets. With the Keuffel and Esser Co., North American built a target device that works like a periscope.

The operator sits in a gimballed seat below the reflector dish and looks at the antenna through a series of mirrors. He aims the viewer at a circumferential row of targets, then swivels the periscope to check the row of targets. Crosshairs in the probe are lined up with the center stripe on the target and any deviation is measured with a micrometer.

The optical system can be referenced to the elevation axis, so the operator can survey target locations for any antenna elevation.

Space experiments. When the Haystack antenna is completed next fall, the Air Force will turn it over to the Massachusetts Institute of Technology's Lincoln Laboratory. The lab will use it for space communications, radar astronomy and other experiments.

Because it is so big and accurate, Haystack is expected to be able to track a target as small as quarter-inch steel sphere at 1,000 miles.

Consumer electronics

Transistors for color tv

In September, when the Emerson Radio & Phonograph Corp. introduces an 11-inch transistorized black-and-white television receiver weighing 16 pounds and selling for less than \$150, it will be taking the first in a series of steps leading to production of a fully transistorized color tv set.

Texas Instruments, Inc., made all the semiconductors for the new Emerson set. It contains 22 germanium and silicon transistors and 13 silicon diodes and rectifiers. A silicon gate-controlled switch, developed specifically for tv application, supplies the high voltage, high current and high-speed switching required for horizontal deflection.

Inch by inch. Benjamin Abrams, chairman of Emerson, says the next step is a 16-inch set, then a 19-inch and in mid-1965, a 21-inch set, all transistorized. He predicts that by 1966 one-third of all tv receivers produced in the United States will be transistorized, and that by 1969 solid-state products will dominate the tv industry.

The General Electric Corp. has already announced that a nine-inch, 13-pound transistorized set with a Japanese picture tube made by the Nippon Electric Co. will be available in September for \$159.95 [Electronics, June 1, 1964, pp. 17, 88]. The Philco Corp. will begin to sell a nine-inch, 10-pound transistorized set this fall for about \$180. The Philco set is made entirely in Japan by the Yaou Electric Co.

Still smaller. At the National Association of Music Merchants show in Chicago June 28, the smaller sets from Japan were introduced. Reaction to the three-inch set, manufactured by the Standard Radio Corp. of Tokyo, focused on its marketability. Most U. S. exhibitors doubted that the personal tv market would be sufficiently large to warrant producing the tiny sets.

The price might have to drop to the \$50 range before such sets could tap a really worthwhile market, suggested an observer from General Electric. Philco showed a three-inch, five-pound tv, about the size of a pair of binoculars—but only as a “dream” model.

The next move. Cecil Dotson, vice president of the Semiconductor Components division of Texas Instruments, predicts that in the next decade Emerson will manufacture a tv set “that will contain not one discrete transistor. This new tv system will be made entirely from solid, functional blocks of semiconductor material”.

**Should you send
a simple solid state
microwave filter
to do a cumbersome
electro-mechanical
preselector mechanism's
job, even air-borne?**

A Loral YIG, yes.

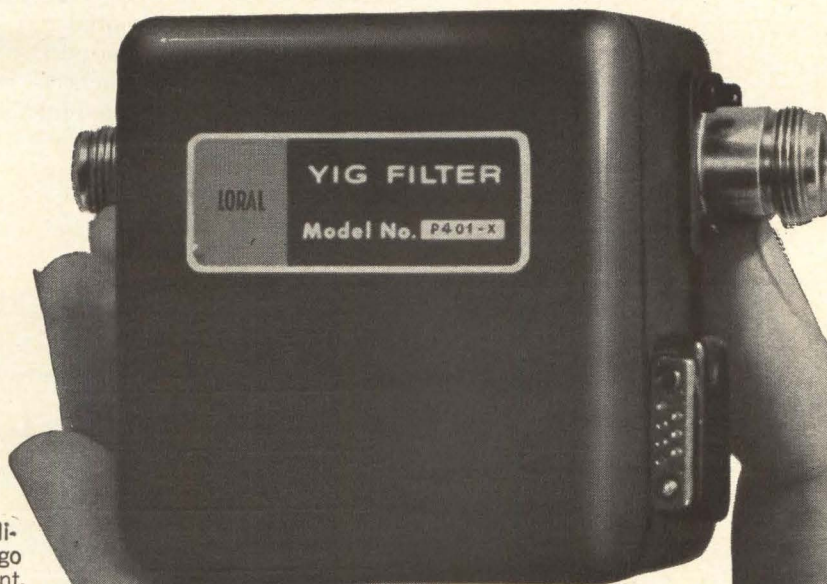

Our YIG filters are highest in performance and reliability...small in size, weight and price...and go straight off the shelf into your end-use equipment. For brochure and further information write:

Advanced Products,

Loral Electronic Systems

A DIVISION OF LORAL ELECTRONICS CORPORATION
825 BRONX RIVER AVENUE, THE BRONX, NEW YORK, 10472.

Specification highlights

Model No.	Freq. Range	Insertion Loss	Off band isolation 15 BWs away	Nominal Tuning Sensitivity
*P-201	.5- 1.0 gc	5.5 db max.	40 db min.	4.6 mc/ma
*L-201	1- 2 gc	4 db max.	40 db min.	4.6 mc/ma
S-201	2- 4 gc	4 db max.	40 db min.	4.6 mc/ma
C-201	4- 8 gc	3 db max.	40 db min.	8.46 mc/ma
X-201	8-11.5 gc	3 db max.	40 db min.	8.46 mc/ma
*P-401	.5- 1.0 gc	7 db max.	70 db min.	4.6 mc/ma
*L-401	1- 2 gc	5.5 db max.	70 db min.	4.6 mc/ma
S-401	2- 4 gc	5.5 db max.	70 db min.	4.6 mc/ma
C-401	4- 8 gc	4 db max.	70 db min.	8.46 mc/ma
X-401	8-12.0 gc	4 db max.	70 db min.	8.46 mc/ma

Typical band width for all units: 20-30 mc.

*These models provided with heaters and thermistor output leads for temperature control.

Circle 33 on reader service card

Universal in Application...



Universal in Reliability...

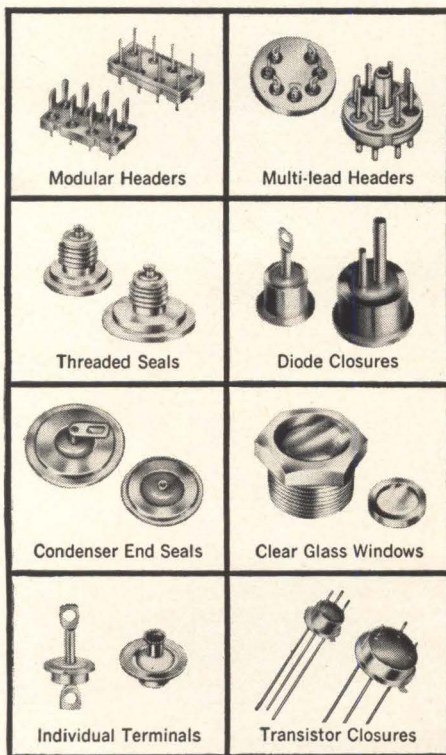

SEMI-CONDUCTOR SEALS
INDIVIDUAL TERMINALS
MULTIPLE-LEAD HEADERS
CONDENSER END SEALS
COLOR CODED TERMINALS
THREADED END SEALS
CUSTOM SEALING SERVICE

Standardized Production

E-I offers designers and engineers the complete flexibility and economy of standardized production on all types of seals from individual terminals to sub-miniature closures. For proven reliability, specify the seals employed by leading manufacturers in both commercial equipment and space age projects.

Nation-wide Field Service

Write today for complete information on standard E-I seals or custom sealing of terminal assemblies of your own manufacture. E-I field engineers will gladly make recommendations on your specific requirements on receipt of your application data.

ELECTRICAL INDUSTRIES

MURRAY HILL, NEW JERSEY

A Division of Philips Electronics & Pharmaceutical Industries Corp.



Patented in the U.S.A., No. 3,035,372;
In Canada, No. 523,390;
And in the United Kingdom, No. 734,583.

Washington Newsletter

July 13, 1964

'66 Defense R&D seen at '65 level

The Defense Department's research-and-development budget for fiscal 1966 will be very close to the present \$6.7-billion-a-year level, predicts Eugene G. Fubini, deputy director of defense research and engineering. That figure represents a \$470-million drop from last year, but Fubini denies that the cut represents a trend. The electronics portion of recent defense R&D budgets has been around 30%.

Success in building up a strategic deterrent force has shifted emphasis to tactical needs such as aircraft and reconnaissance, he says. But he adds that **many improvements are still needed in strategic weapons**, including penetration aids, effectiveness against hardened and mobile targets, and refinement of submarine strategic weapons.

Pentagon combats talk of a downturn

The Pentagon is going all-out to counter talk of a downward trend in defense R&D, and Fubini's remarks comprised the latest efforts. He spoke at the June 29 meeting of the American Institute of Aeronautics and Astronautics.

Fubini said he is fed up with gloomy predictions. Recently he declined to participate in a symposium on helping defense companies convert to civilian production.

The flow of sound ideas from industry to the services is an important factor in the size of R&D budgets, he commented. If scientists get the idea that developments can't be sold, the predictions of a decline in spending can be self-fulfilling, he warned.

He predicted that the military services would be less formal in buying research-and-development. They have been urged to avoid one practice that dampens enthusiasm. Under that practice, a company offers an idea, a military service rejects it and then requests formal proposals for a similar plan, altered so that the originating company has to do more research to compete.

Johnson charting a no-panic course

Fubini's don't-panic approach seems to follow broader White House thinking.

The Johnson Administration has no intention of backing the idea—proposed in Congress—that defense companies be required to set up planning programs for conversion to civilian products [Electronics, June 15, 1964, p. 113].

The Administration will focus on broad policies to keep the economy booming. Business, labor, and state and local governments must carry the main burden of coping with specific dislocations from defense cut-backs.

In the next few months—probably before the November elections—these ideas will be spelled out in more detail in an interim report of the President's Committee on the Impact of Defense and Disarmament.

Luedecke's job: get Ranger going

On July 31, Alvin R. Luedecke will leave his position as general manager of the Atomic Energy Commission to become the new deputy director of the California Institute of Technology's Jet Propulsion Laboratory. The move was initiated and negotiated by James Webb, administrator

Washington Newsletter

of the National Aeronautics and Space Administration.

Luedecke's prime task at the laboratory will be to improve the failure-plagued Ranger program. NASA wants more positive results from the \$250 million invested in the still-unsuccessful attempt to televise close-up pictures of the moon [Electronics, June 29, 1964, p. 93].

An unsubstantiated story is that Luedecke will make his reports directly to the space agency even though he is subordinate to William H. Pickering, director of the laboratory.

"It's like having a guy working for you who reports directly to your boss," said one source at JPL. "This is NASA's way of gaining more control over our operation. Previously we acted pretty much as free agents."

As the AEC's number one staff employee, Luedecke had authority over 130,000 commission and contractor personnel. His specialty was directing nuclear weapons development and test. He was an Air Force major general before joining AEC in 1958.

Pentagon decision on ComSat delayed

Despite opposition from his technical advisers, Defense Secretary McNamara is reported to have tentatively agreed to the Pentagon's sharing of channels in the commercial satellite system. Under the accord, the Communications Satellite Corp.'s satellite would carry separate transponders for military use. The military would use frequencies of 8 and 7 gigacycles while commercial users would transmit at 6 Gc and receive at 4 Gc.

The State Department is still weighing the effect that military use might have on the international arrangements being worked out for use of the commercial system. At stake is an estimated \$30 million a year in military rents—a sum that would get the corporation off to a solid start.

The Pentagon's technical advisers have been arguing that the military should build its own system, although such a system would be more costly. One estimate is \$180 million.

Scientists from the Aerospace Corp., a Pentagon-sponsored nonprofit concern, have emphasized the differences between military and commercial needs. They say military use of commercial systems would be the same as using Greyhound buses to carry troops in the jungle. The military doesn't need very high capacity, they say. The military must have global coverage for transmission between changing crisis points, and a system highly resistant to jamming.

Excise taxes kept on tv, radio sets

Excise-tax reductions for such items as television and radio receivers and business machines, which could have totaled \$350 million next year, will have to wait until the next Congress convenes.

The Administration has beaten down the last attempt to get some cuts enacted this year. Congressmen favor cuts in retail and excise taxes, which comprise a multibillion-dollar source of revenue. But the Administration wants to hold off until the income-tax cut has had time to take full effect.

Income taxes have been cut this year and will be reduced further in 1965. Administration economists would like to hold an excise-tax cut—of about \$4 billion—in reserve in case the economy needs an additional shot in the arm in '65 or after.

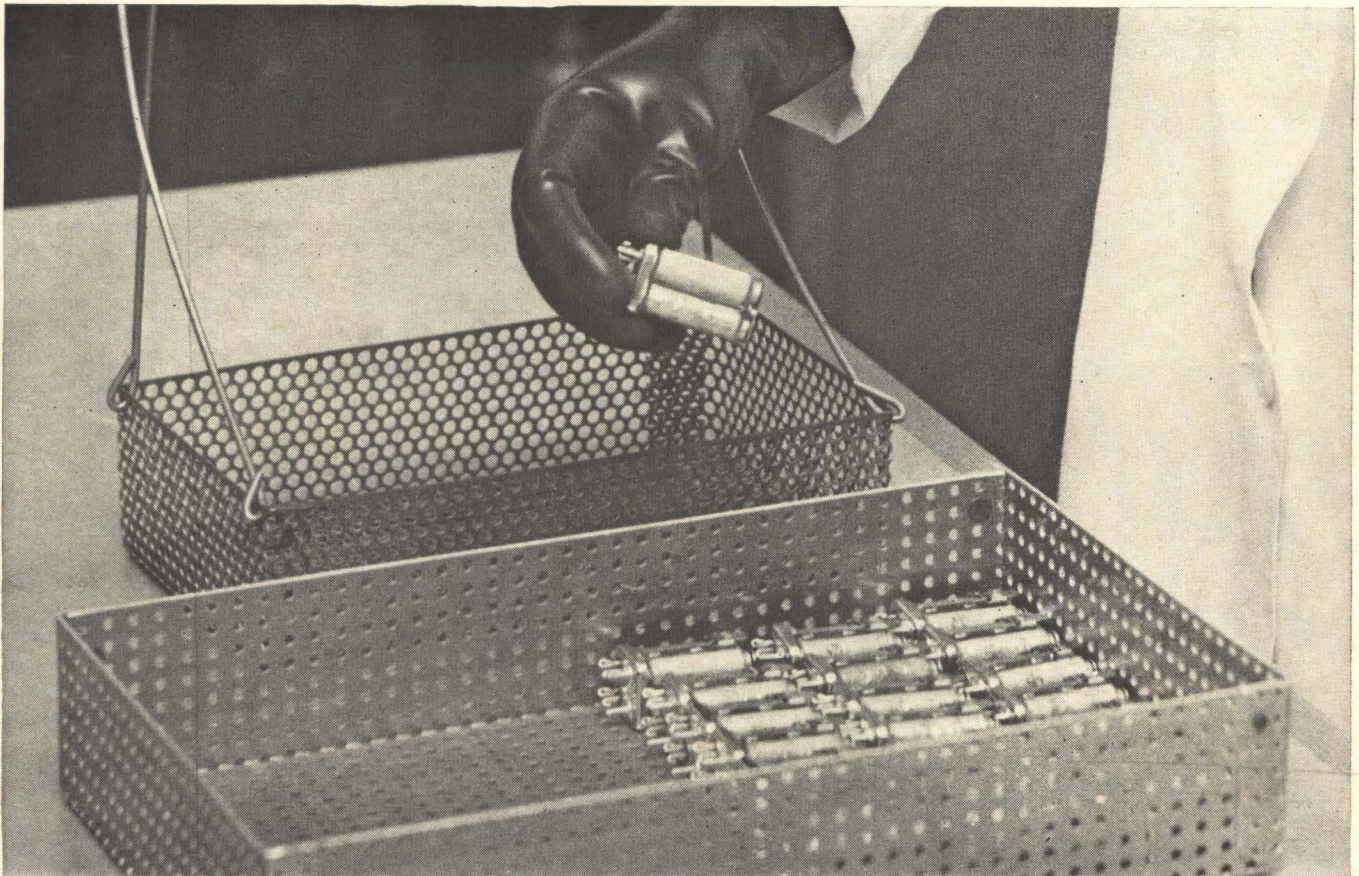

How Sigma Instruments, Inc., cut its reject rate to less than 1%!

PROBLEM: Absolute cleanliness of relay contacts is vital to the reliability of miniature remote-controlled switches. Sigma Instruments, Inc., Braintree, Mass., was previously cleaning contacts with a chlorinated spray, which distributed contaminants over a large area without completely removing them. In-plant rejects were as high as 55%.

SOLUTION: Relay contacts are now cleaned in an ultrasonic bath of FREON® fluorocarbon solvent coupled with vapor rinsing. Ultrasonic action, combined with the extremely low surface tension and high density of FREON, removes contaminants from the tiniest openings. Result: Sigma reports that

FREON solvents give them outstanding cleaning quality and that their reject rate has dropped to less than 1%.

Sigma also points out that FREON dries quickly and leaves no residue. Its very low toxicity and non-flammability permit operation without expensive ventilating equipment. What's more, the new system is economical to use because FREON can be recovered in readily available equipment—for re-use over and over again.

Wherever you have a cleaning problem, FREON solvents can improve operations and cut costs. First, send the coupon for information on cleaning.

FREON®

SOLVENTS



Better Things for Better Living
... through Chemistry

MAIL COUPON FOR BOOKLET ON CLEANING

E. I. du Pont de Nemours & Co. (Inc.)
FREON Products Division E-1
N-2430 F, Wilmington, Delaware 19898

Name _____ Title _____

Company _____

Address _____

Please send new booklet on FREON solvents for precision cleaning.

I am interested in cleaning _____

I would like Du Pont to send a cleaning specialist.

VERSATILE...

*Radiation Logic Modules
are packaged for flexibility,
reliability, high density mounting*

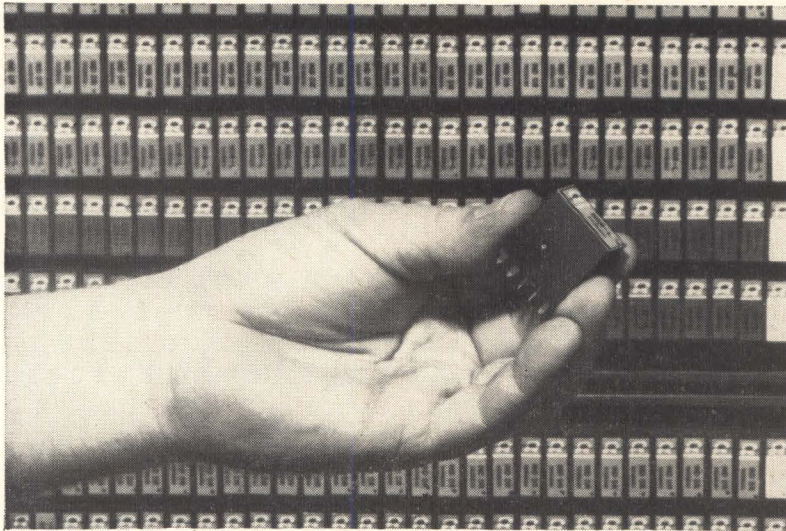

RADIATION
INCORPORATED

There's no need for design compromise when you specify Radiation Logic Modules. They can be used in any configuration, type or number compatible with your digital system requirements. They can be mounted in vertical or horizontal drawers, in standard 19" racks, or on breadboards... fixed or removable.

Radiation Logic Modules are supplied from stock in standard as well as special-purpose types. Two sets of fully compatible resistor-transistor logic circuitry are available. They cover bit rates up to 200 kc, and rates to 1 Mc. More than a dozen types include: 4-input NOR—Counter Shift Register—Power Inverter—Emitter Follower—Complementary Driver—Differential—Filter (Decoupler).

RELIABILITY

Superior engineering and rigid component selection assure highest reliability: based on extensive tests, MTBF for low-speed NOR Modules exceeds 2,940,000 hours! The units are also packaged for rugged use. Construction consists of welded circuitry molded in epoxy and mounted with high-density module connectors on cast aluminum frames. The resulting positive-contact units measure only 0.4" x 1" x 1.1", with a 0.25" pin protrusion.

ECONOMY

Each module represents a fraction of the entire digital system. Each is designed for easy interrogation. Change or replacement is as simple as plugging in another unit. Thus, expensive downtime is reduced, costly benchwork eliminated.

APPLICATIONS ASSISTANCE

Radiation offers the services of its engineering staff in the application of digital logic modules or in helping solve your unique data problems. Write or phone for technical data sheets. Radiation Incorporated, Products Division, Department EL-07, Melbourne, Florida. Telephone: (305) 723-1511.

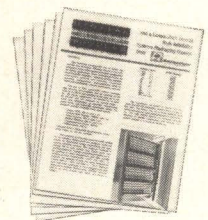

PRICE LIST—DIGITAL MODULES

Low initial cost is another attractive feature of Radiation Digital Logic Modules. Contact Radiation for unit prices on greater quantities than indicated below:

Part Number	Description	Unit Price
503815G1	NOR—Medium Speed	\$ 10.38
503816G1	NOR—Low Speed	6.40
503818G1	Power Inverter—Low Speed	5.95
503818G2	Power Inverter—Medium Speed	10.69
503819G1	CSR—Low Speed	8.82
503819G2	CSR—Medium Speed	11.66
503819G3	CSR—Medium Speed	37.65
503820G1	MSMV "B" Side	7.74
503821G1	Diff (MSMV "A" Side)	9.68
503834G1	Filter (Decoupler)	7.55
503860G1	Compl. Driver—Low Speed	12.55
505694G1	Diode Gate	11.40
505703G1	D/A Converter	14.20
505704G1	Indicator Driver	14.15
506030G1	CSR-M1	21.20
507318G1	Emitter Follower—Low Speed	7.29
507318G2	Emitter Follower—Medium Speed	12.11
508334G1-G8	Octal Patch	4.20
508335G1-G2	Jumper Patch	4.84
508367G1	5 Volt Reference	196.20
508517G1	Module, Special Component	13.62
509050G1	Indicator Driver (Negative Coincident Input)	15.15

Specifications and prices subject to change without notice due to technological advances. Delivery, discount schedules and additional pricing information available upon request.

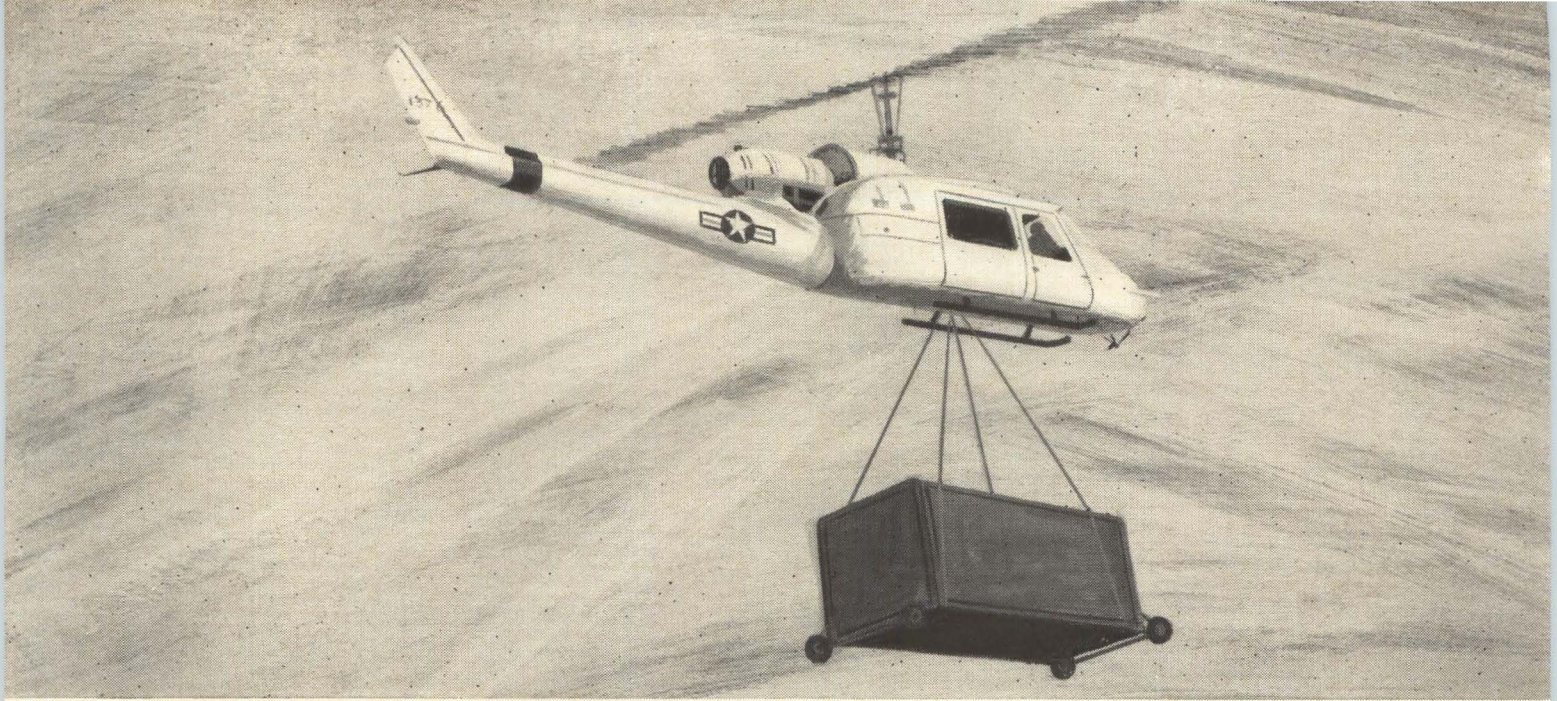

Deliver 3 Westinghouse mobile huts like this—

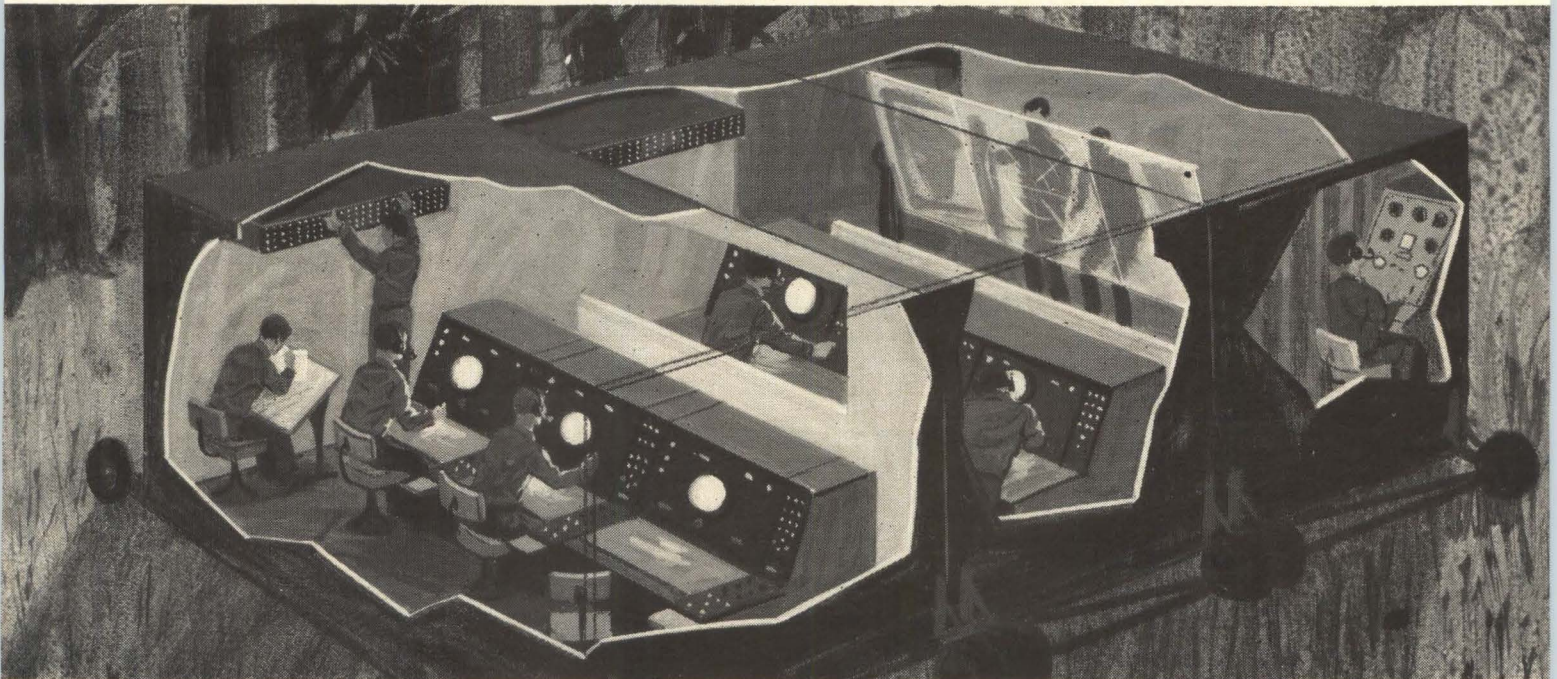

and you have a complete radar operations center

Until now, tactical operations centers have been large and unwieldy complexes. Time-consuming assembly and low intercept capacity have resulted in limited capability.

A new Westinghouse concept has changed the picture. The Westinghouse Mobile Radar Operations Center is a modular, pre-wired and pre-assembled system that adapts to the mission requirements. A basic three-hut configuration can be

transported in a single C-130 and can be placed in operation in 20 minutes or less. To adapt to changing tactical situations, modules may be added or subtracted. All huts are easily transportable over terrain on standard vehicles or with mobilizers.

The addition of DIGITRAC—an optional Westinghouse digital weapons control system—is a major aid to the weapons controller. DIGITRAC greatly increases capac-

ity and accuracy in the control of tactical interceptors. The DIGITRAC control system can also provide highly mobile, ground-based guidance for close support, interdiction, resupply and air traffic control.

For complete information on the Westinghouse Mobile Radar Operations Center, write for Bulletin SD-1-1-4. Westinghouse Electric Corporation, P.O. Box 868, Pittsburgh, Pennsylvania 15230.

J-02359

You can be sure if it's Westinghouse



Circle 39 on reader service card

design ideas for the OEM engineer . . .

USE HEINEMANN CIRCUIT BREAKERS FOR BOTH PROTECTION AND CONTROL

Heinemann hydraulic-magnetic breakers get the nod from many OEM engineers who rate them as excellent protective devices. A growing number of equipment designers are aware of another important fact: our breakers make excellent and economical control devices. With a little ingenuity and one of our special internal circuit forms, you can often get the job done with fewer components and a simpler circuit. In addition to the basic series-trip internal circuit (coil and contacts in series), Heinemann breakers are available with shunt-trip, calibrating-tap, relay-trip, dual-rating, auxiliary contacts, and other special internal circuits.

The examples here are typical of what's being done. Together with a variety of internal circuits, the Heinemann line features current ratings from 10 milliamps to 200 amperes in any integral or fractional value, models that range from subminiature to larger panelboard and switchboard sizes, and multi-pole breakers to six poles. All use the proven hydraulic-magnetic principle which guarantees temperature-stable ratings and trip points.

For more information, request a copy of the Heinemann **Engineering Guide, Bulletin 202.**

goof-proof circuit for sequential startup and shutdown

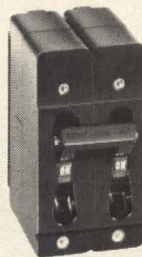
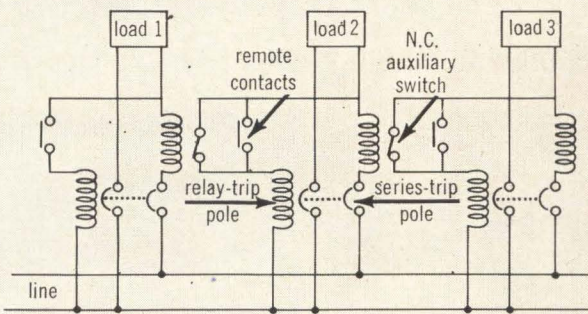

The three two-pole breakers in this circuit can be turned on only in the sequence 1-2-3, and off only in the sequence 3-2-1. Proper sequencing is guaranteed by the relay-trip pole in each ganged pair. Typically, if breaker #2 is switched on out of sequence, its relay-trip pole is tripped by the line voltage "seen" through the N.C. auxiliary switch on breaker #1. If breaker #2 is turned off out of sequence, its own auxiliary switch closes, causing breaker #3 to trip. The relay-trip coils can also be actuated from remote contacts if desired. Overload protection is furnished by the series-trip poles in each pair of circuit breakers.

high-temperature limit control with manual reset

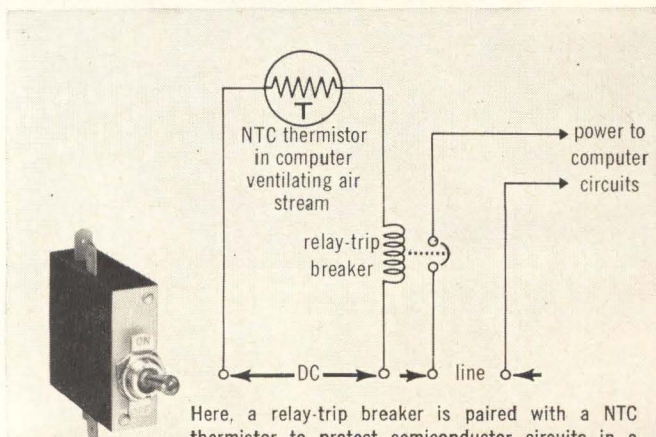

Here, a relay-trip breaker is paired with a NTC thermistor to protect semiconductor circuits in a computer from over-heating. Temperature rise in ventilating air will drop thermistor resistance, raise breaker coil voltage, and cause instantaneous tripping. Breaker contacts open power lines to semiconductor circuits, prevent burnout. Design was chosen as the most economical means of providing high-temperature cutoff with manual reset.

Because of the electrical isolation of the coil and contacts, a relay-trip breaker can control one circuit from another that uses an entirely different voltage or current. Relay-trip is one of the most versatile special circuit forms in our line.

protecting a diesel generator from frequency drift

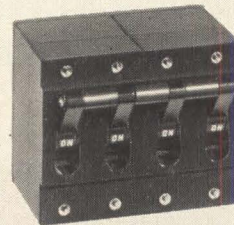
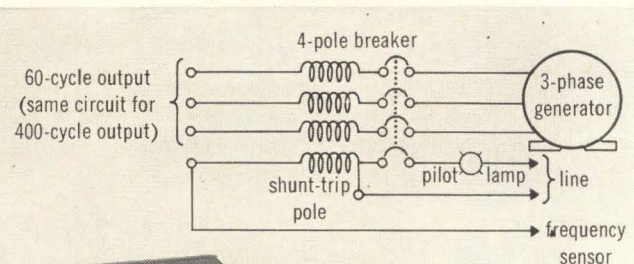

A compact, portable, diesel-driven generator needed protection against frequency drift for its 60- and 400-cycle three-phase outputs. A lightweight, economical solution was effected by adding a fourth shunt-trip pole to each of the generator's three-pole output breakers. (Diagram shows one of the two output circuits.) Should frequency drift, a separate frequency sensor delivers a "jolt" of voltage to the shunt-trip coil, tripping all four poles. Use of shunt-trip trip poles saved the weight and cost of two separate three-pole contactors.

Though breakers are usually current-rated, Heinemann can supply voltage-rated models if voltage is the easier variable to monitor.

HEINEMANN ELECTRIC COMPANY



2600 Brunswick Pike
Trenton, N.J. 08602

SA2951

Technical articles

Highlights

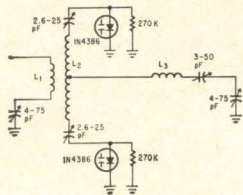

Charge storage varactors boost harmonic power: page 42
Solid-state devices are moving in on triodes and klystrons in uhf and microwave applications. Now a new varactor can handle power to 50 watts at 150 Mc. Applied to multiplier circuits, the device allows a lot of communication, radar and telemetry gear to be designed solid state.

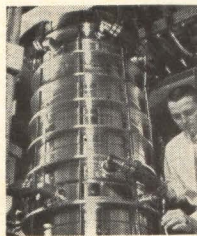

Superpower tubes: their capabilities and limitations: page 48

The slump in military orders has forced makers of microwave tubes to learn more about their high-power tubes. This survey examines the design features that impart high-power performance to a variety of tubes and compares several tubes' performances in half a dozen respects.

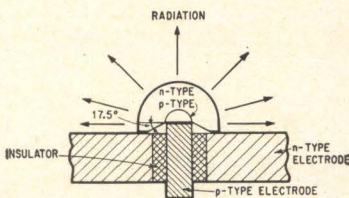

New light sources from p-n junctions: page 61

If high current is pushed through a gallium arsenide p-n junction a laser effect results, producing coherent light. But if low current is passed through the same junction, noncoherent light is emitted. Applications of this kind of radiation broaden the circuit designer's horizon and may even change the semiconductor industry.

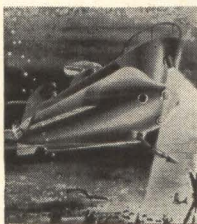

Frontier of the deep: page 70

More often than ever, man's exploration is taking him underwater. Electronics is fighting an uphill battle against mechanical and electromechanical instrumentation, the traditional favorites of oceanographers. Here's an examination of the measurement and data-acquisition problems, and some ways they have been solved electronically.

**Coming
July 27**

- Applying optoelectronic components
- Automatic testing with computers
- A new thermal filter in solid state
- A satellite for electronic weather forecasting
- Solid-state switch resists interference

Charge storage varactors boost harmonic power

High power varactor multipliers, 180 watts at 100 Mc, are replacing triodes and klystrons in uhf and microwave applications

By Gerald Schaffner

Motorola, Inc., Semiconductor Products Division, Phoenix, Ariz.

Semiconductor techniques are now at the point where relatively high power can be supplied at ultrahigh and microwave frequencies by solid-state generators. A new varactor achieves power outputs of more than 50 watts at 150 Mc and 20 watts at 450 Mc. Previously, power handling capability was limited to about 10 watts. The use of two varactors in push-push circuits can produce more than 180 watts at 100 Mc. Efficiencies at these power levels—approximately 60 to 70%—are comparable to those achieved by lower power devices.

Varactor multipliers, circuits that convert an applied signal of one frequency to some higher frequency, complement transistors by translating power output to at least a decade of frequency above normal transistor cutoff. A single transistor can supply up to 20 watts at 50 Mc. More than 100 watts at 50 Mc can be achieved by paralleling two or more devices. Transistor-varactor combinations replace triodes and klystrons in many uhf and microwave applications such as communications, telemetry and radar because of their advantages over vacuum tubes. They are reliable—there is none of the burnout that occurs with tubes; operate instantly—no warming is needed; have small power drain—no heating is required, and high d-c plate voltages are eliminated.

The high power-handling capability of the new varactors, 1N4386 and 1N4387, is made possible by special graded junctions formed by a diffusion process. In addition, new effects called charge storage and step recovery enhance harmonic generation (see panel on p. 44). The harmonic-current generation is not level-dependent. It is a function of the waveform which is kept constant over most of the input power range. This leads to a more constant efficiency of harmonic generation than is obtain-

able with devices dependent on junction-capacitance variations alone. Also, since capacitance doesn't change much with voltage ($\frac{1}{2}$ power law), circuit detuning is minimized. Thus, better linearity characteristics are possible in amplitude-modulated

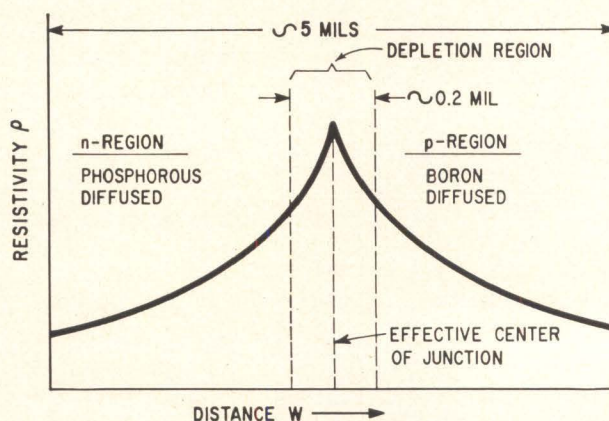

The resistivity profile of the special diffused varactor enhances charge storage. The electric fields set up by the steep resistivity gradients keep the minority carriers close to the depletion layer.

The author



Gerald Schaffner has his doctorate in electrical engineering. He has worked on microwave instrumentation, parametric amplifier and varactor circuit development since joining Motorola Inc. in 1957. Before that he was at Stewart-Warner Electronics where he developed L-band and S-band microwave beacons.

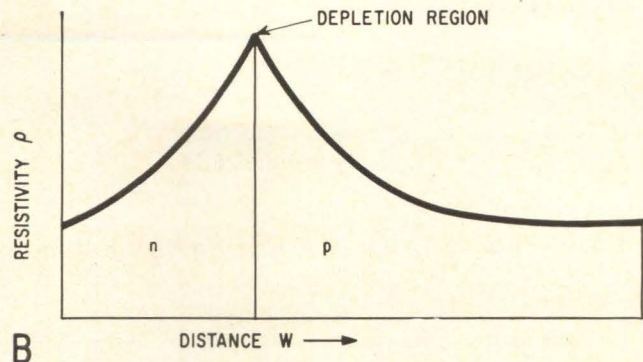
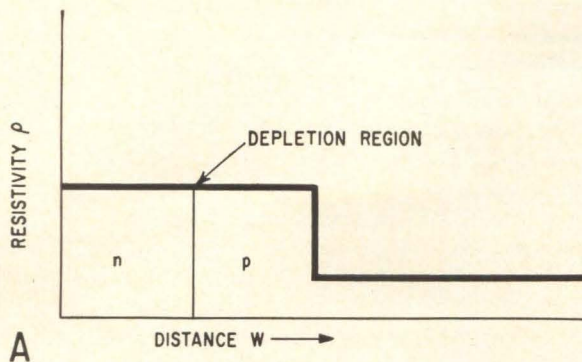

Typical resistivity profiles are for the abrupt, or step, junction (A) and for the linear-graded junction (B). Step junction has constant resistivities near the depletion region; linear-graded junction has an impurity concentration that decreases linearly as the depletion region is approached.

circuits. The devices are also characterized by minimization of their series resistance (R_s) over most of the operating voltage range. These characteristics clearly point out the attractive features resulting from the diffusion process that produces the special resistivity profile shown on p. 42. Resistivity is less than 0.01 ohm-cm throughout most of the device, but rises to approximately 100 ohm-cms near the depletion layer—the carrier-free transition region between the n and p regions.¹

Abrupt and linear junctions

Resistivity profiles of abrupt and linear graded junction varactors are shown above. The abrupt, or step, junction has a constant resistivity near the depletion region and this leads to an inverse half-power dependence of junction capacitance on voltage

$$C = C_0 / \left(1 - \frac{V}{\phi}\right)^{1/2} \quad (1)$$

where C is the capacitance for an abrupt pn junction; C_0 is the zero bias capacitance; V is the applied voltage and ϕ , the contact potential, is the voltage across the junction before the external voltage is applied. $\phi \approx 0.5$ volt for silicon devices.

With the linear graded junction, semiconductor impurity concentrations decrease linearly with distance as the depletion region is approached. Since the resistivity is inversely proportional to impurity level, the resistivity profile has a positive rate of change of slope as the depletion region is approached. This resistivity, or impurity, profile leads to an inverse third-power dependence of capacitance on voltage

$$C = C_0 / \left(1 - \frac{V}{\phi}\right)^{1/3} \quad (2)$$

where C is the capacitance of the linear graded junction.

Except for greater change of resistivity near the depletion region, the new diffused varactors are similar to the linear graded devices which also exhibit, but to a lesser degree, the attractive char-

acteristics of charge storage and low series resistance.

Special resistivity profile

The special diffused profile results in high breakdown voltage because narrow high-resistivity regions are adjacent to the junction. Since power handling is proportional to breakdown voltage squared ($P \propto CV_B^2$) for both abrupt and linear graded junctions,² it is reasonable to expect a similar dependence for varactors having the resistivity profile shown on p. 42. The high-power capabilities of the 1N4386 and 1N4387 varactor diodes are attributed partially to their high breakdown voltage of approximately 300 volts which is a direct result of the unusual resistivity profile. Abrupt and linear graded varactors are not available with breakdown voltages much above 180 volts because they are not efficient and the series resistance is too high. Although a high breakdown voltage is desirable, the result is high resistivity which means a high series resistance, thus low Q and poor efficiency.

Both resistance and capacitance vary with applied voltage in a different manner than with an abrupt junction device. The series resistance decreases rapidly with increasing reverse voltage because the depletion layer spreads rapidly into the high-resistivity region. To counteract the effects of the applied voltage a fixed amount of charge must be included within the depletion region. Because the fixed charge density is less in high-resistance material, the depletion layer spreads more than in low resistance material. As a consequence, the capacitance-voltage variation follows an inverse $1/5$ power law

$$C = C_0 / \left(1 - \frac{V}{\phi}\right)^{1/5} \quad (3)$$

where C is the junction capacitance of the special diffused varactors.

A parallel plate analogy illustrates why the capacitance varies only slightly with voltage. Application of a relatively low voltage initially spreads the depletion layer (parallel plates) considerably so that further increases in voltage have relatively little

effect on capacitance. Similarly, spreading the plates of a capacitor would have the same effect. Typical series resistance and Q at 50 Mc, where $Q = 1/\omega C_J R_S$ are shown below for the 1N4387. The low series resistance over much of the rf cycle contributes to its high efficiency.

Harmonic generation

The typical abrupt-junction varactor provides harmonic voltages generated from sinusoidal currents that result only from capacitance varying with instantaneous applied junction voltage. This type of harmonic generation has a disadvantage in that the output is not proportional to the input. Two reasons for this are: 1) the percentage of harmonic current is a function of fundamental current amplitude and 2) average varactor capacitance changes with input level, resulting in circuit detuning.

With the 1N4386 and 1N4387, on the other hand,

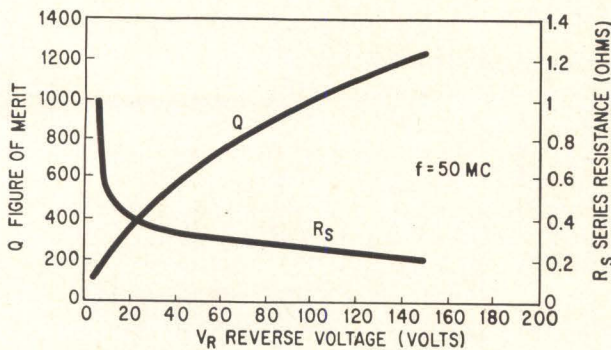

Low series resistance contributes to the high efficiency of the 1N4387 as shown by plot of figure of merit Q versus the reverse voltage.

the output level is nearly a linear function of input. This means that a-m signals can be passed with little distortion. The proportional relation between output and input results when the varactor is driven into the forward voltage region by the applied signal voltage to generate harmonics. By allowing varactor bias voltage to vary with applied signal level, the percentage of harmonic current generated by charge storage effects is maintained at a fairly constant level. Also, by minimizing the change of capacitance with change of signal voltage, circuit detuning is minimized. All this improves the response to amplitude-modulated signals.

Multiplier circuit design

Multiplier circuit design with 1N4386 and 1N4387 varactors is relatively straightforward, although some amount of experimental circuit optimization should be expected because of the unusual non-linearities associated with the devices.

In the design of harmonic multipliers, lumped circuit techniques are used up to 450 Mc with little performance degradation provided inductors and capacitors Q values of 200 to 300 are maintained.

Above 450 Mc, coaxial, stripline, or helical coil resonators are recommended for inductors. Although component values are not particularly critical excessive inductance or insufficient coupling can cause low efficiency while insufficient inductance or excessive coupling can cause poor filtering. Simple experimentation with well constructed and shielded breadboards is generally sufficient for circuit optimization. An adequate tuning range (approximately $\pm 20\%$) must be provided to insure input match in spite of normal varactor variations.

Charge storage and step recovery

Charge storage varactors have specially graded junctions which lead to harmonic generation because of a discontinuity in the current waveform. The harmonic content of the waveform can be analyzed by Fourier analysis. This current discontinuity, called step recovery, is a result of charge storage.

Charge storage and step recovery result from driving the varactor into the forward voltage region. There, charged carriers from one region are injected into the other to form minority carriers. If permitted to wander around in the area long enough, these minority carriers will combine with majority carriers and produce current flow. The interval between injection and recombination is related to the minority carrier lifetime of the material. In the interval between the time of injection and recombination, these minority carriers are effectively stored charges contributing to junction capacitance. As a result, charge storage manifests itself as a large increase of device capacitance.

If the period of the applied forward voltage is less than the carrier lifetime, as is usually the case, most of the injected carriers can be brought back to the point of origin before recombination. Step recovery comes about when the injected minority carriers are returned to the point of origin in a compact bunch. Such a movement of carriers constitutes a current waveform (shown on p. 45) which for purposes of analysis is expressed by:

$$i = -I_0 \sin \omega t \left[\begin{array}{l} \omega t = \pi/2 \\ \omega t = -\pi \\ \pi/2 + \alpha \\ \pi \\ \pi/2 \\ \pi/2 + \alpha \end{array} \right] - \frac{I_0}{\Delta\alpha} (\omega t - \frac{\pi}{2} - \Delta\alpha) \quad (4)$$

where it is assumed that the supply of stored carriers starts to limit varactor current at $\pi/2$ radians, and that all carriers are returned $\Delta\alpha$ radians later.

Because of the sudden cessation of reverse current when all of the carriers are returned to their original regions, the waveform is rich in harmonics which may be used in multiplier applications.

The resistivity profile of the special diffused varactor enhances step recovery because the electric fields set up by the steep resistivity gradient are a short distance, about 0.2 mil, away from the center of the depletion region. This keeps the minority carriers close to the depletion layer rather than permitting them to wander to random depths into the opposite regions. Thus, when the voltage is reversed, they return to their point of origin.

The step-recovery phenomenon, not as pronounced in

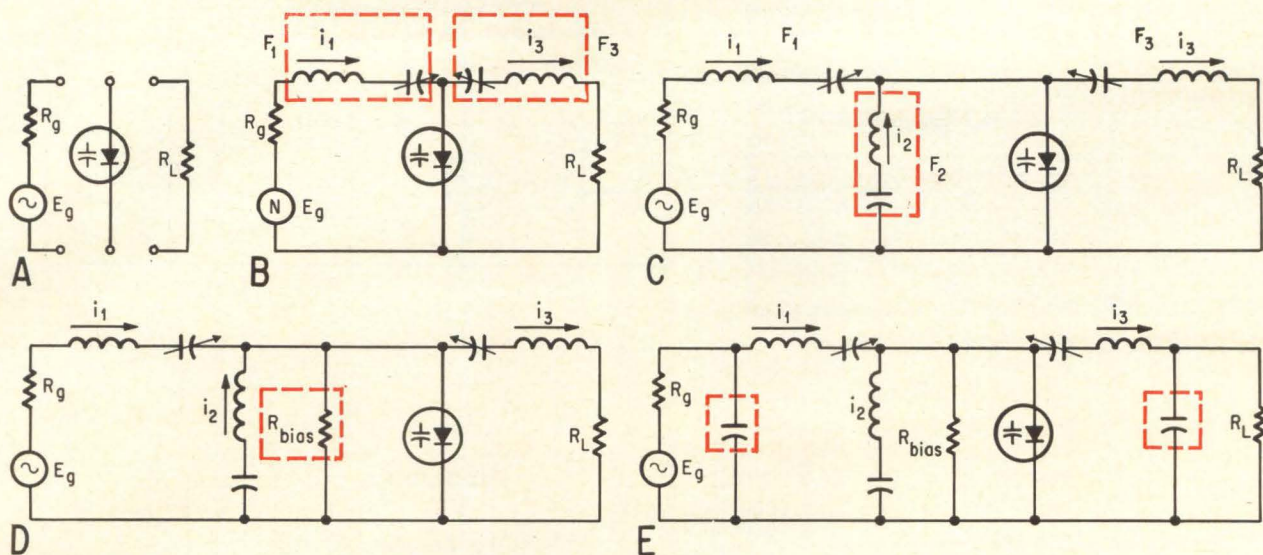

Development of a multiplier circuit starts with a varactor converting the signal to harmonic current through the load (A). Input and output circuits (color) are added for suitable current paths (B). If the desired load current is at the third or fourth harmonic, an idler circuit (color) is added (C). A bias resistor (color) provides bias voltage (D). Input and output matching capacitors (color) provide proper matching between the source and load (E).

Spurious signals between stages should be kept below 30 db by suitable filter circuits.

If self-bias is used, bias resistor values between 68 and 270 kilohms are suitable. The higher values give more efficient operation, whereas the lower values permit more linear operation. Amplitude-modulated signals can be passed with relatively low distortion (approximately four to five percent) if the bias resistance, R_B is approximately 100 kilohms and the varactor r-f input power level is kept less

than 65% of the rated maximum limit.

For all multiplier stages other than doublers, idler circuits should be provided to optimize circuit efficiencies. An idler circuit is a tuned filter which permits the flow of a harmonic current needed to generate the desired output. Its purpose is to generate the low order harmonics, such as the second, and add it to the first to get the third. The fifth may be obtained by adding the third to another generated second. Since it is more efficient to gen-

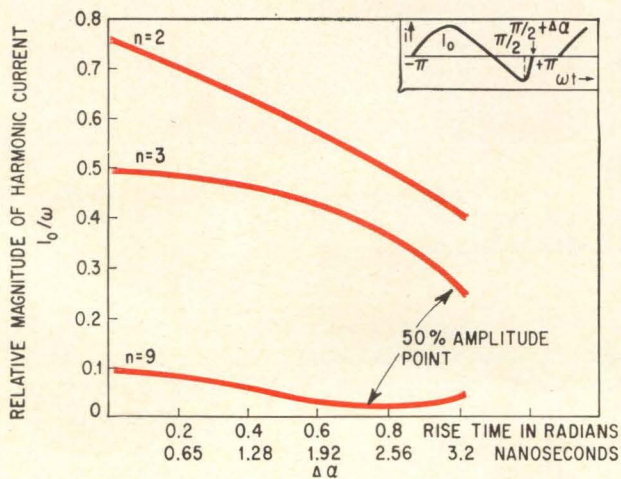

Fourier analysis gives the second, third and ninth harmonic components ($n =$ order of harmonic) of the current with a sinusoidal 50-Mc input voltage. Relative harmonic amplitude is shown as a function of the rise time $\Delta\alpha$ of the recovery step. Faster recovery corresponds to greater percentage of harmonic current. Enclosed in the upper right hand corner is the current waveform of a step-recovery diode.

step-junctions because of the constant impurity level, provides the 1N4386 and 1N4387 with additional non-linearity which contributes to harmonics generation.

Step recovery also results in a device with more linear power characteristics because the percentage of harmonic-current generation is not a function of signal level. It is a function only of the waveform and the abruptness of the decline of reverse current. And if self-biasing is employed, as it should be for linearity, the shape of the current wave remains constant over a considerable power input range. Further circuit-detuning effects that occur with change of bias level are minimized because of the relative insensitivity of capacitance to voltage changes. Thus, a more constant efficiency of harmonic generation as a function of signal is possible than with devices dependent on junction-capacitance variations alone. This is important when using varactors in a-m circuits.

Both charge storage and step recovery add to the power handling capability of the varactors. Since charge is stored during forward voltage and not recombined as in silicon diodes, the voltage swing is not limited between 0 volts and breakdown voltage. Considerable forward voltage and therefore, considerable extra power because of the large currents involved, can be tolerated without dissipating excess power in the varactor. In addition, to obtain step recovery, resistivity must peak near the depletion region. Thus breakdown voltage is high because of its dependence on resistivity and high breakdown voltage contributes to a high power-handling capability.

COAX	LENGTH	DIAMETER (INSIDE)	TURNS	WIRE DIA.
L ₁	1-3/8"	1-1/16"	7	3/32"
L ₂	1-1/2"	1-1/16"	4-3/4	3/32"
L ₃	1-1/4"	1/2"	3-1/2	3/32"
C ₁	2.8-11 pF	E. J. JOHNSON	167-1	CAPACITOR
C ₂	6.7-140 pF	HAMMERLUND	APC-140	VARIABLE CAPACITOR
C ₃	3.0-25 pF	"	APC-25	"
C ₄	2.9-35 pF	"	MAPC-35	"
C ₅	3.0-25 pF	"	APC-25	"

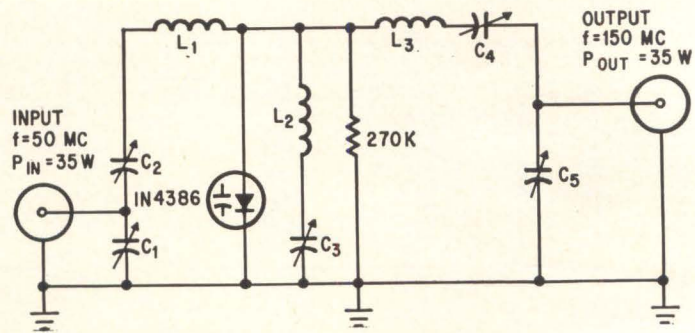

This 50 to 150 Mc tripler test-circuit has an efficiency of 70%. Circuit components must have Q's exceeding 200.

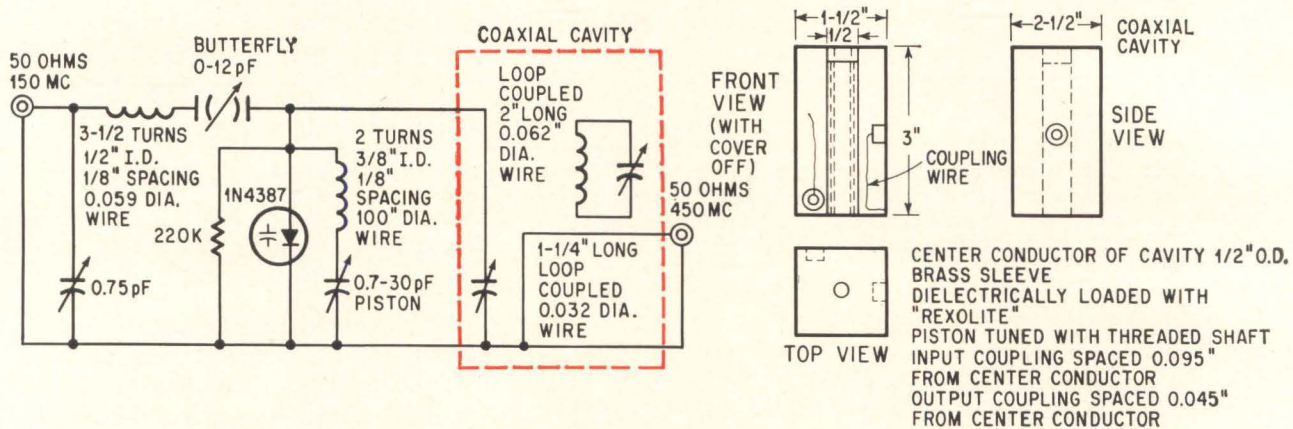

Tripler test-circuit for the 1N4387 puts out 20 watts at 450 Mc for 40 watts of 150 Mc input. The output stage (color) is a coaxial cavity with a tuned coupling loop leading to the varactor.

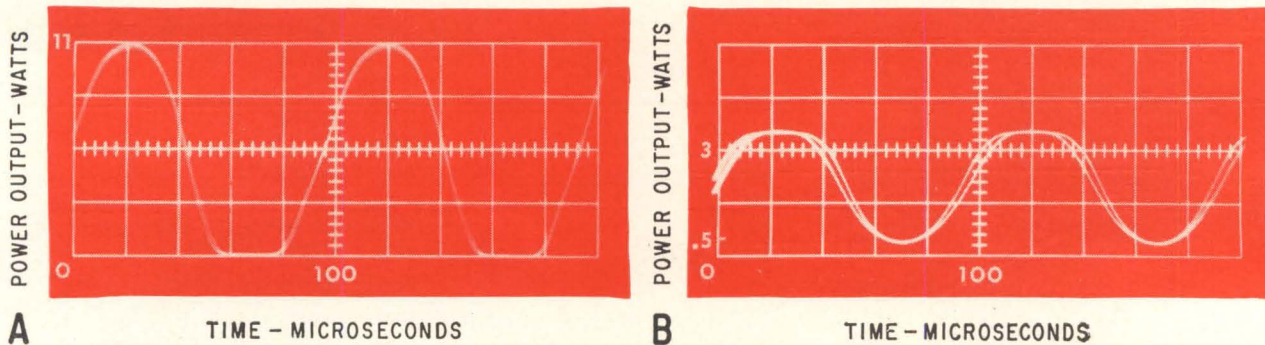

Superimposed displays of 100% a-m input and output waves (A) is for a 1N4387 tripler circuit. A similar display for an abrupt junction varactor (B) exhibits increase in distortions.

erate low order harmonics, over-all efficiency of the circuit results when high order harmonics are obtained by adding the low order harmonics. In typical applications, doubling efficiency is 5% greater than that for tripling and tripling efficiency is 5% greater than that for quadrupling.

50 to 150 Mc tripler

The development of a multiplier circuit is shown on p. 45. The basic premise, as shown in (A) is the conversion of a signal from a signal source to a harmonic current through the load (R_L) by means

of a varactor. The necessary considerations entail provisions for the necessary current paths and associated filters; proper matching of source to load and development of suitable bias voltage for the varactor.

The first step in the design is the development of suitable current paths, as shown in (B). If the output is to be the second harmonic, filter F_1 is tuned to the fundamental frequency, and F_3 is tuned to the second harmonic. In designing the tuned circuits, the capacitance of the varactor must be taken into account. Since this varies over the

applied signal cycle, the average value of varactor capacitance should be used. This can be approximated at the capacitance value at one-third the breakdown voltage rating of the varactor (assuming a signal voltage swing from about breakdown voltage V_B to some small positive value). Since the average capacitance varies with signal power, some circuit detuning occurs if input power changes appreciably. This effect is less pronounced with devices of the 1N4386 structure than with step-junction devices, because of its inherently smaller capacitance-voltage dependence.

If the third or fourth harmonic is desired at the load, configuration (C) may be used. Here, F_1 is again tuned to the fundamental and F_2 is an idler tuned to the second harmonic. This permits fundamental and second harmonic current to mix in the varactor to provide a voltage component of frequencies, f_1 , f_2 , $f_1 + f_2$, and $2f_2$ across the varactor. Even if f_2 were omitted, there would be components of higher order harmonics, such as f_3 and f_4 across the varactor, but it is usually more efficient to employ a suitable addition of the fundamental and second harmonic. Filter F_3 is then tuned to the desired third or fourth harmonic so that only the desired current will flow through the load.

Bias voltage for the varactor is obtained by shunting the varactor with high value (around 100 kilohms) bias resistance, as in (D). Bias current is provided when the varactor is driven slightly into conduction at the peaks of the applied signal. The varactor doesn't short out the resistor because the period of the applied forward voltage is less than the carrier lifetime. Thus the injected carrier can be brought back to the point of origin before recombination has a chance to take place.

Proper matching between source and load can be accomplished by adding matching capacitors as shown in (E). Tapped input and output coils could accomplish the same purpose. The matching is done experimentally. The input capacitance is varied to match the impedance looking into the multiplier and the output capacitance is varied until maximum power output is obtained.

A 50 to 100 Mc tripler based on this development is shown on p. 46. This circuit has an efficiency of over 70% with an input greater than 50 watts. Circuit component Q's must exceed 200.

Recent results with the 1N4386 include 180 watts out of a push-push doubler at 100 Mc with 70% efficiency. This circuit is shown above.

150 to 450 Mc tripler

A 150 to 450 Mc tripling circuit for the 1N4387 is shown on p. 46. Over 20 watts output at 450 Mc can be obtained from 40 watts input at 150 Mc. The circuit is similar to the 50 to 150 Mc tripler except that the output stage is a coaxial cavity with a tuned coupling loop leading to the varactor. In effect this is a double-tuned output circuit which not only provides a proper impedance match for the varactor, but also reduces all spurious responses to 35 db or more below the desired output. Since

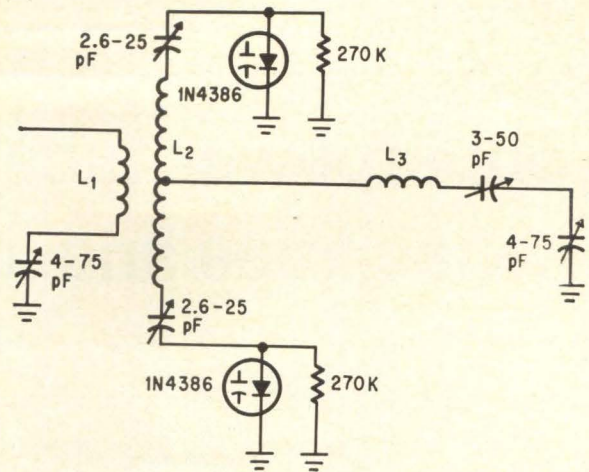

Push-push doubler circuit provides 180 watts output at 100 Mc with 70% efficiency. Components L_1 and L_2 have 3 and 10 turns of number 10 wire respectively (1 inch diameter coil); L_3 has one turn of no. 10 wire ($\frac{3}{4}$ inch diameter coil); all capacitors are Hammarlund MACP'S.

the placement of the cavity coupling loops must be optimized, easy accessibility to the cavity is important to facilitate adjustments.

Amplitude modulation

An attractive feature of the 1N4386 and 1N4387 is their ability to multiply the frequency of amplitude-modulated signals with low distortion. Over 35 watts for the 1N4386 and 25 watts for the 1N4387 of peak a-m power can be applied with little a-m distortion. This is in sharp contrast to the distortion abrupt junction varactors introduce.

Superimposed on each other, detected input and output signals processed by the tripler are shown on p. 46. The waveforms represent maximum possible modulated signals (as evidenced by base clipping) with peak input power of 20 watts and output power of 11 watts. The level of the waveforms is controlled by the gain adjustment of the dual-trace scope. The ordinate of the trace represents the detected output voltage whose peak corresponds to the power. The superimposed a-m signals show that the output waveform looks exactly like the input waveform.

A similar display shows results for an abrupt junction varactor when 11 watts peak power, modulated 50%, is applied at the input. Using this modulation level with less distorted input signals, the abrupt-junction multiplier produced a 4% to 10% increase in distortion at a carrier level of 1.4 watts while with the 1N4387 multiplier, the distortion of a similar 6-watt carrier output (4%) was not measurably degraded. The specially graded varactor clearly improves amplitude modulation.

References

1. A. B. Phillips, *Transistor Engineering*, pp. 95 and 109, McGraw-Hill Book Co., N.Y., 1962.
2. P. Penfield, Jr., and R. P. Rafuse, *Varactor Applications*, The M.I.T. Press, Cambridge, Mass., 1962.

Superpower tubes: their capabilities and limitations

They're likely to be doing more jobs in the future. Here's how some modern types measure up

By Lester F. Eastman

Cornell University, Ithaca, N.Y.

The slump in military orders for operational hardware is forcing makers of microwave tubes to find more civilian applications for their products. That search, in turn, is encouraging industry to learn more about microwave efficiency and limitations.

Microwave continues to play important roles in research. A thousand klystrons will be contained in a two-mile-long linear accelerator under construction at Stanford University. A pair of klystrons is used for radar astronomy in Arecibo, Puerto Rico.

Beyond these exotic tasks at the frontiers of knowledge, microwave components are finding more prosaic uses.

Their speed, efficiency and ease of electronic control make microwave tubes effective in heating of materials in the processing industries—canneries, oil refineries, lumber curers [Electronics, Apr. 6, 1964, p. 34].

Continuous-wave power, necessary for communications in outer space, requires high-power tubes. Space developments are responsible for some interesting research into power transmission by microwave [Electronics, June 1, p. 24].

Measuring performance

The performance of a high-power microwave tube is the product of the power and the square of the frequency. The frequency also is a factor in tube size: high-frequency tubes are generally smaller than their low-frequency cousins.

Another basic factor is wavelength. In linear-beam tubes, the electron beam area is proportional to the square of the wavelength. Similarly, in crossed-field tubes, the area of anode circuit dissipation is proportional to the square of the wavelength.

In measuring performance, usable power is limited by the absolute values of the power and by the

size and cost of the physical structures. At high frequencies, a larger percentage of the generated power is lost through dissipation of radio-frequency power. Another limitation on usable power is the smallness and intricacy of the electrodes. They cannot conduct away much heat, and are difficult to construct.

Peak power vs. frequency

The four graphs on page 50 compare the performances of some modern high-power microwave tubes. Many tubes have characteristics similar to the Sperry SAX 191 and Litton L-3302 shown on the graph of peak microwave power as a function of frequency. There is also a series of domestic and foreign S-band tubes with higher merit factors for linear accelerators, but few existing tubes are capable of outputs above this pulse amplitude.

One exception is the Watkins-Johnson WJ-225, shown on the graph.

A strong development effort has been made for this backward oscillator, especially in the generation of a powerful, small-diameter beam. The beam, 0.035 inches in diameter comes from a 900-to-1 area convergence electron gun connected to the bottom insulator. The beam carries more than 1,000 amperes per square centimeter at a voltage of 200 kilovolts. It passes through a 1.2-inch-long interaction region made up of a copper cylindrical structure alternating from 0.070 inches diameter and 0.025 inches long to 0.112 inches diameter and 0.025 inches long in a disk-loaded waveguide structure. It then passes to a collector (photo, p. 51).

The high power is taken off in twin waveguides at the gun end of the short backward-wave interaction structure. For measurement, the power is dissipated in a load consisting of a coiled, lossy, stainless-steel waveguide, where power is measured

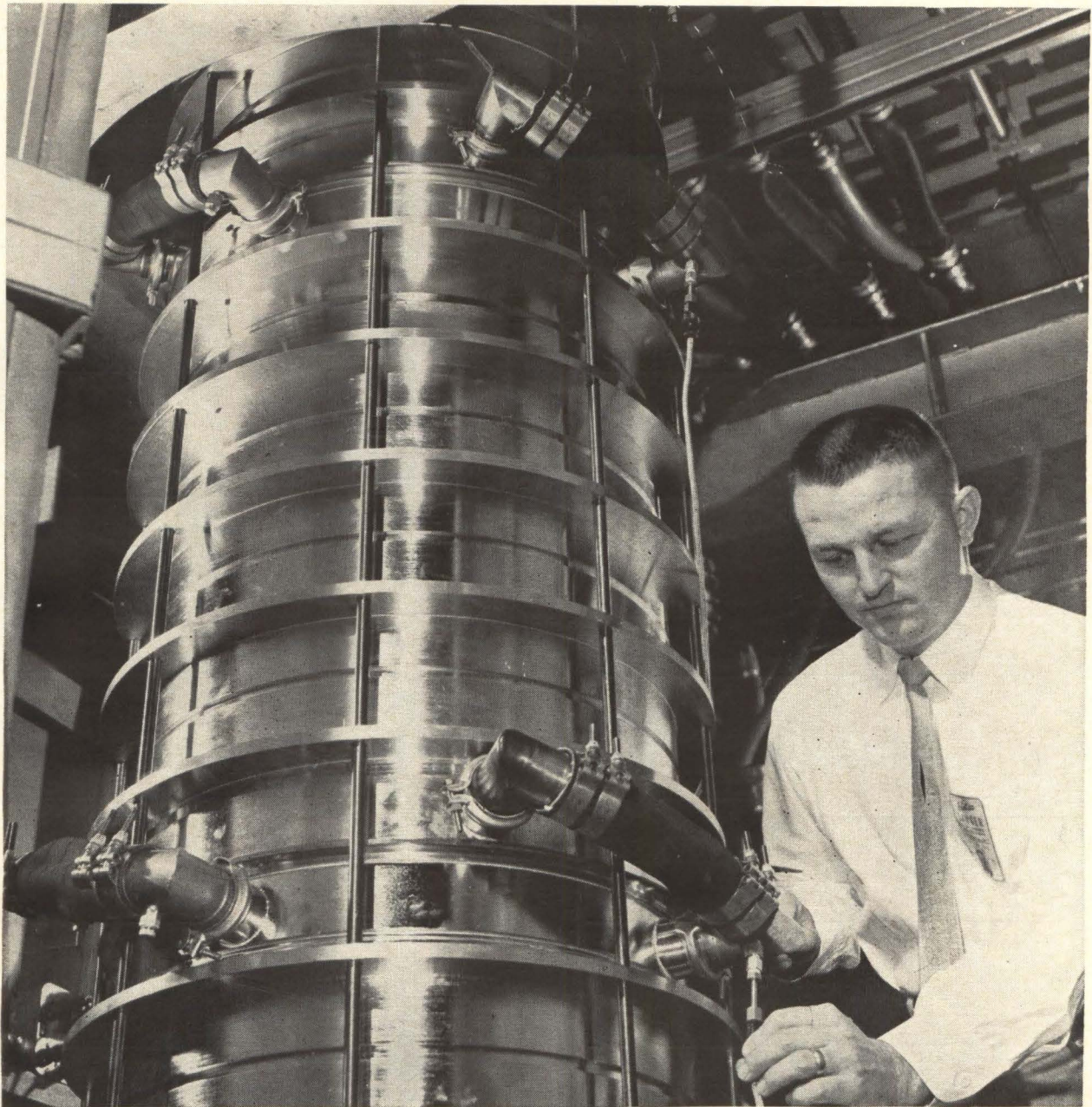

Collector for Eimac X3030 superpower klystron that is still under development. This tube is expected to achieve 1,000 kw at X-band.

as heat. For monitoring of the pulse shape, a mica window is provided at a low-power point in the waveguide.

Average power vs. frequency

Two figure-of-merit lines are plotted on the graph of average microwave power versus frequency of high average power or c-w tubes. There are many good tubes in the region represented by the solid line; they are typified by the SAX 418 and the Litton L-3401. The WJ-225, with its average power limit, is shown again for reference.

The VA-873 klystron represents a capability of 100 kilowatts of c-w power at X-band. A development program, conducted for the Rome Air Development Center by Eitel-McCullough, Inc., is represented on the graph by the X-3030. This tube is expected to attain 1,000 kw of c-w power at X-band. But the entire structure is seven feet high.

In the X-3030, a beam about 0.4 inch in diameter

is formed in a 30-to-1 area-convergence-ratio gun, and is sent in confined flow along a tunnel about 0.8 inch in diameter with beam-current interception maintained at less than 5 parts in 10,000.

To handle the output power with good bandwidth and efficiency, an extended-interaction circuit is used for a cavity. This circuit has three rings supported by four vanes each, in a large-diameter cylinder, forming four interaction gaps along the beam for one cavity of the klystron. Efficiencies as high as 60% have been measured during tests with 2 megawatts in the 160 Kv beam.

A Raytheon Amplitron, yielding over 400 Kw during continuous operation, is shown between the two figure-of-merit lines. In the photograph on p. 52, the output ceramic dome does not have the associated electromagnets attached. This tube, about six feet long, consists of dual cascaded Amplitron network assemblies in a common vacuum envelope. Total gain is nine decibels, with 70%

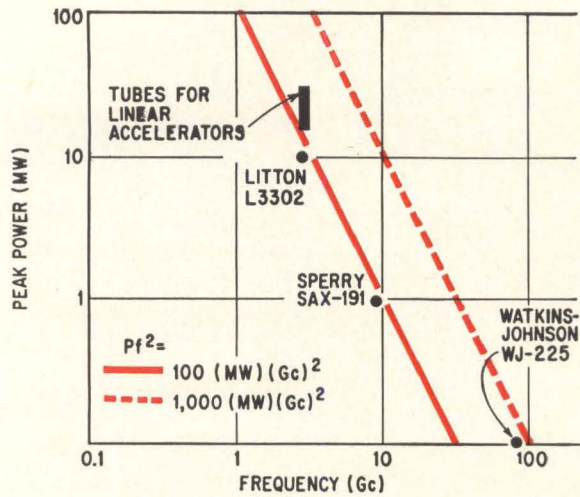

A

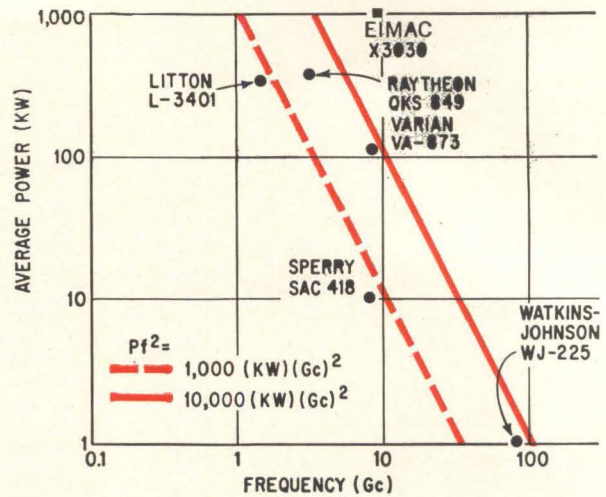

B

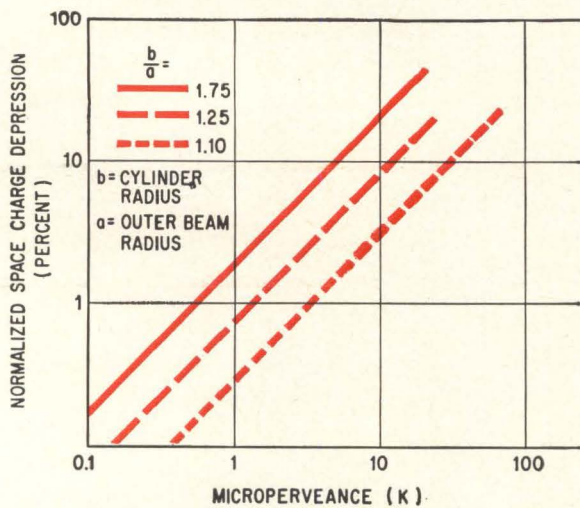

C

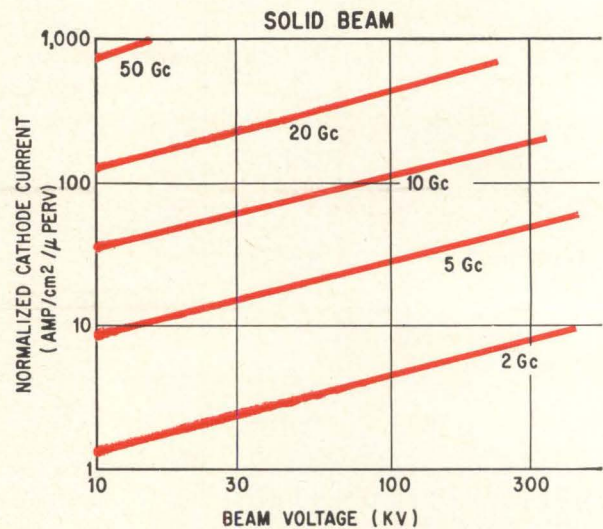

D

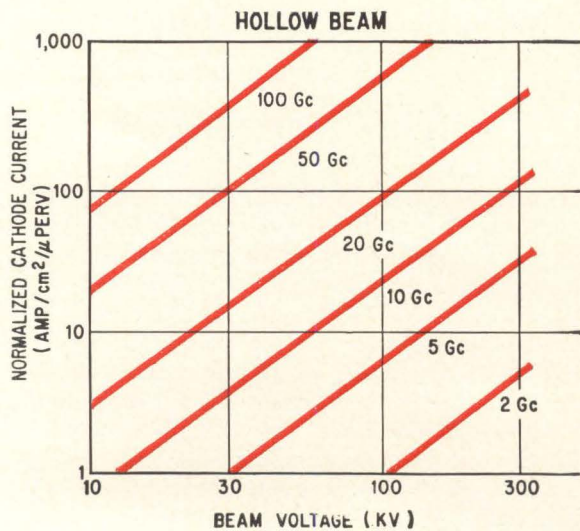

E

Figure of merit lines plotted for peak power vs. frequency (A) and for average power vs. frequency (B), with same typical tubes shown on the plots. Effects of radius of electron beam on its surrounding metal cylinder is apparent in the microperveance graph (C). Dimension b is the radius of the cylinder, and a is the radius of the beam. Microperveance K is a measure of density of the beam. If K is too high, potential depression can be excessive unless the beam-to-cylinder ratio is properly maintained. The graphs of normalized cathode current vs. beam voltage for solid (D) and hollow beams (E) indicate a trend and also give numerical values for scaling the performance of present cathodes and their guns and beams to various frequencies. The increase in Pf^2 that results from research into high-emission current density can thus be assessed accurately.

efficiency and 5% bandwidth. As in most cross-field tubes, the power is limited by the dissipation power density of the spent electron beam on the microwave interaction structure. Up to 10 kilowatts per square centimeter can be accommodated.

Limiting factors

To increase the power of these tubes, either the voltage or the current or both must be raised. In general, beam current is equal to a geometrical constant (called perveance) times the voltage raised to the three-halves power. Conventional linear-beam tubes have perveances that are near 1×10^{-6} ; thus units of microperveance are used.

If power is raised by using high voltages, difficult problems are encountered. The pulsed linear accelerator tubes operate up to 250,000 volts. At these levels, not only are power supplies massive and expensive, but it is difficult to apply such large voltages to the tubes. Therefore, it is practically mandatory that current be increased as high as possible.

When a large beam current passes through a metal cylinder, the negative charge causes a depression of potential so that the electrons in the beam move considerably slower than the speed associated with the potential along the cylinder. The depression of potential on the outer edge of the beam below the potential of the metal cylinder should be kept small for good performance; say 10% or less. This can be done by having the outer edge of the beam closer to the metal cylinder walls if more current is to be sent down the cylinder for a given beam voltage.

The 10% depression of potential represents 10% of the beam power wasted and spent at the (undepressed) collector. If a well-designed depressed collector is used, high efficiency can be retained with even greater depression of potential. If a klystron has 10% depression of potential in its drift space, it could easily have up to 20% depression of potential in the gaps in its output cavity, even without large signal effects. This would seriously alter the tube's efficiency.

Charge depression vs. perveance

The relation between the normalized space-charge depression of the beam potential (in percent) and the beam microperveance uses as a parameter the ratio of the cylinder radius to the outer beam radius. This plot is appropriate for both solid and hollow electron beams.

Most solid beams are designed with microperveances of 3 or under, but hollow beams with microperveances of over 30 have also been generated. No fully successful solid beam has been operated with a microperveance of 3 or higher.

Thus, for a microperveance of 30, the outer radius of the beam must be within 10% of the radius of the metal cylinder wall to prevent excessive depression of potential. This requires better-than-normal control of the electron dynamics, to prevent the occasional interception of part of the electron

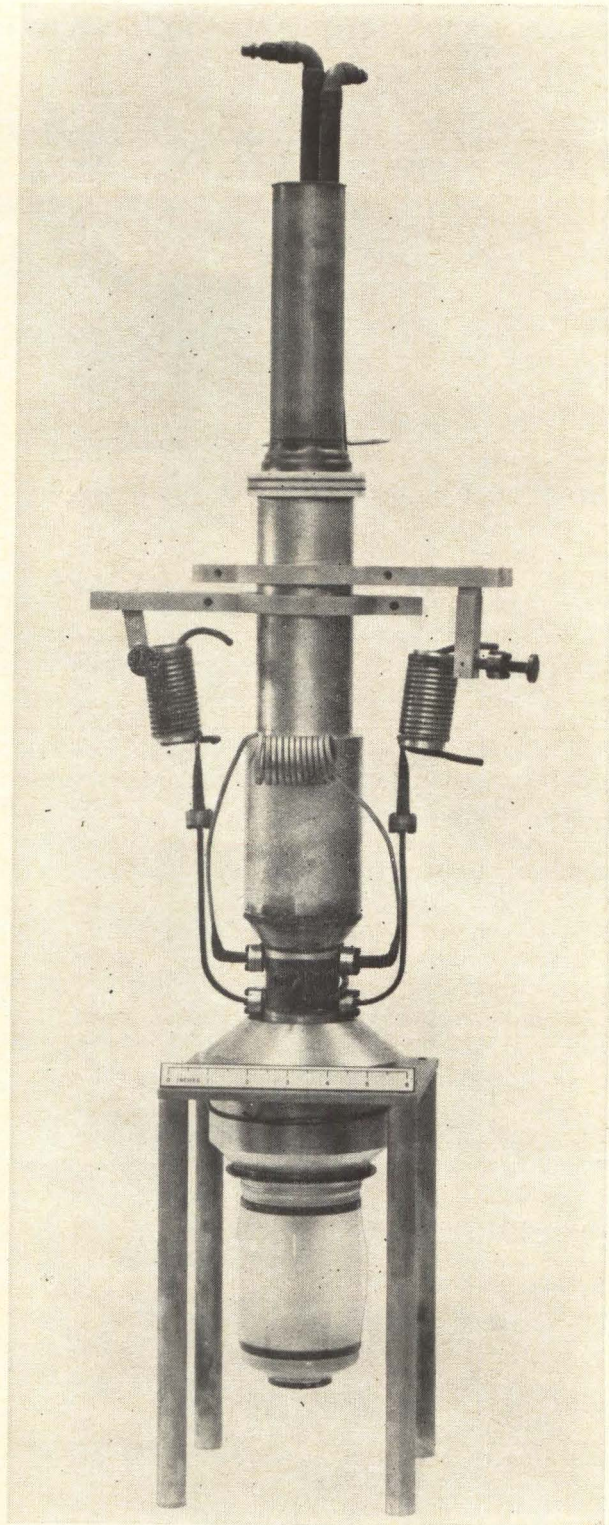

Backward-wave oscillator made by the Watkins-Johnson Co. is capable of 100 kw peak power at 100 Gc. Twin waveguides, shown at left and right of the tube, connect to coiled lossy waveguides of stainless steel, which act as loads.

stream on the metal cylinder. It also means that the width of gaps in the metal wall should not be more than 10% of the beam radius for such a high microperveance beam.

However, such short gaps may break down under radio-frequency voltages near the value of the beam voltage. This indicates that a whole new family of interaction circuits for klystrons and traveling-wave tubes is necessary for the use of hollow beams. These circuits must have nearly solid metal walls

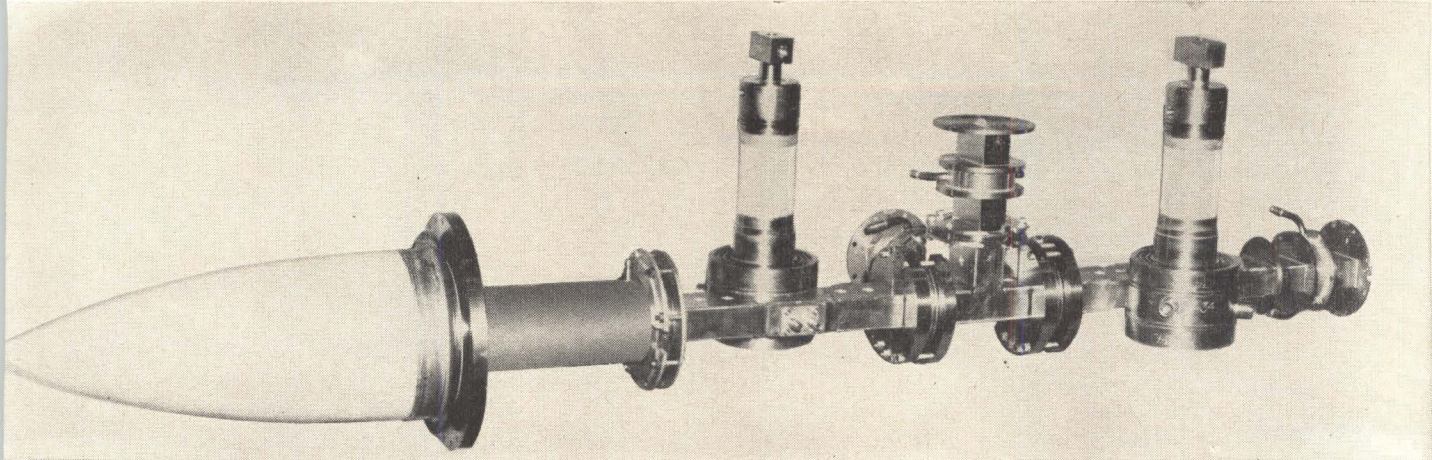

Raytheon Amplitron, shown without electromagnets attached, is about six feet long.

along the beam to prevent longitudinal depression of potential at the interaction gaps. The problems of better control of high-microperveance beams and associated interaction circuits can be solved, but will involve considerable engineering effort.

Next comes the problem of the limited current densities of cathodes. These are seldom above two amperes per square centimeter, although Philips Gloeilampenfabriken, N. V., of the Netherlands, has produced cathodes yielding up to five amperes per square centimeter. The problem arises because as the frequency of operation becomes higher, the diameter of the metal cylinders becomes smaller, being a function of wavelength.

At nonrelativistic voltages with solid beams, the product of the operating radian frequency, ω , and the cylinder diameter divided by the electron velocity, must not exceed a value of 2. Otherwise, poor interaction results and electromagnetic waves may propagate down the cylinder, causing feedback and oscillation problems. Thus, the limit on cylinder diameter requires more beam-current density than cathodes can emit directly to obtain reasonable microperveances.

Convergent electron guns with cathode areas

Klystrons in phased-array radar

Researchers for the Air Force and Cornell University believe that klystrons, or a composite klystron and traveling-wave tube, can match other tubes for phased-array applications. They are convinced the klystrons may even exceed the performances of other types if only a few high-power, phase-variable tubes are needed to feed many ports.

The latter case is the only phased-array application where superpower microwave tubes are needed. Otherwise, a medium-power tube would be used for each port.

The klystron's biggest problem is its form factor, rather than any electrical characteristic. At a given frequency, present klystrons are much too wide to fit close enough together to drive the phased array with one tube per port. A new kind of cavity is needed: longer and thinner.

A distributed-interaction klystron cavity can be developed to allow a good form factor and triple the present bandwidth, as well as raise the efficiency. The biased-gap klystron can also raise efficiency; experiments at Cornell have yielded efficiencies up to about 70%. This system can also help to stabilize, or electronically vary, the phase delay with constant output power.

larger than that of the beam have been built for some time, but in most high power tubes the cathode-to-beam area-convergence ratio has not been raised beyond 100 to 1. The ratio has exceeded 1,000 to 1 only in rare cases, because of the engineering difficulties and the poor control of beams for such highly convergent guns.

Cathode current vs. beam voltage

The normalized cathode current density required, as a function of beam voltage for solid beams, has as a parameter the maximum frequency of operation. Relativistic effects have been neglected here for simplicity.

R is the ratio of the cathode to the beam area (convergence ratio), and K is the microperveance of the gun. For a given microperveance, either higher convergence ratio or higher density of cathode-emission current must be achieved at higher frequencies or at higher voltages.

Large improvements in convergence ratio over that currently available do not appear to be feasible, but much higher cathode emission-current density can be achieved. On a pulsed basis at Cornell University, laser-impulse heating of tungsten surfaces has yielded emission current densities of over 10,000 amps per square centimeter, compared with the 2 A/cm² typical of the present impregnated cathode.

A similar plot for hollow beams shows a normalized relation between cathode-current density and beam voltage, again with the maximum allowable operating frequency as a parameter. The current density appears considerably improved, but allowance must be made for the thinness of the beam and the high perveances used. Ratio of the actual beam area to the area of the beam's outer diameter circle is δ (the minimum aperture that will pass the beam). K is the microperveance.

For system design, the circuit limitations of linear-beam super-power microwave tubes must be considered. As the pulsed beam voltage and current are raised, spurious high-frequency oscillations develop. At the lowest spurious output frequency—which is still somewhat above the desired operating frequency—the first higher-order field-reversing mode of the klystron cavity appears. This field-

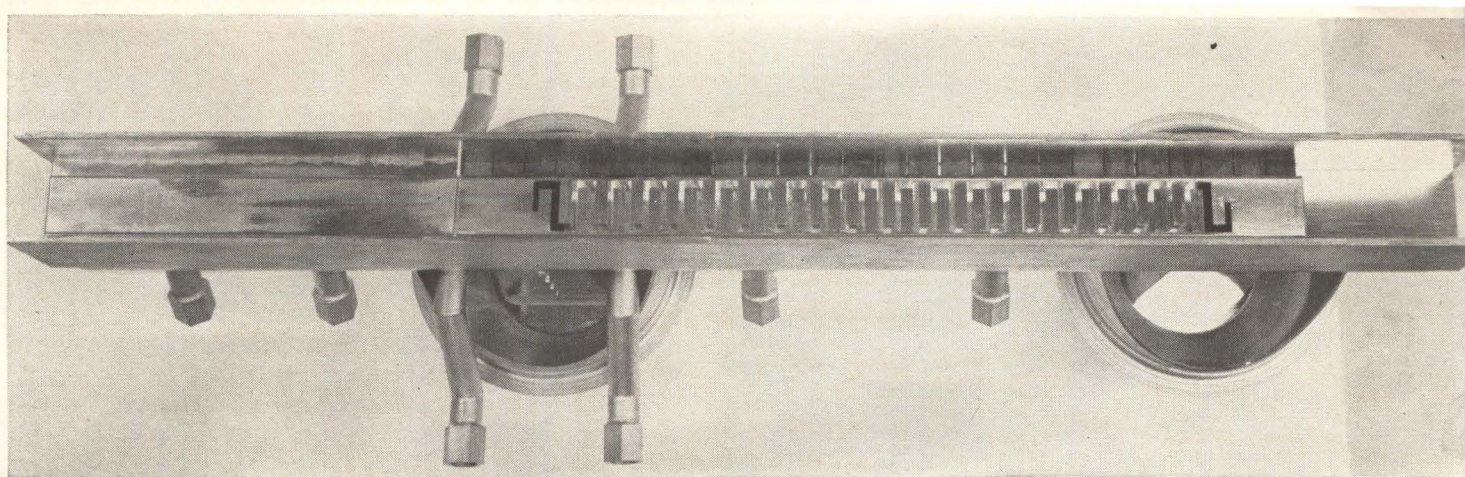

Superpower crossed-field amplifier, a Litton L-3778, with r-f input at right and delay line exposed. This tube has a bandwidth about four times as broad as a klystron's.

reversing mode can be controlled by offsetting the gap from its usual center position in the cavity. At the next higher group of spurious output frequencies, in the range of two to three times the desired operating frequency, the problem of propagation along the metal drift cylinders between the cavities arises. This causes feedback at specific frequencies where the cavities react strongly. It is possible to engineer solutions to these problems, but considerable effort is necessary at the higher power levels.

As average or c-w power levels rise, the dissipation power densities due to r-f ohmic losses become troublesome. These losses can often be reduced by external cooling. In addition, by increasing the number of gaps in output cavities, electronic interaction efficiency can be improved as well as the circuit losses reduced. Long output cavities with several interaction gaps (distributed interaction cavities) have shown remarkable improvement in efficiency, power-handling ability and bandwidth. In these cavities, cooling rings are supported around the beam by two or four heavy metal radial struts that also carry coolant to the rings. This technique overcomes losses produced by the concentration of r-f current in the support struts.

Further gains in the generation of high power at microwave frequencies may be achieved by paralleling linear beam tubes. With care, the outputs of as many as eight klystrons have been combined at a common load. Many more have been combined in radar phased arrays where tube interaction is not as important as in a single load. In linear accelerator applications, many more than eight have been maintained in a tightly controlled phase relationship while feeding separate loads.

The biggest problem in paralleling tubes for operation into a common load or multiple loads is phase variation from tube to tube, which causes the load to appear reactive to some of the tubes, preventing the delivery of full power by those tubes. Phase variations in klystrons can best be controlled by phase-locking the signal in various parts of the klystron. The multiple-beam klystron of the General Electric Co. does just this. If several beams are produced in a common vacuum system, optimum phase-locking is possible, but this advantage is offset by having to replace the entire unit

if one or more beams should fail.

Efficiency

Although limited efficiency is not a barrier to high-power generation with linear-beam tubes, economy and other benefits result from higher efficiency. Efficiencies in the range of 50% to 60% have been achieved in several isolated cases. Some recent experiments by I. Hefni at Lincoln Laboratory of Massachusetts Institute of Technology have shown that applying a d-c bias in the nonlinear region of the next-to-the-last cavity increases the electron velocity and improves efficiency by at least 10%. In one case the technique yielded over 70% efficiency.

Cross-field tubes

Crossed-field tubes operate with lower applied voltages and considerably higher current flow than linear-beam tubes. There is neither a strongly limiting potential depression nor a limit on cathode-emission current density. In fact, the electrons are

Performances of some superpower tubes

Tube and Type	Approximate Frequency (Gc)	Power (watts)	Operation	Manufacturer
QK5849 amplifron	3	.425 × 10 ⁶	continuous	Raytheon
VA873 klystron	10	.106 × 10 ⁶	continuous	Varian
X-3030 klystron	10	1 × 10 ⁶	continuous	Eimac
SAX-191 Linear accelerator klystron	10	1.0 × 10 ⁶	pulsed	Sperry
713-H travelling wave tube	3	24 × 10 ⁶	pulsed	Sperry
6799 magnetron	10	.10 × 10 ⁶	pulsed	Hughes
L-3778 crossed-field amplifier	35	.120 × 10 ⁶	pulsed	Sylvania
WJ-225 backward wave oscillator	3.0	10 Mw peak 200 kw Avg.	pulsed	Litton
L-3702	100	.10 × 10 ⁶	pulsed	Watkins-Johnson
L-3401	1.3	30 × 10 ⁶	pulsed	Litton
L-3775	1.3	300 kw	average	Litton
	0.4	30 × 10 ⁶	pulsed	Litton

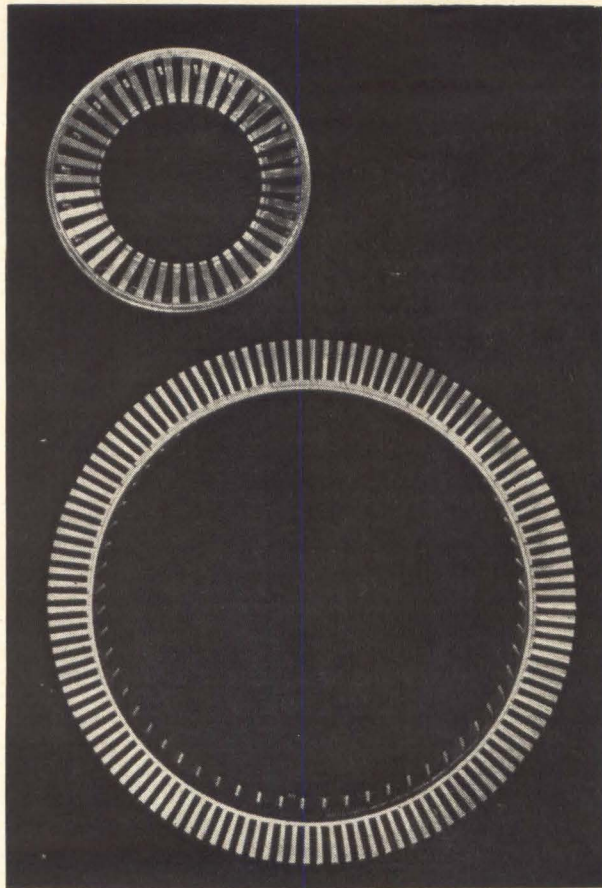

Microwave anode structures demonstrate intricacy of parts as frequency rises. Vane lengths are about one-quarter wavelength. Largest of these disks is about four inches in diameter.

usually generated at the cathode by a secondary electron-emission process from a simple solid metal, requiring no indirect heating and involving no reliability or life-time limit.

In high average or c-w power crossed-field tubes, the main limitation is the allowable dissipation-power density of the anode. In these tubes the spent electron stream is collected on a relatively delicate microwave anode structure. Despite high electronic interaction efficiencies (70% or more), a sizable fraction of the total power is dissipated on the anode structure. By cooling the microwave anode electrodes, average dissipation power densities of two kilowatts per square centimeter can be allowed, and even more is permissible at the cost of reduced reliability.

The only way to increase significantly the power-generating ability of crossed-field tubes is to add current and area by effectively paralleling interaction sections, preferably in a vacuum chamber.

The author



Lester F. Eastman is an associate professor of electrical engineering at Cornell University, where he received his doctorate in 1957. He and two colleagues developed a graduate research program at Cornell in microwave and physical electronics. Eastman is a lecturer and consultant in microwave theory and technique to a number of industrial organizations.

The photo shows two single sections of microwave anode structures that are used in crossed-field tubes at S-F-D Laboratories, Inc., a subsidiary of Varian Associates. The length of each vane is nearly one-quarter of a wavelength at the operating frequency. The smaller anode section was built to have the cathode inside; the larger anode section was built to have the cathode outside.

The larger anode shown is about four inches in diameter. The smaller anode structure, intended for an X-band tube, was developed to produce two megawatts of peak power at low-duty cycle.

To generate high peak powers, or fairly high average or c-w powers, with cooling, J. Feinstein, executive vice president of S-F-D has suggested that several of the large sections be mounted side by side with a common metal cylindrical waveguide into which the r-f power is coupled. This oversized cylindrical waveguide can be driven in a TE_{01} mode so that extremely high powers may be propagated without breakdown. In such a large anode-waveguide configuration, control of the several possible modes is the major engineering problem.

Progress expected

Single linear-beam tubes of high average or c-w power, capable of producing up to one megawatt at X-band, are expected to be developed. These will use the distributed interaction principle in the design of their output cavities, and perhaps even in the next-to-the-last cavity, with a short final drift cylinder. Theoretically, multiple-beam tubes could be developed to generate 5 to 10 Mw average or c-w power at X-band by beams in multiples of 10, with a few output waveguide ports.

In the same manner, S-band beam tubes can theoretically generate up to 1,000 Mw peak at low-duty cycles. In fact, about 20,000 Mw peak power at low-duty cycles and properly phased at isolated loads, is being planned for the Stanford accelerator.

Crossed field tubes may also be paralleled in multiples of 10 to produce from 5 to 10 Mw average power at S-band.

High pulsed power can also be generated by paralleling the anode circuits of crossed-field tubes. This is accomplished by mounting the several vane-type anode circuits in a common vacuum, slightly separated, on a common metal cylinder acting as an oversized waveguide. The waveguide acts both to transport signal power between sections and to deliver power to the load.

At frequencies above 100 gigacycles, conventional slow-wave structures used for beam interaction will be supplemented or replaced by fast-wave interaction schemes. Although fast-wave structures have not been well developed for this range, it is expected that ordinary or oversize rectangular waveguide would be used, although other suitable structures are possible.

The author thanks Prof. G.C. Dalman for assistance in preparing this article.

Four-layer diodes form staircase generator

Simpler design uses Shockley devices to reduce number of required components

By H.W. Wieder

U.S. Naval Ordnance Laboratory, Corona, Calif.

Staircase waveforms are used in counting circuits and for dividing the frequency of a recurrent waveform by a preselected divisor. Staircase generators commonly use thyratrons or semiconductor devices such as silicon controlled rectifiers or unijunction transistors as the active elements.

A simple circuit for generating staircase waveforms has been developed which combines the good features of both semiconductor and tube circuits. It employs Shockley diodes and uses fewer components than any previously developed staircase generator. The circuit is powered by a single supply source with very low current drain. Its output signal is considerably larger than that obtainable from a solid-state circuit using unijunction transistors and its reliability is superior to vacuum tube counterparts.

Equivalent circuit

The principle of operation may be understood by referring to the equivalent circuit shown below. The a-c generator charges capacitors C_1 and C_2 in series on the positive half of the cycle. On the negative potential swing, C_1 discharges through the shunt diode D_1 ; however, the charge on C_2 is maintained by the large reverse impedance of D_2 .

Each cycle causes a discrete increment of charge to be added to C_2 . Thus the potential rises in the form of a staircase up to the amplitude which actuates the voltage controlled switch S causing the discharge of C_2 . Subsequently, as the switch is again opened, the entire process is repeated. Switch S may be a thyatron or its solid-state equivalent provided that it has a high reverse-leakage resistance in order that C_2 may perform its integrating function.

Basic circuit

A simple circuit for generating a staircase waveform is shown on p.56. The circuit is based on the thyatron-like properties of silicon four-layer diodes. The voltage-current characteristic for a pnpn (four-layer) diode is shown on p.56. When switch S is closed, if the potential across D_1 is higher than the breakover potential V_{B1} , D_1 is switched into its low impedance state ($r_b \approx 1$ ohm). Capacitor C_1 charges in series with C_2 until the voltage across D_1 drops below the sustaining potential V_h .

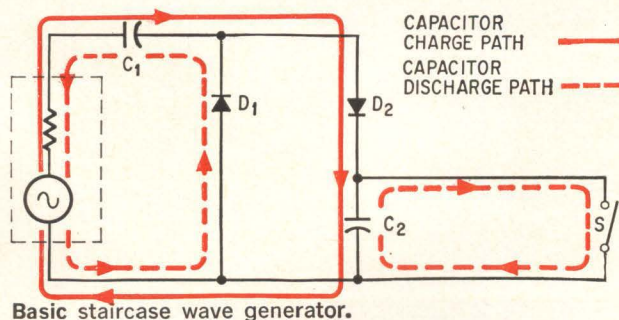

Diode D_1 is then returned to its high impedance state ($r_o \cong 10^8$ ohms). With D_1 switched off, C_1 discharges through R_1 causing the potential across D_1 to rise once again to the breakover value and the cycle is repeated.

Successive cycles cause the potential on C_2 to rise to the breakover voltage V_{B_2} of D_2 terminating the staircase by discharging C_2 and regenerating the entire process. The purpose of R_2 is to limit the peak current during the discharge of C_2 to a nominally safe value. The timing diagram for the staircase wave generator is given below. Typical oscillograms of the staircase waveforms measured across R_L are also depicted below.

An expression for the number of steps per staircase is derived below. In the circuit, D_1 and D_2 are represented by an open circuit except in the avalanche mode, when their impedances are considered to be negligible. Since $C_1 \Delta V_1 = C_2 \Delta V_2$, at the end of the charging cycle:

$$\Delta V_2 = \Delta V_3 \left(\frac{C_1}{C_1 + C_2} \right) \quad (1)$$

where $\Delta V_1 =$ change in C_1 voltage;

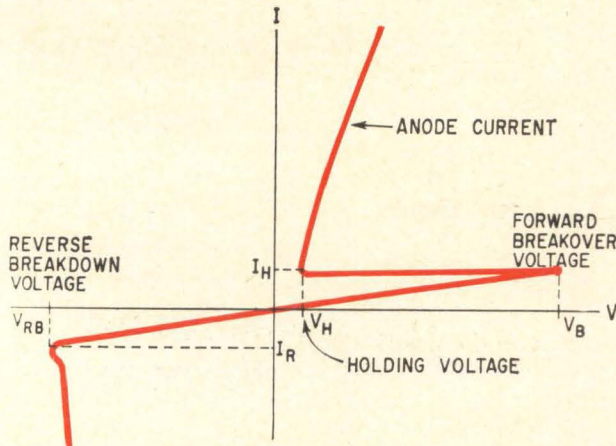

Voltage-current characteristics for the Shockley four-layer diode showing forward breakover voltage (V_B), holding voltage (V_H) and reverse breakdown voltage (V_{RB}).

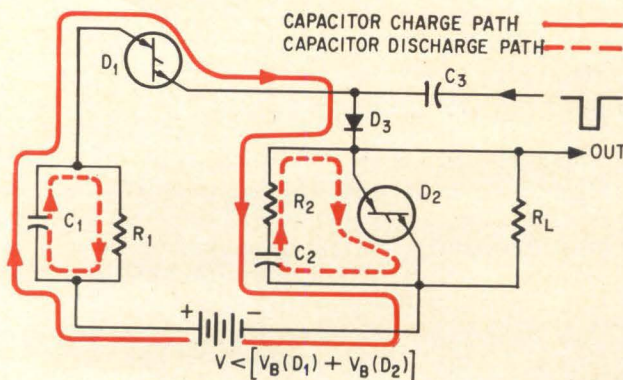

Synchronized staircase wave generator using four-layer diodes.

$\Delta V_2 =$ change in C_2 voltage;

$$\Delta V_3 = \Delta V_1 + \Delta V_2$$

The potential V_3 rises to the breakover voltage V_{B_1} of D_1 and then drops to nearly zero as D_1 is switched on. Consequently, substituting V_{B_1} for ΔV_3 the amplitude of each stairstep, $S = \Delta V_2$ is:

$$S = V_{B1} \left(\frac{C_1}{C_2} \right) \quad (2)$$

for $C_2 \gg C_1$. The potential across C_2 increases to V_{B_2} , therefore the maximum number of steps in the staircase, determined from $V_{B_2} = nS$, is:

$$n = \left(\frac{V_{B2}}{V_{B1}} \right) \left(\frac{C_2}{C_1} \right) \quad (3)$$

Thus a considerable latitude is available to the designer in choosing the number of steps per staircase as well as the amplitude per step—primarily in terms of the breakover potentials of D_1 and D_2 and the potential divider formed by C_1 and C_2 . Resistor R_1 is significant in determining the discharge rate of C_1 and hence the duration of the stairsteps, while R_L must be large enough to prevent any appreciable charge leakage from C_2 during the

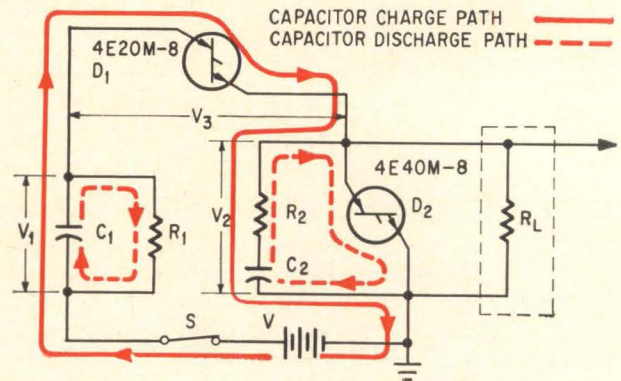

Staircase wave generator using four-layer diodes.

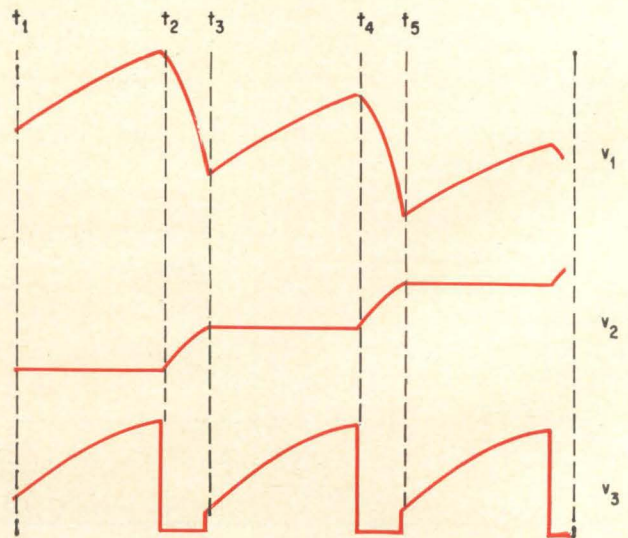

Timing diagram for the staircase wave generator.

staircase buildup. In any case, the supply voltage must be chosen so that D_1 and D_2 cannot be switched on simultaneously.

Triggered circuit

A modified circuit for triggered and/or synchronized operation of a staircase wave generator is shown p.56. The supply potential V is reduced below the sum of the breakover voltages of D_1 and D_2 . Capacitor C_3 injects a negative pulse whose amplitude, A , must be large enough to trigger D_1 into conduction. At the end of the pulse, D_1 resumes its quiescent state. Again the value to which C_2 charges, depends upon the conditions discussed earlier for the free-running staircase generator. Care must be exercised, however, that the intervals between successive pulses should not be large enough to allow appreciable decay of V_2 through R_L . The purpose of the conventional diode D_3 is to decouple the load circuit during the application of the triggering pulse.

With $V = 60$ volts, $C_3 = 0.05 \mu\text{f}$, $D_3 = 1\text{N}34$, an applied negative voltage pulse of 0.1 millisecond duration with an amplitude of 50 volts, and the other component values given in the chart, the waveforms shown were obtained.

The pulse repetition rate was kept between 100 and 1,000 pps. If the supply potential is raised just below the free running state, then a negative signal applied to C_3 will synchronize the staircase wave generator between 100 and 1,000 pps. The exact upper and lower boundary criteria under which the circuit will perform reliably have not yet been determined.

Specific staircase functions may be assembled with ease due to the commercial availability of four-layer silicon diodes with breakover voltages in the range between 20 and 200 volts and peak current handling capability of 10 amperes.

The 4E20M-8 and the 4E40M-8 four layer diodes are manufactured by the Shockley Transistor Unit of the Clevite Corp., Palo Alto, Calif.

Bibliography

- F.E. Terman, Radio Engineering, McGraw-Hill Book Co., Inc., N.Y., 1947, pp.606-608.
 W. Shockley, The Four-Layer Diode, Electronic Industries and Tele-Tech. Aug., 1957.
 General Electric Transistor Manual, General Electric Co., Semiconductor Products Dept., Charles Building, Liverpool, N.Y., 1959, p.143.
 Notes on the Application of the Silicon Unijunction Transistor, General Electric Co., February, 1959, p.74.
 H.H. Wieder, Patent #3,123,723, Staircase Wave Generator Employing Two Four-Layer Diodes, March 3, 1964.

The author



H.H. Wieder is a supervisory physicist in the research department of the Naval Ordnance Laboratory. He is studying the physics of crystalline solids. Wieder has written several articles on ferroelectric phenomena and on intermetallic semiconductor film technology and devices.

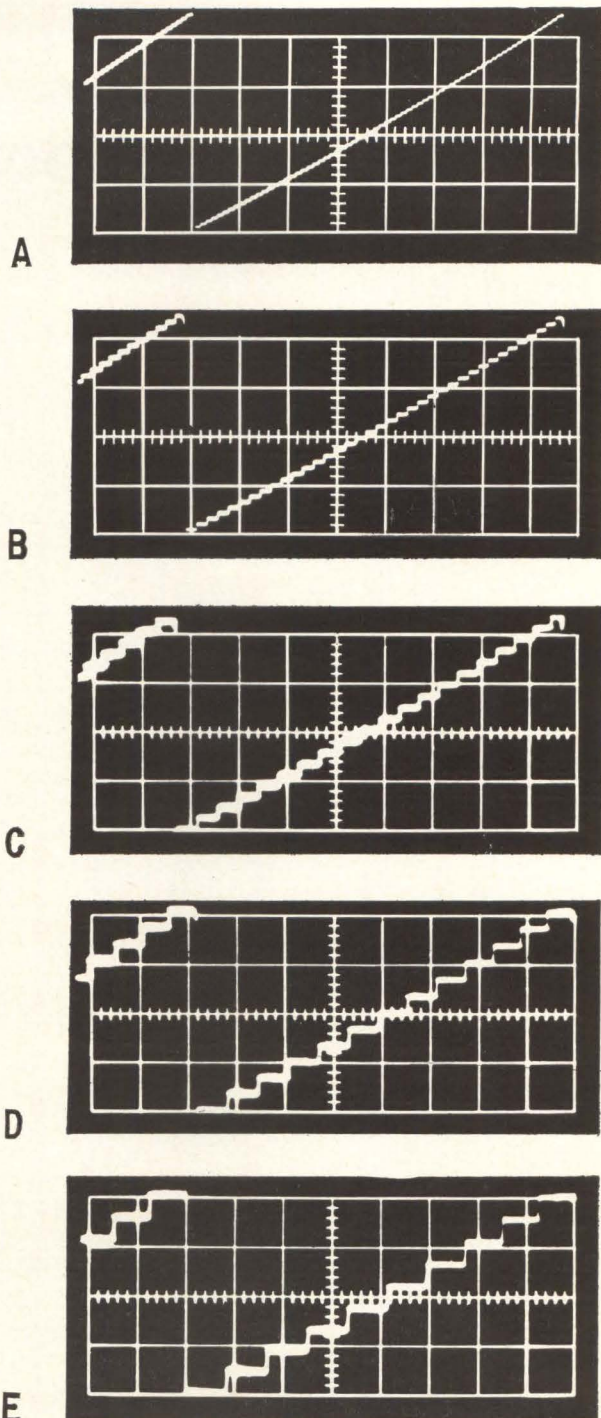

Typical oscillograms obtained for the staircase wave generator with $R_L = 10^7$ ohms. The ordinate = 10 volts per cm, the abscissa = 1 millisecond per cm, $V_{B1} = 20.2$ volts, $V_{B2} = 40.5$ volts and $V = 135$ volts. Other components values are:

Oscillogram	R_1 (ohms)	C_1 (μf)	C_2 (μf)
A	1.2×10^5	0.04	0.22
B	1.2×10^5	0.035	0.22
C	1.7×10^4	0.1	.2
D	4.7×10^4	0.01	1.02
E	4.7×10^4	.002	.22

Designer's casebook

Designers' casebook is a regular feature in Electronics. Readers are invited to submit novel circuit ideas, packaging schemes, or other unusual solutions to design problems. Description should be short. We'll pay \$50 for each item published.

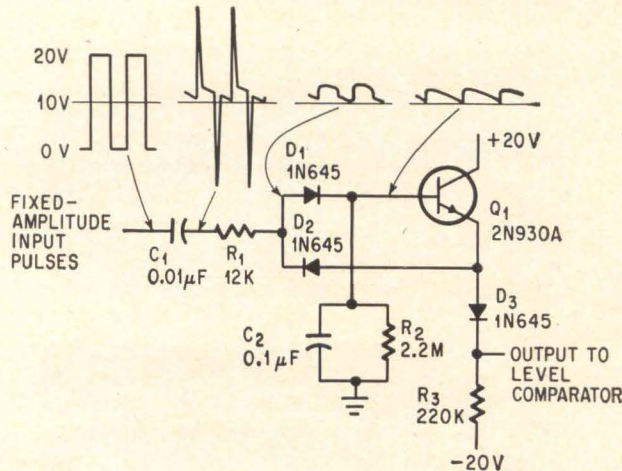

Frequency-to-voltage converter portion of the interrogator circuit

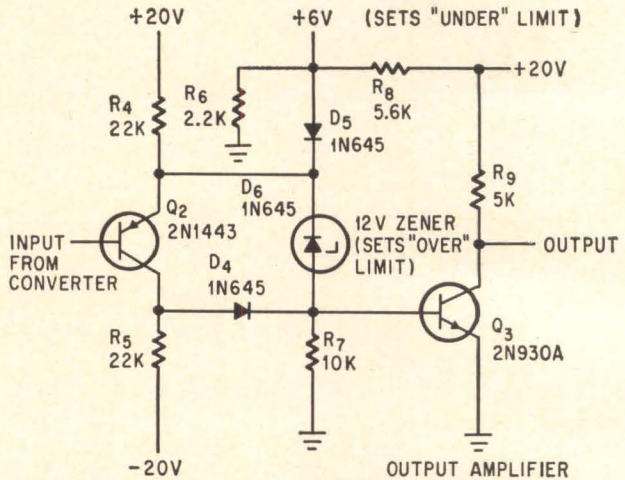

Over-on-under portion of the circuit (left) and the output amplifier (right)

Interrogator circuit can tell good data from bad

By Monty Merlen and David Grossman

Barnes Engineering Co., Stamford, Conn.

Although this pulse rate interrogator circuit was designed for a highly-specialized use in space navigation equipment, it is also suitable for widespread monitoring or control use in go/no-go applications.

An interrogator circuit was needed in a conical-scan horizon sensor system of a space vehicle. In this system, the instantaneous fields of view of two

sensors scan conical paths across earth and space. The detector output signal level changes significantly when the field of view passes from the cold temperatures of space to the earth's warm atmosphere, or vice versa.

When the vehicle is in level flight, the two sensors detect earth for equal periods, and the earth pulses are centered with respect to an internal spacecraft reference. Roll errors cause uncentered earth pulses in the sensor that is scanning along the line of flight. Pitch errors result in uncentered earth pulses in the sensor that scans across the line of flight. Sensor system electronics then generate analog-type pitch and roll error signals to indicate or correct vehicle attitude.

Normal operation produces earth pulses at the same frequency as the scanning, and this frequency represents usable data. If some abnormal condition occurs (such as excessive vehicle tilt, excessive system noise, or abnormal scanning conditions) the number of pulses will either increase or decrease by more than 30%. A change either way means that the system data is unusable since the anticipated earth pulse repetition rate, with normal scanning speed variations, could not exceed these limits. Relays then prevent faulty information from reaching the vehicle control system; they can also switch in alternate redundant circuits and perform other logic functions.

The pulse-rate interrogator circuit, which distinguishes between the good and bad data, consists of a frequency-to-voltage converter; a three-level (over, on, under) comparator; and an output power amplifier.

The magnitude of the output voltage produced

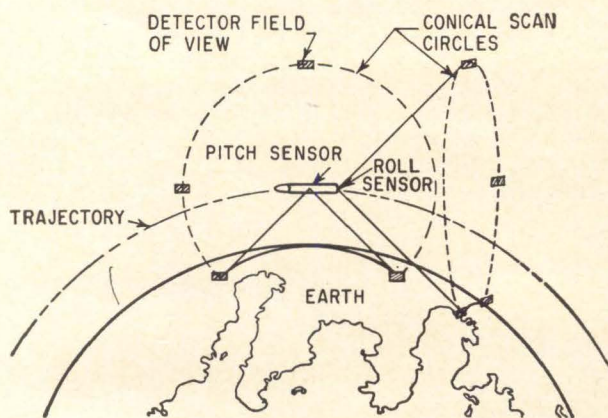

Orientation of scanners with respect to the spacecraft, and the pattern traced by the fields of view.

by the converter circuit is proportional to the pulse repetition frequency. The circuit is basically a linear staircase generator. By placing resistor R_2 across the count-accumulate capacitor C_2 , the staircase generator is converted into a linear frequency-to-voltage transducer circuit. Resistor R_1 and capacitor C_1 because of their integrating time constant prevent full-count accumulation for any spurious noise pulse whose duration is too short to produce serious errors in the sensor's altitude readout circuits.

The level comparator circuit receives the converter output and uses only the input transistor to perform the required three level-determining functions; its output is readily usable at the base of the power transistor final stage.

When the base of input stage Q_2 is driven below six volts (under condition), its emitter is held at six volts by diode D_5 between it and the +6 volt supply. This gates the transistor, and current flows into the base of the output amplifier transistor.

If the input voltage rises above 12 volts (over condition), the 12-volt zener diode D_6 conducts. Current again flows into the base of the output transistor.

Basic uhf circuit forms amplifiers and multipliers

By August E. Munich

Airborne Instruments Laboratory, Deer Park, N.Y.

Ultrahigh-frequency amplifiers or frequency multipliers with capabilities to 1,000 Mc may be constructed with appropriate lengths of tank coil wire selected from the chart at the right.

A common-base amplifier stage, see page 60, is used as the basic building block for both amplifier and frequency-multiplier service. When the stage is used as an amplifier, the tank circuit is tuned to the input frequency; in doubler service, the tank circuit is tuned to twice the input frequency.

The power gain provided by the stage in amplifier service is between 10 and 16 decibels, with the bandwidth ranging from 10 to 40 Mc depending upon loading and center frequency. When the stage is used in doubler service, the gain varies from zero to six decibels, depending on frequency.

At lower frequencies the power output per stage is approximately 50% of the stage d-c supply. The power output at the high-frequency output stage may be estimated as about 25% of the stage d-c supply.

To design a particular amplifier in the 40 to 1,000 Mc range, the correct length of tank coil wire is obtained from the chart by referring to the signal

No output signal is supplied during the on condition, when desired data is being processed in the sensor system. Unwanted data (over or under condition) generates a power amplifier output signal that initiates corrective action. The comparator accepts a wide range of signal inputs and will indicate when the input falls outside predetermined limits. These limits can be altered by changing the reference potential and the zener reference diode. Adjustment of the positive and negative voltage supply may also be required.

The over-on-under circuit makes it possible to solve a number of routine indicating problems with minimum cost, because only one transistor is required. The circuit can monitor electronic power supply voltages and actuate an alarm when variations exceed specified limits. If a rectifier is placed at the circuit's input, line voltage can be monitored in the same manner. Power line frequency changes can be detected by using the described frequency-to-voltage converter with the over-on-under circuit. The circuit will monitor or control many industrial process parameters such as pressure, flow rate, liquid level, temperature or any others for which a transducer will provide an electric signal output.

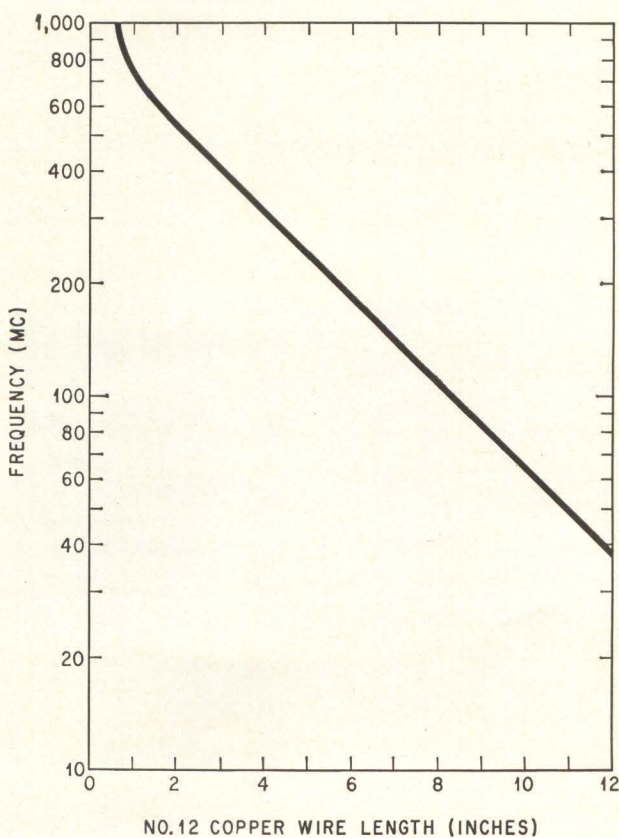
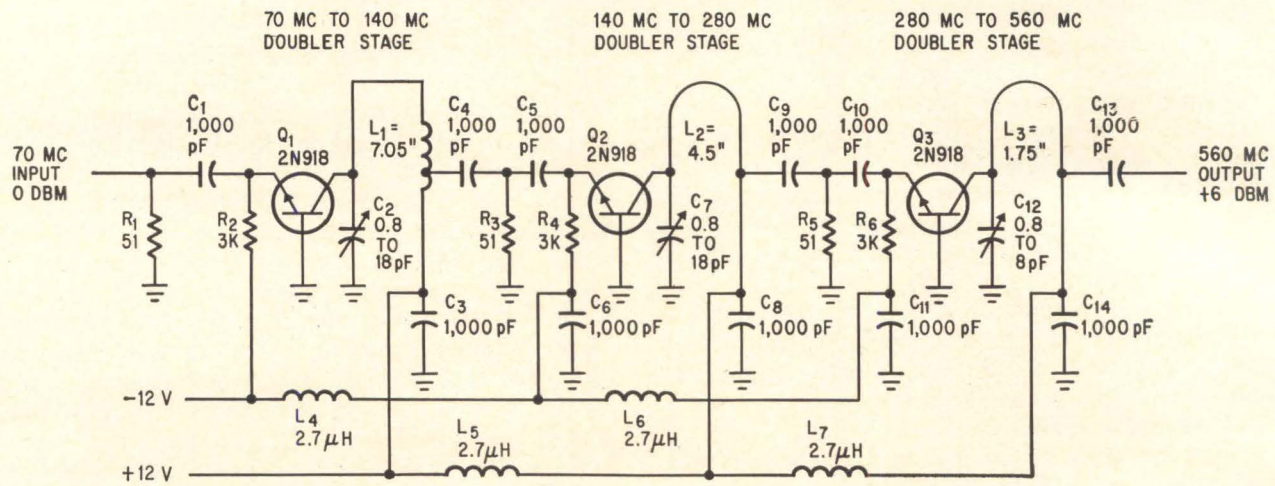
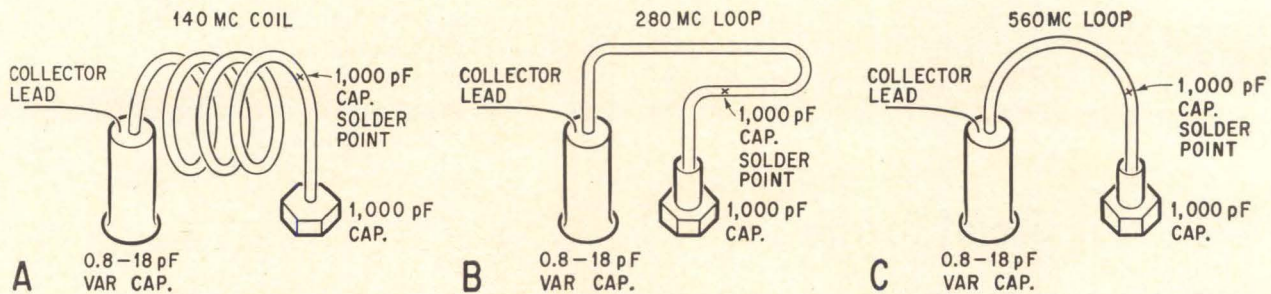

Chart gives lengths of tank coil wire.

frequency (the output frequency is used when designing a doubler stage). The length of wire is wound into a coil on a half-inch diameter form



Cascaded quadrupling amplifier



Tank coil and loops for the cascaded quadrupling amplifier. The first-stage, 140-Mc coil (a) is 7.05 inches long, the second-stage, 280-Mc loop (b) is 4.5 inches long, and the third-stage, 560-Mc loop (c) is 1.75 inches long.

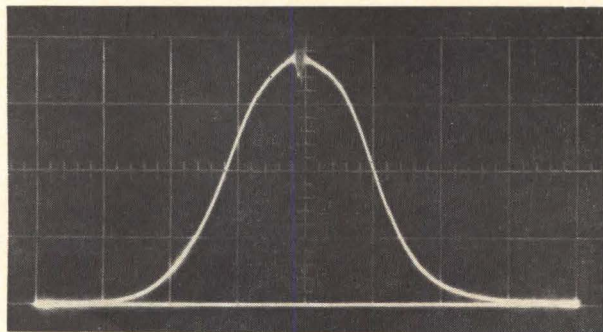

Response curve at 560-Mc center frequency. Each x-axis large division represents 2.5 milliwatts of output power. Each y-axis large division is equivalent to 8 Mc.

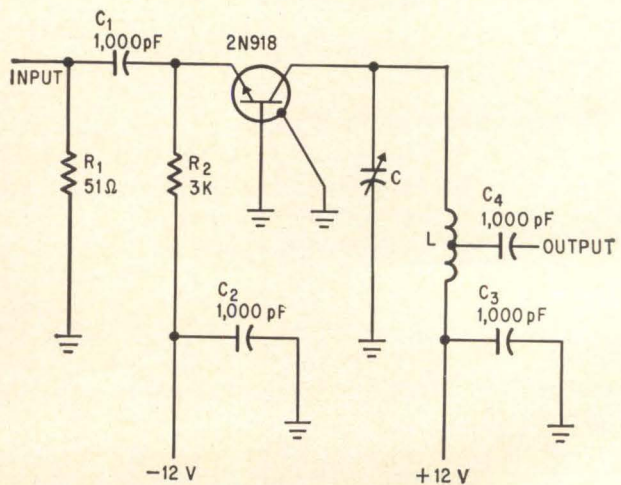

One-stage amplifier or frequency doubler

if it is longer than five inches; if the wire length is less than five inches the wire is formed into a hair-pin loop.

The tuning capacitor is selected as follows:

Frequency (Mc)	Tuning capacitor range (pf)
Below 100	1 - 90
100 - 400	0.8 - 18
Above 400	0.8 - 8

Each transistor is mounted to a grounded shield plate by soldering both the base and shield leads

to the shield plate. Effectively, the transistor fits into a hole in the shield plate with the base lead projecting from the input side and the collector lead projecting from the output side. For high frequency operation, particularly above 300 Mc, lead lengths should be kept as short as possible.

A typical example of the use of the basic circuit to construct a three-stage amplifier is given. The required tank circuit coil and loops and the 560-Mc sweep response are also illustrated.

P-n junctions as radiation sources

High-efficiency radiation from semiconductor diodes may one day light buildings and spaceships

By M. F. Lamorte and R. B. Liebert

Radio Corporation of America, Somerville, N.J.

Semiconductor diodes, used as sources of infrared or visible radiation, may one day be used as cheap, highly efficient pilot lamps, in instrument lighting and even general-purpose illumination.

Such diode sources, possessing infinite life-spans, would be based on the high-efficiency radiation derived from the radiative recombination of hole-electron pairs in forward-biased gallium arsenide p-n junctions.¹ The radiation is noncoherent at low current density and becomes coherent at high current density;^{2,3} the latter case is that of the semiconductor diode laser.

The phenomenon producing the noncoherent radiation has been used in the past to study band structure and crystalline quality.⁴ Practical applications of this radiation are only recent; however, it already has significantly broadened the horizons for the circuit designer and may very well revolutionize the semiconductor industry.

Laser mode

Although much of the recent work deals with gallium arsenide, which emits in the near-infrared region of the spectrum, junctions made of other semiconductor materials emit further into the infrared as well as in the visible region.⁵⁻⁹ In most cases it has been shown that the laser mode can also be obtained. Much of the discussion on gallium arsenide is also pertinent to these other junction light sources.

Because several semiconductor materials are known to emit, there is little doubt that light-emitting junctions will be developed to span a considerable portion of the near-infrared and visible spectrum. Moreover, by mixing different crystals to form another crystal with its own distinctive properties, it should be possible to fabricate light-emitting junctions covering a continuum of wavelengths from the near-infrared to the blue end of the visible spectrum.

The junction light source emits a line radiation several hundred angstroms wide. With black-body radiative sources such as tungsten, in contrast, the output radiation exists over a wide range of the spectrum, the sources must operate at very high temperatures, cannot be modulated at high repetition rates, are fragile, and have limited useful life-spans. Usually only a small fraction of the spectrum may be used in any one application; this results in low efficiency.

The junction light source, on the other hand, is a selective radiator, operates close to ambient temperature, may be internally (electronically) modulated,¹⁰ is rugged and small, and, when fully developed, should have indefinite life. Moreover, the operating voltages and currents are compatible with transistor circuits, and in some applications the reverse characteristic of the light-emitting junction may be used to advantage in the associated electronic circuits.

As a result of these important advantages, the junction light source may some day compete in cost with other light sources in many applications. The junction light source also has many advantages over light sources with narrow spectral characteristics, such as the gas laser and the insulator-type, solid-state laser such as a ruby or calcium-fluoride laser. Some of the advantages stem from its very

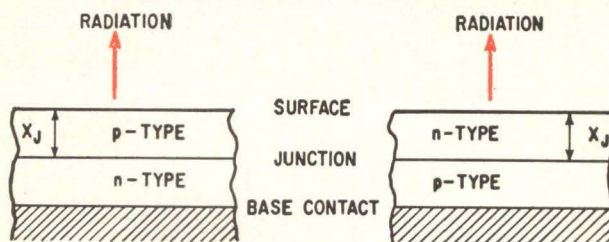

Basic geometry for the p- and n- surface, employed as the exit surface of diode radiation

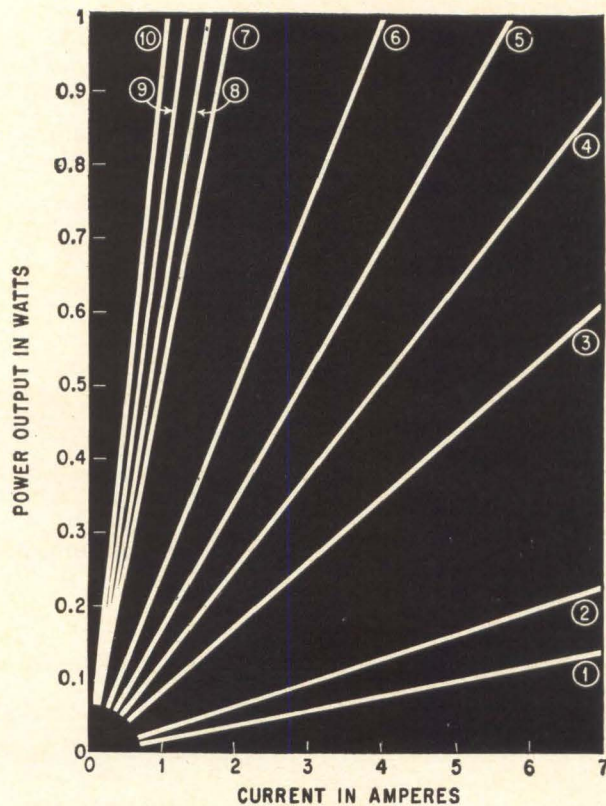

Power consumption and current at 77°K for the diode geometries listed in the table reflects the effect of geometry on output.

Listing of P/I and Q_{ext} for Various Geometries at 77°K

Curve	Geometry	P/I mv/a	Q_{ext} %
1	p- or n-surface without antireflection coating	21.8	1.45
2	P- or n-surface with antireflection coating	<34.5	<2.3
3	edge emission, rectangular, $L, w \leq 3.15 x_j$, without antireflection coating	87.2	5.8
4	edge emission, rectangular, $L, w \leq 3.15 x_j$, with antireflection coating	<127	<8.5
5	edge emission, circular $d \leq 3.15 x_j$, without antireflection coating	170	11.3
6	edge emission, circular, $d \leq 3.15 x_j$, with antireflection coating	<247	<16.4
7	hemispherical point junction, without antireflection coating	520	34.7
8	hemispherical point junction, with antireflection coating	<750	<50.0
9	hemispherical and edge emission, without antireflection coating	605	40.3
10	hemispherical and edge emission, with antireflection coating	<878	<58.5

small size, ruggedness, low cost, high efficiency, and the ease of high internal modulation by varying input current. Junction light sources may also be fabricated to give higher power output, by orders of magnitude, than these other sources, with the exception of the ruby laser.

At present, junction light sources are being developed for a wide variety of applications. The rapidity with which systems using gallium-arsenide radiation are being proposed has been enhanced by the availability of detectors for this radiation.

Gallium-arsenide radiation is at the peak of the sensitivity curve of the S-1 photocathode over the useful temperature range of the light source. Phototubes, multiplier phototubes and image-converter tubes using the S-1 photocathode have been developed over the last several decades. In addition, silicon and gallium-arsenide p-n junctions may also be used as detectors, although the solid-state detector does not provide the current gain that is desirable in some applications.

Junction light sources are being developed for applications in special illumination, in a variety of control circuits—particularly in computers and associated peripheral equipment—and for low-cost short-range communication systems, ranging, and display equipment.

Boon to architects

P-n junction light sources, emitting in the visible portion of the spectrum, may one day compete for general lighting purposes, provided their room-temperature efficiency can be increased and the cost reduced. For example, in some architectural forms where the lighting fixtures are not easily accessible, an infinite-life light source is desirable. If its cost were generally competitive with tungsten and fluorescent lamps, the infinite-life lamp could find a permanent place in architecture.

In long-range manned space flight, present-day lamps might not have sufficient life for the entire journey; therefore, longer-life lamps would be required for lighting the vehicle.

In jetliners, the failure of panel warning lights reduces safety; the junction light source would minimize this hazard.

Flash photography is another field in which junction light sources may one day be competitive with present light sources.

In computers and peripheral equipment, tungsten lamps in conjunction with solid-state detectors are used for read-out and for sensing. However, failure of the lamps can be costly; the gallium-arsenide light source may replace the tungsten lamp in these applications.

There are other possibilities, too. The junctions emitting in the visible spectrum may be used as read-out displays. Also, where it is inconvenient to use wire or cable, information may be transmitted by the junction light source.

Short-range communication has been demonstrated by electronically modulating the light from gallium arsenide.^{11, 12} This method has several ad-

vantages over radio-frequency equipment due to the diodes' compactness, ruggedness, projected low cost, light weight, high over-all efficiency and increased directionality. Moreover, since light beams do not interfere with one another as radio beams do, this source of noise is eliminated. Employing the light beams alleviates crowding of the already-overloaded radio-frequency spectrum. Ranging is another promising application.

How diode sources work

Light is emitted when recombination occurs in a forward-biased gallium-arsenide p-n junction. Thus, electrical energy is converted to radiant energy.

Although the device in which this effect is used is relatively new, a wealth of information exists for its reciprocal circuit element—the gallium-arsenide solar cell. Many of the problems in the fabrication and design of these reciprocal circuit elements are common to both devices.

Among the most important of these common problems is the correlation between the forward characteristic of the junction and its radiative efficiency. This effect has been studied for the gallium-arsenide solar cell.¹³ The exact nature of this influence on the light source is now under investigation; there is strong evidence that it is as great as in the case of the solar cell.

On the other hand, the small critical angle (maximum angle at which a light ray is refracted; at greater angles there is total internal reflection) due to the relatively high index of refraction in gallium arsenide is much more important for the light source than for the solar cell. As a result it is rewarding to investigate geometries that circumvent the limitation of the critical angle, in order to increase the light output.⁴

The quantum efficiency Q is defined as the ratio of the number of photons emitted from the crystal to the number of electrons crossing the junction, and is given by

$$Q = \frac{P}{\left(\frac{h\nu}{q}\right) I}$$

where P is the radiative power in watts and I is

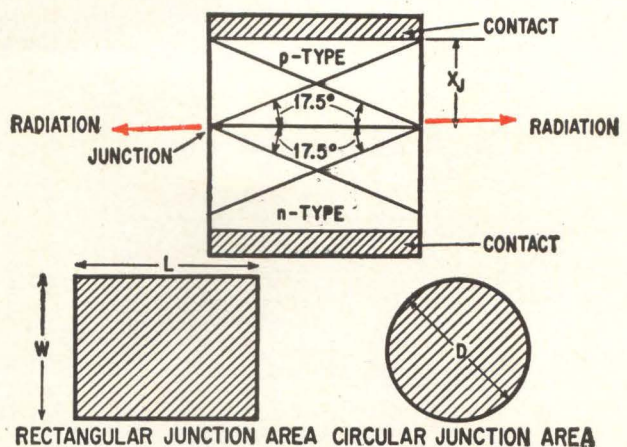

Rectangular and circular junction geometries, in each case using edge emission.

the junction current in amperes. The quantity $h\nu/q$ is the voltage across the space charge region of the junction (at 77°K it is approximately 1.5 volts), and h is Planck's constant, ν the frequency and q the space charge.

The equation then reduces to $Q = 0.667 (P/I)$

Therefore, the ratio of power output to current input is a measure of the efficiency. It is a useful parameter for the engineer, because the power is the product of this ratio and the current.

This ratio will be used in the discussion of the various geometries. The equation shows that if all the power generated in the junction region could get out, the ratio would be 1.5 watts per ampere for unity quantum efficiency.

The simplest geometry, shown on p. 61, permits the radiation to leave the p or n surface. Depending on the absorption characteristics of the radiation generated in the junction region, the spectrum from the p or n surface may be slightly different. These differences are of minor importance in properly designed light sources.

The index of refraction for gallium arsenide (3.32) results in a critical angle of 17.5°. Power may leave the crystal from either the p or n region; the ratio of this power to the power generated in the junction region is 1 to 68.7 without an antire-

The authors



Michael F. Lamorte has had a taste of the military and the academic, as well as the industrial career. After obtaining his master's degree at Brooklyn Polytechnic Institute he joined the teaching staff there; later he taught at the University of Pittsburgh. He spent four years at Fort Monmouth with the Signal Corps, then worked for the Westinghouse Electric Co. Now, as

head of the electrooptics advanced devices section at RCA in Somerville, he works on the development of laser diodes, noncoherent radiating diodes and detectors.



Richard Liebert graduated as a metallurgical engineer from Drexel Institute of Technology. He holds a master's degree in management engineering from Rensselaer Polytechnic Institute, and has worked at RCA on alloy preparation, vapor-phase epitaxial deposition of gallium arsenide, and now on gallium-arsenide electrooptical devices.

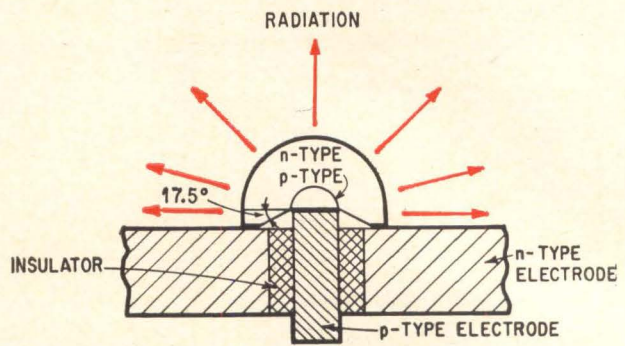
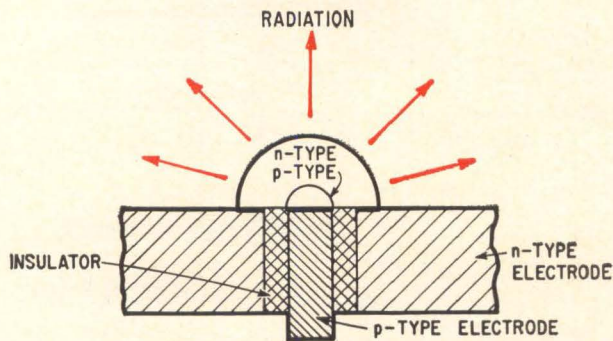

Hemispherical geometry using surface emission, left; hemispherical geometry and edge emission of radiation, right

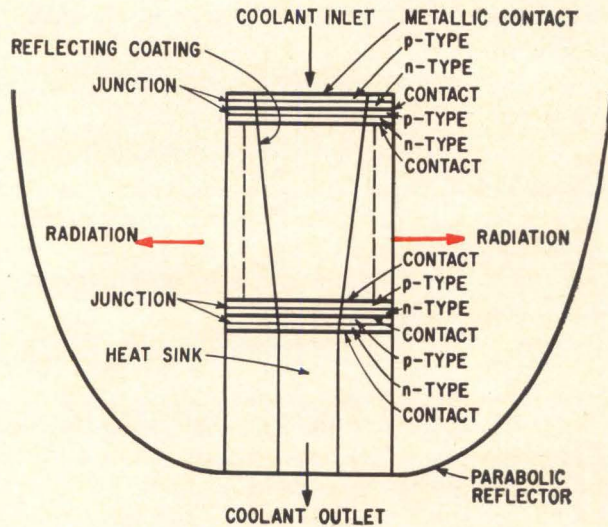

Stacked-junction geometry, resulting in a doughnut-shaped light source with cooling sink in the center

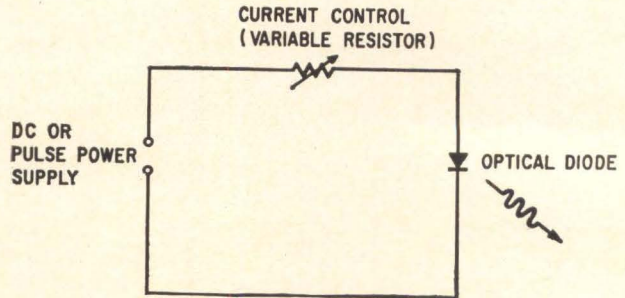

Simplified circuit diagram of a radiation-emitting optical diode

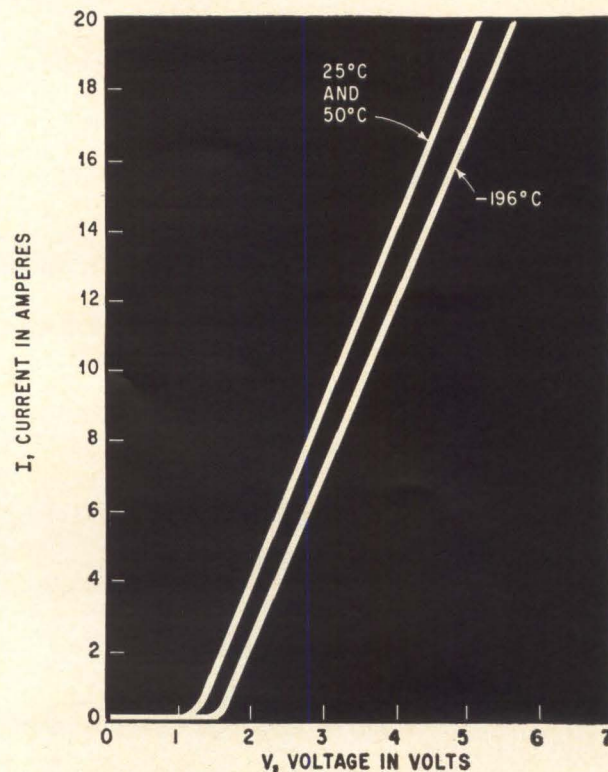

Junction forward current characteristic curve is affected by the junction temperature.

fection coating. This relationship results in an upper limit of 21.8 milliwatts per ampere for unity internal quantum efficiency.

The small ratio of P/I is a consequence of the small critical angle in gallium arsenide. An evaporation-deposited antireflection coating, in this case silicon monoxide or dioxide, may increase this ratio up to 34.5 milliwatts per ampere. These results, along with the external quantum efficiency, are given in the table; the corresponding curves of power output as a function of junction current are shown on p. 62 for the case in which junction heating is absent.

The p or n surface radiation, as given by curves 1 and 2 on p. 62, is too low for many practical applications. Power output per unit junction area is restricted to less than one watt per square centimeter, and maximum efficiency is limited to 1.45%. At higher temperatures, the power output and efficiency decrease. Thus, if junction light sources are to become practical, these device characteristics must be improved. To accomplish this, new geometries must be explored.

Improving efficiency

The P/I ratio with an antireflection coating can be considered only as an upper limit, since it is difficult to reduce the reflectance to zero for all incident angles. Therefore, these ratios are designated as less than the value given in the table.

One new approach is to employ the radiation that leaves the periphery of the junction, as shown on p. 63. The term "edge emission" has been used to describe this geometry. A rectangular junction area is used, for which the lateral dimensions

L or w are not larger than $3.15 x_j$, where x_j is the junction penetration depth (see p. 61). This results in ratios for P/I of 87.2 milliwatts per ampere without an antireflection coating, and 127 milliwatts with a coating. Corresponding external quantum efficiencies are 5.8% and $< 8.5\%$.

These values represent an improvement of performance by a factor of four. This improvement results because the radiation generated at each point of the junction may leave through four surfaces. In contrast, each generating point in the simple geometry may radiate through only one surface—the p or n surface. Curves 3 and 4 on p. 62 show the marked improvement in power output. The power output per unit junction area for this geometry will be greater than one watt per square centimeter.

Further improvement can be obtained by making the area of the junction circular rather than rectangular, so that the diameter $d \leq 3.15 x_j$, as shown on p. 63. This geometry results in a P/I ratio of 170 milliwatts per ampere without an antireflection coating and 247 milliwatts with a coating. The corresponding values for external efficiency are 11.3% and $< 16.4\%$. These values represent an eight-fold increase over the simple geometry, due to the fact that a smaller fraction of the radiation is incident at an angle greater than 17.5° on the cylindrical surface than is present for the rectangular junction area. The power curves 5 and 6 are shown on p. 62.

The hemispherical geometry shown on top of p. 64 gives further improvement in performance. In this case, the radiation leaves over the entire hemispherical surface. When the junction area is circular and the diameter is not greater than one-third that of the hemisphere, then all the radiation directed upward can leave. The values obtained are 520 milliwatts per ampere without an antireflection coating and 750 milliwatts with the coating. The corresponding external efficiencies are 34% and $< 50\%$. The hemispherical geometry shown at top right p. 64, also employs edge emission and results in further improvement. The P/I values are 605 milliwatts per ampere without an antireflection coating and 878 milliwatts with the coating; the corresponding efficiency values are 40.3% and $< 58.5\%$. Curves 7 and 8 are for the hemispherical geometry without edge emission, and curves 9 and 10 are with edge emission.

A somewhat different approach from those discussed above is to build stacks of junctions all emitting through the periphery, as shown at center left of p. 64. Although the figure shows a stack of doughnut-shaped junctions, the same approach may be used for rectangles, squares and disks. While the peak power density may be quite high for such a geometry, the average or continuous power output and corresponding efficiency are low, because of the high thermal resistance of the stacked junctions, and of very little practical interest at present. Stacks have been built with as many as 20 junctions; the peak power output increases with

the number of junctions in the stack.

These estimates show how improved geometries can increase the performance of simple planar p and n surface emission. They indicate the projected power outputs and efficiencies that may be expected from junction light sources. The power output per unit junction area may exceed 10 watts per square centimeter or even more under d-c operation. Under these conditions, the junction light source is valuable for many applications.

Employing edge-emission geometry with circular junction, P/I ratios of about 150 milliwatts per ampere have been obtained, giving out several watts over a junction area of less than one square centimeter at 77°K . The improvement in the P/I ratio that can be expected in the future, when combined with further improvement in the internal quantum efficiency, is at least several fold.

To make the junction light sources of more general use, the room-temperature performance must approach that at 77°K . In state-of-the-art devices, the reduction in performance from 77°K to 300°K is a factor of 10. Thus there is considerable room for improvement at room temperature.

Transmitting data

As shown on p. 62, the power output is a linear function of the junction current. Therefore, a circuit in which the current through the junction may be modulated can be employed to transmit information. A simplified circuit is shown at center right, p. 64. The light source is placed in series with a d-c or pulse-power supply of the appropriate polarity so that the current is passed through the junction in the forward direction. Continuous-wave or pulse operation may be employed.

A forward characteristic of a gallium-arsenide light source is shown at bottom of p. 64 at several temperatures. Emission starts when the point of operation is slightly beyond the knee of the curve. For class A operation, such as in voice communication, a quiescent operating point beyond the knee is required so that the negative swing of the junction current does not fall below the knee. The light output is replica of the current up to modulation frequencies near one gigacycle.

References

- 1 R.J. Keyes and T.M. Quist, Proc IRE 50, p 1,822 (Aug 1962)
- 2 R.N. Hall, G.E. Fenner, J.D. Kingsley, T.J. Soltys, and R.O. Carlson, Phys Rev Lett 9, p 366 (1962)
- 3 M.I. Nathan, W.P. Dumke, G. Burns, F.H. Dill, Jr., and G. Lasher, Appl Phys Lett 1, p 62 (1962)
- 4 R. Braunstein, Phys Rev 99, p 1,892 (1955)
- 5 N. Holonyak, Jr. and S.F. Bevacqua, Appl Phys Lett 1, p 82 (Dec 1962)
- 6 I. Melngailis, Appl Phys Lett 2, p 176 (May 1963)
- 7 K. Weiser and R.S. Levitt, Appl Phys Lett 2, p 178 (May 1963)
- 8 I. Melngailis, A.J. Strauss, and R.H. Rediker, Proc IEEE 51, p 1,154 (Aug. 1963)
- 9 R.J. Phelan, A.R. Calawa, R.H. Rediker, R.J. Keyes, and B. Lax, Appl Phys Lett 3, p 143 (Nov 1963)
- 10 J.I. Pankove and J.E. Berkeyheiser, Proc IRE 50, p 1,976 (Sept 1962)
- 11 R.H. Rediker, R.J. Keyes, T.M. Quist, M.J. Hudson, C.R. Grant, and R.G. Burgess, Electronics, Oct 1962
- 12 R.J. Keyes, T.M. Quist, R.H. Rediker, M.J. Hudson, C.R. Grant, and J.W. Meyer, Electronics, Apr. 5, 1963
- 13 M.F. Lamorte, Advanced Energy Conversion 3, p 551 (1963)
- 14 R.B. Liebert, M.F. Lamorte and L.J. West, 1963 Electron Devices Meeting, Washington, D.C., Oct. 31-Nov. 1, 1963

Pocket-size transmitter uses body heat to control frequency

Solid-state transmitter, kept on frequency by holding crystal in armpit, transmits narrow-band signals by skywave to distant emergency monitors

By James G. Arnold

Communications Systems Div., Radio Corp. of America, Tucson, Ariz.

Thirty years ago The New York Times sent a radio message to Admiral Richard Byrd's operator in the Antarctic asking him to tell Fred Meinholtz to hang up his telephone. Meinholtz, a Times em-

ployee, was on Long Island monitoring the Byrd transmissions and the Times office in New York wanted to talk to him. The message, relayed by radio over many thousands of miles, got through to Meinholtz when it was impossible to reach him over a few miles of telephone line.

Now search-and-rescue study has combined information theory, radio propagation research and electronics packaging to produce something like the Meinholtz effect. With a 10-ounce transmitter—no bigger than a pack of cigarettes—delivering only 100 milliwatts to the antenna, a downed pilot can transmit signals by skywave to a distant receiving monitor with less power than he needs to communicate locally. His distress message can be relayed to a nearby rescue center, proving that the longest way round can be the shortest way home for an SOS.

Specially keyed (frequency-shift) signals have been received successfully by engineers in Tucson, Ariz., from points in Alabama, North Carolina, Virginia, Maryland, New York and Ohio on 10, 13.4 and 15.9 megacycles.

Body heat

The success of the narrow-bandwidth system depends in large part on frequency control. The tiny transmitter accomplishes this with the body heat of the user who places the crystal in his armpit and keeps it there.

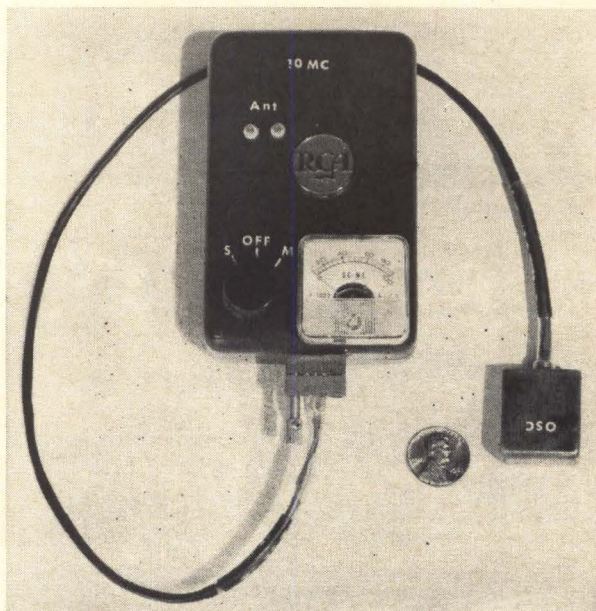

Prototype of the 10-ounce transmitter for operation at 10 mc shows the separate oscillator capsule that is held in the armpit for temperature stability.

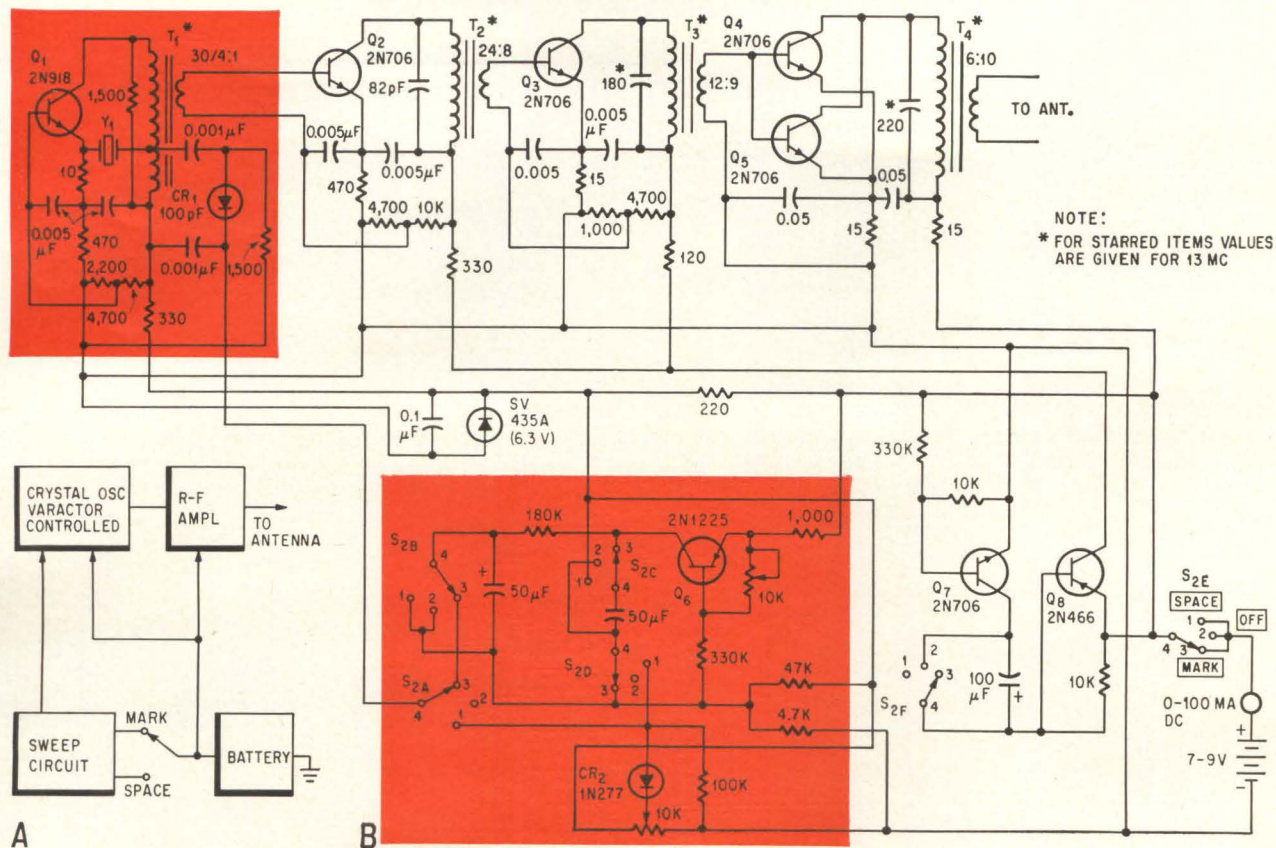

Functions of the pocket-size transmitter (A) and circuit diagram of a prototype (B). The sweep circuit used for signaling comprises Q_6 and associated components shaded in color. The frequency control unit held under the arm depends upon Y_1 and is also shown in color.

The signals received in Tucson ranged from 20 to 40 decibels above atmospheric noise and were readily detectable without any noise-cancellation techniques or signal processing gain.

Rescue operation

The signal is strong within a few miles and perfectly adequate several thousand miles away but in between there is a skip zone where the signal is inaudible. However, modern direction-finding installations of the Air Force and the Federal Aviation Agency are linked by networks that can relay distress information almost anywhere in the world. Although a downed pilot will not be able to communicate with a ground station only 100 miles away, his small transmitter can be received on line of sight by an aircraft flying within his radius of 100 to 200 miles. The transmitter can therefore be used also as a beacon by searching aircraft. The functional block diagram and the circuit are shown above.

The continuous-wave transmitter sends a binary type of information only. A manually operated switch moved to either side of center sends the equivalent of a mark or space (corresponding to a binary one or zero) signal. For rescue use it is necessary to prearrange a code between the airman and the listening rescue stations. Similarly, the frequency of the transmitter is chosen for optimum

propagation conditions in the area of use.

Skywave and bandwidth

The successful transmission concept is based on using the high frequency skywave medium for transmission and an extremely narrow bandwidth for reception. The concept is simply derived. If the receiver bandwidth is reduced to one-half on a given transmission path, the required transmitter power can be halved and consequently a much smaller transmitter can be used. Followed to its ultimate conclusion, it would seem that the receiver bandwidth could be reduced indefinitely and a ridiculously small amount of transmitter power would be required. There are constraints, however, and the system is eventually limited.

Since there will be modulation present owing to the effects of a constantly changing ionosphere, the received signal over a skywave path will not be pure. This effect can be regarded largely as doppler shift of the signal owing to changes in layer height and ionization level. In addition, the receiver bandpass must be sufficient to accommodate frequency drift in the system. Finally, the receiver must pass a definite band of frequencies to derive intelligence from a signal.

Spectrum limitation

The doppler effects of the ionosphere are nor-

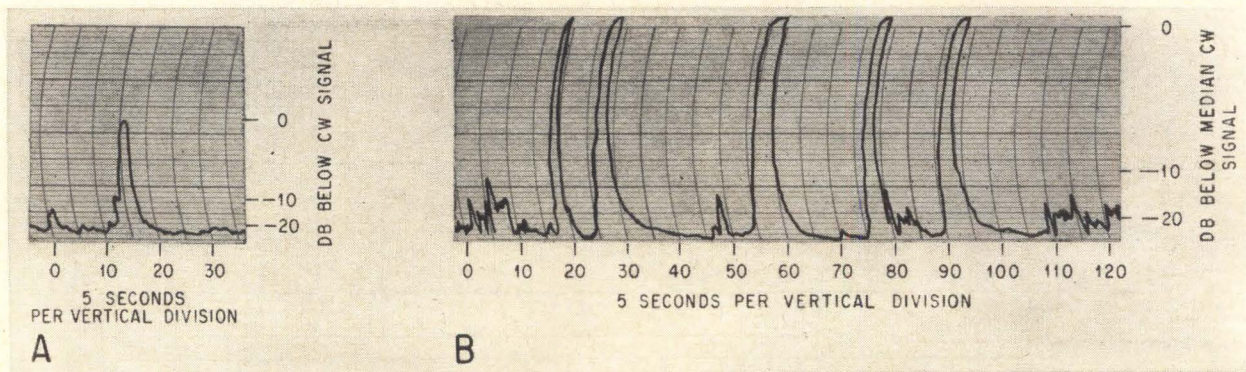

Filter response to a sweeping signal (A) and response from a single filter to a signal received on a 2,000 mile skywave path (B).

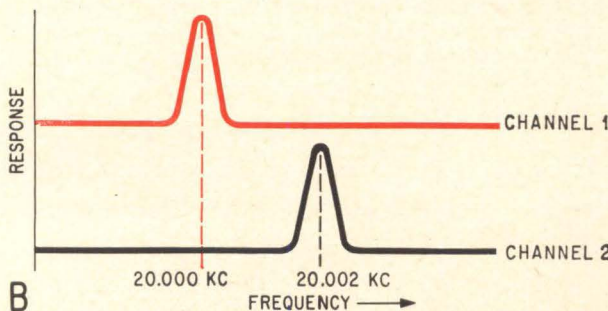
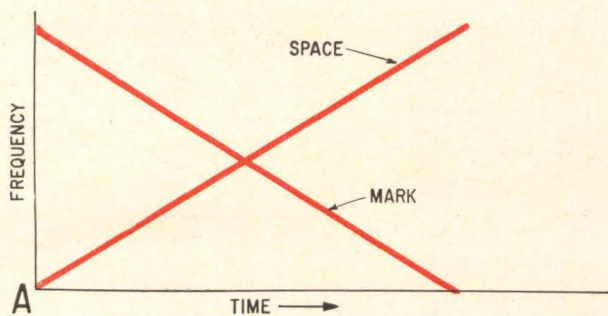

Decreasing frequency of the transmitter represent a mark and increasing frequency a space (A). The receiver (B) senses a pulse in channel 1 followed by a pulse in channel 2 as a space (the opposite sequence would be a mark).

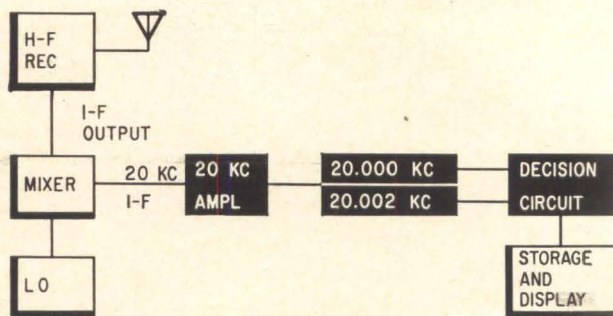

Functional diagram shows that a standard communications receiver can be modified to receive and interpret the swept-frequency distress signal.

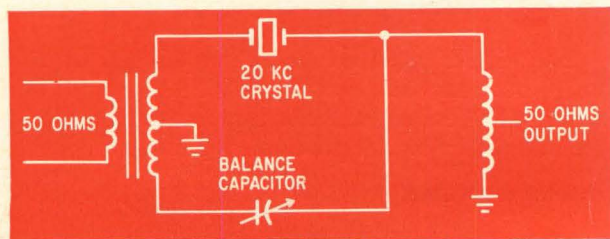

Narrow-band filter circuit follows output of 20-kc i-f amplifier.

mally about $\frac{1}{2}$ cps at 15 megacycles. The rates of modulation are highly variable. As a result, the received signal is not a single spectrum line but has, instead, a finite width. The bandpass required to enclose most of the energy in this spectrum is about $\frac{1}{2}$ cps. For this reason it was initially concluded that a bandwidth of much less than one cps would not be useful over a skywave path.

The signal is intended to transmit information at a very low rate of only a few bits per minute and thus a bandwidth of $\frac{1}{2}$ to 1 cps again seemed desirable.

Frequency control

Without an elaborate oven, it is not feasible to control a small transmitter to an accuracy of 1 cps. This represents 1 part in 10^7 at 10 megacycles. A closely controlled oven would require a large amount of power and is obviously not compatible

with the cigarette-pack transmitter concept. In the system developed, the entire frequency generator is enclosed in a separate capsule and held under the operator's arm pit while transmitting. Thus, the temperature stability of the human body is utilized to maintain some degree of frequency stability. Practically, a stability of greater than 1 part in 10^6 per week has been realized with this method.

Even such stability is inadequate to place the signal in the narrow passband of the receiver. This problem is resolved by having the transmitter slowly sweep over a frequency band from 10 cps above the carrier frequency to 10 cps below the carrier frequency. The signal will then pass through the receiver bandpass even though it may be off frequency by ± 10 cps. The rate at which the signal can sweep is limited by the bandpass of the receiver.

Mark-space signal

It was decided to use the direction of the sweep to convey intelligence since the stability requirements of the system dictate a slowly sweeping signal. The method of transmitting binary information is demonstrated in the figure (A) at the left. A slowly increasing frequency is used to convey a space while a decreasing frequency represents a mark. The relative size of the transmitter is shown in the photograph on page 66.

In the transmitter circuit diagram the sweep circuit comprises Q_6 , CR_2 and the associated components. A ramp signal drives varactor CR_1 to cause a frequency change. In operation, the switch S_2 is in its center position for off condition. Operation of the switch to the right produces a space and to the left, a mark. In practice, the user will simply move the switch right and left of center according to a pattern that can be etched or printed on the transmitter case.

Since the system developed uses a 1 cps bandwidth and the sweep rate is limited to 1 cps per second, the time to complete a sweep is 20 seconds. The bit rate is then 3 bits per minute (bpm).

The 3-bpm rate used in these tests is not the limit for the 1 cps bandpass. A rate of 20 bpm can be readily achieved using a more sophisticated receiver.

Receiver sensor

Actually, it is necessary to use two narrow passbands in the receiver to determine the sweep direction and hence, the sense of the bit. In the system used, these bandpasses are 1 cps in width and spaced 2 cps apart. The relative position of the two channels is illustrated in (B) of the figure on page 68. As the signal sweeps through each channel an output pulse results. If a signal occurs first in channel 1 and two seconds later in channel 2, a space would be indicated, while the opposite sequence would indicate a mark.

The sequential outputs of the two bandpasses are in good form for processing to a low speed logic system for indication and storage. Simple interlocking relay circuits operated by these two pulses can then make the appropriate decision and simultaneously indicate mark or space. The detected envelope of a single channel as the signal sweeps through is shown on page 68 in the short section of a strip chart. The longer section beside it shows the typical form of the received signal of a single channel over a 2,000 mile skywave path at about mid afternoon. The signal-to-rms noise ratio is about 30 db. This chart merely demonstrates typical signal-noise ratios (noise is seen in the intervals between the pulses). Each pulse represents a bit, but without the corresponding output of the second channel the mark-space sense cannot be determined.

Receiver circuits

The receiver shown as a block diagram, opposite

page, is a completely conventional, commercial high-frequency receiver slightly modified to improve the frequency stability. The i-f output is converted to 20 kc and the narrow band filtering is performed at this frequency.

An extremely simple filter circuit, shown on page 68, has proved adequate to achieve the 1 cps band with 60 to 80 db rejection on the skirts. A single 20 kc crystal is used in a bridge configuration. The crystal Q is approximately 30,000.

The output of each filter is amplitude-detected and the resulting pulse is used to drive a simple relay decision circuit. For convenience, a five-bit storage and display was used. If desired, the outputs of the filters could be directly recorded by a two-channel pen recorder and read visually. No noise cancellation or correlation techniques have been applied to this system. However, the use of these techniques in signal processing would considerably enhance the system. The resulting transmitter power reduction could double the battery life.

One-ounce antenna

The transmitting antenna comprises two pieces of number 22 wire, each a quarter wave long; at 13.4 Mc the antenna was about 17½ feet. One wire is attached to any convenient support such as a tree limb and is used as the vertical radiator. The other quarter-wave wire is supported about one foot above the ground and is used as the counterpoise. The total weight of the transmitting antenna is only one ounce and it is easily erected in a few minutes.

The receiver utilizes a rhombic antenna with 230-foot sides. Although the rhombic gain is not necessary for system operation, the atmospheric-noise discrimination characteristic of the rhombic is desirable. The system has been operated successfully with a simple vertical antenna for the receiver.

The effectiveness of such a low power system depends heavily upon the accurate prediction of good skywave paths. All paths used have been predicted on the basis of the monthly ionospheric data published by the National Bureau of Standards and to date all predictions have been correct. Except for the effects of severe ionospheric disturbances, there is every reason to believe that reliable communications can be maintained with this low power transmission.

The author



J. G. Arnold received his engineering degree from Alabama Polytechnic Institute in 1951. He has been actively engaged since then in the design and development of communication systems and equipment for the Radio Corp. of America.

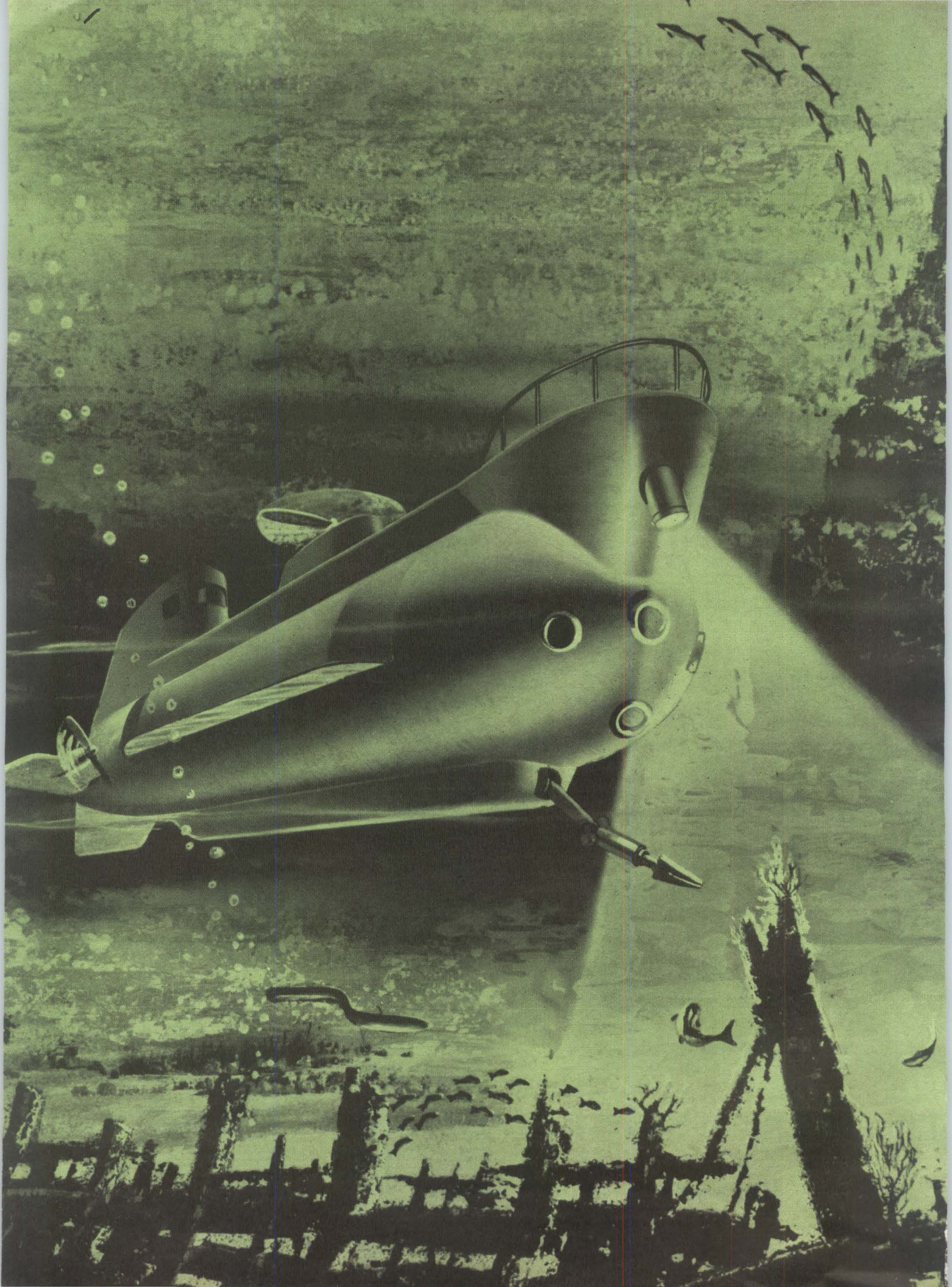

Frontier of the deep

Better electronic gear is necessary if man is to explore the earth's oceans adequately. Such exploration may be necessary to his very survival

By John M. Carroll

Managing Editor

and Harold C. Hood

Los Angeles Regional Editor

Although the exploration of outer space is getting far more attention, efforts directed at exploring the oceans—inner space—may yield earlier, more valuable results.

Both kinds of exploration create markets for electronic equipment. The space effort, already a large market, is expanding rapidly. The market created by ocean exploration is still small, and its growth is slow. It may not grow very much at all. Whether it does or not will depend largely upon how well electronics manufacturers meet the needs of oceanographers for instruments and other apparatus.

The oceans, representing 71% of the earth's surface, are nearly as little-known as the space around our planet. Yet, while outer space is the object of a \$5 billion exploration effort by the United States, the basic study of hydrospace is now budgeted for only about \$150 million a year.

The sea's challenge

The relatively shallow waters of the continental shelves, comprising only about 6.5% of the earth's surface, have already yielded oil and diamonds, and may be a source of other valuable minerals. And man has yet to utilize the biological life of these waters, except for some primitive hunting of sea creatures. Proper farming could tape the sea's amazing fertility to help feed the world's multiplying inhabitants. The oceans could even provide an environment for homes, under huge pressurized domes, for some of the population of a crowded—

Three-man Aluminaut, shown in artist's conception, will have a depth capability of 15,000 feet.

or radioactive—earth.

A potential enemy might approach our shores undetected in modern nuclear submarines and launch guided missiles against our cities, block our seaports from shipping, or land subversive agents on our beaches.

Oceanographic instruments function in a hostile environment 1,000 fathoms down. The oceanographer's problems are difficult. His solutions are often unique and perhaps worthy of application outside of his relatively narrow field.

It is not remarkable that the men engaged in oceanography should devise unique solutions to their problems, for they themselves are uncommon individuals. These pipe-smoking scientists and engineers, dress in shorts and tee shirts, enthusiastically pursue nature through the vastness of the ocean depths. Sun-bronzed, some of them bearded, they work and live in beauty spots like Woods Hole, Mass., Bermuda, Miami, La Jolla, Calif. and make substantial contributions to the state of the electronics art everywhere.

Birth of a science

Over 100 years ago, because of the genius of Lt. Matthew Fontaine Maury, later a commodore of the Confederate States Navy, the United States led the world in physical oceanography, or the study of the motions of the sea. This knowledge of waves and swell, tides, currents and turbulence, and of the locations of rocks and shoals, enabled the tall Yankee Clipper ships to emerge preeminent in an international struggle to dominate the rich tea trade of the East Indies.

But when steam power and steel ships swept the stately clippers from the seas, mariners no



BT WINCH plunges hundreds of feet of wire, with a bathythermograph attached, into the sea.

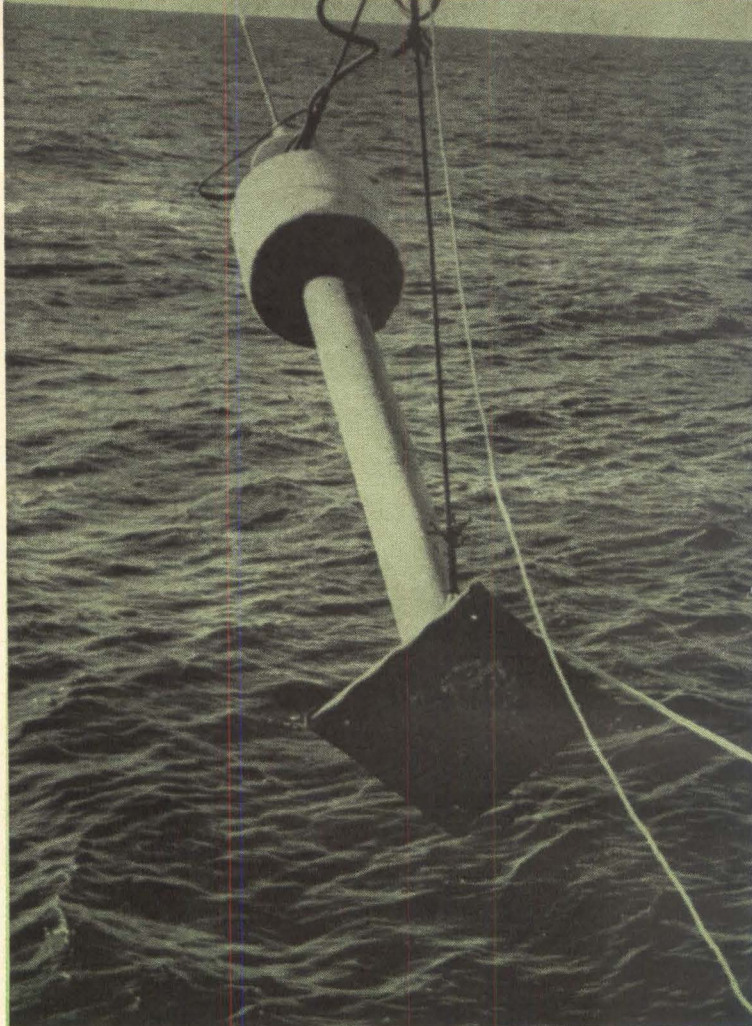

Oceanographers preparing to measure the temperature of Arctic waters, moor a telemetering buoy in Davis Strait, between Baffin Island and Greenland.

longer considered a knowledge of the oceans to be as important. The speed and power of modern ships had triumphed over the elements.

Now oceanography has come about a full cycle. The existence of the true submersible, the nuclear submarine, makes oceanography important again; not just physical oceanography but all its companion sciences: marine biology, submarine geology and marine chemistry, which relates to the distribution of chemicals in sea water and the study of chemical processes. Knowledge of oceanography and of oceanographic conditions are as important to the skipper of a nuclear submarine as are knowledge of meteorology and weather conditions to the pilot of an aircraft. Our national survival may, in fact, depend upon how well we get to know and use the oceans.

Sparse spending

In contrast to the billion-dollar market in space electronics, total spending for electronics in oceanography—including gear for instrumentation, control, data processing, communications and navigation—is a miniscule part of even the small budget for our national oceanographic effort.

Most of the money goes to operate oceanographic ships and stations. Much of the instrumentation used is electromechanical and mechanical. In fact,

many oceanographers have a strong prejudice against electronics. In the early 1950s, one of the world's leading oceanographers expounded a "law" that said, in effect, that the best oceanographic instrument is always the one having the fewest vacuum tubes. However, the advent of the transistor, with its improved reliability, has done much to erase this prejudice.

The national oceanographic effort may be subdivided for study in several ways. One is by the type of "platform" used to conduct oceanographic studies. There are oceanographic research vessels, both surface ships and submarines; deep-diving research vehicles such as bathyscaphes; airplanes; ocean buoys, both anchored and free-floating; experimental ranges using a number of anchored buoys; and even a submerged experimental laboratory.

Oceanographic parameters

Another way of subdividing the field of oceanography is to consider the various parameters in which an oceanographer is interested. In this way, it becomes possible to associate with these desired parameters the various kinds of electronic and non-electronic instruments capable of measuring them.

The naval oceanographer is frequently interested in the speed of sound in water. This physical

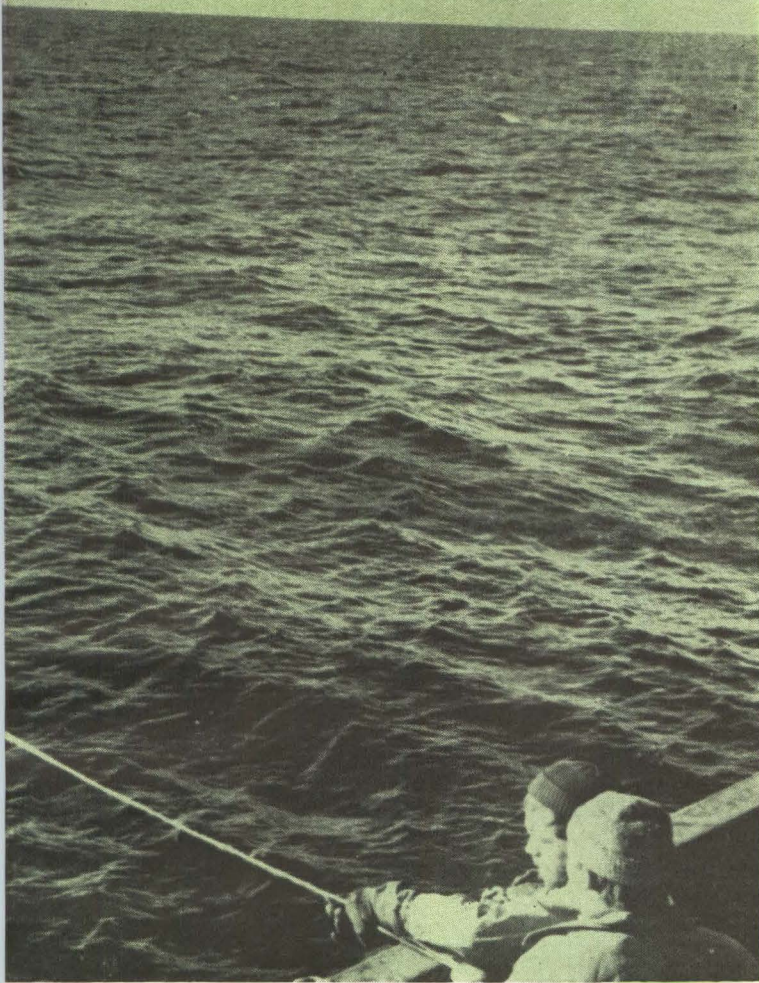

parameter is essential to the success of submarine and antisubmarine operations. Instruments exist that measure the speed of sound in water directly. The speed of sound can also be determined from water temperature, pressure and salinity.

Temperature and pressure are often measured simultaneously by an instrument known as a bathythermograph, of which both electronic and mechanical versions exist. Salinity of sea water can be determined either by chemical analysis or by measurement of its electrical conductivity.

Other physical parameters of interest to oceanographers include the speed of ocean currents, the height of the waves and the depth to which light waves penetrate the water. The values of free-fall acceleration due to the earth's gravity and the magnitude of the earth's magnetic field at various locations at sea are also significant in some studies.

The marine geologist and the hydrographer, or maker of navigational charts, are both interested in the depth of the ocean and the composition and profile of the bottom. Sonar depth finders can be of some assistance. But penetrating the layers of sediment that frequently build up on the ocean floor calls for special apparatus and techniques such as reflection and refraction seismometry.

Both the geologist and the marine biologist need to gather specimens on or near the ocean bottom.

The sound channel

Nature plays a curious trick on sound traveling in water. It forms a "sound channel" some 700 to 1500 meters down, in which strange things happen.

The speed of sound in seawater depends upon the water's density. The denser the water, the faster sound travels. The density of seawater depends, in turn, upon its temperature, pressure and salinity. As water gets deeper, it gets colder and its pressure increases. But its salinity decreases. Near the surface, salt content is high, owing to the effects of evaporation, and salinity is the controlling factor. But as salinity decreases with depth, the speed of sound decreases.

The crossover between the effect of decreasing salinity and increasing temperature-pressure occurs in the sound channel. Here sound travels at about 1,500 feet per second—the slowest it can travel in seawater.

In the sound channel, the main burst of a sonic signal arrives first. And sound originating within the channel is usually bent back so that it stays in the channel.

The sound channel is very much a part of the underwater environment, and its role in communications, navigation and surveillance will become highly significant in years to come.

This requirement has led to the development of deep-diving research vessels with their attendant needs for remotely controlled claws, special sonar, communications equipment, underwater closed-circuit television, high-power flash lamps—some of which are triggered by a weight bouncing on the bottom—that can take pictures down to 10,000 feet, and safety devices such as radio beacons.

Instrument platforms

Research vehicles of all kinds—ships, subs and planes—have requirements for communications and navigation equipment similar to those used on any other kind of vehicle. However, a research platform requires more precise navigational instruments. Ocean buoys used for research purposes are frequently equipped with telemetering transmitters to radio back their findings.

Understanding the ocean requires gathering masses of data from all over the world in both digital and analog form. Rapid, accurate automatic processing of this observed data has become increasingly important. For example, a frame-at-a-time motion picture camera now records meter readings aboard unattended ocean buoys, and it is planned to read the resulting photographic images by an optical data scanner.

The three most important recent developments in

electronics for oceanography are:

1. Adoption of a systems approach to data gathering, rather than an individual-instrument approach. The system approach will permit a synoptic picture of the sea to be obtained at any place at any time.

2. Use of aircraft to supplement ships, subs and fixed stations in gathering oceanographic data. The airplane's first contribution to oceanography has been the rapid measurement of the temperature of the ocean surface at many points.

3. Use of automatic equipment to reduce observed data to formats acceptable for subsequent processing.

Instrumentation

The underwater world is fascinating and grotesque. The requirements for electronic equipment destined to invade this world are stringent and not often understood by engineers new to the field. Because pressure builds up at one-half pound per square inch per foot of depth, construction of an instrument case to be lowered to 6,000 feet requires careful layout and selection of materials. Instruments to be used to profile the ocean—that is, to measure its characteristics throughout its entire depth—are designed for dunking. They are built with sturdy metal casings and usually are surrounded by a frame known as a bird cage.

Instruments to be used to observe ocean characteristics near the surface and over a wide area are often towed behind a research vessel. The instrument package is known as a fish. Instrument sensors may be attached at intervals along the string, or cable, leading from the ship's taffrail to the fish. The hydrodynamic characteristics of a fish are important; the fish must glide smoothly through the water to avoid placing undue strain on the cable or umbilical connectors.

Pressure-temperature plots

The basic instrument for physical oceanography is the bathythermograph. It is most commonly used in its mechanical version, which consists of a bourdon tube to measure pressure and a copper capillary tube to measure temperature. Data is recorded mechanically by scratching an x-y plot of temperature versus pressure in a thin film of gold deposited on a glass plate. A major data-processing problem involves reading thousands of these recordings received from all over the world. Opto-electronic scanning is under consideration for this task.

An electronic bathythermograph was introduced 10 years ago but has failed thus far to replace the mechanical device. The electronic instrument consists either of a thermistor or a platinum resistance thermometer to measure temperature, and a bourdon tube linked to the wiper arm of a potentiometer to measure pressure. The two varying d-c voltages are plotted on an x-y recorder.

Platinum resistance thermometers, each about the size of a hypodermic needle, can achieve a

temperature discrimination of about 0.01°C . They are replacing thermistor beads for oceanographic measurement because thermistor beads give temperature discrimination to only about 0.1°C , do not hold their calibration well, and show some sensitivity to pressure as well as to temperature.

Serious problems in oceanographic measurements arise from the resistance and capacitance of the cables used to transmit meter readings to the surface. Heretofore, oceanographers have preferred to use an analog recorder in situ—that is, underwater—but a more modern approach is to convert the varying d-c voltage to a varying frequency for transmission up the cable.

An even more advanced proposal is to convert the analog data to digital form for transmission. Voltage-to-frequency conversion is often achieved by using the platinum resistance thermometer as one of the arms of a Wien bridge oscillator.

An infrared bolometer, in airborne surveys of the surface temperature of the ocean, supplied by the Barnes Engineering Co., is employed. The sensor of this instrument is a thermistor bead.

Thermistor strings

Although many oceanographers insist that thermistors, when used underwater, are far better for measuring temperature differences than for measuring temperatures in an absolute sense, thermistor strings have been towed through the water to plot isotherms or contours of constant water temperature. The thermistor string instrumentation is modified to interpolate between thermistors by using an isotherm follower, which incorporates a servo loop.

Water pressure can be measured directly by means of the Vibratron, or vibrating strain gage. In this instrument, a wire under tension is hooked to a flat plate that responds to changes in water pressure. The wire is kept vibrating and constitutes the tuning element of an electronic oscillator. These devices can be used to determine a point of reference for measurement of ocean wave motion.

The salt content of water, and its temperature and pressure, determine the speed of sound in the medium. Salinity may be measured by chemical analysis, but more commonly the electrical conductivity of discrete samples is measured.

Two methods are used. In one method, the conductivity is measured between two platinum electrodes and compared in a bridge arrangement with the conductivity of a standard sample of sea water. But the electrodes become "poisoned" in use and measurements become unreliable. In the other method, a bottle of sea water is inserted within a toroidal inductor that forms one arm of an inductance bridge. A toroid with a standard sample of sea water inserted in it comprises one of the other arms of the bridge. Inductive salinity meters have been designed for use in situ.

The Synoptic Oceanographic Shipboard Survey system represents a major advance in oceanography.

graphic instrumentation. It is being designed by the Bissett-Berman Corp.'s Hytech division in Santa Monica, Calif. The system measures temperatures using a platinum resistance thermometer connected as one of the arms of a Wien-bridge oscillator; depth of the instrument package as a function of pressure sensed with a Vibratron or vibrating-wire oscillator; salinity by means of an inductance bridge using the water sample inserted in a toroid; and light penetration by means of a photocell.

Another major integrated instrumentation system under development for research ships will augment the measurement of classical oceanographic parameters by measuring geophysical parameters.

Stop-watch on sound

It is possible to measure the speed of sound directly. One method uses a sing-around circuit in which the frequency of an oscillator is dependent upon the transit time in an acoustic path through the water.

The model TR-4 sound velocity meter, made by ACF Electronics of Riverdale, Md., a division of ACF Industries, Inc., and designed for an Autech array project to be described later in this article, is made in the form of a two-foot-long fish. It has four sonar transducers on its endplate. All transducers are energized or "pinged" simultaneously, and the travel time between the nearest transducer pairs measured. It can measure the speed of sound in water down to 0.1 foot per second.

There are at least three instruments for measuring wave motion. Two of these are gages called wave staffs. A single insulated wire set vertically in the water can constitute a capacitance-type wave staff. Changes in capacitance measure the rise and fall of water level.

A step-gage wave staff consists of a vertical string of resistors that are progressively shorted out as water level rises.

An acoustic device by the Radio Corp. of America is mounted in the bow of a ship and transmits a 38-kilocycle sonic pulse to the ocean surface to measure distance by sound ranging. Accelerometers on the ship sense its motion so that ship motion can be canceled out. Accelerometers are also used on buoys that measure wave motion, but buoys using only heavy damping dishes have been used successfully for the same purpose. Upward-looking sonar has measured wave motion.

There are three ways to measure ocean currents, but none really meets the oceanographer's requirement for measuring flows of 0.01 to 1.0 knot. The Roberts current meter is completely electrical. It has a screw-type impeller that rotates because of ocean-current flow. The impeller is magnetically coupled to a gear train. The gear train drives a contact lifter that makes and breaks contacts while the impeller rotates. The contacts gate a 1,000-

Oceanographer in the Antarctic drops a magnetometer into the icy waters of the Ross Sea.

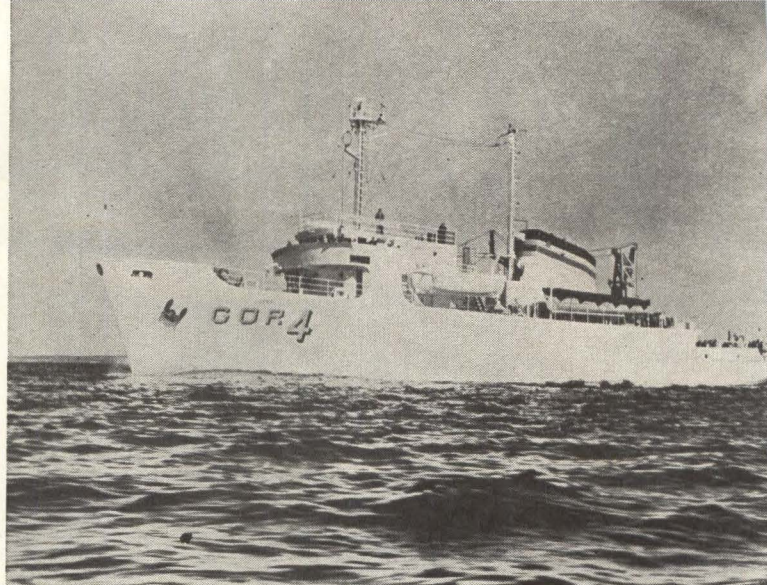

USNS Gilliss, one of the Navy's newest oceanographic research ships

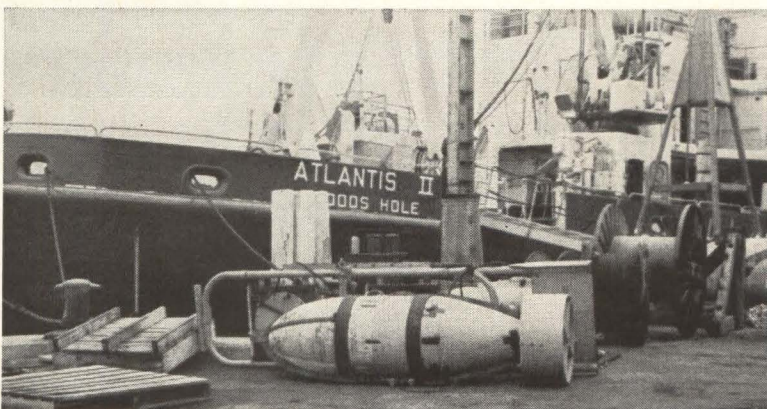

Transducer for boomer sonar ready for loading aboard the Atlantis II as she is fitted out for a cruise to Puerto Rico.



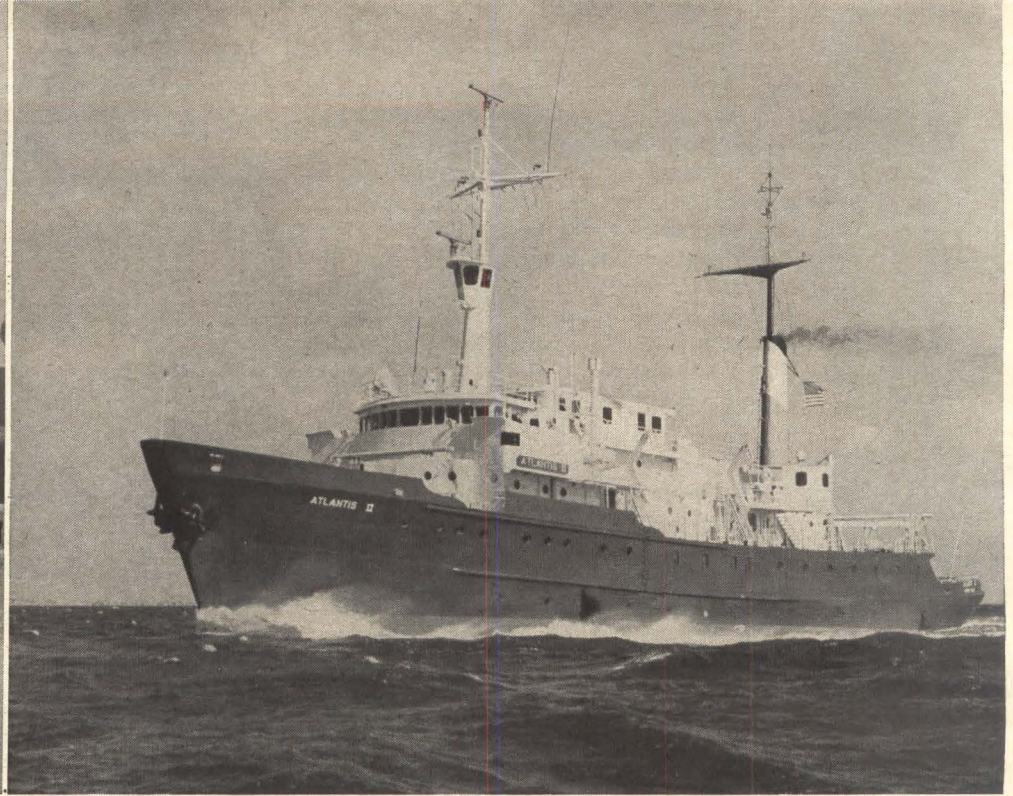

Oceanographic buoys are loaded aboard the Atlantis II. These buoys are fitted with a radar-actuated xenon flash lamp to help in locating them at night. The ship, designed for oceanography, has a steam-powered trawl winch with seven miles of cable. She can accommodate a crew of 30 and a scientific party of 25. She's 210 feet long, 44 feet wide, displaces 2,300 tons and can travel 8,000 miles at 12 knot.

cycle oscillator, and the cycles are counted to provide a measure of the rate of ocean-current flow.

In another instrument, a rotor with a vane shaped like a double S (called a Savonius rotor) turns with current flow. The rotor is coupled to a conducting disk. As the disk rotates, four pulses per revolution are fed to a counter that is gated to count all the pulses occurring in standard intervals of time. The instrument case is six feet long by six inches in diameter. For unattended operations, current flow can be recorded photographically.

The geomagnetic-electrokinetograph measures surface currents from a moving ship. The instrument consists of two trailing cables, one of them 100 meters longer than the other. Electrodes are attached at the end of each cable. The vector component of water motion normal to the direction of travel of the ship interacts with the vertical component of the earth's magnetic field to generate an electrical current in the wire. The current is proportional to the physical ocean current. The cable must have zero buoyancy, because any droop causes the cable to cut the horizontal component of the earth's magnetic field and leads to inaccurate measurement.

Ocean depth

Precision depth recorders capable of measuring to one fathom are used in oceanography. A sonic carrier frequency of 12 kc is often used for deep soundings. The instruments transmit pulses one millisecond wide at a repetition rate of one pulse per second.

It has been mentioned that penetrating the layer of sediment on the ocean bottom presents a prob-

lem. Therefore, to penetrate this layer, white noise sources such as sparkers (electric arcs discharged in water), thumpers or boomers (metal plates separated by dielectric tubes charged and discharged by a capacitor bank), and gas-discharge devices are used.

Reflection seismometry is also used. Every two minutes researchers fire explosive charges equivalent to one-half pound of TNT. Each shot triggers a tape recorder. When the tape is played back, frequency components may be separated by use of either a variable-frequency filter or several band-pass filters. Each frequency channel is recorded electrographically.

A variation of this technique is refraction seismometry. Here charges are fired by one ship and received by another. Sounds traveling through air and through water are both recorded in this procedure. All these depth-finding methods require sensitive hydrophones with preamplifiers and good low-frequency amplifiers.

Oceanographic research vessels have requirements for extremely precise navigation equipment. A phase-comparison, making use of the powerful very-low-frequency transmitters of the Omega navigational system, has been utilized by the Woods Hole Oceanographic Institute. Omega stations are located at Rugby, England; Balboa, Canal Zone; and in Australia.

The Ship's Inertial Navigation System (SINS) used by Fleet Ballistic Missile (Polaris) submarines has proved too expensive for oceanographic ships and Loran C equipment (a relatively new, highly-accurate pulsed hyperbolic system operating at low frequencies) heretofore presented too many main-

tenance problems. Common loran A (a medium-frequency system) and Decca (a proprietary continuous-wave hyperbolic system) are used.

Measuring the acceleration of freefall due to the earth's gravity at various points in the earth surface requires removing the vector components of the ship's motion from the readings obtained with a conventional geophysical gravity meter. This can be done by mounting the meter on a gyro-stabilized table or by using accelerometers and double integrating circuits to determine the ship's motion and cancel it out. Probably both systems will be used.

Some studies have involved measuring the total magnetic field of the earth. Towed fishes, contain-

ing either flux-gate or precession magnetometers, have been employed.

A new development in oceanography is the use of a digital system to acquire data for marine biologists. In one study, researchers wanted to cross-correlate the presence of Sargasso-weed slicks with the number of plankton in the water and with water temperature. In this application, a three-channel system was used to furnish computer-compatible data. A thermistor measured water temperature, and a photocell and light provided the plankton count. The third data channel carried time markers. These channels then fed into three voltage-controlled oscillators.

Vehicles to probe the ocean's depths

Surface vessels, ocean buoys, deep-diving submersibles and an underwater laboratory all need special navigation gear and sensors

Deep-diving submarines are the glamor vehicles of modern oceanography, but surface vessels or even buoys do most of the work.

The earliest oceanographic ships were converted naval vessels, and many still are. Others are auxiliary sailing ships, used because of their low noise level. The Atlantis II, operated by the Oceanographic Institute at Woods Hole, Mass., was designed from the keel up as an oceanographic ship.

She affords comfort and stability for scientists and crewmen. Her decks are connected by wide staircases instead of the ladders usually found on shipboard. Her working spaces are broad and commodious, not chopped up into tiny compartments as on naval vessels.

In addition to a low-frequency radio-direction finder, radio communications equipment and Decca navigation equipment, there is installed on her bridge a four-rack console for measuring wind direction and speed and for recording information from radio sondes.

There are two helix-type precision depth recorders, made by Alden Electronic & Impulse Recording Equipment Co., Westboro, Mass., for use with sonar and depth-sounding gear. These recorders also receive direct and inverted echoes from pingers attached to cameras, bottom corers and dredges

lowered from the ship on cables. The direct echo bounces off the air-water interface; the inverted echo bounces also off the bottom. By recording both echoes, it is possible to measure the height of the camera above the ocean bottom.

The precision recorder can also be used with the thumper or boomer. In addition there is a rack of variable-frequency filters and amplifiers to sort out the echo frequencies. The boomer, when used with the precision recorder, can develop an accurate profile of the ocean bottom. The hydrophone arrays for the boomer are towed behind the ship. Another sonar projector is the lollypop transducer. This vehicle is towed deep to get the array away from the ship's noise.

Digital data scanner

A new instrument on the bridge of the Atlantis II is a digital data acquisition system made by the Dymec division of the Hewlett-Packard Co. It is used in conjunction with 52 series thermistors on a 600-foot cable to measure ocean temperature. An electronic crossbar switch samples each thermistor individually and sequentially. The thermistor chain is energized by a one-mil, constant-current power supply.

It requires six to eight minutes to scan the chain. An integrating voltmeter, used to measure the volt-

age drop across each thermistor, dwells 0.1 second on each unit to get a true time-averaged reading. The equipment converts voltage readings to binary-coded decimal notation for recording on punched paper or magnetic tape. If desired, a pair of pressure transducers using bourdon tubes and potentiometers may be inserted in the chain in place of two of the thermistors.

Anchored buoys

Anchored ocean buoys are perhaps the cheapest type of oceanographic research vehicle. The Atlantis II carries three buoys. As many as 15 at a time have been anchored between Bermuda and Nantucket Island off Cape Cod, Mass.

Buoys play a major role in a Navy program called antisubmarine warfare environment prediction system. The Navy is presently outfitting two Nomad (Navy Oceanographic Meteorological Automatic Device) weather buoys to check out instrumentation for oceanographic buoys. [Electronics, Feb. 21, 1964, p. 14]

This summer the Convair division of the General Dynamics Corp. will deliver two prototype buoys for the antisub program. These buoys will permit shallow-water evaluation of a type that may later be moored as much as 2,500 miles from shore. The working models, to be delivered in July, 1965, will telemeter information on water temperature and ocean currents.

The prototypes, to be installed off Miami and San Diego, will transmit data using f-m/f-m telemetry and vhf line-of-sight propagation. The long-range working models will transmit pulse-coded information by frequency-shift-keying of a high-frequency carrier.

The buoys will use all-solid-state circuits. They will have two memories: a magnetic tape recorder as a long-term store (about one year) and a ferrite-core memory as a short-term store (24 hours). Shore stations will call the buoy every six hours, at which time it will transmit the last 24 hours of the data.

The buoys can handle 100 channels of information, 10 bits per channel. Prototype buoys will use their information channels principally to transmit strains on the mooring cable and other mechanical parameters to facilitate design of future buoys.

Oceanographers at Woods Hole have made extensive use of moored ocean buoys. They originally used Richardson buoys carrying Savonius-rotor ocean-current meters. The buoys stored data in 24-bit digital code on photographic film.

The Richardson buoy has been modified to transmit by high-frequency radio telemetry. Ocean-current information is sent to the surface as d-c pulses at 20 bits per second. Pulses from the rotor are counted for a 15 second period and the count is stored in seven flip flops. The reading of the buoy's magnetic compass is obtained from a coding disk attached to the compass. Information is transmitted by frequency-shift keying of a seven-megacycle carrier.

Finding a buoy at sea at night is no easy task, but Woods Hole has developed a radar-actuated flash lamp to mount on ocean buoys. Pulses from X-band radar aboard a plane or ship are received by Sonobuoy antennas mounted on the buoys. These antennas have built-in crystal mixers. The energizing signals are then fed through a transistorized i-f amplifier and used to trigger a xenon flash lamp.

A Woods Hole buoy, to be used in a survey of the Indian Ocean, will support a 600-foot string carrying 16 thermistors to measure water temperature. There will be four thermistors on a 20-foot tower above the buoy to measure air temperature. The method of successive approximation will be used to convert analog temperature measurements into 11-bit binary code for transmission by frequency-shift-keyed high-frequency telemetry. The 20 thermistors can be sampled in seven seconds.

Moored buoys play a leading role at the Navy's Atlantic Undersea Test and Evaluation Center off Andros Island in the Bahamas. Each of the three ranges (weapons, sonar and acoustics) will have at least one instrumentation array. The arrays will be mounted on vertical buoyed cables set in 6,000 feet of water 10 miles offshore. The arrays, to be built by the Martin-Marietta Corp., will transmit data by hard-line (wire) telemetry with sampling periods ranging from 2 to 32 minutes; about 500,000 data points will be recorded on magnetic tape using an incremental recorder.

The system operators can visually monitor data on Nixie readout tubes. The system also provides for redundant recording on punched tape, and affords a two-way parity check. The data will be collected in a form suitable for use directly on an IBM 7040 computer.

The sensors of the instrument array include 14 platinum resistance thermometers in the Wien-bridge configuration (made by Hytech), six Model TR4 sound velocimeters (ACF) and three pressure sensors (Hytech).

Ocean-current meters for the range will be installed on a separate string and will report data by radio telemetry. An ambient-noise recording system will record frequencies from 10 to 70 kc; its magnetic tapes must be unloaded manually. Portable thermistor arrays for measuring temperature will be used elsewhere on the range.

Free-floating buoys

Two types of free-floating buoys are used to measure deep ocean currents. The Navy Swallow float is neutrally buoyant—that is, it floats underwater. It emits a sonic signal so that a research vessel can track it. It gives an accurate indication of deep ocean currents, but it can be tracked at up to only four miles.

An alternative method of measuring deep currents, used at Woods Hole, is the parachute drogue. A buoy carrying a radio beacon is dropped by parachute. The parachute sinks to a predetermined depth and is carried along by the deep currents

while a radio beacon on the buoy to which it is attached is tracked by radio direction finders.

The parachute drogue is a less accurate method of measuring deep currents than the swallow float, because of the surface drag of the buoy, but it can be tracked over thousands of miles.

Woods Hole oceanographers use a high-frequency beacon on 3 or 7 Mc and fly to the buoy with a P2V aircraft to establish its position.

But a newer version uses the Consolan navigation stations in Miami and Nantucket. These stations broadcast on 190 and 194 kc. At each transmitter, two Consolan antennas rotate electrically, one sending dots and one sending dashes. The received signal consists of a series of dots and a series of dashes separated by an equi-time period in which the dots and dashes merge. By counting the number of dots received prior to the equi-time period, a radial line of position from the Consolan transmitter is established. By determining the intersection of the two lines of position, the vehicle can be located.

The free-floating buoy carries an omnidirectional Consolan receiving antenna consisting of four ferrite rods in quadrature. Upon interrogation by the base station or research vessel, the buoy alternately switches between two Consolan frequencies at a 1.5-minute rate as it receives and retransmits their signals. The number of dots received on each frequency establishes a line of position from the Consolan station to the buoy.

Deep-diving subs

If man is to exploit the mineral and agricultural wealth of the seas, he must penetrate vast depths. At least two U. S. submarines—they happen to be conventional diesel-electric types—are used by the Navy as oceanographic research vessels. But the really deep dives—1,000 feet or more—have been made in special diving vehicles such as the famous Trieste.

The Trieste dives by admitting seawater to compress and displace aviation gasoline that is initially used to fill her flotation tanks. She ascends by releasing lead-shot ballast by a magnetically controlled valve. But she has a very limited range on the bottom. She is essentially a tethered vessel.

This year, however, several true deep-diving submarines have made their appearance. These vehicles borrow many techniques and systems from outer-space exploration vehicles. For example, the Navy's 33-foot Moray (cover) has a life-support system that incorporates several features of the Mercury space capsule.

Alvin

On June 5, one of the more promising of these deep-diving subs was christened on the Woods Hole docks. Named Alvin (after oceanographer Allyn Vine) and built by the Applied Science division of Litton Industries, Inc., this 13-ton two-man submarine cost the Navy \$575,000 and will be operated by Woods Hole personnel in studies

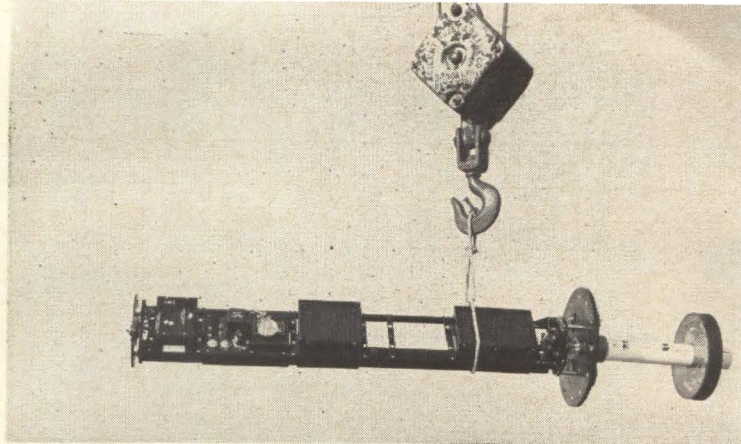

Free-floating buoy retransmits Consolan signals to keep the base station or research vessel aware of the buoy's position.

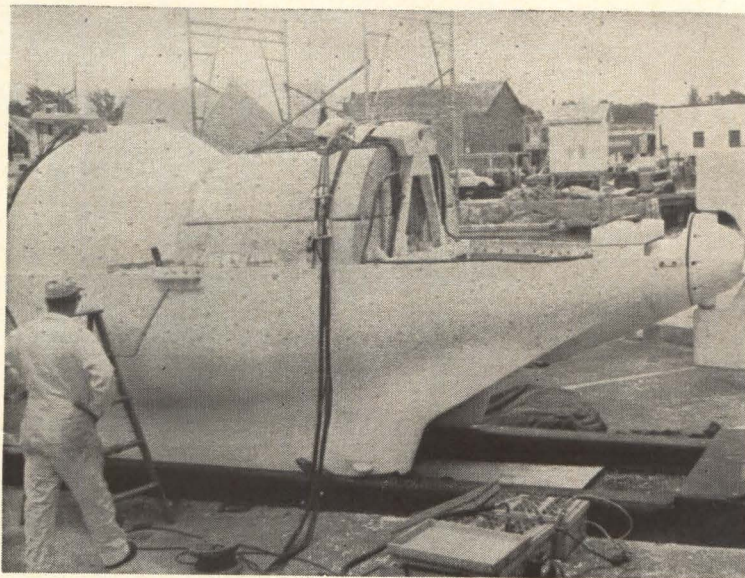

Two-man submarine Alvin can dive to 6,000 feet. Woods Hole personnel prepare to test her.



Diving Saucer, being prepared for a test at San Diego, Calif., has a 1,000-foot capability.

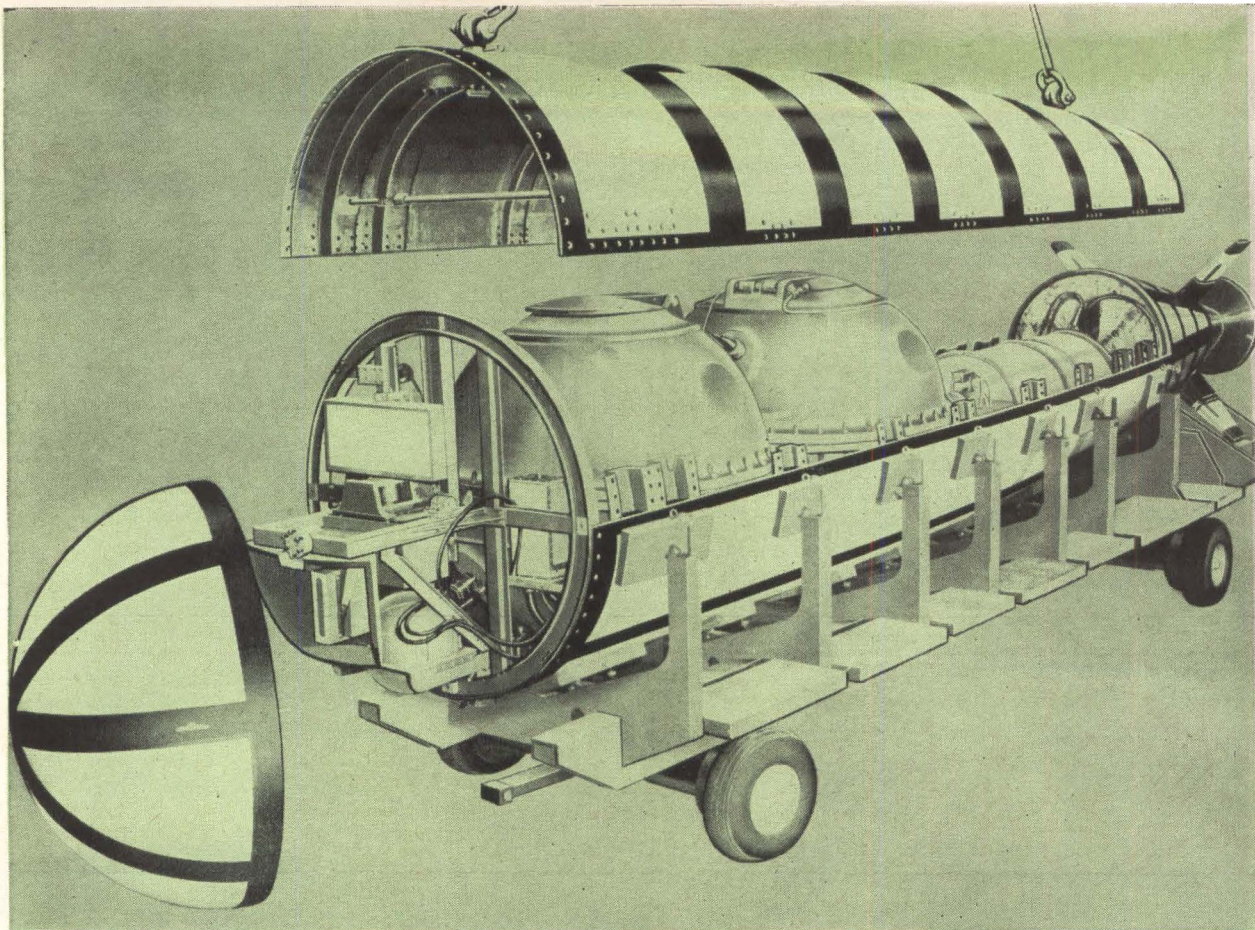

Two-man submarine Moray has separate pressure spheres for electronics equipment and for the crew.

of biology, geology and physical oceanography. Alvin's 6,000-foot depth capability will permit her to explore one-sixth of the area of the world's ocean bottoms, including all of the potentially productive "continental shelf" areas. Her 1,200 pounds of instrumentation include two types of scanning sonar, underwater tv, an underwater telephone and a high-energy, short-pulse sounder of the inverted echo type.

Her navigation system includes a magnetic compass, a gyro compass, and a doppler navigator made by Janus, Inc., Inglewood, Calif., the first of its kind to be installed on a submarine and accurate down to six-foot increments. With her 10-hour underwater endurance capability, Alvin can be launched from her mother ship and drift downward through desired water columns, obtaining probably the best continuous profiles of temperature, salinity and other water characteristics ever made. Unlike the famous Trieste, which has extremely limited travel capabilities other than up and down, Alvin will be able to cover reasonable distances. Maximum speed is six knots and range is 30 miles.

Aluminaut

The somewhat larger and more expensive three-man Aluminaut (75 tons and \$3 million), also to be operated by Woods Hole personnel, hopefully will be launched late this summer. Being built for Reynolds International, Inc., by General Dynamics, Electric Boat division, Aluminaut is supposed to convince designers of deep submersibles of the

superiority of aluminum. She boasts a 6½-inch-thick hull, a 15,000-foot depth capability and an underwater endurance time of three days. Her electronics inventory will be similar to Alvin's. Her multiple-sonar equipment will make use of three transducers (up, down and forward), which reportedly are being pressure-tested to 22,000 pounds per square inch.

Moray

The Navy's two-man Moray has been shrouded in secrecy in recent months, but certain facts are known. Unlike the Alvin, which has a single pressure-resisting sphere for both instrumentation and crew, the Moray has a separate electronics sphere forward of the crew sphere. Built at the naval ord-

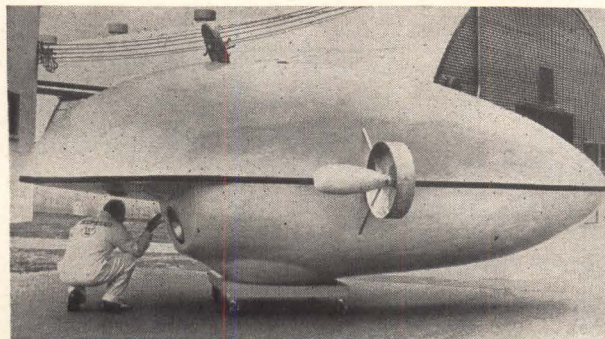

Deepstar research vehicle is designed to attain a depth of 4,000 feet. Later versions may reach 12,000 feet.

nance test station, China Lake, Calif., the deep submersible with a 15-knot speed recently underwent sea trials off California's San Clemente Island and is now back at China Lake. The craft has controls similar to those of a dirigible. Like the Alvin and several others, the Moray has a relatively thin exterior hull through which sea water is readily admitted. The hull functions more as a streamlined fairing than as a conventional submarine hull.

The Moray may have been plagued by more than her share of woes, both political and engineering. There seems to be some question as to the exact delegation of responsibilities to the Navy Bureau of Ships and to the Bureau of Weapons. Is she more ship or more weapons system for antisubmarine warfare? Also, her two pressure spheres, supposedly capable of withstanding the hydrostatic pressures encountered at 10,000-foot depths, seem to be annoyingly leaky.

Special high-frequency sonar systems of a military nature are to be installed in the Moray, indicating that she is intended for considerably more than oceanographic research.

Even fewer available details are available about the Navy's Deep Jeep, a vehicle believed to combine some of the better features of Moray and other deep submersibles to realize a versatile underwater workboat with rescue, salvage and general exploration capabilities.

Deepstar

The ordnance division of the Westinghouse Electric Co. Defense Center in Baltimore has teamed up with the French office of Underwater Research and with Capt. Jacques-Yves Cousteau to produce the family of Deepstar deep submersibles. Progenitor of these two-man craft is Cousteau's famous Diving Saucer, built in 1959 and currently boasting 180 successful dives.

The interim Deepstar vehicle will be designed to achieve a depth of 4,000 feet. It is being built in Westinghouse Electric's facility in Sunnyvale, Calif., and is slated for an April 19, 1965 launching. Six months later, a 12,000-foot version will be completed in France and will feature flooded a-c propulsion motors, frequency controls using static devices and surveillance sonar similar to that developed for the search for the missing nuclear submarine Thresher.

Navigation will be handled by a small inertial system. All batteries, motors, pumps and other potentially hazardous items will be carried outside the 78-inch diameter steel crew sphere. A rotary inverter with semiconductor controls will provide variable-frequency power to the induction-drive motors. Pitch will be controlled by a patented system that pumps mercury fore and aft.

Turtle

Among other manufacturers in the aerospace business who are interested in becoming equally well known in the hydrospace field are the Lock-

heed Aircraft Corp. and the Autonetics division of the North American Aviation, Inc. Lockheed hopes to build several saucer-shaped submersibles, called Turtle, for deep undersea exploration as well as for repair and construction. Autonetics is working on a submersible similar to Alvin, and is said to have developed articulated manipulating arms that can be useful in deep-sea mining and petroleum exploration and exploitation. The sub is expected to be shown to the public in the next few months.

Autonetics plans to exploit its missile guidance know-how by developing small, efficient inertial-navigation units for its deep submersibles. Inertial navigation should make it feasible to pilot the sub in an accurate Archimedian spiral, said to be the best pattern for scanning the ocean bottom.

Underwater eyes

Various types of sonar and specially designed underwater systems provide eyes for this mushrooming fleet of deep submersibles. Both conventional pulse sonar and continuous-transmission frequency-modulated sonar (CTFM) are used.

The Trieste, the first small submersible to be equipped with continuous-transmission sonar, put her "first generation" CTFM system to good use in her tedious search for the Thresher last year and this spring. The CTFM sonar allowed her to grope along the ocean bottom, 8,400 feet down and evade hazardous protrusions. Masses of wreckage from the nuclear hunter-killer submarine showed up as large blobs on the Trieste's sonar scope.

Straza Industries, of El Cajon, Calif., which provided Trieste with her CTFM sonar, has added several refinements to "second generation" systems that will aid Woods Hole's Alvin and Aluminaut in their crawling along the ocean bottom. Several deep-diving vehicles, currently in the design and fabrication stages, likely will use the same type of gear.

A plot of frequency versus time indicates the basic principle of CTFM sonar. Transmitted frequency (f_t) is varied continuously in linear sawtooth fashion while the received frequency (f_r) from an echo-producing object arrives after a time that is proportional to the range of the object. Specific ranges are represented by the frequency differences Δ_f between the transmitted and received frequencies.

Resolvable range increments are determined by several adjacent bandpass filters that select increments of the Δ_f beat-frequency spectrum for display on a cathode-ray tube. In addition, the operator can listen to the tonal qualities of the beat frequency as another way of determining echo characteristics typical of certain types of objects. Sonar operators make effective use of the tonal quality in detection and classification.

The block diagram shows how the received signals are picked up by the hydrophone and the Δ_f frequency spectrum obtained at the output of the balanced modulator which provides a means of

obtaining the difference frequencies. Since the Δ_f frequencies are directly proportional to range, it is necessary to frequency compensate for round-trip transmission losses in the water. This is accomplished by a slope amplifier whose gain increases as the frequency increases, thus compensating for the increasing transmission losses at greater ranges.

After compensation for range loss, a Δ_f output amplifier feeds the Δ_f frequencies to a loudspeaker so that they can be heard. This amplifier also feeds the Δ_f output to a multichannel spectrum analyzer consisting typically of a group of bandpass filters with adjacent filter passbands intersecting at the 3-db points.

A typical analyzer has filter bandwidths of about 50 cps, and 100 filters ranging from a low center frequency of 525 cps to a high of 5,475 cps. The outputs of the frequency analyzer are scanned in synchronization with the sweep of the crt display, thereby providing visual range information. Angular position, corresponding to the relative bearing of the hydrophone, is displayed by a servo system that orients the sweep on the display.

Range gating

Three refinements added to Alvin's high-frequency (70 to 90 kc) CTFM, which definitely push the state-of-the-art, are range gating for an expanded look at the echo-producing object, lost-time elimination for reduction of the "blind spot" of CTFM sonar operation, and doppler nulling for compensation of the movement of the submersible.

With the range-gating technique, the system may be switched from the "search" mode to the "identify" mode, and the image of the target is electronically magnified tenfold for high-resolution examination of targets. A change in the sweep period of the frequency-modulated oscillator is necessary to center the target in the same frequency analyzer as is used for conventional search purposes. Range resolution in the range-gating or "identify" mode is 0.37 yard and lateral resolution in 3.5 yards. The lost-time signal can be seen occurring during the period when the transmitted signal frequency abruptly recycles in a sawtooth manner, causing the difference frequency (Δ_f) to jump suddenly to a much higher frequency than is normally accepted by the sonar receiver's Δ_f bandpass filter. The corresponding blanked-out angle on the sonar display is significant because, with an angular scan rate of 30° a second and a range of 800 yards, a 30° blind spot appears on the scope. The lost-time eliminator used in the Alvin's system regains the lost-time signal by mixing it with an oscillator operating at frequency identified by the symbol BW_s . This frequency is selected such that the difference frequency between BW_s and the lost-time frequency is again within the Δ_f spectrum.

Side-looking sonar

Supplementing the CTFM sonar in several of the deep submersibles will be another sophisticated type of high-frequency sonar — Scanning Ocean

Bottom Sonar (SOBS). Developed by Westinghouse for the Office of Naval Research, under a contract to the Hudson Laboratories of Columbia University, SOBS, which is trailed by a long cable from surface search vessels, saw action in the Thresher search. In the course of a crash program, Westinghouse developed and built the first version of this side-looking pulse sonar in less than two months.

A follow-on, all-transistorized version of the SOBS, will be installed in the recently completed Trieste II. The Aluminaut and Deepstar will be outfitted with similar equipment. Like the Alvin's CTFM sonar, SOBS operates in both search and identify modes. In the former mode, it can cover about $1\frac{1}{2}$ square miles of ocean bottom each hour while picking up objects as small as two feet by four feet.

The system contains two sonar sets operating at slightly different frequencies, one radiating to port and the other to starboard. In the search mode, the system scans a strip perpendicular to the direction of travel measuring about 5 by 2,400 feet. In the identify mode, the length of the scanned strip is reduced to about 150 feet and a resolution of three inches is obtained.

A boon to the pilot and crew of deep submersibles carrying SOBS is the fact that it provides a three-dimensional picture. Westinghouse reports that objects that previously appeared to be flat can easily be distinguished as protrusions or cavities on the ocean floor.

Television

The market for underwater television equipment for deep submersibles appears, at least for the present, to have been cornered by the fast-growing Oceanographic Engineering Corp. of La Jolla, Calif. Two of the company's cameras have been operating on the Trieste for over two years and a third was recently mounted on a remotely con-

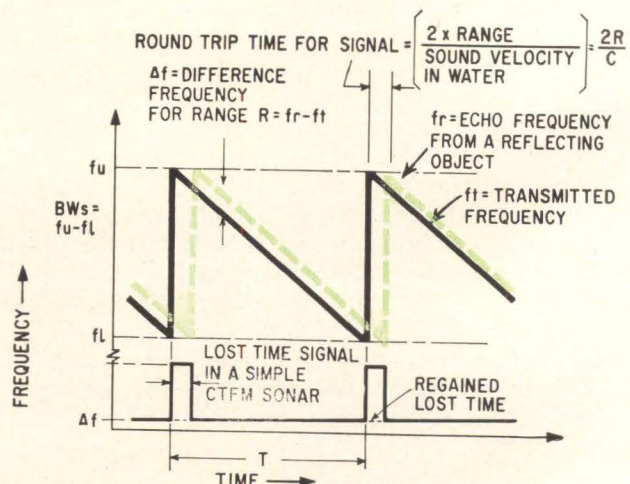

Plot of frequency against time illustrates basic principles of continuous-transmission frequency-modulated sonar.

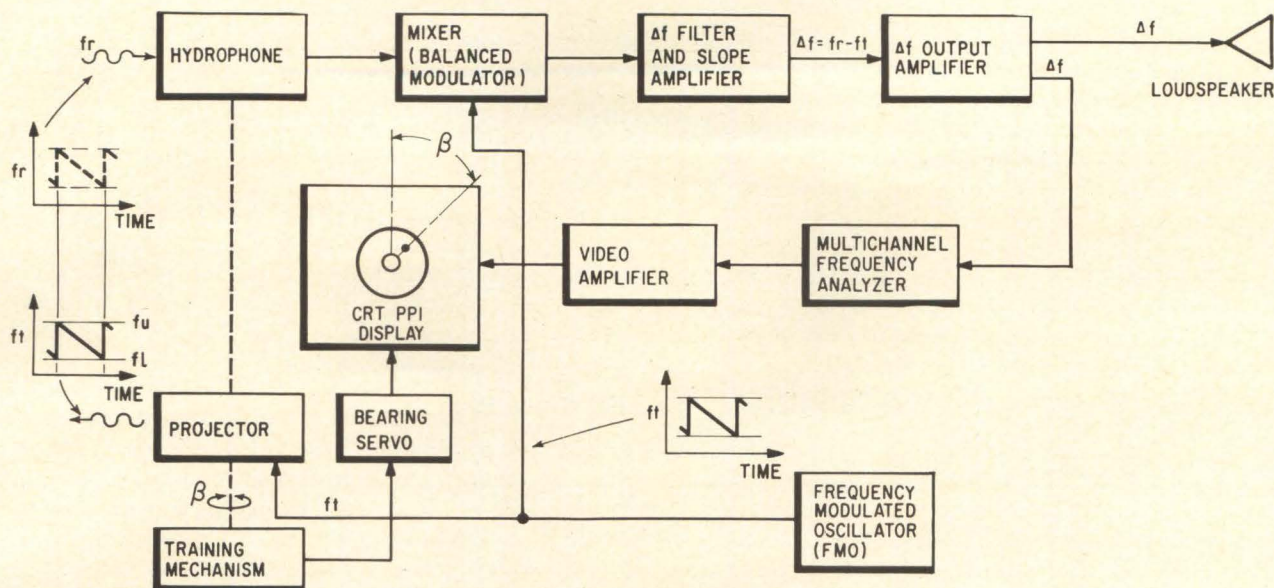

Difference between transmitted and received frequencies is used in CTFM (continuous-transmission frequency-modulated) sonar to determine the range to a target.

trolled manipulating arm aft of the gondola. This television camera provides the operator with a close-up of objects being lifted from the ocean floor.

One of the Trieste's original cameras has a pan-and-tilt mechanism, enabling it to rotate through 360° while the other is permanently aimed directly forward.

The Moray carries a boom-mounted camera which, when submerged, serves as a viewing port for the otherwise blind submarine. When near the surface, the Moray uses the camera as a periscope. Both the Aluminaut and the Alvin are using two cameras and two monitors. Oceanographic Engineering reports that its completely transistorized cameras are the smallest available, withstand pressures to 40,000-foot/depths, and are completely self-contained. A single cable leads from the grounded camera case, which is 22 inches long and 3½ inches in diameter. Mercury-vapor arc lamps

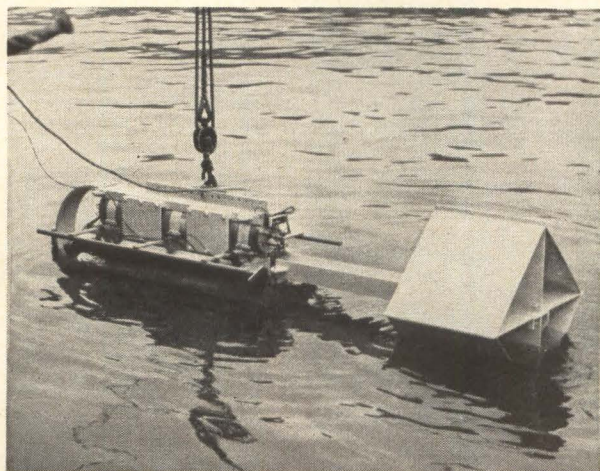

Scanning Ocean Bottom Sonar was used in the search for the Thresher. Basically it is a side-looking pulse sonar.

are furnished with the camera installations. The lamps generate light in that portion of the spectrum to which the vidicon is particularly sensitive, and are packaged to withstand extreme pressures.

Sea lab

Thus far, man has ventured into the sea only on an in-and-out basis. This summer he plans to go and stay a while. Three Navy men and a medical officer will descend 193 feet this summer off Bermuda in a 40-foot laboratory. There, atop an extinct volcano called Plantagenet Bank, they will live under pressure and make frequent trips outside their lab, wearing scuba gear.

They will breathe a mixture of oxygen and helium. The nitrogen in ordinary air complicates a diver's life. Nitrogen bubbles in the blood cause the bends; the gas itself can cause nitrogen narcosis or rapture of the deep—a feeling of euphoria that can make a diver careless, often with fatal results.

Donald Duck effect

Use of helium, however, will create several problems. For one thing, it conducts heat better than does nitrogen. To keep the crew comfortable, electrical heaters will maintain the lab at 92° F.

A greater problem is the phenomenon known as helium speech. Normal speech depends for its intelligibility on the resonances of the mouth, throat and nasal passages. Since helium is lighter than oxygen, it changes the resonant frequencies of these cavities, makes voice frequencies shift upward, and gives the diver's voice a high-pitched, Donald Duck effect. The effect gets worse as the diver goes deeper.

The Applied Science Lab at the Brooklyn Navy Yard in New York is trying to solve the problem electronically—perhaps by heterodyning the voice

frequencies downward. The sea lab will be fitted with microphones to study the effects of helium speech. There will also be an air-filled "telephone booth," entered through an underwater trunk from which divers can talk to the surface in their natural voices.

The challenge

For more than 100 years, man has been systematically studying the mysteries of the oceans. Yet he knows pitifully little about them beyond the first few hundred feet down.

However, the study of the oceans has become a matter of national survival. An attack on the United States could come either from above by jet bombers and intercontinental ballistic missiles or from under the sea by missile-firing submarines.

The Soviet Union possesses over 400 submersibles. Most of them are conventional diesel-electric vessels, and many are relatively short-ranged coastal types. But, despite some serious shielding problems that reportedly "burned up" three crews aboard the icebreaker Lenin, the Russians do have the capability of building and operating naval power reactors. They could build, and perhaps have built, nuclear submarines.

They have also launched missiles from submarines. We know they have launched subsonic missiles from surfaced conventional submarines. There is a strong presumption that they have also launched ballistic missiles.

Thus far there is no evidence that the Soviets have equipped nuclear submarines to fire ballistic missiles either when surfaced or when submerged. But they are undoubtedly hard at work on a program comparable to our Fleet Ballistic Missile program. And their progress to date, although it does not yet constitute a critical threat, should nevertheless be a warning.

Antisubmarine warfare is a poor third in U.S. military spending, coming well after retaliatory missile and preparations for conventional limited warfare. Our failure to commit our resources wholeheartedly into defense against submarines stems not from parsimony nor from a failure to recognize the threat. It stems, rather, from a sense of futility.

Ineffective defense

Conventional antisub measures employing destroyers, destroyer-escorts, helicopters and fixed-wing aircraft have only limited effectiveness against conventional submarines and are useless against nuclear-powered vessels.

Nuclear-powered subs are probably the best defense we have against other nuclear submarines. They have yet to exercise against each other in a conclusive, or even meaningful, fashion.

Technical advances in the design of long-range sonar, and of sonar with the capability of effectively identifying targets, appears to bring only modest incremental advances in the state of the art. More exotic detection systems, such as the elusive blue-green laser, are far off, and their tactical

usefulness has yet to be proved.

The plain fact is that we do not yet know enough about the undersea world to establish any adequate defense against the number two threat to our national security. We—and perhaps our potential adversaries too—are operating nuclear submarines beyond the reach of our detection gear or of search-and-rescue apparatus if anything goes wrong. Our limitations in this latter respect were demonstrated during the search for the remains of the nuclear submarine Thresher after her loss off the New England coast last spring.

Expensive ignorance

The key to effective antisubmarine warfare is a thorough knowledge of the environment deep in the ocean. This knowledge can be acquired only through an oceanographic research program. And until we know enough about the oceans, including how to get into and use the sound channel or even get below it, our antisub program will remain an exercise in futility and we will continue to push a lot of money down a large and deep rathole.

But from an intimate knowledge of the deep-ocean environment there cannot help but come a more profound understanding that will help engineers design effective underwater search and detection equipment, equipment that will complement our early-warning radar and give the "two-if-by-sea" warning in this age of nuclear-powered submarines armed with nuclear-tipped ballistic missiles.

This is the greatest challenge of the deep frontier.

Acknowledgments

The authors thank the following individuals and their organizations for their assistance in making this article possible: Dr. Hugh McClellman, Office of Naval Research; Gilbert Jaffee, director of the Navy Oceanographic Instrumentation Center; Dr. W.C. Jacobs, National Oceanographic Data Center; W.E. Maloney, C.H. Cline and Ed Ridley, Navy Oceanographic Development Division; and Robert G. Walden, Woods Hole Oceanographic Institute.

Electronics

A cure for transistor breakdown, page 66
Solid state modernizes boiler control, page 85
Cutting costs of thin-film manufacture, page 94

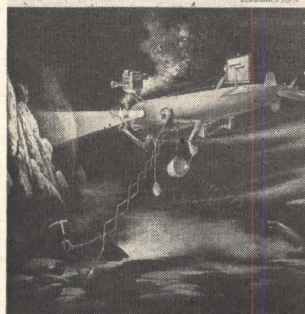

Front cover

The moray is a large, savage eel that inhabits warm seas. It's also the name of a deep-diving manned submersible being designed at the Naval Ordnance Test Station in China Lake, Calif. Our painting, by Charles Nardone, art director of the test station, points up the Navy's role in various aspects of underwater research.

Reprints of this report are available. Use the reader service card at the back of this issue.

Lab standards for your most critical requirements

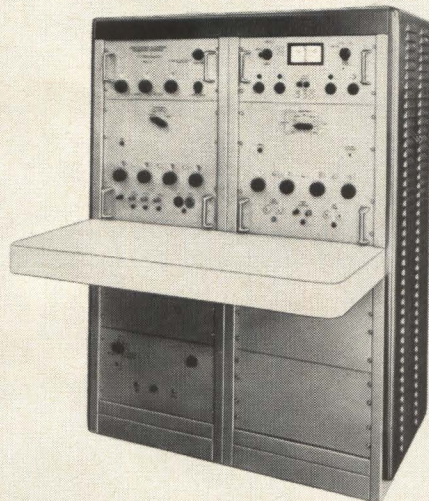

Model 172 Variable Frequency Calibration Console—provides current and voltage output within $\pm 0.05\%$ of reading, up to 2500 cps. Wattage outputs within $\pm 0.1\%$. Variable frequency output from 50 to 10,000 cps. Short term stability 0.01%.

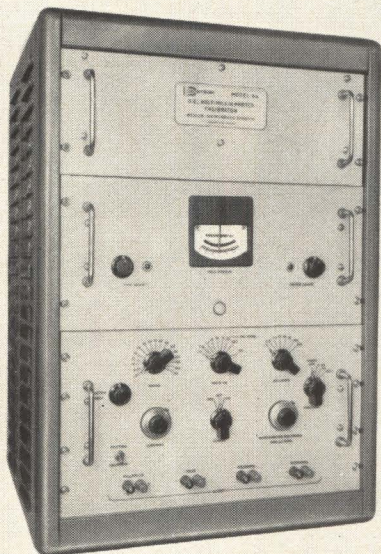

Model 64 DC Voltage Calibrator — gives simple, rapid and accurate DC instrument calibration. Automatically divides range into as many as 15,000 equal parts. Accuracy within $\pm 0.05\%$ of indicated value.



Models 1493-1 1494-1 Bolometer Bridge and Reference Current Generator—provides automatic measurement of microwave power with $\pm 0.1\%$ accuracy. Supplied for standard rack mounting or with individual cases.

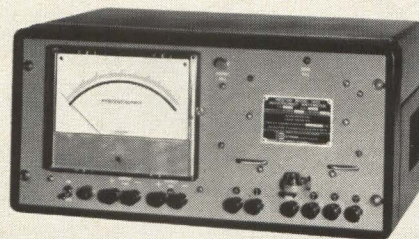

Model 1483 Inductronic Wattmeter — a primary standard for measuring AC/DC power. Transfer accuracy DC to AC within 0.01%. Excellent frequency range. DC output to drive strip chart recorders.

Model 1572 AC/DC Volt-Ammeter — self-contained, portable instrument with digital readout. Measurement accuracy within $\pm 0.05\%$ of indicated value. True RMS response for AC measurements. Self-contained Zener reference.

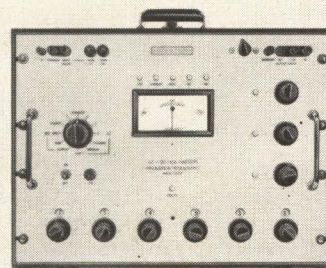

Model 1573 Direct-Reading AC/DC Thermo Voltmeter — usable on DC and AC to 50 kc. Accuracy: 0.015% on DC, 0.025% on AC, 0.005% as a transfer standard. Range: 1 to 1,000 volts, 6-place readout. Voltmeter, transfer standard, and DC reference for digital voltmeter calibration.

world's standard in measurement and display



WESTON
INSTRUMENTS & ELECTRONICS

614 Frelinghuysen Ave.,
Newark 14, New Jersey
Division of
Daystrom, Incorporated

Circle 85 on reader service card

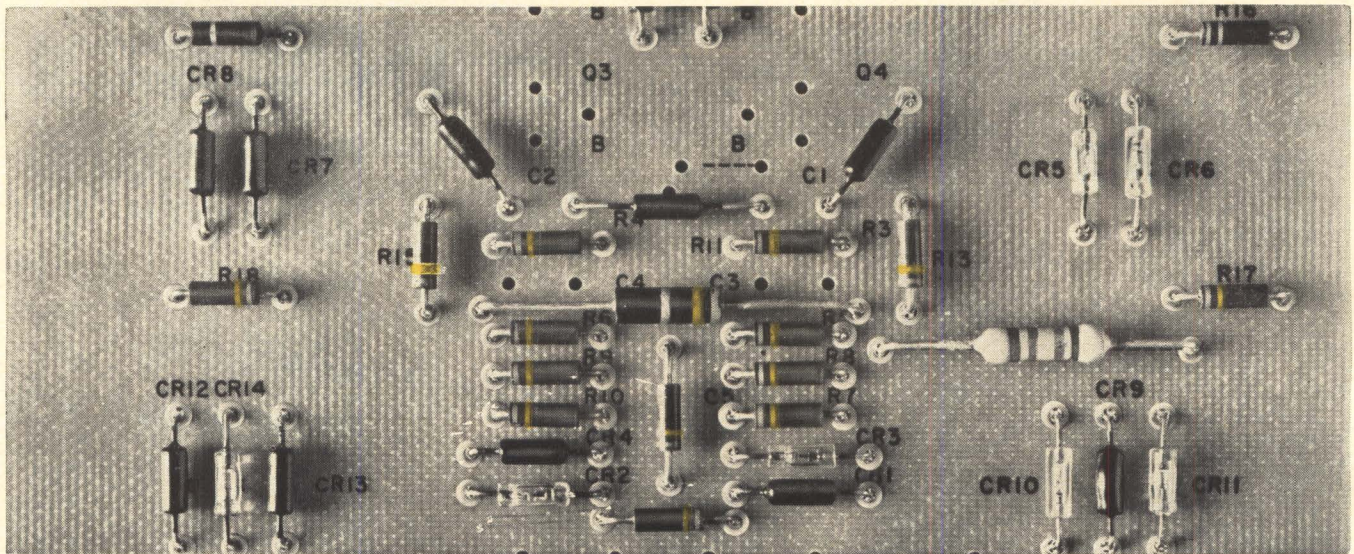

45 hours . . . \$750.

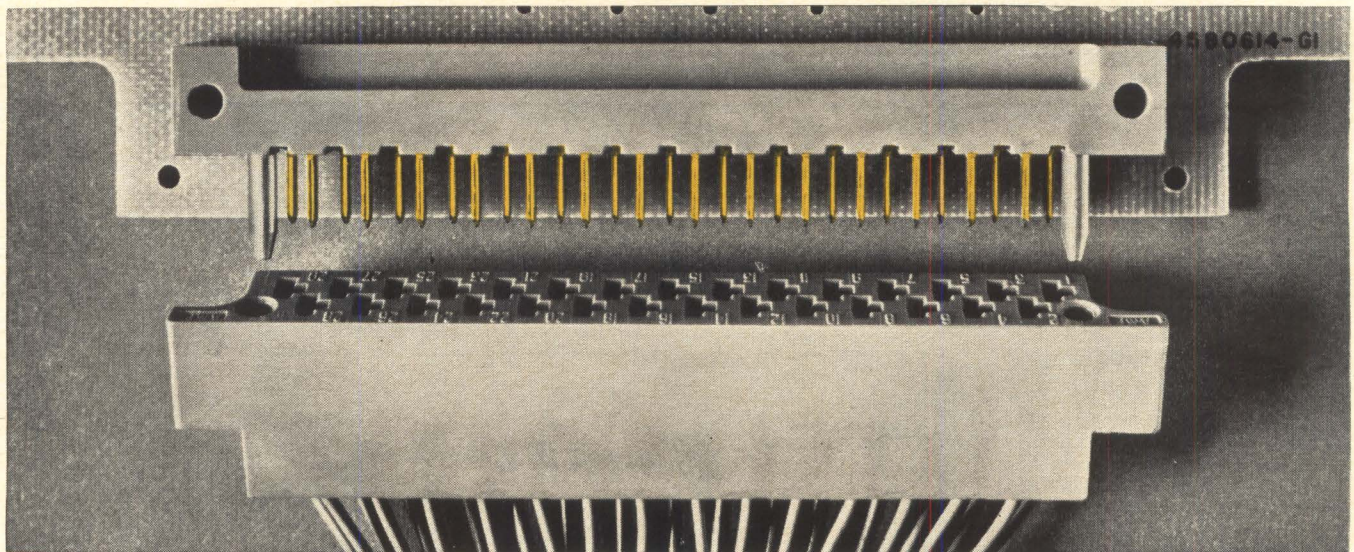

Doesn't it deserve the best connector ?

You bet it does! And the best going is the AMP-BLADE® Connector you see above. Here's why:

Staked Down Construction. Each male tab is mechanically staked to the board. This rigid staking eliminates all board warpage problems. Joins male housing solidly to board. Assures intimate contact between board paths and male contacts.

Molded Male Tab Housing. Male tabs, encapsulated into the housing, assure correct alignment with receptacle contacts. This eliminates any possibility of mismatching, leading to plating wear, environmental problems and poor contact.

Large Areas of Contact. Receptacle contacts provide 3 "long" areas of contact with male tab. This eliminates "rocking" and plating wear. Special contact spring assures uniform contact pressures. Stabilizing boss controls receptacle float in housing.

Crimp, Snap-in Design. Receptacle contacts are terminated automatically at rates up to 4,000 per hour. Precision crimping with automatic machines assures

unvarying mechanical and electrical uniformity, lowest possible installed costs. Snap-in assembly means no unused contacts. You pay for only those contacts you need.

Gold Plating. .000030" gold over .000030" nickel contact plating is standard. Never an option or extra. Control by X-ray measurement assures uniformity in thickness and prevents metal creep and oxide buildup.

You can count on AMP-BLADE Connectors to deliver smooth, uninterrupted current flow in your most advanced solid state designs. But don't take our word for it. Find out for yourself. Our test reports tell the story in facts and figures that make interesting reading for any design engineer. Send today for your free copy.



AMP products and engineering assistance are available through subsidiary companies in: Australia • Canada • England • France • Holland • Italy • Japan • Mexico • West Germany

*Trademark of AMP INCORPORATED.

Probing the News



Moscow's metro system carries 3.5 million passengers daily and 4 million on Sundays and holidays. There are few cars in Moscow and motorcycles are just coming into vogue.

Industrial electronics

Commuter and computer

Mass transit is a problem the world over. Now electronic systems promise a better day for straphangers in Moscow, London, Paris and San Francisco

By Louis S. Gomolak

Industrial Electronics Editor

When President Johnson signs the Mass Transit Bill the United States, at long last, will get on the electronic-train track. While it's true that the Soviet Union, Great Britain, Japan, Germany and France have been experimenting with various kinds of train automation since

1956, the equipment we'll start with is more advanced than anything going.

Transit systems around the world may differ but the goal is identical—to get more train riders, to transport them faster and more comfortably and to operate the trains

with a minimum of power consumption. The driverless or robot train is not the goal; neither labor unions nor passengers are ready for the black-box driver.

I. San Francisco trials.

Earlier this year the Bay Area Rapid Transit District in San Francisco awarded contracts to four electronics control manufacturers who will produce and install equipment on a test track.

Each of the four companies has proposed a different method of passing direction and control signals back and forth between the high-speed trains and the control computer.

The General Electric Co. will use radar as an anti-collision device. Carrier and data-link communications will be used for safety and operational control.

The Westinghouse Electric Corp. plans to use a wire pattern between the train rails to communicate signals to an inductive receiver in the train.

The Westinghouse Air Brake Co. is proposing high-frequency voice and data communications systems between the control room and trackside substations and trains.

The General Railway Signal Co., a unit of the General Signal Corp., plans a system that will be based in fixed signal zones. Signals will be sent through the tracks.

Unlike the systems in use abroad, the four proposed for San Francisco will use computers to control train scheduling (ninety seconds apart during rush hours), train dispatching, routing and speed control and running time. Under computer direction, trains will stop within six inches of designated points at each station.

Each test system at San Francisco will include three separate subsystems. One spaces the trains, another supervises and adjusts operating schedules, and the third directs over-all train scheduling.

Pleasure trip. Although operators will be aboard, they won't have anything to do but enjoy the ride

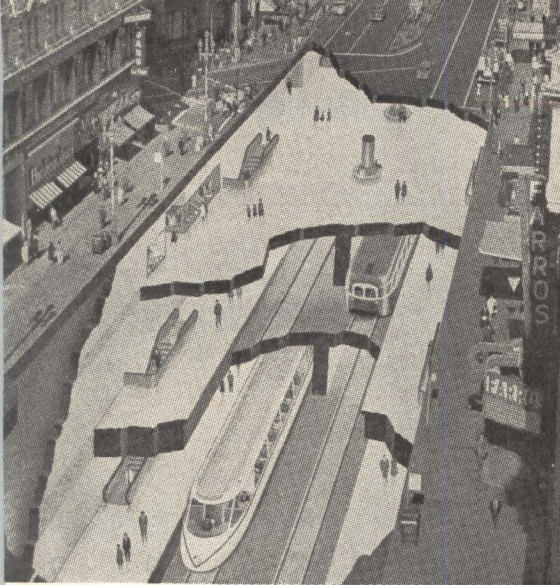

San Francisco's new rapid transit system will be the first American subway built in almost half a century.

at speeds up to 70 miles per hour.

The control system will monitor and direct every train at every instant. In March of 1965 the test track will only be four miles long but by 1968 it will cover 75 miles.

Computers will do the bookkeeping. They will handle cash fares as well as a credit-card fare system with monthly billing.

The San Francisco system is the first breakthrough in American mass transit in almost half a century. The only other major system to be tested soon is in Pittsburgh; it will use rubber-tired vehicles on elevated concrete roads. A central command room, equipped with a computer and closed-circuit television, will direct the electrically powered trains by remote control. The Westinghouse Electric Corp. is building the system for operation in the fall of 1965.

Both the San Francisco and Pittsburgh trials are being financed under grants, made before the passage of the Mass Transit Bill, by the Housing and Home Finance Agency. The cost of San Francisco's four miles of test track is \$4,880,000.

II. In Great Britain

Last April full-scale trials of automatically controlled commuter trains got underway in Great Britain. The electronic controls of the London system are in trackside boxes and the signals are pre-set for the optimum running of individual trains.

The trackside communications units are linked with relay rooms at each station. The automatic safety and operation command signals are transmitted through the tracks. The signals are picked up by the train through induction coils mounted in the front of each train. The various speed codes are checked by a filter network and passed to the appropriate control relay.

A train accelerates from a station until it hits a signal section; there it receives the pre-set 15 kilocycle-signal that cuts off the motors and the train coasts to a stop at the next station platform. Another signal actually brings the train to a complete stop.

The British train signaling and control equipment was made by the Westinghouse Brake and Signal Co., Ltd. at its Chippenham works in England.

III. Soviet nyet yet

In the Soviet Union the Moscow metro, or subway, carries about 3.5 million passengers a day; as many as 4 million on Sundays and holidays. The Sunday transportation pattern differs from ours because, generally, Russians don't own cars, and motorcycles are just coming into vogue.

To handle more passengers, metro safety engineers want to increase top speeds by ten miles an hour—from 46 to 56—and reduce rush-hour train separation from 90 to 70 seconds. The Russians say this cannot be done without automatic electronic control.

Igor A. Fialkovsky, chief safety

engineer of the Moscow metro system, says that fully automatic operation of metro cars has been given a top priority by Communist Party officials. But, he adds, this priority is superseded by track expansion construction. Major automatic control expenditures will come in 1967, he feels.

Moscow experiment. Metro engineers have been testing an automatic train on a five-and-a-half-mile-long test track in Moscow since 1962. So far, Fialkovsky says, the system is not up to snuff, though it's improving. But, he adds it's not good enough yet to show to the foreign press.

The test system includes a pre-programmed profile of the route that is fed into the automatic driver. The profile considers the slopes in the track, curves, station locations and regulates motor power accordingly.

What seems to be a simple analog computer aboard the train alters the pre-programmed profile according to the received signals. It will nullify a plus signal from the profiler if, say, another train is stopped on the slope for which the plus or increased speed signal is given. The Moscow system, like an experimental one in Leningrad, is fully transistorized.

Fialkovsky admits that the test system is a bit complicated for general use, and efforts are being made to simplify it.

Man or monkey? A shortcoming of the inductive type of system used in the Moscow tests is that it can't tell if something on the track is a man or an animal. "It



A five-kopeck piece must be inserted first or an electric-eye system will prevent passengers from entering the Moscow metro.

shouldn't be a problem with people," Fialkovsky said with tongue in cheek. "Soviet citizens don't go out on the tracks. Once we had a fox on the rails—he perished. Another time there was a monkey in one of the tunnels, and the engineer managed to stop in time. Thought it was a child."

IV. West Germany

West Germany's federally-owned railroads, the Deutsche Bundesbahn (DB), are turning to electronics to stop the decline in passenger traffic and revenues, to ease personnel shortages, and to meet increased competition from trucks and airlines.

Progress is slower in electronic control of subways. The nation's only two subway systems, in Berlin and Hamburg, do date from postwar years but German subway planners, intensely active in the country's ten largest cities, are not keen on electronic "brain" trains. Their reluctance may be traced to a collision between a Hamburg subway train and a flatcar laden with I-beams a few years ago. Forty people died and blame was placed, partially, on the failure of an automatic safety-signal.

Signaling problems. The high-speed passenger trains call for new approaches to signaling systems—now the main problem. At 125 miles per hour the required braking distance goes up to over 8,000 feet; considerably more than the present 3,000 feet needed at 65 miles per hour. Trains traveling at high speed must rely on signals picked up without variation, disturbances or delays—conditions that electronic devices can handle but cannot always be met by electro-mechanical signaling.

Siemens & Halske AG, a giant producer of electrical products, and the Bundesbahn have jointly developed one type of safety and control system providing continuous wireless communications between trackside signalers and moving trains. The system uses cables, laid between the tracks, to transmit distance and position signals in a time-multiplex process to an inductive coil aboard the train.

The signals are analyzed and then fed to the train-operator's console where they are displayed as

optimum speed. The operator must keep his train's speed below the displayed figure or automatic braking will start.

The Siemens company already has two of these systems in day-in, day-out operation in Belgium.

V. Tokyo to Osaka

The Tokaido line of the Japanese National Railways, running between Tokyo and Osaka, plans to begin automatic operation this fall. The Japanese will use single-side-band communications between trains and trackside transmitter-receiver units. The carrier frequency, synchronizing with the traction power frequency, will be modulated by the signal frequency and transmitted through the tracks. Power for the motors will be manually controlled and braking will be automatic.

To prevent rear-end collisions, inductive signalers will be installed at certain points along the track. If a train should enter a track section that is already occupied, the brakes are set immediately.

The equipment is completely transistorized and housed in 29 automatic traffic control houses spaced evenly along the 515 kilometers of track. The houses are all connected back to a central control room in Tokyo. The center controls the signaling equipment at individual houses, each house controlling, with pre-set signals, its specific section of track.

VI. En France

The Societe Nationale des Chemins de Fer, France's national railway company, has been working on automated trains for several years. It has developed a remote control system for suburban trains that uses a single locomotive to pull the train in one direction and push it on the return trip. This is done to avoid turn-around and other expenses. On the return trip the engineer operates the locomotive—now at the rear of the train—from a cab equipped with frequency-modulated transmission equipment. From his cab, he controls the rear locomotive, using an f-m control system with a 160-megacycle carrier-frequency.

The Regie Autonome des Transports Parisiens (RATP), which runs



Railroads in Germany are pushing hard for electronic control.

the French metro system is also studying automatic train-drives and signaling, but says it is not far enough along to release details. However, it has been said that one reason for silence now could be the large number of engineers and train-starters who would be replaced by automation. Politically, this is a sticky subject.

According to reports though, the RATP has been studying a robot-conducted subway train since 1951 and testing it since 1956, on a short length of track. The train observes speeds and safety signals; it stops and starts itself, apparently using a pre-programmed routing similar to the Russian system.

VII. The Transit Bill

The bill authorizing \$375 million in U.S. grants will help cities modernize or rebuild the antiquated mass-transit systems familiar to every commuter. San Francisco and Pittsburgh are in the vanguard.

The harassed commuter may have a long wait before things get better but at least, while he's staring at the car bumper ahead of him on a crowded highway, he can dream.

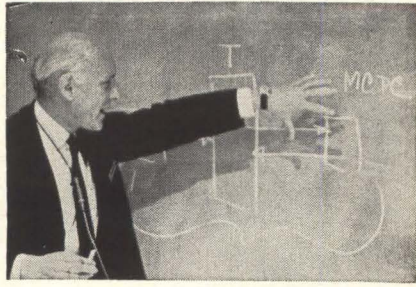

Cybernetics research has led to programs that enable computers to win at checkers. Heinz von Foerster explains how it is done.

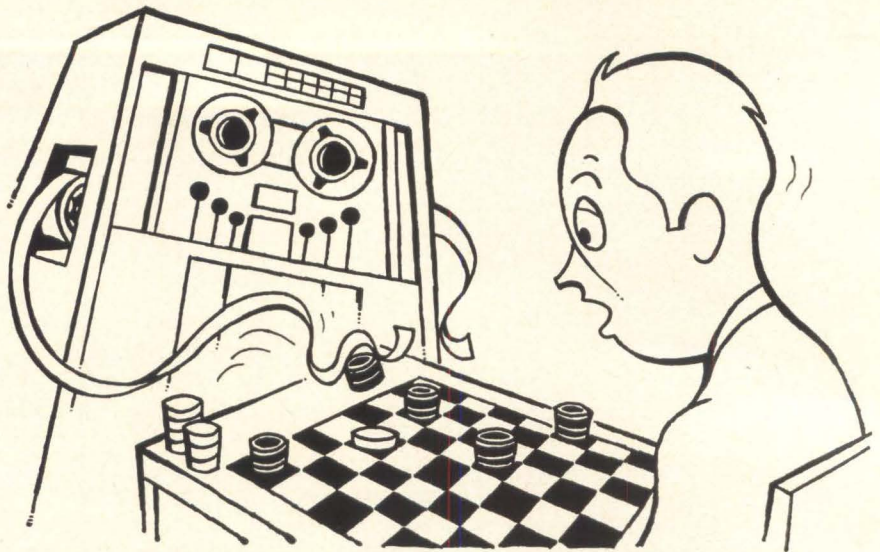

Advanced technology

Machines that think like people

We don't have one yet, but cyberneticists are encouraging work in adaptive systems

By George V. Novotny

Advanced Technology Editor

Today's digital computers can spew out a million bits in a second. But when it comes to solving certain kinds of problems, they are idiots compared to a schoolboy.

Unless a new generation of computers is developed soon, scientists will be unable to cope with increasingly complex problems.

The boy, for example, can recognize a playmate in a flash. How to make a computer do just that has baffled computer designers for years. The bit-by-bit processes employed by computers are hopelessly inadequate.

New techniques are needed. The study of these is one of the functions of cybernetics, an interdisciplinary field that is experiencing a renewal of interest after years of disfavor.

I. Hope or dream?

Proponents of cybernetics have developed a lot of impressive theory since the late Norbert Wiener, of the Massachusetts Institute of

Technology, published his book, "Cybernetics," in 1948. But cybernetics has fallen into disfavor because, while it has influenced system design, its theory has not been directly reduced to hardware.

Some critics consider cybernetics to be as occult as astrology. Others simply note that the theories have failed to deliver.

Influence. Not so, say the handful of top scientists in the field who gathered last month at Cloudcroft, N. M., to sum up and evaluate their recent work. They admit the lack of "cybernetic hardware" but their thinking has already influenced systems designers and advanced computer programming, and has triggered work on a variety of pattern-recognition and adaptive control equipment.

The Air Force backs up their claim. Through its office of Scientific Research, it sponsored the symposium at Cloudcroft and underwrites almost \$1 million worth of cybernetics research a year. Pos-

sible military applications include machines that can read aerial photographs and find targets, systems that can identify aircraft, automatic adaptive controls for sophisticated weapons systems, even a new breed of computers to analyze the complex strategy of modern warfare.

II. What is cybernetics?

Cybernetics is hard to define. It deals mostly with ways of making machines, computers and systems operate similarly to the human brain or other biological systems—not because cyberneticists want machines in their own image, but because brains are far more efficient than computers in solving certain problems.

To show the need for cybernetic equipment, W. Ross Ashby, a cybernetics pioneer at the University of Illinois, offers the following example.

A relatively simple problem in pattern recognition is to tell whether a single pattern, out of all the patterns that can be formed by a square matrix of 400 lamps, has some given property.

Toward infinity. The number of different possibilities is 10 raised to the power of 10^{120} —a figure vastly larger than any known astronomical number. No computer, present or future, could possibly run through all the combinations. After all, only some 10^{23} microseconds have elapsed since the earth solidified, and the visible universe contains only about 10^{73} atoms.

Actual problems, such as recog-

When reliability counts, count on MYLAR®!

When you are recording or processing data, you want to be able to depend on your tape without worrying about it. If your tape is on a base of "Mylar"*—you can! "Mylar" is strong (a tensile strength of 20,000 psi). "Mylar" is stable (unaffected by temperature or humidity changes). "Mylar" is durable (no plasticizer to dry out or become brittle with age). "Mylar" is proven in use (a ten-year record of successful performance). When reliability counts, count on "Mylar".

*Du Pont's registered trademark for its polyester film.

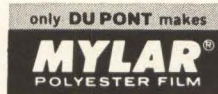

BETTER THINGS FOR BETTER LIVING THROUGH CHEMISTRY

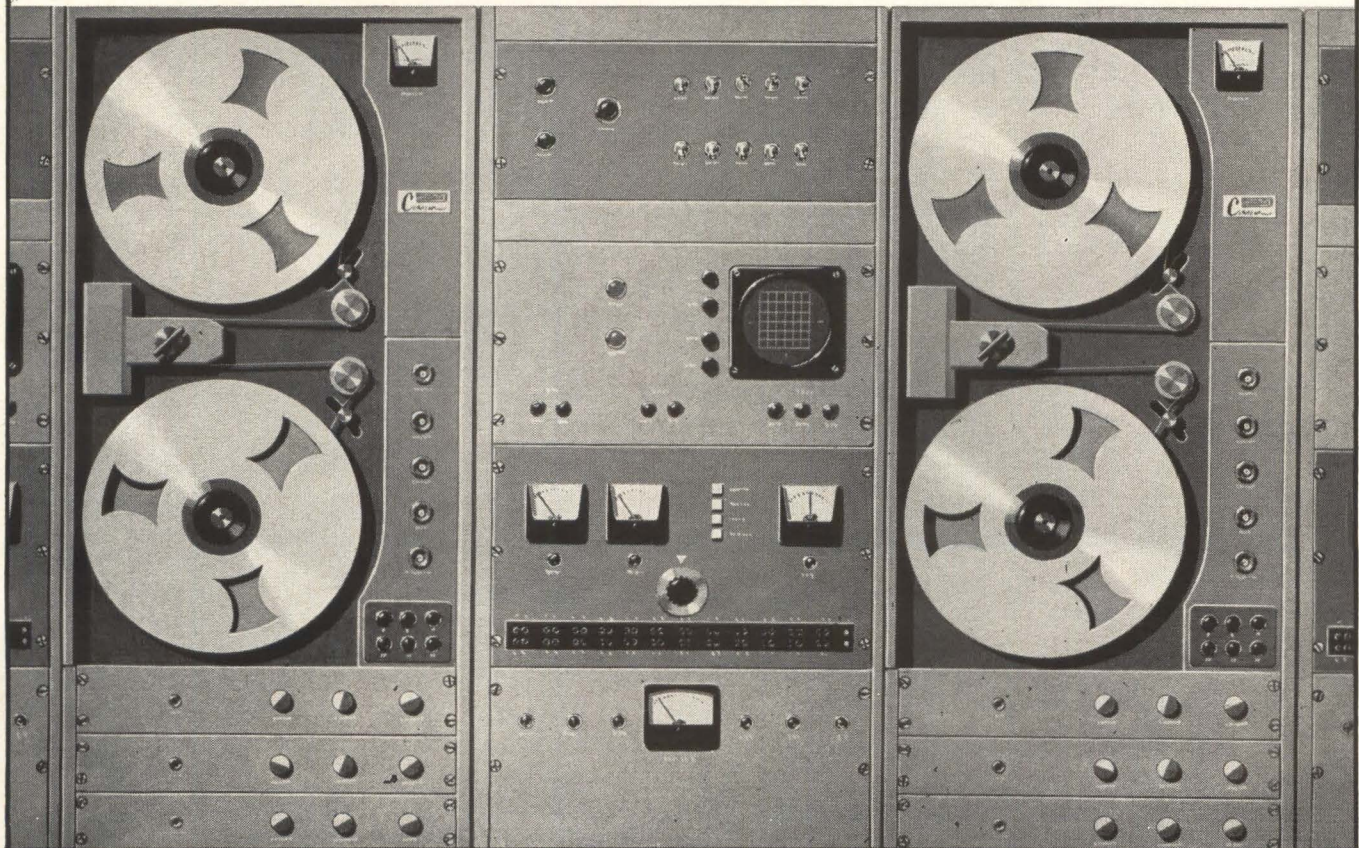

You expect it first from API

1% tracking
is now standard
for API taut-bands
—at no extra cost!

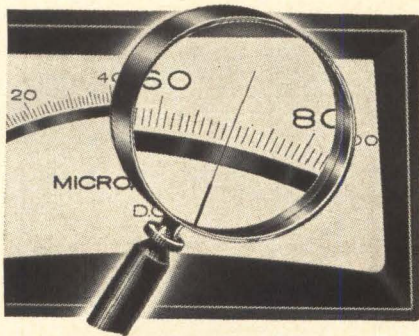

You get an inherently better meter—and it costs us less to make it. Hence it'll cost you less too.

That's the net result of exciting design and production improvements in taut-band panel meters now being offered by Assembly Products. Effective April 1,

**When you order
an API taut-band meter,
you automatically get
±1% tracking**

The only exceptions will be extremely sensitive and extremely small meters. Please ask about these.

**1% tracking gives you
better measurement**

1. You can measure very precisely the fractions of a full-scale signal.
2. Therefore, as long as you know (and can control) the current that makes the meter read full-scale, you will read very accurate absolute values anywhere on the scale.

Ask for Bulletin 38



Assembly Products, Inc.
CHESTERLAND, OHIO • AREA CODE 216 HA 3-3131

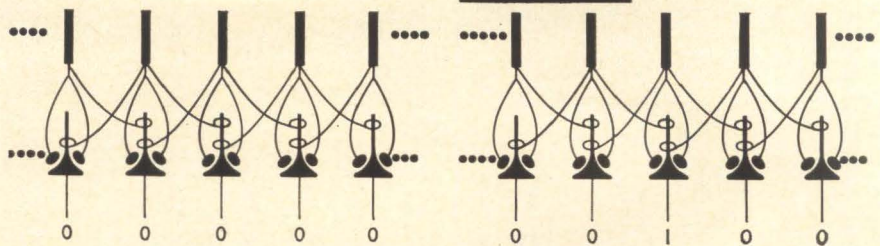

Animal systems reduce input information to a workable amount. In the human retina, only one retinal rod tells the brain it sees the edge of an object. Hair-like connections inhibit neighboring rods.

nizing man-made features—the shadow of a missile, for example—in reconnaissance photos, or visually identifying a human face, are much more complex than this.

Proof of the numbers barrier was developed by H. J. Bremermann of the University of California. He proved that no computer made of matter can ever process more than some 10^{47} bits per gram per second.

III. Heuristic programing

Ashby suggests that biological systems solve problems by first breaking them down into smaller steps. This approach, which attacks the exponent of the combinatorial numbers, is called “tree pruning” because it cuts branches off the tree of possibilities.

Computer programs that can do this are called heuristic, from the Greek for “discover.” Such programs search for an acceptable solution, not necessarily the best one. By contrast, an algorithmic program, the type commonly used in computers, finds the best possible solution by a brute-force analysis of all the possibilities. This may require an impossibly huge expenditure of time and equipment.

One heuristic rule is to work backward from a supposed solution to known premises. This is presumably how a human recognizes a known face.

Practical use. Heuristic programing is the object of considerable investigation. At the Carnegie Institute of Technology, it is being studied for balancing production lines. Its use in a computer to solve calculus problems has been studied at the Lawrence Radiation Laboratory in Livermore, Calif.

Heuristic programs also include those of learning machines, adap-

tive and conditioned-reflex programs, and pattern recognition.

“Ten years ago,” Ashby says, “the question of whether computers could perform certain human-like tasks, and how, could have been raised. Today we know definitely that a computer can do anything a human brain can do—or more. The problem is how to do it without exceeding Bremermann’s limit.”

IV. Self-organizing systems

Heinz von Foerster, head of the Biological Computer Laboratory at the University of Illinois, suggests that self-organizing systems, such as man, tend to develop along heuristic lines.

There are, for example, two raised to the power of 10^{20} possible forms of the human brain. Since no more than 10^{11} brains have existed, the brain’s development cannot have been random, but must have tended toward a desirable form from the beginning.

Man, like any adaptive system, copes with his surroundings by developing suitable transducers,

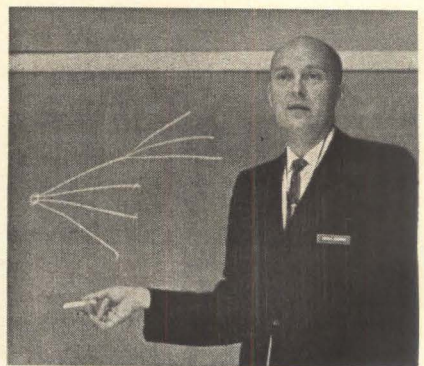

David Johnson, of the University of Washington, thinks present computers may be limiting scientific investigation because scientists tend to tackle problems that present computers can solve.

which are analogous to the engineer's impedance-matching networks—maximum power transfer occurs between equal impedances. Simple mechanical tools, such as hammers or pulleys, match man's limited physical ability to the "impedance" of the task he wants to perform.

Similarly, Von Foerster says, a computer—whether it be a slide rule or a complex chess-playing machine—matches man's limited brain capacity to the problem to be solved.

Man cannot know how difficult a problem is until he meets it and solves it. The problem-solving computer must be able to measure the difficulty as it goes along, and match it by automatically adjusting its own internal organization.

This is one way of looking at adaptive systems.

Playing checkers. For example, A. L. Samuel of the International Business Machines Corp. devised a program that allowed a computer to learn how to play checkers. With his electronic protege, Samuel defeated R. W. Nealey, the checkers champion of Connecticut.

By following adaptive and learning procedures, computers may attain higher "intelligence" than man, Von Foerster suggests. In the future, intelligent computers may be able to extend man's intellectual ability just as mechanical tools have extended his physical strength. This would require adaptive and learning procedures, not merely faster arithmetic operation.

One vital requirement of an adaptive system is that it handle only a workable amount of information. The human eye, for example, receives about 4×10^9 bits of information a second, but reduces the amount going to the brain by the technique illustrated.

Allen Newell, of the Carnegie Institute of Technology, wants inductive capacity built into commercial and scientific computers. This would be expensive at first, he concedes, but the initial costs would be absorbed as computers attain an order-of-magnitude increase in capability every five years or so. Newell has taught a computer to deal with symbolic logic and chess-playing programs, as part of his research in inductive programming.

the new standard
in ultra portability...

PEMCO 110 general purpose data recorder



**17 lbs-35 watts-dc to 100 kc
fm and direct-ac or dc power**

The Pemco Model 110 general purpose data recorder sets a new standard in ultra-portability for high-performance instrumentation recorders. Less than 1/5 the size, weight and power consumption of most conventional portable recorders, the Model 110 boasts a signal to noise ratio of 40 db FM and 35 db Direct, long term speed stability of better than $\pm 0.5\%$ from a 22-34 VDC input, and FM center carrier drift of only 0.1% over a full reel of tape.

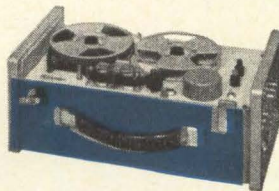

Shown above with the Model 14 rechargeable Power Pack, the Model 110 offers standard 2-speed drive over a range of $1\frac{1}{8}$ to 30 ips, with 3-speed ac and 4-speed dc available. With optional converter, the model 110 easily operates from 12v dc, in addition to the standard 28v dc or 117v ac. $\frac{1}{4}$ ", $\frac{1}{2}$ " or 1" tape widths accommodate 2, 7 or 14 standard IRIG channels respectively. Interchangeable plug-in FM and direct record/reproduce electronics.

Entirely compatible with double bandwidth and IRIG standards, the PEMCO Model 110 offers lab precision for extreme and remote environments. Ask your PEMCO representative or write us direct. We'll be pleased to send complete technical and operating data.



**PACIFIC
ELECTRO
MAGNETICS**

942 Commercial Street
Palo Alto, California • (415) 321-1177

Cow-Palace closeups

New gear, such as electron 'telescopes' and black-light audio, help networks cover the Republican convention

By Alexander A. McKenzie

Communications Editor

Besides top Republicans from all over the country, the G.O.P. national convention is attracting to San Francisco such television-broadcasting innovations as electronic "telescopes" and black-light audio systems.

The three major networks are determined to make this year's convention coverage the best ever. They are zooming in on problems that have plagued electronic journalists ever since the creepy-peepy and Dwight D. Eisenhower became national favorites in 1952.

I. Conquest of space

One of the biggest problems in

a vast arena like the Cow Palace is distance. The American Broadcasting Co. is using several portable Newschiefs, self-contained camera-transmitter units built by Sylvania Electric Products, Inc., a unit of the General Telephone & Electronics Corp., and tried out earlier this year at the Winter Olympics in Innsbruck, Austria.

The National Broadcasting Co. has a new ultraportable television camera with a separate electronic range-finder that insures getting the desired picture. This unit is much lighter than the creepy-peepy of 12 years ago.

Smaller and lighter. Because

modern, smaller components and compact construction allow more circuits to be squeezed into less space and weight, the synchronizing generator's master oscillator can be operated automatically from a self-contained crystal, and the camera can go anywhere within 1½ miles of the pickup receiver. If a 60-cycle signal is available, the generator can be locked into that and annoying roll-over of the viewer's television screen can be avoided.

The Columbia Broadcasting System is using a unique small television camera originally built by the Fernseh Co. of Germany and modified at CBS Laboratories, Inc., to use a Plumbicon picture tube eight inches long and 1¼ inches in diameter, made by North American Philips, Inc., a unit of Philips Gloeilampenfabrieken N.V. of the Netherlands. The Plumbicon has the same general characteristics as the larger, more expensive image orthicon. However, its high sensitivity, linear characteristic and satisfactory response to low illumination levels are advantages over the small vidicon.

Versatile mobile units, employed by all broadcasting networks, use more and lighter cameras, often with the new lightweight tv relay transmitters and receivers recently demonstrated by Microwave Associates, Inc. [Electronics, June 29, p. 17]. Mobile tape recorders will insure that a difficult pickup—that may fail to come through a microwave link perfectly—will not be lost and can be played back later.

NBC's secret weapon. Hitherto a secret, but easy enough for competitive engineers to duplicate, is NBC's electronic zoom technique that brings people and things from way off there to right up here.

Two television cameras are equipped with a new electronic magnifier circuit; one uses a 40-inch lens system and the other an 80-inch lens. Either camera can electronically multiply its magnification as much as twice, in five discrete steps. NBC engineers explain the system this way:

At a range of 200 feet, a 40-inch lens views a scene 76 inches wide by 57 inches high. With the electronic multiplier set at a maximum magnification, giving the equiv-



An NBC convention crew shows off its new equipment. Cameraman (kneeling) peers into viewfinder to see girl member of the floor crew holding a microphone and audio transmitter. Man at left, supplying light for tv picture, stands near cone of black-beam audio transmitter. Doghouse with lens, in background, is a black-beam pickup device normally located on a balcony. Picture at right is a self-contained television station weighing less than 30 pounds. It will be used by ABC at the national convention.

alent of an 80-inch lens system, the field is 38 by 28½ inches. When the 80-inch system is multiplied twice, the resulting system—the equivalent of a 160-inch lens—has a field of only 19 by 14¼ inches.

In this way, the heads of two people conversing in a corner across a big room can easily be televised with existing light. Although a glass lens to do this job could cost as much as \$50,000 and be unwieldy, the smaller lenses are available in the open market and the electronic circuits are inexpensive.

In the image orthicon tube used in the television camera, the picture viewed by the lens is focused on a photocathode. On the reverse side of the cathode a conducting photosensitive surface is deposited. Illumination of the photocathode creates an electron image that is drawn back to a target electrode made of thin, low-resistivity glass. On the reverse side of the target, a charge image results. When this charged glass is scanned by a moving electron beam, the beam is modulated by the charge and returns to the electron gun with this signal information. Altering the potential between photocathode and target, and varying the focus field, results in magnification.

II. Intercom

Another problem involves the ability of employees of the same network to confer on or off the air.

Because each network is limited by the Federal Communications Commission to four audio channels over the air, the amount of intercommunication and remote-broadcast voice pickup in a convention hall is sometimes severely hampered.

Ultraviolet radiation, though not yet licensed by the FCC, can be modulated to carry voice. NBC has equipped two floor reporters with "black-beam" transmitters, small cones on rods that stick up above the crowd. The transmitting lamps are coated with a filter material that cuts off almost all visible light.

At the receiving point on a balcony, a camera-like device picks up the modulated ultraviolet beam and focuses its flickering light on a multiplier phototube for conversion to audio.

GUDEBROD CABLE-LACER SPEEDS AND IMPROVES WIRE HARNESS TYING—

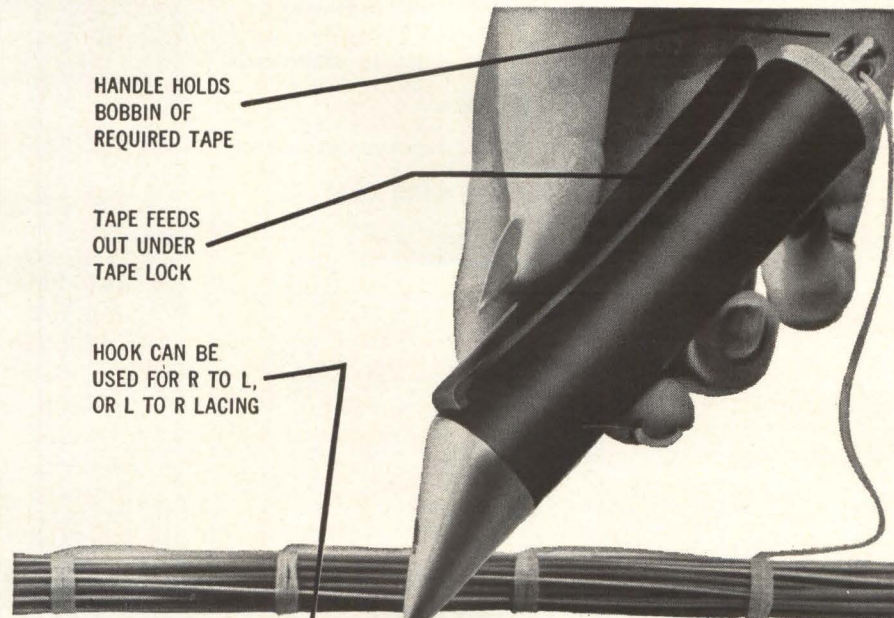

GUDEBROD
FLAT BRAIDED
LACING
TAPES FOR
EVERY NEED

Specify Gudebrod Lacing Tapes for all your requirements. They meet or exceed all MIL-T specifications and commercial requirements. They will help increase your production because Gudebrod carefully tests, measures, and maintains close tolerances for slip resistance, fray resistance, breaking strength, wax content, fungistatic effectiveness. Standard, burn proof, high temperature tapes available in regular spools or in bobbins for the Cable-Lacer.

The Gudebrod Cable-Lacer is the first production tool specifically designed to speed, ease and improve the lacing of wire harnesses.

A bobbin of tape in the handle feeds tape as needed making the handling of long sections unnecessary. The number of splices are reduced too.

The hook (which can be arranged for left to right, or right to left hand lacing) facilitates the passing of the tape over or under the wiring.

The tape lock provides a firm hold on the tape augmenting the hand pull for up to 30% tighter knots. Hand contact in knot tying is eliminated.

The ease of handling the tape, the speeding of the knot tying, the elimination of hazard to hands are all appreciated by the harness section worker. Efficiency improvements of 20% and more have been proven. The Gudebrod line of lacing tapes is available in bobbins for use in the Cable-Lacer.

Gain these advantages for your harness tying operation—improved worker conditions—increased production—higher quality harness. For complete information get in touch with the Electronic Division.



GUDEBROD BROS. SILK CO., INC.

FOUNDED IN 1870

Electronics Division

12 SOUTH 12TH STREET, PHILADELPHIA 7, PENNSYLVANIA

NASA had this switch problem:

to retrofit a high performance solid state switch in place of a mechanical one

here's how  solved it:

a single-pole, 10-throw switch with
10 nanosecond switching speed



NASA's problem was to replace a mechanical switch which had such problems as corrosion of contacts, loosening and wearing of contact pins, and intermittent contact operation... with a solid state switch that would fit into the existing system both mechanically and electrically. AEL solved the problem with the switch shown here.

CHECK THESE FEATURES:

- Switching speed was increased from 30-50 milliseconds to 10 nanoseconds.
- Required drive power was reduced from 56 watts to less than 1 watt.
- Switch life was increased virtually indefinitely because of no moving parts.
- Switch is completely potted to withstand severe shock and vibration.
- Removal of switch relay eliminates all switching noise.
- Switch weight was reduced by 90 percent.

Do you have a switch problem in the range 1 mc to 50 Gc . . . then let AEL solve it for you . . . from single-pole, single-throw switches to the most complex of configurations. Write to us . . . now.

Send for your copy of AEL's Solid State Switch Technical Bulletin



American Electronic Laboratories, Inc.
P. O. BOX 552, LANSDALE, PENNSYLVANIA • (215) 822-2929

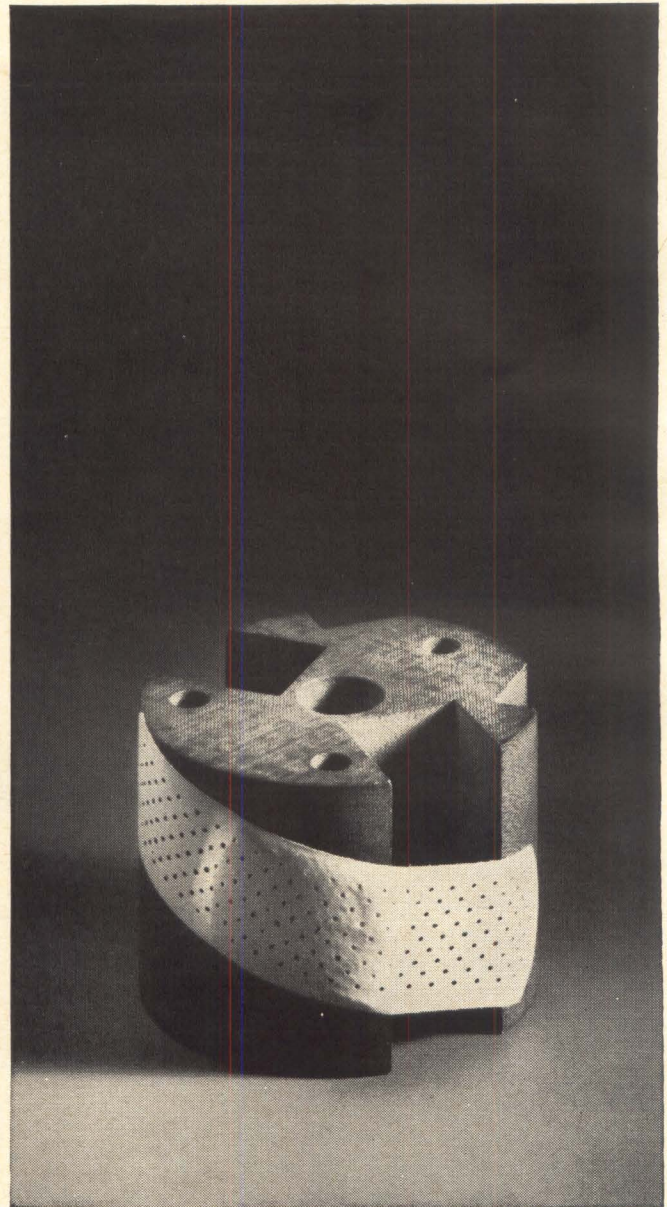

Is quality an accident?

Not when you buy Synthane laminated plastics. Quality is tightly controlled from the start. All incoming raw materials are rigidly inspected. Resin binders and reinforcements of paper or fabric are the best that money can buy.

Thirty five years of experience, exclusively in laminated plastics, are wrapped with every tube or rod we wind, every sheet we press, every part we fabricate. See for yourself what a difference Synthane quality can make in performance and satisfaction. Write for "Laminated Plastics Parts—Make or Buy." Synthane Corporation, 36 River Rd., Oaks, Pa.

You furnish the print...we'll furnish the part

SYNTHANE

CORPORATION  OAKS, PENNA.

Synthane-Pacific, 518 Garfield Avenue, Glendale 4, California

Spectrum analyzer provides 2-Gc display

Fully-calibrated instrument helps to minimize the problem of radio-frequency interference

A new instrument features an electronic window that can simultaneously display every shortwave broadcast in its location, using only a tenth of its capacity. It has twenty times the range of any such device previously offered for general sale, according to the manufacturer.

Sweep bandwidths up to 2 Gc from 10 Mc to 40 Gc, accurately calibrated dynamic range of 60 db, and sensitivity to -100 dbm are features of the model 851A/8551A spectrum analyzer. Designed to give a large increase in the scope, speed and accuracy of spectrum monitoring, spectrum signature identification, and rfi analysis, the unit occupies 19 in. of rack space.

Contributing to the utility of the instrument is the fact that all basic functions are fully calibrated. Spectrum width accuracy is $\pm 5\%$ from 100 kc to 3 Mc, $\pm 5\%$ at 10 Mc, and ± 4 Mc from 30 Mc to 2 Gc. Sweep rate may be set with 2% accuracy. Resolution is adjustable, manually or automatically, at 1, 3, 10, 100 or 1,000 kc. Over the full 2-Gc sweep frequency response is better than ± 5 db. The vertical display is also calibrated: logarithmic

mic response 60 db ± 2 db, linear 70:1 $\pm 3\%$, and square (power) 70:1 $\pm 5\%$.

Contributing to performance and operating convenience is a newly-developed r-f attenuator which may remain constantly in the circuit without penalizing sensitivity, since it has zero loss at d-c, and less than 2 db at 10 Gc.

Frequency response of the model 851A/8551A is ± 3 db over the 2-Gc sweep, and ± 1 db or better over 1 Gc. The analyzer is not limited to such wide sweeps, however. Sweeps down to 100 kc may be selected. A built-in signal identifier determines the frequency of each response by identifying the harmonic of the internal oscillator with which it is beating. The frequencies can then be read from the appropriate dial scales. Separate and potentially confusing frequency markers are therefore not needed.

The analyzer obtains its broad spectrum through the use of a backward-wave oscillator. It is the first local oscillator, and is electrically swept across the 2-to-4-Gc range. Three advantages are derived from this departure from the more usual practice of sweeping

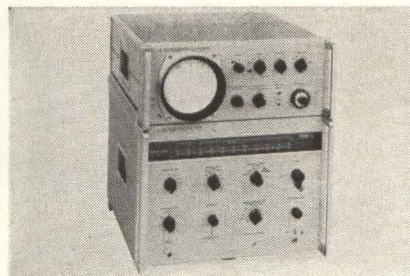

the second oscillator: 1) broad-range flat response is not dependent upon the response of the first i-f amplifier; 2) residual responses—displays appearing on the analyzer when no signal is present at the input—are virtually eliminated by use of a narrowband i-f amplifier; 3) mechanical backlash and resettability problems are eliminated.

The input system of the analyzer is coaxial, but waveguide systems are accommodated.

First applications of the new instrument are expected to be in defense, especially in weapons launch systems where spurious rfi might cause a detonation. The FAA and FCC also are interested in signal detection in as wide a spectrum range as possible.

Hewlett-Packard Co., 1501 Page Mill Road, Palo Alto, Calif.
Circle 301 reader service card

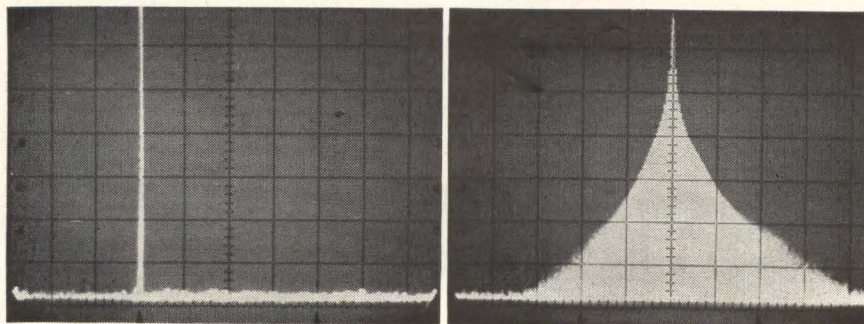

Spectrum analyzer scope shows calibrated 2-Gc sweep, 60-db dynamic range. A pure 800-Mc signal is shown at left. Sweep is 2 Gc centered at 1.2 Gc. Vertical scale is 10 db/cm. Absence of second harmonic signal demonstrates suppression of internally generated responses. Photo at right displays spectral analysis of 800 Mc. 1 μ sec pulse. Sweep is 300 Mc centered at 800 Mc. Vertical scale is 10 db/cm.

Metal film resistors exceed MIL-R-22684

Two new metal film resistors of the RL07 and RL20 types, with parameters appreciably exceeding requirements of MIL-R-22684, are in production. The $\frac{1}{4}$ -w M-07 is rated for 250 v, the $\frac{1}{2}$ -w M-20, for 350 v. Resistance values for the M-07 range from 50 to 150,000 ohms; for M-20, from 50 to 500,000 ohms. Clarostat Mfg. Co., Dover, N.H. [302]

The Next Generation of Microelectronics Now

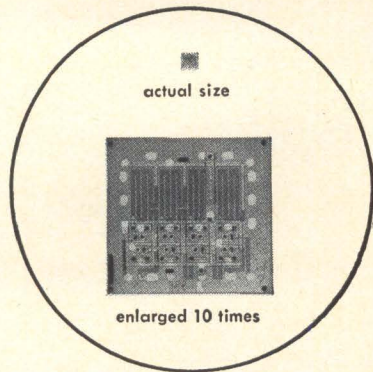

Flip-Flop Circuit

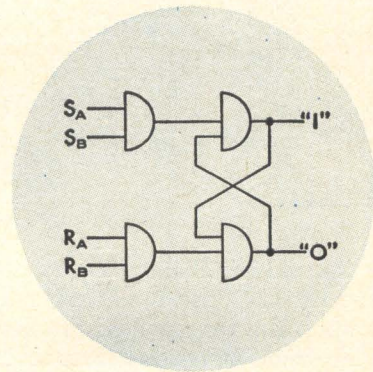

Microwatt Systems Built with CBS Laboratories BLUE-CHIP* Microcircuits

CBS Laboratories BLUE-CHIP* microcircuits featuring microwatt power consumption are now being utilized in the design and fabrication of subsystems. The low power requirements of the BLUE-CHIP* circuits are ideally suited for space applications. Typical of this low power consumption is a BLUE-CHIP* flip-flop which dissipates 60 microwatts maximum from a 3-volt supply. Among the systems which can be achieved using CBS Laboratories micropower concept are A/D converters, read-write amplifiers, time sys-

tems, arithmetic computer elements and other subsystems having comparable power consumption.

Low power consumption is not the only advantage you get with CBS Laboratories BLUE-CHIP* microcircuits. Other benefits include significantly low heat radiation, higher packing density and reduced power supply requirements.

Let us incorporate the technology of tomorrow in your system — today.



CBS LABORATORIES

A Division of Columbia Broadcasting System, Inc.
High Ridge Road, Stamford, Connecticut

*BLUE-CHIP is CBS Laboratories' trade name for its microelectronic circuits, modules and systems.

Circle 207 on reader service card

Don't let the price tag fool you!

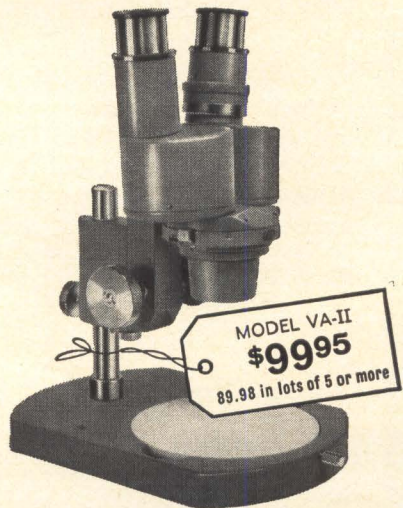

This is a genuine, full-quality Elgeet-Olympus STEREO microscope

Distortion-free optics, brilliant imagery. Ideal for quality control, inspection and assembly of miniature parts and circuits. Magnification: 8X to 40X. A complete range of coated achromatic optics is available. For details, write Elgeet Optical Co., Inc., 303 Child Street, Rochester, New York 14611.

Elgeet

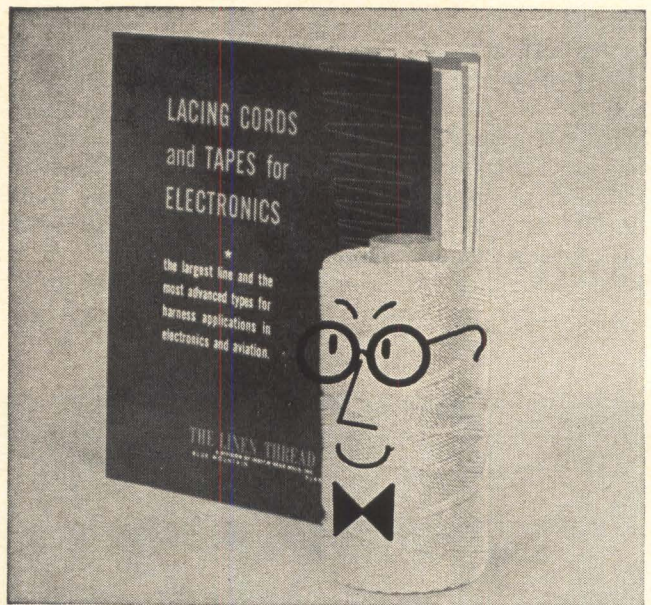

It's the 'Who's Who' in Electronic Threads

The most complete catalog in the industry... LTCO's illustrated brochure covering electronic lacing cords and tapes. LTCO's line includes nylon, linen, teflon, cotton and dacron... a variety of constructions, put-ups and special finishes.

For catalog, write:



THE LINEN THREAD CO.

Blue Mountain, Alabama
A DIVISION OF INDIAN HEAD MILLS, INC.

New Components and Hardware

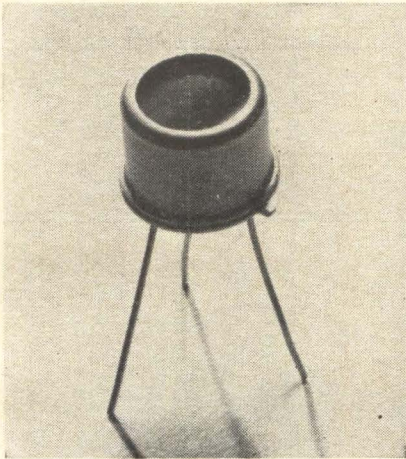

GaAs infrared emitter has low threshold

A gallium arsenide infrared emitter, the RSE-1, delivers a narrow band of incoherent infrared energy at 9,000 angstroms. The c-w light source is a 1-sq.-mm. chip of gallium arsenide mounted inside a TO-5 can with an optical-quality window. A current of only 20 ma is sufficient to initiate infrared emission. It can be operated in either a pulsed or c-w mode. Price is \$105.

Raytheon Co., Special Microwave Devices Operation, 130 Second Ave., Waltham, Mass. 02154. [311]



Tiny capacitors with values to 18 μ f

Subminiature solid tantalum capacitors, the Kemet Z-series, exhibit extremely low d-c leakage current, low dissipation factor, and good capacitance stability with respect to frequency and temperature. They are designed for continuous operation from -80°C to $+125^{\circ}\text{C}$; and are available in two case sizes designated as A3 (0.085 in. by 0.250 in.) and A2 (0.127 in.

by 0.375 in.). Capacitance values range from 0.047 to 18 μ f, with working voltages from 6 to 50 v at 85°C . These values are up to three times the capacitance/voltage ratings available from solid tantalum capacitors of standard size, according to the manufacturer. The capacitors contain dry tantalum anodes encapsulated in corrosion-resistant metal cases. A direct glass-to-metal seal, formed by bonding the hermetic end seal to the anode lead wire, eliminates the ferrule or tabulation of the end seal. Thus there is no aperture to be soldered. Union Carbide Corp., 11901 Madison Ave., Cleveland, Ohio [312]

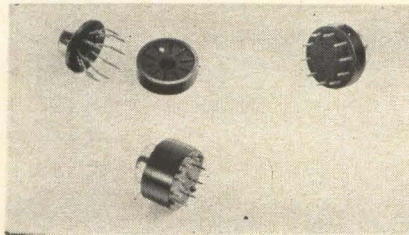

P-c mounting pads for 10-lead cans

A pair of new mounting pads has been introduced for easier installation of integrated circuits in p-c boards. Both the model 10006 (left) and a combination of models 10050 and 10051 (right) accommodate 10-lead TO-5 packages. To allow mounting on conventional printed boards, the new Transipads spread leads to a circle diameter of 0.400 in. and require only 0.500-in. diameter of board space. One-piece model 10006 accepts pin circle diameters of 0.200 in. It gently slopes the leads and elevates the device 0.205 in. above the board, leaving ample space for a complete wash-out of residual flux after soldering. The 10050 Transipad slopes leads at a generally-acceptable 45° . If extra assurance is desired, leads may be first passed through model 10051. Used in combination with 10050, this Transipad relieves strain on leads and makes it impossible for leads to short against case. Model 10050 raises its component

- 1/ Are paper tape readers as reliable as photo-readers?
- 2/ Do you know the difference between star wheel and pin sensing?
- 3/ Is star wheel sensing suitable for programming, and control applications?

Here are a few facts, which will prove useful

In case you're not familiar with star wheel sensing, it is somewhat like pin sensing, except that the pin has become several pins on a wheel (a star wheel) which is free to rotate at the same time that it is sensing a hole. This sensing method has some rather unique features.

The star wheel can sense holes in a paper tape while the tape is in motion. As the star wheel enters a hole, its axis is lowered, rocking the arm carrying the star wheel in a counter-clock wise direction.

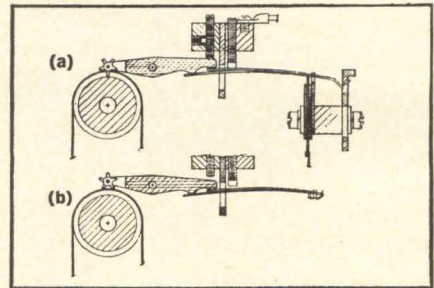

FIG. 1 Diagrammatic sketch of star wheel sensing (a) hole and (b) no hole.

When a series of successive holes is sensed, the star wheel rotates in mesh with the holes, like a gear on a rack, with no resultant motion on the carrier arm and with the switch remaining closed. Only when the star wheel approaches a no-hole, and moves up and over the top surface of the paper tape, is the switch opened. This feature makes star wheel sensing ideal for programming and control applications. A single channel on the paper tape can control the pull-in, holding and drop-out of a relay (or solid-state device).

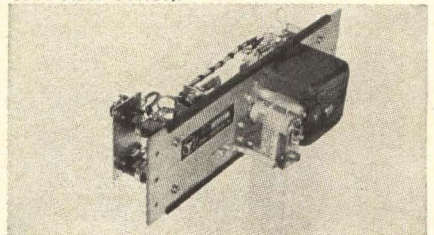

FIG. 2 This is our star wheel sensing Paper Tape Reader Model 119.

It is bi-directional, reads 5 to 8 channel punched paper tape at speeds up to 30 characters (lines) per second, and sells for \$350.

Incidentally, we life-tested our Reader for 125 million cycles. During the test, our Reader was hooked to a parity checking circuit. To our own amazement, it never misread a single bit throughout the test. We think this performance puts us above photo-readers in the reliability spectrum.

If you're from Missouri, and would rather do the testing yourself, we will lend you the use of a Reader, free, in return for a copy of your test data.

For technical information on our Paper Tape Reader circle the number below, or write for Bulletin #119950.

OHR-TRONICS, INC.

SOUTH HACKENSACK, NEW JERSEY



we've got your number

... in binary coded decimal format at 50,000 conversions per second, including sample and hold. Texas Instruments new Model 846 A-D Converter features 100 megohm input impedance, voltage ranges from 1 to 10 volts (manual or external selection) and 100 nanosecond aperture time.

Available options include three digits (± 999) or four digits ($\pm 1,999$), differential input, decimal or BCD display and digital to analog conversion capability. The 846 is another high-speed, high-accuracy instrument in TI's line of digital data handling equipment.

Model 844 and 845 high-speed Multiplexers are ideal companion instruments for use with TI A-D Converters.



Addressable, sequential and addressable/sequential models are available, sampling at 50,000 channels per second. Features up to 160 channels, variable frame length, accuracy $\pm 0.02\%$ full scale with input levels to ± 10 volts.

Write for complete information.

INDUSTRIAL
PRODUCTS
GROUP



TEXAS INSTRUMENTS
INCORPORATED
P. O. BOX 66027 HOUSTON, TEXAS 77006

New Components

0.150 in. above the board, also allowing thorough flux washing. Both these models have a pin circle diameter of 0.230 in. Both are precision-molded from glass-filled diallyl phthalate that meets MIL-M-14F, SGD specifications.
Milton Ross Co., Southampton, Pa.
[313]

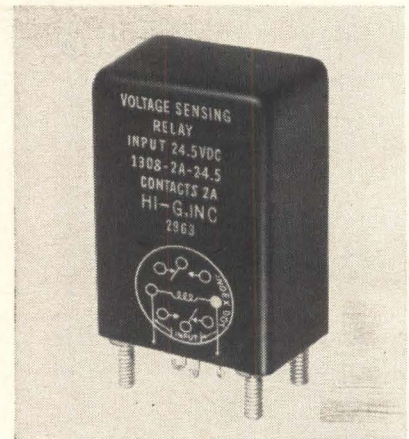

Sealed relay senses low voltages

A hermetically sealed voltage sensor, type 1308, meets the environmental requirements of relay specification MIL-R-5757, namely temperature range from -65°C to $+125^{\circ}\text{C}$, 20-g vibration, 50-g shock, insulation resistance of 1,000 megohm at 500 v d-c; it also withstands a dielectric strength test of 1,000 v. Accuracy is $2\frac{1}{2}\%$ over the entire temperature range. The device may be applied where dropout must be close to pull-in, where high impedance inputs are required, and where low voltages must be sensed.
Hi-G, Inc., Spring St., and Rt 75, Windsor Locks, Conn. [314]

Pressure transducers require little space

A series of subminiature absolute-pressure transducers, which may be incorporated into fluid-flow systems to detect and measure pressure changes, have numerous applications in the aerospace industries, in model and prototype an-

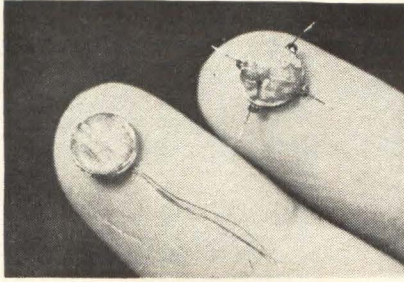

alysis, in process-transduction studies, and in medicine and dentistry. Extremely small and thin (0.004 cu in.), they offer practically no interference with gas or liquid flow when introduced into a fluid system. The transducers are designed to operate over the temperature range of -20°F to 150°F . Within this range, linearity and hysteresis are ± 1 percent of full-scale output. Present models cover the pressure ranges of ± 2 psi, 0 to 15 psia, 0 to 30 psia, and 0 to 100 psia. The transducers can be operated either on a-c or d-c. Under normal conditions, the nominal output voltage for a 0-to-30 psia unit is 0.042 mv per v per psi. All the transducers are designed with a 120-ohm input, so they may be used with various types of standard strain-gage instrumentation. The natural frequency for all models is 20,000 cps.

Scientific Advances, Inc., 1400 Holly Ave., Columbus, Ohio 43212. [315]

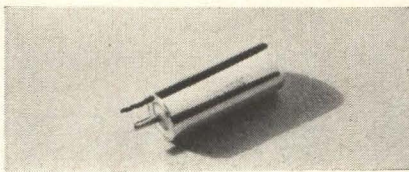

Miniature thermostat with 3° differential

The VAL 90 has a reliability rating of three rejects out of 2,300 miniature thermostats released to the user. The manufacturer claims that each unit is contact calibrated for a snap-action differential of 3°F , adjusted, cleaned, hermetically sealed, checked, load-cycled for a day and rechecked before shipping. The 0.372 in. diameter by $\frac{7}{8}$ in. capsule snap action handles 2 amp 30 v d-c to 150 w 120 v a-c/d-c. Valverde Laboratories, 252 Lafayette St., New York 12, N.Y. [316]

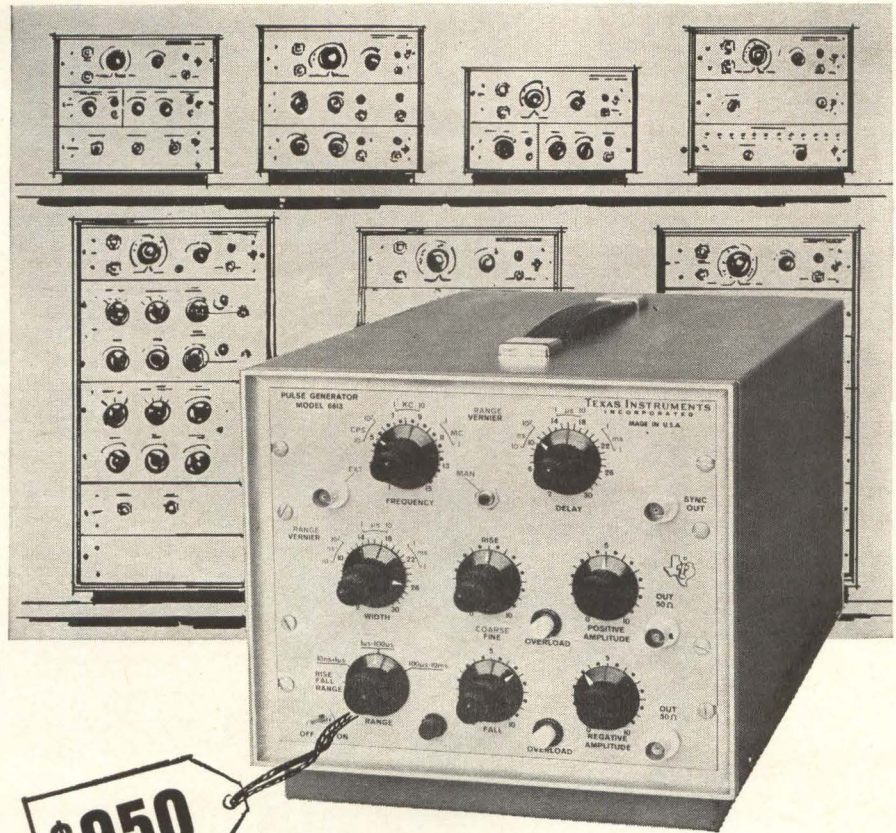

\$950

a new one off the shelf... quality, high-spec pulse generator featuring variable rise and fall

The Model 6613 General Purpose Pulse Generator fills the need for a low-cost, high-quality test instrument with exceptional performance specifications. It is a general purpose instrument ideal for most pulse applications such as testing integrated circuits, digital circuit design, system design and checkout, testing of diodes and transistors.

The 6613 provides coincident positive and negative pulses determined by an internal clock generator or external source, with rep rate variable in 6 steps. Pulse width and delay are also variable in 6 steps. Amplitude is variable from near zero to 10 volts, with overload protection provided. Solid-state circuitry is utilized throughout. The compact unit measures $8\frac{1}{2}$ in. high, $8\frac{1}{2}$ in. wide, 12 in. deep and weighs only 10 lb.

SPECIFICATIONS

Clock Pulse Repetition Frequency

15 cps to 150 cps	15 to 150 kc
150 to 1500 cps	150 kc to 1.5 mc
1500 cps to 15 kc	1.5 mc to 15 mc

Delay

30 to 300 nano-secs	30 to 300 microsecs
300 nanoseconds to 3 microsecs	300 microsecs to 3 milliseecs
3 to 30 microsecs	3 to 30 milliseecs

Width

30 to 300 nano-secs	30 to 300 micro-secs
300 nanoseconds to 3 microsecs	300 microsecs to 3 milliseecs
3 to 30 microsecs	3 to 30 milliseecs

Pulse Amplitude—10 v into 50 ohms

Rise and Fall Times—variable; less than 10 nanoseconds to 1 microsec, 1 microsec to 100 microsecs, 100 microsecs to 10 milliseecs, minimum rise time typically 8 nanosecs

INDUSTRIAL PRODUCTS GROUP



TEXAS INSTRUMENTS INCORPORATED
P.O. BOX 66027 HOUSTON, TEXAS 77006

663

COMMUNICATIONS RECEIVER FOR SSB

300 kc to 30 mc
with xtal stability

\$995

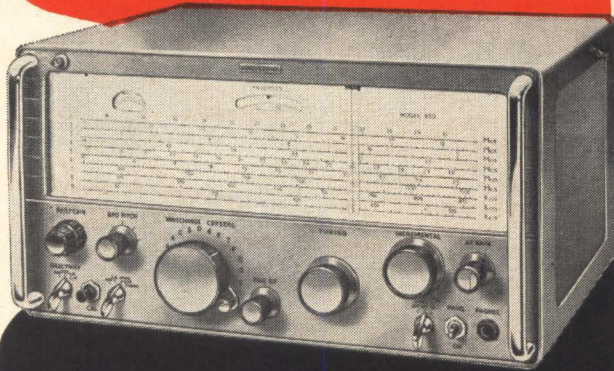

Eddystone Model 830/2

- xtal circuit achieves 1 kc/hr stability
- Variable 1st I.F. accepts frequencies ± 100 kc about xtal frequency.
- ± 100 kc bandsread with 1 kc resolution.
- 2nd I.F. can be xtal controlled for ultimate stability.
- Sensitivity better than 3uV for 15db S/N.
- Separate AM/SSB detectors with upper/lower sideband switch selected.
- xtal calibrator gives 100 kc check points.

Write
for detailed
catalog sheet.

MARCONI
INSTRUMENTS
DIVISION OF ENGLISH ELECTRIC CORPORATION
111 CEDAR LANE • ENGLEWOOD, NEW JERSEY
Main Plant: St. Albans, England



REFRACTORY METALS APPLICATION NOTES

**G-E Moly rod makes the
heat, or takes the heat.
Anyway you cut it,
it's protean.***

Consider the versatility of this form of General Electric molybdenum. Moly rod is used to heat and stir molten glass. It makes ideal furnace resistance heating elements and structural parts. It is easily machined into complex shapes for use in electronic power tubes or as fasteners in high temperature applications. Here are a few examples of parts made of G-E Molybdenum rod:

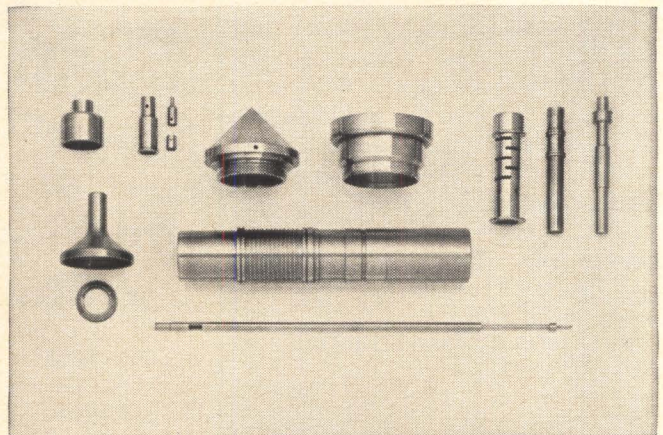

General Electric unalloyed powder metallurgy moly rod is available in diameters .020" through 4". Standard diameters can be delivered *off the shelf*. Alloyed or unalloyed arc-cast moly rod is also available.

G.E. makes most other forms of moly, too—including powder, wire, sheet, plate, foil and pressed and sintered shapes. No matter what form you need, if it's molybdenum call General Electric Lamp Metals & Components Department. For a starter, write today for information on G-E Powder Metallurgy Molybdenum rod. We'll send it to you along with data on other moly forms in which you indicate interest.

Write to: General Electric Co., Lamp Metals & Components Dept., 21800 Tungsten Rd., Cleveland, Ohio 44117. Or call (216) 266-2970.

**Pro-te-an, adj. 1. (P-), of or like Proteus. 2. readily taking on different shapes and forms.*

Progress Is Our Most Important Product

GENERAL  ELECTRIC

New Instruments

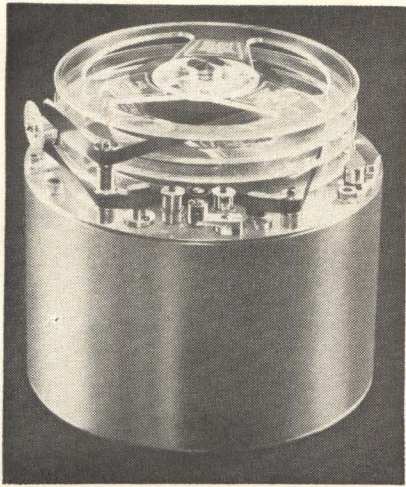

Instrument tape recorder for oceanographic use

An instrument tape recorder designed specifically for oceanographic applications is now being manufactured. Weighing only 4 lb. and standing 4½ in. high, type 313 fits into a standard 6-in. pressure case. Recording capability is 4 hr. continuous or 4,320 5-sec recordings with either digital or analog input. Uses include recording meteorological data, sound velocity, salinity, temperature and depth data. Flexible design permits rapid modification for special applications, making the unit a compact and reliable means of storing any type of electrical output. Braincon Corp., Marion, Mass. [351]

Electronic micrometer features 1% accuracy

Electronic micrometer model B-721 offers absolutely stable measurement of distances or displacements

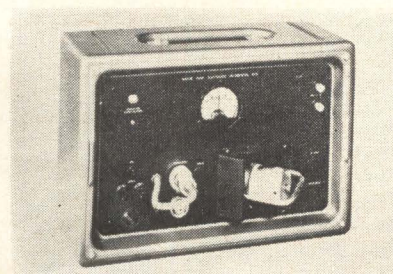

in the range from 50 to 45,000 microinches. Employing a non-contacting, guarded-capacitance probe, the instrument is suited for measurements on rotating machinery, delicate or fragile assemblies, or any application where other sensors impair measurement accuracy by loading the test structure. The micrometer requires no physical contact with the material. Measurement of temperature coefficients, modulus of elasticity, displacement, rigidity, bulk, Poisson's ratio, and dilation are prime functions. The B-721 utilizes the principle of the transformer-ratio-arm bridge, with its inherent capability for three-terminal measurements. This eliminates the influence of extraneous impedances, including capacitance in the interconnecting cables and provides a measurement accuracy of 1% over the entire range. It also permits remote measurements (up to 75 ft from probe to meter) without loss of accuracy. Price of the instrument, less probes, is \$760.

Wayne Kerr Corp., 1633 Race St., Philadelphia. [352]



Ultrasensitive meters cover wide range

Full deflection across a 6-in. slide-rule scale for currents as low as 200, 250 and 300 na is offered by the model 700US series without the aid of amplifiers or other electronic circuitry. As many as 23 ranges can be included in a single meter to permit complete coverage of the microampere, milliampere and low-ampere bands. The meters are available with full-scale accuracies of $\pm 0.25\%$ and $\pm 0.5\%$. A bifilar

HOW TO KEEP YOUR TELEMETRY DATA HONEST

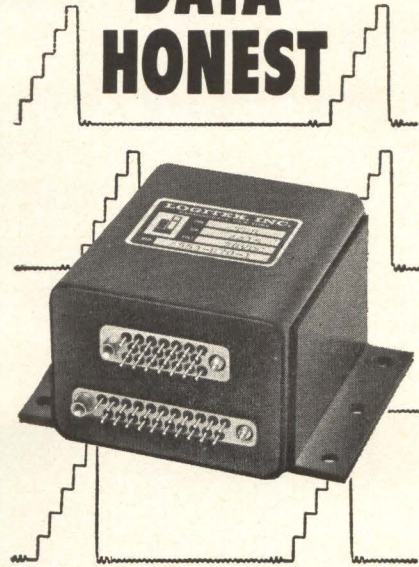

LOGITEK'S SOLID STATE SYSTEM CALIBRATES ANY NUMBER OF TELEMETRY CHANNELS IN FLIGHT

Designed specifically for aerospace service, Logitek's A718 Telemetry Calibrator provides repetitive five-step, multi-channel reference signals that assure accurate translation of telemetered data. Miniature, lightweight—these solid state systems generate precise 0-5 volt staircase functions, with adjustable calibrate duration and cycle time. Four-channel master can be extended to calibrate any number of channels by miniature 4- and 6-channel slave units, includes provision for one-cycle operation, manual advance and reset by command pulse. Abridged specifications:

Calibration Accuracy: $\pm 0.1\%$ of calibrate voltage

Calibration Voltage Duration: 0.16 to 1.6 sec. per step

Cycle Time: 15 to 180 sec.

Idling Current: less than 90 ma.

Calibration Current: less than 150 ma.

Temperature Range: -20° to 71° C.

For complete specifications, simply write or call. Logitek offers a complete range of solid state timing devices and systems for critical applications. Our engineering staff welcomes inquiries regarding the creation of units and systems to your specifications.

LOGITEK, INC.
42 Central Drive, Farmingdale, N. Y. • (516) NY 4-3080

WHEN YOU NEED A PROTOTYPE MOTOR OR BLOWER

RIGHT NOW

CALL GLOBE

DIAL 513-222-3741

WE WILL SHIP YOUR ORDER WITHIN 24 HOURS



Sample 24-hour stock (subject to change)

A.C. MOTORS			HYSTERESIS SYNCHRONOUS						
type	P/N	dia.	length	torque	rpm	volts	cycles	phase	
SC	53A106-2	1 1/16"	1 3/8"	.12 oz. in.	12,000	115	400	1	
MC	18A107	1 1/4"	2 1/4"	.7 oz. in.	1,800	115	60	1	
MC	18A108	1 1/4"	2 1/4"	.7 oz. in.	3,600	115	60	1	
FC	75A119-2	1 1/16"	2 1/4"	1.0 oz. in.	1,200	115	60	1	
FC	75A120-2	1 1/16"	2 1/4"	1.0 oz. in.	1,800	115	60	1	
FC	75A121-2	1 1/16"	2 1/4"	1.0 oz. in.	3,600	115	60	1	

D.C. MOTORS			PLANETARY				
type	P/N	dia.	length	torque	rpm	volts	amps
SS	41A100-13	7/8"	1 3/8"	.20 oz. in.	17,000-20,000	27	.18 to .25
MM	3A1002-10	1 1/4"	2 1/2"	.5 oz. in.	9,000	24	.30
LL	3A1003-1	1 1/4"	2 3/8"	1.0 oz. in.	11,000	24	.65
GRP	166A100	2 1/4"	3 3/4"	.75 lb. in.	8,000	27	4.0

GEARMOTORS			PLANETARY						
type	P/N	dia.	length	torque	rpm	volts	cycles	phase	amps
MM	5A555-1	1 1/4"	3 3/4"	250 oz. in.	11.5	24 v.d.c.	—	—	.6
MC	33A603-600	1 1/4"	3 3/2"	170 oz. in.	6	115 v.a.c.	60	1	—
FC	83A115-27.94	1 1/16"	3.190"	20 oz. in.	64.4	115 v.a.c.	60	1	—

BLOWERS									
type	P/N	dia.	cfm @	"H ₂ O	volts	cycles	phase	amps	watts
VAX-1-AC	19A1173	1 1/8"	10	.6"	26 v.a.c.	400	1	.32	7.7
VAX-1-DC	19A1040	1 1/8"	8.5	.5"	26 v.d.c.	—	—	.25	6.5
VAX-3-FC	19A911	3"	60	1.0"	200 v.a.c.	400	3	—	65
VAX-3-GN	19A908	3"	68	1.5"	115 (a.c. or d.c.)	60	—	—	55
AC-AXIAL	19A533	2 3/8" sq.	20	0"	115 v.a.c.	60	1	—	13

If we can't meet your requirements precisely we can probably tide you over until we manufacture the exact units you need.

Globe Industries, Inc., 1784 Stanley Avenue
Dayton, Ohio 45404, U.S.A., Area 513 222-3741

GLOBE

New Instruments

suspension-meter movement has very small millivolt drops. A light-beam pointer eliminates parallax errors. A dynamic overload-protection feature prevents mechanical damage to the movement from slamming against internal stops caused by overloads higher than 1,000,000 X on the most sensitive ranges.

Greibach Instruments Corp., 315 North Ave., New Rochelle, N.Y. [353]

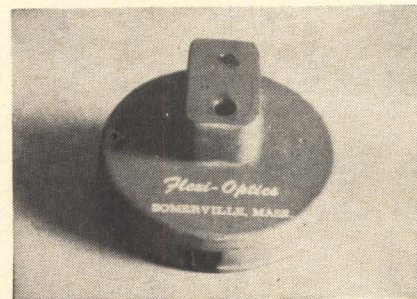

Optical sensor scans periphery of objects

A new optical device has been developed for electronically viewing a full 360° periphery of objects. Model PS-109 peripheral sensor employs optical fibers precisely arranged to carry light to the object under inspection and transmit it back to photo-detectors for electronic read-out. Through the use of Flexi-Optics (light pipes), no maintenance is required as mirrors, lenses and other conventional optical parts are eliminated. The peripheral sensor is said to have unlimited application in quality control for continuous monitoring and inspection of liquids, gases and solids. Materials passed through the sensor can be examined for particle size, gas inclusion, surface imperfections, discontinuities, color changes, as well as speed sensing and automatic control functions. The sensor is of rugged construction, cast in epoxy; easily calibrated to be used with customer-designed electronic read-out under suitable arrangements. Many sizes and configurations to suit individual applications are available.

Flexi-Optics Laboratories, 117 Dover St., Somerville, Mass. 02144. [354]

New Subassemblies and Systems



Dispersive delay lines are compact and light

Solid-state dispersive delay lines, series 300, have been designed for chirp radar systems. These light compact filters can replace the complex circuitry of LC filters and provide compact, high-performance dispersive delay lines. They offer good reliability, power utilization from output tube, increase in radar range and resolution of long-duration pulses. The units, built to mil specs, are available in a variety of standard units or may be custom designed. Standard lines are available up to 5 Mc with bandwidths to 2 Mc and compression ratios up to 500 to 1. Typical size for a 5-Mc filter is 2¼ in. by 1 in. by 10 in. Price range is from \$975 to \$2,750. Richard D. Brew and Co., Airport Rd, Concord, N.H. [371]

Addressable, sequential solid-state multiplexer

A combination addressable and sequential multiplexer has been developed for use in data acquisition, data gathering or hybrid computer systems. Model 845E, an all-solid-state time-division multiplexer, offers high-speed bipolar operation with accuracy of 0.2% full scale (± 10 v) at a sampling rate of 50,000 channels per second. It features fast settling time and variable sampling duration.

The mode, addressable or se-



quential, may be chosen automatically by means of an external mode-select signal, or manually by a front-panel rotary switch. Addressing is done by means of eight address lines with logic levels to suit the accompanying equipment. Up to 160 channels can be accommodated by the 845E in increments of 16. Expansion to full capacity, without wiring changes or additions, is possible by utilizing plug-in printed-circuit cards.

The unit can simplify engineering problems by providing internally for a-d converter start command, and by furnishing an address-confirm output. The latter is of particular use in sequential operation where an address may not be available from another source. Packaged in a case only 5¼ in. high, the 845E is designed for standard relay-rack mounting. The manufacturer says this product is more flexible, more compact and cheaper per channel than competing equipment. Prices start at \$2,800.

Texas Instruments Inc., 3609 Buffalo Speedway, Houston, Tex. [372]

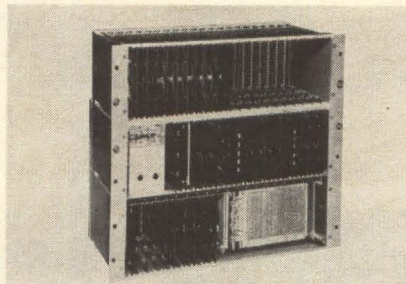

Compact and fast memory systems

Two completely-packaged memory systems are announced—the 52.05 with a 5- μ sec read/write cycle time and the 52.06 with a 6- μ sec read/write cycle time. Access times of 2 μ sec and capacities to 16,384 words can be supplied in both units. Compact in size, a complete memory system with a capacity of 4,096 words, each 25 bits long, measures only 19 in. wide by 16½ in. high by 8 in. deep. Extended temperature range of operation is

SQUARE WAVES & PULSES

1cps to 10mc

5"x7"x12"

\$620

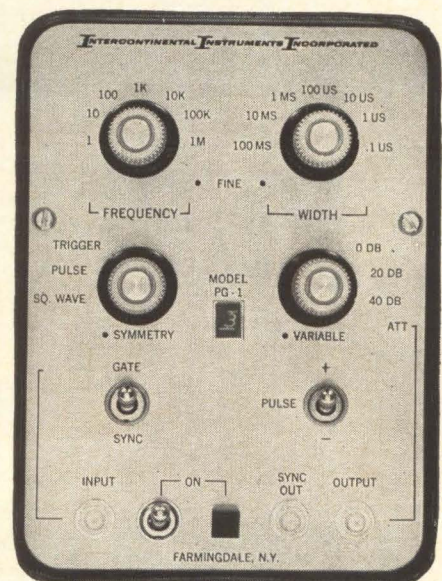

Small size, light weight, big performance. For example: positive or negative pulses, 20 v from 50 ohms...rise and fall time better than 10 nsec...pulse widths variable from 30 nsec to 200 millisc...external gating...dc coupled output...external bias to 100 ma...3 v sync signal. Rack mountable in single unit, or multiplexer sets.

Complete specifications on Model PG-1 are in our Bulletin 108. Yours for the asking.



INTERCONTINENTAL INSTRUMENTS INC.
123 Gazza Blvd., Farmingdale, N.Y.
Phone: (516) MYrtle 4-6060

DO-IT-YOURSELF MAGNETIC SHIELDS

*Cut Quickly—
Wrap Easily*

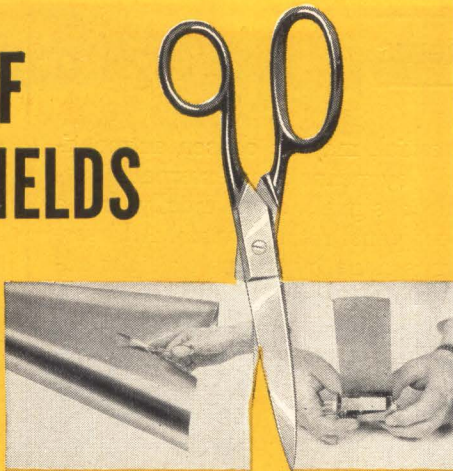

With ordinary scissors, cut flexible Co-Netic and Netic foil to any size or outline. Your component is quickly wrapped and protected—within seconds. Component performance is dramatically enhanced. Co-Netic and Netic foils stop degradation from unpredictable magnetic fields. When grounded, they also shield electrostatically. Foils are not significantly affected by dropping, vibration or shock, and do not require periodic annealing. Available in thicknesses from .002" in rolls 4", 15", and 19-3/8" wide. High attenuation to weight ratio possibilities. Widely used in experimental evaluation and production line operations for military, commercial and industrial applications.

MAGNETIC SHIELD DIVISION

Perfection Mica Company

1322 N. ELSTON AVENUE, CHICAGO 22, ILLINOIS

ORIGINATORS OF PERMANENTLY EFFECTIVE NETIC CO-NETIC MAGNETIC SHIELDING

Circle 210 on reader service card

Pt/Pt Rh

Thermocouple
Wire
600°C-1500°C

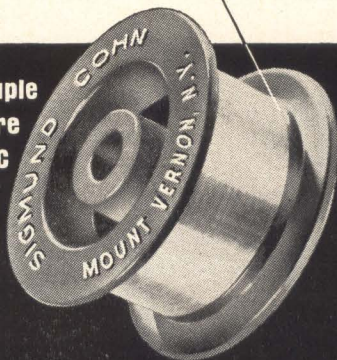

Maximum purity for reproducibility

Thermocouples made of Reference Grade Platinum/Platinum-Rhodium match the EMF values given in National Bureau of Standards Circular No. 561 within $\pm 0.1\%$ above 600°C.

Write for Bulletin on Thermocouple Wires

SIGMUND COHN Corp.

121 So. Columbus Ave., Mount Vernon, N.Y.



SIGMUND COHN CORP. OF CALIFORNIA, Burbank, Cal. / SIGMUND COHN-PYROFUZE, INC., Dallas, Texas

New Subassemblies

from 0°C to +65° without environmental compensation. Switch core access circuitry directly drives the coincident-current memory stack. This results in a 30% reduction in total system semiconductor requirements and over-all increased reliability. Low temperature coefficient cores and silicon semiconductors provide the wide temperature range of operation. All logic circuitry is potted in hermetically sealed modules for maximum reliability under adverse environmental conditions. Ferroxcube Corp. of America, Saugerties, N.Y. [373]



Voltage comparator in a 9-pin package

A voltage comparator sensitive to 100 mv over an input range of -6 v d-c to +6 v d-c has been designed for digital applications. Model T-174 operates from a reference voltage input and the input signal voltage to be compared. When the input signal voltage is more positive than the reference voltage, the output is -3 v d-c; when the signal is more negative, the output is -11 v d-c. Minimum input level shift to cause full excursion of the output is less than 20 mv d-c. For an input level shift from 0.5 v d-c below the reference to 0.5 v d-c above the reference occurring in less than 1 μ sec, the output rise time is less than 1 μ sec.

Model T-174 is housed in a standard 9-pin cylindrical package 0.9062 in. in diameter and $2\frac{7}{8}$ in. tall (seated height). Prices range from \$23 in lots of 1-10 to \$13.64 in lots over 200.
 Engineered Electronics Co., 1441 E. Chestnut Ave., Santa Ana, Calif. [374]

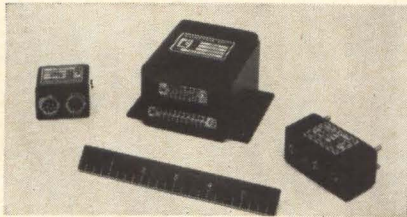

Telemetry calibrator for multichannel use

Multipoint, multichannel in-flight calibration of telemetry data is provided by a modular, solid-state system. Designed for service in rockets, space vehicles, and high-performance aircraft, the system uses miniature master and slave units to provide calibration for any desired number of telemetry channels. Model A718 calibrator utilizes as its basic element a master module designed for calibration of four data channels. Optional add-on slave units may be used for any additional number of channels, in groups of four or six channels, to meet particular system requirements. All timing, control and reference signal circuits are contained in the $2\frac{1}{2}$ in. by 3 in. by $3\frac{1}{4}$ in. master unit, permitting it to be used independently as a single-unit four-channel calibrator. In operation, the A718 periodically interrupts each data channel in sequence, and injects a precision zero to 5-v staircase signal, accurate to 0.1%, into the transmission. Sequences of staircase voltages are preceded by an open circuit and a ground, and are followed by another open circuit, thus providing an eight-step calibration waveform. Duration of the calibration wave for each four- or six-channel group is adjustable from 0.16 sec to 1.6 sec. Interval time between calibration cycles is adjustable from 15 to 180 sec. Both of these timing adjustments are made by means of external resistances.
 Logitek, Inc., 42 Central Drive, Farmingdale, N.Y. [375]

cppe TANDEM SYNCHROS SAVE YOU SPACE, GEARING, COST, ACCURACY

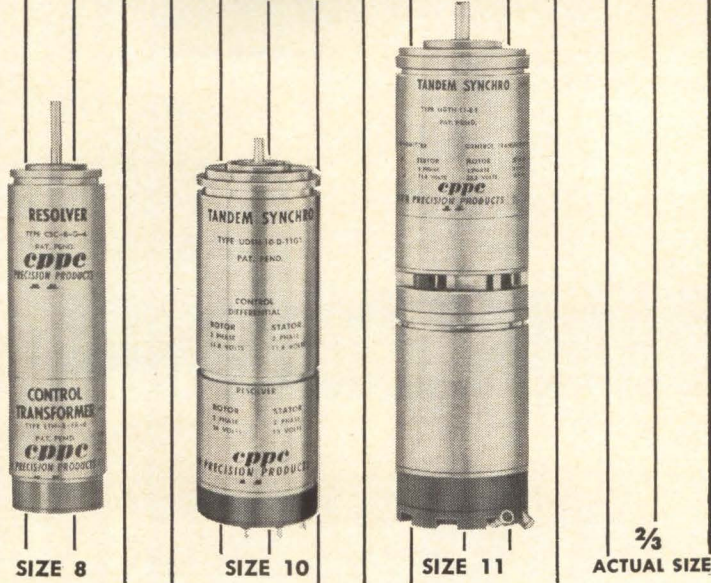

Our tandem synchros offer two synchro functions (transmitter, control transformer, differential, resolver, etc.) in a single housing with a common shaft.
 If the extra length of tandem synchros doesn't bother you, there are attractive advantages. For instance, a gear train may be entirely eliminated (and its accompanying backlash). Or, a simpler gear train may be possible. Thus there is likely to be a saving in cost.
 Stainless steel housings give Clifton units the necessary rigidity to overcome vibration problems.

We also use a unique mechanical coupling device which has reduced coupling errors to one minute max.
 Any two of our hundreds of differing electrical and mechanical characteristics are available in sizes 8, 10 or 11.
 Lengths are: Size 8—2.900 inches, size 10—2.700 inches, size 11—3.900 inches.
 For price and delivery, contact: Sales Dept., 5050 State Rd., Drexel Hill, Pa. Area 215 MAdison 2-1000. TWX 215 623-6068—or our Representatives.

CLIFTON PRECISION PRODUCTS
 Division of Litton Precision Products, Inc.
 CLIFTON HEIGHTS, PA. COLORADO SPRINGS, COLO.



Circle 107 on reader service card

WANT TO DO BUSINESS WITH THE GOVERNMENT ????????

Then check the Military and Government Procurement Guide in the orange section of your **ELECTRONICS BUYERS' GUIDE**.

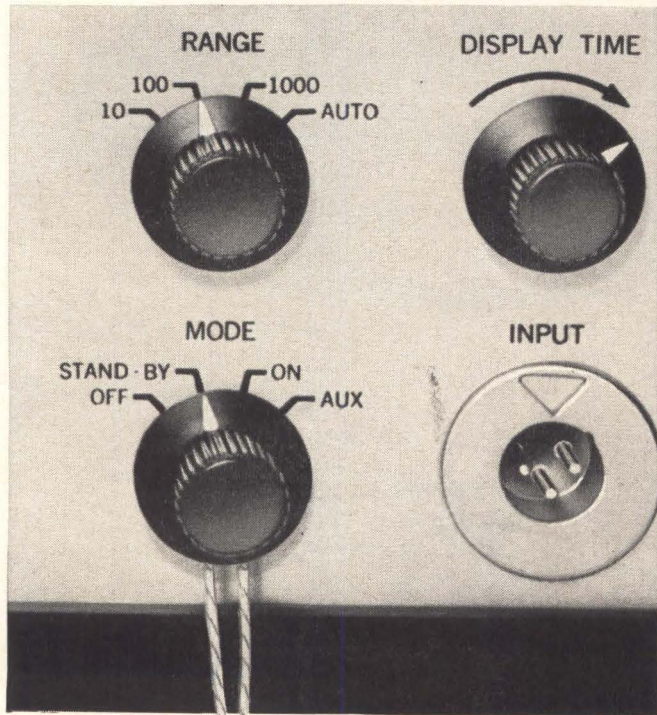

**SAVE \$1,000
on this Hughes DVM!**

For only \$2695 you can have a top-quality, 5-digit, integrating digital voltmeter with built-in features usually found only in DVMs selling for at least \$1,000 more:

Speed: 9 readings per second

Accuracy: ± .01% of reading or
± .002% of F.S.

Reliability: All solid state,
all electronic.

Get the facts now! Call, wire or write for full information on the Model 5100 and other Hughes DVMs and plug-in accessories: HUGHES INSTRUMENTS, 2020 Oceanside Blvd., Oceanside, Calif. 92057. For export information, write: Hughes International, Culver City, California 90232.

HUGHES

HUGHES AIRCRAFT COMPANY
HUGHES INSTRUMENTS
OCEANSIDE, CALIF.

NEW! HECO MINIATURE FANS

Value engineered for
high reliability and low cost

Model 4010 as shown
\$505/1000
(less grill)

Series 4000 miniature axial flow fans use symmetrical induction motor, special snap-back fan design and rugged, lightweight die-cast housing for superior performance at lowest cost. Air deliveries in excess of 100 CFM. Extremely shallow depths as low as 1 $\frac{1}{16}$ ".

Many models available from stock including: Impedance protected unit • Sleeve or ball bearings • Special fans for high static pressure operation or extreme quiet • Front end/or rear guards • Motor and fan combinations, without housings, with or without guards.

Send for literature and local source: Heinze Electric Company, 685 Lawrence St., Lowell, Mass. 01853. Phone (617) 457-7556.

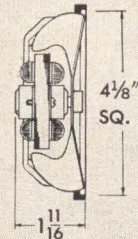
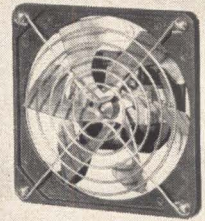

HE HECO PANEL FANS made by
Heinze Electric Company
Heat Torches and Guns • Fans • Blowers

Circle 211 on reader service card

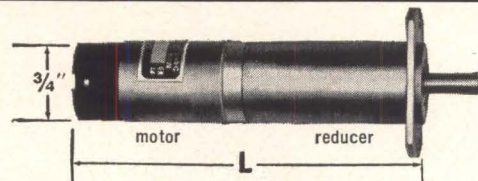

NEW 3/4" GEARHEAD MOTOR

Now you can get up to 300 oz. in. torque from a precision miniature gearmotor only 3/4" in diameter. Globe's new SD permanent magnet d.c. motor with integral planetary gearhead provides 19 standard ratios, wound for 4 to 50 volts. Armatures can be wound to produce any speed-torque combination within the capacity of the motor. Can meet environmental and other applicable portions of MIL-8609. Request Bulletin SDG from Globe Industries, Inc., 1784 Stanley Ave., Dayton 4, Ohio.

Speed Reduc. Ratio	Max. Cont. Torque In. Oz.	L	Speed Reduc. Ratio	Max. Cont. Torque In. Oz.	L
14.58	3.0		733	100	
22.03	4.5	2 $\frac{3}{4}$	1108	150	2 $\frac{5}{8}$
33.28	7.0		1853	200	
			2799	300	
55.66	10		4230	300	3 $\frac{1}{8}$
84.11	14	2 $\frac{5}{8}$	6391	300	
127.1	21		10689	300	
192	30		16150	300	3 $\frac{1}{4}$
321	45	2 $\frac{3}{4}$	24403	300	
485	70		36873	300	

GLOBE

**GLOBE
INDUSTRIES,
INC.**

Circle 212 on reader service card
Electronics | July 13, 1964

New Semiconductors

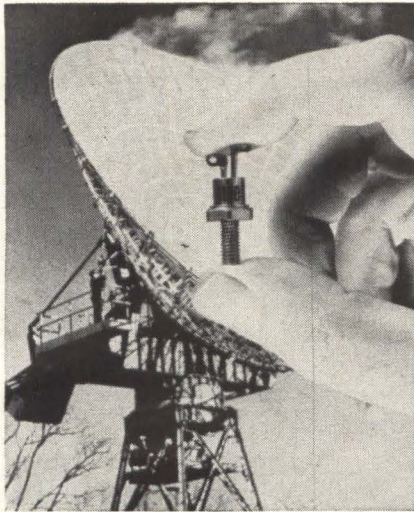

an operational amplifier in miniaturized analog computers, as a precision instrumentation amplifier, or in other applications requiring a feedback amplifier useful from d-c to 10 Mc. Typical characteristics, operating from +12 v and -6 v supplies include: input offset voltage, 2 mv; input offset current, 0.5 μ a; thermal drift, 5 μ v/ $^{\circ}$ C; input impedance, 10,000 ohms; voltage gain, 2,800; bandwidth, 1.1 Mc; output impedance, 200 ohms; output swing, \pm 5 v; input power, 90 mw; and operating temperature range, -55 $^{\circ}$ C to +125 $^{\circ}$ C.

Fairchild Semiconductor, 545 Whisman Road, Mountain View, Calif. [332]

Fast-switching scr for pulse-modulator use

A line of fast-switching silicon-controlled rectifiers is designed for pulse-modulator applications. The NCM series is rated up to 700 v forward breakover voltage in 100-v increments, offers repetitive pulse frequencies greater than 10 kc and repetitive pulse currents to 130 amps. Very stable switching characteristics are exhibited over a wide temperature range. Turn-on time is typically 0.5 μ sec; turn-off time typically 6 μ sec. Price of the NCM-500C is \$75 in 100-lot quantities.

International Resistance Co., 401 N. Broad St., Philadelphia. 19108. [331]



Operational amplifier on single silicon chip

A high-gain, d-c amplifier has been constructed on a single silicon chip using the planar epitaxial process. The μ A-702 is intended for use as

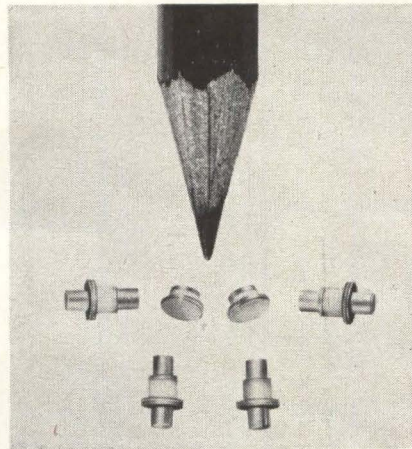

Silicon p-i-n diodes can handle up to 5 kw

A series of silicon p-i-n diodes, MS-6000, is announced for high-power microwave switches, modulators and attenuators. Breakdown voltages up to 1,400 v are available with values of junction capacitance suitable for applications in the uhf to X-band frequency range. Peak power handling capability of single units is approximately 5 kw, with low insertion loss and high isolation characteristics. Units are available in either the microwave pill or coaxial pin packages. The hermetically-sealed packages feature low parasitic capacitance and inductance and are easily used in strip-line, coax or waveguide circuits.

Micro State Electronics Corp., 152 Floral Ave., Murray Hill, N.J. [333]

Librascope magnetic encoders



have a

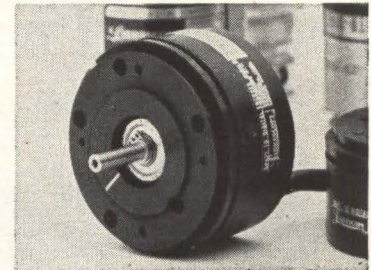

service life of

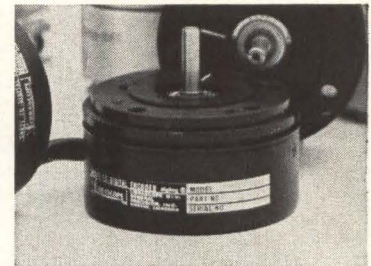

1 billion cycles

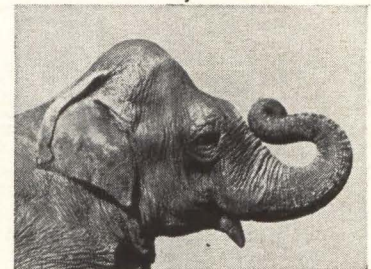

From Librascope, magnetic non-contact encoders that perform for 1 year at 2,000 rpm without failing. Plus 232 other mil-spec. encoders with the widest choice of codes, capacities, and sizes available. **Write today for your Magnetic Encoder Brochure.**

LIBRASCOPE GROUP

**GENERAL
PRECISION**

COMMERCIAL COMPUTER DIVISION
808 WESTERN AVENUE • GLENDALE 1, CALIF.

G3-10384

Informative and Useful References for the Engineer

Effects of Radiation on Materials and Components

by John F. Kircher, *Battelle Memorial Institute, Columbus, Ohio* and
Richard E. Bowman, *Atomic Energy Commission, Washington, D.C.*
1964 720 pages \$22.50

This book was written to provide design engineers and materials and components specialists with a critical summary and compilation of data and information on the permanent effects of radiation on organic materials, ceramics and metals, and semiconductors and electronic components. Here anyone who must supply materials, components or systems to "live" in a radiation environment, and who must be aware of the behavior of these materials, components, and systems in such an environment will find the information he needs to combat the deterioration that occurs. Includes valuable background chapters on theoretical considerations and dosimetry.

Sample-Size Determination

by Arthur E. Mace, *Research Associate, Applied Statistics Division, Battelle Memorial Institute.*
1964 240 pages \$12.00

A compilation of mathematical procedures for determining the optimum size of a research experiment. Some 40 different types of objectives for a research experiment are considered. For each type of objective a formula for sample-size determination is developed, and a case example applying the formula is carried out. The principles of statistical sampling presented here are valid for any kind of research—including biological, chemical and physical.

Inertial Guidance Sensors

by J. M. Slater, *Chief Scientist, Navigation Systems Division, Autonetics, A Division of North American Aviation, Inc.*
1964 272 pages \$11.00

A primer on gyros and accelerometers, this practical book covers the entire field of inertial guidance sensors in a way that makes it readily understandable to the interested non-specialist. For each of the major types of sensing instruments, the book explains and illustrates the principles of operation, characteristic features, and advantages and limitations for particular applications. Every step has been taken to meet the needs not only of those who invent and design sensing instruments, but also those who incorporate them into systems.

Electronic Transformers

by Harold M. Nordenberg, *Head of Electronics, Parts and Assemblies Unit, Bureau of Ships, Navy Department.* 1964 320 pages \$13.50

Directed to electronic equipment engineers, transformer engineers, and electronic part application engineers, this book is a complete guide to the design, construction and application of electronic transformers. Here you will find the latest transformer design, testing and manufacturing techniques . . . the advantages and limitations of various types of transformer materials . . . recommended types of transformer fabrication . . . and a completely worked-out design procedure for power transformers.

Available at your bookstore or write

REINHOLD BOOK DIVISION / 430 Park Ave. / New York, N. Y. 10022

30 DAY APPROVAL OFFER

REINHOLD BOOK DIVISION, 430 Park Avenue, New York, New York 10022

Please send me the book(s) checked below on 30 days' approval (U.S.A. and Canada only) under the following terms:

- Payment enclosed (Reinhold pays regular delivery charges)
- Bill me (plus delivery charges)
- Please send me a copy of your latest catalog.
- (500-527) Kircher-Bowman: RADIATION\$22.50
- (500-557) Mace: DETERMINATION\$12.00
- (500-567) Slater: SENSORS\$11.00
- (500-560) Nordenberg: TRANSFORMERS\$13.50

NAME _____

ADDRESS _____

CITY _____

STATE _____

ZIP _____

SAVE MONEY! Send full payment with your order and Reinhold pays regular delivery charges. Same return privilege guaranteed. Please include sales tax on Calif., Ohio, Pa., and N.Y.C. orders. For your protection—do not send cash. Send check or money order. Dept. M-394

Find the manufacturer... Fast!

It's just a matter of seconds to get the valuable information you need about electronic manufacturers and suppliers in the Electronics Buyers' Guide. The EBG has over 200 pages listing the names, addresses, phone numbers and key individuals of manufacturers of electronics equipment, related components and materials. All this plus vital company statistics. At a glance you know important facts about the company, exactly what each company makes, and where to find the manufacturers' representatives in your area. No wonder the EBG is the industry's standard catalog-directory!

Electronics Buyers' Guide

A McGraw-Hill Publication

330 West 42nd Street, New York, N. Y. 10036

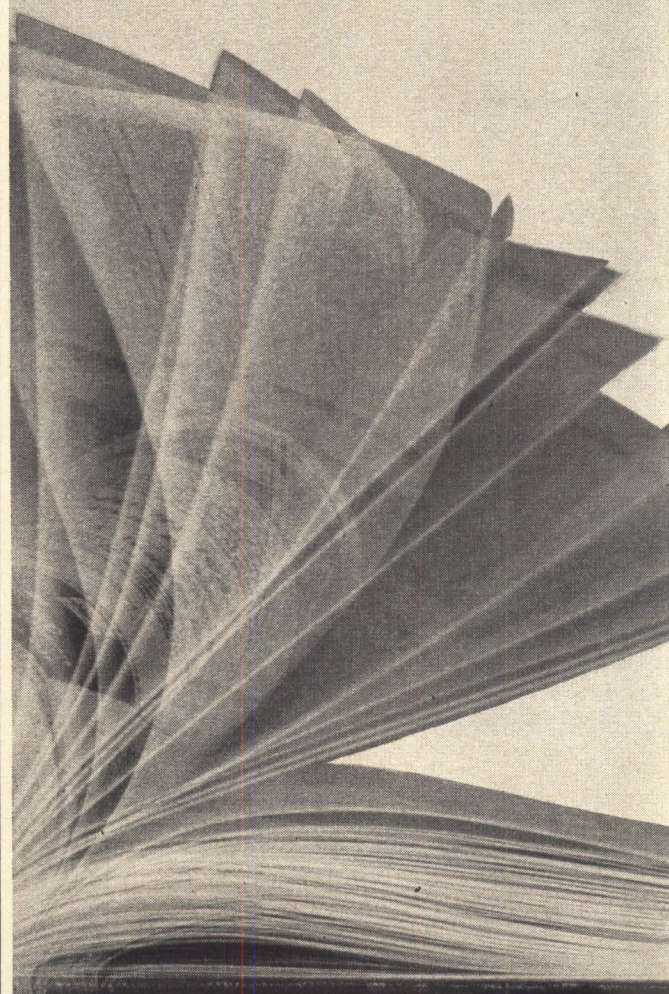

New Microwave

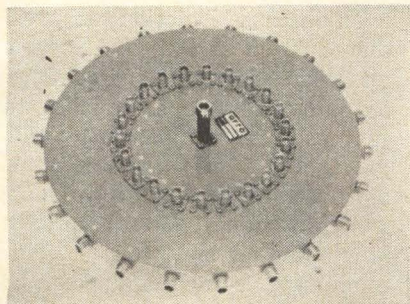

Diode switches for the 1- to 2-Gc range

Coaxial diode switches have been developed with single-pole, 22-throw construction. Specifications for the 3782 series are: frequency range, 1 to 2 Gc; bandwidth, ± 50 Mc; typical maximum insertion loss, 3.5 db; typical minimum isolation, 30 db; r-f power, 1 w max; switching time, 100 nsec; size, 12 in. diameter by 1 in. deep. Leakage current is less than 100 μ a with a reverse bias of -35 v. ARRA, Inc., 27 Bond St., Westbury, L.I., N.Y. [391]

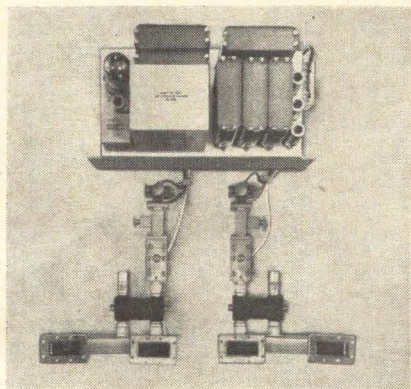

C-band paramp for dual-channel use

A dual-channel C-band parametric amplifier is designed for use in the AN/TRC-66 or similar dual-channel communications receiver. Designed to meet MIL specifications, the unit is of the remote one-knob voltage-tunable type. Field replaceable standard components (including varactors) coupled with balanced-diode mount design make

the amplifier simple to operate and maintain. Frequency range is 4,400 to 5,000 Mc, tunable; bandwidth 40 Mc typical; noise figure 3.0 db typical; and gain 18 db nominal. Airborne Instruments Laboratory, a division of Cutler-Hammer, Inc., Deer Park, L.I., N.Y. [392]



Four-way power divider offers high isolation

A decade-bandwidth, high-isolation unit, model PD-40-55 four-way power divider has a frequency range of 10 to 100 Mc. Amplitude and phase outputs over the four ports are equal within 0.1 db and 1 deg, respectively. Impedance is 50 ohms; vswr (all ports) less than 1.3; isolation (between ports), greater than 25 db typical; insertion loss, less than 0.5 db typical; power, to 2 w average; size, 1 1/4 in. by 2 1/4 in. by 3 1/4 in. Price in small quantities is \$150. Merrimac Research and Development, Inc., 517 Lyons Ave., Irvington 11, New Jersey [393]

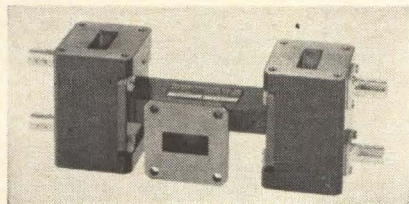

Waveguide switch features high speed

A single-pole, four-throw waveguide switch, model X460 permits switching one port to any of four other ports or to any combination of ports. It features a switching speed of less than 20 nsec and an

PAMOTOR

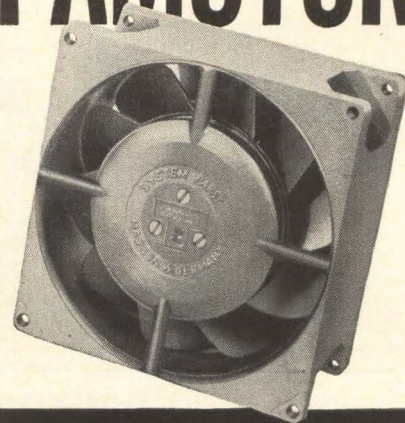

A VERSATILE NEW LINE OF MINIATURE AXIAL FANS

with features that surpass
other cooling devices in
**CONSTRUCTION,
PERFORMANCE,
RELIABILITY!**

Superior inside-outside rotating motor design yields higher torque capabilities • Flywheel effect produces constant, quiet fan speed • Available in both induction (capacitor-type squirrel cage) and shaded-pole types • Large surface sinter-metal sleeve bearings designed for permanent lubrication • Housings are of die-cast, warp-free metal construction, unlike plastic housings of many conventional fans • Ruggedly-built, yet extremely light in weight—18 oz. to 26 oz., depending upon model no. • Wide range of performance characteristics to meet specific requirements.

model no.	volts	freq. (cy.)	air flow (cfm)	overall size (inches) w. h. d.
1000A	115	60	125	4 1/2 x 4 1/2 x 2
1000B	115	50	100	4 1/2 x 4 1/2 x 2
1100	115	400	100	4 1/2 x 4 1/2 x 2
1200	115	60	60	4 1/2 x 4 1/2 x 2
1300A	220	60	125	4 1/2 x 4 1/2 x 2
1300B	220	50	110	4 1/2 x 4 1/2 x 2
2000A	115	60	134	4 1/2 x 4 1/2 x 2
2000B	115	50	116	4 1/2 x 4 1/2 x 2
2000C	220	50	116	4 1/2 x 4 1/2 x 2
2500A*	115	60	100	4 1/2 x 4 1/2 x 2
2500B*	220	60	90	4 1/2 x 4 1/2 x 2
2500C*	220	50	80	4 1/2 x 4 1/2 x 2
3000A	115	60	60	3 1/2 x 3 1/2 x 2
3000B	115	50	54	3 1/2 x 3 1/2 x 2
3000C	220	50	54	3 1/2 x 3 1/2 x 2
5000A	115	60	115	5 dia. x 2 1/2 deep
5000B	220	50	100	5 dia. x 2 1/2 deep

*Series 2500 is shaded-pole type. All others are induction type, equipped with appropriate capacitor.

For complete specifications and name of nearest stocking distributor, write to:

PAMOTOR, INC.
312 SEVENTH STREET • SAN FRANCISCO, CALIF.

WHICH DEFLECTION YOKE FOR YOUR DISPLAY ?

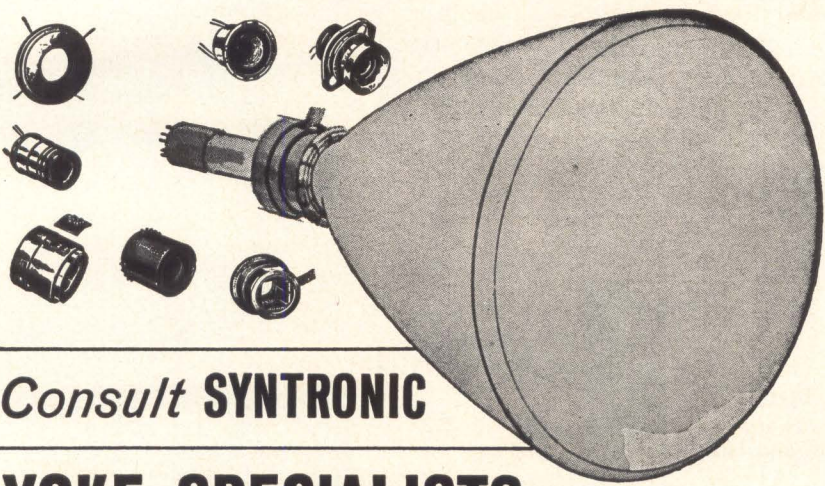

Consult **SYNTRONIC**

YOKE SPECIALISTS

Syntronic's team of experts knows more about yoke design, engineering and quality control than anyone else. A solid 10-year record of leadership—acknowledged throughout the industry. Benefit from it.

syntronic INSTRUMENTS, INC.
100 Industrial Road, Addison, Illinois
Phone: Kingswood 3-6444

Circle 213 on reader service card

You Get Things Done With Boardmaster Visual Control

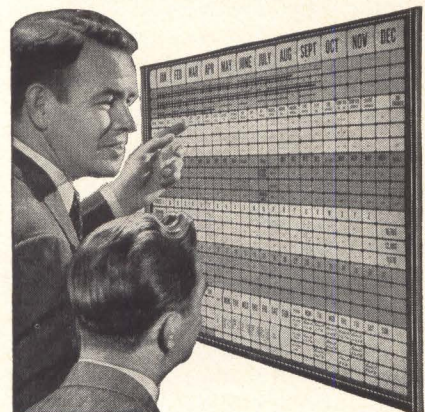

- ★ Gives Graphic Picture of Your Operations—Spotlighted by Color
- ★ Facts at a glance — Saves Time, Saves Money, Prevents Errors
- ★ Simple to operate — Type or Write on Cards, Snap in Grooves
- ★ Ideal for Production, Traffic, Inventory, Scheduling, Sales, Etc.
- ★ Made of Metal. Compact and Attractive. Over 750,000 in Use

Full price **\$49.50** with cards

FREE 24-PAGE BOOKLET NO. C-20 Without Obligation

Write for Your Copy Today
GRAPHIC SYSTEMS
Yanceyville, North Carolina

112 Circle 112 on reader service card

ELECTRONIC SYSTEMS ENGINEERS

We are looking for recent graduates and experienced Systems Engineers with an MS degree in electronics.

Specific areas include:

Laboratory design in electronics, optoelectronics, and infrared.

Communication systems analyses and design, including voice, teletype, data link, vocoders, crypto, and automatic switching.

Computer systems and applications in command and control, automatic checkout, and navigation.

Electromagnetic compatibility analyses and tests, designed to reduce interference in new aircraft designs.

If you are tired of specializing in a narrow field of electronics and wish to broaden your experience through systems work, investigate these openings at the Lockheed-Georgia Company, located eight miles from metropolitan Atlanta.

Send complete resume, in confidence, to: Thomas I. Thrasher, Professional Employment Manager, Lockheed-Georgia Company, 834 West Peachtree Street, Atlanta, Georgia 30308, Dept. BB-88.

LOCKHEED-GEORGIA COMPANY
A Division of Lockheed Aircraft Corporation

An equal opportunity employer

New Microwave

open-channel isolation of greater than 20.0 db at 10.0 Gc. Novel applications include switching the outputs of four separate microwave sources to a common port, dividing power between the ports equally or according to desired ratios, and switching one power source to four antennas or to four individual microwave circuit branches. Useful frequency range is 8.2 to 12.4 Gc; modulation frequency, d-c to 200 Mc; power-handling capability, 6.0 w c-w, 300 w peak; dimensions, 7¼ by 2¾ by 2¾ in.; weight, 1.5 lb. Price is \$395.

Somerset Radiation Laboratory, Inc., P.O. Box 201, Edison, Pa. 18919. [394]

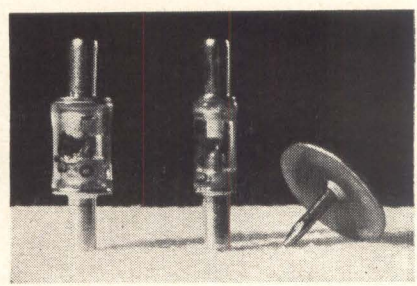

Switching diode for Ku-band waveguide

Housed in tiny glass packages, hermetically sealed, series L4750 have optimum switching performance in RG-91/U waveguide and operate without tuning or adjustment. The waveguide switch using one of them can be repaired simply by replacing the diode. The series of eight diodes features one specified for every 500 Mc from 14.0 to 17.5 Gc, each exhibiting a typical insertion loss of less than 1 db with a typical isolation greater than 30 db at its specified operating frequency. Switching speed of all eight diodes is typically 10 nsec. The c-w power-handling capability of the series is 2.5 to 5.0 w, the diodes operating at the lower frequencies handling the higher power levels. The diodes are ideal for use in microwave modulators, phase shifters, limiters and other microwave power-control applications.

Philco Corp., Lansdale division, Lansdale, Pa. [395]

New Production Equipment

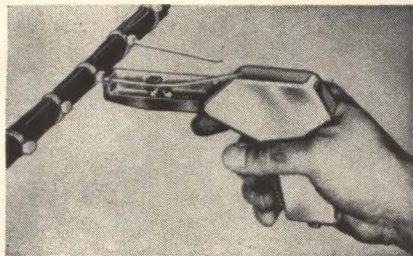

Tension-controlled cabling tool

A new, gun-type manual cabling tool, designated GS-2B, is of the direct (in-line) feed type with strap cut-off at a preset and controlled strap tension. The tension level is readily controlled and adjusted without the need of separate and auxiliary tools. Tension setting is easily calibrated for complete operator convenience and control. The same tool is used to install both the standard and miniature Sta-Strap line of cable ties, clamps and identification markers. Panduit Corp., 17301 Ridgeland Ave., Tinley Park, Ill. 60477. [421]

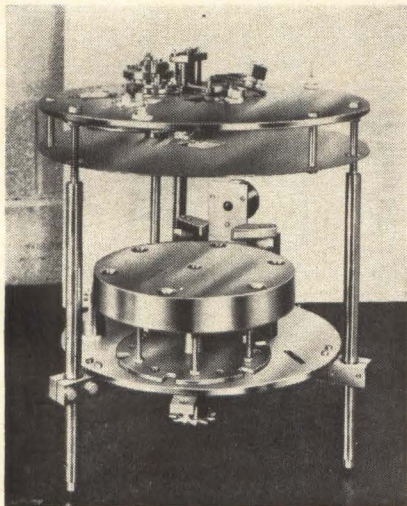

Microcircuit jig with electron gun

A compact microcircuit jig with electron gun (designed for the evaporation of microcircuit materials) requires no special mounting flanges nor water cooling. It is available with all Speedivac 19E

and 19A2 evaporators. Capable of evaporating any refractory material (to 3,300°C), this equipment includes six 2-in. square substrates providing for coating with six different materials through six different masks. It also contains the company's patented glow discharge cleaning rings along with the rotating six-position vapor source. The accuracy of registration of each successive mask in contact with a given substrate is within ± 0.001 in.

Edwards High Vacuum, Inc., 3279 Grand Island Blvd., Grand Island, New York [422]

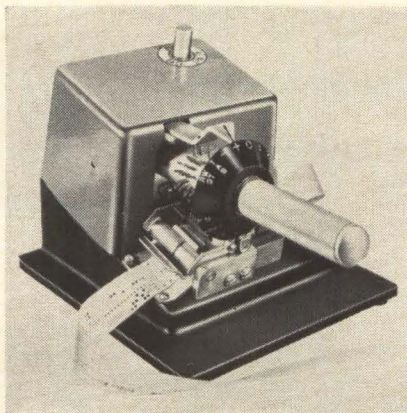

Hand-operated tape-puncher

A low-cost, precision tape puncher is designed to let the operator of a numerically-controlled machine tool punch his own tapes without leaving his work station. The machine operator or setup man can punch over a hundred X-and-Y locations in the control tape in less than a half hour. Feed of the tape is timed to punch 4 in. of tape to 0.008-in. to 0.010-in. accuracy, well within the limits required by tape reading heads. Tape can be corrected by masking out the incorrect signal with ordinary transparent tape and re-punching. Operation is merely a matter of turning the punching spindle to the correct dial setting and pressing down the handle. Price of the unit is \$489. Production Engineering Corp., 117 Second St. North, Minneapolis 21, Minn. [423]

LEAK DETECTION

CEC's 24-039 Automatic Counting Station now provides a new dimension in efficiency for users of the Radiflo Leak Detector System. The 24-039 operates virtually unattended, yet tests components at approximately *four times* the speed of manual methods. By checking two or three components per test, the ACS can leak-check 40,000 parts a day—more than 10,000,000 a year—at a cost of only two mils per part!

Super counter

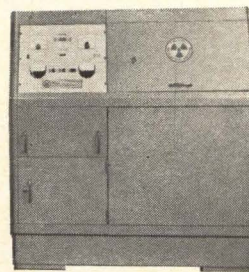
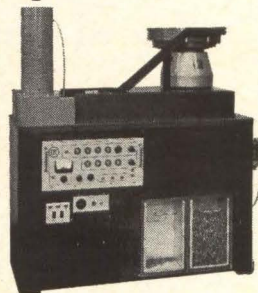

100% testing

CEC's 24-510A Radiflo Leak Detector makes it economically feasible to checkout mass-produced components—such as transistors, diodes and relays—with 100% reliability. The 24-510A detects leaks of 1×10^{-5} to 1×10^{-11} atm cc/sec, and allows checking at rates up to 2,500 components per hour.

For full information about these two instruments, call or write for Bulletins CEC 24510-X10 and CEC 24039-X5.

CEC

Analytical & Control Division

CONSOLIDATED ELECTRODYNAMICS

A SUBSIDIARY OF BELL & HOWELL/PASADENA, CALIF. 91109
INTERNATIONAL SUBSIDIARIES: WOKING, SURREY, ENGLAND
AND FRANKFURT/MAIN, GERMANY

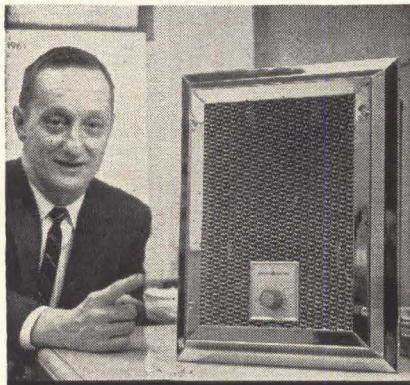

John A. Rovegno, manager of special products at General Electric's Home Care & Comfort Products Department, Bridgeport, Conn., shows heater frame.

Di-Acro adjustable punch and die sets cut over 3/4 from this tooling cost

Now you can beat the short-run profit squeeze with Di-Acro Adjustable Punch and Die Sets that reset quickly and easily with a minimum of down time. A department of General Electric's Housewares & Commercial Equipment Division, for example, reduced tooling costs on one product line, the GE built-in wall heater, by more than three-fourths.

Department Manager John A. Rovegno says, "We have found that adjustable punch and die sets give us versatility and flexibility in our manufacturing methods. In addition, they have afforded us significant savings in tooling costs."



"Modular" setup proceeds rapidly with these reusable components.

After making the number of parts needed, you can reset this adjustable punch and die for any minor change or for a completely new part. No more extensive and costly stockpiling—any part "repeats" quickly.

All Di-Acro Adjustable Punch and Die Set components are fully reusable. Die set sizes range up to 18" x 36" for punch presses and up to 5 1/4" x 96" for press brakes with a wide range of standard and "electrical" die shapes available—also made-to-order specials. See your nearest Di-Acro distributor or write for information—ask about savings on the special starter set.



Simple standard operation—note multiple punching setup.



DI-ACRO CORPORATION

437 Eighth Street
Lake City, Minnesota

New Materials

Epoxy coating resin with low exotherm

A general-purpose, low-cost, epoxy casting compound has been developed. A 1-lb quantity of Hightemp 5506, when cured at room temperature, will set overnight to a strong, rigid, tack-free solid with an exotherm peak below 100°F. Other features include a viscosity of less than 3,500 cps; a pot life of two to three hours; shrinkage of less than 0.1%; excellent thermal conductivity; and water absorption of 0.1%. Price is 60 cents per lb in quantity.

Hightemp Resins Inc., 225 Greenwich Ave., Stamford, Conn. [411]

Magnet material offers high coercive force

A sintered Alnico VIII magnet material offers a high coercive force combined with a good maximum energy product. It is well suited for small or complex-shaped magnets where powder metallurgy techniques offer important economic advantages. Typical applications include: core meters, small ppm twt stacks, polarized relays and holding and torque transmitting devices. The sintered material can be produced in a wide variety of shapes, such as bars, rods, rectangles, disks, cylinders and complex configurations. All magnetic properties are comparable to cast Alnico VIII. However, magnets of sintered Alnico VIII have greater physical strength, are finer grained and hold closer tolerances than a cast material. Temperature characteristics are similar to cast Alnico VIII. Orientation must be straight. Indiana General Corp., Valparaiso, Ind. [412]

Epoxy compounds cure with heat

The Isochemgel 100 series consists of 100% solids, single-component systems that do not react at room temperature but cure readily with

heat. They are flexible, thixotropic, epoxy compounds formulated to offer maximum electrical, physical properties and chemical resistance. The manufacturer says, they do not run or sag during cure. The compounds are used for dip-coating small coils, motor fields, transformers, chokes, resistors, capacitors and similar items. They are also used as an encapsulant, paint, adhesive and potting material. Prices range from \$2.25 per lb. in 50-gallon drums to \$3.15 per lb. in quart cans.

Isochem Resins Co., 221 Oak St., Providence 9, R.I. [413]

Inert fluid coolant reduces costs

A new fluorochemical coolant, called FC-77, has been developed. Company claims that, due to economical production methods, FC-77 is being marketed at about 25% less than the cost of previous inert fluids used to stabilize temperatures of components in the electronic and aerospace industries. The clear fluid boils at about 100°C and has a dielectric strength in excess of 35 kv.

3 M Company, 2501 Hudson Road, St. Paul, Minn. 55119. [414]

Aluminum sheet is fused tin-plated

Fused tin-plated aluminum sheet stock in 3-ft. by 8-ft. sizes, for chassis, brackets, enclosures, mounting plates and hermetically-sealed containers is now available. It permits electrical soldering directly to the sheet after fabrication. The fused tin plate is a tin electroplate of 0.0002 in. to 0.0005 in. thickness and completely eliminates the need of corrosive fluxes. Soldering characteristics are equivalent to soft solder, exceed those of cadmium, and are superior to unfused tin plate. Conventional solders and soldering techniques may be used. MetaLine Products, 4355 E. Sheila St., Los Angeles 23. [415]

Two Unique Reasons Why Hughes Can Offer You A Truly Rewarding Career In Systems Analysis

1 **Continuing responsibility throughout product development.** The shaping of basic concepts is only the beginning of your contribution as a Hughes systems analysis engineer. It also includes systems and subsystems optimization, and responsibility for technical integrity of the system through prototype design and development, production design and testing, and operational phases. You monitor each stage of the program, evaluating all pertinent technical information and suggestions for refinement or possible modification. Your strong involvement from start to finish, and the responsibility you have for a successful outcome, provide the kind of incentives that inspire a man's best efforts.

2 **"Accent on enlightenment" among technical managers.** From immediate supervision to the policy forming level, Hughes managers

are young, vigorous and technically oriented. A high percentage hold advanced degrees in science and engineering — an achievement encouraged and respected at Hughes. Many present technical managers began their careers just a few years ago as Fellows in the Howard Hughes Masters and Doctoral Fellowship programs. The resulting climate of rationality assures that your work and professional growth will be recognized and rewarded.

These policies have contributed measurably to the Hughes position of leadership in the systems industry. The company has grown rapidly from 2,000 employees in 1950 to over 24,000 in 1964. And this growth is continuing.

Hughes systems analysis is not limited to current programs. Much is directed toward the conception and development of advanced systems requiring such techniques as synthetic array radar, infrared sensors, LASERS and

MASERS, ion engines, television sensors, millimeter wave devices, inertial devices, digital computers, displays and controls.

If you are a graduate of an accredited engineering university, are a U.S. citizen, and have acquired some applicable technical experience, we would like to acquaint you with some of our hundreds of openings.

For immediate consideration, please airmail your resume to:

MR. ROBERT A. MARTIN
Head of Employment
Hughes Aerospace Divisions
11940 W. Jefferson Blvd.
Culver City 7, California

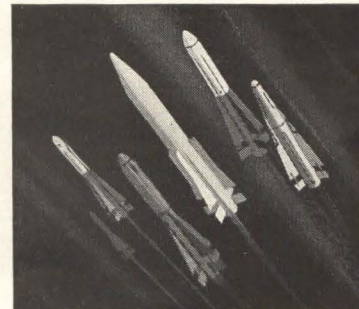

WE PROMISE YOU A REPLY WITHIN ONE WEEK

An equal opportunity employer.

Creating a new world with electronics

HUGHES

HUGHES AIRCRAFT COMPANY
AEROSPACE DIVISIONS



Find
the
product...
Fast!

It's quick and easy to locate any of the thousands of electronic and allied products in your **Electronics Buyers' Guide**. All are listed clearly and unmistakably, cross-indexed with end use terms, synonyms and newly devised terms. And, all advertisers in the EBG are carefully cross-referenced to their catalog-advertisement. Top this off with 6,000 trade names indexed alphabetically and you have the most complete, accurate and authentic product listings in the industry!

Electronics Buyers' Guide
A McGraw-Hill Publication
330 West 42nd Street,
New York, N.Y. 10036

New Literature

Telemetry system. Beckman Instruments, Inc., Systems Division, 2500 Harbor Blvd., Fullerton, Calif. Model 4400 pam/pdm ground telemetry system is described in bulletin SY64397. Circle 451 on reader service card

Switch layout wheel. Oak Mfg. Co., Crystal Lake, Ill., has available a 12-point type rotary-switch design wheel with a protective coating for durability. After the first use and erasure, future markings with a pencil will be clear and highly readable. [452]

Electronic circuit cards. Bryant Computer Products, 850 Ladd Rd., Walled Lake, Mich. Four data sheets describe read amplifier 8005, write amplifier 8010, single-head select 8020, and multihead select 8025. [453]

Silicon transistor chopper. Solid State Electronics Co., 15321 Rayen St., Sepulveda, Calif. A bulletin describes model 70 silicon transistor chopper, a solidly encapsulated unit designed alternately to connect and disconnect a load from a signal source. [454]

Data systems equipment. Packard Bell Computer, 2700 S. Fairview St., Santa Ana, Calif. 92704. Catalog SP-171 covers a line of a-d and d-a converters, sample and hold amplifiers, and multiplexers. [455]

Time sharing system. Digital Equipment Corp., Maynard, Mass. An 8-page brochure provides a condensed description of the hardware and software that enables time-shared operations on PDP-6 programed data processor. [456]

Noise performance of f-m microwave systems. Lenkurt Electric Co., Inc., 1105 County Road, San Carlos, Calif. An 18-page technical paper, monograph 196, describes the noise performance of f-m microwave systems using single sideband, suppressed carrier multiplex equipment. [457]

Power supply engineering data. Trio Laboratories, Dupont Drive, Plainview, N.Y., offers a compendium of technical information for guidance of the equipment designer faced with the necessity of selecting, designing, and/or purchasing a power supply. [458]

Microwave components. Microwave Associates, Inc., Northwest Industrial Park, Burlington, Mass. Two new short form catalogs describe a full line of microwave components for X and K-band applications. [459]

Subminiature ceramic capacitors. Muccon Corp., 9 St. Francis St., Newark, N.J. 07105. Catalog 0-1, with complete information about subminiature ceramic capacitors may be obtained by writing on company letterhead.

Capacitance measuring system. ESI/Electro Scientific Industries, 13900 N.W. Science Park Drive, Portland, Ore. 97229. Catalog sheet C-51 describes model 701 capacitance measuring system, featuring $\pm 0.01\%$ direct-reading accuracy and one-part-per-million comparison accuracy. [460]

Pressure transducer. Micro Systems, Inc., 170 N. Daisy Ave., Pasadena, Calif. Type 1004, a rugged, ultraminiature, semiconductor pressure transducer, is described in a new data sheet. [461]

Digital systems. Navigation Computer Corp., Valley Forge Industrial Park, Norristown, Pa., has available a sample set of "Pulse Techniques," a monthly technical note describing interesting techniques and procedures used in designing digital systems with the 400-series logic modules. [462]

Semiconductor products. Motorola Semiconductor Products Inc., P.O. Box 955, Phoenix 1, Ariz. A 26-page condensed catalog covers a complete line of standard industrial and MIL-type semiconductor products. [463]

Digital printer. Franklin Electronics, Inc., Bridgeport, Pa. 19405. A high-speed digital printer, model 1000 is fully described in bulletin 2301. [464]

Transformers. Sterling Transformer Corp., 510 Driggs Ave., Brooklyn, N.Y. 11211. A 16-page booklet contains important engineering information in easy-to-read graph and chart form, as well as photos of many transformers and their major applications. [465]

Radar performance monitors. Airborne Instruments Laboratory, a division of Cutler-Hammer, Inc., Deer Park, L.I., N.Y. A 4-page brochure sets forth the theory of operation of radar performance monitors, their characteristics, features, and a typical specifications sheet. [466]

Microcircuit production. El-Pac Co., Inc., 800 E. Main St., Norristown, Pa. 19404, has published a 6-page brochure providing complete technical information on its facilities and capabilities for the packaging and production of microcircuitry. [467]

Coupler. Radiation Systems Inc., 440 Swann Ave., Alexandria, Va., has published a technical bulletin on model 2633, an 8-to-1 bandwidth 3-db coupler that operates from 100 to 8,000 Mc in four bands. [468]

Instrument specifying guide. Berkeley Division, Beckman Instruments, Inc., 2200 Wright Ave., Richmond, Calif. 94804, announces a comprehensive catalog on an entire line of electronic test and measuring instruments. [469]

New Books

Transformers

Electronic Transformers.
Harold M. Nordenberg.
Reinhold Publishing Corp.
New York, 1964, 298 pp., \$13.50.

Despite its drawbacks—and it has several—this book is of value to the engineer as a reference document. The author has collected a considerable amount of data and information, largely from published articles, which should prove helpful to students and engineers. The discussion of transformer materials is particularly thorough and adequately documented with tables of physical and electrical characteristics.

However, the book, which is limited to the use of audio power and pulse transformers in electronics, is much too heavily oriented to the author's military experience rather than to commercial practice. It would have been better if the first chapter had been entirely omitted. The extensive discussion of unrelated historical developments concerning electronic parts and the organizational development of various government and military groups may belong somewhere—but certainly not in this book on electronic transformers. The space could have been more effectively used to expand the material on transformer construction and wire-winding methods or transformer design procedure—both areas are painfully inadequate if the book is to serve as a working reference.

Other minor drawbacks include occasional inconsistencies in assuming or not assuming knowledge on the part of the readers, split organization of material (as in the case of discussions concerning corona) and more than the normal share of flubs in the grammatical department.

Jerome Eimbinder
Circuit Design Editor

Transform reference

Laplace Transform Tables.
Paul A. McCollum and Buck F. Brown.
Oklahoma State University,
Stillwater, Okla., 1964, 108 pp., \$3.50.

This new listing of 520 Laplace

transform pairs was undertaken by the authors to expand the field of usefulness of a similar but less comprehensive table assembled by D.L. Johnson and published in 1951.

The plan of the authors was to place special emphasis on topics related to operational methods and to arrange the transform pairs for quick and easy reference by engineer users.

With the specific interests of its selected audience in mind, the project has been markedly successful. First, there is a clear and concise statement of the several properties of the Laplace transform. The value increases with an exposition of 17 most-often-used Laplace transform pairs, applicable to a wide range of boundary problems and other theoretical concepts encountered in electronics and physics calculations.

The authors have followed the table with a meaty and lucid textual review of the functions of this complex variable, which increases the usefulness of the volume. Not intended to be a rigorous treatment, this convenient refresher chapter neatly summarizes topics ranging from complex differentiation, integration and Laurent expansion to evaluating closed-path integrals through the use of residues and partial fraction coefficients.

Half a dozen miscellaneous charts and tables of special interest to engineers dealing with electrical theory, follow, and a short but complete bibliography of operational mathematics and related subjects complete the volume.

The typeface and format are crisp and legible, and great care has been exercised in checking and rechecking content. Three errors were detected after printing of the volume and are listed in a tipped-in note.

The volume should find a place in the desks and reference libraries of the world-wide fraternity of practicing electrical and electronic engineers.

David Valinsky
Baruch School of Business
City College of New York

McGRAW-HILL
BOOKS

Just Published

STANDARD ELECTRONICS QUESTIONS AND ANSWERS

Vol. I: Basic Electronics
Vol. II: Industrial Electronics

Provides in question-and-answer form practical information for solving everyday operating and maintenance problems in all branches of electronics. Volume I covers basic principles, including such topics as direct current, magnetism, vacuum tubes, semiconductors, power supplies, and others. Second volume treats basic industrial circuits, explaining exactly what happens in each circuit and device to make it function. Oscillators, control systems, color TV, and industrial processes and devices are some of the subjects covered. By S. M. Elonka, *Power*; and J. L. Bernstein, *RCA Institutes, Inc.* 2 Vols. 445 pp., illus., \$15.95. Convenient Terms: See Coupon

FUNDAMENTALS OF MICROWAVE ELECTRONICS

Just Out. Treats principles underlying the design and operation of microwave tubes. Electron beams, space-charge waves, traveling waves, and other topics are covered. By M. Chodorow, *Stanford Univ.*, and C. Susskind, *Univ. of Calif.* 288 pp., 46 illus., \$12.50

PHYSICS OF SOLIDS

Just Out. Explains physical nature of matter in the solid state. Covers crystal structure of solids, electronic structure, dielectric and magnetic properties, and more. By C. Wert & R. Thomson, *Both of Univ. of Ill.* 436 pp., illus., \$10.50

MATHEMATICAL METHODS IN RELIABILITY ENGINEERING

Just Out. Presents the fundamental mathematical and analytical tools which are the basis for reliability engineering. Includes statistics, rudiments of set theory and Boolean algebra, simple model theory, and more. By N. Roberts, *Univ. of Washington.* 304 pp., illus., \$12.50



10 DAYS' FREE EXAMINATION

Convenient Mail Service

Direct from McGRAW-HILL

McGraw-Hill Book Co., L-8-13
327 W. 41st St., New York, N. Y. 10036

Send me book(s) checked below for 10 days on approval. In 10 days I will remit for book(s) I keep plus few cents for delivery costs, and return unwanted book(s) postpaid. (If you remit with coupon, plus local tax, we pay delivery costs—full refund and return privilege.)

- Elonka & Bernstein—Std. Elec. Q. & A., \$15.95
 Payable \$5.95 in 10 days, and \$5.00 monthly
 Chodorow & Susskind—Fund. of Microwave Elec., \$12.50
 Wert & Thomson—Physics of Solids, \$10.50
 Roberts—Math. Methods in Reliab. Engrg., \$12.50

Name

Address

City State..... Code

Company

Position

For price and terms outside U.S.
write McGraw-Hill Int'l., N. Y. 10036 L-8-13

To order

reprints

fill in, cut out

coupon below,

insert in envelope

and mail to:

Electronics Reprint

Dept.

330 West 42nd Street

New York, N. Y. 10036

Reprint order form

For listing of reprints available see the reader service card

To help expedite mailing of your reprints please send cash, check or money order with your order.

For reprints of the latest Feature article:

Oceanography

Send me reprints of key no. R-58 at 50¢ each.

For reprints of previous special reports fill in below:

Send me reprints of key no.(s)

..... at ¢ each.

For prices see the reader service card.

Name

Number & Street

City, State

Zip Code

Technical Abstracts

All-weather altimeter

A cw/fm altimeter for commercial aircraft. By J.L. Ware and B.B. Mahler. ITT Federal Labs, Nutley, N.J.

The exact determination of altitude is of major importance in the operation of aircraft, and most important when considering all-weather landing capability.

The operation of a frequency-modulated radio altimeter involves a transmitted signal, whose frequency varies linearly with time, and the determination of the time required for the signal to travel from the aircraft to the ground and back again. The mixing of the transmitted and received signals give a difference frequency (Δf) that is proportional to the time interval (Δt) and is therefore proportional to altitude.

Sinusoidal modulation is used in this altimeter. This type of modulation makes it impossible to indicate height directly on a frequency meter. Mathematical analysis, however, shows that the average frequency difference is directly related to height in the same manner as a constant frequency that would have been obtained with an ideal linear system.

The derivation of the frequency equation produces an expression for F_{av} [$F_{av} = 4\tau \Delta f \Delta t$] that is of the same form as the ideal linear system; or $F_{av} =$ cycles per foot of altitude. The continuous-wave f-m principle helps in simplifying the design by permitting a higher resolution time for the altimeter.

The "step distance" or "step error" is the smallest increment of height an f-m altimeter can resolve. The height indication is proportional to the average frequency count per modulation sweep; more counts per sweep are introduced as the height increases. Therefore, the effective step distance is equivalent to the rate of f-m sweep per average count. Typical altimeters give step distances of about 2.5 feet.

The altimeter's transmitter is a velocity-modulated coaxial line oscillator (Heil tube). Long life, freedom from spurious moding and ease of tuning characterize this tube. The modulator is a motor-

driven, double-vane butterfly assembly inside the waveguide cavity. It is rotated at 150 rps between two capacitive stators in the cavity, and provides sinusoidal modulation at 300 cps to the carrier.

The amplifier section has a peak gain of 100 decibels, and the frequency response is characterized by a slope of five decibels per octave. Anti-interference circuits are incorporated in the amplifier to reduce the effects of stray pulses on count accuracy, and to bypass much of the random noise encountered at high altitudes.

A feature of this radio altimeter is its alarm system, which is activated when the altimeter fails, when unreliable signals are being received or when the aircraft is above 2,500 feet. A flag alarm appears, and the indicator pointer disappears behind the mask at the high end of the scale.

Presented at the national aerospace electronics conference, May 11-13, Dayton, Ohio.

Microwave delay line

A YIG delay line for use at microwave frequencies. R.A. Sparks, G.R. Gourley and E.L. Higgins, Emertron-Litton, College Park, Md.

Recent experimental investigations of the microwave acoustic properties of yttrium iron garnet (YIG) have resulted in single-crystal YIG bars for microwave delay lines up to 4 Gc/sec.

The device operation is based on the conversion of r-f energy to elastic vibrational energy so that the delay is proportional to the crystal length and the velocity of propagation of sound in YIG.

The YIG rod is placed in a d-c magnetic field of sufficient magnitude to bias the end faces near ferromagnetic resonance. When excited by an incident electromagnetic pulse, the short-circuited end of the input coaxial center conductor produces a large oscillating magnetic field which is transduced by a magnetostrictive process to a circularly polarized acoustic shear wave in the YIG. The acoustic wave propagates down the rod and a fraction of the energy is

transmitted via the output antenna. The balance of the energy is reflected to the input. The reflected pulse continues to traverse back and forth in the YIG rod until all the energy is transmitted, or dissipated by scattering and sonic absorption processes. The output signal is observed as a train of pulses, damped exponentially and pulsed at intervals corresponding to the round trip time in the medium.

Prototype designs for YIG delay lines reduce the magnet size considerably and incorporate a matching section as an integral part of the device.

Presented at the 1964 international symposium of the professional technical group on microwave theory and technique, May 19-21, Kennedy International Airport, N.Y.

Ship-shore tropo

Diversity techniques applied to a ship-to-shore tropospheric scatter path. H.R. Johnson, Combat Command and Control, ODDR/E, Washington, D.C. and T.J. Meek, Jr., Edison-Page, S.A., Rome, Italy.

Tropospheric scatter communications between a coastal station and the USS Northampton at sea have been carried on over the range between 200 to 250 miles using diversity techniques and a stabilized ship antenna.

At the shore terminal, two antennas were lined up roughly parallel to the shoreline, providing horizontal diversity at short range. On the ship, a single antenna stabilized in three directions generated two paths to the shore antennas, creating space diversity.

Use of frequency diversity requires splitting the transmitter power, at a 3-db penalty, but the tracking problem is reduced. Equipment reliability results from use of two frequencies because failure of a single transmitter or receiver will not be catastrophic. Space diversity exists in vertical and horizontal directions so the resultant quadruple diversity insures high reliability for voice circuits and digital data.

Information derived at the ship from loran or other navigational aids can be used for automatic tracking and control, with a small computer supplying the ship-to-shore bearing.

Presented at IEEE-University of Pennsylvania Globecom VI June 2-4, Philadelphia.



The 960 receiver is designed to operate from a 50-ohm source impedance. Separate inputs are provided permitting the use of optimum antenna for each frequency. Solid state devices and vacuum components are used for those functions for which they are best suited. This permits the design of an instrument with high performance and small size.

Frequency range.....	30-300mc in 2 bands:	Type of reception.....	AM-FM-CW
	Band A: 30-90mc	IF bandwidths....	2 operating simultaneously:
	Band B: 60-300mc		2mc, and either 200kc
Noise figure.....	Band A: 4.5 db max.		or 20kc, selectable from
	Band B: 6.5 db max.		front panel.

Communication Electronics Incorporated

4908 HAMPDEN LANE, BETHESDA 14, MARYLAND

Circle 214 on reader service card

TR MICRO TV TUNER

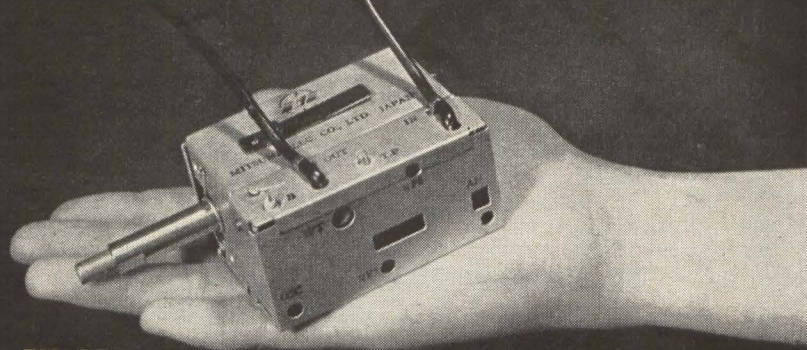

MODEL TU-15U

This MICRO TV TUNER, using 3 transistors, provides you with excellent performance while keeping high quality stability, thanks to our latest technical advancement. Spurious radiation meets the requirements of FCC and is guaranteed for performance of more than 40,000 operations. We also offer you many other lines of components for your use. Please write us asking for catalogs available on the following products:

Main Products

Polyvaricon, IF Transformers, Oscillator Coils, Antenna Coils, Variable Resistors, FM Tuners, TV Tuners, Micro-motors, Sockets.



MITSUMI ELECTRIC CO., LTD.

Head Office Komae, Kitatama, Tokyo, Japan.
New York Office 11 Broadway, New York 4, N.Y., U.S.A.

QUALIFICATION FORM FOR POSITIONS AVAILABLE

ATTENTION: ENGINEERS, SCIENTISTS, PHYSICISTS

This Qualification Form is designed to help you advance in the electronics industry. It is unique and compact. Designed with the assistance of professional personnel management, it isolates specific experience in electronics and deals only in essential background information.

The advertisers listed here are seeking professional experience. Fill in the Qualification Form below.

STRICTLY CONFIDENTIAL

Your Qualification form will be handled as "Strictly Confidential" by Electronics. Our processing system is such that your form will be forwarded within 24 hours to the proper executives in the companies you select. You will be contacted at your home by the interested companies.

WHAT TO DO

1. Review the positions in the advertisements.
2. Select those for which you qualify.
3. Notice the key numbers.
4. Circle the corresponding key number below the Qualification Form.
5. Fill out the form completely. *Please print clearly.*
6. Mail to: Classified Advertising Div., Electronics, Box 12, New York, N. Y. 10036.

COMPANY	SEE PAGE	Key #
ATOMIC PERSONNEL INC. Philadelphia, Pa.	121	1
LOCKHEED-GEORGIA COMPANY Division of Lockheed Aircraft Corp. Atlanta, Ga.	112	2
PAN AMERICAN WORLD AIRWAYS, INC. Patrick Air Force Base, Fla.	121	3

(cut here)

Electronics WEEKLY QUALIFICATION FORM FOR POSITIONS AVAILABLE

(cut here)

(Please type or print clearly. Necessary for reproduction.)

Personal Background

NAME
 HOME ADDRESS
 CITY ZONE STATE
 HOME TELEPHONE

Education

PROFESSIONAL DEGREE(S)
 DATE(S)
 UNIVERSITY
 MAJOR(S)

FIELDS OF EXPERIENCE (Please Check)

71364

- | | | |
|----------------------------------------------|----------------------------------------------|---------------------------------------|
| <input type="checkbox"/> Aerospace | <input type="checkbox"/> Fire Control | <input type="checkbox"/> Radar |
| <input type="checkbox"/> Antennas | <input type="checkbox"/> Human Factors | <input type="checkbox"/> Radio-TV |
| <input type="checkbox"/> ASW | <input type="checkbox"/> Infrared | <input type="checkbox"/> Simulators |
| <input type="checkbox"/> Circuits | <input type="checkbox"/> Instrumentation | <input type="checkbox"/> Solid State |
| <input type="checkbox"/> Communications | <input type="checkbox"/> Medicine | <input type="checkbox"/> Telemetry |
| <input type="checkbox"/> Components | <input type="checkbox"/> Microwave | <input type="checkbox"/> Transformers |
| <input type="checkbox"/> Computers | <input type="checkbox"/> Navigation | <input type="checkbox"/> Other |
| <input type="checkbox"/> ECM | <input type="checkbox"/> Operations Research | <input type="checkbox"/> |
| <input type="checkbox"/> Electron Tubes | <input type="checkbox"/> Optics | <input type="checkbox"/> |
| <input type="checkbox"/> Engineering Writing | <input type="checkbox"/> Packaging | <input type="checkbox"/> |

CATEGORY OF SPECIALIZATION

Please indicate number of months experience on proper lines.

	Technical Experience (Months)	Supervisory Experience (Months)
RESEARCH (pure, fundamental, basic)
RESEARCH (Applied)
SYSTEMS (New Concepts)
DEVELOPMENT (Model)
DESIGN (Product)
MANUFACTURING (Product)
FIELD (Service)
SALES (Proposals & Products)

CIRCLE KEY NUMBERS OF ABOVE COMPANIES' POSITIONS THAT INTEREST YOU

1 2 3 4 5 6 7 8 9 10 11 12 13 14 15

EMPLOYMENT OPPORTUNITIES



The advertisements in this section include all employment opportunities — executive, management, technical, selling, office, skilled, manual, etc.

Look in the forward section of the magazine for additional Employment Opportunities advertising.

— RATES —

DISPLAYED: The advertising rate is \$52.00 per inch for all advertising appearing on other than a contract basis. Contract rates quoted on request.

An advertising inch is measured $\frac{3}{8}$ " vertically on a column—3 columns—30 inches to a page.

Subject to Agency Commission.

UNDISPLAYED: \$2.70 per line, minimum 3 lines. To figure advance payment count 5 average words as a line.

Box numbers—count as 1 line.

Discount of 10% if full payment is made in advance for 4 consecutive insertions.

Not subject to Agency Commission.



E. E.'s for FEE-PAID Positions WRITE US FIRST!

Use our confidential application for professional, individualized service . . . a complete national technical employment agency.

ATOMIC PERSONNEL, INC.
Suite 1207L, 1518 Walnut St., Phila. 2, Pa.

ADDRESS BOX NO. REPLIES TO: Box No.
Classified Adv. Div. of this publication.
Send to office nearest you.
NEW YORK, N. Y. 10036: P. O. Box 12
CHICAGO, Ill. 60611: 645 N. Michigan Ave.
SAN FRANCISCO, Cal. 94111: 255 California St.

POSITIONS VACANT

Transmitter Engineer — American International Shortwave Broadcaster has European opening for transmitter engineer with E.E. or equivalent. Applicants should have good experience in AM transmitters. Management and/or overseas experience helpful but not essential. Substantial overseas salary, benefits. Resume for last ten to fifteen years and background sketch should be provided with initial response. Replies confidential. Our engineers know of this ad. Reply to P-4611, Electronics.

Electronic and Electro/Mechanical Technicians, designers, checkers, draftsmen and detailers—Work for leading firm of licensed professional Engineers. Write to United Engineers, 150 Causeway Street, Boston 14, Mass.

SELLING OPPORTUNITY WANTED

Mfrs' Export Reps with excl. world-wide connect., on their toes around the clock, are eager to export for you. Aacor International, 198 Broadway, New York 8, N. Y.

"Put Yourself in the Other Fellow's Place"

TO EMPLOYERS TO EMPLOYEES

Letters written offering Employment or applying for same are written with the hope of satisfying a current need. An answer, regardless of whether it is favorable or not, is usually expected.

MR. EMPLOYER, won't you remove the mystery about the status of an employee's application by acknowledging all applicants and not just the promising candidates.

MR. EMPLOYEE you, too, can help by acknowledging applications and job offers. This would encourage more companies to answer position wanted ads in this section. We make this suggestion in a spirit of helpful cooperation between employers and employees.

This section will be the more useful to all as a result of this consideration.

Classified Advertising Division

McGRAW-HILL PUBLISHING CO., INC.

330 West 42nd St., New York, N. Y. 10036

NOW FORMING:

A NEW SYSTEMS MANAGEMENT GROUP

in advanced range technology

This new hand-picked group of senior technical managers will perform an important function for Pan Am's Guided Missiles Range Division at Cape Kennedy. Its members will have responsibility for the development, acquisition, and operational capacity of major range instrumentation systems at the Eastern Test Range.

Project management assignments are currently open on the following systems: MISTRAM, GLOTRAC, MIPIR, Telemetry, Real-Time Computer Center, Range Instrumentation Control System, and ARIS ships.

Reporting to the Division Manager, this staff management group will be responsible for planning, organizing, directing and coordinating the collective efforts of functional technical groups, and acting as GMRD advisor to system contractors. The goal: to provide more effective range support by meeting system performance specifications, controlling costs, meeting schedules, and obtaining maximum usable data during test operations for the life of the system.

These new systems must be ready to support the nation's coming space and missile programs, such as: GEMINI... MOL... GEMINI B... APOLLO... ASSET... and TITAN III.

If you have a BS degree in EE (Masters preferred) and 7 or more years of project management background in CW or pulse radar, data handling, communications or telemetry, we invite you to write, in strictest confidence, to Manager, Professional Employment, Dept. 28 G.



GUIDED MISSILES RANGE DIVISION

PAN AMERICAN WORLD AIRWAYS, INC.
P. O. BOX 4465, PATRICK AIR FORCE BASE, FLORIDA
AN EQUAL OPPORTUNITY EMPLOYER

AUTOTRACK ANTENNA MOUNT

360 degree azimuth, 210 degree elevation sweep with better than 1 mil. accuracy. Missile velocity acceleration and slewing rates. Amplidyne and servo control. Will handle up to 20 ft. dish. Supplied complete with control chassis. In stock—immediate delivery. Used world over by NASA, USAF. TYPE MP-61-B. SCR-584.

SCR 584 RADARS AUTOMATIC TRACKING 3 CM & 10 CM

Our 584s in like new condition, ready to go, and in stock for immediate delivery. Ideal for telemetry research and development, missile tracking, satellite tracking, balloon tracking, weather forecasting, anti-aircraft defense tactical air support. Used on Atlantic Missile Range, Pacific Missile Range, N.A.S.A. Wallops Island. A.B.M.A. Write us. Fully Desc. MIT Rad. Lab. Series, Vol. 1, pps. 207-210, 228, 284-286.

NIKE "AJAX" MOUNTS

Complete antenna mounts, as new, in stock for immediate delivery.

PULSE MODULATORS

MIT MODEL 9 PULSER 1 MEGAWATT—HARD TUBE

Output 25 kv 40 amp. Duty cycle, .002. Pulse lengths 25 to 2 microsec. Also .5 to 5 microsec, and 1 to .5 microsec. Uses 6C21. Input 115v 60 cycle AC. Mfr. GE. Complete with driver and high voltage power supply. Ref: MIT Rad. Lab. Series, Vol. 5, pps. 152-160.

500KW THYRATRON PULSER

Output 22kv at 28 amp. Rep. rates: 2.25 microsec. 300 pps. 1.75 msec 550 pps. 4 msec 2500 pps. Uses 5C22 hydrogen thyatron. Complete with driver and high voltage power supply. Input 115v 60 cy AC.

2 MEGAWATT PULSER

Output 30 kv at 70 amp. Duty cycle .001. Rep rates: 1 microsec 600 pps. 1 or 2 msec 300 pps. Uses 5948 hydrogen thyatron. Complete with driver and high voltage power supply. Mfr. GE. Complete with high voltage power supply.

15KW PULSER—DRIVER

Biased multivibrator type pulse generator using 3E29. Output 3kv at 5 amp. Pulse lgths .5 to 5 microsec, easily adj. to 1 to .5 msec. Input 115v 60 cy AC. \$475. Ref: MIT Rad. Lab. Series, Vol. 5, pps. 157-160.

MIT MODEL 3 PULSER

Output: 144 kw (12 kv at 12 amp.) Duty ratio: .001 max. Pulse duration: .5, 1 and 2 microsec. Input: 115 v 400 to 2000 cps and 24 vdc. \$325 ea. Full desc. Vol. 5, MIT Rad. Lab. series, pg. 140.

MICROWAVE SYSTEMS

C-BAND RADAR

250 KW output, C-band, PPI indicator, 5C22 thyatron modulator. Antenna hi gain parabolic section. Input 115 volts 60 cycle AC. complete \$2750.00.

300 TO 2400MC RF PKG.

300 to 2400 MC CW. Tuneable. Transmitter 10 to 30 Watts. Output. As new \$475.

X BAND DOPPLER SYSTEM

AN/APN-102 G.P.L. ANT/RCVR/XMTR PKG. 4 Beam Pulsed Janus Planar Array—New \$1,600 ea.

AN/TPS-ID RADAR

500 kw 1220-1359 mcs. 160 nautical mile search range P.P.I. and A Scopes. MTI. thyatron mod. 5J26 magnetron. Complete system.

10 CM. WEATHER RADAR SYSTEM

Raytheon, 275 KW output S Band. Rotating yoke P.P.I. Weather Band, 4, 20 and 80 mile range. 360 degree azimuth scan. Price \$975 complete.

AN/APS-15B 3 CM RADAR

Airborne radar. 40 kw output using 725A magnetron. Model 3 pulser. 30-in. parabola stabilized antenna. PPI scope. Complete system. \$1200 each. New.

10KW 3 CM. X BAND RADAR

Complete RF head including transmitter, receiver, modulator. Uses 2F42 magnetron. Fully described in MIT Rad. Lab. Series Vol. I, pps 616-625 and Vol. II, pps. 171-185. \$375. Complete System \$750.

AN/APS-27 X BAND RADAR

Complete 100 kw output airborne system with AMTI, 5C22 thr. mod. 4J52 magnetron, PPI, 360 deg az sweep, 60 deg. elev. sweep, gyro stabilizer, hi-gain revr. Complete with all plugs and cables \$2800.

M-33 AUTO-TRACT RADAR SYSTEM

X band with plotting board, automatic range tracking, etc. Complete with 1 megawatt acquisition radar.

AN/APS-45 HEIGHT FINDER

Airborne system, 40,000 ft. altitude display on PPI & RHI. 9375 mcs. 400kw output using QK-172 magnetron. 5622 thyatron.

3KW RCA PHONE & TELEG XMTRS

2-30 MC. 10 Autotone channels plus MO. Input 220 vac. 50/60 cycles.

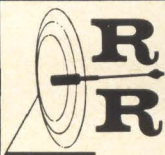

Radio-Research Instrument Co.
550 5th Ave. New York 36, N.Y.
Tel. JUdson 6-4691

CIRCLE 950 ON READER SERVICE CARD

SEARCHLIGHT SECTION

(Classified Advertising)

BUSINESS OPPORTUNITIES

EQUIPMENT - USED or RESALE

DISPLAYED

The advertising is \$27.25 per inch for all advertising other than on a contract basis. AN ADVERTISING INCH is measured 7/8" vert. on a column, 3 cols.—30 inches—to a page. EQUIPMENT WANTED or FOR SALE ADVERTISEMENTS acceptable only in Displayed Style.

Send NEW ADVERTISEMENTS or Inquiries to Classified Adv. Div. of Electronics, P. O. Box 12, N. Y. N. Y. 10036

—RATES—

UNDISPLAYED

\$2.70 a line, minimum 3 lines. To figure advance payment count 5 average words as a line. BOX NUMBERS count as one line additional. DISCOUNT of 10% if full payment is made in advance for four consecutive insertions.

ARROW

FREIGHT FORWARDERS

Sub. of LIFSCHULTZ TRANSPORT, Inc.

FASTEST COAST TO COAST

5th & 6th DAY EAST COAST TO
CAL., ARIZ., NEV., ORE. and WASH.

7th DAY TO EAST COAST
from CAL., ARIZ., NEV., ORE. and WASH.

Specialists in Shipment of
Electronics Products
Call for information

NEW YORK — PHILADELPHIA
BALTIMORE — BOSTON — NEW JERSEY
HOLYOKE — NEW HAVEN — PROVIDENCE
LOS ANGELES—SAN FRANCISCO—SEATTLE

CIRCLE 951 ON READER SERVICE CARD

SMALL AD but BIG STOCK

of choice test equipment
and surplus electronics

Higher Quality—Lower Costs
Get our advice on your problem

ENGINEERING ASSOCIATES

434 Patterson Road — Dayton 19, Ohio

CIRCLE 952 ON READER SERVICE CARD

EMPLOYMENT OPPORTUNITIES:

for all employment advertising including Positions Vacant or Wanted and Selling Opportunities Offered or Wanted.

SEARCHLIGHT SECTION:

A national medium for Surplus New or Used Equipment and other Business Opportunities.

PROFESSIONAL SERVICES:

A dignified method for Specialized consultant skills and services.

BENEFIT YOURSELF BY ADVERTISING IN THESE SECTIONS

For Rates and Information Write:

Electronics

Classified Advertising Div.,
P.O. Box 12, New York, 10036

STEPPING SIGMA HERMETICALLY
SWITCHES KURMAN SEALED
SENSITROLS WARD LEONARD
STRUTHERS M. AUTOMATIC
DUNN ELECTRIC
ROTARY LEACH
RACHET CLARE
ALLIED EVENS
LEDEX NOLD
CLARE ANCE
LEACH ALLIED
MINIA CRAFT
SIGMA LEDEX
NORTH KEYING
ELECTRIC PHILLIPS
DORMEYER CONTROLS
TELEPHONE AMPERITE
TYPE
KURMAN PRODUCTION WESTERN
STEVENS QUANTITIES ELECTRIC
ARNOLD MOST MAKES CUTLER
IN STOCK HAMMER
CONTACT Send for GENERAL
MERCURY Latest ELECTRIC
SOLENOIDS Catalog GUARDIAN
ADVANCE E CONTACTORS
ALLEN BRADLEY PRICE ELECTRIC
POTTER SQUARE D WESTON
BRUMFIELD MINIATURE AIRCRAFT

**LARGEST
STOCK OF
RELAYS
IN THE
WORLD**

Universal RELAY CORP.

42 WHITE ST. NEW YORK 13, N. Y. WALKER 5-6900

CIRCLE 953 ON READER SERVICE CARD

MINIATURIZATION IS OUR BUSINESS!

★ TRANSISTORS ★ TRANSFORMERS
★ DIODES ★ ELECTROLYTICS

★ TANTALYTICS

VOLUME CONTROLS AND SWITCHES
New surplus only. Large or small quantities available.

We also buy new surplus stock.
WRITE FOR LATEST FREE CATALOG

Transistors Unlimited Company
462 JERICHO TURNPIKE, MINEOLA, N. Y.
516 PI 7-7221

CIRCLE 954 ON READER SERVICE CARD

TUBES & COMPONENT FREE...CATALOG BARRY ELECTRONICS

512 BROADWAY 212-WALKER 5-7000
NEW YORK 12, N.Y. TWX-571-0484

CIRCLE 955 ON READER SERVICE CARD

LIQUIDATING \$6,000,000.00 ELECTRONIC CHEMICAL PLANT

- 7—Stokes Core Pullers.
- 5—Westinghouse Crystal Pullers.
- 2—Crystal Pullers complete with induction heating units.
- 1—Furnace Travelling Device.
- 2—Furnaces, Heavy duty electric.
- 1—Raytheon Impact Grinder.
- 2—Engelberg-Huller, Model L-4, Centerless Grinders.
- 1—Cincinnati #2 Centerless Grinder.
- 1—Buehler Ltd, Grinding Apparatus.
- 1—Lebel 23.5 KVA RF Generator.
- 39—Lebel 12.5 KVA RF Generators.

EPITAXIAL REACTORS

12 Reactors for Epitaxial wafers complete with 6" quartz bell units, power supply and 2 reactor control panels.

- 14—Westinghouse 5 KVA RF Generators.
- 6—Lebel 10 KW RF Generators.
- 3—Westinghouse 10 KW RF Generators.
- 1—Lapmaster Model 12 Lapping Machine.
- 1—P. R. Hoffman Planetary Lapping Machine.
- 17—Greyhound, automatic twin bowl Polishing Machines.

COMPLETE LAB INSTRUMENTS AND EQUIPMENT

Balances—Furnaces—Microscopes
Potentiometer I & N Type K 2
Electro Chemographs—Ovens
Mercury Distillation Apparatus.
Dew Pointers—Ultrasonic Cleaners
Spectrophometers—Vacuum Gauges.

- 89—Silicon reactors complete with transformers.
- 100—Welch Model 1397 Vacuum Pumps with motors.
- 2—Stokes Model 149H with 3 HP motors.
- 1—Diamond Saw, Felker DI-Met, Model 80BQ
- 2—Do-All, I.D. Micro slicer, Model 70.
- 7—Constant temperature Blue M electric water baths.
- 46—Stokes Zone Refiners complete with RF generators.
- 1—Lab Zone Refiner complete.

ELECTRONIC TESTING EQUIPMENT AND METERS

Complete electronic testing equipment.
All Makes All Types

- 2—Continuous load casting machines.
- 1—Logan 14" connect change lathe.
- 1—Sheldon precision tool room lathe.
- 1—Bridgeport turret milling machine.
- 1—Reid #618 P surface grinder.
- 1—Hammond Dry belt grinder.

CHEMICAL PROCESS EQUIPMENT

- 2—Pfaudler 500 gal. series "R" glass lined reactors.
- 1—200 gal. type 316 stainless steel jacketed reactors.
- 10—Silver jacketed reactors—50 to 200 gals.
- 10—Silver Condensers.

G. T. DOYLE, INC.

P.O. Box 122

ORADELL, N. J.

Telephone 201-261-9546
Danville, Pa.—Call 717-275-3200

An Investment!

Productive advertising is an INVESTMENT rather than an EXPENDITURE.

"Searchlight" advertisers invariably report prompt and satisfactory results.

BE CONVINCED — send us your advertisement TODAY.

Address
Classified Advertising Division

ELECTRONICS

P. O. BOX 12, N. Y., N. Y. 10036

WRITE FOR NEW KEYSTONE free catalog

BATTERY HOLDERS, TERMINALS,
TERMINAL BOARDS & HARDWARE

KEYSTONE ELECTRONICS CORP.
49 BLEECKER ST., NEW YORK 12, N. Y.

CIRCLE 959 ON READER SERVICE CARD

ELECTRON TUBES

KLYSTRONS • ATR & TR • MAGNETRONS
SUBMINIATURES • C.R.T. • T.W.T. • 5000-
6000 SERIES

• SEND FOR NEW CATALOG A2 •

A & A ELECTRONICS CORP.
1063 PERRY ANNEX
WHITTIER, CALIF.
AN 92865 OR 696-7544

CIRCLE 960 ON READER SERVICE CARD

OPTICAL BENCHES

\$13. to \$13,000. New Catalog

THE Ealing CORP.

2250 Massachusetts Avenue, Cambridge, Mass., 02140

CIRCLE 961 ON READER SERVICE CARD

CIRCLE 956 ON READER SERVICE CARD

FREE Catalog

OF THE WORLD'S FINEST
ELECTRONIC GOV'T
SURPLUS BARGAINS



HUNDREDS OF TOP QUALITY
ITEMS — Receivers, Transmitters,
Microphones, Inverters, Power Sup-
plies, Meters, Phones, Antennas,
Indicators, Filters, Transformers,
Amplifiers, Headsets, Converters,
Control Boxes, Dynamotors, Test
Equipment, Motors, Blowers, Cable,
Keys, Chokes, Handsets, Switches,
etc., etc. Send for Free Catalog—
Dept. E-4.

FAIR RADIO SALES

2133 ELIDA RD. • Box 1105 • LIMA, OHIO

CIRCLE 957 ON READER SERVICE CARD

Color DIAL TELEPHONES \$10.95

Factory rebuilt Western Electric
in white, beige, ivory, pink, green,
or blue. If 4 prong plug is re-
quired add \$2.00. Fully guaranteed.
Write for free list. All ship-
ments FOB.

SURPLUS SAVING CENTER
Dept. MH-E 6164 Waymart, Penna.



CIRCLE 958 ON READER SERVICE CARD

Electronics advertisers

July 13, 1964



■ AMP Inc. Garceau, Hargrave & McCullough Inc.	86	Logitek, Inc. Murray Heyert Associates	103
American Electronic Laboratories Inc. Benn Associates	96	Loral Electronics Corp. Pritchard, Wood Incorporated	33
Assembly Products George Z. Griswold Adv.	92	Marconi Instruments Armand Richards Adv. Agency	102
Astro Communication Laboratory	29	McGraw-Hill Book Co. Inc.	117
Brush Instruments, Div. of Clevite Carr Liggett Adv., Inc.	3rd Cover	Melpar Inc. Lewis, Dobrow and Lamb	9
CBS Laboratories James A. Ford Advertising Agency	98	Minnesota Mining & Mfg. Co., Mincom Division Reach, McClinton & Co., Inc.	22
■ Clifton Precision Products Div. of Litton Precision Products Inc. Ivey Adv. Inc.	107	Mitsumi Electric Co., Ltd. Dentsu Advertising Ltd.	119
■ Cohn Corp., Sigmund William G. Seidenbaum & Co.	106	■ North Atlantic Industries Inc. Murray Heyert Associates	8
Communication Electronics Inc. John E. Waterfield/Admasters Adv. Inc.	119	Ohr-Tronics Conti Advertising Agency Inc.	99
Consolidated Electrodynamics Corp. Hixson & Jorgensen, Inc.	113	Pacific-Electro Magnetics Co. Inc. Sturges and Associates	93
Continental Electronics Sub. of Ling Temco Vought Evans, Young, Wyatt Advertising	11	Pamotor, Inc. Harry P. Bridge Co.	111
Di-Acro Corporation Charles E. Brown Adv.	114	■ Perfection Mica Company, Magnetic Shield Div. Burton Browne Advertising	106
DuPont de Nemours & Co. Inc., E.I.	14, 37, 91	Radiation Inc. G.M. Basford Company	38
Batten, Barton, Durstine & Osborn, Inc.		Radio Corporation of America Al Paul Lefton Co.	4th Cover
■ Dymec Div. of Hewlett Packard Co. L.C. Cole Company Inc.	1	Reinhold Publishing Corporation Frank Best & Company Inc.	110
Electrical Industries George Homer Martin Associates	34	Sprague Electric Co. The Harry P. Bridge Co.	5, 6
■ Electro Instruments Inc. Teawell Inc. Adv.	31	■ Synthane Corp. Arndt, Preston, Chapin, Lamb & Keen Inc.	96
Electronic Specialty Co. Grant Adv. Inc.	16	■ Syntronic Instruments, Inc. Burton Browne Adv.	112
Elgeet Optical Co. Inc. Hutchins Adv. Co., Inc.	98	Texas Instruments Incorporated Industrial Products Group Robinson-Gerrard, Inc.	100, 101
Flying Tiger Line Hixson & Jorgensen, Inc.	19	Thompson Ramo Wooldridge, Aerospace Center Div. Fuller & Smith & Ross Inc.	7
Formica Corporation Perry-Brown Inc.	23	Westinghouse Electric Corp., Defense Pmts. Ketchum, MacLeod & Grove Inc.	39
General Electric Company, Lamp Metals & Components Dept. Batten, Barton, Durstine & Osborn, Inc.	102	■ Weston Instruments & Electronics, A Div. of Daystrom Inc. G.M. Basford Co.	85
General Precision, Librascope Div. Weekley and Valenti, Inc.	109		
General Radio Company K.E. Morang Co.	2nd Cover		
■ Globe Industries Inc. Odiorne Industrial Adv. Inc.	104, 108		
Graphic Systems Inc. Caswell Adv. Agency	112		
Gudebrod Bros. Silk Co. Inc. Lee Ramsdell & Co. Inc.	95		
Heinemann Electric Co. Thomas R. Sundheim Inc.	40		
Heinz Electric Reynolds & Foster Inc.	108		
■ Hewlett Packard Co. L.C. Cole Company Inc.	2, 12, 13		
■ Hughes Aircraft Company Foote, Cone & Belding	108, 115		
Intercontinental Instruments Inc. Murray Heyert Associates	105		
ITT Cannon Electric Inc. West, Weir & Bartel Inc.	24		
Jerrold Corp. Irving Gould Adv. Inc.	10		
■ Linen Thread Company Robert Luckie Adv.	98		
Ling-Temco-Vought Wyatt, Allen & Ryan Inc.	20, 21		
Lockheed-Georgia Co. A Div. of Lockheed Aircraft Corp. West, Weir & Bartel Inc.	112		

Advertising sales staff

Gordon Jones: [212] 971-2210
Advertising sales manager

Atlanta, Ga. 30309: Gus H. Krimsier,
Michael H. Miller, 1375 Peachtree St. N.E.,
[404] TR 5-0523

Boston, Mass. 02116: William S. Hodgkinson,
McGraw-Hill Building, Copley Square,
[617] CO 2-1160

Chicago, Ill. 60611: Robert M. Denmead,
Daniel E. Shea, Jr., 645 North Michigan
Avenue, [312] MO 4-5800

Cleveland, Ohio 44113: Paul T. Fegley, 55
Public Square, [216] SU 1-7000

Dallas, Texas 75201: Frank Le Beau, The
Vaughn Building, 1712 Commerce Street,
[214] RI 7-9721

Denver, Colo. 80202: John W. Patten, David
M. Watson, Tower Bldg., 1700 Broadway,
[303] AL 5-2981

Houston, Texas 77025: Kenneth George,
Prudential Bldg., Halcombe Blvd.,
[713] RI 8-1280

Los Angeles, Calif. 90017: Ashley P.
Hartman, John G. Zisch, 1125 W. 6th St.,
[213] HU 2-5450

New York, N.Y. 10036:
Donald R. Furth [212] 971-3616
Donald H. Miller [212] 971-3615
George F. Werner [212] 971-3617
500 Fifth Avenue

Philadelphia, Pa. 19103: William J. Boyle,
Warren H. Gardner, 6 Penn Center Plaza,
[215] LO 8-6161

San Francisco, Calif. 94111:
James T. Hauptli, 255 California Street,
[415] DO 2-4600

London W1: Edwin S. Murphy Jr., 34 Dover
Street

Frankfurt/Main: Matthee Herfurth, 85
Westendstrasse Phone: 77 26 65 and
77 30 59

Geneva: Michael R. Zeynel,
2 Place du Port 244275

Paris VIII: Denis Jacob, 17 Avenue
Matignon ALMA-0452

Tokyo: Shigeo Chiba, 1, Kotohiracho,
Shiba, Minato-ku (502) 0656

Osaka: Kazutaka Miura, 163, Umegae-cho,
Kita-ku [362] 8771

Nagoya: International Media
Representatives, Yamagishi Bldg.,
13,2-Chome, Oike-cho Naga-ku

R.S. Quint: [212] 971-2335
General manager
Electronics Buyers' Guide

David M. Tempest: [212] 971-3139
Promotion manager

Henry M. Shaw: [212] 971-3485
Market research manager

Richard J. Tomlinson: [212] 971-3191
Business manager

Theodore R. Geipel: [212] 971-2044
Production manager

Classified Advertising

F. J. Eberle, Business Mgr.	
Employment Opportunities	121
Equipment (Used or Surplus New) For Sale	122-123

Classified Advertising Index

A & A Electronics Corp.	123
Arrow Freight Forwarders	122
Barry Electronics	122
G.T. Doyle, Inc.	123
Ealing Corporation, The	123
Engineering Associates	122
Fair Radio Sales	123
Keystone Electronics Corp.	123
Radio Research Instrument Co.	122
Surplus Saving Center	123
Universal Relay Corp.	122

■ For more information on complete product line
see advertisement in the latest Electronics Buyers' Guide

Executive, editorial, circulation and advertising offices: McGraw-Hill Building, 330 West 42nd Street, New York, N.Y., 10036. Telephone Area Code 212-971-3333. Teletype TWX N.Y. 212-640-4646. Cable McGrawhill, N.Y. Officers of the Publications Division: Shelton Fisher, President; Vice Presidents: Joseph H. Allen, Operations; John R. Callahan, Editorial; Ervin E. DeGraf, Circulation; Donald C. McGraw, Jr., Advertising Sales; Angelo R. Venezian, Marketing. Officers of the Corporation: Donald C. McGraw, President; Hugh J. Kelly, Harry L. Waddell, L. Keith Goodrich, Executive Vice Presidents; John L. McGraw, Treasurer; John J. Cooke, Vice President and Secretary. Title R registered U.S. Patent Office; © copyright 1964 by McGraw-Hill, Inc. All rights reserved, including the right to reproduce the contents of this publication, in whole or in part.

COPYRIGHT 1961

BRUSH INSTRUMENTS

DIVISION OF CLEVITE CORPORATION

CLEVELAND, OHIO

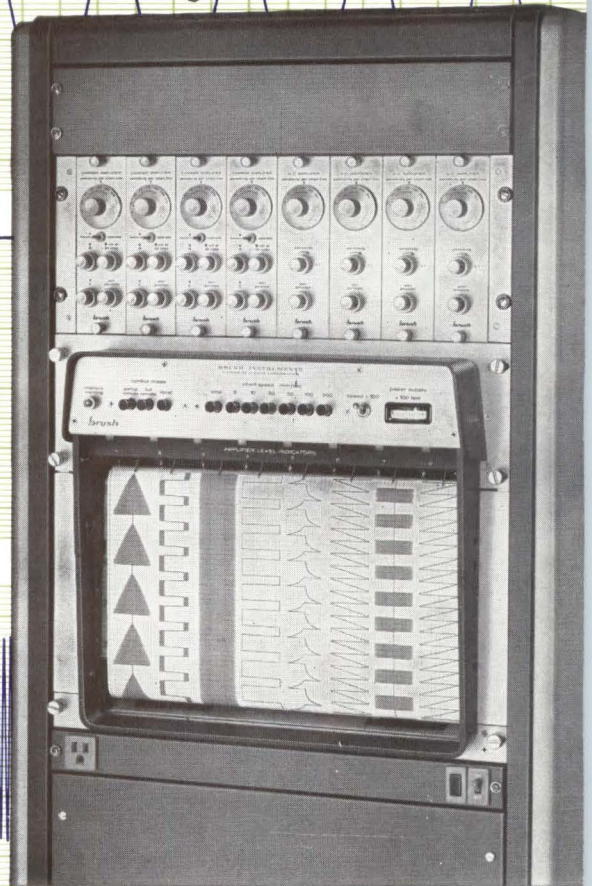
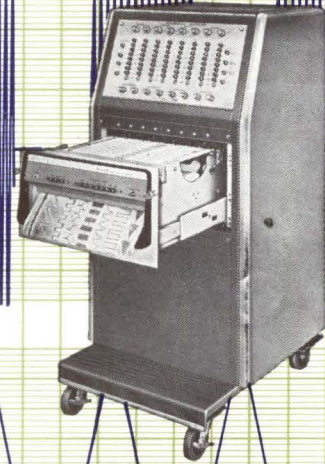

precision and
clarity never
before achieved...

The new **Brush Recorder Mark 200** made these incredibly crisp tracings. No other recorder in existence can match them. Note the line width. It never varies . . . regardless of writing velocity, regardless of chart speed. The writing mechanism is electrically signaled by the position-seeking "Metrisite" transducer . . . no parts to wear, infinite resolution, verifiable dynamic $\frac{1}{2}\%$ accuracy. Traces are permanent, high-contrast, reproducible . . . on low cost chart paper. The Mark 200 has but three standard controls . . . attenuator, pen position, chart speed. Such fidelity, simplicity and economy are possible with no other direct writing recorder. Available in both vertical and horizontal models with interchangeable plug-in preamplifiers or signal conditioning push-button controls. Write for details . . . they'll speak for themselves.

Circle 901 on reader service card

brush INSTRUMENTS
DIVISION OF CLEVITE 37TH AND PERKINS, CLEVELAND 14, OHIO

For production-line testing...
 Equipment maintenance... Product quality checks...
 Laboratory measurements...

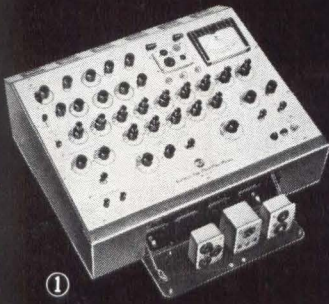

①

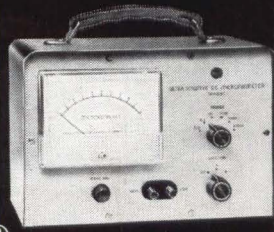

②

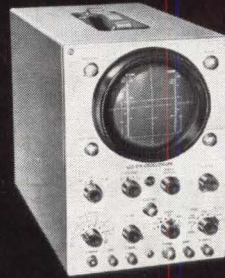

③

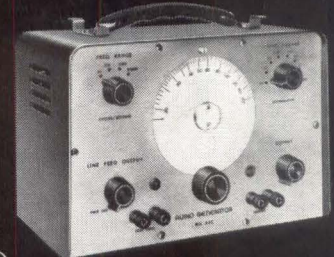

④

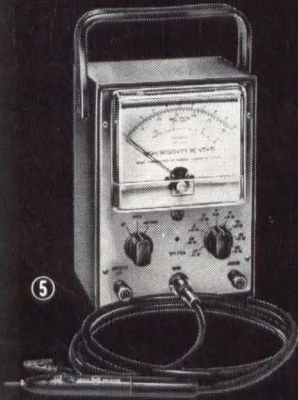

⑤

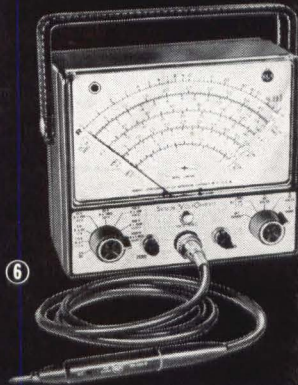

⑥



⑦

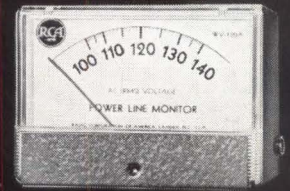

⑧

USE HIGH-QUALITY RCA TEST INSTRUMENTS

These rugged, high-quality test instruments offer you several important advantages in industrial testing:

- They give you excellent performance at moderate cost... enabling you to buy more test instruments within budget. This in turn expedites production line testing, product quality checks, and equipment maintenance work.
- They eliminate the need to tie up your high-cost instruments on routine tests and measurements—and increase the overall efficiency of your electronic maintenance department.

① RCA WT-100A MICROMHOMETER Measures tube characteristics under actual operating-voltage conditions.

Tests vacuum tubes, gas-filled tubes, semiconductor diodes. Measures: True transconductance (both control-grid-to-plate and suppressor-grid-to-plate) to an accuracy of better than 3%; Transconductance up to 100,000 micromhos in six ranges; DC plate, screen grid, and grid-No. 1 test voltages; Electrode currents from $3\mu\text{a}$ to 300 ma; Heater-cathode leakage currents; . . . and other important electron tube parameters. **\$989.00***

② WV-84C ULTRA-SENSITIVE DC MICROAMMETER Battery-operated vacuum-tube microammeter measures down to 0.0002 microampere. Especially useful in measuring "dark currents" in vidicons and phototubes as well as minute currents in image orthicons. Can also be used as a high-impedance voltmeter and as an ohmmeter to measure extremely high resistances in the order of billions of ohms. **\$110.00***

③ WO-91A RCA 5-INCH OSCILLOSCOPE A high-performance, wide-band 'scope—serves as a display-type VTVM. Choice of wide band (4.5 Mc—0.053-volt rms/inch sensitivity) or narrow high-sensitivity band (1.5 Mc—0.018-volt rms/inch sensitivity). New 2-stage sync separator provides solid lock-in on composite TV signals. **\$249.50***

*Optional Distributor Resale Price

④ WA-44C RCA AUDIO GENERATOR Generates sine-wave and square-wave signals over range of 20 to 200,000 cps to test audio systems. Can be used to measure intermodulation distortion, frequency response, input and output impedances, speaker resonance, transient response, and phase shifts. Less than 0.25% total harmonic distortion over range of 30 to 15,000 cps. **\$98.50***

⑤ RCA WV-76A HIGH-SENSITIVITY AC VTVM. A combination voltmeter and preamplifier for audio applications. For signal tracing, audio-level and power-level measurements, gain measurements, amplifier balancing applications, and audio voltage measurements. Frequency response from 10 cps to 1.5 Mc with "direct" probe, 10 cps to 500 kc with "low-cap" probe. Measures decibels from -40 to +40 db in 9 overlapping ranges (up to 56 db with probe switch in "low-cap" position). As a pre-amplifier, provides up to 38 db maximum gain. **\$79.95***

⑥ WV-98C NEW RCA SENIOR VOLTOHMYST® For direct reading of peak-to-peak voltages of complex waveforms, rms values of sine waves, DC voltages, and resistance. Accuracy: 3% full scale on both AC and DC, with less than 1% tracking error. Color-coded scales differentiate peak-to-peak from rms readings. New 0.5 volt full scale DC range for use in low-voltage transistor circuits. $6\frac{1}{2}$ " meter. **\$79.50***

⑦ RCA WV-38A VOLT-OHM-MILLIAMMETER One of the most versatile electronic test instruments. 0.25-volt and 1.0-volt DC ranges. Big easy-to-read $5\frac{1}{2}$ " meter. Non-breakable sealed plastic case. Jacks located below switches to keep leads out of the way. Spring clips on handle to hold leads. Attractive, scuff-resistant, rugged carrying case, only \$4.95* extra. **\$43.95***

⑧ RCA WV-120A POWER LINE MONITOR. Provides a constant check on incoming line voltage. Responds to voltage fluctuations. Highly accurate ($\pm 2\%$ at 120 volts). Gives true rms reading. 5" wide meter. **\$14.95***

SEE THEM ALL AT YOUR AUTHORIZED RCA TEST EQUIPMENT DISTRIBUTOR.

RCA ELECTRONIC COMPONENTS AND DEVICES, HARRISON, N.J.



The Most Trusted Name in Electronics