

Electronics

FEB 7 1966
W/D 10/15/77

Putting superconductors to work: page 95
Controlling telemetry by computer: page 103
Simple packages for complex systems: page 109

LIBRARY
UNIVERSITY OF TENN. MED. UNITS
MEMPHIS
February 7, 1966
75 cents
A McGraw-Hill Publication

Below: Strip line card (center) does job of surrounding gear, page 72

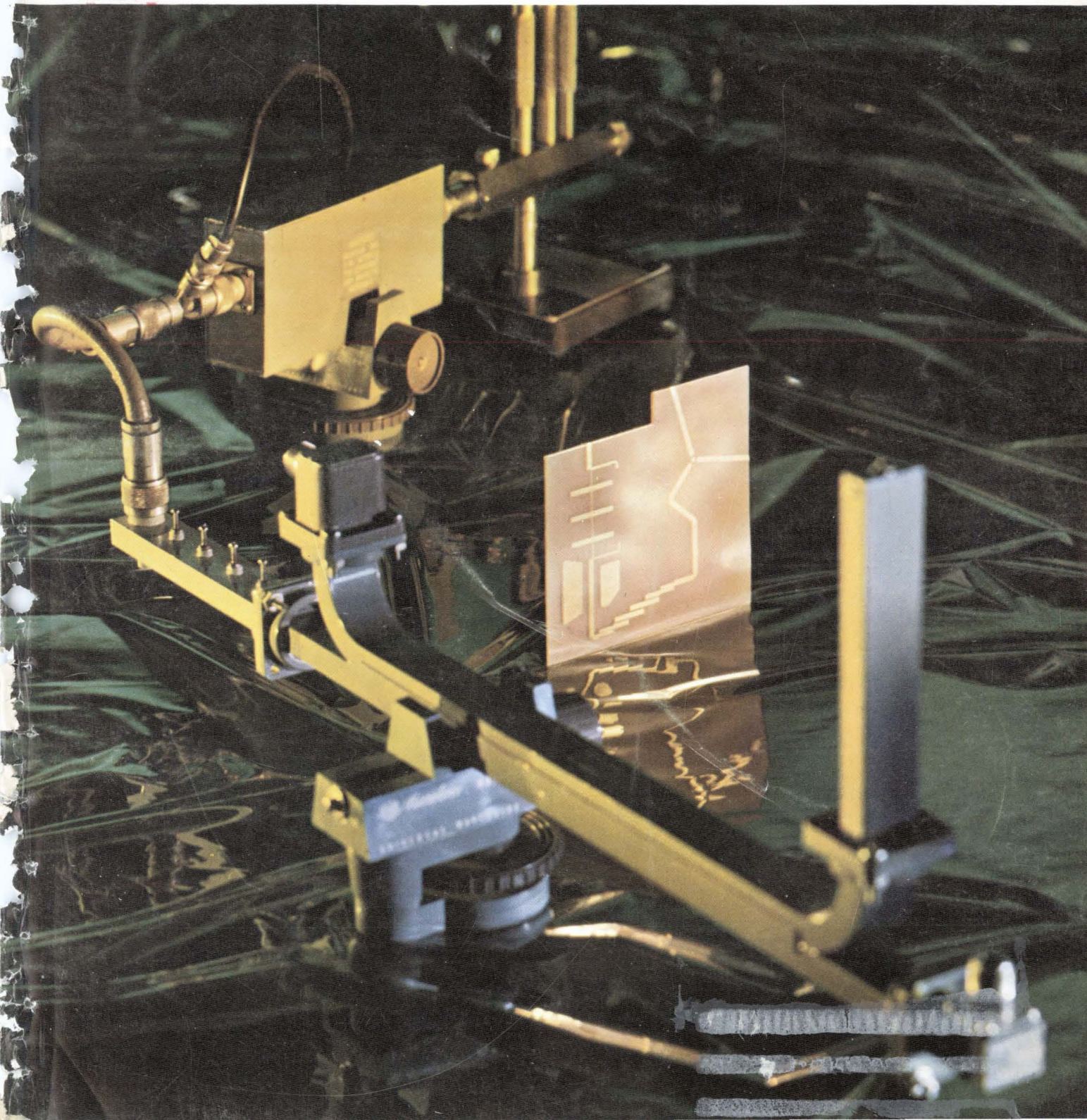

AUDIO TRANSFORMERS

DO-T No.	Pri. Imp.	D.C. Ma.† in Pri.	Sec. Imp.	Pri. Res. DO-T	Pri. Res. DI-T	Mw Level	DI-T No.
DO-T44	80 CT 100 CT	12 10	32 split 40 split	9.8	11.5	500	DI-T44*
DO-T29	120 CT 150 CT	10 10	3.2 4		10	500	
DO-T12	150 CT 200 CT	10 10	12 16		11	500	
DO-T13	300 CT 400 CT	7 7	12 16		20	500	
DO-T19	300 CT	7	600	19	20	500	DI-T19
DO-T30	320 CT 400 CT	7 7	3.2 4	20		500	
DO-T43	400 CT 500 CT	8 6	40 split 50 split	46	50	500	DI-T43*
DO-T42	400 CT 500 CT	8 6	120 split 150 split	46		500	
DO-T41	400 CT 500 CT	8 6	400 split 500 split	46	50	500	DI-T41*
DO-T2	500 600	3 3	50 60	60	65	100	DI-T2
DO-T20	500 CT	5.5	600	31	32	500	DI-T20
DO-T4	600	3	3.2	60		100	
DO-T14	600 CT 800 CT	5 5	12 16	43		500	
DO-T31	640 CT 800 CT	5 5	3.2 4	43		500	
DO-T32	800 CT 1000 CT	4 4	3.2 4	51		500	
DO-T15	800 CT 1070 CT	4 4	12 16	51		500	
DO-T21	900 CT	4	600	53	53	500	DI-T21
DO-T3	1000 1200	3 3	50 60	115	110	100	DI-T3
DO-T45	1000 CT 1250 CT	3.5 3.5	16,000 split 20,000 split	120		100	
DO-T16	1000 CT 1330 CT	3.5 3.5	12 16	71		500	
DO-T33	1060 CT 1330 CT	3.5 3.5	3.2 4	71		500	
DO-T5	1200	2	3.2	105	110	100	DI-T5
DO-T17	1500 CT 2000 CT	3 3	12 16	108		500	
DO-T22	1500 CT	3	600	86	87	500	DI-T22
DO-T34	1600 CT 2000 CT	3 3	3.2 4	109		500	
DO-T51	2000 CT 2500 CT	3 3	2000 split 2500 split	195	180	100	DI-T51
DO-T37	2000 CT 2500 CT	3 3	8000 split 10,000 split	195	180	100	DI-T37*
DO-T52	4000 CT 5000 CT	2 2	8000 CT 10,000 CT	320	300	100	DI-T52
DO-T18	7500 CT 10,000 CT	1 1	12 16	505		100	
DO-T35	8000 CT 10,000 CT	1 1	3.2 4	505		100	
*DO-T48	8,000 CT 10,000 CT	1 1	1200 CT 1500 CT	640		100	
*DO-T47	9,000 CT 10,000 CT	1 1	9000 CT 10,000 CT	850		100	
DO-T6	10,000	1	3.2	790		100	
DO-T9	10,000 12,000	1 1	500 CT 600 CT	780	870	100	DI-T9
DO-T10	10,000 12,500	1 1	1200 CT 1500 CT	780	870	100	DI-T10
DO-T25	10,000 CT 12,000 CT	1 1	1500 CT 1800 CT	780	870	100	DI-T25
DO-T38	10,000 CT 12,000 CT	1 1	2000 split 2400 split	560	620	100	DI-T38*
DO-T11	10,000 12,500	1 1	2000 CT 2500 CT	780	870	100	DI-T11
DO-T36	10,000 CT 12,000 CT	1 1	10,000 CT 12,000 CT	975	970	100	DI-T36
DO-T1	20,000 30,000	.5 .5	800 1200	830	815	50	DI-T1
DO-T23	20,000 CT 30,000 CT	.5 .5	800 CT 1200 CT	830	815	50	DI-T23
DO-T39	20,000 CT 30,000 CT	.5 .5	1000 split 1500 split	800		50	
DO-T40	40,000 CT 50,000 CT	.25 .25	400 split 500 split	1700		50	
DO-T46	100,000 CT	0	500 CT	7900		25	
DO-T7	200,000	0	1000	8500		25	
DO-T24	200,000 CT	0	1000 CT	8500		25	
DO-TSH	Drawn Hipermalloy shield and cover 20/30 db						DI-TSH

†DCMA shown is for single ended usage (under 5% distortion—100MW—1KC) . . . for push pull, DCMA can be any balanced value taken by .5W transistors (under 5% distortion—500MW—1KC) DO-T & DI-T units designed for transistor use only. U.S. Pat. No. 2,949,591; others pending.
 §Series connected; §§Parallel connected → *Units newly added to series

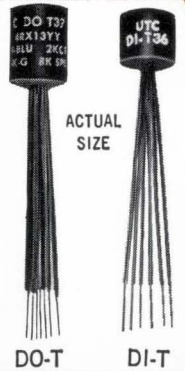

DO-T & DI-T

Transistor TRANSFORMERS and INDUCTORS

NOW! Hermetically Sealed to MIL-T-27B

*16 New Items Added to Stock Line
IMMEDIATE DELIVERY FROM STOCK

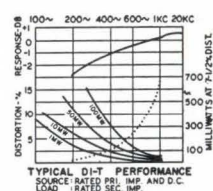
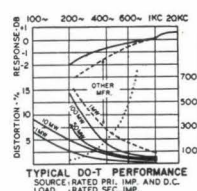

- High Power Rating up to 10 times greater
- Excellent Response twice as good at low end
- Low Distortion reduced 80%
- High Efficiency up to 30% better . . . compare DCR
- Moisture Proof hermetically sealed to MIL-T-27B
- Rugged Grade 4, completely metal cased
- Anchored Leads will withstand 10 pound pull test
- Printed Circuit Use (solder melting) nylon insulated leads
- Suited to Clip Mounting use Augat #6009-8A clip

INDUCTORS

DO-T No.	Inductance Hys @ ma	DO-T DCRΩ	DI-T DCRΩ	DI-T No.
*DO-T50 (2 wdg.)	\$.075 Hy/10 ma, .06 Hy/30 ma \$.018 Hy/20 ma, .015 Hy/60 ma	10.5 2.6		
DO-T28	.3 Hy/4 ma, .15 Hy/20 ma	25		
	.1 Hy/4 ma, .08 Hy/10 ma		25	DI-T28
DO-T27	1.25 Hys/2 ma, .5 Hy/11 ma	100		
	.9 Hy/2 ma, .5 Hy/6 ma		105	DI-T27
DO-T8	3.5 Hys/2 ma, 1 Hy/5 ma	560		
	2.5 Hys/2 ma, .9 Hy/4 ma		630	DI-T8
DO-T26	6 Hys/2 ma, 1.5 Hys/5 ma	2100		
	4.5 Hys/2 ma, 1.2 Hys/4 ma		2300	DI-T26
*DO-T49 (2 wdg.)	\$.20 Hys/1 ma, 8 Hys/3 ma \$.85 Hys/2 ma, 2 Hys/6 ma	5100 1275		

POWER TRANSFORMERS

*DO-T400	Pri 28V 380-1000 cycles, Sec 6.3V @ 60 ma
*DO-T410	Pri 28V 380-1000 cycles, 2-Sec 6.3 @ 30 ma each
*DO-T420	Pri 28V 380-1000 cycles, Sec 28V @ 20 ma (Isol. Electrostatic Shld.)

Write for catalog of over 1,300 UTC HIGH RELIABILITY STOCK ITEMS IMMEDIATELY AVAILABLE from your local distributor.



UNITED TRANSFORMER CORP.

150 VARICK STREET, NEW YORK 13, N.Y.

PACIFIC MFG. DIVISION: 3630 EASTHAM DRIVE, CULVER CITY, CALIF.
 EXPORT DIVISION: 13 EAST 40th STREET, NEW YORK 16, N. Y. CABLE: "ARLAB"

Circle 900 on reader service card

Find Coax Cable Faults FAST!

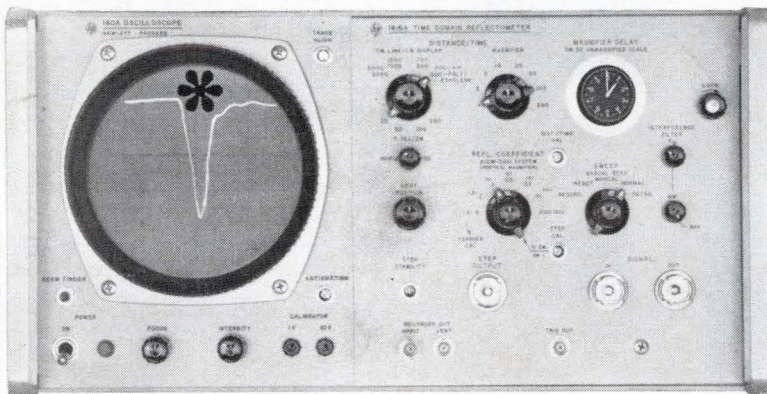
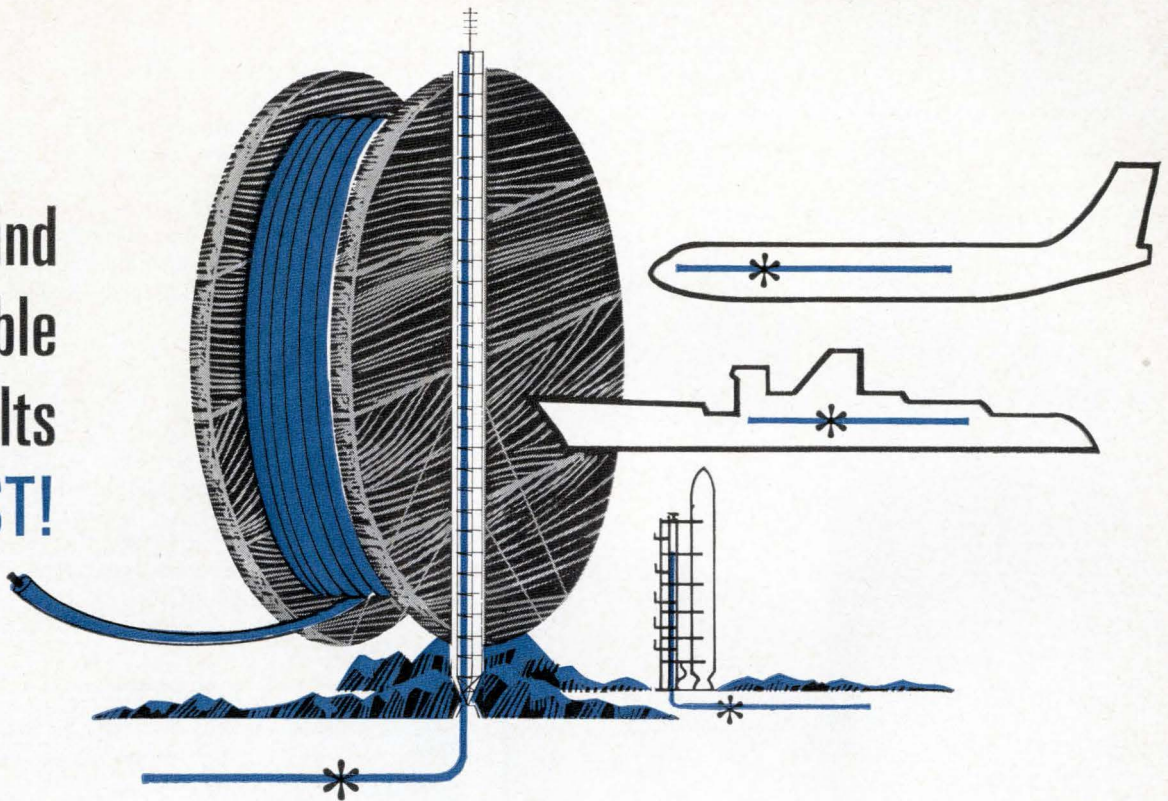

*Use the hp
140A Oscilloscope
and 1415A Time Domain
Reflectometer Plug-in!*

Quickly find and identify such problems as water in cables, crushed cables, damage caused by flex and bends in cables, transmission difficulties in buried or hard-to-reach cables, cables damaged by temperature extremes, and bad connectors joining cables.

With the 140A/1415A combination, you can instantly locate problems in cables up to 600 ft. (to 3000 ft. with Option 14), and you can identify their exact nature—opens, shorts, resistive or reactive discontinuities. You can separate, on the scope crt, discontinuities as close as one inch—making Time Domain Reflectometry (TDR) ideal for analyzing connectors and checking coax switches and attenuators.

The 140A/1415A is calibrated *directly* in distance for air and polyethylene dielectric cables, and a special slide-rule furnished permits quick conversion for other dielectrics. With the scope and TDR plug-in you can measure characteristic impedance and dielectric constant of unknown cables, and recorder outputs permit recordings on any x-y recorder, for applications such as studies of cable degradation with age.

The 140A costs \$575, the 1415A TDR Plug-in \$1050. Besides accepting double-size special-purpose plug-ins, such as the 1415A, the 140A is

useful as a general-purpose oscilloscope, accepting both vertical and horizontal plug-ins. Five vertical and two time base plug-ins provide maximum versatility. Performance includes sensitivities to $10 \mu\text{V/cm}$, bandwidths to 20 MHz.

Contact your Hewlett-Packard field engineer for more information on the versatile 140A General-Purpose Scope... and especially on the 1415A Time Domain Reflectometer. A technical discussion of TDR techniques and their application is available, for the asking, in Application Note 67, "Cable Testing With Time Domain Reflectometry."

You can get a copy from your hp field engineer or by writing Hewlett-Packard, Palo Alto, California 94304, Telephone (415) 326-7000; Europe: 54 Route des Acacias, Geneva. *Prices f.o.b. factory.*

HEWLETT  **PACKARD**
An extra measure of quality

★ SOLID-STATE ★ DC — 75 KC
 ★ GAIN OF 1000 ★ NO CHOPPER

Precisely measure thermocouple, strain gage and similar low level dc outputs with this high performance new Model 8875A Data Amplifier. Use it with modern data acquisition systems employing analog-to-digital converters, digital printers, magnetic data recorders, oscillographs, digital voltmeters, and other readout instrumentation. The new 8875A is a solid-state wideband dc amplifier with an output of ± 10 v, 100 ma and features dc — 75 kc bandwidth, 1000x amplification, $\pm 0.1\%$ gain accuracy, $\pm 0.01\%$ gain stability, and 120 db common mode rejection — at \$495 including power supply.

This new Sanborn amplifier measures just 4-3/4" high by 1-9/16" wide by 15" deep, weighs 3.5 lbs., including integral power supply. For multi-channel use, ten units can be mounted in a 5" x 19" modular cabinet which contains input and output connections, power cable, on-off switch, cooling, fuse, and mating connectors for ten amplifiers. These modules can be stacked, or equipped with tilt stands for bench-top use. When used individually, the completely enclosed amplifier requires no cooling.



SPECIFICATIONS

Bandwidth:	dc to 75 kc within 3 db.
Gain:	from 1 to 1000 in seven fixed steps
Gain Accuracy:	$\pm 0.1\%$.
Gain Stability:	$\pm 0.01\%$.
Vernier Gain:	continuously adjustable between fixed steps.
Gain Trim:	$\pm 3\%$ with sufficient resolution for setting any one gain to $\pm 0.01\%$.
Common Mode Rejection:	120 db from dc to 60 cps, 40v p-p tolerance.
Output Circuit:	± 10 volts across 100 ohms and 0.2 ohms max. output impedance at dc.
Drift:	$\pm 3 \mu\text{v}$ referred to input, ± 0.2 mv referred to output.
Non-Linearity:	Less than 0.01% full scale value, 10 volts.
Overload Recovery Time:	recovers to within 10 μv R.T.I. +10 mv R.T.O. in 10 msec. for 10 v overload.
Power:	115/230 volts $\pm 10\%$, 50-400 cps, 6 watts.
Available options:	Switch-selected filtering, dual output ($\pm 10\text{v}$, $\pm 10\text{ma}$; $\pm 10\text{v}$, $\pm 100\text{ma}$; a short on one output has negligible effect on the other output).

For complete specifications and application assistance, call your local HP/Sanborn field engineering office, or write: Sanborn Division, Hewlett-Packard Company, 175 Wyman Street, Waltham, Mass. 02154.

HEWLETT
 PACKARD  SANBORN
 DIVISION

SANBORN 8875A
 DIFFERENTIAL AMPLIFIER

VERNIER
 GAIN

10 30 100 300 1000
 3
 1
 OFF

CALIBRATED

ZERO

LOCK

GAIN
 TRIM

NEW
wideband
DC data amplifier
for \$495

including integral power supply

Electronics

February 7, 1966
Volume 39, Number 3

Page	4	Readers Comment
	8	People
	14	Meetings
	16	Meeting Preview
	23	Editorial
	25	Electronics Newsletter
	51	Washington Newsletter
	146	Reprints
	155	New Products
	187	New Books
	188	Technical Abstracts
	195	New Literature

Electronics Review

Page	39	Designed by computer	42	Fewer errors in Apollo data
	40	Spending more for computers	44	ZIPping the mail
	41	Faster, denser memory	46	Tv camera on a block
	41	3-D by vibration	47	Lighting up with scr's
			48	Electronic notes

Probing the News

133	The 1967 budget: a blockbuster
133	Lion's share to defense
134	A review and a forecast
138	Slowdown for NASA
141	Brakes applied in avionics
145	Gains on the home front
148	Factories of the future

Electronics Abroad

197	Are Russians scuttling Secam?	199	Controlling nuclear power
198	Color on demand	200	Composition by computer

Technical Articles

I. Design

Microwave	72	Using strip transmission line to design microwave circuits Part one of a survey examines design procedures for multipliers, filters and diode switches J.R. Dangel and K.P. Steele, Sylvania Electronics Systems
Circuit design	84	Designer's casebook <ul style="list-style-type: none">▪ FET converts transducer for use in a-c bridge▪ Charge feedback increases pulse-rate meter accuracy▪ Low-cost emitter-follower extends voltmeter's range
Instrumentation	88	Phase-locked marker improves spectrum analyzer's accuracy New approach overcomes the limitations of conventional spectrum analyzers Charles W. Wilson, Georgia Institute of Technology
Components	95	Putting superconductors to work New materials are expanding applications for superconductors Donald K. Fox, Westinghouse Electric Corp.
Communications	103	Automated ground station will check out Saturn Computer-controlled telemetry is installed as the quantity of data received explodes G.D. Shollenberger, Defense Electronics, Inc.

II. Application

III. Manufacturing

Packaging	109	Simpler designs for complex systems Two-sided boards simplify the organization of complex digital systems built of integrated circuits Rex Rice, Fairchild Semiconductor Division
-----------	-----	--

Title R registered
U.S. Patent Office;
© copyright 1966
by McGraw-Hill, Inc.
All rights reserved,
including the right to
reproduce the contents
of this publication,
in whole or in part.

Electronics

Editor: Lewis H. Young

Senior editors

Technical: Samuel Weber

News: Kemp Anderson Jr.

Senior associate editors: John F. Mason, George Sideris

Department editors

Advanced technology: Joan Blum

Avionics: W.J. Evezia

Circuit design: Michael Elia

Computers: Wallace B. Riley

Consumer electronics: Richard Lipkin

Electronics review: Stanley Zarowin

Instrumentation: Carl Moskowitz

Manufacturing: George Sideris

Military electronics: John F. Mason

New products: William P. O'Brien

Solid state: Jerome Eimbinder

Space electronics: Peter R. Sigmund

Regional editors

Bonn: John Gosch

Boston: Thomas Maguire, editor; Robin Carlson

London: Derek Barlow

Los Angeles: William B. Wallace, Walter Barney, editors; June Ranill

San Francisco: Laurence D. Shergalis, Edmond G. Addeo, editors; Mary Jo Jadin

Tokyo: Charles Cohen

Copy editors

Howard Rausch, Sally Powell, Kenneth Munn, James J. Moran

Graphic design

Art director: Saul Sussman

Assistant art director: Donna M. Griffiths

Editorial production: Ann Mella

Production editor: Arthur C. Miller

Editorial secretaries: Claire Benell, Mary D'Angelo, Lynn Emery, Lorraine Fabry, Kay Fontana, Lorraine Longo, Carolyn Michnowicz

McGraw-Hill News Service

Director: John Wilhelm; **Atlanta:** Fran Ridgway; **Chicago:** Reck Johnson;

Cleveland: Arthur Zimmerman; **Dallas:** Marvin Reid;

Detroit: N. Hunter; **Houston:** Ron Lovell; **Los Angeles:** Michael Murphy, Gerald Parkinson;

San Francisco: Margaret Ralston;

Seattle: Ray Bloomberg; **Washington:** Arthur L. Moore, Charles Gardner, Herbert W. Cheshire, Seth Payne, Warren Burkett, Warren Kornberg

McGraw-Hill World News Service

Bonn: John Johnsrud; **Brussels:** Arthur Erikson; **London:** John Shinn;

Mexico City: Bruce Cross; **Milan:** Ronald Taggiasco;

Moscow: Donald Winston; **Paris:** Dan Smith;

Rio de Janeiro: Leslie Perry; **Tokyo:** Marvin Petal

Circulation manager: Hugh J. Quinn

Reprints: T.M. Egan

Publisher: C.C. Randolph

Electronics: February 7, 1966, Vol. 39, No. 3

Printed at 99 North Broadway, Albany, N.Y., 12207
Second class postage paid at Albany, N.Y.

Subscriptions are solicited only from those actively engaged in the field of the publication. Position and company connection must be indicated on orders. Subscription prices: United States and Possessions and Canada, \$6.00 one year, \$9.00 two years, \$12.00 three years. All other countries \$20.00 one year. Single copies, United States and Possessions and Canada 75¢. Single copies all other countries \$1.50.

Published every other Monday by McGraw-Hill Inc, 330 West 42nd Street, New York, N.Y. 10036. Founder: James H. McGraw, 1860-1948.

Subscribers: The Publisher, upon written request to our New York office from any subscriber, agrees to refund that part of the subscription price applying to copies not yet mailed. Please send change of address notices, subscription orders or complaints to Fulfillment Manager, Electronics, at the address below. Change of address notices should provide old as well as new address, including postal zone number if any. If possible, attach address label from recent issue. Allow one month for change to become effective.

Postmaster: Please send Form 3579 to Fulfillment Manager, Electronics, P.O. Box 430, Hightstown, New Jersey 08520

Readers Comment

Impossible may be possible

To the Editor:

I read with interest your article on the PAL Television system [Jan. 10, p. 239].

I wish to bring to your attention that J. Y. Roy, an employee of the Canadian Broadcasting Co., has done interesting theoretical work on a color-television system called PICS. His system is used in the receiver only to receive a standard NTSC signal, and some of the things you mention in your article as being impossible appear possible in the PICS system.

For example, equiband vestigial sideband is possible without cross-talk. It has been said that PICS will eliminate phase errors and no hue control is necessary on the receiver. Differential-phase errors are changed to desaturation without loss of resolution, vertical or horizontal.

I have heard that the system is simple and would cost little.

P. Herbert-Dupont
Mount Royal, Canada

A reader's tolerance

To the Editor:

The article by A. J. Talamini Jr. and E. C. Farnett of the Radio Corp. of America about optical radar data processing [Dec. 27, 1965, p. 58], states that a closed loop servo was used to hold the speed to one part in 10 million. I wonder if this is an error. This would seem to be an extremely close tolerance.

I'd also like more details.

Donald Breslow
Itek Corp.
Lexington, Mass.

▪ Reader Breslow is right. It should have been one part in a million.

Counter recounted

To the Editor:

The logical arrangement of a BCD counter shown in the note by P. Ward of Texas Instruments [Dec. 13, 1965, p. 74] is not new. A decade counter using this design has been available from the Ger-

New from Sprague!

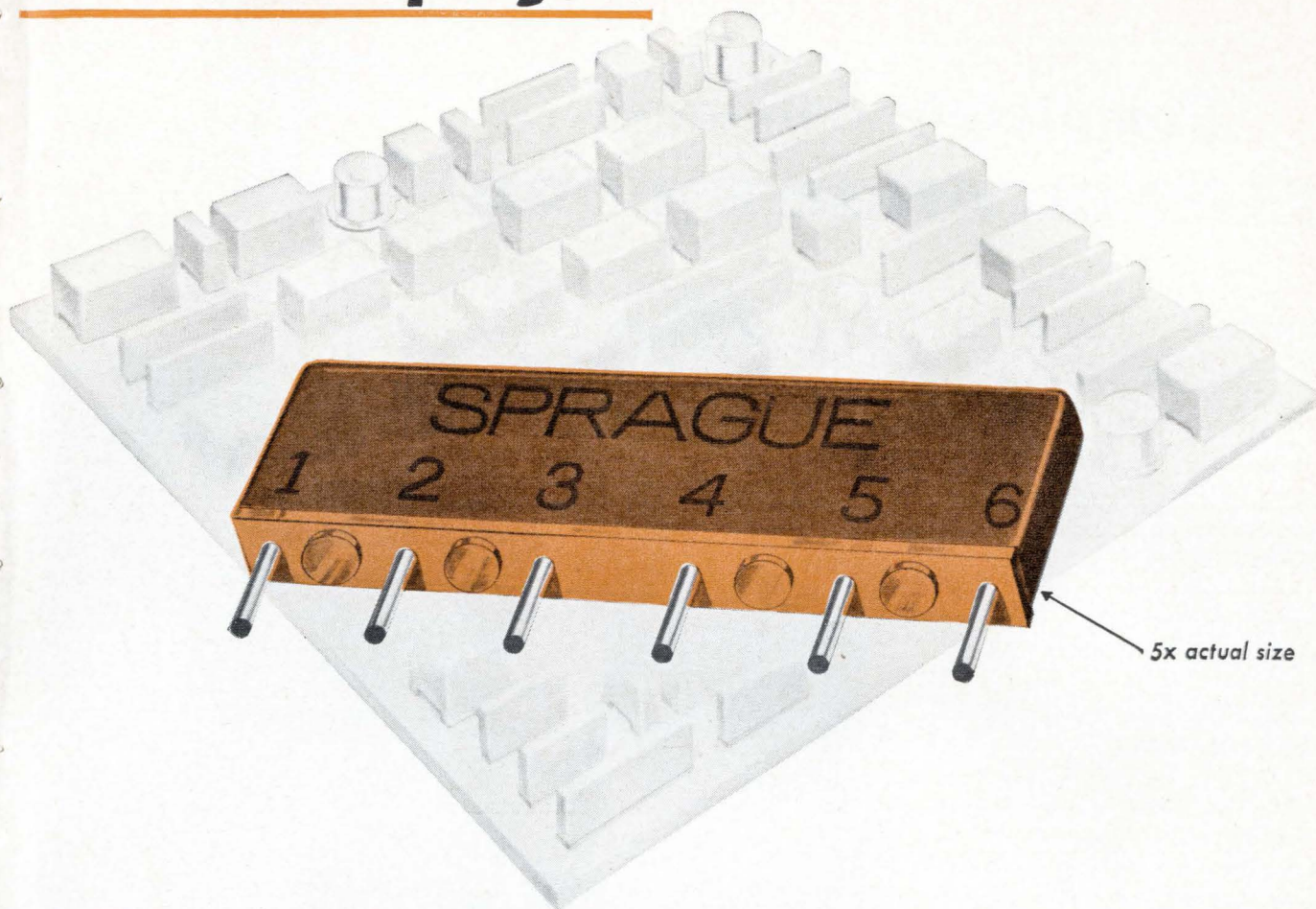

METANET[®] TRUE METAL-FILM NETWORKS PRECISION RESISTOR NETWORKS

Save Space, Time, and Money

- High packaging density—4 to 8 times that of individual components.
- Fewer components to stock, handle, inspect, install. Entire module can be hand-inserted faster than one axial-lead component.
- Permit substantial savings over equipment assembled with individual components.
- Epoxy terminal board keeps pin terminals free of resin coating, unlike conventional dipped components, and provides uniform lead spacing.
- Stand-off bosses permit efficient flux removal after soldering. Also prevent dirt and moisture traps around leads.
- Extremely stable and reliable. Meet performance requirements of MIL-R-10509E. Resistance tolerances to $\pm 1\%$.
- Ceramic capacitors can be incorporated for further savings and size advantages over individual components

For complete information write to
Integrated Circuit Application Engineering Dept.,
Sprague Electric Company, 35 Marshall St.,
North Adams, Massachusetts 01248

SPRAGUE COMPONENTS

RESISTORS

CAPACITORS

TRANSISTORS

INTEGRATED CIRCUITS

THIN-FILM MICROCIRCUITS

48 M-175-53 R3

PULSE TRANSFORMERS

INTERFERENCE FILTERS

PULSE-FORMING NETWORKS

TOROIDAL INDUCTORS

ELECTRIC WAVE FILTERS

CERAMIC-BASE PRINTED NETWORKS

PACKAGED COMPONENT ASSEMBLIES

BOBBIN and TAPE WOUND MAGNETIC CORES

SILICON RECTIFIER GATE CONTROLS

FUNCTIONAL DIGITAL CIRCUITS



[®]'Sprague' and [®]'(S)' are registered trademarks of the Sprague Electric Co.

Completely Automatic CAPACITANCE BRIDGE



*Just Insert a Capacitor...
and Read the Answer*

Direct Reading... C and D (or G) indicated with decimal point and correct unit of measurement.

Fast... measuring rates up to 2 per second... works with scanner-type inputs.

Accurate... $\pm 0.1\%$ of reading for C and G; $1\% \pm 0.001$ of reading for D.

Stable... a true bridge whose accuracy depends only on passive standards and fixed transformer ratios and is independent of generator voltage variations and phase-sensitive-detector errors. Three-terminal configuration permits accurate remote measurements.

BCD Output... BCD (1-2-4-2 code) for data processing and recording.

Wide Range

Frequency	120c/s	400c/s	1kc/s
Capacitance	0.0001 μ F to 1000 μ F 4 ranges	0.01pF to 100 μ F 7 ranges	0.01pF to 100 μ F 7 ranges
Conductance	1 μ s to 1 τ s 4 ranges	0.1ns to 1 τ s 7 ranges	0.1ns to 1 τ s 7 ranges

Dissipation Factor: 0.0001 to 1.0 in one range

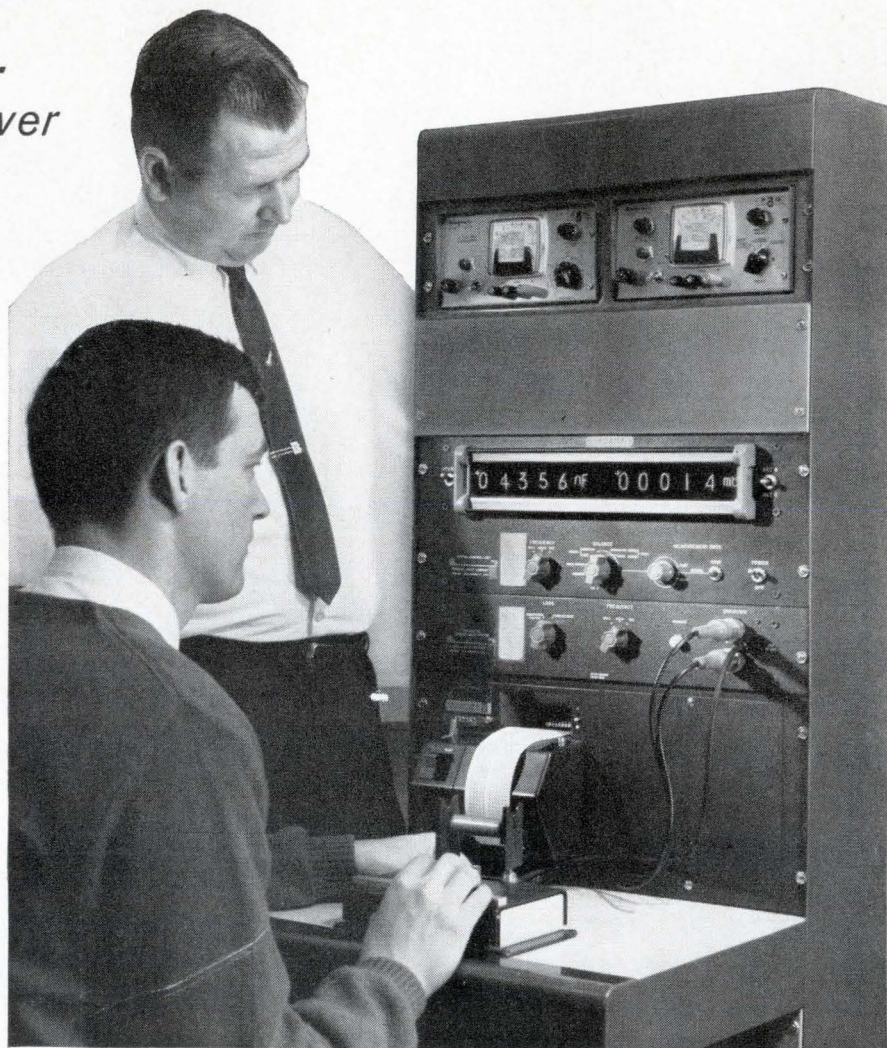

RCA Aerospace Systems Division, Burlington, Massachusetts, has responded to the Department of Defense's challenge to industry to attain new levels of product quality by instituting a company-wide Zero Defects program. For example, in their Purchased Materials Inspection Department, new test equipment has been installed to upgrade measurement techniques and accuracy. A GR Type 1680 Automatic Capacitance Bridge and Type 1137 Data Printer are now used for incoming inspection of capacitors, whereas a manually balanced bridge was previously used. Capacitance measurements were not only tedious and time-consuming, but were also subject to a considerable amount of human error. With the installation of the Type 1680 Automatic Bridge, a thirty-percent saving in time has been realized; accuracy has been increased ten times; and data is automatically and permanently recorded.

Automatic Capacitance Bridge Assembly Type 1680-A ... \$4850 in U.S.A.

If you think a 1680 Automatic Capacitance Bridge can save you time and money and improve accuracy, why not write or call us for a demonstration?

BOSTON • NEW YORK • CHICAGO • PHILADELPHIA • WASHINGTON, D.C.
SYRACUSE • DALLAS • SAN FRANCISCO • LOS ANGELES • ORLANDO
CLEVELAND • TORONTO • MONTREAL
GENERAL RADIO COMPANY (Overseas), ZURICH, SWITZERLAND
GENERAL RADIO COMPANY (U.K.) Ltd., BOURNE END, ENGLAND

GENERAL RADIO
WEST CONCORD, MASSACHUSETTS

man subsidiary of Phillips, under the code number 2xDCA 2 since 1963. Perhaps other readers may point to even earlier versions.

Irwin Schollar

Valvo GmbH
Bonn, West Germany

Nothing new department

To the Editor:

I was rather surprised to read about the "new" storage oscilloscope with a variable persistence facility [Nov. 29, 1965, p. 66].

The instrument very closely resembles the one developed by my company in 1956. The initial work was done for the Atomic Research Establishment at Harwell, the equipment being used during thermonuclear fusion experiments. An oscilloscope called the Remscope came into general use in 1958.

The equipment embodied early Hughes Memotron tubes, and later the English Electric E-702 half-tone direct-view storage tube, and for data transmission the Raytheon QK-685 "electrical - in electrical - out" tube.

The only difference between Kolar's equipment and the Cawkell 1958 Remscope appears to be in his use of a tube with two flood guns; this of course improves writing linearity and possibly collimation; the older tubes had one flood gun and an offset writing gun.

All of the facilities described by Kolar, including variable persistence achieved by variable duty cycle pulsing of the backing electrode, were included in the 1958 instrument.

It would have been very interesting had the author discussed writing speeds because this is a

well known limitation of storage tubes. The English Electric tube would write at about 5 cm/ μ s, while 20 cm/ μ s was achieved on some later tubes. The CSE TEI-603 would write at about 30 cm/ μ s. It is believed that they have still not been exceeded.

In conclusion, the Cawkell instrument was probably the first storage oscilloscope in the world embodying the features mentioned; another version of the instrument is now being manufactured by Dawe Instruments, Ltd.

A. E. Cawkell

Middlesex, England

■ The author replies:

While we were aware of specialized radar cathode-ray-tube displays which function in much the same way as our new variable persistence scope, we did not know of any other laboratory oscilloscope which made this feature available.

Reader Cawkell's comments on writing speed are also appreciated. We recognized this limitation and continued development. Model 141-A scopes now being delivered incorporate new circuits, added since the article appeared, to maximize this characteristic. For single shot transient storage, specified writing rate is one cm per microsecond. We believe this is conservative since all instruments observed to this time will easily produce a usable trace at 5 cm per microsecond. Ten cm per microsecond has been displayed on some. Among production storage scopes, this appears to be unusually good.

Bob Kolar

Applications engineer
Hewlett-Packard Co.
Colorado Springs, Colo.



now...

VITREOSIL®

PURE FUSED QUARTZ

CONICAL

PIPE JOINTS

Designed as a practical demountable joint for vacuum or pressure, liquid or gaseous systems. The conical (or Buttress) joint is available in clear pure fused quartz in sizes to 2" I.D. and in opaque fused silica in sizes 3" I.D. to 6" I.D.

Clear fused quartz joints have grooves into which gasket material is forced for tighter joints. Opaque fused silica joints have precisely ground flat ungrooved surfaces. Gasketing material may be selected to meet requirements.

Conical pipe joints are ideal for joining fused quartz or fused quartz to metal, ceramics, plastics, etc. Interchangeable with borosilicate pipe joints. Joint hardware can be supplied at additional cost.

Special auxiliary apparatus with furnace annealed pipe joints includes thermocouple wells, end caps, closed and/or reduced end furnace tubes in various sizes, one, two and three neck round bottom flasks up to 2 liters capacity in clear pure fused quartz and up to 15 liters in opaque fused silica.

THERMAL AMERICAN
FUSED QUARTZ CO.

RT. 202 & CHANGE BRIDGE RD.
MONTVILLE, NEW JERSEY

SUBSCRIPTION SERVICE

Please include an Electronics Magazine address label to insure prompt service whenever you write us about your subscription.

Mail to: Fulfillment Manager
Electronics
P.O. Box 430
Hightstown, N.J. 08520

To subscribe mail this form with your payment and check new subscription renew my present subscription

Subscription rates: in the U.S.: 1 year, \$6; two years, \$9; three years, \$12. Subscription rates for foreign countries available on request

CHANGE OF ADDRESS

ATTACH LABEL HERE

If you are moving, please let us know five weeks before changing your address. Place magazine address label here, print your new address below.

name

address

city

state

zip code

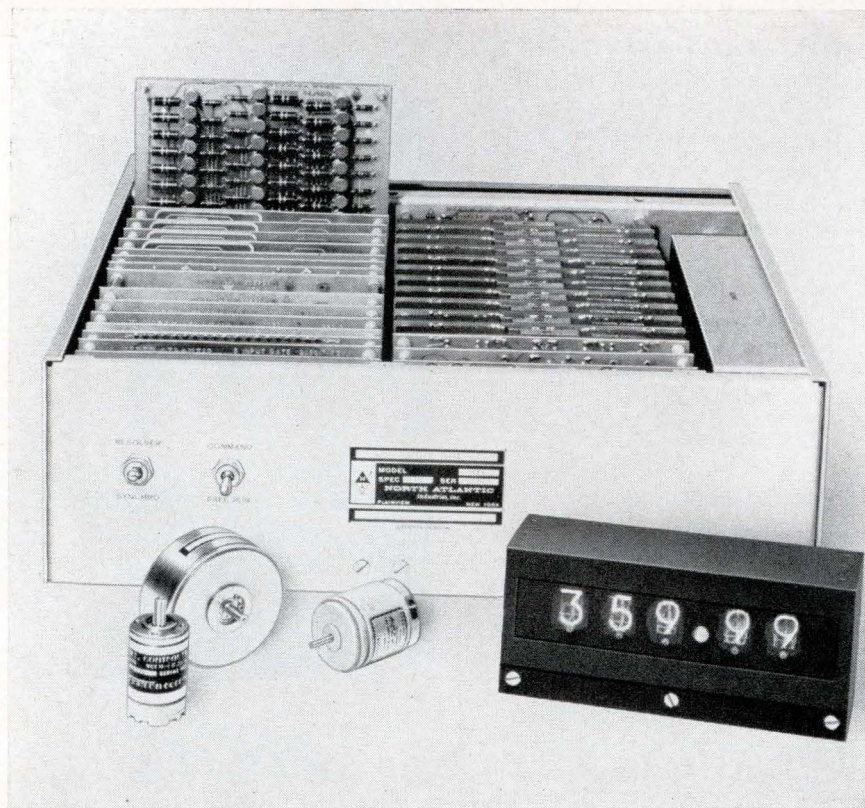

how to convert resolver and synchro angles to digits (and vice versa)

North Atlantic now brings you a new family of solid-state analog-to-digital and digital-to-analog converters for resolver and synchro data. They offer a major advance in conversion accuracy in modern navigation, simulation, data processing and measurement systems.

Typical of these new instruments is the Model API-5450 shown here. It provides both continuous and command conversion of both resolver and synchro angles, accommodates all line-to-line voltages from 11.8 to 90 volts at 400 cps. Output data is in decimal digits and is presented both as a Nixie-tube display and a five-digit printer output with supplementary print command. Accuracy is 0.01° and update time is less than 1 second.

All instruments in this family are designed to MIL-T-21200 and feature all solid-state circuitry and precision transformers—there are no motors, gears, or relays. Their flexible plug-in modular circuit design permits a wide range of variations to suit your specific requirements. For example:

- 18 bit or 10 second accuracy and resolution
- binary, BCD, or decimal inputs/outputs
- multiplexed channels
- multi-speed inputs/outputs
- high conversion speeds
- other signal frequencies

Your North Atlantic representative has complete application information. He'll be glad to help you solve interface problems in measurement and data conversion. Simply call or write.



NORTH ATLANTIC industries, inc.
TERMINAL DRIVE, PLAINVIEW, L. I., NEW YORK • OVerbrook 1-8600

People

The North American Philips Co. has appointed **John S. Auld** general manager of its Studio Equipment division. He will guide two moves by the division: expansion of production of the Nor-elco Plumbicon color television camera and expansion into other broadcast products areas.



Demand for the color tv camera, which was introduced last March, was unexpectedly high, explains Auld. The effort now is to step up output to meet the surge in buying; the division already has an order backlog that will keep production at full speed until the summer of 1967.

Both these goals fit Auld's background, which includes engineering, production and marketing. He came to North American Philips from the Fairchild Camera & Instrument Corp., where he was general manager of the Instrumentation division.

North American Philips' parent company is Philips Gloeilampenfabrieken, N. V., of the Netherlands.

The name on the door—Environmental Synthesis Laboratory—gives no hint of the work that's actually going

on inside: oceanography. But **B. E. Simmons**, a physicist who heads the new lab at the Syracuse University Research Corp., explains: "The name does give a hint of the scientific approach we'll be taking: it will be a systems approach." The lab will try to synthesize the work of a dozen or more specialties and try to come up with an entire under-water package. The package, for example, could be an entire military base on the floor of the ocean, says Simmons.



He explains that there's still much development work to be per-

He explains that there's still much development work to be per-

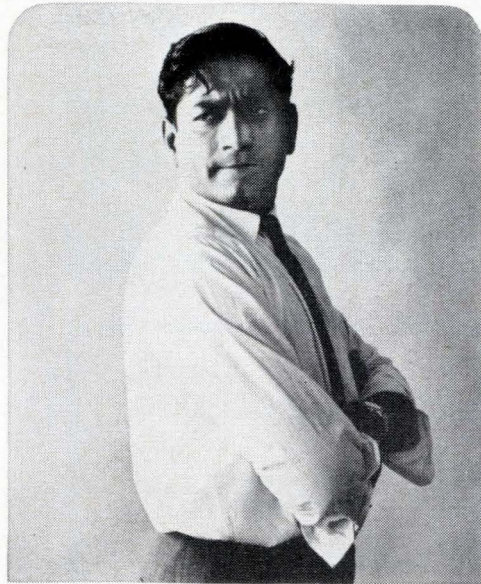

Looking for rugged 3 amp transistors?

Prabodh Shah speaks your language.

Prabodh Shah is one of our applications engineers. We call him Pete. Customers call him just plain great, because he's made available *both* 3 amp germanium DAP and alloy power PNP transistors. Over 60 types in all. All competitively priced. Available in TO-5, TO-37, stud nut MT-27 and hexagonal nut MT-28 packages.

You can use our DAP® (Diffused Alloy Power) transistors for audio amplifiers, pulse amplifiers, relay drivers and switching. Featured are switching times in microseconds without worry of secondary breakdown; high collector-to-base voltage V_{CBO} to -200 V; high DC current gain: $h_{FE}=30$ to 90 at $V_{CE}=-1$ V, $I_C=-0.5$ A; low collector cutoff current: $I_{CBO}=-3$ mA maximum at $+85^\circ\text{C}$; low saturation voltage: $V_{CE(s)}=-0.2$ V typical with $I_C=-1$ A, $I_B=-0.5$ mA; excellent frequency response: $f_{ab} \geq 2.5$ MHz. All are SOAR (Safe Operating Area) specified.

Use our Alloy power transistors for solenoid drivers, small power supplies (inverter/converter), audio amplifiers and control circuits. They feature V_{CBO} to -100 V, V_{CEO} to -60 V, $I_C=-3$ to -3.5 A, $V_{CE(s)}=-0.25$ V maximum with $I_C=-1$ A, $I_B=-0.1$ A; high DC current gain: $h_{FE}=20$ to 60 at -3 A; $f_T \geq 0.25$ MHz. All Bendix 3 amp Alloy transistors are SOAR specified.

Ten types are now available meeting military specifications. In addition, our commercial DAP and Alloy lines offer packages that meet MIL-S-19500, MIL-STD-750 and MIL-STD-202 environmental and mechanical requirements.

More information? Just phone or write our nearest sales office. If it's a particularly tough application, we'll have Prabodh Shah translate it into easy terms for you.

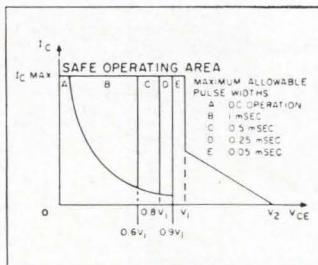
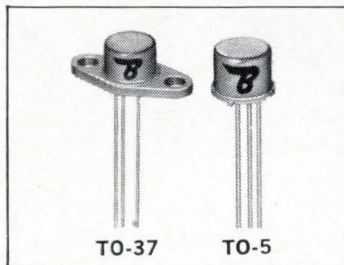

TYPE NUMBER	Ic Amps	V1 Volts	V2 Volts
DAPS			
2N2282—2N2284	3	30 to 70	70 to 110
2N2467—2N2469		70	110
ALLOYS			
2N1038—2N1045	3 to 3.5	30 to 60	60 to 90
2N2552—2N2567			

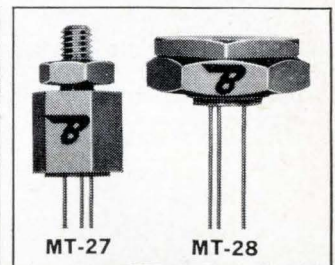

Bendix Semiconductor Division
HOLMDEL, NEW JERSEY



Baltimore, Md.—(301) 828-6877; Chicago—(312) 637-6929; Dallas—(214) 357-1972; Detroit—(313) JO 6-1420; Holmdel, N. J.—(201) 747-5400; Los Angeles—(213) 776-4100; Miami—(305) 887-5521; Minneapolis—(612) 926-4633; Redwood City, Calif.—James S. Heaton Co., (415) 369-4671; Seattle—Ray Johnston Co., Inc., (206) LA 4-5170; Syracuse, N. Y.—(315) 474-7531; Waltham, Mass.—(617) 899-0770; Export—(212) 973-2121, Cable: "Bendixint," 605 Third Ave., N. Y.; Ottawa, Ont.—Computing Devices of Canada, P.O. Box 508—(613) TA 8-2711.

Did You Know Sprague Makes 32 Types of Foil Tantalum Capacitors?

125 C TUBULAR TANTALEX® CAPACITORS



Type 120D polarized plain-foil
Type 121D non-polarized plain-foil
Type 122D polarized etched-foil
Type 123D non-polarized etched-foil

ASK FOR BULLETIN 3602C

Circle 332 on reader service card

85 C TUBULAR TANTALEX® CAPACITORS



Type 110D polarized plain-foil
Type 111D non-polarized plain-foil
Type 112D polarized etched-foil
Type 113D non-polarized etched-foil

ASK FOR BULLETIN 3601C

Circle 333 on reader service card

RECTANGULAR TANTALEX® CAPACITORS



Type 300D polarized plain-foil
Type 301D non-polarized plain-foil
Type 302D polarized etched-foil
Type 303D non-polarized etched-foil

ASK FOR BULLETIN 3650

Circle 334 on reader service card

TUBULAR TANTALUM CAPACITORS TO MIL-C-3965C



CL20, CL21 125 C polarized etched-foil
CL22, CL23 125 C non-polarized etched-foil
CL24, CL25 85 C polarized etched-foil
CL26, CL27 85 C non-polarized etched-foil
CL30, CL31 125 C polarized plain-foil
CL32, CL33 125 C non-polarized plain-foil
CL34, CL35 85 C polarized plain-foil
CL36, CL37 85 C non-polarized plain-foil

Circle 335 on reader service card

RECTANGULAR TANTALUM CAPACITORS TO MIL-C-3965C



CL51 polarized plain-foil
CL52 non-polarized plain-foil
CL53 polarized etched-foil
CL54 non-polarized etched-foil

Circle 336 on reader service card

For comprehensive engineering bulletins on the capacitor types in which you are interested, write to:
Technical Literature Service
Sprague Electric Company
35 Marshall Street
North Adams, Mass. 01248

45C-5161

SPRAGUE®
THE MARK OF RELIABILITY

*Sprague' and '®' are registered trademarks of the Sprague Electric Co.

People

formed before the sea can be exploited. Some of the work will be building basic hardware—power sources, communications gear, transportation equipment; and some of it will involve “the social aspect of having man in the sea”—politics, economics and psychology.

“We’ll be able to draw on the expertise of some 250 people” who work at the not-for-profit company, he says. And if needed, he can turn to members of the staff at Syracuse University, through which the company is chartered. The lab staff is made up of six senior scientists.

Enjoys building. Simmons describes himself as a “physicist with a little bit of the engineer in me. I don’t like to limit myself to theory. Hardware is a means to an end, and I enjoy building.”

“Look at it this way: it often takes longer to get from downtown New York to Kennedy Airport than from the airport to Washington,” says **Robert J. Shank**, the newly named vice president of Cutler-Hammer, Inc.’s Airborne Instruments Laboratory division. It was with this problem in mind that Cutler-Hammer named Shank, a former associate administrator of the Federal Aviation Agency, to a post that will guide the division in the broad field of transportation.

“We’ll be interested in all kinds of transportation, including high-speed trains,” says the 51-year-old executive-engineer. The job will be to translate Cutler-Hammer’s experience in such fields as avionics and materials handling to the task of transporting people. This move will mean a “shift in emphasis” for the company, explains Shank.

One project that Shank hopes to convince the company to pursue is the development of all-weather automatic controls for helicopters. “We’re developing such gear for fixed-wing craft,” he says, “but so far nothing has been done for the helicopter.” Stabilization equipment for helicopters would have to be tailor-made because they are very unstable when flown on instruments, Shank adds.

200 kW power output with .7 kW drive from magnetically beamed Machlett triode

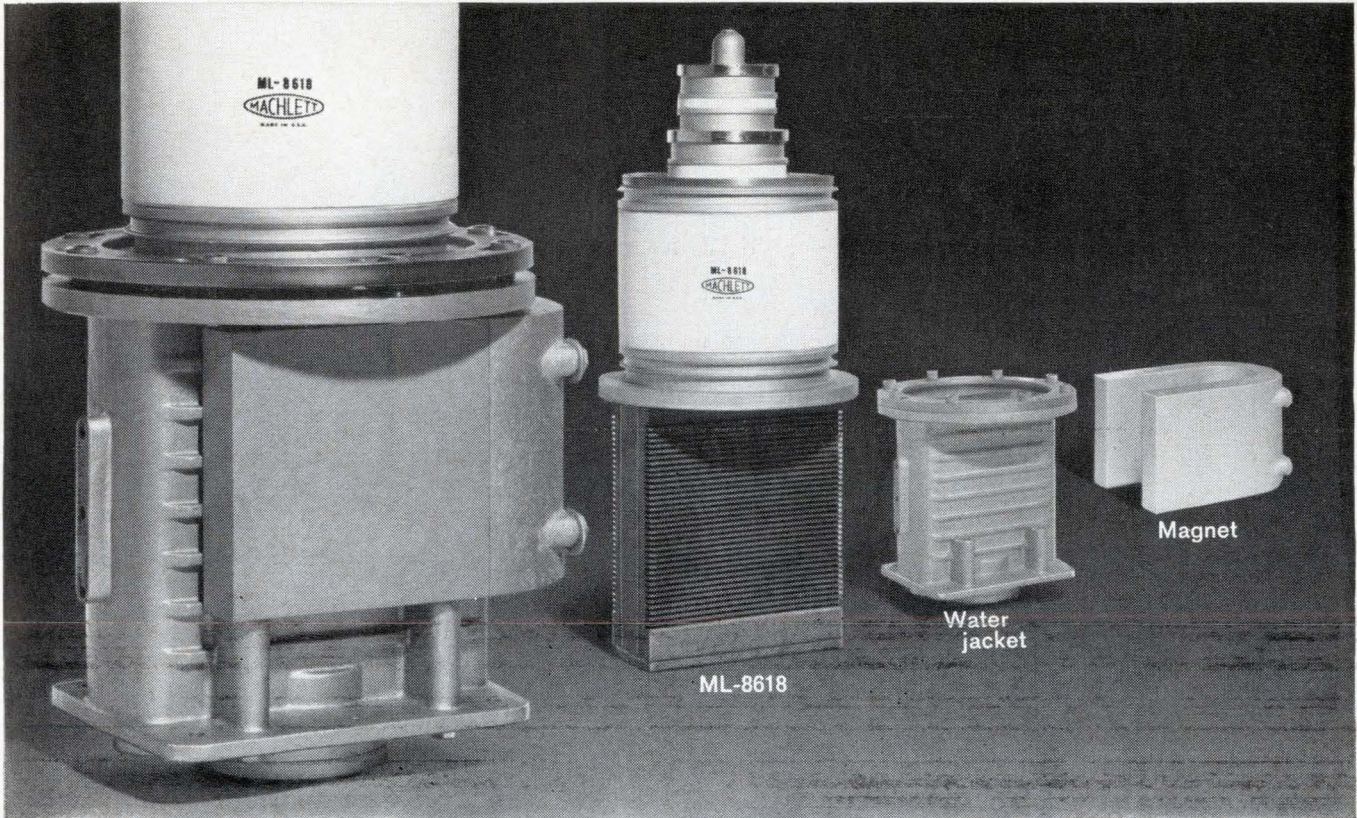

ML-8618, Machlett's new magnetically beamed water-cooled triode, provides high power gain, high plate efficiency and maximum cathode utilization. Electron trajectory from cathode to plate is magnetically controlled to greatly reduce electron interception by the grid . . . and therefore decrease grid current and heating and allow significantly higher performance levels.

Result: the ML-8618 delivers a typical 200 kW power output with .7 kW drive as a Class C rf amplifier or oscillator. As a switch tube in pulse modulators, it is capable of a maximum 8 Mw high duty pulse. For full operating details, write to The Machlett Laboratories, Inc., Springdale, Conn. 06879.



A SUBSIDIARY OF RAYTHEON COMPANY

**Planar II
is the purest
manufacturing
process ever
put into mass
production.**

**By 1970 every
semiconductor
manufacturer
will use it.
You can wait.
Or get it now
from Fairchild.**

Planar is a patented Fairchild process.

**±1% tracking
plus taut-band
in 20 models,
9 styles---with
many in stock**

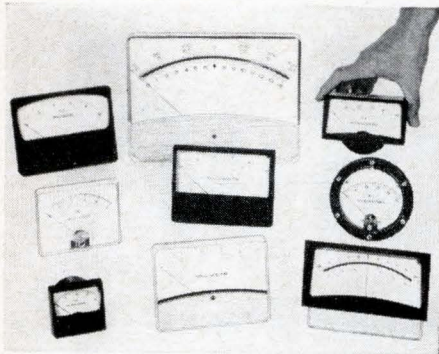

API offers 1 percent tracking, at no extra cost, in virtually every popular DC panel meter style, size and sensitivity—clear plastic, black phenolic, or ruggedized-sealed.

As long as you specify taut-band construction, you'll automatically get ±1 per cent tracking—in all but the smallest and most sensitive API meters.

Taut-band is a bonus in sensitive meters

You don't even have to specify taut-band if you order meters in ranges from 0-3 to 0-50 microamperes and from 0-3 to 0-25 millivolts. These meters just naturally come with taut-band. Besides responding best to exceptionally small signals, this friction-less design is much more resistant to damage from shock and vibration.

(Taut-band costs a little extra for less sensitive meters than those named above. There's also a slight charge for 1 per cent tracking in sensitive ranges of 0-10 μ a or 0-3 mv, or better.)

Immediate delivery for 10 models

Ten API panel meter models, in the most popular taut-band ranges, are now being stocked for off-the-shelf delivery.

*New Bulletin 47 has full information
on all*

API panel meters and pyrometers

api
INSTRUMENTS CO.

Formerly Assembly Products, Inc.

CHESTERLAND, OHIO · PHONE: 216-423-3131

Meetings

Association of Data Processing Service Meeting, ADAPSO; Stardust Motor Hotel, San Diego, Feb. 17-18.

National Meeting on Space Applications, Communications, and Environment, American Astronautical Society; San Diego, Calif., Feb. 21-23.

Offshore Exploration Conference, OECON; Lafayette Hotel, Long Beach, Calif., Feb. 22-24.

Radioisotope Applications in Aerospace, AFSC and Atomic Energy Commission; Sheraton-Dayton Hotel, Dayton, Ohio, Feb. 22-24.

International Fair for Electronics, Automation and Instruments, Danish Electronics Industry; Exhibition Hall, Copenhagen, Denmark, Feb. 25-March 6.

Conference on Nondestructive Testing, Society for Nondestructive Testing; Biltmore Hotel, Los Angeles, March 7-10.

Symposium on Manufacturing In-Process Control and Measuring Techniques, Air Force Materials Laboratory and Motorola Semiconductor Products Division; Hiway House, Phoenix, Ariz., March 9-11.

International ISA Aerospace Instrumentation Symposium, ISA, College of Aeronautics; College of Aeronautics, Cranfield, England, March 21-24.

International Convention and Exhibition of the IEEE; New York Hilton Hotel and the Coliseum, New York City, March 21-25.

Microwave Measurement Symposium, Weinschel Engineering Co.; Essex House Hotel, N. Y., March 21-24.

Seminar on Computers and Automation in Europe, Lomond Systems, Inc.; Washington, D.C. and European tour, March 21-April 7.

National Association of Broadcasters Convention, NAB; Conrad Hilton Hotel, Chicago, March 27-30.

International Conference on Electronic Switching, Union of International Technical Associations, Societe Francaise des Electroniciens et des Radioelectriciens; UNESCO

Conference Hall, Paris, France, March 28-31.

Digital Electronics Seminar, RCA Institutes, Inc.; Hotel New Yorker, N. Y., March 28-April 1.

Automatic Control in Electricity Supply Meeting, IEE; Renold Building, Manchester College, England, March 29-31.

Conference on Analysis and Synthesis of Networks, IEEE-NTG; Stuttgart, West Germany, March 31-April 1.

Industrial Engineering Conference, AIEE; Hotel Pontchartrain, Detroit, March 31-April 1.

Advanced Seminar for Automatic Data Processing, International Computation Center; International Computation Center, Rome, Italy, April 6.

Symposium on Electron and Laser Beam Technology, IEEE, University of Michigan; Ann Arbor, April 6-8.

IEEE Region III Convention, IEEE; Mariotta Motor Inn, Atlanta, April 11-13.

National Telemetry Conference and Exhibit, ISA, AIAA, IEEE; Prudential Center, Boston, May 10-12.*

Call for papers

ISA Conference and Exhibit, ISA; Hotel New Yorker, Statler Hilton, New York Coliseum, N. Y., Oct. 24-27. March 15 is deadline for submitting 200-word abstract on state-of-the-art instrumentation in measurement systems, telemetry, information processing, and automatic control to 1966 Conference Program Coordinator, Instrument Society of America, 530 William Penn Place, Pittsburgh, Pa. 15219.

International Telemetry Conference, International Foundation for Telemetry; Ambassador Hotel, Los Angeles, Oct. 18-20. June 1 is deadline for submission of completed manuscripts on the theory and technological advances of telemetry in the fields of aerospace, military, earth sciences, life sciences, and industry to J. E. Hinde, 9231, Program Chairman, ITC/66, Sandia Corp., P. O. Box 5800, Albuquerque, N. M. 87115.

* Meeting preview on page 16

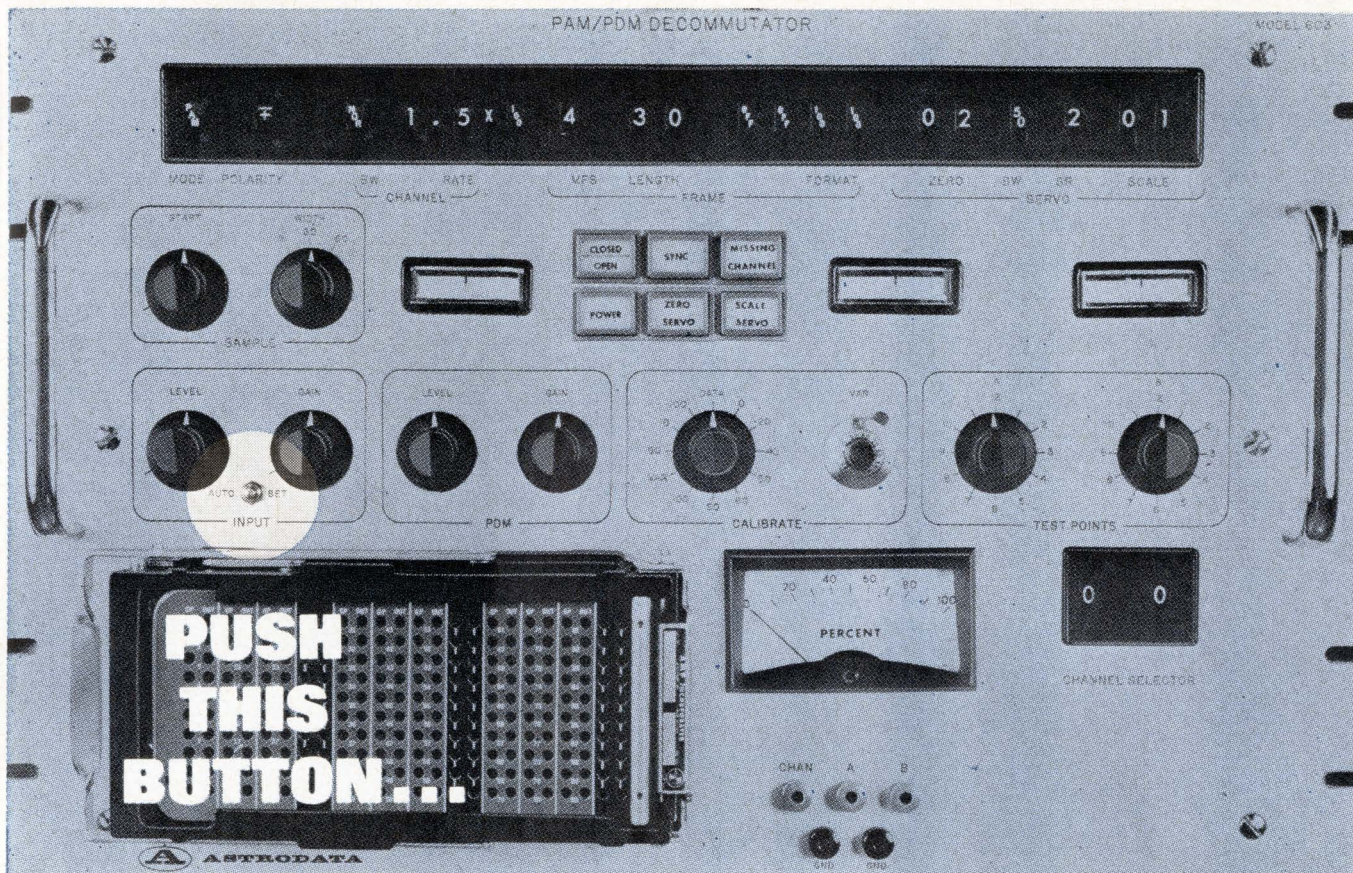

and watch Astrodata's new PAM/PDM Decommulator start a revolution in set-up and performance

Just blink once and you could miss all the set-up procedures necessary for Astrodata's new telemetry decommutator. It takes less than a second to hit the AUTO-SET button. The Model 603 Decommulator does the rest unattended, adjusting the level and gain of the input amplifier automatically.

ABSOLUTELY NO RATE PLUG-INS

Model 603 does away completely with rate plug-ins. Thumbwheel switches are centralized around the front panel for entire selection of frame length (up to 128 channels), rate (1 pps through 10,000 pps), and reference channels. Touch AUTO-SET and away you go. Calibrated, synchronized and ready to unscramble the noisiest signal, extracting good data from what would have been otherwise useless data in any other decommutator.

HOW MUCH NOISE IMMUNITY?

We are prepared to demonstrate that the Model 603 Decommulator offers the most noise immune PAM-NRZ performance ever available. For example, synchroni-

zation is acquired and maintained with a 24 db peak signal-to-rms-noise ratio when all adjacent PAM-NRZ data channel excursions are limited to as little as 20% full scale. For the full technical statement on noise immunity, please ask for our 603 brochure.

What About Input Capture Range and Rise Time Limitations?

- 1) Exceptionally wide capture, $\pm 30\%$ from pre-set rate; and if you have very low pulse rates —
- 2) Virtually no rise time limitations.

SEEING IS BELIEVING

We could go on and on about unique pattern recognition, frame synchronization, zero and full-scale options, etc., but you're not going to believe how much difference these 603 design innovations can make until you see them demonstrated. So why not contact the Astrodata representative in your area and see for yourself? Or write to Astrodata direct on company letterhead and request a demonstration. Some of our most satisfied customer relationships start this way.



ASTRODATA

P. O. Box 3003 ■ 240 E. Palais Road, Anaheim, California ■ 92803

Nine AUTOMATIC operations with this Cat-Whisker Welding Machine

by **KÄHLE**

This KAHLE machine is fully automatic. It flattens the lead wire; then the whisker wire is fed, cut, transferred and welded to the flat with a synchronous electronic timer insuring a uniform weld. Finally, it forms to the required configuration . . . PRODUCTION RATE 3,000 TO 4,000 PER HOUR!

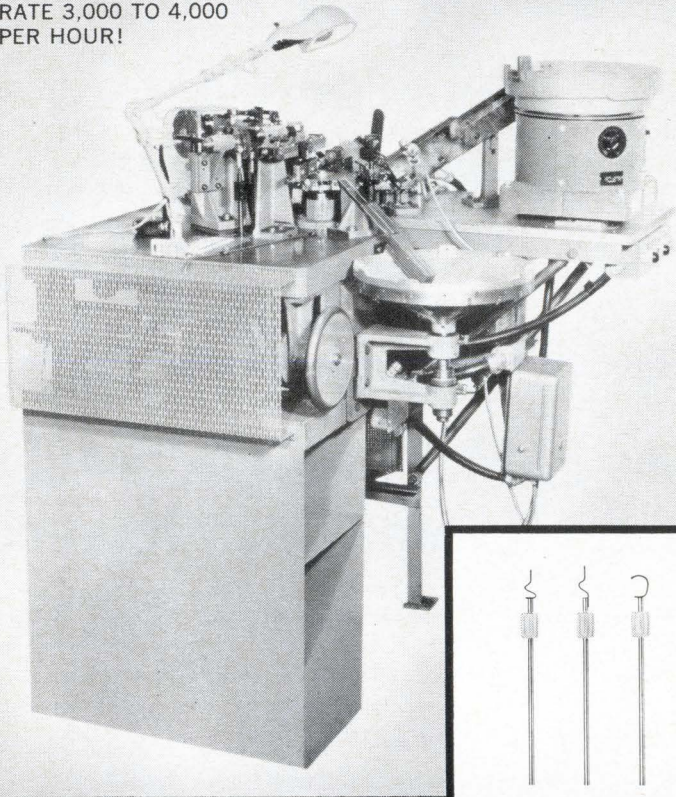

Let KAHLE automate your Production, Assembly, Control, Inspection, Testing!

KAHLE Servos and Feedbacks detect rejects prior to completion of assembly

Instrumentation feedbacks and servos can be supplied that will reject faulty parts prior to assembly and product finishing . . . saving materials and time in production.

KAHLE Machines are Customer-approved under actual operating conditions

Your equipment is run in our factory, using your materials in the presence of your engineers; the machine is not shipped to you unless you approve it!

CONSULT KAHLE—Save time and money by letting professionals build your specialty production equipment for automation!

Kahle Engineering Company

3324 HUDSON AVE., UNION CITY, N. J.
Telephone: UNion 7-6500 (Area Code 201)

KAHLE

Designers and Builders
of Automatic Equipment
for High Speed Production
for Over 30 Years

Meeting preview

Telemetry in Boston

Technical details of the European Space Research Organization (ESRO) satellite program will be described at the National Telemetry Conference in Boston May 10 to 12. Representatives from European industry and ESRO will discuss the over-all status of telemetry in Europe.

Three of the 22 technical sessions will be devoted exclusively to industrial application. A highlight will be the description of a new economical long-distance telemetry system for oil, gas and railway companies. The San Francisco Bay Area Rapid Transit System's telemetry methods will be described. In the industrial sessions the Army Corps of Engineers will tell about a novel battery-powered telemetering device that can be dropped from an aircraft to provide terrain information to aid in deciding whether aircraft can land there.

In a panel session moderated by H. A. French of Trans-Canada Pipe Lines, Ltd., manufacturers and users will consider which characteristics in industrial telemetry equipment have to be defined more accurately to prevent confusion.

Many topics. The United States space programs will provoke many topics for the aerospace-telemetry sessions. System design concepts which suggest the laser's promise to compete with r-f in wideband deep-space communications will be assessed in a paper by a team of scientists from the Raytheon Co. Equipment used in the successful Mariner flight past Mars and planned for use in the Apollo lunar mission will be discussed.

A panel on the clinical aspects of biotelemetry and two other sessions will describe the uses of telemetry in medicine. Dr. E. B. Johnson of ITT Federal Laboratories in California, a subsidiary of the International Telephone and Telegraph Corp., will present a paper on stimulating the brain with remote telemetry. A team of researchers from the Veterans Administration Clinic in Boston will discuss the advantages of telemetering medical data from a patient's home over testing in a laboratory.

ON YOUR MARK...



Kay 154: 50 KHz to 100 MHz

Kay 159: 1 MHz to 300 MHz

**PM 7650 Plug-in:
Pulse Markers
0.5 to 100 MHz**

**PM 7660 Plug-in:
Harmonic & CW Markers
1 to 300 MHz**

These solid-state sweep and marker generators cover the range in a single sweep; provide a continuously-variable narrow sweep.

Performance characteristics include line-lock, cw, manual and variable sweep rates, and external input.

PM 7650 and PM 7660 plug-in marker heads offer up to eight optional, individually-switched crystal plug-in markers **per head**.

A variable birdie marker provision is standard. All plug-in marker heads may be changed or added as required.

External modulation from dc up to more than 15 KHz, a built-in detector and switched attenuator are standard features. Sweep high-to-low or low-to-high.

For literature and prices write:

KAY ELECTRIC COMPANY

Pine Brook, Morris County, New Jersey • (201) 227-2000

Wide-Sweep Generator

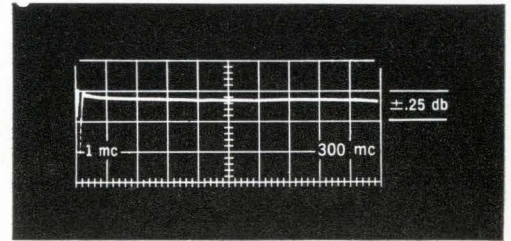

Full 300 MHz Wide Video Sweep

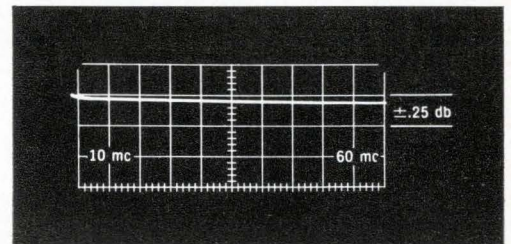

Programmable, Voltage Controlled Oscillator

Marker Generator



Pulse-Type Markers



Harmonic (or Comb) Birdie Markers

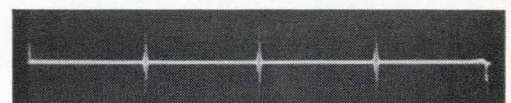

Single-Freq. Type Birdie Markers

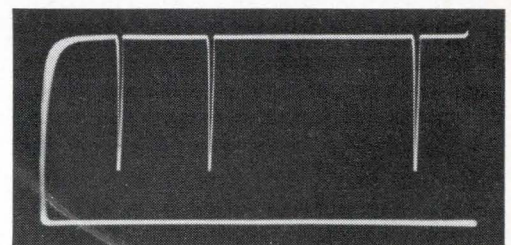

Detected Turn-Off Markers

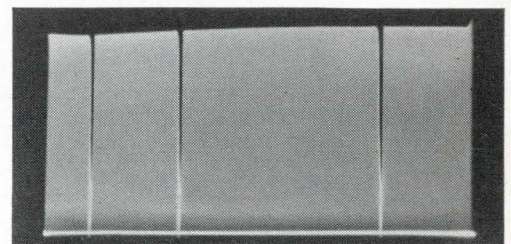

Undetected Turn-Off Markers

Visit Kay at the IEEE Show, Booths 3C11 - 3C17

KODAK PLUS-X PAN-FILM



→ 8A

→ 9

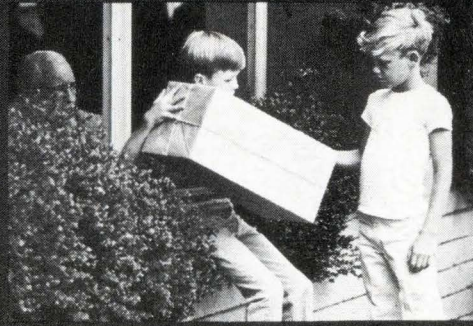

→ 9A

→ 10

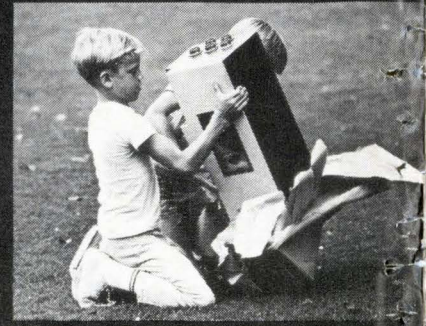

→ 10A

KODAK PLUS-X PAN-FILM



→ 11A

→ 14



→ 14A

→ 15

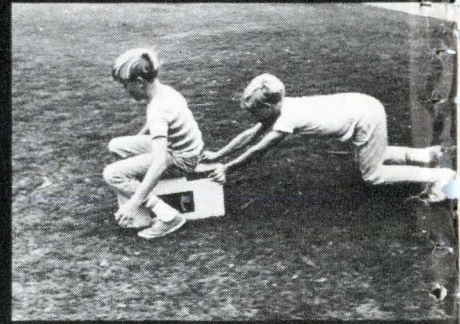

→ 15A

KODAK PLUS-X PAN-FILM



→ 18A

→ 19

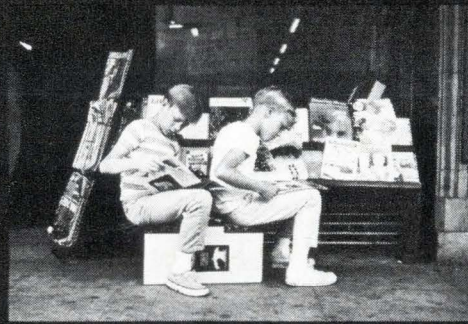

→ 19A

→ 20



→ 20A

KODAK PLUS-X PAN-FILM



→ 23A

→ 24



K J H

→ 25



→ 25A



→ 11A →



→ 16A →



→ 21A →

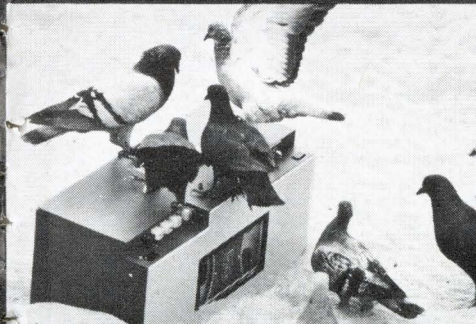

→ 26A →

Tough Recorder Environments: Kid Stuff!

Try leaving a couple of kids alone for ten minutes with a brand new toy. Result: the kind of chaotic environment Leach recorders thrive on. Like in-flight testing, automotive torture tests, hydrofoil recordings, etc. . . . if you can keep a transducer on it, we'll monitor the output.

Take the MTR-3200 for example. For a modest power input of as little as 50 watts at 28VDC, this compact 44 pound package records, stores and reproduces data under the toughest conditions. Conditions like 10g shock with less than a 3% peak to peak flutter. 10g vibration with less than a 6% peak to peak flutter. 25g acceleration. -40° to 71°C operating temperatures. 95% humidity. 150,000 foot altitude. Check these specs against any other recorder/reproducer and see if they'll operate through conditions like that.

And the MTR-3200 is versatile, too. Plug in electronic modules provide up to 14 analog and FM or 16 digital channels usable in any combination. Six tape speeds are selectable in speed pairs. Even data bandwidths are extended beyond IRIIC standards, and the entire unit is compatible with IRIIC standard data reduction equipment. For those special applications, Leach offers a wide range of little luxuries such as analog to digital, serial to parallel and parallel to serial conversion equipment.

If these specs meet your immediate requirements, or if you have a highly improbable environmental situation to be challenged and accommodated, write us. No one knows more about high environmental tape recorders than Leach Corporation, Controls

LEACH

Division, 717 North Coney Avenue,
Azusa, California Phone: (213) 334-8211.
Export: Leach International, S.A.

An industry first from IRC...PAR

metal film resistors meet 3 assured reliability levels

published prices for PAR

(Program for Assured Reliability)

.1%, .01% or .001% levels

Up to now, assured registered reliability could only be obtained through negotiations for screening or additional lot testing.

Now IRC eliminates the need for negotiation and offers a truly low-cost approach to established reliability. For the first time in the industry, users of standard evaporated metal film resistors can specify one of three assured failure rate levels at established published prices.

PUBLISHED SPECIFICATION

IRC has published a specification covering three established reliability levels for its standard evaporated metal film resistors—.1%, .01% and .001%. These failure rates are per 1000 hours, full rated load at 125°C, to 60% confidence.

This Program for Assured Reliability marries the high stability performance requirements of MIL-R-10509 and the stringent reliability levels of

MIL-R-55182. It also defines the requirements to prove failure rate levels as well as necessary control procedures to assure continuing compliance.

LOWEST PUBLISHED PRICES

IRC is the first to publish a price schedule for a predetermined level of resistor reliability. And, only IRC can offer such assured reliability at these low prices.

FAILURE RATE LEVEL	IRC TYPE	T.C. (/°C)	COST (250 LOT)
.1%	CCA	±100ppm	.21
.01%	CCA	±50ppm	.57
.001%	CCA	±25ppm	3.32

Above prices are excerpted from IRC's published price schedule.

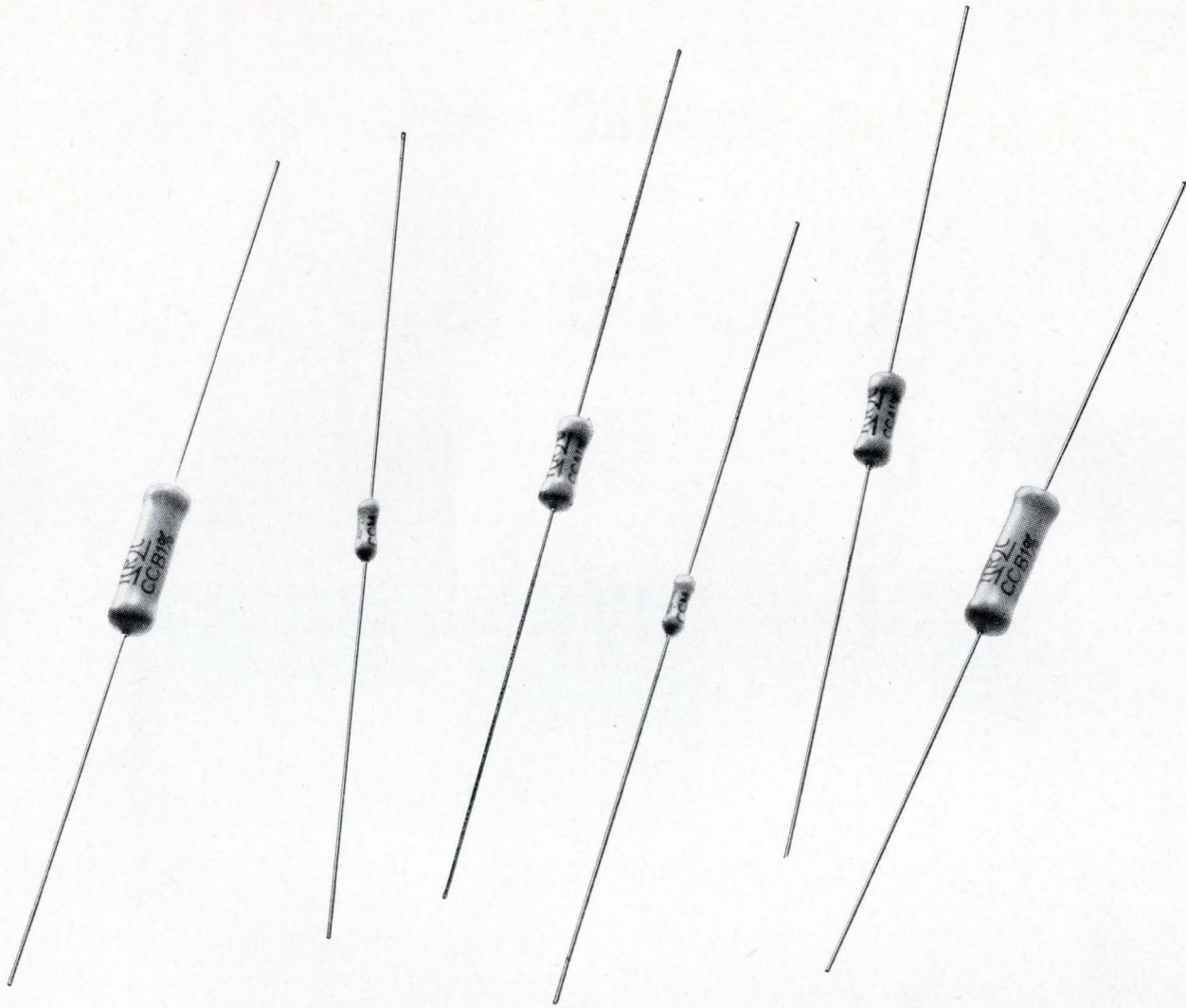

ESTABLISHED RELIABILITY IN A STANDARD PRODUCT LINE

All evaporated metal film resistors covered by IRC's Program for Assured Reliability meet MIL-R-10509, characteristics C and E, with the added benefits of assured reliability at the lowest cost. These types are immediately available.

TYPE		MIL-R-10509 CHAR.	WATTAGE			TOLERANCE	TEMPERATURE COEFFICIENT	RESISTANCE RANGE*
IRC	MIL		@ 70°C	@ 100°C	@ 125°C			
MMC	RN50	Meets all MIL-R-10509 environmental requirements	1/8	1/10	1/20	± 1% ± 0.5%	± 25ppm ± 50ppm ± 100ppm	20 to 100K
CCM	RN55	E C D	1/8	1/10		± 1% ± 0.5% ± 0.25%	± 25ppm ± 50ppm ± 100ppm	20 to 301K
CCA	RN60	E C D	1/4	1/8		± 1% ± 0.5% ± 0.25%	± 25ppm ± 50ppm ± 100ppm	20 to 499K
CCB	RN65	E C D	1/2	1/4		± 1% ± 0.5% ± 0.25%	± 25ppm ± 50ppm ± 100ppm	20 to 1 meg

*Summarized. Standard values fully described in PAR Specification.

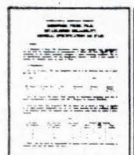

Fill out the coupon for your copy of IRC's Program for Assured Reliability and price schedule. The specification defines performance characteristics, failure rate determination, testing methods and conditions.

IRC, Inc., 401 N. Broad St., Philadelphia, Pa. 19108
Attn: Dept. 201

Send me a copy of IRC's Program for Assured Reliability and price schedule.

NAME _____ TITLE _____

COMPANY _____

ADDRESS _____

CITY _____ STATE _____ ZIP CODE _____



IN LINE REGULATED ADJUSTABLE DC POWER SUPPLIES

KEPCO'S DESIGN SIMPLICITY MAKES THE DIFFERENCE!

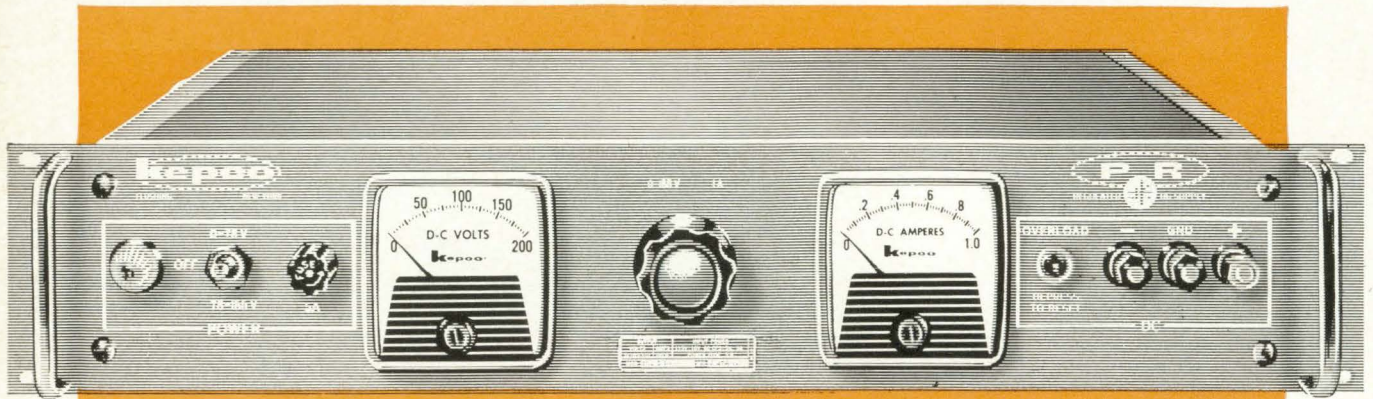

Model PR 155-1M

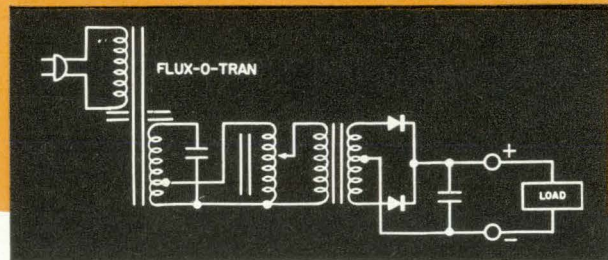

RELIABILITY GREATER THAN 40,000 HOURS MTBF

(Mean time before failure computed per RADC Reliability Notebook PB 161894 and the MIL Handbook 217)

The FLUX-O-TRAN[®] is the heart of Kepco's PR GROUP of DC Power Supplies. By delivering a square-wave-form to the rectifier, the FLUX-O-TRAN increases rectifier utilization and improves the loading characteristics of the filter capacitors. This characteristic provides a relatively low intrinsic source impedance, improving load regulation and affording a low ripple content. The result is a simple, highly reliable and efficient source of regulated DC power in *minimum space* and at *minimum cost*.

The PR GROUP offers a wide choice of *adjustable* output voltage and output ratings with:

- typical ripple values 0.5 to 3%
- overcurrent protection
- no voltage overshoot
- power efficiency typically 50-70%
- reliable, efficient silicon full-wave rectification
- output essentially free of line voltage variations
- isolation of line transients
- current limiting protection from current overloads and external short-circuit

± 1% LINE REGULATION
105-125 V AC, 60 CPS ± 5%* - SINGLE PHASE

MODEL	DC OUTPUT VOLTS	RANGE AMPS	PRICE
PR 15-10M	0-7.5-15	0-10	\$360.00
PR 15-30M	0-15	0-30	525.00
PR 38-5M	0-19-38	0-5	340.00
PR 38-15M	0-38	0-15	495.00
PR 80-2.5M	0-40-80	0-2.5	340.00
PR 80-8M	0-80	0-8	475.00
PR 155-1M	0-78-155	0-1	340.00
PR 155-4M	0-155	0-4	450.00
PR 220-3M	0-220	0-3	450.00
PR 310-0.6M	0-165-310	0-0.6	360.00
PR 310-2M	0-310	0-2	450.00

± 2% LINE REGULATION
208/230 V AC ± 10%, 60 CPS ± 5%* - 3-PHASE

PR 20-100AM	0-20	0-100	1,050.00
PR 40-50AM	0-40	0-50	895.00
PR 50-40AM	0-50	0-40	895.00

*For models to operate at 104 ± 9V AC; 115 ± 10 V AC; 208 ± 18V AC or 230 ± 20V AC, 50 cps ± 5%, add suffix "-50" to model no. and derate output voltage by 20%.



OUR NEW CATALOG CONTAINING COMPLETE SPECIFICATIONS AND APPLICATIONS NOTES IS NOW AVAILABLE

WRITE FOR YOUR FREE COPY!

Applicable Patent Nos. furnished on request



KEPCO, INC. • 131-38 SANFORD AVENUE • FLUSHING, N.Y. 11352 • Phone: (212) 461-7000 • TWX #212-539-6623 • Cable: KEPCOPOWER NEWYORK

Editorial

Federal budget: the prime mover

In Washington every year, the end of January is a time of nervous anticipation and nagging worry for government officials waiting for the President to finish polishing the federal budget. This year, the waiting and worrying were intensified because everybody feared that the cost of the fighting in Vietnam would take money away from other projects. It was not until Jan. 21, when government officials got their first advance look at the completed budget, that many officials heard which of their projects had been approved, killed or postponed.

Clearly this year's budget, examined in detail on pages 133 to 145, is a military one. It is the biggest in our history, calling for \$112.8 billion, with \$61.4 billion earmarked for national defense.

For the first time since hostilities started in Vietnam, Congress is being asked to program money for that war. Previously, the Defense Department had kept the forces supplied by shifting matériel from bases around the world and by juggling budget accounts. The Pentagon's fiscal experts finally ran out of ways to shift funds. In fact, at the same time President Johnson presented the \$112.8 billion budget with \$61.4 billion slated for the military, he asked for an additional \$12.3 billion for fiscal 1966, the current year. In August, the Administration had asked for \$1.7 billion more for Vietnam. Incidentally, Defense Secretary Robert S. McNamara, who until May of last year had been denying that the Pentagon needed more money for Vietnam, has now told a congressional committee in closed hearings that he was wrong—his first admission that he might not be infallible.

The great expenditures for Vietnam are changing the character of defense spending. There is far less money going into strategic weapons and far more into what the foot soldier can see and carry: helicopters, radars and radios. Even more important, some money has been directed away from civilian expen-

ditures. Spending plans of the Federal Aviation Agency for air-traffic control will need a drastic new look because of a \$22-million cut (p. 141). Many plans for the Great Society will not be realized in fiscal 1967 because not enough new money was authorized. Although health and education agencies were disappointed that plans will have to be curtailed for at least a year, many officials breathed a sigh of relief that their budgets are about the same size as last year's. Little of the work already started will have to be cut back.

A close examination of the federal budget is likely to alarm those interested in research and development. Federal expenditures for R&D are plateauing and may slide in the future.

At the Pentagon, research-and-development spending has leveled off after a spectacular rise in the early 1960's. One reason: the big strategic projects are nearly completed, and although there are more R&D projects under way, the new ones cost less. One Pentagon expert opined, "It takes a lot less money to develop a radio than a missile."

At the National Aeronautics and Space Administration, officials are also worried about a leveling off of R&D funds. Advanced projects, like the Voyager mission to land instruments on Mars, have been postponed. And the agency has no big specific program to follow Apollo, the moon shot, which is now moving rapidly into the hardware phase.

Unfortunately for electronics engineers and business men, the official budget carries no breakdowns of electronics spending. These figures are buried in gross numbers for departments or big projects. Only a veteran government employee can supply the details that help industry people estimate how much of the \$112.8 billion will end up in engineers' paychecks and company coffers. To obtain this kind of information, Electronics sent three editors from New York to work with six members of McGraw-Hill's Washington Bureau the week before the President delivered his message.

This task force attended advance budget briefings over the weekend and interviewed scores of department and agency controllers and contract officers.

The story, starting on page 133, spells out how the budget will affect the electronics industry. The federal budget, earmarking about \$10 billion in calendar 1966 for electronic systems, equipment and hardware, accounts for more than one-half of all the business of the U. S. electronics industry—supplying the prime power behind the industry and the fuel for much of its technology.

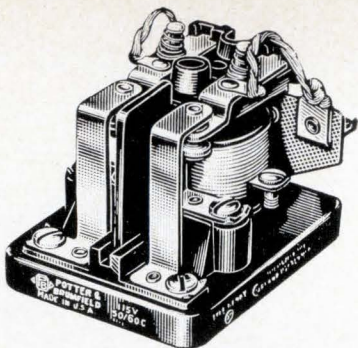

Here's why engineers have specified this heavy duty 25 amp relay by P&B for over 30 years

This is the granddaddy of all P&B relays. Our very first design. Many millions are in use throughout the world . . . starting motors, controlling elevators, switching high current and voltage loads, doing a multitude of heavy duty jobs, reliably. Year after year, the PR Series remains high on our best-seller list. Here are some reasons why.

EXCELLENT CONTACT WIPE ACHIEVED WITH FLOATING CONTACT CARRIER

PR relays are designed with a full floating carrier for the movable contacts. Beside providing sufficient contact pressures, the floating carrier builds-in an abundance of wipe to keep the contacts scrubbed on every operation. Large, $\frac{3}{16}$ " diameter contacts switch 25 ampere non-inductive loads or 1 HP at 115/230 VAC, single phase. A phenolic barrier between the contacts of multipole relays prevent flash-over between contacts.



SELECT FROM A VARIETY OF CONTACT ARRANGEMENTS

PR reliability is available in relays having the following contact arrangements: SPST-NO, SPST-NC, SPST-NO-DB, SPST-NC-DB, SPDT, DPST-NO, DPST-NC, and DPDT. Coil voltages range from 6 to 440 volts A.C., and 6 to 110 volts D.C. A vast number of special variations of these standard parameters have been engineered over the years.

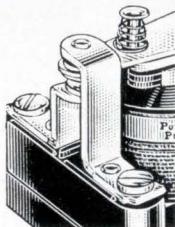

AUXILIARY CONTACTS ADD TO VERSATILITY OF PR RELAYS

A single set of auxiliary contacts (Form A, B or C) can be supplied when the application demands. They are rated at 5 amperes at 115 VAC, 60 cycle resistive. Standard models of PR relays with auxiliary contacts are available from leading electronic parts distributors.

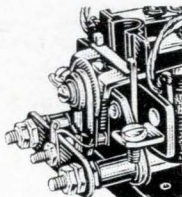

MANY STANDARD RELAYS ARE LISTED BY U/L AND CSA

A wide range of standard PR relays is listed by Underwriters' Laboratories (File E22575) and Canadian Standards Association (File 15734). CSA listing covers AC relays only. These listings can often save you time and extra expense when obtaining UL or CSA qualification for your products.

MAGNETIC ARC-QUENCHERS FURNISHED ON SOME MODELS

For DC loads over 28 VDC, PR relays with normally open contacts can be furnished with permanent magnets to quench arcs. These magnets increase the DC voltage rating to 220 volts resistive . . . and often increase the life of contacts handling DC inductive loads.

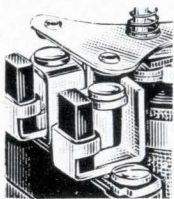

PR SERIES SPECIFICATIONS

GENERAL:

Mechanical Life: Single-pole, 1,000,000 (cycles); double-pole 10,000,000 (cycles).

Contacts: 100,000 cycles at rated load. Contact life increases at smaller loads or with appropriate arc suppression.

Breakdown Voltage: 1,500 volts rms minimum between all elements and ground.

Ambient Temperature Range:

DC: -55 to +80° C.

AC: -55 to +45° C.

Weight: Approximately 10 ozs.

Pull-In

DC: 75% of nominal voltage (approx.)

AC: 78% of nominal voltage (approx.)

Terminals: Heavy-duty screw type terminals are standard for coil and contacts.

Available with printed circuit, plug-in, $\frac{1}{4}$ " quick connect and terminals for rear panel wiring.

Enclosure: PR dust cover.

CONTACTS:

Arrangements: Up to 2 Form C (DPDT.)

Material: $\frac{3}{16}$ " dia. silver standard. Other materials available for special applications.

Load: 25 amps non-inductive or 1 HP @ 115/230 volts AC, single phase. Special version—30 amp. non-inductive at 115/230 VAC; single phase available. (Consult factory)

COIL:

Voltage: AC: 6 to 440 volts.

DC: 6 to 110 volts.

Power: DC: 2.0 watts nominal.

AC: 9.8 volt-amps.

Resistance: 63,800 ohms maximum.

Duty: Continuous, AC or DC (DC coils will withstand 8 watts @ +25° C.

Mounting: Two $\frac{3}{16}$ " diameter holes on $1\frac{1}{8}$ " centers.

LEADING ELECTRONIC PARTS DISTRIBUTORS STOCK 44 DIFFERENT PR RELAYS

Immediate delivery at factory prices.

Ask your distributor for a copy of Stock Catalog 100

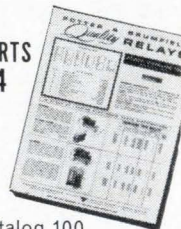

POTTER & BRUMFIELD

Division of American Machine & Foundry Company, Princeton, Indiana
Export: AMF International, 261 Madison Avenue, New York, N.Y.

Electronics Newsletter

February 7, 1966

D-c transformer? Yes—at -450°F

Contrary to what every electronics engineering student is told as a freshman, a d-c transformer is possible, says a scientist at the General Electric Co.'s laboratories in Schenectady, N. Y. **The only catch is that the transformer he built operates at cryogenic temperatures and, so far, can only raise and lower voltages in the millivolt range, with efficiencies of 10%.**

The developer, Ivar Giaever, says two thin films made of tin, separated by a thin layer of silicon oxide, form the transformer. It has a transformation ratio of 1-to-1. The bottom thin film is the primary and the top film is the secondary. If two thin films are deposited in either layer and connected in series, the transformation ratio becomes 2-to-1 or 1-to-2.

Most materials at low temperatures are not penetrated by magnetic fields. But tin at -450°F is an example of a Type II superconductor that is penetrated at certain magnetic flux spots. When a direct current passes through the tin, the magnetic flux spots move along with it. **If another thin tin film is placed nearby—within 0.000001 inch— these spots will penetrate it, too, and their motion will generate a direct current in the second film.**

IC television sets planned by RCA

The Radio Corp. of America has become the first manufacturer to use integrated circuits in its television sets. RCA bypassed transistorization in going to the IC's, which are now being built into selected models scheduled for marketing in the early spring. Each IC will replace 26 components in the sound circuits.

RCA says it will eventually use the IC's in all sound circuits in its tv receivers and in radios and stereo sets; but initially they will only be in selected tv models—black-and-white and color, transistorized and tube. In its present tv line, RCA has one transistorized receiver—a 12-inch black-and-white; but its 15-inch color set, due late this year, will be at least partially transistorized and will presumably use IC's as well.

Last year it was learned that the Admiral Corp. planned to produce a hybrid 15-inch color tv set with an integrated circuit [Electronics, Dec. 27, 1965, p. 103]. Production is to begin late this year.

Air-defense center opening in April may need updating

By the time the North American Air Defense Command (Norad) opens its Combat Operations Center in April, the electronics complex will already be five to seven years behind the state of the art. **It will have less speed and reliability than are possible with the newest equipment.**

The \$142-million facility is buried in 1,400 feet of granite in Cheyenne Mountain, near Colorado Springs, Colo., safe from even a direct hit by a nuclear bomb. Because the complex was designed about seven years ago, its computers aren't the fastest, reliability isn't the best and none of the information-display systems operate in real time.

The role of the center is to detect—with the help of a radar network—the approach of enemy missiles or planes to North America and then to assess the danger and methods of defense and counterattack. **With the present equipment, it takes 11 seconds for the computers to grind out an analysis of an attack, but Norad officials are considering revamping the electronic gear so it will work in real time.**

Also under consideration is a sharp boost in reliability. "We've had

Electronics Newsletter

to buy a multiredundancy system because we have to work with mean time between failures of about 20 hours," says a Norad official. The goal, he adds, is equipment with a mean-time rate of up to 300 hours.

Manufacturers are already preparing proposals for faster, more versatile and more reliable equipment. The Burroughs Corp., prime contractor for the electronic gear, is proposing its new B-8500 computer system.

Norad officials are also interested in simplifying computer language; ideally, the military wants its computers to understand ordinary English. Work along these lines is already under way at several research centers.

NASA expanding MOS circuit role in space vehicles

Encouraged by the latest reliability tests on the Interplanetary Monitoring Platform (IMP) that will be orbited this summer, the National Aeronautics and Space Administration is planning wide use of metal-oxide-semiconductor (MOS) integrated circuits for space applications. IMP, a package of scientific experiments that will orbit the moon, is the first use of MOS IC's in a space vehicle. NASA turned to them because of their low-power requirements.

NASA says it has continuously tested an IMP subsystem containing 360 MOS integrated circuits for more than 9,500 hours without a failure; the test is continuing.

During the next two weeks, NASA plans to award a contract to Honeywell, Inc., to build a plated-wire nondestructive memory driven by MOS integrated circuits. Beryllium-copper wire coated with Permalloy—a nickel-iron alloy—will be used for the memory. The contract price, still being negotiated, is expected to be about \$50,000. Delivery of a working model by Honeywell to NASA is planned for November.

Honeywell recently installed a facility for building MOS IC's at St. Petersburg, Fla. The company plans to use high-current linear IC's in the memory-drive circuitry. The IMP scientific satellite uses low-current digital MOS IC's.

A NASA spokesman indicated that several other contracts also involving the use of MOS IC's in computers were being considered.

Germanium is back for hi-fi transistors

Germanium power-output transistors are back in fashion for high-fidelity equipment produced by the Harmon-Kardon division of the Jerrold Corp. Harmon-Kardon had switched from germanium to silicon power transistors about three years ago.

Engineers at Harmon-Kardon say they made the change because silicon power devices were suffering from secondary breakdown caused by high transient currents; this kind of failure doesn't occur with the germanium single-diffused power transistors, they say.

Addenda

A French laboratory is understood to have built a carbon dioxide-nitrogen laser with an output of one kilowatt, continuous wave. The efficiency of the laser is said to be about 10%. . . . Motorola, Inc., hoping to maintain a price differential between silicon and germanium transistors, has sharply reduced the price of its premium germanium transistor line by between 14% and 91%. The price cuts affect 29 high-speed switching transistors, low-noise radio-frequency amplifiers and transistors for television and a-m and f-m receivers. Prices for the low-cost germanium line and the power germanium line aren't affected.

from SYLVANIA Electronic Components Group

DIODES

Newest point contact diode simplifies both specifying and circuit design

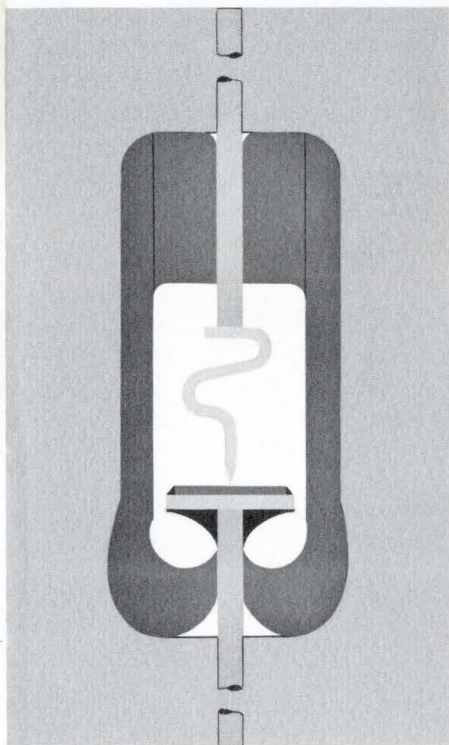

Almost everyone who's had occasion to specify germanium point contact diodes knows the 1N541. And those specifiers may also know that the 1N542, commonly used in FM ratio detector and discriminator circuits, is actually the same diode. But, and here it begins to get confusing, two 1N541s become one 1N542 when they're supplied as a matched pair. Now, take one unit from one 1N542 matched pair and one unit from another 1N542 and what have you got? Right, two 1N541s. Here's how Sylvania puts an end to this confusion while, more importantly, announcing a greatly improved diode.

There is no longer a need for the 1N542 germanium point contact specification.

Sylvania has just sampled the electronic manufacturing industry with a greatly advanced version of the stand-

ard 1N541. Results show that the new 1N541 is so uniform from diode to diode that any two Sylvania 1N541s will give satisfactory performance in a ratio detector application, which up until now required the 1N542.

To insure this uniformity of the 1N541, the forward voltage and the reverse current characteristics are both specified at several levels. In addition to these static characteristics, tight control is maintained on 10.7 mc rectification efficiency.

Sylvania developed the new 1N541 especially to meet the demands of manufacturers of ratio detectors who need two things: an improved 1N542 and the ability to avoid the added expense of handling individual matched pairs. *(continued)*

This issue in capsule

Readouts— a new EL panel design of special interest to aerospace display designers.

Integrated Circuits — how a new sense amplifier may solve your memory systems problem.

CRTs — a high-sensitivity, electrostatic tube especially for compact, portable equipment.

Microwave Diodes — new silicon mixer diode operates over the 50 to 90 GHz range.

Receiving Tubes — rugged 10,000-hour premium tubes for new designs or upgrading equipment.

Television — how new small-neck 12" CRTs lead to economy and TV set compactness.

TYPICAL FORWARD BIAS CAPACITANCE DISTRIBUTION

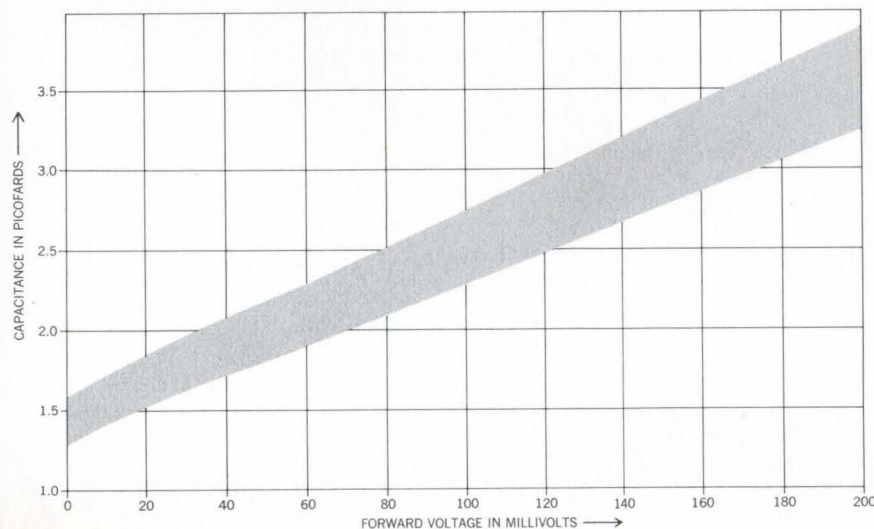

DIODES (continued)

Tests on random samples show that the advanced 1N541 exhibits a greatly improved forward capacitance characteristic (see Figure 1). The narrow spread between capacitance and voltage indicates Sylvania's close control during the manufacturing process. The same control also results in narrow spreads in capacitance vs. reverse voltage, an especially important diode parameter.

If the spread shown in Figure 1

were not narrow, it would indicate that the forward capacitance change with signal voltage would be radically different from one diode to another, and performance characteristics of a ratio detector would be less than desirable. Under these conditions the characteristic detection curve of the detector becomes highly distorted. This is due to the detuning of one of the secondary circuits which in turn causes an unwanted output from the detector.

TYPICAL PARAMETER SPECIFICATIONS

Parameter	Test Conditions	Min.	Max.
Forward Voltage	$I_F = 1.0 \text{ ma}$		0.45 v
Forward Voltage	$I_F = 10 \text{ ma}$		1.5 v
Forward Voltage	$I_F = 30 \text{ ma}$		3.0 v
Reverse Current	$V_R = 2.0 \text{ v } 25^\circ\text{C}$		3.0 μa
Reverse Current	$V_R = 30 \text{ v } 25^\circ\text{C}$		150 μa
Reverse Current	$V_R = 45 \text{ v } 25^\circ\text{C}$		350 μa
Reverse Current	$V_R = 2.0 \text{ v } 55^\circ\text{C}$		20 μa
Reverse Current	$V_R = 30 \text{ v } 55^\circ\text{C}$		250 μa
Reverse Current	$V_R = 45 \text{ v } 55^\circ\text{C}$		450 μa
Dynamic Resistance	$I_F = 10 \text{ ma}$	40	80 Ω
Rectification Efficiency	1.0 V eff	76	80 %
	3.0 V eff	83	89 %
	$R_L = 33 \text{ K}$ $C_L = 330 \text{ pf}$		

CIRCLE NUMBER 300

DIODES

How a versatile new diode improves discriminator and ratio detector circuits

The advanced Sylvania 1N541 germanium point contact diode has found wide usage in discriminator and ratio detector circuits. A circuit diagram of a typical ratio detector circuit is shown here. The AM rejection characteristic, which is a major parameter in judging ratio detector performance, is greater than 25 db with a 10 mv input signal. 1N541 diodes, picked at ran-

dom, have performed satisfactorily in this circuit.

Another application for the 1N541 is the balanced modulator, also shown below. This modulator is currently incorporated in the National Radio Company's NCX-5 single side band transceiver. This circuit provides an overall carrier suppression of 50 db under extreme environmental condi-

tions. The stability of this circuit eliminates the need for an external balance control in this transceiver.

Here are two typical applications for the 1N541. The imaginative engineer will find many more instances where this point contact diode saves time while improving performance.

CIRCLE NUMBER 300

BALANCED MODULATOR CIRCUIT

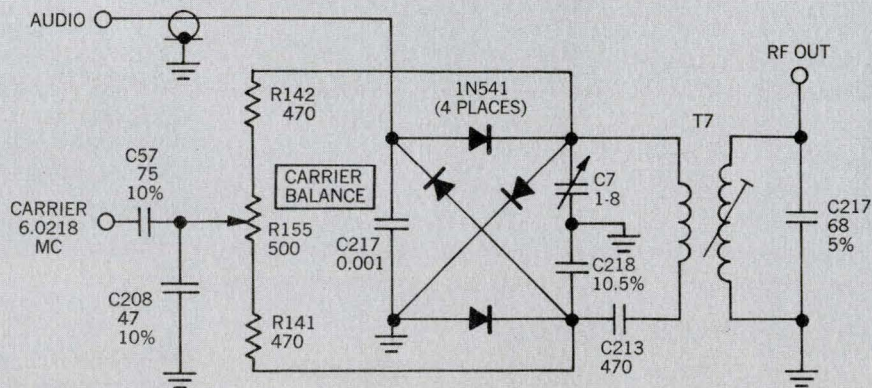

FM RATIO DETECTOR

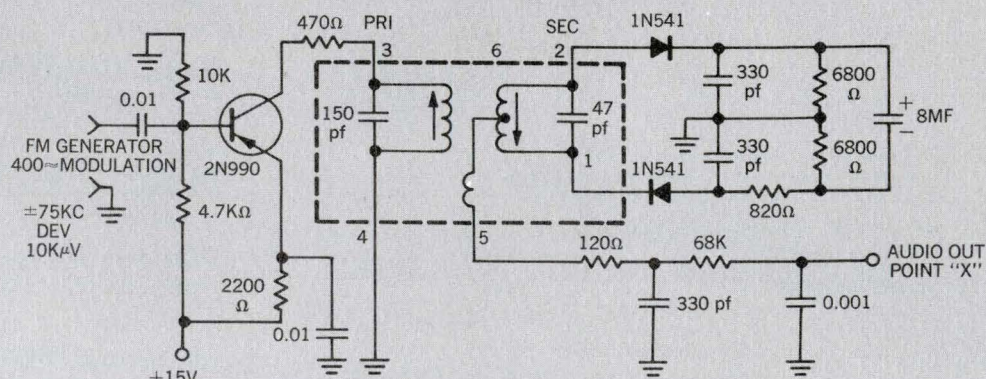

PEAK SEPARATION	AM REJECTION	LINEARITY WITH 0.01 VOLT INPUT		AUDIO RECOVERY
		±75 KC	±240 KC	
850 KC ABSOLUTE MIN	25 DB MIN.	1% MAX.	1.5% MAX.	65 ± 10%

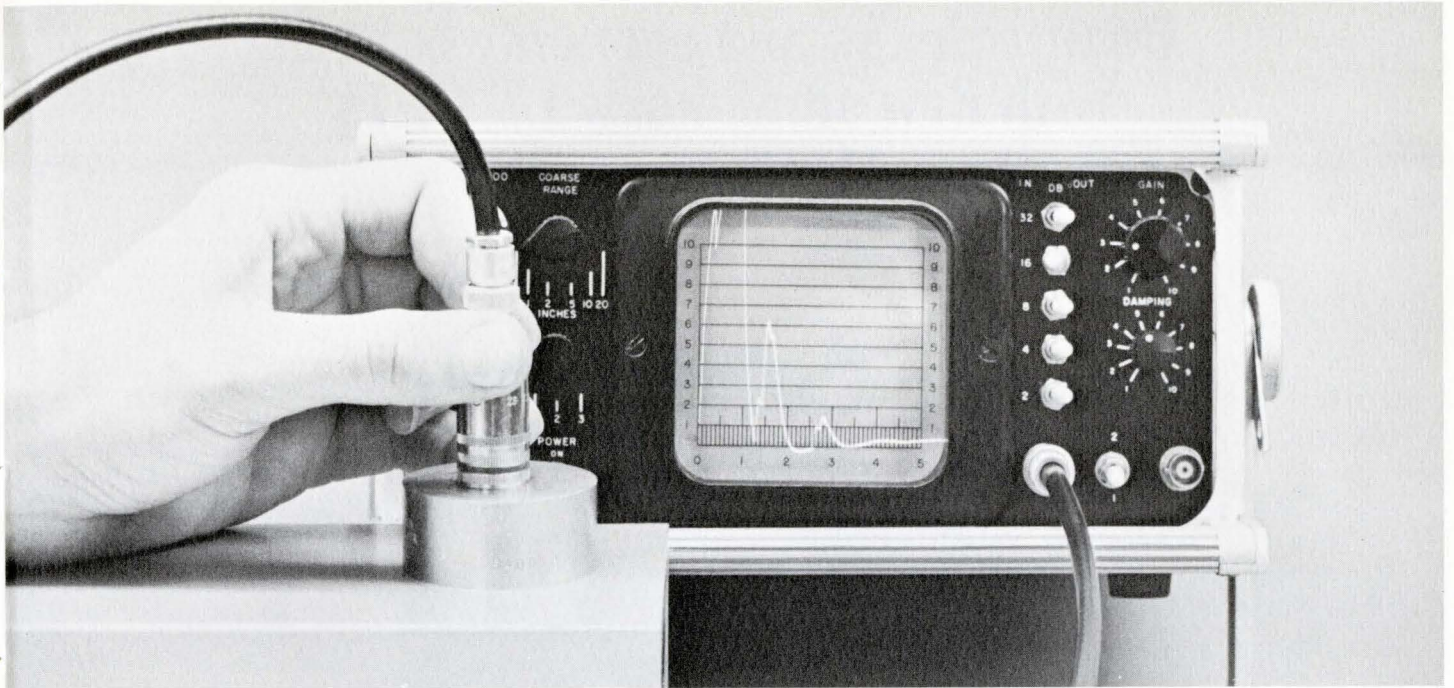

A high-sensitivity, electrostatic tube designed for compact, portable equipment

Characteristics such as portable, lightweight, transistorized and battery-powered are closely associated with today's consumer demands in television sets. But there's also a large demand for these very same features in industrial and military equipment. Cathode ray tubes are built to fit the bill in both cases. Here's an instance where just such a tube was perfect for an unusual test instrument.

Now a Sylvania CRT helps measure pipe wall thicknesses, detect corrosion in ship hulls and find fatigue cracks in jetliners. The electrostatically focused and deflected SC-3511 tube is a vital part of the Sonoray model 301 ultrasonic flaw/thickness tester, developed by Branson Instruments Inc.

The entire unit weighs only 16 pounds and is battery-operated. Since the tester is easily portable, it can be carried into such difficult areas as manholes, catwalks and scaffolds.

Accurate readings are directly viewed on the tube's 2½" x 2½" screen in the face of the tester. No calculations are required. Since a feature of the tube is its low heater power, the readings are always instantaneous.

Sylvania designed the SC-3511 as a part of a CRT product line to suit compact portable equipment such as the Branson model 301. The tube has helical-resistor post-deflection acceleration to achieve a high writing rate, high deflection sensitivity, and a distortion-free pattern. And the tube itself weighs just a pound and a half.

The CRT receives its information from a dual transducer which detects reflecting surfaces .030" below a front surface. Transmitting and receiving crystals are contained in single housings sized as small as ¼" in diameter.

Other Sylvania CRTs for compact equipment include the round SC-3802 as well as the square SC-3377 and SC-3551. These tubes all have clear faceplates, very high deflection sensitivity, low heater power and helical-resistor post-deflection acceleration.

CIRCLE NUMBER 301

SC-3511 CHARACTERISTICS

Heater Voltage	1.5 volts
Heater Current	0.14 ± 10% amperes
Focusing Method	electrostatic
Deflection Method	electrostatic
Minimum Useful Screen	2¾" x 2¾"
Useful Scan	2½" max.
Weight	1½ pounds
Overall Length	13½ inches

SC-3511, SC-3377, and SC-3551 Outlines

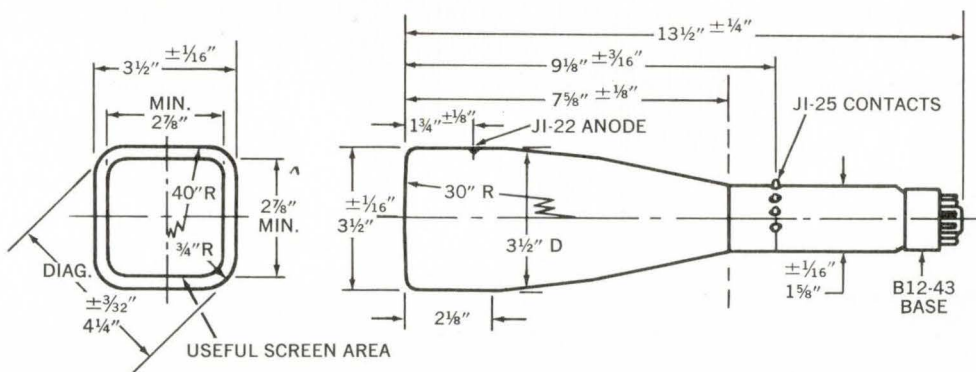

Compactness and economy built-in with new small-neck 12" CRTs

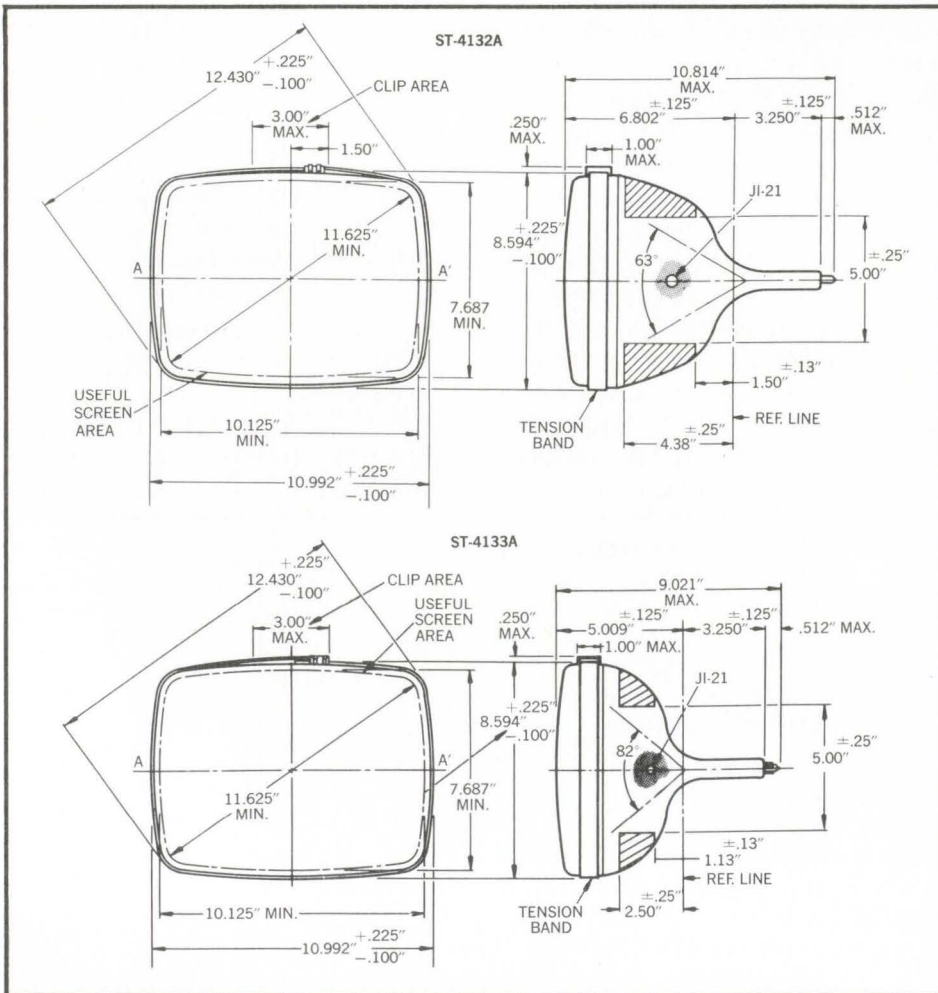
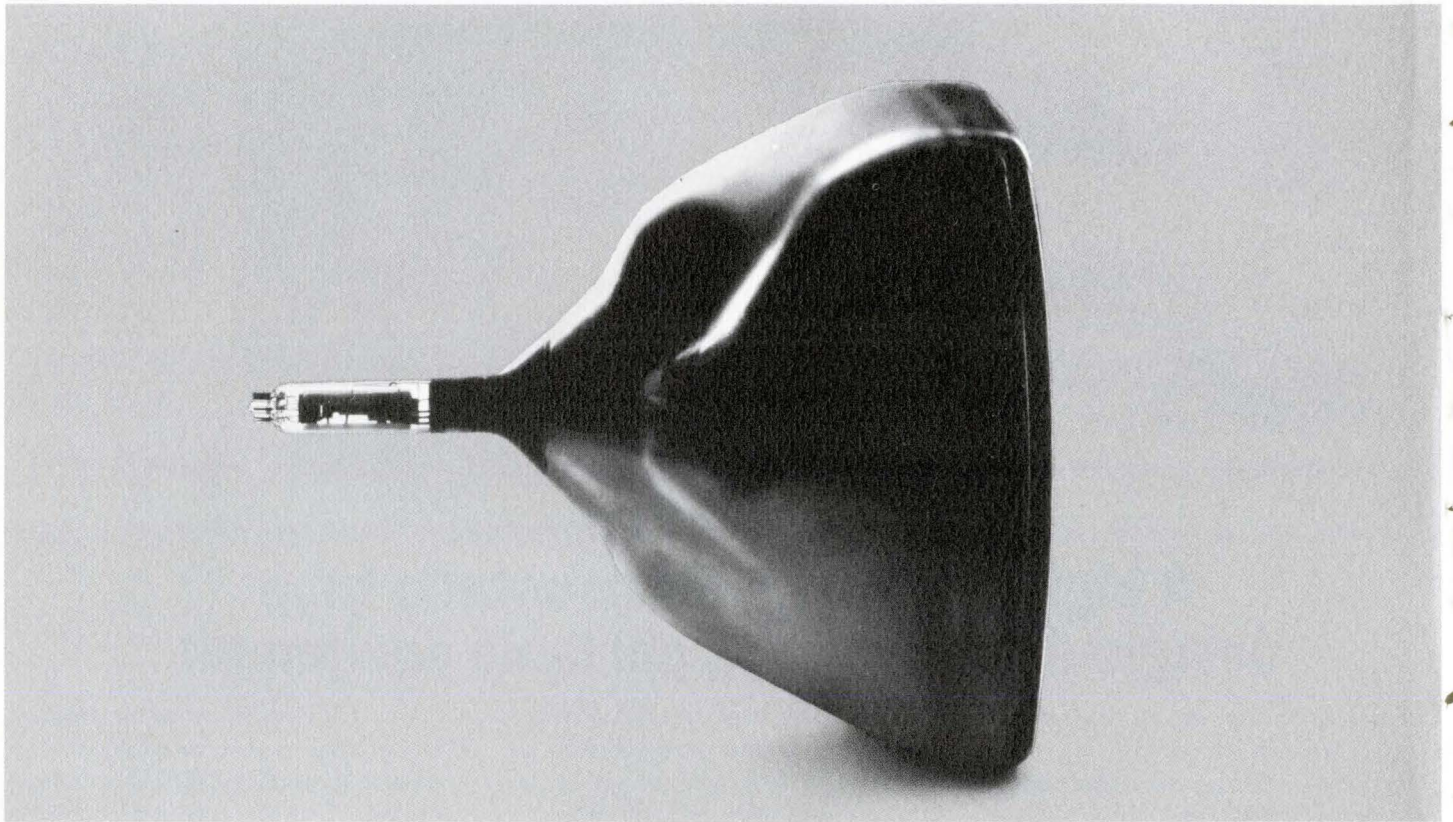

Historically, black-and-white picture tubes have been among Sylvania's important products. Over the past several months consumer demands have been spiralling for smaller, more portable sets. Sylvania is playing a leading role in improving and broadening its CRT line to keep pace with set manufacturer demands. Here's news on two picture tubes designed especially to meet small-set requirements.

Television circuit designers will be especially interested in two significant features of Sylvania's newest line of 12" monochrome picture tubes: small-neck size (for compact set design) and resultant production economies.

With the new ST-4133A and the recently announced ST-4132A, designers now have the opportunity of specifying CRTs with overall lengths of just 9.021" and 10.814" respectively. Substantial savings in component costs as well as reduction of weight in the overall set can now be realized.

The ST-4133A has 110° magnetic deflection, while the ST-4132A has 90° deflection. Both types are 12" direct viewed rectangular glass tubes with aluminized screens and gray filter glass.

These tubes have the added safety factor of T-Band implosion protection. Neck length is only 3 $\frac{3}{4}$ " with a small neck diameter of .788".

Other features include a straight electron gun which requires no ion trap, a 150 milliamperere 12.6 volt filament, and 100 volt G2 for cathode or grid drive.

Both of these CRTs are equally suited to solid-state as well as tubed sets. Light weight and compact size make them perfect for portable and battery-operated sets.

CIRCLE NUMBER 302

TENTATIVE DATA		
Electrical Data	ST-4132A	ST-4133A
Focusing Method	Electrostatic	
Deflection Method	Magnetic	
Deflection Angles (approximate)		
Diagonal	90 degrees	110 degrees
Horizontal	80 degrees	99 degrees
Vertical	63 degrees	82 degrees
Direct Interelectrode Capacitances		
Cathode to all other electrodes (approx.)	5 $\mu\mu\text{f}$	
Grid No. 1 to all other electrodes (approx.)	6 $\mu\mu\text{f}$	
External conductive coating to anode*	850 max. $\mu\mu\text{f}$	
	550 max. $\mu\mu\text{f}$	
Resistance Between External Conductive Coating and Implosion Protection Hardware		
	50 min. megohms	
Heater Current at 12.6 Volts, DC or AC	150 \pm 10ma	
Heater Warm-up Time	14 seconds	
Optical Data		
Phosphor Number	P4 Aluminized	
Light Transmittance at Center (approx.)	52 percent	
Antireflection Treatment	None	
*Measured with implosion protection hardware connected to external coating.		

READOUTS

New solid-state EL panels perfect for 115-volt aerospace display usage

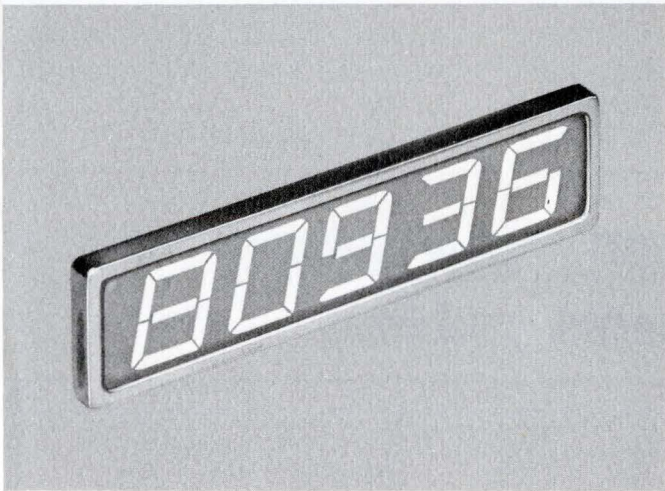

The line of hermetically sealed Electroluminescent (EL) readout panels developed by Sylvania has been presented in recent issues of IDEAS. Now this line is complemented with a new panel design that permits even lower operating voltages, while meeting the stringent environmental and performance requirements of the aerospace industry.

Solid-state EL is now offered in a wider range of operating conditions. In addition to operating at a lower voltage, the newest panel design has increased brightness and an effective life comparable to the higher voltage units. Operating typically at 115 volts rms, 400 hertz (see graph), the new readout has an initial brightness of 15 footlamberts and a minimum brightness of 6 footlamberts, even after 1200 hours' operation.

The device's low power requirement, an outstanding feature of EL,

is shown in the table below. This low power aspect is of special interest to aerospace system designers. (The values given in the table are with all segments lighted and 5-digit, 7-segment numeric panels with half-inch characters).

The new design was developed by Sylvania in conjunction with the GT&E Laboratories as a result of efforts to develop an EL readout which would operate at a lower voltage, but with brightness and life comparable to, or better than, existing units.

Because of the solid-state nature of the EL readout panel and its construction features, stable performance is assured under conditions of temperature and pressure extremes. The true hermetic seal assures maximum protection to phosphors that are sensitive to moisture. With proper mounting the panels withstand severe shock and vibration.

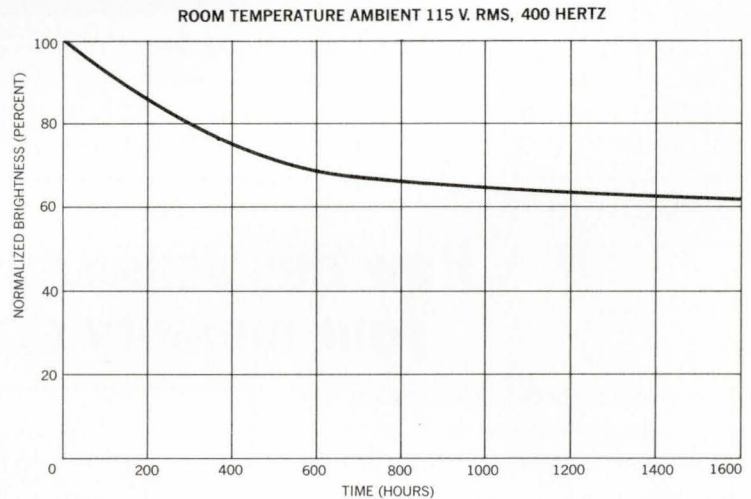

With its sandwich panel-type compactness, EL readout panels take up minimal space. They are light in weight, an important aerospace consideration also.

Inherent advantages in all EL units are the wide (almost 180°) viewing angle, rapid information display, and a pleasingly readable blue-green presentation.

CIRCLE NUMBER 303

TYPICAL OPERATING CHARACTERISTICS AND MAXIMUM RATINGS		
Operating Characteristics		
Light Output (Initial Brightness)	12-18 FL	
Wavelength	5100 Angstroms	
Voltage	115 V AC, RMS	
Frequency	400 Hertz	
Current (Max.)	1.1 Ma	
Power (Max.)	55 Mw	
Power Factor (Pf)	.80	
Maximum Ratings		
Peak Voltage	300	
RMS Voltage	130	
Peak Transient Voltage	400	
Operating Temperature Range	-55 to +71 °C	

100mc linear amplifier for high-gain wide bandwidth information transmission

CORRECTION

If we've succeeded in keeping you puzzled all month, let's admit now that the January issue of IDEAS contained a very obvious error. The input and output traces shown on page 1 (under this same headline) were mislabeled. The scope trace is shown here in its correct form.

Now there's a linear amplifier with 20 db typical gain that has broad problem-solving versatility. Whether the problem is in driving low impedance loads, avoiding large signal clipping or cross-talk, or in achieving a broad frequency response with flat gain, Sylvania's SA-20 can well be the logical solution.

The strong capabilities of this wideband linear amplifier lie in the device's outstanding combination of

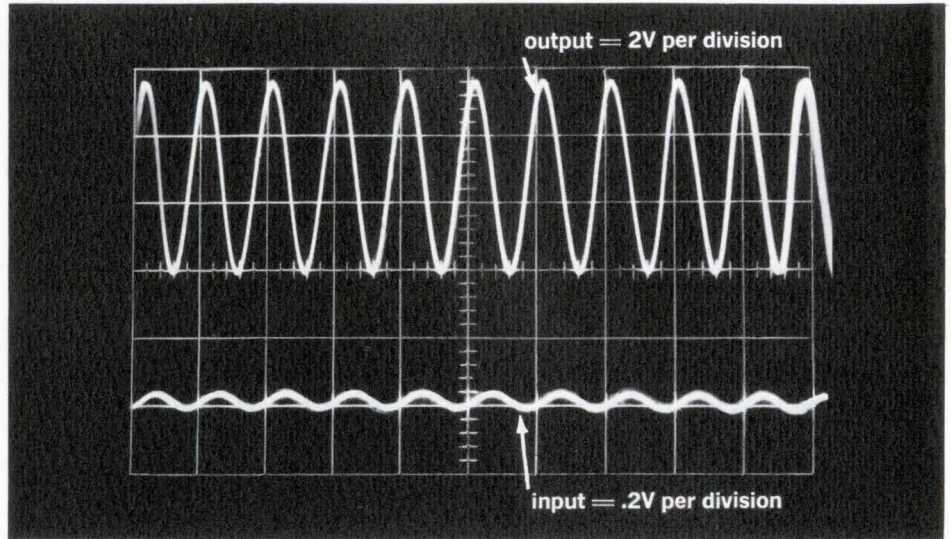

features. These include -65 db intermodulation (harmonic) distortion, externally variable gain-bandwidth and phase shift, 1.6k input im-

pedance, output voltage 14Vp-p swing, and less than 10ns pulse response.

CIRCLE NUMBER 304

INTEGRATED CIRCUITS

How this sense amplifier can solve your memory systems problem

Here's some useful information on practical applications of Sylvania's SA-10 sense amplifier. This is the device announced in IDEAS last November which showed an unusual combination of high sensitivity, minimum offset, and high common mode rejection.

The applications diagrammed here again show the SA-10's versatility. This is in large part the result of the aforementioned favorable characteristics, plus monolithic silicon epitaxial construction, a differential amplifier, and an externally variable threshold detector.

Still another advantage of this sense amplifier is that it can be used with any digital logic family including the entire SUHL (Sylvania Universal High-level Logic) line of ICs. Its high speed, fast response time and a wired ORd capability are other performance features.

Available in the standard 14-lead flat package, the SA-10 will operate effectively over a -55°C to +125°C temperature range.

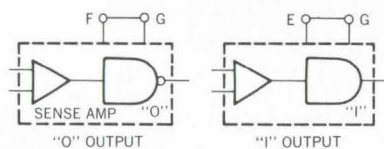

For either positive or negative going output, the connections need only be varied, as shown here. A negative output requires that leads G and F be connected. For positive going output, just connect leads G and E.

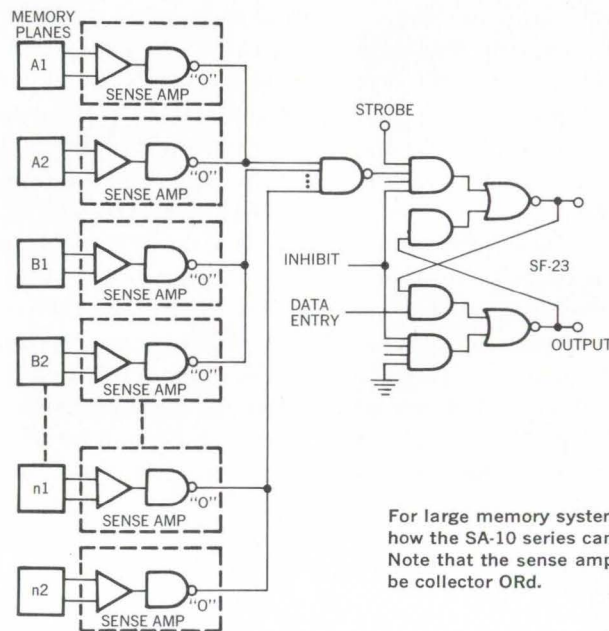

For large memory systems, here's how the SA-10 series can be used. Note that the sense amplifier can be collector ORd.

10,000-hour ruggedized premium tubes available from Sylvania distributors

Now, an exceptional line of premium tubes, available from Sylvania Industrial Distributors, can do a high performance job at extreme environmental conditions.

A line of tubes that withstands 500-g impact shocks and has 10,000-hour life is often the answer to problems of both new designs and up-graded equipment. Sylvania GB Gold Brand tubes also show exceptional stability, maximum uniformity and extreme physical ruggedness.

All tubes in the extensive GB product line are engineered to the specific requirements of critical commercial and industrial service. Their many qualities add up to built-in reliability.

Assurance that these tubes do a better job than any others is found in both their proven performance record as well as in the stringent tests and quality controls that Sylvania applies. These include: Multiple Life Tests at high temperature and room temperature conditions; 500-g Shock and 10-g Vibration Tests; Thermal Shock Tests (Glass Strain); Low Pressure Breakdown (High Altitude); Basic Tube Parameters—controlled to 0.65% AQL; Noise and Vibration to 2.5% AQL; and Continuity and Shorts to 0.4% AQL.

In a recent issue of IDEAS we explained how such features as bonded grid design, improved heater design, and increased cathode stability were built into the GB line. Here are more technological reasons why these tubes

are proving themselves as problem solvers:

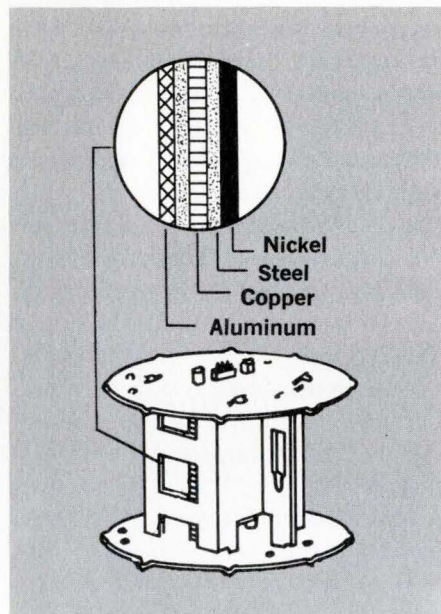

HIGH DISSIPATION SAFETY FACTOR PLATES

...laminated plate construction to conduct heat more uniformly and radiate it more efficiently—provides 10% to 20% safety factor in heat dissipation.

...uniform heat dissipation of laminated construction—to eliminate hot spots, often the cause of gassing that hastens early replacement.

...multilayer laminated construction (combination of as many as five different metals) to optimize the heat transfer characteristics of the plate.

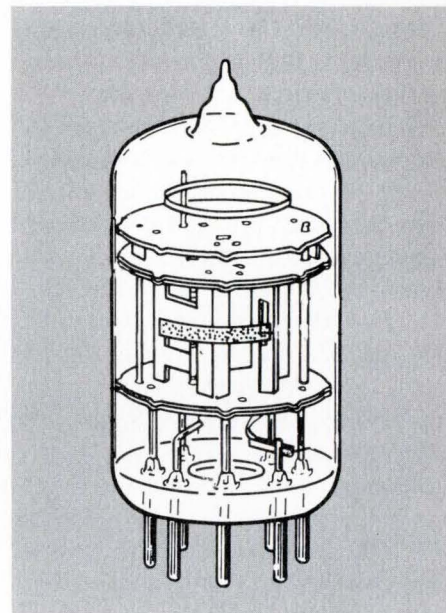

OTHER STRUCTURAL FEATURES

...isolation mica—to improve insulation resistance between elements by containing getter flash.

...double top and bottom micas with more contact points—to support elements more securely.

...U-bolt construction of supports between top and bottom micas—to clamp and lock elements in rigid mount cage.

...controlled atmosphere welding—to reduce weld splash and minimize loose and dangling particles.

...controlled annealing of glass—to eliminate strain, cracking and chipping.

CIRCLE NUMBER 306



HOT LINE INQUIRY SERVICE

Use Sylvania's "Hot Line" inquiry service, especially if you require full particulars on any item in a hurry. It's easy and it's free. Circle the reader service number(s) you're most interested in; then fill in your name, title, company and address. We'll do the rest and see you get further information almost by return mail.

BUSINESS REPLY MAIL

No Postage Stamp Necessary if Mailed in the United States

POSTAGE WILL BE PAID BY

SYLVANIA ELECTRONIC COMPONENTS GROUP

Sylvania Electric Products Inc.
1100 Main Street
Buffalo, New York 14209

FIRST CLASS
Permit No. 2833
Buffalo, N.Y.

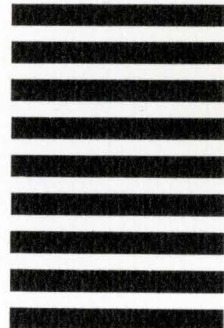

What price IC reliability?

Pity the poor inspector! Consider his steady parade of products, packages, tests, specifications, etc. But now his existence is complicated even more by products that require test equipment that he may not even have.

Users of integrated circuits, for instance, face the complex problem of having to establish virtually an entirely new incoming inspection department capable of testing the huge variety of IC types now on the market. Look at the package styles alone — 8-, 10- and 12-pin TO-5's; 10-, 12- and 14-pin flat packs; 14-pin plug-ins; oversize packages of 16 pins, and even more styles.

The user must invest in the development, production and maintenance of highly specialized test equipment. The installation cost of such equipment runs into the hundreds of thousands of dollars and, in addition, there is the manpower/maintenance cost to keep it running. These investment costs must be weighed against constantly changing system programs.

But on the other hand, IC manufacturers like Sylvania can justify their own test equipment costs on the basis of reduced device costs. And they can plan the utilization of this equipment far better than a user can.

A recommended solution, then, is

to use the established facilities of the suppliers. Review their standard quality control (both on-line and outgoing) procedures and equipment. Establish a monitoring program based on your needs (and compatible with the supplier's procedures) which will assure continuity of testing and also will allow the supplier to do full testing for you. Establish correlation samples from each lot, together with the detailed parameter readings on this control sample. These correlation samples can then be checked by incoming inspection and filed with test data for review against subsystem assembly and overall system field performance. Approval of the vendor's facilities, procedures and the correlation samples would result in automatic lot releases. This type of program enables users to cut inspection costs. It frees the user's Q.C. engineers for reliability analysis and specification analysis programs.

Where such procedures have been used they have generally resulted in appreciable savings without increasing component cost! (Typical of the type of IC testing done at Sylvania is 100% testing, at temperature, of all DC parameters.) Further, the manufacturer is not required to do anything incompatible with his established

Q.C. procedures. This type of cooperative program will lead to improvements in test procedures, device analysis and failure analysis (with shorter feedback loops to improve product performance). It can also improve communications between user and supplier resulting from more efficient use of Q.C. engineering talent.

And it can reduce equipment costs, equipment maintenance costs, reliability costs, and costs resulting from order lead times.

With the advent of multiple circuit functions in complex packages, (e.g. integrated scratchpad memories, full adders, multi-bit shift registers and frequency synthesizers); the cost of 100% testing in an incoming inspection department is prohibitive to most. Based on cost savings alone, the adoption of cooperative quality assurance programs will be mandatory.

Since establishing such programs requires adherence to a detailed review procedure and the establishment of good communications between user and supplier, it seems desirable for all systems manufacturers who plan extensive use of integrated circuits to initiate a program to develop experience in this area.



Harry Luhrs

H. M. LUHRS

SYLVANIA

SUBSIDIARY OF
GENERAL TELEPHONE & ELECTRONICS GTE

NEW CAPABILITIES IN: ELECTRONIC TUBES • SEMICONDUCTORS • MICROWAVE DEVICES • SPECIAL COMPONENTS • DISPLAY DEVICES

This information in Sylvania Ideas is furnished without assuming any obligations.

NAME _____

TITLE _____

COMPANY _____

ADDRESS _____

CITY _____ STATE _____

Circle Numbers Corresponding to Product Item

300	301	302	303	304
305	306			

Please have a Sales Engineer call



HOT LINE INQUIRY SERVICE

Need information in a hurry? Clip the card and mail it. Be sure to fill in all information requested. We'll rush you full particulars on any item indicated.

You can also get information using the publication's card elsewhere in this issue. Use of the card shown here will simplify handling and save time.

If you want to capture signals from way way out,

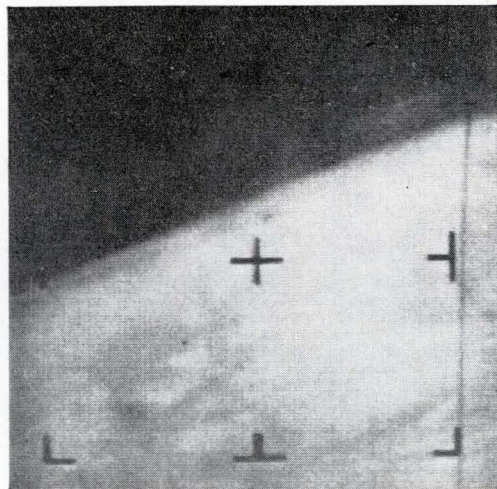

record them on the tape with total recall

MEMOREX
PRECISION MAGNETIC TAPE

When you put a reel of Memorex instrumentation tape on your transport, you can expect the most reliable performance, both from the tape and from your recorder. Because Memorex coating formulations are highly uniform, you'll find fewer dropouts; because they are extremely durable, you'll find significantly less oxide shedding, and freedom from head build-up or gap smear. The result is multi-pass

stability of performance unequalled by any other tape.

If you write Memorex Corporation at 410 Memorex Park, Santa Clara, California 95052, we will send you instrumentation tape specification data and a bibliography of technical information available without obligation from the Memorex library of reprints.

Memorex Branch Offices in New York, Philadelphia, Washington, Atlanta, Orlando, Dayton, Chicago, Detroit, Dallas, Los Angeles, San Francisco; Offices and Affiliates in London, Cologne, and Paris

NEW

Frequency Stability

50 KC to 455 MC



2 parts in $10^7/10$ minutes

with a new synchronizer and improved signal generators

- Unique sampling phase-lock: stabilize at any frequency
- Frequency or phase modulation capability: better than 1% linearity
- Low-distortion amplitude modulation: less than 3% at 80% AM
- Constant power, constant modulation with frequency change: time-saving and easier operation

The new 8708A Synchronizer lets you add unprecedented stability to improved 606B and 608F Signal Generators. It offers 2×10^{-7} /10 minutes frequency stability in the important and universally used 50 kc-455 mc range. This represents a 250-time improvement in frequency stability over earlier signal generator performance. The 8708A can lock at any frequency, rather than at discrete points only. Lock is automatically re-established after changing frequencies. The stabilized rf signal has high spectral purity and highly linear frequency/phase modulation capability.

The improved 606B and 608F are MOPA-type signal generators that can be synchronized with the 8708A while retaining their own full performance flexibility. This means you can AM

or pulse modulate the instruments and utilize the full output level range while stabilized. You also can use, simultaneously, a 5245L Electronic Counter to achieve highest frequency accuracy along with the high stability.

Application Note 71, "Advances in RF Measurements, Using Modern Signal Generators", describes measurement techniques for HF and VHF receivers, amplifiers, filters, etc., with special emphasis on test equipment performance criteria. A call to your Hewlett-Packard field engineer will provide you with assistance in meeting your requirements. Or you can get the application note and complete specifications on all models with a letter to Hewlett-Packard, Palo Alto, California 94304, Tel. (415) 326-7000; Europe: 54 Route des Acacias, Geneva.

MAJOR SPECIFICATIONS

hp 8708A Synchronizer

Frequency range: 50 kc - 500 mc (uses aux. rf output from 606B/608F Generators)
Frequency stability: 5×10^{-8} per minute
 2×10^{-7} per 10 minutes
 2×10^{-6} per day
 $2 \times 10^{-7}/^{\circ}\text{C}$ (0° to 55°C)
 2×10^{-7} for 10% line voltage change
Price: \$1800

hp 606B Signal Generator

Frequency range: 50 kc - 65 mc ($\pm 1\%$ accuracy)
Output: $0.1 \mu\text{V}$ - 3 v into 50Ω (± 1 db accuracy); aux. cw output, 100 mv min.
AM modulation: 0 - 95%, (Internal, 400 and 1000 cps; External, dc - 20 kc)
FM modulation: Typically 0.2% min. deviation
Price: \$1550

hp 608F Signal Generator

Frequency range: 10 mc - 455 mc ($\pm 1\%$ accuracy)
Output: $0.1 \mu\text{V}$ - 0.5 v into 50Ω (± 1 db accuracy); aux. cw output, 180 mv min.
AM modulation: 0 - 95%, (Internal, 400 and 1000 cps; External, 20 cps to 20 kc; also external pulse modulation)
FM modulation: Typically 0.2% min. deviation
Price: \$1600

Data subject to change without notice. Prices f.o.b. factory.



*For applications
not requiring
the synchronizer:*

SPECIAL

New 608E with major improvements over popular 608C and 608D
 10 mc to 480 mc frequency coverage with 0.005%/10 minutes frequency stability
 Output 1 v into 50 ohms with rf buffer stage for lowest incidental FM (< 1000 cps pk at 50% AM)

Feedback circuit in rf amplifier results in low envelope distortion ($< 1\%$ at 30% AM, $< 3\%$ at 80% AM) and constant output level with rf frequency change.
 Auxiliary rf output (cw) for frequency check with a counter, or other external applications
 Crystal calibrator for frequency checks

The broad frequency coverage, high power output and high degree of low distortion modulation make the 608E an ideal signal generator for driving bridges, antennas, etc. and for receiver and filter measurements. Price, \$1450.

NEW:

Digital Thermometer/Temperature Controller

0.1°C accuracy* from -192.0°C to +999.9°C

features:

- High absolute accuracy
- Direct reading
- Easily calibrated
- Fully automatic operation
- Outputs for control, recording, or telemetry
- Modular construction
- High reliability

The PAR Model DTS-1 offers a new order of reliability, convenience, and accuracy in laboratory and process control thermometry. The unit operates by comparing the resistance of a sensor element of platinum (the material whose characteristics define the International Temperature Scale) with an internally generated reference function which employs a unique resist-

ance analog network** that precisely duplicates the temperature-versus-resistance change of platinum. This method allows an absolute accuracy* of 0.1°C to be achieved. A modified self-balancing Kelvin bridge eliminates sensor lead resistance errors, permitting precise remote temperature monitoring.

In addition to the direct visual readout, measured temperature information is available in binary coded or 10-line decimal form for printer or computer input as well as in pulse code modulated form for telemetry applications. For temperature control or strip-chart recording applications, an analog signal is provided which is proportional to the difference between the measured temperature and the desired temperature

selected by front panel thumb-wheel switches.

All circuits use solid state components except the comparator amplifier where two miniature nuvistor tubes are used to obtain high input impedance and the reference function generator where mercury-wetted relays are used. The entire Kelvin bridge, including the resistance analog network, is isothermally enclosed to assure a high degree of accuracy and good long-term stability. Rugged modular construction, utilizing printed circuit boards, contributes to reliable performance and extended service-free life.

Price: \$3,950.00 (excluding probe). Write for Bulletin #118.

*Subject to operating range of actual sensor used.

**Patent Pending

PAR PRINCETON
APPLIED RESEARCH CORP.
DEPT. D
Box 565, Princeton, N. J., Tel. (609) 799-1222

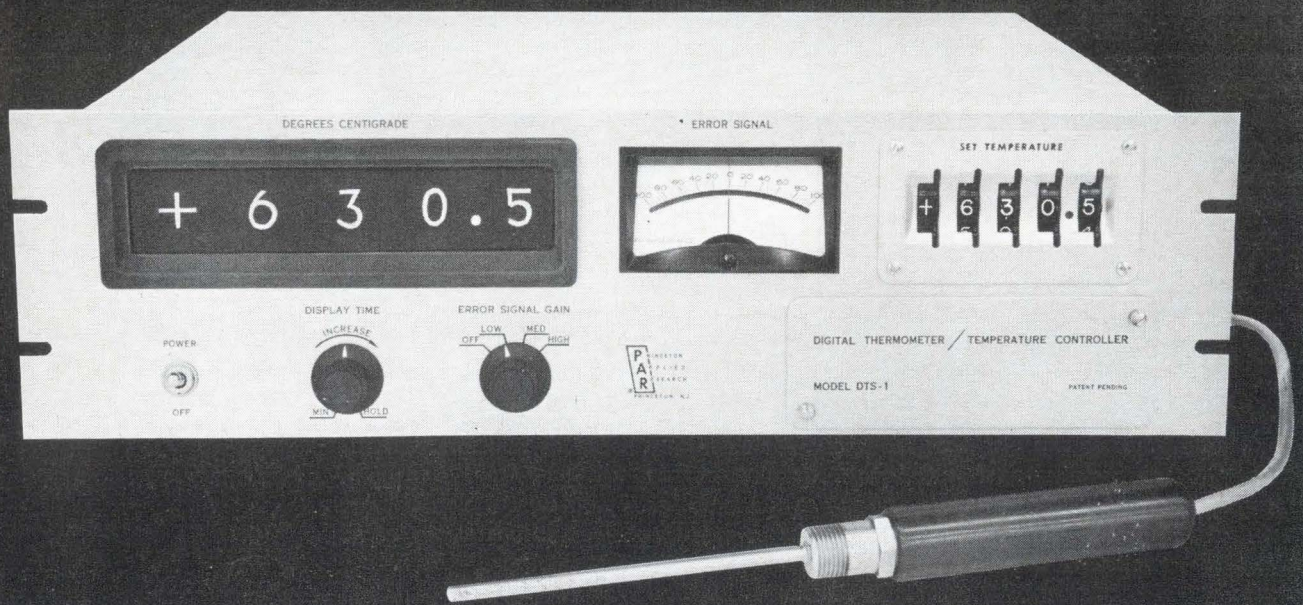

Electronics Review

Advanced technology

Designing circuits

Circuit designing will soon be taken over by time-shared computers, researchers at the Massachusetts Institute of Technology believe.

The principles of computer-aided design—or CAD as the men who work with it call it—were outlined last week in Los Angeles by Prof. J. Francis Reintjes at the Winter Convention on Aerospace and Electric Systems. Reintjes is director of the MIT Electronics Systems Laboratory, where he heads a CAD project.

In concert. The essence of CAD is on-line, real-time design of circuits by man and machine in concert. The designer need not know how to program a computer.

“Computer modeling,” says Reintjes, “will let the engineer know how the circuit will vary with environmental changes, and enable him to be more precise in his design by taking into account effects which were formerly ignored or just approximated.”

Adds Assistant Prof. Michael Dertouzos, who's also working on the CAD project: jobs that now take days could be performed in seconds. “In fact,” he points out, “computer-aided design could eliminate bread-boarding altogether.”

The MIT team is convinced that only through time-shared computers will the process be inexpensive enough to be widely used. The group has access to a time-sharing system at MIT known as Project MAC [Electronics, Nov. 29, 1965, p. 83].

Uses a 'pen.' To use CAD, a designer points with a light pen to a desired position on a graphical input and presses appropriate computer buttons for the type of electrical element he wishes to introduce and its orientation or direction. The element appears on the

cathode-ray tube in conventional schematic form and the user types into the computer relevant information about the element, such as its value and type. By repeating this process for each component, the user gradually composes the entire network, including sources of excitation, on the crt.

On command, the computer can analyze and store the dynamic response at all points of the network. It can present a display of voltages between nodes or the waveform of the network under a given excitation. The designer can then

merically controlled tools or production lines could be instructed to convert the computer design into hardware. The system could store catalogues supplied by manufacturers on tape; and the computer, by searching these files, could determine how a circuit could be built most satisfactorily and inexpensively.

The MIT group is already at work on another extension, called “nesting.” Once the designer and machine have created a circuit, this information could be stored in the computer. Subsequently, it can

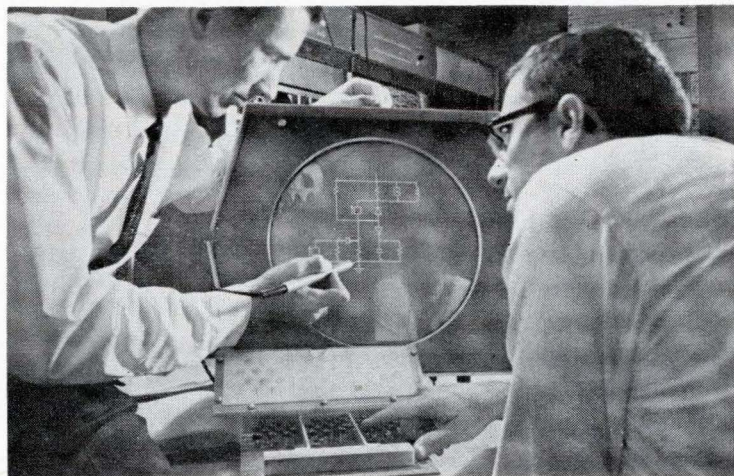

Computer designs circuits. Researchers Michael Dertouzos, left, and Charles Therrien of the Massachusetts Institute of Technology “write” a circuit with the help of a time-shared computer and graphic input-output equipment.

change the network or modify some parameters until he is satisfied with the results. He can also introduce environmental factors and watch performance vary.

The project is still in the research stage, and the present system is limited to 20 network elements. The researchers are building on earlier work done at MIT on numerical control of machine tools and on graphical construction programs like Sketchpad [Electronics, May 16, 1963, p. 16].

Beyond CAD. Extensions of CAD are already envisioned. After the design process is finished, nu-

be called out of the memory as a “black box” and then put into a network.

Also under study is the possibility of creating new devices. The designer might crank into a computer the electrical characteristics needed in a certain part of the network. Even though no such device exists, the computer could spell out what the device should do. “Then perhaps you could go in the back room and build such a device,” suggests Dertouzos.

The MIT researchers plan to extend the technique from electronic networks to digital systems, treat-

ing logic gates as components. They will also apply it to distributed systems, transmission and acoustic lines.

Set up blocks. CAD includes a unique circuit analysis technique called Circal, a computer program developed by an MIT graduate student, Charles Therrien.

"Circal is more simulation than analysis," says Therrien. "We set up blocks within the computer memory for each branch element, and interconnect them so that the circuit equilibrium laws—Kirchhoff's laws and the voltage-current relationships—are satisfied."

Thus it does not—like most analysis techniques—convert the circuits to equations and analyze the equations.

"Throughout Circal," says Therrien, "the internal computer model or data structure is established in almost one-to-one correspondence with the actual network. Thus, resistors, inductors, capacitors and other elements are represented within the computer with computational blocks that carry all the relevant information about their corresponding real elements. These blocks are in turn interconnected through a convenient addressing system in correspondence with real element interconnection of the given network. So, additions, deletions or modifications of elements in the network correspond to identical operations on the computational blocks."

For example, Therrien's program sets up a block of words, or locations, in the core memory. Each of these words, also called registers, represents an element of the network, and they are interconnected through a referencing system. The computer solves the network—finds out what it will do under a given excitation—by a mathematical technique called relaxation. The computer guesses at a solution. If the guess is wrong, the equilibrium constraints will not be satisfied. The computer will then repeatedly modify its guess until all the network equilibrium conditions are met.

Programs like Circal are best written in a language like MIT's Automated Engineering Design.

Computers

Growing numbers

Washington will spend more on computers next year than on defense against air and missile attack. Its computer inventory will exceed its stock of intercontinental missiles and strategic bombers combined.

From almost a standing start in 1956, when only 90 computers were serving the government, the number has skyrocketed to about 7,575—more than 30% of the computers in the United States. The figures include machines that Washington owns, leases or controls through arrangement with contractors.

The percentage may have reached a peak, however; the total is expected to be unchanged next year. The leveling off does not reflect any decrease in agencies' reliance on computers for tasks as varied as guiding rockets and controlling generating plants in the Tennessee Valley. Rather, it reflects a shift from many small computers to fewer large ones, and better management of the government's computer operations.

Fewer but bigger. Through increased computer sharing, round-the-clock operations, and more reliance on computers of the caliber of the System 360 made by the International Business Machines Corp., agencies will reduce their

computer purchases next year to \$115 million from \$125 million in fiscal 1966. Only 50 machines will be bought, at an estimated cost of \$50 million; replacement costs are down to \$34 million for 32 machines, compared with \$73 million for 132 machines this year. Conversion from lease to purchase will cost \$45 million for 64 machines, compared with \$12 million for 21 machines this year.

These figures are for computers working for the government, except those in secret military operations and those operated for Washington by contractors. Similar trends are anticipated in those two areas, but data is unavailable.

More tasks. Computer applications in government are constantly expanding. An official in the Bureau of the Budget describes the situation as one where agency managers are exploring additional applications of the computer inventory.

The Battelle Memorial Institute is studying the Monte-Carlo digital-computer simulation techniques developed at the University of California at Los Angeles. The goal is to find ways to calculate freight rates and to set traffic-control patterns quickly and accurately.

The Tennessee Valley Authority is controlling the balance of hydroelectric and steam-fed power systems with computers and auto-

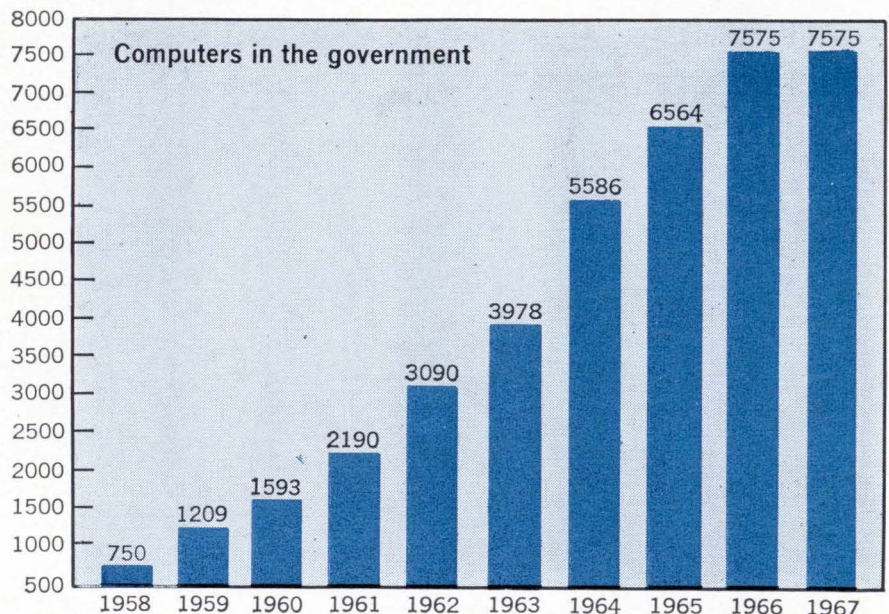

matic monitoring equipment.

The National Institutes of Health is installing a remote-console IBM system for use by researchers at its various facilities.

The Department of Justice is exploring a retrieval system for crime data and legal precedents. A similar system already in operation at the Air Force, may be expanded to some other agencies.

At the National Bureau of Standards, specialists in data processing are seeking guidelines for standardizing computer hardware and programs. One goal is to encourage agencies to share them.

Administrative coordination by the General Services Administration is also being beefed up. The GSA soon will begin to offer the services of procurement specialists to help agencies negotiate for computers with the industry. One effect may be an increase in dicker-ing between agencies and suppliers. A specialist in the Budget Bureau notes that, as costs of associated software soar to more than one-half the cost of computer equipment, and as competition among suppliers intensifies, more suppliers are becoming eager to bargain over the more flexible costs of computer software as leverage into the market.

Think faster

International Business Machines Corp. has developed an experimental thin-film computer memory that has a 120-nanosecond cycle time, a 589,824-bit capacity and fits in a frame 68 by 42 by 7 inches—including the electronic circuits for driving and sensing.

Other thin-film memories—experimental or commercial—are perhaps a bit faster, but none can hold nearly as much data.

The move toward faster and faster memories is taking other tacks at IBM, also. For example, IBM is working on a ferrite-core memory with a cycle time of 250 nsec that holds 8,192 words [Electronics, Dec. 27, 1965, p. 36].

The thin-film memory (with a capacity of 8,192 words of 72 bits each) is made of permalloy rectan-

gles 0.030 inch long, 0.025 inch wide and 0.000003 inch (800 angstroms) thick. There are 4,128 of these rectangles on a silicon-monoxide-coated copper plate three inches square; two arrays of 72 plates each are mounted in a frame 68 by 42 by 7 inches. [The reader who checks the arithmetic will find that the number of rectangles is greater than the number of bits. Thirty-two rectangles on each copper plate are not used; it was convenient to place them in an array 86 by 48.]

The frame is about the same size as the ones in conventional computers.

Stacking the bits. Electrically conducting thin-film lines are deposited, in sequence, on top of the thin-film rectangles. The first layer to be deposited has one line for each word in the memory. Then an insulating layer is applied above these word lines. Finally the bit and sense lines corresponding to the bits in each word are deposited alternately atop the insulating layer; these lines are at right angles to the word lines. A ferrite keeper on top of the bit and sense lines partially closes the magnetic path around the lines.

This thin-film memory, like most others, takes advantage of the anisotropy of thin magnetic film—their tendency to be magnetized in certain directions more easily than in others. The easy magnetic axis of the thin films can be magnetized in either of two directions, 180° apart—one corresponding to a stored "1" and the other to a "0."

The easy axis in IBM's experimental memory is parallel to the word lines. A current on the word line then rotates the magnetization toward the hard axis; this rotation generates a voltage pulse on the sense line. When reading, the data is taken from the sense lines in this way. When writing, the combination of a large word current and a small bit current creates a resultant magnetic vector that points a few degrees to one side or the other of the hard axis, depending on the direction of the bit current. First, the word current is turned off, then the bit current; this order allows the magnetization to "flop"

to the easy axis in one direction or the other, depending on the bit being stored.

Noise a problem. The memory's designer, Q. William Simkins, had to find a way to distinguish between signals and noise, one of the major problems in thin-film memory design. Read noise is of approximately the same magnitude as the signal and is caused by capacitive coupling between the word line and the sense line. It is canceled by differentially sensing the voltage pulses on the sense line and a dummy sense line.

Write noise can be several times larger than the signal and can carry over into the next read cycle; it is caused by capacitive and inductive coupling between the bit line and the sense line. Capacitive and inductive noise reinforce one another at one end of the line and tend to cancel one another at the other end.

Simkins put the bit driver and sense amplifier at opposite sides of the array and thus eliminated much of the write noise. When writing, two of the bit drivers are turned on at once—one in each of the two arrays—but only one word line is turned on; differential sensing of pulses from the two arrays distinguishes between noise and signal.

Instrumentation

3-D by vibration

A researcher at the Mitre Corp. of Bedford, Mass., has developed a technique to make a three-dimensional display with mirrors and an off-the-shelf loudspeaker.

For the mirror, physicist Alan C. Traub stretches taut a sheet of Mylar—a flexible, half-mil-diameter plastic membrane coated with a thin film of metal—over the loudspeaker.

As the flexible mirror vibrates, becoming alternately concave and convex under the influence of the speaker's pneumatic drive, the change in curvature causes a re-

flected image vibration also.

Faster than the eye. The mirror vibrates so quickly—too quickly for the human eye to resolve—that the eye sees a steady, solid figure in three dimensions instead of a series of discrete, two-dimensional images advancing and receding.

When the source of the image is



3-D image created by physicist Alan Traub uses an off-the-shelf loudspeaker and a Mylar mirror.

the periodic pattern of an oscilloscope, or similar time-varying display, the source can be electronically synchronized with the mirror, and display depth.

The technique also permits the introduction of phase changes between an oscilloscope tube face and the mirror motions, permitting images in the shape of circles of ellipses. These are similar to the Lissajous figures produced on the screen of a cathode-ray tube for frequency and phase measurements. But Traub's display can add up to periodic motions along the Z—or depth—axis as well as the X and Y axes.

One of the potential applications of the research project is in air traffic control for displaying air-space in three dimensions: range, azimuth and elevation. The pattern could be generated by a computer at the same rate as the vibrating mirror, and the distance between altitude levels might be calibrated in a grid.

Tracking in 3-D. Other potential applications are in missile trajec-

tory display during the early moments of a launch. In a truly graphic display the missile could be represented as traveling within a 3-D "tube" whose boundaries represent safe paths.

Applications are also seen in analysis of radar signals, and of human speech signals, to display time as well as frequency and amplitude.

As part of his research program, Traub is trying to combine the flexible mirror technique with a bank of Nixie tubes to generate an array of numerals at different depths within the image space.

For wall-size displays beyond the diameter of loudspeakers, Traub says, a membrane mirror acting like a giant capacitor could be vibrated electrostatically. In fact, a study is already being made of an electrostatically driven mirror as an alternative to an acoustically driven one.

In depth. Traub, a member of the technical staff in the Applied Science Laboratories of the Mitre Corp., says the technique could also be used as a psychology laboratory tool for measuring human depth perception.

Looking at much longer-range possibilities, he adds educational and entertainment applications such as 3-D television and moving pictures. "As of today, however, it would be an expensive process, since a lot of bandwidth would be required," Traub says.

The technique of varying the focal length of the mirror gives an effect similar to existing displays of the oscillating or rotating screen type. But Traub says the varifocal mirror technique is simpler, lighter and more reliable. "The amount of motion required to vibrate the mirror is very little," he says. "Only milliwatts of power are put into the speaker, and noise levels are quite tolerable."

"Compared with the depth achieved in the image," Traub says, "the mirror motion is very small. For a seven-inch diameter mirror, the center of the taut Mylar moves less than $\frac{1}{16}$ of an inch."

In contrast to some stereoscopic techniques, Traub points out, this mirror display has the property of

parallax, permitting an observer to move around and from each vantage point to see a different angle of the image, much as in holography [Electronics, Nov. 30, 1964, p. 86].

For the record

Used separately, the techniques of predetection recording and diversity combining have worked adequately in cutting down the data bit errors that plague telemetry-receiving systems. But then the systems have never been faced with a tough test. Now, however, that test is coming up: during the Apollo moon mission, the spacecraft will often be near the outer limit of a ground receiving station's range. To be sure that valuable data isn't lost in space, engineers at the National Aeronautics and Space Administration decided to combine the two recording techniques, hoping for a further reduction in the error-bit rate. The test results were beyond their fondest hopes: errors of threshold signals were reduced by a factor of at least 1,000—and with some improvements ranging as high as a factor of 100,000.

Costs are cut. The NASA engineers were delighted, not only because of the sharp decline in errors but also because of huge money savings. By adapting the dual techniques, the space agency realized it wouldn't have to scrap its existing receiving gear; it would simply have to modify it and add some processing equipment in the laboratories where all the data tapes are studied.

Predetection recording [Electronics, Sept. 13, 1963, p. 30] is a method of universal recording, capable of operating with any modulation technique. Any telemetered data is received and recorded with conventional equipment, without regard to the modulation techniques.

Once the data is recorded—without any attempt to demodulate—the tape is processed by telemetry experts in a lab under ideal conditions. With conventional receiving systems, special demodulating cir-

TRW ANNOUNCES NEW MILITARY MYLARS

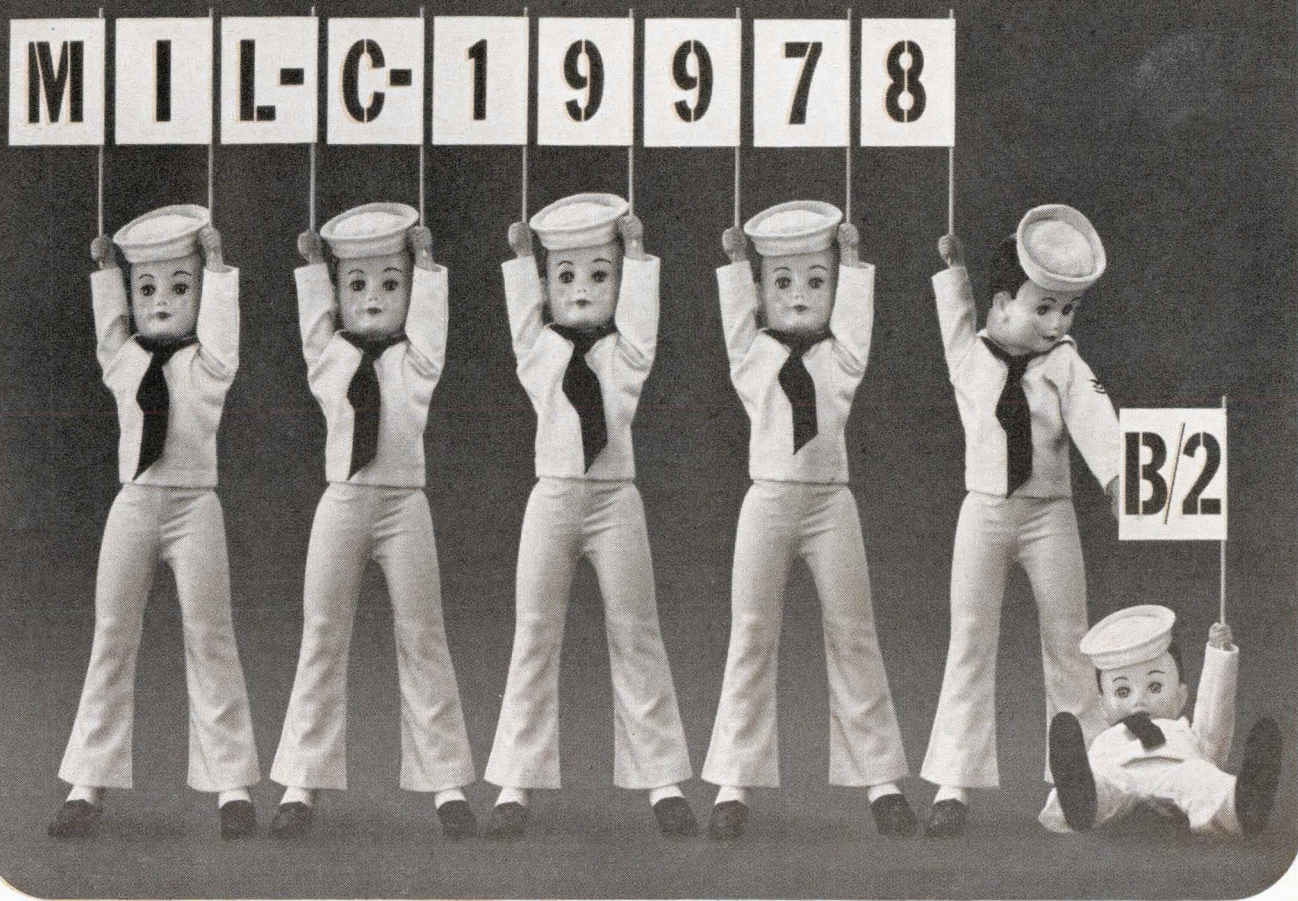

Up to 72% smaller than MIL-C-25C paper capacitors!

MIL-C-19978B/2 reduces capacitor size drastically—down to .125" diameter by 1/2" long. At the same time electrical characteristics are upgraded sharply.

MIL-C-19978B/2 hermetically sealed mylar* capacitors are available now from TRW with immediate delivery in production quantities.

- REDUCED SIZE—35% to 72% smaller than MIL-C-25C.
- VOLTAGE CHOICE—30V, 50V, 100V, 200V, 600V, 1000V.
- CAPACITANCE CHOICE—.001 mfd through 10.0 mfd.
- TOLERANCE CHOICE—±10%, ±5%, ±2%, ±1%.

For full information contact: TRW Capacitors, 112 W. First St., Ogallala, Nebraska. Phone: 308-284-3611 • TWX: 910-620-0321

These capacitors—when designated TRW Type 693—are available to high reliability specifications, and in custom capacitances and tolerances beyond the range of MIL-C-19978B/2.

*Du Pont registered trademark

TRW CAPACITORS

cuits reduce the telemetered information to usable data—occasionally resulting in the loss of some valuable data.

Diversity combining is a technique in which the signals from two oppositely polarized antennas are combined. The two input signals are converted into a single signal in a combiner; the result is a signal with a signal-to-noise ratio that is as much as three decibels better than either of the two original signals.

Order is increased. The space agency is buying the equipment—called pre-d combiners—from the Vitro Corp. of America's Vitro Electronics division. The agency had planned to buy five pre-d combiners; now, however, based on the optimistic results, NASA plans to acquire seven.

In its search for accurate data-receiving equipment, NASA wasn't limited to the pre-d combiner gear. It could have selected the type of receiving system that has been developed for such deep-space missions as the Mariner's Mars fly-by. The gear would probably have worked equally well, space engineers concede, but the price would have been many times higher.

For example, to overcome the problem of low-signal threshold levels on Mariner, NASA fitted a special antenna with a narrow-band, pulse-modulation and phase-locked demodulator. But to install such gear on a worldwide network of antennas—which it would have had to do to get full-time data from Apollo—the cost for ground-station telemetering gear would have skyrocketed.

Industrial electronics

ZIPping the mail

After a decade or more of experimenting with electronic equipment, the Post Office Department has settled on a program for automating its operations. The initial price tag is nearly \$100 million.

In a year or so, the department will purchase \$65 million of auto-

matic-mail sorting equipment for 109 post offices and a \$30-million electronic data-processing system to serve 75 major post offices.

"This is the first step in a nationwide program to improve operating conditions," says Postmaster General Lawrence F. O'Brien. "It will be followed up with a systematic effort to modernize the entire postal complex within the coming few years."

The automation depends primarily on an alphanumeric optical scanner for reading addresses—printed either by hand or machine. The scanner was developed by the Philco Corp. and proved out in tests at the Post Office laboratories in Washington and in operational tests at the Detroit Post Office [Electronics, Jan. 11, 1965, p. 130]. The equipment can sort mail at speeds up to 36,000 pieces an hour. Additional scanners are due in the next year in Buffalo, Boston, Houston, Minneapolis, San Francisco, Seattle and Portland, Ore.

In the bag. Though bids will be sought for the alphanumeric scanners, Philco almost certainly will get the contract. Scanners that can read only zip code numbers have been developed by Rabinow Electronics, Inc., now a subsidiary of the Control Data Corp., and the National Cash Register Co. These will be installed later in smaller post offices.

The \$30-million data-processing complex will be based on a system

undergoing tests in Milwaukee and Minneapolis since 1964; in that time the Post Office estimates it has saved more than 20 man-years of work. The International Business Machines Corp. built the computers and Control Data installed the input stations.

These corporations presumably will have the inside track for a system that will serve 75 major post offices from Portland, Maine, to Los Angeles. Installation begins next November, with a target date in mid-1968 for full operation.

At first, the complex will be used to gather information such as mail volume, workload, manpower fluctuation and attendance records, and will transmit the data to high-speed computers for analysis and evaluation. Results will be flashed to postmasters, with the aim of moving the mail more effectively.

Early bugs. Most of the equipment in the \$65-million order—contracts will be awarded by June 30—was developed as a result of experience with Project Turnkey at Providence, R. I., an experimental automated post office. For the first six months, this operation proved something of a fiasco. But the bugs since have been worked out and postal officials now class Providence as "one of our very best operations."

In addition to the optical scanners, bids will be sought on:

- Letter sorters that can be operated with or without the use of

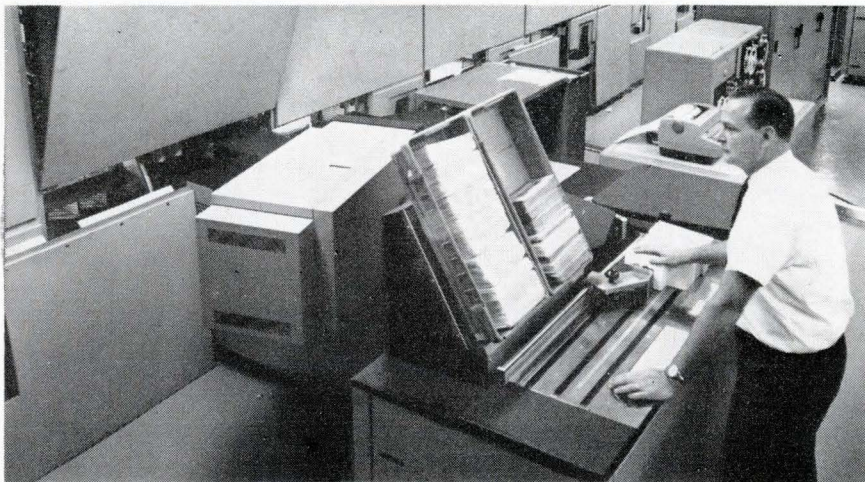

Optical scanner developed by the Philco Corp. can sort 30,000 pieces of mail an hour. The Post Office Department will soon order nearly \$100 million of equipment to automate its operations.

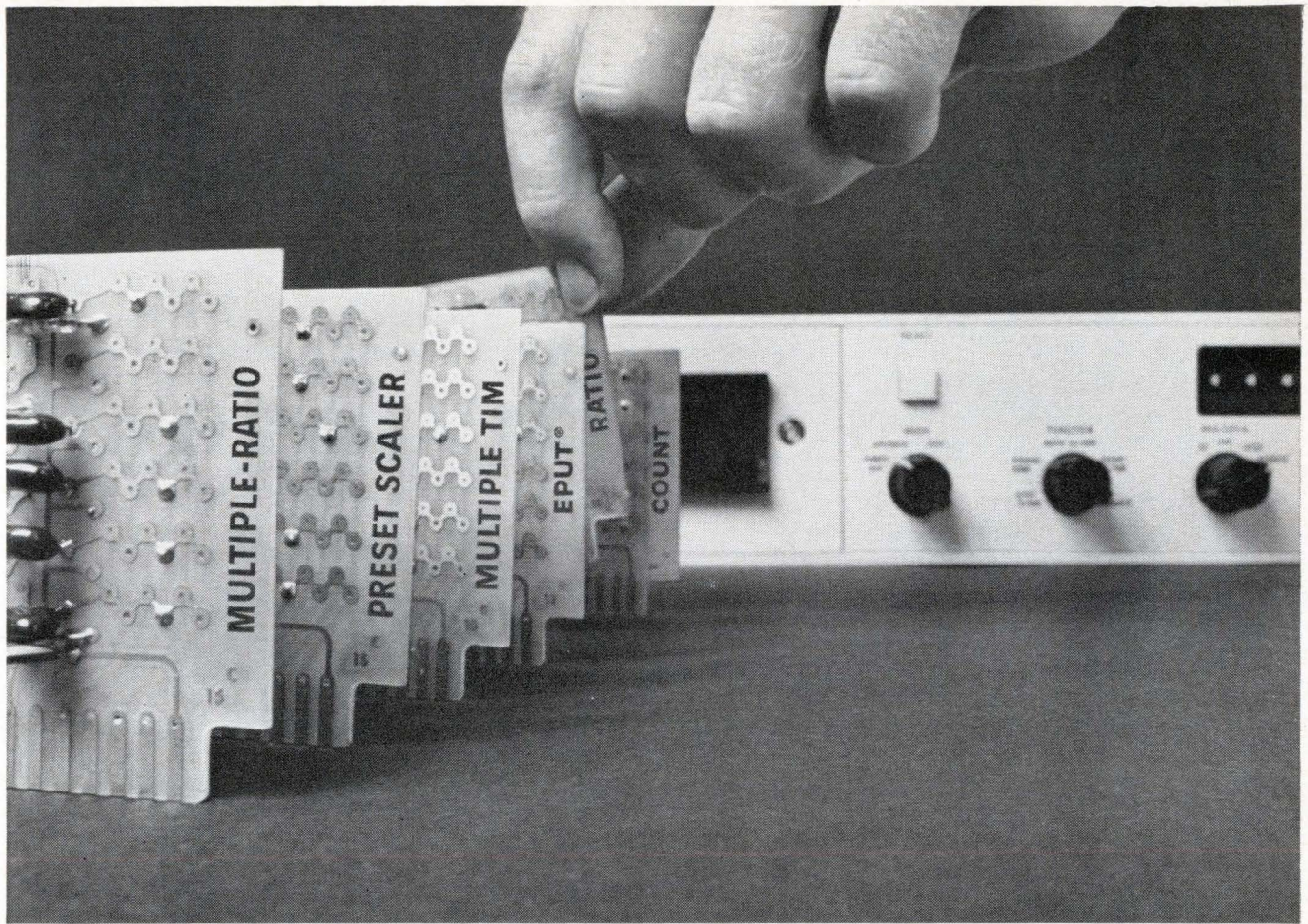

The digital instrumentation you create!

This new and imaginative application of the building block concept enables you to specify the exact digital instrumentation you need — and you pay only for the functions you require! The new Beckman Berkeley modular 6000 Series permits packaging standard off-the-shelf circuit elements into a variety of instrument configurations . . . without the high engineering costs required for custom instruments.

Here are some examples of 2-mc 6000 Series instruments: Accumulators, Preset Accumulators, Reversing Accumulators, Preset Reversing Accumulators, Preset Frequency Meters, Time Interval Meters, Gated Counters, Limit Frequency Meters, Deviation Frequency Meters, Preset Pulse Genera-

tors, Digital Clocks . . . all are provided to *your* specifications.

And these are only a few examples. You can have one- to six-digit display, remote control, storage for visual display and BCD data, or you name it! So why not start now to solve your digital measurement problems . . . just call your Beckman Berkeley representative.

Beckman®

INSTRUMENTS, INC.

BERKELEY DIVISION

RICHMOND, CALIFORNIA • 94804

INTERNATIONAL SUBSIDIARIES: GENEVA; MUNICH; GLENROTHES, SCOTLAND; TOKYO; PARIS; CAPE TOWN; LONDON

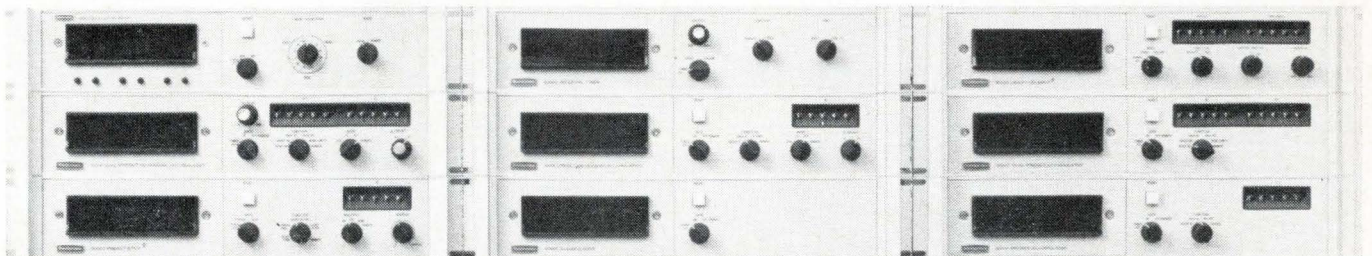

**ONLY
TRYGON
HR-B Series
POWER
SUPPLIES
give you all
these features**

- All silicon —60°C operation
- Constant voltage/constant current
- .01% regulation; 0.5 mv ripple
- Up to 300 watts—voltages to 160V.
- Remote sensing—remote programming
- TRYLINK® precision current mode
- Automatic overvoltage protection option
- Half Rack Size—Bench or rack mount

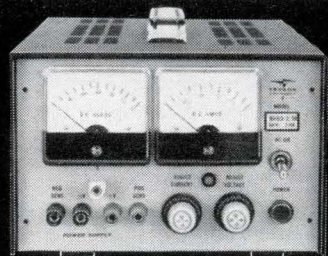

Looking for a challenging engineering opportunity with growth potential? Contact D. Hauptman at Trygon. An equal opportunity employer.

TRYGON
ELECTRONICS, INC.
Roosevelt, N.Y. 11575

Please rush me your new 52-page Power Supply Handbook—FREE

Name _____
 Title _____
 Company _____
 Address _____
 City _____ State _____ Zip _____

the electronic scanner;

- Facing and canceling machines with photoelectric cells that can search out and cancel stamps at 30,000 per hour;

- Machines that stack mail, remove odd-sized mail and stack letters for automatic canceling machines;

- Semiautomatic sack and parcel post sorting machines; and

- Overhead closed-circuit detection monitoring systems to help regulate the flow of mail.

Solid state

Tv camera on a block

Both the Air Force and the National Aeronautics and Space Administration agree that the best way to develop a smaller, lighter, more rugged television camera is to build a solid state image sensor. But they disagree on what kind of sensor is needed.

So the Air Force and NASA are independently funding efforts to build different kinds of solid state sensors capable of providing pictures with resolution at least equal to that of commercial television systems.

Dual approach. The military is backing the Radio Corp. of America's effort at its Princeton, N. J., research laboratories, and the space agency is backing the Westinghouse Electric Corp.'s work at its Aerospace division in Baltimore.

RCA's plan is to put a large array of evaporated antimony-trisulfide photoconductors on a substrate, with each photoconductor in series with a diode. But Westinghouse prefers to use silicon phototransistors in its "mosaic" sensor.

When RCA's photoconductor samples light, its resistance changes and a signal is sent to an address strip. The company has built a working model that has 32,400 photoconductor elements arranged in a 180-by-180 array.

"The picture quality is not as good yet as that obtained with

tubes," concedes Paul K. Weimer, who heads the project, "but we've just scratched the surface. We're learning every day but we still need to know more about solid state scanning."

The RCA system uses two 180-stage scan generators. The horizontal generator moves from one element to another 180 times faster than the vertical generator. Each generator has 1,080 components: 540 cadmium-selenide thin-film transistors, 360 nichrome resistors and 180 silicon-monoxide capacitors.

Weimer says the next step is to build a 129,600-photoconductor array with elements arranged in a 360-by-360 square and with a distance of one mil between element centers.

In the 180-by-180 array, the distances between element centers is two mils.

The other way. Westinghouse built two cameras, each using a 2,500-element sensor (a 50-by-50 array measuring 0.6 by 0.6 inch), which produces a crude picture. Now, Westinghouse is working on a 12,800-element sensor (a 100-by-128 array measuring 0.6 by 0.7 inch). William List, program manager, expects the new sensor to sharply improve the camera's resolution.

Delivery to NASA is scheduled for April.

Although this will still leave the company behind RCA as far as resolution capability is concerned, Westinghouse plans to catch up quickly. If NASA approves, Westinghouse will start to work on a 51,200-element sensor (200-by-256 array) in the spring and follow that one with a 160,000-element sensor (400-by-400 array) later this year.

In the Westinghouse camera, the current output of each phototransistor is determined by the light hitting the phototransistor. Conventional monolithic integrated circuits are used in the readout circuitry.

Contact prints can be made with both the RCA and the Westinghouse cameras. This is not practical with present vidicon-tube cameras because of the thick glass

wall needed to maintain the vacuum.

Consumer electronics

Lighting up with scr's

An electronic "match" that uses a silicon controlled rectifier will replace the familiar pilot light on several gas appliances to be introduced this year. The electronic pilot light was developed by the Wilcolator Co. of Elizabeth, N. J.

The first appliance to incorporate the new pilot light is a gas range that Sears Roebuck & Co. will market this month.

Wilcolator — a subsidiary of Ranco, Inc., which produces home and industrial appliances — says the electronic match costs between \$10 and \$20, pending on the complexity of the model. Other appliance makers also plan to incorporate the unit soon, Wilcolator adds.

See a flame. Two types of electronic pilots were designed: one for ranges, where the flame can be seen by the user, and the other for such appliances as ovens, where the flame can't be seen.

To light a range electronically, a burner control knob is first set to the "light" position; this opens a gas valve and turns on the electronic match circuit. The circuit consists of a neon lamp oscillator that triggers an scr. During the "on" cycle, a capacitor is charged to a peak voltage. When the scr is off, the capacitor is discharged into the primary of a transformer. The high voltage from the transformer secondary creates a spark across a gap and lights the burner. Once the flame is lighted, the control knob is placed on the regular "on" position, deactivating the electronic match.

In the model where the flame is out of view, the problem of lighting the gas is different. Usually these appliances are thermostatically controlled, such as in an oven; hence, the gas flame is turned on and off automatically to maintain the proper temperature.

Safety factor. But to prevent an

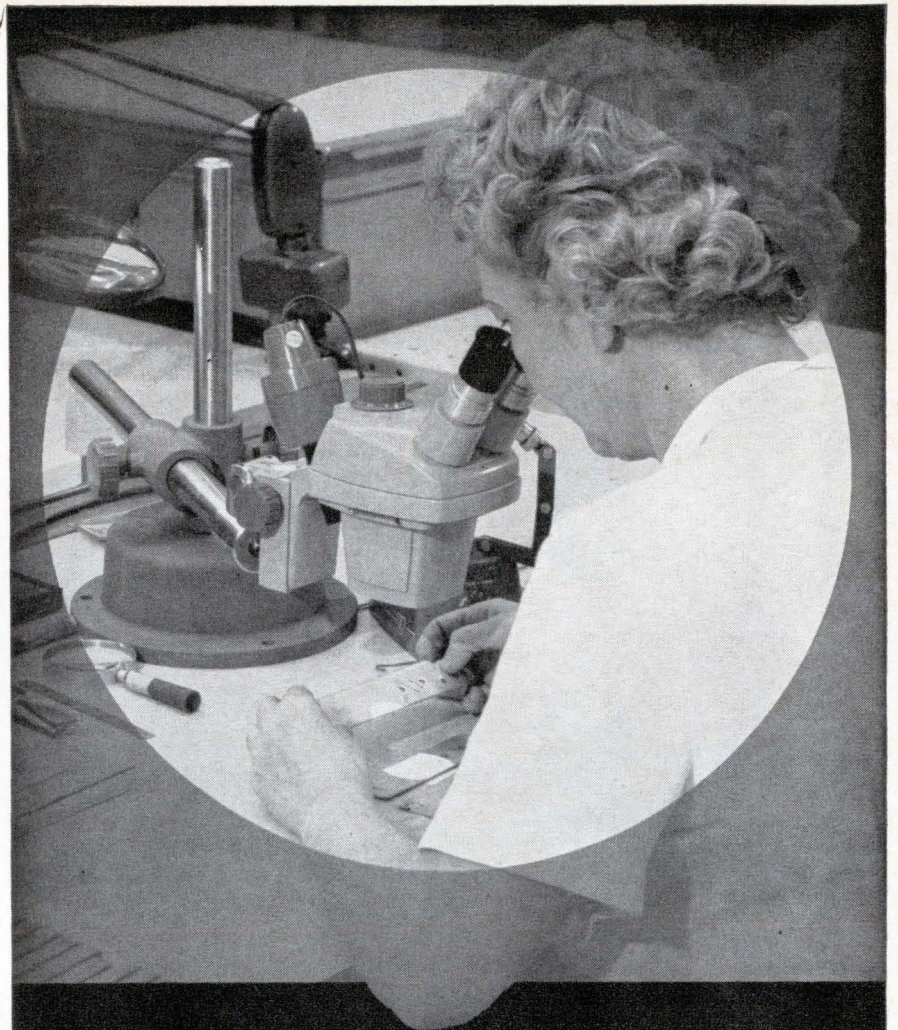

*To find micro-size voids, pits,
porosity and nodulation...*

**WESTINGHOUSE DEPENDS ON
BAUSCH & LOMB STEREOZOOM®**

The Aerospace Division of Westinghouse found StereoZoom ideally suited for spotting defects in Printed Circuit Boards with plated-through holes. The three-dimensional viewing it offers is the only way these holes can be checked properly. The bright, clear, magnified detail simplifies the inspector's work. With StereoZoom, breaks in circuit and shorts between layers can be clearly seen. Pinholes, dents and scratches can be found. To do this, many changes of magnification are required. StereoZoom adjusts its continuously variable magnification quickly and easily. The flexibility of the mounting parts and stand of StereoZoom allows complete freedom of movement of the parts under visual inspection.

For your quality assurance, choose a StereoZoom. There are 24 complete models as well as selected components. Call your dealer or write for Catalog 31-15, Bausch & Lomb, 61426 Bausch Street, Rochester, New York 14602.

BAUSCH & LOMB 

To make or buy a power supply ...let SOLA quote you both ways

Make the decision a realistic one. Let SOLA quote you on a custom built CV transformer *and* CVDC power supply. You will then have the costs and specifics to make the right decision.

Building your own d-c supply?

Start with the SOLA CV, custom built to match your power supply's outputs, exactly. Save extra component costs in your design. Get short circuit protection, regulation within $\pm 1\%$ for line variations to $\pm 15\%$. Send output power and circuit requirements, we'll return price of CV and values of circuit components.

Buying a complete d-c supply?

Choose the SOLA CVDC, custom built to your specified output requirements. Get a high watts-per-pound package combining the CV's tight regulation, low forward voltage drop of the rectifier and low output impedance of the capacity filter.

Let SOLA quote both ways. Send us your specs for custom-built CV's and CVDC's, or call your distributor and ask about his line of standard CV's and CVDC's.

SOLA Electric Division, SOLA Basic Industries, 1717 Busse Road, Elk Grove Village, Illinois 60007 (312) 439-2800.

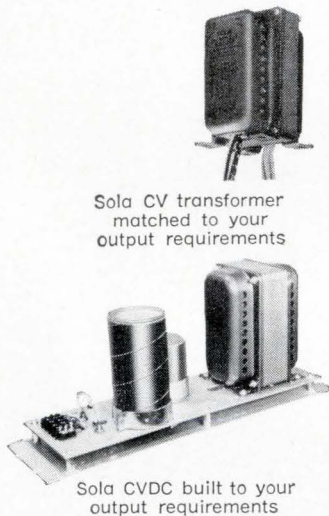

CUSTOM VOLTAGE REGULATION HEADQUARTERS

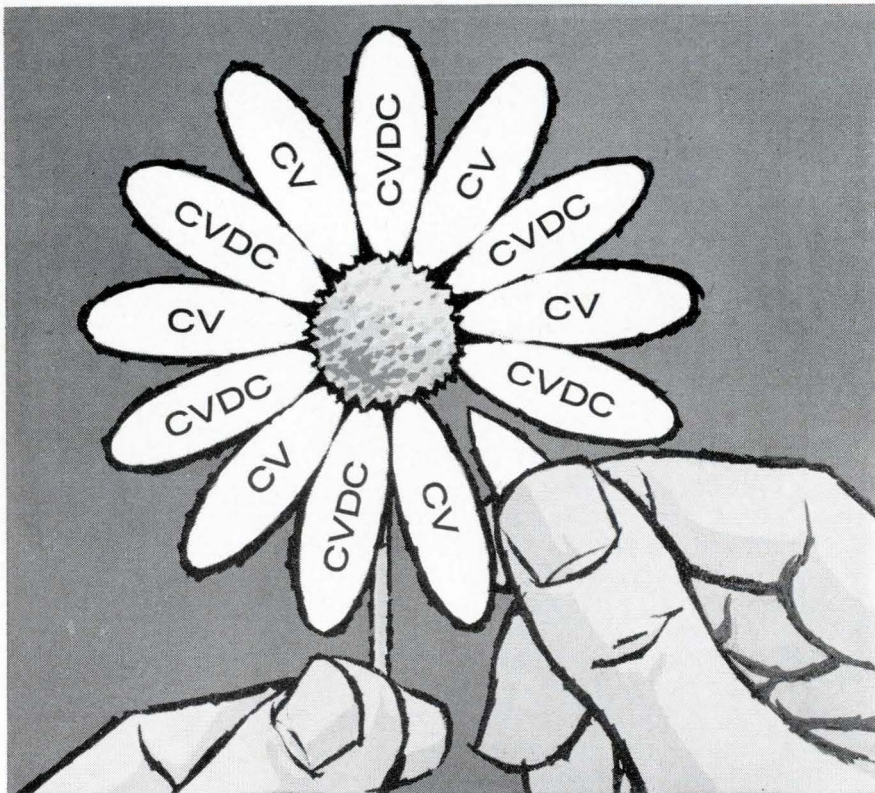

SOLA ELECTRIC

DIVISION OF SOLA BASIC INDUSTRIES

Electronics Review

explosion, there must be a way of insuring that a large quantity of gas will not seep into the oven before the electronic match is lighted. To solve the problem, Wilcolator uses, in addition to the electronic match, a conventional gas-operated pilot light that is lighted only when the oven is in use.

The electronic match is activated when the oven is turned on; this lights the temporary gas pilot. The flame from this pilot then heats a "flame switch"—a tube of mercury that is vaporized by the heat—which opens a solenoid valve that allows the gas to enter the oven. If the temporary pilot should go out during the oven's cooking cycle, the memory switch will return to its liquid state, closing the gas valve.

Although the electronic match adds a few extra dollars to the price of an appliance, Wilcolator claims that the savings in fuel costs—because the pilot isn't on continuously—pays for the unit in a few years.

Wilcolator cites another advantage for the electronic match that would make it an attractive feature in warm climates: a pilot light burning continuously can raise the temperature to an uncomfortable point in a poorly ventilated room.

Electronic notes

▪ **Nike X computer.** The Sperry Rand Corp.'s Univac division has received a \$24-million contract from Bell Telephone Laboratories for the development of computers and high-speed thin-film memory models for the Army's Nike X anti-missile system.

▪ **Rechargeable battery.** Gulon Industries, Inc., has developed a prototype of a rechargeable lithium cell. Lithium is more efficient for storing electricity than nickel-cadmium, but can't be stored in air or water. The new battery is hermetically sealed and uses a nonaqueous electrolyte. The test model has a capacity of 100 watt-hours per pound, compared with 26 for nickel-cadmium.

Now—Bourns Gives You a Complete Choice Of 7/8" Precision Potentiometers

Take your pick from the industry's finest, most extensive 7/8"-diameter precision potentiometer line:

BUSHING MOUNT	SERVO MOUNT
Model 3500, 10-turn	Model 3550, 10-turn
Model 3507, commercial 10-turn	Model 3560, 3-turn
Model 3510, 3-turn	Model 3570, 5-turn
Model 3520, 5-turn	Model 3580, single-turn*
Model 3530, single-turn	

*Meets all requirements of MIL-R-12934C; can be ordered by Bourns model number or by MIL-Spec designation RR09.

In quantity and quality, this line is unmatched. Exclusive

SILVERWELD® multi-wire termination eliminates the chief cause of potentiometer failure. All-sealed construction insures MIL-Spec humidity performance (cycling and steady state). One hundred per cent inspection and the double-check follow-through of the Bourns Reliability Assurance Program are your final quality guarantees.

No matter what your requirements in precision potentiometers, you will find the answer at Bourns—the complete source. Write for technical data on our entire line of bushing- and servo-mount models, KNOBPOT® potentiometers, and turns-counting dials.

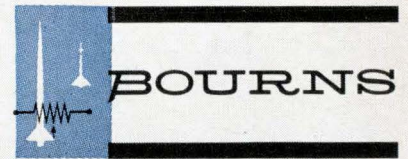
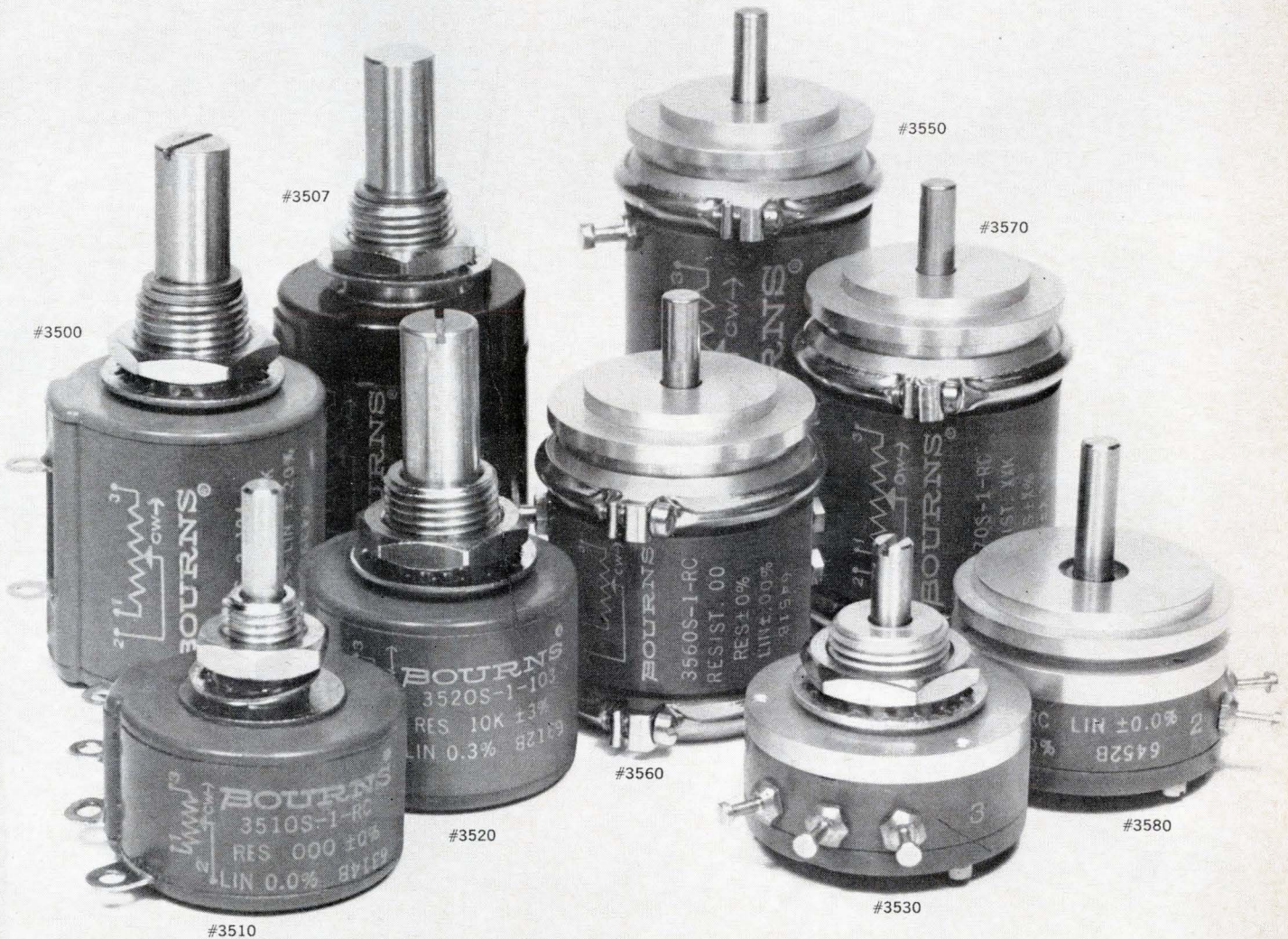

BOURNS, INC., TRIMPOT DIVISION
1200 COLUMBIA AVE., RIVERSIDE, CALIF.
PHONE 684-1700 · TWX: 714-682 9582
CABLE: BOURNSINC.

INTERNATIONAL RECTIFIER

PROUDLY PRESENTS

A CONTROLLED RECTIFIER FAMILY

WITH RATINGS UP TO

350 AMPS*

UP TO 1200 VOLTS PRV EPITAXIAL SCR

1,000,000 TO 1 RATIO, FIRING POWER TO RATED POWER

Proven performance backed by years of intensive research and environmental testing.

World's most advanced line of

HIGH POWER EPITAXIAL SCRs UP TO 1200 VOLTS PRV

- 350 Amps epitaxial SCR
- 300 Amps epitaxial SCR (standard)
- 300 Amps epitaxial SCR (fast switching)
- 250 Amps epitaxial SCR

IR opens new vistas in the field of power control and conversion with these compact SCRs. They are indispensable tools of the engineer in meeting demanding design requirements for higher performance. **Increased efficiency, increased reliability, reduced size and reduced weight** are merely a few of the advantages engineered into IR's high power SCR line.

The inherent capabilities in the design of these devices, combined with the application experience of our engineering staff offers you an opportunity to utilize the most advanced SCR technology available today in the design of your high power equipment.

350 Amps - Bulletin A-116
300 Amps (standard) - Bulletin A-114
300 Amps (fast switching) - Bulletin A-115
250 Amps - Bulletin A-113

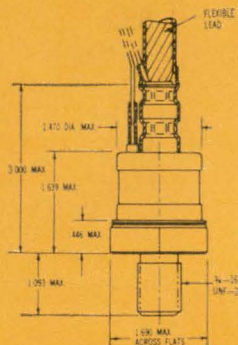

CALL MR. RECTIFIER

He is your Sales Engineer. He's experienced. Understands your problems. Has the answers. Works closely with you. You can deal in confidence with "Mr. Rectifier" - your rectifier specialist. Call him.

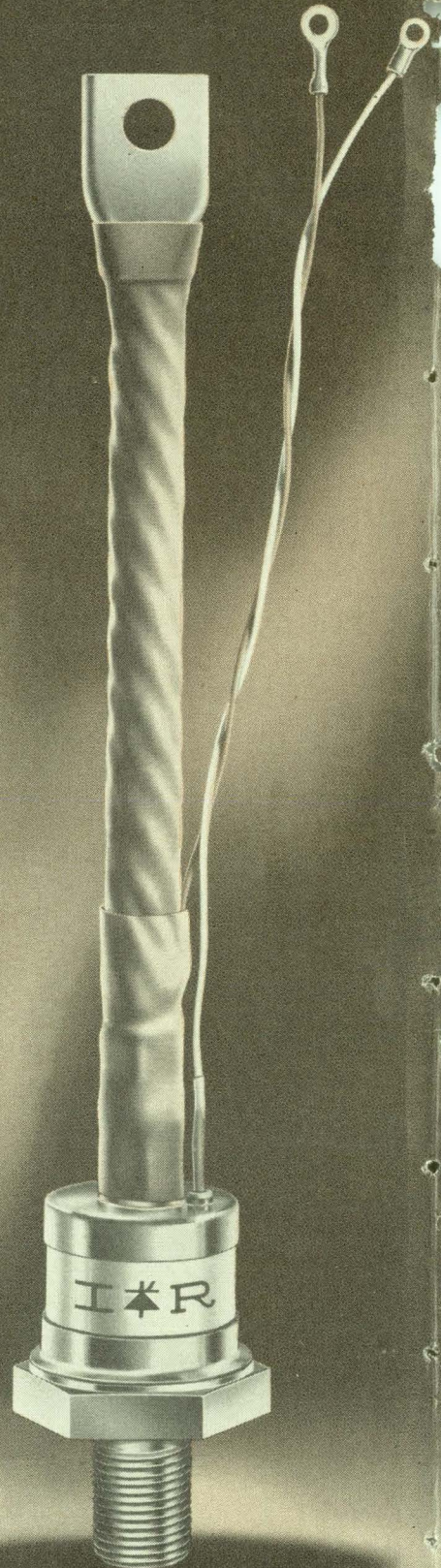

*Average DC amperes

WORLD'S LARGEST RECTIFIER SPECIALISTS



INTERNATIONAL RECTIFIER

INTERNATIONAL RECTIFIER, EL SEGUNDO, CALIF., PHONE (213) OR 8-6281 • CABLE RECTUSA • REGIONAL OFFICES IN NEW YORK CITY, (212) CH 4-0748 • FORT LEE, N.J., (201) WI 7-3311 • SYRACUSE, N.Y., (315) HE 7-8495 • CAMBRIDGE, MASS., (617) UN 4-6520 • ARDMORE, PA., (215) MI 9-3666, (215) GR 3-3931 • SILVER SPRING, MD., (301) JU 9-3305 • MIAMI, FLA., (305) 445-5201 • CHICAGO, ILL., (312) OR 6-4090 • CLEVELAND, OHIO, (216) 734-4100 • DAYTON, OHIO, (513) 223-7691 • HUNTINGTON WOODS, MICH., (313) LI 8-1144 • ST LOUIS, MO., (314) TE 8-6333 • MINNEAPOLIS, MINN., (612) 920-1200 RICHARDSON, TEX., (214) AD 1-2504 • SAN MATEO, CALIF., (415) 349-2373 • LOS ANGELES, CALIF., (213) 678-2181 • IN CANADA: TORONTO, ONT., (416) 421-5970 • MONTREAL, QUEBEC, (514) 861-0562
EUROPEAN GENERAL SALES OFFICE: 38 AVENUE DES ARTS, BRUSSELS, 4, BELGIUM • TELEPHONE 111774

Washington Newsletter

February 7, 1966

China's atom threat gets more attention on new evidence . . .

The United States may take a new look at its missile-defense system, a result of reports indicating that **Communist China is much further along in the development of missiles than Pentagon planners had suspected.**

The reports also indicate a big push by the Chinese to develop a missile-carrying submarine fleet. The growing evidence of China's offensive potential will produce new pressure this year for:

- **Speeding up developments of the Nike X antimissile missile system** to allow deployment of at least a limited array of missiles to counter a crude Chinese attack.

- **Intensifying development and deployment of antisubmarine-warfare systems,** already second only to missiles in the defense budget.

This new information intensifies the Pentagon's concern over China's nuclear capability. China's exploding of a nuclear bomb last year was serious, but U.S. military officials emphasized that the Chinese lacked an effective way to deliver atomic bombs onto a target. This was a major argument for delaying deployment of the Nike X. **This year the Pentagon has allocated more than \$400 million for further development of the anti-missile system, holding off decisions on when and how to deploy it.**

The Defense Department is weighing two broad approaches to the Nike X: a \$6-billion system of defense against crude Chinese missiles, and one costing \$20 billion for defense against sophisticated Soviet missiles.

. . . of Peking's gains in ICBM's and subs for firing them . . .

Some of the evidence of the growing missile-submarine threat from China came last week from several authoritative sources:

- Ralph W. Powell of the Far Eastern Studies Department at American University in Washington told a House Foreign Affairs subcommittee that **China's first deployment of missiles would be ready by 1975.**

- Defense Secretary Robert S. McNamara, agreeing with Powell's timetable, told the House Armed Services Committee that **submarine defenses would have to be beefed up, even while missile-killer deployment and manned-bomber development is held back;** it fills a gap, he said, in defenses against both Soviet and Chinese missile threats.

- It was learned also that defense officials are taking very seriously reports that **China already has in operation submarines equipped with short-range—300 miles or so—missiles,** unequipped yet with nuclear warheads, and that she could have intermediate-range—1,500 miles—missiles for deployment on submarines before 1970.

. . . but science gap is still enormous

Despite gains in missiles and shipbuilding, China remains far behind the United States in over-all scientific and engineering abilities, concludes Chu-Yuan Cheng in a report for the National Science Foundation. The author, former research director of Hong Kong's Union Research Institute, reports that China will miss, by 20 to 30 years, its goal of reaching scientific and engineering parity with the West by 1967. Older, Western-trained scientists are still distrusted and placed under political management of Communist party members, he says. **And economic and political pressures often force specialists into fields with which they are unfamiliar and inefficient,** he adds. Cheng teaches at the University of Michigan.

Washington Newsletter

Panel opposes automation curbs

The President's Commission on the Impact of Automation advises against raising barriers to the natural growth of automation, though it concedes that the threat to employment today is greater than in recent years. To offset automation's effects on the United States economy, the commission recommends the government consider an active manpower retraining policy, tax breaks for low-income groups, extension of free education through junior college and federal works programs for the unemployed.

First total-package buy for the Army: avionics for LOH

The Army has awarded the avionics contract for the light observation helicopter (LOH) to Sylvania Electric Products, Inc., making use for the first time of a "total package" procurement technique pioneered by the Air Force. Sylvania, a subsidiary of the General Telephone and Electronics Corp., received a \$3.5-million installment on what eventually will be a \$16-million contract.

Under total-package buying, development and follow-on production of military equipment are combined into a single contract, let competitively. The Air Force used this technique first with the award of a \$1-billion contract to the Lockheed Aircraft Corp. for development and production of the C-5A transport plane. And the Navy will soon seek bids on a new class of cargo vessels called fast-deployment logistics ships.

The principal components of the LOH system include a-m and f-m very-high-frequency transceivers, ultrahigh-frequency a-m and f-m auxiliary transceivers, a communications control package and an automatic direction finder.

Surge in orders slows Pentagon's drive for economy

The Pentagon is trying to avoid sloppy buying habits resulting from the surge in military orders for the war in Vietnam. But so far, figures for fiscal 1966—ending June 30—indicate that the Defense Department is losing ground in its efforts. Although cost reductions in fiscal 1966 are still expected to exceed the Pentagon's goal, as they have since the program began four years ago, the level will be below that of 1965. But this is the first year in which the total reduction is expected to be lower than the previous year's level.

The Defense Department estimates that such programs as competitive buying and cost effectiveness will result in savings of \$2.99 billion in fiscal 1966, down \$71 million from the \$3.7-billion reductions of 1965.

The biggest dollar setback occurred in the area of competitive buying. Pentagon officials estimate that reductions from competitive buying will decline 35% this year to \$414 million. Increased competition has been credited with reducing purchase prices an average of 25%. In one move to tighten purchasing policy, Defense Secretary McNamara has ordered that any procurement officer who wants to switch an order from a competitive to sole-source basis must first obtain authorization from McNamara himself, or from his second in command, Deputy Secretary Cyrus Vance.

According to the Pentagon, cost reductions from the elimination of "goldplating" will total \$83 million this year, down substantially from \$204 million last year; reductions from the use of excess inventory, rather than new buying, will total \$78 million, against \$181 million in 1965.

What cleans parts 20 times faster?

Consolidated Electrodynamics says: FREON[®] Solvents and a Baron-Blakeslee degreaser

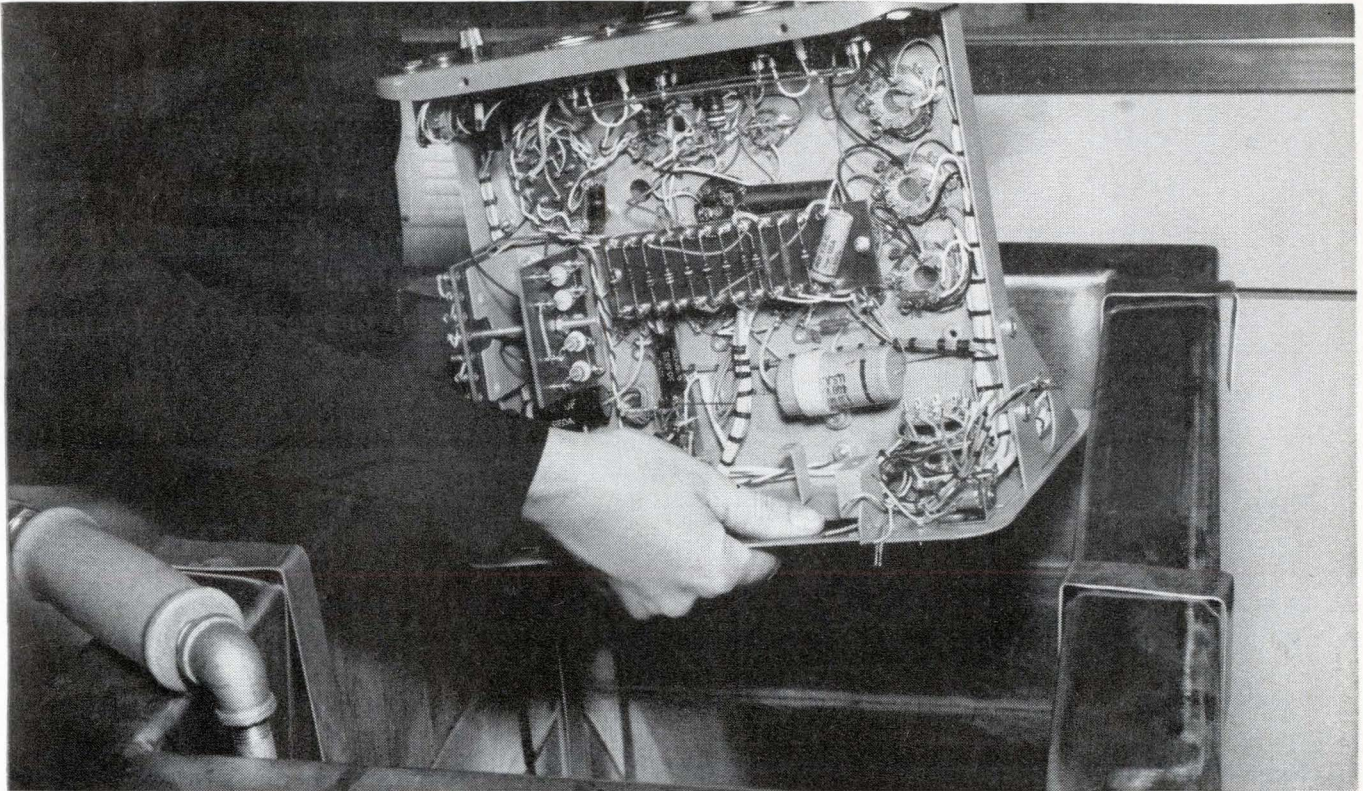

Consolidated Electrodynamics' Transducer Division in Monrovia, Calif., cleans with FREON TMC solvent in a Baron-Blakeslee Model M degreaser. FREON TMC is a patented azeotrope of FREON TF and methylene chloride . . . another tailored solvent from Du Pont. All kinds of components—from transistors to terminal boards, from subassemblies to complete chassis—are cleaned faster, better, at lower cost than ever before. For example, hand-cleaning one part used to take more than an hour. With FREON it takes just three minutes!

Besides requiring high labor costs, hand cleaning failed to do the job completely. Hidden corners and crevices went untouched. Solvent residues remained after drying. Brushes damaged delicate components. But FREON is a selective solvent—it cleans entire assemblies without harming commonly used components. And FREON has low surface tension to penetrate the smallest pores . . . high density to float away even microscopic particles. It dries quickly, leaving no residue.

Because FREON can be used over and over again, it helped cut CEC's solvent costs in half. And because FREON is nonflammable and relatively nontoxic, no special exhaust systems are needed.

FREON solvents are used for cleaning in many of CEC's divisions. Chances are FREON can give you faster, better, less costly cleaning, too. For more information, write Du Pont Co., Room 3630, Wilmington, Delaware 19898.

(In Europe, write: Du Pont de Nemours International S.A., FREON Products Div., 81 Route de l'Aire, 1211 Geneva 24, Switzerland.)



Better Things for Better Living
. . . through Chemistry



FAST-SWITCHING FREQUENCY SYNTHESIS TO MATCH YOUR REQUIREMENT:

*JUST CHOOSE FROM THREE HEWLETT-PACKARD SYNTHESIZERS,
DC TO 50 MHz, WITH THESE PERFORMANCE CHARACTERISTICS:*

- 20 μ sec switching time, the fastest available
- small frequency increments, as small as 0.01 Hz
- digital pushbutton and remote frequency selection
- internal search oscillator for continuous tuning, sweep capability
- low spurious signals
- high stability
- high spectral purity
- solid-state, modular construction for high reliability

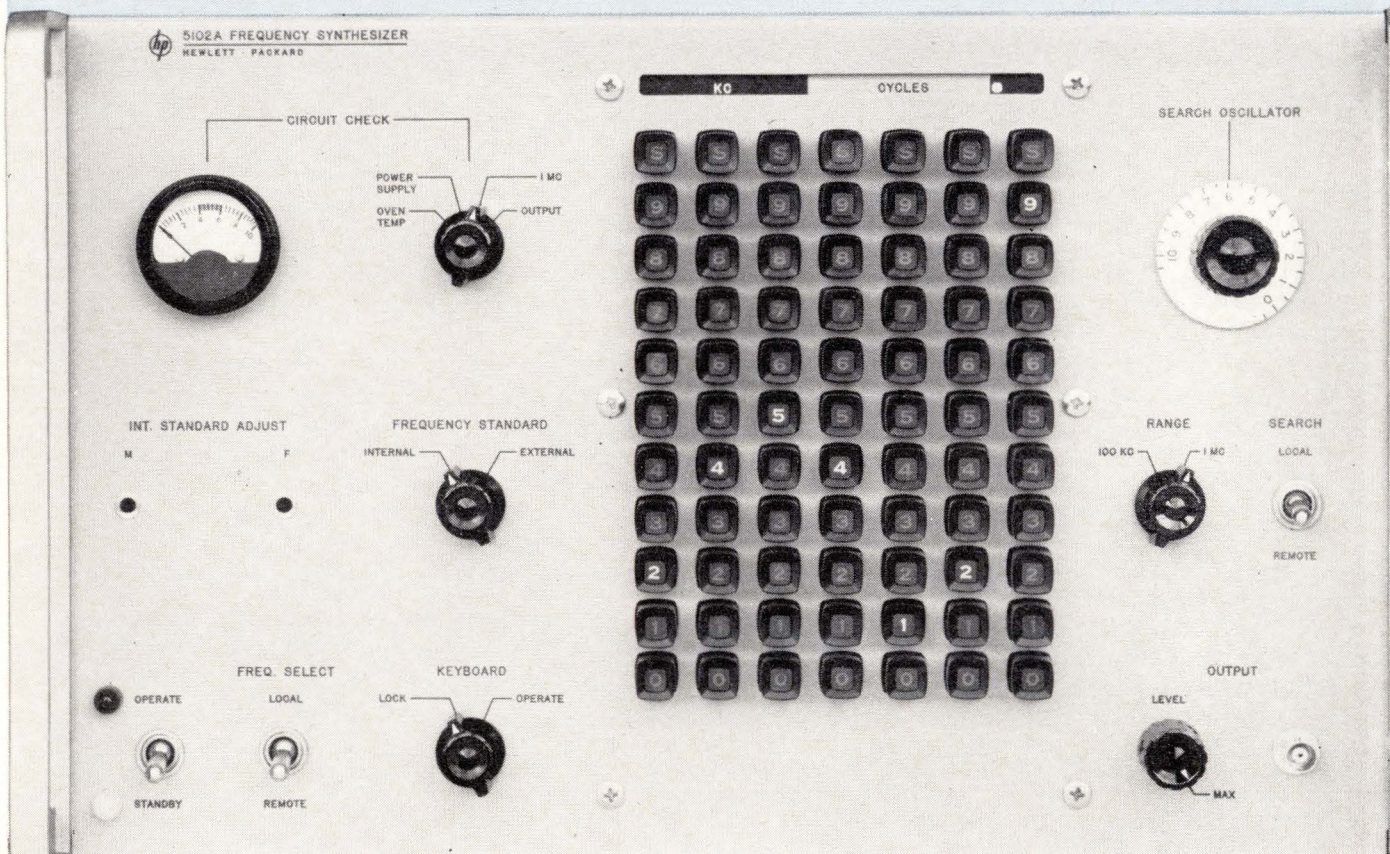

Your selection from three Hewlett-Packard frequency synthesizers gives you the broadest source of spectrally pure, stable test signals especially useful for their fast switching capability, digital pushbutton and remote programmability with random access, as well as superior signal-to-noise performance.

Signals are derived from a stable (3×10^{-9} / 24 hrs.) internal frequency standard, or you can use an external 1 MHz or 5 MHz standard. Each instrument employs a direct synthesizing technique, using arithmetic operations instead of phase-locked techniques. The stability of the source standard is preserved, and unknown variations caused by loss of phase lock are eliminated. Any significant column may be continuously "searched" over a discrete range.

Relate the brief specifications of the three hp synthesizers to your specific application, then call your hp field engineer for a demonstration or write for complete specs to Hewlett-Packard, Palo Alto, California 94304, Tel. (415) 326-7000; Europe: 54 Route des Acacias, Geneva.



Data subject to change without notice. Prices f.o.b. factory.

5100A/5110A Synthesizer—DC to 50 MHz (mc) selectable in steps as small as 0.01 Hz. The 5110A Driver generates 22 spectrally pure signals from the standard; these signals are fed to the 5100A Synthesizer, with arithmetic operations used to synthesize the variable output. Spurious signals 90 db down. Output 1 v rms ± 1 db, 100 kHz to 50 MHz; 1 v rms $+2$ db, -4 db, 50 Hz to 100 kHz. Price: 5100A, \$8150; 5110A, \$4350.

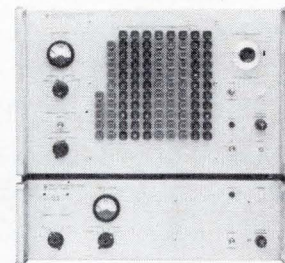

5102A Synthesizer—Dual-range, dc to 100 kHz (kc) with increments as small as 0.01 Hz (cps) and dc to 1 MHz (increments as small as 0.1 Hz). Spurious signals 90 db down (70 db down in 1 MHz range). Output 300 mv to 1 v rms; rear-panel auxiliary outputs include a dc to 1 MHz + 30 MHz signal. Price \$6500.

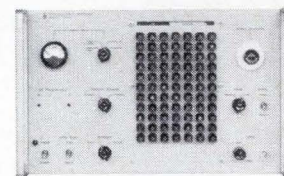

5103A Synthesizer—Dual-range, dc to 1 MHz (mc) increments as small as 0.1 Hz (cps) and dc to 10 MHz (increments as small as 1 Hz). Spurious signals 70 db down (50 db down in 10 MHz range). Output 300 mv to 1 v rms; rear-panel auxiliary outputs include a dc to 1 MHz + 30 MHz signal. Price \$7100.

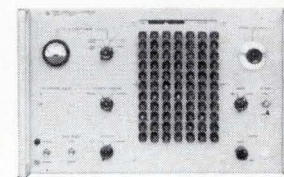

The outstanding performance of hp synthesizers has opened the door for solutions to many unusual problems. A special team of engineers assigned to synthesizer applications is at your service.

Also available: The 10514A Double-Balanced Mixer, which extracts the sum or difference of two input frequencies with high efficiency, low intermodulation, input 200 kHz (kc) to 500 MHz (mc), output dc to 500 MHz; price \$250. The 10515A Frequency Doubler, which extends the usable frequency range of the synthesizers, input 500 kHz to 500 MHz, output 1 MHz to 1 GHz; price \$120.

904

**MILITARY RTL
MC900G SERIES**

... for the most critical design jobs!

Designed for low-power military applications in which wide environmental extremes may be encountered in normal application, the series is specified for -55°C to $+125^{\circ}\text{C}$ operation.

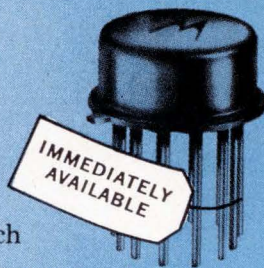

**INDUSTRIAL RTL
MC800G SERIES**

... for broad applications of all types!

Specially intended for reliable operation in industrial logic applications, this series operates over a temperature range from 0 to $+100^{\circ}\text{C}$. Priced for economical use in areas where wider temperature of operation is not required.

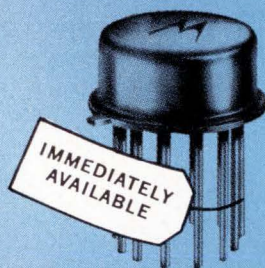

Both Offer These Key Performance Features . . .

- 12 nsec Propagation Delay
- Fan-out Capability Up to 5
- 15 mW/Node Dissipation
- For System Clock Rates to 8 mc

. . . and this wide range of circuit functions:

Buffer	MC900G/ MC800G
Counter Adapter	MC901G/ MC801G
Flip-Flop	MC902G/ MC802G
3-Input Gate	MC903G/ MC803G
Half-Adder	MC904G/ MC804G
Half-Shift Register	MC905G/ MC805G
Half-Shift Register (W/O Inv.)	MC906G/ MC806G
4-Input Gate	MC907G/ MC807G
Dual 2-Input Gate	MC914G/ MC814G
Dual 3-Input Gate	MC915G/ MC815G
J-K Flip-Flop	MC916G/ MC816G
J-K Flip-Flop	MC926G/ MC826G
Quad Inverter	MC927G/ MC827G

**...THERE'S A
MOTOROLA
RTL
INTEGRATED
CIRCUIT
TO FIT YOUR
EXACT
PERFORMANCE
AND COST
REQUIREMENT!**

*... you can choose from
4 different RTL complements
for your design.*

LOW-COST COMMERCIAL RTL MC700G SERIES



... combining RTL & mWRTL circuits for utmost versatility!

Designed and priced for a wide variety of commercial applications (as low as \$2.55 for a 3-input gate circuit in quantities of 100 or more), this low-cost series offers a combination of mWRTL and RTL circuits including some 22 circuit functions from which to choose. They open the door to new economical integrated circuit applications in such areas as instrumentation, industrial controls, test equipment, and many commercial computer designs.

COMPARE THESE LOW, LOW PRICES!

		100-Up
Buffer	MC700G	\$2.55
Counter Adapter	MC701G	3.80
Flip-Flop	MC702G	3.20
3-Input Gate	MC703G	2.55
Half-Adder	MC704G	2.65
Half-Shift Register	MC705G	4.35
Half-Shift Register (W O Inv.)	MC706G	3.65
4-Input Gate	MC707G	2.65
Adder	MC708G	3.75
Buffer	MC709G	2.55
Dual 2-Input Gate	MC710G	2.65
4-Input Gate	MC711G	2.65
Half-Adder	MC712G	3.65
Type D Flip-Flop	MC713G	6.35
Dual 2-Input Gate	MC714G	2.65
Dual 3-Input Gate	MC715G	3.20
Dual 3-Input Gate	MC718G	3.20
J-K Flip-Flop	MC720G	6.35
Expander	MC721G	2.65
J-K Flip-Flop	MC723G	6.35
J-K Flip-Flop	MC726G	6.35
Quad Inverter	MC727G	4.60

LOW-POWER MILLIWATT RTL MC908G SERIES



... where minimum operating power level is required!

- 2.5 mW/Node Power Dissipation
- 40 nsec Propagation Delay
- Full Military Temperature Range —
-55°C to +125°C

The low-operating power requirements of this Motorola RTL circuit series (only 2.5 mW/node) makes this logic complement especially attractive to military and space users. To meet the requirements of this market, the series is designed for operation throughout the full military operating temperature range from -55°C to +125°C.

Adder	MC908G
Buffer	MC909G
Dual 2-Input Gate	MC910G
4-Input Gate	MC911G
Half Adder	MC912G
Type D Flip-Flop	MC913G
Dual 3-Input Gate	MC918G
J-K Flip-Flop	MC920G
Gate Expander	MC921G

See your local Motorola semiconductor distributor for the Motorola RTL integrated circuit type which fits your immediate need. For production quantity requirements, call your nearest Motorola district office — or write Motorola Semiconductor Products Inc., Box 955, Phoenix, Arizona 85001.



MOTOROLA
Semiconductor Products Inc.

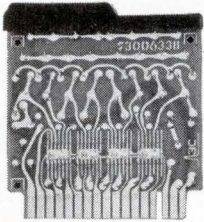

OD-335 OCTAL/DECIMAL DECODER PAC contains a prewired binary-to-octal decoder and two additional independent NAND gates to expand the matrix for BCD-to-decimal decoding.

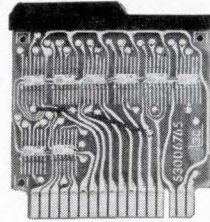

BC-337 FAST CARRY COUNTER PAC contains an eight-stage prewired counter which can be easily converted to a binary counter or BCD counter by using jumper connections.

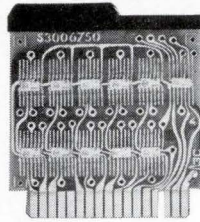

BC-336 BINARY COUNTER PAC contains between 8 and 20 prewired binary counter stages; number of stages is determined by user. Can be used for counting and frequency division.

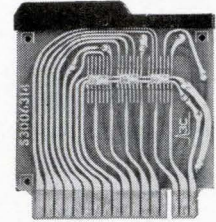

BC-335 COUNTER PAC contains six independent flip-flops with appropriate inputs for operation as binary counters; may also be employed individually as complementing flip-flops.

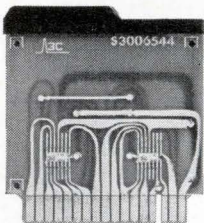

EO-335 EXCLUSIVE OR PAC contains five independent functional gate structures and one independent NAND gate; each contains 3 two-input NAND gates and performs AND-OR and AND-OR-INVERT functions.

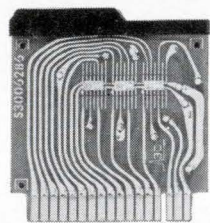

BR-335 BUFFER REGISTER PAC contains six flip-flops with independent set-reset capability for parallel loading of information. Common clock reset inputs make possible simultaneous operations on all stages.

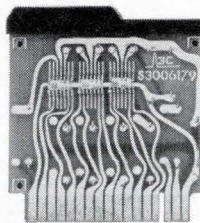

XD-335 TRANSMISSION LINE DRIVER PAC contains 6 two-input driver circuits. Each circuit is capable of driving standard 50 ohm, 75 ohm and 93 ohm coaxial cables at repetition rates up to 5 megacycles.

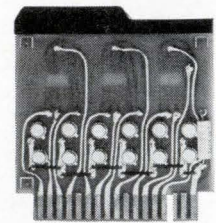

LD-330 LAMP DRIVER PAC contains twelve identical independent lamp driver circuits. Each circuit is capable of switching 70 milliamps of current at any positive voltage up to 20 volts, at a maximum frequency of 1 mc.

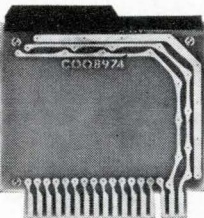

BP-330 BLANK PAC — standard card with etched buses for +6V, -6V and ground — facilitates mounting special circuits using standard component lugs and point-to-point wiring. Also available: standard copper clad PAC kit for custom etching.

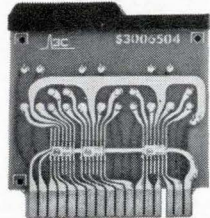

DL-335 NAND TYPE 2 PAC contains 6 four-input NAND gates; two have disconnected collector load resistors brought out on separate terminals. By tying the gate outputs to a single load circuit a number of gates can be connected in parallel without reducing output drive capability.

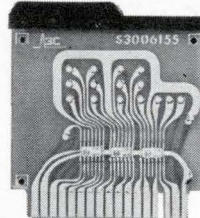

DN-335 EXPANDABLE NAND PAC contains 6 three-input NAND gates with nodes; two have disconnected load resistors which are brought out on separate terminals. Gate node input allows for expansion of the number of gate inputs by attachment of diode clusters.

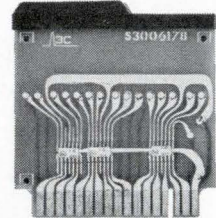

DI-335 NAND PAC contains 10 two-input NAND gates; two have collector loads separate from the collector outputs. By tying the gate outputs to a single load circuit, a number of gates can be connected in parallel without reducing output drive capability.

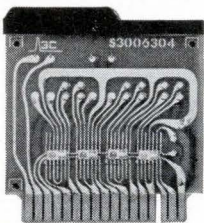

DG-336 SELECTION GATE TYPE 2 PAC contains two independent functional gate structures; each has 4 three-input NAND gates and performs the AND-OR-INVERT function.

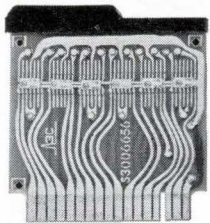

DG-335 SELECTION GATE TYPE 1 PAC contains four independent functional gate structures. Each has 3 two-input NAND gates and performs the AND-OR-INVERT function.

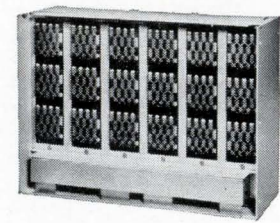
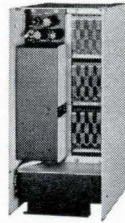

MOUNTING HARDWARE is available with PAC capacities between 24 and 144 modules, and a choice of wire-wrap or taper pin connectors. Power supplies are offered in plug-in or rack-mount models. Accessories include auxiliary wire wrap kits, wire wrapping tools, taper pin insertion tools, extender PACS, jumper lead sets, instruction manuals and logic symbol sticker kits.

Modules

5 mc operation • high packaging density • low cost per logic function • inherent reliability • noise protection in excess of one volt • low power consumption • NAND logic • DC coupled circuitry

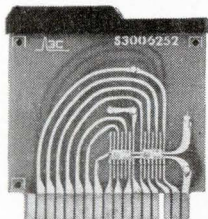

FA-335 GATED FLIP-FLOP PAC contains four independent flip-flops, each with AC and DC inputs and a common reset; allows for control of the flip-flop from a variety of level and pulse inputs.

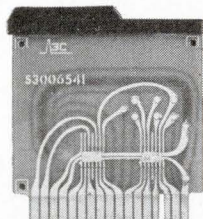

UF-335 UNIVERSAL FLIP-FLOP PAC contains three independent flip-flops each with AC and DC input gating and a common reset; can perform all functions of other μ -PAC flip-flops plus many additional logic operations.

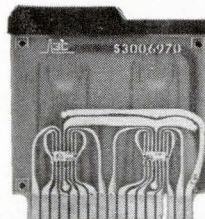

FF-335 BASIC FLIP-FLOP PAC contains eight independent flip-flops. Each stage has a DC set and reset input and a set and reset output. Circuit consists of two NAND gates internally wired back-to-back.

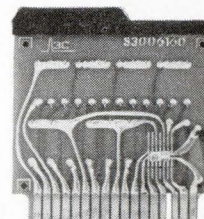

DC-335 MULTI-INPUT NAND PAC contains 2 six-input NAND gates with nodes and 4 three-diode clusters. Gate node input allows for diode cluster expansion of the number of gate inputs.

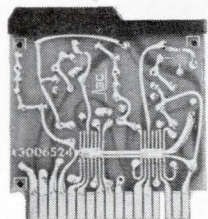

DM-335 DELAY MULTIVIBRATOR PAC contains two independent monostable multivibrators capable of generating assertion and negation pulses in a variety of widths. Each circuit has two NAND inputs, an Enable and three discrete variable delay taps.

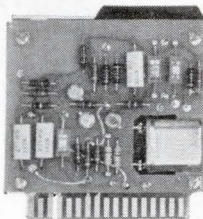

MC-335 MASTER CLOCK PAC contains a crystal controlled oscillator, a pulse shaper and a pulse amplifier. The oscillator operates between 200 kc and 5 mc. The pulse shaper section can vary pulse width between 50 and 150 nanoseconds.

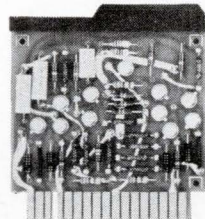

ST-335 SCHMITT TRIGGER PAC contains two independent trigger circuits capable of converting various shaped inputs to a μ -PAC output. Switching levels can be varied from +2.5 volts to -2.5 volts by making appropriate pin connections.

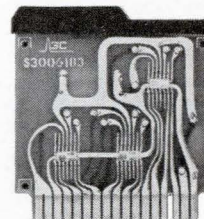

PA-335 POWER AMPLIFIER PAC contains 6 three-input high-drive NAND gates, each capable of driving 25 unit loads and 250 picofarads stray capacitance. Each gate has two electrically common outputs to reduce load distribution current.

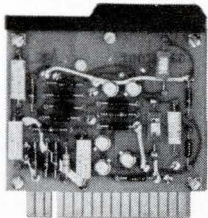

MV-335 MULTIVIBRATOR CLOCK PAC contains a free-running variable frequency multivibrator, a pulse shaper and a pulse amplifier. The multivibrator operates between 200 kc and 5 mc; frequency and pulse widths can be varied by means of potentiometer-capacitor networks.

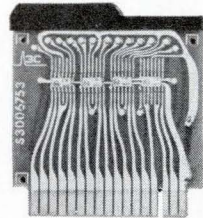

TG-335 TRANSFER GATE PAC contains four independent functional gate structures. Two of the structures have 4 two-input NAND gates, one input on each gate being common to the four gates. The remaining two structures have 3 two-input NAND gates, one input being common to the three gates.

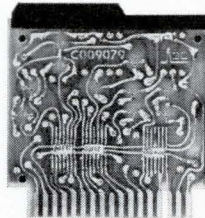

LC-335 NEGATIVE LOGIC LEVEL CONVERTER PAC contains 10 independent two-input circuits. Each circuit accepts signals at ground and -4 to -15 volts and provides a μ -PAC output. Also available is the S-PAC LC-35 Positive Logic Level Converter PAC which mates μ -PAC signals with 3C's S-PAC.

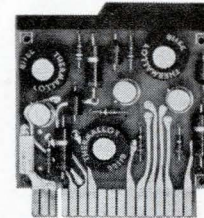

SD-330 SOLENOID DRIVER PAC contains three independent circuits for driving heavy resistive, capacitive or inductive loads. Each circuit has two NAND inputs and is capable of switching up to one ampere of current at 500 cycles per second from a positive supply of up to 28 volts. One independent two-input NAND gate is also included.

3C SALES OFFICES: NEEDHAM, MASS.; FOREST HILLS, N.Y.; LEVITTOWN, PA.; SYRACUSE, N.Y.; SILVER SPRING, MD.; HOUSTON, TEXAS; HUNTSVILLE, ALA.; ORLANDO, FLA.; DES PLAINES, ILL.; DETROIT, MICH.; CENTERVILLE, OHIO; LOS ANGELES, CALIF.; PALO ALTO, CALIF.; KENT, WASH.; ALBUQUERQUE, N.M.

COMPUTER CONTROL COMPANY, INC.
OLD CONNECTICUT PATH, FRAMINGHAM, MASSACHUSETTS 01702

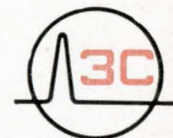



Six Semiconductor Innovations Help

1. New tetrode FET attains 8000 μ mhos

Very high transconductance, frequency capability into the uhf range—these are the major advantages you get with TI's new TIXS35 N-channel tetrode field effect transistors. These represent a two-to-one improvement over currently available tetrode FETs.

Transconductance is typically 8000 μ mhos with substrate gate connected to source, and 10,000 μ mhos minimum with gates connected together. Other characteristics: $V_{(BR)GSS} = 30$ V min; $C_{rssl} = 1.4$ pF max; $C_{issl} = 8$ pF max.

Isolation between gates minimizes "pulling" in mixer applications and greatly reduces skewing problems in AGC applications at IF. In autodyne mixer circuits like the one at left, the TIXS35 reduces circuit components. Circle 71 on Reader Service card for data sheet.

2. New N-channel FET features 60 ohms $R_{DS(ON)}$

TI's new TIXS33 field-effect transistor features a very low drain-source resistance of 60 ohms maximum. This makes it ideal for a wide range of switching applications such as low-level choppers and commutators as well as low- and medium-frequency amplifiers.

This planar epitaxial device offers high transconductance ($Y_{fs} > 12,000$ μ mhos), high drain current (> 25 mA), low leakage ($I_{GSS} < 1$ nA), and low capacitance ($C_{DG} < 5$ pF and $C_{ISS} < 20$ pF).

Symmetrical geometry makes drain and source leads interchangeable. This permits use in multiplex and sample-hold circuits and allows replacement of older devices with non-standard lead configurations. Package is the TO-72 (four-lead version of the TO-18). Circle 72 on Reader Service Card for data sheet.

3. High-density diode arrays save space, improve product

Custom monolithic and discrete diode arrays, combining up to 20 diodes in standard flat-pack, low-profile TO-5 and TO-18 packages, are available from TI.

Benefits include high-density packaging, compatibility with integrated circuits, uniformity of parameters, and close thermal tracking. Core drivers, diode AND gates, common-anode and common-cathode arrays are typical of devices that are available. Circle 75 on Reader Service Card for information.

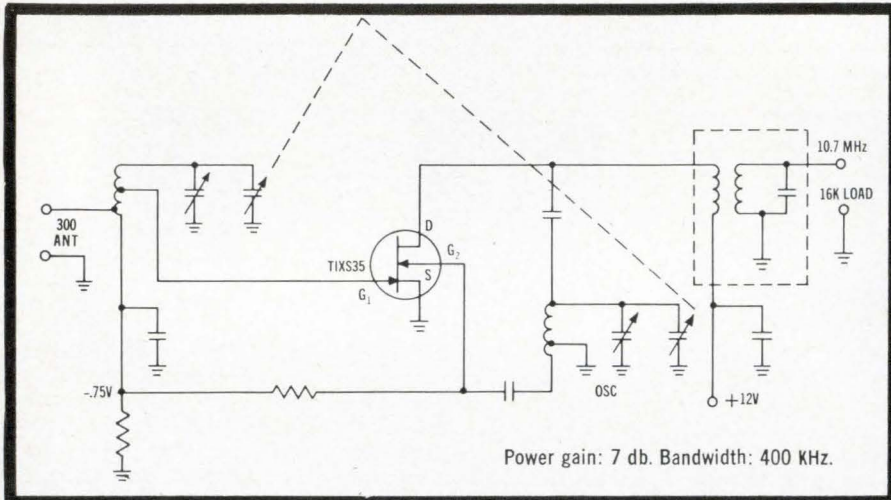

1. Unique autodyne mixer employs TIXS35 FET which functions as both mixer and local oscillator.

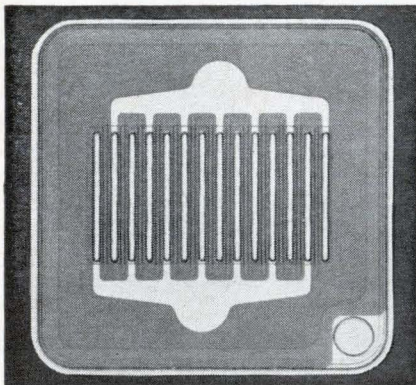

2. Symmetrical geometry of TIXS33 FET.

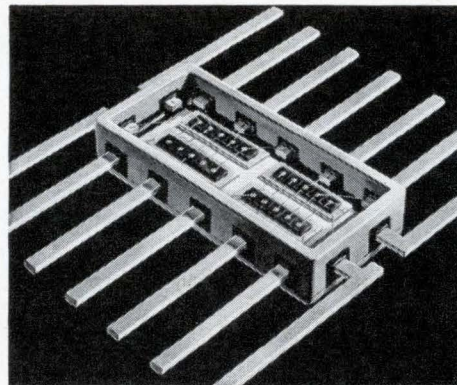

3. Up to 20 diodes may be packaged in a single case.

TI cannot assume any responsibility for any circuit shown or represent that they are free from patent infringement.

You Improve Performance, Reduce Cost

4. New diodes employ oven for high stability, low cost

TIXD746 - 759 temperature-compensated reference diodes offer temperature coefficients as low as 0.001%/°C and voltage ratings from 3.3 to 33 volts. Cost is less than conventional multi-junction reference diodes.

The unique unit comprises a Moly/G[®] diode within a self-regulating polycrystalline semiconductor oven as shown at right. The oven holds 120°C within ±8°C from -55°C to +100°C and within ±2°C from -10°C to +50°C. Temperature is held within 1°C over a 10% voltage change. The oven operates on 24 V ac or dc.

Typical applications include regulated power supplies, high-frequency crystals, differential amplifiers, and instruments requiring voltage reference. Circle 73 on Reader Service Card for data sheet.

5. Simplify assembly with TI customized light sensor arrays

Now you can reduce manufacturing costs, increase reliability, improve performance, and minimize optical crosstalk with PC-board light sensor and light emitter arrays from TI.

You can reduce assembly, testing and inventory costs because TI arrays are preassembled and pretested units ready for installation. Reliability is improved because PC-board design is inherently more rugged than individually wired sensing devices. All components are hermetically sealed for long life.

LS600 planar light sensors give high, uniform sensitivity. Typical output is 1 mA, light, and 0.01 μA, dark, at 25°C. Sensitivity can be matched to ±20% across arrays. Lens confines admission angle to 10° off axis, minimizing optical crosstalk with close sensor spacing. Circle 74 on Reader Service Card for information.

6. 400 V power transistors permit simplified circuitry

TIP04 NPN silicon transistors feature 400 volt minimum $V_{(BR)CEO}$ — permitting simplified circuitry for high-power line-operated equipment and circuits with inductive or capacitive loads.

Low saturation voltage (1V max at 2A) gives high efficiency. Low leakage ($I_{CEX} = 10$ mA max at 400 V and 100°C T_C) permits high-impedance bias circuitry for high gain. Other features include an f_T of 3 MHz and fast switching speed. Circle 76 on Service Card for data sheet.

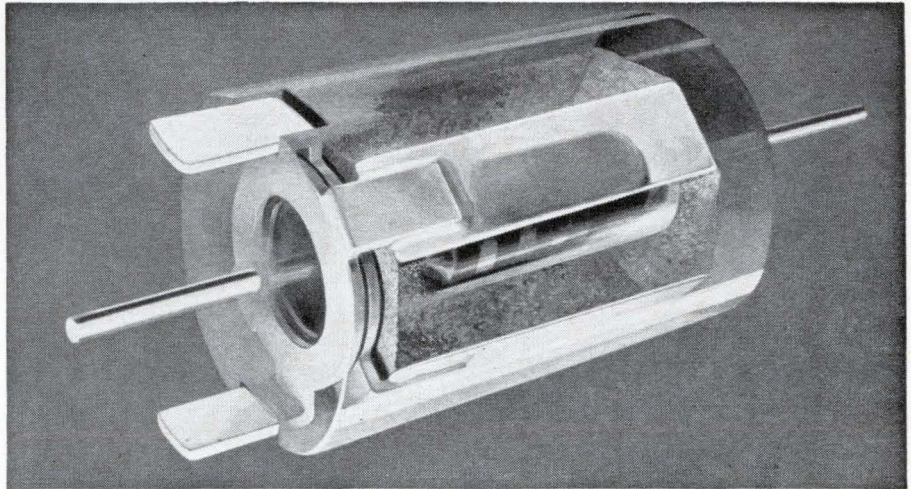

4. Unique construction of TIXD746—759 series temperature-compensated reference diodes.

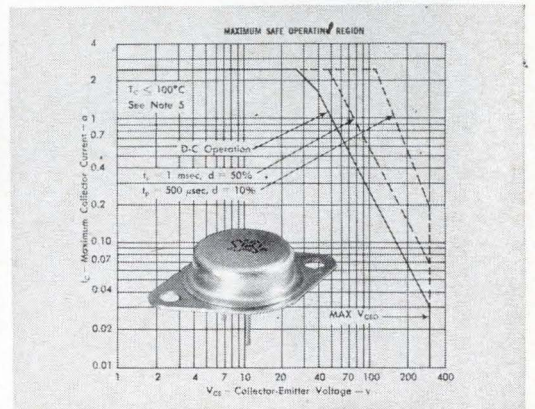
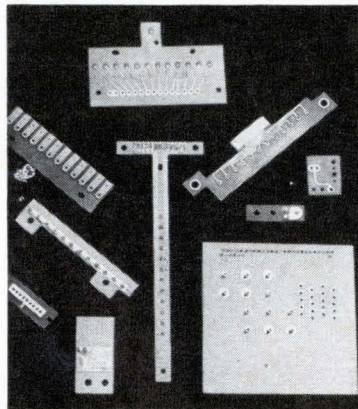

5. Typical light sensor arrays produced by TI. 6. High voltage capability of TIP04 permits simple circuitry



TEXAS INSTRUMENTS
INCORPORATED
13500 N CENTRAL EXPRESSWAY
P. O. BOX 5012 • DALLAS 22 TEXAS

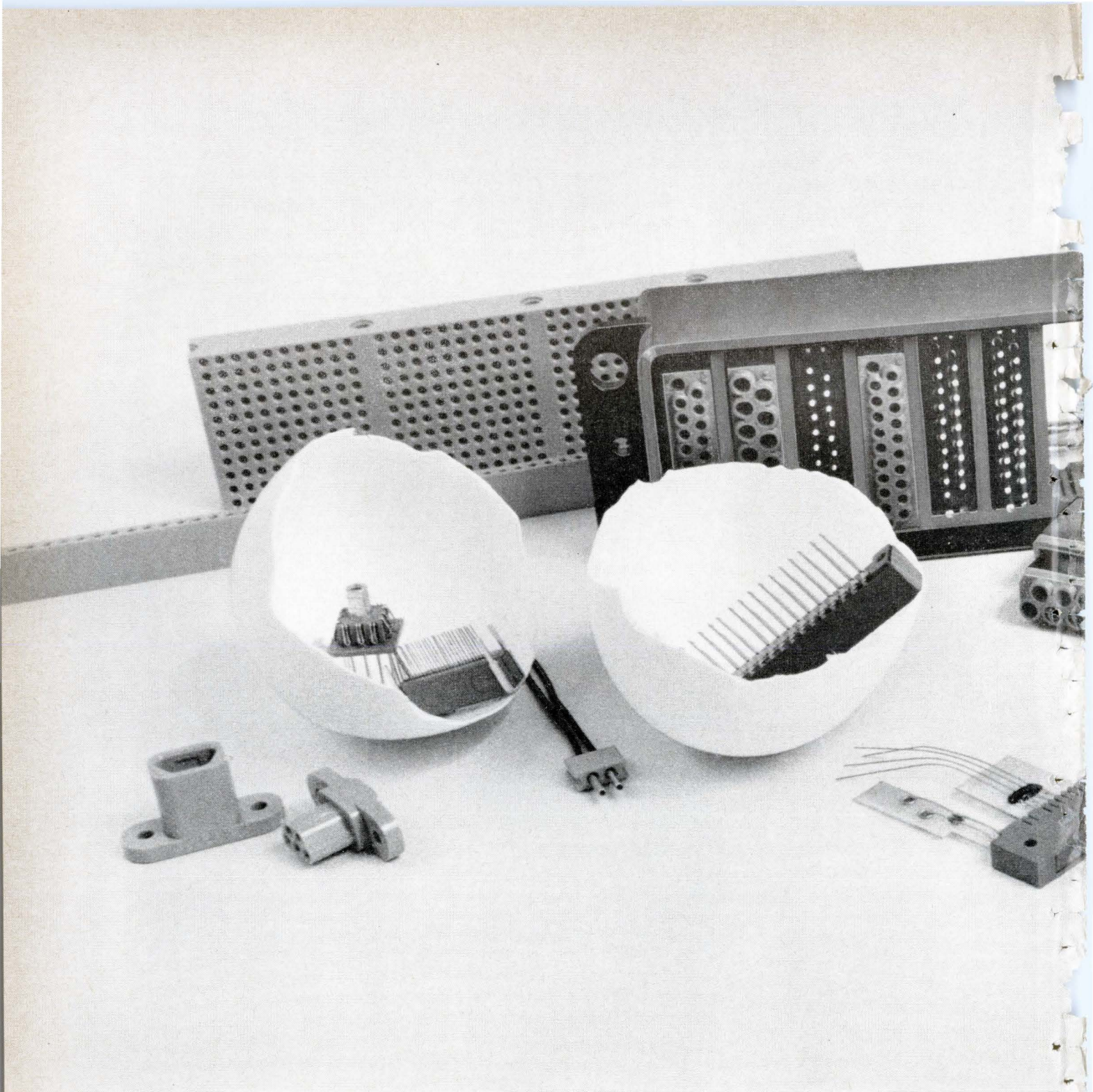

***How Amphenol's 108
microminiature connectors
help you hatch new ideas***

They give engineers the complete selection needed to break out of the shell . . . to innovate . . . to design smaller, cheaper and more reliable equipment.

Now, you can choose from the most complete line of standard microminiature connectors in the industry. Amphenol builds connectors for printed circuit board, rack and panel and modular applications; min-

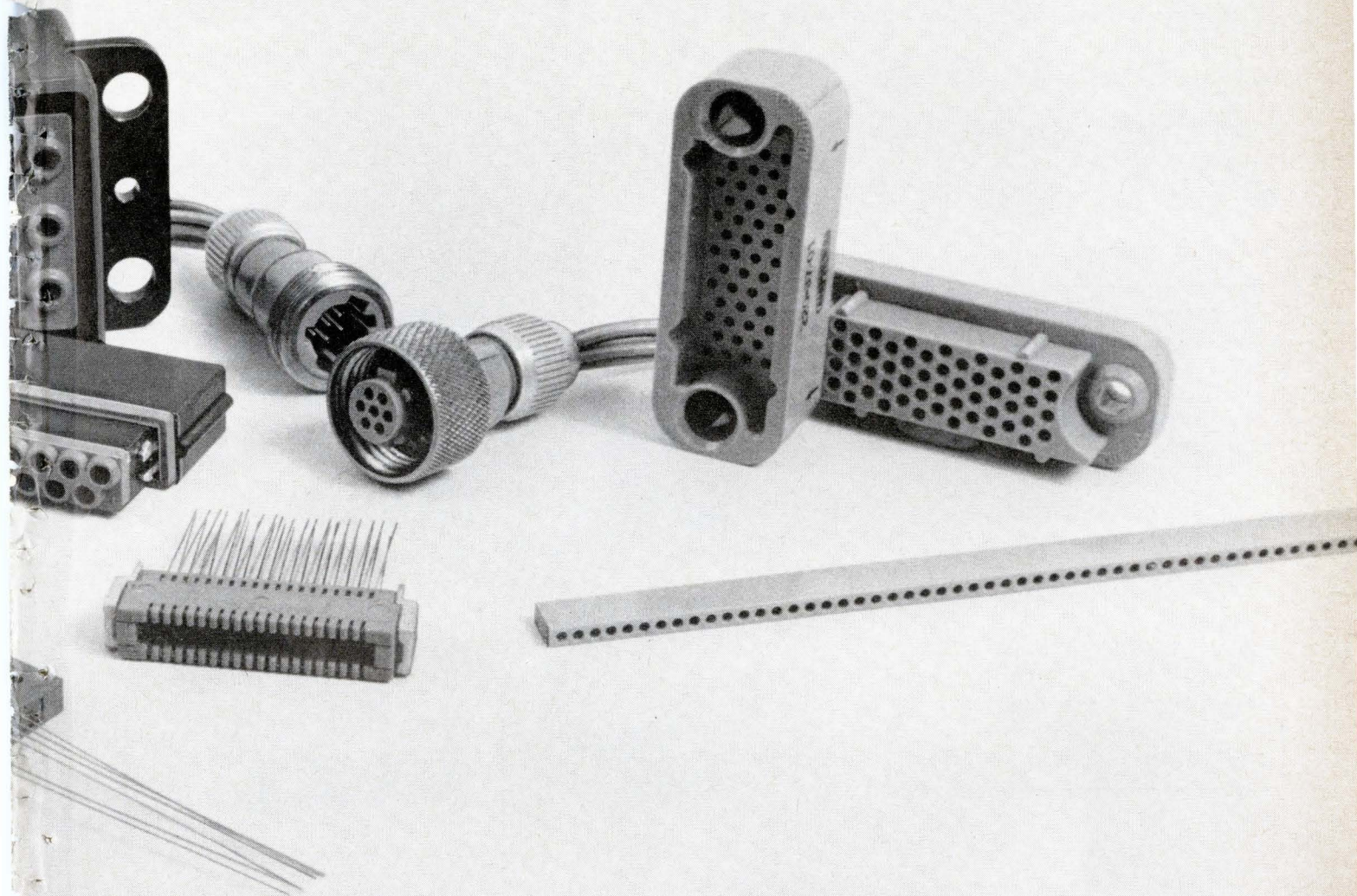

ature circuitry and thin film networks; cable-to-cable and cable-to-chassis connections. Many of which meet unusual environmental requirements.

Amphenol builds specials, too. Some are variations of standards. Others were hatched to solve one-of-a-kind interconnection problems.

For instance, Amphenol designed and built a new high density micro-

miniature "Multi-Mod" connector with environmental seals, removable contacts and full modular construction. You can program both the contacts and the modules.

Amphenol's tiny Micro-Med bipolar probes are helping medical technicians make inexpensive brain implantations in laboratory animals.

And a modification of our 74 Series Micro-Min® connector is delivering

new cost and reliability advantages in a high-volume communication handset.

Ask an Amphenol Sales Engineer to show you how we can help you hatch a new idea in microelectronics and microminiature interconnection techniques. Call your distributor for off-the-shelf delivery. Amphenol Microelectronics, 2837 S. 25th Ave., Broadview, Illinois 60155.



AMPHENOL CONNECTOR DIVISION
AMPHENOL CORPORATION

Specify Amphenol . . . the leading name in cable, connectors, assemblies, RF switches, potentiometers, motors, microelectronics

A design advance

**Broadest line of standard
silicon modular power
supplies for fixed
voltage applications**

UP TO 60 VDC • UP TO 90 AMPS

Features and Data

Meet Mil. Environment Specs.

RFI—MIL-I-16910

Vibration: MIL-T-4807A

Shock: MIL-E-4970A • Proc 1 & 2

Humidity: MIL-STD-810 • Meth. 507

Temp. Shock: MIL-E-5272C •
(ASG) Proc. 1

Altitude: MIL-E-4970A • (ASG) Proc. 1

Marking: MIL-STD-130

Quality: MIL-Q-9858

Convection cooled—no heat sinking or
forced air required

Wide input voltage and frequency
range—105-132 VAC, 45-440 cps

Regulation (line) 0.05% plus 4mV
(load) 0.03% plus 3mV

Ripple and Noise—1mV rms, 3mV p to p

Package G

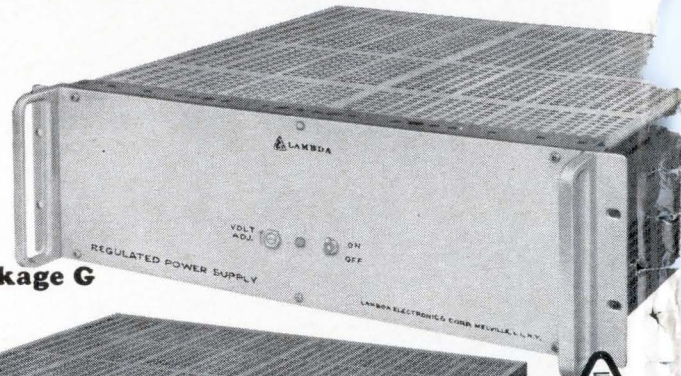

Package F



Package E



Package D

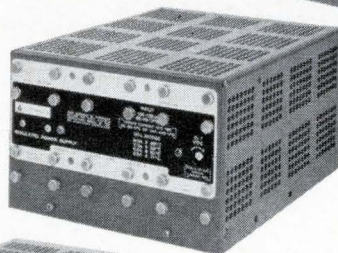

Package C

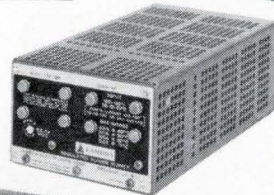

Package B

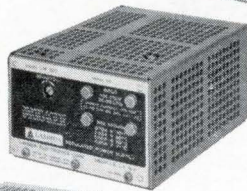

Package A

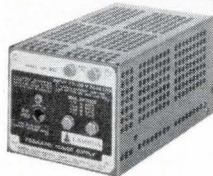

PATENTS PENDING

Circle 64 on reader service card



RACK ADAPTERS

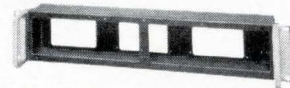

LRA-5—3½" height by 27/16" depth.
Mounts up to 4 A package sizes;
3 B or C package sizes; or 2 A and 1 B or
C package sizes. Price \$35.00

LRA-4—3½" height by 14" depth.
(For use with chassis slides)
Mounts up to 4 A package sizes; 3 B or C
package sizes; or 2 A and 1 B or C
package sizes. Price \$55.00

LRA-3—5¼" height by 27/16" depth.
Mounts up to 4 A, B or C package sizes;
2 D or 2 E packages sizes; or 2 A, B or C
and 1 D or 1 E package sizes. Price \$35.00

LRA-6—5¼" height by 14" depth.
(For use with chassis slides)
Mounts up to 4 A, B or C package sizes;
2 D or 2 E packages sizes; or 2 A, B or C
and 1 D or 1 E package sizes. Price \$60.00



LAMBDA ELECTRONICS CORP.
515 BROAD HOLLOW ROAD • MELVILLE, L. I., NEW YORK • 516 MYRTLE 4-4200

from Lambda

Ordering Information

METERS— $3\frac{1}{2}$ " Metered panel MP-3 is used with rack adapters LRA-4, LRA-5 and packages A, B and C.

$5\frac{1}{4}$ " Metered panel MP-5 is used with rack adapters LRA-6, LRA-3 and packages A, B, C, D and E.

To order these accessory metered panels, specify panel number which MUST BE FOLLOWED BY the MODEL NUMBER of the power supply with which it will be used.

Examples For Lambda Panel Model No.
Metered Panels Model and Price
MP-3 LM-B2 MP-3-LM-B2 \$40
MP-5 LM-B2 MP-5-LM-B2 \$40

Note—F and G LM Packages are full rack power supplies available metered or non-metered. For metered

OVERVOLTAGE PROTECTION—Externally mounted adjustable crowbar type overvoltage protection accessory for use with A, B, C and D packages—\$25.

E, F and G packages available with built-in overvoltage protection. To order crowbar type overvoltage protection for E, F and G packages, add suffix OV to the model no. and \$60 to the E package price and \$90 to the F and G package price.

FIXED VOLTAGES—In addition to the fixed voltages listed, any fixed voltage is available up to 65 VDC at moderate surcharge.

models, add suffix M to the Model No. and \$30 to the non-metered price.

Package A $3\frac{1}{16}$ " x $3\frac{3}{4}$ " x $6\frac{1}{2}$ "

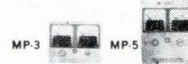
Accessory Metered Panels: \$40.00

Model	ADJ. VOLT. RANGE VDC	I MAX. AMPS ¹				Price
		40°C	50°C	60°C	71°C	
LM-201	0-7	0.85	0.75	0.70	0.55	\$ 79
LM-202	0-7	1.7	1.5	1.4	1.1	99
LM-203	0-14	0.45	0.40	0.38	0.28	79
LM-204	0-14	0.90	0.80	0.75	0.55	99
LM-205	0-32	0.25	0.23	0.20	0.15	79
LM-206	0-32	0.50	0.45	0.40	0.30	99
LM-207	0-60	0.13	0.12	0.11	0.08	89
LM-208	0-60	0.25	0.23	0.21	0.16	109

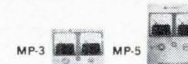

Package B $3\frac{1}{16}$ " x $4\frac{1}{16}$ " x $6\frac{1}{2}$ "

Accessory Metered Panels: \$40.00

Model	ADJ. VOLT. RANGE VDC	I MAX. AMPS ¹				Price
		40°C	50°C	60°C	71°C	
LM-217	8.5-14	2.1	1.9	1.7	1.3	\$119
LM-218	13-23	1.5	1.3	1.2	1.0	119
LM-219	22-32	1.2	1.1	1.0	0.80	119
LM-220	30-60	0.70	0.65	0.60	0.45	129
LM-B2	2 ±5%	3.4	3.0	2.3	1.4	119
LM-B3	3 ±5%	3.4	3.0	2.3	1.4	119
LM-B4	4 ±5%	3.4	3.0	2.3	1.4	119
LM-B4P5	4.5±5%	3.3	2.9	2.2	1.4	119
LM-B5	5 ±5%	3.3	2.9	2.2	1.4	119
LM-B6	6 ±5%	3.2	2.8	2.2	1.3	119
LM-B8	8 ±5%	3.0	2.7	2.2	1.3	119
LM-B9	9 ±5%	2.7	2.5	2.1	1.3	119
LM-B10	10 ±5%	2.6	2.4	2.1	1.3	119
LM-B12	12 ±5%	2.4	2.3	2.1	1.3	119
LM-B15	15 ±5%	2.1	1.9	1.7	1.2	119
LM-B18	18 ±5%	1.8	1.6	1.5	1.2	119
LM-B20	20 ±5%	1.6	1.4	1.3	1.1	119
LM-B24	24 ±5%	1.3	1.2	1.1	1.0	119
LM-B28	28 ±5%	1.2	1.1	1.0	0.90	119
LM-B36	36 ±5%	1.1	1.0	0.90	0.85	129
LM-B48	48 ±5%	0.90	0.85	0.80	0.75	129



Package C $3\frac{1}{16}$ " x $4\frac{1}{16}$ " x $9\frac{1}{4}$ "

Accessory Metered Panels: \$40.00

Model	ADJ. VOLT. RANGE VDC	I MAX. AMPS ¹				Price
		40°C	50°C	60°C	71°C	
LM-225	0-7	4.0	3.6	3.0	2.4	\$139
LM-226	8.5-14	3.3	3.0	2.5	2.0	139
LM-227	13-23	2.3	2.1	1.7	1.4	139
LM-228	22-32	2.0	1.8	1.5	1.2	139
LM-229	30-60	1.1	1.0	0.80	0.60	149
LM-C2	2 ±5%	4.9	4.2	3.5	2.4	139
LM-C3	3 ±5%	4.9	4.2	3.5	2.4	139
LM-C4	4 ±5%	4.9	4.2	3.5	2.4	139
LM-C4P5	4.5±5%	4.9	4.2	3.4	2.4	139
LM-C5	5 ±5%	4.8	4.1	3.3	2.4	139
LM-C6	6 ±5%	4.6	4.0	3.1	2.4	139
LM-C8	8 ±5%	4.4	3.8	3.0	2.0	139
LM-C9	9 ±5%	4.2	3.6	3.0	2.0	139
LM-C10	10 ±5%	4.0	3.5	2.9	2.0	139
LM-C12	12 ±5%	3.8	3.3	2.8	2.0	139
LM-C15	15 ±5%	3.4	3.2	2.7	1.8	139
LM-C18	18 ±5%	3.0	2.8	2.5	1.7	139
LM-C20	20 ±5%	2.9	2.7	2.4	1.7	139
LM-C24	24 ±5%	2.5	2.4	2.2	1.5	139
LM-C28	28 ±5%	2.3	2.1	2.0	1.4	139
LM-C36	36 ±5%	2.0	1.8	1.7	1.3	149
LM-C48	48 ±5%	1.6	1.4	1.3	1.0	149



Package D $4\frac{1}{16}$ " x $7\frac{1}{4}$ " x $9\frac{1}{4}$ "

Accessory Metered Panels: \$40.00

Model	ADJ. VOLT. RANGE VDC	I MAX. AMPS ¹				Price
		40°C	50°C	60°C	71°C	
LM-234	0-7	8.3	7.3	6.5	5.5	\$199
LM-235	8.5-14	7.7	6.8	6.0	4.8	199
LM-236	13-23	5.8	5.1	4.5	3.6	209
LM-237	22-32	5.0	4.4	3.9	3.1	219
LM-238	30-60	2.6	2.3	2.0	1.6	239
LM-D2	2 ±5%	13.1	11.3	9.2	6.2	199
LM-D3	3 ±5%	13.1	11.3	9.2	6.2	199
LM-D4	4 ±5%	13.1	11.3	9.2	6.2	199
LM-D4P5	4.5±5%	13.1	11.3	9.2	6.2	199
LM-D5	5 ±5%	12.6	10.8	9.2	6.1	199
LM-D6	6 ±5%	12.4	10.6	8.9	6.0	199
LM-D8	8 ±5%	12.2	10.3	8.8	5.9	199
LM-D9	9 ±5%	11.3	10.0	8.6	5.7	199
LM-D10	10 ±5%	10.8	9.7	8.5	5.7	199
LM-D12	12 ±5%	10.0	9.2	8.3	5.7	199
LM-D15	15 ±5%	9.0	8.4	7.9	5.3	209
LM-D18	18 ±5%	7.9	7.4	6.9	5.0	209
LM-D20	20 ±5%	7.4	6.9	6.5	4.9	209
LM-D24	24 ±5%	6.7	6.3	5.8	4.8	219
LM-D28	28 ±5%	6.0	5.6	5.2	4.7	219
LM-D36	36 ±5%	5.4	5.0	4.7	4.3	239
LM-D48	48 ±5%	4.1	3.9	3.6	3.1	239



Package E $4\frac{1}{16}$ " x $7\frac{3}{4}$ " x $11\frac{1}{2}$ "

Accessory Metered Panels: \$40.00

Model	ADJ. VOLT. RANGE VDC	I MAX. AMPS ¹				Price
		40°C	50°C	60°C	71°C	
LM-E2	2 ±5%	18.0	16.0	15.0	10.0	\$269
LM-E3	3 ±5%	18.0	16.0	15.0	10.0	269
LM-E4	4 ±5%	17.0	16.0	15.0	10.0	269
LM-E4P5	4.5±5%	16.0	15.0	14.0	10.0	269
LM-E5	5 ±5%	16.0	15.0	13.0	10.0	269
LM-E6	6 ±5%	15.0	14.0	12.0	10.0	269
LM-E8	8 ±5%	14.0	13.0	12.0	9.5	269
LM-E9	9 ±5%	13.5	12.5	11.0	9.5	269
LM-E10	10 ±5%	13.0	12.0	10.0	9.2	269
LM-E12	12 ±5%	12.0	11.0	9.5	9.0	269
LM-E15	15 ±5%	11.0	10.0	9.0	8.5	269
LM-E18	18 ±5%	10.5	9.5	8.5	8.1	269
LM-E20	20 ±5%	10.0	9.0	8.3	7.7	269
LM-E24	24 ±5%	9.0	8.5	7.7	7.0	269
LM-E28	28 ±5%	8.5	8.0	7.3	6.6	269
LM-E36	36 ±5%	6.8	6.3	5.9	5.2	279
LM-E48	48 ±5%	5.0	4.6	4.3	3.9	299



Package F $3\frac{1}{2}$ " x 19 " x $16\frac{1}{2}$ "

For metered models, add suffix (M) to model number and \$30.00 to the price below.

Model	ADJ. VOLT. RANGE VDC	I MAX. AMPS ¹			Price	
		40°C	50°C	71°C		
LM-F2	2 ±5%	44.0	39.0	32.0	24.0	\$425
LM-F3	3 ±5%	44.0	39.0	32.0	24.0	425
LM-F4	4 ±5%	44.0	39.0	32.0	24.0	425
LM-F4P5	4.5±5%	44.0	39.0	32.0	24.0	425
LM-F5	5 ±5%	44.0	38.0	31.0	24.0	425
LM-F6	6 ±5%	43.0	37.0	30.0	23.0	425
LM-F8	8 ±5%	40.0	34.0	28.0	22.0	425
LM-F9	9 ±5%	38.0	32.0	26.0	21.0	425
LM-F10	10 ±5%	36.0	31.0	25.0	20.0	425
LM-F12	12 ±5%	30.0	26.0	21.0	16.0	425
LM-F15	15 ±5%	25.0	22.0	18.0	15.0	425
LM-F18	18 ±5%	23.0	20.0	17.0	13.0	395
LM-F20	20 ±5%	21.0	19.0	16.0	12.0	395
LM-F24	24 ±5%	18.0	16.0	13.0	10.0	380
LM-F28	28 ±5%	17.0	15.0	13.0	9.5	380
LM-F36	36 ±5%	13.0	11.0	10.0	7.5	395
LM-F48	48 ±5%	10.0	9.0	7.5	6.0	425

Package G $5\frac{1}{4}$ " x 19 " x $16\frac{1}{2}$ "

For metered models, add suffix (M) to model number and \$30.00 to the price below.

Model	ADJ. VOLT. RANGE VDC	I MAX. AMPS ¹				Price
		40°C	50°C	60°C	71°C	
LM-G2	2 ±5%	90.0	83.0	62.0	43.0	\$575
LM-G3	3 ±5%	85.0	80.0	62.0	43.0	575
LM-G4	4 ±5%	77.0	71.0	61.0	43.0	575
LM-G4P5	4.5±5%	72.0	68.0	60.0	43.0	575
LM-G5	5 ±5%	68.0	64.0	59.0	43.0	575
LM-G6	6 ±5%	60.0	55.0	52.0	43.0	525
LM-G8	8 ±5%	59.0	54.0	48.0	39.0	525
LM-G9	9 ±5%	58.0	53.0	47.0	37.0	525
LM-G10	10 ±5%	56.0	52.0	44.0	35.0	525
LM-G12	12 ±5%	48.0	44.0	37.0	29.0	525
LM-G15	15 ±5%	39.0	37.0	31.0	24.0	525
LM-G18	18 ±5%	32.0	30.0	27.0	21.0	525
LM-G20	20 ±5%	30.0	28.0	25.0	20.0	525
LM-G24	24 ±5%	27.0	25.0	20.0	16.0	480
LM-G28	28 ±5%	25.0	23.0	19.0	15.0	480
LM-G36	36 ±5%	22.0	20.0	16.0	13.0	525
LM-G48	48 ±5%	17.0	14.0	12.0	9.0	575

¹ Current rating is from zero to I max.

Current rating applies over entire output voltage range.

Current rating applies for input voltage 105-132 VAC 55-65 cps.

For operation at 45-55 cps and 360-440 cps derate current rating 10%.

Now there are 2 split- screen bistable storage oscilloscopes on the market!

(Tektronix developed both of them)

The exclusive Tektronix split-screen, bistable storage feature is now available in two oscilloscopes, the new DC-to-30 MHz Type 549 and the familiar DC-to-15 MHz Type 564.

Both offer the unique capability for simultaneous storage and conventional oscilloscope operation, plus general purpose convenience and plug-in versatility. These features and new, reduced prices for the Type 564/RM564 add up to the kind of value you can expect from Tektronix.

Tektronix Bistable Storage Offers
Contrast of a stored trace independent of viewing time
Brightness of a stored trace independent of viewing time
Brightness of a stored trace independent of writing speed

Storage Scope		Type 549	Type 564	Type 564 Mod 08
Brightness		2.5 ft. L	6 ft. L	2 ft. L
Writing Speed	Normal	0.5 cm/ μ s	25 cm/ms	100 cm/ms
	Enhanced	> 5 cm/ μ s	> 125 cm/ms	500 cm/ms
Contrast Ratio		> 4:1	2:1	2:1
Erasure		split screen full screen remote/Auto	split screen full screen	split screen full screen
Display Area		6 cm x 10 cm	8 cm x 10 cm	8 cm x 10 cm

■ **3 display modes**—(1) split-screen combination of storage/conventional displays, (2) full-screen storage, or (3) full-screen conventional displays.

■ **saves film**—extended viewing times of stored displays permit detailed waveform analysis in many instances without photography.

■ **simplifies trace photography** — once initial camera setting has been determined, no further camera adjustments are necessary, regardless of conditions under which future stored traces are obtained.

■ **beam locate**—locate pushbutton offsets beam into a non-store area on left edge of display, permitting precise vertical positioning of beam before signal is stored.

■ **adapts easily to various applications**—accepts major plug-in lines for such applications as multi-trace, low-level differential, sampling, spectrum analysis, others.

■ **Type 549 automatic erase**—can be selected for periodic or after sweep operation with selectable viewing times from 0.5 second to 5 seconds. In addition, Erase-and-Reset pushbutton—which permits erasing display and rearming single sweep—can be controlled remotely, if desired.



Type 549 DC-to-30 MHz

with sweep delay and
> 5 cm/μs writing
speed; accepts letter
and 1-series plug-ins

Type 564 DC-to-15 MHz

accepts 2 and 3 series
vertical and time-base
plug-ins

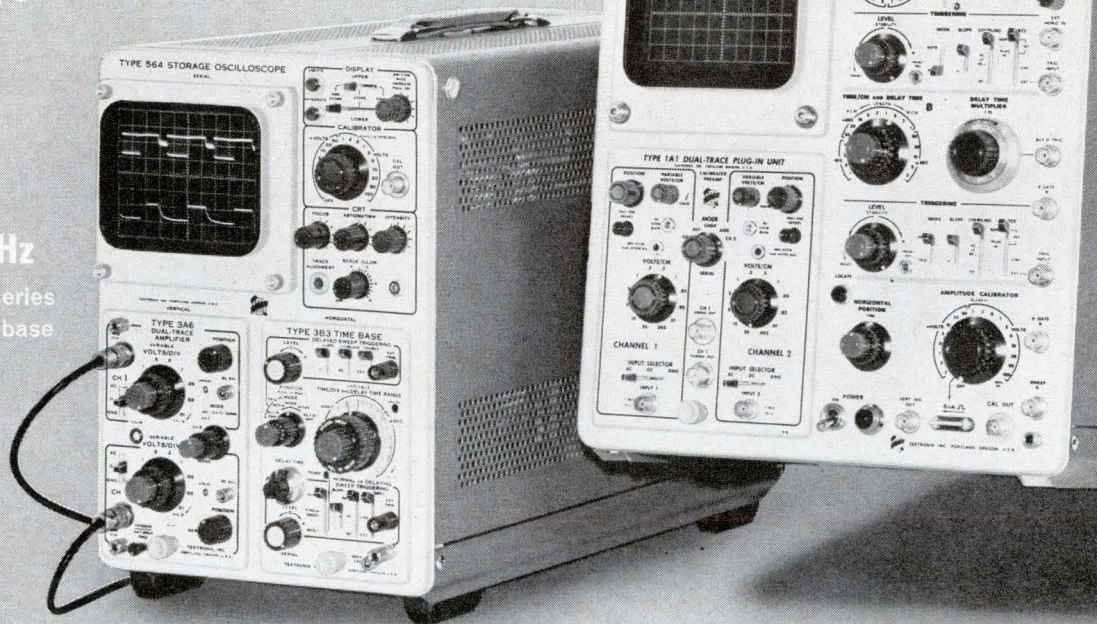

TYPE 564

Storage time — Bistable Storage provides a stored display for up to one hour.

Erase time — 250 ms full cycle at normal operating level.

Type 564 Storage Oscilloscope \$875
Size is 13½" high by 9¾" wide by 21½" deep; net weight is 33 pounds.
Uses 2-series and 3-series plug-ins.

Rack Mount Model RM564 \$960
(same performance specifications, yet occupies only 7" standard rack height)

(Bandwidth DC-to-15 MHz with Type 3A5 Plug-in)

Plug-ins illustrated

Type 3B3 Time-Base Unit \$585
(normal and delayed sweeps — 0.5 μs/cm to 1 s/cm, calibrated sweep delay — 0.5 μs to 10 sec, single sweep, 5X Magnifier, full passband triggering, flexible, easy-to-use — simplified trigger logic)

Type 3A6 Dual-Trace Unit \$540
(Dual-Trace—10mV/cm at DC-to-10 MHz, 5 display modes)

U.S. Sales Prices, f.o.b. Beaverton, Oregon

TYPE 549

Storage time — Bistable Storage provides a stored display for up to one hour. When applications require maximum writing speed, viewing times of 20 minutes or less are recommended.

Erase time — 200 ms maximum, complete cycle.

Time base features — **Sweep Delay** — from 1 microsecond to 10 seconds. **Sweep Range** — 5 s/cm to 0.1 μs/cm (Time Base A) and 1 s/cm to 2 μs/cm (Time Base B). X5 Magnifier extends fastest sweeps to 20 ns/cm (Time Base A) and to 0.4 μs/cm (Time Base B). **Single Sweep** — manually, automatically, or remotely. **Full Passband Triggering** — with flexible, easy-to-use facilities, and **Simplified Trigger Logic** — with lever control of trigger functions.

Type 549 Storage Oscilloscope \$2,375
Size is 17" high x 13" wide x 24" deep; net weight is ≈ 67 pounds.
Uses letter and 1-series plug-ins.

Type 1A1 Dual-Trace Plug-In Unit (illustrated) \$600
(Dual Trace—50 mV/cm at DC-to-30 MHz*, 5 mV/cm at DC-to-23 MHz*. Single Trace—500 μV/cm at 2 Hz-to-14 MHz, 5 Display Modes, front panel signal output)

*When used in Type 549.

For information on how Tektronix can solve your measurement problem with a storage oscilloscope, call your Tektronix field engineer.

Tektronix, Inc.

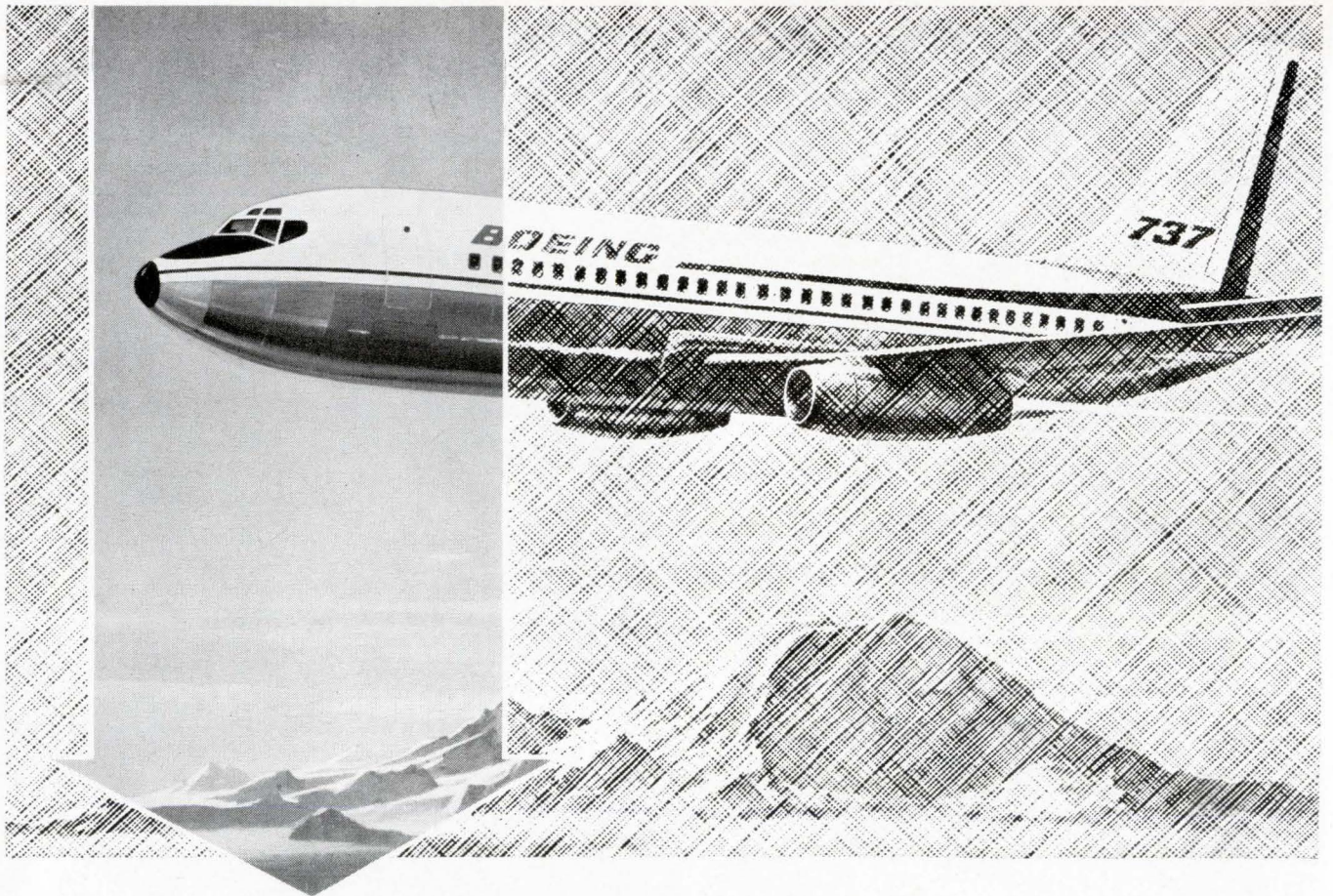

When 737 Simulators Were Needed MCDONNELL WAS A NATURAL

United Air Lines and Boeing have picked 737 Simulators built by McDonnell. They had good reasons. Naturally.

They found at McDonnell:

- Simulator design concepts based on efficient application of modern general purpose digital computers.
- Direct conversion of digital outputs to synchro instrument drives, without use of servos.
- All-digital computer inputs.
- Digital accuracy.
- Digital input flexibility.
- Self-test programs.
- Standard parts and solid-state components.
- Design for reliability.

McDonnell's years of simulation engineering and development experience—from fighter aircraft design evaluation to Gemini mission training—provide the practical know-how both air transport management and air line pilots can depend upon. McDonnell welcomes the tight reliability requirements of the 737 Simulator. We know the penalties of "down time" and we design to avoid them.

McDonnell is also prepared for other simulation problems.

Naturally.

MCDONNELL

*Phantom II Fighter, Attack and Reconnaissance Aircraft • STOL Transport •
Gemini and Aeroballistic Spacecraft • Escape Systems •
Electronic Systems • Photo Instrumentation Equipment and Systems • Automation*
ST. LOUIS

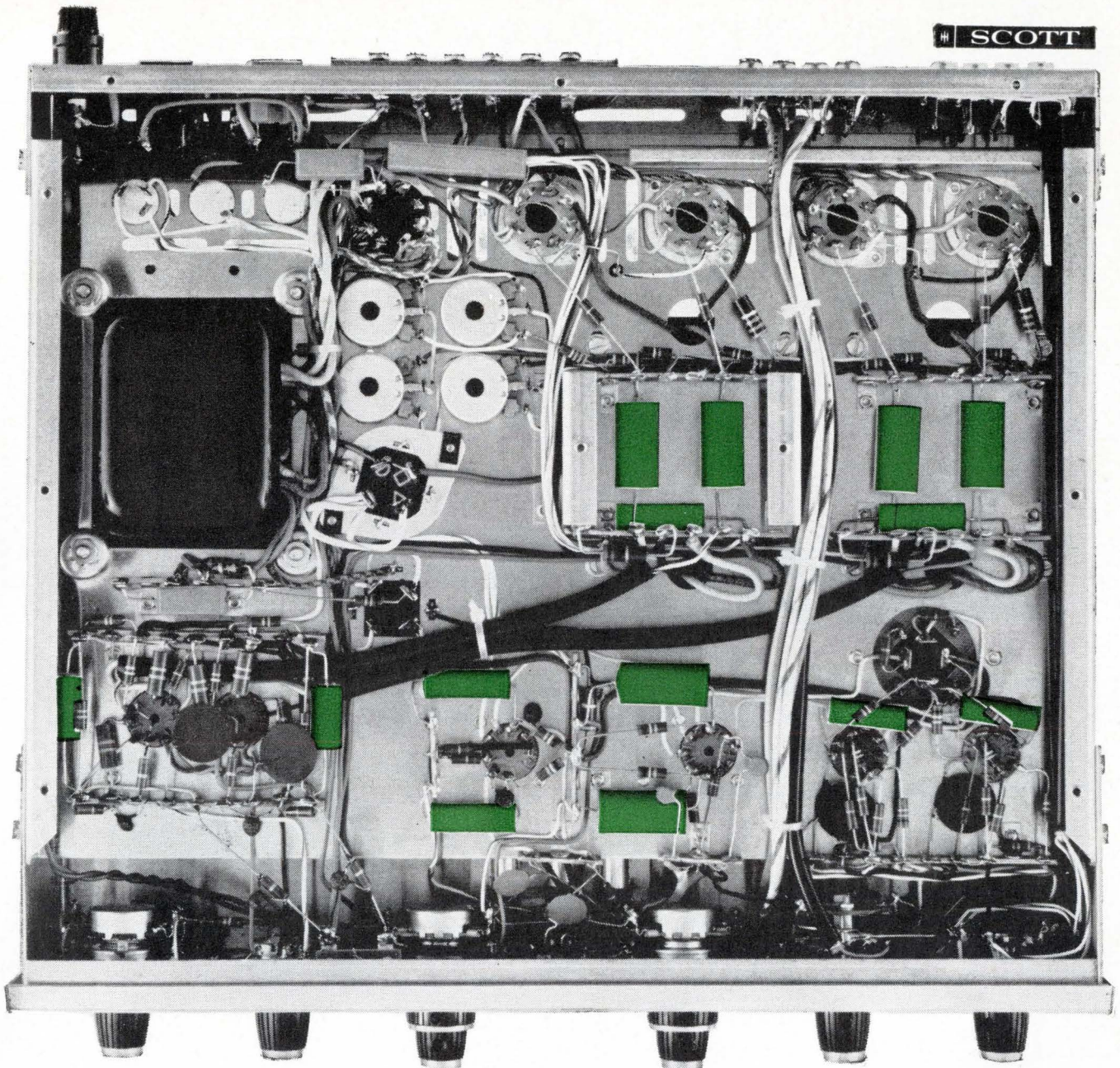

Capacitor reliability? Take Scott's word for it: MYLAR®

H. H. Scott manufactures some of the world's most widely used stereo amplifiers. They are recommended by many leading independent testing organizations. Because this kind of reputation depends on capacitor reliability, engineers at Scott use capacitors of MYLAR* exclusively for audio circuits from .047 to .47 microfarads:

"We don't have to worry about performance with capacitors of MYLAR in our components and consoles," says Chief Engineer Dah von Recklinghausen. "We use capacitors of MYLAR because of their low leakage, extremely long life, excellent capacitance stability and ability to withstand the wide temperature and humidity

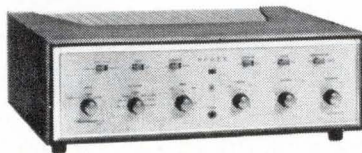

ranges encountered in high-power hi-fi amplifiers." MYLAR also offers high dielectric strength in thin gauges, so capacitors can be made smaller, leaving space for more circuitry. And, in many cases,

capacitors of MYLAR cost less than paper.

Scott components and consoles are known for excellence in quality, performance and reliability. So are capacitors of MYLAR. For complete information write DuPont Co., Room 3370A, Wilmington, Delaware 19898. (In Canada, write Du Pont of Canada Ltd., P.O. Box 660, Montreal 3, Quebec.)



Better Things for Better Living
...through Chemistry



*DU PONT'S REGISTERED TRADEMARK FOR ITS POLYESTER FILM.

This is the BCD decoder that ends make/buy decisions

Many users seem to think so.

We've built our numeric readout (the noteworthy NIXIE® tube, naturally!) into a handsome, compact package that not only gives you dependable low-level BCD-to-decimal conversion, but also enhances your most elegant design.

Most important, our BIP-8211P readout assembly carries a price tag so low that the savings in design, development, production, and testing will convince even the most parsimonious do-it-himselfer to reach for a P. O. instead of a slide rule.

Convenience? The decoder socket packs can be mounted in one of our bezel assemblies that handles up to 15 digits, mounts into your front-panel opening with just two screws, accommodates decimal points and colons.

Flexibility? It's odds-on that your own BCD circuits will drive the BIP-8211P without modification. But we also offer optional versions which accept just about any form of BCD, or one that gives you straight decimal-to-decimal driving, should that be what you need.

Reliability? Continuing environmental and life testing add up to dependable operation in severe environments of temperature, shock and vibration. All this and an enthusiastic Zero Defects Program, too!

Availability? We've tooled up a new production line that's turning out BIP-8211P modules in quantities large enough to make shipment possible in an interval no longer than the time it takes to process the paperwork. Need them even faster for bread-boarding or prototyping? They're priced low enough to order them now, and have them in arm's reach.

Got a BCD-decoding requirement? Leave it to Burroughs! You'll be glad—so will your comptroller—so will the user.

Write or call for full information.

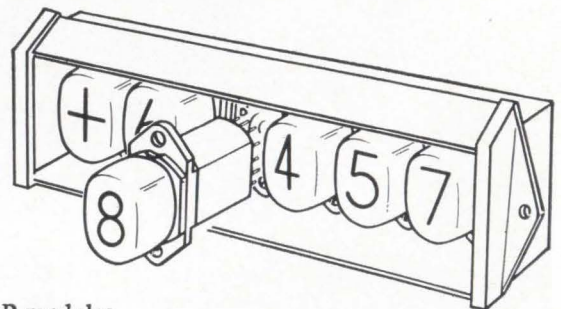
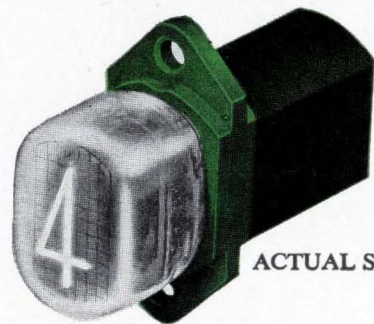

Burroughs Corporation

ELECTRONIC COMPONENTS DIVISION

PLAINFIELD, NEW JERSEY 07061

Technical Articles

Using strip transmission lines to design microwave circuits, part I: page 72

Electronics



Though strip transmission lines are not new, many engineers have been reluctant to use them because they don't understand them. But the pressure to miniaturize microwave equipment—a byproduct of the acceptance of solid state devices—has stimulated their use. One big advantage is the size reduction, shown clearly by this issue's cover. In the photograph, taken at the Sylvania Electric Products, Inc.'s Williamsville, N. Y., plant, the strip line card does the work of the other hardware.

Phase-locked marker improves spectrum analyzer's accuracy: page 88

A new instrument allows the rapid identification and accurate measurement of any frequency in the spectrum. This frequency-measuring spectrum analyzer has a phase-locked marker and a modified display to offset the limitations of previous spectrum analyzers. It can aid in analyzing radio-frequency interference.

Putting superconductors to work: page 95

More than a dozen companies are making superconductor magnets and systems. The discovery of new materials is speeding the use of superconductors in applications as diverse as giant research magnets, masers and magnetohydrodynamic generators.

The packaging revolution—simpler designs for complex system: page 109

To avoid complicated, expensive interconnection structures, an engineer has to adopt new procedures when designing a complex digital system with integrated circuits. These new practices force the system's functional organization to be regular and the interconnections simple.

Coming February 21

- Optoelectronic devices in memories
- Converting to hybrid integrated circuits
- Survey of strip transmission lines: part II

Using strip transmission line to design microwave circuits, part I

The first article in a two-part survey of the characteristics and capabilities of strip transmission line examines tested design procedures for reliable, low-cost multipliers, filters and diode switches

By J. Richard Dangl and Kenneth P. Steele

Sylvania Electronics Systems, Williamsville, N.Y.

Practical design procedures, developed over the last few years, are resulting in the wider use of strip transmission line in miniaturized microwave circuits. Ideally suited for low and medium power applications, strip transmission line is used to design low-cost, solid state circuits with improved electrical characteristics and increased reliability. But design engineers, interested in taking advantage of the line's capabilities, have been hard put to find a broad examination of this invaluable technology.

Strip transmission line consists of a thin rectangular center surrounded by dielectric, and spaced between two highly conducting ground planes, as shown in the diagram on page 73. Printed circuit techniques are used to construct the line. The fundamental propagation mode is a trans-

verse electromagnetic wave.

Components such as semiconductors and ferrites can be embedded in the line, and passive elements such as filters can be formed by chemically etching the center conductor. The low cost of etching passive components means that multiresonant filters can be used to improve the electrical performance of many semiconductor circuits such as varactor multipliers and tunnel-diode amplifiers.

Characteristics

Strip transmission line reduces equipment size because equivalent electrical line lengths are reduced in inverse proportion to $\sqrt{\epsilon_r}$, where ϵ_r is the relative dielectric constant of the material used in the construction of the line. For dielectrics such as the polyolefins, $\epsilon_r = 2.3$; thus linear dimensions are reduced by a factor of 1.5. Size reduction by a factor of two or three can be provided by higher dielectric constant materials, but their other physical characteristics, such as brittleness, make them less suitable. An example of size reduction is illustrated in the photograph on page 73.

Uniformity and accuracy of circuits designed in the line depend on the quality of the dielectric material. The development of irradiated polyolefin dielectrics was a major breakthrough because it made available low-loss dielectric materials with desirable electrical and physical characteristics. These materials typically have dielectric constants of about 2.25 to 2.32, and loss tangents as low as 0.0001 into the K_u frequency band (12.4 to 18 Gc). Polyolefin is more temperature-stable than previously available low-loss dielectrics, permitting its use in miniature equipment operating at ambient temperatures as high as 85°C. Even

The authors



J. Richard Dangl, the microwave department manager, graduated from the Massachusetts Institute of Technology in 1947. He specializes in semiconductor applications for the uhf, microwave and millimeter frequency-bands.



Kenneth P. Steele, a research engineer at Sylvania, has for the past seven years been engaged in the design and development of high power, solid state microwave signal sources. One of his prime responsibilities is the development of new multipliers.

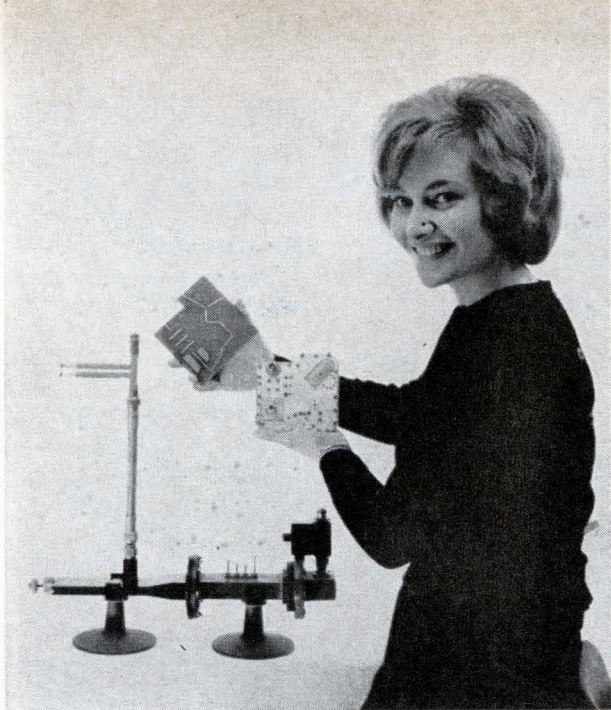

Comparison of equivalent microwave and strip transmission line circuits shows the reduction in size offered by the latter technique. Girl holds both the basic strip transmission line circuit board and the complete package for a varactor tripler.

when produced in large quantities, the material is extremely homogeneous.

The superiority of strip transmission line over waveguide or coaxial cable can be demonstrated by showing that a solid state frequency source, consisting of a chain of varactor multipliers, can be made to operate more reliably without increasing its cost. To reduce the number of diode stages, each stage should multiply the frequency by a large factor. However, high-order multiplication is less efficient than an equivalent chain of low-order multipliers. To increase the circuit's efficiency, additional resonators for sustaining idler frequen-

cies must be added. Also, multiple resonator filters with Chebyshev or maximally flat characteristics are needed to increase bandwidth and prevent spurious outputs. When strip transmission line is used, these complex circuits can be produced economically because the additional resonators can be etched at a negligible increase in cost. The increased efficiency permits the use of high-order multiplication, resulting in fewer diode stages. Additionally, the large bandwidths prevent severe physical environments from changing electrical parameters and performance. Both factors increase the circuit's reliability.

Another distinguishing characteristic of strip transmission line is its compatibility with solid state devices. This feature acquires increased significance now that semiconductor manufacturers are producing devices in sizes to match the line's thickness and to fit special diode mounts. The ultimate in compatible design—the use of the same semiconductor material as the strip transmission line's dielectric and as the substrate for active elements such as diodes—is under experimental investigation in a number of laboratories.

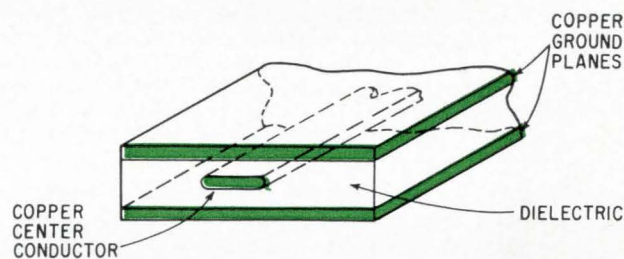

In a typical strip transmission line, a center conductor guides electrical energy between two conducting ground planes. Here the thickness of the center and ground planes has been greatly exaggerated.

I. Synthesis of strip transmission line

The evolution of strip transmission line is illustrated on page 74.^{1,2} The line may be considered as a development of the parallel-wire line. In this line, the two wires carry equal and opposite currents and the field is in the form of a transverse electromagnetic wave (TEM). In a TEM wave, no longitudinal component of field exists, that is, there is no component of field in the direction of propagation. The TEM mode is the principal mode in coaxial cable, but cannot exist in rectangular waveguide.

If a thin, perfectly conducting metal plate that is infinite in extent is placed perpendicular to, and at the midpoint of, the line joining the centers of the wires, the field pattern will not be disturbed if one of the wires is removed. In effect, a virtual image of the remaining wire is produced in the

metal plate to maintain the same electric field configuration. This basic concept leads to microstrip—one of the earliest and simplest of lines. In microstrip, the wire conductor is formed into a rectangle and a dielectric material is added as mechanical support for the conductor. The metal plate is called a ground plane.

A major disadvantage of microstrip is the radio-frequency leakage resulting from the use of only one ground plane. This difficulty is overcome by adding a second ground plane as in the three air-dielectric transmission lines in the center panel of the diagram.

Of the three types of line illustrated, only the line with the circular center conductor is still used extensively. This line, called shielded strip line or slab line, is used for breadboard and research

The evolution of strip transmission line . . .

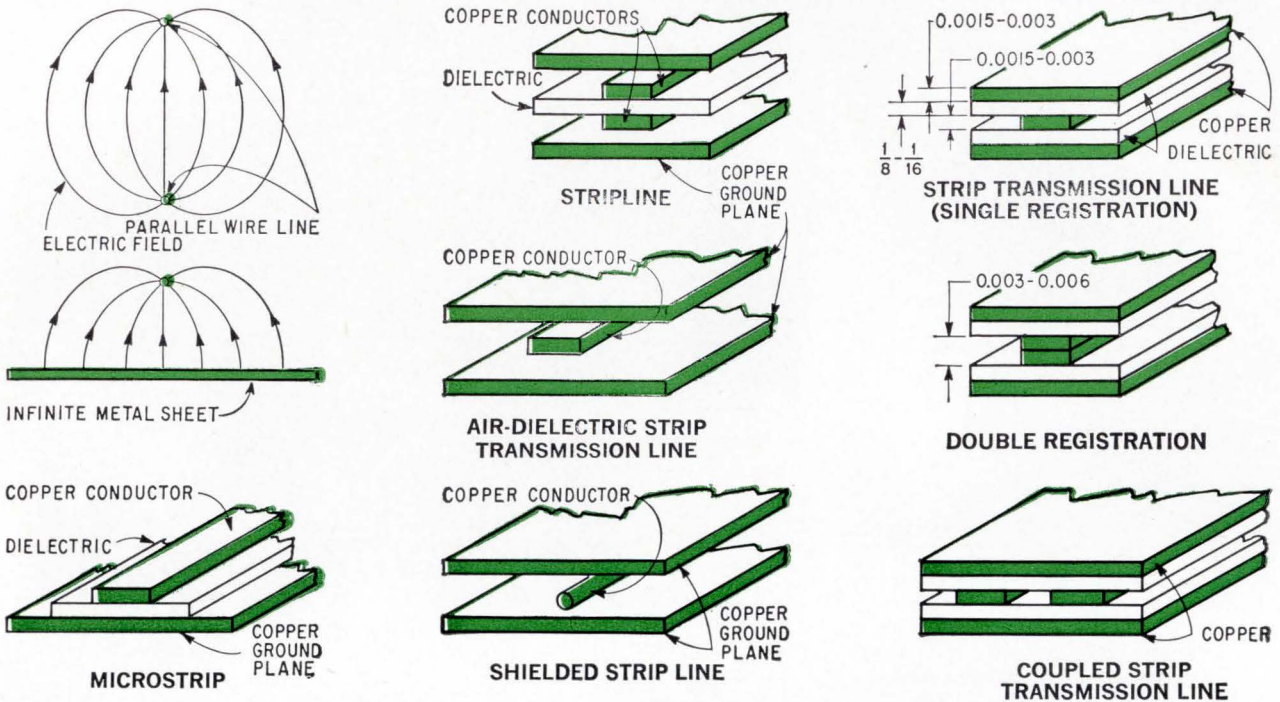

Strip transmission line development starts with the parallel wire line at the upper left. The field around the upper wire is not changed if a metal sheet is inserted between the wires, and the lower wire is removed. This leads to the microstrip configuration. Air dielectric lines in the middle of the diagram reduce r-f radiation but the center conductors are difficult to support. Strip transmission line at the upper right is formed from two copper clad sheets that are sandwiched together to form a rugged, compact package. Both single and double registration are used in circuit design. The coupled strip transmission line is the basic structure for various coupling networks and filters, and is one of many configurations that can be designed.

purposes because it is easy to modify. In addition, short-circuited stubs, which are useful in experimental work, can be built easily in the shielded strip line configuration.

The major problem with the three air-dielectric transmission lines is that the support for the center conductor is too complex and may not be rugged enough for many environmental conditions. The deficiency is overcome by using the strip transmission line shown at the right in the diagram.

Strip transmission line is built using two sheets of copper-clad dielectric. The dielectric is normally 1/16 to 1/8 inch thick and is clad with 1 or 2 ounces of copper per square foot. The center conductor is formed by chemically etching away the copper on

one side of a doubly-clad board. Then the two sheets are brought together to form the sandwich structure. To provide rigidity and insure uniformity, the boards are fastened between two lightweight, metal pressure plates.

Because of the thickness of the center conductor, there is an air gap of .0015 to .003 between the dielectrics of the two sheets. This air gap is important only when there is a possibility of peak power breakdown.

Both single and double registration types are shown in the diagram. In double registration, center conductors are etched on each of the dielectric sheets. Double registration is used when the lines are butted together. The additional thick-

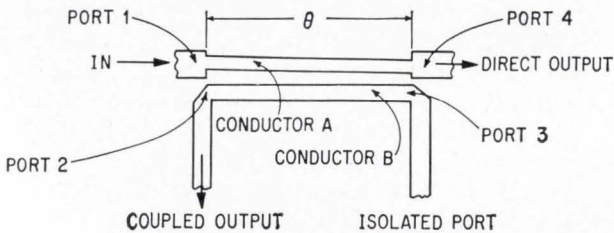

Directional coupler may be constructed with the center conductor configuration shown at the left. The coupler supports even and odd modes whose electric fields are shown in the figures at the right. In the odd mode (the lower figure), the direction of the electric field on one side of this axis of symmetry is opposite to the direction on the other side.

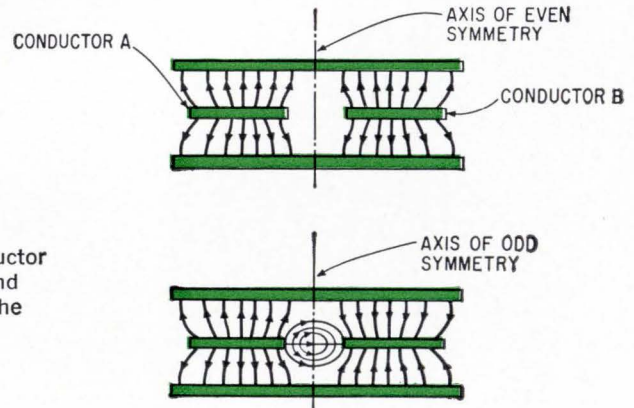

conductor reduces the possibility of discontinuity at the joint and therefore low voltage standing wave ratios. Single registration can suffice if proper alignment and processing controls are used. The coupled strip transmission line, shown in the right hand corner of the panel on page 74, is the basic configuration for many important components such as directional couplers, hybrid couplers and parallel coupled filters.

The center conductor configuration and the four ports of a directional coupler are shown at the left of the diagram at the bottom of page 74. The coupling mechanism may be explained by the electric field distribution for the fundamental TEM modes, shown at the right of the diagram. The even mode results when the currents in the two conductors are both equal and in the same direction. The odd mode results when the currents in the conductors are equal but in opposite directions. It is the odd mode which couples the two conductors.

Energy flow

If one superimposes the fields from the two modes, it can be seen that the fields will be additive at one conductor and opposing at the other. Under these conditions, most of the energy is concentrated along one of the conductors and a small coupling field exists between the two conductors. The conductor which supports the larger field is represented by the direct line between ports 1 and 4 in the center conductor. Most of the energy flowing into port 1 will flow out of port 4. Some of the energy will be coupled to the other line and will flow out of port 2. Theoretically, no energy flows out of port 3 if it is properly terminated. The coupling mechanism may also be explained in terms of the capacitance between the two lines. This is a useful viewpoint when the coupled lines are used as filter elements. For maximum coupling to occur, the electrical length of the line is $\lambda/4$ where λ is wavelength in the dielectric.

The coupler is theoretically matched at all frequencies if the input impedance of the coupler is equal to the source impedance Z_o . The input impedance, Z_o , and coefficient of coupling, k , of the coupled line is given by

$$Z_o = \sqrt{Z_{oe}Z_{oo}}$$

$$k = \frac{Z_{oe} - Z_{oo}}{Z_{oe} + Z_{oo}}$$

where Z_{oo} is the odd-mode characteristic impedance, which is defined as the characteristic impedance of one line to ground when equal currents are flowing in the two lines; and Z_{oe} is the even-mode characteristic impedance, defined as the characteristic impedance of one line to ground when equal and opposite currents are flowing in the two lines. The width of each of the coupled conductors and the spacing between them can be found in nomograms in terms of Z_{oo} and Z_{oe} .²

Although strip transmission line is most accurately represented by distributed impedances,

Circuit equivalents . . .

CHARACTERISTIC IMPEDANCE

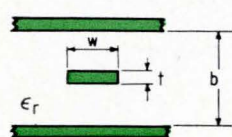

$$Z_o = \frac{60}{\sqrt{\epsilon_r}} \ln\left(\frac{4b}{\pi d_o}\right) \text{ OHMS}$$

ϵ_r = RELATIVE DIELECTRIC CONSTANT

d_o = DETERMINED FROM GRAPHS²

$w/b < 0.35$

SHUNT CAPACITANCE

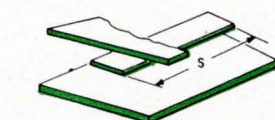

s IN INCHES

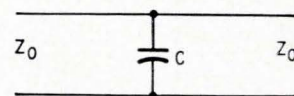

$$C \approx 0.9 \epsilon_r s \frac{w/b}{1-t/b} \text{ pF}$$

SERIES INDUCTANCE

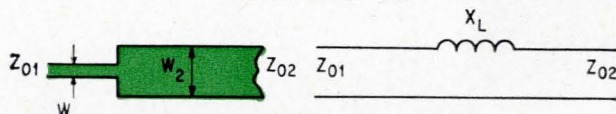

$$\frac{X_L}{Z_{o2}} = \left[\frac{2w_2 + (4b/\pi)(\ln 2)}{\lambda} \right] \text{CSC} \left(\frac{\pi}{2} \frac{Z_{o2}}{Z_{o1}} \right)$$

SERIES-RESONANT SHUNT CIRCUIT

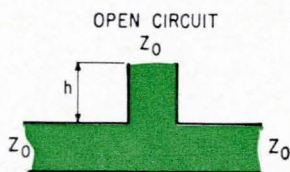

B_{OC} = SUSCEPTANCE

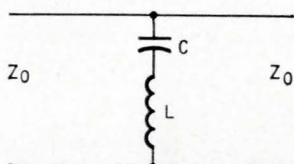

$$B_{OC} = \frac{j}{Z_o} \tan \left(2\pi \frac{h}{\lambda} \right) \text{ mhos}$$

Basic impedance relations and lumped circuit equivalents are indicated. These impedance configurations may be combined in many ways to form different circuits. Only the top view of the center conductor is showing in the diagrams of the series inductance and parallel resonant shunt circuit.

lumped-element circuits may be approximated with lengths of line that are small fractions of a wavelength. Because the line may be represented by lumped constant networks, it is possible in many instances to use low-frequency analysis to design passive microwave circuits such as filters. Illustrated in the diagram shown above are some of the equivalent impedance relationships.^{2,3} In this diagram the first two figures are end views of the line; the third and fourth figures are top views.

The characteristic impedance of the line is a function of the dimensions of the line and a parameter, d_o , which is a function of the thickness, t , of the center conductor. The value of d_o can be determined from graphs.²

In the second figure, shunt capacitance is seen to be equivalent to a short length of line, s . The total capacitance may be considered to be the sum

of the capacitance between the center conductor and the ground plane and the fringing capacitance at the edge of the center conductor.

Shunt capacitance may also be obtained with a metal post; one end forming a small gap with the center conductor and the other end shorted to the ground plane. Small machine screws are often used as the metal post.

A series capacitance (not shown) is formed by overlapping lengths of center conductor that are separated by a small piece of dielectric. The technique is useful when large capacitances are required. Smaller values of series capacitance are

obtained easily by cutting a ring in the center conductor. Series inductance is obtained by changing the width of the center conductor.

The open-circuited stub—the last figure in the diagram—is equivalent to a series-resonant circuit and is very useful, particularly for impedance matching and for low-pass filters. To permit tuning with a variable capacitor, capacitively loaded open-circuited stubs are also used. The circuit may be made to appear primarily capacitive or inductive depending on whether the stub is shorter or longer than $\lambda/4$.

II. Varactor multiplier frequency sources

Varactor multipliers use the nonlinear voltage-variable capacitance characteristics of a diode to generate microwave frequencies from a stable source.

A simple form of varactor multiplier is the doubler, which contains most of the elements that are common to all other multipliers.⁴

The shunt-type circuit at the top of the diagram shown below can be easily fabricated in strip transmission line. The low-pass filter matches the 50-ohm source impedance of the external generator. The filter prevents higher frequencies generated by

the varactor from appearing at the input. The input frequency is applied to the diode through the low-pass filter and the matching network. The nonlinear reactance of the diode generates the second and higher harmonics and the mixing products of the input frequency. The desired second harmonic is selected by the bandpass filter at the output.

The matching networks are usually quarter-wave transformers that match the real part of the diode impedance to the characteristic impedance of the line. Line lengths between the diode and the two

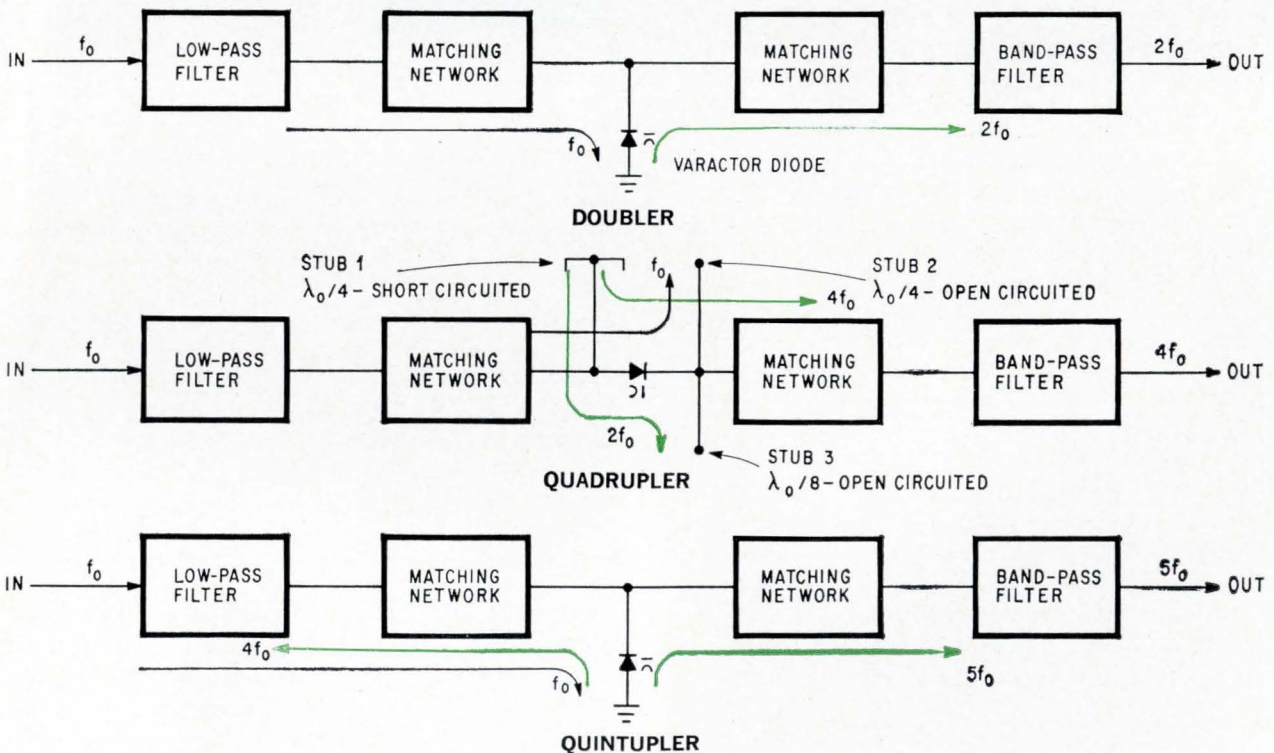

Multiplier circuits use various filters and matching networks to increase the bandwidth and provide conduction paths for the idler frequencies. Idler frequencies such as $4f_0$ in the quintupler are not available as the output, but improve the efficiency of converting the fundamental, f_0 , to the desired output frequency.

cancel the capacitive reactance. In addition, tunable line-stretchers, or variable capacitors, are added to the circuit for fine tuning. The major problems in multiplier design are canceling the diode impedance. The impedance of the diode, lead, junction and other parasitic reactances, which vary with both power level and frequency. An excellent theoretical analysis⁵ showing how diode reactance varies under different conditions, points out ways to reduce the amount of empirical work required in practical multiplier design.

The bandwidth of a doubler (top figure) may be increased considerably by making the input and output filters a complementary or pseudo-complementary filter pair which presents a theoretically constant load to the varactor over a wide frequency band.⁶ In a complementary pair, one of the filters tends to become more capacitive as frequency increases, and the other more inductive. As a result, the impedance seen by the diode remains constant. This arrangement sacrifices some efficiency since higher frequencies and harmonics are not generated. However, an efficiency of about 50% across a 20% frequency band has been obtained in both S (1,550-5,200 Mc) and C (5,000-6,500 Mc) bands.

Quadrupler

The quadrupler in the center of the figure at the left illustrates the use of a series diode configuration.⁷ The three stubs provide circuit paths through the diode for those frequencies which contribute to the desired output. Depending on the frequency, the stubs present either short circuits or open circuits to the line.

For the input frequency, f_0 , the path through the diode is terminated by the short circuit presented by stub 2. The second harmonic idler—a frequency which contributes to the desired output by mixing with other harmonics—flows between stubs 1 and 3. The desired output frequency $4f_0$ flows from stub 1 through the output filter. At f_0 and $4f_0$ the stubs present open circuits or high reactances so that these frequencies are not shorted out.

Quintupler

A strip transmission line quintupler designed by Sylvania engineers is shown at the bottom of the figure at the left. The quintupler is similar to the doubler previously described. However, in the quintupler, the line lengths between the diode and the filters are chosen both to cancel the diode capacitive reactance and to provide proper idling.⁸ For high efficiency, maximum current should flow through the diode at f_0 , $2f_0$, and $5f_0$. The presence of higher order harmonics also increases the efficiency.

Design of a varactor tripler

An example of the design of a tripler will indicate some of the important calculations and considerations required in designing multipliers in strip transmission line. For the tripler considered

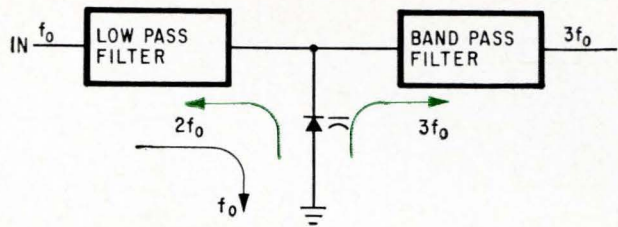

In the varactor tripler, separate matching networks are not included. Matching is obtained by properly positioning the filters on either side of the varactor diode.

here, an output power of 1 watt was required at a frequency of about 5,500 Mc. The input frequency, therefore, had to be 1,833 Mc. The specified bandwidth at the output was less than 1%, which presented no problem for this design.

The basic design is a shunt-diode configuration with the varactor placed between the input filter and the bandpass filter, as is shown above. For both electrical and mechanical reasons the shunt-diode configuration is the best for strip transmission line work. In this configuration, one end of the varactor is physically grounded, with the ground plane acting as an excellent heat sink. Tuning and access to the diode are also easier with the shunt configuration.

Positioning the diode

Location of the diode between filters depends both on the reflected impedance of the filters and the reactances of the diode. As in a doubler, the first approximation is to place the diode between the filters at a point which satisfies two conditions—namely, that the input low-pass filter present an open circuit to the diode junction at the third harmonic frequency and that the output bandpass filter present an open circuit to the diode junction at the fundamental frequency. These conditions prevent dissipation of the third harmonic and the fundamental at the input and output filters.

To idle the second harmonic, the tripler design also requires an additional circuit which presents a short circuit to the diode at $2f_0$. In the diagram shown above, this circuit could be a series tuned circuit, connected in parallel with the diode and resonant at $2f_0$. Here, the short at the diode was obtained by properly positioning the diode between the filters. The design of both the low-pass and bandpass filters is described later in this article.

The appropriate position of the open circuit which the input filter must present at the third harmonic, 5,550 Mc, can be calculated, but it is more precise to measure the position using a model of the filter. Measurements were made on a model fabricated in 1/16-inch Rexolene "P" dielectric. In these measurements the diode is not in the circuit. The output impedance of the low-pass filter at the second and third harmonic frequencies is measured with a coaxial slotted line, and plotted on a Smith chart. The Smith chart indicates the distances from the reference plane to the open and short circuits. The distance to the open circuit is represented on

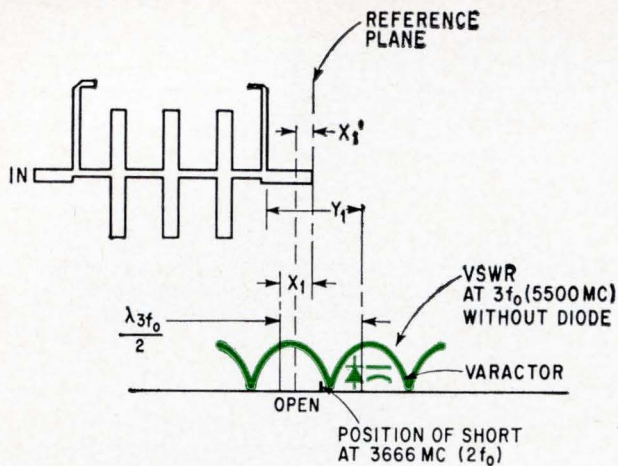

Position of the varactor with respect to the output port of the low-pass filter is determined from voltage standing wave measurements made at a frequency of $3f_0$ (5,500 Mc.). Distance X_1 indicates the position of an open circuit. Consideration of diode capacitance would require that the diode be placed at X_1 , which is too close to the filter. Therefore, the diode is moved back a half-wavelength placing it a distance Y_1 from the filter.

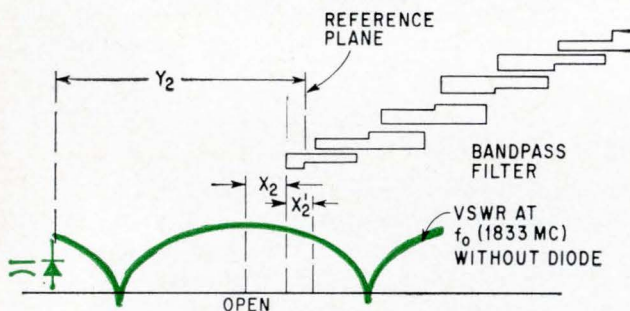

Bandpass filter at the output of the tripler is realized by using parallel-coupled transmission lines. As in the low-pass filter, the position of the varactor diode with respect to the filter is determined from measurements and the capacitance of the diode. The vswr measurement is made at a frequency of f_0 (1,833 Mc.).

the diagram of the low-pass filter shown above as distance X_1 .

Because of the capacitance introduced by the diode, the measured distance X_1 to the open circuit would not be correct. When the diode capacitance is accounted for, a standard Smith chart analysis shows that the open circuit actually occurs at X_1' . This would place the mounting structure for the diode too close to the filter. Therefore, the diode position is moved back a half-wavelength from X_1' . At this position it is a distance Y_1 from the output of the low-pass filter.

The value of capacitance used to calculate the position X_1' is taken from the diode data sheet—in this case, a type D4852E diode was used in the tripler. It has been found that the capacitance of the diode at -6 volts is a good approximation for the average capacitance. For the type D4852E diode this capacitance is 1.5 picofarads.

For the bandpass filter, input impedance measurements were made at 1,833 Mc to determine the location of the open and short circuits, as in the

lower diagram at the left. The diode relative to the input of the filter is determined by using the same procedure as for the low-pass filter.

The prototype of the multiplier is then fabricated with the initial position of the diode at a distance Y_1 from the low-pass filter and distance Y_2 from the bandpass filter. Past experience has shown that this initial position is very close to the final position which gives maximum power output, indicating the procedure yields a rather good approximation for the design of the multiplier.

To determine the final position of the diode, measurements of the tripler's performance are made at various power levels, frequencies, and diode positions. A peak in the power output indicates the exact position for mounting the diode. In these tests, a special diode mount is used to reposition the diode relative to each filter. In addition, the strip transmission line is cut at the calculated diode position to allow the distance between the filters to be varied slightly by adding spacing blocks. Using this technique for trimming the position of the diode, only one breadboard is required before an engineering model is made.

Evaluation of the completed tripler showed that the spacing between the filters remained the same as in the breadboard but that the diode was located at the short-circuit point of the second harmonic. This point is shown in the diagram of the input filter at the top of the page. This provides the necessary idling of the second harmonic, yet positions the diode closely enough to an open circuit at the third harmonic to satisfy the original conditions.

Fine tuning is achieved by capacitive tuning screws placed on each side of the diode. The distances between the diode and the two filters are slightly foreshortened to accommodate the tuning screws.

A good way to bias the varactor diode is to connect a d-c blocking joint (a microwave analog of a blocking capacitor) followed by a physically small carbon resistor at the input of the low-pass filter. The resistor, which should be at least 10,000 ohms, is connected in shunt with the line. It provides the required r-f isolation for the d-c power supply and acts as a current limiter for the varactor. Another common biasing circuit is an L-C filter. This method often causes spurious response problems and ringing, in the case of pulse operation.

Performance results

Test results obtained for the broadband tripler were in good agreement with predicted performance. A conversion loss of 4 db was obtained for a power input of 2 watts, yielding an output of 0.8 watts at 5,500 Mc. The varactor was well saturated, indicating that the output power obtained was very close to the maximum obtainable. The frequency-output power curve was very flat over the required bandwidth of 1%. The dynamic range of the tripler was relatively small, as expected for a

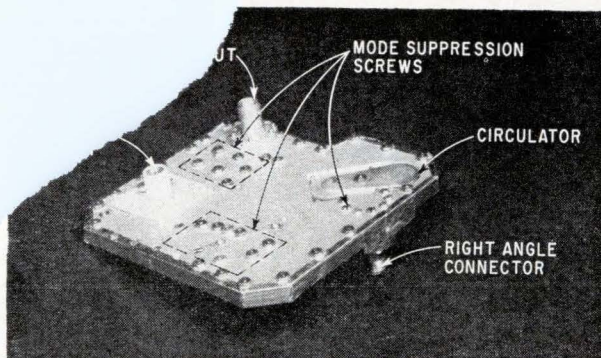

Engineering model of the varactor tripler includes a circulator to isolate the diode circuit from the load. Mode suppression screws on the face of the unit prevent the generation of higher modes at discontinuities at the filters, diode and output connector.

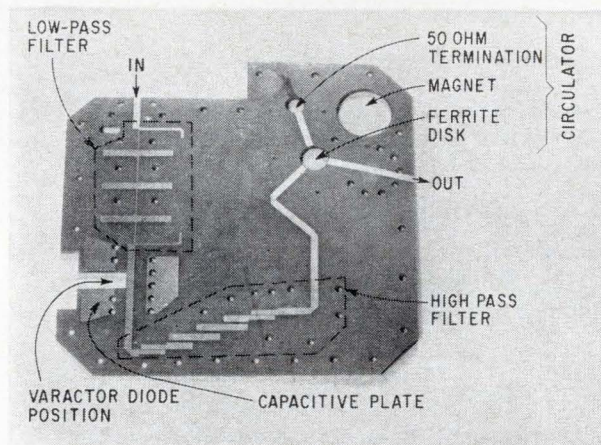

Center conductor configuration of the strip transmission line tripler shows the relative positions of the circuit's elements. Three large holes at the upper right hold the components used in the circulator. Clearance holes near the filters, diode, and output lines are for mode suppression screws. The capacitive plate provides additional mode suppression near the diode.

multiplier with fixed external bias, and operated in saturation. Restricted dynamic range is not a problem in system integration if the variations of both the bias and the input drive power are made small.

Another engineering model of the tripler was built with right-angle, rather than in-line, connections to the circuit board. A circulator, integrated with the board, at the output of the bandpass filter, provided constant loading. This model yielded an output power of 1 watt for an input of about 3.3 watts—a conversion loss of 4.8 db. The higher conversion loss was attributed to right-angle connections and the addition of the circulator.

Test results on the engineering model with a large quantity of diodes proved very encouraging in terms of large-scale production. Ten diodes, type D4852E, were tested in the unit and each yielded approximately the same output power. In each case, only a change in the diode bias was required to optimize the output.

Spurious signals in the output were more than 50 db below the desired signal. Spurious signals are undesired frequencies generated in the low-

frequency oscillator or are radiated signals that are picked up and amplified by stages preceding the tripler. Although not fully understood, it has been found from experience that spurious frequencies and noise within the bandwidth of the multiplier may be amplified as much as 5 to 10 db when passing through the multiplier circuit. The input signal, however, undergoes a conversion loss in the multiplication process. This means that the signal-to-noise ratio and spurious rejection—ratio of signal amplitude to spurious amplitude—at the input must be about 10 db greater than the values desired at the output.

In a chain of multipliers this effect is compounded, because each stage will amplify the undesired signals. As an example, a chain of four multipliers may reduce the spurious rejection and signal-to-noise ratio at the output by 20 to 40 db below its value at the input. To reduce the problem, the stages must be well shielded and spurious signals at the input must be held to a minimum.

An engineering model of the tripler that uses a circulator at its output is shown in the top photograph. The screws mounted on the unit are shorted to both ground planes and serve a dual purpose; one of them being to hold the strip transmission line sandwich together and the other to suppress spurious strip transmission line modes. The screws around the circumference also shield the unit preventing radiation from entering or leaving the board. Metallized tape around the edge of the unit also aids in shielding. Other screws on the face of the unit are mode suppressors which prevent the propagation of higher strip line modes that would be generated by the discontinuities at the filters, varactor diodes and connector.

The lower photograph, left, shows the center conductor configuration of the tripler, and more clearly indicates the relative positions of the diode mount, filters and suppression screws.

III. Filters in strip transmission line

Filters are important parameters in most strip transmission line designs. Impedance matching networks, frequency selecting circuits and broadbanding networks are all, in the most general sense, filter structures designed by similar techniques. The filters used in the varactor tripler offer a good example of some of the design considerations.

Low-pass filter

The low-pass filter in the varactor multiplier is illustrated in the figure on page 80 with its lumped-constant equivalent circuit and its frequency response. The characteristic impedance of

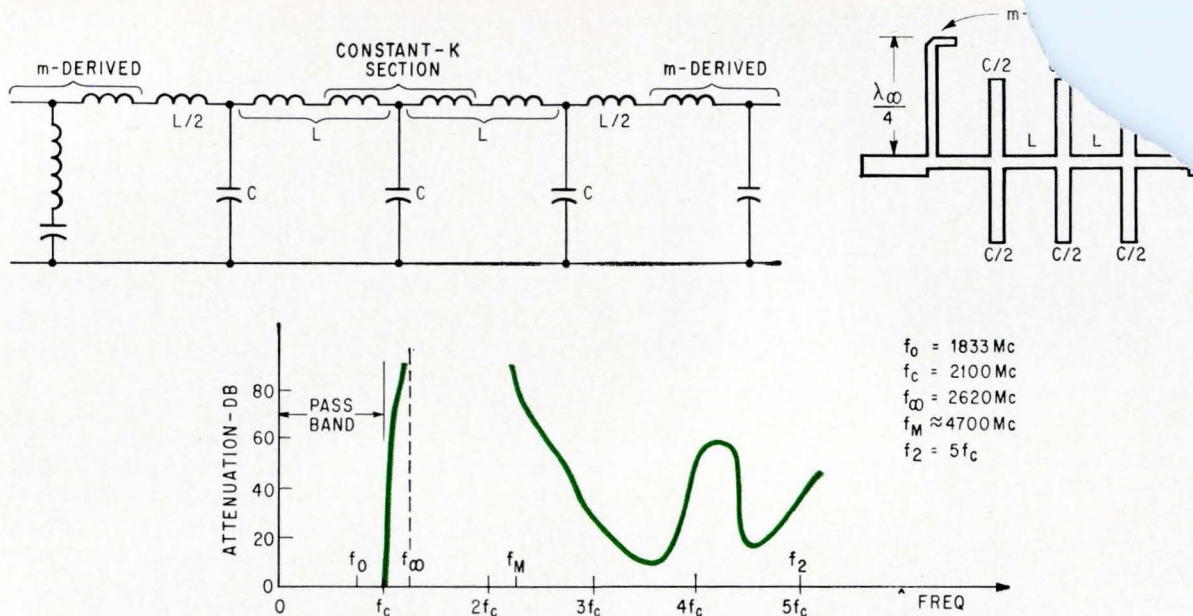

Prototype circuit of the low-pass filter is directly related to the elements of the actual strip transmission line filter. The theoretical frequency response of the constant-k and m-derived filter is shown at the bottom of the diagram. Frequency f_c is the cutoff frequency, f_∞ is the frequency at which infinite attenuation occurs and $f_M = \sqrt{f_c f_2}$ where $f_2 = 5f_c$.

the filter is set at 50 ohms to match the input source. The 50-ohm impedance determines the width of the center conductor at the input and output of the filter. No attempt is made to match the filter impedance to the varactor diode's, because, in the overdriven condition, or at high power levels, the diode's impedance characteristics are difficult to predict accurately. The cutoff frequency f_c of the filter is established at 2,100 Mc. This is sufficiently above the fundamental frequency of 1,833 Mc so that the insertion loss at the fundamental frequency, f_0 , is only about 0.2 db.

The design of the filter is based on an elementary lumped-constant filter consisting of three constant-K prototype L-C sections between m-derived end sections.³

As shown in the diagram, the various elements of the filter are directly related to various sections of the strip transmission line filter. The impedances of the various sections have been discussed in the section on equivalent circuits on page 75.

Making the width of the series-inductance line very narrow permits the characteristic impedance to be high and the filter length to be short. The length of these sections are set so that $X_L = 2R$ at the cutoff frequency, f_c , where R is the 50-ohm load impedance that is to be matched by the filter. The shunt capacitive section lengths are $\lambda_M/4$, where the mean frequency $f_M = \sqrt{f_c f_2}$, and f_2 is defined as the upper limit of the stop band. The frequency f_2 is arbitrarily chosen to be $5f_c$. The widths of the shunt capacitive sections are determined by the characteristic impedance required to make $X_C = R/2$ at the frequency f_c . The values of X_C and X_L satisfy the basic impedance relationship for a constant-K filter.

$$X_L X_C = R^2$$

Lengths of the m-derived end sections are chosen to be a quarter-wavelength at the frequency of infinite attenuation, f_∞ where,

$$f_\infty = \frac{f_c}{\sqrt{1 - m^2}}$$

The selection of $m = 0.6$ results in a very flat image impedance over the passband. The rate of cutoff outside the passband is determined by the number of constant K-sections and the resonant frequency of the end sections. Frequency response for the 3-section filter is down 3 db at $1.3f_c$ and decreases to 60 db at $1.7f_c$.

The frequency response in the stop band of the filter must be considered as carefully as in the passband's. When the filter elements are a half-wavelength long, a resonance occurs reducing the attenuation. In the low-pass filter, the first undesired resonant response occurs at $3.7f_c$ when the inductive sections are $\lambda/2$ long. A second undesired resonant response occurs at $4.5f_c$ when the shunt capacitive sections are $\lambda/2$ long. Spurious signals or harmonic frequencies appearing at these frequencies will not be sufficiently attenuated and must be reduced or eliminated before the filter.

Bandpass filter

The bandpass output filter in the varactor tripler is illustrated in the figure on page 81. Its frequency response is of the Chebyshev type also shown in the diagram.

A Chebyshev response is characterized by equal ripples in the passband. Maximally flat, or Butterworth, filters may also be constructed but the skirt selectivity is not as great as the Chebyshev response.

The filter is a parallel coupled resonator type

er-waves length sections repre-
 lengths of line, a . Each of these
 at the midband frequency, which,
 is the tripler's output frequency of $3f_0$,
 (c). The filter may also be considered as a
 p of parallel coupled transmission lines.

The equivalent circuit of the bandpass filter does not have the obvious relationship to the filter elements, as did the low-pass equivalent circuit to its filter. The equivalent circuit for the five-section, Chebyshev-response filter is shown in the diagram below. In this circuit each parallel L-C circuit represents a half wavelength resonator. The boxes between the resonators—representing the coupling between the resonant bars—are ideal impedance inverter circuits that have a -90° phase shift.

The bandpass filter was required to have low insertion loss in the passband and to attenuate the second and fourth harmonic by at least 50 db. A five section filter is used because it gives 60 db rejection at the harmonic frequencies with less than 0.5-db insertion loss. Larger values of skirt attenuation are obtained by increasing the number of sections but this also results in an increase in the insertion and loss.

For a given number of filter sections, increasing the bandwidth reduces the insertion loss but requires increased coupling between sections and therefore closer spacing between the resonators. The bandwidth is made as large as possible to obtain low insertion loss but not so large that the spacing of the filter elements produces an etching problem. A 10% bandwidth is about the maximum that can be obtained with a five-section filter. For this bandwidth the spacing between elements must be as small as 0.005 inch. Closer etching toler-

ances can be maintained only with difficulty.

The dimensions of the filter are determined, using a suitable prototype filter for a model. For designing a five-section Chebyshev filter, the prototype is a low-pass filter consisting of shunt capacitive and series inductive elements.¹⁰ The prototype's frequency response is similar to the desired response, except that it is centered at zero frequency. Basically, a low-pass prototype circuit is used in filter design to take advantage of the symmetry of the response curve and because it may be easily transformed into various low-pass and bandpass configurations.

The ripple, A_n , determines the value of the inductive and capacitive elements in the prototype. These values and the characteristic impedance of the filter, Z_0 , specify the even and odd impedances, Z_{oe} and Z_{oo} , respectively, of the coupled strip transmission line sections. Definitions of even and odd impedance appear on page 75 in the discussion of parallel coupled strip transmission lines. Once the even and odd impedances are known, the width and gap dimensions of the resonators can be obtained from nomograms.²

In the bandpass filter, the line lengths must be corrected for fringing capacitance at the ends, by trimming each section by a small amount, d . The trimming is usually performed empirically, but is guided by approximate design equations for the capacitance derived by Cohn.¹⁰

Strip transmission line filters designed at Sylvania have shown excellent correlation with the results predicted by the design procedure given above. However, the correlation is closely governed by the accuracy obtainable in the graphic and etching processes to be discussed in the next article of this series.

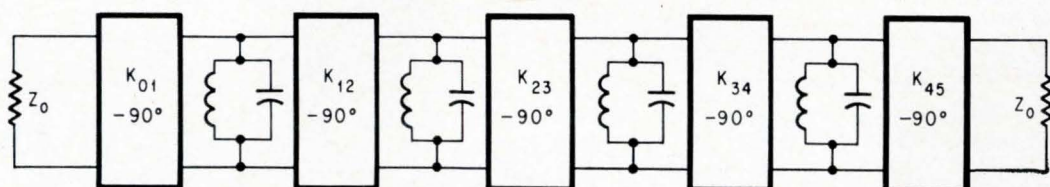
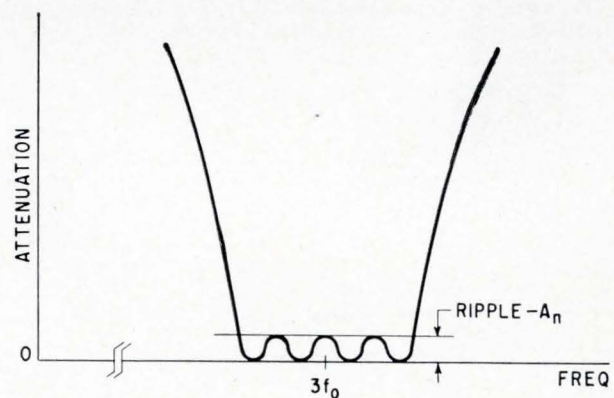
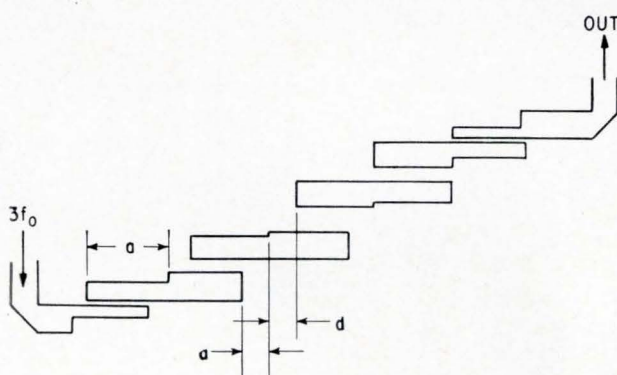

Chebyshev frequency response of the bandpass filter is characterized by equal amplitude ripples in the passband. The equivalent circuit of the filter consists of ideal inverters, represented by the boxes labelled K_{01} to K_{50} , and tuned resonant circuits, represented by the parallel inductance and capacitance.

IV. Multiple-pole diode switches

Strip transmission line is much less expensive than waveguide or coaxial line for the construction of multiple-pole diode switches. Such switches consist of many individual circuit elements which are costly to machine but are relatively economical to etch. Costly mounts are unnecessary in low-power strip transmission line switches, since the diodes can be inserted in cut-outs in the dielectric and attached simply to the center conductor.

A shunt-type switch is illustrated in the first schematic below. The diode is represented by its equivalent circuit consisting of the elements L_D , C_J and R_D . If the spreading resistance, R_D , is neglected, the diode may be considered an ideal switch. When the diode is forward-biased it conducts, placing a near short circuit across the line

so that no r-f energy reaches the output. The circuit is tuned to series resonance by an external capacitor, X_{CS} . The reactance across the line, therefore, is theoretically zero and the isolation of the switch is infinite. With reverse bias, the diode does not conduct; the parallel circuit is tuned to resonance by external inductance, X_{LP} , and the reactance across the line is theoretically infinite. In this condition, all available r-f power is transmitted to the output. For this switch, the external capacitive and inductive reactances must satisfy the following conditions:¹¹

$$X_{CS} = \omega_0 L (1 - \omega_0^2 L_D C_J)$$

$$X_{LP} = \frac{(1 - \omega_0^2 L_D C_J)}{\omega_0 C_J}$$

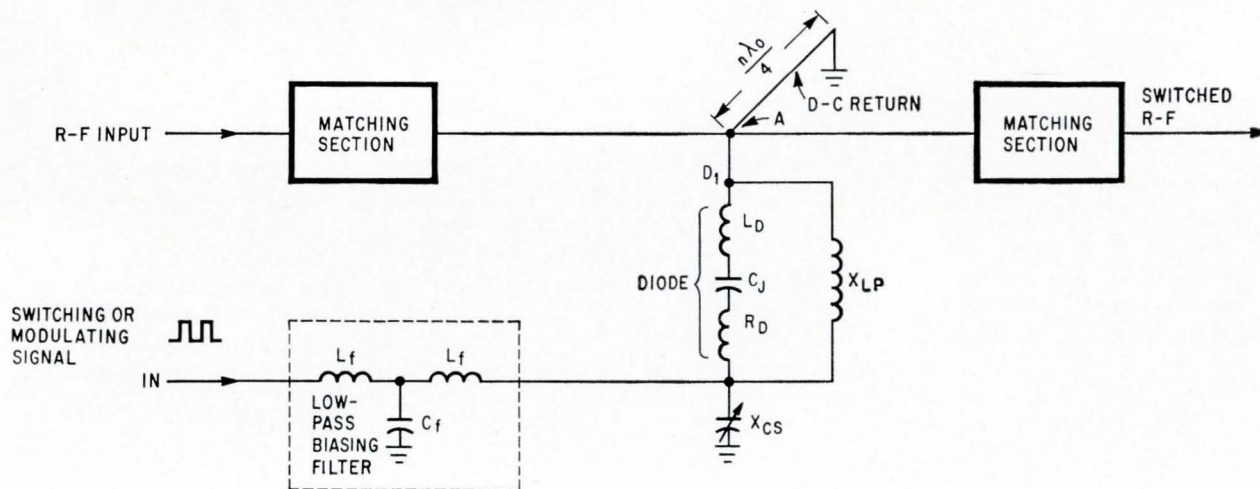

Diode in this schematic of the switch is represented by the elements L_D , C_J , and R_D . Parallel reactance jX_{LP} is added to increase the bandwidth by resonating the diode.

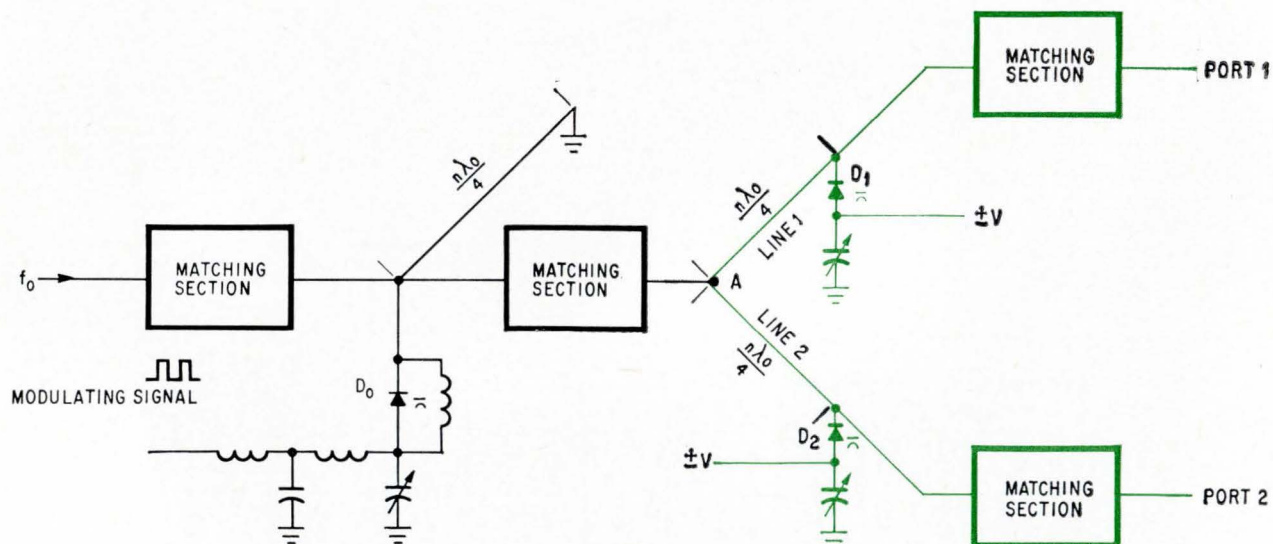

Multiport switch is formed by adding additional lines and shunt diodes (shown in color) to the basic switch circuit. In this configuration, the output at port 1 or 2 may be pulse modulated by the biasing waveform at diode D_0 . For clarity, bias circuits are not shown in detail.

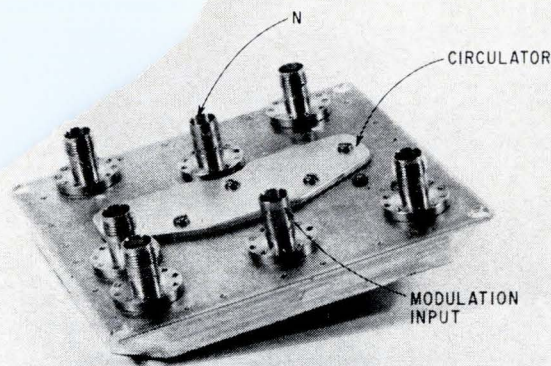

Five-port diode switch allows the output to be modulated by a single source. The five connectors, which are not marked, are the output ports. An input connector and the diode bias lines on the bottom of the switch are not visible. The port marked N is not a part of the switch.

where L_D = diode series inductance
 C_J = diode junction capacitance
 X_{LP} = shunt resonant inductance (includes diode package capacitance)
 X_{CS} = series resonant capacitance
 $\omega_0 = 2\pi f_0$

The matching sections, which may be quarter-wave transformers or tapered sections, are designed to match the source and load to a characteristic impedance value of

$$Z_0 = \frac{1}{2} \frac{V_D}{I_D} (1 - \omega_0^2 L_D C_J)^2$$

where V_D and I_D are the rated diode voltage and current, respectively. The maximum switching power is given by $P = \frac{1}{2} V_D I_D$, when diode and circuit ohmic losses are neglected.

The biasing circuit shown in the schematic of the switch comprises a d-c connection with a low-pass r-f biasing filter at one end of the diode and, at the other end, a d-c return that consists of an r-f short circuit at a distance $n\lambda_0/4$ from the diode, where n is an odd number and λ_0 is the wavelength in the strip transmission line at mid-band. The low-pass filter for the bias circuit is composed of alternate capacitive and inductive, C_r and L_r , strip transmission line sections. The circuit is similar to the low-pass filter discussed on page 80, except that the cutoff frequency is much lower.

The tuning reactance, X_{CS} is normally considered a part of the biasing filter. If X_{CS} is not needed, it may be replaced by an r-f bypass in the form of a large capacitor spaced a half wavelength from the diode.

With the addition of other shunt diodes spaced a quarter-wavelength from a point, A, as in the lower diagram on page 82, the circuit becomes a multiport switch with an additional feature—the output signals may be pulse modulated by diode D_0 . The tuning inductance across the diodes and the biasing networks are not shown.

If diode D_0 is back-biased, energy at the input port will flow past D_0 towards point A. If, at the same time, diode D_1 is back-biased and D_2 is forward-biased, energy will flow out of port 1, and no energy will flow towards port 2. The reason for this is that the bias essentially removes D_1 from the circuit and makes line 1 appear as a properly terminated 50-ohm line; line 2, on the other hand, presents an open circuit at point A because of the reflected impedance of the shorted diode.

If, under the above conditions, diode D_0 is forward biased, it will prevent energy from reaching point A and both output ports will be isolated from the input. Therefore, a pulse modulated waveform that alternately forward- and reverse-biases D_0 will similarly modulate the output at port 1. If the d-c biases on diodes D_1 and D_2 are reversed, the modulated waveform will appear at port 2.

More than two outputs may be added. As an example, a five-port shunt diode switch that allows the outputs to be pulse modulated is shown in the photograph at the left. The BNC connector labeled "N" is not part of the switch circuit.

Series diode switches are also feasible, but while the series type has the advantage of greater potential bandwidth, it is not as convenient for design with strip transmission line. The bandwidth of a shunt diode switch is inversely proportional to the lead inductance and can be improved by the use of small pill-type diode packages.

Although the preceding designs are only outlined in many instances, the reader can gain insight into the techniques of designing with strip transmission line together with an idea of some of the pragmatic but crucial hardware problems.

In the next article of this series, additional circuits such as tunnel-diode amplifiers and antenna arrays will be discussed. The article will also deal with methods of eliminating spurious responses, factors involved in etching, and maximum frequency and power limitations.

References

1. H.S. Keen, "Scientific report on study of strip transmission lines," AIL Report No. 2830-2, Contract No. AF19(604)-780, December 1955.
2. S.B. Cohn, P.M. Sherk, J.K. Shimizu and E.M.T. Jones, "Strip transmission lines and components, final report," SRI Project 1114, Contract No. DA36-039SC-63232, February 1957. Reprinted in IRE Trans., PGMTT-3, 2, March 1955, pp. 119-126.
3. N.R. Wild, et al., "Handbook of TRI-PLATE," Sanders Associates, Inc., Nashua, N.H., 1956.
4. C.E. Dowdell and K. Steele, "A versatile varactor multiplier," National Electronic Research Engineering Meeting (Nerem), Boston, November 1964, pp. 144-145.
5. C.B. Burckhardt, "Analysis of varactor frequency multipliers for arbitrary capacitance variation and drive level," Bell System Technical Journal, April 1965, pp. 675-692.
6. R.J. Wenzel, "Wideband varactor harmonic multipliers," 1965 PGMTT Symposium, Clearwater, Fla., pp. 61-65.
7. D.O. Fairley "How to design solid-state microwave generators," Electronics, Oct. 11, 1963, pp. 23-28.
8. C.E. Dowdell, "New concepts for parametric multipliers," International Convention on Military Electronics (MIL-E-CON-8), Washington, D. C., September 1964.
9. S.L. Cohn, E.M.T. Jones, etc al., "Research on design criteria for microwave filters, final report," Stanford Research Institute SRI Proj. 1331, Contract No. DA36-039 SC-64625, June 1957.
10. S.B. Cohn, "Parallel-coupled transmission-line-resonator filters," IRE Trans. PGMTT Vol. MTT-6, April 1958, pp. 223-231.
11. M.E. Hines "Fundamental limitations in r-f switching and phase shifting using semiconductor diodes," Proc. of IEEE, June 1964, pp. 697-708.

Designer's casebook

Designer's casebook is a regular feature in Electronics. Readers are invited to submit novel circuit ideas, packaging schemes, or other unusual solutions to design problems. Descriptions should be short. We'll pay \$50 for each item published.

FET converts transducer for use in a-c bridge

By Alan R. Greenfield
and William H. McCloskey

Oceanics division of
Interstate Electronics Corp., Anaheim, Calif.

A field effect transistor (FET) operating as a voltage-controlled resistor converts d-c voltage output of a transducer to a-c so the transducer can be used in a bridge-controlled f-m oscillator, as in the circuit shown below. Transducers that are essentially variable resistors provide easy measurement of many parameters in a typical data acquisition system. Placed in an a-c bridge, the transducers control the output frequency of an f-m oscillator and provide extremely high sensitivity. But some transducers produce a variable d-c voltage rather than a varying resistance and must be converted.

Three matched precision resistors (R_1 in the schematic) form the arms of a bridge; the FET's drain and source terminals are connected to make

the bridge's fourth arm. The bridge is excited by a reference a-c voltage E_{in} . The amplitude of the a-c output voltage E_o varies proportionally with the d-c transducer output voltage, V_{gs} . E_o is expressed

$$E_o = \frac{E_{in}}{2} \left(\frac{R_{ds} - R_1}{R_{ds} + R_1} \right) \quad (1)$$

where R_{ds} is the effective resistance between the FET's drain and source terminals. If $R_{ds} \cong R_1$, then:

$$E_o \cong \frac{E_{in}}{4} \left(\frac{R_{ds}}{R_1} - 1 \right) \quad (2)$$

and the ratio, R_{ds}/R_1 , will be either slightly greater or slightly less than unity. E_o then becomes a small alternating voltage, which has either positive or negative phase with respect to E_{in} . In the oscillator, the phase of E_o controls the direction of the output frequency's deviation.

With low drain-source voltages (less than 1 volt) near the origin of the I_d versus V_{ds} curves, the FET displays the characteristics of a variable resistor. Because the FET is unipolar, this property holds, regardless of the polarity of the drain-source voltage. The variable resistance effect is best observed in an FET having high pinchoff voltage and high gate-source voltage compared to V_{ds} . Expressed

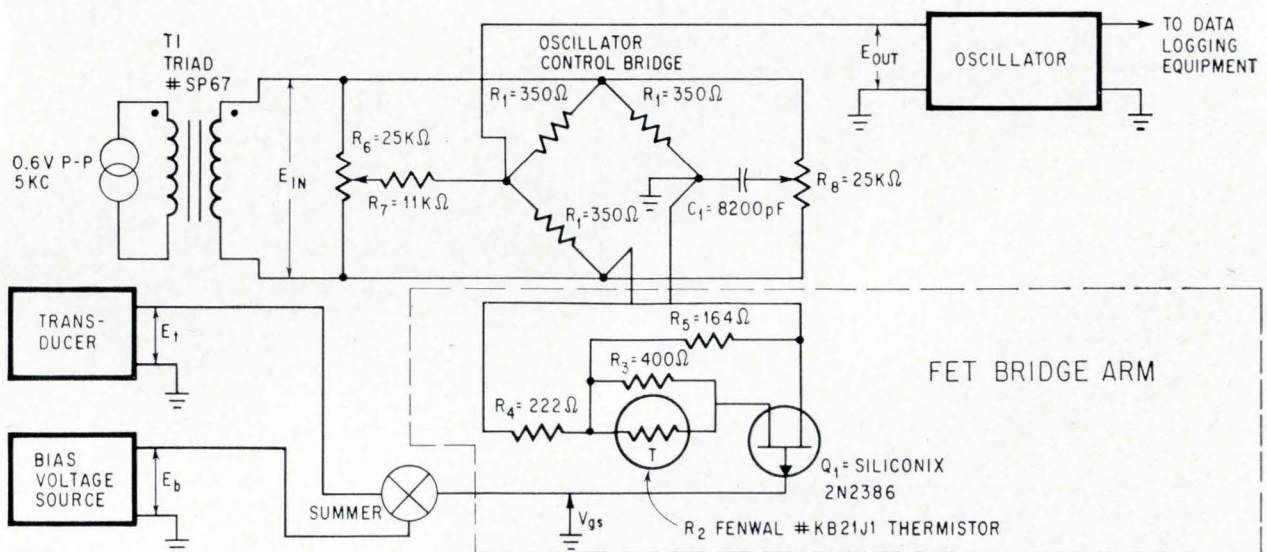

Drain-source resistance of the Siliconix 2N2386 is controlled by the transducer d-c output. This unbalances the bridge and provides an a-c output whose frequency change is directly proportional to the d-c voltage change.

ally:

$$= R_o e^{\eta V_{gs}} \quad (3)$$

where R_o and η represent characteristics of the FET. If this equation is substituted into equation 2, then:

$$E_o = \frac{E_{in}}{4} \left(\frac{R_o e^{\eta V_{gs}}}{R_1} - 1 \right) \quad (4)$$

Because E_{in} , R_o , R_1 , and η are constants, E_o is controlled only by V_{gs} .

The transducer output E_t is summed with a 0.6 volt d-c bias to obtain V_{gs} . The bias is set to provide zero temperature coefficient at the quiescent operating point, for example when $E_t = 0$. Zero temperature coefficient occurs only at the bias point, so R_{ds} varies slightly with temperature as E_t takes on non-zero values. Thermistor R_2 compensates for changes in FET resistance caused by temperature; resistor R_3 (in parallel with R_2) ad-

justs the thermistor changes so that they are equal in amplitude but opposite in polarity to the FET's variations.

Resistors R_4 and R_5 are computed to produce a 350-ohm resistance for the entire FET bridge arm, and to adjust the effects of controlled changes of R_{ds} . Resistors R_6 and R_7 comprise an adjustable balance network required to compensate for slight differences in the values of the bridge resistors R_1 . The RC combination made up of potentiometer R_8 and capacitor C_1 has a similar function: it balances any reactive components which can upset the bridge balance.

Transformer T_1 isolates the input to the bridge circuit, allowing the FET source terminal to be returned to common, and eliminating floating input to the oscillator.

The balanced bridge represents zero output for the transducer. The oscillator is adjusted to run at center frequency for the bridge's zero output.

Charge feedback increases pulse-rate meter accuracy

By R.J. Smith-Saville and S. Ness

University of Manchester, England

In many pulse-rate meters the input pulse triggers a monostable multivibrator to supply a current pulse to an output ammeter. The width of the current pulse determines the meter scale factor. For a given meter deflection, the ratio of time between pulses to the pulse interval is a constant, independent of the range. This makes it easier to calculate the true pulse rate of statistically distributed pulses from the apparent pulse rate. It also allows the ammeter to be calibrated directly in terms of true rate, if desired.

The circuit on page 86 also operates on this principle. However, for improved accuracy, the current pulse width is controlled by a feedback voltage proportional to the charge on the output capacitor. The feedback insures that the same charge is fed to the output circuit for each pulse. The unit measures pulse rates from 50 to 5×10^5 pulses/sec in five ranges. On each range, the dead time is 5% of the mean pulse interval at the maximum count rate.

For equally spaced pulses, the response can be extended linearly to beyond 5 megacycles per second by increasing the value of resistor R_2 . However, the ratio of dead time to pulse spacing increases, with the result that the extended range is not suit-

able for measuring statistically distributed pulses.

The description of the circuit operation assumes that the range switch is connected to C_1 . An input pulse, 50 nanoseconds wide and about 0.8 volts in amplitude, triggers a monolithic dual input NOR gate (Motorola type MC 359) cross-connected to operate as a flip-flop. This module's advantage over a standard MC 352 flip-flop is that the input switching threshold voltage is defined by an external bias voltage of 0.4 v and its temperature coefficient is only $+0.2 \text{ mv}/^\circ\text{C}$ as opposed to $+1.7 \text{ mv}/^\circ\text{C}$ for the MC 352.

When the flip-flop is triggered, switching transistors Q_1 and Q_2 are turned off, removing the short circuit across both the range capacitor, C_1 , and the output circuit consisting of R_2 , C_6 , and C_7 . As a result, charging current flows through R_1 to C_1 and through R_2 to C_6 and C_7 . Under these circumstances the charge per pulse delivered to the output capacitor is

$$Q_o = \int_0^t r \frac{v_i - V_r}{R_2} dt \quad (1)$$

and the voltage, v_c , across the range capacitor, C_1 , is

$$v_c = \int_0^t \frac{v_i - v_{ic}}{R_1 C_1} dt \quad (2)$$

where v_i is measured at the high-potential ends of R_1 and R_2 (neglecting the voltage drop across the diodes D_1 and D_2); V_r is the steady voltage, proportional to count rate r , developed across the output integrating capacitors due to the finite resistance of the ammeter; and v_{ic} is the instantaneous value of v_c . Since V_{ic} is less than $0.05v_i$, the

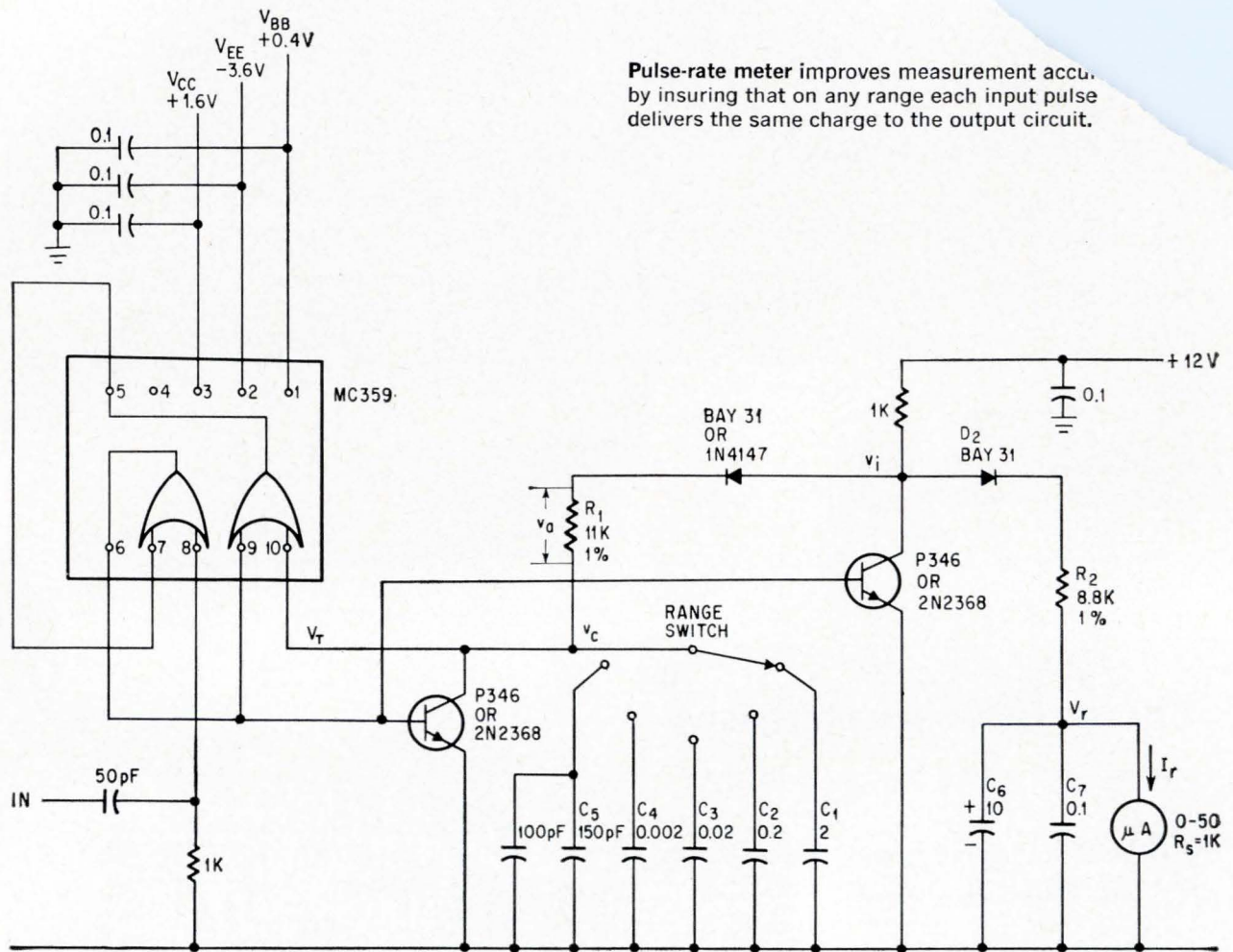

Pulse-rate meter improves measurement accuracy by insuring that on any range each input pulse delivers the same charge to the output circuit.

second term in the integrand of equation 2 can be ignored with an error less than 0.2%.

When v_c exceeds the input switching threshold, V_T , the flip-flop returns to its initial state, rapidly discharging C_1 and cutting off the current flow to the output. The time, t_r , at which this occurs is

$$t_r \approx \frac{V_T R_1 C_1}{v_i} \quad (3)$$

Equation 3 assumes that v_i is a step voltage.

At this time, v_c and V_T are equal.

$$v_c = V_T \quad \text{at } t = t_r \quad (4)$$

Substituting equations 2, 3 and 4 into equation 1; multiplying by the rate r ; and using the fact that V_T is a constant, the d-c current in the meter is

$$I_r = r \frac{R_1 C_1}{R_2} \left(V_T - \frac{V_r}{v_i} \right) \quad (5)$$

Except for the small error term, V_r/v_i the meter current, I_r , is independent of the amplitude or waveform of v_i , and is defined solely by r , R_1 , R_2 , C_1 , and V_T . Since the error term is proportional to r^2 it does introduce a nonlinearity. However, this term

will not exceed 0.6% for the circuit values shown. If necessary, the error term could be eliminated by connecting R_2 into an operational amplifier which presents a virtual ground at its input. The amplifiers output could be arranged to drive either a linear or logarithmic display. The circuit is thus capable of linearity and accuracy well within 1%.

The $+0.2 \text{ mv}/^\circ\text{C}$ temperature coefficient associated with V_T is compensated for by the temperature coefficient of the residual voltage across Q_1 . As a result, the over-all temperature coefficient of the meter current, I_r , is less than $0.02\%/^\circ\text{C}$. In addition to its dependence on the $+0.4$ volt supply, V_T also partially depends on the values of the $+1.6$ and -3.6 volt supplies to the flip-flop. For maximum accuracy, these three voltages must be stabilized. The circuit is less sensitive to variations of the $+12$ volt supply and will accommodate deviations of $\pm 10\%$ with an error of less than $\pm 0.5\%$ on all but the highest pulse range. On the highest pulse range the turnoff time of the circuit becomes comparable to the current pulse width, resulting in less effective charge feedback.

Low-voltage emitter-follower extends voltmeter's range

by Allan K. Scidmore

University of Wisconsin, Madison

Many commercial multimeters whose lowest voltage scales are either 1.5 or 3 volts cannot be used with semiconductor circuits because the V_{BE} of germanium transistor is about 150 millivolts. The saturated V_{CE} of both germanium and silicon transistors is even smaller. But a low-voltage d-c pre-amplifier that is inexpensive and stable with temperature and supply voltage variations, below right, extends the range of such instruments so they can be used effectively in semiconductor circuit measurements.

Transistors Q_1 and Q_2 in the diagram below left constitute an emitter-coupled amplifier; Q_3 is an emitter-follower connected so the circuit's entire output voltage is fed back to Q_2 . With constant input voltage, the output voltage is essentially fixed, so a variation of $R_E = (R_2 + R_3)$ changes the collector current of Q_1 . Therefore, R_E may be adjusted to equalize the base-emitter drop of Q_1 and Q_2 and thus make the output voltage zero for zero input. The gain of this emitter-follower circuit is almost unity.

If a fraction, f , of the output voltage V_2 is fed

back to Q_2 , then the amplifier will have a gain approaching $1/f$. The circuit shown below can provide gains of 3 and 10 to extend the range of a 1.5-volt vacuum tube voltmeter, for example, down to 500 and 150 millivolts full scale. However, there are two disadvantages: the open circuit gain is not very large (typically 50) and it is sensitive to supply voltage variations. Since feedback helps stabilize the circuit and insure linearity, increased gain is obtained at their expense. Sensitivity to supply voltage variations is defined as $S = \Delta V_2 / (A \cdot \Delta V_s)$ where $A = V_2 / V_1$ is the over-all gain, and V_s is the supply voltage. S gives the effective input voltage change produced by supply voltage variations, typically 1 to 4×10^{-2} .

Additional open circuit gain may be obtained by substituting a current source for the load resistor of Q_2 . This reduces the battery supply effect on the zero setting. To reduce sensitivity to negative supply voltage excursions, a current source can also be substituted for the common emitter resistors R_2 and R_3 . These changes are shown in the circuit below right. These modifications provide open circuit gains of greater than 300 and sensitivities to supply voltage changes of about 4×10^{-3} . The circuit now has gains of 3, 10, and 30, which extend the 1.5-volt meter scale to 500, 150, and 50 millivolts full-scale deflection.

In the circuit below, right, zero-adjust control is provided by variable resistor R_1 . This resistor controls the collector current of Q_2 . R_7 permits open-circuit zero adjustment.

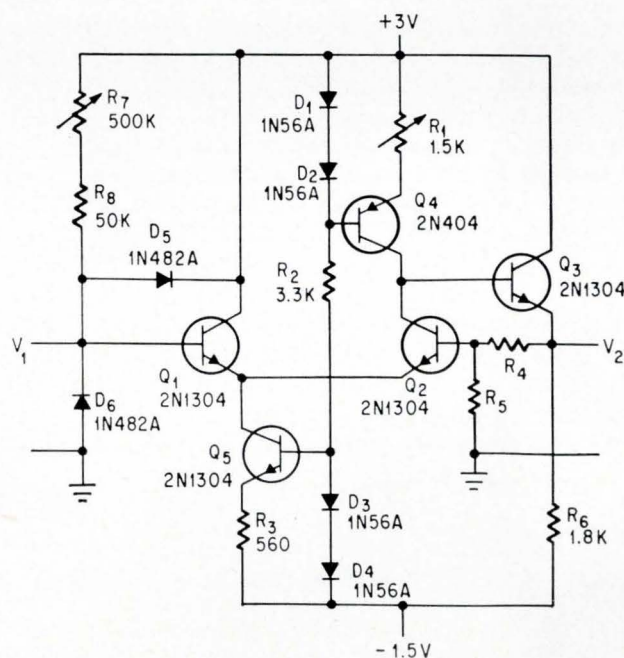
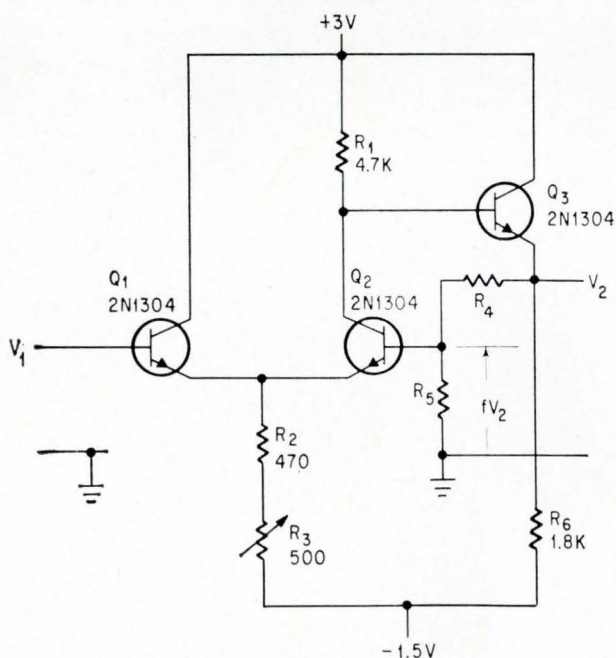

Emitter-follower amplifier uses feedback for stability and linearity; these are requirements for application in multimeters at low ranges. For additional open circuit gain, the circuit is modified to include current sources for load resistor and common emitter resistors. R_1 in drawing at right provides circuit zero-set.

Phase-locked marker improves spectrum analyzer's accuracy

By measuring the frequency of the marker oscillator, the operator precisely determines the frequency of any spectral component; modified display makes readability easier

By Charles W. Wilson

Georgia Institute of Technology, Atlanta, Ga.

Rapid identification and accurate measurement of any frequency in the spectrum under analysis are now possible with an instrument called the frequency measuring spectrum analyzer (FMSA). Spectrum analyzers are versatile tools for analyzing complex waveforms and for finding out approximately what frequency components are in a given spectrum. But the conventional spectrum analyzer is inherently limited by the linearity of its sweep and the operator's ability to read its calibrated scale. The FMSA overcomes the limitations of the conventional analyzer by adding a phase-locked marker and a modified display.

Using the new display, the operator positions the marker on the screen to coincide with the frequency component to be measured. The marker, which appears as a negative-going pip, automatically locks phase with the unknown component when their frequencies are equal. Direct measurement of the marker frequency yields the component frequency.

The precise measurement of undesired frequencies, of course, is a prerequisite for their elimination. As a result, spectrum analyzers are widely used for radio-frequency interference (rfi) testing.

The author

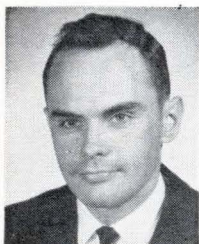

Charles S. Wilson has been a member since 1961 of the Georgia Tech Engineering Experimental Station staff, where he has worked on the problem of electromagnetic compatibility. He is responsible for the reduction of radio interference in equipment and the development of better techniques for measuring rfi.

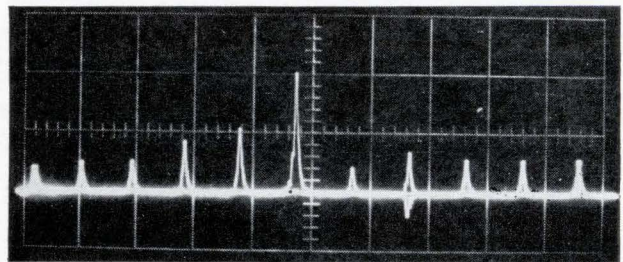

Oscilloscope display of spectrum analyzer output shows the negative-going pip produced by marker oscillator. The marker is phase locked to spectral line directly above it.

One basic rfi application involves the analysis of the various components that appear in the intermediate-frequency passband of a receiver. This cannot be done with conventional frequency counters because the individual components cannot be isolated from the composite spectrum.

Similar, but not the same

As in a conventional analyzer, the input signal to the FMSA is heterodyned with a local oscillator whose sweep rate and sweep width are functions of the sawtooth voltage's frequency and slope, respectively. The bandwidth of the intermediate-frequency amplifier is made variable so that any desired resolution between the individual frequency components is possible in the display. The output of the i-f amplifier is rectified and passed through a low-pass filter. The d-c voltage that results is proportional to the time-varying amplitude of the i-f signal. This d-c voltage is fed to the vertical-axis amplifier of the cathode ray oscilloscope; the sawtooth voltage is fed to the horizontal-axis amplifier.

...vers the automatic gain control... have the dynamic range needed to... ere fading; if the received signal is... age may not function at all. So the... must have an input amplifier with an age... assures continuous phase lock between the... scillator and the desired frequency components. The age system in the FMSA has a dynamic range of 30 decibels, sufficient for maintaining the over-all performance of the analyzer even with severe signal fading. The input amplifier has a voltage gain of 85 decibels and therefore provides positive action on signals as low as 50 microvolts.

In the schematic of the age portion of the input amplifier at the right, R_1 and diodes D_1 and D_2 form an L-attenuator. When transistor Q_1 is off, the impedance of the two diodes is high with respect to R_1 and the signal attenuation is small. As the level of the input signal increases, the positive d-c voltage derived from the rectifier increases. This drives Q_1 into conduction; the impedance of the diodes is lowered and attenuation of the input signal increases.

Marker oscillator and phase detector

The 455-kilocycle marker oscillator in the diagram on page 90 is a conventional Hartley circuit. A Hughes HC7005 varactor diode acts as a voltage-controlled element in the phase-lock loop. Automatic amplitude control restricts the voltage swing across the tuned circuit. The oscillator output is taken from the low-impedance emitter circuit of the oscillator to prevent any loading effects. To prevent the narrowing of this oscillator's frequency swing as the control voltage increases, part of the amplified signal is rectified by a conventional doubler,

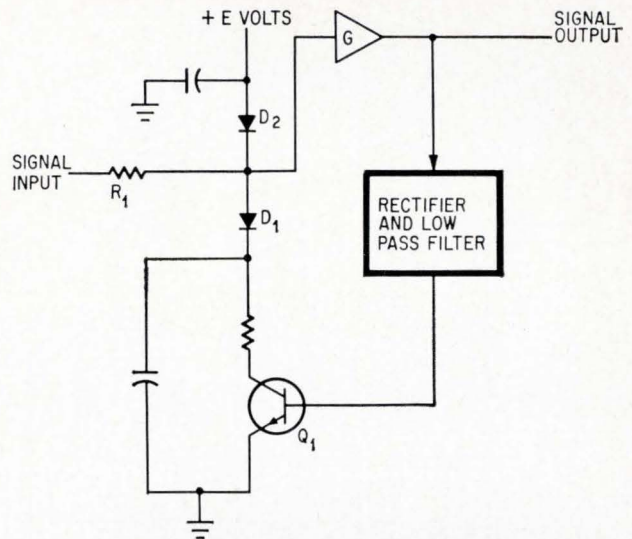

For automatic gain control, transistor Q_1 is driven into conduction as the input signal increases. Diodes D_1 and D_2 conduct, lowering their impedance, and increasing the signal attenuation.

averaged in a low-pass filter, and compared with an internal d-c reference. The difference voltage then biases the oscillator transistor. This bias voltage controls the oscillator transistor gain to maintain the signal swing across the tuned circuit at a level that will not forward bias the varactor. The loop gain is sufficient to maintain the signal level across the resonant circuit at 1.5 volts peak-to-peak.

The oscillator has a tuning range of 93 kc and will maintain phase lock over a change in synchronizing signal frequency of approximately 40 kc.

A simple shunt switch, with a 2N706 transistor

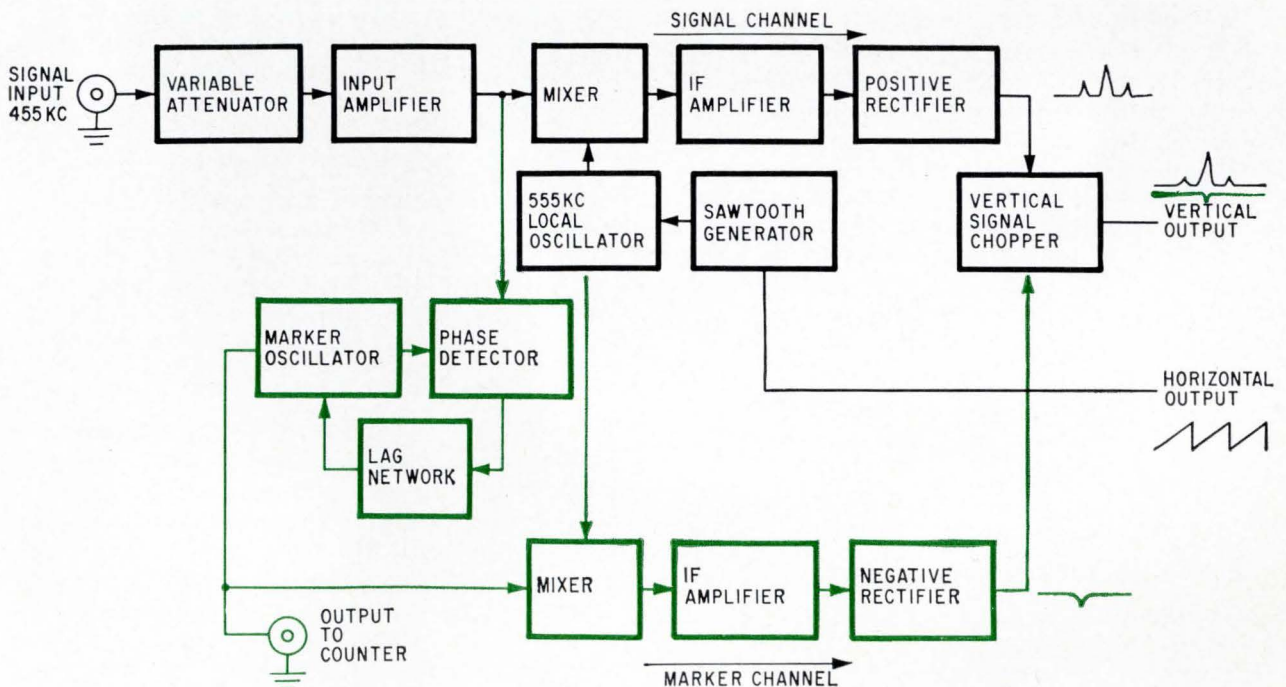

Frequency measuring spectrum analyzer (FMSA) differs from conventional analyzers by the addition of a marker oscillator, phase detector and vertical signal chopper. The FMSA makes accurate frequency measurements of individual components in a panoramic spectral display.

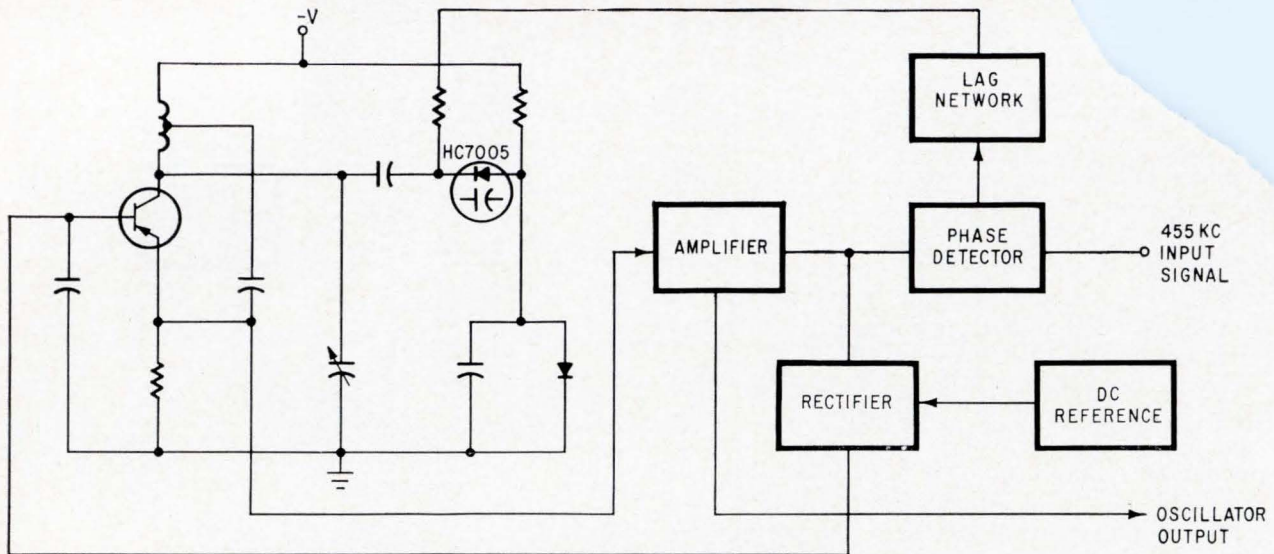

Marker oscillator is a conventional Hartley design. The varactor diode, HC7005, controls marker frequency and allows phase locking with any specific component in the spectrum.

serves as the phase detector for the marker oscillator as shown in diagram below. The marker oscillator signal E_m drives the transistor into saturation, short-circuiting the input signal to the analyzer E_s to a-c ground. The resulting sampled waveform is at left in the figure below. The d-c component of this waveform is zero since the two signals, E_m and E_s , are 90° out of phase—a condition existing when the natural frequency of the oscillator is the same as the input signal.

Should the input frequency tend to increase, an error signal must be developed to control the marker oscillator and maintain lock. This condition is met as the phase of E_s changes with respect to E_m , leading to the other waveform below. The d-c component is now positive. This error voltage applied to the varactor reduces its capacitance. The oscillator frequency increases and tracks the input signal.

To keep the oscillator stable, the total loop phase shift must not equal 180° at any frequency where the loop gain equals or exceeds unity. The phase-locked oscillator introduces an inherent 90° phase lag into the loop because this frequency is controlled by the phase error. So, the low-pass filter

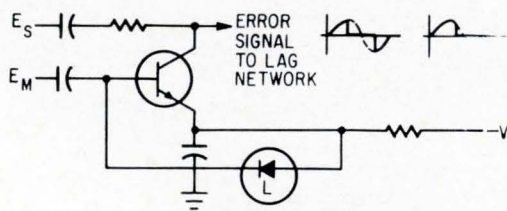

Phase detector is a shunt switch. If the input and oscillator signals are in quadrature, a condition that occurs when their frequencies are the same, the d-c component of the error signal is zero. A change in either of these frequencies causes the d-c component of the error signal to increase or decrease, changing the capacitance of the HC7005; this causes the oscillator frequency to track the input signal frequency.

must add less than 90° phase lag at the frequencies where the loop gain either equals or exceeds unity. A simple RC filter, which can introduce a phase shift of almost 90° , requires a small phase shift in the remainder of the loop. This is a difficult criterion to meet. A filter of the type in the diagram atop page 91 insures a stable loop. The maximum phase shift through this filter is calculated from:

$$\theta_{max} = -\tan^{-1} \frac{R_1}{2\sqrt{R_2(R_1 + R_2)}}$$

The maximum attenuation is determined by the ratio of R_2 to $(R_1 + R_2)$. If greater attenuation is needed, two filters may be cascaded to give a maximum attenuation equal to the product of the two sections. However, the maximum phase shift through each of the filter sections must occur at a different frequency to maintain oscillator loop stability. Only a fixed amount of attenuation can be obtained for the high-frequency components, no matter how high in frequency these components may be, as in the diagram shown atop page 91. The fixed attenuation is directly related to the maximum phase shift and is the price for the necessary phase control.

Sweep rate and width are controlled

The sawtooth generator consists of a unijunction transistor oscillator with constant-current charging of the timing capacitor. This is a well-known, straightforward method of obtaining a linear sawtooth. The sawtooth generator, with a frequency variable in two ranges from 0.1 to 16 cycles per second, controls the sweep rate and the sweep width of the 555-kc local oscillator.

The design of the local oscillator is essentially the same as that of the marker oscillator except that three varactor diodes are used rather than one, and the local oscillator has a different biasing arrangement. This modified biasing circuit overcomes

the nonlinear variation in oscillator frequency produced by the linear sawtooth voltage.

I-f signals produced

The local oscillator is heterodyned with the input signal to produce a 100-kc i-f in the signal channel and with the marker oscillator to produce a 100-kc i-f in the marker channel. These signals are mixed in a shunt-transistor mixer. At the output of each mixer is a low-pass, two-section RC filter to attenuate the original input signals before the difference frequency is fed to the i-f amplifiers. A single control that selects the proper filters for both channels determines the bandwidths of the two i-f amplifiers. Any one of three bandpass filters in the signal channel can provide 3-db bandwidths of 25, 150 and 1,000 cycles. Two filters are in the marker channel. A 100-kc crystal filter is for the 25-cycle bandwidth, while the two broader filters are conventional L-C filters.

A linear/logarithmic gain control is provided for the signal channel i-f amplifier while the gain of the marker channel i-f amplifier is fixed. Because of the logarithmic feature, the gain can be increased sufficiently so low-level components can be seen while larger signals won't overdrive the amplifier. A conventional voltage-doubling rectifier is used in both channels to derive the d-c voltage proportional to the amplitude of the 100-kc signal component. The voltage is positive in the signal channel and negative for the marker channel. A low-pass filter averages the rectifier output.

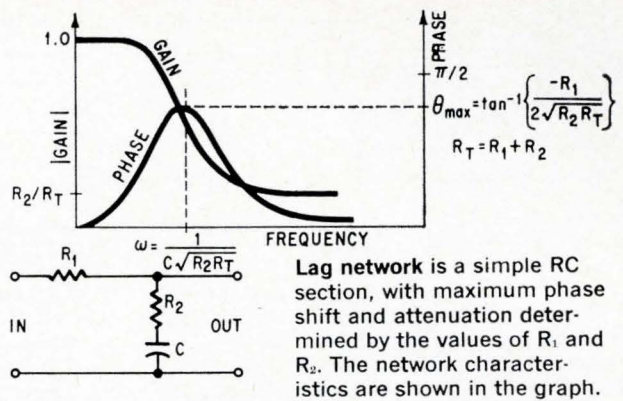

The low-pass filter in the signal channel has a cutoff frequency of 15 cps or 125 cps. This cutoff is controlled from a front-panel switch and determines the basic sweep rate of the local oscillator. The 15-cps filter is for the low range, when the sweep rate varies from 0.1 cps to 1.6 cps. The 125-cps filter is for the 1.5-cps to 16-cps sweep rate. The narrow bandpass i-f amplifier filter, which requires a slower sweep rate to compensate for the response time of this high-Q filter, provides good resolution of closely spaced components. In this instance, it is then desirable to use the 15-cps filter of the rectifier circuit to attenuate any beat frequency that may arise from adjacent components. The broadband i-f filter makes it unnecessary to use a slow sweep speed. However, as the sweep frequency is increased, a shorter time constant is

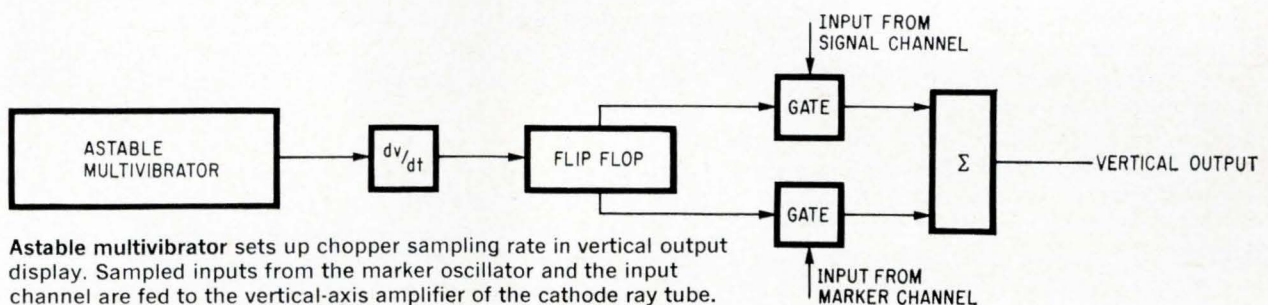
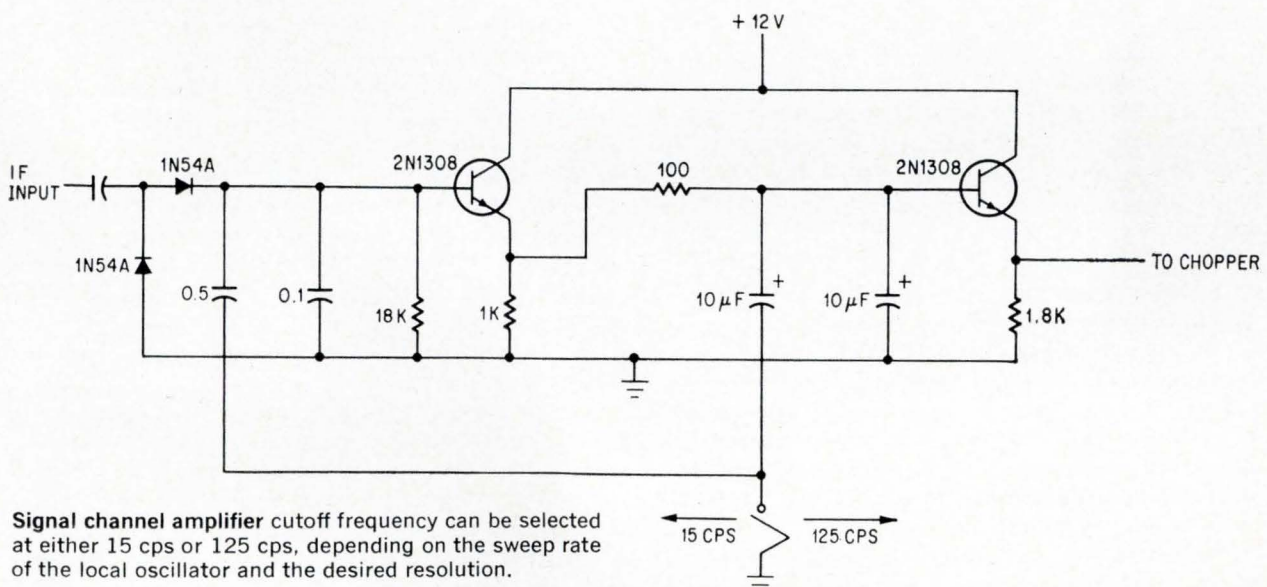

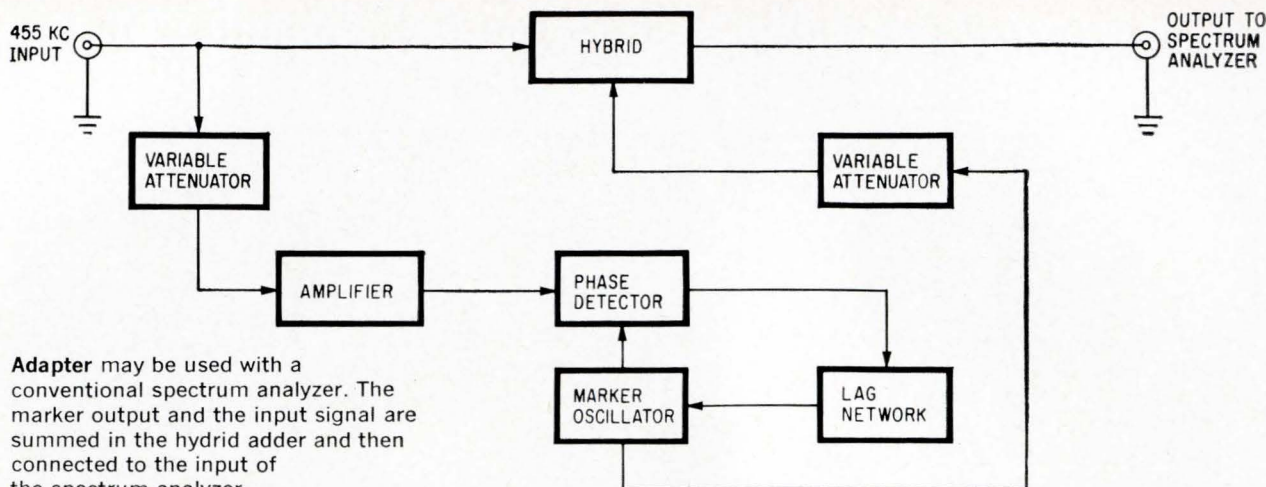

Adapter may be used with a conventional spectrum analyzer. The marker output and the input signal are summed in the hybrid adder and then connected to the input of the spectrum analyzer.

required in the low-pass filter; thus, the need for the 125-cps cutoff.

Since the marker channel contains only one frequency component, a simple low-pass filter is sufficient. A schematic of the signal channel amplifier and the low-pass filter is on page 91.

With each horizontal sweep, the vertical display system provides a simultaneous presentation of the input signal components and the marker. The marker is directly under the component to which it is locked, as shown in the photograph on page 88. The simultaneous display is accomplished by a sequential sampling of the signal channel and the marker channel at a much higher rate than the sweep speed. For example, at a 10-kc sampling rate, a minimum of 625 samples per centimeter are produced on a standard 10-centimeter sweep.

To simultaneously display these two signals, an astable multivibrator is used to gate the sampling circuit. The output of this 20-kc multivibrator, in the diagram on page 91, is differentiated and amplified to provide a trigger for a flip-flop. The two outputs from the flip-flop, 180° out of phase, drive a pair of transistors, which alternately shunt the signal and marker to ground. The chopper outputs in the diagram on page 91, are summed and displayed on the cathode-ray tube.

The display signal is connected to the signal input jack on the front panel of the FMSA; the horizontal and vertical outputs are connected to an oscilloscope. The two horizontal outputs are internally paralleled so that either a coaxial cable or test lead may be used to connect the sawtooth sweep signal to the oscilloscope.

The input signal must be direct-coupled to the vertical input of the scope and the sensitivity of the input amplifier should be approximately 2 volts per centimeter.

For sweep widths of only several kilocycles, a visual indication of the marker locations with respect to the input signal components is sufficient to establish a phase-locked condition. For larger sweep widths, it is difficult to determine visually when a particular component is within the capture range of the marker oscillator. For these cases, a portion of the phase detector output drives an

audio amplifier with a loudspeaker output. This gives an audible indication of the beat frequency between the marker oscillator and the components of the input signal.

To lock the marker oscillator to a particular component, the phase-loop button is pressed, disabling the phase control loop. The oscillator is then tuned until the marker lies under the proper component, producing a zero beat from the audio oscillator. Releasing the button permits the marker oscillator to assume a phase-locked condition.

Another identification approach

An alternate method of spectrum component-identification is to use an adapter and a conventional spectrum analyzer. Although this unit is not as versatile as the FMSA system, it is simpler. As before, the phase-locked oscillator determines the frequency of the individual components of a composite spectrum. The adapter's functional block diagram is shown above.

The display is amplified and referenced with the marker oscillator in a phase detector. The marker and input signals are summed in a hybrid coupler to prevent marker oscillator feedback to the input amplifier and phase detector. This feedback would upset the locking action of the oscillator. The result is a positive marker pip superimposed on the analyzer display.

Besides measuring the components that appear in the i-f passband of a receiver, the FMSA may be used for analysis of a complex waveform or for measuring the frequency of a pulse-modulated carrier and its sidebands. Although it is less versatile than other methods, the spectrum analyzer adapter can provide the same frequency information when used with a conventional spectrum analyzer. The same principles may be incorporated in equipment capable of operating over a wide range of frequencies.

Acknowledgement

This work was sponsored by the Vulnerability Reduction Branch of the Rome Air Development Center under contract no. AF 30(602)-3282. The author is indebted to W.B. Warren Jr. and D.W. Robertson for the guidance and assistance.

1

HIGHEST QUALITY

Quality and reliability demonstrated by a proven 4½ million hours MTBF

2

GREATEST VERSATILITY

Complete families of rugged potted germanium and silicon modules

3

LOWEST COST

For example, 100 Kcps S-R flip-flop module \$3.95 each in quantities of 100

Practical reasons why so many engineers choose EMC

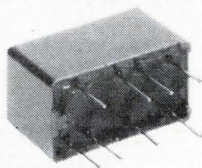

digital logic modules potted in *TIMONIUM*

Complete families of digital logic modules operate over an ambient temperature range of -55°C to +125°C

**ELECTRONIC
MODULES
CORPORATION**

Electronic Modules Corporation • COMPONENTS DIVISION
1949 GREENSPRING DRIVE • TIMONIUM, MARYLAND • TEL. (301) 252-2900 • TWX-301-252-0723

#66-4

Solitron

announces

325_v

300_v

250_v

225_v

200_v

V_{CEO} (SUS)

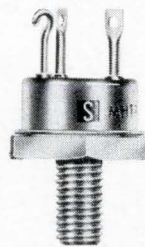

*in a 10 Amp. NPN Silicon
Planar Power Transistor
Plus
50 mcs ----- 150 pfs*

Type Number	Pkg. Size	DESIGN LIMITS						PERFORMANCE SPECIFICATIONS					
		T _J	θ	P _T	BV _{CEO}	V _{CEO} (SUS)	BV _{EB0}	h _{FE}		V _{BE} (sat)	V _{CE} (sat)	I _{CBO}	f _T
		°C	°C/W	Watts	Volts	Volts	Volts	@I _C = 5A V _{CE} = 5V		Volts	Volts	μA	mc
		Max.	Max.	Max. @100°C Case	Min.	Min.	Min.	Min.	Max.	Max. @I _C = 5A I _B = 0.5A	Max. @I _C = 5A I _B = 0.5A	Max. V _{CB} = 60V	Min.
MHT7801	TO-61	200	2	50	225	200	8	20	60	1.2	0.50	1.0	50
MHT7802	TO-61	200	2	50	250	225	8	20	60	1.2	0.50	1.0	50
MHT7803	TO-61	200	2	50	275	250	8	20	60	1.2	0.50	1.0	50
MHT7804	TO-61	200	2	50	325	300	8	20	60	1.2	0.50	1.0	50
MHT7805	TO-61	200	2	50	350	325	8	20	60	1.2	0.50	1.0	50

Solitron

TRANSISTOR DIVISION

DEVICES, INC.

1177 BLUE HERON BLVD. / RIVIERA BEACH, FLORIDA / (305) 848-4311

Leader in Germanium and Silicon Power Transistors, Cryogenic Thermometers, High Voltage Rectifiers, Temperature Compensated Zeners, Voltage Variable Capacitors, Random/White Noise Components and Microelectronic Components.

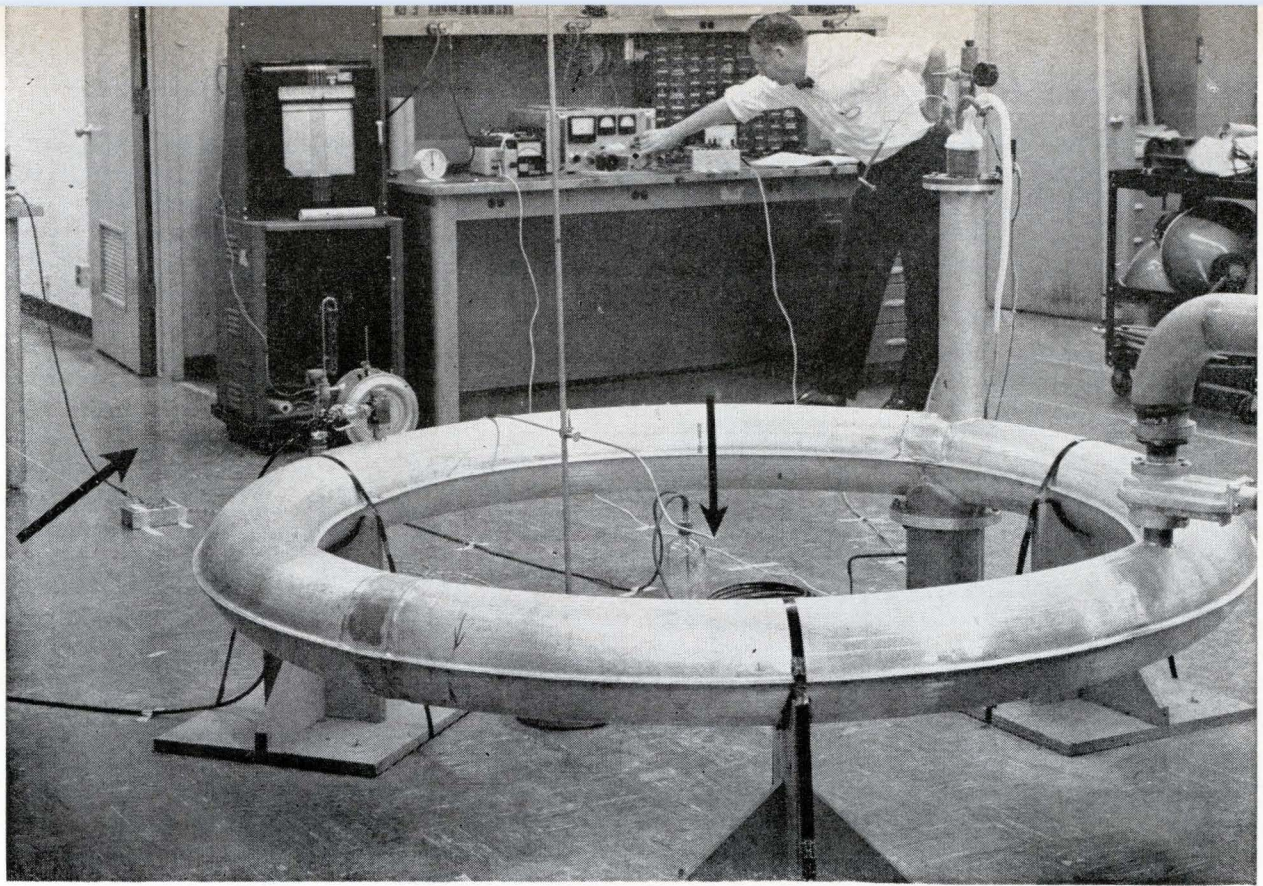

Six-foot diameter superconducting coil used to study radiation shielding. The black arrows are stamped steel pieces that are being supported by the magnetic field.

Components

Putting superconductors to work

Although superconducting materials are limited mainly to research applications, total sales should top \$1 million this year with a dozen companies manufacturing magnets and magnet systems

By Donald K. Fox

Westinghouse Electric Corp., Pittsburgh, Pa.

The bright future predicted for superconductors draws nearer as new superconducting materials are discovered—some of them able to operate at the relatively high temperature of 18°K. The manufacture of a variety of superconductor magnets and magnet systems is under way at more than a dozen commercial companies. Sales of superconductor equipment to universities, industrial laboratories

and original equipment manufacturers are expected to top a million dollars this year. Superconductor applications are seen for computer elements, gyroscopes, frictionless motors, transformers, circuit breakers, rectifiers and transmission lines. Their ability to store large amounts of energy, as well as their small size, light weight and fast operation, give them potential advantages for military equip-

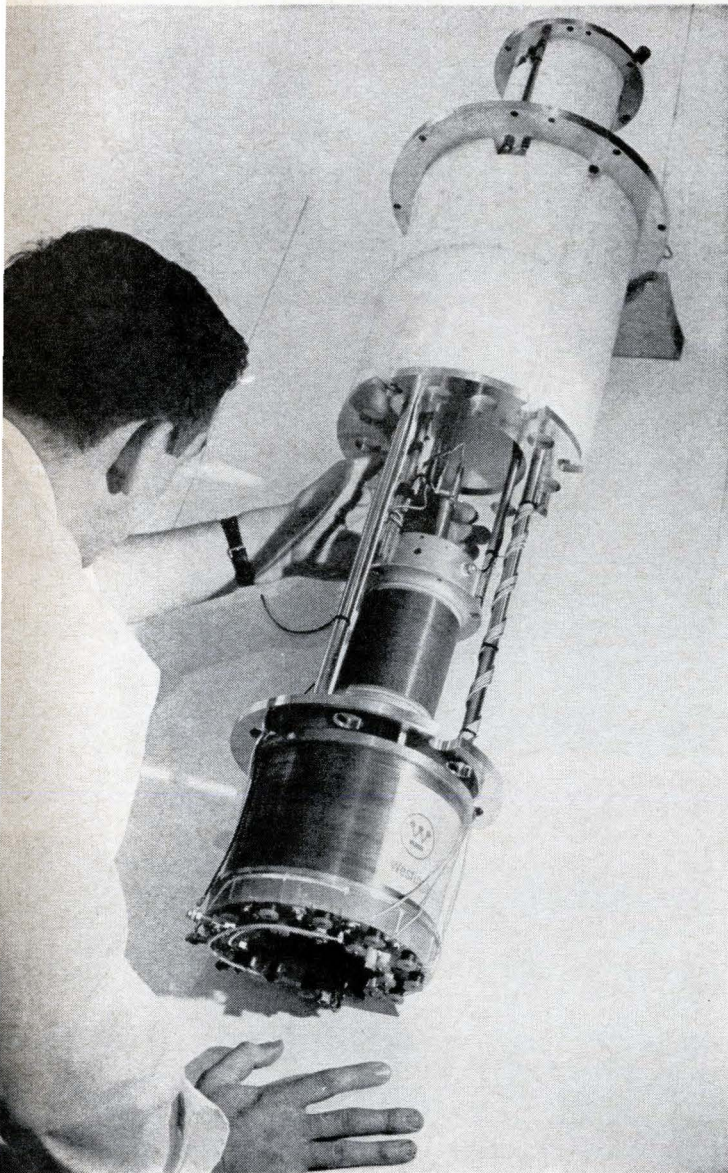

A 100-kilogauss superconducting magnet. Three concentric magnets were used to produce the field; the smallest one is shown next to the researcher's left hand.

ment such as portable power supplies and advanced weapons.

Applications of superconductors

As an example of the potential of superconductors, the 100,000-gauss magnet at the National Magnet Laboratory at the Massachusetts Institute of Technology requires approximately 1.7 million watts to produce the field, and 1,000 gallons of water per minute to remove the heat generated in the copper windings. But for the same field strength, the superconducting magnet shown above requires only a six-volt battery—300 watts—power supply and a cryogenic environment maintained for a long time by a 10,000-watt refrigerator—the type used to cool helium. But at present, superconducting magnets have two limiting features: the cryogenic environment needed for such magnets; and, if improperly operated, the fact that they might go

“normal”—reverting from the superconducting state to the resistive state. The heat produced boils off the coolant almost immediately and may damage the magnet. These two factors bar many industrial applications of superconductivity.

However, compact superconducting magnets, such as those on page 97, with field strengths up to 80,000 gauss and working volumes of 3 inches in diameter and 8 inches long, are being used to study superconducting properties of materials, nuclear magnetic resonance, magneto-optical phenomena, infrared absorption, neutron diffraction, adiabatic demagnetization and many other low-temperature effects. A complete superconducting magnet system includes a Dewar vessel, a superconducting coil, a transistorized power supply for energizing the coil, a gaussmeter for measuring the magnetic field intensity, a helium transfer tube, and a liquid-helium-level monitor.

Besides the relatively small magnets, several larger ones have been built for special applications that vividly illustrate the potential of superconductivity. One of these is a 6-foot-diameter superconducting magnet constructed for the U. S. Air Force to determine whether large superconducting coils could shield space vehicles against high-energy radiation. The test results indicate such a possibility because the magnet's liquid helium stayed at a cryogenic temperature long enough for a space mission.

The largest-volume, highest-field superconducting magnet is at the Argonne National Laboratory's accelerator division. This enormous magnet is a composite of three concentric coils with a 6-inch inside diameter and a field strength of 67 kilogauss. The stored field energy is greater than 600,000 joules. The magnet will be used with a 10-inch diameter superconducting helium-hydrogen bubble chamber, a device for showing the traces of ionized particles. Economical operation of such a bubble chamber could give rise to a new generation of superconducting magnets for high-energy physics applications.

Superconductors for masers

Superconducting materials can also be used in masers. If a superconducting electromagnet can replace the conventional permanent magnet, the maser's weight can be reduced by a factor of 50 to 70. Also, hard superconductors rolled into sheet resist magnetism and have made good magnetic insulators, preventing flux leakage from the region around the magnetizing coils. This means greater field stability and uniformity. Recent experiments with columbium-titanium alloy sheets indicate magnetic shielding capabilities of up to 4 kilogauss.

A 70-gigacycle traveling-wave maser with field coils wound of superconducting wire is in the photo on page 97. The columbium-zirconium superconducting magnet produces a 5-kilogauss field with a deviation less than one gauss perpendicular to the 1.5-inch length of the traveling-wave maser

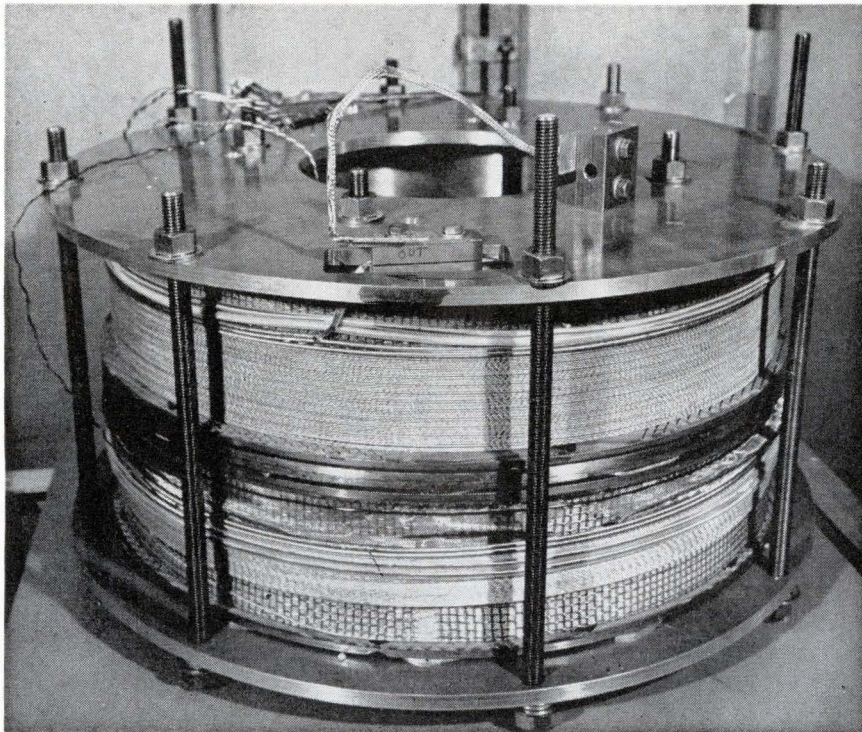

World's largest superconducting magnet—6-inch bore, 67,000 gauss. For ease of coil construction, a braided superconductor wire consisting of six wires was wrapped around a seventh wire.

Typical wire-wound superconducting solenoids. Although both magnets have the same rated field, there is a 10:1 ratio of working volume between the large and small solenoids.

Traveling-wave maser has a superconducting field coil that is housed in the metal section attached to the left side of the maser.

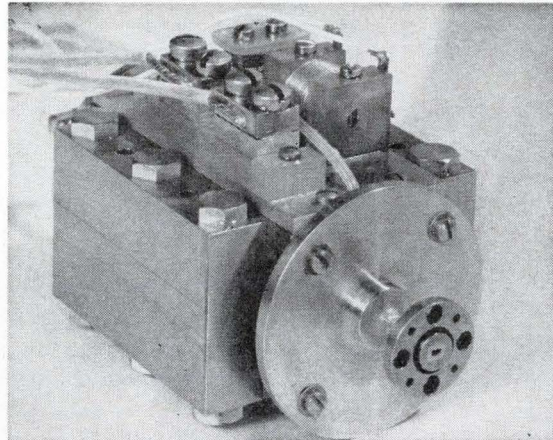

element. The magnet weighs about three pounds and can operate in the persistent mode. In this mode, a superconducting switch is placed across the power leads. The columbium-zirconium wire has zero resistance, so the coil current theoretically should flow for infinite periods. This does not occur in practice because of losses at the wire junctions; however, 50-kilogauss coils have been operated in the persistent mode for several days without any detectable decrease in field strength.

Conventional electrical energy is stored in capacitor banks or batteries. The banks are limited by relatively low-energy densities, the batteries by relatively long discharge times. One superconducting coil, designed differently from the simple solenoids discussed previously, can be charged over a long period with a low-voltage power supply. The coil is made of braided wire to reduce inductance, thus reducing the high voltage that may be induced

when discharging the coil. This method also avoids hazards to personnel. With a thermal switch, the coil's current can be made persistent, thereby storing the energy for indefinite periods or until a rapid discharge is required. Several energy storage devices of this type, which deliver up to several hundred joules, have been built to pump lasers. But the high cost of materials makes energy storage by superconductors uneconomical at energies less than 10^7 joules—compared with conventional methods—unless the lighter weight, smaller size, and faster operation are decidedly advantageous, as in certain military applications.

The persistent mode

Superconducting magnets are often equipped with a persistent mode switch for optimum field stability. The switch, a piece of superconductor placed across the magnet's leads, allows the current

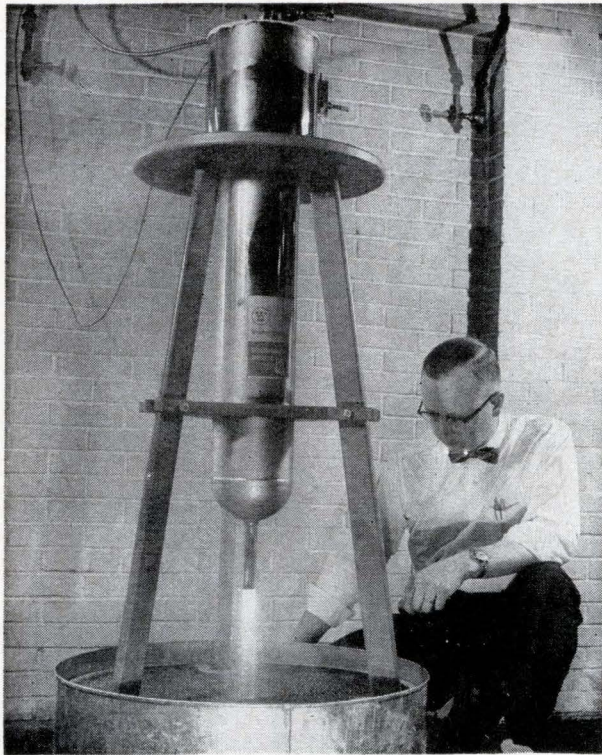

Magneto hydrodynamic (MHD) generator uses a 1-inch air-core superconducting coil for the field coil. The coil and its support are being lowered into the Dewar vessel.

of the energized solenoid to flow indefinitely without loss through the shorted circuit. Once the short circuit is established, the power supply can be disconnected with no effect on the magnetic field.

The persistent mode has two advantages—lower helium loss rate and a completely stable magnetic field. Operation is continuous as long as the coil remains immersed in liquid helium. The switch is controlled thermally by a resistance-type heater wound in close proximity to it. The heater raises the temperature of the switch causing it to go into the resistive state, and in effect, opening the switch.

Conversely, turning off the heater results in a closed switch. The circuit at the left is for a superconducting magnet with a persistent mode switch.

MHD power generators

The widest potential application for superconducting magnets is for magneto hydrodynamic (MHD) power generation. In MHD devices, a high-velocity jet of ionized gas—a plasma—is passed between the poles of a powerful magnet. An electromotive force is produced in the plasma conductor at right angles to both the magnetic field and the direction of the plasma's motion. Direct current can be extracted from the system by placing electrodes in the hot gas stream.

Superconducting magnets also reduce the weight of the field coil per unit of power output, thereby improving the competitive position of MHD generators over conventional power plants. The figure at the left shows a small, experimental MHD generator that has an air-core superconducting magnet with a 1-inch inside diameter as the field coil and a strength of 30 kilogauss.

So far, all of the superconductor devices described in this article are direct-current. But broad potential applications also exist in transformers, transmission lines, rectifiers, rotating equipment, and other alternating-current equipment. The practicality of these devices depends on producing superconductors that can carry high a-c currents with little or zero resistance. Evidence has shown that a-c losses in superconductors are substantial; however, some recent work on superconductor delay lines with ultrahigh-frequency pulses indicates that these losses can be reduced.

Intermetallic compounds and alloys

Superconductor materials with a combination of high current-carrying capacity (J_c), high critical magnetic field (H_c), and practical critical temperatures (T_c), fall into two classes—intermetallic compounds and alloys.

Intermetallic compounds such as columbium-tin, vanadium-gallium, and vanadium-silicon develop their useful superconducting properties from chemical composition. Although these materials exhibit higher levels of H_c and T_c than those of alloys, their brittleness results in serious fabrication problems. Only columbium-tin is now available commercially.

Because of inherent mechanical disadvantages or high cost, the available intermetallic compound

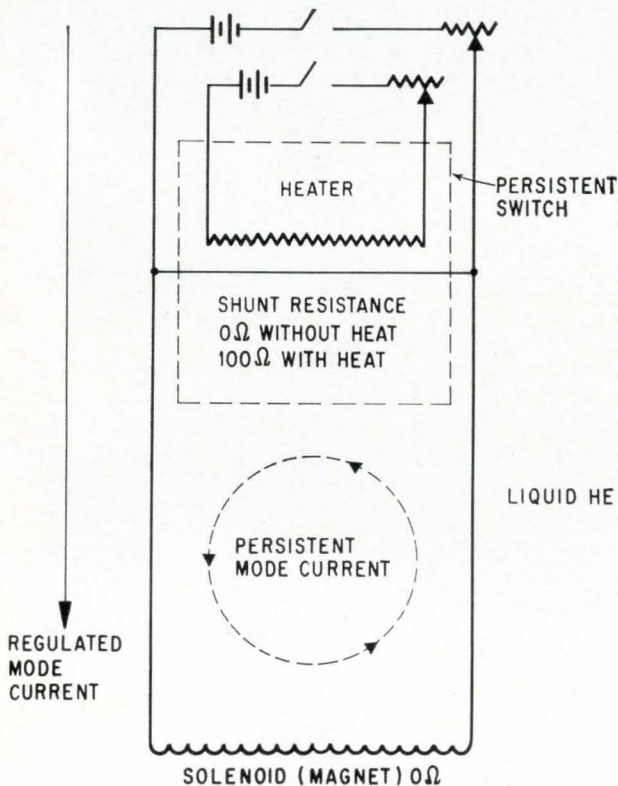

Circuit for a magnet with a persistent mode switch. When the heater raises the temperature of the switch to the transition point, resistance decreases the current flow through the magnet. Cooled, the switch becomes superconducting and allows current to flow.

Theory of superconductivity

Some metals at or near absolute zero completely lose their resistance to the passage of current. A graph illustrating this relationship is shown below.

One explanation of this phenomenon: the electrons in an element or compound that is at a very low temperature give off part of their energy in the form of a phonon, or quantity of thermal energy arising from vibrations in the crystal lattice. A pair of de-energized electrons share each phonon, thus binding themselves together. These pairs are the superconducting electrons. Bound only to each other, their motion is no longer restricted by the confines of a crystal lattice and they move through the material without hindrance.

Critical temperature

The temperature at which a superconductor loses its "normal state" electrical resistivity, as shown below, is called the critical temperature, T_c , and is a characteristic of a given material. For example, the critical temperature of an alloy consisting of 75% columbium and 25% zirconium is 10.8°K. The highest known T_c for a compound superconductor (columbium-tin) is 18°K.

Another characteristic important to the discussion of superconductivity is the critical field, H_c , the maximum magnetic field in which a superconductor material will continue to carry current. This field may be externally applied, or self-generated.

Until a few years ago, superconductor applications were severely limited because the superconducting state in all known superconducting materials could be destroyed by a magnetic field of modest strength—3 or 4 kilogauss. In 1961, however, it was discovered that certain alloys and compounds could sustain large current densities on the order of 10^5 amperes per square centimeter in externally applied magnetic fields up to 90 kilogauss. Some of these materials even carry some current at 350 kilogauss.

Filamentary superconductors

These hard, or filamentary, superconductors owe

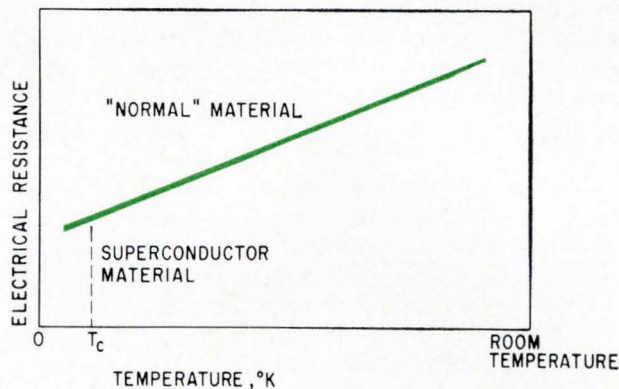

Variation of electrical resistance with temperature for normal and superconductor materials. The resistivity of a normal material decreases linearly with temperature; superconductors lose all resistivity at a specific temperature.

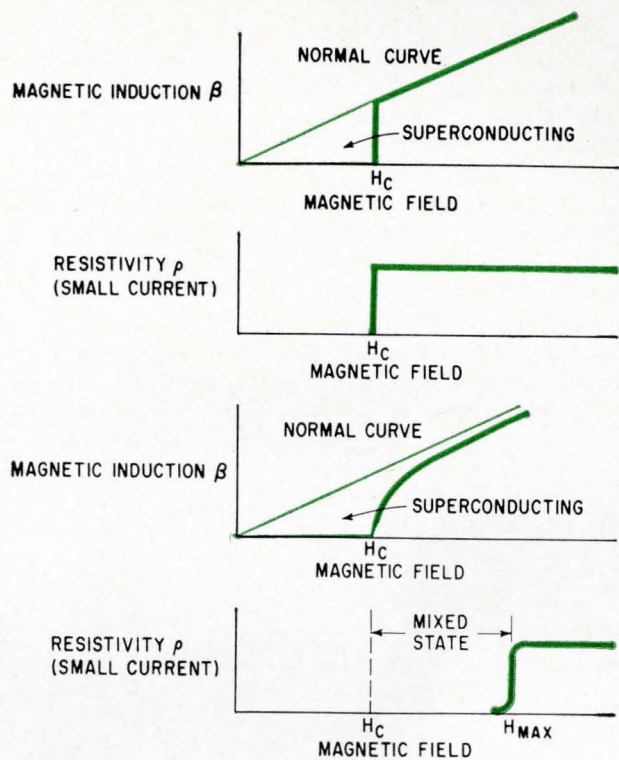

General features of magnetic and resistive transition behavior for soft and hard superconductors. The soft superconductor exhibits a well-defined magnetic transition; the hard superconductor passes through a mixed state in which both superconducting and nonsuperconducting regions exist.

their unusual high field capabilities to an electronic structure which allows portions of the material to continue carrying current in spite of large magnetic flux. The curves at the top illustrate the relationship between magnetic and nonmagnetic states for soft, or very low-field superconductors such as lead, tin, and columbium; and hard, or super-field superconductors such as columbium-zirconium, columbium-titanium, and columbium-tin. The critical magnetic fields and the critical temperatures for a number of important alloy and compound filamentary superconductors are shown in the table below. Because of their high critical fields, high critical temperatures, and ability to sustain large current densities, some of these materials are being used commercially.

Alloy	H_c (gauss)	T_c (°K)
Columbium-25% zirconium.....	70,000	10.8
Columbium-50% zirconium.....	90,000	9.3
Columbium-48% titanium.....	120,000	10.7
Compound		
Columbium-tin.....	183,000	18.0
Vanadium-silicon.....	156,000	17.0
Vanadium-gallium.....	350,000	17.0

superconductors have been limited to small-volume, research laboratory magnets. If superconducting magnets of field strengths more than 100,000 gauss are to be mass produced, improved fabrication methods are necessary.

To date, all commercial superconducting magnet systems have solenoid windings of columbium-zirconium or columbium-titanium alloys, or a combination of both. Although these ductile materials must be used with considerably lower maximum

fields than the intermetallic compounds, they can be easily worked into wire or strip products, require no heat treatment in coil, and are available in long continuous lengths (e.g., 30,000 feet of 10-mil-diameter wire) at a reasonable cost.

One alloy, containing 25% zirconium, and 75% columbium, is the most widely used because of its good current-carrying capability and high critical magnetic field. The figure just below shows a typical current vs magnetic field curve for a 10-mil-diameter bare wire sample of Cb-25% Zr alloy. At zero applied magnetic field, the wire can carry about 180 amperes (a density of 3.6×10^5 amps/cm²). At an applied field of 70 kilogauss, the current capacity falls to zero amperes. Because the current-carrying capacity of ductile superconductors depends on metallurgical variations, the shape and magnitude of the I versus H curve can be altered—depending how much the wire has been

drawn, the hydrogen, nitrogen, and oxygen content, and the heat treatment. Most coil manufacturers use the I vs H curve of a short-length sample to assure that wire received from the supplier is comparable to past shipments, and is consistent with the manufacturer's design parameters.

Columbium-titanium series

Offering higher critical magnetic field and a lower current density, a newer alloy is based on a columbium-titanium series. A typical I vs H curve for a 10-mil-diameter bare wire sample of this alloy is shown below, left. At zero applied magnetic field this alloy has a current-carrying capacity of over 2×10^5 amps/cm². Unlike the Cb-Zr alloys, it does not quench out (lose its current-carrying capability) at fields below 100 kilogauss. At 80 kilogauss, for example, the current density is approximately 4×10^4 amps/cm².

When either the critical current, critical temperature or the critical magnetic field is exceeded, a superconducting coil switches into normal conductivity. The circulating current meets a large resistance in the wire and the stored energy is rapidly dissipated as heat. This normalization is accompanied by the vaporization of liquid helium, which permeates the coil windings.

More important than the temperature rise, which can be on the order of 100°K, is the voltage induced by the rapid current decay according to the relationship $V = -L(di/dt)$. In an inductive magnet, this voltage can be large enough to cause arcing between windings, to melt the wire, and to create a hazard. By coating the superconductor with copper, the coil current from the superconducting path can be shunted to the low-resistance normal path during normalization, thereby reducing the rate of current decay and induced voltage. The metallic coating also serves as additional insulation during the superconducting state, and diminishes the normalizing possibility from electrical and thermal transients at low currents or fields.

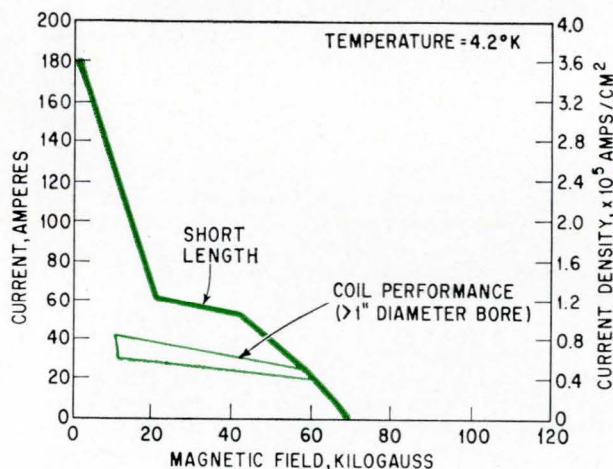

Typical current versus magnetic field relationship for Cb-25% Zr, 10-mil-diameter superconductor wire. Depending on design requirements, short-length performance can often be duplicated in the working coil.

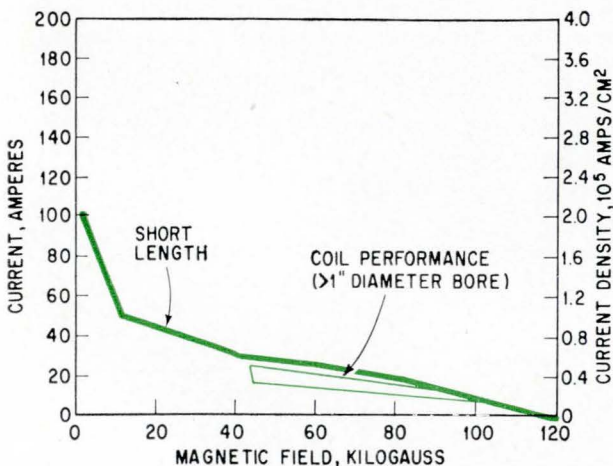

Typical current versus magnetic field relationship for Cb-Ti, 10-mil-diameter superconductor wire. This material demonstrates closer short-length performance in a coil than the one represented by the previous graph.

Copper coating is standard

Copper is chosen for shunting because of its low electrical resistivity, high thermal conductivity and high heat capacity at 4.2°K. Although other metals such as silver, cadmium, and lead might function as well, techniques for electrodepositing copper on columbium-zirconium substrates were developed during the early manufacturing stages, so copper has been accepted as the standard for the industry.

Because the ability to sustain maximum solenoid currents and coil stability depends on the quality of the deposited copper coating, many electrical tests to rate and grade wire have been developed. One of the most important grading parameters is the bond between the copper plating and the superconductor substrate. The lower the electrical resistance of the bond, the better the energy transfer during normalization, improving the absorption of local thermal transients that might cause the coil to go normal. Another significant parameter is the

ratio of copper's resistivity at room temperature to its resistivity at liquid-helium temperature (11°K). At temperatures close to absolute zero, electrical resistivity is primarily due to impurities. Thus the resistivity ratio is a way to determine the purity of the copper deposit: the higher the ratio, the higher the plating purity and energy transfer capability. Although there is some variation in different magnet manufacturers' products, the standard copper plating thickness on 10-mil-base wire is 1 mil, measured along the radius.

Some preliminary work has been done on cladding superconductor wire by drawing a copper tube over the base wire. This configuration shows electrical characteristics that are better than electroplated coatings and provides more economical, thicker coatings. To date, however, the lengths required by the magnet industry have not been produced.

Besides copper plating, an organic compound to prevent shorting between turns and to minimize arcing insulates much superconductor wire. The three most common insulations are epoxies, nylon, and Formvar. Epoxies, which can be applied by conventional methods to yield a very thin, uniform coating—less than $\frac{1}{4}$ mil on the radius—are considered the best insulators. Nylon absorbs moisture and is often limited to a minimum 1-mil buildup on the radius because the nylon must be wrapped and fused. Although Formvar can be applied as a thin coating, its high curing temperature can cause annealing of the base material.

Superconductor coils

Significant decreases in current capacity of wire in coils, as compared to that observed in short-length tests, is characteristic of all superconductor materials, particularly at low magnetic field levels. Why this loss occurs is not completely understood, although it is generally accepted that the relationship between adjacent lines of magnetic force generated by the coil turns are manifested by flux-jumping. This causes the magnet to go normal at a lower field or current than anticipated from the short-length test. Flux jumping is the spontaneous and unpredictable movement of flux lines into the wires. Designers have attempted to achieve coil currents approaching short-length performance by increasing the spacing between wires and/or layers at the sacrifice of the packing factor. The packing factor is defined as the ratio of conductor wire area to the total winding area available. The increased performance has been achieved by increasing the amount of metallic coating or insulation on the wire. The performance of typical large coils (bore greater than 1-inch) of Cb-Zr and Cb-Ti is shown by the areas in color in the figures on the opposite page. The point within these areas at a specified magnetic field will vary depending on the wire composition, thickness of metal coating and insulation, coil configuration, and coil construction techniques. Generally, Cb-Ti coils operate closer to the short-length test sample curve than do Cb-Zr coils.

The cause of this difference in performance is not clear.

Great care must be taken during the construction of a superconducting coil. If joints between lengths of superconducting wire, or between the power leads and superconductor leads, are not properly assembled, they will become the source of thermal transients and premature normalization. The common method of making joints is by stripping the copper a short distance from the ends of the superconductor wires, mechanically abrading the stripped ends and rinsing them in acetone, tinning the ends with pure indium solder, and clamping the wires between indium-tinned, high-conductivity copper joint blocks, which are subsequently placed on the flanges of the coil former. At a test current of 10 amperes, the voltage drop across such a joint at 4.2°K should not exceed 100 microvolts.

Thermal treatments affect characteristics

As mentioned previously, thermal treatments can markedly influence the shape of the I versus H characteristics of the superconductor wire and subsequently affect coil performance. Indium tinning must be done carefully and without excessive heating of the base wire. Poor coil performance has been traced to wire leads that were overheated during the tinning operation. The placement of the joint block on the coil former is also important because the joints may show current-directional behavior if the round wire is flattened. Optimum current capacity can be assured if the position of the wire joint is parallel to the magnetic field direction at the point of attachment to the coil former.

To maintain a solid, tightly wound solenoid at cryogenic temperatures, the thermal contraction characteristics of the wire must be matched to those of the coil former. Unless this is done, the coil former might shrink, resulting in a loose pack and erratic coil behavior. Winding tension may also influence coil performance and should be maintained at a back tension of about 6 to 8 pounds on a nominal 10-mil-diameter wire.

Progress in applying intense magnetic fields to ore beneficiation, forming of metals, nuclear fusion containment, chemical processes, and power generation and distribution will depend on contributions from basic research. A better understanding of superconductor materials, the development of new and improved materials, and manufacturing innovations will determine superconductivity's eventual role in industry.

The author



Donald K. Fox is senior metallurgical engineer at the Westinghouse Research and Development Center. He works on superconductor materials and on product-oriented metals research.

DISTORTION ANALYZERS GO SOLID-STATE

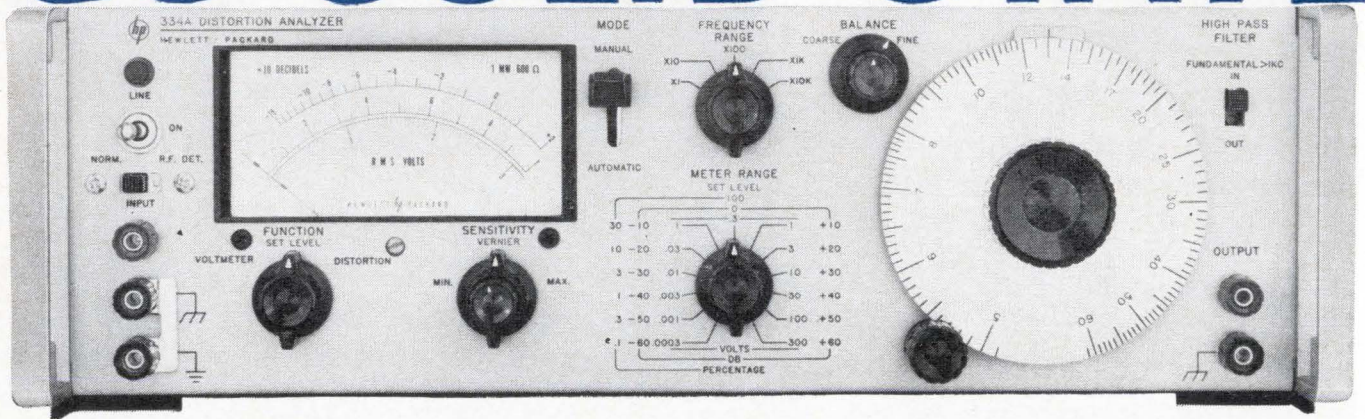

to offer you harmonic distortion measurements 5 cps to 600 kc with 0.1% full-scale distortion sensitivity... plus these features:

"AUTOMATIC NULLING" for simple, fast measurements

0.3 v rms input sensitivity for 100% Set Level reference

300 μ v rms voltmeter full-scale sensitivity (residual noise < 25 μ v)

Solid-state design in four Hewlett-Packard distortion analyzers offers you extended frequency range, greater Set Level sensitivity, improved selectivity, greater overall accuracy, unprecedented ease of use. All four measure total distortion down to 0.1% full scale, 5 cps to 600 kc, with harmonics indicated to 3 mc. They measure voltage 300 μ v to 300 v full scale, have flat frequency response 5 cps to 3 mc. Distortion analyzer and voltmeter input terminals are the same. One-megohm input impedance. Floating input and floating, low-distortion output for scope or true rms voltmeter monitoring.

Two models feature automatic fundamental nulling (>80 db rejection): Manually null to less than 10% of the Set Level reference, flip a switch, and nulling is completed automatically. No more tedious tuning on the more sensitive ranges! Two other models employ high reduction gear drive to aid manual tuning.

Two of the analyzers provide a switchable high-pass filter which attenuates frequencies below 400 cps on signals greater than 1 kc... removes hum and gives you pure distortion measurements.

Two models incorporate an amplitude modulation detector that covers 500 kc to greater than 65 mc, measures distortion at carrier levels as low as 1 v. Options include an indicating meter with VU ballistic characteristics (01) and rear terminals in parallel with front input terminals (02).

Ask your Hewlett-Packard field engineer for a demonstration of the model incorporating features most useful to your application. Or write for technical data on all four models to Hewlett-Packard, Palo Alto, Calif. 94304, Tel. (415) 326-7000; Europe: 54 Route des Acacias, Geneva; Canada: 8270 Mayrand St., Montreal.

Model	Automatic Fundamental Nulling	High-Pass Filter	AM Detector	Gear Reduction Tuning	Price
331A				✓	\$590
332A			✓	✓	\$620
333A	✓	✓			\$760
334A	✓	✓	✓		\$790

Data subject to change without notice. Prices f. o. b. factory.

HEWLETT  **PACKARD**
An extra measure of quality

4211

Automated ground station will check out Saturn

Computer-controlled telemetry at Marshall Space Flight Center will speed the testing of space vehicles and reduce the time required to change from one transmission mode to another

By George D. Shollenberger

Defense Electronics, Inc., Rockville, Md.

An automated ground station may be NASA's solution to the problem of coping with the fast-growing volume of data transmitted by space vehicles. Construction of such a station, with its telemetry functions controlled by a general-purpose computer, will begin Feb. 25 at the Marshall Space Flight Center in Huntsville, Ala.

The National Aeronautics and Space Administration expects the automated station to speed the change from one operational mode to another—for example from pulse-amplitude modulation (pam) to pulse-code modulation (pcm)—and to reduce the testing time in each mode. The basic method of monitoring will remain the same because, although the volume of data received from space has increased enormously, the complexity has remained about the same.

Built by Defense Electronics, Inc., of Rockville, Md., the automated station will be controlled by a model 930 computer made by Scientific Data Systems, Inc.

The automated station's first major task will be to check out Saturn launch vehicles before their delivery to Cape Kennedy as part of the Apollo program to land men on the moon by 1970.

The author



George D. Shollenberger has been working on telemetry systems for more than twelve years. At Defense Electronics Inc., he is systems project engineer of the receiving and predetection recording system for the Eastern Test Range.

Catching up with the transmitters

Telemetry systems aboard most missiles are already automated. Sensors automatically determine the vehicle's rate of climb, its roll, pitch and yaw, and variations in its temperature and pressure. This information is converted from analog to digital form and transmitted automatically to ground stations. Because each vehicle has its own telemetry modes and frequencies, ground stations at the test sites must adapt quickly to a variety of techniques.

In the automated station, the speed of this change is limited only by the response time of the electronic equipment. The computer will be preprogrammed with information about the operating mode of each piece of equipment in the ground complex. When it receives a command to change state, such as from pam to pcm, it changes the operational mode of all the receiving equipment.

Automated telemetry does not require special receivers, transmitters or other components. However, it does require control circuitry that accepts and executes the digital addresses and instructions received in "words" meaningful to a computer.

Each computer word controls equipment that sets up an operational sequence for the telemetry system or for the fault-detection equipment; it also provides a means of system testing. Each computer-control word contains 25 bits—one strobe bit and 24 instruction or address bits. Digital control information is transferred to individual subsystems during a strobe pulse, the 750 nanoseconds that it takes for a digital word to travel from the computer's digital control bus and be stored or routed.

The telemetry receivers at Huntsville have the same basic design as do receivers in manually op-

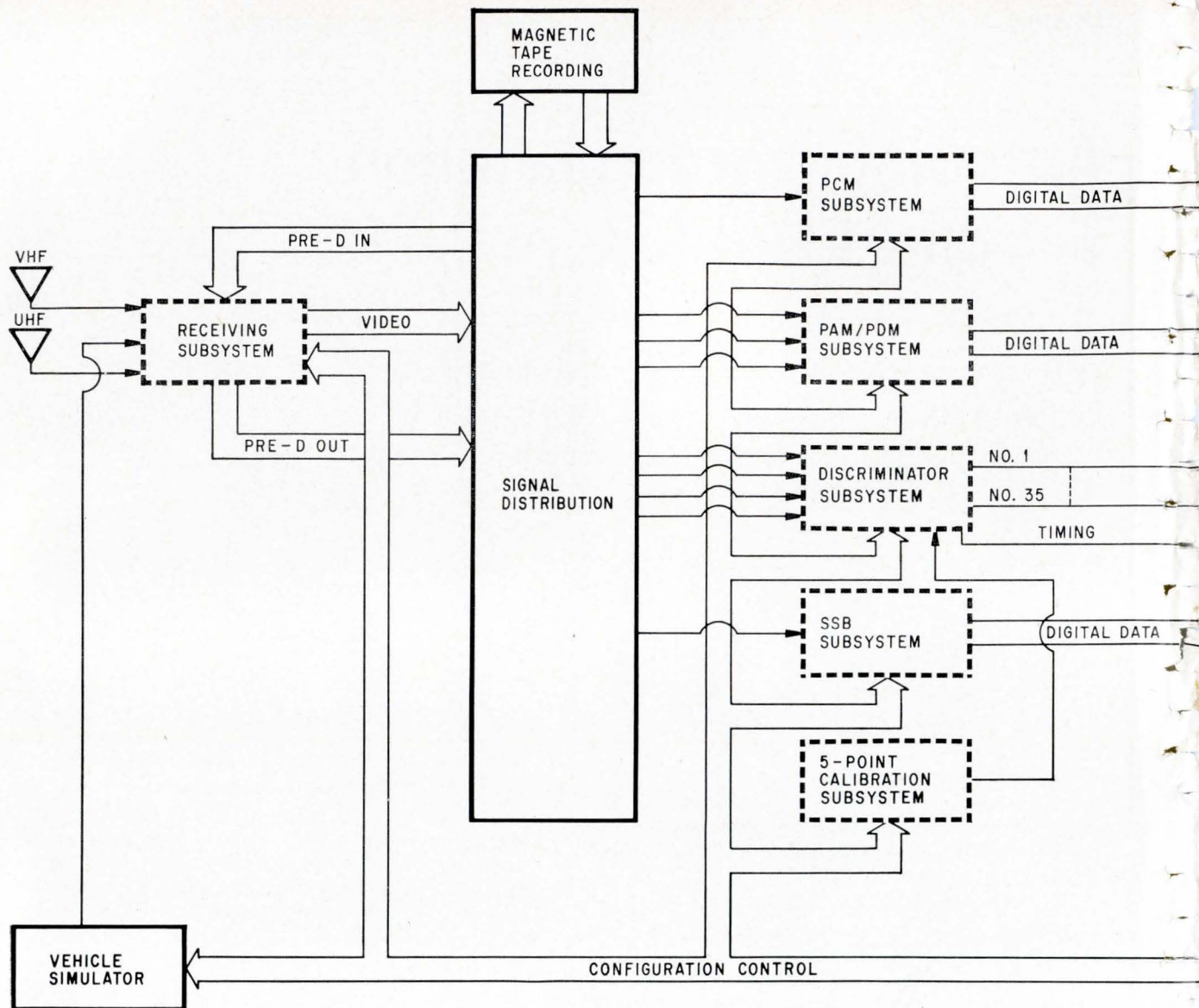

erated stations, except that its 16 operating frequencies, four intermediate-frequency bandwidths, three video bandwidths, receiver mode—for receiving or playing back—and its up-converter input—simulator or tape recorder—are all controlled by the computer.

For receiving signals from the Saturn rocket, four computer-control words will set up the eight receivers in any mode; each receiver requires 10 instruction bits for its set-up logic; 4 bits for frequency selection, 2 bits for i-f selection, 2 bits for video selection and 1 bit each for mode and up-converter input selection.

Although the strobe may repeat at rapid intervals, the equipment cannot respond quickly to the computer's instruction.

Sacrificing selectivity

Receivers in an automated ground station must be tuned rapidly to any standard IRIG (inter-range instrumentation group for the Department of De-

fense) frequency. A computer-tuned receiver with the selectivity of a manually tuned receiver would be impractical. Instead, a receiver with a nonselective front end was designed; selectivity is achieved by controlling the i-f bandwidth.

Difficulties arise when strong extraneous signals are received at frequencies near that of the desired signal; the receiver cannot reject these, and it may become overloaded, causing spurious responses and suppressing the desired signal.

The telemetry standard IRIG 106-60 permits error of only 0.005% in the transmitter frequency at ultrahigh frequency. Thus a transmitter operating at 2,300 megacycles per second may be off frequency by 115 kilocycles. This error is intolerable in receivers that have narrow bandwidths required in the i-f, down-converter and predetection stages. At present, the IRIG does not specify an allowable receiver error at very high frequencies because all uhf receivers are assumed to be manually tunable.

To eliminate manual operations, two approaches

Pulse's progress through the automated station

The automated station receives inputs from a space vehicle, a vehicle simulator, or both. In the simulation mode, telemetry carrier signals are generated as f-m modulation on a 600 kc carrier and then directed into any one or all of the predetection up-converters in the receiving subsystem. This mode is used for aligning and checking the automated station. Station operation may also be checked by stimulating the up-converters with known signals previously recorded on the magnetic tape recorder.

The receiving subsystem delivers all signals to the signal-distribution system. Signal distribution is variable but is not computer-controlled because the distribution is fixed for the same vehicle and varies only for different airborne telemetry systems.

Next in the data path are the decommutation subsystems—pcm, pam, pdm, ssb and f-m carrier demodulation. The setup of these subsystems is under complete control of the computer. All of these subsystems have digital output signals, which go to the formatter. The exception is the discriminator subsystem, which has analog outputs for oscillographic displays. These analog signals are selected by the computer in the formatter.

The formatter multiplexes the digital outputs from the decommutation subsystems into many records for entry into the computer. These records are used by the computer and or the control operator for mode switching.

Since the formatter has access to all airborne data channels, any random channel may be selected and routed to the display subsystem for monitoring. The formatter also contains digital-to-analog converters.

A 25-bit control word, divided into three syllables, aligns the system. The first, a single bit, is a strobe order; the second, of four bits, is an instruction address; the third is a 20-bit instruction.

During the time of the first syllable, the system accepts the word from the control-word bus; the second syllable routes instructions into storage elements when more than one word is required; the third syllable contains instructions for adjusting the equipment.

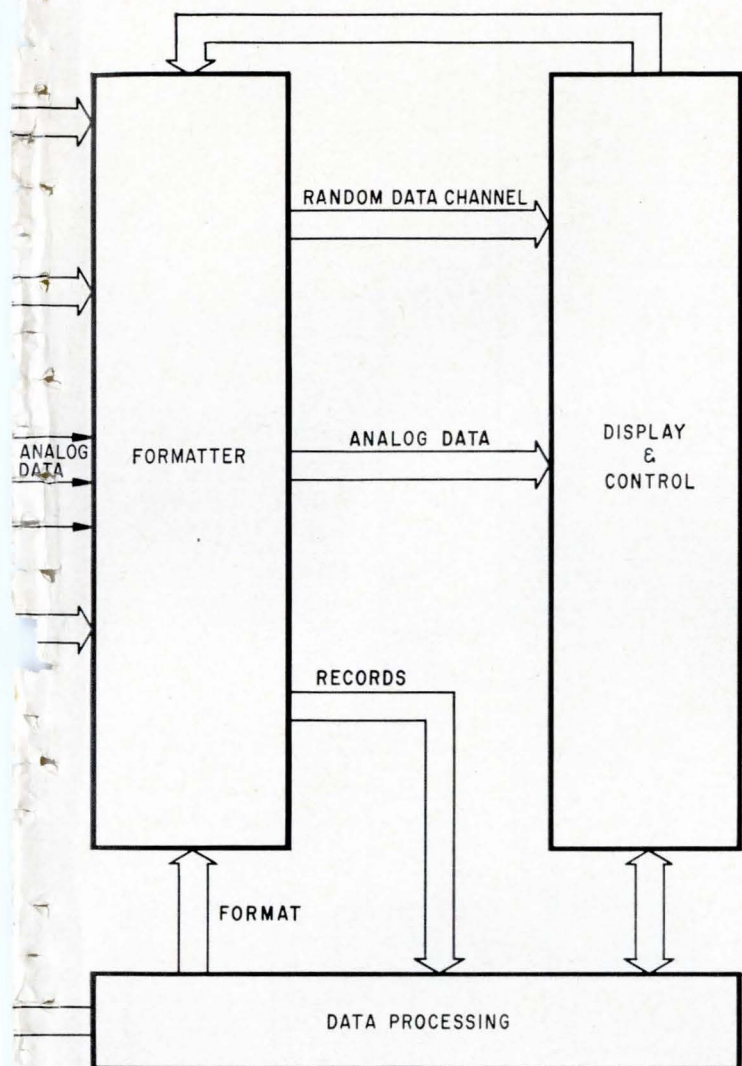

are being tried. One is a semiautomatic feature that requires the receiver's second local oscillator frequency to be variable in discrete steps. A central operator, using pushbuttons and go-no-go tuning indicators, makes the necessary adjustments.

The second approach adds a demodulator circuit, which examines the signal band and automatically adjusts the second local oscillator in discrete steps, or continuously (afc) until the received signal is centered within the preselected passband.

The other principal subsystems in the automated station have the same basic design as in manually controlled stations. These subsystems are a digitizer for pulse-amplitude modulation, pulse-duration modulation (pdm); a single-sideband (ssb) demultiplexer and digitizer, and an IRIG f-m demultiplexer.

In the pam/pdm digitizer, the three synchronizers can be fed simultaneously from three non-coherent pam or pdm wavetrains that have the same recurrence rate. The computer-controlled inputs are conditioned, sampled, converted to 8-, 9-,

10-bit binary code and multiplexed into a parallel output with the necessary frame and master-frame synchronization information. An analog-to-digital converter codes the pam and pdm samples.

The pcm decommutator accepts a pcm pulse train, locks on to the pulse synchronization pattern and pulse rates, then converts the serial digital words to a parallel output. Words containing discrete data are decommutated to ten event registers. These registers drive event recorders, lights and other displays in other parts of the ground system.

One word from the computer. . . .

The ssb subsystem accepts as its input a composite ssb signal consisting of 15 multiplexed data channels and one special service channel; the subsystem also receives a calibrate signal. On command from the digital control unit, the subsystem's analog multiplexer connects the digitizer to the calibrate signal, the special service channel or to one of the demultiplexed data channels.

Subsystems for pulse-code modulation and single-side band

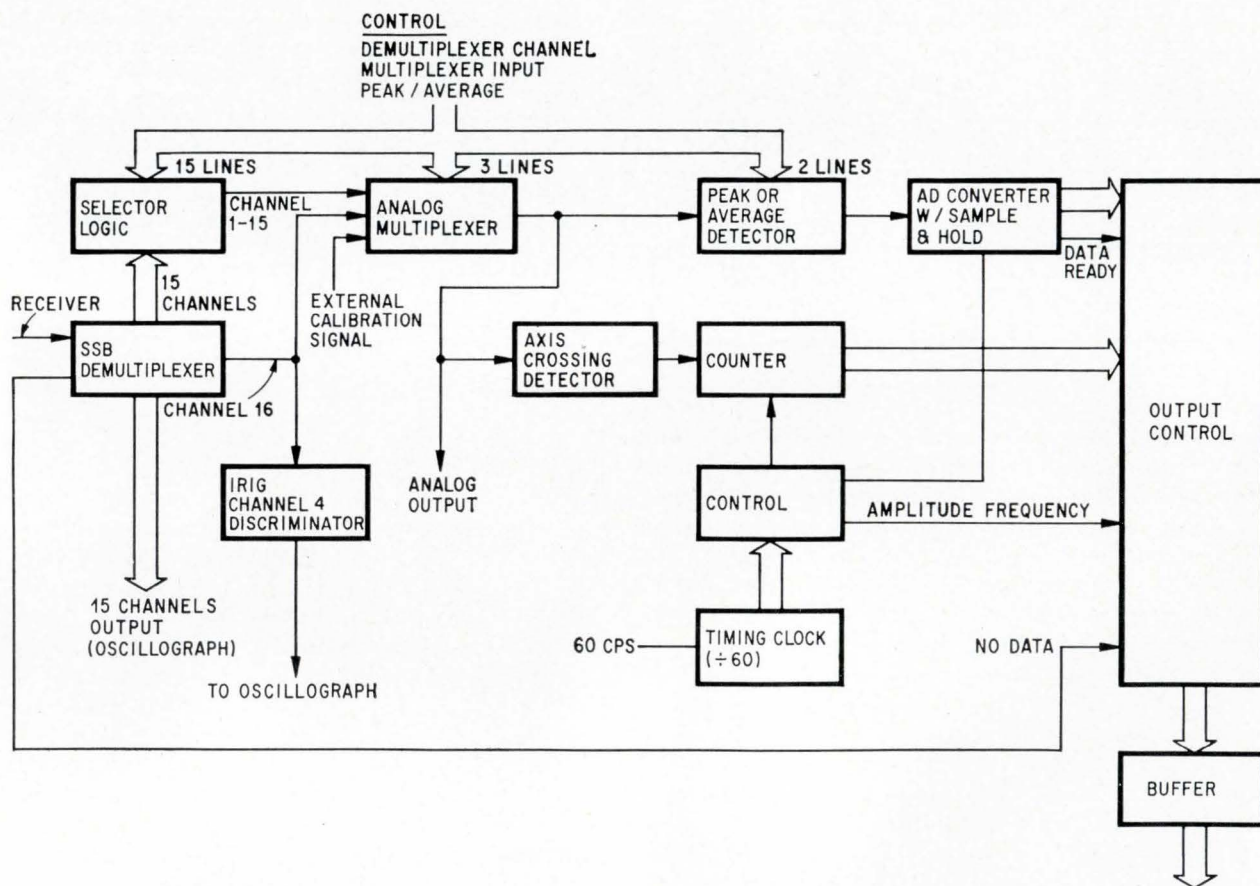
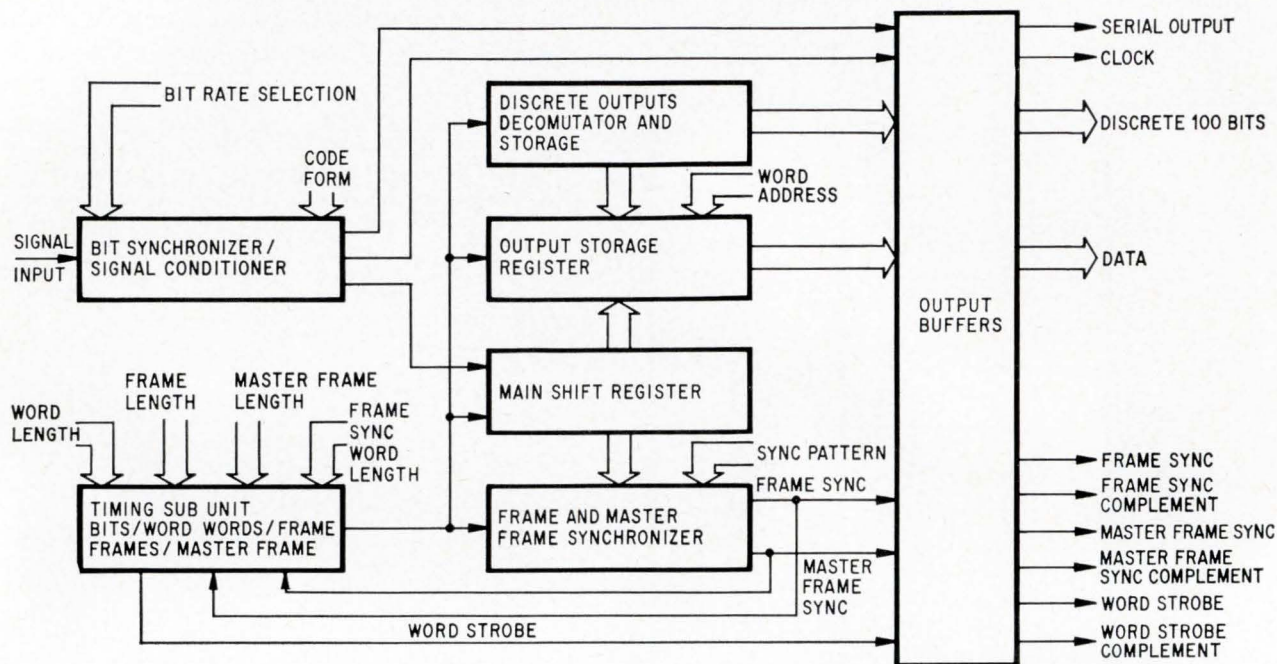

Pulse-code modulation subsystem (top) and single-side band subsystem (bottom) receive inputs from a signal-distribution panel. After processing and buffering, their outputs are sent to the formatter, where they are selected by the computer for display and control. Pcm systems are one of the easiest types to automate, because their outputs are already in a digital format. In this system, the serial pcm wavetrains are converted to parallel outputs. The single-sideband subsystem is more complex. There are numerous channel and logic selectors as well as analog-to-digital converters. Every time a signal is operated upon in an analog subsystem, the incidence of error increases.

A single word from the computer is enough to make the ssb demultiplexer adjust to any of the 15 channels; to prepare the analog multiplexer to accept either the ssb demultiplexer output, a special service channel or the calibrate signal; and to set up the digitizer's mode.

The digitizer looks at the analog multiplexer's output for one second. During this time the signal amplitude is converted to a "n" bit binary word while the signal is gated to a counter where the incoming frequency is measured. Then the signal's digitized amplitude is gated to output buffers, which use the digitized amplitude and frequency count to determine the frequency response of all channels in the airborne multiplexer.

Another drawback: degraded performance

The switching of analog channels in an automated system can introduce data errors that are avoided in digital channels. An error is possible each time the system automatically switches any part of the f-m demultiplexer: 34 data discriminators, a timing discriminator, five reference-frequency discriminators, three delay lines (each tapped for a choice of five delays), and a band-switching discriminator.

The data discriminators conform to IRIG channels 1 through 21 and A through H. For IRIG channel 18, a 70-kc channel, a special $\pm 30\%$ deviation of the center frequency discriminates the data. Each discriminator is connected to one of three input buses, from three receivers or three tracks of a tape recorder, through a three-position analog multiplexer. The multiplexer has a 50,000-ohm impedance at 200 kc and a linear dynamic range of 0 to 10 volts peak-to-peak. Minimum detectable signal level in the discriminator is 10 mv root-mean-square; however, losses through the analog multiplexer increase the minimum detectable signal of the system to approximately 25 mv rms. This deterioration is tolerable because the rms level of the multiplexed signals at the receiver or tape-recorder output is approximately 1 volt rms.

The complex f-m calibration subsystem is set up by the computer with only two words. The first 15 instruction bits of the first control word determine the calibrate mode, the calibration deviation from center frequency, automatic sequencing and the sequencing dwell times.

The final five instruction bits of the first control word and the first 16 instruction bits of the second control word define the channels in each of four possible modes. Mode 1 encompasses IRIG channels 1 through 21; mode 2 has IRIG channels A through H; mode 3 contains channels 18 through 21; and mode 4 is triple f-m.

For Saturn telemetry, triple modulation results when IRIG channels 14 and 17 are multiplexed after each has been modulated by multiplexed channels 2 through 6 and 2 through 8 respectively.

The computer automatically calibrates the f-m multiplexers and discriminators at five equally spaced and discrete frequencies in the four individual modes. When commanded by the computer to strobe (change calibration channels), each chan-

In a word

The alignment of each subsystem in the automated station is determined by computer-control words. Here are some examples of adjustments made by 25-bit control words.

F-m demultiplexer. Four control words and the first four bits of a fifth word adjust the following:
The input bus (one of three) to which each data discriminator is connected; two binary bits are used for each discriminator.

Adjustment of discriminators 25 through 34 to the standard, optional, or special IRIG channels.

The remaining 16 instruction bits in the fifth word perform the following functions:

Activate or deactivate the data discriminator's flutter-compensation input.

Connect the reference discriminator to any one of the three input buses.

Set up the reference discriminator and delay lines for 25-, 50-, 100-, 120- and 200-kc reference tones.

Connect the bandswitching discriminator to any one of the three input buses.

Set up the bandswitching discriminator for any IRIG channel through the 18th.

Pcm decommutator. The first control word adjusts:
The input bit rate, from one to one million pulses per second.

Input format (return-to-zero, nonreturn to zero, and so forth).

The second control word adjusts:

The number of bits per word, up to 12.

The number of words per frame, up to 127.

The number of frames per main frame, up to 63.

Control words 3 through 9 adjust:

Length of the frame-synchronization word

Pattern of frame sync

The 10th control word adjusts the address word in the input format which discrete data. This word is the same for each frame.

Pam/pdm digitizer. The first control word adjusts:

Pam or pdm input

Input polarity

Saturn or not Saturn format

The second control word adjusts:

Synchronizer number 1 scan/no-scan

Full-scale calibrate-information channel:

Output word length (8, 9, or 10 bits)

The third control word adjusts:

Synchronizer number 2 scan/no-scan

Zero-scale calibrate-information channel:

Zero and full scale offset

The fourth control word adjusts:

Synchronizer number 3 scan/no-scan

Number of channels per frame, up to 256

Number of frames per main frame, up to 256

nel in the multiplexed group sequences automatically through the frequencies at selectable dwell times of $\frac{1}{4}$, $\frac{1}{2}$, 1, 2, or 4 seconds.

How much automation?

If automation passes its test in Huntsville, the next question will be, "How much of each station should be automated?" The prototype station at Huntsville will be only about 85% automated.

For best efficiency, advances in automating ground stations should be matched by improvements in sensing and telemetry equipment aboard the space vehicles. Wholesale conversion to computer controls also will require more standardization of equipment both in the air and on the ground.

Nothing new . . . nothing "state of the art" in low-cost digital voltmeters? Don't you believe it! Right now, all but one low-cost DVM is "old hat" because **only one**—EI's brand new Model 620—has AUTOJECT.

With AUTOJECT, noise is **automatically rejected** by synchronizing the sample period with the noise component. The result? Noise integrates to zero—irrespective of its phase or frequency.

And that's not all. Even by the traditional yardsticks, the Model 620 is quite a package. Look at the year's best buy in low-cost DVM's . . . point by point . . .

AS OF NOVEMBER, 1965
IF YOU DON'T KNOW
autoject,
YOU NO LONGER
KNOW DVM'S



MODEL 620

	HP 3440A	NLS 5005	Cubic DV-271	Kintel 511	EI 620
Circuitry: All-solid-state?	Yes	No	No	No	Yes
Common-mode noise rejection (@ 60cps, no filters)	70db	106db	20db	100db	140db
Normal-mode noise rejection (superimposed noise)	30db	30db	40db	50db	60db
Accuracy (as % of reading)	±.05% ±1 digit	±.01% ±.01 FS	±.01% ±1 digit	±.01% ±1 digit	±.01% ±.01 FS
Encoding speed (readout to meter's full accuracy and max. noise rejection at any noise frequency) in milliseconds	450 (to .1%)	600 (avg)	500 (avg)	700 (to 2 sec.)	250 (fixed to full accuracy)
Over-range (5th digit to extend meter resolution)	5%	none	10%	none	20%
4-Wire ratio capability (ratio between 2 unknown voltages with no common lines)	no	no	no	no	yes

FROM **\$995.00**

- automatic ranging and polarity
- electrical outputs
- remote control
- high input impedance to signal and external reference (1000 megohms on 10 volt range)—zener reference
- plug-in module available for AC, resistance and preamplifier



Electro Instruments, Inc.

8611 Balboa Avenue, San Diego, California 92112

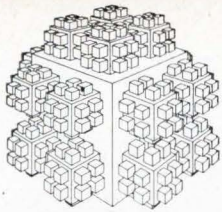

The packaging revolution, part V: simpler designs for complex systems

Integrated circuits can be assembled economically in large digital systems if the design procedure demands simplicity in the wiring structure; multilayer circuit boards aren't needed—two-sided boards will do

By Rex Rice

Fairchild Semiconductor, a division of Fairchild Camera & Instrument Corp., Mountain View, Calif.

The engineering practices that worked for digital systems built with discrete components fail when digital systems are built with integrated circuits. The engineers will waste time and money designing complex interconnection structures.

Digital systems can be made economical to design and produce with off-the-shelf IC's, if the right design procedures are used. Even large, high-speed systems can be built with a few two-sided circuit boards.

It is important to adopt procedures that force the system's functional organization to be regular and the interconnections simple. This demands orderly arrangement of the components of a function and rejects the old concept of standard subassemblies with as few components as possible.

The advantages of systematic design were recently demonstrated at Fairchild Semiconductor division of Fairchild Camera & Instrument Corp. by a digital-systems research model. The model, an equivalent to the arithmetic portion of a large, com-

mercial computer's central processor, contains approximately 5,000 logic gates, in 1,550 IC packages. All the packages are soldered into nine double-sided printed-circuit boards, and the nine boards are interconnected with one single-sided mother-board. The completed model, shown on the next page, has a clock rate of 5 megacycles—a high speed by commercial-computer standards. The performance characteristics are given in the table on the following page.

To have designed this system with discrete components and conventional, commercial design practices would have taken an estimated 200 man-months of professional engineering time, or longer. The IC version required less than 20 man-months to design.

The engineering crew enjoyed the work. The headaches of circuit and interconnection design were eliminated by design procedures which virtually wiped out the need for routine decisions. The design was so simple, in fact, that no computers were needed to devise circuit and wiring layouts. Technicians did most of the layouts in a total of eight man months.

The project was not an idle exercise. It generated data that has aided in development and application of a new family of logic circuits. It also shows that digital system engineers who persist in trying to apply discrete-component design practices to the organization and interconnection of IC systems are borrowing trouble.

Although the research model can compute, it was not designed for production or use as a computer. However, if it had been a prototype, it could have been converted readily into a model that could be produced by low-cost, conventional assembly techniques. The packages of the control and logic

This article is part of Electronics' continuing report on techniques of interconnecting integrated circuits. Part I, in the Oct. 18, 1965, issue, and Parts II and III, in the Nov. 1, 1965, issue, surveyed system fabrication and packaging methods. Part IV, Nov. 29, 1965, discussed design and repair of complex multilayer boards.

The author



Rex Rice established Fairchild Semiconductor's digital systems research department in 1963. He directs studies of the interactions between integrated circuits, packaging and information processing. Rice had been manager of the research section concerned with cost-oriented systems at the International Business Machines Corp.

circuits are inserted directly into the circuit boards and the joints are made by a conventional flow-soldering machine. There are no complicated, difficult-to-fabricate interconnection structures such as multilayer circuit boards or transmission lines.

System costs are different now

Digital-system design practices should be re-evaluated to capitalize on the very low cost of mass-produced monolithic IC's. It is now economical to "waste" circuits, when extra circuits make the system organization and interconnection simpler. It is now expensive, in most cases, to custom-design circuits to satisfy an arbitrary system design.

The goals of discrete-component design practices are obsolete when IC's are used. Trying to retain a modular construction based on a few types of standardized subassemblies forces complex and costly interconnection structures. Attempting to make the circuits with a minimum number of components and a system with a minimum number of circuits raises design and fabrication costs.

Packaged IC's now cost less than the connectors and wires needed to make plug-in subassemblies. Soldering the IC packages to large circuit boards, to assemble large functional units, is less expensive than assembling functions the old way, with a large



Digital system research model, on the table, contains approximately 5,000 logic gates. Nine two-sided printed circuit assemblies are plugged into a connector card, left foreground, facing the reader.

System specifications and organization

Speed

A 5-megacycle clock rate with 12 AND gates, 3 logical level setters and 16 wired-OR locations provided in one clock cycle.

Add or subtract 11 decimal digits (floating decimal point) in 4 microseconds in a serial-by-character mode.

System characteristics

Decimal input and output from typewriter.

Field length of numbers is variable from 1 to 15.

Automatic (hardware) conversion to and from floating operations with exponent range of ± 99 .

Serial-by-character operation.

Add, subtract, multiply, divide and transfer previous result (note: the system is not intended to be a complete stored-program calculator).

Packaging and functional design

Interconnection structure is 10 printed circuit boards. The first nine boards listed below are two-sided printed circuit boards measuring 14 by 12 inches and the tenth is a single-sided board. Numbers refer to those in the block diagram and table on the facing page.

1. Input-output control and 8-bit code translator.
2. Decimal formatting and instruction controls.
3. Two 72-bit registers, gating and controls (A-input and B-input).
4. Two 72-bit registers, gating and controls (multiply-divide-input and multiply-divide-temporary).
5. Two 72-bit registers, gating and controls (C-output and multiply-divide-output).
- 6-9. Arithmetic processing unit (register and adder, phase control, register and delay, and flip-flop control).
10. Printed-circuit base which interconnects the other cards.

number of small plug-in cards. It is also more reliable because joints are fewer.

The traditional design emphasis—make the function with as few circuits as possible—can also be expensive because it results in a rat's nest of plugs and wiring. Traditionally, parts placement follows logical design and the circuit interconnections are developed last.

When IC's are used, the primary design emphasis should be on coordinating interconnection and functional design with parts placement. Reducing the cost, in numbers of circuits, per function, is a second goal. The result will be a more regular system.

It pays to use a few extra IC's to make interconnection and packaging simpler. For example, a package may contain three circuits. If it is difficult to get the interconnections to one of the circuits, it may be cheaper not to use that circuit. Trying to use every circuit in every package may prevent interconnection with a simple two-sided board and require a more expensive multilayer board. It may be less costly to provide additional circuits elsewhere on the board.

Here's a more specific example. A control signal can be left in a coded form on the system interconnection bus wire and then be decoded locally at each functional element. Local decoding requires a few more circuits but can greatly reduce wiring complexity.

Another way to save money is to design the system to use inexpensive, mass-produced IC's. It is a waste of engineering time to propose special circuits, with minor variations that optimize circuit parameters, merely to satisfy the whims of digital-circuit designers. The initial development expenses of IC's are high—making low-production, custom

circuits costly. The circuit manufacturer has already freely used devices in his circuits to optimize their processing, performance and cost. He has this freedom because it matters little in mass-production costs whether a circuit has six transistors or twenty.

First steps in system design

The objectives of the research-model project were to establish simple procedures for building a large system and to aid in the development of Fairchild's new Complementary Transistor Micrologic circuits (CT μ L). At the time the project began, in September, 1964, these circuits were in pilot production and their packages, the dual-inline package, were also new and untried.

As a first step, the economic valuations were stated as three rules intended to make the design work easy:

- Keep the logical, functional and packaging designs—and design records and documents—simple.
- Organize the specifications, design and construction so that the hardware is reduced to orderly elements. This eliminates many routine and unnecessary design decisions.
- Relax all tolerances. No attempt was made, for instance, to squeeze the last nanosecond of speed out of the circuits or to obtain a minimum-sized system, since extremely high parts density is costly.

Defining the system, which took four man-months of engineering, was completed in November, 1964. The system organization and functional units are given in the illustration and tables at the left and on this page.

The system contains 1,550 CT μ L packages, equivalent to 5,040 NOR gates, exclusive of the power supplies for the processor and the typewriter.

Detailed design work, done by April, 1965, re-

Packages and pin population

Functional modules	CT μ L packages	Estimated equivalent gates	Connector pins used*	Pins per gate
Input/output	-1	110	78	0.28
Format/control	-2	160	78	0.20
Registers	-3	215	67	0.07
	-4	215	67	0.07
	-5	215	67	0.07
Process unit	-6	175	68	0.15
	-7	210	127	0.24
	-8	170	107	0.25
	-9	80	200	0.33
Total	-9	1,550	5,040	—

* Base connector has 162 pins.

quired 11 man-months of engineering time, plus 8 man-months of technician's time. Most of the technicians' time was spent in layout and preparation of the printed-circuit artwork.

Design procedures are detailed in another publication.¹ Their applications to the research model and the design flow of the project are summarized on the next page. After the logic flow chart is prepared, the engineers begin writing a logic glossary and continue to add to it as package locations and wire routings are developed in later design stages.

Fast circuitry, simple wiring

The upper graph of the figure on page 114 illustrates the effect of circuit speed on system packaging. Circuits that operate at speeds of 1 to 5 nanoseconds require terminated strip-transmission-

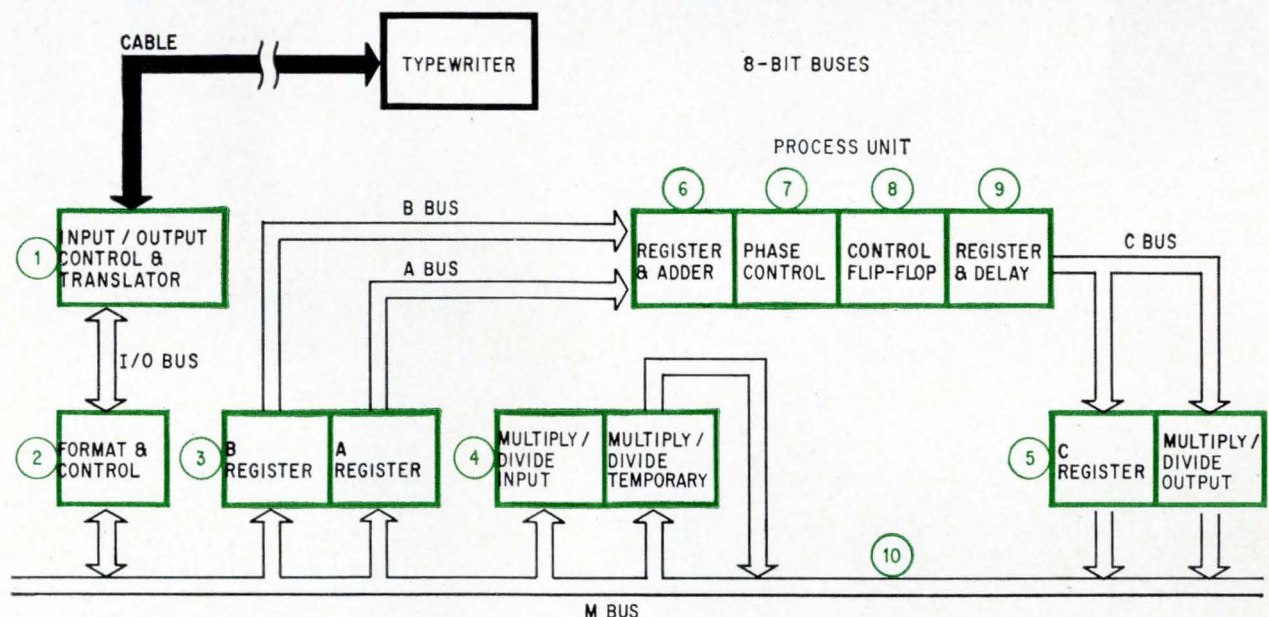

Functional organization of the digital research model. It is comparable to the arithmetic unit of a large computer's central processor. The module numbers, circled, are the same as those in the tables above and at the left. The functional boards are outlined in color; the tenth board interconnects the others.

line interconnections. Ordinarily, these speeds require complex circuits and interconnection media such as multilayer printed circuit boards or coaxial cable.

When the speeds range from 5 to 10 nanoseconds, strip line can be avoided. Then two-sided printed circuit boards may be used to reduce total system costs. The dot on the curve labeled "simple package" on the graph shows an ideal cost-oriented design point.

To maintain simple packaging, the pulse rise time should be no faster than about 7 nanoseconds. However, as shown by the lower graph of the figure on page 114 logic-stage delays of about 3 nanoseconds can be achieved with emitter-follower circuits. Net speeds of about 5 nanoseconds, or less, can be obtained by providing at least three stages of logic between level setters.

Also, more logic can be provided in the average stage and fewer interconnection lines will be needed with the logic-circuit configuration known as the "dot" or "wired" OR, in which the OR function is performed by the connecting wiring rather than by separate circuits.

Packaging is further simplified by reducing circuit sensitivity to the noise generated in the interconnections. Large signal swings provide good noise margins; for the CT μ L family, a swing of 3 volts was chosen. The circuits are designed to

eliminate unwanted oscillations.

The research model reflects these cost-oriented design decisions. Its pulse rise time is 7 nanoseconds, its gates are 3-nanosecond emitter-follower circuits, signal swings are 3 volts and the wired-OR configuration is used.

Logic-string considerations

Once the basic logical-design ground rules were established, the next step was to set up the logic implementation and wiring rules governing the functioning and location of the circuits in the logic chains. The result is illustrated on page 114.

It is unnecessary to conduct extensive preliminary analyses of system operation to predict all worst-case system conditions when the design procedures are systematic and the circuits are IC's. It is cheaper and faster to set reasonable rules, design and build the system and then fix the few inadequate parts of the system. Experience with the research model verified this.

The project engineers reviewed the CT μ L specifications then being prepared for publication and, as in any design project, conducted several simple tests with a few circuits working in the proposed packaging environment. It is difficult, if not impossible, for a manufacturer to prepare circuit specifications that apply to all possible applications and system environments.

System engineering procedures

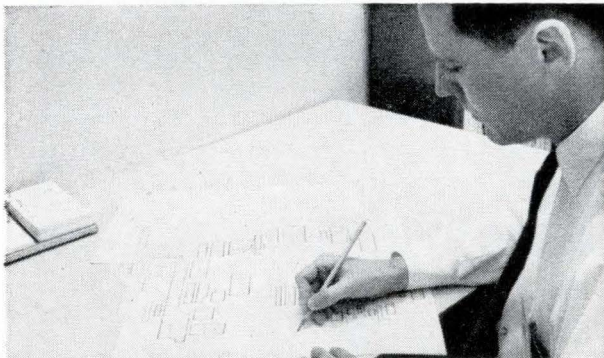

Logic flow chart is prepared for the input-output function. Then a glossary of the logic is begun.

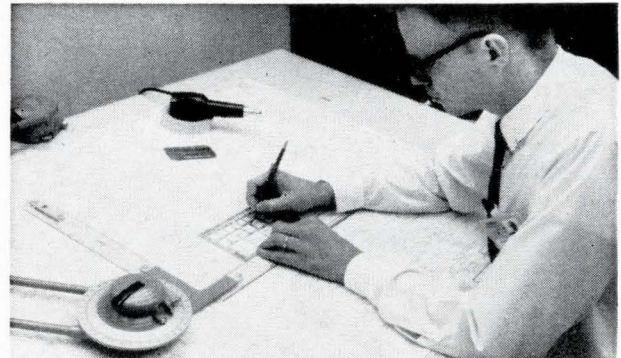

Referring to the logic flow chart, an engineer prepares the logic diagram. Next step is at the right.

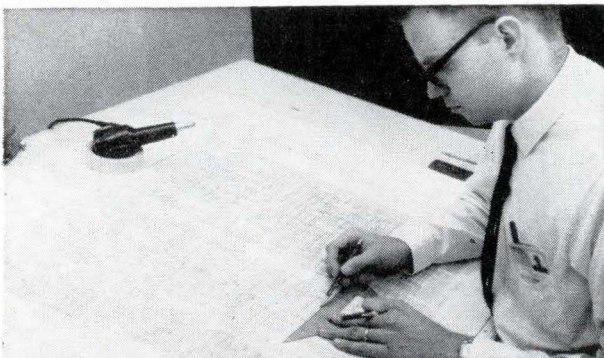

Signal-wiring layout is prepared on vellum over the logic design master pattern.

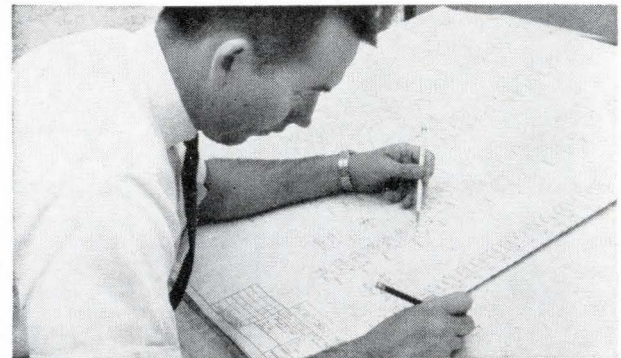

Wiring layouts on board-artwork masters are checked against the logic diagram.

An estimate of system overhead was then made. Overhead refers to such design factors as delays due to timing problems (clock skew) and wiring delays. This estimate, the logic design rules and the CT μ L circuit performance, as published in preliminary data sheets,² were combined and restated as logic-implementation rules as follows:

- The normalized loading rules were those in the CT μ L specifications.²

- Three gates were allowed before level setting. In the illustration on page 114, the levels are restored after each set of three gates G by the following circuits: CT μ L type 952 inverter, type 956 buffer and type 957 flip-flop.

- Four sets of gate and level-setter combinations were allowed in one clock cycle. This provides up to 15 AND logic decisions and 16 wired-OR logic decisions within one clock cycle. At a clock rate of 5 megacycles per second, the clock cycle is 200 nanoseconds long.

- The lengths of the printed circuit conductors between circuits could average 12 inches.

The following additional rules govern the clock timing, as shown in the figure on page 114:

- As the clock goes negative, the data transfers from the first rank to the second rank of the 957 flip-flops. Transfer is completed in 25 nanoseconds.

- The clock is left negative long enough to allow for data propagation (estimated worst case) and

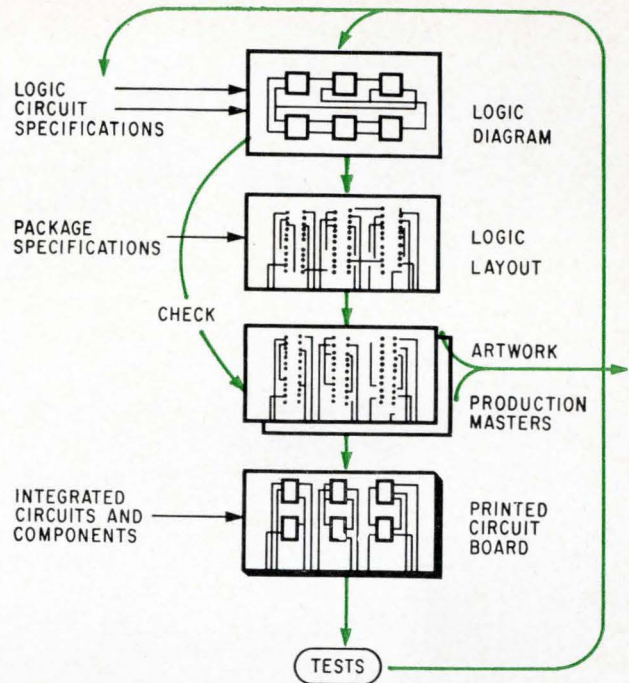

Flow of work through engineering and production. Modifications are made after system debugging.

system overhead delays. Propagation time is 100 nanoseconds and overhead is 51 nanoseconds.

- The clock is driven positive long enough to allow data to be entered into the first rank of the 957 flip-flops. This requires 24 nanoseconds.

- The clock pulses are generated on the input-output control and translator board (see diagram on page 111) and sent to all other boards through the base interconnection board. The clock pulse is repowered locally on each board with buffer circuits.

Master plan for interconnections

Studies by Fairchild engineers and another study recently published by another source³ show that an economical interconnection structure is obtained by soldering the IC package leads into large, two-sided printed circuit boards.

Fairchild placed its design emphasis upon obtaining maximum interconnection density, not maximum circuit density, so that the boards could carry a relatively large number of IC packages without additional wiring layers. This was accomplished by having all the printed wiring on the board conform in general to an X-Y wiring matrix. That is, all the wiring runs in a horizontal direction on one side of the board and in a vertical direction on the other. The positions of the IC packages on the boards were worked out to accommodate this arrangement.

The boards measure 14 by 12 inches and can carry 242 dual-inline packages in 11 rows of 22 packages each. However, there are blank locations on the research model's boards; the omissions allowed the use of only two layers of wiring. The package count per board is given on page 111.

The package and wiring layouts were prepared

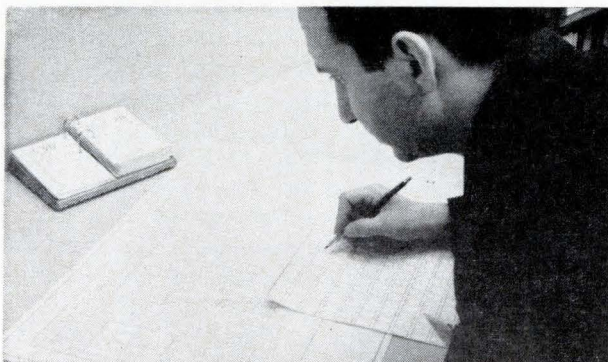

Trial arrangement of IC packages is made on a component layout master to provide an interconnection schedule.

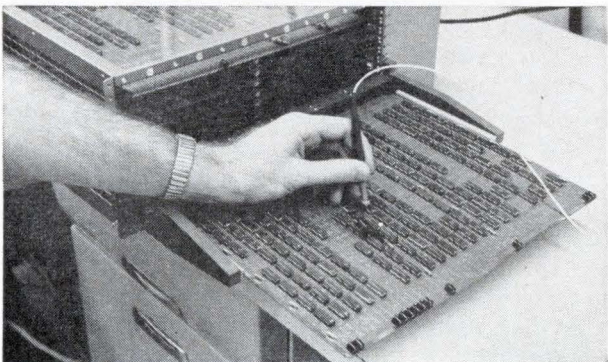

After system fabrication, card extenders expose the boards for functional testing and debugging.

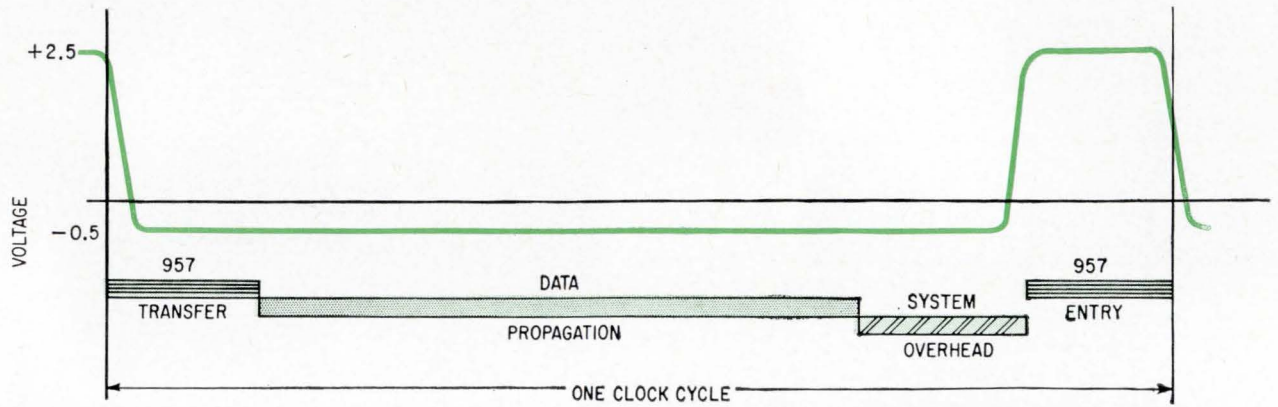
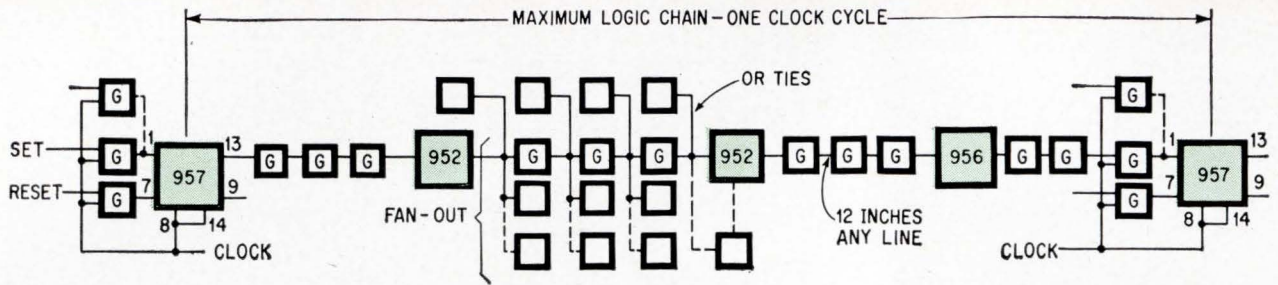

Logic implementation and wiring rules. Block diagram indicates allowable numbers of gates between level restorers, shown in color. The curve below indicates clock timing.

with a coordinated set of layout masters, one for component layout and one for logic design. These and the associated board-artwork masters are shown at the right and can also be seen in the photographs on the preceding pages.

At first, package positions are tentatively assigned on the component layout master, which is the same size as a board. The positions are firmed up as the interconnection patterns take shape.

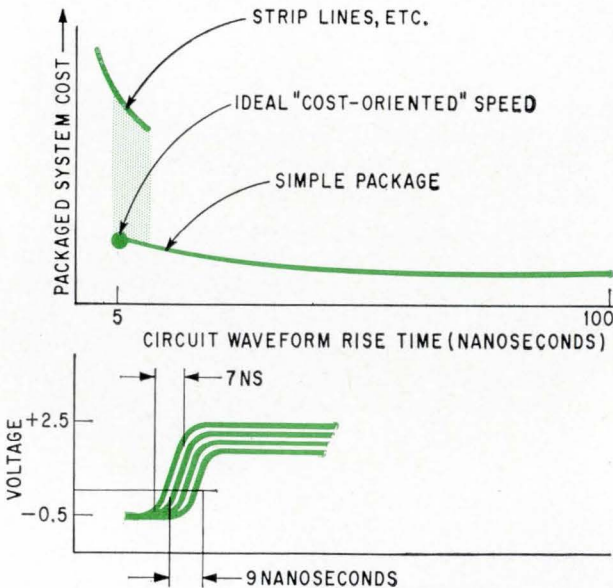

Strip transmission-line interconnections, a costly packaging technique, are required for logic speeds faster than 5 nanoseconds. Two-sided boards can be used at slower speeds (top graph). Emitter-follower circuitry allows stage delays of about 3 nanoseconds (lower graph) in the simpler package form.

Packages are relocated and extra circuits occasionally used to make wiring layout easier. A few positions are purposely left vacant to further ease wiring layout problems and in anticipation of logic modifications during system debugging. This master, plus a logic diagram, provides a point-to-point wiring schedule (not the actual wire routing).

The logic design master is twice the length and width of the board. The line grid consists of dark lines at 200-mil increments (0.2 inch) and light lines (invisible in the photo) at 100-mil increments. The light-line spacing reduces to 50 mils on the actual board; these lines govern the spacing between wiring runs. The spacing of the dark lines corresponds to the 100-mil spacing of the plug-in pins of the dual-inline packages.

At each package-pin position is a disk 80 mils in diameter. On the finished board, these are 40-mil soldering pads with a plated-through hole that is 22 to 25 mils in diameter at the center of each pad. All connector positions are also shown on the master.

The master is preprinted with all plus and minus voltage lines, ground lines and the return paths for these lines. The ground lines are the lower zigzag lines of each group of three horizontal lines; the top lines of each group are the plus-voltage lines, and the minus-voltage lines are in the center of each group.

The horizontal lines are fabricated on the top, or component-mounting side, of the board. Since the dual-inline package pins have stand-offs which raise the package above the boards, these lines can be run through the package positions. The vertical lines run between the pin rows on the bottom,

Master patterns for circuit layouts

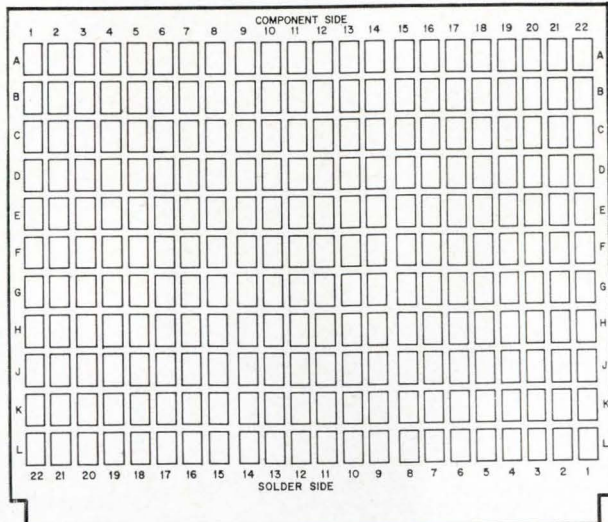

Component layout master assigns package positions.

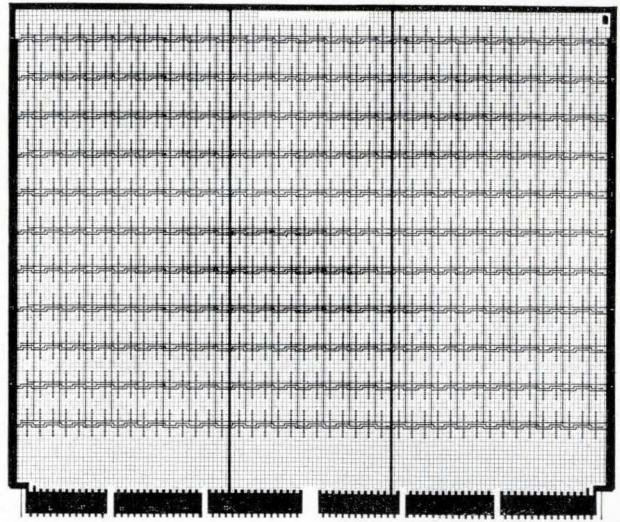

Logic design master for drafting printed wiring routes.

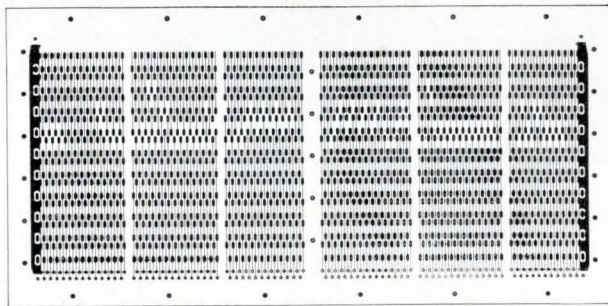

Master layout for base card, the interconnection board.

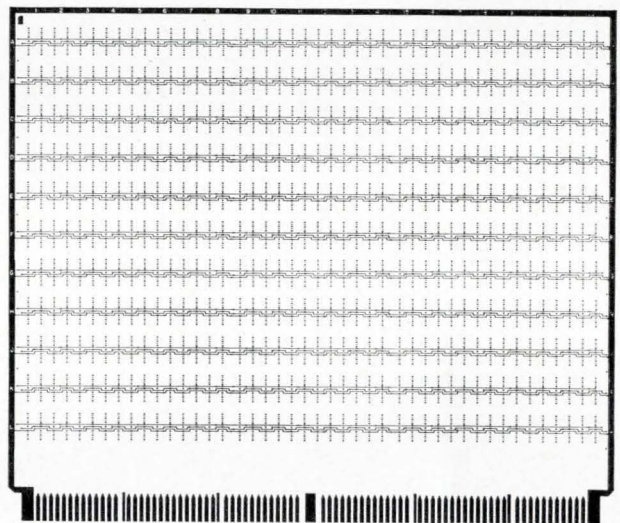

Artwork taping master for top side of printed circuit.

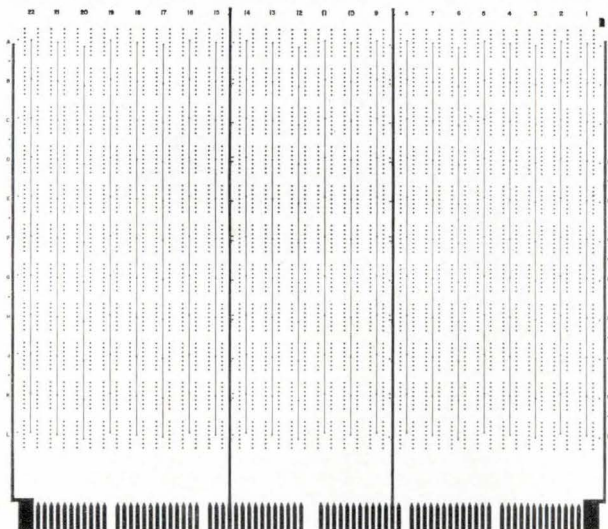

Standard artwork for bottom side of printed circuit.

Superimposed artwork for top and bottom of one board.

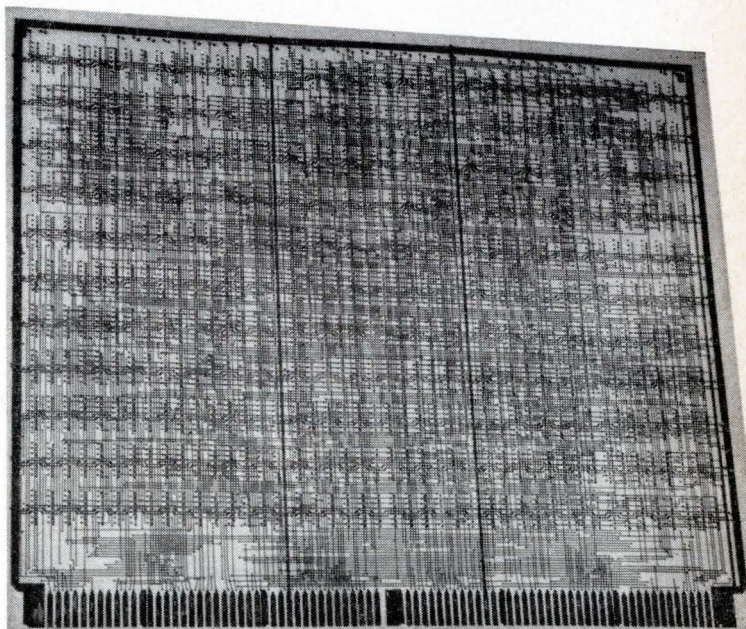

or soldering side, of the printed-circuit board.

The designers draw in the signal wiring needed to interconnect the IC packages.

The drawing is done on vellum placed over the logic-design master. The signal wiring can run along any of the grid lines not already occupied by the standardized voltage and ground lines. Blue pencil is used for the horizontal, top-of-the-board wiring and red pencil for the vertical runs. Through-hole positions are marked where the runs change direction.

The completed wiring pattern is transferred to artwork taping masters. There is one master for the top and one for the bottom of the board. These masters, also double scale, contain all the hole locations and interconnections common to all functional boards. Red adhesive tape is applied to duplicate the signal wiring. After the patterns are double-checked with the original logic diagram, they are photographically reduced to provide the photo-etching tool films for board fabrication.

The base-card layout is a unique and striking example of the simplicity that can be achieved in IC systems. The other nine boards will be interconnected with the board produced by this pattern, a single layer of copper with only 162 straight, parallel wiring runs. To remove unwanted interconnections between the boards, the standard pattern shown is modified by merely deleting segments of the lines between connector-pin positions.

Pin count drops

One measure of layout efficiency is the ratio of circuit leads to board-interconnection pins. The layout of the model is efficient, as shown by the table on page 111.

Although 162 connector pins are available on each board, most boards use less than half the pins. The large number of pins was retained to keep the base-card wiring orderly.

The register boards are exceptionally efficient in pin usage because their component and interconnection densities are high and the wiring is very orderly. The other boards require control logic or tree logic, which makes the wiring runs highly random and restricts the number of IC's that can be mounted on the boards. Nevertheless, the ratios compare favorably with those of multilayer boards [See, for example, *Electronics*, Nov. 29, 1965, page 90].

Packaging and assembly

The nine logic and control modules were assembled by plugging the IC packages into the lead-insertion holes. Seven boards were soldered on a flow-soldering machine and two were hand soldered. A few discrete wires were added to the boards to correct errors.

The power supplies were built of conventional components. The only other conventional wiring in the system are the cables between the power supplies and the base card and typewriter.

The contact springs of the connectors on the

base card are soldered directly into that printed circuit. The other boards slide into guides in the rectangular system frame and plug into the base-card connectors, as shown in the photographs on pages 110 and 113.

During board insertion or removal, the connector contact springs are open. They are locked onto the contact fingers of the boards by cams; the cams are long, round rods with a flat spot. When the cams are rotated to the closed position, with a key, they apply more than 750 grams of pressure to each contact.

The circuits are cooled by air, blown by fans at a minimum of velocity of 50 feet per minute over the boards and out through the card guides.

System debugging

The detailed design was completed by April, 1965. Fabrication began in February and ended in August. During August and September, the system was debugged; that took 3½ man-months of engineering time.

To test the operation of each module board while the system was operated, an extender card was connected between the board being tested and the base-board connector. Strip transmission lines were not used on the extender; the increase in lead length did not present any difficulty because the extender was a two-sided board with ground runs between adjacent signal wires.

Two engineers cooperated in tracing the logic step by step with a normal oscilloscope test probe and test lights plugged into terminals provided along the top edge of the board as part of the printed wiring pattern. The test documents were a reduced-scale copy of the logic diagrams, the flow charts and a set of artwork prints.

The usual design errors, logic oversights, taping errors and other mistakes were encountered and fixed. A few circuits proved to be faulty (the CT μ L circuits in the model were from a preproduction run). Components were replaced by desoldering and resoldering, a few IC's were added at vacant positions on the boards and wiring was changed by adding discrete wires.

No wiring changes were needed on the three register boards nor on the base board. Each of the other boards had a few changes. No faulty solder or connector joints were found.

The system is now operating according to specifications. It is presently being used to accumulate data on CT μ L circuits and as a test bed for improved IC configurations.

References

1. Rex Rice, "Systematic Procedures for Digital System Realization from Logic Design to Production," Proceedings of the IEEE, Vol. 52, No. 12, Dec., 1964. A more detailed version is available from the Marketing Services Dept., Fairchild Semiconductor, 313 Fairchild Drive, Mountain View, Calif. 94041.
2. Preliminary Data Sheet, CT μ L-952 through CT μ L-957, March, 1965, Fairchild Semiconductor.
3. G. Rupprecht and E. Stubler, "Two Dimensional vs. Three Dimensional Packaging of Integrated Circuits," Advances in Electronic Circuit Packaging, Vol. 6, Cahners Publishing Co., Englewood, Calif., August, 1965.

FAIRCHILD RADIATION RESISTANT DIODES

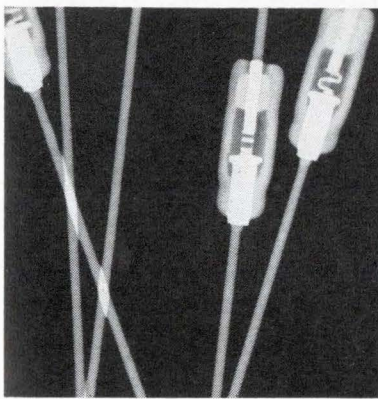

All three families in standard DO-7 packaging.

Ultra-fast, high conductance FDR-600: guaranteed forward voltage of one volt or less, at 200mA forward current, after radiation exposure.

Picosecond switching FDR-700: guaranteed forward voltage of one volt or less, at 30mA forward current, after radiation exposure.

High voltage rectifiers FRR-300: the only Planar passivated rectifiers in the 350-450V range with guaranteed forward voltage of one volt or less, at 100mA forward current, after radiation exposure.

For evidence see chart below. For proof see our data sheets. See your Fairchild Distributor or write us.

SERIES	GUARANTEED PERFORMANCE AFTER EXPOSURE	EXPOSURE TO FAST NEUTRON RADIATION (@10KeV)	BREAKDOWN VOLTAGE
Ultra fast, high conductance FDR-600	$I_f = 200\text{mA} @ 1.0\text{V}$	$1 \times 10^{16}\text{nvt}$	FDR-600: $B_v 75\text{V} @ I_R = 5\mu\text{A}, t_{rr} = 4.0 \text{ nsec.}$ FDR-601: $B_v 50\text{V} @ I_R = 5\mu\text{A}, t_{rr} = 4.0 \text{ nsec.}$
Picosecond switching FDR-700	$I_f = 30\text{mA} @ 1.0\text{V}$	$1 \times 10^{16}\text{nvt}$	FDR-700: $B_v 30\text{V} @ I_R = 5\mu\text{A}, t_{rr} = 750 \text{ psec.}$ FDR-701: $B_v 20\text{V} @ I_R = 5\mu\text{A}, t_{rr} = 750 \text{ psec.}$
High voltage high conductance FRR-300	$I_f = 100\text{mA} @ 1.0\text{V}$	$5 \times 10^{14}\text{nvt}$	FRR-300: $B_v 300\text{V} @ I_R = 100\mu\text{A}$

FAIRCHILD
SEMICONDUCTOR

New total protection... against all hostile environments

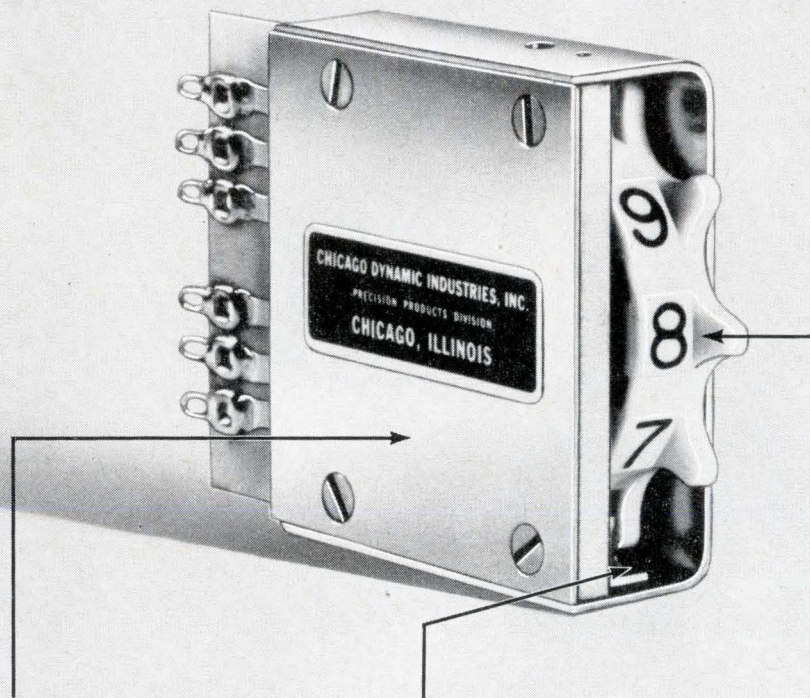

Completely sealed switching area for positive switching and long, trouble-free life

Wheel totally panel sealed against all hostile environments

Machine-engraved numerals or legends white paint filled for maximum readability & life

Most switch manufacturers seal just the switching area. But Only CDI Seals BOTH The Switching Area AND THE PANEL. Pat. Pending.

Exclusive CDI total switch sealing benefits you by protecting all other components in your system against dust, dirt, salt spray and other foreign elements which reduce performance. Switching area and panel are independently sealed for full protection and reliability.

Clean room assembled. Decimal or coded models. For R.F.I. applications. Series PS tab type Thumbwheel Switch mounts on $\frac{5}{8}$ " centers and retrofits Series TTS. Switch life exceeds 100,000 operations. Send for data sheet.

NO SCREWS VISIBLE. NEW ALUMINUM BEZEL permits rear mounting of miniature and standard type switches with no screws visible. Accommodates to 20 switch modules. Miniature model fits CDI Series TTD and TTB standard type switches. Available in colors to match any instrument panel. Send for data sheet.

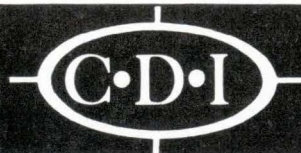
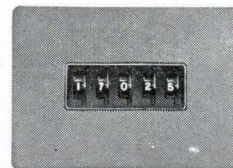

CHICAGO DYNAMIC INDUSTRIES, INC.

PRECISION PRODUCTS DIVISION 1725 Diversey Blvd., Chicago, Illinois 60614 Phone: (312), 935-4600

EIMAC

25 kW magnetron is now at work putting the crackle in potato chips for Cryodry Corporation

Microwave heating has recently emerged from the laboratory and is now finding its place in the food processing and other industries. Because it is fast, efficient, and highly controllable, microwave heating is particularly suitable for on-stream operations.

For example: Revolutionary new potato chip processing machinery manufactured by the Cryodry Corporation, a subsidiary of the Armour Company, uses the EIMAC EM15LS magnetron in a conveyerized microwave oven to finish-dry to optimum color potato chips which have been pre-cooked in oil.

M. R. Jeppson, President of Cryodry, says: "We chose Eimac's new magnetron to power our machinery because the tube has an unusually high dc-to-rf conversion ratio—80%—and promises a very com-

petitive life cost per kilowatt hour of only 2¢."

Moisture removal is only one of the tasks which industry can assign to microwave heating. Others include chemical catalysis, distillation, puffing, fermentation, and sterilization. Eimac has built pioneering tubes to supply microwave power for this new technique. As fast as new applications for microwave heating arise, Eimac is developing appropriate power supplies. If you'd like to find out more about what you might do with microwave heating, write on your letterhead to *Microwave Marketing, Eimac*.

EIMAC

San Carlos, California 94070
A Division of Varian Associates

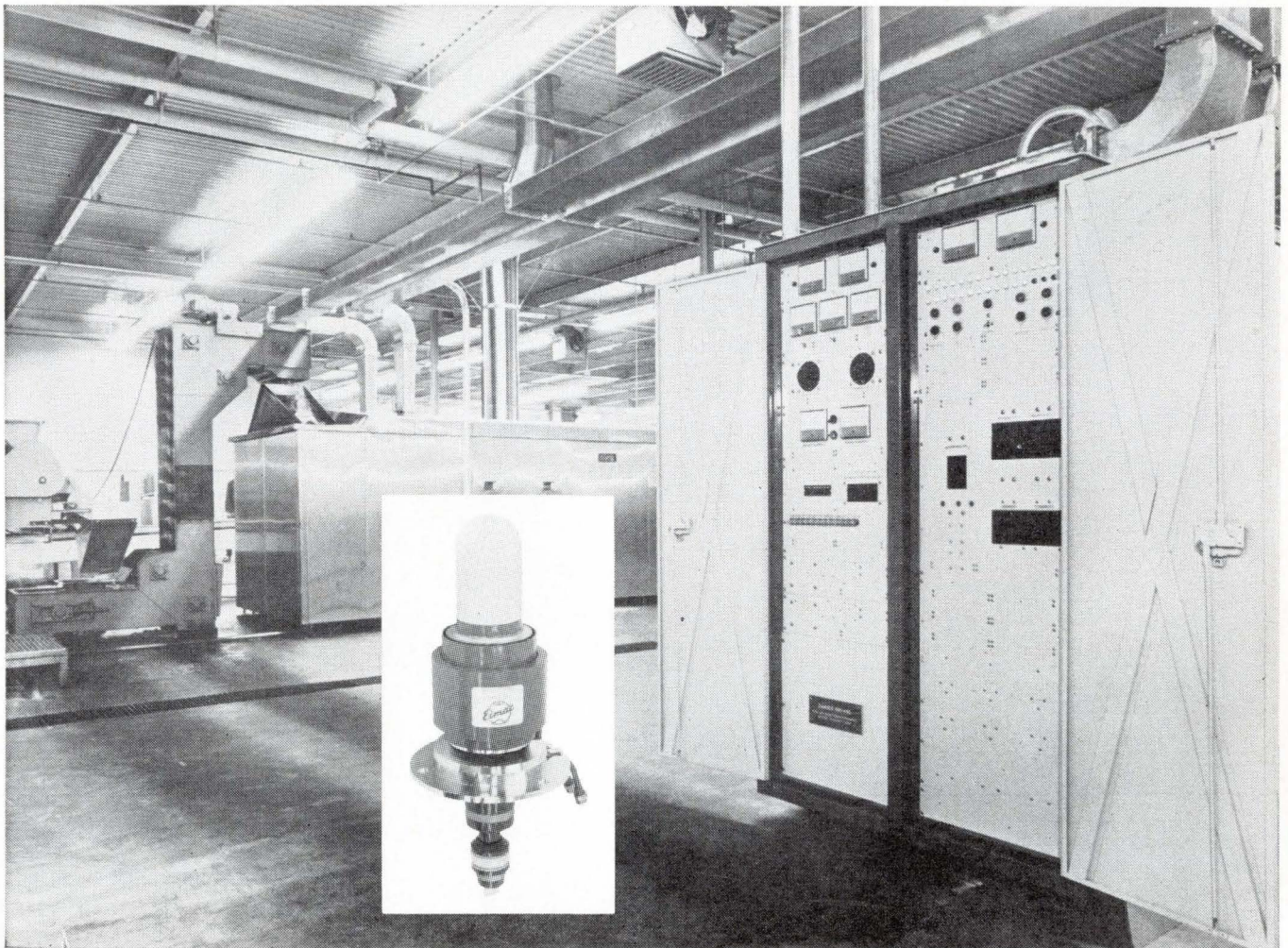

Achieve optimum strike potential with Ferranti F1600

The family of computers that permits initiation of real-time retaliation within two radar sweeps.

Before the antenna has completed its second sweep the F1600 carries out a thorough threat evaluation and presents Central Command with an overall picture of the national defence situation. Subject to human decision, retaliation can proceed instantly.

This is how member nations of NATO can achieve strategic superiority with a defence system based on the *F1600* — organised in a radically new mode pioneered by Ferranti to make it the world's fastest and most powerful computer for advanced military applications.

The *F1600* compiles 'track files' on attacking aircraft and missiles, evaluates the state of readiness, performance and location of individual units in the defence network, and selects the most likely weapon for effective combat from the nation's armoury. Performs all these functions in micro-seconds.

Based upon information gathered from surveillance radar the *F1600* then calculates and transmits vital

'kill point' data to a fighter aircraft before it leaves the ground, to a fighter already in the air, or to a surface-to-air missile complex.

This very high speed stored program computer has been chosen to form the heart of the British Royal Navy's *Action Data Automation System (ADA)* for the new generation of aircraft carriers and guided missile destroyers.

Within a few hours flight of every European capital, Ferranti have unequalled experience in the creation of real-time computer-based systems to meet specific Service requirements. Having worked closely and successfully with members of NATO, Ferranti are uniquely qualified to provide an individual solution to problems of national defence.

Ferranti Ltd., Digital Systems Department, Moston, Manchester 10, England.

DSD Research and Development Laboratories, Bracknell, Berkshire, England.



FERRANTI
DIGITAL SYSTEMS:
F1600 SERIES

DS8

WANT TO SAVE MONEY BY
 USING **GUDEBROD**
 LACING TAPE? . . .

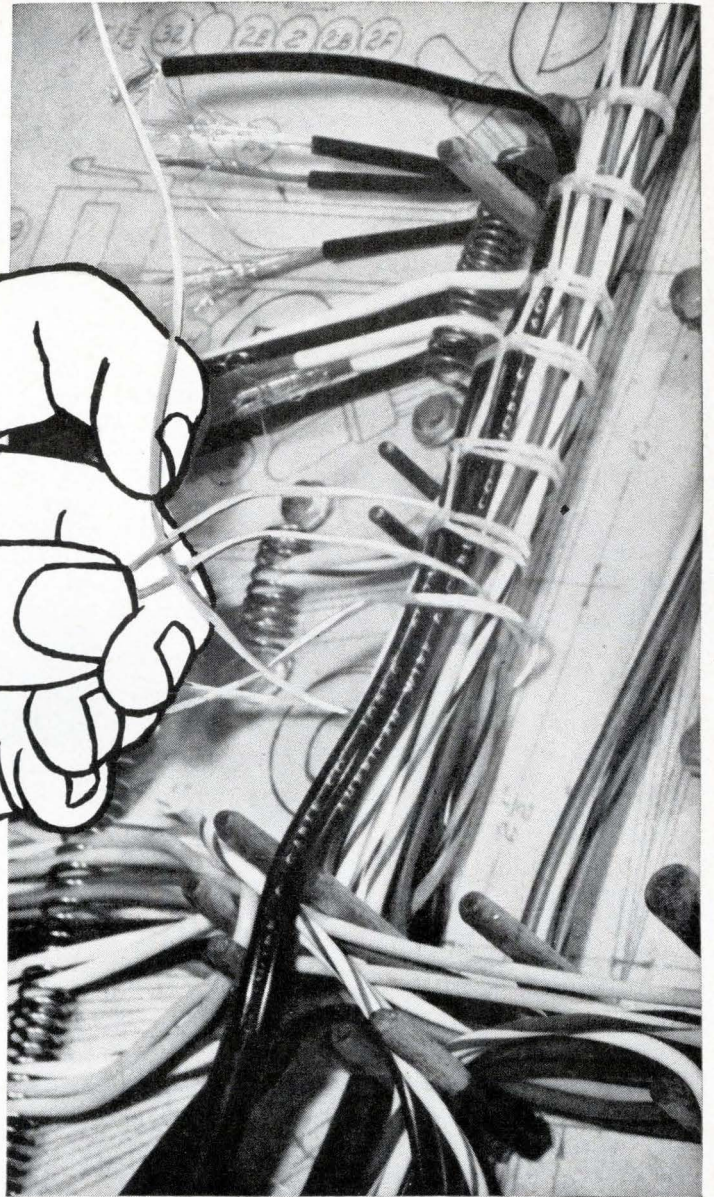
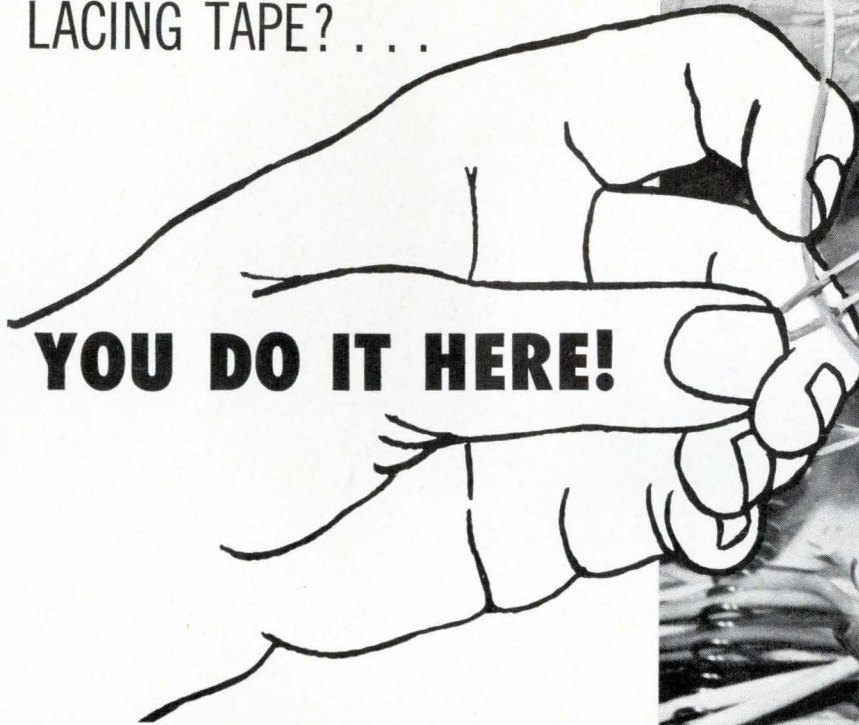

Harness tying may be a relatively minor operation. But it also can be a major cost drain. Lacing tape is one of the smallest costs in the harnessing operation but with Gudebrod Tape you can save dollars in making harnesses. Knots tie easier, workers say they almost tie themselves, knots stay tied, the harness workers can go right on with the harnessing without having to go back for re-tightening. Workers like to use Gudebrod Tape. You cut harnessing time—you have fewer rejects. All of this works for you in saving money on cable harnesses—that's why it pays to specify Gudebrod Lacing Tape, the original flat braided tape. Prove these statements in your own harnessing department—give Gudebrod Tape a comparative test.

GUDEBROD
 CABLE-LACER



—ANOTHER MONEY SAVER

The first hand tool specifically engineered for continuous wire harnessing. Handle holds bobbin, feeds tape as needed, grips tape for knotting. Speeds, eases harnessing. Has paid for itself in a day in many plants.

CABLE LACING INFORMATION:

When you need help on knots, on spacing, on the type of tape to use—Gudebrod is your one best source for information. We have over 200 different lacing tapes in stock, for temperatures up to 1500° F. or down to -100° F., burn proof

tapes, tapes that do not outgas in vacuum, color coded tapes, cut lengths, tapes of nylon, Dacron*, Teflon*, spun glass, silica fiber. Ask for a copy of our Product Data Book.

*Du Pont Registered Trade Mark

Area Code 215, WA 2-1122



GUDEBROD BROS. SILK CO., INC.

FOUNDED IN 1870

Electronics Division

12 SOUTH 12th STREET, PHILADELPHIA, PENNSYLVANIA 19107



(Actual size)

The newest, finest Bendix Autosyn Synchros won't carry much weight.

Unless you consider the 1.3 ounces typical of the new Size 08 Autosyn® Synchros "much". Which most engineers don't. And which, when coupled with the fact that the 16 new Size 08 Synchros boast a maximum diameter of just 0.750 inch, is enough to influence almost every weight- and size-critical design on the drawing boards.

But subminiaturization is only one of the talents Bendix Autosyn Synchros offer you. All sizes (08, 10, 11, 15 and 22) are available in stainless steel or aluminum housings, for instance. Some are accurate and stable at operating temperatures as high as 800° F, which makes them ideal for use in supersonic aircraft. Others are

built for increased radiation resistance. And hundreds more are specifically designed for aircraft instrument applications.

There's certain to be an Autosyn Synchro that's right for your needs. To find out which one, call us at 717, 278-1161, in Montrose, Pennsylvania. Or write for our new 42-page catalog.

Montrose Division



Only ONE dvm



offers you the advantages of integrating AND potentiometric operation:



Measure 1 v to 1000 v with $\pm 10 \mu\text{V}$ resolution, to 1200 v with overranging, and get the noise rejection performance of an integrating DVM, plus the accuracy of a potentiometric DVM. Range selection by front-panel pushbuttons, automatically or remotely. Function symbol is displayed, and decimal point is positioned automatically.

You need to read all the specifications to learn the uniqueness of this remarkable instrument which is the heart of a series of systems available from the Dymec Division. Or see it perform on your bench or in your system. Call your Hewlett-Packard field engineer for a demonstration or write for complete data to Hewlett-Packard, Palo Alto, California 94304, Tel. (415) 326-7000; Europe: 54 Route des Acacias, Geneva; Canada: 8270 Mayrand Street, Montreal.

the new hp 3460A!

Unique design offers you this:

- Accuracy:** $\pm 0.005\%$ of reading ± 2 counts, $+10^\circ$ to $+40^\circ\text{C}$!
- Stability:** Calibrate only once every 2 months!
- Speed:** Up to 15 readings per second!
- Ranges:** Four 5-digit ranges, 1 v to 1000 v ($10 \mu\text{V}$ sensitivity)!
- Input impedance:** 10 megohms ($\pm 0.03\%$) on all ranges!
- Price:** Only \$3600!

Plus all these features, yours on the STANDARD instrument, at no increase in cost!

- Autoranging
- 20% overrange on all ranges, 6th overrange digit
- CMR of 160 db at dc
- Remote programming
- BCD printer output
- Selectable front and rear inputs
- Manual trigger
- Overload indication
- Operation to 50°C
- Optional ac/ohms measurements

Data subject to change without notice. Price f. o. b. factory.

HEWLETT  **PACKARD**
An extra measure of quality

Engineers and Scientists:

*The Hughes Aircraft Company
is proud to announce the establishment of*

THE HUGHES PROFESSIONAL CAREER DEVELOPMENT PROGRAM

This new Program emphasizes individual career growth through a sequence of selected work assignments for graduate engineers who have acquired between two and eight years of professional experience. It is designed primarily for two types of development:

1. Specialized, in-depth assignments to develop unusual proficiency in a specific area of interest.

2. Broad, systems-types of assignments to prepare for system and project engineering responsibilities.

There will be a maximum of three assignments which will be determined jointly by the participant and the Professional Development Section. The assignments, which are flexible in length would normally extend for one year each. They may be selected from a broad spectrum of aerospace electronics hardware and systems-oriented programs and will be designed to provide optimum backgrounds in specialized areas of interest.

The Program will be limited to 50 participants in 1966. These will be selected from candidates who are graduates in E.E., M.E. or Physics from fully-accredi-

ed universities and who have acquired from two to eight years of professional-level technical experience. U.S. citizenship is required.

Those in the Program will receive salaries commensurate with levels established by their overall experience and qualifications.

We invite interested Engineers and Physicists to submit their qualifications for consideration.

Please forward your resume including details of your educational and experience background to:

Mr. Robert A. Martin
Head of Employment
HUGHES Aerospace Divisions
11940 W. Jefferson Blvd.
Culver City 5, California



An equal opportunity employer



what ceramic capacitor manufacturer can meet or exceed all these MIL specs?



Hi-Q can!

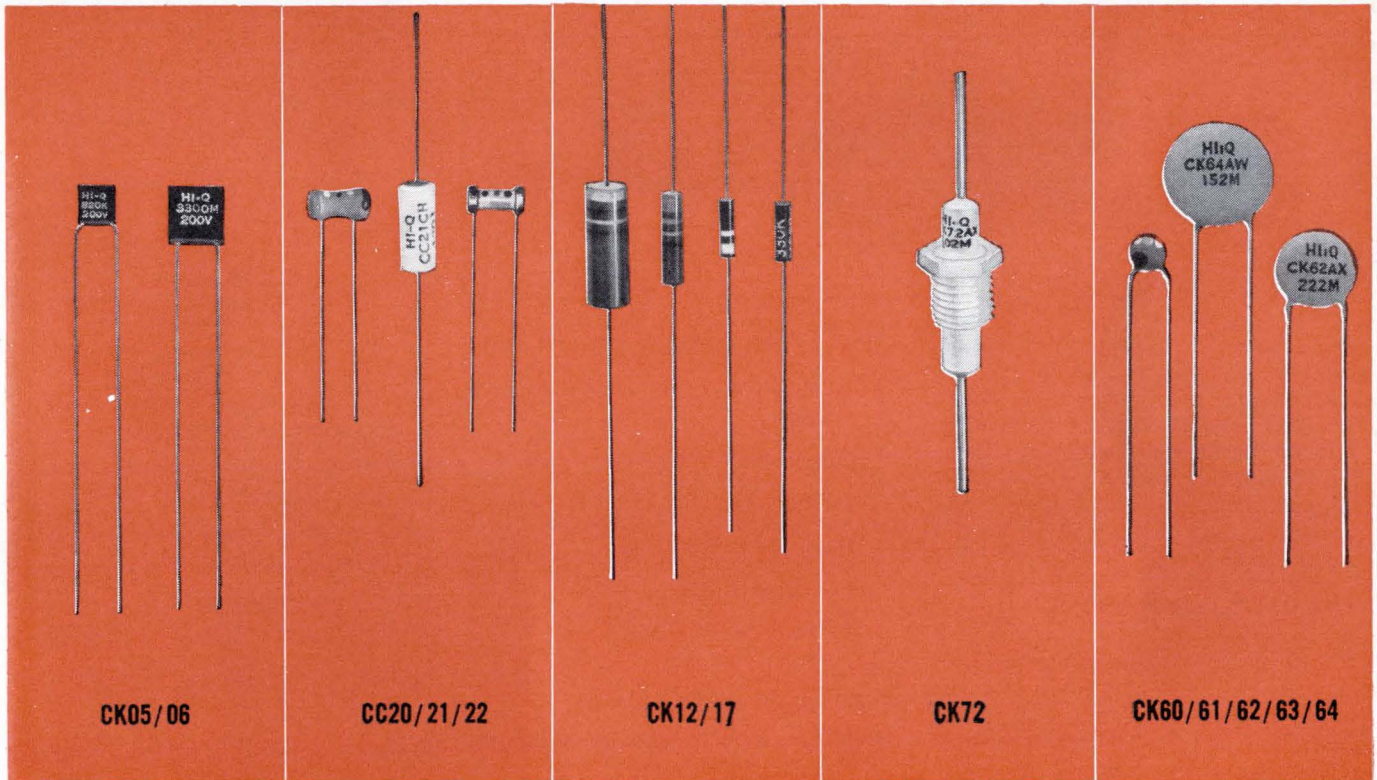

...and does. Right in step with the increasingly stringent demands of aero/space technology, Hi-Q today provides "one-stop shopping" for all types of Military ceramic capacitors. State-of-the-art temperature compensating, high K, and high reliability ceramic formulations are always available from the company that leads the pack in product advancement. Styles? Whether you need a ceramic high voltage disc, a subminiature radial lead part, a feed thru, a temperature compensating tubular, or a molded high capacitance tubular...you can be sure of getting it from Hi-Q.

And now Hi-Q has developed CERALAM to dramatically increase capacity-to-volume ratios—typified by the CKR12, the CKR13, and the extended range CKR06.

To meet MIL Specs like NPC-200-3, MIL-STD-790, and MIL-Q-9858, Hi-Q has created in-house Reliability and Quality assurance programs that cover everything from design

and raw material to the carefully controlled process and inspection that produce the world's finest capacitors. And all this is carried out in outstanding clean room facilities at Myrtle Beach, S. C. and Olean, N. Y. — clean rooms that make it possible to meet the unique demands of HI REL specifications such as MIL-C-38101 and MIL-C-39014.

So if you're looking for a manufacturer that can meet any or all of your requirements for Military ceramic capacitors, call us. We're it.



AEROVOX
CORPORATION
OLEAN, NEW YORK
MYRTLE BEACH
SOUTH CAROLINA

TEMPERATURE MEASUREMENT REPORT



REPORT NUMBER 1

Revolutionary new temperature transducers fit both bridge circuitry and sensing elements in the measuring stem.

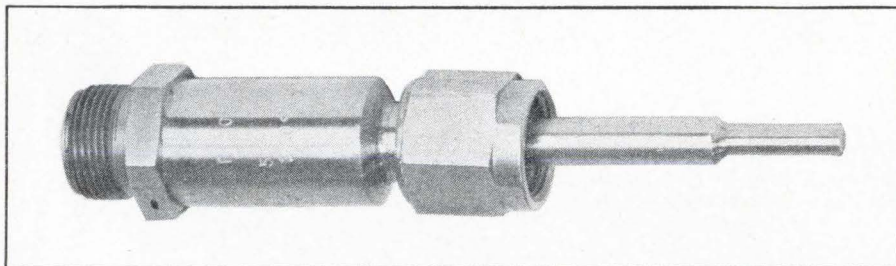

CEC's Type 4-550 Integral Bridge Temperature Transducers introduce a *consistent* degree of accuracy never before achieved in the temperature measurement of liquids and gases. Also, being engineered to withstand extreme vibration and shock environments, these new transducers are the logical choice for missile applications.

The secret is in the stem.

A new design concept has made it possible to locate *both* the bridge completion circuitry and the sensing elements within the measuring stem of the transducer. Result: since all critical resistors remain at the same temperature, effects of temperature changes on the bridge are included in the calibration and standardization of the transducers. No longer need you be concerned about possible errors due to variations in external ambient air temperature.

Three models are available.

The 4-550 family includes the 0001, 0002 and 0003. The distinction between them is in range only, which is, respectively: 0 to 200°F, 0 to 100°F and 0 to 500°F. All employ special strain-free, vibration-resistant sensing elements of high purity nickel. The completion bridge is designed to provide a linear output with temperature, 40 mv full scale. No need to call for computer help to unscramble non-linear functions.

The six advantages of the 4-550s:

1. Elimination of external bridge circuitry.
2. Operational simplicity.
3. Interchangeability of calibrations.
4. Improved overall system accuracy.
5. Linearized output.
6. Less weight and space.

Significant specifications:

- **Range:** Zero to full scale within the limits of -100 and $+500^{\circ}\text{F}$.
- **Output:** 4.0 mv/V full scale.
- **Overall Accuracy:** $\pm 0.25\%$ of full scale (including calibration interchangeability).
- **Nominal Excitation Voltage:** 10.0 volts d-c.
- **Rated Load Impedance:** 100,000 ohms.
- **Output Impedance:** 500 ± 25 ohms.
- **Time Response:** 250 milliseconds for 63% response in water at 3 ft/second.
- **Working Pressure:** 1500 psig.
- **Calibration:** Five point calibration certificate supplied with 0, 25, 50, 75 and 100% of full scale temperature vs. output values.

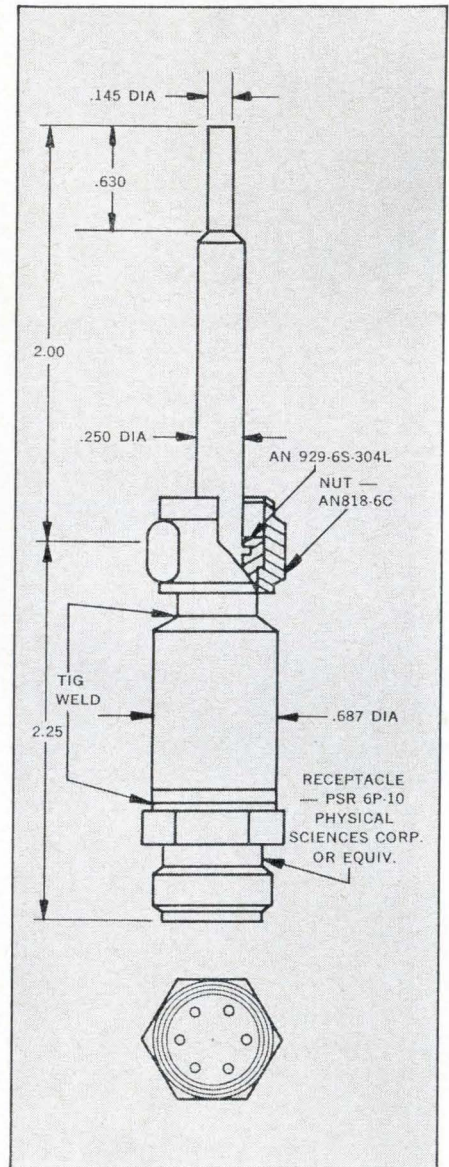

For complete information, call or write CEC for Bulletin 4550-X1.

CEC

Transducer Division

CONSOLIDATED ELECTRODYNAMICS

A SUBSIDIARY OF BELL & HOWELL/PASADENA, CALIF. 91109
INTERNATIONAL SUBSIDIARIES: WOKING, SURREY, ENGLAND
AND FRIEDBERG (HESSSEN), W. GERMANY



The Leader IN MAGNETIC MATERIALS AND SPECIALTY RESISTORS



now coast-to-coast

General Electric can meet your permanent magnet, thermistor and Thyrite® Varistor needs.

We've redrawn our sales map. General Electric now has magnetic material and specialty resistor sales assistance in 18 offices from coast-to-coast . . . one is near you.

G-E Alnico and Lodex® permanent magnet materials, thermistors, and Thyrite® Varistor materials are already at work in dozens of industries helping to solve sticky and critical design problems. They can help you, too.

Just give us a call today and we'll send a man with technical assistance your way fast. Let us show you why General Electric is the industry leader in magnetic materials and specialty resistors. **MAGNETIC MATERIALS SECTION, (Telephone 517-427-5151), Edmore, Michigan 48829.**

® Registered Trademark of General Electric Co.

731-08

Progress Is Our Most Important Product

GENERAL  ELECTRIC

G-E MAGNETIC MATERIALS SALES AND SERVICE OFFICES

- | | | | |
|---|---|----|---|
| 1 | Seattle, Washington
220 S. Dawson Street
206-725-6804 | 10 | Rochester, New York
39 Jefferson Road
716-436-2800 |
| 2 | Redwood City, California
555 Veterans Blvd.
415-369-7151 | 11 | Clifton, New Jersey
200 Main Avenue
201-757-3673 |
| 3 | Los Angeles, California
11840 W. Olympic Blvd.
213-479-7763 | 12 | Wellesley, Massachusetts
468 Washington Street
617-235-5521 |
| 4 | Phoenix, Arizona
Suite 712, Guaranty Bank
Bldg.
602-264-1751 | 13 | Philadelphia, Pennsylvania
3 Penn Center Plaza
215-568-1800 |
| 5 | Denver, Colorado
201 University Avenue
303-388-5771 | 14 | Baltimore, Maryland
1 N. Charles Street
301-685-6500 |
| 6 | Dallas, Texas
4447 N. Central Expressway
214-521-1931 | 15 | Washington, D. C.
777-14th Street NW
202-393-3600 |
| 7 | Cedar Rapids, Iowa
210 Second Street SE
319-364-9149 | 16 | Lynchburg, Virginia
Carroll Avenue
703-846-7311 |
| 8 | Kansas City, Missouri
106 W. 14th Street, Room
2500
816-221-4033 | 17 | Charlotte, North Carolina
129 W. Trade Street
704-375-5571 |
| 9 | Chicago, Illinois
3800 N. Milwaukee Avenue
312-777-1600 | 18 | Tampa, Florida
2106 South Lois Avenue
813-877-8311 |

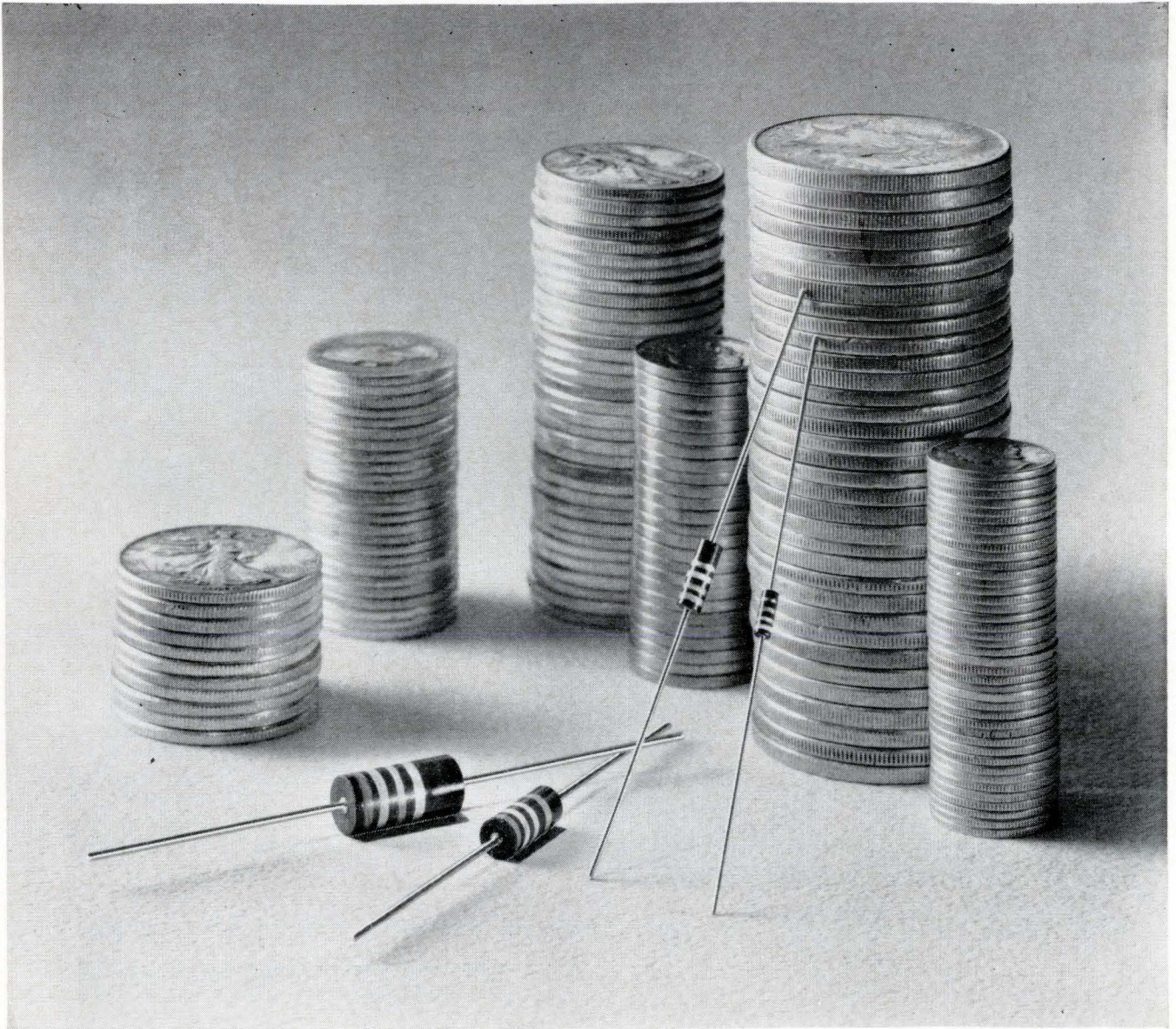

Quality Need Not Be Expensive

Some people would have you believe that to buy the best, you must pay the most. This is not necessarily true. Price is only a measure of value—never a substitute for it.

At Stackpole, the real value of any resistor is determined by a combination of its performance record and its price. Perhaps this is why so many of our customers continue to specify Stackpole resistors year after year to maintain top performance for established products and for their new ones, too. Such confidence and loyalty cannot be based on price alone.

Uniformity has become the accepted characteristic of Stackpole resistors. Unique production methods, coupled with in-depth experience in manufacturing and testing are your assurance that Stackpole resistors will give you absolute performance. The resistors you order today will be identical in every way to your last order.

Most leading manufacturers of electronic equipment have long recognized Stackpole resistors for reliability,

Whether it be the rugged demands of portable television or the critical tolerances of space age communication and tracking equipment, Stackpole resistors deliver the performance you expect—the kind of dependability that builds a reputation for your products.

Why continue to pay a premium for quality? Let us prove that you get value from Stackpole. Quality resistors, economically priced, are delivered promptly and backed up by our complete corporate facility. Next time, specify Stackpole. There's a family of fine resistors available in sizes of 2, 1, ½ and ¼ watts. For samples and additional information, write: Stackpole Carbon Company, Electronic Components Division, Kane, Pa. Phone: 814-837-7000 — TWX: 510-695-8404.



STACKPOLE
ELECTRONIC COMPONENTS DIVISION

At last- a production laser welder that really works:

the *Linde* LWM-1

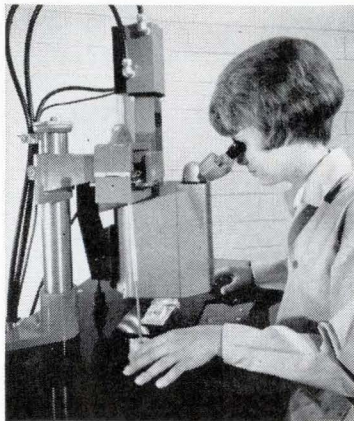

See and try the LWM-1 at the IEEE Show.

This is the first practical laser welder that makes precise, reproducible welds *on a production basis*—the LINDE LWM-1.

Another important thing: it's easy to use. Almost anyone can learn to operate it in about five minutes. The 25:1 ratio micro-manipulator makes positioning a snap. And the operator has a continuous right-side-up image in the binocular viewer, *even during welding*.

The LWM-1 Laser Micro-Welder is manufactured by Korad Corporation to LINDE specifications. Want complete details? Contact the nearest Linde Division office, or send the coupon.

"Linde" is a registered trade mark of Union Carbide Corporation. Korad Corporation is a subsidiary of Union Carbide Corporation.

FILL IN — CLIP TO BUSINESS LETTERHEAD — MAIL

Union Carbide Corporation
Linde Division, Dept. E-21
270 Park Avenue, New York 10017

Please send me details of the LINDE LWM-1
Laser Micro-Welder.

Name _____

Title _____

**UNION
CARBIDE**
**WELDING
PRODUCTS**

"ROOM AT THE TOP"

Here are growth opportunities in Communications with TRW Systems in Los Angeles and Houston

There is "room at the top" for your special talents on America's major missile and space programs with TRW Systems' Communication Laboratory in either Los Angeles or Houston. From the beginning of communications via space, this group has played a pre-eminent role in developing communications systems for the nation's major missile and space programs. Major achievements include the first unified carrier tracking, telemetry and command system and the first PCM telemetry system for space. Now is the time for you to investigate these opportunities with this outstanding professional organization.

MAJOR PROGRAMS . . .

- Apollo spacecraft systems
- Advanced Minuteman systems
- Mars mission and spacecraft studies
- Nuclear Detection (Vela) Satellites
- Pioneer interplanetary spacecraft
- Weather satellite systems
- Standardized tracking, telemetry and command system (SGLS)
- Advanced space probes
- Lunar telemetry systems
- Communication satellite systems

Senior Communication Engineers

For design, analysis and management of communication systems and evaluation of scientific and military applications of communication techniques for aircraft, spacecraft and underwater craft use. BSEE, MSEE or PhD.

Communication Equipment Design Engineers

Several years' experience in design and analysis in the following fields: RF filters, diplexers, antennas, phased arrays, feeds, solid-state transmitters, receivers, phase-lock loop techniques, cavity techniques, strip line, very wide and very narrow band circuits, circuit engineering, and modulation techniques. BSEE or MSEE.

Communication System Analysis Engineers

Conceptual design, analysis and synthesis of wide variety of digital and analog communication systems, employing coding, modulation, and statistical communication theory. Systems include integrated coherent-carrier systems, phase lock demodulation (restrictive/non-restrictive), communication satellites and deep space probes. MSEE or PhD.

Signal Processing Engineers

Design and development of sophisticated communication systems and components. Signal conditioners, analog and digital encoding and decoding, modulation tracking and carrier tracking phase lock loops, and multiphase modulation are involved in tracking, telemetry and command equipment which includes but is not limited to space applications. BSEE or MSEE.

Telemetry Circuit Design Engineers

To design a wide variety of analog and digital signal processing circuits for spacecraft digital telemetry equipment. Experience should relate to the design of analog-to-digital converters, analog and digital multiplexers, logic and data storage. Familiarity with microelectronics desirable. BSEE or MSEE.

Telemetry System Engineers

Experienced in the functional and logical design of analog and digital telemetry systems. Familiarity with design, development, application and evaluation of spacecraft instrumentation systems. Experienced in the design of data systems to interface with a wide variety of data sources including scientific experiments, and engineering measurements.

Please submit resume and salary history in confidence to R. J. Brown, TRW Professional Placement, Dept. L-21, One Space Park, Redondo Beach, California 90278. TRW is an equal opportunity employer, male and female.

TRW SYSTEMS

CHALLENGE US!

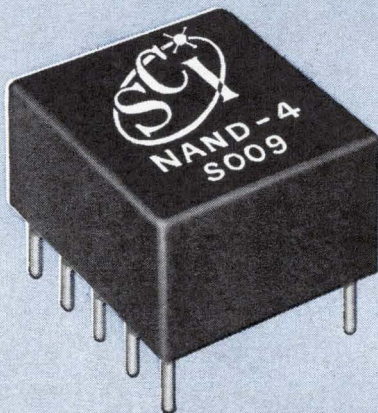

SPACE CRAFT, INC.

8620 SO. MEMORIAL PARKWAY
HUNTSVILLE, ALABAMA 35802

Gentlemen:

Consider yourselves challenged. Send me your short form specification sheet for custom-welded modules. I'll fill it out. Then you quote a price and give me whatever suggestions you may have for improving the module.

Name _____

Title _____

Company _____

Address _____

City _____ State _____ Zip _____

If you would like your system to have the reliability and size reduction advantages of custom welded modules but think you can't afford it, challenge us! Whether you need to design an all-new circuit, to adapt an existing design to welded packaging or to locate a qualified vendor for production quantities of your circuits, Space Craft will perform for you at surprisingly low cost. To call our hand, just use the coupon above.

SPACE CRAFT, INC.

8620 SO. MEMORIAL PARKWAY / HUNTSVILLE, ALABAMA 35802
TELEPHONE: (205) 881-1611 TWX: (510) 579-2234



Opens fresh design horizons...

microminiature solid cermet discrete resistor

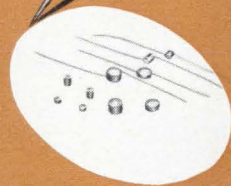

Explore new design areas with these Ceradot[®] pellet resistor characteristics available only from CTS:

- To $\pm 1\%$ tolerance.
- 15 watts/cm³ power to size ratio.
- Won't short out under any operating conditions.
- Extreme stability under extreme environments.
- 15 ohms to 200K ohms resistance range.
- Not affected by radiation.
- Operates at 175°C hot spot without leads.
- Available with leads or terminating surfaces for soldering or welding.

Current CTS Ceradot applications include numerous aerospace, military and industrial microcircuits, such as discrete components inside transistor cans and flat packs, microwave loads, temperature compensated transistor circuits, load resistors, etc. How can Ceradot's unique characteristics help solve your design problem?

EXPERIMENT WITH CTS CERADOTS

Designers' Kit contains an assortment of pellet resistors in these sizes: .050" dia. x .030"; .050" dia. x .062"; .100" dia. x .030" and .100" dia. x .062" in random resistance values. Uses: in prototypes, development programs, testing and experimental microcircuits. Kit price \$10.00. Immediate delivery.



Founded 1896

CTS CORPORATION Elkhart, Indiana

Sales Offices and Representatives conveniently located throughout the world.

Principal Products

Variable Resistors
Selector Switches
Loudspeakers
Trimming Potentiometers
Fixed Resistor Micromodules
& Microelectronic Circuitry
Crystals, Filters,
Oscillators & Ovens

Subsidiaries

CTS of Asheville, Inc., Skyland, N.C.
CTS of Berne, Inc., Berne, Indiana
CTS of Paducah, Inc., Paducah, Ky.
Chicago Telephone of California, Inc.,
South Pasadena, Calif.
CTS of Canada, Ltd., Streetsville, Ontario
CTS Microelectronics, Inc., Lafayette, Ind.
CTS Research, Inc., Lafayette, Ind.
CTS Knights, Inc., Sandwich, Ill.

Probing the News

The 1967 budget: a blockbuster

Through 1965, the United States budget had never exceeded \$100 billion. Now the Johnson Administration has presented an 18-month spending plan that would propel two budgets beyond that imaginary barrier—the \$106.4-billion plan for fiscal 1966 and the \$112.8-billion budget for 1967, both boosted by supplemental spending requests totaling \$14.7 billion.

Defense spending, which constitutes 57% of next year's \$112.8-billion budget, offers rich rewards to military electronics companies. There are also a few consolation prizes to the industry's participants in the Great Society and other civilian programs.

The military buildup hastens the trend away from strategic weapons and toward equipment for close-range fighting of the kind encountered in Vietnam. Intercontinental missiles such as the land-based Minuteman and the submarine-launched Polaris will continue to be built, and development of both types will be accelerated. But high on next year's military preferred list are helicopters (3,678 ordered), radars, and portable radios that can transmit through the jungle.

Civilian programs also are relying more heavily on electronics, although many projects—particularly in aviation and astronautics—are being postponed, curtailed and slowed down. Budget Director Charles Schultze says his bureau chopped about \$20 billion off agencies' requests for funds. He doesn't enumerate them, but some of the casualties are known:

- The Voyager program to land instruments on Mars by 1971 has been set back at least two years.

- The Federal Aviation Agency is requesting \$22 million less for air-traffic control facilities than it received last year.

- The National Institutes of Health, which supports 40% of the nation's medical research, will receive only a \$59-million increase—the smallest in a decade.

Beyond Project Apollo, NASA has had little success in speeding work on advanced programs such as the Apollo Applications Project to put scientists into orbit for months at a time. But if it's any consolation to the space agency, the budget-cutters have also been stern with the military. The Air Force's plan for a manned orbiting laboratory has received only token authorizations.

Other programs that have been touted by Administration officials

will have to achieve their goals with little or no research money. There will be some impetus for electronics in the control of air and water pollution and in instrumentation for nuclear reactors. But plans for research into better high-speed ground transportation have been slashed almost in half, and work on the highly publicized supersonic transport plane will move along no faster than it did this year.

The new highway-safety program will have to rely on the automobile industry for any sophisticated testing and research it may require. That's like asking the steel industry to help establish wage-price guidelines.

Covering the budget

This report on the federal budget's impact on the electronics industry was prepared by a team of editors with the assistance of the Washington News Bureau. Howard Rausch directed the project. John F. Mason, military electronics editor is responsible for the Defense Department story starting on this page and William J. Evanzia, avionics editor, wrote the aviation report on page 141. The space story on page 138 is by Seth Payne, the civilian electronics report on page 145 is by Warren Kornberg and the budget analysis on page 134 is by Don Loomis, all of our Washington Bureau.

Military electronics

Lion's share to defense

The war in Vietnam, long called the "unbudgeted war" by many members of Congress, has suddenly become the most conspicuous item in the federal budget. Because of it, President Johnson, within five days—from Jan. 19 to Jan. 24—revised the fiscal 1966 defense budget upward by \$12.3 billion to make a total authorization of \$66.46 billion. He then asked for a huge 1967 budget—\$61.42 billion. If this is not enough, the President told Congress, "I will not hesitate to request the necessary sums."

Most of the extra money in both budgets will go for Vietnam; it will

help replenish stockpiles in the United States and Europe that were dipped into before the Vietnam war was budgeted fully; it will help pay for the present fighting in Southeast Asia; and it will help finance further escalation if it takes place. If the war does expand, supplemental requests are inevitable in 1967.

The money on hand, and that requested, should hold the Defense Department for a while. The 1967 budget calls for \$59.85 billion in new obligational authority (NOA)—new funds that the Defense Department can spend, or can prom-

ise to spend in 1967 or later. Added to this amount are unused funds brought forward from 1966; these will bring the total contractual authority next year to an estimated \$61.42 billion.

Still more money may end up in the 1967 kitty if some is left over from 1966. Beginning as a modest \$51.74 billion when the 1966 budget was first drawn up, the total obligational authority for 1966 was expanded with a \$700-million supplemental authorization in May, 1965; \$1.7 billion more in August, 1965; and the \$12.3 billion on Jan. 19, 1966, five days before the 1967 budget was introduced. The Pentagon's total obligational authority for 1966 comes to a hefty \$66.46 billion; \$63.681 billion of this will be committed to contractors, and \$54.2 billion will actually be spent. The \$9.5-billion difference between commitments and expenditures represents long-lead-time items that won't be delivered or paid for until 1967—such items as aircraft, ammunition, and missiles including

Bullpup, the air-to-surface missile used by all three armed services.

In 1967, contracts totaling \$62.8 billion are expected to be awarded, with \$58.3 billion being spent. Only \$4.5 billion is earmarked for long-lead-time items in the 1967 budget.

The impact of Vietnam is seen in the sharp contrast between the 1965 budget and those for 1966 and 1967. Contract awards in 1966 are expected to exceed 1965's by \$13.5 billion, and 1967 contracts will total \$12.6 billion more than in 1965. Expenditures in 1966 are \$6.8 billion more than in 1965; and in 1967 they will be \$10.9 billion more than in 1965.

I. Vietnam supplementals

The war in Vietnam is not being funded completely from supplemental appropriations—the Defense Department says it doesn't know how much the war is costing. The supplementals, however, are paying for part of the war, and the Defense Department knows what this money is buying. A total of

\$4.635 billion of the supplementals is scheduled for spending for Vietnam during the rest of fiscal 1966, and \$10.335 billion in 1967.

Aircraft. With the supplementary funds for Vietnam, the Army will spend \$826 million for aircraft and related equipment, \$168 million of this will be used to equip new aviation units. The Navy will spend \$738 million for aircraft, and the Air Force \$1,586 million.

The services will buy 2,005 helicopters—1,813 of them for the Army—and more than 900 fixed-wing planes—only 64 for the Army. Aircraft to replace those lost in Vietnam will cost \$1.8 billion.

Missiles. The three services will buy a total of 4,830 tactical missiles, including the Army's Hawk for use against low-flying planes and the Navy's Bullpup for use against ground targets. The Air Force will spend \$64 million for missiles; the Navy \$26.2 million; the Army \$64 million and the Marine Corps \$27.5 million.

Replenishing stockpiles. Some

A review and a forecast

The federal budget is a many-splendored thing: a financial accounting of the past year, a midstream adjustment of the \$99.7-billion spending plan for the current year, and a forecast of plans and expenditures for the fiscal year ending June 30, 1967.

It is also a snapshot of each agency's programs, from studying ferroelectricity to buying missiles or transistors; perhaps most important, the budget is a political document designed to put the President and his administration in the most favorable light possible.

The document that President Johnson has sent to Congress for approval indicates that he expects the Treasury to write checks totaling \$112.8 billion during fiscal 1967. He is also asking for \$106.3 billion of new spending authority, to be added to \$15.6 billion of previous appropriations which can be carried over into the new year. These two amounts would authorize him to spend \$121.9 billion in 1967.

When Congress authorizes spending, it ties it to specific programs. For example, the Pentagon is seeking \$6 billion in new obligational authority for the purchase of aircraft. If Congress approves, as it undoubtedly will, the purchasing

officials of the Army, Navy, and Air Force will be free to sign firm contracts with airplane manufacturers, electronics companies and other suppliers. These contracts will become "direct obligations"; they will call for deliveries over varying periods—some for three or four months from now, others 18 to 24 months from the time the contract is signed.

Direct obligations for aircraft purchases actually will total \$7.2 billion in 1967—well over the \$6 billion in new obligational authority. This discrepancy is possible because of the carry-over of obligational authority from previous years, including the aircraft-procurement authority granted in the request, now before Congress, for a \$12.3-billion supplement to the fiscal 1966 budget.

As this equipment is delivered, the Treasury writes checks to the suppliers. The total of these checks constitutes the "expenditures" section of the budget—the most-widely used measure of the government's activities.

For aircraft, for instance, "spending" in fiscal 1967 is expected to be \$6.7 billion. But Defense Secretary Robert S. McNamara and his procurement chiefs have considerable leeway within the congress-

sional authorizations and appropriations—particularly leeway to refrain from spending funds that Congress has appropriated.

In this way McNamara has conducted a successful foot-dragging operation to keep Congress from forcing the development and procurement of the B-70 supersonic bomber and other projects favored on Capitol Hill.

Not all budgetary discrepancies are on the credit side. In his budget message last year, Johnson requested \$106.4 billion of new obligational authority for the current year, fiscal 1966. Now, for military expansion alone, he has asked Congress for about \$14 billion more for this year, including the \$12.3 billion for Vietnam that he requested on Jan. 19.

For most government programs—research and development, or the activities of the Federal Aviation Agency or of the Federal Communications Commission—the appropriations by Congress are apt to be closer to the spending totals.

Thus, the Defense Department expects to have new obligational authority of \$6.9 billion next year for research, development, test and evaluation, and it expects to obligate exactly the same amount. Spending is expected to be \$6.4 billion, the \$500-million difference being for such things as equipment or facilities that can't be delivered until after fiscal 1967.

of the supplemental money for Vietnam—but only a small portion of the amount needed—will be spent to replenish stockpiles at Army depots in the United States and Europe; these supplies kept the war in Vietnam going. Although Secretary of Defense Robert S. McNamara has not released, in any form, a report prepared by the Senate Armed Services Preparedness Investigating subcommittee on the condition of these stockpiles, many kinds of equipment are known to be in short supply and must be replaced—radar, helicopters, portable radio transmitters and receivers, generators, electronic test equipment, rockets and other gear.

Particularly important are survival radios such as the AN/URC-10, which is used by lost troops or pilots; the radio transmits a signal that can be used for homing, and also has voice capability.

II. General-purpose forces

Although it is customary in discussing the defense budget to take up strategic forces first, general-purpose forces such as those used in Vietnam are far bigger in this budget. While emphasis on strategic offensive forces is holding its own—with \$5.1 billion in 1967, the same as in 1966—general-purpose forces in 1967 will cost five times this amount: \$25.7 billion. With all the supplementals, much of which will spill over into 1967, the total obligational authority for general-purpose forces in 1966 is even higher—\$30 billion.

Communications and electronics. The Army has requested \$292.3 million for communications—80% for tactical gear, such as the AN/VRC-12 and the AN/PRC-25 radios for Vietnam—and other electronic equipment. Avionics will cost an additional \$60 million, and ground-support for Army aircraft will cost \$11.6 million.

Helicopters. Both the Army and the Marine Corps will organize additional helicopter units; the Army will buy 1,400 and the Marines 273. Most of the choppers will be UH-1D Iroquois built by the Bell Helicopter Co. and the CH-47A Chinook produced by the Vertol division of the Boeing Aircraft Co. The Army spent \$75.2 million for Chinooks in 1966. An-

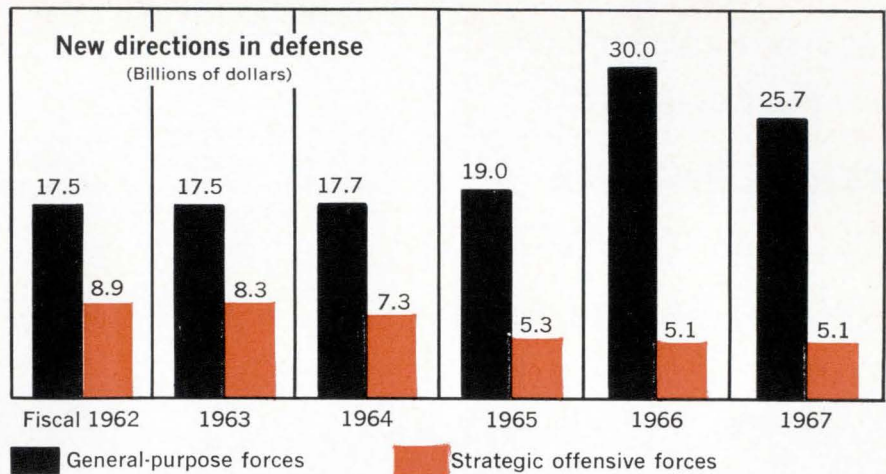

other item is the CH-54 heavy-lift chopper produced by the Sikorsky division of the United Aircraft Corp.

The first of 714 Light-Observation Helicopters (LOH), being produced by the Hughes Tool Co., will be delivered in June. The avionics package, mainly for communications, will be built by Sylvania Electric Products, Inc., a subsidiary of the General Telephone and Electronics Co. (see p. 52).

Development of the advanced airborne fire-support system (AAFSS) will begin in fiscal 1967. This fighting helicopter will be designed for its combat mission and will replace the HU-1B which, in spite of its success in Vietnam, was not built specifically for its fighting role. The Lockheed California Co., a division of the Lockheed Aircraft Corp., has the project-definition phase for AAFSS.

Fixed-wing. The Pentagon plans to order 868 tactical fixed-wing aircraft in 1967. These will include additional carrier-based attack aircraft and land-based antisubmarine planes for the Navy. The Air Force will get the A-7A, the new attack aircraft already in production for the Navy. Produced by Ling-Temco-Vought, Inc., the A-7A is equipped with the AN/APN-153 doppler radar for navigation, built by the GPL division of General Precision, Inc. The A-7A also will use Texas Instruments Incorporated's AN/APQ-99 search radar.

Also for Vietnam will be more production of the F-4B and 4J Phantom II fighter-bomber built by the McDonnell Aircraft Corp. The plane has an infrared seeker, four computers, two data-link systems and two bombing systems.

Large-scale purchases of the F-111A for the Air Force will begin. And for all three services a new, lightweight, multipurpose aircraft will be developed for counterinsurgency (COIN) warfare.

Missiles. The three services will buy a total of 52,297 strategic and tactical missiles next year, 11,286 more than in 1966. The programed cost is \$1.98 billion.

The Army will continue to buy Redeye, the hand-held, heat-seeking missile that knocks down aircraft. Redeye cost \$58.3 million in 1966. Chaparral, the air-to-air Sidewinder converted to a surface-to-air missile, will be another big buy; this year about \$20.4 million is being spent for these missiles. The surface-to-surface Shillelagh missile that is mounted on the M-60 tank will continue to be a big production item; sales totaled \$60 million in 1966.

Procurement of the surface-to-surface Lance missile will begin in 1967. With a 45-statute-mile range, Lance will replace the Honest John and Little John missiles. If tests at the Naval Ordnance Test Station, China Lake, Calif., turn out well, Lance may also be used by the Navy as an off-shore weapon to support ground troops.

Funding will be substantially increased for the development of a surface-to-air missile known now as SAM-D and formerly as AADS-70; the missile will be used in the battlefield and for continental defense. It is effective against aircraft and tactical missiles.

Research and development will continue on two wire-guided missiles: TOW, and a new medium-assault weapon called MAW.

The Navy will begin full pro-

Got a Problem of
DIMENSIONS?
TEMPERATURE?
UNUSUAL CYCLING?
SHOCK RESISTANCE?

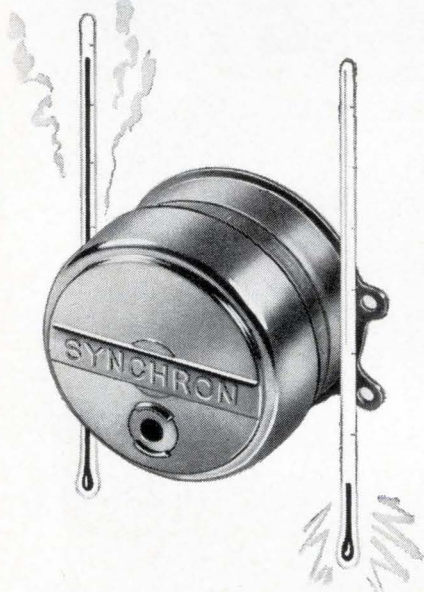

turn the job over to SYNCHRON® MOTORS!

What's the motor problem you face in the design you're working on? One of tricky performance requirements? Difficult environment? Total accuracy? Before you do anything else, see how SYNCHRON Motors can be applied. (Do the same thing even when you have a simple, straightforward application in mind!) Just write us at Hansen Manufacturing Company and tell us what you want a motor to accomplish. You'll get an immediate answer and any help you need for specific problems.



HANSEN REPRESENTATIVES: CAREY & ASSOCIATES, Houston, Tex., R. S. HOPKINS CO., Sherman Oaks, Calif., MELCHIOR & MACPHERSON, INC., San Carlos, Calif., THE FROMM CO., Chicago, Ill., H. C. JOHNSON AGENCY, INC., Rochester, N. Y., WINSLOW ELECTRIC CO., Essex, Conn., Narberth, Pa., and New York, N. Y. EXPORT DEPARTMENT, 64-14 Woodside Ave., Woodside, N. Y.

Defense budget by mission

	Total obligational authority (Billions of dollars)		
	Fiscal 1965	1966	1967
Strategic offensive forces	5.3	5.1	5.1
General-purpose forces	19.0	30.0	25.7
Air and missile defense of North America ...	1.6	1.7	1.4
Research and development	4.9	5.3	5.5
Airlift and sealift forces	1.5	2.2	2.1
General support	14.5	16.8	16.7
Other (military assistance, retired pay, reserve and guard forces)	4.8	5.4	5.8
Total authority to contract	51.6	66.5	62.0
Total estimated expenditures	47.4	54.2	58.3

duction of the Standard ship-to-air missiles in 1967. It will also continue to buy Talos missiles and support items for the Tartar and Terrier missiles. Tartar D, the result of the Navy's "get-well" program for this bug-ridden missile, will go into production in 1967; the modification consists of a new computer to increase the missile's accuracy and reaction time.

The Navy and the Air Force will buy Shrike, the antiradiation bird that can be launched from an aircraft to home on and destroy ground-based radar. An improved version of Shrike, called Arm-I, is also being developed.

Besides Shrike, the Air Force will buy the air-to-ground Bullpup B missile, the air-to-air Sparrow, the air-to-air trainer called Falcon, and the Firebee target drone.

Ships. The big news in the 51-ship construction and conversion program is the request for authorization to build a nuclear-powered aircraft carrier—the second in the fleet. The new one will use a two-reactor propulsion system; its sister ship, the Enterprise uses a four-reactor system.

Besides the carrier, 20 ships will be constructed or converted for antisubmarine warfare (ASW). New construction consists of five nuclear-powered attack submarines and 10 destroyer escorts; five destroyers will be converted.

Two new guided-missile destroyers will be built—the new Tartar D missiles will be tried out on these—and five frigates; one cruiser will be modernized.

Twelve amphibious ships will be built—11 tank-landing ships and one dock-landing ship. Five logistics ships will be built for the sea-lift program, and five ocean mine-sweepers.

III. Continental defenses

"The relative decline of the threat from bomber attack permits further downward adjustments in active-force interceptor aircraft, surface-to-air missiles and radar sites," the President said in his budget message.

Increased funds are proposed, however, for continued development of the Nike X antimissile defense system; more than \$400 million was spent in 1966. Development will continue on satellite interception and detection, and on over-the-horizon radar. Another continuing program is modification of radars along the seacoasts to enable them to detect missiles as well as bombers.

IV. Strategic offensive forces

More Minuteman II and Polaris A-3 missiles will be bought. Development of the Minuteman III and the Navy's advanced Poseidon submarine-launched ballistic missile will be accelerated. Poseidon's \$35-million appropriation for 1966 will be exceeded next year. Total development of Poseidon will cost close to \$900 million. Modifying the submarine to accommodate the larger missiles will cost \$1.1 billion.

Penetration aids for ICBM's, which cost \$138 million in 1966, will remain at about the same level in 1967.

Bombers. In answer to requests by Congress and the Air Force for a bomber to replace the aging B-52 and B-58, the Pentagon plans to modify the ever-changing F-111, adding a capability to drop bombs and to fire the short-range air-to-surface Sram missile. The 1966 budget calls for modifying the aircraft, and the 1967 budget provides for buying the first of the

planned 210 planes. The Martin-Marietta Corp. and the Boeing Co. are both competing in the project-definition phase for Sram.

The advanced strategic manned aircraft (ASMA) concept is being kept alive; the Pentagon is asking for funds to continue work on its avionics.

V. Airlift and sealift

Procurement of the gigantic C-5A cargo/transport plane will begin this year. The cost of development and procurement will exceed \$2.2 billion. Meanwhile, procurement of the C-141 jet cargo plane will be completed in 1967. The Air Force plans to spend \$400 million in fiscal 1966 for C-141's. The Lockheed Marietta Co., a division of the Lockheed Aircraft Corp., is building both the C-5A and the C-141.

Contracts for competitive design will be awarded later this year for the first of a new class of fast-deployment logistic ships. These vessels will provide larger capacity, greater speed and more efficiency than do present transport ships.

ASW. The antisubmarine-warfare (ASW) effort seems to be permanent and stable; for the past two years it has represented one-quarter of the Navy's budget for research, development, test and evaluation. Last year this amounted to \$386 million. For all search and surveillance programs, the Navy is spending \$188 million this year.

Procurement will continue of such ASW weapons as Subroc, the torpedo-missile-torpedo; Asroc, the rocket-torpedo; Dash, the drone helicopter; and for various torpedoes.

VI. Research and development

The \$5.1-billion research-and-development category includes all R&D efforts not directly identified with other programs.

The manned orbiting laboratory (MOL) will continue at its 1966 pace—about \$150 million. Work also will continue on the military communications satellite, with some effort beginning on the small tactical terminals for each service's use. Other space programs will be the navigation satellite, nuclear test detectors and early warning of missile launches.

Other continuing R&D projects

high-voltage workhorse VICTOREEN DIODES

Regulator
Pulse Coupler
High-Impedance
Voltage Divider
High-Voltage
Reference



Victoreen GV1A Corotron diode actual size; other types available.

You probably think of Victoreen Corotron diodes as high-performance thoroughbreds for exotic uses. And they are. But this is only part of the Corotron pedigree. They're also real workhorse diodes for everyday uses. As regulators and H-V references . . . H-V pulse couplers . . . high-impedance voltage dividers. And still we haven't run out of Corotron applications. So put your imagination to work. Savings in cost, complexity and weight can put you on velvet. Right away, write away for latest dope on Corotron diodes — high-voltage workhorse. Address Applications Engineering Department.

Write for free copy of illustrated 40-page catalog of Victoreen diodes.

THE VICTOREEN INSTRUMENT COMPANY
10101 WOODLAND AVENUE • CLEVELAND, OHIO 44104
EUROPEAN SALES OFFICE: GROVE HOUSE, LONDON RD., ISLEWORTH, MIDDLESEX, ENGLAND



5471-A

Where the money goes

	Total obligational authority (Millions of dollars)			Direct obligations (Millions of dollars)			Expenditures (Millions of dollars)		
	Fiscal 1965	1966	1967	1965	1966	1967	1965	1966	1967
Procurement									
Aircraft	6,429	10,153	6,560	5,891	8,793	7,274	5,200	6,000	6,717
Missiles	2,422	2,036	1,981	2,075	1,946	1,939	2,096	1,872	1,751
Ships	1,815	1,930	2,041	1,905	1,770	1,907	1,713	1,650	1,700
Communications and other electronics	1,055	1,377	963	1,072	1,351	1,034	897	1,001	1,048
Other procurement	2,576	7,179	6,290	2,540	6,743	6,319	1,934	3,357	4,754
Totals	14,422	22,675	17,835	13,483	20,603	18,473	11,840	13,880	15,970
Research, development, test and evaluation									
Military sciences (basic research)	621	608	625	620	607	616	573	572	592
Aircraft	1,136	1,205	1,028	1,095	1,226	1,037	1,017	1,094	1,034
Missiles	1,977	1,998	2,334	1,955	1,964	2,315	1,901	1,855	2,063
Astronautics	908	1,036	843	897	1,048	853	921	981	835
Ships	286	331	282	257	340	271	249	282	309
Other	1,600	1,769	1,793	1,563	1,826	1,801	1,576	1,586	1,567
Totals	6,528	6,947	6,812	6,388	7,011	6,893	6,237	6,370	6,400

include Defender, to study techniques protecting the United States against ballistic missiles, a program that cost \$125 million in 1966; Project Agile, to study techniques for guerrilla and counterinsurgency warfare—this cost \$160 million in 1966 and will cost at least as much in 1967; the Deep Submergence Systems Program, which will cost much more than its \$18 million in 1966; and development of the V/STOL vertical or short take-off and landing plane.

Missile ranges. Expanded activity on the Eastern Test Range will cost more than the \$221 million bill

in 1966. The Western Test Range, now preparing for MOL, will cost more in 1967 than in 1966: the Navy gets \$77 million of the 1966 bill and the Air Force \$62 million.

The space-detection network costs \$46.8 million in 1966, and the Satellite Tracking and Control Facilities with headquarters at Sunnyvale, Calif., \$30 million. Both costs should increase next year.

VII. General support

The Defense Communications System is getting bigger and costing more to operate. In 1966 it cost \$387 million. Other communica-

tions systems will also cost more than the \$700 million of fiscal 1966. These include the Army's Starcom, Navy's Navcom and Air Force's Aircrom.

The National Military Command System, the major part of the worldwide military command-and-control system, will cost about \$120 million next year, about the same as in 1966. The system was established to provide the national command authorities—the President, the Secretary of Defense and the Joint Chiefs of Staff—with the means to provide strategic direction to the armed forces.

Space electronics

Slowdown for NASA

"I believe that this nation should commit itself to achieving the goal, before this decade is out, of landing a man on the moon and returning him safely." That objective, enunciated by John F. Kennedy on May 25, 1961, is so clearly in sight that Lyndon B. Johnson can cut the space budget for next year and still express confidence that Kennedy's goal will be attained.

Requests for space funds have been pared down to \$6.7 billion, after this year's peak of \$6.97 billion. The figures include money for

five federal agencies that are active in space; the National Aeronautics and Space Administration, the Defense Department, the Atomic Energy Commission, the Commerce Department's new weather-satellite organization, and the National Science Foundation.

The reductions may not be felt until next year. The government figures that spending will decline by \$320 million next year to \$7.1 billion, but NASA, whose budget has been reduced for the first time in the agency's eight-year history,

expects its expenditures to climb nearly \$300 million above the Budget Bureau's official estimates, nearly balancing the cuts elsewhere. On July 1, at the start of fiscal 1967, NASA will have \$2.9 billion in unspent money that was previously appropriated; about \$100 million of this will not have been contracted for, according to officials of the space agency.

Either way, the space effort will continue to be a valuable market for the electronics industry. Frank J. Sullivan, director of NASA's electronics and control division, says 40% to 50% of the space agency's funds go for electronics.

I. Eye on the moon

The dominant space program continues to be Project Apollo,

whose mission is to land men on the moon. It accounts for \$2.97 billion in next year's budget, about the same as this year's and more than half of NASA's \$5.01-billion request for fiscal 1967. The Gemini program of orbiting two-man spacecraft, nearing an end, drops sharply to \$40.6 million from \$226.6 million this year.

After Apollo peaks out next year, NASA hopes to spur its lagging Apollo Applications Project to orbit scientists for several months at a time. The agency wanted to spend \$200 million on this program next year, double the present year's amount, but the Budget Bureau said no.

Ups and downs. The austerity atmosphere has already claimed a casualty. The Voyager program to land instruments on Mars by 1971. The new timetable calls for a landing in 1973 at the earliest.

Although research and technology will be cut nearly \$10 million next year, to \$278.3 million, electronics systems research will be increased \$4.5 million to \$36.8 million. Ten million dollars of this is earmarked for the Electronics Research Center in Cambridge, Mass., up from \$6 million this year.

About \$2 million of the center's funds will go into studies of reliability of electronic components; NASA would like to reduce its 10 or more reliability standards to 2 or 3. Another \$1.5 million to \$2 million will go for studies of guidance systems developed at other NASA centers to see whether a system designed for one program can serve in other space ventures.

Purchases of equipment for tracking and data acquisition will increase \$48.2 million to \$279.3 million this year, largely for a manned space-tracking network for Apollo.

Looking at lasers. Lasers will receive close attention in instrumentation and data processing—which will take about \$2 million of the research center's money—and for possible applications in gyroscopes and in holography. Lasers also figure prominently in the center's plan to spend about \$3 million studying communications and tracking. NASA also plans to explore the use of the submillimeter waveband, near the infrared, for deep space communications.

At NASA's Langley Research

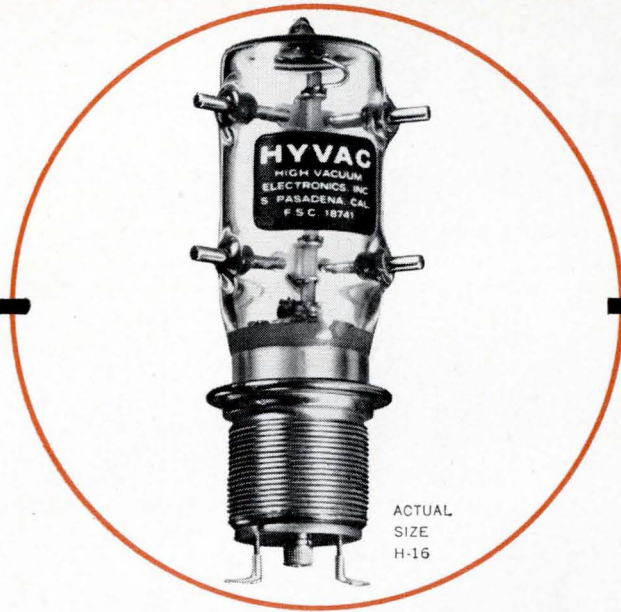

Why Hyvac puts a high voltage relay in a vacuum—
one word... **RELIABILITY!**

VACUUM RELAY RELIABILITY means short contact travel, low contact mass, contacts free of oxides and pitting and minimum contact bounce. These long-life reliability features are made possible only because of operation in a high vacuum dielectric. Vacuum technology has made high reliability, long life high voltage switching practical, with considerable savings in space and weight. Developed for high voltage, high peak current applications, Hyvac relays are well suited and widely used in radar, communications, pulse forming networks, ECM, sonar, medical electronics, antenna switching and antenna couplers, microwave systems and switching in explosive atmospheres. Hyvac's broad line and "Quick Reaction Time" is geared to your most critical delivery schedule. We have the high vacuum experience, design and production capability to provide special modifications of our standard off-the-shelf designs in unbelievably short order. Hyvac, a company small enough to be responsive, large enough to be responsible. Check the brief specifications of our "H" series:

HYPAC TYPE	H-8	H-9	H-11	H-12	H-14	H-16	H-17
Contact Arrangement	SPDT	SPST	SPST	SPDT	DPDT	DPDT	SPDT
Rated operating voltage (kv dc)	20	20	12-air 18-oil	8-air 12-oil	8-air 12-oil	12-air 18-oil	25
Continuous current, *max. (amps-rms)	15	15	15	15	15	15	25
Operating time, max (ms)	15	15	18	18	18	20	25
Coil voltage, nominal (vdc)	26.5	26.5	26.5	26.5	26.5	26.5	26.5
Approx. price (1-9 pcs)	\$98	\$98	\$105	\$110	Factory quote		

*Carry only

For complete technical information, contact your nearest sales engineering representative, or write directly to us.

HYPAC

HIGH VACUUM ELECTRONICS INC. • 538 MISSION STREET
SOUTH PASADENA, CALIFORNIA • PHONE: (213) 682-2149 • TWX 213-449-2552

**WHEN
THE CHAIN
TO SPACE
DOESN'T
TOLERATE A
WEAK LINK...**



Of critical importance to present day telemetry systems is the reliable performance of high frequency patching components. **COAX** components assure the most dependable communication links available today • A unique cable strain relief feature in the single plug illustrated here is just one of several features which make **COAX** components superior • Write for complete data on all **COAX** components.



ADC PRODUCTS, INC.

6325 CAMBRIDGE ST., MINNEAPOLIS 26, MINN.

NASA research and development

(Millions of dollars)

	Fiscal 1965	1966	1967
Manned space flight:			
Gemini	308.40	226.61	40.60
Apollo	2,614.61	2,967.38	2,974.20
Advanced mission studies	26.00	10.00	8.00
Totals	2,949.02	3,204.00	3,022.80
Space science and applications:			
Physics and astronomy	139.08	143.50	131.40
Lunar and planetary exploration ...	206.03	251.34	197.90
Sustaining university program	46.00	46.00	41.00
Launch vehicle development	96.50	55.30	33.70
Launch vehicle procurement	154.49	178.70	152.00
Bioscience	28.50	36.70	35.40
Meteorological satellites	30.99	38.90	43.60
Communication and applications technology satellites	30.77	32.80	26.40
Totals	732.36	783.23	661.40
Advanced research and technology			
Basic research	21.23	22.00	23.00
Space vehicle systems	44.19	35.00	36.00
Electronics systems	25.62	32.30	36.80
Human factor systems	13.32	14.90	17.00
Space power and electric propulsion systems	58.22	45.20	42.50
Nuclear rockets	57.00	58.00	53.00
Chemical propulsion	76.50	39.70	37.00
Aeronautics	35.24	41.50	33.00
Totals	331.33	288.60	278.30
Tracking and data acquisition	253.24	231.06	279.30
Technology utilization	4.75	4.75	4.80
Totals	4,270.69	4,511.64	4,246.60

Center in Virginia, the big search next year will be for better guidance and control in space rendezvous and later for landings on the moon. Besides this \$7-million study, Langley engineers will work on radiation conditioning of semiconductor strain gauges, which show promise for force measurements but are very sensitive to temperature changes. By radiating the silicon strain gauges, NASA thinks it can improve their performance.

The Ames Research Center in

California will spend about \$3.7 million on electronics research, concentrating mainly on guidance and control.

II. Military and nuclear programs

The armed services will receive \$1.62 billion for space projects, down \$72.8 million from this year. Spending, however, will rise \$10 million to \$1.65 billion. Most of the military space program is classified.

One cutback is in the Air Force's Manned Orbiting Laboratory

Space research and development

(Millions of dollars)

Agency	Fiscal 1965	1966	1967
NASA	5,035.0	5,521.0	5,211.0
Defense Dept.	1,591.8	1,640.0	1,650.0
Atomic Energy Commission	232.2	201.0	173.7
Commerce Dept. (Environment Science Service Administration)	24.1	19.2	27.0
National Science Foundation	3.0	3.5	2.8
Totals	6,886.1	7,384.7	7,063.5

(MOL), which is scheduled to orbit in 1968 with two astronauts aboard. Despite a \$150-million appropriation for this year, the Air Force is being allowed to spend only \$100 million; next year's spending will be held to the same level.

While keeping its spending plans secret, the Pentagon says its intermediate satellite-communications program is on schedule, with the first launches due this spring. By 1968 the advanced military-satellite communications system is expected to be in operation.

Joint ventures. Together with the Atomic Energy Commission, NASA will continue to work on the largest auxiliary power plant being developed for space—a 30- to 50-kilo-watt system. The program is called SNAP-8, for systems for nuclear auxiliary power.

Another joint project of NASA and the AEC is Project Rover, whose goal is to develop a nuclear rocket engine with 250,000-pound thrust, for flight in the mid-1970's. NASA will spend \$53 million on nuclear rocketry next year and the AEC has budgeted \$78 million.

Civilian aviation

Brakes applied

President Johnson's budget is almost certain to put the skids under many long-sought advances in avionics. The leading candidates for stretch-out or interruption are development programs aimed at avoiding collisions, detecting clear-air turbulence, introducing digital communications into commercial aircraft, and speeding the collection of weather information.

The Federal Aviation Agency's authorization is slashed to \$757.99 million from \$868.36 million in the year ending June 30. While accounting departments worry about the cutbacks this year, engineers and stockholders are not likely to notice their effect until 1967. To fulfill its long-term commitments, the FAA will actually spend more next year than this—\$840 million compared with \$799.9 million.

Unlike most governmental departments, the FAA is allowed to

NOW from SAGE

Two new Smaller Sizes in METAL SLEEVED TYPE C

Clipper RESISTORS

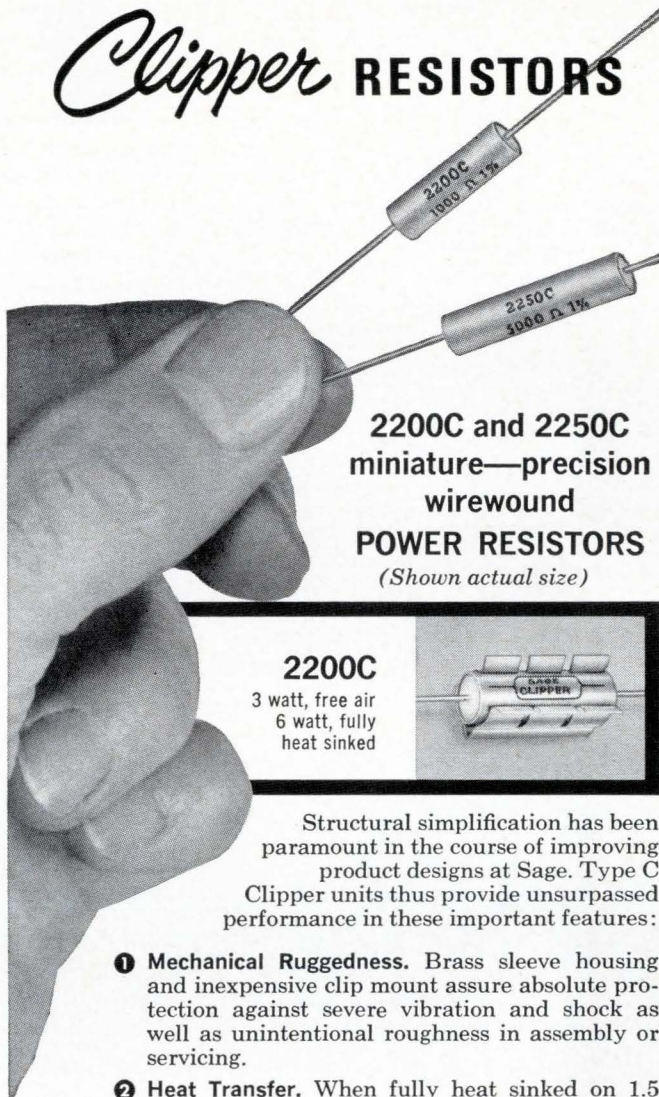

2200C and 2250C
miniature—precision
wirewound
POWER RESISTORS
(Shown actual size)

2200C

3 watt, free air
6 watt, fully
heat sunked

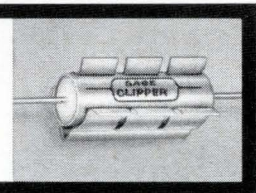

Structural simplification has been paramount in the course of improving product designs at Sage. Type C Clipper units thus provide unsurpassed performance in these important features:

- Mechanical Ruggedness.** Brass sleeve housing and inexpensive clip mount assure absolute protection against severe vibration and shock as well as unintentional roughness in assembly or servicing.
- Heat Transfer.** When fully heat sunked on 1.5 square inches .040" aluminum per watt, power rating is increased **2 for 1** over the free air rating.
- Reliability.** Construction is fully welded; IMPERVOHM® insulation rated for 350°C operation and 1000 volt rms dielectric strength.



STYLE	POWER RATING		RESISTANCE .05 Ω to
	Free Air	Body Mounted	
*2200C	3	6	20 K Ω
*2250C	3	6	40 K Ω
2400C	3.5	7	42 K Ω
2550C	5.5	11	88 K Ω
2600C	7	14	114 K Ω
2650C	8	16	170 K Ω
2750C	10	20	257 K Ω

*new

Ask for Catalog R-62 giving full details

SAGE

SAGE ELECTRONICS CORP.
BOX 3926 • ROCHESTER, N. Y. 14610



**Why sacrifice high speed
for low power in aerospace systems?**

**You can get both
in Signetics SE 400 series
integrated circuits.**



**Signetics SE 400 series provides:
40% to 70% less power consumption than comparable devices while
maintaining equal or greater speed and noise immunity,
50% reduction in flip-flop can-count with a new dual binary,
off-the-shelf delivery**

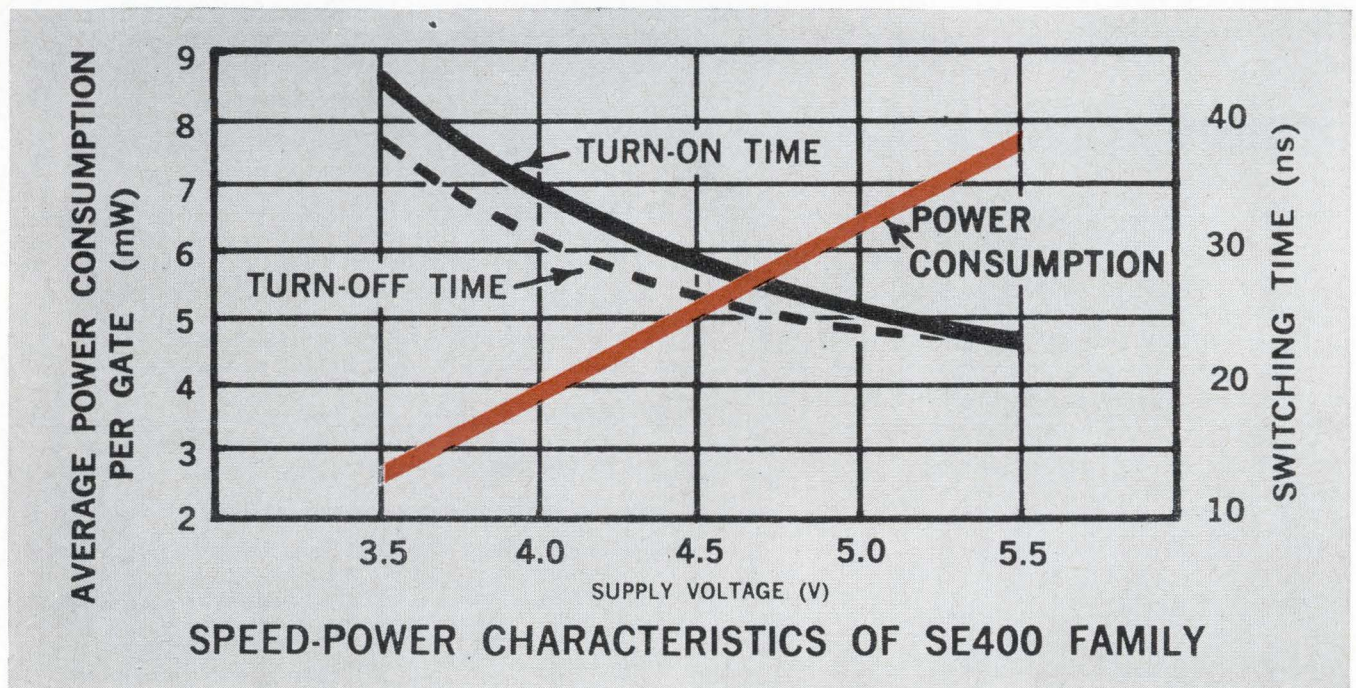

This family of four full MIL range integrated circuits features a dual 5 Mc Binary element operating on less than 9 mW per flip-flop. Like the other members of the family, it was designed for maximum speed consistent with low power operation. The

family is intended for use in applications where high density packaging and the ability to drive high capacitances associated with multilayer printed circuit boards are important considerations. For complete data and specifications, write today.

SIGNETICS INTEGRATED CIRCUITS

A subsidiary of Corning Glass Works,
811 East Arques Avenue, Sunnyvale, California
Tel.: (408) 739-7700 TWX: (910) 737-9965



Signetics SE 400 series elements include a Low Power Dual AC Binary, a Dual NAND Gate, a Dual Driver-Buffer, a Quad NAND Gate.

At IEEE—Booth 2J40-2J42

Federal Aviation Agency

	New obligational authority (Millions of dollars)			Expenditures (Millions of dollars)		
	Fiscal 1965	1966	1967	1965	1966	1967
Operations						
Operation and maintenance of air-traffic control (ATC) system, including installation, materials and administration	551.99	556.49	561.50	549.47	543.00	550.00
Facilities and equipment						
Purchase of ATC, navigation and related equipment	50.00	49.80	28.00	77.94	65.00	73.00
Research and development	40.00	37.50	30.00	35.77	35.00	30.00
FAA-owned airports	9.86	9.57	8.49	12.97	11.89	11.99
Grants in aid for airports	75.00	75.00	50.00	70.60	65.00	60.00
Supersonic transport development		140.00	80.00	47.99	80.00	115.00
Totals	726.85	868.36	757.99	794.74	799.89	839.99

carry its spending authority over from one year to the next. Many carry-overs to fiscal 1968 are going to be skimpier than usual. An example is in the classification for facilities and equipment. The new budget provides for a \$67.65 million balance at the end of fiscal 1967; that's little more than half the \$123.32-million balance anticipated at the end of this year and barely one-third of the \$181.39 million on hand at the end of fiscal 1965. This means that expenditures in 1968 and 1969 are going to be very lean unless liberal new authorizations are voted for those years.

The FAA hopes an aggressive cost-cutting program will soften the effects of some budget cuts. The agency's engineers already have reduced the average cost of an instrument-landing system to about \$100,000 from \$300,000; this has been accomplished by housing the equipment in trailers instead of in permanent buildings. Automated equipment also may allow fewer employees to do as much work for the FAA; 441 people who are expected to retire or resign this year will not be replaced—a 1% cut in the work force.

1. In R&D, nothing new

"The 1967 budget is for the continuation of past programs," says one FAA official. "There are no new programs."

That's why the agency will receive only \$30 million for research and development next year, down from \$37.5 million in fiscal 1966. The only program that is not expected to be curtailed is aviation medicine—the attempt to identify and eliminate human factors that

can affect safety. Cuts are expected as well in these major R&D programs:

- Air-traffic control (ATC).
- Navigation, both short and long range, including landing systems and in-flight inspection.
- Weather-reporting programs, including transmission and display of information.
- Improved airport design.
- Aircraft safety devices.

Airway modernization. Now that the FAA has completed construction of its air-traffic control centers, the next step is the installation of the more-sophisticated solid state electronic systems for the National Airspace Stage A and for Metroplex air-traffic control complexes.

Installation of NAS Stage A—automation of the en-route air-traffic control centers with digitized, computer-controlled equipment and alphanumeric displays—is expected to proceed on schedule. Tests of the engineering model of the system will begin early next year at Nafec, the National Airways Facilities Experimental Center in Atlantic City, N. J. The first operation site at Jacksonville, Fla., will be ready in April, 1968. About one year behind is the Stage A Metroplex—automation of airport terminal areas. Metroplex will consist mostly of NAS components fitted to terminals' needs. Last year \$5.3 million was spent on NAS Stage A; the estimate for fiscal 1966 is \$12.2 million. In 1965 the FAA also spent \$200,000 on Metroplex development; this figure will rise to \$5.4 million this year and remain at that level in 1967.

Instrument landings. In 1965 the FAA received \$2.8 million in ap-

propriations for research on instrument landing systems (ILS). This jumped to \$4.8 million in 1966; next year the agency would have liked to allot even more to the development of ILS localizers, glide-slope markers, visual lighting systems, distance-measuring equipment, flare computers, and other gear, especially those that apply to category-2 (100-foot decision level, ¼-mile runway visual range) and category-3 (zero-altitude decision level) criteria and to development of a supersonic transport (SST). This year there will only be about \$3.5 million for ILS research.

In 1959, the FAA bought a complete single-channel automatic-landing system as a test bed. The system was first installed on a DC-3; later it was modified with a Sperry autopilot, made by the Sperry Gyroscope division of the Sperry Rand Corp., and fitted aboard a DC-7. More than 1,000 automatic landings were made with this system. The FAA now has a DC-7 equipped with a manual system for studying blind landings. Lear-Siegler Inc., makes the attitude indicator, Collins Radio Co. the peripheral vision indicator, Bendix Corp.'s Radio division the altimeter, and Sperry Gyroscope Co. the gyrocompass. This system, which is being evaluated at Nafec, is directed toward determining the landing-system requirements of the SST.

In any weather. Other landing studies, aimed at determining what is needed for a true category-3 all-weather landing system, are being conducted by the Lockheed-Georgia Co., a division of the Lockheed Aircraft Corp. This joint program

of the FAA and the Air Force will determine the operating requirements of autopilots, throttle controls and other instruments and displays.

The FAA has given the Bunker-Ramo Corp. a contract to build a simulated airplane cockpit that would contain all the displays and controls needed for an all-weather landing system. The simulated cockpit will help the FAA determine how the pilot can best participate in a programmed all-weather landing.

Lockheed will outfit its C-141's with category-2 equipment; one plane will carry category-3 equipment. The C-141's, which are getting category-2 equipment, will begin their tests next fall. These aircraft will have automatic touch-down capability, but there will be no decrabbing (compensation for wind shear) equipment and other redundant equipment required for category-2 landing. The category-3 tests by the FAA are scheduled for June, 1967.

The FAA is also investigating new guidance and distance-measuring equipment (DME) for airport runways. In the category-3C situation, where there is no runway-visual-range (RVR) precision, DME equipment on the runway and precise displays in the cockpit are needed to indicate to the pilot the proper turns for maneuvering on and off the ramp.

Pinpointing the storm. Heavy rain and snow can be a hazard both to pilots and to air-traffic controllers. The pilots can fly around or over storms but the controller sometimes loses the plane in the radar weather return.

Several research programs are being conducted to detect, report and display weather on the ATC controller's scope. Most of the detection programs are directed to the detection of clear-air turbulence. This kind of storm is most hazardous to high-speed jets. Others are concerned with weather analysis and the most efficient way to outline the weather on the controller's scope. One technique is to measure the radar signal (line of equal intensities), then use a digitizer to draw weather contours on the scope.

More R&D. Other programs—such as the advanced radar track-

ing system (ARTS), the stored-program alphanumeric (SPAN) and Common IFR (Instrument Flight Rules) Room will proceed almost on schedule.

The first SPAN system will be operating in July at the Lake Ronkonkoma, N. Y., air-route traffic-control center. This system, which is designed to provide area positive control above 24,000 feet, will give traffic controllers three-dimensional position information as well as aircraft identification. ARTS is being tested at the FAA's Atlanta facility. The agency has already started construction of a Common IFR Room at Kennedy International Airport in New York. The consolidated airport radar room will control all traffic at Kennedy, La Guardia, Newark and Teterboro, N. J., and 12 other metropolitan airports. An entire ARTS facility, including the Common IFR Room, will be in operation at Kennedy Airport in about two years.

II. Operation and maintenance

A total of \$561.5 million has been requested for the operation and maintenance of the air-traffic control system next year. The FAA expects to spend \$550 million, up from \$543 million in fiscal 1966. Another \$28 million was requested for the purchase of long-range radars, terminal radars, instrument landing systems, automation equipment, navigational equipment and other facilities that will be installed in the FAA's traffic-control centers and airports; this is down sharply from \$49.8 million authorized for 1966. The agency operates and maintains 28 air-route traffic-control towers, in addition to numerous flight-service stations and remote communications sites across the country.

About \$75.2 million will be spent on electronic equipment next year, down from \$91.1 million this year. This category includes installation of 152 Vortacs (Vertical Omni-range-Tactical Air Navigation System) and 118 direction finders of the uhf-vhf type. The International Telephone and Telegraph Corp. makes the Vortac antenna and transmitter, and the Raytheon Co. produces the test and monitoring subsystem.

Two hundred of the 280 control

towers in existence at low-density airports differ from each other; the FAA is replacing them with standardized modern towers. Next year the agency will only obligate \$7.4 million for improvements of tower facilities; that's less than half the amount obligated for fiscal 1966.

III. No push for SST

Despite Johnson's announcement that he will offer a joint government-industry program this year to build a prototype of a supersonic transport, there will be no speed-up of the SST program.

The \$80 million in new funds requested in the budget will complete the \$220 million originally programmed for the SST's development phase. This phase is now scheduled to be completed in December. The President must request more money later this year for the prototype phase.

The development costs are being shared, 75% by the government and 25% by the manufacturers. The 1966 budget earmarks \$140 million for this work and for supporting studies. Congress previously had appropriated \$91 million for SST research and design. This year's total obligations are about \$128 million, of which the FAA expects to spend about \$115 million. Some FAA officials peg the total cost of a flying prototype at about \$1.5 billion. The FAA's budget for SST development requires a separate appropriation.

Other than for basic system studies, avionics has played only a small role in SST development so far. Most of the avionics work has been sponsored by the two competing airframe manufacturers—the Boeing Co. and the Lockheed-California Co., a division of the Lockheed Aircraft Corp. The SST will benefit from the design experience gained in military avionics programs such as those for the F-111, C-5A and C-141 aircraft.

The FAA insists that new systems must be phased into existing systems both functionally and geographically. The terminal area at Kennedy and the en-route air-traffic center at Lake Ronkonkoma are being studied on computer-driven simulators at Nafec. In this way the system's operational advantages will be available as quickly as possible.

Gains on the home front

From weather eyes to water monitoring, from surgical suites to particle accelerators, electronics is playing an increasing role in the Great Society. Unlike military development, which is leveling off at about \$5 billion a year, these civilian programs are likely to continue expanding.

In health and medical research, for instance, where estimates of electronics' share range from 15% to 30% of the expenditures, federal spending in fiscal 1967 will increase \$1.6 billion from this year's level, to \$7.8 billion.

I. Medical electronics

At the National Institutes of Health which supports 40% of the biomedical research in the nation, the \$59-million increase to \$1.3 billion is one of the smallest in a decade. But some identifiable electronics projects have been singled out for growth:

- A shared-time computer center for NIH scientists will receive \$3.3 million, up from \$2.7 million this year.

- A major effort to develop artificial kidneys, including instruments small enough for chronic sufferers to carry with them, is up \$1 million to \$3.5 million.

- Artificial-heart research is holding steady at \$3.8 million, while a group of aerospace corporations—including the Convair division of the General Dynamics Corp., the Avco-Everett Research Laboratory and Westinghouse Electric Corp.—complete feasibility studies on a more massive push.

- Automation of the pathology department of the NIH clinical center will double this year's authorization to \$240,000.

- Efforts to perfect a computerized monitoring program, which will ultimately cost \$1 million, in the clinical center's new surgical suite will continue.

Similarly, while the Veterans Administration is asking only \$15.3 million, down from this year's \$16.3 million, the VA is poised for a prob-

able investment of \$100 million between fiscal 1968 and 1970 on a hospital-automation project being checked out in Washington.

II. Revolution in science

Under pressure of the President's pollution-control program, the Water Pollution Control Administration will increase its spending for automatic monitoring equipment to \$194,000 from this year's \$128,000. Air-pollution control grants to states for monitoring and other technical equipment will rise to \$1.96 million from \$1.40 million, equipment will rise to \$1.96 million from \$1.40 million and purchases of electronic equipment for measuring air pollution will be increased to \$625,000 from \$495,000. "Electronics," says a White House science adviser, "is revolutionizing several scientific disciplines."

The National Science Foundation, which estimates that 7% to 10% of its budget goes for electronics, comes up roses in the President's tight proposals for 1967. The NSF will get a \$45-million increase, to \$525 million. Geared largely to university support, NSF is increasing its matching-grants \$3 million to \$12 million; the program is aimed at helping universities obtain computer facilities for scientific and general purposes.

Inner and outer space. The NSF will also finance the operation of a nuclear particle accelerator, which will generate 10 billion electron volts, at Cornell University. Later, it expects to share with the Atomic Energy Commission and the Department of Defense bigger shares of the "big science" roles in high-energy physics and radio astronomy.

And despite a holdback on the \$375 million, 200-bev accelerator, the Atomic Energy Commission is moving ahead with two other accelerator programs that are highly electronic: the \$55-million, 300-mev "meson factory" at Los Alamos Scientific Laboratory in New Mexico and a \$45.8-million modifi-

cation of the 33-bev machine at Brookhaven National Laboratory, New York.

Here are some other programs:

- The Coast Guard's spending for electronics will jump 25% to \$11.6 million for operations and maintenance, with a \$500,000 chunk to start a long-range program to install single-sideband equipment on vessels as well as in aircraft and ground stations.

- Expanding research efforts at the National Bureau of Standards, where about \$2 million a year is spent on electronic instrumentation, will concentrate on the semiautomated Standard Reference Data System's effort to keep engineering data up to date.

- The new Environmental Science Services Administration, incorporating the Weather Bureau, Coast and Geodetic Survey and the Radio Propagation Laboratory in Boulder, Colo., will receive a \$20.5-million increase to \$165.1 million, with continued emphasis on earthquake prediction, meteorological satellites and electromagnetic wave propagation. Replacement of an ocean survey vessel and weather-surveillance radars down the Midwest's "tornado alley" increase the agency's facilities budget \$2.8 million to \$7 million; satellite operations will rise \$8.5 million to \$33.6 million.

Slight gains. Over-all, the government's interagency research budget for the atmospheric sciences will rise \$10 million to \$234.6 million.

Similarly, the interagency budgets for oceanography and ocean technology will rise only \$41.7 million to \$219.9 million.

- The Post Office Department will spend \$100 million on post-office modernization, including procurement of alphanumeric scanners and an electronic data-processing complex to serve 75 major installations.

- High-speed ground transportation will be funded at \$24-million—a good start even though it's less than the \$35 million the planners had hoped for. Research on such exotic devices as the linear induction motor may be stretched out. Highway-safety projects, however, are being left to industry—or postponed until more federal money is available.

How to cut the high cost of electronic measuring:

**Use the Below Coupon To
Order Editorial Reprints
From Electronics!**

Fill in, cut out the coupon, insert in envelope
and mail to:

Electronics Reprint Department
330 West 42nd Street, New York, N.Y. 10036

Reprints Available:

(Price: 50¢ each unless otherwise noted.)

- Key no. **R-85 U. S. Electronics Markets 1966** 24 page forecast report with 6 page fold-out chart.
- Key no. **R-84 European Electronics Markets 1966**, 16 pages with 4 page foldout chart.
- Key no. **R-83 A Look at Japanese Electronics Technology**, 36 pages.
- Key no. **R-82 Computer Time Sharing**, 20 pages
- Key no. **R-80 The Packaging Revolution In Microelectronics** (2 part series, 32 pages.) \$1.00.
- Key no. **R-79 MOS Integrated Circuits Save Space and Money**, 16 pages.
- Key no. **R-78 The Overlay Transistor**, 4 color special feature, 15 pages.
- Key no. **R-77 Cold Cathode Tubes** (3 part series, 28 pages).

Reprint order form

(See the above list, please order by key number.)

To help expedite mailing of your reprints, please send cash, check, or money order when you order.

Send me reprint(s) of key no(s) at ¢ each.

Name

Number & Street

City, State, Zip Code

Get the extra capability, greater reliability, and longer useful life of Rohde & Schwarz!

Since 1933, Rohde & Schwarz' group of unusually creative engineers have been designing electronic instruments that are truly unique. These instruments are constantly ahead of what is considered to be the state-of-the-art. They are more precise. They are easier to use and read. Many perform extra functions. Some do jobs never done before. All are constructed with uncompromising quality—drastically reducing maintenance requirements. As a result, they do not become obsolete as fast as ordinary instruments—they provide more years of useful life. As you might expect, you pay a little more initially for some of these—but an investment in Rohde & Schwarz saves you plenty in the long run!

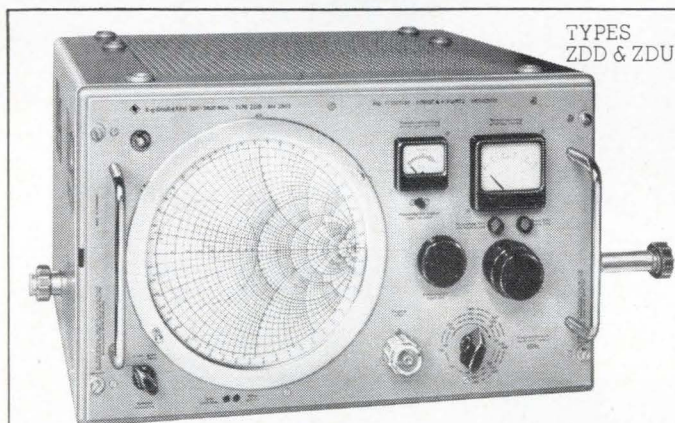

TYPES
ZDD & ZDU

Now! One Diagraph measures and plots

- Impedance and admittance
- Transmission characteristics
- Phase differences

— perfect for measuring transistor characteristics!

Plot important characteristics rapidly and directly on a Smith Chart—Carter Chart—or polar-coordinate diagram—eliminating the need for calculations. Plot impedance of antennas, cables, transistors, varactors, terminations, four-terminal networks, etc., with the accuracy of a slotted line! And since a Rohde & Schwarz Diagraph incorporates the circuitry of a superhet receiver, it can also be used as a linear measuring receiver!

FEATURES:

- Two frequency ranges available: 30 to 420 MHz or 300 to 2400 MHz.
- Characteristic impedances of 50 and 75 ohms available.
- With transistor adapter, it measures transistor parameters in the VHF and UHF ranges.
- Use of precision connectors results in exact definition of electrical lengths and excellent repeatability.
- Many accessories make this Diagraph one of the most versatile instruments.

For 6-page Data Sheet with complete specifications, CIRCLE 80 ON READER SERVICE CARD.

Measure video noise in presence of sync and blanking pulses!



TYPE
UPSF

The new R&S UPSF Video Noise Meter is an extremely versatile instrument, suitable for noise voltage measurements on TV cameras, film scanners and video tape recorders, radio links, coaxial lines, and TV transmitters, receivers, and transposers. Measurements of both weighted and unweighted noise voltages can be made, and in the presence of sync and blanking pulses, thanks to a new idea in circuit design. The UPSF can also be used as a conventional VTVM, extending the value of your investment.

FEATURES:

- Meets requirements of all U.S. black-and-white and NTS color systems.
- 40 Hz to 5 MHz frequency range.
- 7 measurement ranges: 1/3/10/30/100/300/1000 mVpp.
- Either RMS or peak-to-peak indication.
- Input impeded. 1M Ω shunted by 30 pF, or 75 Ω bridging.
- Output for oscilloscope.

For complete 4-page Data Sheet, CIRCLE 81 ON READER SERVICE CARD.

Measure the overall efficiency of your receiving system! Covers 47 to 225 MHz!



TYPE
HUZ

This proved-in-operation Rohde & Schwarz portable Field Strength Meter is perfect for use both in the field and in the laboratory. It covers FM, TV, aircraft, police and mobile radio bands, and is ideal for determining propagation conditions, polarization and radiation patterns. The HUZ is especially useful to help select the best location for receiving antennas.

Since the HUZ is also a selective voltmeter, it can be used to measure antenna gain and antenna cable attenuation, under various weather conditions. It locates and measures interference and can measure automotive noise. All in all, as you would expect from Rohde & Schwarz, a very versatile instrument!

FEATURES:

- 47 to 225 MHz.
- 1 μ V — 100 mV.
- AM/FM detection.
- Battery or AC operation.
- Weighs only 9 lbs.
- Self calibrating.

For complete Data Sheet, CIRCLE 82 ON READER SERVICE CARD.

Rohde & Schwarz, 111 Lexington Ave., Passaic, N.J. 07055 Phone: (201) PRescott 3-8010

Inquiries outside the U.S.A. should be directed to: Rohde & Schwarz, Muehldorferstrasse 15, Munchen 8, West Germany

Factories of the future

Beams of light automatically trace unique wiring patterns on large monolithic circuits

Researchers peering into a monolithic array of integrated circuits can see factories of the future in its curious wiring pattern. They envisage computer-controlled production of other computers, at a fraction of the cost per circuit of today's computers.

The pattern shown below was traced on the slice of silicon by an improved version of the beam-of-light technique that the International Business Machines Corp. now uses to produce custom-designed printed circuit boards [Electronics, Nov. 1, 1965, p. 90]. The thin-film wiring of the slice is unique because it was designed by a computer to thread its way around the unusable circuits on the slice. On another slice, the beam would follow a different path.

Eventually, the scientists at the

IBM Watson Research Center in Yorktown Heights, N. Y., hope to produce computer subsystems with up to 1,000 gates in an array. Other researchers are also striving toward the same goal. At Texas Instruments Incorporated, for example, a computer runs a drafting machine that makes photographic etching masks [Electronics, April 19, 1965, p. 36 and Jan. 24, 1966, p. 26]. Westinghouse Electric Corp. has been developing ways of tracing interconnections on silicon with electron beams [Electronics, Nov. 16, 1964, p. 82].

In each case, the aim is an economical way of forming a different pattern for each array. Standard patterns can't be used because each slice has a different arrangement of good and bad circuits. Standard patterns would re-

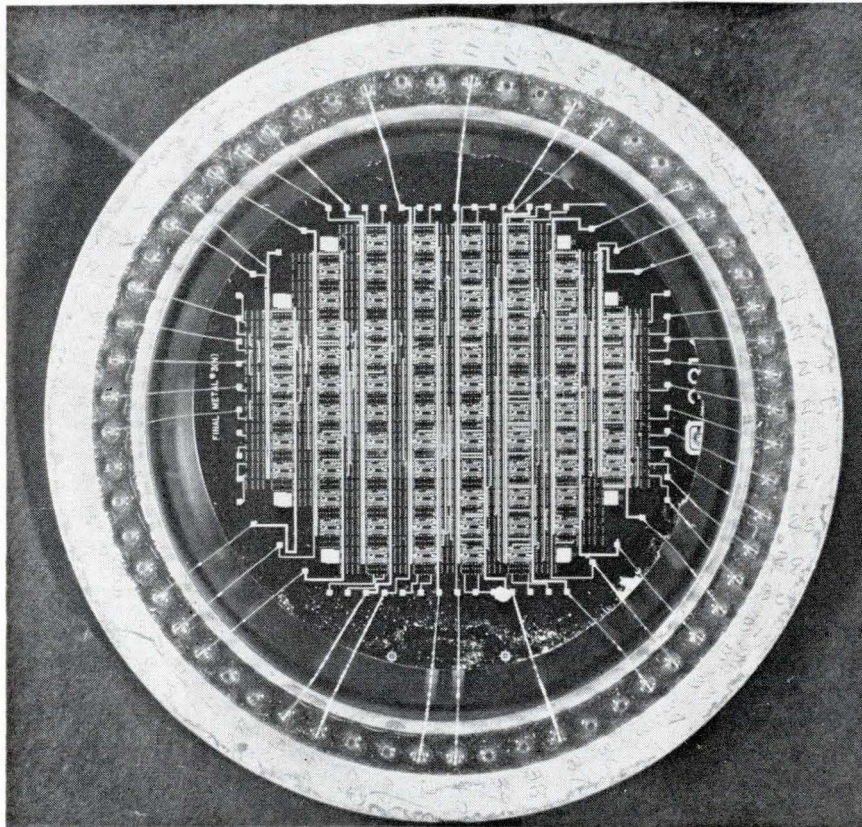

Thin-film wiring pattern, generated directly on a slice of silicon, converted this array of 80 gates into 12 and 24-gate logic functions.

DELCO RADIO SEMICONDUCTORS AVAILABLE AT THESE DISTRIBUTORS

EAST

- BINGHAMTON, N. Y.**—Federal Electronics, Inc.
P. O. Box 1208/PI 8-8211
- PHILADELPHIA 23, PENN.**
Almo Industrial Electronics, Inc.
412 North 6th Street/WA 2-5918
- PITTSBURGH 6, PENN.**—Radio Parts Company, Inc.
6401 Penn Ave./361-4600
- NEWTON 58, MASS.**—Greene-Shaw Company
341 Watertown Street/WO 9-8900
- CLIFTON, N. J.**—Eastern Radio Corporation
312 Clifton Avenue/471-6600
- WOODBURY, L. I., N. Y.** 11797
Harvey Radio Company, Inc.
60 Crossways Park West, Phone (516)-921-8700
- BALTIMORE 1, MD.**—Radio Electric Service Company
5 North Howard Street/LE 9-3835

SOUTH

- BIRMINGHAM 5, ALA.**
Forbes Distributing Company, Inc.
2610 Third Avenue, South/AL 1-4104
- WEST PALM BEACH, FLA.**—Goddard, Inc.
1309 North Dixie/TE 3-5701
- RICHMOND 20, VA.**—Meridian Electronics, Inc.
1001 West Broad Street/353-6648

MIDWEST

- KALAMAZOO, MICH.**—Electronic Supply Corporation
P. O. Box 831/381-4623
- INDIANAPOLIS 25, IND.**
Graham Electronics Supply, Inc.
122 South Senate Avenue/ME 4-8486
- CLEVELAND 1, OHIO**—The W. M. Pattison Supply Co.
Industrial Electronics Division
777 Rockwell Avenue/621-7320
- CHICAGO 30, ILL.**—Merquip Electronics, Inc.
4939 North Elston Avenue/AV 2-5400
- CINCINNATI 10, OHIO**—United Radio, Inc.
7713 Reinhold Drive/241-6530
- KANSAS CITY 11, MO.**—Walters Radio Supply, Inc.
3635 Main Street/JE 1-7015
- ST. LOUIS 17, MO.**
Electronic Components for Industry Co.
2605 South Hanley Road/MI 7-5505
- TULSA, OKLAHOMA 74119**—Radio, Inc.
1000 South Main Street/(918)-587-9124
- MINNEAPOLIS, MINNESOTA 55413**
Northwest Electronics Corporation
336 Hoover St., N. E./612-331-6350

WEST

- DALLAS 1, TEXAS**—Adleta Company
1907 McKinney Ave./RI 2-8257
- HOUSTON 1, TEXAS**—Harrison Equipment Company, Inc.
1422 San Jacinto Street/CA 4-9131
- SAN DIEGO 1, CAL.**
Milo of California, Inc.
2060 India Street, Box 2710/232-8951
- LOS ANGELES 15, CAL.**—Radio Products Sales, Inc.
1501 South Hill Street/RI 8-1271
- LOS ANGELES, CAL. 90022**—Kierulff Electronics
2585 Commerce Way/OV 5-5511
- MOUNTAIN VIEW, CAL.**—Kierulff Electronics
2484 Middlefield Road/968-6292
- DENVER, COLO.**—L. B. Walker Radio Company
300 Bryant Street/WE 5-2401
- SEATTLE 1, WASH.**—C & G Electronics Company
2600 2nd Ave./Main 4-4354
- PHOENIX, ARIZ.**—Midland Specialty Co., Inc.
1930 North 22nd Ave./258-4531
- ALBUQUERQUE, N.M.**—Midland Specialty Co., Inc.
1712 Lomas Blvd., N.E./247-2486
- TUCSON, ARIZ.**—Midland Specialty Co., Inc.
951 South Park Ave./MA 4-2315

Ask for a complete catalog

DELCO RADIO

DIVISION OF GENERAL MOTORS • KOKOMO, INDIANA

Delco Radio's new 400V silicon power transistors will change your thinking about high voltage circuitry. You can reduce current, operate directly from rectified line voltage, and use fewer components. Our standard TO-3 package stays cool (junction to heat sink 1.0°C per watt). And price is low—less than 3c a volt even in sample quantities—for wide ranging applications. Vertical and horizontal wide-screen TV out-

The heat's off high energy circuits

puts, high voltage, high efficiency regulators and converters. Your Delco Radio Semiconductor distributor keeps them on ice. Call him today for data sheets, prices and delivery.

RATINGS	DTS 413	DTS 423
VOLTAGE		
V _{CEO}	400 V	400 V
V _{CEO} (Sus)	325 V (Min)	325 V (Min)
V _{CE} (Sat)	0.8 (Max)	0.8 (Max)
	0.3 (Typ)	0.3 (Typ)
CURRENT		
I _c (Cont)	2.0A (Max)	3.5A (Max)
I _c (Peak)	5.0A (Max)	10.0A (Max)
I _B (Cont)	1.0A (Max)	2.0A (Max)
POWER		
	75 W (Max)	100 W (Max)
FREQUENCY RESPONSE		
f _t	6 MC (Typ)	5 MC (Typ)

FIELD SALES OFFICES

UNION, NEW JERSEY*
Box 1018 Chestnut Station
(201) 637-3770

SYRACUSE, NEW YORK
1054 James Street
(315) 472-2668

DETROIT, MICHIGAN
57 Harper Avenue
(313) 873-6560

CHICAGO, ILLINOIS*
5151 N. Harlem Avenue
(312) 775-5411

SANTA MONICA, CALIF.*
726 Santa Monica Blvd.
(213) 870-8807

General Sales Office:
700 E. Firmin, Kokomo, Ind.
(317) 457-8461—Ext. 500

*Office includes field lab and resident engineer for application assistance.

DELCO RADIO

Division of General Motors, Kokomo, Indiana



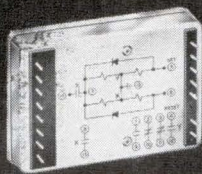

LOGIC REED RELAYS



MAGNETICALLY-BIASED LATCH REED RELAYS

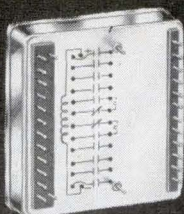

15-WATT PRINTED CIRCUIT TYPES



CROSSPOINT REED RELAYS

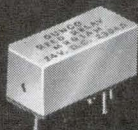

MINIATURE 1-2 POLE PC TYPES



4-WATT, 1-12 POLE MOLDED REED RELAYS



"TRUE" FORM C REED RELAYS ... many styles.

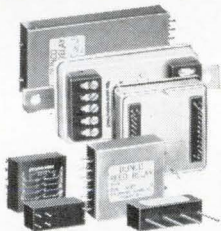

CUSTOM PACKAGING to individual requirements



15-WATT, 1-4 POLE MOLDED RELAYS

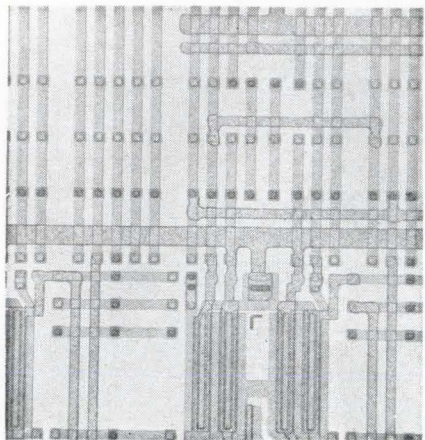
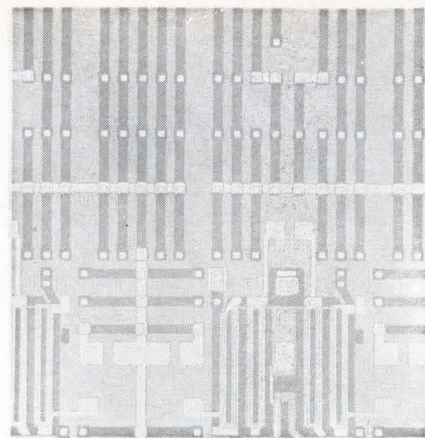

Logic cells are tested by probing the test pattern seen in the top photo, before thin-film interconnections (bottom photo) are designed.

Name your REED RELAY!

If you don't find it at Struthers-Dunn, chances are you won't find it anywhere. Here's an idea of the range of standards and specials available to you in the world's broadest line. Save time! Try us *first!*

LEARN MORE! Write today for Reed Relay Catalog C.

STRUTHERS-DUNN, Inc.

Pitman, New Jersey 08071

tel: 609-589-7500

twx: 609-589-1548



SALES ENGINEERING OFFICES IN: Albuquerque • Atlanta • Belmont, Calif. • Boston • Buffalo • Charlotte • Cincinnati • Clearwater, Fla. • Cleveland • Clifton • Dallas • Encino • Englewood • Glen Ellyn, Ill. • Houston • Kansas City • Las Vegas • Memphis • New York • Phoenix • Pittsburgh • St. Louis • St. Paul • Salt Lake City • Richardson, Tex. • Seattle • Southfield • Wichita • Wilmette. Canadian Licensee: Renfrew Electric Co., Ltd., Toronto. Export Dept.: 1505 Race St., Philadelphia, Pennsylvania 19102, U.S.A.

strict array production to those slices with large enough clusters of good circuits and would make custom-design of the logic functions, another important research aim, impractical.

Direct masking. Photographic-film masks are customarily used to develop IC interconnections. "It takes two months to prepare a set of masks," explains Sol Triebwasser, IBM program manager. "Our process generates the masks directly on the array in half a day."

IBM tests the gates automatically by a system that probes the test pattern seen in the photo at the top of this page. Test information goes into an IBM 7094 computer, which decides in 30 seconds what gates are usable and how to connect them. The slice is recoated with aluminum and negative photoresist and placed on a table that moves the slice under a 0.002-inch-square beam of light which is turned on and off by shutters. This operation, controlled by a tape prepared by the computer, generates

Low Cost Test Signals

10 MHz to 1000 MHz

—with the **3200B VHF OSCILLATOR**

Using the new Frequency Doubler Probe 13515A

Features:

±0.002% Frequency
Stability

External AM and
Pulse Modulation

Waveguide-Below-
Cutoff Output
Attenuator

Solid-State Power
Supply

Data subject to change
without notice.



The VHF Oscillator Model 3200B is designed for general purpose laboratory use including receiver and amplifier testing, driving bridges, slotted lines, antenna and filter networks, and as a local oscillator for heterodyne detector systems in the frequency range from 10 to 500 mc.

The push-pull oscillator is housed in a rugged aluminum casting for maximum stability and extremely low leakage; six frequency ranges are provided for adequate bandsread on the slide-rule dial. Internal CW operation is provided; AM and pulse modulation may be obtained through the use of a suitable external source. The RF output is coupled through a waveguide-below-cutoff variable attenuator; in addition, an electrical RF level vernier is included as a front panel control.

An optional accessory Frequency Doubler Probe, Model 13515A incorporates a solid-state doubler circuit and provides additional frequency coverage from 500 to 1000 mc.

SPECIFICATIONS 3200B

Frequency range: 10 to 500 Mc (MHz)
in six bands: 10 to 18.8 Mc; 18.5 to 35 Mc;
35 to 68 Mc; 68 to 130 Mc; 130 to 260 Mc;
260 to 500 Mc.

Frequency accuracy: within ±2% after
½ hour warmup (under 0.2 mw load).

Frequency calibration: increments of
less than 4%.

Frequency stability (after 4-hour warmup under
0.2 mw load): short term (5 minutes)
±0.002%; long term (1 hour) ±0.02%;
line voltage (5-volt change) ±0.001%.

RF output:

Maximum power (across 50-ohm external load):
≥200 mw (10 to 130 Mc);
≥150 mw (130 to 260 Mc);
≥25 mw (260 to 500 Mc).

Range: 0 to >120 db attenuation from
maximum output.

Load impedance: 50 ohms nominal.

RF leakage: sufficiently low to permit
measurements at 1μv.

Amplitude modulation: externally modulated.

Range: 0 to 30%.

Distortion: <1% at 30% AM.

External requirements: approximately 15 volts
rms into 600 ohms for 30% AM,
200 cps to 100 Kc.

Pulse modulation: externally modulated.

External requirements: 1 volt peak pulse
into 2000 ohms. 5-volt rms sine wave will
provide useable square-wave modulation.

Power: 105 to 125 v or 210 to 250 v,
50 or 60 cps, 30 w.

Dimensions: 7²/₂" wide, 6¹/₂" high,
12¹/₂" deep (198 x 165 x 318 mm.)

Weight: net 15 lbs. (6, 8 kg),
shipping 19 lbs. (8, 6 kg).

Accessories available: 13515A Frequency
Doubler Probe; 501B, 514B, 517B Output
Cables; 502B, 506B Patching Cables.

Price: Model 3200B, \$475.
F.o.b. factory.

13515A FREQUENCY DOUBLER PROBE

Frequency range: 500 to 1000 Mc (MHz) with
the 3200A/B operating at 250 to 500 Mc.

Harmonic suppression: (at 4 mw output):
fundamental: >16 db down;
higher order: >16 db down (500 to 800 Mc);
>14 db down (800 to 1000 Mc).

RF output: more than 4 mw across external
50-ohm load, controlled by probe depth.

Weight: net 4 oz. (110 gms),
shipping 8 oz. (220 gms).

Price: Model 13515A, \$95.
F.o.b. factory.

For more information contact your local Hewlett-Packard field engineer or write Hewlett-Packard, Green Pond Road, Rockaway, N. J. 07866; Europe: 54 Route des Acacias, Geneva.

HEWLETT  **PACKARD**
An extra measure of quality

Aeme Electric SHOULD BE YOUR BEST SOURCE

FOR REGULATED D. C. POWER SUPPLIES

If design experience and performance reliability are factors to be considered in your buying, then Acme Electric should be your first-choice source for D. C. Power Supplies. Converting alternating current to direct current is an old Acme Electric specialty. In over 35 years we have produced millions of low-voltage power supplies for battery charging and thousands of high voltage power supplies for electrostatic precipitons. We've had our hand in the "state-of-the-art" for a long time and know the limits of each component for each application.

The standard stock model "off-the-shelf" D. C. Power Supplies listed below were designed to provide reliable performance at an economical price.

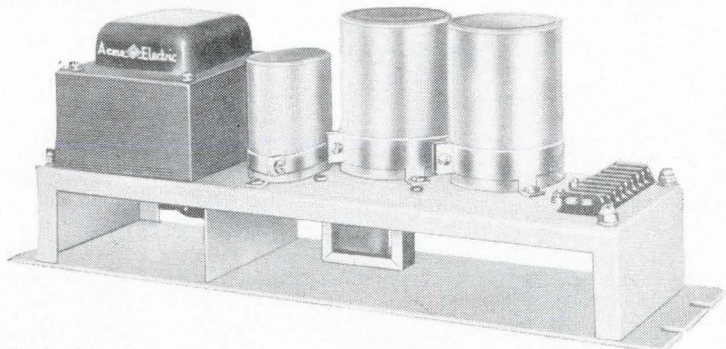

Check these features:

- ✓ All solid state components are rated for continuous duty.
- ✓ Convection cooled — no fan or other moving parts.
- ✓ May be paralleled for multiplying ampacity.
- ✓ Fast response to line and load changes.
- ✓ Line regulation, $\pm 1\%$.
- ✓ Load regulation $\pm 2\%$.
- ✓ Ripple, 1% RMS maximum.
- ✓ Operating temperature range, 0°C. to 50°C.

PARTIAL LISTING OF STOCK MODELS AVAILABLE SINGLE PHASE, 100-130 Volts; Input 50 or 60 Cycles

Catalog Number	D. C. OUTPUT			Catalog Number	D. C. OUTPUT		
	Volts	Amps	Watts		Volts	Amps	Watts
PS-47509	10	4	40	PS-1-47461	24	75	1800
PS-47623	12	3	36	PS-1-47200	24	100	2400
PS-47508	15	2	30	PS-47202	26	4	104
PS-57352	22	25	550	PS-47638	28	8	224
+PS-41422	24	2	48	PS-47712	28	25	700
+PS-41423	24	6	144	PS-57355	28	30	840
PS-57353	24	10	240	PS-57356	44	25	1100
+PS-47125	24	15	360	PS-41424	38	4	192
PS-57354	24	20	480	PS-57357	48	6	288
+PS-47173	24	25	600	PS-47519	48	10	480
PS-1-47127	24	50	1200	PS-57358	48	15	720

+ 24 volt output units of same current rating can be paralleled to multiply current capacity.

Write for catalog 175 and full list of "off-the-shelf" D. C. Power Supplies.

Aeme  Electric
Engineers and Builders of...

312 WATER STREET, CUBA, NEW YORK
Canadian Representative: Polygon Services, Ltd.
50 Northline Rd., Toronto 16, Ont.

SAA-3932-3220

REGULATED POWER SUPPLIES
STATIC POWER RECTIFIERS
VOLTAGE STABILIZERS
VOLTAGE REGULATORS

the interconnection pattern in about 30 to 45 minutes. The connections are then etched and the array tested and packaged.

Triebwasser will be reporting on these "exploratory" processes at the Solid State Circuits Conference in Philadelphia on Feb. 9.

Logic cells. The lab-model arrays are composed of 80 cells consisting of four-input NOR gates and a group of diffusion stripes for connections that must be routed under the thin-film wiring. Each gate has five insulated-gate field effect transistors (Igfet's) made by the metal-oxide-semiconductor process (MOS).

The combination of stripes and films seen in the lower photo on page 150 provides an X-Y wiring matrix that resembles the design of the printed-circuit boards made for the IBM System 360 computer.

The circuits operate at a speed of about 500 kilocycles and each gate has a power dissipation rating of 100 milliwatts in the ON state.

Future plans. The cells now measure 0.06 by 0.1 inch. Ernest Wurst, head of the fabrication and test group, says arrays that have eight gates in 0.02-by-0.03-inch cells are being planned. Another plan is to program the length of the Igfet, electrodes, which will vary device characteristics and allow each gate to be custom-designed.

Under consideration is a switch from the MOS process to the silicon-nitride-semiconductor process [Electronics, Jan. 10, 1966, p. 156]. MNS could allow npn, as well as the present pnp devices, to be made and might improve circuit performance.

The pattern-generation and device modification methods will be applicable to circuits made of bipolar devices, Triebwasser says.

The Watson group selected MOS because it is a simpler process with higher yields than conventional bipolar-device fabrication.

IBM still hasn't figured out the best way of packaging the arrays. The leads of the experimental arrays are bonded wires, but the large number of leads—60 in the array on page 148—makes this method impractical for large-scale production. Nor will the face-bonding used to make the System 360 circuits be suitable, Wurst adds.

DESIGN ENGINEERS:

NOW . . . Capacitance-to-volume ratio to 20 mf/cu. in.
in Subminiature, Highly Reliable Ceramic Capacitors

SUBMINIATURE MONOBLOC* CAPACITORS



Featuring HIGH CAPACITANCE . . . HIGH RELIABILITY

Erie's new Monobloc ceramic film Capacitors represent the most significant design advance in more than a decade. Now, Erie's exclusive Monobloc Process, in which very thin films of ceramic can be bonded into solid structures, permits virtually unlimited range of capacitance values, characteristics and sizes to suit exacting design requirements. Monobloc Capacitors provide volumetric efficiencies from 10 to 100 times the capacitance (to 20 mf/cu. in.) attainable in conventional components of the same size . . . and still meet Established Reliability specifications for Aerospace, Military and Commercial applications.

These proven subminiature Monobloc Capacitors are encapsulated to suit the design engineers' need; hermetically sealed, glass encased . . . precision molded . . . and phenolic coated as illustrated at right. No other manufacturer produces a true hermetically sealed, glass encased capacitor . . . and in capacitance values to 10,000 pf.

Write TODAY, for literature and samples to: Monobloc Dept., Erie Technological Products, Inc., Erie, Pa.

Design Advantages . . .

- Volumetric efficiency to 20 mf/cu. in.
- Capacitance values 5 pf. to .5 mfd . . . higher values upon request.
- IR at room temperature...100 K megohms.
- Working Voltage . . . 50 V, 100 V and 200 V.
- Inherent stability due to monolithic construction.
- Conservatively rated for long, trouble-free life.
- Available to Established Reliability or to your custom specification.

*Trade name for Erie Technological Products, Inc.

Another series of components in Erie's Project "ACTIVE" . . .
Advanced Components Through Increased Volumetric Efficiency.

ERIE MONOBLOC CAPACITORS . . .

- Hermetically Sealed Glass Encased Types



- Precision Molded Types

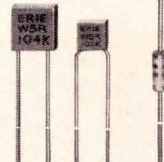

- Phenolic Coated Types Weecons

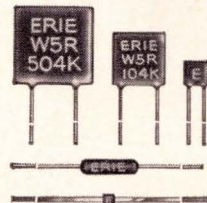

ERIE

TECHNOLOGICAL

PRODUCTS, INC.



Formerly
Erie Resistor
Corporation

644 West 12th Street
Erie, Pennsylvania

AIRPAX Signal Conditioning Amplifier

The Airpax MAS50 Signal Conditioning Amplifier is a dc-to-dc amplifier. It converts a transducer signal (current or voltage) to a standard output range of 0 to +5 vdc. Input is differential and floating. • Voltage gain, 0 to 100 with a stability of $\pm 0.01\%$ per degree C. • Linearity is within 0.1% of full scale. • Zero null stability of 0.5 microvolts per degree C. • Common mode rejection at 60 CPS is 120 db minimum.

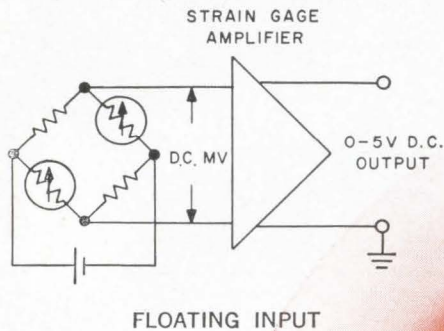

STRAIN GAGE AMPLIFIER
FLOATING INPUT

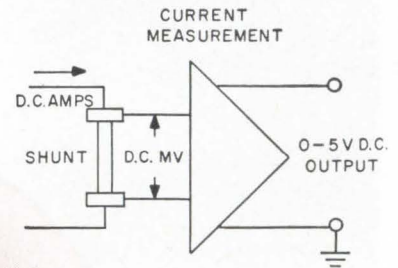

CURRENT MEASUREMENT
HIGH-SIDE MONITORING

Strain-Gage Amplifier: Extremely high rejection of common mode interference by the MAS50 enables it to operate with a floating input circuit, as in strain gage applications. The signal, after conditioning by the amplifier, can be multiplexed with other conditioned signals because any number of MAS50's can share a common ground at their outputs.

Current Measurement: Having its input well insulated, the MAS50 can be connected across a shunt in the high side of a line if necessary. For example, measurement of the plate or screen current of a power tube operating at high voltages can be done with the case of the MAS50 grounded.

\$157

EACH

(1 to 6 pieces)



TYPE MAS50

*Delivery
from stock*

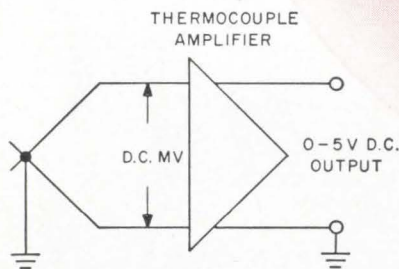

THERMOCOUPLE AMPLIFIER
ISOLATION OF GROUNDS

Thermocouple Amplifier: In applications such as amplification of a thermocouple output, the MAS50 combines inherently stable high gain with negligible drift in zero offset. Because input and output are electrically isolated from each other, the input can be either grounded or ungrounded while the output has one side grounded. Calibration of thermocouple lead length is unnecessary in normal-length runs because amplifier input resistance is much higher than thermocouple resistance.

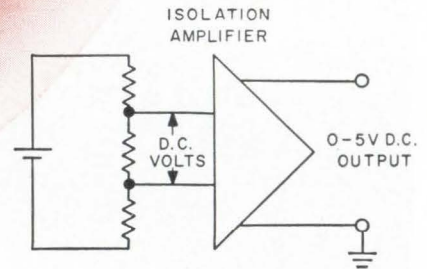

ISOLATION AMPLIFIER
SCALE CHANGE

Isolation Amplifier. Basically the MAS50 is an active 4-terminal device that produces 0 to +5 vdc output from a 0 to 50 microampere input. The amplifier provides a change of scale and of zero in several ways: by using a resistance in series with the input, by choice of a voltage gain of 1 or of 100 within the amplifier and by a bias current through the auxiliary winding. A screwdriver adjustment on the amplifier changes the gain by about 20% to calibrate the scale change and to compensate for tolerance in metering circuits.

AIRPAX ELECTRONICS incorporated Seminole Division, Fort Lauderdale, Florida

PHONE 305 587-1100 • TWX 305 587-1000

FET voltmeter called accurate up to 1,200 Mc

Only vacuum tube circuitry could previously provide equivalent frequency range and accuracy, according to Data Instruments

A broadband voltmeter, designed with field effect transistors, is said to provide a frequency range and accuracy that were previously attainable only with vacuum-tube circuitry. The manufacturer, Data Instruments Division, subsidiary of IEH, says its model SSVM-1 is accurate to 2% at up to 100 megacycles per second and 1 decibel at up to 700 megacycles. The company explains that accuracy is expressed in decibels at frequencies above 100 megacycles because at these higher frequencies the instrument is more likely to be used as an indicator than for measuring voltage. Data Instruments says this is the first broadband voltmeter designed with FET's and that it is effective at as high as 1,200 Mc.

Peter Reynolds, chief engineer at Data Instruments, attributes the broadband response to the packaging of the coaxial probe. The high-frequency diode is mounted in the probe to rectify the input signal. The input capacitance presented by the probe is approximately 2 picofarads, including the diode and the probe housing. At low frequencies, the a-c input impedance is 15

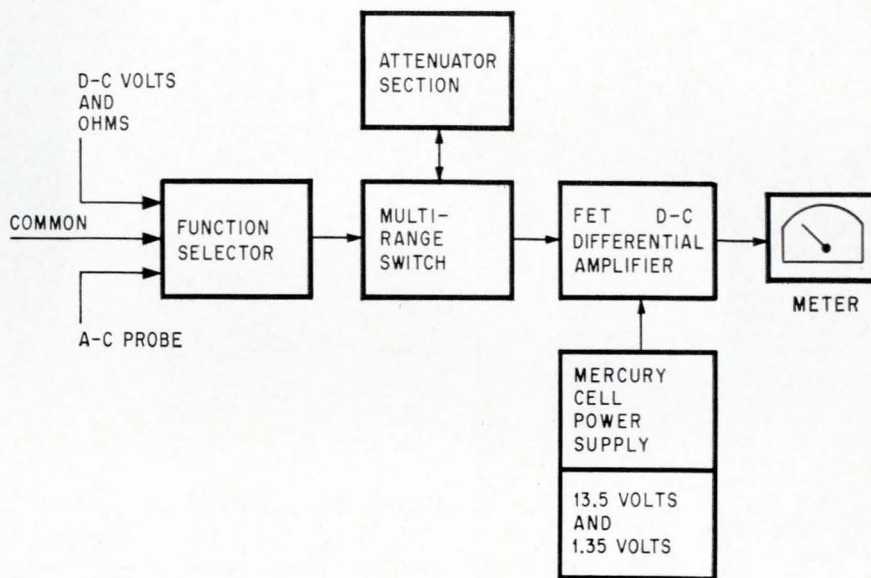

Balanced FET's in differential d-c amplifier is the nucleus of this solid state voltmeter.

megohms in parallel with 2 picofarads; the d-c resistance is greater than 100 megohms.

The unit requires no warm-up time and is free from any significant drift, a characteristic inherent in conventional vacuum tube designs. Reynolds says this drift-free performance is due to the use of two balanced FET's operating as a differential amplifier. Symmetrical arrangement tends to make the two n-channel FET's self-compensating for temperature effects. Also, because the circuit operates at very low currents, there is practically no heating, resulting in stable performance.

The circuit is isolated from the case, allowing measurements to be made remote from ground. Isolation and portability are possible through the use of a self-contained power supply consisting of three mercury cells. In normal use the minimum life of the cells is at least six months. However, this depends on how often the ohms scales are

used, with maximum drain on the lowest ohms scale.

For measurements above 100 megacycles, the manufacturer recommends use of a coaxial tee adaptor for inserting the probe into a coaxial system.

Specifications

D-c voltmeter	0 to 1,000 volts in 7 ranges
A-c voltmeter	0 to 300 volts in 6 ranges
Ohmmeter	0 to infinity (midscale values to 10 megohms)
Frequency response	±1 db from 20 cps to 700 Mc ±2% from 50 cps to 100 Mc
Input impedance	D-c, greater than 100 megohms A-c, low frequency—approximately 15 megohms shunted by 2 picofarads 50 megacycles—greater than 100,000 ohms shunted by 2 picofarads
Size	6 by 3½ by 8 in.
Weight	5 lb.
Price	\$215

Data Instruments Division, 3700 Crescent Boulevard, Pennsauken, N.J.
Circle 350 on Reader Service Card

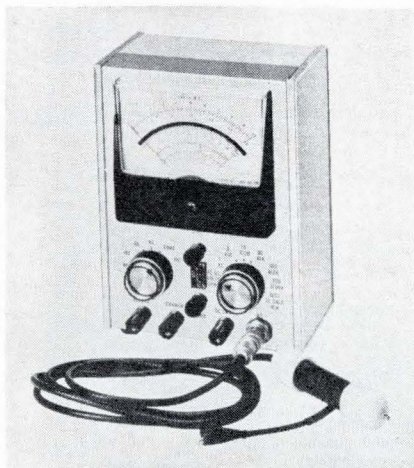

Need
crystal
oscillators?



Try
Bulova
first!

Whatever the type, whatever the range, Bulova can fill your requirements. Our full line of packaged crystal oscillators is sure to include the type you need. For example:

VCXO—Voltage controlled crystal oscillators with frequency shifts of $\pm .1\%$ of center frequency with linearities of 1% in frequency range of 1 Mc to 20 Mc.



.4 cu. in.

Small packages. A new line of one cubic inch packaged crystal oscillators from 66 Kc to 100 Mc is now available. Where space is a major problem, units can be provided in a package as small as .4 cubic inches.

High Stability—Up to ± 2 pp 10^6 per day in a package 2x2x4½ inches.

Low and High Frequencies

—Bulova provides the widest range of frequency available in solid state, packaged crystal oscillators—frequencies up to 500 Mc in a package 2x2x4½ in. No one gives you a wider range, thanks to Bulova's in-house crystal capability.

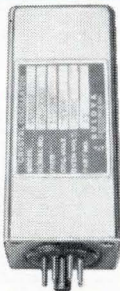

Model PC02HP
 ± 2 pp 10^6 per day

TCXO—Temperature-compensated crystal oscillators built to your requirements.

Special Problems? Bulova's engineers are frequency control specialists ready to tackle any problem—large or small. Just tell us your requirements. Chances are we've already found the answer! Just call or write Dept. E-20.

BULOVA
FREQUENCY CONTROL PRODUCTS

ELECTRONICS DIVISION
OF BULOVA WATCH COMPANY, INC.

61-20 WOODSIDE AVENUE
WOODSIDE, N.Y. 11377. (212) DE 5-6000

New Components and Hardware

Crt produces uniform size spot

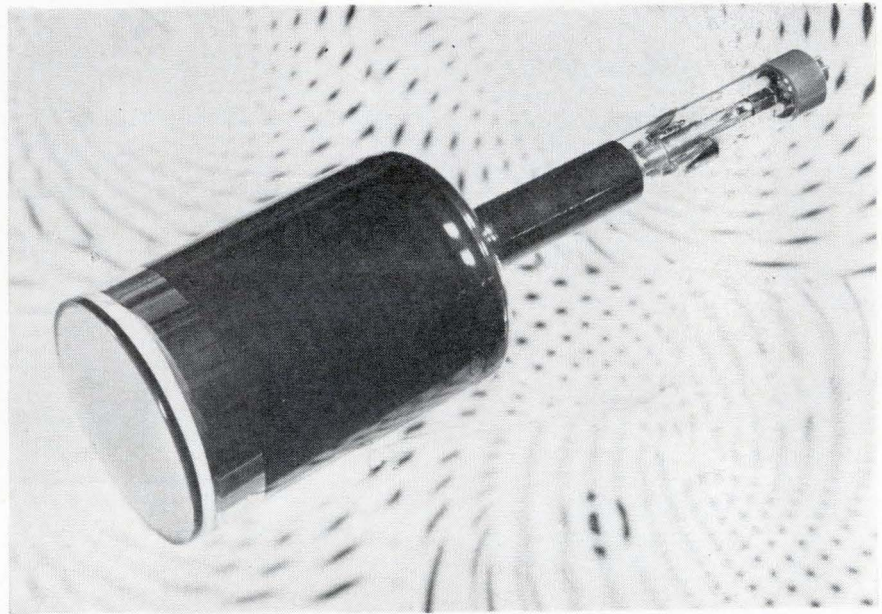

A high-resolution cathode ray tube (crt), which produces a uniform size spot independent of its position on the face of the tube, has been developed by DuMont Electron Tubes, a division of the Fairchild Camera & Instrument Corp. Maximum spot sizes of 0.0015 mil at the center—and 0.002 mil at the edge—of the flat-faced tube are claimed by DuMont. This is a reduction in spot-size variation of about 30% when compared to similar tubes.

High resolution and small spot-size variations permit a uniform, high-density presentation of numbers and letters on the face of the tube, as might be required in digital readout applications. It also permits fine-lined traces for accurate measurements in laboratory.

These characteristics are achieved in the KC2515 crt by using a precision electron gun, fine-grain phosphor screen and specially designed electrostatic focusing and magnetic deflection elements. To minimize deflection defocusing, the deflection angle has been reduced to 26°. In addition, high-quality glass—optically finished to 0.005 mil—insures that defects or blemishes in the glass are smaller than the resolvable spot size.

An aluminized screen backing increases light output and prevents the buildup of spurious charge effects. Three phosphors of varying persistence are available for high resolution displays. These include a type P-1 medium-persistence yellow-green phosphor with a spectral range of 4,900 to 5,800 angstroms; a type P-11 medium-to-short persistence blue phosphor with a spectral range of 4,000 to 5,500 angstroms; and a type P-16 short-persistence bluish-purple phosphor with a spectral range of 3,500 to 4,500 angstroms.

A fiber-optic face plate that covers the entire viewing area is optional. It allows light generated by the phosphor screen to be used for direct photographic recording of full scope traces.

The tube has a maximum diam-

Specifications

Crt type	KC2515
Outside diameter	5¼ in.
Diameter of viewing surface	4½ in.
Length	18¼ in.
Typical operating conditions	
Accelerating voltage	20,000 v
Grid No. 2 voltage	300 v
Grid No. 1 voltage	-40 to -65 v
Focusing electrode voltage	4,750 to 6,450 v
Price (approximate)	\$800
Price with fiber optics (approximate)	\$2,000
Delivery	30 days



New low-cost Daystrom Model 333 commercial trimmer has knurled finger-tip adjustment knob. It also has an Allenhead for fine adjustment . . . 4 to 1 ratio, nominal. Designed for PC board use, it requires approximately 1/2 cubic inch of space. Price is another unusual feature—only \$1.45 in 100 lot quantities!

Model 333's unique resistance element is the same as used in MIL-type Squaretrim® pots for high resolution, linearity, and low noise. Also,

it is vibration and shock resistant.

This is just one of the special-purpose Daystrom units—from industry's broadest line of subminiature square-trimming potentiometers. Chances are that we can fill your most exacting requirements with a standard, off-the-shelf model.

See your Weston distributor for catalog, prices and evaluation units. Weston Instruments, Inc., Archbald Division, Archbald, Pennsylvania 18403. Phone: (717) 876-1500.

Only Weston's exclusive wire-in-the-groove offers  **LOCKED-IN LINEARITY** 

From Weston's broad trimmer line



actual size

Model 333 — 1/2" by 3/8" by 3/8". Dual adjustment: knurled finger-tip knob and Allenhead. For PC board mounting. Resistance: 50Ω to 10k, up to 50k on special order. Rating: 0.2w @ 40°C in still air.



Series 200 — 3/8" Square-trim, 0.150" thick, slotted or Allenhead adjustment screws. This is only one of a full line of 3/8" pots. Operation: from -55 to 150°C. Resistance: 10Ω to 50k. Rating: 1w @ 50°C in still air.

let your
fingers
do the
trimming

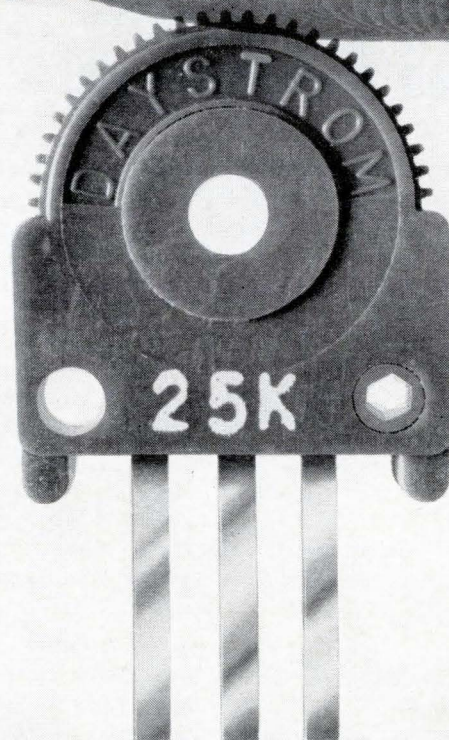

WESTON® *prime source for precision... since 1888*

WOOD ELECTRIC CIRCUIT BREAKERS



When the specs say . . .
"Meet Requirements of
MIL Standard 202B"

You can depend on us!

The above photograph shows Circuit Breakers at Wood Electric being tested for temperature and humidity requirements of MIL Standard 202B. Units undergo temperature changes from 14 to 160° F during a 10 day cycle while relative humidity is held constant at 50%. Test chamber is controlled within $\pm 2^\circ$ F and $\pm 2\%$ humidity.

There are other specs and other tests, lots of them, but they all have one purpose in common—to assure the most reliable performance in the industry. If it's by Wood Electric—you can depend on it!

Choose from a wide variety of proven commercial and military Circuit Breakers to meet the specific needs of your application—Thermal types with time delays from 0.5 to 90 seconds and Magnetic types with temperature-stable trip points from instantaneous to 10 seconds. Models are available with ratings from $\frac{1}{2}$ to 50 amps . . . AC or DC . . . single pole, two pole and three pole.

Write for Circuit Breaker Catalog CB-10-65



**WOOD ELECTRIC
CORPORATION**

244 Broad St. Lynn, Massachusetts (617) 598-5313

New Components

eter of $5\frac{1}{4}$ in. and a flat viewing surface $4\frac{1}{2}$ in. in diameter. Its $18\frac{1}{2}$ in. length is slightly larger than that of other tubes of this diameter, because the reduction in deflection angle required moving the electron gun back from the face of the tube.

DuMont Electron Tubes, a division of Fairchild Camera & Instrument Corp., 750 Bloomfield Ave., Clifton, N.J. [351]

Servo/differential Solid-state relay

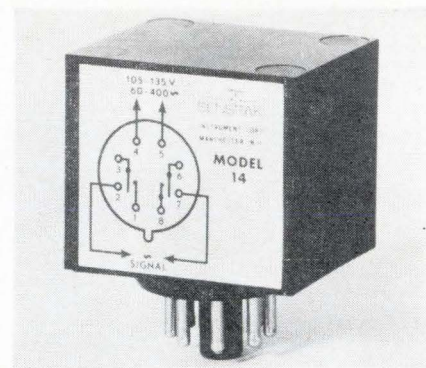

Model 14 servo/differential relay is an all a-c operated device requiring a primary power source and a phase-sensing signal source derived from the same primary power source. It can be used as a servo relay, differential relay or phase detector.

The relay is an epoxy-encapsulated, all-silicon solid state device incorporating two dry reed switches. The signal source is normally derived from a four-arm bridge excited by a low voltage a-c source. When the bridge is balanced, both reeds are open. When the bridge is unbalanced in one direction, one reed will close. When the bridge is unbalanced in the other direction, the other reed will close. Signal power requirements to cause switch closure are less than $10 \mu\text{w}$, allowing high positional or other sensing accuracy. Primary source requirements are 1 w, 120 v $\pm 15\%$, 60 to 400 cps. The relay is unaffected by temperature or voltage variations in its operating range of -40° to $+85^\circ\text{C}$.

For operation as a servo relay the four-arm bridge may consist of two

CONSIDER COLORADO

...where research and education are industry's partner...
Directly. Indirectly. From government, university and private sources...

Consider 103 research organizations located in the state... headed by a total of 3500 graduate scientists who guide the efforts of 23,000 employees to discover the unknown. Everything from economics and marketing to cryogenics and advanced nuclear research and neutron generator performance.

In close support of science, research and industry are Colorado's educational institutions: 12 colleges and universities; 7 junior colleges. Plus an increasing number of vocational and trade schools whose primary mission is to serve the needs of Colorado and the nation's industry.

If research and education are important to your business, consider industrial Colorado for your expansion or relocation. Complete information is available from Dwight E. Neill, Director, Division of Commerce and Development, 14 State Services Building, Denver, Colorado.

INDUSTRIAL COLORADO



diffitrans



New Components

potentiometers, one used to provide a set point and the other coupled to an actuator driven by a reversible motor. The resulting positional accuracy depends on the potentiometer quality and the exciting voltage. Use of standard available potentiometers can produce 1% accuracy.

Another application of the relay is as a temperature indicator or controller. In this application the signal is derived from a four-resistor bridge. One resistor is a thermistor. The bridge is balanced at a required temperature. When the thermistor senses temperature below the preset point, one reed will remain closed. When the bridge is balanced, both reeds are open. When the thermistor senses temperature above the balance point, the other reed will close. The high/low differential can be as small as one degree. Price of model 14 is \$21.75.

Sensitak Instrument Corp., 531 Front St., Manchester, N.Y. [352]

Dual trimming pot in miniature size

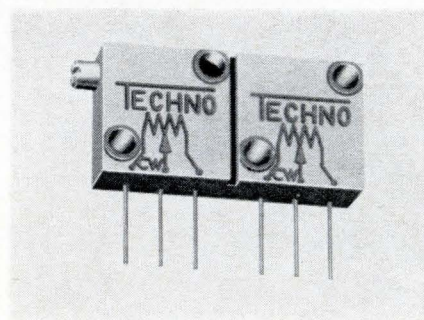

Series 190 dual trimming potentiometer measures only 0.405 x 0.775 x 0.185 in. Designed for precision applications, it features two in-phase resistance elements controlled by a single adjustment screw. With matched resistance elements, an electrical phasing of $\pm 5\%$ is standard.

Standard p-c board pin spacing of 0.1 in. center-to-center is used with a choice of terminations—printed circuit pins or 2-in. weldable leads, both gold plated. Series 190 is designed to meet the require-

* Stumped? Don't be. We made up the word to emphatically set forth the ability of Phelps Dodge coaxial cable assemblies to solve very difficult transmission and installation problems.

A coaxial cable assembly, designed to specific requirements, is often the ingenious solution to cable connections in close physical confines or under difficult environmental conditions. Very tight specs can be met: delay time, $\pm .02$ NS — phase length, 0.4° relative — VSWR, 1.01; insertion loss, 0 to 40 db ± 0.5 db and 40 to 60 db ± 1.0 db — impedance, absolute value of average, 0.2% .

Phelps Dodge Electronics coaxial cable assemblies have been designed and built as tracking antenna harnesses, special oscillator and receiver lines, transitions to waveguide, airborne vibration isolators, matching sections, and for equalizing and balancing networks. We have a new catalog that describes many more. Please write for it. Bulletin CC, Issue 1.

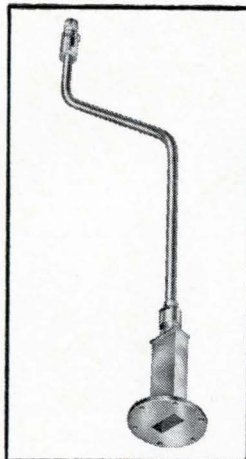

PHELPS DODGE ELECTRONIC PRODUCTS
NORTH HAVEN, CONNECTICUT



ments of applicable Mil-Spec paragraphs.

Adjustment ratio is 25:1; resistance range per section, 10 to 50,000 ohms; resistance tolerance, $\pm 5\%$; power rating per section, 1 w at 50°C; operating temperature range, -65° to 175°C; temperature coefficient, 50 ppm/°C maximum. Techno-Components Corp., 7803 Lemon Ave., Van Nuys, Calif., [353]

Terminal junctions with modular design

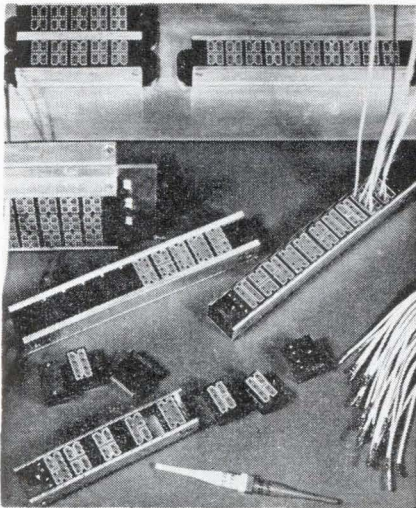

The TJ series of terminal junctions provides convenient, reliable replacements for bulky terminal strips, even in areas exposed to extreme environments, and at the same time reduces wiring steps and weight. The lightweight devices, which are also available in nonenvironmental styles, feature a modular design which, together with associated hardware, allows junctions of varying lengths. The modules are available in a wide variety of bussing configurations.

The terminal junctions use crimp-type contacts in sizes 20, 16, 12, and 8, designed to geometry similar to NAS1600. The contacts are inserted and removed from the rear by the use of a single insertion-removal tool; they are crimped by the use of a standard MS3191 tool. The socket assembly is an integral part of the bus bar, and features a chamfer lead-in to accept the pin contact.

Each module features high-temperature silicone inserts with triple-web rear seals, and meets electri-

For precise temperature testing from -300°F to $+525^\circ\text{F}$

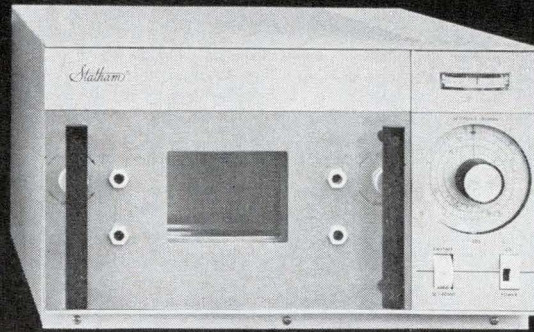

STATHAM MODELS SD6 AND SD3 ARE 700 CU. IN. CAPACITY CHAMBERS FEATURING $\pm 1/4^\circ\text{F}$ CONTROL ACCURACY

Designed for precise temperature testing of electronic components, Statham Models SD6 and SD3 chambers feature true proportional control of heater power by all solid-state circuitry.

This new generation of test chambers eliminates the conventional heater power relay, prevents cycling about the control point, and substantially *reduces* RFI noise.

The controller maintains a set-point temperature within $.01^\circ\text{F}$ per $^\circ\text{F}$ ambient. An improved controller design provides excellent temperature uniformity with gradients of $\pm 1.3^\circ\text{F}$ at 300°F .

SUPERIOR TEMPERATURE CONTROL

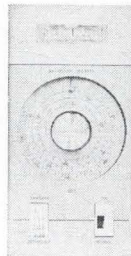

24 Inch Dial Control

Models SD6 and SD3 feature 24 lineal inches of calibrated set-point scale. Temperature readout is obtained by a deviation meter calibrated in one-degree increments. This expanded scale approach provides a level of accuracy and readability not attainable in conventional chambers.

Optional Push-Button Control

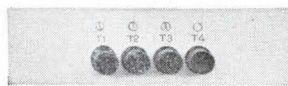

Frequently repeated temperature settings can be made faster and more accurately with Statham's *push-button* temperature selection control. The buttons, which may be set at any desired temperature, provide precise repeatability.

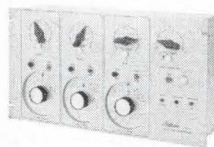

Cycle Time Controller

Statham cycle time controllers permit programming the chambers in any required sequence of hot-ambient-cold-ambient, etc.



Statham Instruments, Inc.
Environmental Products Division
2221 Statham Blvd., Oxnard, Calif.
HUnter 6-8386 (Area Code 805)

Write for Statham's new 12-page Temperature Test Chamber Brochure.

IMPORTANTLY NEW!!

SOLID STATE STANDARD OSCILLATORS ■■

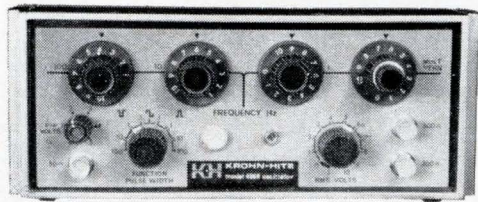

K-H SERIES 4000/4010/4020

THE ONLY

WIDE-RANGE •

FLAT-RESPONSE • LOW-DISTORTION
STABLE-AMPLITUDE • CALIBRATED-
OUTPUT • OSCILLATORS MADE!!!

If you think your present signal source fits that description, we suggest that you question its performance again from a slightly different viewpoint. For instance:

		← Is your tuning range from 1 Hz to 100 kHz? →
		← K-H gives you three extra decades, covers from 0.001 Hz to 100 kHz. →
		Flat ± 0.2 db in this range?
		K-H response is flat ± 0.05 db over seven decades.
		0.1% distortion here?
		K-H gives you 0.1% over eight decades — 0.01% over five of them.
		$\pm 1\%$ /hr amplitude drift?
		K-H gives you $\pm 0.05\%$ /hr over this range.
		$\pm 1\%$ voltage accuracy here?
		K-H gives you $\pm 0.5\%$ to 1 Hz, without a meter.

The Krohn-Hite point of view is simple: a precision oscillator must deliver state-of-the-art performance in the basics of frequency range, frequency response, sine wave purity, amplitude stability, and amplitude calibration. That's what saves time and trouble on the really critical jobs. K-H oscillators deliver this kind of performance *first* . . . then add the useful extras like quadrature output, square wave, variable-width pulse, transient-free tuning, and external synchronization. If your viewpoint is at all like ours, you should lose no time in meeting these remarkable new instruments. Write NOW!

ADVANCE NOTICE!

SEE THESE NEW OSCILLATORS AT THE IEEE SHOW . . . BOOTHS 3F12-14



KROHN-HITE CORPORATION

580 Massachusetts Ave., Cambridge, Mass. 02139
Telephone: 617/491-3211

Pioneering in Quality Electronic Instruments

New Components

cal and mechanical requirements of MIL-C-26482.

The Deutsch Co., Electronic Components division, Municipal Airport, Banning, Calif. [354]

Miniature, high-speed sensitive relays

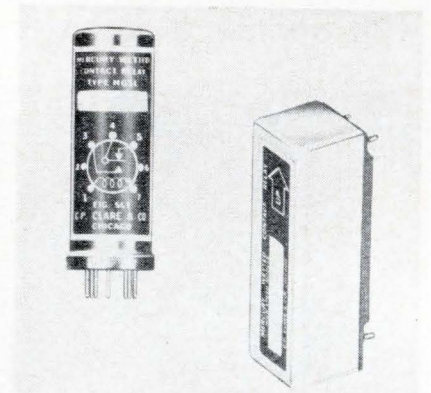

Two miniature, mercury-wetted contact relays have been announced. Type HGSL is designed for wired assemblies; type HGSM, for printed circuit board applications. The high-speed relays provide two sensitivity ratings: 40 mw single-side stable, and 20 mw bi-stable.

Either Form D (bridging) or Form C (nonbridging) contacts are available. The contacts can handle power switching requirements up to 100 v-a, a-c or d-c, over billions of operations. Low-level contact ratings are 0 to 300 mv, 0 to 100 ma.

The HGSL has a contact circuit resistance of 35 milliohms max; the HGSM, 20 milliohms max. Both types have a nominal operate time of 1.0 msec at maximum coil power. Compact, space-saving packages meet a wide range of design requirements for both p-c boards and wired assemblies.

The relays are said to be applicable in both commercial and military electronic systems. For example, their complete freedom from contact bounce, isolation between coil and contacts, and high speed qualify them as excellent input buffers to solid state circuitry; or, as output buffers, they can be driven by low-power circuitry with

an input-to-output power gain of up to 5,000.

As scanner contacts in checkout systems, the relays can stand off a high-potential voltage of 1,000 v a-c and, at the same time, offer a contact resistance variation of less than 2 milliohms over life for critical resistance-measuring circuits.

C. P. Clare & Co., 3101 Pratt Blvd., Chicago, Ill., 60645. [355]

Snap-slide wedge-action switch

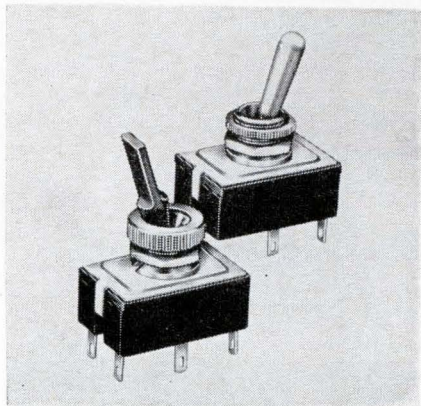

The 84000 series of snap-sliding wedge-action switches is said to be the first of its size and rating to offer: a-c and d-c ratings; quick make, quick break with wiping contact action; two- or three-lever positions; maintained or momentary action—on one or both sides of center; choice of three contact materials; and compact physical dimensions.

The switches are rated for a-c at 5 amps 125 v, and 2 amps 250 v; and for d-c at 4 amps 125 v and 1 amp 250 v. The 84000 series is offered in all circuits spst through dpdt.

Three types of contact materials are offered—silver plated bronze, supplied as standard and best for power circuits; silver alloy, best adapted to low-voltage circuits; and gold plated, providing long shelf life and used on low-energy circuits.

The new switch line is supplied with either a nickel-plated, brass bat lever handle or a paddle-shaped nylon lever. Wiring terminals are the combination solder-lug and quick-connect type.

Arrow-Hart & Hegeman Electric Co., 103 Hawthorn St., Hartford, Conn. [356]

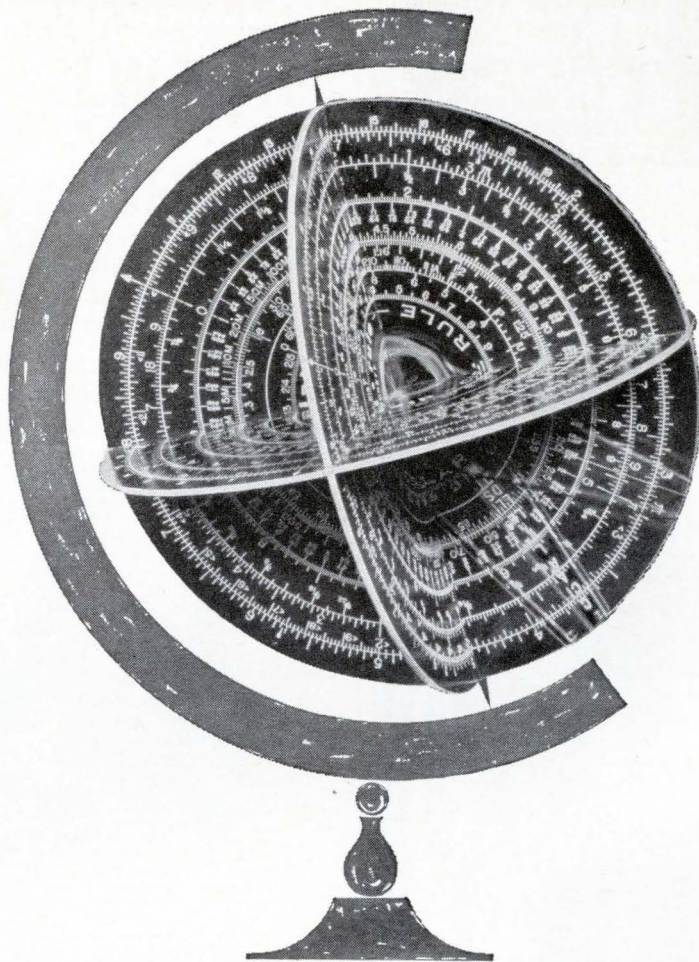

INTERSTATE ELECTRONICS ... where longitudinal experience and latitudinal capability form a world all by themselves.

That's right, Interstate Electronics is long on experience and wide in capability. It took both to develop the sophisticated and highly successful test instrumentation equipment for the FBM weapon system of the Polaris submarine program. As prime contractor for this important equipment, Systems Development Division of IEC relies heavily on its staff of top experts, and excellent facilities. The same applies to the Data Products Division which specializes in the development of real-time permanent paper or film video recorders, phase lock devices, timing systems, data handling systems and analog-to-digital conversion equipment. Lots of savvy. Lots of ability.

And although the seas have been here since time began, Man is only now beginning to read, understand, and use the waters of the world. OceanicS Division, formerly National Marine Consultants Division, for over a decade has used scientific principles to develop unique products and methods for studying everything from piers to pollution, from sand to salinity. It's all done with people... the best in the business.

You see, it's really elementary. People with ability are what make the world go round at IEC.

INTERSTATE ELECTRONICS CORPORATION

707 E. VERMONT AVE., ANAHEIM, CALIFORNIA 92803

Regional Offices: Atlanta, Georgia • Washington, D. C.

Subsidiary of

INTERSTATE ENGINEERING CORPORATION



IEC

25,000 SIZES AND SHAPES

DEEP DRAWN ALUMINUM BOXES & COVERS

now available
"off-the-shelf"
one week delivery
no tooling cost

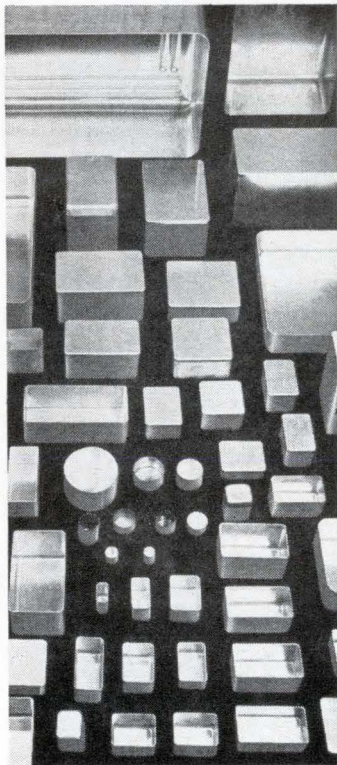

Choose from more than 25,000 sizes and shapes. Rectangular, square, round. Sizes from $\frac{7}{8}$ " x $1\frac{5}{8}$ " to 28" x 54-3/16". Draft-free deep drawn aluminum. No Welds. Satiny, wrinkle-free surface requires no preparation for painting. Shipment made from \$1,000,000 inventory, normally within one week, from the nearest factory. Complete facilities available for economical secondary operations and finishing if required.

Send for
New 38-Page Catalog



Zero Manufacturing Co.

1121 Chestnut Street
Burbank, California 91503
Telephone Victoria 9-5521
area code 213
TWX 213-846-8094



Factories in Burbank, Calif. and Monson, Mass.

New Semiconductors

Scr handles 550 amperes

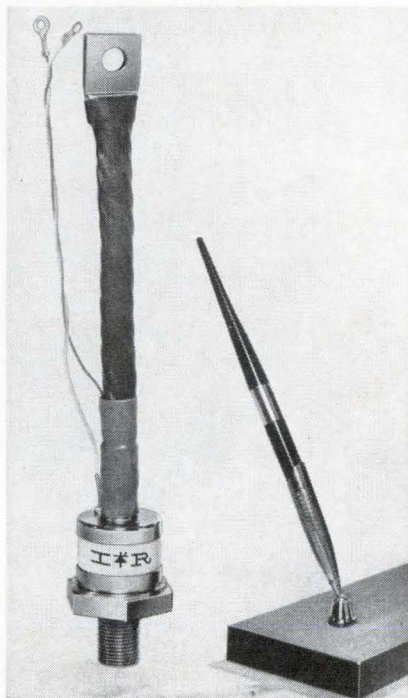

A silicon controlled rectifier capable of handling root-mean-square forward currents to 550 amperes can simplify the design of adjustable motor controls that are operated directly from 3-phase 480-volt power lines. With the new scr water cooling is not required.

The rectifier, which is being manufactured by the International Rectifier Corp., does not as yet have a type number assigned. Because it can be operated directly from high-voltage a-c distribution lines, it should also find application in battery-charging equipment in central telephone offices, and in electric-vehicle controls, welding and oven controls, high-power plating power supplies and machine-tool drives.

Forced-air cooling is recommended by the manufacturer in most applications of the scr. The copper-base device has an over-all length of approximately 10 inches. It measures 1.69 inches from flat to flat and has a $\frac{3}{4}$ in.-16 mounting stud.

Other variations of the new scr are being made available, including one with a turn-off time of 40 microseconds.

Specifications

Maximum peak forward voltage drop at 350 amperes	1.48 volts
Maximum rms forward current	550 amperes
Maximum average forward current	350 amperes
Maximum peak 1-cycle surge current, 60 cps	6,250 amperes
Maximum allowable peak reverse voltage	1,200 volts
Maximum transient peak reverse voltage	1,800 volts
Minimum peak forward breakover voltage	1,200 volts
Availability	6-8 weeks
Price:	
1-9	\$629
10-99	\$561

International Rectifier Corp., El Segundo, Calif. [361]

Plastic-encapsulated dual switching diodes

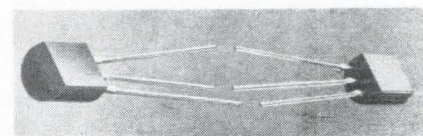

Users of silicon switching diodes, particularly computer and test-equipment manufacturers, can improve product performance and reduce total system costs by using the new MSD6100 dual switching diodes, according to Motorola Semiconductor Products Inc. Ideal for high-speed switching and other critical applications, the dual switching diodes are fabricated simultaneously on the same chip of silicon; therefore, their characteristics are closely matched. A common cathode configuration simplifies subsequent assembly operation.

The MSD6100 is encapsulated in a single-piece, transfer-molded plastic form that provides a uniform package free of voids and leaks. Because it is a pressure-molded solid, the package offers extra physical strength to the internal leads and connections while insuring excellent heat-transfer characteristics. The "D" shaped package lies flat for easy printed-circuit mounting.

Each diode in the device has a high breakdown voltage of 100 v minimum and a low capacitance of

1.5 pf maximum at a reverse voltage of zero. The reverse recovery time for each diode is 4 nanoseconds maximum at 10 ma.

Because of the plastic encapsulation, the common cathode configuration and improved process techniques, the dual diode device is priced as 75 cents in quantities from 100 to 999.

Motorola Semiconductor Products Inc., Box 955, Phoenix, Ariz. [362]

Integrated-circuit video amplifier

A low-cost integrated-circuit video amplifier, type E13-511, features high stability from -55° to $+125^{\circ}$ C. It amplifies from d-c to over 50 Mc (-3 db) with an essentially flat gain characteristic to 40 Mc.

Key specifications include voltage gain of 24 db, bandwidth (-3 db) of 50 Mc, gain variation (-55° to $+125^{\circ}$ C) of ± 0.3 db, limits of gain variation (d-c to 10 Mc) of ± 0.5 db, and dynamic range of 7.0 v.

Silicon planar production techniques using high resolution photo-etching and epitaxial material are said to achieve exceptional isolation between circuit parts and uniformity of characteristics. Delivery of the new device is from stock; price is \$12 each from 1 to 99 with lower prices available on higher quantities.

Amelco Semiconductor, 1300 Terra Bella Ave., Mountain View, Calif. [363]

Uhf transistor for microcircuits

Designed for thin-film and other microcircuit packaging techniques, the K2857C double-diffused npn silicon transistor is intended for uhf and vhf amplifier applications. Exceptional performance is noted in converter and oscillator circuitry, according to the manufacturer.

Typical performance at 450 Mc is 14-db gain with a noise figure of less than 4 db. Selected versions of the transistor are available with noise figures down to 2.5 db maximum at 450 Mc.

Price is \$24.75 with delivery currently at 10 days.

Kmc Semiconductor Corp., Parker Road, RD 2, Long Valley, N.J. [364]

PRINT ELECTRONIC COMPONENTS ... EFFICIENTLY

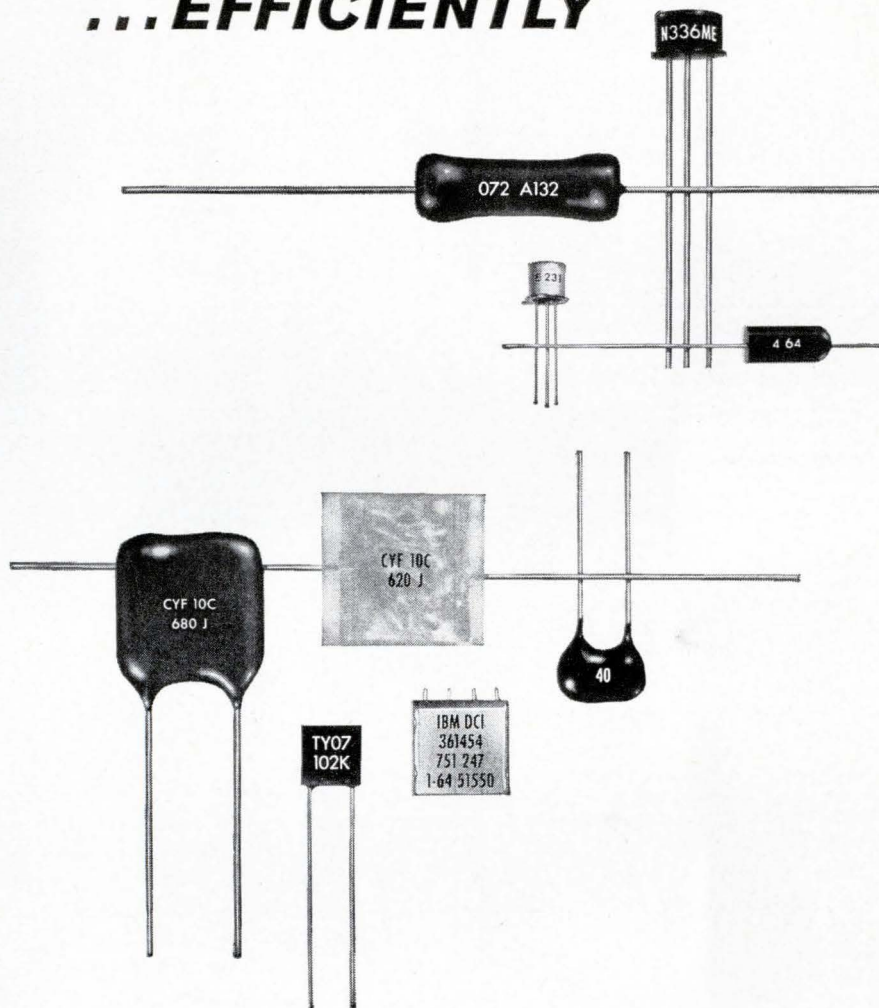

That word *efficient* means a high ratio of output to input. In a MATTHEWS OFFSET PRINTER marking transistors, modules, capacitors and other electronic wonders, it means trouble-free operation, legible printing, it means a spoonful of ink goes a long way—installing a MATTHEWS printer means at least one of your problems is solved.

Write for illustrations of our electronic component printers or send a sample of your product. We'll be glad to see if we can be efficient for you too.



JAS. H. MATTHEWS & CO.
Industrial Marking Products Division
6788 PENN AVE., PITTSBURGH, PA. 15206

MARKING METHODS SINCE 1850

Design Brochure Cable Assemblies & Coaxial Delay Lines

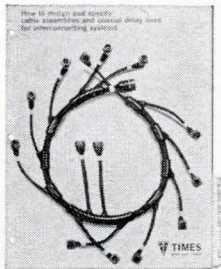

This 4-page brochure details specifications and multiple design possibilities of cable assemblies and coaxial delay lines. It also follows through with evaluation, production and test procedure info.

For your copy write or phone:
Times Wire & Cable, Wallingford,
Conn. (203) CO 9-3381

Circle 230 on reader service card

Seamless Metal Tube Sheathed Coaxial Cable



Times' new semiflexible coaxial cable with seamless aluminum tube sheath conductor is available in two standard versions:

1. ALUMIFOAM® — Foam polyethylene dielectric where pressurizing isn't practical.
2. ALUMISPLINE® — Air dielectric where pressurizing is practical. These cables offer more isolation—at 80 < db more than ordinary coax. Uniformity average — VSWR 1.1 or less. Stability — 10 times better. Lower loss — 30% less. Pulse reflection — less than 1%. Less distortion. Also avail. in solid dielectric and high temp. constructions.

For prices & data write or phone:
Times Wire & Cable, Wallingford,
Conn. (203) CO 9-3381

Circle 231 on reader service card

Connectors for Solid Sheathed Cable

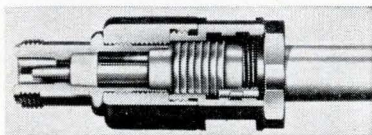

Only one step required to use the new one-piece TIMATCH® Connector with its own pat. CoilGrip® clamp—just unpack it. Its reusable and repeated assembly and disassembly does not impair either the RF or physical characteristics of the connector or the cable. Available in all popular sizes and fits all metal tube sheathed coaxial cables.

For prices & data write or phone:
Times Wire & Cable, Wallingford,
Conn. (203) CO 9-3381

New Instruments

Coupler makes dvm printer of calculator

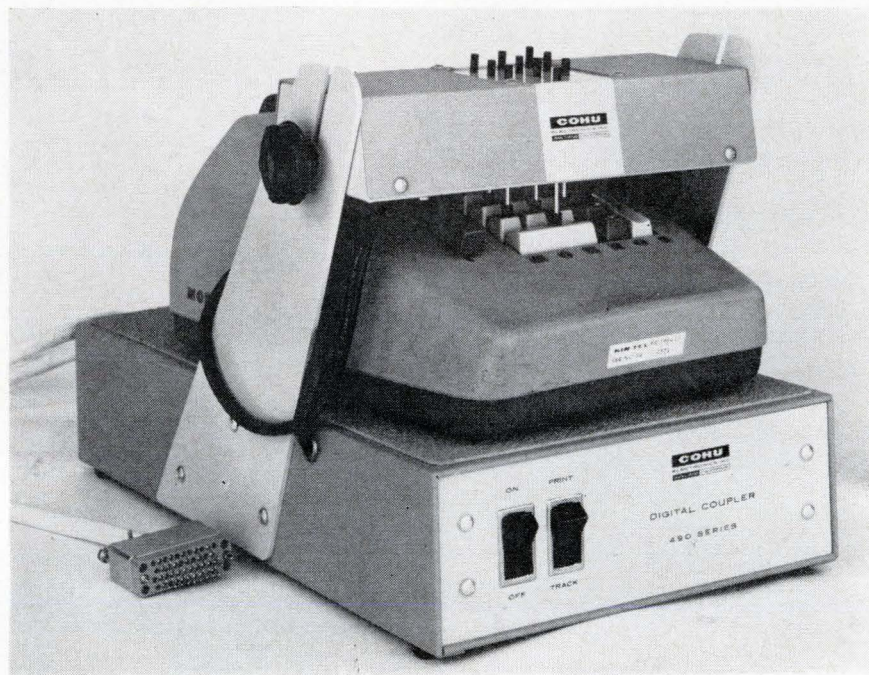

A digital coupler, developed by Cohu Electronics, Inc., turns an ordinary desk calculator into a digital printer. By combining the series 490 coupler with Cohu's series 510 digital voltmeter and a desk calculator, it is possible to have a digital-voltmeter printout system that is less expensive than presently available dvm printers. Including the cost of the calculator, says a company spokesman, the Cohu system is at least \$100 less than comparable digital printers.

The desk calculator fits between the coupler's electronics module and a set of 11 solenoids. Ten solenoids drive plungers which activate the calculator's number keys; the 11th operates the tabulating key. The printer is activated only when the voltage changes and the dvm seeks a new null. The plunger-assembly arms are slotted for calculators of different heights.

The coupler is fitted to the dvm through a 42-pin connector—the only modification necessary to enable the series 510 voltmeter to work with the coupler. The coupler operates from the same biquinary-code system as the series 510 dvm. Dvm's that use other codes can be

connected if a suitable converter is provided.

The calculator can be used for routine office tasks when not installed in the coupler. Even installed, it can be used for quick computations by operating the calculator's keys with the solenoid shafts that extend through the coupler. Standard office calculators need no modifications to work with the series 490 coupler. This is an attractive feature, according to Kenneth Walker, engineering supervisor at Cohu, since warranties on the calculators would be affected if alterations were made.

Specifications

Input power	105 to 125 volts, 50/60 cps
Size	19 3/8 in. long, 12 1/8 in. wide, 11 1/2 in. high
Price	\$795.00

Cohu Electronics, Inc., Box 623, San Diego, Calif. 92112 [371]

Highly accurate lab potentiometer

A three-dial, four-range potentiometer, known as model 2784, is designed to measure voltages from 0

to 11.110 v. Its stated calibrated accuracy on the 1-v range is $\pm (0.002\% + 10 \mu\text{v})$.

The instrument uses a noncon-voluted, single-turn slidewire to achieve infinite resolution on the third dial. The ability of the user to read between scale divisions is the only factor limiting resolution, the company says.

The extremely low temperature coefficient of the model 2784 permits its use as a high-accuracy production calibration instrument as well as for measurements in temperature-controlled standards laboratories. Thermal emf's are held to less than $0.1 \mu\text{v}$. The instrument has guarding provisions to intercept both internal and external leakage currents.

Other features include a single window readout of all digits, automatic decimal-point positioning, complete electrostatic shielding, and self-checking capability. Price is \$860; delivery, stock to 30 days. Honeywell, Inc., Denver Division, 4800 E. Dry Creek Road, Denver, Colo., 80217. [372]

Swr meter features high usable range



A standing-wave-ratio meter now available has a noise-figure specification of less than 4 db, giving it greater usable range than any previously offered swr meter, according to the manufacturer.

Model 415E is used in r-f and microwave measurement systems, not only to measure standing wave ratio, but also to measure attenuation, gain, or any other parameter determined by the difference between two signal levels. It is a tuned amplifier-voltmeter calibrated in db and swr for use with square-law detectors. Its low noise

An Operational

AUTOMATIC MICROWAVE SPECTRUM SURVEILLANCE SYSTEM

And The Management/Engineering Team That Made It Work

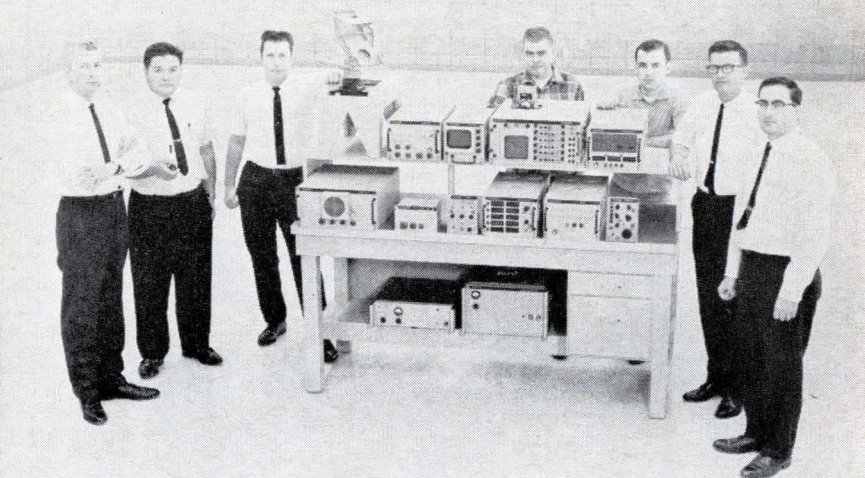

The new Watkins-Johnson microwave collection system combines the most sophisticated techniques and proven materials to receive, detect and analyze electromagnetic emissions in the frequency range of 1 to 18 GHz. Whether airborne, aboard ship, in a mobile van or at a fixed location, the WJ-1007 performs automatically and continuously for ferret, ELINT and reconnaissance applications.

- The WJ-1007 requires no mechanical tuning — it is fitted with electrically-tracked preselectors and oscillators. It provides continuous coverage through automatic switching of full octave and waveguide frequency bands.
- Digital tuning and direct digital readout delivers automatic data for transmission and teletype reproduction.
- The ability of the system to measure frequency to an accuracy of .01 percent is the result of a solid-state local oscillator development unique at W-J.
- The system is of solid-state design throughout, except for TWT's and CRT's.
- A core memory unit provides a "lock out" and recall capability.
- The modular design provides for ease of system expansion to cover the 18 to 40 GHz range as well as frequency bands lower than 1 GHz.
- Each module is fully self-contained with its own power supply (diplexers, local oscillator synthesizer, spectrum display, DF display, demodulator, digital tuner, receiver control, frequency memory, IF pan display, analysis indicator and so forth), resulting in a perfectly synchronized system.
- Supplementary equipment is available to suit any application.

The team that delivered the WJ-1007 as promised can be engaged to any similar systems program calling for refined skills and engineering ingenuity.

WATKINS | JOHNSON



3333 HILLVIEW AVENUE
STANFORD INDUSTRIAL PARK
PALO ALTO, CALIFORNIA 94304

NEON or INCANDESCENT SUB-MINIATURE INDICATOR LIGHTS

MEET OR EXCEED ENVIRONMENTAL
AND OPERATIONAL REQUIREMENTS
OF MIL-L-6723 AND MIL-L-3661

Miniaturization is made possible by the wide selection of Dialco Sub-Miniature Indicator Lights for mounting in 15/32" or 17/32" clearance hole. Among the features offered are: Watertight construction; resistance to vibration and corrosion; high-heat plastic or glass lenses; anti-rotation (locked) construction; phenolic insulation of military specification grade.

Neon assemblies accommodate T-2 lamps in two types: NE-2D (MS25252) for 105-125V AC-DC; and High Brightness NE-2J for 110-125V AC only. In DIALCO units, the current limiting resistor is built-in (U.S. Pat. No. 2,421,321).

Incandescent assemblies accommodate T-1 3/4 lamps in voltages from 1.35 to 28V—with life ratings to 50,000 hours.

SAMPLES ON REQUEST—AT ONCE—NO CHARGE.

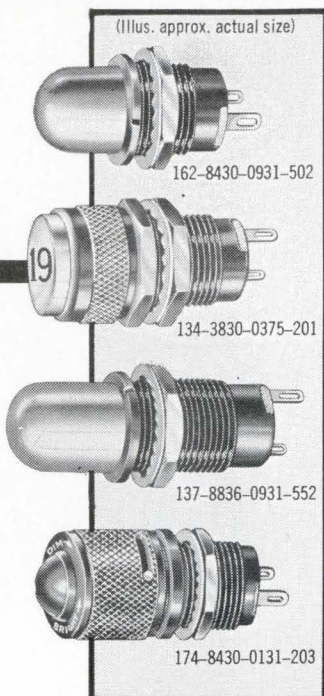

WRITE FOR CURRENT CATALOG

DIALCO

Foremost Manufacturer of Indicator Lights

DIALIGHT CORPORATION

60 STEWART AVENUE, BROOKLYN, N.Y. 11237 212 HYACINTH 7-6000

Circle 210 on reader service card

New Instruments

figure permits accurate measurement at lower levels than formerly were practical. A result is the ability to exploit fully the newest state-of-the-art detectors, around whose source impedance the 415E noise figure was optimized. Usability of low signal levels reduces the necessary drive to the measured array and reduces the necessary modulation index for the detected signal, easing the problems of such measurements in all respects.

Additional accuracy improvement arises from a new high in specified attenuator precision. An expand-offset feature allows any 2-db portion of the instrument's 70-db range to be expanded to full scale for maximum resolution, at a specified linearity of ± 0.02 db.

Model 415E operates with either crystal or bolometer detectors, with capability to operate from both low (100 ohms) and high (5,000 ohms) source impedance crystals. It provides precise bias currents of 4.5 or 8.7 ma as selected on the front panel to activate all standard bolometers. Bias is peak-limited for bolometer protection.

The instrument has both recorder and amplifier outputs, which are isolated. The fully transistorized unit weighs 8 lb and consumes only about 2 watts. Price is \$350; delivery, an estimated 4 weeks. Hewlett-Packard Co., 1501 Page Mill Rd., Palo Alto, Calif., 94304. [373]

Comparison bridge for resistance ratio

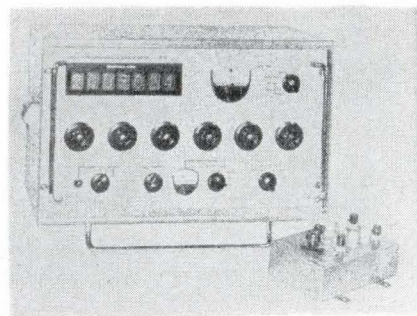

Model VLF51 precision resistance comparison bridge uses current transformers operated at 1 kc to determine the ratio of two resist-

INNOVATION
INNOVATION
INNOVATION
INNOVATION



In Electrical Electronics Engineering

- 80 Technical sessions, 300 papers — all at the New York Hilton
- 4 floors of exhibits — all at the New York Coliseum. Four days only — Monday - Thursday
- Gala IEEE Banquet—Wednesday, 7:15 p.m., New York Hilton Grand Ballroom — \$15.00
- Free shuttle busses between the Hilton and the Coliseum — every few minutes
- Registration — Members \$2.00 — Non-members \$5.00. Ladies \$1.00. Good for all days — Technical Sessions and Exhibits. In and out privileges.

EXHIBITS (4 days only)

Monday through Thursday
11:30 a.m. - 9:30 p.m.

NEW YORK COLISEUM

TECHNICAL SESSIONS

Monday through Friday
NEW YORK HILTON

MARCH 21-25, 1966

Students (over 14) accompanied by adult will be admitted to Exhibits Thursday only. \$2.00. (Not more than 3 per adult)



IEEE EXHIBITION

ances. A novel technique of modulation and demodulation enables the resistance comparison to be made at 5 cps, thus taking advantage of the accuracy of the highly permeable toroidally wound transformers, while eliminating the reactive effects of a-c.

Balancing the bridge with the six decades produces a digital readout of the resistance ratio to seven figures accurate within 20 ppm. This accuracy is available for measurements from 0.1 to 500 ohms. Measurements with reduced accuracy may be made from 10^{-5} to 10^4 ohms. The rapid measurements possible with the VLF51 greatly facilitate calibration work. While the bridge is specifically designed for resistance thermometry, it is applicable to any resistance comparison within its range.

Rosemount Engineering Co., 4900 W. 78th St., Minneapolis, Minn. [374]

Signal selector for vibration testing

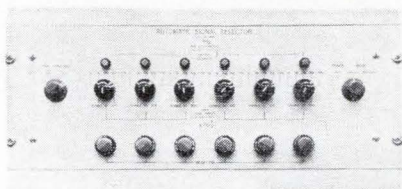

An automatic signal selector for vibration testing, model N668 automatically compares up to six accelerometer input signals, and can be set to select either the largest or smallest for presentation to the automatic exciter control, rejecting the remaining five.

Previously, in operating to test specifications that require control to a specified level, selection of the control point had been by approximation. The model N668, a solid state unit, in addition to automatically selecting and controlling to the maximum or minimum, includes provision for weighing the input signals, permitting comparison and selection between signals at different levels.

A wide range of inputs can be handled satisfactorily. The extremely fast switching time of less than 1 microsecond insures that there are no transients during switching.

MB Electronics, division of Textron Electronics Inc., 781 Whalley Ave., New Haven, Conn. 06508. [375]

MOL Resistors

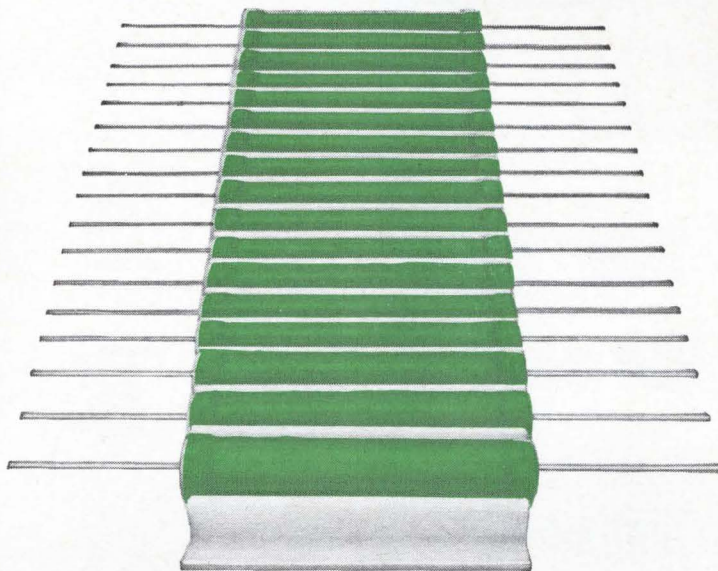

PROMPT DELIVERY

...is one reason why all major TV manufacturers use Mallory MOL film resistors.

Other reasons? Temperature coefficient only 250 PPM/°C; proved flame resistance; high stability in humidity; less than 5% resistance change after 10,000-hour load-life test. Write for data and quotation. Mallory Controls Company, a division of P. R. Mallory & Co. Inc., Frankfort, Indiana 46041.



DUAL OUTPUT POWER SUPPLIES



Dual output power supplies are housed in one case 3-5/16" x 4-5/32" x 4-11/16" high. Identical or different output voltages from 1.5 to 75 are available in 1 volt increments for each of the DC outputs. The graph below furnishes maximum current corresponding to output voltage. Select the two outputs needed and telephone Acopian for all the details — plus guaranteed 3-day shipment after receipt of your order.

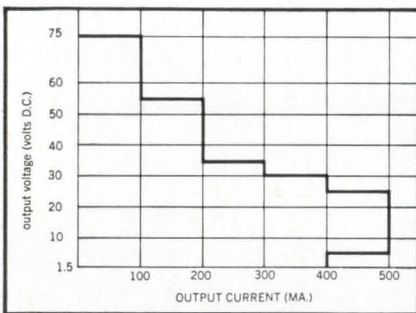

TYPICAL SPECIFICATIONS

Input Voltage: 105 to 125 VAC
 Line Regulation: ± 0.5 to $\pm 0.05\%$
 (depending on model)
 Load Regulation: ± 1.0 to $\pm 0.05\%$
 (depending on model)
 Ripple: 5 to 1 mv (depending on model)
 No additional external heat sinking required.

Write for Acopian's 16-page catalog and price list to: Acopian Corp., Easton, Penna., or call collect (215) 258-5441.



New Subassemblies and Systems

Core plane production tester

Designers testing the ferrite core planes from which computer memories are built must measure a number of parameters to learn in great detail how the memory will perform under all kinds of conditions. On the production line many of these parameters need not be measured in testing core planes, since the question in production is simply whether a particular plane comes up to specification. Therefore, a laboratory-model core plane tester usually has capabilities that are never used in a production testing; and a manufacturer that buys a laboratory tester for production pays for equipment that is scarcely ever used.

The model 1527 ferrite tester, according to Digital Equipment Corp., is a fast, inexpensive unit for production testing of core planes. It is mounted in two standard 19-inch racks. The operator can reach all the knobs and buttons, calibrate all measurements, even open the panels for maintenance—without getting out of his chair. And it sells for less than half the price of most testers of comparable capability, according to DEC.

The new tester has a diode-transistor matrix adapted from DEC's line of Programed Data Processor (PDP) computers; the matrix generates test patterns for the memory connected to it. In effect, the tester is a computer without a memory; when a memory from the production line is plugged into the tester, it puts the memory through its paces by writing and reading one or more test patterns in the memory and verifying the results. The matrix required a special packaging technique to overcome inductance and capacitance in the long leads between the tester and the core plane. The performance of even a perfectly functioning core plane could be affected if the lead length were not compensated for.

Test patterns that the unit can use with a core plane include all 1's, all 0's, alternate 1's and 0's, (single checkerboard) and some-

thing called a double checkerboard with variations. A double checkerboard has this pattern repeated along the full length of every row of ferrite cores in the plane:

```
0 1 1 0 0 1 1 0 0 1 1 0 0 1 1 0
1 0 0 1 1 0 0 1 1 0 0 1 1 0 0 1
1 0 0 1 1 0 0 1 1 0 0 1 1 0 0 1
0 1 1 0 0 1 1 0 0 1 1 0 0 1 1 0
```

Four variations of the double checkerboard start with one of the four bits shown in the upper left corner (first two bits, first two rows). The various patterns are designed to present worst-case noise and signal waveforms to the sense windings and amplifiers. External pattern generators may also be connected to the unit.

The tester is of modular construction. There is a timing and control section, a switching system that can cycle from address to address of a 128 by 128 core array in less than two microseconds, a difference amplifier, and a four-channel discriminator. The input to the difference amplifier is a response signal from the core plane and generates four positive and four negative signals that can be

Specifications

Timing and control	
Stepping frequency	340 cps to 2 Mc
Burst duration	3.5 μ sec to 3 μ sec
Test patterns	All 1's, all 0's Checkerboard, complement External, complement
Core plane size (address capacity) Up to 128 by 128	
Difference amplifier	
Bandpass	5 kv to 50 Mc
Common mode rejection	1 Mc > 1,000 30 Mc > 200 50 Mc > 100
Output rise time	≤ 8 nsec (input rise ≤ 2 nsec)
Signal delay	6.5 nsec
Gain nonlinearity	$\leq \pm 0.5\%$
Differential Input impedance	300 ohms, $\pm 0.1\%$
Four-channel discriminator	
Offset voltage	$\leq \pm 2 \mu$ v per mv common-mode voltage
Temperature coefficient	$\leq \pm 150 \mu$ v per degree C.
Input voltage range	0 to -1 volt
Input current	≤ 50 microamperes
Strobes—number	4
width	10 to 600 nsec
position	50 to 600 nsec from reference time

connected in any combination to the discriminator. An optional oscilloscope display and two external pattern generators for the equipment are available.

Digital Equipment Corp., Maynard, Mass. [381]

Plug-in power supply has wide voltage range



A plug-in power supply now available furnishes a regulated d-c output from 8 to 21 volts at 200 ma. Input voltage is 105 to 125 v a-c. Load regulation is $\pm 0.1\%$; line, ± 0.05 ; ripple, 1 mv. The voltage may be adjusted either by a built-in accessible internal potentiometer or by a remote potentiometer.

Case size is $3\frac{3}{8} \times 3\frac{1}{4} \times 4\frac{1}{2}$ in. Price is \$70. Shipment is 3 days after receipt of order. Acopian Corp., P.O. Box 585, Easton, Pa., 18043. [382]

Optical encoder has half-bit accuracy



Model 219 is an 8-bit, cyclic binary (Gray) code photoelectric shaft position encoder with $\frac{1}{2}$ -bit accuracy. It measures 3 in. high by 2.625 in.

SIGNAFLO

... aci systems
employing advanced
interconnection
expertise ...



Signals flow through "wiring that moves" in this retractile rack and panel aci Signaflo system of round wire to flat cable connections and memory coiled flat conductor cable



SIGNAFLO SYSTEMS

Send for literature

aci DIVISION OF
KENT CORPORATION

206 INDUSTRIAL CENTER, PRINCETON, N.J. 08540

Let the aci engineering staff and its unique problem solving capability design aci

SIGNAFLO

systems into your circuitry cabling . . . whether you require shielded or unshielded, fixed impedance, minimum cross talk, etc.

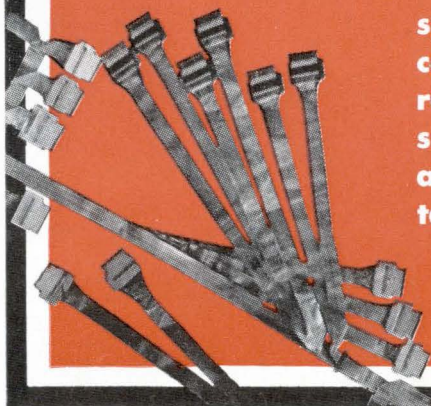

Signals flow by the millions through this multiple layered aci Signaflo system for computers. Narrow cable uses exclusive aci "spread pitch" development for connector compatibility.



Great editorial is something he takes to lunch

(What a climate for selling!)

Electronics

A McGraw-Hill Market-Directed Publication
330 West 42nd Street, New York, N.Y. 10036



New Subassemblies

in diameter, and weighs 14 oz. It has long-life, low-torque bearings with life expectancy in excess of 125×10^6 revolutions. Maximum slew rate is 5,000 rpm; moment of inertia, 30 gm-cm²; and maximum acceleration, 30,000 rad/sec².

A replaceable 5,000-hour nominal life lamp requiring $6.3 \pm 5\%$ d-c volts is used. Output for a logical "1" is $40 \pm 10\%$ millivolts, and logical "0" 8.0 millivolts maximum. Working temperature is from -40°F to $+131^\circ\text{F}$; storage temperature from -72°F to $+185^\circ\text{F}$. Rotation for increasing count is counter-clockwise as viewed from shaft end.

Price is \$279. Quantity discounts are available on request.

Baldwin Electronics, Inc., 1101 McAlmont St., Little Rock, Ark. [383]

Delay line memory module

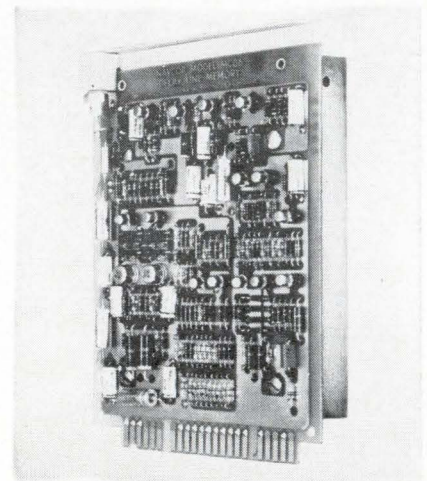

Model 06 delay line memory module is one of a complete new line of 1-Mc system logic modules now available in both germanium and silicon versions. It can be used to store up to 2,000 bits of information for 2 milliseconds. The information can be recirculated to increase the storage period, or, in the case of shorter records, can be recorded repetitively to decrease the access time. Delay lines of other lengths are also available on special order.

A flexible array of input gating is incorporated on the module, and readout is via standard flip-flop

outputs. Model 06 contains its own clamp supply to minimize circuit susceptibility to noise transients. A heavy ground plane on the module provides additional shielding for the delay line itself. Price is \$333; delivery from stock.

Navigation Computer Corp., Valley Forge Industrial Park, Norristown, Pa. [384]

Six-inch crt display with silicon IC logic

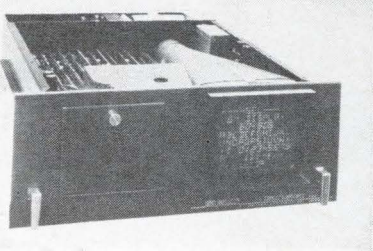

An inexpensive, general purpose six-inch crt display has all logic designed of silicon monolithic integrated circuits. Model 80-806 is a compact electrostatic display having many state-of-the-art advantages found only in more expensive units. Bright and easy to read, the crt is ideally suited for industrial and scientific uses that require alphanumeric display, small-screen monitoring for direct computer readout, data display for plotting, bar graph display, vector or dot display, remote monitoring and photo-recording display.

The unit is capable of an alphanumeric display of up to 512 characters. More than 3,800 dots or vectors can be displayed.

Features include P-31 phosphor tube, 0° to 55°C temperature operating range, accuracy of $\pm 1\%$ of full scale and a 60-cycle refresh rate for prevention of flicker. Crt shielding permits asynchronous operation with 60-cycle a-c line. The unit can be operated remotely up to 1,000 ft. from a refresh memory.

Designed to fit in a 24 by 19 by 7-in. rack mounting or the manufacturer's standard multiplexer case, the display includes all power supplies needed for complete operation.

Systems Engineering Laboratories, Inc., Box 9148, Fort Lauderdale, Fla., 33310. [385]

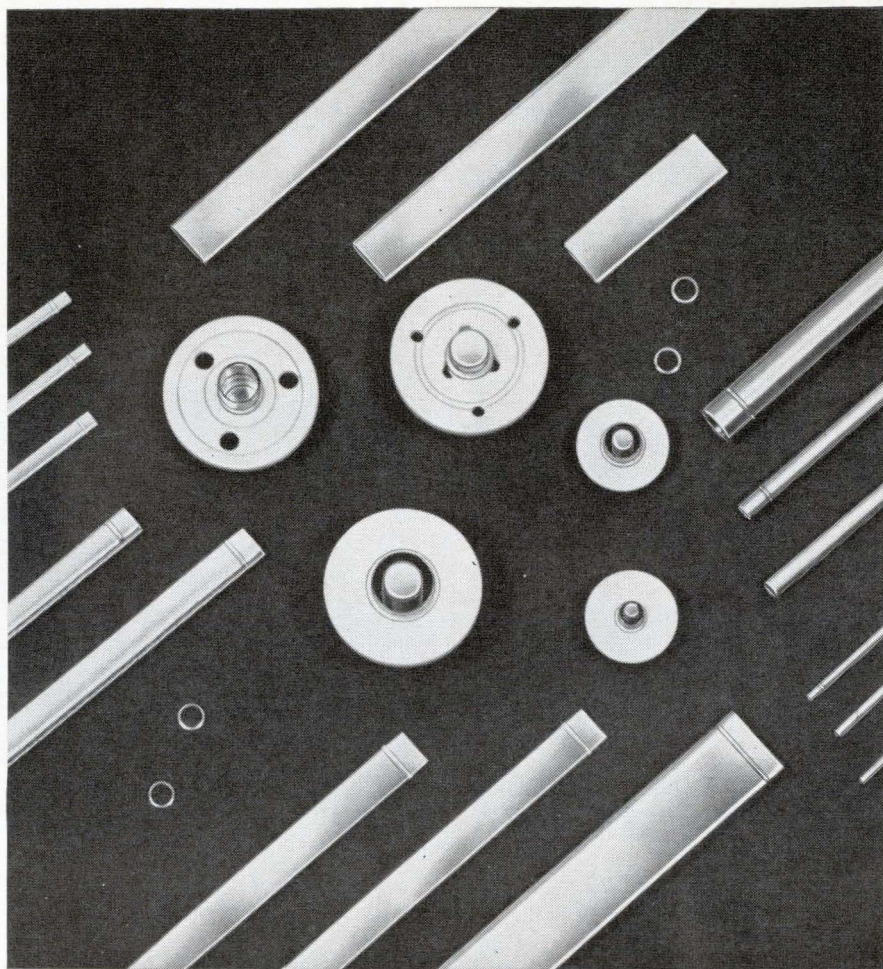

NEED CATHODES? WANT ON-TIME DELIVERY?

It's a reasonable request. And Superior gives you tangible assurances. First, every cathode we make is for our customers—none for ourselves. Second, we have two large, modern plants, located about 600 miles apart, with identical facilities to protect you against delays. And you can choose from the widest variety of cathode types and materials in the field. So why do you suppose we are the world's leading independent cathode supplier? Send for our Catalog 51. Dept. 2500.

Superior Tube 

The big name in small tubing

NORRISTOWN, PA. 19404

West Coast: Pacific Tube Company, Los Angeles, California

Johnson & Hoffman Mfg. Corp., Carle Place, N. Y.—an affiliated company making precision metal stampings and deep-drawn parts

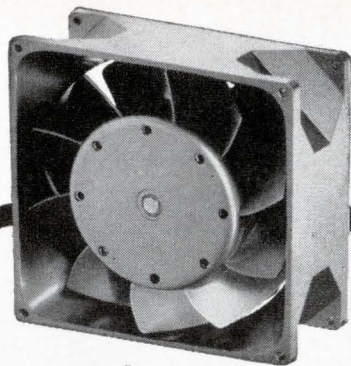

New
4 1/2"

**SHADED-POLE
Model 2500
PAMOTOR
Miniature
Axial Fans**

- 20,000 + operational hours at 45°C
- Low-cost design
- All metal construction
- Unexcelled performance and reliability
- Universal 4 1/2" mounting for interchangeability
- 50-60 cycles at 110 or 220 vac
- In stock for immediate delivery

Write for technical data on the Model 2500 and other PAMOTOR axial fans to:

PAMOTOR, INC.
312 SEVENTH STREET • SAN FRANCISCO, CALIF.

New Microwave

Customer can assemble flexible waveguide

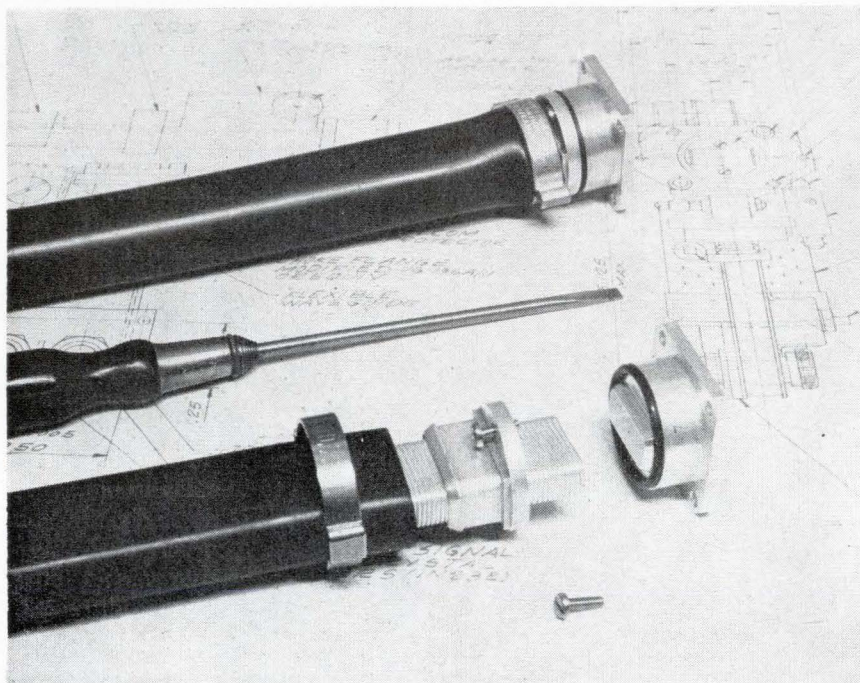

Designers of waveguide assemblies for microwave systems can now purchase lengths of flexible waveguide that can easily and quickly be cut and assembled to meet configuration needs.

Flexible waveguide sections in a microwave assembly are used where vibration or movement is expected, or to compensate for the fixed mechanical tolerances of rigid waveguide sections. Previously, engineers estimated the required length of the flexible section, ordered it from a manufacturer, and waited four or five weeks for delivery.

But now, Airtron, a division of Litton Industries, offers immediate delivery of flexible tubing and flanges that the customer can assemble. Called Airflex and designated type AFF by the company, the tubing is cut to the length required and the ends are flared. Each flange consists of two sections. The flared ends are inserted between the flange sections, which are fastened by two screws. No brazing or soldering is necessary.

Although the waveguide can be cut and assembled with ordinary

tools, Airtron offers a tool kit that makes assembly neat and efficient. The kit includes a heavy serrated blade and tools to flare the tubing.

An extruded neoprene rubber jacket is provided for applications where the flexible section must be pressurized. The jacket is slipped over a waveguide tubing and clamped. The waveguide can be pressurized up to 60 psig.

Although lengths of two or three feet are commonly needed, Airtron can provide tubing in any length from six inches to 10 feet. Each foot of Airflex can be stretched or compressed one-half inch.

Flexible waveguide for X band, which is designated size WR-90, is available. It can be bent to a radius of 1 3/8 in. in the E-plane and 2 1/4 in. in the H plane. Airtron expects to expand the line to include sizes for S, C and K bands within the next few months. Either military or EIA (Electronic Industries Association) types of flanges are available.

Airtron also provides twistable waveguide tubing, designated AFT, which is made of convolutely wound brass strips 5 mils thick—

like the flexible section—but with the seams of the convolution left unsoldered. AFT waveguide can be twisted 180° for each foot of length.

The company also offers the new flexible waveguide sections completely assembled. Cost of AFF and AFT, according to the company, is less than that for conventional flexible waveguide with molded jacketing and brazed flanges. Cost upon request. Delivery immediate.

Specifications

Frequency	8.2 to 12.4 gigacycles
Attenuation	0.08 decibel per foot
Vswr	1.10 maximum across full frequency range
	1.08 maximum across a 10% bandwidth
Peak power at 60 psig	1.2 megawatts
Temperature	-55° C to 125° C
Military specification	Mil-W-287C

Airtron, 200 East Hanover Ave., Morris Plains, N.J. [391]

X-band oscillator delivers 1-mw average

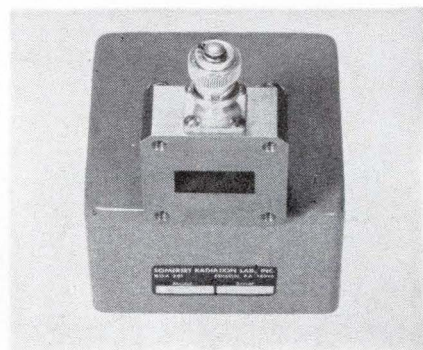

An X-band oscillator, model X920, features 1-mw (0 dbm) output at a center frequency tunable over a 100-Mc band in the 8.2-Gc to 9.6-Gc range. A silicon planar epitaxial transistor is operated in the oscillator-varactor-multiplier mode to drive a step-recovery diode multiplier with output in WR-90 waveguide.

The oscillator is ideal for production-line and bench-test equipment, system breadboards, antenna ranges, classroom demonstrations, portable X-band traffic beacons and similar applications where lightweight low-voltage power supply requirements, and low cost are prime factors. A novel application, as a calibrations laboratory trans-

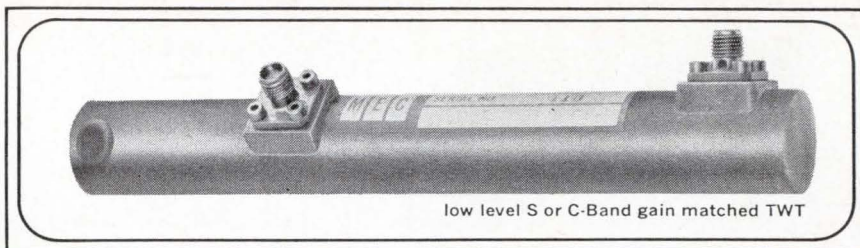

miniaturized twts for those who think small

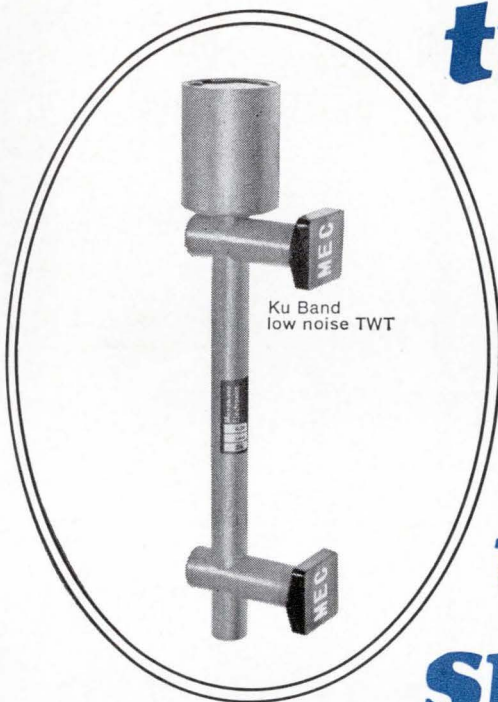

What is small? Merely $\frac{1}{3}$ to $\frac{1}{2}$ the size and weight of tubes built just a year ago.

Available? Yes, we're delivering miniature low-noise, low- and medium-power TWTs in quantity for military systems.

Why small? To anticipate urgent requirements for reduced size and weight in military, airborne and other applications where component density is critical.

But not small in performance. Noise figure, gain, power output and other performance characteristics are equal to or better than their bigger and heavier ancestors. And all MEC miniature tubes have PPM focusing, full magnetic shielding, military environmentalization and rugged metal-ceramic construction.

What's next? Contact MEC's representative in your area for details, or drop us a line in Palo Alto.

Exceptional opportunities on our technical staff for qualified scientists and engineers. An equal opportunity employer.



Microwave Electronics

3165 Porter Drive
Palo Alto, California

a division of Teledyne, Inc.

SOLID STATE LASER SYSTEM Model SSCW

- Frequency: 1.06 microns
- Power output: 500 milliwatts
- Power input: 1000 watts
- Total weight of head: less than two pounds

SEMI-ELEMENTS SPECIALS OF THE MONTH . . .

GOOD UNTIL MARCH 15, 1966

COHERENT LASER DIODE SELD-2 \$250.00

LASER DIODE SYSTEM LDS-2 \$975.00

Complete with coherent laser diode,
cryogenic dewar and heat sink

RUBY LASER CRYSTAL \$125.00

1/4" diameter by 2" long
Finished and coated ends

LARGE VARIETY SINGLE CRYSTALS AVAILABLE

LATEST IN SINGLE CRYSTALS . . .

- Lithium Niobate
- Potassium Tantalum Niobate
- Tantalum Pentoxide
- Barium Titanate
- Beryllium Oxide
- Spinel ($MgO \cdot AL_2O_3$)
(also $MgO \cdot 3AL_2O_3$)

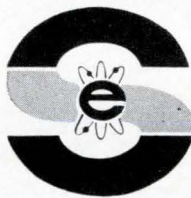

semi-elements, inc.

Saxonburg Blvd., Saxonburg, Pa. 16056
Phone: 412-352-1548

For literature write Dept. EL-1

Circle 212 on reader service card

PACKAGE INSURANCE

SKYDYNE sandwich construction TRANSPORTATION/OPERATING CASES

Simple insurance to make sure that your expensive equipment gets where it's going in operable condition. It's a good policy to use Skydyne sandwich cases for 100% protection of your equipment against shock...vibration...dust...water...and virtually every other environmental hazard that it might encounter.

Transit and combination cases to meet MIL-T-945, MIL-T-21200, MIL-T-4734 and MIL-T-4150 can be readily assembled to meet just about every equipment configuration from the hundreds of standard components available...and without special tooling charges.

Write for our 22 page Skydyne Design Manual for Mil. Spec. Cases.

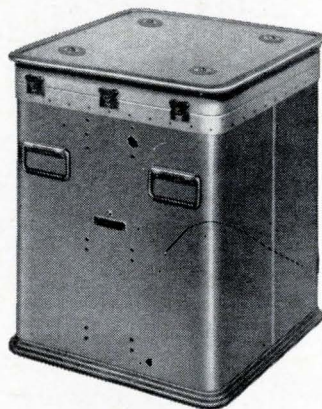

Skydyne, Inc.

RIVER ROAD, PORT JERVIS, N. Y.
Telephone (914) 856-5241

New Microwave

fer standard, would be a power reference level for checking the accuracy of microwave power meters and thermistor mounts. The price is \$195; availability, 20 days from receipt of order.

Somerset Radiation Laboratory, Inc.,
P.O. Box 201, Edison, Pa., 18919.
[392]

L-band circulators for high-power use

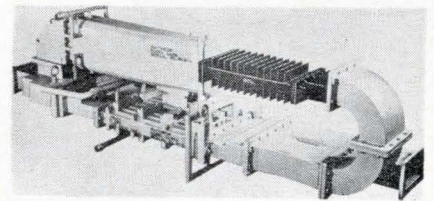

Two high-power, differential phase shift circulators have been introduced for L-band operation. Model CLH13 operates over the frequency range of 1.28 to 1.35 Gc. Peak power is 10 Mw. The average power, based on a 2:1 load mismatch, is 16 kw. Maximum vswr is 1.10.

The CLH14 operates between 1.29 and 1.31 Gc. With dummy loads connected to ports 3 and 4, a short circuit at port 2—the antenna port—will safely reflect 5-Mw peak and 9-kw average transmitter power into port 3. Maximum vswr is 1.10.

Both circulators have an isolation of 20 db minimum and a maximum insertion loss of 0.6 db. The 76-in. long CLH13 weighs 150 pounds. The CLH14 weighs 170 pounds and is 75 inches long.

Each of the units is fitted with WR-650 waveguides and mates with UG-418/U flanges.

Raytheon Co., Special Microwave Devices Operation, 130 Second Ave., Waltham, Mass., 02154. [393]

Fixed attenuator pads operate to 1.2 Gc

The model FP-75 line of precision 75-ohm fixed attenuator pads is designed for operation from d-c to 1.2 Gc. The company says they provide accurate attenuation never before

GLOBE

COMMERCIAL PLANETARY GEARMOTOR

to 200 lb./in. continuous duty to 600 lb./in. intermittent duty

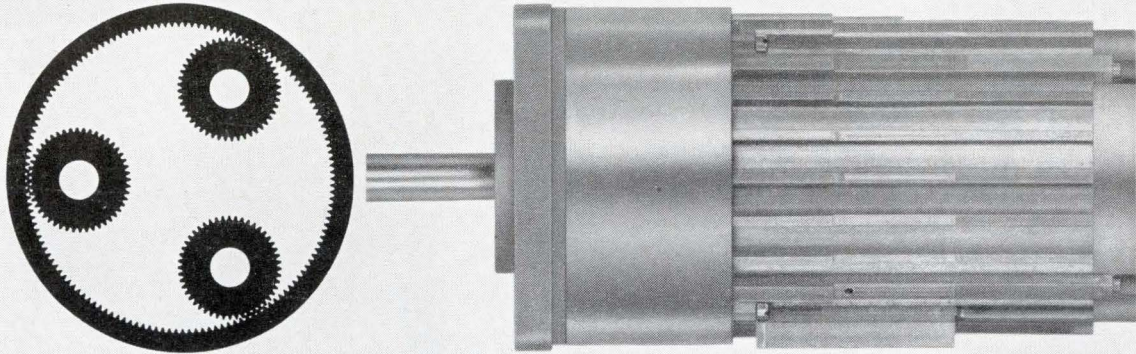

Now you can get 200 lb. in. of torque from a gearmotor only 3 1/2" dia. x 9" long. Globe's new Type CLC commercial planetary gearmotors are ideal for your most demanding high-torque applications. Designed for long reliable service, Type CLC gearmotors give you highest torque at lowest dollar cost. Call 513 222-3741 for application assistance. VOLTAGE: 115 or 230 v.a.c.

FREQUENCY. 50 or 60 cps.

PHASE: 1 or 3.

OUTPUT SPEED: 17 standard speeds from 1 to 300 rpm. Custom units also available. For information, request Bulletin CLC.

Globe Industries, Inc.

2275 Stanley Ave., Dayton, Ohio 45404, U.S.A. Tel.: 513 222-3741.

Circle 213 on reader service card

DRAMATIC REDUCTION

formerly 77" h. x 33" w. x 33" d.

now only

29" h x 17" w x 17" d

(5 KW Audio Power Amplifier)

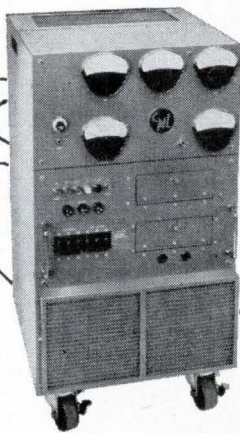

All other models similarly reduced... (but in size only!) For instance, 10 KW Model, formerly 78" h. x 78" w. x 36" d., now only 48" h. x 34" w. x 24" d. CML Audio Power Amplifiers produce tremendous power in the smallest packages. Wide frequency range. Low distortion. Ideal for CW and pulsed operation,

acoustic testing, vibration testing, plasma tubes, ion propulsion engines. Perfect for marine installations. All units with wide range of output impedance taps. Air-cooled and vapor-cooled units. Full power available into low power factor loads. Call or write today for details.

CML, Inc.

A subsidiary of Tenney Engineering, Inc.
350 Leland Avenue • Plainfield, New Jersey
(201) 754-5502 • TWX: 201-756-2064



Circle 214 on reader service card

FORK CONTACTS

Radiused Mating Surfaces Provide Smoother Positive Mating. Assure Repeated Low Resistance Contact. Available in Bulk Or In Permanent Dielectric. Connectors Available With 15 to 47 Contacts. All Popular Termination Styles.

IMMEDIATE DELIVERY

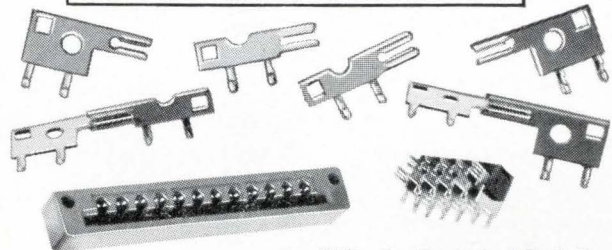

Write For Technical Bulletin



Methode Electronics, Inc.

7447 W. Wilson Ave. • Chicago, Illinois 60656

Underhill 7-9600

Licensed under Elco patents.

Circle 177 on reader service card

177



MAGNETICALLY SHIELD YOUR COMPONENT IN SECONDS
 Versatile Netic and Co-Netic Foils cut to any size or outline with ordinary scissors—wrap easily

High attenuation to weight ratio possibilities; can dramatically enhance component performance. The shields stop degradation from unpredictable magnetic fields. When grounded, they also shield electrostatically. Co-Netic and Netic shielding foils are not significantly affected by dropping, vibration or shock, and do not require periodic annealing. Foils are available in thicknesses from .002" in rolls 4", 15", and 19-3/8" wide. Extensively used in experimental evaluation and production line operations for military, commercial and industrial applications.

MAGNETIC SHIELD DIVISION
 Perfection Mica Company
 1322 N. ELSTON AVENUE, CHICAGO 22, ILLINOIS
 ORIGINATORS OF PERMANENTLY EFFECTIVE NETIC CO-NETIC MAGNETIC SHIELDING

Circle 215 on reader service card



IMPORTANT DIGITAL CLOCK APPLICATIONS

- 1 Data Loggers
- 2 Data Transmission Systems
- 3 Time Displays
- 4 Telemetry Systems
- 5 Computer Systems
- 6 Digital Printout Systems

In eight years of actual field operation, Chrono-Log Digital Clocks have proved their accuracy and reliability for . . .

- REAL-TIME
- ELAPSED TIME
- COUNTDOWN OPERATIONS

Solid-state and electro-mechanical models . . . both at low prices. Get all the details. Write for technical literature . . . or telephone

(215) EL 6-6771

CHRONO-LOG CORP.
 2583 W. CHESTER PIKE, BROOMALL, PA.

14:25:56 - 14:25:59 - 14:26:02 - 14:26:05 - 14:26:08 - 14:26:11

Reprint order form

Send to: **Electronics Reprint Dept.**
 330 West 42nd Street
 New York, N. Y. 10036

For listing of reprints available see the reader service card.

To help expedite mailing of your reprints please send cash, check or money order with your order.

For reprints of the latest special report:

U. S. Electronics Markets 1966

Send me . . . reprints of key no R-85 at 50¢ each.

For reprints of previous special reports fill in below:

Send me . . . reprints of key no.(s) . . . at . . . ¢ each.

For prices see the reader service card.

Name

Number & Street

City, State

Zip code

New Microwave

available at a 75-ohm impedance level.

The higher frequency performance is not only an asset for operating above 300 Mc, but a result is superior accuracy specifications at lower frequencies.

The FP-75 fixed pads are available at standard attenuation values of 1 db, 2 db, 3 db, 6 db, 10 db, and 20 db with attenuation accuracies of better than ±0.3 db to 500 Mc and ±0.5 db to 1 Gc. Each pad is calibrated at two frequencies, 30 Mc and 1 Gc, with the calibration recorded on the body of the attenuator. This provides convenient, easily read calibration data. The vswr of these units is held to less than 1.2:1 to 500 Mc and 1.3:1 to 1 Gc.

The fixed pads are available with BNC or TNC, male or female connectors. They are tubular in construction, measure approximately 2 in. by 1/2 in. in diameter, and weigh about 1 oz. They are priced at \$12.50 each in small quantities with delivery from stock. Texscan Corp., 51 South Kowebe Lane, Indianapolis, Ind. [394]

Stripline-type triode oscillator

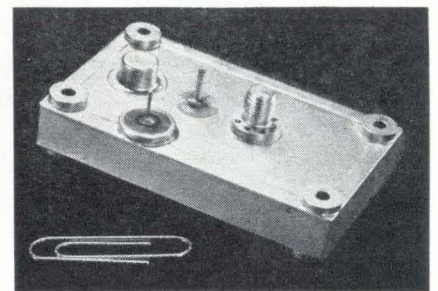

Model GSJ-1001 stripline triode oscillator is a new concept in oscillator design which offers conventional triode-oscillator electrical characteristics with the added advantage of a simple, small-size, lightweight, rugged package. Grid pulsed power is in excess of 0.8 kw at a frequency of 2.25 Gc. Volume is 1.5 cu in. excluding projections, and weight is 3 oz. Terra Corp., 505 Wyoming Blvd. N.E., Albuquerque, N.M., 87112. [395]

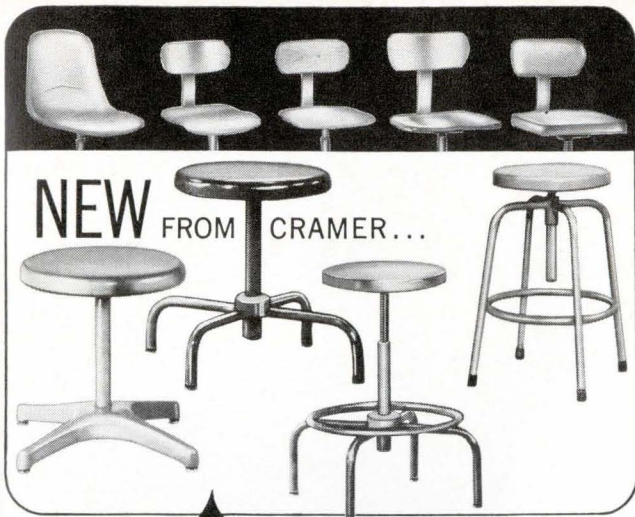

NEW FROM CRAMER...

CRAMER LIFT-LOK Stools

adjust to every worker like fine tools!

Because Cramer Lift-Lok is infinitely adjustable! Just lift the seat and stop at the most comfortable height. It takes less time than to read this sentence. Since fatigue is a critical factor in efficiency of seated workers, it makes good sense to provide tools that minimize fatigue. With Lift-Lok every worker can seek exactly his own efficient level. Available in four base types, steel, wood or plastic seats, contoured or flat, adjustable or flexible backs. To find out about the stools that qualify as production tools, write:
V.P. Sales, Cramer, 625 Adams, Kansas City, Kan. 66105.

Industrial supplier inquiries invited.

CRAMER

CRAMER INDUSTRIES INC. • KANSAS CITY, KANSAS

Fine seating—safety ladders—stands and related products for office, industry and institutions.

Circle 217 on reader service card



give...so more will live

HEART FUND



\$295
GAS LASER

(\$295?)

Right. Here's the world's only gas laser under \$300. Another important first for Optics Technology. We've been able to design a precision laser which we can produce for only \$295. It's our Model 170 AC Continuous Gas Laser.

Rounding out our complete line of quality lasers and laser products, the Model 170 offers:

- Adjustment-free, reliable operation
- A plasma tube with built-in reflectors
- No Brewster windows, or optics, to collect dust or get damaged
- Operation directly from the AC line by means of a built-in transformer, no other power supply involved
- Power over .3 milliwatts in TEM₀₀ mode, guaranteed
- Beam divergence less than .4 milliradians

We see great potential for the Model 170 as a basic tool in optics: for example, as an aid in aligning your apparatus. We'll be glad to send complete data. Just write \$295 Laser on a postcard (with your name and address) and mail it to:

OPTICS TECHNOLOGY INC



901 California Avenue, Palo Alto, Calif.
327-6600 (Area Code 415)

In Europe, contact
Optics Technology Instruments,
Ghent, Belgium



Great editorial is something he takes home

(What a climate for selling!)

Electronics 

A McGraw-Hill Market-Directed Publication
330 West 42nd Street, New York, N.Y. 10036

New Production Equipment

IC's control board driller

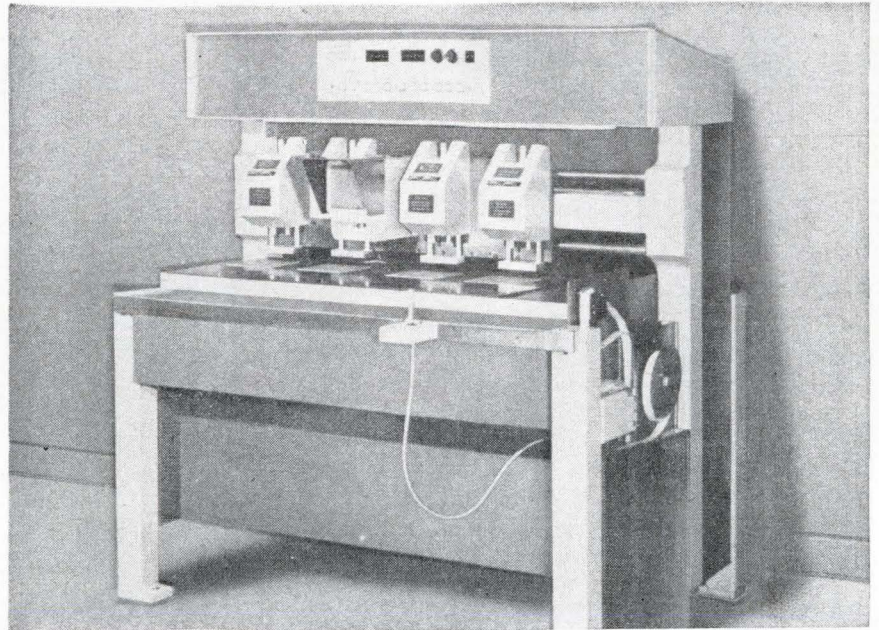

The controller of a new printed-circuit-board driller is made of monolithic integrated circuits—probably the first use of IC's in commercially available electronics production equipment.

The Model 105, numerically controlled, will automatically drill 50 or more holes per minute when programmed with punched tape, which it can prepare with an optical programmer.

According to the Machine Control Corp., the monolithic circuits makes the controller small, highly reliable and easy to maintain. All the circuitry is on eight plug-in cards, two of which are interchangeable. The controller measures 7 by 14 by 24 inches and weighs 50 pounds—about half that of previous controllers. The controls are mounted at eye level and interlocked to prevent operator error.

As in most numerically controlled drillers, the boards are placed on a table that moves in the X and Y directions to bring the hole locations under drill heads that move up and down in the Z direction. These motions can be commanded by tape or manually. The depth and drilling rate are also controllable. Depth precision is 0.01 inch.

The operator prepares tapes with the optical programmer. The drills follow the hole pattern in a photographic transparency of the hole pattern. At each hole location, the coordinates of the location are punched into the tape.

Four boards can be drilled simultaneously, with hole location repeatable to 0.0002 inch. This means that the drilled hole in the fourth board will be within 0.0006 inch of the position in the first board. Each of the four drilling stations has two drill heads, so that drills can be changed while the machine operates.

Specifications

Drill motors	1/3 horsepower, 35,000 rpm
Runout	0.0002 inch maximum
Resolution	0.001 inch
Price	\$45,000
Delivery	60 days

Machine Control Corp., 4112 Del Rey Avenue, Venice, Calif. 90292 [401]

Ultrasonic degreaser for bench mounting

The Gibson Girl MSVR-1 ultrasonic degreaser is designed to operate either with chlorinated or fluorinated solvents, changing from one to the other with the flick of a

VERSATILE WORK HORSE Ultrasonic Spectrum Analyzer

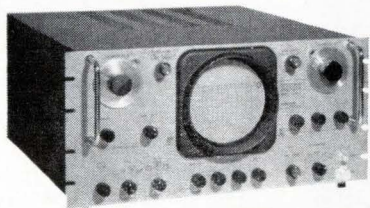

The LCA-1 ultrasonic spectrum analyzer monitors signals and presents a spectral display of the 50 cps to 600 Kc range. Excessive harmonic content, intermodulation distortion, Loran C checkout, vibration analysis, medical research studies, multiplex voice and teletype monitoring are some of its many uses.

EXCLUSIVE FEATURES INCLUDE:

Input Zo — balanced input 55K or unbalanced
Amplitude Scale — Linear, 40 dB, 60 dB, 2.5 dB on screen calibration.

Power In — 105-125 VAC, 47 to 430 cps, no line volt. regulator required.

OTHER FEATURES:

Freq. Markers — 10 Kc and 100 Kc plus harmonic Xtal marks every 10 Kc.

Scanning Rate — 30 sec — 60 cps

Sweep Width — 1 Kc to 200 Kc.

Resolution — 50 cps to 4 Kc.

Full Scale Volt. Range — 200 uv to 200 V.

PROBESCOPE

516-GE 3-8120
211 ROBBINS LANE
SYOSSET, L. I., NEW YORK

Circle 219 on reader service card

It's new from IMC



How fast do you need a step servo motor?

1 millisecond fast; day after tomorrow fast? That's what's new from IMC—The first factory stocked broad line of step-servo motors. 18 models including a unit capable of one thousand pulse per second operation—bi-directionally. And all for day after tomorrow delivery. Sizes from 5 to 20. Running torque up to 8 oz. in. Step angles of 15 and 90 degrees. And proven capability on programs such as Polarix, Surveyor, Mariner and LEM. Included in the stock program are units designed for business machine and commercial applications.

Call your nearest IMC Engineering Representative or use the coupon for IMC's latest literature which will include our line of stock step-servo motor electronic controllers. Better still, test us with a fast order!

Check IMC also for: Precision Solenoids—factory stocked!

ENGINEERING REPRESENTATIVES FOR IMC STEP SERVO MOTORS
(Not to mention solenoids,

synchros and resolvers, DC synchro indicators)

Albuquerque: J. F. Quirk & Assoc., 256-0884

Dallas: Hillman Enterprises, Inc., LA 1-2070

Georgetown, Tex.: Hillman Enterprises, Inc., UN 3-3780

Los Altos, Calif.: Richard Strassner Co., 948-334

Portland: Shaffer & Nelson, Inc., 234-7437

Salt Lake City: Oscar Salme & Assoc., Inc., AM 2-2349

Seattle: Shaffer & Nelson, Inc., MU 2-0186

Tempe: IMC Magnetics Corp., Ariz. Div., 967-7851

Chicago: Berndt & Klein Assoc., SP 5-3488

Dayton: Bek Assoc., Inc., CR 8-1343

Kansas City: Design & Sales Eng. Co., GR 1-1640

Minneapolis: D. A. Schultz Co., FE 9-7701

St. Louis: Design & Sales Eng. Co., PA 1-6403

Atlanta: Bill Henry Assoc., 255-0920

Charlotte, N. C.: Bill Henry Assoc., 375-8958

Sarasota: Bill Henry Assoc., 955-4637

Binghamton, N.Y.: Engineering Components, RA 3-4197

New Haven: Edcom, Inc., MA 4-7291

Newtonville, Mass.: Edcom, Inc., WO 9-9710

Ottawa, Ontario: M. J. Howard Co., Ltd., PA 8-2991

Philadelphia: Burgin-Kreh Assoc., Inc., OR 7-1646

Syracuse, N.Y.: Engineering Components, HE 7-8181

Towson, Md.: Burgin-Kreh Assoc., Inc., VA 5-3212

Westwood, N. J.: Clarfield-Stollmack Assoc., 666-8989

Manufactured by IMC Western Div., 6058 Walker Ave., Maywood, Calif. 90270. Tel. (213) LU 3-4785, TWX 213-773-5307.



IMC Magnetics Corporation
Marketing Division: 570 Main Street
Westbury, New York 11591. Telephone:
(516) 334-7070. TWX (516) 333-3319

Send my Step Servo Motor Catalog, fast

Send a Rep, faster

And/or tell me about _____

Name _____

Title or dept. _____

Company _____

Address _____

City _____

State _____

Zip Code _____

WORLD'S LARGEST ELECTRONIC KIT CATALOG...FREE!

- Laboratory & Test Instruments
- Malmstadt-Enke Laboratory Educational & Research Instrumentation
- Radio-TV Repair Instruments
- World's Largest Selection Of Amateur Radio Equipment
- Citizens Band Radio Equipment
- Color And Black & White TV
- Stereo Hi-Fi Equipment
- Electronic Organs
- Marine Electronics
- Instrumentation For Biology & Physiology



Heath Company, Dept. 67-2

Benton Harbor, Michigan 49023

Please send FREE 1966 Heathkit Catalog.

Name _____

(Please Print)

Address _____

City _____

State _____

Zip _____

CL-234

Circle 220 on reader service card

Circle 181 on reader service card

181

TRYLON ROTATABLE LOG PERIODIC ANTENNA

Single-layer, horizontally polarized,
for 6.5 to 32 mc. 65° azimuth beamwidth.
6 db gain/std. dipole. Power to 50 kw PEP.



**"One cannot continually disappoint a Continent."
We have designed, constructed, and installed
antenna and tower systems in North America,
South America, Europe, Asia, Africa, Antarctica.
We wish someone from Australia would call us.**

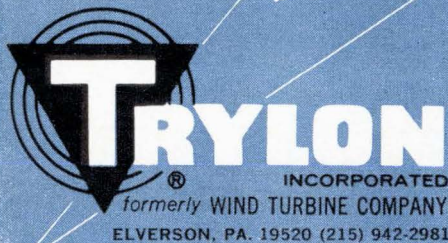

Circle 221 on reader service card

**ENGRAVE
EVERYTHING
FROM
6 FT. PANELS
TO TINY
NAMEPLATES**

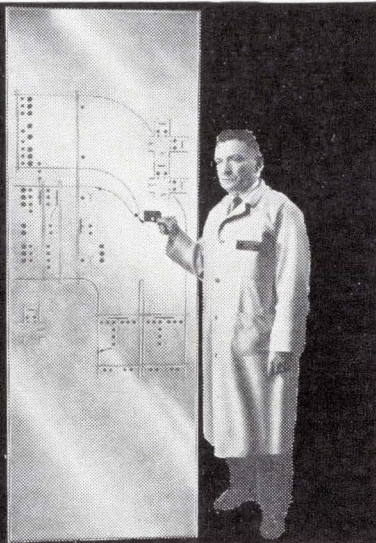

**Tracer-guided arm guides the worker—
makes everyone a skilled engraver.**

Convenient—It's right in the plant when and where you need it.

Accurate—Positive depth of cut with automatic depth regulator. 15 accurate ratios.

Speedy—Self-centering work holder cuts set-up time in half.

Ask for complete, illustrated catalog EE-14

new hermes engraving machine corp.

154 WEST 14TH ST., NEW YORK 11, N. Y. Chicago, Atlanta, Dallas, Los Angeles, Montreal

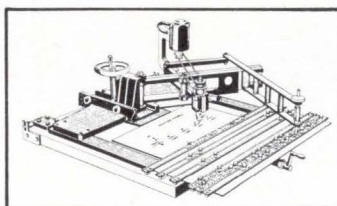

Production Equipment

selector switch. Ful-Wall cooling is provided to minimize the loss of solvent. The dual heating system changes the heat density as well as the temperature setting necessary for each type of solvent.

The Gibson Girl degreaser is designed for bench mounting, and the generator and the control station are remotely located. A model is available for easy transporting, and the generator fits snugly into the Ful-Wall cooling jacket for packing and carrying.

The MSG 90 generator operates at 40 kc, the most effective cleaning frequency for small precision components and assemblies, and has automatic sonic control providing the most even cavitation pattern, and high cleaning efficiency.

Units are available from stock to one week.

Multisonic Corp., 1100 Shames Drive, Westbury, L.I., N. Y. [402]

Crimping press cuts wiring cost

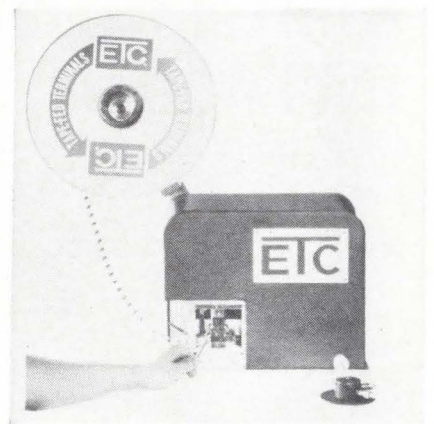

An air-operated crimping press now on the market lowers installed wiring cost by automatically feeding up to 1,500 tape-mounted solderless terminals an hour. Tape automatically positions and loads the terminal barrel in crimping dies, and holds each terminal securely for hazardless, fool-proof wire insertion.

Changed in seconds, dies crimp any of 5 terminal tongue types and

5 barrel styles for termination 22-10 Awg solid or stranded wire. Quick-disconnects for 0.250 in. and 0.187 in. male tabs are taped for 18-12 Awg wire ranges.

The bench press, weighing 28 pounds, can be moved easily and operated anywhere on standard 90 psi shop pressure.

Up to 1,000 terminals are mounted on each reel-wound tape belt. The press sets up in less than a minute—no special preparation is necessary. Tape and reel are disposable.

ETC Inc., 990 E. 67th St., Cleveland, Ohio, 44103. [403]

Spray etchers feature rotating work rack

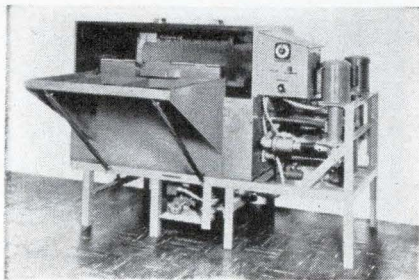

Rotational spray etchers produce a fast, uniform, precise etch without patterning for chemical machining of metal parts and printed-circuit production.

A rotating work rack insures a 360° movement of each small area being etched through the spray of several nozzles. Fixed spray heads spray straight down on the work piece at a 90° angle, reducing undercutting. There is no puddling of the etchant because of the constant movement of the work rack.

The resulting etch is faster and more precise than conventional etches, with better resolution and no patterning, says the manufacturer. Speed of the rotary motion is controlled by a variable speed motor.

The new etchers have heavy wall polyvinyl chloride etching chambers of dovetailed, cemented and welded construction. The etchers also have metal parts of titanium or stainless steel, corrosion-free pumps, an electric timer with automatic reset for repeat runs, and a built-in loading and rinse station. Seelye Plastic-Fab, Inc., 9812 James Circle So., Minneapolis, Minn. [404]



loci

...shortest
distance
between
problem &
solution

LOCI-2 (Wang Laboratories' LOGarithmic Computing Instrument) is the most powerful desk-top computer you can obtain. At its keyboard you can expand your horizons, multiply your problem-solving capabilities and penetrate straight to the answer.

Because of its revolutionary logarithmic approach to data manipulation, LOCI-2 provides an inherent, absolutely unique flexibility and simplicity of operation. For example, it can compute $\ln(x)$ or e^x in only two keystrokes.

LOCI-2 can be readily programmed for a broad variety of complex routines, by means of pre-scored, easily-punched cards. Thus, with the appropriate card inserted in the reader, you can instantly compute and display $\sin(x)$ or $\cos(x)$ with a single keystroke. An extensive library of programs (statistical, general mathematical, etc.) is furnished free of charge to LOCI-2 purchasers.

And, best of all, LOCI-2 is always at your command. No standing in line for computer time, no complicated operating procedures, simply drop in your program card, enter variables, press RUN key and see your results immediately.

LOCI-2 prices range from \$2750 to \$8450. If you would like to learn more about this remarkable instrument, write for complete descriptive literature.

WANG

LABORATORIES INC

DEPT. N-2, 836 NORTH ST., TEWKSBURY, MASS. 01876, TEL. (617) 851-7311

MULTIPLE CHANNEL TEAR-SEAL

Zippertubing®

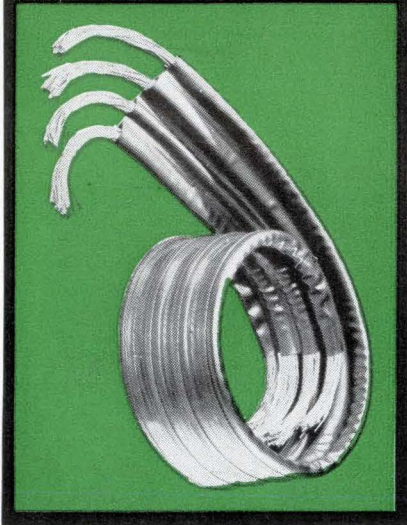

PRODUCE CUSTOM CABLES WITH STANDARD PRODUCTION TECHNIQUES

No T's, Y's, forks or fingers, no special boots, no special techniques are required when you use Multiple Channel Tear-Seal Zippertubing®. Two, three and four-channel construction is standard — additional channels are available on special order as is a cross-over feature. Unique Z-Trac closure permits easy access for modifications or repairs. If desirable, track can be permanently sealed.

Like to know more about Multiple Channel Tear-Seal Zippertubing®? Write or call:

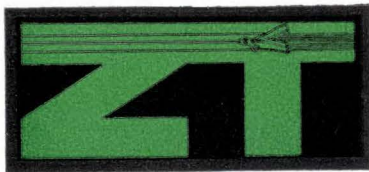

THE Zippertubing® CO.

Main Office and Plant:
13000 S. Broadway, Los Angeles 61, Cal. • FA 1-3901
Eastern Office and Warehouse:
480 U. S. Hwy. 46, S. Hackensack, N. J. • HU 7-6261

New Materials

Fine-grain alumina casting ceramic

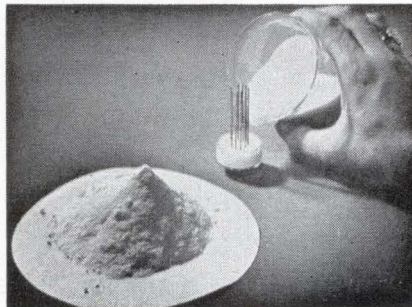

Ceramacast 505 is a 96% fine-grain alumina casting ceramic with use temperatures as high as 1,600°C. It is a hydraulic setting material requiring no heat to set. The material combines good dielectric strength with high thermal conductivity and low thermal expansion rate (1.4×10^{-7} in./in./°F), thus offering excellent thermal shock resistance. Since the material shrinks only 0.2% volumetrically after curing, it offers many applications as an encapsulant, coating or cement. Furthermore, Ceramacast resists oils, solvents, and all acids except hydrofluoric.

Applications for Ceramacast 505 include encapsulation of electronic components such as resistors, end-seal material for thermocouples, high-temperature furnace coatings, and potting material for r-f heating coils.

The material is available in powder form. Research quantities are offered at \$25 per quart container, with delivery from stock. Aremco Products, Inc., P.O. Box 145, Briarcliff Manor, N.Y., 10510 [406]

Thermoplastic cures without heat, pressure

A crystal-clear, thermoplastic, methyl methacrylate, called Klearmount, requires no heat or pressure for curing. Its applications include embedments, encapsulations, preparation of models, potting, coating, specimen mounting, casting, sealing and duplicating. It bonds to

plexiglass with no visible parting lines. Klearmount is crystal-clear in its cured state and is rigid and tough, with high impact strength. It is said to have unusual resistance to effects of exposure, sunlight, heat and weathering. Vernon-Benshoff Co., Inc., P.O. Box 350, Albany, N.Y., 12201. [407]

Fluorescent coating for p-c boards

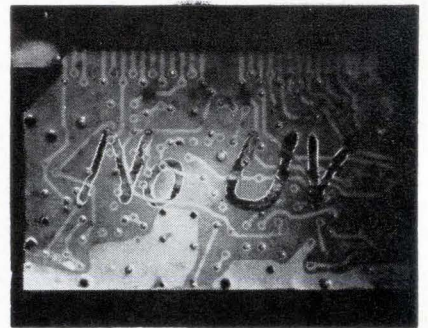

Eccocoat T264F is a two-part, thixotropic epoxy coating designed particularly for printed circuit boards. In daylight it is transparent and water white; under ultraviolet light it fluoresces a bright yellow green. Inspection under UV highlights surfaces that have not been coated, thus providing a simple and rapid means for quality control.

The coating is a solventless system, so that any porosity in the laid-down film is eliminated. Its adhesion to plastics, ceramics, glass, metals and wood is excellent. Because it is thixotropic, it holds well on sharp corners to give a rounded edge. At room temperature, its useful pot life is 5 to 6 hours. It can be applied by brush, dip or spray.

Typical properties of cured film (10 mils thick) are: Shore D hardness, 80; flexibility, unaffected by 1/8-in. bend; dielectric strength, above 300 volts/mil; volume resistivity, 10^{12} ohm-cm; dielectric constant (60 to 10^{10} cps), approximately 3.0; dissipation factor (60 to 10^{10} cps), less than 0.02.

Eccocoat T264F is available in 2-lb kits, 1-gallon cans, and 5-gallon pails. Price is \$2 to \$2.25 per lb. Emerson & Cuming, Inc., Canton, Mass. [408]

LEADING TEXTILE COMPANY
ANNOUNCES DEVELOPMENT OF
Disposable Dust Cloths*

*NON-WOVEN FABRIC

UNIFORMLY TREATED-HIGH CAPACITY
PLUS A HIGHLY EFFICIENT BACTERIOSTATIC AGENT

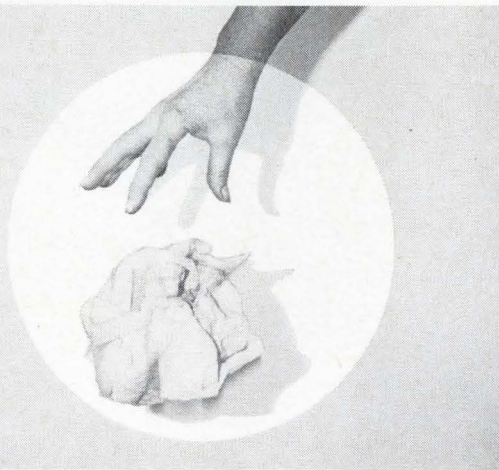

FOR SAMPLES AND INFORMATION

Chicopee Mills, Inc.

1450 BROADWAY, N. Y. 10018

Circle 222 on reader service card

YOUR
**SHORTEST
ROUTE**



to what's new in
Semiconductor Coolers
**WAKEFIELD DISTRIBUTOR
PRODUCTS CATALOG**

The latest designs in Heat Sinks are as near as your nearby authorized WAKEFIELD Electronic Distributor. His name is in our catalog along with the full line he stocks: milliwatt to high power coolers, circuit board coolers, extrusions, thermal joint compound, DELTA BOND 152 Thermally Conductive Adhesive.



NC-680-1.0

FOR YOUR COPY, WRITE

**WAKEFIELD
ENGINEERING, INC.**



139 FOUNDRY ST. / WAKEFIELD, MASS. (617) 245-5900 • TWX 617-245-9213

Circle 223 on reader service card

testing integrated circuits?

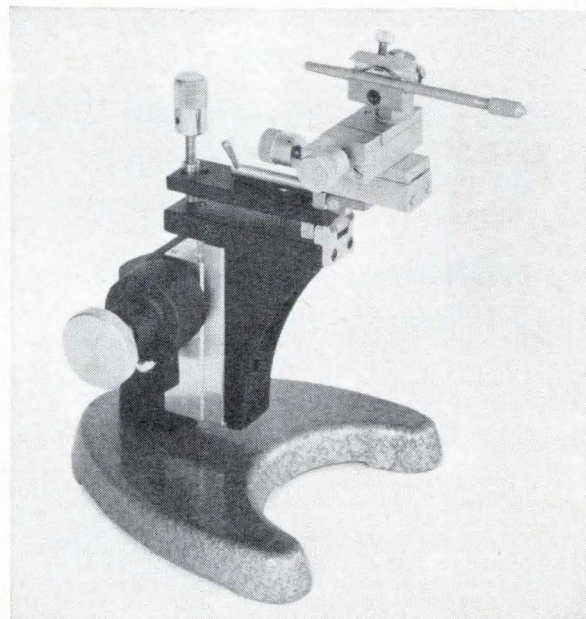

We now offer 40 different micro manipulators for single or multiple test stations—in various designs and with various sensitivities.

**BRINKMANN
INSTRUMENTS**
CANTIAGUE ROAD, WESTBURY, N. Y. 11590/ED 4-7500

Circle 185 on reader service card

NEW ZELTEX AMPLIFIER WITH FETS!

- New, Smaller Package
- Lower Cost
- Improved Performance

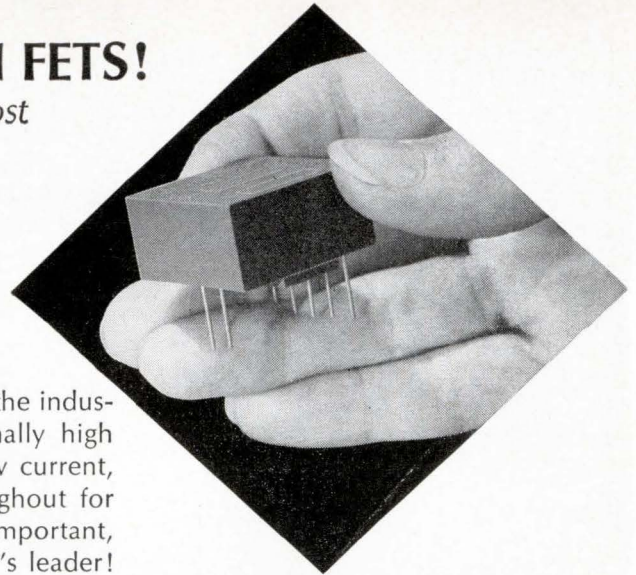

More FET amplifier news from Zeltex—true economy with the industry's most outstanding performance! Featuring exceptionally high differential and common mode input impedance with low current, this new Zeltex amplifier utilizes silicon transistors throughout for utmost reliability. Where performance, cost and size are important, the Model 132 offers the industry's best from the industry's leader!



ZELTEX, INC.

1000 Chalamar Road, Concord, California
Phone: (415) 686-6660

The broadest spectrum of Amplifiers
and Computer Elements

Check these key specifications:

Input Current: 100 picoamp
Voltage Gain: 100,000
Voltage Drift: 20 μ volt/ $^{\circ}$ C
Input Impedance: 10,000 meg
Slew Rate: 10 v/ μ sec

Model 132 Differential Operational Amplifier with Field Effect Transistors...

Also available in a 0.4 in. high enclosure, this remarkable new Zeltex FET Amplifier is available virtually from stock. For complete information, write or phone today.

Circle 224 on reader service card

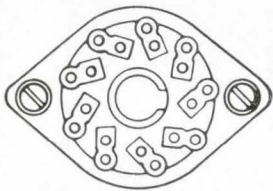

**YOU CAN
REDRAW THIS
DETAIL IN
2 HOURS OR...**

**do it with Stanpat in 60 seconds and
spend 1 hour 59 minutes creatively!**

Engineers and draftsmen should use their time creatively. Let STANPAT prepare any symbol, diagram, spec, detail, title block, or any other drawing that appears in your tracings repetitively. Simply apply the STANPAT in seconds directly to your drawing. It will be accurate . . . permanent . . . perfectly reproducible . . . and you will gain more creative time!

Drawing-board time should be used for creative problem-solving . . . not for repeated and re-repeated rendering of often-used elements. STANPAT changes draftsmen from drawing-machines to creative assets. It's like adding another draftsman to your staff! You save checking time, too.

But it has to be STANPAT if you want STANPAT's advantages: pre-printing on finest tri-acetate; crisp, clean reproduction even with microfilm, matte surface that thrives on erasures; no ghosting problems.

Send for literature and samples today.

*faithfully serving the engineer
for over two decades*



STANPAT PRODUCTS INC.

Covert and Main St., Dept. J2
Port Washington, N.Y. 11050
Telephone: 516 883-8400

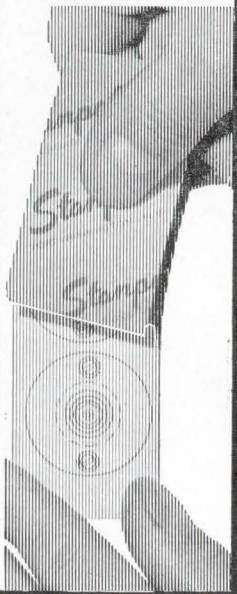

DELAYS

FROM 10 TO  10,000 μ S

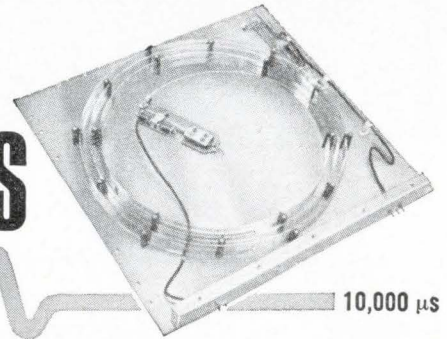

delttime
**MAGNETOSTRICTIVE
DELAY LINES**

Delttime, with over a decade of experience in precision magnetostriuctive delay line technology, offers models to fill virtually every delay requirement. Complete input-output circuit modules for carrier and RZ or NRZ digital systems . . . torsional, longitudinal, tapped and adjustable models as well as high vibration and shock withstanding delay lines for airborne applications are included in the standard line.

If your application requires a signal delay or extremely economical delay line memory element, contact us, our application engineers are at your service . . . or write for our complete technical catalog.



SUB-SYSTEMS DIVISION
**SEAELECTRO
CORPORATION**

HOYT STREET • MAMARONECK • NEW YORK
PHONE 914 698-5600 TWX: 710-566-1110

Sealectro Ltd., Portsmouth, Hants, England

New Books

Tube design

Power Travelling-Wave Tubes
J.F. Gittins
American Elsevier Publishing Co.
276 pp., \$10

Not since J. R. Pierce's classic work "Traveling Wave Tubes," published in 1950, has a book dealt exclusively with these high-power devices. Nearly all aspects of traveling-wave tubes are discussed, including slow-wave circuits, electron beams and guns, collectors, windows, severers (intentional breaks in the circuit) and attenuators, construction techniques and measurements. However, klystron-twt hybrid tubes, which are certainly power traveling-wave tubes, are not discussed. This is a major omission.

The book addresses itself to the engineer designing traveling-wave tubes. Although there is much of interest to power-tube users as well, major topics related to application such as phase characteristics, amplitude-to-phase conversion and intermodulation are not covered.

The theoretical treatment begins with an analysis of an artificial model of the traveling-wave, based on interaction at successive klystron-like gaps. The a-c beam currents and circuit voltages at the successive gaps are calculated; with these calculations the author shows through vector diagrams the relationships between current and voltage in a variety of circumstances. This analysis, although not well suited for practical calculations, illustrates many fundamental concepts of traveling-wave interaction.

The rest of the theoretical material is based upon Pierce's small-signal theory. The notation essentially conforms to that of Pierce—a major convenience, since the majority of twt literature uses this notation.

Throughout the book the emphasis is on concept and principle, not on details. Neither sample design calculations nor analysis of any specific tube design is given. However, this approach is acceptable since such calculations often

make tedious reading and rarely applies to a new design problem. With its numerous references, the book is a good guide to significant technical literature on traveling-wave tubes since the early 1950's.

The organization is quite logical and reading is easy. There is a fair amount of mathematics, but the demands on the reader are modest.

A problem the author faced was in deciding what knowledge to assume on the reader's part. He decided, he says in the preface, to assume the reader is familiar with other types of vacuum tubes, but had no knowledge of traveling-wave tubes. Yet, the concept of space-charge wavelength is introduced without a word of explanation, and it is highly unlikely that anyone who is familiar with this concept is not familiar with twt's.

The author says the magnetic field required to confine a hollow beam to a specific radius is the same as that required to confine a solid beam of the same current. This is true only if potential depression due to space charge is negligible. In high-perveance hollow beams, the required magnetic field increases as the beam is made thinner.

The author also says that there is no condition in a hollow beam which corresponds to Brillouin flow, that is, uniform axial velocity. Such a condition, which reduces to Brillouin flow as the inner beam radius is reduced to zero is described by Samuel in the Proceedings of the Institute of Radio Engineers, November, 1949, p. 1252.

In discussing slow-wave structures, it is also implied that gains of about 40 decibels are the maximum attainable without multiple severers. However helix circuit tubes with stable gains of 60 db or more have been built with single severers.

In the discussion of window electron discharges, the author suggests that an r-f electric field applied normal to the window is necessary to draw electrons back to the window surface. D-c charging of window surfaces can also provide the restoring force, and vigorous multipactor discharges

can take place on windows where the electric field is purely tangential to the window and does not vary along the waveguide, as is the case with a half-wave window. In the United States, at least, windows have been coated primarily to reduce secondary emission rather than to provide charge drainage.

In the section on tube techniques, no mention is made of the precautions required in handling metal stock to avoid problems due to defects in the metal known as "pipes." Also, the text implies that sprayed colloidal carbon is the usual way of making film attenuators on ceramic rods. Pyrolytic deposition of carbon films is commonly used today.

The discussion of demountable techniques displays a preference for O-ring seals. However bakeable metal gasket seals are far more satisfactory.

These criticisms are not major. The book is a worthwhile addition to the literature.

Philip M. Lally
Sperry Rand Corp.
Gainesville, Fla.

Recently published

Space Charge Conduction in Solids,
R.H. Tredgold, American Elsevier Publishing
Co., 143 pp., \$10

Basic Tables in Electrical Engineering,
G.A. Korn, McGraw-Hill Book Co.,
370 pp., \$3.95

Electron Optics, P. Grivet, Pergamon Press,
Inc., 781 pp., \$30

Video Tape Recording, Cris H. Schaefer,
Cedric L. Suzman & Associates, Hobbs,
Dorman & Co., 104 pp., \$12

Air Force Research Resumes 1964, Vol. 5,
Office of Aerospace Research, U.S.
Air Force, 558 pp.

Electromechanical Energy Conversion,
A.J. Ellison, Reinhold Publishing Corp.,
200 pp., \$8

Introduction to Semiconductor Phenomena
and Devices, Lloyd P. Hunter, Addison-Wesley
Publishing Co., 218 pp., \$8.95

Space Communications Techniques, R.F.
Filipowsky, E.I. Muehldorf, Prentice-Hall, Inc.,
333 pp., \$11.95

International Series of Monographs in
Electromagnetic Waves, Vol. 1
Electromagnetic Diffraction and Propagation
Problems, V.A. Fock, Pergamon Press Inc.,
414 pp., \$25

Non-Linear Transformations of Stochastic
Processes, edited by P.I. Kuznetsov, R.L.
Stratonovich, V.I. Tikhonov, Pergamon Press
Inc., 484 pp., \$20



Model 71A
Capacitance/Inductance Meter

**Instant readings
of capacitance and
inductance at
1 Mc/s... with
an accurate
DC analog of
the measured
value**

- Measures 3-terminal capacitance from 0 to 1000 pF; basic accuracy, 1%; resolution, 0.01 pF
- Measures 2-terminal inductance from 0 to 1000 μ H; basic accuracy, 1%; resolution, 0.01 μ H
- Ideal for semiconductors
 - DC bias to ± 200 V
 - 1 Mc/s crystal controlled test frequency
 - 15 mV test level
- Accommodates both high and low Q devices
- DC analog output; linearity, 0.1%

The Model 71A provides Continuous Measurement of C and L with the speed and convenience of a VTVM. DC analog output is capable of at least 4-digit resolution with appropriate DVM; permits rapid plots of such functions as capacitance vs. voltage of varactor diodes or linearity of variable capacitors on scope or X-Y plotter. Also useful for automatic go/no-go testing, sorting, batching, or matching.

Price: \$735.00

Full technical details on request.

**BOONTON
ELECTRONICS**
CORPORATION

ROUTE 287 AT SMITH RD., PARSIPPANY, N. J.
TELEPHONE: 201-887-5110 TWX: 510-235-6747

Technical Abstracts

Physics of failure

Minuteman 2, physics of failure program

Capt. J.F. Wiesner
Air Force Ballistic Systems Division

Failure mechanisms associated with thermocompression bonds in integrated circuits

G.V. Browning, L.E. Colteryahn and D.G. Cummings

Failure mechanisms associated with thermally induced mechanical stress in Minuteman devices

C.G. Jennings

Properties of plastic materials and how they relate to device failure mechanisms

S.M. Lee, J.J. Licari and A. Valles

Investigation of surface failure mechanisms in semiconductor devices by envelope ambient studies

G.V. Brandewie, P.H. Eisenberg and R.A. Meyer

Imperfections and impurities in silicon associated with device surface failure mechanisms

J.E. Forrester, R.E. Harris, J.E. Meinhard and R.D. Nolder

Failure mechanisms associated with die-to-header bonds of planar transistors

J.D. Guttenplan and F.H. Stuckenborg

Design and process contribution to inherent failure mechanisms of microminiature electronic components for Minuteman 2

A.J. Borofsky and D.C. Fleming

All authors, with the exception of Wiesner, are with the Autonetics division of North American Aviation, Inc., Anaheim, Calif.

The Air Force's Minuteman missile programs have been prime movers in the improvement of design and reliability of electronic components. Many of the improvements in discrete components resulting from the original Minuteman program have already been applied to components used in other types of equipment.

Now, the Air Force is sponsoring a more advanced program—called the Component Quality Assurance Program—to upgrade the integrated circuits and other devices for the new Minuteman 2 system. In this program, a physics of failure approach to reliability improvement is being added to the life testing, process controls and failure analysis techniques employed in the previous program. The objective of the physics of failure approach is to uncover and define the physical mechanisms which cause component degradation or failure so that corrective action

can be taken in component design and processing.

The series of papers listed above are a preliminary report on the program, explaining its organization, goals, procedures and results to date. Among the highlights of the reports:

- Discovery of a new failure mode in semiconductor lead bonds, the interdiffusion of gold and aluminum. This subject was also reported at the Western Electronics Show and Convention [Electronics, Aug. 23, 1965, p. 46].

- Development of techniques to measure and identify stresses caused in semiconductor devices by manufacturing and test procedures. Although thermally induced stress may not cause device failure, that stress coupled with other stresses will cause device failure.

- Analysis of the plastics used to encapsulate components. For example, ammonia was found in a phenolic encapsulant for diodes; the ammonia made the diode's reverse current erratic. In another case, resistor values rose above specification limits because of moisture passing through the plastic, setting up an electrolytic cell that corroded the resistor wire.

- Methods of analyzing gases within the sealed cases of semiconductor devices. Chemicals that corroded aluminum interconnections, such as chlorine, were found in the supposedly inert atmosphere.

Scores of proven or suspected failure causes are identified in the papers, along with many corrective processes. Equally important, since many solutions have not yet been found, are the ways in which the failure detectives are employing electron microscopy, infrared spectroscopy and other highly precise investigative methods to seek failure mechanisms and contaminants.

Presented at the Fourth Annual Symposium on the Physics of Failures in Electronics, Rome Air Development Center and IIT Research Institute, Chicago, Nov. 16-18.

Guiding star

Sensor problems in space and interplanetary navigation
Hans D. Heyck
Aircraft Armaments Inc.
Cockeysville, Md.

Space missions near earth are controlled by networks of ground radar and radio command stations. But

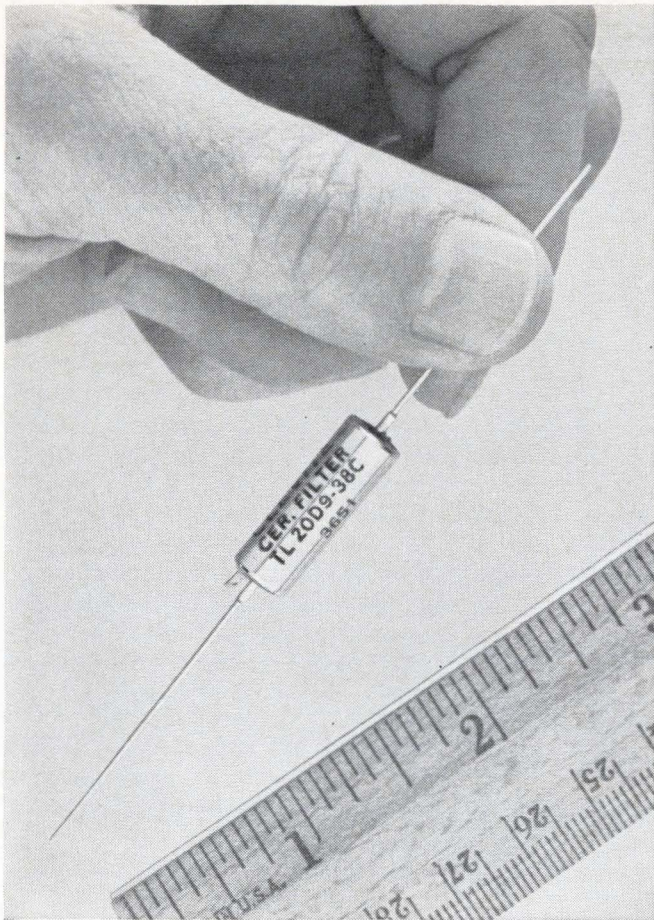

Just Out!

Compact Ladder Filter from Clevite

Good Selectivity at a Practical Price

Take a close look at the newest member of Clevite's family of i-f filters. This 9-disc ceramic miniature is a rugged, light-weight device (MIL 202B) that offers excellent selectivity and stability in less than .07 cu. in. It's perfect for transistorized i-f amplifier circuitry plus many other applications requiring a fixed-tuned filter element. Stop band rejection is 50 db, center frequency tolerance is ± 3 kc. Stability: within $\pm 0.2\%$ for 5 years; within 0.2% from -40°C to $+85^{\circ}\text{C}$. Impedance (in and out) @ 27°C : 10 kc B/W 2000 ohms, 16 kc B/W and above 1000 ohms.

Following models standard (custom models on special order):

Model Number	B/W @ 27°C	
	min. @ 6db	max. @ 60db
TL10D9-20A	10 kc	20 kc
TL16D9-32A	16 kc	32 kc
TL20D9-38A	20 kc	38 kc
TL30D9-57A	30 kc	57 kc
TL40D9-72A	40 kc	72 kc

*PRICES: 1 to 24—\$25 ea; 25 to 99—\$20 ea; 100 to 499—\$17.50 ea; 500 to 1999—\$15 ea; 2000 to 4999—\$12.50 ea.

Send order or request for Bulletin 94021 to: Clevite Corporation, Piezoelectric Div., 232 Forbes Rd., Bedford, Ohio 44014.

*Prices subject to change without notice.

CLEVITE

Circle 226 on reader service card

What happens when you insulate with HYGRADE SLEEVING?

No cracking, no corrosion, no wicking, no dielectric breakdown . . . nothing! It just sits there . . . preventing trouble the way it's supposed to. In fact, you can forget it! Isn't that what you want in insulating sleeving? Just tell us where you plan to use it, under what conditions. We'll recommend the right material. You can take our word for it . . . because we've been insulation specialists for 44 years.



HYGRADE

INSULATING SLEEVINGS

Markel HYGRADE Sleeveings are constructed of carefully braided fiberglass yarn, impregnated and coated with specially formulated varnishes, vinyls, resins, or silicone rubber compounds. A wide range of types, grades and sizes meet virtually every conceivable requirement for dielectric and mechanical strength under all kinds of operating conditions . . . at continuous temperatures from -70°F to 1200°F . We'll be glad to send you specifications and Sample File on the entire HYGRADE Sleeveings line. Just write. No charge or obligation.

L. FRANK MARKEL & SONS

Norristown, Pa.

215-272-8960

INSULATING TUBINGS & SLEEVINGS • HIGH TEMPERATURE WIRE & CABLE

Circle 189 on reader service card

189

To order reprints

from Electronics

fill in, cut out

coupon below,

insert in envelope

and mail to:

Electronics Reprint
Dept.

330 West 42nd Street

New York, N. Y. 10036

Reprint order form

For listing of reprints available see
the reader service card

To help expedite mailing of your
reprints please send cash, check
or money order with your order.

For reprints of the latest
Special report:

U.S. Electronics
Markets 1966

Send me reprints of key
no. R-85 at 50¢ each.

For reprints of previous special
reports fill in below:

Send me reprints of key no.(s)
. at ¢ each.

For prices see the reader service
card.

Name

Number & Street

City, State

Zip Code

Technical Abstracts

deep-space probes do their own navigating, and like the ancient mariners, must look to the stars to guide them.

Successful space travel requires extremely precise information on a vehicle's trajectory. Six degrees of freedom must be known and controlled:

- Angular acceleration, velocity and position (or altitude) must be found in three axes: pitch, roll and yaw.

- Linear acceleration, velocity, and position also must be known in three axes: fore and aft, up and down, and left and right.

The Mariner spacecrafts, in the Venus and Mars fly-by missions, used the sun and one of the brightest stars, Canopus, as direction references. The difficulties Mariner 4 had in finding Canopus, and staying locked on, indicated the need for improved sensors.

Typical accuracies of sensors today are: direction 0.001° to 0.01°; attitude 0.1° to 0.5°; acceleration 0.001 G to 0.01 G; velocity 10 feet per second to 100 feet per second; position 1.0 to 10 miles.

The shortcoming of today's sensors and proposed equipment which may help are described.

Twelfth Annual East Coast Conference on
Aerospace and Navigation Electronics,
Baltimore, Md., Oct. 27-29.

Voltage-tapered twt's

Efficiency improvement of traveling wave tubes by step velocity and voltage tapering

O. Sauseng and W. Hant
Microwave Tube Division
Hughes Aircraft Co., Los Angeles, Calif.

The efficiency of traveling-wave tubes can be improved 50% by using velocity or voltage tapering. These corrective measures maintain synchronism between the slow space-charge-wave velocity of the beam and the phase velocity of the radio frequency wave in the tube. Velocity tapering has been used previously, but voltage tapering is a new technique. Efficiencies ranging from 37% to 56% have been measured on a tube that under standard conditions has a corresponding efficiency of only 26% to 40%. A one-dimensional, large-

signal model of the twt was used for a computer analysis of the velocity and voltage schemes.

In a conventional twt, the kinetic energy of the electron beam is converted to radio-frequency power by the interaction between the electrons and the r-f field that occurs in resonant cavities located along the tube. Under large-signal conditions, the loss in kinetic energy slows down the beam velocity. This results in a loss of synchronism, which causes the tube to saturate. To maintain synchronism, either the beam must be reaccelerated or the phase velocity of the r-f wave must be decreased.

In velocity tapering, the phase velocity of the r-f wave is reduced at the output end of the tube by decreasing the period of the coupled cavity circuit. Two abrupt changes in the period reduced the phase velocity to nearly 50% of its original value. The efficiency was 37%, as compared with an efficiency of 26% for the untapered tube.

In voltage tapering, the electron beam is reaccelerated at the output section of the tube by providing an abrupt change in voltage level. A 50% increase in the voltage produced a velocity change that was 20% of the original beam velocity.

In depressed collector operation, in which the collector voltage is reduced below the beam acceleration voltage to produce enhanced beam bunching, the efficiency with the velocity taper was 50%; with the voltage taper, 56%. This compares with 40% efficiency obtained with an untapered circuit.

The computer predicted and experiments verified that efficiency was improved when the circuit voltage was lowered considerably below the voltage for maximum small-signal gain. This had been unexpected, because the efficiency of conventional twt's reaches an optimum when the circuit voltage is increased above the voltage for maximum small-signal gain. In small-signal theory, this unusual result corresponds to a very strong coupling of the circuit wave to the fast space-charge wave of the beam, rather than the slow space-charge wave.

Presented at the International Electron
Devices Meeting, Washington, Oct. 20-22.

QUALIFICATION FORM FOR POSITIONS AVAILABLE

ATTENTION: ENGINEERS, SCIENTISTS, PHYSICISTS

This Qualification Form is designed to help you advance in the electronics industry. It is unique and compact. Designed with the assistance of professional personnel management, it isolates specific experience in electronics and deals only in essential background information. The advertisers listed here are seeking professional experience. Fill in the Qualification Form below.

STRICTLY CONFIDENTIAL: Your Qualification form will be handled as "Strictly Confidential" by Electronics. Our processing system is such that your form will be forwarded within 24 hours to the proper executives in the companies you select. You will be contacted at your home by the interested companies.

WHAT TO DO. (1.) Review the positions in the advertisements. (2.) Select those for which you qualify. (3.) Notice the key numbers. (4.) Circle the corresponding key number below the Qualification Form. (5.) Fill out the form completely. *Please print clearly.* (6.) Mail to: Classified Advtg. Div., Electronics, Box 12, N. Y. 10036.

COMPANY	PAGE #	KEY #
ATOMIC ENERGY OF CANADA LTD. Ontario, Canada	192	1
ATOMIC PERSONNEL INC. Phila., Pa.	192	2
BAUSCH & LOMB Rochester, N. Y.	191	3
BOOZ-ALLEN APPLIED RESEARCH INC. Chicago, Illinois	184*	4

ELDORADO ELECTRONICS Concord, Calif.	192	5
ELECTRONIC COMMUNICATIONS INC. St. Petersburg, Fla.	192	6
GENERAL TELEPHONE & ELECTRONICS LAB Bayside, New York	183*	7
LOCKHEED-CALIFORNIA CO. Burbank, Calif.	161*	8
SPACE GENERAL CORP. El. Monte, Calif.	191	9
TRW SYSTEMS Redondo Beach, Calif.	130	10

* These advertisements appeared in the January 24th issue.

PERSONAL BACKGROUND

Name
 Home Address
 City Zone..... State.....
 Home Telephone

EDUCATION

Professional Degree(s)
 Major(s)
 University
 Date(s)

FIELDS OF EXPERIENCE (Please Check) 1/24/66

- | | |
|---|---|
| <input type="checkbox"/> Aerospace | <input type="checkbox"/> Medicine |
| <input type="checkbox"/> Antennas | <input type="checkbox"/> Microwave |
| <input type="checkbox"/> ASW | <input type="checkbox"/> Navigation |
| <input type="checkbox"/> Circuits | <input type="checkbox"/> Operation Research |
| <input type="checkbox"/> Communications | <input type="checkbox"/> Optics |

- | | |
|--|---------------------------------------|
| <input type="checkbox"/> Components | <input type="checkbox"/> Packaging |
| <input type="checkbox"/> Computers | <input type="checkbox"/> Radar |
| <input type="checkbox"/> ECM | <input type="checkbox"/> Radio-TV |
| <input type="checkbox"/> Electron Tubes | <input type="checkbox"/> Simulators |
| <input type="checkbox"/> Engineering Writing | <input type="checkbox"/> Solid State |
| <input type="checkbox"/> Fire Control | <input type="checkbox"/> Telemetry |
| <input type="checkbox"/> Human Factors | <input type="checkbox"/> Transformers |
| <input type="checkbox"/> Infrared | <input type="checkbox"/> Other |
| <input type="checkbox"/> Instrumentation | <input type="checkbox"/> |

CATEGORY OF SPECIALIZATION

Please Indicate number of months experience on proper lines.

	Technical Experience (Months)	Supervisory Experience (Months)
RESEARCH (pure, fundamental, basic)
RESEARCH (Applied)
SYSTEMS (New Concepts)
DEVELOPMENT (Model)
DESIGN (Products)
MANUFACTURING (Product)
FIELD (Service)
SALES (Proposals & Products)

CIRCLE KEY NUMBERS OF ABOVE COMPANIES' POSITIONS THAT INTEREST YOU 1 2 3 4 5 6 7 8 9 10

SPACE
GENERAL TIRE
GENERAL

IN EL MONTE, CALIF.

(Suburban Los Angeles)

Has Immediate Requirements For

INSTRUMENTATION DESIGN ENGINEERS

To participate in R & D programs involving design of scientific instruments for unmanned space probes and/or vehicles. BS in Engineering or Physics and recent design development experience in one or more of the following instrumentation areas: biological, nuclear radiation measurement, magnetometers, and geophysical sensors.

RELIABILITY ENGINEERS

Will function in electronic systems reliability with emphasis on hardware and component applications. Requires BS in engineering plus 2 or more years experience.

MICROWAVE ENGINEERS

BSEE or Physics plus five or more years experience in microwave systems and component design. Project function for development and design of radiometric hardware. Millimeter circuit design experience and background in circuit troubleshooting desirable.

Please Submit Resume in confidence to W. K. MURRAY

SPACE-GENERAL CORPORATION

(Subsidiary of Aerojet-General Corp.)

9200 E. Falir Dr. El Monte, Calif.

We are an equal opportunity employer and welcome minority applicant response.

Bausch & Lomb has openings for

ELECTRONIC ENGINEERS

B.S. or M.S. with one to five years experience in the design of analog and digital circuits and systems. Good theoretical background in math, physics and network analyses desirable. Experience in control systems and low signal level circuit techniques helpful. Projects involve development of sophisticated instruments in bio-medical, chemical, optical and electronic fields at the applied research stage.

Please send resume in confidence, including salary requirements to: E. J. Walter, Employment Specialist, Bausch & Lomb, 620 St. Paul St., Rochester, N.Y. 14602.

BAUSCH & LOMB 

An Equal Opportunity Employer

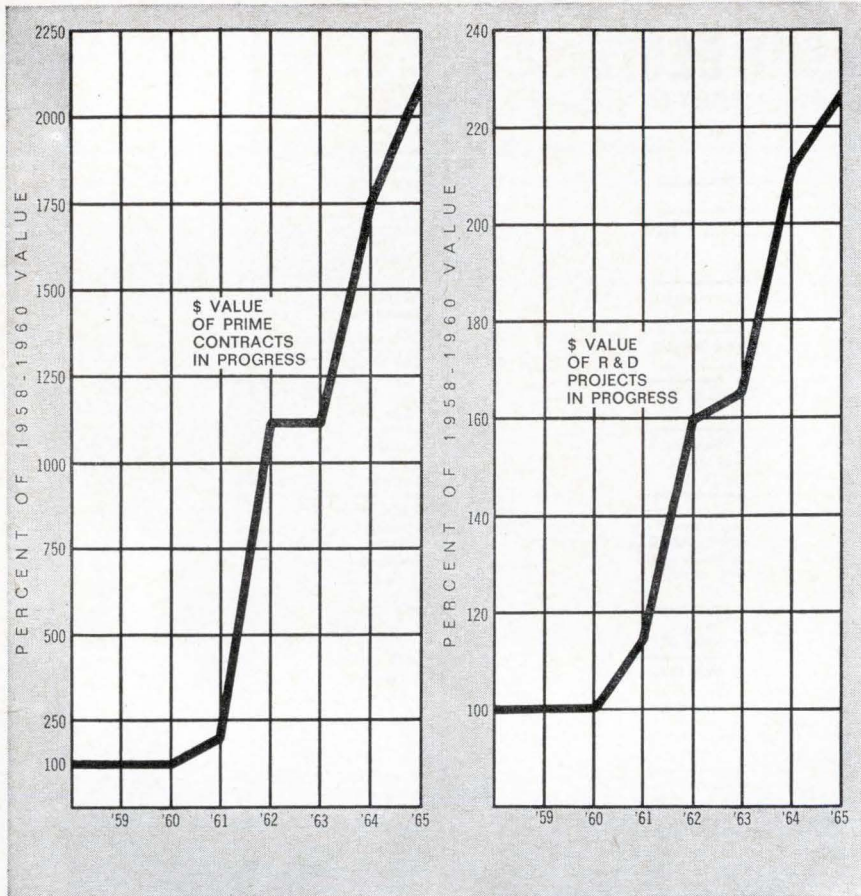

2 REASONS WHY THERE'S MORE ENGINEERING OPPORTUNITY AT ECI

Where there's engineering excitement there's engineering opportunity. Two key indicators — prime contracts in progress and R&D work in progress — prove that exciting things are happening at Electronic Communications, Inc. ECI has generated these remarkable activity increases by building a solid, successful reputation in airborne systems, multiplexing, space instrumentation and other areas of military and aerospace communication. You can get aboard this upward trend immediately if you are qualified in:

RF ENGINEERING — aggressive new programs are now under way in the design and development of microminiature transmitters and receivers. Positions require at least a BS degree, with a minimum of three years experience, and sound knowledge of transmitter and/or receiver design theory.

SPACE INSTRUMENTATION PROJECT ENGINEERING — you'll need in-depth technical ability, plus six years experience in data handling, control or analog instrumentation.

THIN-FILM CIRCUIT DESIGN — involving theory and application of thermodynamics, mechanics of materials and electronic component design in the development of microelectronic circuitry. BS or MS in EE or physics required.

SYSTEMS INTEGRATION — you must be thoroughly grounded in aircraft electrical systems and be familiar with interface problems involved in installation of airborne communications equipment. Prior systems integration or field installation experience is most desirable.

If you are qualified, send your resume, in confidence, to Duane Meyer, ECI, Box 12248E, St. Petersburg, Fla., or call him collect at (813) 347-1121. (An equal opportunity employer.)

ELECTRONIC COMMUNICATIONS, INC.

ST. PETERSBURG, FLORIDA



ELECTRICAL ENGINEERS

in the field of
RADIO FREQUENCY POWER

Graduate Engineers with Masters Degree or one to five years experience in the design of high power radio frequency power supplies are required for work at the Chalk River Nuclear Laboratories.

Duties entail the design of radio frequency power chains, ranging from 400 kW at 40.68 Mc/s to 2.5 MW at frequencies up to 50 Mc/s. These power chains will be used for experimental studies associated with cavity resonators to accelerate a proton beam.

Salary will be commensurate with qualifications and experience.

For further information please reply in writing giving full particulars to:

FILE 1 A

ATOMIC ENERGY OF CANADA LIMITED
Chalk River, Ontario

SENIOR ELECTRONIC ENGINEERS

Design and project responsibility for high performance digital commercial instruments. Strong background in design/analysis a solid state circuits, switching theory, and/or circuits desired. BSEE or Physics. Salary open. Contact D. Condon.

ELDORADO ELECTRONICS

601 Chalmar Road
Concord, Calif. 94520
(415) 686-4200

An Equal Opportunity Employer



E.E.'S WRITE US FIRST FOR FEE-PAID positions

Use our confidential application for professional, individualized service. A complete national technical employment agency. We're "Experienced Engineers Working Full Time... For You."

ATOMIC PERSONNEL, INC.
Suite L, 1518 Walnut St., Phila., Pa.

ADDRESS BOX NO. REPLIES TO: Box No. Classified Adv. Div. of this publication. Send to office nearest you.
NEW YORK, N. Y. 10036: P. O. Box 12
CHICAGO, Ill. 60611: 645 N. Michigan Ave.
SAN FRANCISCO, Cal. 94111: 255 California St.

POSITIONS VACANT

Electronics Technology Teacher: Formal training and current industrial experience in electronics. Send application to Dr. Charles W. Meister, President, Eastern New Mexico University, Portales, New Mexico.

Design Engineer—BSME or BSEE degree or equivalent experience in electro-mechanical design of relays, circuit breakers or switches. Excellent opportunity for growth and reward in forward-moving Southern New Hampshire manufacturing organization. P-8464, Electronics.

PROFESSIONAL SERVICES

GIBBS & HILL, Inc.
Consulting Engineers

Systems Engineering
Operations Research • Development
Field Studies • Design • Procurement
Power • Transportation • Communications
Water Supply • Waste Treatment
393 Seventh Avenue New York 1, N. Y.

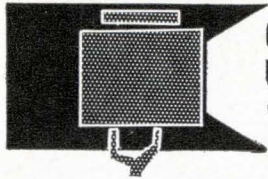

SEARCHLIGHT SECTION

• CLASSIFIED ADVERTISING • BUSINESS OPPORTUNITIES
• USED OR SURPLUS EQUIPMENT

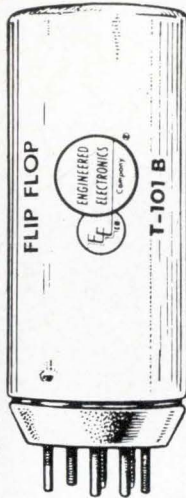

Transistorized Packaged Circuits

T-101B Flip Flop...	8.15
T-102A Flip Flop...	6.75
T-103 Flip Flop...	6.40
T-104 Multivibrator...	7.25
T-105A One-Shot...	6.65
T-106 Squaring Amplifier...	5.80
TM-106* Squaring Amplifier...	6.80
T-108 Amplifier...	9.40
T-109 Reset Generator...	6.00
TE-109* Reset Generator...	9.50
T-112 Emitter Follower, Dual...	4.40
T-113 Emitter Follower, Triple...	5.35
T-115 Emitter Follower, Dual...	5.05
T-116 Emitter Follower, Triple...	6.40
T-128 Relay Driver (0-24V)	9.05
T-129 Reset Generator...	4.75
T-139 Driver 0-30V	14.30
TM-170* Driver...	9.20
TM-171* Driver...	10.30
TM-411* Pulse Logic	8.15
TM-620* DC Logic...	8.25
TM-644* Flip Flop	11.90
TE-648* Flip Flop	11.05

*Improved.

Actual Size

Prices subject to change without notice. Usual terms to rated Accounts—All others 25% Cash with order—Balance C.O.D. F.O.B. Bay Area. All items subject to prior sale. Minimum order \$10.00

EMMONS ELECTRONIC SUPPLY CO.

405-10th St.,
Oakland 7, California
TWin Oaks 3-7411

See Our Ad Page 913

1965 ELECTRONICS BUYERS' GUIDE

CIRCLE 957 ON READER SERVICE CARD

New VACUUM PENCIL

for picking up miniature parts

\$7.50 ea.

Selected Distributors available.

PHILIP FISHERMAN COMPANY
7 CAMERON ST., WELLESLEY, MASSACHUSETTS

CIRCLE 958 ON READER SERVICE CARD

GET INSTANT MONEY !!

We want your surplus, obsolete, or excess inventory equipment, components & parts! Need ground & air communication equip., teletype, all GRC, PRC, ARC, ARN—all test equip. What have you? WE PAY TOP DOLLAR! We make deals—now! And we pay freight. Tell us what you have—not tomorrow—today!

COLUMBIA ELECTRONICS—Dept E
4365 W. Pico Blvd.,
Los Angeles, Cal. 90019

CIRCLE 959 ON READER SERVICE CARD

EQUIPMENT FOR SALE?

Advertise in Electronics Searchlight Section for fast results!

GENERAL RADIO Standard Frequency Multiplier
Model 1112A 495.00
Model 1112B 495.00

GENERAL RADIO Power Amplifier
Model 1233-A 225.00

GENERAL RADIO Pulse Amplifier
Model 12-19-A 110.00

HEWLETT PACKARD Pulse Generator
Model 212-A 175.00

HEWLETT PACKARD Oscilloscope
Model 150-A w/Dual Trace Plug-in Model 152-A 650.00

STODDART CO.
Radio Freq. & Field Intensity Meter Model NM-20-B with AC Supply Model 90780-2 750.00

ADAGE VOLDICON DC Volts
Model V-16-AD 250.00

CALIBRATION STANDARDS
Wheatstone Bridge Model WB-100A 175.00

GERTSCH CO. Tuned Null Indicator
Model THI-1 250.00

BAUSCH & LOMB
10 Inch Optical Comparator Model 33-12-11 with Stage, Model 38-12-25-01 750.00

POLORAD Signal Generator
2000 to 4600 MC Model MSG-2A 650.00

POLORAD Microwave Receiver
9500 to 15,600 MC Model R Plug-in Model RKS 950.00

WILTRON CO. Phase Indicator
Model 305 with Direct Reading Microwave Phase Meter Model 300 1250.00

See previous issues for more equipment.
Send for Flyers.

All material in excellent condition. All prices F.O.B., San Francisco, Cal. subject to prior sale. Send for Listing and Flyers.

Marty's Mart

1236 Market St., San Francisco 3, California
Phone: UNDERhill 3-1215

CIRCLE 952 ON READER SERVICE CARD

ELECTRON TUBES

KLYSTRONS • ATR & TR • MAGNETRONS
SUBMINIATURES • C.R.T. • T.W.T. • 5000-6000 SERIES
• SEND FOR NEW CATALOG A2 •
A & A ELECTRONICS CORP.
1063 PERRY ANNEX
WHITTIER, CALIF.
696-7544

CIRCLE 953 ON READER SERVICE CARD

DIGITAL RECORDERS

H.P. 561B, never used, \$550 each. Electro Instruments Inc., mod. 500 XY recorder, nul detector. Mod. 472, never used, \$600. Misc. tec. tec. plug-ins and g.r. lab equip. Mepco prec. resis. .01%.

W. D. CONTRACTING ENGINEERS
5437 West Division Chicago, Illinois 60651
Phone: (312) 378-7461

CIRCLE 954 ON READER SERVICE CARD

SMALL AD but BIG STOCK

of choice test equipment
and surplus electronics

Higher Quality—Lower Costs
Get our advice on your problem
ENGINEERING ASSOCIATES

434 Patterson Road — Dayton 19, Ohio

CIRCLE 955 ON READER SERVICE CARD

TEST EQUIPMENT

For over 20 years specializing in top brands only. Write for our latest listing. We buy complete inventories.



ELECTRONIC SALES

1413 Howard Street, Chicago, Illinois 60626
Telephone ROgers Park 4-0600

CIRCLE 956 ON READER SERVICE CARD

AUTOTRACK ANTENNA MOUNT

360 degree azimuth, 210 degree elevation sweep with better than 1 mil. accuracy. Missile velocity acceleration and slewing rates. Amplidyne and servo control. Will handle up to 20 ft. dish. Supplied complete with control chassis. In stock—immediate delivery. Used world over by NASA, USAF. TYPE MP-61 B. SCR-584. NIKE AJAX mounts also in stock plus several airborne trackers.

SCR 584 AUTOMATIC TRACKING RADARS

Our 584s in like new condition, ready to go, and in stock for immediate delivery. Ideal for telemetry research and development, missile tracking, satellite tracking, balloon tracking. Used on Atlantic Missile Range, Pacific Missile Range, N.A.S.A. Wallops Island, A.B.M.A. Write us. Fully Desc. MIT Rad. Lab. Series, Vol. 1, pps. 207-210, 228, 284-286. Compl. inst. Bk. avail. \$25.00 each.

AN/GPG-1

SKYSWEEP TRACKER

3 cm. automatic tracking radar system. Complete package with indicator system. Full target acquisition and automatic tracking. Input 115 volts 60 cycle. New. In stock for immediate delivery. Entire System 6' long, 3' wide, 10' high. Ideal for infrared Tracker, Drone Tracker, Missile, Tracker, R. & D.



PULSE MODULATORS

MIT MODEL 9 PULSER

1 MEGAWATT—HARD TUBE

Output 25 kv 40 amp. Duty cycle .002. Pulse lengths .25 to 2 microsec. Also .5 to 5 microsec, and .1 to .5 microsec. Uses 6C21. Input 115v 60 cycle AC. Mfr. GE. Complete with driver and high voltage power supply. Ref: MIT Rad. Lab. Series, Vol. 5, pps. 152-160.

2 MEGAWATT PULSER

Output 30 kv at 70 amp. Duty cycle .001. Rep rates: 1 microsec 600 pps. 1 or 2 msec 300 pps. Uses 5948 hydrogen thyratron. Input 120/208 VAC 60 cycle. Mfr. GE. Complete with high voltage power supply.

MIT MODEL 3 PULSER

Output: 144 kw (12 kv at 12 amp.) Duty ratio: .001 max. Pulse duration: .5, 1 and 2 microsec. Input: 115 v 400 to 2000 cps and 24 vdc. \$325 ea. Full desc. Vol. 5, MIT Rad. Lab. series, pg. 140.

250KW HARD TUBE PULSER

Output 16 kv 16 amp. duty cycle .002. Pulses can be coded. Uses 5D21, 715C or 4PR60A. Input 115 v 60 cycle ac. incl. H.V. pwr supply \$1200 ea.

5949 THYRATRON AGING RACK

Compl. Chatham Electronics Console incl. 15 kv power supply & PFN's. \$1800.

MICROWAVE SYSTEMS

E-4 FIRE CONTROL SYSTEM

Hughes Aircraft X Band. Complete. In stock.

C-BAND RADAR

250 KW output, C-band, PPI indicator, 5C22 thyratron modulator. Antenna hi gain parabolic section. Input 115 volts 60 cycle AC, complete \$2750.00.

300 TO 2400MC RF PKG.

300 to 2400 MC CW. Tuneable. Transmitter 10 to 30 Watts. Output. As new \$475.

500KW "L" BAND RADAR

500 kw 1220-1359 mcs. 160 nautical mile search range P.P.I. and A Scopes. MTLI thyratron mod. 5J26 magnetron. Complete system.

PHILCO MICROWAVE LINKS

C Band Microwave Link terminal bays and repeater bays in stock. New \$1500 each or \$2500 per pr.

100—800MC. CW SOURCE

150 watts CW nominal output 115 V 60 Cy AC Input. \$1600.

100KW 3CM. RADAR

Complete 100 kw output airborne system with AMTI, 5C22 thyr. mod. 4J52 magnetron, PPI. 300 deg az sweep, 60 deg. elev. sweep, gyro stabilizer, hi-gain rvr. Complete with all plugs and cables.

M-33 AUTO-TRACK RADAR SYSTEM

X band with plotting board, automatic range tracking, etc. Complete with 1 megawatt acq. radar.

PLAN POSITION INDICATOR CONSOLE

Complete PPI console operating from 115 volt 60 cycle AC. 10" CRT range 4 to 250 miles. Digital height readout. Complete AN/UPA-25.

3KW RCA PHONE & TELEG XMTR

2—30 MC. 10 Autotone channels plus MO. Input 220 vac. 50/60 cycles.

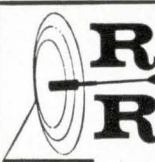

Radio-Research Instrument Co.

550 5th Ave. New York 36, N.Y.
Tel. JUdson 6-4691

CIRCLE 951 ON READER SERVICE CARD

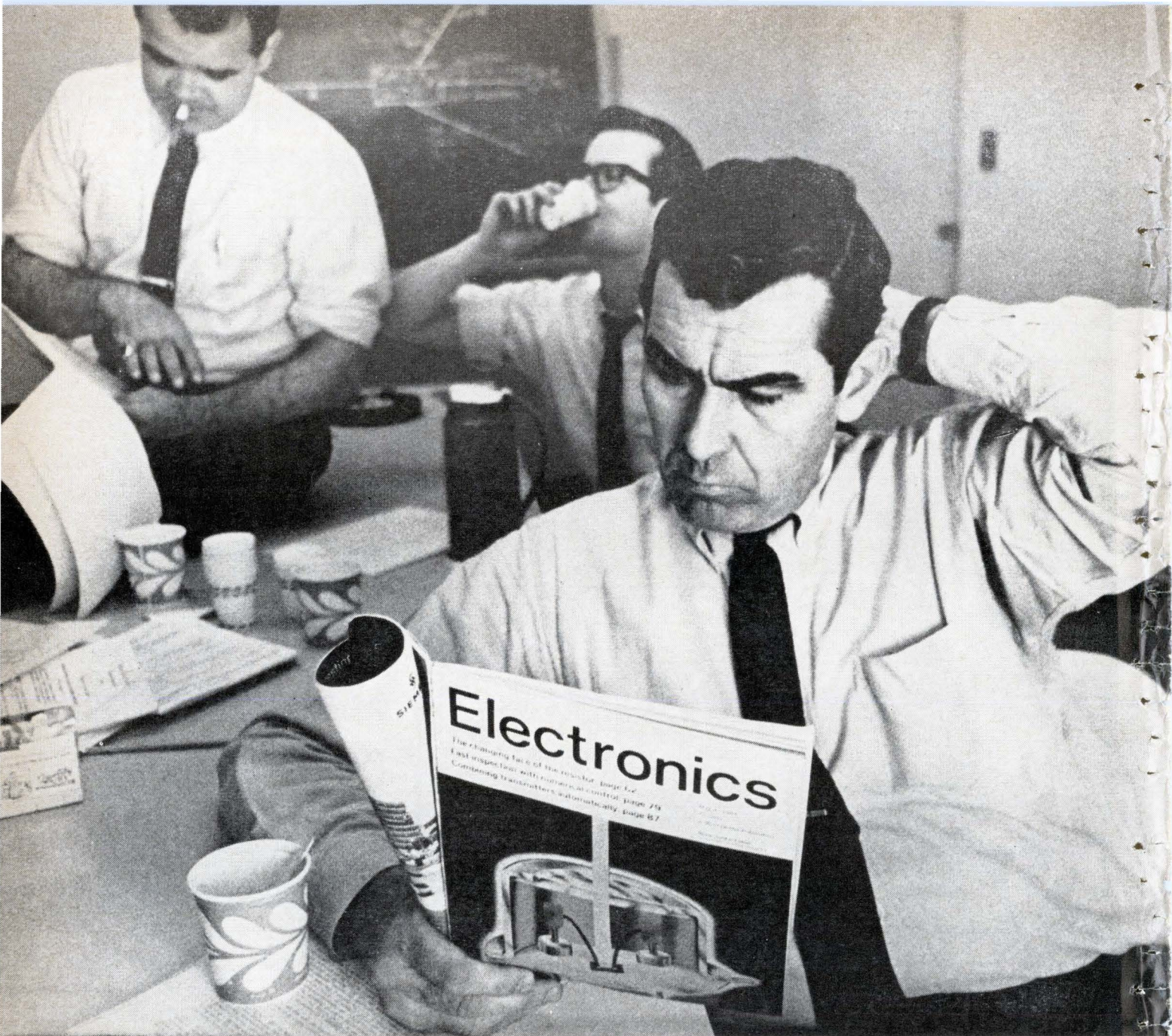

Great editorial is something he takes to a meeting

(What a climate for selling!)

Electronics

A McGraw-Hill *Market-Directed* Publication 
330 West 42nd Street, New York, N. Y. 10036

MEMBER: AUDIT BUREAU OF CIRCULATIONS, AMERICAN BUSINESS PRESS

New Literature

Operational amplifiers. Analog Devices, Inc., 221 Fifth St., Cambridge, Mass., 02142. A 17-page application note discusses advantages and disadvantages of the three operational amplifier configurations — inverting, non-inverting and differential.
Circle 420 on reader service card.

Digital voltmeter. International Electronic Research Corp., 135 W. Magnolia Blvd., Burbank, Calif., 91502. Capabilities of a new digital voltmeter—with accuracy of one part in 20,000—are described by technical bulletin PG-2025. [421]

Varistor kit. Victory Engineering Corp., 122-48 Springfield Ave., Springfield, N.J., 07081. Bulletin SE102 Rev. describes the KV1002 educational varistor kit, which contains four silicon carbide varistors complete with electrical and physical descriptions plus detailed experiments with these passive circuit elements. [422]

Vswr detector. Telonic Engineering Co., 480 Mermaid St., Laguna Beach, Calif., has prepared an eight-page application bulletin containing vswr measurement techniques for broadband swept radio frequencies. [423]

Interferometric surface testers. Carl Zeiss, Inc., 444 Fifth Ave., New York, N.Y., 10018, offers a catalog explaining the use of interferometric surface testers and illustrating practical examples of application with 15 micrographs of interference images. [424]

Glass-to-metal seals. Airpax Electronics Inc., Cambridge, Md., 21613. A 90-page glass-to-metal seals indexed catalog describes a complete line of standard compression and matched seals. Request a copy on your letterhead.

Vaneaxial blowers. Globe Industries, Inc., 2275 Stanley Ave., Dayton, Ohio, 45404. Type VAX-1.5-DC vaneaxial blowers with outputs to 15 cfm at 1.3 in. H₂O, 27 or 50 v d-c are described in bulletin C-5120. [425]

Fiber optics. Chicago Aerial Industries, Inc., 550 West Northwest Highway, Barrington, Ill., 60010. An illustrated two-color brochure gives a comprehensive list of fiber optics applications, and graphically explains the basic principle of fiber optics. [426]

Digital voltmeter. Trymetrics Corp., 204 Babylon Turnpike, Roosevelt, N.Y., 11575, has published a four-page, two-color folder on its series 4000 solid-state digital voltmeter. [427]

Aerospace indicators. The Bendix Corp., Montrose Division, South Montrose, Pa. Synchro, servoed and tachometer aircraft indicators are covered in catalog No. 15. [428]

Power twt amplifiers. Alto Scientific Co., Inc., 4083 Transport St., Palo Alto, Calif., has released a data sheet describing the 20-watt twt amplifiers that operate from 1.0 Gc to 12.4 Gc. [429]

Component testing. Teradyne, Inc., 87 Summer St., Boston, Mass., 02110, has available a 32-page, illustrated booklet entitled "Automatic Test Instruments For Electronic Components." [430]

Aircraft batteries. Sonotone Corp., Elmsford, N.Y., 10523. A four-page brochure lists the firm's nickel-cadmium batteries used in aircraft as original equipment or retrofitted to aircraft. Replacement batteries are also listed. [431]

Octave filter nomograph. TT Electronics, Inc., Box 180, Culver City, Calif., 90231. A nomograph for octave filter arrays gives center frequencies for 2 to 20 channels spaced with equal frequency ratios within the octave. A method for determining frequencies in the octave below the reference frequency is included. [432]

Communications amplifiers. Sierra Electronic Operation of C&E division, Philco Corp., 3885 Bohannon Drive, Menlo Park, Calif., 94025, has available brochure PM-109 describing a line of amplifiers designed for wideband data transmission and scatter communications. [433]

Infrared ovens. Infra-Red Systems, Inc., Route 23, Riverdale, N.J., has released a bulletin on a line of infrared ovens that give fast heat and close control in the curing of protective coatings for p-c boards. [434]

Continuous-wave generator. James Electronics, Inc., 4050 N. Rockwell St., Chicago, Ill., 60618, announces data sheet F-3851 on a new continuous-wave generator for ultrasonic testing systems. [435]

Varactor diodes. Amperex Electronic Corp., Hicksville, N.Y., 11802, has published an application report outlining a course in varactor diode theory and applications for communications design engineers. Copies may be obtained by writing on company letterhead.

Instrument rectifiers. Edal Industries, Inc., 4 Short Beach Road, East Haven, Conn., 06512. Bulletin 102 describes a full line of copper oxide instrument rectifiers. [436]

Mylar dielectric capacitors. The Gude-man Co., 340 W. Huron St., Chicago, Ill., 60610. Engineering bulletin 383 covers a series of miniature mylar dielectric capacitors in hermetically sealed (glass-to-metal) tubular metallic cases. [437]

SPECIAL PURPOSE CAPACITORS

Energy-storage

Discharge Switches

Impulse Systems

Pulse Networks

Low-Z Pulse Lines

Specialists in the design of high-transient-energy devices. Talk with us

For immediate quotations, Call:

TOBE DEUTSCHMANN
LABORATORIES (TD)

CANTON, MASS. 02021 Tel. (617) 828-3366 TWX 617-828-2567

Circle 227 on reader service card

Telrex

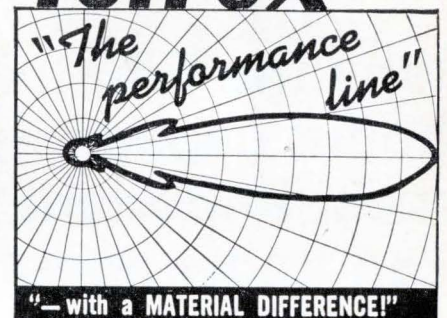

The Choice of the Discriminating Communication Engineer . . . the Man who Never Settles for Anything Less than THE-VERY-BEST!

telrex "BEAMED-POWER"
ANTENNAS and ANTENNA SYSTEMS

Provide optimum performance and reliability per element, per dollar. Antennas from 500 Kc to 1500 Mc. Free PL88 condensed data and pricing catalog, describes military and commercial antennas, systems, accessories, Towers, Masts, Rotators, "Baluns" and transmission line data.

ANTENNAS Communication and TV Antennas
SINCE 1921 **telrex**
LABORATORIES
Asbury Park 41, New Jersey, U.S.A.

When a capacitor failure means the failure of an entire system, you can't afford to take chances!

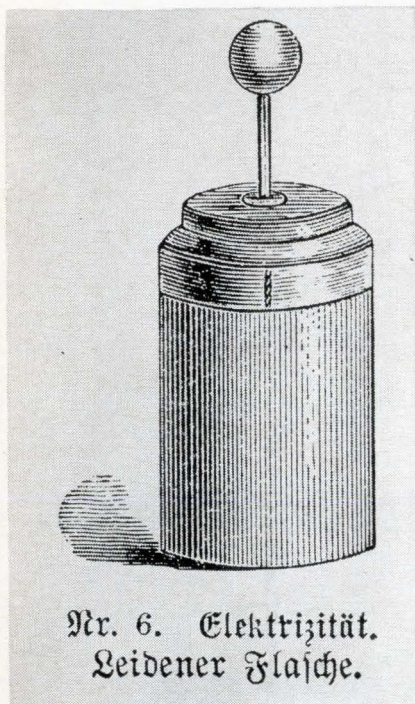

The Bettmann Archive

Why the first thing you learned about capacitors is still the most important thing you can know about them.

You remember the Leyden jar, the classic capacitor. Made of glass.

The Leyden jar is two centuries old. So is man's recognition of glass as the ideal dielectric.

You can boil glass, freeze glass, bury glass, drown glass, irradiate glass—and its dielectric properties won't change measurably.

You know how a glass capacitor will behave. Classically. According to the book.

In 1965, CORNING® glass capacitors give you this classically predictable performance, backed up by

stability and reliability data that is unequalled.

Why settle for less than the predictable performance that's your with CORNING glass capacitors. Millions have performed without failure on Titan, Surveyor, Syncom, Apollo, Mariner, Gemini, and Minuteman.

Specify CORNING glass capacitors and tuned circuits stay tuned, RC time constants stay constant, coupled circuits stay coupled, decoupled circuits stay decoupled, phase shifters stay fixed. There's none better for high-frequency applications.

Send to Corning Glass Works, 3913 Electronics Dr., Raleigh, N.C., for complete technical data on CORNING glass capacitors, or ask your Corning distributor.

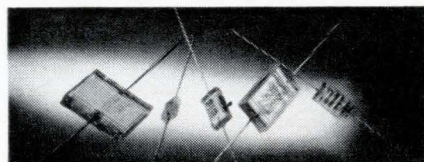

CORNING
ELECTRONICS

Soviet Union

Scuttling Secam?

Are the Russians losing their enthusiasm for Secam? Their proposed improvement for the French sequence-and-memory approach to color television stirred that speculation last month. The Soviet version, called NIR, is closer to PAL (phase-alternation line)—the rival system developed in West Germany—than to Secam.

France has rejected NIR. But the suggestion from Moscow prompted international observers to wonder whether Secam's principal ally outside France might be considering defecting. Without Soviet support, Secam probably would lose even its underdog chance of adoption as Europe's color-tv standard. The Russians have not said whether they will continue to support Secam or insist on NIR.

Secam's rivals are PAL and the United States system, called NTSC for National Television Standards Committee.

Strange ally. Coming from an ally, the Soviet proposals are strange indeed. They would:

- Scuttle Secam's biggest difference with its rivals: its form of modulation. Secam frequency-modulates the subcarrier with color information, but NIR transmits its color information as amplitude- and phase-modulated signals—the same quadrature modulation used by PAL and NTSC.

- Appear to offer no improvement over PAL. NIR would have the same control over differential phase distortion as is inherent in PAL, but apparently the Russian approach requires somewhat more complicated circuitry at both the transmitting and receiving ends. Furthermore, an expensive delay line is mandatory in NIR receivers but optional in PAL [Electronics, Jan. 10, p. 239].

- Offer no evidence that the sys-



"Just a little further forward, please"

tem really works. The Russians have shown only diagrams; they have not said whether they have been able to design the coding and decoding circuits needed for NIR. Nor does NIR seem to have been field-tested, a time-consuming procedure that might well prevent fulfillment of Moscow's pledge to introduce color tv in 1967, in time for the 50th anniversary of the Russian Revolution.

PALward shift. Why have the Russians proposed this shift toward PAL and NTSC? Their changes would eliminate two potential faults in Secam, both caused by frequency-modulating the subcarrier with color information. The faults, which may have shown up in field tests, are:

- A loss of color from the picture in weak signal areas, resulting in white streaks called silverfish.

- Lack of compatibility with black-and-white receivers, causing an objectionable dot pattern on monochromatic screens.

Comparison. In NTSC and PAL, red and blue color information

quadrature-modulates the color subcarrier so that the final color signal, added to the black-and-white luminance information, is in the form $C \sin(\omega t + \theta)$, where the amplitude C contains the color-saturation information and the phase θ contains hue information, and ω is the frequency of the color subcarrier. (Pink and red are the same hue, but red has a higher saturation.)

This signal is recovered in the receiver by impressing it with a locally generated subcarrier, which must be kept in perfect phase synchronization with the color signal to recover the correct hue. In NTSC and PAL, a reference subcarrier burst is transmitted between the lines of picture information to synchronize the local oscillator.

However, because of nonlinearities in recording, transmission and receiving equipment, instantaneous differences in phase between the color signal and the local subcarrier cause differential phase distortion.

PAL eliminates this distortion by

reversing the phase of the signal every line, so that phase errors cancel out every two lines. NIR prevents the introduction of phase errors during demodulation by making up its signal in such a way that there is no need for a demodulator or local oscillator in the receiver. NIR, like PAL, does this by alternating the form of the color information from line to line. On one line, the color signal transmitted is in the form $\sqrt{C} \sin(\omega t + \theta)$ —the same as in NTSC and PAL except that the amplitude is the square root of the saturation. On the next line, the NIR signal leaves off the phase information and takes the form $\sqrt{C} \sin \omega t$.

The receiver. In the receiver, a multiplier combines the signal being transmitted with the signal transmitted during the last line—stored in a delay. The result of the multiplication is $\frac{1}{2}C \cos \theta$ plus a high-frequency component, which is filtered out. This corresponds—with some gain correction—to the blue information component $B - Y$, which can be used directly by the color picture tube.

Another multiplier, in conjunction with a 90° phase shift, results in $\frac{1}{2} C \sin \theta$, which is equal to the red information, $R - Y$. To maintain the correct polarity for the $R - Y$ component, the 90° phase shift must be positive when shifting $\sqrt{C} \sin \omega t$ and negative when shifting $\sqrt{C} \sin(\omega t + \theta)$. So NIR, like PAL, requires a switch in the receiver, synchronized to the incoming signal.

A spokesman for the Radio Corp. of America says the Russians might

have trouble building circuits to code the complicated signal at the transmitting end and to shift the phase of the signal in the receiver. He points out that the phase shifter must be wideband to accept the sidebands of the color signal. Phase-shifters in NTSC and PAL receivers, in contrast, are narrowband because they shift only the single frequency of the subcarrier from the local oscillator.

Japan

Color on demand

A frustrating experience for a color-television set retailer is to see a couple musing over his wares—with only a black-and-white picture on the screen. One impractical solution is for the retailer to invest \$100,000 in color studio equipment. But now the Sony Corp. of Japan says it has come up with a practical solution: these retailers will soon be able to keep their sets aglow not only with pretty pictures, but with full-color spot announcements advertising wares in other parts of the store—all for about \$2,600.

Sony recently demonstrated its Colormat, a color-tv recorder that stores as many as 40 full-color still pictures on a magnetic disk the size of a long-playing record. Pictures are recorded on three tracks as red, blue and green information signals by three heads in contact with the disk. The disk rotates at 30 revolutions per second so that the picture information needed for

a complete frame—which takes 1/30 second to scan—is available in each revolution.

During playback, the red, blue and green signals are available simultaneously to produce a full-color picture on each frame. However, the three colors are recorded separately in sequence so that a simple black-and-white vidicon camera can be the source. To record pictures from color film slides, one at a time, red, blue and green filters are placed between the camera lens and the slide projector and that information is recorded in the appropriate track.

Tentative prices. Although Sony has not yet completed its production and marketing plans, it has carried development far enough to determine tentative prices for most of the various units making up the Colormat system. The basic record-playback unit, with one disk and a separate f-m modulator needed for recording, will cost about \$1,500. A color injector, one of which is needed for each color set in the system, will sell for about \$100. Additional recording disks will cost about \$40 each.

A slide projector and monochrome camera will sell for about \$300. A shading amplifier, required with both cameras to correct their brightness characteristics for color use, will cost about \$100. Also necessary is a color controller to adjust color balance; its price is about \$600.

Pictures can also be recorded live—without using color film—with a monochrome camera and rotating color wheel controlled by a switching unit, but no price has been set for this combination.

Disk wear is negligible since very little pressure is needed to maintain good contact between the heads and the flat disk. Sony engineers say the signal-to-noise ratio is better than 50 decibels, compared with 35 db for a broadcasted NTSC color signal.

The recording disk. The magnetic disk—the same material used for high-quality video tape—is cemented to an aluminum ring for support. The ring has an outside diameter of 12 inches and an inside diameter of 11 inches. The

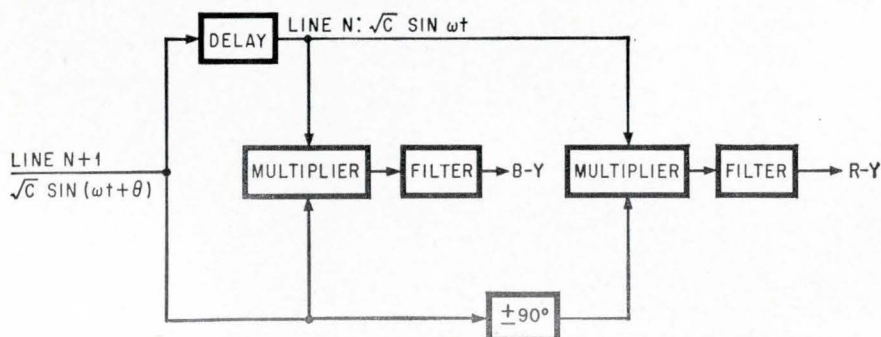

Russian color system multiplies line N 1 being received, with line N stored in delay, to recover red and blue color information without demodulation. Green information is recovered by matrixing red, blue and luminance signals.

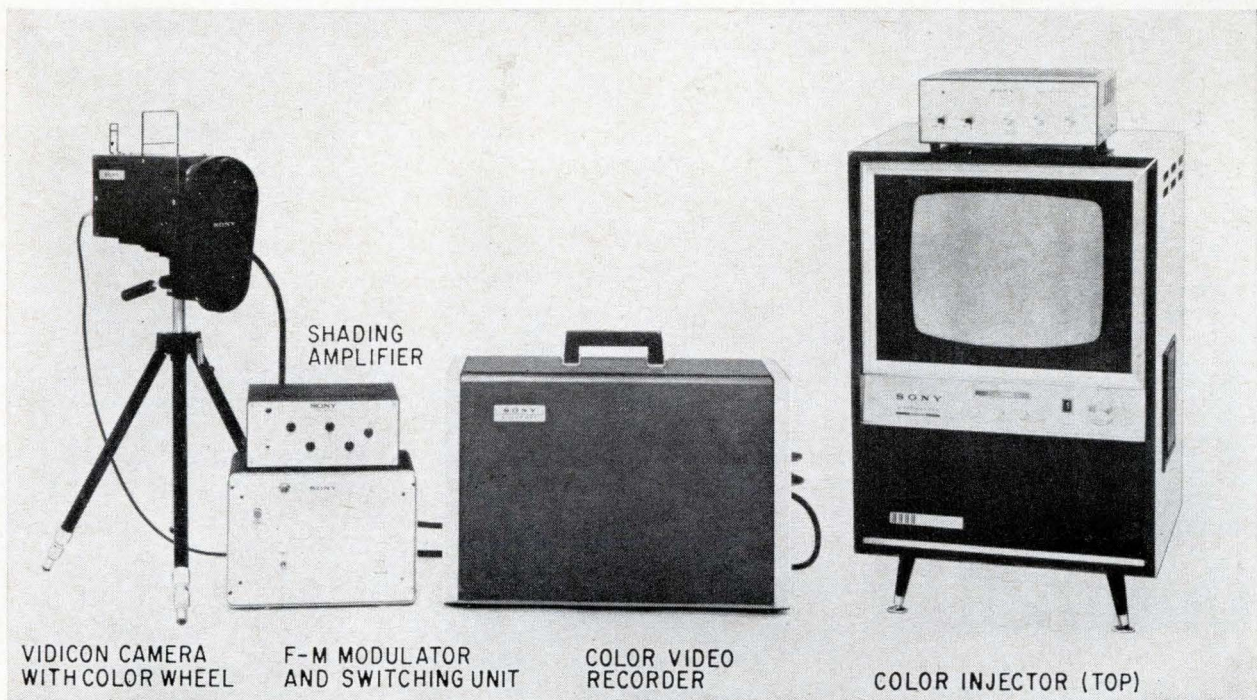

Sony's video demonstrator, shown with some of its components, records 40 full-color still pictures on a magnetic disk the size of a long-playing record and replays it through any color-television set.

recording area is a 20-millimeter band between four and five inches from the center. At this distance from the center, the head-to-tape speed is high enough—about 800 inches per second—to produce a horizontal resolution equal to 350 vertical lines.

The radial motion of the head assembly from the first to the fortieth set of three tracks is only six millimeters—less than the 7-mm spacing between adjacent heads so that the 40 tracks of one color do not overlap the 40 tracks of another. The record-playback head assembly is indexed from one set of three tracks to the next set by a lead-screw mechanism similar to that used for positioning in machine tools. Each half turn of the 0.3-mm-pitch lead-screw places the head assembly over another set of tracks to reproduce another picture. Individual tracks are 0.1 mm wide and have a 0.15-mm center-to-center spacing.

The Colormat can be easily connected to any standard television set—either shadow mask or Chromatron. The signal from the recorder, amplified in the color injector, is connected directly to the picture tube's three grids through

an adapter inserted between the picture-tube base and the tube socket. A synchronization signal from the injector is also applied to the tv antenna terminals.

Tubes are used in the color injector because of the high voltage required for picture-tube grid drive. Other units, however, are transistorized. The Colormat recorder can be used with an audio recorder to provide background music and announcements. Pictures can be changed automatically by a control signal on one track of the audio tape so that audio and video remain synchronized.

Sony hopes to market the video demonstrator in 1966, but only for professional use because it considers the system too complex and expensive for consumer use.

Sweden

Controlling nuclear power

The 140-megawatt nuclear power plant rising at Marviken, 100 miles south of Stockholm, may be the first one to be started and shut

down automatically by a process computer. Full plant operation, with on-line control by a closed-loop computer made in Britain, is scheduled late in 1968.

Complete digital control of a swimming-pool reactor was claimed last year by the Tokyo Shibaura Electric Co. (Toshiba). Various degrees of computer control also have been achieved over nuclear reactors in the United States, Canada and France [Electronics, Sept. 6, 1965, p. 180].

The Swedish plant's normal operations will be controlled by the CON/PAC 4060 computer, manufactured by Associated Electrical Industries, Ltd. (AEI) under license with the General Electric Co. of England.

Alternatives. Computer programs will permit automatic operation whether the heavy water is saturated or superheated. Superheating will permit increase of the plant's capacity to 200 Mw, according to AEI. The computer can also be programmed to permit certain manual operations while the computer's output relays continue to run other operations in an open-loop mode.

The \$330,000 computer system



Qualified Electronics Technicians

(Where do you find them?)

Many Companies will tell you the best source is their present staff of technical personnel. These men have the necessary aptitude and ambition ... can be readily up-graded through a planned electronics training program.

Since 1934 Cleveland Institute has developed such programs for hundreds of leading companies ... has provided thousands of men with practical, useable knowledge of electronics theory and fundamentals. These men understand the "why" of electronics ... can install, maintain, troubleshoot, and repair the sophisticated equipment you're using today, and will be using in the years ahead. Learn how CIE can "tailor" an Electronics Training Program to your specific needs. Its effectiveness and economy will amaze you. Send coupon today for FREE brochure. Cleveland Institute of Electronics, Dept. E-20, 1776 E. 17th St., Cleveland, Ohio 44114.

SEND COUPON TODAY

**Cleveland Institute
of Electronics**

Dept. E-20, 1776 E. 17th St., Cleveland, Ohio

Gentlemen: I am interested in learning more about your Electronics Home Study Programs. Please send complete information.

Name _____

Title _____

Company _____

Address _____

City _____ State _____ Zip _____

Accredited Member, National Home Study Council.

Electronics Abroad

is scheduled to be delivered May 1, 1967; software costs will be extra. Training of plant operators will begin soon with another computer, a CON/PAC 4040. The 4040 will be installed at the headquarters of ASEA, the Swedish electrical company that is building the nuclear facility. In addition to its training function, the 4040 will be used with an analog-computer simulation of the reactor process to check out systems for controlling the power plant.

Three displays. A unique feature of the Marviken installation will be three alphanumeric data displays on a cathode-ray screen. These will replace conventional indicators, alarms and annunciating equipment.

Two screens will display process variables: one will continuously monitor key variables while the other, on demand, displays other variables requested by the operator. Each display will show 30 lines of text, with the latest incoming information being shown at the bottom of the screen. The third crt will be for alarm annunciation, data logging and for information display about research tests on the station.

The station will have one control panel for manual operation and a second for computer control.

Great Britain

Composition

Although more people are reading newspapers than ever before, the number of daily publications has been dwindling on both sides of the Atlantic because of high costs. This trend may soon be reversed in Britain, with the help of a new kind of computer system and a publisher's confidence in it.

Lord Thomson, publisher of Britain's newest daily, is so hopeful of success with computerized typesetting that he is planning similar ventures. Thompson already owns 128 newspapers—14 in Britain—and 150 trade publications.

On line. Typesetting under com-

puter control is not new. Such systems are operating at about 90 newspapers in the United States, including the Los Angeles Times, Kansas City Star, Miami Herald and Washington Post; they are also helping to produce six papers in Britain, six in West Germany, three in the Netherlands and one in France, according to Composition Information Services of Los Angeles. In most of these systems, edited articles are translated onto punched tape to be fed into a computer. The computer justifies each line.

What is new at the four-month-old Reading Evening Post, 40 miles west of London, is its on-line time-shared computer. Each of 12 operators feeds edited articles directly into the computer by means of a keyboard, instead of punching tape, and immediately sees each line of type printed out.

The 803B computer, made by Elliott-Automation, Ltd., automatically justifies each line—adjusts the spaces between words so that the lines of type are flush left and right. If spacing alone won't do the job, because the spaces would be too narrow or too wide, the last word on the line must be hyphenated; in that case the computer alerts the operator and prints out the two extremes between which the last word can be split—with the maximum and minimum allowable spacing between words. The operator then keys in a hyphen at the appropriate place in the word. The final tape feeds a Photon 713 photo-composition machine, which sets the type.

Backtalk. Conventional computerized typesetting doesn't have this dialogue between operator and computer.

The off-line approach presents several problems, all of which are said to be overcome by the in-line method. Processing the tapes through the computer, instead of electronic signals, creates the possibility of a bottleneck or of failure in case a punch should breakdown. Also, if hyphenation is to be directed by the computer instead of by the operator, a large memory is required with a massive backup to store all the hyphena-

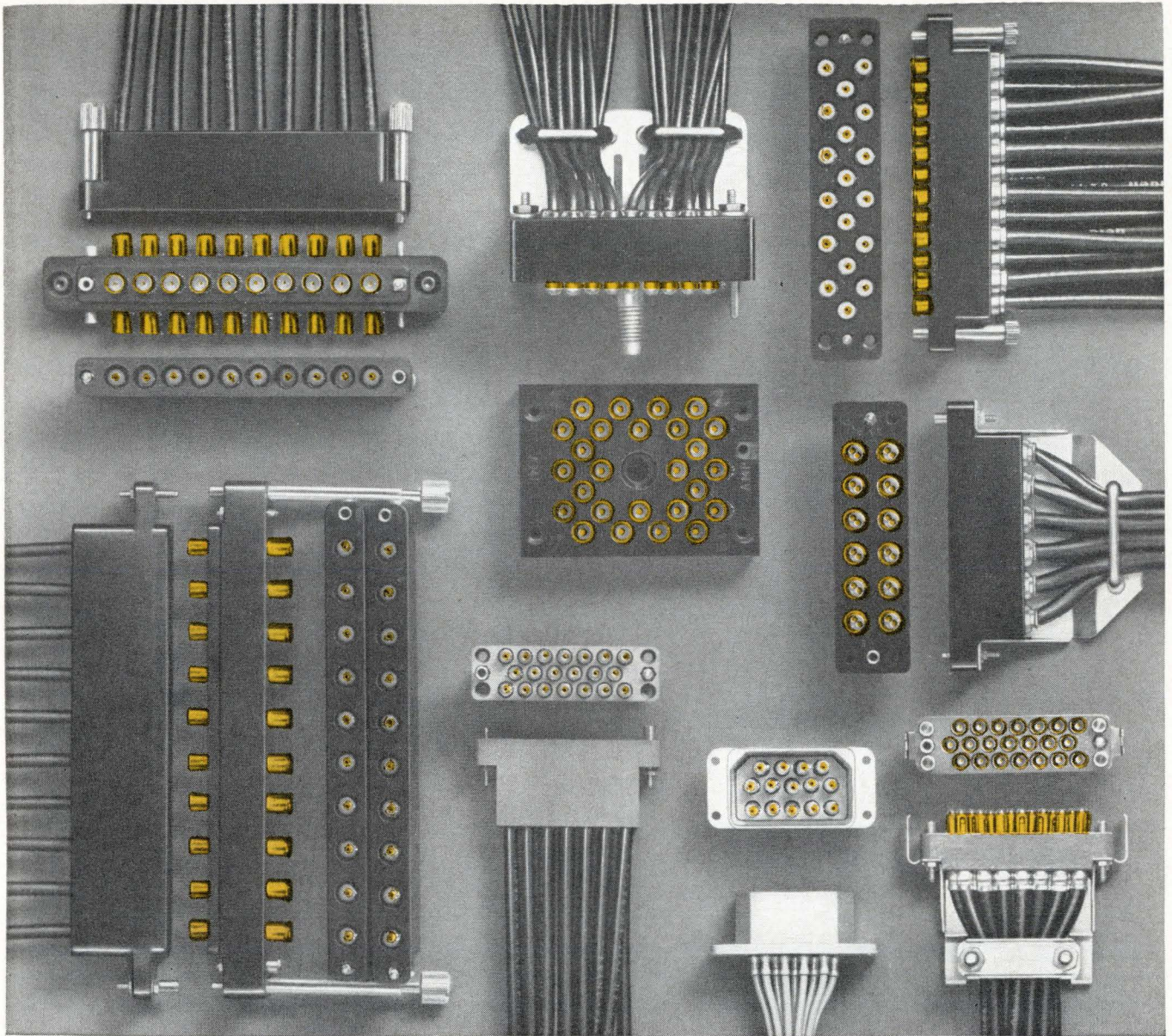

Economy and reliability do come in one package

AMP's full line of COAXICON★ connectors give you both the low cost and the high reliability you need for your coaxial cable circuits.

Reliability comes from AMP's formidable engineering and manufacturing know-how combined with finest quality materials.

Economy comes from AMP's simplified tooling and assembly procedures.

This is one of the most comprehensive coaxial connector lines on the market and still growing. You can find just the connector you want in the Standard, Twin Standard, Miniature and Sub-miniature lines—including the new T and Y configuration connectors.

And no matter which size you choose, you'll get

all the benefits of AMP's unusual COAXICON contact. Both the inner conductor and the outer shield of your cable are simultaneously terminated with just one precise, controlled crimp. Contacts then snap quickly and securely into housing through AMP's special retention spring.

So get the reliability you need, the economy you want for all your coaxial cable requirements . . . from AMP. Get the full story today.

★Trademark of AMP INCORPORATED



AMP★ products and engineering assistance are available through subsidiary companies in: Australia • Canada • England • France • Holland • Italy • Japan • Mexico • West Germany

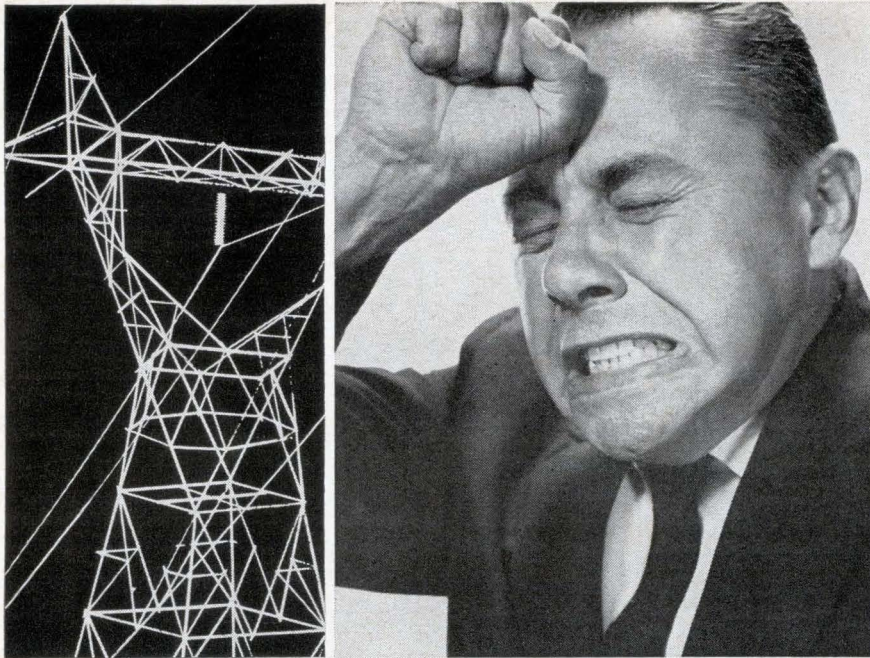

BUGGED BY DIRTY POWER-LINE NOISES?

**Keep
power clean
with
Hopkins
filters!**

Hopkins filters clean dirty lines — remove radiated and conducted interference from your power circuits. Meeting MIL-STD-220A, Hopkins Series 1960 power-line filters suppress interference more than 100 db in frequencies from 14 kc to 10 kmc.

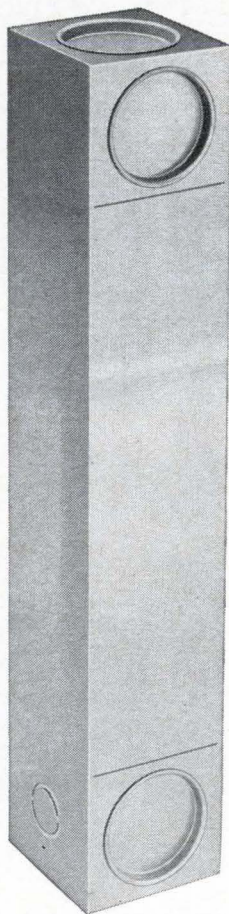

As a pioneer in power-line filtration Hopkins has designed and built more than 2,000 different types of filters. Used in thousands of varied applications under all operating conditions in ground installations, in secure rooms, aircraft, on board ships, HOPKINS POWER-LINE FILTERS HAVE PROVED UNSURPASSED.

Designed for easy economical space-saving installation, Hopkins power-line filters are available individually or in groups (preassembled in cabinets) for multiple-circuit applications. They are available in a choice of three basic series—each with top performance—in the frequency range needed for your circuit.

Send for complete information on Hopkins power-line filters

HOPKINS
Engineering Company

12900 Foothill Blvd., P. O. Box 191, San Fernando, Calif. 91341
Telephone: (213) 361-8691 • TWX 213-764-5998 • Cable: HOP

A Subsidiary of Maxson Electronics Corporation

tion combinations. Some such systems store hyphenation possibilities for 300,000 to 400,000 words.

Another problem with the conventional approach is the difficulty of making corrections; errors cannot be detected until the final type has been produced by the computer and run through the type-setting machine or a secondary printout system.

The Reading system provides a feedback printout for each operator, and holds as many as 70 characters before punching the output tape. If the operator sees an error, he can eliminate it by pressing a "kill" key, which deletes the last-typed word from the memory.

Proofreaders can sample the printed copy rather than read every word. Since the system is either correct or outrageously wrong, most of the errors can be caught by the operators. Only three proofreaders work at Reading; for a similar 24-page paper, 16 to 20 readers are usually required, according to Tom Margerison, scientific adviser to the Thomson organization.

Savings. How effective is the Reading system? Margerison says 12 operators can set the 24-page paper in one eight-hour shift; with conventional line-casting machines, he says 24 operators would be needed. Speed is also increased by the ability of a compositor to set any of eight styles of type in four sizes without moving from his keyboard. Conventional typesetting machines require a separate operation for each change in type style or size.

The computerized installation costs about \$100,000, Margerison says. The computer accounts for \$34,000 of this; the rest goes for the keyboard and the printout for each operator.

Do the savings justify the expense? It's still too early to know with certainty, Margerison says, because of other associated expenses. But he adds: "A paper using these techniques of computer-controlled tape production, phototypesetting and offset production, as does the Reading Evening Post, should be able to break even at a daily circulation of 25,000."

Electronics advertisers

February 7, 1966



ACI Division of Kent Corporation Richard L. Renner	171	Delco Radio Company Campbell-Ewald Company	148, 149	Kahle Engineering Company George Homer Martin Associates	16
ADC Products Inc. John Gompfer & Associates	140	Dialight Corporation H.J. Gold Company	168	Kay Electric Company Josephson Cuffair Company	17
AMP Incorporated Garceau, Hargrave & McCullough Inc.	201	DuPont de Nemours & Co. Inc. E.I. Batten, Barton, Durstine & Osborn Inc.	53, 69	Kepec Inc. Weiss Advertising	22
API Instrument Company George Z. Griswold	14			Krohn-Hite Corporation Stern/Frank Adv. Inc.	162
Acme Electric Corporation Scheel Adv. Agency	152				
Acopian Corporation Mort Barish Associates Inc.	170	EIMAC Div. of Varian Associates Hoefler, Dieterich & Brown Inc.	119	Lambda Electronics Corporation Michel Cather Inc.	64, 65
Aerovox Corporation, Hi-Q Division Lescarboursa Advertising Inc.	125	Electro Instruments Inc. Van Der Boom McCarron Inc.	108	Leach Corporation Jay Chiat & Associates	18, 19
Airpax Electronics Inc. Welch Mirabile & Co. Inc.	154	Electronic Modules Corporation Ray Thompson & Associates	93		
Amphenol Borg Electronics Corp., Connector Division Marsteller Inc.	62, 63	Erie Technological Products Inc. Altman Hall Associates	153		
Astrodata Inc. Bonfield Associates Inc.	15			Machlett Laboratories Fuller & Smith & Ross Inc.	11
		Fairchild Semiconductor Corporation Faust/Day Inc. Advertising	12, 13, 117	Magnetic Shield Div. of Perfection Mica Co. Burton Browne Advertising	178
Bausch & Lomb Inc. Wolff Associates Inc.	47	Ferranti Ltd. Rowlinson-Broughton Ltd.	120	Mallory Company, P.R. Aitkin Kynett Co. Inc.	169
Beckman Instrument Inc. Berkeley Division Hickson & Jorgensen	45			Markel & Sons L. Frank George Moll Advertising Inc.	189
Bendix Corporation, Montrose Division MacManus, John & Adams Inc.	122	General Electric Company, Magnetic Materials George R. Nelson Inc.	127	Matthews & Co. Jas. H. W.S. Hill Company	165
Bendix Corporation, Semiconductor Products MacManus, John & Adams Inc.	9	General Radio Company K.E. Morang Company	6	McDonnell John Patrick Starrs Inc.	68
Boonton Electronics Kniep Associates	188	Globe Industries Inc. Odiome Industrial Adv. Inc.	177	Memorex Corporation Hal Lawrence Inc.	35
Bourns Inc. Allen, Dorsey & Hatfield Inc.	49	Gudebrod Bros. Silk Co. Inc. Ramsdell, Buckley Company	121	Methode Electronics Inc. Burton Browne Advertising	177
Brinkmann Instruments The Shaller-Rubin Co. Inc.	185			Microwave Electronics Corporation Bonfield Associates Inc.	175
Brush Instruments Div. of Clevite Corp. Carr Liggett Adv. Inc.	3rd Cover	Hansen Mfg. Co. Inc. Keller-Crescent Company	136	Motorola Semiconductor Products Inc. Lane & Bird Adv. Inc.	56, 57
Bulova Electronics Div. of Bulova Watch Co. Ted Gravenson Inc.	156	Heath Company Advance Advertising Services Inc.	181		
Burroughs Corporation Conti Advertising Inc.	70	Hewlett Packard Company Lennen & Newell Inc.	1, 36, 37, 54, 55, 102, 123	New Hermes Engraving Machine Corp. Doner Harrison Inc. Advertising	182
		Hewlett Packard Company, Boonton Div. George Homer Martin Associates	151	North Atlantic Industries Inc. Murray Heyert Advertising	8
CML Inc. Keyes, Martin & Company Inc.	177	Hopkins Engineering Company Philip J. Meany Company	202	Optics Technology Inc. Hoefler, Dieterich & Brown Inc.	179
CTS Corporation Burton Browne Advertising	132	Hughes Aircraft Company Foote, Cone & Belding Inc.	124		
Chicago Dynmics Industries Inc. Burton Browne Advertising	118	High Vacuum Electronics Inc. Bonfield Associates Inc.	139	Pamotor Inc. The Harry P. Bridge Company	174
Chicopee Mills Inc. Bert Paul Kun Advertising Agency	185			Phelps Dodge Electronic Products Corp. Smith, Dorian & Burman Inc.	160
Chrono-Log Corporation The Hill Associates Inc.	178	IEEE Alpaugh Advertising	168		
Clevite Corporation, Piezoelectric Div. Carr Liggett Advertising Inc.	189	IMC Magnetism Corporation Monad Advertising Design	181		
Cleveland Institute of Electronics Rapp & Collins	200	IRC Inc. Gray & Rogers Inc.	20, 21		
Colorado Dept. of Development Buchen Advertising Inc.	159	International Rectifier Corp. Willard G. Gregory & Co.	50		
Computer Control Company Franklin P. Folts Inc.	58, 59	Interstate Electronics Corporation Hixson & Jorgensen Inc.	163		
Consolidated Electrodynamics Corp. Hixson & Jorgensen Inc.	126				
Corning Electronic Company Rumrill-Hoyt Company	196				
Cramer Industries Potts & Woodbury Inc.	179				

■ For more information on complete product line see advertisement in the latest Electronics Buyer's Guide

Executive, editorial, circulation and advertising offices: McGraw-Hill Building, 330 West 42nd Street, New York, N.Y., 10036. Telephone (212) 971-3333. Teletype TWX N.Y. 212 640-4646. Cable: McGrawhill, N.Y. Officers of the McGraw-Hill Publications: Joseph H. Allen, President; Vice Presidents: J. Elton Tuohig, Operations; John R. Callahan, Editorial; Ervin E. DeGraff, Circulation; Donald C. McGraw, Jr., Advertising Sales; Angelo R. Venezian, Marketing. Officers of the Corporation: Donald C. McGraw, Chairman of the Board; Shelton Fisher, President; L. Keith Goodrich, Hugh J. Kelly and Robert E. Slaughter, Executive Vice Presidents; John J. Cooke, Vice President and Secretary; John L. McGraw, Treasurer. Title R registered U.S. Patent Office; © copyright 1966 by McGraw-Hill, Inc. All rights reserved, including the right to reproduce the contents of this publication, in whole or in part.



■ Potter & Brumfield Div. of American Machine & Foundry Co. Grant, Schwenck & Baker Inc.	24
Princeton Applied Research Corp. Mort Barish Associates	38
Probescope Inc. Connolly Associates Inc.	181
Radio Corporation of America Al Paul Lefton Company	4th Cover
Rhode & Schwarz Inc. Ted Gravenson Adv.	146, 147
■ Sage Electronics Corporation Scrivener & Company Inc.	141
■ Sanborn Company Div. of Hewlett Packard Culver Advertising Inc.	2
Seaelectro Corporation Lescarboura Adv. Inc.	186
■ Semi-Elements Cavanaugh Morris Adv.	176
Signetics Corporation Cunningham & Walsh Inc.	142
Skydyne Inc. Lescarboura Advertising Inc.	176
Sola Electric Company Klau-Van Pietersom Dunlap Inc.	48
Solitron Devices Inc. Haselmire Pearson Adv.	94
Space Craft Inc. Neals & Hickok Inc.	131
Sprague Electric Company The Harry P. Bridge Company	5, 10
Stackpole Carbon Company Meek and Thomas Inc.	128
Stanpat Products Inc. Morton Advertising Inc.	186
Statham Instruments Inc. David Johnson Adv.	161
Struthers-Dunn Inc. Harry P. Bridge Co.	150
■ Superior Tube Company Gray & Rogers Inc.	173
■ Sylvania Electric Products Inc. Tatham, Laird & Kudner Inc.	27 to 34
TRW Systems Fuller & Smith & Ross Inc.	130
TRW Capacitors Fuller & Smith & Ross Inc.	43
■ Tektronix Inc. Hugh Dwight Advertising Inc.	66, 67
Telrex Laboratories Inc. George Homer Martin Associates	195
Texas Instrument Incorporated Semiconductor Division Don L. Baxter Inc.	60, 61
Thermal American Fused Quartz Company Knierp Associates	7
■ Times Wire & Cable Company Mohr & Company Inc.	166
Tobe Deutschmann Laboratories Engineered Advertising	195
Trygon Electronics Wexton Company Inc. The	46
■ Trylon Inc. George Moll Adv. Inc.	182

Union Carbide Linde Division J.M. Mathes Inc.	129
■ United Transformer Corporation Philip Stogel Company Inc.	2nd Cover
Victoreen Instrument Company, The Palm & Patterson Inc.	137
Wakefield Engineering Inc. Sales Promotion Services	185
Wang Laboratories Inc. Larcom Randall Adv. Inc.	183
Watkins-Johnson Company William C. Estler Co.	167
■ Weston Instruments Arndt, Preston, Chapin Lamb & Keen Inc.	157
Wood Electric Corporation L.K. Frank Co. Inc.	158
Zero Manufacturing Company Guerin, Johnstone, Gage Inc.	164
■ Zeltex Inc. Sturges Associates	186
Zippertubing Company Inc. Edward S. Kellogg Company	184

Classified advertising

F.J. Eberle, Business Mgr.	
EMPLOYMENT OPPORTUNITIES	191-192
EQUIPMENT (Used or Surplus New) For Sale	193

Classified advertisers index

A & A Electronics Corp.	193
Atomic Energy of Canada Ltd.	192
Atomic Personnel Inc.	192
Bausch & Lomb	191
Columbia Electronics	193
Eldorado Electronics	192
Electronic Communications Inc.	192
Emmons Electronic Supply Co.	193
Fishman Co., P.	193
Marty's Mart	193
Norman Electronic Sales	193
Radio Research Instrument Co.	193
Space General Corp.	191
W.D. Contracting Engineers	193

■ For more information on complete product line see advertisement in the latest Electronics Buyer's Guide

Advertising sales staff

Gordon Jones [212] 971-2210
Advertising sales manager

Atlanta, Ga. 30309: Gus H. Krimmier, Michael H. Miller, 1375 Peachtree St. N.E., [404] TR 5-0523

Boston, Mass. 02116: William S. Hodgkinson McGraw-Hill Building, Copley Square [617] CO 2-1160

Chicago, Ill. 60611: Robert M. Denmead, J. Bradley MacKimm 645 North Michigan Avenue, [312] MO 4-5800

Cleveland, Ohio 44113: Paul T. Fegley, 55 Public Square, [216] SU 1-7000

Dallas, Texas 75201: Richard P. Poole, The Vaughn Building, 1712 Commerce Street, [214] RI 7-9721

Denver, Colo. 80202: Joseph C. Page, David M. Watson, Tower Bldg., 1700 Broadway, [303] AL 5-2981

Detroit, Michigan 48226: Paul T. Fegley 856 Penobscot Building [313] 962-1793

Houston, Texas 77002: Kenneth George, 2270 Humble Bldg., [713] CA 4-8381

Los Angeles, Calif. 90017: Ian C. Hill, John G. Zisch, 1125 W. 6th St., [213] HU 2-5450

Minneapolis, Minn. 55402: J. Bradley MacKimm 1104 Northstar Center (612) 332-7425

New York, N. Y. 10036: Donald R. Furth [212] 971-3615 Frank LeBeau [212] 971-3615 George F. Werner [212] 971-3615 500 Fifth Avenue

Philadelphia, Pa. 19103: William J. Boyle, Warren H. Gardner, 6 Penn Center Plaza, [215] LO 8-6161

Pittsburgh, Pa. 15222: Paul T. Fegley, 4 Gateway Center, (412) 391-1314

Portland, Ore. 97204: James T. Hauptli, Pacific Building, Yamhill Street, (503) CA3-5118

St. Louis, Mo. 63105: Robert M. Denmead The Clayton Tower, 7751 Carondelet Ave. [314] PA5-7285

San Francisco, Calif. 94111: James T. Hauptli, 255 California Street, [415] DO 2-4600

London W1: John W. Patten, Edwin S. Murphy Jr., 34 Dover Street, Hyde Park 1451

Milan: 1, via Baracchini Phone: 86-90-617 86-90-656

Frankfurt/Main: Gerd Hinske, 85 Westendstrasse Phone: 77 26 65 and 77 30 59

Geneva: Michael R. Zeynel, Joseph Wuensch, 1, rue du Temple Phone: 31 95 60

Paris VIII: Denis Jacob, 17 Avenue Matignon ALMA-0452

Tokyo: Nobuyuki Sato, 1, Kotohiracho Shiba, Minato-Ku (502) 0656

Osaka: Ryosi Kobayashi, 163, Umegee-cho, Kita-ku [362] 8771

Hugh J. Quinn: [212] 971-2335 Manager Electronics Buyers' Guide

David M. Tempest: [212] 971-3139 Promotion manager

Milton Drake: [212] 971-3485 Market research manager

Wallace C. Carmichael: [212] 971-3191 Business manager

Theodore R. Geipel: [212] 971-2044 Production manager