

Electronics

LIBRARY
UNIVERSITY OF TENN. MED. SCI.
MEMPHIS
STATE TECHNICAL INSTITUTE
AT MEMPHIS

Designing systems with state variables: page 102

A hybrid circuit for telemetry: page 111

Assembled functions open new markets: page 148

June 26, 1967

\$1.00

A McGraw-Hill Publication

Below ICs increase the promise of numerical control, page 12



142 DIV#62 DNT95 12-69
TN UNIVERSITY
MOONEY MEMORIAL LIBRY
62 S DUNLAP BOX
MEMPHIS TN 38102

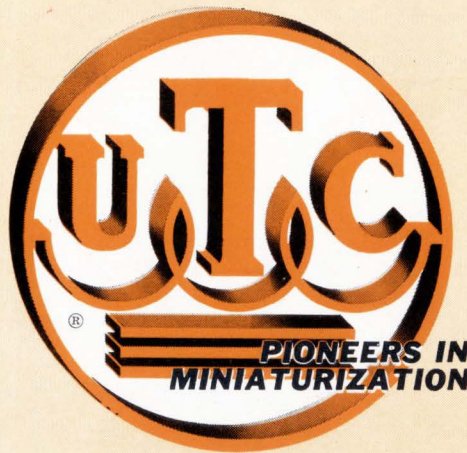

HI-FI

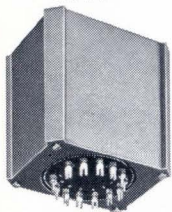

Transistor output; matches any PP transistor to 4, 8, 16 Ω speaker. Primary 48, 36, 12 Ω C.T.; 20 \sim to 20 KC; 40 watts.

MINIATURE MIL TYPE



Metal case hermetically sealed to MIL-T-27B. Gold Dumet leads spaced on 0.1 radius, for printed circuit application.

CHOPPER

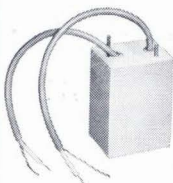

Magnetic shielded plus electrostatic shield for voltage isolation of 2×10^6 . Primary 200K C.T. to within 0.1%. Secondary 50K.

HIGH POWERED AUDIO



Low distortion 2.5 KW output transformer, PP 450 TH's 18,500 ohms C.T. to 24/6 ohms, 20 KV hipot. 520 lbs.

CATHODE FOLLOWER OUTPUT



Provides equal voltages to 5 loads. Primary inductance maintained to 5% with 20% change in DC unbalance and 30% change in AC voltages.

"SPECIAL" CUSTOM BUILT AUDIO TRANSFORMERS TO YOUR SPECIFICATIONS

HI-FREQUENCY CARRIER TO MIL-T-27B



Electrostatically shielded, humbucking, +30 dbm level. Within .5 db 250 cycles to 110 KC. 600/135:600 centertapped to .1% tolerance.

HYBRID TRANSFORMER

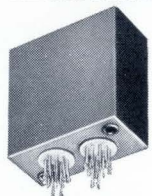

Two transformers each 600 Ω primary, 40K Ω C.T. secondary 250 cycles to 5 KC within 1/4 db. 40 db isolation over band.

MICROMODULE

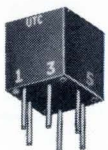

Life tested per micromodule specs: no failures. 10K Ω C.T. to 10K Ω , 100 mw from 400 \sim to 20KC.

SUBMINIATURE MOLDED TRANSFORMER

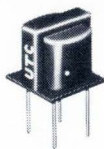

Grade 3 with printed circuit leads for transistor application. 150 Ω to 150 Ω at 10 dbm level. Size 1/2 x 1/2 x 1/2"; weight 5 grams.

BOLOMETER TRANSFORMER



Primary 10 ohms, secondary 530K ohms, 230:1 ratio, response from 1/2 cycle to 25 cycles. 120 db magnetic shielding, plus full electrostatic shielding.

ULTRA-MINIATURE



Electrostatically & magnetically shielded output transformer 1/4 D. x 1/4" H. Pri. 15K CT, Sec. 8K CT; max. level 50 mw; audio range response. To MIL-T-27B, grade 4.

Exceptional quality and reliability is provided in all UTC designs. Over 30 years of engineering knowledge and experience substantiated by extensive field performance assure the highest quality and most reliable components in the industry. Complete environmental testing facilities are incorporated to prove out new designs. Full analysis and evaluation of materials are conducted in UTC's Material and Chemical Laboratories. Rigid quality control measures coordinated with exhaustive statistical findings and latest production procedures results in the industry's highest degree of reliability. Range covered in Audio Transformers is from 0.1 cycles to 400 MC . . . microwatts to 50 KW.

MILITARY AND COMMERCIAL TYPES FOR EVERY PHASE OF THE ELECTRONICS ART

- POWER TRANSFORMERS • AUDIO TRANSFORMERS • INDUCTORS • PULSE TRANSFORMERS • ELECTRIC WAVE FILTERS • LUMPED CONSTANT DELAY LINES • HIGH Q COILS • MAGNETIC AMPLIFIERS • SATURABLE REACTORS • REFERENCE UNITS

Write for catalog of over 1,300 UTC TOP QUALITY STOCK ITEMS IMMEDIATELY AVAILABLE from your local distributor.



UNITED TRANSFORMER CO.
DIVISION OF TRW INC. • 150 VARICK STREET, NEW YORK, N. Y. 10013

Transistor Parameter Measurements with the hp 8405A Vector Voltmeter

NO LONGER
ON CURRENT SHELF

Measurement of transistor h, y or z parameters becomes increasingly difficult above 100 MHz through an inability to obtain consistently good open- and short-circuits. Tedious adjustment of tuning stubs is usually required for each measurement frequency, and unwanted circuit oscillations often occur.

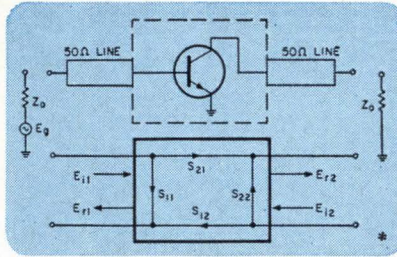

With the 8405A Vector Voltmeter, however, it is easy to measure a slightly different set of parameters—the “s” or scattering parameters. Measurement is simple over a wide frequency range and since the parameters are measured with a Z_0 load, there is little chance for oscillation. The measured s parameters can be plotted directly on a Smith Chart and easily manipulated to establish optimum gain with matching networks. Or the s parameters can be translated into h, y, or z parameters if desired.

*NPN Transistor in common emitter configuration and its equivalent 2 port scattering diagram.

Free Application Data

Hewlett-Packard has prepared an application note on s parameter measurements. Write today for your copy of Application Note #77-1, “Transistor Parameter Measurement”, to Hewlett-Packard, Palo Alto, California 94304. Europe: 54 Route des Acacias, Geneva.

The hp 8405A Vector Voltmeter is a new, wideband, 2-channel RF millivoltmeter-phasemeter. With the 8405A, measurements that were formerly difficult or impossible can now be made quickly, easily and accurately.

Major Specifications, HP 8405A Vector Voltmeter

Frequency Range is 1 to 1000 MHz in 21 overlapping octave bands; automatic tuning within each band.

Voltage Range for Channel A (synchronizing channel), 300 μ v to 1 v rms (10-500 MHz), 500 μ v to 1 v rms (500-1000 MHz), 1.5 mv to 1 v rms (1-10 MHz).

Voltage Range for Channel B (input to Channel A required), 100 μ v to 1 v rms, full scale. Full-scale meter ranges from 100 μ v to 1 v in 10 db steps. Both channels can be extended to 10 v rms with 11576A 10:1 Divider.

Phase Range of 360° indicated on zero-center meter with end-scale ranges of $\pm 180^\circ$, $\pm 60^\circ$, $\pm 18^\circ$, $\pm 6^\circ$. Phase meter OFFSET of $\pm 180^\circ$ in 10° steps permits use of $\pm 6^\circ$ range for 0.1° phase resolution at any phase angle.

Price: \$2750.

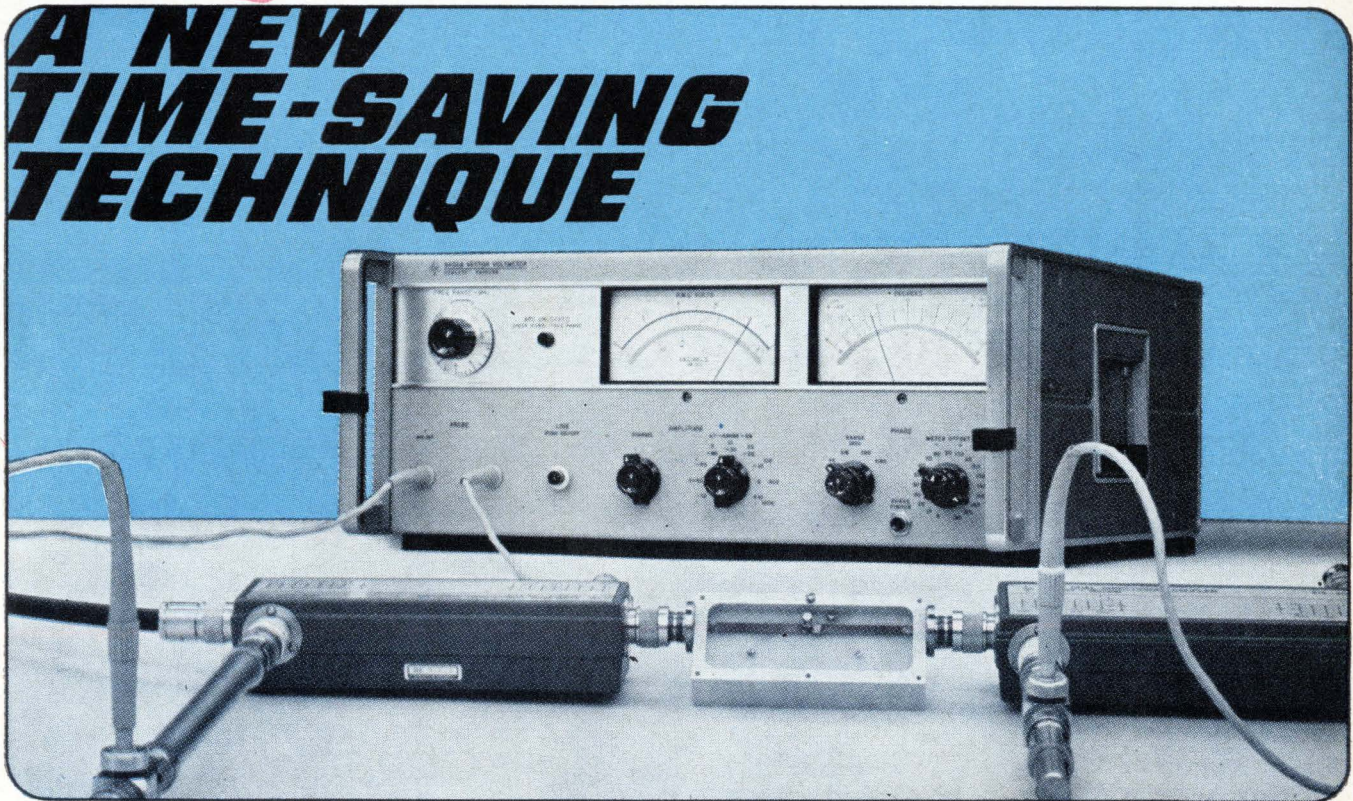

HEWLETT  PACKARD

VARIABLE
BANDWIDTH
MARKERS
PINPOINT THE
FREQUENCY



Sweep Oscillator gives top performance in the 100 kHz to 110 MHz range

All solid-state Hewlett-Packard 3211A Sweep Oscillators with RF and marker plug-ins meet virtually all of your swept frequency testing requirements. Variable bandwidth markers permit accurate, well-defined marking under a variety of test conditions.

The main frame of the 3211A contains everything you could hope to find in a sweeper. RF plug-ins operate at fundamental frequencies with good linearity and spurious mixing products are eliminated. Plug-in markers offer not only variable bandwidth, but also Z-axis or pulse-type marking. An accurate 59-db attenuator makes the unit a valuable tool for testing both high- and low-gain circuits.

Priced at less than \$1000, the 3211A is ideal for general testing in the video to VHF range where flat, linear output and an accurate marking system is required. Typical applications are: alignment, calibration and design of FM tuners and receivers and testing filters, amplifiers, transformers, resonant circuits and IF sections of TV receivers, radar and communications systems. For complete specifications, contact your local Hewlett-Packard field engineer or write Hewlett-Packard, Green Pond Road, Rockaway, N.J. 07866.

HEWLETT  PACKARD
measuring instruments
for science and industry

Circle 2 on reader service card

News Features

Probing the News

- 143 **CATV: the picture of health**
- 148 **Second front for semiconductors**
- 155 **Hewlett-Packard's do-it-yourself IC's**

Electronics Review

- 45 **Instrumentation: Second generation**
- 46 **Consumer electronics: IC's stalled; Schottkys in hi-fi**
- 47 **Optoelectronics: Blind to danger**
- 48 **Military electronics: Nothing borrowed; On-the-job training**
- 50 **Computers: Multilingual**
- 52 **Advanced technology: Now hear this**
- 54 **Manufacturing: On the beam**
- 54 **Avionics: Automatic map**
- 56 **For the record**

Electronics Abroad

- 207 **International: Tumbling walls**
- 208 **Israel: Lessons of war**
- 208 **Japan: Small wonder**
- 209 **Great Britain: Glide guide**
- 210 **West Germany: Off the cuff**
- 210 **France: Toulouse timetable**
- 211 **Canada: Satellite country**

Departments

- 4 **Readers Comment**
- 8 **People**
- 14 **Meetings**
- 16 **Meeting Preview**
- 23 **Editorial**
- 25 **Electronics Newsletter**
- 59 **Washington Newsletter**
- 163 **New Products**
- 164 **New Products Index**
- 194 **New Books**
- 196 **Technical Abstracts**
- 198 **New Literature**
- 203 **Newsletter from Abroad**

Technical Articles

Design theory 102 **State variables smooth the way for designing complex systems**

With a special performance index, an engineer can design a system, like a feedback control system, quickly

Richard C. Dorf, University of Santa Clara

Circuit design 107 **Designer's casebook**

- Diode's resistance variation stabilizes signal amplitudes
- Two flatpacks furnish pulses for IC testing
- Integrated gates form fast monostable multivibrator
- Npn amplifier delivers fast, high-voltage pulses
- Voltage-tuned oscillator measures filter cutoff

Space electronics 111 **Integrating space telemetry systems with thin films on silicon**

Thin-films imposed on monolithic integrated circuits produce two new families of a new kind of hybrid circuit

D.P. Schulz and D.J. Dooley, TRW Inc.

Industrial electronics 125 **Wider horizons for numerical control (cover)**

Integrated electronics will speed the application of numerical control, widening usage from running machine tools to controlling automatic manufacturing centers

Alfred Rosenblatt, industrial electronics editor

Title R registered U.S. Patent Office; © copyright 1967 by McGraw-Hill Inc. All rights reserved, including the right to reproduce the contents of this publication, in whole or in part.

Electronics

Editor-in-Chief: Lewis H. Young

Associate managing editors

Design: Samuel Weber

Application: George Sideris

News: Robert Henkel

Copy: Sally Powell

Senior editor

Special projects: Donald Christiansen

Senior associate editors

John F. Mason, Joseph Mittleman, Stephen E. Scrupski

Department editors

Advanced technology: Stephen E. Scrupski

Avionics: W.J. Evezia

Communications: Leonard Weller

Computers: Wallace B. Riley

Design theory: Joseph Mittleman, Edward Fearon

Industrial electronics: Alfred Rosenblatt

Instrumentation: Carl Moskowitz

Military electronics: John F. Mason

New products: William P. O'Brien

Solid State: Mark B. Leeds

Staff writers: James Brinton, Kay Sloman

Section editors

Electronics abroad: Arthur Erikson

Electronics review: Stanley Zarowin

Probing the news: Eric Aiken

Regional bureaus

Domestic

Boston: H. Thomas Maguire, manager; Robin Carlson

Los Angeles: Lawrence Curran, manager; June Ranill

San Francisco: Walter Barney, manager; Mary Jo Jadin

Washington: William D. Hickman, Paul Dickson, Patricia C. Hoehling

Foreign

Bonn: John Gosch

London: Michael Payne

Tokyo: Charles Cohen

Copy editors

Albert Tannenbaum, James Chang, Frederick Corey

Graphic design

Art director: Saul Sussman

Assistant art directors: Ann Mella, Valerie Betz

Production editor: Arthur C. Miller

Editorial secretaries: Claire Benell, Lynn Emery, Kay Fontana, Patricia Gardner, Lorraine Longo

McGraw-Hill News Service

Director: John Wilhelm; **Atlanta:** Fran Ridgway; **Chicago:** James Rubenstein;

Cleveland: Arthur Zimmerman; **Dallas:** Marvin Reid;

Detroit: N. Hunter; **Houston:** Robert E. Lee; **Los Angeles:** Michael Murphy, Gerald Parkinson

Pittsburgh: Louis Gomolak

San Francisco: William F. Arnold

Seattle: Ray Bloomberg; **Washington:** Arthur L. Moore, Charles Gardner,

Herbert W. Cheshire, Seth Payne, Warren Burkett, James Canan, William Small

McGraw-Hill World News Service

Bonn: John Johnsrud; **London:** John Shinn;

Mexico City: Bruce Cross; **Milan:** Ronald Taggiasco;

Moscow: Howard Rausch; **Paris:** Peter Kilborn;

Rio de Janeiro: Wes Perry; **Tokyo:** Marvin Petal

Reprints: Susan Nugent

Circulation: Milton Drake

Publisher: Gordon Jones

Electronics: June 26, 1967, Vol. 40, No. 13

Published every other Monday by McGraw-Hill, Inc. Founder: James H. McGraw 1860-1958.

Printed at 99 North Broadway, Albany, N.Y. 12207; second class postage paid at Albany, N.Y.

Executive, editorial, circulation and advertising addresses: McGraw-Hill Building, 330 W. 42nd Street; New York, N.Y. 10036. Telephone (212) 971-3333. Teletype TWX N.Y. 212-640-4646. Cable address: MCGRAWHILL N.Y.

Subscriptions are solicited only from those actively engaged in the field of the publication. Position and company connection must be indicated on orders. Subscription prices: United States and possessions and Canada, \$8.00 one year, \$12.00 two years, \$16.00 three years; all other countries, \$25.00 one year. Single copies: United States and possessions and Canada, \$1.00; all other countries, \$1.75.

Officers of McGraw-Hill Publications: Joseph H. Allen, President; Bayard E. Sawyer, Executive Vice President; Vice Presidents: J. Elton Tuohig, Operations; John R. Callahan, Editorial; John M. Holden, Marketing; Huber M. Gemmill, Circulation; Angelo R. Venezian, Production; Robert M. Wilhelm, Controller.

Officers of the Corporation: Donald C. McGraw, Chairman of the Board; Shelton Fisher, President; L. Keith Goodrich, Donald C. McGraw, Jr. and Robert E. Slaughter, Executive Vice Presidents; John J. Cooke, Vice President and Secretary; John L. McGraw, Treasurer.

Title © registered in U.S. Patent Office; © Copyright 1967 by McGraw-Hill, Inc. All rights reserved. The contents of this publication may not be reproduced either in whole or in part without the consent of copyright owner.

Subscribers: The publisher, upon written request to our New York office from any subscriber, agrees to refund that part of the subscription price applying to copies not yet mailed. Please send change of address notices or complaints to Fulfillment Manager; subscription orders to Circulation Manager, Electronics at address below. Change of address notices should provide old as well as new address, including postal zip code number. If possible, attach address label from recent issue. Allow one month for change to become effective.

Postmaster: Please send form 3579 to Fulfillment Manager, Electronics, P.O. Box 430, Hightstown, New Jersey 08520

Readers Comment

Computer in the clear

To the Editor:

The item "Freight fiasco" [May 29, p. 56] creates the erroneous impression that the freight-handling difficulties in the new KLM freight center in Amsterdam were caused mainly by its IBM System/360 computer.

KLM and IBM issued the following statement in Holland. I think it makes it clear that the IBM computer was not to blame to the extent stated in the article.

"In recent press statements the incorrect impression was given that the initial difficulties in the new KLM freight center were caused mainly by the new IBM System/360. This is not correct. This computer is being used exclusively for administrative purposes.

"Although at first the computer was stopped for brief periods because of high temperatures in the computer room, this had no harmful effects on the handling of the freight. The initial difficulties were mainly caused by a number of other factors such as the mechanical and partly automatic freight-handling system.

"The technicians who went to Holland from the United States to work on the freight-handling system were not IBM employees.

"Finally, KLM stated that freight handling has been restored to normal in spite of the fact that the new freight-handling system is not yet being used. The backlog of last week was completely eliminated over the past weekend during which KLM used extra manpower."

E.S. Groo

IBM World Trade Corp.
New York

America first

To the Editor:

Several of us at Amelco have read with great interest your article "Integrated circuits in action: part 5, In search of the ideal logic scheme" [March 6, p. 149]. It is an excellent summary of the situation in many respects. However, on page 156 you describe a "novel logic scheme" announced by Telefunken. This novel logic scheme

Did you know Sprague makes a wide variety of components for industrial control equipment?

TRIGATE* PULSE TRANSFORMERS



for low-cost SCR triggering

Balanced pulse characteristics. Increased energy transfer efficiency. Minimum saturation effect permits increased pulse widths. Fast pulse rise time. Increased current capability prevents SCR di/dt failure.

ASK FOR BULLETIN 40,003

*Trademark

Circle 495 on reader service card

FAST RISE TIME SCR GATE DRIVES

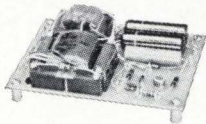

Rise time less than 1 μ S. Full 180° phase shift for inductive load. Fail-safe—if contact signal is lost, SCR gate pulse is instantly suppressed.

ASK FOR BULLETIN 85,525

Circle 496 on reader service card

PROPORTIONAL TEMPERATURE CONTROLS

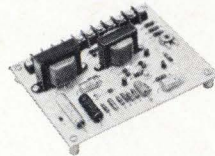

Feature temperature control to $\pm 1/2^\circ$. Conductive only when anode voltage goes through Zero. EMI-free. Also available for on-off applications.

ASK FOR BULLETIN 89,000

Circle 497 on reader service card

ZERO VOLTAGE SWITCHES

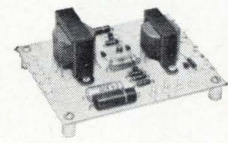

Low-cost EMI-free device for use as on-off switch, proportional temperature control, motor speed control, circuit breaker, etc. Controls resistive or inductive loads. No mechanical contacts to wear, no points to burn.

ASK FOR BULLETIN 87,500

Circle 498 on reader service card

MOLDED-CASE TRIGGER TRANSFORMERS



Molded construction for superior humidity resistance. Rated for operation where line voltages range up to 550 volts a-c. Decreased coupling capacitance reduces likelihood of false triggering by line transients.

ASK FOR BULLETIN 40,004

Circle 499 on reader service card

COMMUTATING CAPACITORS for SCRs



High capacitance, capable of delivering large peak currents with fast rise time at high repetition rates. Low inductance, low dissipation factor. Available with paper, metallized paper, film, or metallized film dielectrics.

ASK FOR BULLETIN 2875

Circle 500 on reader service card

CLORINOL® CAPACITORS for A-C Applications



Askarel impregnant has low power factor, high dielectric constant, high dielectric strength. Drawn metal cases—no soldered seams to leak. Available in ratings to 660 V, 60 cy a-c.

ASK FOR BULLETIN 4500C

Circle 501 on reader service card

For additional data, write Technical Literature Service, Sprague Electric Co., 35 Marshall St., North Adams, Mass. 01247, indicating the Engineering Bulletins in which you are interested.

SPRAGUE COMPONENTS

CAPACITORS

TRANSISTORS

RESISTORS

INTEGRATED CIRCUITS

THIN-FILM MICROCIRCUITS

4350-6150

PULSE TRANSFORMERS

INTERFERENCE FILTERS

PULSE-FORMING NETWORKS

TOROIDAL INDUCTORS

ELECTRIC WAVE FILTERS

CERAMIC-BASE PRINTED NETWORKS

PACKAGED COMPONENT ASSEMBLIES

BOBBIN and TAPE WOUND MAGNETIC CORES

SILICON RECTIFIER GATE CONTROLS

FUNCTIONAL DIGITAL CIRCUITS

SPRAGUE®

THE MARK OF RELIABILITY

*Sprague and ® are registered trademarks of the Sprague Electric Co.

Converts BCD to printed form.



Produces strip-chart record of digital data.

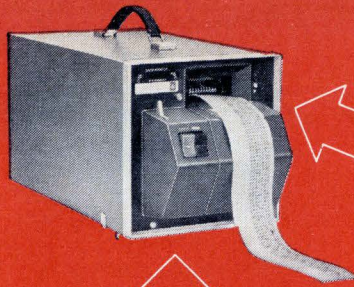

Compares measured values with preset limits.

Selects C and D (or G) range, balances, presents visual and BCD outputs.

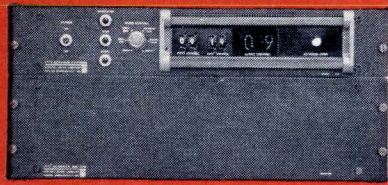

Sequentially connects capacitors to bridge.



Makes parallel-to-serial conversion for data processing and analysis.

Push for Automatic Measurements

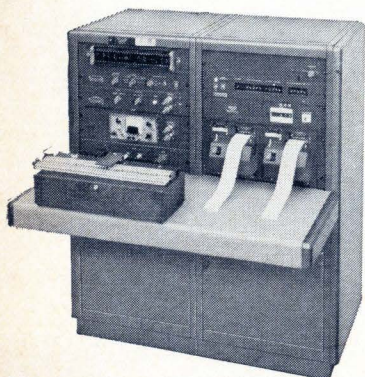

An automatic capacitor-test system produced by General Radio.

These are the basic building blocks for a variety of automatic capacitance-measuring systems that can test capacitors at rates as high as 120 per minute. Such systems are used for production testing and sorting, incoming inspection, zero-defects quality-assurance programs, and environmental-test runs for design evaluation. Cost analyses by owners of 1680 systems indicate savings of up to 80% or more on the per-unit cost of component inspection over manual methods.

The heart of each system is GR's 1680 Automatic Capacitance Bridge, which automatically selects C and D (or G) range, balances, and displays measurements in digital form. Measurement range is 0.01 pF to 1000 μ F and basic accuracy is 0.1% of reading for C and G, 1% of reading ± 0.001 for D. Price is \$4975 in U.S.A.

Other system components designed around the 1680 bridge are shown below:

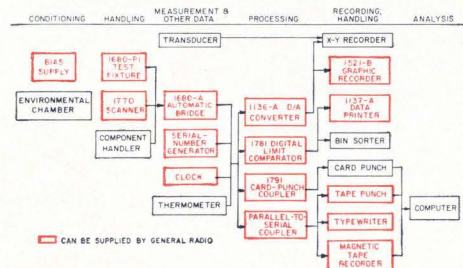

Three of these instruments are new: *Type 1770 Scanner System*, for sequential connection of many capacitors to the bridge; modular construction permits up to 100 input channels; guarded connection; six operating modes; visual display and BCD output of channel number. Price dependent upon requirements; about \$3500 for a guarded, 50-channel model.

Type 1781 Digital Limit Comparator, makes possible fully automatic capacitor sorting; compares BCD output of the 1680 bridge with limits of C and D (or G), preset on the 1781 front panel; GO/NO-GO visual indication and relay-contact output. Price, \$1625 in U.S.A.

Type 1791 Card-Punch Coupler, a parallel-to-serial converter for driving an IBM 526 Card Punch from the BCD output of the 1680 bridge and other digital instruments; 22-digit capacity. Price on request.

For additional information, write General Radio Company, W. Concord, Massachusetts 01781; telephone (617) 369-4400; TWX (710) 347-1051.

GENERAL RADIO

Circle 6 on reader service card

has been in production at Amelco since August, 1966. [Weygandt refers to DTLZ, a form of DTL in which a zener diode replaces the level shifting diode in order to provide a large voltage swing between the 0 and 1 levels. Amelco calls its version HNIL, for high noise immunity logic.]

I am sure that even the most extensive research occasionally fails to turn up all of the pertinent information on a subject. But at the same time, it would seem to be a disservice to your readers to let them know about a form of logic going into production in West Germany and not tell them about the same logic being produced in the U.S. We believe that Telefunken had been working on a high noise immunity logic as long ago as two to three years. However, we don't believe they had reached production status when the Electronics' article was written.

Philip A. Weygandt
Advertising manager
Amelco Semiconductor
Mountain View, Calif.

■ DTLZ and HNIL are one and the same.

No limit

To the Editor:

In "Integrated circuits in action, Part 6" [May 29, p. 76] R.W. Ward discusses magnetostrictive delay lines as being limited to use over a temperature range of 0° to 50°C. Such is by no means the case. Production-line AN/ARN-78 loran C and AN/ARN-85 loran C/D receivers use a miniature 458-bit, 1-Mhz delay line with performance and test specifications of operation from -50°C to +125°C.

A description of the prototype

model of these microcircuit receivers appeared in Electronics [Jan. 31, 1964, p. 23].

Our delay line is hermetically sealed, has no adjustments, and is packaged together with reclocking circuits and interface circuits on a 4" x 6 3/8" x 1/2" plug-in card. It connects directly with standard RTL integrated microcircuits.

Robert L. Frank
Sperry Gyroscope Corp.
Great Neck, N.Y.

Second chance

To the Editor:

Don't you think the example you gave in your editorial [June 12, p. 23] is worth a footnote in the next edition of "Parkinson's Law"? You indicate that the Air Force should be unhappy about not having financed all of RCA's development of the gallium arsenide transistor. This is what I gather from your conclusion that the Air Force is lucky to get a chance to supply further funds.

I suspect this is a paraphrase of a "law" which may be worded something like this: "It is good for the Government to fund research; therefore, to withhold public funds from research is bad."

But I'm quite sure that the Air Force officers, even though they may feel guilty about having broken the law will eventually be forgiven and permitted to obtain the new transistors.

S. Therman
Elmhurst, N.Y.

Readers' letters should be addressed:
To the Editor,
Electronics,
330 West 42nd Street, New York,
N.Y. 10036

World's most sophisticated little computer:

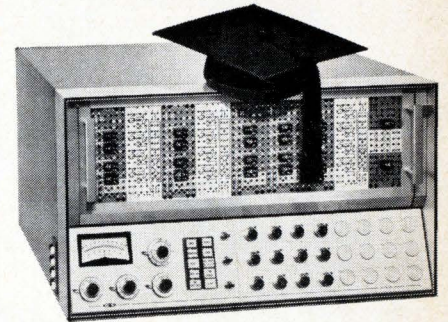

Systron-Donner's desk-top analog computers are available with built-in digital logic that enables you to solve problems the way the big computers do. You can program sub-routines. Run iterative solutions at rates up to 100 computations per second. Change nearly any parameter automatically during a computation. For example, initial conditions, coefficients, fixed voltages and patchboard connections can be programmed to change at a preset time or when a variable reaches a preset value.

Though capable of these sophisticated operations, Systron-Donner computers are unusually simple to set up. The removable patchboards are coded to match textbook diagrams. A "static check" button verifies integrator amplitude scaling instantly. A "dynamic check" button tests integrator time scaling without disturbing patching.

The 20-amplifier computer shown here is our smallest. We have 40 and 100-amplifier models. All use identical plug-in components. To get a good, close look at what you can do with these extraordinary computers, send for our abundantly illustrated 16-page brochure.

Send for free brochure



SYSTRON + DONNER

Systron-Donner Corporation,
888 Galindo Street, Concord, California

SUBSCRIPTION SERVICE

Please include an Electronics Magazine address label to insure prompt service whenever you write us about your subscription.

Mail to: Fulfillment Manager
Electronics
P.O. Box 430
Hightstown, N.J. 08520

To subscribe mail this form with your payment and check new subscription renew my present subscription

Subscription rates: in the U.S.: 1 year \$8; two years, \$12; three years, \$16. Subscription rates for foreign countries available on request

CHANGE OF ADDRESS

ATTACH LABEL HERE If you are moving, please let us know five weeks before changing your address. Place magazine address label here, print your new address below.

name _____
address _____
city _____ state _____ zip code _____

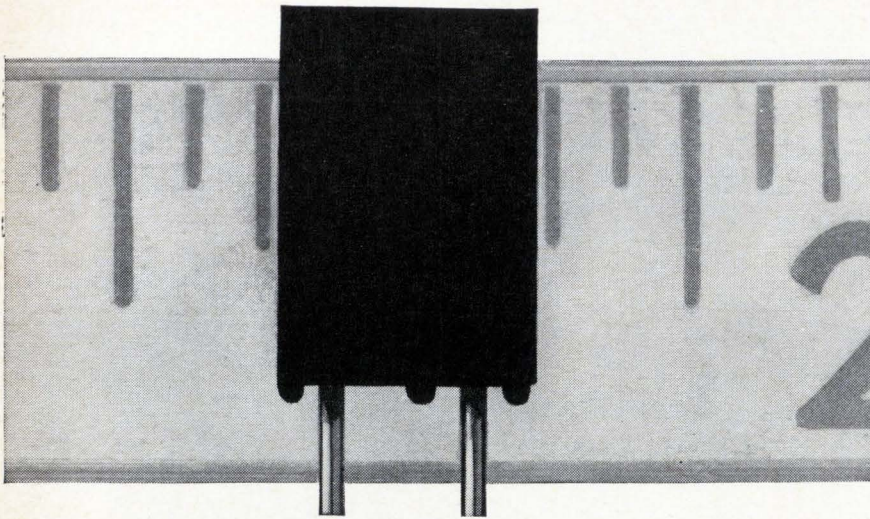

New solid tantalum capacitor for printed circuits

actual size

TIM miniatures are fully molded in a rectangular epoxy case that makes maximum use of space on printed circuit boards. Parallel leads, spaced .125". Ideal for automatic insertion.

Exceptionally stable electrical characteristics, proved by 5000-hour life test at 85°C . . . long shelf life.

Excellent performance in severe environments . . . values stay well within spec limits after 5000-hour humidity test.

One case size: .345" by .288" by .105" thick. Values from 12 mfd, 3 volts to .68 mfd, 50 volts. Temperature rating -55°C to +85°C at full voltage, +125°C at $\frac{2}{3}$ nominal voltage.

Write for Bulletin 4-82, and for quotation. Mallory Capacitor Company, a division of P. R. Mallory & Co. Inc., Indianapolis, Indiana 46206.

MALLORY

People

In Japan, engineers stay put. Except for a brief flurry right after the war, few have quit jobs to start their own companies—and the same holds true for job hopping. So when **Tadashi Nakamura** left his engineering job at Kobe Industries



Corp. last year **Tadashi Nakamura** at the age of 44 to launch Ise Electronics Corp., he not only made a dream come true but flouted custom in a nation where custom counts.

Nakamura made the move because he wanted to market his own ideas. Prime among them is the Digitron, an inside-out cathode-ray tube designed as a digital readout for desk calculators [Electronics, May 29, p. 212]. It was born out of a remark by Nakamura's boss at Kobe that a better display tube was needed, and the suggestion that Kobe's Hayakawa division might beat a path to the door of the man who invented one. The result: Hayakawa developed the Digitron with Ise and is incorporating it into a line of calculators scheduled to appear this fall.

Logical step. The Digitron, says Nakamura, developed logically from the requirements. Low-energy voltage means low-energy electrons; it's ridiculous, says Nakamura, to direct them against the back of the phosphor, as in high-energy electron-beam devices. With low-energy beams, generation of secondary electrons is low, and phosphor backing must be conductive to prevent the collection of a charge that would make the device inoperative. By directing electrons against the front of the phosphor, it's possible to use nontransparent backing for the phosphor and simplify fabrication.

What's ahead for Nakamura and Ise?

First comes expansion of the staff from 40 to 60; on the drawing board are plans to produce equipment using display tubes, including digital voltmeters and counters. This will enable Ise to produce finished

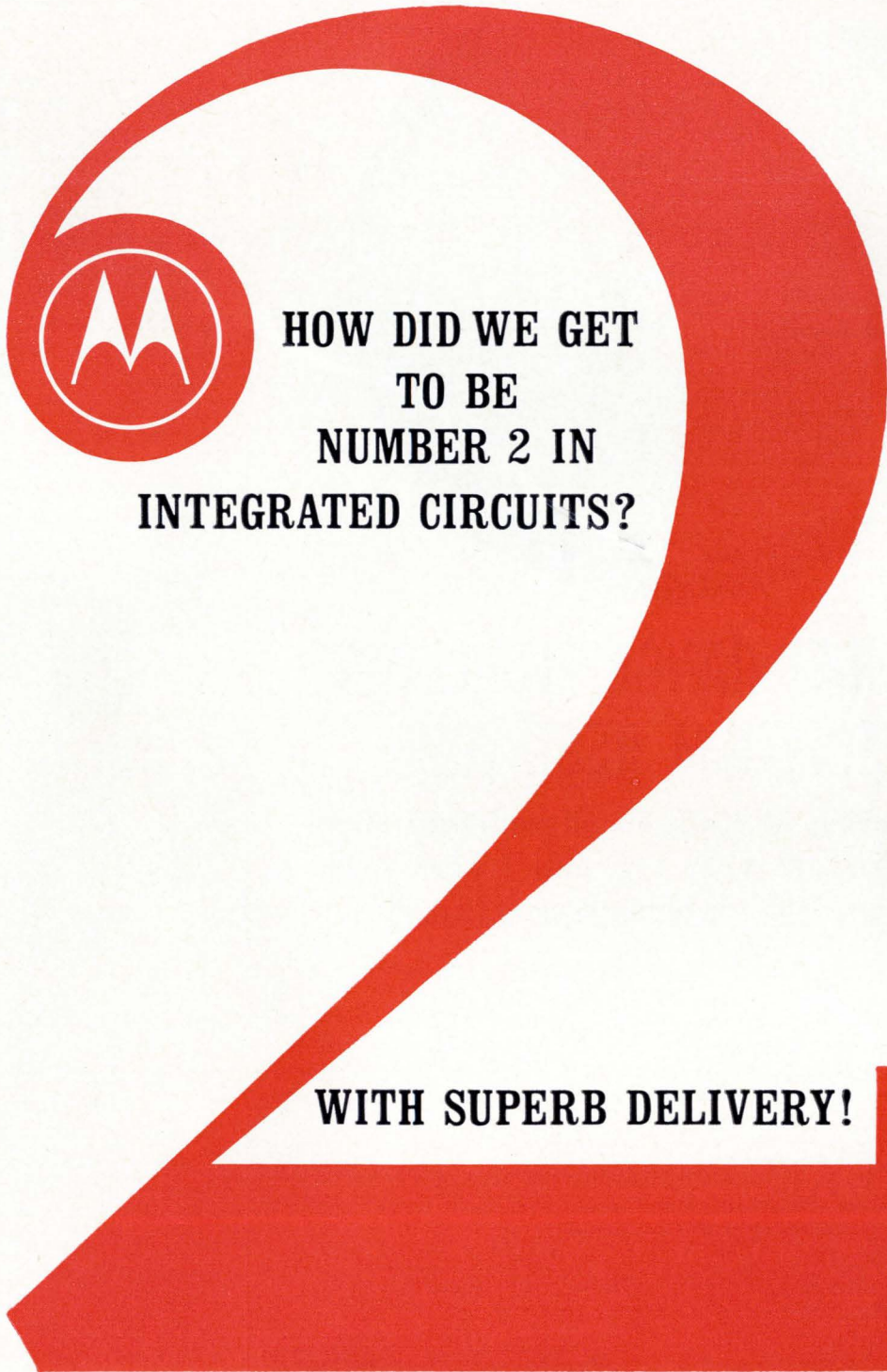

**HOW DID WE GET
TO BE
NUMBER 2 IN
INTEGRATED CIRCUITS?**

WITH SUPERB DELIVERY!



MOTOROLA Semiconductor Products Inc.

New from Sprague!

**5 Times the Resistance of
a Conventional Metal-Film Resistor
of Equal Size!**

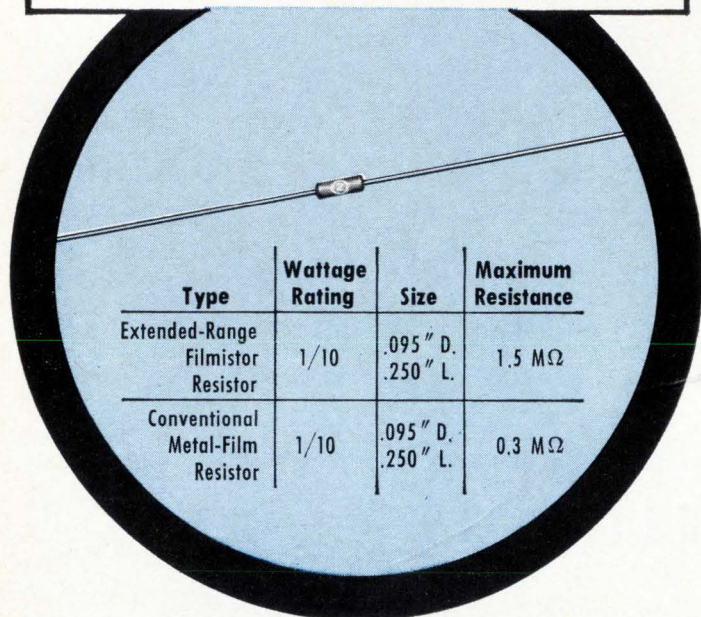

EXTENDED-RANGE FILMISTOR[®] METAL-FILM RESISTORS

**Substantial saving of space in all wattage ratings—
1/20, 1/10, 1/8, 1/4 1/2, and 1 watt—with
absolutely NO SACRIFICE IN STABILITY!**

Extended-Range Filmistor Resistors now offer, in addition to accuracy . . . stability . . . reliability . . . resistance values in size reductions which were previously unobtainable. Size and weight advantages of Filmistor Resistors now make them ideal for applications in high-impedance circuits, field-effect transistor circuits, etc. Many designs which previously had to settle for the higher temperature coefficients of carbon-film resistors in order to obtain required resistance values can now utilize the low and controlled temperature coefficients of Filmistor Metal-Film Resistors.

Other key features are $\pm 1\%$ standard resistance tolerance, low inherent noise level, negligible voltage coefficient of resistance, and tough molded case for protection against mechanical damage and humidity.

For complete technical data, write for Engineering Bulletin 7025C to Technical Literature Service, Sprague Electric Co., 35 Marshall Street, North Adams, Massachusetts 01247.

SPRAGUE COMPONENTS

RESISTORS
CAPACITORS
TRANSISTORS
INTEGRATED CIRCUITS
THIN-FILM MICROCIRCUITS
INTERFERENCE FILTERS

PACKAGED COMPONENT ASSEMBLIES
FUNCTIONAL DIGITAL CIRCUITS
MAGNETIC COMPONENTS
PULSE TRANSFORMERS
CERAMIC-BASE PRINTED NETWORKS
PULSE-FORMING NETWORKS



*Sprague and ® are registered trademarks of the Sprague Electric Co.

People

products rather than components and secure a stable market for a portion of its device production.

The General Electric Co., an electronics giant but a latecomer to the integrated-circuit field, is moving to close the gap.

It named **Donald G. Paterson**



Donald Paterson

manager of engineering for GE's new Integrated Circuit Center in Syracuse, N.Y. At 32, he already has 10 years of experience in semiconductor work, including IC responsibilities with Motorola Inc. and the Sperry Rand Corp. He'll be in charge of design, development, and fabrication of new and special IC's.

Digital drive. Paterson predicts that GE will be among the IC leaders "before the '70's." But he also makes it clear that the company has no intention of getting there via the me-too route as a second source for digital IC's. "We're developing new linear circuits, largely aimed at consumer and commercial applications. We intend to build up a capability in LSI (large-scale integration) in both bipolar and MOS (metal oxide semiconductor) technologies. We also have a strong interest in the TTL (transistor-transistor logic) technology as a possible spearhead for our digital efforts," he reports.

GE recently introduced IC's for triggering thyristors, signal-processing IC's for consumer entertainment equipment, and some general-purpose linear units. In the wings, says Paterson, are IC's for motor control and power regulation.

The center will serve as a focal point for all the company's microelectronics research and development. It also will concentrate on new applications, advanced fabrication processes, and act as a clearing house for intracompany IC needs—including those of the computer division in Phoenix.

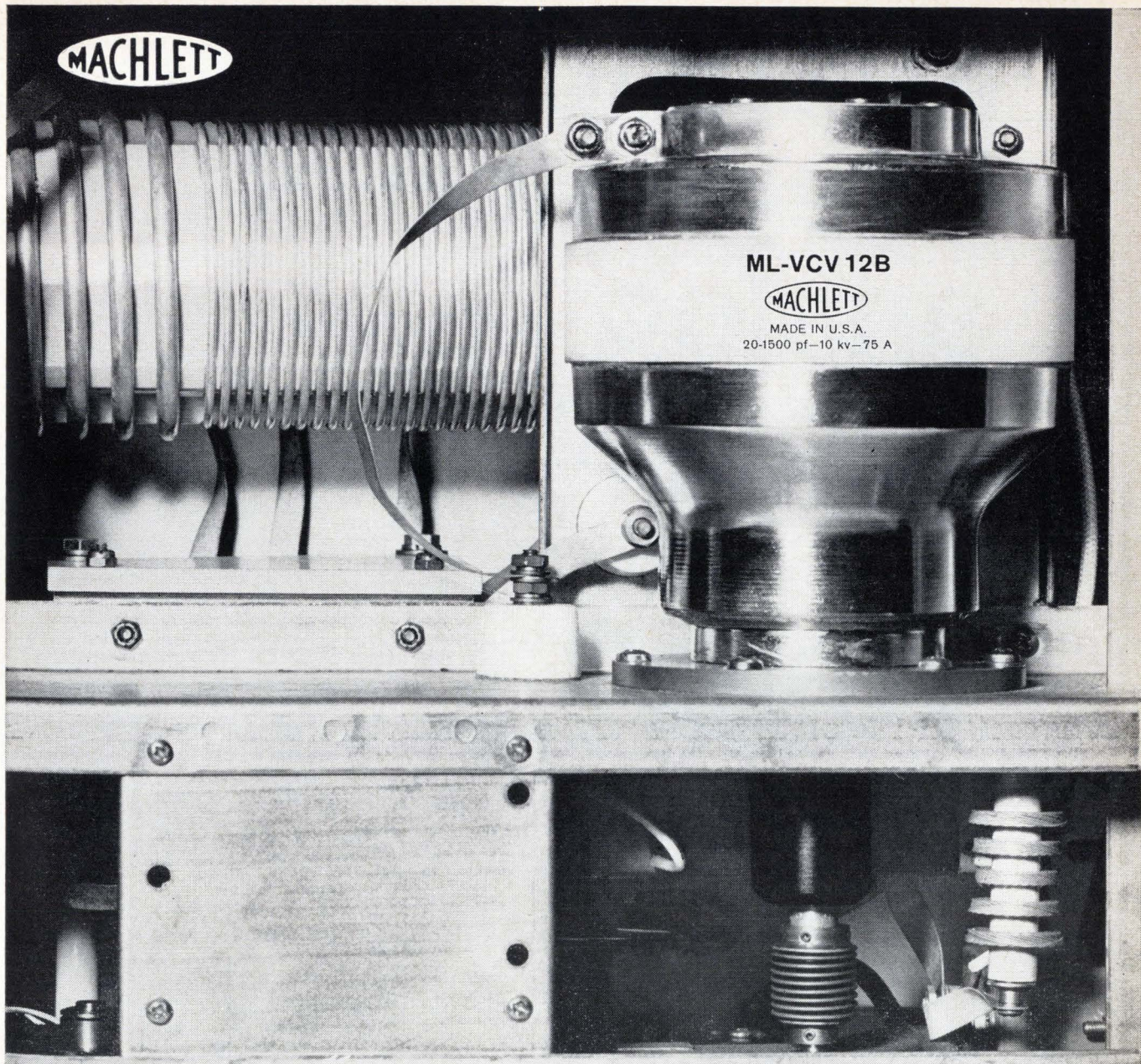

TRW's T-368/URT transmitters* use Machlett variable vacuum capacitors

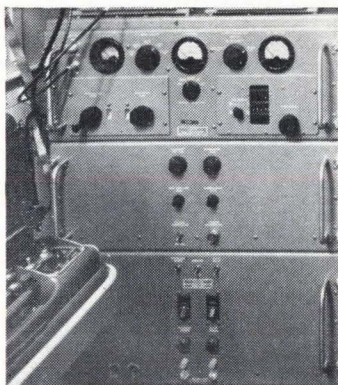

For peak performance under adverse temperature and humidity conditions, TRW's rugged field transmitters for military teletypewriter communications use ML-VCV 12B ceramic variable vacuum capacitors.

The ML-VCV 12 series: 20-1500 pF; 7.5; 10, 15 kV and 75A RMS.

Direct replacements for previously used glass capacitors, these ceramic units provide great structural rigidity and low capacitance change with temperature variation.

Send for "Vacuum Variable Capacitors—An Introduction to their Design, Ratings and Installation," printed in the Machlett *Cathode Press*: The Machlett Laboratories, Inc., 1063 Hope St., Stamford, Conn. 06907.

*Used in Radio Set AN/GRC-26D, Frequency Range: 1.5-20 mc
Power levels: AM voice or FSK/AM 400 watts, CW or FSK 450 watts.

The Machlett Laboratories, Inc., welcomes resumes from engineers and scientists.



THE MACHLETT LABORATORIES, INC.

A SUBSIDIARY OF RAYTHEON COMPANY

Total monolithic integration of analog subsystems:

When?

Now.

Big things are happening in Linear Integrated Circuits. And they're happening where they've always happened — at Fairchild (that's why we supply more LIC's off-the-shelf than all other manufacturers combined). We've got a pile of new data that belongs in your hands. Take a look:

NEW, IMPROVED PERFORMANCE

We've done new things with old products. The original 702 and 710 circuits have powerful new specifications:

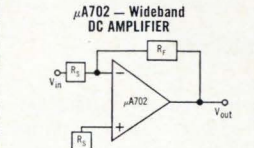
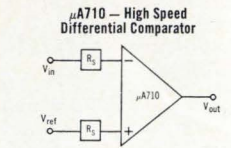
 <p>μA702 — Wideband DC Amplifier</p>			 <p>μA710 — High Speed Differential Comparator</p>		
Typical Parameters	New	Former	Typical Parameters	New	Former
V_{OS}	0.5mV	2.0mV	V_{OS}	0.6mV	2.0mV
I_{OS}	180nA	700nA	I_{OS}	750nA	1.0μA
A_{VO}	3,600	2,600	t_{ON}	40nS	40nS
$V_{OS}/\Delta T$	2.5μV/°C		A_{VO}	1,700	1,500
			$V_{OS}/\Delta T$	2.5μV/°C	

NEW, LOWER PRICES

Fairchild sells more so Fairchild sells for less. Our high volume allows us to again reduce your costs, across the board. For instance, look at these new prices:

702C	\$ 5.50	711C	\$16.00
703E	1.50	716C	5.75
709C	5.95	726C	12.50
710C	4.95	730C	3.85

(all prices are 1000-quantity, industrial grades)

FREE, NEW APPLICATIONS HANDBOOK

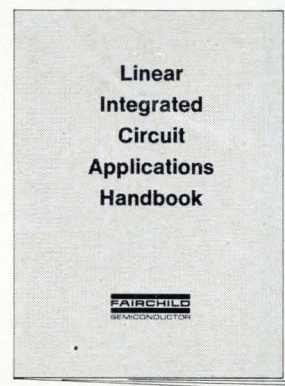

For a limited time, we'll send all inquirers our new 150-page Fairchild Linear Integrated Circuit Applications Handbook (just off the press). It's crammed with new design ideas, new applications, and new information on how to cut costs and improve performance utilizing Total Monolithic Integration (we'll also include complete specification data on the entire Fairchild LIC line). Along with this information, you receive complete rules and entry forms for our Special LIC Contest (see below).

NEW PRODUCTS

We've introduced three completely new circuits to allow you even greater design flexibility:

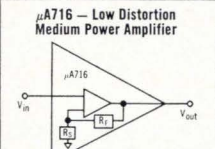
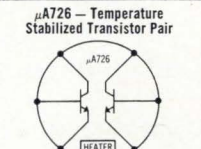
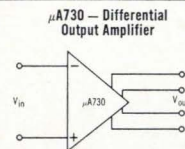
 <p>μA716 — Low Distortion Medium Power Amplifier</p>	 <p>μA726 — Temperature Stabilized Transistor Pair</p>	 <p>μA730 — Differential Output Amplifier</p>
Typical Characteristics	Typical Characteristics	Typical Characteristics
A_{VC}	$\Delta V_{BE}/T$	A_{VO}
10, 20, 100, 200	0.2μV/°C	145
THD	$\Delta I_B/T$	V_{OS}
0.05% @ 150mW	10pA/°C	1mV
I_{OUT}	h_{FE}	I_{OS}
100mA pk	400 ± 5%	0.5μA
V_{OUT}	(-55 to +125°C) ($I_C = 100\mu A$)	V_{OUT}
13V p-p	LV_{CEO}	8V p-p
	30V	R_{OUT}
		70Ω

TOTAL LINEAR CAPABILITY

Fairchild volume production gives you the quantity you need of the circuit you need, when you need it. Choose from the improved 702 and 710; the all-new 716, 726 and 730; or from these field-proven standards:

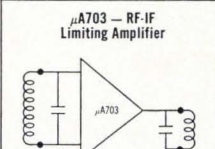
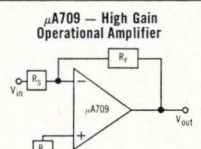
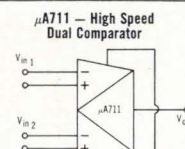
 <p>μA703 — RF-IF Limiting Amplifier</p>	 <p>μA709 — High Gain Operational Amplifier</p>	 <p>μA711 — High Speed Dual Comparator</p>
Typical Characteristics	Typical Parameters	Typical Parameters
G_m	V_{OS}	V_{OS}
35 mmhos	1mV	1.0mV
Y_{12}	I_{OS}	I_{OS}
.001 mmhos	50nA	0.5μA
I_{OUT}	A_{VO}	t_{ON}
4mA p-p	45,000	40nS
R_{IN}	V_{OUT}	A_{VO}
3KΩ	±14V	1,500

CONTEST



Win a new Pontiac Firebird for a year

We've even developed a personal incentive for you to up-date your knowledge of the Fairchild LIC line and the benefits of designing with Total Monolithic Integration. It's an Analog Subsystem Design Contest. If you're a winner, we'll put you behind the wheel of a brand new Pontiac Firebird. Complete contest rules and entry forms are included with your LIC Handbook Data Kit (all you need to do is write us or call your Fairchild Distributor or Sales Office). You can enter as often as you want. But hurry: The contest closes on September 30.

CIRCLE READER SERVICE NUMBER

FAIRCHILD
SEMICONDUCTOR



RCL power wire wound resistors

- Standard Temperature Coefficient ± 10 PPM
- Standard Tolerance $\pm 1\%$ — available to $\pm 0.01\%$
- Sub-Miniature Series available at no extra charge
- 23 Special Temperature Coefficients available from -50 PPM to $+5900$ PPM . . . an industry exclusive
- Available in Standard Wattages $\frac{1}{2}$ Watt through 50 Watts
- Resistance Values from .01 ohms to 275K
- Special Silicone Coating impervious to all cleaning solutions without exception!

- **DELIVERY — IN QUANTITY
WITHIN TWO WEEKS**

RCL

General Sales Office
RCL ELECTRONICS, INC.
700 South 21st Street
Irvington, New Jersey 07111

Meetings

Aerospace Systems Conference and Engineering Display, Society of Automotive Engineers; Statler Hilton Hotel, Los Angeles, **June 27-29**.

Automatic Control Conference, Instrument Society of America; University of Pennsylvania, Philadelphia, **June 28-30**.

Symposium on Electromagnetic Compatibility, IEEE; Shoreham Hotel, Washington, **July 18-20**.

Medac Symposium and Exhibition, Association for the Advancement of Medical Instrumentation; Hilton Hotel, San Francisco, **July 31-Aug. 4**.

Technical Symposium, Society of Photo-Optical Instrumentation Engineers; International Hotel, Los Angeles, **Aug. 7-11**.

Electromagnetic Measurement and Standards, National Bureau of Standards; University of Colorado, Boulder, Colo., **Aug. 7-18**.

Conference on Energy Conversion Engineering, American Society of Mechanical Engineers; Miami Beach, **Aug. 13-17**.

Conference on Medical and Biological Engineering, Royal Swedish Academy of Engineering Sciences; Stockholm, **Aug. 14-19**.

International Conference on Medical and Biological Engineering, International Federation for Medical and Biological Engineers; Stockholm, Sweden, **Aug. 14-19**.

Cryogenic Exposition, Cryogenic Society of America; Cabana Motor Hotel, Palo Alto, Calif, **Aug. 20-23**.

Cryogenic Engineering Conference, Cryogenic Engineers; Stanford University, San Francisco, **Aug. 21-23**.

International Conference on Phenomena in Ionized Gases, International Atomic Energy Agency; Vienna, Austria, **Aug. 27-Sept. 2**.

Cornell Conference on Engineering Applications of Electronic Phenomena, Cornell University and Office of Naval Research; Cornell University, Ithaca, N.Y., **Aug. 29-31**.

Association for Computing Machinery Conference, Association for Computing Machinery; Sheraton Park Hotel, Washington, **Aug. 29-31**.

Guidance, Control, and Flight Dynamics Conference, American Institute of Aeronautics and Astronautics; Sheraton Motor Inn, Huntsville, Ala., **Aug. 14-16.***

Short Courses

Topics in intermediate dynamics; University of Wisconsin's College of Engineering, Madison, Wis.; **June 26-30**; \$150 fee.

Fundamentals of plasmas; University of Wisconsin's College of Engineering, Madison, Wis.; **June 26-30**; \$150 fee.

Modeling and control of distributed systems; Purdue University's Schools of Engineering, Lafayette, Ind.; **July 10-21**; \$250 fee.

Call for papers

Conference on Engineering in Medicine and Biology, IEEE; Instrument Society of America and American Society of Mechanical Engineers; Statler Hilton Hotel, Boston, Nov. 13-16. For information on submission of papers and author packets, contact Murray Eden, conference chairman, Conference on Engineering in Medicine and Biology, 6 Beacon St., (Suite 620) Boston, Mass. 02108. Deadline for submission of papers is **July 31**.

Conference on Optimal Systems Planning, American Automatic Control Council; IEEE and International Federation of Automatic Control; Case Institute of Technology, Cleveland, June 20-22, 1968. **Oct. 1** is deadline for submission of abstracts to Leon F. Kirchmayer, System Planning and Control, Electric Utility Engineering, General Electric Co., Schenectady, N. Y. 12305.

Winter Power Meeting, IEEE; Statler Hilton Hotel, New York, Jan. 28-Feb. 2, 1968. Interested authors should first notify the IEEE headquarters of their intent to submit a paper. Deadline for receipt of papers is **Sept. 15**.

* Meeting preview on page 16.

THE CONNECTOR THING

A periodical periodical, designed quite frankly to further the sale of Microdot Inc. connectors and cables. Published entirely in the interest of profit.



HAPPY 1/2 NEW YEAR

Last December 31 our crass commercialism made us forget to wish you a happy gala in this journal. But now we'll make it up to you, with the celebration you didn't expect...

WELCOME TO LATTER '67 FROM MICRODOT! Grab a gal or a half-gallon, give half a toot on your pizzazz maker, and join us at least half-heartedly in making whoopee. We're sure your 1967 calendar is pretty grubby by now, with all sorts of notations you'd rather forget... so to help you get off to a clean start in 1967 1/2,

GET YOUR 1967.5 CONNECTOR GIRL CALENDAR! Actually, we wanted to make a calendar showing our six beautiful major connector lines; however, some D.O.M. in the Sales Dept. insisted you'd rather have girls. So we've set up this contest where you get both the girls and the connector information. Sneaky.

MATCH OUR MATCHLESS CONNECTORS July through December are represented by Mary through Patricia, otherwise known as the Connector Girls. That's on the calendar. In this ad they're shown representing the six major Microdot connector lines. To get your superb 1967.5 calendar, merely match the letters under the girls with the paragraph number describing the connector each girl illustrates. Read carefully. Careless readers may be punished by being sent a calendar that shows the products.

1.  When you want economical, microminiature pin and socket connections, this one is the ticket. The contact spring member has been eliminated through a breathing helical spring principle. The name is Twist/Con, and its construction permits high-density packaging of contacts on 0.050" centers—up to 420 contacts per square inch. Can you imagine 420 contacts on a postage stamp square? That's dense!

2.  Our special atmosphere controlled furnaces for high reliability parts make it a cinch to produce the highest quality line of hermetic seal connectors. To meet MIL-C-26482 (Rev. B) we offer high pressure units with both push-pull and bayonet connections. Hi temp and High pressure units are also available to meet MIL-C-26500, threaded or bayonet and with feed-thru adapters. For those concerned with MIL-C-5015, there are also special cryogenic, hi temp and high pressure models.

3.  Ultraminiature is the word for this connector line. How ultra? Like 5/32" outside diameter and 3/8" to 7/16" long, depending on your selection from seven configurations. Lepra/Con gets that small because it uses the Twist/Con (see above) closed-entry, tubular-type, gold contacts and helically wound phosphor-bronze pins. Screw-on and slide-on versions in entire line.

4.  Microdot's standard line of coax connectors comes in so many configurations that you'll find selection is a ball. You can, for instance, get Neoprene or silicone bend relief caps—in colors—and knurled or hex nuts, gold plating, slide or screw type, hermetically sealed bulkhead type, etc., etc., and so forth. But get the catalog and see for yourself the hundreds of variations. Oh yes. For the contest, this paragraph describes "standard coaxial connectors".

5.  This line is the greatest in high density, cylindrical, multi-pin connectors. It combines exclusive Posilock ruggedness in push-pull lock coupling with unique Posiseal multiple-silicon rings for sealing. Fingertip operation. No mismatching even in "blind" conditions. Meets MIL-C-38300A (USAF) for altitude—that's the MARC 53. The brand-new rear insertable version, MARC 53 RMD, is revolutionary—field assembly without special insertion or extraction tools. The subminiature lightweight version, the MARC 43, conforms to MIL-C-26482 and it's economical as can be. Neither of the MARC's requires heat to terminate conductors to contacts.

6.  Look, Ma, **both hands**. All you need for any of these coax connectors besides your hands are standard Microdot crimping tools, a bargain. With Microcrimp, you can forget soldering, burning, and miscrimping. Also, Microdot's "snap-lock" feature lets you quickly snap the connector into a bulkhead or mounting block afterwards.



MICRODOT INC.



Attention: Coupon for Connector Girl Calendar

MICRODOT INC.
220 Pasadena Avenue, South Pasadena, California 91030

Dear Sirs:

- Send your 1967 1/2 Connector Catalog.
- Send me a Microdot Rep.
- Send me anything, if it's free.

Here's my matchup below. Send me my groovy 1967.5 Connector Girl Calendar. Hurry! It's almost the 1/2 New Year.

- | | |
|----------|----------|
| A | 1 |
| B | 2 |
| C | 3 |
| D | 4 |
| E | 5 |
| F | 6 |

(Connect letters and numbers with a pencil line.)

Name _____ Title _____

Firm _____

Address _____

City _____ State _____ Zip _____

Telephone _____

Offer void where taxed or restricted.

Meeting preview

Aerospace guidance

Reports on new guidance systems and new applications of old techniques will highlight the Guidance, Control and Flight Dynamics Conference in Huntsville, Ala., scheduled for Aug. 14 to 16. The meeting is sponsored by the American Institute of Aeronautics and Astronautics.

Strapdown inertial guidance and control is an example of an old technique that's gaining favor among aerospace designers. These papers will be given in classified and unclassified sessions on the application of strapdown systems to modern missiles and aerospace programs. Morris Birnbaum of the Hycon Co. and Phil Salomon of the Jet Propulsion Laboratory will discuss a strapdown star-tracking system for spacecraft attitude control. F. Daniel, B. Doane, and R. Kissel of NASA's Marshall Space Flight Center will show how pendulous integrating gyro accelerometers can be used in a strapdown inertial navigation system.

Lasers, too. Some unusual guidance techniques also will be discussed. For example, Russell Campbell and George Hall of the Army's Redstone Arsenal will report on how a hybrid pneumatic guidance system can be used in a missile. Also to be discussed will be the use of lasers in many guidance and control functions, from rate sensing to range finding and communications. Charles Wyman of the Marshall Space Flight Center will report the results of a test with an experimental laser radar for space rendezvous and docking.

In the field of guidance and control, there will be several papers on systems in current aerospace vehicles. James Horsnell, a senior group engineer at the Boeing Co., will discuss the flight control system being developed for Boeing's supersonic transport. And James Templeman, also of the Boeing Co., and Robert Parker of the Sperry Phoenix Co., a division of the Sperry Rand Corp., will tell how the company solved the control and guidance problems for the Boeing 727's automatic landing system.

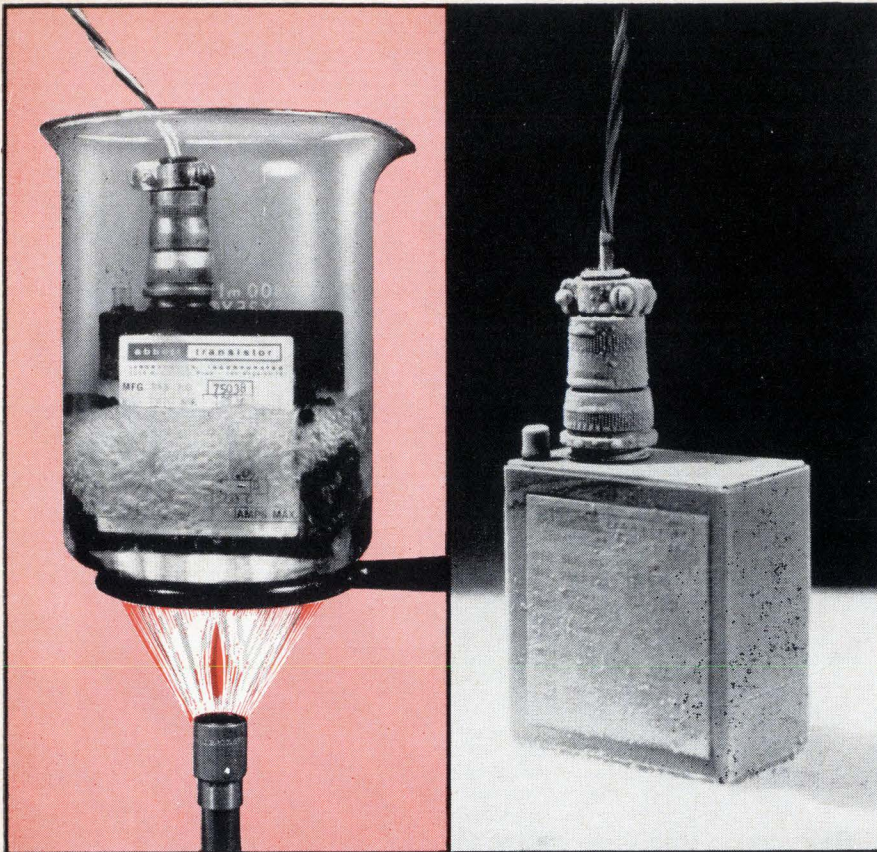

ENVIRONMENTAL TEST No. 1

Converter runs fine at +212°F

ENVIRONMENTAL TEST No. 2

Converter runs fine at -65°F

New Abbott converter (Hi-Temp Model B1A-110A) operates at -65°F to +212°F base temperature. The Model B1A shown above is available with any output voltage you need from 5 volts to 3,500 volts DC with an input of either 28 VDC or 115 VAC.

Using all silicon semi-conductors, this new line of converters is constructed in hermetically sealed, all steel containers to meet Mil-Specs. Advanced circuits yield regulation of 0.2% for input line variations. Highest quality components are used, including all teflon wire, tantalum capacitors, and MIL-T-27A transformers. A complete four-page description of these units is given on Pages 20-23 of the new Abbott catalog.

Abbott manufactures a wide variety of over 2400 different types of power supply modules. These include:

60 A to DC, Regulated	28 VDC to 400 A , 1 ϕ or 3 ϕ
400 A to DC, Regulated	60 A to 400 A , 1 ϕ or 3 ϕ
28 VDC to DC, Regulated	60 VAC or 400 A to DC, Unregulated

The DC output models come with a broad range of voltages and powers — the smallest units are about the size of a pack of cigarettes and weigh less than a pound. The AC output models are available with voltages of 115 volts or 26 volts, 400 cycles, in power levels up to 300 volt-amperes. Unregulated DC output models are low in cost with prices starting at \$64 each.

Some useful data is also included in the new Abbott catalog. It contains a discussion of thermal considerations in using power supply modules, operating hints for power supplies, and a detailed listing of environmental testing parameters with associated costs.

Please send for your **FREE** copy of this new catalog or see **EEM** (1966 **ELECTRONIC ENGINEERS MASTER Directory**), Pages 1496 to 1505.

abbott transistor

LABORATORIES, INCORPORATED
3055 Buckingham Road - Los Angeles 16
Direct Dial 213 - REpublic 1-9331

TO: Abbott Transistor Labs, Inc., Dept. 44
3055 Buckingham Road
Los Angeles 16, California

Sir:
Please send me your latest catalog on power supply modules:

NAME _____ DEPT. _____

COMPANY _____

ADDRESS _____

CITY & STATE _____

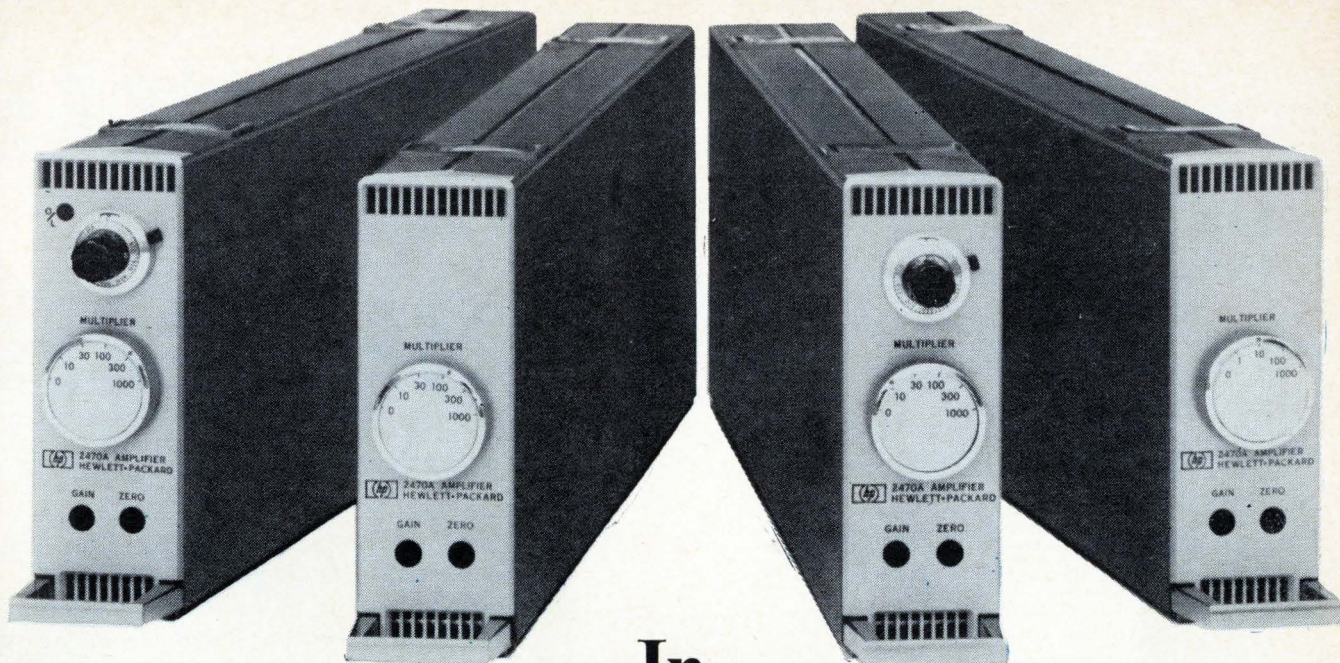

In differential data amplifiers which is more important: performance or economy?

Yes

There's no either-or when you pick the 2470A Data Amplifier.

Performance? The Hewlett-Packard 2470A has the highest across-the-board performance of any wideband amplifier of its type. Fixed gain steps X10 to X1000, X1 and precision vernier optional. DC linearity better than .002%, gain stability .005% per month. Constant 50 kHz bandwidth (3 dB), $\pm 10V$, 100 mA output. Differential input results in less than $1 \mu V / ^\circ C$ drift, RTI; 120 dB CMR even at 60 Hz with 1 k Ω unbalance.

Economy? Each instrument is enclosed in a unique modular package, with self-contained transformer-isolated power supply and rugged connector—no "extra" dust

covers or carrying case to buy. Use on the bench, or plug ten into a combining case which occupies only 5 1/4" of standard 19" rack space. The predicted MTBF for this design is more than 20,000 hours, assuring a long and trouble-free life. All included in the low price of \$585.

Applications? Use it on signals from low-level resistive transducers such as strain gages or thermocouples. Ideal for amplification over long transmission lines. Or use it with resistive or reactive loads: recorders, digital voltmeters, telemetry systems.

Any other questions? Contact your local Hewlett-Packard field engineer. Or write Hewlett-Packard, Palo Alto, California 94304; Europe: 54 Route des Acacias, Geneva.

HEWLETT  PACKARD

Next to our 709 is ancient

That's what Widlar says. And we figure he should know. He designed the 709. For somebody else. Then we got Widlar and locked him in a room with some parameters and he came out later with some curves, a data sheet and a new operational amplifier. The 709's Successor. For the catalog, we call it the LM-101.

He calls it out of sight. Here's why:

It has a minimum voltage gain of 50,000, yet it can be compensated by only one 30 pF capacitor. That makes it stable for all feedback configurations. Even with capacitive loads.

A Class B output—with continuous short circuit protection—provides at least a $\pm 10V$ output swing with a $2K\Omega$ load. There's no erratic operation when the common mode range is exceeded. And the $\pm 30V$ differential input range reduces the chance of burnout from overload. It's specified for operation from $\pm 5V$ to $\pm 20V$. With a power dissipation less than 100mW at $\pm 20V$ supplies.

new LM101, the history.

Also guaranteed: 5mV offset voltage, 200nA offset current and a $\pm 12V$ common mode range. Even though fewer compensation components are used, the LM-101 still has the same pin configuration as the LM-709. No need to change printed circuit boards.

It's on our distributors' shelves. In quantity. So call them.

Start bringing your designs up to date. Write for our application notes. National Semiconductor, 2950 San Ysidro Way, Santa Clara, California 95051 (408) 245-4320.

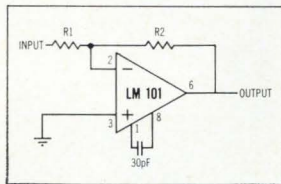

INVERTING AMPLIFIER

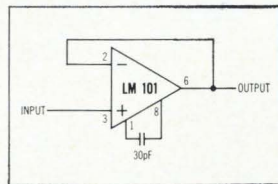

VOLTAGE FOLLOWER

National Semiconductor

*The ever-moving
Mr. Widlar.
What's he
up to now?*

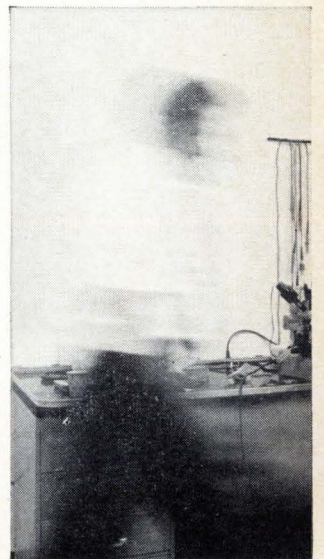

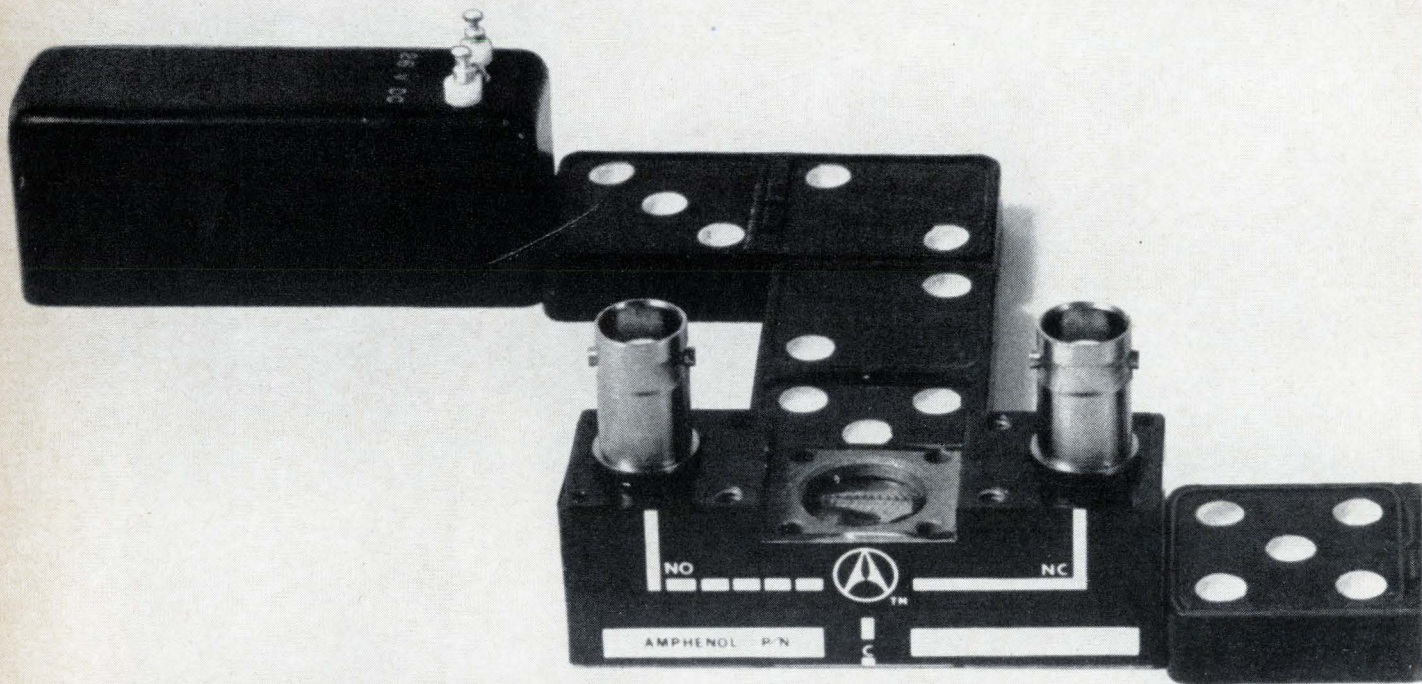

**For a switch,
try to stump Amphenol**

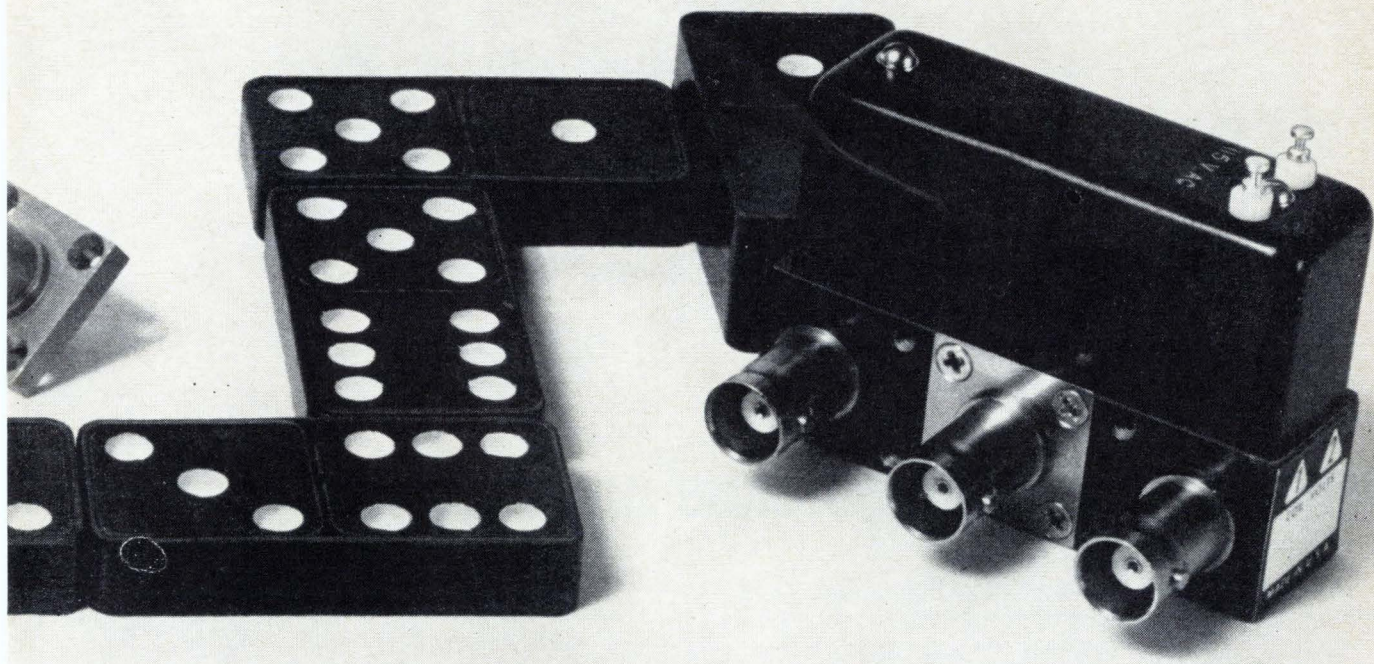

You can't. With our Dynaform* line, 23 standard modules go together like a set of dominoes to build any coaxial switch you like.

Over 300 variations. 1P2T, 2P2T or transfer. Shorting, non-shorting or resistor terminations. BNC, TNC or N type connectors. Same side or

opposite sides. Tell us what you need, and we'll put them together.

Design advances. Dynaform switches offer other advantages, too: aluminum shells for lighter weight, usable frequency ranges to 6 GHz, low crosstalk at all ranges, dust-proof construction, prompt delivery.

For price/delivery data, call your distributor or Amphenol Sales Engineer. For complete specs, write **Amphenol RF Division**, 33 E. Franklin Street, Danbury, Conn. 06810.



AMPHENOL

*Trademark

Specify Amphenol . . . the leading name in cable, connectors, assemblies, RF switches, potentiometers, microelectronics.

Circle 21 on reader service card

CEA

This new IRC metal film resistor handles **4 power ratings**



Think of the convenience and savings

Now, an all-purpose precision metal film resistor that offers design flexibility and opportunities for substantial cost savings. Type CEA can be used at four different ratings with ΔR 's that are all well within MIL limits.

$\frac{1}{2}W$ @ $70^{\circ}C$ $1\% \Delta R$ $\frac{1}{4}W$ @ $70^{\circ}C$ $.5\% \Delta R$
 $\frac{1}{4}W$ @ $125^{\circ}C$ $1\% \Delta R$ $\frac{1}{8}W$ @ $125^{\circ}C$ $.5\% \Delta R$

Flexibility is built-in. Even up to 300% overload, the CEA can be specified where low ΔR 's are required, or for a variety of ambient temperatures. Economy is built-in, too. You can combine your metal film needs to save money and simplify stocking.

All-purpose CEA resistors also have a moisture-resistant coating and a rugged cap and lead assembly. Write for data, samples and prices. IRC, Inc., 401 N. Broad Street, Philadelphia, Pa. 19108.

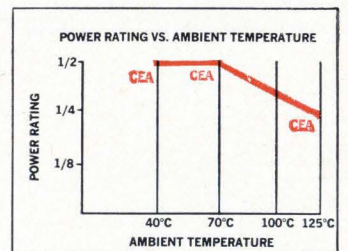
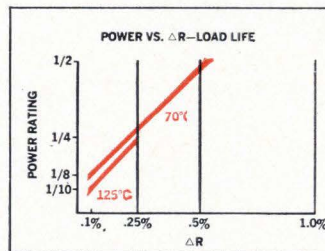

CAPSULE SPECIFICATIONS

MIL-R-10509	Meets or exceeds all performance requirements
Resistance	10 Ω to 1.5 meg.
Tolerance	$\pm 1\%$
Temp. Coef.	$\pm 100ppm/^{\circ}C$



Editorial

Detour

The heralded introduction of integrated electronics into automobiles, expected in 1968 models, has been delayed. The automotive environment has proven far more torturous than semiconductor engineers ever dreamed. Electronics specialists found that a voltage regulator designed to cost about \$3 worked well on the laboratory bench but fell victim to electrical noise, high temperature, and vibration in a car [see story on page 46].

Although a few IC regulators may still find their way into a few higher priced cars in the 1968 line—to provide experience for both auto companies and semiconductor makers—the grand introduction anticipated last fall [Oct. 3, 1966, p. 187] will have to wait.

Looking back, an emphasis on price can be blamed for the fiasco. The semiconductor people concentrated so much on getting the cost down near that of an electromechanical voltage regulator that they ignored some vital engineering factors. The final design, bare of any excess components or elaboration, was too vulnerable to electrical noise generated almost everywhere in the car and couldn't withstand the unexpectedly high temperatures. By the time the IC device was shielded and heat sinks added, the cost had risen beyond what auto companies are willing to pay.

Still, the semiconductor companies can't be blamed for this false start. Automobile technology is not their strength. And it is encouraging that none of the auto engineers or executives involved in the development program are upset about the delay or have given up on IC's. The auto men are as optimistic as ever about integrated circuits. A Ford vice president, Michael Ference, says: "The integrated circuit has forced a revolution in our thinking. We have to examine old concepts in light of these new components. There's no doubt that the integrated circuit will make a great impact on automobile design." Then he adds, "We've found it takes roughly 10 years to get an idea from the laboratory into the mainstream of production."

Ference's statement is significant because the

"we" he is talking about are automotive men, not semiconductor specialists. Auto executives recognize that the stimulus to electronics in their field has to come from within, that only auto men really understand all the ramifications of the automobile application. They expect the semiconductor industry to make a technical contribution in processing, circuit knowledge, and packaging, but they aren't ready to abdicate their own responsibilities for testing and applying the devices.

That philosophy has to be the guide as electronics move into traditionally nonelectronic areas. If the would-be customers don't supply the drive and the application knowhow, the new projects stand a good chance of failing. Electronics people just don't know enough about these businesses to dodge even well-known pitfalls.

This goes a long way toward explaining why some applications of electronics in nonelectronics fields have been successes and others failures. The numerical control of machine tools [see page 125], for example, has made slower progress than many electronics firms would have liked because the machine-tool builders have applied it cautiously. Today, 15 years after the technique was conceived, numerical control has a solid base built on the application experience of machine-tool people. Everybody predicts a widening future for it, and not just running machine tools but controlling entire automatic manufacturing centers.

On the other hand, in air traffic control or electric power generation and distribution, the Federal Aviation Administration and the electric utilities sit waiting for electronics companies to hand them ready-made solutions and hardware they can approve or veto. They themselves contribute nothing. The result has been one equipment disaster after another, much wringing of hands, and bitter assertions that modern technology has failed.

It's a trite saying that technology is only a tool to be used; it cannot solve a single problem itself. The words bear repeating though, because many ignore them.

The application of electronics in areas that have been traditionally nonelectronic is a job requiring two kinds of people: those who understand electronics technology and those who understand the application. Leaving out either one is begging for failure.

In fact, it was being thrown for a loss by laminated steel recording heads. Steel heads couldn't cope with high frequencies. Or measure up to gap definition requirements. Then we substituted the Indiana General Ferramic® O-6 ferrite.

High frequency ceased to be a problem. Our O-6 ferrite has a range through the high frequencies, and maximum permeability of 6000. Plus high saturation, low loss, and a high Curie point.

Gap definition improved, too. Ferramic O-6 has an extremely fine grain crystal structure. It can be manufactured in complex configurations to finishes in the micro-inch range, providing the close gap definition required for high signal efficiency. And, as a bonus advantage, Ferramic O-6 heads have an operating life 5 to 10 times longer than laminated steel.

But the use of O-6 ferrite material isn't limited solely to video or audio tape heads.

Its many advantages are equally applicable to disc, drum, and tape peripheral equipment for digital memory recording/reproduction processes.

You can get an instant playback of our Ferramic O-6 ferrite specifications by writing Mr. K. S. Talbot, Manager of Sales, Indiana General Corporation, Electronics Division/Ferrites, Keasbey, New Jersey.

INDIANA GENERAL 

**Instant video replay
wasn't gaining ground until
Indiana General got in the game.**

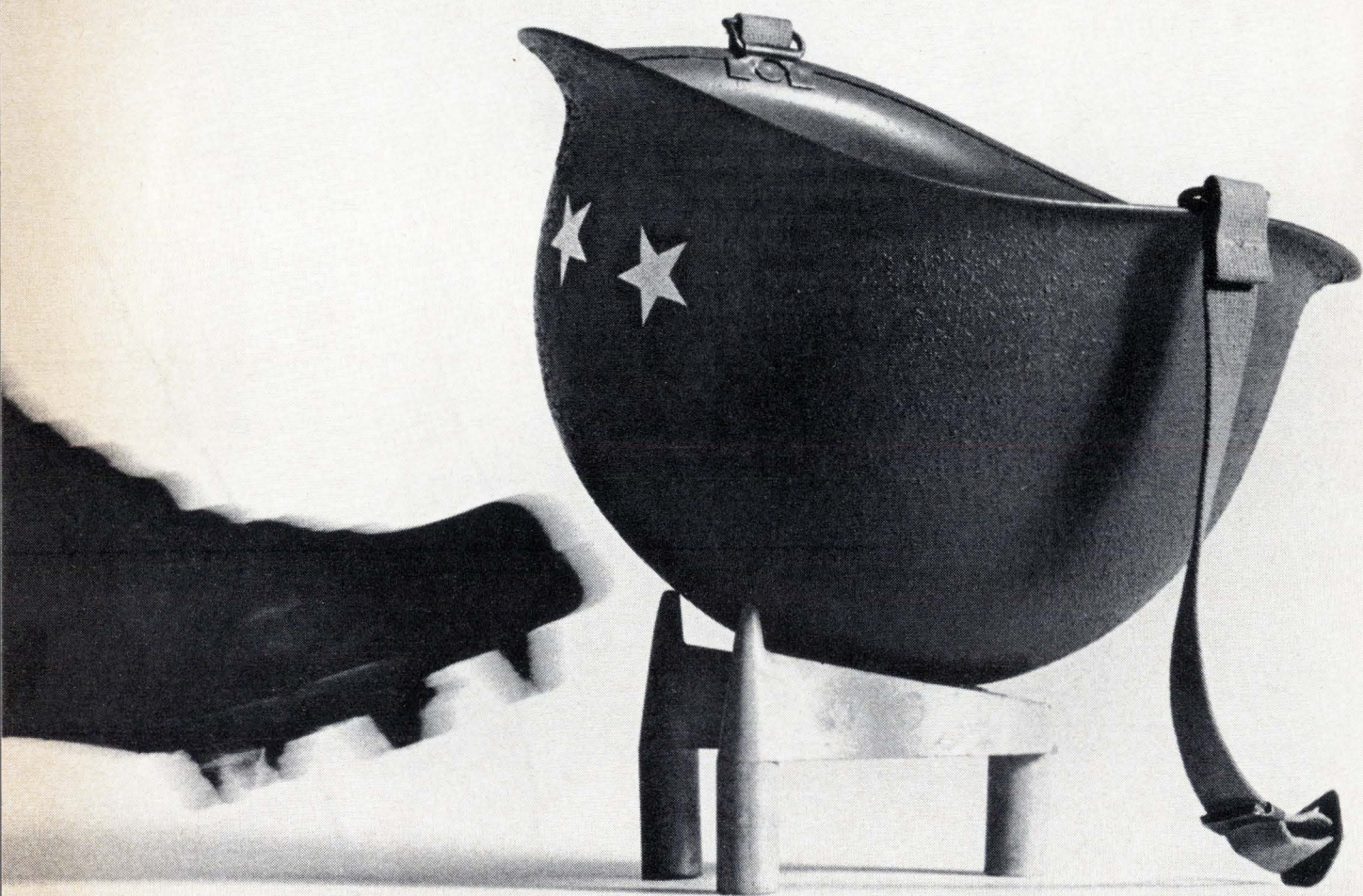

Electronics Newsletter

June 26, 1967

Silicon-nitride transistor line in August debut

After more than 18 months of hearing glowing reports on silicon-nitride-passivated transistors, the electronics industry will finally get a glimpse of the first commercial line. Sprague Electric of North Adams, Mass., is expected to market the transistors early next month.

The nitride method provides better protection against moisture than silicon-oxide passivation, says Sprague. Bell Telephone Laboratories and others have experimented with the technique for several years.

Sprague has yet to decide which transistors will be the first to be introduced with nitride passivation, **but they'll be in epoxy-molded packages.** The company plans to widen the family of nitride transistors first, and then extend the technique to integrated circuits at its new IC plant in Worcester, Mass.

Collins to make its own IC's

Collins Radio is setting up its own integrated-circuit engineering facility. The firm says it can't find suppliers of the highly customized large-scale IC's needed for some of its digital-computing and communications equipment.

For this venture, Collins will add facilities to its Newport Beach, Calif., operation. Initially there will be 30 workers in production, plus 20 to 50 in engineering. The company says it will be turning out digital IC's by early 1968.

Despite the establishment of the Newport Beach group, Collins says **it will continue to buy large quantities of less complex IC's from regular suppliers, and even predicts that this demand will increase.**

Army may drop TRG as designer of 'copter system

The Army's search for a formation-flight instrument system for helicopters continues to run into snags. **The Army probably won't have a system this year as it had planned, or even next year.**

Insiders report that the service will probably cancel its contract with TRG for an X-band stationkeeping radar system. **"The system doesn't live up to expectations,"** an Army official says. This was the Control Data subsidiary's second attempt to sell a follow-the-leader system to the Army; an earlier millimeter system was canceled [Electronics, March 20, p. 26]. The first system was originally scheduled for flight test this fall.

TRG's loss may be Teledyne's gain. Teledyne's formation-flight radar isn't designed for the Army's needs but for the joint Army-Navy integrated helicopter avionics system. Nonetheless, the Army may consider it.

Design review set for Tacsat terminals

Work on the ground terminal portion of the \$100 million tactical satellite communications program is picking up speed in preparation for next year's demonstration test. **Preliminary design review will be held this week on the terminals; production is expected to start in October** [Electronics, June 12, p. 25]. Delivery is slated for next spring on 61 terminals for man-carried, jeep, truck, aircraft, ship, and submarine installations. Sylvania Electronic Systems also expects to deliver digital data modems at the same time. And Hughes should be delivering the largest communications satellite ever built to work with the new terminals. Used as a building block for the giant satellite is Hughes' HS307 spacecraft family [Electronics, May 30, 1966, p. 109]. The multiple-access, spacecraft will

Electronics Newsletter

be nine feet in diameter and almost 20 feet long, excluding directional antennas.

Smallest of the uhf/shf earth terminals will be a portable station called an "alert receiver," to be carried by one man and capable of receive only. A teampack unit, capable of both transmitting and receiving, will be carried and set up by two men.

Planes designed around avionics seen for 1980's

The airframes of the military aircraft of the 1980's will be designed around the craft's avionics, maintains R.D. Alberts, chief of integrated avionics at Wright-Patterson Air Force Base. This reversal of the current situation will begin to appear around 1975, he says, when design work for the planes of the 80's starts. **In this period, avionics companies will become the prime contractors and airframe builders, the subcontractors.**

The change is necessary, Alberts explains, because the craft will have to accommodate 2 million to 5 million integrated circuits; current aircraft use only a handful of IC's.

Solid state imaging array's sensitivity matches vidicon

Researchers at McDonnell Douglas are developing sensitive solid state imaging arrays that operate in the far infrared. The company's solid state group in Santa Monica, Calif., has built an imaging array of 5,625 transistors on a half-inch square silicon chip that has achieved sensitivities of one foot-candle—comparable to the sensitivity of vidicon tubes. Rainer Zuleeg, assistant branch chief, says the device is most sensitive at a wavelength of 0.7 micron.

The group is now working to develop digital readout circuitry for the array, which would use 200 to 250 metal oxide semiconductor integrated circuits.

RCA lays off 600 semiconductor production workers

Even as construction continued on additional integrated-circuit facilities at its Somerville, N.J., plant, RCA laid off 600 semiconductor production workers at three locations—including Somerville. The move reflects the continued sagging sales in entertainment electronics.

About 100 of the layoffs—"to adjust inventory," the company said—were at Mountain Top, Pa. (industrial silicon and germanium transistors). The remainder were split between Findlay, Ohio, (germanium devices) and Somerville (silicon devices and IC's). RCA's Electronics Components & Devices division employs a total of 30,000 workers.

Anyone-can-do-it voltmeter appears

Makers of measurement instruments are getting the word that engineers aren't the only people who turn the dials and set the switches. One manufacturer, the James G. Biddle Co. of Plymouth Meeting, Pa., is now offering a five-place digital voltmeter that has the accuracy of potentiometric instruments (100 parts per million) and can be operated by unskilled production workers.

The key is a built-in correction factor. The operator of a conventional instrument could ruin its calibrations if he didn't know the polarity and range of the applied signal and, as a result, set the switches incorrectly. **But Biddle's voltmeter makes its own operating decisions—the operator follows directions displayed on the front panel—and erases errors before any damage is done.**

IDEAS

from SYLVANIA Electronic Components Group

CRTs

Display information the new way, with one-gun two-color CRTs



It's a truism that applications for a new CRT are limited only by the designer's imagination. And this fact is well illustrated by the introduction of what Sylvania believes to be the most versatile CRT ever devised—a one-gun, two-phosphor, two-color display component. Conventional three-gun color cathode ray tubes designed for consumer TV receivers seldom meet the stringent performance and environmental demands placed on military, industrial and commercial displays. Until now, this meant either foregoing the use of a color display

or living with degraded performance. Sylvania's new one-gun multi-color tubes overcome the limitations of the three-gun shadow-mask tubes through a new construction technique employing multilayer phosphors.

For the first time, designers of displays have a practical multi-color CRT for equipment requiring quick and positive recognition of the different information being displayed. Getting red or green with Sylvania's new one-gun color tube is as simple as switching the voltage on the anode to a higher or lower level. The extra two guns and precise shadow-mask control needed with conventional color CRTs are eliminated.

In the new type tube, multilayer phosphors of red and green produce the two-color outputs on the tube face. Because the three dots of different phosphors required for each information point in the three-gun tube are eliminated, the new tube has very high resolution. Thus, more information can be displayed in a given area.

This new CRT is ideal for applications requiring discrete-color information. In aircraft control displays,

colors could be used to indicate different altitudes to provide quick and positive information on stacked aircraft. Or, colors could be used to indicate various runways. In computer displays, color can be used to indicate particularly significant data or newly deleted, changed or added data. In short, applications are limited only by the designer's imagination.

Using red and green phosphors provides the high contrast and color separation needed for readily and accurately readable displays. The red phosphor, the famous europium developed by Sylvania for TV color tubes, is an example of the continuing improvements in CRT design which are incorporated in the new tube.

Typical of these multi-color tubes is Sylvania's type SC-4689. It features excellent color separation from red to green by switching the voltage on anode No. 3 from 6,000 to 12,000 V.

Using a 5" diameter screen and a high resolution gun, the SC-4689

(continued)

This issue in capsule

Integrated Circuits — Solve your high current drive problems with the right IC.

Manager's Corner—A new approach to low cost fabrication of microwave ICs.

Diodes—An array made up of 13 diodes in a single plug-in package.

Photoconductors — Now you can drive 300 mW loads with a new 250-ohm device; also, news on TO-18 PCs customized to your needs.

Microwave Semiconductors — How you can design broadband systems around a single diode and holder.

SPECTRAL ENERGY DISTRIBUTION (PHOSPHOR TYPE "PSO")

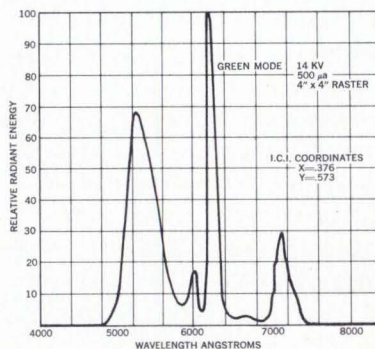
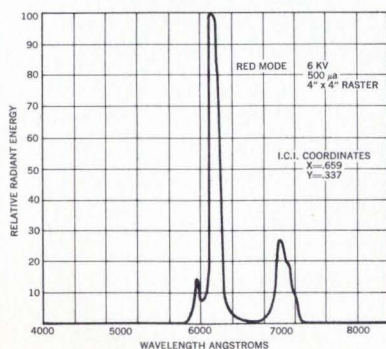

offers spiral post deflection acceleration to minimize the changes in deflection sensitivity and pattern linearity as anode No. 3 is switched.

Sylvania can apply the same principles used in the SC-4689 to other sizes and to other types, such as a two-gun device, to meet users' specific needs.

CIRCLE NUMBER 300

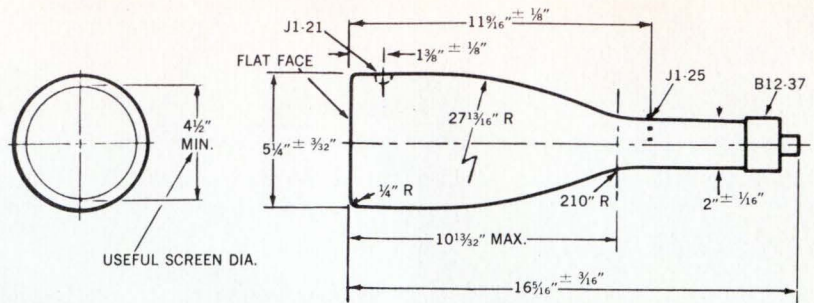

MAXIMUM RATINGS (Absolute Maximum Values)		TYPICAL OPERATING CONDITIONS		
Anode No. 3 Voltage	13,000 Volts dc		Red Operation	Green Operation
Anode No. 2 Voltage ⁽¹⁾	7,000 Volts dc	Anode No. 3 Voltage	6,000	12,000 V. dc
Anode No. 1 Voltage	1,100 Volts dc	Anode No. 2 Voltage	3,000	3,000 V. dc
Grid No. 1 Voltage		Anode No. 1 Voltage for Focus	150-400	150-400 V. dc
Negative Bias Value	220 Volts dc	Grid No. 1 Voltage Required for Cutoff ⁽²⁾	-30 to -70	-30 to -70 V. dc
Positive Bias Value	0 Volts dc	Deflection Factor		
Positive Peak Value	2 Volts	Deflecting Plates 1-2 ⁽³⁾	70-90	95-115 V. dc/In.
Peak Heater-Cathode Voltage		Deflecting Plates 3-4 ⁽⁴⁾	65-85	90-110 V. dc/In.
Heater Negative with Respect to Cathode	140 Volts dc	Line Width "A" @ I _{a3} = 25 μA	.012	.010 In.
Heater Positive with Respect to Cathode	140 Volts dc	Brightness, 2"x2" raster		
Peak Voltage Between Anode No. 2 and Any Deflection Plate	550 Volts	I _{a3} = 25 μA (approx.)	4	35
Post Deflection Spiral Resistance	100-400 Megohms	Anode No. 3 Current @ E _{g1} = cutoff (approx.)	7-30	21-90 μA dc
SC-4689 CHARACTERISTICS		CIRCUIT VALUES		
Focusing Method	Electrostatic	Grid No. 1 Circuit Resistance	1.5 Megohms Max.	
Deflect on Method	Electrostatic	Deflection Circuit Resistance ⁽⁵⁾	5 Megohms Max.	
Heater Voltage	6.3 Volts	NOTES: 1. The product of the Anode No. 2 Voltage and the Average Anode No. 2 Current should be limited to 6 Watts. 2. Visual extinction of undeflected focused spot. 3. Deflecting Plates 1-2 are nearer the screen. 4. Deflecting Plates 3-4 are nearer the base. 5. It is recommended that the deflecting electrode resistances be approximately equal.		
Heater Current	0.6 Ampere			
Minimum Useful Screen Diameter	4.5 Inches			
Weight (approx.)	2.5 Pounds			
Mounting Position	Any			

MANAGER'S CORNER

Microwave ICs—New approach to low cost fabrication

A great deal of effort has been expended over the past few years to develop "Integrated Microwave Circuits". A great many interpretations have been placed on this term, but, in general, the resulting circuits have been limited to a single functional component, usually a ceramic micro-strip structure with semiconductor devices bonded or epoxied in place.

The resulting components usually have a "handmade" look to them; this may be an asset in a wool sweater or a piece of fine furniture, but is no virtue in a microwave component. As with clothing and furniture, hand labor costs a lot of money. What is needed is a technique of fabrication which is adaptable to batch processing with most of the work performed by machines. In this way, large numbers of microwave components and systems could be produced at a cost that would make possible the economical construction of phased array radars and other large scale military systems, as well as open the door to many non-military markets for which microwave components are too expensive today.

One approach to this problem is to apply the techniques of monolithic integrated circuitry. Automation in monolithic circuits has already reached a high level at Sylvania in the manufacture of digital and low frequency linear circuits. However, monolithic techniques have not been extensively used at microwave frequencies because of the difficulty of working with the very high resistivity semiconductor material required for low loss transmission lines.

Sylvania's Beam-Lead Technology

Sylvania has pioneered an exciting new approach to the problem of functionally integrating microwave circuitry with a technique that is compatible with automated manufacturing.

The beam-lead technology is a new and powerful technique for fabrication and mounting of semiconductor devices in microwave integrated circuits. Compared with conventional chip fabrication and mounting, the beam-lead approach offers the following advantages:

- The assembly operations of scribing, chip mounting and wire bond-

ing are replaced by the single step of precise beam-lead welding. Beam leads are also far stronger than ribbon or wire leads.

- Complete uniformity of device and lead geometry is assured from unit to unit through photolithographic definition of the unified structure. This permits accurate characterization and repeatability of device and parasitic parameters.

- Economy in fabrication is realized through batch processing of large numbers of devices.

- Economy in assembly of circuits is realized through the ease and simplicity of device mounting. The process readily lends itself to automation and mass production.

This process creates a device in which individual chips of silicon contain the active areas and are interconnected and mechanically supported by rather thick gold "beams". This type of device, therefore, contains all the advantages of a discrete chip circuit as regards completeness of isolation, while maintaining the batch fabrication process and small size which are the unique advantages of

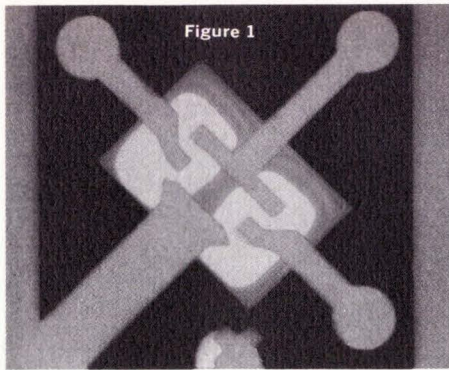

Figure 1

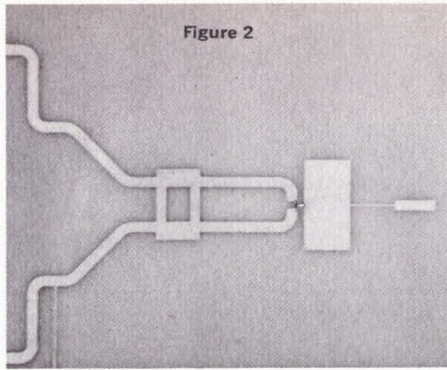

Figure 2

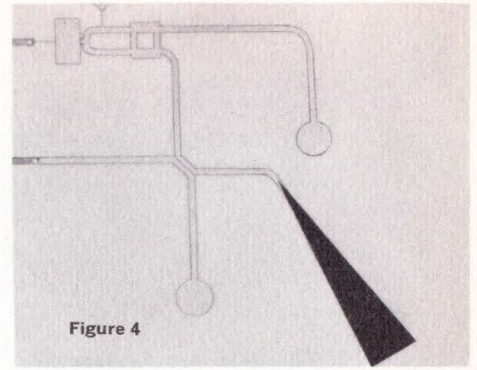

Figure 4

integrated circuits. The interconnection leads are strong and are much less likely to prove unreliable than the alloyed or ribbon leads normally used in standard devices.

Further, the external leads now project beyond the edges of the circuit area for several mils, and are precisely located with respect to one another. This facilitates the assembly of the device onto a premetallized circuit substrate which has a properly prepared metallization pattern which "mates" with the leads. The gold beam leads are excellent for bonding or welding to a microstrip conductor. The reliability of such a bond is as great as that of the lead itself.

One may reasonably compare beam-led microwave integrated circuitry with monolithic circuitry in which semiconductor devices are fabricated integrally with a semiconductor transmission line substrate. In the latter process, one is restricted to devices which are compatible with the monolith; with beam-leading, devices of different starting materials may be used in the same circuit. In monolithic circuits, transmission line losses are higher than in ceramic microstrip circuits with which beam-led devices are used.

The usually-quoted monolithic circuit advantages of cost, reliability and size may be fairly challenged by beam-led hybrid circuits. Since the fabrication and mounting of de-

vices is so well suited to automation, large volume costs of beam-led circuits should not greatly exceed those of monolithic circuits, and may in fact be lower, especially where yield is critical. Reliability of welded beam-led circuits should be comparable to that of monolithic circuits, and units made by the two processes are comparable in size.

Perhaps most important is that beam-led hybrid microwave integrated circuits are here now, have been proven in performance and are far simpler to fabricate and develop than monolithic circuits using silicon transmission lines. In addition, the potential exists for comparable low cost and reliability in automated large scale production.

Sylvania's beam-lead technology has been applied to produce a unique microwave mixer circuit configuration. Two silicon Schottky barrier diodes are fabricated monolithically and beam-led in series, with a center beam between them. The resultant diode pair is as shown in Figure 1. The complete mixer is shown in the photograph of Figure 2.

Here, the diodes are bonded to the arms of a quarter-wavelength branch line hybrid, and the IF signals are combined at the center tap of the diode pair and fed out through a low pass filter. This mixer has successfully performed at X-band with a noise figure of 7 db. Continuing development

programs will extend the application of beam-lead technology to other microwave devices, leading to the development of complex microwave sub-systems on ceramic substrates for radar and communications applications which are reliable, reproducible, and adaptable to automated fabrication.

As an illustration of what can be done, Sylvania has recently constructed a simple demonstration model of a CW integrated doppler radar. This simple system, shown in block diagram form in Figure 3, consists of a 9.5 GHz avalanche diode oscillator, which serves as transmitter and local oscillator (the system operates at zero IF frequency), a directional coupler, separate transmit and receive antennas, a Schottky diode balanced mixer, low pass filter, audio amplifier and loud-speaker. A moving target produces a doppler-shifted return signal, which is downconverted to an audio frequency, amplified and fed to the speaker.

The portion of the circuit shown within the dotted lines has been integrated in alumina microstrip, as in the photo of Figure 4. Shown here are the balanced mixer, which uses a beam-lead Schottky diode series pair, low pass filter, directional coupler with termination, and two slot antennas. Radiation is from the ground plane side of substrate through slots which are not visible in the picture.

The avalanche oscillator used is a miniature coaxial cavity circuit which is directly coupled to the microstrip circuit without a coaxial connector. It produces approximately 40 milliwatts CW power. This system was demonstrated at the 1967 IEEE International Convention.

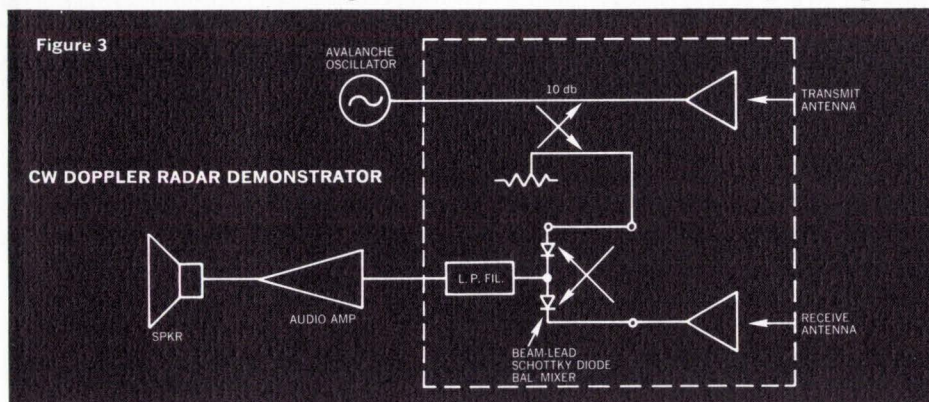

Figure 3

Arthur H. Solomon
 ARTHUR H. SOLOMON
 HEAD, SOLID STATE MICROWAVE COMPONENTS

ICs to solve your high current drive problems

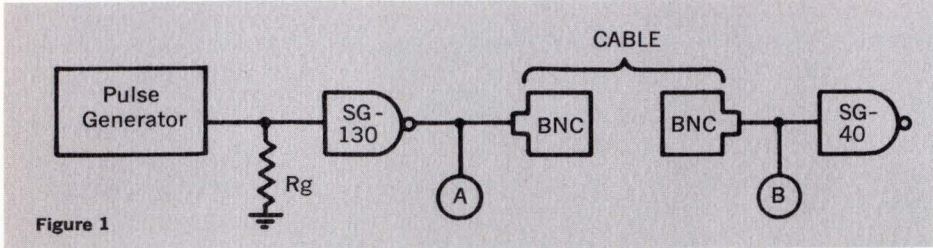

Figure 1

"Output Drive Capability" are the key words describing the type of IC often needed to translate the output of a logic operation into a useable power signal. Ideally, these ICs should be able to drive high fanout and high capacitive loads without sacrificing speed, logic swing or noise immunity. Sylvania's SG-130 series of SUHL™ dual gate drivers meets these device requirements, and they're usually the best choice in line and cable drivers, lamp drivers and other interface applications.

The SG-130 series of SUHL high fanout dual drivers solves the problems associated with many interface applications which require gate outputs with high current drive capability when the output is at "0" and/or "1." They overcome these problems by providing the necessary power without degrading the speed and

noise immunity of the system.

Typical of the output drive capability of units in the SG-130 series are:

A line driver "0" output of 0.45 V max. when sinking up to 40 mA, guaranteed over the applicable temperature range of the device.

"0" output of 0.8 V (nominal) when sinking up to 100 mA (min.) at 25°C.

"1" output of 2.8 V (min.) when supplying up to 3.0 mA, guaranteed over the temperature range.

"1" output of 3.4 V (typical) when supplying up to 20 MA.

Values of the output current at logic "1" and at room temperature show this typical range:

$$I_{out} @ 0V = 110 \text{ to } 140 \text{ mA}$$

$$I_{out} @ 0.5V = 95 \text{ to } 125 \text{ mA}$$

$$I_{out} @ 1.0V = 85 \text{ to } 110 \text{ mA}$$

One use of the drive capability out-

CIRCLE NUMBER 301

lined by these device specifications is in cable or line driver applications. Figure 1 gives the test setup used to check performance of the SG-130 units in such applications. A number of different cables, both short and long lengths, were connected between the SG-130 under test and a SG-40, a NAND/NOR gate in the SUHL family. Cables used included: RG58U (Z_o of 50 ohms), RG62U (Z_o of 93 ohms), twisted wire (Z_o of about 100 ohms), and single wire. Lengths ranged from 2.5 ft. to 37 ft.

Test results for various conditions are given in Figures 2 to 5.

In most cases, a termination of Z_o to ground or to +3.5 volts on the receiving end gives the best matching. In lower power applications, a resistor in series with the SG-130 output can be used at a slight decrease in noise immunity.

The SG-130 series is available in four versions – Military Prime, Military Standard, Industrial Prime, and Industrial Standard – with fan-outs ranging from 12 to 30. Each package uses two four-input AND gates followed by an inverting amplifier to get a NAND function in positive logic.

Figure 2

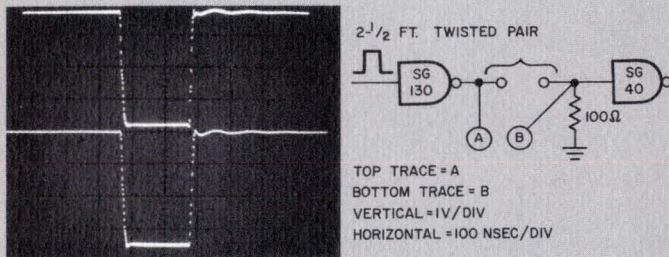

Figure 3

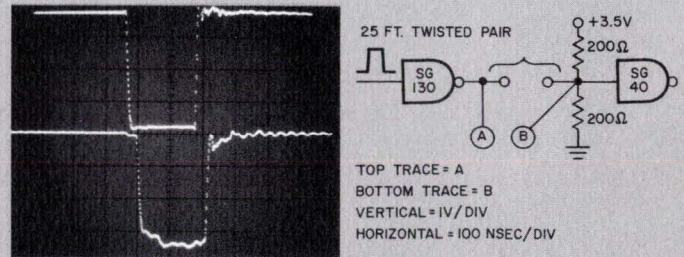

Figure 4

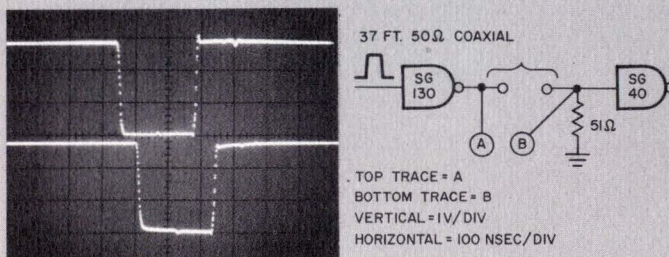
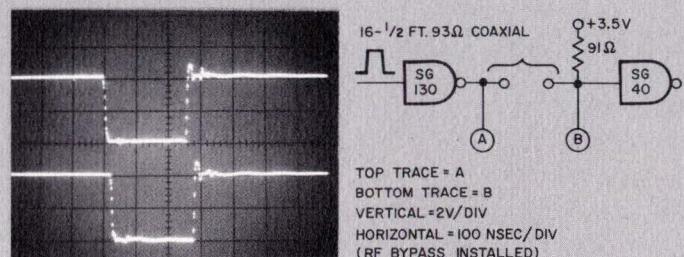

Figure 5



Now, design broadband systems around a single diode and holder

A new family of Sylvania microwave diodes uses an improved coaxial cartridge package to bring the microwave designer a host of benefits. Now, each diode can be used over a much broader frequency range, operation at higher temperature limits is possible, and diode holder design is simplified. In addition, these hermetically sealed units can withstand more severe environments.

Sylvania's new line of microwave mixers and detectors employs a new design glass bead to overcome the frequency limitations found in conventional ceramic-beaded coaxial cartridge microwave diodes. These glass-beaded units provide a much flatter frequency response over a much broader range; each Sylvania unit is designed for a frequency range, not just one specific center frequency. Because the improved process permits better sealing of the diodes, the new devices can be used in any atmosphere at temperatures up to 150°C; therefore, the need for elaborate sealing procedures by the diode user is eliminated.

All these performances and environmental advantages are a result of using a glass bead to support the center conductor in the coaxial package. In conventional coaxial diodes for use above S-band, the center conductor which is attached to the diode's active element is supported by an insulating bead whose length is one-half wavelength at the design frequency. In this way, the desired rf impedance of the rectifying contact will be transformed to the input end of the coaxial diode. Variations in the rf impedance at the terminals of a coaxial diode with a half wavelength bead depends on how far away from the design fre-

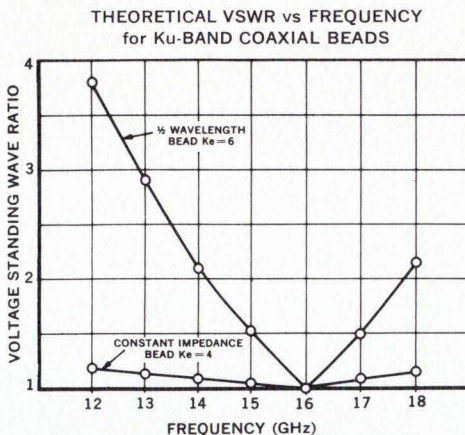

quency the diode is to be operated. A relatively large frequency sensitivity exists for these beads. This can introduce large mismatches capable of degrading overall diode performance.

Because of the large mismatch presented by a half-wavelength bead when operating off the design frequency, it is difficult to design broadband systems utilizing this type of diode. To enable the coaxial diode to be used across a band of frequencies with only minimum mismatch, Sylvania now uses a bead with little or no frequency sensitivity.

The length of the dielectric bead is no longer a half-wave at the design frequency, but is chosen to compensate for the small capacitances which now occur at each end of the bead. The relative frequency insensitivity of this type of bead is illustrated by Figure 1 which compares Ku-band operation for both bead types. The mismatch introduced by the improved bead is very much less than that of the old bead design.

In the past, special diode holders with various tuning and matching adjustments were necessary when a coaxial diode was used at other than the design frequency. The holder re-

EQUIVALENCY CHART

TRI-POLAR		
New Type	Old	Application
D5632	1N1132	3-12.4 GHz Mixer
D5638	1N358	1-12.4 GHz Detector
D5634	1N630	1-12.4 GHz Detector
STANDARD COAXIAL		
D5392	1N2510	8.2-12.4 GHz Mixer
D5391	None	10-16 GHz Mixer
D5282	1N78	12.4-4.18 GHz Mixer
D5326	1N26	18-26.5 GHz Mixer
D5353	1N53	25.6-40 GHz Mixer

quired retuning when frequencies shifted or when another diode was installed. The new device eliminates these tuning devices which used to be part of the diode holder. This means not only is the usefulness of the diode increased across a band of frequencies, but also installation costs are reduced, because a much simpler holder is required and diodes may be replaced without retuning.

In the new construction, high temperature bead materials are now being utilized. Previously, high dielectric constants restricted their use. The result is an integral glass-to-metal seal which can withstand extremes of temperature and mechanical stresses, and still maintain its hermetic integrity.

These new detectors are ideally suited for broadband ECM and test equipments. They are available in singles, matched pairs and matched quads to meet the users' specific needs.

The new bead construction is also used in a tripolar coaxial diode, with input/output termination at different ends. This further simplifies construction of the diode holder.

CIRCLE NUMBER 302

TYPICAL RESPONSE FOR BROADBAND VIDEO DETECTOR (D5634-D5638)
VOLTAGE OUTPUT vs FREQUENCY

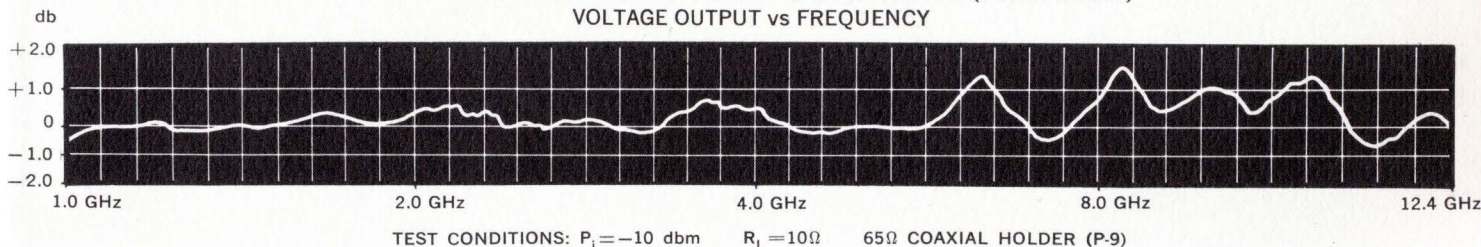

TEST CONDITIONS: $P_i = -10$ dbm $R_L = 10\Omega$ 65Ω COAXIAL HOLDER (P-9)

Arrays: now 13 Sylvania diodes in one dual-in-line plug-in package

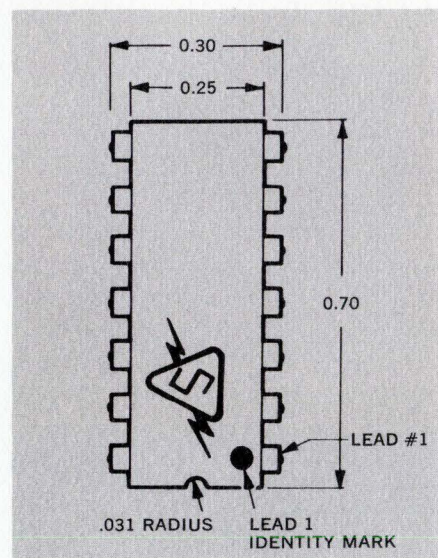
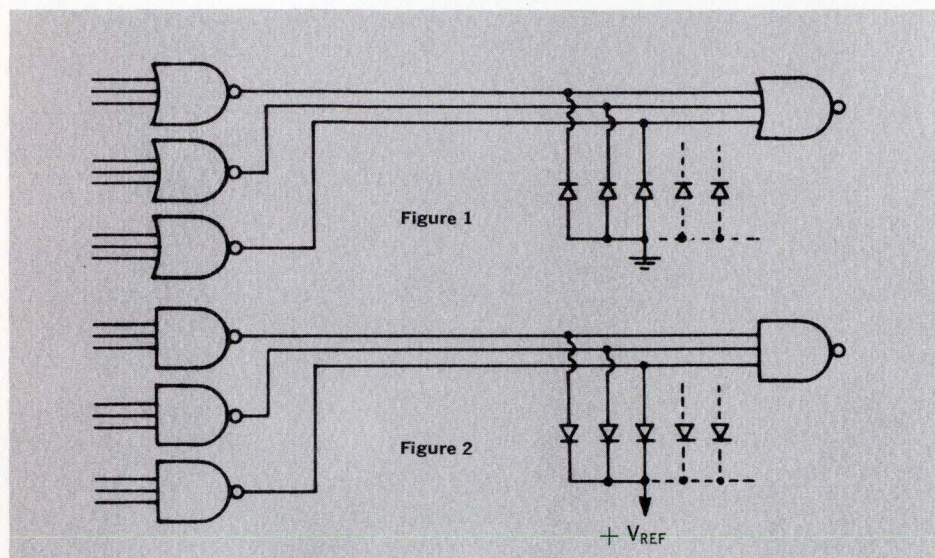

We've gone about as far as we can go. In designing diode arrays which can be mounted in the popular dual-in-line plug-in package (DIP), Sylvania has been an industry pacesetter. There are only 14 leads on standard DIPs and we use all of them to provide 13 diodes and a common connection. And not just 13 ordinary diodes, but monolithic silicon epitaxial diodes with uniform electrical characteristics. These DIP devices are the latest addition to an already broad line of diode arrays which include units packaged in a TO-46 can or in molded epoxy.

Sylvania's diode arrays containing 13 individual silicon junctions per assembly are versatile circuit design tools. Because these arrays are available in both common cathode and common anode versions, they are ideally suited for a wide variety of applications. Applications include systems using integrated circuits as well as those made with discrete components or a combination of ICs and

discrete components.

But the multiple diode feature is only one of the advantages with these units. Use of Sylvania's dual-in-line plug-in package offers significant improvement over other package types. The Sylvania plug-in package lends itself more easily to automated insertion on printed circuit boards, takes up less stacking space and has lead spacing which permits conductive printed circuit paths to be carried under the package without any spidering of leads. And you get these advantages in a package with a true hermetic seal.

Each individual diode in the monolithic array mounted in this superior package is an epitaxial device with the excellent electrical characteristics outlined in the table. The SID13A-1 is a device having a common cathode configuration and the SID13B-1 is a common anode device. Both operate over a range of -55°C to $+150^{\circ}\text{C}$ and are relatively inexpensive.

Typical of the many uses of these

multiple devices is a clamp to reduce ringing from mismatched system elements. One example: when driving fast edges through long coaxial lines, twisted pairs or open wire, the terminating circuit may not be matched to the characteristic impedance of the line. The result is ringing and generation of spurious signals. This ringing travels back and forth along the line to interfere with logical operations.

This noise can be squelched by using these diode arrays as clamps which absorb the energy and reduce ringing. With NOR type emitter coupled logic this would be done with a common anode device as shown in Figure 1. Here the diodes keep the lines from going more negative than one diode drop.

The same principle applies to other logic forms. In some cases it's desirable to clamp positive excursions. Figure 2 shows how this can be accomplished in NAND logic using a common cathode array.

CIRCLE NUMBER 303

SCHEMATIC

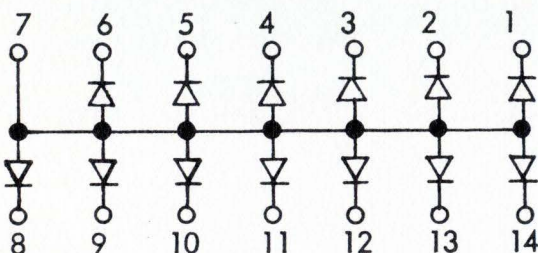

SPECIFICATIONS (each diode):

Forward voltage @ 1.9 mA @ 25°C:	0.875V max.
Reverse current @ 5V @ 25°C:	0.25 μA max.
Reverse current @ 5V @ 70°C:	10 μA max.

TYPICAL CHARACTERISTICS (each diode):

Forward voltage @ 10 mA @ 25°C:	1.0V max.
Reverse current @ 20 V @ 25°C:	0.1 μA max.
Reverse current @ 20 V @ 100°C:	100 μA max.
Breakdown voltage @ 100 μA @ 25°C:	30V min.
Capacitance @ 0V, f = 1 MHz:	6 pf. max.
Reverse recovery, $I_f = I_r = 10 \text{ mA}$, recover to 1 mA:	50 nsec.
Operating & Storage Temp. Range:	-55°C to $+150^{\circ}\text{C}$

Individually or in arrays, TO-18 PCs are customized to meet your needs

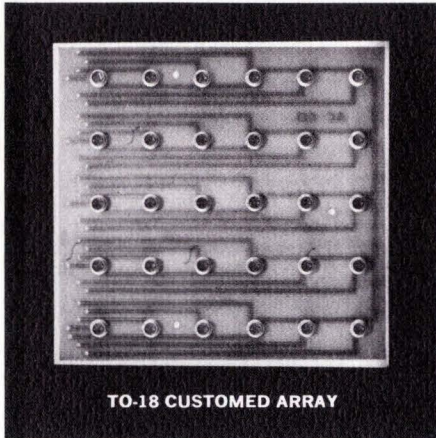

TO-18 CUSTOMED ARRAY

TO-18 cells are among the latest additions to Sylvania's varied line of photoconductors. These miniature, end-viewed cells in transistor-type packages offer the circuit designer stable electrical properties coupled with long life and high reliability. And with Sylvania's customizing capability, you can get the precise cell characteristics dictated by your requirements; or on special order, you can get TO-18 customized arrays.

Sylvania's custom capability in photoconductors isn't limited to arrays or

matrices only. When your requirements make it practical, even the response time and other characteristics of TO-18 devices can be customized. In this way the user gets all the physical advantages of the TO-18 device—small volume, low profile, hermetic sealing, end-viewing, better heat dissipation—in the precise array configuration he wants with the electrical characteristics he needs.

Improved photosensitive material used in Sylvania's standard TO-18 yields response times which are about twice as fast as those obtained with standard cadmium sulfide types. The basic photosensitive material used in the TO-18 can be altered to vary characteristics when required. For example, various peaks in spectral response can be obtained over a wavelength of 5300 to 6300 Angstroms; and cell resistance at 2 foot-candles can be tailored within a range of 10 K to 100 K ohms.

In addition to the obvious space savings, these TO-18s offer other advantages which make them ideal for

use in PC arrays. The glass window sealed in the top of the TO-18 metal container means they are made for end-viewed operations. Thus, there's less chance of stray light influencing them as they can be directed toward the particular light source they are designed to "see." This means they can be stacked closer together than other types.

Hermetic sealing and welded construction insure that the TO-18 cells won't degrade with time, and the metal base acts as a heat sink which keeps the photosensitive substrate cooler.

At Sylvania, the TO-18 is manufactured using the proven processes of transistor technology including dry box atmosphere, projection welding and vacuum bake out. The package measures 0.155 inches maximum height (excluding leads) with a diameter of 0.215 inches. Half-inch leads provide for soldered circuit connections or the leads may be clipped for insertion into conventional transistor sockets. The photosensitive material is formed on a rugged ceramic substrate which aids in heat dissipation and makes possible the 50 mW ratings for these cells.

CIRCLE NUMBER 304

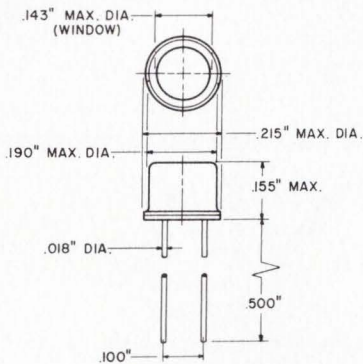
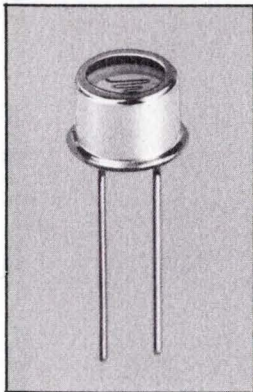

OPTICAL DATA

Wavelength of Maximum Spectral Response.....5300 to 6300 Angstroms
 Various Peaks can be Obtained Within the Above Response Range.

RATINGS (Absolute Maximum Rating System)

Breakdown VoltageUp to 200 Volts
 Dissipation
 T-Amb. = 25°C..... 50 Mw
 T-Amb. = 75°C..... 0 Mw
 Derate linearly from 25°C to 75°C
 Ambient Temperature Range -40 to +75°C

CHARACTERISTICS

Cell Resistance at 2FC.....Various Values Available From 10K to 100K Ohms
 Dark ResistanceIn Megohm Range
 Ratio (2FC to Dark).....Minimum Ratio 100:1
 Average Ratio 1000:1

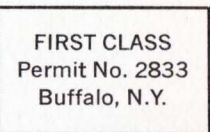

POSTAGE WILL BE PAID BY

SYLVANIA ELECTRONIC COMPONENTS GROUP

Sylvania Electric Products Inc.
 1100 Main Street
 Buffalo, New York 14209

Dept. B6 6

Use Sylvania's "Hot Line" inquiry service, especially if you require full particulars on any item in a hurry. It's easy and it's free. Circle the reader service number(s) you're most interested in; then fill in your name, title, company and address. We'll do the rest and see you get further information almost by return mail.

Now, drive 300 mW loads with a new 250-ohm PC

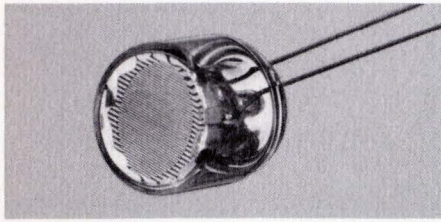

Sylvania's broad line of photoconductors already contains many T-4 devices capable of handling 300 milliwatts. Now the T-4 series is expanded with the introduction of another unit. The extreme sensitivity of this newest low-resistance photocell allows the design and construction of detection circuits to be simplified. Here's how.

A low cell resistance of 250 ohms at 2 footcandles (FC) means Sylvania's newest T-4 photoconductor can directly drive sensitive relays in a wide variety of applications and eases circuit requirements in others. Because the Type 8760 cell supplies more useful power at lower light levels than previously available from units of a similar size, associated circuits are simplified or eliminated. This lower-resistance cell allows the use of less sensitive and more economical relays and can even eliminate stages of amplification. The result is a significant cost advantage in detector design.

The increased sensitivity characteristics of the 8760 at low light levels

comes from the type of photoconductor pattern and material used. A significant decrease in the pattern spacing placed on the $\frac{1}{2}$ "-diameter face of the cell represents a significant improvement in device construction. In the new device, the use of cadmium sulfide as the detector material gives stable operation as ambient temperatures vary.

Typical of the applications for the 8760 are fire and smoke detection systems. One system now being developed uses this improved photoconductor to detect ignition in gas-fired furnaces. With ordinary photocells, the light output of the gas burner is too low to be detected reliably. Of course, the new cells can also be used in oil ignition detection systems.

The 8760 can operate a relay directly at the same low light levels at which other detectors would require

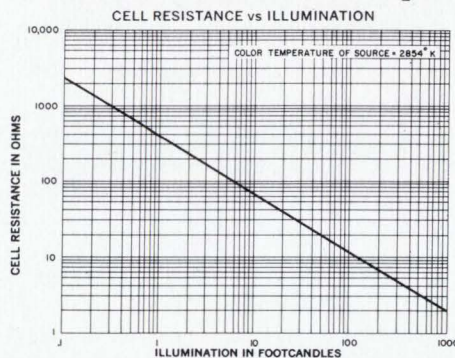

an additional stage of amplification. In addition, this new low impedance device adapts better to switching applications. Impedance of the 8760 approaches zero at even relatively low light levels while showing extremely high values in the dark. Resistance ratio of dark to 2 FC is at least 200:1, with typical values of 500:1. Minimum value for 2 FC to 100 FC resistance ratio is a high 15 to 1.

Despite an intricate finger pattern, plus a low resistance in light (12.5 ohms at 100 FC) and a high dark resistance (100,000 ohms), the 8760's voltage rating is high. In the dark, the new unit can take up to 175 VAC without damage.

All of Sylvania's T-4 devices can take 300-g impact shocks and 2.5-g vibrations. With the addition of the newest devices, light resistance values now cover the range from 250 ohms to 9 K ohms. Sylvania can also supply higher resistance cells on special order. Minimum dark/light resistance ratio for any unit in the line is 100:1 and voltage ratings for these $\frac{1}{2}$ "-diameter end-view cells are as high as 400 volts.

CIRCLE NUMBER 305

8760 CHARACTERISTICS

Cell Resistance	Resistance Ratio	
At 100 FC	12.5 ohms	Dark to 2 FC, min. 200:1
At 2 FC	250 ohms	Dark to 2 FC, typ. 500:1
At Dark	0.1 Megohm	2 FC to 100 FC, min. 15:1
Cell Voltage	175 VAC	2 FC to 100 FC, typ. 20:1

This information in Sylvania Ideas is furnished without assuming any obligation

SYLVANIA

SUBSIDIARY OF
GENERAL TELEPHONE & ELECTRONICS GTE

NEW CAPABILITIES IN: ELECTRONIC TUBES • SEMICONDUCTORS • MICROWAVE DEVICES • SPECIAL COMPONENTS • DISPLAY DEVICES

NAME _____

TITLE _____

COMPANY _____

ADDRESS _____

CITY _____ STATE _____

Circle Numbers Corresponding to Product Item

300 301 302 303 304
305

Please have a Sales Engineer call



HOT LINE INQUIRY SERVICE

Need information in a hurry? Clip the card and mail it. Be sure to fill in all information requested. We'll rush you full particulars on any item indicated.

You can also get information using the publication's card elsewhere in this issue. Use of the card shown here will simplify handling and save time.

We keep some powerful experiments quiet.



Fuel cells don't have to be noisy.

We developed one for the Army that you can't hear only 100 feet away. This 300-watt cell should produce 28 VDC for more than 1000 hours without special attention.

Yet, complete with cell stack, blower, pump, starter and voltage regulator, it weighs only 30 lbs.

Fuel cells are the lightest, most effective, non-mechanical devices yet discovered for generating electric power.

We make them in all sizes.

But fuel cells are only one of the activities that keep Union Carbide up front, on the frontiers of electronics. For instance, among other things, we're leaders in research, development and production of single crystals and crystal products; solid tantalum and foil-film capacitors; laser systems and accessories; solid state devices.

These are among the reasons to think of Union Carbide for help before your projects get beyond the talking stage.



ELECTRONICS

Union Carbide Corporation, Electronics Division, 270 Park Avenue, New York 10017.

Plenty of customers told us what we could do with them.

Your ideas, your designs, your suggestions. These are the things that have made Bendix® JT Pancake™ connectors what they are today: Customer-engineered for numerous applications.

This means that among the thousands sold to date, there's bound to be a Bendix JT connector that's just made for your application.

Choose from crimp or solder terminations. Nine shell sizes—8 through

24. Eight shell styles. 40 different insert patterns with 16-, 20-, 22- and 22M-contact sizes that will accept a wire range of 16 through 28 gage. Included are Double-Density models with up to 128 contacts. Potted, grommetted and hermetic versions, too. All have improved environmental sealing and resistance to pin splaying and bending. Fewer components. Lot control for sensitive items. Alternate keying to eliminate cross

plugging. Better electrical and environmental performance through rigid, glass-filled, one-piece epoxy inserts, instead of conventional, multi-layer sandwich construction. Temperature capabilities to 392°F. continuous operation.

If we still haven't mentioned a feature you need, tell us. We might make it part of a Bendix JT Pancake connector for you. Contact Electrical Components Division, Sidney, N.Y.

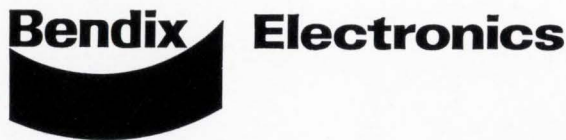



✓ Complete selection
and versatility
✓ Lighter, smaller
✓ Latest design
improvements
✓ Jobber availability
✓ Proven acceptability

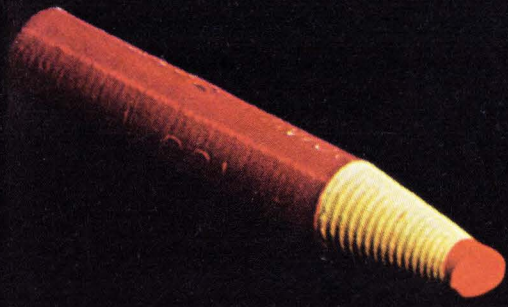

FAST, EFFICIENT OPTOELECTRONIC SOURCES, DETECTORS...

GaAs source, PIN photodiode

Rugged, compact

Proven reliability

Economy priced

...from HPA

Get optimum performance and design flexibility in the HPA 4107 gallium arsenide infrared source and the fast 4205 photodiode. Both are in identical compact pill packages.

The 4107 delivers a narrow, high-intensity beam when forward biased. The 4205 is a fast detector, DC to 1 GHz, with high sensitivity, stability, and low noise characteristics. Together, these solid-state devices offer unexcelled performance for a broad range of high-speed applications. Quantity price discounts.

For information call your local HP field engineer or write HP Associates, 620 Page Mill Road, Palo Alto, California 94304.

Specifications 4107

Total Output Power P	Modulation Rise Time	Price
100 μ W	100 nsec	\$21 (1-9) 18 (10-99)

Specifications 4205

Response at 7700Å	Sensitive Area	Speed of Response	Dark Current	Price
1.5 μ A/ mW/cm ²	3.0x10 ⁻³ cm ²	<1 nsec	150 pA(max)	\$16.00(1-9) 13.60(10-99)

HEWLETT
PACKARD



HP
ASSOCIATES

01705

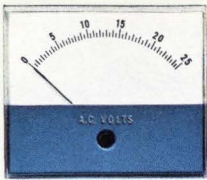

You don't have to be Scottish to go for this.

We're so thrifty-minded at Honeywell that we've been able to put the taut-band meter's price down even lower than the price of a pivot-and-jewel meter. (About 10% lower, on the average.)

Maybe that sounds to you like we've left something out.

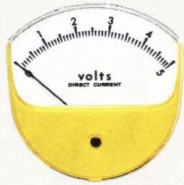

We have.

We've left out half the parts, in fact. (All the unnecessary ones.) This doesn't make the meter less sophisticated. Just less complicated.

It's a very different kind of meter. It costs less, for one thing — for us to make and for you to buy. It's simpler and more reliable.

There's no friction in the moving system, so you get better readout ac-

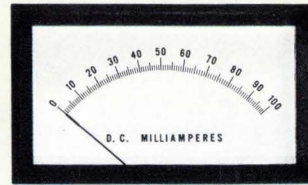

curacy and repeatability. And it's self-shielded.

Honeywell's new taut-band meter. It comes in just about any style you like.

Write Honeywell Precision Meter Division in Manchester, N. H. 03105 and we'll send you a brochure.

Honeywell

**We've put the
taut-band meter's price
where you want it.**

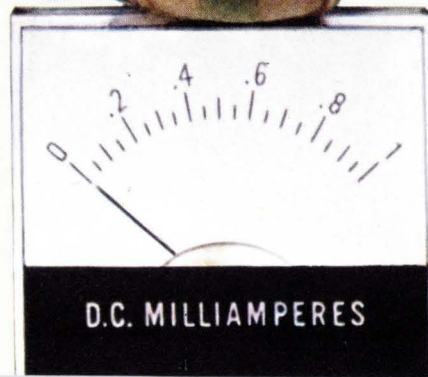

Two more 24 Kt. gold processes from Sel-Rex. One may be 99.99+⁰% better for you.

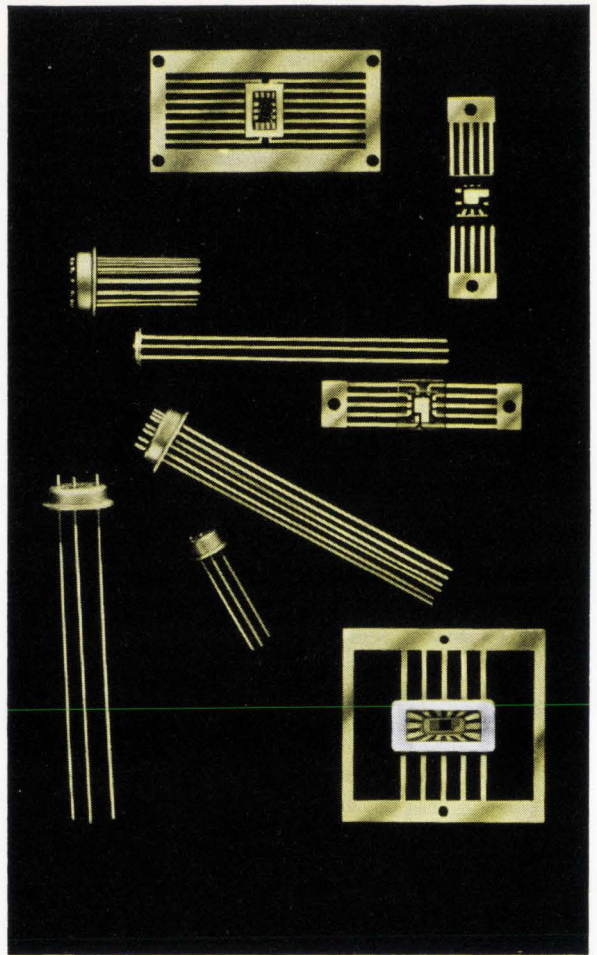

Deposits from Pur-A-Gold 125* and Pur-A-Gold 401* neutral gold plating processes are 99.99+⁰% pure, free of organic contaminants and are uniform in distribution. Both processes are used in semi-conductor manufacture because they're extremely stable and consistently produce high performance results.

One maker of integrated circuits gets excellent die attachment with only .000050" of a 401 deposit in place of the .000100" he needed with a previous process. A transistor manufacturer reports excellent high temperature resistance for a 125 deposit . . . 350°C in air for over one hour without discoloration.

Which process is better for you depends on *your* product, *your* processing cycle and *your* performance specifications. But with either, you get more than a reliable plating process. You get the back-up service that has made Sel-Rex the leader in precious metal plating technology. Write for a comprehensive guide to precious metal processes.

Sel-Rex Corporation
Dept. X-6, Nutley,
New Jersey 07110



*Processes patented, trade marks registered

Subsidiaries and associated companies in Canada, Switzerland, Great Britain, France, Holland, Japan, West Germany.

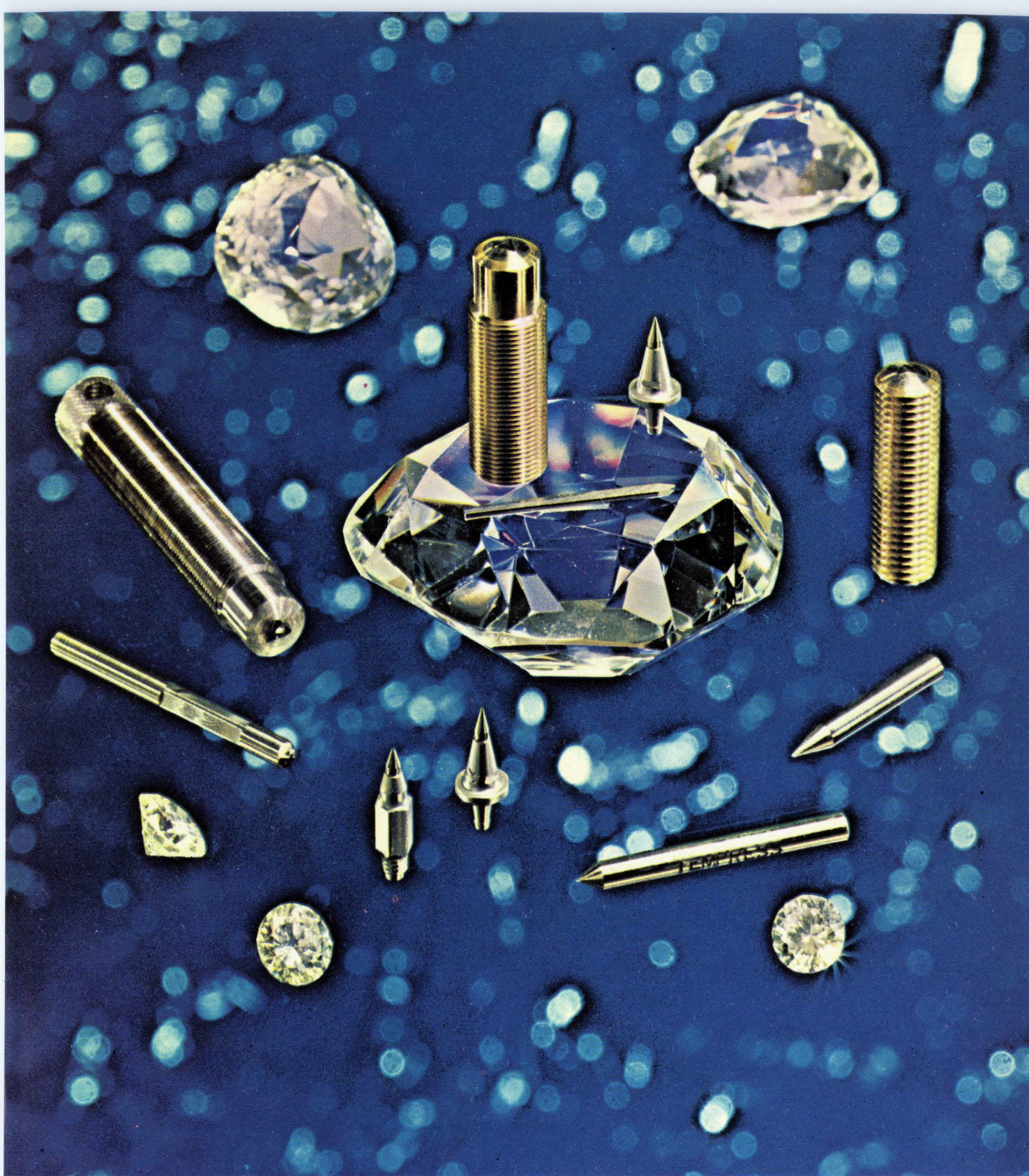

Micro-machined from Jewel-hard Materials

SEMICONDUCTOR PRODUCTION TOOLS ARE THE EXCLUSIVE PRODUCTS OF TEMPRESS RESEARCH COMPANY, based on unique processes developed by Tempress engineers for micro-machining diamonds and jewel-hard materials, such as titanium and tungsten-carbide. The company has become the principal source for the nation's leading semiconductor manufacturers because of the extreme durability and precision of these tools, immediate delivery from stock, and constant, personalized service at a high technical level. Among the Tempress products displayed on this page are: hydrogen flame-off torches,

DIAMONDS COURTESY OF MICHAEL WERDIGER, INC.

tungsten carbide lead bonding wedges, tungsten carbide lead bonding capillary tubes, diamond scribing tools, tungsten carbide probe contact needles, and diamond lapping points. If you have a requirement for any of these devices, let us place a highly detailed booklet in your hands, listing specifications, prices, and ordering information. Please write to us, noting the name of your company, address, and your specific applications.



TEMPRESS

Tempress Research Co., 566 San Xavier Ave., Sunnyvale, Calif.

Circle 41 on reader service card

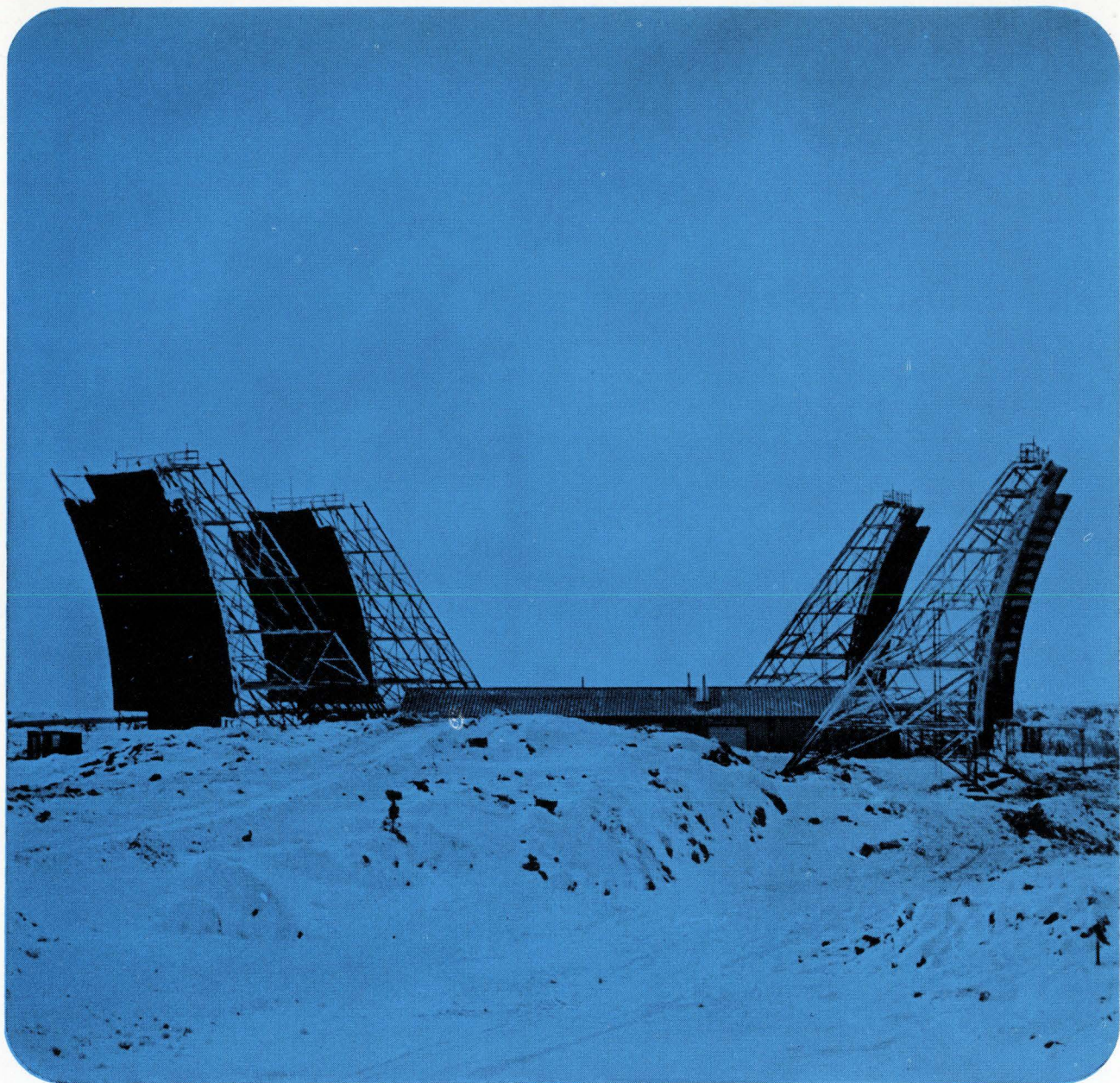

Photo courtesy of Dominion Bridge Company, Ltd.

For your tropospheric scatter antenna needs, whether they be component part or complete feed system, avail yourself of the talent and experience of TRG.



With little or no change in the feed run arrangement, performance of existing tropospheric scatter communication links can be improved several db on each link by replacing the conventional feeds with the TRG Scalar Feed. This is a typical TRG contribution. The same kind of talented engineering can be applied to a complete new feed system. For details on how to put TRG Microwave Antenna experience to work for you, contact your TRG representative or write to: TRG, 400 Border Street, East Boston, Massachusetts 02128. Phone (617) 569-2110.

TRG/A Division of Control Data Corporation

Semiconductor Report



NEW POWER CONTROL PRODUCTS AND IDEAS FROM MOTOROLA

800 mA SCR (RMS) TURNS ON MANY LOW-COST, HIGH-VOLUME APPLICATIONS

With prices pegged below 40¢ in volume quantities, the new 2N5060-63,800 mA SCR series is sure to be a hit with the designer of low-current, low-voltage power control circuitry.

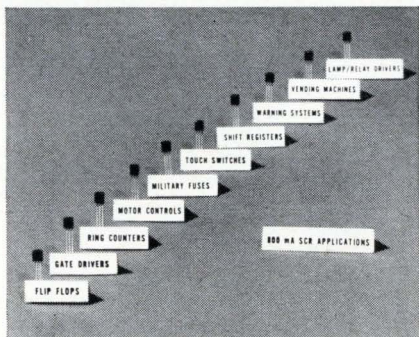

Housed in the miniature Unibloc* plastic package, these 30 to 150-volt units can be plugged into existing TO-18 pin circles without lead crossing.

Only 200 μ A of current triggers them into conduction, too — making them ideal for low-level sensing and triggering circuits.

Applications in low-power consumer / industrial / military designs are limitless: military fuzes (squib firing and safety circuits), flame detectors, automatic warning systems, lamp and relay drivers, tiny motor controls, sensing, detecting and processing control circuits, vending machines, burglar alarms, touch switches, ring counters, shift registers, flip flops, gate drivers for larger SCR's, ad infinitum . . . !



And exclusive Annular† construction affords reliable operation over a wide -65° to $+125^{\circ}$ C operating temperature range. Other features include 6-ampere peak surge current rating, and 1.7-volt forward on voltage @ 1A peak.

Quantity availability of the "big little" series is immediate!

Circle 516 Readers Service Card

PULL THE TRIGGER ON COSTLY THYRISTOR DESIGNS WITH 3 NEW FIRING DEVICES

Look what happens to your consumer / industrial thyristor power control circuitry when you design in a new Motorola Unibloc plastic trigger — you get: symmetrical switch-

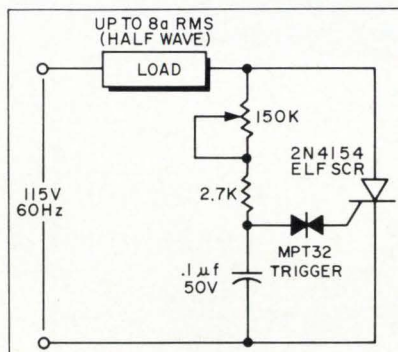

ing characteristics . . . low 50 μ A (max) switching current which reduces trigger capacitor size . . . and larger, 10-volt (typ) switch-back voltage which furnishes higher energy pulses to gate and gives faster turn-on, lower switching losses and more reliable SCR operation.

How can you best use them . . . at below-25¢ volume prices?

Tie the MPT-28, -32, -36 series together with any of the more than 270 different thyristors now available from the industry's broadest, up-to-35-ampere thyristor line including these 8-ampere Motorola units: new 50-400 volt TRIACS, 50 to 600-volt Thermopad* plastic

SCR's and the ever-popular, hermetic, 25 to 400-volt Elf* devices (see circuit).

Try a Motorola thyristor / trigger combination today!

Circle 517 Readers Service Card



NO "GUESSES" WITH NEW RECTIFIER SPEC

Undefined areas on either side of the old JEDEC rectifier-derating-curve method — often filled by confusing performance claims and promises by many manufacturers — have been eliminated with publication of the new Surmetic* rectifier Designers Data Sheet*.

Incorporating the new JEDEC method of defining a diode's capability in terms of lead length and temperature, the design aid shows the low-cost Surmetic to be capable of far more than its former, nominal 1-ampere-at-75°C rating. In fact, at 80°C, with leads clipped close to the body, it can easily handle over 2.5 amperes, resistive or inductive load!

Besides affording invaluable information on output current-temperature conditions, the Data Sheet provides a clear picture on both typical and maximum v_F vs i_F , surge ratings followed by full V_{RM} , v_F at various junction temperatures, plus 10 other important, first-time device specs which permit the design of most circuits entirely from the information presented. Send for a copy now! Motorola Semiconductor Products Inc., Box 955, Phoenix, Arizona 85001.

Circle 518 Readers Service Card

*Trademark of Motorola Inc.

†Annular Semiconductors are Patented by Motorola Inc.

MOTOROLA Semiconductors
— where the priceless ingredient is care!

PRECISE

measurement and control of temperature

DIRECT READING FROM -192°C TO +1000°C

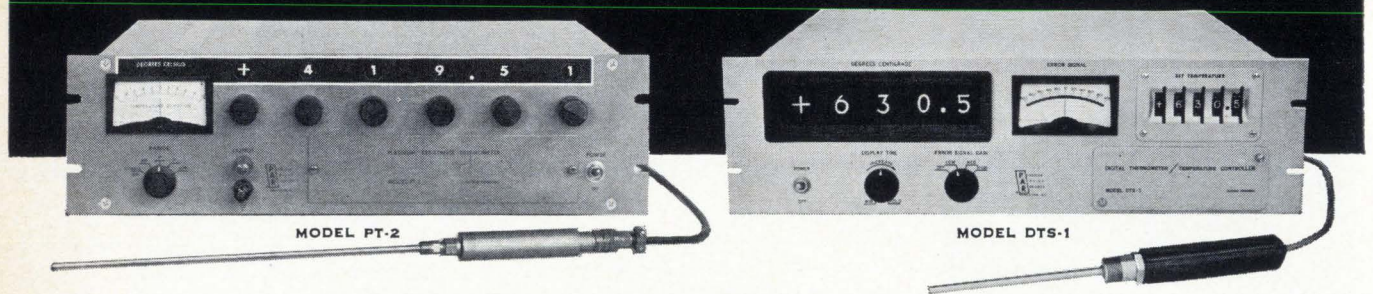

<i>Model PT-2</i>		<i>Model DTS-1</i>
<i>0.0005°C</i>	RESOLUTION	<i>0.002°C</i>
<i>Manual Balancing</i>	OPERATION	<i>Fully Automatic</i>
<i>5-Digit Decade Dials</i>	READOUT	<i>4-Digit Nixie Display</i>
<i>±0.01°C (over 0 to 1000°C range)</i>	ABSOLUTE ACCURACY*	<i>±0.1°C (over full range)</i>
<i>\$2650</i>	PRICE (EXCLUDING PROBES)	<i>\$3950</i>

These digital thermometers/temperature controllers offer a choice of features for high precision temperature measurement and control applications.

For temperature measurement, both operate by comparing the resistance of a sensor element of platinum (the material whose characteristics define the International Temperature Scale) with an internally generated reference function obtained by a unique resistance analog network that precisely duplicates the temperature-versus-resistance change of platinum.

Temperature measurements are obtained with the Model PT-2 by manually balancing a modified Kelvin

Bridge by means of 5 decade dials and a temperature deviation meter. In its most sensitive range the meter reads 0.01°C full scale which results in a resolution of better than ±0.0005°C.

The Model DTS-1 provides a fully automatic digital indication of temperature. In addition, this information is available in binary or 10-line decimal coded form for printer or computer input and in pulse code modulated form for telemetry applications.

For temperature control, both instruments provide an analog signal proportional to the difference between

the desired temperature set on the instrument panel and the sensed temperature. This signal may also be used for recording temperatures about a preselected set point, for expanded scale measurements, or for high/low alarm.

Complete information is available in Bulletins No. 122 (Model PT-2) and No. 118 (Model DTS-1).

*Subject to operating range of actual sensor used.

P A R **PRINCETON**
APPLIED RESEARCH CORP.
Dept. D
Box 565, Princeton, N. J., Tel. (609) 924-6835

Electronics Review

Volume 40

Number 13

Instrumentation

Second generation

In the 38 years since the Leeds & Northrup Co.'s A.J. Williams Jr. helped invent the electronic strip-chart recorder, engineers have made only minor improvements on the original design, never improving resolution and only bettering the response time by a factor of 10. Now the 64-year-old Williams has come up with a recorder, based on some new principles, that increases resolution 40 times—to 40,000:1—and cuts response time to 250 microseconds from 0.25 second.

The resolution breakthrough is accomplished by combining analog and digital techniques to sample the signal, separate input information into five decade ranges, and imprint digital curves on 2½-inch-wide paper. Says Williams: "It's like looking at the same input signal recorded on five separate recorders with their ranges adjusted in ratios of 10:1." Although the prototype—a strip-chart recorder—is limited to a maximum input signal of 19.999 volts, Williams says the machine can be designed to accommodate signals of almost any magnitude. And, he points out, resolution can reach 200,000:1. All that's needed is an analog-to-digital converter with more resolution than the prototype's, which is four decades plus two steps in the fifth decade.

No moving parts. The response time in standard recorders is relatively slow because the null-balancing technique is used; data is recorded by a moving pen. But Leeds & Northrup's new model eliminates all moving parts. Writing is done by current pulses on electrosensitive paper; only the paper moves. Analog input signals from d-c to 100 hertz with dynamic ranges to

92 decibels can be recorded without changes in gain settings. Unlike standard recorders, the new model has a digital readout to provide an instantaneous display of the input value.

Analog input signals are fed to an input switch, such as a high-speed commutator or multiplexer, to permit handling more than one signal. The prototype's electronics is capable of handling six input channels, but only four-channel recording paper is available. A buffer amplifier matches the output impedance of the input switch to the input impedance of the analog-to-digital converter.

After conversion, the digital information is fed simultaneously into the digital display and the recording electronics. A component that the company calls a decade halfer senses whether a digit is in the upper or lower half of the decade.

Electronic writing. Next, the digital information is sent to a diode AND gate decoding circuit. From the decoder the signals are applied to stylus amplifiers and then to an output switch, a selection matrix that feeds the appropriate stylus amplifier's output to the correct stylus. There are 100 marking styluses for the five decades, with each stylus controlled by its own amplifier—an ordinary pulse amplifier. A control circuit coordinates the input and output switches as well as the last entry into the diode gate.

The paper is coated with a metal film, which is the ground for the writing circuit. Data is entered on the chart by conducting pulses from stylus through paper to ground.

Designing the stylus was a ticklish problem. Each channel has five half-inch-wide stylus cards containing 31 styluses, 11 for putting

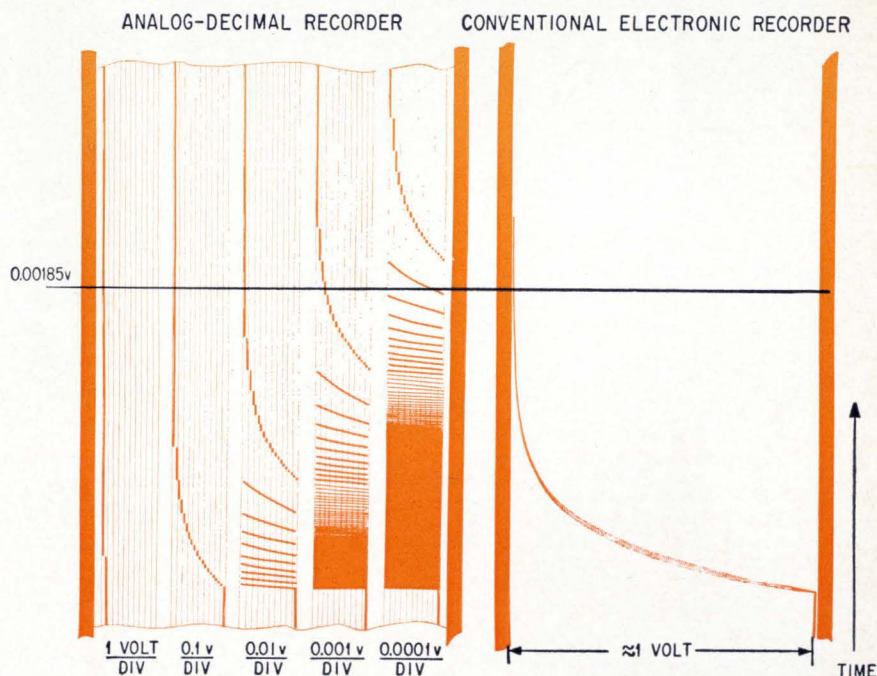

High resolution. Tracings of exponentially decaying voltage show the sharp contrast between the new and conventional recorders. Tracing at right, clearly showing the 0.00185-volt reading, was made by the Leeds & Northrup instrument.

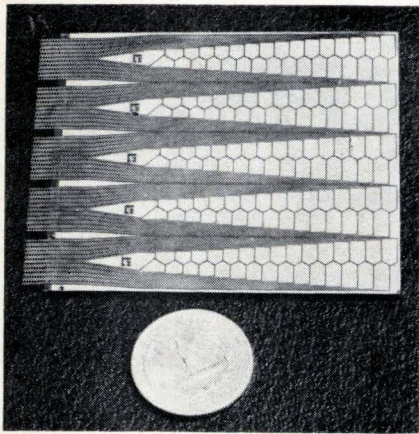

Writing tool. Stylus replaces moving pen in strip-chart recorder.

the calibration lines on paper and 20 for marking. The marking styluses are divided so that there are two data points between each pair of calibration lines in a decade. Because the stylus cards are so small and their accuracies are so vital to the recording technique, Leeds & Northrup engineers turned to photoetching techniques to manufacture them; the techniques are similar to those used in making masks for the production of integrated circuits.

The instrument has almost unlimited applications, says R.H. Cherry, the company's research and development director, because of its wide range, multiple-recording capability, high speed, rapid-data access, and peak-ratio detection. For example, peak-ratio detection alone makes the recorder attractive for such fields as plasma physics and magnetohydrodynamics, where experimental data is frequently lost because recorders can't accommodate signals with a wide range of peak amplitudes. In Williams' new recorder, peak values are displayed in the decade channel where they occur and the ratio between peaks can be determined easily and accurately.

Who's the customer? Ironically, it's this wide range of applications that's giving Leeds & Northrup its biggest headache. "A complete, six-channel instrument built with discrete components to meet the needs of nearly every potential customer," points out John Melcher, a planning aide to the company's marketing and systems vice president, "could

conceivably cost as much as \$30,000 and limit the number of buyers." However, a modular-construction technique could reduce the cost by permitting Leeds & Northrup to tailor the instrument to each application. For instance, the converter could be bypassed for a quick look at curves of digital information—a far better technique than trying to visualize the changes taking place in a long series of digital values. This would eliminate half of the recorder's electronics. Also, customers can use their own a-to-d converters and eliminate the cost of that component.

"With a large market," Melcher adds, "the manufacturing costs can be reduced by incorporating ic's into the electronics. But that could significantly extend the development phase of the project."

Consumer electronics

IC's stalled

In Detroit, the marriage of integrated electronics and automotive equipment is turning out to be harder to arrange than anybody expected. Much to their chagrin, electronics engineers have discovered that the automobile is a torturous environment, even worse than many military atmospheres. Noise, high temperature, and vibration—plus an overriding consideration for low cost—are stretching out schedules for the introduction of integrated circuits into automotive equipment.

Adds up to profit. The auto companies discovered integrated circuits in 1965 at about the same time that the ic makers and semiconductor companies were discovering the auto companies. To engineers at the auto companies, integrated circuits looked like the long sought development to make feasible file-drawers full of ideas that had been suggested over the past 20 years to improve autos. At the Ford Motor Co., for example, engineers drew up a list of more than 100 functions ic's might perform in the family car.

Meanwhile, semiconductor com-

panies did some simple arithmetic; they multiplied these 100 functions by the 9 million to 10 million cars built every year and envisioned the giant auto industry as their second biggest potential customer, right behind computer manufacturers.

By last autumn, [Electronics, Oct. 3, 1966, p. 187], development and planning had progressed so well that all of the big three auto makers were ready to put the first product with integrated circuits—a voltage regulator—into small production runs of 1968 luxury models, roughly 100,000 at each car maker. The design was set: a hybrid circuit. And the price was set: for the first year \$3 each for units for autos, \$3.30 for trucks. When volume stepped up in the second year—assuming the unit was as good as everybody expected—the target cost was to be \$1.40.

Price rise. But when the auto companies put the prototype that worked well on the test bench into a test car, the ic regulator didn't work at all. And by the time it was modified, shielded, and toughened to withstand high temperatures, the price had risen well above the \$3 figure.

Last week an engineer in Detroit noted, "Anybody ready to sell a \$3 ic voltage regulator that works in a car can get a lot of business today"—even though that price is somewhat higher than what the auto companies pay for an electromechanical regulator. He added, "I have yet to see a commercial application of ic's for autos."

Electrical noise and heat are the most debilitating factors. "The automobile is a superb generator of electrical noise," said an electronics engineer who had predicted a quick and bright future for ic's in cars. "Almost everything on it makes noise: spark plugs firing, brushes on motors, relays clanking open and shut, diodes reacting on the alternators, even fuel sloshing in the tanks. The spectrum runs from 10 to 1,000 megahertz," he complained. So much noise interferes with the operation of the electronic regulator, spoiling its accuracy.

Heat rise. Temperature was not expected to be too big a problem because semiconductor engineers thought the specifications would

demand that the device withstand temperatures up to about 120°F. But they did not know about a phenomenon the auto men call soak heat—heat radiated by the cast iron engine block after the engine has been turned off raises temperatures under the hood to 180° or more.

Although the semiconductor portion of the circuit is not affected by the auto's steady vibration, the connectors are. During driving tests, leads disconnected or broke off.

All these disappointments have snarled plans for 1968 models. Although each of the auto companies would like to be first with an ic regulator—to get more experience with ic equipment and to brag about the technical innovation—each is worried about maintenance troubles.

Usually, plans for the new models are locked up tight by June of each year, but this year, the auto companies are still iffy on the ic regulator even as they phase out production of 1967 models.

Slowup. That doesn't mean the auto men or the semiconductor engineers are ready to give up. Almost all feel that the ic will have a great future in automobiles. But now they are saying that it will take longer than they had expected. The experts are still betting that the voltage regulator will be the first application of ic's. Next will come ic's for car radios. Then either a speedometer or an ignition will be built with integrated electronics.

Typifying the new subdued optimism, Michael Ference, Ford's vice president in charge of scientific research, predicted, "In five or six years, you'll see ic's in a lot of places in the car—in control mechanisms, in engine devices (like electronically controlled fuel injection), in radios and music centers, and in brake controls. But some of the most advanced applications, like displays, are at least 10 years away.

Schottkys in hi-fi

Schottky diodes, those relatively expensive but inherently low-noise devices that have been used almost exclusively in high-priced military and industrial communications equipment, are finding their place

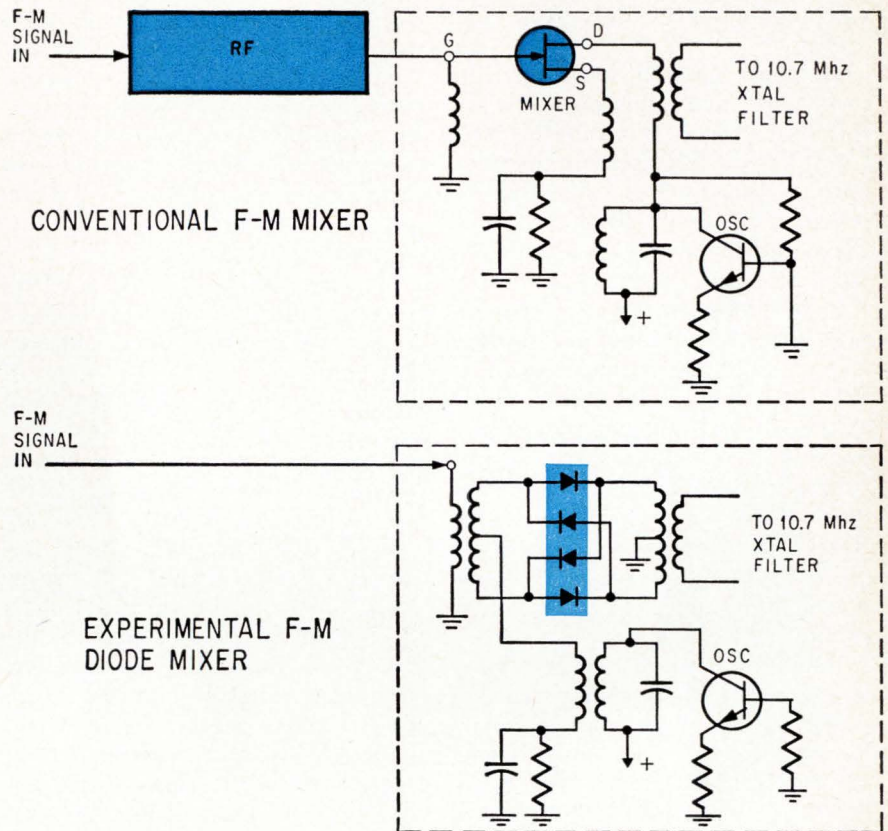

Double balanced. Basic design of experimental diode mixer in a double-balanced diode circuit that replaces a conventional transistor type mixer.

in consumer products. By turning to the barrier diodes, one producer of top-of-the-line hi-fi equipment, the Marantz Co., found it could completely eliminate the two r-f amplifier stages in a stereo receiver it's designing. What's more, Marantz found that the set's overall noise was reduced, sensitivity increased, and production costs were trimmed.

Other hi-fi producers are showing an interest in Schottky diodes, but no other company is as close as Marantz to a product. The Marantz stereo will be on dealers' shelves in the fall, with a \$575 price tag. This will mark Marantz's entry into the integrated-receiver market; previously it sold tuner and amplifier as separate components.

Marantz will use the diode, supplied by Solitron Devices Inc. of Tappan, N.Y., in a balanced quad mixer configuration to achieve an estimated noise figure of 4 decibels or better, compared with 6 to 8 db currently.

Other applications. The other consumer firms appraising Schottky

diodes are looking beyond the first mixer, according to Gary Davies, an applications engineer for Solitron, who says these firms are aiming at limiters and f-m detectors.

F-m tuners using metal-oxide-semiconductor field effect transistors in the r-f amplifier and mixer stages have better noise figures and image rejection capabilities than their tube counterparts. But the r-f gain of these receivers must be carefully controlled to prevent signal overload, as well as to mask the noise generated by the mixer. Thus, the r-f stage serves largely to compensate for noise and the distortion properties of the mixer, rather than to increase sensitivity.

Optoelectronics

Blind to danger

Engineers pay about as much attention to warnings of eye damage from lasers as smokers do to

warnings about cancer from cigarettes.

Doctors' admonitions for the most part have fallen on deaf ears. For example, at this month's IEEE Conference on Laser Engineering and Applications in Washington, where a score of firms exhibited their latest wares, laser beams were shooting in every direction.

Said Glenn Hardway of Space-rays Inc., an exhibitor at the IEEE show: "I'm quite concerned about the way people are using lasers at the show. I just ducked a beam darting around at my eye level."

Army wary. The seriousness of the problem was highlighted by the Army's decision to encourage work on systems operating at invisible wavelengths even as it develops visible-light systems.

Visible-light lasers, such as ruby lasers, are the most dangerous because visible light passes easily through the eye; invisible beams are transmitted poorly. The Army recently suspended field tests for a laser rangefinder on the M-551 Sheridan antitank weapons system while it investigates eye hazards to troops involved in the tests. This leaves the rangefinder's maker, TRG Inc., a subsidiary of the Control Data Corp., wondering which way to turn. According to TRG's marketing manager, Robert J. Seymour, "The hazards are not defined yet. As a man out to sell lasers, I need some answers."

Studies made for the Surgeon General's office, according to Marvin E. Lasser, chief scientist of the Army, have shown that an observer looking into the beam of a laser rangefinder from as far away as 11.2 miles may receive retinal burns. But at Ft. Monmouth, N.J., engineer Donald A. Smith says he has looked into the beam of a 6,328-angstrom (red), 7-milliwatt laser from 3.1 miles with no ill effects.

Dr. Walter J. Geeraets, an ophthalmologist at the Medical College of Virginia, reports seeing 10 or 12 "clear-cut cases of eye damage resulting from lasers" plus cases of possible peripheral damage. He's now working for the Armed Forces Council on Vision, framing recommendations for

safety precautions for people working with lasers. Among them, says Geeraets, will be eye checkups every six months, detailed examination and photographing of a man's eyes when he begins working with lasers, and examinations of workers' eyes within 24 hours of suspected exposures.

A way out. Some answers may be in sight. Biorad Inc. of Hyde Park, N.Y., has a Government contract to ferret out safe uses of lasers outside the laboratory. And the Army's Lasser says that work on the new approach—rangefinders using invisible light—may solve the military's problem. For example, doubling the output frequency of a ruby laser will change its beam from red to blue-violet's 3,471 angstroms—just short of the visible wavelength. Doubling the frequency sharply reduces beam power, but a weaker beam would be less likely to cause damage. And there wouldn't be any loss of performance because detectors used at the shorter wavelength are much more efficient.

Military electronics

Nothing borrowed

Lockheed Missiles & Space Co. engineers assigned to build the instrumentation to flight test the new Poseidon fleet ballistic missile had to start from scratch. Almost nothing could be borrowed from the equipment they used to flight-test the earlier Polaris.

The fresh approach was dictated not only by advances in the state of the telemetry art but because of a tremendous increase in instrumentation needed to test the Navy's C-3 submarine-launched missile, and the required shift of telemetry frequencies from L band (250 megahertz) to S band (2,250 megahertz).

Lockheed is completing the design of the instrumentation for a flight program due to begin within the next couple of years. The two-stage, solid fuel missile—carrying a bigger payload and having a

longer range than the current operational A-3 Polaris—will be carried by 31 U.S. nuclear submarines. About \$900 million is in the fiscal 1968 defense budget to begin developing Poseidon, which the Navy says will be operational sometime in the early 1970's.

Plume problems. The telemetry frequency switch, longer test firings, and the attenuation of the r-f signal due to the exhaust plume—particularly bad in staging and thrust termination—are just a few of the headaches facing the designers. "About the only thing good about going to S band is the small antennas," complains Ralph W. Franks, manager of electrical systems engineering at the Lockheed Aircraft Corp.'s division.

Since much more data will be sent back to ground stations from test missiles, Lockheed went to a 400,000-bit-per-second pulse-coded modulation (pcm) system. Other reasons for dropping the analog f-m/f-m Polaris telemetry were that the pcm needs less power, weight, and space, has greater accuracy, and permits more flexible programming.

Prototype pcm. Lockheed Missiles previously had built its own Polaris telemetry system, but decided to go to an outside supplier for Poseidon because of the new type of telemetry. "It's cheaper to go to an expert," says Franks. About a dozen companies sought Lockheed-funded design contracts and the company chose two a year ago to design and build two prototype versions of pcm multiplexers and encoders. One approach employs junction field effect transistors and the other uses MOS FET's to do the switching, but both systems were built to the same specification.

Lockheed will select the winning company this month. The two companies competing for what is expected to be an award worth tens of millions of dollars are Spaceco Inc. of Huntsville, Ala., and Dynatronics operations of the General Dynamics Corp., Orlando, Fla. Lockheed Electronics Co. of Plainfield, N.J., will build the telemetry ground equipment.

An even tougher development

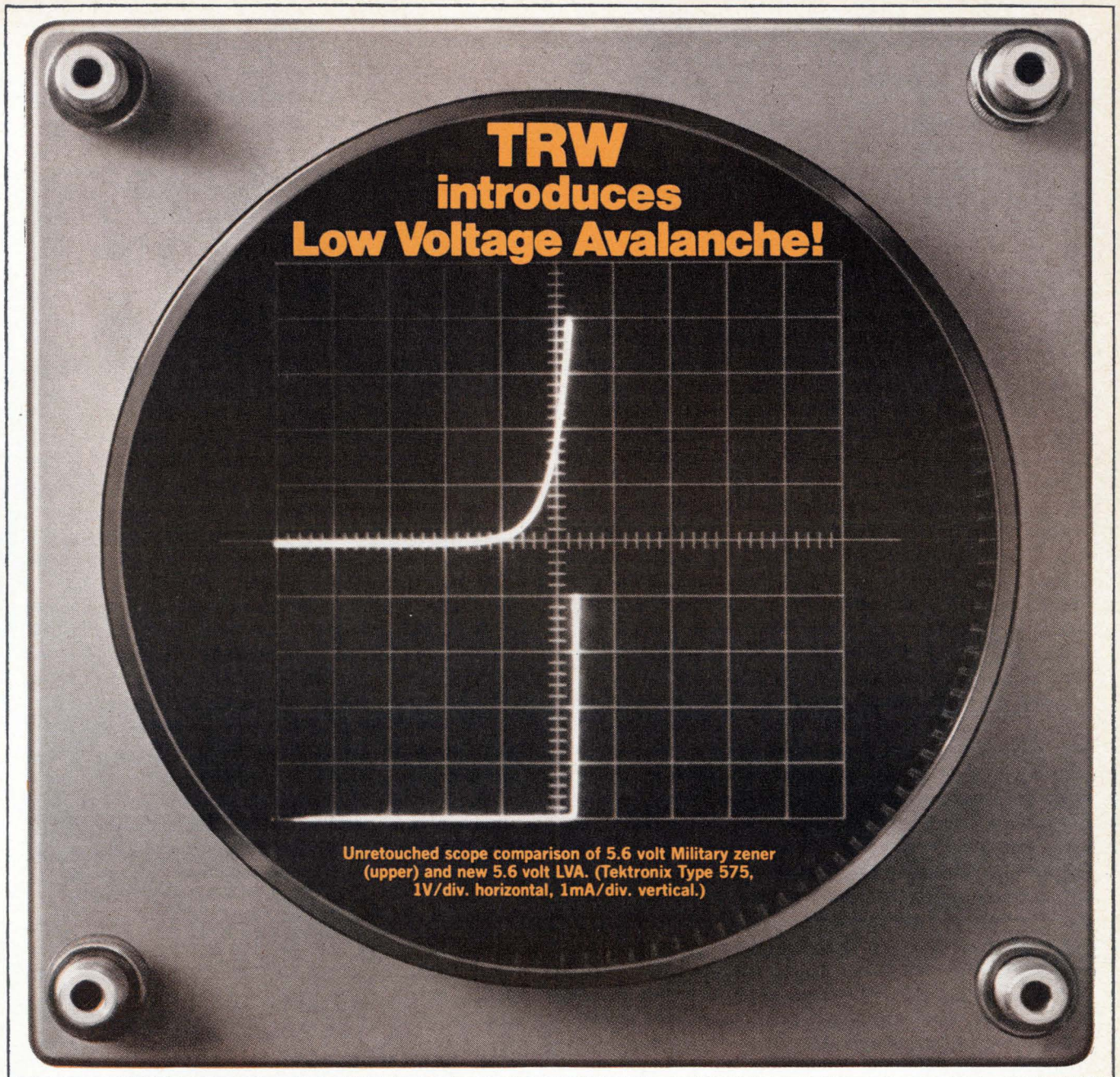

Sharpest Breakdown Below 10 Volts!

The LVA™ is more than just a new diode: it represents a major breakthrough in low voltage regulators (patent pending). Wherever you need a zener below 10 volts, the LVA will significantly improve circuit performance with its avalanche breakdown characteristics.

With the LVA you can design better low current circuits, battery-operated circuits, and operational

amplifier clamping networks. And now for the first time, you can make zero TC reference below 5 volts!

The LVA is available in 10 values from 10 volts down to 4.3 volts. Delivery is off-the-shelf from factory or authorized distributors.

If you'd like to compare, write for test samples and applications data on company letterhead to

TRW Semiconductors, Ray Koch, 14520 Aviation Boulevard, Lawn-dale, California 90260. Phone (213) 679-4561. TWX 910-325-6206. *TRW Semiconductors Inc. is a subsidiary of TRW INC.*

TRW®

effort currently is under way on the ultrahigh frequency telemetry transmitters. Lockheed also picked two companies to develop and build prototype transmitters and expects to award the S-band transmitter contract within the next month or two. Competing for a contract of about the same value as the telemetry equipment are the Conic Corp of San Diego, and Motorola Inc.'s Government Electronics division of Scottsdale, Ariz. Both transmitters being built are of all-solid state design, using varactors to produce a 4-watt output at S band.

Long "buys." The contracts Lockheed will award for Poseidon instrumentation are particularly attractive. Although none of the test instrumentation will go on operational missiles, Lockheed will probably be buying it for five years or longer. Lockheed was really counting its pennies when it selected the instrumentation design because Poseidon is a fixed-price program. The company didn't use its own data compression or adaptive telemetry gear simply because it cost too much.

Blackout is a very difficult problem, says Franks. Lockheed has spent a lot of money on blackout studies, but it reports it hasn't run enough tests to say whether water injection forward of the antennas to cause electron recombination in the plasma solves the difficulty.

Lockheed hopes to solve some communication problems by using a dual-polarization antenna system it has developed for Poseidon. By spotting four S-band antennas equally around the circumference of the missile, it will provide an omnidirectional pattern in all attitudes even when the bird is tumbling. This technique will also permit downrange data gathering from as far away as 950 miles. Two of the four antennas will furnish left and circular polarization while the other two will circular polarize the signal to the right.

The first test Poseidons will carry two of the four-antenna systems as well as two antennas in the reentry vehicle. In an attempt to minimize the effects of the blackout, Lockheed has decided to go to

an endless loop tape recorder that stores data during the blackout period and plays it back afterwards. It will also store data during the underwater portions of the flight.

On-the-job training

Computer tutors are nothing new, but until now they have been kept in the classroom. The Air Force, however, is trying something different: working with the System Development Corp., it has plugged a computer-assisted instruction unit into an operational air defense system. The aim is to train military personnel in the operation of the complex system while they are on the job.

The computer-assisted instruction equipment is being tested in the Air Force's back-up interceptor control (Buic) system. Buic would take over the direction of fighter interceptors and anti-aircraft missiles if the semiautomatic ground environment (Sage) system were to be knocked out during a bomber attack on the U.S. The computer tutor is being evaluated at the Mt. Laguna, Calif., Buic 2 site near Costa Mesa. Standard Buic hardware consists of radars that feed into an AN/GSA-51 computer (Burroughs D-825), a cathode-ray tube display console, and a light pen. Software includes a Jovial program with about 80,000 instructions. Some 2,000 changes in the Jovial program were required to give the system the capability—something that System Development officials think the Air Force will ask for in the Buic 3 system now being developed.

Skill-sharpener. John W. Cullen, senior human factors scientist at Systems Development and one of the developers of the Buic training program, says the system is designed to sharpen the skills of newly arrived operators at an operational Buic site.

Six consoles are tied into the Buic 2 computer. In a typical arrangement, five of them would be devoted to the evaluation of aircraft threats, and one would be used for instruction. The instruction would most probably relate di-

rectly to the student's military task, but it could also be in general education—algebra, for example.

Instead of getting actual inputs from Buic radars, the teaching console uses simulated inputs. The crt might show several aircraft tracks, and the students must identify with the light pen the bombers and the radar-jamming aircraft or ghosts. The operator-student is schooled before he arrives at his duty station, but the training will be his first encounter with operational equipment. The computer tutor capability thus reinforces the transfer of learning from his formal schooling to the operational environment.

Report card. The computer tells him if he has correctly identified the ghost, analyzes any errors, and waits for the student to move to the next problem. Multiple-choice answers are presented on the crt, along with questions, and the student indicates his choice of answers with the light pen. At the end of a given lesson, the student's score is displayed on the crt, and a permanent record is made for inclusion in his personnel file.

Computers

Multilingual

The next major move toward an information utility will be the creation of an experimental network of large time-shared computers, each assigned to specialized tasks.

The plan to link incompatible machines goes a step beyond the Multics (multiplexed information and computing service) system now being built to connect two General Electric Co. 645 computers, one at Massachusetts Institute of Technology, in Cambridge, and the other in Murray Hill, N.J., at Bell Telephone Laboratories.

Preliminary standards for the new links will be discussed next month at a meeting of computer specialists sponsored by the Defense Department's Advanced Research Projects Agency (ARPA), the prime mover in the push toward

150 MHz, 2.4 ns

New performance from probe tip to CRT!

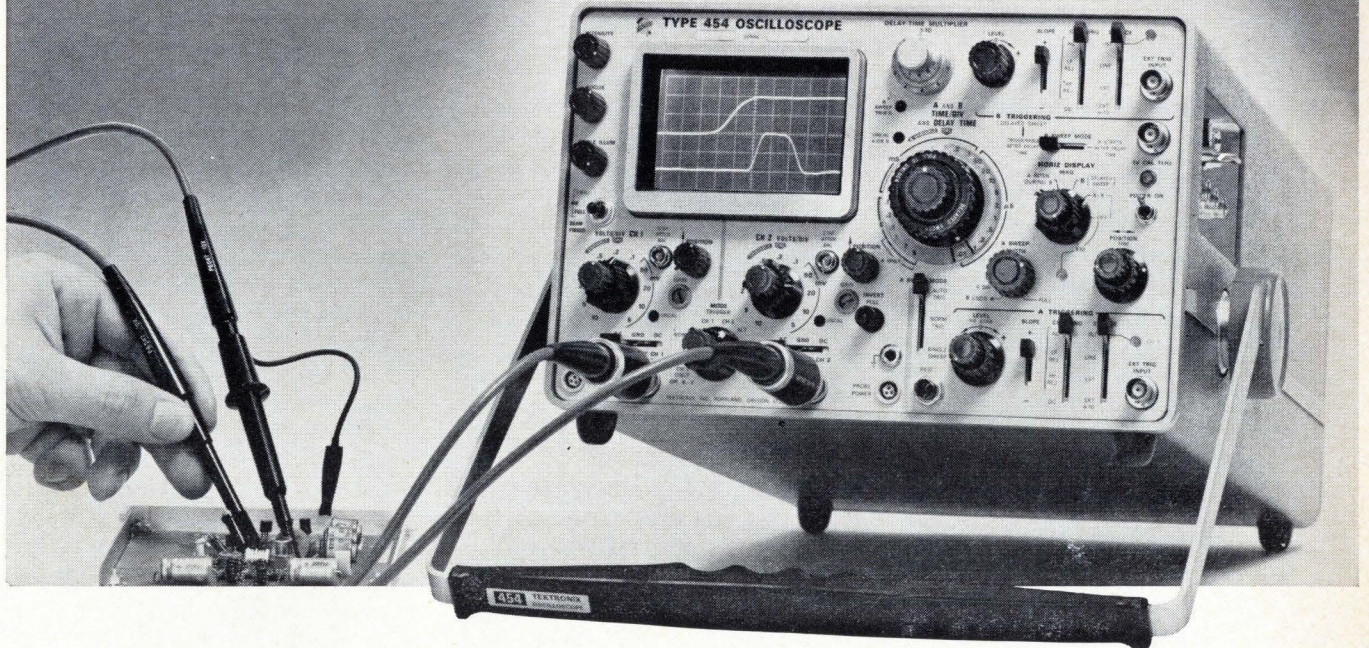

The Tektronix Type 454 is an advanced new portable oscilloscope with DC-to-150 MHz bandwidth and 2.4-ns risetime performance specified at the probe tip. The new P6047 10X Attenuator Probes and the optional FET and current probes are designed to solve your measurement problems.

The Type 454 has a dual-trace vertical, high-performance triggering, 5-ns/div delayed sweep and solid state design. You also can make 1 mV/div single-trace measurements and 5 mV/div X-Y measurements.

The dual-trace amplifiers provide the following capabilities with or without the P6047 probes:

Deflection Factor*	Risetime	Bandwidth
20 mV to 10 V/div	2.4 ns	DC to 150 MHz
10 mV/div	3.5 ns	DC to 100 MHz
5 mV/div	5.9 ns	DC to 60 MHz

*Front panel reading. With P6047 deflection factor is 10X panel reading.

The Type 454 can trigger to above 150 MHz internally, and provides 5 ns/div sweep speed in either normal or delayed sweep operation. The calibrated sweep range is from 50 ns/div to 5 s/div, extending to 5 ns/div with the X10 magnifier. Calibrated delay range is from 1 μ s to 50 seconds.

For further information, contact your nearby Tektronix field engineer, or write: Tektronix, Inc., P. O. Box 500, Beaverton, Oregon 97005.

Two P6047 Miniature 10X Attenuator Probes are included with the Type 454. They have a 10 M Ω input resistance and 10.3 pF input capacitance and provide DC-to-150 MHz bandwidth with 2.4-ns risetime performance when used with the Type 454.

The Optional P6045 FET Probe features unity gain with 10-M Ω input resistance and 4-pF input capacitance. With the Type 454 it provides a system risetime of 2.7 ns and a bandwidth of DC to 130 MHz from 20 mV/div to 10 V/div without signal attenuation. Probe power is obtained from a jack on the front panel of the Type 454.

The Optional P6020 Current Probe is easy to use with its clip-on feature and it provides up to 2.4-ns risetime and 150-MHz bandwidth when used with the Type 454.

Type 454/P6020 Characteristics (454 at 20 mV/div)

P6020	Deflection Factor	Risetime	Bandwidth
1 mA/mV	20 mA/div	3 ns	8.5 kHz to 120 MHz
10 mA/mV	200 mA/div	2.4 ns	935 Hz to 150 MHz

Type 454 (complete with 2-P6047 and accessories) \$2550
 Rackmount Type R454 (complete with 2-P6047 and accessories) . . . \$2635
 Type P6045 FET Probe (010-0204-00) \$ 275
 Type P6020 with Passive Termination (015-0066-00) \$ 135

U.S. Sales Prices FOB Beaverton, Oregon



Research and development

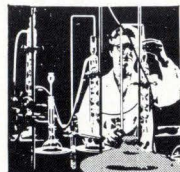

... part of the Tektronix commitment
 to progress in the measurement sciences

networking. Lawrence G. Roberts, assistant to the director of information processing at ARPA, told the International Communications Conference earlier this month that the network will eventually involve about 1,500 remote consoles tied to 35 machines at 16 locations across the country, principally at universities and research institutions doing advanced computer work under ARPA sponsorship. Representatives of these organizations were urged at a Washington meeting last month to start tackling anticipated technical problems.

The benefits. ARPA officials see two principal advantages in connecting machines of different designs and capabilities into a load-sharing network. The user will have on-line access to programs at remote centers, and the network will be able to concentrate on specialized hardware and software for the benefit of all users. The user need not even know where the work was done.

Behind ARPA's push for networking is the Government's drive for fruitful allocation of computer resources within the Defense Department. Also, the programming of today's large systems has turned out in many cases to be a gigantic and costly task. Once a system in the network is programmed for a specific task, it can then play a specialist role for all users, eliminating the need for duplicate programming efforts.

The Pentagon sees specific benefits in the military areas of command and control, intelligence, logistics, and record-keeping. A network of specialist computers linked by data lines is expected to cut the complexity of its house-keeping functions and the cost per computation.

Machine talk. One of the main problems facing planners concerns the method of communication between computers speaking different languages. A proposal by Wesley Clark of Washington University, St. Louis, would interpose a small general-purpose computer between the communications line and the main computer. Others say this function could be performed by programs within the computer it-

self, with the aid of data modems (modulators-demodulators).

Preliminary decisions on communications channels, transmission modes, and requirements for automatic dialing units will be discussed at the July meeting.

A 4-kilohertz, four-wire dial-up system with 1,200-bit-per-second asynchronous modems is employed in an experimental link now operating under ARPA sponsorship. It connects the TX-2 computer at MIT's Lincoln Laboratory in Lexington, Mass., with an FSQ-32 at the System Development Corp. of Santa Monica, Calif.

Advanced technology

Now hear this

Getting zip-coded packages in the right mail sack at the post office and doing outside repair work on an orbiting spacecraft have at least two things in common: they're both jobs requiring four hands and they're both about to be simplified by electronic speech-recognition equipment.

Package processing is currently done by teams of two clerks—one yelling out the zip numbers and the other shoving the packages down the appropriate chutes. An astronaut maneuvering outside his craft can work only in spurts because he has to use both hands when he operates his backpack controls. With speech-recognition gear, the postal worker will be able to tell a machine where to move a package, and the astronaut will verbally direct his backpack maneuvering unit.

Present equipment can't recognize all conversational speech, but small systems are being developed to handle limited vocabulary tasks like these. The Radio Corp. of America's Defense Electronic Products division in Camden, N.J., is putting together the first evaluation model of a numeric speech translation system for the Post Office. It also reportedly is about to get an Air Force contract from Wright-

Patterson Air Force Base in Ohio to develop a prototype voice controller for space jobs.

Taking the count. The Post Office equipment is being developed under a \$250,000 contract awarded last year, and will be delivered in about a year. If it passes a two-month evaluation, RCA will build an engineering model. The system recognizes 11 words—"one" through "nine," "zero," and "oh." This limited vocabulary doesn't vary by just one phoneme (the smallest unit of speech that distinguishes one utterance from another), but by several. This means that the system only needs to recognize "sev" for seven, for example. In a recent laboratory test with seven speakers, the unit made no mistakes.

One problem is the background noise at post office package-sorting areas—as high as 80 decibels. RCA expects to get around this by having postal workers use noise-canceling microphones.

A postal clerk will read out the zip code in what RCA calls a "normal telephone manner," and will then push the package past a photocell. The machine takes over from there and opens a trap door when the package is over the chute indicated by the spoken numbers.

Space commands. The voice controller being developed for an astronaut maneuvering unit will recognize 13 instructions or words. The triggering word, "command," will be followed by such words, as "right," "left," "up," and "down." The controller will provide the signal to turn the backpack's thrusters on and off, freeing the astronaut's hands. The entire controller will fit in a package measuring 100 cubic inches.

The design of both these units is based on an RCA technique called analog-threshold logic. The company has had a research group working on the first step in this field—acoustic analyzers—since 1959. The ultimate goal of work in this area is a machine that could recognize continuous conversation from a very large number of speakers under conditions of poor signal-to-noise ratio, restricted bandwidth, and very poor enunciation.

In ordinary conversation, the final

NEW ERIE Low Pass FILTERS

...LESS THAN $\frac{1}{13}$ The Volume

OF CONVENTIONAL FILTERS

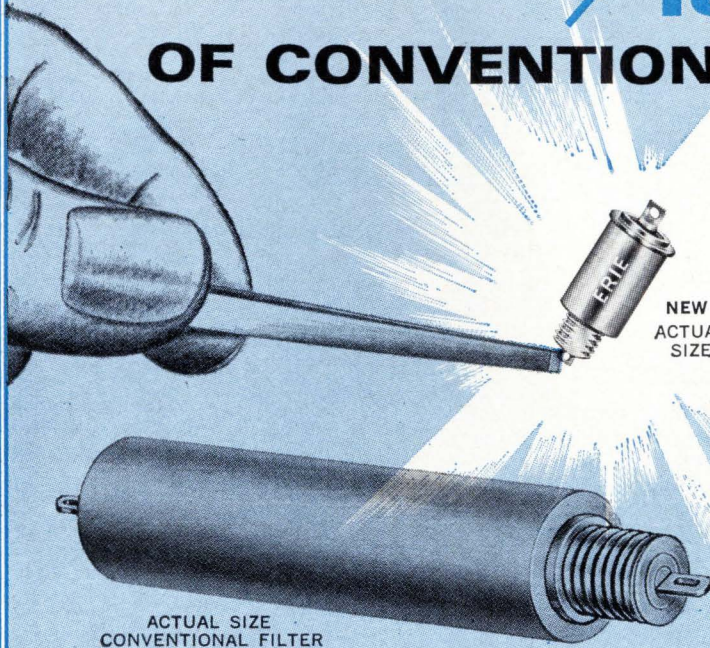

Actual Size

HERMETICALLY SEALED BROAD SPECTRUM REJECTION FILTERS



100 Volts DC line Filter; For L, π and T Circuits; Insertion Loss...67 DB at 150KC DC Current Ratings to 8.0 Amp. $\frac{1}{4}$ -28 Thd. mounts in chassis.

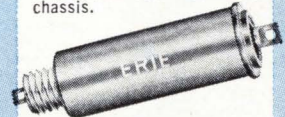

115 Volts AC @ 60 cycles; Insertion Loss. 12 DB @ 150 KC and 60 DB @ 10 Mc.; $\frac{1}{4}$ -28 Thd. mounts in chassis.

SUBMINIATURE STRIPELINE FILTERS



HERMETICALLY SEALED AIR DIELECTRIC STRIPELINE FILTER AND DIODE HOLDER
Two components in one for π circuits...1. Precision capacitor values for selective bias...2. Signal line filter network. Isolation shaped as required.



SUBMINIATURE STRIPELINE T and π SECTION FILTERS
Ribbon leads; 50 DB @ 1 Gc. Excellent VSWR. Effective filtering beyond 4 Gc.

ERIE'S NEW FILTER TECHNOLOGY PERMITS DRASTIC REDUCTION IN SIZE

Now, from Erie's Project "ACTIVE" (Advanced Components Through Increased Volumetric Efficiency) comes a new line of subminiature high pass, low pass and band rejection L, π and T Section Filters.

Volume reduction of these high reliability filters ranges to 13 times smaller than conventional filters of equal capability. Weight is correspondingly reduced, thus providing ideal RFI (electromagnetic interference) Filtering for equipment in aerospace, military and commercial markets.

Erie's new filter technology permits insertion loss ratios of 67 DB @ .25A @ 150 KC ...volumetric efficiencies which were never before possible.

In addition to the standard line filters described at right, Erie offers a full line of compact Bypass Capacitor Systems for transmitting tubes. Also, if you have particular electromagnetic interference problems not covered by standard Erie filters, we will be happy to custom design a filter connector package to suit your application.

Write TODAY for Bulletin 9000 and the name of your nearby Erie Field Sales Engineer.



AIR FLOW SOCKET SYSTEM AND SCREEN GRID BYPASS CAPACITORS

Erie now provides effective and reliable capacitive bypassing and coupling or filtering of all RFI signals in the range of 10 to 3,000 megacycles and beyond. Screen grid values from 1000 pf. to 10,000 pf. at 1000 WVDC. Variety of systems to meet your design requirements. Write for Bulletin 9800.

Erie's Project "ACTIVE"
Advanced Components Through Increased Volumetric Efficiency

ERIE

TECHNOLOGICAL

PRODUCTS, INC.



Erie, Pennsylvania

phoneme is lost and sounds are constantly being eliminated, added, combined, or substituted for one another. To extract meaning from this stream of interfering sounds, the recognition units have networks organized on three processing levels; each level abstracts different information on the sounds, and each functions best under different signal-to-noise and restricted bandwidth conditions.

The specialized analog equipment performs parallel processing; what it does couldn't be done on any digital computer today, according to RCA. The first stage is a filter bank of 19 units, modeled after the inner ear, for preprocessing of the voice input. In the next stage, full-wave rectifiers function as the three-level feature-abstraction networks. The final stage is a log network to make the decisions.

In one potential application of sophisticated equipment, a computer user would verbally instruct the machine over a telephone. "Although it's the subject of some controversy, I think we'll be able to do it," says Thomas B. Martin, an RCA project engineer.

Manufacturing

On the beam

Small millimeter wave klystrons used to be a big production problem at Varian Associates of Canada, with yields no better than 20%. Now the company is using a laser welder that, it claims, boosts yields to better than 95%.

According to Maurice Viant, development manager at the Georgetown, Ont., firm, a subsidiary of Varian Associates, the problems centered on the difficulty of making welds between refractory metals. Compounding the difficulty was the small size of the components being bonded and the limited space for the welding electrodes. The klystrons are built to generate energy at frequencies as high as 220 gigahertz, and components and tolerances for tubes like these are

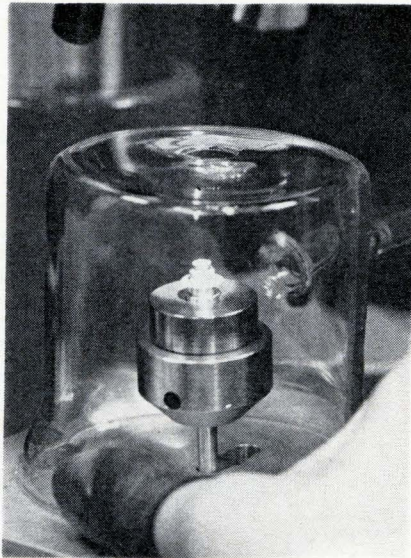

Light welder. A stainless steel jig aligns components for a miniature klystron as a laser beam bonds the parts. The glass bell jar holds argon, which prevents oxidation of the components during the welding operation.

very small indeed, says Viant.

Hot tip. The small tubes' high-temperature cathodes required mounts made of metals such as molybdenum, tantalum, and titanium. The high melting points of these metals made them nearly impossible to bond using resistance welding techniques. Even when bonding was accomplished, the copper welding electrode melted, leaving a coating of copper on the weld. When the tube was turned on, temperature rose and the copper often evaporated and then condensed on the tuning mechanism, cutting output power, or on the cathode, contaminating it.

Even when condensation was no problem, the tube was still apt to fail shock or vibration tests as its brittle welds came apart.

With the welder, a pulsed-ruby laser built by the Union Carbide Corp.'s Linde division, very high temperatures, sufficient to bond refractory metals solidly and easily, are generated in small areas. Since there is no electrode material left on the weld, there is no copper contamination to cause failures. The tubes no longer have to be designed to leave room for welding electrodes.

As a bonus, Varian engineers found that they could tack weld

tube parts together prior to brazing. Cheap multiple-tack welds now replace as many as 20 stainless steel jigs, costing \$30 each, that held the parts together during brazing.

Avionics

Automatic map

At a forward air control post in a battle area, the weapons controller has a radar view of his area on a plan position indicator (PPI). He also has a map, showing perhaps a coastline and other natural landmarks. But he needs a composite display—the landmarks superimposed on the radar video—that would eliminate the necessity of manually plotting mission control points on the radar display.

To develop and build 28 tactical video mappers that superimpose geographical points on the PPI, the Air Force Electronic Systems Division has awarded an \$882,500 contract to Reeves Instrument Co., Garden City, N.Y. First delivery is scheduled for March 1968. The project is part of the 407L tactical air control system.

Aside from providing a convenient view of a battle area, the system would eliminate the many chances of error when target locations are plotted on the PPI with a grease pencil. When a pencil is used, a point is first plotted on an operational map. With an overlay of lines drawn to the control site, the point is converted to range and azimuth from the radar, and is then drawn on the PPI safety glass, where it is subject to further error between the glass and the face of the cathode tube. If the weapons controller wishes to change the display, the point has to be plotted again. If he off-centers the PPI or expands it for close, more accurate, control work, plotting can only be an approximation.

When these errors are added to the accuracy limitations imposed by the range and azimuth limitations of radar, the resulting position may

There's more than one way to squeeze everything in.

Let's just say some ways are better than others.

Maybe you *could* squeeze in some of those conventional parts, but would you be happy with what you had when you got through?

Of course, if weight and reliability are no problem to you, you may very well find cheaper diodes than ours that'll get by.

But if you really *need* miniature components that have high power and tremendous surge capacity, our parts can be a life-saver.

You see, we developed the Unitrode for applications that would require very small components

lasting almost forever with no change in electrical parameters. Now forever is a long time, but that's what we mean.

And *developed* is the right word, too. From the ground up. With entirely new design. With entirely new methods of construction. The metallurgical bond that joins the silicon between the two terminal pins is stronger than the silicon itself, so the silicon will break before the bond does. The entire unit is fused in hard glass at over 800°C. It's voidless, so all contaminants are excluded.

That's why every Unitrode can handle as much energy in avalanche as in the forward direction. And that's why the machine has yet to be built that can fail our diodes in acceleration, vibration, and shock tests.

Because the pins are bonded over the full face of the silicon die, heat due to surge is carried away quickly from the silicon into the terminal pins. So even the smallest Unitrode diode can withstand a one microsecond surge of 600 amps. The largest, which isn't much larger at that, can take 4000.

To top it off, you can apply full PIV to a Unitrode at high temperature, for weeks at a time, and you won't even budge it.

So if you're looking for someone to play a smaller part in your plans, try us. You might get a lot of comfort from knowing our diodes not only fit in where you're squeezed, but will never fail you.

Can we send you samples and more complete information? We're at 580 Pleasant St., Watertown, Mass. 02172. Telephone: (617) 926-0404. TWX (710) 327-1296. Try us.

UNITRODE®

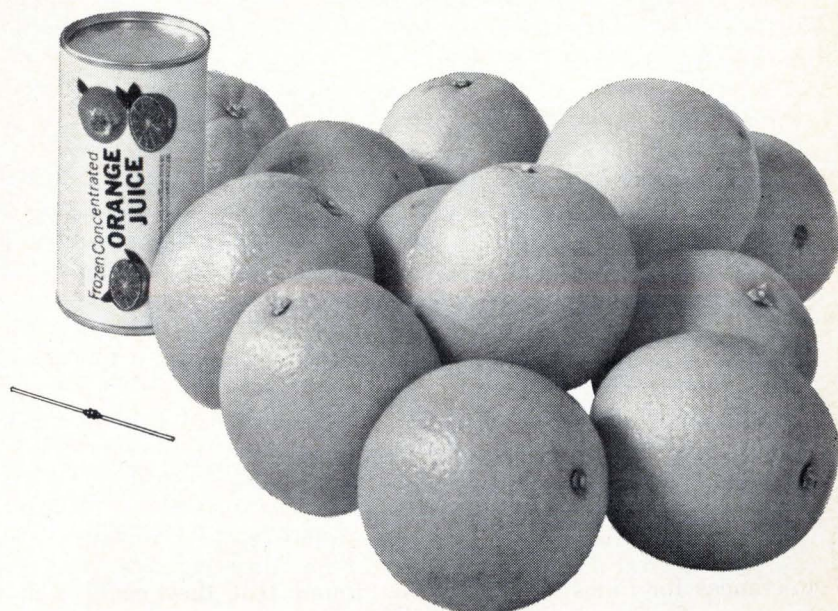

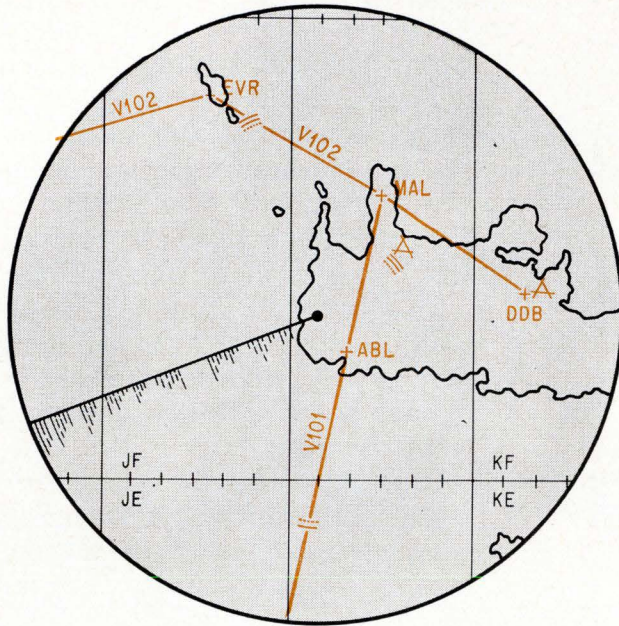

Two in one. The plan position indicator with a map of landmarks superimposed in color. Manual plotting with a grease pencil is eliminated.

be several miles off target.

The competition. Reeves won the contract in a competition with the Westinghouse Electric Corp., which several years ago developed a similar device called the Tac-Map but never sold one.

For security reasons, Reeves won't disclose design plans. In this type unit, however, displays are usually produced by direct manual tracing of the desired geographic features from operational maps onto translucent or transparent acetate overlays. The overlay is then scanned by a vidicon, providing a scaled image on the connected PPI's.

Relatively permanent information such as principal graphic features, national boundaries, fixed navigational aids, and airfields can be traced directly on a transparent overlay, which would be available in a permanent map position for continuous viewing.

Changing information—such as the plotted coordinates of a specific target, the location of a forward air controller, a drop zone, a temporary navigation aid, mission control points, or gun positions—can be drawn on a separate sheet.

The Air Force requires that the video mapper be capable of transmitting tactical information to a PPI for display during a changing

tactical situation with only momentary interruption of the mapper operation.

The equipment will enable use of navigational charts, which span 200 nautical miles; Air Force pilot charts, 100 nautical miles; and approach charts, 50 nautical miles.

Replaceable modules and built-in test equipment will be used in the mapper. Gross weight will be under 200 pounds. The output signal will be capable of driving eight PPI's.

For the record

Quick look. Two phosphors having a 1-nanosecond response time—a thousand times faster than those now available—have been developed by physicist Willi Lehman of Westinghouse Electric. One is made by doping cadmium sulfide with indium, the other by doping zinc oxide with gallium. But there's a drawback: the new phosphors lose from 90% to 99% of the brightness of conventional phosphors.

Psst. Successful demonstration of the whispering-gallery effect in the ionosphere points the way to a pos-

sible new technique for global communications beyond line-of-sight paths. Newly analyzed data from an experiment last November, says the Air Force, shows that extremely strong signals were transmitted between two satellites on opposite sides of the earth. The theory is that the ionosphere is like a whispering gallery in which sound waves travel along a curved area with little loss of volume. Some communications specialists speculate that sound leakage from the ionospheric layers could be tapped by high-altitude military aircraft for round-the-world communication.

Getting big. Interest in microwave integrated circuits is growing. In addition to Texas Instruments and Sylvania, such semiconductor firms as Fairchild, Motorola, and Philco-Ford are trying to develop IC's for X-band applications. TI expects the microwave semiconductor market to soar to \$300 million annually by 1970 from the present level of \$25 million; in the June 12 issue of Electronics, the \$25 million forecast for 1970 was given as annual, rather than a monthly, figure.

Fax facts. A facsimile reproduction system for the home in which the signals would be carried along with regular television broadcasts has been developed by RCA. The company has asked FCC permission to conduct tests after normal broadcasting hours on the New York transmitter of NBC. Adding information to standard tv, without affecting the broadcast, is nothing new. The Japanese have tested a system [Electronics, Nov. 2, 1964, p. 120] and so have the Russians [Electronics, March 20, p. 243].

Ready for sale. DuPont, which last month announced that it was field testing a new chromium dioxide magnetic tape, now says it will go on sale within a month. Manufacturing facilities have been set up at Newport, Del. The new tape, called Crolyn, will cost 25% to 50% more than the conventional kind, but it can record twice as much per inch. Some producers of computer and home video tape equipment have told DuPont that they are already modifying equipment for the new tape.

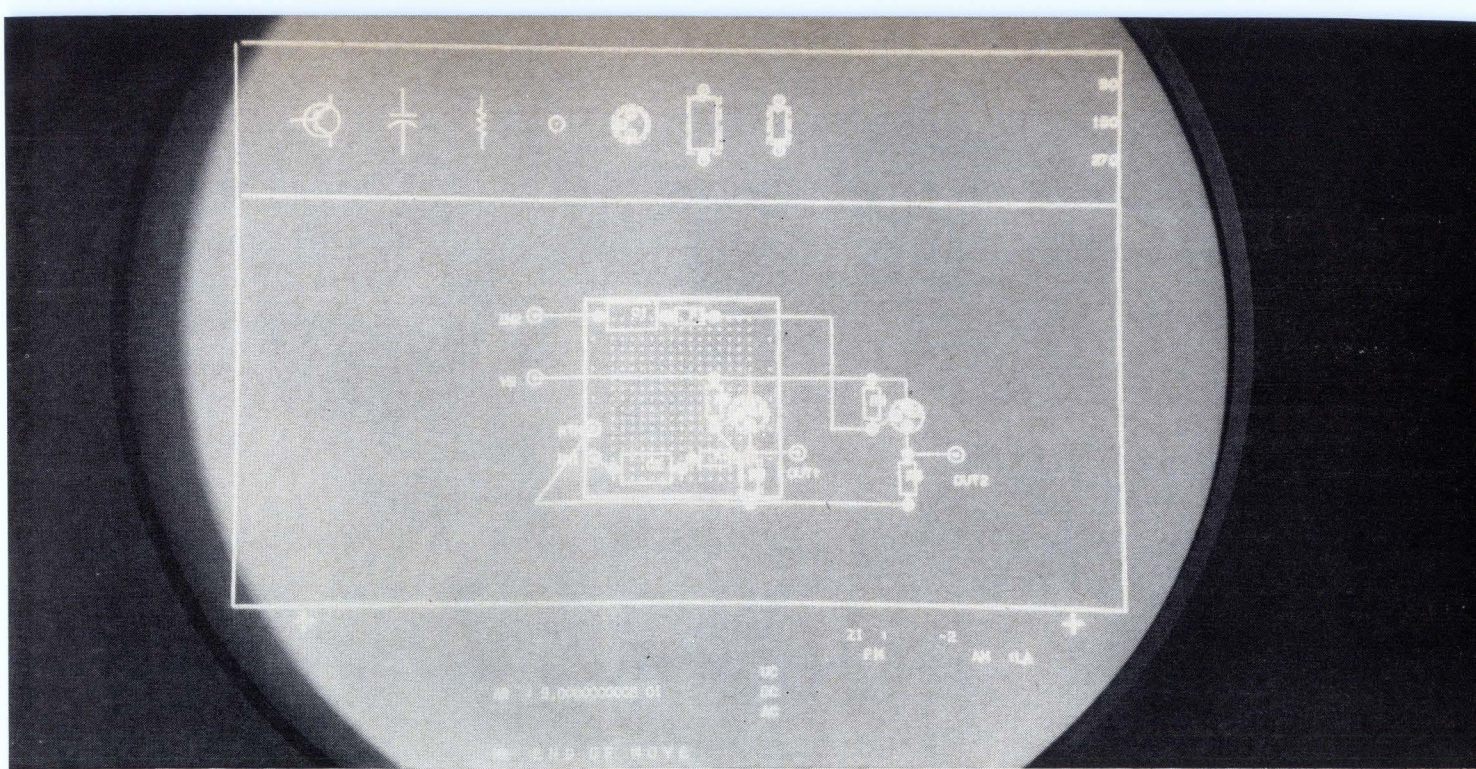

Readouts clear up problems.

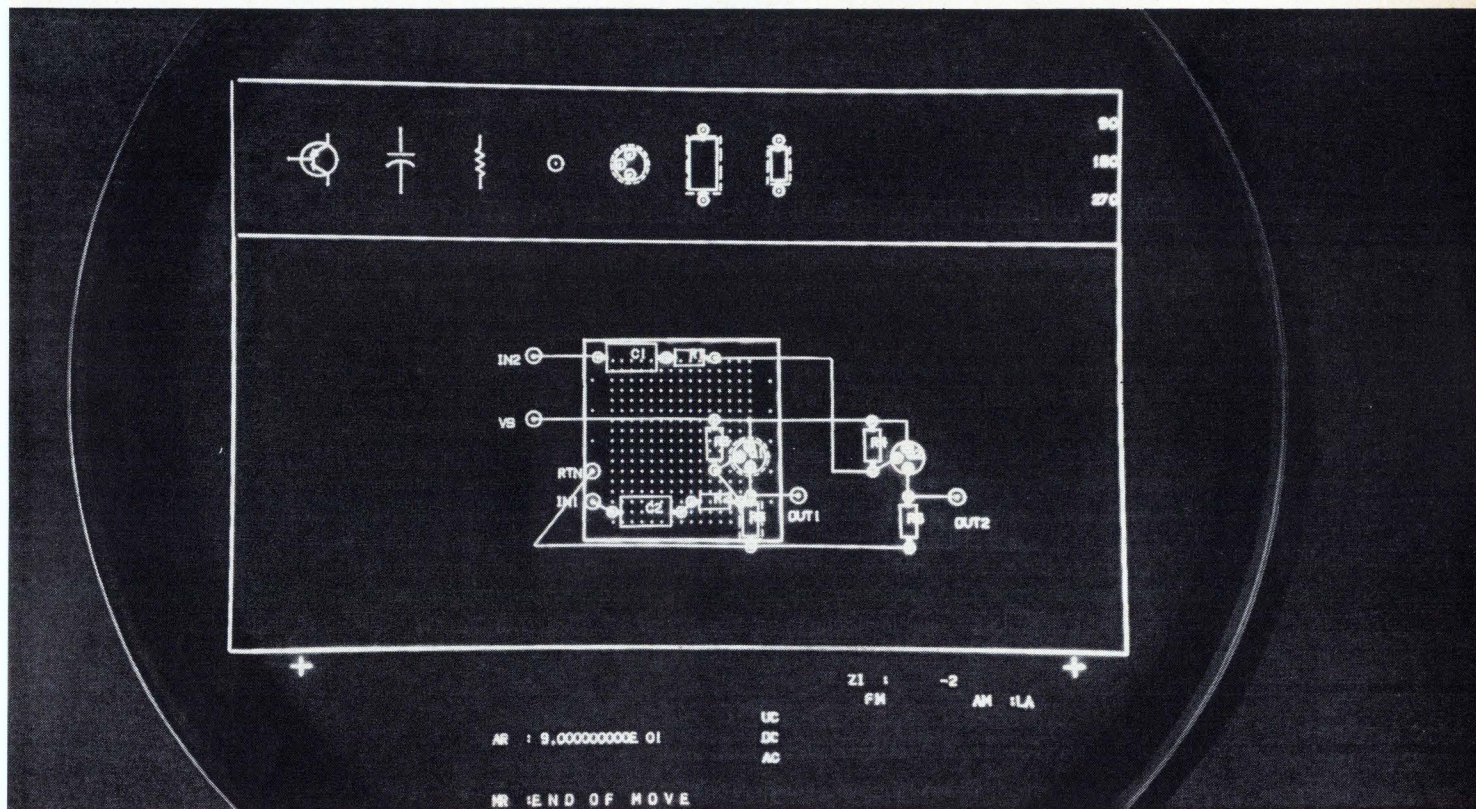

Polaroid circular polarizers clear up readouts.

It's never a problem to read readouts if they're equipped with Polaroid circular polarizers. Our polarizers improve readability from every angle by increasing contrast. In daylight. Or even in brightly lighted rooms.

But now you don't have to take our word for it. Send for our new brochure, and we'll include 3 samples of our circular polarizers (amber, neutral, and green). They'll help you see very clearly why many major display and

instrument manufacturers are now using Polaroid circular polarizers.

Write Polaroid Corporation, Polarizer Sales, Department 59, Cambridge, Massachusetts 02139.
Polaroid Circular Polarizers.

SPERRY

DIVISIONS OF
SPERRY RAND
CORPORATION

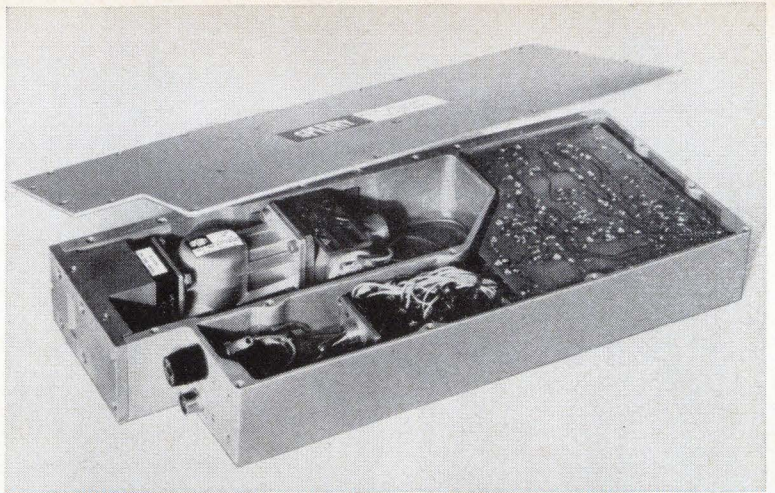

SPERRY RAND CORPORATION has brought its extensive technical resources to bear on the problem of side-looking radar for the RF-111A.

Under contract to Westinghouse Aerospace Group, Baltimore, Maryland, Sperry is providing a complete microwave source, consisting of a klystron oscillator, a stalo cavity and a carefully matched power supply. All these are housed in a single 2½" x 3" x 11" package weighing only six pounds. The unit serves as the radar's local oscillator.

Why Sperry? Because the low-noise, high-environment specifications for RF-111A generated several difficult interfacing problems among tube, stalo, and power supply. Westinghouse engineers elected to buy the entire source as a unit, allowing Sperry to solve the interface problems with techniques available from the "Storehouse of Knowledge." It was a decision which produced an optimum source package, while freeing Westinghouse people to handle the larger, more complex aspects of system integration.

Are there tube/power supply interfaces that annoy and distract you? Why not let Sperry handle them? Contact your Cain & Co. man, or write Sperry Electronic Tube Division, Gainesville, Florida 32601.

**SPERRY MICROWAVE ELECTRONICS AND
SPERRY ELECTRONIC TUBE DIVISIONS**
Sperry Rand Corporation

Clearwater and Gainesville, Florida

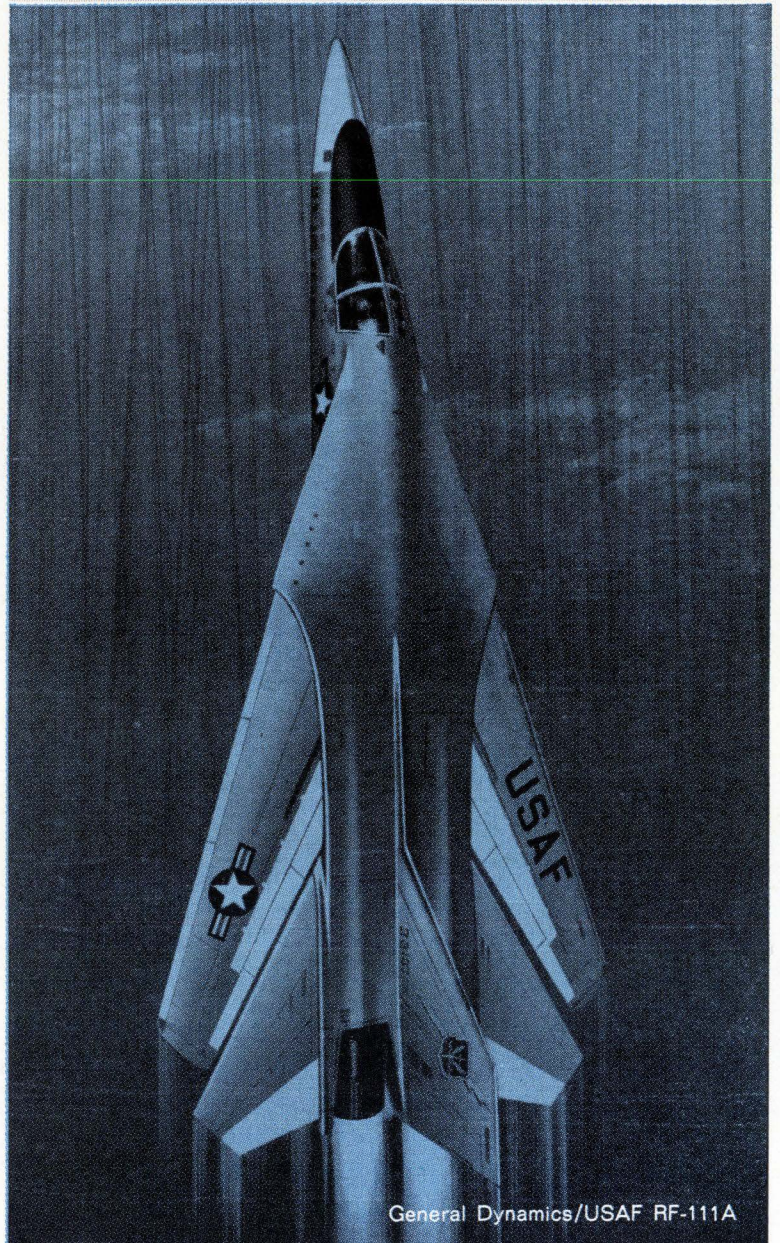

General Dynamics/USAF RF-111A

Why RF-111A taps Sperry's Storehouse of Knowledge.

Washington Newsletter

June 26, 1967

Comsat to get domestic role . . .

The Communications Satellite Corp. will put up a domestic communications satellite. An FCC ruling expected in about a month will give Comsat—which already has a U.S. monopoly in international satellite communications—the go-ahead to develop a pilot domestic system. **For the time being, the FCC action will rule out separate domestic satellite television systems.** Under the plan the FCC is expected to approve, Comsat will put up the satellite, which will include some educational tv capability, in conjunction with domestic communications companies. The ticklish question of who will own the system will be decided later.

. . . and is studying millimeter waves for growing room

Commercial satellite communications may be boosted to millimeter wavelengths to get away from crowded and shared frequencies. Wilbur Pritchard, recently appointed director of Comsat's new laboratories, is confident the answer is in the higher frequencies and has put his small but growing staff to work on research in the millimeter-wave area. Pritchard predicts "spacecraft suitable" millimeter-wave equipment in three to four years.

Air Force dials a wrong number in TRC-124

A tight schedule coupled with tough technical requirements caused the Air Force's crash program for an automatic, intrabase radiotelephone system to fizzle. A \$422,000 contract with Sylvania Electronics Systems has been cancelled "at the convenience of the Government" after the AN/TRC-124 program ran into several problems.

The problems were said to have stemmed from the Air Force's demand that the first production model be delivered within 14 months, even though research and development was necessary. Radio-frequency-interference problems were called insurmountable in the short time provided. But the Air Force would neither relax specifications nor extend the schedule. The automatic switching system was being designed to handle up to 14 simultaneous radiotelephone conversations with up to 200 addresses. **Some companies refused to bid on the work because of the short lead time.**

Webb's biggest test: saving NASA funds

The hard-driving, fast-talking boss of NASA, James E. Webb, has built a reputation for being able to get money from Congress. That reputation is being put to the test this year and Webb may have to push harder and talk faster than ever. For the first time, he may need promised support from the White House in dealing with a Congress wavering because of the Apollo accident and heavy Vietnam spending.

It will be another few weeks before Webb finds out if he has kept his record intact, **but capital observers are now betting that he'll wind up with a cut of \$200 million to \$250 million in his \$5.2 billion fiscal 1968 budget proposals.** This would be something of a victory in view of recent Congressional clamor to pare \$300 million to \$400 million of projects to be started under the Apollo Applications program.

Navy's A-6A slated for avionics changes

There will be avionics changes in new models of the Navy's all-weather attack craft, the Grumman A-6A Intruder. In recent Congressional testimony on the plane's performance in Vietnam, Litton's central

Washington Newsletter

weapons system computer was described as the "least maintainable" of the avionics subsystems. IBM's 4-pi computer appears likely to replace it in the new models.

Another A-6A avionics subsystem with maintenance problems has been the search and track radar supplied by Norden. However, Norden is the odds-on favorite for the radar in the improved version.

Awads system for blind airdrops gets off ground

After a two-year delay, the Air Force is finally getting enough funding to go ahead with its All Weather Aerial Delivery System (Awads) for the C-130 transport. Before the end of July, companies will be asked to submit proposals for equipping several hundred planes. The total package contract will include stationkeeping equipment, multimode radars, and computers. The winner will have only two years to retrofit a squadron of C-130's. The price may hit \$300 million over three years.

The self-contained Awads will permit precision airdrops of men and material even in zero visibility—something that can't be done today. C-5 transports now being built will be equipped with Awads gear, with Lockheed acting as integrator.

Airlines spell out CAS standards

The Air Transport Association—speaking for the nation's airlines—is expected this week to spell out the specifications it wants in a collision-avoidance system (CAS). The technical data package on a standard cooperative system, coming after 12 years of study, will be turned over to manufacturers. Some four or five companies are expected to build flyable prototypes. Evaluation may start in late 1969. The FAA will also use the airlines' CAS standard to make computer simulations to determine how such a system would fit in with its air traffic control system.

Airlines estimate the cost of a collision-avoidance system at \$30,000 to \$50,000 per aircraft. The supersonic transport is expected to be equipped with CAS, and aircraft already in service will eventually be retrofitted, ATA officials predict.

Big Omega order is due this week; more are in offing

The first large order for Omega very-low-frequency navigation receivers will be awarded by the Navy this week. The company selected to build the first 140 shipboard sets is expected to gain an edge on competitors for business that eventually could come close to a billion dollars. [Electronics, March 20, p. 50]. In the running for the estimated \$10 million contract: Decca, ITT, Northrop, Pickard & Burns, Ryan, and Tracor. Navy officials, who had expected to get Defense Department approval in April to expand Omega into a worldwide system, now don't look for an okay until sometime this summer. When it comes, the Navy will spend \$50 million to double the number of its 10.2-to-13.6-kilohertz transmitters to eight and to upgrade the four stations now on the air.

Civil defense net to get radio backup

The Government will build 10 low-frequency transmitters across the U. S. as a backup for cables now used as links in the civil defense warning network. The first three stations will be started this year in the Northeast, using \$1.14 million from the Army's fiscal 1968 budget. Federal civil defense officials are hoping that manufacturers will come up with a reliable 190-kilohertz receiver priced at less than \$100. At least 1,000—perhaps many more—will be needed.

By solving an "unsolvable" cleaning problem, Freon® helped perfect Hamilton's electric watch.

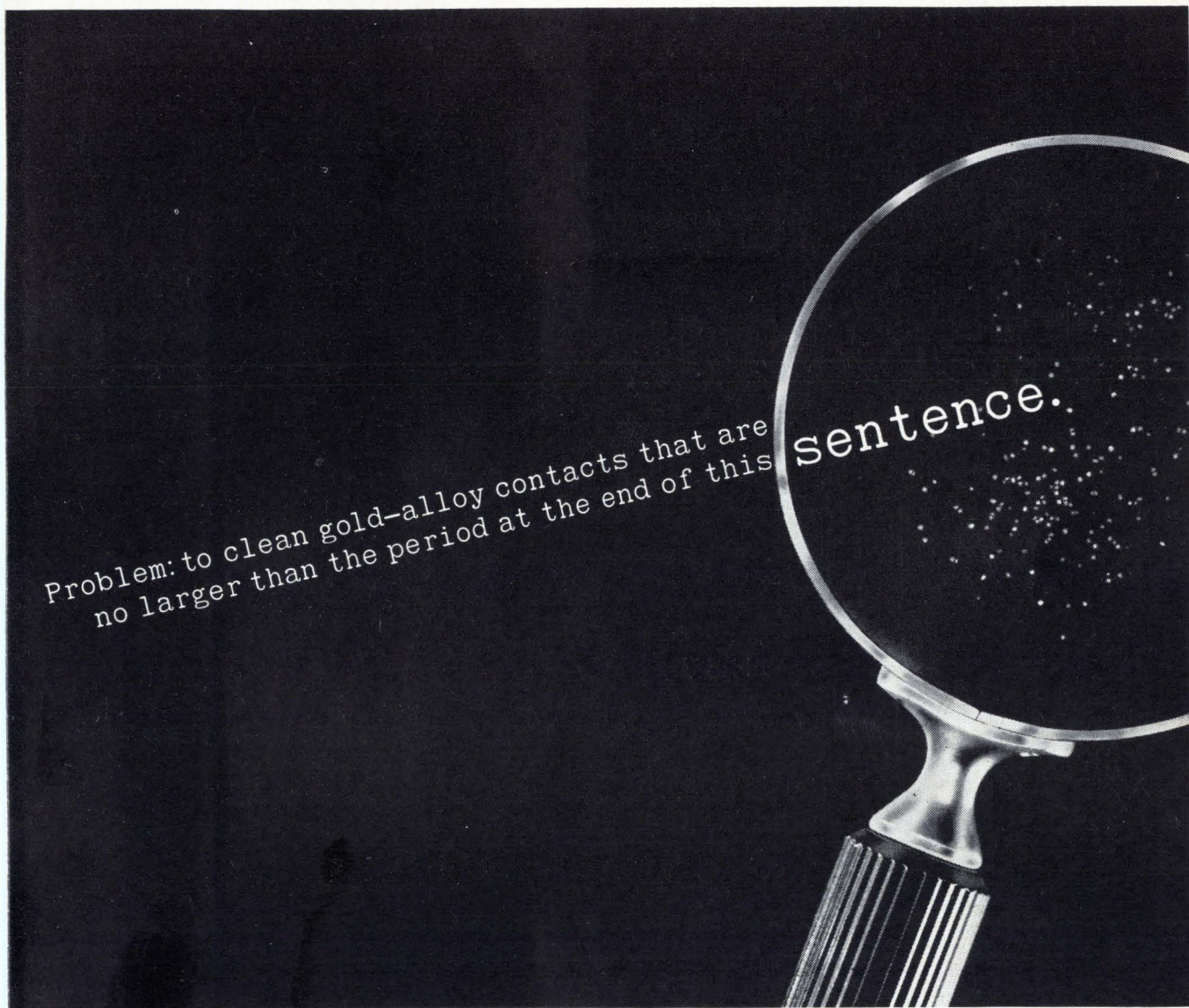

Problem: to clean gold-alloy contacts that are no larger than the period at the end of this

sentence.

Those specks under the magnifying glass are gold alloys. Each one acts as a contact that transmits power from a tiny battery to the timekeeping mechanism of the Hamilton electric watch ... which now ranks with the best of critical timepieces.

Unless these contacts, located in extremely tight assemblies, are *completely free* of soils and stains, however, the watch will malfunction. Or not function at all. And this was precisely the problem that confronted Hamilton engineers during the watch's development in Lancaster, Pa. They simply could not get the contacts clean *enough*. Even the cleaning agents they used left trouble-making stains.

The problem wasn't solved until FREON*, with its unique properties, was introduced into the cleaning operation. FREON has *low* surface tension, which allows it to penetrate the tightest assembly. At the same time, FREON has *high* density. This permits the quick release of all stains left by trapped cleaners. And because it vaporizes at a little above room temperature, FREON dries rapidly, leaving no stains of its own.

Hamilton uses FREON to clean parts ranging from $\frac{1}{16}$ of an inch (the contacts) up to $\frac{1}{4}$ of an inch ... including $\frac{1}{8}$ -inch, intricately designed toothed wheels. As many as 3,000 parts are cleaned in an ultrasonic tank simultaneously. So successful was Hamilton's experience with FREON that the company now uses it in its military area.

For instance, FREON is used in a degreaser to remove soils from a gravity-triggered release installed in parachute flares.

Do *you* have a tough cleaning problem that FREON can solve? Write Du Pont, Room 144A, Wilmington, Del. 19898. (In Europe, write Du Pont de Nemours International S.A., FREON Products Div., 81 route de l'Aire, CH 1211 Geneva 24, Switzerland.)

*DuPont registered trademark for its fluorocarbon cleaning agent.



BETTER THINGS FOR BETTER LIVING...THROUGH CHEMISTRY

State of the design art

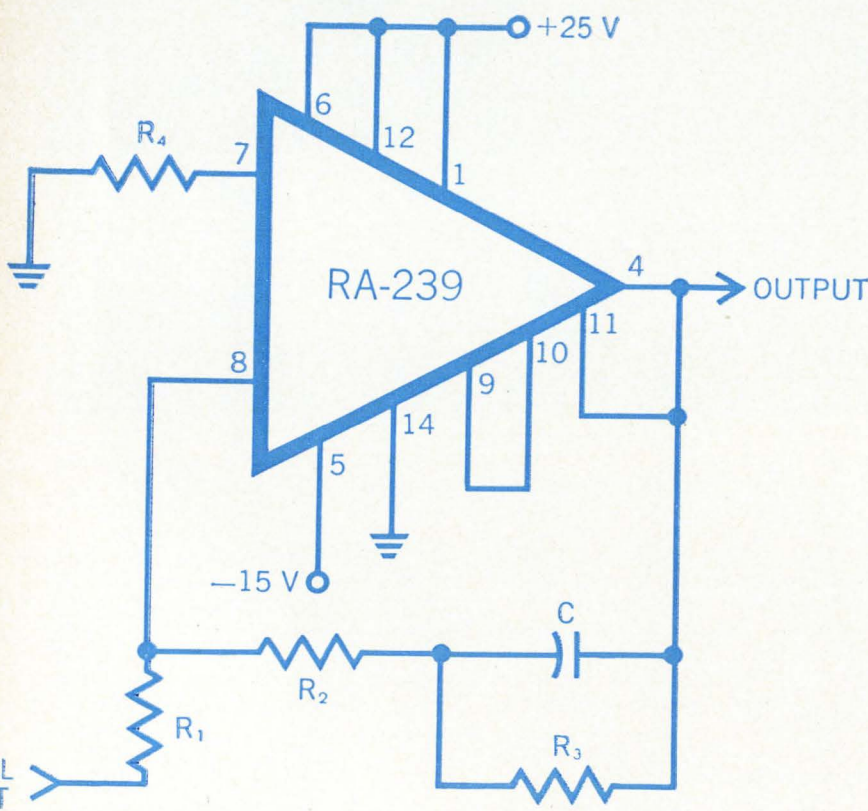

Now . . . simplify design
of servo preamplifiers
with Radiation's
IC Amplifiers

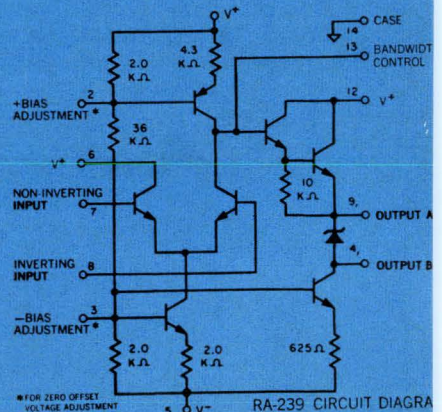

Radiation Operational Amplifiers offer a new dimension in the design of monolithic DC servo preamplifiers. They simplify design, provide unconditional stability without external compensation, and allow accurate determination of lag and lead frequencies. Only Radiation IC Amplifiers offer the characteristics needed for such an application.

For example, Radiation's RA-239 Broadband Amplifier is used in the lag-lead DC servo preamplifier shown at left. Feedback components are selected to optimize overall preamplifier parameters . . . without regard to the active element in this configuration.

Transfer characteristics are:

$$\frac{E_{out}}{E_{in}} = - \left[\frac{R_2 + R_3}{R_1} \right] \left[\frac{1 + j\omega T_1}{1 + j\omega T_2} \right]$$

Where: $T_1 = R_2 C$ and $T_2 = R_3 C$

Frequency of lag and lead are defined by:

$$f_{lag} = \frac{1}{2\pi T_2}; f_{lead} = \frac{1}{2\pi T_1}$$

For a gain of 100, the preamplifier will provide full output up to 140 kHz. Undistorted output voltage is 21.6 V_{p-p}. Total swing is +10.8 V to -12.2 V.

State of the monolithic art

A new line of universal building blocks for integrated analog circuitry is now available to design engineers. Radiation Incorporated supplies three different types of IC operational amplifiers to serve your individual requirements: general-purpose, broadband, and high-gain amplifiers.

These amplifiers provide outstanding performance. Parasitics are eliminated, thanks to our unique dielectric isolation technique. Tighter tolerances and improved temperature coefficients are achieved through use of precision thin film resistors over the oxide.

Thus, Radiation's technology simplifies system designs which

were hampered by limitations imposed by conventional integrated circuit fabrication techniques.

Only Radiation can provide production quantities of inherently stable IC operational amplifiers. These circuits are stocked for immediate shipment in TO-84 flat packages.

Write or phone for our data sheets, which include *worst-case limits* as well as all information required by design engineers. We'll also be glad to send you a copy of our new manual entitled: Operational Amplifier Technical Information and Applications. For your copy, request publication number ROA-T01/A01 from our Melbourne, Florida office.

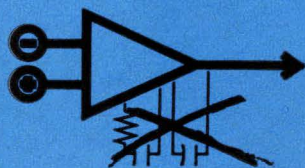

Radiation IC Operational Amplifiers*

Typical characteristics ($T_A = +25^\circ\text{C}$)	GENERAL PURPOSE RA-238	BROADBAND RA-239	HIGH GAIN RA-240	UNIT
Phase margin	60	60	45	Degrees
Bandwidth (unity gain)	7	15	6	MHz
Slew rate	3.2	23	3.2	V/ μs
Voltage gain	2,700	2,700	33,000	
Offset voltage	2.0	2.0	2.0	mV
Offset current	80	400	80	nA
Thermal drift	± 5 ± 1	± 5 ± 5	± 5 ± 1	$\mu\text{V}/^\circ\text{C}$ nA/ $^\circ\text{C}$
Undistorted output swing	21	21	9 (11.6) [†]	V_{p-p}
Power dissipation	90	160	90	mW
Common mode rejection	100	100	100	dB
Power supply rejection	100	100	100	dB
Input bias current	0.4	1.0	0.4	μA

*Standard temperature range: -55°C to $+125^\circ\text{C}$. $V^+ = +25\text{V}$; $V^- = -15\text{V}$.

[†] $V^+ = +20\text{V}$; $V^- = -20\text{V}$.

All Radiation integrated circuits are dielectrically isolated.



RADIATION INCORPORATED

MICROELECTRONICS DIVISION

Sales offices: Suite 622, 650 North Sepulveda Blvd., El Segundo, Calif. (213) 772-6371—Suite 232, 600 Old Country Road, Garden City, N. Y. (516) 747-3730—Suite 704, 2600 Virginia Ave., N. W. Washington, D.C. (202) 337-4914—P.O. Box 37, Dept. EL-06, Melbourne, Florida (305) 723-1511, ext. 554.

Circle 62 on reader service card

Radiation's 8 x 5 Monolithic Diode Matrices improve design of BCD decode systems for cold cathode numeric display. Other integrated BCD decoders are limited to only

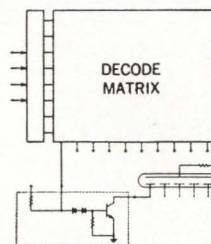

one weighted binary code. However, Radiation Matrices can be "customized" to any weighted binary code to decimal conversion.

This design flexibility is achieved through Radiation's fusing technique for selecting desired coding patterns.

The 8-4-2-1 BCD decoder display, illustrated, is only one example of the many possible monolithic circuit displays which can be formed. The circuit requires only two Radiation RM-17 8 x 5 Monolithic Diode Matrices. Data Storage is provided by two Radiation RD-1521 Dual Pulse Triggered Binary elements, while two high-voltage RD-1536 Hex Indicator Drivers are used to drive the cold cathode numeric indicator tube. Extremely high counting rates can be achieved, since frequency is limited only by the counters.

For detailed information, refer to our ELECTRONIC DESIGN advertisement of May 24.

Our entire line of matrices contains all active devices within a single chip. A fusible link in series with each diode permits unlimited matrix patterns to be formed.

We'll be glad to send data sheets which include *worst-case limits*. Our design manual, Monolithic Diode Matrix Technical Information and Applications, RDM-T01/A01, is also available. Write or call our Melbourne, Florida office for your copy.



Circle 63 on reader service card

DCL[®]

DESIGNER'S CHOICE LOGIC

Signetics puts IC systems design decisions back in the hands of the systems designer.

Some IC families put severe limits on the decisions the systems designer can make. He's often held back by the speed, power, and noise immunity trade-offs built into the family by the IC manufacturer. Now Signetics Designer's Choice Logic changes all that. Signetics DCL[®] Series 8000 includes high speed TTL circuits, slower low power TTL circuits that offer high AC noise immunity, and low power DTL circuits that provide high DC noise margins. The series also includes large functional arrays for counting and storage applications. All elements in the 8000-Series are specified compatibly. And we've got a 46-page data

handbook — the most complete one of its kind ever offered — to guide you in using these flexible circuits. In designing with DCL[®] you can optimize your system performance without drawn-out calculations, expensive and time-consuming ground-plane designs, or extensive use of outboard discrete components. The handbook provides special sections directed to systems, evaluation and design engineers. Find out fast what can be done with our DCL[®] series, and how to loosen constraints on your designs. Write Signetics for your DCL[®] handbook: 811 East Arques, Sunnyvale, California 94086.

® REGISTERED TRADEMARK 1967

**SIGNETICS
INTEGRATED
CIRCUITS**



A SUBSIDIARY OF CORNING GLASS WORKS

SIGNETICS SALES OFFICES: Metropolitan New York (201) 992-3980; Upper New York State (315) 469-1072; Southwestern (214) 231-6344; Western Regional (213) 272-9421; Eastern Regional (617) 245-8200; Mid-Atlantic (609) 858-2864; Southeastern (813) 726-3734; Midwestern Regional (312) 259-8300; Northwestern (408) 738-2710.

DISTRIBUTORS: Compar at all locations listed below. Semiconductor Specialists, Inc. (312) 622-8860; Terminal Hudson Electronics (212) 243-5200; Wesco Electronics (213) 684-0880; Wesco Electronics (405) 968-3475; Hammond Electronics (305) 241-6601.

DOMESTIC REPRESENTATIVES: Jack Pyle Company (415) 349-1266. Compar Corporation at the following locations: Alabama (205) 539-8476; Arizona (602) 947-4336; California (203) 245-1172; California (415) 697-6244; Colorado (303) 781-0912; Connecticut (203) 288-9276; Florida (305) 855-3964; Illinois (312) 775-5300; Maryland (301) 484-5400; Massachusetts (617) 969-7140; Michigan (313) 476-5758; Minnesota (612) 922-7011; Missouri (314) 428-5313; New Jersey (609) 429-1526; New Mexico (505) 265-1020; New York (518) 436-8536; New York (607) 723-8743; New York (716) 684-5731; New York (201) 471-6090; North Carolina (919) 724-0750; Ohio (216) 333-4120; Ohio (513) 878-2631; Texas (214) EM 3-1526; Texas (713) 649-5756; Washington (206) 725-7800.

INTERNATIONAL SALES: France, Germany, Italy, Belgium, Holland, Luxemburg, Spain — **Sovcor Electronique**, 11, Chemin de Ronde, Le Vesinet, (S.-&O.) France. United Kingdom, Ireland, Sweden, Denmark, Norway, Switzerland, Austria, Portugal — **Electrosil Ltd.**, Lakeside Estate, Colnbrook-Bypass Slough, Buckinghamshire, Great Britain. Australia — **Corning**, 1202 Plaza Building, Australia Square, Sydney, N.S.W. 27-4318. Canada — **Corning Glass Works of Canada, Ltd.**, Leaside Plant, Ontario, Canada (416) 421-150. Israel — **Optronix**, P.O. Box 195, Ramat-Gan, Israel 724-437. Japan — **ASAHI Glass Co., Ltd.**, Corning Products Sales Dept. No. 2, 3-Chome Marunouchi, Chiyoda-ku, Tokyo, Japan.

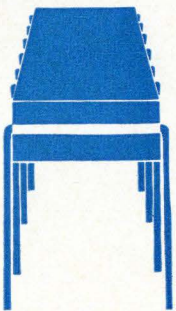
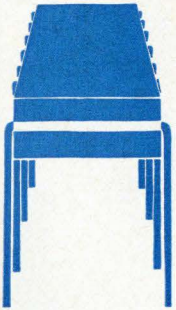
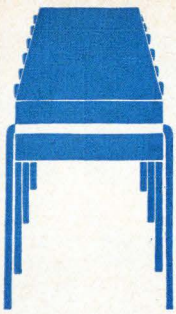

You get all three in Philco's 9930 Series DTL.

Philco's 9930 Series DTL: for military, commercial, and industrial applications. In E-line epoxy dual in line packages, ceramic flat packs, and ceramic dual in line packages. Broad range of circuit functions. Temperature ranges: military and limited for ceramic flat pack and ceramic dual in line; 0 to 75°C for E-line.

Philco's 9930 meets the highest performance and reliability standards. Order now. Immediate delivery in volume quantities.

Call the sales offices and representatives of Philco-Ford: Philco Sales Office, El Segundo, California (213) 772-6226 / Santa Clara, California (408) 245-2966 / Philco Corp. of Canada, Ltd., Ontario, Canada (416) 44-2541 / Straube Associates, Boulder, Colorado (303) 443-8600 / J & J Associates, Hamden, Connecticut (203) 624-7800 / Philco Sales Office, Clearwater, Florida (813) 446-0124 / The John G. Twist Company, Chicago, Illinois (312) 777-2250 / R. O. Whitesell & Associates, Indianapolis, Indiana (317) 359-5374 / Fort Wayne, Indiana (219) 743-4411 / R. O. Whitesell & Associates, Louisville, Kentucky (502) 893-7303 / Philco Sales Office, Burlington, Massachusetts (617) 272-1600 / R. O. Whitesell & Associates, Detroit, Michigan (313) 862-2225 / Benton Harbor, Michigan (616) 927-2041 / Technical Associates, Inc., Minneapolis, Minnesota (612) 929-6721 / Technical Marketing Associates, St. Louis, Missouri (314) 427-3600 / Kansas City, Missouri (816) 523-7865 / Philco Sales Office, Ardsley, New York (914) 693-3700 / Graydon-Sherman Inc., Fayetteville, New York (315) 637-9611 / R. O. Whitesell & Associates, Cleveland, Ohio (216) 333-2585 / Dayton, Ohio (513) 298-9546 / Cincinnati, Ohio (513) 521-2290 / Philco Sales Office, Blue Bell, Pennsylvania (215) 643-2280 / Philadelphia line, Pennsylvania (215) 242-6420 / R. O. Whitesell & Associates, Pittsburgh, Pennsylvania (412) 242-0100 / Dunbar Associates, Inc., Dallas, Texas (214) 363-2536 / Philco Sales Office, Bellevue, Washington (206) 454-5061 / Philco Sales Office, Washington, D.C. (202) 298-7810.

PHILCO



PHILCO-FORD CORPORATION
Microelectronics Division
Santa Clara, California • 95051

GOLD to TINTILLATE

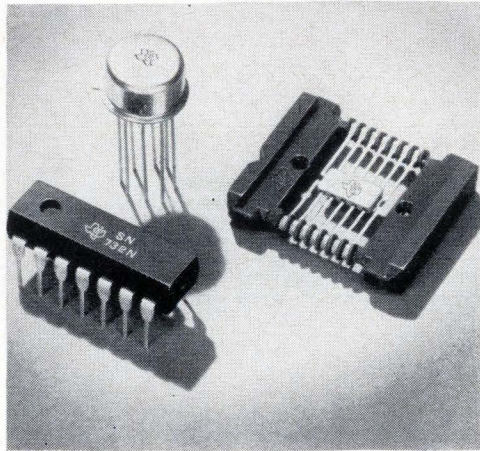
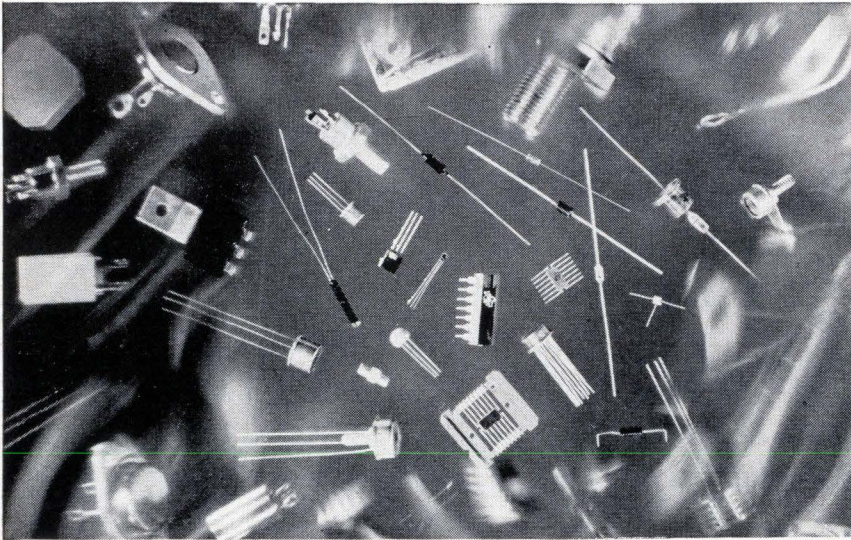

other KENVERT[®] Tintillate Advantages

Eliminates

other tin
tin nickel
nickel
silver
gold

Greater conductivity,
excellent solderability,
easily meets heat age
specifications

Trial parts plated in
our laboratory at
no charge.

**NOW at
TEXAS
Instruments**

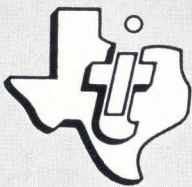

IMPROVED

Reliability
Dependability
Productivity
Quality Control
Easy Inspection

More competitive on
millions of units per
month including:

transistors,
diodes,
integrated circuits,
and flat packs, for
commercial applications



**CONVERSION
CHEMICAL
CORPORATION**

210 East Main Street
Rockville, Connecticut 06066
Phone (203) 872-0541

You can tell Celanese Nylon from other nylons by the label.

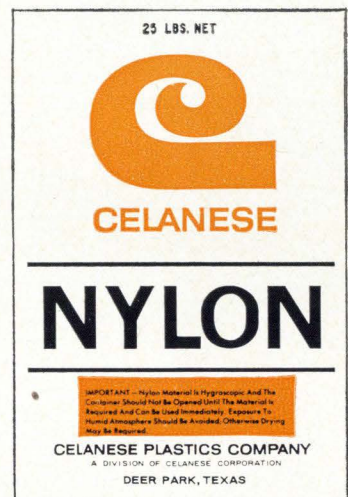

Not at all. Celanese Nylon is fully competitive. In quality. In physical properties. In molding characteristics. In meeting established specifications. Customers who have been using Celanese Nylon resin since the first of the year agree.

And isn't it nice to have another completely dependable source of type 6/6 nylon!

Celanese Plastics Company—and the entire Celanese Corporation—is committed to volume production of the best possible nylon resins. We offer them in quantity right now. Including glass-reinforced Celanese Nylon grades. And a general-purpose black resin. There will be even more in the

near future. More resins. More advanced nylon technology. More molding and marketing assistance.

But you'd expect that from Celanese, a leader in the development of engineering resins. Remember Celcon. And, of course, we do have some twenty-five years of nylon technology behind us.

Let us give you all the facts about Celanese Nylon. Write to: Celanese Plastics Company, Dept. 133-F, P.O. Box 629, Linden, New Jersey 07036.

Celanese® Celcon®



Celanese Plastics Company is a division of Celanese Corporation. Canadian Affiliate: Canadian Chemical Company, a division of Chemcell (1963), Limited. Export Sales: Amcel Co., Inc., and Pan Amcel Co., Inc., 522 Fifth Ave., New York 10036.

Ever need plug-in power supplies in a hurry? Send for our 1967 catalog. It lists 62,000 different types. The one you need will be shipped in 3 days.

(We've never failed to make good on this promise)

DUAL OUTPUT SOLID STATE REGULATED POWER SUPPLIES (400 MA MAX.) Ambient temperature rating 0 to 55°C.

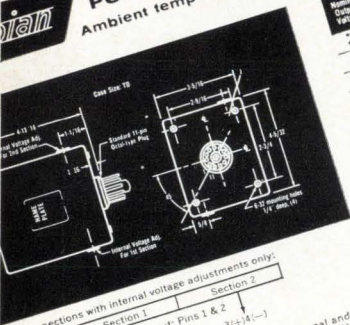

Pin connections with internal voltage adjustments only:
Section 1: Input Pins 1 & 2, Output Pins 3, 4, 5
Section 2: Input Pins 1 & 2, Output Pins 4 & 5
Section 3: Input Pins 1 & 2, Output Pins 4 & 5
Section 4: Input Pins 1 & 2, Output Pins 4 & 5
Section 5: Input Pins 1 & 2, Output Pins 4 & 5

SPECIFICATIONS
INPUT VOLTAGE: 105-125V, AC, 50 to 400 cycle single phase.
OUTPUT VOLTAGE: SEE SPECIFIC SECTIONS
OUTPUT CURRENT: SEE SPECIFIC SECTIONS
REGULATION: SEE SPECIFIC SECTIONS
RIPPLE: SEE SPECIFIC SECTIONS
OUTPUT VOLTAGE ADJUSTMENT: ±1 volt adjustment provided for each section.
POLARITY: Outputs are floating. Each individual section may be connected as a separate power supply. Either negative or positive side of one section may be grounded (irrespective of the other sections).
IMPEDANCE: Approximately 2 ohm at 10Kc.
INSTALLATION: Continuous duty at full load from 0 to 55°C ambient. Plugs into standard 21-pin octal type socket. Mounting holes 1/8" provided at each corner for installation in any position.
WEIGHT: 2 1/2 to 3 lbs., depending on model.

FEATURES
Identical or different sections may be selected • Short circuit protection • No additional heat sinking required • May be used in series • Not encapsulated.

HOW TO ORDER
Select two sections desired. The Model Number is the combination of the two sections selected. Example: Section 6B100D and section 12A400D = Model 6B100D-12A400D. Always assign the lower voltage section first.

OPTIONAL FEATURES
REMOTE OUTPUT ADJUSTMENT—All standard dual power supplies are provided with accessible internal voltage adjustments. For remote external adjustments, add prefix "E" to model number and add \$2.00 to price. Example: 6B100D-E1000D. "E" power supplies will have provisions for both internal and remote adjustments in both sections.
REMOTE SENSING—Provision for remote sensing of the output voltage so as to compensate for drops in the load lines can be furnished at an additional charge of \$20.00 per model. Add prefix "R" to model number when ordering. "R" power supplies will also have provisions for both internal and remote output adjustment.
230 VOLT INPUT—All standard units can be furnished to accept input of 230 to 250V. Add suffix "230" to model number. Additional cost—\$10.00.

DUAL OUTPUT SOLID STATE REGULATED POWER SUPPLIES (400 MA MAX.) Ambient temperature rating 0 to 55°C.

Model No.	Output Current Amps	REGULATION Line %	Ripple RMS	Price per Section	Section (See Order)
1	100	0.5	1	1.00	1A100D
2	100	0.5	1	1.00	1A200D
3	100	0.5	1	1.00	1A300D
4	100	0.5	1	1.00	1A400D
5	100	0.5	1	1.00	1A500D
6	100	0.5	1	1.00	1A600D
7	100	0.5	1	1.00	1A700D
8	100	0.5	1	1.00	1A800D
9	100	0.5	1	1.00	1A900D
10	100	0.5	1	1.00	1A1000D
11	100	0.5	1	1.00	1A1100D
12	100	0.5	1	1.00	1A1200D
13	100	0.5	1	1.00	1A1300D
14	100	0.5	1	1.00	1A1400D
15	100	0.5	1	1.00	1A1500D
16	100	0.5	1	1.00	1A1600D
17	100	0.5	1	1.00	1A1700D
18	100	0.5	1	1.00	1A1800D
19	100	0.5	1	1.00	1A1900D
20	100	0.5	1	1.00	1A2000D
21	100	0.5	1	1.00	1A2100D
22	100	0.5	1	1.00	1A2200D
23	100	0.5	1	1.00	1A2300D
24	100	0.5	1	1.00	1A2400D
25	100	0.5	1	1.00	1A2500D
26	100	0.5	1	1.00	1A2600D
27	100	0.5	1	1.00	1A2700D
28	100	0.5	1	1.00	1A2800D
29	100	0.5	1	1.00	1A2900D
30	100	0.5	1	1.00	1A3000D
31	100	0.5	1	1.00	1A3100D
32	100	0.5	1	1.00	1A3200D
33	100	0.5	1	1.00	1A3300D
34	100	0.5	1	1.00	1A3400D
35	100	0.5	1	1.00	1A3500D
36	100	0.5	1	1.00	1A3600D
37	100	0.5	1	1.00	1A3700D
38	100	0.5	1	1.00	1A3800D
39	100	0.5	1	1.00	1A3900D
40	100	0.5	1	1.00	1A4000D
41	100	0.5	1	1.00	1A4100D
42	100	0.5	1	1.00	1A4200D
43	100	0.5	1	1.00	1A4300D
44	100	0.5	1	1.00	1A4400D
45	100	0.5	1	1.00	1A4500D
46	100	0.5	1	1.00	1A4600D
47	100	0.5	1	1.00	1A4700D
48	100	0.5	1	1.00	1A4800D
49	100	0.5	1	1.00	1A4900D
50	100	0.5	1	1.00	1A5000D
51	100	0.5	1	1.00	1A5100D
52	100	0.5	1	1.00	1A5200D
53	100	0.5	1	1.00	1A5300D
54	100	0.5	1	1.00	1A5400D
55	100	0.5	1	1.00	1A5500D
56	100	0.5	1	1.00	1A5600D
57	100	0.5	1	1.00	1A5700D
58	100	0.5	1	1.00	1A5800D
59	100	0.5	1	1.00	1A5900D
60	100	0.5	1	1.00	1A6000D
61	100	0.5	1	1.00	1A6100D
62	100	0.5	1	1.00	1A6200D
63	100	0.5	1	1.00	1A6300D
64	100	0.5	1	1.00	1A6400D
65	100	0.5	1	1.00	1A6500D
66	100	0.5	1	1.00	1A6600D
67	100	0.5	1	1.00	1A6700D
68	100	0.5	1	1.00	1A6800D
69	100	0.5	1	1.00	1A6900D
70	100	0.5	1	1.00	1A7000D
71	100	0.5	1	1.00	1A7100D
72	100	0.5	1	1.00	1A7200D
73	100	0.5	1	1.00	1A7300D
74	100	0.5	1	1.00	1A7400D
75	100	0.5	1	1.00	1A7500D
76	100	0.5	1	1.00	1A7600D
77	100	0.5	1	1.00	1A7700D
78	100	0.5	1	1.00	1A7800D
79	100	0.5	1	1.00	1A7900D
80	100	0.5	1	1.00	1A8000D
81	100	0.5	1	1.00	1A8100D
82	100	0.5	1	1.00	1A8200D
83	100	0.5	1	1.00	1A8300D
84	100	0.5	1	1.00	1A8400D
85	100	0.5	1	1.00	1A8500D
86	100	0.5	1	1.00	1A8600D
87	100	0.5	1	1.00	1A8700D
88	100	0.5	1	1.00	1A8800D
89	100	0.5	1	1.00	1A8900D
90	100	0.5	1	1.00	1A9000D
91	100	0.5	1	1.00	1A9100D
92	100	0.5	1	1.00	1A9200D
93	100	0.5	1	1.00	1A9300D
94	100	0.5	1	1.00	1A9400D
95	100	0.5	1	1.00	1A9500D
96	100	0.5	1	1.00	1A9600D
97	100	0.5	1	1.00	1A9700D
98	100	0.5	1	1.00	1A9800D
99	100	0.5	1	1.00	1A9900D
100	100	0.5	1	1.00	1A10000D

* ±.5 volt adjustment from nominal.



Acopian Corp., Easton, Pennsylvania (215) 258-5441

HEWLETT-PACKARD MAGNETIC RECORDING SYSTEMS THRIVE ON ANYTHING YOU FEED THEM

Hewlett-Packard 3900 Magnetic Recording Systems are ideal for everything from storage of simple physical phenomena to applications in complex telemetry ground stations. You cannot buy better record, storage and playback performance for your money.

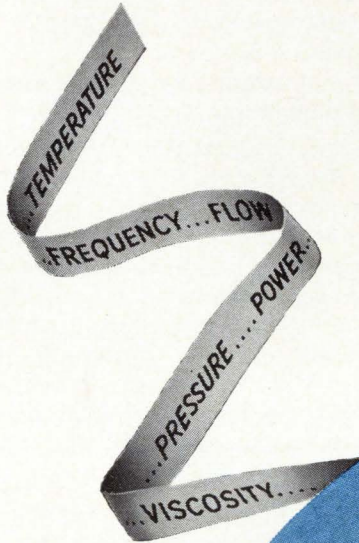

Hewlett-Packard's advanced tape transport design delivers reliable, maintenance-free operation. Three-mode recording — FM, Direct and Pulse — covers all your simple and complex data storage and playback needs. The HP 3900 Systems include 7- or 14-channel recorders in low or intermediate bandwidths. Low bandwidth direct mode is 50 Hz to 100 kHz and FM mode is DC to 10 kHz. Intermediate bandwidth direct mode frequency range is 50 Hz to 250 kHz and FM mode is DC to 20 kHz. Signal/noise ratio is 40 db or better and harmonic distortion is 1% typical 1 kHz per second at 60 ips with 0.2% peak-to-peak flutter. Six pushbutton-selected tape speeds range from 1⁷/₈ ips to 60 ips. HP tape systems are completely IRIG compatible.

Optional equipment includes: closed loop recording adapter, frequency-compensating plug-ins for FM and Direct mode record/reproduce circuits, remote control, voice commentary channel amplifier, input signal coupler, portable cases and rack adapter.



For complete information on the 3900 Systems, their variations and optional equipment, contact your local HP Field Office or write Hewlett-Packard Co., 175 Wyman Street, Waltham, Mass. 02154.

HEWLETT  PACKARD
measuring instruments
for science and industry

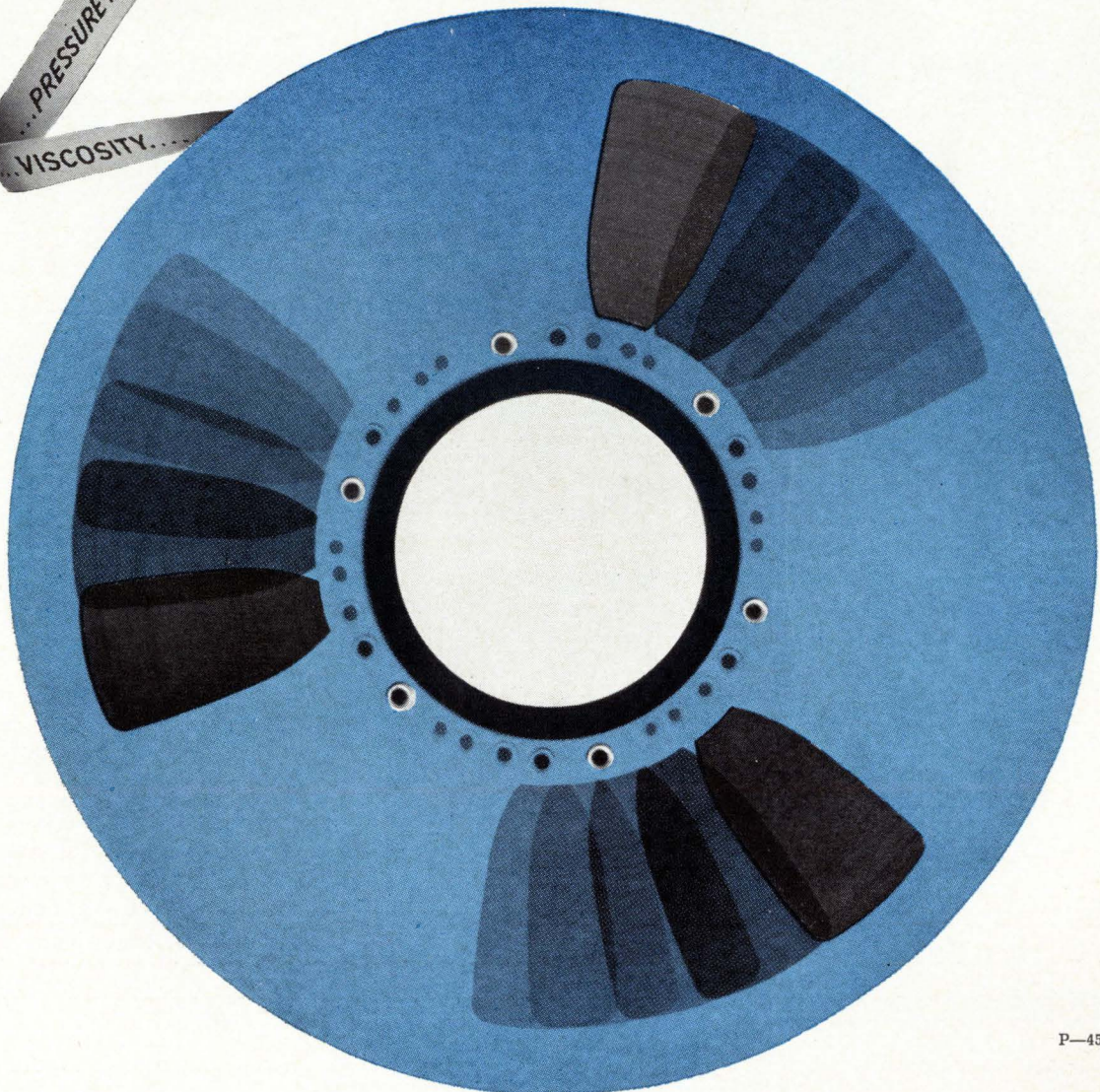

P-450

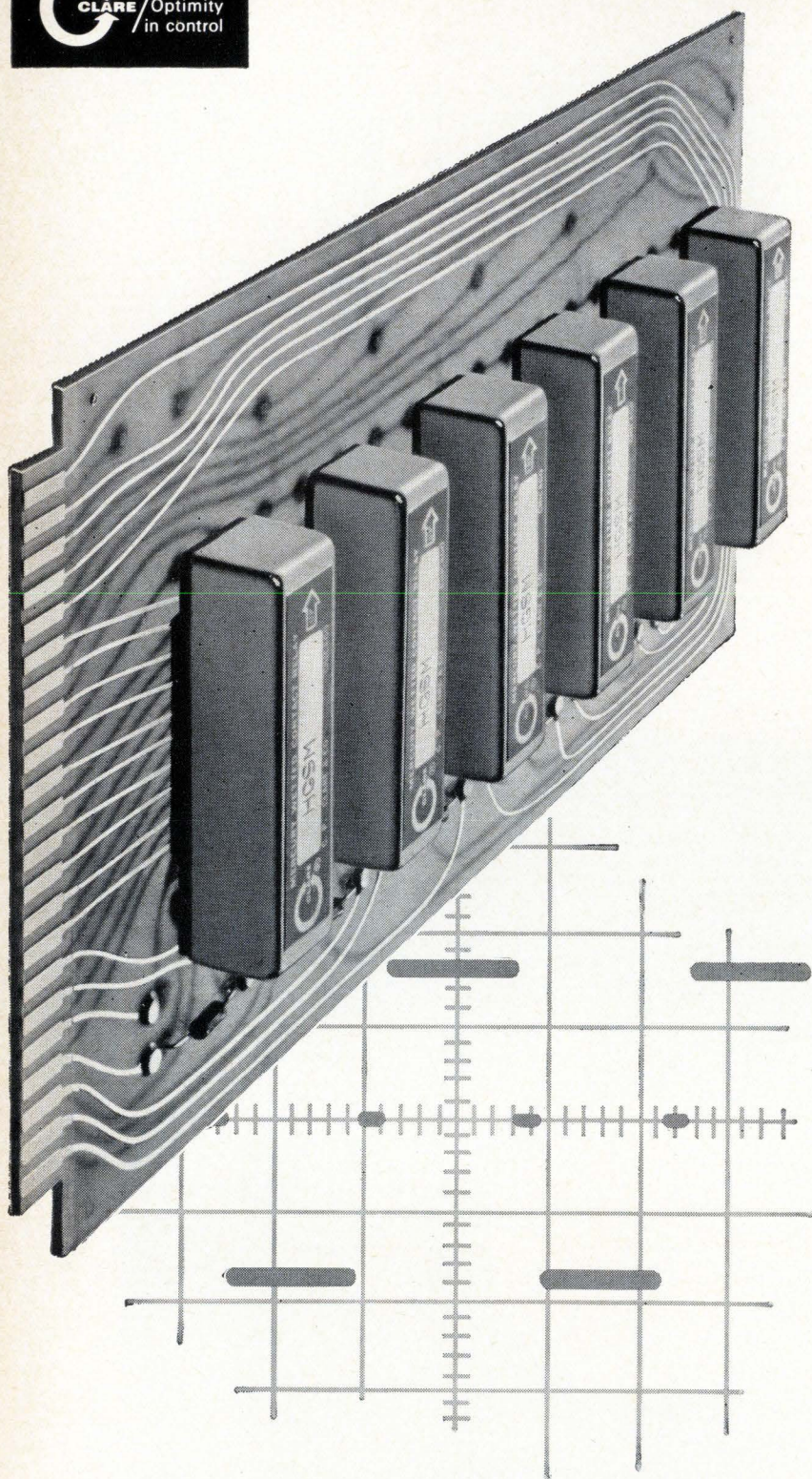

clean-cut,

sharp outputs all along the line!

Clare Polar Relays eliminate distortion, deliver speeds to 180 baud . . . with signal unbalance of 2% or less . . . and no maintenance required over 22×10^9 operations.

You can specify Clare Mercury-Wetted Contact Polar Relays in compact pcb modules or round cans for wired assemblies . . . or make unit-for-unit replacements for less advanced relays in your present system. Either way, you get minimal pulse distortion over billions of operations, with maximum contact efficiency. You end maintenance due to contact contamination or erosion, or mechanical wear. You cut component costs, too.

More facts? Circle reader service number—or ask Clare for Bulletin 853 . . . Write Group 6N8.

C. P. Clare & Co., Chicago, Illinois 60645

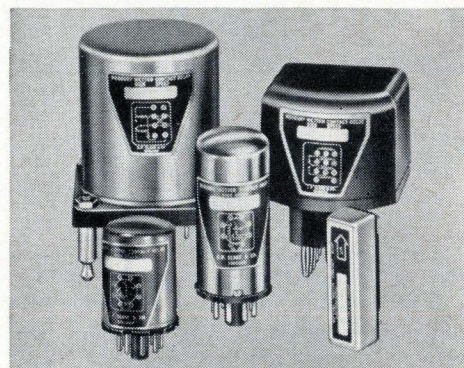

- For direct replacement . . . wired assemblies . . . pcb design
- Maximum 1% pulse distortion initial, 2% over life (22×10^9 operations with no maintenance)
- Low and constant contact resistance, completely independent of drive level
- High contact efficiency . . . 95% total dwell, compared with 85% in other polar relays
- Withstands 1500 volt line surges
- Lowest cost over longest life

CLARE • MERCURY-WETTED CONTACT POLAR RELAYS

for digital data transmission, telegraph and teleprinter service,
impulse repeater, polar signalling, polarity sensing

Most Versatile:

New Power Signal Source from AIL

50 watts-200 to 3000 MHz

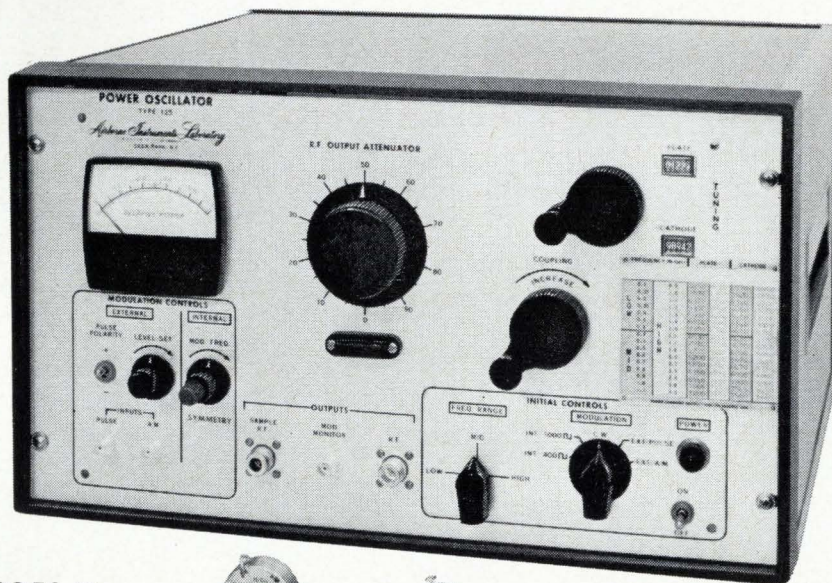

\$3950.00

New AIL Type 125 Power Signal Source is the most versatile power signal source you can buy! You can use it for a wide variety of calibration laboratory tests, general purpose laboratory measurements, incoming-inspection tests, and field and systems applications.

Here are the features that make the AIL type 125 Oscillator so versatile:

- **Frequency Coverage:** Almost four octaves (0.2-3.0 GHz) covered in 3 bands.
- **Power Output:** A million-to-one power range of microwatts to watts, with 50 watts minimum up to 1.0 GHz.
- **Stability:** Power output stabilities of the order of 1% (0.05 db) per hour and frequency stabilities of 0.004% (40 PPM) per hour are characteristic of the instrument.
- **Modulation:** Internal, 100% square-wave modulation, and provision for external A.M. and pulse modulation provide Type 125 users with modulation versatility.
- **Spectral Purity:** Low harmonic and residual AM/FM distortion complement the excellent stability of the Type 125 for use in many exacting measurements.

See your nearby AIL Representative for complete information.

SPECIFICATIONS

Frequency Range	0.2 to 3.0 GHz
Power Output	50 watts min. up to 1.0 GHz, 5 watts min. up to 3.0 GHz
Power Adjustment	
RF Attenuation Range (Variable)	33 db min.
RF Sample Output (Fixed)	30 db \pm 3 db below RF output
Total Power-Output Variation Available	60 db min.
Stability	
Power Output	\pm 0.05 db/hr.
Frequency	
RF	\pm 40 ppm/hr. and \pm 20 ppm/10 min.
Int. Mod. Freq.	\pm 0.25%/hr.
Spectral Purity (CW)	
Residual AM	< 2%
Residual FM	< 0.005%
Harmonics (Minimum)	> 40 db down from fundamental
Signal-to-leakage ratio	> 60 db
Output Impedance	50 ohms nominal. (Max. load SWR 1.5:1, performance not seriously downgraded for load SWR's up to 3:1)
Input Power	115/230 volts \pm 10%, 4.0/2.0 amps, 60 Hz (50 Hz available at slight extra cost)



AIRBORNE INSTRUMENTS LABORATORY
DEER PARK, LONG ISLAND, NEW YORK

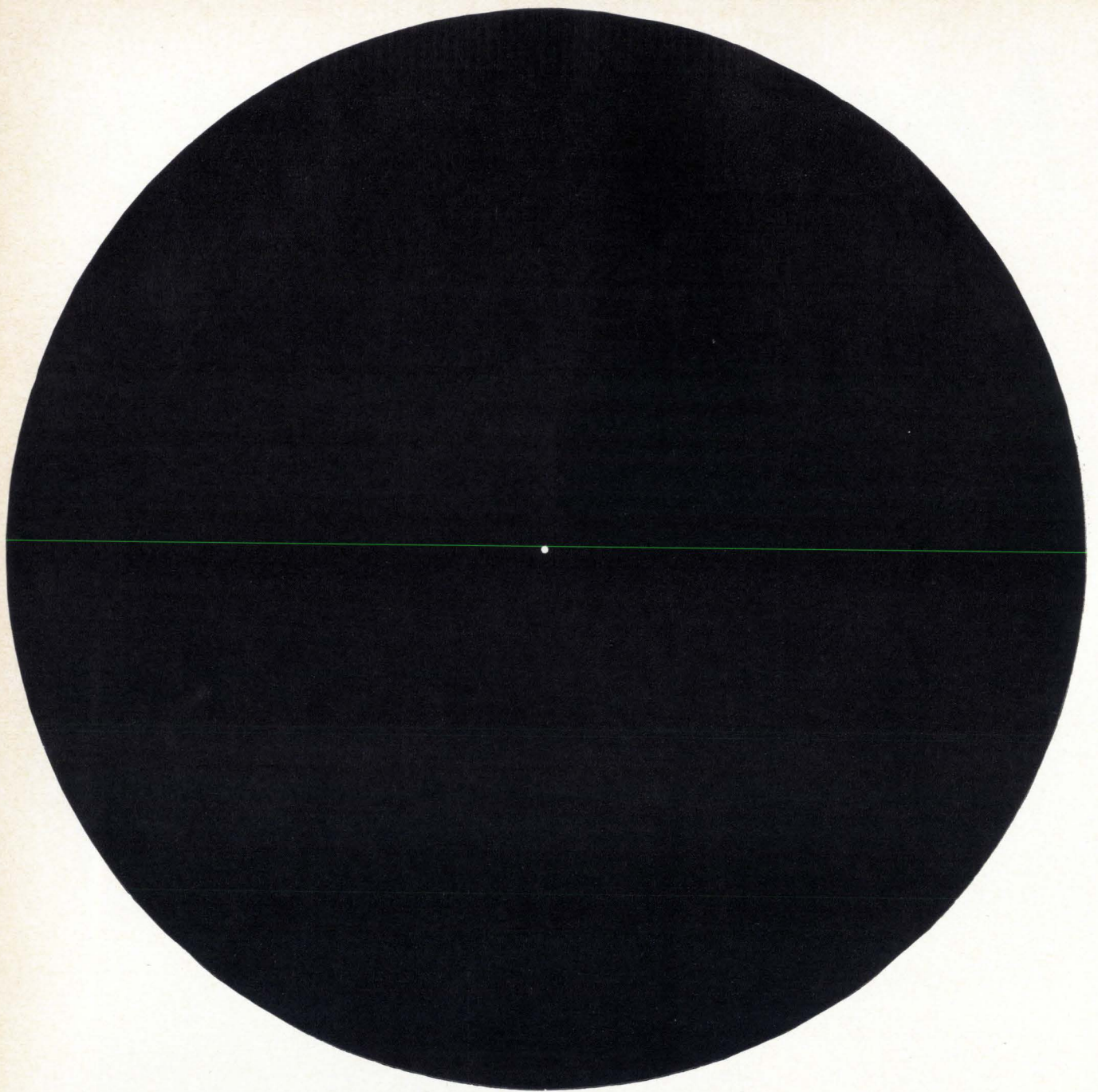

The small pin hole in the center of this circle is more than enough light for MTI Image Orthicon Television Cameras.

MTI is the world's largest manufacturer of low light level TV systems. This simply means that low light levels are our specialty. Specifically, at 1×10^{-5} foot candles of ambient light (approaching total darkness) MTI image Orthicon TV cameras will produce high resolution pictures. So the amount of light illustrated by the pin hole is more than enough.

There are hundreds of applications for MTI low light level equipment. Here are just a few: viewing nocturnal animals performing tasks, microscopy, intensive care observation, data transmission, medical education, and so on. In any application where low light levels are of prime importance, MTI can solve your problems.

Seven different line scan frequencies are available "off the shelf." Specific details available on request. If you have an application problem, call us. We can help.

mti MARYLAND TELECOMMUNICATIONS, INC.

York & Video Roads, Cockeysville, Maryland / Area code 301, 666-2727

WORLD'S LARGEST MANUFACTURER of low light level image Orthicon cameras



IRG

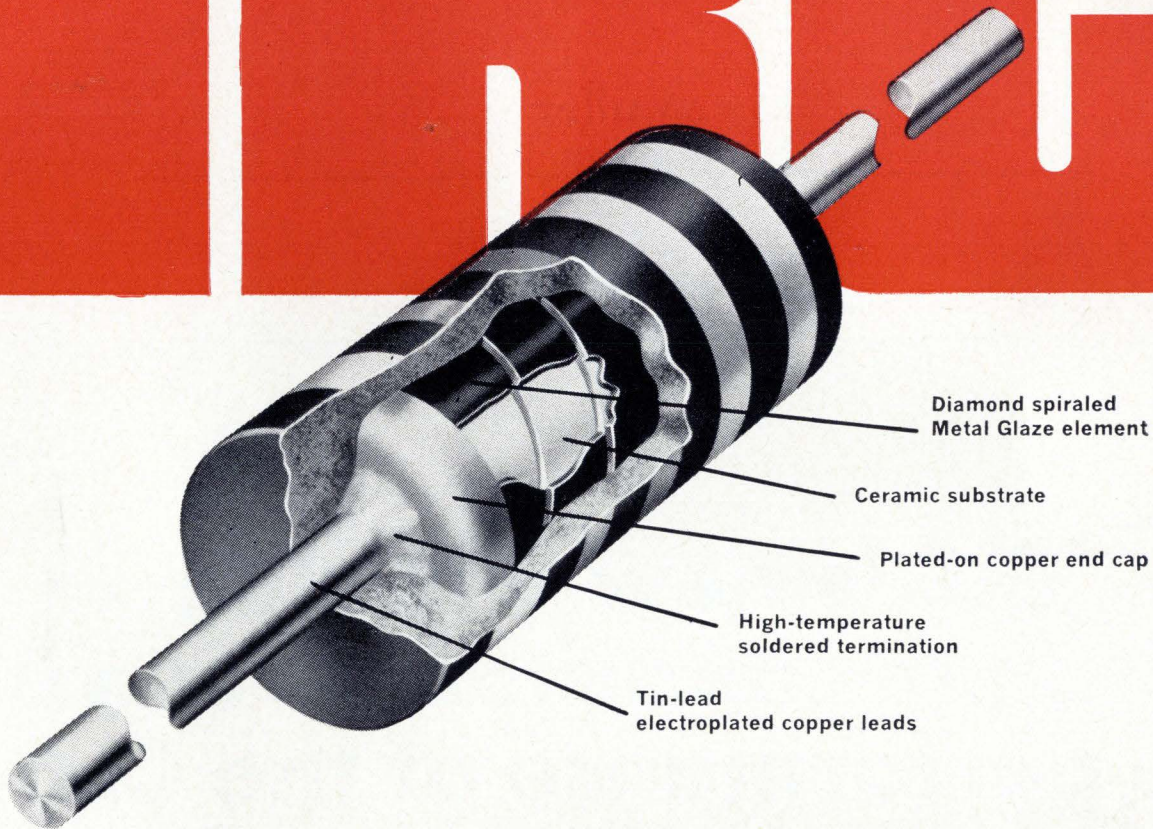

New low-cost Metal Glaze[®] resistors for MIL-R-22684

4 times better load-life stability



IRC's new molded Metal Glaze resistors provide stability, reliability and precision unmatched anywhere for the price.

Tested for over 15 million unit hours, they meet or exceed all MIL-R-22684 requirements. Load life stability, for instance, is four times better than MIL allowance. Typical ΔR is 0.5% after 1000 hours, full load at 70°C. Even at higher temperatures, ΔR is still typically under MIL limits.

The Metal Glaze resistance element is extremely rugged. It is 100 times thicker than conventional films and is impervious to environmental extremes. The tough, uniform molded body resists solvents and the mechanical abuse of automatic machines.

New IRC molded Metal Glaze resistors are immediately available in four forms of packaging to cut your production costs. For complete data, prices and samples, write to: IRC, Inc., 401 N. Broad St., Philadelphia, Pa. 19108.

CAPSULE SPECIFICATIONS

		
MIL-R-22684B:	RL07	RL20
WATTAGE:	¼ W @ 70°C	½ W @ 70°C
RESISTANCE:	51 Ω thru 150K Ω	10 Ω to 470K Ω
TOLERANCES:	± 2%, ± 5%	± 2%, ± 5%
TEMPERATURE COEFFICIENT:	± 200ppm/°C max.	± 200ppm/°C max.
VOLTAGE:	250V max.	350V max.
SIZE:	.250" x .090" dia.	.375" x .138" dia.
IRC TYPE:	RG07	RG20



small



smaller



smallest



G.E.'s new wet slug tantalum capacitor gives you the performance of the CL64 in only 1/2 the case size

Get the highest volt-microfarad product per unit weight and volume of any capacitor you can buy with General Electric's new 69F900 wet slug tantalum capacitor. How? General Electric reduced the case size of the military type (CL64) wet slugs by 1/2 (it's even smaller when compared to solids). Electrical characteristics and performance remain essentially the same. G.E.'s new 69F900 answers the need for a commercial wet slug capacitor with the high volumetric efficiency demanded by modern high density applications.

G.E.'s new addition to its complete line of tantalum wet slug capacitors has excellent high capacitance retention at low temperatures and can be

RATING	CASE SIZE	VOLUME
50V, 30μf		
solid (CS12)	.341 x .750	100%
wet slug (CL64)	.281 x .681	58%
69F900	.145 x .600	15%
15V, 80μf		
solid (CS12)	.341 x .750	100%
wet slug (CL64)	.281 x .681	58%
69F900	.145 x .600	15%
6V, 180μf		
solid (CS12)	.279 x .650	100%
wet slug (CL64)	.281 x .641	100%
69F900	.145 x .600	25%

stored to -65°C. Its wide operating range is -55°C to +85°C. And it meets the parameters of larger military wet slugs: vibration to 2000 Hz, 15g acceleration!

The new sub-miniature 69F900 capacitor is fully insulated and has a low, stable leakage current. Voltage ratings are available from 6-60 volts; capacitance ranges from 3.3-450 microfarads.

Choose from a complete line of G-E wet slug tantalum capacitors to fill your slim, trim circuit needs. Write for GEA-8369 for details about the 69F900 and the other capacitors in General Electric's complete wet slug tantalum line, or ask your G-E sales engineer. **Capacitor Department, Irmo, South Carolina.**

ELECTRONIC COMPONENTS DIVISION

GENERAL  ELECTRIC

430-28A

Now—the broadest line of convection-cooled, all silicon, .015% regulated power supplies

For test equipment and lab use 0-10,-20,-40,-60,-120 VDC, from 0-.5 amp to 0-66 amps

Features and Data

- Rack or bench use
- Full five year guarantee on materials and labor
- Convection Cooled
- Remote Programming
- Regulation—.015% or 1 MV (Line or Load)
- Temp. Coef. .015%/°C
- Completely Protected—Short circuit proof—Continuously adjustable Automatic current limiting
- Remote Sensing
- Constant I./Constant V. by automatic crossover
- Series/Parallel Operation
- No Voltage Spikes or Overshoot on "turn on", "turn off" or power failure
- Ripple—LK models—500 μ V RMS
LH models—250 μ V RMS, 1 MV P-P
- Meet MIL Environment Specs

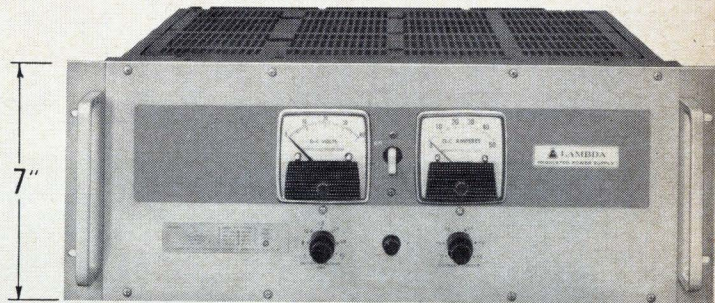

Full Rack 7" LK Series



1/4 Rack LH Series



1/2 Rack LK Series-LH Series

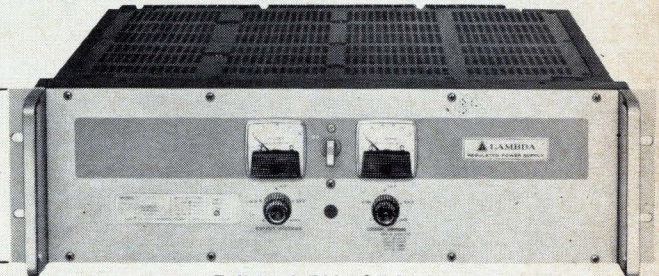

Full Rack 5 1/4" LK Series

3 Full-rack Models — Size 7" x 19" x 18 1/2"

Model ²	Voltage Range	CURRENT RANGE AT AMBIENT OF: ¹				Price ²
		40°C	50°C	60°C	71°C	
LK 360 FM	0-20VDC	0-66A	0-59A	0-50A	0-40A	\$995
LK 361 FM	0-36VDC	0-48A	0-43A	0-36A	0-30A	950
LK 362 FM	0-60VDC	0-25A	0-24A	0-22A	0-19A	995

3 Full-rack Models — Size 5 1/4" x 19" x 16 1/2"

Model ²	Voltage Range	CURRENT RANGE AT AMBIENT OF: ¹				Price ²
		40°C	50°C	60°C	71°C	
LK 350	0-20VDC	0-35A	0-31A	0-26A	0-20A	\$675
LK 351	0-36VDC	0-25A	0-23A	0-20A	0-15A	640
LK 352	0-60VDC	0-15A	0-14A	0-12.5A	0-10A	650

5 Quarter-rack Models — Size 5 3/16" x 4 3/16" x 15 1/2"

Model ²	Voltage Range	CURRENT RANGE AT AMBIENT OF: ¹				Price ²
		30°C	50°C	60°C	71°C	
LH 118	0-10VDC	0-4.0A	0-3.5A	0-2.9A	0-2.3A	\$175
LH 121	0-20VDC	0-2.4A	0-2.2A	0-1.8A	0-1.5A	159
LH 124	0-40VDC	0-1.3A	0-1.1A	0-0.9A	0-0.7A	154
LH 127	0-60VDC	0-0.9A	0-0.7A	0-0.6A	0-0.5A	184
LH 130	0-120VDC	0-0.50A	0-0.40A	0-0.35A	0-0.25A	225

11 Half-rack Models — Size 5 3/16" x 8 3/8" x 15 1/2"

Model ²	Voltage Range	CURRENT RANGE AT AMBIENT OF: ¹				Price ²
		40°C	50°C	60°C	71°C	
LK 340	0-20VDC	0- 8.0A	0- 7.0A	0- 6.1A	0-4.9A	\$330
LK 341	0-20VDC	0-13.5A	0-11.0A	0-10.0A	0-7.7A	385
LK 342	0-36VDC	0- 5.2A	0- 5.0A	0- 4.5A	0-3.7A	335
LK 343	0-36VDC	0- 9.0A	0- 8.5A	0- 7.6A	0-6.1A	395
LK 344	0-60VDC	0- 4.0A	0- 3.5A	0- 3.0A	0-2.5A	340
LK 345	0-60VDC	0- 6.0A	0- 5.2A	0- 4.5A	0-4.0A	395

Model ²	Voltage Range	CURRENT RANGE AT AMBIENT OF: ¹				Price ²
		30°C	50°C	60°C	71°C	
LH 119	0-10VDC	0- 9.0A	0- 8.0A	0- 6.9A	0-5.8A	\$289
LH 122	0-20VDC	0- 5.7A	0- 4.7A	0- 4.0A	0-3.3A	260
LH 125	0-40VDC	0- 3.0A	0- 2.7A	0- 2.3A	0-1.9A	269
LH 128	0-60VDC	0- 2.4A	0- 2.1A	0- 1.8A	0-1.5A	315
LH 131	0-120VDC	0- 1.2A	0- 0.9A	0- 0.8A	0-0.6A	320

¹ Current rating applies over entire voltage range.

² Prices are for non-metered models (except for models LK360FM thru LK362FM which are not available without meters). For metered models, add suffix (FM) and add \$25 to price of LH models; add \$30 to price of LK models.

³ Overvoltage Protection: add suffix (OV) to model number and add \$60 to the price of LH models; add \$70 to price of half-rack LK models; add \$90 to price of 5 1/4" full-rack LK models; add \$120 to price of 7" full-rack LK models.

⁴ Chassis Slides for full rack models: Add suffix (CS) to model number and add \$60 to the price.



LAMBDA ELECTRONICS CORP.

515 BROAD HOLLOW ROAD • MELVILLE, L.I., NEW YORK 11746 • (516) 694-4200 A Veeco SUBSIDIARY

Circle 75 on reader service card

High Current Regulated Power Supply

Adjustable Output Voltage, 27-28 V.D.C.

1% Regulation

50-60 Cycle Operation

Substantial Overload Capability

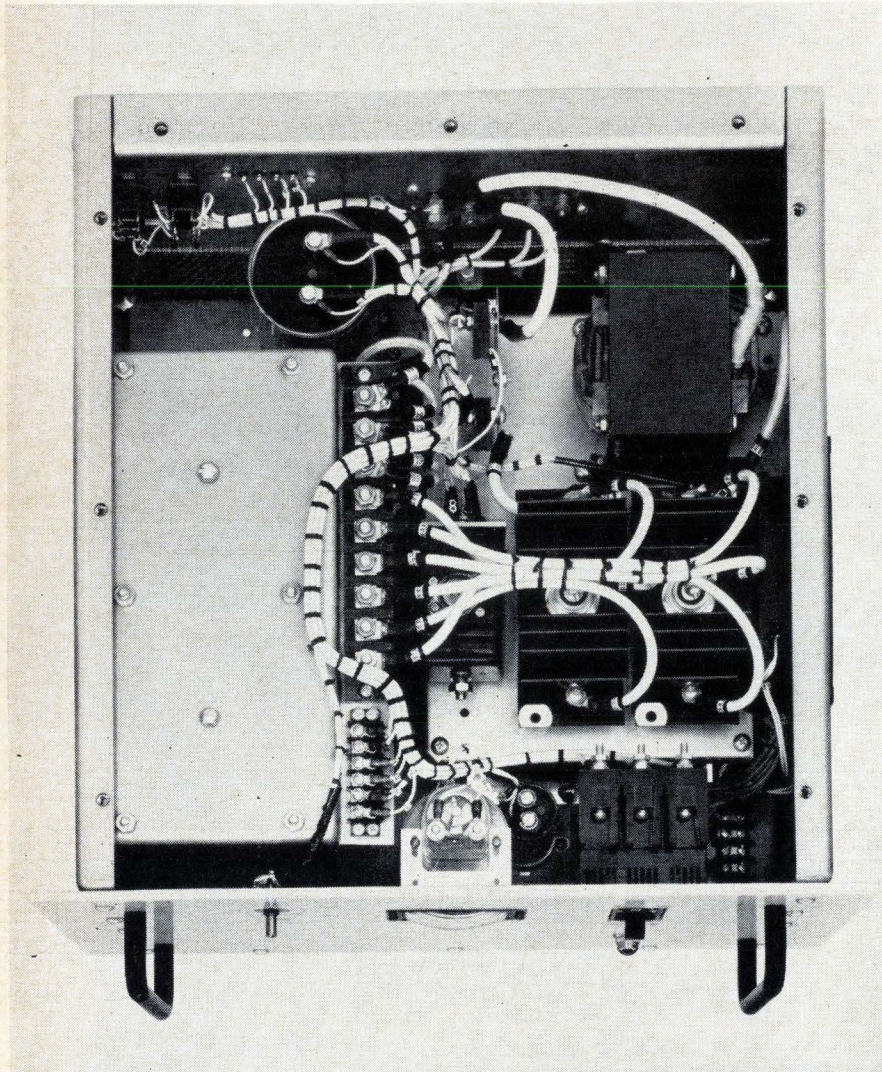

This unit was designed for communications equipment and is available in 25 amp. stages from 25 to 150 amps. It can be operated in parallel, has a remote sense feature, an inverse time circuit breaker and internal fan cooling. Overload capacity is 200% for 5 minutes; 400% for 4 seconds. Environmental capability encompasses a temperature range of -20° to $+130^{\circ}$ F. This equipment is designed for standard rack mounting and is compatible with the system into which it will be designed.

Like other Tung-Sol designed and built power supplies, this one meets precise performance requirements and high reliability standards. The price doesn't sound as though it was custom built.

If you are interested in this, or a power supply to meet other specs, we would like the opportunity to demonstrate that a Tung-Sol designed unit would be your best buy.

CHATHAM PRODUCTS

Tung-Sol Division
Wagner Electric Corporation

LIVINGSTON, N.J. 07039. TWX 710-737-4421

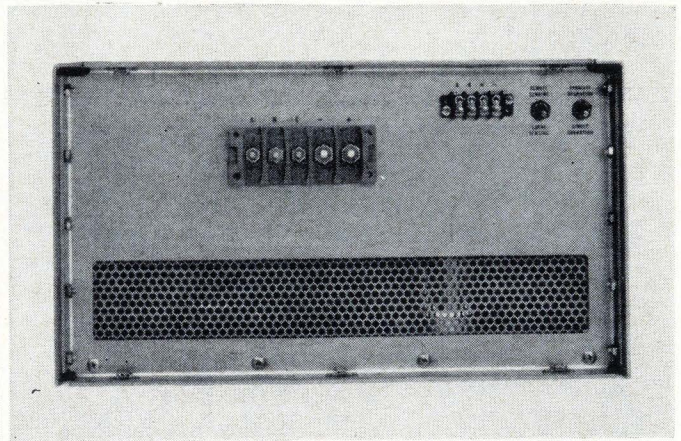
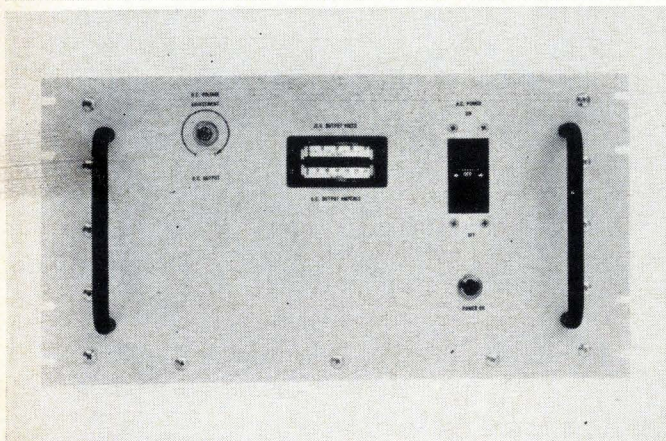

Miniature A-B Type BB hot molded resistors provide over 1,300,000 units per cu. ft.*



...your answer to high packaging density with discrete components

Faced with a severe space limitation for your electronics equipment, the miniature Allen-Bradley Type BB is just the "ticket." Its extremely high packaging density (over 1,300,000 per cu. ft. *) enables a drastic size reduction—with no sacrifice in reliability!

These tiny Type BB resistors are made by the identical exclusive hot molding process as the larger Allen-Bradley resistor. Using precision automatic machines—developed and perfected by Allen-Bradley—the human element is completely eliminated. The resulting uniformity from one resistor to the next—million after million and year after year—is so exact that long term resistor performance can be accurately predicted. And during the twenty-five years this exclusive hot molding process has been in operation, no Allen-Bradley resistor is known to have failed catastrophically.

Allen-Bradley Type BB resistors are available in standard resistance values from 2.7 ohms to 100 megohms with tolerances of $\pm 5\%$, $\pm 10\%$, and $\pm 20\%$. Maximum rated wattage is $\frac{1}{8}$ watt at 70°C and can be derated linearly to zero watts at 130°C. The maximum continuous rated voltage is 150 volts RMS or DC. For complete specifications on the Type BB resistor, please write for Technical Bulletin B-5005. Allen-Bradley Co., 222 W. Greenfield Ave., Milwaukee, Wis. 53204. In Canada: Allen-Bradley Canada Limited. Export Office: 630 Third Ave., New York, N.Y., U.S.A. 10017.

**Theoretical packaging in cordwood arrangement.*

actual size

of Allen-Bradley Type BB hot molded resistors



ALLEN-BRADLEY

QUALITY ELECTRONIC COMPONENTS

Printed circuit board from General Radio Type 1680 Automatic Capacitance Bridge showing use of A-B Type CB ¼ watt fixed resistors and Type F ¼ watt adjustable resistors.

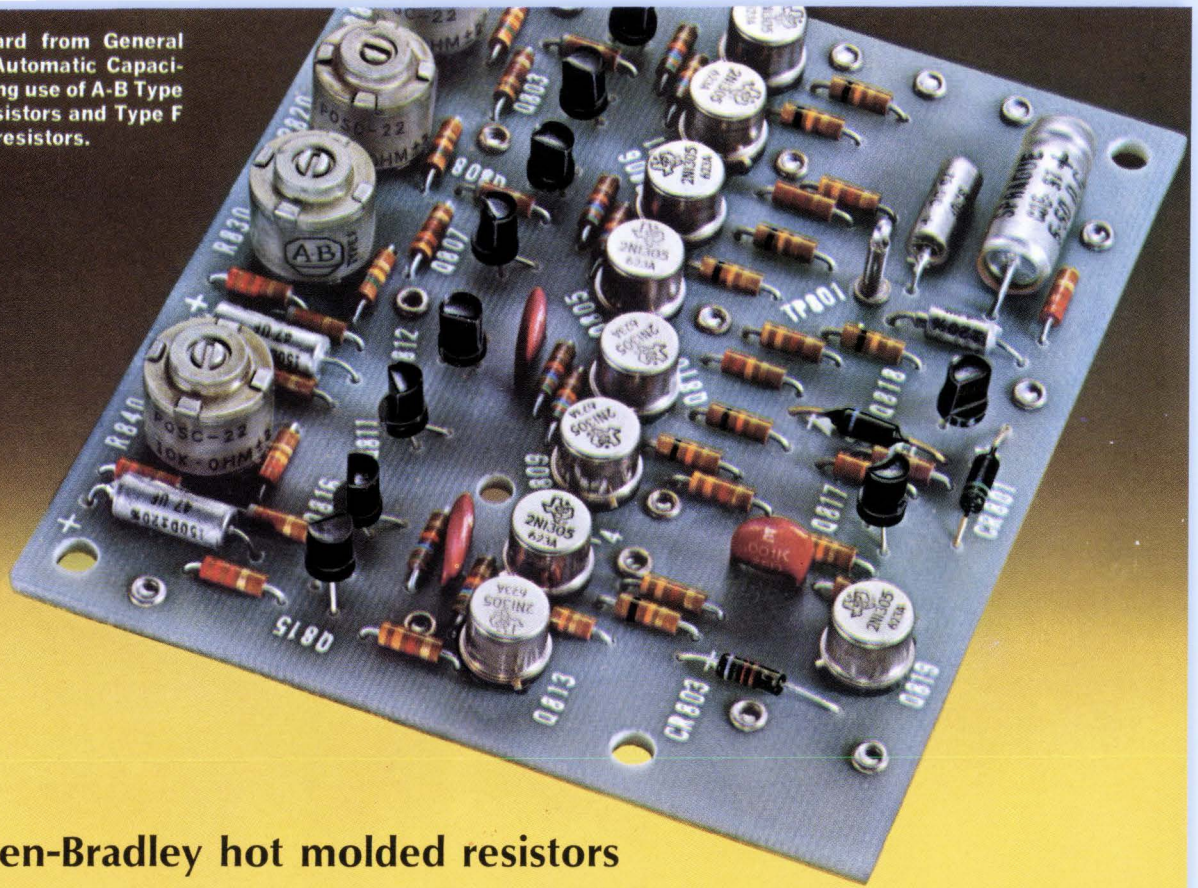

“we use Allen-Bradley hot molded resistors because their consistent, stable characteristics—month to month and lot to lot—ensure repeatable measurements by our instruments.” GENERAL RADIO CO.



General Radio Type 1680 Bridge automatically measures capacitance and loss simultaneously, generates coded digital output data, and displays measured values in about one-half second. The basic accuracy is $\pm 0.1\%$ and the range is from 0.01 pF to 1000 μ F.



Type F variable resistor with pin type terminals for mounting directly on printed wiring boards. Rated ¼ watt at 70°C. Total resistance values from 100 ohms to 5 megohms. Shown actual size.

A-B hot molded fixed resistors are available in all standard resistance values and tolerances, plus values above and below standard limits. Shown actual size.



Just as surely as automatic equipment saves its users' money when it is in operating condition, it is virtually worthless when failure of a component has made the entire device inoperative. To insure the reliable and accurate performance of their new automatic capacitance bridge, General Radio designers selected Allen-Bradley hot molded fixed and variable resistors.

Allen-Bradley resistors are made by a hot molding process using completely automatic machines developed by Allen-Bradley. This results in such precise uniformity from one resistor to the next—year in and year out—that long term resistor performance can be accurately predicted. Furthermore, there is no known instance of catastrophic failure of an Allen-Bradley hot molded resistor.

The same manufacturing technique is used with the Type F variable resistors. Their solid hot molded resistance track assures smooth control from the very beginning and which improves with use—and are completely devoid of the abrupt changes to be expected of wire-wound controls. In addition, A-B variable resistors are essentially noninductive, permitting their use at frequencies far beyond range of wire-wound units.

For more complete information on the full line of Allen-Bradley quality electronic components, please write for Publication 6024: Allen-Bradley Co., 222 W. Greenfield Ave., Milwaukee, Wis. 53204. In Canada: Allen-Bradley Canada Limited. Export Office: 630 Third Ave., New York, N. Y., U.S.A. 10017.



ALLEN - BRADLEY
QUALITY ELECTRONIC COMPONENTS

Pinpointing sound is this RADAR's dish

Twenty years ago, Bell's X-1 cracked the sound barrier and created the world's first sonic boom. Today, Bell is working with NASA and the FAA to find the quietest way to send a plane aloft and bring it back safely. In the vicinity of the Wallops Station, Virginia test site, jet transports fly a series of takeoff and landing "profiles." Engine power, control-surface settings and rate of altitude change are systematically varied. Exact records of the "profiles" are made on a basis of data supplied by a GSN-5 precision radar system manufactured and operated by Bell Aerosystems. Recording devices along the flight path measure the sound level as the plane passes over. The radar and sound information are fed into a computer for analysis and eventual use in planning mini-db flight paths. Maxi-precise radar is a Bell specialty. Brochure mailed on request.

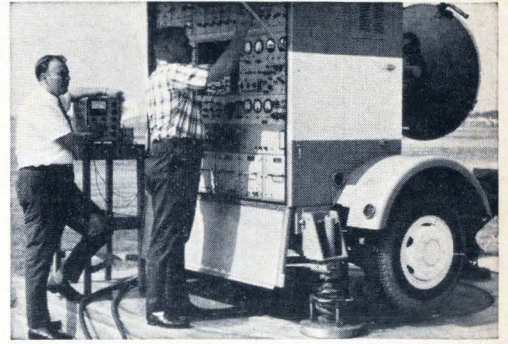

BELL AEROSYSTEMS—A textron COMPANY Buffalo, New York



New epoxy transistors

2N3605A

Electrically similar to the 2N914.
Price: 20 to 25¢ in volume.

V _{CEO} 40V	t _s 20nsec.
V _{EB0} 5V	t _{on} 35nsec.
V _{CE0} 15V	t _{off} 45nsec.
h _{FE} 30-120 @ I _C =10mA; V _{CE} =1V	
V _{CE(SAT)} 0.25V @ I _C =10mA; I _B =1mA	

This is an excellent medium-speed saturated switch for computers and electronic calculators. These transistors offer low storage times and are available in sample quantities now.

2N5027

Electrically similar to the 2N2539.
Price: 20 to 25¢ in volume.

V _{CEO} 60V	t _d @ I _C =150mA.. 15nsec.
V _{CE0} 30V	t _r @ I _C =150mA.. 20nsec.
V _{CE(SAT)} @ 150mA. 0.45V (max.)	t _s @ I _C =150mA.. 35nsec.
V _{BE(SAT)} @ 150mA. 1.3V(max.)	t _f @ I _C =150mA.. 25nsec.

This transistor for medium-current, high-speed saturated switching is available in sample quantities as a core driver for computers. Take advantage of its superior h_{FE} linearity with current (50 @ 150mA min.).

2N4424

Good Beta linearity from 2mA to 100mA.
Price: 25 to 30¢ in volume.

BV _{CEO} 40V min.
I _C 400mA
h _{FE} @ 2mA..... 180-540
V _{CE0} 40V min.

This general purpose amplifier can add even more epoxy economies to auto radios, TV's, home radios and many other products.

2N5029

Electrically similar to the 2N2369.
Price: 20 to 25¢ in volume.

V _{CEO} 40V	t _d @ I _C =10mA..... 10nsec.
V _{CE0} 15V	t _r @ I _C =10mA..... 12nsec.
h _{FE} @ 10mA. 40-120	t _s @ I _C =10mA..... 12nsec.
	t _f @ I _C =10mA..... 14nsec.
V _{CE(SAT)} @ 10mA..... 0.25V max.	
V _{BE(SAT)} @ 10mA..... 0.87V max.	

Now: a high speed saturated switch in an epoxy economy package for computers.

All with the outstanding moisture resistance of GE's newest epoxy package

That's right. These four new NPN planar passivated silicon transistors are as reliable as the hermetically sealed devices you are using now. Yet they cost less than half as much. The reason is GE's newest innovation in epoxy packaging techniques.

General Electric's new epoxy package is far less moisture sensitive than other plastics; and it will improve performance at higher ambients and junction temperatures.

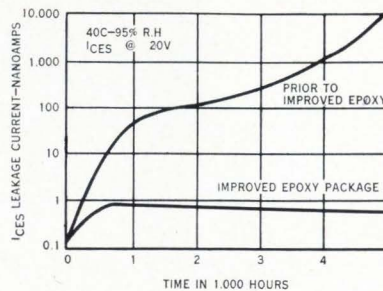

This is just one more example of the total electronic capability you get from General Electric. Call your GE engineer/salesman or authorized distributor for more information. Or write to: General Electric Company, Section 220-51, Schenectady, New York 12305. In Canada: Canadian General Electric, 189 Dufferin St., Toronto, Ontario. Export: Electronic Component Sales, IGE Export Division, 159 Madison Ave., New York, N. Y.

SEMICONDUCTOR PRODUCTS DEPARTMENT

GENERAL  **ELECTRIC**



CERRO-FLEX* Flat Cables and Circuits

**You've heard a lot of talk
about flexible cables.**

Read these facts.

This new, authoritative, 12-page design guide will help you: 1) decide when and where to use flexible cables and printed wiring; 2) exploit their specific advantages; 3) design the proper form for your application; and 4) choose the right insulation and conductor size.

The booklet is free. Write today. It'll show you how to reduce weight, save space, simplify assembly, increase reliability and uniformity and...cut costs.

CERRO-FLEX* flat flexible cables and printed wiring are the logical solution to critical demands of modern electronic equipment. And Cerro is the logical source of reliable, up-to-date information.

Cerro Wire & Cable Co., Division of Cerro Corp.
New Haven, Connecticut 06504.

Please send me "CERRO-FLEX*
Flat Flexible Cables"

NAME _____

TITLE _____

COMPANY _____

ADDRESS _____

CERRO
WIRE & CABLE

*Trademark

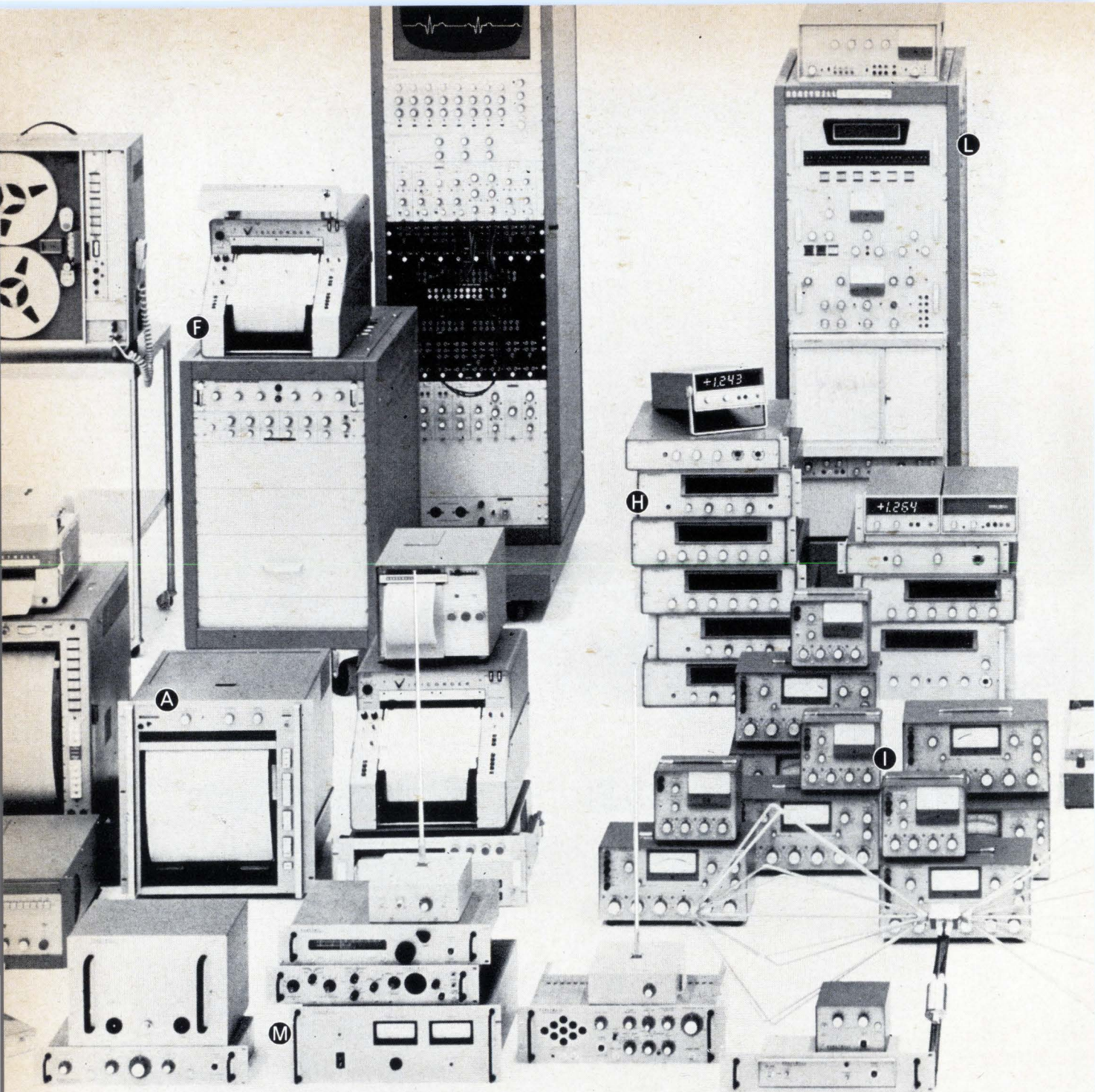

Here's just part of the full Honeywell line, which includes: **A** 117 Visicorder direct-recording oscillographs in 6", 8", and 12" models; **B** 2 Model 1806 fiber-optics CRT Visicorder oscillographs; **C** 26 magnetic tape systems, including the 7600 Series in 10½" and 15" reel versions; **D** 84 amplifiers and other signal-condi-

We build **847**
instruments to be sure we
have the exact **1** you need.



tioning units; **E** 78 analog recording systems; **F** 46 electronic medical systems; **G** 14 oscilloscopes; **H** 37 digital multimeters; **I** 29 differential voltmeters; **J** 179 precision laboratory standards and test instruments; **K** 128 data loggers; **L** 9 analysis systems; **M** 61 EMI products; **N** 37 X-Y graphic recorders.

Your Honeywell sales engineer can zero in on the *precise* solution to your instrumentation problems. Quickly and efficiently. You won't have to settle for "almost" what you need because the Honeywell sales engineer isn't handicapped by a limited line. He can choose from 847 basic instruments whose combinations and permutations approach the infinite.

The solution might be a Visicorder recording oscillograph. Or one of our modular magnetic tape systems. Or an X-Y recorder, a digital multimeter, or a portable potentiometer. But whether it's a single instrument or a complete data system, you can be sure the solution will be the right one, carefully thought out with your future requirements considered as well as your current needs.

Local service and nationwide metrology facilities back up your Honeywell instrument or system. And, we can even provide factory training courses for *your* operating personnel. For the full story on how Honeywell can help you, call your local sales engineer or write: Honeywell, Test Instruments Division, Denver, Colorado 80217.

Honeywell

Honeywell engineers
sell solutions

Circle 83 on reader service card

Fastest Thermal Switch.

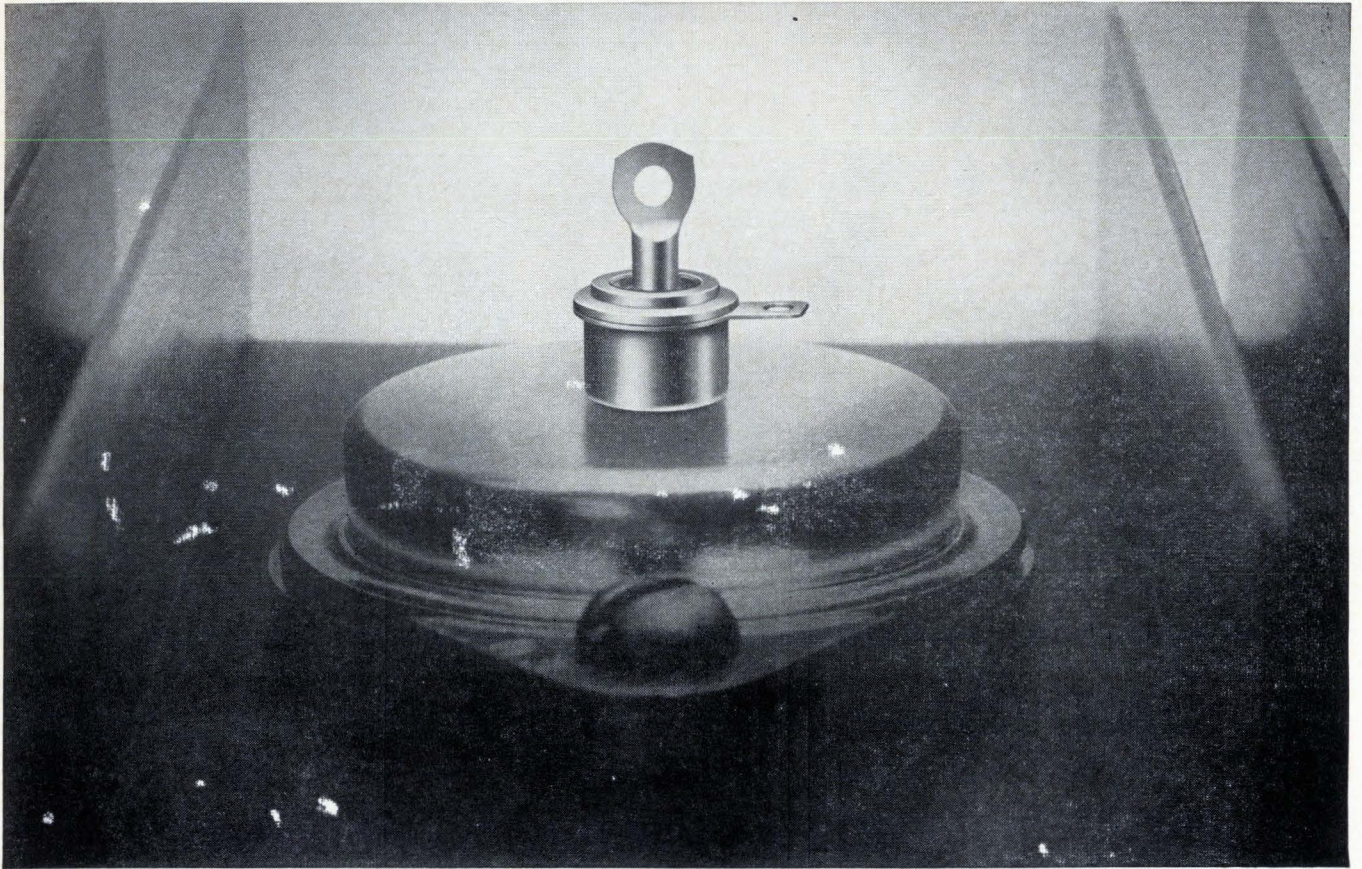

You're looking at the smallest snap-action thermal switch on the market today. That's why it has a faster thermal response than any other. It's a KLIXON® "Tiny-Stat", now widely used to control temperatures in missile radar, aircraft and commercial electronic applications.

KLIXON 3BT and 4BT Series Tiny-Stat thermal switches respond to temperature change 5

times faster than their nearest equivalents. They're rated at 1 amp, 115-ac/30v-dc for 10,000 cycles. Temperature range is 0° to 350°F, open or close on temperature rise. Vibration resistance is 5 to 2000 cps at 30 G. Their small size makes them ideal replacements for thermistors and their electronic switching circuitry.

We offer a complete line of precision thermal switches, solid

state switches, electromechanical switches, thermal and magnetic circuit breakers, cooling effect detectors, component ovens, proportional temperature controllers and power storage systems.

For complete information on your specific requirements for any one of our products in these lines write to TI Control Products Group, Attleboro, Mass. 02703 or phone (617) 222-2800.



TEXAS INSTRUMENTS
INCORPORATED



For A Quality Source Of Electronics Products Visit

JAPAN ELECTRONICS SHOW '67

Osaka
September 28
to October 4

When planning to buy, be sure to attend the

JAPAN ELECTRONICS SHOW '67



September **28**th — October **4**th

OSAKA, JAPAN

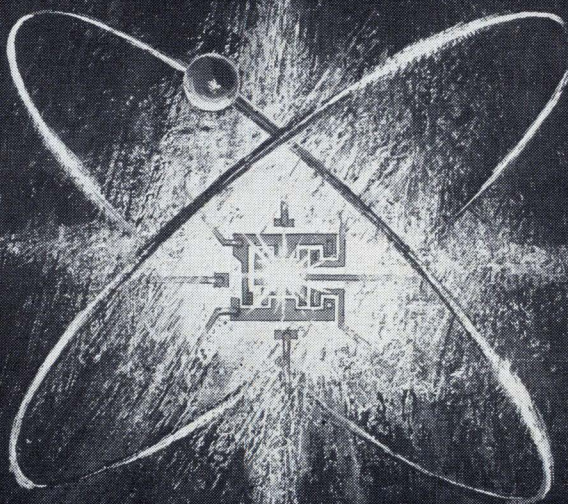

The Biggest Electronic International Trade Show In The Orient

- Place:** Osaka International Trade Fair Grounds, Osaka City.
- Exhibitors:** Japanese and foreign manufacturers of electronic equipment, devices, and parts.
- Exhibition Area:** Pavilion No. 1 & 2 (13,300 square meters)
- Exhibits:** Consumer Electronic Products, Industrial Electronic Products, Electronic Components, etc.
- Admission:** Free

For further information, write to:



ELECTRONIC INDUSTRIES ASSOCIATION OF JAPAN

3-14 Marunouchi, Chiyoda-ku, Tokyo, Japan Cable: ELINDASO TOKYO

Overseas Offices

Electronics Section **Japan Light Machinery Information Center, JETRO**

New York: 437 5th Avenue, New York, N.Y., U.S.A. Phone: MU-6-0731

Duesseldorf: Düsseldorf Berliner Allee 32, Bundesrepublik Deutschland Phone: 12351-3



For A Quality Source Of Electronics Products Visit

JAPAN ELECTRONICS SHOW '67

Osaka
September 28
to October 4

High Reliability Instruments

meguro



MAK-658

Dist. meter

— for AUDIO LABS and PRODUCTION —

FEATURES:

- Efficiency is achieved in measurements by elimination input level and balancing adjustments for each change in the frequency; errors due to personal factors are reduced.
- The null network for the fundamental frequency suppression (patent applied for) has such a characteristic that makes possible the determination of the distortion due to frequency modulation in tape recorders.

• Catalog sheet on request



MEGURO DENPA SOKKI K.K.

Meguro Electronic Instrument Co., Ltd.
No. 5, 1-2-chome, Chucho-cho, Meguro-ku, Tokyo, Japan
TEL. 711-7191-7 Cables: MEGURODENPA TOKYO

Circle 216 on reader service card

San-Esu
poly varicon
for FM .AM

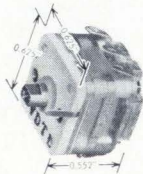

4X-16BET

Main Features:

- * Micro-miniature sized yet with large capacity.
- * High reliability against temperature and humidity.
- * 4 Trimmers of AM, FM sections.
- * Good howling-proof.
- * Smooth rotation torque.
- * Excellent "Q" characteristics.

San-Esu is always contributing to cut your production costs through precise delivery by mass-production under conditions of the rigid quality control.



SAN-ESU ELECTRONICS CO., LTD.

1-2, 6-chome, Nishiōi-Shinagawa-ku, Tokyo, Japan
Tel. Tokyo (783) 7311 Cable: SANESVARICON TOKYO

Please send me free literature on your poly varicon.

Name: _____

Firm: _____

Address: _____

86 Circle 86 on reader service card

NEW

RECTIGRAPH

**World Acclaimed
for Reliability
and Lower Cost**

An entirely new concept in ink-writing oscillographs, the remarkable San-ei TYPE 8S RECTIGRAPH now gives you accurate arc-error-free rectilinear recording of maximum accuracy. Equipped with galvanometers, plug-in amplifiers and a multitude of advanced features for sharp, clear rectilinear presentations.

Sole agent or cooperator for RECTIGRAPH wanted.
For further information, please write to:



SAN-EI INSTRUMENT CO., LTD.

Specialist in the field of oscillographs

1-89 Kashiwagi, Shinjuku-ku, Tokyo, Japan Cable: SANEIINSTRUMENT TOKYO

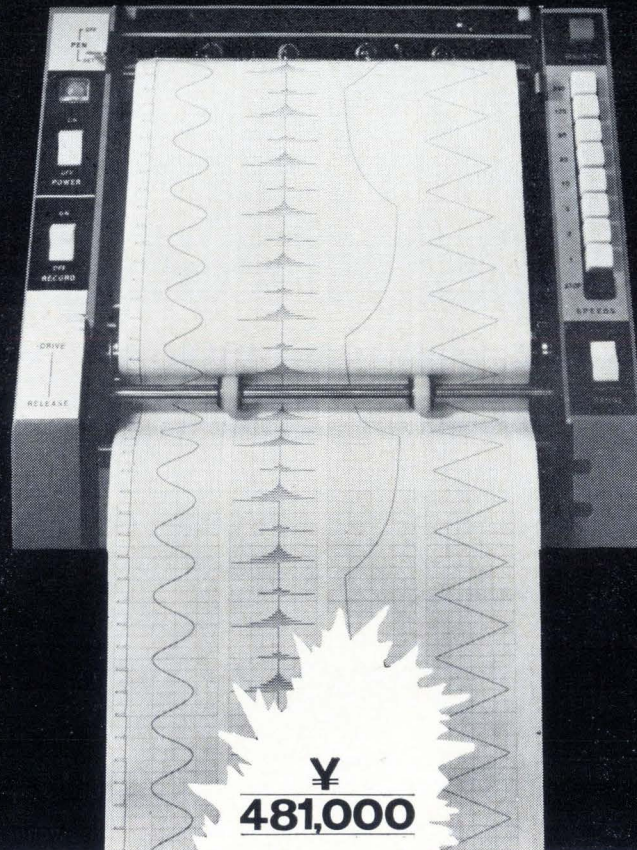

¥
481,000

Circle 217 on reader service card



THE ECONOMICAL HITACHI VIDICON

The new Hitachi Vidicon 8758 is an improved, low-cost, replacement for the 7735A or 7262A Vidicons:

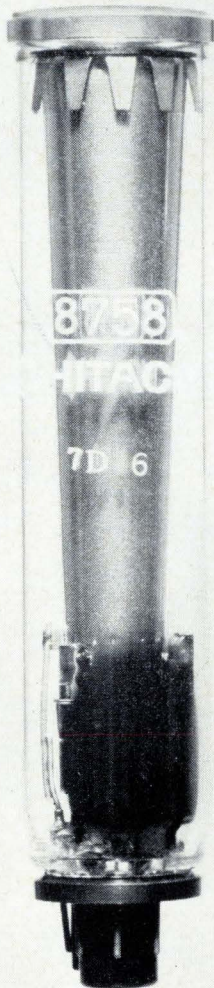

ACTUAL SIZE

TYPE—1 inch.

SHORTER LENGTH—for small transistorized cameras.

LOWER HEAT POWER—6.3 V, 95 mA.

HIGHLY SENSITIVE PHOTOCONDUCTIVE LAYER—clear images even with poor lighting.

HIGH RESOLUTION—over 600 TV lines at the center of the screen.

FOR ECONOMY — THE HITACHI VIDICON 8758

Size	Overall length (mm)	133±3
	Greatest diameter (mm)	28.6φ±0.3
Method	Focusing method	magnetic
	Deflection method	magnetic
Examples of usages	Heater voltage (V)	6.3±10%
	Heater current (mA)	95
	Illumination (lx)	10
	Target Voltage (V)	20 ~ 40
	Dark current (μA)	0.02
	Signal output current (μA)	0.2
	Center resolution (TV lines)	600

Additional economies: the Hitachi Vidicon 8758 has the same base connection as the 7 pin-stem of conventional picture tubes, permitting the use of the lower-priced standard sockets. It is suitable for use with industrial television equipment and other closed-circuit television systems.



HITACHI SALES CORPORATION: 333 N. Michigan Avenue, Chicago, Ill. 60601, U.S.A. Tel: 726-4572/4 / 666, 5th Avenue, New York, N.Y. 10019, U.S.A. Tel: 581-8844 / HITACHI, LTD., DUESSELDORF OFFICE: 4 Duesseldorf, Graf Adolf Strasse 37, West Germany Tel: 10846

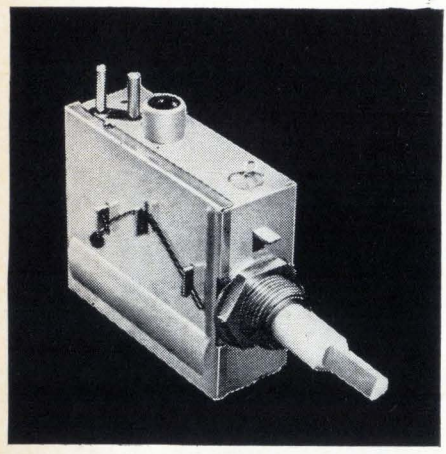

MITSUMI UHF TV TUNER

outrating international tuner standards!

Far outrating the FCC and VDE specifications, which are widely prevailing in the World as tele-communication standards, the MITSUMI UHF tuner only radiates spurious signals less than 33.5 dB below the reference field strength. Material, plating, soldering, as well as the proprietorial circuit design are the technical achievements by MITSUMI based on a long-term fundamental research. By virtue of high compactness, light-weight, outstanding durability and overall use of silicon transistors, the MITSUMI TV-tuner has made possible of minimum frequency drift due to temperature variation. And also, the MITSUMI TV-tuner is made available to tube-type TV sets.

Specifications	Model	UHF TV tuner
Gain (dB)	UK-A32 for American channel	10 min.
Noise figure (dB)		14 max.
Image ratio (dB)		30 min.
IF rejection (dB)		60 min.
Frequency stability	Temperature stability :	± 300 kc at 25-65° C
	Voltage stability :	± 100 kc at 11V ± 1V
Outer dimensions (mm)		51 × 62.5 × 24.5

Specifications	Model	UHF TV tuner
Gain (dB)	U-ES12B for European channel	-10 min.
Noise figure (dB)		16 max.
Image ratio (dB)		35 min.
IF rejection (dB)		55 min.
Frequency stability	Temperature stability :	800kc at 20-30° C
	Voltage stability :	± 400kc at 11V ± 1.1V
Outer dimensions (mm)		46.5 × 50 × 19

MAIN PRODUCTS

- Polyethylene variable capacitors
- IF Transformers
- Micro-motors
- Synchronous motors
- Front-end FM tuners
- UHF & VHF TV tuners
- CdS photoconductive cells
- Trimming potentiometers
- Various types of coils
- Various types of sockets
- Trimmer capacitors
- Various types of terminals
- Fuse holders



MITSUMI ELECTRIC COMPANY, LIMITED
 1056 Koadachi, Komae-machi, Tokyo. 415-6211
 302, Cheong Hing Bldg., 72 Nathan Road, Kowloon, Hong Kong. 666-925
 Marienstrasse 12, Düsseldorf, W. Germany.
MITSUMI ELECTRONICS CORPORATION
 11 Broadway, New York 4, N.Y. 10004. HA5-3085
 333 N. Michigan Avenue, Chicago, Ill. 60601 263-6007

HRS Connectors

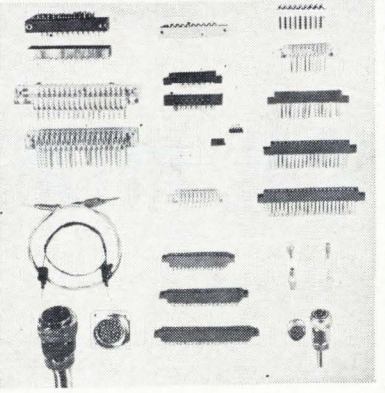

- * Cylindrical
- * Printed Circuit
- * Rectangular, Rack & Panel
- * Co-axial, Standard & Miniature

For detailed information, Please contact to,

HIROSE ELECTRIC CO., LTD.

23, 5-5 Chome, Osaki, Shinagawa-Ku, Tokyo, Japan Cable: BESELECONHIROSE

Circle 218 on reader service card

DX TV ANTENNAS ARE RENOWNED THROUGHOUT THE WORLD !!



BUSINESS ACTIVITIES

- Manufacture of DX Television Antenna's.
- Sales of DX Television Antenna's Accessories.
- Sales of DX Twin Lead Wires & Cables.
- Sales of Various apparatus for TV Community Reception.

MANUFACTURERS DX ANTENNA CO., LTD.

No. 6, Irie-dori 5-chome, Hyogo-ku, Kobe, Japan.

Circle 219 on reader service card

KOKUSAI'S MECHANICAL FILTER

50cps..... 500kc



LOW FREQUENCY ML SERIES

300cps.....50kc
 Percent Bandwidth 0.1%.....10%
 Low Impedance Termination

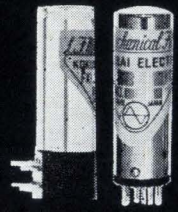

LOW FREQUENCY FK SERIES

100cps 6kc
 Available as filter and oscillator

Telecontrol and Telemetry use

BAND WIDTH
 0.1% 1% 10%



V x 12 CHANNEL FILTER

64kc.....108kc
 Carrier telephone terminal equipment application



RADIO FREQUENCY MECHANICAL FILTER

100kc.....500kc
 SSB, AM, FM, TRANSCEIVER use



Patented in France, Federal Republic of Germany, Great Britain, U.S.A. and Japan
KOKUSAI ELECTRIC CO., LTD.
 9, Nishikubo-Sakuragawa-cho, Minato-ku, Tokyo, Japan
 Cable Address: SINESHIBA TOKYO

Circle 220 on reader service card

88 Circle 88 on reader service card



For A Quality Source Of Electronics Products Visit
JAPAN ELECTRONICS SHOW '67

Osaka
 September 28
 to October 4

yes,
 CCTV Cameras work best



with **COSMICAR[®] LENSES**

Superior cameras deserve superior lenses. COSMICAR's proven precision performance is the combined result of advanced optical engineering and exquisite workmanship.

Now widely used, COSMICAR LENSES come in 23 models for focal lengths ranging from 12.5 mm to 500 mm, and in 3 zoom models including a remote control zoom.

Your CCTV camera and COSMICAR LENSES will make an unbeatable team. For technical data and other particulars write to:



568, Shimoochiai, 2-chome, Shinjuku-ku, Tokyo
 Cable Address: "MOVIEKINO TOKYO"

Circle 221 on reader service card



ASSURES...

High Quality!
 Excellent Technique!
 Fast Delivery!

VARIABLE RESISTORS

Item No. RV08Y (carbon type)



Item No. RV10Y (carbon type)



Item No. RA08Y
 (wire-wound type)



Item No. RTC11PN
 (trimmer potentiometers)

MAIN PRODUCTS:

- Variable Resistors
- Fixed Resistors
- Trimmer Potentiometers
- Photo Cells. CdS.

* For catalog write to

Tokyo Cosmos Electric Co., Ltd.

No. 303, 1-chome, Horinouchi, Suginami-ku, Tokyo, Japan
 Tel. Tokyo 313-1111. Cable: "COSMOSDENKI" TOKYO

**AS LOW AS -150db COM-
 MON MODE REJECTION
 —WITH HIGH
 IMPEDANCE**

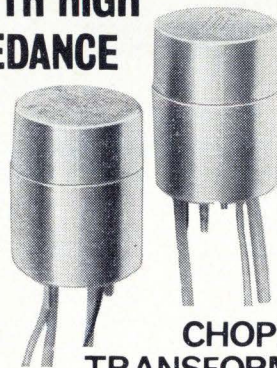

**CHOPPER
 TRANSFORMER**

This smallest size chopper transformer combines many improvements to offer you unsurpassed performance and price economy.

■ Impedance: 5MΩ Max. ■ Input level: 1mV Max. ■ Common mode rejection: -150db Max.



**NIHON KOHDEN
 KOGYO CO., LTD.**

Foreign Dept.: Chiba Bldg., 93,
 Tsunohazu-2, Shinjuku-ku, Tokyo, Japan

MOSAIC INDICATOR

MODEL

MS-21A
 MS-21B

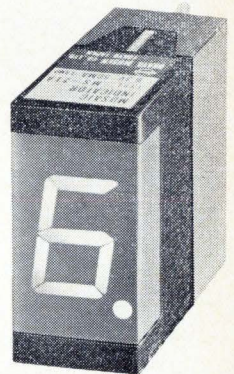

Ideal for
 a wide variety
 of numerical
 indications

Features

1. Display illuminated with white light, giving sufficient brightness with low power.
2. Wide viewing angle display on a single surface, permitting a viewing angle of about 150°
3. Compact and lightweight, character size maximized, installation space minimized.

Specifications

Lamp used: Voltage: 6.3V
 Current: 0.05A



OKAYA ELECTRIC INDUSTRIES CO., LTD.

YASUDA BUILDING, 3-8, 1-CHOME,
 SHIBUYA, SHIBUYA-KU, TOKYO, JAPAN

Agent in the U. S. A. and Canada
ALCO ELECTRONIC PRODUCTS, INC.

LAWRENCE MASS. 01843 ■ TEL (617) 686-3888



For A Quality Source Of Electronics Products Visit

JAPAN ELECTRONICS SHOW '67

Osaka
September 28
to October 4

MATSUO

High Reliable Capacitors

POLYESTER FILM CAPACITORS.

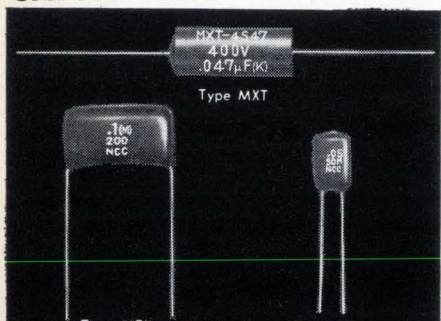

Type MXT
In plastic tube.
Capacitance Range: .001 MFD to .22 MFD.
Voltages: 100v, 200v, 400v, 600v DC.

Type MFK
Dipped flat shape, non-inductive construction.
capacitance Range: .01 MFD to .47 MFD.
Voltages: 100v, 200v, 400v, 600v DC.

Type MFL
Dipped flat shape.
Capacitance Range: .001 MFD to .22 MFD.

METALLIZED POLYESTER FILM CAPACITORS.



Type FNX-H
Mylar wrapped semi oval with epoxy end seal.
Capacitance Range: .1 MFD to 10 MFD
Voltages: 100v, 200v, 400v, 600v DC.

SOLID TANTALUM CAPACITORS.

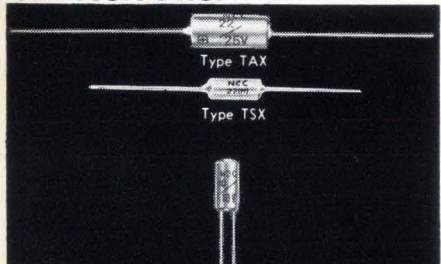

Type TAX
MIL-C-26655A hermetically sealed.

Type TSX, TSL
Sealed with epoxy resin.
Capacitance Range: .22MFD to 330 MFD.
Voltages: 3v, 6v, 10v, 15v, 20v, 25v, 35v, 50v DC.

for full details, contact :

MATSUO ELECTRIC CO., LTD.

3-chome, Sennari-cho, Toyonaka-shi, Osaka, Japan
Cable Address "NCC MATSUO" OSAKA

Metronix

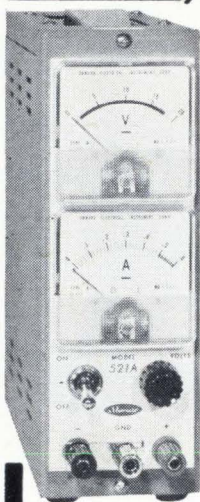

REGULATED
DC
POWER
SUPPLIES

MODEL
521A

RIPPLE: 3mVp-p

MODEL	VOLTS	AMPS	REGULATION (line or load)
521A	1~18V	0.5A	± 20mV
541A	1~35V	0.25A	± 20mV
543	1~35V	0.5A	± 20mV
531B	0~35V	1A	± 10mV
533C	0~35V	5A	± 3mV

Metronix Metronix corp.
76, CHOFU-CHIDORI-CHO, OTA-KU, TOKYO, JAPAN

Circle 224 on reader service card

50MC UNIVERSAL COUNTER UC-578

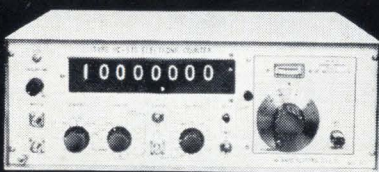

The most versatile and reliable solid state universal counter of the plug-in type for measuring frequency, period, frequency ratio and time interval.

- Frequency measuring range from 0.1 c/s to 50 Mc directly; up to 3 Gc with a plug-in frequency converter
- 3×10^{-9} /day time base stability
- 8 digits, display storage
- Plug-ins for UC-578

Frequency converter PC-152 (50 to 510 Mc)
Frequency converter PC-133 (0.3 to 3 Gc)
Time interval unit PC-216

(1μs to 99,999,999 s)

ANDO ELECTRIC CO., LTD.
19-7, Kamata 4-chome, Ohta-ku, Tokyo

Circle 225 on reader service card

VARISTORS PROTECT YOUR CIRCUITS



Silicon Varistors

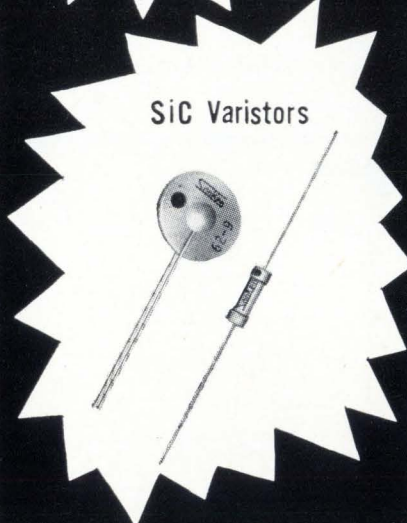

SiC Varistors

Si diodes, Si rectifiers,
Si transistors, Se rectifiers,
CdS photo cells, Power supplies.

Sanken®

SANKEN ELECTRIC CO., LTD.

1-22-8 NISHI- IKEBUKURO,
TOSHIMA-KU, TOKYO

CABLE: SANKELE TOKYO Phone: 986 6151

Circle 226 on reader service card

90 Circle 90 on reader service card



For A Quality Source Of Electronics Products Visit

JAPAN ELECTRONICS SHOW '67

Osaka
September 28
to October 4



New! Lamps for Compet

Don't lose valuable time in mistakes caused by overflow or forgetfulness. Sharp's newest electronic desk calculator, Compet model CS-30B, has reminder lamps. If an operation exceeds the calculator's 14 digit capacity, a red lamp automatically indicates overflow. A yellow lamp comes on when the Memory Register is in use - you can't forget those intermediate answers.

The lamps are only the newest way in which Sharp saves time for you. Silent Compet automatically displays plus, minus and decimal signs; makes it impossible to press 2 keys at once; rounds off fractions for you; can't be harmed by misuse; simplifies maintenance with plug-in circuits. Because of its speed and capability Compet is Japan's most widely used electronic desk calculator.



COMPET Model CS-30B

SHARP

HAYAKAWA ELECTRIC CO., LTD. Osaka Japan

U.S. Subsidiary: SHARP ELECTRONICS CORP. 178 Commerce Road Carlstadt, New Jersey

Circle 227 on reader service card

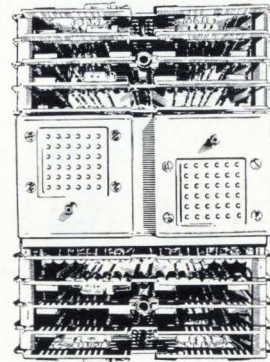
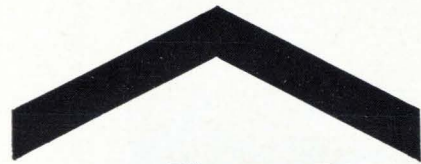

all under
one roof:

Tokin memory systems are totally **Tokin** from start to finish. At **Tokin** we handle everything concerned with the memory systems we make. That's why we guarantee top quality: the **Tokin** quality you expect. We not only save time by doing it all ourselves, we save you money by cutting costs.

Tokin is the largest manufacturer of memory cores, planes and stacks in Japan. (We make more 20-mil-and-under cores than anyone else here.) **Tokin** uses its famous ferrite cores for the very latest in 2½D memory systems: you get improved performance, lower cost potential in larger memory sizes.

Write:

Tokin

Tohoku Metal Industries, Ltd.

4, 7-chome, Ginza-Higashi, Chuo-ku, Tokyo, Japan

Telephone: Tokyo 542-6171 Cable Address: TOHOKUMETAL TOKYO

Circle 91 on reader service card

91



For A Quality Source Of Electronics Products Visit
JAPAN ELECTRONICS SHOW '67

Osaka
 September 28
 to October 4



11 experts at work
 on every printed board

High Quality
**Printed
 Circuit
 Boards!**

(UL Approved: E-38255)

Through the strictest quality control system, Tokyo Print have won the fullest confidence, as top printed circuit board manufacturers in the field. Indeed, all the manufacturing processes are so systematically installed and organized that all engineers can keep watch on every part and every process.

For computer use

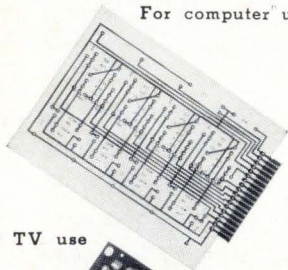

For TV use

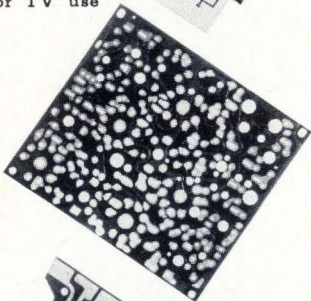

For TR.
 Radio use

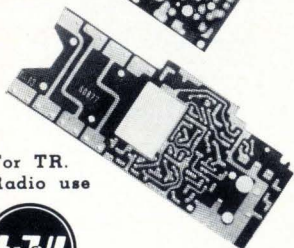

* For further please write to

Tokyo Print Industrial Co., Ltd.

No. 782, Shimoishihara, Chofu-shi, Tokyo,
 Japan Tel. 0424(83)5711

FIXED COMPOSITION RESISTORS

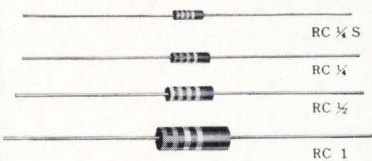

SEMI-FIXED RESISTORS



NOISE SUPPRESSORS
 FOR CAR RADIOS

TYPE K(II)

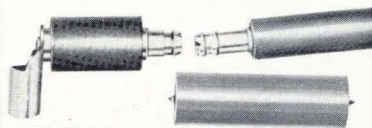

TAIYO DENKI CO., LTD.

1-12, 3-Chome, Sunamichi
 Sakai c., Osaka, Japan
 TEL: SAKAI (3) 6841

Circle 228 on reader service card

A Wide Variety Of
 NTK Electro-Ceramics
 Can Meet Your Demand

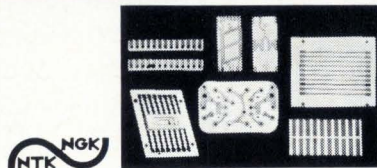

Rectifier Containers, Transistor Headers, Varactors
 I.C. Substrates & Packages, Hermetic Terminals,
 Out Put Windows, Ceramic Ladder Filters, Ultrasonic
 Transducers, Gas Lighters, Pick-up Element, etc.

NGK SPARK PLUG CO., LTD.

NTK Technical Ceramics Division
 Mizuho, Nagoya, Japan
 Cable: PLUGNGK NAGOYA

U.S. Office: NGK SPARK PLUGS (U.S.A.), INC.
 4010 Sawtelle Blvd., Los Angeles, Calif. 90066, U.S.A.

92 Circle 92 on reader service card

**Relay Reliability
 Results from
 Engineering
 Know-How!**

Over forty years of specialized experience PLUS integrated manufacturing of almost all parts at our own plants guarantee dependable and durable Takamisawa relay performance. Extra added advantage is their competitive prices.

**MQ Series
 MINIATURE DC RELAYS**

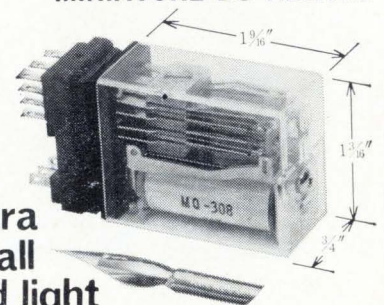

Extra
 small
 and light
 with big performance

- Weighs only 1.5 oz
- Contact current up to 0.7 Amp at 100 VDC
- Twin contact for greater reliability anti-shock performance
- High sensitivity
- Excellent anti-shock (5G) and vibration capacity
- Plug-in or screw-mounting

**MA-R Series
 MULTIPLE USE RELAYS**

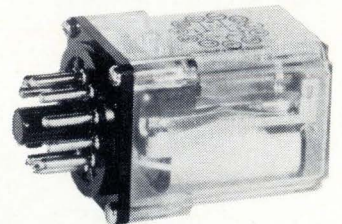

Conveniently compact
 with — extra large
 contact load capacity

- Completely new, advanced design
- Easy-to-use plug-in type
- A diversified variety in use
- Both DC and AC types are available



For catalogs, please write to Planning Dept.

**TAKAMISAWA
 ELECTRIC CO., LTD.**

35-4, 1-chome, Koyama, Shinagawa-ku, Tokyo, Japan

Circle 229 on reader service card

Circle 230 on reader service card



**To make your product lighter,
Use TOTOKU MAGNET WIRE
with the
lightness of aluminum,
solderability of copper,
and excellent
winding properties !**

A very fine copper-clad aluminum wire developed to meet your need to make your product lighter and smaller, TOTOKU Magnet Wire is the result of a technical breakthrough in which we have successfully solved hitherto unsurmountable problems in the drawing of aluminum wire.

With a specific gravity less than half that of copper, TOTOKU Magnet Wire is being used with most satisfactory results in voice coils, moving coils, motor rotor coils, and other applications in which lightness is a crucial factor.

With complete confidence, TOTOKU Magnet Wire is recommended for use in your product to make it still lighter.

★ **STRUCTURE**

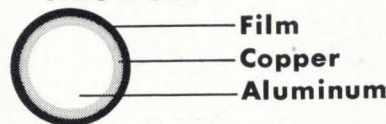

★ **MAIN TOTOKU PRODUCTS**

— U/L — NEMA — MILITARY —

ELECTRIC WIRE AND CABLE

- | | |
|---------------------------------|---------------------|
| PVC cord | Communication cable |
| Coaxial cable | Resistor Wire |
| Telephone wire | Magnet Wire |
| Shielded cable | Coiled cord |
| Flexible cord (UL approved) | |
| Power supply cord (UL approved) | |
| Rubber insulated wire and cable | |

WIRE FOR SPECIAL USE

- Cable assemblies
- Heater assembly for blanket
- Heater element for refrigerator
- Magnet wire with friction surface
- Anti-rodent electric wire and cable
- Aluminum and some aluminum alloys ultra fine wire

ELECTRIC COMPONENTS

- Precision coils
- Deflection yoke
- Level indicator (Gemmeter)
- Horizontal output transformer
- Vertical output transformer
- Rotary solenoid
- Transistorized automatic voltage regulator



WRITE FOR DETAILS

TOTOKU ELECTRIC CO., LTD.

307, 2-CHOME NISHI-OKUBO SHINJUKU-KU TOKYO, JAPAN.
CABLE ADDRESS: "TOTOKUWIRE" TOKYO TELEPHONE: TOKYO (369)2161

NOBLE

**Small Molded Capacitor
(Gimmick Type)**

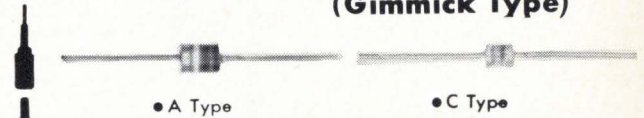

Variable Resistor

Special element for color TV available

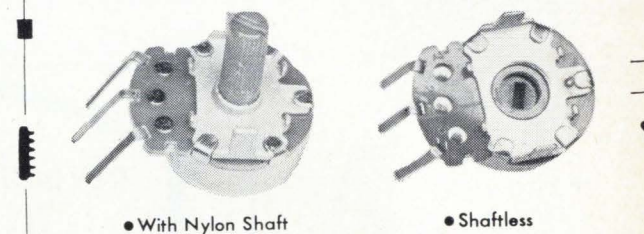

MAIN PRODUCTS: Variable Resistor • Electronic Switch • Capacitor • CR Composite Parts • Fixed Resistor • Coil & IFT • Power Resistor



TEIKOKU TSUSHIN KOGYO CO., LTD.

335, Nishinaka-Machi, Kariyado, Kawasaki-City, Japan
PHONE: NAKAHARA (42) 3171 TELEX: 3842-155
CABLE: KAWASAKI-TEITSU

Circle 232 on reader service card

**ANOTHER WORLD'S SMALLEST
Soshin's Dipped Mica Capacitors /DM05**

Developed by SOSHIN ELECTRIC, the only mica capacitor maker in Japan with MIL-C-5C qualifications. This newest and its bigger brothers will meet all your requirements. Volume orders accepted.

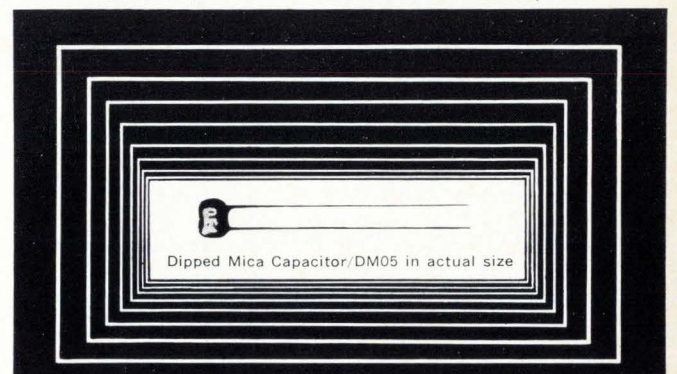

Types	Max Allowable Capacitance (pf)			Dimension (mm)								
	100 WV	300 WV	500 WV	100 WV			300 WV			500 WV		
Standard				L Max	W Max	T Max	L Max	W Max	T Max	L Max	W Max	T Max
DM 05	200	130	—	7.0	5.0	3.5	7.0	5.0	3.5	—	—	—
DM 10	440	390	330	8.5	5.5	3.5	8.5	5.5	3.5	8.5	5.5	3.5
DM 15 (C-M05)	2000	1200	510	13.0	11.0	6.5	12.5	10.5	6.0	12.0	10.0	5.5
DM 19 (C-M06)	10000	6800	5100	18.0	15.0	8.5	18.0	15.0	8.0	17.5	15.0	7.5

For further information, write to



SOSHIN ELECTRIC CO., LTD.

18-18, Nakamagome 1-chome, Ohta-ku, Tokyo, Japan
Cables: SOSHINCAPACITOR TOKYO



For A Quality Source Of Electronics Products Visit

JAPAN ELECTRONICS SHOW '67

Osaka
September 28
to October 4

\$1,050

(F.O.B. YOKOHAMA)

25 ~ 230MHz

Field Strength

Meter

M-321C

with Doublet or
Loop antenna



Field strength measuring value

(Min.) Less than 4dB at 25—38 MHz
by doublet antenna.

(Max.) Minimum value +100dB

Accuracy ± 2 dB

Pass band width approx. 80 kHz (6dB)

Noise measurement: combination with
Quasi-peak meter MH33A. \$583

Other models available for frequency
ranges from 150kHz to 11,700 MHz.

Anritsu Electric Co., Ltd.

4-12-20, Minamiazabu, Minato-ku, Tokyo
cable address ANRIT DENKI TOKYO

HDK

Offers you the finest quality
products at low cost by the
controlled mass-production.

(Fixed Composition
Resistor Type RC-1/2)

MAIN PRODUCTS:

- Fixed Film Resistors (High stability)
- Variable Resistors
- CR Modules

● For catalog write to



HOKURIKU ELECTRIC INDUSTRY CO., LTD.

1873, 3-chome Kamimeguro, Meguro-ku, Tokyo, Japan
Tel. Tokyo 713-1146~9. Cable: HDKELECTRIC TOKYO

**REVOLUTIONARY
NEW!!
Printed Resistor Circuit
TYPE PRC**

Type PRC printed resistor circuits are
resistors printed on the printed circuit board.
The plane construction of elements makes
available the miniature circuit design for
radios, transceivers, tape recorders, TV,
computers, etc.

Circle 233 on reader service card

DIFFERENTIAL TRANSFORMERS
For measurement and remote control use

Capable of obtaining output voltages
exactly proportional to any kind of
mechanical variation.

Measuring value: 1/100,000~100mm
More than 500 types are available.

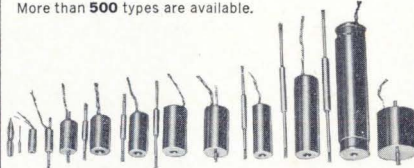

Features:

- *Outstanding interchangeability
- *Quite free from outer magnetic field
- *Insensitive to ordinary shock, water and heat

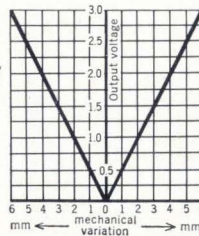

Manufacturers of Differential Transformers

NIPPON COIL CO., LTD.

Amakawa Bldg. 1, 1-chome, Hommachi, Higashi-ku, Osaka, Japan.

**NOW!
WORLD'S
FIRST
10.7MC
CERAMIC FILTERS
FOR
FM RADIOS.**

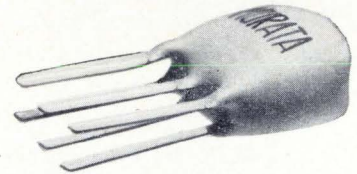

Murata's remarkable new ceramic
filter Model SF-10.7MA give you
more selectivity for their size than
any conventional I-F filter.

They are fixed tuned and need
no alignment—are non-magnetic
and non-microphonic. There is no
mechanical coupling but wholly
electrical.

By the application of trapped
energy theory about vibration
mode to piezoelectric ceramics,
Murata has succeeded to make
this new high frequency ceramic
filter that anyone could not suc-
ceed.

Improve your next FM radio de-
sign with the new ceramic filter
Model SF-10.7MA.

Request today for the latest tech-
nical bulletin #761-E for complete
specifications and selectivity
curve.

muRata

MURATA

MANUFACTURING CO., LTD.

Nagaoka, Kyoto, Japan

Phone: 075-92-1121

Cable Address: MURATAKYOTO

Telex: 5422-317KYO

IN THE UNITED STATES

MURATA CORP. OF AMERICA

160 Broadway, New York, N.Y. 10038

Phone: (212) 686-2510

Telex: MURATA421690



For A Quality Source Of Electronics Products Visit JAPAN ELECTRONICS SHOW '67

Osaka
September 28
to October 4

THIS SPACE CONTRIBUTED BY THE PUBLISHER



A woman's body.

Architecturally, quite interesting. To a man. But not to the woman who owns one. Most women tend to ignore their own bodies.

Do you? Do you check your body, particularly your breasts, every month, for any lump or thickening? You should. A lump or thickening in the breast or elsewhere could be a warning signal of cancer. And cancer is easier to cure when it's detected early.

Sophia Loren knows the seven warning signals of cancer. So should you:

1. Unusual bleeding or discharge.
2. A lump or thickening in the breast or elsewhere.
3. A sore that does not heal.
4. Change in bowel or bladder habits.
5. Hoarseness or cough.
6. Indigestion or difficulty in swallowing.
7. Change in a wart or mole.

If a signal lasts longer than two weeks, see your doctor without delay.

It makes sense to know the 7 warning signals of cancer.

It makes sense to give to the American Cancer Society.



SHIN-EI'S

Printed Circuit Boards! (UL Standard Approved No. E-41166)

For Tr. Radios, Industrial Measuring Instruments & Communication Equipments...

Also, for special use;

- Smooth Printing
- Flexible Printing
- Front-Back Through-Hole Processing
- Multi-Layer Printing

Select the best that meets your specific application!

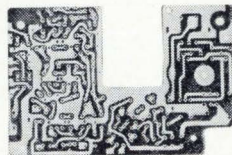

For audio use



For industrial measuring instruments use

* For further information please write to



SHIN-EI INDUSTRIAL CO., LTD.

9-7, Megurohon-cho 4-chome, Meguro-ku,
Tokyo, Japan Tel. Tokyo 714-1651-9

Circle 237 on reader service card

0.315 CUBIC INCH MINI TRANSFORMERS

SMALLEST...in SIZE
LIGHTEST...in WEIGHT
BEST...in QUALITY

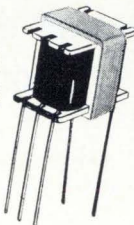

TRANSFORMERS FOR TR.
POWER TRANSFORMERS
AUDIO TRANSFORMERS
CHOKE COILS
& OTHER COILS

for detailed information, write to....

REPRESENTATIVE:

AIKOW SHOJI KAISHA LTD.

IZUTA Bldg. No. 52 Usimarucho, Kita-ku,
Osaka, Japan

MANUFACTURER:

KAMI ELECTRONIC IND.CO.,LTD.

2-30 Kami-hosodacho, Higashi-sumiyoshi-ku,
Osaka, Japan

Circle 238 on reader service card



Actual Size

Meet the Marcon MC PACK

Set-reset type Flip-Flop Model D-3100, the Marcon MC PACK is a newly-developed thick-film integrated circuit. Solid, flat and packed, it gives excellent performance and durability. Ideal for digital and analog circuits. Offers greater applicability because it can be hybridized with semi-conductor IC's.

Other Marcon MC PACK standard products include:

Audio amplifier D-2009 (9 to 12V)

Tone control amplifier D-2011

(12 to 18V)

Flip-Flop circuit D-3044

(12V and 4.3V, 10Mc)

Flip-Flop circuit D-3046

(12V and -6V, 100Kc)

Schmitt trigger circuit D-3060

(12V, 500Kc)

Flip-Flop circuit D-3101 (6V, 1Mc)

Tokyo Denki will mc-pack other digital and analog circuits to meet your special requirements. For detailed information write today.

Other Superior Marcon Products:

- Aluminum Electrolytic Capacitors
- Tantalum Solid Electrolytic Capacitors
- Tantalum Foil Electrolytic Capacitors
- Metallized Paper Capacitors
- Oil Filled Capacitors



TOKYO DENKI CO., LTD.

9, 4-chome, Nihonbashi-Honcho, Chuo-ku,
Tokyo, Japan

Cable Address: ELECTROMARCON TOKYO

Circle 95 on reader service card



For A Quality Source Of Electronics Products Visit

JAPAN ELECTRONICS SHOW '67

Osaka
September 28
to October 4

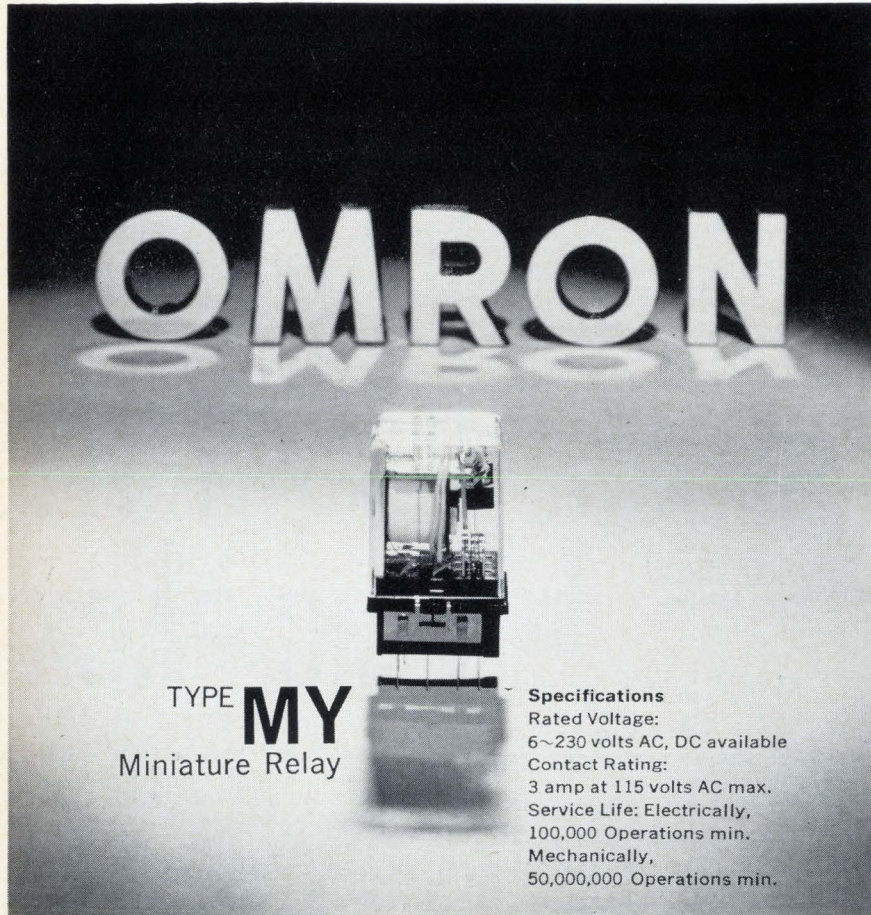

OMRON can't recommend anything... but high quality products

Every component in today's automation must be miniaturized, have it printed and be advanced—like OMRON's relay, type-MY. The products the world wants are produced through OMRON's unique technology. OMRON—first in the field of industrial electronics with application of semi-conductor elements.

We are confident of the quality and usefulness of every product with the name OMRON.

Other OMRON Products: Proximity Switch, Photoelectric Switch, Ultrasonic Switch, Solid State Control Relay, Electronic Counter, Annunciator, Transducer, Shift Resistor, Motion Detector, Solid State Level Control Switch, Precision Switch, Electromagnetic Relay, Time Relay, etc.



Main Sales Office Toa Bldg., 5, Yonban-cho, Chiyoda-ku, Tokyo, Japan Phone (265) 4611 Cable Address: OMRONELCO TOKYO Telex 25 279
New York Office Room No. 1215, 23-25 East 26th Street, New York 10010 N.Y. U.S.A. Phone OR 9-6858 Cable Address: OMRONELCO NEW YORK Telex 224612
Overseas Agencies Carlo Gavazzi S.P.A. Vie G. Clardi, 9 Milano, Italy Phone: 40,50,51 Carlo Gavazzi N.V. Radout Amsterdam (Buitenverdert) Holland Phone: 42, 85, 32 Carlo Gavazzi Mess-und Regeltechnik Gm-BH 6 Frankfurt/Main Berger Strebe 40-42 West Germany Phone: 0611-43, 84, 14 49, 18, 64 Carlo Gavazzi-GMBH Schwedenplatz 2 1011 Vienna, Austria Phone: 0222/63 68 05/63 93 99
Carlo Gavazzi AG, Kanzleistrasse 80 Postfath CH-8026 Zurich Switzerland Phone: 051-44, 93, 30 Carlo Gavazzi S. A. R. L. 74 Rue de
Billman Regulator AB Agency Department Pack, Hubbinge 1 Sweden Phone: 774 00 00
Keyswitch Relays Ltd. 120-132 Cricklewood Lane London N.W. 2 England Phone: Gradstone 1152 H. Rowe & Co. Pty. Ltd. 7 Flinders Court Melbourne 626511 Australia P. J. Yelland & Co. (pty) Ltd. 110 Gale Street Durban St., South Africa Phone: 34-2487

Circle 96 on reader service card

Is your Blood Pressure HIGH?

Only your doctor can tell. And he can now help most cases of this disease with new drugs and new methods of treatment developed with the help of your Heart Fund dollars. More Heart Fund dollars will support more research to prevent and cure this leading cause of heart attack and stroke.

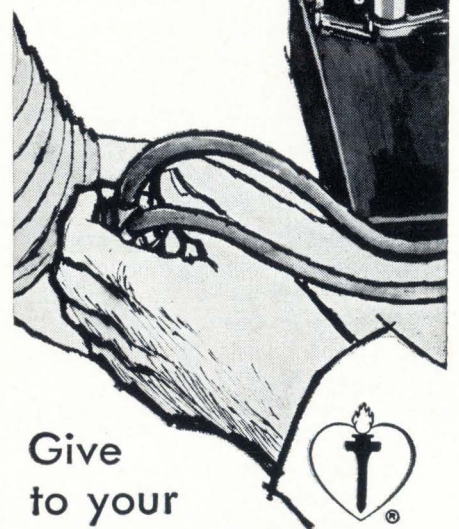
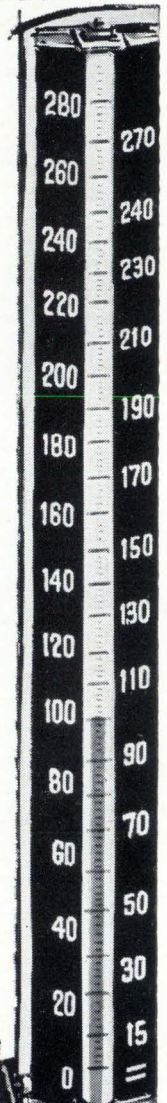

Give
to your

HEART FUND

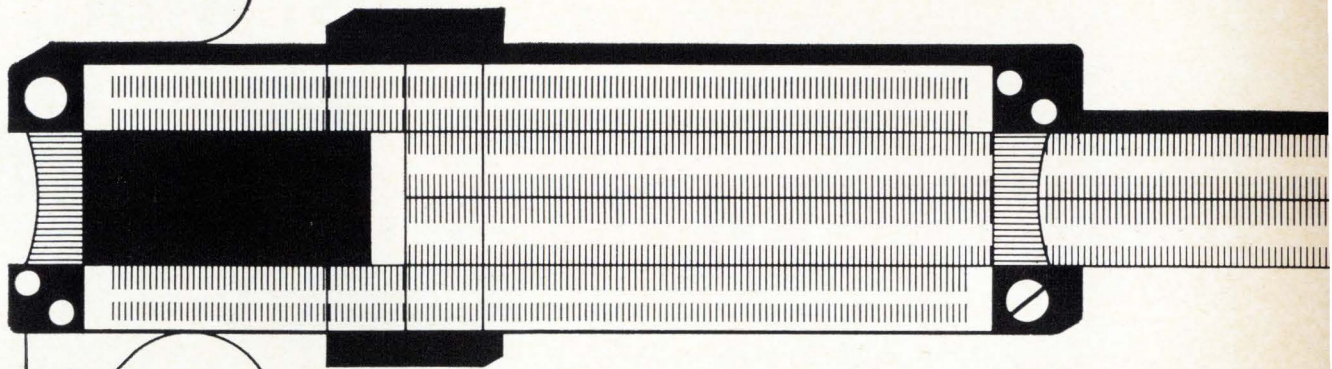

The precision compounds deliver.

Durez[®] phenolic, diallyl phthalate, and alkyd molding compounds

Whether your specs call for moldability that can give you walls as thin as .050 inch, or superior heat and chemical resistance on the job, the precision molding compounds from Durez deliver.

Durez' broad line of phenolic, diallyl phthalate, and alkyd molding compounds offer the balance you want from among these key design requirements: good electrical and thermal properties, impact strength, durability, relatively low cost; heat, corrosion, and chemical resistance; flame retardance, dimensional stability, and retention of electrical properties after

long periods at high humidity.

The precision compounds are now playing a major role in electrical component design. Ask our sales engineers and technical service men to check your specific application or materials selection problem.

Specify the precision compounds from Durez.

For complete information on the complete line of precision compounds write Durez Division, Hooker Chemical Corporation, 9006 Walck Road, North Tonawanda, New York 14120.

 **hooker**
DUREZ DIVISION

Burroughs the leader...

- Originator of the NIXIE® tube
- Originator of ultra-long life NIXIE tubes
- Originator of wide viewing-angle NIXIE tubes
- Originator of rectangular space-saving NIXIE tubes
- Originator of biquinary NIXIE tubes
- Originator of the decimal point NIXIE tubes
- Originator of the low cost NIXIE tubes
- Originator of alphanumeric NIXIE tubes
- Originator of miniature NIXIE tubes
- Leader with the broadest line of NIXIE tubes
- Leader in quality NIXIE tubes
- Leader in development of NIXIE tubes

Burroughs, the originator of the NIXIE readout tube, has continually led the field in the development of the latest in readout tubes, readout devices and readout systems. Burroughs engineering ability and experience will continue to lead the way in readout displays.

*For further information contact: Burroughs Corporation,
Electronics Component Division, P.O. Box 1226, Department
N2, Plainfield, New Jersey 07061 Tel: (201) 757-5000*

FIRST WITH...



■ **STANDARD**
Character Size ... 0.6"
Viewing Distance ... 30'
for instrumentation



■ **STANDARD
RECTANGULAR**
Character Size ... 0.6"
Viewing Distance ... 30'
for instrumentation —
preferred type for
minimal width displays



■ **MINIATURE**
Character Size ... 0.3"
Viewing Distance ... 14'
for mobile and airborne
instrumentation



■ **MINIATURE
RECTANGULAR**
Character Size ... 0.3"
Viewing Distance ... 14'
for mobile and airborne
instrumentation

continues to lead with

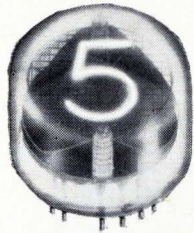

■ **SUPER**
Character Size . . . 0.8"
Viewing Distance . . . 38'
for instrumentation

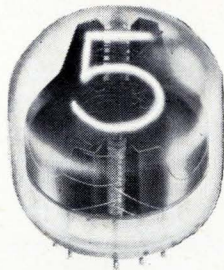

■ **LARGE**
Character Size . . . 1.4"
Viewing Distance . . . 65'
for large audience
displays to 65'

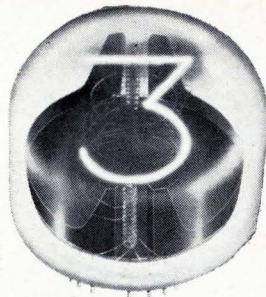

■ **JUMBO**
Character Size . . . 2.0"
Viewing Distance . . . 100'
for large audience
displays to 100'

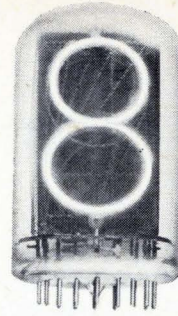

■ **JUMBO SIDE VIEWING**
Character Size . . . 2.0"
Viewing Distance . . . 100'
for large audience
displays to 100'
**preferred type for lower
cost and minimal width**

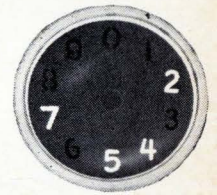

■ **PIXIE® POSITION
INDICATOR TUBES**
Character Size . . . 0.125"
Viewing Distance . . . 8'



■ **STANDARD
ALPHANUMERIC**
Character Size . . . 0.6"
Viewing Distance . . . 30'
for information display
systems readable to 30'



■ **MEDIUM
ALPHANUMERIC**
Character Size . . . 1.5"
Viewing Distance . . . 65'
for large audience
information display
systems to 65'

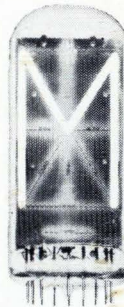

■ **LARGE
ALPHANUMERIC**
Character Size . . . 2.5"
Viewing Distance . . . 100'
for large audience
information display
systems to 100'



■ **BIQUINARY NIXIE
TUBE**
Character Size . . . 0.6"
Viewing Distance . . . 30'
for instrumentation with
biquinary driving



■ **B-5440**
Character Size . . . 0.6"
Viewing Distance . . . 30'
for **low-cost**
instrumentation



■ **B-5440A SERIES**
Character Size . . . 0.6"
Viewing Distance: . . . 30'
for **low-cost** highly
reliable instrumentation
with minimal panel
dimensions. This new
improved NIXIE tube is
16 2/3% shorter than the
B-5440 series. Available
options include • built in
"keep alive" for rapid
ionization • two decimal
points, right and left.



■ **B-5560**
Character Size: . . . 0.5"
Viewing Distance: . . . 25'
new side-view NIXIE tube
offers the maximum
character size for the tube
bulb diameter, providing
the best readability with
minimal instrument panel
dimensions.

■ **B-XXXX**
See this latest Burroughs
NIXIE tube development
at WESCON — Booth
No. 2816-17.

■ **B-XXXX**
Burroughs is continually
developing new and
improved readouts for
future display
requirements. Write us
about your future
requirements.



 **Burroughs Corporation**

Circle 99 on reader service card

Westinghouse 0.5 to 820 amp rectifiers keep everything from TV sets to locomotives competitive into the 1970's



TV sets and locomotives have one thing in common—both need top quality silicon rectifiers with competitive price and performance.

TV rectifiers must withstand repetitive surges, be highly reliable, yet low in cost. The new Westinghouse 1N4816 series, rated at 1.5 A. half-wave average at voltages to 1000 V., meets the need. It offers plastic economy with metal case performance for TV, Hi-Fi, and other consumer applications. Exclusive manufacturing techniques insure hermeticity. Replaces 1N536, 1N1217, similar rectifiers. Price of 400 V. (1N4820) unit in 1000 quantity: only 30¢.

The new Westinghouse Type 790 rectifier, rated 240 A. at 2400 V. allows upgrading of diesel-electric locomotive performance. Alternator rectifiers must provide 3500 KW under conditions of heat, cold, Circle 100 on reader service card

dirt, and overloads. The 790 rectifier meets this requirement. Exclusive Westinghouse Compression Bonded Encapsulation makes it immune to thermal fatigue and rugged enough for railroad service.

Anywhere between these extremes, Westinghouse has advanced-performance rectifiers for your application—low, medium, or high power; standard and high speed. High voltage stacks and potted assemblies are also available in most ratings. And most have the unique Westinghouse Lifetime Guarantee identified by this symbol ♣ on the case.

Get data now. Call your Westinghouse distributor for a copy of our Semiconductor Condensed Catalog. Or write to Westinghouse Semiconductor Division, Youngwood, Pa., 15697.

♣ Westinghouse warrants to the original purchaser that it will correct any defect or defects in workmanship, by repair or replacement f.o.b. factory, for any silicon power semiconductor bearing this symbol ♣ during the life of the equipment in which it is originally installed, provided said device is used within manufacturer's published ratings and applied in accordance with good engineering practice. This warranty shall constitute a fulfillment of all Westinghouse liabilities in respect to said products. This warranty is in lieu of all other warranties expressed or implied. Westinghouse shall not be liable for any consequential damages.

You can be sure
if it's Westinghouse



SC-2037

Technical Articles

**State variables smooth
the way for designing
complex systems
page 102**

As networks become more complex, and more engineers turn to computers to design them, there is increased interest in a method of design that uses state variables [Dec. 26, 1966, p. 63]. Now the method has been extended to simplify the design of electronic systems. Using a specially calculated performance index, the author shows how state variables can be used to design a feedback control system rapidly.

**Integrating space
telemetry with thin
films on silicon
page 111**

The exacting demands of telemetry have often kept conventional integrated circuits out of equipment. Two new families of circuits have been developed for use in applications that have the same demands for reliability and low cost. They are made by depositing thin films onto monolithic chips, thus creating a new kind of hybrid integrated electronics.

**Wider horizons for
numerical control
page 125**

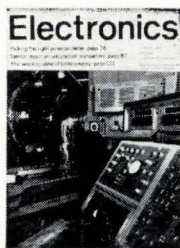

Developed for metalworking, numerical control techniques are spreading to other applications, including the manufacture of electronic equipment. Some experts are predicting the establishment of electronic manufacturing centers where the steps from design to final production will be automatic. The advent of integrated circuits that can meet industrial requirements for low cost, high reliability, and relatively high powers is speeding the development. For the cover, Joseph Sommers photographed a milling machine run by a new Acramatic IV numerical controller, built with integrated circuits by Cincinnati Milling Machine Co., as it turned out helicopter parts at the Sikorsky Aircraft division of United Aircraft Corp.

**Coming
July 10**

- A case history of computer-aided design
- Graphical processing for a computer
- A doctor criticizes the engineering approach in the first article of a series on medical electronics

State variables smooth the way for designing complex systems

A facile technique based on a performance index allows the engineer to build a feedback control system rapidly and conveniently with the help of a digital or analog computer

By Richard C. Dorf

University of Santa Clara, Santa Clara, Calif.

Large and complex feedback control systems are rarely built on the first try, but applying state-variable methods to the evaluation of a special performance index makes the design job far easier. A state variable is a quantity that describes the energy stored in a system, hence the state of the system. For instance, the voltage across the capacitor is often designated as a state variable since it completely describes the state of the capacitor at any time.

With the help of a computer, an engineer can quickly and conveniently optimize his design and evaluate how a system's capabilities are affected by various parameter tradeoffs.

The index, called J , is a quantitative measure of a system's performance, chosen to emphasize the important system specifications, and required to achieve an optimal system. When J is at minimum value, the system is said to be optimized with these characteristics:

- Assured stability.
- Accurate response to applied input signals.
- Insensitivity to changes in circuit parameters, such as component tolerances.
- Assured minimum steady-state error.

The author



Richard C. Dorf is chairman of the department of electrical engineering at the University of Santa Clara. He is also a consultant for Sylvania Electric Products Inc., where he works on computer and adaptive control systems.

All the designer need do is form a set of first-order differential equations that relate the circuit's capacitor voltages, inductor currents, and input signal to a specified matrix equation, and then use a computer to manipulate the matrixes to a desired form. A brief summary of the state-variable concept is offered on page 104.

The performance index of a system is defined in terms of its state variables,

$$J = \int_0^{t_f} g(\mathbf{x}, \mathbf{u}, t) dt$$

where \mathbf{x} is the state vector and \mathbf{u} is the control vector. The state and control vectors are column matrixes,

$$\mathbf{x} = \begin{bmatrix} x_1 \\ x_2 \\ \vdots \\ x_n \end{bmatrix} \quad \text{and} \quad \mathbf{u} = \begin{bmatrix} u_1 \\ u_2 \\ \vdots \\ u_m \end{bmatrix}$$

where x_1, x_2, \dots, x_n are the state variables of the circuit, representing currents flowing through inductors or voltages across any circuit capacitors; u_1, u_2, \dots, u_m represent the input signals.

Optimum performance is obtained by evaluating J . For example, a first-order system with one state variable x_1 has a performance expressed by

$$J = \int_0^{t_f} [x_1(t)]^2 dt \quad (1)$$

where $x_1^2 = g(x_1, u)$, and $t_f =$ the time at which the evaluation is desired. Thus, if the state $x_1(t)$ equals the system error, equation 1 represents a

performance index that is equivalent to the integral of the square of the error. The energy dissipated by the control vector is not accounted for in this equation. When it is desired, as for example keeping track of the energy in a battery aboard a space vehicle, an alternate performance index is used. Namely,

$$J = \int_0^{t_f} (x_1^2 + \lambda u^2) dt \quad (2)$$

where λ is a weighting factor, specified by designer and usually a fractional value.

To evaluate the performance index of a system with several state-variable terms consider the system at the right. The system could be a friction motor, an attitude control of a space vehicle, or any open-loop circuit without resistance and is represented by the linear vector differential equation

$$\dot{\mathbf{x}} = \mathbf{A}\mathbf{x} + \mathbf{B}\mathbf{u} \quad (3)$$

where \mathbf{u} is some function of the measured state variables \mathbf{x} as written by

$$\mathbf{u} = \mathbf{h}(\mathbf{x}) \quad (4)$$

and the control vector may be represented by the terms

$$\begin{aligned} u_1 &= k_1(x_1 + x_2) \\ u_2 &= k_2(x_2 + x_3) \\ &\vdots \end{aligned} \quad (5)$$

where k_1 and k_2 are constants.

In this illustration the feedback function is assumed to be linear, thus $\mathbf{u} = \mathbf{H}\mathbf{x}$ where \mathbf{H} is an $m \times n$ matrix. In expanded form, the matrixes are written as,

$$\begin{bmatrix} u_1 \\ u_2 \\ \vdots \\ u_m \end{bmatrix} = \begin{bmatrix} h_{11} & \cdots & h_{1n} \\ \vdots & & \vdots \\ h_{m1} & \cdots & h_{mn} \end{bmatrix} \begin{bmatrix} x_1 \\ x_2 \\ \vdots \\ x_n \end{bmatrix} \quad (6)$$

Substituting equation 6 into equation 3, yields

$$\begin{aligned} \dot{\mathbf{x}} &= \mathbf{A}\mathbf{x} + \mathbf{B}\mathbf{H}\mathbf{x} \\ &= \mathbf{D}\mathbf{x} \end{aligned} \quad (7)$$

where \mathbf{D} is the $n \times n$ matrix resulting from the addition of the element \mathbf{A} and $\mathbf{B}\mathbf{H}$.

A performance index written for two state variables is expressed by

$$J = \int_0^{t_f} (x_1^2 + x_2^2) dt \quad (8)$$

The term $x_1^2 + x_2^2$ can be rewritten by using the definition of a transpose matrix multiplied by a column matrix. Hence,

$$\begin{aligned} \mathbf{x}^T \mathbf{x} &= [x_1, x_2, x_3, \dots, x_n] \begin{bmatrix} x_1 \\ x_2 \\ \vdots \\ x_n \end{bmatrix} \\ &= (x_1^2 + x_2^2 + x_3^2 + \dots + x_n^2) \end{aligned} \quad (9)$$

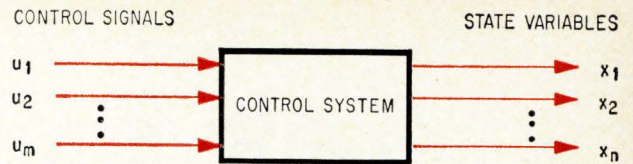

Control systems are represented by two basic parameters—the input control signal u , and the state variable x .

is applied where \mathbf{x}^T indicates the transpose of the \mathbf{x} matrix. The performance index, in terms of the state vector, is then expressed as

$$J = \int_0^{t_f} (\mathbf{x}^T \mathbf{x}) dt \quad (10)$$

In evaluating equation 10, the final time of interest is assumed as $t_f = \infty$. To obtain the minimum value of J , the existence of an exact differential is postulated so that

$$\frac{d}{dt} (\mathbf{x}^T \mathbf{P}\mathbf{x}) = -\mathbf{x}^T \mathbf{x} \quad (11)$$

where \mathbf{P} is a matrix to be determined. A symmetric \mathbf{P} matrix is assumed to simplify the algebra without any loss of generality. Hence, for a symmetric \mathbf{P} matrix, $P_{ij} = P_{ji}$ when $i \neq j$. Completing the differentiation indicated on the left-hand side of equation 11, yields

$$\frac{d}{dt} (\mathbf{x}^T \mathbf{P}\mathbf{x}) = \dot{\mathbf{x}}^T \mathbf{P}\mathbf{x} + \mathbf{x}^T \dot{\mathbf{P}}\mathbf{x} \quad (12)$$

Then, substituting equation 7 into equation 12 produces

$$\begin{aligned} \frac{d}{dt} (\mathbf{x}^T \mathbf{P}\mathbf{x}) &= (\mathbf{D}\mathbf{x})^T \mathbf{P}\mathbf{x} + \mathbf{x}^T \mathbf{P}(\mathbf{D}\mathbf{x}) \\ &= \mathbf{x}^T \mathbf{D}^T \mathbf{P}\mathbf{x} + \mathbf{x}^T \mathbf{P}\mathbf{D}\mathbf{x} \\ &= \mathbf{x}^T (\mathbf{D}^T \mathbf{P} + \mathbf{P}\mathbf{D}) \mathbf{x} \end{aligned} \quad (13)$$

where $(\mathbf{D}\mathbf{x})^T = \mathbf{x}^T \mathbf{D}^T$ by the definition of the transpose of a product. If $(\mathbf{D}^T \mathbf{P} + \mathbf{P}\mathbf{D})$ is assumed equal to the identity matrix, $-\mathbf{I}$, equation 13 becomes

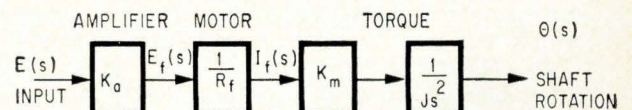
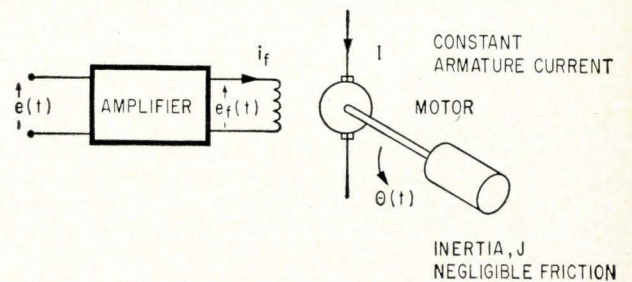

Transfer functions for each of the d-c servomechanism parts—amplifier, motor, and load—are expressed with the complex variable s .

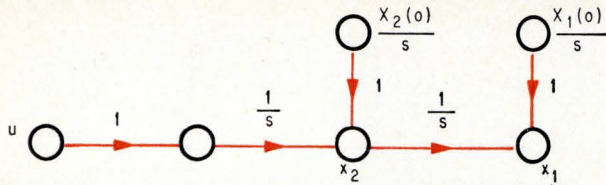

Signal-flow graph of open-loop portion of the uncompensated d-c servomechanism system with state variables, x_1 and x_2 . The input of the servomechanism is u .

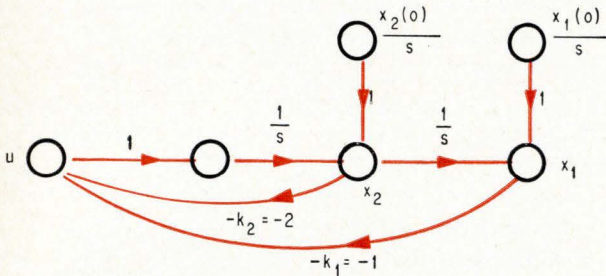

Servomechanism is optimized by feedback with the constants k_1 and k_2 equal to 1 and 2, respectively. Compensated system is not very sensitive to changes in k_2 .

$$\frac{d}{dt} (\mathbf{x}^T \mathbf{P} \mathbf{x}) = -\mathbf{x}^T \mathbf{x} \quad (14)$$

which is the exact differential sought. The identity matrix is defined as a matrix with all terms on the main diagonal equal to unity and whose off-diagonal terms equal zero. Substituting equation 14 into equation 10 yields

$$\begin{aligned} J &= \int_0^{\infty} -\frac{d}{dt} (\mathbf{x}^T \mathbf{P} \mathbf{x}) dt \\ &= -\mathbf{x}^T \mathbf{P} \mathbf{x} \Big|_0^{\infty} \\ &= \mathbf{x}^T (0) \mathbf{P} \mathbf{x} (0) \end{aligned} \quad (15)$$

In the evaluation of the limit at $t_f = \infty$, it is assumed that the system is stable and hence $\mathbf{x}(\infty) = 0$, a requirement for stability. Therefore, to minimize the performance index J , the designer should determine the matrix \mathbf{P} that satisfies $\mathbf{D}^T \mathbf{P} + \mathbf{P} \mathbf{D} = -\mathbf{I}$ when \mathbf{D} is known, and minimize J by determin-

ing the minimum value of

$$J = \int_0^{\infty} \mathbf{x}^T \mathbf{x} dt = \mathbf{x}^T (0) \mathbf{P} \mathbf{x} (0).$$

Designing a d-c servomechanism

As an example of how this technique is applied, consider the d-c servomechanism represented by the block diagram on page 103. The transfer function representing this motor, load, and amplifier neglects the inductance of the field coil and the friction of the rotating load. It is also assumed that the product of the amplifier gain K_a and motor gain K_m divided by the motor resistance R_f times J ($K_a K_m / R_f J$) equals 1 and the value of the feedback gains remain to be determined. In this example the state variables x_1 and x_2 represent the position and velocity of the control system and are depicted for the open-loop portion of the system shown at the above left. As the system is defined, the performance is quite unsatisfactory since an undamped response will result from a step input or disturbance signal. To achieve the best design the engineer first determines the vector differential equation of this system using equation 3. Hence,

$$\frac{d}{dt} \begin{bmatrix} x_1 \\ x_2 \end{bmatrix} = \begin{bmatrix} 0 & 1 \\ 0 & 0 \end{bmatrix} \begin{bmatrix} x_1 \\ x_2 \end{bmatrix} + \begin{bmatrix} 0 \\ 1 \end{bmatrix} u(t) \quad (16)$$

where $\mathbf{A} = \begin{bmatrix} 0 & 1 \\ 0 & 0 \end{bmatrix}$. A feedback control system is chosen so that

$$u(t) = -k_1 x_1 - k_2 x_2 \quad (17)$$

producing a control signal that is a linear function of the two state variables. As the sign indicates, the feedback is negative. Substituting equation 17 into 16 yields,

$$\begin{aligned} \dot{x}_1 &= x_2 \\ \dot{x}_2 &= -k_1 x_1 - k_2 x_2 \end{aligned} \quad (18)$$

or, expressed in matrix form,

$$\begin{aligned} \dot{\mathbf{x}} &= \mathbf{D} \mathbf{x} \\ &= \begin{bmatrix} 0 & 1 \\ -k_1 & -k_2 \end{bmatrix} \mathbf{x} \end{aligned} \quad (19)$$

Reviewing state variables

The state variable is a quantity that describes the energy stored in a system, hence, the state of the system. When a system is an electrical network, the variables considered are usually the currents through the inductors and the voltages across the capacitors of the network.

This choice allows the engineer to describe the dynamic behavior of a network with n first-order differential equations rather than one n th-order differential equation.

Thus, if a network is usually described by a second-order differential equation, the state-variable method describes the network with two first-order differential equations. These first-order equations are written in terms of the chosen state variables and any input voltage or current sources.

The first-order equations produced by the state-variable technique are ideally suited to solution by either analog or digital computer. In an analog computer,

only one integrating network is required for each equation. Furthermore, state techniques need not be restricted to systems that are described only by differential equations; they may also be used to analyze and design sequential machines, switching networks, and sampled data systems. The steps required for setting up a state-variable equation are given in detail by Louis dePian in "Analyzing networks with state variables," [Electronics, Dec. 26, 1966, p. 63].

In this case the friction is assumed negligible, x_1 represents the location of the position control system, $G(s) = 1/s^2$ represents the transfer function of the open-loop system, and $K_a K_m/R_a J = 1$. In addition, k_1 is chosen as equal to 1 to simplify the algebra and the value for k_2 remains to be determined for a minimized performance index.

Examining the closed-loop feedback system when $k_1 = 1$ produces

$$D^T P + PD = -I$$

$$\begin{bmatrix} 0 & -1 \\ 1 & -k_2 \end{bmatrix} \begin{bmatrix} p_{11} & p_{12} \\ p_{12} & p_{22} \end{bmatrix} + \begin{bmatrix} p_{11} & p_{12} \\ p_{12} & p_{22} \end{bmatrix} \begin{bmatrix} 0 & 1 \\ -1 & -k_2 \end{bmatrix} = \begin{bmatrix} -1 & 0 \\ 0 & -1 \end{bmatrix} \quad (20)$$

Completing the matrix multiplication and addition of equation 20 yields

$$\begin{aligned} -p_{12} - p_{12} &= -1 \\ p_{11} - k_2 p_{12} - p_{22} &= 0 \end{aligned} \quad (21)$$

$$p_{12} - k_2 p_{22} + p_{12} - k_2 p_{22} = -1$$

solving these equations simultaneously produces, $P_{12} = 1/2$, $P_{22} = 1/k_2$, and $P_{11} = (k_2^2 + 2)/2k_2$. The integral performance index can now be evaluated from equation 15. The evaluation of J begins by assuming a trial displacement for each state. For example, assume the system is initially displaced one unit from equilibrium so that $\mathbf{x}^T(0) = [1, 1]$. Therefore, equation 15 becomes

$$\begin{aligned} J &= [1, 1] \begin{bmatrix} p_{11} & p_{12} \\ p_{12} & p_{22} \end{bmatrix} \begin{bmatrix} 1 \\ 1 \end{bmatrix} \\ &= [1, 1] \begin{bmatrix} p_{11} + p_{12} \\ p_{12} + p_{22} \end{bmatrix} \\ &= (p_{11} + p_{12}) + (p_{12} + p_{22}) = p_{11} + 2p_{12} + p_{22} \end{aligned} \quad (22)$$

Substituting the values of the P elements into equation 22 yields

$$\begin{aligned} J &= \frac{k_2^2 + 2}{2k_2} + 1 + \frac{1}{k_2} \\ &= \frac{k_2^2 + 2k_2 + 4}{2k_2} \end{aligned} \quad (23)$$

To minimize the performance index, the derivative of equation 23 with respect to k_2 is set equal to 0 as follows:

$$\frac{\partial J}{\partial k_2} = \frac{2k_2(2k_2 + 2) - 2(k_2^2 + 2k_2 + 4)}{(2k_2)^2} = 0 \quad (24)$$

Solving equation 24 shows that J is a minimum, when the value $k_2 = 2$ is substituted into equation 23. Hence, $J_{\min} = 3$. The system matrix D , obtained from equation 7 for the compensated system, is then

$$D = \begin{bmatrix} 0 & 1 \\ -1 & -2 \end{bmatrix} \quad (25)$$

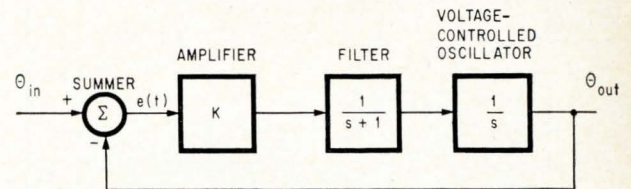
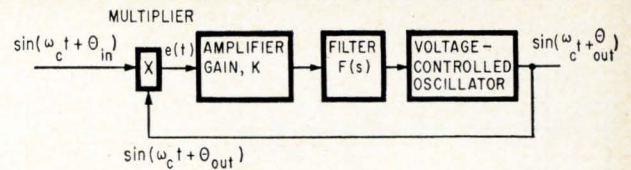

Transfer functions represent system relationships for the phase detector. Input error, $e(t)$, is the algebraic product of the two sine terms. When $\theta_{in} - \theta_{out}$ is less than 0.5 radian, $e(t)$ becomes equal to the algebraic sum of θ_{in} and θ_{out} and the multiplier stage of the top diagram is replaced by a summer.

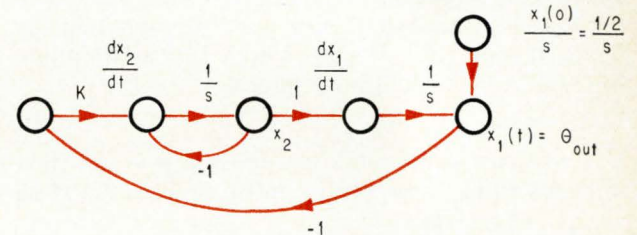

Compensated network for the phase detector is represented by a signal-flow graph. When the gain, K , is set equal to 1 the system is optimum.

and the characteristic equation of the compensated system is equal to

$$\begin{aligned} \det[\lambda I - D] &= \det \begin{bmatrix} \lambda & -1 \\ 1 & \lambda + 2 \end{bmatrix} \\ &= \lambda^2 + 2\lambda + 1 \end{aligned} \quad (26)$$

The characteristic equation is of the form $(s_2 + 2\xi\omega_n s + \omega_n^2)$ since this is a second-order system. By examining equation 26 for coefficients the damping ratio of the compensated system is observed as $\xi = 1.0$. This is considered to be optimum because it results in a minimum value for the performance index. Of course, this system is only optimized for the specific set of initial conditions that were assumed. A flow graph of the compensated system is illustrated in the lower drawing on page 104. The system is relatively insensitive to changes in k_2 .

Designing a phase detector

A phase-lock system, for color television, missile tracking, and space telemetry, is designed to maintain zero-phase difference between the input carrier signal and the local voltage-controlled oscillator (vco). Such a system is represented in block-diagrams shown above. The filter is designed to provide a narrow bandwidth for the system and reduce the effect of input noise at the output of the vco. The multiplier stage of the circuit forms an error

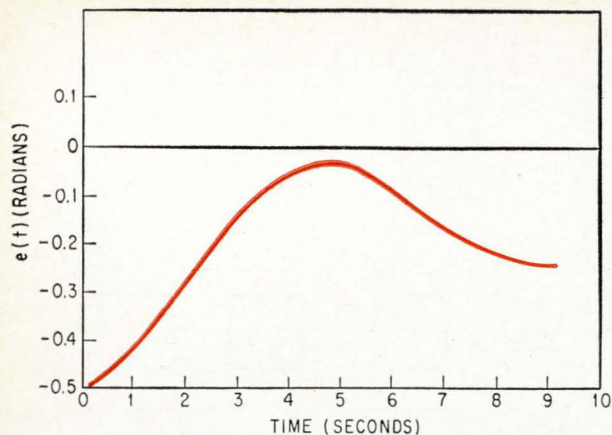

Error $e(t)$ is reduced to within 0.08 radian after 2 seconds and phase lock is achieved within 8 seconds.

signal, $e(t)$, that is equal to the product of $\sin(\omega_c t + \theta_{in})$ and $\sin(\omega_c t + \theta_{out})$. The upper sideband signal resulting from the multiplication is neglected because it is at a frequency much higher than the bandwidth of the detector. Under this assumption, the result of the multiplication is

$$e(t) = \sin(\theta_{in} - \theta_{out}) \quad (27)$$

If the phase error, $e(t)$, is sufficiently small (less than 0.5 radian) the error can be approximated as

$$e(t) = \theta_{in} - \theta_{out} \quad (28)$$

Determine the gain of the amplifier, K , needed to optimize the performance of the detector. The performance of this closed-loop system is characterized by its ability to reduce phase error $e(t)$ to zero when the initial condition of the vco is different from the phase of the input signal. This condition may be represented by an initial condition $\theta_{out}(0) = 0.5$ radian at time $t = 0$. Then, for an input signal with a phase equal to zero radian, the initial error is

$$e(0) = \theta_{in}(0) - \theta_{out}(0) = -0.5 \text{ radians} \quad (29)$$

A flow graph of the system, on page 105, helps to determine the state-variable equations. In this example the state variables are chosen as the output of the integrators and determined from the following set of first-order differential equations:

$$\begin{aligned} \frac{dx_1}{dt} &= x_2 \\ \frac{dx_2}{dt} &= -Kx_1 - x_2 \end{aligned} \quad (30)$$

in matrix form, equation 30 is expressed as

$$\frac{dx}{dt} = \mathbf{D}x \quad (31)$$

where the matrix for \mathbf{D} is given by

$$\mathbf{D} = \begin{bmatrix} 0 & 1 \\ -K & -1 \end{bmatrix}$$

For this system, equation 29 is expressed as $e(0) = -x_1(0) = -\theta_{out}(0) = -0.5$ radian. It is

assumed that $x_2(0) = 0$, and the performance index of the system is determined from equation 15 to be,

$$J = \mathbf{x}^T(0) \mathbf{P} \mathbf{x}(0) \quad (32)$$

Since $\mathbf{x}^T(0) = [0.5, 0]$,

$$\begin{aligned} J &= \mathbf{x}^T(0) \begin{bmatrix} p_{11} & p_{12} \\ p_{12} & p_{22} \end{bmatrix} \begin{bmatrix} x_1(0) \\ 0 \end{bmatrix} \\ &= [x_1(0), 0] \begin{bmatrix} p_{11}x_1(0) \\ p_{12}x_1(0) \end{bmatrix} = p_{11}x_1^2(0) \end{aligned} \quad (33)$$

To minimize the performance index J with respect to the gain K , the value of the element p_{11} must be obtained using equation 20. Thus,

$$\begin{aligned} \mathbf{D}^T \mathbf{P} + \mathbf{P} \mathbf{D} &= -\mathbf{I} \\ \begin{bmatrix} 0 & -K \\ 1 & -1 \end{bmatrix} \begin{bmatrix} p_{11} & p_{12} \\ p_{12} & p_{22} \end{bmatrix} + \\ \begin{bmatrix} p_{11} & p_{12} \\ p_{12} & p_{22} \end{bmatrix} \begin{bmatrix} 0 & 1 \\ -K & 1 \end{bmatrix} &= \begin{bmatrix} -1 & 0 \\ 0 & -1 \end{bmatrix} \end{aligned} \quad (34)$$

This matrix equation yields the following three equations:

$$\begin{aligned} 2K p_{12} &= 1 \\ p_{11} - p_{12} - K p_{22} &= 0 \\ 2p_{12} - 2p_{22} &= -1 \end{aligned} \quad (35)$$

from which the designer obtains p_{11} as

$$p_{11} = \frac{1}{K} + \frac{K}{2} + \frac{1}{2} \quad (36)$$

Substituting p_{11} into equation 33 results in an expression for J :

$$J = \left(\frac{1}{2K} + \frac{K}{2} + \frac{1}{2} \right) x_1^2(0) \quad (37)$$

where $x_1^2(0) = 1/4$. Taking the derivative of J with respect to K leads to

$$\frac{dJ}{dK} = \frac{x_1^2(0)}{2} \left(-\frac{1}{K^2} + 1 \right) = 0$$

and therefore, minimum J is obtained when $K = 1$ and results in

$$J = (3/2) x_1^2(0)$$

A plot of the normalized performance index $J/x_1^2(0)$ versus the amplifier gain K can be obtained from equation 37. The transient response of the error $e(t)$ is shown above. Note that the error is reduced to within 0.08 radian after 2 seconds and phase lock is established within 8 seconds.

Although these examples are amenable to computer calculation, they would most likely be evaluated by manual techniques. The prudent designer saves the computer for complex systems.

Bibliography

- Richard C. Dorf, "Time-Domain Analysis and Design of Control Systems," Addison-Wesley Publishing Co., 1965.
 Louis dePian, "Analyzing networks with state variables," Electronics, Dec. 26, 1966, p. 63.
 Richard C. Dorf, "Modern Control Systems," Addison-Wesley Publishing Co., 1967.

Designer's casebook

Designer's casebook is a regular feature in Electronics. Readers are invited to submit novel circuit ideas, packaging schemes, or other unusual solutions to design problems. Descriptions should be short. We'll pay \$50 for each item published.

Diode's resistance variation stabilizes signal amplitudes

By F. Giannazzi

Societa Italiana Sviluppo Propulsione a Reazione
Rome, Italy

A voltage-controlled oscillator's output amplitude is stabilized over its frequency range by a circuit that applies a junction diode's dynamic resistance variation. The circuit acts as a nonlinear resistive divider whose output varies inversely with input changes.

Diode D_1 and capacitor C_1 detect the input, V_1 , which is the vco's signal amplitude. The input is also applied through capacitor C_2 to the resistive divider formed by R_2 and R_d , the dynamic resistance of diode D_2 .

The amplitude of the output signal, V_2 , is a function of V_1 and R_d . The diode dynamic resistance varies inversely with bias current. This bias current is established by kV_1 , the detected voltage at node B (k = detector efficiency).

When V_1 is restricted to small values (about 0.5 volt), k is not a constant, but increases with V_1 . Thus, an increase in V_1 has two opposite, but unequal, effects on V_2 . The increased voltage, V_1 ,

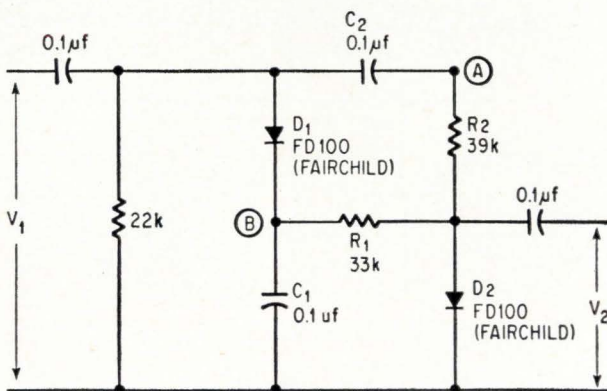

Oscillator's output, V_1 , is stabilized by variations in dynamic resistance of D_2 . Voltage V_2 is the oscillator output after stabilization.

at node A causes V_2 to increase. However, the increase in kV_1 at node B increases D_2 's bias current and reduces R_d proportionately. This causes a decrease in V_2 . The drop in R_d more than compensates for the increase in V_1 at node A. The net result is a drop in V_2 . Conversely, a decrease in V_1 produces an increase in V_2 .

To ensure proper circuit operation, V_2 should be about 10 millivolts. If the circuit is a feedback branch of an oscillator loop, the forward branch should have a gain of 50, to compensate for the attenuation of V_1 by this circuit.

Two flatpacks furnish pulses for IC testing

By M.V. Pitke

Tata Institute of Fundamental Research
Bombay, India

Two integrated circuit flatpacks are the only active circuit devices required to produce pulses of variable width and repetition rate. The output levels are compatible with diode-transistor logic (DTL) and transistor-transistor logic (TTL), and yield an inexpensive source of test signals for the occasional user of IC's.

The circuit consists of an oscillator and a monostable multivibrator. The multivibrator's pulse repetition rate is established by the oscillator frequency, and the output pulse width is controlled by the multivibrator.

Three inverters, G_1 , G_2 , and G_3 , are connected as a push-pull oscillator whose frequency is controlled by the capacitors C_1 and potentiometer P_1 . Because the capacitors load the inverters heavily, the oscillator output is distorted, and G_4 is needed to reshape the output to the desired waveform. Inverter G_4 's threshold characteristics produce a square-wave train for triggering the multivibrator.

Two inverters, G_5 and G_6 , from a TTL flatpack

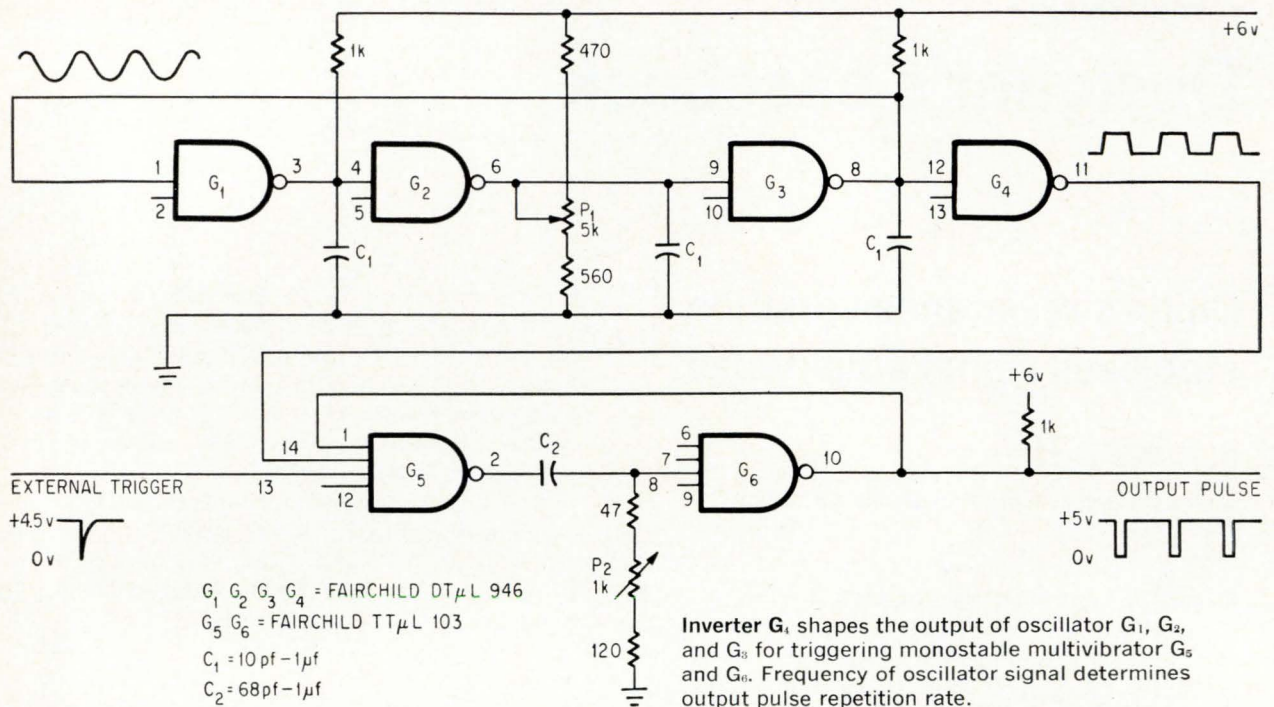

form the monostable multivibrator. Capacitor C_2 and potentiometer P_2 are coarse and fine controls of the output pulse width. The output goes from 5 to 0 volts, with a 6-volt supply, and the circuit output impedance is sufficiently low (approximately 120 ohms) to drive a number of gates in parallel. By adding an additional inverter to the chain, posi-

tive pulses are obtained.

With values of C_2 ranging from 68 picofarads to 1 microfarad, pulse widths from 30 nanoseconds to about 2 milliseconds are obtained. Pulse repetition rates between 12.5 megahertz and 500 hertz are possible with C_1 capacitor values that range from 10 pf to 1 μf .

Integrated gates form fast monostable multivibrator

By Paul Sandland

University of the West Indies, Kingston, Jamaica

Three of the four NAND gates in a single integrated circuit form a fast multivibrator whose output pulse width is independent of the input pulse width and insensitive to changes in supply voltage. In addition, the reverse supply voltage is never applied to the gates as in a conventional circuit—a possible cause of transistor breakdown.

Under quiescent conditions, the logic relations for the gates are:

$$X_2 = Z_3 = \overline{Z_1} \cdot \overline{Z_2} = \overline{Y_3} \cdot \overline{X_3} = \overline{X_3} \cdot \overline{X_3} = 1$$

Hence, $X_1 = X_2 = Z_3 = Y_3 = Z_1 = 1$

$$X_3 = Y_1 = Y_2 = Z_2 = 0$$

When X_1 receives a negative pulse, X_3 and Z_2 switch to the 1 state. As a result, Z_3 and X_2 switch to the 0 state. After the X_1 negative pulse is removed, X_3 remains at 1, since X_2 is at 0. With Y_3 switched to 0, capacitor C discharges toward 0.

When the voltage at Z_1 reaches 0, Z_3 switches back to 1. Thus X_3 returns to 0 and applies feed-

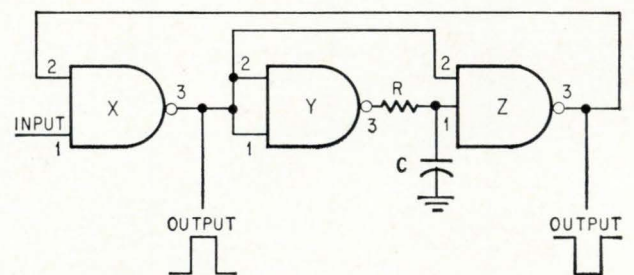

X, Y and Z are 3 of the 4 gates of a Sylvania SG223

Complementary outputs are obtained when a negative pulse is applied to X_1 .

back to Z_2 , causing it to switch states. Capacitor C recharges through R to the 1 state, and the cycle is completed.

Complementary outputs, isolated from the timing components, R and C , are available from X_3 and Z_3 . The minimum output pulse width is less than

50 nanoseconds, and the rise and fall times are less than 10 nsec. With a 1 level of 4 volts and a 0 level of less than 0.45 volt, the period of the monostable is $1.4 RC$. To meet the current requirements of the gates shown, (2.5 milliamps input in the zero state), R should not exceed 220 ohms.

Npn amplifier delivers fast, high-voltage pulses

By David Perlman

Eastman Kodak Co., Rochester, N. Y.

An amplifier delivering a train of high voltage, high-duty cycle pulses to a capacitive load must have a low output impedance to transfer the charge rapidly to and from the load. An emitter follower is not suitable for this application, because transistor turn-off at the end of the pulse presents the load with a considerably increased impedance.

If a complementary emitter follower is used, the desired output impedance is obtained. In this circuit, the load charges through pnp transistor Q_A and discharges through npn transistor Q_B with essentially equal time constants. However, the maximum pulse amplitude that can be handled is limited by the breakdown voltage of transistor Q_B , since the breakdown ratings of pnp transistors

are usually lower than that of npn transistors. The amplifier shown below uses only npn transistors, providing high-voltage operation and offering output impedance characteristics equivalent to those of the complementary emitter follower. Transistor Q_1 is a common-emitter amplifier that drives the Darlington combination of Q_2 and Q_3 , a high-current-gain emitter follower. Resistor R_2 reduces the loading at Q_1 's collector by bootstrapping the emitter follower input.

The amplifier's output impedance is controlled

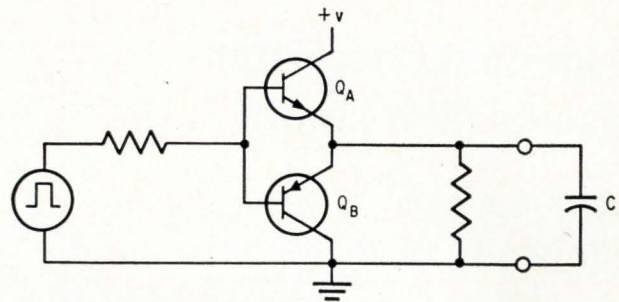

Complementary emitter-follower configuration is often used as a low-output-impedance pulse amplifier.

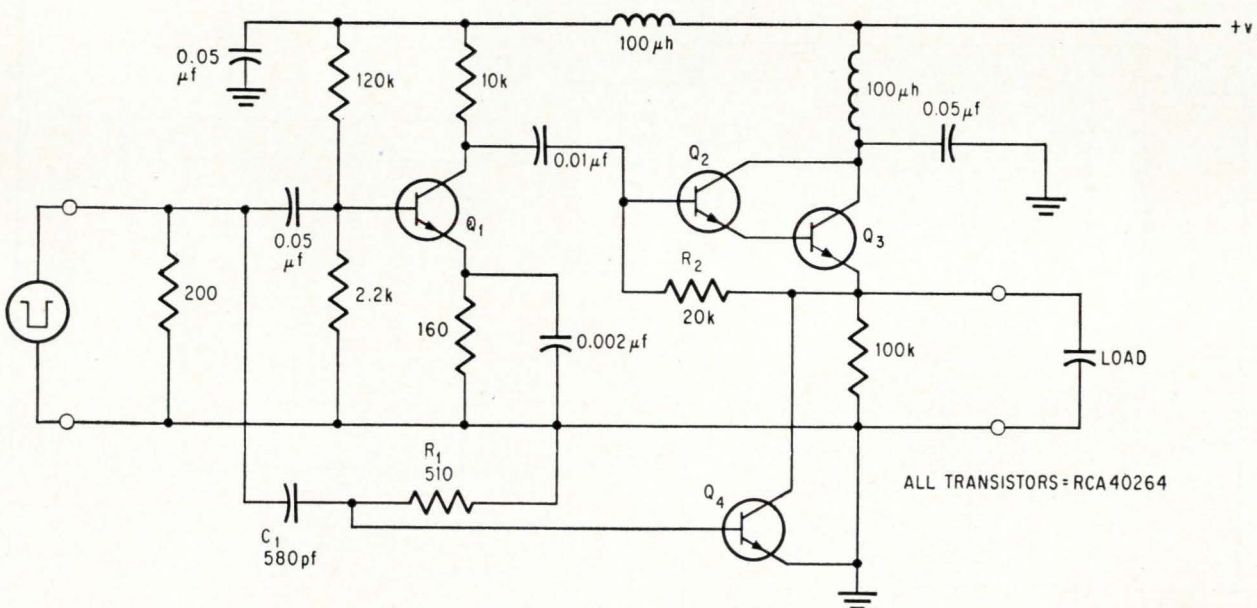

Differentiating circuit, R_1 and C_1 delivers a positive spike to transistor Q_1 at the end of the input pulse. The saturated transistor provides a low-impedance discharge path for the capacitive load.

by differentiating circuit R_1 and C_1 , connected across the input, and transistor Q_4 , which shunts the capacitive load. For each input pulse, the differentiating circuit transmits a pair of alternate negative and positive spikes to the base of Q_4 . The negative spike, corresponding to the leading

edge of the input pulse, reverse-biases transistor Q_4 and cuts it off until the end of the input pulse. At this point, the positive spike, corresponding to the input pulse's trailing edge, drives Q_4 into saturation. This provides a very low impedance discharge path for the load capacitance.

Voltage-tuned oscillator measures filter cutoff

By James M. Kasson

Santa Rita Technology Inc., Menlo Park, Calif.

A filter's cutoff frequency is quickly and automatically determined by a voltage-controlled oscillator (vco) arranged in a feedback loop with two detectors that measure the filter's output and input levels. When the difference between these levels falls off to a specified value (usually 3 decibels), the vco frequency equals the filter's cutoff value and can be measured with a meter.

When testing a low-pass filter, detector A_1 pro-

vides a positive signal corresponding to the filter input level, and detector A_2 provides a negative signal corresponding to the filter output level. These voltages are applied to potentiometer P_1 at points A and B. The adjustable arm of P_1 is set so that a null exists at the input to integrator A_3 when the filter output is 3 db less than the input. (A filter insertion loss of 0 db is assumed.)

As an example of circuit operation, consider that the filter is retuned to increase its cutoff frequency. The input to the integrator goes negative, causing the integrator's output to become more positive. This signal is applied to the vco, causing its frequency to increase. If the potentiometer is adjusted for 3 db, the new vco frequency equals the cutoff frequency.

For testing high-pass filters, the positions of the positive and negative detectors are reversed.

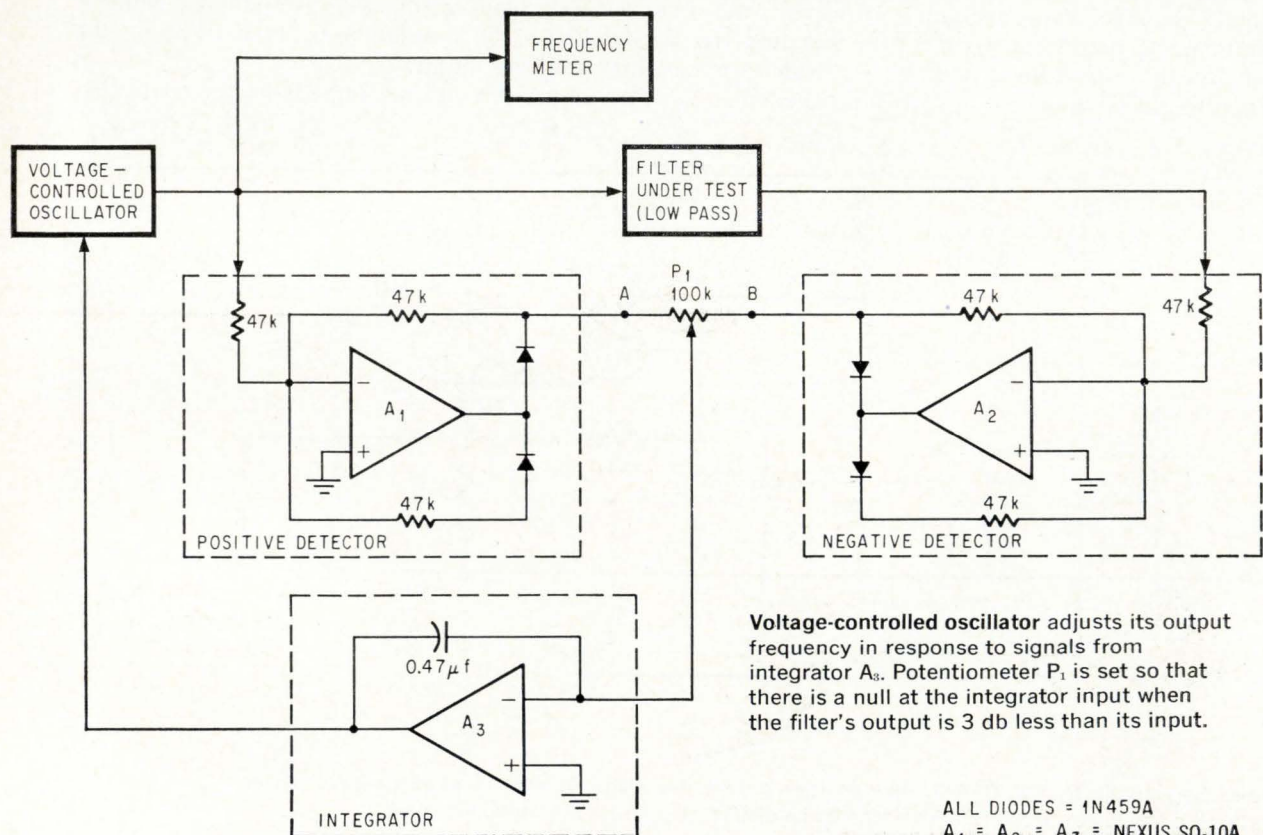

Voltage-controlled oscillator adjusts its output frequency in response to signals from integrator A_3 . Potentiometer P_1 is set so that there is a null at the integrator input when the filter's output is 3 db less than its input.

ALL DIODES = 1N459A
 $A_1 = A_2 = A_3 =$ NEXUS SQ-10A

Integrating space telemetry systems with compatible thin films on silicon

Conventional IC's can't perform as well as discretely in telemetry gear—but two new families of circuits combine the best features of monolithic and thin-film technology to improve airborne systems

By D.P. Schulz and D.J. Dooley

TRW Systems Group, Redondo Beach, Calif.

Although the motivation for applying integrated circuits in aerospace telemetry systems is strong, the potential advantages of reduced size and weight, improved reliability, and lower maintenance costs can't be realized in such systems through the use of conventional techniques.

For example, the weakest links in telemetry systems won't be strengthened by merely substituting integrated circuits where discrete component circuits are now used. IC's just cannot perform as well as conventional components in telemetry functions like comparators and commutators.

The best approach is to eliminate the weak links and reorganize the system around new kinds of integrated circuits.

TRW Systems group has developed two new families of compatible IC's which combine the low cost and reliability of monolithic silicon devices with the precision and flexibility of thin-film technology. The families are used to compare and commutate transducer signals under control of logic IC's that are off-the-shelf items.

One of these families is based upon a gated differential comparator amplifier. This type of circuit does the job of both comparator and commutator. The second circuit family is a NAND-type voltage level shifter that provides the interfaces needed between the signal channels and the remaining elements of the telemetry system.

Monolithics plus thin-film

The families are called compatible because of the way they are made—as monolithic IC's containing both npn and pnp transistors, with thin-film resistors deposited on the silicon crystal substrate.

The resistors are of cermet or nichrome films, deposited directly on silicon by a technique developed at TRW to produce highly stable and accurate resistive elements. This construction improves electrical performance and permits numerous variations in circuit design. In addition it is relatively inexpensive to make because the active elements are treated as basic building blocks which can be modified by changes in the thin-film devices.

Many IC's in the compatible family can be mated with off-the-shelf digital units such as diode-transistor logic (DTL) or transistor-transistor logic (TTL), keeping the linear-digital interface to a minimum. The level shift circuit elements provide enough output amplitude to connect directly with discrete semiconductor stages, such as driver networks and

The authors



Donald P. Schulz is currently responsible for integrated circuit applications at TRW Systems. A UCLA graduate, he has worked with semiconductors for the past 8 years, concentrating on evaluation, testing, development, and production. Schulz has written 15 articles on semiconductor device applications.



Daniel J. Dooley, TRW project engineer, has completed work for his MS in electrical engineering at California State College. Dooley is responsible for the design and fabrication of monolithic and hybrid IC's. He also specializes in high-frequency circuitry and spacecraft data-processing systems.

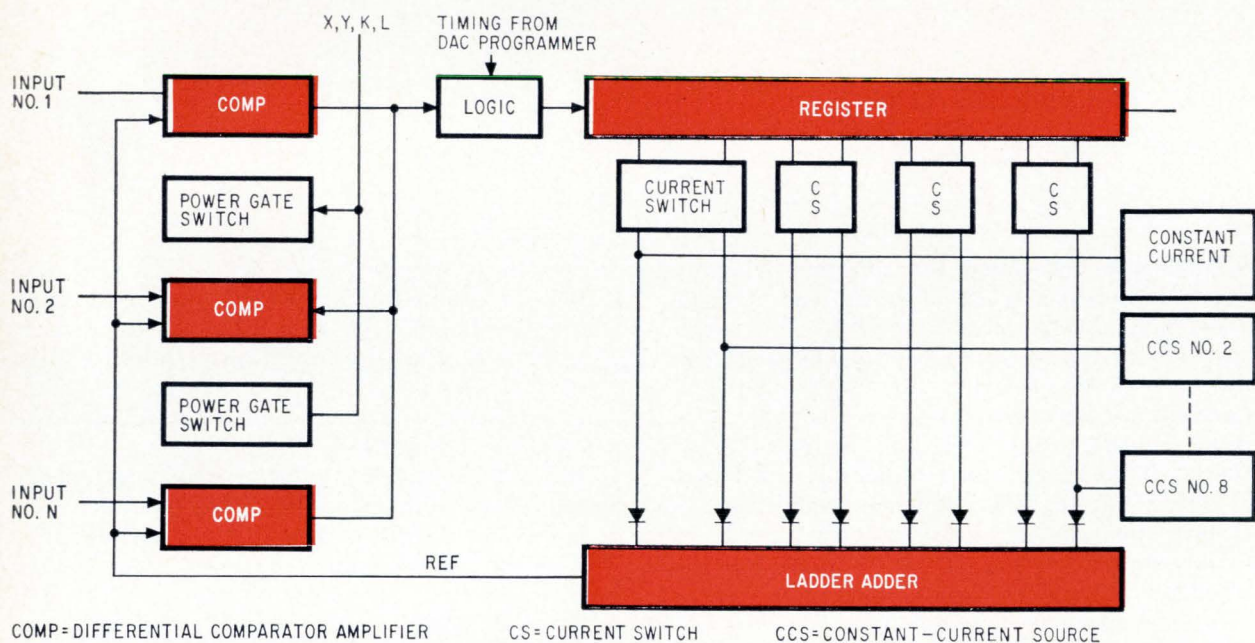
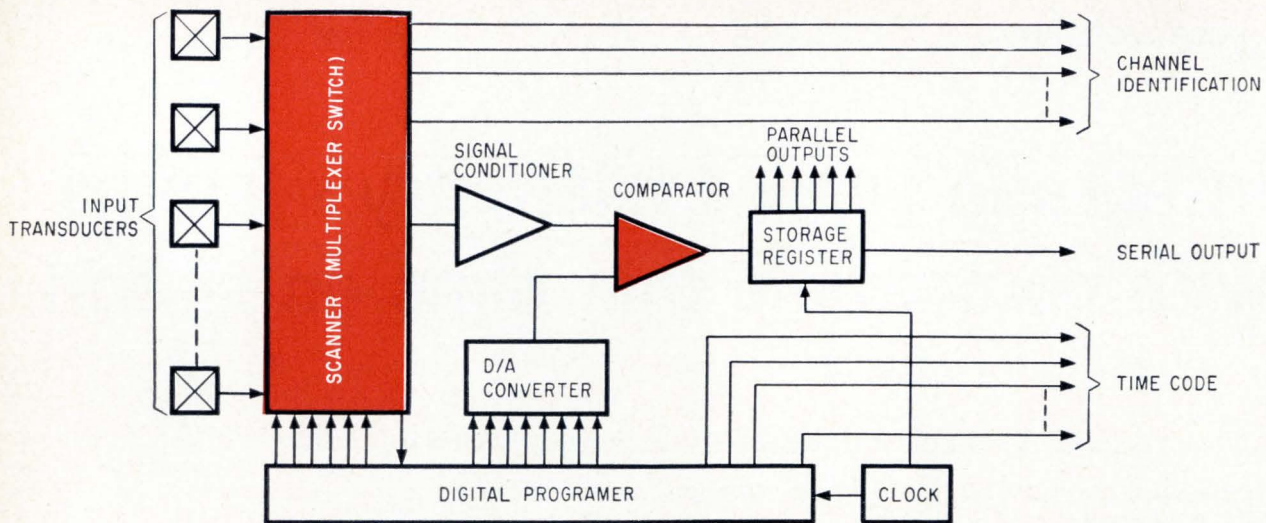

Conventional telemetry system (top) uses a single comparator to process analog signals from the scanner (multiplexer) and the digital-to-analog converter. Malfunction of the comparator renders the entire system inoperable. When a multiple-gated multiple-comparator scheme is employed, the ensuing redundancy makes the system more reliable.

buffer amplifiers.

In the design with integrated circuits, the weaknesses of the conventional system are eliminated by assigning a complete signal channel, with its own comparing, commutator, and level shifting circuits, to each signal source or transducer. This redundancy means that the telemetry system is more reliable—even if one channel fails, the others will continue to operate.

Why compatibility is needed

Off-the-shelf monolithic IC's cannot be used extensively in telemetry designs, primarily because many of the required circuit blocks just aren't available. Size and weight can be somewhat reduced, but the increase in complexity offsets those advantages. In addition, the mere substitution of

monolithic replacements does not overcome performance limitations in the conventional (discrete component) system, shown in top diagram, above.

There, a commutating-type multiplexer, with a single comparator, is used. If the comparator breaks down, the entire system becomes inoperable. A multiple-gated, multiple-comparator system, implemented with standard IC's improves system performance and reliability, but such a scheme is not easily fabricated with ordinary monolithics.

On the other hand, the compatible approach is amenable to this multichannel switching and processing redesign. The circuit needs of the multiple approach—comparators, switching, level shifting, current sourcing, etc.—can be implemented with the basic compatible IC blocks. In many cases the only changes required are those of resistor values

and the number and configuration of active devices. Thus, economy and flexibility are attendant, reliability is higher, time-sharing is more extensive, and over-all performance is more accurate and precise.

Common elements of telemetry systems

Typically, a conventional telemetry signal conditioning and processing scheme includes a single, multiplexed comparator—usually servicing input channels from several transducers; a staircase or sawtooth reference voltage generator; a data storage register; control, and sequence logic circuits.

These elements sequentially compare an analog input voltage to an internally generated reference voltage, convert the result into a digital number, and provide temporary storage of the input data. The output may take several forms—serial and/or parallel; pulse-amplitude modulation; pulse-duration modulation; binary—or combinations of these.

Most high-speed (> 1 megabit per second) systems employ a data conversion technique known as the method of successive approximation. It sequentially compares each analog input voltage from the transducer with a fraction of the reference voltage to minimize total conversion time. Converters of this type are only economical when used with a multiplicity of input channels. Time sharing of the input comparator requires an analog commutator which sequentially connects the various input voltages to the converter. A representative commutator consists of a set of analog voltage switches with their associated drivers, a timing generator, several d-c buffer amplifiers, and control logic circuits.

Although parts of the system can be implemented with commercially available digital integrated circuits (such as DTL) several critical circuit elements have only recently become amenable to microcircuit fabrication. These include the comparator amplifier, the interface digital circuits, and the digital-to-analog converter circuits—all fairly complex units; they have not achieved off-the-shelf status.

IC's overcome weaknesses

The previously described system suffers from two major disadvantages. The primary one arises from signal errors introduced because of excessive voltage drops and leakage currents in the input analog switches. The voltage drops are due to losses in the ON (sample) input channel. Leakage currents are simultaneously flowing in the remaining (OFF) input channels.

The second limitation relates to system dependence upon the performance of a single comparator. If many gated comparator elements were used instead, the system would be independent of any one comparative channel, and therefore, less critical.

The new approach uses differential comparators but does not need the input analog switches. A multiplicity of active (diode-gated) independent input channels are also employed. Logic circuits, instead of a commutator, gate the inputs sequentially and the resulting redundancy (due to the multiplicity) increases over-all system reliability, as dis-

played in the lower diagram on page 112.

Power gating between the system power supply and the input channel comparator amplifier is used so that only one channel is on at a time. Thus, total power dissipation is essentially the same as with the multiplexed single comparator method. System complexity is increased, but this is more than offset by the inherent advantages of size, weight, and increased reliability offered by the IC's.

Critical comparator

The differential comparator, detailed on pages 114-115, is a critical element in the integrated telemetry system. It accurately resolves signal differences and provides a linear output level indicating which of two input voltages is greater. Analog input E_a is a signal ranging between 0 and 5 volts; reference signal E_r covers the same range.

The circuit consists of three cascaded direct-coupled differential amplifier stages working into a single-ended output. An external load resistor of 1.4 kilohms and a pnp level-shift stage are connected to the output of this monolithic structure to help maintain a minimum over-all gain of 15,000.

To simplify the IC design and provide for multiplexing of outputs, the pnp output stage Q_{14} is an external transistor chip. This transistor also provides a shift in level which permits the output to swing between 0 and 15 volts.

Although a small input bias current, less than 400 nanoamperes, was one circuit requirement (to prevent loading errors), it was decided not to use a Darlington input stage because of the increase in thermal sensitivity and higher offset usually encountered with the Darlington. In addition, with the Darlington configuration, input impedances and input currents vary as the product of the current gains of the compounded devices.

Current sources galore

Common-mode biasing of the differential stages is accomplished by a constant-current source in the emitter of each stage. The current source utilizes the high output impedance of a transistor operated in the common-base configuration. Performance of the critical first stage (Q_1 - Q_2) is improved by current source Q_9 using a diode-connected transistor (Q_{10}) in the base potential divider to provide temperature compensation. Because high beta devices are used, the collector current of constant-current source Q_9 is determined by the voltage drop across emitter-resistor R_{11} . Therefore, if the base-emitter junction of Q_{10} tracks the base-emitter junction of the current source device, temperature compensation is accomplished.

An additional constant-current source, Q_{11} , provides additional biasing for other stages. This is achieved by dropping a portion of the B+ supply voltage across resistor R_4 . There is a slight increase in power dissipation, but the method is more stable and less expensive than conventional (resistive) potential dividers.

Fault protection from system malfunctions is

furnished by diode-connected transistors Q_7 and Q_8 , and resistor R_1 . If the analog input rises above the breakdown limits of the emitter-base diode of Q_8 , the device goes into avalanche breakdown and the current is shunted to ground; this current is limited by the 1K resistor, R_1 . A typical value of avalanche breakdown for Q_7 (and Q_8) is 8 volts. If the analog input is a negative-going signal, diode Q_8 becomes forward biased and again protects the input stage. Diode Q_7 prevents current flow to ground through the power supply.

The comparator can be turned off by disconnecting the B- voltage. During the OFF condition all current sources, including the active level shifter, stop conducting. The only existing current path from the B+ supply is through these current sources; therefore the comparator consumes minimum power. The B- voltage is removed with a special-purpose level shifter, which is described on page 116.

Multiplexing options

A single-ended output is taken from the collector of Q_6 . The comparator is used as a single circuit; the outputs of several comparators may also be multiplexed. One arrangement for multiplexing the outputs appears in schematic form on this page.

The gated comparator amplifier has the following characteristics:

- resolution: ≤ 0.5 mv
- voltage gain: $\geq 15,000$
- input offset voltage: $\leq \pm 1$ mv
- input offset current: ≤ 200 na
- common-mode input voltage: ≥ 5 v
- comparison delay: < 1 μ sec
- power dissipation: ≤ 55 mw

This is attributable to the combination of active devices with compatible thin-film elements. All resistors are thin film (silicon monoxide, chromium) cermet, deposited with resistivities of 300 ohms per square upon the active silicon substrate.

The thin film exhibits an absolute temperature coefficient of less than 100 parts per million/ $^{\circ}$ C. In addition, parasitic effects are minimized by optimizing active device diffusions, rather than making tradeoffs to obtain desired resistor characteristics. The diffusion cross section and equivalent circuit of the monolithic silicon structure used in this circuit appear at the bottom left of page 116.

The level shift gate

Interfacing problems in the IC telemetry system are overcome by a low power, level-shift gating circuit. For example, positive output levels (typically 4 volts here) must be made negative to drive several p-type telemetry circuits. The latter include p-channel MOS follow-and-hold circuits, gates of FET-input multiplexer switches, current switches, and the power (B-) gate of the comparator.

In general, the level shift circuit must provide the necessary amplitude and/or polarity translations between the outputs of commercially available microcircuit logic elements and the bipolar input

Comparator: makeup and purpose

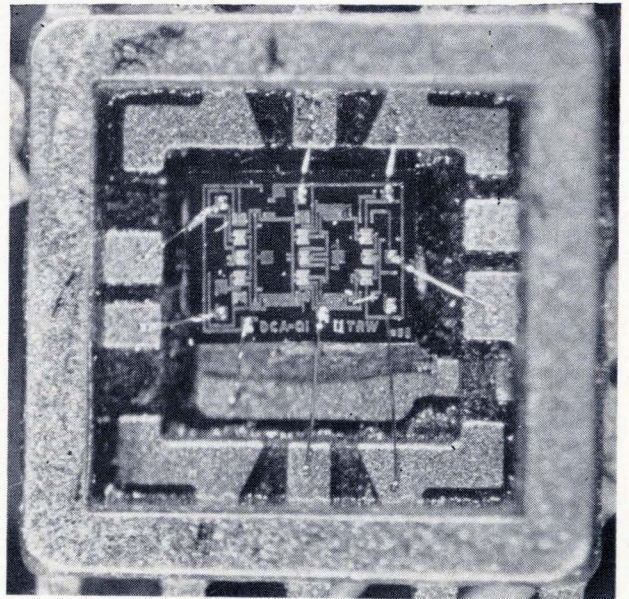

Chip combines monolithic and thin-film IC elements

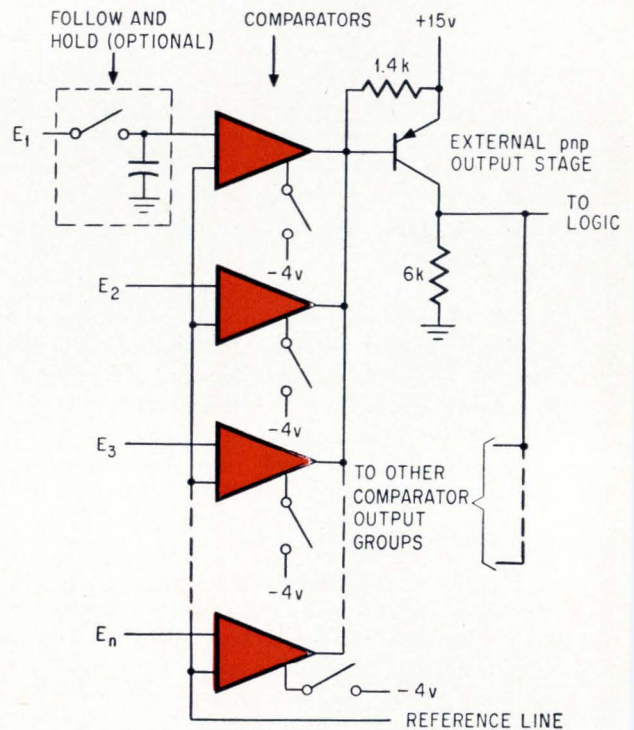

Multiplexed comparators provide redundancy

Differential comparator chip in the photo contains npn transistors and thin-film resistors. External pnp-npn piggyback stage and load resistor (shown in the schematic at the top of the opposite page) shifts amplifier output level. The three differential amplifier stages, current sources, and diode-connected transistors, and resistors R_1 through R_7 are fabricated on a 0.09-by 0.07-inch substrate (as shown in the layout at the bottom of the opposite page). Multiplexing of comparators (displayed above) is achieved by power gating. The B- supply to each is switched on and off by standard IC multiple-input gates (represented here by ordinary switches). Follow-and-hold circuit provides a memory or delaying function, if desired.

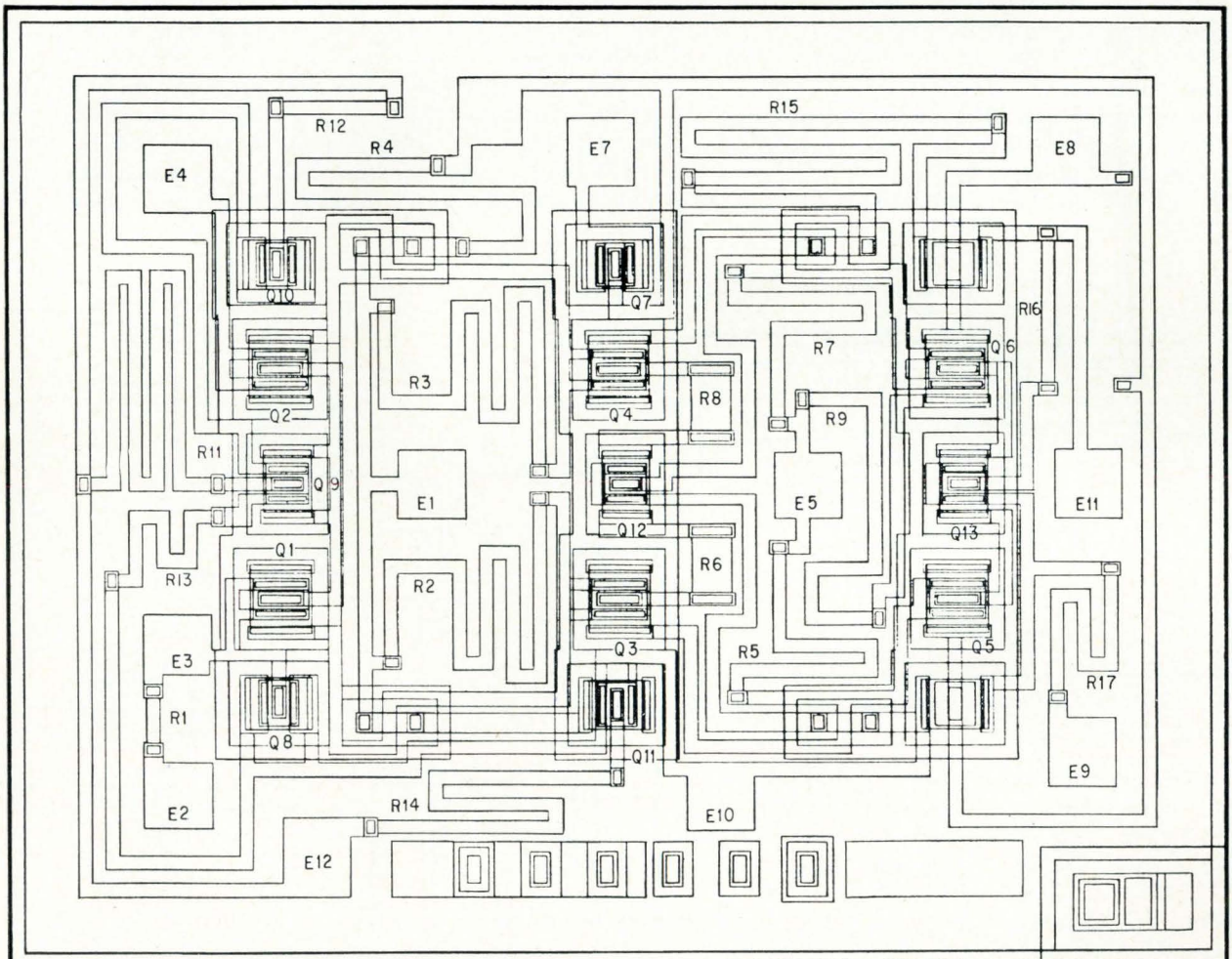
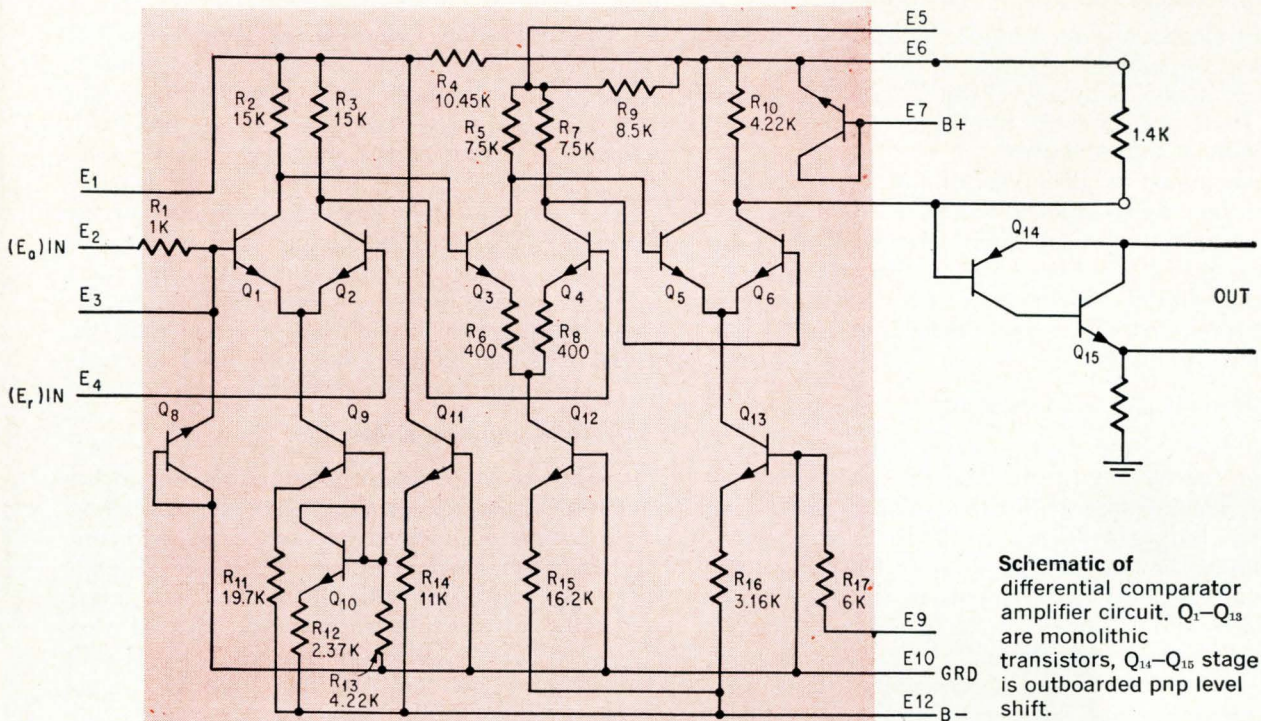

Thin-film cermet resistors are deposited on the substrate. These are more stable and accurate than diffused resistors, and are particularly advantageous in high frequency (>100 Mhz) applications.

voltage levels required of the various telemetry circuit elements. For example, with the differential comparator amplifier, gating of the analog inputs must be achieved by a level shift action. This "selective switching" lowers total power consumption and reduces offset errors.

With minor modifications of the one basic configuration this level shift can be used in d-a converters and sample-and-hold circuits. Among the advantages of such an all-purpose microcircuit are design flexibility and lower costs for masks, tooling, and production. Moreover, device and circuit performance of digital ic's can be optimized.

Off-the-shelf IC's are unsuitable

Standard off-the-shelf digital ic's cannot be used for the master circuit, because the attendant level translation requirements differ. For example, the positive output voltages available at the digital portion of the system logic do not satisfy the negative voltage level requirements of the comparator amplifier and the gate of the p-channel MOS-FET used in the sample-and-hold circuit. A special ic must be fabricated; also, compatibility with existing ic logic families—DTL, TTL, RTL—is desirable.

Generally, level shifting can be accomplished with one of the following elements:

- A voltage-dropping series resistor.
- A series zener diode.
- A pnp transistor.

Use of a voltage-dropping series resistor imposes a severe tolerance problem on the value of the resistor and is wasteful of power.

Zener diodes are only available with specific

nominal voltage ratings that are characteristic of the impurity profiles used in their fabrication. Close tolerances at low voltages are difficult to maintain.

Compatible monolithic npn-pnp structures having comparable electrical characteristics are not easily fabricated, but this method provides the most satisfactory solution to over-all circuit performance. Because the biasing polarity requirements of the pnp transistors are opposite to those of the npn transistors, the level shifting is accomplished automatically. In addition, the fabrication of npn elements on the chip consumes less space than the resistor method and poses less severe tolerance requirements than the zener construction.

Compatible pnp-npn shifts

Several feasible circuit configurations employing compatible npn-pnp structures are shown below. Level shifting is achieved in both cases with one pnp transistor. Input gating to the level shift stage is accomplished with off-the-shelf DTL or TTL ic's. In the lower configuration minimal device requirements of the side-diffused pnp level shift transistor exist and, only one pnp transistor is required per three gates. Also, the parasitic capacitance arising from the base-to-substrate isolation of the side-diffused pnp does not adversely affect the switching time for this common-base circuit configuration.

The diffusion cross section and equivalent circuit for the structure actually used are seen in the photo on page 117. The isolation junction is formed between the base and substrate of the pnp transistors and the collector and substrate of the npn transis-

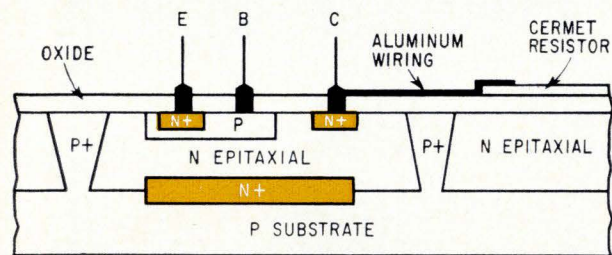

CROSS-SECTION

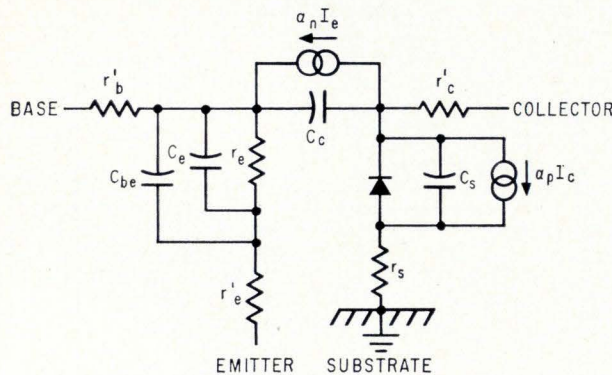

EQUIVALENT CIRCUIT

Junction isolation is used between npn elements in the chip. These npn transistors form the differential amplifier stages of the comparator and are closely matched.

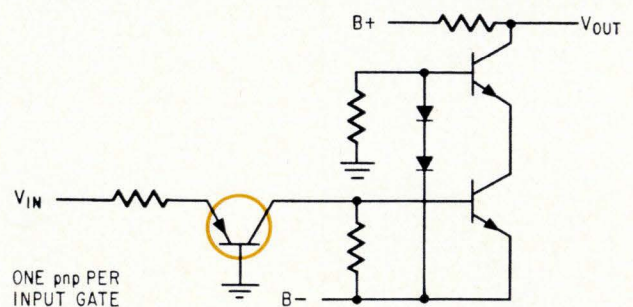

ONE pnp PER INPUT GATE

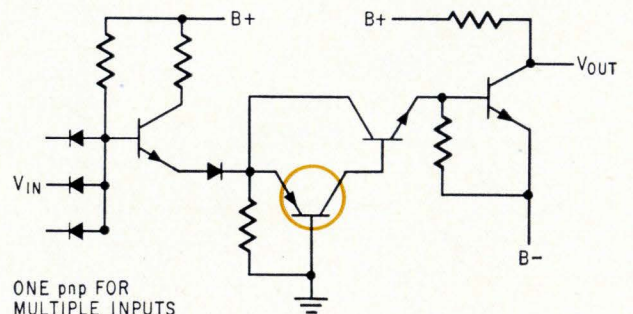

ONE pnp FOR MULTIPLE INPUTS

Level shifting is achieved by using a compatible pnp-npn integrated design. Lower configuration is preferable because side-diffused pnp structure is easier to fabricate than separate transistor of upper configuration

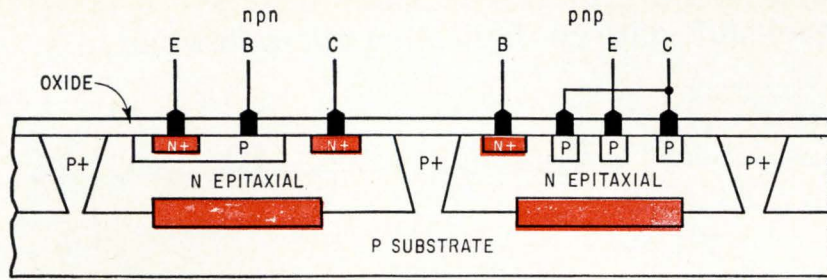

INTEGRATED STRUCTURE

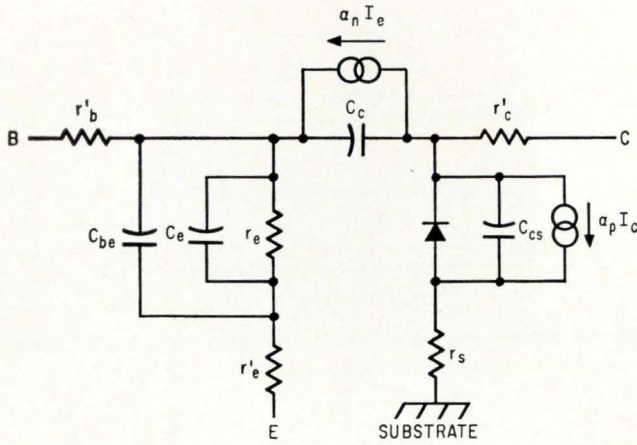

nnp EQUIVALENT CIRCUIT

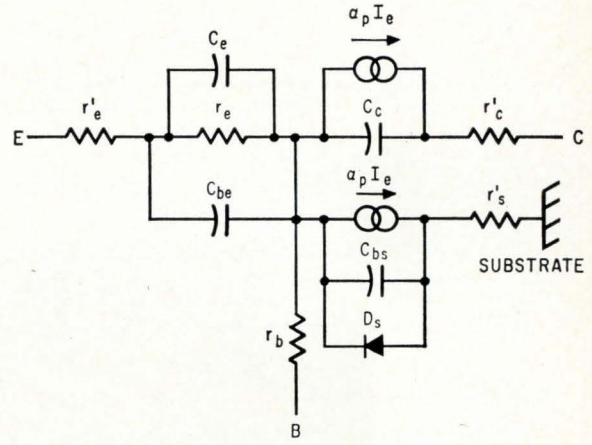

pnp EQUIVALENT CIRCUIT

Compatible pnp-npn structure calls for fabrication side by side. Isolation is between collector of npn transistor and base of pnp transistor through the common substrate.

tors. Parasitic pnp action in the negatively biased substrate can arise in either type of device and must be reduced. Precautions include selective gold diffusion to cut the carrier life time in the vicinity of the npn devices, and insuring that the epitaxial collector thickness is sufficiently wide with respect to the lateral emitter-to-collector spacing of the side-injection pnp. The location and concentration of the gold diffusion must be controlled to maintain a reasonably high lateral pnp current gain.

Minimum collector-to-emitter spacing and corresponding effective base width of the lateral pnp device are largely determined by the dimensions and tolerance of the npn base photoresist and subsequent diffusion depth. Thus, extremely narrow pnp base widths (necessary for high current gain structures) are difficult to produce.

The "piggyback" npn is a convenient method for increasing the apparent current gain of the lateral pnp structure. The effective current gain of the lateral npn-pnp combination pair is then approximately equal to the product of the individual device current gains, and the circuit operates satisfactorily with nominal common-emitter current gains approaching unity for the lateral pnp device.

Looks like DTL NAND gate

The basic level shift circuit most capable of meeting the special-purpose digital requirements for various microelectronic telemetry system applications is displayed at the top of page 118. The

circuit closely resembles a dual, 3-input, modified DTL NAND gate. It consists of an input diode gate, a common-base pnp-npn combination level shift stage, and, an npn output inverter. Separate, positive power supply terminals permit clocked B+ and

Continued on page 120

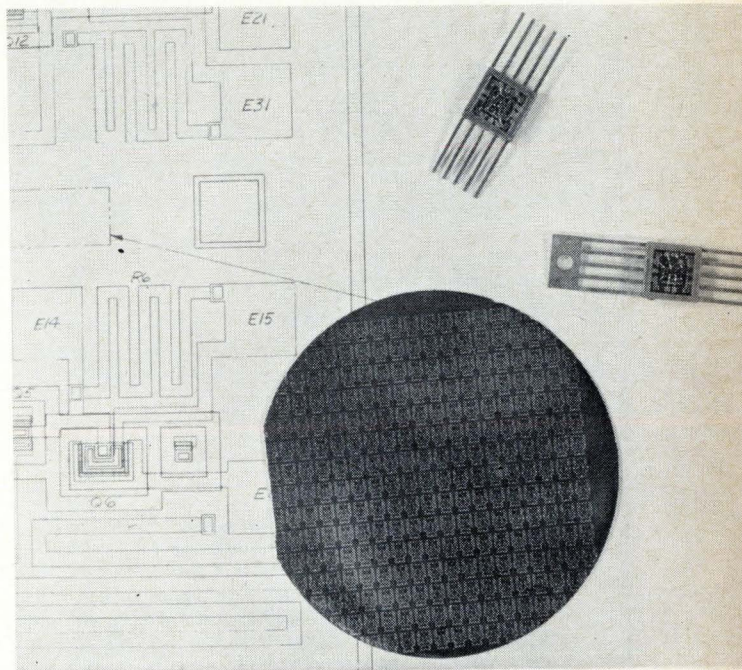

Level shift gate, a master circuit in the IC telemetry system, in chip and wafer forms.

Master level-shift gate configuration offers flexibility . . .

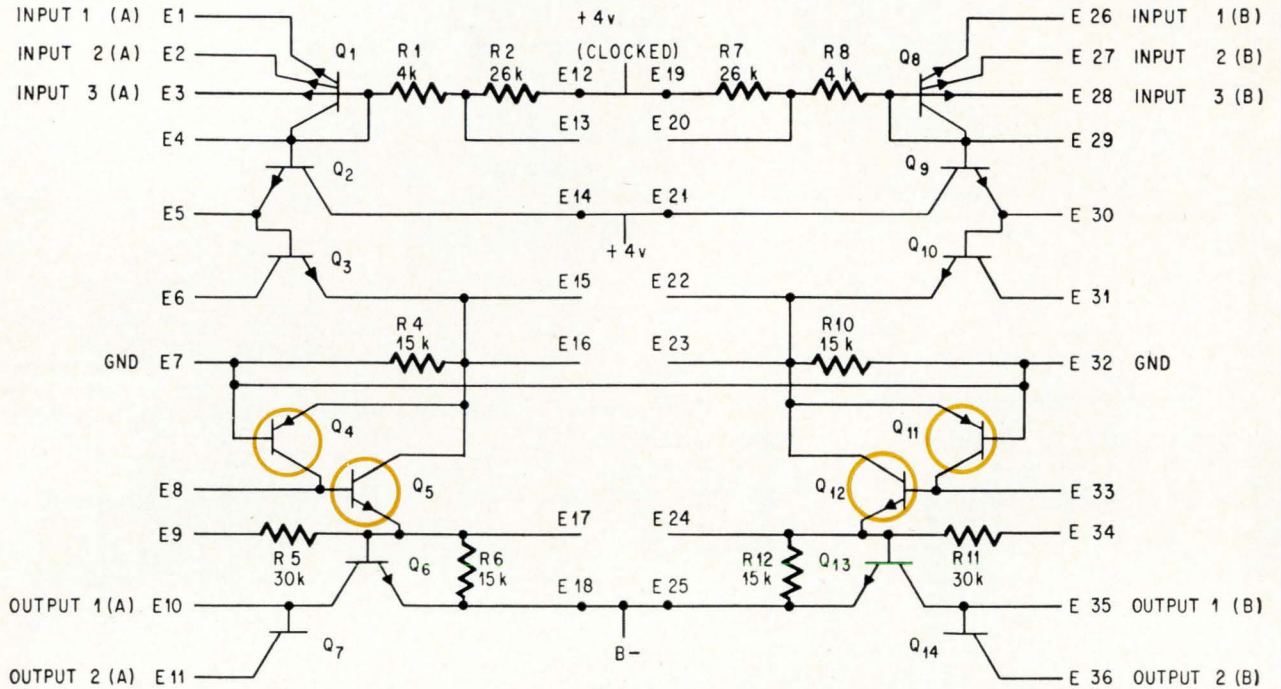

Here it's a dual, 3-input, modified DTL gate . . .

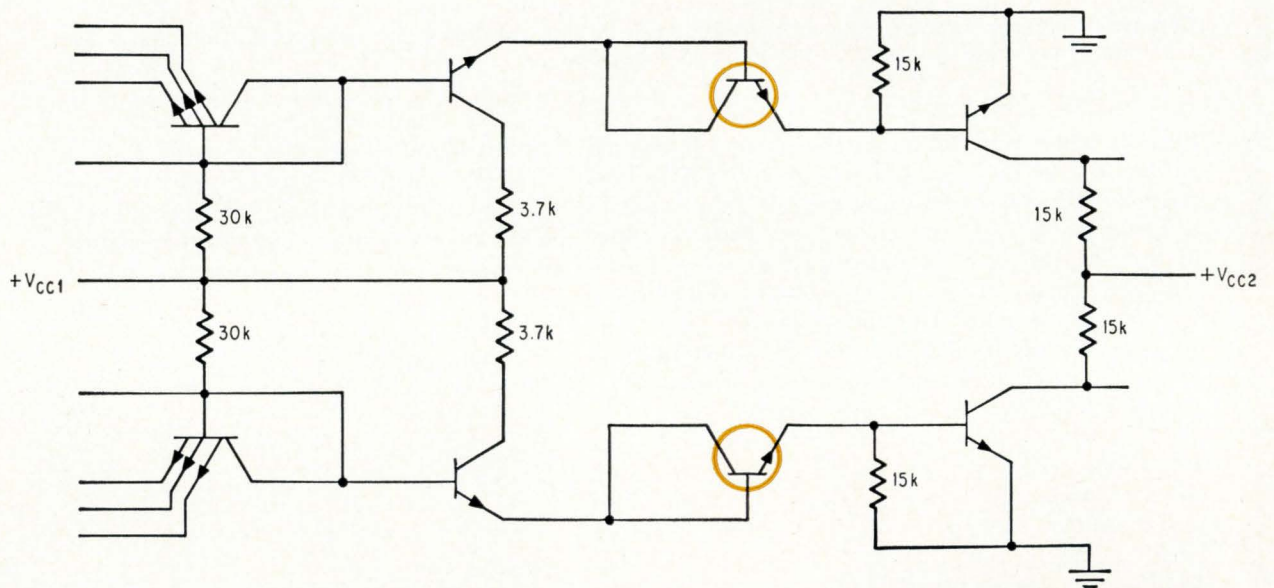

Now a buffer amplifier . . .

Minor modification of interconnection pattern and number of elements on pnp-npn level shift yields a variety of circuit functions. Photo exhibits the 0.70- by 0.90-inch layout of this versatile circuit. The basic current-mode configuration of the level shifter is a NAND gate shown in the top schematic. Resistor and interconnect patterns can be altered to make it a buffer amplifier, a sample-and-hold network, and a gate amplifier for a comparator.

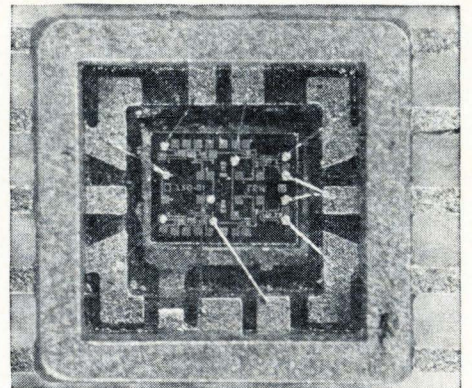

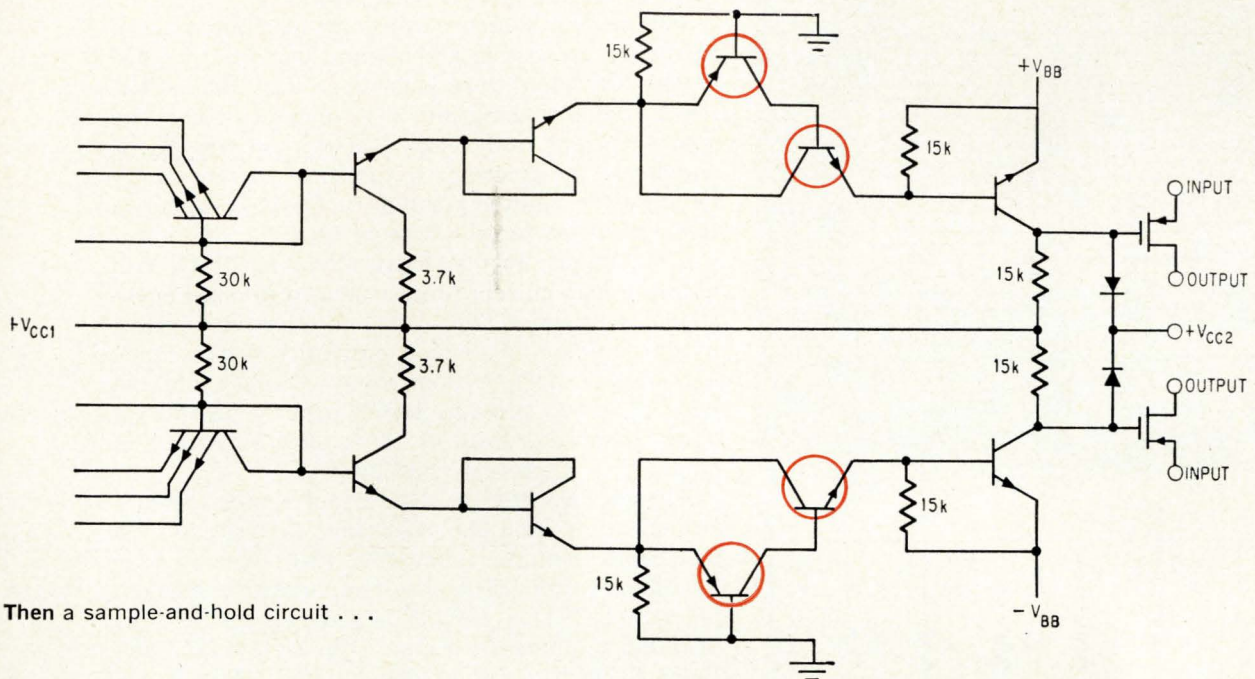

Then a sample-and-hold circuit . . .

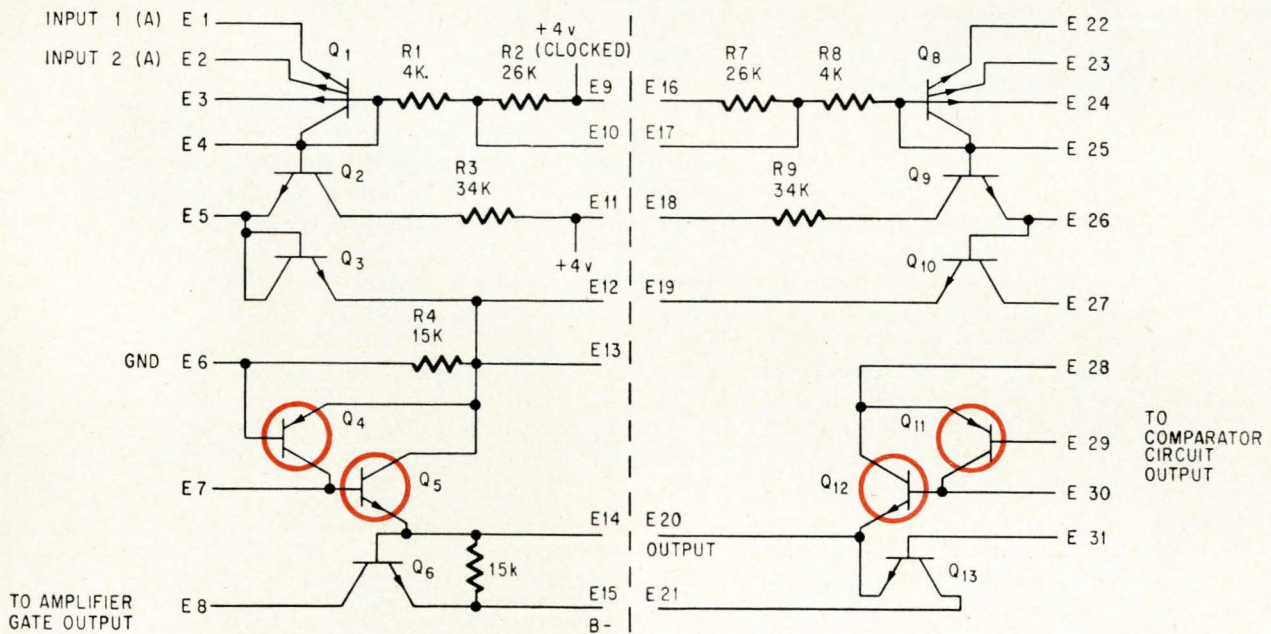

Finally, a level-shift gate amplifier

Telemetry IC characteristics

Level shift gate

logic function.....	= dual, 3-input NAND
propagation delay.....	= 350 nsec
input loading current.....	= 200 ua
output driving current.....	= 8 ma
output voltage range.....	= 0 to ± 15 v
power dissipation.....	= 1 mw/gate at 4 v

Sample-and-hold circuit

logic function.....	= dual, 3-input NAND
propagation delay.....	= 1 usec
input loading current.....	= 200 ua
output ON impedance.....	= 650 ohms
output OFF impedance.....	= 10 ¹⁰ ohms
power dissipation.....	= 1 mw/gate at 4 v

Voltage reference IC characteristics

Gated current source

reference current.....	= 1.28 ma
reference voltage.....	= 6.20 v
accuracy.....	= 0.2%
rms error, E.....	= 0.6 mv
power dissipation.....	= 12 mw/gate at +15 v

Ladder adder (8-bit)

resistor tolerance.....	= ± 0.5%
resistance ratio.....	= 0.25%
temperature coefficient.....	= ± 15 ppm
temperature tracking.....	= ± 5 ppm
ladder impedance.....	= 2 K
power dissipation.....	= 80 mw at 5 v

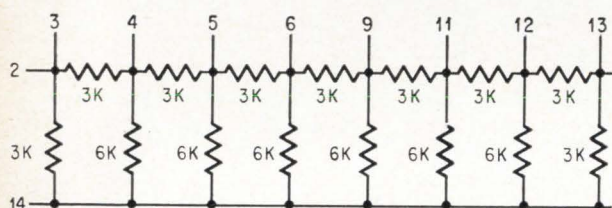
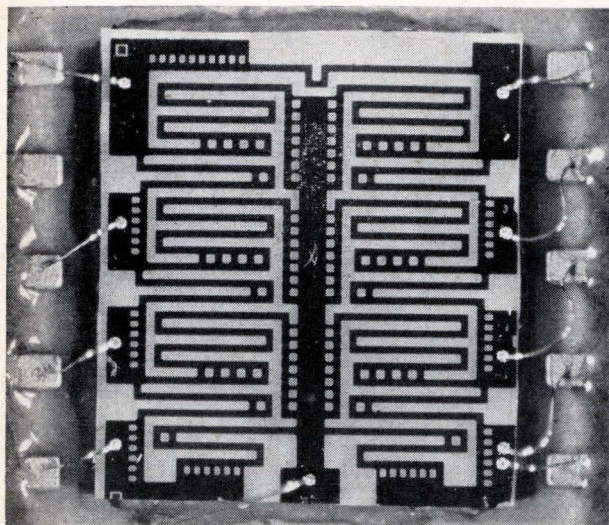

Voltage reference signals are formed by the ladder adder. An 8-bit element, it is fabricated on a 0.210 x 0.230-inch substrate using thin-film nichrome resistors on a glazed alumina substrate.

standby mode operation.

Since in most applications the power output inverter is switched both positive and negative, the substrate must be biased more negative than the peak negative voltage appearing at the inverter collector. This is accomplished by connecting the substrate to the B- terminal. The universality of this configuration is evident; minor modification in resistor values and interconnect patterns make it suitable as a power gate and pnp output stage, a MOS-FET driver, and a buffer amplifier for sample-and-hold applications.

As a power gate and pnp output stage combination, the circuit is used with the gated comparator amplifier. Typical characteristics of these IC elements are summarized in the table on page 119.

Current source needs IC

Current switching, another key function in the IC telemetry system, is achieved with a npn-pnp compatible piggyback configuration like that used for the level shift. Minor modification of the intra-connections results in a gated current switch, which provides the clocking and current source needs in the d-a converter subsystem of the telemetry.

These functions, together with a ladder adder, constitute the precision voltage reference generator. A current-driven voltage reference is employed in place of a voltage-switched IC configuration because it is innately more accurate and faster. Also, this approach avoids the problems of monolithic

fabrication of the low offset voltage devices necessary for the voltage-switched reference.

The current source consists of two pnp transistors in a unity feedback configuration, shown below. A very high input impedance is seen by the ladder-driving point looking into the collector of Q_2 . The source current is developed across resistor R_3 . It equals the load current if the base current of Q_1 entering the emitter junction of Q_1 is identical to the current leaving the base of Q_2 .

Changes due to temperature in V_{BE} of Q_1 will alter the load current unless some form of compensation is provided. This compensation is supplied by an amplifier, Q_1 , which has unity voltage gain. The output of Q_1 is then direct coupled into the base of Q_1 to provide 100% negative feedback. With matched transistors the collector current of Q_1 remains essentially constant.

The resistors used in the current source are fabricated using thin-film nichrome deposited upon a glazed alumina substrate. The resistor ratio is tailored to $\pm 0.5\%$ with a temperature coefficient of 5 ppm/ $^{\circ}\text{C}$. This provides a peak error of 0.6 mv over the temperature range -35°C to 70°C . Resistor R_3 is trimmed to develop +2.560 volt ± 1 mv at the node of the ladder. This represents a resolution of approximately 0.05%.

Ladder adder reference

The current source is connected through a diode to the output of a current switch, as well as to the ladder adder. In this manner, the collector can either be gated to the ladder or to the ground; therefore, the collector current of Q_2 is programed by the current switch. The gated current source drives a ladder adder to generate a high-precision, accurate analog voltage reference, which is tabulated on page 119. A series of digital inputs, zeroes (0 volts) and ones (4 volts), are used to represent analog voltages between 0 and 5 volts; the latter levels correspond to the voltage reference signals.

The ladder adder is an 8-bit element consisting of

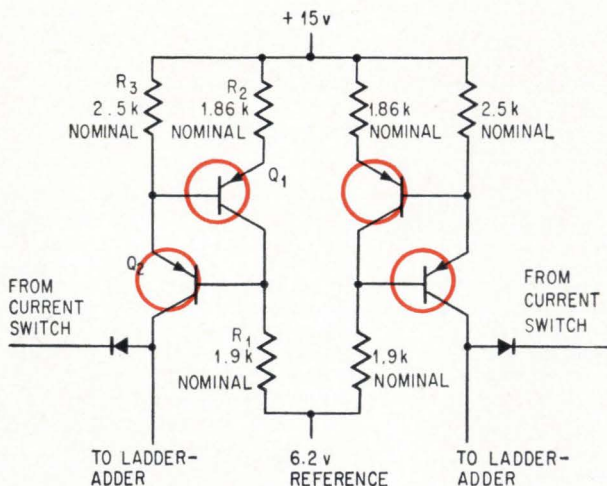

Dual-gated current source drives the ladder adder. Note that the npn-pnp piggyback configuration of the master level shift circuit is used.

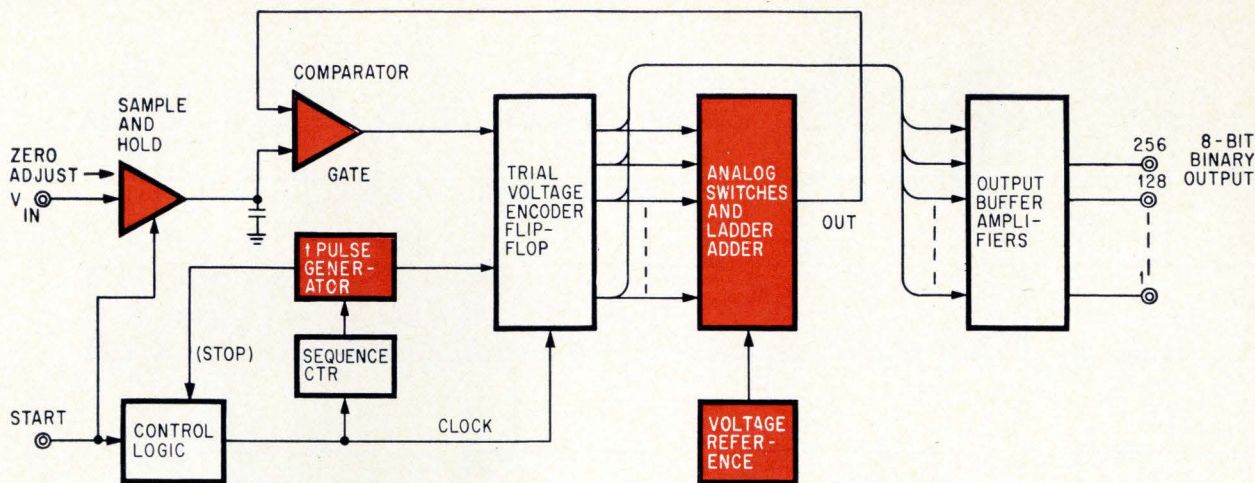

Analog-to-digital converter implemented with compatible IC's. Although a single input channel is shown, system can accommodate multiple inputs with the addition of comparator and gating circuits, and appropriate sequencing logic elements.

nine 3-K and six 6-K thin-film nichrome resistors deposited on a glazed alumina substrate shown on page 120. The network is fabricated on a 0.210 x 0.230-inch substrate, then mounted in a 0.375 x 0.375-inch flatpack. The resistors in this circuit exhibit an absolute temperature coefficient that is less than 15 ppm, and a tracking temperature coefficient between resistors of less than 5 ppm. This is measured over the temperature range -35°C to $+70^{\circ}\text{C}$. The resistors are mechanically tailored to possess a ratio tolerance of $\pm 0.25\%$ or better.

For an 8-bit converter, the least significant bit is $1/256$ or 0.39%; therefore the error due to the resistors is somewhat less than the least significant bit for an 8-bit converter. Since the current source is dynamically trimmed for a specific output at the node to which it is connected it is more valuable to evaluate accuracies and precision of the system, rather than those of any one circuit configuration.

This concludes the discussion of the innate circuit types for the compatible ic telemetry system. As opposed to those units based upon the two master elements, the ladder adder is the only configuration of a special-purpose nature. However, even that pattern may be considered somewhat universal, in that the thin-film process accommodates altera-

tion of the values and number of resistor elements. By the same token, capacitor fabrication may be achieved the same way. Thus, conceivably, any linear system ic needs can be met by compatible techniques.

A/d converter and other applications

The extensive integration of data-processing systems permitted by compatible ic designs will be demonstrated by a few application examples. In each, the differential comparator amplifier and level shift are the key elements.

A simplified block diagram of an 8-bit analog-to-digital converter which uses several of the compatible ic types previously described is shown above. The system operates upon receipt of a start signal by converting the input voltage to an 8-bit binary number proportional to the amplitude of the input. The number appears in parallel form at the output of the converter and is maintained until another conversion is initiated.

The trial voltage encoder contains eight flip-flops, each of which is connected through an analog switch to a ladder adder. The ladder adder generates a precision analog voltage associated with each flip-flop and then sums the resultant voltages into a

IC count for a-d converter

Circuit type	Power dissipation	Package size	Quantity
Gated differential comparator.....	25 mw	$\frac{1}{4}'' \times \frac{3}{8}''$, 14 lead	1
Sample-and-hold.....	2 mw	$\frac{1}{4}'' \times \frac{3}{8}''$, 14 lead	1
Flip-flop.....	4 mw	$\frac{1}{4}'' \times \frac{1}{4}''$, 14 lead	16
Dual current switches.....	2 mw/gate	$\frac{1}{4}'' \times \frac{1}{4}''$, 10 lead	4
Dual current sources.....	30 mw/gate	$\frac{1}{4}'' \times \frac{1}{4}''$, 10 lead	4
8-bit ladder adder.....	100 mw	$\frac{3}{8}'' \times \frac{3}{8}''$, 10 lead	1
Reference voltage source.....	30 mw		1
Dual, 2-input gates.....	1 mw/gate	$\frac{1}{4}'' \times \frac{1}{4}''$, 14 lead	10
Four 1-input buffer amplifiers.....	4 mw/gate	$\frac{1}{4}'' \times \frac{3}{8}''$, 14 lead	2
Quad NAND gates.....	8 mw/gate	$\frac{1}{4}'' \times \frac{1}{4}''$, 14 lead	1

Total packages: 41

Total system power: 375 mw max.

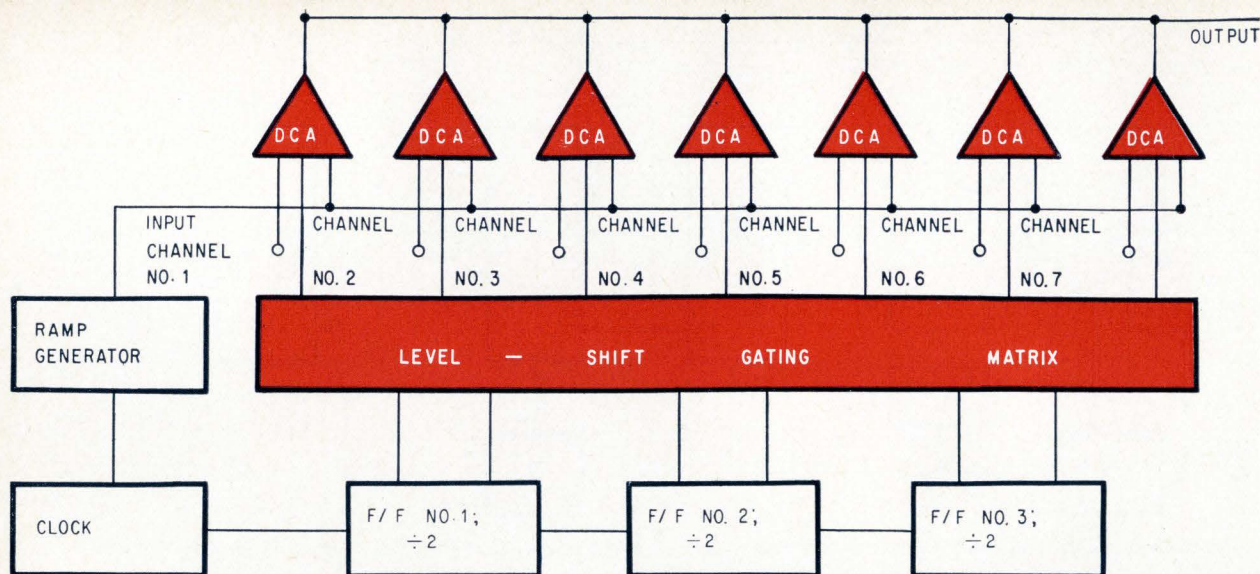

DCA = DIFFERENTIAL COMPARATOR AMPLIFIER
 F/F = FLIP-FLOP

Personal telemetry system for data transmission from remote environments may be used by astronauts. Small size (11 compatible IC's are used) and low power requirements (44.2 mw) are features of 7-channel, hand-carried system.

single output. This summed voltage is compared with the output of the sample-and-hold gate, and the comparator amplifier output is used to gate the trial encoder flip-flops. When the analog input voltage is greater than the summed output voltage at the ladder adder, the sequence counter advances the trial voltage encoder flip-flops until the output voltage is equal to or slightly less than the reference voltage.

Window option exists

The sample-and-hold gate permits the sampling of only a very narrow "window" of input voltage, preventing transient variations during the conversion from affecting the result. Since it is gated on by the start command, the gate may also be used to sample voltages only during specific intervals.

Although the system uses only a single input comparator, the number of input channels may be easily expanded with the addition of parallel input gated comparators and appropriate sequencing logic. The sequence counter and control logic, trial voltage encoder flip-flops and output buffer amplifiers can be implemented with commercially available IC logic elements. The sample-and-hold gate, differential comparator amplifier, level shift power gate, analog switches and ladder adder are the previously described compatible IC's.

The required number and circuit-types needed for the 8-bit a-d converter are tabulated on page 121. Total system package count is 41 IC packages; estimated system power consumption is less than 375 milliwatts.

Bionic need met

Another example of an application of compatible IC's is the 7-channel pulse duration modulation (PDM) personal telemetry system shown above.

This system is suitable for telemetry of biological data. Critical design considerations include low power dissipation, high stability versus environmental temperature changes, high resolution, and minimum component count. Small size and minimum weight are also stringent requirements.

To minimize the circuit parts for this application a ramp conversion technique is employed. This eliminates the d-a converter and associated circuitry. The conversion of analog voltage to pulse duration is accomplished by sequentially comparing the channel analog input voltage with a sawtooth voltage appearing at the output of the ramp generator. The differential comparator amplifiers are sequentially gated on by appropriate decoding of a low power binary counter and a level shift gating matrix. Since only one amplifier is active at a time, all amplifier outputs are connected together and the corresponding pulse train at the output contains seven duration-modulated pulses and one synchronization time gap per pulse frame.

Specific characteristics of the PDM telemetry system are:

- Pulse format: seven PDM pulses and one gap per 5 millisecond period.
- Pulse frame repetition rate: 200 frames per second.
- Input signal voltage: 0-20 millivolts for 60% PDM modulation.
- Input impedance: greater than 50 kilohms.
- Output impedance: less than 1 kilohms.
- Output pulse amplitude: 0 to 15 volts.
- Operating temperature range: 0 to +55 C.
- Power dissipation: less than 50 milliwatts.

A system employing standard monolithic and discrete interfacers, instead of compatible IC's would be three times as complex and would require four times as much power.

Strange how nobody's borrowed Walter's Mark 200 lately

You might say Walter brought it on himself. First week he had that Mark 200 Recorder he started telling everybody how great it was. How a patented Hydrostatic Inking System put a smudge-proof razor-sharp trace into the paper—not just on it. How something called "position feedback" gave him total system accuracy of better than 99½%. How a choice of 32 plug-in preamplifiers would take care of any signal conditioning requirement that ever came along. Word got around. Dept. 14 borrowed Walter's Mark 200 for a "day or so." Had it for three weeks. Then a chap in the lab needed it for "just one little series of tests." He had it a month.

"Enough," said Walter and he brought in the Doberman. And that solved his problems.

That's how it is with a Mark 200. There just isn't *any* recording job it can't handle. But you really have to see one perform to know what we mean. Ask your Brush Sales Engineer. With more than 20,000 channels in operation, he can easily set up a demonstration under actual field conditions.

Who knows, there may be one in the next department. Seen any Dobermans lately?

Clevite Corporation, Brush Instruments Div., 37th & Perkins, Cleveland, Ohio 44114.

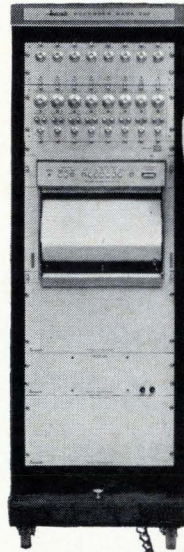

brush **CLEVITE**
INSTRUMENTS DIVISION



Back in 1964 we told you:

This is a super/reg™ synthesized zener diode.

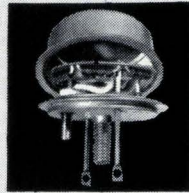

**It enables you
to build a precision
power supply
in minutes using
any DC
power source.**

Typical super/reg zener impedances of 2 to 8 milliohms—lowest ever yet achieved—makes possible .01% regulation and .5mv ripple. Voltage-adjustable as much as $\pm 10\%$, as small as a millivolt, with no derating or degradation. The "third terminal" lets you trim the output. .01%/°C temperature compensation at high power levels; thermal stability 100-times greater than that of the standard zener. Zener voltages from 5.6 to 56 V.

7 $\frac{1}{2}$ watts dissipation rating, 50% higher than any other available zeners.

Looks, mounts like any other diode. Standard TO-36 case. Performance-proven reliability; patent-pending design. Suitable for MIL applications.

Write or call for complete data and application bulletin.

Semi-conductor Division, Trio Laboratories, Inc., Dupont St., Plainview, L. I., N. Y.

(516) Overbrook 1-0400

super/reg

© 1964, TRIO LABORATORIES, INC. • PIONEERS IN BUILD-IN INSTRUMENTS AND CUSTOM POWER SUPPLIES

Now there are 104 super/reg® instant answers to your power regulator needs.

We figure if you've got something good, why stop there. Why not go ahead, expand the line, and give designers practically unlimited capability.

And that's what we've done — 104 times. Nobody else comes close.

Super/reg's come in shunt and series versions. Just connect rough DC from whatever source you have — semi-filtered, half-wave rectified transformer output, or even a battery — you get instant, precision DC power where you need it: at the load itself.

Super/reg precision miniature regulators are uniquely designed for maximum heat transfer and

power-handling capability. Ultra-compact configurations provide maximum flexibility over a wide range of voltage levels. Point-of-load installation eliminates distribution-line losses and cross-talk.

Write for complete data sheets and applications bulletins.

We've got 104. And if the mail is slow, we may have 105.

Trio Laboratories, Inc.,
Plainview, L.I., N.Y. 11803.
Tel: (516) 681-0400.

super/reg®

New Ideas in Power Sources from

triolab®

Wider horizons for numerical control

Developed for metalworking, numerical control techniques are spreading to other applications—a trend that could lead to computer-based systems that embrace the entire design-through-manufacturing process

By Alfred Rosenblatt

Industrial electronics editor

Numerical control, born 15 years ago out of the metal-cutting needs of the aerospace industry, is having an impact on all design and production—including electronics. Once defined simply as a means of operating a machine tool automatically through coded position and speed instructions on punched tape, it is now spoken of in terms of an over-all manufacturing system.

Advocates contend that numerical control techniques are on the verge of a new era. Present-day applications—still almost exclusively in metalworking—barely skim the surface of the technology's potential, they argue.

Says Shizuo Hori, of the IIT Research Institute of Chicago: "We are entering the second industrial revolution, the result of developing a technology in which machines can respond automatically to symbolic instructions." Hori heads the institute's Automatically Programed Tools project (APT), a language and computer system aimed at improving human communication with machine tools.

"The range of symbols," he points out, "began with written words resembling an ordinary vocabulary. Now the range is being extended to include drawings and gestures—motions of a light pen before a graphical input station connected to a computer. Thus the full power of man's ability to communicate concepts to machines by appropriate symbolic models can be exploited in the automatic control of machines."

'Islands of automation'

Hori stresses machines, not machine tools, an indication that the next step in the development of the technology may be away from such tools. However, it has been the success with machine tools that has established what the General Electric Co.'s Paul D. Ross calls "islands of automation." Ross heads GE's specialty control department in

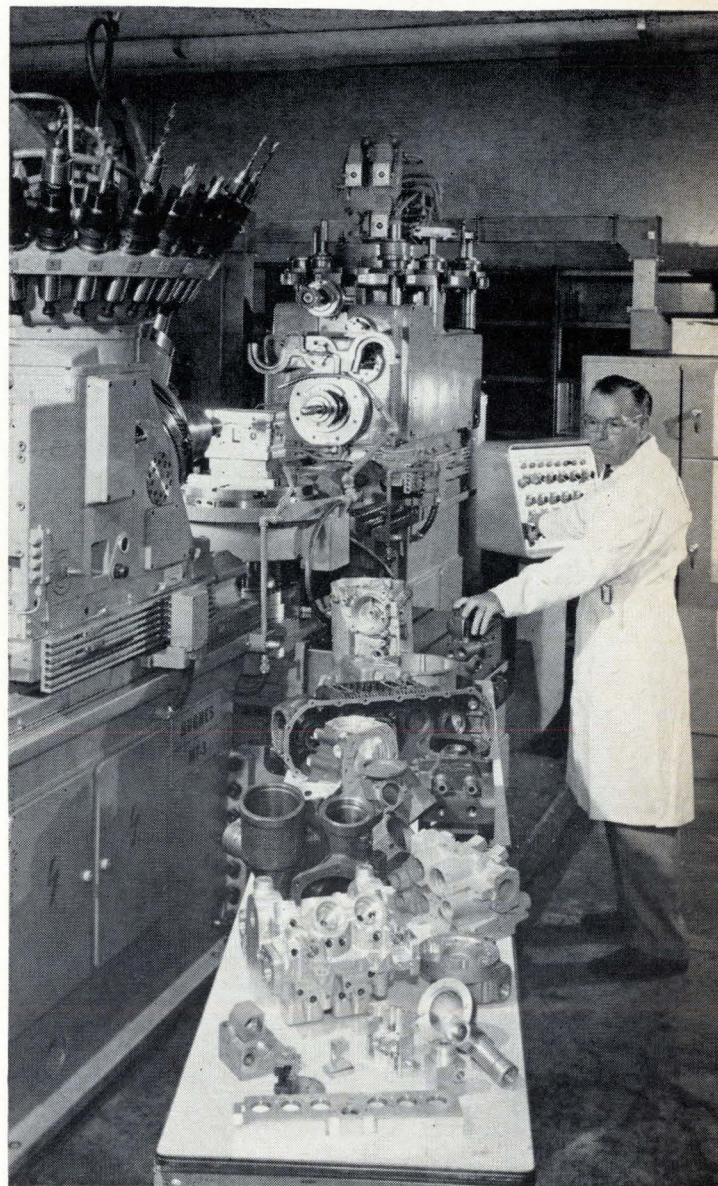

Machining centers made possible by numerical control perform a variety of tasks. One of the tool heads, upper left, on Hughes Aircraft's MT-3 unit holds 30 tools. It can change from one tool to another in less than 3 seconds.

Computers coordinate design and manufacturing

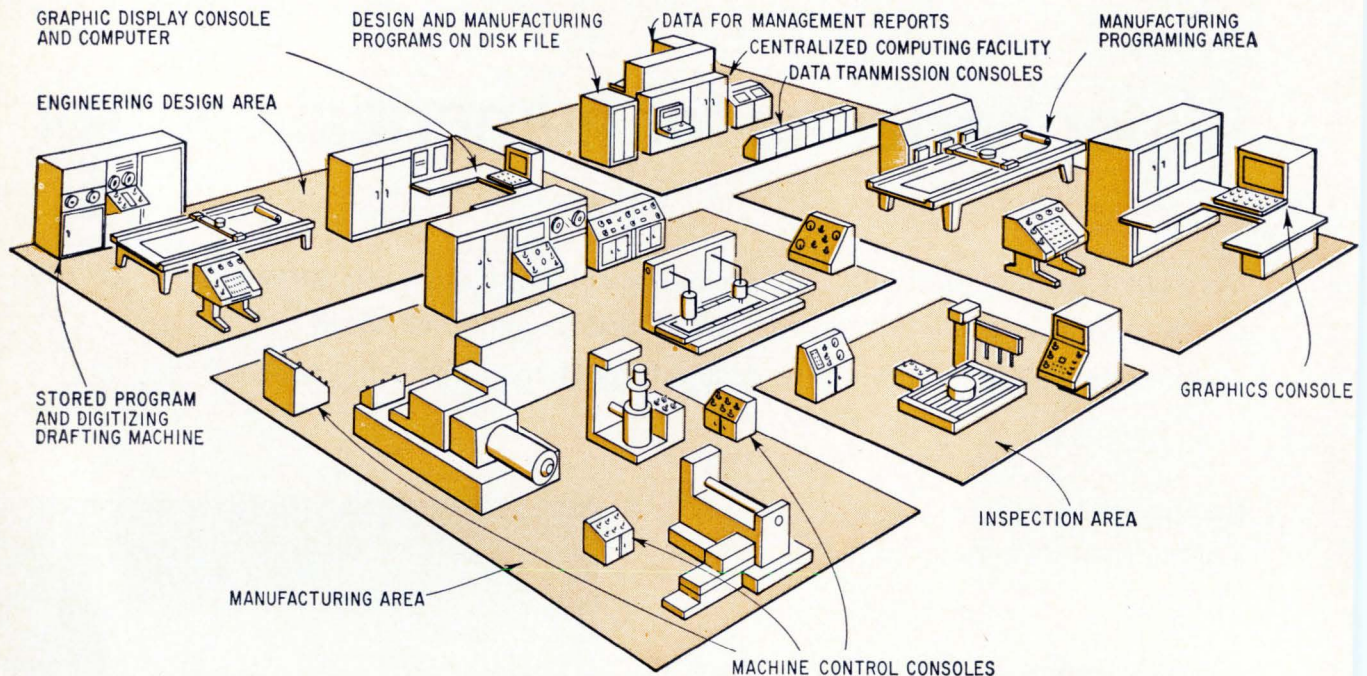

Design-through-manufacturing center is the goal of North American Aviation. Based on central computer control, this integrated system would carry an idea from concept to inspection via graphics data displays, digitized drafting, and machine and inspection controls. Data is continuously gathered for management decisions.

Waynesboro, Va., a leading supplier of numerical controls for drilling and milling machines, and large, multipurpose machining centers.

Says Ross: "Although there has been great progress represented in these installations, the long-range potential for numerical control will only develop when these islands are tied into an integrated manufacturing system. The characteristic ability to assemble isolated processes into macro-systems is, by any measure, the most outstanding feature of the numerical control technology."

These islands are many and varied. Integrated into a total computer-based complex, shown above, they form a powerful design-through-manufacturing center. Based on electronics technology, the parts in this center include:

- Graphics display consoles for designing circuits and systems as well as machined parts.
- Automated drafting systems that not only produce hard copies of mechanical drawings or printed-circuit pattern layouts but also translate the drawings into digital form for insertion into a computer or numerically controlled machine.
- Inspection machines to verify dimensional accuracy. Programed by tape, or directed by computer, these machines can check a printed-circuit board layout as well.

One for many

Another technique that holds great promise is the use of a central computer to control a group of machine tools instead of having a punched-tape for each machine.

Also promising is the use of adaptive controls to optimize a production process despite changing environmental and operating conditions.

The electronics industry has already seen the introduction of numerical techniques to control the wiring of components and systems. These include tape- and computer-controlled machines used to manufacture such parts as printed-circuit boards. Typical systems drill holes, check pattern layouts, and control welding or soldering assemblies. They are also used to fabricate etching masks for large-scale arrays [Electronics, Feb. 20, p. 123]. The numerical instructions are provided from either a punched card, a tape or a computer.

From start to finish

These techniques and those still in the offing will gradually be applied to integrate all elements of the complex process that carries an idea from concept, through design, development, manufacturing, and inspection. A central computer installation will be the key.

It is predicted that ultimately, an engineer will be able to sit down in front of a display terminal, design a part or a circuit and know almost immediately whether it will work. Strength tests of materials, temperature, pressure, and stress analyses will be automatically run on it if it is a machine part; electrical tests will be applied in the case of a circuit. Studies would also be run to determine the best materials for its construction.

From both this and the design information, the computer will be able to provide instructions for

the machines needed on the production line to produce the parts or circuits.

Parallel with the growth of numerically controlled design and production processes will be the development of improved computer-based information systems, points out R.K. Wilson, corporate director of North American Aviation Inc.'s facilities and industrial engineering. Such systems are already being developed and, in some cases, installed. The total effect will be to provide management with a high degree of control over operations never before possible.

"Shop drawings will be replaced to a great extent

by photos of completed designs on computer graphics-design consoles and by increased use of numerical control tapes," says Wilson. "Direct input from computers to production machines will become prevalent. The new information systems will provide current data for management decisions in such areas as production planning and inventory control, engineering part number breakdowns, parts lists, advanced material procurement, priorities, records of machine use, and quality control."

Inventory and production control systems, although not tied directly to a design computer, are already in use in many plants.

Industrial electronics II

Machining it right the first time

Tapeless computer control, adaptive techniques and IC's will lead to centralized, more responsive tool direction

Numerical control in metalworking enables management to plan a job from beginning to end before chips are even cut [see "How numerical control works," page 130]. It reduces sharply the time required to set up the job and orient the operator to a new set of production steps. This is particularly valuable on small- and medium-size job lots.

Because all operations are spelled out on the punched tape, operator errors are virtually eliminated and quality is greatly improved—the human factor, with its coffee breaks and blue Mondays, is minimized. By reducing inspection operations, production-line time is cut because there are fewer stations.

Numerical control has been applied to a wide range of machine tools since it was first used in 1952 to control a milling machine in an Air Force-sponsored feasibility study at the Massachusetts Institute of Technology's servomechanisms laboratory. Applications include drilling, milling, and boring machines, as well as lathes, punch presses, spot-welding, pipe-bending, and rocket-motor filament-winding machines. And this list continues to grow as manufacturers seek to make old, but structurally sound, machines more efficient by retrofitting them with numerical controllers.

New numerically controlled machine tools continue to be introduced, such as the wire-marking and measuring equipment from the Conrac Corp.'s Datex division. New controllers, like the Coleman Engineering Co.'s integrated-circuit point-to-point positioner are also being brought out.

Presently there are more than 9,000 numerically controlled machine tools in operation in 2,400 factories—about 4% of the total number of plants in

the U.S. Although this percentage is low, it represents a marked upswing; the rate of installation has doubled every two years since 1959.

Last year, about \$220 million worth of machine tools sold were equipped with numerical controls, accounting for 20% of all machine tool sales. By 1971, the figure is expected to climb to 35%. The cost of the electronics portion of the control package ranges from 10% to 50% of the tool's price.

New directions

Perhaps the greatest departure from conventional machining practices resulting from numerical control is the machining center. These centers combine in a single unit such capabilities as milling, drilling, boring, tapping, and reaming—all usually done by separate tools. Punched tape controls the operations sequentially, calling in the next tool upon completion of each step in the machining process.

Experimental work with numerical control is also leading to new machining techniques. Among these are:

- Controlling banks of machine tools directly from a digital computer, doing away entirely with the need for punched tape.
- Developing adaptive controls that sense the machine's performance, immediately compensating for any change in machine and environmental characteristics.

Tapeless control

Probably the first use of direct, tapeless control on a production line was in 1965 at the International Business Machine Corp.'s Endicott, N.Y., plant [Electronics, Nov. 1, 1965, p. 90]—and it's still in

use today. Holes in the printed-circuit cards for the System 360 computers are drilled with specially designed 24-spindle drilling machines controlled by a central 1710 computer. Each machine control guides the drilling via instructions received from the 1710 over a data link. The computer, in turn, selects the correct drilling patterns from a disk store that contains information on all of the card types being produced. The vast tape library that ordinarily holds all of the programs is eliminated. Set-up time is reduced sharply, because there isn't a need to hand-carry program tapes to the machines.

The Cincinnati Milling Machine Co. in Cincinnati, Ohio, last summer demonstrated the feasibility of operating more-complex machine tools remotely by driving a contouring machine from a digital computer via a 3,000-foot coaxial cable. A prototype of the company's integrated-circuit Acramatic IV controller [see cover; *Electronics*, Sept. 5, 1966, p. 14] operated the machine. A closed-circuit television camera enabled the machining to be monitored from the computer site.

Another remote control operation was demonstrated recently by General Electric. A milling machine at GE's Waynesboro, Va., plant was controlled with data transmitted through telephone lines from a computer at GE's Phoenix, Ariz., facility—2,000 miles away. General Electric is developing a special data terminal to be used at the machine tool that checks data for transmission accuracy while it controls the machine drives.

Central control

The most ambitious scheme reported to date for controlling tools from a central processor may be the System 70 from the Bunker-Ramo Corp., Cleveland, Ohio. Pilot tests are under way at the Boeing Co., Seattle, Wash.

In its system, shown on page 129, Bunker-Ramo tries to hold the electronics in the controllers at the machine tool to a minimum. Instead, it concentrates the electronics in a central processor, called a time-shared interpolator, used only for numerical control. The interpolator performs the calculations necessary to move the tool through its programmed operation.

In this system, the tool's control unit contains digital-to-analog conversion circuits and the servo-controls for driving either electric or hydraulic

motors. A data terminal at the control unit accepts the information from the interpolator and checks it for accuracy.

The program information for the operation of the machine tools is stored in a random-access disk file. On demand, the data is fed into the interpolator. Only small parts of each machining program are stored at a given time in core memory. They are distributed to the machine tool control units via coaxial cable. Transmission rate ranges upwards to 10 kilohertz.

Also included in the system is a larger general-purpose processor that converts the instructions originally written by the programmer to tool language.

As many as 10 three-axis contouring machines or up to 20 simpler point-to-point machines can be handled by one time-shared interpolator, says Bunker-Ramo. Although a tape reader isn't required at the machine tool control, a data terminal and a certain amount of logic circuitry are.

The greatest advantage will most likely stem from the central management of tool operation that the system affords and the savings resulting from the elimination of the punched tape and its handling.

Adaptive control

Fred L. King, a development engineer at the Ford Motor Co., Dearborn, Mich., describes adaptive control as a theoretically perfect machinist who senses intuitively every cutting condition and immediately adjusts the control to produce maximum cutting performance. Taking into account the limits of tool life and the desired production output, adaptive control operates the tool at maximum levels.

Adaptive control doesn't replace numerical control; it makes the latter work better. An adaptive control system senses relatively unpredictable changes in the material being worked, in the wear of the cutting tool and the load on it—all factors not considered in a numerical control program. The adaptive system superimposes itself on the numerical control and adjusts the machining operation to compensate for the variations as shown below.

Adaptive systems are available in machine tools to a limited extent—one, by Dyna Systems Inc., Torrance, Calif., senses the torque on a cutting tool and adjusts the speed and feed rate accordingly. Welders have also had adaptive control fea-

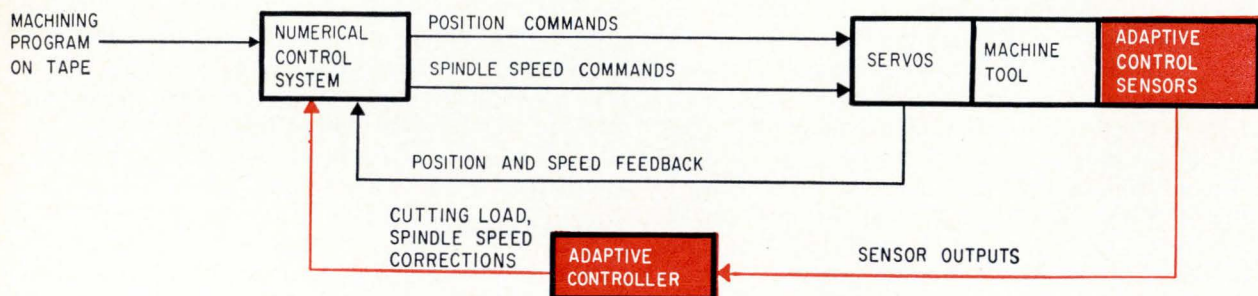

Adaptive control, an adjunct to the numerical control system, overrides the programmed instructions to compensate for changing work conditions.

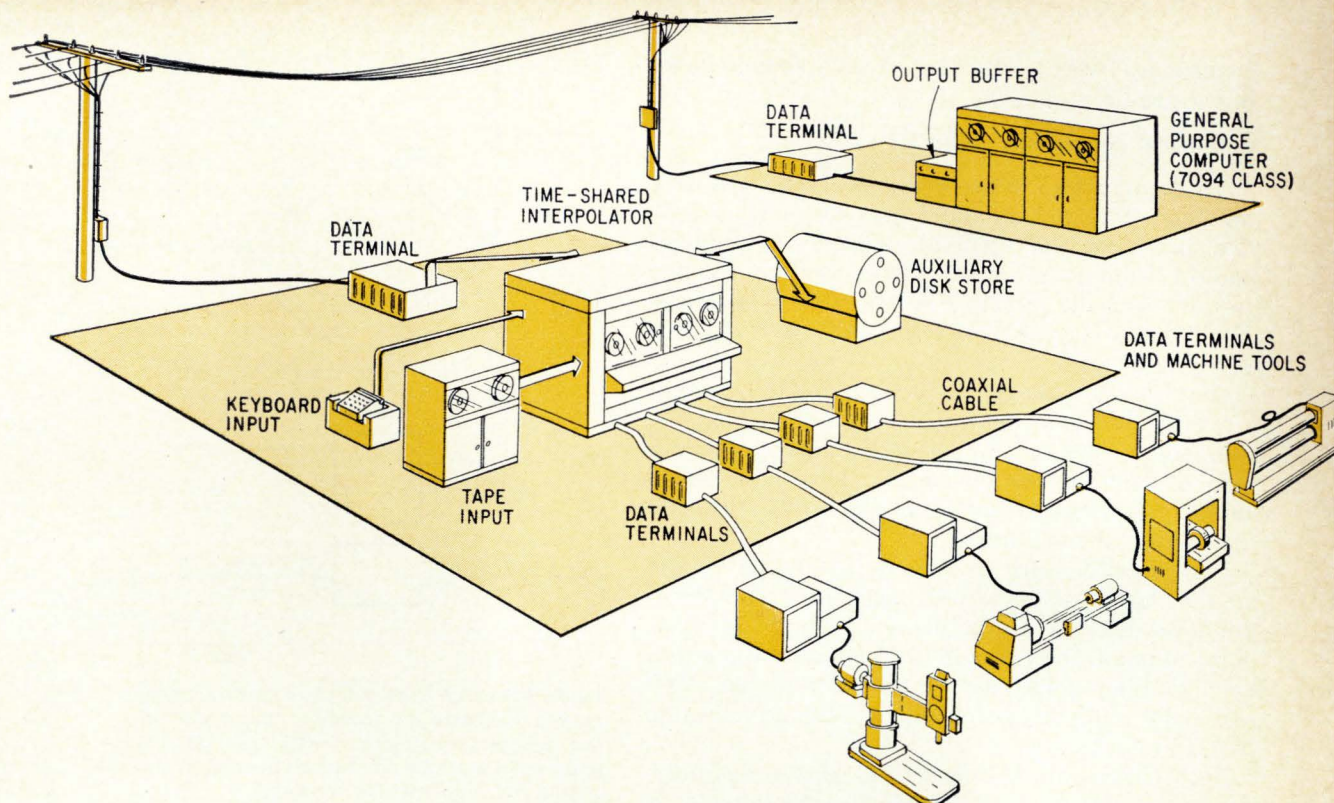

Electronics normally found in the numerical controllers of each machine tool are located in a central interpolating unit in Bunker-Ramo concept for computer control of banks of tools. The central interpolator is time-shared by all the tools and can be operated by a remote computer.

tures that sense the quality of the weld while it's being made.

Another system was developed by Bendix Research Laboratories, Southfield, Mich., a division of the Bendix Corp. Applied to a milling machine, the system was partially underwritten by the Air Force Materials Laboratory, Wright-Patterson Air Force Base, Ohio.

Controlling the variables

In Bendix' system, according to engineer Robert J. Valek, sensors placed as close as possible to the tool-material interface sense three operating variables—spindle torque, tool vibration, and the temperature at the working tip of the tool. Signals from the sensors are then fed into a special-purpose "performance" computer that, in effect, decides on the adjustments to be fed into the numerical control system for controlling the machining variables. Bendix chose spindle speed and tool feed rate as the variables to be controlled.

Strain gauges are placed on the spindle in planes of maximum tension and compression to sense torque, shown on page 130. An accelerometer senses the spindle acceleration, which is related to the tool vibration.

Tool-tip temperature is measured by a thermocouple method that uses the tool and tip themselves. Since the tool and workpiece metals are dissimilar, a voltage produced at their junction is proportional to temperature.

An external sensor isn't suitable for measuring temperature because cooling liquid is sprayed,

during the milling operation, onto the work area. No matter how close the sensor was placed to the tool, the presence of the coolant affected the temperature reading.

The performance computer converts the sensors' analog signals into digital signals, which are stored in core memory. These signals are constantly being compared in threshold logic networks with data, which were gathered previously under test conditions, that relates them to the quality of the part being produced.

This test data is part of an experimentation period required before the computer, made largely of integrated circuits, can be programed for a particular machine.

For example, during the set-up period the milling machine is operated at various speeds and the workpiece is carefully examined to determine how speed affects the surface finish. At the same time, the tool-tip temperature and the amount of vibration are noted. Then various combinations of measured characteristics and variables are studied and compared. The result is a set of threshold limits at which the logic is set for monitoring what is happening during the milling operation.

"What we're doing is recognizing operating patterns," says Valek. "When our sensor signals come in we equate them with what has happened before and adjust the operation of the machine accordingly. As our computer is now designed, we can accept up to 10 inputs and calculate up to five different outputs."

Bendix has also been investigating the adaptive

system's use with a lathe, an electron beam welder, and a grinding machine.

Numerical controllers going IC

"In the next two to five years, everyone will have gone to integrated circuits," says Dean W. Freed, vice president and general manager of Bunker-Ramo's Numerical Control Systems division. "It will be very difficult to sell a system that won't have IC's. The IC's could be more for sex appeal than for anything else."

However, Bunker-Ramo cites the higher speed of IC's over discrete circuitry as having enabled the company to design simpler serial logic to replace parallel logic in some controllers. The higher speed also makes it easier to drive a controller directly from a digital computer.

Integrated circuits are already having an impact on the design of numerical controllers. The Westinghouse Electric Corp. came out with an all-IC point-to-point controller in 1965. Bunker-Ramo has been building selected portions of its models 3000 and 3100 contouring controllers with IC's for the past 18 months.

Both Cincinnati Milling and Coleman Engineering are using IC's and the Hughes Aircraft Co. is readying its all-IC NC 500 contouring controller for a fall debut.

Not everyone agrees on just how valuable IC's will be in numerical controllers. Certainly they will make feasible adaptive controllers such as the Bendix performance computer. Those companies with IC controllers also point to the increased reliability they can promise a customer, but those who don't have an IC unit yet say that transistorized solid-state logic is exceptionally reliable already. Almost all

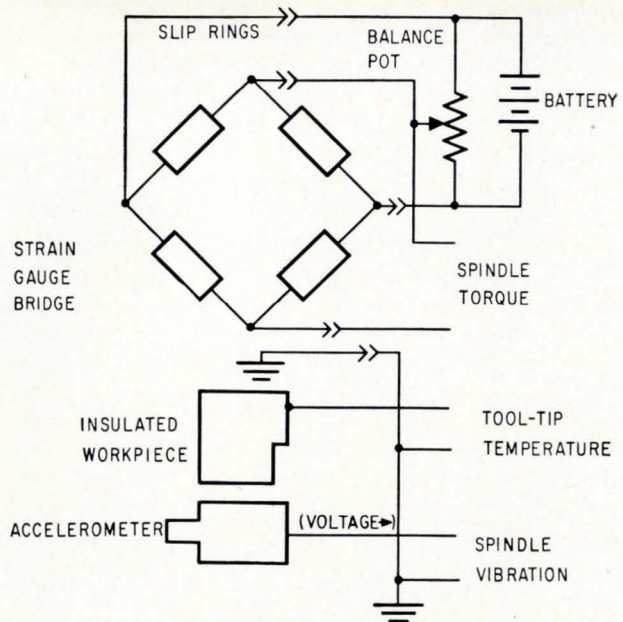

Bendix Research Labs' adaptive control system, used to maximize the quality of the machined part, senses spindle torque with strain gauges mounted in a bridge. Tool-tip temperature and the spindle vibration are also sensed.

agree that IC's will undoubtedly bring down the price.

"The move from tube circuits to solid state was a big jump in both reliability and speed," points out a spokesman for GE. "The move to IC's will not be nearly as functionally dramatic."

General Electric may not have an IC controller on the market, but it has been working with one for at least the past three years, according to GE's Ross.

How numerical control works

Numerical control in machining means the automatic operation of a machine tool from digitally coded instructions. The instructions control the tools' position and cutting path on the workpiece.

A typical numerically controlled machine receives instructions coded on an eight-channel punched tape. Read into the control a block at a time, the taped information provides the dimensions of the part to be produced and instructions for the operation of the machine tool. The data directs the tool's motions, controlling operational functions such as tool speed, feed rate, and the selection and flow of coolant.

Inherent in numerical control is accuracy and the capability of simultaneous control of multiple axes of the machine. Positioning accuracies of 0.0001 inch are common.

Basically, there are two types of control systems: point-to-point (positioning) and contouring (path). In point-to-point control, the tool is moved from one point to another for the next machining step. In these machines—drilling, boring, punching, and riveting devices—precise positioning at each point is essential.

Contour control is used on milling and grinding machines, lathes, and other devices that perform shaping functions. Linear interpolation circuitry in the contouring control maintains an accurate path by synchronizing electronic pulses applied to drive motors that position the machine's axes. The pulse ratio determines the tool's path, while the pulse rate determines the speed.

By programming in a series of tiny straight-line increments of movement, linear interpolation can

also be used to approximate curves. Contouring systems may also include circular interpolation circuitry. And some manufacturers of controls are offering parabolic interpolators.

Signals from the tape reader go to an information storage section that transmits them to the motor drives. The storage section consists of various registers, usually one for each machine axis to be controlled, plus relays for initiating auxiliary or on-off commands. A buffer store is included when a relatively slow tape reader is used and the operating time of the machine is shorter than the tape-reading time.

Positioning-sensing devices on the machine tool axes sense the actual position of the tool. This information is fed back and compared with the position commanded on the input tape. Servoloops adjust the position precisely while the machining continues.

The company began with resistor-transistor logic and has now moved to transistor-transistor logic, with its higher noise immunity and greater fanout ability. Bendix is also believed ready to make an IC announcement (it uses IC's in adaptive control, not numerical control) and Bunker-Ramo may be readying another.

R.C. Bell, head of engineering of Hughes' Industrial Systems division concedes that "it isn't entirely clear whether there is any real improvement right now in reliability over a well-designed solid state discrete component system. However, as the state of the art improves, the IC system certainly has the potential for improved reliability."

Hughes already makes several solid state systems, but these systems probably won't be redesigned with IC's, says Bell. Developed during the last five years, the systems have a high degree of reliability, which Bell doubts IC's could improve. In addition, the manufacturing costs are already low, he says.

Choosing the IC spots

One of the first to use IC's in numerical controls, Bunker-Ramo turned to the areas where the circuits' high speed and reliability could be used to best advantage—in the contour generator or linear interpolator and in the feed-rate generator of the model 3000, and in the circular interpolator offered as an option in both the model 3000 and lower-priced model 3100, shown in the basic outline below.

The feed-rate generator supplies the interpolator, which generates a straight line or circular contour, with a train of pulses that are gated to synchronize and control the travel of the machine axes.

In the model 3000, the feed-rate generator and linear interpolator make up roughly 20% of the total electronics, which is completely solid state in both controllers.

Another factor in selecting these areas for applying IC's, says Bunker-Ramo's Richard P. Bloss, was their central location within the entire system. They are away from the interface of both the incoming and outgoing circuitry so that minimum buffering is required. Bloss, applications engineering super-

visor at the control systems division, says this was important in the changeover from discrete components because the controllers operate in shops that have noisy electrical environments, caused by relay contactors, solenoids, motor starters, overhead cranes, arc welders, and the like.

Modulating reference signals

Digital instructions are read from tape by a photoelectric or magnetic tape reader in the Bunker-Ramo controller.

The pulses modulate a command reference signal that is compared to a position reference signal. Error differences resulting from this comparison cause the servos to move the tool.

The data distribution area converts the tape reader output signal to data signals compatible with the system. Various bit-parity checks are made on this data to insure reliability. The data signals are then distributed to a particular buffer store—at one of the machine tool's axes, for example—indicated by the address on the tape. The buffer store transfers the data to the active store on command from the control logic.

Although the control logic tries to keep the tape program moving without interruption, it will stop all commands if a malfunction occurs. The control is divided into tape reader, sequence, start-stop logic, timing pulse, and tape error sections.

A cycle time—the time it should take for the machine tool to move from any point to another—is established for the system by the feed-rate generator and a contour generator are used for all the plied by a voltage-controlled oscillator that varies between 150 and 200 khz. A single feed-rate generator and a contour generator are used for all the axes of the controller.

The feed-rate unit controls the frequency of the pulse train it supplies to the contour generator. Frequency depends on the programmed feed command that relates the speed of the tool spindle and the distance it must travel.

Pulses from the feed-rate generator provide a time base for the contour generator, which gates

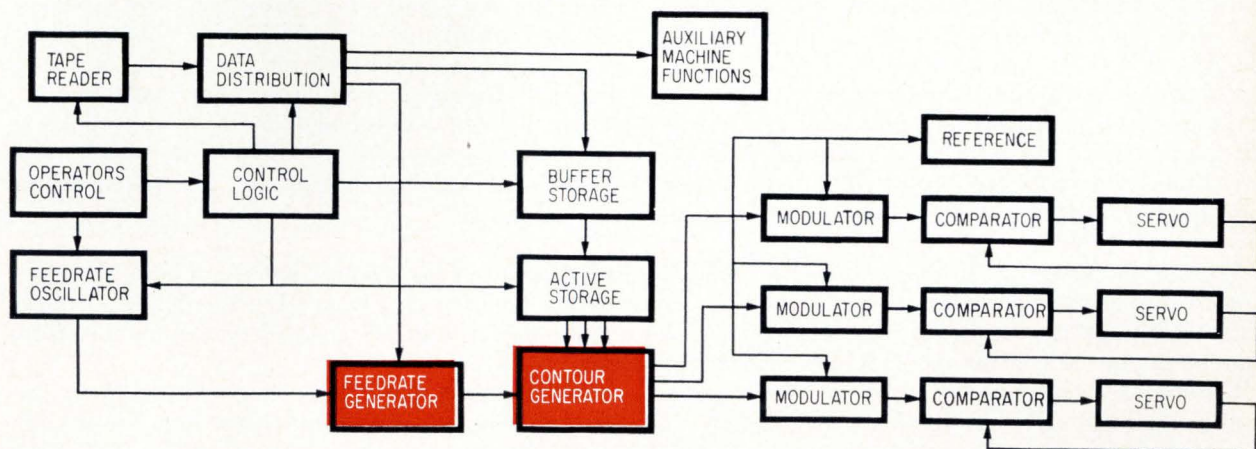

Integrated circuits are used in the feed-rate and contour generators (color) in Bunker-Ramo's models 3000 and 3100 controllers. The rest of the circuitry is also solid state. The generators control the motions of the machine's axes.

pulses to each axis of the machine in accordance with the dimensions placed in the active store. Each pulse represents an axis increment of 0.0001 inch. The interpolator ensures all axes are synchronized so that the proper path is traced by the tool. The closed-loop servosections convert the digital command pulses into proportional voltages to operate the machine motors.

Speed simplifies logic

Speed, which increases with ic's by a factor of 10 over the discrete design, is of great importance, according to Bloss. Propagation delays range from as much as a full microsecond with discrete components down to about 10 to 30 nanoseconds with ic gates, and 50 to 75 nanoseconds with flip-flops. Rise times are on the order of tens of nanoseconds, instead of 3 microseconds. Because of such speeds, serial logic replaced parallel logic in the counter stages. This simplified the circuitry because asynchronous counters, which require less gating to implement than their synchronous counterparts, could be used.

In the discrete-component counter circuit there were many different elements, including the four basic flip-flops, three gates, a one-shot multivibrator, several short time-delays, a series of emitter followers to buffer the flip-flop output, and a kilohm resistor to prevent a possible timing prob-

lem in the gating.

In contrast, the ic counterpart built around the Signetics Corp.'s Utilogic consists essentially of only J-K flip-flops and gates; everything is d-c coupled. Signetics is a subsidiary of Corning Glass Works.

Discrete component multivibrators are used in the gating area. This is the point where the 4.5-volt ic logic interfaces with the 20-volt logic of most of the system. However, in most instances where ic's are used, the circuitry also includes discrete components. The reason: certain logical functions in a numerical control system must be different from application to application. The width of an output pulse, for example, may have to be varied from one installation to another depending on the design of the particular machine tool to be directed. If the one-shot multivibrator circuit producing this pulse was completely enclosed in a single package, control of this pulse width would be lost. Thus it is advisable to keep such timing components discrete.

Another reason for using discrete components is that they are economical—the logic function involved can be produced at a lower cost if discrete components are combined with ic's. For example, diode-resistor gates are used when current or voltage amplification isn't needed. These are less expensive at present than comparable ic gates.

Industrial electronics III

Eyeing new applications

Engineers are turning to numerical control techniques for automated inspection systems and computer-aided design

Although most manufacturers of numerical control devices have concentrated on the metalworking industry, some are turning to other industries that could benefit from their wares. Woodworking, sewing and fabric-cutting machines, seam welders and flame cutters, and layout generators for p-c boards all operate by following a predetermined path.

"Numerical control has been tied to the machine tool industry for too long," says Leon Musser, general sales manager of Bendix' numerical control group in Detroit. "We're looking for motion control applications in other areas as well."

One new application Bendix has developed, for example, is in the control of a machine that sprays polyurethane foam onto the inside panels of automobile doors. Ford is using this controller on its auto production line.

Agreeing with Musser are Ara Aykanian and Tom Linn, president and vice president, respec-

tively, of the Boston Digital Corp., a relative newcomer to the field. The firm has developed a contour control that costs \$6,500—about the same as an ordinary point-to-point controller, but less than half the price of other contour controllers.

Boston Digital developed its IM-10 interpolator [Electronics, May 29, p. 181] with techniques learned in designing controls for automated drafting equipment.

"The interpolator uses a serial digital differential analyzer technique that's common to other contour devices, says Linn, "but it's designed to be more efficient logically, using fewer gates and flip-flops."

Made almost completely with Philco-Ford integrated circuits, the interpolator can be driven from punch-tape readers, manually operated digit switches, or directly from a digital computer. With a resolution better than one part in a mil-

lion, the interpolator, driven by a computer, could be used to precisely position a tracking antenna, according to Aykanian. Thus, a smaller computer than is ordinarily needed could be used.

Electronics assembly

Seeing possible fruitful markets for numerical controllers on electronics assembly lines is John W. Tarbox, project manager for the recently formed assembly automation group of Hughes' Industrial Systems division.

"The philosophy of our group is to come up with production-line building blocks that can be numerically controlled," explains Tarbox. "Then we put them together on an assembly line and direct them either from a central computer or from individual numerical control tapes. The flexibility possible with numerical control is the main reason for using it. With it, we can pick up the process anywhere along the line, change the pattern quickly and proceed."

Hughes has already introduced numerical controllers to its concept of automated assembly, coupling an NC-200 point-to-point controller to an x-y positioning table and adding either a micro-circuit welder, ultrasonic bonder, or solderer.

Positioning tables have been, in one form or another, under automatic control for years. Hughes' success will depend on how well it can automate the bonding operation with the mechanical feeds required to bring the part into position.

Hughes is also investigating the controller's application to IC probers, handlers and testers. Its controllers are also being used on a circuit-card assembly machine for discrete components sold by Technical Devices Inc., Culver City, Calif., and on Hughes' own back-panel wiring and cable-laying machine.

Inspection machines

The greater productivity of numerically controlled machines has made the traditional manual inspection methods too costly because they take too much time.

"Waiting for the first part to be inspected can be a very expensive bottleneck," says North American's Wilson. "Production is held up until it's known whether the first part meets all of the tolerance requirements. Numerically controlled inspection equipment is definitely needed to speed things up. So is more in-process inspection, not only by providing digital readouts of table position but through actual part measurement as well."

Automated inspection systems have been developed by companies such as Bendix' Automation and Measurement division in Dayton, Ohio, [formerly the Sheffield Corp.] and the Potter Instrument Co., Plainview, N.Y. Both have machines for measuring two- and three-dimensional coordinates that provide an operator with a fast digital readout as he moves a probe to each of the key positions on the finished part.

The part is securely fastened to a flat work

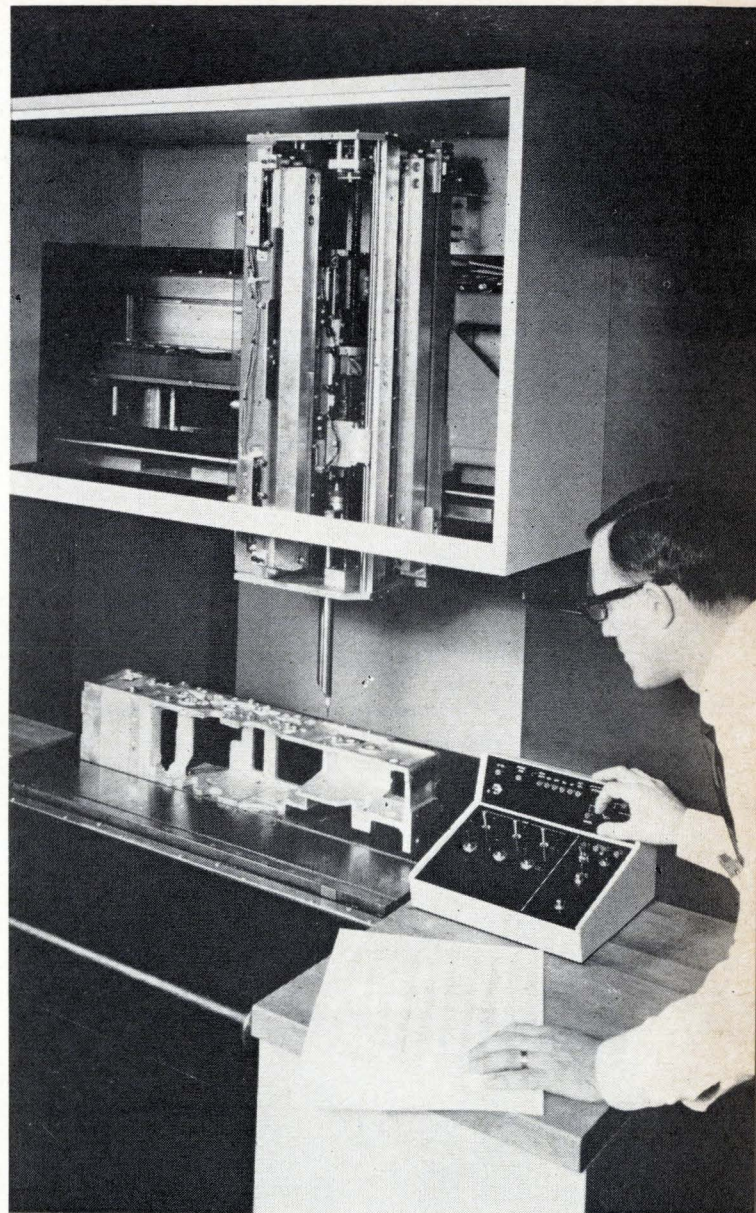

Computer-controlled inspection machine being developed by IBM automatically positions its own probe according to program stored in memory and measures dimensions of parts along three axes.

table. Suspended above it is the inspection probe, a metal cylinder with a replaceable pointed tip.

With a tip suited to the part being inspected, the probe is moved to an initial reference point where the x and y readouts are set to zero. The probe is then moved progressively to the various inspection points. As it moves, its position is sensed by an optical grating having thousands of lines scribed per inch. There is one grating for the x and one for the y direction.

The probe also moves in the vertical direction for z dimension measurements. Pulses are sent to digital counting circuits, which activate the readouts.

Recently, Potter added to its Picomm II inspection machine a digital computer that stores the

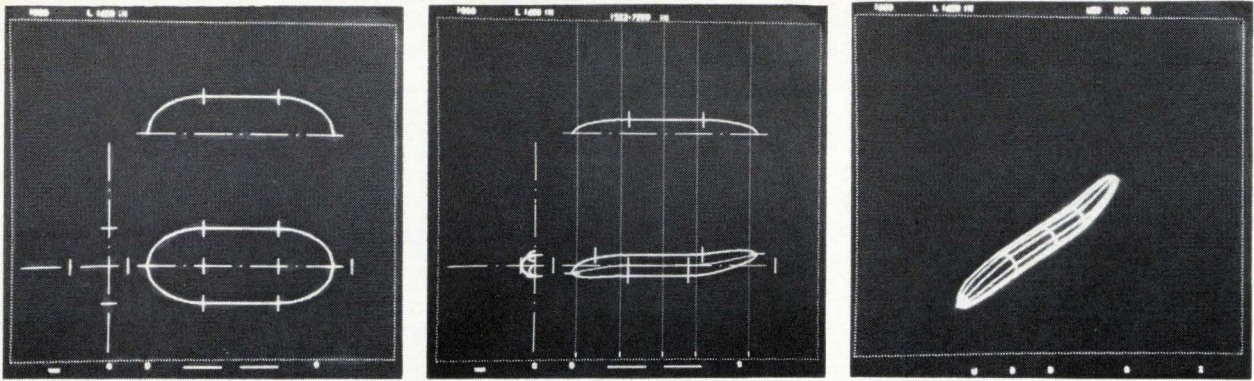

Cathode-ray tube display at Lockheed-Georgia shows design progression starting with basic surface (left) that is then shaped (center) and finally displayed in perspective.

dimensions and tolerances for the parts coming off the production line. These are fed into the computer from master program tapes.

The machine reads out the dimensions on each axis to six digits and, at the same time, feeds the data to a computer, which calculates any deviation from the specifications, printing them out together with the dimensions. Operated in reverse to probe prototype models, the inspection machine can also prepare numerical control tapes with which to reproduce the prototype.

IBM recently developed an experimental machine, shown on page 133, that not only stores programs in

a computer but also automatically moves the probe. Metal parts are measured with a conducting probe that contacts the part and completes a low-voltage circuit. Transducers along the axes of the machine sense the probe's position.

Printed-circuit layout patterns are measured with an optical probe that automatically recognizes the edges of reflective features. A pressure-sensitive probe is also being developed for measuring plastic and other nonconducting parts.

An unusual feature of the machine is that a part can be placed almost casually on the table, as much as 1/16 inch from its intended position. Special set-up points on the part, specified in the program, are probed by the machine. The locations of these points are used to manipulate the stored data in such a way as to rotate and translate the part to compensate for its actual location.

Position sensors on the machine also compensate for any external alignment errors. Thus, if the table itself is askew, data fed into the computer eliminates the effects from the measured coordinates.

Designing on a scope

The active integration of computer graphics with numerically controlled machine operations may well become the most significant development affecting design and manufacture in the future. Computer graphics or computer-aided design is already changing the electronic engineer's approach to the design of circuits and systems. It will become increasingly more important to the designer of machine and structural parts.

"We're hoping eventually to bridge the gap between an engineer's conceptual design of an aircraft or space vehicle to the production of finished parts," says M. David Prince, associate director of research systems sciences at the Lockheed Aircraft Corp.'s Lockheed-Georgia division, Marietta, Ga. "We hope to do this by improving the man-computer partnership, and hence increase man's productivity and creativity."

Lockheed-Georgia has perhaps the most advanced computer graphics facility for producing

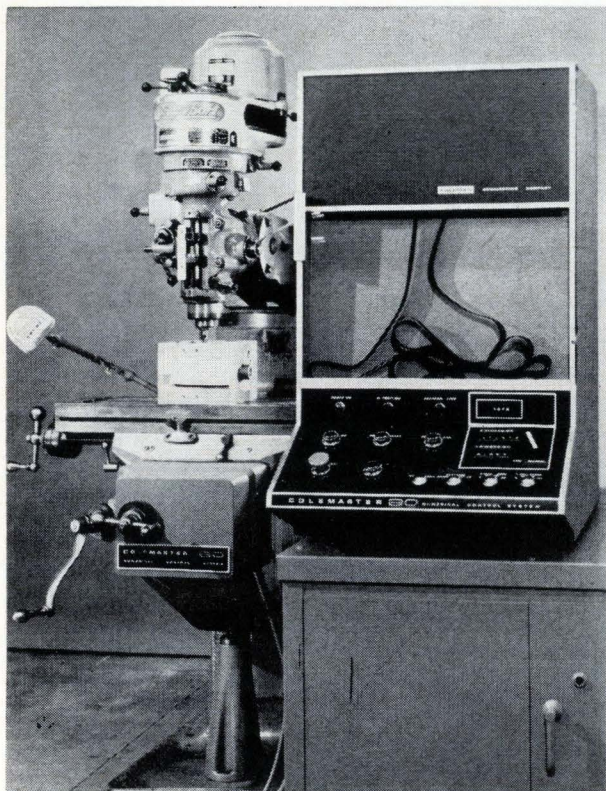

Point-to-point controller designed with integrated circuits by Coleman Engineering Co. is being used to retrofit vertical milling machines.

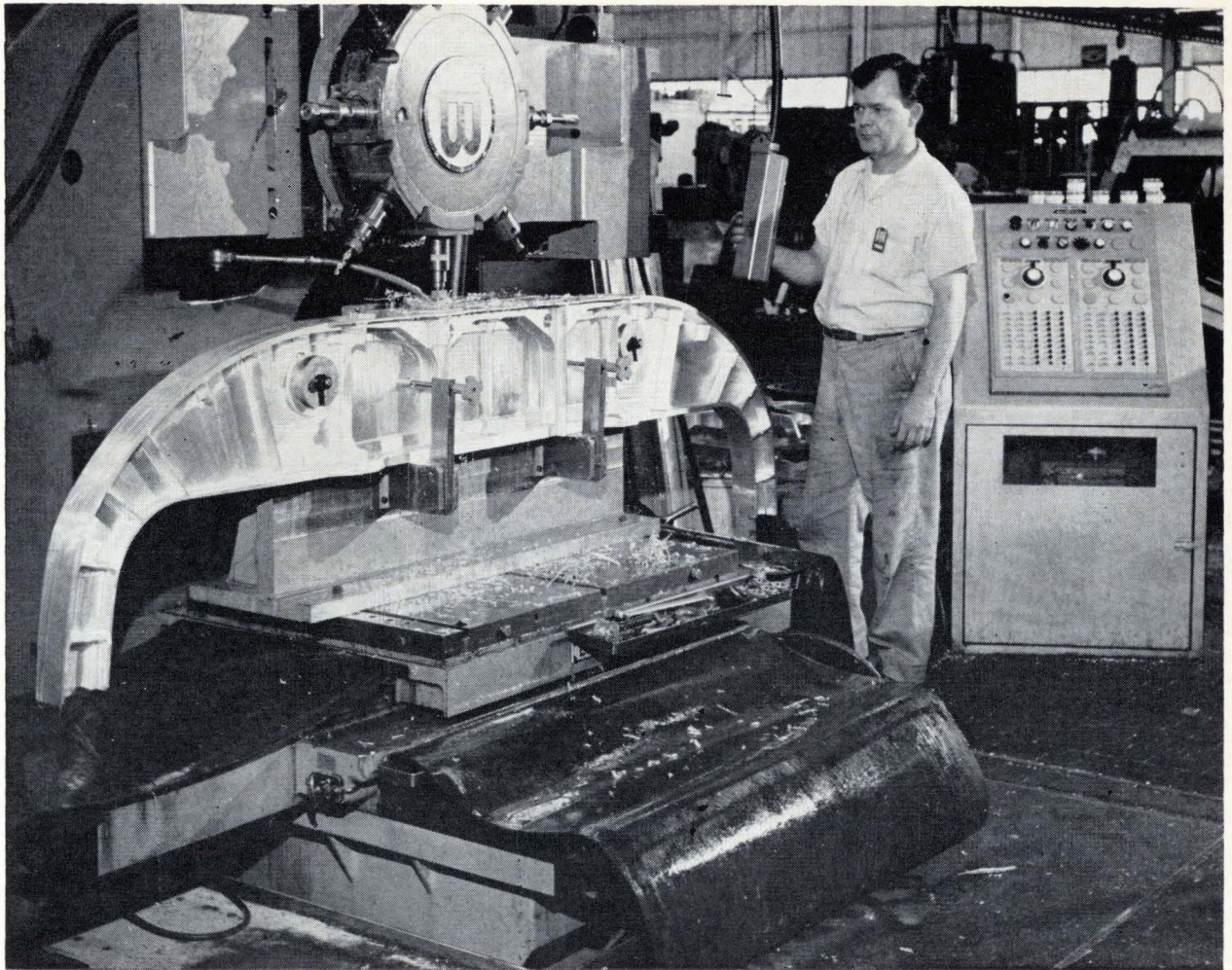

Multispindle drilling machine, directed by a General Electric two-axis numerical controller, turns out airframe parts at Sikorsky Aircraft plant in Stratford, Conn.

machine parts. The company has three control Data Corp. model 270 graphics consoles and light pens, time-shared to a CDC 3300 computer, a 32,000-bit core memory, and a disk storage unit. The system is used both for research and to produce the tooling for roughly 90% of the smaller parts on Lockheed's C-5A transport. It's running 14 hours a day on two shifts.

In the system, the light pen, consisting of a fiber-optic bundle connected to a photomultiplier tube, places straight-line or curved elements on the scope face by sensing the location of a computer-generated reference or tracking cross. As the pen is moved, the cross moves with it, generating the curve on the display. Exact coordinates of any point or geometric shape are entered into the system on a typewriter. A special set of words that call for such functions as drawing a straight line or a circle, are displayed along the edge of the scope. Their locations are known precisely by the computer so that any function can be called for by merely positioning the light pen over it and pressing an input button. Alphanumeric characters are also placed on the scope face and can be selected by the light pen.

Lockheed displays parts that have already been designed on the console, their dimensions keyed into the system directly from the blueprint. Working with his light pen, the operator then traces out the path that a cutting tool would have to follow in order to produce the part. Information for operating the machine tool, such as the feed rate of the cutting tool and the rotating speed of the tool spindle, are also keyed in.

Once the cutter path and machine instructions have been determined, programs in the computer automatically produce a numerical control tape that can be put onto a machine tool so that the part can be machined. Lockheed reports about a 3 to 1 improvement in the time it takes to produce a tape with the graphics console compared with the time it takes to mesh the cutter path with the part dimensions using a conventional part-programming language.

Lockheed is also experimenting with using the scope to help design parts, but this capability isn't being applied to production work yet. "We're not really trying to do any accurate work on the scope itself," points out B.F. McCollum, technical programming coordinator at Lockheed's manufac-

turing group. "Accuracy is maintained inside the core memory. The scope is more like a paper and pencil. An arc drawn by the operator using the light pen is, for example, referenced to the two points it joins. These points have already been accurately stored in the system in 24-bit words with floating-point arithmetic."

The company has developed most of its own programs for the system. Programing comes in two parts: a system program that maintains control over the three consoles, the central processor and the auxiliary memory, performing such functions as time-sharing the consoles and loading subroutines from the disk into the core; secondly, the applications-level program that handles scale changes and data modification, generates displays, and provides cutting tool calculations.

"The capacity of the core storage is a major element holding back further development of the part-design techniques," says McCollum. "Adding new programs and capabilities or more consoles cuts down on the amount of core available for each unit; response time also increases. As we plan to enlarge the system there is always the tradeoff to be made between cost, response time, and the storage needed to do bigger and bigger jobs. We're always looking for more memory without slowing down the response time too much.

"One thing we may do is try putting all data in the core for a particularly active console and store the rest in the disk."

Engineering aid

Eventually, the computer graphics will be used for both design and manufacture.

"After a part is designed we want to be able to analyze it as a structural or a lifting device," says Robert A. Locke, head of the structural system section at Grumman Aircraft Engineering Corp., Bethpage, N.Y. "For example, we may want to know how it will behave aerodynamically with pressure distributed over its entire surface and what its structural deformation will be under an applied set of loads for various flight conditions. Right now, we're developing programs that will apply such stresses to a part that's drawn on the cathode-ray tube of our display console."

Still another application of computer graphics is in the design of textiles, a project being undertaken at IBM's New York Science Center.

"We're putting fabric patterns on our display scope and then modifying them until we get what we want," says A. Donald Rully, manager of advanced systems at the IBM center. "We can decide not only on the pattern but on the kind of weave we want, and there are over 100 kinds of weaves. The result of the work is a printed output of the pattern, which is used to produce a set of punched cards for driving automated looms."

"One problem we have," Rully points out, "is getting patterns in and out of the computer system accurately. With machine parts, designers work with exact dimensions. With textile designs, the

artist's random design is what must be reproduced. Often these are done freehand and it's not possible to get them into x-y coordinates. One of the things we're looking at are Rand tablet-like devices that sense what the artist draws and get it immediately into the computer."

Automated drafting and digitizing

Another application of numerical control is automated drafting. Special tables are useful for providing accurate hard copies of a design developed on a scope. But in general, the drafting tables are graphic input-output devices for all kinds of data, working directly from a digital computer, or from punched or magnetic tape, or punched cards. They're being used for drawing such things as aerodynamic surfaces, automobile body designs, machine parts, topographic maps, and photographic quality masters for p-c board layouts and ic intra-connection patterns.

The drafting system is very much like a two-axis machine tool under contour control. However, it traces a contour while inking or scribing a drawing at a much higher rate—up to 750 inches per minute, compared to 30- to 60-inch speeds for fast-moving tools.

Many models, such as those produced by the Gerber Scientific Instrument Co. in Hartford, Conn., or the Universal Drafting Machine Corp. in Bedford Heights, Ohio, have either their own computer interface buffers or built-in digital computers. Special programs stored in the computers may operate on the drawing data so that, for example, different views of the same object are produced.

Drafting systems can also digitize information instead of just drawing it. That is, a drawing, placed on a drafting table, is converted to digital form. This is achieved by reversing the table's positioning system—instead of driving the system with digital data to trace the drawing, a reticle, suspended over the table in place of the usual inking mechanism, is tracked carefully over the lines of the drawing. The x-y movements are sensed and converted to digital data. Closed-circuit tv cameras in the tracking head, coupled with automatic line-following circuitry, are also available.

Automotive companies are using three-dimensional systems to prepare tooling dies for auto bodies. The systems work directly from clay or wooden models and produce the control tape from which the dies are machined. The time saved in preparing the dies can be enormous. Tooling normally takes 18 months. But by using the new system, the time can be shaved by as much as 14 months, down to four months.

Some companies offer systems that only have this drafting ability in reverse. One, recently announced by the Warner Electric Brake and Clutch Co., Beloit, Wis., uses a joystick to slew a reticle over undimensioned art work. It produces standard eight-channel punched tape that can be used to drive a machine tool.

"Worst Case" Noise Immunity is our best case

AMELCO HNIL

Logic guarantees 3.3-volt noise immunity,
now packaged and priced for industrial users!

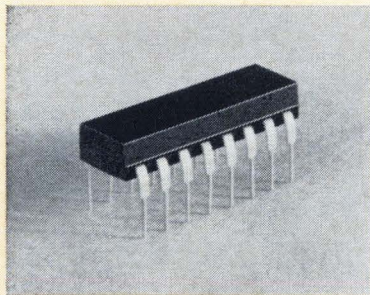

GENERAL SPECIFICATIONS

V_{cc}	12 volts
Logical "1"	11 volts
Logical "0"	1.2 volts
Fan Out	5 (min.)
Noise Immunity	4.2 volts (typ.) 3.3 volts (min.)
Propagation Delay	60 nsec

Amelco's new High Noise Immunity Logic family was made for nasty, noisy industrial applications. Available for the first time in a low-cost 16-lead dual in-line epoxy package, the nine-function HNIL Series guarantees a worst case noise immunity of 3.3 volts—from 0 to 70°C, in both the Logic "1" and Logic "0" states. HNIL circuits can be used in the noisiest industrial control applications, without fear of spurious operation. Compare the prices and write for full details today. HNIL may be the logical answer for your next process control or data monitoring system. Amelco HNIL is available in the following nine logic elements*

301 Dual 5-Input Buffer with Expanders	(\$2.90)
311 J-K Flip-Flop	(\$4.20)
321 Quad 2-Input Gate with Expanders	(\$2.75)
322 Dual 5-Input Gate with Expanders	(\$2.75)
331 Dual 5-Input Expander	(\$2.75)
341 Dual Exclusive OR with Expanders	(\$2.90)
342 Dual One-Shot	(\$5.30)
361 Input Interface Circuit	(\$4.20)
362 Output Interface Circuit	(\$4.20)

*Prices shown are for quantities of 1000 or more.

AMELCO SEMICONDUCTOR

DIVISION OF TELEDYNE, INC. • 1300 TERRA BELLA AVENUE • MOUNTAIN VIEW, CALIFORNIA • Mail Address: P. O. Box 1030, Mountain View, California • Phone: (415) 968-9241 • REGIONAL OFFICES: East—Westwood, Mass., 805 High Street, (617) 326-6600; Melville, L. I., N. Y., (516) 692-4070; Syracuse, N. Y., (315) 437-8343; Paterson, N. J., (201) 696-4747; Glenside, Pa., (215) 887-0550; Towson, Md., (301) 825-3330; Orlando, Fla., (305) 423-5833 • Midwest—Des Plaines, Ill., 650 W. Algonquin Rd., (312) 439-3250; Cedar Rapids, Iowa, (319) 366-0635; St. Louis, Mo., (314) 427-7200; Farmington, Mich., (313) 474-0661; St. Paul, Minn., (612) 488-6634; Columbus, Ohio, (614) 299-4161; Dallas, Texas, (214) 631-6270 • Northwest—Home Office, Mountain View, Calif.; Los Altos, Calif., (415) 941-0336; Seattle, Washington, (206) 323-5100 • Southwest—Los Angeles, Calif., Suite 213, 8621 Bellanca Ave., (213) 678-3146; Los Angeles, Calif., (213) 870-9191; San Diego, Calif., (714) 298-4711; Phoenix, Ariz., (602) 277-9739; Albuquerque, N.M., (505) 268-0928; Littleton, Colo., (303) 798-8439 • Canada—Montreal, P.Q., (514) 384-1420.

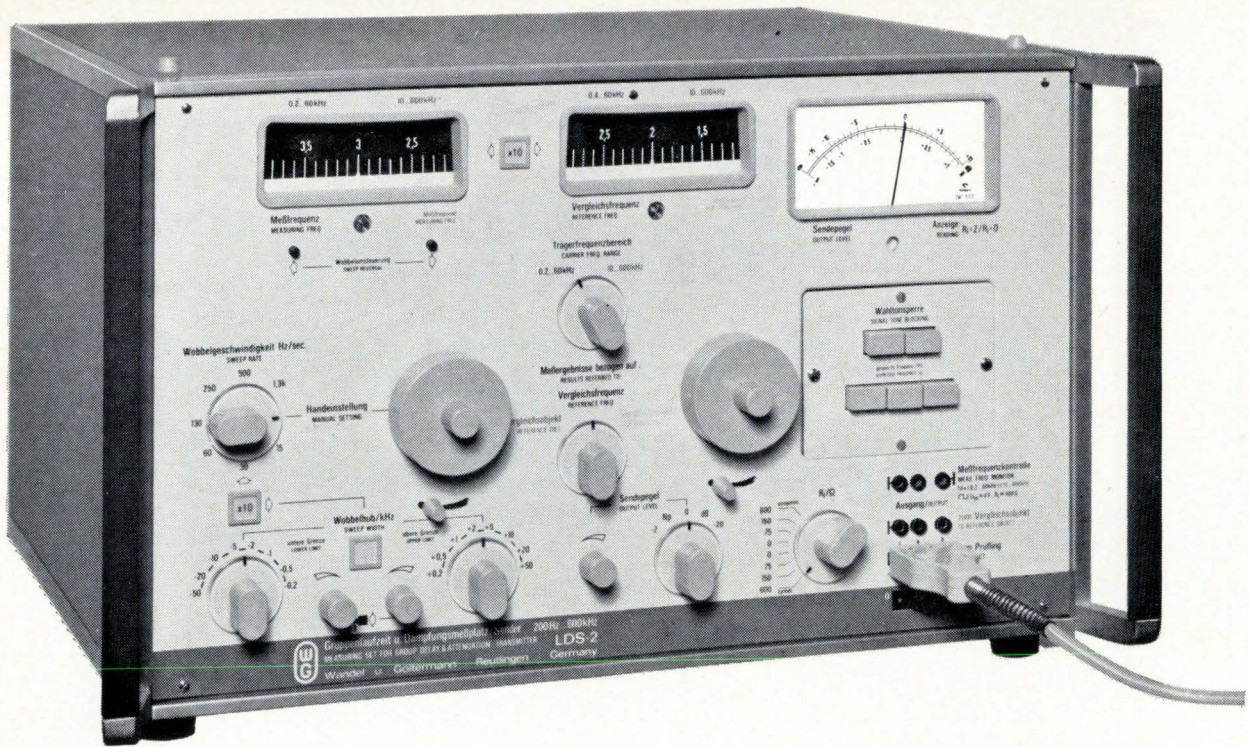

Automatic Phase Control

the Solution for

End-to-End Measurements of Envelope Delay on Data Transmission Circuits.

Group Delay plays an important role in high speed data transmission where maximum system capacity is to be utilized.

Measurement of Group Delay (as a function of measuring frequency) in the laboratory poses no problem as transmission of the reference phase is easily accomplished.

But how do you solve the problem if the circuit under test is hundreds of miles long and cannot be looped?

Even the best crystal oscillator has a drift which superimposes itself on the measurement if transmitting and receiving ends are not synchronized. Can you afford a two hour wait while the crystal temperature reaches its as-

signed value? Will you tolerate constant phase readjustments to compensate for instability in your measuring instrumentation or for the changing value of the absolute delay of the measured circuit (as in the case of a satellite transmission)?

You have more important things to do. You can insist that your group delay measuring instrumentation be operable immediately upon turn-on and that it yield reproducible, stable results. You can because W & G has now developed a measurement technique which eliminates the drawbacks of all former methods of measurement.

Based on the measuring set to 14 MHz (Model LD-1) which has proven itself as the only instrument available for

measurements on video tape recorders, a group delay measuring instrument was developed for the frequency range from 200 Hz to 600 kHz. Only one, fixed, modulation frequency of 40 Hz is used for the entire frequency range — in spite of this the instrument attains the remarkable sensitivity of 1 μ s at all measuring frequencies.

You can sweep or measure point by point; the result is always exactly reproducible.

The results are displayed on three meters simultaneously: Frequency; Attenuation; and Group Delay. You can connect an X-Y-Recorder and immediately have a permanent record of the test results. Obviously solid state — Naturally 19" Rack Mountable.

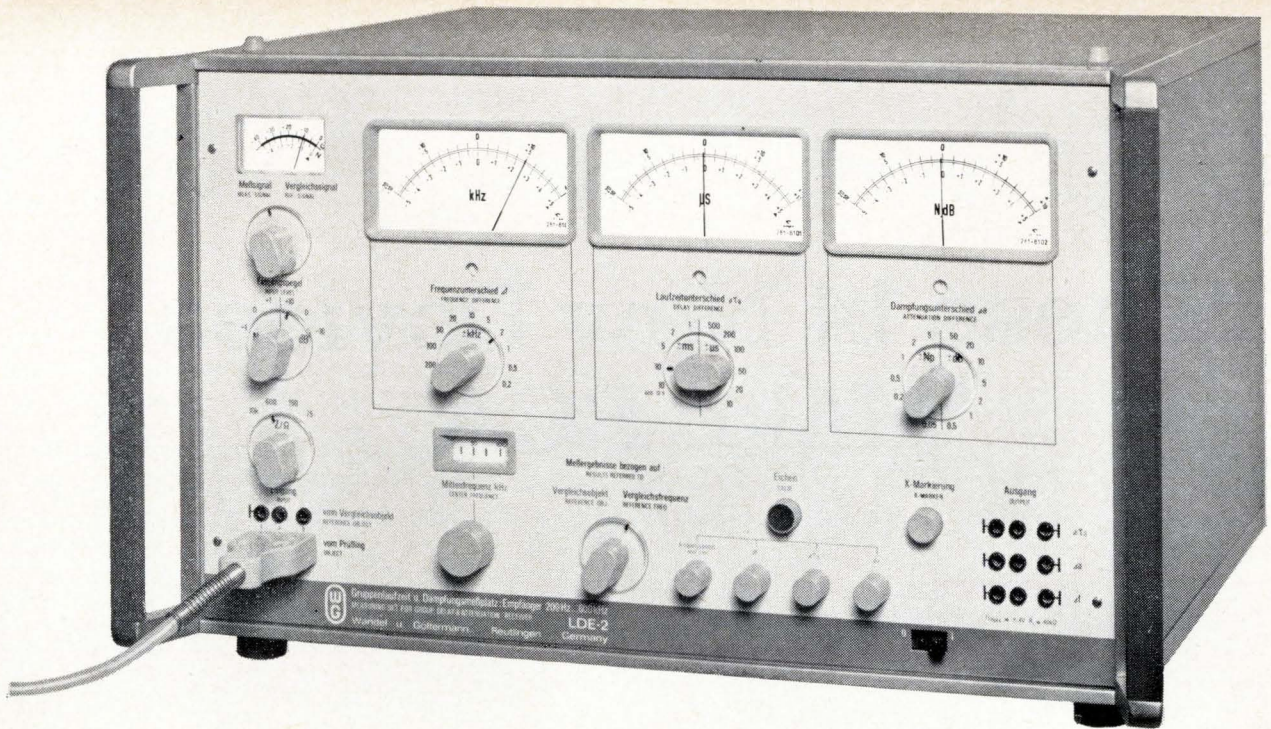

The New Wandel & Goltermann Envelope Delay Measuring Set LD-2

Features:

Principle:

Nyquist principle, modulation frequency 40 Hz, therefore, no beat with the line frequency.

Readout:

Simultaneous, separate, meter displays of frequency and group delay and attenuation distortion; or frequency and absolute group delay and attenuation—for either point by point or sweep measurement. Output for X-Y-Recorder available.

Dial Tone Elimination:

Provisions are incorporated in the generator to avoid unwanted actuation of dial tone receivers within a system under test.

Typical diagram of a telephone connection recorded by an X-Y Recorder connected to the output.

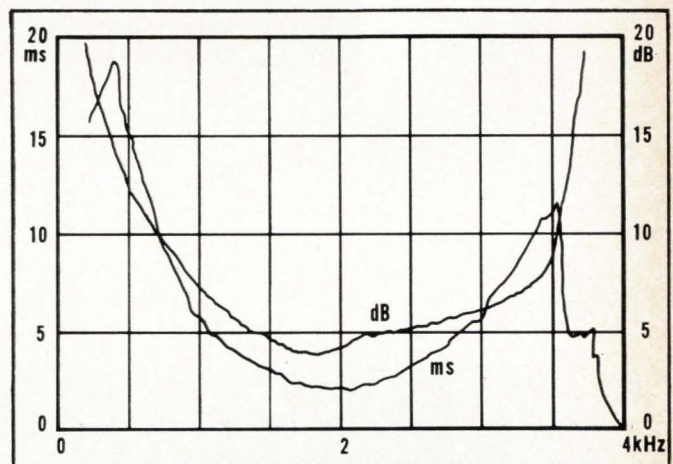

Frequency Range:

200 Hz to 600 kHz. Accurate frequency adjustment assured by an 8 foot long projection scale with sub-ranges 200 Hz to 60 kHz and 10 kHz to 600 kHz.

Phase Control:

The receiver is automatically phase synchronized to the generator via a phase reference transmitted through the circuit under test, thus assuring repeatable measurements without warmup or preliminary phase adjustments.

Resolution:

1 μ s for group delay measurements; 0.05 dB for attenuation.

Sensitivity:

Transmitter output level +10 to -35 dB. Receiver sensitivity +10 to -50 dB. Dynamic range of the receiver 40 dB.

Impedances:

75, 150, 600 ohms; plus 0 Ω (generator) and 10 k Ω (receiver).

Sweep:

Sweep width from 400 Hz to 600 kHz continuously adjustable. Sweep time from 0.3 second to 1 hour.

Power Supply:

Operation from AC line or a 24 volt battery.

TEL-COM
INSTRUMENTS, INC.

U.S. Agents for

Wandel & Goltermann

Representatives in CANADA: R-O-R Associates Ltd., Don Mills, Ontario; ENGLAND: Wandel & Goltermann (UK) Ltd., London, W3; AUSTRALIA: Jacoby, Mitchell & Co., Sydney, and in 30 more countries.

17715 Chatsworth Street • Granada Hills,
California 91344 • Phone (213) 360-2278

741 Reutlingen • Germany • Postbox 259



These 14 New Devices Make RCA

the Triac Leader of the Industry

Now, RCA offers you the industry's broadest line of Triacs, with an unmatched choice of ratings and triggering characteristics in space-saving packages ... all at truly economical prices! Triacs are today's most modern, effective component for ac phase-control and load switching. Because they can perform the functions of two SCR's, Triacs make possible new economies in full-wave power circuit design and cost for industrial and commercial applications.

So for efficient, inexpensive solid-state control of motors, lighting, and heating, look to RCA, the Triac Leader. Your RCA Sales Representative will be happy to give you more details, including price and delivery. Also, ask him about RCA's complete line of SCR's. For additional technical data, write RCA Commercial Engineering, Section RN6-3, Harrison, N.J. 07029. See your RCA Distributor for his price and delivery.

*Priced in quantities of 1,000 and up.

Current Rating $I_T(\text{rms})$	Low Voltage (100V)	120V Line (200V)	240V Line (400V)	Package
2.5A ($I_{GT} = 3 \text{ mA max}$)	40525	40526	40527	modified 3-lead TO-5
2.5A ($I_{GT} = 10 \text{ mA max}$)	40528	40529	40530	modified 3-lead TO-5
6A		40429	40430	TO-66
6A		40485	40486	modified 2-lead TO-5
6A		40431 (with integral trigger)	40432	modified 2-lead TO-5
15A		TA2834	TA2835	TO-66

RCA Electronic Components and Devices



The Most Trusted Name in Electronics

Sensitive-Gate Triacs under \$1.00*

Extremely high gate sensitivity...rms (on-state) current = 2.5A...and a price level that makes possible a new generation of controls for small appliances, induction motors, and sensing circuits. Maximum gate sensitivities of 3 mA or 10 mA are actually many times greater than that of conventional Triacs! This means simplified triggering circuits and reduced component costs. The 100V versions (40525 and 40528) sell for \$0.95*; the 200V types (40526 and 40529) are priced at \$0.98*; and the 400V units (40527 and 40530) are available at \$1.40*!

6A Triacs in 2-lead TO-5 to Control up to 1440 Watts

With the new 40485 and 40486 6A Triacs, RCA doesn't have to use an expensive press-fit package to control a lot of power. Both types employ the low-cost TO-5 case which can be easily mounted on heat spreaders using mass produced pre-punched parts and batch soldering techniques for improved heat-sinking ability. The 40485 sells for only \$1.50* and controls 720 watts. The 40486 can control 1440 watts and sells for \$1.98*. And reliability is assured with surge current protection up to 100A!

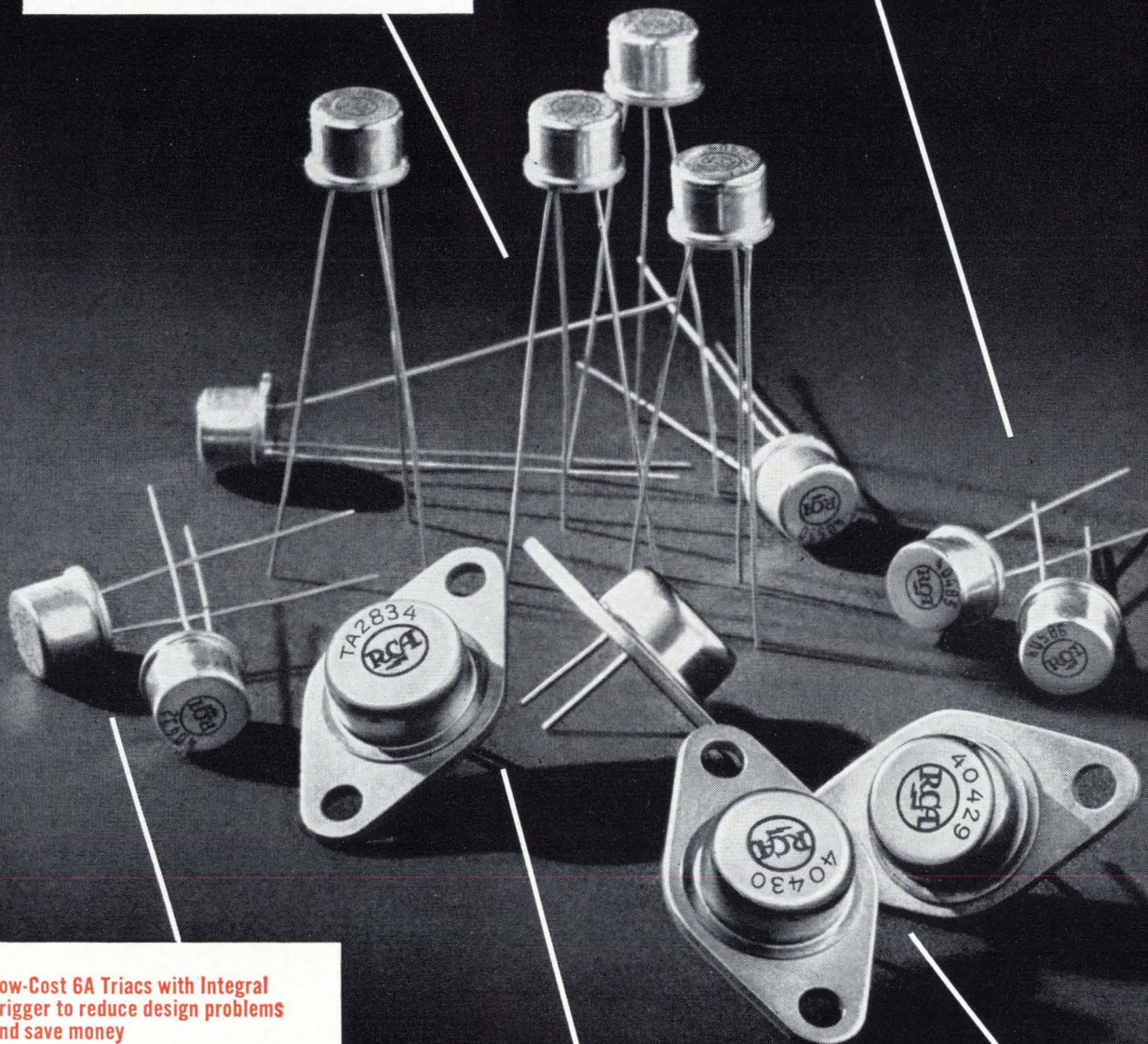

Low-Cost 6A Triacs with Integral Trigger to reduce design problems and save money

Because the triggering device and the firing characteristics of the 40431 and 40432 Triacs are coordinated inside a compact TO-5 case, you don't have to worry about designing in additional triggering components. You benefit further from reduced circuit and assembly costs, plus improved packaging densities! So if your ac-load control circuits require a trigger, why not have it built-in for you? The 40431 controls 720 watts at 120V and costs \$1.80*; the 40432 controls 1440 watts at 240V and costs only \$2.48*.

15A Triacs for Load Control up to 3600W

RCA developmental types TA2834 and TA2835 Triacs extend solid-state control way up into the kilowatt range. These powerful TO-66 units have surge current protection up to 100A, plus all of the other design benefits of RCA's lower current Triacs. Possible applications include power supplies, heating controls, motor drivers, and many other industrial and commercial usages.

6A Triacs in Popular TO-66 Package

Need full-wave control of up to 1440 watts in a TO-66 package? RCA 40429 and 40430 Triacs are your answer... they feature high gate sensitivity, symmetrical triggering characteristics ($I_{GT} = 25 \text{ mA max}$), and surge current protection up to 80A. The 200V 40429 costs \$1.50*, the 400V 40430 only \$1.98*.

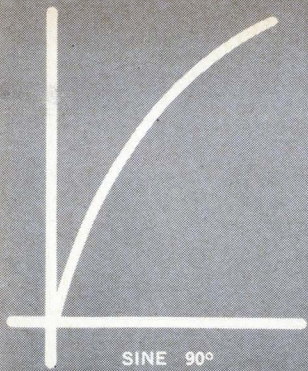

SINE 90°

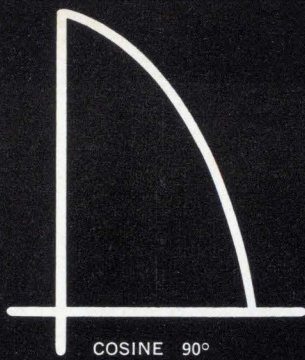

COSINE 90°

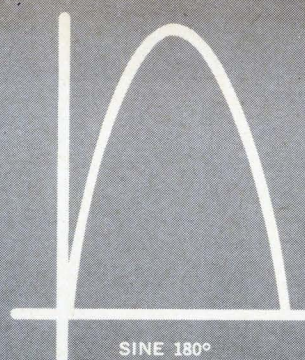

SINE 180°

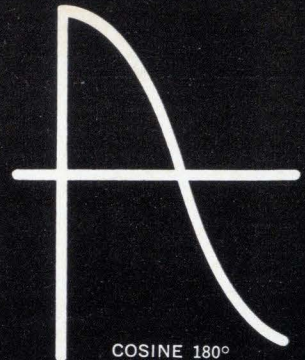

COSINE 180°

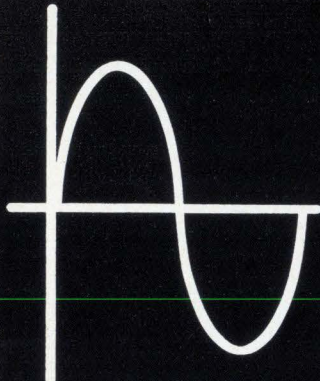

SINE 360°

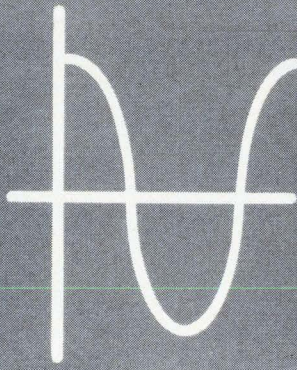

COSINE 360°

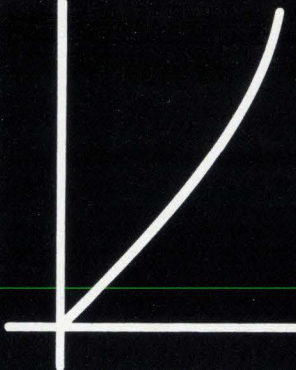

SINGLE SIDED SQUARE

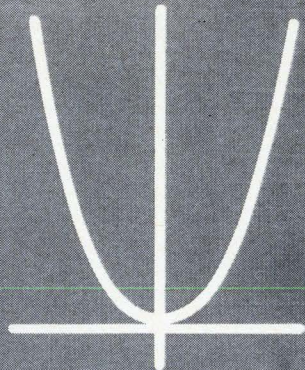

DOUBLE SIDED SQUARE

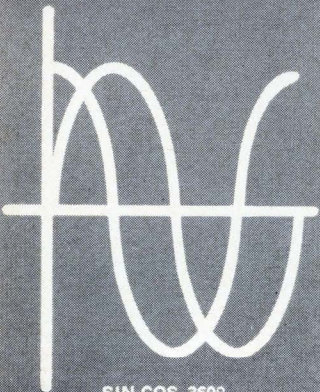

SIN-COS 360°

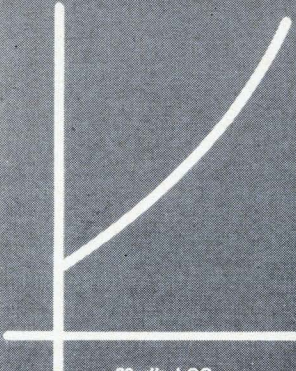

20 db LOG

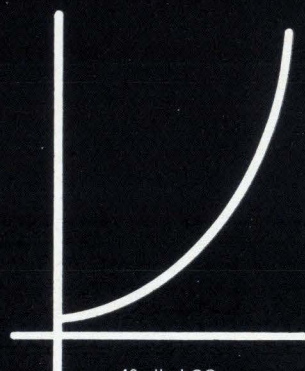

40 db LOG

A FEW LINES ABOUT NONLINEARS

Bourns offers you a wide selection of single and multiturn nonlinear potentiometers . . . available in either bushing or servo mount styles. The curves shown on this page illustrate **standard** nonlinear functions available from Bourns.*

If these standard functions do not meet your needs, many others can be provided by Bourns to satisfy your most exacting requirements. When it comes to that "out-of-the-ordinary" need, call Bourns . . . where total-value is a reality. Contact your nearest Bourns office, representative, or write the factory direct, outlining your requirements . . . let us help you save time and cut costs.

*Write for our 4-page bulletin "Nonlinear Functions" for data on capabilities, resistance ranges, conformity, etc.



BOURNS, INC., TRIMPOT DIVISION • 1200 COLUMBIA AVE., RIVERSIDE, CALIF.
TELEPHONE 714 684-1700 • TWX: 910 332-1252 • CABLE: BOURNSINC.

TRIMPOT® and Precision Potentiometers - Miniature Relays - Electronic Modules - Microcomponents.
Circle 142 on reader service card

Probing the News

Consumer electronics

CATV: the picture of health

Regulatory, copyright, and ownership problems have not braked operators' pell-mell expansion pace; over-the-air broadcasters, longtime industry foes, are now scrambling to get into the act

By Kay Sloman

Staff writer

At the annual convention of the National Community Television Association (NCTA) in Chicago this week, the trade group will announce a larger public relations budget aimed at adding impetus to the community antenna television (CATV) industry's rapid growth. Left for dead barely a year ago in the wake of bitter hassles over regulation, copyright, and ownership, operators have surprised many observers by continuing to thrive. And despite the Congress's failure to act on vital legislation and a spate of lawsuits, the CATV business is stepping up its expansion pace.

"Despite the wrangling among operating interests, consumers are willing to pay hard cash for CATV," says Irving B. Kahn, president of the TelePrompTer Corp., a large operator of cable systems. Available data suggest Kahn is right. From a standing start 17 years ago, CATV has grown into a lucrative business in which some 1,770 systems serve well over 2 million subscribers who pay an installation fee plus about \$5 a month for cable service. Currently, the industry is adding about 18,000 subscribers a month.

Community antenna systems offer home viewers a wider choice of programming and better reception. The equipment involved is relatively simple: an antenna picks up the broadcast signals and relays them to a point where they are amplified. From there the signals are fed into a coaxial cable distribution

network wired into subscribers' homes.

I. The Government game

Until March 1966, the Federal Communications Commission (FCC) made only token efforts to regulate the fast-growing offshoot of the tv business. At that time, the commission issued its eight-point second report and order asserting its jurisdiction over all CATV systems and asking Congress to ratify its authority [Electronics, March 7, 1966, p. 151]. Perhaps the most controversial of the FCC's eight rulings effectively froze operators out of the top 100 metropolitan markets, which encompass 90% of all the tv receivers in the U.S.

Predictably, the industry reacted

to the agency's change of heart with outraged cries and a spate of lawsuits. Robert Beisswenger, president of the Jerrold Corp., a leading supplier of CATV apparatus as well as an operator, says: "The FCC's jurisdiction over CATV is an unprecedented attempt to restrict the freedom of tv reception in this country. Cable tv has proven to be the best method for obtaining clear, multichannel reception. The benefits of this technology shouldn't be denied anyone desiring this service."

The Alice Cable Corp., a Jerrold subsidiary, is one of several systems suing, in separate cases, to test the commission's authority to deny petitions by the plaintiffs to reconsider provisions of the second report and order as applied to them.

Interest groups. "Some of the pressures on the FCC to do something about CATV have come from broadcasters. They feel that since the FCC regulates them, CATV should also be regulated," says Robert Kolb, an account executive with CBS Films, a division of the Columbia Broadcasting System Inc.

Robert E. Lee, one of the seven FCC commissioners, says, "We finally changed our minds and decided that we had jurisdiction over CATV because it has the potential to destroy local broadcasters. Although cable antenna television does serve previously unserved markets, and has a useful place in the communications industry, the FCC is trying to protect the status quo of the broad-

Growth of CATV industry

Year	Operating systems*	Wired homes
1952	70	14,000
1953	150	30,000
1954	300	65,000
1955	400	150,000
1956	450	300,000
1957	500	350,000
1958	525	450,000
1959	560	550,000
1960	640	650,000
1961	700	725,000
1962	800	850,000
1963	1,000	950,000
1964	1,200	1,085,000
1965	1,325	1,275,000
1966	1,570	1,575,000
1967	1,770	2,100,000

* As of Jan. 1 Source: 1967 TV Factbook

ATTENUATE

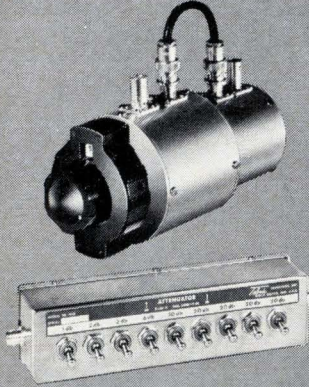

Telonic Rotary Attenuators—available in 50 and 75 ohm impedances, DC to 1250 MHz, graduated in .1, 1, and 10 dB increments, and have a range up to 109 dB. Toggle Switch Attenuators also come in 50 and 75 ohms, cover DC to 300 MHz, steps of 0.5 and 1 dB, range up to 102 dB.

DETECT

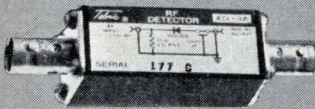

Telonic Detectors—for general purpose applications with signal and sweep generators are useable to 3000 MHz, have a VSWR of less than 1.2:1, may be specified with 50 or 75 ohm impedance, and with a variety of connectors.

SWITCH

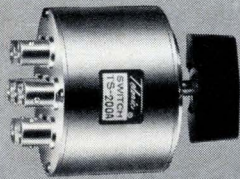

Telonic Coaxial Switches—compact, light weight, over 70 dB crosstalk rejection, with VSWR less than 1.1:1 and insertion below .1 dB, at 1 GHz. One pole, 6-position, two and four pole, 2-position are all available with optional external wafer switch.

Telonic
INSTRUMENTS

A Division of Telonic Industries, Inc.

60 N. First Ave., Beech Grove, Ind. 46107
Tel. (317) 787-3231 TWX-810-341-3202

SWEEP/SIGNAL GENERATORS AND ACCESSORIES

Representatives throughout the U.S., Canada and Overseas. Branch offices in Maidenhead, England, Frankfurt, Germany, and Milan, Italy.

... the Congress shows no inclination to pass CATV legislation this session ...

casting industry.”

Lee concedes, however, that “in a way broadcasters promoted the CATV industry by not being responsible. They got fat at an early age and didn’t worry about small tv markets.”

II. Task force

Last December, the FCC established a CATV task force ostensibly to deal with the flood of waiver requests from operators seeking entry into the top 100 markets. But Stanley Kaufman, deputy chief of the task force, cites another reason: “The CATV industry complained that it was unfair to have their activities regulated by the FCC’s broadcast bureau.”

Some observers feel that CATV’s freeze-out problem may be moot if waivers continue to be granted in as lenient a manner as they have been. The nation’s two top markets, New York City and Los Angeles, have been thrown open to CATV systems, and installations are being made in other major areas.

Publicly, broadcasters are concerned about the commission’s permissive approach to waivers. A leading broadcasters’ trade group, the Association of Maximum Service Telecasters contends: “This erosion must be curbed or the damage to existing and future free broadcasting will be beyond the power of the FCC or Congress to ever repair.”

Commissioner Kenneth A. Cox agrees: “The FCC has not been carrying out the provisions of the second report and order in allowing some CATV systems to import distant signals. We are undermining our own rules.”

By simply enacting legislation—pro or con—Congress could turn down the volume on the regulatory debate. But although the FCC’s proposed amendment to the Communications Act is pending, the legislative branch shows no inclination to pass such a law this session.

III. Copyright capers

Congress has also passed the buck on another issue vital to CATV interests—the question of fees for copyright holders. In the absence of legislation—CATV provisions were

deleted from the House version of the proposed new copyright law now pending in the Senate—the industry is making do with judicial decisions.

The landmark case, so far, is United Artists Television Inc. vs. the Fortnightly Corp. In this case, Federal District Court Judge William Herlands ruled in New York over a year ago that the CATV operator, Fortnightly, had to reimburse the plaintiff for relaying its copyrighted motion pictures by cable. Last month, a Federal appeals court upheld Judge Herlands’ decision. An appeal will be made to the Supreme Court.

The appeals court judges stressed in their decision that the Fortnightly case doesn’t cover all the ramifications of CATV vis-à-vis the copyright laws. For example, they suggest that if a CATV system carries signals that a viewer would be able to get from a conventional antenna, the operator would only be making the signal clearer and thus would not be subject to copyright fees.

No solution. “The copyright decision didn’t satisfy anyone,” says Frederick W. Ford, president of NCTA and a former FCC commissioner. “The rules of the game must be laid down by Congress. Its first decision will probably be on copyright. Once this is decided, everything will fall into place. The future of CATV will obviously be decided in Congress.”

IV. Who’s on first

Meanwhile, a real scramble is developing for CATV properties. “While the FCC and Congress are agonizing over the regulation of CATV, people in the communications field are no longer asking what’s to be done. Instead, they’re trying to find ways to get in on the act,” says NCTA’s Ford. Publishers, radio interests, independent telephone companies, and—ironically enough—tv broadcasters are all flocking into the CATV business.

Accurate figures on ownership are hard to come by since the FCC didn’t require operators to file with the commission until the second order and report. Frequent changes

in ownership and feverish installation activity also make soundings difficult. However, on the basis of the partial reports on file with the FCC, the NCTA calculates that there were 1,765 CATV systems operating at the beginning of 1967. Another 370 were in various stages of construction and some 1,000 would-be operators held building permits. At least one-third of the operating CATV systems have ties with radio or tv broadcasting interests, 15% are owned by newspaper and magazine publishers, and about 25% are in the hands of independent telephone companies or on lease from the American Telephone & Telegraph Co.'s Bell System.

Ambivalence. Broadcasting interests are of two minds about CATV. William Carlisle, vice president for station services at the National Association of Broadcasters, says, "The NAB isn't opposed to the growth of CATV, but it is against its uncontrolled growth. It is a parasitic industry, feeding off an existing field, and until recently it didn't have to pay for anything except equipment."

Carlisle notes, however, that the association has no particular objection to broadcasters' owning CATV systems. It's just as well. For despite the official enmity of their leading trade organizations, a number of broadcasters—networks and independent groups alike—are jumping into the CATV business.

"There's a paradox about CATV: while public opinion is that all broadcasters are against CATV, the broadcasting industry has embraced it," says Larry Walz, administrator of CATV development at the National Broadcasting Co. "NBC is continually exploring and seeking CATV acquisitions and franchise operations. We have a subsidiary in Kingston, N.Y., and three months ago we bought 80% of a system in Los Angeles County."

CBS has interests in some Canadian CATV systems and one in a small village in Argentina. "We have an option on a system that's been in existence for 15 years in San Francisco. It is a reasonable assumption that CBS is waiting to see what happens in Congress and the courts before going into CATV in the U.S.," says Merle S. Jones, president of CBS-TV Stations Inc.

The Cox Broadcasting Co.'s CATV

Columbia Components Thick-film hybrids.

Send us your specs for fast action.

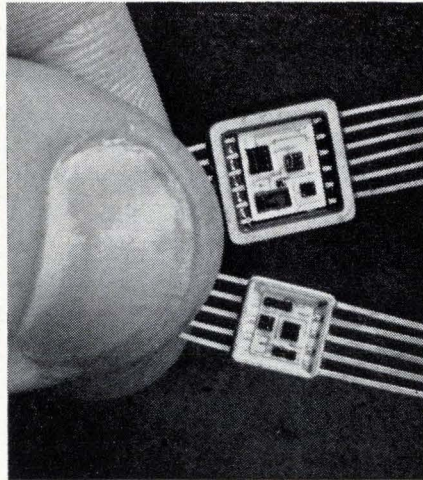

The answers to your micro-packaging problems are as close as this coupon.

The hybrid circuit is a versatile tool in the hands of the design engineer faced with problems in high power ratings, thermal tracking, precision component tolerances, intermixing monolithic IC's and other interfacing circuitry and components. In applications where the design may undergo changes up to the first production article, the hybrid offers the designer freedom to institute necessary changes with minimal cost and time.

Columbia Components Corporation's Thick-Film Hybrid Circuits are capable of reproducing any given circuit without degradation in circuit functions. These hybrids also present the most economical approach to most problems.

Please sketch schematic (or print, if available) and attach.						
Application _____						
Customer Print # _____						
Rev: _____ Lead Forming _____						
Is qualification acceptance required? _____						
Is lot acceptance required? _____						
Package style & size: _____						
Body Material _____						
Lead materials _____						
MAXIMUM RATINGS						
Storage Temp. Range _____ Operating Temp. _____						
Ambient Temp. _____ Power Dissipation of 25°C _____						
<input type="checkbox"/> Have your engineer call. <input type="checkbox"/> Send descriptive literature.						
Name _____ Title _____						
Company _____						
Address _____ Telephone _____						
City _____ State _____ Zip _____						
 COLUMBIA COMPONENTS CORP. A Subsidiary of Computer Instruments Corp., Woodside, N. Y. 11377. Tel: (212) 726-2600						

R	Value	Tol.	T.C.	Wattage	Q	Generic Type	Tol.
R1					Q1		
R2					Q2		
R3					Q3		
R4					Q4		
R5					Q5		
R6					Q6		
R7							
R8							
R9							
R10							

C	Value	Tol.	Rated Voltage	CR	Generic Type	Tol.
C1				CR1		
C2				CR2		
C3				CR3		
C4				CR4		
C5				CR5		
C6				CR6		
C7						
C8						
C9						
C10						

Environmental Specifications _____

Military Specs., if any _____ Frequency _____

Other applicable specs _____

Voltages _____

New, Tunable (Lock-in) Coherent Amplifier



MODEL 300-A

For Measurement of Ultra-Low Level Signals in the Presence of Noise

- Continuously tunable from 1.5 Hz - 200 kHz
- Variable Q from broadband to 25
- 160 db gain (100 nV - full scale)
- 0.1 uV equivalent noise voltage
- Plug-in preamplifiers
- Reference channel drives coaxial switch or chopper directly

Applications:

The Model 300-A Coherent Amplifier is useful for detection of effects of biological stimuli, photometric measurements at low S/N ratios, conversion of a communications receiver to sensitive radiometer, magnetic field effect studies, cross-correlation measurements, and general amplification and measurement of low level signals in the presence of noise.

Write for data on the Model 300-A
Price \$1795 (including basic pre-amp)

Also available are: Fixed Frequency Coherent Amplifiers, Coaxial Switches, Radiometric Receivers, and Klystron Frequency Stabilizers.

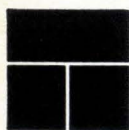

Teltronics, Inc.

Subsidiary of Roanwell Corporation

P.O. Box 466, Nashua, New Hampshire 03060
603-889-6694

subsidiary owns systems in six states. "Cox's faith in the future of CATV is shown by our recent purchases of two systems in California—Mission Cable Tv Inc., the largest system in the U.S., and Bakersfield Cable Tv Inc. We've doubled our number of subscribers to a total of about 75,000," says a spokesman.

Charles Woodard, president of the Westinghouse Electric Corp.'s Group W CATV subsidiaries says, "We've owned such systems for three years, and believe CATV is a natural extension of the communications business. However, we supported the FCC's freeze on the top 100 markets because of the competition for local stations. We'd go into the top 100 in a situation where CATV would fill the gaps."

V. Busy signals

Some CATV operators like Westinghouse own their own cables, since it is generally more economical to build than to lease. As a rule, operators who don't own their own cables pay to use Bell System lines.

For years CATV operators have been complaining to the FCC that the phone company's pole rental and cable rates favor AT&T subsidiaries. The commission is now conducting hearings on these allegations.

Stop order. A 1956 antitrust consent decree enjoined AT&T from engaging directly, or indirectly through its subsidiaries, in any business other than the furnishing of common carrier communications services. But this decree didn't apply to the some 2,246 independent phone companies in the U.S. and Puerto Rico. United Telephone Co. of Ohio, a subsidiary of United Utilities Inc.; General Telephone & Electronics Corp.; and the Continental Telephone Co. are among the independent phone companies owning CATV systems. GT&E alone owns 36 such systems. "In some places we lease cables, in others we own the cable," a company spokesman reports.

The FCC has maintained that CATV is not a common carrier. If it were, the commission would have to approve rates and franchises as well as establish operating ground rules under provisions of the Communications Act.

Despite a court ruling affirming the commission's stand, Bell is

still trying to get the FCC to call CATV a common carrier. Cliff Williamson, assistant vice president of engineering at AT&T says, "We consider CATV a common carrier and sell them a communications service."

But the FCC's Kaufman warns: "If the FCC changes its definition of CATV, Bell could take over tomorrow. The prospect of one line into every home conveying all messages, owned by a small minority frightens the hell out of me. An educated guess is that the phone company will get its way with the FCC. By the time those on Capitol Hill and the public realize what's happening, it'll be too late."

NCTA's Ford comments: "If the FCC changed its mind and now declared CATV a common carrier, it would be the height of irresponsibility. They'd have to reopen hearings and such a change in policy would be inconsistent. Redefining CATV as a common carrier is a possibility, but not a probability. I doubt if Congress would stand for this."

Operators tend to agree with Ford. One asserts that local governments are so involved with CATV that if the FCC declared it a common carrier, they'd lose money.

Rebuttal. Gordon N. Thayer, an AT&T vice president, emphasizes that the Bell System has no intention of providing CATV service directly to customers. However, a CATV task force member rejoins, "Bell says it's not now involved in CATV because of the terms of the 1956 consent decree.

For all the furor over its growth, CATV is not yet a particularly profitable proposition for some operators. Ford claims that broadcasters paint a much rosier picture of the industry than actually exists. He says, "If the system I'm involved in is any barometer of the industry as a whole, profits are pretty lousy."

Westinghouse's Woodard says, "There are only two types of CATV operators making profits—those who've been in the business for 10 years or so and those running a one-man operation."

But TelePrompTer's Kahn disagrees: "We are staking our corporate life that 85% of all U.S. homes will have CATV within eight years. We have \$29 million to invest and are looking to buy large systems."

NEW!

IMMEDIATE DELIVERY
FROM STOCK

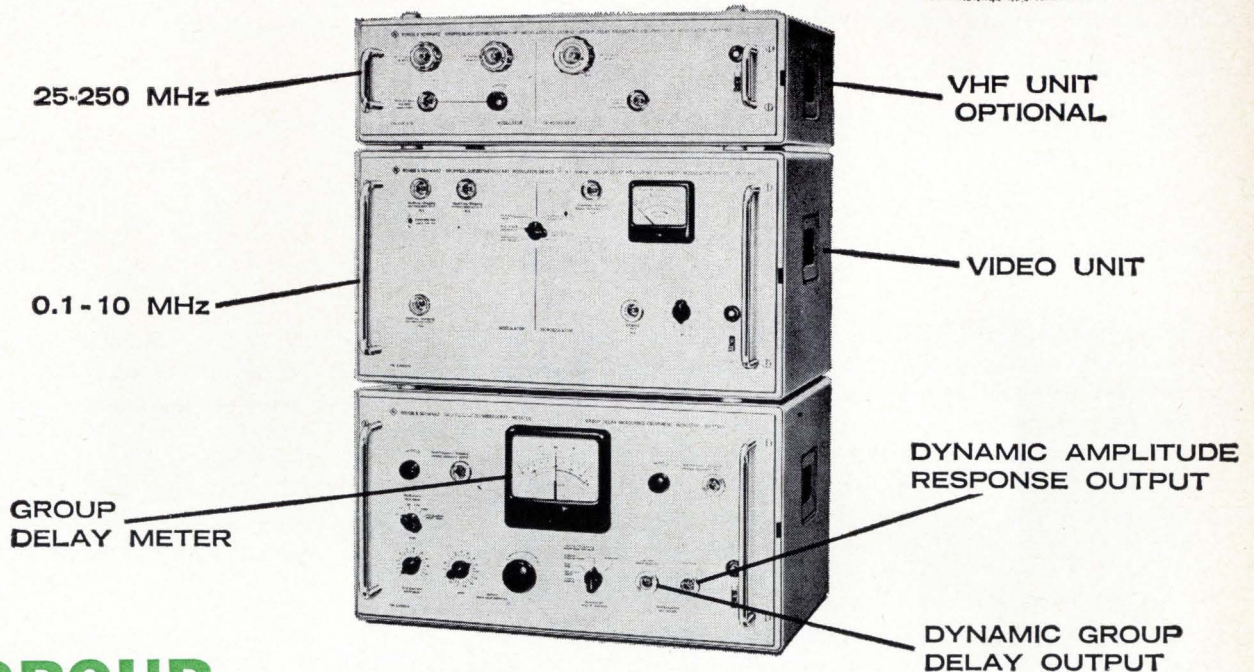

GROUP TYPE LFM (ENVELOPE) DELAY TEST ASSEMBLY

FEATURES:

- Measures Group Delay Of:
 - Video Systems, 0.1 - 10 MHz
 - VHF Systems, 25 - 250 MHz
 - UHF Systems, 250 - 1000 MHz (extended with Type MAD Modulator)
- Measurement Range: ± 10 to ± 1000 nsec, f.s.d. with a resolution of 0.25 nsec.
- Accuracy (Group Delay): $\pm 2\%$ f.s.d.
- 20 kHz probing frequency generated by internal Xtal reference
- Measures Group Delay in Presence of Sync. and Blanking Pulses

APPLICATIONS

Measure Group Delay Of:

- Active and Passive Devices
- TV Transmitters
- Video Tape Systems, Amplifiers, etc.
- Data Transmission Systems

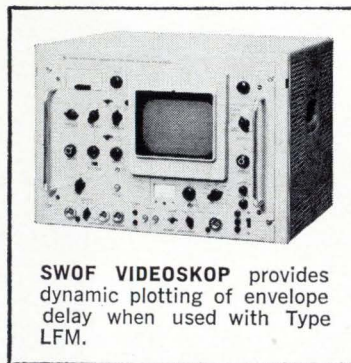

SWOF VIDEOSKOP provides dynamic plotting of envelope delay when used with Type LFM.

Group (Envelope) Delay measurement is of primary importance for the reduction of phase distortion of high quality TV and data transmission systems. Type LFM Group Delay Test Set has been designed particularly for measurements on TV-systems and networks. Measurements are made in the base-band, at VHF and UHF, and on modulated VHF carriers. Measure point-by-point or dynamically by means of Type SWOF Videoskop which plots these data automatically. Use of a low pass (30 Hz) filter in the phase bridge makes plotting of the envelope delay curve possible in the presence of sync and blanking pulses.

Get The Extra Capability,
Greater Reliability, and
Longer Useful Life Of . . .



ROHDE & SCHWARZ

111 LEXINGTON AVENUE, PASSAIC, N. J. 07055 • (201) 773-8010

Inquiries outside the U.S.A. should be directed to Rohde & Schwarz, Muehlhofstrasse 15, Munchen 8, West Germany

Second front for semiconductors

Component manufacturers are supplying functional solid state packages for applications in consumer, industrial, and military markets; ease of installation appeals to customers not oriented to electronics

By Mark B. Leeds

Solid state editor

Alert semiconductor makers noticed several years ago that middlemen were buying a few dollars worth of components and converting them into devices selling for several times the original cost of parts. Carefully picking their spots—so as not to ruffle the feathers of important customers—four large houses have edged into similar ventures. By going a step beyond their traditional activities, they have quietly built a thriving trade in a new breed of modular subassemblies and are now opening up markets hitherto untapped by the electronics industry.

The devices are variously called solid state control assemblies; unitized semiconductor assemblies; assembled functions; and advanced product subsystems. But all are substantially equivalent: they are low-cost, solid state modules, incorporating semiconductors and

other components, designed to do specific tasks, electronically, in industrial, consumer, and military products. Modular subassemblies should not be confused with diode and rectifier bridges, amplifier units, or other complex semiconductor packages. Typically, manufacturers operate out of semiconductor facilities, and their high volume production is quite different from the development activities of laboratory groups, aerospace design centers, and industrial systems divisions.

Nice and easy. Unlike integrated circuits or large-scale-integration (LSI) devices which require further engineering design before they can be incorporated in a particular piece of equipment, modular subassemblies can be produced in volume lots and plugged into a system to be put to work. Alternatively, they can be made to operate

on their own as separate units. Temperature controls for facsimile photocopying machines, speed controls for hand tools, and shutter controls for cameras are but a few of the integral applications. Lamp dimmers for standard sockets, battery chargers, and portable light flashers are some end products.

Now six years old, the business is already running at an annual rate of close to \$200 million. But within 10 years, semiconductor houses' volume in this area could reach \$3 billion—an estimated 30% of the total subsystems market and greater than projected IC sales.

At the moment, this field is still the private preserve of just four firms, each of which uses a different name for its wares. Senior member of the select group is the General Electric Co., which has been producing since 1961. Motorola Inc. has been in the business for four

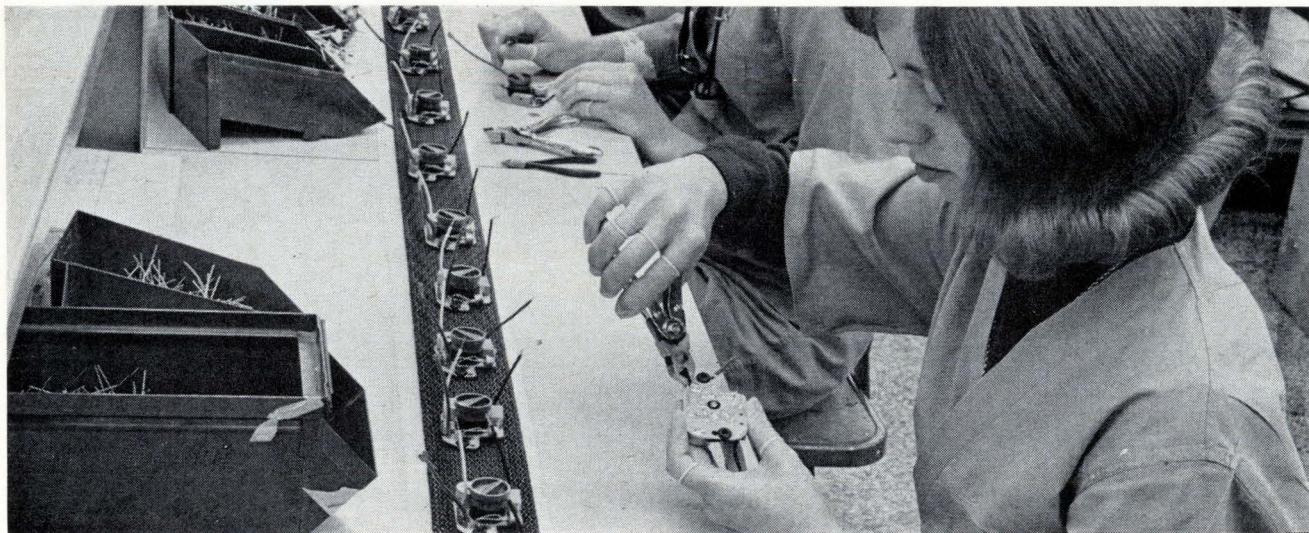

On the line. Employees at Motorola work on motor-speed controls for power tools. Subassemblies of this type can be easily installed by customers in a variety of industrial and consumer goods.

years, while Texas Instruments Incorporated has just over one year's formal experience. Newest in the fraternity, with less than one year's exposure in the marketplace, is the Philco-Ford Corp.

There are a number of attractions in subassemblies: research and development costs are minimal, sales growth averages a handsome 25% to 60% a year; and profits can be realized almost immediately.

I. The waiting game

Semiconductor firms are providing their specialty services largely for companies that have neither the resources nor the desire to become deeply involved in electronics. Ostensibly, such outfits approach device makers with a particular function in mind, furnishing size, environment, packaging, and cost specifications. If an analysis indicates that the unit can be built profitably, the semiconductor house will generally take on the project. When it's finished, the customer plugs, wires, or otherwise attaches the assembly to his equipment—without concerning himself with the technology involved.

Over the transom. The almost diffident approach of semiconductor firms to the field is reflected in the way they have been getting business. John Mungenast, manager of market development for GE semiconductor products, says, "Approximately two-thirds of our orders have been unsolicited—although most customers have used GE products or heard about them in the past."

At Motorola, Ian Dickson, operations manager, says that 80% of the company's unitized functions business comes in without an active procurement effort.

On the other hand, Philip R. Thomas, who heads TI's assembled functions group, attributes better than 50% of the company's subassembly bookings to aggressive selling tactics. Philco-Ford's experience has been similar to that of TI.

All four firms are stepping up marketing efforts and expect other large semiconductor manufacturers to enter the market soon because the potential is so great. For one thing, a subassembly group can operate as a separate profit center. For another, such an operation can be a steady customer for a firm's

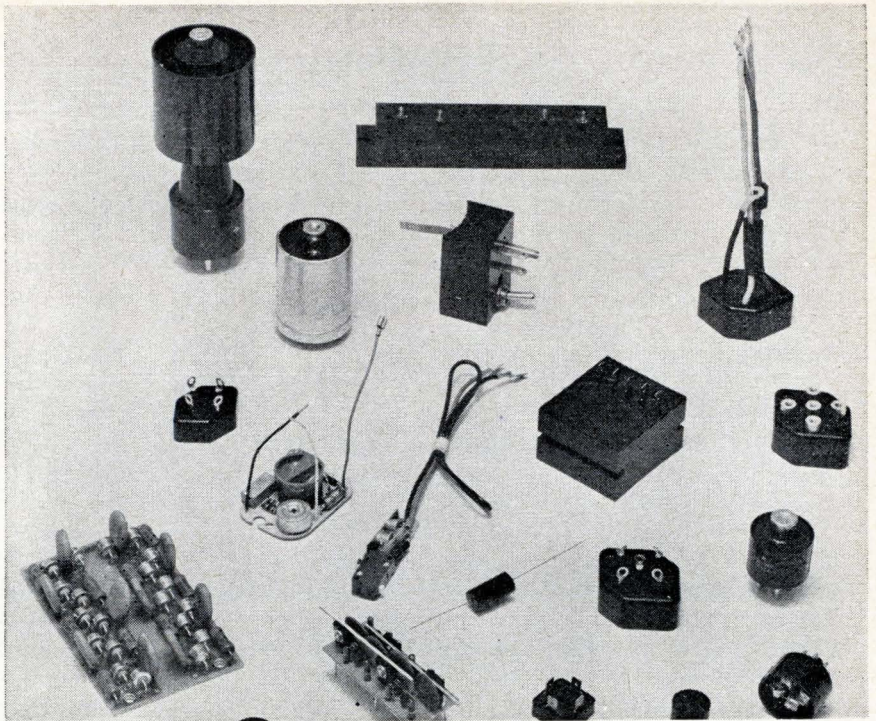

Easy way out. Subassemblies like these Motorola devices are popular with manufacturers that don't want to get involved in electronics.

component groups. Finally—and perhaps most important—modular subassemblies afford an excellent means for market development, particularly in industrial and consumer areas where electronics technology has made no significant penetration.

II. Serendipity

General Electric, which pioneered modular subassembly techniques, made its start through chance. Six years ago when the silicon controlled rectifier was in its infancy, GE engineers developed scr motor-control circuitry.

A large manufacturer of electric saws recognized the possibilities of scr control. However, this company was unwilling to get involved in circuit design and reluctant to set up a production line. Accordingly, it requested GE to supply scr subassemblies. On the grounds that its operations were not attuned to the venture, General Electric at first demurred. But the saw maker insisted.

Capitulation. Eventually, GE, still showing its distaste for the project but committed to the worth of scr control, agreed to make the subassemblies. It offered to produce the first 10,000 units for \$7 apiece, the next 10,000 for \$8 per unit, the next 10,000 for \$9, and so on, hop-

ing the escalated terms would encourage the saw maker to take over production. But things didn't work out that way.

During the first few months of the venture, GE turned out 50,000 scr units. Anticipated production problems never developed and the company found itself making a tidy profit on scr orders. Subsequently, other control circuit needs were identified and satisfied for additional customers and the solid state control assemblies group was on its way.

Neal Dowling, GE's product planner for subassemblies, points out that GE has been careful to pick its spots. "We didn't want to compete with our component customers, so we restricted ourselves to new markets," he says. "We tried to reach established firms, rather than fly-by-night operators. We prefer those oriented to innovation—people with marketing savvy whose acceptance of solid state controls would induce others to follow suit."

Dowling reports that during the last six years GE has considered some 200-odd subassemblies but only 50 or so devices have been built. However, more than 2 million modules have been produced over this span. Among the commercial units GE has made are speed controls for a drill manufacturer, dim-

... customers couldn't care less about the insides of the module ...

mers for slide projectors, air conditioner controls, and power switching modules for utility systems as well as light-switching controls for automobiles, appliance controls, thyratron firing modules, dashboard indicator arrays, computer lighting subassemblies, and heater controls.

In the case of nonproprietary subassemblies, GE has slightly modified designs so it can offer off-the-shelf wares. "We now have more than a dozen standard items for various industrial and consumer applications," Dowling says. "The number is growing and they may pave the way for more rapid acceptance of solid state controls. Prices are lower than on custom units, and orders can be filled more quickly."

III. Something to gain

Texas Instruments entered the field on a somewhat different basis than GE. Thomas says, "We saw the need for a group to explain the potential of subassemblies to our customers and we wanted to crack the industrial and consumer markets—particularly, potentially profitable areas where management was unaware of what solid state electronics could do."

Along with its industry fellows, TI quickly concluded such customers were without know-how, reluctant to invest in staff and production equipment, short on time, and extremely dollar conscious. "If they go solid state, they want to know how much, how soon, and what size—they couldn't care less about the insides of the module," says Thomas. "As a rule, they want a black box that can be fastened to their equipment and put right to work, lighting a lamp, turning a motor, switching something, or whatever. And we offer this service."

Potpourri. Texas Instruments has turned out more than 50 assemblies, and in some cases, volume has run into the hundreds of thousands of units. In addition to semiconductor assemblies similar to those offered by GE, the company vends integrated circuit modules for the military, logic modules for

machine tools, power-distribution switching modules, and refrigeration controls for trucks and vans. On the verge of introducing standard assembled function products, TI plans to lead with complex integrated circuit modules. The company hopes these devices will pave the way for LSI. "The ultimate," says Thomas, "will be assembled integrated equipments, combining LSI, power devices, transducers, interfaces, and the necessary means for heat sinking."

Reverse order. Motorola's entry in the modular business resulted from customer requests and management's appreciation of the market potential. Unlike the others, it first developed standard items, then went into the custom field. The company prefers to group its complex module products with unitized assembly operations. Dickson considers modular subassembly the precursor of LSI, and expects future assemblies to be highly integrated. The company's product lines are similar to those of its competitors.

Philco-Ford's move into the subsystem sweepstakes stemmed from the Microelectronics division's difficulties with the Victor calculator project [Electronics, March 6, p. 231] and a management decision to reorganize operations along engineering and manufacturing lines

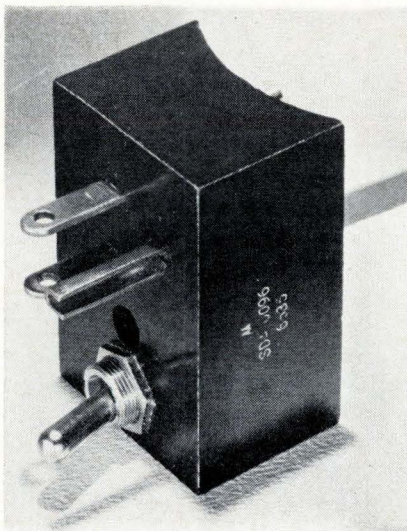

Double duty. Solid state converter is used for starting motors in lawn mowers and snow blowers.

instead of remaining a component house. Assembly operations were included in the new effort. Dave Condon, manager of engineering, considers subassembly activity "as important as component operations now." To date, Philco-Ford, which devotes a higher percentage of its modular effort to military business than any of its three rivals, has made electronic fuzes, automotive controls, code-detector modules, and navigational subsystems.

Turnkey. In most cases, the development and design of modular subassemblies is handled by the solid state houses. Instead of normal engineering assistance, the semiconductor firm provides a complete job—including contents, production, and the packaging. Typically, the innards are semiconductor components purchased down the hall. Passive elements, wiring, heat sinks, printed circuit boards, and even relays, tube sockets, and switches, also find their way into modular subassemblies.

IV. In the driver's seat

Semiconductor houses have several advantages over other firms that want to get into the modular subassembly business. For one thing, they have easy and relatively inexpensive access to components. For another, the testing of most of the individual elements has already been done, which saves a production step. Related materials, such as epoxy, or the metal for chassis, can usually be obtained from local sources. Richard J. Hanschen, assistant vice president and marketing manager for TI's Semiconductor-Components division says, "Only a few firms have a broad enough product and materials capability to provide the start-to-finish work on functional modules."

In most cases, the engineering talent required is already on the premises. Personnel in the applications department, instead of being limited to circuit design, develop a module to fit a particular function. One critical skill, assembly, isn't always as readily available; so semiconductor makers have been hiring mechanical and industrial engineers, creating a demand for these specialists.

Dumping ground. Semiconductor makers enjoy yet another plus: they can use general-purpose and even

out-of-tolerance units in their devices. Most industrial and consumer goods companies don't require high-speed transistors or low-power ic's. Moreover, they're primarily concerned with the input and output operations—not internal layouts. Both TI's Thomas and GE's Mungenast stress the importance of this factor. The freedom to use functional rejects permits semiconductor firms to price their wares at attractively low levels.

In the few cases where a customer has his own design featuring alien components and semiconductors, the big houses, with their vast resources, can usually come up with equivalent devices so that a total package can be furnished from in-house stocks. Moreover, most large firms generally produce resistors, capacitors, and related items, enabling them to operate as sole-source suppliers. Smaller semiconductor makers simply do not enjoy these advantages; nor do they have ready access to mass industrial and consumer outlets.

Squeeze. Spokesmen at major semiconductor houses believe the smaller makers, medium-sized subcontractors, and original-equipment manufacturers will experience some erosion of their business. No one will paint a bleak picture of the future of the distributor market but clearly, as the sales of individual components are affected by modular subassemblies, volume will decline. However, this decrease may be offset somewhat if enough standard devices are retailed as off-the-shelf items through distributors.

V. Good business

General Electric's Mungenast notes, "The business is more stable than component sales. With semiconductors, you have to live with continually dropping prices, and the dynamics of technological change. Subassembly prices remain fairly firm. We're still producing and selling units introduced years ago for the same price. Once you've penetrated a new market, you stand a chance of picking up business from the lagging competition with either a standard unit or a new custom design. With semiconductors, you rarely know when you'll be undercut, overpowered, or outmaneuvered."

"In addition, our custom items

**30,000 INCREMENTAL FREQUENCIES
(3×10^{-5}) FOR \$ 2.100**

Codasyn 301

**GENERATOR VERSATILITY
SYNTHESIZER ACCURACY**

TRIPLE RANGE 0.1 Hz to 100 kHz • DIGITAL FREQUENCY SELECTION • REMOTELY PROGRAMMABLE • 7 MILLISEC SWITCHING SPEED • IC DESIGN AND SOLID STATE RELIABILITY • SPECTRAL PURITY AND HIGH STABILITY • VARIABLE OSCILLATOR • COMPACT AND LIGHT WEIGHT.

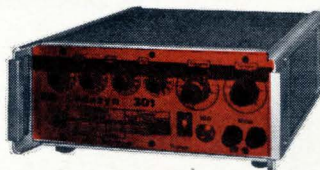

301
2100 \$

+

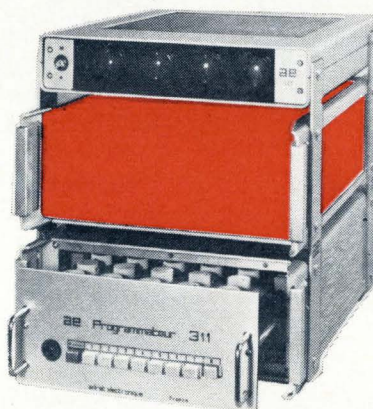

321
350 \$

=



311
400 \$

2850 \$

304

The Codasyn 301 in laboratory measurements permits: bridge measurements, work with filters, networks — rapid location of loss peaks in testing crystal filters — operation of the generator-synthesizer as a sweep generator — communications, carrier-current telephony, narrow band telemetry measurements — electroacoustic — medical electronic — vibration tests — all measurements or operations requiring source of reference frequencies for standards labs, etc. The Codasyn 301 in automatic measurements is adaptable to the programmer 311 and the display UNIT 321.



adret electronic co

507 FIFTH AVENUE NEW YORK, N.Y. 10017
TELEPHON (212) 661-1768. CABLE ADDRESS: ADRETEL

INTRODUCING

A New Member of
The
Transformer Electronics Co.
Family of
Miniature Regulated
POWER SUPPLIES

THE 6 WATT
9589 SERIES
(23 Models)

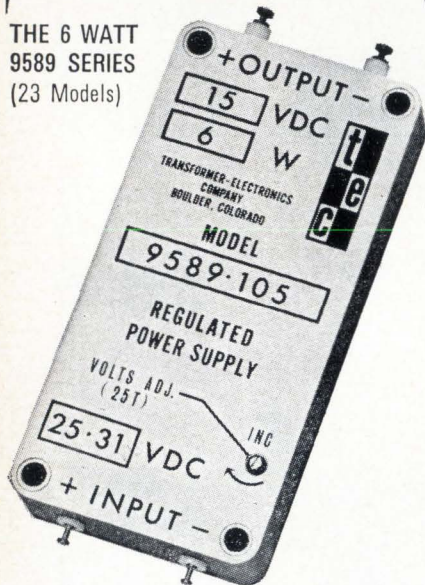

Output Power Capability: 6 watts
Operating Temperature: -55°C to $+100^{\circ}\text{C}$
Input Voltage: 25-31vdc
Line Regulation: 0.1%
Load Regulation: $<3\%$ ($\frac{1}{2}$ to full load)
Output Ripple: $<0.6\%$ p-p
Efficiency: $>46\%$
No Load Current: <75 ma
Voltage Adjustability: $\pm 10\%$
Volume: 4.3 cu. in. ($1.75'' \times 3.5'' \times .7''$)
Weight: 7 oz.
Voltage Range: 5 to 5000vdc;
 $\pm 15, \pm 25, \pm 50, \pm 100$

Other T. E. C. Power Supplies—**1 WATT**, 9583 Series; **3 WATT**, 9567 Series; **10 WATT**, 9584 Series—Write or Call for complete details.



**TRANSFORMER
ELECTRONICS
COMPANY**

BOULDER INDUSTRIAL PARK
BOULDER, COLORADO
TWX 303 443-2561 PHONE (303) 442-3837

**POWER SUPPLIES • INVERTERS
CONVERTERS • TRANSFORMERS**



Good deal. General Electric's John Mungenast and Neal Dowling agree the modular subassembly business is more stable than the component field.

are manufactured on a contractual basis," says Mungenast. "They go immediately to the customer and don't lie around on shelves. We won't even build a subassembly unless a market is established, or close to it, and the profit projection substantiated. This greatly reduces capital risks."

Volume. Thomas of TI points out that the production runs are usually long term: "We may have a dozen different products being assembled at one time, and the schedules run into months, sometimes years—on an intermittent basis, of course. We program the lines to fit the contract, and this gives us a flexibility rarely found in component manufacture, where one must often anticipate, rather than provide."

What's ahead. Certainly, semiconductor makers' ability to provide industrial and commercial customers electronics—on a low-cost, volume basis—has played the leading role in the success of modular subassemblies. Now, producers are zeroing in on other potentially lucrative outlets, the computer field and the military, where the specification ground rules are a bit tougher. Spokesmen at Motorola, GE, and TI all say the military is showing greater interest in their work.

Texas Instruments is now working on standard IC modules for the Navy, which, Thomas says, "could be the biggest thing for us since Minuteman." He adds, "We soon expect to be supplying 100-gate assemblies and other functions to bridge the gap between today's IC's

and tomorrow's LSI products." John Keyes, engineering manager at Philco-Ford's Microelectronics facility, reports his company is working on three metal oxide semiconductor subsystem projects for aerospace and military customers. All four firms are after orders in these areas, hoping to make deep inroads before rivals get in on the act.

However, with IC's, including LSI devices, more design is required. Input and output, biasing, interfacing, and related factors must all be considered. A working knowledge of digital and linear techniques is also a must. Since IC's are fundamentally small-signal units, their power handling is restricted to medium levels of a few watts. For dissipations above this point, devices may be harnessed with discrete chip-driving or controlling thyristors, power transistors, and the like [Electronics, May 15, p. 26]. This has already been accomplished with modular subassemblies. The IC's used have been complex units or combinations of older types. Thus, LSI will simplify the IC portion of future modular products.

By the same token, makers will introduce more complex component assemblies—for example, a small-signal transistor and a power pellet in one can. Such devices would interface with an IC subsystem to become part of a new unit. There is no conceivable power limit for modular subassemblies; nor are there particular restraints in terms of frequency or complexity. Devices are technically limited only by the skill and ingenuity of their producers.



A COMPUTER DESIGNED FILTER CAN MAKE YOUR ENGINEERING EASIER

Telonic RF and Microwave Filters cover such a wide range of frequencies, types, and performance characteristics that you don't have to design "around" them. Your specific requirements are programmed into an engineering computer, the filter designed and then produced to these precise parameters.

Basically modular, Telonic filters can be manufactured from elements in stock, providing another benefit in fast delivery.* With over 100,000 filter designs already produced, even so-called special types may already be standard. Here is the broad selection you have in designing —
Frequencies from 30 MHz to 12 GHz • Lowpass • Bandpass • Tubular
• Miniature • Cavity • Interdigital • Tunable

With that variety, quick delivery, and high performance, do you even need a second source?

*Three-day, Jet Order Service available

Telonic **ENGINEERING CO.** A Division of
Telonic Industries, Inc.

Box 277 • Laguna Beach, Calif. 92652 • Tel.: 714-494-9401 • TWX: 910-596-1320

Representatives throughout the U.S. and foreign countries. Factory offices in Maidenhead, England, Frankfurt, Germany, and Milan, Italy.

• 52 page Filter Textbook •

Telonic's new catalog contains never before published data on filter-insertion loss, attenuation, physical size, frequency and bandwidth tolerances, and pass band relationships. Send for your copy.

WE'VE GOT OUR WINGS! Types IN4942, IN4944, IN4946, IN4947 and IN4948 are . . . ideal for use in high reliability airborne and missile power supplies. Semtech Fast Recovery High Current Silicon Rectifiers offer maximum rectification efficiency with high frequency power sources. Offering reverse recovery (typically) of 100 nanoseconds up to 600 volts and 250 nanoseconds, up to 1000 volts PIV. Rated to handle an average rectified current of one amp at 55°C offering extremely low leakage current of 0.1 micro-amp at rated PIV, 25°C.

TX and MIL Types

Fast Recovery Rectifiers

Meets MIL-S-19500/359 (USAF)

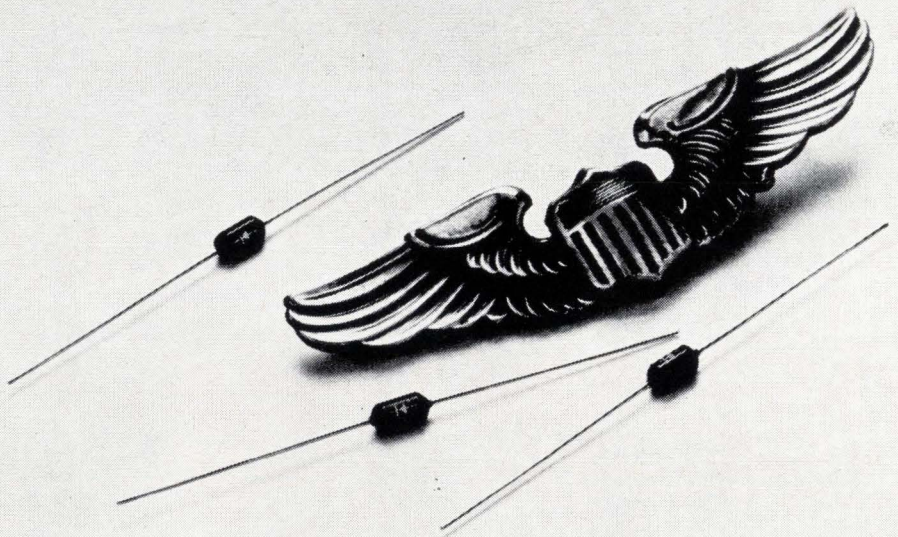

Semtech hermetically seals the rectifiers in rugged Alumina filled glass body (.275" long by .135" diameter). Internally,  equal area heat sinking is provided on both sides of the silicon junction with tungstaloid pins that match the thermal expansion characteristics of the silicon. The junction tungstaloid pins and solid silver (.030") leads are bonded above 900°C. Immediate delivery.

SEMTECH  **CORPORATION**

Western Office: 625 Mitchell Road, Newbury Park, California, (805) 498-2111/from L.A. (213) 628-5392/TWX 910-336-1264

Regional Offices—Central: 4957 Main St., Downers Grove, Ill. (312) 968-2322. TWX 910-683-1896. Eastern: 71 West 23rd St., N.Y., N.Y. (212) 989-7550/TWX 710-581-5807

European Sales: Bournes A G, Alpenstrasse 1, Zug, Switzerland (042)4 82 72/73

Hewlett-Packard's do-it-yourself IC's

Circuitry training program and IC facility give instrument maker flexibility in make-or-buy decisions and an edge in marketing

By Walter Barney

San Francisco Regional editor

During development work on the integrated-circuit counter that eventually became the Hewlett-Packard Co.'s model 5216A, John McMains, an instrument man by trade, got on-the-job design training in IC technology. His ability to come up with the right circuitry—which reduced the number of IC packages in the finished instrument—was the payoff for Hewlett-Packard's determination to expose instrument designers to integrated circuits.

From the outset, the company planned that the 5216A would incorporate IC's designed in-house by instrument engineers and produced in its own manufacturing facility. The reasoning behind this was threefold: designers could anticipate components that are beyond the current state of the art; they weren't limited to whatever devices the semiconductor industry designs to produce; and the company could merchandise whatever proprietary circuit features were developed on an exclusive basis.

One of a new breed of instrument designers being schooled by the company, McMains has learned his lessons well. When he discovered he was going to need a decade counter with a certain type of gating to blank insignificant zeroes from the display, he knew he had to start from scratch because no such circuit existed. But as a result of his unique grounding, McMains didn't simply toss his problems to the sizable IC facility at the company's Frequency & Time division in Palo Alto, Calif. [Electronics, Feb. 20, p. 50]. Instead, he designed the circuit himself, working out the logic functions and even drawing the actual masks used for production.

On the move. To achieve its

ends, Hewlett-Packard has committed considerable amounts of time, money, and personnel in building an IC capability that enables the company not only to design its own circuits but also to make them in sufficient quantities to supply its own production lines. The IC manufacturing facility is anything but a shoestring operation; the company's investment runs into the millions of dollars. Hewlett-Packard is by no means committed to making all its own circuits; but it is now in a position where it can reach an intelligent make-or-buy decision.

Eventually, the company expects to have at least pilot integrated-circuit facilities at all of its major divisions so that all design engineers will have the same access to IC technology that is now enjoyed by staffers at the Frequency & Time division. At present, the only

activity outside Palo Alto is in Loveland, Colo., where work has started on an IC laboratory. Loveland makes some of the older Hewlett-Packard instruments, such as analog and digital voltmeters, ammeters, ohmmeters, voltage and resistance standards, distortion analyzers, and communications test equipment.

I. The first steps

McMains joined the company as a design engineer two years ago, after completing graduate work at Stanford University. About a year ago, the company began work on the 5216A and its smaller cousin, the 5221A. "We knew they would have integrated circuits," McMains says, "but we had to decide exactly what we had to design and build. I was told that it was up to me to learn something about IC's."

He already had a basic course at

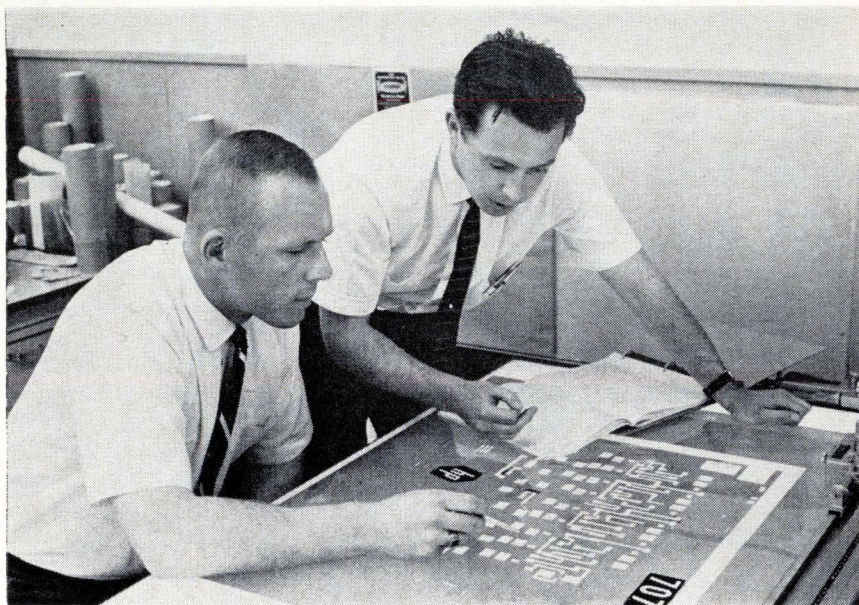

Masked marvel. John McMains, an instrument designer schooled in IC's by Hewlett-Packard, checks mask he drew for circuitry in a new counter with Ian Band, his advisor from the company's integrated-circuit facility.



Homemade. Production worker inserts proprietary Hewlett-Packard IC's into circuit board which will be installed in a new electronic counter.

Stanford. But McMains went on to take advanced training with the Integrated Circuit Engineering Corp., a consulting firm, and then under Ian Band of the company's own ic facility.

One of McMains' first tasks was to find out what circuits were available—since, as Band notes, “to make an intelligent make-or-buy decision, you first have to know what there is to buy.”

Tradeoffs. “We found,” McMains says, “that either counter [5216A or 5221A] could have been built with off-the-shelf components; but that route would have required more packages, more power, and

more interconnects. The time-base decade, for instance, would have had to have extra gating to select one decade in the time-base chain; those extra gates would have added one can per decade.”

“A year ago, the actual price of a single decade, without the extra gating, was already high, and availability was low,” he says. “We had to analyze our engineering investment in terms of cost and volume; but there didn't seem much point in trying to buy a special circuit when the cost of a standard circuit was already high. At that time you couldn't buy a standard ic decade for the price of a discrete decade.”

“There was another problem,” Band adds. “You couldn't buy a Nixie driver with the specifications we required. There was a high probability that the drivers would be available by the time we were ready to build the counter. But there was still an element of risk, so we treated the decade, buffer storage, and Nixie driver as a unit.”

II. Away with zeroes

“There was still no zero suppression,” says McMains. “Although this was a ‘maybe’ item in the beginning, it was one of our objectives.” Zero suppression—the blanking of all zeroes to the left of the first significant digit—doesn't enhance the accuracy of a counter. It does, however, make the unit much easier to read. The 5216A is a seven-digit multipurpose counter. Instead of reading “0000186,” the display shows “186.”

“At that time,” McMains points out, “I didn't know the limitations of the chip geometry, but at least I knew what a decade looked like—I had a starting point. The process people gave me the figures on tolerances and actual chip size. For a given size, there is a given yield; you shrink the geometries for higher frequencies and yield decreases. They tell you how big a chip you can expect.”

Of the process of drawing the ic mask, he merely says: “If you don't already know something about circuit design, you won't be a good ic designer.” But Band is quick to point out that there were very few changes in the mask once the original decisions about size and function had been made.

In all, four special circuits were designed for the 5216A: the time-based decade with special gating, a readout decade with zero suppression, a buffer storage circuit with extra outputs for printers, and the Nixie driver with zero suppression decoding.

III. The IC facility

The ic facility, under Ed Hilton, didn't design any counter chips; it simply builds and tests circuits for these units. Although the company doesn't rule out taking its designs to large semiconductor manufacturers for production lots, it is presently turning out a sufficient number of circuits to meet all

of its requirements.

Hewlett-Packard begins its IC fabrication with the silicon slice, which it buys. It performs the epitaxial and diffusion operations, masking, and packaging itself. The fledgling facility was the first IC operation anywhere to make use of a laser interferometer camera to transfer masks to a silicon slice [Electronics, April 3, p. 26; and April 17, p. 47].

As an example of the flexibility afforded by an in-house operation, the company's first circuits were produced in a 16-lead dual in-line package, rather than the conventional 14-lead dip.

IV. Close harmony

One of the principal advantages of the IC facility is the close cooperation that exists between it and other Hewlett-Packard operations. "There's an awful lot of engineering mind-changing," says Hilton. "They [the engineers] might want to change the basic circuit, or perhaps just the pin configuration. We give them control over design, freedom of design, and a fast turn-around time."

Good neighbors. "The instrument man can design with circuits that are six months to a year ahead the state of the art," Band points out. "He can develop the IC's as he develops the instrument." All three men—Hilton, Band, and McMains—stress the value of the physical

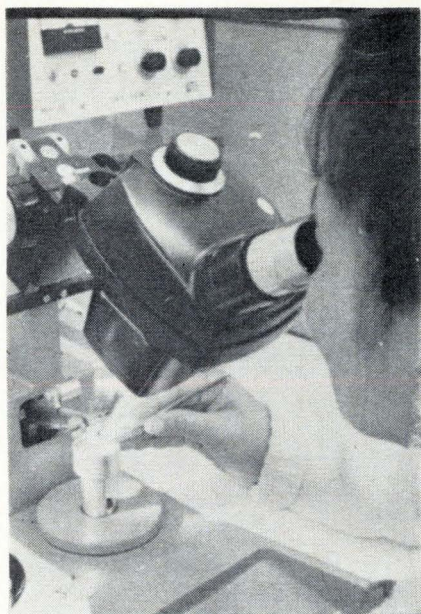

Eagle eye. Worker bonds flatpack assembly in Hewlett-Packard's integrated-circuit facility.



hp 203A

Variable-Phase Function Generator

provides reference and variable-phase sine, square waves
range 0.00005 Hz to 60 kHz
distortion less than 0.06%
continuously variable phase shift 0-360°
four simultaneous adjustable outputs 0-30 v peak-to-peak

Use it for:

- phase shift measurements
- low-distortion signal generation
- vibration studies
- frequency response measurements
- servo applications
- medical research
- geophysical problems
- subsonic, audio testing

Here is a solid-state function generator offering simultaneous sine and square-wave signals 0.005 Hz to 60 kHz in 7 overlapping bands (two optional bands available, down to 0.00005 Hz). Total harmonic distortion hum and noise (0.06%) is less than 64 db below fundamental.

Accurate 1% frequency dial calibration with 180 dial division, vernier drive for precise adjustment. All four floating output circuits have individual 40 db continuously adjustable attenuators. One each of the sine and square-wave outputs

contain the 0-360° phase shifter. A front-panel calibration provision permits easy line-frequency calibration of the oscillator to the environment in which it's being used. Price, \$1200.

For a demonstration of the unique 203A call your Hewlett-Packard field engineer. Or write for complete specifications to Hewlett-Packard, Palo Alto, California 94304, Tel. (415) 326-7000; Europe: 54 Route des Acacias, Geneva.

Data subject to change without notice. Price f.o.b. factory.

HEWLETT  **PACKARD**
An extra measure of quality

1186



**Your plant
may be ready
for new
electronics
equipment...**

**but how about
your people?**



Every day more sophisticated electronic equipment is used by more companies to perform more critical operations. Computers. Calculators. Control systems. Process instrumentation. Communications equipment. It's highly efficient... as long as you have qualified electronic technicians who understand it, know how to maintain it... and can fix it fast if it ever fails.

A good way to build a competent staff of skilled electronics technicians is to up-grade your present technical personnel. And a good way to do it is with a Cleveland Institute of Electronics Training Program. CIE "AUTO-PROGRAMMED" Courses are fast, effective and economical. What's more they can be "tailored" to your specific training needs. There are other advantages, too... and hundreds of satisfied users. Learn about them. Send coupon today for FREE details. Cleveland Institute of Electronics, Dept. E-29, 1776 E. 17th St., Cleveland, Ohio 44114.

SEND COUPON TODAY

**Cleveland Institute
of Electronics**

Dept. E-29, 1776 E. 17th St., Cleveland, Ohio

Gentlemen: I am interested in learning more about your Electronics Home Study Programs. Please send complete information.

Name _____

Title _____

Company _____

Address _____

City _____ State _____ Zip _____

Accredited Member, National Home Study Council.

**... semiconductor houses aren't interested
in filling relatively small orders ...**

proximity of the IC facility to the company's other sections. McMains' desk is a 30-second walk from Hilton's domain. "There is continuous feedback," says Band.

Something to gain. Hewlett-Packard's IC activity has taken the mystery out of integrated circuits for its instrument designers at the same time that it has answered one of the most pressing questions posed by the technology: how IC's will affect the functions of the systems designer and the business of the instrument manufacturer. In this respect, the company is a bellwether in the instrument field.

J. Philip Ferguson, head of the Philco-Ford Corp.'s Microelectronics division says that with more and more circuit functions being crammed onto a single chip, the component manufacturer is tempted to add a power supply and a display, and market an instrument himself. But Philco-Ford's woes with the Victor Comptometer Corp.'s calculator [Electronics, March 6, p. 231] prove that it's easier said than done. However, it is undeniable that instrument makers must find a way to protect the value contributed by their expertise in the field.

Some component companies—Philco-Ford among them—are

offering customers a chance to participate in circuit design; but such participation has proved largely ineffective thus far.

Hewlett-Packard has found from experience that the semiconductor houses aren't terribly interested in devoting much effort in filling relatively small orders required by the company. "Our idea of large volume is small to them," McMains points out.

"Now that the instrument and the circuit have been designed," Band says, "we are in a better position to go to an outside source if we want to. We can give him the masks and tell him how to make the circuit, so that his development costs are low."

Perhaps most important to Hewlett-Packard, home-designed circuits preserve the individuality of the company's instruments and, at the same time, they provide enough flexibility to be designed into other equipment. A circuit that may be a custom job for a component company is likely to be a general-purpose device to Hewlett-Packard, which now has four IC counters in its line. Since Hewlett-Packard is one of the most product-oriented companies in the industry, it seems likely that there will be more IC instruments to come.

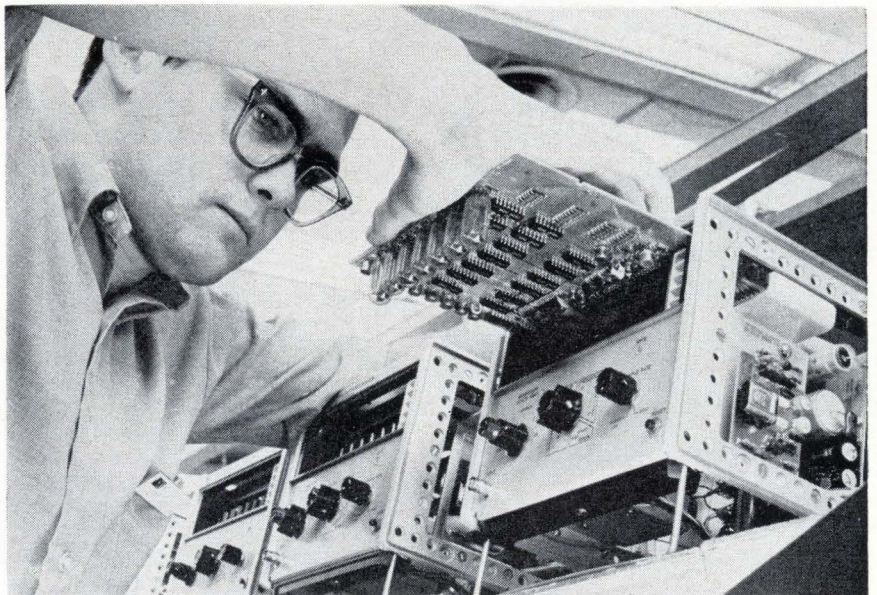

End man. On final assembly line, circuit board incorporating Hewlett-Packard's own IC's is installed in electronic counter.

ARNOLD IS



SILECTRON CORES

**Standard and Custom Designed Cores With
Highest Performance Characteristics**

Arnold Silectron cores are fabricated from the highest grades of grain-oriented silicon steel. We maintain complete control over all phases of fabrication . . . processing, rolling, slitting, winding, annealing and final test are all "in plant" functions. Many are in stock ready for same day shipment.

Arnold is also ■ Permanent Magnets ■ Tape Wound Cores ■ Bobbin Cores ■ MPP Cores ■ Iron Powder Cores ■ Electrical Alloy Transformer Laminations ■ Transformer Cans & Hardware ■ Magnetic Shields ■ Special Magnetic Materials

Our facilities are complete



ARNOLD
SPECIALISTS in MAGNETIC MATERIALS

THE ARNOLD ENGINEERING COMPANY, Main Office MARENGO, ILL.
BRANCH OFFICES and REPRESENTATIVES in PRINCIPAL CITIES

Let's take an engineer's look at TTL from TI

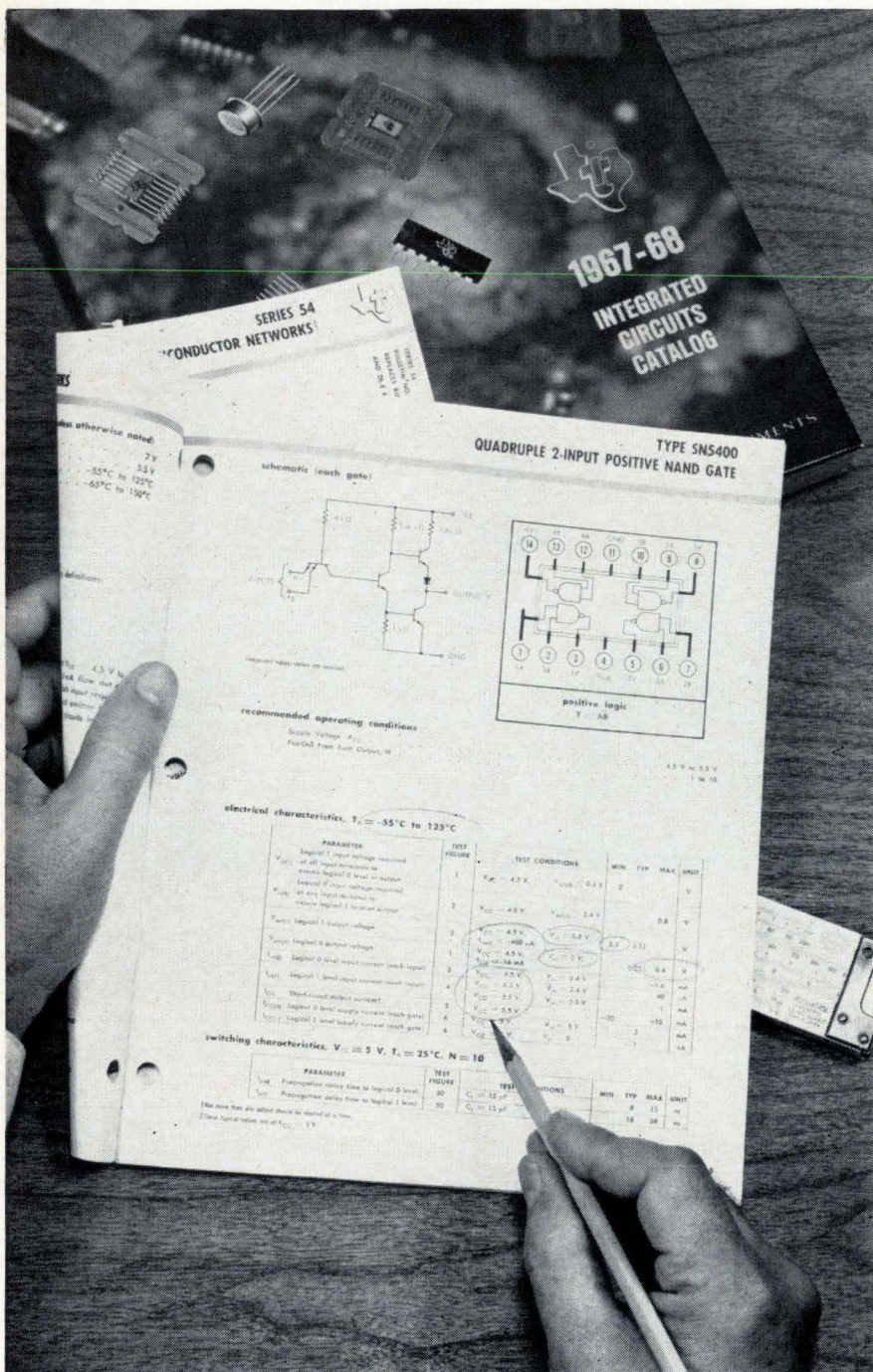

Many key TTL performance characteristics are not readily understood. What do the specifications really mean? How were they determined?

Answers to these questions are important to engineers involved in designing digital systems. Here are some of the reasons why we "spec" Series 54/74 TTL circuits the way we do. It's all part of our efforts to assure reliable, high-performance system operation

Logical zero DC noise immunity

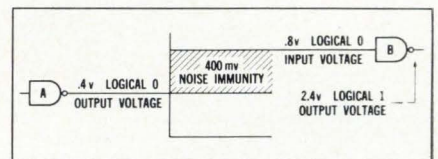

The noise required to false trigger a gate is typically more than one volt. However, TI's guaranteed logical zero noise immunity is 400 mV. Here's how this is determined:

The logical zero input test condition (voltage at which the output does not fall below its 2.4 volt logical one minimum) is 0.8 V. However, guaranteed maximum logical zero output voltage is 0.4 V. Thus, the difference (400 mV) becomes guaranteed noise immunity.

Logical one DC noise immunity

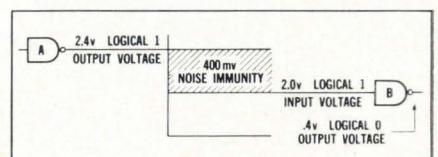

Similarly, guaranteed logical one noise immunity is 400 mV. In this case it's the difference between guaranteed minimum logical one

output voltage (2.4 V) and logical one input test condition of 2.0 V.

Here again, it typically takes more than one volt of noise before a gate actually false triggers.

**Low logical one
AC noise susceptibility**

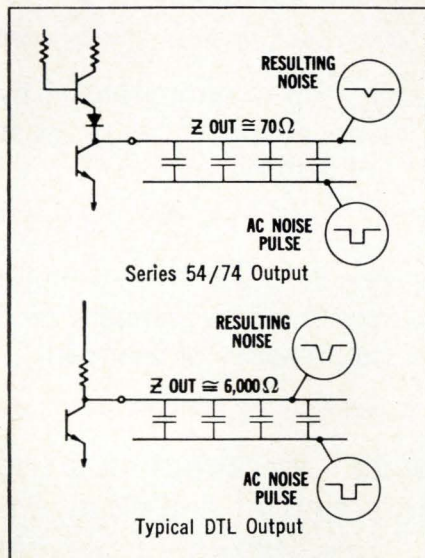

Series 54/74 TTL has a high immunity to signal line noise. It also exhibits a low susceptibility to noise getting there in the first place. Here is an example:

Low output impedance results in a low susceptibility to capacitively-coupled noise... and Series 54/74 logical one output impedance is only 70 ohms. This is far better than for DTL, which typically has a 6000-ohm logical one output impedance.

**Worst-case
Supply voltage conditions**

TI uses the worst-case voltage test condition when testing input current and output voltage. The low supply voltage is critical when

testing output voltage, so the minimum 4.5 volt supply is used. For logical zero, a lower supply voltage reduces the base drive to the lower output transistor... thus creating a worst-case condition.

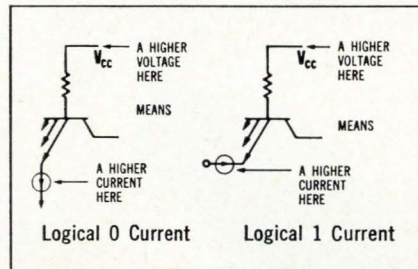
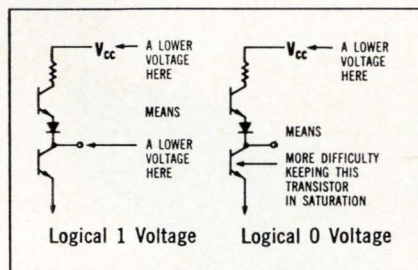

On the other hand, when testing input current, the high supply voltage is critical, since a higher supply voltage means a higher input current. For these measurements, TI uses the worst-case high supply voltage of 5.5 volts.

Worst-case loading conditions

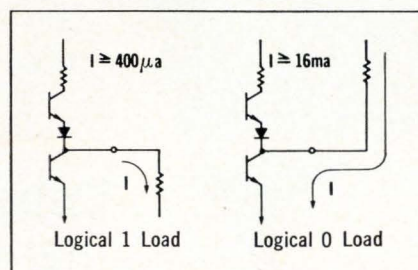

TI measures output voltages while output current is at least the value

required for a fan-out of 10. For logical one, this value is 400 μA, while for logical zero, it is 16 mA.

Worst-case temperature conditions

Since all circuit parameters vary with temperature, many look better at 25°C than at temperature limits (for example -55°C or +125°C). However, TI guarantees all Series 54/74 DC parameters over the full temperature range.

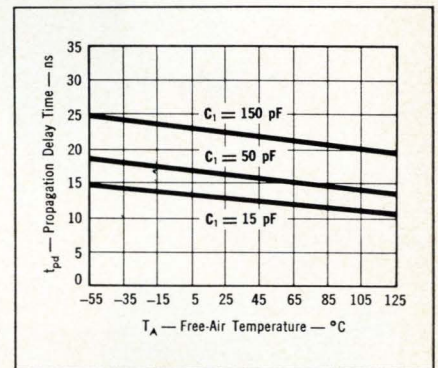

Furthermore, propagation delay of TTL circuits — an important measure of AC performance — is only minimally affected by temperature changes (see chart).

New TTL Brochure

Want to know more about TI's family of TTL circuits? A new 48-page brochure is just off the press and provides in-depth information on all Series 54/74 ICs. For your copy, circle 212 on the Reader Service card or write us directly at P.O. Box 5012, Dallas, Texas 75222.

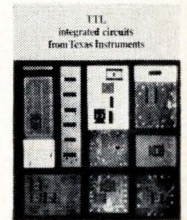

AIRPAX ELECTROMAGNETIC TIME-DELAY CIRCUIT PROTECTORS SERIES APL

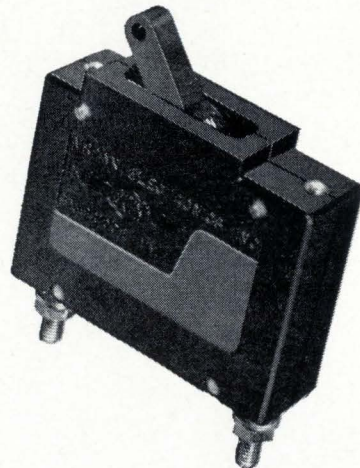
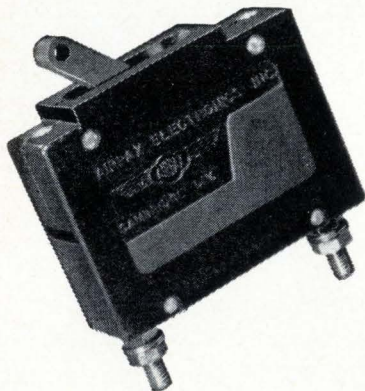
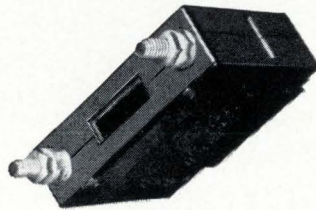
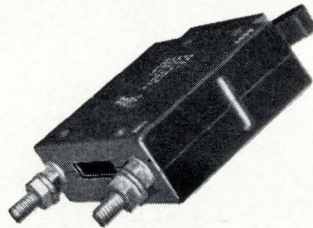
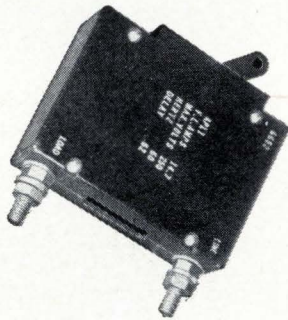
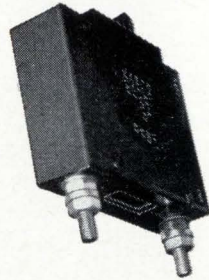
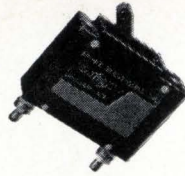

Sensitive - trip levels as low as 50 milliamperes

Rugged - withstand shocks of 50 g while operating

Powerful - trip levels as high as 50A at 50 v dc or 250 v ac

Reliable - rated for at least 10,000 operations

Stable - trip level unaffected by ambient temperature or past current history

Safe - handle is trip free so that a protector cannot be manually held closed in presence of overload

Versatile - instantaneous trip for protection of sensitive circuits - time delays of normal surges without tripping

Adaptable - units can be stacked for mechanical interlock, auxiliary contacts permit remote electrical interlocking and signalling

Dependable - designed and manufactured by Airpax

AIRPAX ELECTRONICS, Cambridge, Md. 21613

Phone 301 228-4600 • TWX 710 865-9655 • TELEX 8-7715

Hybrid IC's aim at the consumer market

Monolithics may someday prevail but for today's needs hybrids are more economical and afford greater design flexibility

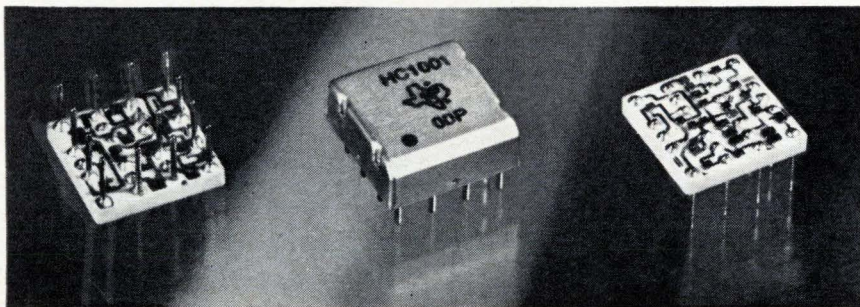

While most integrated circuit makers are trying to penetrate the huge consumer electronics market with selected types of monolithic IC's, Texas Instruments Incorporated plans to establish a broad beachhead with hybrid IC's. For openers, it has introduced a series of five circuits, ranging from a triple-circuit television sound system to amplifiers for radios and phonographs.

Company spokesmen expect monolithic IC's to prevail eventually in the consumer market, but they contend that hybrids will win quick acceptance as an interim step between discrete components and monolithics. The hybrids, they explain, are more economical at present and offer greater design flexibility. Several large manufacturers of radios are already converting to in-house production of hybrid IC's.

Texas Instruments hopes to convince other equipment designers of the merits of IC's—and is pricing its circuits in the \$2 range to encourage them to buy rather than build. The hybrids, TI points out, are closer to discrete-component assemblies in their functioning than are monolithic IC's. Therefore, the designer faces fewer problems in interfacing them with existing discrete and vacuum tube circuitry stages.

Also, the company submits, it costs less to develop hybrids and to produce them in small and medium quantities during the period when consumer equipment manufacturers are making their initial use of IC's: It would be difficult and expensive to produce monolithic circuits requiring a mix of components, such as bipolar and field

effect transistors, complementary npn and pnp transistors, zener diodes, and power devices.

The television sound module—½-inch square by 0.2-inch high—contains the functional equivalent of 30 individual components. The HC-1001 module combines a wide-band amplifier, an f-m detector, and an audio preamplifier in a 0.5 x 0.5 x 0.2-inch package containing discrete semiconductors and thick-film resistors. The semiconductor chips are coated with glass, assuring an effective moisture barrier. Transistor, diode and capacitor chips are inverted and bonded by a solder reflow process that increases reliability. The completed assembly is enclosed in a metal case with 12 rigid pins on 0.125-inch centers projecting from the bottom of the package.

The module accepts typical 4.5-Mhz television i-f signals and produces an audio signal that needs no preamplification to drive an output amplifier. The circuit's output can be taken from an emitter-follower to drive transistorized audio power amplifiers, or from a common emitter to provide high level audio for driving a vacuum tube amplifier.

At the input, sensitivity is 300 microvolts, about half that of comparable tv transistor or tube circuitry, and a-m rejection is 35 db, making unnecessary the electrolytic capacitors normally found in f-m detector circuits. With vacuum tube receivers, the circuit accepts supply voltages of 130 volts; it operates from 18 volts with transistorized receivers.

Other hybrid IC's in the series are audio amplifiers. A low input impedance circuit (HC-1003) is designed for a-m radio applications; a high input impedance circuit (HC-1005) is aimed at f-m radios

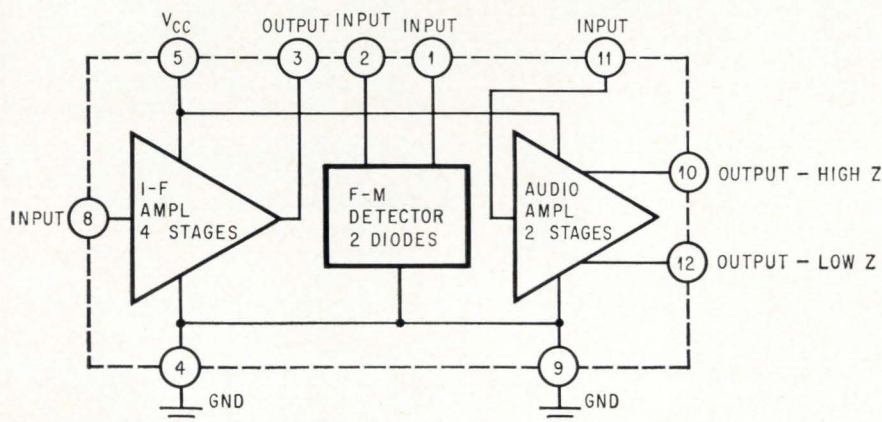

Hybrid integrated circuit television sound module.

New Products

and phonographs. Both deliver a minimum of 300 milliwatts of audio power and operate from a 9- to 12-volt power supply. A 40-volt d-c supply powers these units as direct-coupled amplifiers capable of driving silicon power transistors to 15 watts rms output per channel for high power stereo systems. For 1-watt audio systems, designers can choose either the HC-1004 low-input-impedance module, or the HC-1006 high-input-impedance unit. These IC's differ only in input

circuitry, the HC-1004 using an npn transistor while the HC-1006 uses a FET. Both modules operate on 18- to 24-volt power supplies.

Specifications (for HC-1001)

I-f signal input	4.5 Mhz
Output audio signal	
High level	34 v p-p
Low level	0.3 v rms
Operating voltage	
For vacuum tube receivers	130 volts d-c
For transistor receivers	18 volts d-c
A-m rejection	35 db

Texas Instruments Incorporated, P.O. Box 5012, Dallas 75222
Circle 349 on reader service card

Bull's-eye for Gunn signal generator

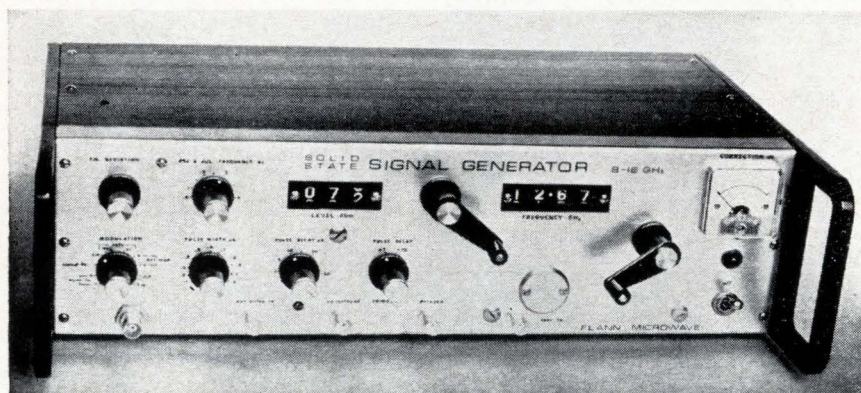

A signal generator with a frequency range of 8 to 16 gigahertz is the first commercial instrument to use a Gunn-effect diode as the basic power source. Replacing the con-

ventional klystron with a Gunn diode results in a considerably smaller package. But operating specifications and over-all cost are comparable with klystron gener-

ators now in use.

Because the Gunn diode requires only 10 volts d-c to set it into microwave oscillations, power-supply costs as well as size, are sharply reduced; klystrons require costly high-voltage supplies. Only 4½ inches high, the new generator weighs 15 pounds. Klystron generators, on the other hand, are typically 12 inches high and weigh about 40 pounds.

The Gunn generator delivers about 0.5 milliwatt in the continuous-wave mode and about 10 to 20 milliwatts peak in the pulse mode. The diode operates in a broadband high-Q coaxial resonator that is tuned by a mechanically driven piston. A frequency-linearizing cam mechanism actuates the piston. The cam mechanism is coupled to an odometer-type frequency-setting dial on the panel.

Power is coupled to the output connector through a matched piston attenuator that has an accuracy of ±3 decibels. Because the Gunn diode is extremely sensitive to supply voltage changes, spectral width isn't as good as that of a klystron source.

Specifications

Power requirements	10 v d-c
Spectral width	15 khz
Power output (c-w)	-3 dbm
Output level range	-3 to -130 dbm
Attenuated output accuracy	±3 db
Price	\$2,800

Flann Microwave Instruments Ltd., Old Bridge Street, Kingston-on-Thames, Surrey, England. [350]

New products in this issue

163 Hybrid IC's aim at the consumer market

164 Bull's eye for Gunn signal generator

Components

166 Eddy currents trip proximity switch

166 Low-resistance circuit protector

167 Dual-gun tube can read, write

168 Hysteresis sync motor

168 Spark gaps feature precise arc voltage

169 Miniature capacitors span 66 values

170 Compact 3- and 5-turn pots

171 Shielded transformers give high isolation

172 Nonmagnetic p-c board guides

172 Wirewound pot resists humidity

174 Modularly designed connector header

Semiconductors

178 Matched transistors in 1 package

178 Low-cost trigger

178 Scr's handle high voltage

178 Zener diodes rated at 1 watt

178 Fast-switching power transistors

Instruments

180 H-f spark tester

180 Resistance bridge measures rapidly

180 Dvm covers wide range

181 Wideband raster generator

Subassemblies

182 Missing-pulse detector

182 Dual-output power supply

182 Neodymium-doped YAG laser system

183 Compact discriminator for f-m telemetry

Microwave

184 Voltage-variable attenuator

184 Source produces 2 watts at 1 Ghz

184 Telemetry transmitter for video use

185 Broadband balanced mixers

185 Hard r-f head for altimeter

Production equipment

186 Automatic sorter handles IC's

187 Soldering system needs no hands

187 Long-pulse laser welding system

188 Evaporation source for film deposition

189 Molder handles delicate components

190 Production testing of memory cores

191 Hand-operated lead bender

191 Desoldering tool

Materials

192 Epoxy encapsulants

192 Semiconductor phosphides

192 Conductive epoxy adhesives

ulano is the leading manufacturer
of screen process stencil film

...any kind!

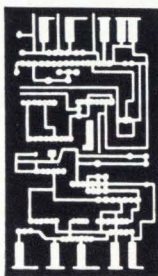

*In screen processing
of complex printed circuitry ...
there's no margin for error!
That's why Ulano offers
a complete line of
Screen Process Stencil Films
especially designed for
the Electronics Industry.*

ulano

^{T.M.}

610 DEAN STREET, BROOKLYN, N. Y. 11238

NEW YORK • CALIFORNIA • CHICAGO • ZURICH

In Europe: ULANO A. G., Untere Heslibachstrasse 22, Kusnacht 8700, Switzerland

*For free working samples, write today
on your letterhead for Kit No. 5848*

Circle 165 on reader service card ^T

HICKOK

DMS-3200 DIGITAL MEASURING SYSTEM (Fully transistorized)



DMS-3200 Main Frame \$320
(shown with DP-100)



DP-100
DC Voltmeter
Plug-in
\$175

DP-150
1-MC Counter
Plug-in
\$195

DP-170
Ohmmeter
Plug-in
\$240

DP-200
Capacity
Meter
Plug-in
\$240

DP-140
Event Counter
and
Slave Plug-in
\$75

DESCRIPTION

The Hickok DMS-3200 Digital Measuring System is a precision electronic measuring device which displays readings in digital form instead of the relatively inaccurate and difficult-to-read moving-pointer meter display.

Because the DMS-3200 consists of a main frame which will accept a number of "plug-in" units, it can be used to measure a variety of electrical parameters. The main frame provides display of the reading; the plug-in determines the application.

The DMS-3200 is designed for rugged industrial and laboratory applications. Solid-state construction and conservative design ratings insure long, trouble-free life. By utilizing a design which has the optimum combination of accuracy capability and number of digit display, the DMS-3200 meets the general purpose measurement needs of industry for reliable digital measurement equipment in the \$400-\$500 price range.

Ask Your HICKOK Distributor For A Demonstration!

THE HICKOK ELECTRICAL INSTRUMENT COMPANY
10514 Dupont Avenue • Cleveland, Ohio 44108

New Components and Hardware

Eddy currents trip proximity switch

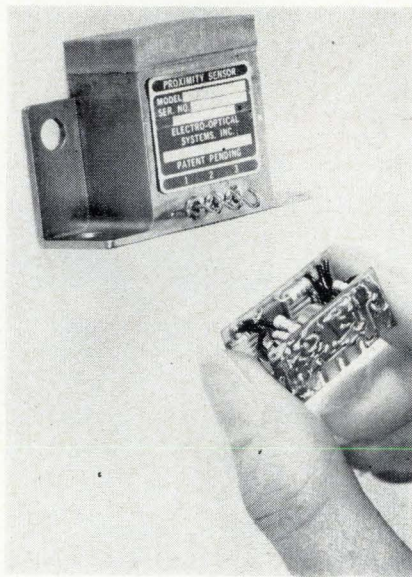

Normal operating temperature is -65 to 250°F , although the device can sense objects heated to 800°F if the circuitry is placed in a location remote from the sensor head. The switch's rise and fall time is less than 20 microseconds, and its deadband can vary from 0.002 inch to 50% of the specified sensing distance. Switches have been cycled more than 15 million times without a change in the switch point.

The current price is about \$160, but the manufacturer expects to cut this to about \$75 each for quantities of 200 or more. Electro-Optical Systems Inc., 300 N. Halstead St., Pasadena, Calif. [351]

Neither snow, nor ice, nor dirt can falsely trigger a proximity switch whose operation is based on eddy-current effects. It senses only the presence of metal; cheaper and more popular capacitance sensors can be triggered by other materials.

Switching in the new device is done with a transistor to avoid the contact bounce, spark, and deterioration problems of mechanical switches.

An oscillator circuit sets up a magnetic field around the sensor head. When a metal object enters the field, eddy currents set up in the metal are sensed as a loss by the detecting circuitry, and an output transistor is switched on. Short or open circuits cause the transistor to revert to the off state, making the sensor fail-safe.

The only external connections are power-supply and output-signal leads. The case is electrically isolated and contains an electromagnetic interference filter. The unit operates from a 12-volt supply and can deliver a 100-milliamperere signal.

The sensor was originally developed to indicate when a plane's landing gear is locked in position; mechanical switch failures sometimes cause a pilot's indicator lamp to light prematurely.

Low-resistance circuit protector

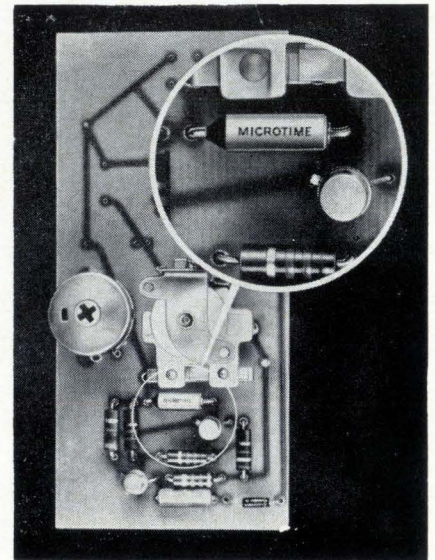

A hermetically sealed circuit protector has a resistance far lower than that of fuses previously available to industry, according to the manufacturer. This permits use of the device, called the Microtime, in lower-voltage and low-power circuits, but doesn't bar its use in higher-powered circuits.

The Microtime's size is subminia-

ture, and its design doesn't require solder as support for the fusible element. The fuse is of rugged metal construction, and is insensitive to shock and vibration.

The circuit protector has been developed as a companion product to the manufacturer's line of sub-miniature Microtemp thermal fuses, which open upon a critical increase in ambient temperature. The new protectors' response to electrical-current increases can be specified within microseconds or milliseconds.

Micro Devices Corp., P.O. Box 501, Far Hills Station, Dayton, Ohio 45419. [352]

Dual-gun tube can read, write

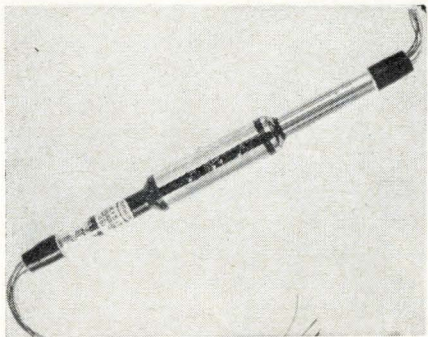

A miniature storage tube is capable of reading and writing simultaneously. The CK1519 is a dual-gun tube that can be regarded as an electronic storage device combining high output signal with high resolution.

The tube has a nominal length of 16½ in. and a maximum bulb diameter of 1½ in. Resolution is typically 850 tv lines per diameter.

The chief application would be scan conversion to television-type presentation of the outputs of such airborne sensors as sonar, infrared and radar. The system yields a bright display with adjustable gradual erasing.

Stored signals can be held for a long period, read several thousand times, or erased in a fraction of a second. The storage capabilities permit additional coherence of target information despite high noise levels.

The tube provides a wide range of gray shades, fast writing speeds, and selective erasure of stored in-

New Barnstead Purity Meters take the work out of being right!

The new solid-state Barnstead instruments greatly simplify measuring, monitoring and controlling water purity. In accuracy, speed and economy they are way ahead of other models.

The Model PM-5 (foreground), an inexpensive workhorse for testing distilled and demineralized water, is a good example. To test water purity, you merely set one knob to water temperature; turn the other until both red and amber signal lights come ON. Then read the dial, calibrated 0 to 1.5 Megohms and .01 to 10 ppm. (A)

The red light indicates that water is below desired purity settings — the amber above — thus permitting hi/lo tests. Price: \$88 (not including conductivity cell).

Other stars in the new foursome:

PM-20 — same as PM-5, but calibrated 0 to 18 Megohms. Price: \$118 (not including conductivity cell). (B)

PM-50 — direct-reading, 0 to 18 Megohms; three large scales — 0 — .18, 0 — 1.8 and 0 — 18 Megohms. No temperature settings needed; temperature compensation is automatic. Price: \$148 (not including conductivity cell). (C)

PMC-50 PUROMATIC® Controller Type Purity Meter — same as PM-50, with built-in relay and "above/below" monitor lights added. Protects against distribution of substandard water by activating valves, alarms. (D)
Price \$198 (not including conductivity cell).

Write for information.

Helping you get more out of water!

Barnstead

A Subsidiary of Ritter Pfaudler Corporation
451 Lanesville Terrace, Boston, Massachusetts 02131

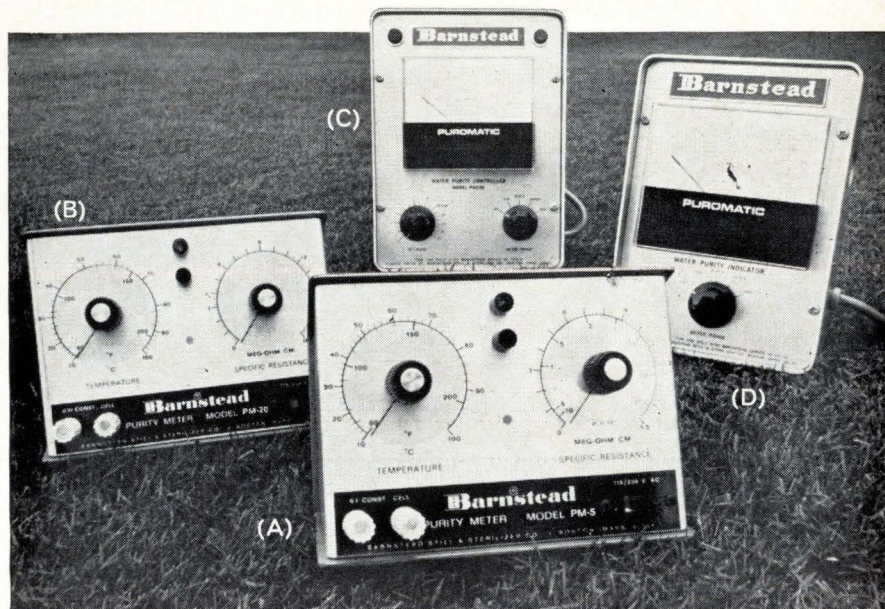

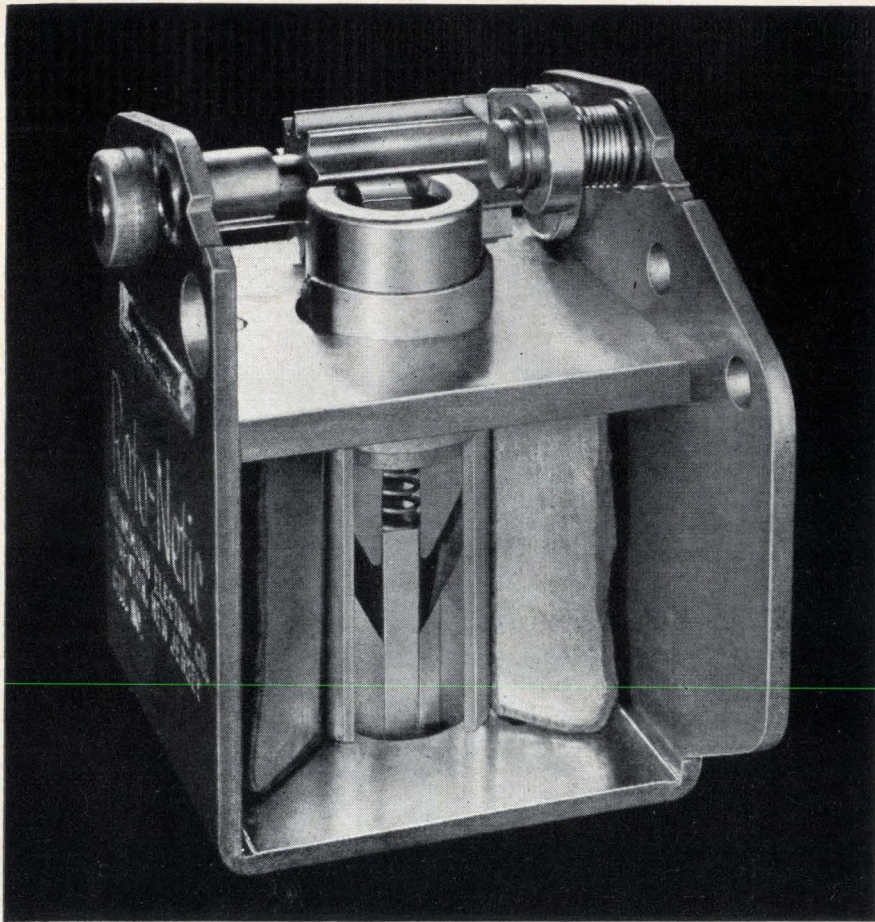

Nobody ever built a stepping motor this way before.

Or sold one for so little.*

A stepping motor has always been a rotary motor that steps. With all the design and manufacturing difficulties that implies. Precision bearings, dynamic balance, and the like. Incremental rotation calls for detents, springs, balls. Or magnetic braking. Then there's the axial thrust problem. Not surprisingly, you pay a lot of money for a rotary motor that steps.

Our picture shows a stepping motor that is not a rotary motor. It's a solenoid in disguise. A spring-loaded armature actuates a ratchet and pawl mechanism. Mechanically, that's all there is to it.

But functionally, there's a great deal more. For example, there's a double-ended shaft that lets you choose the direction of output rotation. An output torque of 0.1 inch-pounds. A ten-step star wheel (very handy for decade functions). A standard stepping speed of 600 steps/min.

There's still more, but we'll save it until you ask—either for Bulletin 701, which is free, or for a sample motor, which costs ten dollars. If you'd like the sample, please let us know whether you want the 12 VDC or 115 VAC model. Heinemann Electric Company, 2600 Brunswick Pike, Trenton, N.J. 08602.



*\$8, to OEM's, in quantities of 100 to 499.



HEINEMANN

New Components

formation. Erasing operations can be carried out by either the reading or the writing gun.
Raytheon Co., 465 Centre St., Quincy, Mass. 02169. [353]

Hysteresis sync motor comes in two sizes

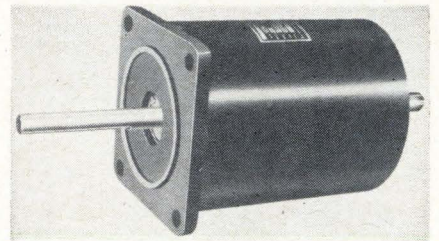

Starting torque approximates running torque in a line of self-starting hysteresis synchronous motors. The motors run at synchronous speed, but are not phase-polarized as are other polarized synchronous motors. The rotation direction of the shaft is reversible externally. Dual-voltage and/or dual-speed motors are available in frame size 47 (3 $\frac{3}{8}$ in. in diameter), and frame size 59 (4 $\frac{3}{8}$ in. in diameter), but many electrical variations are possible. Rpm's are 1,200, 1,800, and 3,600.

Air-cooled bearings keep operating temperature low. Dimensionally stable aluminum alloys are used for the motor frame, with all surfaces or parts machined simultaneously to assure concentricity. Rotors are dynamically balanced to exceed requirements of MIL-M-17059.

McLean Engineering Laboratories, Princeton Junction, N.J. 08550. [354]

Spark gaps feature precise arc voltage

Protection from transient voltages up to 2,500 v is provided by a series of spark gaps. The devices' precise arc voltage and low cost make them suitable for color tv applications.

Less expensive, lower voltage components can be used in grid and deflection circuitry because the units assure the harmless by-

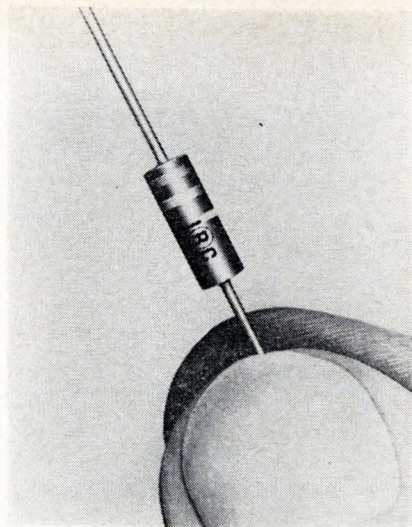

pass of stray transients. By using the cross section of a wire lead as the electrode, and by precisely controlling the gap width, repeated arcing is achieved with no appreciable increase in start voltage.

Called type sc, the units are available with arc voltages ranging from 1,500 to 2,500 v. Two standard EIA color-coding bands indicate first two figures of breakdown voltage.

Price is \$25 per 1,000 in lots of 10,000. Delivery takes four weeks. IRC Inc., 401 N. Broad St., Philadelphia, Pa. 19108. [355]

Miniature capacitors span 66 values

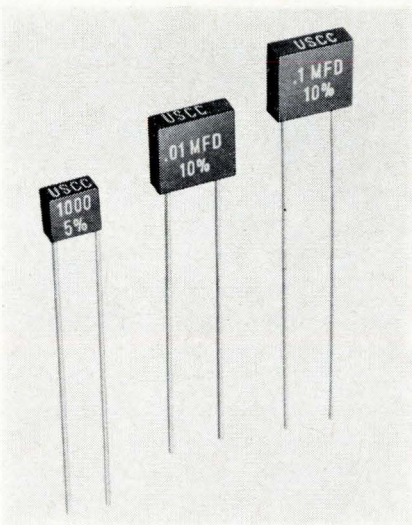

A miniature ceramic capacitor has been developed for 200 working volts d-c. Designated the series 16,

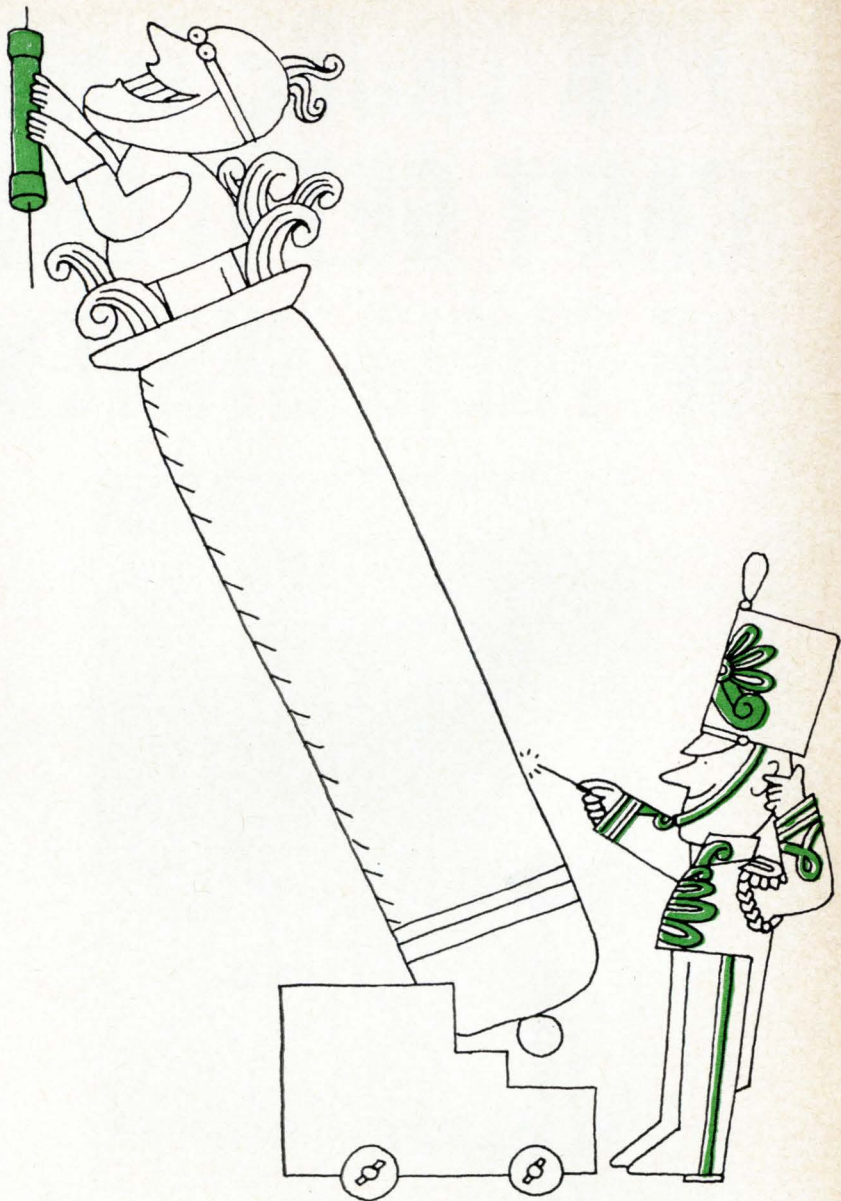

Want film resistors...fast?
Say "MOL"...
and stand back!



Delivery of MOL metal oxide film resistors is now *immediate*. From our expanded, automated plant we're shipping them to most leading TV and electronic equipment manufacturers. Delivering them, in fact, almost as fast as you can say, "High-stability MOL's have less than 5% resistance change on 10,000 hour load-life test . . . and the price is right." Try us. Call or write for details to Mallory Controls Company.

MALLORY

MALLORY CONTROLS COMPANY
a division of P. R. MALLORY & CO. INC.
Box 327, Frankfort, Indiana 46041

FOR THOSE WHO CAN'T GET IT OUT OF THEIR SYSTEM

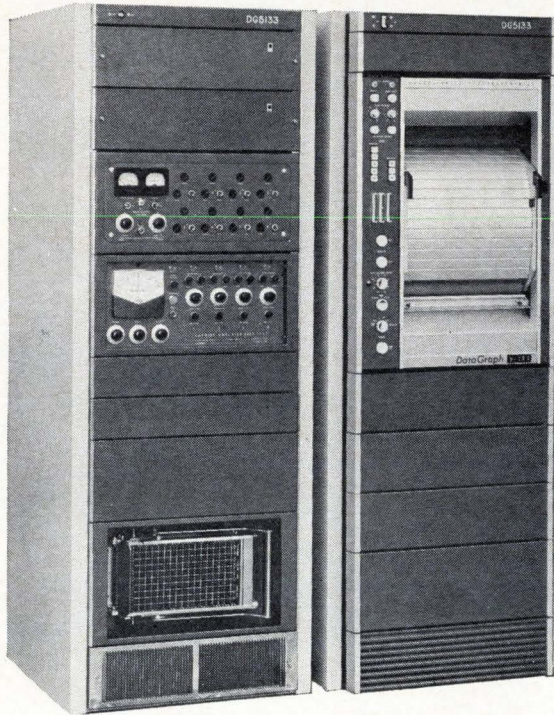

We have a better system. The DG 5000, an assembly of CEC standard products systematized into a *complete configuration*. Nothing else can match it for the acquisition and measurement of dynamic or quasi-static data from event to readout.

As a result, the DG 5000 has become the ideal answer for industry, aerospace and medical science.

What makes the DG 5000 System so superior?

It is uniquely versatile in the *three ways* most important to every user.

1. CEC's building-block concept makes it possible to tailor-make the system to virtually *any* configuration. It will accept any of CEC's wide range of oscillographs, delivering up to 52 recording channels with light-

beam galvanometers or 8 channels for thermal writing applications.

2. Maximum application flexibility can be provided for variations of system configuration through a programmable building-block interconnection.

3. The DG 5000 System may be *easily and economically* expanded to meet any future configuration requirements.

So—with a DG 5000, you *can* get it out of your system. Every bit of it.

For complete information, call your nearest CEC Field Office, or write Consolidated Electrodynamics, Pasadena, California 91109. A subsidiary of Bell & Howell. Bulletin DG 5000-X 8.

CEC/DATAGRAPH PRODUCTS

 **BELL & HOWELL**

New Components

the square, epoxy-encased units are available in 66 capacitance values ranging from 10 pf to 0.12 μ f. Case sizes measure 0.200 x 0.200 x 0.100 in. for values of 10 pf to 1,000 pf and 0.300 x 0.300 x 0.100 in. for 1,200 pf to 0.12 μ f.

The radial lead unit is designed for p-c board applications with 0.20-in. lead spacing. The lead material is nickel—with a diameter of 0.025 in. per MIL/STD-1276 N-1 for welded or soldered connections.

Standard capacitance tolerances are 10% with tolerances of 5% and 20% also available. Temperature characteristics are -55° to 125°C $\pm 15\%$.

U.S. Capacitor Corp., 2151 N. Lincoln St., Burbank, Calif. 91504. [356]

Potentiometers offered in compact size

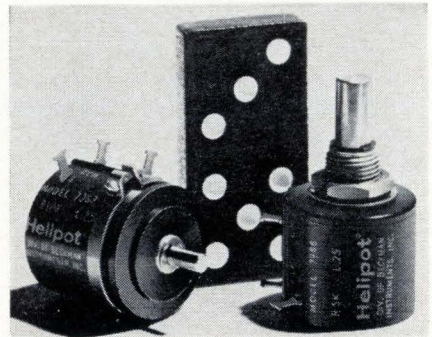

Compact three- and five-turn precision potentiometers are available in standard bushing and servo-mount models, as well as standard two-gang units.

The units have 1.5-watt power ratings, $\pm 3\%$ standard resistance tolerances, $\pm 0.25\%$ standard independent linearities in most values, and are $\frac{7}{8}$ in. in diameter and less than 1 in. long.

Series 7360 potentiometers have standard resistance values ranging from 10 to 30,000 ohms. Series 7460 values range from 10 to 50,000 ohms. Both series meet MIL-R-12934E requirements.

Construction features include molded plastic housings, gold-plated terminals, and stainless-steel shafts. Numerous custom fea-

tures are available on special order.

Beckman Instruments Inc., Helipot Division, 2500 Harbor Blvd., Fullerton, Calif. 92634. [357]

Shielded transformers give high isolation

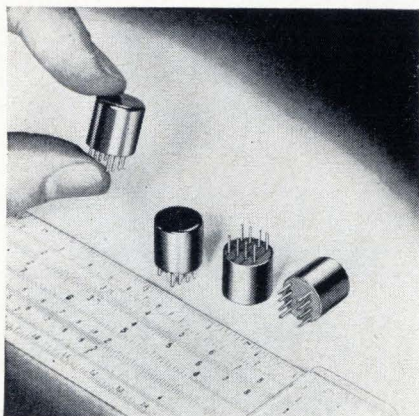

Six miniature Data-Guard shielded transformers designed for p-c board mounting provide pulse or signal circuit isolation.

The series 8200 is offered in a wide range of nominal impedances from 100 ohms to 100,000 ohms. Frequency response is from 0.500 hz to 1 Mhz. High performance is assured by full application of box-type electrostatic shields, fine wire windings, and high permeability nickel core. Common-mode isolation is 75 db at 20 khz.

Electrostatic shielding is provided for each winding and it reduces capacitance between windings to less than 0.2 pf and attains circuit isolation in excess of 100 db. All units are fully encapsulated for severe environmental protection.

Phase shift is minimal over the operating range and insertion losses are below 1 db in most circuits. Operating temperature range is -55° to 100° C. Shield-to-shield insulation at 300 v d-c is 5×10^9 ohms minimum. Shield-to-winding insulation at 100 v d-c is 5×10^9 ohms minimum. Frequency response is as much as 3 decades.

Units are designed with six p-c type connecting gold plated 0.0285-in. diameter pins, or in a shielded lead coaxial package, $1\frac{1}{8}$ in. long and 0.5 in. in diameter for in-cable installation.

Price range for the series 8200

100's of times more stable 100's of times more sensitive than conventional microwave power meters

new RF
Microwattmeter
with
70 dB range



Model 41A

High frequency full wave diode detector overcomes stability, sensitivity, and overload limitations of thermal types

- Frequency range: 100 KHz to 7 GHz
- Power range: $0.01 \mu\text{W}$ (-50 dBm) fs to 10 mW ($+10 \text{ dBm}$) fs with a single detector
- Power sensitivity: $0.001 \mu\text{W}$ (-60 dBm)
- Drift less than $0.001 \mu\text{W}$ per hour
- No zero balancing except for fractional-microwatt measurements
- Withstands overloads up to 300 mW
- Can be calibrated from low frequency rf source
- Stable dc output
- Price: \$695.00, fob Parsippany, N. J.

Full technical details available on request

**BOONTON
ELECTRONICS**
CORPORATION

ROUTE 287 AT SMITH RD.
PARSIPPANY, N. J. 07054
TELEPHONE: 201-887-5110
TWX: 710-986-8241



how to measure resolver or synchro position with 30 second repeatability

In both production test and ground checkout systems, North Atlantic's high performance Angle Position Indicators provide exceptional operator ease and precision in the measurement of synchro and resolver position. Features include: digital readout in degrees and minutes, 30 second resolution, continuous rotation, plug-in solid-state amplifier and power supply modules. Due to the design flexibility of these units, they can be readily provided with a variety of features for specific requirements. Typical units in this line incorporate combinations of the following features:

- Single Synchro or Resolver Input
- Dual Synchro or Resolver Inputs
- Retransmit Synchro, Resolver, Potentiometer, or Encoder
- 2-Speed Synchro Input
- Multi-frequency Inputs
- DC Input
- 0-999 Counter

BASIC SPECIFICATIONS

Range	0°-360° continuous rotation
Accuracy	6 minutes (standard)
Repeatability	30 seconds
Slew Speed	25°/second
Power	115 volts, 400 cps
Size	API-8025 1 3/4" h x 9 1/2" w x 9" d
	API-8027 3 1/2" h x 4 7/8" w x 9 3/4" d



Your local North Atlantic representative has complete data on the API line. Call him today or write direct for technical literature.

NORTH ATLANTIC industries, inc.
TERMINAL DRIVE, PLAINVIEW, L. I., NEW YORK • Overbrook 1-8600

New Components

miniature transformers in small quantities is \$20 to \$30 each. Production lots in excess of 100 are \$10 to \$18. Delivery takes seven to nine weeks.

James Electronics Inc., 4050 N. Rockwell St., Chicago 60618. [358]

Nonmagnetic, 1-piece p-c board guides

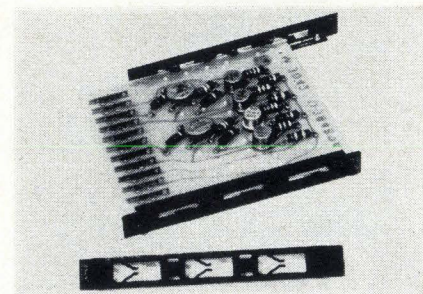

The series 30 printed circuit board guides include integral cantilever spring grips that hold boards securely and prevent lateral motion and assure high retention under severe stress, shock, and vibration. The units are polycarbonate, non-magnetic, one-piece, lightweight, and easy to assemble. Gauges ranging from 0.050 in. to 0.125 in. can be held. Press lugs permit the guides to snap into place without fasteners.

The corrosion-proof guides withstand temperatures up to 250° F.

The guides are available at 15 cents each in quantities of 5,000. Taurus Corp., Academy Hill, Lambertville, N.J. 08530. [359]

Wirewound pot resists humidity

A wirewound potentiometer that resists humidity has a resistance range of 10 to 50,000 ohms, power rating of 1 watt at 70° C, and an operating temperature range of -65° to +175° C.

The Model 3290, measuring only 0.150 in. x 3/8 in. square, has positive-end stops, plus a clutch action to prevent damage from forced adjustment. It meets or exceeds en-

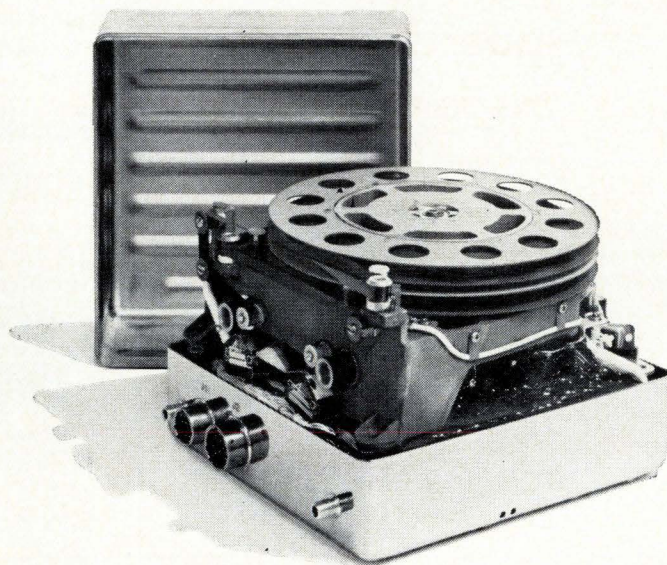

With our custom recording systems one of a kind beats a full house

This satellite recorder, for example. To date, we've built 24 variations of it. Each was a special. No production-line unit will solve the tough recording problems we take on.

Of course, a lot of our custom projects are under tight security wraps, and we can't talk about them. But we

can show you part of our hand.

We've put together a catalog of recorder applications that aren't classified. It's called, "Technical Abstracts on Record/Reproduce Systems." Programs like LEM, Apollo, the Prime re-entry vehicle, and a host of satellites are all in it.

Ask for a free copy. It shows you why our recorders don't have to be classified to have class.

Leach Corporation, Controls Division,
717 No. Coney Ave., Azusa, California

LEACH Phone (213)334-82
Export: Leach
International, S.A.

A BIG PUSH, PULL, TWIST OR TURN, IN A SMALL SPACE

Ledex solenoids can help you get a lot of work done in places where you don't have much room. We make both push/pull and rotary solenoids in a wide variety of shapes and sizes to solve just about any actuating problem you have.

PUSH/PULL

Our push/pull solenoids are designed for fast response and high force-to-size. Generally, the flat face is best for big loads and short strokes, and the conical gives you more force with longer strokes. Here's a performance comparison for a Ledex size 5 ($1\frac{3}{8}$ " dia. x $1\frac{1}{16}$ "):

STROKE	FORCE flat-face plunger, 90 watts, 1/10 duty	FORCE conical plunger, 90 watts, 1/10 duty
.020 inch	96 pounds	35 pounds
.120 inch	12 pounds	27 pounds

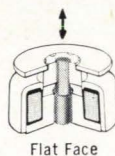
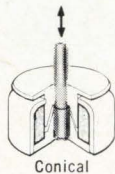

ROTARY

Ledex rotary solenoids are known best for their shock resistant ability and high torque-to-size rotary motion. For example, with a load that must be moved through a 25° arc, our smallest rotary solenoid (1 " dia. x $\frac{5}{8}$ ") snaps 1.1 pound-inches, and our largest ($3\frac{3}{8}$ " dia. x $2\frac{5}{16}$ ") moves a hefty 117 pound-inches.

Because Ledex rotary solenoids have a relatively flat output torque curve, they are often used to move linear loads. They are also used for linear loads when shock conditions exist or when stroke length is beyond the efficient range of push/pull solenoids.

Call Ledex when you need a lot of power in a small space to push, pull, turn, twist, step, index, hammer, punch or trigger. For a quick start on your prototype, choose from over 350 different stock model designs. Or, send details and we'll custom design a space-saving solenoid for you.

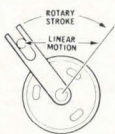
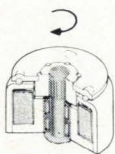

New Components

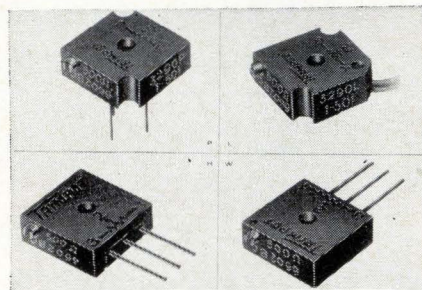

environmental conditions of MIL-R-27208 and is guaranteed by the company.

Standard resistance tolerance is $\pm 5\%$; absolute minimum resistance, 0.1% or 1.0 ohm, whichever is greater; insulation resistance (500 v d-c), 1,000 megohms minimum; temperature coefficient per MIL-R-27208, 50 ppm/ $^\circ$ C maximum; load life, 1,000 hours per MIL-R-27208; vibration, 30 g; and shock, 100 g.

The company's Silverweld process eliminates vulnerable single-wire terminations.

Bourns Inc., 1200 Columbia Ave., Riverside, Calif. 92507. [360]

Modularly designed connector header

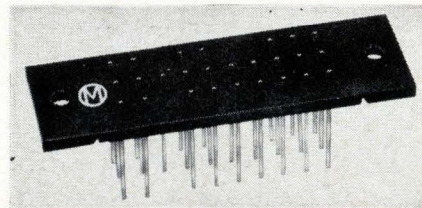

Available in configurations of from one to 30 pins, a modular connector header can be used in a large number of applications where space and weight are frequently critical factors. The SS-0100-2800-00 connector has a glass-filled diallyl phthalate insulator that is durable, does not become brittle under changing environments, withstands stress, and performs well under adverse operating conditions. Contact points are made of gold plated phosphor bronze for the ultimate in conductivity and reliability. Methode Electronics Inc., 7447 West Wilson Ave., Chicago 60656. [361]



LEDEX INC., 123 WEBSTER STREET, DAYTON, OHIO 45402
Custom Circuitry & Controls phone (513) 224-9891

Save time and money with Philbrick Transconductors* for active nonlinearity

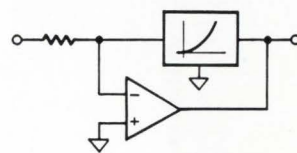

Examples: Linearize transducer outputs; convert DC Digital Voltmeters to stable, accurate dB-meters; make true-RMS measurements; get accurate ratios over wide dynamic ranges; perform trigonometric and vector operations; generate arbitrary nonlinear functions, adjustable to virtually any form; measure discharge time constants instantaneously; build instantaneous wattmeters; square, root, or compute any arbitrary power.

PHILBRICK TRANSDUCATORS are economical, stable, accurate, highly-reliable passive networks. With them, in conjunction with operational amplifiers (ideally, Philbrick), you can build high-performance non-linear

circuits as easily as linear circuits . . . at mass-production prices you can't match in-house, whether you need 1 or 10,000.

Your local Philbrick Rep, backed up by our Applications Engineers, is eager to help you use these versatile standard packages to save time and money. Call him in today, or write for Bulletin 6220. Philbrick Researches, Inc., 22 Allied Drive at Route 128, Dedham, Mass. 02026. Tel. (617) 329-1600, TWX: 617 326-5754, Telex: 094-6576.

*A Philbrick Transconductor is an active or passive network, the short-circuit output current of which is a specific, accurately known, often non-linear function of the input voltage.

ELECTRONIC ANALOG COMPUTING EQUIPMENT for MODELLING, MEASURING, MANIPULATING and MUCH ELSE



PHILBRICK
A TELEDYNE COMPANY



Shown actual size.

Our operational amplifiers start at \$9.75. We have compensated μ A709's, FET-IC's, and a full line of high-gain, low drift, compact modules. Try one on a small signal. You'll make it big.

FAIRCHILD
INSTRUMENTATION

New Semiconductors

Matched transistors in one package

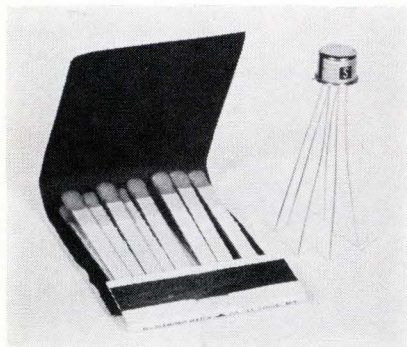

Popular npn and pnp differential amplifier transistors are now available in production quantities. The devices are used primarily as differ-

ential amplifiers and input stages of differential amplifier circuits, and in flip-flop and mixer circuits. They include the 2N2920 and the SMT-105 series and are mounted in six-lead TO-78 or TO-71 packages.

Because the devices are constructed of two transistor chips mounted on the same header, they exhibit the same parameters as a single transistor, with d-c gains matched to 0.9, base-emitter voltages matched to 3 and 5 mV, and voltage tracking matched to 10 μ V per $^{\circ}$ C. Typical characteristics include d-c gain of 175 at 10 μ A, leakage (I_{CBO}) of less than 1 nanoampere at 45 volts, and a noise figure of 2 db at 10 μ A.

Solitron Devices, Inc., Riviera Beach, Fla. [362]

Low-cost trigger for thyristors

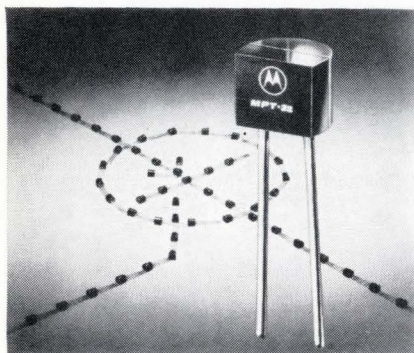

Neons, zeners, four-layer diodes, and other thyristor triggering devices can be replaced with a low-cost, three-layer bilateral trigger. Designated the MPT series, these plastic units have typical breakover voltages of 28, 32, and 36 volts and a breakover current of 20 μ A. They cost 48 cents each in lots of 100.

The two-terminal devices present a high internal resistance until the applied voltage reaches the switching level and causes internal breakover. Beyond this level the devices go into the negative resistance region, producing a current pulse suitable for thyristor triggering. Switching is induced by either

positive or negative polarity voltages, permitting simplified full-wave phase control.

Delivery is from stock.

Motorola Semiconductor Products Inc., Box 955, Phoenix, Ariz. 85001. [363]

New scr's handle high voltages

New planar silicon controlled rectifiers are intended for high voltage switching; blocking voltage capabilities extend to 400 v. Designated types TT-50-2, 3, and 4, they have a peak inverse voltage of 200, 300, and 400, respectively, gate current of 200 μ A and a gate voltage of 0.8 v maximum.

The units are packaged in TO5 cans and are available from stock for \$6 each in quantities of less than 100 and \$4 in lots of 100 to 999.

Transitron Electronic Corp., 168 Albion St. Wakefield, Mass. [364]

1-watt zener diodes keep cool in sink

Twenty-one new zener diodes, each rated at 1 watt, are priced at 99

cents each. Designated the SZ family, the diodes cover the 2.4-to-16-volt range.

All utilize gold-plated, pure nickel leads. Encapsulation in an alkyd resin case bolstered by a heavy tantalum heat sink ensures cool operation. These zeners have an inner epoxy seal, long leakage paths, and a low dynamic impedance.

The zeners may be applied in voltage regulator circuits as power supplies, waveform clippers, or protectors against pulse voltages.

Off-the-shelf delivery in limited quantities is available.

Semitronics Corp., 265 Canal St., New York, N.Y. [365]

Fast-switching power transistors

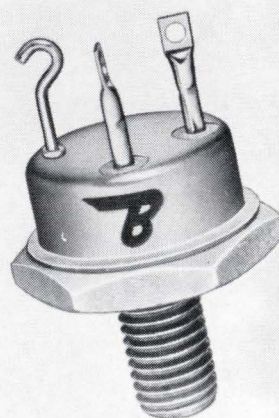

Silicon planar power transistors for high-power and fast-switching amplifier applications are available in 15- and 20-ampere ranges. Designated the B148000 series, the transistors come in TO-61 packages with the collector connected to the case.

Collector-to-emitter voltage runs from 60 to 100 v; power dissipation is 100 w; thermal resistance is $\leq 1.5^{\circ}$ C per watt; switching speed $t_r \leq 200$ nsec; and saturation voltage is 1 v maximum at 10 amperes collector current. Secondary breakdown is said to be no problem.

Prices range from \$20.50 to \$35.50 each in lots of 100 to 999. Availability is immediate.

Bendix Corp., Semiconductor Division, Holmdel, N.J. [366]



Operational amplifiers

Check the specifications of our compensated μ A709's, FET-IC's and economy modules. Check our prices: they start at \$9.75. Check with us for complete information and applications assistance. Then check out one of our modules. Try it on a small signal. You'll make it big.



Typical Specifications	Economy Solid-State Modules		Compensated ICs μ A709C μ A709		FET-IC Modules		FET Input Modules	
	ADO-44	ADO-45	ADO-49C	ADO-49A	ADO-29	ADO-26	ADO-25	ADO-24
Open Loop Gain	10,000	100,000	40,000	40,000	140,000	140,000	50,000	50,000
Bandwidth	550KHz	1.5MHz	1MHz	1MHz	1.5MHz	1.5MHz	10MHz	10MHz
Slew Rate	0.2V/ μ s	1.4V/ μ s	0.2V/ μ s	0.2V/ μ s	2V/ μ s	2V/ μ s	15V/ μ s	15V/ μ s
Difference Current	10nA	10nA	100nA	100nA	10pA	10pA	10pA	10pA
Input Impedance	300Kohm	300Kohm	250Kohm	250Kohm	10 ¹¹ ohm	10 ¹² ohm	10 ¹² ohm	10 ¹² ohm
Drift	20 μ V/ $^{\circ}$ C	10 μ V/ $^{\circ}$ C	5 μ V/ $^{\circ}$ C	5 μ V/ $^{\circ}$ C	25 μ V/ $^{\circ}$ C	1 μ V/ $^{\circ}$ C	10 μ V/ $^{\circ}$ C	10 μ V/ $^{\circ}$ C
Output Voltage	10V	10V	10V	10V	10V	10V	10V	10V
Output Current	1mA	5mA	5mA	5mA	5mA	5mA	2.5mA	20mA
Price (1-9)	\$9.75	\$15.00	\$29.00	\$80.00	\$45.00	\$98.00	\$85.00	\$105.00
(100 pcs)	\$9.00	\$13.00	\$18.00	\$55.00	\$37.00	\$75.00	\$69.00	\$ 80.00

For the supplier nearest you, and/or for technical information and assistance, call Gaylon Patterson at Fairchild (415) 962-2030 or 962-2086, or TWX 910-379-6944.

This new DVM from Trymetrics proves—

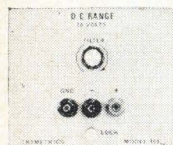

DELIVERY FROM STOCK ON MOST MODELS
Models 103—104—105
Single range plug-in heads
10V, 1V, 100MV

Models 300A—400A—500A
3, 4 and 5 automatic range
plug-ins; 10 μ V—1000VDC

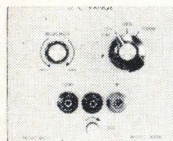
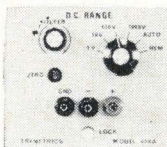

Models 300M—
400M—500M
3, 4 and 5 manual
range plug-ins;
10 μ V—1000VDC

Check these Trymetrics features:

- Full 4 digit resolution. ■ Accuracy $\pm 0.01\%$ of reading ± 1 count. Automatic polarity and overscale indicator. ■ High common mode rejection. ■ Complete range of plug-in heads for optimum flexibility. All silicon solid state circuitry. ■ Operation up to 50°C. ■ Sampling speeds up to (10) samples/second. ■ Sensitivity to 10 μ V. ■ BCD printer output. ■ Crystal controlled oscillator guarantees ultra stable voltage-to-time conversion system.

Check this Trymetrics price:

Model 4000 DVM \$840 with Model 103 10V Range Plug-In. For complete information and prices, write to:

TRYMETRICS
Corporation
204 Babylon Tpke., Roosevelt, L.I., N.Y.
Phone 516-378-5020 Zip 11575

New Instruments

Spark tester operates at high frequency

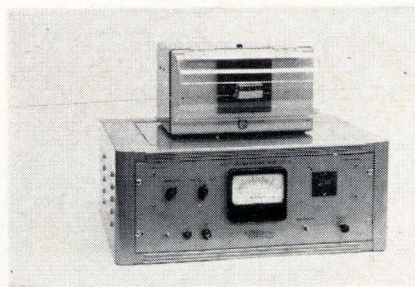

A fresh concept in dielectric test equipment for wire and cable manufacture and consumer inspection is a high-frequency sine wave spark tester. The unit, designated HF-20, operates at a true sinusoidal frequency of 3,000 hz, and contains a short electrode, allowing speeds up to 10,000 ft per minute, with positive, instantaneous, bipolar fault indication.

Regulated test volts, variable from 1 to 15 kv rms, create a complete conducting sheath of ionized air around the wire insulation.

The unit's transient control allows up to 3% overshoot. Direct calibration and adjustable fault sensitivity provide increased reliability and economy.

Addison Electric Co., 1101 Bristol Road, Mountainside, N.J. [371]

Resistance bridge measures rapidly

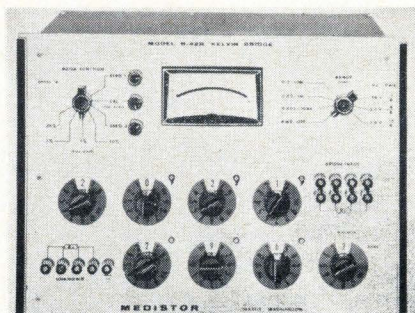

An instrument that measures precision resistors uses a Kelvin bridge circuit to eliminate the effect of lead resistance and insure full accuracy at low values. The unit con-

sists of a Kelvin comparator bridge and resistance standard, as well as regulated, short-circuit-proof power supply and a null detector.

The null detector enables the percentage deviation from the standard to be read directly from the panel meter rather than from the readout dials, and does away with any further adjustments. The overall accuracy is $\pm 0.01\%$ of reading or 0.2 milliohm. The deviation meter is calibrated to read 10%, 1%, 0.1% and 0.001% full scale. The $\pm 0.01\%$ range allows resistors to be measured at the resolution of ± 1 ppm.

The null detector recovers rapidly from large overloads, allowing the instrument to be used without the foot switches normally required. There is no shock hazard since there is never more than 4 v d-c present in the bridge circuit.

Three calibrating controls make possible measurements to within 0.01% or better.

The model B-42R resistance bridge is priced at \$1,550 and delivery is within 20 days.

Medistor Instrument Co., 1443 N. Northlake Way, Seattle, Wash. 98103. [372]

Digital voltmeter covers wide range

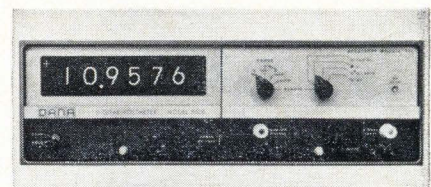

A solid state, null-balance digital voltmeter measures d-c voltages from 1 μ V to 1,100 v. It is a five-digit instrument with a sixth digit overrange to preserve accuracy in the range crossover regions. Five full-scale d-c ranges are provided: 110 mv, 1,100 mv, 11 v, 110 v, and 1,100 v. Ranging is controlled manually by a front-panel switch, by remote program signals, or automatically after the selection of either the millivolt or the volt full-scale mode. Polarity is selected and

displayed automatically.

Model 5500/112 has a d-c voltage accuracy of $\pm 0.005\%$ of reading and $\pm 0.0009\%$ of full scale. The millivolt accuracy is $\pm 0.01\%$ of reading and $\pm 0.02\%$ of full scale on the 100-mv range; $\pm 0.01\%$ of reading and $\pm 0.005\%$ of full scale on the 1,000-mv range. The value of the least significant digit on the 100-mv range is $1\mu\text{v}$, establishing the units ultimate resolution. Dana Laboratories Inc., 2401 Campus Drive, Irvine, Calif. 92664. [373]

Raster generator spans 50 hz to 25 Mhz

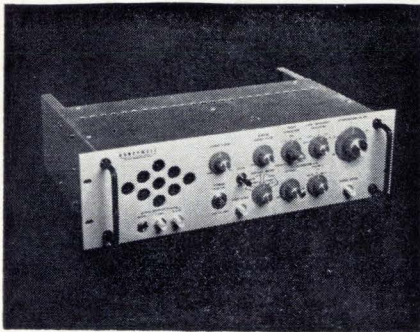

A wideband raster generator is designed to enhance the detection capability of electromagnetic interference (EMI) testing systems. Called the Model 4856, the unit is said to provide a statistical means of detecting and analyzing unknown periodic signals in the presence of known random noise or interference.

The instrument operates over the 50-hz-to —25-Mhz range with other units of EMI test systems. Its minimum impulse bandwidth is 15 Mhz.

Other features include raster sweep rates that can be externally synchronized, a manually controlled single raster for photographic purposes, a slideback peak detector, a variable pulse stretcher for improving response to impulse signals, variable high-pass filters for adjusting video bandpass, and a high-level aural signal monitor.

A dual-beam oscilloscope with long-persistence crt phosphor normally operates in conjunction with the raster generator.

The solid state generator weighs 19 lbs. Honeywell Inc., P.O. Box 391, Annapolis, Md. 21404. [374]

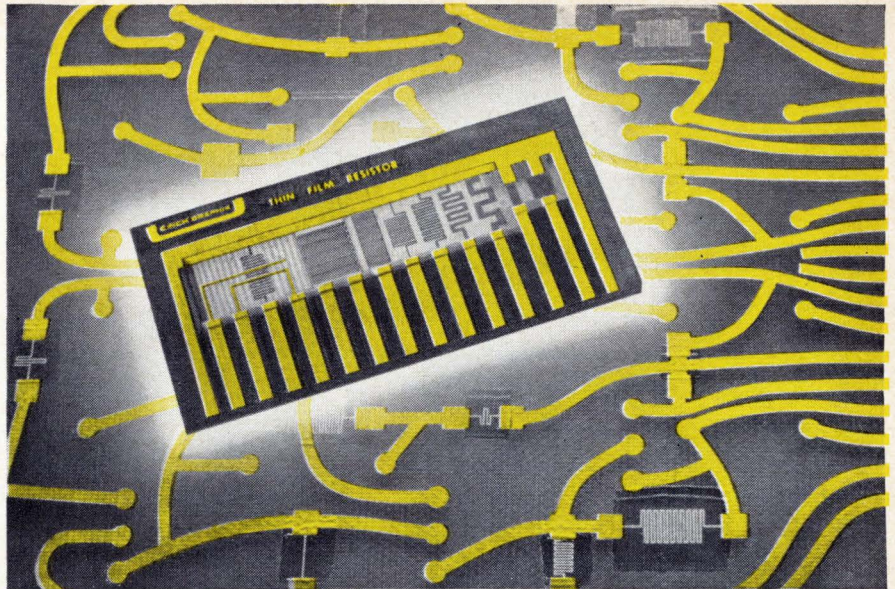

Now... Thin Film Resistors from Cinch-Graphik

Now you can order thin film resistors as an integral part of the world's finest printed circuits. This Cinch-Graphik innovation offers packaging design flexibility and economy never before possible. These electronically deposited resistance patterns are only 2 millionths of an inch thick. They occupy virtually no space, weigh practically nothing, and are competitive in price and performance with discrete resistors. In addition, Cinch-Graphik's thin film resistors are stable, reliable and have electrical characteristics as good as ordinary resistors. Available in resistance values from 10Ω to $150\text{K}\Omega$, these resistors can be utilized in single or multilayer circuits on standard printed circuit laminates. Other components or conductor paths can be placed directly on top of the thin film resistors.

Specifications:

Value Range on Single Resistivity	10 ohms-150,000 ohms	(5000 hours @ 75°C @ 2 watts/in ²)	Drift	always positive
Sheet Resistivity	10 ohms-50 ohms/sq.	Resistor line width and spacing		Less than 2%
Resistor Tolerances	5%, 10%, 20%	Resistor thickness		5 mils min.
Temperature coefficient of Resistance	+80 ppm			600 angstroms @ 50 ohms sheet resistivity.
				Power dissipation 2-4 watts/in ²

For additional details or specifications, call, write or wire:

CINCH-GRAFIK

DIVISION OF UNITED-CARR



200 South Turnbull Canyon Road, City of Industry (Los Angeles), Calif. 91744 • Phone (213) ED 3-1201. Sales offices in 33 principal cities throughout the United States, Great Britain, Canada, Australia and West Germany.

CONSISTING OF CINCH MANUFACTURING COMPANY, CINCH-GRAFIK, CINCH-MONADNOCK, CINCH-NULINE, UCINITE (ELECTRONICS) AND PLAXIAL CABLE DEPT.

WHEN YOU ATTEND*
WESCON
 STOP BY FOR SOME

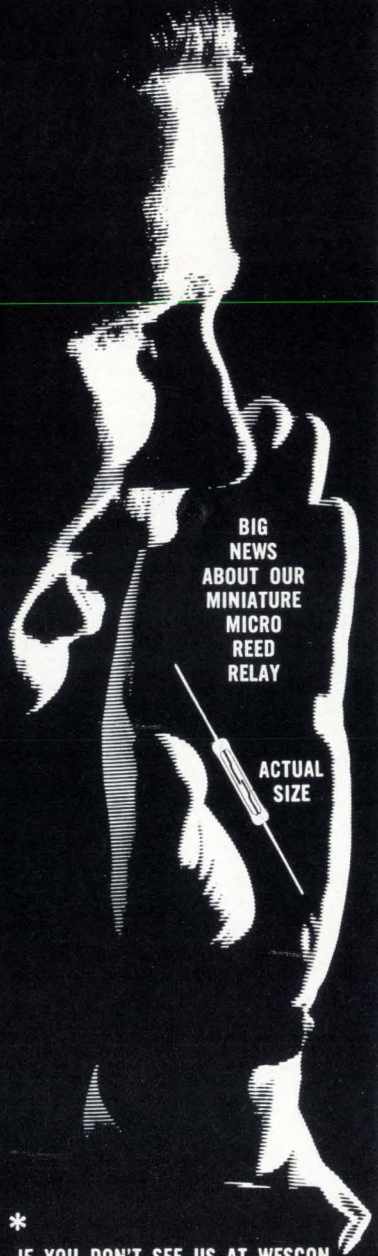

*
 IF YOU DON'T SEE US AT WESCON
 WRITE OR CALL

HATHAWAY
 INSTRUMENTS, INC.

5250 EAST EVANS AVENUE
 DENVER, COLORADO 80222
 (303) 756-8301 • TWX 292-2935
 Distributed Nationally by
 COMPAR CORPORATION

New Subassemblies and Systems

Device to detect gaps in the BITE

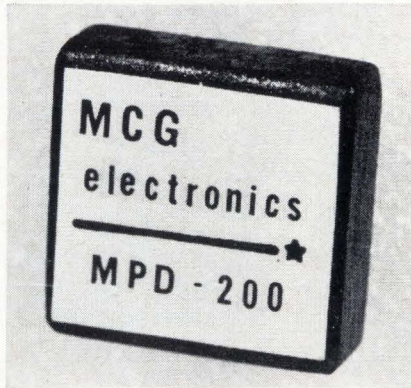

Breadboard and final systems are expected to benefit from a general-purpose detector of missing pulses. The unit, designated MPD-200, is suited for avionic applications requiring the use of BITE (built-in test equipment) circuitry for fault indication down to the module level.

The MPD-200 delivers a fault pulse whenever the system or subsystem pulse repetition frequency drops below a predetermined threshold frequency. The lower threshold for an unmodified MPD-200 is 200 hz, but the unit can monitor pulse frequencies down to 100 hz quite easily with the addition of an external capacitor. Alternatively, the monitoring threshold of the MPD-200 can be raised to 15,000 hz by the use of an external resistor. The detector will monitor any pulse repetition rate larger than its threshold frequency up to 100,000 hz.

Other pertinent specifications for the solid state, epoxy-encapsulated MPD-200 are: pulse signal input, 2 to 5 v at 0.5 μ sec or greater; and fault pulse output, +3 v peak (minimum) with pulse width of 0.4 μ sec at the 2-v level. The power supply required is 24 v at 0.5 ma (regulated).

MCG Electronics, 11-22 Joselson Ave., Bay Shore, N.Y. 11706. [381]

Regulated supply provides dual output

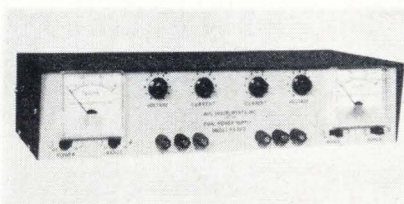

A solid state power supply features two continuously adjustable outputs covering the range from 1.2 to 30 v at currents from 0 to 500 ma and with a ripple level below 1 mv rms. When operated in series as one unit, the two supplies will furnish voltages between 2.4 and 60 v at currents up to 1/2 ampere.

Output voltages of the RSD-30 are monitored by two front-panel meters. The output terminals of each supply are isolated so that either terminal can be grounded. Short-circuit protection and cur-

rent limiting are provided.

The RSD-30 is designed for easy servicing; all components are accessible for checking and replacement. The unit is 3 1/2 in. high, 15 in. wide, and 8 in. deep. It is priced at \$85. Delivery is 30 days from receipt of order.

Aul Instruments Inc., 24-13 Bridge Plaza North, Long Island City, N.Y. 11101. [382]

Neodymium-doped YAG laser system

Capability of up to 5,000 pulses per second is one feature of a Q-switched, neodymium-doped, yttrium-aluminum-garnet (YAG) laser system. Called the LCW3-QS, the system uses a double elliptical cavity with two 1,000-w tungsten lamps. Peak output power ranges from 0.75 to 1.0 kw in pulse widths of 150 to 200 nsec.

Repetition-rate range of the laser is 1,000 to 5,000 pulses per second, and beam divergence is 5 millira-

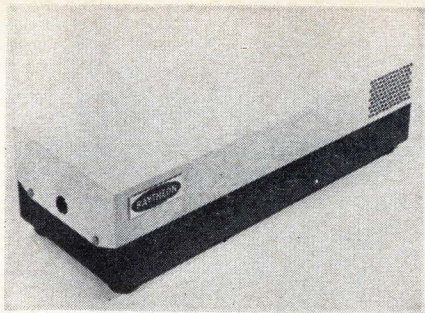

dians. The LCW3-QS is water-cooled and capable of continuous-wave operation with a 1.5-w output. Output is at 1.06 microns.

Compactly packaged, the unit measures 21 in. long and has a volume of less than 0.6 cu ft. Weight is approximately 35 lbs.

The system includes an adjustable a-c power supply and a power supply for the Q-switching element. For extremely stable operation, a stabilized d-c power supply can be ordered.

Raytheon Co., Laser Advanced Development Center, 130 Second Ave., Waltham, Mass. 02154. [383]

Compact discriminator for f-m telemetry

A portable f-m telemetry system needs a compact discriminator with a low current drain. Such a unit is the A-135A subcarrier discriminator, which is designed to operate from 27 to 32 v d-c at a nominal current of 50 ma. It features subcarrier center frequencies, deviation ratios and intelligence bandwidths for mrc bands I through 18 ($\pm 7\frac{1}{2}\%$ channels) and for A through E ($\pm 15\%$ channels), and 100 khz for demultiplexing a transmitted reference frequency.

With the compactness of the A-135A, 18 units weighing less than 1 lb each can be mounted in a RETMA rack 19 in. long, 3 $\frac{1}{2}$ in. high, and 16 in. deep. The R 1005 rack has space in the rear for the required power supplies and connectors. Each channel has a BNC connector on the rack for the limiter output of the discriminator.

The unit has an input impedance of 200 kilohms, an output impedance of 0.5 kilohm, and an operating temperature range of 0°C to 55°C.

Genisco Technology Corp., 18435 Susana Road, Compton, Calif. 90221. [384]

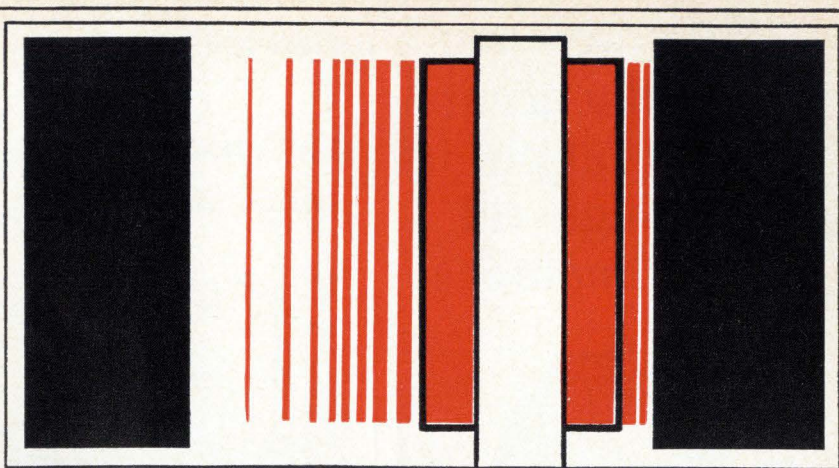

Why is a Jennings vacuum relay the only choice for high voltage switching?

There's nothing to it!

That's right. Only a vacuum dielectric can provide a solution to almost every high-voltage switching problem—and only a Jennings vacuum relay offers the numerous advantages unequalled by any other relay type. You pick a Jennings vacuum relay when you want the utmost in performance for switching sonar transducers, switching between antenna couplers, tap changing on rf coils, switching between transmitters, antennas, and receivers, and many similar applications in airborne, mobile, or marine communication systems. In fact, in any application where reliability is a must and space is minimal.

Why?

Check these features: High RF Current Ratings • Faster Operation • Highest Voltage Ratings • Long Contact Life • No Contact Maintenance • Impervious To Environment • Models To Interrupt High DC Power...*plus* the reliability and quality backed by more than 24 years experience in the design and manufacture of

vacuum electronic components.

If you have a high-voltage switching problem, Jennings probably already has a solution. If not, no one is better experienced to find one. For complete information write for our relay catalog No. 102. ITT Jennings, a subsidiary of International Telephone and Telegraph Corporation, 970 McLaughlin Avenue, San Jose, California 95108.



JENNINGS **ITT**

**“9 years ago
we had a great
idea that put us
in the high-rel
relay business.**



**It's still a great
idea, and now
we've put it
in a one-inch
package!”**

Wedge-action* was the great idea. By combining long precious-metal contact wipe with high contact force, it gives Electro-Tec relays the highest dry-circuit confidence level ever reached. (90% based on a failure rate of only .001% in 10,000 operations.)



Packing wedge-action into a one-inch envelope wasn't easy. But it was worth it. It gives you maximum reliability in minimum space. And it's available for both 6PDT and 4PDT operations, in relays that exceed all requirements of MIL-R-5757/1 and /7.

The one-inch relay is just one of our family of wedge-action relays, which cover almost every dry-circuit to 2 amp application. When you need a high-rel relay that really works, remember our great idea, and put it to work for you.

*U.S. Patent No. 2,866,046 and others pending.



Electro-Tec Corp.

SLIP RINGS • RELAYS • SWITCHES • OPTICS

P.O. Box 667 • Ormond Beach, Florida

(904) 677-1771 • TWX 810-857-0305

Manufacturing Facilities:

Ormond Beach, Fla. • Blacksburg, Va.

New Microwave

Voltage-variable switch attenuator

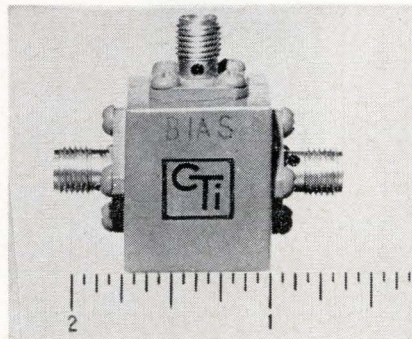

A voltage-variable attenuator can operate in a frequency range of 8 to 12 GHz at a switching speed of less than 20 nsec.

Maximum vswr for the model MAC-004 is guaranteed less than 1.8:1 but typically is less than 1.5:1. Insertion loss is 0.5 db. To swing from 0.5 to 30 db requires 0.5 ma of control current.

The unit is available with coaxial or strip line connections, standard brackets or mounting holes. Weight is 1½ oz. and size is less than a cubic inch.

Price is \$925. Delivery takes two weeks.

Comtronix, Inc., Box 69, Alpha Road, Chelmsford, Mass. 01824. [391]

Source produces 2 watts at 1 Ghz

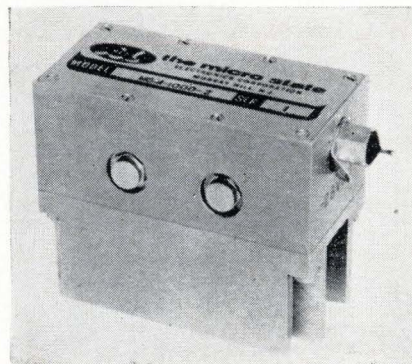

A microwave source employing varactor multipliers produces two watts of power in the 1-GHz range. The unit has a mechanical tuning range from 950 to 1,080 Mhz and a

frequency stability of two parts in 1,000 over a temperature range of -30° to +60°C. It converts electrical energy from d-c to r-f frequencies with an efficiency greater than 30%.

Spurious response is -35 db below the fundamental frequency. The source operates on a supply voltage of -28 v d-c.

Dimensions of the unit are 2½ x 1 x 2 in. including heat sink. Delivery time is 90 days.

Micro State Electronics Corp., 152 Floral Ave., Murray Hill, N.J. [392]

Telemetry transmitter for video applications

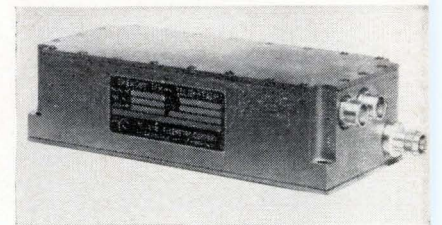

Transmitters for S band and L band utilize solid state multiplier chains to produce r-f output power levels from 0.5 to 10 watts. Designed for missile and satellite applications, the TR2200 (S band) and TR1400 (L band) transmitters are capable of wideband deviation and high-frequency response for high resolution, real-time video applications.

Improvements in free running r-f oscillators afford linear wideband modulation with better than 1% linearity to ±10 Mhz, and uniform response within ±1 db from d-c to over 7 Mhz. Deviation sensitivities are 0.4 mv/khz peak. Automatic gain control in the r-f power and amplifier chain produces nearly constant r-f power outputs even with large variations in supply voltage and operating temperature. The units will operate with over-voltages as high as 36 or transient voltages up to 70. As an option, current limiting circuits are available to protect against reverse polarity and current surges during turn on.

All transmitters meet require-

ments of IRIG 106-66.

Prices start at \$2,900 with total cost depending on options and output power. Delivery takes 90 days. Teledyne Telemetry Co., 9320 Lincoln Blvd., Los Angeles 90045. [393]

Balanced mixers stress range and size

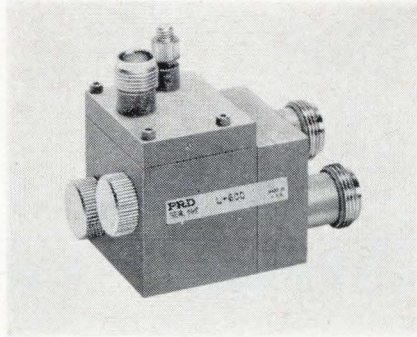

Six broadband balanced mixers, covering a frequency range from 10 Mhz to 18 Ghz, are suitable for both coaxial and waveguide systems. Noise figure as low as 8 db and a conversion loss of 6.5 to 7 db, plus small size, make the 600 series useful for system or laboratory operation.

The mixers were designed to extend the frequency range of the company's 915-B attenuation calibrator but can also operate as standard single output devices. PRD Electronics Inc., 1200 Prospect Ave., Westbury, N.Y. 11590. [394]

Hard r-f head for altimeter

Designed to function as the r-f portion of a C-band radar altimeter, a miniature air-strip package contains a single-sideband generator, two balanced mixers employing tunnel diodes, four isolators, and three directional couplers.

This rugged and compact unit meets the reliability requirements of MIL-E-5400 Class 1. All the diodes are easily and quickly replaceable.

Measuring 5 x 5.5 x 1.9 in. high, the package is available in a variety of frequency bands. Micro-Radionics Inc., 14844 Oxnard St., Van Nuys, Calif. [395]



Time integrator consumes μ watts; fires 100-w load

Try it yourself! Using a Bissett-Berman E-CELL* in the power-switching circuit shown below, a signal current of 200 microamps or less will fire the SCR and light the 100-watt lamp exactly 72 hours after you throw the switch. You get a complete time integration function performed virtually power-free. (Actually, 600 microwatts are consumed by the timing circuit shown.) To get the equivalent time delay using conventional microcircuitry would increase both the power drain and the cost by several orders of magnitude.

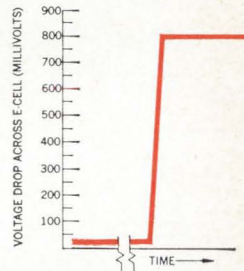
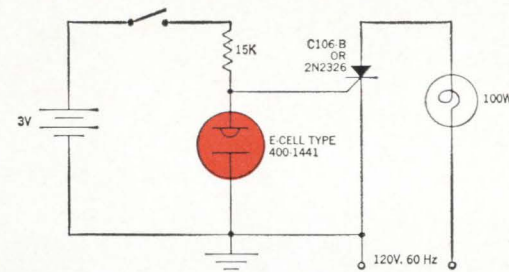

* The Bissett-Berman E-CELL[™] is a unique "liquid state" electrochemical timing and integrating component now being manufactured in high volume on fully automatic production lines. E-CELLS are designed for single use or re-cycling, can be set or re-set in the field, and are furnished in wire-lead or plug-in versions. A multiple-electrode E-CELL enables complex functions such as two-phase timing — or subtotaling and totaling — with



Actual size

signal outputs at each step. E-CELLS can generate accurate time delays ranging from a fraction of one second to months; can integrate events from one to infinity; and can operate in the **nanowatt** range. Operating/storage temperature is -55°C to 75°C . E-CELLS have been tested and approved by users for severe shock and vibration tolerance in accordance with military specifications. Patents applied for.

For technical information and application notes, contact: Components Division. The Bissett-Berman Corporation, 3860 Centinela Avenue, Los Angeles, California 90066; Telephone: Area Code 213, 394-3270.

**BISSETT
BERMAN**

Compare the
All-New PAMOTOR
Model 4500 with
 the miniature
 axial fan
 you're now using!

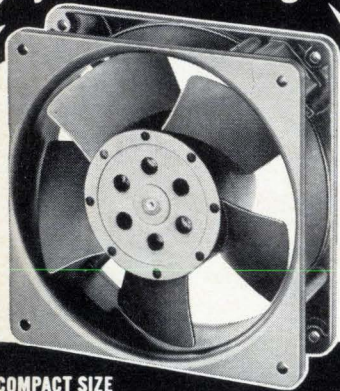

COMPACT SIZE

Only 4 1/16" x 4 1/16" x 1 1/2". Weighs just 1 1/4 lbs. Interchangeable with similar, less reliable 4 1/16" fans.

POWERFUL MOTOR

Dependable shaded-pole motor operates with low internal heat rise. Efficient inside-out design.

ALL-METAL CONSTRUCTION

Precision die cast housing, hub, impellers. Corrosion resistant. Natural heat sink. Warp-free, unlike conventional plastic fans.

**115 CFM WITH LESS
 THAN 37.5 dB SIL***

*Speech Interference Level

- Lubrication-free life in excess of 20,000 operational hours, continuous duty at 55° C.
- Delivers more air at a lower noise level, yet priced under similar conventional plastic fans.
- Model 4500 designed for 117V/50-60 Hz operation. Model 4550 operates at 230V/50-60 Hz.
- Now available for immediate delivery through leading electronic distributors or directly from factory stock.
- Has Underwriters' Laboratories Inc. Yellow Card Component Recognition Number E41168.

Write to
 PAMOTOR, INC., 312 Seventh St.
 San Francisco, California 94103.

PAMOTOR, INC.

New Production Equipment

Automatic sorter handles IC's with care

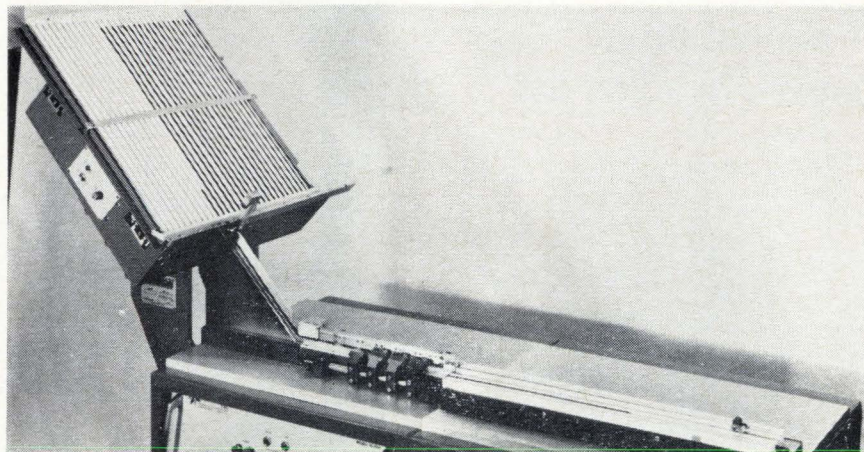

The problem of handling integrated circuits in rapid testing has become acute. Unless handled carefully, the IC's could develop flaws that would hamper later assembly operations. To maintain the leads in their proper place without bends, an in-line transfer system has been developed that automatically contacts, allows testing, and then sorts multilead devices. In addition, the system enables many tests to be performed during a single pass.

Called the model IC-500, the system includes input, test, and sort modules. Depending on the types of carriers and magazines selected, it is capable of handling flatpacks, TO-5 cans, or dual in-line packages.

There are four versions of the input module available: manual, magazine, multimagazine, and bulk.

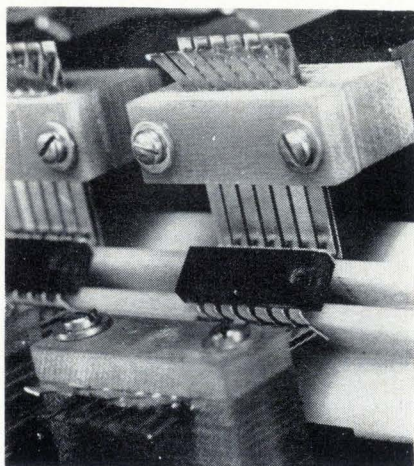

In the manual model, one circuit at a time is fed by hand into an input track; in the magazine version, the IC's are fed from a pre-determined magazine; in multi-magazine form, they are fed from an automatically selected magazine; and in the bulk version, the module is an automatic vibratory feeder.

Transfer and contacting are performed by the test module. A high-speed mechanism separates the IC's at the input track and transfers them to positions along a rail that leads to five test stations. At each station, a set of d-c or a-c contacts is pressed against the device leads, and the electrical test is performed. The contacts accommodate a variety of horizontal or vertical lead configurations on the IC package.

The sort module, which is tied in with the output of the test section, is available in three configurations: go/no-go, multibin, and multimagazine.

An scr shift register holds the information specifying to which magazine or bin the tested IC goes. One shift register chain is used for each magazine and one for the reject bin.

When the IC package reaches the sorting section, the shift register energizes a d-c stepping motor. As the section revolves, the package is moved from a horizontal to a vertical position, allowing it to fall into the proper magazine. Proxim-

HIGH RELIABILITY *Nurl-Loc*[®]
TERMINALS • TEST JACKS
 MOLDED Diallyl Phthalate

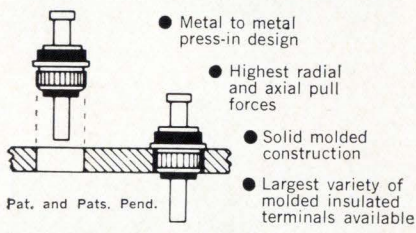

Nurl-Loc[®] STANDOFF TERMINALS

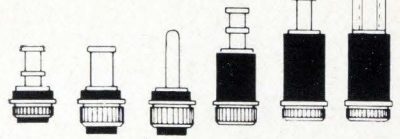

Nurl-Loc[®] FEED-THRU TERMINALS

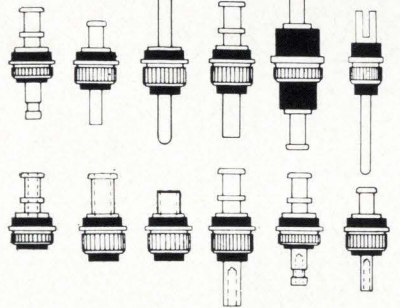

STANDOFF TERMINALS

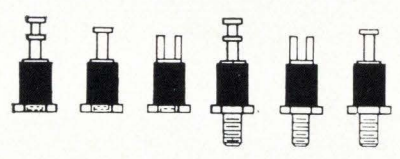

MIL-T-55155 FEED-THRU TERMINALS
 INSULATED TERMINALS

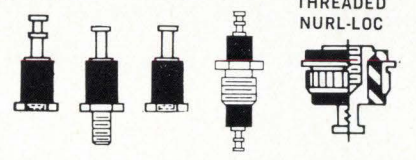

TEST JACKS

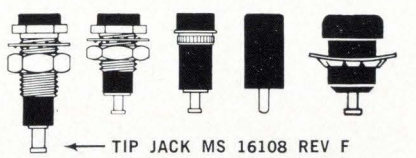

Write for *Nurl-Loc*[®] Catalog
 TERMINALS

EMC
ELECTRONIC MOLDING CORP.
 38 Church Street
 Pawtucket, R. I. 02860
 (401) 726-2100

ity switches defect full magazines and provide a command signal to switch in an empty one. Reed switches are used as interlocks to shut down the machine if a malfunction occurs and turn on lights to indicate the location of the problem. Diode-transistor-logic IC's comprise approximately 40% of the circuitry.

Transistor Automation Corp., 18 Moulton St., Cambridge, Mass. 02138. [401]

Soldering system needs no hands

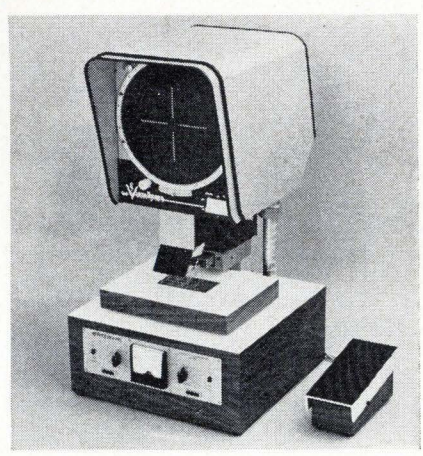

A resistance soldering system with hydraulic foot control permits complete "hands off" soldering. The automatic soldering cycle incorporates precise ball bearing x-y table positioning and full-color direct viewing of the highly magnified work area.

Solid state power supply and timing circuits in the model 2500 offer solder temperature control with 1% repeatability.

Browne Engineering Co., 2003 State St., Santa Barbara, Calif. 93105. [402]

Laser welding system with longer pulses

A long-pulse ruby laser system is suitable for a variety of welding applications with materials as thick as 0.040 in. It can achieve pulse lengths of 7 to 10 msec at 5 to 60 joules repetitively, compared with the 4-msec pulse lengths of presently available laser welders, according to the manufacturer.

New welding applications are

ONLY TRYGON HR-B Series POWER SUPPLIES give you all these features

- All silicon —60°C operation
- Constant voltage/constant current
- .01% regulation; 0.5 mv ripple
- Up to 300 watts—voltages to 160V.
- Remote sensing—remote programming
- TRYLINK[®] precision current mode
- Automatic overvoltage protection option
- Half Rack Size—Bench or rack mount

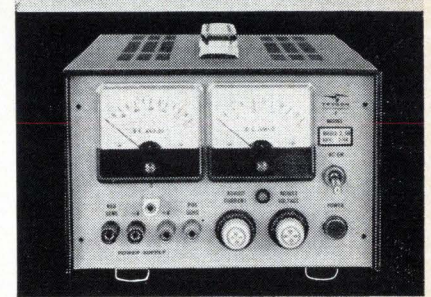

TRYGON
 ELECTRONICS, INC.
 Roosevelt, N.Y. 11575

Please rush me your new 52-page Power Supply Handbook—FREE

Name _____
 Title _____
 Company _____
 Address _____
 City _____ State _____ Zip _____

You name the meter. Ideal has it.

(or we'll make it for you)

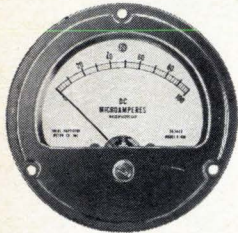
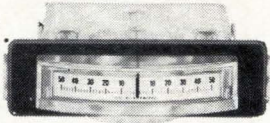
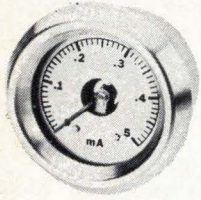
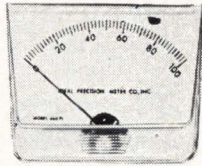
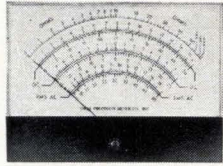

If one concentrates long and hard enough on panel meter development and engineering, one becomes expert.

IDEAL meters are used by all the Military and by leaders in defense and industry. For everything in meters—ruggedized or commercial, custom and stock, 1/2" to 7"—you can count on IDEAL, the proven leader.

Write for free 32-pg. catalog, Ideal Precision Meter Co., Inc., 218 Franklin St., Brooklyn, N.Y. 11222. (212) EVERgreen 3-6904.

Circle 244 on reader service card

Production Equipment

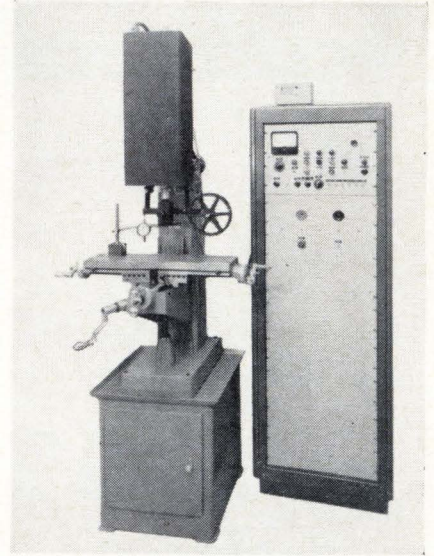

opened up for the laser because of the longer pulses. These include seam and tack welding for electronic components, and butt welding of Inconel, zircalloy, brass, copper, dissimilar metals, and the like.

The system is made up of a laser head, power supply, water-cooling unit for repetitive operation, and a milling machine base. Options include closed-circuit tv and a simple eyepiece device for focusing and viewing.

Prices start at \$17,500. Spacerays Inc., Northwest Industrial Park, Burlington, Mass. 01803. [403]

Evaporation source for film deposition

A wide range of laboratory and production ic and optical-coating applications can be handled with a 6-kw evaporation source that provides rapid, ultrapure deposition of thin films.

Designated e-Gun, the evaporator is easy to install in a vacuum system and can be operated from either front panel or remote controls. Since it creates temperatures up to 3,500°C, it evaporates any material (for example, aluminum at 3,750 angstroms/minute and titanium at 10,000 angstroms/minute). The source is usable with vacuums down to 1×10^{-11} torr and can be baked to 250°C. Its crucible

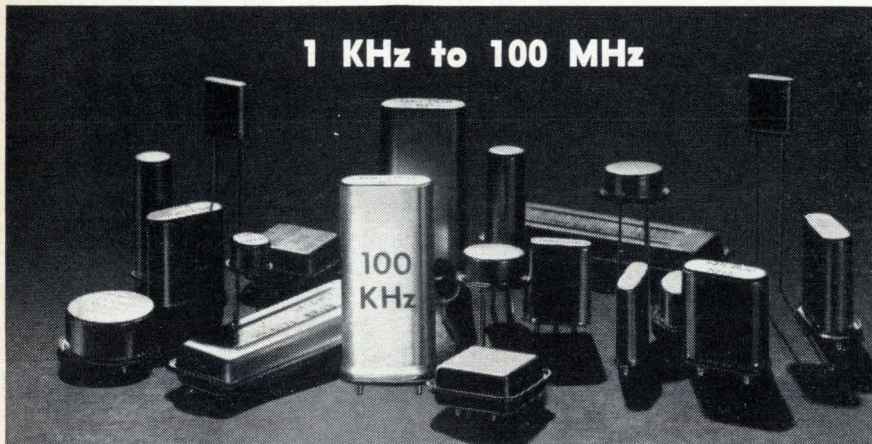

Can a 100 KHz crystal get lost in the field of frequencies?

Not if you look at Reeves-Hoffman! We are artists in ultra-precision crystals . . . but we're also experts and efficient at meeting less-demanding requirements. For example, the 100 KHz crystal shown above, and specified below, can be supplied in production quantities for less than \$2.50 each. How much less? Let us quote.

Frequency	100 KHz
R ₁ , ohms	1,800
L ₁ , henries	67
C ₁ , picofarads	0.037
C ₀ , picofarads	5.78
Q	24,000
5° X crystal for filter or oscillator applications, fundamental extensional mode.	



400 WEST NORTH STREET, CARLISLE, PENNSYLVANIA 17013

MISSING PULSE DETECTOR



- Monitors presence of pulse repetition frequencies from 100 Hz to 100,000 Hz
- Operating temperature range from -40°C to +75°C
- Ideal Sensor for "BITE" Built-in-Test Equipment application
- Completely Solid State - long life
- Small size - less than .6 inches

Phone (516) 586-5125

MCG Electronics	1122 Joselson Ave. Bay Shore, N. Y.
--------------------	--

Circle 245 on reader service card

THIS SPACE CONTRIBUTED BY THE PUBLISHER

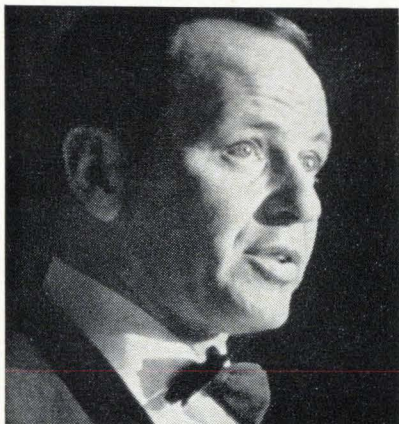

The Voice. Anybody's voice. Your voice. It has a special quality and timbre all its own. But.

If it should become hoarse or if a cough should persist, find out what the reason is. Promptly. It could be a warning signal of cancer. And cancer is easier to cure when it's detected early.

Frank Sinatra knows the seven warning signals of cancer. Do you? 1. Unusual bleeding or discharge. 2. A lump or thickening in the breast or elsewhere. 3. A sore that does not heal. 4. Change in bowel or bladder habits. 5. Hoarseness or cough. 6. Indigestion or difficulty in swallowing. 7. Change in a wart or mole.

If a signal lasts longer than two weeks, see your doctor without delay.

It makes sense to know the seven warning signals of cancer.

It makes sense to give to the American Cancer Society.

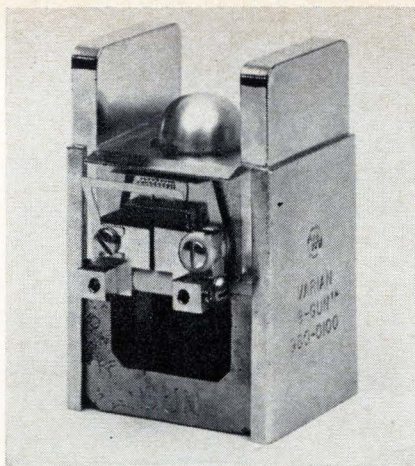

holds a charge 1 1/4 in. in diameter (8 cc in volume).

Varian Associates, Vacuum Division, 611 Hansen Way, Palo Alto, Calif. 94303. [404]

Molder handles delicate components

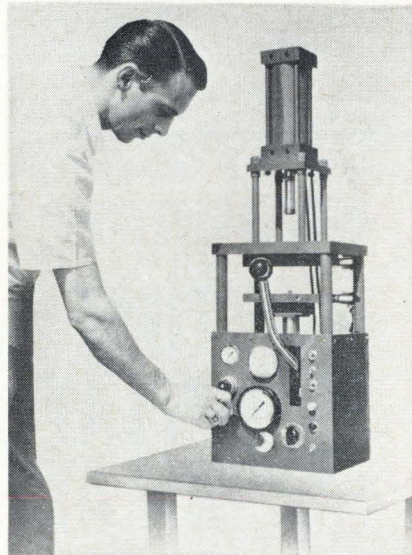

A compact molding machine, designed for inexpensive aluminum molds and the recently developed soft-flow epoxy molding compounds, encapsulates delicate electronic components such as transformers, coils and semiconductors, or molds cups, cases, lead forms and terminal blocks.

Model JD-11 has a 5-ton hydraulic clamp; a fully adjustable air transfer system; front panel gauges that indicate hydraulic ram force in tons and psi, air transfer pressure, top and bottom platen temperatures; two-handed ram opera-

ONLY TRYGON SILICON RACK POWER SUPPLIES pack 0 to 320 volts into a 3 1/2" height!

Meet the biggest 3 1/2" in transistorized power supply history... and enjoy all these features:

- All silicon design
- Full power ratings to +71°C without derating, heat-sinking or forced air
- Ratings from 0-20 volts @ 7.5 amps to 0-320 volts @ 1.5 amps
- Constant current/constant voltage operation with mode indicator light on front panel

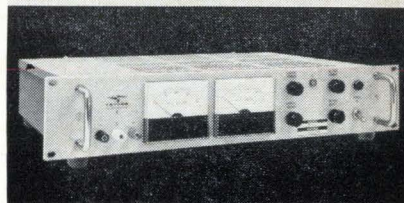

Get the facts on all Trygon's exclusive power supply advances.

MAIL COUPON TODAY!



TRYGON

POWER SUPPLIES

Pleasant Avenue
Roosevelt, N.Y. 11575

Please rush me your new 52-page Power Supply Handbook—FREE

Name _____

Title _____

Company _____

Address _____

City _____ State _____ Zip _____

ACTIVE FILTERS

TUBE: Plug-in feedback amplifier-network combinations for single-tuned or higher order band pass responses as illustrated. Center frequencies down to 0.005 cycle. Q's to 75. Widely used where LC filter sections are impractical. High pass, low pass and narrow notch response characteristics available.

TRANSISTOR: Integral transistorized amplifier-network units for single-tuned band pass responses. No external components required. Units will cascade for higher order responses. Center frequencies down to 0.01 cycle. Q's to 40. High pass, low pass and narrow notch response characteristics available.

PASSIVE FILTERS

LC FILTERS: Stable toroidal LC's—low, high, band pass and reject over wide impedance ranges in the audio frequency spectrum.

RC TWIN-T NETWORKS: Null frequencies 0.005 cycle to 50 kc in wide range of impedance levels. Useful for low pass filtering, harmonic rejection, feedback circuits.

- STANDARD FILTERS AND NETWORKS HERMETICALLY SEALED
- SPECIAL ENCAPSULATIONS AVAILABLE
- PLUG-IN OR STUDS FOR MOUNTING (OR BOTH)
- EARLY DELIVERIES—MODERATE PRICES
- PROMPT ENGINEERING ON INDIVIDUAL PROBLEMS

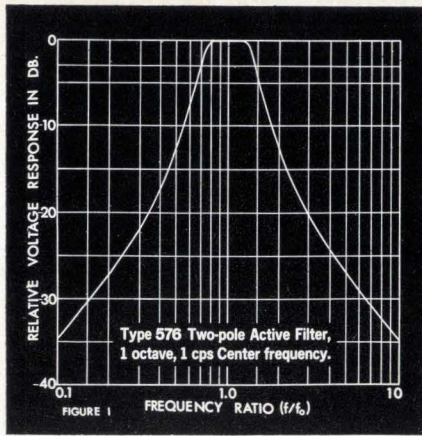

Write for technical bulletins describing filters in the audio spectrum and below, active and passive; Network Notes containing filter selection and application suggestions. Much performance information not yet published available on request. Ask about low-frequency spectrum analyzers.

White

INSTRUMENT LABORATORIES
Incorporated

Phone Area 512 — GL 3-6621
Box 9006 Austin, Texas 78756

Circle 246 on reader service card

FREE FOLDER ECCOSHIELD® RF SHIELDING MATERIALS

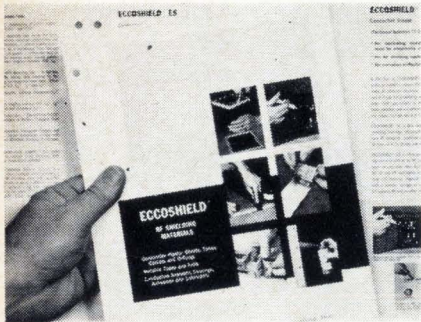

Brand new six page folder in color describes a complete line of Eccoshield products to combat RFI—conductive plastic shield and gaskets, adhesives, coatings, caulking compounds, metallic foil—the works.

This valuable Folder is yours. Write or use Reader Service Card.

Write or Use Reader Service Card

Emerson & Cuming, Inc.



CANTON, MASS.
GARDENA, CALIF.
NORTHBROOK, ILL.
Sales Offices
in Principal Cities

EMERSON & CUMING EUROPE N.V., Oevel, Belgium

190 Circle 190 on reader service card

Production Equipment

tion for operator safety; and mechanical timer.

Simple to operate, the press measures 12x12x36 in., may be bench mounted, and is shipped ready to operate on shop air and 115 v line.

Price is \$1,450. Delivery takes six weeks.

Morris Enterprises, Inc., 16799 Schoenborn St., Sepulveda, Calif. 91343. [405]

Memory core handler for production tests

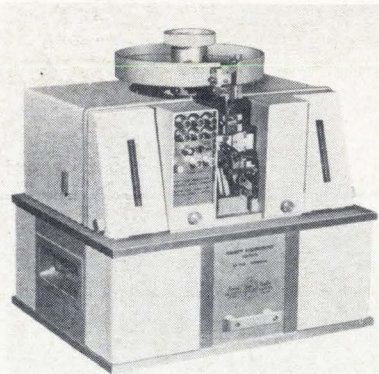

Mass production testing is the major application of a memory core handler that processes ferrite cores with outer diameters ranging from 12 to 50 mils at rates of from 18,000 to 60,000 cores per hour.

The unit can process small, fast-switching cores because the high-frequency wiring techniques used in its construction result in improved noise cancellation of the electrical test circuits. All mechanical motions in moving individual cores to and from the test position are minimized in the CH-103 handler. Cores are tested serially as they reach the bottom of a feed chute connected directly to a feed bowl. The cores are tested while they remain in the chute. Movement to an adjacent test station by a mechanical carrier and vacuum holding system is eliminated, which increases the handler's speed by as much as 20,000 cores per hour.

The CH-103 sorts cores into two accept and one reject categories. This permits tighter limits on pa-

New! From MESON! New!

ELECTRONIC TIME DELAY RELAY



- High Accuracy, $\pm 10\%$
- Repeatability, $\pm 3\%$
- Fast recycling time — .05 sec. max.
- Input — 115 VAC
- Up to 180 sec. delay, fixed or variable with external variable resistor.

\$6⁹¹
Only **6** in 100 lots
IMMEDIATE DELIVERY!

Order one for test at \$8.80. Your MONEY BACK if not satisfied!

MESON
ELECTRONICS CO. INC.
380 Cottage St., Rochester, N.Y. 14611
Phone (716) 235-7070

Circle 247 on reader service card

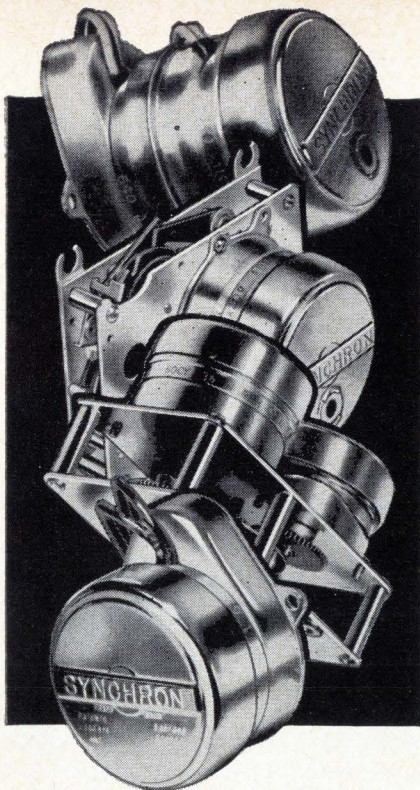

SYNCHRON[®] PRODUCTION NEARLY DOUBLED TO MEET YOUR GROWING DEMANDS

More engineers than ever before are now designing high-performance SYNCHRON Motors into their products. Result: The biggest demand in SYNCHRON history. To meet it, production capacity has been nearly doubled and our precision-trained work force increased. If you, too, require the finest synchronous hysteresis motor made, it *can* be supplied you. Not off the shelf, of course. But you can confidently make SYNCHRON Motors part of your design, knowing deliveries *will* be made to meet your production schedules. However, please don't delay. Write now, or call or write your nearest Hansen Mfg. Co., Inc., representative.



HANSEN REPRESENTATIVES: CAREY & ASSOCIATES, Houston and Dallas, Texas; R. S. HOPKINS CO., Sherman Oaks, Calif.; MELCHIOR & MacPHERSON, INC., San Carlos, Calif.; THE FROMM CO., Elmwood Park, Ill.; H. C. JOHNSON AGENCY, INC., Rochester, N.Y.; WINSLOW ELECTRIC CO., Essex, Conn.; Narberth Pa., and New York, N.Y.
EXPORT DEPARTMENT: 64-14 Woodside Ave., Woodside, N.Y.

rameters such as lower over-all memory plane delta noise, or tighter "one" envelope.

Computer Test Corp., 3 Computer Drive, Cherry Hill, N.J. 08034. [406]

Compact lead bender operated by hand

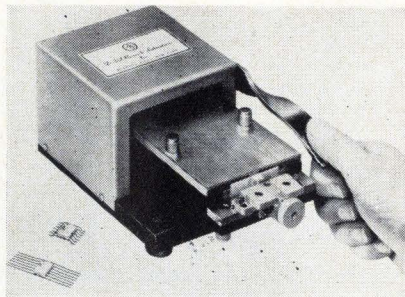

A hand-operated lead bender preforms and bends the leads of multi-lead components such as IC's, flat-packs, and reed switches. The device, supplied with one or more custom dies made to user specifications, operates at a rate up to 100 units per hour.

Ruggedly constructed, the model 100B weighs 5 lbs and requires no power for operation. It measures 2¾ x 4 x 8¼ in. Dies are available for TO84 through TO95 micrologic packages as well as for standard 2-lead components such as diodes and resistors.

D-Vel Research Laboratories Inc., 555 Bedford Road, Bedford Hills, N.Y. 10507. [407]

Desoldering tool for component rework

A hand-held desoldering tool removes unwanted solder from solder joints rapidly. Called the Soldapullt, the unit is easy to handle, is self-cleaning, and provides swift vacuum action.

Molten solder is drawn into the receiving chamber with a high-impulse vacuum stroke caused by a spring-loaded piston. Hand position need not be changed when the Soldapullt is reloaded.

Price of the unit is \$11.96, with immediate delivery available from stock.

Edsyn Inc., Box 868, Arleta Station, Pacoima, Calif. 91331. [408]

Definition:

power supply modules

should be:

- all silicon
- 71°C rated
- independent of external heat sinks
- fully maintainable
- highly reliable — MTBF > 60,000 hrs.
- modest in cost

Only Trygon gives you all 6!

33 models in a complete range of voltage and currents. Send for catalog today to Dept. EDN-29.

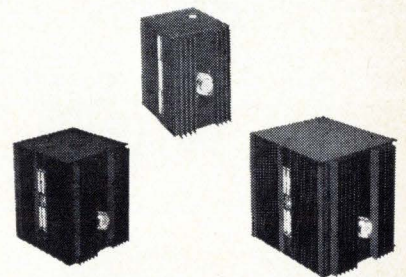

TRYGON[®] POWER SUPPLIES

Roosevelt, L. I., N. Y. (516) FReeport 8-2800

AMPERITE

GLASS ENCLOSED Thermostatic DELAY RELAYS

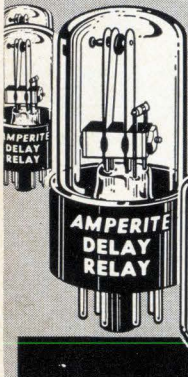

Offer true
hermetic
sealing—

— assure
maximum
stability
and life!

Delays: 2 to 180 seconds

Actuated by a heater, they operate on A.C., D.C., or Pulsating Current... Being hermetically sealed, they are not affected by altitude, moisture, or climate changes... SPST only — normally open or normally closed... Compensated for ambient temperature changes from -55° to $+80^{\circ}\text{C}$. Heaters consume approximately 2 W. and may be operated continuously. The units are rugged, explosion-proof, long-lived, and inexpensive!

TYPES: Standard Radio Octal and 9-Pin Miniature... List Price, \$4.00
PROBLEM? Send for Bulletin No. TR-81.

AMPERITE

BALLAST REGULATORS

Hermetically sealed, they are not affected by changes in altitude, ambient temperature (-50° to $+70^{\circ}\text{C}$), or humidity... Rugged, light, compact, most inexpensive.

List Price, \$3.00

Write for
4-page
Technical
Bulletin
No. AB-51

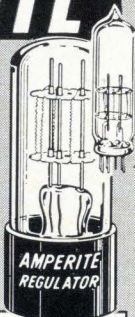
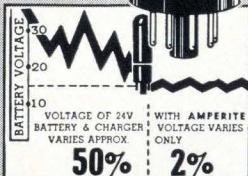

AMPERITE

600 PALISADE AVE., UNION CITY, N.J.
Telephone: 201 UNION 4-9503
In Canada: Atlas Radio Corp., Ltd.,
50 Wingold Ave., Toronto 10

New Materials

Epoxy encapsulants protect components



Two-part epoxy potting and encapsulating resins, designated Stycast 2651 and 2651-40, come with a choice of hardeners. Catalyst 9 is for room temperature cure and end-

use temperatures up to 300°F ; catalyst 11 is for elevated temperature cure and end-use temperatures to 450°F .

Both resins are on the qualified products list under MIL-I-16923. They are suitable for encapsulating a variety of electrical and electronic equipment, from transformers to transistors, that will be exposed to environments as widely diversified as ocean depths and outer space.

Some typical properties of Stycast 2651 and 2651-40 include: a catalyzed viscosity of 28,000 and 2,800 hz; dielectric strength, 410 and 390 v/mil; volume resistivity (dry), 11×10^{14} and 5×10^{14} ohm-cm; volume resistivity (240 hrs at 96% RH), 0.6×10^{14} and 1.3×10^{14} ; dielectric constant (1 Mhz), 3.97 and 4.06; loss tangent (1 Mhz), 0.027 and 0.026; flexural strength, 22,000 and 15,000 psi; thermal shock (-55° to 155°C) > 10 cycles. Emerson & Cuming Inc., Canton, Mass. 02021. [409]

Phosphorous materials almost 100% pure

Commercial quantities of phosphorous trichloride are part of a line of high-purity phosphorous materials for semiconductor applications. The line includes red phosphorous, gallium phosphide, and indium phosphide.

The semiconductor-grade red phosphorous is more than 99.999% pure. Typical sulfur content is 3 to 4 ppm. It is packaged in 10- and 50-gram pyrex ampules and can be used as a starting material for gallium phosphide, indium phosphide and gallium arsenic phosphide.

The phosphorous trichloride has a typical sulfur content of 0.05 ppm and 0.22 ppm of arsenic. Packaged in 50- or 100-gram glass ampules, the material is suitable for vapor phase production of gallium phosphide epitaxial systems or as a catalyst and doping agent.

Indium phosphide is produced

upon request and the new materials are available from stock.

American Smelting & Refining Co., 120 Broadway, New York City. [410]

Two epoxy adhesives boast high conductivity

Two highly conductive epoxy adhesives, with volume resistivity less than 0.01 ohm-cm, are available at prices claimed to be substantially below their silver-filled counterparts. Sympoxy 5710 is a one-component, heat cure adhesive, while Sympoxy 5415 is a two-part room cure material. Paste consistency permits easy application.

Both adhesives are supplied in 6-ounce kits, or in 1- and 2-ounce sizes. Price for either 6-ounce package is \$10.90.

Kits contain the adhesive, a stirring stick and sufficient cleaner to thoroughly remove grease, dirt, and other foreign material.

Symplastics Inc., 1902 Broadview Drive, Glendale, Calif. 91208. [411]

Super

SOLID CARBIDE CIRCUIT BOARD DRILLS AND ROUTERS

DESIGNED FOR PRECISION DRILLING AND ROUTING OF ALL CIRCUIT BOARD LAMINATES



CBU

A precision solid carbide circuit board drill designed with a 1/8" uniform shank for simplified chucking. Tapered webs for maximum strength. In wire gauge, fractional and metric diameters.



CB

The original solid carbide circuit board drill design with tapered web guaranteed to produce precision bur-free holes, as the CBU above, in single or stacked board operations where flute lengths permit. In wire gauge, fractional and metric diameters.



DIR

A diamond cut design solid carbide profile-router for plunge or outside profiling. The cross-hatch flute principle of this diamond-cut design provides many positive overlapping cutting edges to insure clean, sharp profiling with absolutely no delamination. In fractional size range.

Super circuit board drills and routers are guaranteed to perform efficiently in all circuit board laminates. Tolerances and concentricity are minimal to permit

exact locating or repositioning in N/C or conventional equipment. Literature No. EL-67-1 available at distributors and branches or directly from:



SUPER TOOL COMPANY

SINCE 1927

A DIVISION OF UNIVERSAL AMERICAN CORPORATION

ELK RAPIDS, MICHIGAN 49629

PHONE (616) 264-8151

BRANCHES:

Chicago
5428 N. Milwaukee Ave.
Chicago, Illinois 60630

Detroit
Suite 508, Professional Bldg.
Eastland Center, Detroit, Mich. 48236

New York
350 Hudson St.
New York, New York 10014

Los Angeles
5908 E. Washington Blvd.
Los Angeles, California 90022

Circle 248 on reader service card

PRECISION-PLUS

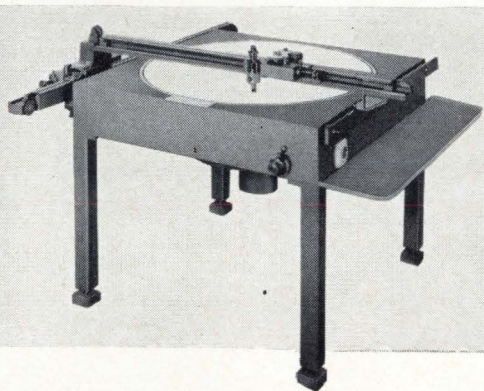

AN ARISTO COORDINATOGRAPH WILL SOLVE YOUR MOST COMPLEX DRAFTING OR LAYOUT PROBLEMS

The fine family of Aristo Coordinatographs was designed specifically for those operations where precision is a prime factor. Any drafting or layout job can be completed quickly and accurately with this multi-function instrument. Available in several models, from manually-operated to high-speed programmable, the Aristo Coordinatograph is the perfect tool for:

- Plotting coordinate points for grids, templates and irregular curves
- Preparing pencil, ink or scribed grids
- Scribing artwork for printed circuits
- Measuring dimensions and coordinates of precision layouts, charts, etc.

... and more

Write for free brochure

UNITECH CORPORATION

Subsidiary of Charvoz-Carsen Corporation / 12 Daniel Road, Fairfield, N.J. 07006
In Canada: 31 Scarsdale Road, Don Mills, Ontario

Circle 249 on reader service card

"mini-STAKING" with the NEW Black & Webster GRAVITRON

□ A high-precision drop hammer for "light touch" staking with exceptional repeatability.

Features Include:

- Fast operation — compressed air return provides up to 100 strokes per minute
- Impact force adjustable from 1/2 inch-lb. to 11 1/4 inch-lb.
- Simple, rugged, trouble-free operations
- Hand or foot switch operated
- Free fall for consistent impact force



Write today for complete details on this new precision tool.

BLACK & WEBSTER, INC.

297 WINTER ST. WALTHAM, MASS. 02154 — TEL: (617) 891-8100

Circle 193 on reader service card

193

New Books

In planar language

Physics and Technology of
Semiconductor Devices
A.S. Grove
John Wiley & Sons, 366 pp., \$12.95

Although most semiconductor devices are now made by the silicon planar process, most textbooks still deal with models for germanium alloy devices. Probably no one has been more conscious of this lag than author Grove, head of a surface and device physics section at one of the major developers of the planar process—Fairchild Semiconductor. He has done a good job of filling the void.

Primarily a text, the volume can also be worthwhile for practicing engineers, since electronics engineering is taking on more and more aspects of a materials-oriented science. The author takes the reader from basic semiconductor processing through device operation, but doesn't go into circuit operation.

The book is divided into three parts: solid-state technology, semiconductors and semiconductor devices, and surface effects and surface-controlled devices. The solid-state technology section concentrates primarily on diffusion and epitaxy; the semiconductor section, which gets the lion's share of attention, discusses junction transistors and junction field effect transistors; and the surfaces section examines insulated-gate FET's and the problems associated with oxide insulators.

Few specialized devices are covered. Microwave components, such as Schottky-barrier and Gunn-effect diodes, and microwave transistors, aren't discussed at all. Although integrated circuits aren't covered, the discussions of individual device operation can easily be extended to include them.

Organizationally, the book has several nice touches: important formulas are grouped at the end of each chapter, many references to recent articles are given, the discussions are broken into short doses for fast information retrieval on specific subjects, and the drawings are nearly self-explanatory.

In keeping with recent develop-

ments, gallium arsenide is given almost equal treatment with germanium and silicon, a recognition of the importance it will have in future devices.

Putting IC's to work

Applied Microelectronics
W.M. DeBoice, R.E. Hovda
R.C. Platzek, R.L. Ramont
Edited by C.F. O'Donnell
American Aviation Publications Inc.
265 pp., \$6.00

Unquestionably, the Autonetics division of North American Aviation Inc. has accumulated more man-years of experience in designing and applying integrated circuits than most electronic equipment companies. Five Autonetics engineers have written about their experiences with IC's, gained on a wide variety of programs—including Minuteman.

In this relatively inexpensive paperback book, the reader gains an insight into efficient IC application and the techniques used. Starting off with a discussion of materials and processing technologies, the authors proceed to cover digital systems, electromechanical control systems, high-frequency analog circuits, and, very briefly, trends in the technology—as they see it.

The book's chief virtue is that the authors discuss only what they are most familiar with—applying IC's. Such topics as p-n junction theory are omitted on the premise that these are covered better elsewhere. And, as the authors note, they "succeeded in overcoming the temptation to cover the subject of device design."

Recently published

Analysis of Discrete Physical Systems,
H. Koenig, Y. Tokad, H. Kesavan, McGraw-Hill
Book Co., 447 pp., \$13.75

A discipline is presented for the analysis of systems containing a finite number of interacting components, drawing primarily on examples of applications in electrical, mechanical, and hydraulic processes. The authors outline a general theory for systems modeling, including state-space concepts and numerical solutions, as a foundation for advanced work in design, synthesis, and control.

Gas Lasers, C.G.B. Garrett, McGraw-Hill
Co., 144 pp., \$10.95

This first book-length treatment of the subject of gas lasers covers origin and development, mechanisms, design parameters, and output characteristics. Detailed descriptions are

given of specific systems, such as helium-neon, argon ion, and carbon dioxide.

The Programmer's ALGOL, Charles P. Lecht,
McGraw-Hill Book Co., 251 pp., \$8.95

A programmer's reference book, this work contains a detailed description of the structure and format of a widely used computer language. The 10 ALGOL statements and declarations are presented as expanded forms of a large number of instruction. A directory is provided to aid in identifying a particular statement or declaration in relation to the basic ALGOL forms.

Transistors for Audiofrequency:
Audiofrequency Amplification, G. Fontaine,
Hayden Book Co., 384 pp., \$7.95

The author approaches the subject via a thorough examination of the various transistor parameters and characteristics rather than by specific circuit examples. Semiconductor theory is described in terms of concentration curves, a relatively new means of explaining static and dynamic effects.

Automation and Instrumentation, edited by
Luigi Dadda and Umberto Pellegrini,
Pergamon Press, 722 pp., \$22.50

The proceedings of the Eighth International Automation and Instrumentation Convention, held in Milan, Italy, in 1964. Aspects of such topics as control theory, information processing, electronic techniques, and industrial instrumentation are discussed. Of the 56 papers included, 22 are not in English.

Modern Control Systems, Richard C. Dorf,
Addison-Wesley Publishing Co., 387 pp.,
\$12.50

An introduction to the analysis and design of industrial and laboratory feedback control systems. In addition to classic theory, the author discusses modern concepts of sensitivity, performance indices, state variables, and optimum control systems. Because of the introductory nature of the work, the author limits his discussion to linear, constant-parameter systems.

Communication System Engineering
Handbook, edited by Donald H. Hamsher,
McGraw-Hill Book Co., 950 pp., \$28.50

More than 30 experts contributed to this overview and appraisal of the field, resulting from applying the systems approach to communications engineering. Fundamental design considerations, systems and circuit engineering, facilities construction, and basic areas such as switching, noise, coding, and acoustical theory are covered.

Electronic Conduction in Solids, Arthur C.
Smith, James F. Janak, Richard B. Adler,
McGraw-Hill Book Co., 342 pp., \$13.50

A graduate-level text concerned with electrical conductivity, thermoelectric, galvanomagnetic, and thermomagnetic effects in metals and semiconductors. Irreversible thermodynamics, crystal symmetry, energy bands, and Boltzmann transport theory are covered in detail from both the microscopic and macroscopic viewpoints.

Power Supplies for Electronic Equipment,
Leo G. Sands, John F. Rider Publisher Inc.,
187 pp., \$6.25

A guide to the purchase, application, and maintenance of power supplies. Basic theory of transformers, rectifiers, filters, and voltage and current regulators is presented. The considerations involved in preparing power supply specifications are discussed.

Switching Circuits for Engineers, Mitchell P.
Marcus, Prentice-Hall Inc., 338 pp., \$12

An introduction to the simplification and design of combinational and sequential switching circuits, with the emphasis on the latter. Throughout, the author deals with the practical aspects rather than the abstract. A review of Boolean algebra accents application of the theorems to specific simplification problems.

Not much of a plot, but a great cast of characters.

The characters are 6,000 manufacturers and more than 4,000 product listings. Even if you're not the literary type, you'll be interested in the unprecedented opportunity the Electronics Buyers' Guide affords you to reach *readers*. Over 445,000 engineer users go to EBG year round as a one-stop shopping center for all their electronic needs.

Closing date: Space reservations: July 14.
Plate closing July 28. Book some space now!
First come, first served.

Electronics Buyers' Guide

A McGraw-Hill *Market Directed* Publication,
330 West 42nd Street, New York, N.Y. 10036



MANY OF OUR CONTACTS ARE CONTACT PEOPLE

That's the strange thing about our business. We often don't know just who needs help with contacts. Our own people find many of the people we serve, but the rest of our leads come from customers themselves.

That's why we urge you to let us know when contact problems beset you. Or, as we say, "contact us, so that we can contact you." Once you indicate your particular need, we put skilled, experienced contact specialists to work on a solution. They work with the most modern facilities and technology to provide you with the contact you need, when you need it, and at a reasonable cost too.

So, do us a favor . . . do yourself one, too. When the subject of contacts comes up, contact Deringer. You'll get the closest thing to tailor-made contact service you'll find anywhere.



1250 Town Line Road - Mundelein, Illinois 60060

Technical Abstracts

Magnetic substrates

All-garnet microstrip circulators for integrated circuits
B. Hershenov
RCA Laboratories, Princeton, N.J.

Ferrites are particularly useful in such nonreciprocal devices as isolators and circulators in integrated microwave circuits. Excellent results have been reported at X band with a three-port circulator consisting of an yttrium-iron-garnet disc mounted in a ceramic substrate with microstrip transmission-line connections [Electronics, March 20, 1967, p. 122]. A more ideal approach from the design and fabrication standpoint would be to use an all-garnet substrate.

The value of magnetic insulating substrates was demonstrated by the construction of an all-garnet, three-port microstrip circulator. A copper disc, ground plane, and transmission lines were evaporated on a garnet substrate upon which a chrome flash coating had been deposited. A disc of 23 mils diameter and transmission lines 25 and 27 mils in width were used. In tests performed with a permanent magnet and an electromagnet located near the ground plane, insertion losses were slightly greater than those observed with a ceramic substrate. Bandwidths were significantly greater at the 20-decibel isolation points over a range of 8 to 9 gigahertz.

Feasibility tests were performed on a latched microstrip circulator made with the garnet circulator and a second piece of garnet containing the latching wire and a dielectric ring of magnesium titanate. Tests with this fairly crude model yielded a 20-db isolation bandwidth of 400 megahertz.

The latched circulator can be fabricated in one piece using the same techniques employed in making laminated ferrite memories. This construction provides an improved closed flux path and eliminates losses through the gap between separate pieces. Sheets of latched circulators could be fabricated, and individual units could be connected together or used separately.

Work on ferromagnetic insulators indicates that it may be possible to locally dope substrates to produce active devices, using undoped portions for passive devices.

Presented at the International Microwave Symposium, Boston, May 8-11.

Modular satellites

Application of microwave building blocks to communications satellites
R.E. Cooper, J.O. Holmes, R.M. Lockerd, and M.W. Smith
Texas Instruments Incorporated, Dallas.

Microwave integrated-circuit antennas may make possible a nearly ideal tactical communications satellite—one that serves many users within a small geographical area and is nearly immune to jamming and message interception. A proposed ic phased-array antenna, besides providing such operation, would also offer power and reliability bonuses.

The MECA (for molecular electronics for communications applications) communications satellite would be a frequency-translation repeater in a synchronous orbit. It differs from present relay satellites in that it would use two electronically steered 500-element arrays of 1-inch diameter spiral antennas for reception and transmission, rather than dipole or parabolic antennas. The modular antenna idea is similar to that applied by Texas Instruments in the Air Force's MERA (molecular electronics for radar applications) phased-array-radar program.

Behind each spiral antenna in the reception array would be microwave ic's—frequency down-converters, phase shifters and intermediate frequency amplifiers. The amplified i-f signals would be transmitted in-phase to a manifold, where they would be combined and sent through a central signal processor to another manifold. Here they would be divided among the modules of the transmission array, amplified again, raised in frequency, phase shifted, and retransmitted.

Though powered by solar cells supplying only 500 watts, MECA

would have an effective radiated power of about 32 kilowatts because of its narrow beam and high gain; beamwidths of 3 to 5 degrees and gains of about 34 decibels are predicted.

A small computer would generate electronic beam-steering commands, deflecting the beam through a 10-degree-wide cone; from an altitude of 23,000 miles, this 10-degree swing would be more than sufficient to cover a tactical area.

Presented at the National Aerospace Electronics Conference, Dayton, Ohio, May 15-17.

Like peas in a pod

Dielectrically isolated matched transistor pairs
W.C. Rosvold, W.H. Legat, L.K. Russell
Raytheon Co.
Mountain View, Calif.

Since two transistors in adjacent sites on a semiconductor wafer experience the same processing conditions, there is a good likelihood that they will have nearly identical electrical characteristics. To operate as a matched transistor pair, however, they must be isolated. This can be done with a dielectric isolation technique similar to that used with integrated circuits. A polycrystalline silicon layer is used as a substrate, a silicon-dioxide layer as an insulator and an etching process separates the two transistors into mesa structures projecting off the silicon dioxide layer.

In the process, a single-crystal silicon wafer is first coated with a layer of silicon dioxide. A polycrystalline silicon layer then is grown atop the silicon dioxide. The single-crystal side of the wafer is polished, and diffused with n-type impurities which will ultimately form the collectors of the finished transistors. Next, the individual transistor mesas are etched. Base and emitter impurity diffusions are performed and contacts deposited at the appropriate spots. Now the wafers are complete and ready for final scribing and dicing into two-transistor chips.

The resulting transistors in each pair have betas of about 50 that are within 5% of each other and differences in base-to-emitter voltages within 1 millivolt.

Presented at the Electrochemical Society Meeting, Dallas, May 7-12.

HIGH VOLTAGE POWER SUPPLIES from NJE

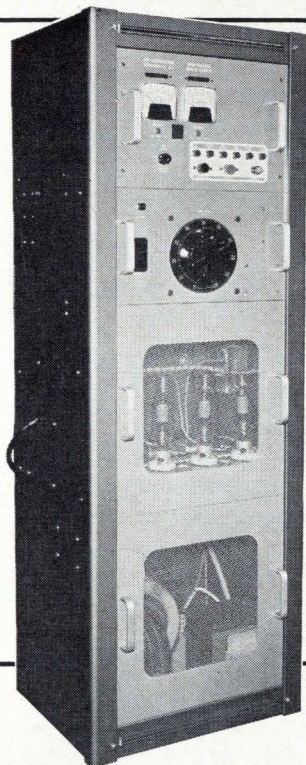

55 models available from:

- 0-2.5 KV up to 250,000 volts
- 0-5 Ma up to 6,000 Ma
- Load regulation 1%-20%
- Line regulation $\pm .5\%$ for $\pm 10\%$ input
- Over-voltage and over-current protection
- Reversible polarity
- Adjustable over-current trip-out, 20 to 120%
- Adjustable over-voltage trip-out, 80 to 110%
- Three-range grounded voltmeter
- Three-range grounded milliammeter
- Automatic output-grounding switch

ONE YEAR WARRANTY

Write for new catalog. It's free.



N.J.E. Corporation

Kenilworth, N. J. 07033 / (201) 272-6000

Telefax: FFP • TWX: (201) 276-7630

Electronic Development and Manufacture 306

How do we stack up?



*You'll be surprised...
Don't miss our low-cost,
Hi-Quality Reed Relays
designed for commercial
application...*

HERE'S OUR VITAL STATISTICS...

Utilizing automated assembly techniques, Grigsby-Barton introduces a completely NEW Reed Relay design for LOW-COST commercial applications. This series, GB 350, embodies all important characteristics such as reliability, hermetically sealed contacts, long life and excellent environmental characteristics. Add to these the outstanding individual features: compact size (1.15" x 1/2" x 1/2") • rugged Nylon housing • inputs and outputs terminated for printed wiring board installation • terminals stepped by .025" for easy cleaning • operate time of less than 1 millisecond including bounce and release time of 800 microseconds maximum • life at rated resistive load is 10×10^6 cycles and at dry circuit 10^8 cycles.

Two versions of this basic design are now available . . . Series GB350 (as Form A, Form B, Form C, and Form AHW Mercury Wetted) and Series GB352 (as a double pole relay with similar switch forms).

At your option electrostatic and electromagnetic shielding is available along with dual wound coils for latching types.

For the answer to all your relay and switching problems, look to Grigsby-Barton designers and producers of Reed Relays, Logic Cards and Switching Systems.

GRIGSBY-BARTON, INC.
107 NORTH HICKORY STREET
ARLINGTON HEIGHTS, ILL. 60006
PHONE AREA 312 / 392-5900

GRIGSBY-BARTON



New Literature

Pushbutton bridge. Wayne Kerr Corp., 22 Frink St., Montclair, N.J. 07042, has available a brochure on the B641 universal impedance pushbutton bridge, which measures impedance to 0.1% accuracy with no manual balancing required. Circle 420 on reader service card.

Aerospace telemetry. Radiation Inc., Box 37, Melbourne, Fla. 32901. Aerospace telemetry and data handling systems and capabilities are described in a 40-page booklet. [421]

Analog building blocks. Philbrick Researches Inc., Allied Drive at Route 128, Dedham, Mass. 02026. Bulletin 6630 is a 16-page illustrated brochure that discusses the Q3 series of modular analog instruments and systems. [422]

Time code generator. Electronic Engineering Co. of California, 1601 E. Chestnut Ave., Santa Ana, Calif. 92702, offers a data sheet describing the ZA37000 airborne time code generator. [423]

Modular supplies. E-Tronics, 5901 Noble Ave., Van Nuys, Calif. 91401, has released bulletin MP-102 covering a new line of modular d-c power supplies. [424]

IC analyzer. Computer Test Corp., 3 Computer Drive, Cherry Hill, N.J. 08034, has published a technical brochure on the MICA-150, a modular, semiautomatic IC analyzer. [425]

P-c board production. Remcor, 3136 N. 29th Ave., Phoenix, Ariz. 85017. A four-page brochure shows the step-by-step production of advanced design printed circuit boards, from custom circuit engineering through final inspection. [426]

Three-axis numerical control. Westinghouse Electric Corp., P.O. Box 868, Pittsburgh, Pa. 15230. The model 30 three-axis numerical control, most recent of the company's new generation of positioning and straight-cut machining controls, is the subject of four-page bulletin DB22-751. [427]

Operational amplifiers. Computer Dynamics Inc., 179 Water St., Torrington, Conn. 06790, announces a four-page short-form catalog describing its economy line of ± 10 -volt operational d-c amplifiers. [428]

IC logic cards. Monitor Systems Inc., Fort Washington, Pa. 19034, has issued a bulletin covering its Monologic TTL and DTL integrated circuit logic cards. [429]

Permanent-magnet material. Thomas & Skinner Co., 1120 E. 23d St., Indianapolis, Ind. 46205. Illustrated with demagnetization and energy product

curves, bulletin M304-B lists the typical magnetic and material characteristics, and points out the specific features of Alnico 8-C. [430]

Resistors. EMC Technology Inc., 1133 Arch St., Philadelphia, Pa. 19107, has available technical bulletins describing high-range, high-voltage, and high-frequency resistors. [431]

Acoustic transponders. The Bendix Corp., Electrodynamics Division, 11600 Sherman Way, N. Hollywood, Calif. 91605, has issued a four-page brochure illustrating and describing bottom-mounted acoustic transponders. [432]

Programmable pulse generators. Data-pulse Inc., 10150 W. Jefferson Blvd., Culver City, Calif. 90230. Programmable pulse generators providing remote control and automatic programming of all pulse parameters are described in technical bulletin 110FP. [433]

Recorders. Esterline Angus Instrument Co., P.O. Box 24000, Indianapolis, Ind. 46224. A 28-page publication includes complete information about electro-dynamometer recorders, permanent-magnet moving coil recorders, inkless and ink event recorders, pressure and vacuum recorders, and position and motion recorders. [434]

General-purpose relay. Sigma Instruments Inc., 170 Pearl St., Braintree, Mass. 02185. Series 65 catalog bulletin contains latest technical data on a general-purpose, 1-ounce relay rated to switch 1-amp loads at least 1 million times from 90-mw signals. [435]

Quadruplexer/preamplifier. Aertech, 250 Polaris Ave., Mountain View, Calif., offers a technical data sheet giving complete specifications for the model A1623H solid state quadruplexer/pre-amplifier. [436]

Instruments. Monsanto Co., 620 Passaic Ave., West Caldwell, N.J. 07006. An eight-page condensed catalog on electronic instruments describes digital equipment based on integrated circuit techniques without hybrid compromise. [437]

Operational amplifier. Opamp Labs., 172 So. Alta Vista Blvd., Los Angeles 90036. Specifications and 42 schematics on two loose-leaf sheets explain applications of the model 4009 operational amplifier. [438]

Memory exerciser. Honeywell Inc., Old Connecticut Path, Framingham, Mass. 01701. Model 3602 memory exerciser, designed for laboratory development and production testing of magnetic core memory systems, is discussed in a 12-page brochure. [439]

Multiple-use computers. Scientific Data Systems, 1649 Seventeenth St., Santa Monica, Calif. 90404. Brochure 64-00-08A devotes 16 pages to a family of real-time, multiple-use computers. [440]

Attenuator and signal calibrator. Weinschel Engineering Co., Gaithersburg, Md., has published a data sheet covering the model VM-3, an attenuator and signal calibrator that can make r-f power ratio measurements under a variety of conditions. [441]

Rotary power switches. Electro Switch Corp., Weymouth, Mass. 02188. Catalog E5000-2 describes more than 400 standard Series 100 quick-snap switches in four sizes, for loads from 3 to 200 amps a-c or d-c. [442]

Liquid flow switches. Magnetrol Inc., 5300 Belmont Road, Downers Grove, Ill. A complete line of liquid flow switches is described with text, photos, and drawings in a 12-page brochure. [443]

Environmental test equipment. Associated Testing Laboratories Inc., 200 Route 46, Wayne, N.J. 04740 has available catalog M-6 describing a new line of environmental test equipment featuring solid state $\frac{1}{4}$ °F and $\frac{1}{2}$ °F controllers. [444]

Matrix program boards. Co-Ord Switch, 102-48 43d Ave., Corona, N.Y. 11368, offers an applications and data brochure on matrix program boards. [445]

Operational amplifiers. GPS Instrument Co., 188 Needham St., Newton, Mass. 02164, offers a brochure describing the series 600, low cost, computer-quality operational amplifiers. [446]

Low-loss ferrite. Indiana General Corp., Keasbey, N.J., has published a technical engineering data bulletin on Ferramic TC-8, a high Q, low-loss ferrite material. [447]

Connector performance. Star-Tronics Inc., Georgetown, Mass. Bulletin CA-7339-40 describes the Star-Lok STM connectors' engineering performance under MIL test conditions. [448]

Audio tone signaling. Quindar Electronics Inc., 60 Fadem Rd., Springfield, N.J. 07081, offers a bulletin covering audio tone signaling systems for remote supervision and telemetering. [449]

Silicon power modules. Deltron Inc., Wissahickon Ave., North Wales, Pa. 19454. Bulletin 110A describes six, new, compact and rugged, low cost, silicon power modules. [450]

Spacer/bushings. Sealectro Corp., 225 Hoyt St., Mamaroneck, N.Y. 10543, has issued bulletin 157A on Teflon spacer/bushings that are designed to eliminate nuts, bolts, and the other hardware required to mount p-c cards. [451]

NEW Ultrasonic Soldering Systems

I/C PACKS
COMPONENTS
SUBASSEMBLIES

- Fluxless
- Increase throughput
- Reduce rejects

Redford has a broad range of fully automated, semi-automated, and manual systems. With ultrasonic soldering there is no worry about corrosion caused by residual flux because no flux is used. Pre-cleaning and post-cleaning eliminated. Send our application engineers a sample of your 'problem'—or call and tell them about it... even between noon and 1 pm.

1092 Catalyn Street
Schenectady, NY 12303
Phone 518/377-2204

REDFORD
CORPORATION

Circle 251 on reader service card

Not much of a plot, but a great cast of characters.

The characters are 6,000 manufacturers and more than 4,000 product listings. Even if you're not the literary type, you'll be interested in the unprecedented opportunity the Electronics Buyers' Guide affords you to reach readers. Over 445,000 engineer users go to EBG year round as a one-stop shopping center for all their electronic needs. Closing date: Space reservations: July 14. Plate closing July 28. Book some space now! First come, first served.

Electronics Buyers' Guide

A McGraw-Hill Market Directed Publication,
330 West 42nd Street, New York, N.Y. 10036

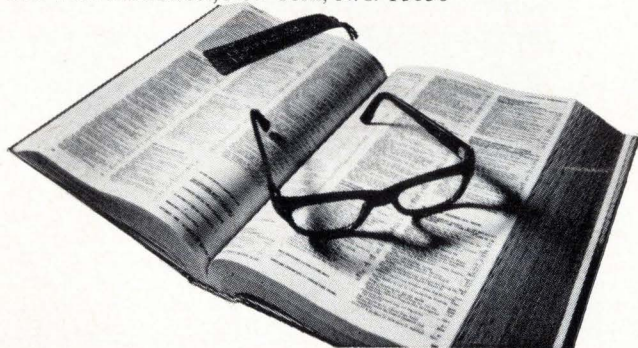

FIVE GUESSES...

WHAT ARE THEY?

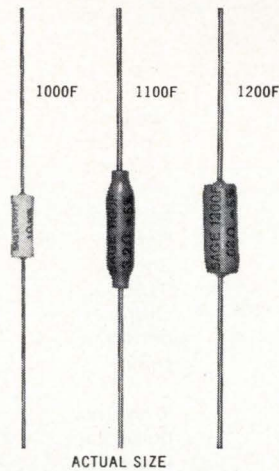

- CAPACITORS?
- DIODES?
- INDUCTORS?
- RESISTORS?
- FUSES?

If you said resistors you'd be right of course. And if you said fuses you'd be right again.

That's right, FUSIBLE RESISTORS.*

This new adaptation of miniature power resistors comes from SAGE ELECTRONICS, a leading producer of standard silicone and custom designed wirewound resistors.

As the name implies, SAGE type F units are special, dual-function resistors... custom-made, typically in fractional or very low ohm values.

*PAT. PENDING

HERE'S THEIR DUAL FUNCTION...

1. Act as long-life, highly stable, fixed resistors up to specified current level.
2. Safely and permanently blow circuit open within a specified time interval if critical current level is exceeded.

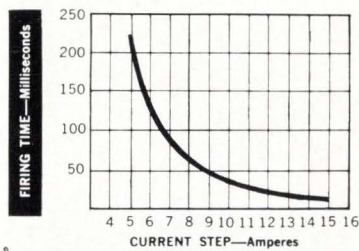

Graph shows representative results on a SAGE 1000F 1Ω part.

For a prompt analysis of your application, contact us, outlining details of resistance value, fusing time and current.

Or for specifics of environmental performance, body size, etc., write, wire or phone for a copy of Catalog R-66.

SEE OUR SPECIFICATIONS IN
VSMF
THE MICROFILM CATALOG FILE



SAGE

SAGE ELECTRONICS CORP.
BOX 3926 • ROCHESTER, N. Y. 14610

PHONE: 716-586-8010

RF CIRCUIT ENGINEERS
SYSTEMS ANALYSIS ENGINEERS
SYSTEMS INTEGRATION ENGINEERS
INDUSTRIAL ENGINEERS
DIGITAL ENGINEERS

SEARCHING FOR

OPPORTUNITY instead of promises?

We can't promise you'll realize all your career objectives at ECI, but we will give you every opportunity. And we'll help you every way we can. The rest is up to you.

CHALLENGE instead of a chance?

Challenges lead to accomplishments. Chances don't necessarily lead to anything. If you like the satisfaction of accomplishing things, you'll like working at ECI. We're objective oriented.

GROWTH instead of a groove?

In our business you can't afford to stop learning ... to stop growing. At ECI you'll be pushing the state-of-the-art. There are few confining grooves when you explore the unknown.

And LOCATION too?

If you're going to like your job, you might as well like where you're living. We'll pit the St. Petersburg area against anyplace in the U.S. for stimulating, comfortable living.

INVESTIGATE ECI!

We have immediate openings in design and supervision. You'll work on systems and equipment in satellite communications, multiplexing, electronic switchboards, and advanced VHF/UHF communications using microcircuitry and state-of-the-art techniques.

Send your resume, in confidence, to K. S. Nipper, Supervisor of Professional Placement, Electronic Communications, Inc. Box 12248E, St. Petersburg, Florida 33733. (An equal opportunity employer.)



St. Petersburg Division
Electronic Communications, Inc.

YOU'RE H!RED

Do you need electronics engineers or technical management men? Electronics magazine is the way to recruit them. Electronics is designed specifically for the working engineer. 68,000 subscribers and an additional 133,000 pass-along readers turn to it to keep up with their industry. You can find the man that meets your qualifications with an advertisement in the Employment Opportunities Section.

For rates & information write: Electronics, a McGraw-Hill Publication. Classified Advertising Division, Post Office Box 12, New York 10036.

CLASSIFIED ADVERTISING
SEARCHLIGHT SECTION
 BUSINESS OPPORTUNITIES
 USED OR SURPLUS EQUIPMENT

For Sale
**VACUUM METALIZER
 or COATING SYSTEM**
 N.R.C. Type 3143B-42301. Chamber size 36" dia. X 6' long complete with diffusion pumps, mechanical pumps, gauges and power supplies. Overall dimensions 19' long, 8' 6" high. Used 3 months.
 Also 2 G.E. 5 KW dielectric heaters, 45 megacycles.
INSTRUMENTS & MACHINES, INC.
 1200 Grove St. Irvington, N.J. 07111
 Telephone: (201) 371-7900

CIRCLE 966 ON READER SERVICE CARD

RADAR AUTO-TRACK & TELEMETRY ANTENNA PEDESTALS 3 & 10 CM. SCR 584 AUTOTRACK RADARS. M-33 RADAR TPS-1D SEARCH. APS-45 TPS-10D HT. FINDERS. WX RADARS. FPN-32GCA. APS-10 APS-15B APS-27 (AMTI) SEARCH. APN-102 DOPPLER. DOZENS MORE. CARCINOTRONS. PFN'S. .25-5-1-2-3-6 MEGAWATT PULSE MODULATORS. CAVITIES. PULSE TRANSFORMERS. IF STRIPS. WAVEGUIDE. BENDS 200 MC. 1 KMC. 3 KMC. 6 KMC. 9 KMC. 24 KMC. RF PKGS.
RADIO RESEARCH INSTRUMENT CO.
 550 5TH AVE., NEW YORK 36, N. Y. JU 6-4691

CIRCLE 967 ON READER SERVICE CARD

**PROFESSIONAL
 SERVICES**

Donald C. Harder, Inc.
 Magnetic Component Engineers
 Reactors—Transformers—Filters
 Serving the Research Laboratory
 2580 K Street, San Diego, Calif. 92102
 Phone (714) 239-8021

**THE
 TREND
 TOWARD
 ECONOMY—**
 The service of the consulting engineer is a real economy. With his knowledge of organization and production problems and his wide and varied experience, he can usually reveal the points of waste and inefficiency that are costing you money and suggest inexpensive means for their elimination.

engineers

Here is your opportunity to associate with a high calibre staff in its formative state. At our research center in Ithaca we are engaged in exploratory activities in aircraft and ocean instrumentation. Our job is to come up with new ideas and new designs for transducers, modules and subsystems using the latest techniques and components. We seek the help of talented and resourceful engineers (E.E. & M.E.) having up to ten years applicable experience.

Technical domain of this work will range through... Solid-state applications • Servo-mechanisms • Transducer design • Circuit design • Electromechanical design • Subsystems design & testing • Analog and digital techniques.

This is a real ground floor opportunity. Your opportunity also to live and work in the stimulating atmosphere of Ithaca, the educational, recreational and scenic center of the Finger Lakes region.

Inquiries will be treated in confidence. Send resume to: Mr. R. G. Thrasher, Dept. E

THE BENDIX CORPORATION
FLIGHT & ENGINE INSTRUMENTS DIVISION
 RESEARCH CENTER, CORNELL RESEARCH PARK, ITHACA, N.Y. 14850



An Equal Opportunity Employer

ECM SPECIALIST
Investigate Now!!
 Challenging position is immediately available for experienced ECM Specialist who can readily accept responsibility and perform his assignments with a minimum of supervision.
 Qualifications should include a B.S.E.E. and a minimum of 3 years experience in one or more of the following:

- Receivers
- Transmitters
- Reception Techniques
- High Power Tubes

SALARY TO \$21,000
 Dependent Upon Background and Experience
 Arrange an immediate interview with New York City area Manufacturer, by sending comprehensive resume to: P-3064, Electronics, Class. Adv. Div., P. O. Box 12, N. Y., N. Y. 10036. (All replies held in strict confidence.)
 An Equal Opportunity Employer, M/F.

R.U. 1
answering more than advertisement? Then please send a separate reply to each box number. It will help you get an answer sooner.

E.E.'s
 For FEE PAID positions throughout U.S.
SEND RESUME TODAY
(if none, send coupon for confidential application.)
ATOMIC PERSONNEL, INC.
 Suite L, 1518 Walnut St., Phila., Pa.
 Experienced Engineers
 Working Full Time for You!

Name _____
 Address _____
 City _____ State _____

AN EMPLOYMENT AGENCY FOR ALL TECHNICAL FIELDS

The only expense HP spared in making these versatile counters...

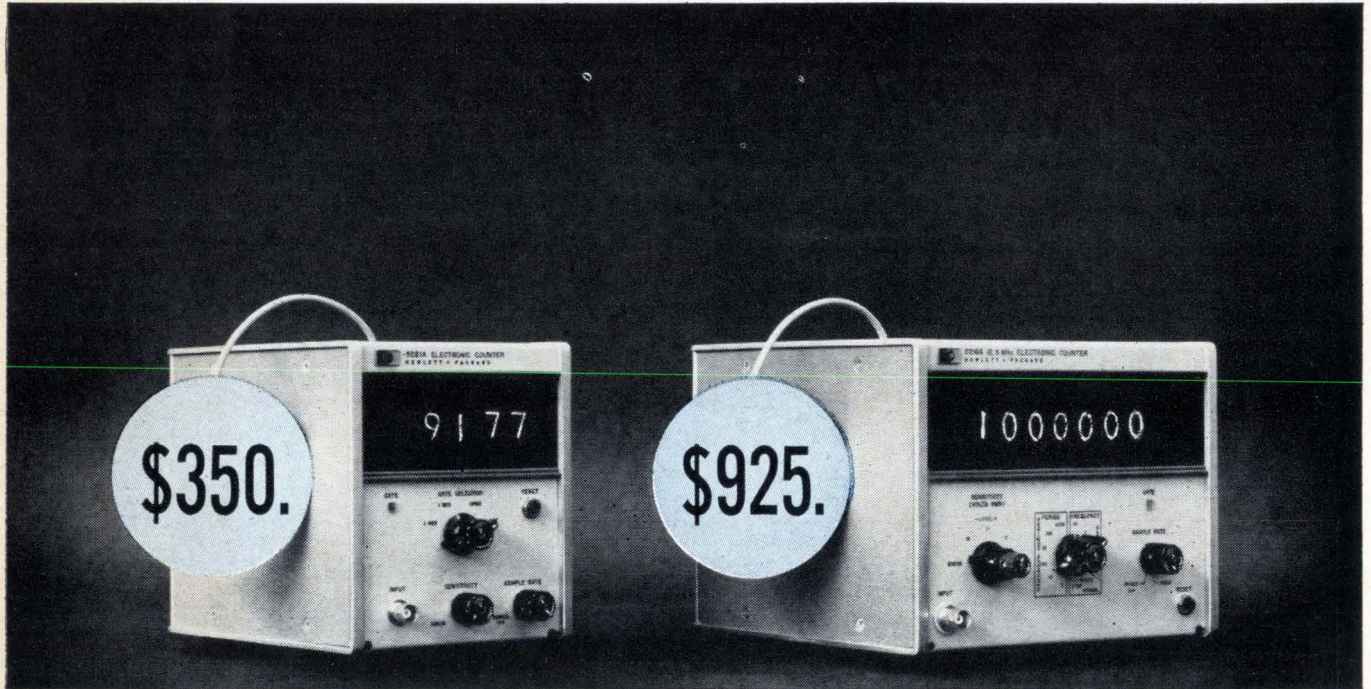

... is yours.

Only Hewlett-Packard offers the versatility-economy combination represented by the new 5221A and 5216A Electronic Counters, using integrated circuits. Wide frequency range, high input impedance and sensitivity, long-life readout tubes with display storage, six measuring functions (in 5216A)... all this at prices as low as *one-half* that of comparable electronic counters available today.

The HP 5221A Counter has 0.1 and 1 second gate times (power line frequency time base), 1 meg/30 pF input impedance and an input signal sensitivity of 100 millivolts. It is the lowest cost frequency counter with a 10 MHz counting rate available. 4-digit readout is standard, 5 or 6 digits optional.

The HP 5216A Counter is an extremely versatile, 7-digit, 12.5 MHz counter for measuring frequency, time interval, period, multiple period average (in

decade steps from 1 to 10^5), frequency ratio and totalizing. Gate times: 0.01/0.1/1.0/10 sec. Input sensitivity: 10 mV. Input impedance: 1 meg/50 pF. Time base: crystal with $< \pm 2 \times 10^{-6}$ /month maximum aging rate. BCD output for operating data printers and other system elements. The price, even though the 5216A's frequency range is greater, is 30% below counters with similar functions.

Both counters feature HP's exclusive zero blanking, which makes reading easier and faster by suppressing any zeros to the left of the most significant digit. This unique benefit results from specially designed Hewlett-Packard proprietary integrated circuits used in both of the new counters.

Call your local HP field engineer for more details, or write Hewlett-Packard, Palo Alto, California 94304; Europe: 54 Route des Acacias, Geneva.

HEWLETT  PACKARD

Newsletter from Abroad

June 26, 1967

Europe to stress communications satellite projects

The first concrete steps toward a unified Western European space program may be taken in early July when European science ministers meet in Rome.

Little chance is seen for an expected proposal by the smaller countries to merge three existing international space agencies into a European counterpart of NASA. **But the ministers very likely will work out some scheme to mesh more closely the activities of the three agencies—the 10-nation European Space Research Organization (ESRO), the seven-nation European Launcher Development Organization (ELDO), and the European Conference for Space Telecommunications, made up of the European members of the International Telecommunications Satellite Consortium.**

Also likely to come out of the Rome meeting is an agreement to put communications satellites uppermost in future joint European space efforts. All the countries involved are Intelsat members and none is happy about U.S. domination of the consortium.

An agreement in principle, however, wouldn't immediately produce a European communications satellite project. France and West Germany have a joint project of their own under way and would balk at any substantial increase now in the budgets for the international agencies.

But the emphasis on communications satellites may doom ESRO's most ambitious research project, the 1,800-pound astronomical laboratory originally scheduled for a 1971 launching. Estimated costs of the orbiting laboratory are now well beyond the \$50 million budgeted. ESRO officials fear the program may be dropped and the funds diverted to communications satellite development.

Soviets hit by lack of disk memories

A dearth of magnetic-disk memories is slowing the introduction of the Soviet Union's new generation of transistorized computers. **Soviet data-processing experts say no disks are produced in the country for non-military use and, quite likely, none for military applications.** The explanation: state planners overlooked the vital peripheral, and the computer-building facilities all thought someone else had the task in hand.

The Soviets now expect to be turning out disk memories within a year. Meanwhile, they'll try to buy abroad. Most likely suppliers are Britain's International Computers & Tabulators Ltd. and the Mitsubishi Electric Corp. of Japan. Both have already made sales pitches to the Russians. U.S. manufacturers are shut out by the embargo of strategic equipment exports to Soviet-bloc countries.

Japanese nix high royalties for Nixie tubes

Japanese desk-calculator makers and the Burroughs Corp. are getting nowhere in their attempt to set royalty rates on Japanese copies of the Nixie tube, Burroughs' patented cold-cathode display. **The impasse threatens exports of desk-calculators to the U.S.**

The Japanese concede that Burroughs has royalties coming, but say the U.S. company wants far too much. Burroughs wants to settle for something like 45 cents a tube; the Japanese see a royalty rate of 8%—about 16 cents a tube—as their limit.

Any rate agreement would have to be okayed by Japan's powerful Ministry of International Trade and Industry. The agency rarely approves

Newsletter from Abroad

a licensing arrangement setting royalties higher than 5%, although it may go along with an 8% deal in this case as Burroughs' patents cover both the device and the associated circuitry.

With no immediate accord in sight, the pressure on the Japanese companies will grow in the next few months. Most have tooled up to produce new desk-calculator models and are counting on exports for the bulk of sales. The government has warned electronics firms with patent problems to hold off on exports. Along with the Burroughs impasse, producers of integrated-circuit desk calculators have yet to unsnarl a licensing tangle with Texas Instruments Incorporated [Electronics, April 3, p. 258].

French find takers for new missile

The French may have an armaments best seller in a highly mobile, low-altitude ground-to-air missile system they call the "Crotale"—rattlesnake.

Although Crotale still is in the prototype stage, its developers say "several" countries have ordered systems after 25 successful firings from the French missile test range. Compagnie Francaise Thomson Houston-Hotchkiss Brandt developed the electronics for the radar-guided weapon and Societe des Engins Matra the missiles themselves.

Crotale can handle targets flying at supersonic speeds at altitudes from 165 feet to 9,800 feet. It takes just 5 minutes, Thomson-Houston says, to set up the system and have it operating. A nine-ton vehicle carries the acquisition radar. The missile-firing batteries, each with its own guidance radar, also are vehicle mounted.

With 165-pound missiles, Crotale is much lighter than the Hawk, the 1,275-pound staple ground-to-air weapon of West European armed forces. **Thomson-Houston claims there's no equivalent to Crotale in the U.S. arsenal.** Nearest thing to it was the Mauler forward area air defense system abandoned in 1965 after \$200 million had been spent trying to develop it.

Japan seeks bigger French market slice

The Japanese Electronic Industries Association will try next month to persuade the French government to ease its curbs on Japanese electronics imports. **The association, backed by the Tokyo government, will plump for an end of the restrictive French quota system within two years.**

Japan pulled out of a five-year-old electronics trade accord with France last month [Electronics, May 15, p. 228]. Instead of the hoped-for increase in quotas, the Japanese found themselves stymied by the pact. They maintain that since Japan has lifted most quota restrictions on imports, France should follow suit. Both countries are members of the Organization for Economic Cooperation and Development, the 21-nation body that pressured Japan into easing its curbs on foreign capital investment.

Boeing sale boon to Hawker-Siddeley

Hawker-Siddeley Dynamics Ltd. is counting on a lot of fallout from its sale this month of a \$1 million Trace automatic test system to the Boeing Co. Peter Brett, the British company's sales manager, expects major airlines that fly Boeing jetliners will follow Boeing's lead. **The market in sight: some 40 Trace units in the U.S. and about 200 worldwide.**

Hawker-Siddeley bested nine U.S. bidders for the Boeing order. Boeing will use the equipment—three test stations controlled by a Scientific Data Systems Sigma 2 computer—on its jetliner production line starting in July 1968.

New economy Semiconductors from TI... get 'em first from Electronic Wholesalers

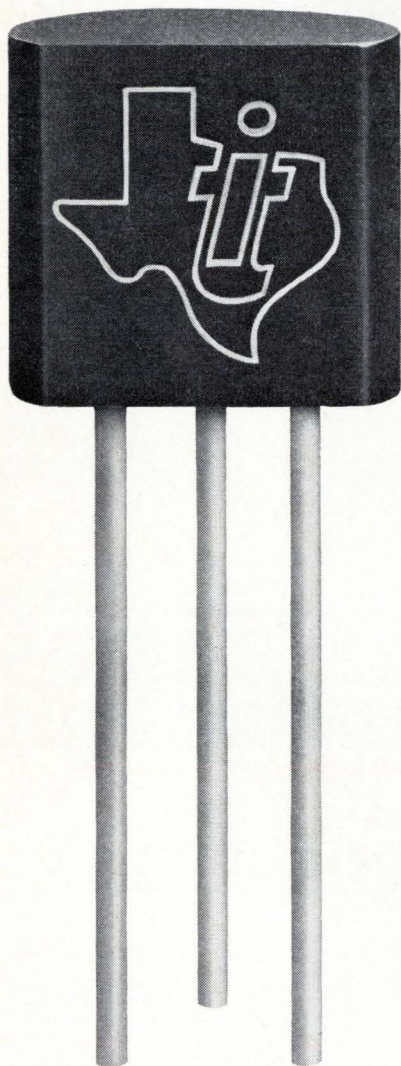

Here is a new series of TI "firsts" in SILECT™ semiconductors. Get 'em first from our complete stocks which include the entire TI line.

Industry's first plastic encapsulated MOS FET

The TIXS67 is the first p-channel silicon enhancement mode field-effect transistor to be encapsulated in plastic. Circle 290 for data sheet.

New low-cost, high-voltage FET replaces vacuum tubes

The new TIXS78 silicon N-channel FET offers a 300-volt minimum breakdown voltage, making it a one-for-one replacement for many vacuum tube applications. Circle 291 for data sheet.

New economy matched pair FETs
The TIS68 pair is matched within 5 percent for I_{DSS} and y_{fs} , yet are low in cost. Circle 293 for data sheet.

New FET switches

The TIS73-75 series are industry's first low on-resistance, low-leakage switching FETs. Circle 295 for data sheet.

New planar UJT's

The 2N4892 series of planar silicon UJT's in SILECT packages are the first such devices to be characterized for specific applications. Circle 296 for data sheet.

Smallest, lowest cost SCRs

TI's new TIC44-47 SCRs are the smallest available, yet are priced only one-third as much as metal-can equivalents. Circle 297 for data sheet.

SILECT™ package

These economy semiconductors feature TI's new SILECT molded package with TO-18 pin circle lead configuration. A recent report, covering 10 million hours of testing, concludes that SILECT transistors are as reliable as metal-can devices tested under the same conditions.



New Economy Semiconductor Designer's Kit

Save more than 75 percent on a broad assortment of economy semiconductors for evaluation. Get your kit from us.

Circle 298 for information.



"SERVING THE ENTIRE SOUTHEASTERN U.S."

ELECTRONIC WHOLESALERS INC.

WASHINGTON, D. C. 2345 Sherman Ave., N.W. Phone 202-483-5200
BALTIMORE, MARYLAND 3200 Wilkens Avenue Phone 301-646-3600
WINSTON-SALEM, N. C. 938 Burke Street Phone 919-725-8711

MIAMI, FLORIDA 9390 N.W. 27th Avenue Phone 305-696-1620
ORLANDO, FLORIDA 345 N. Graham Avenue Phone 305-841-1550

Electronics Abroad

Volume 40
Number 13

International

Tumbling walls

Late June found harried foreign trade officials in Washington racing against the clock to fit together the pieces of a staggeringly complex jigsaw puzzle—the thousands of tariff cuts involved in the Kennedy round of trade liberalization negotiations.

The main outlines of the package, the most ambitious attempt ever to lower trade barriers, were set last month in Geneva after four years of haggling among the 53 member countries of the General Agreement on Tariffs and Trade. But when they plunged into the enormous job of codifying—before June 30—some 6,000 tariff cuts, the U.S. negotiators found that many pieces of the puzzle still had to be trimmed to size.

Still, the odds are overwhelming that the complex documents spelling out specific reductions in levies on thousands of items will somehow be ready for signing by President Johnson before his blanket authority to lower tariffs expires on June 30. But it will be long after that before the electronics industry gets a clear picture of just what it stands to gain—or lose—in the deal.

Briefing. The first solid indication of what U.S. negotiators horse-traded during the long negotiations, which essentially pitted the U.S. against the six-nation European Economic Community, won't come most likely until the first week in July. At that time, such ranking U.S. officials as Commerce Secretary Alexander Trowbridge and William Roth, the top U.S. Kennedy-round negotiator, will brief businessmen in Washington on the details of the cuts.

Even then, marketing seers will need crystal balls to gauge the impact of the Kennedy round on U.S.

foreign trade in electronics, which last year totalled nearly \$2 billion. The tariff cuts will be spaced out over a five-year period ending in 1972. During that time the whole complexion of foreign trade patterns could change because of fast-developing technology and imponderable political developments.

Clues. Although Washington has kept mum on specific cuts, the Japanese government has hinted that tariff reductions of 50% are in the offing for a dozen electronics products. These include transistor radios, television receivers, tubes and semiconductors, and tv picture tubes. Except for picture tubes, protected by a 30% barrier, current U.S. tariffs on these products are no more than 12.5%.

At first glance, then, the upcoming Kennedy-round cuts pose few problems in the U.S. domestic market. Of last year's \$720 million of electronics imports, a full two-thirds came in at tariffs between 10% and 12.5%.

Halving these relatively low tar-

iffs won't cause much of a change in prices of imported radio and tv receivers, most of which come from Japan. The Kennedy round, though, should be a boon to Japanese producers trying to make headway in the Common Market. There the common tariff for receivers is set at 22% and halving that would make a difference.

For U.S. electronics exporters, the Kennedy-round numbers look favorable. In Japan and Britain, for example, the cuts will be applied to existing tariff levels that generally run between 15% and 22%. Component makers can expect to do better in Britain when protection there drops from 20% to 10%.

But for many products, the Kennedy round doesn't mean much. The major U.S. semiconductor producers, for example, won't derive any particular benefit from Common Market tariff cuts since they're already running plants inside the EEC tariff wall. Computer makers, who last year accounted for a quarter of the \$1.2 billion in U.S. electronics exports, can't expect any significant change because of tariff cuts. Their major selling point is performance and programing backup, not price. And for military hardware, tariffs simply don't count.

Other hurdles. Despite the impending cuts, U.S. exporters still will have hurdles to hop when they sell abroad. The attempt in the Kennedy round negotiations to slash nontariff obstacles to trade largely failed and they remain to hamper foreign trade.

One stumbling block is the "buy national" policy followed by nearly all governments. The practice curbs foreign firms competing for military and telecommunications equipment contracts in particular.

Then there are quotas, overt and sub rosa. Japanese semiconductor makers, for example, long have complained that they're hamstrung in the French market by a piddling



Negotiator. William Roth led U.S. team in Kennedy-round bargaining.

quota for transistors and diodes.

Even when there are low tariffs and no quotas, exporters often find that complex customs regulations, border taxes, and the like keep the scales tipped in favor of domestic producers.

Israel

Lessons of war

Before the Arab-Israeli war, Israel's electronics industry was poised for a great leap forward. Now the government is more convinced than ever that the nation's growth and security will largely depend on the strength of its electronics industry.

Nachum Shamir, Israeli economic minister to the U.S., says the war proved that superior technology is vital. In line with Israeli contentions on who started the war, Shamir says it was "our radar that caught the takeoff of Egyptian jets from airfields in Sinai and enabled our planes to catch the rest of the Egyptian craft on the ground. Also, good, reliable communications are vital in a war with widely separated units in action on three fronts."

Not only that, he notes, but France, Britain, and West Germany at the outbreak of war halted delivery of items needed to keep the army and air force moving for more than a few weeks. And Israeli manufacturers couldn't maintain stockpiles because the country's reserve call up left gaps in their work force. It became clear in this short war that the domestic electronics industry will have to get into new military areas while increasing production of its old lines.

Captive audience. Israel also gobbled up Arab territory—Gaza and the west bank of the Jordan—that it says it won't give back. This undeveloped area, home for 250,000 people, is a potential new market for products ranging from generating equipment to radios and telephones. And government officials say they have no intention of backing away from prewar plans to establish a national entertainment

television network and to increase exports of such items as custom-built computers and electromedical equipment.

There are 33 electronics companies in Israel, but only four of them can be classified as major; the rest are essentially assembly plants. The largest firm is Tadiran Ltd. of Tel Aviv, owned jointly by the Defense Ministry, the national labor federation, and private interests. Tadiran makes military communications equipment—both of its own design and under U.S. license—and exports to the U.S., Scandinavia, and most of the new African nations. In the consumer field it turns out radios and air conditioners, and for industry it makes telephone exchanges, digital control systems, and the like.

Electronics Corp. of Israel, also in Tel Aviv, is partly owned by Americans. It does some military work in communications equipment and also makes consumer radios and television sets.

Israel Aircraft Industry, near Lod, specializes in aircraft communications equipment and instrumentation, including airborne radar and radar test equipment.

Elron of Haifa is said to have the best research and development setup in the country. It's best known for its scientific and medical equipment, but also produces a table-model computer.

Motorola (Israel) in Tel Aviv is a small plant making two-way radios. But Israeli officials say it will be expanded to become a base for part of Motorola's European, African, and Asian operations.

Tv boom. The industry has been growing at an annual rate of 20%, and officials see an acceleration in sight. Exports, which hit the \$1 million mark in 1964, are expected to reach about \$18 million by 1970. In nonmilitary areas, consumer products accounted for about 25% of output and professional equipment for the remainder; but with the advent of television the ratio could become 50-50 within three years.

Prewar plans called for 100,000 operating tv receivers by 1969—there are 30,000 now—and 200,000 by the early 1970's.

Japan

Small wonder

The Sony Corp. stoutly insists that it never introduces a new product until it has something really different to offer. And at this month's consumer products show of the U.S. Electronic Industries Association, the Japanese firm showed that it's sticking to its long-standing marketing strategy.

Sony, which had steered clear of the American color television market, now plans to sell a transistorized 7-inch color set in the U.S. next spring. Later next year, the company will see what sort of waves it can make in the black-and-white market with a lilliputian portable built around a 1-inch picture tube. Sony unveiled prototypes of both sets, along with a portable video tape recorder, at the EIA consumer show.

Guinea pig. With its black-and-white set, Sony has gone about as far with miniaturization as anyone would care to go. The picture, whose viewable diagonal measures about 1.2 inches, is so small that Sony has paired it with a magnifying glass that increases the image 1½ times—to just under 2 inches.

Company officials frankly admit they don't expect much of a market for the set—at the outset, anyway. They see it mainly as a sort of adult toy or a gift item rather than a mass seller. The price will be in the \$200 range.

Even if the set doesn't catch on, though, Sony expects the development to pay off. The 1-inch portable marks Sony's first use of integrated circuits in tv receivers and thus is a guinea pig of sorts. Sony plans to put the ic know-how gained with the tiny tv to use in later, larger models. What's more, the 1-inch tube and much of the associated circuitry also turn up in the new portable video recorder, for which Sony has high hopes.

Accent on IC's. Along with the 1-inch, 30° picture tube, Sony has developed special integrated circuits for the black-and-white receiver. Discrete semiconductors turn up only in the tuner and the

output stage of the horizontal deflection circuits. The rest of the circuitry is accounted for by 11 ic packages, some monolithic, some hybrid. The speaker is the same one Sony uses in its ic radio.

The tiny set has all-channel tuning in the very-high-frequency and ultrahigh-frequency bands, and runs about two hours off its four rechargeable, penlite-size, nickel-cadmium cells. Tuning controls are grouped on one side of the lower half of the set. The upper half slides forward to simultaneously switch on the receiver and focus the magnifying glass.

With its transistorized color tv, Sony hopes to do in the U.S. color market what it has done in the black-and-white market—gain a foothold with a set smaller than local producers offer. Rather than compete head-on with U.S. manufacturers like the General Electric Co., which has an 11-inch set on the market, Sony has slimmed its first export color set to 7 inches, the same screen size as its successful transistorized black-and-white portable, and priced it at \$350.

Unmasked. Design of the production color set still hasn't been frozen, but Sony engineers hint it will have between 40 and 50 transistors. For the picture tube, Sony will use its Chromatron, a three-gun tube with color-switching grids rather than the conventional shadow-mask.

With the 7-inch picture tube, Sony expects to avoid the production-line headaches it has had with the 19-inch Chromatron used in the few color sets it produces for the Japanese market. A big problem here is the bulb—bought outside, expensive, and hard to handle. Sony will make its own glass for the small picture tubes. The tight tolerances for the switching grids are obviously easier to hold in a small tube than a large one.

Great Britain

Glide guide

Helicopters have their problems when bad weather closes in on commercial airports. Most often they are grounded while other craft continue to operate. The slow-flying choppers, which normally steer clear of the main runways, fit awkwardly into traffic patterns geared to handle fast-moving jets guided down low-angle glide paths by instrument landing systems.

All that is about to change. In the U.S. the Federal Aviation Administration has run tests of an instrument landing system that can handle a helicopter making a steep approach from any angle. And looking forward to the advent of all-weather heliports in Britain, the

Royal Aircraft Establishment at Farnborough is readying an experimental system to guide helicopters onto landing pads. Officials expect to run operational tests before the year is out.

Computer control. Conventional instrument landing systems establish a fixed glide path by means of highly directional transmission from antennas on the ground. By contrast, the experimental British system puts the kingpin transmitter in the aircraft and stores a choice of glide paths in a general-purpose digital computer on the ground. There, a microwave interferometer constantly monitors the elevation and azimuth angles of the approaching helicopter. Range data also is fed into the computer.

With these three inputs, the computer can compare the actual glide path to the assigned one and calculate corrections. These are transmitted to the aircraft over a very-high-frequency radio link. In the early trials, pilots will make the course corrections under guidance from instrument landing displays. Later, the correction signals will be fed directly into an autopilot.

Charles Phillips and Charles Weaving, who led the team that developed the system, say they opted for microwave interferometer guidance because of its precision. They expect the accuracy of azimuth and elevation angle measurements to be much better than 1 milliradian.

Cross. Aircraft using the system will have 500-milliwatt transmitters operating at C band. The transmissions will be picked up on the ground by a Mills cross array with 10-foot-long arms containing three pairs of antenna elements. The signals from each pair will be converted to a frequency of 100 megahertz and then fed into opposite ends of a transmission line.

Amplitude of the standing wave along the line is sampled sequentially at four points, and a sine wave extracted from this sampling is compared to a reference to generate a gating waveform for a pulse generator. For high accuracy, the technique is used simultaneously with six antenna-pair combinations.

The range measurement, less

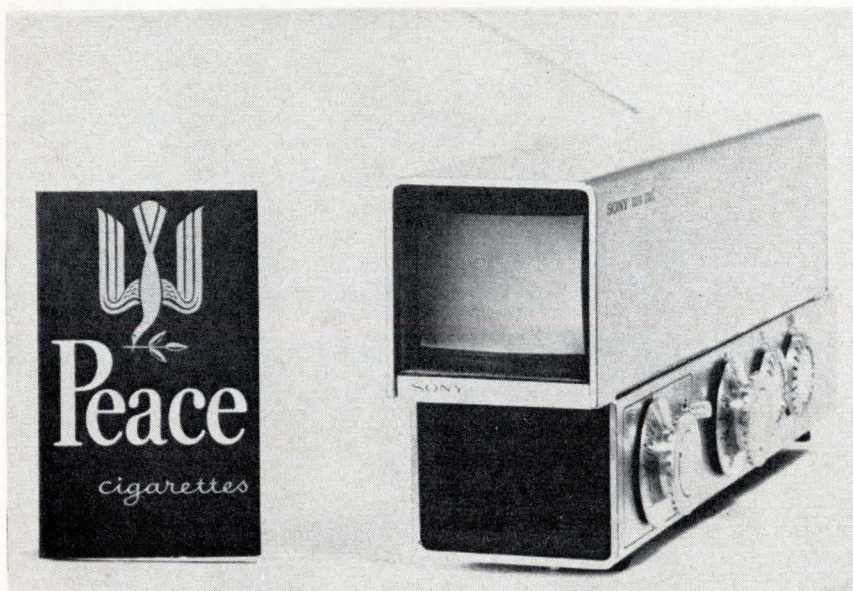

Eye opener. Sony's first tv set with integrated circuits has 1-inch picture tube.

critical than the azimuth and elevation, isn't picked off the microwave interferometer. Instead, a 7.5-kilohertz modulation tone is put on the upgoing vhf data link and is relayed back by the aircraft's C-band transmitter. Range is determined by phase comparison.

West Germany

Off the cuff

Medical researchers long have considered classical methods of measuring blood pressure as marginal. Readings taken by an air cuff—the manometer device used by doctors everywhere—are indirect and influenced to some extent by the size of the patient's arm. True blood pressure readings—obtained by a catheter threaded through an artery to a point near the heart—so far have been limited to laboratory conditions with the patient wired up to nearby recording instruments.

A system that gives true blood pressure readings as patients pursue their everyday activities will be put on the market in three months or so by a small Bavarian instrument manufacturer, Firma Ing. Karl Frank. The system, based on concepts developed over the past two years by Dr. Kurt Bachmann of the medical clinic at Erlangen University, couples a catheter to a pressure transducer that modulates a small telemetry transmitter strapped to the patient's back. The signals can be picked up by a receiver up to 700 yards away.

Trials. The prototype of the unit has been tested on about 160 patients under real-life conditions—working, walking, climbing stairs, driving cars. For the tests, a doctor usually goes along with a walkie-talkie and tells another doctor at the cardiovascular clinic what the patient's doing. So far the equipment has been used to help determine how different stresses affect people who have had heart attacks. Another important use is checking the effect medicines have on patients.

Double-modulation. In the system, blood pressure in an artery near the heart is applied to the transducer through a tube, about 2 millimeters in diameter, filled with an anticoagulant solution. The transducer signal amplitude varies between 50 and 5,000 microvolts depending on the patient's blood pressure. The output signal is amplified about 500 times and then modulates a 1.3-kilohertz sub-carrier that in turn modulates the 151-megahertz carrier frequency of the transmitter. Transmitter power is only 50 milliwatts, but because of the double frequency modulation the system operates even where there's strong radio or electrical interference.

Prototype of the transmitter weighed four pounds. But Joachim Thebis, the Frank engineer who developed the system, says production versions with integrated circuits will be half as heavy.

France

Toulouse timetable

The aircraft industry's rumor mill continues to grind out speculation that the Anglo-French Concorde supersonic transport is falling behind schedule. But as it began installation of the electronics system this month, Sub-Aviation stoutly maintained the first prototype would make its maiden flight from Toulouse, as planned, next February 28, "give or take a week or two." And Sud's British partner, the British Aircraft Corp., says it's ahead of schedule with the second prototype, slated to fly six months after Sud's.

When the Sud prototype starts its test flights—almost three years before the heavier, faster U.S. supersonic transport prototype is slated to take to the air—the electronics gear U.S. avionics makers will watch most closely is the inertial navigation system. Although the contract for the Concorde prototypes went to a pair of French and British companies, U.S. firms figure they'll stand a better chance when

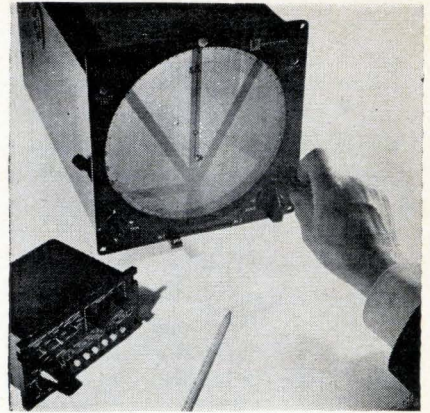

On the map. Computer-controlled display in Concorde navigation system shows aircraft's position on a chart.

Sud and BAC start buying navigation equipment for production versions of the transport. For one thing, the follow-on systems will be more complex. For another, the plane's producers will be more cost-conscious when it comes to production aircraft.

Adapted. The inertial guidance system for the Concorde prototypes was essentially adapted from military equipment developed by its suppliers, Britain's Ferranti Ltd. and France's Société d'Applications Générales d'Electricité et de Mécanique (Sagem).

The pair say their inertial system will err in its position fixes no more than 20 nautical miles after a flight of 3,600 nautical miles at a cruising speed of 1,400 miles an hour. Along with the inputs from the inertial platform, the navigational computer is set up to handle data from conventional navigation aids such as loran and very-high-frequency omnidirectional range systems.

With the exception of a new automatic chart display, the entire system is duplicated. The display, a Ferranti development, shows the aircraft's position against a background of charts controlled by the navigation computer and projected onto an 8-inch screen. The 30-foot-long film can represent an area 8,000 miles by 2,000 miles on a scale of 1:2,000,000. There is also room on the film for 1:500,000-scale displays of airport approach areas and for landing check lists that the pilot can call up from the computer.

Canada

Satellite country

If Canadian communications companies have their way, the country will have a claim staked on "sky territory" by 1970.

They say a domestic satellite network is essential for Canada's development and want to get their satellites up while space is still available. The sector along the equator from which a satellite can cover the country is limited and must be shared with the U. S.

All the major common carriers—both private and government-owned—joined last month to petition the government for an immediate start on an \$80 million program to put a pair of stationary satellites in orbit during the next 30 months. The government hasn't announced a decision, but the betting in Ottawa is that a go-ahead will come fairly soon.

Persuasive. The scheme proposed by the common carriers' consortium is attractively drawn. The first step in the three-part plan would extend television coverage to the Northwest Territories, an area where the government is pushing development. This coverage would come from a network of ground stations working with a leased channel in an existing satellite. The next step would be a nationwide system of 54 ground stations tied into the proposed pair of 12-channel Canadian-owned satellites, and the final part of the plan calls for a research program.

The consortium's most persuasive argument, though, is its plan for financing the satellite; the common carriers say they're willing to pick up the full \$80 million tab, if that's what the government wants. Almost half of this would go for ground stations, pointing to a windfall for Canadian communications equipment makers if the plan goes through. Some \$17 million earmarked for the satellites themselves also would fatten the order books of Canadian electronics companies. The remaining \$25.5 million would go for launching services supplied by the U. S.

Designed for UHF APPLICATIONS

A WIDE RANGE OF

RMC

TEMPERATURE COMPENSATING SOLDER-INS

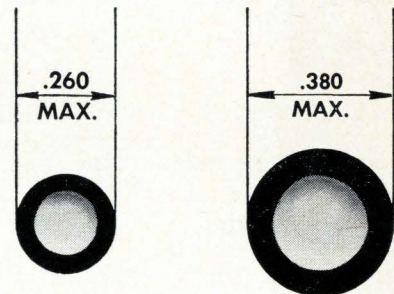

Nom. T. C.	Cap. Range	Cap. Range
NPO	1.5—10.0 pfd.	11— 22 pfd.
N-30	1.5—10.0 pfd.	11— 22 pfd.
N-75	2.2—12.0 pfd.	13— 23 pfd.
N-150	2.2—12.0 pfd.	13— 25 pfd.
N-220	2.4—15.0 pfd.	16— 27 pfd.
N-330	2.7—15.0 pfd.	16— 33 pfd.
N-470	2.7—15.0 pfd.	16— 33 pfd.
N-750	4.7—27.0 pfd.	28— 47 pfd.
N-1500	11.0—47.0 pfd.	48—105 pfd.

SPECIFICATIONS

CAPACITANCE: Within tolerance @ 1 MC and 25°C

CAPACITANCE TOLERANCES: ±5%, ±10% or ±20% (but not less than ±.25 pf)

WORKING VOLTAGE: 500 VDC

INSULATION RESISTANCE: Greater than 7500 Megohms @ 500 VDC

TEMPERATURE COEFFICIENT: As noted on Capacitance chart

FLASH TEST: 1000 VDC for 1 second

ELECTRODE: Pretinned for assured solderability

These new "Solder-In" capacitors are designed for use in UHF applications requiring the absolute minimum in lead inductance effects.

If your applications require special physical or electrical characteristics, contact RMC's engineering department.

Write today on your company letterhead for your copy of the RMC Catalog.

DISCAP
CERAMIC
CAPACITORS

RMC

RADIO MATERIALS COMPANY

A DIVISION OF P. R. MALLORY & CO., INC.

GENERAL OFFICE: 4242 W. Bryn Mawr Ave., Chicago 46, Ill.

Two RMC Plants Devoted Exclusively to Ceramic Capacitors

FACTORIES AT CHICAGO, ILL. AND ATTICA, IND.

Abbott Transistor Labs., Inc. Technical Adv. Agcy.	16	DX Antenna Co., Ltd. Sanko Sha Adv. Agcy. Co., Ltd.	88	Ideal Precision Meter Co., Inc. Zam & Kirshner, Inc.	188
■ Acopian Corporation Mort Barish Assoc.	68	Electro Tec Corp. Wilson, Haight & Welch, Inc.	184	Indiana General Corp., Ferrites Div. Griswold & Eshleman	24
Adret Electronique Promotion Vente Publicite	151	Electronic Industries Assoc. Asia Adv. Agcy.	85	I R C Incorporated Gray & Rogers, Inc.	22, 73
Aikow Shoji Kaisha, Ltd. Sanko Sha Adv. Agcy. Co., Ltd.	95	■ Electronic Molding Corp. The Williams Co.	187	■ ITT Jennings Mfg. Co. West, Weir & Bartel, Inc.	183
Airborne Instruments Laboratory Campbell-Mithun, Inc.	71	Emerson & Cuming, Inc. Edwin F. Hall	190	ITT Semiconductors Div. Neals & Hickok, Inc.	214
Airpax Electronics, Inc. Welch, Mirabile & Co., Inc.	162	Erie Technological Products Co., Inc. Aitman-Hall Assoc.	53	Kokusai Electric Co., Ltd. Asia Advertising Agcy., Inc.	88
Allen-Bradley Co. Fensholt Adv. Agcy.	77, 78	Fairchild Instrumentation Faust/Day, Inc.	176, 177, 179	■ Lambda Electronics Corp. Michel Cather, Inc.	75
■ Amelco Semiconductor, Div. of Teledyne, Inc. Sturges Advertising	137	Fairchild Semiconductor, Inc. Faust/Day, Inc.	12, 13	■ Leach Corporation Jay Chiat & Assoc.	173
Amperite Company H.J. Gold Co.	192	■ General Electric Co., Capacitor & Components Div. Robert S. Cragin, Inc.	74	Ledex, Inc. Yeck & Yeck, Inc.	174
■ Amphenol Corp., RF Div. Marsteller, Inc.	20, 21	■ General Electric Co., Semiconductor Products Div. Robert S. Cragin, Inc.	80	■ Machlett Laboratories, Div. of Raytheon Co. Fuller, Smith & Ross, Inc.	11
■ Ando Electric Co., Ltd. Diamond Agcy. Co., Ltd.	90	General Radio Co. Horton, Church & Goff, Inc.	6	■ Mallory & Co., P.R., Mfg. Div. Aitkin-Kynett Co.	8, 169
Anritsu Electric Co., Ltd. Diamond Agcy. Co., Ltd.	94	Grigsby Barton, Inc. Sprinkle & Green, Inc.	197	Maryland Telecommunications, Inc. Ray E. Finn Adv.	72
Arnold Engineering Co. Burton Browne Adv.	159	Hansen Manufacturing Co. Keller-Crescent Co.	191	■ Matsuo Electric Co., Ltd. Fuji Agency	90
■ Barnstead, Sub. of Ritter Pfaudler Corp. Creamer Trowbridge & Case, Inc.	167	Hathaway Instruments, Inc. Eby & Everson, Inc.	182	M C G Electronics	189
Bell Aerosystems Co. Comstock Advertising, Inc.	79	■ Hayakawa Electronics Co., Ltd. Dai-Ichi International, Inc.	91	Meguro Electronic Instrument General Adv. Agcy.	86
Bendix Corp., Electrical Components Div. MacManus, John & Adams, Inc.	36, 37	Heinemann Electric Co. Thomas R. Sundheim, Inc.	168	Meson Electronics Co., Inc. Wolff Associates, Inc.	190
Bissett-Berman Corp. S.F. Associates	185	■ Hewlett Packard Associates Lennen & Newell, Inc.	38	■ Metronix Corp. General Adv. Agcy.	90
Black & Webster Larcom Randall Adv., Inc.	193	■ Hewlett Packard, Dymec Div. Lennen & Newell, Inc.	17	Microdot, Inc. Gumpertz, Bentley & Dolan Adv.	15
Boonton Electronics Corp. The Creative Group	171	■ Hewlett Packard, F & T Div. Lennen & Newell, Inc.	202	■ Mitsumi Electric Co., Ltd. Sanko Tsushinsha, Ltd.	88
Bourns, Inc., Trimpot Div. Lester Company, The	142	■ Hewlett Packard, Loveland Div. Tallant/Yates Adv., Inc.	157	Motorola Semiconductor Products, Inc. Lane & Bird Adv., Inc.	9, 43
■ Brush Instruments, Div. of Clevite Corp. Carr Liggett Adv., Inc.	123	■ Hewlett Packard, Microwave Div. Lennen & Newell, Inc.	1	■ Murata Mfg. Co., Ltd. Daiko Adv., Inc.	94
Burroughs Corp., Electronic Components Div. Conti Adv. Agcy. Inc.	98, 99	■ Hewlett Packard, Rockaway Div. Culver Adv., Inc.	2	National Semiconductor Corp. Jay Chiat & Assoc.	18, 19
Celanese Corporation of America, Celanese Plastics Div. West, Weir & Bartel, Inc.	67	■ Hewlett Packard, Sanborn Div. Culver Adv., Inc.	69	N G K Spark Plug Co., Ltd. Dentsu Adv., Ltd.	92
Cerro Wire & Cable, Div. of Cerro Corp. Marsteller, Inc.	81	■ Hickok Electrical Instrument Co. Parsells Adv. Service	166	Nihon Kohden Kogyo Co., Ltd. Overseas Catalog Specialists, Inc.	89
Cimron, Div. of Lear Siegler, Inc. Phillips-Ramsey, Inc.	3rd Cover	Hirose Electric Co., Ltd. Diamond Agency Co., Ltd.	88	Nippon Coil Co., Ltd. Dai-Ichi International, Inc.	94
■ Cinch Graphik, Div. of United Carr Fastener Co. Reach, McClinton & Co.	181	Hitachi Ltd. Dentsu Advertising	87	■ N J E Corporation Keyes, Martin & Co.	197
Clare & Company, C.P. Reincke, Meyer & Finn Adv., Inc.	70	Hokuriku Electric Industry Co., Ltd. General Ad Agency, Inc.	94	North Atlantic Industries, Inc. Murray Heyert Assoc.	172
Cleveland Institute of Electronics Foote, Cone & Belding, Rapp & Collins Div.	158	Honeywell, PMD Div. Batten, Barton, Durstine & Osborn, Inc.	39	Okaya Musen Co., Ltd. Diamond Agcy. Co., Ltd.	89
Columbia Components Corp. Zam & Kirshner, Inc.	145	Honeywell, Test Instruments Div. Campbell Mithun, Inc.	82, 83	Pamotor, Inc. Harry P. Bridge Co.	186
Consolidated Electrodynamics Corp., Sub. of Bell & Howell Hixson & Jorgensen, Inc.	170	Hooker Chemical Corp., Durez Div. Rumrill-Hoyt, Inc.	97	■ Philbrick Researches, Inc. Culver Adv., Inc.	175
Conversion Chemical Co. The F.W. Prella Co.	66	■ Ichizuka Optical Co., Ltd. Matsushita, Inc.	89	Philco/Ford Co., Microelectronics Div. Hoefler, Dieterich & Brown, Inc.	65
Deringer Metallurgical Corp. Roy E. Bishop Adv.	195				
■ DuPont de Nemours & Co., Freon Div. Batten, Barton, Durstine & Osborn, Inc.	61				



Advertising sales staff

Frank E. LeBeau [212] 971-6464

Advertising sales manager

Wallis Clarke [212] 971-2187

Assistant to sales manager

Donald J. Austermann [212] 971-3139

Promotion Manager

Atlanta, Ga. 30309: Michael H. Miller, 1375 Peachtree St., N.E. [404] TR 5-0523

Boston, Mass. 02116: William S. Hodgkinson McGraw-Hill Building, Copley Square [617] CO 2-1160

Chicago, Ill. 60611: Robert M. Denmead, J. Bradley MacKimm, Ralph Hanning, 645 North Michigan Avenue, [312] MO 4-5800

Cleveland, Ohio 44113: William J. Boyle, 55 Public Square, [216] SU 1-7000

Dallas, Texas 75201: Richard P. Poole, 1800 Republic National Bank Tower, [214] RI 7-9721

Denver, Colo. 80202: Joseph C. Page, David M. Watson, Tower Bldg., 1700 Broadway, [303] 255-5484

Detroit, Michigan 48226: Ralph Hanning 856 Penobscot Building [313] 962-1793

Houston, Texas 77002: Kenneth George, 2270 Humble Bldg., [713] CA 4-8381

Los Angeles, Calif. 90017: Ian C. Hill, John G. Zisch, 1125 W. 6th St., [213] HU 2-5450

Minneapolis, Minn. 55402: J. Bradley MacKimm, 1104 Northstar Center [612] 332-7425

New York, N.Y. 10036

500 Fifth Avenue

Donald R. Furth [212] 971-3615

James R. Pierce [212] 971-3616

Stanley J. Kail, Jr. [212] 971-3617

Philadelphia, Pa. 19103:

Warren H. Gardner, Jeffrey M. Preston, 6 Penn Center Plaza, [215] LO 8-6161

Pittsburgh, Pa. 15222: Warren H. Gardner, 4 Gateway Center, [412] 391-1314

Portland, Ore. 97204: James T. Hauptli, 218 Mohawk Building, 222 S.W. Morrison Street, Phone [503] 223-5118

Rochester, N.Y. 14534: William J. Boyle, 9 Greylock Ridge, Pittsford, N.Y. [716] 586-5040

St. Louis, Mo. 63105: Robert M. Denmead The Clayton Tower, 7751 Carondelet Ave. [314] PA 5-7285

San Francisco, Calif. 94111:

James T. Hauptli, 255 California Street, [415] DO 2-4600

London W1: John W. Patten, Edwin S. Murphy Jr., 34 Dover Street, Hyde Park 1451

Milan: Robert M. Saidel 1 via Baracchini Phone: 86-90-656

Frankfurt, Main: Gerd Hinske, Dieter Rothenbach, Elsa-Brandstroem Str. 2 Phone: 72 01 81

Geneva: Michael R. Zeynel, 1, rue du Temple Phone: 31 95 60

Paris VIII: Kenneth Davey, 17 Avenue Matignon Phone: 359 6637

Tokyo: Nobuyuki Sato, 1, Kotohiracho Shiba, Minato-Ku [502] 0656

Osaka: Ryoji Kobayashi 163, Umegae-cho Kita-ku [362] 8771

Business department

Wallace C. Carmichael, Manager

[212] 971-3191

Stephen R. Weiss, Production Manager

[212] 971-2044

Thomas M. Egan, Assistant Production Manager [212] 971-3140

Dorothy Carmesin, Contracts and Billings

[212] 971-2908

Circulation and research

Milton Drake, Manager [212] 971-3485

Isaac Siegel, Assistant Circulation Manager

[212] 971-6057

David Strassler, Assistant Research Manager

[212] 971-6058

Chloe D. Glover, Research Associate

[212] 971-6057

Electronics buyers' guide

George F. Werner, General Manager

[212] 971-2310

Ray Smyth, Eastern Regional Manager

[212] 971-6538

Regina Hera, Directory Manager

[212] 971-2544

Thomas M. Egan, Production Manager

[212] 971-3140

Polaroid Corp. 57
Doyle Dane Bernbach, Inc.

Princeton Applied Research Corp. 44
Mort Barish Assoc., Inc.

Radiation, Inc. 62, 63
Basford, Inc.

Radio Corporation of America 4th Cover, 140, 141
Al Paul Lefton Co.

■ **Radio Materials Co., Div. of P.R. Mallory & Co.** 211
Gallay Adv., Inc.

RCL Electronics, Inc. 14
Morway Adv. Agcy.

Redford Corp. 199
Communications Associates

■ **Reeves Hoffman, Div. of Dynamics Corp. of America** 188
Adams Assoc., Inc.

Rohde & Schwarz Co. 147
Walker & Gessell, Inc.

Sage Electronics Corp. 199
Mathison Adv., Inc.

■ **San-Ei Instrument Co., Ltd.** 86
Standard Adv., Inc.

San-Esu Electronics Co., Ltd. 86
General Adv. Agcy.

Sanken Electric Co., Ltd. 90
Seikosha Adv., Inc.

Sel-Rex Corporation 40
Gaynor & Ducas, Inc.

Semtech Corporation 154
Burruss Advertising

Shinei Industrial Co., Ltd. 95
General Ad. Agcy., Inc.

Signetics Corp., Sub. of Corning Glass Works 64
Cunningham & Walsh, Inc.

Soshin Electric Co. 93
Shinwa Adv. Co., Ltd.

Sperry Rand Corp., Microwave Components 58
Neals & Hickok, Inc.

Sprague Electric Co., The 5, 10
Harry P. Bridge Co.

■ **Stackpole Carbon Co., Electronic Components Div.** 206
Meek & Thomas, Inc.

Super Tool Co. 193
Varon Advertising

Sylvania Electric Products, Inc., Gen. Telephone & Electronics Div. 27 to 34
Tatham-Laird & Kudner, Inc.

Systron-Donner Corp. 7
Bonfield Assoc., Inc.

Taiyo Denki Co., Ltd. 92
Sanko Sha Adv. Co., Ltd.

Takamisawa Electric Co., Ltd. 92
Overseas Catalog Specialists, Inc.

Tateisi Electronics Co., Ltd. 96
Dai-Ichi International, Inc.

■ **Teikoku Tsushin Kogyo Co., Ltd.** 93
Diamond Agcy. Co., Ltd.

■ **Tektronix, Inc.** 51
Hugh Dwight Adv., Inc.

Tel-Com Instruments, Inc. 138, 139
Gross Advertising Serv.

Telonic Engineering Co. 153
Jansen Assoc., Inc.

Telonic Instruments 144
Jansen Associates, Inc.

Teltronics, Inc. 146
Tech/Reps, Inc.

Tempress Research Co., Inc. 41
Hal Lawrence, Inc.

Texas Instruments Incorporated 84
Horton, Church & Coff Incorporated

Texas Instruments Incorporated Semiconductor/Components Division 160, 161, 205
Don L. Baxter Incorporated

Tohoku Metal Industries Ltd. 91
Hakuhodo, Inc.

Tokyo Cosmos Electric Co., Ltd. 89
General Adv. Agcy., Inc.

Tokyo Denki Co., Ltd. 95
Asia Adv. Agcy., Inc.

Tokyo Print Industrial Co., Ltd. 92
General Adv. Agcy., Inc.

Totoku Electric Co., Ltd. 93
Diamond Agcy. Co., Ltd.

Transformer Electronics Co. 152
Dacey, Wolff & Weir

TRG, Inc., Div. of Control Data Corp. 42
Culver Adv., Inc.

Trio Laboratories, Inc. 124
Zam & Kirshner, Inc.

TRW Semiconductors 49
Fuller, Smith & Ross, Inc.

Trygon Electronics, Inc. 187, 189, 191
Solow/Wexton Co., Inc.

Trymetrics Corp. 180
Solow/Wexton Co., Inc.

■ **Tung Sol Div., Wagner Electric Corp.** 76
E.M. Freystadt Assoc.

Ulano & Co., J. 165
Byrde, Richard & Pound, Inc.

Union Carbide Corp., Electronics Div. 35
J.M. Mathes, Inc.

Unitech Corp. 193
Newman-Marwel, Inc.

■ **United Transformer Co.** 2nd Cover
Philip Stogel Co.

■ **Unitrone Corp.** 55
Silton Brothers, Inc.

Westinghouse, Semiconductor Div. 100
McCann/ITSM

■ **White Instrument Laboratories** 190
Wilson & Associates

Classified Advertising

F.J. Eberle, Business Mgr.

PROFESSIONAL SERVICES 201

EMPLOYMENT OPPORTUNITIES 200-201

EQUIPMENT 201
(Used or Surplus New)
For Sale

ADVERTISERS INDEX

Atomic Personnel, Inc. 200

The Bendix Corp., Flight & Engine Instr. Div. 201

Electronic Communications, Inc. 201

Instruments & Machines, Inc. 201

Radio Research Instrument Co. 201

■ **For more information on complete product line see advertisement in the latest Electronics Buyers' Guide**

Every ITT 2N3375 gives you 66% more P_{OE} than EIA specs demand

28V CLASS B POWER OUTPUT VS FREQUENCY

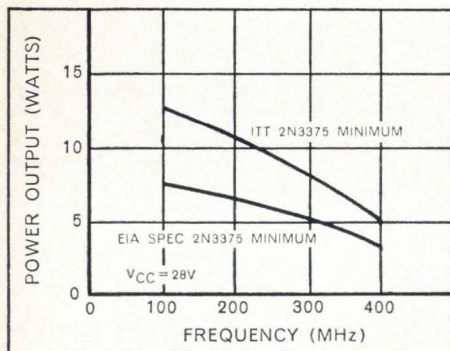

When you apply ITT 2N3375s, you get 5 watts minimum saturated power output at 400 MHz and $V_{CC}=28$ V, tested 100%.

The secret lies in ITT's unusually close control of resistivity, combined with interdigitated construction.

To find out more about the superior performance of the ITT 2N3375, write today for your free copy of "VHF/UHF Power Transistor Amplifier Design" and complete 2N3375 specs. Or see for yourself — order sample quantities off-the-shelf from your ITT distributor or factory representative. ITT Semiconductors is a division of International Telephone and Telegraph Corporation, 3301 Electronics Way, West Palm Beach, Florida.

ITT
SEMICONDUCTORS

FACTORIES IN WEST PALM BEACH, FLORIDA; PALO ALTO, CALIFORNIA; LAWRENCE, MASSACHUSETTS; HARLOW AND FOOTSCRAY, ENGLAND; FREIBURG AND NUREMBURG, GERMANY