

#20

CURRENT SHELF

Electronics®

OCT 3-1967

Three theoretical design tools: page 82
Stripline that works with IC's: page 109
Doubling data for transmission by h-f: page 115

October 2, 1967
\$1.00
A McGraw-Hill Publication
Below: H-shaped resonators find new uses for tone signaling, page 99

NO LONGER

w/d 2/9/72

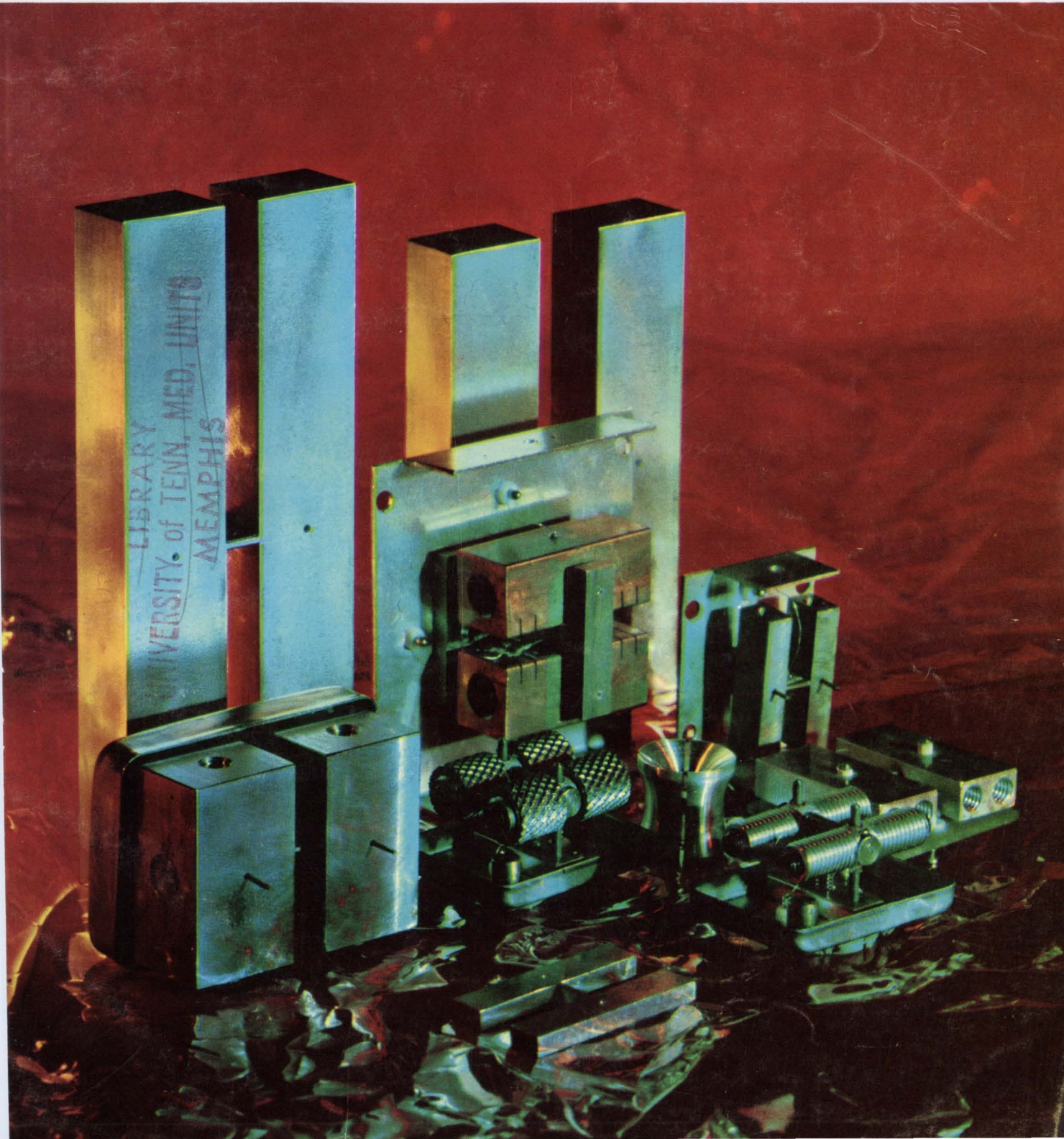

OSCILLATOR
10 Hz - 50 kHz

1313-A

SERIAL 125

GENERAL RADIO
MASSACHUSETTS



POWER

OFF

500 MV

50 MV

5 MV

0 V

OUTPUT
60

10 Hz to 50 kHz with one dial turn



With our new Type 1313-A Oscillator, you can manually sweep through its entire frequency range with one turn of the main dial. There are no range-switching transients or ambiguous dial multipliers to contend with; frequency changes can be made quickly and conveniently. The all-solid-state 1313-A provides both sine- and square-wave outputs, has a calibrated 60-dB step attenuator with a zero-volts-behind-600 Ω output position, and a 20-dB continuously adjustable attenuator. Distortion is only 0.5% from 100 Hz to 10 kHz.

The 1313-A is the fourth in our new line of "sync-able" oscillators. Like

the others, the 1313-A has a SYNC jack for external synchronization, is completely self-contained, and is small and lightweight (8 by 6 by 8 in., 7 lb). Even the price is a feature — it's only \$325*!

For complete information, write General Radio Company, W. Concord, Massachusetts 01781; telephone (617) 369-4400; TWX 710 347-1051.

*Price applies in USA only.

GENERAL RADIO

Inkless recording isn't a "record-breaking" technique.

It's designed not to be.

The exclusive new inkless writing option for the Hewlett-Packard 10" 7100 series or the 5" 680 series strip-chart recorders won't "break" your records by tearing, smearing or running out of ink when you're not around to notice it.

Instead, it takes the uncertainty out of strip-chart use by offering reliable, long-term recording—without interruption or constant attention—with economical and maintenance-free operation. This new low-

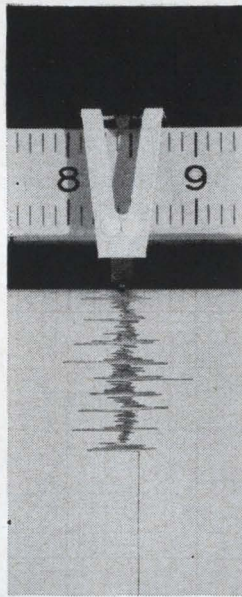

voltage electric writing method gives you sharp and clear printing on unique electro-sensitive paper—and with instant start-up.

Call your local HP field engineer or write Hewlett-Packard, Palo Alto, Calif. 94304. Europe: 54 Route des Acacias, Geneva.

HEWLETT  PACKARD

GRAPHIC RECORDERS 11702

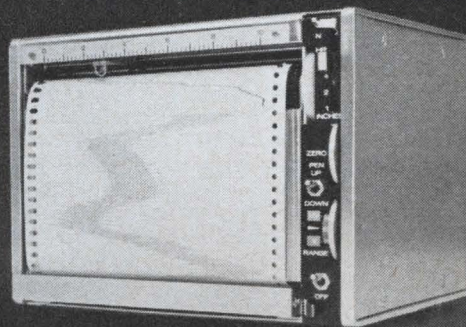
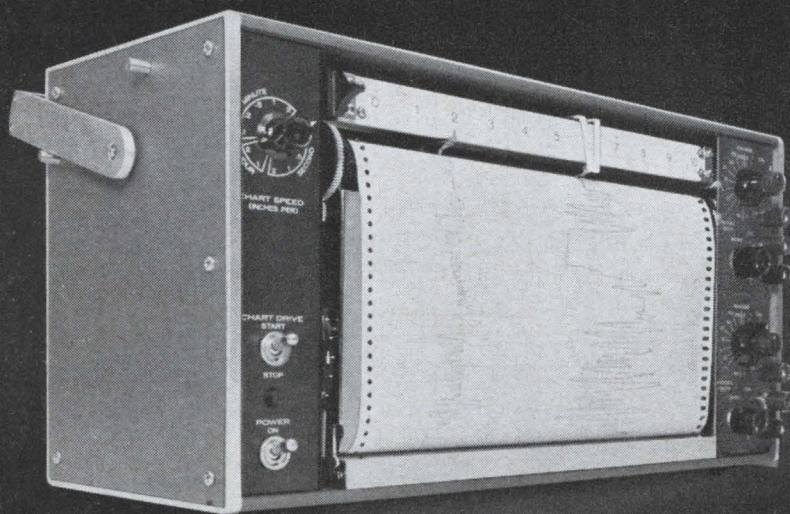

Rugged, Reliable and Versatile!

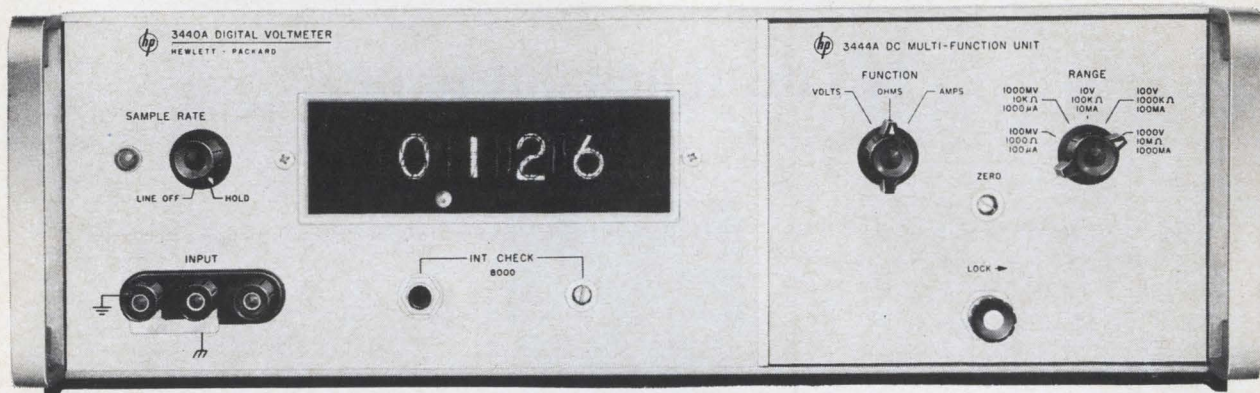

USE THIS hp DVM ANYWHERE!

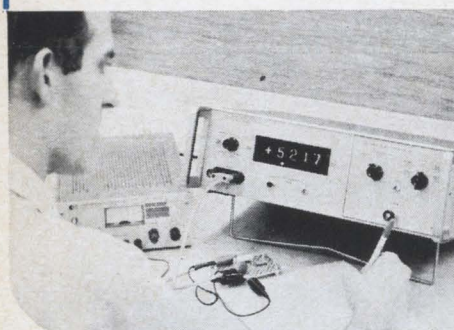

LABORATORY

The hp Models 3439A and 3440A Digital Voltmeters are compact, accurate, rapid, multiple function instruments—built rugged, reliable and versatile! With the appropriate plug-in, you get automatic ranging, remote or manual operation with an accuracy of 0.05% of reading on a four-digit readout; 50 Hz to 50 kHz bandwidth with 10 μ V; 10 nA sensitivity!

Rugged!—Models 3439A and 3440A are built with solid-state circuitry and reed relays to provide a rugged instrument. Use of solid-state components also gives a lighter weight for easy portability. These units are test operated at temperatures from 0°C to 50°C with relative humidities of 0 to 95%, vibration tested at 10 to 55 Hz at 0.010" peak-to-peak excursion, and drop-tested four times from four inches. Construction and testing assure you of a rugged instrument—ideal for bench or systems applications.

Reliable!—With either the 3439A or 3440A, you get an internal calibration source with a TC better than 0.002%/°C and a stability typically better than $\pm 0.005\%$ over a three month period. You can verify accuracy of these models simply by pressing a front panel button. You get digital readout on large rectangular display tubes which hold the previous reading until the input voltage is changed. Long-term reliability is assured with solid state components—but, if something should happen, the easy-to-service plug-in circuit cards mounted in the modular enclosure can be quickly replaced to minimize down-time.

Versatile!—You get a dc accuracy of better than $\pm 0.05\%$ of reading ± 1 digit. Specified accuracy is retained to 5% beyond full scale. The ac filter has a rejection of 30 dB at 60 Hz. Response time to a step change is 450 msec to read 99.95% of final value. The 10 M Ω impedance presents a constant load on all voltage ranges.

Add the capability of six plug-ins to these features and you have a truly versatile instrument! *But—that's not all!* You can make true RMS measurements using the dc output of the hp Model 3400A RMS Voltmeter and either the 3439A or 3440A. The 3440A has a BCD recorder output to operate with the hp



PRODUCTION

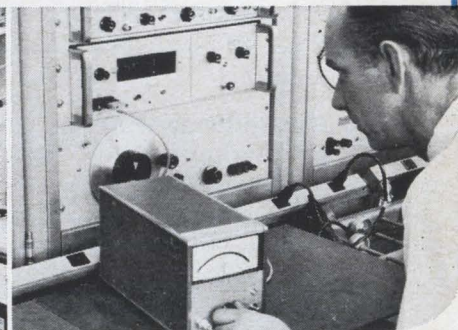

SYSTEMS

Model 562A Digital Recorder to produce a printed, six-column readout.

Plug-in*	3441A	3442A	3443A	3444A	3445A	3446A
AC volts 10V to 1000V	**	**	**	**	X	X
DC volts 10V to 1000V	X	X	X	X	X	X
DC volts 100mV to 1000V			X	X		
DC amps				X		
Ohms				X		
Manual ranging	X	X	X	X	X	X
Auto-ranging		X	X		X	
Remote ranging		X	X		X	X
Remote function						X
Floating input	X	X	X	X	X	X

*3439A and 3440A require a plug-in to operate

**Average response measurements: 100 μ V to 300 volts. 50 Hz to 500 kHz—hp-457A or 1 mV to 300 volts. 10 kHz to 10 MHz with -hp-400E/EL. True RMS measurements: 1 mV to 300 volts, 10 Hz to 10 MHz use -hp-3400A.

Get the full story on the rugged, reliable, versatile hp Model 3439A or 3440A Digital Voltmeter from your nearest hp field engineer. Or, write to Hewlett-Packard, Palo Alto, California, 94304. Europe: 54 Route des Acacias, Geneva. Price: hp model 3439A, \$950.00; hp Model 3440A, \$1160.00, plus plug-ins (\$40.00 to \$575.00).

097/9

HEWLETT  **PACKARD**
An extra measure of quality

News Features

Probing the News

- 137 **General Motors pulls ahead**
142 **C'est la guerre**
146 **Thin Nike means fat orders**

Electronics Review

- 39 **Companies:** Out in the cold
39 **Electro-optics:** Light track
40 **Solid state:** Making the scene
41 **Manufacturing:** The cold touch
42 **Avionics:** Long-range lookout
43 **Consumer electronics:** Life's darkest moment; Low-budget picture
46 **Space electronics:** Fallout by default
48 **Oceanology:** Monster rally
48 **Components:** Bright shield
50 **Communications:** Rapid response
50 **Military electronics:** Mounting . . . greenery
52 **For the record**

Electronics Abroad

- 233 **East Germany:** Western ways
233 **The Netherlands:** Sealed power
234 **Great Britain:** Galloping GaAs; Captain's tabulator
235 **Japan:** Plenty of scope
235 **West Germany:** It's a gasser
236 **Vietnam:** Breaks on the barrier
236 **Canada:** Choice of foils
238 **Around the world**

New Products

- 167 **Oscilloscope in living color**
168 **Watching the waves**
170 **New components review**
170 **New components:** Auto tape head improved; For discrete users
179 **New semiconductor review**
179 **New semiconductors:** Motorola steps up TTL pace; High-power triacs
184 **New instruments review**
184 **New instruments:** Extra head doubles recorder's capacity; Defining the need; Checking out an IC in 20 seconds
199 **New subassemblies review**
199 **New subassemblies:** Electronic equipment keeps it cool
203 **New microwave review**
203 **New microwaves:** Bonding method increases power

Title R registered U.S. Patent Office; © copyright 1967 by McGraw-Hill Inc. All rights reserved, including the right to reproduce the contents of this publication, in whole or in part.

Technical articles

I. Design

Design theory 82

Topology: a shortcut to understanding systems

Systems analysis is speeded up by a trio of graphical techniques
S.P. Chan, University of Santa Clara

Circuit design 95

Designer's casebook

- Five valuable circuits from changes in feedback
- Simple feedback network shapes trailing edges
- MOS phase-shifter controller cuts motor hunting
- Operational amplifier gain varied by FET chopper

Components 99

Microstrip plus equations adds up to fast designs

Accurate formulas eliminate cut and try in designing hybrid IC's for microwave
Alfred Schwarzmann, Radio Corp. of America

Microwave 109

Data at twice the speed eases h-f traffic jam

A new modulator-demodulator permits more traffic and cuts error rate by 1,000
Gene C. Porter, Martin B. Gray and Charles E. Perkett, General Dynamics Corp.

II. Application

Communications 115

H-shaped resonators signal upturn in tone telemetering (cover)

A single telephone line can handle 1,000 channels using a new generator and filter
Hugh Baker and John R. Cressey, HB Engineering Corp.

Departments

- | | | | |
|----|------------------------|-----|------------------------|
| 4 | Readers Comment | 40 | Indexes of activity |
| 8 | People | 63 | Washington Newsletter |
| 14 | Meetings | 206 | New Books |
| 16 | Meeting Preview | 210 | Technical Abstracts |
| 23 | Editorial | 218 | New Literature |
| 25 | Electronics Newsletter | 227 | Newsletter from Abroad |

Electronics

Editor-in-Chief: Lewis H. Young

Associate managing editors

Design: Donald Christiansen
Application: George Sideris
News: Robert Henkel
Copy: Sally Powell

Senior associate editors

John F. Mason, Joseph Mittleman, Stephen E. Scrupski

Department editors

Advanced technology: Stephen E. Scrupski
Computers: Wallace B. Riley
Consumer electronics: John Drummond
Design theory: Joseph Mittleman
Industrial electronics: Alfred Rosenblatt
Instrumentation: Carl Moskowitz
Military electronics: John F. Mason
New Products: William P. O'Brien, Stephen Fields
Solid state: Mark B. Leeds
Staff writers: James Brinton, Kay Sloman, Howard Wolff

Section editors

Electronics abroad: Arthur Erikson
Electronics review: Stanley Zarowin
Probing the news: Eric Aiken

Regional bureaus

Domestic

Boston: H. Thomas Maguire, manager; Robin Carlson
Los Angeles: Lawrence Curran, manager; June Ranill
San Francisco: Walter Barney, manager; Mary Jo Jadin
Washington: Robert Skole, manager; William D. Hickman, Paul Dickson, Patricia C. Hoehling

Foreign

Bonn: John Gosch
London: Michael Payne
Tokyo: Charles Cohen

Copy editors

Albert Tannenbaum, James Chang, Frederick Corey

Graphic design

Art director: Saul Sussman
Assistant art directors: Ann Mella, Valerie Betz
Production editor: Arthur C. Miller

Editorial secretaries: Claire Benell, Lynn Emery, Kay Fontana, Patricia Gardner, Lorraine Longo

McGraw-Hill News Service

Director: John Wilhelm; Atlanta: Fran Ridgway; Chicago: James Rubenstein;
Cleveland: Arthur Zimmerman; Dallas: Marvin Reid;
Detroit: N. Hunter; Houston: Robert E. Lee; Los Angeles: Michael Murphy, Gerald Parkinson
Pittsburgh: Louis Gomolak
San Francisco: William F. Arnold
Seattle: Ray Bloomberg; Washington: Arthur L. Moore, Charles Gardner,
Herbert W. Cheshire, Seth Payne, Warren Burkett, James Canan, William Small

McGraw-Hill World News Service

Bonn: John Johnsrud; Hong Kong: Don Kirk; London: John Shinn;
Mexico City: Bruce Cross; Milan: Ronald Taggiasco;
Moscow: Howard Rausch; Paris: Peter Kilborn;
Rio de Janeiro: Wes Perry; Tokyo: Marvin Petal

Reprints: Susan Nugent

Circulation: Milton Drake

Publisher: Gordon Jones

Electronics: October 2, 1967, Vol. 40, No. 20

Published every other Monday by McGraw-Hill, Inc. Founder: James H. McGraw 1860-1948.
Printed at 99 North Broadway, Albany, N.Y. 12207; second class postage paid at Albany, N.Y.

Executive, editorial, circulation and advertising addresses: McGraw-Hill Building, 330 W. 42nd Street
New York, N.Y. 10036. Telephone (212) 971-3333. Teletype TWX N.Y. 710-581-4235. Cable address:
MCGRAWHILL N.Y.

Subscriptions solicited only from those professionally engaged in electronics technology. Subscription rates:
qualified subscribers in the United States and possessions and Canada, \$8.00 one year, \$12.00 two years,
\$16.00 three years; all other countries \$25.00 one year. Non-qualified subscribers in the U.S. and
possessions and Canada, \$25.00 one year; all other countries \$50.00. Air freight service to Japan \$50.00
one year. Single copies: United States and possessions and Canada, \$1.00; all other countries, \$1.75.

Officer of McGraw-Hill Publications: Joseph H. Allen, President; Bayard E. Sawyer, Executive Vice-President;
J. Elton Tuohig, Senior Vice-President-Operations; Vice Presidents: John R. Callahan, Editorial;
John M. Holden, Marketing; Paul F. Cowie, Circulation; Angelo R. Venezian, Production; Jerome D. Luntz,
Planning & Development; Robert M. Wilhelm, Controller.

Officers of the Corporation: Donald C. McGraw, Chairman of the Board; Shelton Fisher, President;
L. Keith Goodrich, Robert E. Slaughter, Executive Vice Presidents; Donald C. McGraw, Jr.,
Senior Vice-President; John J. Cooke, Vice-President & Secretary; John L. McGraw,
Vice-President & Treasurer.

Title © registered in U.S. Patent Office; © Copyright 1967 by McGraw-Hill, Inc. All rights reserved. The contents
of this publication may not be reproduced either in whole or in part without the consent of copyright owner.

Subscribers: The publisher, upon written request to our New York office from any subscriber,
agrees to refund that part of the subscription price applying to copies not yet mailed.
Please send change of address notices or complaints to Fulfillment Manager; subscription
orders to Circulation Manager, Electronics at address below. Change of address notices
should provide old as well as new address, including postal zip code number. If possible,
attach address label from recent issue. Allow one month for change to become effective.

Postmaster: Please send form 3579 to Fulfillment Manager, Electronics,
P.O. Box 430, Hightstown, New Jersey 08520

Readers Comment

Healthy situation

To the Editor:

The article, "Ion implantation gets a shot in the arm," [Aug. 7, p. 162] obviously requires our comment. In particular the reporting of a source's comment on our progress reports goes, we believe, beyond the reasonable bounds of editorial license and of good taste.

The implantation program, initially company-funded six years ago at Ion Physics, early gained supplemental support from the Air Force and later from NASA. The Air Force particularly is to be commended in recognizing with us the potential of the method. Progress in an expanding research, development and, now, production program has been continuous. Indication of this is the arrangement made in April this year with the Corning Glass Works for additional development programs and licensing. Sustenance for continued health has been our way of life; not sickness-connoting shots in the arm.

Inaccuracies in the article include "Ion Physics . . . plans to skip discrete devices and start work immediately on ic's." Even though the previous Electronics article [May 15, p. 42] reported "Ion Physics plans to continue work on high-frequency transistors because it feels that implantation offers advantages in junction resolution and depth."

Further, we do not claim to produce more radiation resistant solar cells. A reading of our progress reports would establish this.

A. John Gale

President
Ion Physics Corp.
Burlington, Mass.

No complications

To the Editor:

The item in Electronics Newsletter, [July 24, p. 25] "Even chance seen for h-f transistor parameter shift," appears like an overly dramatized description of the status of transistor characterization.

The situation is very simple:

1. It is easier to measure transistors in the microwave frequency

SPRAGUE SSL[★]

(Super-Speed Logic)

IS THE BEST DOGGONE TTL



★ Trademark

**DON'T BE DOGGED
BY CIRCUIT SPEED**

**SPRAGUE SSL
TO THE RESCUE!**

PROPAGATION DELAY	5 nsec*
POWER DISSIPATION	25 mW*
NOISE IMMUNITY	1.0 V
FANOUT	11
FLIP-FLOP TOGGLE FREQUENCY	60 MHz

* As faithful as our four-footed friend, these values are typical, NOT exceptions.

**For additional information on
Sprague SSL Super-Speed Logic,
write to:
Semiconductor Division
Sprague Electric Company
115 Northeast Cutoff
Worcester, Mass. 01606**



SPRAGUE WORCESTER... the world's finest microcircuit facility

45B-7145

*Sprague' and '®' are registered trademarks of the Sprague Electric Co.

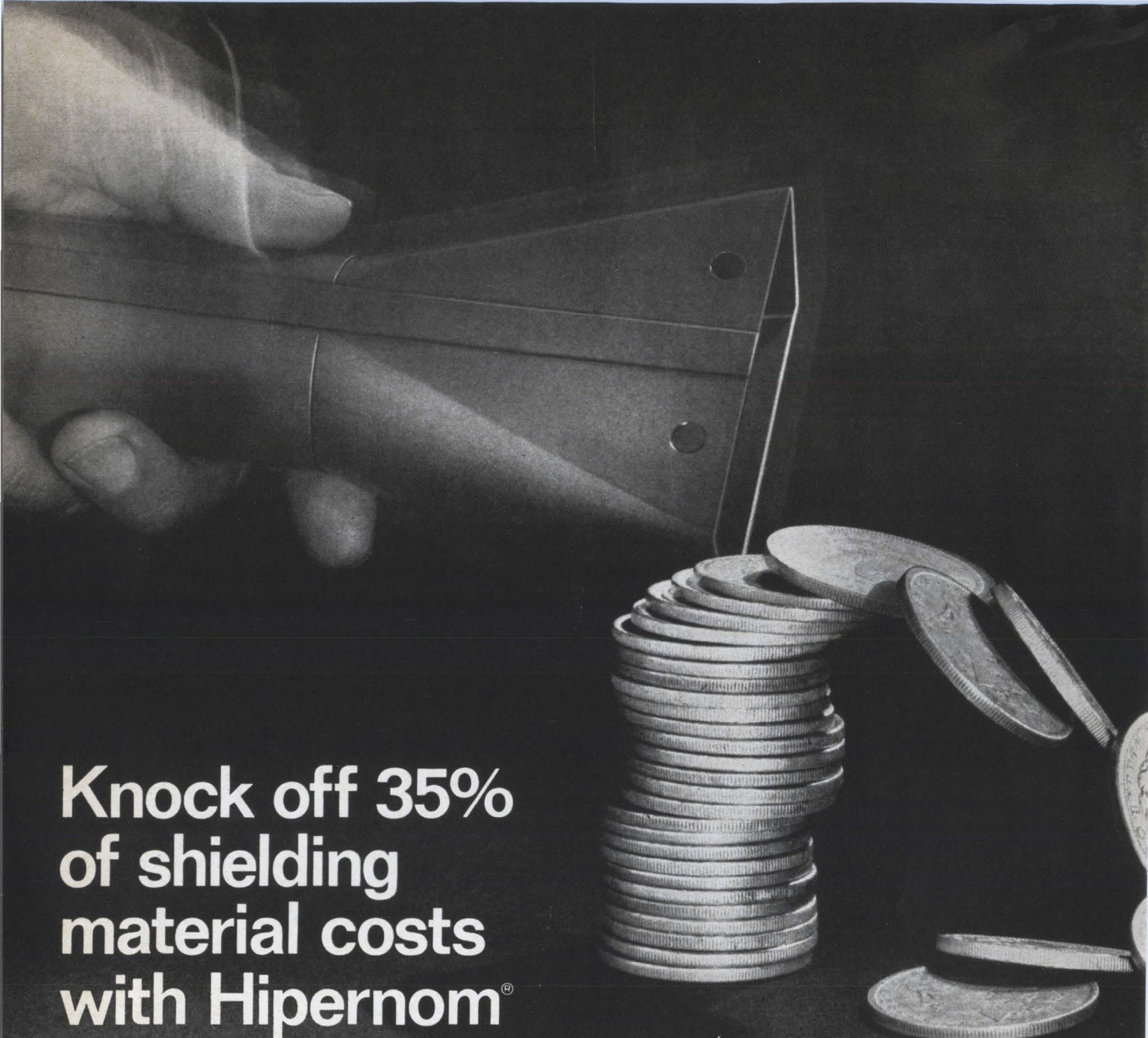

Knock off 35% of shielding material costs with Hipernom[®]

Hipernom meets the requirements of Federal Standard No. 222.

...and stay competitive into the 1970's.

Of course you want to pay less for magnetic shielding against DC to 10,000 Hz. fields. Solution: Get Westinghouse Hipernom alloy. Of all commonly used shielding alloys, Hipernom has the highest permeability. It lets you use thinner, lighter shields, allows easier, lower-cost fabrication. And you use less material per shield.

Circle 6 on reader service card

The 35% material cost saving per shield cited above is typical. Hipernom also brings you an important extra... the largest group of metallurgists specializing in magnetics. They'll put Westinghouse's 50 years of research leadership in magnetics at your service. Want specific details? Call Bob Carroll at 412-459-9400.

Free 36-page book on magnetic shielding
Any engineer who reads this book becomes one of America's foremost authorities on magnetic shielding. It is just that complete, practical and unique. For your free copy, write for "Shielding Book." Address Westinghouse Metals Division, Box 868, Pittsburgh, Pennsylvania 15230.

You can be sure if it's Westinghouse

J-05013



range with s-measuring sets than with y- or h-measuring sets, and if the transistors are to be used in 50-ohm circuits, circuit design is generally easier.

2. Y and h parameter characterization is often more useful in transistor development for the manufacturer, or for the circuit developer, to the extent that the s-parameters are measured and are then transformed to the y's with a computer.

3. Y-parameters can just as well be entered on a Smith chart as s-parameters. In fact, the Smith chart is most popularly employed in terms of immittance parameters, y and z.

4. There is no "simmering"; the situation is as follows: because easier-to-use s-parameter measuring equipment is now more readily available, and some manufacturers are converting to this equipment, work is in progress to prepare an s-characterization document, similar to the current y-characterization document now nearing completion. Involved in this preparation will be the evaluation of the existing equipment.

John Zorzy

Microwave group leader
General Radio Co.
Bolton, Mass.

It works in Denmark

To the Editor:

In the article about automatic phototypesetters [May 29, p. 137], it was surprising for us to see that none of the third-generation devices has yet been proven in full-fledged printing operations.

Our company, the Telephone Company of Copenhagen, received

the first Videocomp (here in Europe sold under the name Digiset) from Dr. Ing. Rudolf Hell about six months ago. The typesetting of the directory for Copenhagen has been accomplished on the Videocomp.

This book contains about 1,200 pages with about a half-million entries, and has been printed in 700,000 copies. The films have been made here in the Telephone-House in Copenhagen and delivered to our printer in Aarhus.

We are preparing the publication of other Digiset directories and the production of up-to-date catalogs for our information service.

Olaf Nielsen

Kjobenhavns Telefon Aktieselskab
Copenhagen

No connection

To the Editor:

In the article "Regenerative plan turns up in combiner," [July 10, p. 164], describing Raytheon's PDC-4 predetection combiner, it can be inferred from the first two paragraphs, particularly from the phrase, "building on this work," that our regenerative technique was derived from information in a technical paper presented at the IEEE International Communications Conference in 1966. To the best of our knowledge the IEEE presentation cited in your article dealt with different technical subject matter and did not describe our regenerative technique. There is no relationship between our work and the technique described in the IEEE presentation.

John E. Severance

Raytheon Co.
Lexington, Mass.

MEASURE

transient response

output impedance

loop stability

proper regulation

microvolt ripple

short and
long term drift

of your power supply

WITH ONE (1) INSTRUMENT

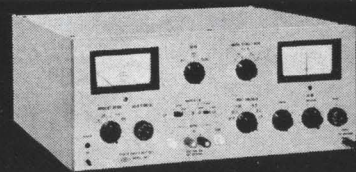

Now you can perform a complete check on all important parameters of your power supply . . . in a fraction of the time you used to take . . . with one small instrument instead of a bank of equipment.

PM's new Model 1004 Power Supply Test Set contains an electronic load capable of pulse loading a supply up to 20A and 70V. Operates in pulse or DC mode. Contains a regulation monitor for precise drift and regulation measurements. The meter is calibrated directly in % regulation. 10%, 1%, .1%, and .01% full scale. Accuracy is 3PPM/min. and 10-PPM/8 hrs.

PM 1004 — \$1100.00

PM 1003 (without regulation monitor) \$750.00

PM PACIFIC
MEASUREMENTS
INCORPORATED

940 INDUSTRIAL AVENUE,
PALO ALTO, CALIFORNIA
(415) 328-0300

SUBSCRIPTION SERVICE

Please include an Electronics Magazine address label to insure prompt service whenever you write us about your subscription.

Mail to: Fulfillment Manager
Electronics
P.O. Box 430
Hightstown, N.J. 08520

To subscribe mail this form with your payment and check new subscription renew my present subscription

Subscription rates: qualified subscribers in the U.S.: 1 year \$8; two years, \$12; three years, \$16. Non-qualified: 1 year \$25. Subscription rates for foreign countries available on request.

CHANGE OF ADDRESS

ATTACH
LABEL
HERE

If you are moving, please let us know five weeks before changing your address. Place magazine address label here, print your new address below.

name _____

address _____

city _____

state _____

zip code _____

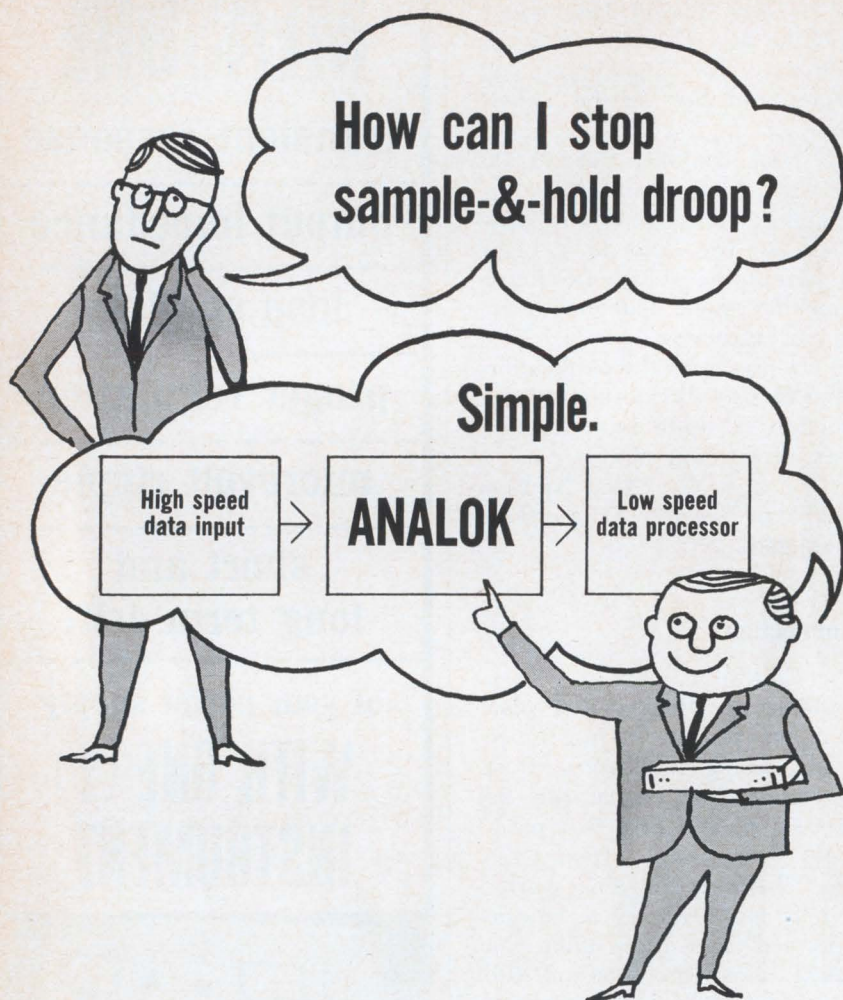

Forget about droop with ANALOK because it doesn't. What it *does* do is give you a simpler, less expensive system with greater flexibility.

Here's how. ANALOK is a multichannel unity gain track-and-hold amplifier with *zero* decay. It can retain stored values *in an analog state* indefinitely. This unique memory capability gives you greater flexibility because there's no time restriction between acquisition and use of sampled values. Check these applications:

- Use ANALOK as a high speed data buffer. Sample multiple functions simultaneously, or transient phenomena in a programmed sequence. Transfer the data to your low speed data processor as slowly or rapidly as you wish. No matter how much time you take, the stored values won't droop.
- Decommuration with one DAC and a multichannel ANALOK eliminates the need for periodic updating necessary when using conventional sample-and-hold channels. The result of using ANALOK is optimum use of your computer since it need only address each ANALOK channel when it has *new* information.
- Provide the information storage capability in your analog system with ANALOK. You may not have to go hybrid.



Get complete specifications. Write to ANALOK Sales, Dept. 215, Analog-Digital Systems Division, Control Data Corporation, 4455 Eastgate Mall, La Jolla, California 92037. Or phone 714/453-2500.

CONTROL DATA

CORPORATION

4455 Eastgate Mall, La Jolla, Calif.

People

One of RCA's most sensitive jobs, general manager of the Defense Electronics Products division, opened suddenly last month amid rumors of production problems on a supersecret project, called R-13. Named to the job was **Irving K. Kessler**, who also received the title of division vice president. [For more on the project, see page 39.] The 48-year-old Kessler replaces Arnold K. Weber, corporate vice president, who's been with RCA since 1918 and served as general manager of the division since last March.



Irving K. Kessler

Contract loss. Kessler's appointment came only weeks after it was learned that the Radio Corp. of America division had lost the National Security Agency contract because of production problems on R-13, which involves fast cryptographic equipment.

Industry insiders say Weber was named to the job when his predecessor became ill and the production problems became evident to management, and that Weber's selection was an interim one—at least as long as it would take for the veteran RCA official to solve the manufacturing problems.

The new general manager, in an interview, conceded that the Camden, N.J., division was having production problems—especially with multilayer boards. However, he said that the problems were not insurmountable and should be solved quickly.

Step up. Kessler previously served as general manager of the Aerospace Systems division. In his new post he will be responsible for five operating divisions within the Defense Electronics division: Aerospace Systems, Burlington, Mass.; Astro-Electronics, Princeton, N.J.; Communications Systems, Camden; Missile and Surface Radar, Moorestown, N.J.; and the West Coast division, Van Nuys.

Kessler is no newcomer to the defense industry. In 1957 he was manager of the defense division's



AT WABC-TV MACHLETT ML-7007 HIGH-POWER TRANSMITTING TUBES HAVE JUST LOGGED 125,000 HOURS.

Where prime time requires prime performance specify Machlett transmitting tubes. Available now:

The new Machlett short form catalog, from The Machlett Laboratories, Inc., 1063 Hope Street, Stamford, Connecticut 06907.

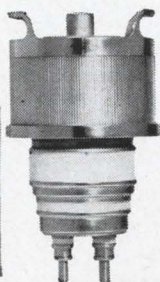

THE MACHLETT LABORATORIES, INC.

A SUBSIDIARY OF RAYTHEON COMPANY

New from Sprague!

**5 Times the Resistance of
a Conventional Metal-Film Resistor
of Equal Size!**

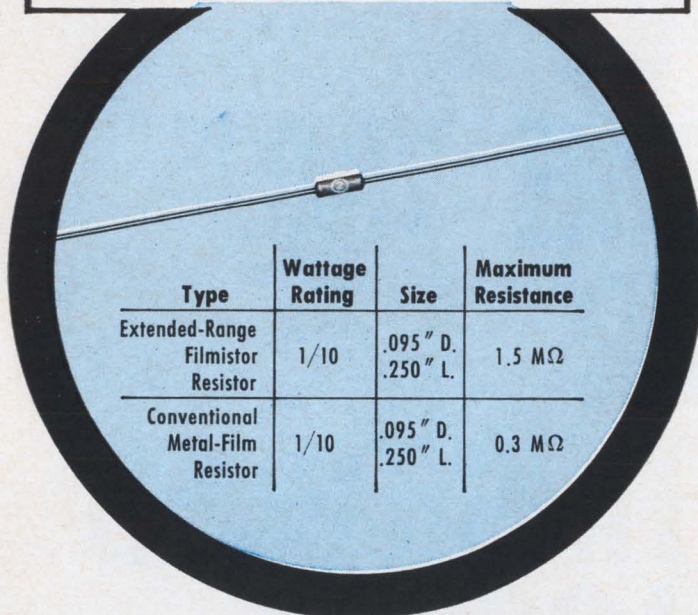

Type	Wattage Rating	Size	Maximum Resistance
Extended-Range Filmistor Resistor	1/10	.095" D. .250" L.	1.5 MΩ
Conventional Metal-Film Resistor	1/10	.095" D. .250" L.	0.3 MΩ

EXTENDED-RANGE FILMISTOR® METAL-FILM RESISTORS

**Substantial saving of space in all wattage ratings —
1/20, 1/10, 1/8, 1/4 1/2, and 1 watt—with
absolutely NO SACRIFICE IN STABILITY!**

Extended-Range Filmistor Resistors now offer, in addition to accuracy . . . stability . . . reliability . . . resistance values in size reductions which were previously unobtainable. Size and weight advantages of Filmistor Resistors now make them ideal for applications in high-impedance circuits, field-effect transistor circuits, etc. Many designs which previously had to settle for the higher temperature coefficients of carbon-film resistors in order to obtain required resistance values can now utilize the low and controlled temperature coefficients of Filmistor Metal-Film Resistors.

Other key features are $\pm 1\%$ standard resistance tolerance, low inherent noise level, negligible voltage coefficient of resistance, and tough molded case for protection against mechanical damage and humidity.

For complete technical data, write for Engineering Bulletin 7025D to Technical Literature Service, Sprague Electric Co., 35 Marshall Street, North Adams, Massachusetts 01247.

SPRAGUE COMPONENTS

RESISTORS
CAPACITORS
TRANSISTORS
INTEGRATED CIRCUITS
THIN-FILM MICROCIRCUITS
INTERFERENCE FILTERS

PACKAGED COMPONENT ASSEMBLIES
FUNCTIONAL DIGITAL CIRCUITS
MAGNETIC COMPONENTS
PULSE TRANSFORMERS
CERAMIC-BASE PRINTED NETWORKS
PULSE-FORMING NETWORKS



® 'Sprague' and '©' are registered trademarks of the Sprague Electric Co.

People

management engineering group. Two years later he was appointed general manager of the former Airborne Systems division and the following year became division vice president and general manager.

After 25 years at the Philco-Ford Corp., **Oscar T. Simpson** has resigned as vice president of the

firm's electronics group to become vice president and general manager of the Magnavox Co.'s Government and Industrial division, Fort Wayne.



Oscar T. Simpson

Why the move after 25 years? Simpson, 49 years old, says the smaller Magnavox organization offers him broader responsibility and a greater chance for top management positions. He also hopes his experience in satellite communications and microelectronics will help expand Maxnavox's already profitable Government business, now concentrated on antisubmarine warfare and avionics work.

Heir unapparent. There's no assurance a successor will be named at Philco-Ford. The six-division manager formerly under Simpson will now report to Robert O. Fickes, president, the way it was done before Simpson was named group vice president. If a successor is named, some insiders bet it will be Lou De Rosa, director of engineering and research for the group, who was named vice president the day after Simpson left.

Simpson denies that the slump at Philco-Ford's Microelectronics division forced his departure, and insiders at Philco-Ford agree. But the division's ledger has been slightly in the red for most of 1967. These losses may have triggered the current marketing reorganization, which has already cost the division its marketing, sales, and product managers. These men left because they differed with management's reorganization plans, Simpson says, adding that his reasons were personal.

Sorensen modular power supplies

$3\frac{5}{16}$ " x $3\frac{7}{8}$ " x 7", $\pm 0.005\%$ regulation

\$89⁰⁰

any questions?

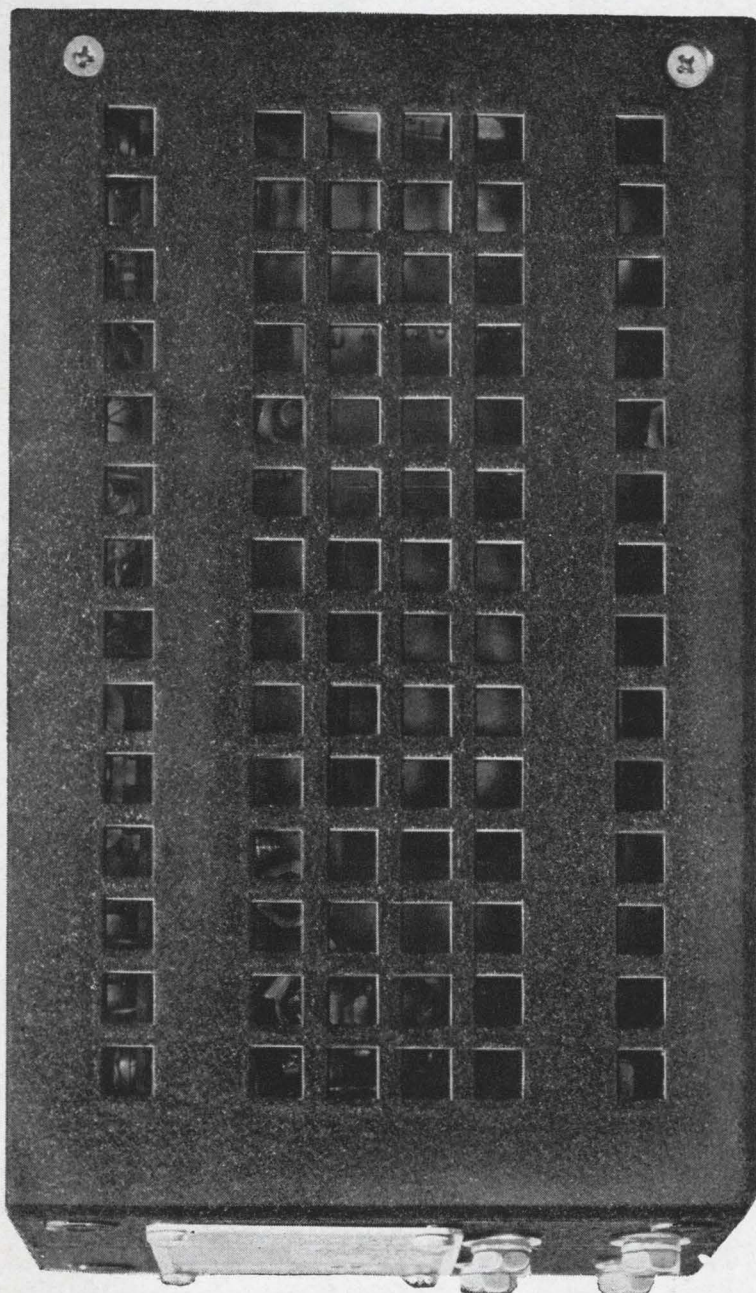

Model QSA48-.4 Power Supply, shown actual size, illustrates the compactness of the Sorensen QSA Series. New off-the-shelf models cover the range to 150 volts.

All silicon transistor design—convection cooled—operating temperatures up to 71°C.

Requires no external heat sink—mount in any position.

Lowest ripple of any modular supplies—300 μ V rms.

Best voltage regulation— $\pm 0.005\%$ line and load combined.

Lowest prices—\$89 to \$149.

Overload and short circuit protection.

20 μ s response time—no turn-on/turn-off overshoots.

Three sizes in each voltage range depending on power level—all are rack mountable with optional 3½" rack adapter.

Remote sensing and remote programming—capable of series/parallel operation.

Any further questions? For QSA details or for other standard/custom DC power supplies, AC line regulators or frequency changers contact your local Sorensen representative or: Raytheon Company, Sorensen Operation, Richards Avenue,



Norwalk, Connecticut
06856. Tel: 203-838-6571

Wednesday morning, October 11th:

You're invited to a briefing on integrated circuits. Don't dress up. It's at your house.



Fairchild has produced a half-hour color television program, a briefing on integrated circuits. It's not a big state-of-the-art spectacular. In fact, it's pretty basic.

If this seems like an extraordinary move for a technical company, we agree. It's been an extraordinary decade.

BRIEFING OUTLINE

- I. What is an Integrated Circuit?
 - A. What it looks like
 - B. What it does
 - C. How it compares to other circuits
- II. How an Integrated Circuit is made.
 - A. Circuit design
 - B. Masking
 - C. Etching
 - D. Diffusion
 - E. Metallization
 - F. Wafer testing
 - G. Scribing
 - H. Packaging
 - I. Testing the completed circuit
- III. Uses of Integrated Circuits.
 - A. Functions now available
 - B. Applications in industry
 - C. Applications in research

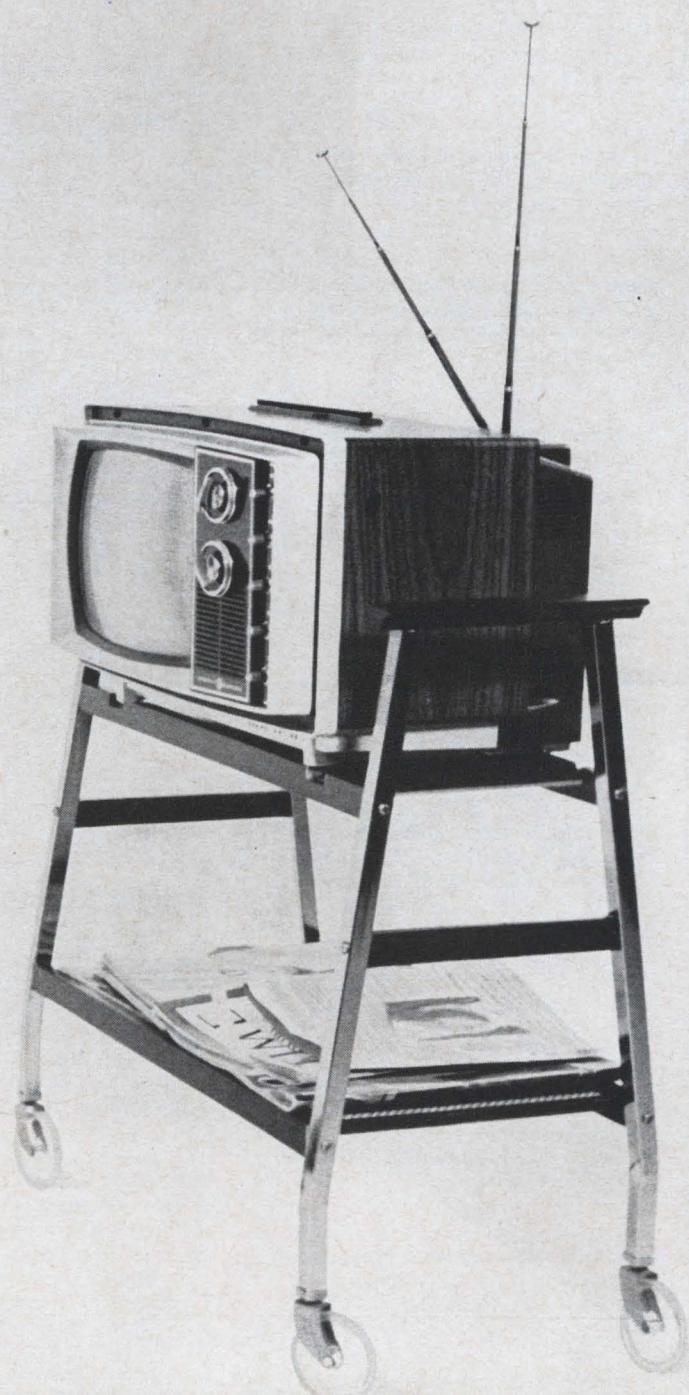

CITY	CHANNEL	TIME
Albuquerque	KOB-4	7:00 AM
Baltimore	WMAR-2	7:00 AM
Boston	WNAC-7	6:30 AM
Chicago	WBKB-7	6:30 AM
Cincinnati	WKRC-12	7:00 AM
Cleveland	WEWS-5	7:00 AM
Dallas-Fort Worth	KTVT-11	6:30 AM
Dayton	WHIO-7	7:00 AM
Denver	KLZ-7	7:00 AM
Detroit	WWJ-4	6:30 AM
Fort Wayne	WANE-15	7:00 AM
Houston	KHOU-11	7:00 AM
Huntsville	WAAY-31	7:00 AM
Indianapolis	WISH-8	7:00 AM
Kansas City	KCMO-5	7:00 AM
Los Angeles	KHJ-9	7:00 AM
Miami	WCKT-7	6:30 AM
Milwaukee	WITI-6	7:00 AM
Minneapolis-St. Paul	WCCO-4	7:00 AM
New Orleans	WVUE-12	7:00 AM
New York	WPIX-11	6:30 AM
New York	WPIX-11	7:00 AM
New York	WPIX-11	7:30 AM
Orlando	WDBO-6	6:30 AM
Philadelphia	WFIL-6	7:00 AM
Phoenix	KTAR-12	9:00 AM*
Rochester	WHEC-10	7:00 AM
St. Louis	KPLR-11	7:00 AM
San Diego	KOGO-10	6:30 AM
San Francisco-Oakland	KPIX-5	6:30 AM
Seattle-Tacoma	KING-5	6:30 AM
Syracuse	WHEN-5	7:00 AM
Utica	WKTV-2	7:00 AM
Washington, D.C.	WTTG-5	7:00 AM

*Sunday, October 15.



A Division of Fairchild Camera and Instrument Corp.
 313 Fairchild Drive, Mountain View, Calif. 94040
 (415) 962-5011 / TWX 910-379-6435

There always has to be a winner—and when it comes to all-purpose sweep signal generators, the Jerrold Model 900-C is a shoo-in.

Measure a *narrow* band circuit (sweep-width down to 10 kHz) or check the *entire* coverage of broad band units such as mixers, amplifiers, or filters (sweepwidths up to 400 MHz). Design, test or measure a variety of VHF, UHF, narrow and wide band devices in the frequency range 500 kHz to 1200 MHz... and do it with incomparable ease and accuracy. Here is convenience only an all-purpose sweeper can provide.

The 900-C and ultra-reliable Measurement-by-Comparison techniques permit accurate and simple measurement of gain, loss, and VSWR. You can disregard variables such as nonlinearity of detectors, oscilloscope drift, and line voltage variations.

If you need more convincing, send for complete data—or contact us for a demonstration. Write Government and Industrial Division, Jerrold Electronics Corporation, 401 Walnut St., Philadelphia, Pa. 19105.



clean sweep!

IN TEST,
MEASUREMENT,
AND
DESIGN

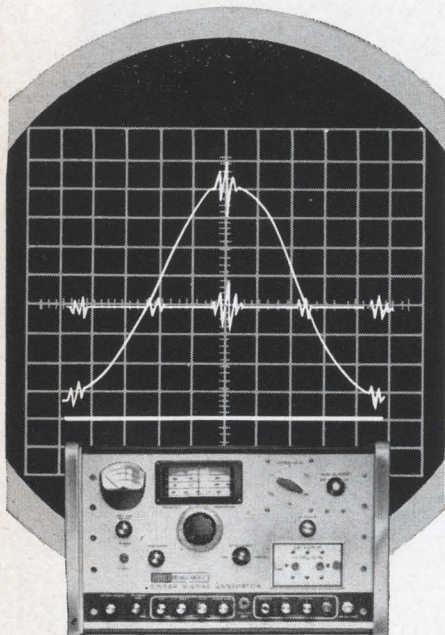

Meetings

Active Sonar Classification Symposium, Department of the Navy; Naval Postgraduate School, Monterey, Calif., Oct. 3-5.

Ultrasonic Symposium, IEEE; Bayshore Inn, Vancouver, Canada, Oct. 4-6.

Engineering Management Conference, IEEE; Jack Tar Hotel, San Francisco, Oct. 9-10.

Machine Tool Conference, IEEE; Cleveland Sheraton Hotel, Cleveland, Oct. 9-11.

Systems Science and Cybernetics Conference, IEEE; Statler Hilton, Boston, Oct. 11-13.

Symposium on the Physics of Selenium and Tellurium, Senlenium-Tellurium Development Association Inc.; Montreal, Oct. 12-13.

Electrical Insulation Conference, IEEE; Palmer House, Chicago, Oct. 15-19.

Seminar-in-depth on Laser Range Instrumentation, Society of Photo-Optical Instrumentation Engineers; Hilton Inn, El Paso, Texas, Oct. 16-17.

Joint Materials Handling Conference, American Society of Mechanical Engineers and IEEE; Pfister Hotel, Milwaukee, Oct. 16-18.

Electronics and Aerospace Systems Technical Convention, IEEE; Sheraton-Park Hotel, Washington, Oct. 16-18.

International Scientific Radio Union Meeting, International Scientific Radio Union; University of Michigan, Ann Arbor, Oct. 16-18.

Society for Nondestructive Testing Conference, Society for Nondestructive Testing; Hollenden House, Cleveland, Ohio, Oct. 16-19.

International Antennas & Propagation Symposium, IEEE; University of Michigan, Ann Arbor, Oct. 17-19.

International Electron Devices Meeting, IEEE; Sheraton-Park Hotel, Washington, Oct. 18-20.

Symposium on Switching and Automata Theory, IEEE; University of Texas, Austin, Oct. 18-20.

Conference of the Association of Data Processing Service Organization, Association of Data Processing Service Organization; Fairmont Hotel, San Francisco, Oct. 19-20.

Symposium on Adaptive Processes, IEEE; International Amphitheater, Chicago, Oct. 23-25.

Electronics Conference, IEEE; International Amphitheater and Sherman Hotel, Chicago, Oct. 23-25.*

Short Courses

Fundamentals of infrared technology, University of Michigan's School of Engineering, Ann Arbor, Oct. 23-27; \$175 fee.

Engineering seminar on electric contact phenomena, Illinois Institute of Technology and IIT Research Institute Chicago, Nov. 6-9; \$125 fee.

Image Processing, University of California's Engineering and Physical Sciences Extension, Los Angeles, Nov. 6-10; \$225 fee.

Call for papers

Automatic Control Conference, IEEE; University of Michigan, Ann Arbor, Mich., June 26-28, 1968. **Nov. 1** is deadline for submission of papers to Michael Athans, program chairman, 1968 JACC, Room 24-306, MIT, Cambridge, Mass. 02139

Frequency Control Symposium, U.S. Army Electronics Command; Shelburne Hotel, Atlantic City, N.J., April 22-24, 1968. **Dec. 15** is deadline for submission of summaries to Director, Electronic Components Laboratory, U.S. Army Electronic Command, Att. AMSEL-KL-ST (M.F. Timm), Fort Monmouth, N.J. 07703

* Meeting preview on page 16.

Even though Fluke differential voltmeters feature dc accuracies high as 0.0025%, ac accuracies of 0.05%, and 100 microvolts full scale sensitivity, they are so well designed that use is both simple and easy. Solid state bench top models are adaptable for half- or full-rack mounting... Many are offered in both line and rechargeable battery operated versions. Vacuum-tube models are available in cabinet or full-rack configurations. There are many accessories, too. All the fine features of Fluke differential voltmeters should surprise no one familiar with the Fluke line. For uncommon standards laboratory performance in portable instrumentation has always been and continues to be *standard*.

For particulars, write Fluke, Box 7428, Seattle, Washington 98133. Phone: (206) 774-2211. TWX: (910) 449-2850. In Europe address Fluke International Corporation, P. O. Box 5053, Ledeborstraat 27, Tilburg, Holland. Telex: 844-50237.

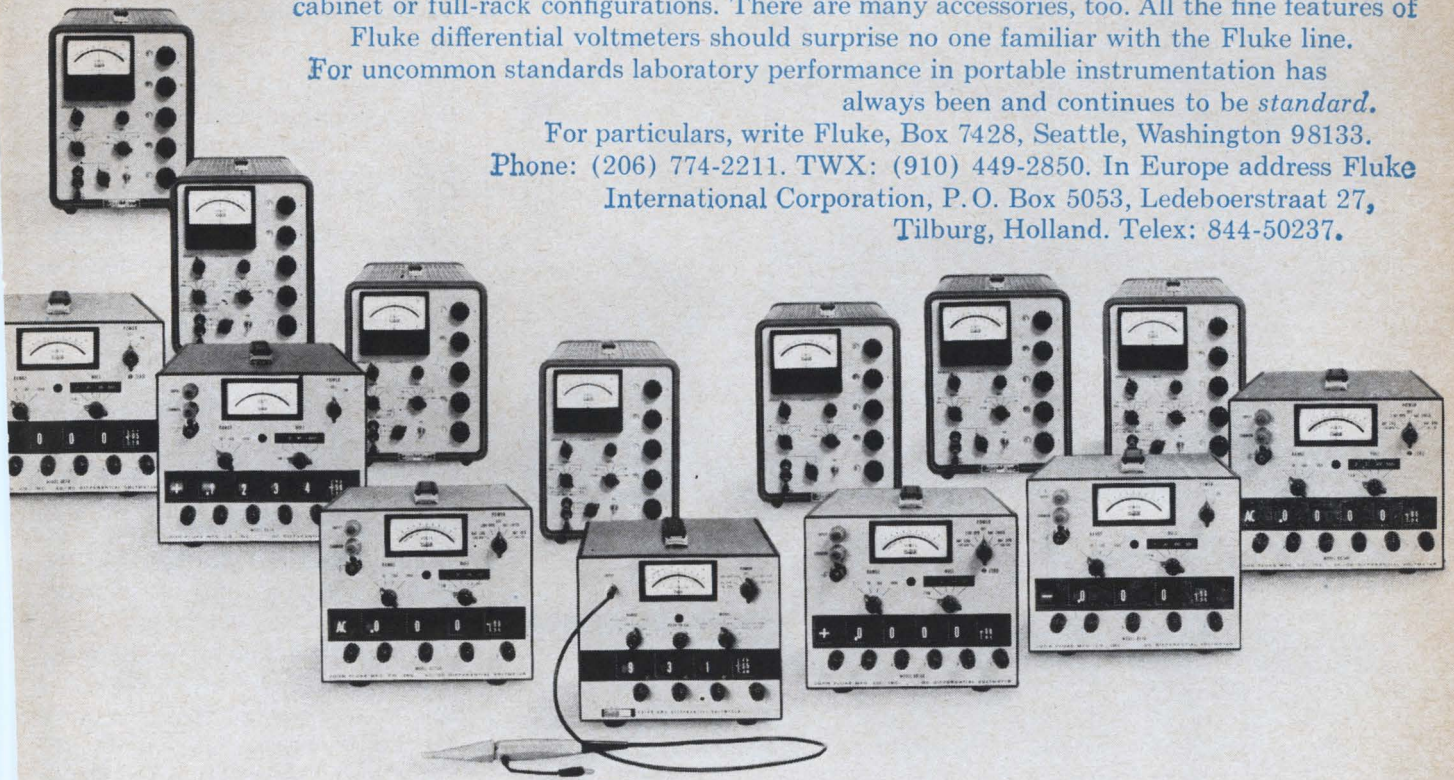

Count 'em. It's the world's largest, most sophisticated line of differential voltmeters. And what a line! You can buy a solid state dc, ac/dc, or true rms voltmeter. Or our vacuum tube version. You'd think Fluke invented the differential voltmeter. Well, we did.)

DC DIFFERENTIAL VOLTMETERS

INPUT VOLTAGE	ACCURACY % OF INPUT	INPUT IMPEDANCE	MAX. METER RESOLUTION	PRICE	NOTES
0-500 VDC	±0.05%	Infinite at null	50 uV	\$ 485.00	+ \$20 for rack models
0-500 VDC	±0.02%		5 uV	\$ 590.00	
0-500 VDC	±0.01%		5 uV	\$ 795.00	
0-1100 VDC	±0.02%	Infinite at null to ±11V 10 Meg above ± 14V Infinite at null to ±1100V	10 uV	\$ 565.00	+ \$130.00 for rechargeable battery pack
0-1100 VDC	±0.005%		1 uV	\$ 825.00	
0-1100 VDC	±0.0025%		1 uV	\$ 965.00	
0-1100 VDC	±0.0025%		1 uV	\$1,195.00	

AC/DC DIFFERENTIAL VOLTMETERS

0-500V AC or DC	±0.05% DC, ±0.2% AC	Infinite at null DC } 1 Meg, 35-50 pf AC }	50 uV	\$ 875.00	+ \$20 for rack models
0-500V AC or DC	±0.02% DC, ±0.1% AC		5 uV	\$1,055.00	
0-500V AC or DC	±0.01% DC, ±0.1% AC		5 uV	\$1,215.00	
0-1100V AC or DC	±0.02% DC, ±0.2% AC	Infinite at null to 10 Meg above 11 VDC } 1 Meg, 40 pf AC }	10 uV	\$ 875.00	+ \$160.00 for rechargeable battery pack
0-1100V AC or DC	±0.005% DC, ±0.1% AC		1 uV	\$1,215.00	
0-1100V AC or DC	±0.0025% DC, ±0.05% AC		1 uV	\$1,375.00	

TRUE RMS DIFFERENTIAL VOLTMETER

0-1100V AC	±0.05% AC	1 Meg, 8 pf with BNC Input	20 ppm of dial setting	\$ 895.00	+ \$ 50.00 for permanent probe
		1 Meg, 5 pf with probe			+ \$100.00 for rechargeable battery pack

State



Circle 15 on reader service card

Just your phone

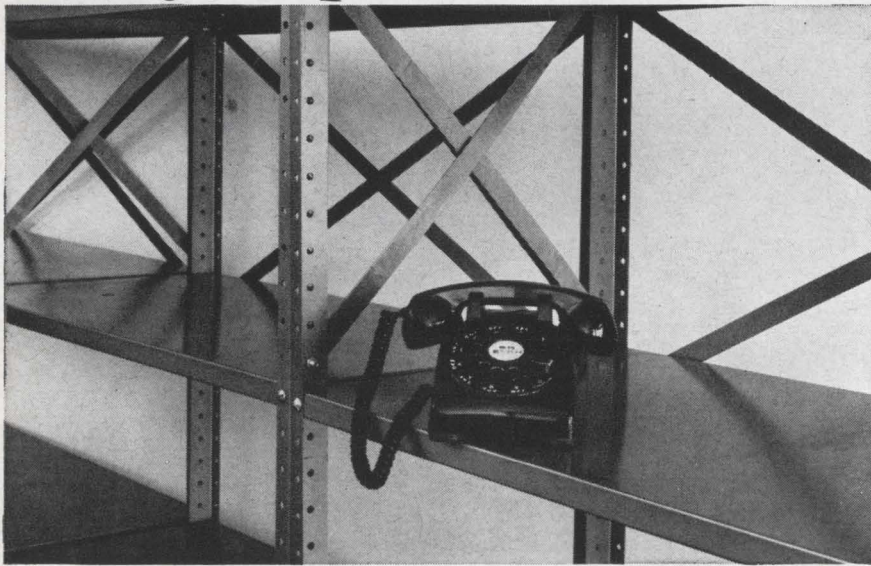

and a Triad catalog



and you have over 1700 transformers in stock.

A TRIAD catalog and your phone gives you instant access to the largest stock of standard transformers. TRIAD distributors are practically everywhere, offering you over 1700 off-the-shelf transformers for immediate delivery. And at factory prices! Your TRIAD distributor will also give you ready technical assistance and application help. The secret is in getting a TRIAD catalog. If your requirements can be met with a standard component, your phone and a TRIAD catalog are two things you shouldn't be without. Triad Distributor Division, 305 North Briant St., Huntington, Indiana.

T Triad Distributor Division
of Litton Industries

Meeting preview

The consumer side

Although surrounded by sessions on communications, computer-aided design, microwaves, and solid state components, the discussions on consumer applications at this year's National Electronics Conference (NEC) promise the most interest. The papers on consumer electronics point to growing use of integrated circuits in radio and tv.

NEC has scheduled 200 technical papers in 45 sessions, running from Oct. 23 to 25 in Chicago's International Amphitheater. Four discussions make up the fourth annual consumer electronics symposium, cosponsored by IEEE groups on electroacoustics, broadcast and television receivers, and electron devices.

Where the action is. Many of the papers in these four sessions cover new IC's for television applications, most of them in thick-film hybrid format. One paper from the Radio Corp. of America's J.A. Dean describes a hybrid IC vertical deflection circuit. The IC uses a transistor multivibrator oscillator combined with a diode-equipped vertical output tube to provide performance and cost advantages in tv sets.

Texas Instruments engineers J.C. Prabhakar and R.L. Weber will describe a thick-film hybrid tv intermediate-frequency video amplifier. The π achievement lies in development of high-Q ferrite inductances compatible with hybrid IC's and in manufacturing techniques which can make the i-f strip self-aligning.

Packed. A thick-film circuit has been combined with electron tubes in a single vacuum envelope designed by General Electric's R.J. Walker and D.M. Wilson. It's called a moduletron. In this approach a tube and its accessory resistances and capacitances are placed in one package. When the tv receiver is designed, only wiring to and from the tube sockets need be considered; grid or cathode resistors, and even coupling capacitors are on the thick-film circuits and plug in with the tube.

Moduletrons could be useful in all but high-voltage sections.



3950
Series

At 1.5 MHz...

How many miles of tape before maintenance?

More miles than with *any* other analog tape recorder.

If down-time and troublesome adjustments continually hamper high-performance operation—check with Hewlett-Packard for your tape systems where maintenance and adjustments are at an absolute minimum.

Approach your recording problems with reliability and worry-free operation. No cooling is required with HP's all-silicon solid-state circuitry—designed to give you the maximum service and long-term reliability before any maintenance is required.

Eliminated: adjustment and realignment when you switch speeds or change from Direct to FM recording... the tape path is cleaned in a matter of seconds; easy field replacement of all assemblies.

The HP 3950 Series typifies the excellent performance of all HP magnetic tape systems: mount tape reels on snap-on hubs, select one of six switchable tape speeds, then record with an unprecedented 30 dB signal-to-noise ratio for full

1.5 MHz bandwidth. (Outstanding specifications are also available in 300 kHz tape systems.)

A great price/performance ratio—that's why Hewlett-Packard is the principal choice for users of IRIG-compatible analog tape recorders and IBM-compatible digital tape units. The 1.5 MHz analog systems start at \$16,550; others even lower.

Want more information? It's as near as your local HP field engineer. Or write Hewlett-Packard, 690 Middlefield Rd., Mountain View, California 94340. Europe: 54 Route des Acacias, Geneva.

42705

HEWLETT  PACKARD
RECORDING SYSTEMS

**Why Astro/348™ won the
high contact density
design competition**

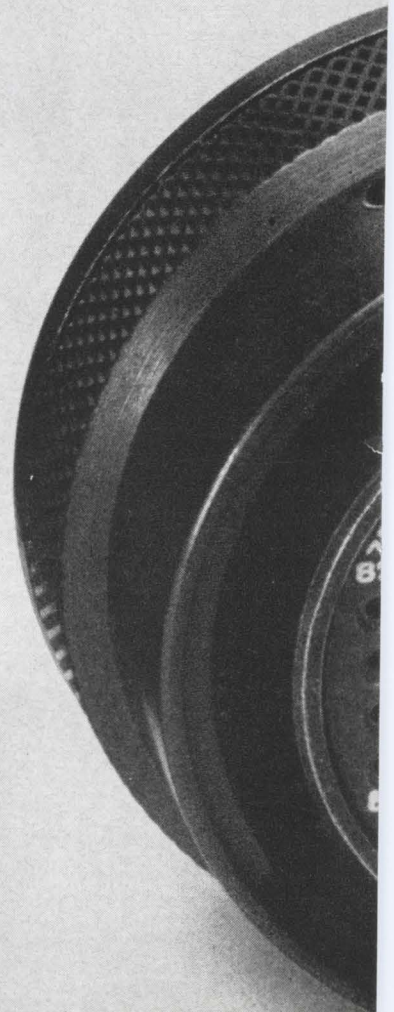
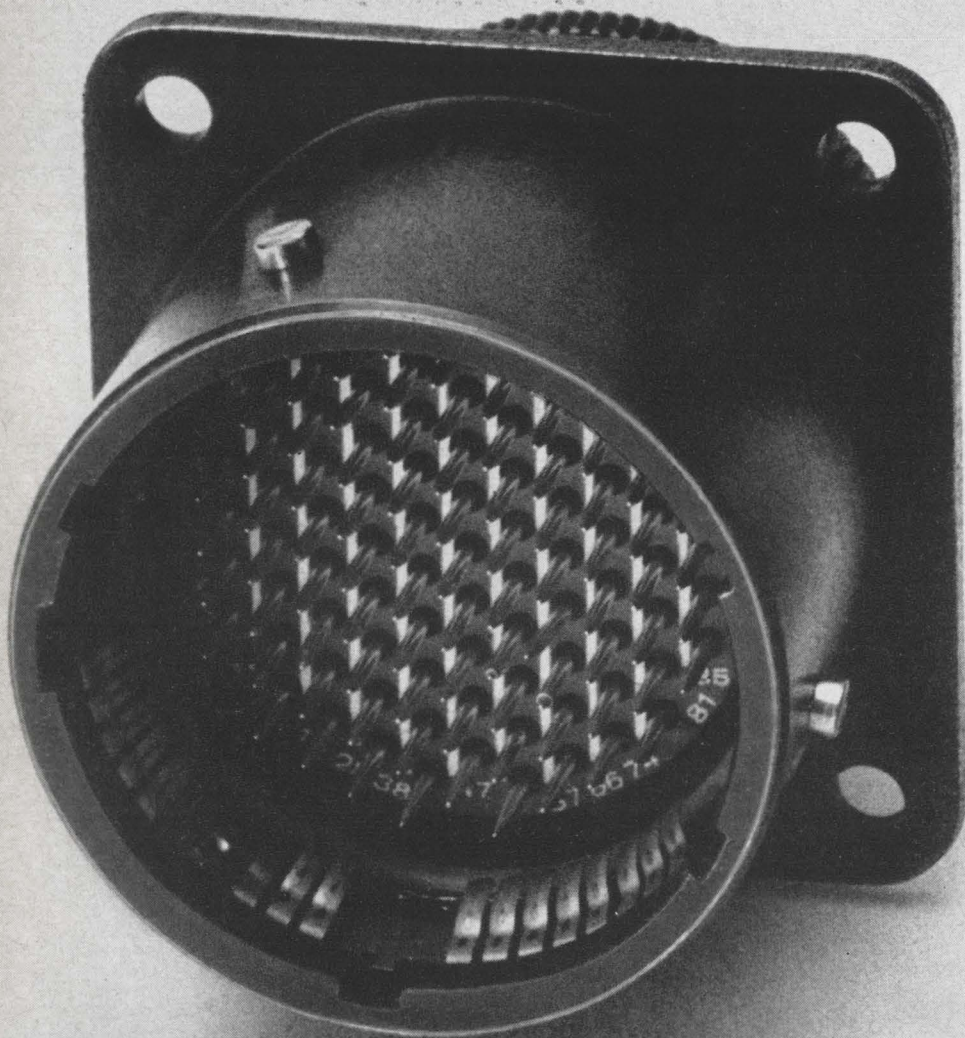

Better features

- One-piece dielectric retention system eliminating metal retention clips.
- Contact dielectric separation of .021 in on .085-in centers, equivalent to existing miniatures with .130-in centers.
- Monoblock construction eliminating air voids between contacts. Wire sealing range of .030 to .054 in.
- Dual environmental mating protection providing interfacial and shell "O" ring seals.
- Damage-proof mating. Pins recessed beyond reach of shells. Closed entry hard socket inserts, prod-proof socket contacts.
- Grounding springs that mate prior to electrical engagement. Shielding for EMI/RFI protection.
- Front release, rear serviceable crimp contacts.
- Front or rear mounted receptacles on 1/8" panels.

A complete family (6 shell styles, 4 to 85 contacts) is now being qualified to MIL-C-81511 (Navy).

Ask an Amphenol sales engineer about Astro/348. Or write Amphenol Connector Division, 1830 S. 54th Ave., Chicago, Ill. 60650.

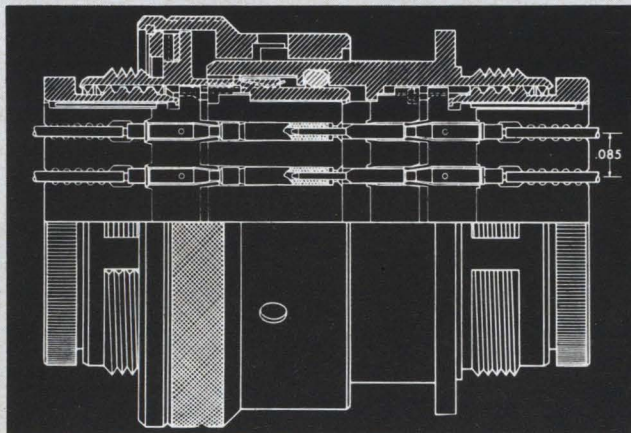

AMPHENOL



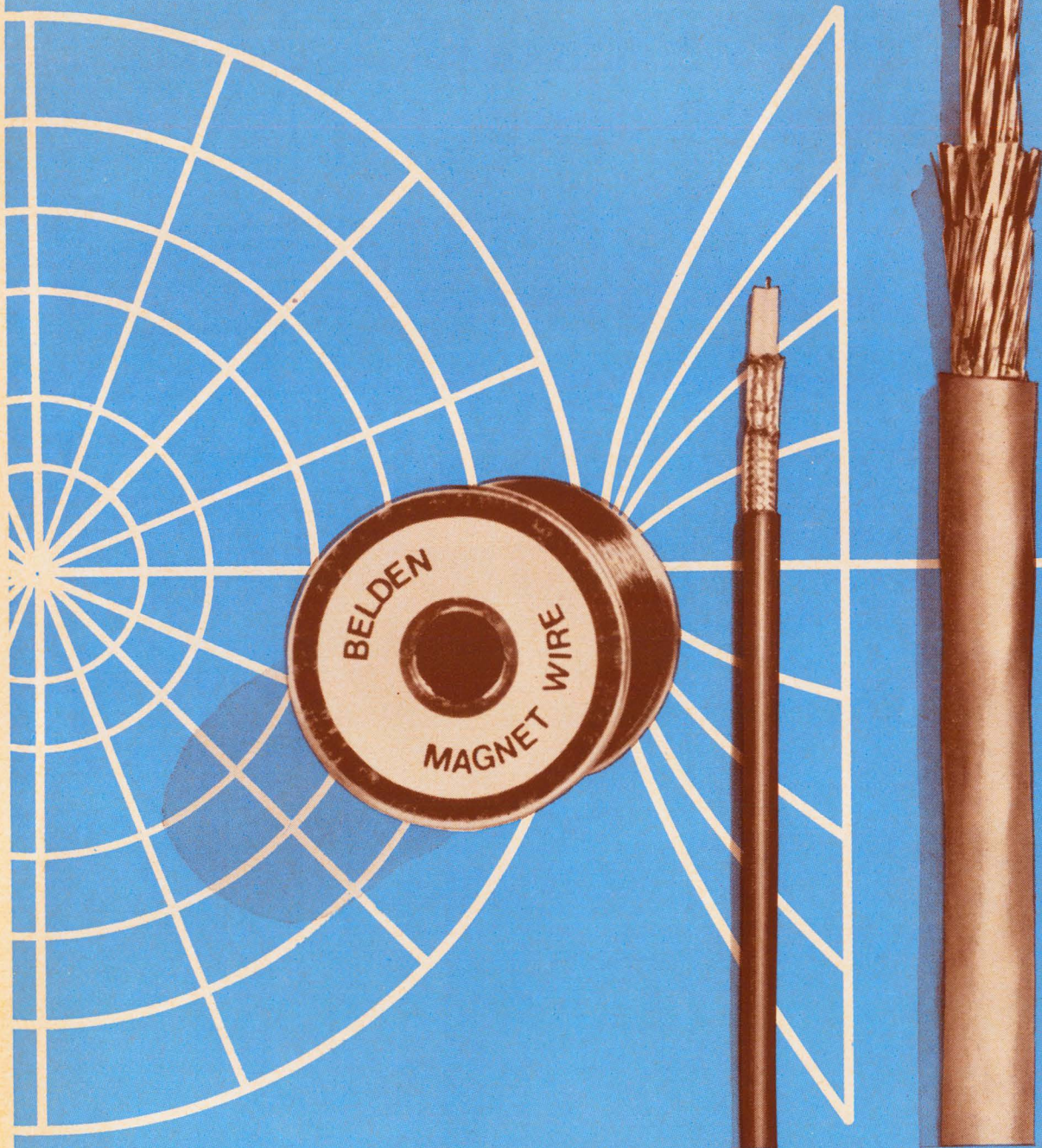

Belden's Wire Specialists know that as systems become more exotic and their functions more difficult, wire becomes more important. Wire carries the messages...conveys the power...links components into true systems. And they know that wire can make a big difference in how well the completed product operates. They know that by prescribing the right wire or cable to

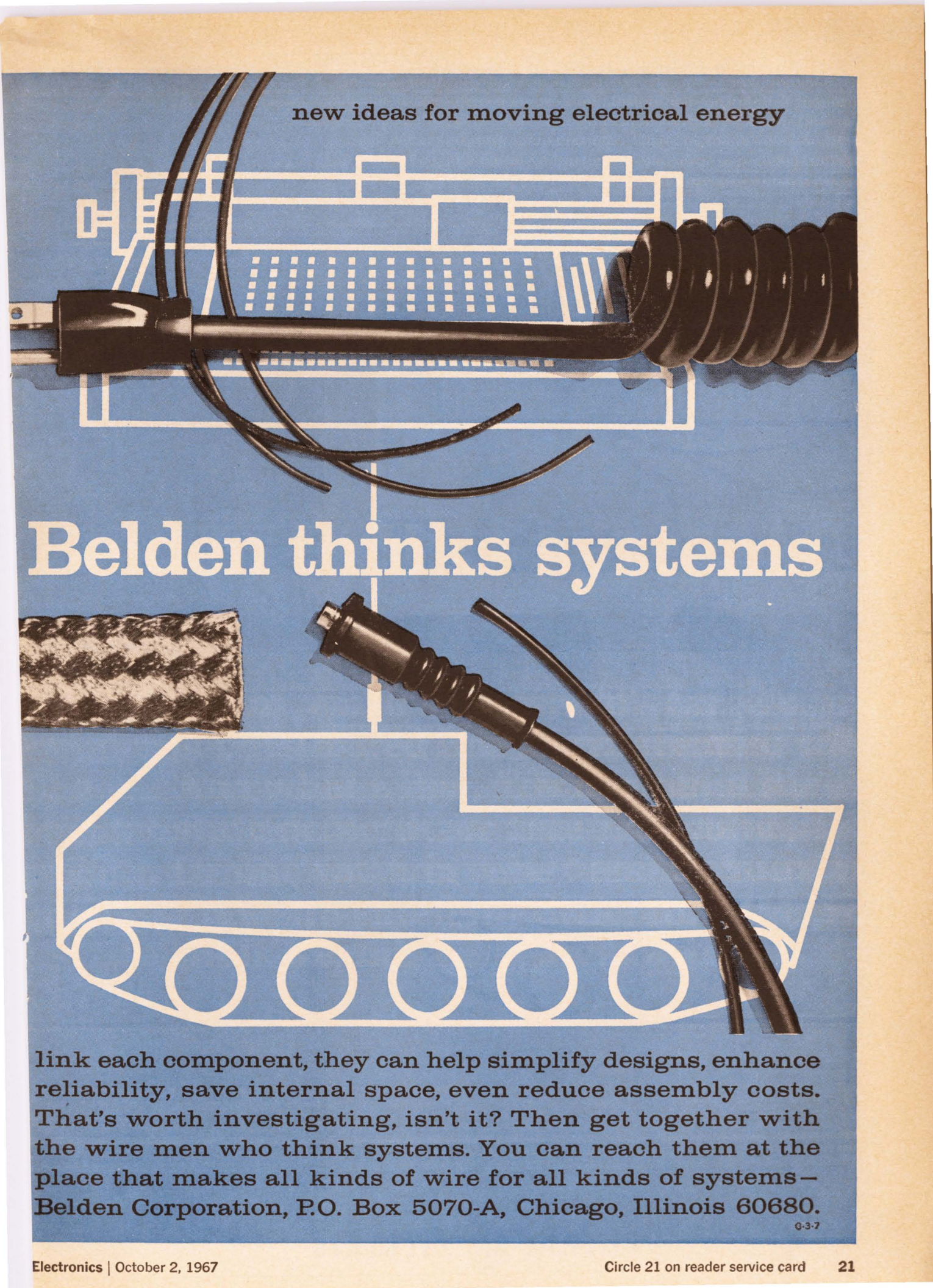

new ideas for moving electrical energy

Belden thinks systems

link each component, they can help simplify designs, enhance reliability, save internal space, even reduce assembly costs. That's worth investigating, isn't it? Then get together with the wire men who think systems. You can reach them at the place that makes all kinds of wire for all kinds of systems—Belden Corporation, P.O. Box 5070-A, Chicago, Illinois 60680.

G-3-7



COMPONENT CAPSULES

New low-cost triode
for airborne
oscillators and amplifiers

We designed it specifically for the 1090 megahertz master-oscillator power amplifier function in the AIMS APX-72 tri-service IFF-ATC transponder. But it's also a natural for new tunable DME designs and/or for broadband amplifiers in the 1025-1150 megahertz range. It easily meets all their size, weight, shock and cost requirements. You can depend on Y-1537's to operate at power levels well above the specified minimum of 500 watts. **Circle Number 90.**

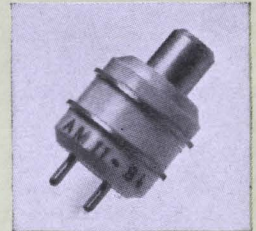

Actual size GE Y-1537 planar ceramic triode

And another
GE transistor line
goes epoxy.
Result: Cost savings
up to 50%

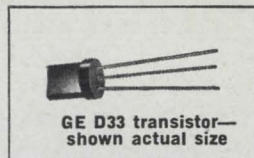

GE D33 transistor—
shown actual size

No loss in performance. No change in electrical characteristics. Latest group to make the switch is our GE line designed for high grade and critical, industrial and military applications. Several series choices, too. Among them: the D33A general purpose amplifier; D33B (2N3973-76, 2N4951-54) medium current, general purpose switch/amplifier/driver; D33D high gain driver; D33E (2N3605-07, 05A, 06A) high speed digital switch; D33G (2N5029, 30) low current, high speed digital switch; D33K high current core driver and medium current, high speed switch; and D33L low voltage, very high speed switch. Seen our latest epoxy transistor reliability story? Order a copy now. **Circle Number 91.**

150-grid relays
now rated 2 amps . . .
now come in 4 forms

That's right. We've doubled our 150-grid relays' current ratings from 1 amp to 2. And now there are four forms to choose from—the 2 Form C, 4 Form C, 4 Form C AND logic, and the 50 mW 1 Form C (or 1A + 1B). All 150-grid relays are just 0.32" high. Take advantage of the space-saving size and get performance as good or better than much larger mil spec relays. **Circle Number 92.**

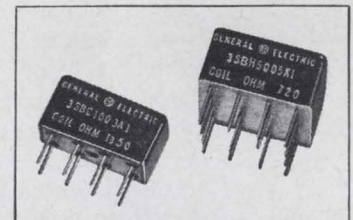

Actual size

Proved:
In-circuit reliability
for military uses

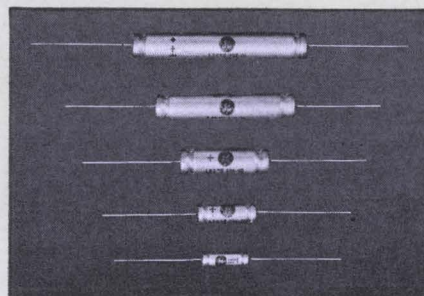

GE tantalum capacitors

More than 20 million GE tantalum foil capacitors have already been applied. They are designed to withstand unsuspected voltage reversals and are self-healing. Low impedance circuits or catastrophic failures are no problem with GE tantalum foils. Ratings are available up to 450VDC, 0.15 to 3500 μ f —55C to 85C, or 125C with voltage derating. For all the facts on these capacitors, **Circle Number 93.**

WE MAY NOT OFFER EVERYTHING YOU WANT FROM ONE COMPONENTS SUPPLIER. BUT WE DO COME A LITTLE CLOSER THAN ANYONE ELSE.

GENERAL  ELECTRIC

Editorials

A lamentable decision . . .

The U.S. decision to build an antiballistic missile defense system, which will cost about \$5 billion even though it will be just a thin one, raises mixed emotions. On the one hand, it is joyful economic news for the companies that will participate in the production [page 146]. But on the other, it smacks of great waste because so many engineers believe the current Nike X system is technologically obsolete.

Among electronics firms, the news of production of the ABM system will mean the most to semiconductor companies. The giant computers that will steer the phased array radars onto incoming missiles demand mountains of discrete transistors. And so far in 1967, it is the discrete segment of the semiconductor business that has performed the least brilliantly.

Instrument companies, particularly those that make devices that work in the microwave region, will also enjoy some additional business as production of the ABM system starts.

Still, even with these apparently pleasing prospects, Electronics believes it is unfortunate that the present system has been ordered into production. Despite protestations to the contrary by Defense Secretary Robert McNamara, the decision was a political one. The Administration, already facing a hostile Congress, moved to head off more Congressional agitation and hostility that could be embarrassing during the election year.

Our objections are technical ones. Although the ABM problem has stimulated development of phased array radar techniques, the current system is still a Model-T because it's really the first big one that's been designed. Engineers are just on the verge of making great developmental strides in phased array radar; they are close to understanding much of the theory. Nike X in contrast, is a brute-force way to switch an antenna electronically.

To us, it makes far more sense to take the millions that will go into Nike X this fiscal year and spend them to improve phased array techniques and to convert the Nike-X computers to LSI circuitry. If the government were to put its \$175 million, not spent from previous years, into development of bulk-effect generators, theoretical studies of control circuits, and phase relations, and antenna radiator designs, not only would the military have a better Nike-X system in 24 months, but the fall-out into other military projects and the rest of the civilian economy would be awesome.

. . . And one to be applauded

It there can be no lament about President Johnson's decision to ask the Department of Transportation to build a better, more efficient air traffic control system. The President's request for \$7 million to start the project

is a symbol, a drop in the bucket of what such a system will eventually cost. What is important is the President's personal involvement in the project. It comes as a result of an increasing awareness in high Government circles that the Federal Aviation Administration is floundering in its job of assuring air safety. [July 24, p. 141 and Aug. 7, p. 23].

Stung by criticism of its avoidance of technology, this summer, the agency has tried to offset the barbs with a giant public relations campaign: posters are appearing in airports and puff stories are showing up in newspapers depicting Administrator William McKee as Sir Launcelot fiercely attacking the Black Knights who stingily dole out budget appropriations. In reality, McKee admitted to a Congressional committee this summer that he has done little fighting with budget cutters and even defended cuts in the agency's budget, prompting one Congressman to chastise him for sounding more like the director of the Bureau of the Budget than the administrator of the FAA.

President Johnson's move will be only lip service unless the Transportation Department is courageous enough to insist on the following:

- A tough, but honest, investigation of the current system of time separation, which is fundamental in air traffic control today;
- An open-minded examination of all other possible approaches;
- An impartial technical evaluation of the Beacon System planned for the National Air Space System, and recognition that any system that excludes 97% of the traffic is asinine;
- A concentrated effort to mechanize the controllers' work using the full advantages of computer and communications technology, instead of a one-for-one mechanization of the current procedures;
- A long-term solution to the problem of terminal control with a system that can have a new technology imposed upon it without destroying it;
- Short-term aids for the controllers—like 3-D radar at heavily trafficked terminals. Despite FAA insistence that 3-D radar cannot be used for air traffic control, the U.S. Navy is using it successfully at Saigon Airport, one of the world's busiest these days. The Navy could give the FAA reliability, accuracy, and operational data if the FAA would only listen.
- Give the job of developing an effective air traffic control system to some other section of the Department of Transportation so that the moribund and technically backward management of the FAA cannot torpedo new ideas;
- Or, restaff the management of the FAA with energetic men who understand technology and are willing to listen to outside experts.

The biggest and toughest job in improving the air traffic control system will be changing the negative attitude of the Federal Aviation Administration. For the President has given the FAA a stupefying alternative: to delay traffic. The current FAA could easily be seen shutting down the airways rather than changing its pet concepts.

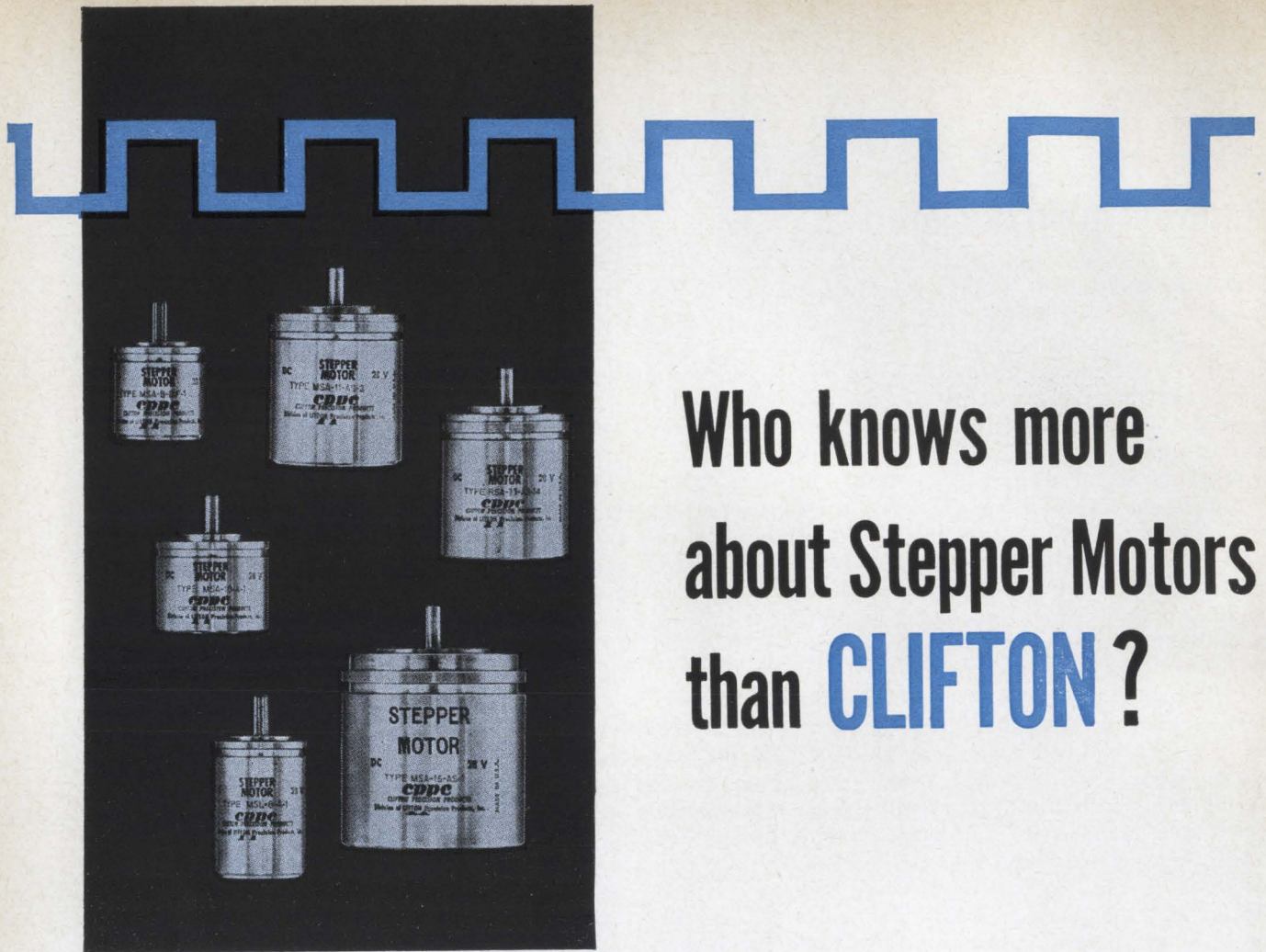

Who knows more about Stepper Motors than **CLIFTON**?

CLIFTON STEPPER MOTORS TYPICAL CHARACTERISTICS

SIZE	8	8	8	10	11	11	11	15
Length (M.F.)	1.112	0.770	0.770	0.770	1.215	1.215	1.215	1.535
Weight (oz.)	1.5	1.0	1.0	1.6	3.2	3.2	3.2	7.2
Inertia (gm-cm ²)	0.45	0.19	0.19	0.19	0.77	0.77	0.60	2.4
Index Angle	90°±3°	90°±3°	45°±2°	90°±3°	90°±3°	45°±2°	15°±1°	90°±3°
Type	PM 2Ø	PM 2Ø	PM 2Ø	PM 2Ø	PM 2Ø	PM 2Ø	VR 3Ø	PM 2Ø
Rate DC Volt	28v	28v	28v	28v	28v	28v	28v	28v
Resistance (Ohms/Phase)	300	300	135	300	300	130	150	150
No Load Response Rate Pulse/Sec.	250	220	580	300	185	490	500	150
No Load Slew Rate Pulse/Sec.	320	750	1800	750	235	750	1000	160
Holding Torque Oz-In One Phase	0.75	0.30	0.50	0.35	1.0	1.8	1.0	3.2
Detent Oz-In Zero Input	0.13	0.05	0.05	0.05	0.25	0.30	—	0.40
Type Number	MSL-8-A-1	MSA-8-A-1	MSA-8-A-3	MSA-10-A-1	MSA-11-AS-1	MSA-11-AS-2	RSA-11-AS-14	MSA-15-AS-1

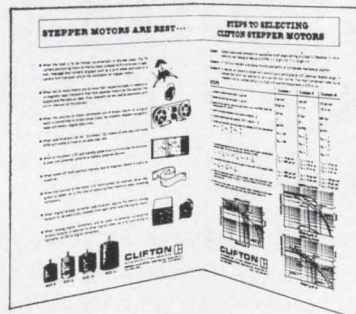

At Clifton, you will find not only an exceedingly wide variety of permanent magnet and variable reluctance sizes and types, but the application know-how that goes with them!

Our Stepper Motor Brochure entitled "Stepper Motors Are Best When . . ." tells

not only when to use stepper motors, but how to select the Clifton motor for your particular application.

Stepper motors should not be considered apart from the logic and pulse source modules which control them. Clifton designs and manufactures controllers for use with all Clifton stepper motors (PM or VR). Thus, you can have single source responsibility in your system.

Inquire today for further information and a copy of our Stepper Motor Brochure. Clifton Div. of Litton Industries, Clifton Heights, Pa. 19018; 215 622-1000; TWX 510 669-8217.

CLIFTON 
DIVISION OF LITTON INDUSTRIES

Electronics Newsletter

October 2, 1967

Fairchild challenged by TI for IC lead

Texas Instruments, second largest producer of integrated circuits, is gaining fast on the leader, Fairchild Semiconductor, and threatens to pull nearly even.

So far this year, TI's sales have climbed more than 60% from year-earlier levels, while Fairchild has had a rise of slightly over 40%. If these gain rates are maintained through the year, each firm will close 1967 with IC sales around the \$60 million mark, but with Fairchild still ahead by a narrow margin of about \$3 million. Fairchild's lead over TI last year was estimated at up to \$10 million.

Bipolar and MOS teamed in op amp

Fairchild Semiconductor, determined to maintain its lead in linear integrated circuits, will soon introduce a new monolithic operational amplifier. Company sources say the new device is superior to any existing IC product on the market. The IC contains both bipolar and metal oxide semiconductor elements, with the MOS-FET's used for the input stage.

Behind the development: linear IC sales, spearheaded by operational amplifiers, have grown large enough to support a higher-priced device; all bipolar IC's are now near their theoretical limits; competitive op amps are beginning to chip away at sales of 700-series circuits, and Fairchild finds it uneconomical to develop only slightly better circuits.

The new unit will have, among other things, higher input impedance and less drift. Fairchild hopes to introduce the item before year's end. Rivals, such as Motorola, Westinghouse, and Philco-Ford, are also working on the MOS-bipolar combination, but are further behind.

Bulova is working on IC wristwatch

Bulova is working on an IC-equipped electronic watch. Development of the thin-film hybrid integrated circuits for the watch was done at Aerojet-General's Von Karman Center, Azusa, Calif. Bulova's aim is to replace the large tuning fork in their Accutron electronic watch with a smaller electronic oscillator suitable for ladies' wristwatches.

Although Bulova, probably for competitive reasons, denies plans for an IC watch, Aerojet sources say the watch company asked for price quotes on production quantities. Aerojet declined to bid, according to sources, because it was busy producing microelectronics for its own systems.

Monsanto readying process-control instrumentation line

Monsanto, a chemical-industry giant, is planning to market its own line of process-control instrumentation. The move is significant since it combines the firm's heavy process-control applications experience with its in-house electronics instrumentation development capability.

An engineering team from Monsanto's Central Research and Central Engineering divisions—including engineers newly hired from instrument companies—is setting up a product and marketing plan.

First major product will be an electronic analog controller with a digital tie-in, insiders say. The controller will use integrated circuits and will be connected, via a digital multiplexer and programing link, to a cathode-ray tube readout. The system will display—in either alphanumeric or graphic form—normal process operation. In addition, the operator has the option of calling out any process information he wishes.

Electronics Newsletter

Tape recorder snags space data link

The Air Force's Advanced Space-Ground Link Subsystem (ASGLS) may be a bit too advanced. Requests sent out in late August for industry proposals on the tape-recorder portion of the 20-million-bit-per-second data link [Electronics, April 3, p. 65] for such sophisticated systems as the Manned Orbiting Laboratory and Program 949—the top-secret integrated reconnaissance satellite—have so far drawn only “no bids.” The 20-megabit requirement, it's suggested, is beyond the state of the tape-recorder art.

An industry observer maintains that 2 million bits per second is the present available maximum rate, though Air Force researchers say they've come up with a combination of systems to handle the required data recording. However, an Air Force spokesman concedes that the tape-recorder portion of the ASGLS “remains to be engineered,” and adds that because of engineering difficulties, the firm that wins the contract may not make any money on it.

More electronics, news firms team up to sell stock data

The teaming up of news-gathering organizations and electronics firms to offer information services to brokerage houses, financial institutions, and industry continues.

Last week, Trans-Lux Corp., which provides large, overhead displays of stock prices, introduced, with CBS Laboratories, a service that presents stock data on television screens. Also last week, Reuters, a London-based worldwide wire service, announced that by the first of next year it will join Ultronic Inc., a subsidiary of Sylvania Electric Products, to market a financial news service throughout the U. S. Ultronic, which offers stock information displays and inquiry services worldwide [Electronics, Aug. 21, p. 137], will transmit the Reuters-Ultronic Report over 100-word-per-minute teleprinter lines and display it on its newly developed television monitors. The report will compete with the Dow-Jones news service.

TI gets new look: market-oriented organization

As expected, a complete reorganization, shifting the company from a product-oriented to a market-oriented organization, has been undertaken at Texas Instruments [Electronics, Aug. 21, p. 25]. The aim is to pave the way for products using large-scale integrated circuits, avoid intra-company product competition, and ease customer interface problem. TI recently set up its microwave department along this line.

The new company-wide structure consists of three groups and 10 operating divisions. The new groups are headed by J. Fred Bucy (components), R.C. Dunlap Jr. (equipment), and E.O. Vetter (materials and services).

Desk-top calculator has floating point

A small nuclear instrumentation firm has developed a desk-top calculator with a floating-point capability and a new calculating algorithm that boost the machine's speed by a factor of 3,000 over conventional machines. The company, Nanosecond Systems Inc. of Fairfield, Conn., which also produces high-speed counters, plans to introduce the machine shortly. The algorithm was an outgrowth of the firm's nuclear instrumentation work.

Because the unit's output, on adding-machine tape, has to be printed with a conventional mechanism, its speed is of no advantage except in iterative calculations, in which an operation is repeated many times before the printer is activated.



Don't risk it!

These wires were subjected to a transient current overload in a normal atmosphere. The insulation smoked, then burst into flame. This won't happen with insulation of Du Pont TEFLON® fluorocarbon resins.

TEFLON will not propagate flame. It is *nonflammable*... by all recognized vertical and horizontal flame tests. The point is simply this: for proven reliability you need the combined benefits offered *only* by TEFLON. Nonflammability is just one. Among others: • *TEFLON is rated for continuous use from -450°F. to +500°F. (TFE)* • *Inert to virtually all chemicals and corrosives* • *Provides space and weight savings without sacrificing performance or long-term reliability.*

It comes as no surprise, then, that when reliability is considered, TEFLON answers the need. Its reliability has been proven in use for more than 20 years.

We'd like to send you detailed performance data on nonflammability. Write Du Pont Company, Room 5365, Wilmington, Del. 19898. **TEFLON®...for an extra measure of reliability!**



Better things for better living
...through chemistry

20 AMPS
10 AMPS

2 OZ.

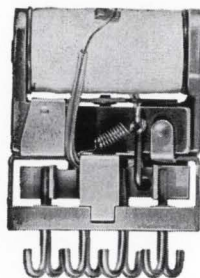

DPDT

+ 25,000 OPERATIONS
+ 100,000 OPERATIONS

The rugged Hi-G "T" Series of 10 amp. crystal can relays meet all applicable requirements of Mil-R-5757. Testing has proved more than 25,000 operations typical at 20 amps. They match or out-spec. other 10 amp. DPDT crystal can relays and are priced competitively or lower. Case size: 1.234" x 1.025" x .515". All standard configurations and header styles are available for fast delivery.

Write or call Hi-G for bulletin which provides full details on this high quality line of 10 amp. crystal can relays. Test data and performance capabilities are available on request. Tel: 203-623-2481.

Hi
G
INCORPORATED

SPRING STREET & ROUTE 75 / WINDSOR LOCKS, CONNECTICUT 06096

From Monsanto: 130,000,000 discrete frequencies with almost perfect purity.



Computer-aided design and integrated-circuit construction in this new Frequency Synthesizer bring a new level of perfection to signal generation.

The new "4th generation" Model 3100A Digital Frequency Synthesizer obsoletes just about every current concept of general purpose signal sources. Pick your frequency from 0.01 Hz to 1.3 MHz in 0.01 Hz steps. The result — signal purity you can get only from Monsanto, with a stability of 1 part in 10^9 / day. Other refinements include: internally supplied rapid or slow sweep and provision for

external sweep; dc coupled output permitting internally supplied offset; continuous control of output level over a 90 dB range; provision for amplitude modulation; and, in the remotely programmable version, switching time of less than 20 microseconds. Best of all, you can put this *better way* of signal generation to work for you for only \$3,950*. Call our field engineering representative in your area for full

technical details, or contact us directly at: Monsanto Electronics Technical Ctr., 620 Passaic Ave., W. Caldwell, N.J. 07006. Ph. (201) 228-3800; TWX 710-734-4334.

*U. S. Price, FOB West Caldwell, N. J.



ELECTRONICS

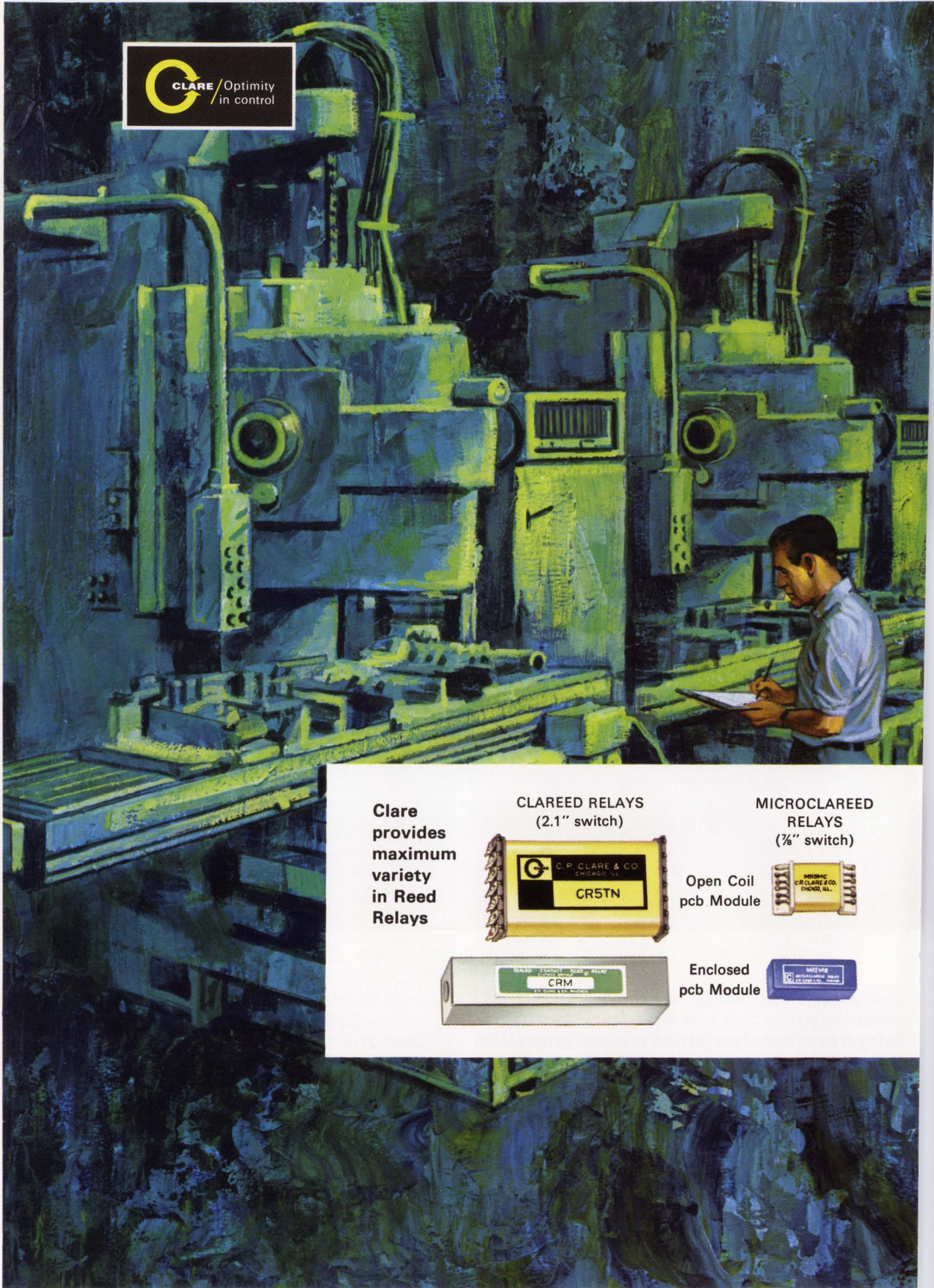

Clare provides maximum variety in Reed Relays

CLAREED RELAYS
(2.1" switch)



MICROCLAREED RELAYS
(7/8" switch)



Open Coil
pcb Module



Enclosed
pcb Module



handles them all ...large and small,

matches design versatility to the speed, reliability and long life demands of industrial process control systems !

CLAREED and MicroClareed Sealed-Contact Reed Relays are fast—speeds in the low millisecond range serve advanced system requirements. And no matter what's around them, there's virtually no falsing, no sequence disruption—these relays are insensitive to transient electrical noise !

Sealed-in-glass contacts never need adjustment, stay clean whatever the location. Use 'em singly or in combinations up to 12 contacts, for switching millivolt low level signals or up to 15 va (ac or dc) loads. Count on long service, up to 100 million operations at full rated loads, in pcb applications and wired assemblies.

Send for full facts. Circle Reader Service Number, or ask Clare for Clareed Bulletin 951A, and MicroClareed Data Sheet 961...write Group 10N4,

C. P. Clare & Co., Chicago, Illinois 60645

Four Different Switches

2.1"—General Purpose,
Mercury-Wetted,
High Voltage
(available in models illustrated, and in plug-in and solder-type for wired chassis)

7/8"—MicroClareed

- Switching speeds in low millisecond range
- Immunity to transient electrical noise
- Life: 20×10^9 or 100×10^6 (depending on switch)
- 1 to 12 contacts—Clareed
1 to 5 contacts—MicroClareed
- Complete input/output isolation

CLAREED® SEALED-CONTACT REED RELAYS

for industrial control, data logging and instrumentation, communication switching, ground control and check-out systems

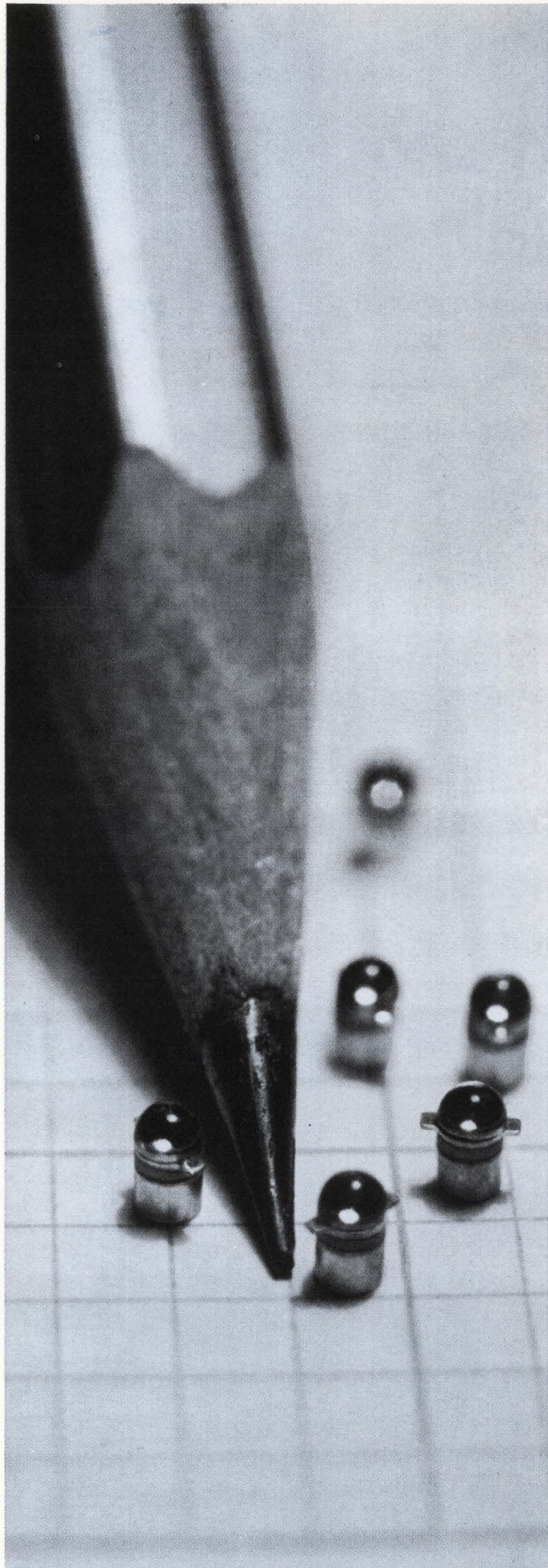

FAST, EFFICIENT OPTOELECTRONIC SOURCES, DETECTORS...

GaAs source, PIN photodiode

Rugged, compact

Proven reliability

Economy priced

...from HPA

Get optimum performance and design flexibility in the HPA 4107 gallium arsenide infrared source and the fast 4205 photodiode. Both are in identical compact pill packages.

The 4107 delivers a narrow, high-intensity beam when forward biased. The 4205 is a fast detector, DC to 1 GHz, with high sensitivity, stability, and low noise characteristics. Together, these solid-state devices offer unexcelled performance for a broad range of high-speed applications. Quantity price discounts.

For information call your local HP field engineer or write HP Associates, 620 Page Mill Road, Palo Alto, California 94304.

Specifications 4107

Total Output Power P	Modulation Rise Time	Price
100 μ W	100 nsec	\$21 (1-9) 18 (10-99)

Specifications 4205

Response at 7700Å	Sensitive Area	Speed of Response	Dark Current	Price
1.5 μ A/ mW/cm ²	3.0x10 ⁻³ cm ²	<1 nsec	150 pA(max)	\$16.00(1-9) 13.60(10-99)

**HEWLETT
PACKARD**  **HP
ASSOCIATES**

01706

Maybe it seems so.

In our thrifty, Scottish way, we've brought out a Honeywell taut-band meter that costs even less than a pivot-and-jewel meter. (About 10% less, on the average.)

Does that make you think we might be short-changing you? We're not: We left all the unnecessary parts out of our taut-band meter. (Fewer parts: fewer things to go wrong.)

It's simple. Which is the whole idea.

It's self-shielded.

There's no friction in its moving parts. Which gives you better readout accuracy, better repeatability.

And it comes in just about any style you'd like.

Obviously, the low-cost taut-band meter from Honeywell has a brilliant future ahead of it.

But the question is: Will it ever replace the pivot-and-jewel meter?

We doubt it. We believe there are some sensitivities and applications that will always be

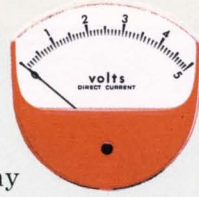

handled best by our good, old pivot-and-jewel meter.

But if you like the idea of our low-cost taut-band meter, by all means write us for our brochure. It'll tell you all the sizes, styles and prices.

Honeywell Precision Meter Division, Manchester, N.H. 03105.

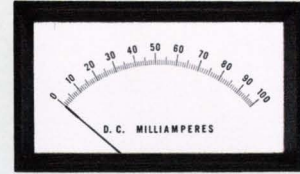

Honeywell

Is the pivot-and-jewel meter going out of the picture?

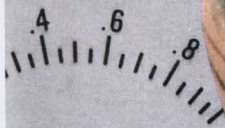

MILLIAMPERES

Satellite communications transmitters can now operate broad band using MEC's high power, high efficiency TWT, the M4444. This tube delivers more than 12 kilowatts of c.w. power from 7.7 to 8.4 GHz at efficiencies greater than 35%. For the first time, a TWT matches klystron efficiency while providing 14 times the instantaneous bandwidth!

The metal-ceramic construction of the M4444 permits high temperature processing, and its integral ion pump and low cathode current density assure stable, long lived dependability.

A single stage depressed collector minimizes power supply complexity, and broad band operation is obtained at constant beam voltage.

Complete gain, phase shift, intermodulation, power and electrical characteristics are available for the asking. Our technical staff will be pleased to fill in the details on the M4444 or its counterparts in other frequency ranges.

The M4444 is one more example of MEC being first with the best in high power TWTs.



A new dimension in satellite communications



MICROWAVE ELECTRONICS

A TELEDYNE COMPANY

3165 Porter Drive • Palo Alto, California 94304

Smallest 4-pole relays to qualify for U/L Component Recognition Program

P&B Quality, too!



only
1.281" x 1.109" x .859"

Meet our new KHU relays... companions to our KHP series

These new 4-pole relays have an extraordinary combination of features. Small size (only slightly larger than one cubic inch), 4-poles, exceptional electrical stability over a long life, a wide choice of mountings... all of these and Underwriters' recognition, too. Spacings provided are 1/16" through either air or over the surface and are maintained between any uninsulated live part of opposite polarity or grounded part, including the grounded frame.

Switch four circuits from low level to 3 amps

The KHU, available in both AC and DC versions, has gold flashed silver contacts rated 3 amps 120V AC (80% PF), 3 amps 28V DC (resistive), and 1/10HP 120V AC (40-50%PF). Coil ratings are to 120V 60Hz, and to 120V DC.

Minimum power requirement for AC relays is 0.55 volt amperes at 25°C. DC relays will operate on only 0.5 watts at 25°C. Expected mechanical life is exceptionally great; 100 million cycles for DC relays; 50 million for AC relays.

Variety of mountings

The relay has pierced solder terminals with a No. 3-48 mounting stud. Three sockets are available, two having solder terminals and one having printed circuit tabs. Each is acceptable for mounting under U/L File No. E22575 when the combination is found suitable by Underwriters' Laboratories.

Send for complete specifications or contact your local P&B representative or the factory direct for complete information.

P&B STANDARD RELAYS ARE AVAILABLE AT LEADING ELECTRONIC PARTS DISTRIBUTORS



POTTER & BRUMFIELD

Division of American Machine & Foundry Company, Princeton, Ind. 47570
Export: AMF International, 261 Madison Avenue, New York, N. Y. 10016



CONTROL KNOBS FROM RAYTHEON

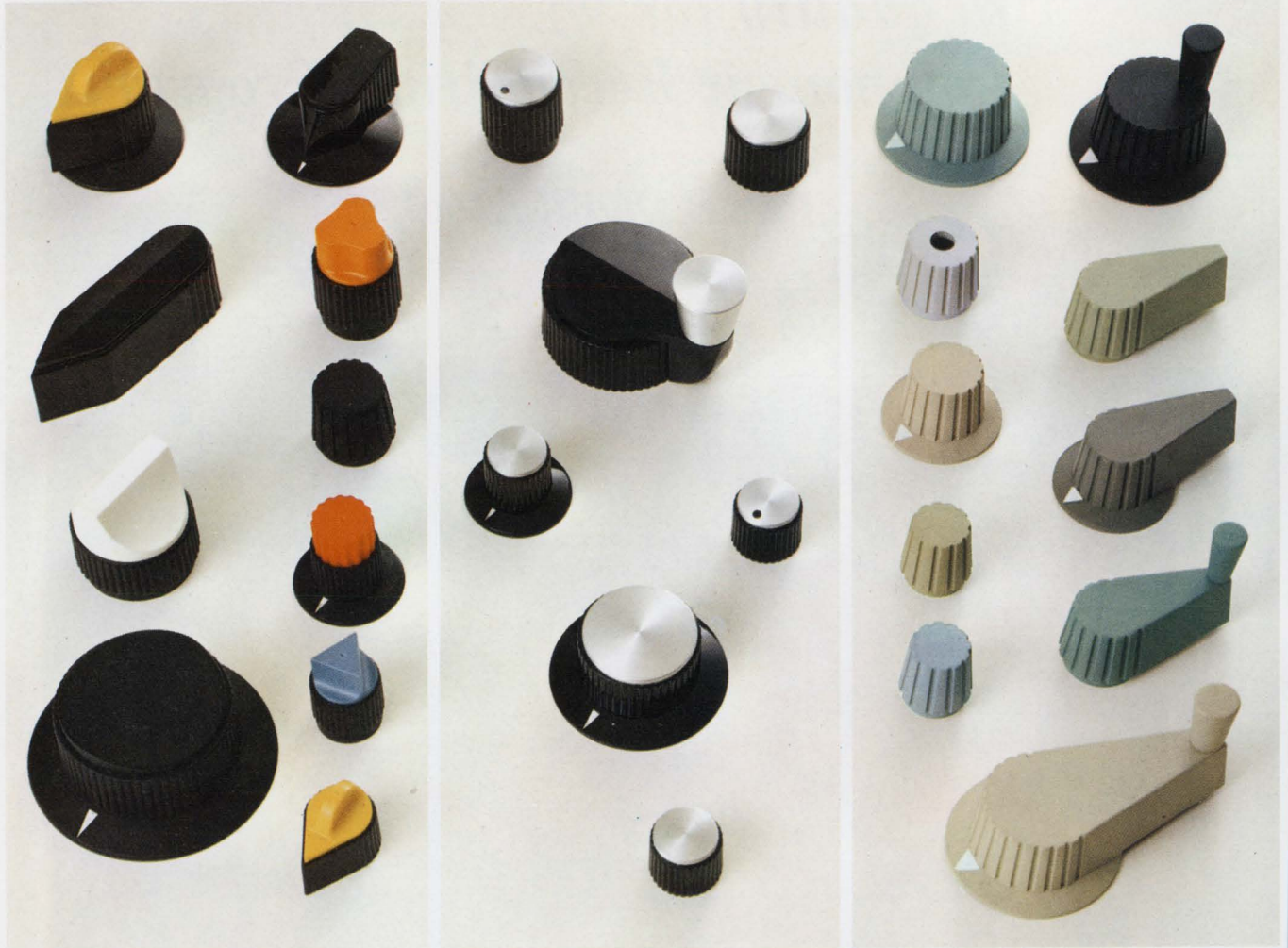

Military knobs, aluminum cap knobs, color knobs for every panel requirement

You can meet military specs, select styles and colors that harmonize or contrast with any panel design and decor — when you specify Raytheon control knobs.

Because, Raytheon offers the largest selection of military and commercial knobs. And *makes them promptly available to you through distributors from coast to coast.*

Meet MS91528C Military Specifications from more than 300 standard types. Raytheon has custom designed over 2,000 "specials."

Every knob in the Standard Series is functionally designed. All styles have an integrated design to give uniformity to your panel. And each knob meets MS91528C for resistance to flame, torque, temperature and humidity extremes, salt spray and

ultraviolet radiation. Colors include black, red, gray or to your special order.

Or, specify aluminum-cap knobs. These handsome knobs are made of strong plastic with satin finish aluminum caps. Raytheon aluminum caps are treated with an epoxy coating for corrosion resistance. Colors: black, gray, or to your order.

Color knobs highlight panels. Choose from eight colors plus black — in ten styles — to harmonize or contrast with commercial equipment design. Raytheon makes these 400 Series Knobs of durable high-impact ABS.

Call your distributor or nearest Raytheon regional sales office for catalogs and data sheets. Or, circle the reader service card. *Raytheon Company, Components Division, Quincy, Mass. 02169.*

Industrial Components Operation—A single source for Circuit Modules/Control Knobs/Display Devices/Filters/Hybrid Thick-Film Circuits/Industrial Tubes/Optoelectronic Devices/Panel Hardware

RAYTHEON



Some people can make anything with Signetics' linear integrated circuits.

Like this FM receiver our friend put together. Its IF strip is made up of Signetics' new 510 Dual RF/IF Amplifiers. It will never win a prize for either industrial or electronic design—but then, it wasn't intended to. Does it work? We had it running continuously during the recent WESCON show. Our booth traffic indicator says that some 20,000 engineers saw it, heard it, and thought it sounded pretty good. We know that lots of them can design a better receiver with the same parts. That's their business. Ours is making integrated circuits.

Want to know more about the Signetics' 510 Dual RF/IF Amplifier? Send for a data sheet and a reprint of Ralph

Seymour's WESCON paper on its design and applications.

Want to know more about Signetics' other new linear IC's—the 515 Differential Amplifier and 516 Operational Amplifier—or about the field-proven 501 Video Amplifier and 518 Voltage Comparator? Just ask. We'll get data sheets and application notes to you...fast.

**SIGNETICS
INTEGRATED
CIRCUITS**



A SUBSIDIARY OF CORNING GLASS WORKS

SIGNETICS SALES OFFICES: Metropolitan New York (201) 992-3980; Upper New York State (315) 469-1072; Southwestern (214) 231-6344; Western Regional (213) 272-9421; Eastern Regional (617) 245-8200; Mid-Atlantic (609) 858-2864; Southeastern (813) 726-3734; Midwestern Regional (312) 259-8300; Northwestern (408) 738-2710.

DISTRIBUTORS: Compar at all locations listed below. Semiconductor Specialists, Inc. (312) 279-1000; Terminal Hudson Electronics (212) 243-5200; Wesco Electronics (213) 684-0880; Wesco Electronics (405) 968-3475; Hammond Electronics (305) 241-6601; Avnet Electronics Corp. of Massachusetts (617) 272-3060.

DOMESTIC REPRESENTATIVES: Jack Pyle Company (415) 349-1266. Compar Corporation at the following locations: Alabama (205) 539-8476; Arizona (602) 947-4336; California (213) 245-1172; California (415) 697-6244; Colorado (303) 781-0912; Connecticut (203) 288-9276; Florida (305) 855-3964; Illinois (312) 775-5300; Maryland (301) 484-5400; Massachusetts (617) 969-7140; Michigan (313) 476-5758; Minnesota (612) 922-7011; Missouri (314) 428-5313; New Jersey (609) 429-1526; New Mexico (505) 265-1020; New York (518) 436-8536; New York (607) 723-8743; New York (716) 684-5731; New York (201) 471-6090; North Carolina (919) 724-0750; Ohio (216) 333-4120; Ohio (513) 878-2631; Texas (214) EM 3-1526; Texas (713) 649-5756; Washington (206) 725-7800.

INTERNATIONAL SALES: France, Germany, Italy, Belgium, Holland, Luxemburg, Spain—Sovcor Electronique, 11, Chemin de Ronde, Le Vesinet, (S.-&O.) France. United Kingdom, Ireland, Sweden, Denmark, Norway, Switzerland, Austria, Portugal—Electrosil Ltd., Lakeside Estate, Colnbrook-By-Pass Slough, Buckinghamshire, Great Britain. Australia—Corning, 1202 Plaza Building, Australia Square, Sydney, N.S.W. 27-4318. Canada—Corning Glass Works of Canada, Ltd., Leaside Plant, Ontario, Canada (416) 421-150. Israel—Optronix, P.O. Box 195, Ramat-Gan, Israel 724-437. Japan—ASAHI Glass Co., Ltd., Corning Products Sales Dept. No. 2, 3-Chome Marunouchi, Chiyoda-ku, Tokyo, Japan.

When even the Best Carbon or Wirewound Pots won't do...

CTS Cermet Pots Offer a Solution

6 WEEKS DELIVERY...NEW LOWER PRICES...

due to CTS automated production techniques and the industry's biggest output.

Consider these CTS Cermet Pot characteristics:

1. 20 Ω to 5 megohms resistance range.
2. Greater power/size ratio. (See captions.)
3. The environmental stability & higher wattage rating of wirewound.
4. The wide resistance range & infinite resolution of carbon.
5. Extremely high temperature capabilities.
6. Stability under extreme humidity.
7. No catastrophic failures.
8. Low noise. Long life.
9. Exceed MIL-R-23285 (Navy) metal film; far exceed MIL-R-94B.

Specify from the broadest line of thick film controls available.

New low prices begin at \$1.35 each in large quantities.

Series 500
3/4" dia.
1-1/2 watts @85°C



Series 400
1-3/64" dia.
3 watts @85°C



Series 600
1/2" dia.
3/4 watt @85°C



Series 550
3/4" dia.
2 watts @70°C



Series 2-500
3/4" dia.
1-1/2 watts @85°C
Tandem Series 500

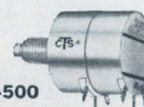

Series 385
11/32" dia.
1/8 watt @125°C
For P.C. applications

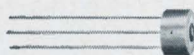

Series 600PC
1/2" dia.
3/4 watt @85°C
For P.C. applications



Series 660
3/8" dia.
1/4 watt @125°C



Series 630
1/2" dia.
1/2 watt @85°C



Request Cermet Catalog.



Founded 1896

CTS OF BERNE, INC.
BERNE, INDIANA

Subsidiary of CTS Corporation, Elkhart, Indiana

Electronics Review

Volume 40

Number 20

Companies

Out in the cold

The Radio Corp. of America, one of two companies building super-secret cryptographic equipment for the National Security Agency, has been dropped from the program, industry insiders say. RCA's loss of the multimillion-dollar contract, these sources add, stemmed from apparently insurmountable difficulties the firm's Camden, N.J., facility encountered in producing the high-speed gear. The NSA project carries the code name R-13.

RCA isn't the only company hurt by the contract loss; the Philco-Ford Corp.'s Microelectronics division has been a major supplier of milliwatt resistor-transistor-logic circuits to RCA, and also stands to lose a substantial amount of business.

The dimensions of the problem came to light last month when the NSA awarded two follow-on orders for R-13 work to Texas Instruments Incorporated, and allowed RCA's contract to lapse. The other firm holding substantial R-13 orders is Honeywell Inc.; its circuits are supplied by the Sprague Electric Co. and Motorola Inc.

New faces. RCA has apparently been having problems with the R-13 program for some time, and the turnover in executives in charge of the contract has been unusually fast. Last spring, the program's chief engineer, Hi Waters, was fired. And last month, Arnold K. Weber, the general manager of the Defense Electronics Corp., the division making the equipment, was given new duties within RCA. He was replaced by Irving K. Kessler, a divisional vice president and general manager of the Aerospace Systems division in Burlington, Mass. [For more on Kessler's appointment, see page 8.]

An RCA spokesman, who incidentally declined even to confirm that the concern holds an R-13 contract, contends that the personnel moves were unrelated to any production difficulties at the defense division. He did concede, however, that executive turnover has been unusually high.

One of the production problems, according to engineers close to the project, involves the manufacture of multilayer boards (on the order of 15 to 20 layers). It was easy enough to line up the layers, but when they were sealed under pressure and heat they slipped out of line.

Rivalry. Philco-Ford, left with a circuit made especially for the R-13 project, is still looking for a share of the program. It's hoping the Government won't allow Texas Instruments to be its own sole source, but it may find that TI, a competitor, won't want to throw any business to it. It's understood TI will go outside for 50% of its needs.

The incident comes at a particularly awkward time for the Microelectronics division, since Philco-Ford is understood to have been slightly in the red for most of 1967 after two years of profitable activity. And the Microelectronics division could tip the scale.

Electro-optics

Light track

Although satellites can be tracked with lasers, most systems depend on cooperation in the form of a reflector attached to the satellite [Electronics, May 29, p. 50]. Now a continuous-wave doppler-type laser radar under development at the Massachusetts Institute of Technology's Lincoln Laboratory,

which does not need reflectors, may point the way to laser systems to track unannounced and hostile space vehicles.

It could be a next-generation Spacetrack radar. But only "on clear days," quickly adds Robert H. Kingston, leader of the Optics and Infrared section at the laboratory.

Although the 10.6-micron output of the carbon-dioxide laser is better for penetrating bad weather than other wavelengths, it will still not cut through heavy clouds and rain.

Many improvements are still required before a workable laser radar system can be realized. Today, the exploratory Lincoln system tracks and measures the speed of pedestrians, cars, and aircraft. Doppler return signals have been observed from objects up to 2 miles away.

Beam bouncing. Researchers working from the roof of the Lexington, Mass., laboratory bounce beams off low-flying aircraft, cars running along nearby Route 128, and colleagues on foot with protective goggles.

The system depends on a detection scheme using the heterodyne principle. The return laser beam, shifted in frequency by the moving object in proportion to the velocity of the object, is combined with a sample of the laser output on a fast square-law detector. The output of the detector includes a signal at the difference frequency of the two mixed beams that is proportional to the velocity of the target. The heterodyne detection is accomplished by copper-doped germanium photoconductors operating at liquid-helium temperature, about 4°K.

A closed-circuit vidicon camera aligned to the laser beam axis simplifies target acquisition. The laboratory is also developing an automatic tracking system similar

to that used in microwave systems, where the receiver uses the return signals to keep the transmitter locked onto the target.

Solid state

Making the scene

If the small producers of metal oxide semiconductors had written the script themselves, Fairchild Semiconductor's entry into the mos picture couldn't have come out better. To their relief, Fairchild isn't stealing the scene by slashing prices.

"Price is not the problem," says Charles H. Sutcliffe, Fairchild's manager of mos integrated circuits. "Price cuts simply won't stimulate

sales."

With a six-channel multiplexer, the 3701, and a dual three-input gate, the 3102, already on the market, the company is ready to go all out with mos. It has set the stage for the introduction of the 3700 multiplexer and a pair of shift registers, the 3303 and the 3300, within the next few months. Not too far behind is a large-scale accumulator, the 3800, which is so complex that a pair of them could perform all the arithmetic functions for a small calculator. And in 1968, Fairchild plans to introduce new mos circuits at the rate of one a month.

Welcome aboard. The problem in mos, says Sutcliffe, is the suppliers. "The people we've talked to are wary because the present suppliers are small," he says.

The suppliers are well aware of

the fact. Because of it, some of them—J.P. Ferguson of the Philco-Ford's Microelectronics division is an outspoken exception—actually welcome Fairchild Semiconductor into their ranks.

There are several reasons for Fairchild's late start in a field for which it has already supplied much of the technical knowledge—and, many of the employees now housed at Philco-Ford, American Microsystems, and General Instrument. First, Sutcliffe says, "If, like Fairchild, you have a large, successful business in one technology (bipolar), the incentive to push another is small."

"More important," he adds, "we have been looking at reliability problems. There isn't enough basic knowledge of the oxides; contaminants, such as sodium, can connect high-voltage lines on a chip and shorten the pulse width in a shift register, for example. I don't mean that the mos products now on the market aren't reliable. They are. But we're going to stress reliability, and offer data on high-temperature stress testing, at 30 volts d-c reverse bias. In mos cases, current testing is strictly functional."

Sutcliffe scoffs at the idea that mos is hard to make. Fairchild uses the thick-oxide process in general use throughout the industry; the trick, Sutcliffe says, is to design with loose tolerances so that the process always works and yields are relatively high.

A question of selling. His confidence will be welcome to some users who were skeptical when Fairchild advertised a 256-bit read only memory, then abruptly stopped talking about it. "The question was not whether we could make it," says Jerome D. Larkin, large-scale integrated (LSI) products manager, "but whether we could sell it. A 256-bit memory was not complex enough for sine, cosine functions; also, there is a \$4,000 masking charge to put a given customer's code into the memory. But we did generate customer help on what was really needed, and we are now working on a device that has a 1,024-bit

Electronics Index of Activity

October 2, 1967

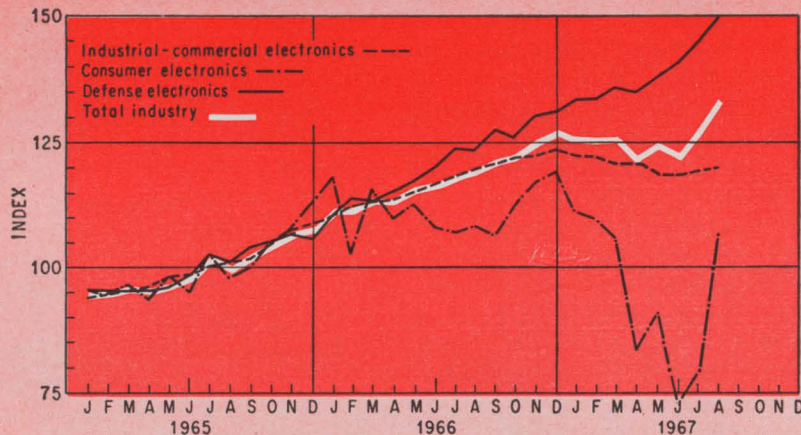

Segment of Industry	August 1967	July 1967*	August 1966
Consumer electronics	106.5	79.5	108.0
Defense electronics	149.9	144.7	123.5
Industrial-commercial electronics	119.8	119.3	119.6
Total industry	133.7	128.1	119.7

Volume of electronics production jumped 5.6 index points in August to a level 14 points ahead of the August 1966 pace. Much of the gain was due to a 27-point spurt in consumer production. One of the factors in the latter rise was an inventory buildup by RCA after a strike settlement. Despite the surge, however, the consumer index was still 1.5 points below the year-earlier level. Output of defense electronics rose 5.2 points in the month, while the industrial-commercial segment made a modest half-point advance.

Indexes chart pace of production volume for total industry and each segment. The base period, equal to 100, is the average of 1965 monthly output for each of the three parts of the industry. Index numbers are expressed as a percentage of the base period. Data is seasonally adjusted.
* Revised.

memory.”

Fairchild now has about a dozen diffusion ovens in its MOS facility, but plans to double that number shortly. “It’s now a pilot-size line but organized on production methods,” Sutcliffe says. “Our engineering commitment is heavy. There are three groups—one for large-scale integration, one for shift registers, read-only memories, and other fairly complex devices; and one for simple components, such as gates, flip-flops, and multiplexers.”

When Sutcliffe joined Fairchild last year, he reported to the then general manager, Charles E. Sporek. When Thomas Bay succeeded Sporek last winter, the MOS operation was placed under Gordon Moore, the research and development director. But now that production has started, Sutcliffe expects the operation to be shifted back to Bay.

Although its introduction is six months away, the 3800 accumulator has already been produced by the LSI group. This device, in a 36-pin ceramic dual in-line package, is an eight-bit slice of the arithmetic unit of a computer. It has more than 200 gates and more than 600 MOS transistors on a chip 116 by 86 mils. Two of these chips plus a memory would make a small calculator; and if four of them were put together, the calculator would have square-root capability.

Routine products. The 3800 is not necessarily destined for a calculator. It could be used as part of computer hardware to replace software in either control programs or fixed subroutines. Fairchild has hired a group of systems engineers to advise it on the needs for just such products.

If the 3800 is a glamor product, the rest of Fairchild’s line is routine. The 3303 dual 25-bit shift register is almost a copy of General Instrument’s. “We think the 3701 is the best multiplexer on the market,” Sutcliffe says, “but it’s true—at present we’re not the ‘most’ of anything. I don’t think we need to be. Fairchild has a strong reputation, and if we’ve got a product, people will buy it.”

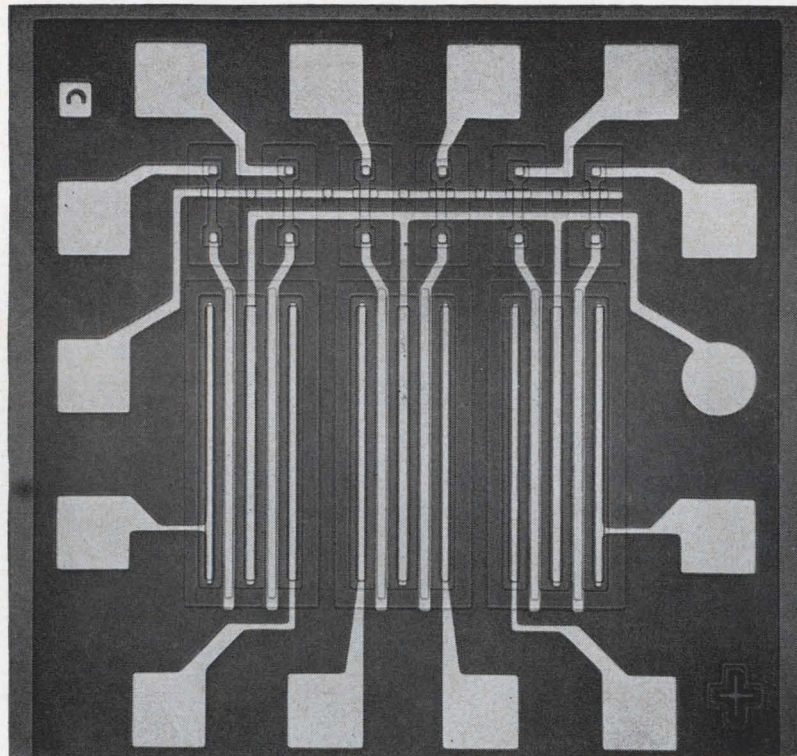

Getting its feet wet. Fairchild Semiconductor’s move into the metal-oxide semiconductor market begins with a six-channel multiplexer, the 3710. Soon the company plans to offer one new MOS product a month.

Manufacturing

The cold touch

Passive networks with resistance values of 100,000 ohms per square and capacitances of 60,000 picofarads per square inch have been achieved with a cold substrate-deposition technique developed by the Librascope group of General Precision in Glendale, Calif. This compares with around 500 ohms per square, which is about the best for standard hot-deposition systems.

The resistance values were obtained with a temperature coefficient of resistance of less than 300 parts per million, says Donald Fresh, manager of the group’s physical research department. The capacitors have a thermal coefficient of capacitance of 300 ppm and breakdown voltages of 20 volts.

Cold deposition, says Fresh, has three advantages over hot deposition:

- Adherence is better.
- The film is smoother and more

homogeneous, minimizing the island structures and thus allowing high performance with a thinner film.

- The process is simpler.

Fresh claims that the results obtained by Librascope aren’t one shot. “We could produce to these specifications within six months,” he says.

He points out that Librascope isn’t interested in getting into the semiconductor business and doesn’t plan to produce circuits using the technique. However, the company expects to conclude an agreement with NASA shortly under which the process would be made available to the space agency’s semiconductor vendors. It is now negotiating a license for the process with a solar-cell manufacturer, but Fresh won’t reveal which company.

Librascope plans to negotiate licenses with any company interested in using the process.

Meanwhile, the company has a contract with NASA’s Electronic Research Center in Cambridge, Md., which calls for producing sample networks that will withstand 300°C,

and has resistance values of 100,000 ohms per square with a temperature coefficient of less than 300 ppm. The contract also calls for networks having capacitances of 100,000 pf per square inch with a thermal coefficient of 300 ppm per degree C and a breakdown voltage of 30 volts. The networks will be deposited on passivated silicon wafers.

Means to an end. Librascope started on the project not as a means of producing electronic circuits, but for the deposition of optical coatings—depositing anti-reflective coatings for conductive coatings on plastic lenses, for example. The problems with heat deposition are that it takes time to heat up large lenses and some plastics cannot be heated because of outgassing.

Fresh says modified vacuum-deposition equipment is used and that deposition is done at room temperature at 10^{-8} or 10^{-6} torr. He claims the process lends itself to depositions at cooled or super-cooled temperatures in cases where they tend to outgas at room temperature.

Rejection masks can be put on the substrate itself, which makes the process simpler than hot deposition, he says. Standard photoresist film is put on the substrate prior to deposition.

"This could not be done with a heated substrate because you would polymerize it," he explains. "Also, with our process you don't subject the film to any severe chemical etchants, which avoids such problems as undercutting your depositions."

Librascope has deposited standard nichrome, chromel and chromium resistors, and standard dielectric capacitors, such as silicon monoxide, aluminum oxide, and titanium, plus some compounds of cermets. Depositions have been made on such substrates as silicon dioxide, silicon monoxide, glass, quartz, glazed and unglazed ceramics, and polyimide. A variety of metals, including tungsten, platinum, tantalum, copper, cobalt, gold, and nickel have also been deposited.

Outpaces sputtering. Reactive

depositions can be made with the process by introducing a gas into the system and causing it to react with a purer material to deposit a compound. Librascope has deposited zinc oxide by using zinc under a partial pressure of oxygen. It has also made a tantalum nitride-type deposit with tantalum and nitrogen. This method for reactive depositions is faster than sputtering, Fresh says.

One application for reactive deposition would be deposition of silicon nitride, which some manufacturers believe may one day replace silicon dioxide as a dielectric. At present, silicon nitride is deposited by a pyrolytic process, which isn't done in a vacuum.

So far, the main application of the process has been for depositing 0.002-inch coatings of silicon dioxide on space vehicle solar cells to prevent radiation damage. The conventional method has been to glue a cover glass on to each cell. But this method has its drawbacks. The glue may cut down on transmission to the cell, and the glue may fail, so that the glass separates.

Librascope has already coated solar cells for NASA and several firms working with the agency, primarily for experimental arrays. The company recently received a contract from Jet Propulsion Laboratory at Pasadena, Calif., to coat more than 5,000 cells.

Avionics

Long-range lookout

The application of large-scale integration to military avionics may be five years or more away but the Navy wants to take a good look now at the prospective benefits the technique offers.

Litton Industries, which the Navy has already contracted to develop an IC version of the AN/AWS-27 digital data link, has now been asked to design an LSI model of the system for an applications study. Production of the IC version should start before 1970 and the large-scale integration model could make its bow between 1975 and

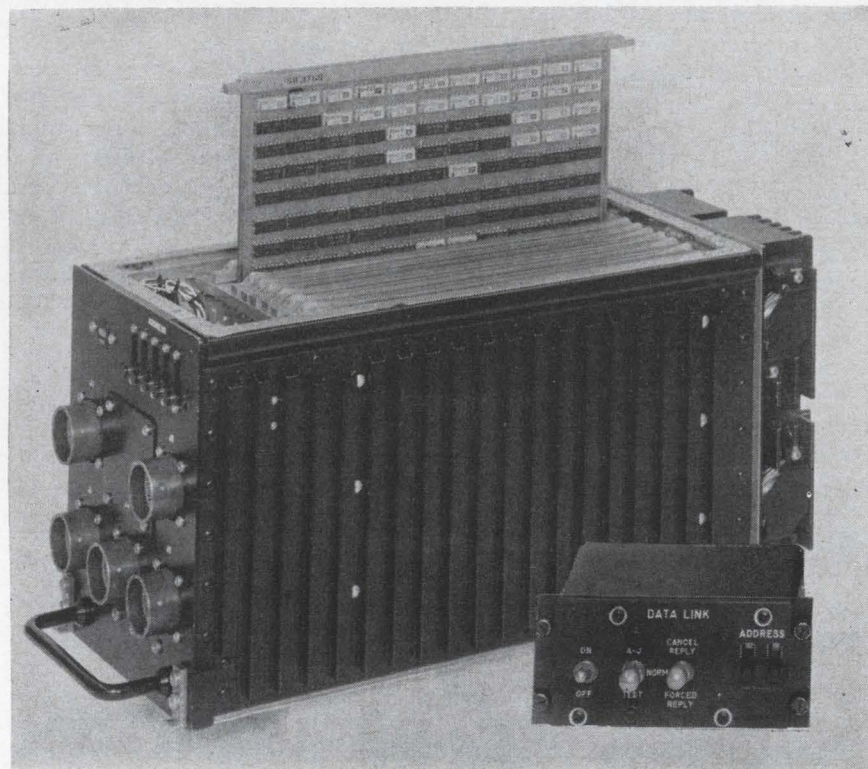

Next step. Litton is trying to apply large-scale integration to this AWS-27 communications system. Engineers say an LSI version of this IC model would be far smaller and more reliable.

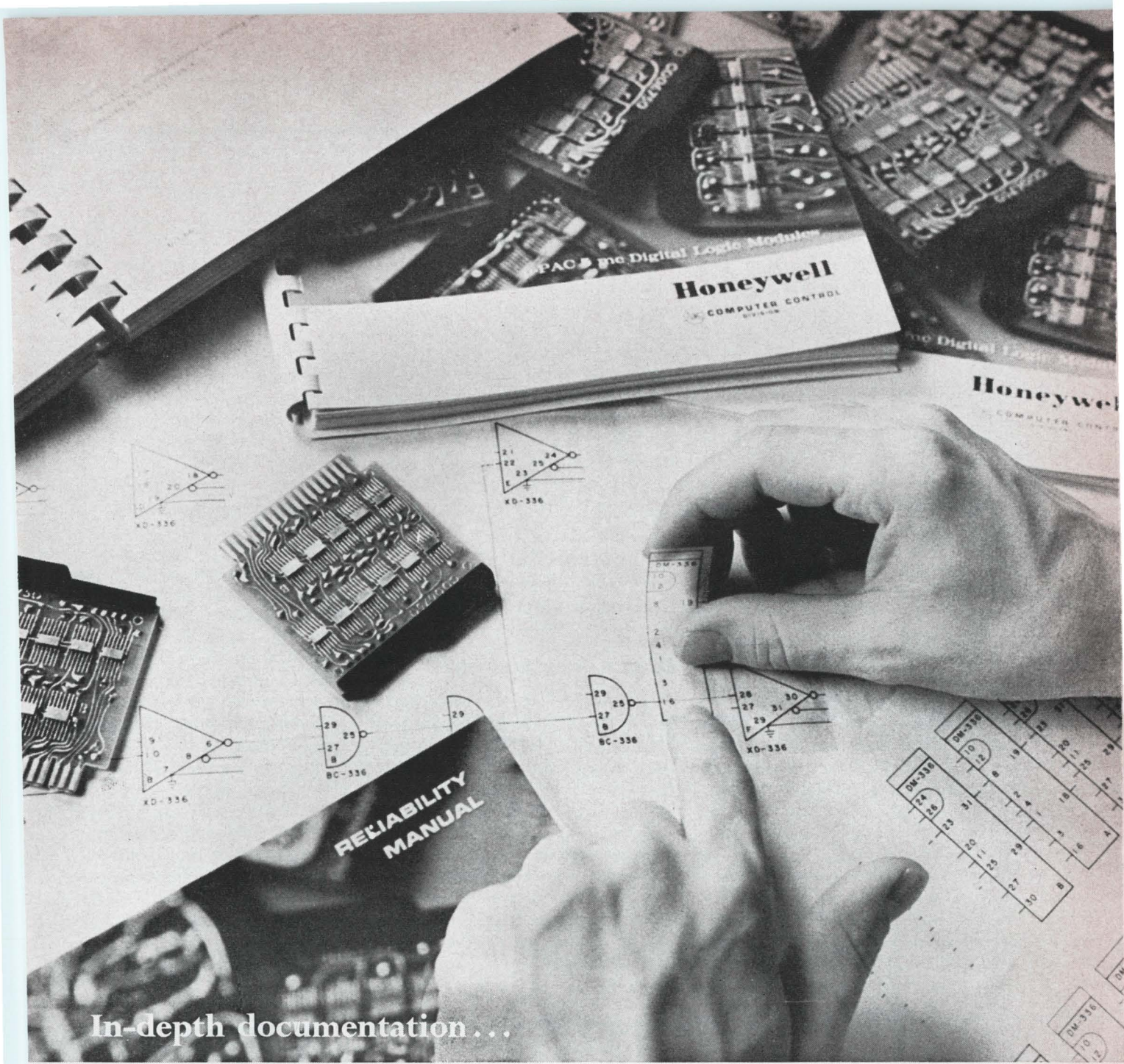

In-depth documentation...

... speeds you from sketch
to I/C μ -PAC system
installation without
costly re-design

NEW PRICES —
UP TO 46% LOWER

You get documentation that means a lot more than just a spec sheet when you design with I/C μ -PAC digital logic modules. It means design aids, detailed instruction manuals, reliability facts, wiring & assembly notes, application notes. It means the best design support you can get — support based on nearly 14 years of module experience.

Whether you face design of a one-shot black box, or an entire product line, why not rely on μ -PACS. You'll never have to read between the lines to figure out what to do with them. It's spelled out in page after page of documented facts. Write for details. Honeywell, Computer Control Division, Old Connecticut Path, Framingham, Massachusetts 01701.

Honeywell

 **COMPUTER CONTROL**
DIVISION

Circle 43 on reader service card

1980 if the Navy approves the design.

Litton engineers predict that the LSI system will be 10 times more reliable than the IC version and only one-quarter the size; it will require 1/10th the circuitry area and 1/5th the power. The IC model has a specified mean time between failure of 2,000 hours, occupies 770 cubic inches, and requires an input power of 80 watts.

The Data Systems division of Litton in Van Nuys, Calif., is developing the IC version under a contract with the Naval Air Development Center at Johnsville, Pa. The system will link aircraft and such networks as the Navy and Marine Corps Tactical Data Systems.

Plane and missile. To direct air sorties and control all-weather carrier landings, controllers need a wealth of data, including aircraft position, fuel level, and weapons status. The AWS-27 will be installed in the F-111B plane, which will carry the complex Phoenix missile, to supply this information.

Although neither the Navy nor Litton will disclose the value of the LSI order, it's known that the money will come in three increments. In the first four months, already funded, Litton will evaluate potential suppliers of LSI devices, do a partitioning study of the system to work out applications, and determine component specifications.

The second increment, now being negotiated, will cover a year and "should lead to a flyable LSI version of the ASW-27," according to Floyd Smoller, manager of Litton's program. The final phase, also a year long, would yield a production model that employs LSI "everywhere it makes sense to use it," says Jerome Weissman, the company's engineering product manager. Smoller sees a flight model in perhaps two years.

Leapfrog. Weissman notes that partitioning hasn't gone far enough to indicate where LSI can be introduced. But he adds: "LSI is amenable to a large majority of the circuitry. Anything that can be done in integrated circuits can be done

in LSI, and the discretes we're now using could jump to LSI without being converted to IC form first."

The upcoming ASW-27 is compatible with such present ultra-high-frequency transceivers as the AN/ARC-124, expected in about a year. Because the system is time-division addressable, many planes can be controlled on one frequency.

Litton's Weissman says the IC set employs about 600 dual in-line packages of diode-transistor logic in the digital circuitry, plus some linear IC operational amplifiers and summing comparators.

Consumer electronics

Life's darkest moment

The word leaked by Fisher Radio before the New York High Fidelity Show promised "the most significant engineering feature of the year." Well, the show opened last week and the company unveiled a low-cost, table model f-m radio with an electronic pushbutton tuning device—the same device Audio Dynamics was displaying in a top-line, f-m stereo receiver costing \$379.95. Fisher has set the price of its radio at \$99.

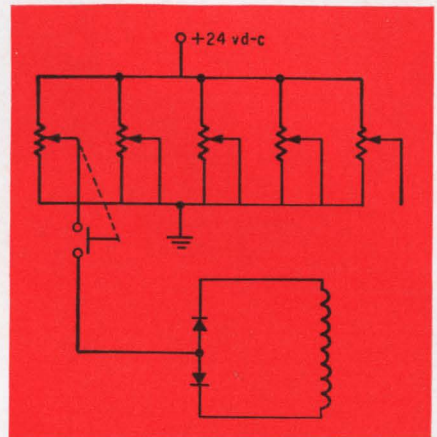

Push button. Tuning a radio electronically.

Fisher's embarrassment, according to Leonard Froemel, Audio Dynamics' general manager, stems from the fact that both firms bought their preselector from the same supplier, PREH-Werke of Bad Neustadt, West Germany.

Station hopping. The main feature of the new device is a series of five vertical scales that enables the listener to preselect five stations and tune to any one of them simply by pressing a button.

A similar function is provided by an electronic touch tuner that Matsushita Electrical Industrial Co. has introduced in a low-cost table-model radio.

The receiver tuning circuit pre-



Vive la difference. Fisher Radio and Audio Dynamics introduced receivers with the same "exclusive" electronic tuning device, which they both happened to buy from the same German firm.

FOR YEARS, YOU'VE PROBABLY HEARD WE'RE IN "2nd PLACE" IN THYRISTOR PRODUCTS...

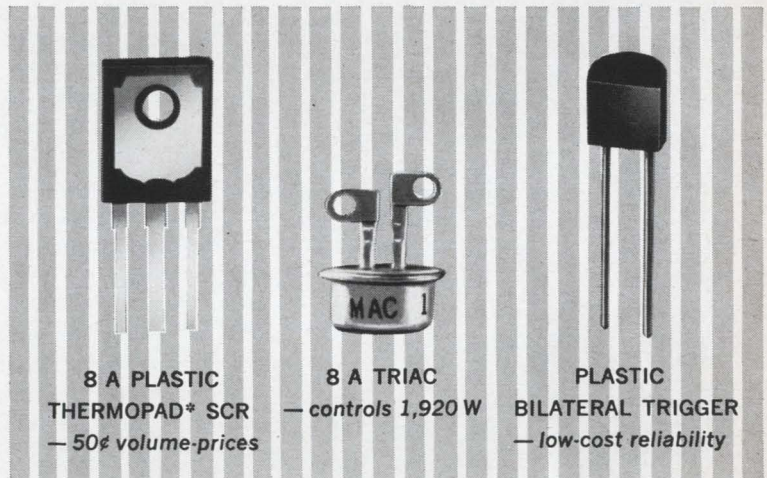

LISTEN CAREFULLY NOW.

In just 6 months, Motorola has introduced more than 15 state-of-the-art thyristor and trigger products — more than all other manufacturers combined! There are now more than 270 different Motorola SCR's, TRIAC's, triggers and unijunctions in 14 individual cases available for your power control applications. And, since you'll design in thyristor power control only once this year, why not look over the newest developments first? . . . send for the comprehensive, new, applications-oriented, "Power Control Circuits Library" and a Selection Guide to the broadest, up-to-35-ampere thyristor line available. Box 955, Phoenix, on your company letterhead.

*Trademark of Motorola Inc.

- where the priceless ingredient is care!



MOTOROLA
Semiconductors



Cassette set. Harmon-Kardon's music system, which features industry's first built-in stereo cassette tape recorder.

sented at the show consists of a pair of varactor diodes, wired back-to-back, across the tuning inductor. The diode tuning voltage is supplied by a regulated 24-volt d-c power supply across a tuning potentiometer. At maximum voltage—24 volts—the tank circuit tunes the high end of the f-m band, 108 megahertz. At minimum voltage—about 4 volts—the circuit tunes the low end of the spectrum, 88 Mhz.

Back at the ranch. Besides the Fisher-Audio Dynamics confrontation, the show featured the introduction by Harmon-Kardon of a 30-watt μF , compact, f-m stereo music system—the first with a built-in stereo cassette tape recorder. The unit, which sells for \$399, includes a Garrard changer and a low-distortion receiver with an integrated circuit intermediate-frequency amplifier.

Low-budget picture

A video tape recorder selling for less than \$500 could be on the market next year. Prototypes are already being demonstrated at All American Engineering Co., Wilmington, Del.

The system was developed by Par Ltd., Clifton, N.J., which has patents pending. But All American, which holds options to buy the patents, will decide within three months whether to pick up its options and build the system.

Picture quality is claimed to be as good as that of home machines

like the Sony Corp.'s \$695 model, according to All American's general manager for consumer products, James Guenveur. The system has about one-third the electronic components of the Sony device; there are only about 35 transistors in its record and playback amplifiers.

"The picture was so good that, when I first saw the machine demonstrated, I searched the next rooms to find hidden electronics," says Guenveur. "Nothing that small should have worked so well."

Tiny tricks. Measuring 12.5 by 13 by 8 inches, the system weighs only 18 pounds—less than many audio recorders. The under-\$500 price is also below that of many audio machines.

The tape transport is similar to many low-cost audio recorders; it uses a single motor to control both reels and capstan drive. Tape speed for both record and playback is 60 inches per minute.

Guenveur says wow and flutter in the tape transport was reduced even though a single motor and belt drive were used. Earlier low-cost video recorders never reached the market because of these problems, despite the fact that more complex tape transport designs were used.

Although one-quarter-inch wide instrumentation tape is specified, Guenveur says audio tape can be used at a sacrifice in picture quality. But the instrumentation tape itself only costs about \$15 for a one-hour reel, about one-half to one-quarter the cost of tape for comparable machines, says Guenveur.

He says the tape heads will be low-cost replacement items—only \$4 to \$5 each—much lower than replacement heads for audio tape recorders. And because the heads are stationary, he says, they will last up to four times longer than those of comparable machines in which the heads spin. Rotation makes for faster relative tape speeds—and for faster wear.

Behind the tube. All American engineers say a slight modification allows the recorder to work with any home television set. A pick-off stage just before the cathode ray

tube accepts horizontal and vertical deflection and electron-beam intensity signals from the tv set and transmits them to the recorder via an emitter-follower circuit. Another connection sends sound to the tape deck. The modification also includes addition of a record-playback switch on the television set.

Space electronics

Fallout by default

NASA may be first to use a side-looking radar developed for the Army because the Army hasn't yet found a program to incorporate the system.

Built for the Army by Philco-Ford's Aeronutronic division, the classified system is being modified for tests aboard a NASA Electra aircraft. It's one of the sensors being considered for inclusion in the space agency Earth Resources Survey (ERS) satellite program. The system was a casualty of the cancellation of an Army program that was to provide the aerial platform.

The space agency describes the system as a K-band (12.4 to 18 gigahertz), unfocused, side-looking radar imager with a 10° beamwidth and operating in the 1.82-centimeter portion of the spectrum. An Aeronutronic contract calls for the firm to modify two of the Army units. The principal modification, however, would be covered by a second contract, which would encompass the design and testing of the multipolarized antenna, and installation of the system in the aircraft. Company officials are confident the second phase will be funded. Oscar Schlusel, manager of the radar engineering department at Aeronutronic's radar and intelligence operation, Santa Ana, Calif., believes both units can be delivered to the space agency by next March.

One for four. Frank Jayne, supervisor of the facility's antenna and microwave section, says the new wrinkle in the synthetic-aperture antenna is that it combines

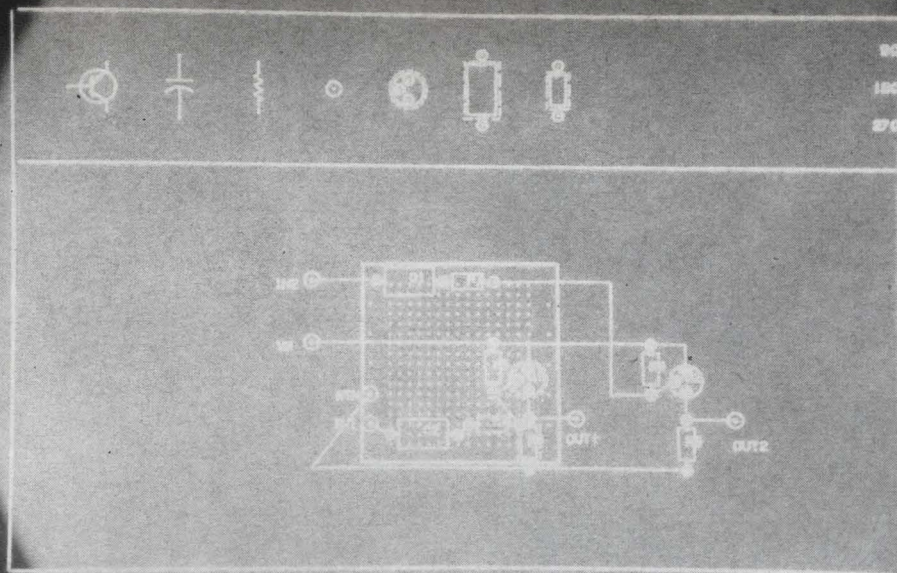

Readouts clear up problems.

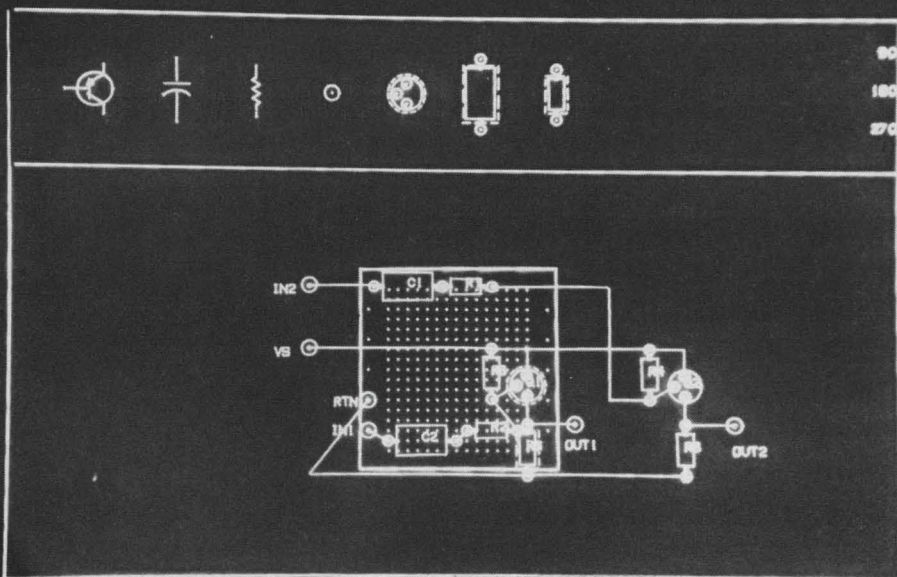

Polaroid circular polarizers clear up readouts.

It's never a problem to read readouts if they're equipped with Polaroid circular polarizers. Our polarizers improve readability from every angle by increasing contrast. In daylight. Or even in brightly lighted rooms.

But now you don't have to take our word for it. Send for our new brochure, and we'll include 3 samples of our circular polarizers (amber, neutral, and green). They'll help you see very clearly why many major display and

instrument manufacturers are now using Polaroid circular polarizers.

Write Polaroid Corporation, Polarizer Sales, Department 59, Cambridge, Massachusetts 02139.
Polaroid Circular Polarizers.

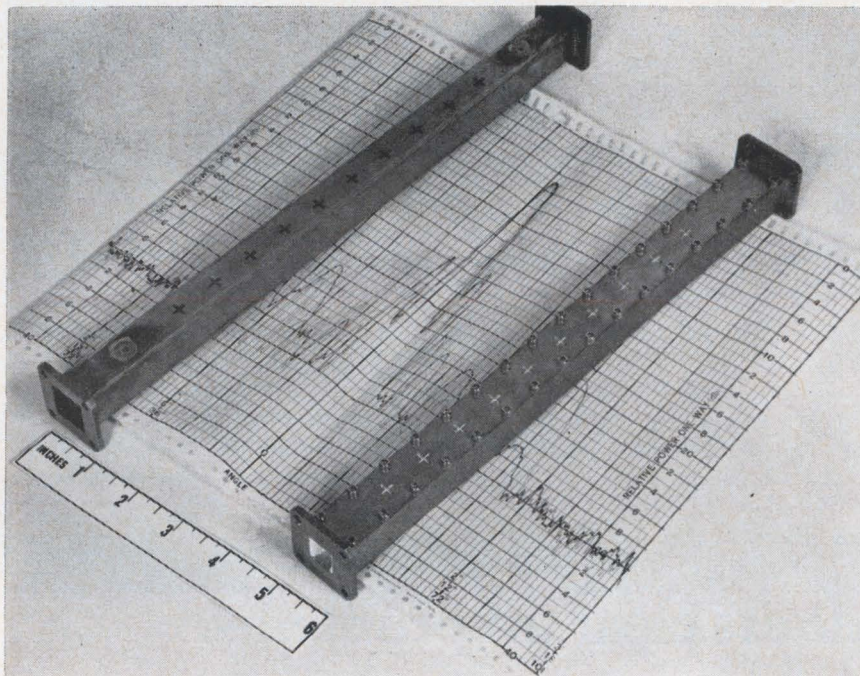

Broad look. Waveguides for Aeronutronic's new side-looking radar, developed for the Army, may be used by the space agency. Strip chart shows typical antenna spike pattern—decibels compared with radiated beam width.

in one square waveguide the horizontal and vertical polarization for which two separate waveguides are usually needed. Crossed slots in the waveguide yield a combination of horizontally and vertically polarized radiators that operate simultaneously and independently.

This means that an aircraft or satellite carrying the system would need only one pass over a given terrain swath to gather data that would previously have required four passes: one for vertically polarized data, one for horizontally polarized returns, one for combination of horizontally and vertically polarized returns, and one for a combination of vertically and horizontally polarized returns.

In the Aeronutronic scheme, this capability results in the generation of four side-by-side strip maps simultaneously, each with a different polarization, and each enhancing certain terrain features that may be either indistinct or not apparent on the other three strips.

Less than 150 feet. The NASA system will have the same power requirement as the Army radar, which is classified. Schlüssel says the system power would have to

be boosted for a satellite application. Schlüssel describes the swaths the radar can record as medium range. The typical line of sight from a 200-mile altitude would be a 1,600-mile-wide swath, "but we don't want to record all that data," he says. Calculated mean time between failures for the Army radar is more than 500 hours, according to Schlüssel. One observer who examined a radar photo of the Washington, D.C., vicinity generated by the system estimated that resolution is less than 100 feet.

Schüssel says flatpack, digital integrated circuits are used wherever possible, chiefly in the signal processor's timing circuitry. This processor enables integration of radar returns as successive pulses and gives the radar its synthetic-aperture feature, by which a 4-foot-long antenna is made to behave as though it were about 50 feet long, says Schlüssel. He maintains integrated electronics could be used elsewhere in the system, but explains that NASA officials wanted to avoid any extensive redesign of the Army radar, which is almost entirely solid state and weighs 164 pounds.

Oceanology

Monster rally

Next year, two 100-ton buoys, dubbed "Monsters" [Electronics, July 25, 1966, p. 48] and loaded with more than 100 sensors and other electronic gear, will be towed to stations in the North Pacific to telemeter oceanographic and meteorological data over 4 million square miles of ocean. Each will transmit data from its sensors and from surrounding clusters of smaller buoys.

The mission, to be carried out by the Scripps Institute of Oceanography under Navy sponsorship, marks the first attempt to survey a large area of ocean with automated devices. The two Monsters, developed by the Convair division of the General Dynamics Corp., have been undergoing rugged Navy tests over the past two years.

In a trial last week, one of the buoys telemetered data on such variables as salinity, temperature, and wave direction from its mooring off the California coast to a mobile shore station in Washington, D.C. Another Monster recently purchased by the Coast Guard is being used as a navigational aid in place of a manned light-ship, and next month will start operating as a collector of oceanographic data.

Components

Bright shield

The black box may soon have a plated lining. The metal enclosures now used for radio-frequency and electromagnetic shielding may be replaced by plastics plated with copper, chrome, and nickel.

Metal-plated plastics aren't new, but they haven't yet been successful in shielding equipment. However, engineers at a Philadelphia plating and casting concern, La-France Precision Castings Co., report that plated plastics have helped solve problems of crosstalk between line amplifiers in closed-circuit color tv systems. Spurred

There's a NEW title at your RCA Distributor

RCA's new SILICON POWER CIRCUITS MANUAL (SP-50) was written by engineers for engineers (the circuits and systems design variety) who are working with solid-state power devices and want to know more about them.

With more than 10 main chapters and more than 400 pages, the new manual provides comprehensive design information for a broad range of power circuits using RCA silicon transistors, rectifiers, and thyristors (SCR's and Triacs). Procedures are also included for applications involving rectification and power-supply filtering, power conversion and regulation, ac line voltage controls, rf power amplifiers, and control and low-frequency power amplifiers.

While the new manual is intended primarily for engineers, it will also be of use to educators, students, hobbyists and others interested in learning about solid state devices.

The introductory chapters of the manual familiarize the reader with semiconductor physics and describe each type of silicon power device in terms of construction, operation, and ratings. Clear understanding of the fundamentals of silicon power devices and how they operate in circuits is set forth with specific design criteria.

Drop by at your RCA Distributor and pick up your copy of this important new manual today.

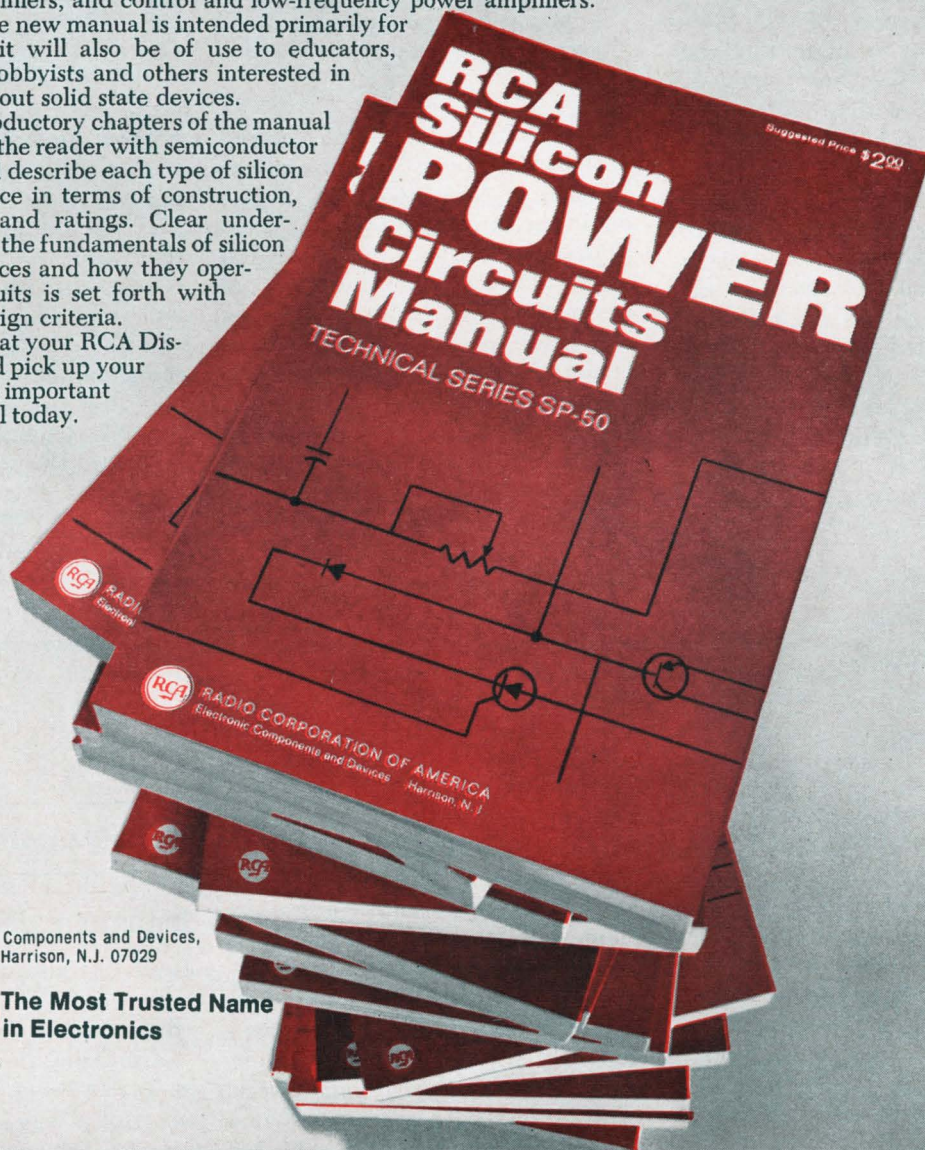

RCA Electronic Components and Devices,
Harrison, N.J. 07029



**The Most Trusted Name
in Electronics**

by these reports, the company is embarking on a program to further evaluate metal-plated plastics in shielding applications. LaFrance is currently negotiating with a testing facility to subject a variety of plated parts to rfi and emi tests.

Reevaluation. Other companies have tried to use metal-plated plastics for shielding but have rejected the idea because it was only useful for very low-level fields. However, LaFrance believes that many opportunities exist in the area of low-level fields for such applications as enclosures for tuners in tv receivers, f-m sets, and electronic instruments. Metal-plated plastics would be especially useful in equipment on ships, where corrosion problems are acute.

LaFrance uses the Marbon process, developed by the Marbon Chemical division of the Borg Warner Corp., to plate the plastic parts. The firm has achieved a strong bond with this process, often sufficient to withstand a 7-pound pull.

The lightest metal generally used for enclosures, aluminum, is almost three times heavier than the plastic sandwich. Also, though raw aluminum castings are cheaper than injection-molded plastic parts, they require finishing operations that raise their cost above that of the plastic. And in volume, the molded plastic parts would be cheaper than even the raw metal castings.

Communications

Rapid response

This past summer the Federal Communications Commission's common carrier bureau recommended changes in the long-standing law under which the Bell System tries to bar unauthorized attachments to telephones. Although a decision on the recommendation is not expected for several months, two firms are already conducting marketing drives for electronic devices that compete with Bell's rapid card-dialing system.

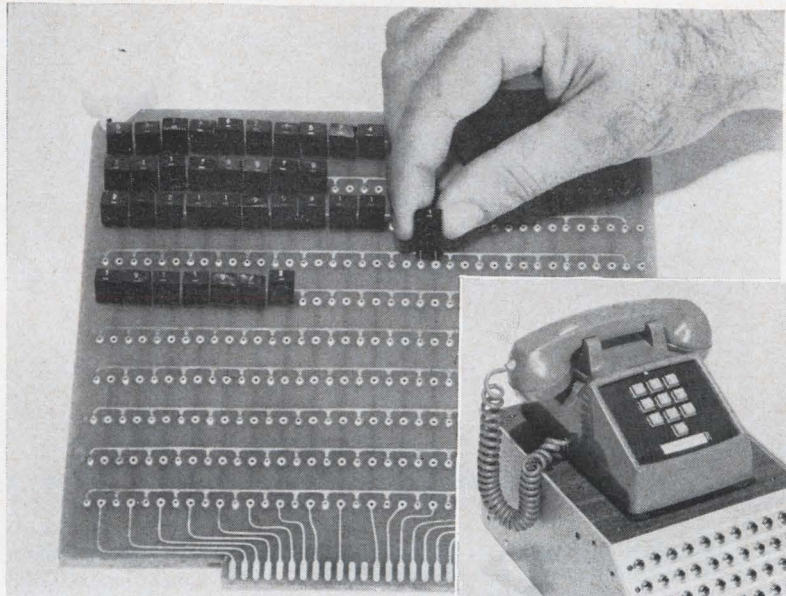

Speedy dial. Automatic telephone dialer can ring a number in seconds. To program the unit, produced by Atlantic Research, the user inserts tiny cubes into a printed-circuit board.



The Atlantic Research Corp.'s Electronics and Communications division in Alexandria, Va., is producing a rapid dial system, called Repertory Dialer, for industrial users and G-V Controls Inc., of Livingston, N.J., will, for the time being, sell its device, dubbed Auto-Dialer, through independent phone companies. Neither system has been approved by American Telephone & Telegraph, but both are being used by the military.

Make a call. Each system costs between \$1,000 and \$2,000. Both can dial a touch tone number in about a second and a rotary or pulse number in about 10 seconds. For example, a touch of a button on either unit is enough to dial a digit for an outside line, a unit area code, and the full number of an addressee. The Atlantic Research console has 50 buttons for 50 numbers, and will accommodate up to 18 digit numbers. The G-V system handles 132 eight-digit numbers or 66 of 16 digits.

Both companies offer programming of numbers which a layman can master. G-V's Auto-Dialer contains slide-switches on removable printed circuit boards. The switch is dialed to the digit the operator

wishes to program. Atlantic Research's Repertory Dialer is programmed with digit module cubes that are plugged into one of five removable p-c boards. Each cube is marked with the number that it will program.

Both devices employ discrete semiconductors, although J.L. Wallace, the designer of Atlantic Research's dialer, says, "We are looking into the possibility of using integrated circuits in the near future."

Both companies see the dialers as an alternative to the card-dial system of the phone company, which costs about \$15 for initial installation and about \$3 a month thereafter.

Military electronics

Mounting greenery

How do radio signals penetrate a dense jungle? They don't. They rise above it.

The Army Electronics Command at Fort Monmouth, N.J., has come up with a way—short of hurling it up—to lift an antenna into the

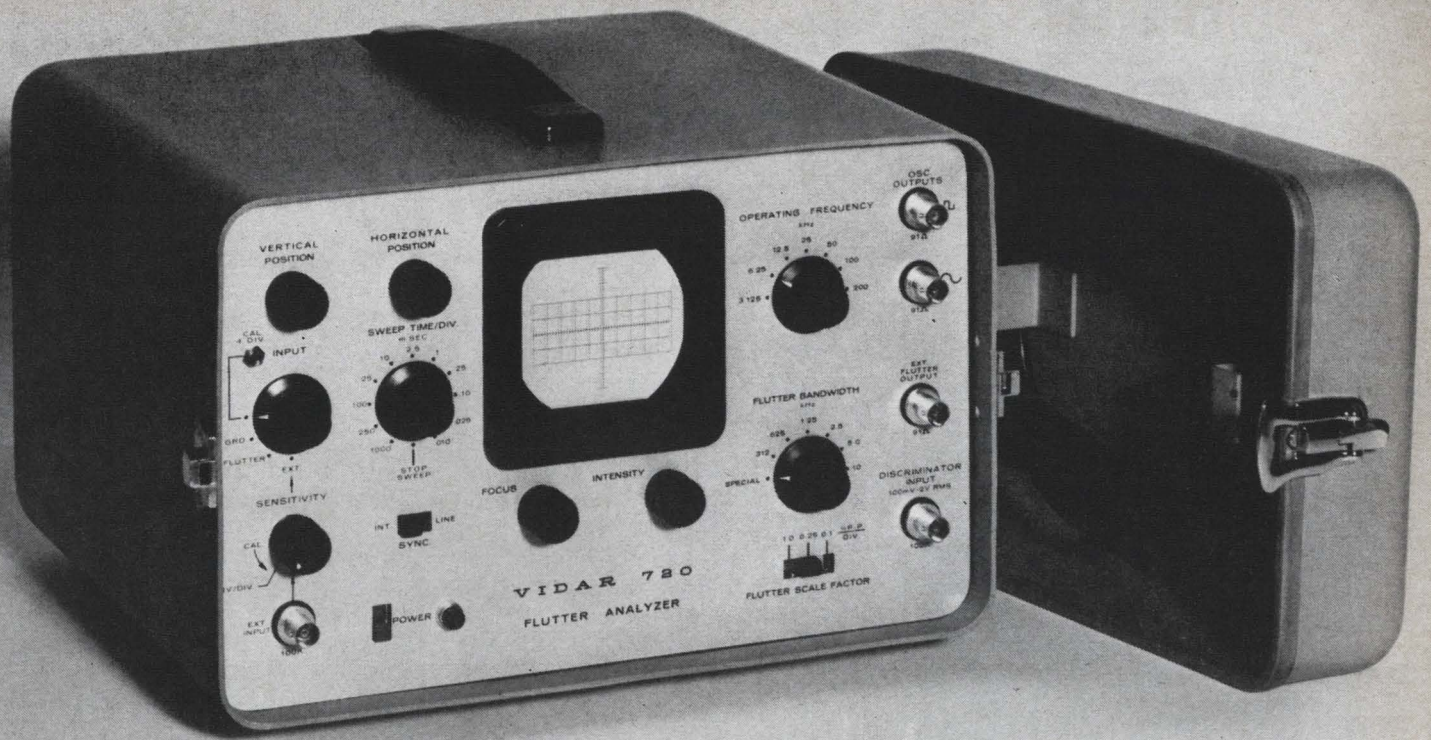

If you use recorders...

shouldn't you check flutter *before* you gather valuable data? VIDAR'S 720 analyzes and measures flutter accurately, quickly, and conveniently in accordance with IRIG 106-66 and recorder manufacturers' recommendations. The oscilloscope display helps you analyze and track down flutter components as low as 0.02% peak-to-peak over flutter bandwidths ranging from 0.2 Hz to 20 KHz. For complete details on this VIDAR laboratory-quality instrument contact Carl Smith, (415) 961-1000, VIDAR Corporation, 77 Ortega Avenue, Mountain View, California 94040.

VIDAR

CONVERT COMPUTER DATA TO TV DISPLAY WITH THE ELECTROSTORE®

.....
This TV Display shows a high resolution alphanumeric presentation derived from

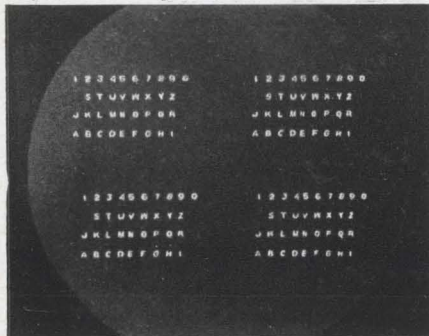

a computer. It is only one example of a computer display using the Electrostore, Model 221.

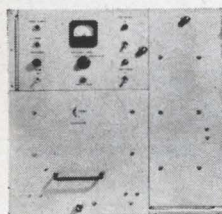

Model 221 Electrostore
single-gun storage tube
Input/Output Response
10 MHz or 20 MHz
Input Amplitude
Required 0.7 volts to
2.0 volts p-p
Deflection Amplitude
5 volts p-p
Deflection Response
DC to 800 KHz
Programmer Optional

The Model 221 scan-converter utilizes a cathode-ray recording storage tube. Input video signals and deflection information are applied to the tube through various amplifiers and control circuitry. Data is stored within the tube in the form of a raster, circular, or spiral scan. This information can be read off periodically through appropriate amplifiers without destroying the stored data. The input can be up-dated periodically and the stored information erased partially or in its entirety. By introducing the proper signals, the Electrostore can convert a variety of formats to TV display, i.e. computer-to-TV, radar-to-TV, IR-to-TV, or sonar-to-TV.

Write for technical memos and application notes covering the Electrostore.



223 Crescent Street
Waltham, Mass. 02154
Tel. (617) 894-8200

A DIVISION OF
DASA CORPORATION

Electronics Review

tree tops without alerting the whole jungle. A standard M-79 grenade launcher, using a special shell which muffles the sound of the report, lofts a 200-foot braided copper wire into the top branches of a tree.

Over the limb. For log periodic or yagi antennas, which have more complex configurations, Army engineers will use a similar shell and the M-14 rifle to shoot a weight, trailed by a strong, 250-foot nylon string, over the tree limb. The antenna will then be tied to the string and hoisted.

The shells were originally developed for the Army's Limited War Laboratory as a nylon line thrower by engineers at the AAI Corp., Cockeysville, Md. They'll be tested in the jungles of Southeast Asia, and if successful, will probably be bought in quantity.

For the record

Transition. Carl A. Frische is retiring as president of the Sperry division to become a special consultant to J. Frank Foster, president of the parent firm, the Sperry Rand Corp. Frische will not be replaced.

This change follows a corporate reorganization for the Sperry division, which, during the past year has been under increasing financial pressure after losing a major contract with Pan American Airways for an inertial navigation system [Electronics, Sept. 4, p. 44-45]. The division also has been running into technical problems with its computer-operated traffic control system for New York City [Electronics, May 29, p. 56].

Punched polls. The largest single order for an electronic voting system has been placed by Los Angeles County for the International Business Machines Corp.'s Votomatic recorders. Ordered were 33,000 recorders and 7,000 demonstrators units, which are worth \$5.6 million.

The Votomatic recorder permits each voter to place his ballot on a punched card; when the polls

close, the ballots are tabulated on computers. In the two years since the Votomatic was introduced, it has been adopted by 10 other counties of California, and by counties in Oregon, Illinois, and Georgia.

At present, the cards must be carried from each polling place to a central computer. Eventually, data-transmission terminals could conceivably be placed in polling places to transmit the count to the computer.

Acquisition. Applied Technology Inc., a military reconnaissance systems company based in Palo Alto, Calif., became a division of the Itek Corp., Lexington, Mass., after stockholders approved a stock swap last month. Applied Technology has five plants in the San Francisco area and one in Lincoln, Neb.

Domestic squabble. The Ford Foundation, a strong advocate of publicly owned domestic tv broadcast satellites, urged the Federal Communications Commission to withhold approval of a pilot domestic satellite program proposed by the Communications Satellite Corp. McGeorge Bundy, foundation president, told the FCC in a letter that approval of the Comsat plan would "prejudge" the work of the President's task force on telecommunications policy and, secondly, would indicate that Comsat has "the inside track to the preferred position" in the field. Comsat, which proposed its five-year \$57 million system in March [Electronics, June 26, p. 59], responded in a letter from Chairman James McCormack, who said "nothing could be further from the truth. . . ." He maintains that quick approval of the pilot program would supplement rather than hinder the task force's job and that Comsat realizes that the pilot program could be taken over for public ownership.

The foundation also argued that by delaying the pilot plan, improved technology might be developed to handle frequencies for satellite broadcast above 10 gigahertz. This would lessen interference with frequencies in the crowded 6 GHz range now being used.

tricky tapers...

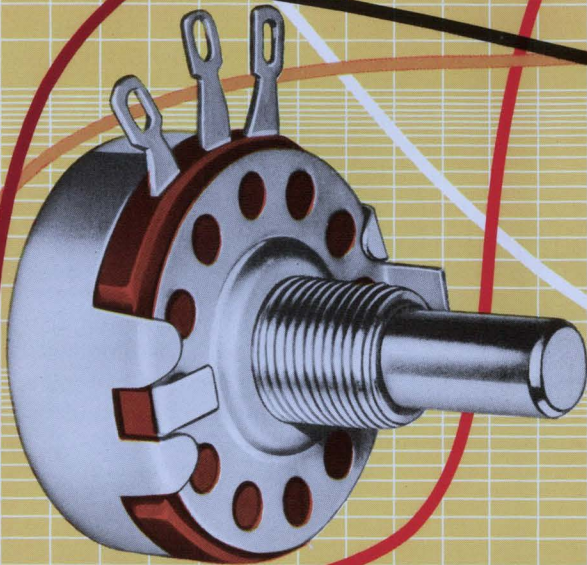

Allen-Bradley Type J
hot molded variable resistor
shown twice actual size

Allen-Bradley Type J potentiometers offer tapers designed to your special needs!

■ When standard tapers fail to provide the control you desire, Allen-Bradley Type J potentiometers have the unique capability to provide a virtually limitless variety of curves to meet your specialized requirements. While not a precision device that is continuously taper-trimmed to very close tolerances, Allen-Bradley's control of the resistance-rotation characteristics during production assures a high degree of conformity.

Allen-Bradley Type J potentiometers have a solid hot molded resistance track made by an exclusive process which was pioneered and perfected by A-B. This solid resistance track assures smooth adjustment at all times—with none of the discrete changes in resistance that are encountered in wire-wound units. And being essentially noninductive, Type J controls can be applied in high frequency circuits where wire-wound units are useless.

Furthermore, A-B's solid molded resistance track assures low noise and long life. On accelerated tests, Type J potentiometers exceed 100,000 complete operations with less than 10% change in resistance.

For more complete details, please write: Allen-Bradley Co., 222 W. Greenfield Ave., Milwaukee, Wis. 53204. In Canada: Allen-Bradley Canada Limited. Export Office: 630 Third Ave., New York, N.Y., U.S.A. 10017.

ADDITIONAL ALLEN-BRADLEY HOT MOLDED VARIABLE RESISTORS

TYPE G CONTROLS are only $\frac{1}{2}$ " in diameter. Quiet, stepless operation. Rated $\frac{1}{2}$ watt at 70°C. Values to 5 megohms. Type L are similar in construction but rated $\frac{1}{2}$ watt at 100°C.



TYPE F TRIMMERS are for mounting directly on printed wiring boards by means of their terminals. Rated $\frac{1}{4}$ watt at 70°C. Values to 5 megohms. Type O are similar but rated 0.4 watt at 70°C.



TYPE R ADJUSTABLE RESISTORS for trimming applications are built to withstand environmental extremes. Only $1\frac{1}{4}$ " in length. Have stepless adjustment. Watertight and can be encapsulated. Rated $\frac{1}{4}$ watt at 70°C. Values to 2.5 megohms. Type N for less severe environments are rated $\frac{1}{3}$ watt at 50°C.



ALLEN-BRADLEY
QUALITY ELECTRONIC COMPONENTS



we've made a mistake

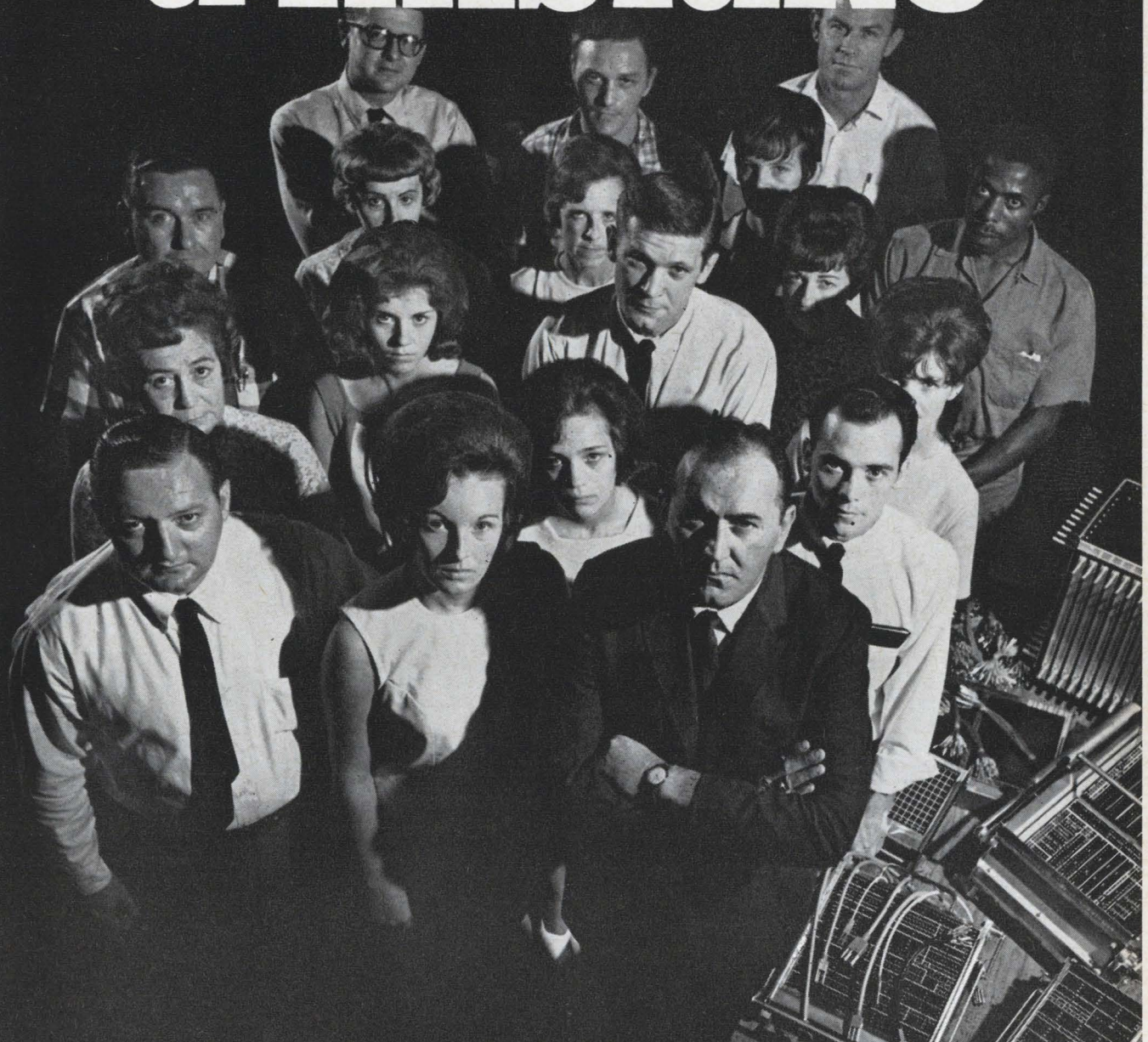

...unless there's no further engineering development in patchboard programming systems. We've made a mistake unless there's no need for faster deliveries. We've made a mistake unless there's no need for innovation and design improvements in receivers, removable patchboards, patchcords and accessories. □ Most of us have been in the programming business long enough to know these needs exist. So...here we are. Give us a try. If we're right you'll be hearing a great deal about us...if we're wrong you won't see us again. Send for Catalogs 567 and 667 and find out. ALLIED SYSTEMS CORP., 4 Tri-Port Circle, Greensboro, N.C. 27420

A

**Starting today you
voltage regulator on**

can afford to put a every circuit card.

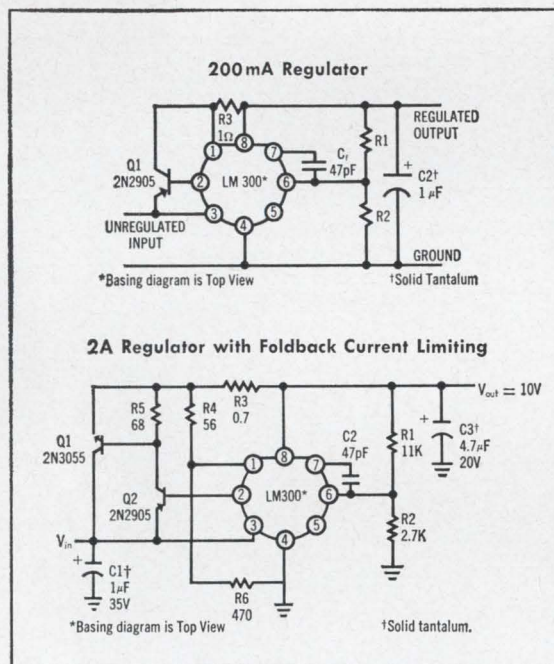

For \$3.60 in 1000 lots you can now simplify your power distribution problems with our new LM-300. It's a plastic TO-5 version of the LM-100. It operates over a temperature range of 0°C to 70°C with output voltage adjustable between 2 and 20 volts.

The LM-300 is built on a single silicon chip and can

deliver up to 5A with added external transistors.

It's probably the biggest bargain you'll find in this magazine.

You can get them at any of

our distributors, or for more information, write National Semiconductor Corporation, 2975 San Ysidro Way, Santa Clara, California 95051 (408) 245-4320.

National Semiconductor

The newest look in a new look at

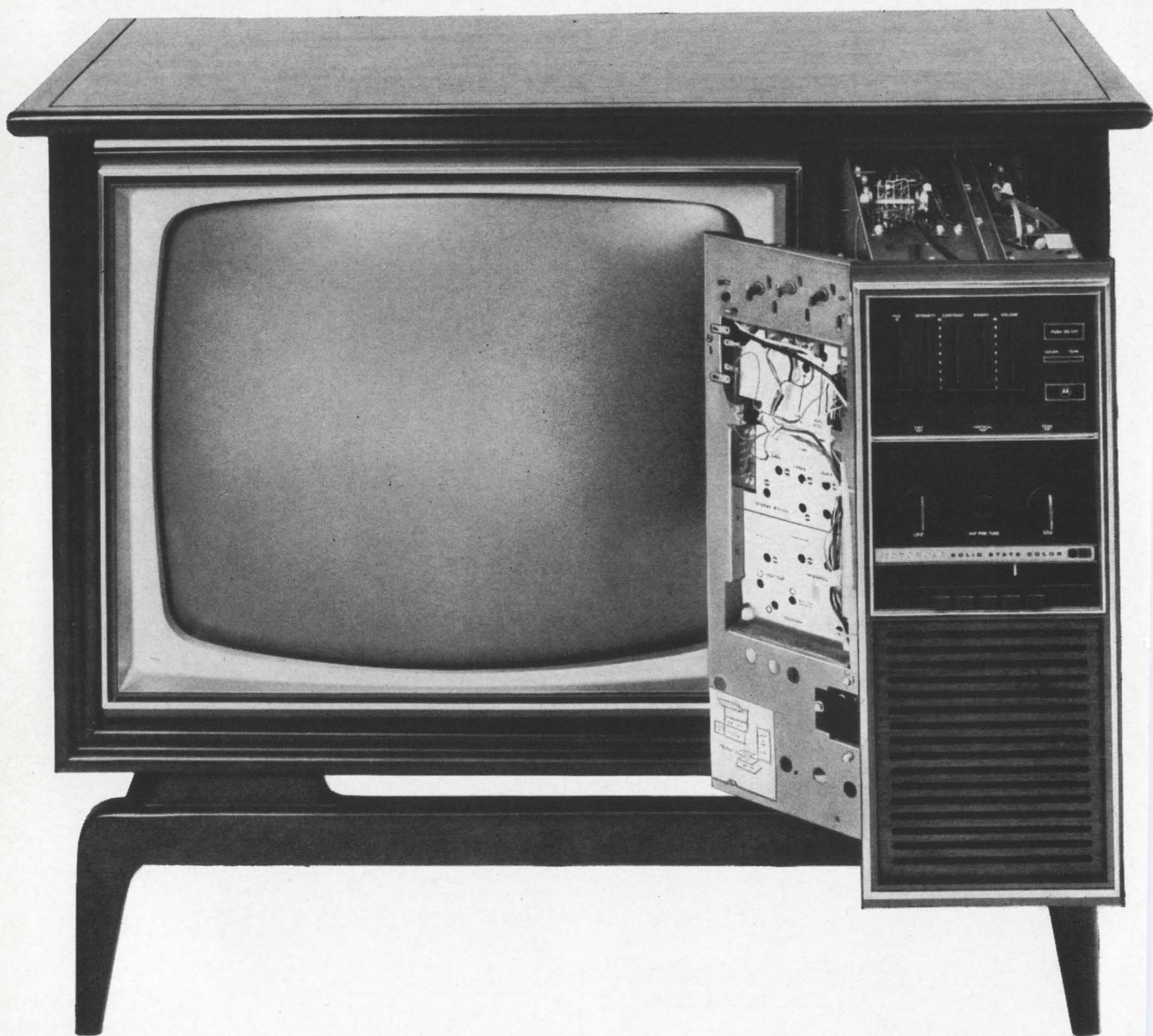

color TV requires interconnections.

Major innovation from Motorola: ten pluggable solid-state modules in one solid-state color TV. All with AMPMODU* Interconnection products. Why? Reliability. Economy. Serviceability. The AMPMODU System: a post and a double-spring receptacle. For hand or automated wiring. Infinite variety of modular combinations. Joins circuits electrically. And mechanically. So all circuits can be assembled or replaced in minutes. Joining circuitry? Investigate AMP's Interconnection ideas now.

*Trademark of AMP Incorporated

PUT YOUR IDEAS INTO ACTION WITH THE HELP OF AMP ENGINEERING... WORLDWIDE.

AMP

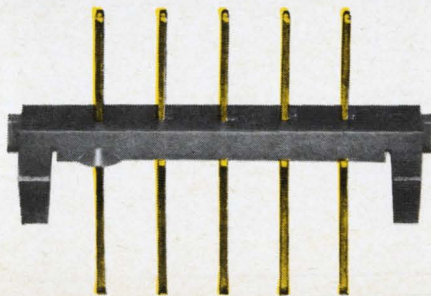
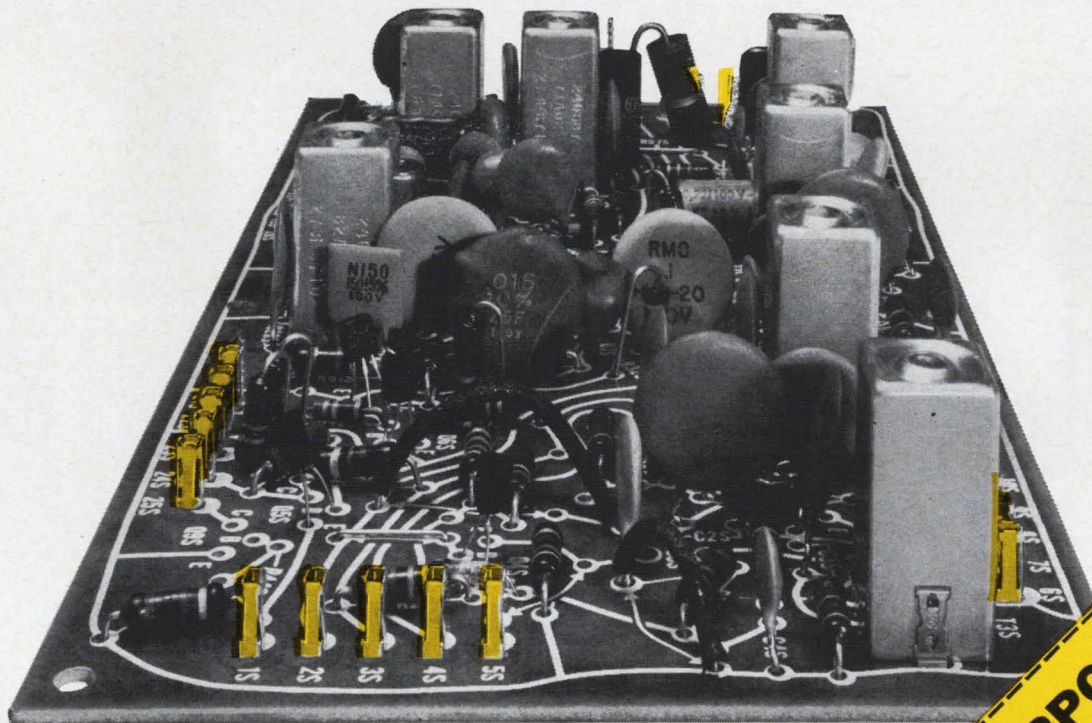

AMP INCORPORATED
Harrisburg, Pa. 17105

Send data on AMPMODU Interconnection Products to me fast.

NAME _____
COMPANY _____
ADDRESS _____
CITY _____ STATE _____
ZIP _____

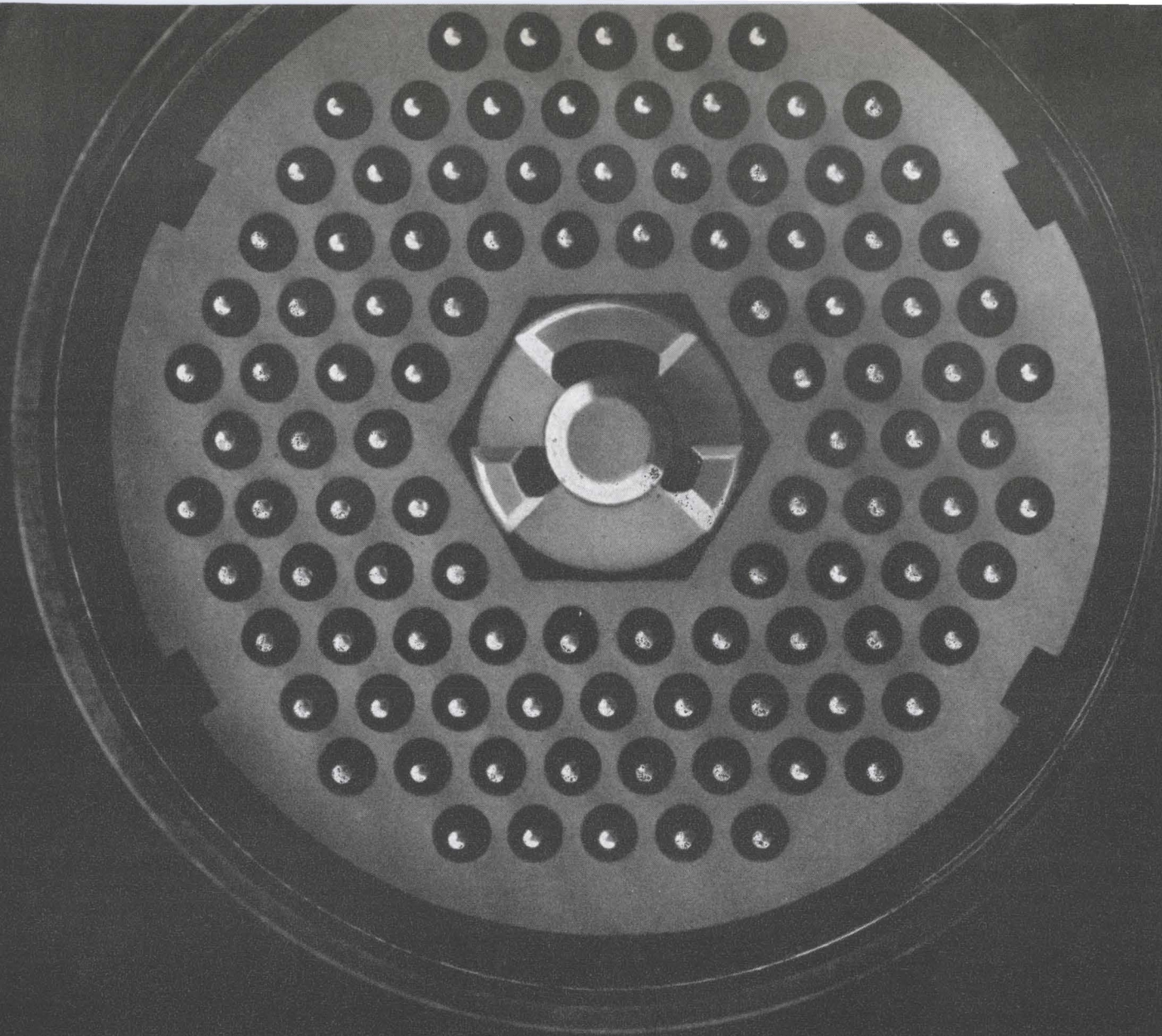

Hughes just crammed 102 contacts

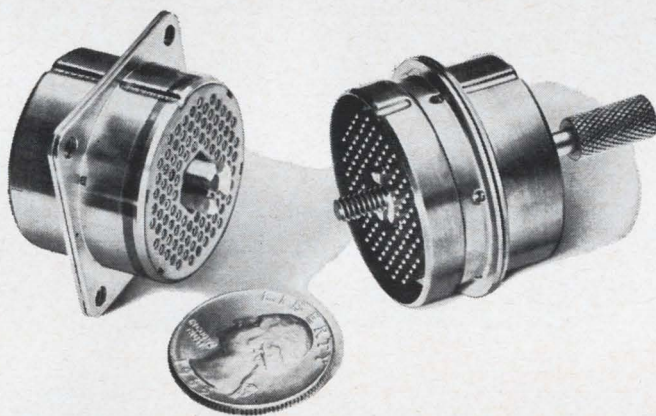

into a shell the size of a quarter.

Our new BULLS-EYE connector gives you the greatest contact and mounting density available in a circular subminiature.

The idea behind our new BULLS-EYE connector was to *increase* contact density and at the same time *decrease* space and weight. To make it work we used our proven PolarHex center-mounted jackscrew for positive contact alignment and mating. Then we designed a slim line, stainless steel shell which eliminated conventional coupling methods.

The result was a connector with all the performance characteristics of the latest MIL-C-26500, MIL-C-26482, and MIL-C-81511 connector types, but

with a contact density that actually increased from 50% up to 200% over the next highest comparable connector: 102 size #22 contacts in a size #18 shell! And the PolarHex jackscrew also lets you mount far more connectors per panel, or use smaller panels, because you can mount them flange to flange in standard MS cut-outs.

The BULLS-EYE incorporates the same contact design and contact retention system as in the famous Hughes rectangular subminiatures.

Available in arrangements of 14 to 102 contacts in six shell sizes and four body styles, all in environmental, non-environmental, and potting versions.

For complete information on the connector that's the best choice for *any* space age application, write to Hughes Aircraft Company, Connecting Devices, 500 Superior Avenue, Newport Beach, California 92663.



You've named it!

Here's the winner:
Dale's new

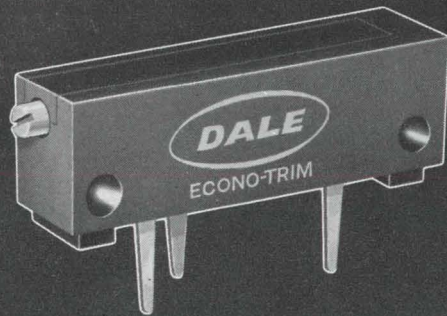

"Econo-Trim"



Our contest proved it... you want a better 1" commercial trimmer (for less than a buck)*.

Our 2300 Series has created so much industry interest that several thousand engineers, procurement specialists and even a few vice presidents suggested names for it. For example:

J. P. Thompson of Lockheed MSC wanted to call it the *Sta-Set*; which has merit because the way we install the 2300's lead screw creates excellent setting stability.

Abe Pearlman of Westinghouse suggested *Quik-Trim*. Good idea, but maybe a bit too close to competitive models (with which our 2300 Econo-Trim Series is directly interchangeable).

We picked **Econo-Trim** submitted first by **Barry Donohue of Teledyne**. It describes the cost and performance breakthroughs made by Dale in the commercial trimmer field. What's an *Econo-Trim*? It's a lot of mil-style trimmer features for less than a buck.*

Call us today for Econo-Trim details – including delivery information. Phone 402-564-3131.

SPECIFICATIONS:

Standard Resistance Range: 10 ohms to 50K ohms

Resistance Tolerance: $\pm 10\%$ standard

Resolution: .18% to 1.82%

Power Rating: 0.5 watt at room temperature to 0 watt at 85° C

Operating Temperature Range: -55° C to 85° C

Mechanical Adjustment: 15 turns nominal

Mechanical Stops: None. Clutch mechanism permits overtravel without damage

Dimensions: 1.0" L x .36" H x .28" W

Terminals:

P.C. terminals (Model 2387)

Hook-type solder lugs (Model 2389)

*In 1,000 quantities



DALE ELECTRONICS, INC.

1300 28th Ave., Columbus, Nebraska 68601
In Canada: Dale Electronics Canada, Ltd.



Circle 62 on reader service card

Washington Newsletter

October 2, 1967

Pentagon revises programs in light of Nike X go-ahead

The Pentagon is making changes in several major programs as a result of its decision to build a thin Nike X system.

- Raytheon's development of the SAM-D air defense missile [Electronics, Feb. 20, p. 54] will be accelerated so the system can be deployed with the Nike X.

- The Airborne Warning and Control System (Awacs), a detection and interceptor-vectoring air defense program [Electronics, Aug. 7, p. 66], will get boosted funding, technical updating, and possibly a formal deployment go-ahead.

- Strat-X studies of the requirements for an advanced ICBM for the 1980's will be stretched out, as defensive planning seems, at least temporarily, to have gained the upper hand over the offensive.

Hughes team favored to win Navy ABM study

The commitment to Nike X brightens chances for a seaborne antibalistic-missile system, according to observers. If they're right, prospects are also brighter for Hughes Aircraft, which seems a sure winner over Aerojet-General and Boeing in the final bidding for a \$610,000 Navy-sponsored study [Electronics, July 24, p. 50] of a seaborne ABM system.

Teamed with Hughes on the six-month preliminary design study will be the Lockheed Missile & Space Co. and the Newport News Shipbuilding & Drydock Co.

'Flight insurance' for the President

The cynics are calling President Johnson's air safety program an obvious maneuver to rob the Republicans of a campaign issue. One observer renamed the program "pre-election flight insurance" and said it was intended to protect Johnson against the charge of neglecting air safety in the event that any serious air accidents occur between now and election time.

The President's program isn't expected to produce any immediate changes. In fact, one point—directing Secretary of Transportation Alan S. Boyd to develop a long-range plan for future air traffic control equipment and facilities—may delay acceptance of new hardware or systems because the aviation industry will be expected to share system costs. Another directs the FAA to study air traffic regulations and recommend changes; the study isn't expected to be ready for at least a year.

Burroughs yields; TRW gets 407L

The TRW Systems Group will receive a contract this week to integrate, assemble, and check out the Air Force 407L tactical air control system. The award has been held up more than a month by a protest from low-bidder Burroughs, the other contract finalist [Electronics, Aug. 21, p.25]. Under life-cycle buying, a military service can award a contract to a higher bidder if it feels the total cost of producing and maintaining the equipment through its lifetime is lower.

Burroughs withdrew its objection after being briefed by the Air Force's Electronic Systems Division, Hanscom Field, Mass. The cost-plus-fixed fee contract for coordinating field deployment of the system will be worth \$3 million the first year, then climb to \$10 million a year and continue at that level for several years.

Washington Newsletter

Rx for Apollo ills: X-ray inspections

Bent and recessed pins and improper potting have been a growing headache for the Apollo program so NASA wants all connectors examined with a simple X-ray unit. The results would be photographed for analysis. The Navy has had good results with similar testing on its Polaris program.

NASA is asking Grumman, RCA, and Ryan to make connector tests. All three have been encountering connector problems in the radar systems for the lunar module. If persuasion fails, the agency is expected to make connector testing a requirement. NASA plans eventually to ask all Apollo contractors to test connectors.

IBM's Dacor gets trial at test range

IBM has received a \$1.1 million contract to install its Dacor (data correction) system along a portion of the Air Force's Eastern Test Range. If the system succeeds in improving the quality of the National Range Division's high-frequency radio telemetry, it will be expanded to cover the division's worldwide r-f data links.

Dacor, in contrast to other error-correction systems, can handle both random and burst-pattern errors. It also does its job without having to retransmit messages in which errors are detected. It won't be used with the highly reliable submarine cables linking Cape Kennedy launching pads with downrange sites, but with the often-unreliable radio links.

NASA pushing space spin-offs

NASA officials, sample cases in hand, will hit the chicken-and-mashed-potatoes trail in an accelerated campaign to shine up its image and get public backing. Hurting from \$500 million in budget cuts, NASA has its Office of Space Technology Utilization switching to a harder sell on space spin-offs. The technology office, for example, issued more than 1,000 "Tech Briefs" last month, equaling its normal annual output.

The office also will oversee the ad hoc technology task force about to be created by the Administration to get technology out of Government agencies and into industry. However, some argue that space programs have yet to produce any appreciable spin-off.

House panels battle for right to probe Pentagon's buying

Two House subcommittees are locked in a behind-the-scenes battle for the right to investigate the Pentagon's procurement policy. The electronics industry will be involved in the hearings no matter how the Congressional squabble is resolved.

The Government Operations subcommittee on military operations, headed by Rep. Chet Holifield (D., Calif.), claims prime responsibility in this area and wants to form a blue-ribbon Government-industry commission to investigate military buying. But the Armed Services Investigating subcommittee, chaired by Rep. Porter Hardy (D. Va.), plans 18 months of hearings on all aspects of the buying policy, and asserts that Holifield is pushing his subcommittee's claim because he wants to make sure the big contractors in California are protected.

The result is likely to be separate investigations.

CATV may gain third FCC backer

CATV is expected to pick up another supporter on the FCC. It's anticipated that Commissioner Nicholas Johnson will come out strongly for community antenna television in a speech at an Oct. 9 regional meeting of the National Community Television Association. This would change the FCC alignment to three for, three against, and one undecided.

CIRCUIT CONTROL AND PROTECTION BY AIRPAX

style **AP**

Style AP is all magnetic trip, hermetically sealed, meets MIL-C-39019, available 1, 2 or 3 pole, 10 ma to 20 amperes AC or DC, interrupts 1000 ampere fault at 240 volts AC.

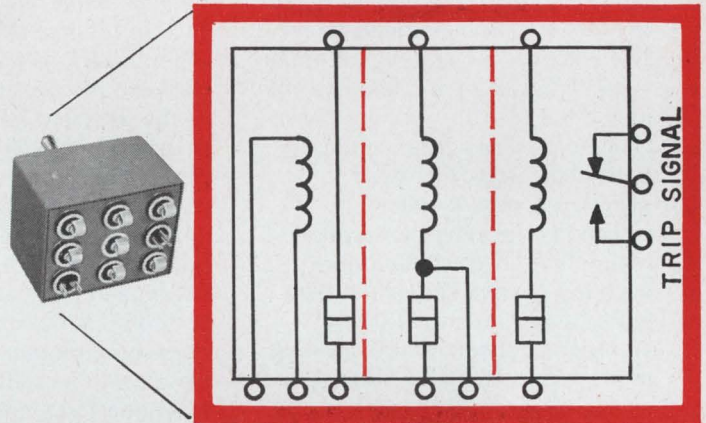
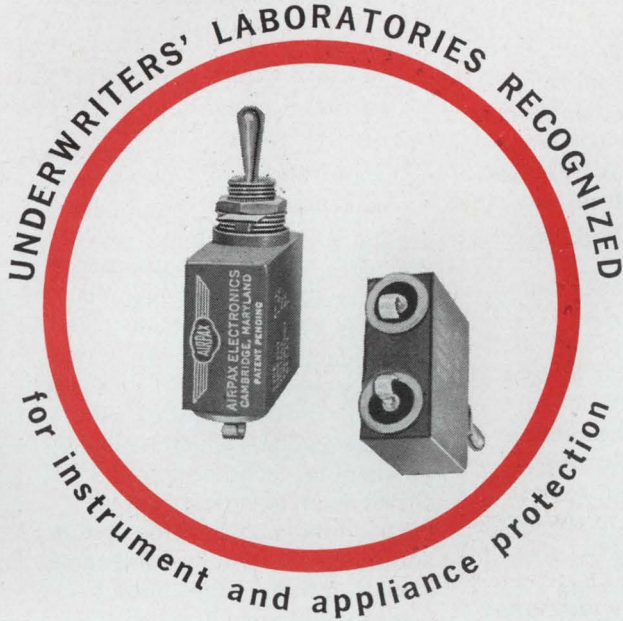

style **50-APL**

Style 50-APL is entirely magnetic trip (no heating elements), available 1, 2, 3, 4 and up to 10 poles, 10 ma to 50 amperes AC or DC, will open a 5000 ampere fault at 240 volts AC.

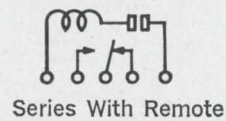
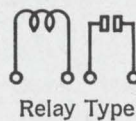
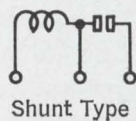
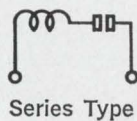
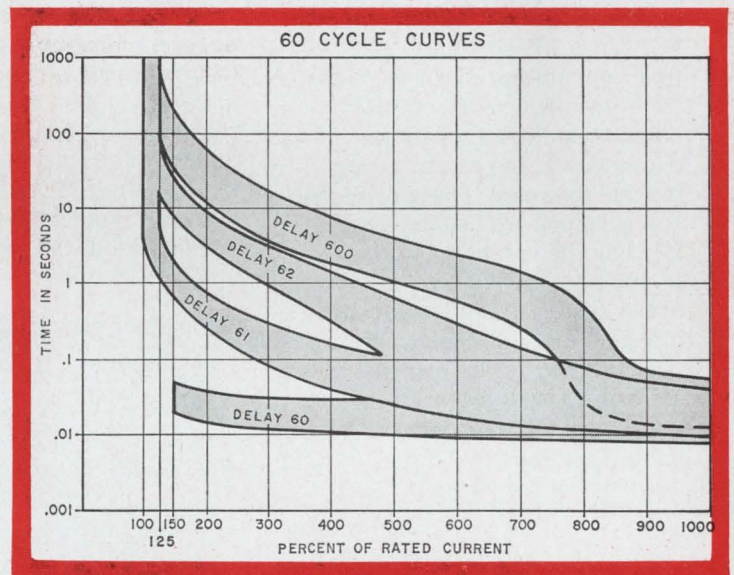
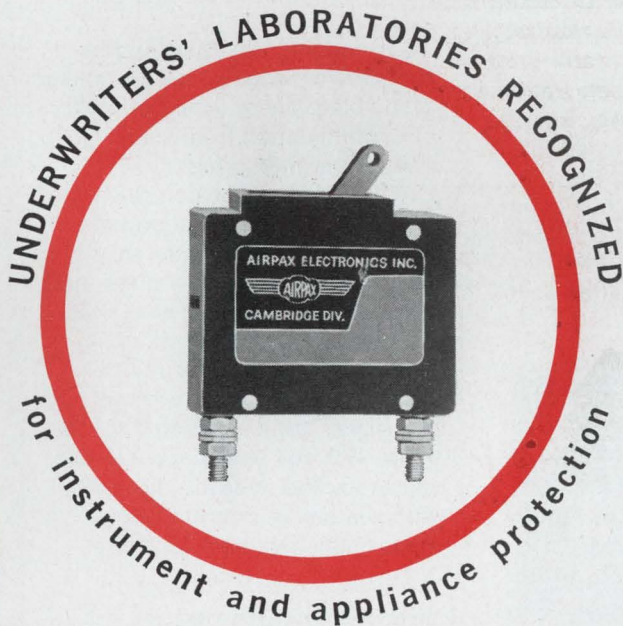

Completely magnetic circuit breakers depend on current only trip. Any coil or combination within listed ranges can be supplied for immediate delivery.

AIRPAX ELECTRONICS
incorporated
Cambridge, Maryland
(301) 228-4600

AIRPAX ELECTRONICS
incorporated
Ft. Lauderdale, Fla.
(305) 587-1100

AIRPAX ELECTRONICS
incorporated
Van Nuys, Calif.
(213) 781-2821

AIRPAX ELECTRONICS incorporated Cambridge Division, Cambridge, Maryland

How to keep relay contact forces balanced at 30 G's.

Picking a relay for an extreme shock/vibration environment is a tough problem for many a circuit designer. Few relays are designed to meet the problem head on. There is now one notable exception — a 4PDT, 10 ampere relay in a one-inch cube.

Using a new design principle — balanced-force — this relay withstands severe shock, vibration or acceleration while maintaining high contact and overload capabilities. It will take more than 30 G's to 3000 Hz vibration, a shock of 100 G's and has a minimum life of 100,000 cycles. This one-inch cube is all welded, weighs 2.5 ounces, and is rated at 2.9 watts coil power.

EFFICIENT MAGNETIC CIRCUIT

In the conventional relay motor, forces for open and closed contacts are unequal. Energized coil power causes the armature to close the normally open contacts. But, when the coil power is removed and the contacts return to the normally closed position, only the spring forces of the contacts and the return spring provide the force. These combined spring forces are usually low, allowing the contacts to bounce. In addition, the low spring force allows the armature to rebound off the armature stop, again knocking the contacts open — sometimes, for as long as several milliseconds after they have initially closed.

Force-Stroke Curve of Typical Relay and Balanced-Force Relay.

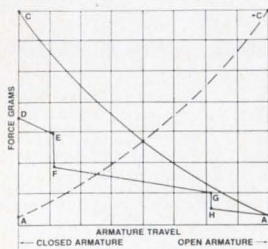

Curve CA — Balanced-Force Relay normally closed contacts.
Curve A' C' — Balanced-Force Relay normally open contacts.
Curve DEFGH — Typical Relay.

Leach Balanced Force Relay by use of an extremely efficient magnetic design. It has to be to

keep the forces balanced while ignoring 30 G's. Basically it is a controlled application of magnet and coil flux. In the de-energized position, a permanent magnet flux flows between the armature and the tip of the adjacent pole piece, resulting in a high holding force. The motor is, therefore, relatively immune to shock and vibration. When coil power is applied, the flux from the permanent magnet is nullified by the coil flux flowing in an opposite direction. The armature closes with a rapid build-up of magnetic force driving it against the contact overtravel forces and into a sealed position.

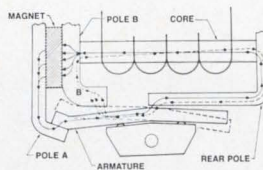

Balanced-Force Motor De-Energized

When coil power is removed and the armature returns, the

restoring force of the permanent magnet builds up quickly. The armature is then driven against the overtravel forces of the normally closed contacts and into its de-energized sealed position. With this type of force-displacement, the armature isn't about to rebound.

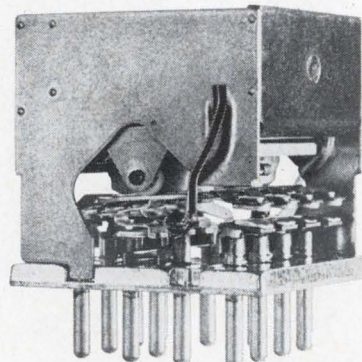

New Leach Model K employs balanced-force concept.

BUFFERED CONTACTS

The moving contacts are mounted to an armature, which is held firmly at the end of each stroke by high magnetic forces. Since the armature can't move during shock

or vibration, undesirable contact opening is eliminated.

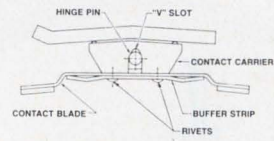

Moving Contact System

Reinforcing the moving contact is a buffer strip which assumes a

variety of chores. It has a bow in the center to act as a spring load while serving as a rivet plate. It works as a heat sink. It will break the contact strip free from a weld if one occurs because of excessive overload. It makes contact with the moving blade which results in excellent low contact drop. It serves as an electrical contact between the moving blade system and the header. And, as the name implies, it buffers the contact blade against extreme shocks and vibrations.

WELDED ASSEMBLY

In assembling the relay all detail parts are welded. No part is solder assembled. There is no possibility of contamination from solder flux. The unit is then pressed into a can and electron-beam sealed, leaving only an evacuation hole. After a high temperature bake, the relay is filled with a dried inert gas, and the hole is welded shut. Here, ready for shipment, is a relay with a magnetic circuit designed so the force without coil power applied is equal to the force with coil power applied, but in exactly the opposite direction. And you can rest assured those forces stay balanced no matter how you shake them.

Complete Motor and Contact Assembly

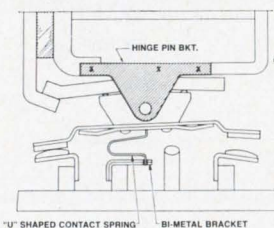

U-SHAPED CONTACT SPRING BI-METAL BRACKET

Write for your copy "Tomorrow's Relay Today", a technical paper presented at the

National Relay Conference. Leach Corporation, Relay Division, 5915 Avalon Boulevard, Los Angeles, California 90003
LEACH (213) 232-8221.

Our I.C. digital modules reject more noise than anybody's.

Integrated flip-flops, inverters and buffer amplifiers in T Series modules are made to our proprietary design and hermetically sealed in TO-5 cans.

Full-width copper ground plane sandwiched between epoxy-glass boards minimizes circuit inductances and discourages noise spikes. Mounting cases also have full-width shield planes to retard noise coupling between logic wiring.

T Series input and load resistors, made to much tighter tolerances than can be attained with integrated components, are mounted outside the integrated circuit containers, eliminating power dissipation problems.

Discrete input diodes enable us to place the switching threshold right in the middle of the logic swing.

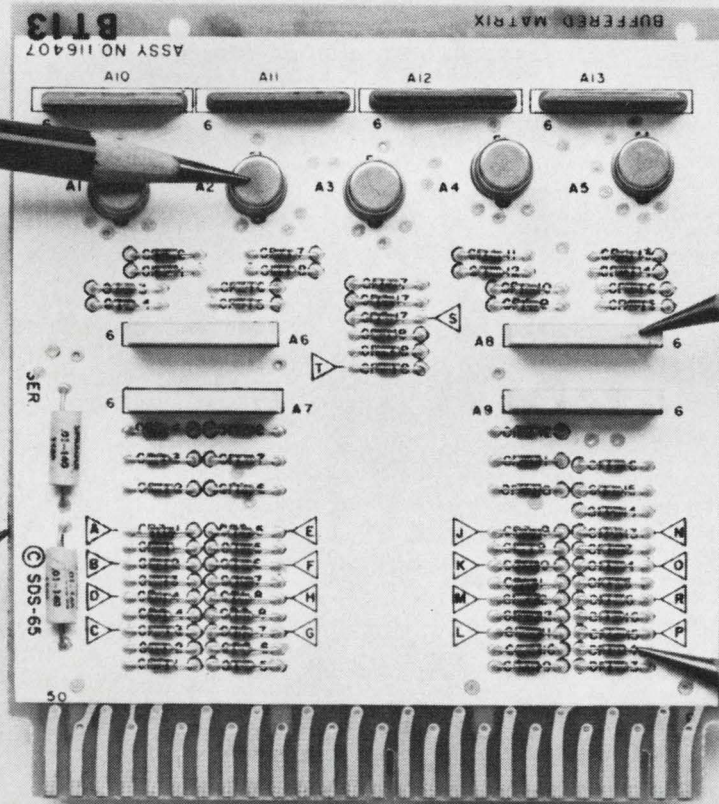

The payoff.

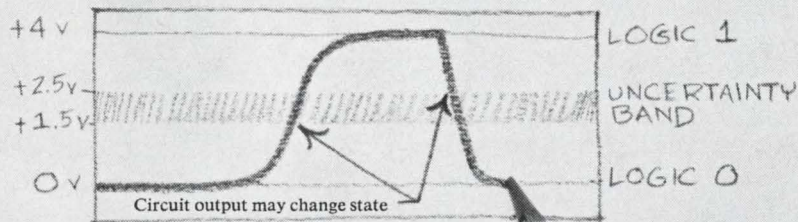

T Series logic levels are 0 and +4 volts, and noise rejection is 1.5 volts minimum, leaving a maximum uncertainty band only one volt wide within which noise can trigger the circuit output. This uncertainty band of 25% is far narrower than those of other I.C. modules on the market.

SDS
Scientific Data Systems,
Santa Monica, California

Here's how to get more cooling with less size and weight: Use Garrett-AiResearch "ICE".

The Garrett-AiResearch systems approach to "black box" cooling is called Integrated Cooling for Electronics ("ICE"). It can save you development dollars, cut system weight, and reduce circuit enclosure size.

Simply give us your circuit design heat transfer problem and we'll do the rest: trade-off studies, interface details, heat transfer system design, and manufacturing.

You'll get an optimized system with minimum power consumption for maximum cooling, and a compact, lightweight chassis with an

integral or separate heat transport loop or heat pump.

If you're developing electronics circuits for space vehicles, weapons systems, aircraft or ground communications, or other critical applications, call in AiResearch while your package is being conceived; we'll work with you to match an "ICE" system to your specific needs. Contact AiResearch Manufacturing Company, 9851 Sepulveda Blvd., Los Angeles, California 90009.

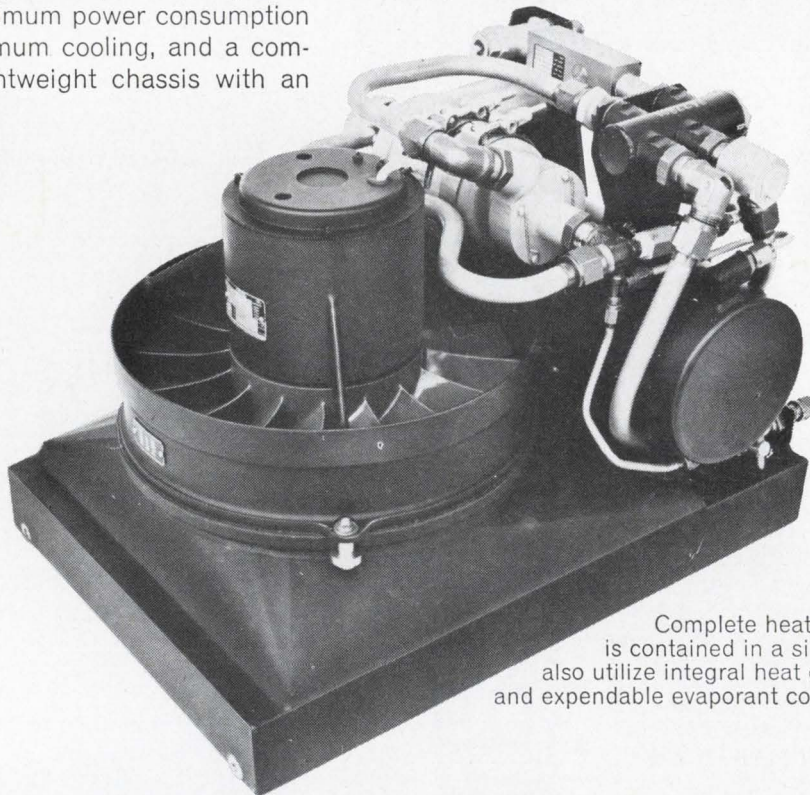

Complete heat transport system (left) is contained in a single, compact unit. We can also utilize integral heat exchangers, heat pumps, and expendable evaporant cooling methods.

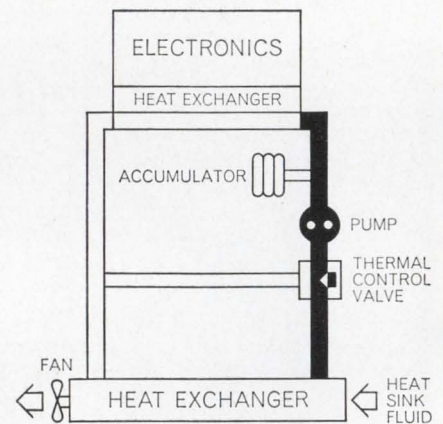

TYPICAL "ICE" SYSTEM SCHEMATIC

This AiResearch "ICE" system includes both the heat transport system and electronics enclosure with integrated heat exchanger.

GARRETT AiResearch
Heat
Transfer Systems



Ready-made or tailor-made... RCA's new L-Band Microwave Power Source

Instant specifications to fit—that's the versatility of the S190, RCA's new L-Band Solid-State Power Source. Designed for low-voltage operation for efficient use of battery and space in rocketsonde applications, the standard unit operates as a fundamental frequency oscillator delivering 200 mW of output power at 1680 MHz.

S190 employs a single RF transistor in a unique dual-cavity microwave circuit. Its specifications can be readily tailored for operation at any frequency in the range from 1.2 to 1.9 GHz. You can have the power output, temperature range, and packaging most suited to your application, as well as your selection of supply voltages from -15 to -30 Vdc with integral regulator; from -12 to -30 Vdc without regulator.

Available in a compact, rugged package, the S190 can withstand extreme shock, vibration, and acceleration conditions during operation with minimal variation in frequency. The device is temperature compensated to be frequency stable within 4 MHz.

For full information on RCA's S190 and how it can be tailor-made to your specifications, call your RCA Representative. For technical data, write: RCA Commercial Engineering, Section J19Q-1, Harrison, N.J. 07029.

Typical Characteristics of S190 and S170 Power Sources

Parameter	S170V100	S190
Voltage	-20 Vdc	-20 Vdc
Current	160 mAdc	90 mAdc
Power Output	200 mW (Min.)	200 mW (Min.)
Frequency	1680 MHz	1680 MHz
Spurs	-10 dB @ 560 MHz -15 dB @ 1120 MHz -30 dB @ 3360 MHz	-60 dB @ 3360 MHz -20 dB @ 5040 MHz
Pulling Figure	2 MHz	4 MHz
Pushing Figure	1.5 MHz/Volt	0.5 MHz/Volt
Efficiency	8-10%	10-15%
Length	1.4 in	2.3 or 2.1 in
Weight	2.5 oz	3 or 2.5 oz

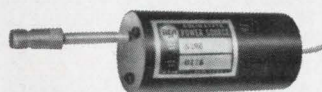

S190 L-Band Solid-State Power Source

RCA Electronic Components and Devices



The Most Trusted Name in Electronics

Actual photographs show the filtering effect of Stackpole ferrite beads on critical electronic circuits. Left — without beads, right — with beads.

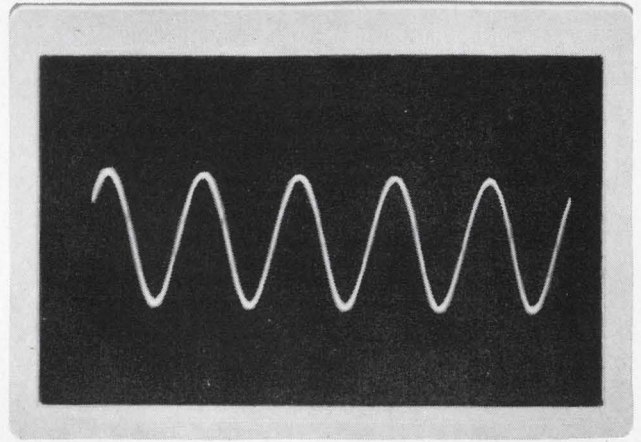
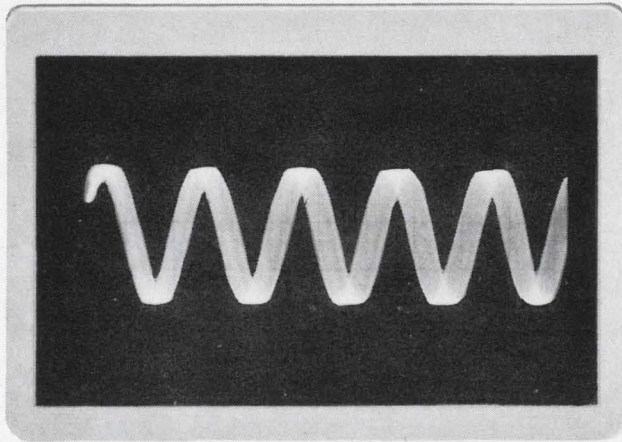

Stackpole Ceramag® beads solve noise and filter problems easily and economically

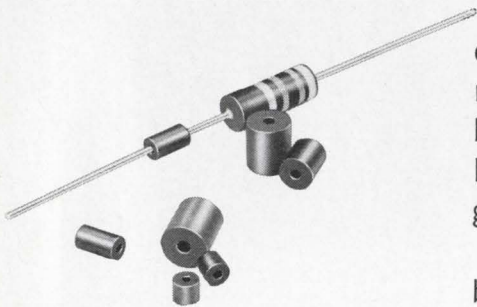

Ceramag® ferrite beads offer a simple, inexpensive, yet effective means of obtaining RF decoupling, shielding, and parasitic suppression without sacrificing low frequency power or signal level.

Unlike conventional RF chokes, beads are compact, have no DC losses, and will not couple to stray capacity and introduce detuning or spurious oscillations. Ceramag® beads offer an impedance which varies from quite low at low frequencies to quite high at noise frequencies. Beads need not be grounded; how-

ever, chassis contact is permissible when desired, as beads possess sufficiently high resistivity to preclude grounding.

Installation of Stackpole beads is easy. Simply slip one (or several) over appropriate conductor(s) for the desired noise suppression or high frequency isolation. Beads are available in sleeve form in a range of sizes starting at .025 ID, .060 OD, and .400 long. For special compact filtering applications such as cable connectors, beads can be supplied to tight mechanical tolerances.

Several ferrite grades provide a variety of attenuation characteristics. Inductance tolerance is normally $\pm 30\%$ as measured on an LC meter. The performance of a Ceramag® 7D bead as a parasitic suppressor is shown in Figure 1.

Other typical applications might include: decoupling in "B" circuitry; noise suppression; RF isolation in filament circuits; use in combination with capacitors to form "L" networks.

FIGURE 1

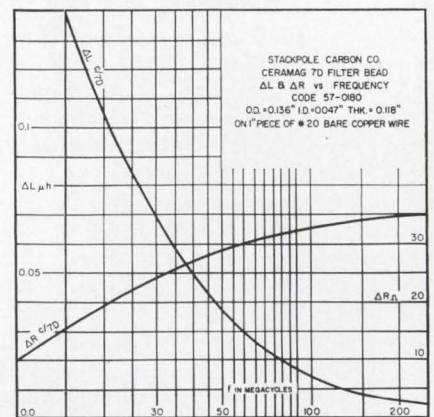

Sample quantities of Ceramag® beads are available without charge upon request. Send your requirements to Stackpole Carbon Company, Electronic Components Division, St. Marys, Pennsylvania 15857. Phone: 814-717-8521. TWX: 510-693-4511.



STACKPOLE
ELECTRONIC COMPONENTS DIVISION

200 amp logic triac

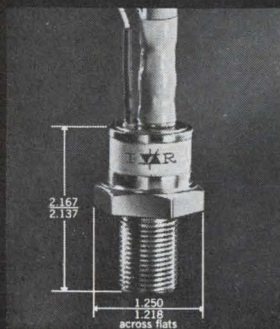

World's first 200 amp logic-triac is in pilot production at International Rectifier in voltage ratings from 400 to 1000 Volts. This unique "logic" capability allows the selection of the conduction direction as a function of the gate signal. The logic-triac is an advanced development made possible by IR's exclu-

sive epitaxial process. Send your purchase order today for immediate delivery: 200AC100, 1000 Volts, \$850; 200AC80, 800 Volts, \$625; 200AC60, 600 Volts, \$352; 200AC40, 400 Volts, \$270. Or ask for complete technical data via inquiry card, letter, or telephone.

INTERNATIONAL RECTIFIER



SEMICONDUCTOR DIVISION □ 233 KANSAS STREET, EL SEGUNDO, CALIF. 90245 □ PHONE (213) 678-6281
FIELD OFFICES AND DISTRIBUTORS IN MAJOR CITIES AROUND THE WORLD



Our vacuum capacitor testing is the next best thing to the worst field conditions.

Only ITT Jennings maintains the facilities to test vacuum capacitors in an environment that exactly duplicates actual operating conditions—and then some. In fact, as a government-approved facility equipped to perform capacitor qualification testing under MIL-C-23183A, we carry our testing to extremes far beyond the worst possible field conditions.

Our vacuum capacitors are rf tested at rated voltage and current or to customer specifications on transmitters ranging in frequency from 17 kc to 600 mc and up to 100 kw cw power.

ITT Jennings environmental testing includes capacitance shift versus temperature from -65°C . to $+125^{\circ}\text{C}$.; dynamic vibration; static vibration; shock; salt spray; humidity; and bellows life testing.

All of this testing is done to assure you the most reliable performance from every vacuum capacitor we make: units up to 5000 pf in the 15 kv range, 1000

pf to 55 kv and 200 pf to 120 kv. Current ranges of our ultra high vacuum dielectric capacitors are available up to 250 amps rms at 16 mc with convection air cooling and 1000 amps rms with water cooling. Small units for lower power or space-saving use range from less than 1 pf to 25,000 pf.

TYPICAL SPECIFICATIONS

	CADA 600	CVTW 1600	CVDD 1000
Capacity Range (PF)...	40-600	100-1600	25-1000
Peak Test Voltage (kv)	10,15	55, 60, 65	7.5, 10, 15
Amps rms (16MHz)....	65	600	125
Overall Length.....	5.8 in.	23 in.	8 in.

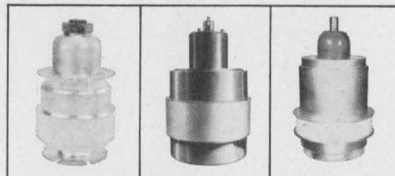

CADA 600

CVTW 1600

CVDD 1000

ITT Jennings has more to offer than the industry's only complete testing facility. To back up our reputation for design leadership—which began with the first vacuum variable capacitor ever built and has been responsible for virtually every significant new development since—we rely on a staff of experienced communications engineers. This staff directs its capacitor design capabilities toward meeting the anticipated communication equipment needs of the future. This is why new developments in advanced vacuum capacitor design are always on their way from ITT Jennings. Before they ever reach you, however, they must first pass the most rigid quality control in the industry: testing in our own testing facility.

For complete information on vacuum capacitors, write for Catalog No. 101. ITT Jennings, a division of International Telephone and Telegraph Corporation, 970 McLaughlin Avenue, San Jose, California 95108.

JENNINGS **ITT**

Today \$1495 buys you immediate delivery of our new 540 Series Integrating Digital Voltmeter.

Stability: within specs for six months. No zero adjust. It automatically corrects for zero offset as a part of each computation. Reliability: at least an order of magnitude better than our competitors' most reliable IDVM.

How come? Because 90% of the design is done with integrated circuits. No vacuum tubes or mechanical choppers. No wonder it delivers specs like these:

Accuracy: 0.01% of reading ± 1 digit in four ranges from 1.5000 to 1000.0 volts dc. Automatic and manual ranging via illuminated, inter-

locking pushbuttons, with automatic polarity selection. Input impedance: 10 megohms on all ranges. Normal mode rejection: ≥ 80 dB at 60-Hz without the use of an input filter. Speed: 1.5 readings per second.

For \$2750 you can get immediate delivery on the 540 Integrating Digital Multimeter. It measures dc millivolts, dc volts, ac volts, dc current, and resistance.

Prices FOB San Diego. Additional export charge. Full details are available from your nearest Cohu engineering representative, or from Ken Walker, Manager, Instruments and Systems. Telephone: 714-277-6700. Box 623, San Diego, Calif. 92112.



While everybody else is still talking about using integrated circuits to design the most stable and **reliable IDVM** ever...

Cohu ships it.

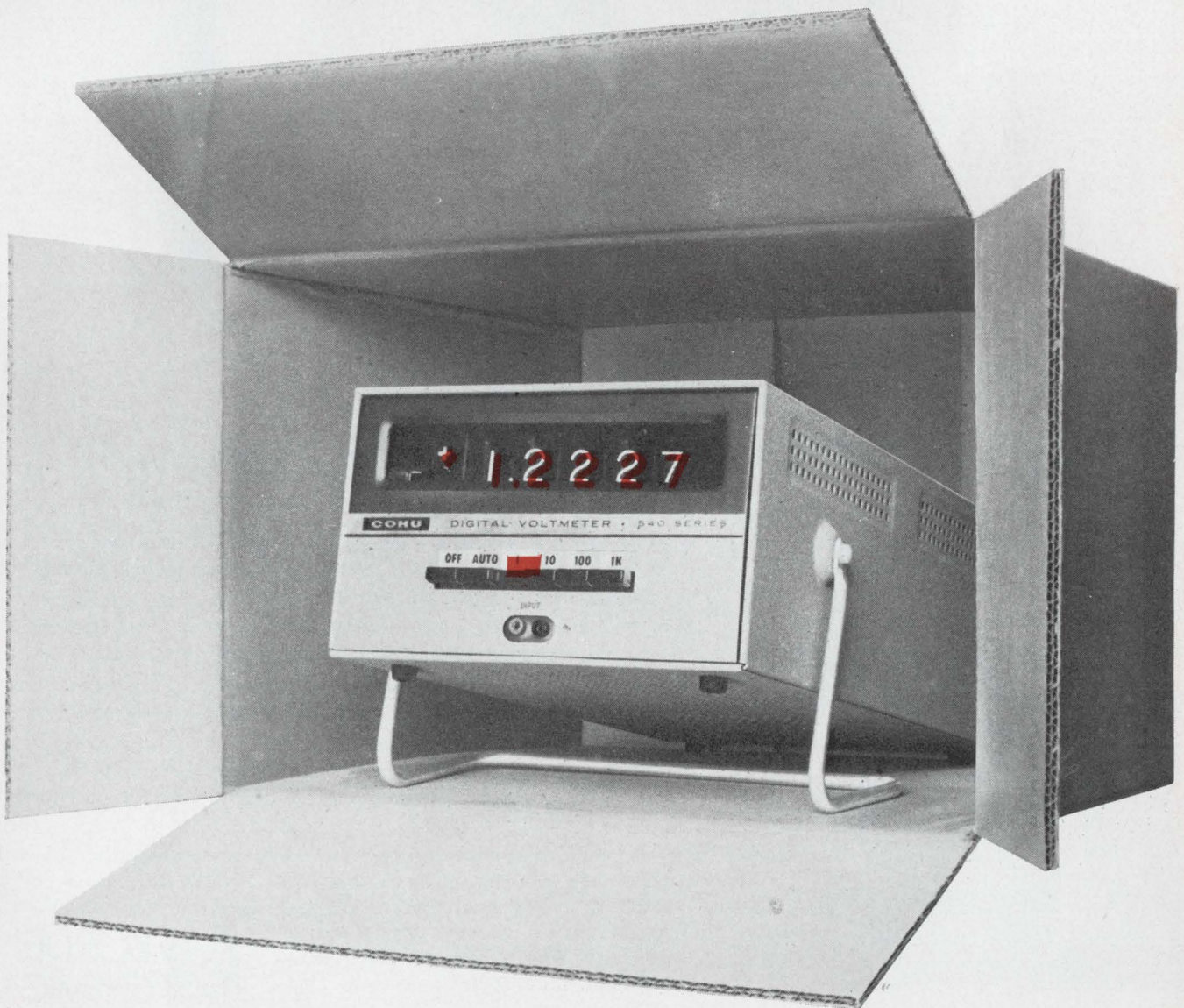

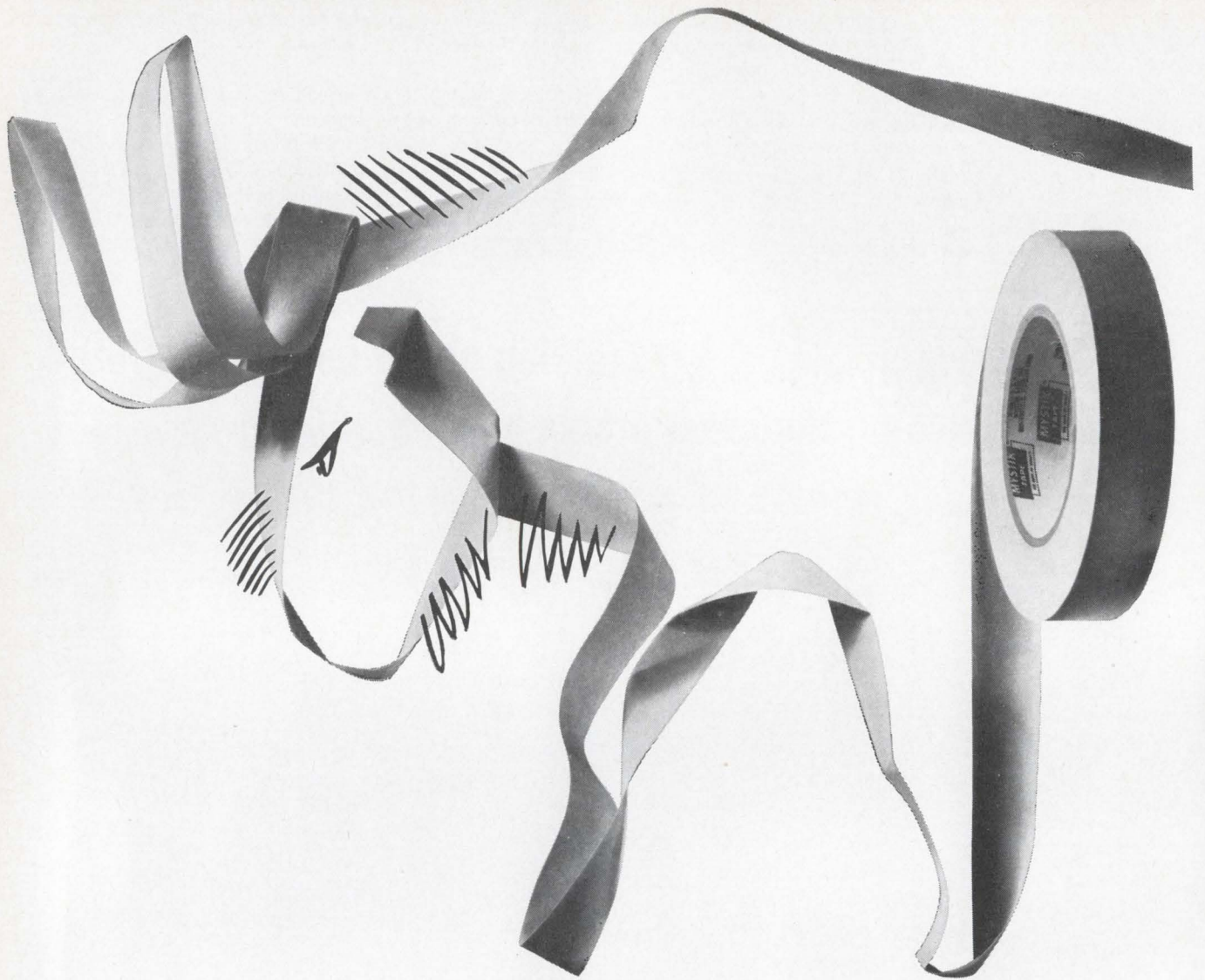

What's gnu? Mystik NOMEX[®], KAPTON[®] and TEDLAR[®], that's what!

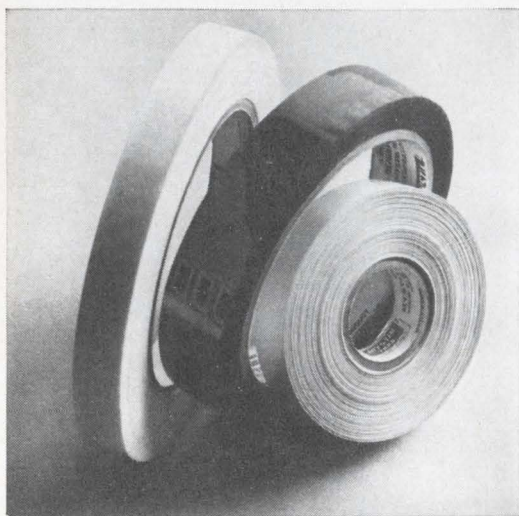

Mystik scores again by being the first to utilize three new materials ... Nomex, Kapton and Tedlar ... and add them to their already extensive line of pressure-sensitive tapes.

NOMEX — a highly conformable tape that offers excellent holding power and dielectric strength characteristics.

KAPTON — the featherweight of wire insulations ... excellent high temperature applications which require low weight structures.

TEDLAR — ideal for electrical applications because of high dielectric strength combined with excellent weather and hydrolytic resistance.

If you would like more information on these or any other Mystik special-purpose tapes, contact your local Mystik distributor. He is listed in the yellow pages under "Tapes—Adhesive". Or, write Mystik Tape Division, The Borden Chemical Company, 1700 Winnetka Avenue, Northfield, Illinois 60093.



**BORDEN
CHEMICAL**

©TBC

**Frenchtown/CFI
can make you
2,000,000 ceramic
dual-in-line bases
and caps a week**

**...or 200,000
ceramic insulated
gold plated
power transistor headers
a year**

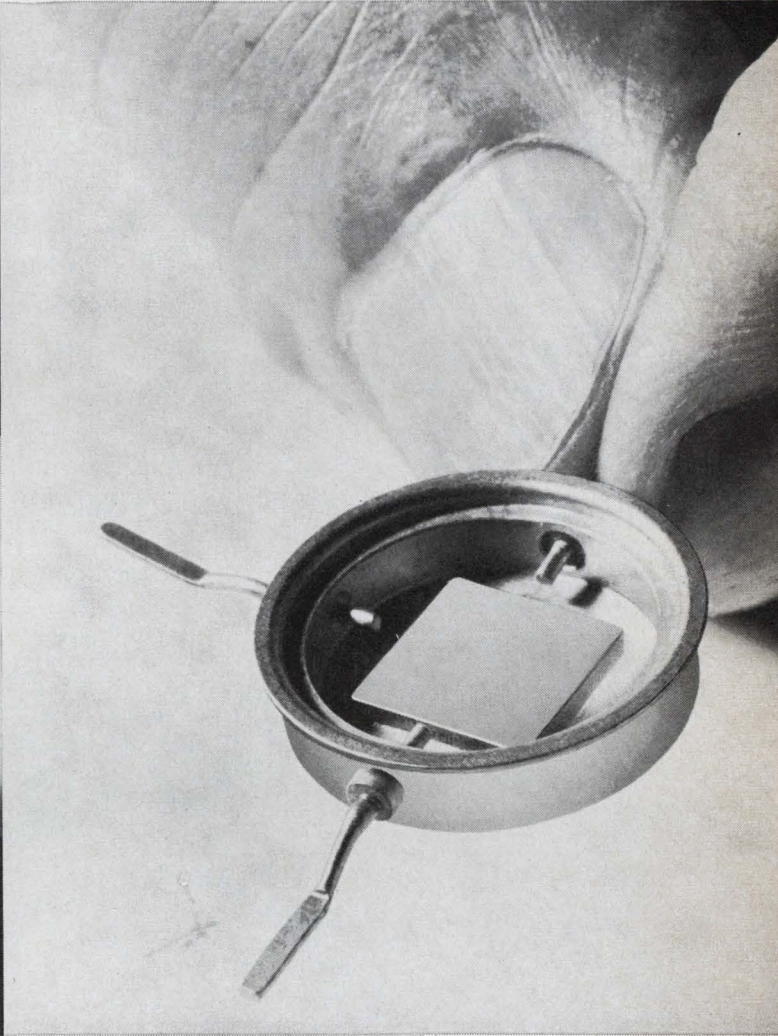
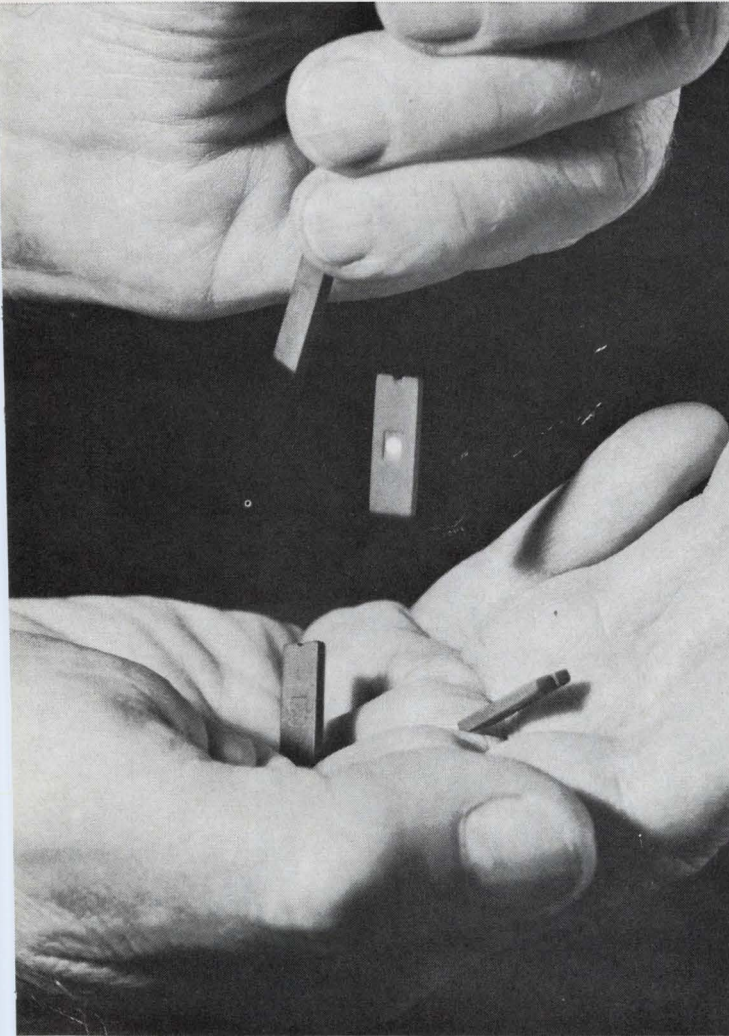

For high volume, custom-made alumina and beryllia ceramic products, astute buyers make sure to contact Frenchtown/CFI, Inc. Shipping rates of more than 5,000,000 pressed parts per week are easily maintained—month after month after month.

For complex parts, too, Frenchtown/CFI is a prime source. You can get them large or small, moly-manganese or gold-platinum metallized. Intricately shaped. Assem-

bled to other ceramics or metal parts. Optically flat. Hermetically sealed.

Whether your application is electronic, electrical, mechanical or chemical, consult Frenchtown/CFI on problems of ceramic production, metallizing and sealing. You can save weeks on your timetable. Describe your need and request a proposal. (We'll send you an informative brochure too.) For fast action call:

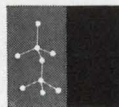

FRENCHTOWN/CFI, INC.

A subsidiary of Alloys Unlimited, Inc.

Eighth Street Frenchtown, New Jersey 08825
(201) 996-2121

FRENCHTOWN/CFI MEANS CERAMICS FOR INDUSTRY

What does the CD-65 have that all other 2½D memory systems don't?

MORE STRINGENT DESIGN CRITERIA + HIGHER RELIABILITY + GREATER USER VERSATILITY.

The CD-65 is designed with the demanding user in mind. Operating margins in this unit are significantly greater than accepted industry standards. Mechanical packaging of key circuits and magnetics in the CD-65 provides a system organization easily adapted to custom application. All circuits are worst case designed and are verified by customer examination. □ Featuring a newer 2½ D packaging concept, the CD-65, with a 650 nanosecond cycle time, permits faster speeds and definite economies for larger word systems. The CD-65 is available in sizes from 8K to 65K words—each containing from 16 to 144 bits. □ Speaking of words, may we have some with you? We'd like to tell you more about the CD-65. For more information, write: Lockheed Electronics Company, Memory Products, 6201 East Randolph Street, Los Angeles, Calif. 90022. Or phone (213) 722-6810.

Visit Lockheed
Memory Land
FJCC Booth 148-151

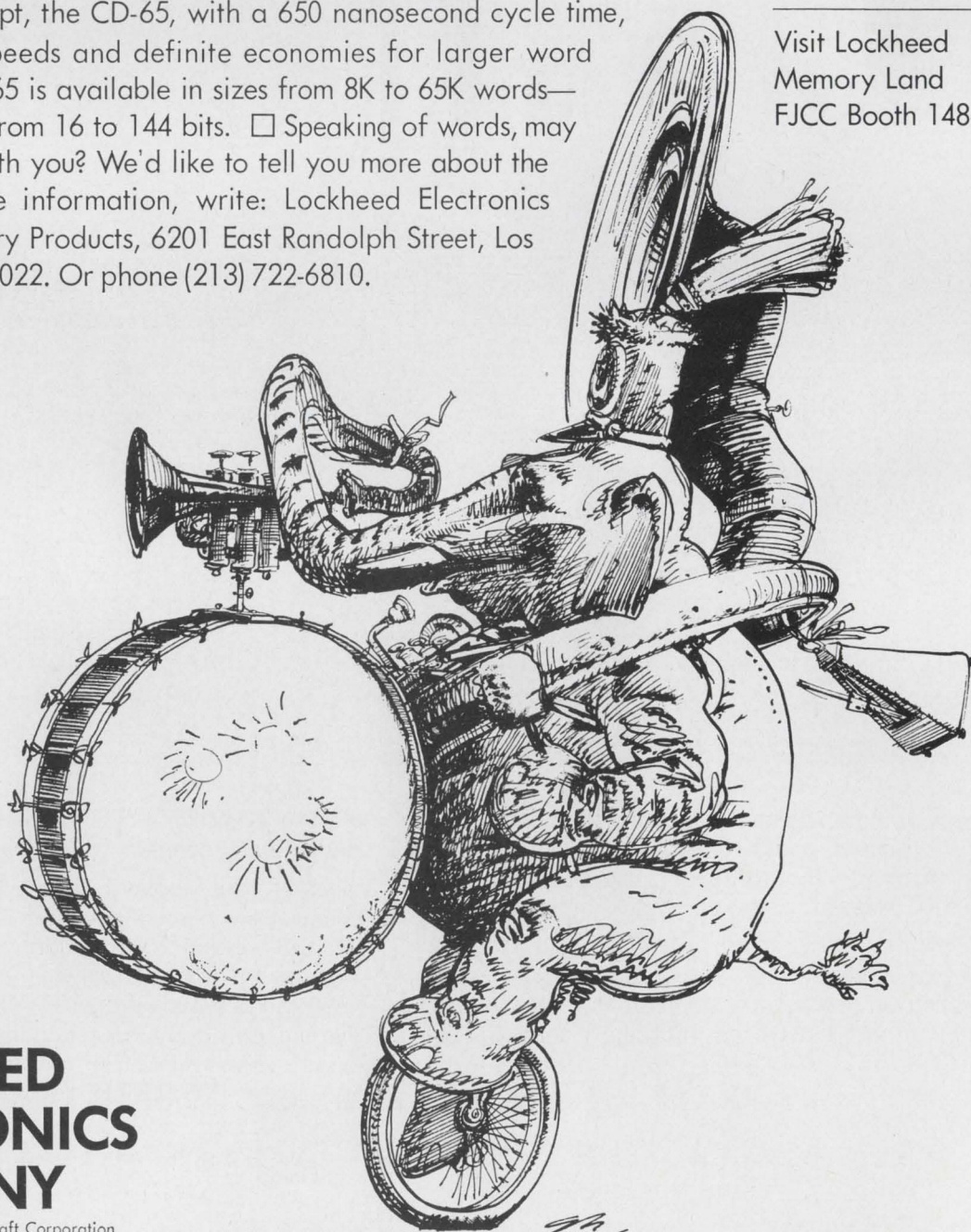

**LOCKHEED
ELECTRONICS
COMPANY**

A Division of Lockheed Aircraft Corporation

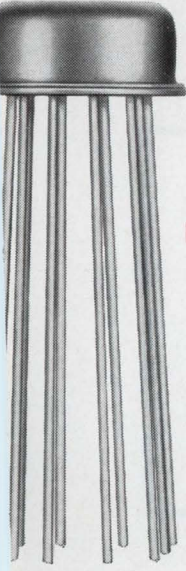

now you can test
**24 parameters of a
10-pin microcircuit
in 2 minutes flat...**

with this new semi-automatic IC analyzer

**MICA
150**

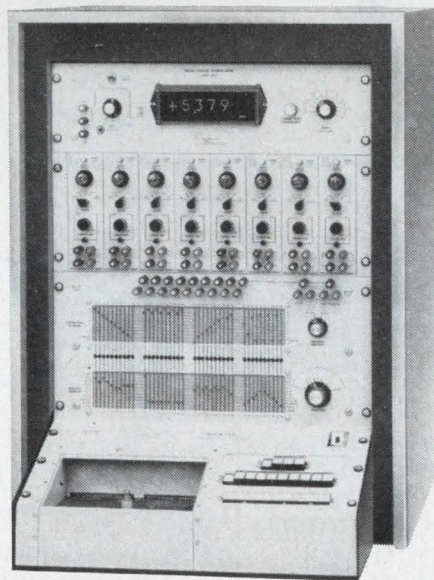

Now even a non-technical operator can speed through comprehensive DC tests on all types of IC packages with from 2 to 40 pins. Test conditions are easily set up on the programming switches of MICA-150 and pushbutton sequencing of the test from pin-to-pin of a device is simple and fast with test results indicated by direct digital readout. On a typical 10-pin, 5-input gate circuit, as many as 24 parameters of the device can be checked within two minutes without changing a single crossbar switch.

For additional information on applications of MICA-150 for DC or high frequency testing, contact W. Leo McBlain, (609) 424-2400

COMPUTER TEST CORPORATION
CHERRY HILL, NEW JERSEY



Circle 77 on reader service card

Want to make something BIG

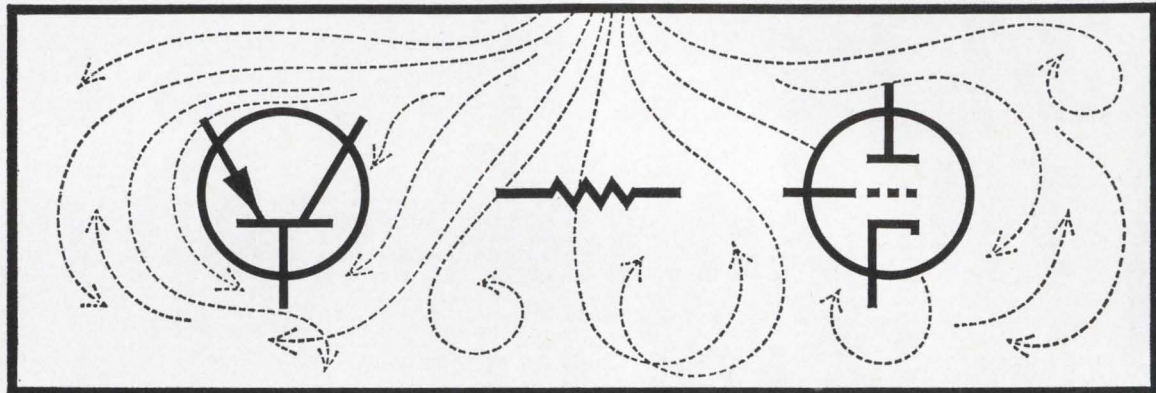

into something Small?

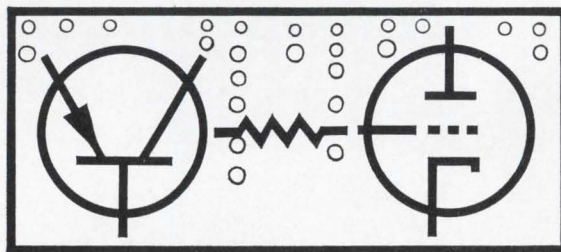

A new technical report on Evaporative Cooling with FREON[®] tells you How!

When miniaturization is your objective, FREON dielectric coolants can solve a lot of design problems. They are the ultimate in heat-transfer effectiveness (*1,000 times as effective as air; 100 times as effective as oil*) and they have a dielectric strength in both liquid and vapor phase that equals or exceeds oil.

Our new technical report describes evaporative cooling systems and makes recommendations for best heat-transfer results. Just fill in the coupon on the right and we will be glad to send you this report. We're pretty proud of it.

DU PONT **FREON[®]**
 dielectric coolants
 BETTER THINGS FOR BETTER LIVING... THROUGH CHEMISTRY

E. I. du Pont de Nemours & Co. (Inc.)
 FREON Products Laboratory
 Development Section
 Chestnut Run
 Wilmington, Delaware 19898

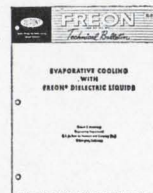

Please send me the 24-page Technical Report "Evaporative Cooling with FREON Dielectric Liquids".

I'm interested in cooling: _____

Name _____ Title _____

Company _____ Address _____

City & State _____ Zip _____

B-2

"It seems good for philosophers to move to fresh ways and systems; good for them to allow neither the voice of the detractor, nor the weight of ancient culture, nor the fullness of authority, to deter those who would declare their own views. In that way each age produces its own crop of new authors and new arts . . ."

Fernel,
16th Century

GLASS

Changing the Structure
of SOLID STATE

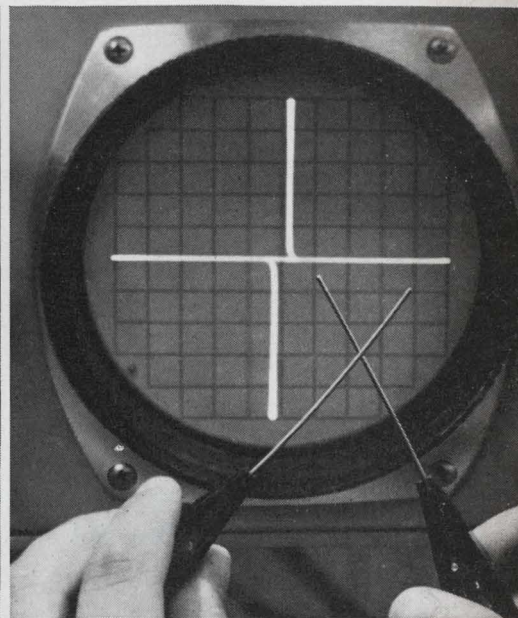

Simplest Switch ever made by man is an active thin film of OVONIC semiconductor material vacuum deposited between two wires. Oscilloscope trace shows inherently symmetrical E-I characteristic. Switching speed is less than 150 picoseconds.

OVONIC

BULK-EFFECT SEMICONDUCTORS*

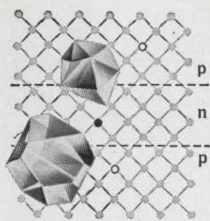

YOU'VE SEEN drawings of crystal lattice structures like this before. Over the past 20 years they've become the classic way of illustrating the basic precepts of present-day solid state physics and semiconductor technology. In fact, the theories and materials represented are so widely known now that most scientists have come to assume

that periodicity, controlled diffusion of impurity atoms in high purity crystals, and rectifying p-n junctions are the fundamental basis for semiconduction and solid state switching.

That may have been a fair assumption once. But it's not any more. For the past seven years, we at ECD have been "moving to new ways and systems" for solid state control of electricity. We've taken some common elements—mixed and melted them in a variety of compositions—and come up with a whole new family of semiconducting devices having many unique characteristics:

First, they're made of OVONIC semiconducting glass—inorganic amorphous materials that need not have periodicity or impurities, and that are not dependent upon p-n junctions for their solid state

switching action. What's more, being homogeneous polymeric materials, they can be processed much like plastics—extruded, hot pressed and spun, or applied as thick or thin films by vacuum deposition and other low-cost batch fabrication techniques.

Regarding electrical characteristics, OVONIC bulk-effect semiconductors are inherently symmetrical with respect to current flow. They respond identically to both polarities; switching speed is less than 150 picoseconds (10^{-12} sec.); and conduction occurs as a free carrier effect through the material. In addition, they can tolerate levels of X-ray and fast neutron radiation several orders of magnitude higher than p-n junction devices without transient or permanent effect on their performance.

State of the art: At the present time we're producing OVONIC Threshold Switches as discrete components for use in a wide range of applications for example: They can perform all circuit functions in digital computers, generate and switch microwaves, control electroluminescent displays, amplify analog signals by pulse width modulation techniques. We're also developing mass arrays and large scale all film integrated circuits—plus unique non-volatile memory devices and sensor amplifiers.

Career opportunities are now open in this new field of OVONIC physics and technology. If you would like to take part in changing the structure of Solid State, send resume.



If you have applications for OVONIC Bulk-Effect Semiconductors, we'd like to discuss them with you. Write or call:

Energy Conversion Devices, Inc.

1675 W. Maple Road • Troy, Michigan 48084 • Telephone 313/549-7300

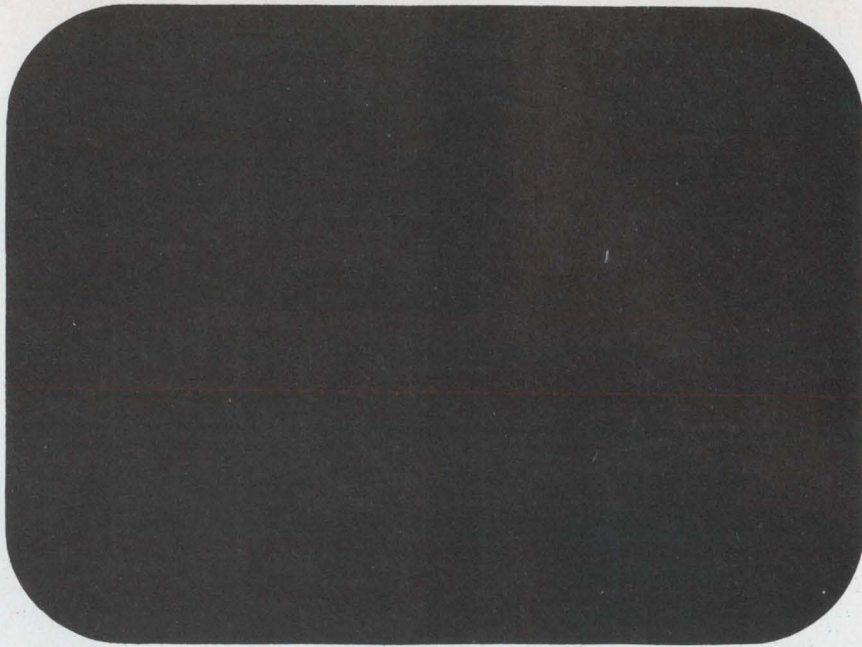

Cold camera

**WE TOLD
WBAL-TV
30 SECONDS—
THEY NOW TELL US
3 SECONDS
IS PLENTY!**



on the air in ~~30~~ seconds at WBAL-TV.

3

The MTI Image Orth is a problem solver at WBAL-TV in Baltimore. Crash news programs can be on camera in seconds with a flick of the switch. No need to interrupt camera crews who might be in the middle of a taping session. Operational set-up is minimal too. Here's how WBAL-TV makes use of the MTI Image Orth.

Camera is aligned and locked in fixed position in a small announce booth studio. Few lights are used due to the excellent

low-light capabilities of the camera. And as a result, no additional air conditioning facilities are required. While desk and chair are fixed furnishings, backdrop can be quickly changed to fit any presentation situation.

WBAL-TV engineers claim camera needs little maintenance, has good depth of focus and needs trimming only once per week. Low light levels do not affect picture quality.

You might have other uses for a camera of this size and quality. If so, give us a call. We'll have a sales engineer to see you quickly—but not as quickly as the MTI Image Orth warm-up period.



mti MARYLAND TELECOMMUNICATIONS, INC.

York & Video Roads, Cockeysville, Md. / 301-666-2727 / World's largest manufacturer of low light level television cameras.

Technical Articles

Topology: a shortcut to understanding systems
page 82

For theoretical design, engineers used to rely on matrix algebra to analyze electronic networks. But once a circuit gets above three nodes, you can't use the techniques of matrix algebra unless you have access to a computer. And even with a computer, the engineer can have trouble visualizing the relationships between elements in the network. That's where graphical techniques come in. The methods of topology not only produce graphical solutions to complex analysis problems but also help the engineer visualize the circuit interrelationships. This article describes three tools of topology: signal-flow graphs, flow graphs and k-trees.

H-shaped resonators signal upturn in tone telemetering
page 99

Electronics

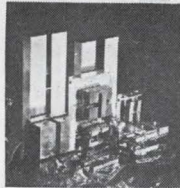

Although tone signaling is used widely in circuits that require only a few signal tones—especially industrial circuits—it normally isn't used in some of the new applications that require many more signal tones. A new design that balances two masses on a connecting spring so improves the selectivity of electromechanical generators and filters that a single telephone line

can carry 1,000 signal tones, thus opening new applications for tone signaling. For the cover, Vincent Pollizzotto has photographed a collection of the new H-shaped resonators. Some are capable of generating tones of variable frequency and others produce fixed frequencies.

Microstrip plus equations adds up to fast designs
page 109

The microstrip process, in which a flat conductor is deposited atop a dielectric and ground plane, is an attractive way to build hybrid integrated circuits for microwave use. But the technique requires that the engineer have accurate equations to design such components as filters and directional couplers. A new set of equations can eliminate the former method of cut and try.

Data at twice the speed eases h-f traffic jam
page 115

Even though new media are being used for communications—like troposcatter systems, and communication satellites—the high-frequency band continues to grow and carry a full load of traffic. A new modulator-demodulator allows the h-f band to carry more traffic by handling data twice as fast. At the same time, the error rate is cut to one in a million—a thousand-fold improvement. Responsible for all this is a technique called frequency-differential phase-shift keying, which means data is represented as the phase shift between signals transmitted in successive time intervals.

**Coming
October 16**

- **Linear IC series: Operational amplifiers**
- **The scope as a computer display**
- **An integrated approach to 3-D radar**
- **More on designing with scattering parameters**

Topology: a shortcut to understanding systems

A trio of techniques, signal-flow graphs, flow graphs, and k-trees, provide a sharp insight into the workings of linear networks so that analysis can be achieved rapidly and readily

By S.P. Chan

University of Santa Clara, Santa Clara, Calif.

Before topology—a graphical technique for analyzing electrical networks from their physical structures—engineers relied on matrix algebra for solutions. Unfortunately, circuits with more than three independent meshes or nodes are troublesome to analyze without the aid of a computer. And calculations for the determinants and cofactors in mesh and node analysis are tedious, time-consuming, and prone to human error.

Since a matrix is but an array of numbers arranged in a specific manner, it is often difficult to visualize the relationships and interactions between signals and variables inside a system. With topology the engineer gets a graphical representation of the signals and their interrelationships and avoids calculating the determinants and cofactors; instead he obtains them by inspection while following a simple sequence of steps.

Compared with conventional methods, the topological technique is faster and simpler; it also includes a check that keeps the engineer on the right track toward obtaining the correct analysis.

The results are the same but topological methods offer these extras:

- All existing feedback loops are readily identified on a drawing.

The author



As principal investigator of a National Science Foundation research project, S. Park Chan studied topological applications for switching networks. Since receiving his Ph.D from the University of Illinois in 1963, he has been teaching at the University of Santa Clara.

- Values for transmittance and input and output impedance are conveniently generated through examination of the drawing. As a result the engineer can quickly determine the effects of disturbances and variations of network parameters.

- The method adapts easily to computer-aided analysis of simple and complex networks.

Three topological techniques currently vying for acceptance are signal-flow graphs, flow graphs, and k-trees. The first two are particularly suited for systems and are developed from the system's defining equations. The k-tree method, subdividing a network graph, is best applied when the designer is concerned with the physical structure of a network.

For example, a system composed of many linear networks can be represented by a block diagram. The defining equations for such a system would be the transfer functions, and input and output variables. Here the designer is not concerned with how the networks are physically constructed to produce these results, he is only interested in the relationships between all the terms. The k-tree technique is applied directly to a network's structure with each component replaced by a line segment called a branch.

Signal-flow graphs work best when the system has only one input; they give excellent physical insight because they reveal the cause-and-effect relationships between the signals at all stages when a graph-reduction procedure is followed. Flow graphs, on the other hand, can be applied to a system with several inputs but the system cannot be dissected by a simple graph-reduction technique. The major feature of the k-tree approach is that it does not produce the redundant mathe-

mathematical terms of the first two methods and thus the calculations are simplified.

Understanding signal-flow graphs

Signal-flow graphs, introduced by S.J. Mason¹ in 1953, are the best known of the techniques for analyzing linear networks and systems, particularly when feedback is present in a circuit. The method graphically displays all signals as they proceed through a network, shows all feedback loops of the system, and enables the analyst to solve for all system unknowns, such as voltages and currents, quickly and without the drudgery common to conventional techniques.

The signal-flow graph, G_m , is a graphical representation of a set of n independent linear relationships of a system, S . Each graph consists of junction points called nodes that are connected by several directed line segments called branches. Nodes represent the signals or variables of a system with each node labeled to denote the signal's strength. A branch is a unidirectional path segment described by arrows that define the signal's direction. These signals show how an input and an output are related. Therefore, an output x_j is equal to a source x_k multiplied by a gain g_{kj} between x_k and x_j , as shown below.

The input and output points, or junctions, are called nodes [see "Signal-flow graph definitions on this page"]. An input node, or source, has only outgoing branches; an output node, or sink, has only incoming branches. A path is a continuous unidirectional succession of branches, all of which travel in the same direction; a forward path is a path from the input node to the output node that encounters all nodes between the two only once; a feedback path is a closed loop that originates from and terminates at the same node, and along which all other nodes are encountered exactly once. A path gain is the product of all the branch gains of the path; and similarly, a loop gain is the product of all the branch gains in a loop.

In the procedure for forming a signal-flow graph from a system of linear algebraic equations, the engineer follows the cause-and-effect relationships of the system. The steps are as follows:

Step 1. Arrange all the equations of the system in such a way that the j th dependent (output) variable x_j in the j th equation is expressed only in terms of other variables. Thus, if the system under study is described by the set of algebraic equations:

$$\sum_{j=1}^n a_{ij} x_j = b_i \quad (1)$$

where

$$i = 1, 2, \dots, n$$

or

$$\begin{matrix} a_{11} x_1 + a_{12} x_2 + \dots + a_{1n} x_n = b_1 \\ a_{21} x_1 + a_{22} x_2 + \dots + a_{2n} x_n = b_2 \\ \dots \quad \dots \quad \dots \quad \dots \quad \dots \\ a_{n1} x_1 + a_{n2} x_2 + \dots + a_{nn} x_n = b_n \end{matrix} \quad (2)$$

Signal-flow graph definitions

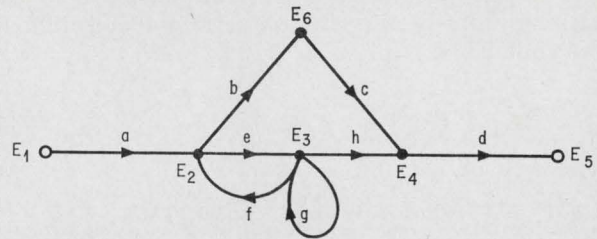

Source node. A node with no branches entering (node E_1).

Sink node. A node with no branches leaving (node E_5).

Intermediate node. A node with branches entering and leaving (nodes E_2 , E_3 , E_4 , and E_6).

Open path. Any path along which a node is encountered only once (abcd or aeh).

Forward path. An open path between a source node and a sink node (abcd or aehd, but not aef).

Feedback loop. A path that returns to the starting node in which no node is encountered more than once except the starting node (loop g and ef, but not egf).

Self loop. A feedback loop consisting of a single branch (g but not ef).

Branch gain. The linear quantity relating one node to another regardless of its dimensions (a, b, c, d, e, f, g, and h).

Loop gain. The product of the gains of branches in a closed loop (e times f).

where b_1, b_2, \dots, b_n are inputs (sources) and x_1, x_2, \dots, x_n are outputs; rewrite the equations as

$$\begin{aligned} x_1 &= \frac{1}{a_{11}} b_1 - \frac{a_{12}}{a_{11}} x_2 - \frac{a_{13}}{a_{11}} x_3 - \dots - \frac{a_{1n}}{a_{11}} x_n \\ x_2 &= \frac{1}{a_{22}} b_2 - \frac{a_{21}}{a_{22}} x_1 - \frac{a_{23}}{a_{22}} x_3 - \dots - \frac{a_{2n}}{a_{22}} x_n \\ &\dots \quad \dots \quad \dots \quad \dots \quad \dots \\ x_n &= \frac{1}{a_{nn}} b_n - \frac{a_{n1}}{a_{nn}} x_1 - \frac{a_{n2}}{a_{nn}} x_2 - \dots - \frac{a_{n-1, n-1}}{a_{nn}} x_{n-1} \end{aligned} \quad (3)$$

Step 2. Select the input nodes in the flow graph by noting all the nonzero b 's and mark them. Each of the source nodes corresponds to a nonzero b_j .

Step 3. Select the output nodes by noting the nodes associated with the dependent variables x_1, x_2, \dots, x_n , and mark them. Each output node corresponds to a dependent variable.

Step 4. Calculate the value of the variable represented by a node; this value is the sum of all the incoming signals.

Step 5. Place the value of the variable represented by a node onto all branches leaving that node and mark the branches and values between the proper input and output nodes.

Hence a general gain formula can now be stated

$$x_k \text{ --- } \xrightarrow{g_{kj}} \text{ --- } x_j \quad x_j = g_{kj} x_k$$

Signal-flow graph. Mathematical relationship between the gain g_{kj} , output node X_j and input X_k is expressed by the equation $X_j = g_{kj} X_k$.

with the following theorem:

Let G_m be the over-all graph gain and G_k be the gain of the k th forward path from the source to the sink. Then

$$G = \frac{1}{\Delta} \sum_k G_k \Delta_k \quad (4)$$

where

$$\Delta = 1 - \sum_m p_{m1} + \sum_m p_{m2} - \sum_m p_{m3} + \dots + (-1)^j \sum_m p_{mj}$$

p_{m1} = sum of all individual loop gains;
 p_{m2} = sum of the gain products of all possible combinations of two nontouching loops;
 p_{m3} = sum of the gain products of all possible combinations of three nontouching loops;
 Δ_k = the value of Δ for that part of the signal-flow graph not touching the k th forward path. It is obtained by removing the k th forward path along with those branches touching the path and examining that part that remains.

Applying the gain formula

Signal-flow graphs can be applied to both systems and network equations, but the gain formula only works when applied between an input and an output node and not between an intermediate and output node. To demonstrate the procedure for using the gain formula consider the system described by equation 5. The terms x_1 and x_3 represent the variables between stages of a block diagram; these could be voltage or distance. The a 's are the transfer functions of the blocks, usually expressed as a gain, b_1 and b_3 are the inputs to the system, possibly velocities, and x_2 is the output. It is desired to find x_2 as a function of the variables using the gain formula.

$$\begin{aligned} a_{11} x_1 + a_{12} x_2 + a_{13} x_3 &= b_1 \\ a_{22} x_2 + a_{23} x_3 &= 0 \\ a_{31} x_1 + a_{33} x_3 &= b_3 \end{aligned} \quad (5)$$

First, rewrite equation 5 in the form:

$$\begin{aligned} x_1 &= \frac{1}{a_{11}} b_1 - \frac{a_{12}}{a_{11}} x_2 - \frac{a_{13}}{a_{11}} x_3 \\ x_2 &= -\frac{a_{23}}{a_{22}} x_3 \end{aligned} \quad (6)$$

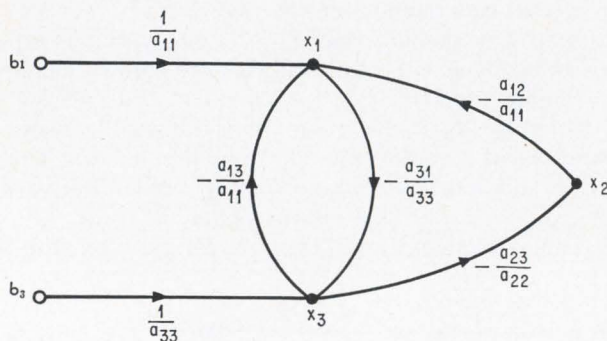

Superposition. Because more than one input is applied, the solution for x_2 using signal-flow graphs requires superposition.

$$x_3 = \frac{1}{a_{33}} b_3 - \frac{a_{31}}{a_{33}} x_1$$

Then draw the signal-flow graph shown below with b_1 and b_3 as input nodes and x_1 , x_2 , x_3 as output nodes. Application of the gain equation yields

$$\begin{aligned} \sum p_{m1} &= \left(-\frac{a_{13}}{a_{11}} \right) \left(-\frac{a_{31}}{a_{33}} \right) + \left(-\frac{a_{23}}{a_{22}} \right) \left(-\frac{a_{12}}{a_{11}} \right) \left(-\frac{a_{31}}{a_{33}} \right) \\ &= \frac{a_{13} a_{22} a_{31} - a_{12} a_{23} a_{31}}{a_{11} a_{22} a_{33}} \end{aligned}$$

$$\sum p_{m2} = \sum p_{m3} = \dots = 0$$

$$\Delta = \frac{a_{11} a_{22} a_{33} - a_{13} a_{22} a_{31} + a_{12} a_{23} a_{31}}{a_{11} a_{22} a_{33}}$$

for the forward path from b_1 to x_2 :

$$G_1 = \left(\frac{1}{a_{11}} \right) \left(-\frac{a_{31}}{a_{33}} \right) \left(-\frac{a_{23}}{a_{22}} \right) = \frac{a_{23} a_{31}}{a_{11} a_{22} a_{33}}$$

and $\Delta_1 = 1$;

and the forward path from b_3 to x_2 :

$$G_3 = \left(\frac{1}{a_{33}} \right) \left(-\frac{a_{23}}{a_{22}} \right) = -\frac{a_{23}}{a_{22} a_{33}}, \text{ and } \Delta_3 = 1$$

Thus, for the input b_1 alone:

$$(x_2)_{b_1} = \frac{1}{\Delta} G_1 \Delta_1 b_1$$

and for the input b_3 alone:

$$(x_2)_{b_3} = \frac{1}{\Delta} G_3 \Delta_3 b_3$$

Finally, by the principle of superposition, the final expression for x_2 is

$$\begin{aligned} x_2 &= (x_2)_{b_1} + (x_2)_{b_3} \\ &= \frac{1}{\Delta} G_1 \Delta_1 b_1 + \frac{1}{\Delta} G_3 \Delta_3 b_3 \\ &= \frac{a_{23} a_{31} b_1 - a_{11} a_{23} b_3}{a_{11} a_{22} a_{33} - a_{13} a_{22} a_{31} + a_{12} a_{23} a_{31}} \end{aligned} \quad (7)$$

As demonstrated in example 1, signal-flow graphs are very useful for analyzing linear systems. This method not only retains the intuitive character of the block diagrams but also allows the analyst to see the gain between an input and an output node. However, the gain cannot be obtained without superposition if more than one input is present.

Forming a flow graph

By slightly modifying the signal-flow graph in 1959, C. L. Coates^{2, 3} introduced a new approach which he called the flow graph. The flow graph, denoted by G_f , enables an engineer to calculate the gain of a system directly, regardless of the number of inputs. This graph's topological structure is dependent only on a set of algebraic equations. Physically, a flow graph is still a collection of branches and nodes, but the interconnections between nodes no longer follow the principles of cause and effect.

A major difficulty encountered in applying signal-flow graphs to solving equation 1 is that it must first be converted into a set of cause-and-effect rela-

Forming a flow graph

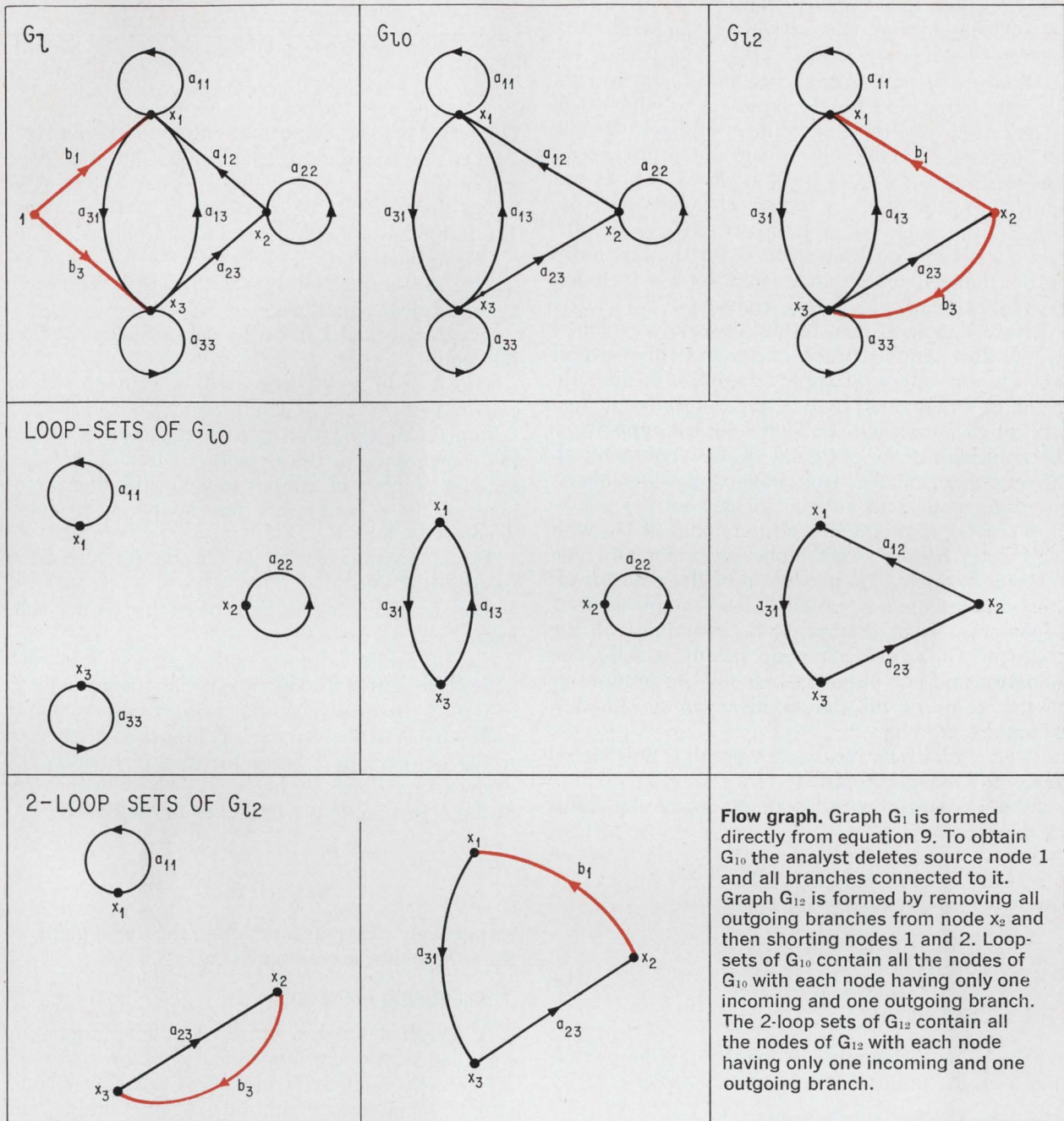

tionships. For example, equation 2 must be re-written in the form of equation 3 to obtain a signal-flow graph. The variables, x_1, x_2, x_n , on the left-hand side of equation 3 may be interpreted as effects, and those on the right-hand side are causes.

A flow graph, however, does not require this arrangement of variables; it can be drawn directly from the equations. The relationship between a flow graph and the linear algebraic equations is

$$\sum_{j=1}^n a_{ij} x_j = b_i \quad i = 1, 2, \dots, n \quad (8)$$

By definition, the variables x_1, x_2, \dots, x_n may be represented by nodes, and a_{ij} by a branch gain. Each branch is connected between nodes x_i and x_j

with an arrow that indicates the signal direction from x_j to x_i .

To draw the flow graph, it is necessary to label each of the n equations with a variable chosen from the variables x_1, x_2, \dots, x_n . For example, if $n = 3$ the defining equations become

$$\begin{array}{l|l} x_1 & a_{11} x_1 + a_{12} x_2 + a_{13} x_3 = -b_1 \\ x_2 & a_{21} x_1 + a_{22} x_2 + a_{23} x_3 = 0 \\ x_3 & a_{31} x_1 + a_{32} x_2 + a_{33} x_3 = -b_3 \end{array} \quad (9)$$

Note that each equation is assigned a variable, which is placed on the left for identification purposes. It is permissible to assign x_2 to the first equation, x_1 to the second, and x_3 to the third, or

any other combination, as long as only one variable is assigned to only one equation.

Constructing the flow graph on page 85 first requires drawing the nodes x_1, x_2, \dots, x_n . Thus for equation 9 the nodes are x_1, x_2 , and x_3 . Each node is a summing point for the equation to which it is assigned. Hence, the first term in equation 9 calls for drawing a branch with a gain a_{11} from x_1 to x_1 , thus forming a self-loop at the node x_1 . The second term is represented by a branch with gain a_{12} drawn from x_2 to x_1 , and finally, a branch with gain a_{13} is directed from x_3 to x_1 for the last term. Furthermore, a source node equal to 1 is included to account for the b_1 and b_3 constants.

Before a general gain formula can be developed for the flow graph it is necessary to define several new graphs and subgraphs. Graph G_{i_0} is the subgraph of G_i obtained by deleting the source node 1 and all the branches connected to it. Graph G_{i_j} is the subgraph of G_i obtained by first removing all the outgoing branches from node x_j and then short-circuiting node 1 to node x_j . A loop set l is a subgraph of G_{i_0} that contains all the nodes of G_{i_0} with each node having exactly one incoming and one outgoing branch. The product p of the gains of all the branches in l is called a loop-set product. A 2-loop set l_2 is a subgraph of G_{i_j} containing all the nodes of G_{i_j} with each node having exactly one incoming and one outgoing branch. The product p_2 of the gains of all the branches in l_2 called a 2-loop-set product.

The gain formula for the flow graph is now stated in the following theorem:

In a system of n independent linear equations in n unknowns

$$a_{ij} x_j = b_i \quad i = 1, 2, \dots, n$$

the value of the variable x_j is given by

$$x_j = \frac{\sum (\text{all } p_2) (-1)^{N_{l_2}} p_2}{\sum (\text{all } p) (-1)^{N_l} p} \quad (10)$$

where N_{l_2} is the number of loops in a 2-loop-set l_2 , and N_l is the number of loops in a loop set l .

Applying Coates' gain formula

Flow graphs, like signal-flow graphs, can also be applied to both system and network equations but unlike the latter direct results can be obtained when more than one input is applied. To demonstrate the ease with which the flow-graph gain formula is used, consider the same equations used in the previous example and find the value of x_2 using the gain formula. The graphs G_i and G_{i_0} of the system are drawn on page 85.

To find x_2 , it is necessary to draw G_{i_2} . The graph is obtained by removing all outgoing branches from x_2 and shorting node 1 to x_2 . The results are shown on page 85. Then, the set of all loop-set products of G_{i_0} and all 2-loop-set products of G_{i_2} are found by drawing one incoming and one outgoing branch for each node in G_{i_0} and similarly for G_{i_2} . Thus,

by applying equation 10, x_2 is found to be:

$$x_2 = \frac{(-1)^2 a_{11} a_{23} b_3 + (-1)^1 a_{31} a_{23} b_1}{(-1)^3 a_{11} a_{22} a_{33} + (-1)^2 a_{13} a_{31} a_{22} + (-1)^1 a_{12} a_{31} a_{23}} = \frac{a_{23} a_{31} b_1 - a_{11} a_{23} b_3}{a_{11} a_{22} a_{33} - a_{13} a_{22} a_{31} + a_{12} a_{23} a_{31}} \quad (11)$$

The result is identical to that obtained previously.

Since the signal-flow graph, G_m , and the flow graph, G_i , both represent the same equations, it is logical that one can be transformed into the other. The interrelationships are stated as follows:

Transformation of G_m into G_i . Graph G_m can be transformed into an equivalent graph G_i , representing equivalent equations:

Step 1. Subtract 1 from the gain of each existing self-loop;

Step 2. Add a self-loop with a gain of -1 to each branch devoid of a self-loop;

Step 3. Multiply the gain of the branch at the k th source node b_k by $-b_k$ ($k = 1, 2, \dots, r$; r being the number of source nodes) and then combine all the r nodes into one source node (now denoted by 1).

Transformation of G_i into G_m . Graph G_i can be transformed into G_m :

Step 1. Add 1 to the gain of each existing self-loop;

Step 2. Add a self-loop with a gain of 1 to each node devoid of self-loop except the source node 1;

Step 3. Break the source node 1 into r source nodes (r being the number of branches connected to the source node 1 before breaking); identify the r new source nodes by b_1, b_2, \dots, b_r with the gain of the corresponding r branches multiplied by

$$-\frac{1}{b_1}, -\frac{1}{b_2}, \dots, -\frac{1}{b_r}$$

respectively. This assures that the new gains of these branches are all equal to 1.

Transforming the graphs

Although signal-flow graphs and flow graphs are regarded as different topological structures, the two are directly related. In fact, it is possible to convert a signal-flow graph into a flow graph, and vice versa. As an example of the technique, transform the graph G_m into G_i using the relationships of equation 5. The graph G_m is already shown.

Equivalent G_i of graph G_m is obtained with the three defining steps, and the result is on page 87. Note that if G_i is obtained directly from equation 5, the graph G_i on page 85 is the result. Although these two graphs do not look alike, they are indeed equivalent since both represent the same equations. This becomes evident by noting that G_i may be obtained directly from the following system

$$\text{For } x_1: -x_1 - \frac{a_{12}}{a_{11}} x_2 - \frac{a_{13}}{a_{11}} x_3 = -\frac{b_1}{a_{11}}$$

$$\text{for } x_2: -x_2 - \frac{a_{23}}{a_{22}} x_3 = 0$$

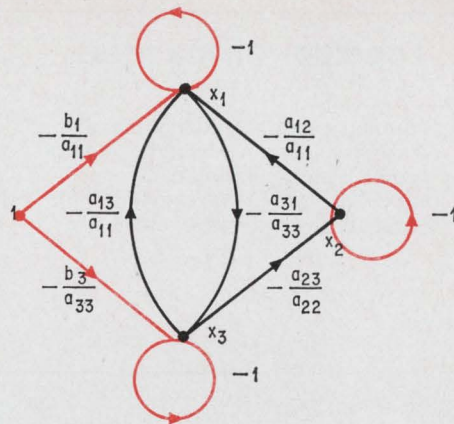
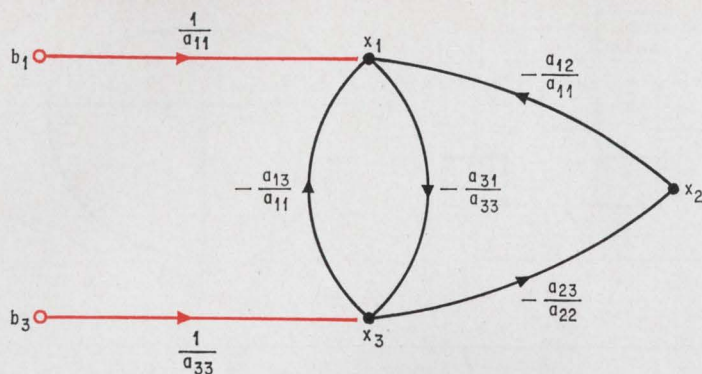

Graph transformation. Graph G_1 , right, is formed from G_m , left, by first adding a self-loop with a gain of -1 to each branch devoid of a self-loop. Then the gain of the branch at source nodes 1 and 3 are multiplied by $-b_1$ and $-b_3$ respectively. These are then combined into one source node, labeled 1.

$$\text{for } x_3: -\frac{a_{31}}{a_{33}} x_1 - x_3 = -\frac{b_1}{a_{33}}$$

Rearrangement of these terms yields the same results as in equation 5 or 6.

System versus networks

For systems, the signal-flow graph provides an excellent physical insight of the signal flow through the subgraphs (forward paths and feedback loops) of G_m . However, the problem is a little different for networks. When a linear network is known, loop or node equations can be written that describe the network, and the analysis achieved with either a signal-flow graph or a flow graph. But if a third approach, the k -tree technique, is employed, the redundancy inherent in the direct expansion of determinants or in the flow-graph techniques can be completely eliminated.

The k -tree technique⁴ was developed quite extensively in "Topology cuts design drudgery," [Electronics, Nov. 14, 1966, page 112]; however, a brief review is helpful. Before demonstrating an actual topological analysis, it is necessary to define the terms with the help of bridged T-network shown on page 88. The network is loaded by impedance Z_5 , and has four nodes (V_1, V_2, V_3 , and V_4) and five branches (Z_1, Z_2, Z_3, Z_4 , and Z_5). The voltage E represents the source.

If each of the five impedances is replaced by a line segment while retaining the four nodes, a graph, G , of the network results. Each of the five line segments of the graph is called an edge of the graph, and each edge corresponds to a branch in the network. For the graph shown, the edges are e_1, e_2, e_3, e_4 , and e_5 . Each of the nodes in the network, N , corresponds to a vertex in the graph, G . Thus, V_1, V_2, V_3 , and V_4 are the vertexes of the graph. The number of edges connected to a given vertex is called the degree of the vertex. For example, vertex V_3 has a degree of 3 since three edges connect to it, and vertex V_1 has a degree of 2.

The graph can be divided into a number of subgraphs, G_i . If G_i does not contain all the edges of the graph, G , it is called a proper subgraph of G .

In the diagram, edges e_3, e_4 , and e_5 would be one subgraph, in this case called a loop-set because it forms a closed loop. Two other types of subgraphs are the path-set and the tree. A path-set consists of a group of edges that link one vertex to another without repeating an edge; e_5, e_1 , and e_2 represents one path-set because it connects vertex V_4 to V_2 . A tree is a connected subgraph that contains all the vertexes of G but does not form any closed loops. One possible tree contains edges e_1, e_2 , and e_4 . Two other trees of G are e_2, e_3 , and e_4 and e_1, e_3 , and e_5 .

Increasing the trees

By subdividing the graph further it is possible to form a 2-tree. A 2-tree of G consists of two unconnected subgraphs that do not contain loops, but when taken together contain all the vertexes of G . Such a 2-tree can be formed with edges e_1 and e_4 or e_2 and e_5 . Note that a 2-tree is obtained by removing one of the edges. The tree-admittance product for the tree e_1, e_3 , and e_5 is $Y_1 Y_3 Y_5$, and is obtained by multiplying the admittances of the three edges. The 2-tree admittance product of the 2-tree e_2 and e_5 is $Y_2 Y_5$.

Further subdivision of the graph G yields a set of trees, called 3-trees or k -trees. A 3-tree consists of three unconnected subgraphs having no loops, which when connected contain all the vertexes of G . Each 3-tree contains $(V - 3)$ branches, where V is the total number of vertexes. In this example each 3-tree contains $V - 3 = 4 - 3 = 1$ branch.

It is necessary to define three more terms, Δ , Δ_{jj} , and Δ_{ij} .

Δ = the sum of all tree-admittance products for a network N , where a tree-admittance product is the result of multiplying the admittance of all branches in a tree.

Δ_{jj} = the sum of all 2-tree admittance products of a network, N , with each 2-tree term formed from a two-part subgraph having node j in one subgraph and the reference node in the other.

Δ_{ij} = the sum of all 2-tree admittance products of a network, N , with each 2-tree term formed from

Continued on page 90

Topological analysis

Forming a graph. Graph of the T-network is formed by removing the source E and replacing each impedance with a line segment that connects the respective nodes.

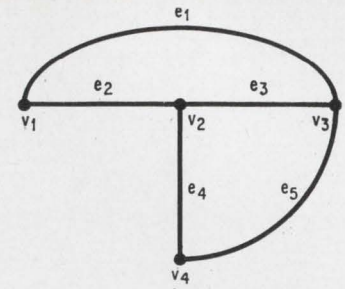
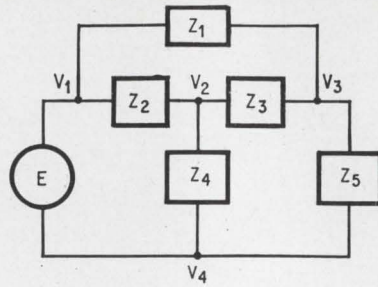

Trees. To form the trees of the T-network all nodes are marked and the edges are drawn between the nodes without forming any closed loops.

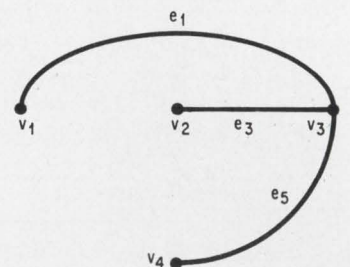
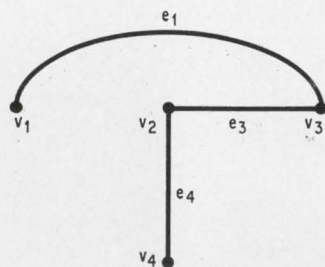
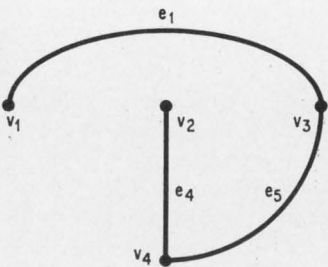
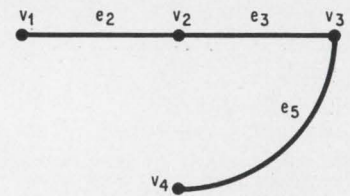
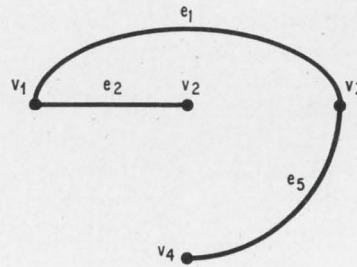
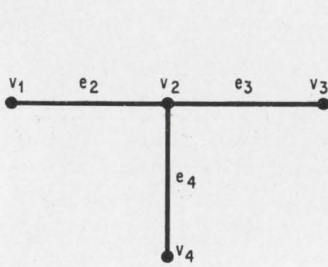
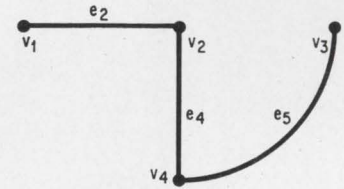
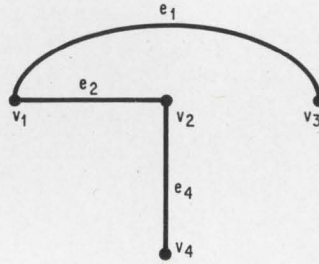

2-trees of Δ_{13} . Those 2-trees common to both Δ_{11} and Δ_{33} are the 2-trees of Δ_{13} .

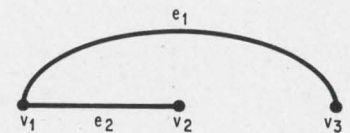

• v4

2-trees of Δ_{11} . Vertex 1 appears in one subgraph and node 4 appears in a second subgraph. Together the two subgraphs contain all the vertices of G.

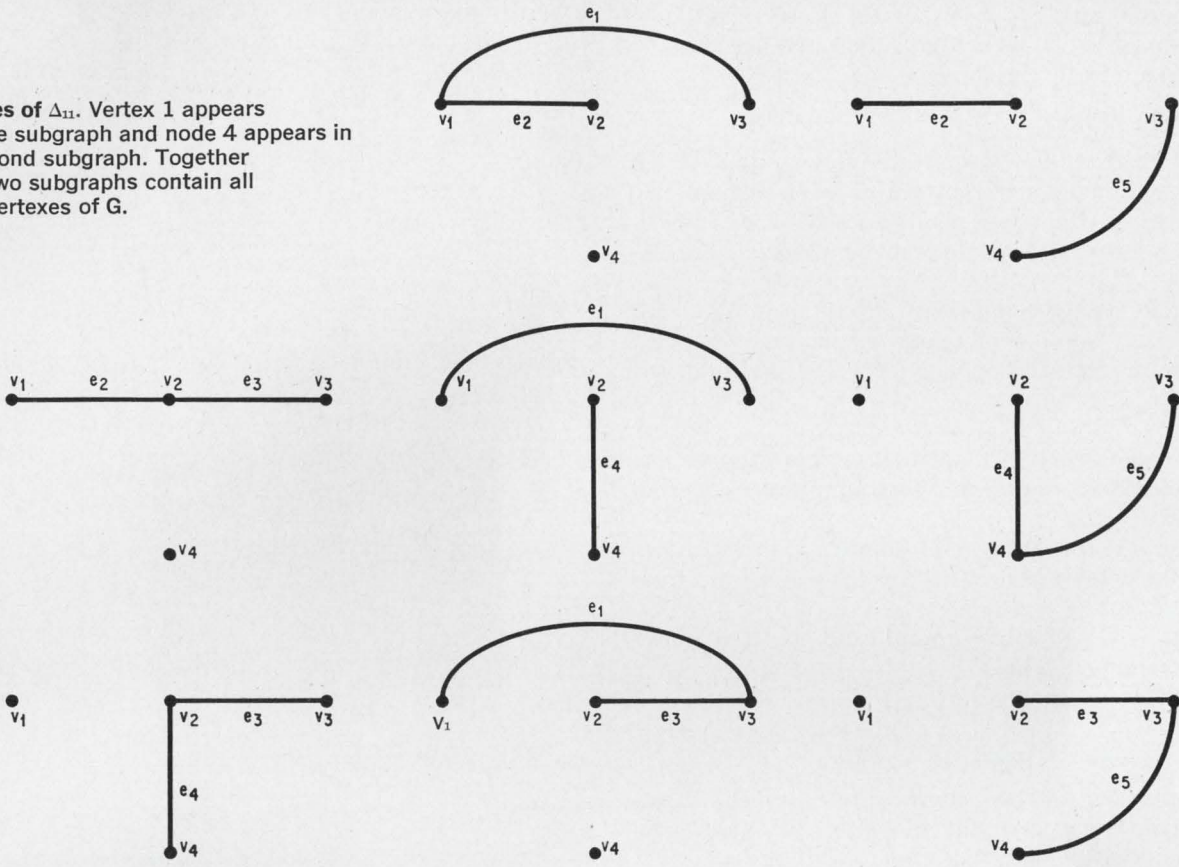

2-trees of Δ_{33} . Subdividing the graph into two unconnected subgraphs that do not contain loops, but together contain all the vertices of the network, forms a 2-tree. Vertex 3 appears in one subgraph and the reference node 4 is in another subgraph.

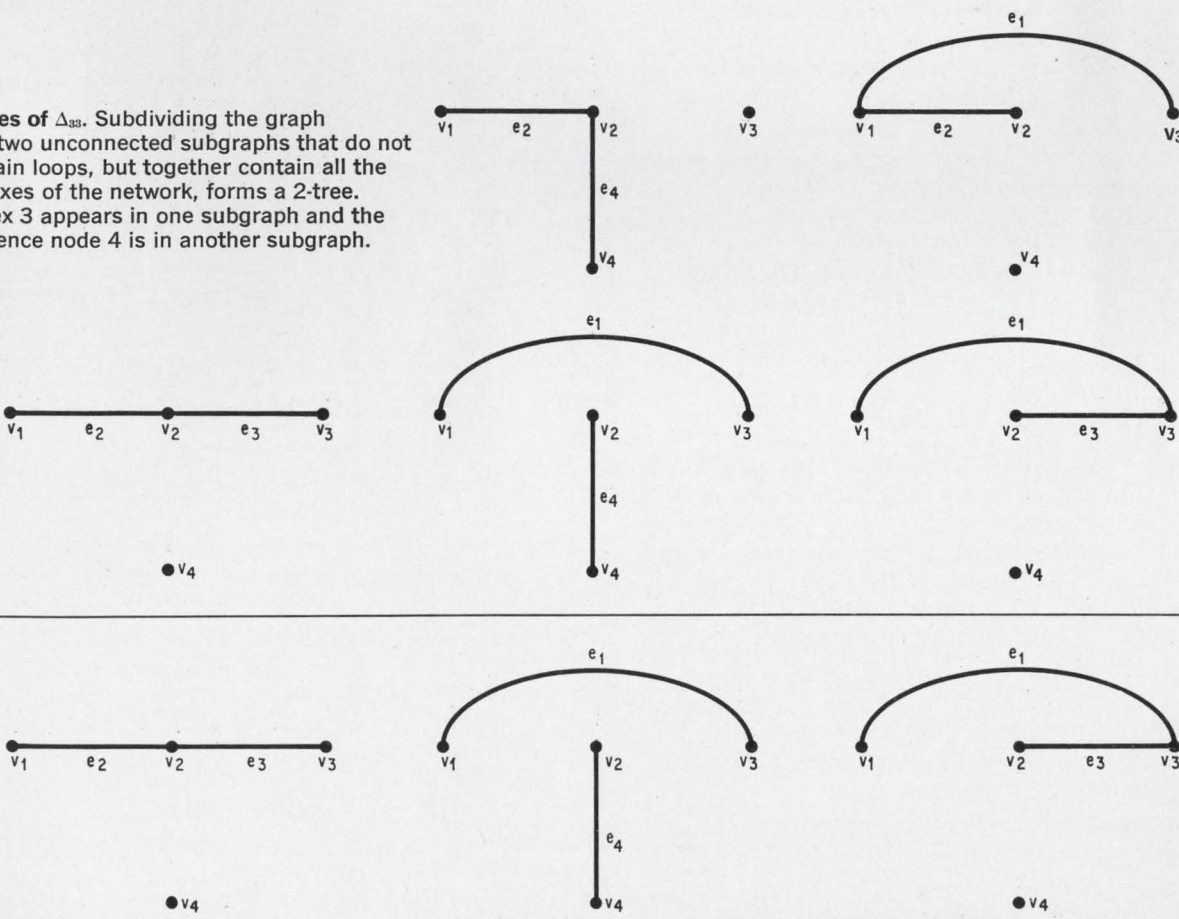

a two-part subgraph containing nodes i and j in one connected subgraph and the reference node in the other.

Applying k-trees

Unlike signal-flow graphs and flow graphs, which are based on a set of network or system equations, the k-tree technique depends on a network's physical structure. The results can be checked. For example:

Obtain the driving-point admittance $Y_d(s)$ for the passive one-port network on the opposite page. As established in "Topology cuts design drudgery," $Y_d(s) = \Delta/\Delta_{11}$.

Step 1. To find Δ , draw the graph of the network by replacing each element with an appropriate line segment that represents the admittance of that branch.

Step 2. Form all tree-admittance products, shown in table 1, for the network by inspecting the trees of the graph.

Step 3. Form Δ by summing all the tree-admittance products. Thus,

$$\begin{aligned} \Delta &= s/2 + 2s^2/5 + 1/12 + s/15 \\ &\quad + 1/20 + 1/6 + 2s/15 + 1/60s \\ &= 2s^2/5 + 7s/10 + 3/10 + 1/60s \end{aligned}$$

Step 4. To find Δ_{11} short vertex 1 to 1' and obtain a new graph of the network, which for convenience is called G_{11}' .

Step 5. Form all 2-tree admittance products of N by obtaining all tree-admittance products of G_{11}' , as shown in table 1.

Step 6. Form Δ_{11} by summing all the 2-tree admittance products. Thus

$$\begin{aligned} \Delta_{11} &= 2s^2 + s/3 + s/5 + 2s/3 + 1/2 \\ &\quad + 2s/5 + 1/12s + 1/20s \\ &= 2s^2 + 8s/5 + 1/2 + 2/15s \end{aligned}$$

Step 7. Form $Y_d(s)$.

$$\begin{aligned} Y_d(s) &= \frac{\Delta}{\Delta_{11}} = \frac{(2s^2/5 + 7s/10 + 3/10 + 1/60s)}{(2s^2 + 8s/5 + 1/2 + 2/15s)} \\ &= \frac{(24s^3 + 42s^2 + 18s + 1)}{(120s^3 + 96s^2 + 30s + 8)} \end{aligned}$$

Comparing the three techniques

The merits and limitations of the three techniques are best judged by comparing an analysis of each technique performed on the same network. Since signal-flow graphs work best on networks with a single input, the circuit, N , top of page 92, was chosen for this example. Examining the results show that signal-flow graphs indicate the cause-effect relationships at various stages; flow graphs cannot be reduced by a step-by-step procedure as can signal-flow graphs; and k-trees are based directly on the physical structure of the network and not by its defining equations.

To visualize these features, determine the gain V_o/V_i using the method of signal-flow graphs, flow graphs, and k-trees.

The two node equations for the network are

given by the relationship

$$\begin{aligned} (Y_a + Y_b + Y_c) V_2 + (-Y_e) V_o &= Y_a V_i \\ \text{for node 2.} \\ (-Y_e) V_2 + (Y_c + Y_d + Y_e) V_o &= Y_c V_i \end{aligned} \tag{12}$$

for node 3.

Where

$$\begin{aligned} Y_a &= \frac{1}{Z_a}, \quad Y_b = \frac{1}{Z_b}, \quad Y_c = \frac{1}{Z_c}, \quad Y_d = \frac{1}{Z_d} \\ Y_e &= \frac{1}{Z_e} \end{aligned}$$

Signal-flow graphs: rewrite equation 12 as follows:

$$\begin{aligned} V_2 &= \left(\frac{Y_a}{Y_a + Y_b + Y_c} \right) V_i + \left(\frac{Y_c}{Y_a + Y_b + Y_c} \right) V_o \\ V_o &= \left(\frac{Y_c}{Y_c + Y_d + Y_e} \right) V_i + \left(\frac{Y_e}{Y_c + Y_d + Y_e} \right) V_2 \end{aligned} \tag{13}$$

or

$$\begin{aligned} V_2 &= A V_i + B V_o \\ V_o &= C V_i + D V_2 \end{aligned} \tag{14}$$

where

$$\begin{aligned} A &= \frac{Y_a}{Y_a + Y_b + Y_c}, \quad B = \frac{Y_c}{Y_a + Y_b + Y_c} \\ C &= \frac{Y_c}{Y_c + Y_d + Y_e}, \quad D = \frac{Y_e}{Y_c + Y_d + Y_e} \end{aligned}$$

The signal-flow graph of the system is on page 92, and applying the gain formula yields

$$\begin{aligned} \Delta &= 1 - BD \\ G_c &= C; \quad \Delta_c = 1 \\ G_{AD} &= A \cdot D; \quad \Delta_{AD} = 1 \end{aligned}$$

Hence,

$$\begin{aligned} \frac{V_o}{V_i} &= \frac{1}{\Delta} \sum_k G_k \Delta_k = \frac{1}{1 - BD} (C + AD) \\ &= \frac{Y_c}{Y_c + Y_d + Y_e} + \frac{Y_a}{(Y_a + Y_b + Y_c)(Y_c + Y_d + Y_e)} \\ &= \frac{1 - \frac{Y_e^2}{(Y_a + Y_b + Y_c)(Y_c + Y_d + Y_e)}}{1 - \frac{Y_e^2}{(Y_a + Y_b + Y_c)(Y_c + Y_d + Y_e)}} \end{aligned}$$

Upon cancellation and rearrangement of terms

$$\frac{V_o}{V_i} = \frac{Y_a Y_c + Y_a Y_c + Y_b Y_c + Y_c Y_e}{Y_a Y_c + Y_a Y_d + Y_a Y_e + Y_b Y_c + Y_b Y_d + Y_b Y_e + Y_c Y_e + Y_d Y_e} \tag{15}$$

Flow graphs: obtain the flow graphs G_{11} , G_{10} , and G_{13} shown on page 92 from equation 12. The set of all loop-sets of G_{10} , and the set of all 2-loop-sets of G_{13} are shown on page 92.

$$\begin{aligned} V_o &= \frac{\sum_{(\text{all } p_2)} (-1)^{N_2} p_2}{\sum_{(\text{all } p)} (-1)^{N_1} p} \\ &= \frac{(-1)^1 (-Y_e) (Y_a V_i) + (-1)^2 (Y_a + Y_b + Y_c) (Y_c V_i)}{(-1)^1 (-Y_e) (-Y_e) + (-1)^2 (Y_a + Y_b + Y_c) (Y_c + Y_d + Y_e)} \end{aligned}$$

Continued on page 94

Table 1. Applying k-trees

TREES OF NETWORK N	TREE-ADMITTANCE PRODUCTS	2-TREES OF NETWORK	2-TREE ADMITTANCE PRODUCTS
			$Y_1 = j\omega C_1 = s$ $Y_2 = 2s$ $Y_3 = 1/3$ $Y_4 = 1/j\omega L = 1/4s$ $Y_5 = 1/5$
	$Y_1 Y_2 Y_4 = (s)(2s)(1/4s) = s/2$		$Y_1 Y_2 = (s)(2s) = 2s^2$
	$Y_1 Y_2 Y_5 = (s)(2s)(1/5) = 2s^2/5$		$Y_1 Y_3 = (s)(1/3) = s/3$
	$Y_1 Y_3 Y_4 = (s)(1/3)(1/4s) = 1/12$		$Y_1 Y_5 = (s)(1/5) = s/5$
	$Y_1 Y_3 Y_5 = (s)(1/3)(1/5) = s/15$		$Y_2 Y_3 = (2s)(1/3) = 2s/3$
	$Y_1 Y_4 Y_5 = (s)(1/4s)(1/5) = 1/20$		$Y_2 Y_4 = (2s)(1/4) = 1/2$
	$Y_2 Y_3 Y_4 = (2s)(1/3)(1/4s) = 1/6$		$Y_2 Y_5 = (2s)(1/5) = 2s/5$
	$Y_2 Y_3 Y_5 = (2s)(1/3)(1/5) = 2s/15$		$Y_3 Y_4 = (1/3)(1/4s) = 1/12s$
	$Y_3 Y_4 Y_5 = (1/3)(1/4s)(1/5) = 1/60s$		$Y_4 Y_5 = (1/4s)(1/5) = 1/20s$

One problem, three solutions

Voltage gain. Bridged-T network, N, with impedance Z_a as a load represents a one-port configuration driven by a voltage source, V_i . Voltage gain for the network is V_3/V_i .

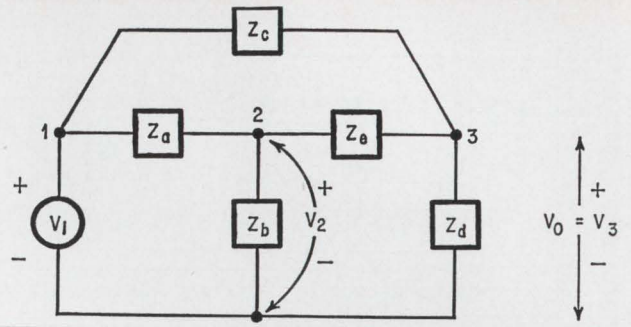

1 Signal-flow graph. By writing the cause-and-effect equations for the network the analyst forms the signal-flow graph.

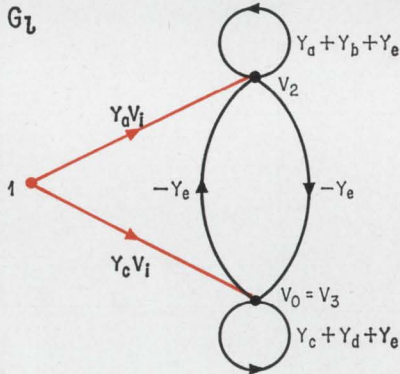
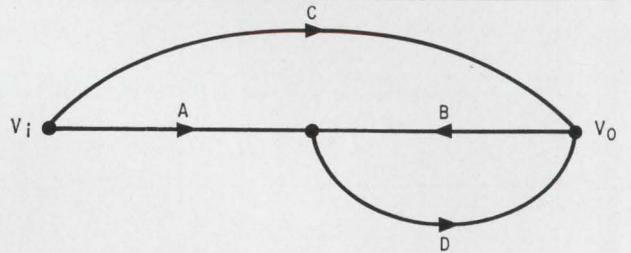

2 Flow graph. By writing the network equations and arbitrarily labeling each with a different unknown the analyst forms the flow graph. Loop sets are then drawn by following the procedure outlined on page 85.

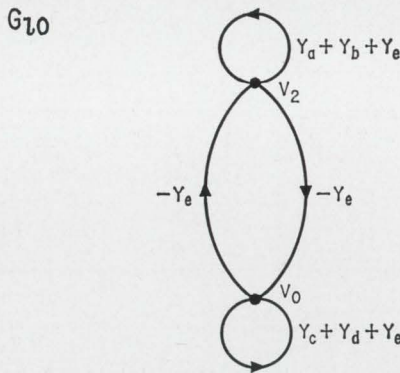

LOOP SETS OF G_{10}

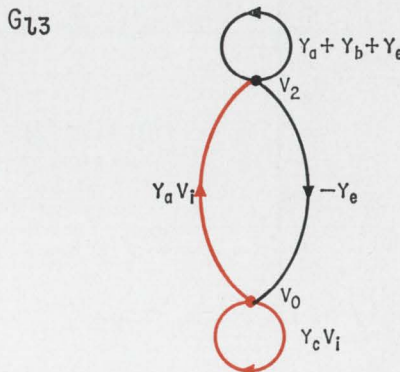
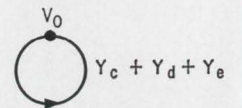
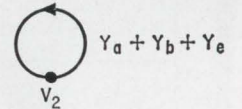
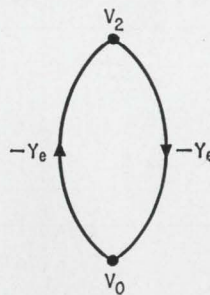

2-LOOP SETS OF G_{13}

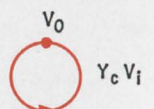
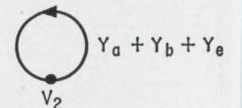
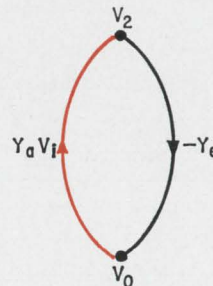

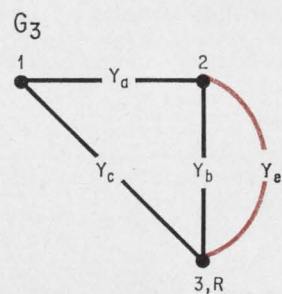
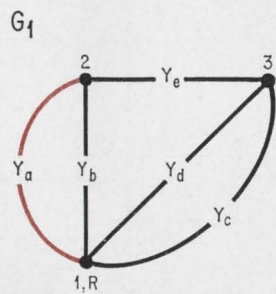
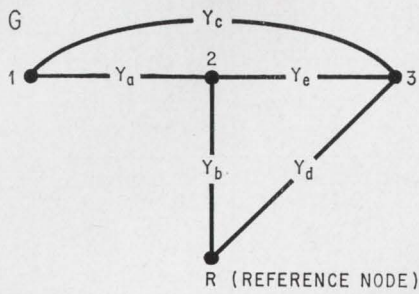

TREES OF G_1								
2-TREES OF G								
ADMITTANCE PRODUCTS	$Y_a Y_c$	$Y_a Y_d$	$Y_a Y_e$	$Y_b Y_c$	$Y_b Y_d$	$Y_b Y_e$	$Y_c Y_e$	$Y_d Y_e$

TREES OF G_3					
2-TREES OF G					
ADMITTANCE PRODUCTS	$Y_a Y_b$	$Y_a Y_c$	$Y_a Y_e$	$Y_b Y_c$	$Y_c Y_e$

2-TREES OF G WITH 1 AND 3 IN ONE PART				
ADMITTANCE PRODUCTS	$Y_a Y_c$	$Y_a Y_e$	$Y_b Y_c$	$Y_c Y_e$

3 **k-trees.** Each branch of the network is replaced by a line segment that represents impedance of the branch. By shorting terminal 1 to the reference node the analyst can form all the 2-trees of Δ_{11} . Similarly, shorting terminal 3 to R yields the 2-trees of Δ_{33} . The 2-trees of Δ_{13} are those common to both.

Comparing topological techniques

Signal-flow graphs	Flow graphs	k-trees
For systems or networks having one input	For systems or networks having any number of inputs	For networks having any number of inputs
Uses system or network equations arranged as,	Uses system or network equations arranged as,	Uses network structure
$X_1 = \frac{1}{a_{11}} b_1 - \frac{a_{12}}{a_{11}} X_2 - \frac{a_{13}}{a_{11}} X_3 - \dots$ $- \frac{a_{1n}}{a_{11}} X_n$ $X_2 = \frac{1}{a_{22}} b_2 - \frac{a_{21}}{a_{22}} X_1 - \frac{a_{23}}{a_{22}} X_3 - \dots$ $- \frac{a_{2n}}{a_{22}} X_n$ $X_n = \frac{1}{a_{nn}} b_n - \frac{a_{n1}}{a_{nn}} X_1 - \frac{a_{n2}}{a_{nn}} X_2 - \dots$ $- \frac{a(n-1), (n-1)}{a_{nn}} X_{n-1}$	$X_1 \left \begin{array}{l} a_{11} X_1 + a_{12} X_2 + \dots \\ + a_{1n} X_n = b_1 \end{array} \right.$ $X_2 \left \begin{array}{l} a_{21} X_1 + a_{22} X_2 + \dots \\ + a_{2n} X_n = b_2 \end{array} \right.$ \vdots \vdots $X_n \left \begin{array}{l} a_{n1} X_1 + a_{n2} X_2 + \dots \\ + a_{nn} X_n = b_n \end{array} \right.$	

Continued from page 90

Or, after simplification,

$$V_o = \frac{(Y_a Y_c + Y_a Y_e + Y_b Y_c + Y_c Y_e) V_i}{Y_a Y_c + Y_a Y_d + Y_a Y_e + Y_b Y_c + Y_b Y_d + Y_b Y_e + Y_c Y_e + Y_d Y_e} \quad (16)$$

which gives the same ratio V_o/V_i as equation 15.

k-trees: the gain formula for V_o/V_i using the k-tree approach is given by

$$\frac{V_o}{V_i} = \frac{\Delta_{13}}{\Delta_{11}}$$

$$= \frac{\sum \left(\begin{array}{l} \text{all 2-tree admittance products} \\ \text{with nodes 1 and 2 in one part} \\ \text{and the reference node R in} \\ \text{the other part.} \end{array} \right)}{\sum \left(\begin{array}{l} \text{All 2-tree admittance products} \\ \text{with node 1 in one part and the} \\ \text{reference node in the other part.} \end{array} \right)} \quad (17)$$

where

Δ_{11} = the sum of all tree-admittance products of the graph obtained by shorting node 1 to the reference node;

Δ_{33} = the sum of all tree-admittance products of the graph obtained by shorting node 3 to the reference node;

Δ_{13} = the sum of all tree-admittance products common to Δ_{11} and Δ_{33} .

Next form the ratio as expressed by equation 1 of 2-tree admittance products. Thus,

$$\frac{V_o}{V_i} = \frac{Y_a Y_c + Y_a Y_e + Y_b Y_c + Y_c Y_e}{Y_a Y_c + Y_a Y_d + Y_a Y_e + Y_b Y_c + Y_b Y_d + Y_b Y_e + Y_c Y_e + Y_d Y_e}$$

which is identical to the results obtained by the two previous techniques.

Checking the k-tree results

Since each tree, or 2-tree, is obtained by inspection, it is quite possible that one may be omitted by oversight. Systematically listing the trees and 2-

trees insures that none are lost. The method for determining the terms in the expansion of Δ_{11} and Δ_{33} requires evaluation of the determinant for the network's node-admittance matrix with each admittance value replaced by the numerical 1. Thus for the bridged T-network, the matrix is

$$\begin{vmatrix} Y_a + Y_c & -Y_a & -Y_c \\ -Y_a & Y_a + Y_b + Y_c & -Y_c \\ -Y_c & -Y_c & Y_c + Y_d + Y_e \end{vmatrix}$$

Substituting 1 for the terms produces the determinant from which the number of trees can be found.

$$N \text{ terms} = \begin{vmatrix} 2 & -1 & -1 \\ -1 & 3 & -1 \\ -1 & -1 & 3 \end{vmatrix} = 18 - 10 = 8 \text{ trees,}$$

they are: $Y_a Y_b Y_c$, $Y_a Y_b Y_d$, $Y_a Y_b Y_e$, $Y_a Y_c Y_d$, $Y_a Y_c Y_e$, $Y_b Y_c Y_d$, $Y_b Y_c Y_e$, and $Y_c Y_d Y_e$.

To find the correct number of 2-tree for Δ_{11} strike row 1 and column 1 from the node-admittance matrix and evaluate the remainder. Thus, the Δ_{11} terms equal 8.

Similarly, the number of terms in Δ_{33} is found by striking out the third row and column of the node-admittance matrix and evaluating the remainder. Hence, the Δ_{33} terms equal 5.

References

1. S.J. Mason, "Feedback theory—some properties of signal-flow graphs," Proceedings of the IRE, vol. 41, pp. 1144-1156, Sept. 1953.
2. C.L. Coates, "Flow graph solutions of linear algebraic equations," IRE CT-6, pp. 170-187, June 1959.
3. S.P. Chan and B.H. Bapna, "A New approach to the Coates-Desoer gain formula," Convention Records, IEEE 1966 Region Six Annual Conference, Tucson, Ariz., April 26-28, 1966.
4. S.P. Chan, "Topology cuts design drudgery," Electronics, pp. 112-121, Nov. 14, 1966.

Designer's casebook

Designer's casebook is a regular feature in Electronics. Readers are invited to submit novel circuit ideas, packaging schemes, or other unusual solutions to design problems. Descriptions should be short. We'll pay \$50 for each item published.

Five valuable circuits from changes in feedback

By Gordon Silverman

Rockefeller University, New York

By simply changing the feedback network in the level detector, shown below, an engineer can modify the circuit to form an astable, monostable, bistable, or gated oscillator. The gate of a field effect transistor is the summing point for signals. In addition, the circuit draws no standby power and requires fewer components than similar circuits.

The basic network is a level detector that has been used to analyze electroencephalographs (EEG). A positive voltage applied to the input adds to the bias voltage across potentiometer, P_1 , reaching the pinchoff potential of FET Q_1 . Then, Q_1 conducts, turning on Q_2 , a conventional bipolar transistor. The collector voltage of Q_2 causes diode D_1 to conduct, returning a small in-phase signal to the input. For the EEG application Q_3 drives a 5-kilohm relay, but most circuits will work without it. The level detector handles inputs ranging from 0 to 20 volts.

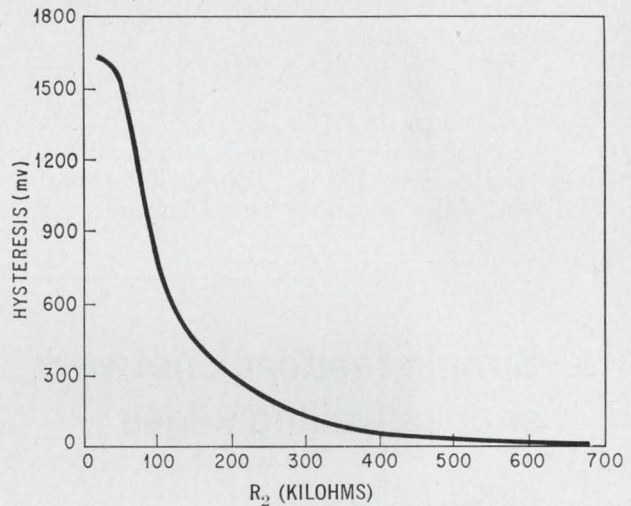

Hysteresis curve. Increasing the value of R_2 , minimizes or eliminates the circuit's hysteresis.

The amount of feedback and hysteresis is determined by R_2 . For example, high values of R_2 can make the hysteresis negligible. Once R_2 is fixed, the hysteresis is independent of the trip point, an advantage over the Schmitt trigger. By removing diode D_1 a large amount of hysteresis is introduced. The hysteresis keeps the circuit from returning to its normal state once it has been tripped. When the

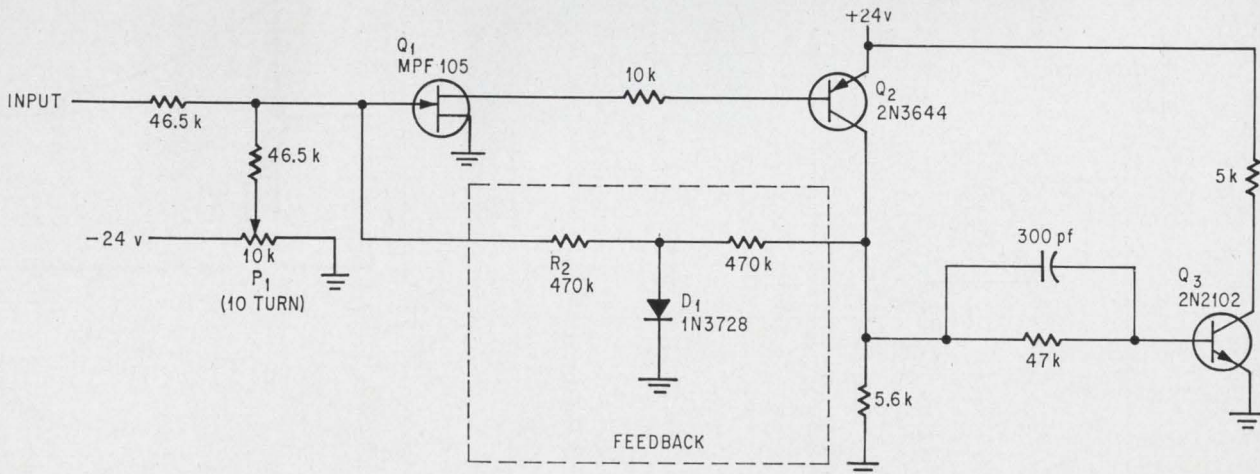

Versatile feedback. Changing the level detector's feedback causes the circuit to behave as an astable, monostable, bistable, or gated oscillator because Q_1 's gate has a high input impedance, allowing signals to be summed at that point.

input reaches the negative value of the upper trip point, the normal state is again established. The circuit uses the pinchoff potential of the FET as a comparison level.

Substituting a capacitor, C, for the feedback network alters the detector to an astable multivibrator. The input must be grounded and P₁ adjusted to make Q₁'s gate-input voltage slightly more than the pinchoff potential. The on time is given by the expression

$$t_{on} = 15 + 7(C - 100)$$

and the off time by

$$t_{off} = 26 + 12(C - 100)$$

where t is in microseconds and C is in picofarads, variable from 100 to 1,000 pf. Returning the input to a pulse generator and adjusting P₁ to cut Q₁

off, makes it a monostable multivibrator whose delay time is equal to t_{on}. This circuit is sensitive to 1-μsec pulses, making it an excellent pulse stretcher. Since both Q₁ and Q₂ are off, capacitor C discharges through a relatively large impedance after the delay time, limiting the duty cycle to about 30%. However, the circuit can be adjusted to divide the input pulse train in two.

Resetting P₁ for astable operation and having the input switch between a negative voltage (-1 volt) and ground produces a gated oscillator with the same on and off times as in the astable mode. If feedback is through a single 100-kilohm resistor, instead of the capacitor, the circuit becomes a bi-stable multivibrator, responding to alternate positive and negative pulses.

Simple feedback network shapes trailing edges

By K.J. Foord

Allen West Ltd., Brighton, England

Adding a diode, capacitor and resistor between the output and threshold reference of a pulse-generator circuit causes a sharp decay in the output pulse's

trailing edge. In addition to shortening the decay time by a factor of 10, the network does not load the output stage and thus enables full amplification of the current.

In the avalanche-type pulse circuit, D₁, C₂, and R₄ form the feedback network. Transistors Q₁ and Q₂ are a complementary pair arranged to switch like a unijunction transistor; transistor Q₃ is the pulse-boosting, emitter-follower output stage. When the voltage on the emitter of Q₁ exceeds the sum of the voltage across R₂ and the base-to-emitter drop of Q₁, both Q₁ and Q₂ turn on abruptly. This

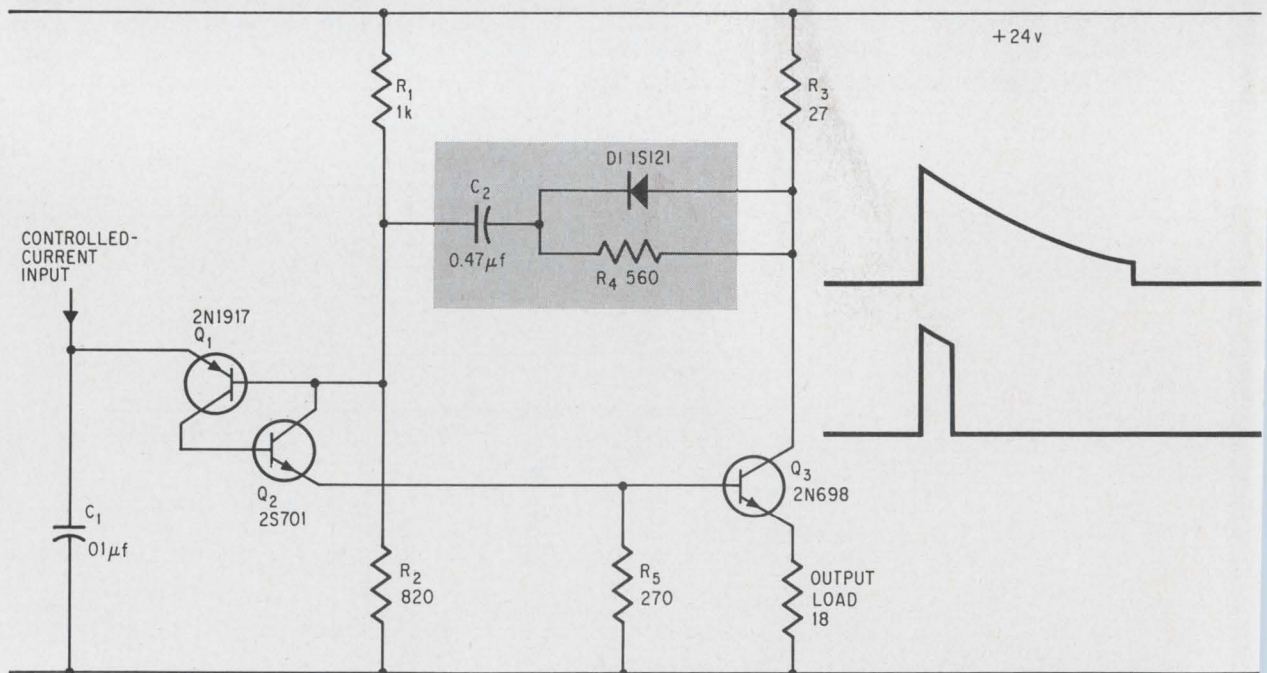

Pulse generator. Feedback network between pulse-circuit output and avalanche-switching input, formed by Q₁ and Q₂, permits trailing edge of output pulse to be shaped. Exponential decay in the trailing edge of pulse output is unwanted. With a sharp decay the trailing edge triggers or controls other circuits.

action brings Q_3 into conduction, causing current to flow through the 18-ohm load.

If the feedback network between the collector of Q_3 and the junction of Q_1 's base and Q_2 's collector were not present, the output pulse would decay exponentially to zero. With the feedback network connected, the collector of Q_3 drops by 12 volts when Q_3 is suddenly turned on, and capacitor C_2 discharges through R_4 , Q_3 , and the 18-ohm output load.

When the input current to transistor Q_3 lowers and (as established by the discharge rate of C_1 through Q_1 and Q_2) Q_3 starts to turn off, its collector voltage

rises. When this level exceeds the potential on the right-hand side of C_2 , diode D_1 becomes forward biased and conducts. This action raises the voltage levels on each side of C_2 ; the increase in the base potential of Q_1 causes the Q_1 - Q_2 combination to turn off sharply.

The rapid transition is the result of the loop formed by Q_1 , Q_2 , Q_3 , D_1 , and C_2 . The remaining components do not affect the trailing edge. Resistor R_3 serves as a current limiter; R_1 and R_2 form a voltage divider that sets the threshold switching point of Q_1 and Q_2 . With R_5 as a potentiometer, the pulse width may be varied.

MOS phase-shift controller cuts motor hunting

By Robert D. Andersen

Lockheed Aircraft Services, West Covina, Calif.

Hunting of a synchronous capstan drive motor is held to a minimum by a phase-shifting network with a metal oxide semiconductor as a voltage-variable resistor.

The rotor hunts or oscillates about its natural synchronous position with respect to the motor's

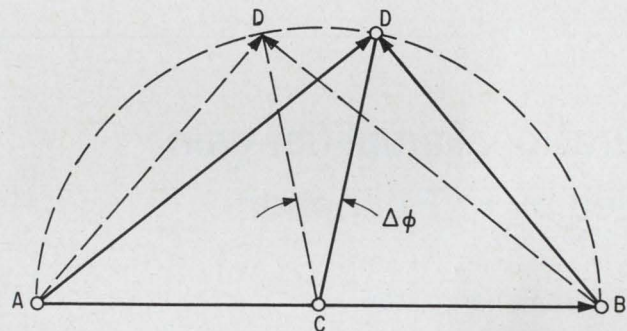

Vectors. Voltage that is proportional to the source-drain resistance of the FET is represented by vector DB. Output of network is a vector that is constant in amplitude and represented by CD.

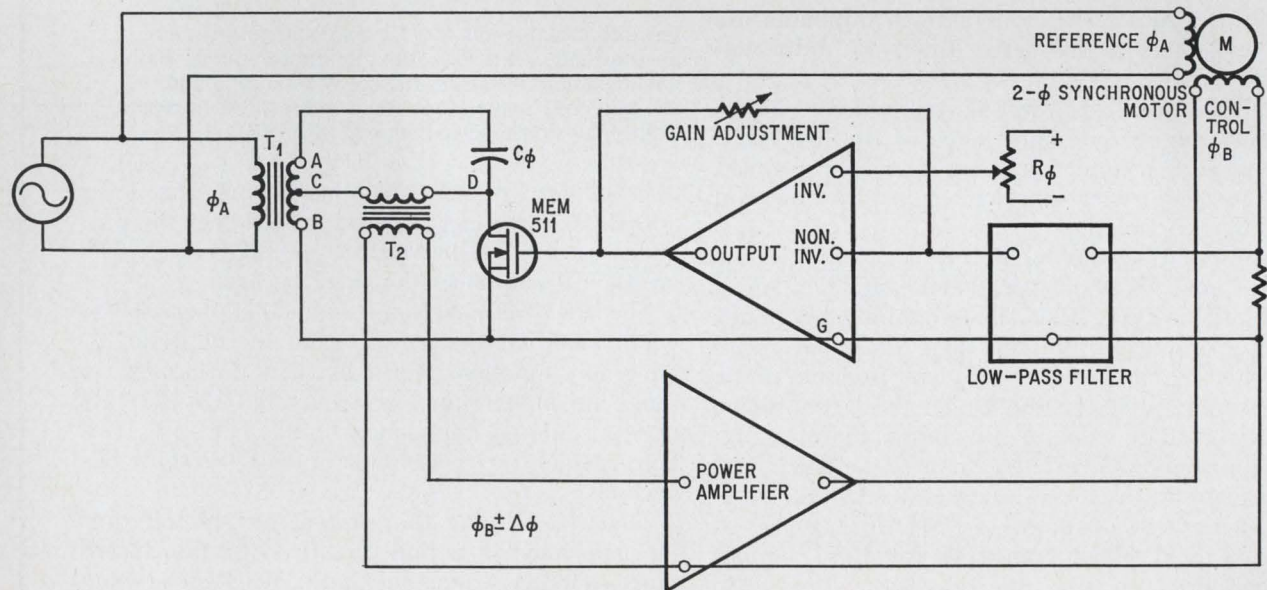

Servo loop. MOS field effect transistor serves as variable resistor in phase-shift network. Output is fed to motor winding to reduce hunting.

rotating field. The result is a phase error, $\Delta\phi$, proportional to the difference between the reference phase, ϕ_A , and the control phase, ϕ_B . When a phase error occurs, the reluctance of the motor's control-phase winding varies, and with it the impedance of the winding. The result is a variation of current through the sensing resistor R_2 , whose value is about 2 ohms.

The hunting or modulation frequency is low compared to that of the primary-drive voltage, and so may be easily detected by a low-pass filter. Hunting signal is then amplified and applied to the gate of the FET, causing a variation in the FET's source-to-drain resistance. Voltage between points D and B varies with the hunting-phase error.

The bias point of the FET and the value of capacitor C_0 are picked so that a nominal 90° phase shift

occurs in the network. The bias point is controlled by varying resistor R_0 , which sets the d-c output level of the operational amplifier. The output of the phase-shifting network, at T_2 , is proportional to vector CD , amplified by the power amplifier, and applied to the control winding of the motor.

The phase shift can either lead or lag the phase of the control winding field. For example, if the motor hunts in such a direction that its rotor lags the rotating field, the phase of the voltage applied to the control winding is advanced. The result is an acceleration torque that nullifies the hunting.

This type of motor-control circuit is able to operate successfully because the FET provides an electronically (high frequency response) variable phase-shift network that has no incidental amplitude variation.

Operational amplifier gain varied by FET chopper

By Donald E. Lancaster

Goodyear Aerospace, Phoenix, Ariz.

Smooth and continuous gain control of an operational amplifier is possible with a single field effect transistor connected to a signal source that is pulse-width modulated. Electronic gain control is especially desirable when operational amplifiers are used to synthesize the active filters in audio networks.

Negligible control power is required due to the extremely high input impedance of the MEM511. Furthermore, several amplifiers may be controlled simultaneously with excellent gain tracking and total channel isolation.

Gain variations are achieved by chopping the input signal to the operational amplifier on a variable duty cycle basis. The chopping frequency must be significantly higher than the upper cutoff frequency set by the desired transfer function of the composite amplifier circuit. Under these conditions, the time average value of the amplifier's input signal determines the resultant gain reduction.

The purely resistive, bilateral switching capability with zero offset of the MEM511 makes it an ideal field effect transistor for this chopper application.

For example, the MEM511 can control the gain

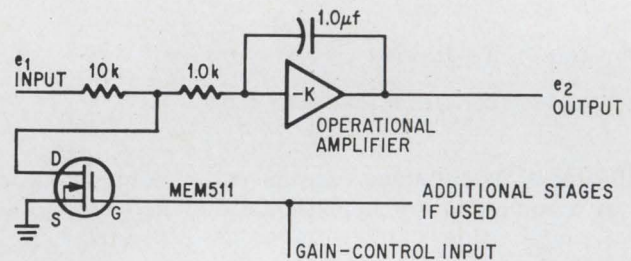

Pulse control. Signals for FET gain-changing circuit are provided by a pulse-width modulated source. High gain results from raising the on-off time ratio and low gain occurs when the ratio is reduced. Additional stages may be added to the gate of the FET.

of a simple low-frequency integrator. The actual operational amplifier used does not effect the principles involved. The MC1530, $\mu A702$, or CA 3010 are typical amplifiers that may be used.

The MEM511 is driven from a 20-kilohertz pulse-width modulated source. During the off time, the integrator functions normally. But during the on time, the input signal is attenuated by the ratio of input source impedance to the FET's on resistance, which for this circuit is $250/10,250$, or 32.3 decibels.

Thus, by varying the ratio of on and off time, the gain may be varied directly over the 32.3-db range. Higher values of input resistance would provide a wider control range.

H-shaped resonators signal upturn in tone telemetering

New design that balances two masses on a connecting web improves the frequency selectivity of electromechanical generators and filters to the point where a single telephone line can carry 1,000 signal tones

By Hugh Baker and John R. Cressey

HB Engineering Corp., Silver Spring, Md.

A new shape for tone generators and filters—a capital H—could spur a renaissance in industrial telemetry at audio frequencies. The revolutionary configuration reduces the cost of constructing electromechanical resonators with Q's of 1,000 or more—a figure that allows the handling of more than 1,000 supervisory-control or data-communications channels on a single telephone line or other voice-grade link.

Railroads, pipeline concerns, electric utilities and other companies that use large numbers of channels have been abandoning tone signaling lately in favor of microwave links and radio-frequency telemetry techniques. Tone signaling has been losing out because of the expense of achieving high Q in tuning forks, resonant reeds, and other conventional

electromechanical resonating devices.

An indication that this tide may turn, however, came this summer with the first major application of the H-shaped resonators, called Twintrons. They are used in a system that reads electric meters in private homes at a cost of about \$15 per meter for the tone-signaling equipment. The resonators are operated by tone signals transmitted over telephone lines; the remote stations are passive.

Break with the past

In its initial and simplest form, the Twintron consists of two balanced masses—the bars of the H—connected by a flexible web. This iconoclastic design avoids energy loss or gain through the mountings of the resonant system, solving the Q and stability problems inherent in conventional resonators [see "Classic electromechanics and Q," p. 104].

The division of functions and the symmetry of the design not only raise Q and make the device immune to shock and vibration, but provide several bonuses in functional versatility.

Piezoelectric transducers—another departure from traditional design—can be fixed to the web to provide unusual combinations of input and output signals. Twintrons can be used as oscillators, encoders and decoders, f-m discriminators, filters that simultaneously pass and reject a discrete frequency, and even as frequency dividers, frequency-selective microphones, and motor drives. They can be mechanically tuned over a broad band of frequencies, or precisely adjusted electrically.

Prices for individual devices run from \$5 to \$25 depending upon Q and other requirements, and may be even lower when several resonators are

The authors



Hugh Baker, the president of the HB Engineering Corp., worked on Bomarc missile designs earlier in his career. He later held engineering and marketing management posts at several instrumentation, control, and data communications companies.



John R. Cressey, chief engineer, has designed both space and industrial telemetry systems. While with the Army, he developed a cloud-cover recording system that is credited with taking the first picture of earth from a satellite, Vanguard II.

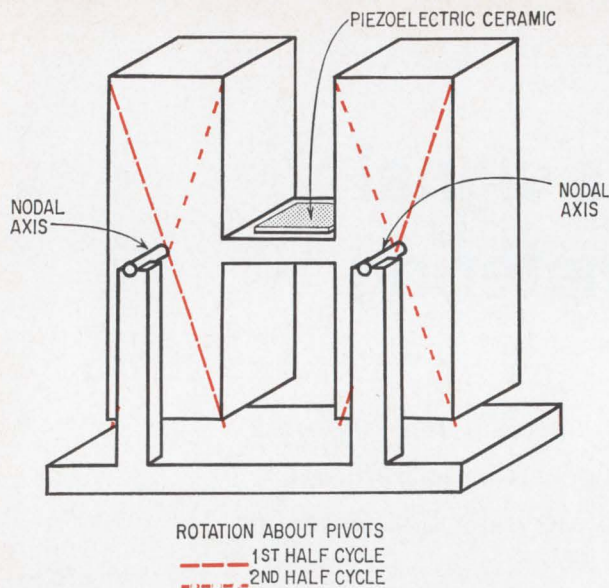

Push-pull. As the piezoelectric input transducer contracts and expands, the web flexes and the bars oscillate in opposing directions. The resonance signal can be picked off by a coil near a bar or by another piezoelectric transducer underneath the web.

packed in a single housing. Costs are higher, though, when Q 's over 5,000 are needed and transducers more sensitive than piezoelectric ceramics are used. Resonant frequencies can range from a fraction of a hertz to 20 kilohertz.

Division of labor

The Twintron's success is partly due to the separation of mass and spring properties in the resonating structure. In the conventional resonator forms, these two properties are inseparable, and the devices give up energy to the mounts.

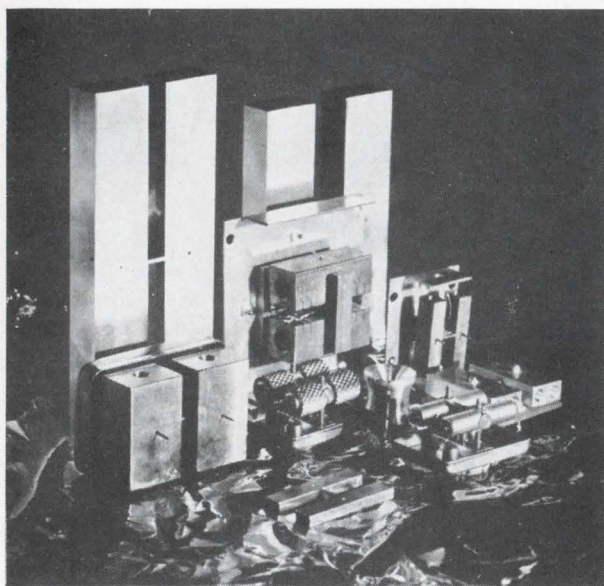

On a theme. Variations on the basic H-shaped design include big models that operate at very low frequencies, models fitted with tuning slugs, and a cylindrical version that can be used as a microphone.

The two parallel bars in the Twintron contribute a mass moment of inertia to the resonant system. They are balanced on axes at their centers of rotation, or nodal points, as in the diagram at the left; there's no lateral motion of the bars at the nodal points.

Acting as a spring, the crossbar, or web, of the H mechanically connects the bars in the plane established by the two nodal axes. When the web is flexed by a piezoelectric transducer, it drives the masses into oscillation. The resonant frequency is also picked off by a transducer on the web.

The Twintron's resonant energy is retained in the masses and the web except for a few low-order losses such as those caused by molecular friction in the materials and by air dampening.

As the web flexes with each half cycle of the input signal, the two bars oscillate in opposition to each other. Each rotates only a few minutes of arc about its own nodal axis. Since the axial pins rotate freely on their supports, none of the rotary motion is transmitted to the mounting base.

The most convenient way of holding the pins is to insert them in moderately firm rubber. Typically, the pins are 0.02 inch in diameter and rotate through 10 minutes of arc. The circumferential displacement of such pins is, for all practical purposes, zero.

The rubber isn't required for mechanical isolation. Welding the pins to the mounting would only add their torsional spring characteristics to the spring stiffness of the web in the over-all resonant system. Since the pins rotate counter to each other, there's virtually no net transmission of energy through the common plane of the base.

The response curve of a Twintron with a Q of 4,000 is at the right. A Q of 1,000 means that a filter can discriminate—at half-power points—between two frequencies 1 hz apart at a nominal frequency of 1,000 hz, or two that are 0.1 hz apart at 100 hz.

Dimensional variations due to temperature changes have little or no effect on the device's balance; the frequency stability of a Twintron made of aluminum bars and a nickel-steel alloy web is better than 0.05% from -40 to $+55^{\circ}\text{C}$. It can have a temperature stability as high as 1 part per million per degree centigrade if the bars and web are of a nickel-chrome-steel alloy such as Ni-Span-C.

Tunability

Resonant frequency can be shifted 20% to 30% by balanced pairs of threaded tuning slugs inserted in threaded holes running the entire length of each bar. Balance about the axis of rotation is maintained by positioning the slugs at equal radii and distances from the nodal points; the Twintron remains immune to shock and vibration as long as this balance exists.

The slugs alter the inertial mass moment of the bars, increasing frequency as they are moved toward the centers of rotation.

Q can be deliberately reduced to broaden the

device's frequency response by setting the slugs at differing distances from the bars' nodes. The two bars will then have different mass moments of inertia and will move out of phase.

The range of adjustment can be extended to a ratio of 10:1 by using both internal tuning slugs for fine adjustments, and using sleeves on the outside of the bars for coarse adjustments, as in the photo at the right. One such Twintron can be made to resonate at any frequency between 300 and 3,000 hz—the entire voice band—and its Q can be adjusted between 50 and 200.

Tunable filters offer a significant advantage when a lower Q is acceptable. Tone control manufacturers can stock up on one type of filter to take advantage of volume-production savings, and can tune each individual unit to suit certain applications.

Flex and reflex

Conventional resonators generally have electromagnetic or magnetostrictive transducers. These don't physically contact the resonator and have little effect on the resonant system's properties. Piezoelectric transducers, on the other hand, don't mate well with conventional resonators.

Both of a tuning fork's tines are in motion over their entire length, for example, and covering them with piezoelectric ceramic to convert all the motion into electrical signals would be expensive and would degrade the tines' mechanical properties.

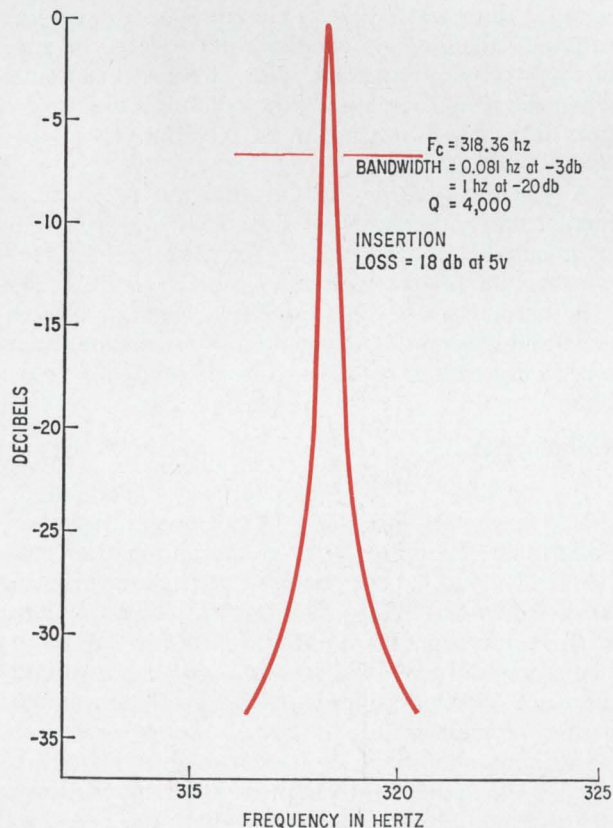

High Q. One Twintron's response curve shows a quality factor of 4,000.

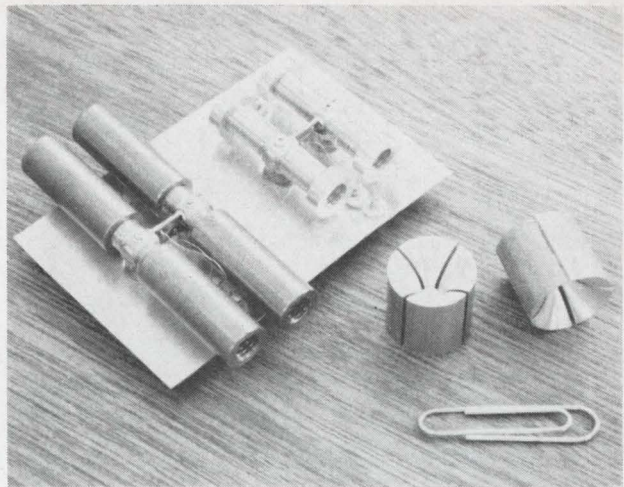

Tuning slugs. Applications versatility is indicated by the pair of resonators on the board at the left. Device with large tuning sleeves resonates at 300 hz, the lower end of the voice band. An identical device, but with small tuning collars, operates at 3,000 hz, the upper end of the band. Cylindrical objects are acoustic resonators; transducers haven't yet been placed on their webs.

Twintrons can use all three kinds of transducers, but generally employ piezoelectric transducers. The H shape capitalizes on the piezoelectric type's high efficiencies. The web is short and stiff compared with a tine or reed, and mechanical coupling between the web and piezoelectric material placed on it is nearly perfect. The amount of material needed to flex the web, or sense its motion, is small and has little effect on the spring properties.

Piezoelectric transducers can deliver a substantial electrical signal into a low-impedance load even though they are inherently high-impedance devices. If the transducer and load are properly adjusted, there can even be a voltage gain of as much as two to one.

Though Twintrons can withstand input signals of up to 40 volts without damage, levels are generally held to between 0.5 and 1 volt. With inputs between a few microvolts and about 1 volt, output varies linearly with the input; above 1 volt, output remains fairly constant until the device is driven so hard that the piezoelectric properties of the transducers are destroyed. The apparent Q drops off when the input rises above a few volts.

The device's self-limiting property can be exploited to protect the circuits following the filter.

The output voltage is high enough to drive the gate of a silicon controlled rectifier circuit directly. The receiver circuit on page 102 can activate solenoids and trigger lights and relays. If a diode is placed in series with the a-c voltage on an indicator, such as a lamp, the circuit becomes a "hold" indicator; once turned on, the lamp remains on until the circuit is opened. Such circuits have wide applications in tone control and selective calling systems.

Multiple combinations of inputs and outputs can be achieved by coupling a number of separate

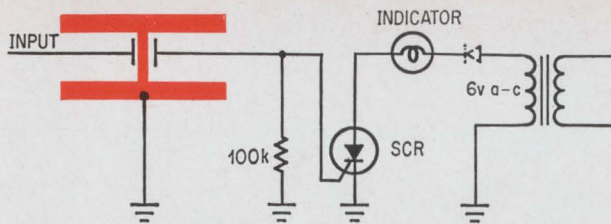

Indicator. Position of switch at remote station is ON if the Twintron receives a tone signal and produces an output that triggers the SCR.

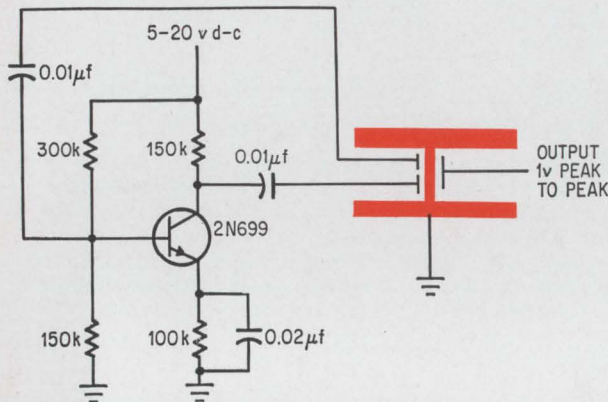

Oscillator. A single transistor is combined with a resonator whose inputs and outputs are out of phase. Third transducer at right is an isolated output.

transducers to the web. Also, since piezoelectric material has a polarity, transducer pairs can be placed so their responses are in phase or 180° out of phase with each other.

The result of setting the input and output signals 180° out of phase is a simple, frequency-stable oscillator, shown above, that needs no phase-shifting networks. The oscillator inputs and outputs are the transducers at the left of the web. The third transducer picks up the resonant frequency for use by a following circuit stage. It provides an isolated output and avoids loading the circuit and changing its frequency. In effect, the third transducer is a buffer between the oscillator and the following circuit stage.

Rejection, or notch, filters are made with a shunt resistor and out-of-phase input and output transducers, as on page 103. The resistance is chosen so that the signal across the resistor at resonance equals the voltage at the output transducer; signals at frequencies other than the resonant pass only through the resistor, and the off-frequency response is flat down through d-c. There is no off-frequency output from the transducer; at resonance, the signal from the transducer and the equal but opposite signal through the shunting resistor cancel each other.

A leading candidate for rejection is the 60 hz of line power and its harmonics. A rejection filter measuring 2 by 1/2 by 1 1/2 inches is being made for this application and has the response curve on page 103. The output can be fed to a field effect tran-

sistor, which provides an excellent impedance match with other circuits, some power gain, and no d-c offset.

This circuit effectively eliminates the 60-cycle hum that has for years been a thorn in the side of designers of instrumentation, communications and consumer electronics equipment.

A Twintron with one input, two outputs and a resistor (bottom, p. 103) acts as both a notch and a pass filter. The output connected to the input through the resistor rejects the resonant frequency and passes all other input frequencies, while the other output passes no frequency but the resonant. This arrangement is a convenient way to put a control tone on the same line as voice communications. The tone emerges from the pass output at the receiver end; the rejection output contains the voice minus the control tone.

Floating differential outputs can also be obtained from isolated output transducers, as in the ultra-narrow-band, f-m discriminator circuit shown on page 105. Slight frequency shifts produce large output signal swings.

Frequency calibration

The resonant frequency of a Twintron can be changed $\pm 1\%$ by biasing the output transducer. A unique feature of piezoelectric ceramics is that their elastic properties change with electrical load. Thus, the spring property of the web can also be varied because web and transducer are mechanically coupled.

Frequency will shift in the circuit on page 105 because the resistor allows electrons to leak off the ceramic, changing its elasticity and hence the resonator's center frequency. This effect is maximum when the resistance equals the ceramic's characteristic impedance—typically 20 kilohms at a frequency of 1,000 hz.

A variable resistor can be adjusted to cause a highly stable oscillator to shift from one discrete frequency to another, or to vary the center frequency of a selective filter.

A thermistor can be substituted for the resistor to obtain a temperature-compensated resonator; a zero temperature coefficient is theoretically possible.

Wobulation

On the theory that if two bars are good, more should be better, work has begun on multiple-bar Twintrons. The object is to create an array of mechanically coupled resonators, not necessarily in pairs. Interesting phase relationships crop up when groups of resonators are tightly coupled through common nodal pins or shafts and are stagger-tuned to create wide pass bands, as in the sketch at the bottom of page 105.

If the mass moments of inertia of all the bars are equal, Q is significantly improved. If the bars are cut so that the moments are unequal, periodic undulations—called wobulations—occur in the resonant system. The phase relationship of each bar

to the system varies in a regular manner.

Fascinating to watch—and pronounce—wobulation may also open up many new applications. Phase modulation can add a new dimension to audio-frequency signaling techniques. Each bar in a row can be cut slightly longer than the preceding one so that the shortest resonates at the input signal's frequency, and the motion of the succeeding bars is progressively delayed. Transducers adjacent to each bar produce outputs whose phase is delayed by a period dependent upon the length of each successive bar.

In one variation on this theme, the bars are coupled to a disk-shaped web. One piezoelectric wafer is the input transducer; another is cut into pie segments to form isolated output transducers. As the device resonates, both the moving ends of the bars and the electrical outputs form Lissajous patterns. One pattern, a slow elliptical rotation, can be put to use as a frequency divider. The division can be continuously variable—not limited to discrete steps or whole integers.

Another variation—the cylinder-like object in the photo on page 101—is the basic part of a highly selective acoustical tone generator or microphone. The design won't interest broadcasters because it only picks up a specific frequency, but producers of security systems could use it. Depending on bar size and contour, a frequency-selective acoustical warning device would radiate or detect sonic or ultrasonic energy in both directions from the plane of the web.

The resonator can be machined from a metal rod so that both ends follow an exponential curve and leave a thin disk of metal as the central web. Pie-shaped longitudinal sections are cut, creating different sized bars coupled to the web, and input and output transducers are then mounted on either side of the web.

Other experimental variations look as if they might work well as timepiece motors—combining the functions of a stable time base and a drive mechanism—and as light choppers or laser modulators.

Passive monitoring systems

Several tone communications systems have been developed that require no active devices at a remote site. The normal signaling tones carried over wire or radio links provide power enough to actuate the Twintrons—a feature that boosts reliability and lowers costs.

One of the simplest such systems is called the "echo." In the case of Twintrons with Q 's greater than 1,000, ON-OFF conditions can be determined at more than 1,000 remote sites through a two-wire voice communications circuit. The capacity of such a circuit using conventional low-cost resonators would be about 30 channels.

At a central station, an oscillator similar to the circuit on page 102 and a receiver filter like the one above it are provided for each channel. At the remote station, a passive resonator is connected to

Choosy filters

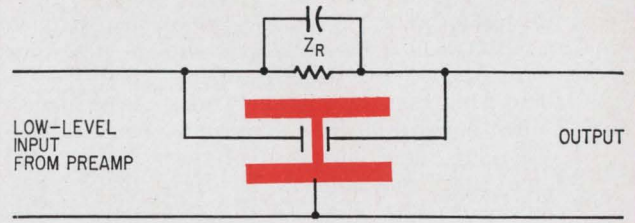

Rejection filter. Only the resonant frequency is blocked by this filter. All other frequencies are detoured through the resistor.

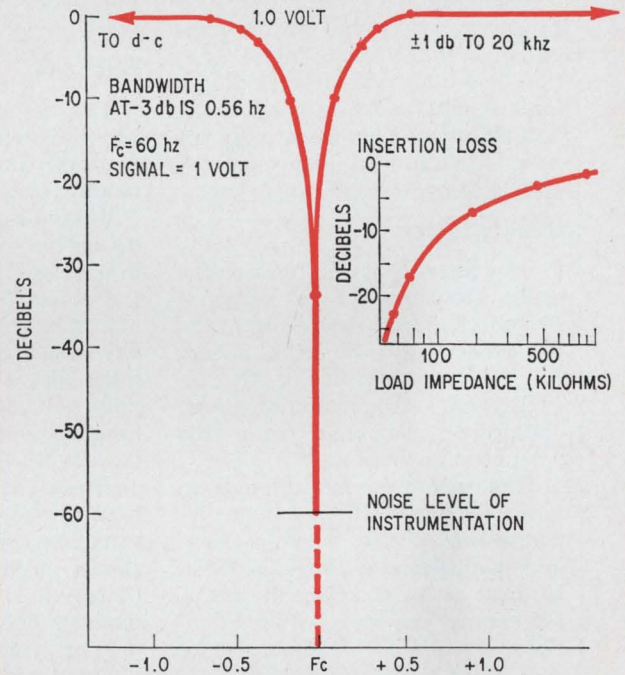

Hum stopper. Characteristics of a filter designed for applications requiring the rejection of 60-hz line frequency—the source of 60-cycle hum.

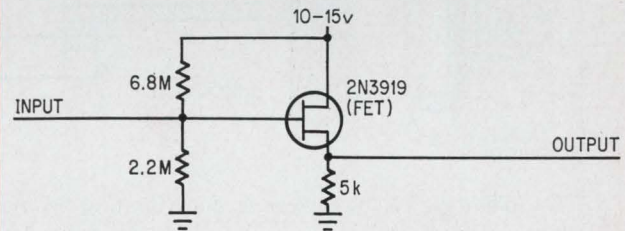

Matching circuit. Piezoelectric transducers are high-impedance devices. Field effect circuits like this will match Twintron outputs to low-impedance loads.

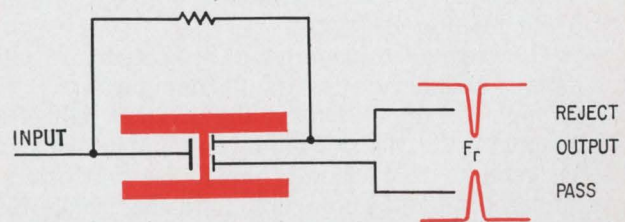

Both ways. Two output transducers give a circuit designer the choice of filtering out the resonant frequency, passing it, or both.

Classic electromechanics and Q

Electromechanical resonators have no peers as filters at audio and sub-audio frequencies. Resistor-capacitor and inductor-capacitor networks cannot equal resonators' frequency selectivity, or Q, because of the large time constants in low-frequency circuits. High Q in such networks would require impractically large capacitors and inductors.

On the other hand, the Q of a resonator can be severely degraded by energy losses through the resonating system's mounting. Worse, the device can be triggered into false operation by external shock and vibration. These two problems have often proved bothersome in classic resonators, shown below.

Quality factor

In a filter, Q is the ratio of the center frequency of the response curve to the total bandwidth at the half-power, or -3-decibel, point. In a mechanical resonator, Q is an expression of the amount of energy conserved compared with the amount dissipated.

Some energy is lost through internal friction in the resonator, air dampening of the moving parts, and inefficiency of the transducer. In most cases, however, the greatest energy loss stems from vibrations transmitted by the resonator

to its mounting base.

Any mechanically resonating body has nodal points—points of least deflection—about which the mass of the body resonates. Resonating efficiency is greatest when the mass is mounted at the nodal points. This, however, invariably leads to loss of energy to the mount in the classic designs because the nodes aren't motionless. The masses rotate slightly about the nodes and move laterally a small amount as the mass vibrates.

False talk

The mounting structure is a two-way street for mechanical energy. A shock can set the resonator in motion, even making it resonate.

Energy from the mount need not be at the resonant frequency, or even close to it, for the output transducer to generate a false signal. Piano tuners prove this every day when they ring their tuning forks with a sharp blow, then amplify the note—a specific audio frequency—by pressing the fork's base against a sounding board.

These characteristics of resonators can be devastating in a tone-signaling system. The circuits should respond only to a command transmitted at a particular frequency, not to the rumble of a passing train or the thump of

heavy machinery.

The problems are compounded when a system requires many closely spaced tones or frequencies. If the filters are mechanically interconnected through a common chassis, the vibrations of one can set its neighbors in motion.

Great care must be taken, therefore, to isolate one resonator from another and from the environment. The filters are often mounted on foam rubber or other vibration-absorbing materials, but this only degrades Q further because the same materials absorb some of the energy the designer wants to keep in the resonating system.

Transducers

Another factor affecting Q is the way the transducer gets energy in and out of the system. Electrical energy must be converted to mechanical energy, and vice versa.

The input and output transducers can be electromagnetic, piezoelectric, or magnetostrictive, and capacitance, photoelectric, or electrostatic devices that sense motions of the mass can be used as output transducers.

The final frustration, of course, is when a designer improves transducer efficiency, to raise filter Q, only to find that spurious resonances are picked up more readily.

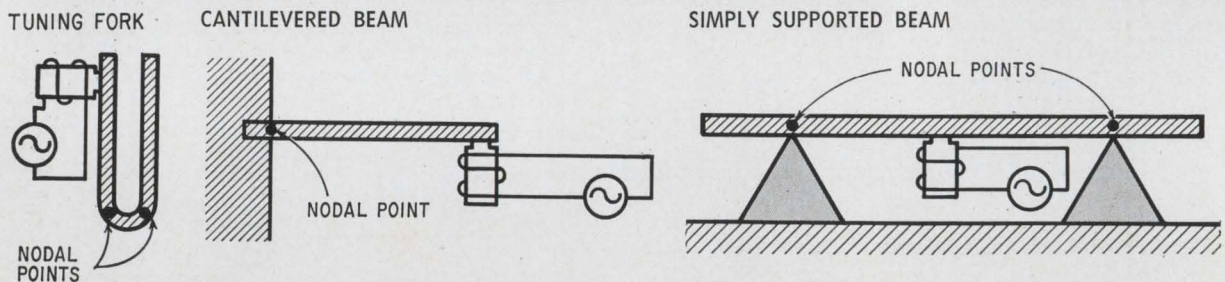

The old way. Tuning-fork tines and vibrating beams always lose energy through mountings at their nodes.

the communications link through a switch that determines the ON-OFF conditions of the equipment being monitored.

The channel transmitter and receiver are alternately connected to the communications link through a chopper. During the transmit half of the chopper cycle, the transmitter sends the tone signal assigned to that channel down the wire (or any duplex communications link), and the remote resonator receives and stores the signal energy. In the receive half of the chopper cycle, the resonator echoes the tone back into the line and the central

receiver's output triggers an indicator.

As long as the switch at the remote site is closed, or ON, the indicator will also remain ON. If the switch is open, no echo is received and the indicator goes to OFF and remains OFF until the switch closes and an echo is received. The system is fail-safe and there is no scanning. The indication can be changed in approximately 8 milliseconds (the transmit-receive period) with a 60-hz chopper, and in less than 2 msec if a 400-hz chopper is used, with allowances for a slight decay time in the channel receiver's Twintron.

If amplification is needed for impedance matching to the line or to overcome signal attenuation, one broadband amplifier can serve all transmitters and receivers. When several echo transponders are required at one remote station, the Twintrons can be packaged in a common housing, as in the photo at the top of page 106.

Another system can actuate an indicator, sound an alarm, or alert a telephone at some remote station. The necessary power is provided not by the tone signals, but by a signal at a fixed frequency—say 2 kHz—continually transmitted on the line. The alarms, however, remain mute until a tone assigned to a station is transmitted. The tone actuates a Twintron-SCR circuit that switches the 2-kHz signal into an alarm, such as a piezoelectrically driven howler.

Rural telephone networks could use this technique to reduce the size of their wires, as the wires wouldn't have to handle heavy surges of separate ringing current. Or they could go entirely to signal-level a-c operation, since there would no longer be the need to handle dialing with d-c and ringing with high-power a-c.

A-c power monitoring

A further variation would free turnpike authorities, railroads, and pipeline companies from worries about burned-out bulbs in safety lights or valves not operating because of a blown fuse or an open switch. An a-c power monitoring system would give a positive indication of proper operation.

The remote site in this case has a pair of Twintron filters and a diode mixer. A tone assigned a station—1,002 hz, for example—is passed through one of the filters, and the diode mixer combines it with the 60-hz frequency picked off the electric circuit. The second filter is tuned to 1,062 hz, the sum frequency. If the second filter receives a 1,062-hz signal from the mixer, it passes back this reply tone to a central station, which then knows the bulb or valve is drawing power and is operating. When the mixer output is 1,002 hz, no reply signal is received, and an alarm or indicator is actuated.

Allowing for 2-hz separation of channels, 500 channels can be provided in a voice-grade circuit—half as many as the basic echo system because interrogation and reply are at different frequencies. All 500 stations can be monitored simultaneously.

Passive telemetry

Many companies have tried to design systems to read utility meters over telephone lines, but they have been frustrated by economic and technical problems. Utilities say they would install automatic reading devices only if the units cost less than \$15 each.

The device must not drain a-c or d-c power from the phone lines, and signals must not interfere with voice communications. Also, the phone company won't send power over its lines to drive another utility's devices, and electric utilities don't want to connect the remote unit to their own

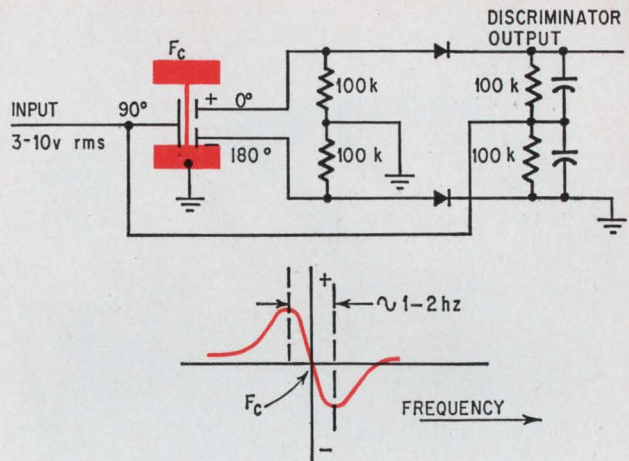

Discriminator. Out-of-phase transducers help f-m discriminator produce a large change in output when a small shift in frequency occurs.

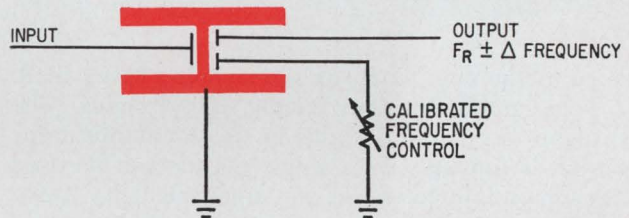

Frequency shift. Resonant frequency of the Twintron can be varied over a range of $\pm 1\%$ by adjusting the calibrated resistor.

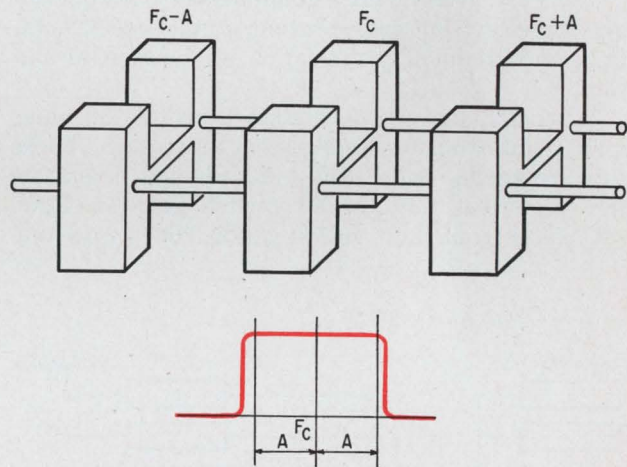

Broader bands. Frequency response can be made very broadband by mechanically coupling several resonators.

power lines because that sort of installation by electricians would be costly. Besides, power supplies and amplifiers would add to cost and present a potential source of unreliability.

The new PRT (passive remote telemetry) system overcomes these difficulties. Meter readings can be transmitted in any numerical format—binary or decimal code, for instance—but the preferred method is to generate decimal data with shaft-position encoders, commutators, or switches built into the meter.

With this decimal data, system capacity is de-

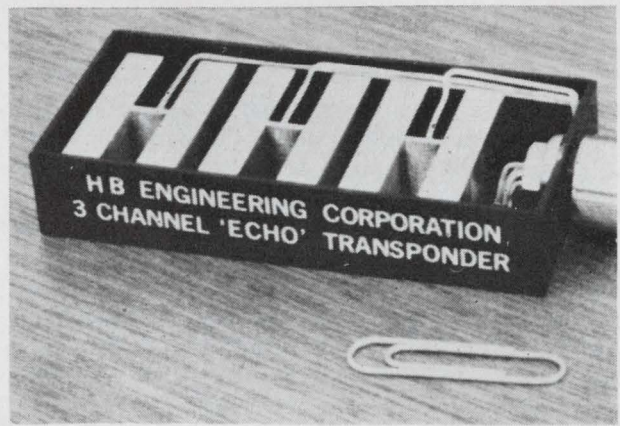
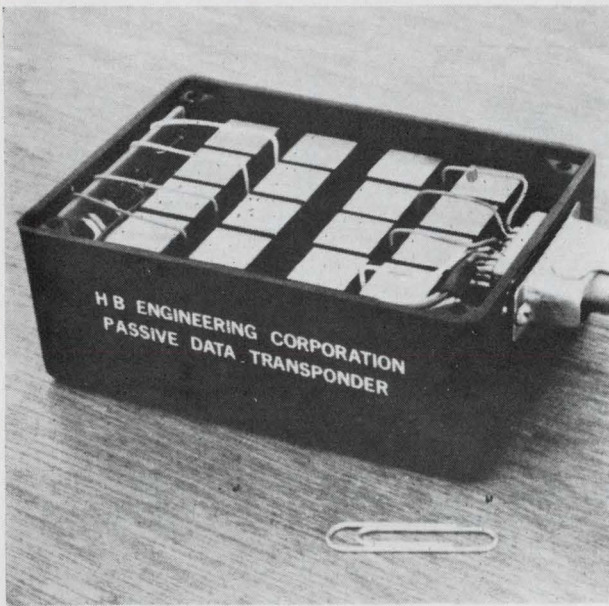

Close quarters. Their immunity to vibration enables several resonators to share a housing. The photo above shows a three-channel transponder for the echo system; at the left is a four-channel transponder for the passive remote telemetry system.

fined as the number of decade switches being read; a voice-grade line can handle 100 decades. The distribution of the decades in the communications circuit is immaterial—a single decade can be used at each of 100 meters (or any other telemetry transducer), or five can be used at each of 20 remote sites. Capacity of the interrogation system can be raised to 1,000 decades if the link's bandwidth is raised from 3 khz to 8 khz.

The PRT system uses a combination of frequency and time-division multiplexing at the central station, and frequency translation at the remote station.

Typically, the central station transmits 20 tones in four interrogation sets of five tones each. These sets are needed to identify a decade and determine the numerical value of the switch position. Each set consists of four interrogation tones and one

encoding tone.

At the remote station, a four-output Twintron converts the four encoding tones into the binary-coded decimal equivalents of the decimal numbers. The seventh position in a unit's decade, for example, can be designated by a combination consisting of tones A, B and D, but not C. The ABD outputs are wired to position 7 on the decade switch or segment 7 of the shaft encoder.

Combined replies

Connected to the wiper arm of the decade is a diode mixer and a Twintron filter tuned to a specific difference, or reply, frequency. As the interrogation tones are transmitted in sequence from the central station, they mix with the encoding tones passing through the decade contact and wiper arm. The single discrete combination tone passed by the filter indicates which decade is being read and the switch position. Tone combinations to produce specific replies are worked out by straightforward summation of the code tones. A four-channel transponder used at sites having four decades is shown above at left.

One encoding tone is transmitted simultaneously with each set of interrogation tones so that one binary-coded decimal bit is read on all decades simultaneously. The maximum time needed to read all decades in the system, therefore, is the time taken to transmit four sets of interrogation tones—typically, 0.1 to 0.5 seconds. The reply tones are filtered at the central station and the decoded numerical values are handled conventionally by a data acquisition system.

This basic design affords great flexibility in the reading of the decades. The system can be modified, for example, to telemeter each decade individually, determining the numeral in any decade with a single set of interrogation tones. The decades would have to be read one at a time, but they could be read selectively.

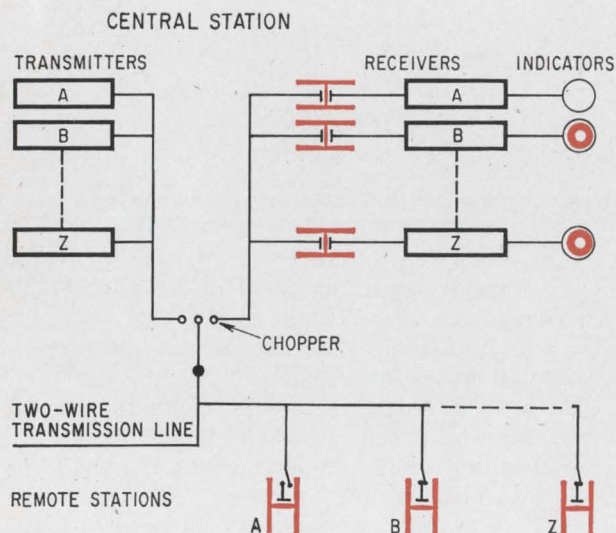

Echo system. Basic passive monitoring setup echoes the transmitted tone when the switch is closed at a remote station.

Now there are four reliable computer tapes



(Delivery is another matter)

As you may surmise from the name at the bottom of this message, CEC is the new challenger in the computer tape field.

We would like to add that the performance of our tape is demonstrably superior to our three competitors'. But that would not be true. All four are well within allowable tolerances of the reference tape used by the computer industry. And all are certified "drop-out free" for the first pass, and remain so for many more.

Obviously, since CEC had no exclusive on excellence, we had to have a pretty compelling reason for climbing on the totem pole.

And we did.

Delivery.

From the time you place your order, you should receive your CEC computer tape within 24 hours — virtually anywhere in the United States.

If you're 100 miles somewhere west of Laramie, it might take a little longer. Perhaps as much as 48 hours.

Quite a difference, we suspect, from the delays you've become accustomed to.

This is no miraculous achievement on CEC's part. The advantage was already there. Namely, the largest established field force in the industry. Plus — the only warehousing facilities strategically located to serve the entire nation.

P.S. One more benefit: if you order CEC Analog Tape along with the new computer tape, you'll also realize some significant savings.

CEC/TECHNICAL SUPPLIES

 **BELL & HOWELL**

Technical Supplies Dept.
Consolidated Electrodynamics Corp.
360 No. Sierra Madre Villa, Pasadena, Calif. 91109
Please send me complete information about
CEC's new Computer Tape.
Bulletin Kit 332-X 8.

NAME _____
ORGANIZATION _____
ADDRESS _____
CITY, STATE & ZIP _____

Will a bargain bypass/filter capacitor jeopardize your entire system?

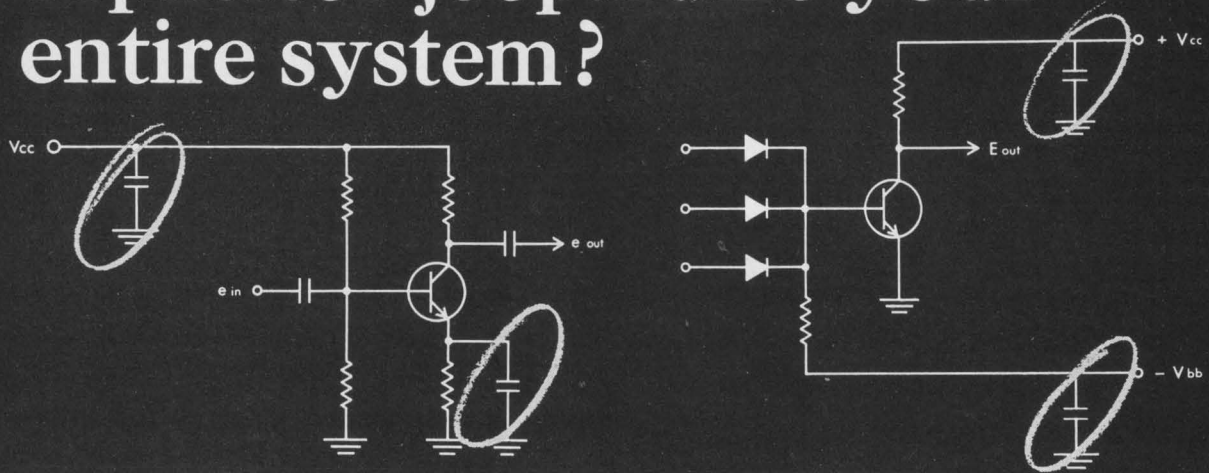

Specify CORNING® Glass-K Capacitors... for confidence

Considering the finality of bypass failure, anything less than the reliability of glass is false economy.

CORNING Glass-K Capacitors guarantee that reliability in two case sizes. Get 1000 to 51,000 pf in .250" x .100", and 12,000 to 100,000 pf in .250" x .140".

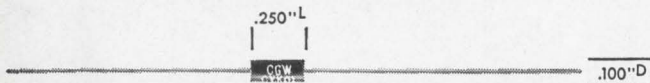

Specify CORNING Glass-K Capacitors when you need:

- bulk capacitance in minimum case size
- the total design flexibility of three stability characteristics, T, U, and V
- capacitor A to track capacitor B with the positive retraceability of glass
- minimum power attenuation and phase error with CORNING Glass-K Capacitors' low power factor

- tight end of life design with the guaranteed low capacitance change of CORNING Glass-K Capacitors
- adaptability to cordwood, printed circuit, and point-to-point packaging.

Get all this in a competitively priced unit that gives ΔC with life as tight as 2%, IR greater than 100,000 megohms, D. F. as low as 1%, and standard item delivery of two weeks or less.

Tell us what you want a bypass/filter capacitor to do, and we'll tell you which CORNING Glass-K Capacitor will give you the confidence you need.

For complete data, write to:
Corning Glass Works,
Electronic Products Division,
3913 Electronics Drive, Raleigh, N. C.

CORNING
ELECTRONICS

Microstrip plus equations adds up to fast designs

New equations for the characteristic impedance of coupled lines sharply reduce the number of steps in microwave IC design

By Alfred Schwarzmann

Radio Corp. of America, Camden, N.J.

The microstrip process, in which a flat conductor is deposited atop a dielectric and ground plane, is an ideal way to build microwave integrated circuits—if there are accurate design equations for such components as filters and directional couplers. The new equation on the next page can eliminate present cut-and-try methods and save much time and expense. Though complex in appearance, they're really straightforward and easy to use.

Agreement between theory and actual circuit is generally poor when the few previously derived equations are used to calculate characteristic impedances and propagation constants. And cut-and-try designing may be acceptable for some discrete-component circuits, but with hybrid IC's, every design means a new drawing and a new etching step. However, when the new equations are applied, one prototype usually serves to fix components to within 1% or 2% of desired values.

The odd couple

The problem in designing coupled circuits in microstrip transmission line has been to analyze the so-called odd mode of propagation, where energy traveling down one microstrip line is coupled into a parallel line and travels in the reverse direction

The author



Alfred Schwarzmann is a design engineer in the advanced technology group at RCA's Communications Systems division. His equations for coupled circuits have been so successful that he now sees microstrip as a viable design for all microwave circuits and says it may completely replace waveguide.

in that second line. Because the odd mode gives tighter coupling than the even, in which the energy travels in the same direction after coupling, the odd is the one most often used in coupled circuits.

Derivation of the equations for the odd mode begins with a consideration of the basic, single microstrip conductor. Characteristic impedance can be calculated with the elementary transmission-line equation $Z_0 = 1/vC_0$, where v is the velocity of propagation down the line and C_0 is the capacitance per unit length.

Unfortunately, the microstrip setup doesn't lend itself to easy calculation of this capacitance, since part of the field is in air and part in the dielectric. To avoid solutions involving infinite series, the total capacitance per unit length is subdivided into three easily analyzed components—the parallel plate capacitance, C_{PP} , between the lower surface of the conductor and the ground plane; the fringing capacitance, C_F , at the edges of the conductor; and the capacitance between the conductor's upper surface and the ground plane, C_{PPU} .

In the case of the single conductor, calculations on this basis provide the characteristic impedance, the propagation constant, and all the other transmission-line parameters. The problem gets a bit more complex when a second conductor is introduced close to the first one, altering the fields. In the even mode, the electric field lines follow a pattern fairly similar to that in the isolated conductor case. In the odd mode, the two conductors are linked by the field lines.

The equation applying to the isolated case is employed to find the characteristic impedance of each of the coupled modes, except that modified capacitances per unit length— C_{0e} for the even mode and C_{0o} for the odd—are used instead of C_0 . Since the even mode is similar to that of the

Microstrip coupled circuits

Isolated conductor

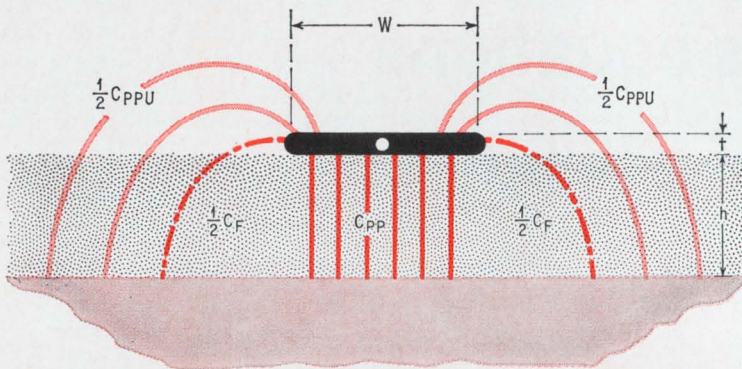

$$Z_o = \frac{\eta}{\sqrt{\epsilon}} \cdot \frac{1}{\frac{W}{h} + \frac{2W}{3h\sqrt{\epsilon}} + \frac{2.7}{\log \frac{4h}{t}}}$$

$$C_{PP} = \frac{\epsilon}{c\eta} \frac{W}{h}$$

$$C_{PPU} = \frac{2}{3} \left(\frac{\epsilon}{c\eta} \frac{W}{h} \right)$$

$$C_F = \frac{\epsilon}{c\eta} \frac{2.7}{\log \frac{4h}{t}}$$

$$C_o = C_{PP} + C_{PPU} + C_F$$

ϵ = relative dielectric constant
 η = free space impedance
 c = speed of light

Even-mode, forward coupling

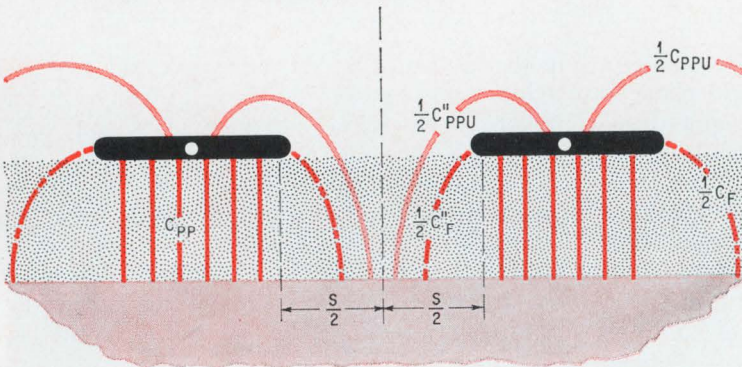

$$Z_{oe} = \frac{\eta}{\sqrt{\epsilon}} \cdot \frac{1}{\frac{W}{h} + \frac{W}{3h\sqrt{\epsilon}} + \frac{1.35}{\log \frac{4h}{t}} + \frac{W}{3h\sqrt{\epsilon}} \frac{1}{\frac{W}{S} + 1} + \frac{1.35}{\log \frac{4h}{t}} \frac{1}{\frac{W}{S} + 1}}$$

$$C''_{PPU} = \frac{\epsilon}{c\eta} \frac{2W}{3h\sqrt{\epsilon}} \frac{1}{\frac{W}{S} + 1}$$

$$C''_F = \frac{\epsilon}{c\eta} \frac{2.7}{\log \frac{4h}{t}} \frac{1}{\frac{W}{S} + 1}$$

$$C_{oe} = C_{PP} + \frac{1}{2} C_{PPU} + \frac{1}{2} C_F + \frac{1}{2} C''_{PPU} + \frac{1}{2} C''_F$$

Odd-mode, reverse coupling

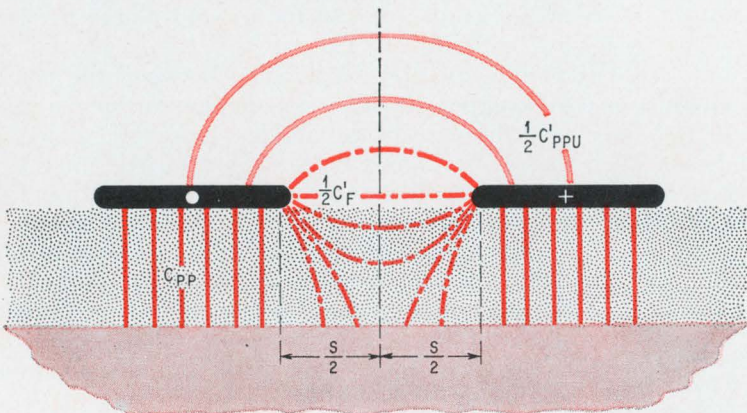

$$Z_{oo} = \frac{\eta}{\sqrt{\epsilon}} \cdot \frac{1}{\frac{W}{h} + \frac{W}{3h\sqrt{\epsilon}} + \frac{1.35}{\log \frac{4h}{t}} + \frac{4}{3\sqrt{\epsilon}} \frac{1}{\frac{S}{W} + 1} + \frac{1.35}{\log \frac{4S \tanh 4h/S}{\pi t}}}$$

$$C'_{PPU} = \frac{\epsilon}{c\eta} \frac{S}{3}$$

$$C'_F = \frac{\epsilon}{c\eta} \frac{2.7}{\log \frac{4S \tanh 4h/S}{\pi t}}$$

$$C_{oo} = C_{PP} + \frac{1}{2} C_{PPU} + \frac{1}{2} C_F + \frac{1}{2} C'_{PPU} + \frac{1}{2} C'_F$$

Propagation constant

$$\gamma = \alpha + j\beta$$

Line velocity

$$v = cK$$

$$K = \frac{1}{\sqrt{1 + l^2(\epsilon - 1)}}$$

$$l_o = \frac{1}{1 + \frac{C_{PPU} \left(1 - \frac{1}{\sqrt{\epsilon}}\right)}{C_o}}$$

$$l_{oe} = \frac{1}{1 + \frac{(C_{PPU} + C''_{PPU}) \left(1 - \frac{1}{\sqrt{\epsilon}}\right)}{2C_{oe}}}$$

$$l_{oo} = \frac{1}{1 + \frac{(C_{PPU} + C'_{PPU}) \left(1 - \frac{1}{\sqrt{\epsilon}}\right)}{2C_{oo}}}$$

Phase constant

$$\beta = \frac{\omega}{cK}$$

Line wavelength λ_G

$$\lambda_G = \frac{2\pi cK}{\omega}$$

$$\lambda_{TEM} = \frac{2\pi c}{\omega \sqrt{\epsilon}} \quad \frac{\lambda_G}{\lambda_{TEM}} = K \sqrt{\epsilon}$$

Attenuation constant

$$\alpha = \frac{R}{2Z_o} + \frac{GZ_o}{2}$$

Conductor loss

$$\alpha_{cond} = \frac{\pi \sqrt{f\rho}}{WZ_{oo}} \text{ nepers/cm}$$

ρ = conductor resistivity

Dielectric loss

$$\alpha_{diel} = \frac{F_P \omega}{2cK_{oo}} \text{ nepers/cm}$$

F_P = dielectric loss tangent

Unloaded Q

$$Q_U = \frac{\beta}{2\alpha}$$

$$Q_U = \frac{WZ_o}{cK} \sqrt{\frac{f}{\rho}} \text{ for } \alpha_{diel} \ll \alpha_{cond}$$

isolated conductor, its characteristic impedance equation degenerates to the isolated conductor's when the spacing between conductors widens.

For all their seeming complexity, the equations for characteristic impedances can be evaluated term by term. And with the aid of a computer, the characteristic impedances can be easily plotted as a function of conductor width with conductor spacing as a running parameter.

With that part of the field represented by the upper-plane capacitance in air and the rest of the field in the dielectric, the velocity of propagation in microstrip is not a simple constant. To find the wavelength along the line, which will determine the length of resonant sections, the free-space value of propagation velocity must be adjusted to account for the heterogeneity. This is done by including the effects of the air-dielectric in a multiplying factor, K , for the velocity in free space, c , in the equation $v = cK$. A subfactor of K , designated as l , relates the heterogeneous air-dielectric capacitances to the capacitances that would occur if the air were replaced with the substrate dielectric.

A universal equation for a directional coupler contains a coefficient of coupling, k , defined as the ratio of the difference, $Z_{oe} - Z_{oo}$, to the sum, $Z_{oe} + Z_{oo}$, of the even and odd mode characteristic impedances. The over-all characteristic impedance is equal to the square root of the product of the even and odd mode characteristic impedances, $Z_o^2 = Z_{oe} Z_{oo}$. These two equations are thus used to calculate the even and odd mode impedances for the desired coupling and the over-all Z_o .

Designing couplers

To design a coupler, one must first choose a substrate material with a known dielectric constant and thickness. Because of skin effect, the thickness of the conductors must also be considered; for low losses, the conductor thickness should be at least six times the skin depth—the distance below the surface at which the current is 37% of its value at the surface.

Good results have been obtained with copper-on-chrome conductors. The chrome layer is placed directly on the dielectric, and the copper layer is deposited over the chrome, which adheres to the dielectric better than copper does. Since the copper

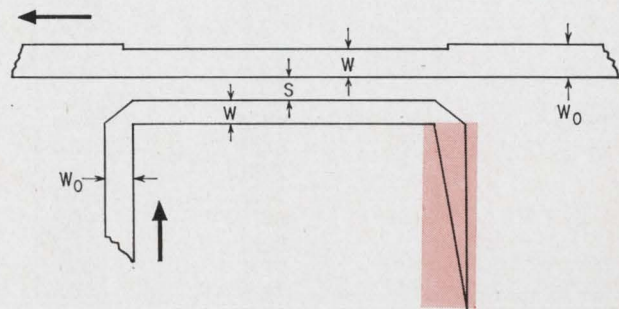

Directional coupler. The 50-ohm line tapers to the proper width for the corresponding coupled-mode characteristic impedance.

Coupling coefficients, 50-ohm Z_0

DB	k	Z_{∞}	Z_{∞}
3	.707	20.7	121
6	.501	28.8	86.7
10	.316	36.1	69.3
20	.100	45.1	55.3

has a higher conductivity than the chrome, it is made thicker. A typical copper thickness is 0.0005 inch; the chrome is usually about 1/50th as thick.

A complicating factor is that the length of the coupling region—a quarter-wavelength—depends on the degree of coupling. A 3-decibel coupler, for example, is considerably longer than a 20-db unit working at the same center frequency, because a greater percentage of the field in its coupling region is in the air. The difference may be larger than 25%, depending on the choice of substrate material. In addition, insertion loss is higher for 3-db couplers because conductors are narrower.

The determination of the needed even and odd mode characteristic impedances through the use of the universal coupling table is followed by an evaluation of the required conductor width and spacing, either from a simultaneous solution of the characteristic impedance equations or from computer-generated curves. To determine the length of the quarter-wave coupling region, line wavelength is then calculated using the upper-plane capacitances in the equations for l_{∞} and K. To figure the losses in the coupler, the equation for conductor loss can be used alone, as this loss is usually much greater than dielectric losses.

Coupled line filters

Half-wavelength resonator filters are well suited to microstrip construction; as open circuits, they don't require ground returns through the substrate as do such shorted quarter-wavelength structures as comb-line or interdigital filters. When a short is required, any inaccuracy in its placement results

Maximally flat response, 50-ohm Z_0

Pole	n	Z_{∞}	Z_{∞}
1	2	64.6	41
		52.9	47.4
2	3	67.9	39.9
		52.9	47.4
3	4	71.1	39.1
		53.5	46.9
4	5	52.2	48
		74.2	38.5
5	6	54.2	46.4
		52.3	47.9
5	6	77.1	38.1
		55	45.8
6	7	52.5	47.7
		52.1	48
6	7	79.8	37.8
		55.8	45.3
6	7	52.8	47.5
		52.2	48

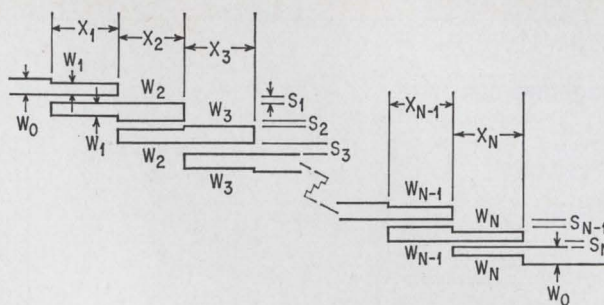

$$X_N = \frac{\arctan \frac{1}{\omega C_{\text{end}} Z_0}}{\beta}$$

$$C_{\text{end}} = \frac{W_{\text{mils}}}{39,000} \frac{\epsilon}{c\eta} \left(\frac{1.35}{\log \frac{4h}{t}} + \frac{WM}{3h \sqrt{\epsilon}} \right)$$

$$M = 1 + \frac{1}{4} + \frac{1}{16} + \dots$$

Multisection filter. In each section, coupling length X_N depends on end capacitance C_{end} for each conductor.

in inaccurate tuning. The microstrip half-wave filters, however, need only be controlled in the outer dimensions, and thus can be accurately tuned.

The half-wave, parallel-coupled filter configuration has been thoroughly studied. A few years ago, S.B. Cohn of the Rantec Corp. published design charts for the even and odd mode characteristic impedances for both the maximally flat and equal-ripple designs. One of his tables, shown at lower left, relates the number of resonators needed for a maximally flat response with 5% bandwidth to the corresponding characteristic impedances.

One of microstrip's disadvantages is that the wavelength along the line varies with line width, W, which is, in turn, a function of the coefficient of coupling k.

Another disadvantage of microstrip is that once the circuit is designed and built, it's difficult to adjust the tuning even by cutting or scraping the conductors off the substrate. Any cutting or scraping lowers the Q of the circuit since some conductor material usually proves impervious to attempts to remove it.

When designing a microstrip filter, the desired response is selected from Cohn's chart. The dielectric material, dielectric thickness, and conductor are chosen and are used to calculate resonator Q.

The conductor width, W, and spacing, S, of the coupled lines are then determined by applying the even and odd mode characteristic impedance curves. Finally, the length of each coupled section is figured using line spacing, wavelength along the line, and extra capacitance at the ends of the resonator sections, which acts to shorten the line.

Bibliography

S.B. Cohn, "Parallel-Coupled Transmission-Line-Resonator Filters," IRE Transactions on MTT, April 1958.

THE

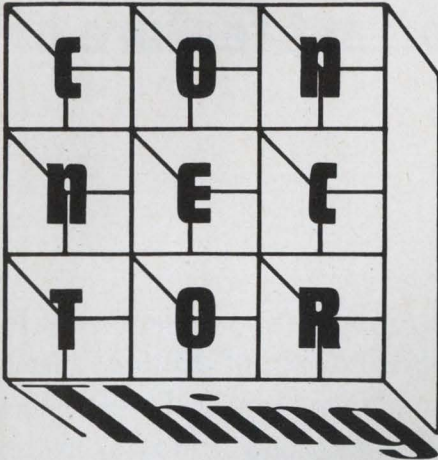

A periodical periodical, designed to further the sales of Microdot Inc. connectors and cables. Published entirely in the interest of profit.

high density
packaging
expert
goes too far!

Let's face it. The reason our connectors lend themselves so superbly to high density packaging solutions is that they are—in and of themselves—outstanding examples of high density packaging. That's a long winded way of saying that we make smaller connectors than anybody. And it takes some pretty far out designers to jam 420 contacts on one teeny square inch of connector surface (see Twist/Con).

One of these far out types—Algonquin G. Squozen in our design group—has a hobby. In his spare time he dreams up all sorts of high density packaging solutions. Trouble is there isn't always a problem to fit the solution. A classic example of Algonquin's creative work is shown on this page. Study it carefully because it will help you to



WIN A

WHOLE BASKET OF GOURMET FOODS!

(Everything from imported sardines and paté de foie gras to Beluga caviar. Shipped to you direct from Vendome's Gourmet Foods in Beverly Hills, Calif.)



Now that we've whetted your appetite, a few well chosen words about the entree—our connectors. You'll need to know about these before you can stuff yourself.



THE TWIST/CON CONCEPT—A LA CARTE

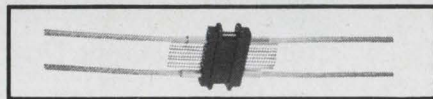

It all started like this: We eliminated the contact spring member normally found in socket contacts by creating a breathing helical spring principle on the pin contact. Smaller. More durable. More economical. The result was the

best family of rack/panel and strip connectors on the market. Some of the high density applications for TWIST/CON include connections for IC's, interconnecting of printed circuit boards, edge-on connections for p.c. boards, and on modules with connectors welded to hybrid circuits. Single pins are being used for high density line splices. TWIST/CON is usable with 22 AWG to 30 AWG standard wires. **Next, we applied the TWIST/CON principle to**

LEPRA/CON— WORLD'S SMALLEST FULL 50 OHM COAX

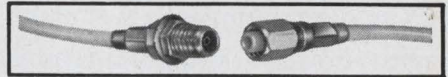

OD is 1/8 inch and mated length is about one inch. That makes it the smallest. And the completely protected contacts also make it the most reliable. The size means you can use a much smaller OD cable for even greater weight/size reduction in your package. **The price is as low as \$1.07 in nominal quantities.** You can get straight plugs, jacks, bulkhead jacks, right angle plugs, or printed circuit receptacles. Screw-on or slide-on versions in entire line. **That's the menu for today.**



BIG WINNERS!

But everybody who enters receives a photo of Squozen's high density packaging solution. Five lucky entrants will receive the cases of gourmet foods. All you have to do is (a) study the information about our Twist/Con and Lepra/Con connectors, and (b) write an appropriate caption or problem statement for the sardine can, working in at least one of the two connectors we've talked about. Contest is not valid anyplace where it is considered illegal, immoral—or fattening.



MICRODOT INC.

MICRODOT INC., 220 Pasadena Avenue, South Pasadena, California 91030

Dear Microdot:

- Enclosed find my entry in your high density packaging contest
- Enough of this foolishness. Just send me literature on (circle) TWIST/CON LEPRA/CON all your connectors
- I have a connector application for high density packaging. Get somebody over here.

Name _____
 Title _____
 Firm _____
 Address _____
 City _____
 State _____ Zip Code _____
 Telephone _____ Ext. _____

Lepra/Con and Twist/Con are registered trademarks of Microdot Inc.

The packaging is unique. Then why isn't it the most important feature of this new crossed-field amplifier?

Because it's self-modulated. That's the most important feature of Litton's new DEMATRON crossed-field amplifier—it starts and stops solely with the application and removal of rf energy.

The tube's outstanding performance characteristics include: excellent phase characteristics in spite of changes in frequency, drive power and cathode voltage; turn on/off time less than 5 nano-seconds; 10% instantaneous bandwidth; gain-variation less than 1 db over 10% bandwidth; amplification of varying pulse widths, rates and amplitude; family concept (common voltage), applicable from L through Ku-bands.

The DEMATRON crossed-field amplifier provides enhanced detection and resolution capability

without the need for high power modulators. It can upgrade the performance of existing radars.

New applications include multi-mode airborne radar, phased arrays and pulse compression systems.

System design flexibility is increased by the tube's high density linear package. A

typical four tube high power X-band array (illus-

trated) is mounted on less than

5" centers. The magnetically shielded

envelope ends tube/component inter-

ference. Tubes can easily be paralleled to

achieve extremely high radiated power levels, operating from a common DC voltage source.

To learn more about the potential of Litton's DEMATRON crossed-field amplifier, write Electron Tube Division, 960 Industrial Road, San Carlos, California 94070 or call (415) 591-8411.

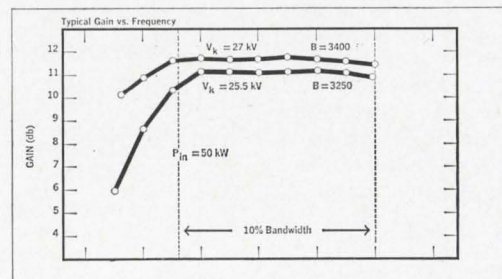
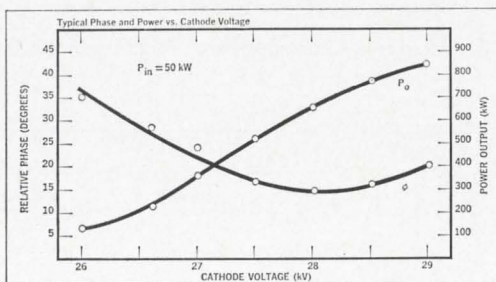
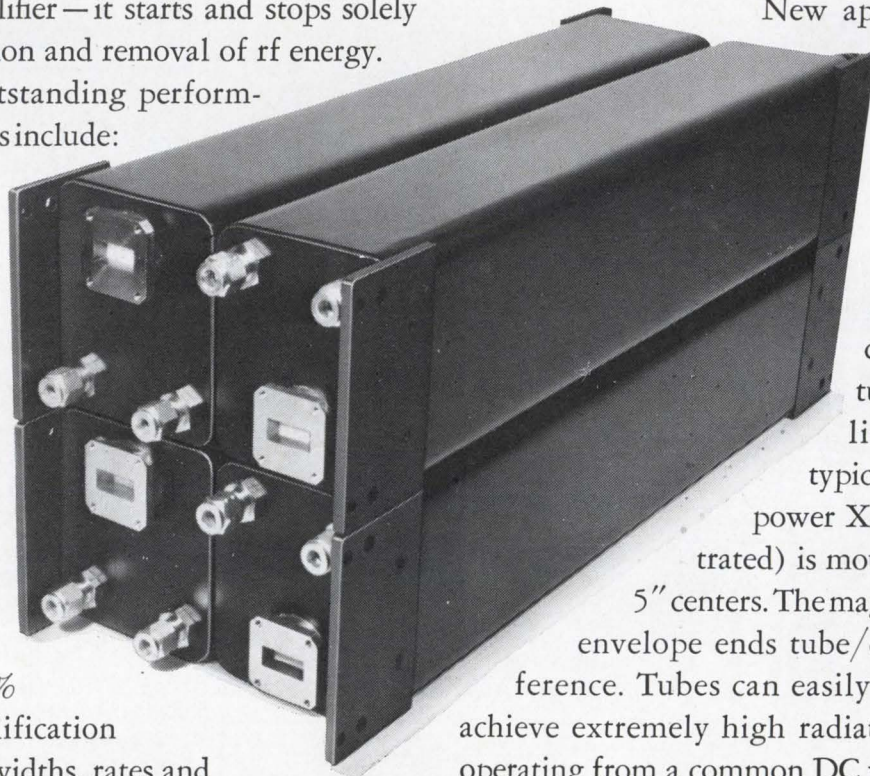

LITTON INDUSTRIES
ELECTRON TUBE DIVISION

Data at twice the speed eases h-f traffic jam

Using phase shifts between simultaneously transmitted signals, modulator-demodulator cuts error rate from one in a thousand to one in a million and doubles the transmission rate

By Gene C. Porter, Martin B. Gray and Charles E. Perkett

Electronics Division, General Dynamics Corp., Rochester, N.Y.

Like an old highway that remains jammed with traffic regardless of freeways, the high-frequency band continues to handle its full share of traffic despite the emergence of coaxial-cable links, troposcatter systems, and communications satellites. But, unlike highways, h-f lanes can't be widened to accommodate the increasing traffic. However, contrary to the best rules of the road, an answer has been found by doubling the speed limits.

Based on frequency-differential phase-shift keying, a digital data modulator-demodulator (modem) has been developed that can transmit data at twice the speed—4,800 bits per second—of previous systems, and in the same bandwidth. With added circuitry, it also reduces the chance of error from one in a thousand to one in a million. A particularly useful system in handling the new teletype and data transmissions, the modem employs the principle that data represented by the phase shift between two simultaneously transmitted signals can overcome delays.

The system, called the Andeft/sc-320, was developed at the General Dynamics Corp.'s Electronics division in Rochester, N.Y. With the advantage of a higher transmission rate, the system can be operated in the same ways as the existing 2,400-bps systems: maximum data-rate, redundant, and error-correcting modes.

In all three, the obvious benefits are in both the amount and speed that data can be transmitted. In the maximum mode, of course, twice as much data can be sent than with existing systems. The same is true in the redundant mode, where greater reliability during severe ionospheric disturbances is achieved by transmitting the same data in each half of the bandwidth. But it's in the error-correcting mode that an additional advantage is gained.

In existing systems, error correcting hasn't found widespread use. To set up an error-correcting code, complex circuitry is required and about half the available number of bits is used; actual transmission of data is halved. Thus, what is a desirable mode is also a costly one. But with a scheme that doubles the transmission capability together with the availability of low-cost digital integrated circuits, coding now becomes more feasible. At 4,800 bps, divided between coding and data transmission, the new system can deliver the same data rate as existing systems operating in the maximum mode. Not only does it meet today's needs, it does it without requiring a wider h-f bandwidth.

Using the ionosphere

The high-frequency band, 3 to 30 megahertz, is often the most inexpensive means of communicating across long distances. Ranges upwards of several thousand miles are obtained by bouncing the signals off the ionosphere, a mass of several layers of rarified air ionized by the sun's ultraviolet rays. The ionosphere starts about 50 miles above the earth's surface. Constantly shifting, the ionized layers produce varying effects on radio signals that are reflected from them. The signals can bounce off different parts of the ionosphere, creating a multipath effect. This causes successive signals to be unpredictably delayed or shifted in phase when they arrive at the receiver.

In time-differential phase-shift keyed systems, where data is represented as the phase shift between signals transmitted in successive time intervals, such delays limit the transmission rate. If data intervals are too closely spaced, multipath effects cause ambiguities at the receiver.

But since the new system is keyed to frequency

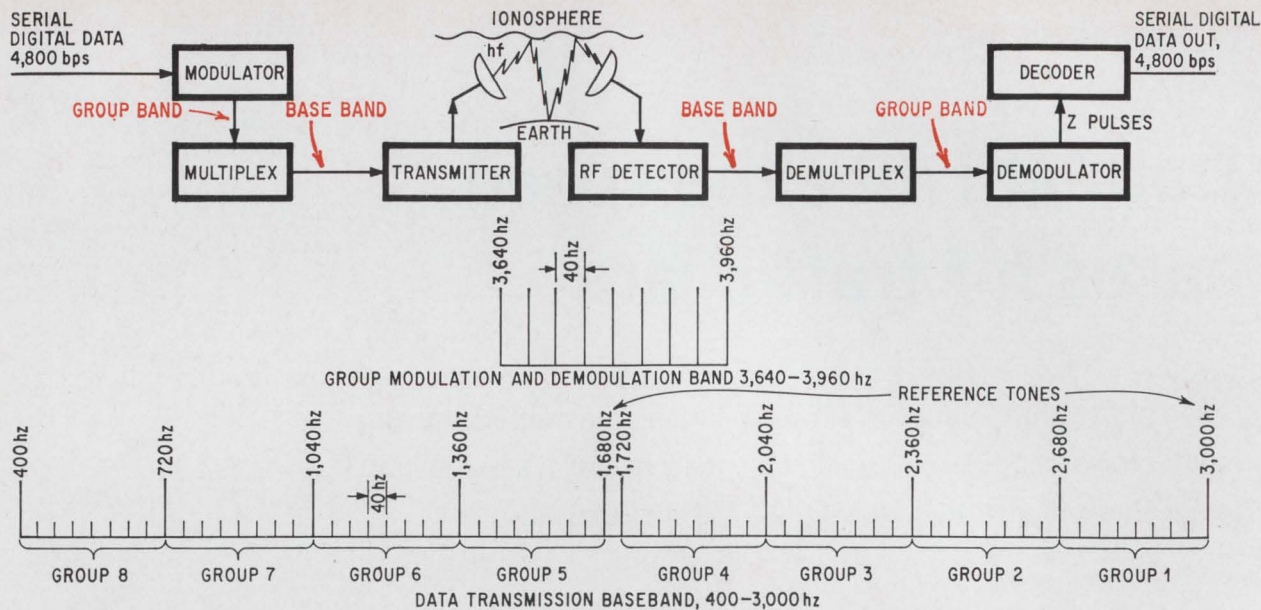

Multiplexing. Each group of eight data characters is first modulated in the groupband, 3,640 to 3,960 hz, and then multiplexed down to the voice, or baseband. The process is reversed at the receiver.

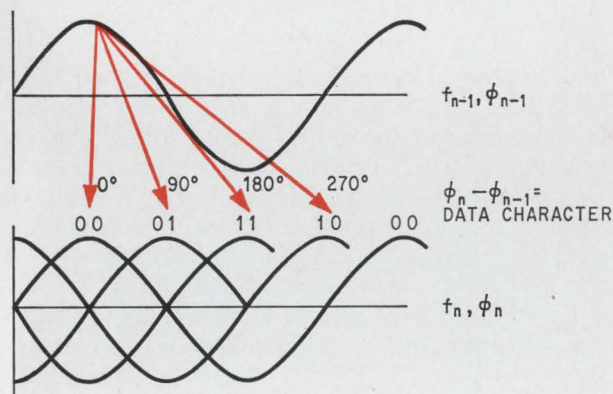

Phase encoding. Digital data is encoded by shifting successive tones by a multiple of 90°. For example, if f_{n-1} is one tone, the next higher tone f_n is shifted by 0° for 00, by 90° for 01, and so on.

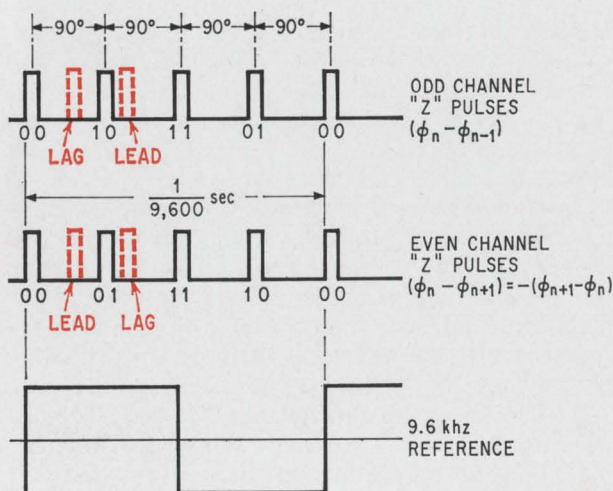

Pulse decoding. The phases of the output "Z" pulses correspond to the original data characters. The pulses, however, may be shifted from their undisturbed positions due to transmission delays. Shifts are in color.

differential, not time differential, time delays have little effect. Information is carried in the phase difference between tones spaced 40 hertz apart, which tend to experience similar phase shifts. The ionosphere's effects thus are minimized, leaving noise from the atmosphere itself and interference from other transmissions as the system's major limiting factors.

The complete modem, with its cooling and power supplies, is contained in a single 6-foot-high cabinet. A feasibility model of the new modem was recently tested in its maximum mode in an h-f transmission between San Diego, Calif., and Bedford, Mass.

Tone-by-tone referencing

In the General Dynamics modem, the allotted baseband, 400 to 3,000 hz, is divided into 66 single-frequency channels—400 hz for the first, then 440, 480 . . . and on to 3,000. Two bits of information are represented by the difference in phase between two adjacent tones. Since two bits offer four possible combinations, four phase differences—in 90° increments—are used. Therefore the phase differences are 0°, 90°, 180°, and 270°, corresponding to 00, 01, 11, and 10, respectively. Each pair of data bits is called a data character and 64 characters—each occupying a single channel—make up a data word.

The phase-shifted signal for each data character is transmitted for 26.67 milliseconds. At the demodulator, the signal is detected over a 25-msec interval and the remaining 1.67 seconds are used as guard time. The guard time is a settling period in which the multiple transmission paths and the demodulator circuitry can clear themselves of one symbol before coping with the next.

By dividing the 64 data channels into eight groups of eight channels each, hardware is mini-

mized. Each group is modulated in the 3,640-to-3,960-hz band and then translated, or multiplexed, down to its proper position in the 400-to-3,000-hz voice, or baseband.

This method only requires 17 synthesized tones—nine for modulation (since a data character corresponds to the phase difference between two tones, nine tones are needed to get eight spaces) and eight for multiplexing.

Eight data channels per group is the optimum. If the data were broken down into either larger or smaller groups, more tones would be required. For example, if four channels per group were used, five tones would be needed for modulation, and 16 for multiplexing—21 in all. If the data were divided into 16 channels per group, 17 modulation tones and four multiplexing tones would be required. And, if modulation were done directly in the 400-to-3,000-hz band on 64 characters (in effect, a single group), 66 tones would be needed for modulation.

Data is fed into the modulator serially at the rate of 4,800 bps. The first data character acts on the phase of the 3,860-hz tone, while the 3,640-hz tone serves as a reference frequency to start the process. If the data character is say, 11, then the 3,680-hz tone would be shifted in phase by 180° with respect to the 3,640-hz reference tone. If the next data character is say, 10, the 3,720-hz tone would be shifted in phase by 270° with respect to the 3,680-hz tone.

This process continues until the eighth data character acts on the phase of the 3,960-hz tone, and then the group is translated down to its proper spot in the voiceband (for the first group, 3,000 to 2,680 hz).

The next group of data characters is then sent into the modulator, with the last character from the previous group serving as the reference for the first character of the second group. The process continues until four groups are processed and placed in the range covering 3,000 to 1,720 hz. Then a new reference, which will later be multiplexed to 1,680 hz, is used to start the modulation process for the second set of four groups.

Demultiplex and demodulate

At the receiver, after radio-frequency detection, the data is again processed in groups of eight data channels, allowing the use of eight identical sets of demodulation circuits. The 400-to-3,000-hz signal containing the encoded data is applied to a group of demultiplexers to convert each of the eight groups back to the 3,640-to-3,960 hz range at which it was modulated. The phase difference between adjacent pairs of frequencies then is sensed and the original data thus is recovered.

The group signal is applied to a bank of nine correlator assemblies (eight data characters correspond to the phase differences between nine frequencies); each assembly consists of two correlator circuits operating on a particular group frequency within the designated range.

Four alternate correlator assemblies—operating

Ionospheric effects

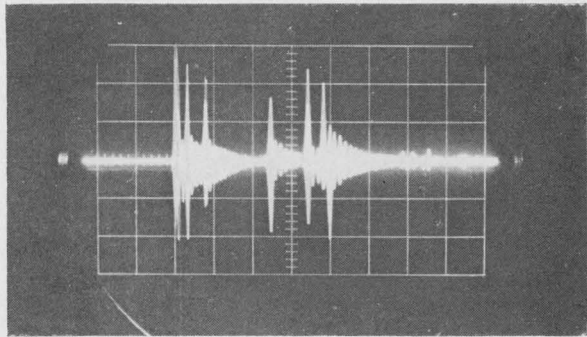

Multipath. A single transmitted pulse may be received as a sequence of pulses due to multipath effects.

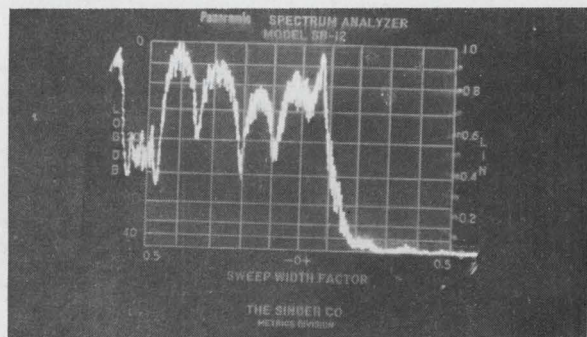

Selective fading. The amount of fading of different frequencies varies with time.

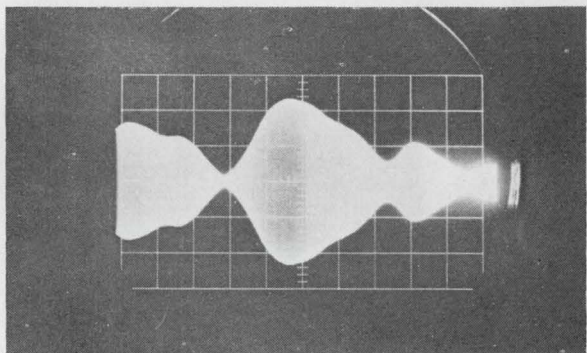

Fading envelope. Large and rapid amplitude changes are characteristic of continuous-wave signals.

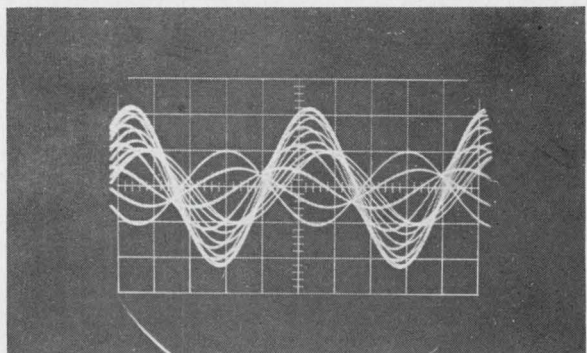

Phase changes. In high-frequency propagation, phase changes can also be large and rapid.

at 3,680, 3,760, 3,840, and 3,920 hz—set up the phase references for the five remaining assemblies, which use the references to provide the differences corresponding to the data characters.

A phase-reference correlator assembly operating at 3,760 hz, for example, correlates the input tone with the sine and cosine components of a locally generated signal at the same frequency to deliver two d-c voltages, $A_n \sin \phi_n$ and $A_n \cos \phi_n$, related to the phase angle ϕ_n between the two (n refers to 3,760 hz; $n-1$ thus will refer to 3,720 hz and $n+1$ to 3,800 hz). This phase angle, ϕ_n , is not the data-

bearing phase angle, but will be used as a reference in determining the data phase.

The two d-c signals then are used to set up a 9,600-hz wave with the phase angle $\phi_n - A_n \sin(\omega t + \phi_n)$, where ω is 2π times 9,600 hz. This phase reference signal then is applied to the modulators of the two adjacent assemblies, 3,720 and 3,800 hz.

A phase-difference assembly, 3,720 hz for example, is similar to a phase-reference assembly except that it produces a 9,600-hz signal with phase angle $\phi_n - \phi_{n-1}$; $A_{n-1} \sin(\omega t + \phi_n - \phi_{n-1} + 45^\circ)$. At this point, the desired phase difference, $\phi_n - \phi_{n-1}$, has

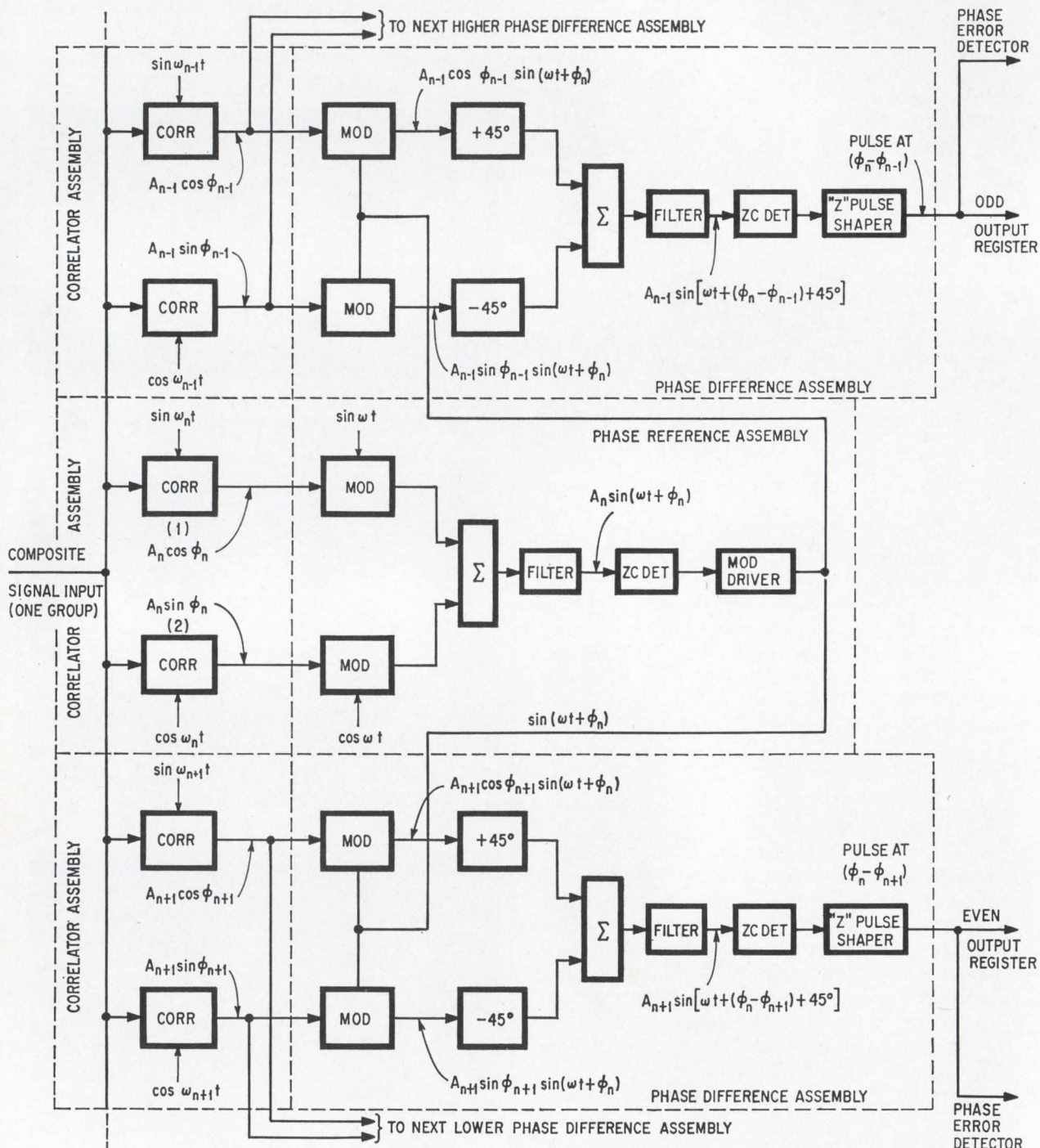

Odd and even. In demodulation, the phase-reference assembly develops a phase angle used by adjacent assemblies to determine phase differences corresponding to the digital data.

been determined and is ready for final sensing and decoding.

The signal now is sent through a zero-crossing detector, which provides a narrow output pulse when the signal crosses zero in an increasing direction.

The pulse, called a "Z" pulse, is positioned in the 9,600-hz cycle at a point corresponding to the phase difference $\phi_n - \phi_{n-1}$, which, in turn, corresponds to the data character that is to be recovered. All that is necessary now is for the Z pulse to gate the proper two-bit character into the digital-output register, the character then is assembled with the rest of the outputs to recreate the 128-bit data word that was transmitted.

The 3,800-hz unit, in a similar way, will produce Z pulses corresponding to the phase difference $\phi_n - \phi_{n+1}$ between 3,760 and 3,800 hz. However, what is desired is the higher frequency's phase minus the lower frequency's, $\phi_{n+1} - \phi_n$. Negative phase angles are produced by the so-called even channels, which correspond to the phase differences between 3,720 and 3,680, 3,800 and 3,760, 3,880 and 3,840, and between 3,960 and 3,920 hz.

Correcting phase errors

The effects of phase shift that might have occurred during transmission must be minimized. The system measures the phase error and the decoding circuitry accommodates this error.

The phase-error detector monitors the positions of the Z pulses. If a phase error has occurred in the transmission link, the Z pulses will be shifted from their undisturbed positions. Five digital-decoding gating waveforms, with different phases, are provided to accommodate the data's phase shift. The phase-error correction circuit selects the gating waveform that is nearest in phase to the phase-shifted Z pulses.

Each of the eight demodulator groups has two

Group decoding. Each group band, corresponding to eight data characters, is decoded with a bank of correlators. Alternate correlator assemblies supply phase references for the phase differences.

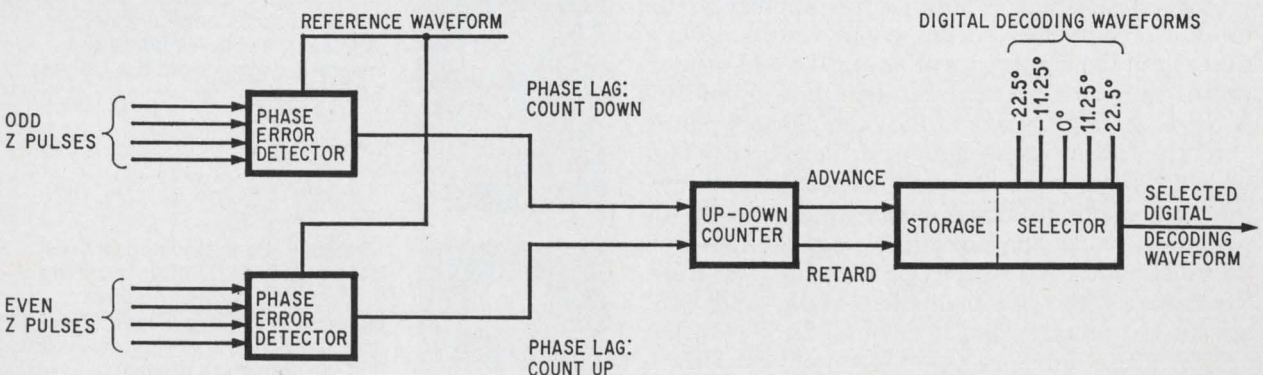
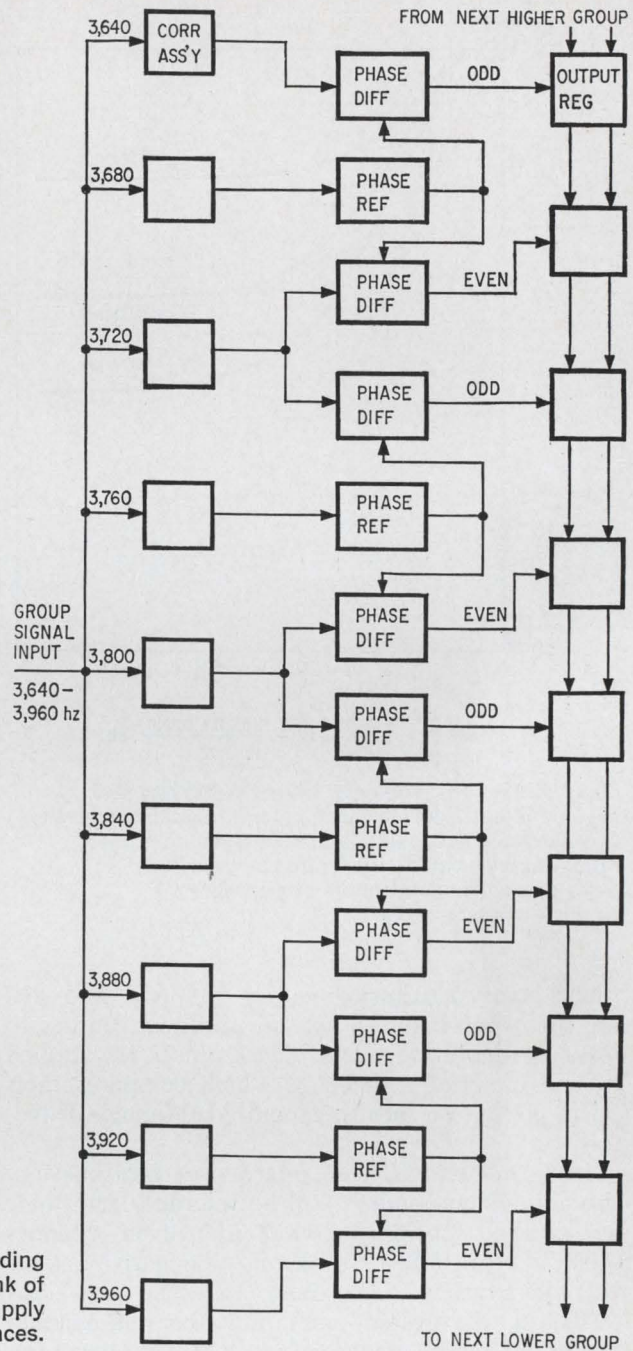

Correcting errors. Time lags in odd-channel pulses are used to sense phase retardation; lags in even-channel pulses are used to sense advances. The counter measures phase error and sets up the digital gating waveform that best accommodates the error.

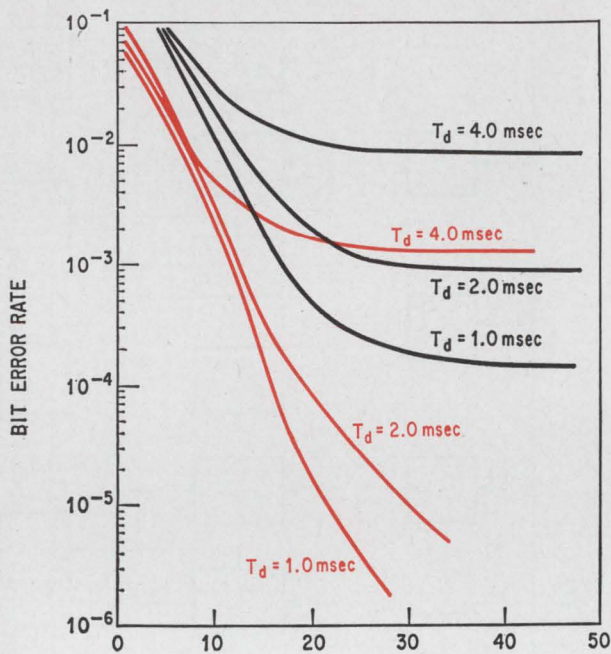

$$S/N \text{ RATIO: } \frac{E_b}{N_0} = \frac{\text{ENERGY PER BINARY DIGIT}}{\text{NOISE POWER DENSITY}} \text{ (db)}$$

Simulated results. The error rate at 4,800 bits per second and at 2,400 bps with inband frequency diversity (in color) decreases with improved signal-to-noise ratio, but levels off and is limited by multipath delay spread, T_d . Ionosphere effects were simulated in laboratory.

phase-error detectors, one for the odd and one for the even channels, and an up-down counter to measure the phase errors. The Z pulses are applied to one input of a detector, which compares their positions with a locally generated reference waveform.

If the phase has been retarded in transmission, the odd-channel pulses will be retarded from their undisturbed positions, while the even channel pulses, because they correspond to negative angles, will be advanced. Therefore, to sense phase retardation, the system uses only the odd-channel pulses. To sense phase advance, the system uses the retardation of the even-channel pulses.

The phase-detector outputs are applied to the up-down counter. A down count results from a time lag in the occurrence of any of the odd-channel pulses and an up count results from a time lag in the occurrence of any of the even-channel pulses.

At the end of each phase-error detection period, which follows each 25-msec correlation interval, the state of the up-down counter indicates the direction in which the phase has been shifted. This information is used to select a decoding waveform from one of the five available—11.25° and 22.5° advance, 0° normal, and 11.25° and 22.5° retarded.

The phase advance-retard information also is used by a fine sync system, which moves the receiver time base so that the best average position of the Z pulses can be achieved for the entire system. Thus, on the average, the same number of Z

pulses will be shifted in one direction as in the other.

The coarse sync system corrects large framing errors that appear when the modem is first turned on. It does this by comparing the transmitted reference tones, at 3,000 and 1,680 hz, with locally generated reference tones, and adjusting the detection interval until there is a maximum correlation.

The transmitted reference tones are phase-reversal modulated—alternate 0° and 180° phase shifts for every two 26.67-msec data-character intervals. At the receiver, one locally generated tone is also phase-reversal modulated, while the other carries a continual 0° phase shift.

The system is aligned when the locally generated phase-reversal-modulated tone shows maximum correlation with the transmitted reference, and the 0° phase-shifted locally generated tone shows zero correlation.

Bibliography

- K. Davies, "Ionospheric radio propagation," National Bureau of Standards Monograph 80, April 1965.
- T. deHaas, "Statistics of the frequency-differential phase/relationship of c-w signals transmitted over a 4,000-mile ionospheric path," 10th National Communications Symposium, Utica, N.Y., October 1964.
- W.F. Walker, "Baseband multipath fading simulator," Radio Science, July 1966, p. 763.
- J.J. Bussgang, and M. Leiter, "Error rate approximations for differential phase-shift keying," IEEE Transactions on Communications Systems, March 1964, p. 18.
- T. deHaas, W.E. Shepherd, "Advanced communications techniques," General Dynamics, Electronics division Report GD-1-165-39, December 1965.
- C.J. Zarcone, G.C. Porter, M.B. Gray, and W.E. Shepherd, "Advanced digital communications," General Dynamics, Electronics division Report GD-166-12, December 1966.

The authors



Gene C. Porter has been a project engineer at General Dynamics' research and advanced technology department since 1960. He has worked on propagation studies and in developing the new data modem.



Martin B. Gray is a senior engineer in the department and has been active in the h-f data-communications field since 1960. He holds a master's degree from the University of Rochester.



Charles E. Perkett joined General Dynamics in 1963 after receiving his master's degree. A senior engineer in the department, he specializes in the design of wireline and h-f radio-data modems.

New *Linde* welding techniques solve most assembly problems.

Laser Welding: LINDE LWM-1—industry's first laser welder that makes precise reproducible welds on a production basis. Use it where the weld area may be smaller than a mil. The LWM-1 features low total heat input but high energy density. Since all this energy comes from the laser light beam, there is no physical contact with the work itself. All that is needed is a line of sight. The welder joins metals like copper, nickel, tantalum, stainless steel, molybdenum, titanium and others. It will join dissimilar metals of widely varying mass and thermal conductivity.

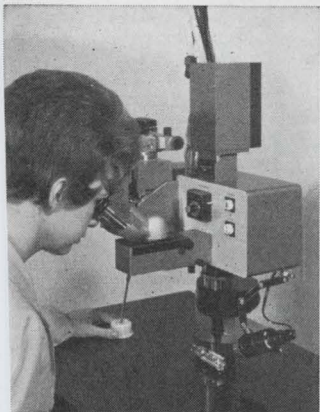

The LINDE LWM-1 is easy to use. The 25:1 ratio micro-manipulator makes precise positioning a simple operation. The binocular viewer in combination with a turret arrangement of three objective lenses gives a continuous view of the weld area at 20, 40 and 100 power of magnification. A shutter protects the operator at the moment the weld is made. LWM-1 adapts readily to automated welding and digital tape controls.

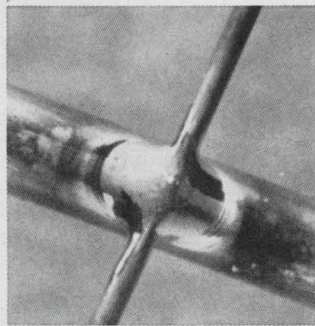

Cross weld between 0.005-in. diameter tungsten and 0.020-in. diameter nickel wires.

Plasma Needle Arc Welding: LINDE PWM-4—the practical, economical way to make high quality fusion welds on thin metals and miniature components. Plasma needle arc welding uses a constricted arc jet which extends more than 1/2 inch beyond the torch nozzle. The needle-like arc is extremely stable and easy to use: melting action remains constant despite great changes in arc length. Current values can be set so that burn-through is impossible. The angle of the torch and the long arc permit an unobstructed view while welding.

Plasma needle arc welding eliminates electrode contact and corrosive fluxes in the weld area; and these, combined with inert gas shielding and the highly stable arc, produce high quality welds without the limitations imposed by other commonly used processes.

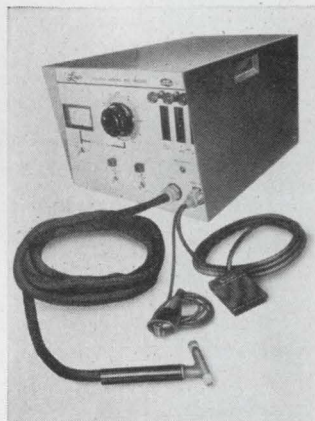

LINDE PWM-4 plasma needle arc welder—a complete package, including power supply/control unit designed for bench mounting. Uses conventional power and water supplies. Foot switch provides on-off arc control; 10-ft. service line connects torch to control unit.

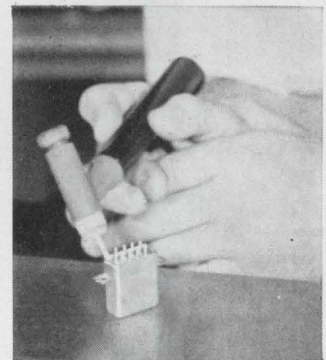

Repair welding of hermetically sealed relay case, using LINDE plasma needle arc torch.

For more information write Union Carbide Corporation, Linde Division, 270 Park Ave. New York, N. Y. 10017.

Throw
away
your
old '67
Burr-Brown
Catalog.
It's 1967½!

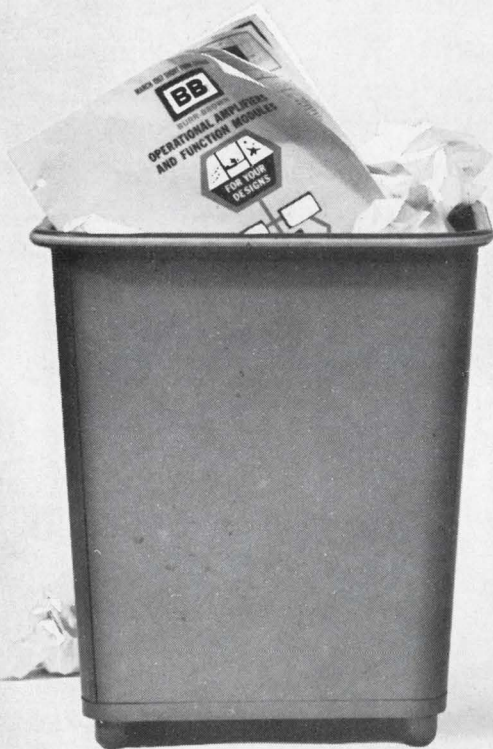

BURR-BROWN
RESEARCH CORPORATION

International Airport Industrial Park • Tucson, Arizona 85706
TELEPHONE: 602-294-1431 • TWX: 910-952-1111 • CABLE: BBRCORP



*Operational Amplifiers
Instrumentation Amplifiers
Function Modules
Analog Simulators
Geophysical Instruments*

ENGINEERING REPRESENTATIVES: ALABAMA, HUNTSVILLE (205) 534-1648 / ALASKA, ANCHORAGE (907) 272-5231 / ARIZONA, PHOENIX (602) 254-6085 / CALIF., LOS ANGELES (213) 665-5181, SAN FRANCISCO (408) 245-3321 / COLO., DENVER (303) 388-4391 / CONN., ENFIELD (203) 749-7888 / D.C., WASHINGTON (SEE MARYLAND) / FLORIDA, ORLANDO (305) 425-2764 / ILLINOIS, CHICAGO (312) 286-6824 / LA., NEW ORLEANS (504) 888-2266 / MD., SILVER SPRING (301) 588-8134 / MASS., BOSTON (617) 245-4870 / MICH., DETROIT (313) 353-3822 / MINN., MINNEAPOLIS (612) 781-1611 / MO., ST. LOUIS (314) 524-4800 / N.C., GREENSBORO (919) 273-1918 / N.J., CAMDEN (215) 925-8711 / N.M., ALBUQUERQUE (505) 255-1638 / N.Y.,

ALBANY (518) 436-9649, BINGHAMTON (607) 723-9661, MT. VERNON (914) 968-2200, NEW HARTFORD (315) 732-3775, ROCHESTER (716) 473-2115 / OHIO, CINCINNATI (513) 761-5432, CLEVELAND (216) 237-9145, DAYTON (513) 277-8911 / OKLA., TULSA (918) 835-2481 / OREGON, PORTLAND (503) 292-8762 / PENN., PHILADELPHIA (SEE CAMDEN, N.J.), PITTSBURGH (412) 243-6655 / TEXAS, DALLAS (214) 363-1671, HOUSTON (713) 928-5251 / UTAH, SALT LAKE CITY (801) 466-3709 / VIRGINIA, (SEE MARYLAND) / WASH., SEATTLE (206) 767-4260 / CANADA, TORONTO (416) 293-7011

NEW OPERATIONAL AMPLIFIERS

Model 3049/15—SMALLEST CHOPPER STABILIZED UNIT. Only 1.80" x 1.20" x .60". Maximum voltage drift: 1 μ V/ $^{\circ}$ C. Maximum current drift: .002 nA/ $^{\circ}$ C. 500 kHz full power response. 160 dB gain. \$165.00

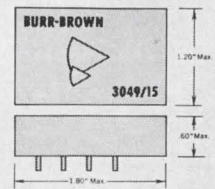

Model 3038/25 — HIGH COMMON MODE VOLTAGE, HIGH SUPPLY REJECTION LOW CURRENT OFFSET. Rated output: 100 V at 20 mA, minimum. 100 V common mode limit. Operates from any power supply voltage from ± 40 V to ± 135 V with output voltage 20 volts less than supply. Input impedance 10^{11} ohm. Input current offset: 0.1 nA. In a 2.40" x 1.80" x .60" package. \$175.00

Model 3071/25 — LOW FLICKER NOISE (6 μ V peak to peak), FAST OVERLOAD RECOVERY (less than 1 μ sec). Voltage drift less than 0.5 μ V/ $^{\circ}$ C max. Current drift 0.001 nA/ $^{\circ}$ C max. From -25° C to $+85^{\circ}$ C. \$175.00

Model 3044/15 — HIGH SUPPLY REJECTION (2 μ V per Volt and 0.5 nA per Volt) VARIABLE POWER SUPPLY (± 6 to ± 32 V) Output Voltage = supply voltage minus 4 Volts. Output current: ± 10 mA. \$75.00

Model 3063/40 — HIGH OUTPUT CURRENT ($\frac{1}{2}$ Amp) — HIGH SUPPLY REJECTION (2 μ V per Volt and 0.2 nA per Volt). Ideal for servo applications. Completely encapsulated in 2" x 2" x 1" package. No external heat sinks required. Operating temperature range: -40° C to $+85^{\circ}$ C. \$135.00

NEW QUARTER SQUARE MULTIPLIER

Model 4012/25 — Fully encapsulated in 2.40" x 1.80" x .60" package. Accuracy: $\pm 0.15\%$, 3 db response is 1 mHz. Rated output: 10 Volts at 10 mA. Will operate in multiply, divide, square, and square-root modes. Requires no external amplifiers. \$695.00

NEW SAMPLE AND HOLD MODULE

Model 4013/25 — Fully encapsulated in 2.40" x 1.80" x .60" package. Accuracy: $\pm 0.1\%$. Aperture time: 50 nsec. Acquisition time as low as 1 μ sec. Frequency response: 500 kHz. \$225.00

NEW 20-PAGE FALL CATALOG

These and many other important new product developments are included in the new Burr-Brown 20-page fall 1967 catalog. It's available from your Burr-Brown Representative . . . or, use this publication's reader service card.

EMI/RFI-SHIELDED PUSHBUTTON SWITCHES

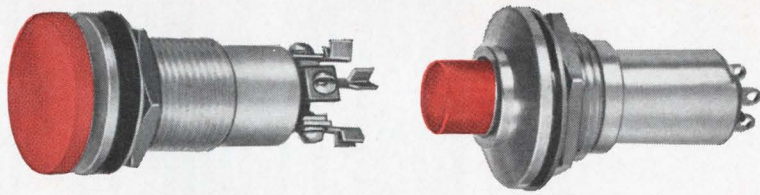

Four models, one with wide button. Choice of two and four circuit momentary, plus DPDT push-push. Ratings of 1 to 10 amps at 28 vdc; 1 amp at 120 vac.

SUBMINIATURE EMI/RFI-SHIELDED INDICATOR LIGHTS



Dome, flat and flush mounting. Lens diameter of 7/32", .22" and .383" respectively; 5v and 28v. Six lens colors, plus clear.

STANDARD EMI/RFI-SHIELDED INDICATOR LIGHTS

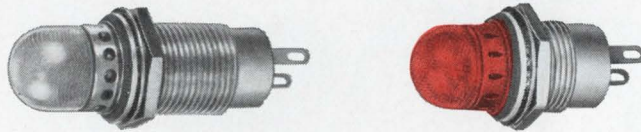

Translucent and transparent dome-type lenses. Incandescent, standard neon and high-intensity neon lamps in all popular voltages. Six lens colors, plus clear.

These EMI/RFI-shielded switches and indicator lights available at Control Switch distributors now!

Still more new EMI/RFI-shielded components on the way.

Need shielding from EMI/RFI leaks in panels and systems? Look to Control Switch . . . first to introduce the types of shielded switches and lights shown above. Now we are deep into the development of still other shielded components. Tell us your requirements. We may be working

on the component you need and be able to help you fast. Order EMI/RFI-shielded switches and lights from your Control Switch distributor, or contact us direct.

FREE BULLETIN!

Check number on Reader Service Card corresponding to number at left below for our Bulletin on EMI/RFI-shielded components. While you're at it, get all the items listed below.



**CONTROLS
COMPANY**
OF AMERICA
CONTROL SWITCH DIVISION
1420 Delmar Drive, Folcroft, Pennsylvania 19032
A Subsidiary of
General Precision Equipment Corp.

- #483 EMI/RFI-shielded Component Bulletin 62A
- #484 Condensed Switch Catalog 100
- #485 Basic Snap-Action Switch Catalog 110
- #486 Toggle Catalog 180
- #487 Indicator Light Catalog 120
- #488 Hermetic Switch Catalog 130
- #489 Switchlite Catalog 220
- #490 Pushbutton Catalog 190

World's only gas lasers with just 1 control: an on-off switch

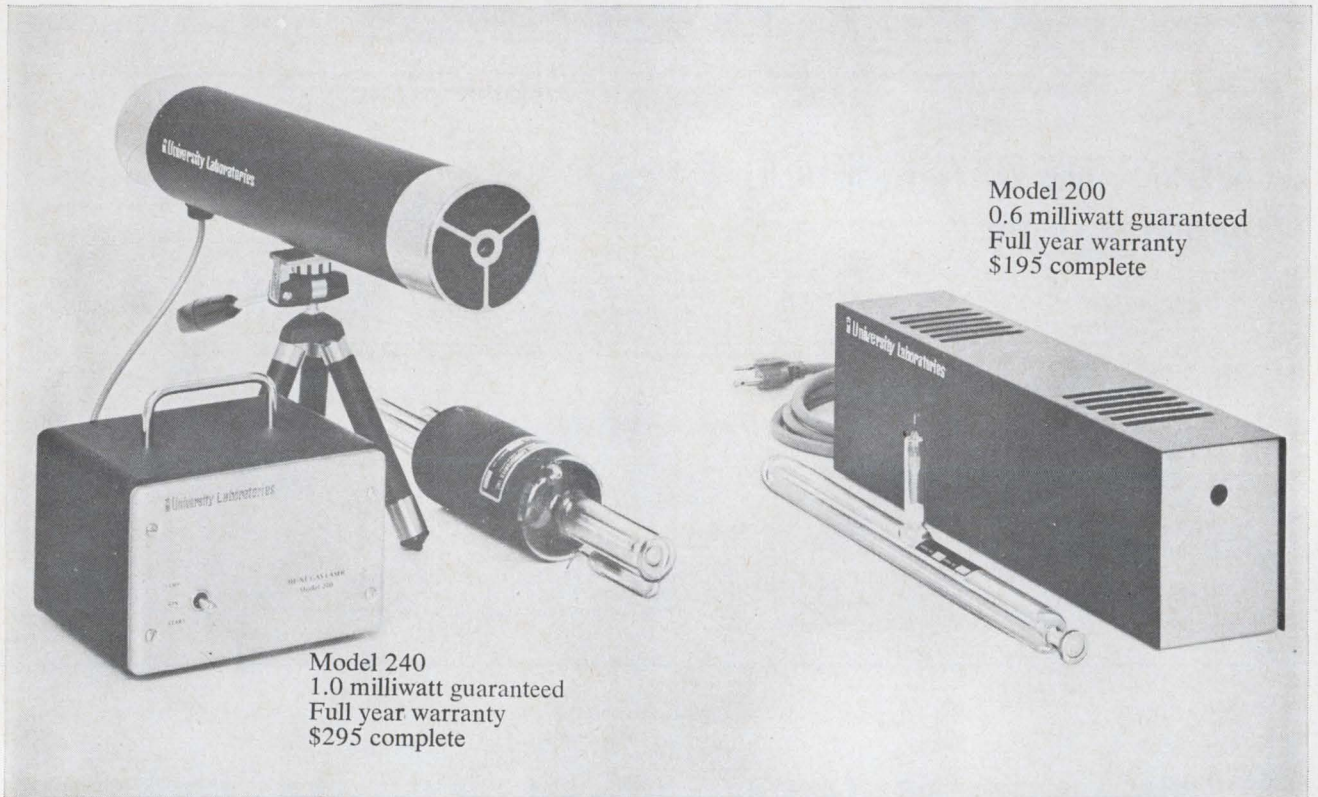

Model 200
0.6 milliwatt guaranteed
Full year warranty
\$195 complete

Model 240
1.0 milliwatt guaranteed
Full year warranty
\$295 complete

Never need adjustment, alignment, or maintenance

As simple to work as a light switch, these new, rugged He-Ne continuous gas lasers are operated by a single on-off control. Nothing more is necessary, because ULI's Lasertron™ plasma tubes have permanently aligned and sealed internal reflectors. Their proprietary design completely eliminates the need for adjusting mechanisms commonly found in other lasers of this type.

The tubes are long-lived and foolproof —will operate even under water! (They are practically complete instruments in

themselves and are available separately to OEMs.)

Since they have no mechanisms to get out of order or out of adjustment, these lasers are excellent performers in tough environments. The solid-state power supplies are simple and thoroughly reliable, assuring immediate, continuing output to specification.

Use the coupon to order now from University Laboratories, Inc./733 Allston Way, Berkeley, California 94710/Telephone: (415) 848-0491.

MODEL 200 \$195 complete
• Power over 0.6 milliwatt • Wavelength: 6328 Å • Uniphase (TEM₀₀) wavefront • Alignment stability guaranteed • Built-in collimator • Low ripple DC supply • Full year warranty.

MODEL 240 \$295 complete
• Power over 1.0 milliwatt • Wavelength: 6328 Å • Uniphase (TEM₀₀) wavefront • Alignment stability guaranteed • Built-in collimator • Adjustable tripod mount • Rugged design • Low ripple DC supply • Full year warranty.

UNIVERSITY LABORATORIES, INC., 733 ALLSTON WAY
BERKELEY, CALIFORNIA 94710

Please send technical data on ULI lasers.

Please reserve a Model 200 a Model 240 from your current production. My official purchase order and shipping instructions will follow.

Name _____

Organization _____

Address _____

City _____ State _____ Zip _____

Terms: 2% discount 10 days, net 30 days. ULI products returned for any reason, prepaid and undamaged, within 30 days will receive full credit.

University Laboratories

an invitation from 5,200 Manufacturers:

"look into VSMF"

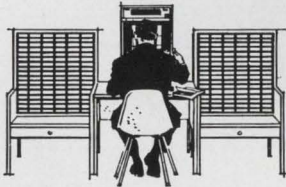

5,200 manufacturers invite your judgment of their products in Visual Search Microfilm Files.

VSMF . . . 1,500,000 catalog pages, 5,200 manufacturers, millions of components and materials, indexed by product for side-by-side comparison. The VSMF Defense Design File, alone, contains over 250,000 pages from defense manufacturers. And, there's a file for OEM, too. In all, Information Handling Services produces 6 different VSMF files for industry and government.

We know that when you design a product you want to use the best components and materials. And, to do this, you need to compare all that is available. VSMF can help you in this comparison because VSMF supplies the data on **all** products. You supply the judgment.

Manufacturers who place their data in VSMF know this and invite comparison. The constantly changing "state of the art" is reflected in the pages of VSMF.

If you have VSMF in your company, look into it. If you don't, you might look into that, too. Write for "Looking into VSMF."

William H. B. Combs, Manager, Engineering Services, Relay Division, Leach Corporation, Los Angeles, uses the VSMF Defense Design File.

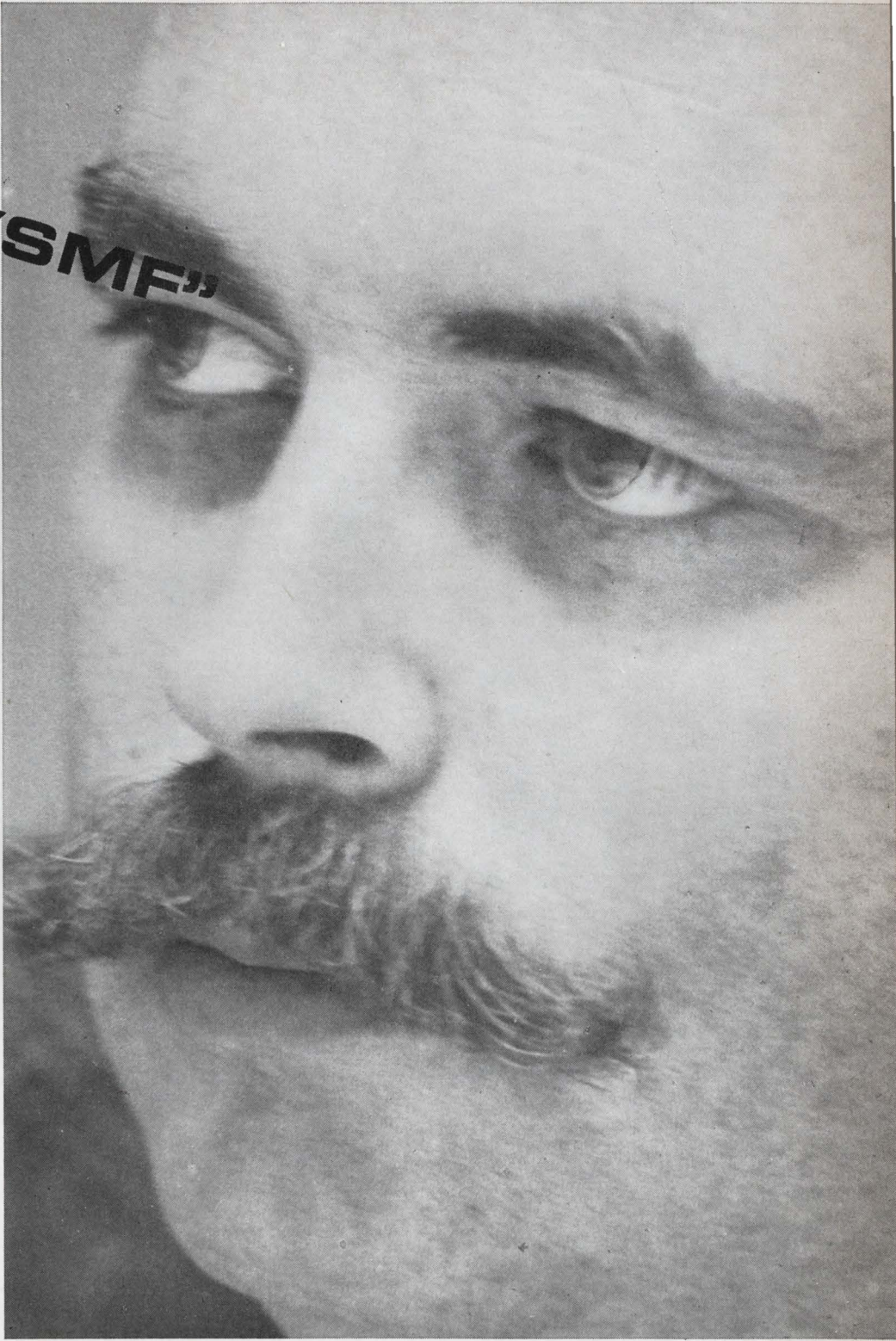

Information

HANDLING SERVICES, INC.

Dept. E-102

Denver Technological Center
Englewood, Colo. 80110

Circle 125 on reader service card

**In this tiny box is
a 1000 ft. antenna,
a 1000 ft. boom,
a 1000 ft. probe.**

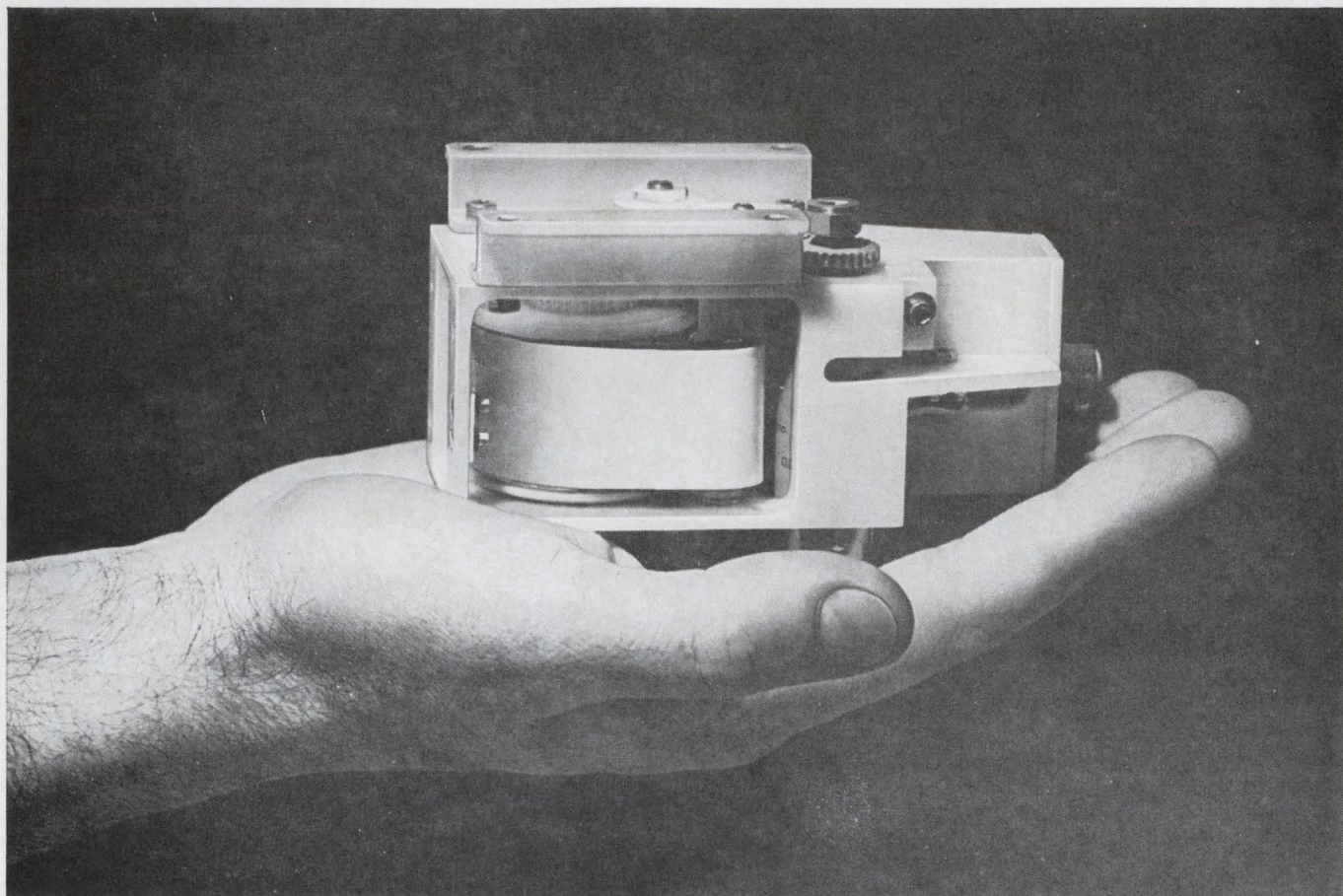

Like the other STEM (Storable Tubular Extendible Member) devices we have developed, it's a strip of specially tempered metal rolled onto a drum.

When the drum unrolls that metal strip forms an unsealed tube. Automatically.

Normally, an unsealed tube would be much weaker than a seamless one. But because we preform it with a 180 degree

overlap it has a bending strength almost equal to a seamless tube of the same measurements.

And because it is unsealed it can be retracted and used over again.

The Mini-STEM was designed specially for use in space. That's why we could afford to make it 1000 feet long. And why we had to make it compact enough to fit

in the palm of a hand.

But the STEM principle can be used in a number of more conventional ground applications. As radio antennas, for example. Or portable masts.

We make them in a variety of alloys, styles and sizes.

You'd be surprised how much we can put into so little.



de Havilland Canada

Special Products & Applied Research Division, Box 6016, Toronto International Airport, Ontario

Silastic® 1603 silicone rubber insulation is

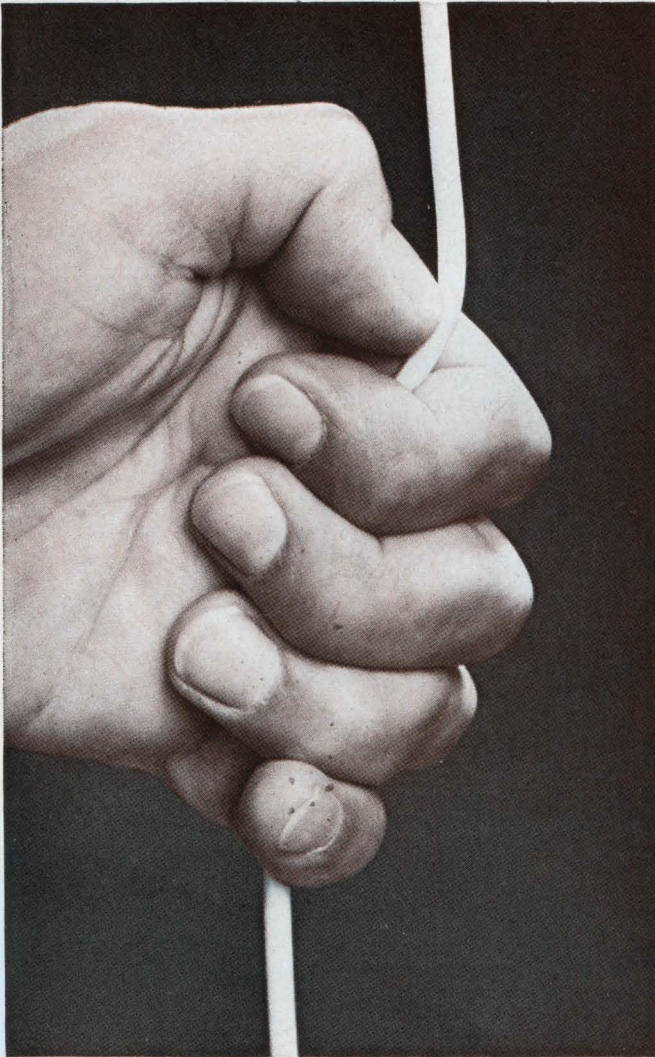

... tougher than nails ... and flame retardant!

This **NEW** Silastic brand silicone rubber insulation takes torture tests without cutting, crawling, oozing or burning. You can now specify braided silicone rubber insulation for hose tough applications... and the hot ones, too.

Typical properties of Silastic 1603 rubber are: 65 durometer hardness; 300 psi tensile strength; 125 ppi

tear strength; 350% elongation; only four inch flame travel and zero seconds burn time in the U.L. vertical flame test. Combine these physical properties with 500 volts per mil and 17 kv insulation breakdown ratings — both after immersion for 24 hours in water — and you have an excellent wire insulating material. Add silicone rubber's resistance to ozone,

moisture, chemicals and corrosives, heat, cold, heat-aging, and you have an ideal insulation for appliances, motor lead wire and high voltage hook up wire.

For further information, write to: Dept. 3722, Engineering Products Division, Dow Corning Corporation, Midland, Michigan 48640.

Display and digital equipment engineers:

Spearhead development of computer-based instruction systems at RCA in Palo Alto, California



RCA Instructional Systems, in the San Francisco Bay area, heads Radio Corporation of America's full-scale entry into the field of educational technology. In the first major joint undertaking of its kind by industry and education, our highly competent nucleus staff is working in close collaboration with nationally-known educators — such as Stanford University's pioneer in computer-based instruction, Dr. Patrick Suppes.

Their task: to study, create, and test total educational systems aimed at coping with the problems created by enormous increases in student population, and in both volume and complexity of knowledge. The market: all levels of education.

At one level alone, the President's Science Advisory Committee has urged colleges to spend \$400 million a year on computer-based instruction by 1971.

Today, RCA Instructional Systems offers you ground-floor opportunity for career growth in this rapidly expanding field. You'll work with RCA's Spectra 70,

first computer family to utilize monolithic integrated circuitry and cross the threshold into the third generation. And be backed by the full spectrum of RCA products, skills, and services in such areas as communications, switching, displays, publishing, and field services.

If you are an engineer experienced in educational systems analysis, electronic display development, and/or computer systems design, we'd like to talk to you. Current efforts include: development of concepts for advanced computer-based instructional systems; design of advanced CRT displays and electronic data entry devices; and design of the elements of digital processing and communications systems for use with computer-based information. Areas of work are: digital circuits; digital logic design; packaging; human factors engineering; display devices design; and analog circuit design.

To inquire about career opportunities at RCA, send your resume to A. J. Tasca, RCA Instructional Systems, 530 University Avenue, Palo Alto, California 94301.



An Equal Opportunity Employer

The Most Trusted Name in Electronics

WHERE IS
O/E/N?

WORLDWIDE

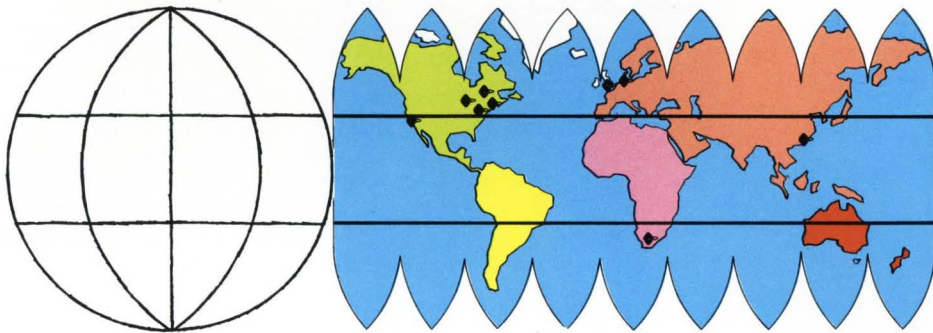

Electronic component needs of the free world are served through the combined efforts of sixteen O/E/N divisions and subsidiaries. Eight in the U.S. and seven off-shore operate a total of twenty-one plants. This import-export balance of manufacturing and sales assures customers throughout the world of a dependable source for quality components.

There is one common denominator of the entire O/E/N organization...a firm belief in engineering excellence. Reliability is built into every component. Customers who rely on O/E/N quality in domestic operations are assured of equal quality for their overseas operations,

supplied by local overseas inventories, direct exports from the U.S., or from the output of O/E/N plants in Canada, England, Holland, South Africa, Japan and Hong Kong.

O/E/N is rapidly moving toward its ultimate goal of becoming the industry's most respected components manufacturer with engineering, marketing and production facilities throughout the world.

For complete information about O/E/N, its facilities and its products, send for a copy of our Facilities & Capabilities Brochure.

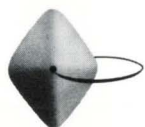

O/E/N OAK ELECTRO/NETICS CORP
CORPORATE OFFICE
CRYSTAL LAKE, ILLINOIS 60014

FLEXIBLE

LEVEL-MEASURING

SYSTEM PSM-5

10 kHz to 36 MHz

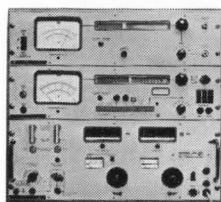
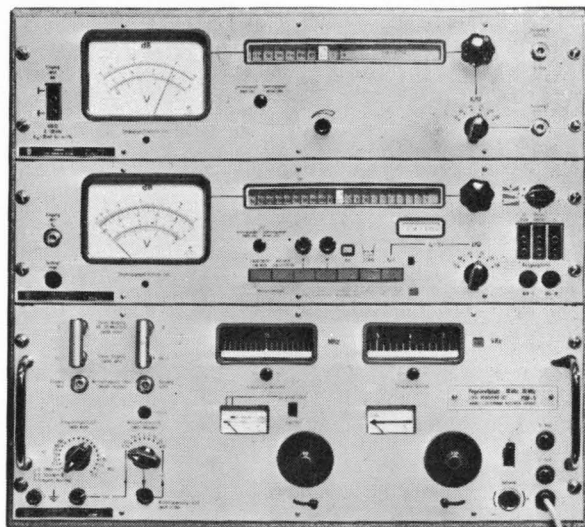

PSM-5



PSO-5



PMO-5

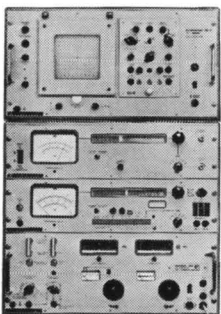

WM-50

Until now, it has been impossible to cover such a wide range of frequencies and applications as is possible with the PSM-5 family of measuring instruments. Accurate within ± 10 Hz at 1 kHz check points and ± 100 Hz at any frequency.

Level Generator and Receiver (combined or separate)

The PSM-5 level measuring system consists of a generator, a receiver and a tuning oscillator. The oscillator and generator may be combined to form a level generator, PSO-5. The oscillator and receiver may be separately combined to form a selective level meter, PMO-5. Any of these combinations can be provided.

Level Calibration Selectable

Both the generator and receiver may be set to measure either voltage level or power level, i.e. levels can be indicated either in dB or dBm. This is accomplished through a front panel switch which physically changes the attenuator scales and electrically compensates the meter circuits for the referenced impedance of the measurement.

Input and Output Impedances

Both generator and receiver portions of the PSM-5 can be switched to match impedances of 50, 60, 65, 75, 135, and 150 ohms. The receiver is equipped with a high impedance "bridging" input (30 pF input capacity) and an accessory high impedance probe (7 pF) is available.

Battery Operation

When normal AC power is not available, the PSM-5 can equally well be powered from a DC source in the range of 23 V to 30 V.

Point-to-Point or Sweep Measurements

The measuring system allows exact point-to-point measurements. With the addition of an oscilloscope display it can also be used for sweep measurements (WM-50). A wide range of sweep rates and ranges is already provided in the tuning oscillator unit.

Frequency adjustment: 10 kHz (2 kHz) to 36 MHz, phase locked to a crystal at 100 kHz points, phase compared at 1 kHz point; optically projected fine and coarse tuning scales, each virtually 8 ft. in length.

Built-in electronic sweep with common tuning of generator and receiver.

Sweep range ± 17.5 Hz to ± 17.5 MHz.

Sweep frequency: 0.1 to 50 Hz, manual and external.

Level measuring range: -130 dB to +20 dB.

Selectable bandwidth: 500 Hz and 3.5 kHz.

Meter scale linear (20 dB) and logarithmic (100 dB).

Calibration: Selectable dB or dBm.

Oscilloscope display unit with electronic calibration line and frequency markers.

Graticule markings, full scale (level): 2 dB to 100 dB.

Graticule markings, full scale (frequency): 35 Hz to 35 MHz.

Accessories: Expanded scale meter (± 1 dB), high impedance probe, dual trace switching unit, return loss bridge (50 - 150 ohms).

Wandel & Goltermann

West Germany

REPRESENTED IN U.S.A. BY

TEL-COM

INSTRUMENTS, INC.

6 Great Meadow Lane, Hanover, New Jersey 07936

Telephone: (201) 887-8700



If you buy HP counters, we have news for you.

Systron-Donner makes advanced counter instrumentation that has no equivalent in the HP catalog. That's why it pays to check with Systron-Donner before you buy. You'll find equipment with unique capability like:

1. A plug-in that will extend your counter's frequency range to 15 GHz – measuring FM and pulsed RF as well as CW and AM. The only way to get the full dc to 15 GHz range in one cabinet. No calculations. Displays final answer.



1.

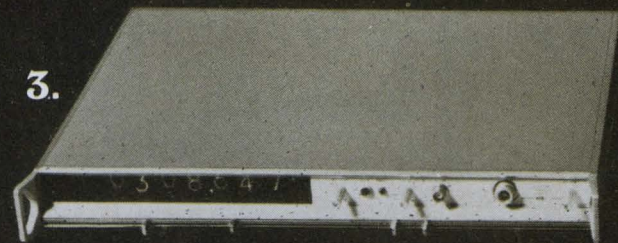

3.

3. "Thin Line" counters that take only 1 1/4" of rack space. Built with ultra-reliable integrated circuits to give you automatic frequency measurements – dc to 100 MHz or 0.3 to 12.4 GHz.

These are the highlights of expandable systems that will make just about any measurement possible with counters. The accuracy of our basic 50 MHz and 100 MHz counters is unsurpassed. (Time base aging rate is only 5 parts in 10¹⁰ per 24 hrs.) All devices to extend the range or add functions are convenient plug-ins – not rack mounts. The newest are a prescaler to extend counter range to 350 MHz and a heterodyne converter to measure noisy signals in the 0.2 to 3 GHz range.

Are you surprised that Systron-Donner is a step ahead of HP in counter technology? How else could we stay in business?

Systron-Donner Corporation, 888 Galindo Street, Concord, California 94520

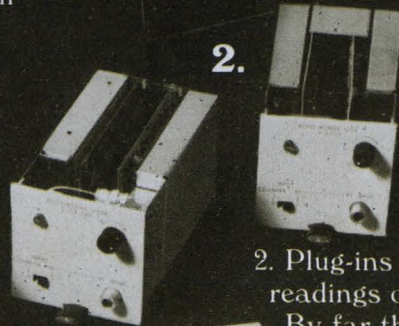

2.

2. Plug-ins that produce automatic readings of microwave frequencies. By far the most compact and economical equipment for producing automatic readings in the 0.3 to 3 GHz band or the 3 to 12.4 GHz band.



Send for catalog.



SYSTRON  DONNER

Circle 131 on reader service card

NUMBER **1**
IN NUMBERS

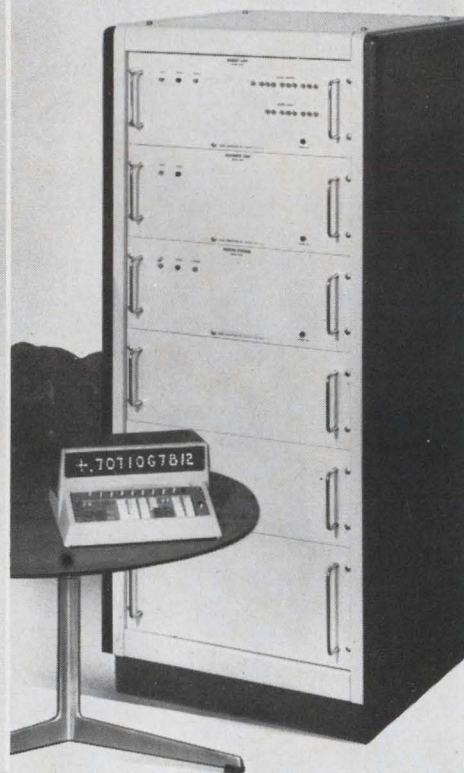

Wang products tend to be friendly...but calculating

Take our Series 300 calculator . . .

It's small, quick, quiet and very easy to get along with. You'd never guess, till you get to know it, that inside this trim little keyboard console lurks the most versatile, most advanced electronic desk-top calculating capability ever developed. Among other things, these vital statistics:

- Petite keyboard and large display
- Silent, fast, and easy to use
- Maximum economy — 4 keyboards can share the cost of 1 "brain"
- 2 adders, and 2 more registers for each keyboard
- Automatic invoice extensions and line counts
- Special keys for $\text{Log}_e X$, e^X , \sqrt{X} , and X^2 , $\text{SIN } (\theta)$, $\text{COS } (\theta)$, $\text{ARCSIN } (X)$ and $\text{ARCTAN } (X)$

. . . then there's the brand new Series 370 programmable calculator

Although it looks like its little Series 300 brother, this new, absolutely unique instrument can do things no other electronic calculator in the world can handle.

- Attaches to the 300 Series
- Same calculating keys
- Program capacity from 80 steps up
- Only 8 1/2" page printed output on a calculator
- Complete programming features including decisions and loops
- Extensive program library
- Additional data storage up to 64 registers (with 10 digits, decimal point and sign)
- Communication with telephone lines and data acquisition equipment
- Fully programmable for long or iterative calculations

. . . and while you're here, meet the Series 4000 on-line data system

Actually a series of compatible "black-box" data modules, this unusual "system" can be custom-assembled, at low cost and virtually on a plug-in basis, to handle any of a broad variety of on-line data acquisition and reduction tasks.

- Completely modular for versatility and expandability
- Fully programmable multiple inputs and outputs
- Data and program storage in modules of 1024 — 10 digit numbers plus decimal point and sign
- Economy of calculator with power of computer

When your calculations are beyond an adding machine and below a computer, call

WANG
LABORATORIES, INC

DEPARTMENT N-10, 836 NORTH STREET, TEWKSBURY, MASSACHUSETTS 01876 — TELEPHONE: (617) 851-7311



**This Babcock
10 amp. relay
also
switches
dry circuit
with the
same contact set**

Now, your Babcock 10 amp. full size crystal relay will also switch dry circuit with the same set of contacts. These exclusive universal contacts have greatly simplified your relay stocking requirements. You can order one model to meet a given set of performance parameters without concern for load requirement — *at no cost premium*. Get complete information about this versatile relay, and the entire Babcock line, all with universal contacts.

Write Babcock Relays, Division of Babcock Electronics Corporation, 3501 Harbor Boulevard, Costa Mesa, California 92626; or telephone (714) 540-1234.



The Babcock Model BR7 relay will perform from dry circuit to 10 amps., with universal contacts, and is designed to meet critical aerospace applications.

SPECIFICATIONS

SIZES
1.300" h. x 1.075" l. x .515" w
WEIGHT:
Approx. 1.0 oz.
CONTACT ARRANGEMENTS:
SPDT and DPDT

PULL-IN POWER:
Low as 80 mw.
LIFE:
100,000 operations, min.
TEMP. RANGE:
-65°C to +125°C

FROM THE BABCOCK FAMILY OF CRYSTAL CAN RELAYS



**TWICE SIZE
DPDT**
dc to 10 Amps.



**FULL SIZE
DPDT**
dc to 10 Amps.



**HALF SIZE
SPDT & DPDT**
dc to 2 Amps.

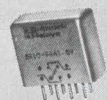

**SIXTH SIZE
SPDT & DPDT**
dc to 1 Amp.

WATCH FOR BABCOCK RELAYS ON THE EDN MOBILE DISPLAY — SOON IN YOUR AREA.

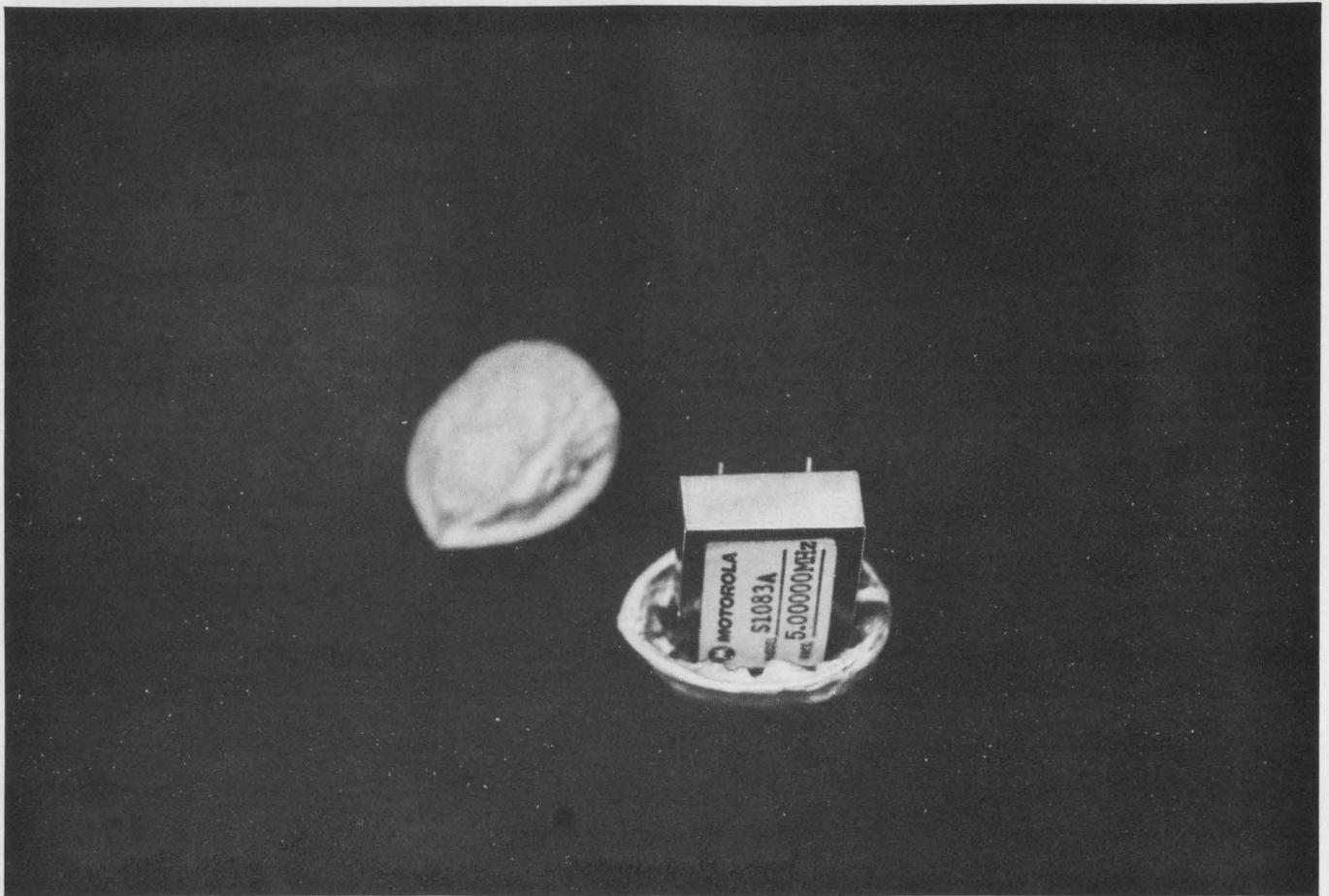

a TCXO that fits almost anywhere

and offers exceptional frequency stability between -55°C and $+85^{\circ}\text{C}$

Only about $\frac{1}{2}$ of a cubic inch in size, this TCXO (temperature compensated crystal oscillator) offers excellent frequency stability; 5 ppm over a temperature range of -55°C to $+85^{\circ}\text{C}$. It's one of four new miniature TCXO's from Motorola. The slightly larger models offer stabilities as low as ± 1 ppm. Zener diode regulated compensating circuits provide on-frequency operation the instant they're turned on. All-silicon solid-state construction provides exceptional reliability. Take a look at these facts.

SMALL SIZE: Sizes range from 0.58 cubic inch to 3.4 cubic inches.

WIDE TEMPERATURE RANGE: From -55°C to $+85^{\circ}\text{C}$.

HIGH FREQUENCY STABILITY: Available as low as ± 1 ppm.

WIDE FREQUENCY RANGE: From 1 MHz to 30 MHz.

LOW POWER CONSUMPTION: As low as 100 milliwatts.

NO WARM-UP TIME: Adjusts instantly to temperature conditions.

FOR MORE INFORMATION contact your Motorola representative. Or write for bulletin TIC-3213.

MOTOROLA COMMUNICATIONS AND ELECTRONICS INC.

Dept. EO, 4900 West Flournoy Street

Chicago, Illinois 60644. A subsidiary of Motorola Inc.



MOTOROLA
PRECISION
INSTRUMENT
PRODUCTS

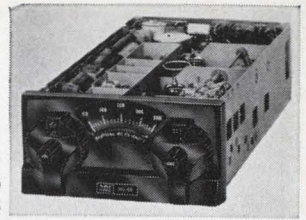

King Radio needed: capacitors that stay reliable even with extreme cold, humidity and vibration. So King Radio chose: capacitors of MYLAR.

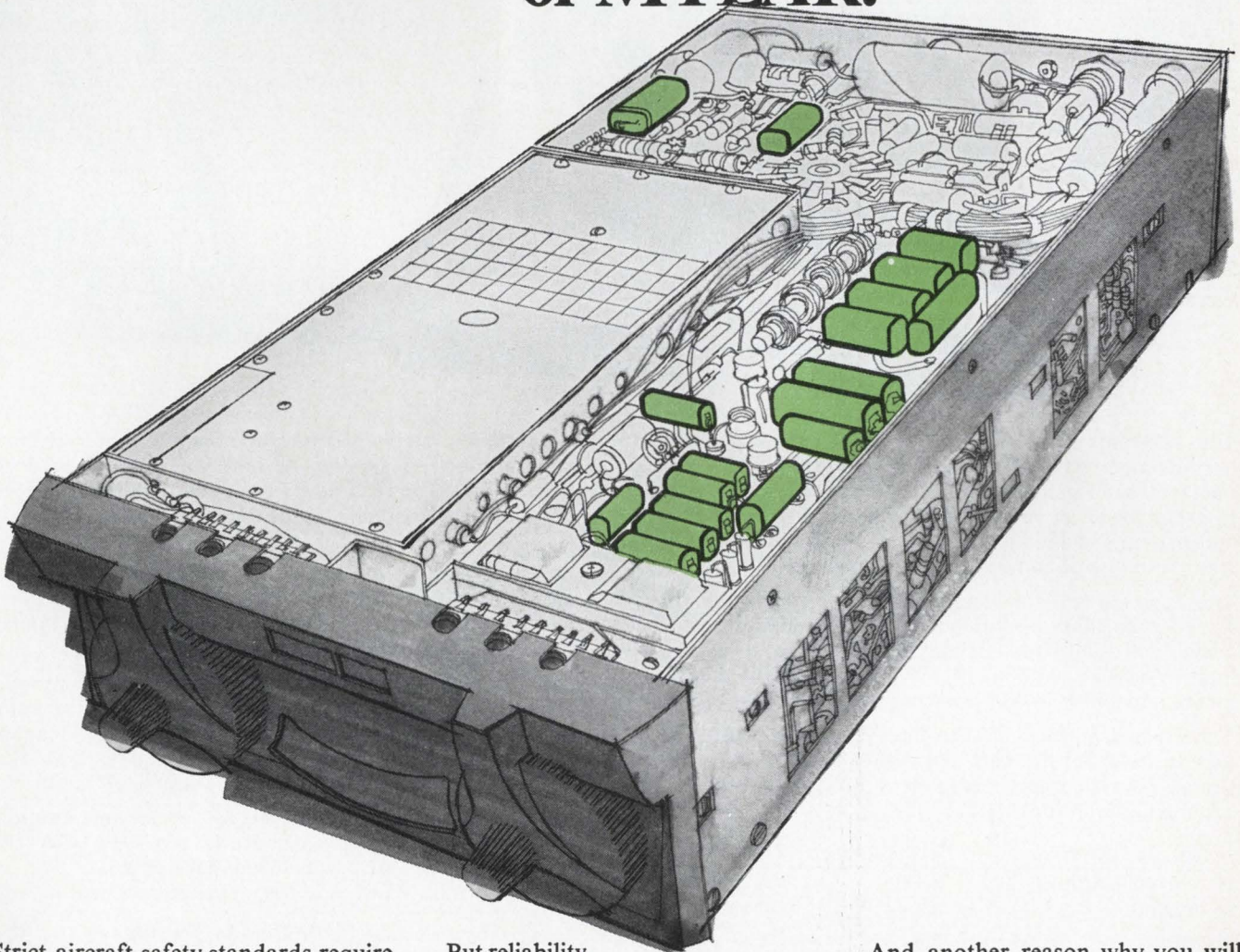

Strict aircraft safety standards require the most reliable navigation equipment available. That's why King Radio Corporation uses capacitors of MYLAR* for their Distance Measuring Equipment. MYLAR can take temperature extremes from -60° to $+150^{\circ}\text{C}$; MYLAR remains constantly stable under humid conditions.

But reliability isn't the only reason King Radio chose MYLAR. The extremely high dielectric strength of MYLAR permits its use in thinner film, thus helping King Radio to build the lightest and most compact distance measuring unit on the market. MYLAR is available in films as thin as 15 gauge.

And another reason why you will want to investigate using capacitors of MYLAR: they usually cost no more than others. Write for complete technical data to DuPont Company, Room 4960A, Wilmington, Delaware 19898. (In Canada, for information write Du Pont of Canada Ltd., Post Office Box 660, Montreal, Quebec.)

 **MYLAR**[®]
REG. U.S. PAT. OFF.

*DU PONT'S REGISTERED TRADEMARK FOR ITS POLYESTER FILM.

150 MHz, 2.4 ns

NOW! at the probe tip

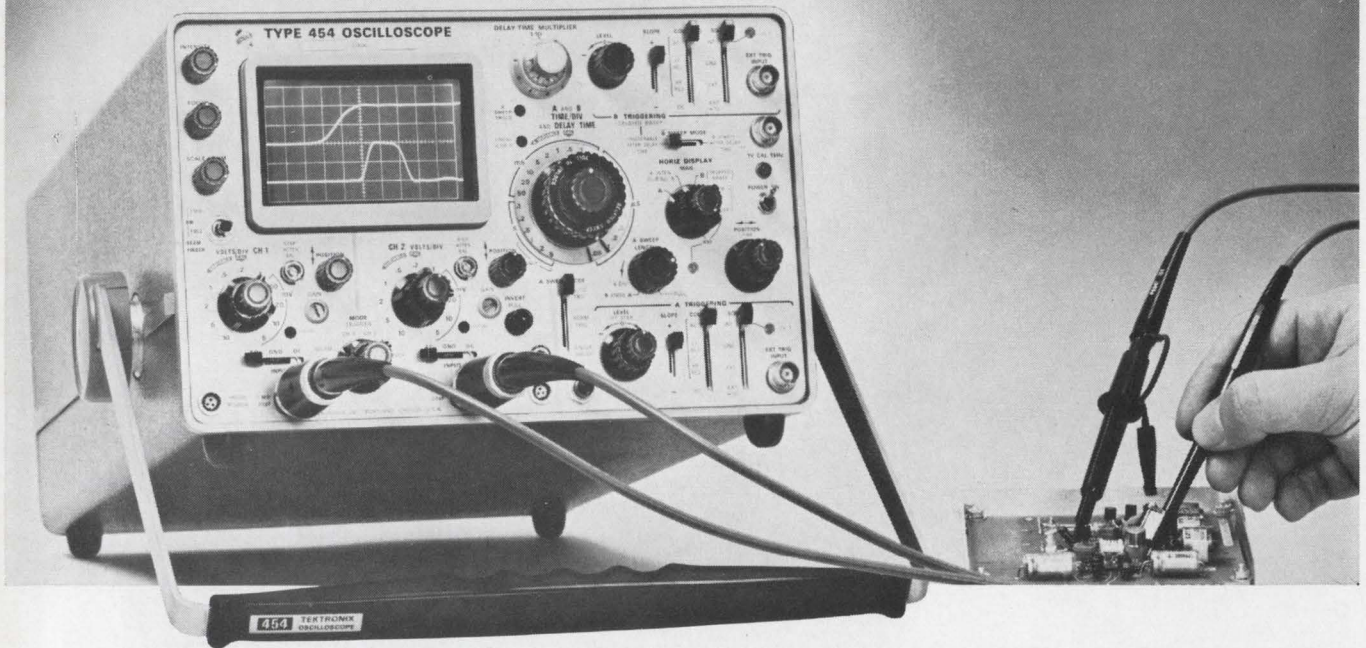

The Tektronix Type 454 is an advanced new portable oscilloscope with DC-to-150 MHz bandwidth and 2.4-ns risetime performance where you use it—at the probe tip. It is designed to let you make convenient measurements of fast-rise pulses and high-frequency signals previously outside the range of conventional oscilloscopes.

The Type 454 is a complete instrument package with dual-trace vertical, high-performance triggering, 5-ns/div delayed sweep and solid-state design, all in a rugged 31-lb. instrument. You also can make 1 mV/div single-trace measurements and 5 mV/div X-Y measurements with the Type 454.

The 2.4-ns risetime and DC-to-150 MHz bandwidth are specified at the tip of the new miniature P6047 10X Attenuator Probe. The dual-trace amplifiers provide the following capabilities with or without probes:

Deflection Factor*	Risetime	Bandwidth
20 mV to 10 V/div	2.4 ns	DC to 150 MHz
10 mV/div	3.5 ns	DC to 100 MHz
5 mV/div	5.9 ns	DC to 60 MHz

*Front panel reading. Deflection factor with P6047 is 10X panel reading.

The Type 454 features a new CRT with distributed vertical deflection plates and a 14-kV accelerating potential. It has

a 6 by 10 div (0.8 cm/div) viewing area, a bright P-31 phosphor and an illuminated, no-parallax, internal graticule. The Type C-30 and the New Type C-40 (high writing speed) cameras mount directly on the oscilloscope.

The instrument can trigger to above 150 MHz internally, and provides 5-ns/div sweep speeds in either normal or delayed sweep operation. The calibrated sweep range is from 50 ns/div to 5 s/div, extending to 5 ns/div with the X10 magnifier. Calibrated delay range is from 1 μ s to 50 seconds.

The Type 454 is designed to be carried and has the rugged environmental characteristics required of a portable instrument. A rackmount, the 7-inch-high Type R454 oscilloscope, is available with the same high performance features. Also available is the new Type 200-1 Scope-Mobile® Cart.

For a demonstration of the Type 454, or the new Tektronix DC-to-100 MHz *plug-in* oscilloscope, the Type 647A, contact your nearby Tektronix field engineer, or write:

Tektronix, Inc., P. O. Box 500, Beaverton, Oregon 97005.

Type 454 (complete with 2 P6047 Probes and accessories)	\$2600
Type R454 (complete with 2 P6047 Probes and accessories)	\$2685
C-30 Camera	\$420
C-40 Camera	\$560
Type 200-1 Scope-Mobile® Cart	\$75

U.S. Sales Prices FOB Beaverton, Oregon



A new Technical Center:



230,000 square feet devoted to R&D
... part of the Tektronix commitment
to progress in the measurement sciences

Probing the News

Consumer electronics

General Motors pulls ahead

Beating out rivals, GM builds its own IC voltage regulator for 1968 Pontiacs but can't find second sources

By John D. Drummond

Consumer electronics editor

Zooming off with the first integrated circuit in the auto industry, the General Motors Corp. left semiconductor makers at the starting line. But now the giant auto maker has run into a roadblock: it's thus far been unable to convince the major IC houses to act as second sources.

Developed by GM's Delco Radio and Delco-Remy divisions, this first device—an IC voltage regulator for the Delcotron generator—is being installed on some models of the 1968 Pontiac line [Electronics, Aug. 21, p. 25]. Because Delco Radio's semiconductor facilities are already severely taxed, the company has been pressing in recent months for other sources of supply. Specifications, along with requests for samples and prices, have gone to at least six major IC makers, but as one Delco-Remy spokesman says, "We haven't had any takers so far." Several IC manufacturers are understood to have already turned down GM; others have yet to reply.

IC makers fear that high production costs and low prices—because the auto companies are tough bargainers—will make the business unprofitable.

But at GM, an engineer believes the reasons are more technical than economic. "The IC voltage regulator cannot be fabricated and tested by electronic technology alone," he says. "Without a knowledge of automotive engineering, or the active support of the auto industry, semiconductor manufacturers will be sweating this one out for a while."

The General Electric Co., the

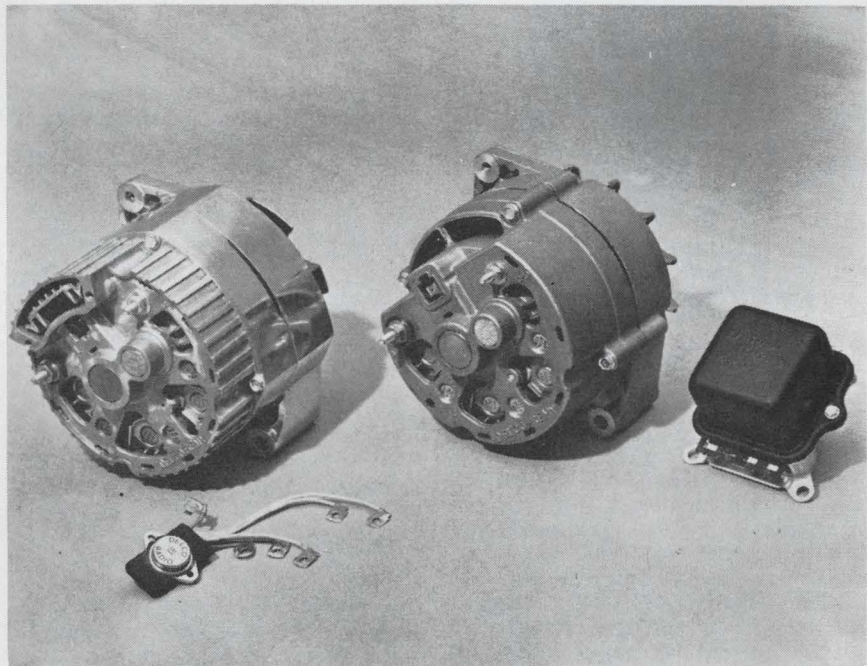

Today and yesterday. The new General Motors Delcotron, with its IC voltage regulator, is at the left. Earlier generator, with its electromechanical voltage regulator, is at right.

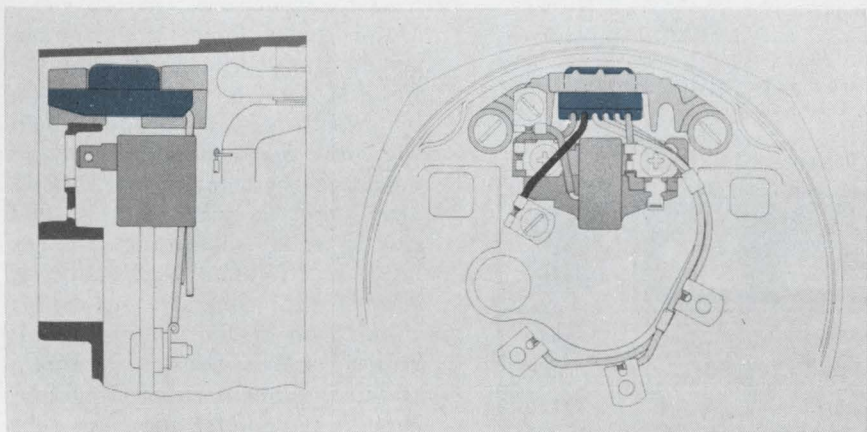

Sitting on top. Block in color shows position of the IC regulator in the Delcotron generator. Side view is at left, end view at right.

Got a 30 MHz counter headache?



Count on Janus for speedy relief!

If your counter instrument or system designs have been a bit sluggish and out of spec, lately, you may have a 30 MHz Counter Headache! Reach for a Janus UC-300 Series 30 MHz BCD Counter-Display, WITH TTL, and get speedy relief! This Series accepts periodic and aperiodic signals to 30 MHz. Important features: BCD outputs, preset to non-zero numbers, external count control and bright in-line display. Input and output levels are compatible with DTL and TTL integrated circuit logic levels. Also available with latch storage for "blur-free" display and BCD data storage. For slower-speed headaches use Janus 5 MHz Counter-Display Modules.

See your local Janus Representative or write for clinical data.



296 Newton St., Waltham, Mass. 02154
Phone (617) 891-4700

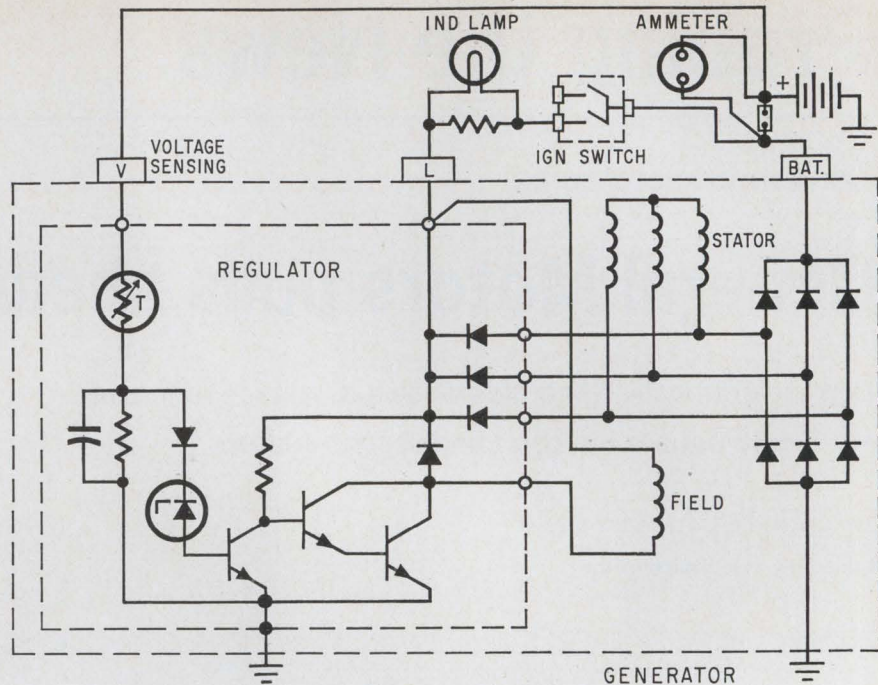

New look. As the voltage of the zener diode increases, the input transistor saturates. This turns off the Darlington pair and the generator field current. As generator output dips, the zener turns off and full current is applied to generator field coil.

Westinghouse Electric Corp., and the Radio Corp. of America won't say whether they have been approached by GM. General Electric's silence is easily explained. As a GE spokesman puts it: "Delco is one of our biggest customers." But one firm that admits it has been approached is Sylvania Electric Products Inc.

In the dark. Says Alvin Phillips, general manager of Sylvania's IC operations: "We had a rather high-level visit [from GM] a few months ago. They demonstrated sample devices and circuits, but didn't say what the IC's were for. A few months later we read about the voltage regulator."

The disclosure of General Motors' Delcotron caught some observers by surprise. Until then, the Ford Motor Co. was the odds-on favorite to be first because it had Fairchild Semiconductor working on an IC regulator. But Fairchild abandoned its work in this area shortly after submitting samples last year. Motorola Semiconductor, another firm contacted by GM, is working on the Ford project, with Philco-Ford as backup. Motorola admits it is now making integrated circuit regulators for an auto maker, but won't confirm that it's Ford.

I. Down the road

Besides Ford, the Chrysler Corp. and the American Motors Corp. are expected to follow GM's lead with an IC voltage regulator—perhaps as early as this winter.

Despite the difficulties of making an IC that can take the torturous environment of a car's engine—and it has to have a low enough price for the auto makers—some auto industry observers estimate that by next fall more than half the vehicles being produced will be equipped with the IC devices. By 1972, when all new vehicles are expected to be equipped with integrated regulators, there would be an annual market of 10 million integrated circuits.

Cut-rates. Auto makers are now paying up to \$3 each for some standard electromechanical regulators. With the present limited production runs, the IC regulator costs about this much to make. However, as volume increases and manufacturing technology improves, the cost per circuit is expected to level off at about \$1.

Standard in Pontiac's Grand Prix and a \$10 optional extra in the Catalina, Executive, and Bonneville models, the IC regulator is about the size of a man's wristwatch. It

fits into a recess in the rear frame of the car's generator, eliminating the conventional external assembly as well as associated harness wiring. It can operate when under-the-hood temperatures are as high as 260°F. and as low as -30°F, while maintaining the generator output within ± 0.2 volt of the prescribed setting.

II. Sales and service

The IC device represents more than a GM marketing gambit in the auto sales wars. The assembly provides better voltage regulation than conventional units, thereby prolonging the life of the battery and lighting systems. Moreover, the sealed IC is unaffected by moisture, aging, weather extremes, and vibration. Because the IC regulator senses only the battery voltage, it is immune to interference by the generator's magnetic field, electrical noises, or transients. From a service viewpoint, the IC requires no periodic adjustment.

The standard electromechanical voltage regulator is prone to relay-contact erosion and wear, which introduce unwanted resistances that change circuit regulation. Metal fatigue in springs can cause voltage and current sensing levels to change. And sticking relay contacts can cause a voltage-regulator failure, which, in turn, can destroy the generator itself.

The function of a voltage regulator is to keep the generator output within preset limits across a wide range of engine speeds and under-hood temperatures. It does this by sensing the voltage at the battery terminals and varying the charge rate of the generator as necessary. As the voltage of the zener diode increases, the diode breaks down, causing the input transistor to saturate. This turns off the Darling-ton pair and the generator field current. As the generator output drops, the zener turns off to bring the input transistor out of saturation, and the full current is once again applied to the generator field coil. A thermistor provides temperature compensation in a voltage-divider configuration.

III. Meeting the challenge

Knowledgeable spokesmen at the leading semiconductor houses feel that Delco Radio engineers

The Clearest Logic:

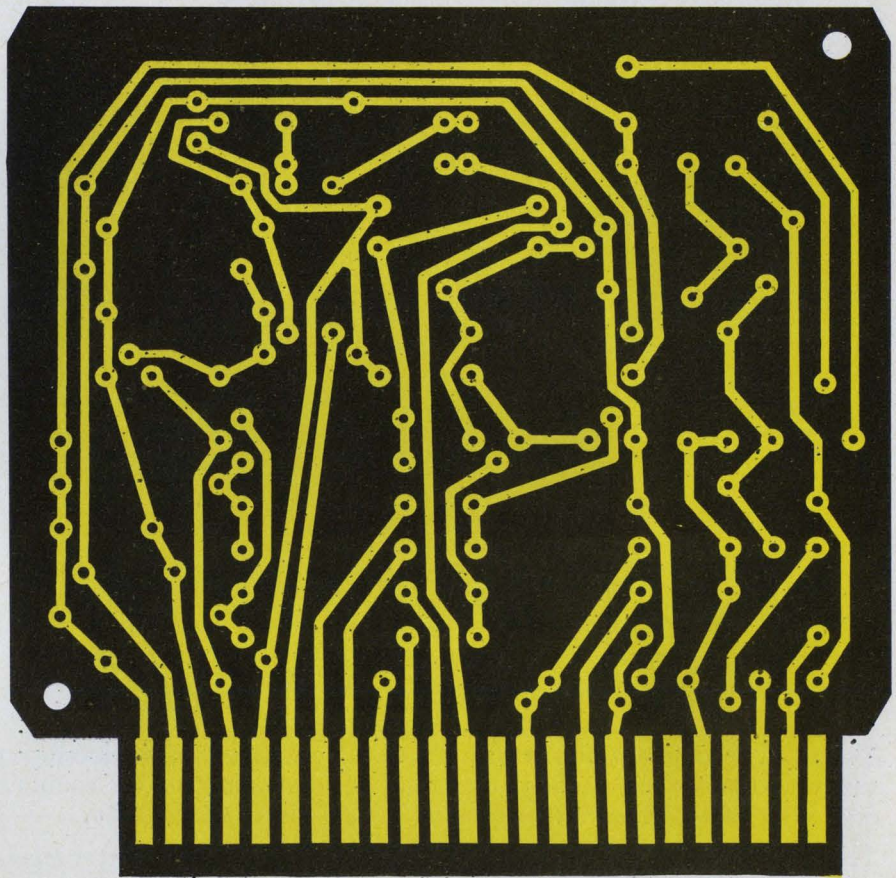

Logic modules are built on printed circuit cards. Hole location and front-to-back registration must be very accurate for machine assembly. **Hand assembly is costly.** Plated thru-holes must provide positive continuity. **Rejects are costly.** Circuit boards for logic modules must be easily solderable. **Poor solderability is costly.** Printed circuit cards must be delivered in volume quantity for large-scale logic module production. **Time delays are costly.**

These are the reasons that Cinch-Graphik boards are built with such exacting precision. **Anything less is too costly.**

CINCH-GRAPIK

D I V I S I O N O F U N I T E D - C A R R



200 South Turnbull Canyon Road, City of Industry (Los Angeles), Calif. 91744 • Phone (213) ED 3-1201. Sales offices in 33 principal cities throughout the United States, Great Britain, Canada, Australia and West Germany.

CONSISTING OF CINCH MANUFACTURING COMPANY, CINCH-GRAPIK, CINCH-MONADNOCK, CINCH-NULINE, UCINITE (ELECTRONICS) AND PLAXIAL CABLE DEPT.

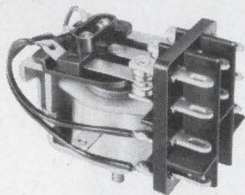
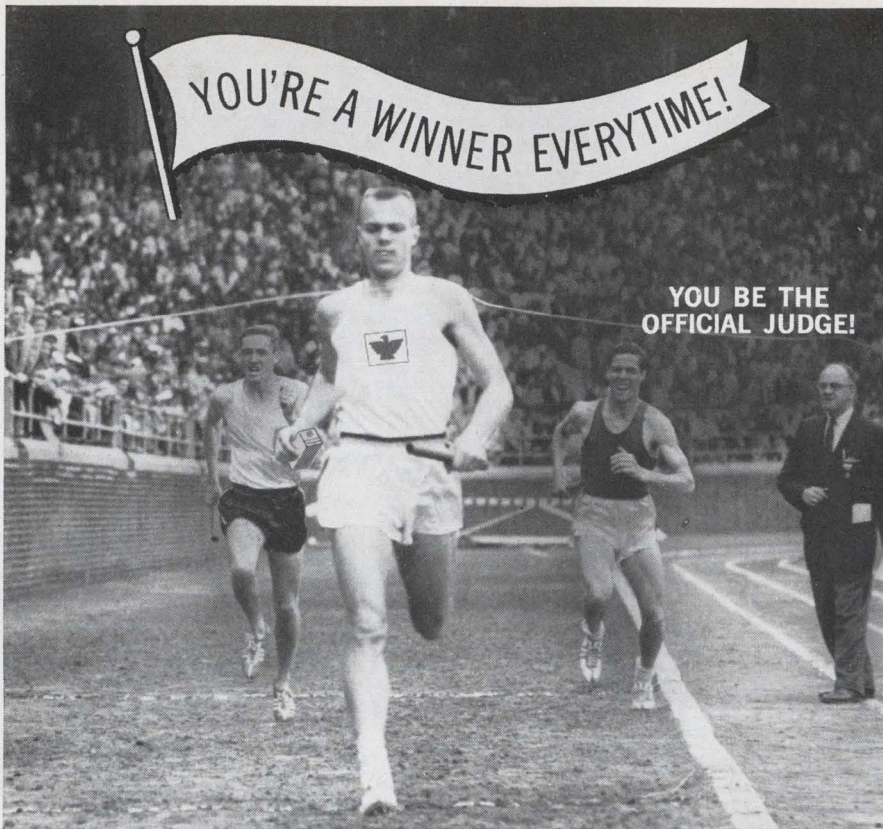

In "THE GREAT RELAY RACE"

You always come out ahead with Eagle relays. After all, we developed them because we use relays in our other products, and we just couldn't find any relays on the market to meet our standards of reliability.

The chart below shows that we have succeeded in building a better relay.

Now, we ask that you be the official judge! **FREE RELAYS AND OFFICIAL SCORE CARDS** are available for your own test . . . under your own conditions. To receive an official entry blank to the great relay race, contact R. W. Emelander, Eagle Signal Division, E. W. Bliss Company, 736 Federal Street, Davenport, Iowa 52808. Or circle the reader service number below.

CONTACTS	COMPETITIVE BRANDS						EAGLE RELAYS
	"A"	"B"	"C"	"D"	"E"	"F"	
Arrangement Rating	3 PDT 5 Amp.	3 PDT 5 Amp.	3 PDT 5 Amp.	3 PDT 5 Amp.	3 PDT 5 Amp.	3 PDT 5 Amp.	3 PDT 5 Amp.
LIFE Mechanical	15,061,261 Operations	14,077,866 Operations	28,808,000 Operations	21,625,333 Operations	16,923,133 Operations	29,433,600 Operations	34,492,950 Operations
ELECTRICAL 5 Amp. Resistive	295,466 Operations	490,433 Operations	129,600 Operations	235,700 Operations	778,200 Operations	921,400 Operations	948,675 Operations
1.6 Amp Inductive	488,666 Operations	1,071,666 Operations	496,000 Operations	284,333 Operations	3,529,466 Operations	1,842,000 Operations	3,102,200 Operations

These "track records" show that Eagle Relays have a consistently longer life. A 20% greater life than the closest competitor at 5 amps resistive. An almost 70% greater electrical life than the average of the six competitors tested.

Like to prove us wrong? Chances are you're more likely to set a new "track record!"



A DIVISION OF THE E. W. BLISS COMPANY

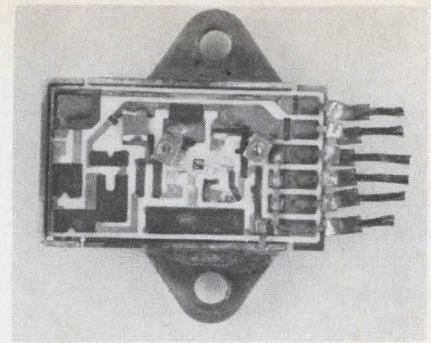

Looking down. Top view of regulator circuit showing hybrid IC configuration.

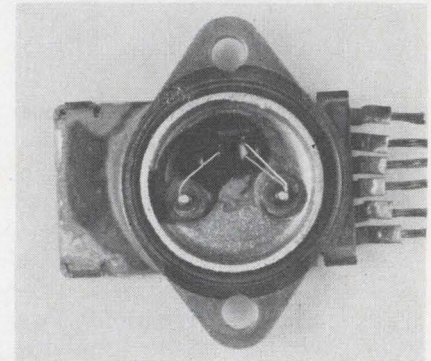

Looking up. Bottom view showing output power transistor in a TO-3.

have taken the lead in this phase of integrated circuitry fabrication. "An IC voltage regulator is tough to design," says Frank Cook, a microcircuits product planner at GE. "There are problems of temperature tracking that present a real challenge. To get the kind of voltage regulation the auto industry wants, components must be matched pretty closely."

At Delco Radio, an engineer says, "At first it seemed like an impossible task. There was always the danger of thermal runaway upon subjecting the substrate to extremely high temperatures. Another problem area is material compatibility as chips are bonded to the substrate."

Mechanically, the lead bonds presented problems since they had to withstand tremendous pressures and vibration. The regulator temperature-compensation circuit had to be designed with the aid of a computer.

General Motors' IC regulator is a hybrid; transistors, diodes, resistors, a capacitor, and a thermistor are mounted on a ceramic substrate. The assembly is mounted on a discrete power transistor packaged in a TO-3 can with six lead terminals

for interfacing with the generator.

Safety first. The high developmental cost of GM's regulator is attributable in part to the rigorous testing that the device has undergone and the caution taken by GM engineers. A Delco-Remy engineer says: "With the present furor over auto safety still simmering, GM couldn't afford to have its cars recalled because of a defective or malfunctioning charging system." Few components in the car have been as thoroughly tested as the IC regulator. "We just had to be sure this thing was foolproof," adds another GM spokesman. The regulator was road-tested for 2 million miles.

After fabrication, each IC is checked for mechanical flaws and undergoes a series of electrical tests. It is then placed in an environmental chamber where it is subjected to temperatures ranging from -30°F to $+260^{\circ}\text{F}$ during a 30-minute cycle. The device then undergoes a vibration test that exceeds the worst the auto can offer. Once these preliminary tests are completed, the regulators are mounted on operating generators for prolonged life testing. Regulation is checked at 0° , 80° , and 160°F .

Sneak preview. General Motors began road testing the IC regulator three years ago in more than 200 cars. Some Delcotron generators were installed in cars driven by company officials as well as service personnel. Others went into development vehicles.

IV. Smoothing it out

After each test cycle, which lasted for about a year, the regulators were removed, checked, and modified. Most of the failures experienced were mechanical in nature. Leads continually broke off and had to be reinforced. Internally, bonds had to be redesigned to withstand the torturous environments of bumpy, dusty roads. The epoxy developed cracks that could only be prevented by adding a thin plate around the sides of the ceramic base. After each modification, the regulators were tested again until all flaws were corrected.

Based on its experiences with the device, GM's next generation of IC regulators will probably be plug-in units without leads.

Taylor's total reliability plan: Glass-Epoxy Copper-clad

in sheets, panels or punched blanks to your specifications and reliability requirements

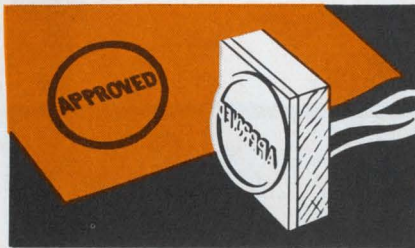

Accepted by an increasing number of major OEMs and commercial etchers who give their stamp of approval, because . . .



. . . they get highest quality level assurance from two fully-equipped copper-clad plants using white-glove techniques . . .



. . . in atmosphere-controlled white rooms, under extremely tight quality control procedures, to produce copper-clad . . .

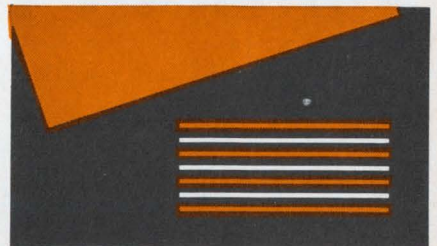

. . . to specifications and established reliability requirements in standard sheets, ultra-thin sheets and multi-layer prepreps . . .

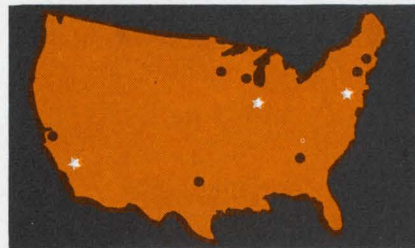

. . . then deliver when promised, or in an emergency, from plant or warehouse stocks in special packages.

Let us prove the advantages of Taylor's TOTAL RELIABILITY PLAN to you! Ask for a demonstration today. Write for a sample (give grade designation and copper combination) and Bulletin GB-2.



...your assurance
of quality

Taylor copper-clad

TAYLOR CORPORATION • Valley Forge, Pa. 19481

Phone: 215-666-0300 TWX: 215-666-0659

West Coast Plant: La Verne, Calif.

Also manufacturer of Taylor laminated plastics, Taylorite® vulcanized fibre and Tayloron® prepreps

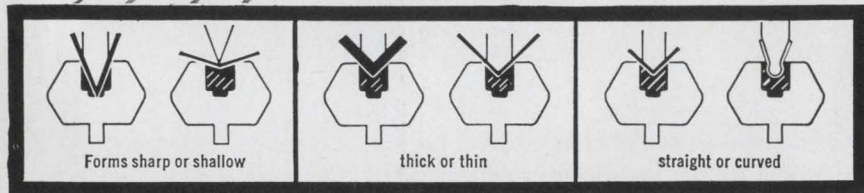
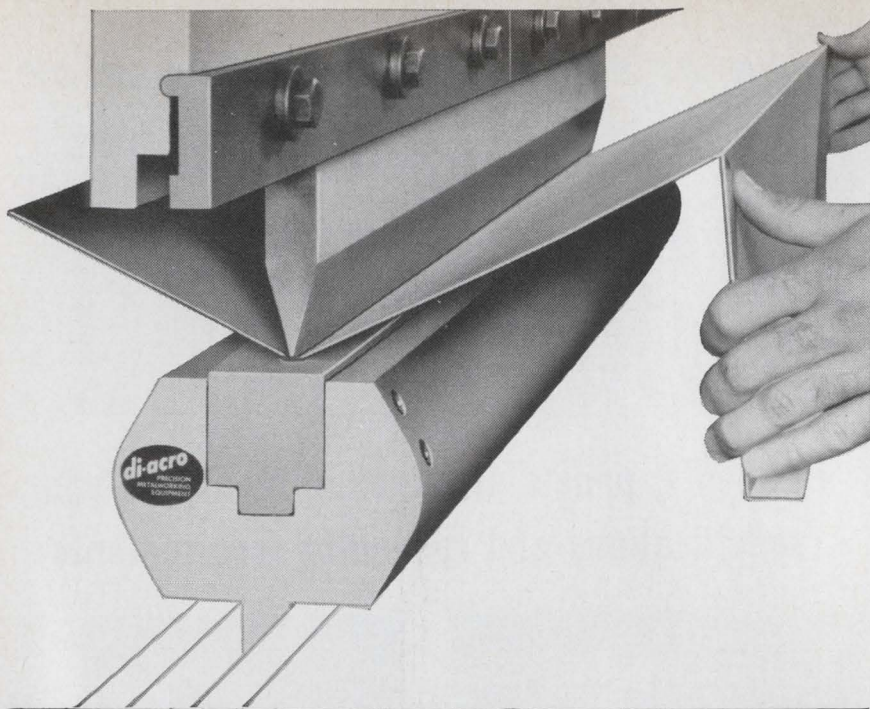

SCRATCH-PROOF, TOO!

Welcome! This is the Di-Acro Tru-Form Die. A Jack of all jobs, as you can see. The secret? A new urethane insert by DuPont. It makes a resilient pad that takes the exact shape of the male die for each forming operation. Again and again.

And it won't scratch the material. Not even polished aluminum. Not even painted surfaces. You can forget about work marking. Period!

Look how frugal! Fewer dies in your inventory. Shorter setup time. This one die does the work of a mob by changing just the male die. No special female dies needed for forming special shapes, either.

Choose a 1" x 1" or 2" x 2" forming pad. Six to 144 inches long.

There are other Di-Acro brake dies too. Rol-Form Dies with half round inserts that provide an easy folding—mar-free—action when forming to any angle up to 60° in material up to 3/8" thick.

Standard V-type press brake dies for bending, box forming, corrugating, curling, hemming, flattening, etc. They fit all standard press brakes on the market. See your nearest Di-Acro distributor or write us for a press brake die catalog.

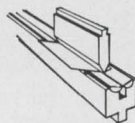

4310 EIGHTH AVENUE
LAKE CITY, MINNESOTA 55041

Companies

C'est la guerre

CSF, France's largest electronics firm, to merge with Thomson-Houston

By Peter Kilborn

Paris news bureau

In the past year or so, the French electronics industry has kept an anxious watch on the Rhine, wondering how it could stand up to the onslaught of huge West German companies when the Common Market abolishes internal tariff barriers next July.

Even France's biggest electronics firm—CSF-Compagnie Générale de Télégraphie sans Fil—felt itself vulnerable. For one thing, the company was in a financial bind; last year's \$306 million of sales just wasn't enough to support the extensive research and development CSF must do to keep its products, especially its defense and space hardware, up to the mark.

Now CSF is going to get some hefty protection, but at the expense of its corporate identity. Compagnie Française Thomson-Houston-Hotchkiss Brandt, a fast-growing producer of electronic gear, appliances, and machinery, is absorbing CSF and plans to make it the core of a yet-unnamed electronics subsidiary. With CSF in its fold, Thomson will become an \$800 million company and rank as the number four electrical-electronics producer in the six-nation Common Market trade bloc behind Holland's Philips and West Germany's Siemens AG and AEG-Telefunken.

I. Or else

Some observers say the merging of the two companies—arch rivals up to now in several electronics lines—may have been the only means of assuring a strong electronics industry for France. Thomson itself has been in trouble; rapid expansion has brought on growing

pains, and the company last year posted a \$1.1 million loss.

Less than two years ago, Thomson-Houston was France's 24th biggest company in terms of sales. Then it took over Hotchkiss-Brandt, primarily an appliance and heavy-vehicle firm, and jumped to 14th biggest. The csr acquisition, to be effected early next year, will put Thomson in the seventh or eighth slot and its electronics subsidiary alone up among the top 15 French firms.

This subsidiary will mesh most of Thomson's nonconsumer electronics business—which accounted for a third of the company's \$460 million sales last year—and all csr.

Mix gently. Until recently, csr and France's finance and industry ministries followed a gradual, piecemeal approach to growth via mergers. Under de Gaulle's Plan Calcul, for example, Paris prodded three firms to merge their computer-manufacturing efforts. And under the newer Plan Composants, the government helped arrange the merger of two firms' semiconductor operations. Three other companies were expected to follow suit until the latest development.

Csr figured importantly in those projects and initiated some of its own as well. It is one of three owners of Compagnie Française de Télévision (CFT), the producer of France's Secam color-tv system and a new picture tube that may one day replace RCA's shadow mask. It signed an agreement last year with West Germany's Grundig to jointly develop advanced components for consumer products. And csr's Compagnie Générale des Semi-conducteurs (Cosem) set up a joint marketing subsidiary with another components concern, Société Industrielle des Liaisons Electriques (Silec).

II. The down staircase

Yet csr continued to flounder. Problems started two or three years ago with drastic cutbacks in the R&D contracts the company had been receiving from U. S. defense agencies. CFT's new tube still hasn't reached the market after six years of trying. And Cosem, without in-house, volume integrated-circuit production, has been forced to market solid state devices at prices set by U. S. components

Dust Detective

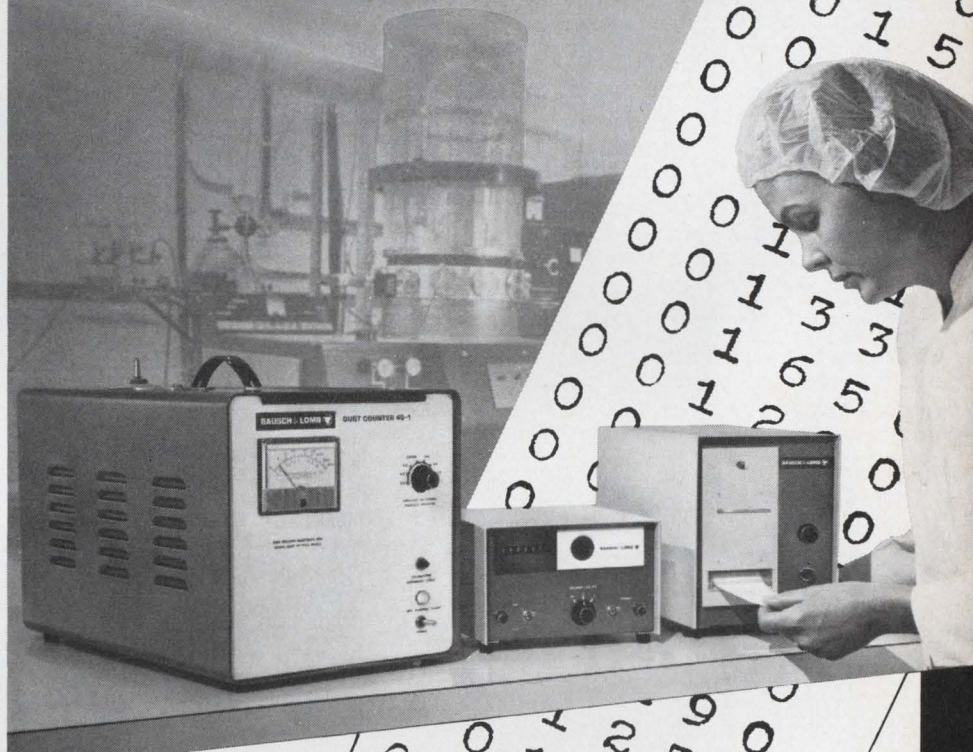

The new Bausch & Lomb Aerosol Dust Counting System keeps a watch on dust in your clean room. Airborne contamination is detected, counted and recorded . . . automatically, accurately, dependably. Particles of different refractive indexes are correctly sized the only accurate way . . . using near-forward light scattering. The efficient concentric optical system can classify particles of any shape and orientation by equivalent diameter. Any particle concentration—up to one million per cubic foot—is read and printed directly. Response is instantaneous. Counts all particles greater than the preset size. Seven presettable sizes can be selected—0.3, 0.5, 1.0, 2.0, 3.0, 5.0 and 10 microns. And, surprisingly, this superior system is priced far below any other commercial unit. Ask for our new Catalog 38-2190 . . . it has the full story. Write Bausch & Lomb, 99746 Bausch Street, Rochester, N. Y. 14602.

BAUSCH & LOMB 

In Canada, Bausch & Lomb Optical Co., Ltd., 16 Grosvenor St., Toronto, Ontario.

Circle 143 on reader service card

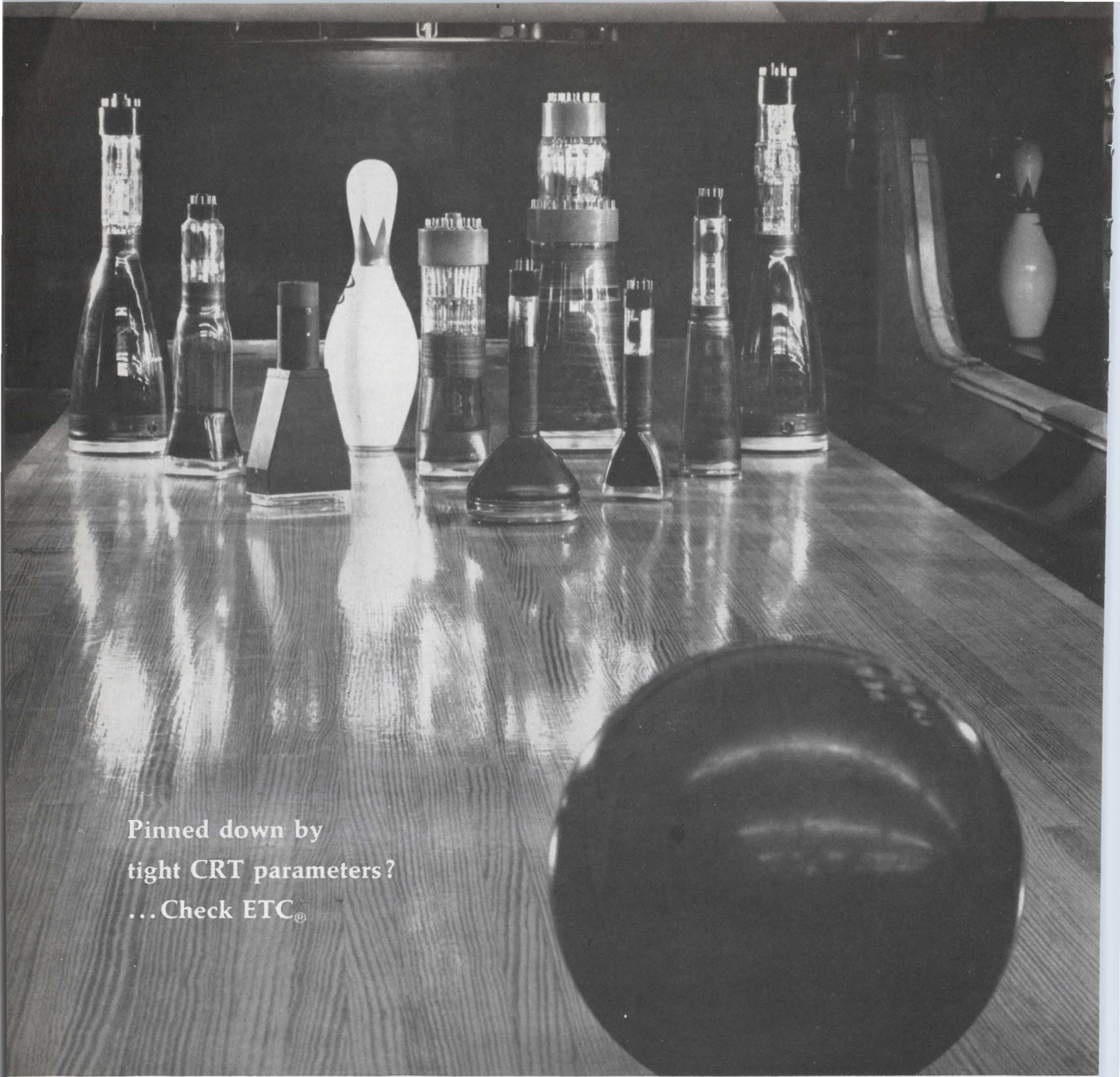

Pinned down by
tight CRT parameters?
... Check ETC[®]

Tube capability is right down our alley

Challenge has been our game for nearly 30 years... the challenge of designing, engineering and producing new CRT's for special applications.

We meet this challenge continually, and from our modern R & D and manufacturing facilities have come many "firsts" in CRT development. Our contributions to industry, science and the military have earned us a reputation for solving the particularly difficult display problem.

Today, as a result of our 3-decades of pioneering activities in tube technology, we offer one of the largest lines of off-the-shelf CRT's in the industry. Each has undergone the quality-controlled product engineering and stringent testing required as a custom fabricated item. And each will provide more performance per dollar in the application for which it was designed.

Try "pinning us down" to your individual CRT needs, whether

they involve multi-gun displays, multi-layer phosphors, special bulb shapes, or ultra-high resolution.

You'll find us "right down your alley" when it comes to meeting your specs. Why not call us today ... or write for our complete capability catalog.

**GENERAL
ATRONICS**
ELECTRONIC TUBE DIVISION
PHILADELPHIA • PENNSYLVANIA 19118



... decision to merge companies caught government with its blueprint down ...

companies that manufacture in France.

Last April, csf's president, Maurice Ponte, disclosed to stockholders the depth of the company's trouble. He announced a 1966 deficit of \$27 million, most of it representing unamortized research that the company decided to put in the liability column for the first time. The biggest liability: a complete new line of telecommunications hardware that spent two years in the lab before its introduction late last year.



Bowing out. CSF chief Maurice Ponte will have advisory role in new setup.

Squeeze. A painful belt-tightening followed Ponte and his second-in-command, Andre Danzin, put a freeze on hiring and the replacement of employees lost by attrition. The company's three big research divisions at Corbeville, near Paris, were consolidated, and a number of their projects were cut back or dropped. Csf's one manufacturing subsidiary in the U.S., Warnecke Electron Tubes, was sold [Electronics, Aug. 7, p. 272].

Talks with Thomson began last summer, but they were initially aimed at implementing the government-sought merger of Cosem, Silec, and Thomson's semiconductor subsidiary, Société Européenne des Semiconducteurs (Sesco).

There were two immediate barriers. First, there was the General

Electric Co.'s 49% ownership of Sesco; GE would have to be bought out, the government felt, but the U.S. firm showed no desire to sell. The other problem was that Thomson didn't view favorably its prospective partner's financial woes. Csf, for its part, concluded that the proposed merger offered scant hope of relieving its pinch in other product areas.

The solution that was ultimately adopted surprised even the government planners. But while the companies' decision upsets the government's blueprint for a delicate, step-by-step strengthening of the industry, the result is just what Paris wanted—a couple of years early.

III. Interested party

It wasn't csf management that initiated the company's move into the Thomson camp. In fact, there is little evidence that management played more than a secondary role in the talks. The central figure was the company's biggest stockholder, Banque de Paris et des Pays-Bas (Paribas). The bank felt it wasn't getting a big enough return on its heavy investment in csf. Paribas hasn't disclosed the extent of its holding, but it undoubtedly has a controlling interest. Until the company's annual meeting last April, the bank held 21% or 22%, Bourse-watchers believe. After that, Paribas reportedly picked up more shares as csf dropped on the Bourse when the 1966 loss was announced. Of the company's 12 directors, three represent the bank.

The takeover by Thomson won't be completed until both firms' stockholders meet again, probably after the end of the year. However, the three parties have reached an accord under which Thomson will move all but its consumer and medical electronics operations into the csf structure, and csf's capital will be increased to cover Thomson's contribution to the new company. The new capital, representing about a third of the company's total, will be held by Thomson; the bank will exchange most of its holding in csf for a noncontrolling



Engineer. Andre Danzin, managing director, will run technical side.

interest in Thomson. As a result of all this, Thomson is expected to wind up with 49% control of the consolidated subsidiary.

Old faces. Managing director of the subsidiary will be csf's Danzin, 41 years old, long Ponte's heir apparent. An engineer, he'll run the technical show. Ponte, who has reached retirement age and was expected to leave csf this summer, will become honorary president of the unit and scientific adviser. The new company's president, Paul Richard, formerly president of Hotchkiss-Brandt and now a Thomson vice president, will concentrate on management and finance.

Though Thomson's acquisition of csf is now all but fact, it will take two or three years to become effective. Early next year, the companies will begin merging those operations that fit most easily together. Consolidating some others will take longer because third parties—GE in the case of Sesco—will have to be dealt with.

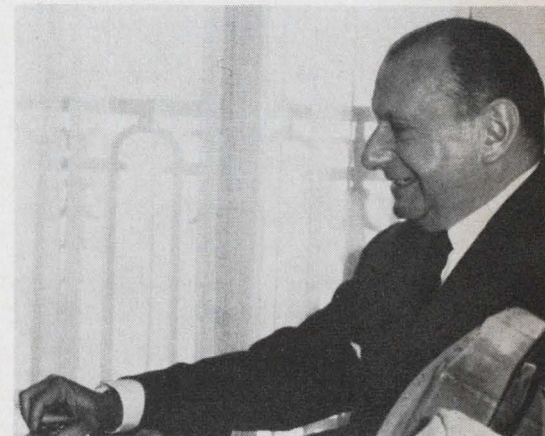

Top title. Paul Richard, president, will worry about finance, management.

NEW MAGNETIC RELAY plugs into your PC board!

NO Springs, NO Wiring,
NO Sockets, NO Soldering,
NO Mechanical Linkage

Printact®

Standard Series G
Latching Series LS/LD

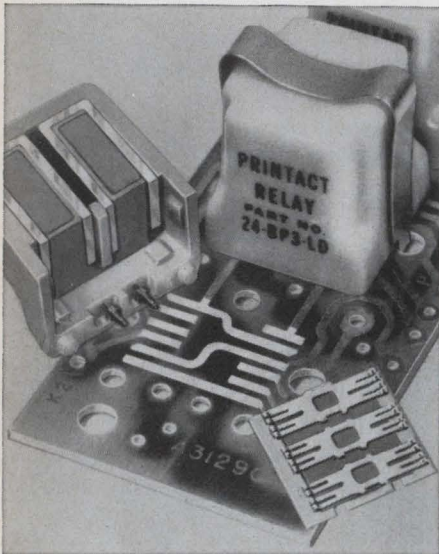

(actual size)

Plated Conductors on Your PC Board are the Fixed Contacts

Save SPACE, MONEY and MANHOURS with these new small, lightweight, highly reliable Standard and Latching PRINTACT Relays.

Available with Bifurcated Palladium or Gold Alloy contacts for more than 10 million cycle 2 to 4* pole switching. Handles up to 2 amp. res. loads. Coils for 6, 12, 24 and 48 vdc at 500 mw. Operating temperature -30°C to $+95^{\circ}\text{C}$. Operate time 7 ms. The little gem is an 0.8 oz. $\frac{7}{8}$ " cube.

Quality features include: double-break contacts; balanced armature, enclosed housing, plug-in application; encapsulated coil; self-wiping contacts and inherent snap-action — saves sockets soldering, and wiring and the cost is lower than you think!

*Switches up to 4 form A plus B, or 4 form C.

For data and prices write or call:
212-EX2-4800

Executone

PRINTACT RELAY DIVISION
47-37 Austell Place
Long Island City, N.Y. 11101

Military electronics

Thin Nike, fat orders

Three-quarters of \$5 billion slated for system
is for electronics, and firms may have to expand

"We are completely in the dark at this point, but the numbers we have heard unofficially indicate we would need to build a whole new plant."

That optimistic comment from semiconductor producer Donald Dickson, president of the Dickson Electronics Corp., Scottsdale, Ariz., typifies the reaction of the electronics industry to the Government's decision to build the Nike X system.

Industry vendors and subcontractors, who will account for most of the 3,000 companies expected to participate in the production of the antimissile system, were anxiously awaiting more details from major subcontractors who met with the Army Missile Command, the program manager, at Huntsville, Ala., late this month. But there's no doubt that Nike X will have an enormous impact on all facets of the industry.

I. Stage is set

Defense Secretary McNamara's grudging go-ahead for the so-called "thin" antiballistic missile (ABM) system raises the curtain on the biggest single job the electronics industry has ever tackled. An estimated three-quarters of the \$5 billion price tag for the limited system will go for electronics equipment—the giant radars and computer complexes that would direct U.S. missiles toward incoming enemy intercontinental ballistic missiles.

Swamped. The biggest gainers will be the makers of discrete semiconductor devices, an area of slumping sales recently. But some observers worry that this segment of the industry may soon have more business that it can handle. Depending on how fast the Pentagon pushes the program—now estimated to be a \$1 billion-a-year pace—Nike X could push much of the

industry beyond present capacities, force a rapid expansion of production facilities and require automated lines. The Army acknowledges that a few new production lines will be opened and that manufacturers will be required to use a high degree of automation.

It will be six months before the first production contract is awarded. Money is already available—nearly \$1 billion. This includes \$440 million approved for continued research and development; \$375 million authorized and awaiting a production go-ahead; and more than \$175 million left over from previous years. In fiscal 1969, \$1 billion will be requested for the thin system and another \$500 million for over-all R&D on Nike X.

The first ABM battery will be in place by the early 1970's—the entire system, which will cost \$500 million annually to operate, will be operational in about five or six years.

Major subcontractors in the R&D program will get the production contracts, but second and third tier contracts, which include most electronic components and subsystems, will be let to dual sources in many cases. Western Electric is the prime contractor; Bell Telephone Laboratories is responsible for design and development.

II. Small packages

As much as 3% of the total outlay will go for discrete semiconductors, or up to \$150 million over the five-year program, predicts Motorola Inc.'s Semiconductor Products division in Phoenix.

The impact of this business on semiconductor firms won't be felt for about a year, say officials of Texas Instruments Incorporated in Dallas. The next several months will see only small-lot orders for prototypes, they believe. Motorola

officials anticipate some tight delivery schedules during the first phase of the Nike X program, but expect scheduling of work for other customers to return to normal after the initial production buildup for the ABM system.

High test. Most of the semiconductor devices ordered for Nike X will be high-reliability units akin to those developed for the Minuteman ICBM program; rigid testing will take up more time than production.

Motorola has been working for some time with all the principal contractors to build devices for projected Nike X equipment. The work has covered most of its discrete line, including zener diodes, rectifiers, small signal transistors, and silicon power transistors in both low- and intermediate-frequency ranges.

Also with Nike X in mind, the Continental Device Corp., Hawthorne, Calif., has been working for two years on 1-watt and 10-watt radiation-hardened high-speed rectifiers. Development of both units is nearly complete. Another producer preparing to bid is the El Monte, Calif., semiconductor facility of Globe-Union Inc.'s Centralab division—formerly a Hoffman Electronics Corp. division. "If the program is as big as we hear it is, we would have to expand production," says E. M. Baldwin, manager. Contracts would be primarily for zener diodes and high-current, high-speed computer diodes.

Dickson Electronics has been working with Nike X prime contractors for more than three years to develop zener diodes, and also will bid on tantalum capacitors.

III. Outdated?

Some engineers, noting that the Nike X was designed five or six years ago, say it will be obsolete before it's built. Integrated circuits are just being introduced into some parts of the system, but only to replace discrete components. Some in the industry say the application of large-scale integration techniques to the large computers, and microwave integrated electronics to the phased-array radars, could revolutionize the system.

Pow. Morgan McMahon, R&D manager at TRW Semiconductors Inc., Lawndale, Calif., believes the

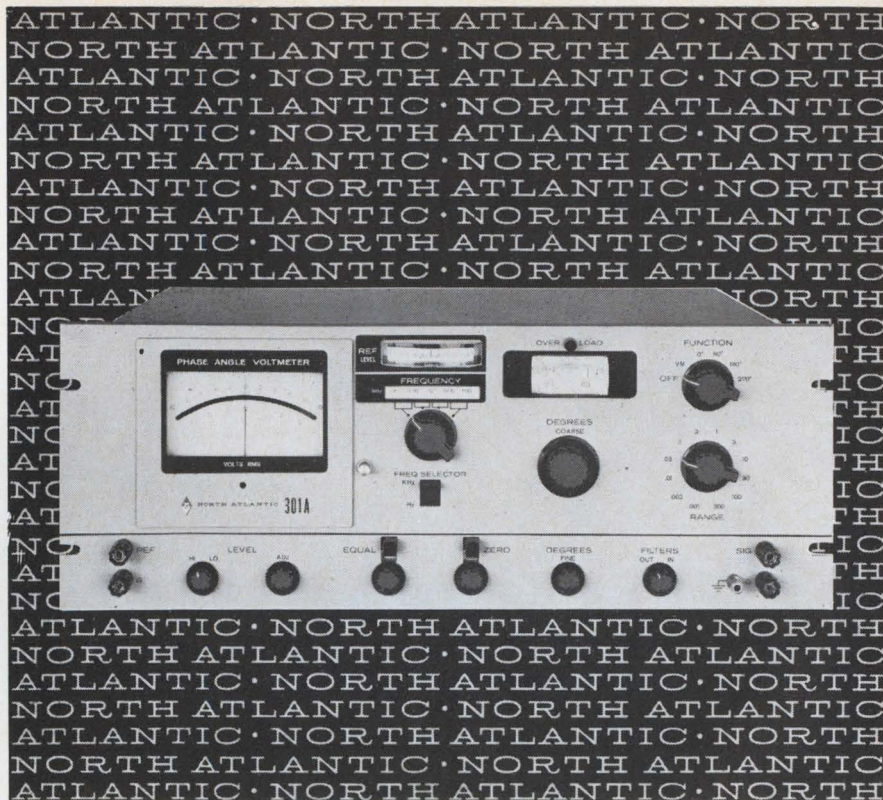

how to measure phase angle down to .25° from 10Hz to 100KHz (plus in-phase and quadrature!)

North Atlantic's Model 301A Broadband Phase Angle Voltmeter* adds a new dimension to AC by enabling you to measure phase angle, in-phase and quadrature while frequency is varying over half-decades...without recalibration. It provides complete coverage from 10Hz to 100KHz and incorporates plug-in filters to reduce the effects of harmonics in the range from 27Hz to 28KHz with only 11 sets of filters. Vibration analysis and servo analysis are only two of the many applications for this unit. Selected specifications are listed below:

Voltage Range.....	1 mv to 300 volts full scale
Voltage Accuracy.....	2% full scale
Phase Dial Range.....	0° to 90° with 0.1° resolution (plus 4 quadrants)
Phase Accuracy.....	0.25°, 31.6Hz to 31.6KHz (derating to .6° at 10Hz, 1° at 100KHz)
Input Impedance.....	10 megohms, 30μf for all ranges (signal and reference inputs)
Reference Level Range.....	0.15 to 130 volts
Harmonic Rejection.....	50 db
Nulling Sensitivity.....	less than 2 microvolts
Size.....	19" x 7" x 13½" deep
Price.....	\$2790.00 plus \$160.00 per set of filters

North Atlantic's sales representative in your area can tell you all about this unit as well as other Phase Angle Voltmeters* for both production test and ground support applications. Send for our data sheet today.

*Trademark



NORTH ATLANTIC industries, inc.
TERMINAL DRIVE, PLAINVIEW, NEW YORK 11803 • 516-681-8600

**who
solved the problem
of excessive rejection rates
for a maker
of precision springs?**

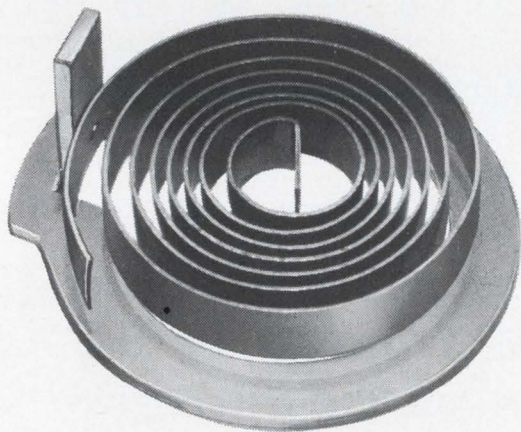

A manufacturer of torque watch gauges searched long and far for a material to meet the rigid specifications for a highly critical, calibrated, helical coil spring. What was needed was a thin, corrosion-resistant, high-strength material with consistent tensile strength and uniform modulus of elasticity. Materials that had been tried resulted in rejects of from 30% to 100%.

With years of experience in precision processing of thin metals, Hamilton Precision Metals recommended 17-7PH cold rolled stainless steel 0.012" thick, $\frac{3}{16}$ " wide, with a ± 0.0002 " thickness tolerance. The result is finished springs that consistently come within 3.5% of actual calibrated value eliminating previous costly trial-and-error methods—to say nothing of the costly rejects.

Hamilton Precision Metals is your prime source for ultra-precision-rolled metals in mass production quantities. 7 proprietary metals, 12 pure metals and 112 commercial alloys are available from Precision Metals. Write today for new 48-page data book.

HAMILTON PRECISION METALS

division of Hamilton Watch Company, Lancaster, Pa. 17604

**... Some say it will be
obsolete before it's built ...**

impact of Nike X will be felt most in the fields of radiation-resistant devices and microwave microelectronics. The program, he says, "could mean a lot to us in our power-at-frequency transistor family." The company, which participated in the early part of the program as a device maker, recently introduced a 50-watt, 500-megahertz transistor.

The systems technology, McMahon claims, "is not as frozen as some people think it is." Another California observer agrees, and predicts that Nike X's design will be upgraded to take advantage of ic's. The redesign effort, he adds, "will throw the whole time schedule off."

According to a top marketing manager on the East Coast, "the Nike X political football could be kicked around for up to a year. If this happens, several subcontractors would be likely to use microwave ic's rather than the giant quantities of discrete semiconductors now contemplated."

If there is a major redesign to take advantage of ic technology, the California observer says, the semiconductor portions of the program "would be up for grabs."

But officials in the Pentagon's Office of the Director of Defense Research and Engineering say otherwise. Rather than wholesale modifications, they see the system evolving gradually to take advantage of technological improvements as they become practical.

When and if. As an example of this piecemeal approach to modernization, the DD&E officials say ic's will be substituted for discrete parts on an individual basis and only when they prove better for the job and won't degrade system reliability.

IV. Playing a zone

The thin system approved by McNamara—the smallest of the ABM deployments considered by the Pentagon—involves an area defense of the country plus a point defense of all Minuteman intercontinental ballistic missile bases. According to Gen. Earle C. Wheeler, chairman of the Joint

Chiefs of Staff, it will give "pretty good protection against the early Chinese-type of ICBM attack in the '70's." He told Congressmen last April, though, that "it wouldn't provide much protection against a Soviet attack."

The Defense Department says the system will have 15 to 20 missile batteries; the main line of defense will be just south of the Canadian border. A battery will be made up of about 10 missiles, each costing roughly \$1 million.

Eyes. Only two of the four phased-array radars being developed under the Nike X program will be built for the thin system—the General Electric Co.'s perimeter acquisition radar (PAR) and the Raytheon Co.'s missile-site radar (MSR). This part of the program is expected to account for about two-thirds of the total cost, or more than \$3 billion.

Each of the radar complexes—both MSR's and PAR's—will cost about \$100 million. An MSR will be located at each battery; there will be fewer PAR's and they'll be spread along the Canadian border.

The PAR radar will handle the long-range search and acquisition of enemy ICBM's. With the extended-range Spartan missile now being developed by the McDonnell Douglas Corp., the target must be picked up at a great distance so that its trajectory can be computed before the Spartan is fired.

Control. Raytheon's MSR, a much smaller, phased-array radar, would be used to control the Spartan and the Martin-Marietta Corp.'s Sprint missile during engagement of the oncoming enemy missile. Several sizes will be built to accommodate the needs of each defended area.

The two larger and more complex radar systems—Raytheon's multifunction array radar (MAR) and GE's tactical MAR (Tacmar) won't be included in the thin system but will continue to be developed and evaluated. If a more sophisticated Nike X system is deployed, these radars will be incorporated to give a high degree of discrimination between warheads and decoys. One MAR radar is located at the White Sands Missile Range, while a second is being constructed on Kwajalein, where an MSR is also being built.

Backup. The thin system will de-

Tolerances to $\pm .5$ ohms with this new miniature coax!

Now, here is a new miniature coaxial cable providing extremely tight electrical characteristics and a greatly extended parameters in a variety of applications including low noise amplifiers, microwave transmission, high speed computers, airborne instrumentation and radar.

Offered in three sizes off-the-shelf: .141", .085" and .070" and in random lengths from 12 feet to 200 feet, construction consists of a silver-plated Copperweld inner conductor with a TFE Teflon dielectric and solid copper sheath. Electro-plated silver, gold and tin outer sheaths are also available from stock.

The new miniature coax offers very low attenuation across Gc band, low VSWR, no radiation or performance deterioration at environmental extremes

and maintains impedance despite extreme bends. This latter feature makes it possible to cut, bend or form the coax into coils for the achievement of signal delay or a variety of shapes for the fabrication of special assemblies for RF front ends and amplifiers without problems of loss or coupling to impair reliability.

This new miniature coax has been qualification tested for severe aerospace applications and has performed remarkably well where desired electrical performance cannot be achieved with conventional braided cables.

Why not write today for your free miniature coaxial cable folder which includes actual samples of the coax plus complete descriptive data?

PHELPS DODGE ELECTRONIC PRODUCTS
NORTH HAVEN, CONNECTICUT

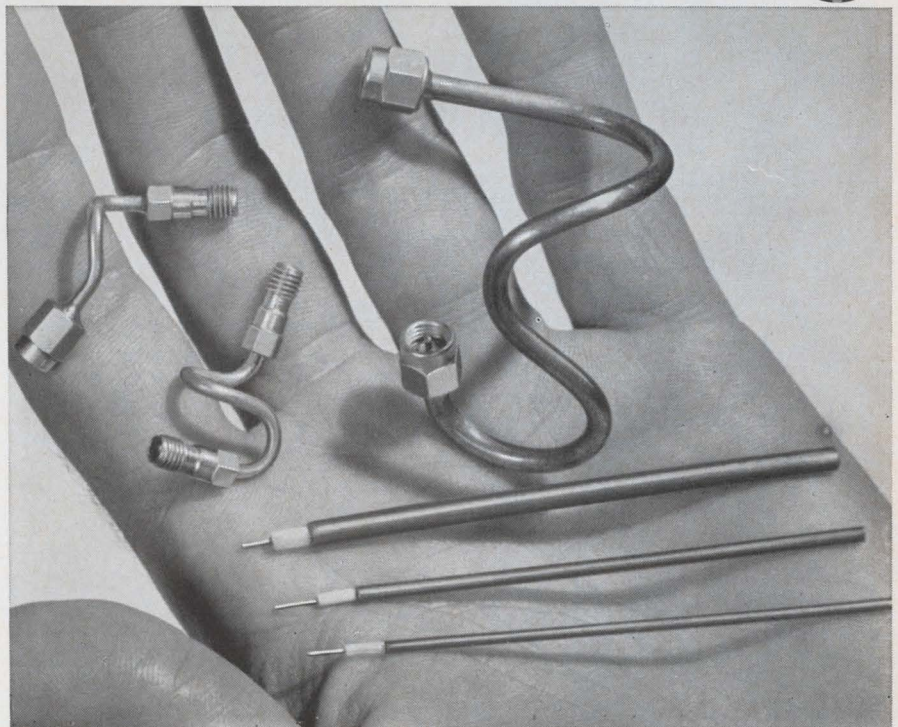



introducing the "PIXIEPOT"TM

at an IMPossibly low price!

Duncan Electronics now offers for the first time in the history of the potentiometer industry a PRECISION, TEN-TURN WIREWOUND pot for less than \$6.00. In fact, the new Model 3253 "PIXIEPOT" potentiometer is yours for as low as **\$3.97** each in production quantities and only **\$5.95** each for 1-24 units.

Outstanding "PIXIEPOT" potentiometer features:

- Length: **ONLY 3/4"**
- Diameter: **7/8"**
- Linearity: **±0.25%**
- Resistance Range: **100 ohms to 100K ohms**
- Power Rating: **2 watts @ 20°C**
- Temperature Range: **-25°C to +85°C**
- Resolution: **Better than any precision pot twice its size.**

The Model 3253 "PIXIEPOT" potentiometer incorporates all of the fine engineering workmanship you've come to expect from other Duncan products. Only our new, unique production techniques enable us to bring this potentiometer to you at these unheard of prices.

And if you need your "PIXIEPOT" potentiometers in a hurry, we guarantee they'll be on an airplane out of Los Angeles within 24 hours after receipt of your order!

How can a "PIXIEPOT" potentiometer help you?

Call or write your Duncan representative (listed on the facing page). He will personally deliver to you, FREE, a 1K "PIXIEPOT" potentiometer for your evaluation in exchange for the filled out certificate.

This certificate redeemable for one 1K "PIXIEPOT"



(TYPE OR PRINT)



MY APPLICATION IS _____

NAME _____

COMPANY _____ TITLE _____

ADDRESS _____ DIVISION _____

CITY _____ STATE _____ ZIP _____

This offer expires December 1, 1967



DUNCAN ELECTRONICS, INC. • 2865 FAIRVIEW ROAD, COSTA MESA, CALIFORNIA 92626

ENGINEERING SALES REPRESENTATIVES

ALABAMA, Huntsville
Orbe, Inc.
Tel: (205) 881-8230

ARIZONA, Phoenix
Southwest Engineering Company
Tel: (602) 944-1521

CALIFORNIA, Costa Mesa
Duncan Electronics, Inc.
(Factory Sales Office)
Tel: (714) 545-8261

CALIFORNIA, San Francisco
Jack Pyle Company
Tel: (415) 349-1266

COLORADO, Denver
Hyde Electronics Co., Inc.
Tel: (303) 936-3456

CONNECTICUT, New Haven
Gerber Sales Co., Inc.
Tel: (203) 777-6279

FLORIDA, Orlando
Orbe, Inc.
Tel: (305) 424-0978

FLORIDA, St. Petersburg
Orbe, Inc.
Tel: (813) 894-0687

ILLINOIS, Chicago
Carlson Electronic Sales Co.
Tel: (312) 774-0277

MARYLAND, Baltimore
Biechler Associates, Inc.
Tel: (301) 825-8222

MARYLAND, Rockville
Biechler Associates, Inc.
Tel: (301) 762-6210

MASSACHUSETTS, East Longmeadow
Gerber Sales Co., Inc.
Tel: (413) LAurel 5-3059

MASSACHUSETTS, Waltham
Gerber Sales Co., Inc.
Tel: (617) 891-8040

MICHIGAN, Detroit
Grant Shaffer Company
Tel: (313) 273-5390

MINNESOTA, Minneapolis
Carlson Electronic Sales Co.
Tel: (612) 788-4111

MISSOURI, Kansas City
Harris-Hanson Company
Tel: (816) 444-9494

MISSOURI, St. Louis
Harris-Hanson Company
Tel: (314) 647-4350

NEW JERSEY, Harrington Park
B. B. Taylor Corporation
Tel: (201) 768-0969

NEW YORK, Baldwin, L.I.
B. B. Taylor Corporation
Tel: (516) 223-8000

NEW YORK, Rochester
Reed Electronics, Inc.
Tel: (716) 473-2767

NEW YORK, Syracuse
Reed Electronics, Inc.
Tel: (315) 468-5488

NEW YORK, Vestal
Reed Electronics, Inc.
Tel: (607) 748-7391

OHIO, Cleveland
Rockford Controls Ohio, Inc.
Tel: (216) 531-4841

OHIO, Dayton
Rockford Controls Ohio, Inc.
Tel: (513) 274-1911

PENNSYLVANIA, Millersville
Biechler Associates, Inc.
Tel: (717) 872-2793

PENNSYLVANIA, Pittsburgh
Rockford Controls Ohio, Inc.
Tel: (412) 731-4600

TEXAS, Dallas
Robert R. Thomas Company
Tel: (214) 363-8591

TEXAS, Houston
Robert R. Thomas Company
Tel: (713) 644-2369

WASHINGTON, Seattle
Hamilton-Electro Corporation
of the Pacific Northwest
Tel: (206) 624-5930



DUNCAN electronics, inc.

... System can be plugged in as easily as a new lamp ...

pend on the long-range Spartans to hit attacking missiles up to 400 miles from their targets, and on a fewer number of fast-acceleration Sprints to take care of any missed by the Spartans. About 25% of the initial deployment cost—or more than \$1 billion—is expected to go for the two missiles.

The Sprint and the MSR radar will be tested as a system first with a large number of target missiles launched from Vandenberg Air Force Base, Calif., to Kwajalein. The Sprint, in flight test since 1965, will engage a hostile ICBM or sea-launched ballistic missile in the atmosphere about 15 to 25 miles from the battery. The Spartan, which is still on the McDonnell Douglas drawing boards, is a complete redesign of the original Zeus missile. Neither the Sprint nor the Spartan have self-contained guidance systems; they will be command-guided by Nike X ground radars.

V. Like Topsy

Army Missile Command engineers boast that the Nike X design is so modular that the various subsystems can be "plugged in like a new lamp in the home." This means that beefing up the thin system would be relatively simple.

That's what worries McNamara and other Nike X opponents; it's too easy to expand the system. The Defense Secretary still holds that offensive weapons such as the Navy's Poseidon missile are the best defense. He says the danger in deploying the small system is that "pressures will develop" to extend Nike X beyond the "prudent level required," and he's concerned that military and Congressional leaders will push the country into a massive Nike X program that could cost up to \$40 billion.

Snowball. Rep. James Harvey (R., Mich.) sees the thin system as "only a start; within a few years we will probably commit \$20 billion to \$40 billion." and Simon Ramo, vice chairman of TRW Inc., and a former chief scientist in the Air Force ICBM program when it was getting started, believes that the initial system will probably cost a lot more than estimated.

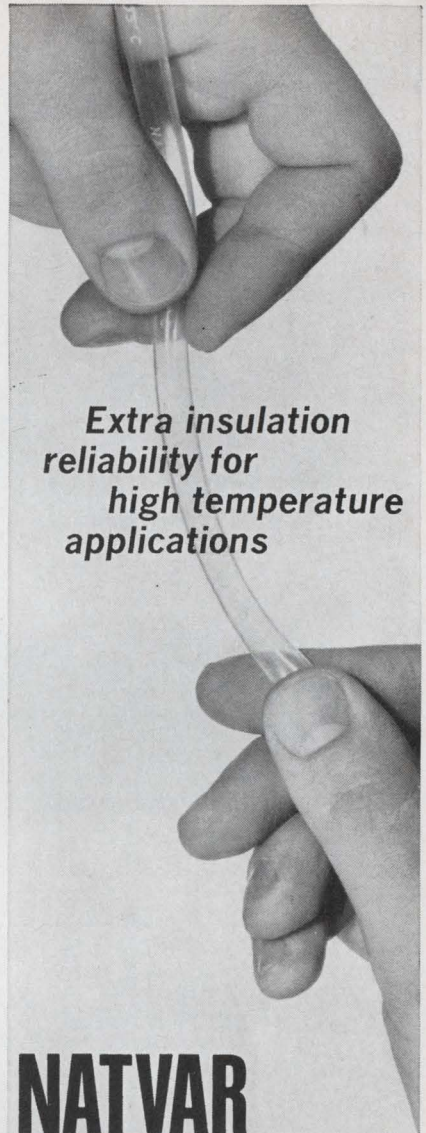

**Extra insulation
reliability for
high temperature
applications**

NATVAR 400 Vinyl Tubing

Here's an insulation you can rely on when the heat's on. Because Natvar 400 vinyl tubing has excellent thermal life. In fact, it's U.L. recognized for 105°C continuous operation. Besides that, it has exceptional resistance to oils.

Use Natvar 400 high temperature vinyl tubing to insulate leads... terminations... wiring... electronic equipment... oil filled transformers... harnesses.

Available in a wide range of sizes and colors—in continuous lengths or cut pieces. Send for FREE samples and complete technical data.

NATVAR CORPORATION
P. O. Box 67, Rahway, New Jersey 07065

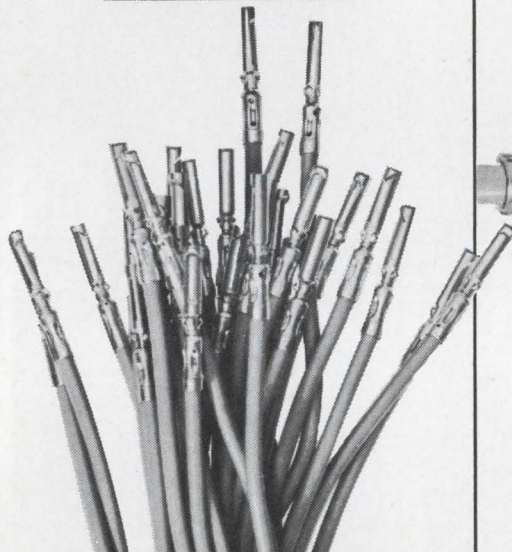
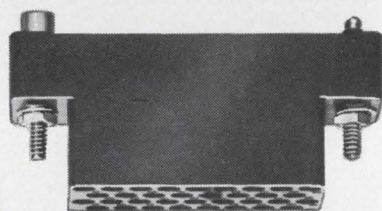
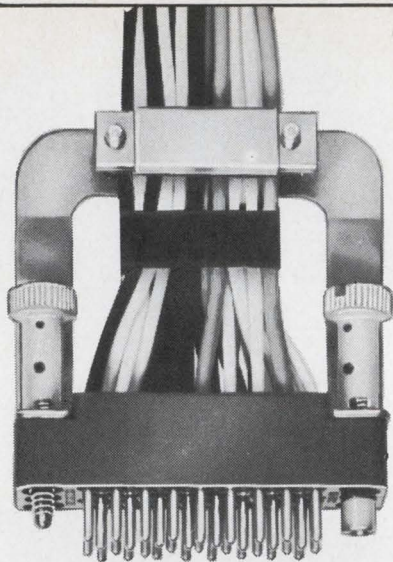

**removable
wire crimp
termination
contacts**

7¢
Complete Set
Both Pin & Socket

**WITH CONTINENTAL'S
SERIES 25 MINIATURE
RACK & PANEL CONNECTORS**



EXCLUSIVE 3-TINE TENSION SPRING CLUTCH

Now, high quality contacts you can depend on and still stay within your budget requirements. Only seven cents a contact set (in quantity) provides you with a choice of .0625 or .040 pin diameters, closed entry cartridge on socket and gold plated phosphor bronze material. Series 25 plug and socket connectors are available with 7, 9, 14, 18, 20, 26, 34, 42, 50, 66, 75 and 104 contacts.

Complete specifications and information are contained in our Series 25 catalog. Write for your free copy today. Phone sales department (212) TW 9-4422 for immediate action on quotations and catalog. Microminiature Series MMM also available.

APPLICABLE MIL SPECS

CONFORM TO MIL-C-22857

MS No.	CCC No.
MS17803-16-20	2500-P6A20
MS17804-16-20	C2500-S6A20
MS17803-16-16	2500-P6A16
MS17804-16-16	C2500-S6A16

For the Sales Representative Nearest You, See Our Listings in EEM and VSMF Directories.

CONTINENTAL  CONNECTORS

CONTINENTAL CONNECTOR CORPORATION ■ WOODSIDE, NEW YORK 11377

Expand your counter range

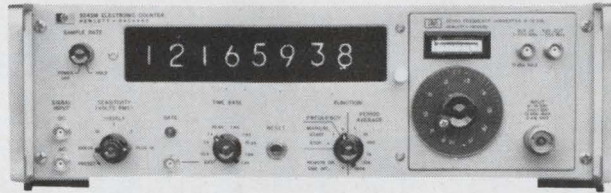

Again

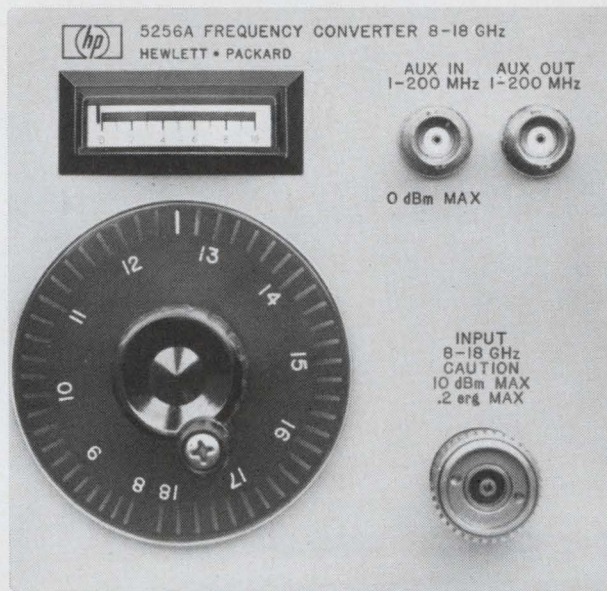

Usefulness of the Hewlett-Packard counters that accept front panel plug-in accessories reach new frequency heights with the 5256A Frequency Converter plug-in. Now you can make measurements from 8-18 GHz with speed, simplicity and highest resolution... another result of HP's continuing efforts to augment the versatility of your HP plug-in counter. (Models 5245L, 5245M, 5246L, 5247M)

The 5256A gives 1 Hz resolution in a 4-second counter gate interval (or 10 Hz in 0.4 sec., 100 Hz in 0.04 sec., etc.). It's therefore 15 to 250 times faster than manual or automatic transfer oscillators, assuming equal resolution.

Easy to use. Turn the 5256A dial upwards from the lower end until the front-panel tuning meter enters the green area, and add the dial reading (8 to 18 GHz) to the counter's display. There are no spurious responses in the 5256A, and you avoid errors in determining which of several indications is true.

The counter is automatically gated when the 5256A is properly tuned, and recycles if the input signal drops out. Unskilled people can use it quickly, and with confidence.

The 5256A also serves as a prescaler for automatic measurement and direct readout of frequencies from 1 to 200 MHz with a sensitivity of 5 mV. It also can be used as a down-converter to extend the range of low-frequency instruments to 18 GHz. Sensitivity is 100 mV; input impedance is 50 ohms nominal. Price: Model 5256A, \$1750.

Complementing the high resolution of the 5256A are two new HP counters, the Model 5245M and 5247M: short-term stability: 5×10^{-11} (rms) per second, long-term stability 5×10^{-10} per day, rapid time base warm-up.

For more information call your local HP field engineer or write Hewlett-Packard, Palo Alto, Calif. 94304. Europe: 54 Route des Acacias, Geneva.

HEWLETT  PACKARD

ELECTRONIC COUNTERS

New lower-cost way to make flat wiring systems

Make them modern
with heat-sealable
Scotchpak[®] polyester film...
BRAND
tough, flat and flexible

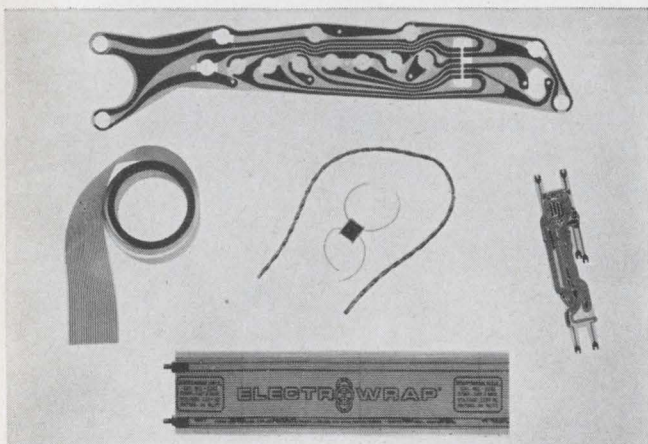
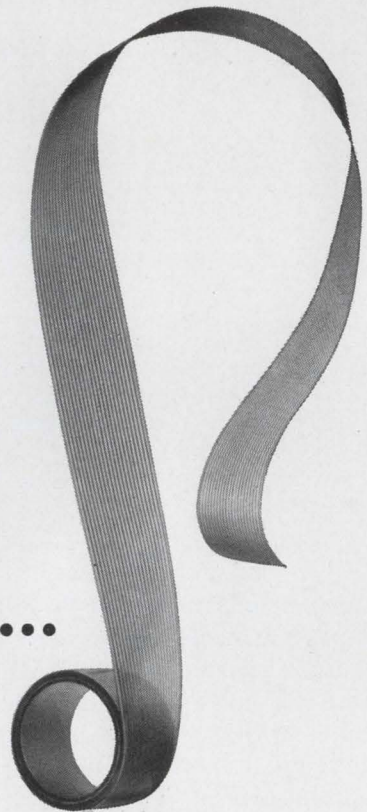

Typical Applications: Pipe and tank-heating cable by Electro-Trace Corp.; printed circuit panels made by firms such as Flexible Circuit Corp.; flat cables by Tape Cable Corp.; and a variety of other uses including coil covers and wire wrap.

"SCOTCHPAK" film laminates easily — like a thermoplastic. And since it is a polyester, it is exceptionally strong... chemically resistant... with high dielectric properties. It's available in various types and thicknesses — probably one just right for your needs. Enables you to make cables that easily follow unusual contours... that lie flat... take up minimum space. Printed circuits that flex... but don't snap. A market potential estimated at over \$100 million by 1970!

Interested? For more information, write: Film & Allied Products Div., 3M Co., 2501 Hudson Rd., St. Paul, Minn. 55119, Dept. ICL-107.

3M
COMPANY

SCOTCHPAK IS A REG. T.M. OF 3M CO.



This is a multi-contact connector. Type MS-M. It works with standard, subminiature and twisted pair contacts.



This means versatility. And using one block insures uniform shop instructions; quality controls.

That saves time and money. For extra safety add polarizing guides, jack screws, strain relief hoods and pin protect-ing skirts.

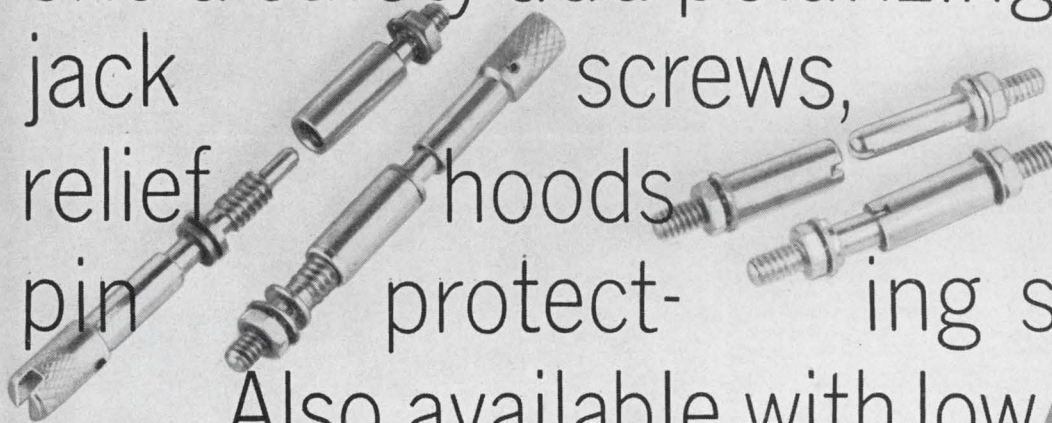

Also available with low cost formed contacts.



Get the complete story. Write for your new MS-67 catalog.



NORWALK, CONNECTICUT
INTERNATIONAL SALES HEADQUARTERS AND MANUFACTURING FACILITIES:
CANADA: Scarborough, Ontario / ENGLAND: St. Helens, Lancs. / BELGIUM: Mechelen
MEXICO: Naucalpan de Juarez / BRAZIL: Sao Paulo / JAPAN: Tokyo / Sales Offices in Other Major Cities.

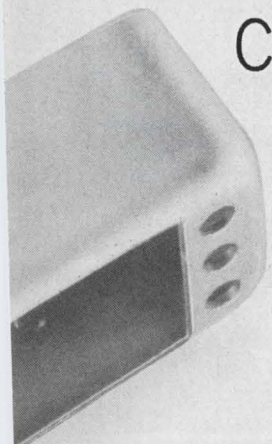

AC BREAKDOWN TESTERS Model PA Series

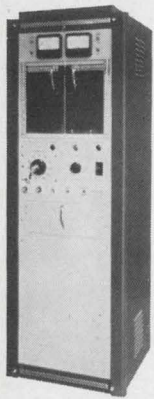

Type PA variable high voltage AC breakdown testers are designed to meet the requirements of ASTM specification D-149, and Federal specification LP-406, Method 4031, as well as all general purpose breakdown testing. Provided with motor-driven control of output voltage with any desired rise of secondary voltage. Available with wide variety of testing jigs.

PA-5-152	15,000 V. rms. 2KVA
PA-5-155	15,000 V. rms. 5KVA
PA-5-252	25,000 V. rms. 2KVA
PA-5-255	25,000 V. rms. 5KVA
PA-5-502	50,000 V. rms. 2KVA
PA-5-505	50,000 V. rms. 5KVA
PA-50-1005	100,000 V. rms. 5KVA

For even greater versatility, dual range units using multiple winding transformers are available on order. These provide two meters and a total of six scales. Typical dual-range models as follows.

PA-5-252/052	25 kv or 5 kv rms. 2KVA
PA-5-502/102	50 kv or 10 kv rms. 2KVA
PA-50-5010/1510/510	50 kv or 15 kv or 5 kv rms. 10KVA

ARC-RESISTANCE TESTERS Model ART Series

Model ART series arc resistance tester is supplied in conformance with ASTM Spec. D-495-56T and Federal Spec. LP-406, Method 4011.2. Unit is employed for the measurement of insulating materials ability to withstand high voltage, low current arcs.

The Model ART-1 has the following steps: 10/8, 10/4, 10/2, 10, 20, 30, and 40. The 10/8 means that a 10 ma arc is applied for 1/8 of a 2 second cycle in one 1/4 second period. The 10/4 means that a 10 ma arc is applied for 1/4 of a 2 second cycle in two 1/4 second periods, etc. The 10, 20, 30, and 40 ma arcs are sustained for 60 seconds. The stepping is automatic at one-minute intervals. On manual operation all steps are available for any time duration.

Model ART-2 provides additional arc intensities of 60, 80, and 100 ma. It also includes metering facility for the volts after tracking measurement.



HIGH-VOLTAGE SCHERING BRIDGE Model PS Series

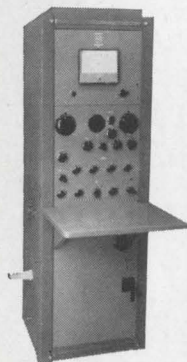

Used to measure dissipation and capacitance of electric insulating material while subjected to high-voltage stress. From these two measured values and the dimensions of the sample and test electrodes, dielectric constant, loss factor, and other values may be calculated.

Exceptionally wide capacitance range Model PS-1GP general purpose bridge from 0.0000025 to 1.0 mfd. Model PS-1C cable bridge from 0.0000025 to 2.0 mfd • Built-in shunts for testing large capacitances without additional equipment • High voltage operation . . . materials can be tested at operating value • Easy-to-operate . . . all controls located on front panel. Few calculations required • High accuracy . . . plus or minus 0.2% capacitance accuracy and 2.0% or better tangent accuracy • Compact design . . . general purpose bridge housed in one unit. Cable bridge housed in one unit with separate air capacitor and power supply.

WIDE-RANGE MEGOHMMETERS Model L Series

Designed for laboratory and high speed testing of motor and transformer winding insulation, cable insulation, high value resistors, capacitor insulation, and for the measurement of surface and volume leakage of insulating materials. Meets requirements for testing insulation resistance in accordance with ASTM D-257, and Federal Spec. LP-406B, Method 4041. Models L-6B and L-7 feature continuously variable, built-in voltmeter for accurate setting.

Model	Voltage TEST	RANGE		POWER Consumption
		Low	High	
L-4A	200 and 500 fixed	1 meg. 2.5 meg.	100,000 meg. 250,000 meg.	50 Watts 80 Watts
L-6B	100 to 600	1 meg.	100,000 meg.	75 Watts
L-7	100 to 600	1 meg.	5x10 ¹³ ohms	



TRACKING AND EROSION RESISTANCE TEST SET TERT-1

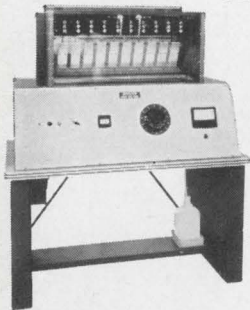

Evaluates relative track and erosion resistance of various materials using Liquid Contamination Inclined Plane method described in ASTM and IEEE specifications. Test represents service exposure evaluation of wide range of insulated material subject to AC surface current. Test conditions simulate water film on insulation surface in which ionizable and other contaminants may dissolve. Contaminant rate easily controlled to simulate different service stresses and outside conditions. Tests conducted on 2" x 5" specimen; actual test covers 1" x 2" track area. Test criteria is either "time to track a fixed distance at a fixed voltage," or "voltage to initiate tracking" — depending on specific service requirement evaluation.

NEW CONVENIENCE FEATURES

- (1) Large clear chamber for sample observation accommodates up to 10 testing stations.
- (2) Regulated power supply delivers test voltages up to 7.5 Kv.
- (3) Straight forward operation offers ease of set up and test control.
- (4) Separates all grades of insulating material.

DIELECTRIC BREAKDOWN TESTER Model PDA-1

Designed to provide simple, safe, accurate means of determining dielectric strength and breakdown voltage in the laboratory or factory (conforms to requirements of ASTM specifications D-149 and Federal specification L-P-406 method 4031).

- Push button selection — four different leakage current meter ranges (six operating modes) — enclosed test cubicle, fail-safe circuitry, interlocked doors and oil immersed gravity-drop shorting switch allows safe use by unskilled personnel.
- Continuously adjustable (automatic or manual) test output voltage control uses full 100% rotation to allow fine control for critical testing (choice of AC or DC).
- Provides for transient suppression and introduction of non-linear resistance into transformer.
- Maximum versatility of test jig set-up using plug-in jigs or high voltage cable to external "hi-pot" testing circuits.
- Self contained unit — portable yet provides easy access to all parts for maintenance.

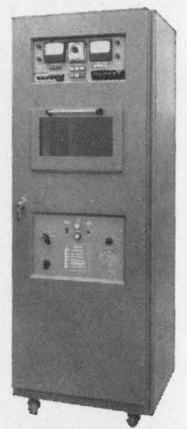

The Beckman line of instrumentation for the evaluation of insulating properties is the most comprehensive in the industry. For complete specifications or assistance with your application call your local sales engineer or write direct.

Design engineer Bob Alden searched for nearly an hour to find he didn't have the information he needed.

Chances are 10 to 1 he'd have found it in less than 5 minutes in the new Sweet's Industrial Information System*

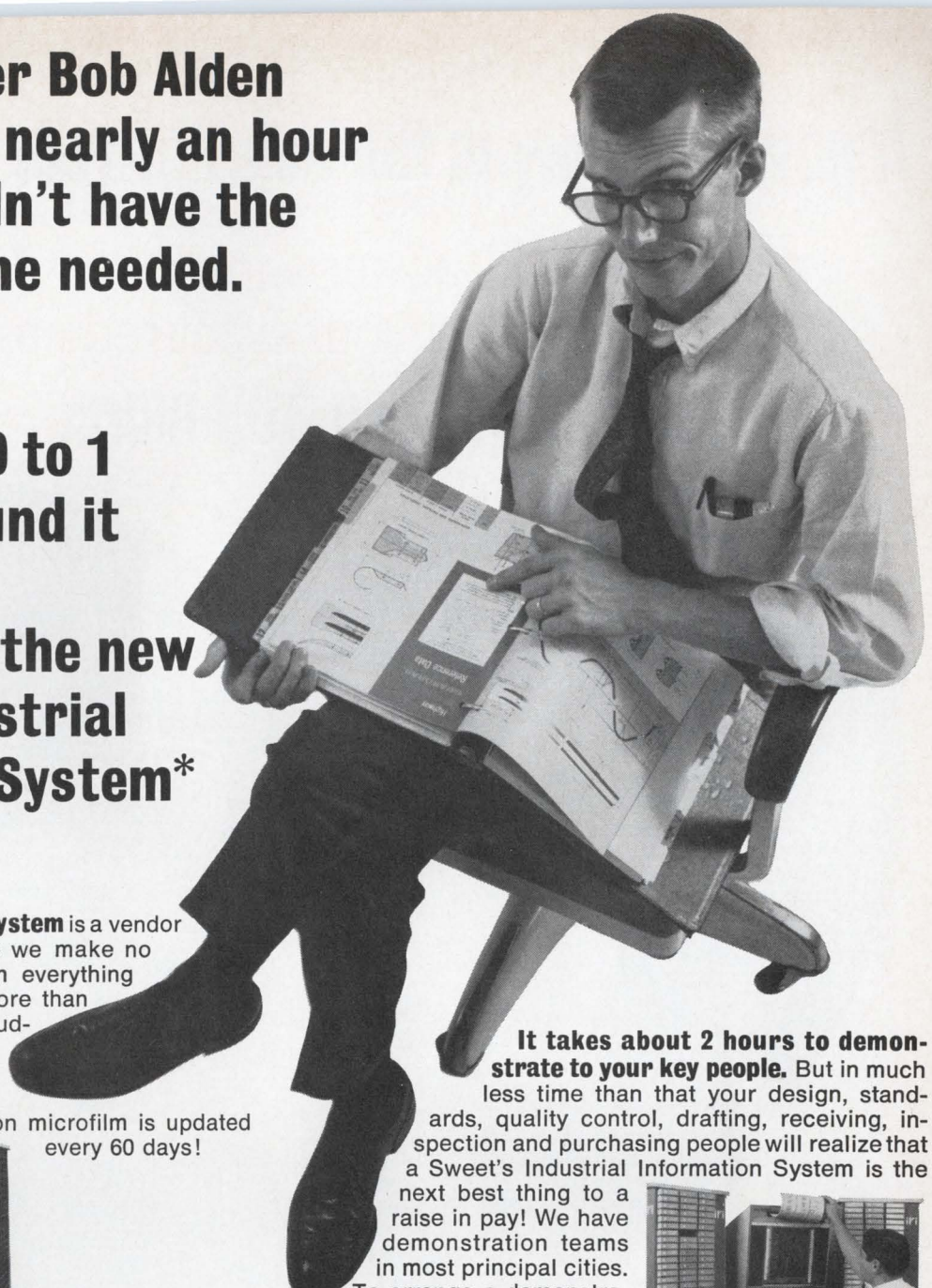

Sweet's Industrial Information System is a vendor catalog file on microfilm. Because we make no charge to vendors, and microfilm everything they have in print, Sweet's has more than 600,000 pages of vendor data including application notes, reliability tests, price lists and names of distributors and reps. What's more, the Sweet's vendor catalog file on microfilm is updated every 60 days!

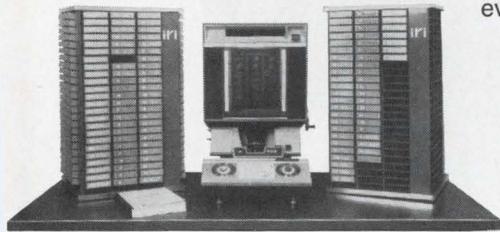

Small wonder.

In addition, the Sweet's system is tailored to your needs by adding the vendors you want - at no extra cost. We start with a basic file of the most wanted information. Update it regularly, and then—to top it off—"personalize" the file by adding the complete vendor information you request. It also reduces storage area by 98%, cuts redundancies in design efforts and increases sources and use of standard items.

You can install a Sweet's vendor catalog file on an annual subscription for less than the cost of a file clerk. Sweet's vendor catalog files are in use in plants with as few as fifty employees. The "user-orientated" idea not only provides current knowledge of the component state-of-the-art, but also expedites the purchasing function. Because of its complete coverage, more than 60% of our recent installations have replaced other microfilmed vendor catalog systems.

S Sweet's Industrial Information System

A new McGraw-Hill Information Service

It takes about 2 hours to demonstrate to your key people. But in much less time than that your design, standards, quality control, drafting, receiving, inspection and purchasing people will realize that a Sweet's Industrial Information System is the next best thing to a raise in pay! We have demonstration teams in most principal cities. To arrange a demonstration, send the coupon today, or call collect: George Stevens, (212) 971-3941.

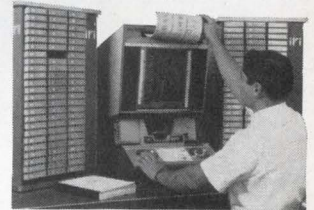

Find it fast. Make a print-out in 6 seconds.

SWEET'S INDUSTRIAL INFORMATION SYSTEM
330 W. 42nd St., New York, N.Y. 10036
Dept. # B-42

- I'd like to see a demonstration of the Sweet's Industrial Information System. Have your representative call me for an appointment.
- I'm not ready for a demonstration at this time, but please send further information.

Name _____ Title _____

Company _____

Address _____

City _____ State _____ Zip _____

Telephone _____ Ext. _____

Number of employees at this location _____

We have have not had experience with a vendor catalog file on microfilm.

In addition to the Vendor Catalog File on microfilm we're interested in Mil Specs Mil Standards

A power supply is the heart of your system

If this NJE power supply
doesn't meet your exact requirements
...we'll show you 309 more.

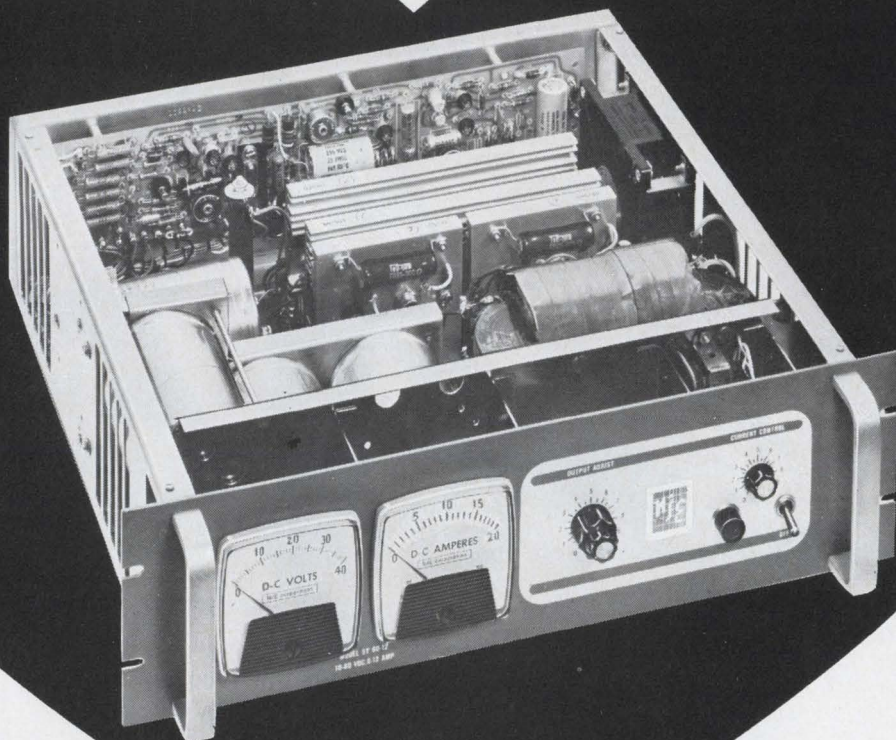

NJE SY 36-20 DC power supply
with output of 10-36 volts.
0 to 20 Amps. $\pm 0.01\%$, Regulation,
1 mv RMS ripple — **Price \$465.**

One of our 310 models is sure to be exactly what you need... no matter if it's a lab rack, full rack, half rack, or modular DC power supply. Fact is, we offer you the widest line of power supplies on the market today—voltage and/or current regulated, system "wide slot," regulated or semi-regulated characteristics, high-voltage DC, regulated high voltage, and frequency converters.

Our wide line also means savings. Using it as your single source for power supplies makes you eligible for volume discounts. (You don't have to buy large quantities of one model to get these discounts.) Your local NJE factory-trained representative will give you complete details.

For technical assistance or a free catalog on all 310 NJE power supplies, write or call today.

NJE CORPORATION
Electronic Development & Manufacturing
Kenilworth, New Jersey 07033 / (201) 272-6000
TELEFAX: FFP • TWX: (710) 996-5967

A SUBSIDIARY OF  CORPORATION

315

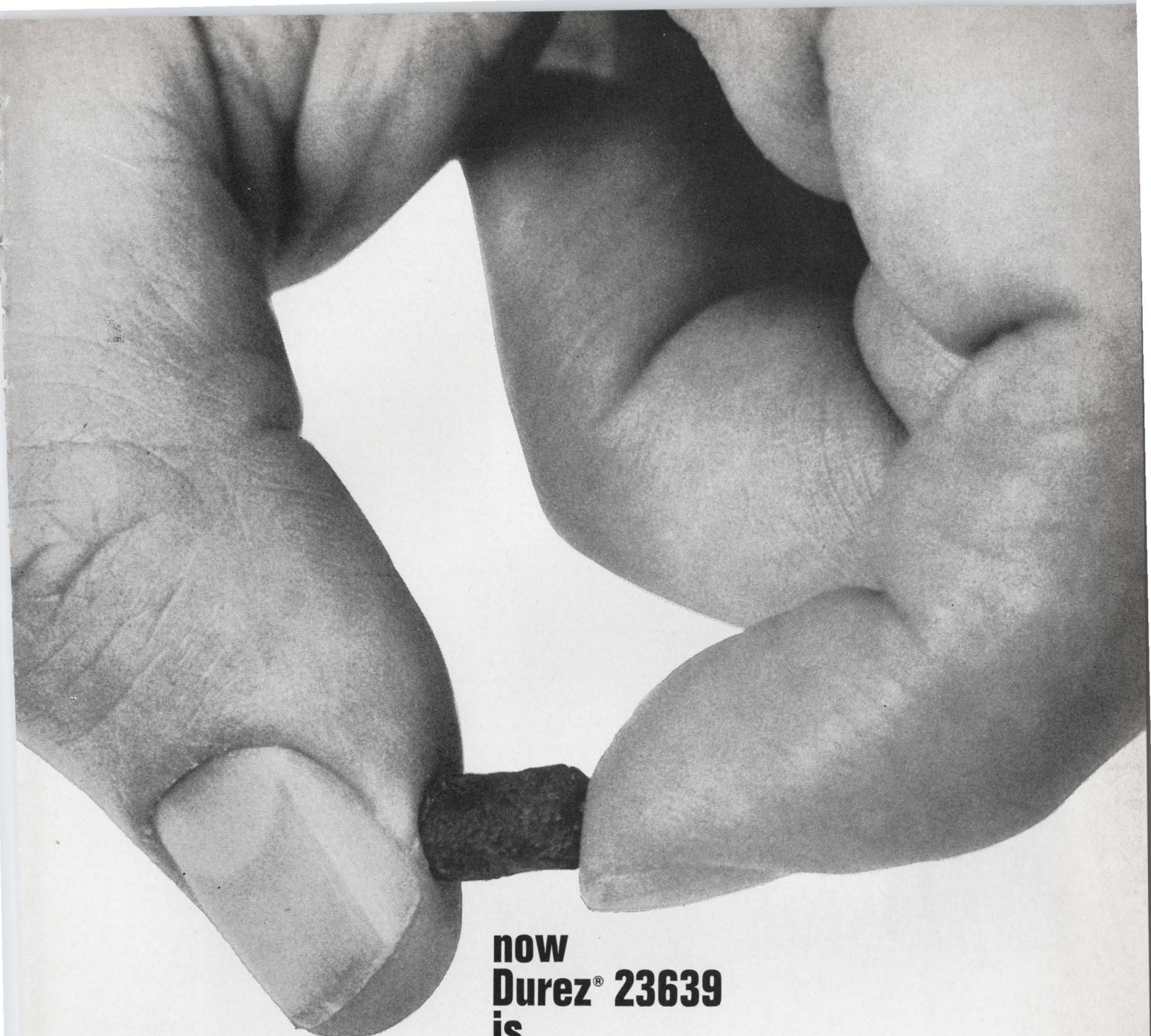

now
Durez® 23639
is
nodular



**for high-speed molding
of electrical parts.**

We have put all the high-impact resistance, heat resistance, and dimensional stability of Durez #23639 phenolic molding compound into a new, nodular form.

Durez #23639 nodular is particularly suited to the latest types of high-speed, screw-type molding equipment, and also greatly facilitates automatic preforming.

We particularly recommend it for such applications as automotive parts and heavy-duty industrial switches.

If your job calls for brown parts, rather than black, you can get the same high-quality performance by specifying Durez #23727 in nodular or flake form.

For complete data on these two members of the Durez family of high-grade molding compounds, please write Durez Division, Hooker Chemical Corporation, 9010 Walck Rd., No. Tonawanda, N.Y. 14120.

 **hooker**
durez DIVISION

Circle 159 on reader service card

Authoritative. Accurate. Current.

Computer programming makes its entire contents as current as the week it went to press.

Comprehensive. 2,000 pages, 126,000 items. Including a complete list of trade names.

Easiest to use. Organized for speed. Locate

products and their sources in one reference.

In wide use. An industry standard. Makes phone to phone discussions more efficient.

Valuable. EBC can help you save time. Make more profit for your company. Meet deadlines. Improve products. Use it often.

Electronics Buyers' Guide

A McGraw-Hill Market Directed Publication, 330 West 42nd Street, New York, N. Y. 10036

integrated product listings—
product sources and specifications in the same section.

color coded readouts—
yellow section for product, green section for manufacturers and trade names.

coming this fall...

The Black Box Explosion

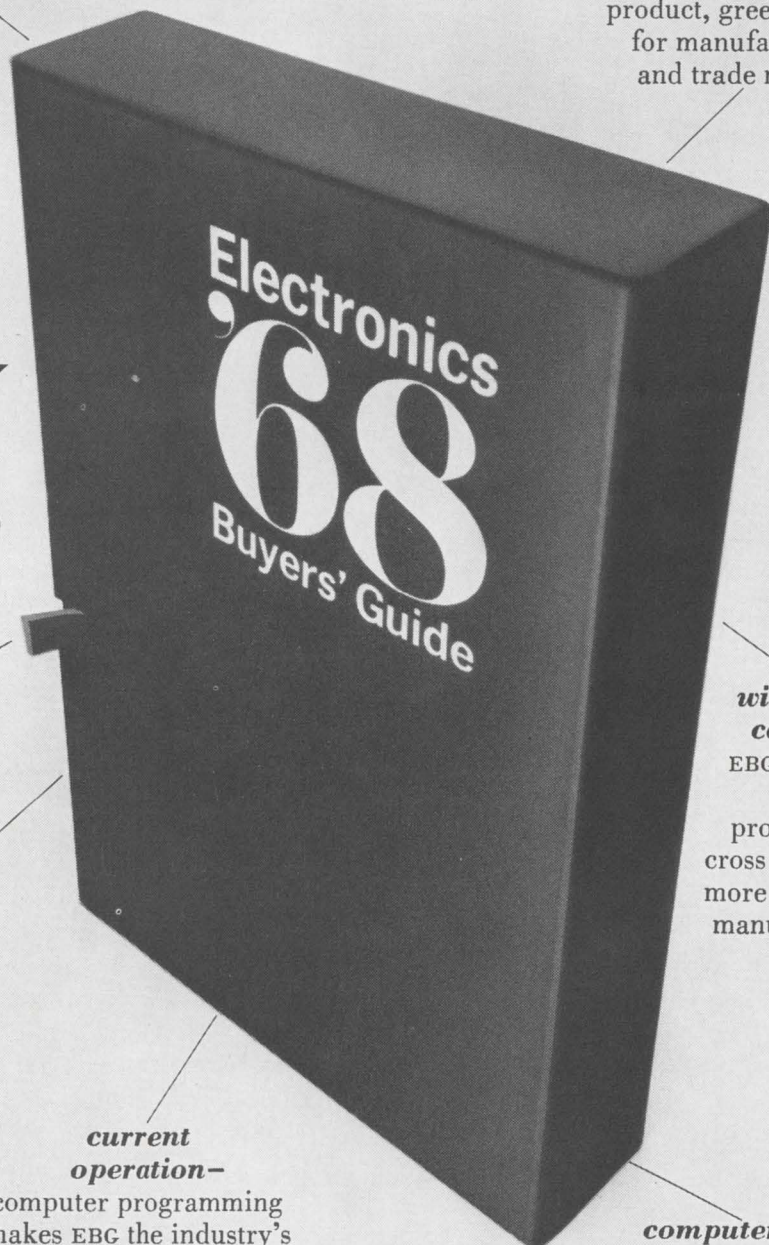

pull here

shelf mounting—
keeps an entire industry within arms length.

current operation—
computer programming makes EBC the industry's most up-to-date directory.

wide band coverage—
EBC lists over 4,000 products and cross references: more than 6,000 manufacturers.

computerized dimensions—
computer programming provides cross references, eliminates duplication.

Accurate coax power measurements to 18 GHz?

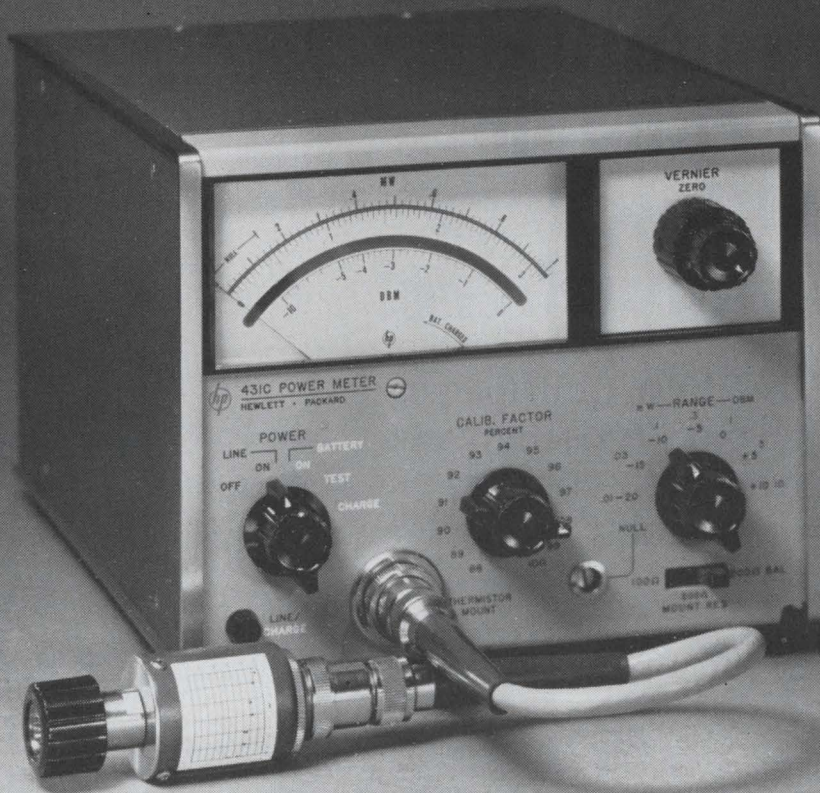

Absolutely!

Here's a new thermistor mount that lets you measure power in coax systems all the way to 18 GHz, the widest microwave frequency coverage available with a single mount. Use the new 8478B Coax Mount with the HP 431C Microwave Power Meter... and be sure of absolute accuracy. All sources of error are accounted for.

Low SWR and high efficiency of the mount combine with the high precision of the 431C to give you high—and known—overall accuracy. For maximum absolute accuracy in power measurements, apply the NBS-traceable Calibration Factor and Effective Efficiency data individually imprinted on each mount. Just set the 431C Calibration Factor control to the

percentage called for on the mount, and your meter reading is automatically normalized. No calculations required. Meter zeroing is easy with a unique balanced-biasing feature in the mount, which keeps bias signals out of the coax system. As with other thermistor mounts for the 431C (coax and waveguide), the 8478B is temperature-compensated for high stability. And all mounts are delivered with efficiency data.

The importance of mount efficiency is described in HP Application Note 64... yours for the asking. For the application note and complete information on the 431C and new 8478B, call your HP field engineer or write Hewlett-Packard, Palo Alto, Calif. 94304; Europe: 54 Route des Acacias, Geneva.



Major specifications:

431C Power Meter

Range: $10\mu\text{W}$ (-20 dBm) to 10 mW ($+10\text{ dBm}$) full scale in 5 dB steps.
Accuracy ($+20^\circ$ to $+35^\circ\text{C}$): $\pm 1\%$ f.s., $100\mu\text{W}$ range and above; ($\pm 1.5\%$, $30\mu\text{W}$; $\pm 20\%$, $10\mu\text{W}$ range) (0° to $+55^\circ\text{C}$): $\pm 3\%$ f.s., all ranges.
Calibration Factor Control: Normalizes meter reading for mount efficiency; range 100% to 88% in 1% steps.
Zero carryover: $< 1\%$ of full scale when zeroed on $10\mu\text{W}$ range.
Price: \$475.

8478B Coax Thermistor Mount

Freq. Range: 10 MHz to 18 GHz.
SWR: See chart.
Mount calibration: Calibration Factor and Effective Efficiency furnished at 7 frequencies between 10 MHz and 18 GHz, NBS-traceable.
RF Connector: Type N male; also available with APC-7 precision 7 mm connector.
Price: \$275; Option 11, APC-7 connector, add \$25.

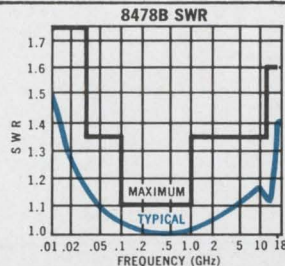

Other HP thermistor mounts for the 431C Power Meter

Coax: 478A, 0.01-10 GHz, \$155.
Waveguide: S486A, 2.6-3.95 GHz, \$195; G486A, 3.95-5.85 GHz, \$180; J486A, 5.3-8.2 GHz, \$170; H486A, 7.05-10.0 GHz, \$165; X486A, 8.2-12.4 GHz, \$145; M486A, 10-15 GHz, \$225; P486A, 12.4-18 GHz, \$195; K486A, 18-26.5 GHz, \$300; R486A, 26.5-40 GHz, \$375.

04705

...and another MTOS first

the only monolithic 16 channel random access multiplexers available...anywhere!

The MEM 5015 is the **first** multiplexer with address storage and decoding capability and the **first** with voltage and current mode operation.

MEM 5015 Random Access Multiplexers \$198⁰⁰ each*

OTHER FEATURES:

- **Exclusive Differential Mode . . .** permitting multiplexing of eight differential signal pairs
- **Expandable . . .** to permit larger multiplexing arrays
- **Low Power Consumption . . .** 80mW (total)
- **Low Leakage . . .** less than 2 nA per channel
- **Zero Offset Voltage . . .** not possible with bipolar switches

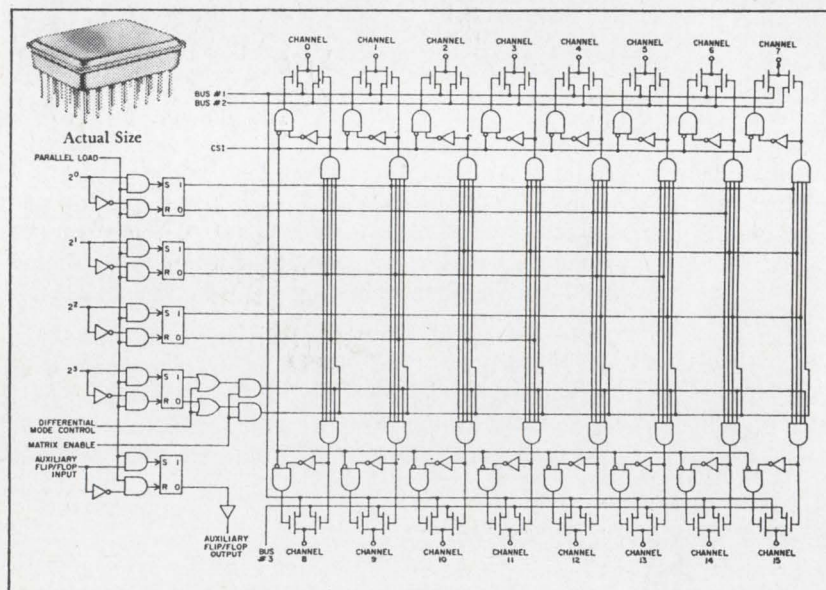

General Instrument's MEM 5015 is the newest complex integrated circuit available in the rapidly expanding line of MTOS firsts. It is a monolithic MTOS Large Scale Integrated Circuit containing 223 P-channel enhancement mode transistors on a chip 77 x 74 mils operating as a 16 channel randomly addressable multiplexer. The unit consists of four address holding flip-flops, a "four-in/sixteen-out" decoding matrix, 16 single-pole-double-throw switches, and some auxiliary logic for increased versatility. A Current Shunt Inhibit control line permits the selection of Current Mode or Voltage Mode multiplexing, while the Differential Control allows the switches to operate as eight ganged pairs. A Matrix Enable line allows multiple MEM 5015s to be connected to form larger multiplexing arrays.

The MEM 5015 is in a 40 lead hermetically sealed in-line package which can be soldered to a printed circuit board or used with a 40 pin socket. They're available off-the-shelf from your authorized General Instrument Distributor. In Europe, contact General Instrument Europe, Via Turati 28, Milano, Italy. Write for complete data.

*in quantities of 100





Our abrasion-resistant TFE wire keeps on flying after others call it quits.

Keeps flying up to 12 times longer, as proved in use on six leading types of commercial and military jets. Reason? It's 100% more abrasion resistant than other airframe wires. Because it has a tough insulation core of mineral-reinforced TFE bonded between pure TFE layers.

Our wire also averages 50% smaller in diameter and 60% lighter in weight than comparably rated wires. It can operate continuously at 500°F and remain tough at -450°F. It's nonflammable, nonhygroscopic, highly resistant to chemicals, has optimum dielectric properties and good flexibility.

Right now, it's reducing wire replacements in aviation, mining, refining, ground transportation and railroad equipment manufacturing. It can do the same for your application. For a free test sample and further data, write: ITT Wire and Cable Division, International Telephone and Telegraph Corporation, Clinton, Mass. 01510.

WIRE AND CABLE **ITT**

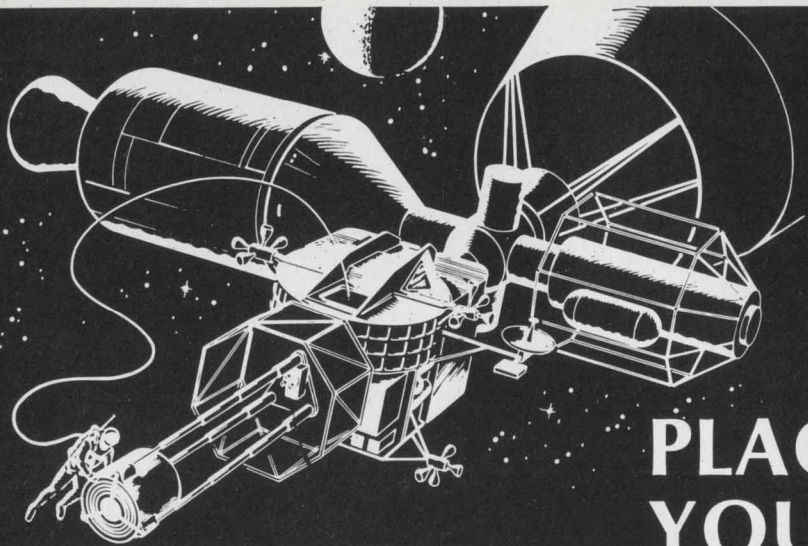

PLACING YOUR WORK IN ORBIT

... is exactly what you will be doing at American Science and Engineering. At AS&E we design and supply scientific payloads for NASA rockets, satellites, and manned orbiting vehicles.

We're a small (slightly over 400 employees), spirited organization; performing dynamic, challenging assignments including the Apollo Telescope Mount, the X-ray Explorer Satellite, the Orbiting Solar Observatory, and Aerobee Rocket Payloads.

To participate in our present and future programs, we currently have openings for:

SENIOR SCIENTISTS-SPACE SCIENCE

To engage in current research programs in x-ray astronomy and space research as scientific investigator. To contribute to the concept and design of future experiments and the design, calibration of instruments, and the analysis and publication of the scientific data. Ph.D. in Physics with or without additional experience.

SENIOR SYSTEMS ENGINEERS

EE or Physics degree required. Must have heavy background in airborne data systems including PCM and FM-telemetry, digital logic design, and spacecraft integration for a minimum of seven years. Must also have had supervisory responsibility.

SENIOR ELECTRONICS ENGINEERS

To assist the project engineer in coordination of project activities and to assume complete design responsibility in specific areas. Must have five to ten years' experience in the design of digital and analog equipment. BSEE required, MSEE desired. Logic and circuit design experience necessary. Experience must also include the supervision of junior engineers.

SENIOR MECHANICAL ENGINEERS

To design aerospace structures, mechanisms, and optics. Must have a BS or an MS degree and at least five years' design experience in these fields.

SENIOR GSE ENGINEERS

Senior Engineers for Ground Support Equipment in new program. Define GSE requirements for in-house system, subsystems test and full operations. BSEE or ME with minimum of 5 years' experience in GSE for electronic systems.

SENIOR RELIABILITY ENGINEERS

To review contract specifications for reliability requirements, perform reliability predictions, conduct circuit stress analysis program, perform design reviews on electronic equipment. Will prepare reliability program plans and be responsible for reliability requirements on project level. BSEE or Physics required. MS desired and at least 6 years' engineering experience which includes 2 years of reliability engineering and component applications and specifications.

DOCUMENTATION SPECIALISTS

Schedule, coordinate, write and edit all contract documentation, reports, etc. Assist in proposal writing. BS Engineering or English with experience in report writing.

SPECIFICATION ENGINEER

Prepare electrical and mechanical systems specifications for instrumentation and related support equipment. Minimum 5 years' related experience with knowledge of NASA Specifications.

If you are interested in these opportunities, please send your resume, in confidence, to:

Mr. Charles J. Clark



**AMERICAN SCIENCE
and ENGINEERING**

11 Carleton Street Cambridge, Massachusetts 02142

An Equal Opportunity Employer.

**if you could
find a more
stable
polyester film
you'd use
it.**



right?

Users report a measurable stability advantage with Celanar polyester film. In printed circuits Celanese polyester film means less shrinkage—hence a more reliable circuit.

Celanar has other substantial advantages, too. Its tensile (pull) strength is 30% stronger than other films. And Celanar film is the cleanest, freest from contamination, in the industry. We produce Celanar in a "White Room" where air filtration systems effectively trap dirt specks as tiny as 0.3 microns—infinitesimal as the point of a needle.

What's more, we lean over backwards to supply

Celanar film in the roll lengths, widths and gauges most convenient for you. Ship it with temperature recording flags, even impact recorders where necessary, to assure your receiving quality as high as we produce.

Those are reasons why major automotive manufacturers use Celanar film for under-the-dash printed circuitry.

And why you should know the full facts about Celanar film. All it takes is a letter to: Celanese Plastics Company, Dept. 133-J, P. O. Box 629, Linden, New Jersey 07036.

Celanese® Celanar®



CELANESE
PLASTICS COMPANY

Celanese Plastics Company is a division of Celanese Corporation.

±0.05% regulation is only one of twelve outstanding specs in Helipot's exclusive new microcircuit dc voltage regulator series.



MODEL 803 DC Voltage Regulator, one of a complete family of six miniature, hybrid cermet thick film units with outputs from 3 to 32 volts.

The other eleven:

- short circuit proof models
- small size—0.5 sq. in.
- low profile—0.170"
- up to 5 amps load current
- output range—3 to 32 volts
- fixed and adjustable outputs
- fully sealed
- hybrid cermet construction
- operating temperature range: -55°C to +125°C
- 60 db ripple rejection
- mil spec tested

The applications:

Helipot Series 800 DC Voltage Regulators are physically compatible with dual in-line and flat pack integrated circuits. This permits system use of unregulated power with precise regulation at the point of use. In addition to the 1,000:1 ripple rejection capability, these units provide excellent circuit decoupling and protection from transients and sudden power surges.

	Application		
	Digital Circuits 3 to 9 Volts	Analog Circuits 9 to 21 Volts	Airborne and General Purpose Circuits 20 to 32 Volts
Fixed Output	Model 805 Reader Service No. 491	Model 801 Reader Service No. 492	Model 803 Reader Service No. 493
Adjustable Output	Model 806 Reader Service No. 494	Model 802 Reader Service No. 495	Model 804 Reader Service No. 496

The price:

- \$30.00—fixed output models
- \$35.00—adjustable output models

(prices are 1-9 quantity, delivery from factory stock)

Ask your local Helipot sales representative for information or circle the appropriate number on the reader service card.

Beckman®

INSTRUMENTS, INC.
HELIPOT DIVISION

FULLERTON, CALIFORNIA • 92634

INTERNATIONAL SUBSIDIARIES: GENEVA; MUNICH; GLENROTHES, SCOTLAND; TOKYO; PARIS; CAPE TOWN; LONDON; MEXICO CITY

New Products

New instruments

Oscilloscope shows doctors waveforms in living colors

Three or more biopotentials can be monitored by Japanese scope that separates waveforms by new system of color coding

Color coding, used extensively in equipment ranging from bulletin boards to x-y plotters, is now being adapted to medical diagnosis and surgery.

The problem in using cathode-ray-tube displays in this area has been the difficulty doctors and their technical assistants have encountered in distinguishing between several superimposed waveforms. Separation of such waveforms as electroencephalograms and electrocardiograms on individual horizontal bands of the tube might be better than superimposing them, but it complicates the correlation of the waveforms and makes for inefficient tube-area utilization.

Japan's Kobe Industries Corp. sees a way out of the problem with an oscilloscope that will show three waveforms—and sometimes more—superimposed but in different colors. The oscilloscope is designed around the Colornetron-type single-gun color crt developed by the company for small-screen, transistor color television [Electronics, May 31, 1965, p. 81].

Kobe Industries hasn't yet gotten production levels up—and price down—to warrant use of the crt in competitively priced color tv sets; it's estimated that this would require a unit price to the manufacturer of under \$30. But company officials claim that markets in special-purpose oscilloscopes and systems are opening up for the tube.

I. Switching grid

Design of the tube makes it especially suitable for portable equipment with transistor circuits. The single-electron gun, efficient use of beam electrons, and post-deflection focusing keep both high-voltage and sweep power requirements moderate. Deflection components, in fact, can be those used for black-and-white tv.

Single-gun design eliminates convergence problems, Kobe says, and the vertical-color-strip characteristic of Lawrence-tube design eliminates most problems of mis-registration caused by the earth's magnetic field.

The tube has a color switching grid of 0.1-millimeter wires with center-to-center spacing of about 0.3-mm. The number of color strips is exactly double the number of grid wires. Since the viewing area of tube face is about 16 mm wide by 12 mm high, there are about 530 color strips—265 blue, 133 green, and 133 red.

In focus. Alternate wires of the color switching grid are connected to opposite terminals of the driving circuit. Between any two grid wires is a center color strip—blue for this tube—that is excited by the electron beam when both halves of the color switching grid are at the same potential. The green strips are under one set of the alternate grid wires, and the red under the other. The proper voltage

and polarity between alternate grid wires deflect the beam and focus it on either green or red color strips.

The capacitance between the two sections of the color switching grid, approximately 700 picofarads, draws a high reactive current when the grid is switched at the 3.58-megahertz frequency required for dot-sequential color tv, but a reasonably small current at the lower repetition frequencies.

Because magnetic deflection is used, the major disadvantage of this tube for some applications is limited frequency response. This isn't considered a serious limitation in medical electronics, however, or some educational and industrial applications where the waveforms of interest occur primarily at low frequencies.

In Kobe's oscilloscope, the vertical deflection coil has an inductance of 0.1 henry. For full-scale vertical deflection at 50 kilohertz—the high end of the amplifier pass-band—the voltage required across the deflection coil is 141 volts. This is provided by a single-ended push-pull amplifier. The low-frequency response of the oscilloscope extends to d-c.

II. Chopped or alternate

Speed of the built-in sweep is variable from 20 microseconds per division to 1/10 μ sec. External sweeps from d-c to 5 khz can also be used.

Waveforms are displayed by

Bulova can supply the crystal you need



to match your specs!

Many years of supplying crystal control units for the most advanced military and space programs enable Bulova to offer a full line encompassing virtually the entire frequency spectrum—2 kc to 125 Mc for oscillator and filter applications. We can supply every type of packaging—including koldweld and glass sealed. Our military crystals meet latest MIL-C-3098D specifications. All reasons why you should make Bulova your single source of supply.

HIGH PRECISION GLASS SEALED CRYSTALS 1 Mc to 125Mc. Available in vacuum sealed, glass enclosures of the HC-26/U and HC-27/U type.

Example: Precision SSB Crystals

Frequency: 1 Mc to 5 Mc
Holder: HC-27/U
Tolerance: $\pm .0025\%$
from -55°C to $+90^{\circ}\text{C}$, or to specification
Aging: 3×10^{-8} per week after one week stabilization at 75°C

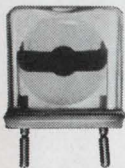

KOLDWELD SEALED CRYSTALS—low aging, high reliability, 1 Mc to 125 Mc. Now available in TO-5, HC-6/U and HC-18/U type cans sealed by the koldweld process to eliminate effects of heat and to reduce contamination.

Example: TO-5

Frequency: 15 Mc to 125 Mc
Tolerance: $\pm .0025\%$ from -55°C to $+105^{\circ}\text{C}$, or to specification
Aging: 1×10^{-7} per week after one week stabilization at 75°C



Write or call for specifications on Bulova's complete line of crystals. Address: Dept. E-17.

BULOVA

FREQUENCY CONTROL PRODUCTS

ELECTRONICS DIVISION OF BULOVA WATCH COMPANY, INC.

61-20 WOODSIDE AVENUE WOODSIDE, N.Y. 11377, (212) DE 5-6000

... waveforms are chopped at 25 khz, displayed as dots of primary colors ...

either dot or field color sequences corresponding to the chopped and alternate sweeps provided in other multichannel oscilloscopes.

In chopped display, the input waveforms are chopped at about 25 khz and displayed as successive dots of primary colors. The highest frequency that can be displayed is about 3 khz, but frequency response extends down to d-c. Phase relationships between input waveforms are preserved, but only one waveform can be synchronized with sweep if inputs are at different frequencies.

Split image. Alternate display allows the utilization of full pass-band to display signals up to 50 khz. Waveforms can be individually synchronized with sweep, but unless the sweep is synchronized from an external trigger common to all three inputs, the phase relationships of the inputs may not be preserved. Alternate sweeps aren't suitable for display or very low frequencies, because individual sweeps will be seen separately rather than superimposed.

It's also more difficult to display more than three colors with alternate sweeps, especially at low frequency, because the two primary colors needed to give composite color when more than three are needed will be seen separately.

Kobe Industries Corp., Kobe, Japan. [338]

New instruments

Watching the waves

Standard strain gage used in improved wave recorder

Recording the ups and downs of waves is becoming important in areas other than oceanography. Marine architects depend on wave recorders to study artificial swells in developing new hull designs. And, since the impact of air waves can be sensed by the same trans-

ducers, spacecraft designers use wave recorders to determine the effects of vibration on the vehicle.

Today's conventional wave recorders use a differential transducer that is mechanically back-loaded by air or a stable oil to compensate for the transducer's operating depth. Consequently readings cannot be obtained rapidly. In addition, these transducers are part of a d-c bridge circuit, which means long-term-drift problems.

No pressure. To overcome these limitations, Alpine Geophysical Associates Inc., has developed a wave recorder incorporating a standard strain gage as the sensing element. This requires no pressurization—it can be electrically balanced. Also, the new instrument operates from an a-c source, which means greatly simplified recorder electronics and improved stability. This design approach enables the instrument to record short-term wave data as well as such long-term phenomena as tides and seismic disturbances of the ocean.

Measurements can be made at any depth to 100 feet without a pressurizing process. The instrument will work with a wide range of strain gages.

Included in the Model 418 electronics is an input balance and quadrature correcting network to permit operation with many pressure transducers.

The depth range switch—0.4, 2, 10, 50, and 100 feet full scale—changes the gain of the input pre-amplifier and electrically balances the transducer. Accuracy is within $\pm 2\%$ except for the 0.4 foot range where it is within $\pm 3\%$. The pre-amplifier is a high-gain, a-c coupled module. Its stability is sufficient to permit tide recordings over a 12-hour cycle. The amplifier handles both the error signal from the quadrature correcting network and the transducer's displacement signal.

The Model 418 can record on magnetic tape or on a paper chart. It will operate from a battery supply or a 115-volt a-c power line.

Alpine Geophysical Associates Inc., Norwood, N.J. [339]

In Making Masks for
Electronic Components...
... there's no
Margin for Error!

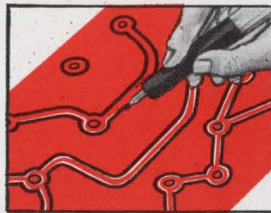

With sharp blade, outline the areas to be masked. Do not cut through the backing sheet. The Ulano Swivel Knife does the job quickly, easily.



Now carefully peel off the film as outlined leaving a completed photo mask, positive or negative, that corresponds exactly to the desired pattern.

THAT'S WHY EXPERIENCED DESIGNERS
AND ENGINEERS ALWAYS INSIST ON...

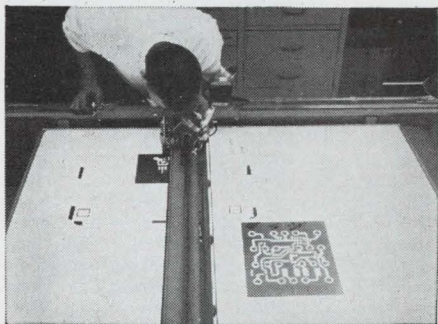

RUBYLITHTM

HAND-CUT MASKING FILM FOR THE GRAPHIC ARTS

THE KNIFE-CUT, LIGHT-SAFE MASKING FILM
LAMINATED TO A STABLE POLYESTER BASE

The most versatile line of hand-cut masking films, including

.0075—RUBYLITH 75 DR* .005 RUBYLITH 5 DR
.005 AMBERLITH 5 DA

These new, thick Ulano films provide the positive answers
where exact register assumes a critical importance.

* Available in sheets only, cut to your specifications.

by

UlanoTM

ulanoTM

610 DEAN STREET, BROOKLYN, N.Y. 11238

NEW YORK • CALIFORNIA • CHICAGO • ZURICH

In Europe: ULANO A. G., Untere Heslibachstrasse 22, Kusnacht 8700, Switzerland

Write on your letterhead for special electronic test kit (no charge) No. 4148

New Components Review

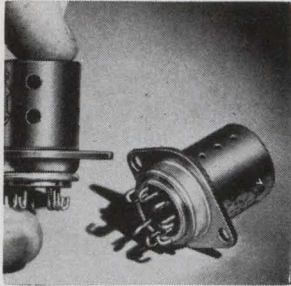

Series LS air-flow switches can withstand vibrations of 10 g to 500 hz and shock loadings up to 50 g at 11 msec. They are suited for use in military aircraft as preventive devices to protect air-cooled mechanical and electronic equipment from overheating. The units are factory set to nominal air velocity from 200 to 1,000 fpm. G-V Controls Inc., Okner Parkway, Livingston, N.J. [341]

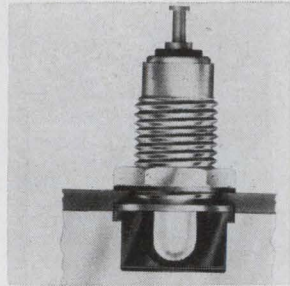

A lamp socket for mounting a T-1 size bayonet-base lamp in edge-lighted instrument panels has an over-all length of less than $\frac{5}{8}$ in., plus mounting centers as close as $\frac{3}{8}$ in. It positions the lamp for maximum lighting efficiency by providing 100% exposure of the lamp filament when installed in panels of $\frac{3}{16}$ in. Western Indicator Co., 1710 N. Potrero, So. El Monte, Calif. [342]

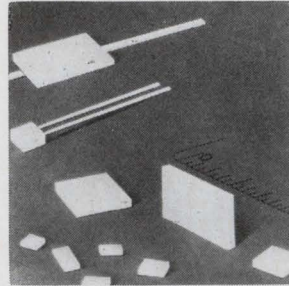

Fixed ceramic capacitors called High K Unicercams come in 17 sizes, the smallest being 0.07 x 0.035 x 0.04 in., and 3 voltage ratings (50, 100, and 200 wvdc). They meet or exceed requirements of MIL-11015C. Insulation resistance is 10^5 megohms- μ f at $+25^\circ\text{C}$. Temperature coefficient is $\pm 15\%$ max for -55° to $+125^\circ\text{C}$. JFD Electronics Co., 15th Ave. at 62nd St., Brooklyn, N.Y. [343]

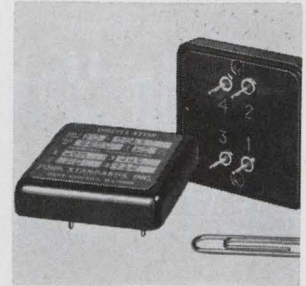

Miniature oscillators using IC's have frequencies as low as 1/10 hz in a case $1\frac{1}{2}$ in. square x 0.600 in. high, for p-c board mounting. Frequency accuracy is maintained from 0° to 65°C . Long-term accuracy is assured by a temperature compensated bimetallic tuning fork operating between 1,000 and 10,000 hz. Fork Standards Inc., 211 Main St., West Chicago, Ill. [344]

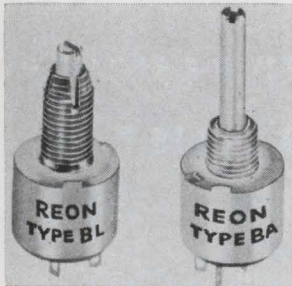

Half-inch-diameter variable resistors with conductive plastic element feature infinite resolution over a 50-ohm to 5-megohm range in sealed units with either standard (type BA) or locking (BL) bushings. Dust-, moisture-, and water-proof to 15 psi, they have an end resistance of less than 5 ohms each end. Reon Resistor Corp., 155 Saw Mill River Rd., Yonkers, N.Y. [345]

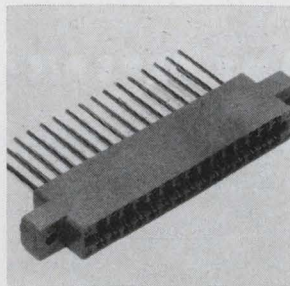

Card-edge receptacle series 6021 has 30 dual-readout or 15 single-readout wire-wrap contacts spaced on 0.156-in. centers. It accommodates a $1/16$ -in. p-c card. The unit is available with simple-cantilever or double-cantilever bifurcated-nose contacts, both rated at 5 amps and made of phosphor bronze with a gold flash over a nickel underplate. Elco Corp., Willow Grove, Pa. 19090. [346]

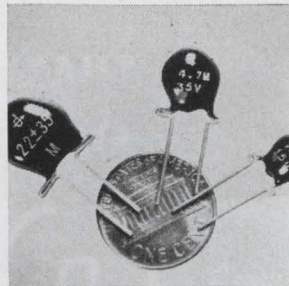

Dipped epoxy, solid tantalum capacitors series G come in 3 case sizes ranging from 0.47 μ f/50 v to 150 μ f/6 v. Maximum moisture protection is offered without costly hermetic sealing. The stand-off lead functions as a stress relief during handling. Prices range from \$1.65 to 32 cents in quantities of 1 to 999. Dickson Electronics Corp., Box 1390, Scottsdale, Ariz. [347]

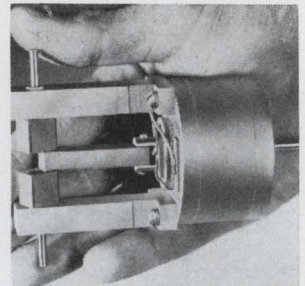

A d-c reciprocating motor consists of a copper-wound piston operating in an annular permanent air gap. The piston connects to a rotating shaft through a push rod and crank, and connects directly to an axial linear shaft. The motor is brushless, and commutated by an electronic circuit. Operating voltage is from 1.25 to 26 v. Mathews Electronics Corp., 312 S. Broad St., Mobile, Ala. [348]

New components

Auto tape recorders headed for improved performance

Glass-filled encapsulant more than doubles life of laminated eight-track stereo head

When Donald Fry, who was general manager of the Ford division of Ford Motor Co. at the time, first came up with the idea of putting a stereo tape recorder in an automobile, most consumer electronics

people were horrified. The automobile is a very hostile environment for electronics equipment and you have only to observe how radio designs have to be upgraded to pass auto company demands to

understand this clearly.

The big problem that equipment engineers saw was the wear on the tape head, wear that would be accelerated by the steady vibration of the car engines. Although everybody agreed such a tape recorder could be built, nobody was willing to bet that a tape head would ever meet the auto company's needs for maintenance-free service while performing as well as a home playback machine.

It is history that such a tape recorder was built and became a smashing success among auto buyers. But the struggle to improve the recording head goes on.

Long life. Last month, Michigan

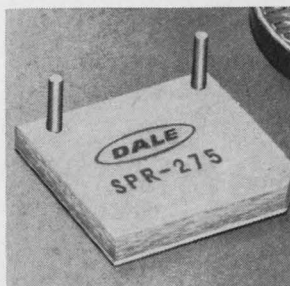

Model SPR-275 is a 21-w resistor designed to isolate line drive impulses and terminate lines within the demanding space requirements of a computer. It has a resistance range of 0.025 ohm to 1 kilohm, within 5% tolerance. Mounted to a heat sink maintained within the computer at 70°C, its maximum temperature on the other side is 100°C at 21 w. Dale Electronics Inc., Columbus, Neb. [349]

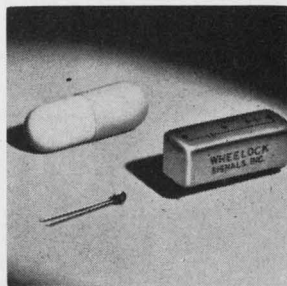

Reed relay series 442SS with built-in solid state driver occupies only 0.05 cu in. Typically, 40 2-pole relays with their driver stages can be mounted on a 4½ x 5½ in. p-c board with adequate spacing between boards. Height is only 0.25 in. Contact is rated at a full 7 w. Units are available in 1-to 4-pole models. Wheelock signals Inc., 273 Branchport Ave., Long Branch, N.J. [350]

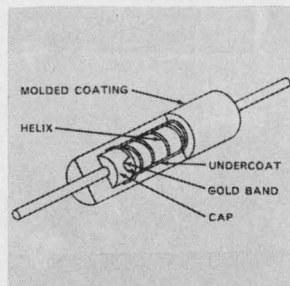

Metal film resistors in the MAF60 series are made by depositing a stable resistive film alloy on a ceramic substrate through a vacuum evaporation process. Units are rated at ¼ w at 70°C and ⅙ w at 125°C. Change in resistance after 1,000 hours load life is less than ±0.5%. Standard temperature coefficient is 100 ppm/°C. Mallory Controls Co., 100 S Parker Ave., Indianapolis. [351]

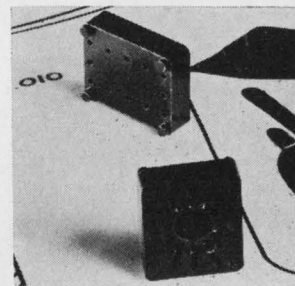

Transipad 10299-DAP adapts 12-lead TO-5 IC's to a standard 0.100-in. grid pattern. It provides insulation and support, elevating the device only 0.150 in., including 0.025-in. feet under the Transipad. The feet permit air ventilation and open area for flushing away excess solder flux. DAP resists heat of 450°F. Milton Ross Co., 511 2nd St., Pike, Southampton, Pa. [352]

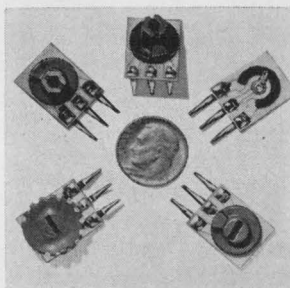

Trimmer resistor named Slim-Trim is useful in consumer, military and industrial equipment. Rated at ¼ w per section at 70°C, it has resistance values ranging from 100 ohms to 15 megohms. Maximum voltage is 350 v. The unit is built upon a base plate of alumina for heat dissipation. Centralab Electronics Div., Globe-Union Inc., 5757 N. Green Bay Ave., Milwaukee, Wis. [353]

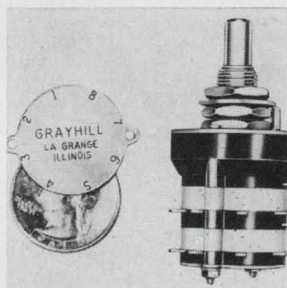

Shorting-contact series 44 rotary switch is available in a 45° angle of throw. It has 1 or 2 poles per deck. The 1-pole unit has up to 6 decks; the 2-pole type, up to 3 decks. Initial contact resistance is 0.005 ohm, rising to 0.020 ohm max after 25,000 cycles of operation. Price is from \$7.70 to \$17.50, depending on poles and decks. Grayhill Inc., 523 Hillgrove Ave., LaGrange, Ill. [354]

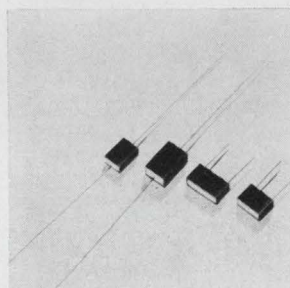

Metalized Mylar capacitors series 322 and 323, in epoxy cases, mount on p-c boards. Radial lead styles have premolded standoffs to permit cleaning agents to pass under the unit and prevent moisture from collecting and introducing leakage paths. Values are 0.001 to 10 µf. The 0.001-µf unit is 0.42 x 0.29 in.; the 10-µf unit, 1.92 x 0.72 in. Gudeman Co., 340 W. Huron St., Chicago. [355]

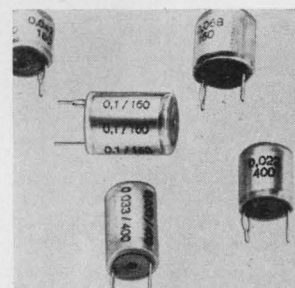

Miniature capacitors type V170 are constructed by wrapping the film dielectric with a synthetic film and thermally sealing the end. They may be subjected to 100% relative humidity for 72 hours at 75°C and suffer not more ⅓ loss in insulation after exposure and subsequent drying. Capacitances range from 0.01 to 0.1 µf. Aerovox Corp., New Bedford, Mass. [356]

Magnetics, one of the principal producers of magnetic recording heads for auto tape recorders, introduced a new head that ought to outperform any developed yet—and at no increase in cost.

The laminated, eight-track stereo head is encapsulated in a newly developed glass-filled composition that lasts two to three times as long as previous encapsulants. The head on a home tape recorder, for example, is usually fabricated of laminations of nickel-alloy iron and copper shims which are encapsulated in a resin plastic like Bakelite. In a car, resin plastics wear away quickly and degrade the performance of the recorders, so other

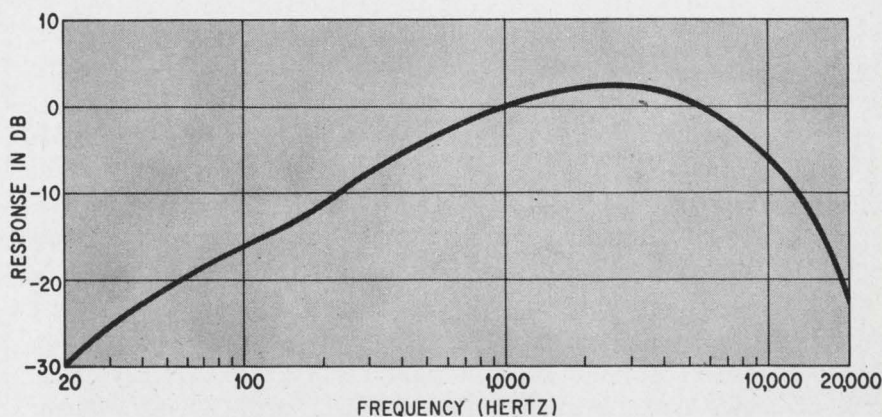

Impressive performance. Frequency response of new head is 10 kilohertz at -6db, with a playback speed of 3¾ inches per second. In addition, crosstalk rejection, which is even a more critical parameter in auto recorders than in home units, is greatly improved, to 80 db.

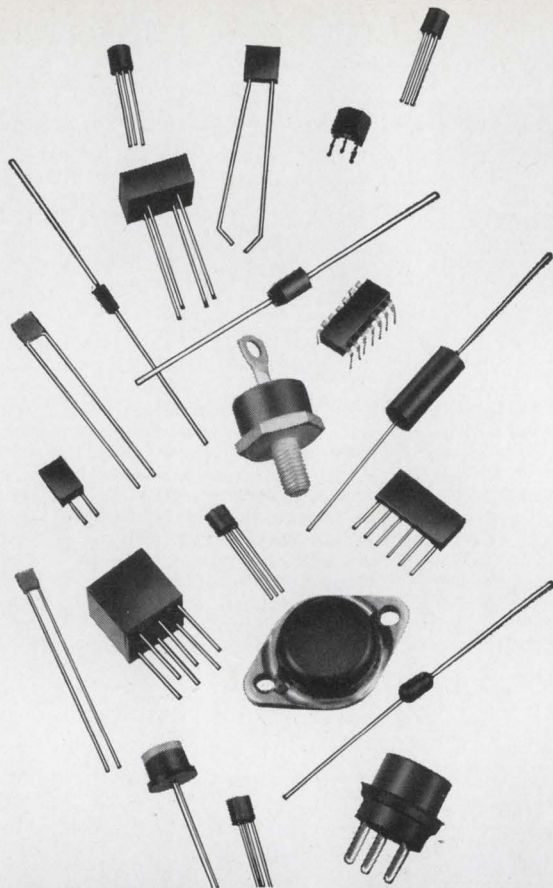

NEW

Unequaled Electronic Grade Epoxy Molding Powder from HYSOL

Now HYSOL has a specially formulated hi-grade electronic molding powder for use in applications where high quality and reliability are a must.

HYSOL recommends using these soft flow molding powders for transfer molding, encapsulation of transistors, integrated circuits, diodes, critical resistors, capacitors, inductors, as well as the more sophisticated semiconductors that demand super quality control, moisture resistance and a broader range of compatibility.

The HYSOL laboratories located in the East and West, have the test equipment procedures and personnel to supply you with test data on the effect of encapsulation on your products. HYSOL can solve your problems now. Write, wire or phone HYSOL, Dept. EM-107, Olean, New York 14760.

PROGRESSIVE PRODUCTS
HYSOL HYSOL CORPORATION • OLEAN, NEW YORK 14760
THRU CHEMICAL RESEARCH LOS ANGELES, CALIFORNIA/HYSOL (CANADA) LTD., ONTARIO/LONDON, ENGLAND

... ought to outperform any developed yet ...

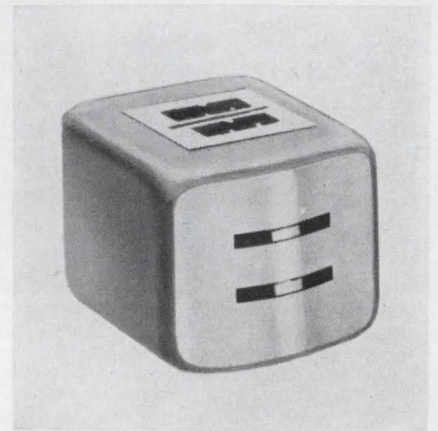

Glass house. Tough, glass-filled material encases new recording head.

materials are needed.

The electrical performance characteristics are equally impressive: Adjacent crosstalk rejection is 80 db and frequency response is 10 khz at -6 db with a playback speed of 3¾ ips. Contour effect is practically eliminated at low frequencies. The NH2LX can be supplied unmounted, or with side, bottom, or rear mountings installed. Price is \$3.40 each in quantities of 10,000 units. For larger orders—50,000 to 100,000 units—the price is negotiated.

Specifications

Impedance at 1 khz	2600 ohms
Record level	-12 db
Playback level	
1 khz	0.8 millivolt
10 khz	-6 db
Frequency response (at 3¾ ips)	10 khz, -6 db
Nominal inductance	0.38 henry
Interchannel crosstalk rejection	50 db min. (1 khz)
Adjacent channel rejection	70 db min
Michigan Magnetics Inc., Vermontville, Michigan 49096 [357]	

New components

For discrete users

Zener diode chip assemblies are step toward IC's

It's a giant step from discrete components to monolithic integrated circuits. For those who are not

When it comes
to color-TV
receiving tubes



...RCA
Engineers
are always
one jump
ahead...



LOOK AT HOW THEY'VE IMPROVED
IF AMPLIFICATION—

Higher gain FOR
YOUR IF STAGES FROM TWO NEW
RCA FRAME-GRID TYPE TUBES
—THE IMPROVED 'JC6A FAMILY
OF SHARP-CUTOFF PENTODES
AND THE NEW 'KT6 FAMILY OF
SEMIREMOTE-CUTOFF PENTODES.



Higher drive values

WITH CONSEQUENT IMPROVEMENTS
IN **GAIN** AND **g_m** PERMITTED
BY NEW PLATE STRUCTURE
INCORPORATED IN EACH FAMILY.
'KT6 FAMILY ALSO HAS AN
EXCELLENT SEMIREMOTE-CUTOFF
CHARACTERISTIC FOR BETTER
AGC CONTROL.



Features:

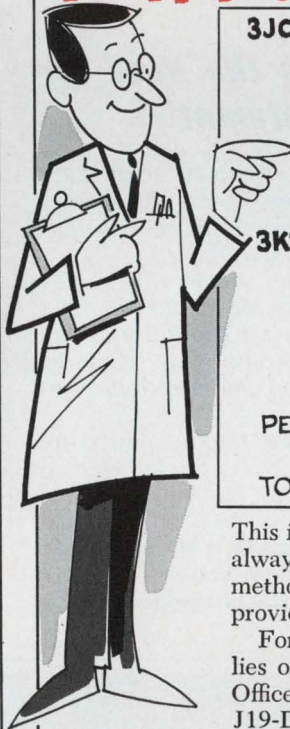

3JC6A, 4JC6A AND 6JC6A SHARP-CUTOFF PENTODES
(9-PIN MINIATURES UNILATERALLY
INTERCHANGEABLE WITH 'JC6 FAMILY)

- * $P_b = 3.1 \text{ W}$
- * $P_{g2} = 0.7 \text{ W}$
- * $g_m = 16,000 \mu\text{mho}$
- * INTERNAL SHIELD

**3KT6, 4KT6 AND 6KT6 SEMIREMOTE-CUTOFF
PENTODES (9-PIN MINIATURES)**

- * $P_b = 3.1 \text{ W}$
- * $g_m = 18,000 \mu\text{mho}$
- * INTERNAL SHIELD
- * SEPARATE BASE-PIN TERMINAL FOR G_{3-}
PERMITS USE OF UNBYPASSED CATHODE RESISTOR
- * TWO BASE-PIN TERMINALS FOR CATHODE
TO REDUCE CATHODE LEAD INDUCTANCE

This is what you can expect from RCA Engineers. They are always on the alert for new ideas, new materials and new methods to give the color-TV circuit engineer tubes that will provide even better performance at the lowest possible cost.

For more information on the RCA 'JC6A and 'KT6 families of receiving tubes, contact your nearest RCA District Office, or write to RCA Commercial Engineering, Section J19-DE, Harrison, N.J. 07029.

RCA DISTRICT OFFICES—OEM SALES: EAST, 2075 Millburn Ave., Maplewood, N.J. 07040, (201) 485-3900 • MID-ATLANTIC, 605 Marlton Pike, Haddonfield, N.J. 08034, (609) 428-4802 • MID-CENTRAL, 2511 East 46th St., Bldg. Q2, Atkinson Square, Indianapolis, Ind. 46205, (317) 546-4001 • CENTRAL, 446 East Howard Ave., Des Plaines, Ill. 60018, (312) 827-0033 • WEST, 6363 Sunset Blvd., Hollywood, Cal. 90028, (213) 461-9171 • INTERNATIONAL OPERATIONS, RCA International Division: Central and Terminal Aves., Clark, N.J. 07066, (201) 382-1000 • 118 Rue du Rhone, Geneva, Switzerland, 35 75 00.

RCA Electronic Components and Devices, Harrison, N.J.



The Most Trusted Name in Electronics

KEITHLEY UNWRAPS *FIRST* MOS FET ALL SOLID-STATE ELECTROMETER



New Model 602 eliminates the need for frequent zero adjustment

Using Mos Fets at the input, this new Keithley solid state electrometer measures voltage, current, resistance and charge over 73 ranges. It is so stable the only discernible drift is with temperature. And only at a rate less than $300 \mu\text{V}/^\circ\text{F}$.

The 602 exhibits minimum zero shift from shock, vibration or voltage overloads up to 500 volts. Battery-operated, this versatile giant operates up to 1500 volts off ground and has battery life of 1000 hours, even when recording! Fast warm-up time, low 5×10^{-15} ampere offset current and freedom from microphonics make it truly unique!

Call your Keithley man for our technical engineering note. Ask for a free in-plant demonstration, too.

Model 602

- 1 mv f.s. to 10v, with 10^{14} ohms input resistance
- 100 ohms f.s. to 10^{13} ohms
- 10^{-13} to 10^{-6} coulomb
- 10^{-14} ampere f.s. to 0.3 amp.
- 500-volt overload protection

\$675, with input leads



**KEITHLEY
INSTRUMENTS**

28775 Aurora Road • Cleveland, Ohio 44139
EUROPE: 14 Ave. Villardin, 1009 Pully, Suisse

**... for users who don't
need military specs ...**

ready to make the big jump, who want to stay close to the discrete technology, and still improve performance, Dickson Electronics Corp. of Scottsdale, Ariz., has geared up to produce zener diode chip assemblies for use in hybrid integrated circuits.

David Hutchins, diode product engineering manager, says the assemblies are also for customers doing research on how to integrate a system—for example, those building a system for the military who are trying to cut space and weight but have not yet adapted to working with monolithics.

The company sees another market segment in equipment makers who are frequently changing designs, such as commercial television manufacturers. They too are used to working with discretely, and will probably buy chip assemblies as a transition to monolithic IC's.

Bonding. Some want the supplier to do the bonding for them, particularly those customers working with active semiconductor devices. Says Hutchins: "If you bond them yourself, you can run into problems of control. If you don't know what kind of solder to use, or you don't have precise control over the bonding temperature, the junctions of active devices might be destroyed."

At Dickson, there's considerable interest in the commercial electronics customer who won't pay the premium prices for military-grade IC's and hybrids. "Most semiconductor manufacturers design to specs that are tighter than many a commercial product manufacturer needs," says Hutchins. "The bigger semiconductor houses aren't too interested in him."

The chips which come in four standard assemblies are nominally 0.025 inch square. Costs for an entire assembly, in quantities of 1,000, range between 75 cents and \$2. Power ratings: 400 milliwatts.

The standard chip assemblies are available with chip zener diode types in voltages ranging from 7.5 to 33 volts. All metallized substrate surfaces are sufficiently gold-plated to permit thermocompression or

No bubble, no trouble.

When you immerse your components in hot 3M Brand Inert Fluorochemical Liquids, bubbles of escaping air quickly detect gross leaks.

No bubble, no trouble.

That's one of the known test bath applications for 3M Inert Liquids. Thermal shock tests, transistor matching, temperature testing of integrated circuits at -55°C and $+150^{\circ}\text{C}$, are just a few other examples.

Our Inert Liquids quickly drain and leave no residue. So when the test is finished, additional cleaning steps are unnecessary. You save time and get greater accuracy.

Test 3M Inert Liquids...and save a lot of trouble.

3M Chemical Division
Dept. KAX-107, St. Paul, Minn. 55119
Send me all the details about 3M Brand Inert Liquids.

Name _____

Company _____ Title _____

Address _____

City _____ State _____ Zip _____

Chemical Division

3M
COMPANY

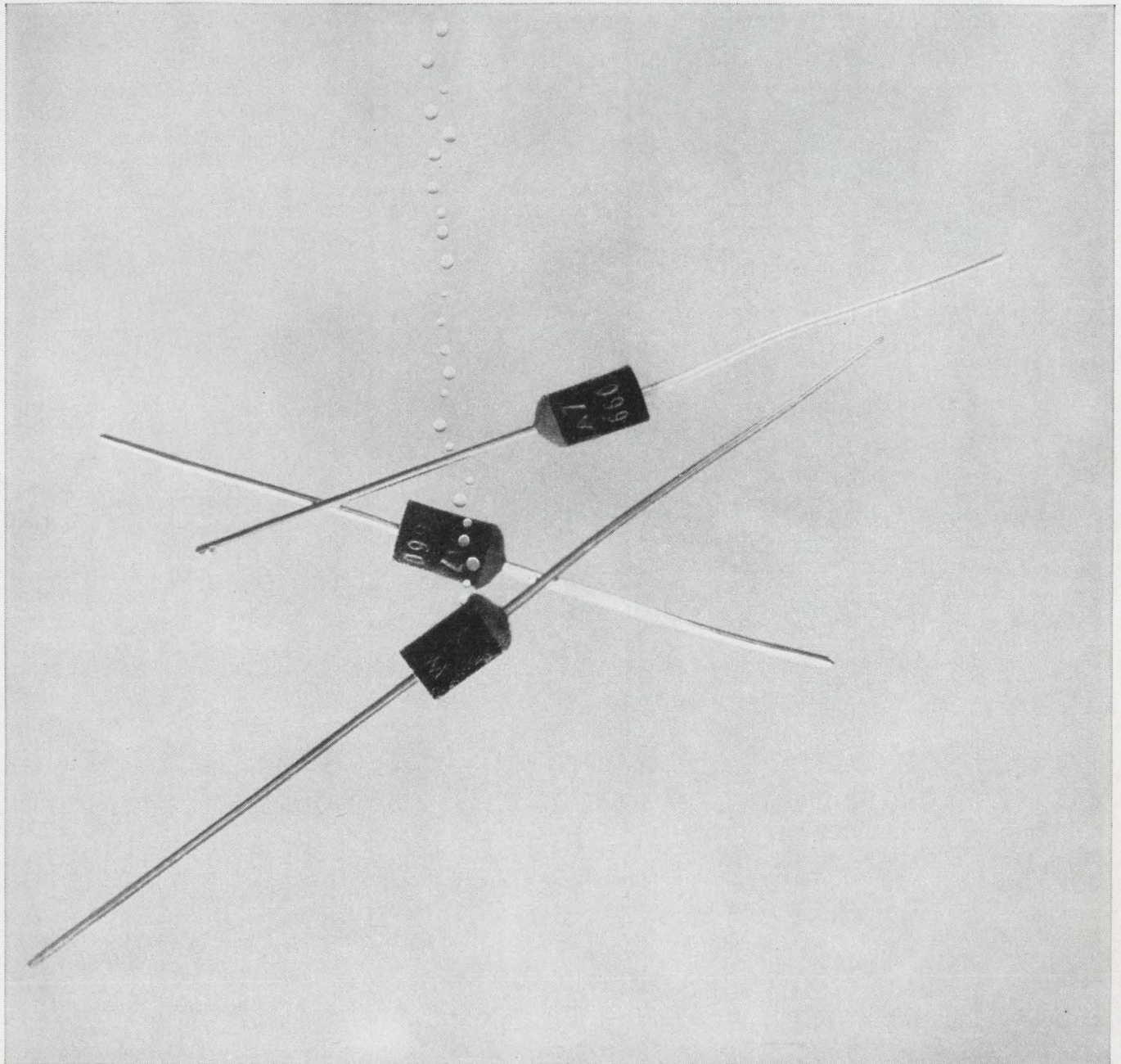

PLOTAMATIC

X-y recorders offer more performance, features, value

just compare the specs

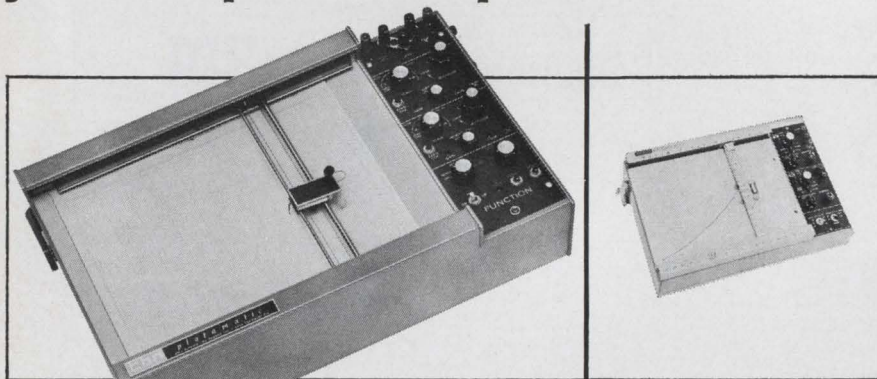

	BBN/DE 600	HP
Input Impedance	1 megohm, constant all ranges	100K on four most sensitive ranges
Paper Holddown System	Vacuum: better holddown, easier line-up, quiet	Electrostatic: attracts dust particles
Servo System	Sealed follow-up pots (no slide wire cleaning kits)	Open slide wires (require frequent cleaning)
Calibration Check	Push-button zero check on control panel	Must remove X-Y input signals
X-Y Zero Adjustment	No shift from zero calibrate position regardless of full scale input range selected	Shifts from zero calibrate position when attenuator input range is adjusted for proper full scale setting
Price	\$25 less	

Plotamatic is a clear winner on these and other basic important features. You'll want to test all features right in your own lab. We have 30 models of X-Y recorders to choose from. Call us, and we'll bring the particular Plotamatic best suited for you to compare and evaluate. Or write for our complete Plotamatic brochure.

BBN BOLT BERANEK AND NEWMAN INC
DATA EQUIPMENT DIVISION

2126 South Lyon Street, Santa Ana, California 92705 ■ Phone: (714) 546-5300

... customers can choose to bond or not to bond ...

ultrasonic bonding. Either aluminum or gold leads can be attached to the assemblies.

Series choices. The MA and MB series are for customers who have their own bonding capability. Dickson says the Kovar substrate of the MA series provides good heat dissipation and allows mounting directly to electrically active surfaces. Only one lead attachment is required to connect the upper contact of the diode chip to other circuit terminals. The MB series uses a ceramic substrate which electrically insulates the diode chip from the bottom of the substrate. Two lead attachments are needed, one to the upper contact of the diode chip, the other to the metallized top surface of the substrate.

The MC and MD series are for those users who do not have their own bonding capability. With the MC series, bonding directly to the diode chip is not required, so the possibility of overheating the device is reduced. In addition to providing heat dissipation, the ceramic provides electrical insulation between the diode chip and an active surface of a hybrid circuit substrate. The substrate is in the form of a channel, with the chip inside. Diode chips mounted in the channel can be enclosed in protective coatings.

Mass production. Assemblies in the MD series are similar to leadless inverted devices. They are mounted onto the circuit substrate by inverting and bonding to four metallized mounting posts, so mass-production mounting techniques can be used. The sturdiness of this assembly, Dickson says, means less skill is required in handling of fragile semiconductor chips. The mounting posts permit testing before installation into circuits, and the assemblies can be color coded for identification.

Dickson will also produce multi-chip assemblies for special applications. The Arizona company, which formerly made field effect transistors, plans to get back into that business eventually with a chip approach.

Dickson Electronics Corp., P.O. Box 1390, Scottsdale, Ariz. 85252 [358]

Radiation now offers

36 Monolithic Diode Matrices & 12 Monolithic Interface Circuits

in TO-84 and Dual In-Line Packages

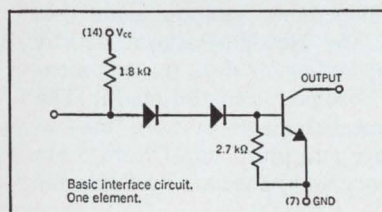
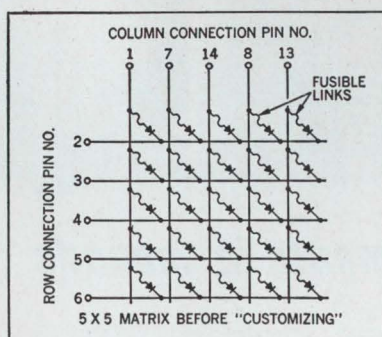

Radiation's Monolithic Diode Matrices and Interface Circuits form a compatible family of integrated circuits to implement any logic design. These circuits perform the AND, OR, and INVERT logic functions. In combination they provide the AND/OR, NAND/NOR and expandable NAND/NOR logic functions. These circuits are compatible to all logic families, RTL, DTL, T²L and CML.

The node-input on the interface circuits provides a universal inverter for circuit applications. They can operate at conventional IC voltages and are ideally suited for interfacing to high-voltage logic to 55 volts.

Radiation's interface circuits and matrices are available for immediate shipment at attractive prices. For example, hex interface circuits are priced as low as \$3.50, and diode matrices as little as \$2.50.

MONOLITHIC DIODE MATRICES			
TO-84 DUAL IN-LINE			
Matrix Size	Fast Recovery	Medium Recovery	General Purpose
5 x 5	RM-74 RM-174	RM-75 RM-175	RM-77 RM-177
5 x 8	RM-10 RM-110	RM-12 RM-112	RM-13 RM-113
6 x 8	RM-30 RM-130	RM-31 RM-131	RM-34 RM-134
8 x 5	RM-80 RM-180	RM-81 RM-181	RM-84 RM-184
8 x 6	RM-40 RM-140	RM-41 RM-141	RM-44 RM-144
4 x 10	RM-90 RM-190	RM-91 RM-191	RM-93 RM-193

MONOLITHIC INTERFACE CIRCUITS		
TO-84 DUAL IN-LINE		
Hex Interface Inverters Output 6 volts	Hex Interface Drivers Output 35 volts	Hex Indicator Drivers Output 55 volts
RD-534 RD-1534	RD-535 RD-1535	RD-536 RD-1536
RD-334 RD-1334	RD-235 RD-1235	
RD-234 RD-1234		

All Radiation integrated circuits are dielectrically isolated.

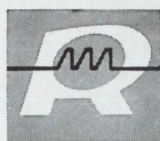

RADIATION
INCORPORATED
SUBSIDIARY OF HARRIS-INTERTYPE CORPORATION

MICROELECTRONICS DIVISION

Sales Offices: Suite 622, 650 North Sepulveda Blvd., El Segundo, California (213) 772-6371—Suite 232, 600 Old Country Road, Garden City, N.Y. (516) 747-3730—P.O. Box 738, Islington, Massachusetts (617) 762-3470—Suite 704, 2600 Virginia Avenue, N.W., Washington, D.C. (202) 337-4914—P.O. Box 37, Melbourne, Florida (305) 723-1511.

Circle 177 on reader service card

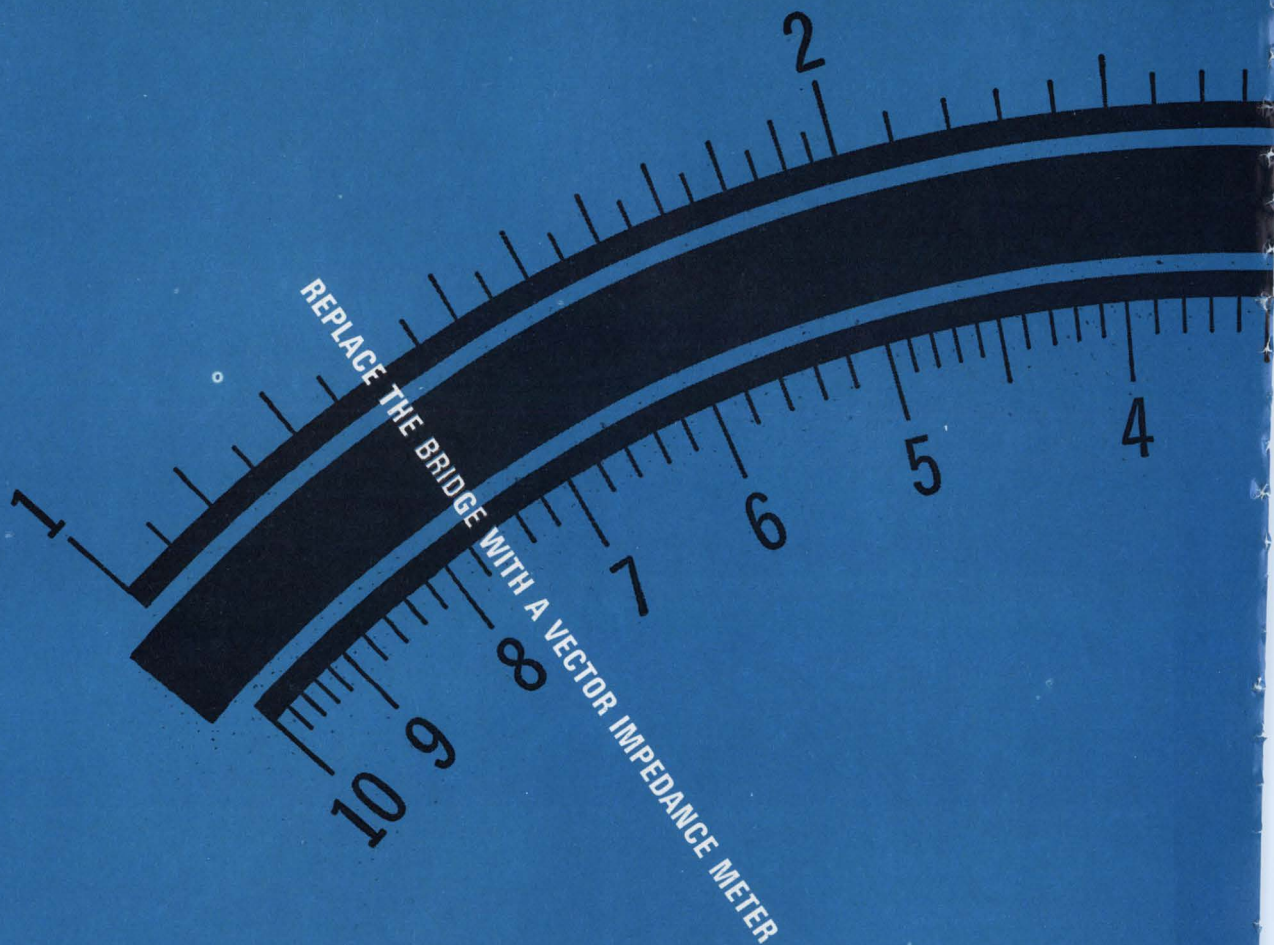

Vector Impedance Meter makes measurements in seconds

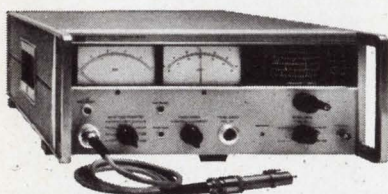

MODEL 4815A OFFERS DIRECT READOUT OF HIGH FREQUENCIES IN OPERATING CIRCUITS

The 4815A offers direct readout of impedance and phase angle measurements from 500 kHz to 108 MHz with continuous tuning. Probe on five-foot cable simplifies in-circuit measurements. Price: \$2,650.00. Complete specifications are yours on request.

Circle 178 on reader service card

Now there's no excuse for not making all the impedance measurements that previously have been too bothersome to make. The Hewlett-Packard 4800A Impedance Meter eliminates bridge balancing and nulling. It does for AC measurement what the ohmmeter does for DC testing. Just plug it in and read it. The 4800A may be mechanically swept to produce measurements over its full frequency range. You get direct readings of impedance and phase angle from 5 Hz to 500 kHz. Analog outputs of frequency, impedance and phase are available for X-Y recording.

The 4800A is an all solid-state integrated vector impedance system that reads out directly in Z and θ . Low-level signal strength prevents overloading of the test component. Price: \$1,650.00. For complete specifications, contact your local Hewlett-Packard field engineer or write: Hewlett-Packard, Green Pond Road, Rockaway, N.J. 07866.

HEWLETT  PACKARD

IMPEDANCE INSTRUMENTS

1071B

New Semiconductor Review

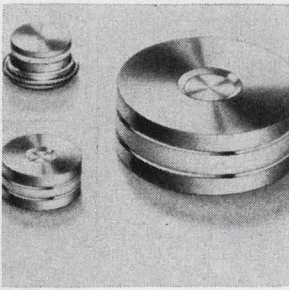

Three series of fast-recovery silicon rectifiers are in flat-button form. The TR series is rated for 20 amps at 100°C case temperature. The RU series handle 40 amps and the RD units 200 amps. Both TR and RU have 500-nsec recovery times; the RD, 700-nsec recovery time. Piv ratings are from 50 to 1,000 v. Electronic Devices Inc., 21 Gray Oaks Ave., Yonkers, N.Y. 10710. [436]

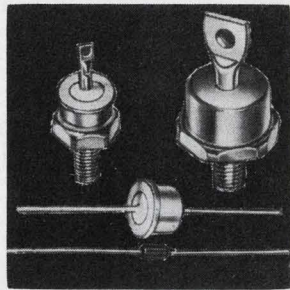

Fast-recovery rectifiers feature 7 current ratings, from 3/4 to 30 amps, and 6 voltage ranges, from 50 to 600 v. More than 50 rectifiers in the series offer 2 reverse recovery speeds of 200 nsec max and 1 μsec max thus providing 2 frequency ranges of 50 khz and 250 khz. Prices (1,000 and up) are 40 cents to \$40.50. Motorola Semiconductor Products Inc., Box 955, Phoenix, Ariz. [437]

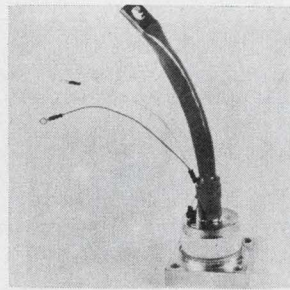

Thyristors in the CR7K series offer surge ratings of 7,000 amps and rms current of 770 amps from a pair in inverse parallel. These cells will replace ignitrons as the SCR is smaller and can be mounted in any position. Arc volt drop and triggering time are reduced by a factor of 20, and power requirement of the gate is 5 w peak. Calvert Electronics International Inc., 220 E. 23d St., N.Y. [438]

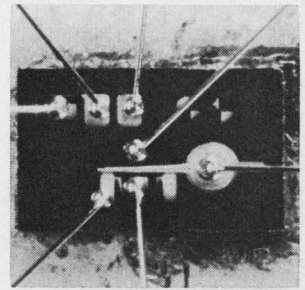

A solid state device called a resonant gate transistor (RGT) is available in evaluation quantities. It is a frequency-selective unit capable of Q's from 20 to 200, and helps solve the problem of building tuned circuits without inductors. Frequency range is presently limited to about 3 to 30 khz. Price is \$67. Molecular Electronics Div., Westinghouse Electric Corp., Elkridge, Md. [439]

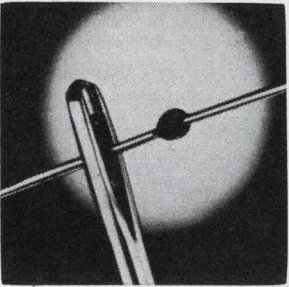

Microminiature zener diodes are electrically interchangeable with standard Jedec types. Measuring 0.075 in. in diameter and 0.125 in. long, the MTC series are encapsulated in high-temperature epoxy. Standard units cover the voltage range of 5 to 12 v. They have either silver leads or gold plated, weld ribbon type. Computer Diode Corp., Pollitt Dr. South, Fair Lawn, N.J. [440]

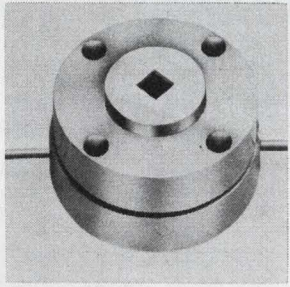

Infrared detector QKN1227 is a mercury-doped germanium unit that responds in less than 100 nsec and is sensitive from 2 to 15 microns. Designed for laboratory, industrial, and airborne use, it detects radiation from carbon-dioxide lasers emitting light at 10.6 microns. The unit measures about 1/2 X 3/4 in. Price is \$2,900. Raytheon Co., Foundry Ave., Waltham, Mass. [441]

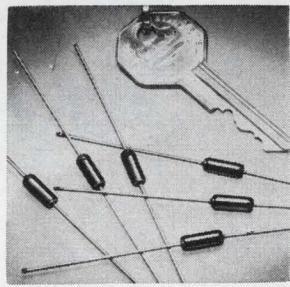

Hermetically sealed, glass-case silicon rectifiers series G have avalanche characteristics for protection from reverse voltage transients. Rated at 1 amp at 55°C, they have piv ratings from 200 to 1,000 v. Max. operating temperature is 175°C. Size is 1/8 X 1/4 in. Prices range from 20 to 46 cents in quantities. Sarks Tarzian Inc., 415 N. College Ave., Bloomington, Ind. [442]

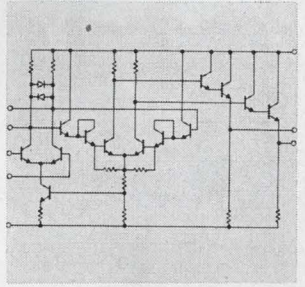

Differential amplifier model SE515 is a linear IC featuring differential input and output, an input-offset voltage of 0.5 mv, and compatibility with commonly used logic-circuit power supplies. It is offered in two operating ranges; -55° to +125°C, and 0° to +70°C. The former costs \$15 for 100 and up; the latter, \$4.75. Signetics Corp., 811 E. Arques Ave., Sunnyvale, Calif. [443]

New semiconductor

Third-place Motorola steps up TTL pace

Will introduce own line of 30 circuits in bid to overtake TI and Sylvania

When you're third, you try even harder.

Motorola Inc.'s Semiconductor Products division, trying to catch up in transistor-transistor logic, will introduce this month the first 30 circuits of its own TTL line.

Called the MC 3000 series, the

line marks the entry of Motorola's own circuit designs into the TTL race. Says E.A. Blanchette, manager of integrated circuit operations: "The series, which will eventually number about 50 circuits, will be directly competitive with and superior to Texas Instru-

ments' Series 74 TTL line."

"By the end of 1967," Blanchette says, "we will be supplying more than 100 TTL circuits."

Most of these will be in the suHL 1 and 2 lines (Sylvania Universal High-Level Logic).

Motorola has been a second source for these lines since December. In addition to its own line, the company will also introduce a dozen circuits in the suHL 2 line, including all the flip-flops, plus some gates, line drivers, and dual flip-flops. Also to be introduced are some Motorola-designed additions to the suHL 1 line.

Stockpile. Development of the

Cost-price squeeze? Downtime? Quantity control? Quality control?

Beat any or all of these problems now with **COUNTER-MEASURE 1...** yours only from Quasar Microsystems

If your product or process can profit from new speed, new accuracy in counting or measuring, it's time to lay COUNTER-MEASURE 1 on the line. Because this rapid, reliable, rugged decade counter counts or measures anything you want to—and flashes the answer in instant, visual display. Thoroughly proven in performance, COUNTER-MEASURE 1 is at work solving problems in more and more industries, and in product after product, with each passing month. What's your application? Chances are COUNTER-MEASURE 1 can help you where it counts most—in the fight for greater profitability.

For your data sheet, and answers to questions on applications of COUNTER-MEASURE 1, simply write, on your letterhead, to:

Quasar
MICROSYSTEMS INC.

466 Rockaway Avenue, Valley Stream, N. Y. 11581
Telephone: 516-872-8680

● You can count on Quasar... always

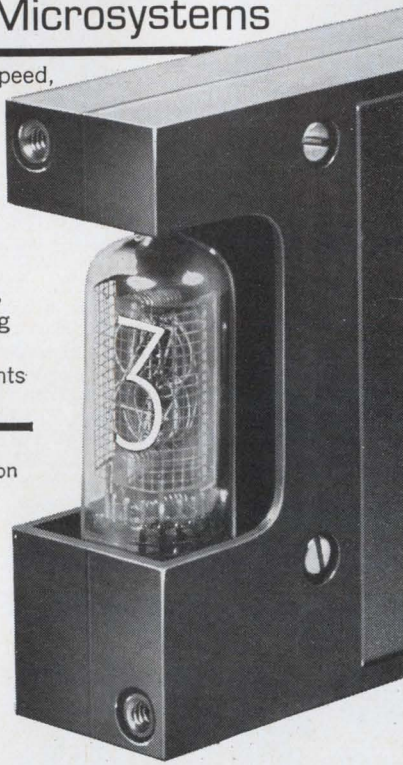

Circle 251 on reader service card

This announcement is a matter of record only.

Teledyne, Inc.

has acquired substantially all the business assets of

Continental Device Corporation

The undersigned assisted in the negotiations leading to this transaction.

LOEB, RHOADES & Co.

September 8, 1967

... Motorola optimism based on 'broadest line' of TTL...

MC 3000 series has been going on for two years, says Robert Lyon, the division's product manager for TTL, and the company has been stocking the circuits for eight months.

Blanchette says Motorola ranks behind Sylvania and TI in TTL production. But the company is optimistic of moving up in the standings. One company spokesman says that with 100 circuits, Motorola will probably have the broadest line. However, Sylvania is generally acknowledged to have the broadest TTL line in the industry [Electronics, Sept. 18, p. 179].

Motorola officials are convinced that, by 1968, 20% of the digital integrated-circuit market will consist of TTL logic.

Details on the proprietary MC 3000 series are few. Lyon says typical speeds will be about 6 nanoseconds, with a maximum of 10 nsec. Other than that, he says only, "we have gone through the key devices in the industry and supplemented them with Motorola design techniques."

Blanchette says the new gates offer an additional decision node, which "allows implementation of complex functions such as shift registers, more easily." He claims that the standard pin connection for IC's in saturated logic appears to be the 930 diode-transistor logic DTL made by most semiconductor houses in which pin 7 is the ground connection and pin 14 the power supply connection. The MC 3000 circuits follow this standard. Thus, they can replace the lower speed DTL circuits in existing systems.

Lyon claims two other advantages for the MC 3000 series: active pulldown that increases noise thresholds, and input-clamp diodes to minimize the ringing effects inherent in TTL.

Among the circuit types being introduced are four kinds of quad two-input gates (NAND, AND, OR, NOR); a dual four-input NAND gate; a single eight-input NAND gate; a triple three-input NAND gate; a dual four-buffer NAND and AND gate; a three-input, three-output series-terminated line driver



information systems

designed for tomorrow

In Classical Greece, a scholar could get almost all the information he needed about society, geography, science, military tactics, and religion from the poems of Homer. Today's information systems, complex as they are, will someday look nearly as quaint.

How do we know? Because our scientists and engineers are building toward tomorrow's information systems, right now. Underway now at Sylvania Electronic Systems are □ programs aimed at global communications networks □ data gathering satellite systems that will make no place on earth inaccessible □ new data handling and display techniques that will bring the world's information into useful focus quickly and efficiently.

We are designing our tomorrow. It can be your tomorrow too. Come help to create it. Send your resume in strict confidence to Mr. Kimball Shaw, Professional Staffing, Sylvania Electronic Systems, Division of Sylvania Electric Products Inc., Box 903, 40 Sylvan Road, Waltham, Massachusetts 02154.

*Opportunities in suburban Boston,
Buffalo or San Francisco.*

GTE
GENERAL TELEPHONE & ELECTRONICS
Total Communications from a single source through

SYLVANIA ELECTRONIC SYSTEMS
RESEARCH • SYSTEMS DEVELOPMENT • PRODUCT & FIELD ENGINEERING

An equal opportunity employer

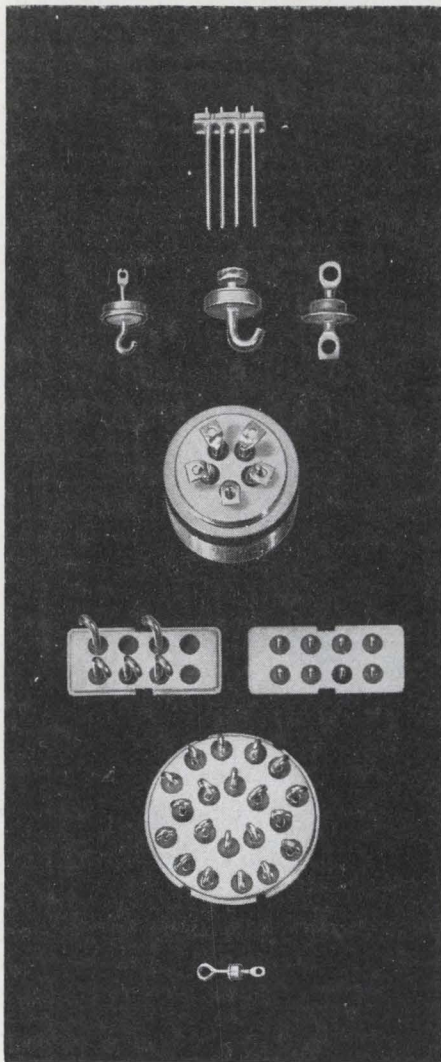

A source you can depend on

Whether you need custom headers or off-the-shelf single-pin terminals, Atlas offers uncommon reliability. That's because we have extensive manufacturing equipment and in-house test facilities to make any header you design, and then test to your specifications or MIL specs.

Electron-beam welding . . . altitude, temperature and humidity cycling chambers . . . metallographic and cross-sectioning photography. In-house facilities such as these mean unmatched quality and reliability for you. Over 150 sizes and configurations of single-pin terminals in stock. Custom headers to your drawings. Send today for complete information. Or phone 215 666-0700.

ATLAS
CHEMICAL INDUSTRIES, INC.
Aerospace Components Division
Valley Forge, Pa. 19481

that includes both NAND and AND circuits; a single J-K flip-flop with a positive-edge trigger and which can be plugged into a Fairchild 9001 socket, a dual high-speed J-K flip-flop that is negative-edge triggered; and a dual type D flip-flop that will fit the same socket as the TI 74/74 unit.

"The people who have expressed most interest in the series are military-equipment manufacturers," says Lyon, who adds that larger computer manufacturers and a supplier of equipment for airliners have also sent out feelers.

Motorola Semiconductor Products, Phoenix, Ariz. [444]

New Semiconductors

High-power triacs

Complete logic-gate control in a-c or d-c operation

Thyristor technology takes two steps forward with the advent of a new triac series with high power-handling capability and complete logic gate control. Designated the logic-triac line by the developers, International Rectifier, the new units handle 200 amperes at 220 kilowatts and provide a digital-like gate sensing element that permits a-c or d-c operation.

The triac, a bidirectional triode thyristor for static switching and a-c power control, is the functional equivalent of two silicon controlled rectifiers connected in inverse-parallel. Prior to the entry of the new series, maximum current capabilities were in the 35-50 ampere range, and gate sensing was restricted by the polarity of the load current to be passed. With the new units, a positive signal to the gate results in scr-like operation, i.e., a low impedance path across the main terminals in one direction, and a blocking (high impedance) state across the terminals in the opposite direction. When bias current is pulled out of the gate, the new triac unit displays bidirectional current handling, much like conventional triacs.

International Rectifier, 233 Kansas St., El Segundo, Calif. [445]

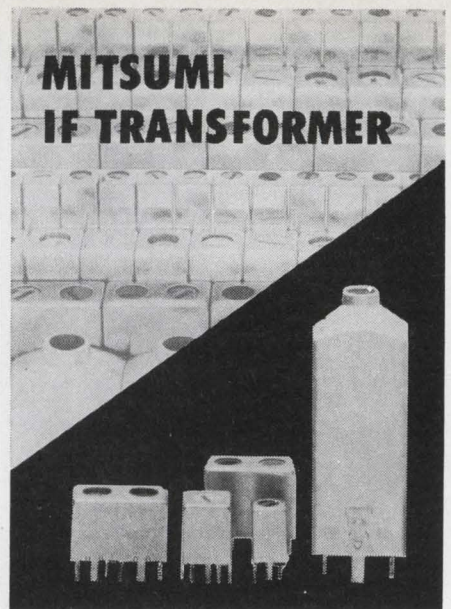

Reliability proved by a Monthly production output of 13,000,000!

The Mitsumi IFT is widely used in many fields such as AM or FM radios, black and white or color television sets and various types of communication equipment. A monthly production output of 13,000,000 . . . Mitsumi's untiring efforts for the promotion of reliability have borne fruit and the Mitsumi IFT has now become an international product used the world over.

Automatic winding machines that assure maximum stability

The Mitsumi IFT, famed for its originality, high quality and excellent performance, is made on digital type automatic winding machines of our own design, which, by inserting punch cards, can wind one IFT every 8 seconds. The use of strictly selected materials and perfect production control always guarantee stable performance.

The mechanical performance of the Mitsumi IFT is also stable with excellent shock resistance and smooth rotation torque. The Mitsumi IFT will give you full satisfaction in every respect.

Specification	Model	K7-E	K10-E	M20-B
For AM IFT	Frequency cover range	455 ± 20kc	455 ± 20kc	455 ± 20kc
	Tuning capacity (built-in)	180 ± 20 μF	180 ± 20 μF	150 ± 30 μF
	Unloaded Q (Q _u)	70 ± 15%	70 ± 15%	80 ± 15%
For FM IFT	Frequency cover range	10.7 ± 0.3Mc	10.7 ± 3Mc	10.7 ± 3Mc
	Tuning capacity (built-in)	A.B.C - 50 ± 5 μF D - 30 ± 3 μF E - 50 ± 5 μF	A.B.C - 50 ± 5 μF D - 30 ± 3 μF E - 50 ± 5 μF	A.B.C - 50 μF D - 30 ± 3 μF E - 50 ± 5 μF
	Unloaded Q (Q _u)	A.B.C - 70 or more D.E - 60 or more	A.B.C - 90 or more D.E - 70 or more	60 or more



MITSUMI

MITSUMI ELECTRIC CO., LTD.
1056 Koadachi, Komae-machi, Tokyo 415-6211
302, Cheong Hing Bldg, 72, Nathan Road, Kowloon,
Hong Kong 666-925
Marienstrasse 12, Düsseldorf, W Germany
MITSUMI ELECTRONICS CORPORATION
11 Broadway, New York 4, N Y 10004 HA5-3085
333 N Michigan Avenue, Chicago, Ill 60601 263-6007

Protects delicate electronic equipment in shipment.

PELASPAN-PAC® loose fill packing will absorb the shock. Unlike other loose fill, dunnage material, it doesn't settle or mat. It's resilient and highly shock absorbent. These curled strands of foamed polystyrene interlock to protect your product no matter how it's

bounced around.

And how PELASPAN-PAC can lighten your shipping problem! A cubic foot of it weighs only 8 oz., eight times lighter than other packing materials. What that does for shipping costs!

PELASPAN-PAC has other advan-



tages. It's clean and dust free. So easy to work with you'll get major savings in labor time and cost. Does your equipment get a boot out of shipping?

Get PELASPAN-PAC from your distributor. Write for his name.

The Dow Chemical Company, Plastics Sales, Department 71231, Midland, Michigan 48640.

Circle 183 on reader service card

PELASPAN-PAC is just for kicks.



New Instrument Review

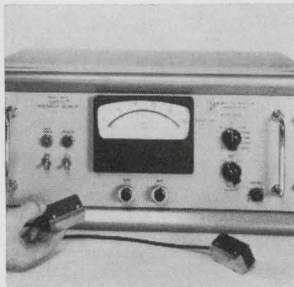

Electrostatic voltmeter model 144 Isoprobe uses a noncontacting $1\frac{1}{8} \times 1\frac{1}{4} \times 2\frac{1}{16}$ -in. probe to permit drift-free measurement with 0.1% accuracy. Range of ± 1 to $\pm 2,000$ v full scale at greater than 10^{18} ohms input impedance allows for many potential applications in general materials research and evaluation. Monroe Electronics Inc., 5 Vernon St., Middleport, N.Y. [361]

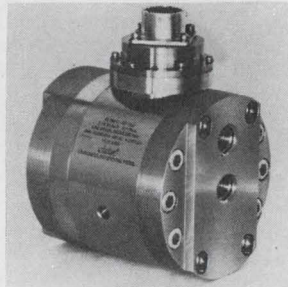

Unidirectional differential-pressure transducer PL385TC is capable of direct exposure to either gas or fluid corrosive pressure media on active or reference ports. Typical pressure ranges are from 0-5 to 0-50 psig. Differential overload is 5,000 psig. and max. allowable internal pressure is 6,000 psig. Price is \$500. Statham Instruments Inc., 12401 West Olympic Blvd., Los Angeles 90064. [362]

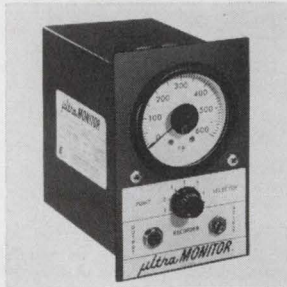

The ultraMonitor reads out any temperature point that can be sensed by a thermocouple. Used with standard thermocouples, the unit, with a $5\frac{1}{2}$ -in. meter scale, is better than 2% accurate. It may be used with a thermocouple in parallel with other equipment because of its high input impedance that almost eliminates additional loading. Airborne Accessories Corp., Hillside, N.J. [363]

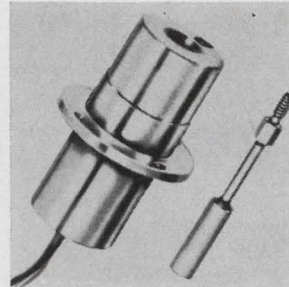

Linear position transducers series 230 are 60-hz units that provide infinite resolution. They are available in 20 different models with range of travel from ± 0.010 to ± 4 in. Units feature sensitivity to 100 mv/mil and linearity to 0.05%. A wide variety of standard mounting options simplifies installation of core and case. Robinson-Halpern Co., 5 Union Hill Rd., West Conshohocken, Pa. [364]

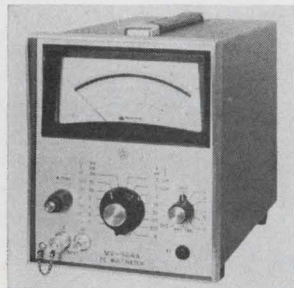

D-c multimeters MV-964A and MV-864A measure 100 μ v to 1 kv full scale, 0.1 ma through 1 amp full scale and 100 milliohms through 5,000 megohms. Both operate on 115/230 v, 50 hz through 450 hz and the 964A also operates on internal nickel cadmium batteries. Price: \$695 for the 964A, \$625 for the 864A. Millivac Instruments Inc., P.O. Box 997, Schenectady, N.Y. [365]



Power factor meter model 83 measures input frequencies ranging from 50 to 2,500 hz. It has an accuracy rating of $\pm 1\%$ of total span with sine-wave inputs of 120 v and currents ranging from 1 to 5 amps. The meter is self-energized from the voltage input and produces direct readings for leads or lags of up to 90° . Weston Instruments Inc., 614 Frelinghuysen Ave., Newark, N.J. [366]

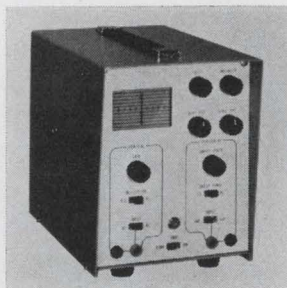

Solid state oscilloscope DM-4 is designed for the communications field. With the FM-9 frequency meter/deviation meter/signal generator, the unit presents the complete deviation picture. Alone, it serves to trouble-shoot audio circuits and to compare frequencies. Unit measures $6\frac{1}{4} \times 8\frac{1}{2} \times 10$ in. Price is \$295. Gertsch Division, Singer Co., 3211 S. La Cienega Blvd., Los Angeles. [367]

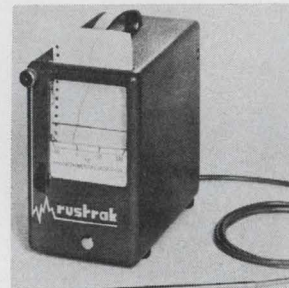

Environmental monitor model 166 uses a dry-writing method for a continuous, permanent record of temperature across -50° to $+100^\circ$ C range, with an accuracy of $\pm 1.5^\circ$ C. The chart speed of 1 in/hr provides a 31-day record with standard 63-ft, style B, 75-division paper. The unit measures $5\frac{3}{8} \times 3\frac{5}{8} \times 5\frac{7}{8}$ in. Rustroak Instrument Co., Municipal Airport, Manchester, N.H. [368]

New instruments

Extra heads double recorder s capacity

Two data channels can now be recorded at the same time with a maximum time-displacement error of 25 nsec

By adding an extra set of recording heads, a change that eventually necessitated the development of an electronic quadrature technique, the Ampex Corp. has added a second channel to its top-of-the-line instrumentation tape recorder. Two sets of data can now be recorded

at a 6-megahertz rate with only 25 nanoseconds of time-displacement error between the channels.

The instrument, the FR-950, was originally developed for the Navy Air Development Center, which wanted to analyze radar data on re-entry vehicles. To assure the track-

ing data corresponded to the special data on altitude, cross-section, and the like, the Navy needed the time-locked, two-channel capability.

"Actually," says product manager John R. Lake, "we only spec 25 nsec because that's the best we can measure. But we have experimented by recording a color-television signal on each of the channels, then switching back and forth to determine changes in hue. This information is contained in the phase of the transmitted signal with respect to a 3.58-Mhz subcarrier burst. It takes a 7-to-10 $^\circ$ phase shift to produce a detectable

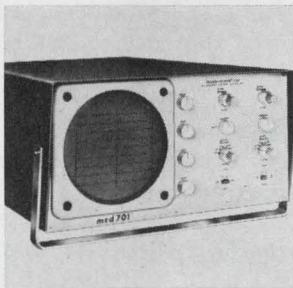

An X-Y monitor, Transi-Scope 701, uses solid state components and IC's. Specifications for the vertical and horizontal amplifiers include: deflection sensitivity of 10 kilohms, 1 kilohm, 100, 10 and 1 mv/major division with a vernier adjustment of X1 to X10 minimum; amplifier response of d-c to 1 Mhz (-3 db). Measurement Control Devices Inc., 2445 Emerald St., Philadelphia, Pa. [369]



Temperature-compensated d-c tachometer 9011-2710-0 has an output gradient, with 100-kilohm load, of 7 v/1,000 rpm. Maximum deviation is no more than 0.01%/°C change from -25° to $+75^{\circ}$ C. Ripple voltage is 3% max. Armature inertia is 6.5 gm-cm² max. Life expectancy is 10,000 hrs at 3,600 rpm at $+25^{\circ}$ C. Beckman Instruments Inc., 2500 Harbor Blvd., Fullerton, Calif. [370]

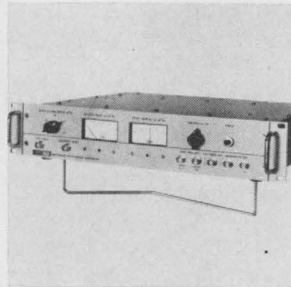

Frequency comparator 103A can make relative frequency comparisons, relative phase measurements, and short-term stability measurements without peripheral equipment. It makes short-term frequency comparisons to 1 part in 10^{11} . Test and reference frequencies of 100 khz to 5 Mhz in 14 discrete increments are accepted. Montronics Inc., P.O. Box 7428, Seattle, Wash. [371]

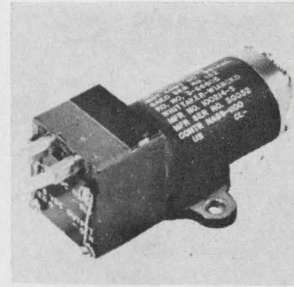

Miniature pressure transducer series P2-5000 combines a precision variable reluctance, twisted Bourdon tube pressure sensor with an integral carrier-demodulator. The series includes models for measurement of gauge, differential, and absolute pressure in ranges from 0-1 to 0-5,000 psi, with $\pm 0.50\%$ accuracy. Whittaker Corp., 12838 Saticoy St., N. Hollywood, Calif. 91605. [372]

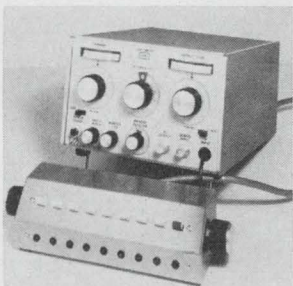

Solid state uhf sweep generator model 1501 features completely automatic frequency tuning and r-f attenuation. An electronic attenuator provides a 30-db dynamic range of r-f output level, and the tuner i-f or tv receiver 2nd detector demodulated curve is maintained at a constant amplitude over this range. Basic unit price is \$425. Sweep Systems Inc., P.O. Box 616, Indianapolis. [373]

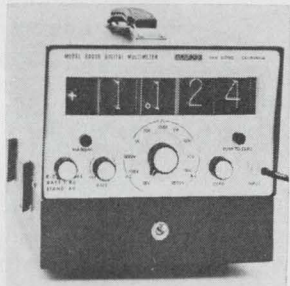

Digital multimeter 8000B is a portable instrument that uses Ni-Cd batteries. It offers 3 ranges of d-c volts, 3 of a-c volts and 5 of resistance. Features include full 4-digit readout, with 10% 5th-digit over-ranging. Accuracy is $\pm 0.05\%$ and resolution is 0.01%. Input impedance on all ranges is 10 megohms. California Instruments Corp., 3511 Midway Dr., San Diego, Calif. [374]

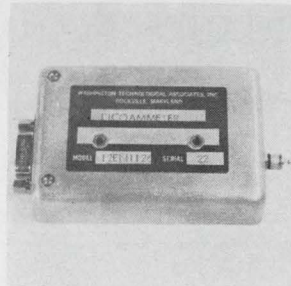

Logarithmic picoammeter model 12EN1126 is a 6-decade (120 db) current-to-voltage transducer capable of processing currents in the -1×10^{-12} to -1×10^{-6} amp range. Output is 0 at minimum input current and $+5$ v at maximum. Rise time is 9 msec maximum and noise is less than 50 mv peak to peak. Washington Technological Associates Inc., 979 Rollins Ave., Rockville, Md. [375]

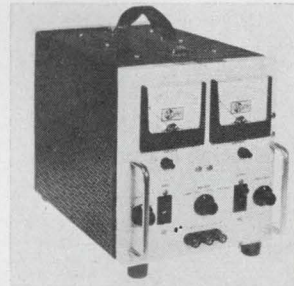

Portable, solid state power converter 4000A is designed for mobile use; the 4000AP is suited for ground service and lab use; the 4000AR, for rack or panel mounting. Input requirements are 120 v a-c, 47-450 hz. Output signals are fixed at 400 hz at 1 kva, or varied from 100-130 v a-c and 360-400 hz at outputs to 1 kva. Power Systems Inc., 4023 Del Ray Ave., Venice, Calif. [376]

change in hue. At about 0.8 nsec per degree, that means that the smallest time delay between signals that would produce a change would be about 6 nsec; and we did not see any change in hue between the channels in our experiment."

The two channels can also be combined into one with a bandwidth greater than the rated 6-Mhz; but because of envelope delay in the transmission path, the top single-channel bandwidth is about 8 Mhz.

Sequential recording. The conventional transverse-tape recorder has four recording heads at 90° intervals around a drum that is

part of the tape-transport system. These heads write across the moving tape. The FR-950 has an additional set of four heads at a 45° angle to the first set, so that information from each channel is recorded sequentially.

In the single-channel form, Lake says, an error of 50 micrometers in the placement of the heads will result in an error of half a microsecond in the time base on the tape. With two sets of heads, Ampex found that optical methods of alignment took too long and were too costly for a production instrument—the drum is smaller than a silver dollar. Considering that the

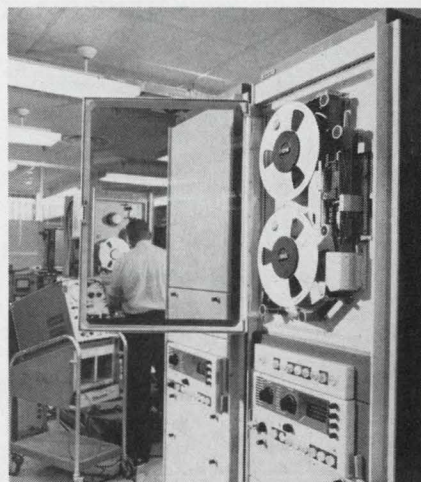

Business end. Extra set of recording heads was squeezed into tape-transport system.

This announcement is a matter of record only.

General Instrument Corporation

has acquired through merger

Universal Controls, Inc.

The undersigned, on behalf of General Instrument Corporation,
assisted in the negotiations leading to this transaction.

LOEB, RHOADES & Co.

September 8, 1967

Circle 253 on reader service card

September 8, 1967

General Instrument Corporation

and

Universal Controls, Inc.

have effected their merger

*The undersigned acted as financial advisor to Universal Controls, Inc.
and conducted negotiations on their behalf leading to this transaction.*

Smith, Barney & Co.

Incorporated

NEW YORK • PHILADELPHIA • CHICAGO • BOSTON • SAN FRANCISCO • MINNEAPOLIS • PARIS
Albany • Allentown • Cleveland • Dallas • Hartford • Los Angeles • Milwaukee • Tampa

... servo network corrects tape speed ...

whole system costs \$130,000, and fills two racks, the cost of optical alignment on that small part must have been astronomical for Ampex to have abandoned the approach. Instead, the company came up with an electronic system to do the job. Ampex considers the new method proprietary. Other than saying that a laser isn't used, the company won't give any details about the method.

Countdown. Positioning of the heads is only part of the problem. Because minute variations in tape speed and the rotation of the drum can cause frequency differences in the reproduced signal, Ampex corrects the variations with a servo network.

Since a four-head drum has at least one head in contact with the tape at all times, the resultant load variations on the drive capstans can cause diversions from the specified 244 revolutions per second.

To overcome the problem, a 500-kilohertz pilot signal, derived from a temperature-controlled quartz oscillator, is utilized. The pilot is counted down to 244 hertz and compared to the actual revolutions per second, generating error voltages to correct the spin rate. This mechanical correction can do the job to only about 200 nsec; the remaining correction is electronic. The signal is fed through a voltage-variable delay line—an inductance-capacitance section in which the capacitor is variable. The phase of the recorded signal is compared with the phase of the pilot tone. The difference is utilized to derive a d-c bias voltage that is equal but opposite to the phase-differential voltage.

IC's are used. The FR-950 uses off-the-shelf integrated circuits in the servo countdown circuitry. Both channels are related to the same stable oscillator; the individual channel's time-base stability of ± 15 nsec is the second component of the ± 25 nsec displacement error between channels.

The system is also available in stripped-down form, with minimum playback capabilities, as a data-acquisition recorder with quick-look, on-site verification. One

NEW DVM

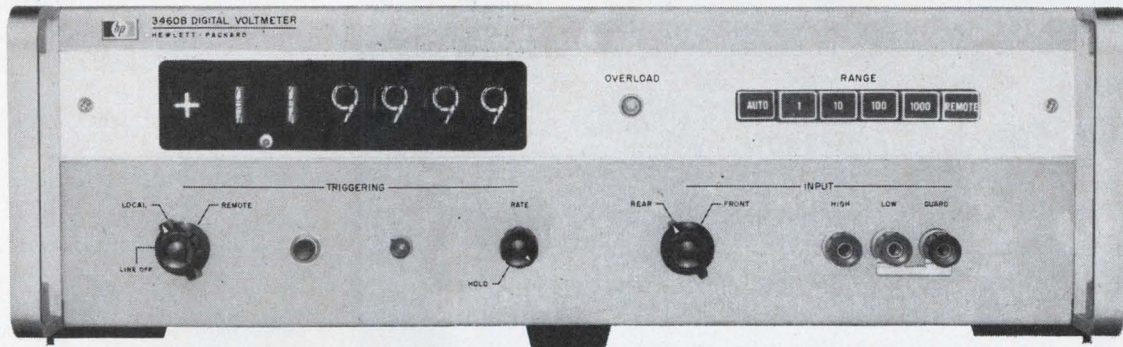

Dual Technique for 0.004% Accuracy

hp 3460B Integrating/Potentiometric Voltmeter Has High Accuracy... $>10^{10}\Omega$ Input Resistance... Systems Compatibility

The new hp 3460B Digital Voltmeter is a dual-technique instrument that combines the best features of an integrating voltmeter with those of a potentiometric voltmeter—to give an accuracy of 0.004% of reading, superimposed noise immunity of integrating DVM's and a high common mode rejection of 160 dB at dc.

You get up to 15 readings per second with five full digits and 20% overranging indicated by a sixth digit. Polarity selection is automatic. The 3460B has 10 μV sensitivity. Four ranges are selectable by pushbuttons on the front panel, or, range selection can be automatic or remote.

Floating and guarded input connectors are on both the front and back of the instrument. Input resistance is $>10^{10}\Omega$ at balance on 1 V and 10 V ranges (minimum 10 $\text{M}\Omega$), and a constant 10 $\text{M}\Omega$ on 100 V and 1000 V ranges.

Programmability.—hp 3460B is designed for

fully automatic operation in a digital data acquisition system. A four-line BCD output (1-2-4-8) on the back of the instrument contains 6 digits of data, polarity, decimal location and overload information. Voltage range and two integration periods can be selected by external circuit closure to ground.

Get the full story on the new dual-technique hp 3460B Digital Voltmeter from your nearest hp field engineer. Or, write to Hewlett-Packard, Palo Alto, California 94304. Europe: 54 Route des Acacias, Geneva. Price: hp Model 3460B, \$3600.00.

097/13

HEWLETT  PACKARD
An extra measure of quality

Gerard W. Mulder, President,
Gibbs Manufacturing and Research Corp.,
Janesville and Milton, Wisconsin,
(Subsidiary of Hammond Corporation)
inspects a variety of the timing devices
his firm manufactures.



It's Time To Investigate Wisconsin's "Profitable Difference"

"We've grown from 125 employees in 1961 to our current level exceeding 600," says Jerry Mulder. "And there has been no shortage of skilled, trainable labor. When your product line includes audio reverberation units and electronic, mechanical, electromechanical, and electrochemical timing devices for military, space, and commercial applications, you must attract a top-notch engineering staff. Ours equals those in the popular east and west coast 'brain centers.' Thanks to Wisconsin's excellent vocational and technical schools, perhaps the best in the nation, we have an ample supply of skilled technicians. Our female labor force is better than I've seen anywhere else and I've been an administrator for 22 years in six states. Gibbs will continue to expand in Wisconsin. We like it here!"

*Our Director of Industry Development,
John R. Frederick, can show you a lot of facts
about Wisconsin's skilled labor force, male and female.
Call him collect at 608-256-3151
or write: Dept. F, P. O. Box 192,
Madison, Wisconsin 53701.*

WISCONSIN
POWER AND LIGHT
An Investor Owned COMPANY

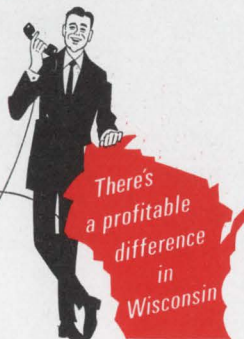

customer—Holloman Air Force Base—plans to use the smaller version, the FR-950-2, on a missile range, and the big FR-950-1 for data analysis. The FR-950-2, which costs \$85,000, does not contain the r-f equalizer or time-base correction electronics, but it may be upgraded into an FR-950-1 by the purchase of additional modules. In addition, Ampex says that beginning in November, all single-channel FR-900 instrumentation recorders—the predecessor of the FR-950—will be constructed so that they may be converted into FR-950's.

Specifications

Input impedance	750 ohms unbalanced to ground
Input signal level	1 v p-p
Output impedance	75 ohms unbalanced
output signal level	1 v p-p at normal recorded level
Frequency response	Within ± 1.5 db, from 5 Hz to 5.5 Mhz; down no more than 3 db at 1 Hz and 6 Mhz referenced to 1 Mhz (extended d-c response available on special order)
Signal-to-noise	40-db p-p signal to rms noise referenced to nominal 1 v signal for 6-Mhz bandwidth
Rise time	Not more than 100 nsec, 10% to 90% signal level
Amplitude linearity	Within ± 0.5 db
Amplitude stability	± 0.5 db, excluding wideband noise
Time-base stability	± 15 -nsec p-p
Size	Two racks, each 75 x 22 x 24 in.
Weight	1,300 lbs
Power	108 v to 132 v, 48 Hz to 62 Hz; 16 amps for 950-1; 6 amps for 950-2

Ampex Corp., 401 Broadway, Redwood City, Calif. 94063 [377]

New instruments

Defining the need — and filling it

New firm bids for 'wide open' markets with special-purpose digital voltmeter

"There are about 90 companies that list digital voltmeters in their catalogs, but only about four or five of them are doing any significant business because the rest of them don't know engineering or marketing or either." The author of that polemic

Don't despair because the company's educational program wasn't planned for your electronics support people...

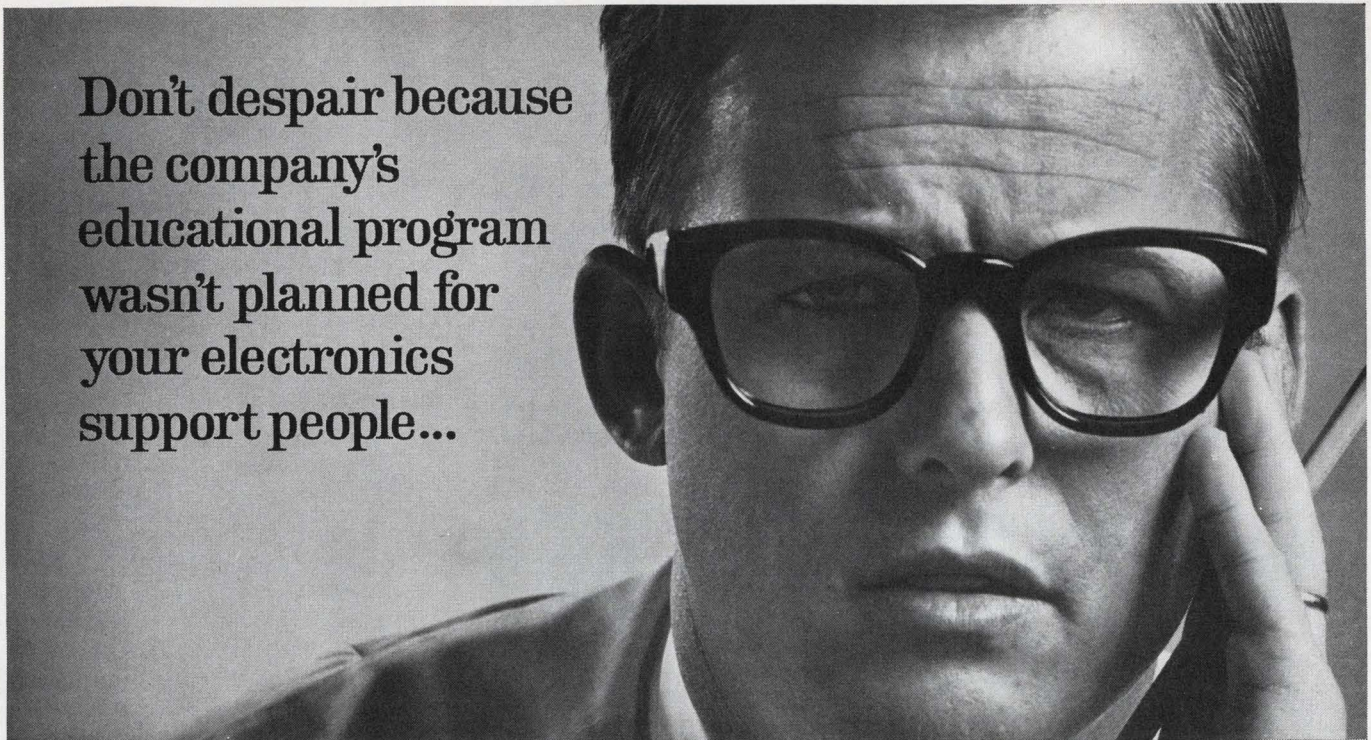

improvise

Look over your men. Pick out a few who are intelligent enough to profit from more education in electronics, ambitious enough to work hard to get it. Send us their names and addresses. We'll send them complete information about CREI Home Study Programs in Electronics, tell them how these programs have helped thousands of young men increase their value to their employers. We'll explain how they can study at home, at their own pace, on their own schedule without traveling

to classes. We'll give them the names of the more than 80 leading scientists and engineers who help us develop and update programs related directly to the needs of industry.

Yes, we'll do all that. If you're lucky some of your men may enroll. Why not give it a try? Fill out the coupon and get it in the mail today.



CREI Programs cover these specialized areas of advanced electronics:

- Communications Engineering • Aeronautical and Navigational Engineering • Television Engineering • Computers • Nuclear Instrumentation and Control • Automatic Control Engineering • Missile and Spacecraft Guidance • Radar and Sonar Engineering • Nuclear Engineering Technology • Industrial Electronics for Automation • Computer Systems Technology.

CREI
THE CAPITOL RADIO ENGINEERING INSTITUTE

A Division of McGraw-Hill, Inc.
Dept. 1810E-1, 3224 Sixteenth Street, N.W.
Washington, D.C. 20010

Gentlemen: The men listed at right are high school graduates working in some phase of electronics. Please send them your FREE book, "How to Prepare Today for Tomorrow's Jobs" and complete information about CREI Home Study Programs.

And please send me the free brochure which tells how we can use CREI Home Study Programs to supplement our educational program for electronics personnel.

Name _____
 Title _____
 Company _____
 Address _____
 City _____ State _____ Zip Code _____

Name _____
 Address _____
 City _____ State _____ Zip Code _____
 Name _____
 Address _____
 City _____ State _____ Zip Code _____
 Name _____
 Address _____
 City _____ State _____ Zip Code _____
 Name _____
 Address _____
 City _____ State _____ Zip Code _____
 Name _____
 Address _____
 City _____ State _____ Zip Code _____

(Not enough room? Attach sheet of paper with additional names and addresses)

Ballantine low-cost DVM's are small, easy-to-use... permit fast, highly accurate measurements in production with unskilled personnel... are ideal, too, for the lab and quality control. Compare their many useful features.



BALLANTINE DC DVM

Model 353

Designed to replace multi-knob manual vm's for speed and accuracy ■ 0 to 1100 V ■ High accuracy $\pm 0.02\%$ of reading $\pm 0.01\%$ f.s. ■ 4 digit with overranging to 5, plus interpolation of last digit ■ Resolution 0.002% ■ Reading retention or continuous observation of varying signals ■ All solid state ■ 10 megohms input resistance ■ Isolated signal ground with high common mode rejection ■ Small size ($\frac{1}{2}$ rack module) and low weight (7.7 lbs.) ■ Power requirement 115/230 V, 50 to 60 Hz ■ Price: \$490

BALLANTINE AC-DC DVM

Model 355

Designed to increase accuracy and speed up readings compared to those made with analog instruments ■ 0 to 1000 V ac, 30 Hz to 250 kHz ■ 0 to 1000 V dc ■ Accuracy 0.25% f.s. ■ Full scale sensitivity of 10 mV on ac; 100 mV on dc ■ 3 digits with overranging to 4, plus interpolation of last digit ■ Single economical package ■ Small size ($\frac{1}{2}$ rack module) ■ Reading retention, or continuous observation of varying signals ■ Isolated signal ground, with high common mode rejection ■ DC output for connection to recorder ■ Amplifier output, 60 dB gain ■ Zener reference ■ Power requirement 115/230 V, 50 to 60 Hz ■ Price: \$620

Write for brochures giving complete details



BALLANTINE LABORATORIES INC.

Boonton, New Jersey

CHECK WITH BALLANTINE FIRST FOR DC AND AC ELECTRONIC VOLTMETERS/AMMETERS/OHMETERS, REGARDLESS OF YOUR REQUIREMENTS. WE HAVE A LARGE LINE, WITH ADDITIONS EACH YEAR. ALSO AC/DC LINEAR CONVERTERS, AC/DC CALIBRATORS, WIDE BAND AMPLIFIERS, DIRECT-READING CAPACITANCE METERS, AND A LINE OF LABORATORY VOLTAGE STANDARDS FOR 0 TO 1,000 MHZ.



Simplicity. The uncluttered front panel of the DS-100 makes it ideal for production line use.

is Albert Frowiss, who, with two former associates at the Test Instruments division of Honeywell Inc., has formed Doric Scientific Corp. to cash in on what he feels is a void in the instrumentation field. Doric's first product is an integrating digital voltmeter, the DS-100, with a four-digit readout by cold cathode tube and a fifth digit for overrange.

"We want the markets for special-purpose digital voltmeters," Frowiss declares. And he believes they're wide open. "Most producers of digital voltmeters build general-purpose instruments instead," he says, "because they don't understand the customers' needs."

Frowiss, who is vice president for marketing in the new company, thinks Doric's greatest current asset is its founders' awareness of these needs. Peter Zarcades, Doric's president, was director of engineering at the Honeywell unit, and earlier designed the first solid state digital voltmeter while at Electro Instruments Inc. Peter Haas, Doric's vice president for engineering, was previously chief development engineer at the Honeywell division.

The new voltmeter will probably be used initially to test transducers and inspect semiconductors on the production line, applications requiring extremely low-level measurements. The instrument for transducer testing will have a power supply to excite transducer bridges plus a special optional feature: a direct readout in pressure or strain rather than voltages.

The DS-100 can measure from 10 millivolts to 1,000 volts. In the 10-millivolt range, sensitivity and repeatability are both one microvolt—a performance that puts the

**The new AO
StereoStar/ZOOM
Microscope
gives you high
resolution,
new convenience,
superior optics
and wide
magnification
range.**

Here are a few of the outstanding advantages that make the new AO® StereoStar/ZOOM Microscope the finest instrument of this type available today:

- Widest total magnification range: 3.5–210X
- High resolution to meet the most exacting needs
- The most convenient zoom control available
- Choice of five interchangeable, rotatable zoom power bodies
- Crisp, sharp images at all magnifications
- Extra large field of view and high eyepoint eyepieces
- Wide choice of stands for every purpose
- Long working distance
- Even illumination over the entire field
- Coolest operating illuminator.

See for yourself. Contact your AO Sales Representative for a demonstration, or write for our 24-page, full-color brochure on the newest in stereo microscopes—the AO StereoStar/ZOOM.

*TM Reg., American Optical Co.



**AMERICAN
OPTICAL
COMPANY**

**INSTRUMENT DIVISION
BUFFALO, NEW YORK 14215**
Circle 191 on reader service card

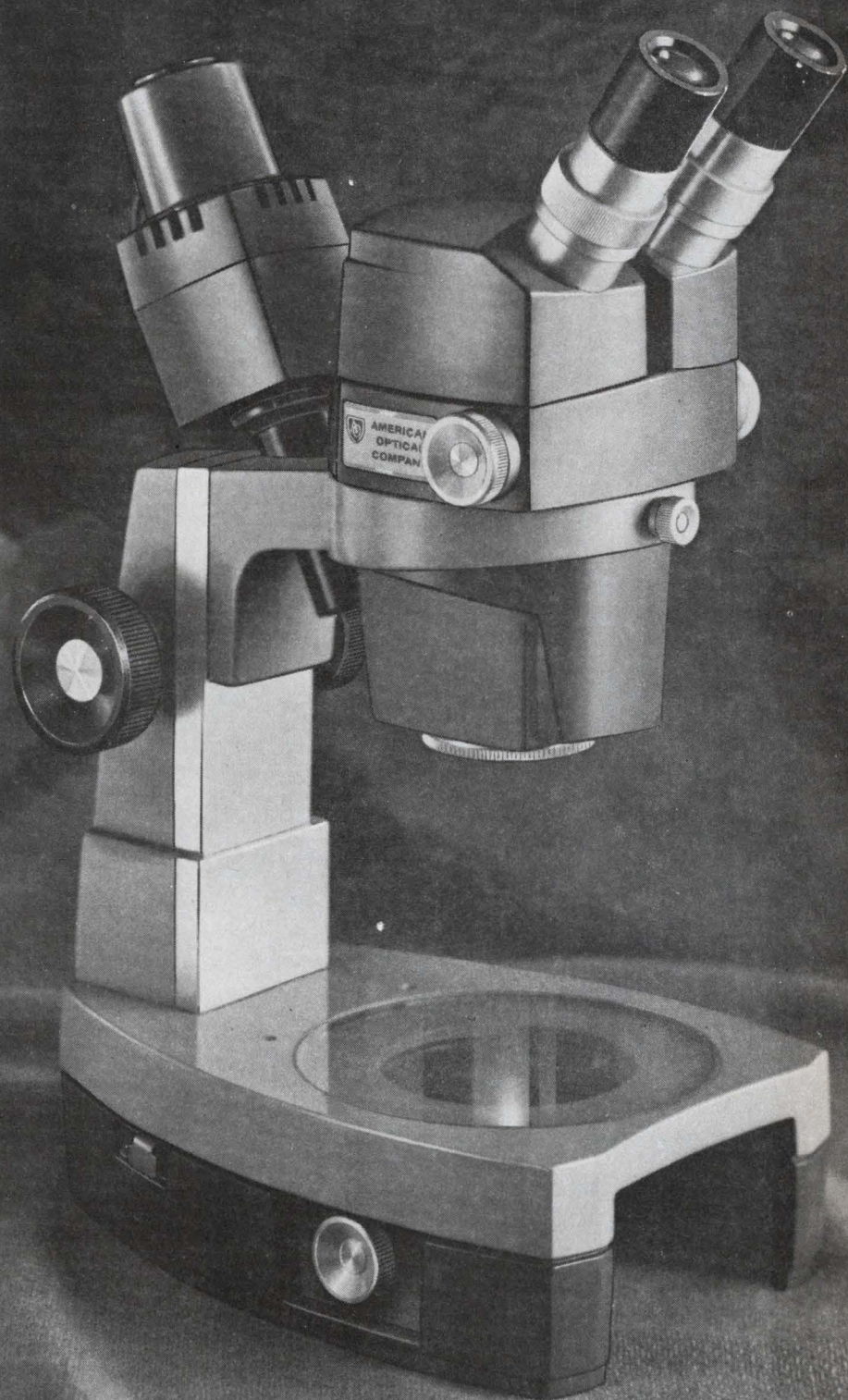

CUT CONSTRUCTION DELAY

with pre-punched **VECTORBORD,* PLUGBORDS and Push-in TERMINALS**

Make circuits the fast, easy way . . . simply insert Vector push-in terminals (wide variety available) and component wires into pre-punched Vectorbord, or use punched copper clad for do-it-yourself etching; and, for production, we're geared to omit the holes not required and assemble terminals, eyelets, etc. to your specifications. Eleven patterns available with .025", .040", .062", .093" holes in XXXP phenolic, glass silicone, glass or paper epoxy and copper clad. Plugboards supplied in many sizes with etched pads, .040" dia. Edge-Pins or Elco Varicon* contacts.

Save time — Save work — Save money!

*TRADE MARK



Send for complete literature

VECTOR ELECTRONIC CO., INC.

1100 Flower St., Glendale, Calif. 91201 Area 213 Phone 245-8971

Circle 255 on reader service card

NORTON Magnetic Tape Heads

4514 1" Tape

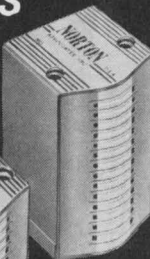

4507 1/2" Tape

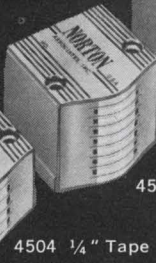

4504 1/4" Tape

SERIES 4500

Crosstalk—50 DB
+75°C Temperature Operation

Send now for complete technical literature.

NORTON

ASSOCIATES, INC.

10 Di Tomas Court, Copiague, N.Y. 11726
Phone: 516 598-1600

GRC[®] Intermold[®]



die cast
ZINC ALLOY

Samples Show How
**NEW MOLDING PROCESS
JOINS 2 DIFFERENT
PLASTICS IN A SINGLE
SMALL PART**

molded
PLASTICS

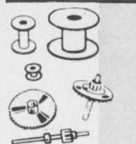

Coil Bobbins
Gears & Pinions

- Combine different colors, physical, chemical properties of different plastics in a single tiny component.
 - Movable-element parts, separable parts, two-color parts, numbered and lettered parts, combination-of-materials parts.
 - Saves assembly costs, enhances appearance, performance of your product.
- Write today for "Intermold" samples and detailed bulletin.

GRIES REPRODUCER CO.



Division of Coats & Clark Inc.
World's Foremost Producer of Small Die Castings
151 Beechwood Ave. New Rochelle, N.Y. • (914) 633-8600
Plants in: New Rochelle, N.Y.; Warren, R.I.; Toccoa, Ga.

instrument in a class with Hewlett-Packard's model 2402A digital voltmeter. That unit, however, sells for \$4,800, far more than the DS-100's \$790 price.

An automatic zero-drift compensation circuit checks out and computes drift, and special noise-rejection circuitry permits 160 decibels of common mode rejection at any frequency. The latter feature, in effect, synchronizes the measurement period with the period of both symmetrical and asymmetrical noise, and, according to Forwiss, enables the instrument to reject noise 10 times as great as the signal range. Noise is rejected in 250 milliseconds, allowing at least four readings per second. A high-speed option costing an added \$200 will permit 20 readings per second.

Specifications

Input circuit	guarded differential
Size	4 1/2 x 13 in.
Measurement range	1 μ v through 750 v d-c
Input impedance	1,000 megohms constant at all ranges through 10v
Accuracy	0.01% of reading and 0.01% of full scale
Speed	up to 20 readings per second
Range time	15 msec
Common mode rejection	160 db
Normal mode rejection	80 db from 59 hz, increasing at 60 db per decade
D-c ratios	four-quadrant bipolar, six-range with autorange
Zero drift	none

Doric Scientific Corp., 7969 Engineer Rd., San Diego, Calif. 92111 [378]

New instruments

Checking out an IC in twenty seconds

Plug-in program modules reduce set-up time on IC tester for low-volume users

About a year ago, \$2,000 was a low price for an integrated-circuit tester. Last month that price tumbled to about \$500.

Now another firm, three-month old Microdyne Instruments Inc., has entered the low-cost IC tester market. Formed by four ex-Sylvania engineers, the firm is offering

Solid State Multipurpose Digital Voltmeter with VTVM Capabilities

VALUE THROUGH INNOVATION

FEATURES:

DC Volts: 10 Microvolts to 10,000 volts @ 100 Meg Ω Input Impedance

AC Volts: 10 Millivolts to 300 Volts 20 Hz to 500 MHz

Ohms: 10 Milliohms to 2000 Megohms

Current: 10 Pico amps to 200 Milliamps

Accuracy: .1% \pm 1 digit

100% Over-range

3 Readings per second most ranges

Floating Input

Unique Low, Medium, High Range Selector

Overload Indicator

Analog Output

Auxiliary Power Supply Output

Dual Ohms Protection

Automatic Polarity

Polarity Indication

Display Storage

Optional Adjustable 30 volts, 150 ma regulated plug-in supply

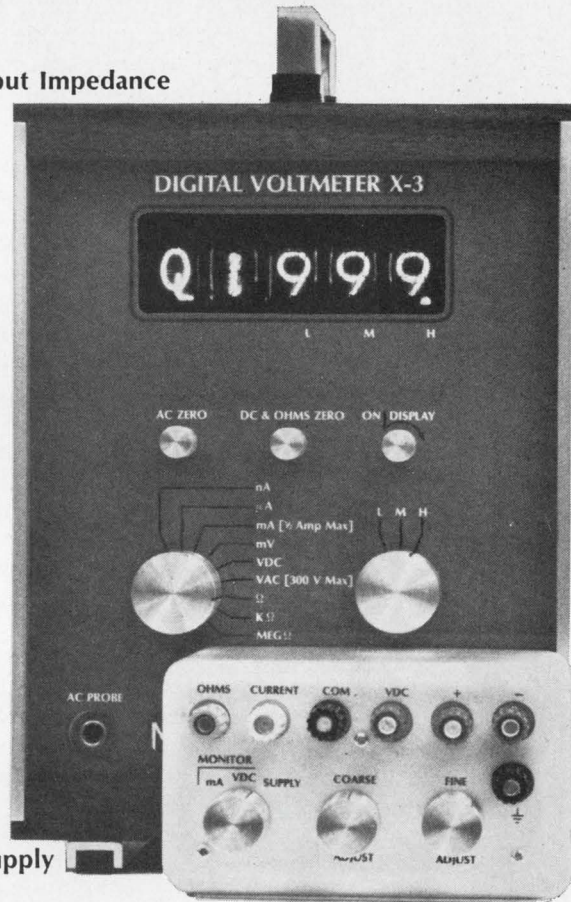

\$695 (including probes)

The NLS X-3 is the first digitally indicating multifunction instrument designed to fill those requirements where .005% and .01% accuracies are not required. The X-3 eliminates the operator training required by inaccurate, difficult-to-read moving pointer meter displays. Parallax is completely eliminated; the unique Hi-Lo-Medium range switch makes the X-3 a pleasure to use; especially in production line testing.

All the features in the X-3 are standard, including the probes. A unique and long awaited innovation in the X-3 is PS-I Power Supply Option. The Standard X-3 provides a filtered 40 volt, 200 ma power supply. When the PS-I is used, it directly plugs into the front panel terminals on the X-3. Now, besides having the measuring capabilities provided by the X-3, you have an adjustable, regulated 0-30 volt, 150 milliamper supply. By simply turning a switch on the supply, you can monitor both supply voltage and supply current and still use all the measuring capability of the X-3.



Originator of the Digital Voltmeter
NON-LINEAR SYSTEMS, INC.
DEL MAR, CALIFORNIA 92014
[714] 755-1134/TWX: 910-322-1132

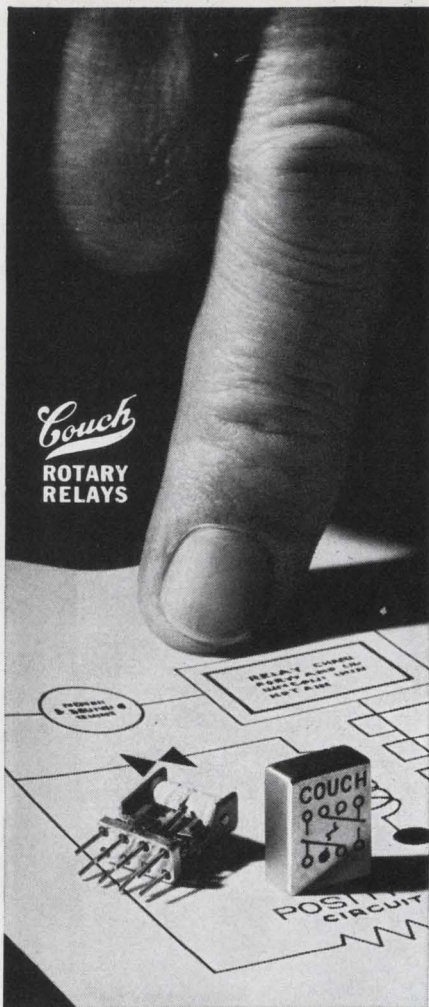

Cramped for space?

Use Couch 1/7-size Relays

Space/weight problem? The new Couch 2X 1/7-size crystal can relay gives you tremendous savings in space and weight. 0.1" grid — plus many outstanding specs — *all in microminiature*. Thoroughly field-proven in electronics and space applications.

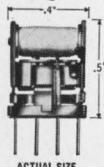

	2X(DPDT) meets MIL-R-5757D	1X(SPDT)
Size	0.2" x 0.4" x 0.5"	same
Contacts	0.5 amp @ 30 VDC	same
Coil Operating Power	100 mw 150 mw	70 mw 100 mw
Coil Resistance	60 to 4000 ohms	125 to 4000 ohms
Temperature	-65°C to 125°C	same
Vibration	20 G	same
Shock	75 G	same

Broad choice of terminals, coil resistances, mounting styles. Write for detailed data sheets.

RUGGED ROTARY RELAYS  Dynamically and Statically Balanced

COUCH ORDNANCE INC.

3 Arlington St., North Quincy, Mass. 02171, Area Code 617, CYPress 8-4147 • A subsidiary of S. H. COUCH COMPANY, INC.

... pulse generator to test flip-flops ...

its Model 701 IC tester for \$545.

Unlike the first testers at this price, the Microdyne unit is not a stripped-down model. Preprogrammed patch plugs eliminate the need to set up a 10 x 20 matrix; all the operator does is select and insert the plug that corresponds to the unit being tested. Such IC's as RTL, DTL, and TTL logic modules can be functionally tested in less than 25 seconds.

Inside. Most of the circuitry is made from discrete components, but the pulse generator is IC. The unit contains only two bipolar voltage power supplies. If more than two voltages are required to perform a test, simple voltage-divider networks are used. This can be done, according to the company, because of the high impedance of the devices under test—the low impedance of the voltage divider will not be affected by the high impedance of the device. Instead of current supplies, the 701 measures the voltage-drop across a resistor. These shortcuts keep the cost of the unit down, but test results still fall within the 2% accuracy of the tester.

Besides the usual d-c tests, the 701 has a built-in pulse generator that enables it to test flip-flops. Two frequencies are provided: 5 hertz and 10 kilohertz. If the flip-flop is functioning properly, the output indicator lamps will flash on and off. Tests can also be performed on operational amplifiers and discrete component circuits by changing the test sockets.

To perform a series of tests on an IC, the operator first sets the power supply and the current limits to the values determined by the

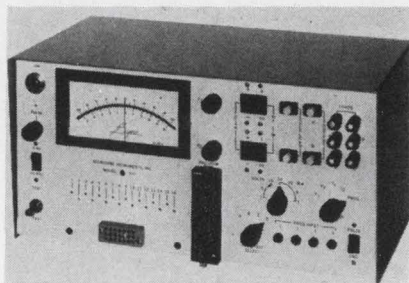

Push button. A selector switch and four buttons allow 16 tests to be run in 20 seconds.

Digital Ohmmeter with 0.1% accuracy, 0.001Ω to 1000MΩ range



DMS-3200 Main Frame **\$320**
DP-170 Ohmmeter Plug-in **\$240**
\$560

The type DP-170 Ohmmeter Plug-in, when used with the DMS-3200 Main Frame, provides digital display of resistance measurements from 0.001 ohm to 1,000 megohms in ten ranges. The system offers accuracy capability of $\pm 0.1\%$ FS $\pm 0.1\%$ of reading. Direct linear readout of resistances above 1 megohm at the accuracies specified represents an industry first in digital instruments.

The measurement system is that of a true wheatstone bridge, with internal electronic automatic null-out and resultant resistance value display. Of special interest is the unusually low power applied to the resistor under measurement — maximum 1 milliwatt. Four-terminal input, with "guard" terminal permits accurate measurement of both extremely low and high resistances. Response time on all ranges except the highest is 1 second and a "null indicator" indicates when the bridge is balanced and a reading may be taken.

The three-digit, all-electronic display uses "Nixie" type readout tubes and includes automatic decimal point indication. 100% over-range capability is provided and display time is variable from .5 second to 6 seconds per reading with provision for holding a reading indefinitely.

Like other DP series plug-ins, the DP-170 is all-solid-state, uses glass-epoxy printed circuit boards, and is complete within a compact plug-in housing which slides into the plug-in port of the DMS-3200 Main Frame. Main Frame size is approximately 9" x 7" x 13" and combined weight is 13 pounds. Combination price is \$560.00.

The DP-170 is but one of a complete line of plug-ins designed for use with the Hickok DMS-3200 Digital Measuring System Main Frame. All plug-ins are available from stock through franchised Hickok Industrial Distributors.



DC Voltmeter Plug-in
0.1 mv to 100 v;
0.1% accuracy
DP-100 — \$175

1 Mc Counter Plug-in
0.1 cps to 1 Mc;
0.005% accuracy
DP-150 — \$195

Ohmmeter Plug-in
0.001 ohm to
1000 Megohms;
0.1% accuracy
DP-170 — \$240

Capacity Meter Plug-in
1.0 pf to
10,000 Microfarads;
0.1% accuracy
DP-200 — \$240

Event Counter Plug-in
Counting Speed
1,000,000 pps
DP-140 — \$75

THE HICKOK ELECTRICAL INSTRUMENT COMPANY
10514 Dupont Avenue • Cleveland, Ohio 44108

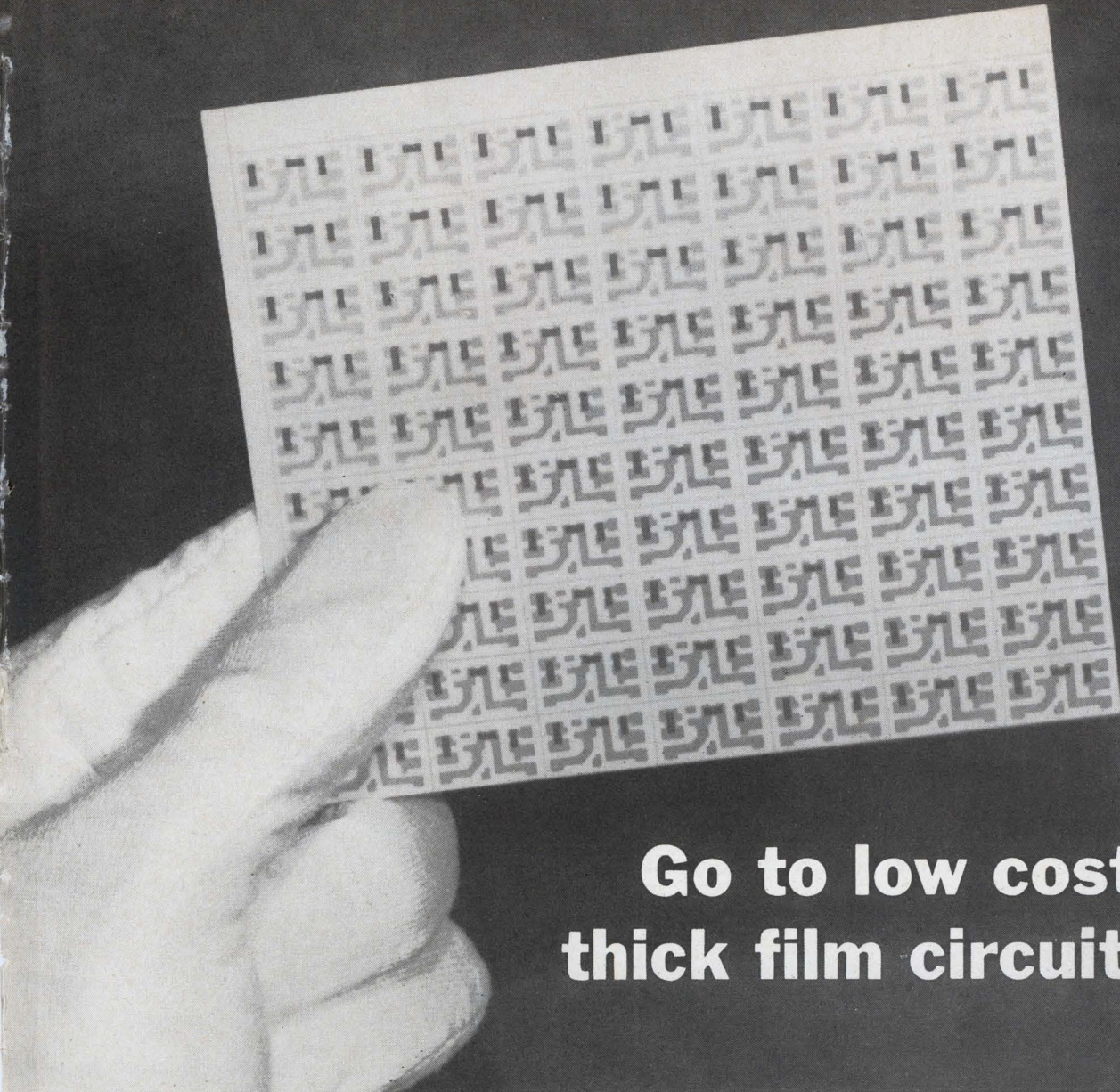

Go to low cost thick film circuitry!

Coors can help you get into the thick film business for low cost microcircuitry and packaging. With new technology, air fired pastes make low cost conductors, resistors and dielectrics. These open up a wide possibility of circuit networks for solid state and high density packaging. Coors can make up complete thick-film-on-ceramic circuit boards—and take the load off your production facilities. Or, Coors can furnish you the ceramic substrates for your in-house operation, plus giving you technical assistance on application techniques. Coors facilities can accommodate fast delivery on orders for thousands or millions. If you are thinking about going to low cost, thick film circuit boards, let's talk. Coors can also help you make the best choice in high temperature, brazed packaging. Get on-the-spot answers. Dial Coors—303/279-6565, Ext. 374. For complete facilities and capabilities, write for Coors Metallizing Data.

*consider
Coors
ceramics*

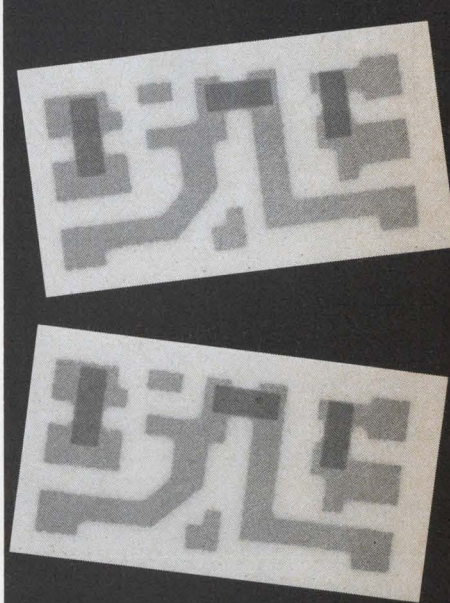

Coors

CERAMICS

ALUMINA • BERYLLIA • MAGNESIA • SPECIAL OXIDES

Coors Porcelain Co., Golden, Colo.

PROBLEM SOLVERS!

BARNES CARRIERS, CONTACTORS AND SOCKETS FOR DUAL-IN-LINE HANDLING AND TESTING

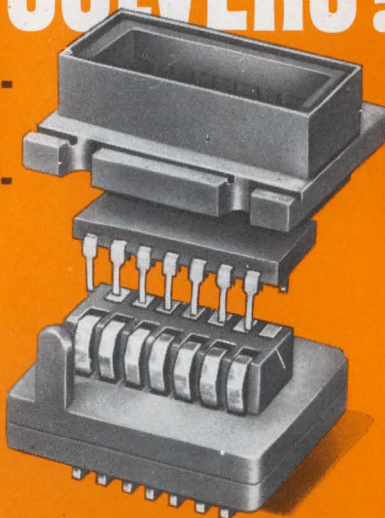
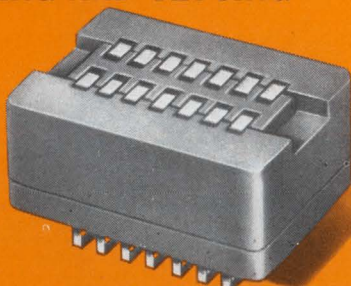

Looking for the right answers to dual-in-line handling and test problems? Now you can guarantee fast, reliable device testing with Barnes new easy-insertion 14 and 16 lead DIP Sockets and Contactors. For high-speed automatic handling . . . device marking, environmental test and automatic production mounting on P.C. boards . . . use Barnes Carriers to speed production and increase yields. Drop us a line for the full story.

barnes
DEVELOPMENT COMPANY

Lansdowne, Pa. 19050 • 215/MA2-1525

barnes / THE FIRST WORD IN CARRIERS, CONTACTORS AND SOCKETS FOR I.C.'S

Circle 257 on reader service card

. . . digital readout
also available . . .

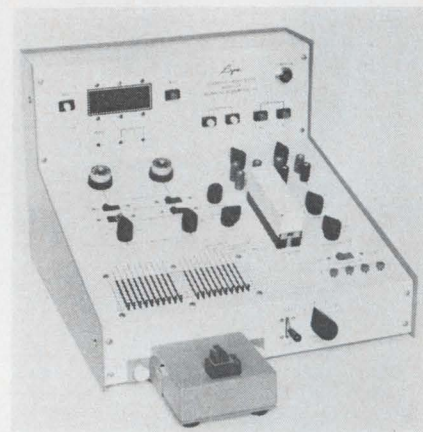

Top of the line. Model 711 has matrix programming and digital readout as standard equipment.

manufacturer. Next, the loads are attached to the external binding posts, and the patch plug is inserted. A selector switch determines to what section of the IC the power supply and loads are connected, and four buttons select the sequence of the tests. Thus the operator can perform 16 tests—four on each of four sections—in a matter of 20 seconds. Voltages and currents are read on the six-inch meter while output conditions, such as on-off state and overloads are indicated by lamps.

This kind of testing, according to John Gallagher, Microdyne's sales manager, is all that the low-volume user has to perform since most of the IC failures are due to bonds opening up. "After an IC leaves the factory, the most probable kind of failure is due to rough handling," Gallagher says.

Two other versions are also being offered. They are similar to the 701, but they offer the flexibility of a 10 x 20 matrix in addition to the patch plugs, and they have internal loads whereas the 701 has to be used with external loads. The 710 with a meter readout—the same as the 701—sells for \$995, and the 711 with a digital readout goes for \$1,595. Patch plugs are available from Microdyne at a cost of \$40 each for most of the logic circuits available; and unwired plugs, for component circuits or custom IC's, cost \$20.

Microdyne Instruments Inc., 225 Crescent St., Waltham, Mass. [389]

it costs you nothing to call on experience:

Reeves-Hoffman design and manufacture is 100% custom . . .
let us quote your needs!

★ quartz crystals

★ crystal filters

★ oscillators

★ discriminators

★ standards

★ ovens

REEVES-HOFFMAN 
DIVISION OF **DCA**

400 WEST NORTH STREET, CARLISLE, PENNSYLVANIA 17013
Telephone 717-243-5929

Md., Del., D.C., Va., W.Va., N.C.
Valley Electronics, Inc.
Baltimore, Maryland
(301)668-4900; (202)659-1760

New England
Howard Jappe Company
Wakefield, Mass.
(617)245-9359

Pa. (except Pittsburgh), So.N.J.
Eastern Components, Inc.
Philadelphia, Pa.
(215)927-6262

New York (except N.Y.C.)
Midstate Research Sales Co.
Syracuse, New York
(315)478-8314; (315)478-0715

New York City, No.N.J.
G. M. Moch Company
Ridgefield, New Jersey
(201)945-0080; (212)279-6758

So. California
Ash M. Wood Company
Arcadia, California
(213)283-1201; (213)287-0449

No. California
L & M Engineering
Santa Clara, Cal.
(408)243-6661

Ill., Ind., Wisc., Minn.
PGM Sales, Inc.
Chicago, Illinois
(312)622-8183

Ohio, W.Pa., Mich., Ky.
Tri-State Marketing, Inc.
Cincinnati, Ohio
(513)631-5060

Texas, Okla., Ark.
Carter Associates, Inc.
Garland, Texas
(214)276-7151

Ariz., N.M., Las Vegas
Carter Associates, Inc.
Scottsdale, Arizona
(602)947-4355

POSITIVE LOW ENERGY SWITCHING

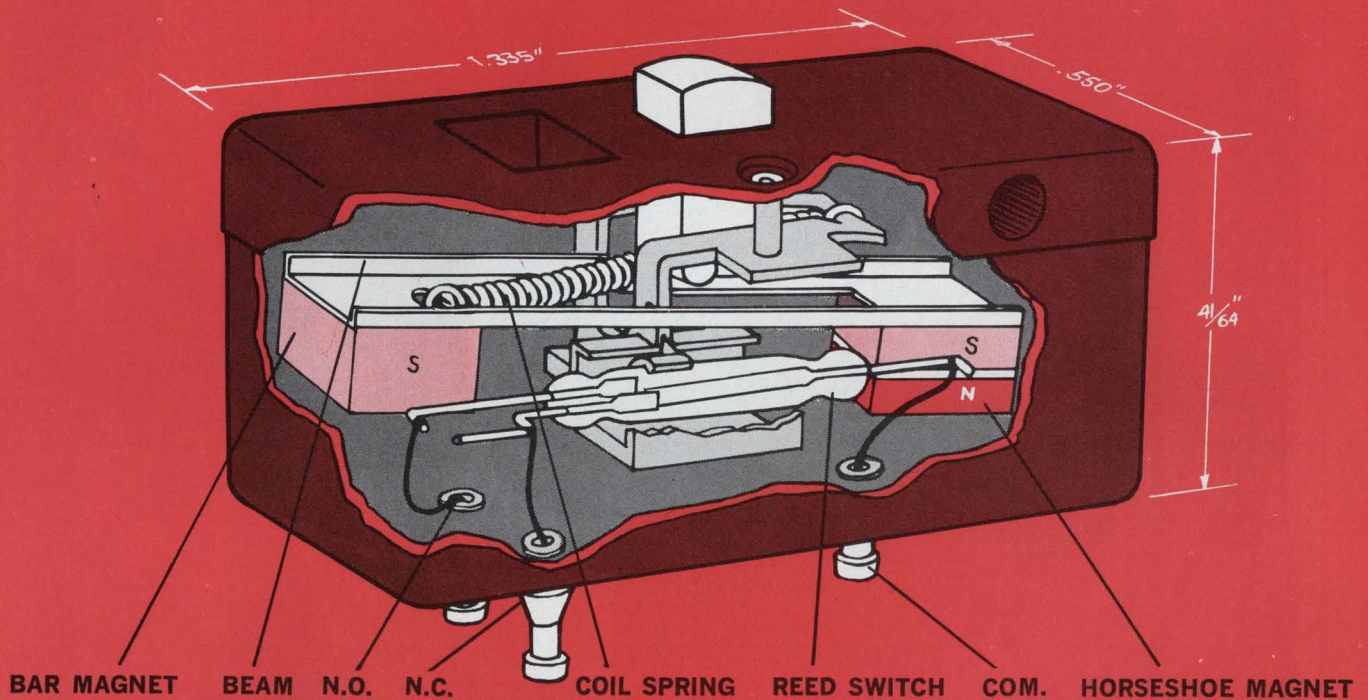

New "snap/reed" switch

Mechanically actuated reed switch . . . combines reed reliability with snap switch utility

All these features in one switch:

- long life*
- high operation rate (60 per second)
- low bounce time (300 microsec., typical on single throw)
- precise operating points (.165 ± .015)
- low movement differential (.010 typical)

A completely new concept in switching low energy circuits, Cherry's "snap/reed" switch utilizes proven coil spring snap-action movement to position magnets, providing a positive push/pull drive of reed to open or closed position.

SWITCH CHARACTERISTICS

Operating Point165 ± .015
Pretravel035 max.
Overtravel040 min.
Insertion Resistance	150 milliohms max.
Maximum D.C. Resistive Loads	3 Watts, 28 Volts, 110 M.A.
Maximum Sinusoidal Mechanical Operation Rate	60 per second

*Expected electrical life at 25% of full load—20 million operations on single throw—10 million operations on double throw.

BOUNCE TIME

	S.P.N.O.	S.P.N.C.	S.P.D.T.
Open Contact	1.0 msec. max. 0.3 msec. typ.		1.0 msec. max. 0.3 msec. typ.
Closed Contact		1.0 msec. max. 0.3 msec. typ.	3.0 msec. max. 1.0 msec. typ.

WRITE for detailed brochure on this new Cherry "snap/reed" Switch—today.



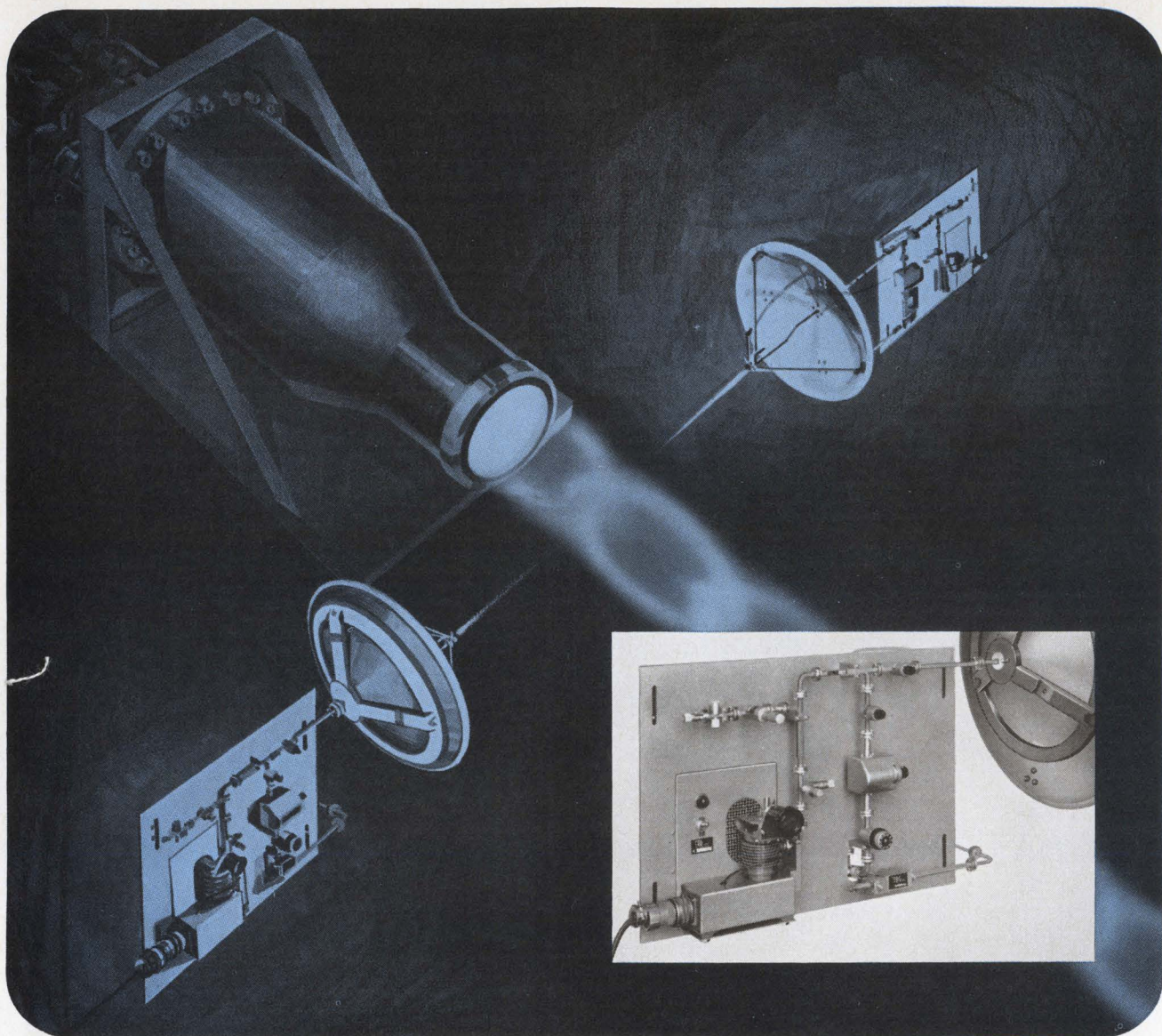

Millimeter interferometers for missile research and other plasma diagnostic applications...

TRG millimeter microwave interferometers (from 12.4 to 220 Gc) provide engineers and physicists with a simple, accurate means of measuring plasma densities and temperatures. The small size and great flexibility of these precision systems make them well suited to applications such as:

1. *Missile wake and re-entry investigation*
2. *Arc and flame studies*
3. *Thermonuclear fusion*
4. *High temperature shock phenomena*
5. *Magneto hydrodynamic (MHD) power production*
6. *Basic plasma research*

The TRG 70 Gc plasma diagnostic system above was designed and built entirely from standard millimeter

components. In operation, the rocket exhaust from the engine (under test) is centered between paraboloid or elliptical reflectors which collimate or focus microwave energy as desired. Features of this system are:

- *Direct, continuous calibration*
- *Wide dynamic range of phase shift (>360°)*
- *Wide dynamic range of attenuation changes (up to 50 db)*

For detailed information, contact your TRG representative or write to: 400 Border Street, East Boston, Massachusetts 02128. Phone (617) 569-2110.

TRG
DIVISION **CONTROL DATA**
CORPORATION

New Subassemblies Review

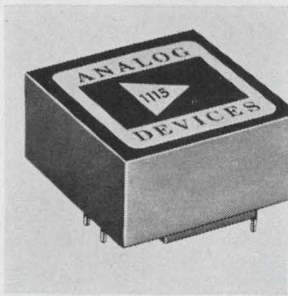

D-c differential operational amplifier model 1115 develops 5 ma output at ± 10 v. Specifications include 15,000 open-loop d-c gain at full load, 20 $\mu\text{v}/^\circ\text{C}$ max. voltage drift from -25° to $+85^\circ\text{C}$, 200 na max. initial bias current drift, and 1.5 Mhz small-signal bandwidth. It measures $\frac{1}{2} \times 1 \times 1$ in. Price is \$13 (\$9.75 in lots of 1,000). Analog Devices Inc., 221 5th St., Cambridge, Mass. [381]

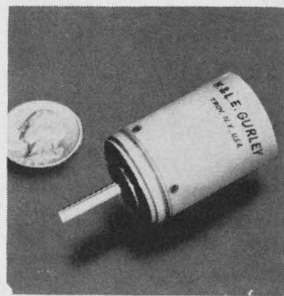

Incremental, photoelectric rotary encoder 8610 is housed in a synchro size 11 package. It is suited for use in computer and process control equipment, and aerospace guidance systems. The unit incorporates GaAs light sources for maximum reliability from -55° to $+100^\circ\text{C}$ and shock in excess of 50 g. Accuracy is ± 1 minute. W.&L.E. Gurley, Troy, N.Y. 12181. [382]

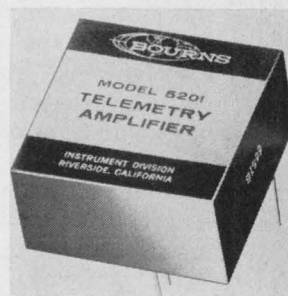

Telemetry amplifier model 5201, suitable for thermocouple, strain gage, and other sensor systems, is also useful in aerospace, ground support, and medical electronics applications. Measuring $1 \times 1 \times 0.5$ in. and weighing 0.6 oz, it produces up to 0-5 v d-c output with a 5-mv input. Frequency response is 7.5 khz. Bourns Inc., 6135 Magnolia Ave., Riverside, Calif. 92506. [383]



Six FET operational amplifiers in the 700 series feature 100,000-megohm input impedance, less than ± 30 picoamps offset current. Gain bandwidth product is 50 Mhz and open loop gain is 1,000,000. Model 701 is a general-purpose unit priced at \$55. Other units range in price from \$75 to \$135. Several come in flatpack cases. GPS Instrument Co., 188 Needham St., Newton, Mass. [384]

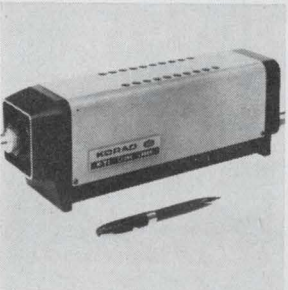

Yttrium aluminum garnet laser K-Y1 has a c-w output of 3 w. Emission is at 1.06 microns with a half-angle beam divergence of 2.5 milliradians at threshold. Power supply is housed in a $10 \times 10 \times 20$ in. cabinet. The laser head is $4 \times 4 \times 12$ in. Applications include trimming of resistors, real-time data display. Korad Corp., 2520 Colorado Ave., Santa Monica, Calif. [385]



Miniature preamplifier-demodulator-quadrature rejector model 324 accepts 400-hz a-c input signals and converts them to phase-sensitive d-c signals for use in instrumentation systems. Maximum output is ± 20 v d-c. Effective quadrature rejection ratio is 30:1 minimum. Input impedance is 10,000 ohms. Control Technology Co., 41-46 29th St., Long Island City, N.Y. [386]



Zener reference, regulated power supply model PZ-131 delivers stable, continuously variable outputs from 0.5 to 25 v at currents to 200 ma. The compact ($4\frac{1}{2} \times 2\frac{1}{2} \times 4$ in.) unit provides load regulation better than 100 mv, line regulation of ± 30 mv, and a-c ripple and noise of less than 2 mv at full load. Price is \$34.95. Viking of Minneapolis Inc., P.O. Box 9507, Minneapolis. [387]

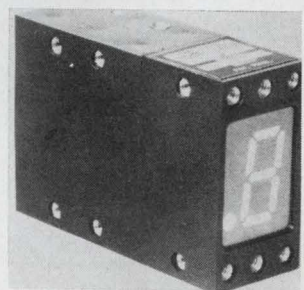

Decade counter model F1850E combines a bright segmented display with a 5-Mhz IC counter. It requires only a single supply voltage of 5 v d-c. Input voltage swing is ± 1 v. Two outputs are provided to drive other counters. The unit is $\frac{7}{8} \times 1\frac{3}{4} \times 2\frac{3}{8}$ in., and weighs 2 oz. Price is \$90 in production quantities. United Computer Co., 930 W. 23d St., Tempe, Ariz. 85281. [388]

New subassemblies

Electronic equipment keeps it cool

Air conditioner for airborne electronic equipment weighs only 38 pounds and dissipates 1,300 watts

Hard on the heels of the drive for higher operating levels in solid state airborne equipment is the need for ways to keep them cool. Not only do these devices dissipate a great deal of heat, but they are becoming even more difficult to cool because they are being packed

closer together. In addition, the trend to more extensive use of integrated electronics has complicated the heat problem. Because so much space can be saved, the temptation is to jam the integrated circuits into such tiny areas that they cannot be cooled at all. The

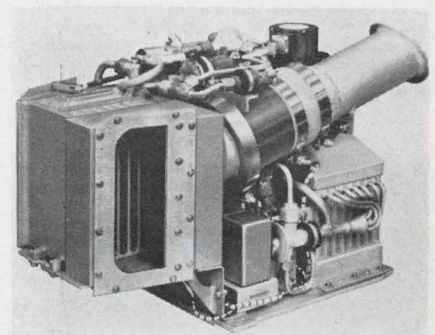

Coolness. Unit maintains 120°F in airborne equipment cabinet.

result can be more circuit failures, and more critical ones since whole functions are involved with IC's.

One way of overcoming the heat

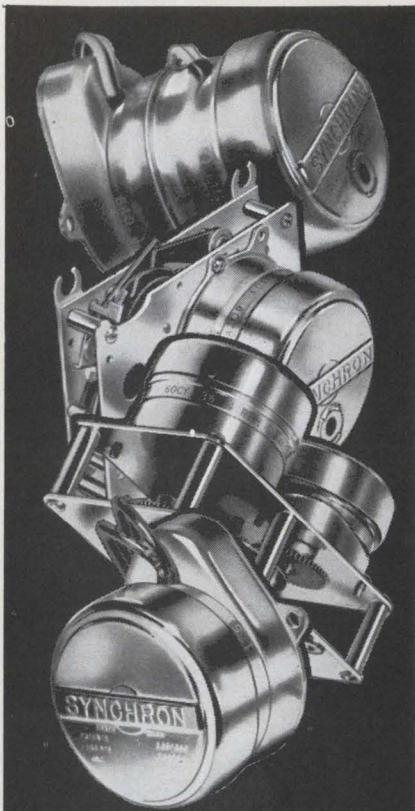

Who needs 168 output speeds on hysteresis motors?

You may want only one speed for your design! But SYNCHRON Motors are used in so many applications that Hansen supplies 168 speeds from which you can choose. 1 RP week to 600 RPM. Besides over 40 standard shafts and pinions, Hansen can also provide more than 300 special drive and gear arrangements, for applications with SYNCHRON Motors. Plus a world of application data to help meet your product's needs exactly. 8, 20 and 30 oz.-in. torques; 220, 110 and 24 volts; 60, 50, and 25 cps., and DC models. Right, left or reversible. Compact; mount in any position. Before you specify any motor, get the SYNCHRON brochure and drive and detail sheets. Write or call us or your Hansen representative.

HANSEN
MANUFACTURING COMPANY, INC.



PRINCETON,
INDIANA

HANSEN REPRESENTATIVES: CAREY & ASSOCIATES, Houston and Dallas, Texas, R. S. HOPKINS CO., Sherman Oaks, Calif., MELCHIOR & MACPHERSON, INC., San Carlos, Calif., THE FROMM COMPANY, Elmwood Park, Ill., H. C. JOHNSON AGENCY, INC., Rochester, N.Y., JOHN ORR ASSOCIATES, Grand Rapids, Mich., WINSLOW ELECTRIC CO., Essex, Conn., Narberth, Pa., and New York, N.Y. EXPORT DEPARTMENT, 64-14 Woodside Ave., Woodside, N.Y.

problem is with closed vapor-cycle systems. Not new, this approach was considered back in the 1950's but was largely ignored because such systems were considered unreliable and too costly in terms of weight, size, and power. But now, Environmental Control Systems, a division of the Pall Corp., has come up with a 38-pound system that can maintain a temperature of 120°F when operating at ram air temperatures of 200°F.

Like at home. Called the AEA-4050, the system uses 2,400 watts, dissipates 1,300 watts, and is small enough to fit into a standard equipment cabinet. In essence, it's an airborne version of a typical home air conditioner.

The first step taken by the company was to develop, under a Navy contract, a compact aluminum heat exchanger that withstands high pressures and isn't porous to refrigerants. And since the intake duct is open to the elements, not only does the heat exchanger have to be lightweight, but it also has to withstand the 600 miles-per-hour impact of foreign objects. New refrigerants also had to be developed because earth-bound air conditioners cool from a 120°F ambient while the airborne units have to cool from a 200°F ambient.

Previous cooling equipment—fans, blowers, or air-cycle equipment—has proved inadequate when applied to high-power, solid state devices. Air-cycle equipment—the kind used on commercial aircraft—is not true air conditioning. It operates on the principle that high pressure air is readily available from jet engines, and if this air is rapidly expanded through a throttling valve, a cooling effect takes place. This may work for passengers but it doesn't work for electronic equipment, because though the air may be cool, it's still wet. And wet air is almost as bad as hot air for electronics. The closed vapor-cycle equipment cools the air and also removes moisture.

The AEA-4050 costs between \$3,000 and \$4,000. Also available are two other versions, the CRA-3082 personnel-suit cooler that operates in ambients of 125°F and dissipates 638 watts, and the AEA-4052 compartment cooler.

Environmental Control Systems, Pall Corp., Long Island City, N.Y. [389]

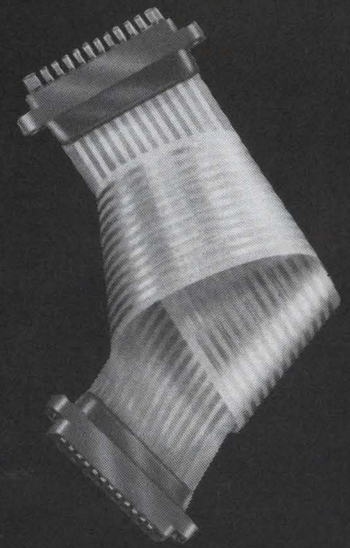

Method's Solution to "Knotty" Harness Problems

Method's unique Plycon harnesses can solve many of your design problems quickly, efficiently!

Available in both straight jumper and extensible styles, Plycon harnesses are ideal for use in drawers or racks or as jumpers between points on a chassis.

Plycon harnesses are a combination of two superior products: long-life Plyo-Duct multi-conductor wiring systems and Reli-Acon connectors.

Through an unusual Methode design, Plyo-Duct has memory characteristics, so that extensible harnesses will extend, then always retract to their original position..

Reliable male or female Reli-Acon connectors are available in a variety of standard sizes and number of contacts to meet your design requirements.

Both single and twin-layer harnesses with from 6 to 48 conductors, and any combination of connector style and number of contacts are available.

Write today for a new, fully-illustrated catalog with complete engineering data.



Connector Division

**Method's
Electronics, Inc.**

7447 W. Wilson Ave. Chicago, Ill. 60656

312/867-9600

**CARBON COMPOSITION AND
WIRE-WOUND POTENTIOMETERS**

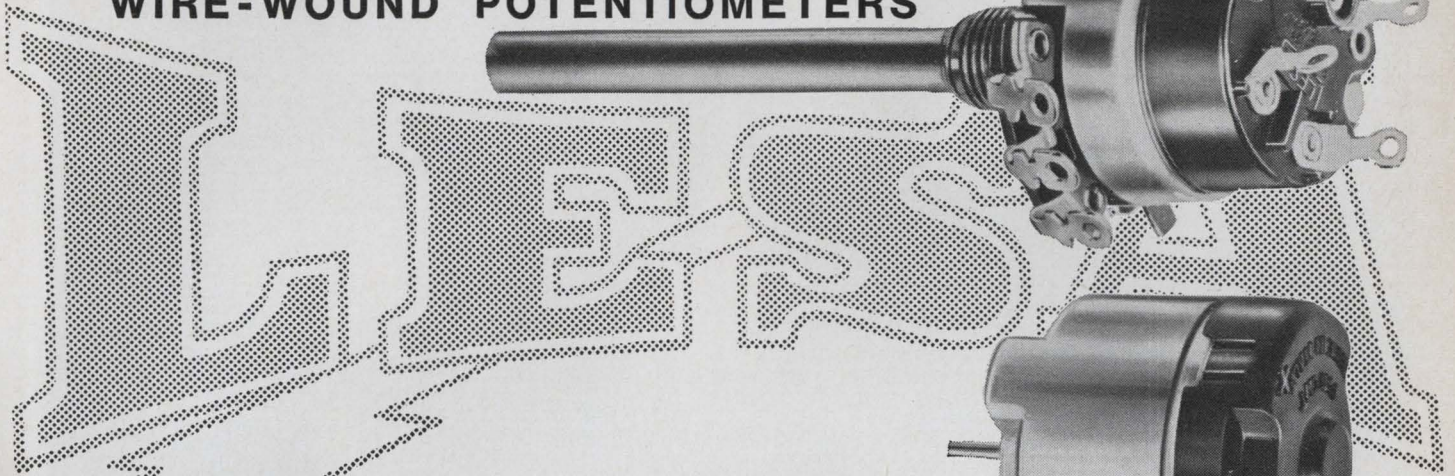

**FRACTIONAL HP ELECTRIC MOTORS
AC. AND D.C. OPERATED, WITH OR WITHOUT SPEED REGULATOR**

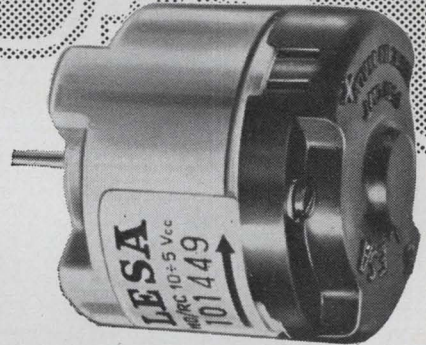

OF AMERICA CORP, 521 FIFTH AVENUE, NEW YORK, N.Y. 10017, TEL. 212 697.5838
 COSTRUZIONI ELETTROMECCANICHE S.p.A., VIA BERGAMO, 21, MILANO, ITALY
 DEUTSCHLAND GMBH, 1 WIESENTALSTRASSE, FREIBURG I/Br. WEST-GERMANY
 ELECTRA, S.A., VIALE PORTONE 27, BELLINZONA, SWITZERLAND
 FRANCE S.A.R.L., 19 RUE DUHAMEL, LYON, FRANCE



Circle 259 on reader service card

Super

SOLID CARBIDE CIRCUIT BOARD DRILLS AND ROUTERS

DESIGNED FOR PRECISION DRILLING AND
ROUTING OF ALL CIRCUIT BOARD LAMINATES



CBU

A precision solid carbide circuit board drill designed with a 1/8" uniform shank for simplified chucking. Tapered webs for maximum strength. In wire gauge, fractional and metric diameters.

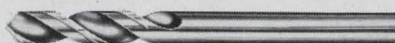

CB

The original solid carbide circuit board drill design with tapered web guaranteed to produce precision bur-free holes, as the CBU above, in single or stacked board operations where flute lengths permit. In wire gauge, fractional and metric diameters.



DIR

A diamond cut design solid carbide profile-router for plunge or outside profiling. The cross-hatch flute principle of this diamond-cut design provides many positive overlapping cutting edges to insure clean, sharp profiling with absolutely no delamination. In fractional size range.

Super circuit board drills and routers are guaranteed to perform efficiently in all circuit board laminates. Tolerances and concentricity are minimal to permit

exact locating or repositioning in N/C or conventional equipment. Literature No. EL-67-1 available at distributors and branches or directly from:



SUPER TOOL COMPANY SINCE 1927

A DIVISION OF **UNIVERSAL AMERICAN CORPORATION**

ELK RAPIDS, MICHIGAN 49629

PHONE (616) 264-8151

Chicago
5428 N. Milwaukee Ave.
Chicago, Illinois 60630

Detroit
Suite 508, Professional Bldg.
Eastland Center, Detroit, Mich. 48236

New York
350 Hudson St.
New York, New York 10014

Los Angeles
5908 E. Washington Blvd.
Los Angeles, California 90022

Circle 260 on reader service card

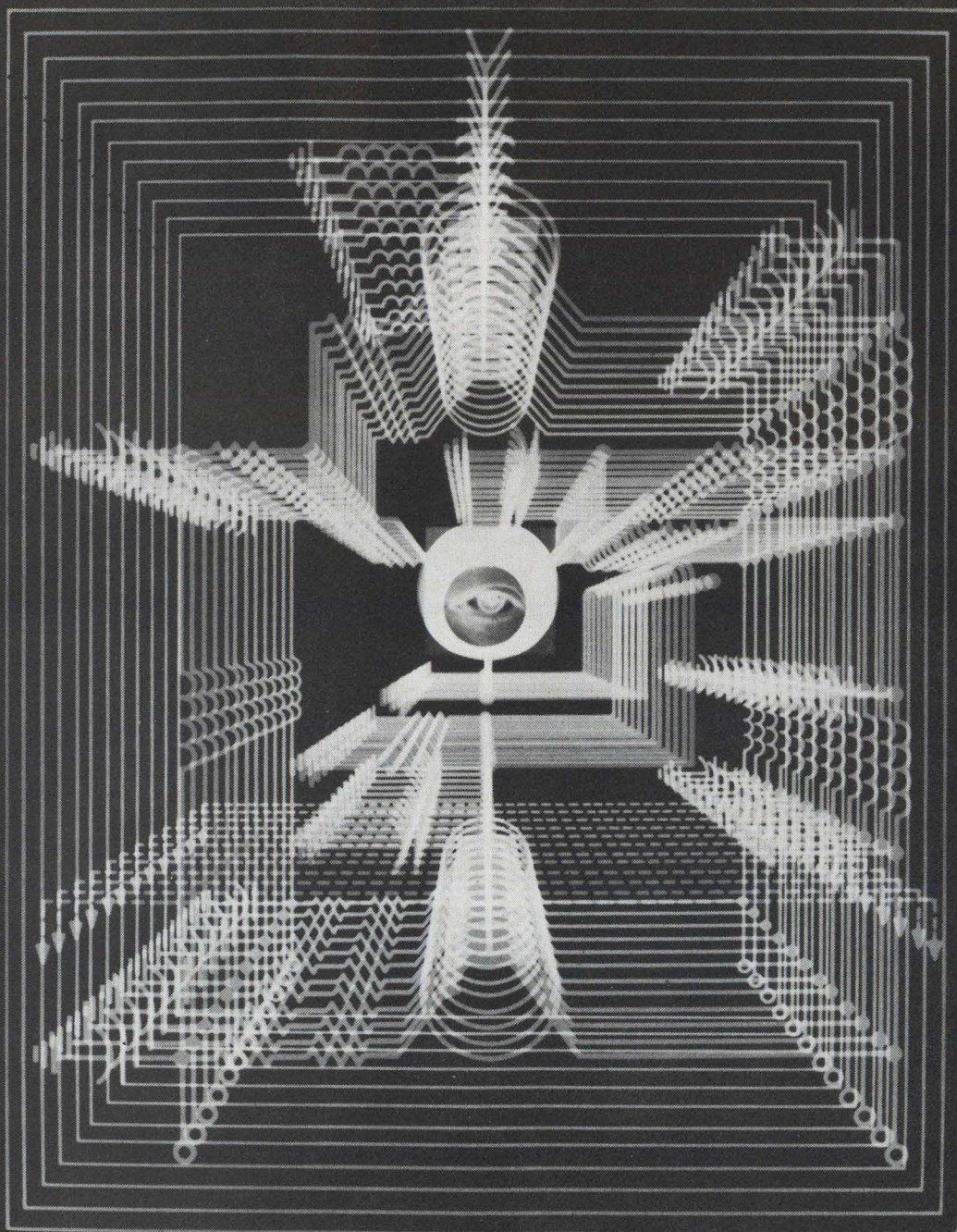

Look into the vehicles of opportunity at Lockheed...for circuit designers.

Opportunity broad enough to interest every circuit designer, that's the sweep of electronics assignments at Lockheed. Big, wide-ranging programs that extend from deep sea to deep space. And with ever-growing commitments comes an increasing need for new concepts and major technical advances in flight controls, communications, antennas and state-of-the-art electronics checkout equipment in both spacecraft and fleet ballistic missiles. In addition to its major vehicle programs... Agena, Poseidon, and Polaris, Lockheed is involved in deep submersibles; unique advanced land vehicles; information systems for states and hospitals; and many other technically alluring programs. For complete information, write Mr. R. C. Birdsall, Professional Placement Manager, P.O. Box 504, Sunnyvale, California. Lockheed is an equal opportunity employer.

LOCKHEED
MISSILES & SPACE COMPANY
A GROUP DIVISION OF LOCKHEED AIRCRAFT CORPORATION

New Microwave Review

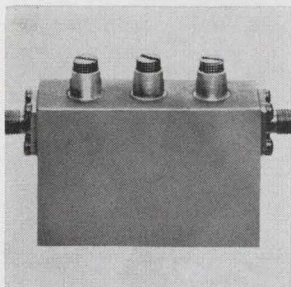

Tunable, coaxial bandpass filters series FBM span 960 Mhz through 6 Ghz in 2, 3, and 4-section combinations. They can be used as preselectors; to provide rejection for image frequencies in receiver front ends; and to eliminate harmonic or spurious signals from an oscillator multiplier chain. Prices start at \$150. Applied Microwave Dynamics Corp., 287 Sherman Ave., Newark, N.J. [401]

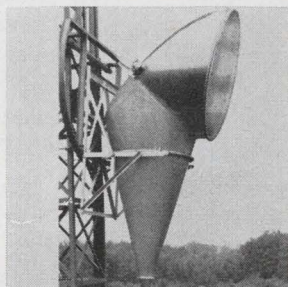

A horn-reflector microwave antenna meets the increasing complexity of frequency interference coordination, use of lower noise receivers, and expanded channel capacities. Gain is 35.9, 39.6, and 44.4 at the 4-, 6-, and 11-Ghz frequency mid-band points. The unit is about 13 ft high. Gabriel Electronics Division, Maremont Corp., Box 471, Saco, Maine [402]

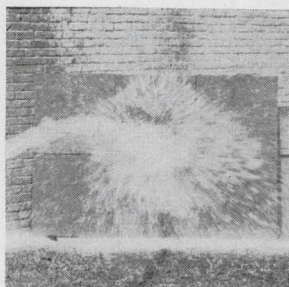

Eccosorb AN-W is a series of flexible, lightweight microwave absorbers with a weatherproof neoprene-coated nylon fabric bonded to the surface to make it watertight. It is available in 6 thicknesses. Type AN-W72 is 3/4 in. thick and designed for use at 20 Ghz and above. AN-W79 is 4 1/2 in. thick and has only 1% reflectivity at 455 Mhz. Emerson & Cuming Inc., Canton, Mass. 02021. [403]

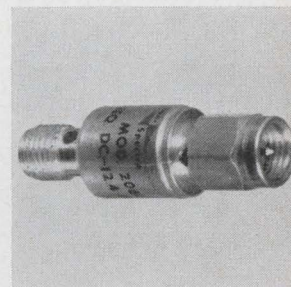

Fixed attenuators series 20600 operate from d-c to 12.4 Ghz. Standard models are available in values of 3, 6, 10, and 20 db with tolerances of $\pm 5\%$ for attenuation values of 6 db or greater. All models are 3/8 x 1 1/4 in. Vswr is 1.20 max from d-c to 4 Ghz and 1.35 max from 4 to 12.4 Ghz. Price is \$80 each. Omni-Spectra Inc., Hallwood Ct., Farmington, Mich. [404]



Double-balanced mixer M1C is for critical circuit functions of a-m with suppressed carrier, pcm, ppm, phase detection, and frequency converting in communications and test equipment. It has a noise figure of 5.5 db (ssb) at 50 Mhz, 45-db isolation between ports at 200 Mhz, and conversion loss of 5 db (ssb) at 50 Mhz. Relcom, 2329 Charleston Rd., Mountain View, Calif. [405]

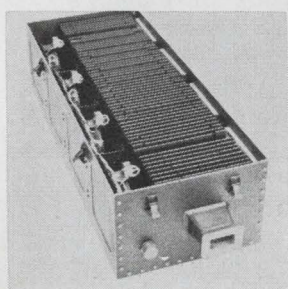

S-band dummy load model WI-A03 can handle 20 kw average power without the use of liquid cooling. It features a built-in forced-air cooling system equipped with an air-flow safety interlock switch. It operates from 2.7 to 3.3 Ghz, and has a max. vswr of 1.20. The unit can withstand an internal pressure of 45 psig. Micro-lab/FXR, Ten Microlab Rd., Livingston, N.J. 07039. [406]

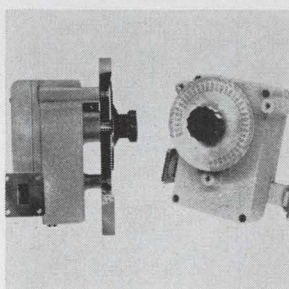

Series DB-X-198 are 0 to 360° direct-reading phase shifters for 7.05 to 90 Ghz. They offer accuracy to $\pm 2.5^\circ$, vswr of 1.20, and max. insertion loss of 1.25 db. All are panel mountable. Short insertion length (6 in. for X band) permits use in systems where compactness is important. DeMornay-Bonardi Division, Datapulse Inc., 1313 N. Lincoln Ave., Pasadena, Calif. [407]

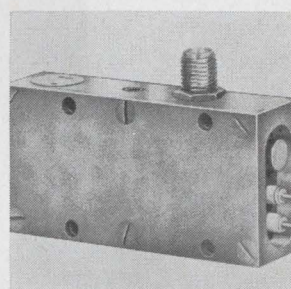

Local oscillator 6009-1100 covers 1.1 to 1.3 Ghz with a manual tuning range of 200 Mhz. Frequency stability vs temperature is 20 ppm/°C at -54° to $+71^\circ$ C. Power input requirements are -28 v d-c at 25 ma nominal. Power output is 10 mw minimum. Shock is 100 g, 11 msec, 3 axes; vibration, 20 g peak, 20 to 2,000 hz, 3 axes. Trak Microwave Corp., 4726 Kennedy Rd., Tampa, Fla. [408]

New microwave

Bonding method increases power

Switching diodes that cover the microwave band can handle 300 kilowatts and cost 400% less

"Looking for a good high-power microwave switching diode was like looking for that pot of gold," according to engineer William Zettler, who used to design radar systems. Microwave switching diodes, components in phased array radar, were mainly low-power devices.

So when Zettler joined Unitrode Corp. in Watertown, Mass. as microwave diode development engineer, he went to work enthusiastically on the development of the company's first high-power device.

The Unitrode method sandwiches a diffused silicon die be-

tween two metallic pins—giving the diode a strong mechanical bond, low resistance, and good heat transfer. And the diodes sell for \$5 to \$25, rather than the \$20 to \$100 price of similar devices.

Delicate job. Because microwave switching diodes were low-power, they had to be followed by amplifiers. "The mechanical and electrical nature of diode construction," says Zettler, "was delicate—and there was small junction area, poor mechanical and thermal bonds to the semiconductor die." Up to now, a whisker contact was needed to absorb thermal expansion.

Available switching devices such

ANOTHER FIRST!

MODELS 20 and 21 (Latching)

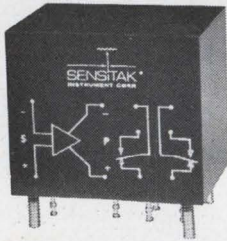

Logic Relays that operate from .7 to 500V

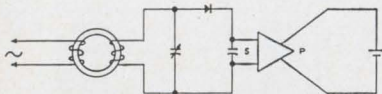

FREQUENCY SELECTIVE RELAY FROM Hz to MHz

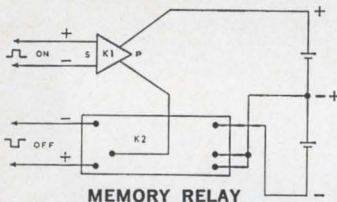

MEMORY RELAY

K1 = #21 RELAY
K2 = SENSITAK 16B-P or 16C-P

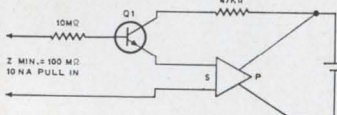

NANOAMPERE SENSING RELAY

Above are three of hundreds of applications possible.

CONDENSED SPECIFICATIONS

Power Source	10-30V DC
Standby Power	Negligible
Input Impedance	1 megohm
Signal Voltage	
Pull In	+ .7V DC Less than 1μA
Drop Out	-10%
Signal Overvoltage	
Direct	35V
with series resistor of 1 KΩ/V	500V
Response Time	
Operate	10 milliseconds
Release	7 milliseconds
Output Contacts	DPDT 5 Amp. Res. Load 150V AC — 50V DC
Operating Temp.	
Environmental	-20°C to 70°C

Only \$7.42 in small production quantities. Complementary NPN and PNP relays available as standard.

Consult us for relay technology to meet individual requirements.

For additional information, contact

SENSITAK®
INSTRUMENT CORP.
531 Front Street
Manchester, N. H. 03102
Phone (603) 627-1432

'... die will break before the bond ...'

as ferrite units handled high power indirectly. "Now," says Zettler, "the diode gives radar designers the chance to switch high power directly and eliminate the amplifier stage at each array element."

Although Unitrode has developed high-power-handling diodes before, its new line is the first made for microwave frequencies, he says. The production technique is Unitrode's traditional one, modified in base width, resistivity, doping and other factors.

The average power dissipation of one new diode is 0.4% of the incident power. For a microsecond pulse, says Zettler, the temperature rise is 4°C for dissipation of 1,000 watts. Since the die can withstand 300°C peak temperature, the diode can dissipate 75 kilowatts for one microsecond.

Low resistance. If there's 0.2 ohms series resistance in a 50-ohm line, the diode can switch a peak power of 18 megawatts—or four and a half megawatts if a short circuit with duplexer applications is used. Larger pulse widths reduce this figure, Zettler points out, but even for one millisecond pulses, 250 watts can be dissipated and 62 kilowatts of peak power can be switched. "The device has a very low resistance, so it absorbs small amounts of power," he points out.

When Zettler talks of 18-megawatt power, he carefully specifies that this is peak power, based on thermal capability, switching theory and power dissipation numbers. The highest power level the device has been switched at so far is one-half megawatt.

For high average power applications, Unitrode suggests a stud-mounted package, but the diode lends itself to almost any kind of packaging and mounting.

In the Unitrode diode, pins are bonded to the die at a temperature of over 1,000°C in a controlled atmosphere furnace. The pin metal matches the low thermal coefficient of expansion of silicon, so the bond is unstressed. "The silicon die itself will break before the bond does," says Zettler.

Glass sleeve. A sleeve of hard glass, fused at more than 800°C,

Very, very Varo.

(Very good. Very inexpensive.)

Each of these Varo epoxy bridge rectifiers has full-wave bridge, controlled avalanche, and 200V, 400V, and 600V ratings.

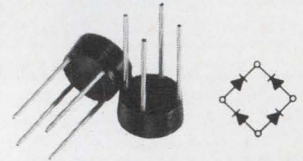

1 amp EBR. For printed circuit board mounting.

ONLY 91¢

in 200V rating and quantity of 1,000.

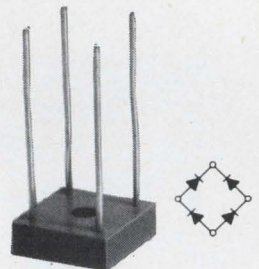

2 amp EBR. For circuit board mounting.

ONLY 95¢

in 200V rating and quantity of 1,000.

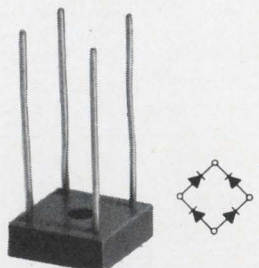

6 amp EBR. For chassis mounting.

ONLY \$1.59

in 200V rating and quantity of 1,000.

Write for complete information on Varo rectifier products.



SPECIAL PRODUCTS DIVISION
2203 WALNUT STREET, GARLAND, TEXAS 75040
(214) 272-3561

ELGENCO Noise Generators

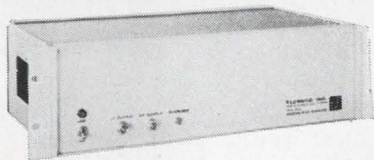

Model 632A

SOLID STATE NOISE GENERATORS

- Model 602A 5 Hz to 5 mHz, 3 Ranges \$ 360
- Model 603A 5 Hz to 5 mHz, 3 Ranges \$ 545
- Model 610A 5 Hz to 5 mHz, 8 Ranges \$1,275
- Model 632A Two outputs DC to 400 Hz and 10 Hz to 35 kHz. \$2,595
- Series 624 (Fixed frequency) 5 Hz to 500 kHz \$270 to \$600. Write for details on frequency ranges and spectral flatness.

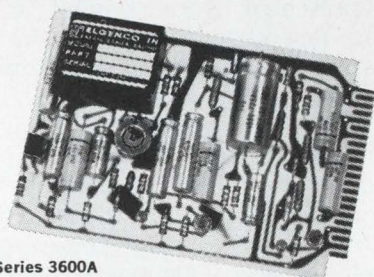

Series 3600A

NOISE GENERATOR CARDS

- Series 3600 \$144 to \$409
- Various frequency ranges and output flatness available. Write for details.



Model 312A

VACUUM TUBE NOISE GENERATORS

- Model 301A DC to 40 Hz \$2,195
- Model 311A Two outputs DC to 40 Hz and 10 Hz to 20 kHz. \$2,595
- Model 312A Two outputs DC to 120 Hz and 10 Hz to 20 kHz. \$2,695
- Model 321A DC to 120 Hz \$2,295
- Model 331A 10 Hz to 20 kHz \$1,395

ENCAPSULATED NOISE SOURCE MODULES

- Series 1600 \$95 to \$350
- Various frequency ranges and output flatness available. Write for details.

For a more complete listing of Elgenco noise generators, write for short form catalog.

ELGENCO INCORPORATED



1550 Euclid Street
Santa Monica, California
Phone: (213) 451-1635
TWX: (213) 879-0091
Cable: Elgenco

DEMONSTRATOR MODELS AVAILABLE
See EEM or Write for Name of Nearest Rep.

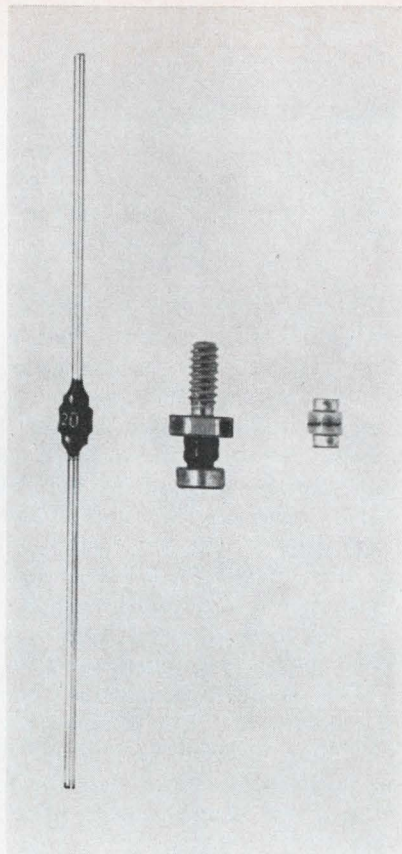

Power packages. Microwave diodes come in three versions: leaded, stud mount, and pill.

covers the pin-die assembly and permanently stabilizes the silicon surface. As a result, the thermal coefficient of the glass matches those of the silicon and the pins. In this condition, the diode will withstand temperature shock or cycling from -196°C to $+300^{\circ}\text{C}$, according to Zettler.

Production of the device in three models is already under way at Unitrode. By varying the resistivity and type of silicon, the dopants, diffusion cycle, and the size of the die, it is possible to produce a full range of switching diodes built identically.

In addition to the high-power phased array application, Unitrode sees substantial markets in switches for solid state duplexers, receiver protectors and antenna switching matrices.

Specifications

Peak dissipation	300 kilowatts for one microsecond pulses up to 40 watts
Average dissipation	0.2 ohm
Series resistance	30-45 days
Availability	\$5 to \$25
Price	

Unitrode Corporation, 560 Pleasant St., Watertown, Mass. 02172 [409]

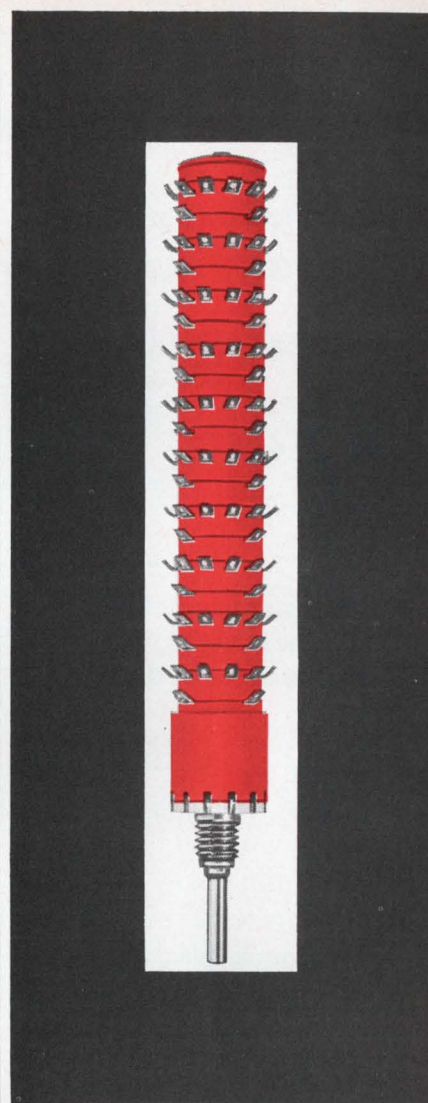

LESS THAN 18¢ PER CIRCUIT

The new Daven "X" switch has been life tested for 50,000 cycles of rotational life with no failure carrying a .500 amp load at 125°C .

The 10 deck, 1 pole, 12 position per deck model shown, sells for only \$21.45 or \$.17875 per circuit in 100 pc quantities.

We build switches like no one else can!



DIVISION OF THOMAS A. EDISON INDUSTRIES
GRENIER FIELD, MANCHESTER, N.H. 03103
(603) 669-0940 • TWX 603-623-4938

New, Tunable (Lock-in) Coherent Amplifier



MODEL 300-A

For Measurement of Ultra-Low Level Signals in the Presence of Noise

- Continuously tunable from 1.5 Hz - 200 kHz
- Variable Q from broadband to 25
- 160 db gain (100 nV - full scale)
- 0.1 uV equivalent noise voltage
- Plug-in preamplifiers
- Reference channel drives coaxial switch or chopper directly

Applications:

The Model 300-A Coherent Amplifier is useful for detection of effects of biological stimuli, photometric measurements at low S/N ratios, conversion of a communications receiver to sensitive radiometer, magnetic field effect studies, cross-correlation measurements, and general amplification and measurement of low level signals in the presence of noise.

Write for data on the Model 300-A
Price \$1795 (including basic pre-amp)

Also available are: Fixed Frequency Coherent Amplifiers, Coaxial Switches, Radiometric Receivers, and Klystron Frequency Stabilizers.

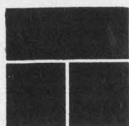

Teltronics, Inc.

Subsidiary of Roanwell Corporation

New Books

Maze for the uninitiated

Fundamentals of Silicon Integrated Device Technology
Vol. I: Oxidation, Diffusion, and Epitaxy
R.M. Burger and R.P. Donovan, Eds.
Prentice-Hall Inc., 495 pp., \$15

This book, described by the editors as the first in a series that will "cover most of the technology necessary for the design and fabrication of contemporary integrated devices," may be useful to those with a strong background in the field. But the novice will have difficulty appraising the relative importance of the topics discussed, and will find some fairly simple aspects explained in detail while more complex ones are skimmed over.

This is the principal drawback: it's not at all clear to what level of technical sophistication the book is addressed. There are, for example, repeated warnings in footnotes early in the book that the terms "ion" and "atom" can be used interchangeably and that the "water" content of silica may in fact refer to "hydroxyl." Any reader who has to be cautioned on such points more than once is hardly likely to get much out of the ternary phase diagram of Si-B-O presented in the same section without a word about the meaning of phase diagrams.

It must be said that the volume is logically structured. As its title suggests, it's divided into three sections, each preceded by a short explanation of the relevance of the topic to the over-all subject. A general theoretical and empirical discussion is then followed by a description of experimental techniques. In the sections on oxidation and epitaxy, applications of such integrated-circuit components as planar and field effect transistors are discussed in some detail, though complete monolithic circuits aren't considered.

Here again, however, there are few directional signs for the novice. Many experimental techniques and results are presented uncritically. For instance, one table lists seven compounds that can be used as sources for the open-tube diffusion of phosphorus into silicon, and these are discussed in nine pages

of text. The advantages and disadvantages of each are noted, but there are no clues as to which sources would be preferred under various conditions.

There are also signs of editorial inattention, the first of which appears in the caption for the frontispiece, where "phosphorus" is misspelled "phosphorous." But more serious are repetitions and inconsistencies. For example, impurity diffusion is discussed in the first chapter without any indication that the topic is covered in much greater detail in the fifth and sixth chapters. Fick's first law is stated in both places—with concentration represented by the symbol "c" in the first chapter and "N" in the later chapters. It's not catastrophic, but it's distracting.

The literature cited is adequate, though the latest references appear to be of mid-1965 vintage. Of the approximately 450 citations, almost 20% refer to U.S. Government contract reports. This may be inevitable in this field, but it puts an enormous burden on the foreign reader and on the American who may not have these reports in his library. Further, this burden is sometimes unnecessary. In chapter 6 alone, there are at least three Government reports cited that long before the apparent closing date of this book were presented in such well-known journals as the Physical Review and the Journal of Applied Physics.

Finally, the \$15 price tag appears excessive to me for a book produced by an offset process but which doesn't seem to have been put out very promptly.

J. Blanc

RCA Laboratories
Princeton, N.J.

Radar revisited

Radar Fundamentals
Gersohn J. Wheeler
Prentice-Hall Inc., 150 pp., \$5.95

Too many engineers know too little about radar. They may know that pulse radar locates objects by sensing echoes and doppler radar finds moving objects by sensing the fre-

Our little black book has over 100,000 phone numbers.

You never had a black book like it. Over 1,500 pages. And those phone numbers!

More than 100,000 telling you who to call/ where to go, for the over 4,000 different product categories listed and advertised in the yellow pages of the Electronic Buyers' Guide. There's never been a buyer's directory like it. The new '68 edition will be coming your way in October. Look for the book in the black box.

EBG for '68... bigger, better and more useful than ever before.

Electronics Buyers' Guide

A McGraw-Hill Market Directed Publication, 330 West 42nd Street, New York, N.Y. 10036

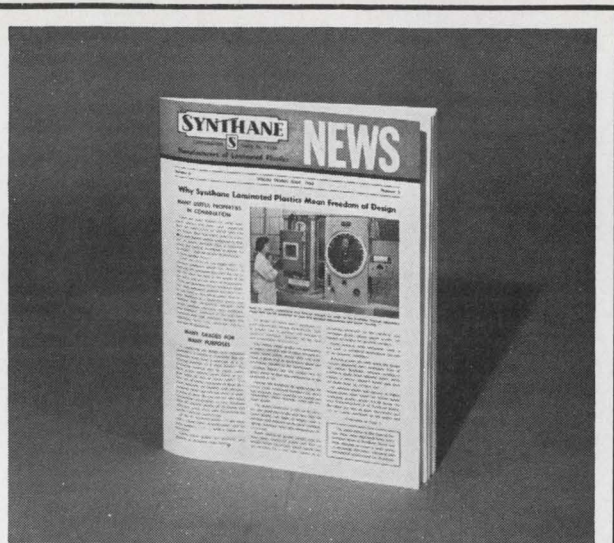

Free . . . tells how laminated plastics are used by designers in over 25 mechanical, electrical, electronic and chemical applications. An excellent guide for the man who is curious to know how laminated plastics can also help him. Write Synthane Corporation, 36 River Road, Oaks, Pa. 19456 for your copy of the Special Design Issue of Synthane News.

SYNTHANE
CORPORATION



OAKS, PA. 19456

Laminated Plastic Sheets, Rods, Tubes and Fabricated Parts

Circle 263 on reader service card

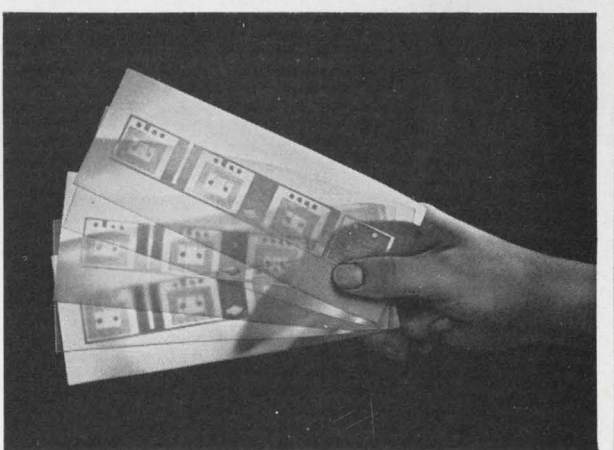

Highest-quality copper-clad laminates for multi-layer printed circuits

Laminated plastics for multi-layer printed circuits have to be a special breed—very thin, made to exacting tolerances, uniform, free of voids and pinholes, suitable for etching and all soldering operations.

Synthane Thin Laminated grades G-10 and FR-4 are highest-quality fabric epoxy laminates. All produced under exacting clean room conditions. Write for leaflet. Synthane Corporation 36 River Road, 666-5011 (Area Code 215).

SYNTHANE
CORPORATION



OAKS, PA. 19456

Laminated Plastic Sheets, Rods, Tubes and Fabricated Parts

Circle 207 on reader service card

207

NEW
mini-mod

**I/C POWER
SUPPLY**

**80%
SMALLER!**

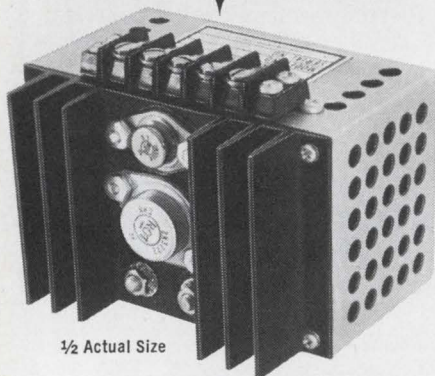

1/2 Actual Size

Powertec's new, ultra-miniature power supply is only 4"x3"x2 5/8" including heatsink.

Mini-mod is specifically designed for use in lightweight chassis with IC or other digital logic. Output voltages are available from 3 to 30 volts with .05% regulation.

INPUT: 115 Volts 47-440HZ

TYPICAL OUTPUTS:

3 V at 6 A

5 V at 5 A

15 V at 2 A

Mini-mod is currently available from stock. Detailed specifications and price are available upon request.

CUSTOM POWER SYSTEMS

Powertec's experts are capable of solving your most difficult power conversion requirements.

**FOR MORE INFORMATION
WRITE**

POWERTEC

9170 Independence Avenue
Chatsworth, California 91311

New Books

quency shift in the echoes, but that's about the total extent of their knowledge. This is unfortunate, though understandable; other electronics specialties never touch radar.

But the engineer who wants to have the satisfaction of knowing more about one of the cornerstones of the radio-frequency business would do well to invest the two hours or so it would take to go completely through this book.

Given a junior college level treatment, the book is well written and requires little effort to extract the information that it offers. The author handles the explanation in his text, rather than disposing of a point by dropping in an equation. He covers the basic types of radars, propagation problems, and even the fundamentals of radar systems design. In fact, here's one of the few books that have come along recently that an engineer might find worth while in his own library. It will certainly age well.

Recently published

Large-Signal Transistor Circuits, Donald T. Comer, Prentice-Hall, 268 pp., \$10.50

The book covers device physics and equivalent circuits, providing a basis for the study of practical circuits. This treatment is in contrast to more commonly used black-box, piecewise linear methods.

Integrated Electronics, K.J. Dean, Chapman and Hall, Ltd., distributed in U.S. by Barnes & Noble, Inc., 132 pp., \$5.25

The limitations and advantages of IC's are discussed along with their principles of operation. The book also deals with applications and design methods both for basic circuits and systems using IC's.

Transistor Circuit Engineering, Basil L. Cochran, The Macmillan Co., 445 pp., \$13.95

Primarily a textbook on the design and analysis of linear active circuits, the book deals with the latest semiconductor devices. It is devoted to the practical design of active filters and high-, and low-frequency amplifiers.

Electromechanical Systems, D.K. Gehmlich and S.B. Hammond, McGraw-Hill Book Co., 469 pp., \$12.50

Knowledge of Laplace transforms and basic mechanics are required for this undergraduate text on control-system analysis and design. Fundamentals of magnetic and electromagnetic devices are covered for both linear and nonlinear systems.

Synthesis of RC Networks, Hun H. Sun, Hayden Book Co., 160 pp., \$7.50

Theory and design of one- and two-port networks are covered in this undergraduate book. A review of the necessary mathematics includes partial fractions, real roots of polynomials, and polynomial decomposition.

**FAMOUS
ENCAPSULATING
TECHNIQUES**

with hull

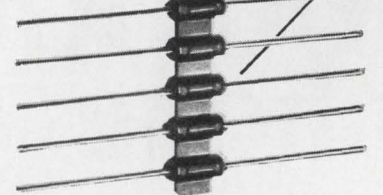

Beat Nature?

Surely! Arts change, technology forges ahead. Your encapsulating techniques change, too.

With Hull's help, work *profit* into your encapsulating jobs. Increase production of diodes, resistors, delay lines, chokes, capacitors or pulse transformers — get reliability, too.

Processes from Hull: direct encapsulation by transfer molding, vacuum potting, continuous dispensing.

Hull wraps a package best for your product, with engineering, compound-selection, design of molds and fixtures, Hull-developed equipment—and the working setup.

You choose specific field-proven equipment: vacuum units for potting and encapsulating with short pot life liquid resins, Blendmasters for continuous metering, mixing and dispensing systems. And, of course, Hull's transfer molding presses — for encapsulation with the new powdered resins.

Naturally!

Write or phone today for (1) specific benefits of the Hull package approach in your production plant, or (2) copy of 11-page Technical Paper T271 on modern techniques for molding and encapsulating. **HULL CORPORATION, 7036 Davisville Road, Hatboro, Pa. 19040. Telephone: 672-7800**

Visit us at Electrical Insulation Conference Booths 364 & 365



H-36R

Air variables from JFD

solve your high Q high frequency problems

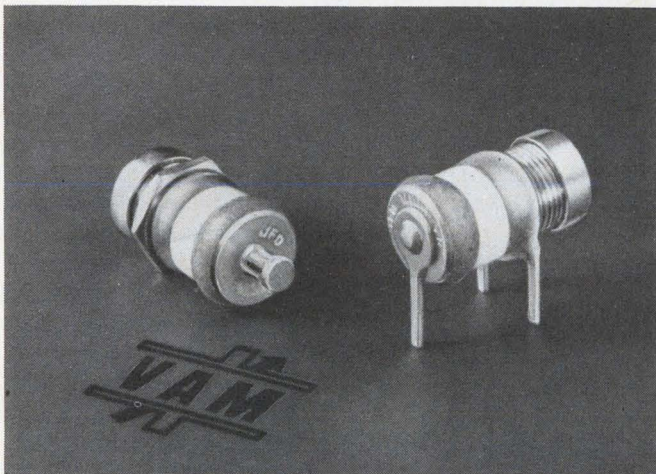

Capacitors shown enlarged 100%

These new JFD air variable capacitors are specially designed for high frequency applications that demand ultra stability, small size and high Q—greater than 2000 measured at 10 pf and 100 MC. These rugged, miniature units are offered in both printed circuit (VAM 010W) and panel mounting (VAM 010) models with capacitance ranges from 0.8 through 10.0 pf measured at 1 MC.

These units which measure less than 1/2" in length are completely interchangeable with competitive devices.

Internal air meshing shells are silver plated to provide good surface conductivity and to prevent corrosive effects. Internal contact springs assure positive electrical contact of rotor at all times. Leads on printed circuit model are tinned for ease in soldering . . . and these units are engineered to resist heat, won't come apart during soldering.

Bulletin VAM-65 gives more details. Write for your copy today.

JFD "TODAY'S COMPONENTS BUILT FOR TOMORROW'S CHALLENGES"

JFD ELECTRONICS CO. / COMPONENTS DIVISION 15th Avenue at 62nd Street Brooklyn, N. Y. 11219 / Phone 212-331-1000 • Sales Offices—Arcadia, Calif. Chi., Ill. / Balt., Md. / Saxonville, Mass. / Bklyn., N. Y. / New Hartford, N. Y. Cinn., Ohio / Phila., Pa. / Pitts., Pa. / Paris, France / Azor, Israel

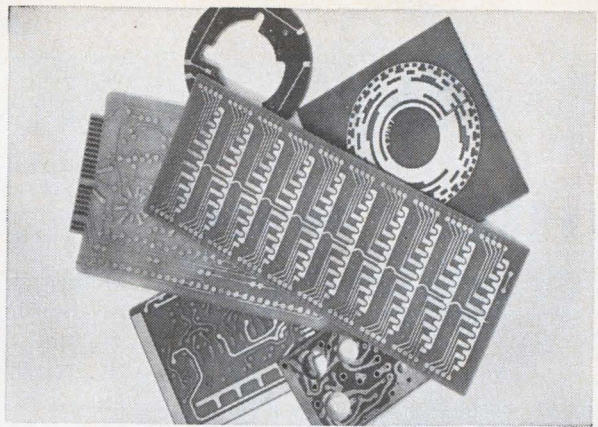

NEW lower-cost, epoxy flame-retardant copper-clad laminate

In response to the demand for a more economical epoxy grade of laminated plastic, Synthane now offers new grade FR-16.

FR-16 is reinforced with a random-oriented glass fiber mat which, because it can be produced on a modified paper machine, costs less than fabric reinforcements used in other flame-retardant grades.

FR-16 is excellent for printed circuits. It is mechanically strong, moisture-resistant, has a low dielectric loss and a high dielectric breakdown. Write Synthane Corporation, 36 River Road for the FR-16 Engineering Data Bulletin.

SYNTHANE

CORPORATION S OAKS, PA. 19456

Laminated Plastic Sheets, Rods, Tubes and Fabricated Parts

Circle 266 on reader service card

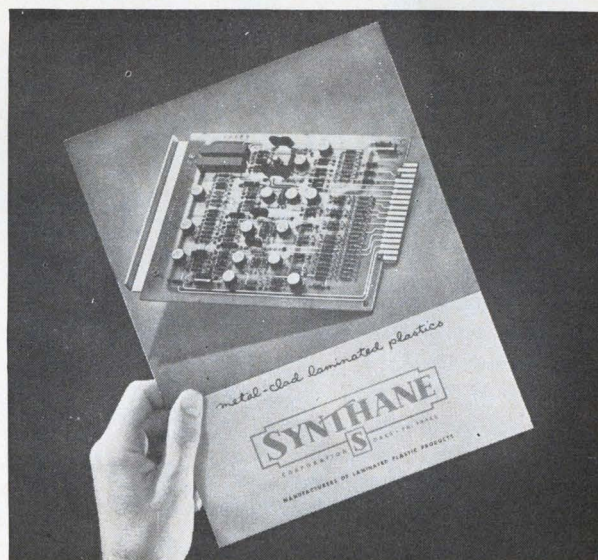

IT'S NEW!

New folder on Synthane metal-clad laminates contains latest information on Synthane copper-clad grades, sizes, foils, trademark identification, typical and guaranteed property values, thin laminates and pre-preg materials. Write for your copy to Synthane Corporation, 36 River Road, Oaks, Pa. 19456.

SYNTHANE

CORPORATION S OAKS, PA. 19456

Laminated Plastic Sheets, Rods, Tubes and Fabricated Parts



VERSATILE POWER

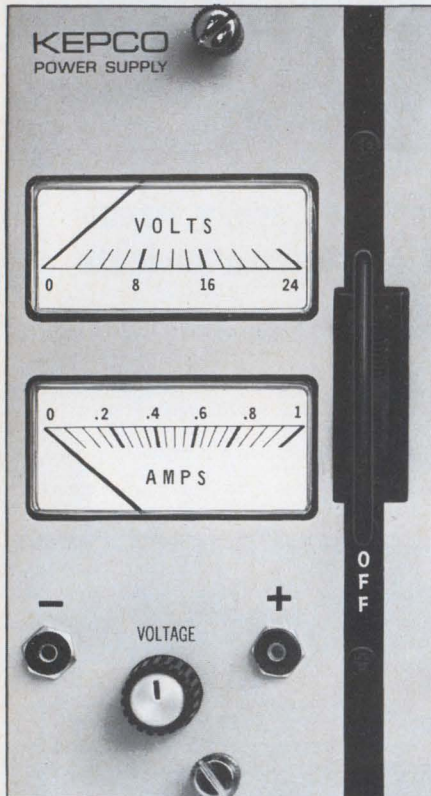

Model PBX 21-1MAT Panel

KEPCO'S PLUG-IN POWER MODULES

Six voltage regulated models from 0-7 volts to 0-100 volts (up to 20 watts) in single, double, triple and six-unit plug-in enclosures. Create your own custom d-c power systems. Mix 'em or match 'em.

Kepeco's new line of versatile PBX-MAT plug-in laboratory modules are covered in the big new Kepeco Catalog B-678. Write for your copy today.



Dual slot housing Model CA-4 Triple slot housing Model CA-5

FOR COMPLETE SPECIFICATIONS AND APPLICATIONS NOTES WRITE DEPT. U-14



131-38 SANFORD AVE. • FLUSHING, N.Y. 11352

Technical Abstracts

Logic on the rebound

High-speed pulse reflection logic
Thomas A. Kriz and T.K. Ishii
Marquette University
Milwaukee, Wis.

Delays and reflection along transmission lines—normally a nuisance in high-speed logic circuits—are turned to advantage with a new logic scheme based on transmission lines terminated with diodes.

The scheme is based on the fundamental rules of transmission line reflections—voltage pulses are reflected with the same polarity if the line is open-circuited and with opposite polarity if the line is short-circuited. The open and short circuits can be obtained with a diode, either reverse or forward biased.

The diode that terminates the signal line can be biased through conventional diode logic networks feeding a second logic line coupled with the first through the biased terminating diode. The logic line is terminated in its characteristic impedance to eliminate unwanted reflections.

In the circuit shown, positive pulses introduced at A, B, and C travel down line 2 and back-bias the coupling diode, which then terminates the line in an open circuit. A positive incident pulse injected at the right end of the signal line

biases the coupling diode, and the pulse's polarity is inverted when it returns, so that the output can be interpreted as a 0. This combination thus represents an AND.

Reversing all the diodes produces an OR circuit that operates in the same way but with a negative incident pulse. Connecting the input diodes in the common side of the coupled lines, and orienting the input and coupling diodes one way or the other, produces a NAND or a NOR circuit, with negative or positive incident pulses required, respectively.

The upper conductor of the signal line can be connected directly to an input diode of another logic circuit. When interconnected, a stub connection is used to insert the pulse. If the input diode of the other logic circuit is reverse-biased by the incident pulse, then all the energy of the pulse travels down the signal line and returns as an input to the logic circuit. But if the logic is such that the input diodes happen to be forward-biased, they will drain off some of the incident pulse's energy.

This loss of energy is a limiting factor in interconnecting lines. A good way to circumvent it in large digital systems is to connect only a few logic blocks in short loops, connected at both ends to a high-speed memory—instead of the dozen or 20 blocks through which logic signals pass in conventional computer organizations. Other problems in larger systems would include pulse timing, stray reflections at various discontinuities, and cross-talk.

Presented at the IEEE Computer Conference, Chicago, Sept. 6-8.

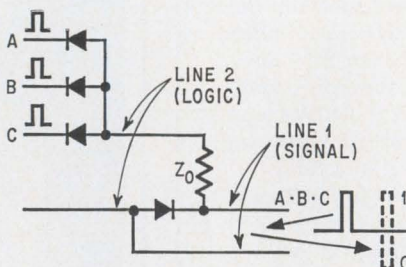

will be reflected from the open circuit, retaining its positive polarity. Because the reflected pulse and the incident pulse have the same polarity, the output is 1. To prevent ambiguity, the width of the pulse must be less than the transit time down the line and back.

A negative pulse at any one of the three input diodes forward-

Heal thyself

An approach to self-repairing computers
P.W. Agnew, R.E. Forbes, and C.B. Stieglitz, International Business Machines Corp., Oswego, N.Y.

Of the four steps in self-repair—error detection, diagnosis, repair, and program restarting—only detection and restarting are well covered by existing techniques. Now, new approaches to diagnosis and

FREE

NEW 1968
ALLIED
INDUSTRIAL
ELECTRONICS
CATALOG
600
VALUE-PACKED PAGES

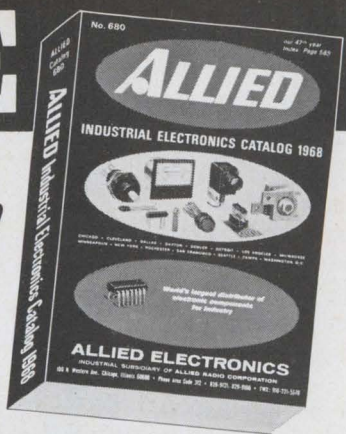

World's Largest Selection
of Electronic Components
for Industry

- Scores of new products
- Factory OEM prices
- Same-day shipment
- All merchandise stocked in depth

Write for Your Copy Today
Write to: Dept. 82-K

ALLIED
ELECTRONICS

A Subsidiary of Allied Radio Corp.

Our 47th Year
100 N. Western Ave.
Chicago, Ill. 60680

Circle 267 on reader service card

P & B
RELAYS

SEE THE 1968
ALLIED CATALOG

Allied stocks Potter & Brumfield Relays in depth: General purpose, special purpose, power, high performance, mercury wetted contact, telephone types.

GLOBE

New 3" A.C. & D.C.
COOLING FANS

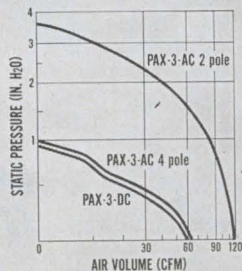

Globe's economical PAX-3 fans are the only units this size available for 28 v.d.c. We also make 200 v.a.c., 400 cps units in 2 and 4 pole versions. We specialize in custom design; we'll meet your specs. A servo ring at each end permits easy mounting in a 3 1/16" dia. hole for airflow in either direction. PAX-3 blowers meet MIL specs. Request Bulletin PAX.

GLOBE INDUSTRIES DIVISION OF TRW INC.
2275 Stanley Ave., Dayton, Ohio 45404, Tel: 513 222-3741

Circle 268 on reader service card

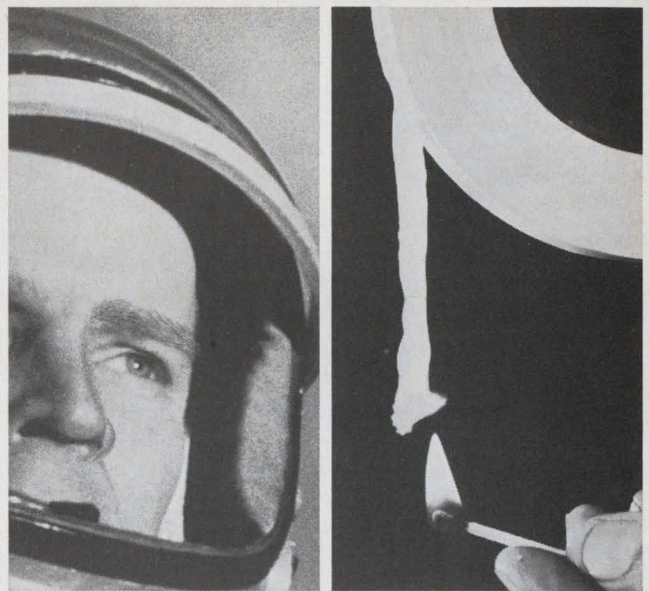

THIS ELECTRICAL TAPE COULD SAVE HIS LIFE

*It will not burn —
when exposed to flame*

Non-combustible E-125 PTFE eliminates the possibility of a fire hazard. It has no adhesive backing either, to break down with age, heat, or oxygen and become gooey or lose its grip.

When used at temperatures between -400 F and 500 F to wrap coils, cables, or other electrical components, it is extremely conformable, self sticking, an excellent dielectric, mechanically stable, and impervious to all acids, gases, solvents.



That's not all! When heated above 621 F, Type E-125 PTFE tape sinters to form a rigid, tough, hermetic seal around any object.

It's available in thicknesses from 0.002" to 0.010" and widths from 1/8" to 3" with tensile strengths from 1100 to 1800 PSI and dielectric strength from 700 to 800 VPM. Interested?

Interested? Complete data and samples are available from Dodge Industries, Fluorglas Division, Hoosick Falls, N.Y. 12090.

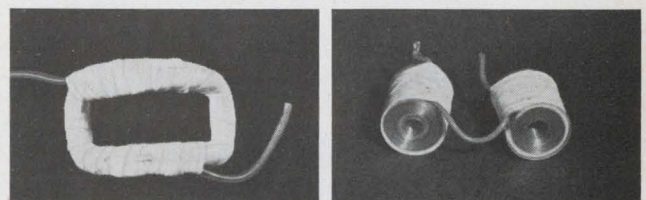

Dodge Industries

Circle 211 on reader service card

211

HYBRIDS



KEPCO POWER SUPPLIES

Hybrids combine sophisticated solid-state reference and comparison amplifiers with rugged, high voltage pass tubes for matchless reliability in precision high voltage Power Supplies.

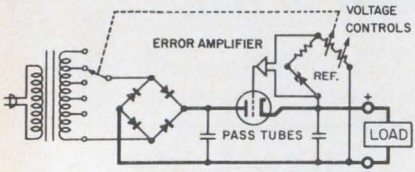
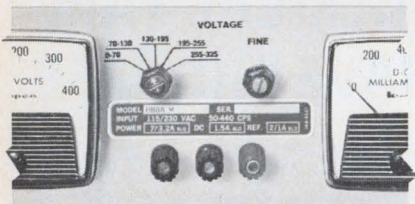

SIMPLIFIED CIRCUIT DIAGRAM

MODEL	DC OUTPUT VOLTS	DC OUTPUT AMPS	PRICE
HB 2AM	0-325	0-0.2	\$295.00
HB 4AM	0-325	0-0.4	330.00
HB 6AM	0-325	0-0.6	365.00
HB 8AM	0-325	0-0.8	395.00
HB 250M	0-250	0-1	495.00
HB 525M	0-525	0-0.5	435.00

- 0.01% REGULATION and STABILITY
- MULTI-POSITION VOLTAGE SELECTOR AND TEN-TURN WIREWOUND HIGH RESOLUTION CONTROL
- OPERATIONALLY PROGRAMMABLE (Accepts voltage, current or resistance commands)
- CONVERTIBLE TO CURRENT REGULATION



WRITE DEPT. H-14
FOR LATEST CATALOG
CONTAINING COMPLETE
SPECIFICATIONS AND
APPLICATIONS NOTES



131-38 SANFORD AVE. • FLUSHING, N.Y. 11352
(212) 461-7000 • TWX #710-582-2631

Technical Abstracts

repair can greatly extend the long-term reliability of computing equipment aboard deep space vehicles.

Error diagnosis and repair involves partitioning the system so that the offending part can be isolated and diagnosed by other parts of the system, and then other subsystems can be switched into the data path. The partitioning, though, must not produce subsystems that are too large, or too many good components are discarded when the subsystem fails. But if they are too small, too many switches are needed and diagnosis becomes difficult. And every system seems to have a "hard core" that cannot be diagnosed by any other part of the system; external intervention then is necessary.

With the new method, the extra hardware is limited to only 15% to 25% more than a completely nonredundant system and the hard core can be held to about 1%. Two computers have been designed with such hardware savings.

Simple systems can be divided in two parts, so that each one can diagnose its counterpart. A more sophisticated partitioning for large systems involves a bootstrap procedure. The partitioning includes two subsystems, each of which can diagnose the other. The two taken together can diagnose the third; these three can diagnose a fourth; and so on, until finally the entire system minus one subsystem can diagnose that subsystem.

For repair, the new approach uses hardware much more efficiently than do most conventional techniques. For example, suppose some function can be performed adequately by the nonredundant system below, containing three iden-

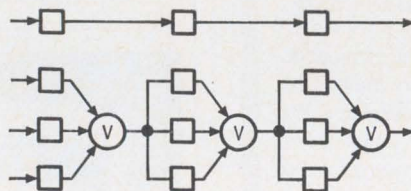

tical modules in series. One well-known method, called triple modular redundancy, or TMR, extends

NEED A MOLDED COIL FAST



MEETS MIL-C-15305

**all values
on the shelf
READY FOR
SHIPMENT**

We offer complete engineering assistance for your application.

Delevan Electronics Corporation / Division AMERICAN PRECISION INDUSTRIES INC.

270 QUAKER RD. / EAST AURORA, N. Y. 14052
TELEPHONE 716/652-3600 TELEEX 091-293

OTHER DIVISIONS OF AMERICAN PRECISION INDUSTRIES INC.:
BASCO INC. • ELECTRO-MECHANICAL PRODUCTS DIVISION

yes,

CCTV Cameras work best



with COSMICAR[®] LENSES

Superior cameras deserve superior lenses. COSMICAR's proven precision performance is the combined result of advanced optical engineering and exquisite workmanship.

Now widely used, COSMICAR LENSES come in 23 models for focal lengths ranging from 12.5 mm to 500 mm, and in 3 zoom models including a remote control zoom.

Your CCTV camera and COSMICAR LENSES will make an unbeatable team. For technical data and other particulars, please write.

Effective September 1, 1967, ICHIZUKA OPTICAL CO., LTD. changed its name to



COSMICAR OPTICAL CO., LTD.

568, Shimoochiai, 2-chome, Shinjuku-ku, Tokyo
CABLE ADDRESS: "MOVIEKINO TOKYO"

Circle 271 on reader service card



SOLDERING EQUIPMENT FOR THE SPECIALISTS

WORLD FAMOUS QUALITY SOLDERING EQUIPMENT

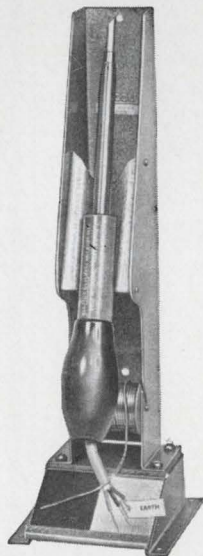

FOR TERMS AND CATALOGUE
APPLY, SALES DEPT
ADCOLA PRODUCTS LTD
ADCOLA HOUSE
GAUDEN ROAD
LONDON, S.W.A.
ENGLAND

TELEPHONES
01-622.0291/3
TELEGRAMS
SOLJOINT LONDON SW 4

KIKUSUI'S 5" OSCILLOSCOPE

NEW!



MODEL
555

DC ~ 7MHz
20 mV / cm

VERTICAL AXIS
Deflection Sensitivity: 20mV ~ 10V/cm (9 ranges)
Frequency Response: DC: 0 ~ 7 MHz, Within -3dB, AC: 2Hz ~ 7MHz, Within -3dB
Input Impedance: 1MΩ
HORIZONTAL AXIS
Sweep Range: 1μS ~ 1S/cm

Magnifier: 5 times
Trigger Ranges: 20Hz ~ 7MHz
EXTERNAL AXIS
Deflection Sensitivity: 1Vp-p/cm
Frequency Response: 2Hz ~ 200KHz, Within -3dB
CRT: 5U1P or 5U P7 F
Dimensions: 205W x 295H x 450Dmm
Net Weight: 11 kg Approx.



kikusui

KIKUSUI ELECTRONICS CORP.

3-1175, SHINMARUKO-HIGASHI, KAWASAKI-CITY,
KANAGAWA-PREF., JAPAN.
CABLE ADDRESS "KIKUSUIDE" KAWASAKI.

To provide you with a practical way of increasing your technical knowledge,

CREI now offers extension programs in Communications Engineering

Not simply courses, but complete programs in advanced electronics with Communications Engineering as a major elective. One program is for engineers who need updating, the other for high school graduates who want to move ahead in electronics.

CREI's industry-approved home study method permits you to study at your own pace, on your own schedule. Our free book gives full information and details on technical material covered. For your copy, use coupon below, or write: CREI, Dept. 1809E-5, 3224 Sixteenth Street, N.W., Washington, D.C. 20010.

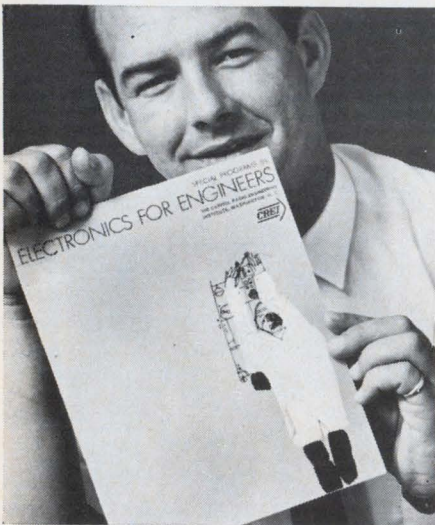

Founded 1927
CREI
 Accredited Member of the National Home Study Council

THE CAPITOL RADIO ENGINEERING INSTITUTE
 A DIVISION OF MCGRAW-HILL, INC.
 Dept 1809E-5, 3224 16th St., N.W.
 Washington, D.C. 20010

Please send me FREE book describing CREI Programs in Electronics and Major Elective in Communications Engineering.

I am interested in Updating Program for Engineers
 Regular Program for men working in electronics

Name _____ Age _____
 Address _____
 City _____ State _____ Zip Code _____
 Employed by _____
 Position _____

Technical Abstracts

reliability with three parallel modules at each stage, and a voting circuit between stages that chooses the best two out of three intermediate outputs, as shown. In such a system, an error in any single module does not propagate beyond the following voter. But errors in the two modules between the same pair of voters bring down the entire system.

The new approach replaces the voting circuits with switches. All three modules between the same pair of switches must fail before

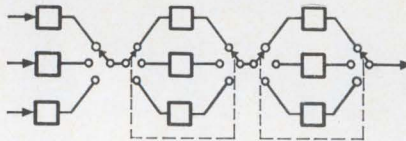

the system fails. Furthermore, the switches can also be arranged to permit any three of the nine to perform the system's function.

Statistical studies of this technique compared with TMR and non-redundancy show that over a long period it is considerably more reliable than either. At the beginning, TMR is substantially more reliable than a nonredundant system because of the two-out-of-three voting. But as time goes on, the probability of a failure in two modules feeding a common voter increases to the point that system reliability is less with TMR than it is with nonredundancy. The new approach is better than either non-redundancy or TMR over its entire lifetime.

Presented at the IEEE Computer Conference, Chicago, Sept. 6-8.

Speed reading

High-speed fixed memories using large scale integrated resistor matrixes
 C.A. David, Bull-General Electric, Paris, France
 B. Feldman, Intellux, Inc., Goleta, Calif.

High-speed read-only memories have been built with an array of low reactance thin-film resistors. Such systems lend themselves to large-scale batch fabrication and



Eight fact-packed pages tell how we've combined up-to-the-minute production facilities with the kind of meticulous New England craftsmanship you probably didn't realize still existed. Read how the combination benefits you, whenever you need quality.

PRINTED CIRCUITS ASSEMBLIES PROTOTYPES



ELECTRO-SONICS, INC.
 210 Main St., Spofford, N. H. 03462
 Tel. 603/363-4701

Circle 272 on reader service card

High Reliability Instruments

meguro

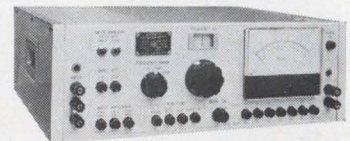

MAK-659

Dist. meter

— for AUDIO LABS and PRODUCTION —

MEASUREMENT RANGES

■ Distortion

Range: 0.1 to 30%, 5 steps; frequency: 20Hz-200kHz; input impedance: 600, 10k, 20k ohms; automatic control range: 40dBm or 100X in voltage; fundamental suppression: over 60dB.

■ Level

Range: -70 to +40dBm, 600 ohms, and -70 to +20dB (0.3mV-10V), 10k and 20k ohms; frequency: 20Hz to 600kHz.

■ S/N (signal/noise)

Range	Input
0 to 70dB	-22 to 0dBm
0 to 90dB	0 to +38dBm

frequency: 20Hz to 60kHz.

● Catalog sheet on request



MEGURO DENPA SOKKI K.K.
 (Meguro Electronic Instrument Co., Ltd.)
 No. 5, 1-2-chome, Chuo-cho, Meguro-ku, Tokyo, Japan
 TEL: 711-7191-7 Cables: MEGURODENPA TOKYO

16 amp
35 amp
55 amp
110 amp

235 amp SCR's

and still growing

- ⊕ Standard dv/dt 10 to 400 v/μsec. depending on type.
- ⊕ Special dv/dt 500 v/μsec. and greater.
- ⊕ Fast turn-off types giving 12 to 20 μsec. turn-off time.
- ⊕ Industry's highest surge current and I²t ratings
- ⊕ Immediate delivery

NATIONAL

REQUEST
BULLETIN

ELECTRONICS, INC.
a varian subsidiary

PHONE: (312) 232-4300 • GENEVA, ILLINOIS 60134

Circle 274 on reader service card

Combined for Convenience!

FREE!



CAMBION[®] Catalog 700 and CAMBION Catalog 700 Supplement

Now — for your convenience, the industry's most complete file of technical data for quick, easy specifying. If you're currently without *both* CAMBION Catalog 700 and CAMBION Catalog 700 Supplement, now you can have them bound together under one convenient cover.

Filled with technical and performance data, specifications, outline drawings and dimensions, the new CAMBION publication offers a complete selection of battery holders, panel and chassis hardware, digital modules, solder terminals, swagers, terminal boards, insulated terminals, coil forms, shielded coil forms, coils, RF chokes, capacitors, connectors — plugs and jacks, component clips, handles, kollet knobs, thermoelectric modules and magnetic bearings.

For your free copy write Cambridge Thermionic Corporation, 405 Concord Ave., Cambridge, Mass. 02138. Tel: (617) 491-5400; or 8703 La Tijera Blvd., Los Angeles, Cal. 90045. Tel: (213) SP6-0472.

CAMBION[®]

Standardize on CAMBION... the guaranteed electronic components

Circle 215 on reader service card

FIVE GUESSES...

WHAT ARE THEY?

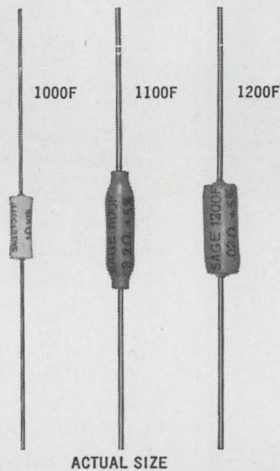

CAPACITORS?
DIODES?
INDUCTORS?
RESISTORS?
FUSES?

If you said resistors you'd be right of course. And if you said fuses you'd be right again.

That's right, FUSIBLE RESISTORS.*

This new adaptation of miniature power resistors comes from SAGE ELECTRONICS, a leading producer of standard silicone and custom designed wirewound resistors.

As the name implies, SAGE type F units are special, dual-function resistors... custom-made, typically in fractional or very low ohm values.

*PAT. PENDING

HERE'S THEIR DUAL FUNCTION...

1. Act as long-life, highly stable, fixed resistors up to specified current level.
2. Safely and permanently blow circuit open within a specified time interval if critical current level is exceeded.

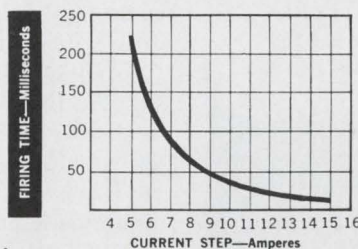

Graph shows representative results on a SAGE 1000F 1Ω part.

For a prompt analysis of your application, contact us, outlining details of resistance value, fusing time and current.

Or for specifics of environmental performance, body size, etc., write, wire or phone for a copy of Catalog R-66.

SEE OUR SPECIFICATIONS IN
VSMF
THE MICROFILM CATALOG FILE



SAGE ELECTRONICS CORP.
BOX 3926 • ROCHESTER, N. Y. 14610

PHONE: 716-586-8010

Now Available...
Power Supply Manual
 From
Transformer Electronics
 Company



DC TO DC POWER SUPPLIES
CIRCUIT BREAKERS
DC TO DC CONVERTERS
HIGH VOLTAGE SUPPLIES

Imaginative engineering, a proven record of reliability and dependability, plus a dedication to customer service have given T.E.C. an international reputation in the design and manufacture of miniature regulated DC to DC converters and associated solid state products for aerospace, military and commercial systems. Now, for the first time in one easy-to-use catalog... the details, the specifications, the technical data and the prices, all packaged for your convenience. For your copy, write or call...

t
e
c

TRANSFORMER ELECTRONICS COMPANY
 BOULDER INDUSTRIAL PARK
 BOULDER, COLORADO
 TWX 910-940-3246 PHONE (303) 442-3837

**POWER SUPPLIES • INVERTERS
 CONVERTERS • TRANSFORMERS**

Technical Abstracts

costs of a penny a bit are feasible. A 250-word, 80-bit-per-word memory was recently tested with a cycle time of 50 to 100 nanoseconds.

The data is stored permanently in the resistor connections—a 1 is represented by resistively coupling a sense line with a drive line, and a 0 by the absence of such coupling. Thus, as in many read-only memories, the stored information cannot be changed once the memory is built.

In operation, one of the 256-word lines is driven through a transistor address matrix and the 80 sense lines deliver a 1 or 0, depending on the resistor connections, to their 80 sense amplifiers.

Sneak paths are the main problem in making the memory; in addition to the directly coupled pulses represented by 1's, the sense amplifiers also receive many low-level inputs from the parallel current paths through other resistors. This problem, however, can be minimized by terminating the word and sense lines with suitable decoupling impedances.

The photoetched tin-oxide resistor matrix is formed of 6,120 resistors, nominally 1,500-ohms each, deposited on an 8 by 10-inch glass plate. Word drive lines are silk-screened with a silver conductive frit and then fired. The plate then is covered with glass frit as an insulation between sense and drive lines, leaving holes over the unconnected ends of each resistor. The plate then is metallized with copper and photoetched to form the sense lines connected to the resistors which are to represent 1's.

Each module, which measures 15 by 8.75 by 2.4 inches, contains four resistor matrixes, each 64 words by 80 bits, with the associated drive and sense circuitry. Up to eight modules may be stacked to form a memory with a maximum size of 4096 words by 40 bits. The eight modules would share address and output registers, power supplies, timing circuits, threshold adjustments and other interface circuitry.

Presented at the IEEE Computer Conference, Chicago, Sept. 6-8.

MICO

NEW MODEL 885

SEVEN RATIO

WIDE-RANGE ENGRAVER

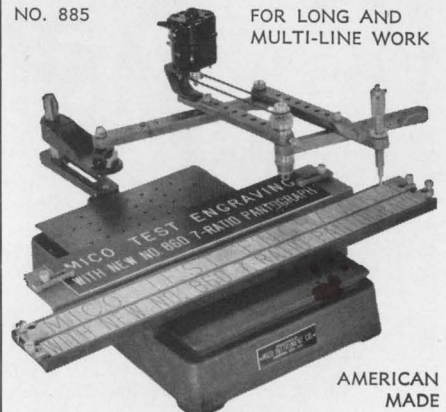

- A time-saver for large plate work.
- Engraves 3" x 19" area in one set-up
- Seven pantograph ratios—from 1:5:1 to 6:1.
- Choice of 3-ball-bearing spindle assemblies for 1/8", 3/16" or taper-shank cutters.
- HSS, COBALT and Solid Carbide Cutters.
- Single and multi-line copy carriers for holding, blanks 3/4" to 3 1/2" high.
- Accommodates Mico standard accessories.

Send for bulletins and prices

MICO INSTRUMENT CO.

77 Trowbridge St. Cambridge, Mass. 02138
 Circle 275 on reader service card

ECONOMICAL Thin Film!

Resistor-Module and Discrete Resistor Plate-ohm have been developed by SUSUMU's unique thin-film techniques. The ideal resistor for your purposes!

HIGH RELIABILITY and LOW NOISE CHARACTERISTICS from SUSUMU's evaporation techniques.
 LESS EXPENSIVE as carbon resistor due to SUSUMU's fine engineering.
 ADVANTAGEOUS for your printed circuit wiring. With high-density assembling.
 EXCELLENT T.C.R.: applicable in range of -100 ppm/°C + 100 ppm/°C.

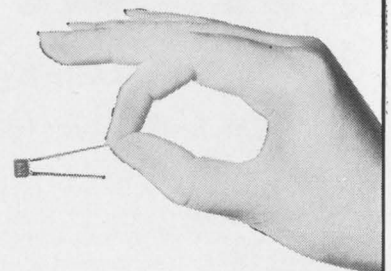

Specialist in Vacuum Evaporation:

SUSUMU INDUSTRIAL CO., LTD.

HEAD OFFICE AND EXPORT DEPT.:
 6, Shonouchi, Chudoji, Shimogyo-ku, Kyoto, Japan
 Phone: Kyoto 075 (311) 4459 Cable address: SUSUMU KYOTO
 FACTORIES: KYOTO, NAGASHINO
 TELEX NO. 5422-359

AND ONE TO GROW ON

Substrates of single crystal sapphire provide an excellent surface for epitaxial deposition of silicon . . . as well as for other thin film growth processes.

Available from Adolf Meller Co., in several standard sizes, are randomly oriented sapphire substrates polished to a finish of 250 Å or better, with dimensional tolerances of $\pm .001$ ".

Custom fabrication services allow you to specify crystal orientation, size, material (including spinel, magnesium oxide, ruby, quartz, and rutile), and additional machining operations.

Expand your knowledge of how sapphire can be of value in your work — write or phone Meller for "A Summary of Available Data on the Physical Properties of Synthetic Sapphire."



ADOLF MELLER CO.
P.O. Box 6001-C
Providence, R.I. 02904
Tel: 401-331-3717

Circle 277 on reader service card

Signal distortion between racks*

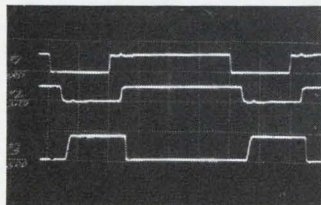
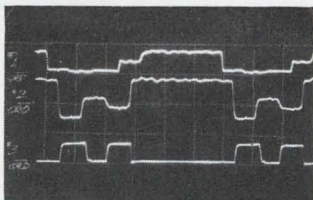

is now
a thing
of the past.**

MONITOR offers a new line receiver card which terminates long transmission lines in their characteristic impedance for higher frequencies. Regardless of transmission line length, you can now have pulses as clean at the destination as they were when transmitted. You get four line receivers on one L-57 card.

The L-57 is just one of over 140 MONILOGIC™ IC cards, in both DTL and TTL logic, all completely compatible. For more information write to us.

*Scope photo shows (top) transmitter output into 40-foot twisted pair; (middle) output of line; (bottom) output of gate. Reflections return to transmitter output, produce distortion in line, erroneous pulses at gate output.

**With L-57 Line Receiver terminating same line, reflections are eliminated. Transmitter output, line output, gate output are all clean, undistorted, and correct.



Fort Washington, Pa. 19034 • A Subsidiary of Epsco, Inc.

Circle 278 on reader service card

ONE-PIECE CONSTRUCTION— A GOOD IDEA THAT CUT LAMP COSTS

Original Design

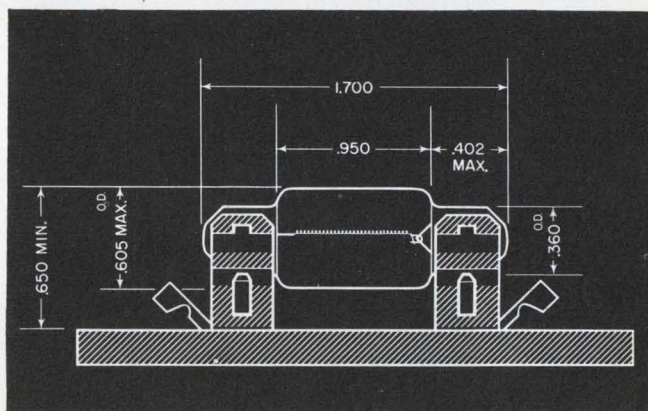

Tung-Sol Re-Design

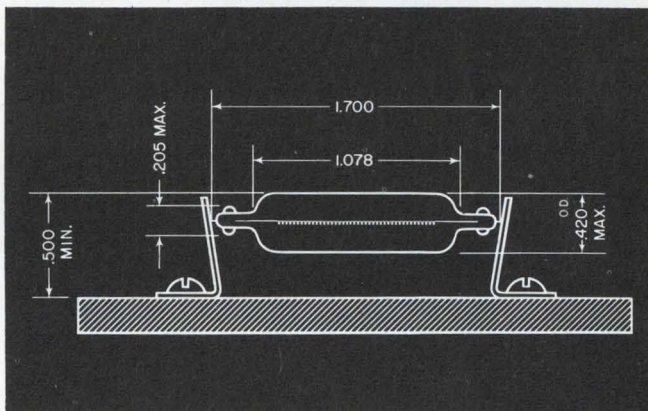

Automobile dome lamps have long employed the cartridge lamp shown at the top. It was a good lamp but it was bulky and had cemented-on end caps for contacts. Also the fuse-clip type mount was comparatively expensive to make.

So, Tung-Sol looked for a simpler idea and came up with a new design. It's made in one piece. Elimination of separate end caps contributes to greater reliability while lowering cost. Additional saving is reflected in the spring-clip bracket. The new lamp is slendrer; achieving a lower silhouette when mounted.

Perhaps you have a lamp application where a little idea-work would give you a better product at a lower cost. We'd like to help. Tung-Sol Division, Wagner Electric Corporation, One Summer Avenue, Newark, N.J. 07104.

TUNG-SOL®

WHERE BIG THINGS ARE DONE
WITH SMALL LAMPS

*REGISTERED TRADEMARK WAGNER ELECTRIC CORPORATION

Circle 217 on reader service card

217

Compare the
All-New PAMOTOR
Model 4500 with
the miniature
axial fan
you're now using!

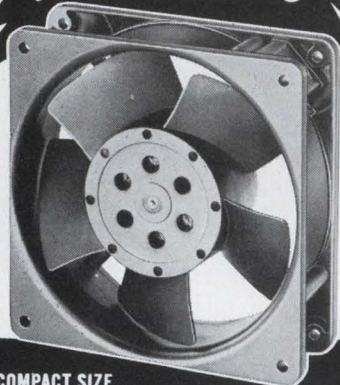

COMPACT SIZE

Only 4 1/16" x 4 1/16" x 1 1/2". Weighs just 1 1/4 lbs. Interchangeable with similar, less reliable 4 1/16" fans.

POWERFUL MOTOR

Dependable shaded-pole motor operates with low internal heat rise. Efficient inside-out design.

ALL-METAL CONSTRUCTION

Precision die cast housing, hub, impellers. Corrosion resistant. Natural, heat sink. Warp-free, unlike conventional plastic fans.

**115 CFM WITH LESS
THAN 37.5 dB SIL***

*Speech Interference Level

- Lubrication-free life in excess of 20,000 operational hours, continuous duty at 55° C.
- Delivers more air at a lower noise level, yet priced under similar conventional plastic fans.
- Model 4500 designed for 117V/50-60 Hz operation. Model 4550 operates at 230V/50-60 Hz.
- Immediate delivery through distributors or from factory stock.
- Has Underwriters' Laboratories Inc. Yellow Card Component Recognition Number E41168.

**ONLY
\$855
EACH**
in lots
of 100

PAMOTOR, INC., 312 Seventh St.
San Francisco, California 94103.

PAMOTOR, INC.

New Literature

Components. Amphenol Controls Division, Amphenol Corp., 120 S. Main St., Janesville, Wis. 53545, offers its 120-page catalog C-67 covering trimmers, potentiometers, counting dials, and instrument motors.

Circle 446 on reader service card.

Accelerometers. Gulton Industries, Inc., 212 Durham Ave., Metuchen, N.J., has available a bulletin on the series AQB-4200 ultrahigh-temperature piezoelectric accelerometers. [447]

Curve tracers. Electro Techniques Co., 18-36 Granite St., Haverhill, Mass. 01830, has released technical bulletin 11A describing its diode or rectifier curve tracers. [448]

Indicator lights. Dialight Corp., 60 Stewart Ave., Brooklyn, N.Y. 11237. Catalog L-206 provides specifications, data, and ordering information for a line of incandescent indicator lights. [449]

Capacitors. Vitramon Inc., P.O. Box 544, Bridgeport, Conn. 06601. A 57-page catalog covers the 20 standard VY porcelain and VK ceramic capacitor series. [450]

Thumbwheel switches. A.W. Haydon Co., 232 N. Elm St., Waterbury, Conn. 06720. Bulletin CS901 describes a line of panel-mounted thumbwheel switches for use in single-pole, double-pole, or four-pole applications. [451]

Microwave systems. Farinon Electric, 935 Washington St., San Carlos, Calif. 94070, offers a brochure describing a family of solid state microwave systems for point-to-point communications. [452]

Telemetry systems. Scientific Data Systems, 1649 Seventeenth St., Santa Monica, Calif. 90404, has issued a brochure on its capabilities for the design and production of computer-based systems for processing telemetry data. [453]

Thermoelectric products. Cambridge Thermionics Corp., 445 Concord Ave., Cambridge, Mass. 02138, has available three catalogs on thermoelectric components, instruments, and assemblies. [454]

Overvoltage protectors. Electronic Research Associates Inc., 67 Sand Park Rd., Cedar Grove, N.J. 07009. Data sheet 152 details features of a new series of universal overvoltage protectors. [455]

Laser welder. Spacerays Inc., Northwest Industrial Park, Burlington, Mass. 01803, has available a four-page brochure describing a long-pulse laser welder suitable for new industrial applications. [456]

Digital computer. Computer Control Division, Honeywell Inc., Old Connecticut Path, Framingham, Mass. 01701. An eight-page brochure describes the DDP-124 general-purpose, IC digital computer. [457]

Transistors. Solitron Devices Inc., 1177 Blue Heron Blvd., Riviera Beach, Fla. A supplement to the 1967 condensed catalog covers a line of small-signal npn and pnp transistors used for military, industrial, and commercial applications. [458]

Miniature rolled pins. Sylvania Electric Products Inc., 12 Second Ave., Warren, Pa. 16365, offers a bulletin describing the types of miniature rolled pins produced for the electrical and electronics industries. [459]

Flame-fusion furnace. Semi-Elements Inc., Saxonburg Blvd., Saxonburg, Pa. 16056, has available literature on the SE-160 flame-fusion furnace that is capable of growing laser quality rubies as well as other single crystals. [460]

Capacitance-conductance bridge. Wayne Kerr Corp., 22 Frink St., Montclair, N.J. A three-color bulletin covers the B201, a capacitance-conductance bridge with 0.1% accuracy. [461]

Dielectric materials. Emerson & Cuming Inc., Canton, Mass. 02021, has published an illustrated folder describing Eccotherm thermally-conductive dielectric materials. [462]

Instrumentation tape. Ampex Corp., 401 Broadway, Redwood City, Calif. 94063. Composition, specifications and proper care of magnetic tape for instrumentation recorders employed in aerospace telemetry, research, industry, and medicine are covered in bulletin TO83. [463]

Dielectric material. American Enka Corp., Willimantic, Conn. 06226. A technical bulletin describes characteristics and applications for Rexolite dielectric material in rod and sheet form. [464]

Battery cells. Sonotone Corp., Elmsford, N.Y. 10523, has released booklet BA-112 on its line of rechargeable, sealed nickel-cadmium battery cells. [465]

Permanent magnets. RFL Industries Inc., Boonton, N.J. 07005. A booklet entitled "How to magnetize, measure, and stabilize permanent magnets," contains the latest magnetic terms and definitions. [466]

Hybrid circuits. Sperry Semiconductor Division, Sperry Rand Corp., 380 Main Ave., Norwalk, Conn. 06852. A brochure on hybrid-circuit production capabilities includes sections on types of com-

What good's 0.03% accuracy here if you can't control it here?

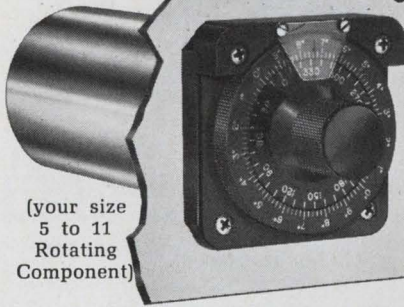

(your size 5 to 11 Rotating Component)

Acton's DSD-7 AccuDrive™ sets, resets, and reads out to 6' of arc accuracy

Acton's patented AccuDrive shaft-positioners are ideal laboratory or system companions for precision control components such as potentiometers, synchros, resolvers, phase-shifters, and tuners. With AccuDrive, you know you're preserving the accuracy of your rotating components.

Six AccuDrive models are available, with accuracies from 12' of arc to 1' of arc (1 part in 21,600 or 0.0046%!). Prices range from \$90 to \$495. Zero-backlash couplings and adjustable slip clutches are available.

SEND NOW FOR THE FULL ACCUDRIVE STORY

ACTON

LABORATORIES · INC.
Subsidiary of Bowmar Instrument Corporation
531 Main Street • Acton, Massachusetts 01720

Circle 279 on reader service card

Speed-up
Wire
Marking
with a
KINGSLEY
Wire & Tube
Marking Machine
right in your plant!



Write
for
Details

Now you can permanently mark wire or tubing directly on the insulation... quickly... economically... right in your own plant!

Cut costs and speed production with the same machine that has consistently proven so successful in the aircraft/missile field.

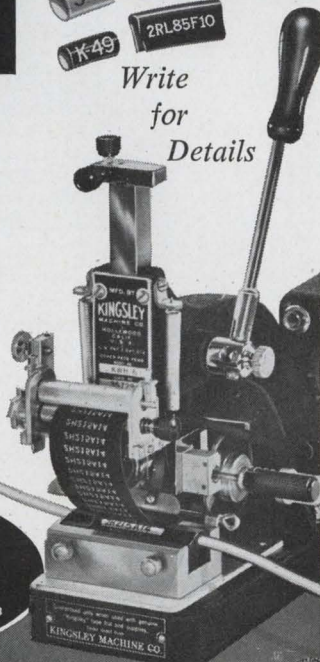

KINGSLEY
MACHINES

850 CAHUENGA • (213) 469-7243
HOLLYWOOD, CAL. 90038

A-207

Circle 280 on reader service card

Still using LC's?
This might change
your mind:

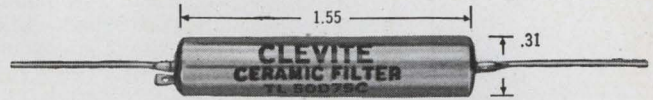

Clevite's ceramic ladder filters deliver 80 db rejection in 0.1 cu.in.!

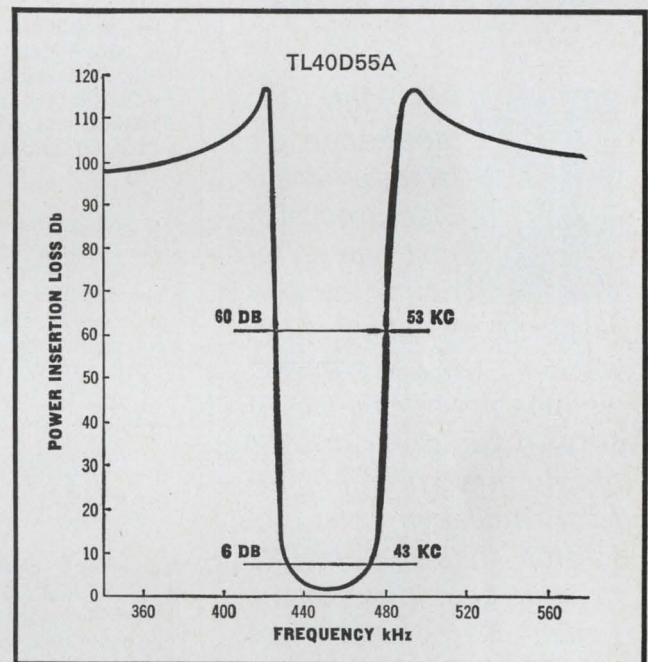

Here's a fixed-tuned filter that offers more selectivity for its size than any conventional i-f filter on the market!

Clevite's non-magnetic, non-microphonic, 17-disc ceramic ladder filter is ideal for i-f stages of high quality superheterodyne radio receivers used in airborne or ground AM and FM communications equipment. Stop band rejection: 60 or 80 db. Center frequency tolerance: ± 1 kHz for 20 kHz B/W and below; ± 2 kHz for 30 kHz B/W and above. Stability: within $\pm 0.2\%$ for 5 years; within 0.2% from -40°C to $+85^{\circ}\text{C}$. Impedance (in and out) 2500 ohms for 12 kHz bandwidth and below; 1500 ohms for 13 kHz to 29 kHz B/W; 1200 ohms for 30 kHz bandwidth and above.

Following models standard at 455 kHz (A) or 500 kHz (C) (custom models on special order):

Model Number	B/W		Model Number	B/W	
	Min. @ 6db	Max. @ 60db		Min. @ 6db	Max. @ 60db
TL-2D5 (A)	2 kHz	5 kHz	TL-20D32 (A)	20 kHz	32 kHz
TL-4D8 (A)	4 kHz	8 kHz	TL-30D45 (A)	30 kHz	45 kHz
TL-6D11 (A)	6 kHz	11 kHz	TL-40D55 (A)	40 kHz	55 kHz
TL-8D14 (A)	8 kHz	14 kHz	TL-45D65 (A)	45 kHz	65 kHz
TL-10D16 (A)	10 kHz	16 kHz	TL-50D75 (C)	50 kHz	75 kHz
TL-16D25 (A)	16 kHz	25 kHz			

PRICES: 1 — \$52.50; 25 — \$42.00 ea; 100 — \$36.75 ea; 500 — \$31.50 ea; 2000 — \$26.00 ea.

(Prices subject to change without notice.)

Send order or request for Bulletin 94017 to: Clevite Corporation, Piezoelectric Div., 232 Forbes Rd., Bedford, Ohio 44014, U.S.A. Or: Brush Clevite Company, Limited, Southampton, England.

CLEVITE

Circle 219 on reader service card

219

at 500 watts
or 30KW...

PEK

means reliability
in high pressure
Xenon Arc Lamps

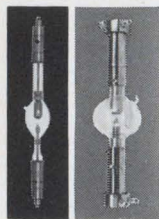

PEK high wattage xenon arc lamps are manufactured with just one criterion in mind—

reliable performance. And, when we say performance we mean performance up to and beyond today's exacting requirements in solar simulation, color projection, instrumentation, or wherever high order radiant energy sources are employed. □ Whether your need is 500 watts or as high as 30KW, you can count on dependable glass-to-metal seals, maximum arc stability and long life when you specify PEK. □ Send for our new Product Reference Guide or tell us what your special need is. There's a PEK lamp to fit your application.

PEK

PEK / 825 E. Evelyn Avenue
Sunnyvale, California
(408) 245-4111/TWX 910-339-9214

New Literature

ponents, package configurations, test procedures, and manufacturing steps. [467]

Wiring systems. ACI Division, Kent Corp., 206 Industrial Center, Princeton, N.J. 08540. Bulletin E-7 describes and illustrates Signaflo wiring systems. [468]

Complementary transistors. KSC Semiconductor Corp., KSC Way (Katrina Road), Chelmsford, Mass. 01824. Application bulletin No. 10 describes how complementary circuits operate with matched pairs of pnp and npn transistors. [469]

Line amplifiers. Quindar Electronics Inc., 60 Fadem Rd., Springfield, N.J. 07081. Release No. 134 contains photographs as well as a description, specifications, and ordering information for the QLA-1 and QLA-10 line amplifiers. [470]

D-c voltage regulators. Semiconductor Division, Bendix Corp., South St., Holmdel, N.J. 07733. An application note gives details on technical specifications, parameters, and series-shunt circuit applications for d-c voltage regulator modules. [471]

Solderless electrical terminals. AMP Inc., Harrisburg, Pa. 17105. Nearly 50 new solderless wiring devices have been incorporated in the latest revision of Catalog 308-5. [472]

Molded r-f chokes. J.W. Miller Co., 5917 S. Main St., Los Angeles, Calif. 90003. An eight-page, short-form catalog describes five complete series of molded r-f chokes. [473]

Reed switch selector. Hamlin Inc., Lake & Grove Sts., Lake Mills, Wis. 53551. A four-page folder serves as a load, size, and switch selector for over 40 magnetic reed switches. [474]

Operational amplifiers. Data Device Corp., 240 Old Country Road, Hicksville, N.Y. 11801, has released a six-page short form catalog on its line of operational amplifiers and related products. [475]

Sputtering sources. Cerac Inc., Box 126, Butler, Wis. 53007, has issued a four-page technical bulletin describing materials for use as sputtering sources in research and production applications. [476]

Varactor bridge amplifiers. Analog Devices Inc., 221 Fifth St., Cambridge, Mass. 02142. A 23-page application note uses seven technical schematics in discussing basic principles, design techniques, specifications, and circuit applications of varactor bridge operational amplifiers. [477]

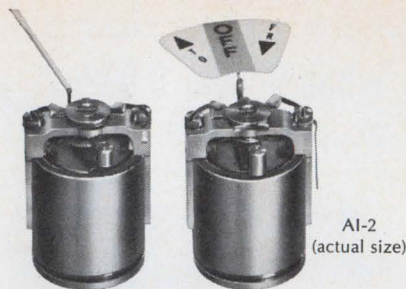

High torque, Self-shielded moving coil mechanism

When critical indicating and control is essential this versatile mechanism will fill your requirements. Available with "On-off", "+, -", "go-no go", null, left-right or scale indicators. High torque, self-shielded core magnet design permits multi-function groupings in small space. Moving coil is 100 mg lighter than most comparable mechanisms, yet provides 10% more torque. Choice of many sensitivities; synchro or standard mounting.

AMMON

AMMON INSTRUMENTS, INC.
345 Kelley St., Manchester, N.H. 03105

Circle 281 on reader service card

400W 28 VDC Servo Amplifier

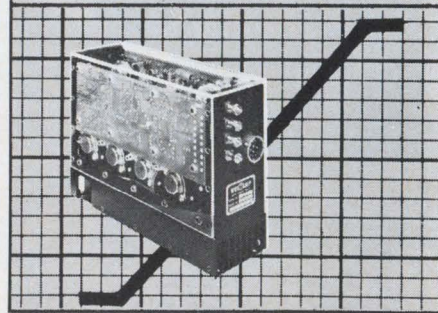

for torquers and
printed circuit motors

Westamp Model A499 is a linear DC servo amplifier which operates directly from 28VDC or 40VDC. It has 3 summing inputs, each independently adjustable in gain from 0 to 500V/V with voltage feedback, or 0 to 50A/V with current feedback. Model A499, an AC carrier type amplifier with built-in frequency generator, provides stability which eliminates a need for balance adjustments. For further data, just send for our catalog.

HIGH POWER SERVO AMPLIFIERS

WESTAMP

1542 15TH STREET
SANTA MONICA, CALIF. 90404
PHONE: (213) 393-0401

Circle 282 on reader service card

Audio Amplifier? AC Power Supply?

the Compact
NA Series
gives you
both!

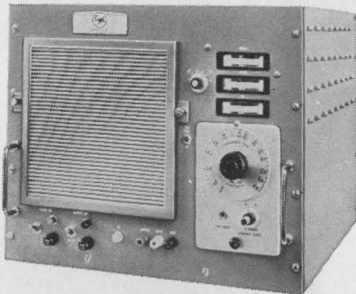

The NA Series of AC Power Supplies are exceptionally flexible sources of audio power. Each power supply consists of a Regulated Audio Power Amplifier with interchangeable fixed or variable Plug-In Oscillators for a wide range of precision AC power

applications. The Amplifier has a full power range of 45-6,000 cycles. With the incorporation of a CML Plug-In Oscillator precise fixed or adjustable output frequencies are available anywhere within this range. For complete information, write today.

CML, Inc. 

A subsidiary of Tenney Engineering, Inc.
350 Leland Avenue • Plainfield, New Jersey
(201) 754-5502 • TWX: 201-756-2064

60

Circle 284 on reader service card

Polystyrene

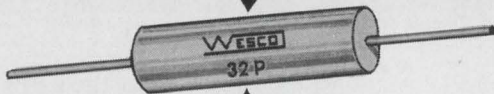

WESCO PROVIDES EXACT TOLERANCES FOR FILTER REQUIREMENTS

No need to buy "standards" and then select the capacitors that meet your requirements when WESCO can supply exact tolerances from $\pm 0.1\%$.

When measuring the Q factor and stability in accordance with standard Mil-C-5, WESCO Polystyrene exceeds mica characteristics. In values from 2200 pf and over, WESCO Polystyrene capacitors are smaller, lighter in weight and more economical than equivalent mica units.

Call or write for complete specifications and pricing information.

WESCO

WESCO ELECTRICAL COMPANY, Inc.

27 OLIVE STREET / GREENFIELD, MASS. 01301 / AREA CODE 413 774-4358

Circle 285 on reader service card

Johnson Introduces Two NEW Components to save space, cut costs!

1. Save space with new, horizontal-mounting, printed circuit, type "U", machined-plate capacitors. Available in various sizes, with capacity values ranging from 1.2 pf to 24.5 pf, these tiny trimmers provide tuning accessi-

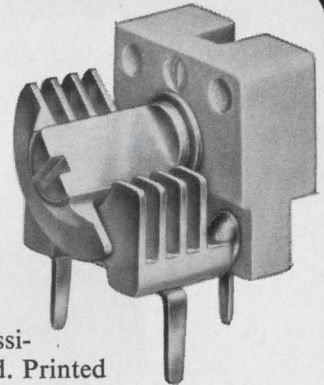

bility from edge of board. Printed circuit boards can be close-spaced, resulting in compact equipment designs. TC—plus 45 ± 15 PPM/ $^{\circ}$ C. "Q"—greater than 1500 at 1 MHz. All metal parts silver plated. Famous Johnson quality throughout.

2. Cut costs with new, Johnson RIB-LOC™

Tip Jacks that save production line time with *press-in* design. No mounting hardware to assemble or handle. Simple insertion tool presses Tip Jack into pre-drilled chassis hole for a secure mount that resists loosening and turning. Jack accepts 0.080" tip plug in a recessed, closed-entry type contact. Insulating body is molded of low-loss polyamide. Brass solder terminal is silver-plated and Iridited. Low cost.

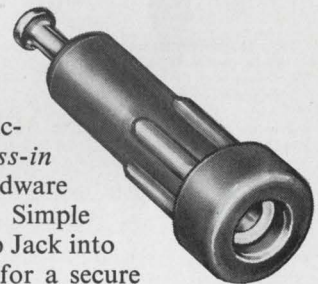

**Write today for details
and complete specifications
on these new Johnson Components!**



E. F. JOHNSON COMPANY

3046 Tenth Ave. S.W., Waseca, Minnesota 56093

Circle 221 on reader service card

EXTENDING MAN'S SIGHT *is the challenge at Grumman*

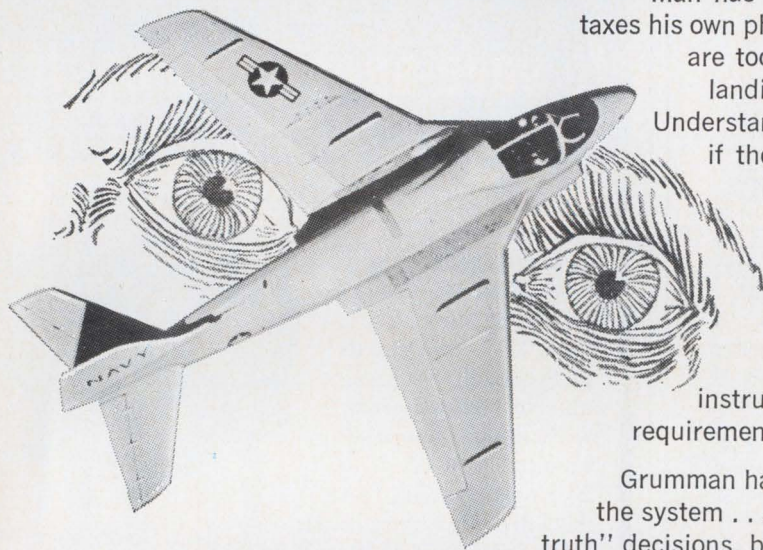

Man has entered into a flight regime which severely taxes his own physical and mental resources. Reaction times are too short, accelerations too high, air too thin, landing speeds too fast, cockpits too complicated. Understandably, man turned to his machines to see if they could fight his battles for him, so leave him with the tasks of thinking and button-pushing. Precisely this . . . is the Grumman A6A, extending man's sight.

Equally at home in daylight, darkness, rain or cloud, the A6A is a collection of electronic equipment, and a group of instruments that completely takes over the mission requirements previously dependent on the pilot's vision.

Grumman has always recognized that **Man** is the heart of the system . . . not only for his ability to make "moment of truth" decisions, but also for the "bringback" capability which only he has. Man is economic. Engineering at Grumman (the man behind the man) takes on deeper significance because of this outlook. The concern for "the man" doesn't stop at the pilot or the astronaut. It pervades all echelons of the company. Grumman is vitally interested in the welfare of the man who joins our company. Engineers and scientists who can infer distinct advantages in such an atmosphere are invited to contact us regarding the following immediately available positions in advanced aerospace programs.

Test Data Reduction Specialists—BS and minimum of 2 years' experience with telemetry ground station operation, digital computer processing of test data, data acquisition systems, data processing planning, and data reduction.

Analog/Digital Operations Systems Engineers—BS or equivalent with a minimum of 1 year experience operating analog/digital data processing equipment including wideband tape recorders, FM discriminators, PCM demodulation systems, and analog display equipment. Computer software experience desirable.

Vibration Analysis Systems Engineers—BS or equivalent and a minimum of 2 years' experience in operation of vibration analysis data reduction equipment including power spectral density, transfer function, correlation, and other typical vibration data output.

Data Systems Programmers—To design and implement software systems for real-time acquisition and processing of telemetry and instrumentation data. Experience in real-time programming preferred. BS in Physics, Mathematics, or Engineering required.

Real-Time Data Processing Programmers—To design and implement control supervisions and scientific applications programs for real-time monitoring and analysis system, including the development of software and techniques for implementation of several remote display systems. Experience in real-time programming preferred. BS in Mathematics, Physics, or Engineering required.

Data Processing & Analysis Programmer—To develop programs for the reduction and analysis of spacecraft and aircraft test data. Current operations include: Thermal Vacuum testing, Aircraft Performance evaluation, Spacecraft Checkout and Spacecraft Mission performance. BS required with minimum of two (2) years' programming.

Guidance Dynamicists—BS or MS in AE, EE, or Applied Mechanics with a minimum of 2 years' experience in the analysis of guidance and navigation systems will analyze and evaluate functional configurations and dynamic characteristics of radar, IR, optical and inertial guidance loops; navigation system performance; signal processing and error analysis.

Control Dynamicists—BS or MS in AE, EE, or ME with a minimum of 2 years' experience in analysis of control systems to synthesize, analyze and evaluate automatic flight control system stability and performance. Familiarity with non-linear digital random process and optimal control techniques is desirable.

Space Dynamicists—BS or MS in Physics, Aerospace Engineering, Applied Math or Applied Mechanics, with a minimum of 2 years' experience in the analysis of flight dynamics. Experience in trajectory optimization, space dynamics, Monte Carlo simulations relating to disturbance torques, orbital mechanics, interplanetary, lunar and re-entry trajectory analysis is desirable.

Guidance & Control Integration Engineers—BS or advanced degree with experience in design, analysis, and integration of vehicle guidance and control systems. Applicants should possess a working knowledge of both analog & digital feedback system & design techniques. System test or hardware design experience desirable. Position entails conceptual work in defining guidance & control systems, establishing subsystems & component requirements, system development & verification.

Instrumentation Measurement Engineers—BS in ME, AE or CE with at least 3 years experience in design and calibration of multi-component strain gage balances, thrust stands, or weighing systems. Assignments will include design of wind tunnel balances, complex structural component gaging and high temperature, high vacuum strain gaging studies.

BS in ME, EE or Physics with 4 years experience in instrumentation measurement problems. A good theoretical and practical knowledge of transducers, their specifications and application to measurement of temperature, pressure flow, acceleration, rate, force, is required.

BS in ME, EE, Physics or equivalent experience in calibration of test instruments & laboratory standards.

Instrumentation Application Engineers—BS in ME or Physics with a minimum of 2 years experience with transducers, recorders, data gathering systems, & interested in lab type work.

BS in ME, EE or Physics with a minimum of 2 years experience, to work with telemetry, digital systems & tape recorders as applied to Flight Test Development Programs.

BSEE with a minimum of 2 years experience in electronics circuit application with knowledge of digital techniques. Will operate analog & digital data acquisition systems.

Instrumentation Design Engineers—BSEE with a minimum of 3 years experience in digital logic & system design. Experience with telemetry & analog multiplex tape systems, highly desirable. Will be responsible for complete check-out of airborne instrumentation from component procurement to systems checkout.

Training Devices Engineers—B.S. plus 2 years experience with weapon system & maintenance trainers or equivalent, capable of programming & utilizing digital computers to solve real-time simulation problems. Will be responsible for development of training criteria, systems analysis, design, subcontractor monitoring, operation & test of training devices and systems.

Electronics Instructors—Will be responsible for instruction of military &/or civilian personnel in aircraft electronic systems (eg. maintenance, trouble shooting, etc.), & for preparing written training material & graphic aids to supplement verbal instruction. A minimum of 4 years electronic experience & 2 years of college or equivalent required.

Aerospace Systems Test Engineers—B.S. in Engineering, Physics or equivalent, with a minimum of 2 years' experience in testing electronic, electrical, hydromechanical or propulsion equipment. Engineers who are selected for these positions will have the unique opportunity to learn the skills required for final acceptance testing of advanced spacecraft utilizing automatic digital checkout systems.

EMC Systems Engineers—BS in Engineering to perform systems analysis, state-of-the-art reviews & develop advanced EMC techniques. Will be responsible for generating design data, control plans, test plans, directing tests, analyzing results, generating fixes and preparing reports for conformance to MIL-E-6051C & 6181D. Should have specific experience & be familiar with all aspects of EMC. Familiarity with computer math modeling is desirable.

EMC Subsystems Engineers—BS with job related experience to generate MIL-I-6181D or equivalent design data, control plans, test plans, direct tests, analyze data, generate fixes & prepare reports for equipments being designed & produced.

EMC Test Engineers—BS or equivalent to supervise test technicians, subsystems & systems test in accordance with test plans of MIL-I-C181D. Responsibilities include correction, modification, & preparation of test plans data analysis & reduction & report writing. Specific experience in EMC instrumentation is essential.

ECM Engineers—BS in Engineering with a minimum of 3 years experience in RF systems performance testing, troubleshooting & evaluation. ECM experience should be extensive, encompassing antenna, receiver, encoder computer, display integration, and malfunction evaluation.

Communications Engineers—BS in Engineering or equivalent and a minimum of 3 years experience in design, development, and test of airborne, spaceborne & navigation equipment systems. Knowledge of communication & RF navigation requirements techniques, methods, and uses as well as knowledge of fabrication techniques, limitations & requirements, are essential.

Computer System Engineers—Engineers & Mathematicians with 1-5 years experience in the analysis, design and development of digital computer systems.

Programmers—Experienced in both general purpose and special purpose techniques, to work on complex systems for aerospace vehicles.

Aerospace Navigations Systems Engineers—BSEE with a major in control theory and 3-8 years experience with small analog computers, inertial sensors and solid-state circuit design. Knowledge of aircraft navigation systems, required; capable of designing small analog computer and investigating total navigation system problems.

Stabilization & Control Engineers—B.S. in E.E. or Physics, with 3 to 5 years experience in aircraft or missile electronic system testing (specifically digital programmer electronics). Primarily assignments will involve integrating & testing of the LM mission programmer including the establishment of requirements for integration test procedures, conducting tests; evaluation of test results & the writing of final test summaries & reports.

Aerospace Electrical Power Systems Engineers—B.S. in E.E. or Physics with a minimum of 2 years experience in design, development, or integration of aircraft or spacecraft electrical, power systems. Positions available in aircraft programs, manned & unmanned spacecraft programs; aircraft & spacecraft advanced systems.

Aircraft Electro-Mechanical Designers—Designers with experience in aircraft electrical/electronic circuit design, installation, liaison, packaging to military specifications.

Electronic Packaging Engineers—B.S. in E.E., M.E. or Physics, with a minimum of 4 years experience in all phases of military airborne electronic packaging per MIL specs.

Reliability Engineers—experienced in at least one of the following areas: design reviews, predictions & tradeoff studies; circuit analysis; system/mission effectiveness studies; reliability testing techniques & procedures; electrical component part evaluation; corrective action; reliability & maintainability data systems. B.S. is desired.

Maintainability Engineers—will establish maintainability goals, plan & direct maintainability programs, perform tradeoff studies & participate in planning & implementation of maintainability testing & demonstration. Experience in supportability, repairability or operations analysis will be put to good use. Degree is desired, but applicable experience is acceptable.

Field Engineers—Expanding Field Engineering force requires individuals who can supply evidence of a professional technical background in integrated weapon systems or experience in one or more of the following areas: radar, digital computers, inertial navigation systems; automatic ground support equipment. Degree is desirable, but not required. Successful Field Engineering background is considered to be the most appropriate qualification. Field benefits are liberal.

Electronic Test Engineers—BS in Electronics or Physics with a minimum of 3 years experience in systems testing. Applicants demonstrating the equivalency will be considered. Experience in one or more of the following areas is mandatory: Search & Track Radars, Digital Computers, Communications, Inertial Guidance & Electrical Power Systems.

Use the attached inquiry form to arrange a mutually convenient interview.



GRUMMAN

AIRCRAFT ENGINEERING CORPORATION
Bethpage • Long Island • New York, 11714
WHERE MAN IS THE HEART OF THE SYSTEM

An Equal Opportunity Employer (M/F)

PROFESSIONAL PLACEMENT INQUIRY

For your convenience and to facilitate your inquiry, please use this form. It will enable the professional staff at Grumman Aircraft to evaluate your background and experience and arrange for a mutually convenient personal interview. All inquiries will be held in strictest confidence. Enclose in an envelope and send to Mr. George E. Kwak, Manager, Engineering Employment, Dept. GR-76, Grumman Aircraft Engineering Corp., Bethpage, L.I., N.Y. 11714.

Background and experience (Brief resume of experience, recent history of employment. If available, attach prepared resume.)

NAME _____ TELEPHONE _____

STREET ADDRESS _____

CITY & STATE _____

NEAREST MAJOR CITY (IF APPLICABLE) _____

COLLEGE GRADUATE: YES ___ NO ___ Degree Subject Year

Major Specialty _____ Yrs. _____ Other Specialty _____ Yrs. _____

Applying for position(in)(of) _____



EMPLOYMENT OPPORTUNITIES

ADDRESS BOX NO. REPLIES TO: Box No.
Classified Adv. Div. of this publication.
Send to office nearest you.

NEW YORK, N. Y. 10036: P. O. Box 12
CHICAGO, ILL. 60611: 645 N. Michigan Ave.
SAN FRANCISCO, Cal. 94111: 255 California St.

POSITION WANTED

Dutch Electronic Eng. BS-EE. Specialization:
short-wave, v.h.f. and u.h.f.; Bands I and III
television. Experience: 3 years with Philips
in telecommunications field service. PW-
4036, Electronics.

*"Put Yourself in the
Other Fellow's Place"*

TO EMPLOYERS

TO EMPLOYEES

Letters written offering Employment or applying for same are written with the hope of satisfying a current need. An answer, regardless of whether it is favorable or not, is usually expected.

MR. EMPLOYER, won't you remove the mystery about the status of an employee's application by acknowledging all applicants and not just the promising candidates.

MR. EMPLOYEE you, too, can help by acknowledging applications and job offers. This would encourage more companies to answer position wanted ads in this section.

We make this suggestion in a spirit of helpful cooperation between employers and employees.

This section will be the more useful to all as a result of this consideration.

Classified Advertising Division

McGRAW-HILL INC.

330 West 42nd St., New York, N. Y. 10036

PROFESSIONAL SERVICES

Donald C. Harder., Inc.

Magnetic Component Engineers

Reactors—Transformers—Filters
Serving the Research Laboratory

2580 K Street, San Diego, Calif. 92102
Phone (714) 239-8021

Today's brand new ocean opens your brand of engineering career opportunity.

Newport News, world's largest and most advanced shipbuilding company—involved with all today's revolutionary marine developments—has immediate career openings in all these engineering fields:

Mechanical Engineers
Electrical Engineers
Marine Engineers
Industrial Engineers
Naval Architects
Nuclear Engineers

Civil Engineers
Metallurgical Engineers
Data Programmers
Systems Analysts
Chemists
Laboratory Analysts

With an order backlog now over \$500,000,000, we're bidding for creative engineers who like challenges and personal responsibility. Write our employment manager, John J. Gaughan. You'll get fast action.



Newport News

SHIPBUILDING AND DRY DOCK COMPANY, NEWPORT NEWS, VIRGINIA

An Equal Opportunity Employer

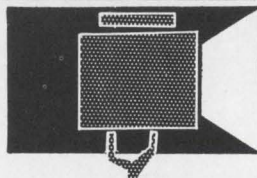

SEARCHLIGHT SECTION

- CLASSIFIED ADVERTISING • BUSINESS OPPORTUNITIES
- USED OR SURPLUS EQUIPMENT

SPOT WELDING TWEEZERS



TWI - 36" Lead \$11.65
AC and Stored Energy Power Supplies
and Welding Heads

EWALD INSTRUMENTS CORP.
KENT, CONN. 06757

CIRCLE 967 ON READER SERVICE CARD

MINI-FLUID DISPENSER

AIR OPERATED

for miniature potting
and encapsulating

Available in 3 sizes
6cc - 12cc - 30cc

\$34.00

PHILIP FISHMAN COMPANY

7 CAMERON ST., WELLESLEY, MASSACHUSETTS 02181

CIRCLE 968 ON READER SERVICE CARD

ELECTRON TUBES

KLYSTRONS • ATR & TR • MAGNETRONS
SUBMINIATURES • C.R.T. • T.W.T. • 5000-
6000 SERIES

• SEND FOR NEW CATALOG A2 •

A & A ELECTRONICS CORP.

1063 PERRY ANNE
WHITTIER, CALIF.

696-7544

CIRCLE 969 ON READER SERVICE CARD

X-band thermistor mount general microwave model
X-401 JETDS MX-3667/U.

New \$25.00 each, also misc other waveguide and
coaxial line components, high temperature tantalum
capacitors, multiterm pots, miniature pots, etc.

Write for List

E. U. BUTLER JR.

517 41st St. Sacramento, Calif. 95819

CIRCLE 970 ON READER SERVICE CARD

RADAR AUTO-TRACK & TELEMETRY ANTENNA PEDESTALS
3 & 10 CM. SCR 584 AUTO-TRACK RADARS. M-33 RADAR
TPS-1D SEARCH. APS-45 TPS-100 HT. FINDERS. WX RADARS.
FPN-32GCA. APS-10 APS-15B APS-27 (AMTI) SEARCH. ■
APN-102 DOPPLER. DOZENS MORE. CARCINOTRONS. PPN'S.
.25-5-1-2-3-6 MEGAWATT PULSE MODULATORS. CAVITIES.
PULSE TRANSFORMERS. IF STRIPS. WAVEGUIDE. BENDS
200 MC. 1 KMC. 3 KMC. 6 KMC. 9 KMC. 24 KMC. RF PKGS.

RADIO RESEARCH INSTRUMENT CO.
550 5TH AVE., NEW YORK 36, N. Y. JU 6-4691

CIRCLE 966 ON READER SERVICE CARD

FOR SALE

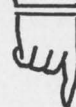

When you have used electronics
equipment to sell, advertise
in Electronics Searchlight
Section for fastest results.

For information:
Searchlight Section
Classified Advertising Division
Post Office Box 12
New York 10036

The one catch in having a bright idea at Hewlett-Packard . . .



You may be the one who has to make it work.

If you're an ivory tower engineer who'd prefer to turn your bright ideas over to someone else and hope for the best, Hewlett-Packard may not be the place for you.

If, on the other hand, you thrive on the chance to learn and work in *all* areas of operation, and the opportunity to follow your concept through every stage from research to marketing, then we believe you will prosper at Hewlett-Packard.

Here you'll find opportunity to exercise your own initiative and judgment; freedom from chains of command; the challenge of "sticking your neck out" when you have something to contribute; and a chance to become totally involved in your project.

Hewlett-Packard's success is based on making sure every product fills a definite need in the science of measurement, produced efficiently and delivered at reasonable cost. This year we will invest \$19 million to research and develop new ideas. One of them could be yours.

If Hewlett-Packard sounds like the kind of company you'd like to be part of, write Ray Wilbur, Vice President, 1501 Page Mill Road, Palo Alto, California 94304. An equal opportunity employer.

HEWLETT  PACKARD



now in 9 sizes HELIAX[®] elliptical waveguide covers the microwave spectrum

With the addition of two new sizes, flexible HELIAX elliptical waveguide is available for all microwave communication bands from 1.7 to 13.2 GHz. The continuous single lengths of HELIAX waveguide assure reliable system performance, with electrical characteristics better than conventional rigid

waveguides at less cost. ■ Investigate HELIAX Elliptical Waveguides for your next microwave system whether it be for a short haul installation or a long high density system. ■ Write for specifications—Andrew Corporation, P.O. Box 42807, Chicago, Illinois 60642.

2-67

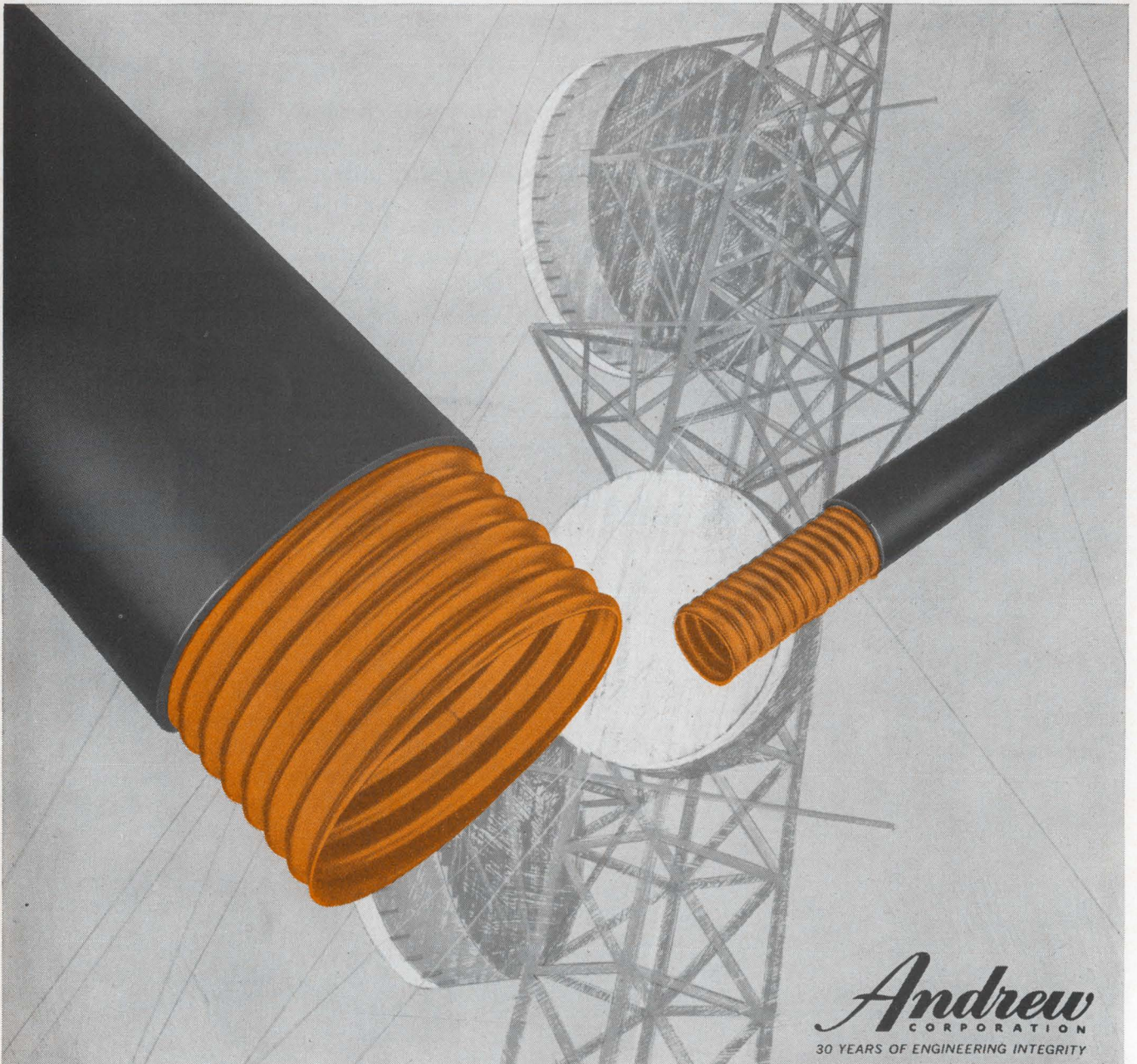

Andrew
CORPORATION
30 YEARS OF ENGINEERING INTEGRITY

9 SIZES OF ELLIPTICAL WAVEGUIDE

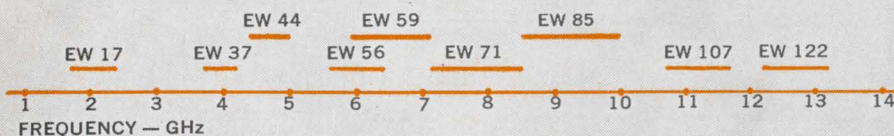

Standard or Tuned Connectors to Fit Standard Waveguide Flanges.

Newsletter from Abroad

October 2, 1967

U.K. avionics firms eye Soviet sales . . .

British avionics makers now think a big market could open up for them in the Soviet Union. Cause of their great expectations: an upcoming agreement between Britain and the USSR to swap knowhow in aircraft-production techniques.

The agreement, negotiated in Moscow last month and expected to be signed soon, presumably will give the British an inside shot at Soviet avionics business. For starters, the Russians showed their TU-144 supersonic-transport project—previously unseen by Westerners—to the British delegation that went to Moscow for the negotiations.

First commercial payoff from the British-Soviet pact most likely will come in automatic-landing equipment. Marconi Ltd. pocketed a \$2.8 million order for landing equipment even before the agreement was worked out. British officials believe the pact will spur more Soviet orders for airfield electronics. Standard Telephone & Cables, a British subsidiary of ITT, is the leading contender for the contract to equip the Moscow and Leningrad airports with automatic landing systems.

. . . and ICT seeks Czech license deal

Britain's top computer maker, International Computers & Tabulators, is angling for a big catch in the Czech computer market. The company has asked the British government to okay a deal—still being negotiated—that would let Czechoslovakia produce the ICT 1901 computer under license.

Since knowhow is involved, the government could kill the deal because of NATO's embargo on exports of strategic equipment and techniques to Soviet-bloc countries. But ICT is stressing that the 1901 is much smaller and slower than many computers already shipped behind the Iron Curtain. The 1901 has a basic internal storage of 4,000 words of 24 bits. The store can be expanded to 16,000 words. Cycle time for the internal memory is 6 microseconds; add time for the computer's central processor is 34 μ sec.

German VTOL gets a lift from NASA

NASA may put new life into an ailing West German vertical-takeoff-and-landing project, the Do-31 jet transport. The U.S. space agency and the plane's builder, Dornier-Werke GmbH, are talking about using the VTOL as a test vehicle for NASA's studies of short-range air transport in densely populated regions.

Dornier developed the transport under a contract from Bonn's defense ministry and has been flight-testing two experimental versions for some months. But until NASA showed interest, the project appeared doomed; no money was earmarked for the Do-31 in the ministry's 1968 budget.

Uhf tv channels in view for Japan

Japanese producers of television broadcast gear will pick up some long-awaited business later this year. Early next month the government will award the first batch of licenses for the country's first full-fledged ultra-high-frequency television stations. Some 10 licenses should be forthcoming and each of the new stations will need roughly \$2 million worth of equipment.

Insiders say the decision to open up uhf channels—15 years after the U.S.—was forced in part by the clamor of set owners in small cities for

Newsletter from Abroad

a wider choice of programs. The country's 12 very-high-frequency channels are saturated.

Another big factor was the advent of Japanese high-power uhf klystrons. The Tokyo Shibaura Electric Co. early this year supplied 15-kilowatt tubes for an experimental uhf station run by the Japan Broadcasting Co. Toshiba expects to have 50-kw klystrons ready before the year is out. Nippon Electric Co. also has high-power uhf klystrons in the works.

Building all-channel sets will pose no problem for Japanese receiver makers. Most already make them for export to the U.S. But because no uhf stations are slated for Tokyo, the Japanese government has no intention, for the moment, of making all-channel receivers mandatory.

Microwave ovens: British firms will cater to housewives

It now looks as if there'll be plenty cooking in British microwave ovens during the next year or so. Convinced that sales of domestic ovens will rise like a good soufflé, a half-dozen companies plan to put 1-kilowatt models on the market.

So far, microwave-oven firms have concentrated on commercial units for restaurants and caterers. But now, major food companies are about to market special precooked food packs, giving the oven-makers an appetite for the domestic market. Philips Electrical Ltd., the market leader, predicts that annual sales will climb to between \$25 million and \$50 million in a few years. Sales currently run about \$250,000 a year.

Philips' 1-kw home oven, priced under \$600, won't be in mass production much before early 1969. By then, a trio of domestic producers will be serving up ovens along with Gingham Kitchen Ltd., the British outlet for Raytheon microwave ovens. Litton Industries almost certainly will take a fling, too, and so will some Japanese producers [Electronics, Sept. 4, p. 207].

Three to build Japan's fourth ground station

The Kokusai Denshin Denwa Co., a public-service corporation that operates overseas radio and cable links, has tapped three of Japan's top communications-equipment manufacturers to build the country's fourth satellite ground station. The \$5-million facility will be used with the Intelsat-3 Indian Ocean satellite slated to be launched next year.

The Mitsubishi Electric Corp., the Nippon Electric Co., and the Tokyo Shibaura Electric Co. (Toshiba) will split the business almost equally among them. Mitsubishi will build the antenna and its control system, Nippon Electric the telephone-channel equipment, and Toshiba the television-channel gear.

Characteristics of the station are still to be decided on, but they presumably will be much the same as those of Japan's third station, scheduled to be completed by yearend. That facility has a 90-foot antenna dish, a 5-kilowatt klystron tv transmitter, and a 2-kw traveling-wave-tube telephone transmitter. The tv transmitter will handle one color channel, and the telephone transmitters two groups of 132 channels.

Australia sticking to own air beacon

Aviation authorities Down Under have rejected a decade-old ruling by the International Civil Aviation Organization that made U.S. distance-measuring equipment the world standard. Except for airports handling international traffic, Australia plans to stick with its own 200-megahertz DME equipment. The Australians claim their system has better propagation characteristics than the 1,000-Mhz U.S. gear.

But how about when you need a flameproof resistor in 1/2-watt size?

Here it is.

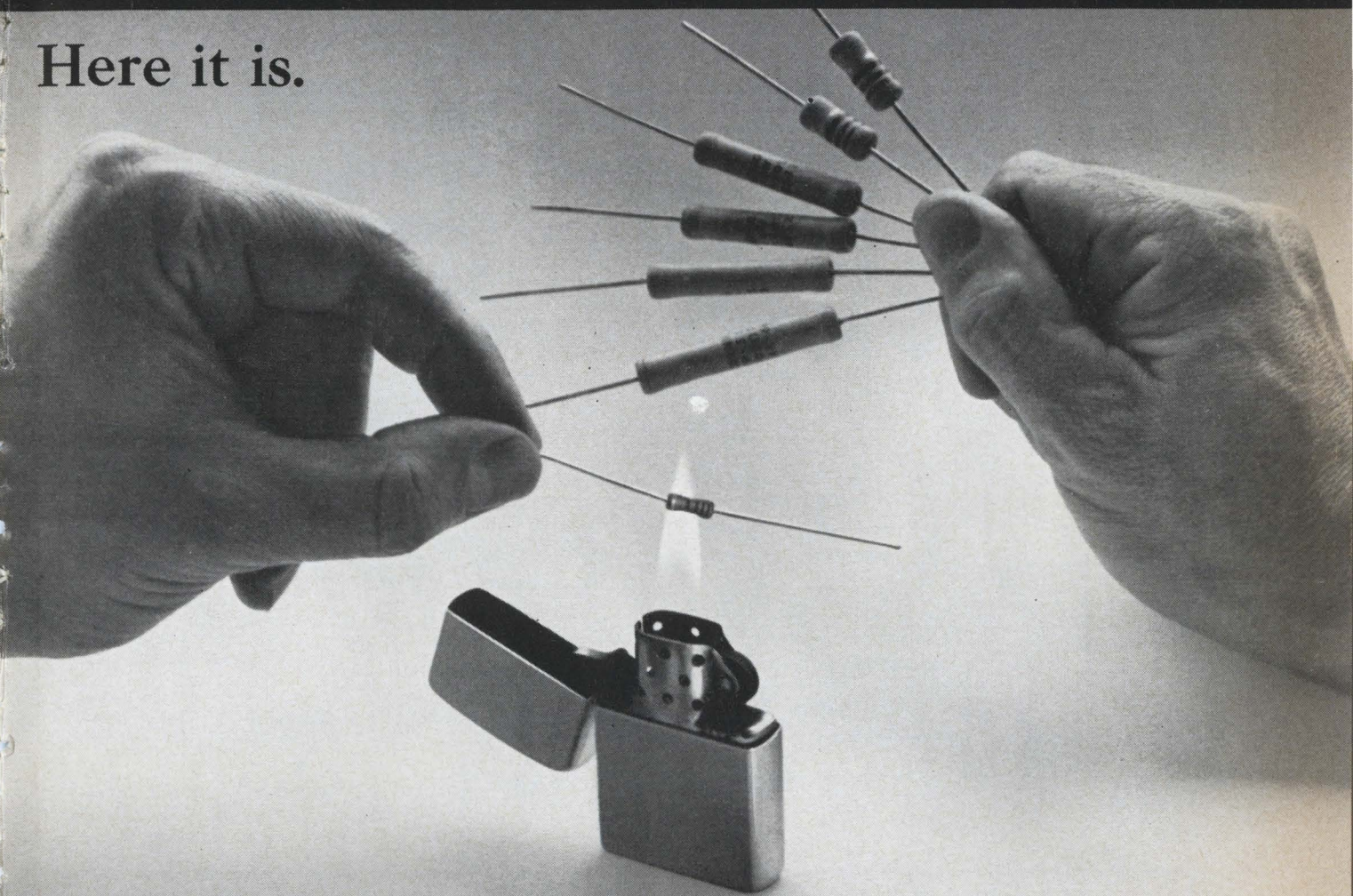

Now Corning offers the exclusive FP Flameproof Resistor in a new, smaller size.

Get 1/2, 2, 3, 4, 5, 7, or 10 watts of stability in a glass-metal oxide film resistor that just won't burn. Under the worst overload, they just fuse, open up, with never a flame. The FP 1/2 provides dependable protection for other, more expensive circuit components.

This newest is 1/2 watt to your choice of 2% or 5% tolerance, in values from 10 ohms to 470K. It conforms to Mil-R-22684B.

Write for free test samples and data. Corning Glass Works,
3900 Electronics Drive, Raleigh, N.C. 27604.

CORNING
ELECTRONICS

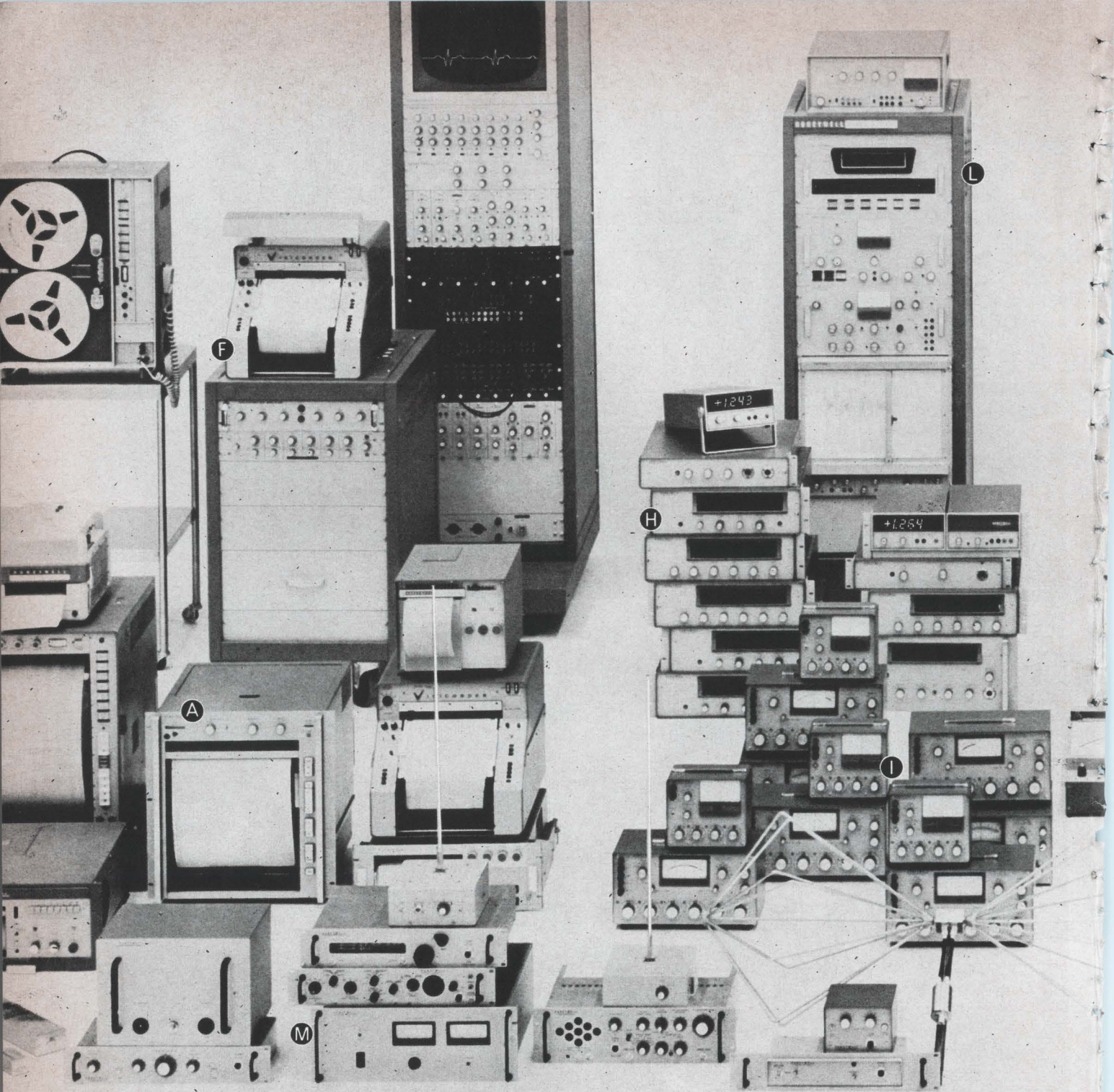

Here's just part of the full Honeywell line, which includes: **A** 117 Visicorder direct-recording oscillographs in 6", 8", and 12" models; **B** 2 Model 1806 fiber-optics CRT Visicorder oscillographs; **C** 26 magnetic tape systems, including the 7600 Series in 10½" and 15" reel versions; **D** 84 amplifiers and other signal-condi-

We build **847**
instruments to be sure we
have the exact **1** you need.



tioning units; E 78 analog recording systems; F 46 electronic medical systems; G 14 oscilloscopes; H 37 digital multimeters; I 29 differential voltmeters; J 179 precision laboratory standards and test instruments; K 128 data loggers; L 9 analysis systems; M 61 EMI products; N 37 X-Y graphic recorders.

Your Honeywell sales engineer can zero in on the *precise* solution to your instrumentation problems. Quickly and efficiently. You won't have to settle for "almost" what you need because the Honeywell sales engineer isn't handicapped by a limited line. He can choose from 847 basic instruments whose combinations and permutations approach the infinite.

The solution might be a Visicorder recording oscillograph. Or one of our modular magnetic tape systems. Or an X-Y recorder, a digital multimeter, or a portable potentiometer. But whether it's a single instrument or a complete data system, you can be sure the solution will be the right one, carefully thought out with your future requirements considered as well as your current needs.

Local service and nationwide metrology facilities back up your Honeywell instrument or system. And, we can even provide factory training courses for *your* operating personnel. For the full story on how Honeywell can help you, call your local sales engineer or write: Honeywell, Test Instruments Division, Denver, Colorado 80217.

Honeywell

**Honeywell engineers
sell solutions**

Circle 231 on reader service card

SCIENCE/SCOPE

A new infrared missile for air-to-air combat with swift enemy fighters has blasted more than a score of jet target drones from the skies in test launches from Air Force F-4s. Latest addition to the Falcon family of air-to-air missiles, the AIM-4D was produced by "cross-breeding" two other Falcons, giving the Air Force a new, more effective missile of proven reliability at lower cost than developing a new model.

The F-4 will carry four AIM-4D missiles on wing pylons when they become operational. The AIM-4D can also be carried by the F-102 and F-101 interceptors.

Biggest communications satellite ever built will be the experimental tactical communications satellite now under construction at Hughes for the U.S. Air Force's Space & Missile Systems Organization. It will have an array of five UHF antennas extending from the top, each nearly eight feet long. Satellite will be spin-stabilized in its synchronous orbit.

A military magnetic drum system with a mean-time-between-failure in severe airborne or ground environments that is conservatively estimated at 10,000 hours, based on several drums now in operational use, has been developed by Hughes.

New memory system has a capacity of 5×10^6 bits, with rapid access. It is sealed for two years of operation, and is interchangeable in the field without adjustment or harmonization.

New commercial products from Hughes: a numerically-controlled wire-laying machine that reduces electronic assembly production time by a ratio of five to one...a six-color krypton laser for industrial and academic laboratories; it can be converted to an argon laser simply by changing tube and mirrors...a thermocompression bonder for bonding gold wire to cold substrates; its pulse-heated tip eliminates pre-heating of parts prior to bonding.

Hughes has immediate opportunities for engineers with at least two years of experience in weapon systems, radar system design and development, computer design, or communications systems. Requirements: accredited degree and U.S. citizenship. Please send your resume to Mr. J. C. Cox, Hughes Aircraft Company, Culver City, Calif. Hughes is an equal opportunity employer.

An improved infrared spectrometer for the Nimbus D satellite to be launched in 1969 is being built by Santa Barbara Research Center, a Hughes subsidiary. It will measure the temperature and humidity of the troposphere, providing useful data for weather forecasting.

An infrared radiometer to measure the surface temperature of Mars is also being developed by SBRC. The two-channel, five-pound instrument will be carried by the two Mariner flyby spacecraft to be launched in 1969.

Creating a new world with electronics

HUGHES

HUGHES AIRCRAFT COMPANY

Circle 232 on reader service card

Electronics Abroad

East Germany

Western ways

For all their preoccupation with industrial electronics, East Germany's economic planners haven't let the consumer side of the industry slide. So well have they coped with the demand for television and radio sets, in fact, that they're now running into a problem all too familiar to West European set producers—a slowing, nearly saturated market.

At last count, some 70% of East German households had tv sets and 95% had radios. The inevitable slowdown in sales started this summer. Against a backdrop of spanking new tv sets at the Leipzig Fall Fair last month, Erhardt Preil of the radio and tv makers' trade association lamented, "It's a field in which less money will be made from now on."

Hard sell. The goal now is to boost the number of households with tv sets to 80% by 1970. And to reach this mark the industry is turning to capitalistic marketing tactics.

Last month, for example, prices for tv sets were slashed 25%. The cuts brought the average price for 19-inch models down to \$300 and for 23-inch models to \$400. At those prices, East German consumers still have to pay roughly twice what West Germans do for black-and-white sets. But East German officials are quick to point out the difference is offset indirectly by much lower costs for housing and services in their "peoples" economy.

Along with the price cuts, tv sales outlets are wooing buyers with "watch now, pay later" schemes. And soon to be introduced are flat-fee contracts between set owners and service shops.

Eye appeal. The slackened demand has also brought a new look to East German tv sets, all produced in one highly automated plant run by VEB-Fernsehgeraetewerke Stassfurt. In marked contrast to last year's lackluster uniformity [Electronics, Oct. 3, 1966, p. 259], a half-dozen basic lines of sets—all differently styled—turned up at this year's Leipzig Fair. Besides the increased emphasis on pleasing the customer, the introduction of implosion-proof picture tubes, which need no protective glass screen, has apparently given East German set designers freer rein.

All the sets, though, are variations on a theme—one basic chassis. Most are hybrids, partly transistorized. Westerners on hand for the fair rated the sets high both for workmanship and performance.

Stassfurt's annual production is between 400,000 and 500,000 sets, more than enough to meet the slowing domestic demand. But so far there's no inventory problem. East Germany is doing well in export markets. About 21% of the

sets imported by other East-bloc countries is supplied by the big East German plant.

The Netherlands

Sealed power

Any competent laser development team nowadays could build a high-power, long-lived carbon dioxide laser—as long as it didn't try to seal the gas inside the discharge tube.

At high powers—50 watts or so—the sealed-in gas degenerates fast. To keep output up over long periods of time, then, most laser builders have opted for open systems requiring paraphernalia like gas bottles, pumps, filters, and valves to renew the gas. This will do for laboratory versions, but it's out of the question for such practical applications as industrial cutting and welding.

NV Philips' Gloeilampenfabrieken, however, has come up with



Supply and demand. East Germany's sole tv-set plant turns out between 400,000 and 500,000 sets a year, more than enough to cover a slowing domestic demand.

a way to make sealed carbon dioxide lasers stand up. The secret: mix some water vapor in the gas mixture, which along with CO₂ has traces of nitrogen and helium. Philips also says it has developed special materials for its 3-meter-long tube and the electrodes that apply the pumping power to make the gas lase.

On sale. The company now has started to market a 50-watt laser with a guaranteed life of 300 hours. But Wilhelm Witteman, head of the research group that developed it, says that in practice the laser's life should run about 1,000 hours. Focused to a spot 150 microns in diameter, the 50-watt beam has a power density of 300 kilowatts per square centimeter, enough to cut materials with high melting points—tungsten, mica, and quartz, for example.

In the U.S. some companies working on sealed carbon dioxide lasers are close to getting 50-watt outputs in laboratory versions. Witteman's group, by contrast, has under development 160-watt prototypes with lives in the vicinity of 1,500 hours.

Slow seller. But although Philips researchers have found a way to make long-life, high-power sealed lasers, the company's marketing men are still looking for major orders. The big potential market is manufacturers who could profitably use lasers for cutting and welding difficult materials. But the most eager prospective customers have been scientists and engineers who want special adaptations of the laser for their own research work. "The main problem is that we haven't yet had enough contact with potential customers," says a Philips sales executive.

Great Britain

Galloping GaAs

Gallium arsenide has made its mark as one of the semiconductor materials that rendered the vacuum tube obsolete for many applications. Now GaAs may be on its

way to finding a place inside tubes like photomultipliers and image intensifiers. It could become a standout photoemitter material, especially for near infrared light.

A.A. Turnbull and G.B. Evans of Mullard Research Laboratories have developed a technique that promises to make practical the theoretical promise of GaAs as a photoemitter. Their ploy: as many as 10 alternating molecule-thick layers of cesium and oxygen atop a cleaved GaAs crystal.

One won't do. For two years, researchers in semiconductors have been aware that a molecule-thick layer of cesium boosts the photoemissive yield of a GaAs crystal. The layer makes it easier for electrons, excited by light played on the crystal, to stream away from the surface as do heat-excited electrons from a thermionic cathode. But for reasons still not completely understood, the spectral response and the photoemission varies considerably from crystal to crystal—and even between different points on the same crystal—when there's only a single-layer of cesium. Another drawback is the stability of the emission, which drops off as time goes by, probably because of cesium loss.

Turnbull and Evans say these disadvantages can be largely overcome by coating GaAs crystals first with cesium, then exposing them to oxygen at room temperature and repeating the process until several layers of cesium and oxide are built up. Between four and 10 layers are needed for maximum photoemission.

More is better. Crystals with multilayer coatings, Turnbull and Evans found, match those with single cesium layers both in photoemissive yield and spectral response. In both cases, good samples showed current outputs of 500 microamperes per lumen when illuminated by a tungsten lamp at a color temperature of 2,854°K. By contrast, 150 microamps per lumen is the average output for S-20 photocathodes, widely used in image tubes.

The crystals with multilayer coatings varied only 2% in sensitivity when exposed to light levels of

270 lux for an hour. For single-layer crystals, variations of 25% are typical.

In addition, performance of below-par single-layer crystals improved considerably when they were retreated and converted to multilayer crystals.

Thin is best. Turnbull and Evans think the multilayer technique is the answer to stable GaAs photoemitters. Compared to S-20 cathodes, GaAs cathodes should perform much better in the near infrared. For image tubes, though, the GaAs material most likely would have to be laid down in a thin layer on a substrate and then coated. Following its success with multicoated GaAs crystals, Mullard now has tackled the problem of depositing photoemittive GaAs.

Captain's tabulator

When Britain's luxury liner Queen Elizabeth II goes into transatlantic service early in 1969, getting there will take less fuel than originally thought.

As the big liner was launched last month, the National Research Development Corp., the government agency that pushes for technological innovation, reported that the 58,000-ton Queen would carry a Ferranti Ltd. Argus 400 computer, a small machine generally used for process control. The agency wants to see how computers can best be used on large merchant ships and will split the \$300,000 cost of the computer installation with Cunard.

Computers have gone to sea before, especially for engine-room data logging and alarm scanning. But aboard the new Queen, the Argus 400 will handle other jobs as well. For one thing, it will calculate on-line the most efficient working conditions for the ship's steam condensers. And it will compute at regular intervals, but off-line, changes in course to adapt to weather and tide conditions. Cunard expects these two operations will cut fuel consumption by 1½% or 2%—between 8 and 10 tons a day.

Cunard also reckons to save

money by using the computer to keep track of the ship's stock of food, liquor, drinking water and housekeeping supplies.

Japan

Plenty of scope

Navigational radar is commonplace equipment for the world's ships—from supertankers all the way down to fishing vessels. So maritime schools generally give their cadets a dry-land introduction to inter-

corder. But Japan Radio also sees possible applications in radar mapping and for troubleshooting. With slight modifications, the system also could serve as a ship's track recorder; with one ppi frame recorded every 5 minutes, a reel could store a ship's movements over a two-day period. Customers for the recorder are expected to span the spectrum from schools specializing in fisheries training to the military.

Polar. To keep the equipment simple, Japan Radio opted for straightforward recording of the radar signal in the polar coordinates used for ppi displays. The

In step. In ppi displays, the circular sweep is kept rotating in pace with the radar antenna through a synchro system. At first glance, it would seem that four synchro signals must be recorded—the three stator phases and the power supply reference. Japan Radio engineers, however, found a way to do the job with a single pair of signals recorded on one of the tape's two audio tracks.

The two signals are simply the voltages in two of the stator windings with respect to the third winding. To reproduce the third stator signal for playback, the two recorded signals are summed, the result halved, and its phase reversed. And since only the envelopes of the synchro signals are recorded, the original carrier—the power supply frequency—doesn't appear. A carrier frequency for the synchros on the ppi scope is inserted at playback. This means that 50- or 60-hertz synchros can be used on the monitor console even though the radar with which the recordings are made uses 400-cycle synchros.

Envelopes of the two recorded synchro signals frequency-modulate subcarriers of 7 and 9 kilohertz in one of the two audio channels on the tape. The lower part of the channel—from 0 to 3 kilohertz—is used to record the at-sea commentary. The second 10-khz audio channel is left clear for post recording.

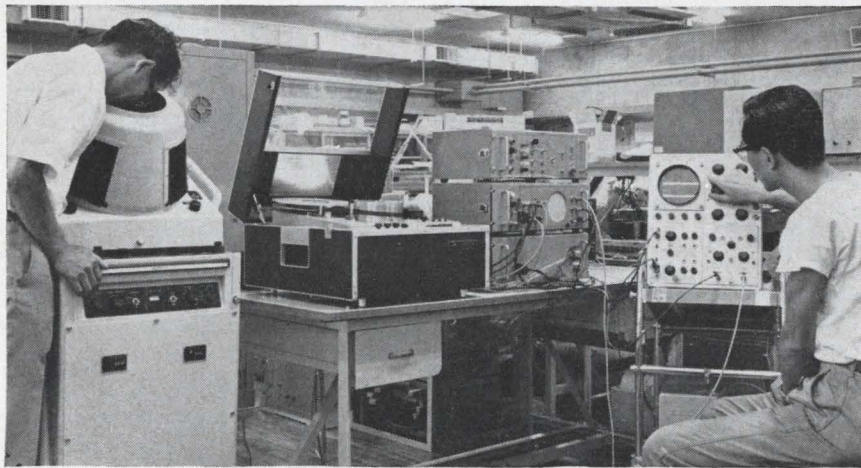

Sea scene. Three-rack adapter and modified video-tape unit make up Japan Radio system to record shipboard ppi displays for playback on shore.

preting radar scope displays with training films. Most often it's not until he's at sea that a cadet gets a real feel for working with a plan position indicator (ppi).

Now the Japan Radio Co. has come up with some relatively inexpensive equipment that brings at-sea ppi displays ashore. It's a \$7,000 system that records shipboard radar data on tape for playback on a standard radar console. The system is built around a slightly modified industrial video tape recorder, and a three-rack adapter developed by Japan Radio. The combination makes it possible to record an hour's worth of ppi displays, along with commentaries by deck officers and instructors, on a 10½-inch reel of tape.

Training of navigators figures to be the major use for the radar re-

modified video tape recorder makes one helical scan every 1/60th second, the duration of a standard television field. During each scan from 5 to 35 radial spokes of the ppi display are recorded, depending on the spoke repetition rate of the radar. Each spoke consists of a trigger pulse from 0.7 to 3 microseconds wide, followed by the video signal. Nominal bandwidth of the tape recorder (made by the Victor Co. of Japan) is 3.5 Mhz.

The major modification in the recorder itself is the addition of a precise 60-hertz oscillator (in the follow-on systems, the oscillator will be built into the adapter). The oscillator's output pulses substitute for the synchronizing pulses in television signals. The pulses control input for the servosystem that holds the tape speed constant.

West Germany

It's a gasser

Electronic components manufacturers long have realized they've been missing out on a potentially huge market—the millions of automobiles produced every year all over the world.

Except for car radios, though, the automotive market has been elusive. To be sure, many auto makers have toyed with transistorized ignition systems and some offer them as optional extras. But none has made the leap to stand-

ard equipment for a mass-produced model. And even with such seemingly simple hardware as integrated-circuit voltage regulators, the auto makers have had their troubles [see story p. 137].

A first solid break into the automotive market for electronics, however, came last month. Then, West Germany's largest auto producer, Volkswagenwerk AG, announced that all its 1968-model VW 1600's destined for the U.S. market would have an electronic fuel injection control system as standard equipment [Electronics, Sept. 18, p. 259]. Volkswagen will do very well if it sells 90,000 of these in the U.S. next year. For U.S. auto makers, that's small change; but Kurt Lotz, VW's deputy chairman, rates the shift to electronic fuel control as "ushering in a new era in the history of the spark ignition engine."

Exhaustive. More than anything else, it was the U.S.'s antipollution laws that spurred Volkswagen to make the switch. Fearful that it would lose out in its best overseas market unless it could comply with the upcoming laws, the company turned to Robert Bosch GmbH for help in cutting down the pollutants—essentially partly burned fuel—in car exhaust gases.

Bosch, West Germany's biggest auto-electric manufacturer, had been working on electronic fuel injection control since 1958 and convinced Volkswagen to consider it for the 1600. The system that evolved out of the Bosch-VW effort cuts exhaust-gas pollution to well below the levels allowed in California, the state with the most stringent standards. The legal limit for VW 1600 exhaust carbon monoxide content is 2.3%. The electronic control holds the level to 1% or less. And the 1968 VW 1600's exhaust has fewer than 200 parts-per-million of hydrocarbon content, less than half that allowed.

What's more, Volkswagen claims the control cuts fuel consumption some 10%—a bonus, since its main purpose was to get a cleaner exhaust.

Trade secrets. Since it has a lead on the competition and because it has yet to file for patents on some facets of the circuitry, Bosch won't

divulge full details. But Bosch engineers say the basic circuits include a monostable multivibrator, an astable multivibrator and a logic switching circuit. All in all, the black box contains 25 transistors, 32 diodes, 20 capacitors, and 140 resistors.

The components are all discrete, and Bosch engineers say there's no plan to incorporate integrated circuits until the system has proven itself in the U.S. market. Prototypes of the discrete-component unit, which is mounted in the rear-engine compartment, were tested in runs adding up to more than 1.2 million miles at ambient temperatures from -30°C to 70°C .

Pulses. The black box matches to the engine operating conditions the amount of fuel sprayed onto the intake valves by the electro-mechanical fuel injectors of the four cylinders. The control pulses have an amplitude of about 4 volts and vary in width between 1 and 3.4 milliseconds.

The kingpin parameter fed to the control unit is intake manifold pressure—essentially it determines the amount of fuel injected. Other engine data fed to the control unit is used to correct the metering of fuel. Information includes oil temperature, cylinder-head temperature, engine speed, and throttle position. There's also a constant-voltage source in the control unit so that variations in the 12-volt battery supply won't affect the duration of the pulses fed to the fuel injectors.

Vietnam

Breaks on the barrier

U.S. military officials, understandably, aren't saying what electronics hardware they plan to put into the "McNamara line" just south of Vietnam's demilitarized zone. But savvy American civilians in Saigon think they have a fair idea of what the Pentagon has in mind to stem the southward flow of men and material from North Vietnam.

When Defense Secretary McNamara

disclosed the barrier scheme last month [Electronics, Sept. 18, p. 52], he made it clear that heavy reliance would be put on sophisticated electronic sensors to spot enemy infiltrators. Saigon observers say the sensors will all be tied into a computer—possibly located in Thailand—that would analyze inputs and choose the appropriate counteraction. The International Business Machines Corp. most likely will build the computer system and handle the tricky job of programming it.

Broad mix. As for the sensors, they are likely to range from simple trip wires to ultrasensitive seismic devices. Included would be magnetic sensors to detect weapons or vehicles passing through the barrier, and microphones to pick up the sounds of tunneling or vehicles. Also under consideration, sources hint, are detection systems based on lasers. And the barrier will be studded with antipersonnel radars.

Mines, it's believed, will have a new twist. Instead of exploding on impact, they will be detonated by switching circuits after the computer has assessed the target.

If, as the Pentagon has hinted, the barrier eventually is extended from Vietnam across Laos, the electronics in the extension would probably be limited to detecting the movement of men and vehicles.

Canada

Choice of foils

Telephone equipment engineers in Canada and the United States are crossing foils—Teflon for the Americans, polycarbonate for the Canadians—to see who'll be the first to develop a practical successor to an old telephone standby, the carbon button transmitter.

Both Canada's Northern Electric Co. and the Bell Telephone Laboratories in the U.S. are working on electret microphones, promising in both cost and performance. Judging from a report made last week in Toronto at the International

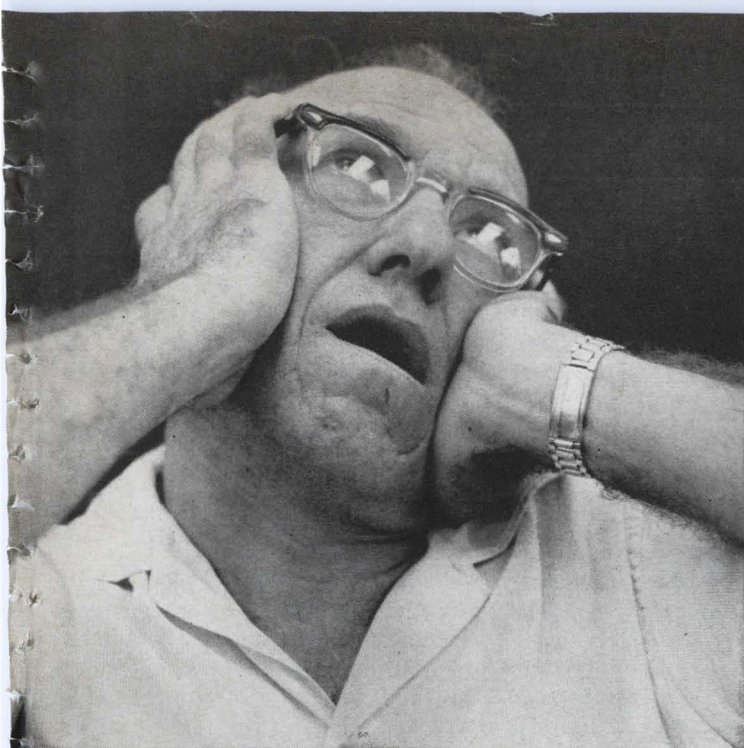

"I was in terrible trouble. The additional circuitry changed my power supply requirements."

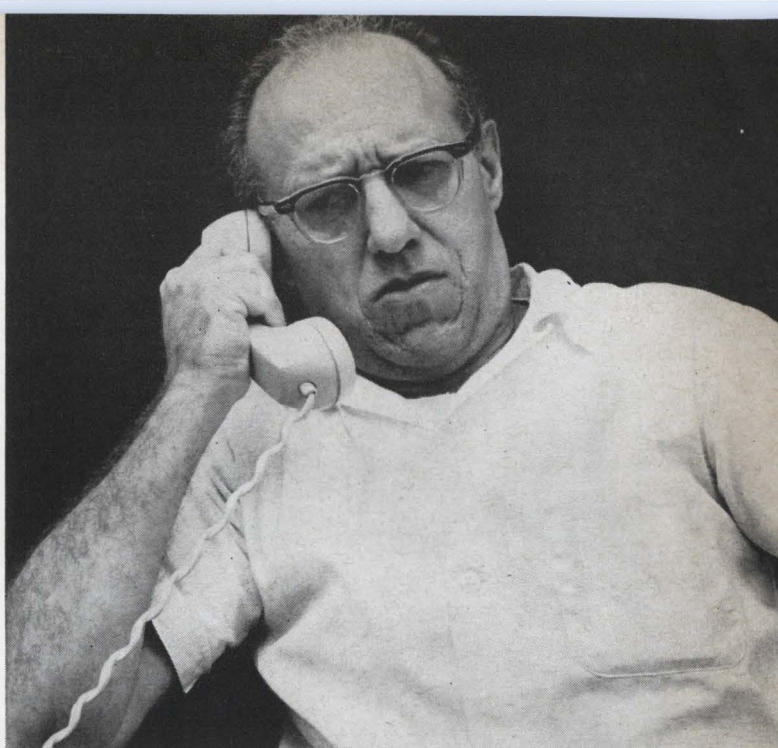

"More trouble . . . my usual source of supply said, 'Six weeks to get power supplies with the new ratings'."

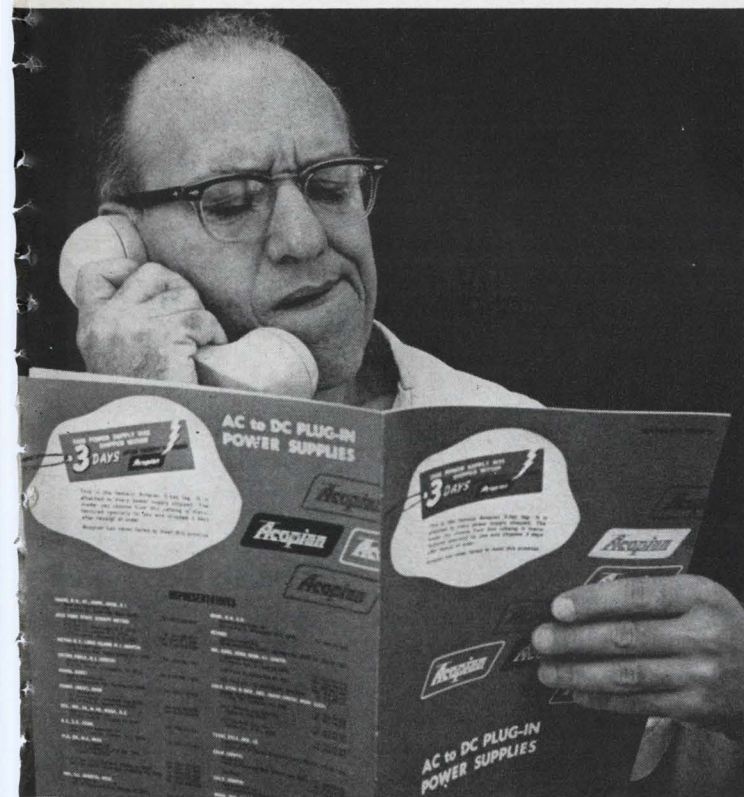

"I had heard about Acopian's incredible 3-day shipment guarantee on their 62,000 different types of AC to DC plug-in power supplies, and decided to give them a try."



"Imagine my glee . . . when a few days later . . ."

Next time you're in trouble with power supply delivery, contact Acopian. If you do not have a copy of our latest catalog, by all means, request one. It lists 62,000 different AC to DC plug-in power supplies, any of which will be shipped to you in just three days! For particulars, contact your local Acopian rep., call us at (215) 258-5441, or write to Acopian Corp., Easton, Penna. 18042.



Circle 237 on reader service card

TOO BAD

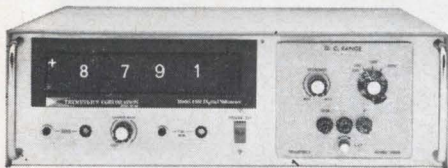

Right now, as you are reading this, someone somewhere is ordering a 3-digit, .05% DVM without stored display for the price of this new Trymetrics .01% 4-digit model. Ouch!

This new Model 4100 is offered with a series of plug-in function heads which provide measurement from 99.99mv to 999.9 volts in 1,3,4 or 5 manual or automatic ranges. \$695 for the basic unit, \$740 with a $\pm 9.999v$ range plug-in.

All units feature automatic polarity and over-scale indication. All have exceptional 0.01% accuracy; all offer a storage register for absolute display stability. There's even more performance with a new compatible multimeter plug-in module which provides DC, AC and OHMS measurement. Printer output is optional.

If there is no need for stored display, Model 4000 offers the identical features of the Model 4100 but costs only \$595 for the basic unit, \$640 with 103 $\pm 9.999v$ range plug-in head.

We'd like to tell you more; there's much more to tell. It's all in a new catalog. Tell us your name and address and ask to see this .01% 4-digit DVM today.

TRYMETRICS
Corporation
A SUBSIDIARY OF TRYGON ELECTRONICS, INC.

204 Babylon Tpke., Roosevelt, L.I., N.Y.
Phone 516-378-2800 11575

Electronics Abroad

Electronics Conference by P.J. Read of Northern Electric, the Canadian company has the edge. Fifty electret microphones are undergoing life tests at Northern Electric. By contrast, Bell has just one in service.

Foils. The microphones under development at the two companies convert acoustic energy to electrical signals in the same way. Both rely on an electrically charged plastic foil as the polarized dielectric in a condenser microphone. The big advantage over carbon granules, whose resistance changes under acoustic pressure, is that no external direct-current bias is needed for an electret.

The Canadians' research tells them that the stability of the polycarbonate makes it far superior—though its ruggedness, bandwidth and blast resistance are comparable to Teflon's. Their study of leakage rates suggests that the polycarbonate could last for 5,400 years, rather than Teflon's 10.

Northern's Read is wary of Teflon. "Its properties," he explains, "aren't as independent of temperature as the polycarbonate is." G.M. Sessler and J.E. West, the Bell electret researchers, on the other hand, defend Teflon. "Polycarbonate has no real advantage as compared to Teflon," Sessler says, "and its frequency responses and sensitivity are both about the same."

Deceptive. And as for stability, West notes that decay rates are a tricky matter. He found that when a polyester film was put inside the electret microphone, the sensitivity of the mike remained constant for a year and a half—even though the charge of a piece of test foil decreased in time.

Both Bell Labs and Northern Electric are trying to better their understanding of decay rates in foils used for electrets.

Electrets still have to compete with other devices and prove themselves before they replace the carbon button, traditionally low in price and high in electric output per acoustic input. Under study are other transmitters based on piezoelectric, semiconductor, and piezoresistive devices.

Around the world

Soviet Union. Russian researchers have developed a carbon dioxide laser with continuous output of 5 kilowatts, according to Nobel-prize physicist Alexander Prokhorov. The laser, Prokhorov says, operates at an efficiency of 30%.

Japan. Matsushita Electric Industrial Co. now has government authorization to buy a 40% interest in a foreign company, the Philippines' Precision Electronics Corp. Matsushita's holding in Precision will be the first important Japanese investment in Filipino electronics. Precision produces radios, phonographs, and television receivers, and plans to add tape recorders to its line. The company has been using Matsushita technology under license since 1965.

Sweden. The government's Labor Market Board, the sole Swedish employment agency, has embarked on a two-month trial of matching jobs and workers by computer. Although now limited to a few job categories in the greater Stockholm area, the scheme will be extended to all employment opportunities in the area if the test is successful. About 100,000 vacancies are filled by the board in Stockholm each year.

Yugoslavia. A deal that would merge three of the largest electronics-producing facilities in Yugoslavia should be completed in the next month or so. Involved are Iskra in Slovenia, RIZ in Croatia, and Rudi Cajevac in Bosnia. The merged organization will have about 20,000 workers and an annual output with a market value of close to \$100 million.

Chile. Empresa Nacional de Telecomunicaciones S.A., the company that handles Chile's long-distance communications, expects to have a ground station in service late next summer to work through the Intelsat-2 and Intelsat-3 satellites. The General Telephone & Electronics Corp. has the contract to build and operate the terminal, which will be 75 miles southwest of Santiago.

Our IC relay is a real problem solver!

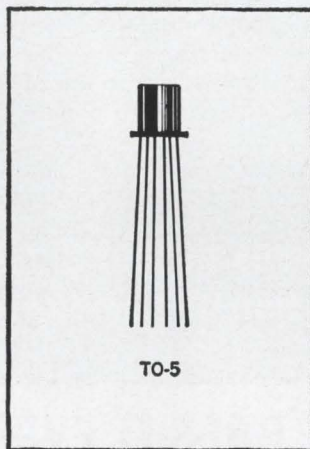

The package is small . . . the performance is big. We have been putting relays in TO-5 cans for quite a while. Now we're taking the next big step. A combination TRANSISTOR and RELAY — all in a TO-5 can. We offer this new product line to help you solve your circuit design problems . . . and to indicate our

awareness and ability to meet industry needs. We would like you to find out all about our new 415 series IC RELAYS as well as our complete line of TO-5 Relays. Send for our Teledyne Relay TO-5 Catalog and become acquainted with a reliable line of problem solving Relays.



TELEDYNE RELAYS A TELEDYNE COMPANY

3155 West El Segundo Boulevard • Hawthorne, California
90250 Telephone (213) 679-2205 • 772-4357

**COULD YOU SLICE THIS ANGLE
INTO 300 EQUAL PARTS?**



**OR MAKE A CRYSTAL FILTER HAVING 0.1% PHASE LINEARITY
OVER 1500° PHASE SHIFT?**



**OR MAKE AN OSCILLATOR ACCURATE TO .001% OR \pm .00001%
AT AMBIENT TEMPERATURE?**

M^CCOY DOES IT EVERY DAY!

M^CCoy makes precision crystal oscillators—in a variety of designs—covering the 400 Hz-150 MHz range.

One example is the completely-packaged HC-6 crystal oscillator shown above. Designs vary from economical commercial units for use in limited environments to highest reliability components and techniques for use in severe aerospace environments. M^CCoy oscillators give optimum performance even under severe changes in temperature, shock and vibration.

M^CCoy engineers and production people apply years of experience to give you many types of oscillators without expensive engineering costs. M^CCoy offers

oven-oscillator assemblies...controlled thermostatically or proportionally; crystal oscillators...temperature-compensated (TCXO's) or voltage-controlled (VCXO's).

M^CCoy also makes the most complete line of precision crystal filters covering 5KHz to 125 MHz, withstanding severe shock and vibration at ambients of -55 to $+105^{\circ}\text{C}$.

Precision of these oscillators and filters results from using M^CCoy-made quartz crystals with proper combinations of inductance, capacity, Q and frequency stability. Specify M^CCoy and get the highest quality available! For full details, write for new catalog.



M^CCOY ELECTRONICS COMPANY

A Subsidiary of OAK ELECTRO/NETICS CORP

Mt. Holly Springs, Pennsylvania 17065

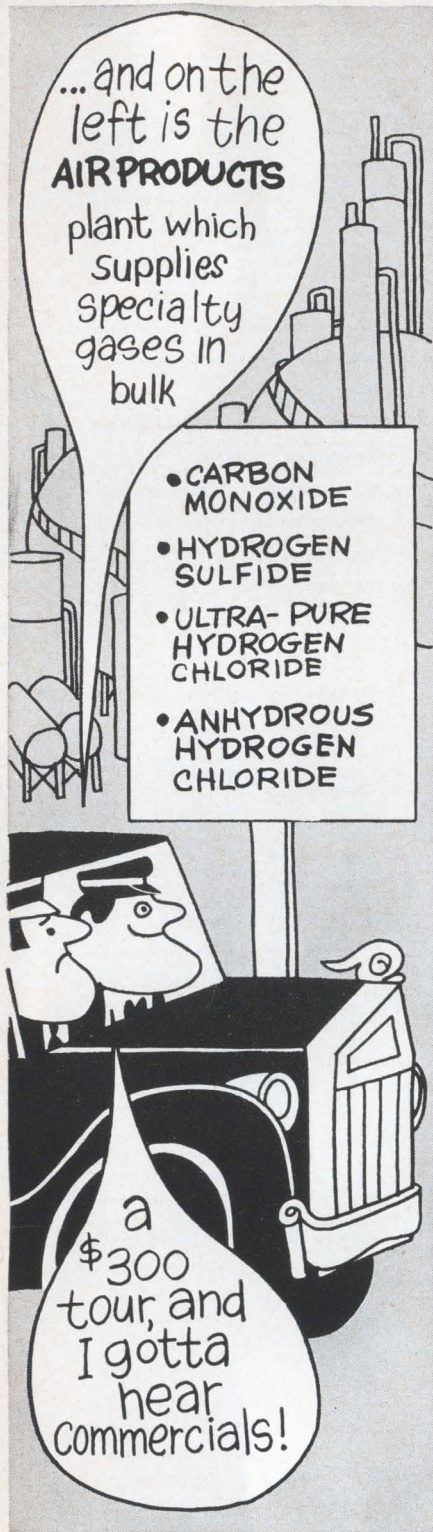

After you've "paid later", write for "spec" sheets on the gases you need and our folder which points out the benefits of bulk delivery from Air Products.



Air Products and Chemicals Inc.
SPECIALTY GAS DEPT.
ALLENTOWN, PA.

Methode Electronics, Inc., Connector Div.	200		
Sander Rodkin Adv. Agcy., Ltd.			
Mico Instrument Co.	216		
Microdot, Inc.	113		
Gumpertz, Bentley & Dolan Advertising			
■ Microwave Electronics Corp., Sub. of Teledyne	34		
Bonfield Associates			
□ Milo International, Div. of Milo Electronics Corp.	OAS 12		
Industrial Marketing Assoc.			
Minnesota Mining & Manufacturing Co., Chemical Div.	175		
Young & Rubicam, Inc.			
Minnesota Mining & Manufacturing Co., Scotchpar Div.	154		
Klau-Van Pietersom-Dunlap, Inc.			
■ Mitsumi Electric Company, Ltd.	182		
Sanko T Sushinsha, Ltd.			
■ Monitor Systems, Inc.	217		
Thomas R. Sundheim, Inc.			
■ Monsanto Company	29		
Foote, Cone & Belding			
Motorola Communications & Electronics, Inc.	134		
K & A, Inc.			
Motorola Semiconductor Products, Inc.	45		
Lane & Bird Adv., Inc.			
National Electronics, Inc.	215		
Connor-Sager Associates			
National Semiconductor Corp.	56, 57		
Jay Chiat Associates			
Natvar Corporation	151		
Sanger-Funnell, Inc.			
■ NJE Corporation	158		
Keyes, Martin & Co.			
■ Non Linear Systems Co., Inc.	193		
Ivy Associates, Inc.			
North Atlantic Industries, Inc.	147		
Murray Heyert Associates			
■ Norton Associates, Inc.	192		
J. J. Coppo Co.			
Oak Electro/Nectics Corp.	129		
Buchen Advertising, Inc.			
■ Pacific Measurements, Inc.	7		
Jack Herrick Adv., Inc.			
Pamotor, Inc.	218		
Harry P. Bridge Co.			
Pek Laboratories	220		
Sturges Advertising			
Phelps Dodge Electronics Products Corp.	149		
Smith, Dorian & Burman, Inc.			
□ Philips Eindhoven, N.V.	OAS 1, 3		
T.A.G. De La Mar			
Polaroid Corp.	47		
Doyle Dane Bernbach, Inc.			
■ Potter & Brumfield, Div. of American Machine & Foundry Corp.	35		
Grant, Schwenck & Baker, Inc.			
Powertec, Inc.	208		
Frost, Shaffer, Gauthier			
Quasar Microsystems, Inc.	180		
Albert, Frank, Guenther, Law, Inc.			
□ Racal Instruments, Ltd.	OAS 10		
Saward Baker & Co., Ltd.			
Radiation, Inc.	177		
Basford, Inc.			
Radio Corporation of America	4th Cover, 49, 69, 128, 173		
Al Paul Lefton Co.			
□ Rally	OAS 25		
Dumesnil Publicite			
Raytheon Co., Components Div.	36		
Fuller & Smith & Ross, Inc.			
Reeves Hoffman, Div. of Dynamics Corp. of America	196		
Adams Associates, Inc.			
□ Rochar Electronique, Div. of Schlumberger	OAS 16		
Promotion Vente Publicite			
Sage Electronics Corp.	215		
Mathison Adv., Inc.			
□ Schlumberger, A.C.B.	OAS 26		
Hi-Fi Publicite			
Scientific Data Systems	67		
Doyle, Dane, Bernbach, Inc.			
Sensitak Instrument Corp.	204		
Allied Adv. Agcy., Inc.			
□ SESCO	OAS 9		
Maurice Ridant Editions Techniques & Publicite de Firmes			
Signetics Corp., Sub. Corning Glass Works	37		
Cunningham & Walsh, Inc.			
Smith, Barney & Co., Inc.	186		
Albert, Frank, Guenther, Law, Inc.			
Sorensen Operation, Raytheon Co.	11		
James Advertising, Inc.			
Stackpole Carbon Co., Electronic Components Div.	70		
Meek & Thomas, Inc.			
Super Tool Company	201		
Varon Advertising			
Susumu Industry Co., Ltd.	216		
Dentsu Advertising			
Sweet's Industrial Information System	157		
Wank, Williams & Neylan, Inc.			
Sylvania Electronic Systems	181		
Briant Advertising			
Synthane Corporation	207, 209		
Arndt, Preston, Chapin, Lamb Keen, Inc.			
Systron-Donner Corp.	131		
Bonfield Associates, Inc.			
Taylor Corporation	141		
Gray & Rogers, Inc.			
■ Tektronix, Inc.	136		
Hugh Dwight Adv., Inc.			
Tel-Com Instruments, Inc.	130		
Kniep Associates			
Teledyne Relays Co.	239		
S. Michelson Advertising			
Teltronics, Inc.	206		
Tech/Reps, Inc.			
□ Thermionic Products, Ltd.	OAS 6, 7		
Southern Advertising, Ltd.			
Transformer Electronics Co.	216		
Dacey, Wolff, & Weir			
TRG, Inc., Division of Control Data Corp.	198		
Culver Advertising, Inc.			
Trymetrics Corp.	238		
Kameny Assoc., Inc.			
■ Tung Sol Div., Wagner Electric Corp.	217		
E.M. Freystadt Associates			
Ulano & Co., J.	169		
Byrde, Richard & Pound, Inc.			
Union Carbide Corp., Linde Div.	121		
J.M. Mathes, Inc.			
University Laboratories, Inc.	124		
West Associates			
■ Varo, Inc.	204		
Tracy-Locke Co., Inc.			
Vector Electronics Co.	192		
VanDer Boom, McCarron, Inc.			
Vidar Corp.	51		
Hal Lawrence, Inc.			
Wang Laboratories	132		
Larcom Randall Adv., Inc.			
Wesco	221		
Westamp, Inc.	220		
Siegmeister-Grant			
Westinghouse/ Metals Div	6		
McCann/ITSM			
Wisconsin Power & Light Co.	188		
Ralph Timmons			
Classified Advertising			
F.J. Eberle, Manager			
PROFESSIONAL SERVICES			224
EMPLOYMENT OPPORTUNITIES			222-225
EQUIPMENT (Used or Surplus New) For Sale			224
ADVERTISERS INDEX			
A & A Electronics Corp.	224		
Butler Jr., E.U.	224		
Ewald Instruments Corp.	224		
Fishman Co., Phillip	224		
Grumman Aircraft Corp.	222, 223		
Hewlett Packard (Corp.), Recruit	225		
Newport News Shipbuilding and Dry Dock	224		
Radio Research Instrument Corp.	224		
■ For more information on complete product line see advertisement in the latest Electronics Buyers' Guide			
□ Advertising in Overseas Section following Newsletter from Abroad			

Advertising sales staff

Frank E. LeBeau [212] 971-6464

Advertising sales manager

Wallis Clarke [212] 971-2187

Assistant to sales manager

Donald J. Austermann [212] 971-3139

Promotion Manager

Atlanta, Ga. 30309: Michael H. Miller, 1375

Peachtree St., N.E.

[404] TR 5-0523

Boston, Mass. 02116: William S. Hodgkinson

McGraw-Hill Building, Copley Square

[617] CO 2-1160

Chicago, Ill. 60611: Robert M. Denmead,

J. Bradley MacKimm, Ralph Hanning,

645 North Michigan Avenue.

[312] MO 4-5800

Cleveland, Ohio 44113: William J. Boyle, 55

Public Square, [216] SU 1-7000

Dallas, Texas 75201: Richard P. Poole, 1800

Republic National Bank Tower,

[214] RI 7-9721

Denver, Colo. 80202: Joseph C. Page, David

M. Watson, Tower Bldg., 1700 Broadway,

[303] 255-5484

Detroit, Michigan 48226: Ralph Hanning

856 Penobscot Building

[313] 962-1793

Houston, Texas 77002: Kenneth George,

2270 Humble Bldg., [713] CA 4-8381

Los Angeles, Calif. 90017: Ian C. Hill,

John G. Zisch, 1125 W. 6th St.,

[213] HU 2-5450

Minneapolis, Minn. 55402: J. Bradley

MacKimm, 1104 Northstar Center

[612] 332-7425

New York, N.Y. 10036

500 Fifth Avenue

Donald R. Furth [212] 971-3615

James R. Pierce [212] 971-3616

Jeffrey M. Preston [212] 971-3617

Philadelphia, Pa. 19103:

Warren H. Gardner, Jeffrey M. Preston,

6 Penn Center Plaza,

[215] LO 8-6161

Pittsburgh, Pa. 15222: Warren H. Gardner,

4 Gateway Center, [412] 391-1314

Portland, Ore. 97204: James T. Hauptli,

218 Mohawk Building, 222 S.W. Morrison

Street, Phone [503] 223-5118

Rochester, N.Y. 14534: William J. Boyle,

9 Greylock Ridge, Pittsford, N.Y.

[716] 586-5040

St. Louis, Mo. 63105: Robert M. Denmead

The Clayton Tower, 7751 Carondelet Ave.

[314] PA 5-7285

San Francisco, Calif. 94111:

James T. Hauptli, 255 California Street,

[415] DO 2-4600

London W1: John W. Patten, Edwin S.

Murphy Jr., 34 Dover Street,

Hyde Park 1451

Milan: Pierre Braude,

1 via Baracchini Phone: 86-90-656

Frankfurt/Main: Pierre Braude,

Elsa-Brandstroem Str. 2

Phone: 72 01 81

Geneva: Pierre Braude,

1, rue du Temple Phone: 31 95 60

Paris VIII: Pierre Braude,

17 Avenue Matignon Phone: 359 6637

Tokyo: Nobuyuki Sato, 1, Kotohiracho

Shiba, Minato-Ku [502] 0656

Osaka: Ryoji Kobayashi 163, Umegae-cho

Kita-ku [362] 8771

Business department

Wallace C. Carmichael, Manager

[212] 971-3191

Stephen R. Weiss, Production Manager

[212] 971-2044

Thomas M. Egan,

Assistant Production Manager [212] 971-3140

Dorothy Carmesin, Contracts and Billings

[212] 971-2908

Circulation and research

Milton Drake, Manager [212] 971-3485

Isaaca Siegel, Assistant Circulation Manager

[212] 971-6057

David Strassler, Assistant Research Manager

[212] 971-6058

Chloe D. Glover, Research Associate

[212] 971-6057

Electronics buyers' guide

George F. Werner, General Manager

[212] 971-2310

Ray Smyth, Eastern Regional Manager

[212] 971-6538

Regina Hera, Directory Manager

[212] 971-2544

Thomas M. Egan, Production Manager

[212] 971-3140

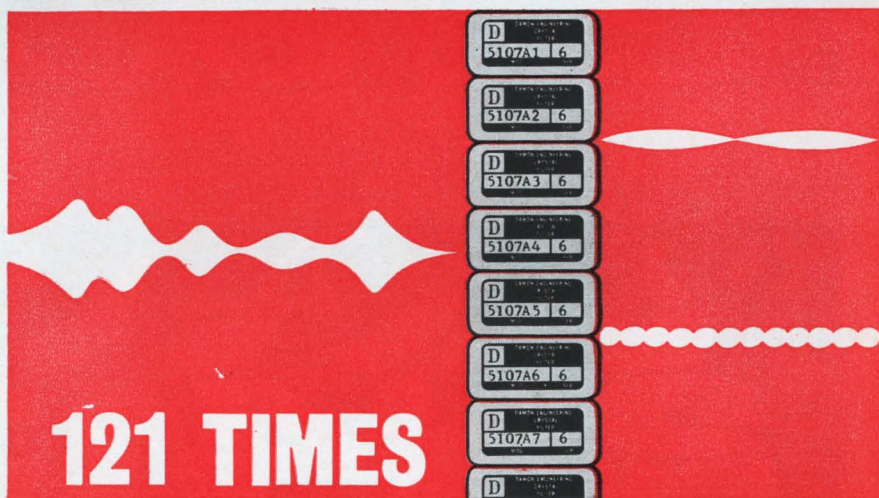
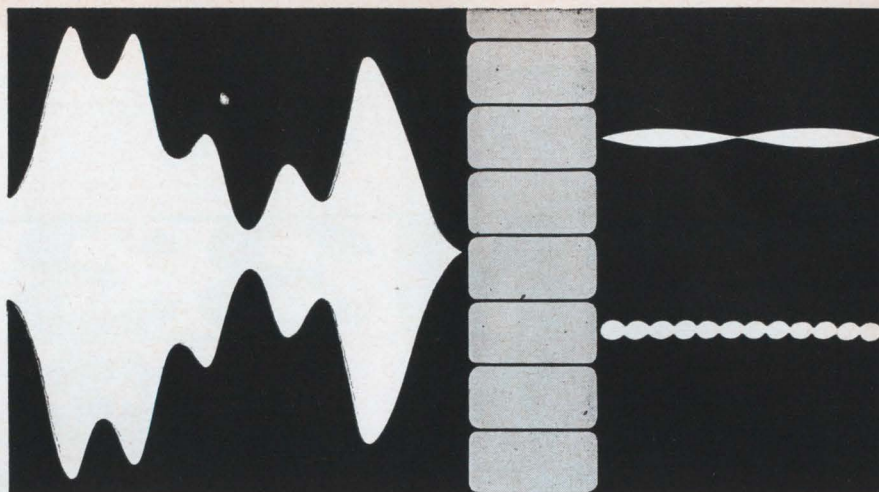

121 TIMES

LESS DRIVE POWER

with Contiguous Comb
Filter Sets
by Damon



Typical Contiguous Comb Crystal Filter, Model 5107A is $1\frac{1}{8}$ " L x $\frac{3}{8}$ " W x $\frac{1}{8}$ " H.

Damon has produced a bank of 200 contiguous comb crystal filters that requires a total of 6.6 watts of drive power to obtain 10 milliwatts from each of the Gaussian (non-overshoot) response filters. This is only 1/121 of the 800 watts of drive power normally required to achieve the same output using conventional resistive padding techniques.

This significant achievement is the result of two advances in crystal filter technology: high efficiency contiguous comb crystal filters combined with new synthesis techniques. These advances permit the adherence to both frequency and time response specifications and offer a

new concept in the design of radar and other spectrum-based systems. Contiguous comb crystal filter banks are also the most reliable, efficient, compact and economical precision systems available for multichannel signal processing of all kinds.

Write for data on Gaussian Response Contiguous Comb Crystal Filters to Damon Engineering, Inc., Needham Heights, Mass. 02194, Tel. (617) 449-0800.

DAMON



**ITT has eight instant solutions
to your VHF/UHF
power transistor procurement problems.**

Is there something missing from your procurement cycle for RF power transistors? Is it predictable delivery? Better-than-competitive pricing? Superior performance?

Let ITT "crack" your RF power vacuum. The eight popular part numbers listed above are in stock and

ready to go — at the ITT factory and at every one of ITT's distributors. Next time you send out an RFQ, send it to The Predictables, and fill your power vacuum.

ITT Semiconductors is a Division of International Telephone and Telegraph Corporation, 3301 Electronics Way, West Palm Beach, Florida.

*New state-of-the-art devices, exclusive from ITT, 1 to 50 W, 30 to 70 MHz.

semiconductors ITT

FACTORIES IN WEST PALM BEACH, FLORIDA • PALO ALTO, CALIFORNIA • LAWRENCE, MASSACHUSETTS • ENGLAND • GERMANY • PORTUGAL • AUSTRALIA