

Electronics[®]

R-f power transistors: page 93

Where transistors are headed: page 126

Electronics looks at the Federal budget: page 137

February 19, 1968

\$1.00

A McGraw-Hill Publication

Below: How their transistor changed electronics, page 77



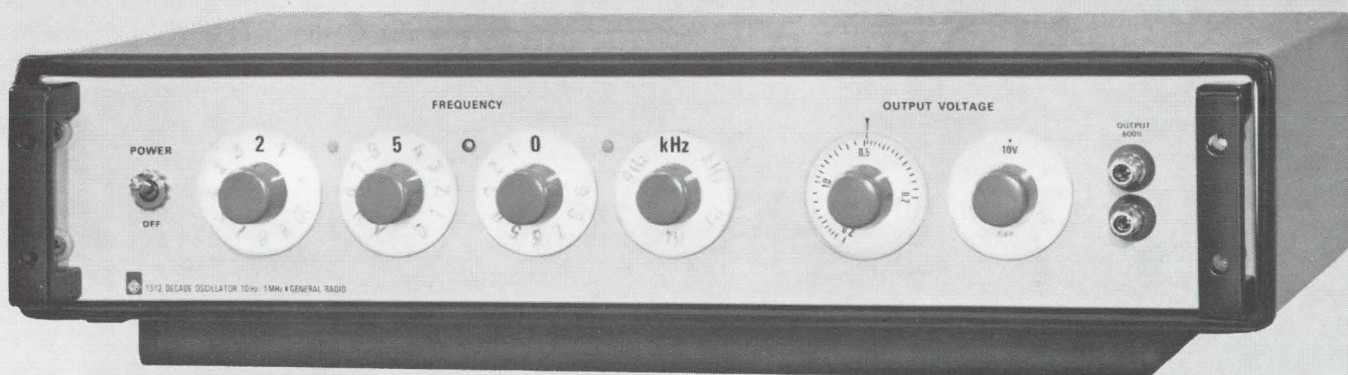

Simple to set ... impossible to misread

For people who must constantly change and repeat oscillator-frequency settings, quick and accurate resettability is one of the most important features of an oscillator. With GR's new general-purpose 1312 Decade Oscillator, you can reset in a jiffy any frequency in the oscillator's 10 Hz-to-1 MHz range. Resettability is better than 0.005%, and it's virtually impossible to misread the in-line readout. The first two frequency digits are set with step decades; the third, with a detented continuously adjustable dial. One more control sets the decimal point and indicates the frequency unit, also in-line. Basic accuracy is $\pm 1\%$ of the setting.

Up to 20 volts is available both at the front-panel OUTPUT terminals and at a rear-panel connector. Output is flat within $\pm 2\%$ from 10 Hz to 100 kHz, and you can even short the output without clipping the waveform. The 1312 has a 100-dB output range, provided by a 20-dB continuously adjustable attenuator and an 80-dB step attenuator calibrated in 20-dB steps.

Output impedance is 600 ohms at all voltage levels, including the four intermediate zero-volt positions of the attenuator that allow you to reduce output to zero without touching the adjustable attenuator.

A sync jack at the rear provides an isolated signal to trigger a counter or scope. Through this sync jack, the frequency of the 1312 can also be phase-locked to an external signal for extreme stability.

With excellent performance characteristics, ease of use even by unskilled operators, and a price of only \$415, the 1312 Decade Oscillator is ideal for any lab or production test station. Ask to see one in your own plant. Call your nearest GR Sales Office or write General Radio Company, W. Concord, Massachusetts 01781.

GENERAL RADIO

Here's a data acquisition system that measures masses of analog data, from 1 to 200 or more inputs, and reduces it to just the answers you need. No wading through raw data. It prints your answers in any format you want—and you can also log on punched or magnetic tape, or transmit over Data Phone.

The data acquisition system that does practically everything... practically.

A small, high-speed digital computer in the system makes the difference. As data is acquired the computer processes it: converting to engineering units, linearizing transducers, solving all kinds of equations—efficiencies, running averages...

You have complete control over all data acquisition functions—measure any kind of input on any channel, in any sequence, at any sampling rate, in real time.

Just tell the system what you want done, in FORTRAN. Change your mind at any time about channel numbers, comparison limits, computation constants, and enter new values through the keyboard without programming or recompiling.

What makes it even more practical is that with a minimum of instruction any engineer can use it... one system to solve many engineers' problems. It's the Hewlett-Packard 2018A Data Acquisition System. Practical. Price: Less than \$50,000.

Call your local HP field engineer for complete information or write Hewlett-Packard, Palo Alto, Calif. 94304; Europe: 54 Route des Acacias, Geneva.

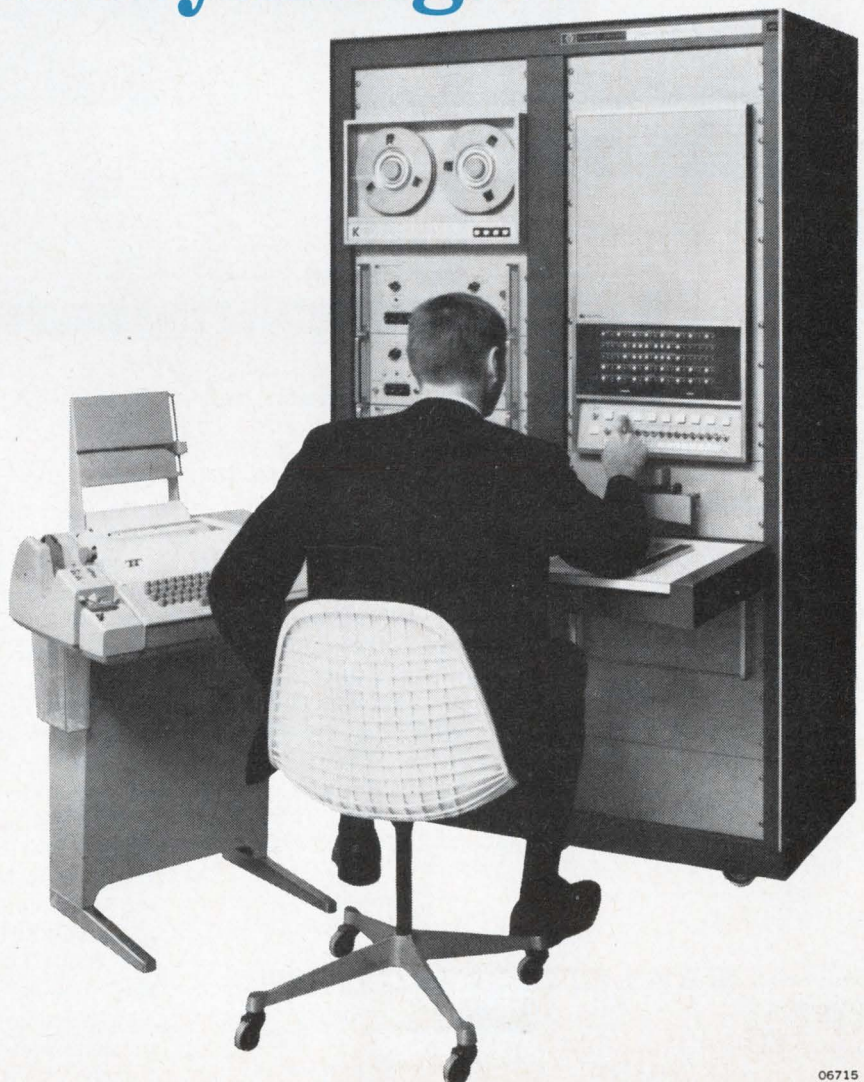

HEWLETT  **PACKARD**
MEASURING SYSTEMS

With HP signal generators you get the widest range of RF test frequencies for every job.

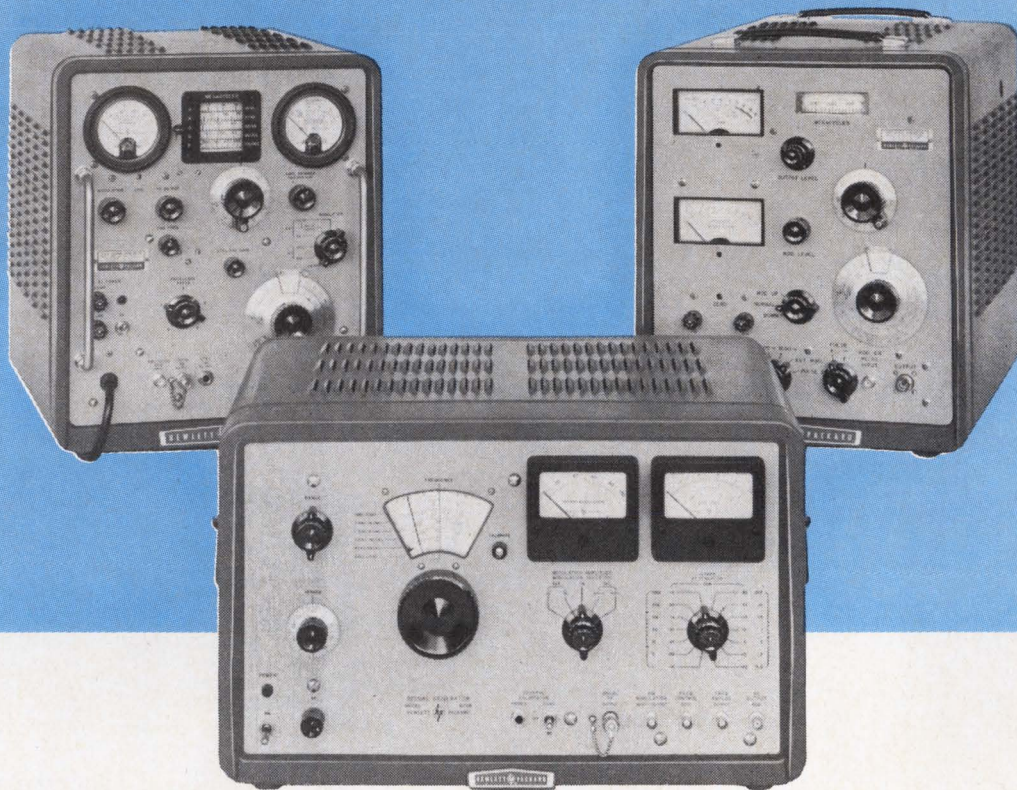

Hewlett-Packard RF signal generators give stable, wide-frequency-range test capability at economical cost. The overlapping coverage from 50 kHz to 1230 MHz embraces broadcast, IF (radar and others), CATV, VHF-TV, UHF-TV, telemetry, mobile communications, military communications, aeronautical communications and navigational aids bands. They are ideal for testing all kinds of receivers, amplifiers, networks and filters.

These HP signal generators are of Master Oscillator-Power Amplifier (MOPA) design for clean, stable signals with low residual FM, high-power output, precision attenuation and versatile modulation with minimum incidental FM.

HF: Model 606B (50 kHz to 65 MHz) delivers 3 V RMS into 50 Ω , constant level and constant modulation percentage with frequency change. Basic stability is 0.005% per 10 minutes; can be phase-locked with 8708A Synchronizer for 2×10^{-7} per 10 minutes stability at any frequency. Price: \$1550.

Model 606A: Same as 606B without phase-lock capability. Price: \$1450.

VHF: Model 608E (10 MHz to 480 MHz) delivers 0.1 μ V to 1 V RMS into 50 Ω , ± 1 dB accuracy; 0.005% stable per 10 minutes; constant output level versus frequency; frequency dial accuracy $\pm 0.5\%$. 1 MHz and 5 MHz crystal calibrator for frequency checks to 0.01% accuracy. Buffer between MO and PA holds incidental FM to 0.001% at 30% AM. Price: \$1450.

Model 608F (10 MHz to 455 MHz) similar to 608E; 0.1 μ V to 0.5 V into 50 Ω ; leveling, low distortion AM, can be phase-locked with 8708A Synchronizer for 2×10^{-7} per 10 minutes stability at any frequency. Price: \$1600.

For FM applications in VHF, select either Model 202H (54 MHz to 216 MHz), price \$1475; or Model 202J (195 MHz to 270 MHz) specifically for telemetry, price \$1595.

UHF: Model 612A (450 MHz to 1230 MHz) 0.1 μ V to 0.5 V output, ± 1 dB; 1% frequency accuracy; $< 0.002\%$ incidental FM at 30% AM; 5 MHz modulation bandwidth for complex modulation or fast pulsing. Price: \$1500.

For more information on how HP signal generators can simplify your RF testing, call your local HP field engineer or write Hewlett-Packard, Palo Alto, California 94304; Europe: 54 Route des Acacias, Geneva.

HEWLETT  **PACKARD**

SIGNAL GENERATORS

04712

News Features

Probing the News

- 137 An uncertain guide for suppliers
- 139 Encore for Pentagon's juggling act
- 145 NASA seeks to fill post-Apollo void
- 151 War puts agencies on short rations
- 155 FAA priorities irk critics

Electronics Review

- 45 **Integrated electronics:** Opening the MOS gate; Active filters
- 46 **Consumer electronics:** Tuner for all channels; Home color
- 48 **Computers:** Back in action
- 50 **Industrial electronics:** Treading softly
- 50 **Displays:** Happy medium; Batch view
- 53 **Government:** Data banks overdrawn; Cleaning the spectrum; LBJ's war on radiation
- 54 **For the record**

Electronics Abroad

- 235 **Japan:** Space hardware; It's a snap
- 236 **France:** Broken color line
- 237 **Great Britain:** Magnetic modulator
- 237 **West Germany:** The low road; Safer pace

New Products

- 169 The triac—from trickle to triumph in three years
- 171 Recorded voice alerts pilots
- 173 **New components review**
- 173 **New components:** British Gunn shoots at X band
- 177 **New subassemblies review**
- 177 **New subassemblies:** Getting the right bump on the right pad; British challenger uses big words; The box filled with echoes
- 187 **New microwave review**
- 187 **New microwave:** Pointless plotting can save time
- 191 **New instruments review**
- 191 **New instruments:** Measuring up to standards; Average-as-you-go computer bows
- 201 **New industrial electronics review**
- 201 **New industrial electronics:** Keeping data on the straight and narrow; Reacting fast to reactions; Inverter packs regulated wallop
- 211 **New semiconductors review**
- 211 **New semiconductors:** Everything—including sink—in one package

Title R registered U.S. Patent Office; © copyright 1968 by McGraw-Hill Inc. All rights reserved, including the right to reproduce the contents of this publication, in whole or in part.

Technical articles

Special 77 report

The transistor—two decades of progress

- 78 **The improbable years**
The transistor's impact far exceeded that envisioned even by the men most closely associated with its development
- 93 **Fingers in the die**
Interdigitation of transistor geometrics has helped boost performance of r-f power transistors
John G. Tatum, ITT Semiconductors
- 98 **A worthy challenger for r-f power honors**
Though only 4 years old, the overlay transistor is setting power and frequency marks
Donald R. Carley, RCA Electronic Components Division
- 105 **A discrete transistor that's a powerhouse**
Auto radios helped launch power transistors; 250-amp, 1-kilovolt units are available today
Leo L. Lehner, Motorola Semiconductor Products Inc.
- 109 **Fabrication control is key to microwave performance**
Improved diffusion and photolithography result in better power, gain, and noise figures
Roger Edwards, Bell Telephone Laboratories
- 116 **A switch in time**
Simplicity and low cost keep the unijunction transistor not only competitive but flourishing
W.R. Spofford Jr. and R.A. Stasior, General Electric Co.
- 120 **An old-timer comes of age**
The field effect transistor, conceptually the oldest of the semiconductors, has emerged as one of the most up to date and dynamic devices
Joel M. Cohen, Crystalonics division, Teledyne Inc.
- 126 **Transistors: A chapter ends—but the story continues**
If the heyday of discrete transistors is past, transistor technology will remain the basis of tomorrow's developments

Departments

- | | | | |
|-----|------------------------|-----|------------------------|
| 4 | Readers Comment | 25 | Electronics Newsletter |
| 8 | People | 59 | Washington Newsletter |
| 14 | Meetings | 215 | New Books |
| 16 | Meeting Preview | 218 | Technical Abstracts |
| 23 | Commentary | 226 | New Literature |
| 233 | Newsletter from Abroad | | |

Electronics

Editor-in-Chief: Donald Christiansen

Associate managing editors

Technical: Stephen E. Scrupski
News: Robert Henkel
Copy: Sally Powell

Senior associate editors

Joseph Mittleman, Harry R. Karp

Department editors

Avionics & Space: Alfred Rosenblatt
Computers: Wallace B. Riley
Communications: William Bucci
Consumer electronics: John D. Drummond
Design theory: Joseph Mittleman
Industrial electronics: Harry R. Karp
Instrumentation: Carl Moskowitz
Military electronics: Richard Gundlach
Solid state: Mark B. Leeds

Regional bureaus

Domestic

Boston: James Brinton, manager; Robin Carlson
Los Angeles: Lawrence Curran, manager; Burton Bell
New York: Howard Wolff, manager
San Francisco: Walter Barney, manager; Peter Vogel
Washington: Robert Skole, manager; William D. Hickman, Paul Dickson

Foreign

Bonn: John Gosch
London: Michael Payne
Tokyo: Charles Cohen

Copy editors

James Chang, Frederick Corey

Graphic design

Art director: Saul Sussman
Assistant art directors: Ann Mella, Valerie Betz
Production editor: Arthur C. Miller

Editorial secretaries: Claire Benell, Lynn Emery, Kay Fontana, Patricia Gardner, Lorraine Longo, Barbara Razulis, Frances Vacca

McGraw-Hill News Service

Director: Arthur L. Moore; **Atlanta:** Fran Ridgway; **Chicago:** Bruce Cross;
Cleveland: Arthur Zimmerman; **Dallas:** Marvin Reid;
Detroit: James Wargo; **Houston:** Robert E. Lee; **Los Angeles:** Michael Murphy
Pittsburgh: Louis Gomolak
San Francisco: William F. Arnold
Seattle: Ray Bloomberg; **Washington:** Charles Gardner, Daniel B. Moskowitz, Herbert W. Cheshire, Seth Payne, Warren Burkett, William Small

McGraw-Hill World News Service

Bonn: Robert Dorang; **Brussels:** George Williamson; **Hong Kong:** Wes Perry;
London: John Shinn; **Mexico City:** Gerald Parkinson; **Milan:** Ronald Taggiasso, Jack Star;
Moscow: Howard Rausch; **Paris:** Robert E. Farrell, Peter Kilborn;
Rio de Janeiro: Leslie Warren; **Tokyo:** Marvin Petal

Reprints: Susan Nugent

Circulation: Milton Drake

Publisher: Gordon Jones

Electronics: February 19, 1968, Vol. 41, No. 4

Published every other Monday by McGraw-Hill, Inc. Founder: James H. McGraw 1860-1948.

Printed at 99 North Broadway, Albany, N.Y. 12207; second class postage paid at Albany, N.Y.

Executive, editorial, circulation and advertising addresses: McGraw-Hill Building, 330 W. 42nd Street New York, N. Y. 10036. Telephone (212) 971-3333, Teletype TWX N.Y. 710-581-4235, Cable address: MCGRAWHILL N.Y.

Subscriptions solicited only from those professionally engaged in electronics technology. Subscription rates: qualified subscribers in the United States and possessions and Canada, \$8.00 one year, \$12.00 two years, \$16.00 three years; all other countries \$25.00 one year. Non-qualified subscribers in the U. S. and possessions and Canada, \$25.00 one year; all other countries \$50.00. Air freight service to Japan \$50.00 one year. Single copies: United States and possessions and Canada, \$1.00; all other countries, \$1.75.

Officers of McGraw-Hill Publications: Joseph H. Allen, President; Bayard E. Sawyer, Executive Vice-President; J. Elton Tuohig, Senior Vice-President-Operations; Vice Presidents: John R. Callahan, Editorial; John M. Holden, Marketing; Paul F. Cowie, Circulation; Angelo R. Venezian, Production; Jerome D. Luntz, Planning & Development; Robert M. Wilhelm, Controller.

Officers of the Corporation: Donald C. McGraw, Chairman of the Board; Shelton Fisher, President; L. Keith Goodrich, Robert E. Slaughter, Executive Vice Presidents; Donald C. McGraw, Jr., Senior Vice-President; John J. Cooke, Vice-President & Secretary; John L. McGraw, Vice-President & Treasurer.

Title © registered in U.S. Patent Office; © Copyright 1968 by McGraw-Hill, Inc. All rights reserved. The contents of this publication may not be reproduced either in whole or in part without the consent of copyright owner.

Subscribers: The publisher, upon written request to our New York office from any subscriber, agrees to refund that part of the subscription price applying to copies not yet mailed. Please send change of address notices or complaints to Fulfillment Manager; subscription orders to Circulation Manager, Electronics at address below. Change of address notices should provide old as well as new address, including postal zip code number. If possible, attach address label from recent issue. Allow one month for change to become effective.

Postmaster: Please send form 3579 to Fulfillment Manager, Electronics, P.O. Box 430, Hightstown, New Jersey 08520

Readers Comment

Two if by Land

To the Editor:

I was interested in Sylvania's cathode-ray tube [May 29, 1967, p. 56] which shows either a red or a green trace simply by changing the accelerating voltage. The purpose of the crt was to provide displays in two colors, but I wonder if the engineers at Sylvania are aware of an even more fascinating application. This tube may solve the biggest problem in constructing a color-television system, based on the Land theory of color vision.

Very briefly, the Land theory states that only two colors are required to produce all other colors in the human brain. With this concept, it should be possible to construct a color television system much simpler than the present three-color system. In fact, a Mexican television station did just that. It used two black-and-white receivers with corresponding red and green filters. The receiver pictures were superimposed by a mirror and a color picture resulted. One argument against development of this method of color transmission was that two receivers are required.

The need for two receivers is a problem, but after some experiments with photographic slides and a rotating slotted disk, I discovered that it is not necessary for both the red picture and the green picture, as seen by the viewer, to be displayed at the same time. These red and green pictures can be displayed sequentially as long as they appear in the same place and the display rate exceeds the persistence of vision. This means that if a picture tube were available which could give red light for one frame and green light for the next frame, a relatively simple color-tv system could be designed that avoids most of the drawbacks of the present three-color system. With the tube developed by Sylvania it should now be possible. The benefits of the Land system over the three-color system are substantial:

- The same bandwidth as a black-and-white channel because it is basically a black-and-white transmission.

- True color which the present

Here's a new linear IC from Sprague. The ULN-2111A.

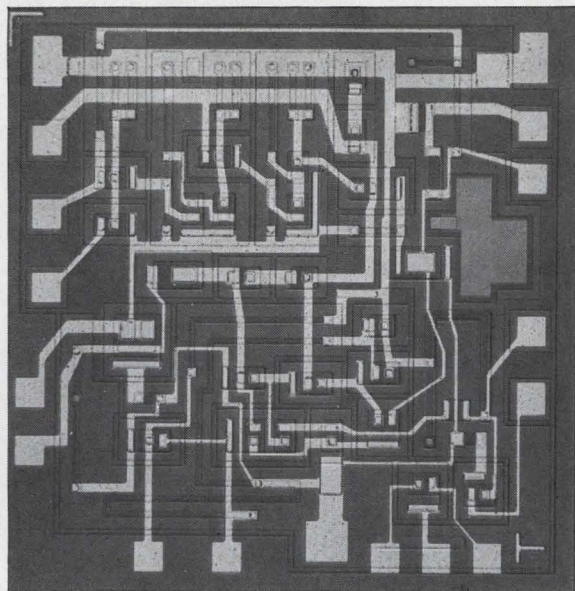

It's a 3-stage 60 db
broadband limiting
amplifier and a
balanced detector.
A single-slug coil tunes it.

You can use it in TV sound channels and FM receivers, for SSB detection in mobile gear, in radar and TV AFC, and in telemetry receivers.

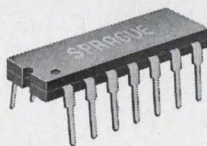

It comes
in a 0-70C DIP.
And it's priced right...!

TYPE ULN-2111A SPECIFICATIONS				
$V_{CC}=12V$, $I_{CC}=16mA$, $P_D=200mW$, bandwidth=5kHz-50MHz				
Typical Characteristics for TV and FM Applications				
	TV	FM	UNITS	CONDITIONS
F_0	4.5	10.7	MHz	
Dev.	± 25	± 75	kHz	
V_{INJ}	60	60	mV rms	
Δf_{p-p}	150	550	kHz	
V_{OUT}	0.60	0.50	V rms	$R_L=2k\Omega$
V_{OUT}	0.35	0.30	V rms	$R_L=200\Omega^*$
Lim. Thr.	400	400	μV rms	-3db output
AM Suppr.	46	40	db	IHF- V_i -10mV
Cap. Ratio	—	1.4	db	IHF-30db-30%
THD	1.5	1.0	%	100% FM mod.
THD	0.6	0.4	%	30% FM mod.
Detuning	—	$< \pm 5$	kHz	$0 < V_i < 0.5 V$ rms

*Requires 1 k Ω , pin 1 to gnd.

To request samples, call your Sprague representative.
For further information, write to Technical Literature
Service, 35 Marshall St., North Adams, Mass. 01247.

SPRAGUE WORCESTER... the world's finest microcircuit facility



Sprague and *®* are registered trademarks of the Sprague Electric Co.



That's our Molex Mini-Connector. It's doing big things. Like saving assembly steps. And time. And money. Getting wiring in place with greater production efficiency and operational integrity than you might think possible. Our business is creating these mini-devices to meet your system requirements. We take it seriously. And have the facilities, design capabilities, know-how and everything it takes to produce economical connections . . . fast!

If you would like a free sample of our Mini-Connector, please write. If you would like a sample of performance, you can make connections by calling (312) 969-4550



PRODUCTS COMPANY
DOWNERS GROVE, ILL.

three-color system does not give.

▪ Cheaper receiver because it is basically a black-and-white receiver with a different picture tube.

It could be said that there is no point in experimenting with a new system because the three-color system is operating and is not likely to be changed. This is true, particularly of the camera and transmission method. But a little thought leads one to the conclusion that it may be possible to build Land-type color receivers which utilize the present transmission method. The Land method uses only two colors and the present system is transmitting three—one more than is needed.

If any of your readers are in a position to make the necessary experiments, we may some day have a much improved standard of color as well as a truly cheap and simple receiver.

Gordon W. Harrison
Professional engineer
Randwick
New South Wales
Australia

Scotching a story

To the Editor:

Concerning the description of the Hewlett-Packard Microwave Link Analyzer [Jan. 8, p. 198], we suspect that you would not want to leave your readers with the impression that this is an American-made instrument when, in fact, it was designed and manufactured at the Hewlett-Packard plant in South Queensferry, Scotland.

The place of manufacture is really of small consequence as far as customers are concerned, but I call it to your attention because our friends in Scotland deserve

recognition for the fine job they have done in developing and producing this instrument.

Howard L. Roberts
Technical Editorial Relations
Hewlett-Packard
Palo Alto, Calif.

Sensitive area

To the Editor:

Your article entitled "Errors of emission" [Dec. 25, 1967, p. 39] states that Lee Robinson, Packard-Bell's director of quality assurance, said [regarding a test run by the California Division of Industrial Safety for X-ray emissions from tv sets] that "this is the first radiation check made by a government group." The article then asserts that this contradicted "a statement made before the check by the firm's president, who said sets had been checked for safety and performance 'by the government.'"

Robinson emphatically denies that he called that test the first made by a government group. He and all other company personnel associated with the matter are well aware that an initial visit was made by the California Division of Industrial Safety on July 18, 1967, at which time it conducted X-radiation emission tests on sets selected at random from our production line. The results of these tests indicated no discernible radiation.

The visit made by the state agency after publication of a Consumer Reports story [charging that sets made by Packard-Bell and another firm emitted excessive radiation] was a second visit.

Robert E. Victor
Vice president
Packard-Bell Electronics
Los Angeles

Make your oscilloscope display linear in db

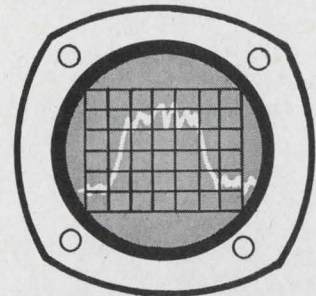

with the new 120 db ultra-fast LOGARITHMIC CONVERTER

This new logarithmic converter provides two unique features: The 120 db dynamic range (one-million-to-one) allows full coverage of virtually any phenomena in a single range. The microsecond response of the PM 1002 makes it the first logarithmic converter fast enough to work with oscilloscopes, integrating digital voltmeters or high speed graphic recorders.

Small, solid state, rugged, and drift free, the PM 1002 is invaluable for all types of ratio measurements and for applications where dynamic range is unknown.

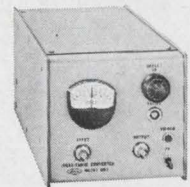

Let us prove it
—write or call

\$660.00

PM PACIFIC
MEASUREMENTS
INCORPORATED

940 INDUSTRIAL AVENUE,
PALO ALTO, CALIFORNIA
(415) 328-0300

SUBSCRIPTION SERVICE

Please include an Electronics Magazine address label to insure prompt service whenever you write us about your subscription.

Mail to: Fulfillment Manager
Electronics
P.O. Box 430
Hightstown, N.J. 08520

To subscribe mail this form with your payment and check new subscription renew my present subscription

Subscription rates: qualified subscribers in the U.S.: 1 year \$8; two years, \$12; three years, \$16. Non-qualified: 1 year \$25. Subscription rates for foreign countries available on request.

CHANGE OF ADDRESS

ATTACH
LABEL
HERE

If you are moving, please let us know five weeks before changing your address. Place magazine address label here, print your new address below.

name

address

city

state

zip code

collage 28

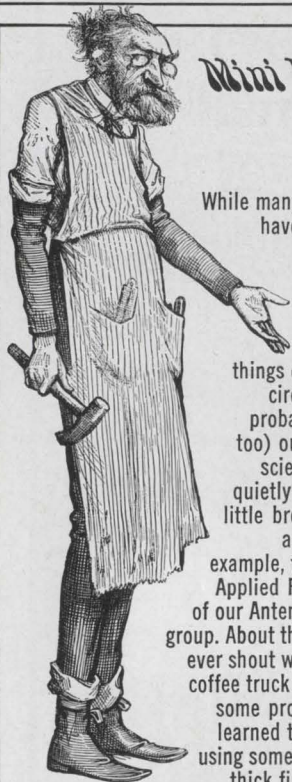

Mini Mouthings on Maxi Achievements in Micromin Microwaves

While many in our industry have been thumping their chests and shouting wildly about fantastic achievements in making things out of integrated circuits (and we've probably been guilty, too) our engineers and scientists have been quietly chalking up one little breakthrough after another. Take for example, the people in the Applied Research Section of our Antenna & Microwave group. About the only time they ever shout wildly is when the coffee truck is late; but after some prodding, COLLAGE learned that they've been using some pretty advanced thick film techniques to fabricate hybrid circuits from UHF to X-band frequencies. One result of this is an rf head for the 1.5 GHz region constructed on a 1" x 1"

substrate. You might refer to the October '67 issue of MICROWAVES in which you'll find an article that tells about it. Our I/C geniuses are also doing some amazing (or at least eyebrow-raising) things in the areas of thin film and monolithic devices. Write to our Advanced Technology Programs office in Scottsdale for some soft-sell, but, we hope, persuasive literature on the subject. HOT FLASH!...CM things are now R things! Just when we thought you were beginning to understand what our CM-610 and CM-620 Radio Receivers are, they were bestowed the honor of official government nomenclature. For you government types, then, you may now order Radio Receiver R-1532/URR when you want the CM-610 VHF receiver; and R-1533/URR when you really mean our CM-620 UHF receiver. Both, as you should know by now, are solid state, compact, lightweight (18 lbs) and completely modular in design. Remember, too, that both are single-conversion, single channel, crystal-controlled, superheterodyne receivers mostly for use in ground-air communications. The VHF model receives in the 115-153 megacycle band and the UHF in the 225-400 megacycle band. If you have any more questions, please direct them to our Chicago Center...



Our PhD-type research people often find themselves smarting with anxiety over the suspicion that some of you still think of Motorola as strictly a hardware-oriented outfit. It isn't so, they complain, and have asked COLLAGE to tell the world they recently proved they have a whole lot of smarts, or at least enough to receive a rather erudite study contract from the people at USAECOM, Ft. Monmouth. It's a 12-month program to study, experiment and evaluate VHF modulation and de-

tection techniques. They'll be covering several intensely technical areas in an effort to optimize the performance of digitalized speech transmission over a 25 KHz channel. FM, SSB, and other modulation detection techniques will be studied, and they'll be concerned with things like selecting an optimum digital modulation technique based on bandwidth vs error rate, compatibility with delta modulation speech, encrypted speech, and data... and so on. No one will comment yet on the outcome of the study (demonstrating the typical conservatism of the truly scientific minds we have), but COLLAGE will go out on a limb and guarantee that the customer will get his money's worth...and then some. If, after all this, you still doubt that we're as egg-headed as anyone, keep it to yourself. Or, better yet, try us out on your study contract.

Aerospace Center Dept. 2008
8201 E. McDowell Rd., Scottsdale
Arizona 85252, Phone (602) 947-8011

Chicago Center Dept. 985
1450 N. Cicero Ave., Chicago,
Illinois 60651, Phone (312) 379-6700

 **MOTOROLA**
Government Electronics Division

People

"Anyone trying to sell saddle soap to the cavalry is having a hard time," says **Samuel J. Rabinowitz**, who has the responsibility of making certain the Philco-Ford Corp.'s Aeronutronic division never finds itself in that position. Rabinowitz became director of the Newport Beach, Calif., division's newly formed advanced systems operation last month.



Samuel Rabinowitz

He knows both sides of the military procurement coin, having served as director of the Advanced Research Projects Agency's Project Defender before becoming associate director of research for Columbia University's Electronic Research Laboratories. From that post, he joined Aeronutronic, a supplier of tactical missiles (Shillelagh, Chaparral), advanced military radars, and reconnaissance and intelligence systems. That was less than a year ago; Rabinowitz's first assignment at the Philco unit was as director of the radar and intelligence operation.

Fertile ground. Establishment of the advanced systems operation is a move to strengthen Aeronutronic's ability to compete for new military business. As Rabinowitz sees it, his group's task is to attract what he calls the "seed corn" research contracts with "the potential for leading to major new programs in such areas as radar, optics, propulsion, and fuzing." In this category is a recent award from the Air Force to study a new gun system. The effort is classified, as is the majority of Aeronutronic's Pentagon business.

While the division will remain within its charter as a military contractor, Rabinowitz says advanced systems planners will be looking for radically different technical approaches to traditional gear, such as radars. They have proposed to the Air Force an airborne reconnaissance radar—a system, Rabinowitz says, that represents a new technical capability at Aeronutronic



The ML-EE64Y is the smallest 10 kv (peak) switch tube—and the smallest 10 kv (peak) regulator tube you can buy. ML-EE64Y gives you up to 36 free cubic inches per tube, and doesn't require a socket. It offers you a 12 amp peak current, high signal sensitivity, and a simple BeO heat sink with no other cooling required. The ML-EE64Y provides tabs for simple, low-cost connection.

For complete data, write to Machlett—the tube specialist most responsive to customer needs—today. The Machlett Laboratories, Inc., 1063 Hope Street, Stamford, Connecticut 06907.

Why use this tube...for high voltage switching or voltage regulation...when this one is better?

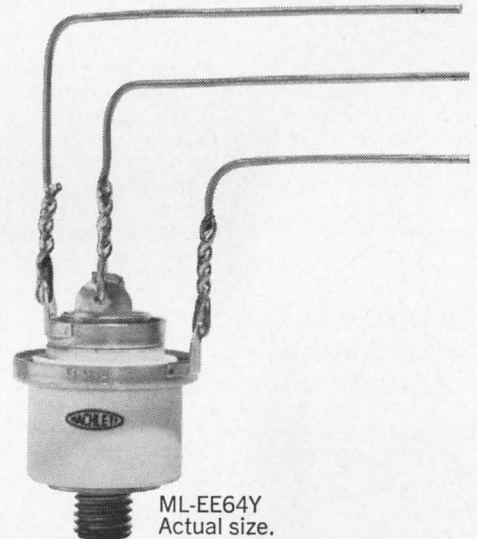
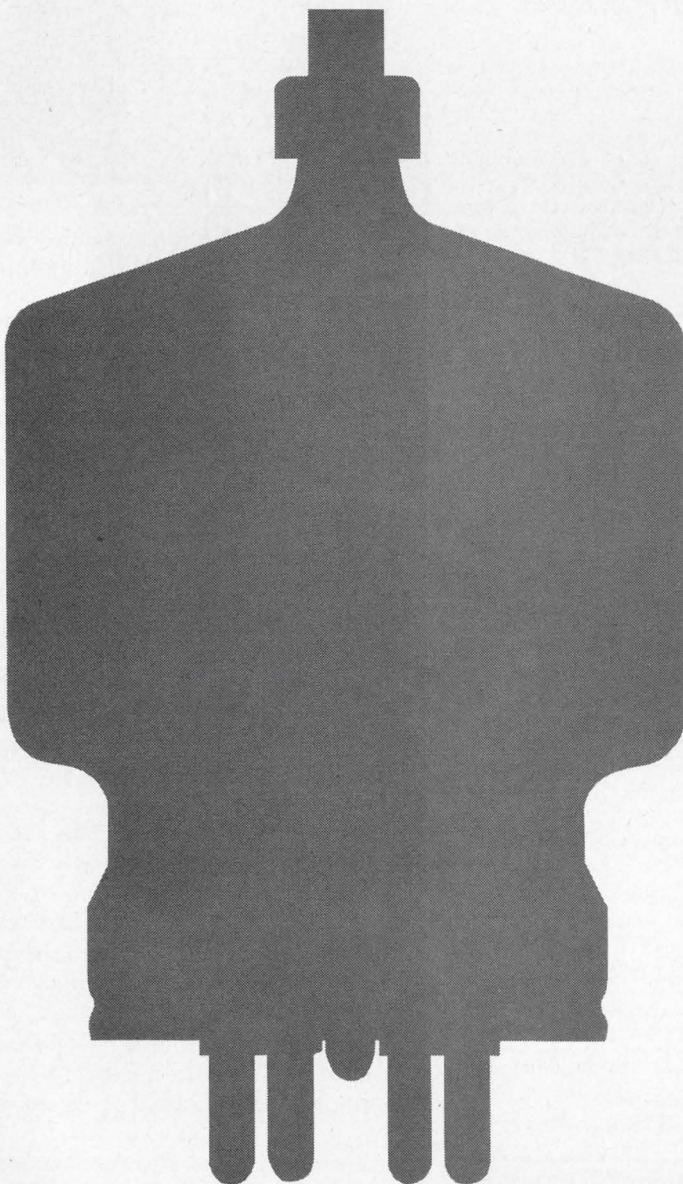

ML-EE64Y
Actual size.

RAYTHEON

THE MACHLETT LABORATORIES, INC.

A SUBSIDIARY OF RAYTHEON COMPANY

Do you have this new capacitor data?



DIPPED MICAS . . . for entertainment and commercial equipment

Single-film silvered-mica capacitors cost less than stacked mica or ceramic types. These capacitors are rated at 300 WVDC and have good stability and retrace characteristics over their operating temperature range of -55°C to $+85^{\circ}\text{C}$. Capacitance values from 10 to 360 pF, $\pm 5\%$ are available. Put this quality and performance into your next design. Ask for Engineering Bulletin 1010.

CIRCLE READER SERVICE NUMBER 331

SPARK GAPS and GAP CAPACITORS . . . for TV tube protection

Spark gaps and gap capacitors suppress transient voltage surges and protect your expensive picture tube and allied circuitry. Spark gaps are available in 1.5 kV and 2.5 kV ratings with less than .75 pF capacitance. The gap capacitor is an air gap in parallel with a .01 μF disc capacitor. All Sprague spark gaps and gap capacitors are 100% tested to insure your circuitry. Use them to protect your picture tube warranty. Ask for Engineering Bulletin 6145.

CIRCLE READER SERVICE NUMBER 332

DISC CERAMICS . . . for general, temperature-compensating, and low-voltage applications in industrial, commercial, and consumer equipment



Cera-mite® general application discs for bypass and coupling at low cost. Nine disc sizes from .300 to .875 inches have 100, 250, 500, and 1000 WVDC ratings, in standard or temperature-stable formulations. Dual-section discs have up to .022 μF @ 1000 V. Ask for Engineering Bulletin 6101D.

CIRCLE READER SERVICE NUMBER 333

Cera-mite temperature-compensating discs for controlled capacitance change with temperature in R-F oscillators, precision amplifiers, timing circuits, other critical applications. Select from ten linear temperature coefficients from NPO to N2200. Capacitance values from 1 to 2200 pF with 1000 WVDC ratings are available, plus popular values at 3000, 4000, and 5000 WVDC for TV yoke circuits. Mini-fied units in 250 WVDC ratings may be obtained with capacitance values ranging from 22 to 990 pF. Ask for Engineering Bulletin 6102B.

CIRCLE READER SERVICE NUMBER 334

Hypercon® ultra-high capacitance discs for low-voltage circuits. Replace electrolytics with non-polar Hypercon capacitors only a fraction as large. The 2.2 μF , 3 volt disc has a diameter of .875 inches; the 0.1 μF , 25 volt unit measures .750 inches. Ask for Engineering Bulletin 6141F.

CIRCLE READER SERVICE NUMBER 335

For bulletins in which you are interested, write
Technical Literature Service, Sprague Electric Co.,
 35 Marshall St., North Adams, Mass. 01247

SPRAGUE COMPONENTS

CAPACITORS
 TRANSISTORS
 RESISTORS
 INTEGRATED CIRCUITS
 THIN-FILM MICROCIRCUITS
 INTERFERENCE FILTERS

PACKAGED COMPONENT ASSEMBLIES
 FUNCTIONAL DIGITAL CIRCUITS
 MAGNETIC COMPONENTS
 PULSE TRANSFORMERS
 CERAMIC-BASE PRINTED NETWORKS
 PULSE-FORMING NETWORKS



Sprague and *®* are registered trademarks of the Sprague Electric Co.

People

—and they hope to work into light-weight special-purpose ground surveillance radars that will incorporate a proprietary design element. This last system could conceivably evolve into a mortar-locating radar.

Having developed a broad-based technology in electronic warfare, ordnance, information control systems, and avionics, the RCA Defense Electronics Products division is now planning to evolve into a total systems developer. Directing this effort at the 1,800-employee division is **Sidney Sternberg**, newly appointed general manager.



Sidney Sternberg

“We have developed the expertise to build quality pieces,” says Sternberg. “Now we are already to put the pieces together to answer a customer’s problem.”

In electronic warfare, the milestone for the division’s move toward systems integration occurred in December, when work began on a classified tactical warfare system for the Navy, says Sternberg. Until then, the division concentrated on countermeasure equipment in frequencies from vhf through K_u band (r-f transmitted power, wideband microwave receivers, data-processing equipment).

In another area of growth, notes Sternberg, the division will apply product lines to new markets. For instance, information-control systems which originated with an RCA ground computer checkout system used for all Saturn launches, will eventually be employed to process the myriad of data necessary to fly complex commercial supersonic jets.

Moreover, the distance-measuring equipment originally designed for commercial airlines’ use is now aboard the Army’s Lockheed Cheyenne helicopter. Distance measuring provides a slant range between an aircraft and a landing strip.



Some people will buy a Sierra High-Power Signal Generator

You can change the output tube in a Sierra Model 470A in as little as 30 seconds. With other signal generators, the job eats up precious hours. So you can't really fault a man who goes overboard on this quick-change act, even though he may be overlooking some of the more important advantages of owning a 470A.

For example, consider the low cost of high-power output, as depicted by this table:

Frequency Range (MHz)	50-200	200-500	500-1000	1000-1800	1800-2500
Maximum Power (W)	50+	65+	60+	40+	20+
Price	\$2,650	\$2,555	\$2,555	\$2,835	\$3,360

Each of the five models puts out more than enough power to comply with field-strength requirements of currently effective EMI specifications.

Consider such conveniences as: Direct-reading, front-panel meters that keep you posted on power output plus grid and cathode current; an output monitor jack that gives you power samples 35 db down from the main output, ideal for waveform analysis and frequency calibrations; automatic protection against no-load or underload conditions.

Weigh the specs. A magnificent body of technical literature awaits your pleasure. Write Sierra/Philco-Ford, 3885 Bohannon Drive, Menlo Park, California 94025.

...for the pure pleasure of changing the only tube in its magnificent solid-state body



PHILCO-FORD CORPORATION
Sierra Electronic Operation
Menlo Park, California • 94025

Circle 11 on reader service card

RCA Solid State Data for Designers

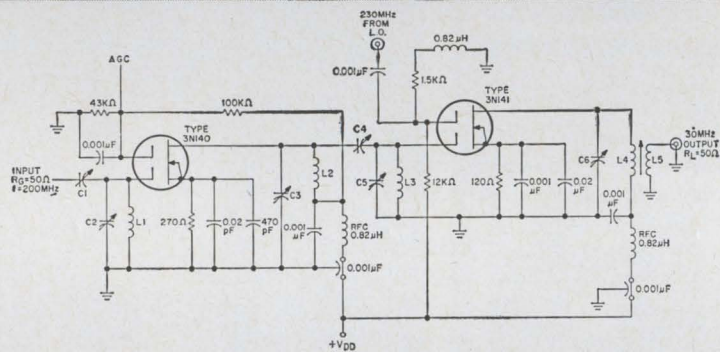

Dual-Gate (Mos) Fet's for vacuum-tube front-end performance

Here are two of the most revolutionary transistors you can work with today—the 3N140 and 3N141 dual-insulated-gate depletion type MOS FET's. Used as an RF amplifier the 3N140 will give you an unneutralized 200MHz power gain of 19dB (typ), maximum feedback capacitance of 0.03pF, transconductance of 10,000 umhos, typically, and the flexibility of working with two independent input electrodes. The 3N141 offers a square law mixing characteristic and excellent isolation between the signal and local oscillator gates which minimizes oscillator pulling under strong signal conditions.

What more do you get? Improved cross modulation performance. Low spurious responses. Exceptional stability at VHF. Reduced oscillator feed-through and increased gain control range with cross-modulation characteristic actually improving near cut-off. Both units feature insulated gates for greater signal handling capability without diode-current loading, negligible AGC power requirement and improved thermal stability. You combine performance characteristics of two well-known devices—vacuum tubes and bipolar transistors—using the best attributes of each. Circle Reader Service #484.

Get your "LINEAR DESIGN LAB" Kit Now

We have a new kit for you—with all the circuits and background materials you need to get your feet wet in linear integrated circuit applications design. For example, 11 different circuits—and with data sheets and application notes for each one. You get all these to work with: RF and IF amplifiers; wideband amplifiers; multi-function amplifiers; op amps; arrays of devices and amplifiers, and our famous "Universal" amplifier. There are 26 units in all—with replacements readily available from your RCA Distributor. Along with the units to make this "lab" complete, you will get the newest RCA Linear Integrated Cir-

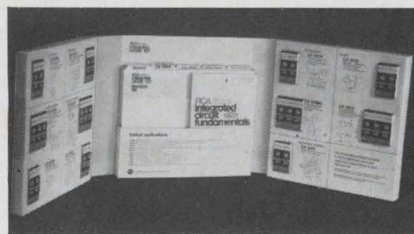

cuits Manual. (IC-41)

You'll find this kit—\$39.95 at your Distributor's*—has it all...in one complete, convenient package that's designed for designers. Circle Reader Service #485.

*Suggested Resale Price.

Noise problems? Check these OP AMP units!

Everybody's talking about OP Amp noise—but we've done something about it! Our new "A" family of units are quiet with a capital "Q" as you can see from the specifications. You can build your designs around any of *four* industry standard packages, too...TO-5; flat pack; plastic dual in-line and our new, exclusive ceramic dual in-line...and with either $\pm 6V$ or $\pm 12V$ supply.

Choose the "package"—and the parameters—from these two lists:

Package style	6-Volt Types	12-Volt Types
Flat pack	CA3008A	CA3016A
TO-5	CA3010A	CA3015A
Dual in-line plastic	CA3029A	CA3030A
Dual in-line ceramic	CA3037A	CA 3038A
Open loop voltage gain	60dB typ.	70 dB typ.
Common-Mode rejection Ratio	94dB typ.	103 dB typ.
Output voltage swing	6.75 V typ.	14 V typ.
Input offset voltage	0.9 mV typ.	1 mV typ.
Input offset current	0.3 uA typ.	0.5 uA typ.
Input bias current	2.5 uA typ.	4.7 uA typ.
Input impedance	20 K Ω typ.	10 K Ω typ.
Output impedance	160 Ω typ.	85 Ω typ.
Noise factor	12 dB max.	16 dB max.
	(@ $\pm 6V$, 1KHz)	(@ $\pm 12V$, 1KHz)

Circle Reader Service #486 for full details.

Hermetic Metal Devices at Plastic Prices*

Look what as little as 19¢ will buy*.

The shielding—dissipation capabilities—hermeticity that only a metal package can give, for one thing. That's why we call these units our PHP line—combining **P**rice, **H**ermeticity and **P**erformance...and we have another name for them, too, the Max Value line because they give designers maximum value right across the board! Many of them meet the requirements of MIL-S-19500 (marked with + below).

Pick from any of these 11 PHP



units for your designs (priced from 19¢ to 39¢*):

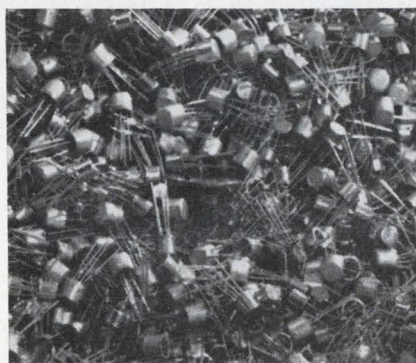

- 2N5179+ Low noise UHF Amplifier
- 2N5180 Low noise VHF Amplifier
- 2N5181 High gain RF/IF Amplifier
- 2N5182 High gain RF/IF Amplifier for low current applications
- 2N5183 1 ampere General Purpose Amplifier
- 2N5184 High frequency high voltage amplifier
- 2N5185 High frequency high voltage amplifier
- 2N5186+ High speed switch
- 2N5187+ Medium current high speed switch
- 2N5188+ High speed high voltage 1/2 amp switch
- 2N5189 High speed high voltage 1 amp switch

*1,000 units. See your RCA Distributor for his price and delivery.

For more information about this broad line which can satisfy most of your signal transistor needs, Circle Reader Service #487.

AC Triggers (DIACS) for sale—Right now—in quantity!!

If you've been having delivery problems on Diacs, rest easy. RCA has a new trigger diode in a hermetic DO-26 case, and the big news is it's available right now in volume quantities. The same RCA assembly line that has been producing millions of lead-mount rectifiers is now rolling out "car loads" of top-quality Diacs. We pass the cost benefits of a mature production line right back to you... and you get the added plus of proven hermetic reliability at plastic prices.

Performance-wise, RCA's new Diac shapes up as follows; typical breakover voltage of 32 V (dc)... excellent breakover voltage symmetry of ± 3 V... Peak pulse current = 2 A... and low breakover current = 50 μ A at breakover voltage.

So if you have Triac circuits that are awaiting triggers, await no longer. Circle Reader Service #488 for details.

RCA—Single source for audio power transistors

Today's audio circuit designer demands a broad line-up of silicon and germanium power transistors. And we'd like to suggest where he should look first for a single source of low cost reliable devices. RCA audio transistors feature the widest choice of silicon power units, making possible quasi-complementary circuits up to 70 watts rms! Matching this silicon capability, we have many fine germanium p-n-p transistors at attractive prices for designers working with the complementary-symmetry approach.

To you, this means an uncompromised choice of quality silicon power transistors (now with 2 pace-setting families in plastic, one having an industry-high dissipation rating of 83 watts, the other 36) for your designs requiring silicon... and a choice of quality germanium power transistors for your designs requiring germanium. We wrapped up the details on RCA's audio power transistor line in an attractive brochure which includes 11 ready-to-go circuits. Circle Reader Service No. #489 for your copy.

Yes... RCA has photocells!!

And, we feel they're the finest in the industry! Why? Well, our devices right now are meeting the toughest demands in applications such as oil burner controls, coin changers, as well as millions of streetlight controls across the country. We have four basic hermetic packages for you to work with—a 1" diameter cell plus TO-5, TO-8 and TO-18 versions that bring solid-state engineering to light sensitive devices.

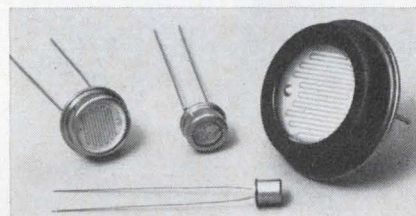

Use them in designs like automatic door openers, light flashers, storage level indicators, counters, door openers, tape card readers—wherever you need quality and performance in a photocell control. There are over twenty-five cadmium-sulfide and cadmium sulfo-selenide types in RCA's line... all of them are fully described in a new data sheet. Write in now and we'll also send you a 30-page application brochure packed with "now" ideas on how to use photocells!!

For product information on all items listed above, write RCA Electronic Components and Devices, Commercial Engineering Sec. QN2-3, Harrison, N.J. 07029. For price and delivery see your authorized RCA Distributor.

RCA

There always has to be a winner—and when it comes to all-purpose sweep signal generators, the Jerrold Model 900-C is a shoo-in.

Measure a *narrow* band circuit (sweepwidth down to 10 kHz) or check the *entire* coverage of broad band units such as mixers, amplifiers, or filters (sweepwidths up to 400 MHz). Design, test or measure a variety of VHF, UHF, narrow and wide band devices in the frequency range 500 kHz to 1200 MHz... and do it with incomparable ease and accuracy. Here is convenience only an all-purpose sweeper can provide.

The 900-C and ultra-reliable Measurement-by-Comparison techniques permit accurate and simple measurement of gain, loss, and VSWR. You can disregard variables such as nonlinearity of detectors, oscilloscope drift, and line voltage variations.

If you need more convincing, send for complete data—or contact us for a demonstration. Write Government and Industrial Division, Jerrold Electronics Corporation, 401 Walnut St., Philadelphia, Pa. 19105.

JERROLD

clean sweep!

IN TEST,
MEASUREMENT,
AND
DESIGN

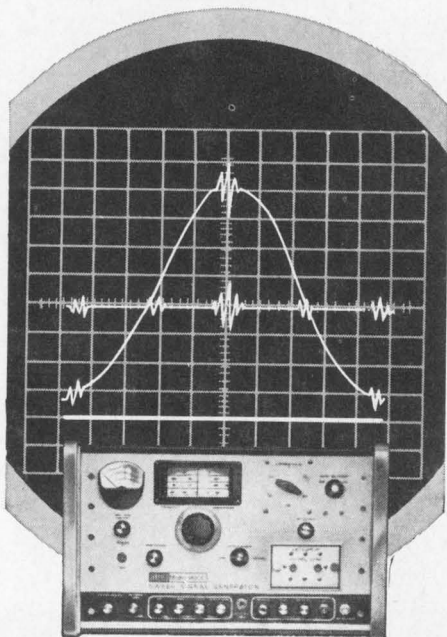

Meetings

Scintillation and Semiconductor Counter Symposium, IEEE; Shoreham Hotel, Washington, Feb. 28-March 1.

Technology for Manned Planetary Missions Meeting, American Institute of Aeronautics and Astronautics; New Orleans, March 4-6.

Western Regional Technical Session, Electrochemical Society; Hilton Inn, San Francisco, March 7.

Conference of the American Society for Nondestructive Testing; Biltmore Hotel, Los Angeles, March 11-13.

Physics Exhibition, Institute of Physics and the Physical Society; London, March 11-14.

International Convention and Exhibition, IEEE; Coliseum and N.Y. Hilton Hotel, N.Y., March 18-21.

International Convention, Aerospace and Electronics Systems of IEEE; Warwick Hotel, New York, March 19.

Modulation Transfer Function, Society of Photo-Optical Instrumentation Engineers; Boston, March 21-22.

Symposium on Microwave Power, International Microwave Power Institute; Statler Hilton Hotel, Boston, March 21-23.

Flight Test Simulation and Support Conference, American Institute of Aeronautics and Astronautics; Los Angeles, March 25-27.

International Aerospace Instrumentation Symposium, College of Aeronautics and Instrument Society of America; Cranfield, England, March 25-28.

Quality Control Conference, American Society for Quality Control; University of Rochester, N.Y., March 26.

Railroad Conference, IEEE and American Society of Mechanical Engineers; Conrad Hilton Hotel, Chicago, March 27-28.

Electrical Engineers Exhibition, American Society of Electrical Engineers; London, March 27-April 3.

International Conference on Color Television, Electronic Industries Association of France; Paris, April 1-5.

International Components Show, Federation Nationale des Industries Electronique; Paris, April 1-6.

Business Aircraft Meeting and Engineering Display, Society of Automotive Engineers; Broadview Hotel, Wichita, Kan., April 3-5.

International Magnetics Conference, IEEE; Sheraton Park Hotel, Washington, April 3-5.

Spring Joint Computer Conference, American Federation of Information Processing Societies; Atlantic City, N.J., April 30-May 2.*

Short Courses

Modern control theory and practice, Iowa State University's Engineering Extension, Ames, Feb. 26-March 1; \$125.

Systematic methods for computer-aided design of computers, University of California, Los Angeles, March 18-29; \$375.

Technical writing and editing, University of California's Engineering and Physical Sciences Department, Los Angeles, April 1-5; \$275.

Call for papers

Microelectronics Symposium, IEEE; Sheraton-Jefferson Hotel, St. Louis, June 17-19. **March 15** is deadline for submission of summaries to Dr. Remo Pellin, Semiconductor Materials Dept., Monsanto Co., 800 North Lindbergh, St. Louis.

International Broadcasting Convention, IEEE; London, Sept. 9-13. **March 21** is deadline for submission of synopses to J.L. Regan, International Broadcasting Convention, Institution of Electrical Engineers, Savoy Place, London, W.C. 2, England.

International Conference on Microwave and Optical Generation and Amplification, IEEE; Nachrichtentechnische Gesellschaft, Verband Deutscher Elektrotechniker; Hamburg, West Germany, Sept. 16-20. **April 10** is deadline for submission of lectures to paper committee, Dr. F.W. Gundlach, Institute for High-Frequency Technology, Jebensstrabe 1, D-1 Berlin 12.

* Meeting preview on page 16.

Check your airborne radar application:

- () Weather Avoidance
- () Fire Control
- () Bomb/Nav
- () Terrain Following and Avoidance
- () Navigation and Landing
- () Beacons and Transponders

Now check the world's broadest line of coaxial magnetrons.

Litton's. These long-lived, highly efficient and stable coaxial magnetrons are available in a series of high power, pulse outputs at Ku-band and X-band. Tubes are available at fixed frequencies or in a number of tunable configurations for frequency agility. The tuning techniques include rapid wide band tuning for ECCM as well as dither for target enhancement. We offer two im-

portant services: fast reaction capability for new applications; extensive applications engineering to help systems designers choose the right tube and related equipment. Check out Electron Tube

Division. See what a difference coaxial magnetrons can make in your airborne radar systems design. 960 Industrial Road, San Carlos, California 94070 or 1035 Westminister Drive, Williamsport, Pennsylvania 17701.



 **LITTON INDUSTRIES**
ELECTRON TUBE DIVISION

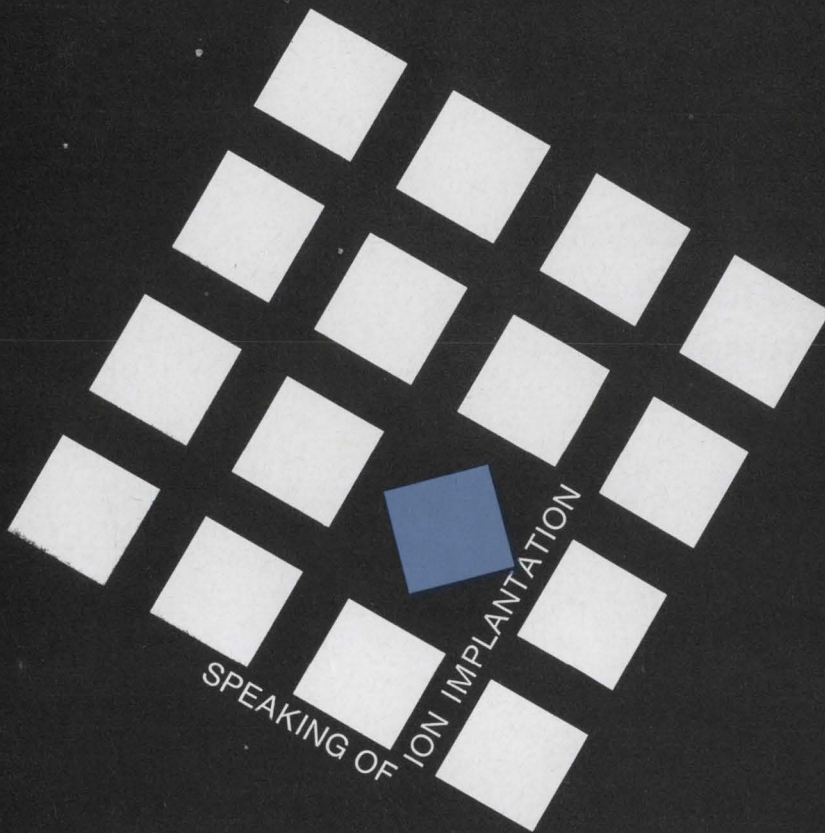

... They laughed
when we set out
to make something useful.

That was seven years ago. We accelerated a beam of heavy ions toward a silicon crystal to see if a semiconducting junction would be implanted. It wasn't. But if you have a team of solid state physicists, atomic physicists, semiconductor specialists, electrical and mechanical engineers boring in on a problem, something's got to give — and it did.

A few people are still laughing about ion implantation as a manufacturing process. Especially us. Because at this point in time we are manufacturing semiconductor devices with our Implion[®] process at the rate of 20,000 a month, and the yield is exhilarating.

Of course our present production

rate isn't going to choke the market, and our device, a high performance solar cell, isn't necessarily what the world is waiting for. But space people like its reliability, uniformly high output, and long life — qualities we are now engineering into more sophisticated devices like transistors. And the controlled-beam Implion process has fascinating possibilities for writing integrated circuits composed of active devices, resistors, capacitors, and connectors — all computer-programmed.

Ion implantation. When you say that, smile. So far there's a lot to be happy about. Write for more information.



ION PHYSICS CORPORATION

A subsidiary of High Voltage Engineering Corporation, Burlington, Mass. 01803

Meeting preview

Back at the boardwalk

Two sessions of particular interest at the American Federation of Information Processing Societies' Joint Computer Conference will cover the timely questions of time-sharing scheduling and the effect of large-scale integration on hardware-software tradeoffs. This year's spring meeting will again be held in Atlantic City, N.J., April 30 to May 2. The midweek dates, customary with AFIPS, permit the holding of special-interest meetings immediately before and after the main conference.

Time sharing, a novel concept as recently as two or three years ago, has grown so rapidly that computer men are talking about second-generation approaches and problems. One of the papers to be presented during this session will discuss ways of sidestepping or taking advantage of scheduling techniques. The authors, Leonard Kleinrock of the University of California and E.G. Coffman of Princeton University, maintain that techniques to counter scheduling algorithms can almost always be worked out, and that they can severely degrade system performance.

LSI or not. The panel discussing hardware-software tradeoffs will be headed by Jack A. Githens, a researcher at Bell Labs. Panelists will note that although large-scale integration can sharply cut hardware, the technique won't reduce the over-all cost of a system unless the designer takes advantage of the hardware savings to trim the software or improve system performance.

Among other papers of interest will be a description by H.N. Cantrell and A.L. Ellison, scientists at the General Electric Co., of a technique for analyzing the performance of the GE 625 computer in a multiprogrammed environment. Kenneth E. Batcher, an engineer at the Goodyear Aerospace Corp., will discuss a device that can arrange a set of numbers in numerical order in relatively few steps; its application is in the switching network that controls paths between the various components of a large-scale computing system.

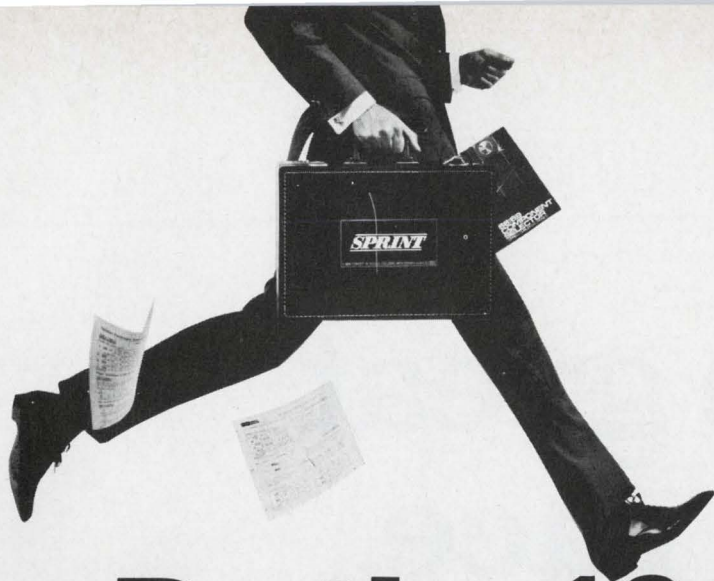

Be the 100,001st to get a CDE Component Selector.

**If you ever received a CDE Component Selector,
your new one is on the way!**

This 68/69 edition is completely revised to cover all the latest developments in electronic components, and refinements in product standardization. It lists CDE's Standard Product line covering 98% of industry requirements. It is designed to guide you in the selection of the proper component to meet your precise requirements.

For your copy, simply mail the coupon below.



CDE CORNELL-DUBILIER 50 Paris Street Newark, N. J. 07101

Please send me a copy of your new Component Selector. I have not requested one before.

My applications are: Home electronics Electronic gear
Industrial (non-electrical) Research

NAME _____

TITLE _____

COMPANY _____

STREET & NUMBER _____

CITY _____ STATE _____ ZIP _____

Circle 17 on reader service card

The great LSI race.

While the rest of the semiconductor industry tried to squeeze enough ICs on a chip to get into the MSI/LSI business, Fairchild turned systems inside out. We were looking for an intelligent alternative to component mentality. Our investigation led to a whole new set of design criteria for medium and large scale integration devices.

A computer isn't a computer.

It's a digital logic system. It has the same functional needs as any other digital system: control, memory, input/output and arithmetic. There's no logical reason to custom design a complex circuit for each system. That's why Fairchild MSIs and LSIs are designed to function as fundamental building blocks in any digital logic system. Even if it's a computer.

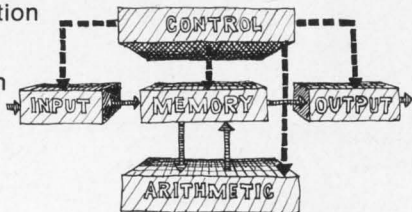

A little complexity goes a long way.

Anybody can package a potpourri of circuitry and call it MSI or LSI. But, that's not the problem. Why multiply components, when you should divide the system? Like we did. We found that sub-systems have a common tendency toward functional overlap. There are too many devices performing similar functions. More stumbling blocks than building blocks. Our remedy is a family of MSIs and LSIs with multiple applications. The Fairchild 9300 universal register, for example, can also function as a modulo counter, shift register, binary to BCD shift converter, up/down counter, serial to parallel (and parallel to serial) converter, and a half-dozen other devices.

Watch out for that first step.

There are all kinds of complex circuits. Some of them have a lot of headache potential. Especially if you want to interface them with next year's MSIs and LSIs. We decided to eliminate the problem before it got into your system. All Fairchild building blocks share the same compatible design characteristics.

We're also making the interface devices that tie them together. For example, our 9301 one-of-ten decoder can be used as an input/output between our universal register, dual full adder and memory cell.

(It could also get a job as an expandable digital demultiplexer, minterm generator or BCD decoder.)

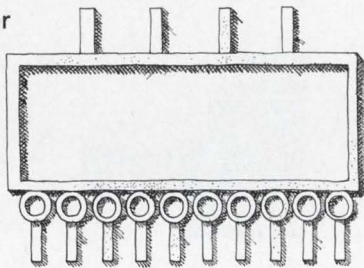

Hurry. Before the price goes down.

Gate for gate, today's complex circuits are about the same price as discrete ICs. But, by the time you're ready to order production quantities, the price should be a lot lower. At least ours will. The reason is simple: Fairchild devices are extremely versatile. There are fewer of them. But, they do more jobs. That means we'll be producing large quantities of each device. That also means low unit cost to you. And you'll have fewer devices to inventory. And fewer to assemble.

If you agree with our approach to medium and large scale integration, we'd like to tell you more about it. There are two ways you can get additional information. One is by mail. Simply write us on your company letterhead. You can also get more data by watching the trade press. Fairchild is introducing a new integrated circuit each week for 52 weeks. (We started on October 9, 1967.)

Many of them will be MSI and LSI. If you'd like to see the last few we've introduced, turn the page.

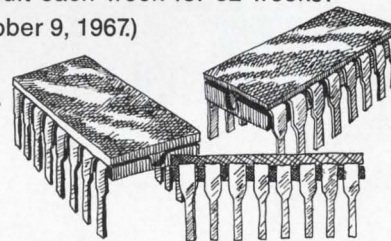

FAIRCHILD SEMICONDUCTOR
A Division of Fairchild Camera and Instrument Corporation
313 Fairchild Drive, Mountain View, California 94040
(415) 962-5011, TWX: 910-379-6435

RECAP:

3102 MOS THREE- INPUT GATE

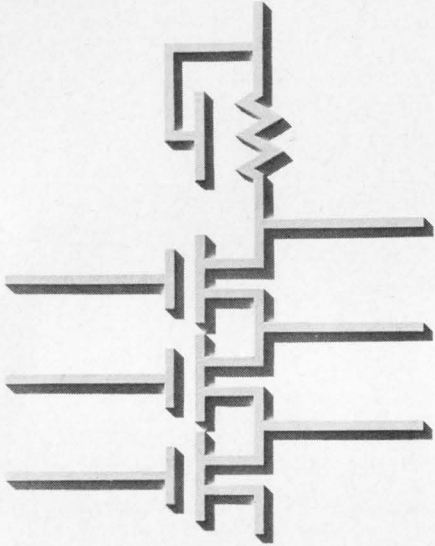

FALCON
SEMICONDUCTOR

FALCON SEMICONDUCTOR, A Division of Fairchild Camera and Instrument Corporation, 310 Fairchild Drive, Mountain View, California 94035, (415) 963-0111, TWX: 910-278-8400

CIRCLE READER SERVICE NUMBER 113

Starting October 9, 1967, Fairchild promised to introduce a new integrated circuit each week for 52 weeks. This is number **13.**

The 3102 is an extremely versatile three-input breadboxed gate which can serve as the fundamental element in any MOS digital logic system. It can also function as an evaluation tool for determining the performance of Fairchild's line of MOS integrated circuits. The 3102 comes in both TO-9 cans (one 3102 per can) and in 16-pin DIPs (two devices per package). The availability of an on-chip and drain leads for each transistor provides excellent logic versatility. Input protection reduces handling problems, and an internal diode typically as low as 50mV. Operating temperature ranges from -55°C to +85°C. Volume quantities of the 3102 are now available. Your Fairchild distributor has it on his shelf. Write us for complete specs and applications information. While you're at it, ask about our other new products, too.

3700 FOUR-CHANNEL MULTIPLEX SWITCH

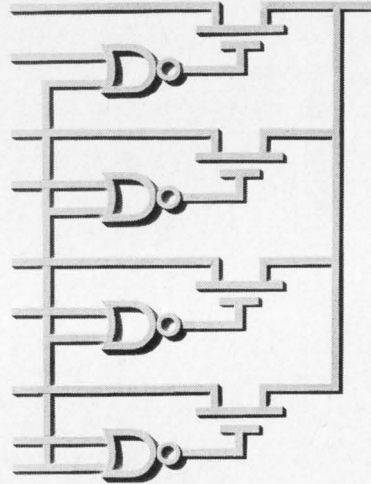

FALCON
SEMICONDUCTOR

FALCON SEMICONDUCTOR, A Division of Fairchild Camera and Instrument Corporation, 310 Fairchild Drive, Mountain View, California 94035, (415) 963-0111, TWX: 910-278-8400

CIRCLE READER SERVICE NUMBER 114

Starting October 9, 1967, Fairchild promised to introduce a new integrated circuit each week for 52 weeks. This is number **14.**

Fairchild's 3700 is designed for use in A/D and D/A converters, multiplexing, analog or digital data transmission systems, and other airborne or ground instrumentation signal routing applications. It can be used in telemetry systems, computers, remote monitoring equipment and transmitter timing equipment. Control logic has been included to make it APN bipolar compatible. It utilizes Planar P⁺-P-channel enhancement mode MOS technology and provides all channel matching control. It also features zero offset voltage, high ON/OFF ratio and input gate protection. And, our 8112 high level hex inverter (see product number 81) can be used to directly interface the 3700 with CDS, input needs. The 3700 is available in two signal ranges: the 3700A2 for -5.0 to +5.0 volts, and the 3700B2 for ranges of 0 to +5.0 volts. Both of the 3700 devices come in flat pack and will operate over the entire temperature range from -55°C to +85°C. They're available now in volume quantities. Your Fairchild distributor has them in stock. Write for complete specs and applications information. Ask about our other new products, too.

3303 DUAL 25-BIT DYNAMIC SHIFT REGISTER

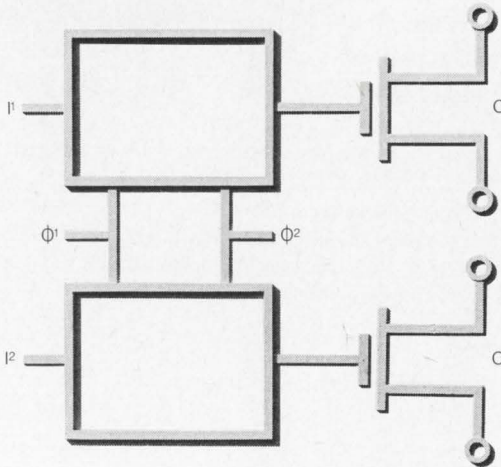

FALCON
SEMICONDUCTOR

FALCON SEMICONDUCTOR, A Division of Fairchild Camera and Instrument Corporation, 310 Fairchild Drive, Mountain View, California 94035, (415) 963-0111, TWX: 910-278-8400

CIRCLE READER SERVICE NUMBER 115

Starting October 9, 1967, Fairchild promised to introduce a new integrated circuit each week for 52 weeks. This is number **15.**

The 3303 is a product of Planar P⁺-P-channel enhancement mode MOS technology. It contains two 25-bit shift register strings with two common clock lines. Output stages can be connected as either inverters or as buffers. It is applicable for digital delay lines in computers and radar systems (both ground and airborne). It can also be used as a serial memory in telemetry systems. The 3303 comes in a 110-pin can and will operate over the entire temperature range from -55°C to +85°C. It operates at 1 MHz typical. Power dissipation is typically less than 200mW per bit. Volume quantities of the 3303 are now available. Your Fairchild distributor has it in stock. Write for complete specs and applications information. Ask about our other new products, too.

9307 BCD TO SEVEN-SEGMENT DECODER

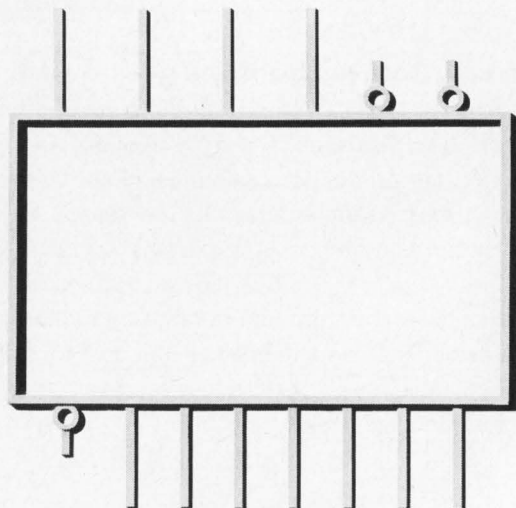

FALCON
SEMICONDUCTOR

FALCON SEMICONDUCTOR, A Division of Fairchild Camera and Instrument Corporation, 310 Fairchild Drive, Mountain View, California 94035, (415) 963-0111, TWX: 910-278-8400

CIRCLE READER SERVICE NUMBER 116

Starting October 9, 1967, Fairchild promised to introduce a new integrated circuit each week for 52 weeks. This is number **16.**

The Fairchild 9307 is designed to be used in any numeric display system which requires seven-segment information. This includes incandescent, electroluminescent, seven-segment neon, or CRT numeric displays. It is an MOS device. It accepts an input in BCD code and produces individual outputs to drive the seven-segment display system. It has an active low input lamp test which overrides all other logic conditions and verifies overall lamp operation. It also has active high outputs for blank override. In addition, it has input blanking inputs and outputs for providing leading edge zero suppression. It also has internally modulation capability. The 9307 is a CMOS device in a 16-pin hermetic DIP. It operates from a single 5-volt power supply. It comes in both military and industrial temperature ranges (-55°C to +125°C and 0°C to +70°C). The 9307 is available in volume quantities. Your Fairchild distributor has it in stock now. Write for complete specs and applications information. Ask about our other new products, too.

Fairchild is introducing a new integrated circuit every week. The last two months look like this.



Starting October 8, 1967, Fairchild promised to introduce a new integrated circuit each week for 52 weeks. This is number **17.**

9620 DUAL DIFFERENTIAL LINE RECEIVER

The 9620 is designed to take differential logic from transmission lines and convert it to CMOS levels. It also has the capability for conversion to higher levels. It is ideal for use in data receivers, or in data processing applications where the central processor and data source are in separate locations. The 9620 can also be used as a CMOS-compatible differential comparator.

Each section of the dual IC consists of a differential amplifier, driving a saturating inverting DTL gate with uncommitted collector. Maximum differential threshold voltage is $\pm 500\text{mV}$ in the presence of ± 15 volts common mode. Typical power dissipation is 500mW per receiver. Propagation delay is 10ns maximum at 25°C. High common mode rejection is also provided.

The 9620 comes in a 14-pin hermetic DIP and will operate in both military and industrial temperature ranges -55°C to 125°C and 0°C to $+70^\circ\text{C}$ if it is available in some quantities. Your Fairchild distributor has it in stock now. Write for complete specs and applications information. Ask about our other new products, too.

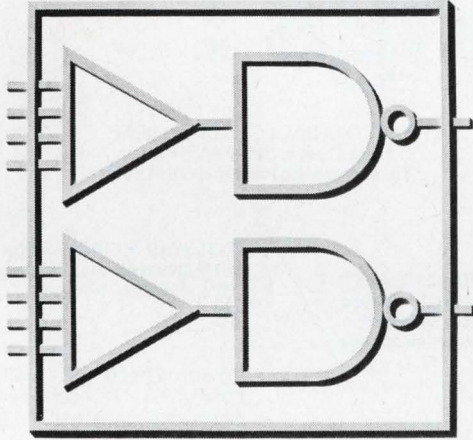

FAIRCHILD SEMICONDUCTOR • A Division of Fairchild Camera and Instrument Corporation
FAIRCHILD SEMICONDUCTOR
 315 Fairchild Drive, Mountain View, California 94035 (415) 961-9111 FAX: 915-973-8410

CIRCLE READER SERVICE NUMBER 117

Starting October 8, 1967, Fairchild promised to introduce a new integrated circuit each week for 52 weeks. This is number **18.**

9621 DUAL LINE DRIVER

Fairchild's 9621 is used to transmit CMOS-level logic-level transmission lines. It can also be used to drive high-capacity loads. It consists of a 2-input inverting DTL gate and a 2-input inverting DTL gate. There is a termination resistor available on each stage which permits you to backmatch 150-Ohm lines, either directly or differentially. An external resistor is available on the 2-input gate which allows you to add additional external loads, and thus obtain more inputs. The 9621 can also be used as a line output impedance driver. Each driver provides maximum output current of 20mA at 0V. Load capacitance is provided to damp reflections on the output.

Maximum power dissipation for the new IC is 210mW. Propagation delay is 20ns maximum into a 50pF load. It comes in a 14-pin hermetic DIP and will operate in both military and industrial temperature ranges -55°C to $+125^\circ\text{C}$ and 0°C to $+70^\circ\text{C}$.

Applications for the 9621 include data processing and computer peripheral equipment. It is designed specifically to operate in conjunction with our 9620 dual differential line receiver (New Product No. 17). Both devices are available in volume quantities. Fairchild distributors have them in stock now. Write for complete specs and applications information. Ask about our other new products, too.

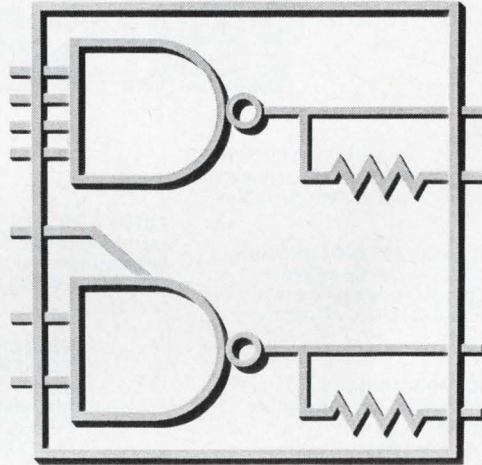

FAIRCHILD SEMICONDUCTOR • A Division of Fairchild Camera and Instrument Corporation
FAIRCHILD SEMICONDUCTOR
 315 Fairchild Drive, Mountain View, California 94035 (415) 961-9111 FAX: 915-973-8410

CIRCLE READER SERVICE NUMBER 118

Starting October 9, 1967, Fairchild promised to introduce a new integrated circuit each week for 52 weeks. This is number **19.**

3300 25-BIT MOS STATIC SHIFT REGISTER

The 3300 is the fifth MOS device we've introduced since December 15, 1967. It has four bits, the 3301 the external multiplex switch, 3302 three-input gate, 3303 four-channel multiplex switch, and the 3304 the 25-bit dynamic shift register.

The 3300 is a monolithic IC utilizing Planar $\text{P}^+\text{-N}^+\text{-P}$ channel enhancement mode MOS technology. It is designed to be used for digital delay lines and long-term memory storage in radio systems and computers. It is also applicable for data storage systems and computers. It is also applicable for data storage systems and computers.

The 25-bit device comes in a TO-8 can and will operate over the entire temperature range from -55°C to $+85^\circ\text{C}$. There are independent 16-, 8- and 1-bit data strings within the package. Power dissipation is typically 200mW per can. Speed is typically 500ns. The clock driver circuit is completed by a single-phase clock input. This input is buffered to improve drive capability. Volume quantities of the 3300 are now available. Fairchild distributors have it in stock. Write for complete specs and applications information. Ask about our other new products, too.

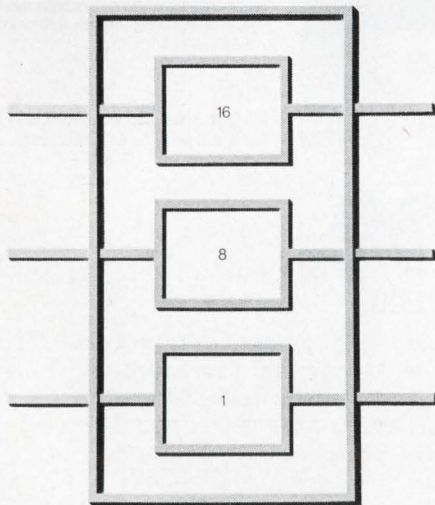

FAIRCHILD SEMICONDUCTOR • A Division of Fairchild Camera and Instrument Corporation
FAIRCHILD SEMICONDUCTOR
 315 Fairchild Drive, Mountain View, California 94035 (415) 961-9111 FAX: 915-973-8410

CIRCLE READER SERVICE NUMBER 119

Starting October 9, 1967, Fairchild promised to introduce a new integrated circuit each week for 52 weeks. This is number **20.**

9110 HIGH LEVEL LOGIC HEX INVERTER

The 9110 is the fundamental element of our new high noise immunity family of buffers and inverters. It has a minimum of 5.5 volts. And, AC noise immunity is even better (it can reject pulses of 100 nanoseconds duration and 20 volts amplitude minimum). Other members of the family provide interfacing capability to make the 9110 compatible with CMOS levels.

The 9110 consists of six high-level DTL gates without input diodes. It can be expanded with external diodes on the input. There is active pull-up on the output for good driving capability. Propagation delay is typically as slow as 170 nanoseconds to reduce sensitivity to high-level noise systems. Output voltage swing is typically 0.5 to 15 volts. The 9110 operates over the entire range of 12 to 20 volts at temperatures of 0°C to $+70^\circ\text{C}$. It comes in an hermetic DIP and is available in volume quantities. It's in stock at your Fairchild distributor now. Write for complete specs and applications information. Ask about our other new products, too.

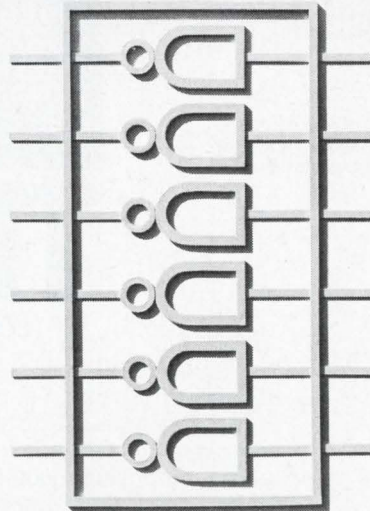

FAIRCHILD SEMICONDUCTOR • A Division of Fairchild Camera and Instrument Corporation
FAIRCHILD SEMICONDUCTOR
 315 Fairchild Drive, Mountain View, California 94035 (415) 961-9111 FAX: 915-973-8410

CIRCLE READER SERVICE NUMBER 120

Which IC Test System does all these things?

DIAGNOSTIC COMPUTER PROGRAMS automatically check out system operation.

FAST TESTING. 1.5 msec per test. If crosspoint is changed, 5 msec. 10 msec on the lowest current scales.

DATALOG A FORCING FUNCTION, such as the input threshold level of a flip-flop needed to produce a specified output.

AUTOMATIC SELF-CHECKING assures accurate data transfer between operator, teletypewriter, computer and test instrument.

GROWING LIBRARY of improved software packages to insure against obsolescence.

TEN-YEAR GUARANTEE for all instrument plug-in circuitry (it's almost all plug-in).

TYPED SUMMARY SHEETS. Whenever desired. No interruption in testing. Give total units tested per test station, test yields and bin yields.

VERY COMPLEX TEST SEQUENCES can be programmed, yet preparation of simple tests can be learned in two hours.

NO ADJUSTMENT OR CALIBRATION POINTS. (Eternal vigilance is the price you pay for a single adjustment.)

DIRECT ENGLISH data logging type-out, showing job name, serial number, test number, decimal point and units.

OPEN AND SHORTED CONNECTIONS and **OSCILLATIONS** are automatically detected. System stops when a selected consecutive number of these occur.

ABSOLUTE SOURCE CONTROL. Sources can be turned ON or OFF and changed in value in any sequence with variable delays from 100 μ sec. to as long as you please.

COMPLETE FRONT PANEL DISPLAY at any desired step, simultaneously indicating all crosspoint connections, forced values, measured limits, binning decisions—everything about each test.

DATALOG at any test station—without slowing down classification tests at any other station.

MINIMIZED REPETITIVE INSTRUCTIONS for the operator through data libraries, variable word length programming, and autopinning.

MULTIPLEXING. Several jobs simultaneously. Any assigned, at any time, to any test station.

PROGRAMMABLE CURRENT LIMITS for each source at each test.

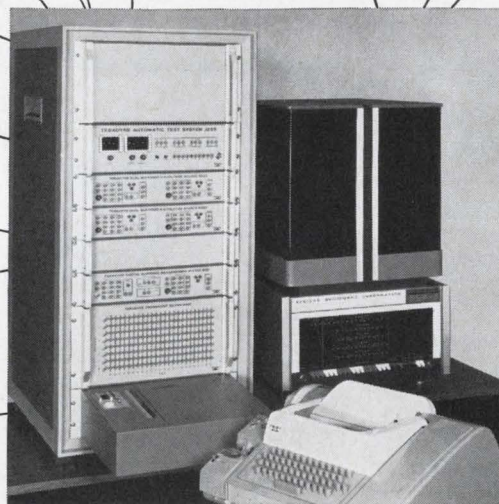

This one.

(complete for only \$65,000)

This is our J259 computer-operated Automatic Circuit Test System. It includes a general-purpose digital computer, teletypewriter, test instrument (comprising modular elements: 24 x 8 crosspoint matrix, four volt-

age sources, measurement system, and test deck), complete software package, and courses in IC testing, system operation, and maintenance. TERADYNE, 183 Essex St., Boston, Mass. 02111 Phone (617) 426-6560.

TERADYNE

Commentary

Charting innovation

Bardeen, Shockley and Brattain, the transistor trio on the cover of this issue, have been asked countless times to explain the steps that led to their breakthrough. Although the question takes any number of forms, it can always be translated as "How did you do it?"

Even though the creative process defies analysis, the search for a magic formula never ends. If creativity could be codified, every musician would be a Beethoven, every painter a Rembrandt, and every writer a Tolstoy. All scientists and engineers would be Newtons, Da Vincis, Faradays, and Galileos.

On one occasion when a respected colleague asked the inevitable question, Dr. Shockley elected to restate it in two ways:

"Was the creation of the transistor a deliberate, planned consequence of an industrial research program?" Or, "Did the transistor come as a lucky accident during the conduct of pure basic research having no practical idea in mind?" Shockley concluded that the transistor was neither the result of the application of known theories to reach a desired practical goal, nor was it an accident that came as a dividend from doing basic research. Instead, the transistor was developed through a combination of men, events and needs; added were the intangibles of intuition and inspiration.

First, there was the need for a rugged reliable amplifier. Bell Laboratories envisioned it as a replacement for relays and vacuum tubes. John Bardeen recalled in his Nobel lecture that two possibilities had been suggested. The first followed from the analogy between a metal semiconductor rectifying contact and a vacuum tube diode. Researchers pondered how to place a grid in the space charge layer at the contact—a layer that is only about 10^{-4} in. wide. Later, Hilsch and Pohl built such a triode in an alkali halide crystal, but it would only amplify signals of less than one hertz.

The second approach was to apply an electric field to a semiconductor film and thus control its conductance. Shockley was among those to suggest this "field effect" form.

Besides the need for the transistor and some ideas on how to achieve it, an important factor was the independent development of the theory of contact rectification by Schottky and others. Furthermore, the work on silicon and germanium had come along well during the war years, spawned by the interest in cat's-whisker detectors for radar. Not all of this work was done at Bell Labs; a group at Purdue University under Lark-Horovitz had

made important studies of germanium.

As a result, when a group of Bell Labs staffers began work on semiconductors after the war, they had, if not uppermost in their minds, at least a good idea of what one of the major results could be—a practical solid state amplifier—and they had a respectable library of information on semiconducting materials and theory.

Bell's direct approach to building such an amplifier was stopped in its tracks when the unforeseen problem of surface states "got in the way" and prevented progress. Bardeen's hunch—the creative variable—led to its solution through the development of a fresh concept.

Those involved remember the steps immediately preceding the achievement of transistor action differently. [On page 78 the details are reconstructed as the inventors recall them.] But it's generally agreed that the observation of point-contact-transistor action was unexpected. What breakthrough is not a surprise? When the first wheel rolled, there must have been the same amazed reaction.

The answer a researcher gives when asked how much of his invention is deliberate and how much is through good fortune is like that of a poker player with a winning hand—both may think less than 10% is luck. The more skilled each is, the more likely his conclusion is right.

One thing seems certain; there are no hard and fast rules for technological innovation. Shockley believes in certain broad principles, but says "rigid plan structures may very well block the path to the desired objectives." Fixed operating rules are more valid as the work shifts from theory to engineering.

Prime requisites for success are the creation of a body of knowledge and an atmosphere in which progress toward a general goal is made easy.

The atmosphere at Bell Labs was apparently near-perfect. Brattain recalls the team as the greatest of any he'd been on, and Shockley attributes success to an important mixture of freedom and constraint at the laboratories.

The chain of events that led to the transistor can be set down to serve as a plan of attack for new, yet unsolved technological problems:

- The problem is defined.
- The body of knowledge bearing upon the problem is reviewed, reorganized and bolstered.
- A solution is postulated.
- Experiments are made to test the proposed solution.
- When snags are hit, it's back to the drawing board, to repositulate a new solution.

It looks beautiful on paper. The sequence is neat and simple but in practice it will be neither orderly nor systematic.

The creative process can be disorganized, frustrating and laborious. The neophyte inventor needs talent, patience and luck. Those ingredients, fortunately, were assembled when Bardeen, Brattain and Shockley worked together.

Electronics Newsletter

February 19, 1968

H-P is entering microwave IC field

An outsider is ready to challenge the semiconductor makers and systems houses that have been preparing to slice up the lucrative microwave IC market. [Electronics, Oct. 30, p. 107]. Hewlett-Packard's microwave division has developed what appears to be the broadest line yet of r-f and microwave integrated circuits. The instrument company will offer the IC's off the shelf by spring.

The hybrid units contain thin-film passive elements and active interdigitated chips, and are designed to handle preamplifier and power-amplifier functions in the spectrum from 10 khz to 2 Ghz. They will be priced in the \$250-to-\$1,500 range, making them competitive with conventional microwave circuits. H-P will offer discounts for volume orders. Five of the six IC's comprising the first wave of these H-P products are built with lumped-component techniques; the sixth uses both lumped and distributed component elements. The IC's will be housed in 12-lead metal cans for p-c board mounting; coaxial connection will be optional.

Under development for two years, the devices were initially intended for use in H-P's instruments.

GE audio-amp IC uses but four pins

General Electric's Semiconductor division has developed a new monolithic audio amplifier that can be designed into existing audio systems with only four pins. Competitive models usually require users to design to eight active pins. The GE device, a 1-watt IC, is part of the firm's PA-200 series of linear circuits. Due to be marketed soon, it will sell for about \$1 in volume quantities.

It contains six npn and one pnp transistors, three diodes, and three resistors. A company spokesman says the design eliminates biasing resistors, high-frequency stabilizing components, and other external auxiliary devices. The new unit will be housed in a standard eight-lead package to avoid retrofit problems. Only six external components—three resistors and three capacitors—are needed with the IC to build a complete audio amplifying stage.

Tacfire may get mortar-spotting role

The Army's Tactical Fire Direction System (Tacfire) will need no other sensors than the eyes of forward artillery spotters. But officials at Litton Industries, the prime contractor, have been talking with representatives of ITT Gilfillan about incorporating data from the AN/TPQ-28 mortar-locating radar into the system. Litton is confident that Tacfire computers will eventually accept direct digital inputs from the 360°-scanning radar being developed by ITT Gilfillan, along with the target information collected by forward observers.

Autonetics seeks LSI plant chief

Autonetics is looking for an experienced hand in microelectronics manufacture to put its new plant for large-scale integrated circuits on a production footing. Heading the list of possible candidates, insiders say, is J.P. Ferguson, who resigned last November as general manager of Philco-Ford Microelectronics. Autonetics announced last July that it intended to begin volume production of LSI devices [Electronics, July 10, 1967, p. 43]. The 40,000-square-foot facility it's now building for that purpose is slated for completion in August.

Electronics Newsletter

Military asks study of plastic packages

Plastic-packaged semiconductor devices—long barred from military electronic gear—may soon be accepted by the Pentagon.

The Air Force's Rome, N.Y., Air Development Center has awarded a contract to Autonetics to study the effects of ionic impurities in plastic-encapsulated bipolar transistors. And Autonetics' project chief, Anthony Valles, believes that if plastic packaging proves feasible for military transistors, studies of its use with other discretes, and even integrated circuits, will soon follow.

Several firms, including Motorola, Texas Instruments, Fairchild, and Signetics, have conducted independent studies indicating that plastic packages would survive military environments.

Another sign that the wider use of plastics by the Pentagon isn't far off is the fact that a recent Navy award to Cardion Electronics didn't rule out the use of plastic-packaged dual in-line IC's [Electronics, Jan. 8, p. 26].

Move of radio site by Pentagon called \$12 million waste

The Pentagon today will be charged with wasting \$12 million on a naval radio-receiving station that won't be as effective as the one it's replacing. Rep. H.R. Gross, an economy-minded Iowa Republican, will take the Pentagon and Defense Secretary McNamara to task for forcing the relocation of the receiver from Cheltenham, Md., to Sugar Grove, W.Va. The receiver is scheduled to be completed in December.

The West Virginia Congressional delegation for years has pushed defense leaders to use the Sugar Grove site for some purpose that would bring jobs to the depressed area. A 600-foot intelligence gathering telescope was started on the location but canceled when costs spiraled [Electronics, Aug. 22, 1966, p. 42].

Gross is armed with a report he ordered from the General Accounting Office. It discloses that McNamara in 1966 ordered a reluctant Navy to proceed with the new station unless the move would result in a "significant loss" in operational capability. But engineering studies showed that Sugar Grove would probably be a less advantageous site than Cheltenham. A fear of "electronic pollution" at Cheltenham, just outside Washington, was given as the reason for the move.

General Precision lays off engineers in fight to survive

General Precision Equipment is quietly laying off engineers and marketing men in a move apparently aimed at thwarting attempts by the Singer Co. to acquire it. Hardest hit is its Kearfott Products division, with Kearfott Systems next. About 250 employees, including some production workers, have already been fired, but the layoffs may hit 2,000 of the 7,000 employed at the two units.

Industry insiders see the layoffs as a move to back up the promise of J.W. Murray, the company's chairman, of a better deal for stockholders. They believe Murray wants to discourage stockholders from selling their shares to Singer by reducing overhead and thus increasing profits.

The company cites production stretch-outs, but the layoffs are coming at a time when General Precision has been winning more than its share of contracts.

Nortronics favored for airborne Omega

Industry insiders say the Navy is now talking only with Northrop's Nortronics division about an airborne Omega navigation receiver, and that the firm will soon get a two-phase award said to be worth more than \$1 million [Electronics, Nov. 13, 1967, p. 56].

SEMICONDUCTOR NEWSBRIEFS

PUBLISHED BY MOTOROLA SEMICONDUCTOR PRODUCTS INC.

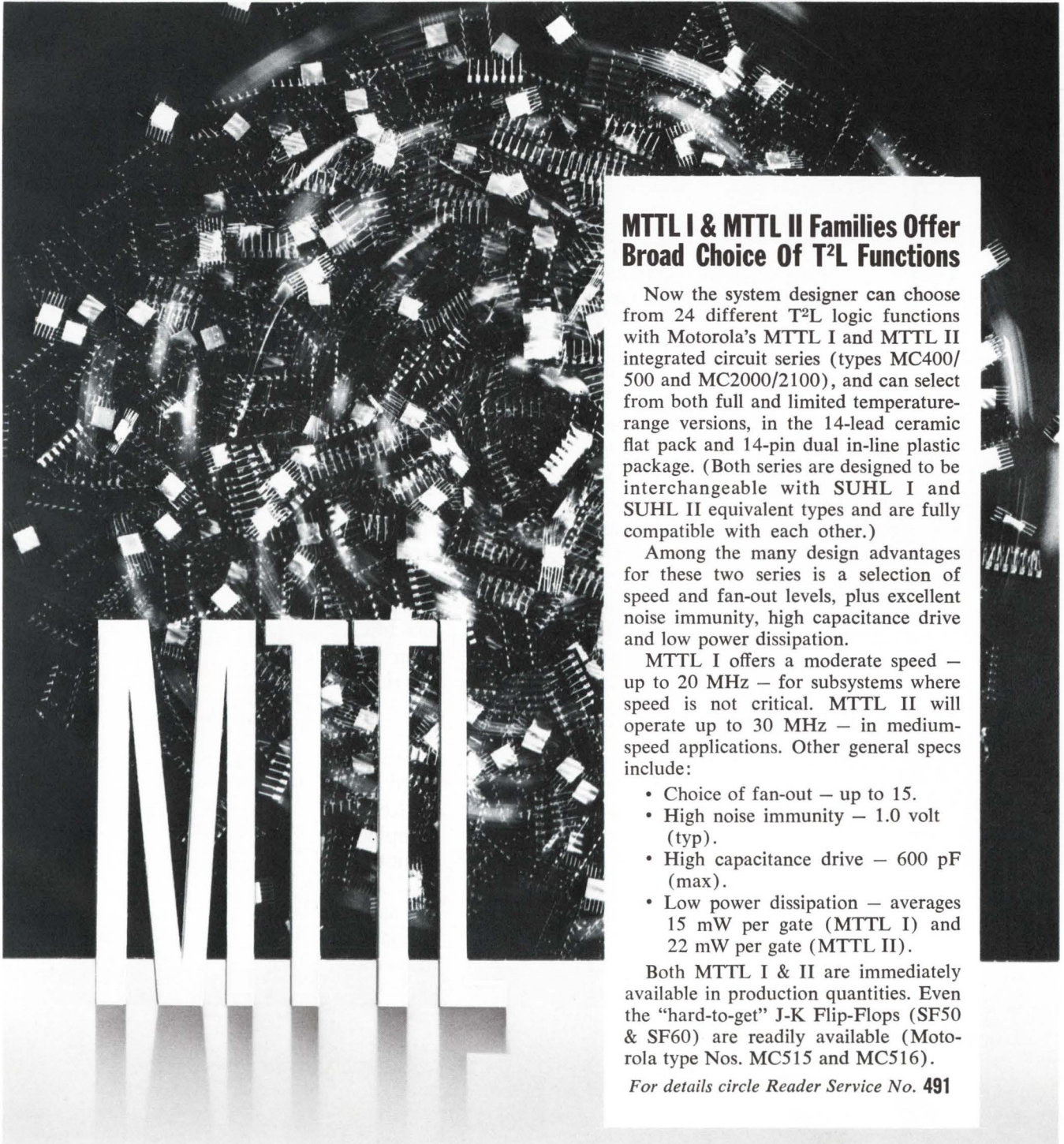

MTTL I & MTTL II Families Offer Broad Choice Of T²L Functions

Now the system designer can choose from 24 different T²L logic functions with Motorola's MTTL I and MTTL II integrated circuit series (types MC400/500 and MC2000/2100), and can select from both full and limited temperature-range versions, in the 14-lead ceramic flat pack and 14-pin dual in-line plastic package. (Both series are designed to be interchangeable with SUHL I and SUHL II equivalent types and are fully compatible with each other.)

Among the many design advantages for these two series is a selection of speed and fan-out levels, plus excellent noise immunity, high capacitance drive and low power dissipation.

MTTL I offers a moderate speed — up to 20 MHz — for subsystems where speed is not critical. MTTL II will operate up to 30 MHz — in medium-speed applications. Other general specs include:

- Choice of fan-out — up to 15.
- High noise immunity — 1.0 volt (typ).
- High capacitance drive — 600 pF (max).
- Low power dissipation — averages 15 mW per gate (MTTL I) and 22 mW per gate (MTTL II).

Both MTTL I & II are immediately available in production quantities. Even the "hard-to-get" J-K Flip-Flops (SF50 & SF60) are readily available (Motorola type Nos. MC515 and MC516).

For details circle Reader Service No. 491

Featured In This Issue:

- Single-Chip 709 Dual Op Amp . . . Page 2
- First EIA Registered Quad Page 3
- New BET RF Power Transistors . . Page 5

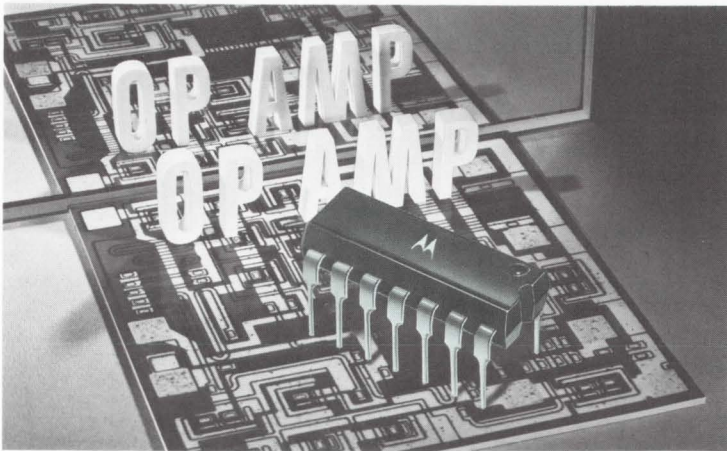

Two closely-matched MC1709C's have been combined, on a single monolithic chip, to yield the dual MC1437P op amp — and you save almost 1/3 the cost of 2 single units!

Single-Chip Monolithic 709 Dual Op Amp Provides Matched Parameters!

We've put two of our popular MC-1709C op amps on a **single monolithic chip** and packaged it in the Unibloc plastic case. We call it the MC1437P.

The result? A matched set of op amps with characteristics that assure optimum dual amplifier performance (see table).

MATCHING CHARACTERISTICS (Both Amplifiers)	TOLERANCES (typ)
Open Loop Gain (A_{VOL1}/A_{VOL2})	± 1.0 dB
Input Bias Current (I_{b1}/I_{b2})	± 0.15 μ A
Input Offset Current (I_{io1}/I_{io2}) @ Average TC (TC_{Iio1}/TC_{Iio2})	± 0.02 μ A ± 0.2 nA/ $^{\circ}$ C
Input Offset Voltage (V_{io1}/V_{io2}) @ Average TC (TC_{Vio1}/TC_{Vio2})	± 0.2 mV ± 0.5 μ V/ $^{\circ}$ C
Channel Separation @ 10 kHz ($\frac{E_{out1}}{E_{out2}}$)	-45 dB

Each amplifier has a typical open loop voltage gain of 45,000 with temperature drift of only ± 3 μ V/ $^{\circ}$ C. It also has the ability to swing almost the entire supply voltage (V_{out} typ. = ± 14 V, peak @ 15 V supply), while output impedance is only 30 ohms, typ.

The MC1437P dual op amp is ideal for chopper stabilized applications requiring extremely high, ultra-stable voltage gain. These "twins" function well as summing amplifiers, integrators, or as amplifiers with operating characteristics as a function of external feedback.

While you can't quite get two op amps for the price of one, with the MC1437P it's pretty close — only \$8.50 (100-up) -vs- \$6.00 for a single MC1709CP.

For details circle Reader Service No. 492

Wideband I/C Diff-Amp Delivers Flat Response From DC to 40 MHz

The MC1510 differential amplifier offers flat response down to dc and does not require ac coupling of the input and output. This reduces "extra" component needs — simplifies design.

In addition to its low-frequency response, the MC1510 also offers a typical bandwidth to 40 MHz (it can be used with gain to above 100 MHz) and, gain is specified typically at $A_V = 93$.

Its high common-mode rejection ratio of -85 dB (typ), along with a dc power dissipation of 220 mW (max)

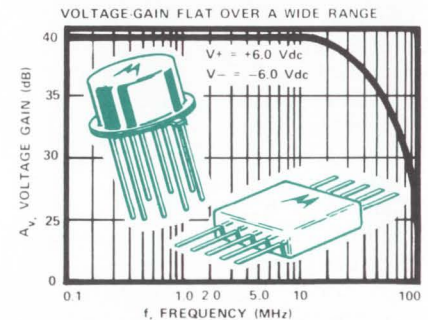

make the MC1510 highly useful in critical differential-amplifier designs.

Other typical characteristics include an output voltage swing of 4.5 V (peak-to-peak) at ± 6.0 V supply; and low output distortion, where THD = 1.5%.

Available in the 8-pin, TO-99 metal "can" and the 8-pin ceramic flat-pack, the MC1510G and MC1510F are priced at \$8.00 and \$9.30, respectively (in 100-up quantities).

For details circle Reader Service No. 494

8-Bit Buffer Register Uses Only 4 MECL II Dual R-S Flip-Flops!

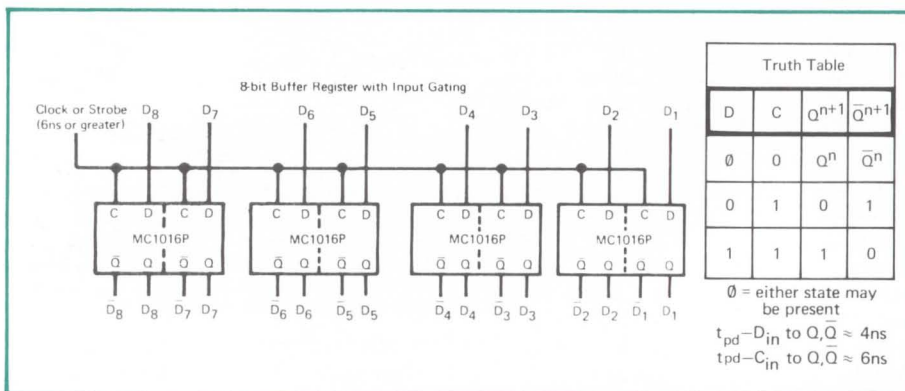

Here's an easier, less-complex and less-expensive way to construct an 8-Bit Buffer Register using just four dual-function MC1016P MECL II integrated circuits! These new dual R-S flip-flops reduce can-count (and system cost) by

doubling the number of functions per package.

The versatile MC1016P, monolithic emitter-coupled flip-flop can be used as a temporary storage element (as shown); as a memory data register; or, as a

For details circle Reader Service No. 493

clocked R-S flip-flop with no undefined logic state.

It employs two single-rail input Set-Reset flip-flops with a positive clock input provided for each of the flip-flops. It has a typical propagation delay of 5.0 ns and operates over a 0 to +75 $^{\circ}$ C temperature range. Typical power dissipation for the MC1016P is 125 mW. Operating frequency is 80 MHz. A minimum dc fan-out of 25 for each output is guaranteed.

A wide-temperature-range version is also available in the 14-lead ceramic flat pack, for -55 to +125 $^{\circ}$ C operating requirements (MC1216F).

The MC1016P is available from distributor stock and is priced at only \$2.60 (1000-up), in the 14-pin dual in-line plastic package while the MC1216F is \$5.75 (100-up).

New TO-66 Packaged Silicon Power Transistors Match Current Ratings Of Many TO-3's

If you've been looking for a smaller silicon power transistor that would still provide the current handling capability of a TO-3 packaged device, the new NPN 2N4231-3 5-amp series, encased in the rugged, compact TO-66, will more than "fill the bill."

These little powerhouse metal-can transistors can serve in a broad spectrum of industrial and military servo-amplifier, driver and switching designs to 4.0 MHz, where space is at a premium . . . and economy is a must!

The units have a minimum guaranteed gain of 25 at $I_C = 1.5$ A — with usable gain up to $I_C = 3.0$ A, which lets them handle much greater current loads while still maintaining a more realistic gain level than similar power transistors. And, as to their safe area capability . . . they can handle up to 29 watts at 1.0 A dc — enough for the most stringent medium-current design requirements!

Peak circuit efficiency is ensured by the exceptionally low power losses of the 2N4231-3 series. For example, the maximum saturation voltage of this series is only 0.7 V at $I_C = 1.5$ A (only about one-half that of comparable types at $I_C = 500$ mA). And, if you're comparing

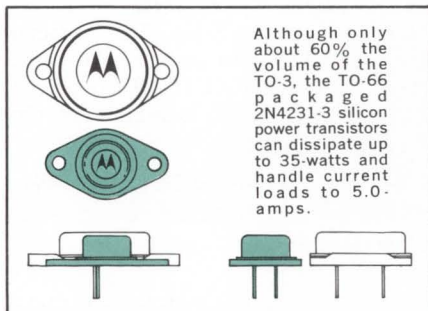

frequency capabilities, note the high 4.0 MHz minimum f_T of the 2N4231-33 series vs. only 800 kHz for other types in the same category.

Here are just a few highlights among many that make the NPN 2N4231-33 silicon power transistor series worth more investigation:

- High $I_{C(\text{cont})} - 5.0$ A
 - Low $V_{CE(\text{sat})} - 0.7$ V (max) @ 1.5 A
 - High $h_{FE} - 25-100$ @ 1.5 A/2.0 V — 10 (min) @ 3.0 A/2.0 V
 - Low Prices (100-up):
 2N4231 ($BV_{CEO} = 40$ V min) \$1.40
 2N4232 ($BV_{CEO} = 60$ V min) 1.60
 2N4233 ($BV_{CEO} = 80$ V min) 2.15
 - High $P_D - 35$ W @ $T_C = 25^\circ\text{C}$
- . . . and they're all available off-the-shelf from your local Motorola distributor.

For details circle Reader Service No. 495

Motorola's new 2N5229-31 silicon Annular TO-46 packaged transistors give you a good "run" of efficient low-level chopper characteristics — and there's more coming soon!

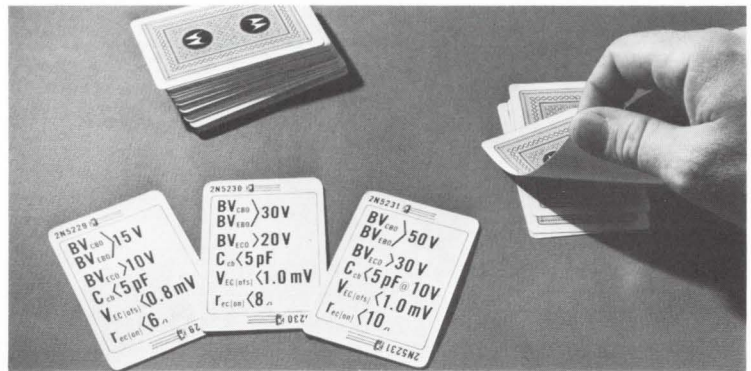

NEW BIPOLAR CHOPPERS BID FOR TOP ROLE IN LOW-LEVEL DESIGNS

Did you know that there are now bipolar devices that make it possible to design chopper circuits which can effectively operate at current levels as low as 100 μA ?

We're talking about Motorola's new 2N5229-31 silicon Annular PNP transistor series having low capacitance values ($C_{cb} < 5.0$ pF, $C_{eb} < 4.0$ pF @ 10 V_{CB}) coupled with saturation resistances of only 5.0 ohms (typ) and offset voltages down to 0.5 mV @ $I_B = 100$ μA . With this combination, the designer is assured of both fast and efficient chopper rates.

Take advantage of this price and performance value in applications such as servo-loop circuitry, sensing instrumentation and control amplifiers for motor-drive systems.

For details circle Reader Service No. 496

1st EIA Registered Quad Transistor Premieres—2N5146!

A state-of-the-art "quad" device, designed for medium-current, high-speed switching and driver applications where minimum space requirements and low circuit inductance are prime requisites, has been introduced as a "stand-ard" off-the-shelf type.

The Motorola 2N5146 PNP silicon Annular quad transistor is the first ever registered with EIA and is intended for a wide number of applications in both military and industrial designs. Since four chips are mounted in a single, compact, TO-86 ceramic flat pack, this quad device takes up *less space than an individually TO-5 encased transistor*.

Compactness, however, is not its only virtue! The 2N5146 exhibits such superlative performance features as:

- High dc gain at high current levels — $h_{FE} = 40$ typ. @ 1.0 A.
- Low saturation voltage — $V_{CE(\text{sat})} = 0.7$ V typ. @ 1.0 A.

For details circle Reader Service No. 497

Here are the factors that make these bipolar transistors worthy candidates for most any low-level chopper requirement:

CHARACTERISTIC	TYPE	Min	Max
BV_{CBO} @ $I_E = 10$ μA — (V)	2N5229	15	
	2N5230	30	
	2N5231	50	
BV_{ECO} @ $I_E = 10$ μA — (V)	2N5229	10	
	2N5230	20	
	2N5231	30	
$V_{EC(\text{offs})}$ @ $I_B = 100$ μA — (mV)	2N5229		0.5
	2N5230		0.5
	2N5231		0.8
$V_{EC(\text{offs})}$ @ $I_B = 1$ mA — (mV)	2N5229		0.8
	2N5230		1.0
	2N5231		1.0
$f_{EC(\text{ON})}$ @ $f = 1$ kHz, $I_B = 1$ mA, $I_E = 0$, $I_C = 100$ μA — (ohms)	2N5229	1	6
	2N5230	2	8
	2N5231	2	10
Prices (100-up)	2N5229		\$2.50
	2N5230		3.00
	2N5231		3.75

Prototype quantities are immediately available in the space-saving TO-46 package.

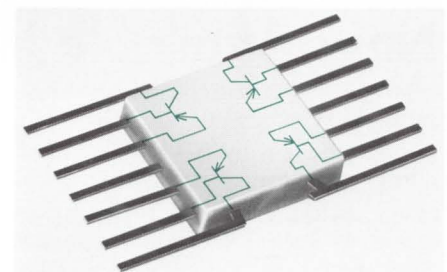

The 2N5146 "Quad," packaged in the 14-pin, TO-86 ceramic flat-pack, makes possible ultra-compact circuitry and reduces wiring requirements, to minimize lead inductance.

- High current-gain-bandwidth product — $f_T = 250$ MHz typ. @ 50 mA.
- Low capacitance — $C_{cb} = 11$ pF typ. @ 10 V.
- High power dissipation — $P_D = 5.0$ W @ $T_C = 25^\circ\text{C}$. . . as well as ultra-fast switching speeds (e.g. $t_s = 30$ ns typ.)!

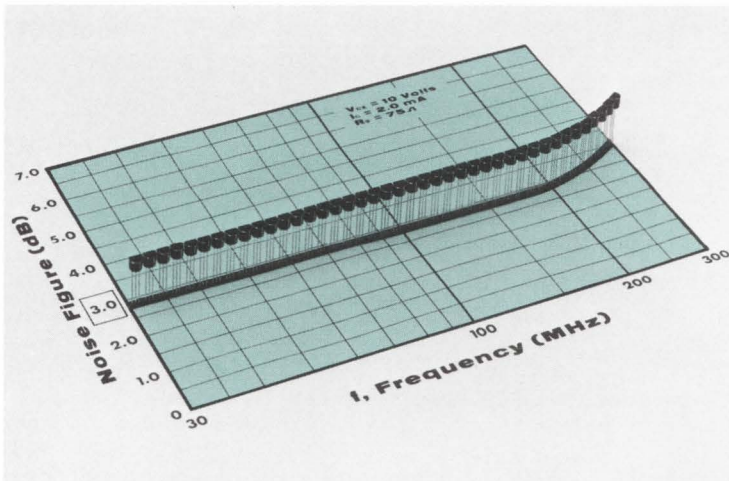

Although spec'd at 100 MHz, the 2N5208's noise figure remains typically less than 3.5 dB even out to 300 MHz—as indicated by the curve in this photo-diagram.

NOW A PEAK-PERFORMANCE BIPOLAR RF TRANSISTOR FOR LESS THAN \$1.00!

You may have doubted that a truly high-performance RF silicon PNP bipolar device, able to fulfill almost any amplifier application up to 300 MHz, would ever be available at a price that made it practical for low-budget designs. And, it has complete "computer-solved" design curves which eliminates tedious calculations!

Even though it is priced at just 90¢, in 1000-up quantities, the 2N5208 gives you top RF performance parameters:

- **High** $G_{pe} > 22\text{dB}$ @ 100 MHz
- **Low** N.F. < 3.0 dB @ 100 MHz
- **High** f_T — 300/1200 MHz @ 10 V
- **Low** $I_{CBO} < 10\text{ nA}$ @ 10 V

- **High** $h_{FE} - 20/120$ @ 2 mA
 - **Low** $C_{cb} < 1.0\text{ pF}$ @ 10 V
- ... and, an $r_b C_c < 10\text{ ps}$ @ 10 V/2 mA/31.8 MHz.

The 2N5208 operates at breakdown voltages (BV_{CEO}) in excess of 25 volts and is encapsulated in the reliable TO-92 Unibloc plastic package.

All-in-all; its low price, its high power gain, its low noise figure, its high f_T , ad infinitum . . . make it a worthy candidate to fill just about any RF socket to 300 MHz in industrial instrumentation and communications equipment. And, you can get fast delivery in both prototype and high volume quantities.

For details circle Reader Service No. 498

The VHF/UHF "FET That Fits" Is Now Available in Plastic Package!

Now a wider scope of low-budget applications is possible for VHF/UHF amplifier designs using field-effect transistors. Motorola's new MPF106-07 plastic packaged (TO-92) JFETs, priced as low as 90¢ each (100-up), provide the economy answer for just about 8 out of every 10 high-frequency requirements.

Featuring unusually low-noise figures (even for FETs), these new devices, while ideal for RF "front-end" circuits, will work equally well in any low-noise, high-gain amplifier, from dc to above 500 MHz. Further complementing the state-of-the-art performance of these new, low-cost FETs is their high-power gain of 18 dB @ 100 MHz and 10 dB @ 400 MHz (min).

Here are some other key specifications

that make these FETs so universally useful:

Characteristics	Min	Max
Forward Transfer Admittance (μmhos)		
MPF106	2500	6000
MPF107	4000	8000
Input Capacitance (pF)		5.0
Output Capacitance (pF)		2.0
Reverse Transfer Capacitance (pF)		1.0
Small-Signal Power Gain (dB)		
@ $f = 100\text{ MHz}$	18	
@ $f = 400\text{ MHz}$	10	
Noise Figure (dB)		
@ $f = 100\text{ MHz}$		2.0
@ $f = 400\text{ MHz}$		4.0

Both the MPF106 and MPF107 are immediately available from distributor stock in the Unibloc TO-92 plastic package. 100-up prices are: MPF106 — 90¢; MPF107 — \$1.00.

For details circle Reader Service No. 499

Ultra-Fast Micro-T MMT2369 Transistor Fits Into Places You'd Never Dream Possible!

If you have an application that requires the miniaturization afforded by integrated circuits, but you can't live with the parasitics — take a good look at the MMT2369 Micro-T NPN silicon Annular transistor.

This new ultra-small transistor opens up a whole new dimension in high-density switching design flexibility. Although only about 1/10 the size of standard TO-18 and TO-92 devices, the MMT2369 retains all the famous high-speed features of its big brothers — the 2N2369 and MPS2369. You can now apply all the performance advantages of these popular switches to miniaturized design concepts, such as thick-film circuitry for computers and instrumentation.

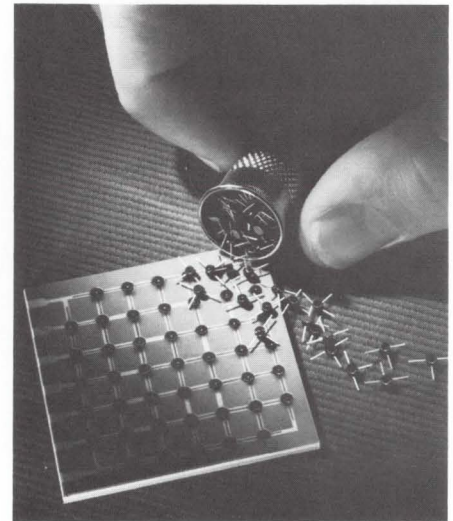

A "thimble-full" of Micro-T Transistors would fill both sides of a 1½" square PC board yet still leave units to spare (we put 100 in the thimble and didn't reach the top)!

The Micro-T Unibloc plastic package also helps you lower your PC board costs. It is ideally suited for drop-in mounting techniques and, significantly reduces circuit board depth — a prime requisite for high-density designs.

Here are some of the MMT2369's high switching performance specs:

- $t_{on} < 12\text{ ns}$; $t_{off} < 18\text{ ns}$
- $f_T > 500\text{ MHz}$
- $C_{ob} < 4.0\text{ pF}$
- $I_{CBO} < 100\text{ nA}$
- $h_{FE} - 40/120$
- $V_{CE(sat)} < 0.25\text{ V}$
- ... all at $I_C = 10\text{ mA}$

Priced at only 97¢ in 1000-up quantities, it is available in production quantities.

For details circle Reader Service No. 500

First True Silicon Replacement For The 2N404 Germanium Switch Now Here!

Now, with the introduction of the MPS404/A PNP switching series, you can have all the benefits attributable to silicon devices and still be able to plug them directly into your germanium 2N404 sockets without redesign.

With the MPS404/A, you get **silicon transistors** that operate at temperatures to +135°C and dissipate up to 310 mW at $T_A = 25^\circ\text{C}$. And their high V_{EBOs} (unusual in silicon) of 12 volts for the MPS404 and 25 volts for the MPS404A eliminate the need for external protection against voltage spikes — saving you money on zener diodes as well as giving you greater design freedom. You also get saturation voltages [$V_{CE(sat)}$] as low as 0.15 V max. and a maximum C_{ob} of 20 pF, making them ideal in computer switching and chopper applications where no silicon device has ever been able to perform like the 2N404.

Packaged in the rugged and reliable TO-92 Unibloc plastic case, the units

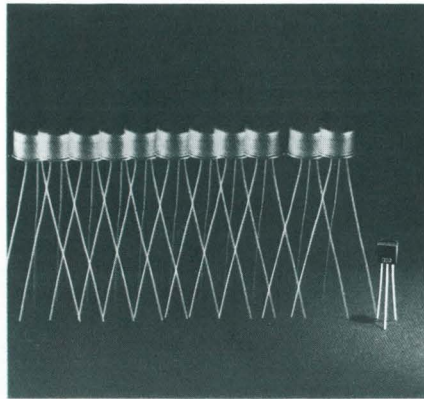

MPS404/A Unibloc silicon switching transistors can do everything the germanium 2N404 can do — only better!

are also inexpensive enough for even the most cost-conscious requirement — only 25¢ for the MPS404 and 35¢ for the MPS404A, in 1,000-up quantities.

Try some! They're available from your local Motorola distributor on an off-the-shelf basis.

For details circle Reader Service No. 501

New 4-Amp NPN/PNP THERMOPAD Plastic Silicon Power Transistors Solve The Cost Vs. Performance Dilemma!

Plastic device performance, cost and reliability have come a long way since first introduced a few years ago . . . and, nowhere is this more dramatically evident than in silicon power transistor advances during the last few months.

The new NPN/PNP 2N5190-95 4-amp Thermopad-packaged transistors, combining high-current, top efficiency and excellent power-handling capabilities (to 30 watts) with economy prices and military-type reliability, are ideal for demanding industrial driver circuits or in switch/amplifier applications where cost/performance is a consideration.

You can use the 2N5190-95 as NPN/PNP pairs to gain all the circuit-simplifying advantages of direct-coupled, complementary symmetry, plus realize a higher degree of frequency stability in both ac and dc driven loads without the addition of expensive, impedance-matching driver transformers.

Exclusive Thermopad construction — with a chip-to-heat sink thermal path of less than 0.030" — means low thermal resistance and minimum derating in all chassis-mounting applications; and the compact, low-silhouette, malleable-lead package is simple to mount in virtually any place or position.

To date, the Thermopad package has passed 42,000 hours of life-testing under ambient temperature, high humidity and reverse-bias—and 100,000 hours storage life at 150°C, *without a single failure!*

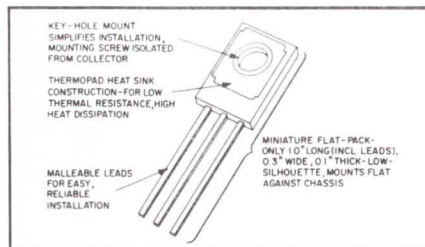

TYPE		V_{CE0} (sus)	I_c (max)	P_D @ 25°C	h_{FE} @ $I_c = 1.5 \text{ A}$	$V_{CE(sat)}$ @ 1.5 A (max)	f_T (min)	PRICE (100-UP)	
NPN	PNP							NPN	PNP
2N5190	2N5193	40 V						\$1.05	\$1.33
2N5191	2N5194	60 V	4.0 A	35 W	25/100	0.6 V	4.0 MHz	1.28	1.50
2N5192	2N5195	80 V						1.67	1.95

For details circle Reader Service No. 502

New BET RF Power Transistors Provide Higher Secondary Breakdown Protection

Two new series of 28-volt NPN RF power transistors offer such large safe operating areas that they are almost impossible to damage in high-frequency circuits, even under mismatched loads.

The two series, types MM1549-51 and MM1557-59, are manufactured using a new "balanced emitter" design that permits uniform spreading of current throughout the devices.

They are available in Motorola's new plastic stripline, "opposed-emitter" package which enables simpler circuit design and easier tuning. Also, the low profile of this new package will be helpful where tight mounting space requirements exist.

The MM1557-59 series is designed for large signal, 175 MHz power amplifier output stages, as well as for driver and oscillator applications in FM, SSB and pulse modulation systems up to 200 MHz. The MM1559 is especially suited for use as the output stage in aircraft radio transmitters.

The MM1549-51 series serves the

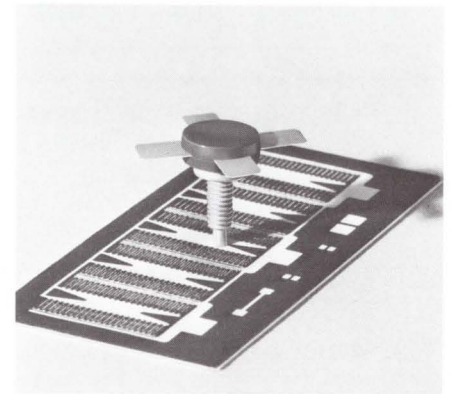

The Balanced Emitter Technology (BET) protects against the development of "hot spots" by providing nichrome resistors in series with each emitter, to facilitate an even current distribution throughout the entire transistor structure.

same types of applications in the 200-450 MHz range. Major use of this latter series will be found in government communications equipment.

TYPE NUMBER	POWER OUT(W)	FREQUENCY (MHz)	POWER GAIN (dB)
MM1557	7	175	8.5
MM1558	20	175	8.3
MM1559	40	175	7.5
MM1549	2.5	175	6.2
MM1550	7.5	400	5.7
MM1551	20	400	4.5

All six types are immediately available from distributor stock.

For details circle Reader Service No. 503

DUAL-CHIP FORWARD REFERENCE DIODE

—Provides a Tight-Tolerance, Low-Voltage Reference at an Economy Price!

Two diodes in the convenience of one package! That's the big advantage of this little performer. Nominally spec'd at 1.35 volts @ 10 mA, the MR2361 offers tight $\pm 4\%$ tolerance at 2 points on the forward characteristic to ensure high conductance (low dynamic impedance) in voltage reference and biasing applications; i.e., audio/servo power amplifier complementary symmetry where stable temperature biasing is mandatory.

Its voltage, current, temperature characteristics and low price make it especially suitable for use with silicon plastic transistors. The MR2361 is packaged in a "glass" case (meeting the DO-7 dimensional and hermetic-seal requirements). Triple-chip units are available on request.

Type No.	V_F @ $I_F = 10$ mA		I_R @ $V_R = 5.0$ V (max)	Price (1000-up)
	(Min)	(Max)		
MR2361	1.30 V	1.40 V	10 μ A	\$.30

For details circle Reader Service No. 504

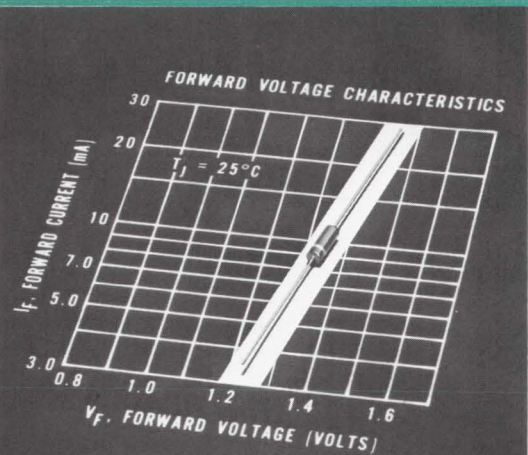
**LOW-COST, JUNCTION FIELD EFFECT TRANSISTORS**

— Offer Exceptionally Low Power-Drain Parameters

Because Motorola's MFE2093-95 junction FET series offers I_{DSS} specs as low as 0.1 mA, it's a natural for low-current amplifier or switching applications, particularly in compact, battery-operated systems. And, in the TO-72 metal package, they are attractively-priced for most military or industrial users . . . just \$1.90 (100-up).

For maximum ease in the use of existing P.C. boards, the series features interchangeable drain and source. In addition, the devices are packaged with the chip isolated and the case is connected to pin 4 for easy grounding. Other features include:

- High dc input resistance ($I_{GSS} - 0.1$ nA @ 15 V)
- High ac input impedance ($C_{ISS} - 6$ pF @ 15 V)
- Low transfer capacitance ($C_{RSS} - 2$ pF @ 15 V)

Any of the three types are available in production quantities.

For details circle Reader Service No. 505

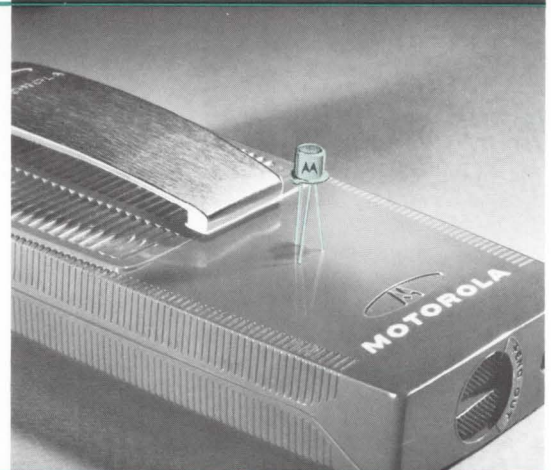
**CLOSELY-MATCHED PNP DIFFERENTIAL AMPLIFIERS**

—Provide h_{FE1}/h_{FE2} Tolerances Within 5% of Each Other!

Another dimension has been added to Motorola's series of 2N3800 PNP dual differential amplifiers with the availability of tightly-matched "A" versions. Not only do these new "A" duals offer all the top-notch specs which have made the rest of their family the first choice of precision diff-amp designers, but their h_{FE1}/h_{FE2} ratio is only 0.95/1.0 (5%), at 25°C, and no more than 0.85/1.0 from -55 to $+125^\circ\text{C}$, both measured at $V_{CE} = 5$ V, $I_C = 100$ μ A. In addition, they exhibit a V_{BE1}/V_{BE2} differential of less than 1.5 mV at 100 μ A.

The 2N3804A/5A are packaged in the TO-72, the 2N3810A/11A in the TO-5 (low-profile) and the 2N3816A/17A in the TO-89 flat-pack — all 6-leaded.

For details circle Reader Service No. 506

**HIGH-VOLTAGE GERMANIUM POWER TRANSISTORS**

—Give Peak Performance at Valley Prices!

The V_{CES} ratings of 200 V and 320 V, coupled with price-tags in the "just over a dollar" area, combine to make the MP3730/31 germanium power transistors leading candidates for inverter, TV deflection, and power supply designs.

And, top efficiency is assured with excellent thermal dissipation — $\theta_{JC} = 1.5^\circ\text{C/W}$ — a figure of merit twice as good as similar units! Both types handle 56-Watts and operate at temperatures up to $+110^\circ\text{C}$.

Other features include I_{EBO} of 50 mA, $V_{BE} = 0.6$ V and $I_{CES} = 5$ mA. The units are packaged in TO-3 cases — and are available in quantity.

TYPE	APPLICATIONS	V_{CES} Volts	I_C Amps	$V_{CE(Sat)}$ Volts	h_{FE} @ I_C	PRICE (100-up)
MP3730	Industrial Power Supplies Inverters TV Vertical Deflection	200	5	0.75 @ $I_C = 2.25A$	15 @ 2.25 A (min)	\$1.05
MP3731	Industrial Power Supplies Inverters TV Horizontal Deflection	320	10	0.5 @ $I_C = 6 A$	15 @ 6 A (min)	1.40

For details circle Reader Service No. 507

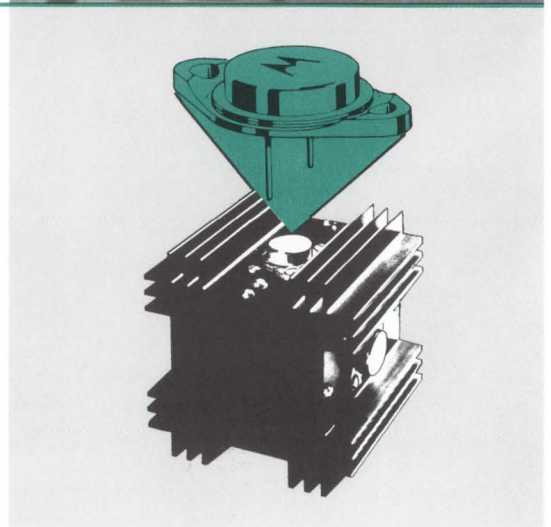

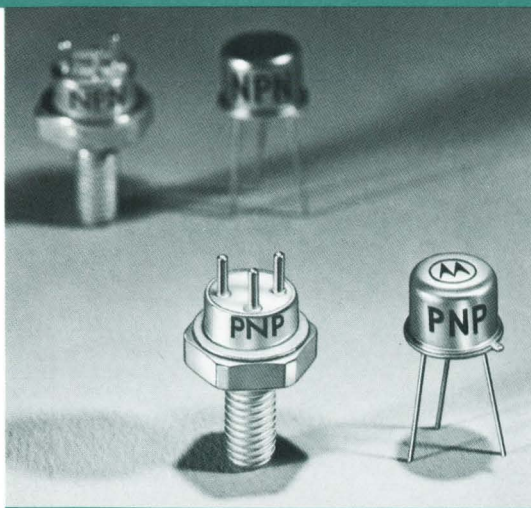

PNP RF POWER TRANSISTORS

— Provide 1, 7.5 And 30 Watts At VHF/UHF — With Positive “Grounding”

There should be a lot of polarity changes in the near future . . . specifically in the final output stages of both industrial and military communications equipment **The Reason:** A new series of PNP transistors offering a positive “ground” advantage and high power output ratings at 175 and 400 MHz!

Motorola types 2N5161 and 2N5162 are designed for amplifier, frequency multiplier and oscillator applications in mobile communications, air-to-ground tactical communications, and as varactor drivers. The third PNP type, designated 2N5160, is suitable for use as a Class A, B or C output; driver; pre-driver or power oscillator in VHF and UHF applications to 800 MHz.

Device Type	Power Out (W)	@ Frequency (MHz)	V_{CB0} (V)	Min. Power Gain (dB)	Typ f_T (MHz)	Pkg. Type	Price (100-up)
2N5160	1.0	400	60	8.0	800	TO-39	\$ 4.50
2N5161	7.5	175	60	8.75	500	TO-60	12.50
2N5162	30.0	175	60	6.0	500	TO-60	18.00

For details circle Reader Service No. 508

UNIBLOC PLASTIC UNIJUNCTION TRANSISTORS

— Offer A Wide Choice of Specs at Economy Prices

You can now choose the spec that fits your particular application and design criteria (and price requirement) with the new Annular MU4891-94 UJT series . . . from timing-to-triggering-to-general purpose. For example, the MU4893, which exhibits a high V_{OB1} of 6.0 volts min, is ideal for use in SCR triggering circuits while the MU4892 can be zeroed right into high frequency relaxation-oscillator circuits due to its low η range of 0.51-0.69. And, a low 1.0 μA maximum I_P makes the MU4894 a natural for long time delay applications.

Type	Primary Use	Highlight Parameters	Intrinsic Standoff Ratio (η)	Prices (1,000-up)
MU4891	General Purpose	Low $I_{E20} = 10$ nA (max)	0.55 — 0.82	\$.51
MU4892	HF Relaxation Osc.	Low η spread = 0.51-0.69	0.51 — 0.69	.70
MU4893	SCR Triggering	High $V_{OB1} = 6.0$ V (min)	0.55 — 0.82	.54
MU4894	Long Time Delays	Low $I_P = 1.0$ μA (max)	0.74 — 0.86	.60

For details circle Reader Service No. 509

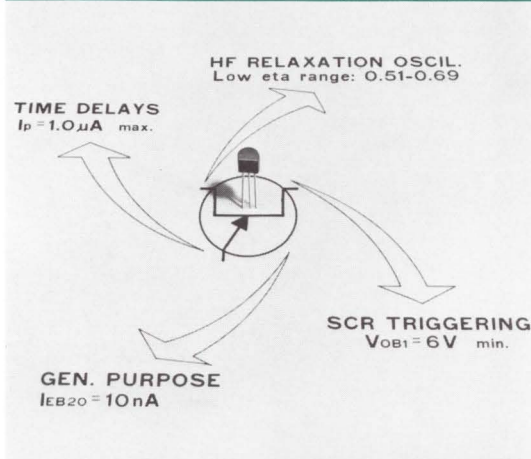

10,000 PULSES-PER-SECOND MODULATOR SCR SERIES

— Provides Voltages from 300 to 600 Volts at 300 Amps (Pulse)

Motorola's rugged 100-amp and 1,000-amp pulse modulator SCR's have now been expanded to include the new MCR1336-5 thru MCR1336-10, 300 amp, 300 to 600-volt units capable of top performance in military/space transponders, beacons, portable aircraft radar and high-pulsing applications.

Typical switching time characteristics include: 75 ns delay and rise (at 100 amps, I_P , capacitive discharge circuit, $I_G = 500$ mA @ 25°C), and 7 μs t_{off} (PFN discharge, 100 amp and pulse). Its dv/dt is 250 V/ μs while di/dt is 1,000 A/ μs . The unit has a wide operating temperature range of -65 to +105°C. 100-up prices start at \$13.75 for a 300 volt unit (MCR1336-5).

For details circle Reader Service No. 510

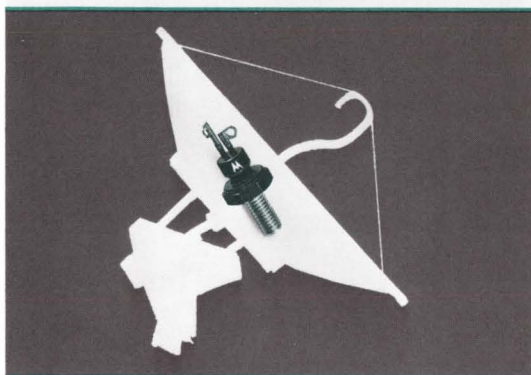

For Fast Action!

. . . on delivery of literature for items described in this publication — fill out this coupon, fold as indicated and drop in the mail.

(NO POSTAGE IS REQUIRED)

FIRST CLASS
Permit No. 2565
PHOENIX
ARIZONA

FOLD HERE

BUSINESS REPLY MAIL
No postage stamp necessary if mailed in the United States

POSTAGE WILL BE PAID BY

Semiconductor NEWSBRIEFS
Motorola Semiconductor Products Inc.
P. O. Box 13408
Phoenix, Arizona 85002

JAN2N499, JAN2N499A, JAN2N501A GERMANIUM TRANSISTORS

— Now Available In Quantity To Fill Mil-Type MADT Sockets

If you say "availability" three times, you've got the big story behind the Motorola JAN2N499, JAN2N499A, and JAN2N501A — newest additions to the growing line of MADT types **immediately** available in production lots for "drop-in" replacement of older, source-limited types. These high-frequency units, fabricated with the Motorola-developed "Selective Metal Etch" process, meet exact parameter-by-parameter specs and achieve nearly identical key MADT characteristic distributions. They can replace MADT types with *no redesign required!*

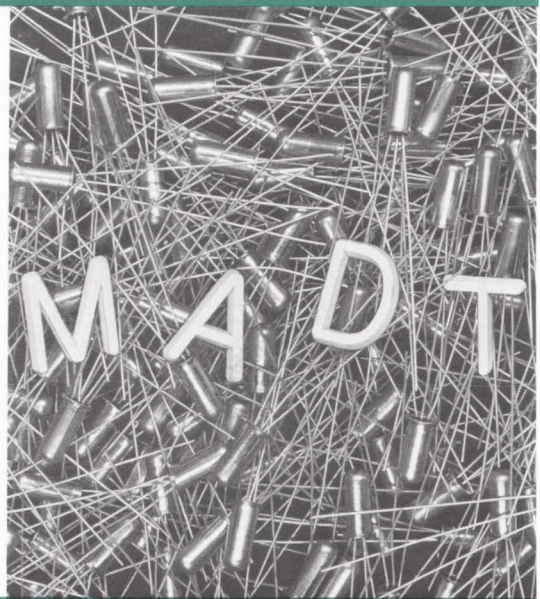

TYPE	APPLICATION	KEY PARAMETERS			
JAN2N499	VHF Amplifier	$h_{ie} @ I_E = 1 \text{ mA}$ $V_{CE} = 9 \text{ V} = 10-250$	$G_{p\omega} @ 100 \text{ MHz}$ $Y_{cb} = -10 \text{ V}, I_E = 2 \text{ mA}$ $= 7.5 \text{ dB (min)}$	$C_{cb} @ 10 \text{ V}$ $= 2.5 \text{ pF (max)}$	$BV_{CEO} @ I_C = 1 \text{ mA}$ $= 18 \text{ V (min)}$
JAN2N499A	VHF Amplifier	$h_{ie} @ I_E = 1 \text{ mA}$ $V_{CE} = 9 \text{ V} = 20-80$			
JAN2N501A	HF Switch	$h_{FE} @ I_C = 10 \text{ mA}$ $V_{CE} = .5 \text{ V} = 30 \text{ (min)}$	$f_r = 175 \text{ MHz}$ (typ) @ 10 mA/.5 V	$V_{CE(sat)} @ I_C = 10 \text{ mA}$ $I_B = 1 \text{ mA} = 0.2 \text{ V (max)}$	

With these three new types, a total of twenty Motorola units are now available for MADT high-frequency amplifier and switching applications.

For details circle Reader Service No. 511

SILICON PNP BILATERAL SWITCHING TRANSISTOR

—For High-Current-Level Chopper Designs.

The bilateral performance capabilities of the Motorola MM4052 transistor frees the designer of sophisticated telephone and communications switching networks from dependence on comparatively slow, cumbersome relays. In addition to all the benefits generally attributable to high-performance transistor switches, this unique device *amplifies high level signals bidirectionally* — e.g., forward $h_{FE} = 15 @ 150 \text{ mA}/1.0 \text{ V}$ and inverse $h_{FE} > 3 @ 150 \text{ mA}/1.0 \text{ V}$.

Combining a host of peak-efficiency parameters (as indicated by the chart below), the MM4052 is worth looking into whenever you have a requirement for a high-level device that can switch in both directions.

Packaged in the miniature TO-46 case, it is priced at only \$3.00 (100-up).

BV _{EBO} (min)	BV _{EEO} (min)	Offset Voltage V _{EC(offs)} (max)	I _{CBO} (max)	"On" Series Resistance r _s @ 10 mA (max)	Capacitance @ 10 Vdc (max)	
					C _{cb}	C _{cb}
30 V	30 V	1.0 mV	0.5 nA	2.0 ohms	10 pF	5 pF

For details circle Reader Service No. 512

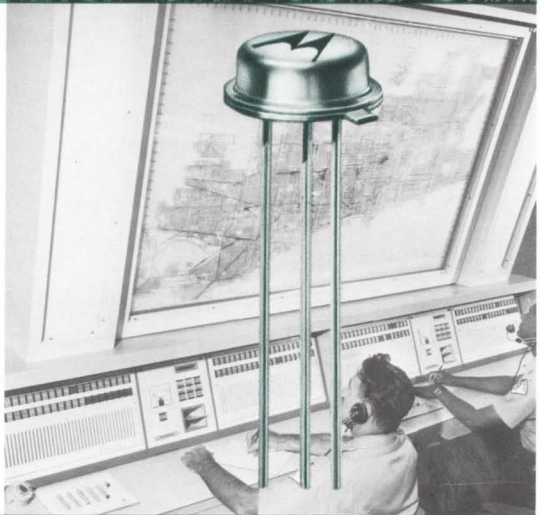

Published by Motorola Semiconductor Products Inc., P. O. Box 955 • Phoenix, Arizona 85001

The circuitry shown external to Motorola products is for illustrative purposes only, and Motorola does not assume any responsibility for its use or warrant its performance or that it is free from patent infringement.

MECL II, M TTL, Unibloc, Micro-T, Annular, Thermopad SME and BET used in this publication are trademarks of Motorola Inc. MADT is a registered trademark of Philco Corp. SUHL is a trademark of Sylvania.

NOTE: If coupon is missing use magazine's Reader Service numbers to order literature on items described in NEWSBRIEFS

SEMICONDUCTOR NEWSBRIEFS

©Motorola Inc. 1968

Tear Along Perforated Line and Drop in Mail (No Postage Required)

To expedite the delivery of the literature you have requested, we would appreciate that you CLEARLY PRINT your name and mailing address below:

NAME, TITLE _____

COMPANY (DIV.) _____

ADDRESS _____

CITY _____

STATE (ZIP) _____

Please circle the Reader Service number of item(s) you are interested in receiving:

E.					
491	492	493	494	495	496
497	498	499	500	501	502
503	504	505	506	507	508
509	510	511	512		

Do you wish a Motorola Field Representative to contact you? VISIT PHONE

Phone No. _____ Area Code _____

NOTICE: Requests for literature on items described in this issue cannot be honored after **May 1, 1968.**

SEAL HERE

with your reputation at stake, which resistor line would you specify?

take a close look—there'll be no question

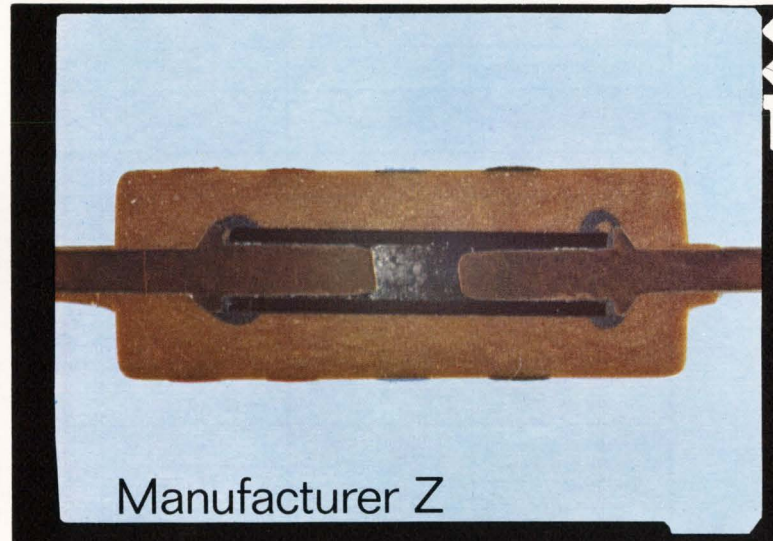
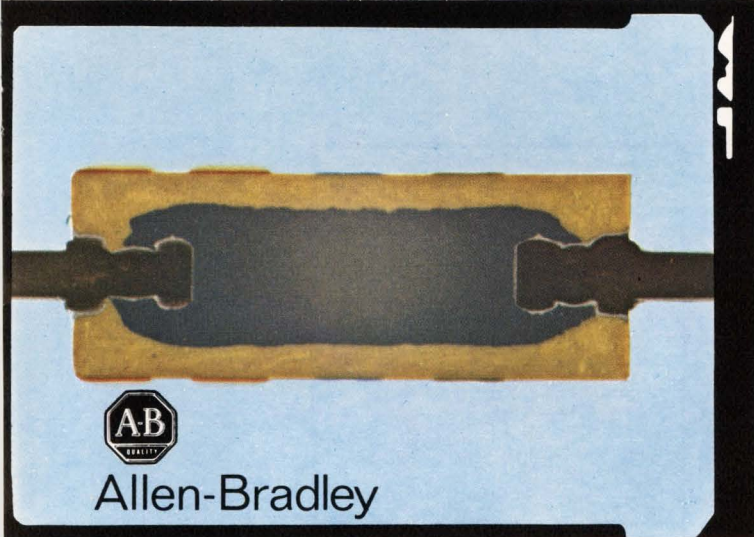

The above illustrations are from unretouched photomicrographs taken of four 1/2-watt fixed resistors. Compare the anchoring of the leads, the seal provided by the insulating jacket at the ends, the homogeneity of the resistance material, the sharp color code bands—and decide for yourself.

For more details on Allen-Bradley hot-molded resistors, please write for Technical Bulletin 5000: Allen-Bradley Co., 110 W. Greenfield Ave., Milwaukee, Wis. 53204. In Canada: Allen-Bradley Canada Ltd. Export Office: 630 Third Avenue, New York, N. Y., U.S.A. 10017.

A-B hot-molded fixed resistors are available in all standard resistance values and tolerances, plus values above and below standard limits. **A-B hot-molded resistors meet or exceed all applicable military specifications including the new Established Reliability Specification.** Shown actual size.



QUALITY ELECTRONIC COMPONENTS



ALLEN-BRADLEY

Circle 35 on reader service card

HERE'S THE LATEST INFORMATION ON THIN-FILM DEPOSITION...

CVC

Five CVC PlasmaVac® Low-energy Sputtering Systems — to handle thin-film applications from laboratory to production line.

Sputtering thin films with a CVC PlasmaVac® system lets you deposit almost any material on almost any surface—with excellent control over film composition, purity, and thickness. You'll increase efficiency, quality, and yields over any other thin-film

deposition method. Please write for full details on any or all of the PlasmaVac systems described below. Consolidated Vacuum Corporation, 1775 Mt. Read Blvd., Rochester, N.Y. 14603.

	PLASMAVAC 100	PLASMAVAC 200	PLASMAVAC 300	PLASMAVAC 400	PLASMAVAC 501
GENERAL	DC triode sputtering. Metals, conductors.	RF triode sputtering. Conductors, semi-conductors, non-conductors.	RF diode sputtering.	Production-type system with DC Crossfire™ and RF capability on in-line basis with air to air substrate transport.	DC Crossfire™ with rotary work holder, multiple targets.
APPLICATIONS	Laboratory and limited production. Ideal with CV-18 vacuum system.	Laboratory and limited production when used with PlasmaVac 100.	Sophisticated research applications. Reactive sputtering, sputter etching, semi-conductors, dielectrics, etc.	Bridges the laboratory/production interface. Modular concept so process can be developed, then scaled up to meet production needs.	Batch-type production unit for pilot plant operation.
Deposit Metals	Yes	Yes	Yes	Yes	Yes
Deposit Dielectrics	No	Yes	Yes	Yes	Yes*
Deposit Semiconductors	Some	Yes	Yes	Yes	Yes*
Deposit Cermets	No	Some	Yes	Yes	Yes*
Deposit Alloys	Yes	Yes	Yes	Yes	Yes
Deposit Organics	No	No	Some	Some	No
Water Cooled Target (for use of thermally sensitive materials)	No	No	Yes	Yes	Yes
Water Cooled Substrate	No	No	Yes	Yes	No
Reactive Sputtering	No	Some	Yes	Yes	Some
Bias Sputtering	Yes	Some	No	No	No
Sputter Etching	Few	Some	Yes	Yes	No
Type of Chamber	Bell Jar	Bell Jar	Bell Jar	Production-type modular chamber	Low profile metal chamber
Multiple Target Sputtering	Yes	Yes, with PlasmaVac 100	No	Yes	Yes

*Available on special order.

CVC

A BELL & HOWELL COMPANY

 **BELL & HOWELL**

This label of "quality"



covers everything
made by
Allen-Bradley

EXCLUSIVE HOT MOLDED RESISTORS

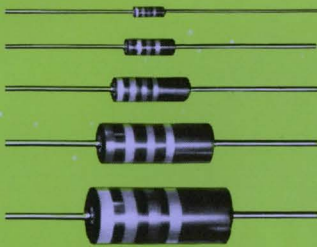

World renowned for their conservative ratings and stable characteristics. Due to uniformity of production, long term performance can be accurately predicted. With billions of these resistors in service, there is no known instance of catastrophic failure. Rated $\frac{1}{8}$, $\frac{1}{4}$, $\frac{1}{2}$, 1, and 2 watts at 70°C. Available in all standard EIA and MIL-R-11 resistance values and tolerances, plus values above and below standard limits.

CERMET TRIMMERS Type S

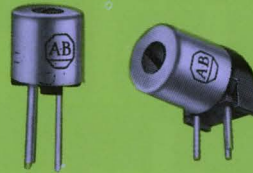

These Type S units are competitively priced one-turn trimmers. They're compact—only $\frac{3}{8}$ " diameter. Enclosure is watertight. Adjustment is smooth at all times—approaching infinite resolution. Temperature coefficient is less than 250 ppm/°C over all resistance values and complete temperature range. Rated $\frac{1}{2}$ watt at 85°C and usable from -65°C to +150°C. Resistances from 50 ohms to 1 megohm.

ADJUSTABLE FIXED RESISTORS Type R

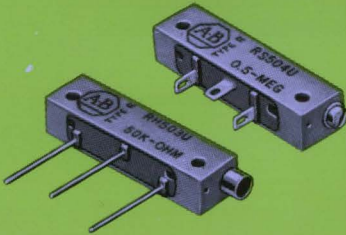

Type R built to withstand environmental extremes. Resistance element and terminals hot molded into integral unit with insulated mounting base. Has stepless adjustment and is noninductive. Watertight, can be encapsulated. Rated $\frac{1}{4}$ watt at 70°C. Values from 100 ohms to 2.5 megohms. Tol. ± 10 and 20%. Type N similar in construction but for less critical environments. Rated $\frac{1}{3}$ watt at 50°C.

HOT MOLDED POTENTIOMETERS Type J and Type K

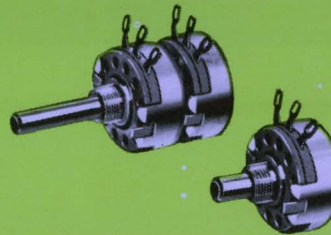

Type J potentiometers have solid, hot molded resistance element. Smooth, quiet control. Available in single, dual, and triple units, also with vernier adjustment. Rated 2.25 watts at 70°C. Values to 5 megohms. Type K have similar construction rated 1 watt at 125°C, 2 watts at 100°C, and 3 watts at 70°C.

HOT MOLDED POTENTIOMETERS Type G and Type L

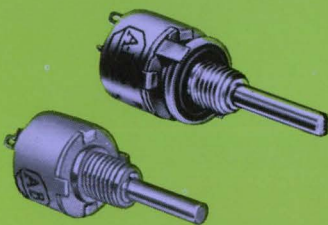

Type G potentiometers are miniature controls with solid molded resistance element. Only $\frac{1}{2}$ " in diameter. Quiet, stepless operation. Rated $\frac{1}{2}$ watt at 70°C. Values to 5 megohms. Type L are similar to Type G but rated $\frac{1}{2}$ watt at 100°C. Can be used at 150°C with "no load."

HOT MOLDED TRIMMERS Type Y

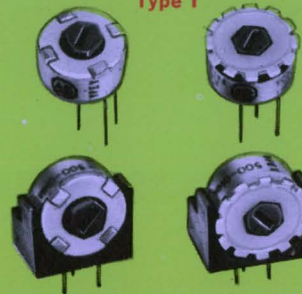

The Type Y single turn trimmer has a low profile which easily fits within the commonly used $\frac{3}{8}$ " stacking space. Can be supplied with an optional thumb wheel for side adjustment, or an optional base for horizontal mounting, or both. Also made with a handy snap-in panel mount. Rated $\frac{1}{4}$ watt at 70°C. Resistances from 100 ohms to 5.0 megohms.

HOT MOLDED TRIMMERS Type F

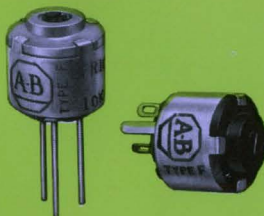

Type F trimmers are single turn controls built to withstand severe environmental condition. Adjustment approaches infinite resolution. Can be used at higher frequencies where wirewound controls are impractical. Only $\frac{1}{2}$ " in diameter. Rated $\frac{1}{4}$ watt at 70°C. Usable from -55°C to +120°C. Available in resistances from 100 ohms to 5 megohms. Various tapers can be furnished.

FERRITES AND CERAMIC MAGNETS



Ferrite cores are available in a wide range of sizes and shapes, such as flared yokes; U, E, and cup cores, and toroids.

Ceramic permanent magnets are available in nonoriented and oriented materials. Also types especially suited for use in the design of high efficiency d.c. motors.

Please send for Publication 6024:
Allen-Bradley Co., 110 W. Greenfield Ave.,
Milwaukee, Wisconsin 53204. In Canada:
Allen-Bradley Canada Limited.
Export Office: 630 Third Ave., New York,
N.Y., U.S.A. 10017.



ALLEN-BRADLEY
QUALITY ELECTRONIC COMPONENTS

**We let the meter
tell us how
to draw its face.**

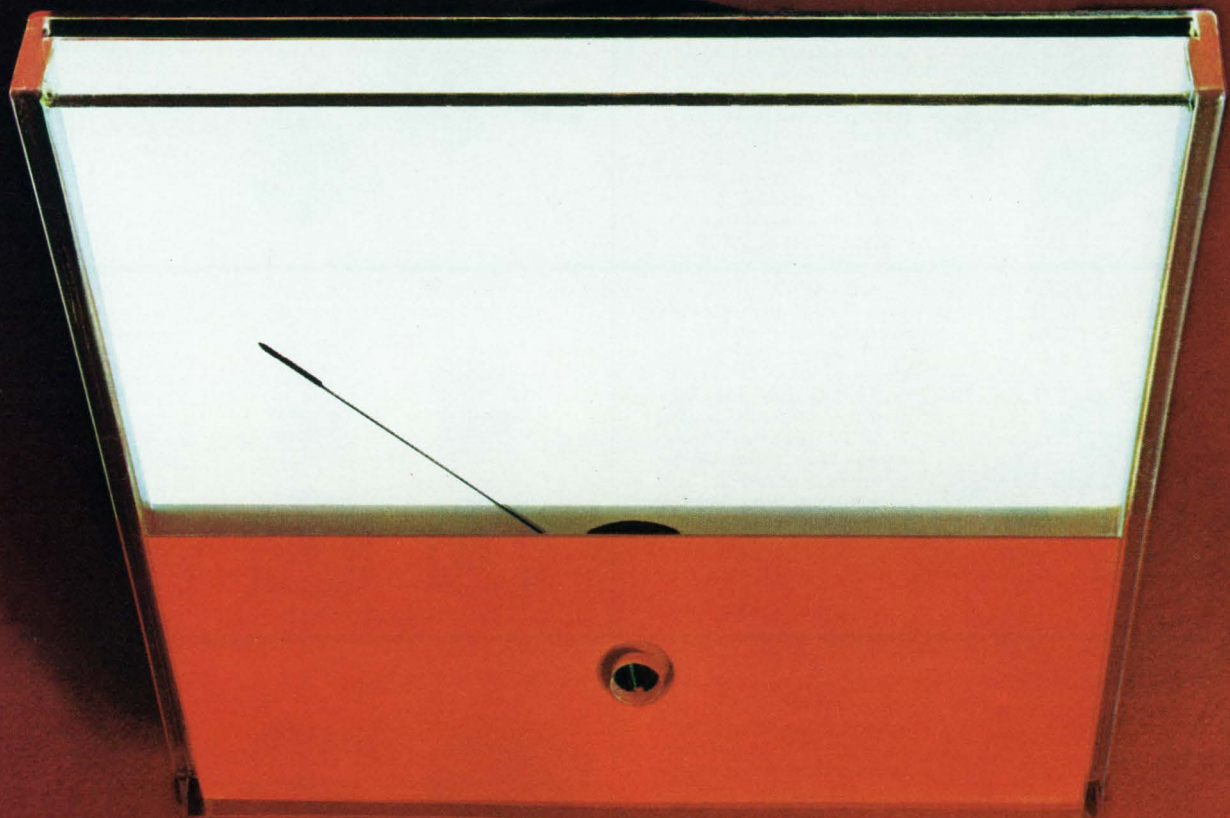

For our Honeywell Precision-Calibrated Taut-Band Meter, we want accuracy and tracking specifications of 1/2 of 1%, full scale. And we want repeatability of .2% or better, full scale.

We're finicky about it. Because we want a meter for the finickiest applications you have.

The meter decides.

We'd never get a meter like that by printing up one standard face and putting it on every single meter. Meters have idiosyncrasies.

So we leave the whole matter of how to draw the dial on the face entirely up to the individual meter itself.

We set up each meter in our special computer-directed dial-marking machine. Then we crank in the current or voltages — one increment at a time. As we do, the machine precisely marks the dial *exactly where the meter's pointer points*, for each increment.

Custom-drawn.

The face we end up with is actually custom-drawn to the meter's own specifications.

And behind it is our best Honeywell taut-band mechanism: Completely frictionless, so it responds to even the slightest inputs. Hysteresis-free, so its repeatability is near perfect.

Finicky.

Our Precision Calibrated Meter is finicky, all right. It's the most precise, closest-tracking meter in the Honeywell line. It comes in six body styles.

Certainly worth writing for a catalog about.

Honeywell Precision Meter Division, Manchester, New Hampshire 03105.

The Finicky Meter from Honeywell

It takes all kinds of meters to make the Honeywell line.

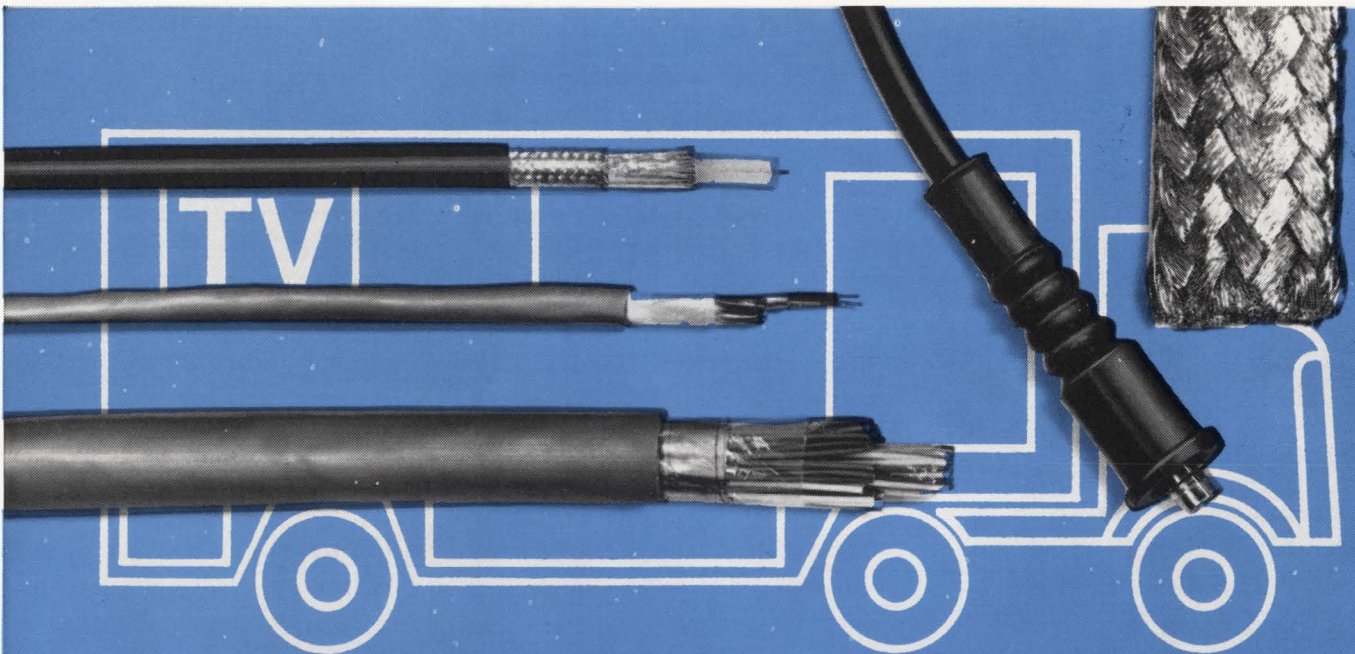

talk about systems...

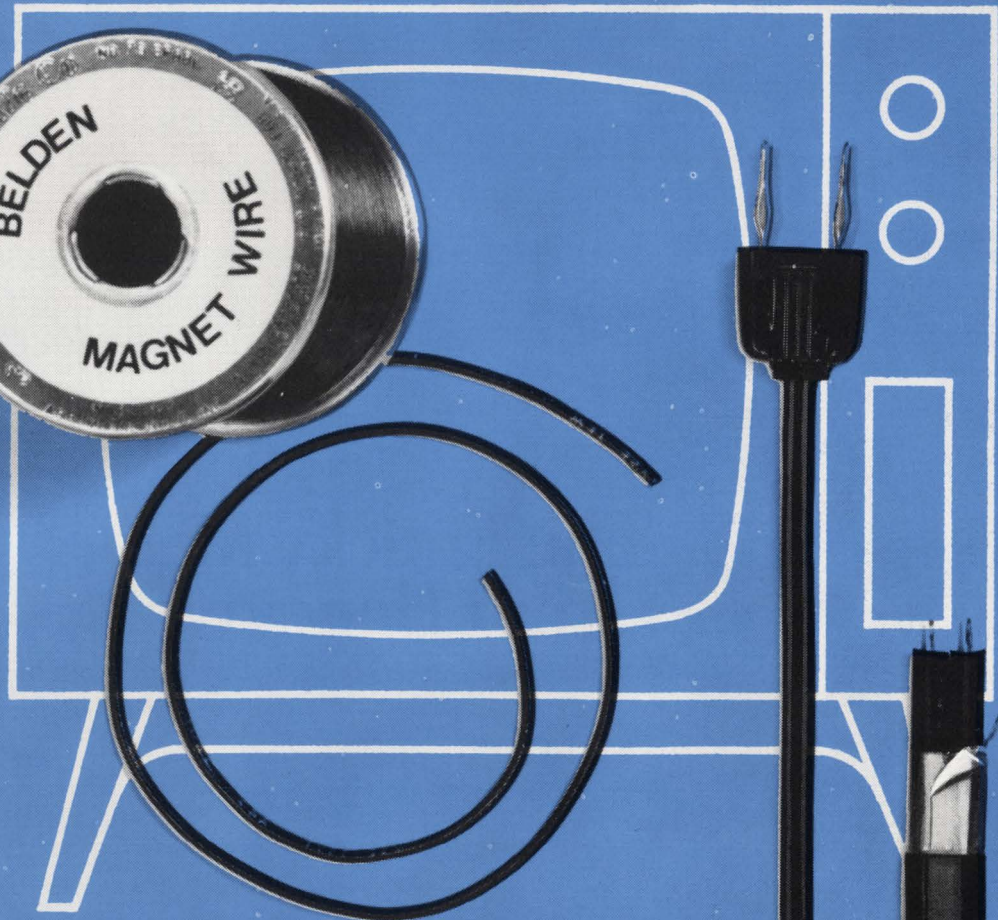
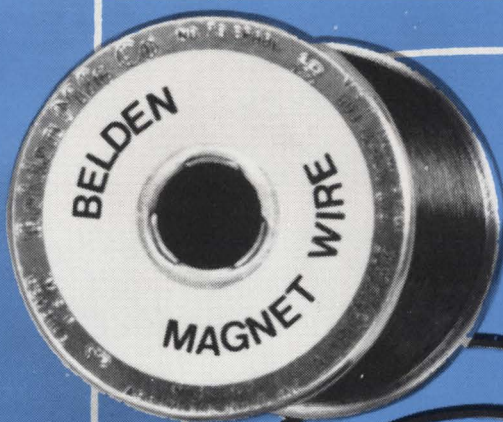

new ideas for moving electrical energy

G-2-7A

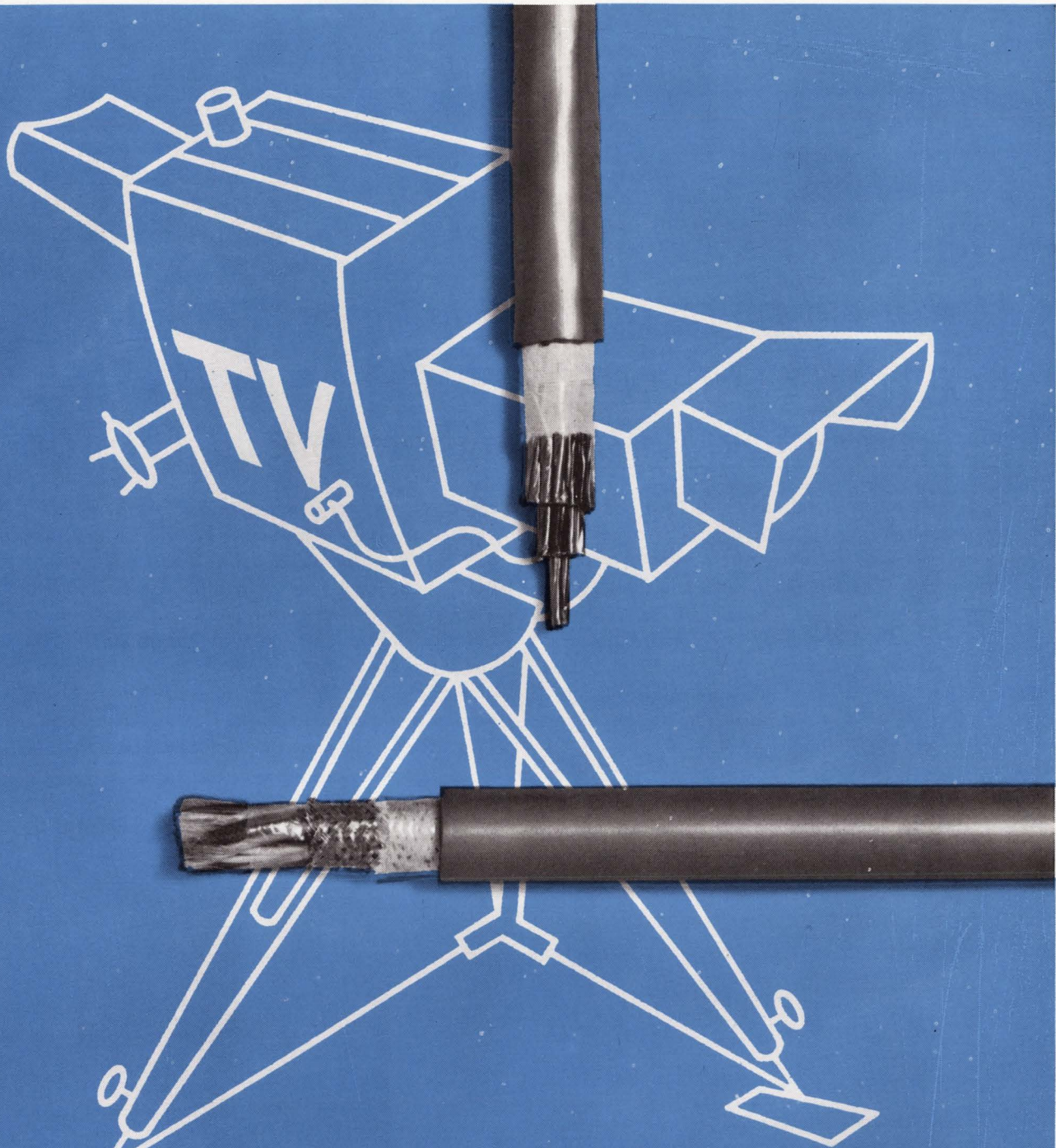

Television. Show Business. To Belden it's all a world of wire. Belden plays a leading role in many complex systems of sight and sound communication. By delving into design, processing, packaging and a host of factors, Belden's team of wire specialists have helped many people wring out hidden costs. Success takes a supplier that is really perceptive – one who makes all kinds of wire for all kinds of systems. Want to join us in wringing out values and costs? Just call us in...Belden Corporation
P.O. Box 5070-A, Chicago, Illinois 60680.





Low-level high speed switching in an A/D converter system is a rare combination anywhere but at Cimron

In fact, we might say unique, in the perfectly literal sense. Cimron's Multiplex A/D Converter System is of interest to anyone looking for a Mux-type system. Here's why. Let's say you're designing for a process control application. You frequently have to measure millivolt signals. And generally a system that does this, does so slowly or uses a lot of expensive amplifiers. This Cimron system gives you economical high-speed sampling of low-level signals, a combination so rare this model may be the first of its kind. You can buy

the Converter and Comparator for less than \$2,500 each — the entire 128-channel system for less than \$12,000. The Multiplexer has a throughput speed of IKC — from input programming to dumped output. The comparator isn't a must, but it does cut computer time. A comparable system, even if *you* build it, could cost 3 times as much, and still not give you Cimron's customer concern philosophy of immediate technical support. For information, write Cimron, Dept. B-103, 1152 Morena, San Diego, California 92110.

CIMRON[®]
A Division of
Lear Siegler, Inc.

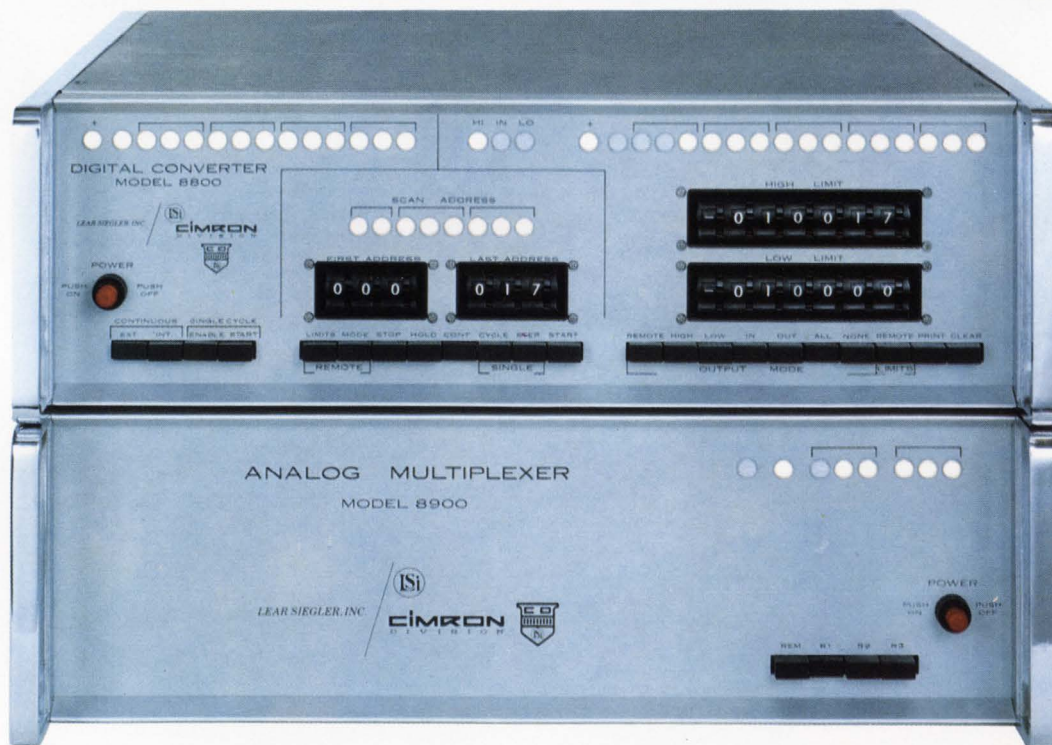

WE CAN SHOW YOU HOW TO IMPROVE YOUR "SLOW" RECTIFIER DESIGNS IN 0.5 μ SEC TO 100 NSEC.

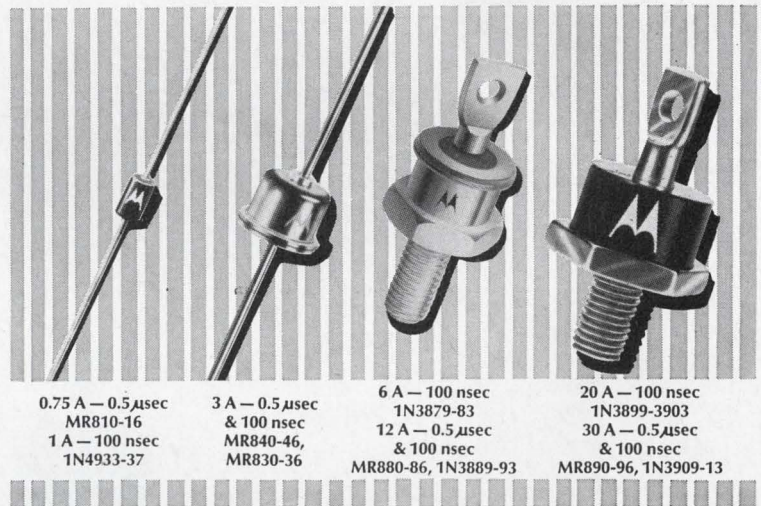

THAT'S TYPICAL

You'd expect your #1 source for rectifiers to be able to tell you how to use the broadest line of 88 fast recovery devices to best advantage in all applications. So we prepared a special paper on use of our $\frac{3}{4}$ -amp to 30-amp "fast" rectifiers in standard speed designs where their switching/commutation characteristics can improve circuit performance and reliability — highly inductive circuits where self-generated voltage transients can destroy the rectifier and other sensitive components, for example. Send for it.

You'd also expect the most agile of these units to perform reliably at less than half their maximum-specified speeds — 200 nsec — in all applications to 250 kHz . . . which they will. And you'd definitely expect them to be stocked in depth at Motorola's 62 North American franchised distributors . . . which they are.

What you might not expect is we can offer you fast recovery rectifiers for as little as \$.45 each (100-up) . . . which is little more than the moderate cost for similar, slower-speed units.

That's not typical.

- where the priceless ingredient is care!



MOTOROLA
Semiconductors

P. O. BOX 955 • PHOENIX, ARIZONA 85001

Bendix Autosyn 08 Synchros.

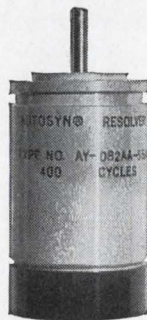

For weight-conscious engineers.

The average weight of Bendix® size 08 Autosyn® synchros is only 1.3 ounces. And their maximum diameter is 0.750". That's a great combination for trimming down servo systems.

There are 16 standard 08 units to choose from. Some are radiation-resistant. Some will perform accurately at sustained temperatures up to 800°F. All have flexible 12" leads, corrosion-resistant construction and aluminum housings.

Stainless-steel housings are avail-

able too. So are hundreds of other Autosyn types in 10, 11, 15 and 22 sizes. As well as Mil-Spec synchros up to size 37. You're almost certain

From Catalog 25	Function	Voltage	Max. Error
AY080AA-40-A1	Transmitter	26/11.8	7'
AY080AA-42-A1	Receiver	26/11.8	—
AY080AA-36-A1	Control Transformer	11.8/22.5	7'
AY083AA-43-A1	Control Differential	11.8/11.8	7'
AY082AA-53-A1	Resolver	26/11.8	7'

to find exactly what you need. And if you don't, we can design one for you. We've been doing it for 40 years. No wonder so many engineers rely on Bendix synchros for performance and dependability. And why you find them in the 747, C-5A and F-111, to name a few. There's no better value anywhere. Ask for our catalog and see for yourself. The Bendix Corporation, Flight & Engine Instruments Division, Montrose, Pennsylvania. Phone: (717) 278-1161.

Bendix
**Aerospace
Products**

Integrated electronics

Opening the MOS gate

Read-only memories have long been considered a natural application for metal oxide semiconductor techniques. But until the Philco-Ford Corp.'s Microelectronics division made its 1,024-bit memory available this month, previous circuits of this type stored too few bits to have much market appeal.

What makes the Philco array even more significant is its decoding circuitry. Of the circuit's 1,340 MOS transistors, 1,024 are for the memory and the rest for decoding. John Gorman, the company's product marketing manager, says a 2,048-bit memory is in the works.

Last summer, Fairchild Semiconductor introduced a read-only memory. But the circuit had only 256 bits and was quickly withdrawn when a market couldn't be found for it. At that time, Fairchild said a 1,000-bit device was the smallest practical in terms of cost.

Next month Fairchild also plans to introduce a 1,024-bit read-only circuit.

Open and shut. Each transistor in the Philco memory functions as a gate. When the individual transistor gate is connected in the final metalization process, current flows from source to drain and the output is interpreted as a binary 1. When the gate isn't connected, there is no current flow and the output is a binary 0.

This method allows the use of very small transistors, says William McKinley, manager of the company's custom-MOS section. This approach departs from the alternative-ratio technique in which a large and a small transistor are connected to form each gate. These transistor pairs look like re-

sistor dividers. If the bottom transistor is on, the voltage out will be low, and if it is off, the voltage out will be high.

Philco's memory array consists of 128 eight-bit words. A 32-by-4 selection matrix allows address of any word. Seven bits are required for the address—five inputs go to the vertical column (2^5), and two inputs to the horizontal lines (2^2). Each of the 128 parallel-word circuits feeds into a buffer driver and an AND gate, so that addition of an eighth address bit can convert the circuit into a 256-by-4 array. Access time is 1 microsecond.

Price is right. Gorman says computer makers have shown considerable interest in the circuit, which can be used for subroutine storage ("firmware") and table-lookup operations such as sine, tangent, and code conversion.

Philco will coat each chip and etch back to lay out a customer's particular interconnection needs. There will be a one-time only tool-

ing charge of around \$750 for small quantities of circuits. After that, the price will be about \$70 per chip in small quantities, or 7 cents a bit. The price will be about 5 cents a bit for larger quantities. Once someone has paid the tooling charge for a given function—such as a sine table—it will be available to anyone for the chip price alone.

Forman says that the circuits are now in production. Turnaround time for final metalization is three to four weeks.

Active filters

In a day when the fully compensated monolithic operational amplifier is itself newsworthy [Electronics, Jan. 8, p. 25], the achievement of three op amps on the same chip may be something of a surprise. The key, of course, is that the devices are built with metal oxide semiconductor technology. They are a part of an active filter—

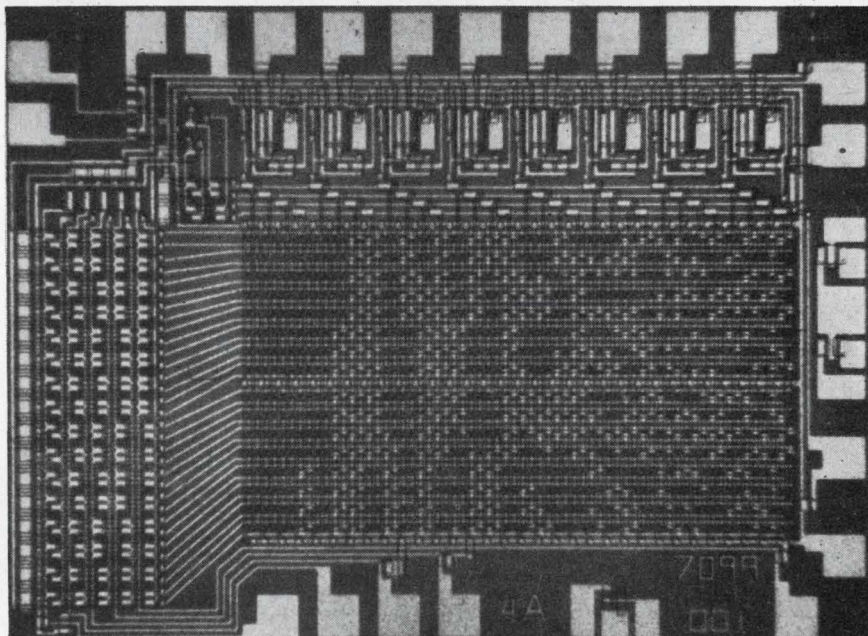

Tightly packed. Philco-Ford's 1,024-bit read-only memory features 1,340 metal oxide semiconductor transistors.

a filter built with active devices instead of the ordinary coil—that will soon be introduced as what its developers say is the first true linear mos integrated circuit on the market.

The active filter is the product of Gunnar Hurtig 3d, a young engineer who has pursued its development over the past three years.

“What we’re trying to do is replace every passive filter below 100 kilohertz with an active filter,” says Hurtig, now manager of the electronic products department of Western Microwave Laboratories Inc. “We’ll never sell an active filter that’s not cheaper than a passive device. But there are no secrets to filter design. In technology, the passive-filter manufacturer has his back against the wall. I can sell an active filter for less than someone else can build a passive filter.”

The key to low prices is batch fabrication, Hurtig says. He has built both discrete and hybrid versions of the active filter, which utilize a gain stage (the op amps) plus two resistors and two capacitors for tuning to a center frequency, and another resistor for determining bandwidth. Only when all of these elements are deposited on the same chip can the price be cut to below \$5, the figure that Hurtig feels is necessary to undercut the passive filter.

The marriage between filter and semiconductor technology was consummated at American Microsystems Inc., an mos manufacturer whose plant is only a few miles from Western Microwave’s Santa Clara, Calif., headquarters. AMI will make dice for Western, which will perform its own die attach, lead bonding, and packaging.

Tiny breadboard. Because Hurtig and his colleagues were venturing into a new field, AMI recommended that the layout for the ic chip be handmade. It built some 50 breadboard dice, measuring 101 by 93 mils, on which mos devices of various sizes were deposited. Some of these devices were connected by bus lines. Western connected the others as it pleased by attaching wires to the 72 bonding pads.

There are six types of load devices, explains AMI’s Richard W. Przyblski, as well as three types of inverters and two types of capacitors, which may be connected in either series or parallel to obtain values of 10, 5, or 2.5 picofarads. Hurtig’s group at Western had to hook up the devices into three differential amplifiers per op amp, then report the chosen values to AMI. The transistors, Przyblski notes, have different gains and transconductances, which are controllable by scaling the sizes. The smaller mos field effect transistors act as resistors. Each amplifying stage has two amplifying devices and two load devices, plus one device as a current source.

The final version of the chip will have from 70 to 90 elements and will measure only 80 mils, since some of the transistors and most of the pads will be eliminated.

Q factor. Western’s first filters, which will be on the market in about six weeks, will operate from d-c to 30 khz. Others will follow, but Hurtig is limiting himself to the field under 100 khz because of the performance of the op amps. The Q of a circuit must be high if the filter is to have sharp skirts, and Q is proportional to amplifier gain. As op amp gain falls off, Hurtig notes, the skirts flare. And filters are one area where miniskirts will never go out of style.

The active filter has a Q range adjustable from 0.5 to 250, and a

Q stability (independent of Q) of 0.001%. Its center frequency can be tuned at least one decade from the nominal center frequency, and center frequency stability is 0.005%.

Low-pass, high-pass, and band-pass outputs are simultaneously available on each filter, so that the user can realize complex zeroes as well as complex poles. Each filter is a basic building block that can be utilized for more complex functions. For example, a 4-pole pair bandpass filter could have relative bandwidth of from less than 1% to more than 100%.

Consumer electronics

Tuner for all channels

A television viewer trying to tune in a station in the ultrahigh-frequency band often looks like a character in an aspirin commercial. For all his dial twisting he can’t lock onto the channel. But this dark picture may be brightened.

Oak Electro-netics Corp.’s Television Products division in Crystal Lake, Ill., has developed a solid state all-channel tuner that does the work of both uhf and vhf tuners. And though the device, called the Mark IV, uses continuous-drive tuning for both bands, it can also be detented by the set manufac-

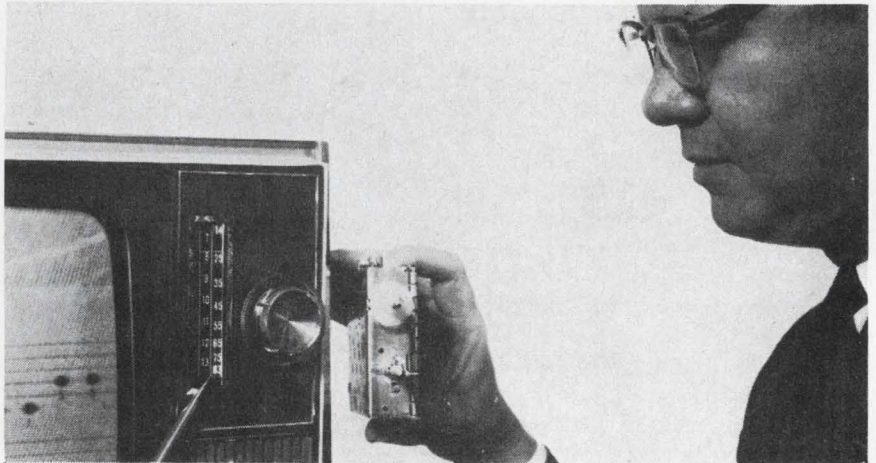

One for two. Combination vhf/uhf tuner does the work of two conventional tv set tuners, but takes up less than half the space.

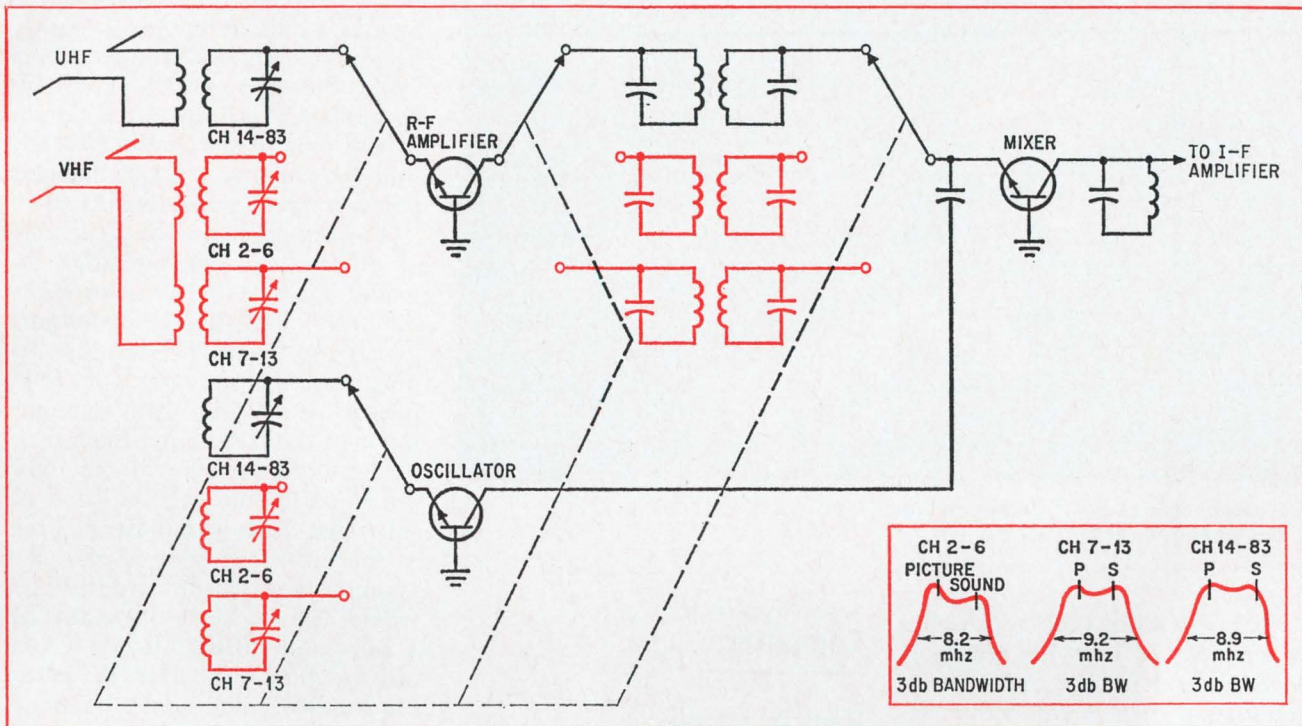

Switched on. Oak Electro-netics' combination very-high-frequency/ultrahigh-frequency tuner uses a simple switching scheme to select one of three frequency bands.

tuner to lock onto the 12 vhf stations and any 12 uhf stations.

Strike up the band. A low-loss switching scheme is used to select one of the three discrete frequency bands covering channels 2 to 6, 7 to 13, and 14 to 83. Any station within the chosen band can then be tuned by vernier or detent action.

When the tuner is switched to uhf, the tuning capacitor stator is grounded and acts as a quarter-wave uhf transmission line. In the vhf band, the stator acts as a low-loss capacitor and tunes the vhf coils in the rotary switch section. Three transistors serve as the r-f amplifier, mixer, and oscillator for both vhf and uhf bands.

Price savings. The combined cost of conventional vhf and uhf tuners is around \$9.50; the Oak tuner, excluding the drive mechanism, is priced at \$6.50. A simple drive mechanism using a tuning ratio of 4:1 for vhf and 16:1 for uhf will cost the set maker an additional 50 cents. However, more sophisticated drives will go for as much as \$3.

Another advantage of the Mark IV is its size. Measuring 1 1/8 by 3 1/2 by 4 inches, it takes up less than half the space required by the

tuners in most present large-screen sets. And, Eugene Walding, an engineering section manager at Oak, claims that "by combining the uhf and vhf circuits into a single unit, we have been able to improve noise figures and image rejection."

Typical performance figures for the tuner—channels 2-6: noise figure, 5.5 decibels; gain, 32 db; image rejection, 70 db; channels 7-13: noise figure, 6.1 db; gain, 31 db; image rejection, 65 db; uhf channels 14-83: noise figure, 7.3 db; gain, 28 db; image rejection, 70 db.

Home color

The wonderful world of home color video tape recording is so costly that there are no color vtr's aimed strictly at the consumer market. The Ampex Corp. has a color vtr on the market for \$4,500 and International Video Corp. is selling one for \$4,200, but both these machines are intended more for industrial and educational closed-circuit tv systems than for the amateur.

However, last week in New York City, the Arvin Industries Inc.'s Electronic System division, intro-

duced a prototype color vtr that reportedly will sell for between \$1,000 and \$1,500. This figure of course, does not include a camera. A black-and-white camera would cost around \$150 but a color camera would be closer to \$12,000.

The Arvin unit—not expected to be in production till next year—is dubbed the cvrxxi. It can record both black-and-white and color broadcasts and has input jacks for a camera for amateur productions.

Making it simple. Instead of employing the complex, and very expensive helical scan principle employed by most vtr producers, Arvin is using the longitudinal fixed-head recording technique and an indexing tape transport developed for vtr's by Newell Associates Inc., Sunnyvale, Calif. [Electronics, May 15, 1967, p. 25]. With this principle—which Arvin is using under a licensing agreement—and a special head, the cvrxxi records both picture and sound on the same tape track, and compresses 10 tracks on a 1/2-inch wide tape that's packaged in a self-threading cartridge.

The first track is recorded as the tape moves past the head from left

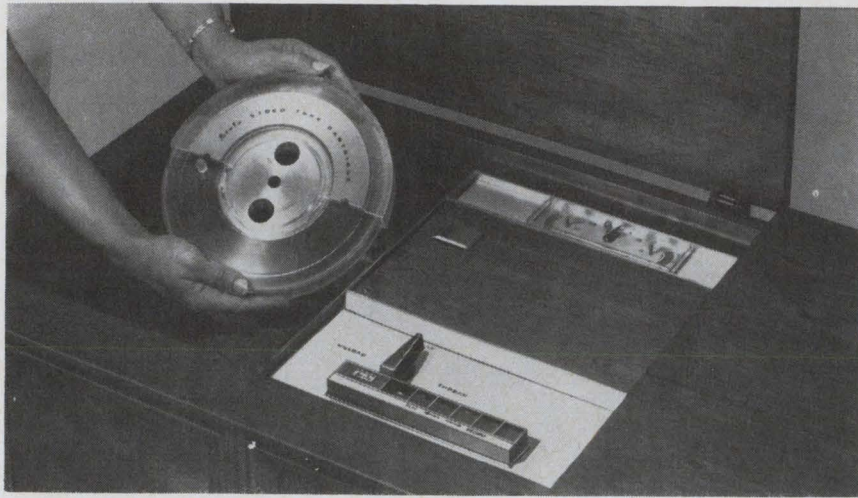

Reel easy. Low-cost color vtr with cartridge tape reel is as simple to operate as a color set and tape recorder.

to right. When the tape approaches the end of the reel, the transport mechanism stops and reverses direction as it steps down to the next track. The program being recorded is interrupted for less than a second by the cycling.

The operating time for a 4,800-foot reel of tape—which runs at 160 inches per second—is an hour, or six minutes for each track. A tape price hasn't been set, but it's expected to be about \$30. This will mean almost a 50% saving on tape costs compared with other machines, which use up the same amount of tape in about 30 minutes. Arvin says it is working on a new head that will further reduce tape speeds to 120 ips without a significant loss of resolution. Arvin's design also offers another economy: it reduces duplication time and costs since all tracks can be duplicated in a single pass.

Easy does it. The system is easy to operate. It uses only stop, start, and tape-direction buttons and those controls normally found on color tv sets and tape recorders, and has none of the recording level indicators and light meters found on more professional video tape recorders.

The recorder's frequency response is flat from d-c to 2 megahertz. Color response is from d-c to 500 kilohertz and audio response is from d-c to 20 khz. Horizontal resolution is 200 lines.

Computers

Back in action

An error-correcting technique, conceived in 1950 and used extensively only in the Stretch computer in the late 50's, has been revived in the International Business Machines Corp.'s new system 360 model 85 computer, first of which will be delivered in the fall of 1969. The technique corrects all single-bit errors in a 64-bit double word, and detects any double-bit errors.

Modern ferrite-core memory technology has developed to the point where errors rarely occur. The conventional parity check—single-bit error detection, covering groups of eight to 32 bits—is usually considered sufficient. The company would not say why it felt that error correction was desirable in the model 85; however, according to one informed guess, the great length of the word, the rate at which words are fetched, and the high performance level of the processing unit made error correction desirable. This capability slows down the attainable speed of the memory by several nanoseconds but the presence of a high-speed buffer memory in the model 85 compensates for the slowdown.

Few extras. The error code used is the Hamming code, named after its originator, R.W. Hamming of

Bell Telephone Laboratories. A redefined data format for the model 85 word as it is kept in the memory makes the error correction possible by adding only a few extra circuits in the data paths leading to and from the memory, without changing the memory organization itself.

All data processed by all models of the System 360, including the model 85, is in the form of eight-bit bytes; pure binary operations, which are useful in scientific applications, operate on 16, 32, or 64 bits at a time, but always as multiples of the basic byte. Each byte, furthermore, carries with it a ninth bit, a parity bit, whose value insures that the total number of 1 bits in the error-free byte is odd. For example, the eight-bit byte 10101100 would carry with it the parity bit 1, becoming 101011001, for a total of five 1 bits in the byte; the parity bit for 00011100 would be 0 because the byte already has three 1 bits in it.

At the end of any operation, the number of 1 bits in each byte is counted; if the count is even, the result is known to contain an error. The error, however, cannot be immediately corrected, because the check does not indicate in which bit it occurred, or even whether the error was a 0 that became a 1, or a 1 that became a 0. Correction processes require more sophisticated techniques, usually involving software.

Watchful eye. All operations in the model 85, except transferring to and from the memory, are performed under the watchful eye of a parity check, just as in the other models. But when a 64-bit double word (eight bytes) is stored in the memory, the eight parity bits are replaced by eight other bits. Seven bits represent parity checks on a selection of 8 to 36 data bits and the eighth is a parity check on the entire 72 data and check bits.

When the word is later fetched from the memory, if a single bit of the 72 data and parity bits is wrong, the full-length parity check will indicate it. The other seven partial parities, some of which will also have failed, may be considered as a binary number with the fail-

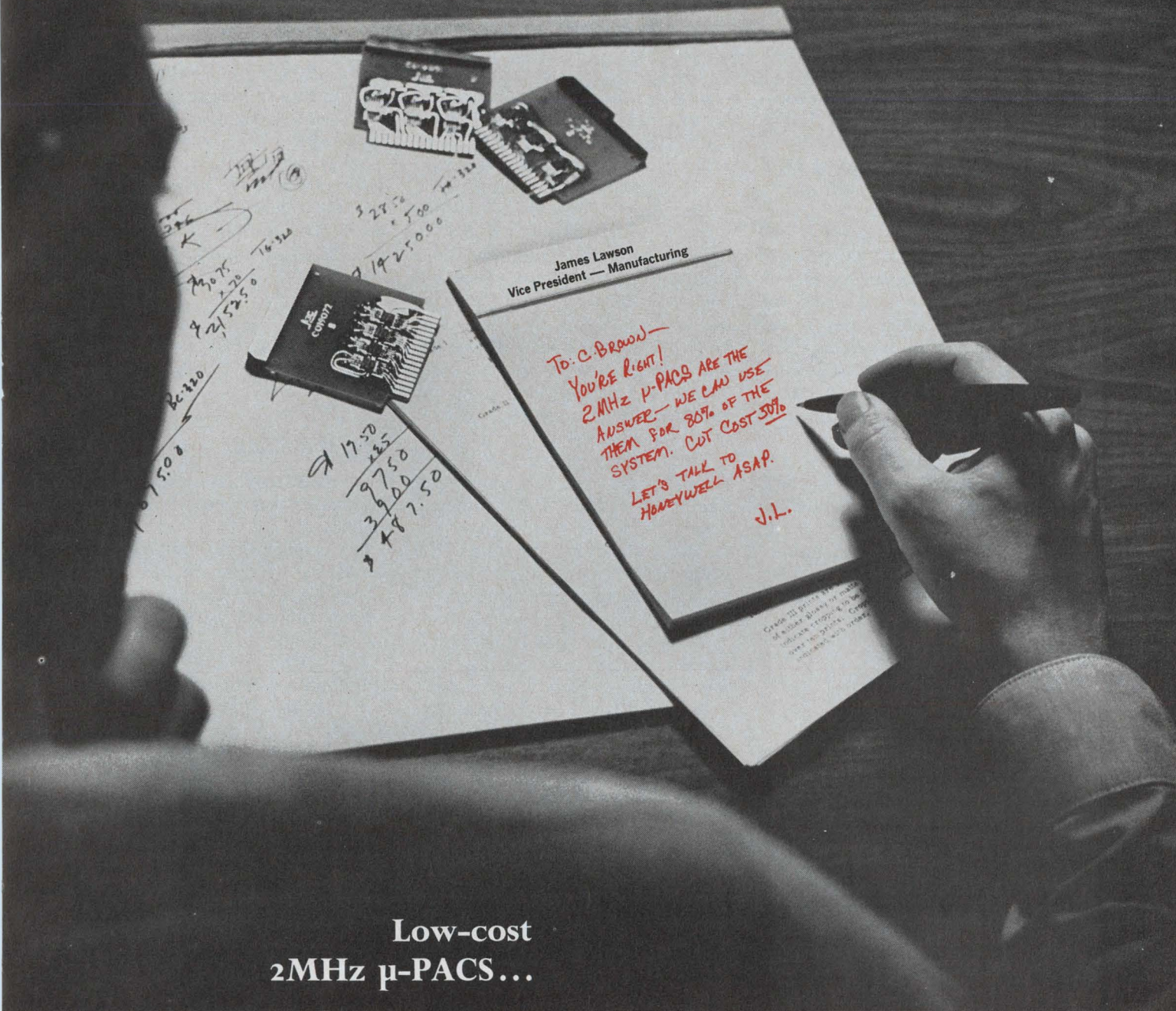

Low-cost
2MHz μ -PACS...

...let you save
up to half the cost
of system logic.

If you face a make-or-buy evaluation for system logic, maybe you've considered μ -PACS. Now, you can use new I/C 2MHz μ -PACS for up to 80% of your logic needs. Cut costs as much as 50%.

Take another look at your make-or-buy: Think μ -PACS at half the cost. Add more savings for volume discounts. Forget the people and equipment you'd need just to begin making your own. Remember μ -PAC quality and reliability. (Both 2MHz and 5MHz μ -PACS are compatible.) If this changes your cost analysis, write for new spec/price brochure. Honeywell, Computer Control Division, Old Connecticut Path, Framingham, Massachusetts 01701.

Honeywell

 **COMPUTER CONTROL**
DIVISION

Circle 49 on reader service card

ures as 1's and the nonfailures as 0's. This binary number is the location of the one bit in 72 that is wrong.

If two bits in the fetched word are wrong, the full-length parity will not fail, because the total number of 1 bits is still odd. But one or more of the partial parities will have failed. And this combination of circumstances—at least one partial parity failure and a full parity nonfailure—indicates that two errors have occurred. The locations of the two wrong bits cannot be determined from the parity checks alone.

In the model 85, once the word has been taken from the memory, and the error correction-detection performed, the original eight parity bits are restored and operation under a byte-for-byte parity resumes.

Industrial electronics

Treading softly

A car buyer who kicks the tires to find out if they're any good derives some satisfaction but little information. Tire makers are becoming more exact—they're letting computers do the "kicking."

Without fanfare—apparently to avoid stirring up "Unsafe at Any Speed" publicity—the major tire makers have quietly installed equipment made by Akron Standard Mold Co. to electronically weed out defective tires and grade acceptable ones.

The Firestone Tire & Rubber Co. recently equipped seven of its plants with the gear. Other manufacturers have done the same.

On the road. Akron Standard's equipment uses an Electronic Associates Inc. computer that calculates a tire's fundamental harmonic while it checks for nonuniformities. Unevenness (hard and soft spots on the tire) generate sine waves that excite the vehicle's suspension system, thus causing rough rides even on smooth highways.

In a typical tire plant operation, a conveyor system carries the tire

to the testing station where it is placed on a chuck and inflated. A rotating groundwheel presses against the tire at a force of up to 2,000 pounds, which is determined by an operator but controlled by the computer. Two load cells—one for measuring lateral forces and the other for radial forces—send their signals to the computer, which calculates peak-to-peak variations during one revolution of the tire. The variations are compared with grade limits set on the computer's dials.

During a second revolution, the computer determines the amplitude of the fundamental, and produces a voltage proportional to it. If this signal, which goes to a comparator circuit, is within predetermined, acceptable limits, the computer calculates a signal proportional to the fundamental's phase angle that corresponds to the high point on the tire. The tire is then marked for grade and high spot location at a different machine. A complete grading test takes about 30 seconds.

Spot matching. In a separate operation, wheel rims are also marked for their high spot. During car assembly, tires and rims are then matched so that their high-spot marks are 180° apart. Thus, the high spots cancel each other's effect on the suspension system.

Akron Standard is developing equipment that tests and then grinds tires to reduce high spots in force variations. Output of a tire

Deflating 'premium' tires

With the Department of Transportation's standards for tire performance, safety, and labeling not expected until next year, the consumer is getting some immediate help from another Government agency—the Federal Trade Commission.

The FTC is cracking down on the use of such terms as "top of the line," "premium," and "select" in tire advertising. The agency is demanding that manufacturers run qualifying statements in their ads cautioning consumers that there are no industrywide standards and that the manufacturer's grade is its own designation.

uniformity computer—this one from Information Development Corp. of Akron—is servocoupled to the grinding wheel.

What happens to rejects? "They don't go to Detroit," says one industry spokesman. The auto makers use similar testing systems to random-check tires received from suppliers.

Displays

Happy medium

Customers seeking remote display terminals for a computer have two choices:

- A sophisticated unit that can handle both keyboard information and graphics but that's priced anywhere from about \$30,000 up to six-figure amounts.

- A terminal that handles only alphanumeric through a keyboard but costs only between \$2,000 and \$7,000.

There's nothing in between.

This spring, though, a new firm, Computer Displays Inc., will introduce a terminal to fill that void [Electronics, Feb. 5, p. 26]. The unit, called ARDS for advanced remote display station, was developed at the Massachusetts Institute of Technology for Project MAC (multiple-access computer). It will be priced at about \$10,000.

Double role. Computer Displays says buyers will get a machine providing many of the economic advantages of cluster displays—several low-cost units tied together—and much of the convenience of the high-priced single terminals that handle both graphics and alphanumeric.

The new firm's president, Robert H. Stotz, and its vice president, Thomas B. Cheek, both worked on the development of the ARDS terminal at MIT.

According to Stotz, the company plans to sell a basic system consisting of a Tektronix 11-inch storage tube, a vector generator, a character generator, and a keyboard capable of relaying data in the 94-

Heard about the pulser revolution?

E-H started it.

The pulser revolution is a big trend toward automation of pulse testing and high-speed switching time measurement and data handling.

The revolution is quickly toppling time-worn ways of buying pulsers. No longer are safe old habit buys from one manufacturer good enough. No longer can you buy on price alone. (Even a high price is no guarantee of sophisticated equipment.)

E-H has consistently led the pulser revolution — innovating, pushing pulser technology ahead to new frontiers. Just one example is the new E-H 1139 — 1420, a new fully programmable pulse driver and timing unit which can be connected directly to a process control computer. The 1139 — 1420 has high stability circuits designed to serve in non-attended system applications. Also available for use in conjunction with this pulse system is a manual control unit.

Whatever your need, there's a pulser in the broad E-H spectrum which is right on target. Other examples: E-H Model 139B, a modestly-priced pulser with a repetition rate to 50MHz which makes it ideal for high-speed integrated circuit and logic testing applications. Or E-H Model 122, a 1 kHz to 200 MHz pulser with all the versatility you'd expect in a low-frequency instrument.

If you're not specifying E-H pulsers, maybe now is the time to revolutionize your thinking. For more information, request the complete E-H pulser catalog.



E-H RESEARCH LABORATORIES, INC.

163 Adeline Street • Oakland, California 94607 • (415) 834-3030 • TWX 910-366-7258

In Europe: E-H Research Laboratories (Ned) N.V., Box 1018, Eindhoven, The Netherlands, Telex 51116

In Japan: Iwasaki Communication Apparatus Co., Ltd. No. 710, 2-Chome Kugayama Suginami-Ku, Tokyo, Japan

character American standard code for information interchange.

The system would read text into or out of a remote computer over ordinary phone lines, and would also display graphic data such as charts, drawings, and schematics.

Drawing board. Computer Displays has no firm price schedule, but Stotz and Cheek plan to offer graphic input at \$250 to \$300 extra. The graphic input device—shaped like a large grapefruit cut in half—is analogous to a light pen, but the user wouldn't have to write on the face of the cathode-ray tube or on a tablet.

Holding the device with the spherical side up, he will slide it across a flat surface to, for instance, trace the outlines of a drawing. The sliding rotates potentiometers attached to the bottom of the sphere, and their changing resistances are transmitted through a cable to the display and converted to cursor movements on the screen.

The company may also offer an acoustic coupler that Stotz says would "perhaps make possible the use of low-cost unconditioned phone lines." The coupler would replace what the telephone company calls a data set.

Later, Computer Displays may add an optional magnetic-tape recorder that could record graphic input data for subsequent rapid feeding into a central computer.

Some gaps. The ARDS won't be able to rotate a image on its screen, but "at least half of all graphic applications don't really require it," according to Stotz. Nor will there be a hard copy output at first; it may be an option later. "At MAC, we found ourselves dropping 90% of the teleprinted readouts into the wastebasket anyway," Stotz says.

The executive feels some users may be distracted by the momentary flash of light as the storage tube is erased; also, some may like a slightly brighter display. "But these disadvantages are a small price to pay for being able to do without display storage and refreshment circuitry," he says. Stotz also notes that with random scanning, ARDS will have a resolution—

100 lines to the inch—at least six times sharper than that of inexpensive displays with raster scanning, "and we don't need expensive electronics to convert digital data to raster format."

Nor is ARDS slaved to a central memory like some low-cost displays. Stotz feels such systems are good for education, say, where many people view the same display simultaneously. But for use in a computer utility, he says the user needs independence. Further, with ARDS, graphic and character generation and image storage are done at the terminal. Some low-cost display systems have to use computer power and memory to generate or refresh displays.

Not unexpectedly, one of Computer Display's first customers will be MIT, which plans to install six of the terminals on campus this summer.

Batch view

Most of the effort in applying light-emitting diodes to products has involved putting them together in an array of separately processed and packaged devices. But one group at RCA feels such an approach is too limiting, especially for display purposes. The cost of handling many individual units is high, and the resulting array, because of the interconnections and output wiring is bulky. RCA is betting its research money on batch-fabricated arrays.

In fact, RCA has already built one—a 5-by-7 array of mesa diodes made from gallium-arsenide phosphide, Ga (As,P). Within two years the company expects to have commercially available arrays that generate alphanumeric displays, says Lawrence A. Murray, who heads the device physics group at RCA's Electronic Components and Devices division in Somerville, N.J.

The array measures 200 by 300 mils, with the 20-mil diameter dots emitting red light at about 6,400 angstroms on 40-mil centers.

In line. The company has also produced an array of 13 diodes forming a 13-line pattern that, depending upon which segments are

energized, can form any alphanumeric. These diodes have been made as large as 8 by 225 mils. But for general-purpose displays, says Murray, the dot array holds out the greatest promise. Next step for the researchers is to develop a 25-by-25 array.

Most of the company's work has been funded by the Avionics Laboratory of Wright Patterson Air Force Base, Dayton, Ohio. Eventually, the Air Force hopes to get displays as large as 4 by 5 inches for use in aircraft cockpits. Integrated circuitry would drive the display.

Texas Instruments has successfully developed several planar monolithic arrays for the military, using gallium arsenide, gallium phosphide, and gallium-arsenide phosphide. The largest array consisted of more than 400 elements in a straight line.

Light-emitting diode arrays have been on the market for more than a year. However, these arrays are discrete, separately packaged diodes held together in metal heat sinks, and they are expensive. A 5-by-7 array of Ga (As,P) diodes offered by the Monsanto Co., St. Louis, for experimental purposes costs \$495. Part of this high cost can be attributed to the fact that each diode has to be handled separately. Coaxial headers are used in arrays developed by both Monsanto and the International Business Machines Corp.

Problems remain. RCA is able to manufacture large, uniform wafers of gallium-arsenide-phosphide. The hard part, of course, is to achieve a 100% yield of good diodes and to make all the diodes in the array identical.

Monsanto also has developed a batch-fabricated Ga(As,P) array—an experimental 3-by-5 matrix of diodes, according to Louis Lutostanski of the company's New Enterprise division. But Monsanto believes discrete diodes will be used in most solid state displays for both military and commercial applications. This opinion is shared by IBM, which has delivered a 6-by-10 array of individually mounted gallium-aluminum arsenide diodes to a military customer.

Government

Data banks overdrawn

Fresh from having just about killed the proposed National Data Bank, The Senate's Mr. Privacy is planning new runs on other information banks.

Sen. Edward Long (D., Mo.), chairman of the subcommittee on administrative practice and procedure, has expanded his attacks on electronic invasion of privacy to include all sorts of computer data banks—private or governmental.

Under the gun. In the first of what promises to be a long series of sessions on computer privacy, the committee has brought many specific schemes under fire. These include:

- The American Bar Association's plan to establish a data bank on disciplinary actions taken against lawyers;

- The Federal Bureau of Investigation's plans for a national crime information center [Electronics, Dec. 11, 1967, p. 149];

- A New Jersey firm's project to market computerized data on the buying habits and personal background of doctors for drug companies;

- The Credit Data Corp.'s plan to computerize credit information on 70% of the U.S. population;

- Schemes by New Haven, Conn., and Santa Clara and Alameda County, Calif., to establish computer-stored dossiers on every citizen in the area.

Other concepts the committee views with distaste include the checkless, cashless society envisioned by those working on electronic banking techniques, the commercial time-sharing concept, and the right of corporations and government to store data on a person without his permission.

Privacy armor. Some surprising proposals were offered to Long's committee. Paul Armer, an official at the Rand Corp., suggests a Cabinet-level department to handle the computer invasion.

Alan F. Westin, a Columbia Uni-



Modine technician prepares test core for wind-tunnel test. VIDAR Digital Data Acquisition System speeds testing of automotive and industrial radiators, oil coolers, and other related products.

How Modine saves test dollars...

Automatic measurement — -60 times faster than previous manual methods—and more accurate—allows one man to do the work of three in testing automobile and industrial heat exchangers (radiators and oil coolers). An enormous amount of data is generated by three wind tunnels and two oil-cooler testers.

Modine's Automotive and Industrial Test Supervisor says, "A year ago it took 120 readings to make one valid test run . . . in 20 minutes. Now, our VIDAR system does the job *in one minute*. Transducers in the test cells are scanned and their output voltages converted into numbers on the paper tape — and it's all completely automatic. Water-flow measurements are made at the same instant heat-transfer data is recorded . . . particularly important in determining how much fin surface is needed for correct performance."

Time saved, dollars saved, accuracy increased . . . this is the "magic" of VIDAR. Let us show it to you. VIDAR Corporation, 77 Ortega Avenue, Mountain View, Calif. 94040. (415) 961-1000.

VIDAR

versity professor of public law and government, urged stiff Federal and local protection laws. Wiley Branton, executive director of the United Planning Organization—a Washington group doing computer studies of poverty problems in the city's ghettos—asked for a plan to encode data; names of individuals would be separate from substantive data to protect the individual. Branton says his group is already establishing such a program.

Cleaning the spectrum

Up to now, the Federal Communications Commission has been philosophical about interference from toy walkie talkies. "For a few weeks after Christmas, it's rough," says one FCC engineer. "Thank God those things break after a few weeks."

Garage door openers, though, present a more serious problem, one that the FCC can't take so lightly since r-f radiation from these devices frequently interfere with aviation navigation systems. Tracking down offending transmitters has been a costly, time-consuming job.

But now, it appears that there is going to be some cleanup in what FCC commissioner Robert E. Lee calls "spectrum pollution."

Under a bill moving through Congress, the FCC will be empowered to set standards and regulate manufacture, import, sale, and shipment of any device that could cause harmful interference with air channels.

Zip treatment. In surprisingly fast action, the bill last week was reported out of the House subcommittee on communications and power within minutes of the close of a two-hour hearing. The measure is expected to win Congressional approval this session.

"The bill," says Lee, "will enable the FCC to deal with the interference problem at its root source by prohibiting manufacture and sale of devices that fail to comply with agency regulations."

He told the subcommittee the FCC received about 40,000 complaints of interference in fiscal 1967. Several thousand of these complaints, he testifies, were attribut-

able to such devices as high-power electronic heaters, diathermy machines, welders, garage-door openers, and low-power walkie talkies. Lee added that the FCC is frequently requested to make special provisions to permit use of new radio devices.

"In the absence of authority to make the manufacturer responsible for compliance with our interference specifications, we are reluctant to sanction the use of such devices due to the difficulty of tracking down individual users of noncomplying devices," he said.

Save a buck. Lee emphasized that manufacturers "have cooperated generously" to minimize interference. But he said those who hold down excessive radiation are at a competitive disadvantage with "the marginal manufacturer who cuts corners to save a few dollars in this vital area."

The FCC emphasizes it will not have its inspectors examining production lines or interfering in development. Nor will the legislation mean stricter technical standards: the FCC has authority already to adopt what standards it feels necessary. But it could, explains Lee, make existing technical standards "applicable at the manufacturing level." This means the maker—rather than the user—would be responsible.

He promised that any new standards would be set only by going through the conventional process of holding hearings and inviting industry opinion.

The Electronic Industries Association has come out for the bill, and a spokesman for the Electronic Industries Association of Japan says the legislation makes sense.

LBJ's war on radiation

"Delayed or chronic effects (of radiation) include such serious consequences as leukemia and other cancers."

With this and similar observations, the Administration last week swung aboard the bandwagon for radiation protection. And not to be outdone by Congressmen pushing their own bills—Rep. Paul G.

Rogers (D., Fla.) and Sen. E.L. Bartlett (D., Alaska)—the President has submitted his. It takes the best of the Rogers and Bartlett bills, says Dr. William H. Stewart, the Surgeon General, and adds some Johnson touches.

Easy passage. The bill will probably get quick approval by a Congress out to make a reputation for itself in the field of consumer protection. The President's bill came as somewhat of a surprise. He was previously expected simply to endorse the Rogers and Bartlett measures and push for their passage [Electronics, Feb. 5, p. 60]. However, this consumer "cause" has shaped up as one the White House couldn't pass up.

The President's measure would enable the Welfare Secretary to finance research in biological effects of radiation and "set mandatory standards for the control of hazardous radiation emissions from electronic products." The bill covers "any manufactured product or device which has an electronic circuit which during operation can generate or emit a physical field of electro-magnetic radiation or sound radiation."

The bill would also require manufacturers to state on labels that they are complying with the standards, maintaining testing records, and allowing plants to be examined by Federal inspectors. And it would set up procedures for notifying purchasers of products considered hazardous, as well as procedures for recall and repair.

Rampant rays. Meanwhile, a Congressional panel was told that the problem of excessive radiation in color-television receivers is industrywide. The charge was made in a preliminary report by James T. Terrill Jr., director of the National Center for Radiological Health, on a Washington-area sampling of 200 receivers.

For the record

For the bird. The Army Materiel Command has awarded a \$300,000 contract to Martin Marietta's Or-

GOOD

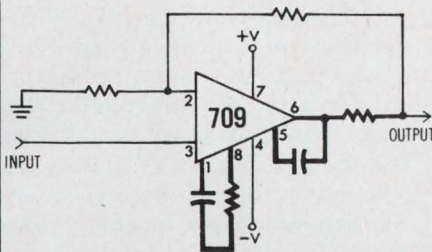

This buffer has a 10M Ω input . . .

BETTER

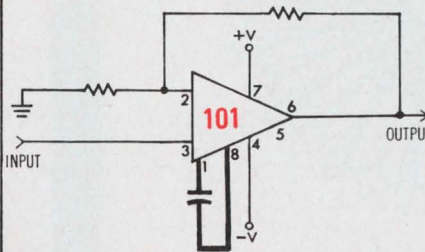

but the circuit can be improved

BEST

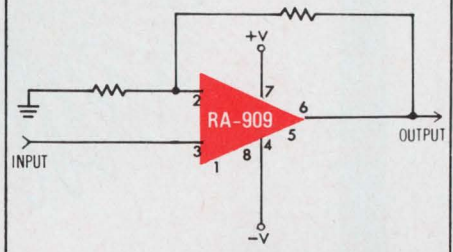

. . . or it can be optimized!

Now all 709 circuits can be optimized by using the NEW compensationless RA-909.

This pin-for-pin replacement eliminates extra components and offers performance better than the very latest versions of the 709.

It's possible to achieve an equivalent input impedance of 10M Ω or better and provide unity gain with a maximum error of .004% with the buffer illustrated on the left above. But why not get the same performance with less components? Use the new RA-909.

Design it in or use it as a replacement. Available in the popular eight pin TO-5 configuration and the TO-86 flatpack, both having blank pins where the 709 and 101 require compensation so that existing compensation networks will not affect the

RA-909. Eliminate possible failure sources and get better performance for a comparable price. You can expect improvements such as a slew rate of 5 volts per microsecond; power dissipation of only 52 milliwatts; transient response of 40 nanoseconds (10 to 90% points) with a 200 millivolt output into a 2K Ω , 100pF load in the worst-case unity gain configuration; and a maximum equivalent input noise of 5 microvolts rms. Yes, five microvolts!

Contact your nearest Radiation sales office for further information.

Visit us at IEEE '68 Booth 4H19-4H21

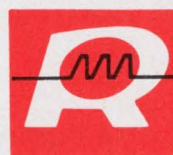

RADIATION
INCORPORATED
SUBSIDIARY OF HARRIS-INTERTYPE CORPORATION
MICROELECTRONICS DIVISION

Sales Offices: 600 Old Country Road, Garden City, N.Y. 11530, (516) 747-3730 — 2600 Virginia Avenue, N.W., Washington, D.C. 20037, (202) 337-4914 — 6151 W. Century Boulevard, Los Angeles, Calif. 90245, (213) 670-5432 — P.O. Box 37, Melbourne, Florida 32901, (305) 727-5430 — International Sales: Marketing Department, P.O. Box 37, Melbourne, Florida 32901, (305) 727-5412

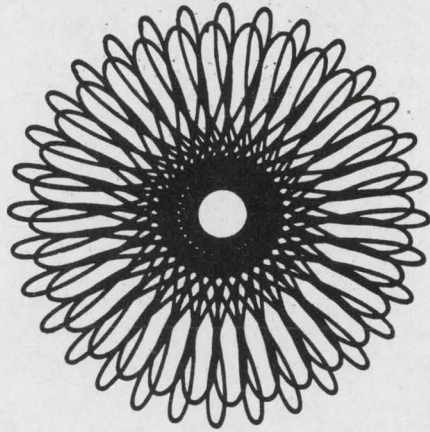

CYCLIC A/D CONVERTER

For more than a decade, engineers have attempted to design a workable CYCLIC A/D converter. Bunker-Ramo has engineered and manufactured the first practical Cyclic A/D converter, the B-R 850.

- **CYCLIC!** Within the B-R 850, the signal is synthesized rather than successively approximated. Input data conversion is continuous, eliminating requirement for sample and hold. Output can be sampled continuously or on command.
- **FAST!** Worst-case conversion time: 1 μ sec. for 8-bit word. 1-bit changes as short as 60-nsec. When following a multiplexer, conversion time will add less than 1 μ sec.
- **ECONOMICAL!** \$1,348 (single unit price); POWER: max 7½ watts; SIZE: 3¾" x 4¾" x 7½"; WEIGHT: less than 2-lbs.

For more information on the BR-850 and on our upcoming line of components, (i.e.: 12-bit, 300 KHz; 8-bit, 3 MHz converter; 16-channel multiplexer and others) please contact Mr. W. G. Garner. Phone (213) 346-6000 or write:

"SEE YOU AT THE IEEE SHOW—Booth 4E39-41"



THE BUNKER-RAMO CORPORATION
DEFENSE SYSTEMS DIVISION
8433 FALLBROOK AVENUE • CANOGA PARK CALIFORNIA 91304

Electronics Review

lando division to determine the applicability of random access discrete address techniques, to Project Mallard, the proposed international military communications system. This award is Martin Marietta's fourth Mallard study contract; the total value is nearly \$1 million.

It figures. The Singer Co.'s Friden division is offering what it bills as the first electronic printing calculator using all integrated-circuit logic. Not only that, says Friden, but the \$1,495 price is \$750 to \$2,300 under the competition's tags. The typewriter-size machine, called the 1150, prints 37 characters a second and rounds off answers automatically.

Desk set. Interstate Industries of Chicago has introduced a new toy for the executive who has everything, including time on his hands. Touted as an electronic desk, it features a portable tv set, an a-m/f-m clock radio, a cassette tape recorder, and a \$1,300 price tag.

Dual on line. Honeywell's Computer Control division is bringing out its first dual processor, the DDP-324. Consisting of two computers similar to the company's two-year-old DDP-124, it will be used principally for simulation, process control, and lab applications. Each component machine has 8,000 to 24,000 words of memory, and they share a third 8,000-word memory module. A little extra hardware serves to streamline the dual operation.

Band splitting. In trying to satisfy demands for more land mobile spectrum, the FCC has allocated 165 new radio channels, for business and public use, including 20 solely for the police. The new channels were taken from the cluttered 450-to-475-megahertz band by reducing the channel width from 50 to 25 kilohertz. Those holding licenses to use these frequencies will have until June 1 to make some technical changes, but full compliance will not be required until 1971.

An FCC official says that about 20% of the approximately 125,000 transmitters now operating in the 450-to-475-Mhz range, will have to be replaced by 1970, but he notes these are mostly of pre-1950 vintage.

RCA supersedes the 2N681-690 SCR family with better performing devices at "mind-changing" prices!

			Voltage
2N690 2N689	2N3899 \$6.50	2N3873 \$6.35	600 V
2N688 2N687 2N686	2N3898 \$4.50	2N3872 \$4.35	400 V
2N685 2N684	2N3897 \$3.25	2N3871 \$3.10	200 V
2N683 2N682 2N681	2N3896 \$3.00	2N3870 \$2.85	100 V
25 A	35 A	35 A	RMS current

Prices in quantities of 1,000 and up

If you're using conventional SCR's in the mid-current range...RCA's 35-amp types offer greater protection from voltage transients, better performance...and just check the prices!

RCA's 2N3870-2N3873, 2N3896-2N3899 35-amp power-rated SCR's offer you a choice of press-fit or stud-mounted packages...and your circuits will not only be more reliable, they'll be a good deal less expensive! Just check the performance advantages of RCA's "mind-changing" SCR's over those of the 2N681-690 family:

	<u>2N681-690</u>	<u>RCA</u> <u>2N3870-2N3873</u> <u>2N3896-2N3899</u>
Forward Current	25 A	35 A
Peak Surge Current	150 A	350 A
Gate Power	5 W	40 W (for 10- μ s duration)
Gate Current	2 A	Any value giving maximum gate power is permissible.
Gate Voltage	10 V	
Thermal Resistance	0.9°C/W	2°C/W

Of course, if your design requirements call for the famous 2N690 family, RCA can still deliver more performance for less cost. Your RCA Field Representative can give you complete details. For additional technical data, write RCA Commercial Engineering, Section RN2-4, Harrison, N.J. 07029. See your RCA Distributor for his price and delivery.

RCA

Circle 57 on reader service card

MINIATURE SIZE RELAY □ **CONTACT RATINGS:** Contact Material: Rhodium. Maximum Voltage (Volts): 50 VDC, 150 VAC. Maximum Current: Switch, .500 amp. Carry, 2.5 amps. Maximum Power (Watts, DC): 6 Watts. Resistive or properly suppressed (VA, AC): 10 VA. Maximum Resistance Initial: 100 milliohms. End-of-life: 2 ohms. Peak Breakdown Voltage: 300 volts rms. Life & Reliability At Rated Load: 20×10^6 operations. Dry Circuit: 500×10^6 operations. **OPERATING PARAMETERS:** Speed: Depending on sensitivity and number of poles, the speed for miniature size relays is from 1 msec to $2\frac{1}{2}$ msec, including contact bounce and coil time. Insulation Resistance: Coil to ground: 50 megohms (min). Coil to contact: 500 megohms (min). Temperature Range: -50°C to $+105^{\circ}\text{C}$. Vibration: 10G @ 10-55 cycles/sec (open or closed). Shock: 15G (min).

STANDARD SIZE RELAY □ **CONTACT RATINGS:** Contact material: Rhodium. Maximum Voltage (volts): 150 VDC, 250 VAC. Maximum Current: Switch, 1.5 amps. Carry, 6 amps. Maximum Power (Watts, DC): 25 watts. Resistive or properly suppressed (VA, AC): 40 VA. Maximum Resistance Initial: 50 milliohms. End-of-life: 2 ohms. Peak Breakdown Voltage: 500 volts rms. Life & Reliability, At Rated Load: 20×10^6 operations. Dry Circuit: 500×10^6 operations. **OPERATING PARAMETERS:** Speed: Depending upon sensitivity and number of poles, the speed for standard size relays, including contact bounce and coil time, is: $2\frac{1}{2}$ msec to 6 msec. Insulation Resistance, Coil to ground: 100 megohms (min). Coil to contact: 2000 megohms (min). Temperature Range: -50°C to $+105^{\circ}\text{C}$. Vibration: 10G @ 10-55 cycles/sec (open or closed). Shock: 15G (min).

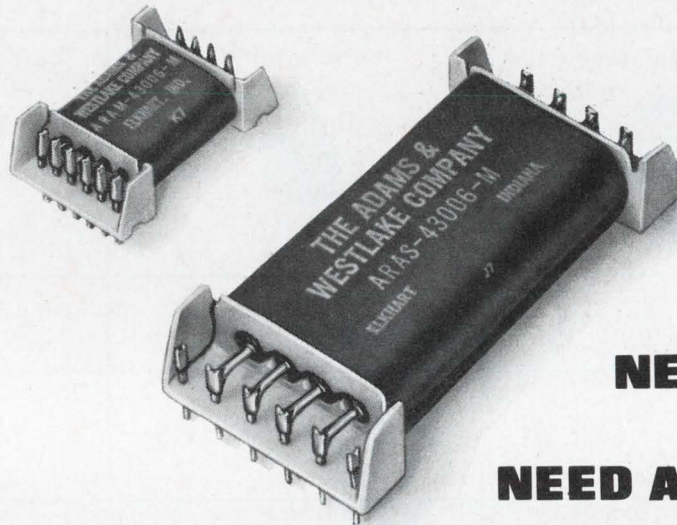

**NEXT TIME YOU
NEED A DRY REED RELAY
THERE'S A BRAND NEW SOURCE
WHERE YOU CAN GET IT FASTER**

It's Adlake—the company you call on for mercury relays. We now supply dry reed relays in standard and miniature sizes; single, double, and 4-pole. And we promise you the same fast delivery that made us the leader in mercury-displacement and mercury-wetted relays.

There's no compromise with quality. Our dry reed relays have the most accurately-wound coils and the most reliable switches you can find anywhere. They are specially recommended for such applications as automatic numerical machine controls, telephone and telegraph switchgear, and data processing.

Write today for our new catalog. And don't forget that at Adlake we always stand ready to assist you with design and engineering.



THE ADAMS & WESTLAKE COMPANY
A SUBSIDIARY OF **ALLIED PRODUCTS CORPORATION**

Elkhart, Indiana 46514 • 219 264-1141 • TWX 219 522 3102 • TELEX 25-8458 • CABLE ADLAKE

Washington Newsletter

February 19, 1968

Early warning nets get a reevaluation

The Pentagon is taking a hard look at its surveillance and early warning radar networks to determine which systems overlap and which are expendable. Major improvements in existing networks have been delayed until a Pentagon group on systems integration decides which are still needed in the light of developing new systems.

One likely casualty is the Ballistic Missile Early Warning System (BMEWS). It would be dropped in favor of the Sentinel antiballistic missile system's perimeter acquisition radar, as well as over-the-horizon radar installations.

Originally scheduled for major overhauls this year were the Navy Spasur and the Air Force Spacetrack detection networks. But now only minor improvements in data processing and communications gear will be made to keep up with the growing number of orbiting objects the two installations must detect and catalog.

Radiation standards to open big market for color-tv testers

There'll be a host of companies scrambling to get into the radiation-detection business once industry and the Federal officials can agree on a standard measuring device for checking home color-television sets. The National Center for Radiological Health and the Electronic Industries Association will hold a joint seminar March 28-29 in Washington, and the hope is that standard systems, calibration, and procedures will be hammered out then.

But the job won't be easy. A battle is expected between the center, which will champion its own lightweight radiation detector, and makers promoting their commercial instruments. The center's device has six Geiger-Mueller tubes aligned in two rows over a face area 16.5 by 14.5 inches. It can record radiation levels down to 0.05 milliroentgens per hour at a 5-centimeter distance in 10 minutes, compared with the half-hour exposures needed with older instruments. Center spokesmen say their detector could be produced at a cost of \$200 or less.

Comsat out to buy Intelsat 3.5 and 4

Comsat now wants to buy both the Intelsat 3.5 and the Intelsat 4 satellites. If it gets the okay from the International Consortium's interim committee, Comsat will launch the 3.5 craft in mid-1969; launchings of the giant Intelsat 4 would begin in mid-1970.

If Comsat follows this operating plan, it's highly doubtful that it would exercise its option to purchase more Intelsat 3 craft from TRW Systems. It doesn't appear though that Comsat would cut back its current order of six. The first Intelsat 3 is several months behind schedule and is now due for launch this fall.

Proposals are due March 9 on the Intelsat 3.5, which would provide 1,900 two-way voice circuits—700 more than the Intelsat 3. TRW has studied such a craft, achieving the increased capacity by "squinting" or narrowing the Intelsat 3 antenna beam. However, the work statements in both the 3.5 and 4 proposal requests leave the two contests wide open to all technical approaches. "Don't conclude that the 3.5 will be a modified 3. It could be a different satellite entirely, and from a different manufacturer," notes a Comsat official. Plans are to buy two satellites.

Since Intelsat 4 will weigh more than a ton, the craft will require a

Washington Newsletter

Titan 3B Agena booster. Bids are due April 8. Comsat plans to order four of the 5,000-circuit craft.

Work to begin soon on center for MOL

Construction of a mission control center for the Air Force Manned Orbiting Laboratory (MOL) will begin this spring. The \$6 million building is part of a five-year improvement program at the Advanced Satellite Test Center in Sunnyvale, Calif., that will also include nearly \$50 million of electronics hardware.

The Lockheed Missiles & Space Co. holds a \$36 million prime contract for data processing equipment, and Philco-Ford is subcontractor for displays. Computers will include three IBM 360/67 systems operating together, plus a Control Data 3800. Also, Collins Radio has a \$7 million contract to modernize communications equipment and convert it to S-band frequencies.

Payments speeded on defense orders

The Pentagon is speeding up payments on fixed-price contracts, partly to offset an expected new wave of industry complaints about low profits on defense orders. Beginning next month, the Pentagon will increase total progress payments on such awards to 80% from the present 70%.

Contractor claims are supported by a new Pentagon-sponsored study by the Logistics Management Institute showing not only that contractors make more money on commercial work than on defense jobs, but that this trend is growing as the Pentagon awards more fixed-price contracts. The institute estimates pretax profit on capital investment at 6.9% on defense business and 10.8% on commercial work done by the same companies. In contrast, the average for durable-goods makers is 12.4%.

Bill to decentralize patent hunt on way

Help is on its way for executives and researchers who have to track down patents. Congress is expected to pass a bill this session authorizing the Patent Office to set up patent search centers throughout the nation. Such searches can now be made only in Washington. The sponsor of the bill, Sen. Gaylord Nelson (D. Wis.), says microfilming makes the project technically and economically feasible.

Once the bill is passed, the Patent Office will seek funds for one or two pilot centers, but these stations won't be operating until 1970 at the earliest. The U.S. lags far behind other countries in establishing such centers; there are 40 in West Germany and 20 in Britain.

Addenda

NASA's Goddard Center has gained more backing in its in-house fight with the Houston Manned Spacecraft Center for unmanned rather than manned missions. An interim report from 100 top scientists who met last summer at Woods Hole, Mass., has come out strongly in favor of unmanned missions for space applications work, calling them more economical, effective and practical. . . . The Renegotiation Board is now certain to continue operating. The only questions are whether it will be made a permanent agency (doubtful), and if it will be empowered to review contracts smaller than the current \$1 million minimum (backers want it to look at all contracts over \$250,000, but will probably settle for \$500,000) . . . As expected [Electronics, Feb. 5, p. 60], William H. Watkins, the FCC deputy chief engineer who would like to see the agency do more research and technical planning, was named chief engineer.



Sorensen's new QRS 40-75 delivers 1½ times the watts per dollar of most competitive power supplies... with no stinting on performance.

New Sorensen QRS:

- Voltage Regulation/Current Regulation (with automatic crossover).
- Voltage Regulation: $\pm 0.01\%$ or $\pm 1\text{mv}$ for maximum line and load changes combined.
- Voltage Ripple: $400 \mu\text{V}$ r.m.s. (6 mV peak-peak to 25 M Hz)!
- Output Voltage Resolution: 0.01% of maximum output voltage.
- Remote Programming.
- Remote Sensing.
- Ambient Temperature 0-71°C

Model Number	Output Voltage Range	Output Current Range @ Ambient			Size (inches)			Price
		@ 40°C	@ 55°C	@ 71°C	h	w	d	
QRS 15-2	0-15 Vdc	0-2.20A	0-2.00A	0-1.20A	3½	8	13	\$145.
QRS 20-4	0-20	0-4.40	0-4.00	0-2.40	5¼	8	13¼	\$255.
QRS 30-1	0-30	0-1.10	0-1.00	0-0.60	3½	8	13	\$145.
QRS 40-75	0-40	0-0.83	0-0.75	0-0.45	3½	8	13	\$145.
QRS 40-2	0-40	0-2.20	0-2.00	0-1.20	5¼	8	13¼	\$255.
QRS 60-5	0-60	0-0.55	0-0.50	0-0.30	3½	8	13	\$155.
QRS 60-1.5	0-60	0-1.65	0-1.50	0-0.90	5¼	8	13¼	\$265.

Contact your local Sorensen representative or: Raytheon Company, Sorensen Operation, Richards Ave., Norwalk, Conn. 06856. TWX 710-68-2940.



for more data on this versatile instrument . . . **Call Sorensen: 203-838-6571**

Control, monitor, measure, regulate, duplicate, automate, analyze, reproduce, evaporate, program...

thin films



1

DEPOSIT THICKNESS MONITOR — DTM3

A quartz crystal monitor for the thickness control of vacuum deposited thin films.
REPRODUCIBILITY: $\pm 10 \text{ \AA}$ @ 1000 \AA . **RANGE:** 0-100 KHz in five ranges — 1, 3, 10, 30, 100 KC.
SENSITIVITY: better than $2 \times 10^{-8} \text{ gm/cm}^2$. **STABILITY (1 hour):** $\pm 30 \text{ ppm}$.

Circle 308 on readers service card



2

ANALYTICAL ION GAUGE — RGA

For analysis of residual gas spectrum, single gas monitoring and control or leak detection. Measures partial pressures to 2×10^{-10} torr over mass range of 2 to 50. Five pressure ranges, — automatic sweep.

Circle 309 on readers service card

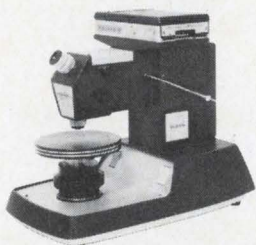

3

ANGSTROMETER — M-100

A multiple beam interferometer for measuring thickness of thin film depositions.

RANGE: 40 \AA to 20,000 \AA .
RESOLUTION: between 5 \AA & 100 \AA (dependent upon sample quality).
MAGNIFICATION: 100,000 x vertical equivalent, 15 x horizontal.
OPTICAL ABSORPTION: less than .5% by reference flat.

Circle 310 on readers service card

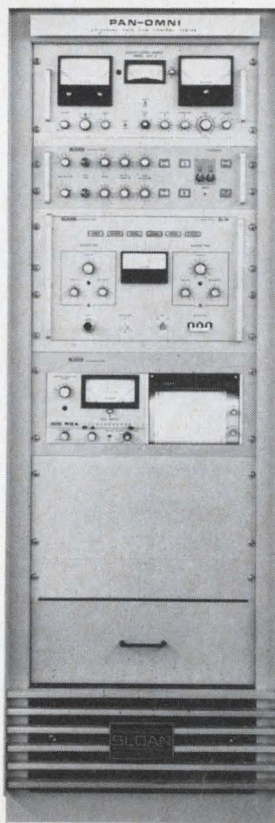
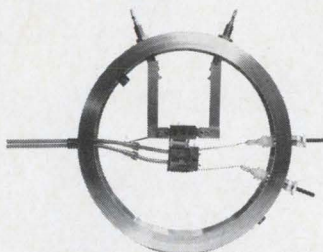

4

CONTROL CENTER — PAN OMNI

A custom control center engineered to automate your specific thin film production. Complete with stainless steel collar sized to match your vacuum system, fixtured with all feedthroughs, sources, and evaporation sensors. Converts any automatic vacuum system into a programmed thin film production center.

Circle 311 on readers service card

SLOAN

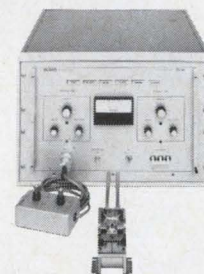

5

ELECTRON BEAM POWER SUPPLY & GUN — SIX/TEN

A constant voltage, variable emission type power supply engineered for manual or automatic OMNI II control. Variable beam sweep allows broad area evaporation without defocusing. Mates with Sloan 6 KW 180° bent beam E B Gun. Available in single or multiple hearth. **VOLTAGE:** 10,000 VDC @ 0.6 amps.

Circle 312 on readers service card



6

DEPOSIT CONTROL MASTER — OMNI-II

Automatically controls deposition rate, thickness, and rise and soak sequences. Rezeroing allows programming for sequential control of layered depositions. **RATE CONTROL:** up to 1000 $\text{\AA}/\text{sec}$. **THICKNESS:** up to 60,000 \AA -Al or mass equivalent. **OUTPUTS:** 12 pin control 27 pin program, frequency meter, two frequency meter relays, rate meter, rate meter relay, aux. power, recorder, audio and frequency.

Circle 313 on readers service card

7

AUTOMATIC THIN FILM SYSTEM

A completely integrated thin film production facility combining the finest automatic vacuum system, deposition controls and production chamber.

Circle 314 on readers service card

For technical details, call your Sloan representative or write direct.

**Frenchtown/CFI
can make you
100,000 ceramic
electron tube spacers
a week**

**...or 10,000 ceramic
coil forms
(4 to 40 turns per inch)
a year**

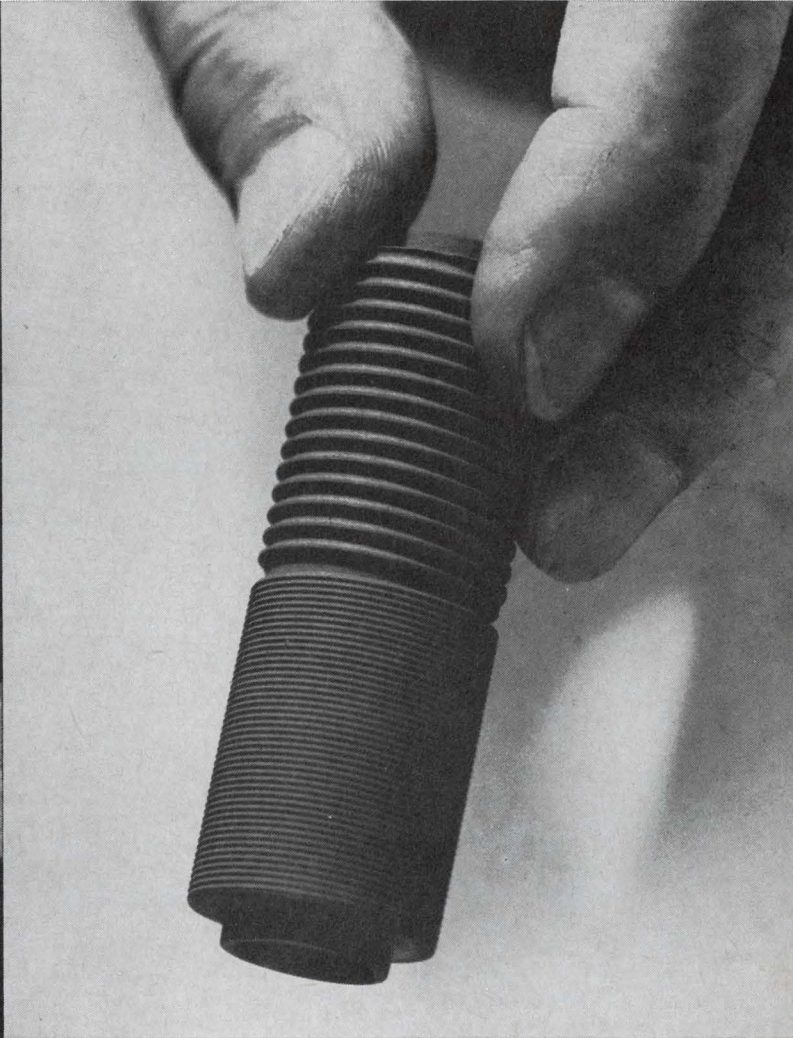
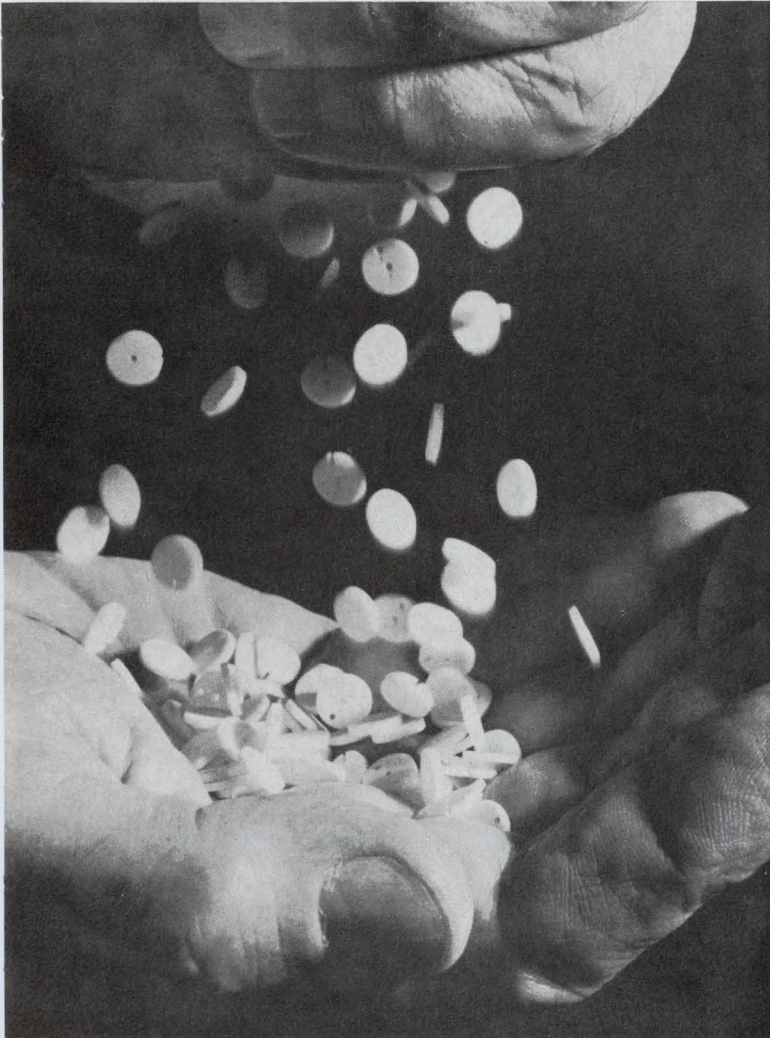

For high volume, custom-made alumina and beryllia ceramic products, astute buyers make sure to contact Frenchtown/CFI, Inc. Shipping rates of more than 5,000,000 pressed parts per week are easily maintained—month after month after month.

For complex parts, too, Frenchtown/CFI is a prime source. You can get them large or small, moly-manganese or gold-platinum metallized. Intricately shaped. Assem-

bled to other ceramics or metal parts. Optically flat. Hermetically sealed.

Whether your application is electronic, electrical, mechanical or chemical, consult Frenchtown/CFI on problems of ceramic production, metallizing and sealing. You can save weeks on your timetable. Describe your need and request a proposal. (We'll send you an informative brochure too.) For fast action call:



FRENCHTOWN/CFI, INC.

A subsidiary of Alloys Unlimited, Inc.

Eighth Street, Frenchtown, New Jersey 08825

(201) 996-2121

Circle 63 on reader service card

FRENCHTOWN/CFI MEANS CERAMICS FOR INDUSTRY

left photo: 92-96% alumina—dry pressed—fired—diamond ground. right photo: 94% alumina—isostatically pressed—form ground—fired—diamond ground.

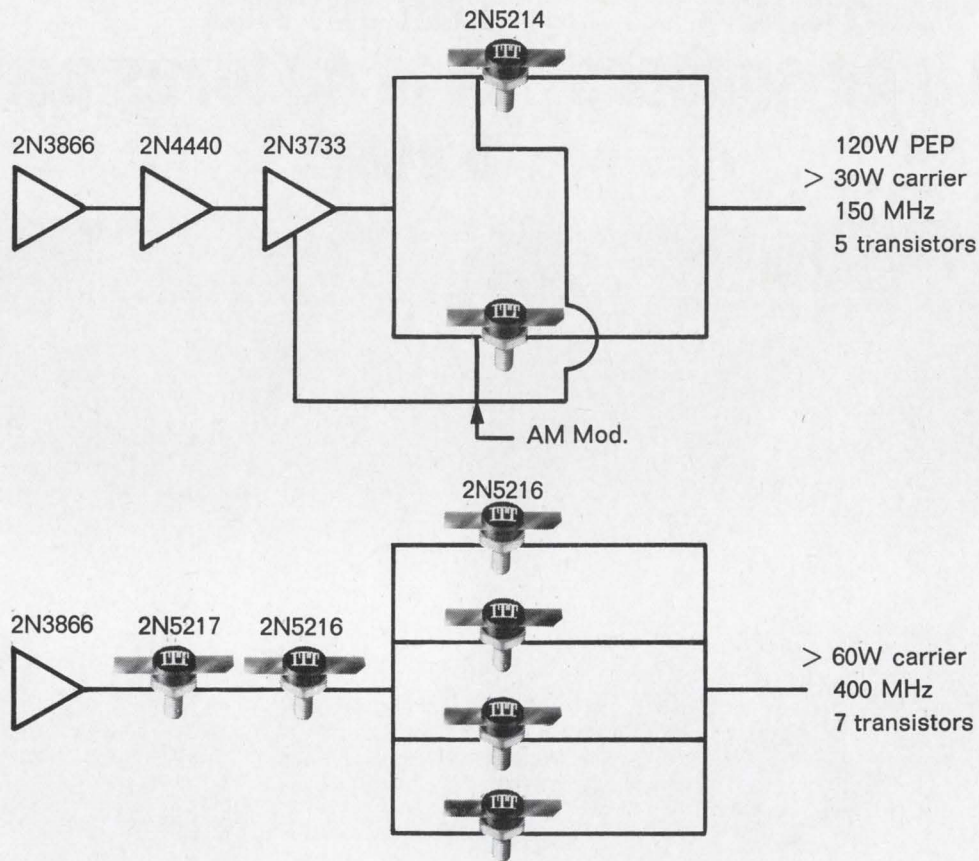

Only ITT delivers so much broadband RF power with so few transistors

Another reason to buy from "The Predictables"

Is your goal circuit simplification through higher power? Would you like to increase reliability and cut cost by reducing the total number of components in your equipment? Then ITT's strip line RF power transistors are for you.

Two application examples are

shown above, but the possibilities are almost endless. Here's why:

Strip line packaging gives you lower inductance, higher power output, broader bandwidth and greatly improved stability. The high BV_{CEO} ratings of the 2N5214 and 2N5216 give you better up modulation capabilities and reduce the danger of damage from transients. Resistor stabilization provides increased safe operating area and built-in bias stability

for class A and AB amplifiers.

Want more information? Write for a free copy of "VHF/UHF Transistor Power Amplifier Design". Want immediate delivery of strip line transistors? Contact any ITT distributor or your ITT factory representative. ITT Semiconductors is a Division of International Telephone and Telegraph Corporation, 3301 Electronics Way, West Palm Beach, Florida.

semiconductors **ITT**

FACTORIES IN FLORIDA • CALIFORNIA • MASSACHUSETTS • ENGLAND • FRANCE • GERMANY • PORTUGAL • AUSTRALIA



6 switches are 5 more than you need.



Actual Size 33006A

Because either one of the Hewlett-Packard 33006A / 33007A Solid-State Switches takes the place of the six normally needed for coverage of the 400 MHz to the 18 GHz range in single-pole-double-throw switching applications. So you only need one small, lightweight switch for the

entire microwave spectrum. Why use six? And that's not all. The HP 33006A / 33007A Switches fit either coaxial or stripline configurations and offer improved sensitivity for ECM, radar, missile guidance, communications and lab check-out applications. They're excellent replacements for electro-mechanical switches, too, because of their speed, reduced size and high reliability. And they meet MIL specs.

Isolation-Arm #1-Arm #2	55 dB typical
Insertion Loss	1.5 dB typical
VSWR (any port-insertion loss condition)	2:1 typical
Switching Speed	200 nanoseconds typical
CW Power Handling Capability	1 watt
Price: (Quantity 1-9) HP 33006A	\$395
HP 33007A	\$250

For more details, call your local HP field engineer or write Hewlett-Packard, Palo Alto, California 94304; Europe: 54 Route des Acacias, Geneva.



SOLID STATE DEVICES

01714

MTOS now makes possible the ideal RF amplifier...

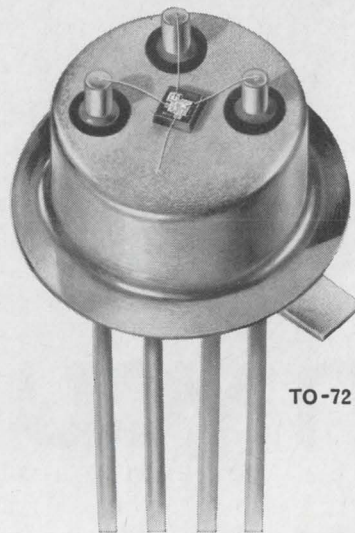

with Cascode Performance

General Instrument's exclusive MTOS N-channel Dual Gate FETs combine the high power gain and low noise figure of bipolar transistors with the large signal handling capability and low cross-modulation distortion of vacuum tubes.

In 1948 the "cascode" amplifier was born.* Of course, it was designed around vacuum tubes but it yielded what has come to be recognized as the ideal RF amplifier configuration. It featured the low noise high G_m performance of triodes and the low feedback capacitance-high output resistance of pentodes.

Now, within a single integrated solid state device, the N-channel Dual Gate MTOS Transistor (MEM 554 Series), a high performance cascode circuit has been developed and is available in quantity. It combines the advantages of both bipolar transistors (high gain and low noise) and vacuum tubes (high input impedance, large signal handling capability and low distortion) to make the device an ideal RF amplifier.

Its applications are by no means limited to RF amplifiers. Major advantages result in spurious response reduction in FM tuners when the device is used as a highly linear mixer. In VHF tuner mixers very low cross-modulation distortion is also obtained.

Here today is the answer to the constantly increasing problem of frequency spectrum crowding:—solid state devices that reduce the annoying effects of interfering signals.

Features... MEM 554 Series

- 18 dB @ 200 MHz Power Gain
- 3.5 dB @ 200 MHz Noise Figure
- 120 mV undesired signal for 1% cross-modulation distortion
- Reverse AGC capability
- 150 mW dissipation
- Dual Gate provides Linear Mixing Capability
- C_{rss} .025 pF
- G_m 12,000 mhos

*Proceedings of IRE, June 1948, "A Low-Noise Amplifier"

Call your authorized General Instrument Distributor for off-the-shelf delivery. Write for complete data.
For all information relating to MTOS in Europe, write to: General Instrument Europe, Via Turati 28, Milano, Italy.



GENERAL INSTRUMENT CORPORATION • 600 WEST JOHN STREET, HICKSVILLE, L. I., NEW YORK



We offer over 200 talking pictures. Pick one that speaks your language.

Our CRT's have been articulate right from the start. Our first, thirty years ago, told us we were onto a good thing. Some people didn't believe it, but that one spoke our language.

Since then we've gone on to develop and produce CRT's that make up an electronic United Nations.

One speaks to the weather-

man. Another to a heart specialist. There's one that sits on a desk and talks to bookkeepers or accountants. And one that communicates with aircraft control tower personnel. One that strikes up a conversation with geologists. And even one that displays nuclear explosion data to anyone who cares.

That's asking a lot from a CRT.

But then we've always done that. And we'll go right on doing it. Because even as our customers tell us, there's almost no limit to what a CRT can talk about.

Want to start a conversation with a CRT? Call or write us to arrange a meeting... anytime.

Electronic Tube Division,  General Atronics, Philadelphia, Pennsylvania 19118



GENERAL ATRONICS

Tips on cooling off hot "plastic" transistors

See how circuit and packaging designers use new IERC heat dissipators to increase the efficiency of epoxy and ceramic semiconductors. Models are available for all TO-5, TO-18 and D-case sizes, with and without flanges.

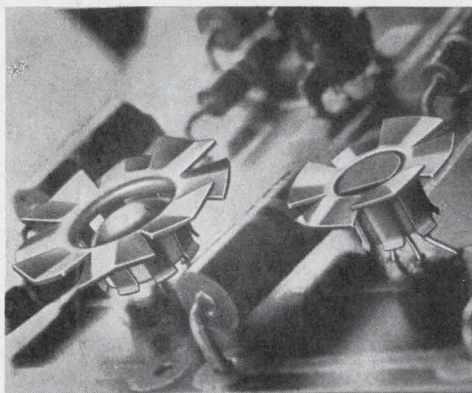

New, press-on "Fan Tops" fit all TO-5, TO-18 and D-case size devices. Need no board area; add virtually nothing to board height. An RO-97 with Fan Top dissipates 400 milliwatts at 65°C. compared to 200 milliwatts with no dissipator.

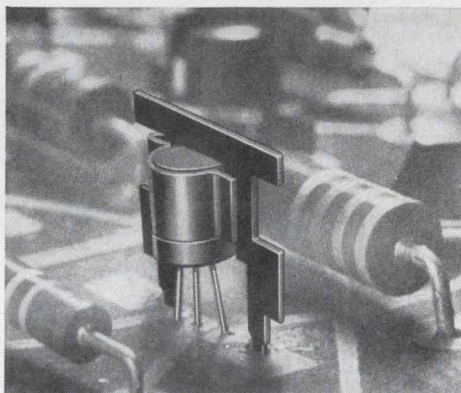

New "Universal" Spade types fit all D-case sizes, including the flanged type. Permit operating power of transistors to be increased 33%. Unique spring-clip retainer accommodates variations in case diameters. Single and dual models.

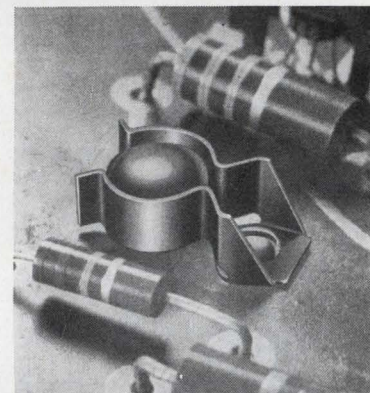

New Clip types are especially effective in high g environments. Hold TO-5 and TO-18 size devices securely; reduce load on leads. Allow 30% more operating power.

Unique new Spade types fit all TO-5, TO-18 and no-flange D-case sizes. Provide excellent retention and dissipation and are also valuable production aids. "Stand-off" legs give a positive 0.1" grid location for automatic insertion in p-c boards and hold transistors above the solder, preventing possible thermal damage. Single and dual models.

New PA and PB dissipators for medium power plastic devices accommodate the flat, rectangular shaped thyristors, transistors and SCR's. Patented, staggered-finger design and aluminum construction maximize dissipation. In natural convection a PA will permit a single X-58 or M332 case device to be operated with 80% more power. A PB type will allow matched pairs or larger devices to be operated with 200% more power.

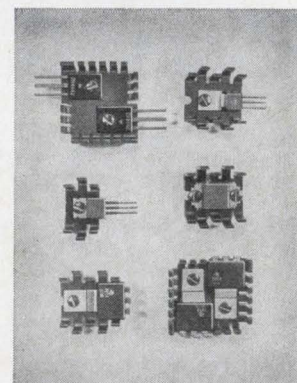
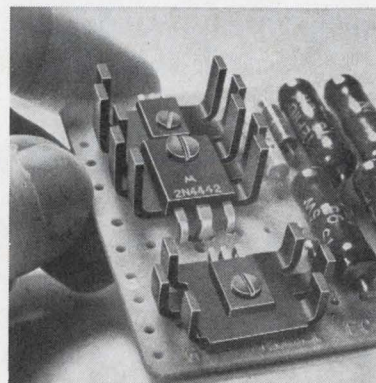
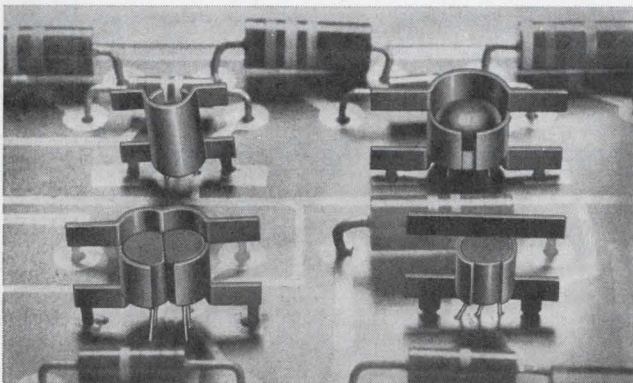

IMPROVED SEMICONDUCTOR PERFORMANCE FOR ONLY PENNIES

Epoxy and ceramic case semiconductors, like those in metal cases, have maximum allowable operating temperatures. Exceeding these limits can damage or destroy the component. Low cost IERC dissipators/retainers reduce operating temperatures, permitting semiconductors to be operated at power ratings up to 33% higher without increasing case temperatures. Their use also sharply reduces failures caused by excessive solder heat during assembly. **New SHORT FORM CATALOG** gives complete specifications and other helpful information for selecting transistor dissipators. May we send you a copy?

Transistor dissipators/retainers • Forced air cooling packages • Fluid cooled heat sinks • Tube shields

ierc
SEMICONDUCTOR
HEAT DISSIPATORS

This is a Telonic 2003 Sweep/Signal Generator

It's completely plug-in so we can change frequency and attenuation ranges, markers, et cetera, with no sweat.

This 2003 has a 5 MHz to 1500 MHz oscillator that's so broad it's in use constantly.

So when the boys in telemetry start their new project, we're all in trouble*



Al's working in L-band, Neil's interested in VHF, Jim is designing receiver gear and Sastry's in mobile communications. Yet they can all use the 2003 Sweep Generator since its 3305 oscillator covers so broad a frequency range—I.F. to microwave.

And they can sweep that 5 to 1500 MHz region at full width or as narrow as 500 kHz. Two calibrated tape dials permit selection of band width by end points (F_1/F_2) or by a symmetrical region around a center frequency ($F_c/\Delta F$).

In addition, the instrument supplies a .35VRMS output over the entire range at a flatness of ± 0.5 dB with absolute linearity of 1.2:1.

Operating parameters of each 2003 Sweep/Signal Generator System will depend on the oscillator, attenuator, marker, and other plug-ins specified.

Here's a list of specifications on the 3305 oscillator plug-in.

FREQUENCY RANGE	5-1500 MHz
SWEEP WIDTH	500 kHz-500MHz
MAX. RATED OUTPUT	0.35 v. R.M.S. (+4dBm into 50 Ω)
OUTPUT FLATNESS	± 0.5 dB
ATTN. VERNIER RANGE	3 dB
F_c DIAL ACCURACY	5%
ABSOLUTE LINEARITY	1.2
FREQUENCY DRIFT (1 min.)	100 kHz
RESIDUAL FM	50 kHz

Details and further specifications on the 2003 Sweep/Signal Generator System may be found in catalog 70-A and Addendum. Send for your copy.

*You can always get another instrument, Sastry.

Telonic

INSTRUMENTS

A Division of
Telonic Industries, Inc.

60 North First Avenue, Beech Grove, Indiana 46107 • Tel: (317) 787-3231 TWX: 810-341-3203

Representatives throughout the U.S. and Canada, Distributors Overseas. Branch offices in Maidenhead, England, Frankfurt, Germany, and Milan, Italy.

Circle 69 on reader service card

1.5 MHz to 220 MHz is standard on this FM/AM Signal Generator

... no extender required!

\$1,110.

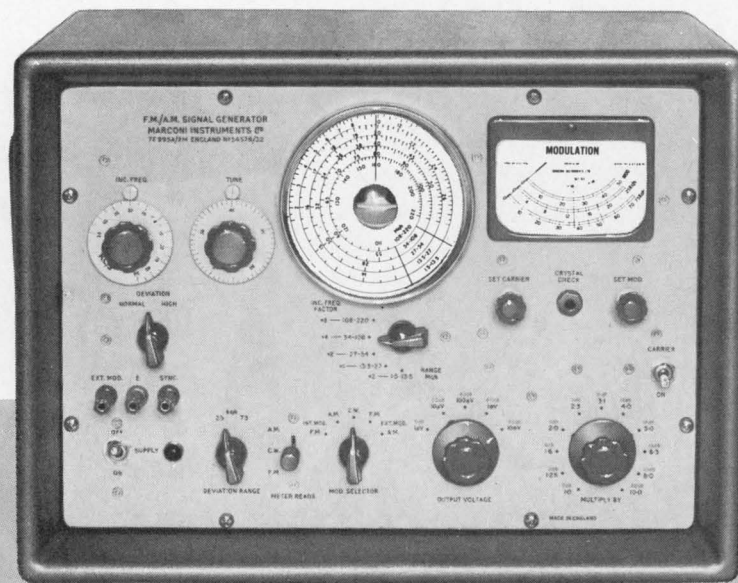

Model 995A/2M

- FM to ± 75 KHz all ranges; up to ± 600 KHz on top band
- AM up to 50%
- Simultaneous FM and AM for AM rejection checks
- Crystal Calibrator
- Direct Reading Incremental Tuning
- Special Stereo and Low Noise Models available

Available upon request
SIG. GEN. BOOK I

The Sig. Gen. Book I presents detailed discussions on signal generators and receiver measurements including: source impedance of feeder connected receivers, coupling to loop antennas, signal-to-noise ratio, automatic gain control, plotting response characteristics, measurement of adjacent channel suppression and spurious responses, etc.



mi **MARCONI**
INSTRUMENTS

Division of English Electric Corporation
111 CEDAR LANE • ENGLEWOOD • NEW JERSEY 07631
TELEPHONE: 201-567-0607

704

Now- Count to 150 MHz for \$640!



With Trio/Lab's new Universal Counter Pre-Scaler

Forget the cost of a new high frequency counter – for a modest \$640 it is now possible to extend the useful range of your old low frequency counter – *any* counter – to 150 MHz! The unique, extremely easy-to-use Trio/Lab Model 556 Pre-Scaler performs simultaneous scaling functions of divide-by-100 and divide-by-10 over the range of 1 MHz to 150 MHz.

A remarkable instrument that demands demonstration – at your convenience.

- Truly universal – Scales *any* counter
- No controls – Power switch only
- High sensitivity – 50 MV at 150 MHz
- Large output swing – 1 V drives any counter
- Self-powered – All solid-state.

Trio Laboratories, Inc. • 80 DuPont St., Plainview, L. I., N.Y. 11803
Tel.: 516-681-0400 • TWX: 510-221-1861



Original Concepts in Instrumentation
Circle 71 on reader service card

Chart yourself a foolproof RF shield:

If you want to shield...

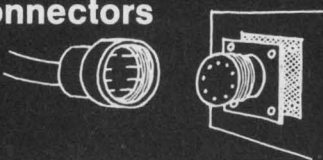
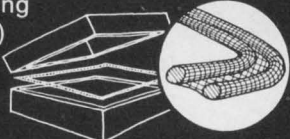
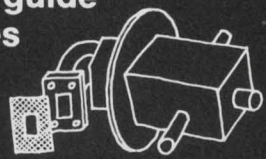
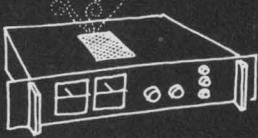
<p>Electrical connectors</p> 	<p>use Metex Porcupine Metalastic™ Its many contact points make this an ideal gasket for RFI/EMI. Silicone rubber provides a pressure and moisture barrier.</p>
<p>Metal boxes with flat mounting surfaces (no sealing problem)</p> 	<p>use Metex double round, single fin mesh strip. This is provided in many different metals and sizes.</p>
<p>Wave guide flanges</p> 	<p>use Metex Feltex™ material. Designed for wave guides, specifically provided for either pressurized or non-pressurized systems.</p>
<p>Electronic equipment (and cool it, too)</p> 	<p>use Metex Cool-Shield honeycomb panels. It's designed to meet specific attenuation requirements over specified frequency ranges. Many standard sizes and materials are available.</p>
<p>QUICKLY</p>	<p>call (201) 287-0800 for 48-hour premium service (for your rush rush requirements)</p>

For Free Samples, Prices and Literature on any or all of these RFI shielding materials—or for technical assistance on your particular requirements—write:

METEX Corporation
970 New Durham Road, Edison, N. J. 08817
(201) 287-0800 • TWX 710-998-0578
West Coast: Cal-Metex Corp., 509 Hindry Ave., Inglewood, Calif.



ANOTHER OUTSTANDING DEVELOPMENT BY THE MAKERS OF BUSS FUSES

TRON RECTIFIER FUSES

for the
Protection
of
Solid State
Devices

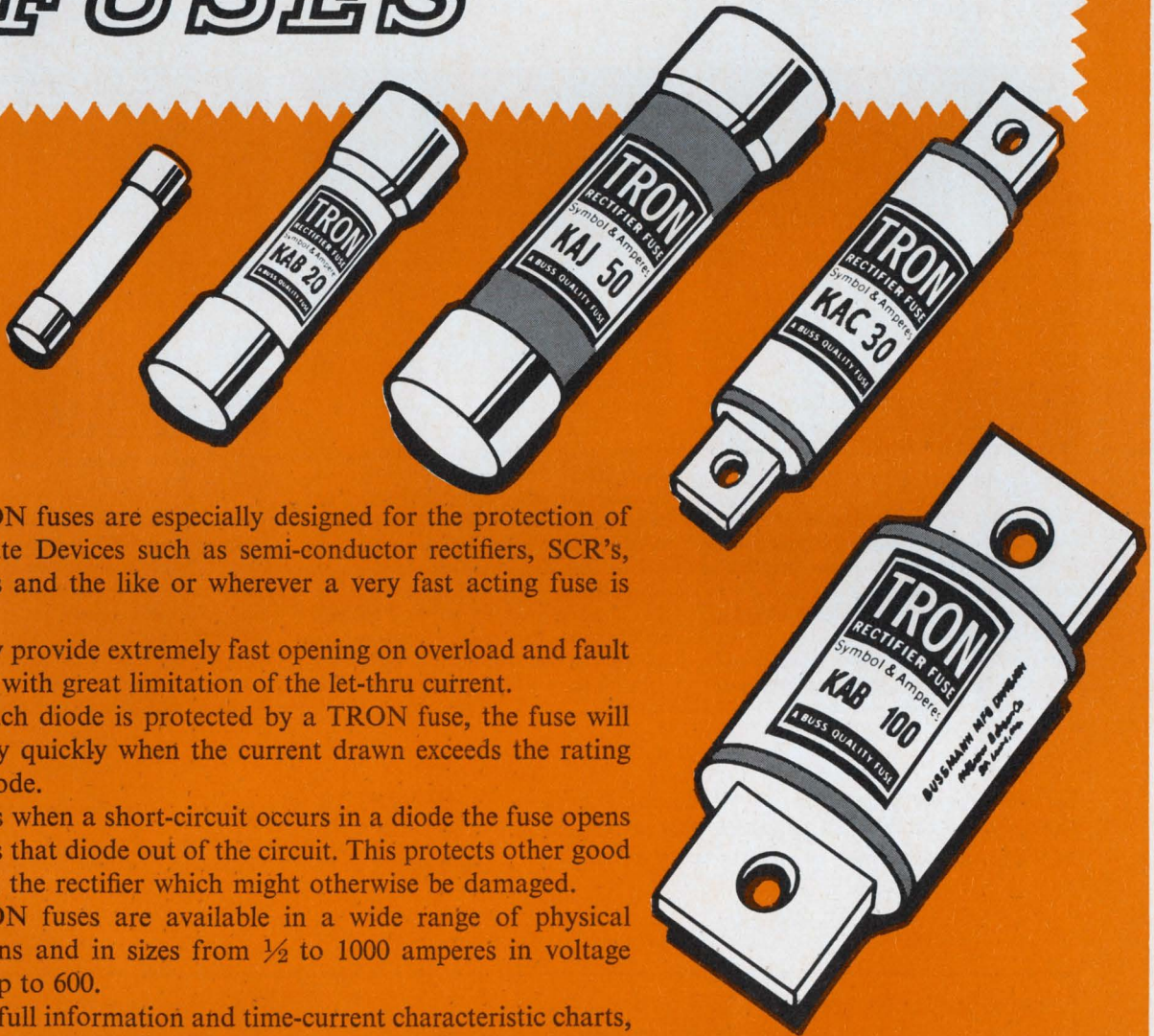

TRON fuses are especially designed for the protection of Solid State Devices such as semi-conductor rectifiers, SCR's, thyristors and the like or wherever a very fast acting fuse is needed.

They provide extremely fast opening on overload and fault currents, with great limitation of the let-thru current.

If each diode is protected by a TRON fuse, the fuse will open very quickly when the current drawn exceeds the rating of the diode.

Thus when a short-circuit occurs in a diode the fuse opens and takes that diode out of the circuit. This protects other good diodes in the rectifier which might otherwise be damaged.

TRON fuses are available in a wide range of physical dimensions and in sizes from $\frac{1}{2}$ to 1000 amperes in voltage ratings up to 600.

For full information and time-current characteristic charts, ask for BUSS Bulletin HLS.

BUSSMANN MFG. DIVISION, McGraw-Edison Co., St. Louis, Mo. 63107

FOR MODERN ELECTRICAL
PROTECTION *Insist on...*

SUPPLIED THE ECONOMICAL WAY... THRU
ELECTRONIC DISTRIBUTORS

BUSS QUALITY

FET analog switches & drivers

For commutators, choppers, digital filters - choose from dozens... here are some examples:

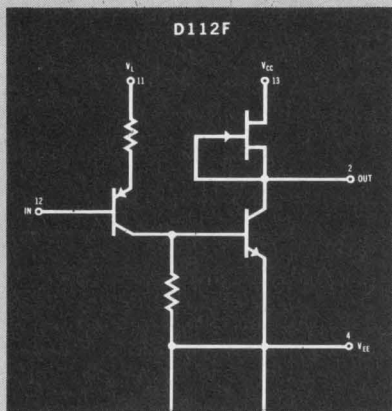

"D" Series FET Switch Drivers

These drivers are designed to couple between low-level logic and junction or MOS FET switches. Input thresholds are adjustable to your logic and you can preset the output voltage swing up to 30 volts peak-to-peak.

The D series has as many as six drivers per package with a variety of electrical and logical options.

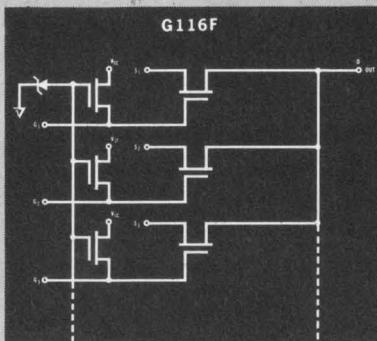

"G" Series MOS Switches

Here's a five-channel enhancement-mode MOS FET switch array that can be used directly with the Siliconix six-channel drivers. No external parts needed; just two IC packages and you've got five complete channels for multiplexing. The Zener diode protection is integrated, as are the FET pull-up elements that supply collector loads for the drivers. Other G-series circuits offer a wide choice of switching functions.

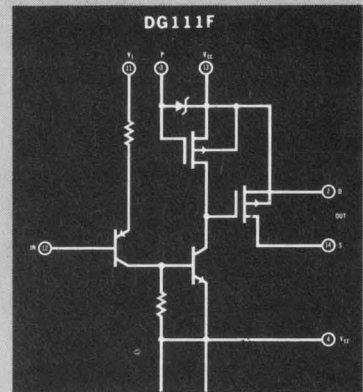

"DG" Series Drivers with FET Switches

Two complete channels—each with a driver and FET switch—are included in this one package. Connect the circuit directly to your low-level logic and it's ready to go. Each channel can control a millivolt whisper or a 20 volt roar. Driver gates (DG series) come in a variety of logical and electrical options.

Special requirements? Even 50 standard devices can't solve everybody's problem, so you're invited to write for a solution to your specific need.

 **Siliconix incorporated**
1140 W. Evelyn Ave. • Sunnyvale, CA 94086
Phone (408) 245-1000 • TWX: 910-339-9216

ANALOG SWITCH/DRIVER DATA

Write for your FET switch data kit with information on all standard Siliconix switching products. If you have a current project that needs immediate attention, write or phone for applications assistance.

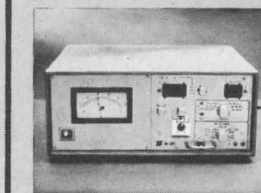
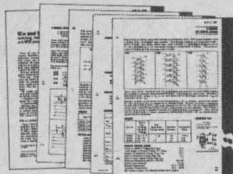

NEW LOW COST FET TESTER

The SI200 Semiconductor Tester features plug-ins for expandable test capability, simplicity of operation, and low cost.

Price: SI200 Tester . . . \$960.
Price: SI201 (DC & g_{fs}) Plug in Module . . . \$1335.

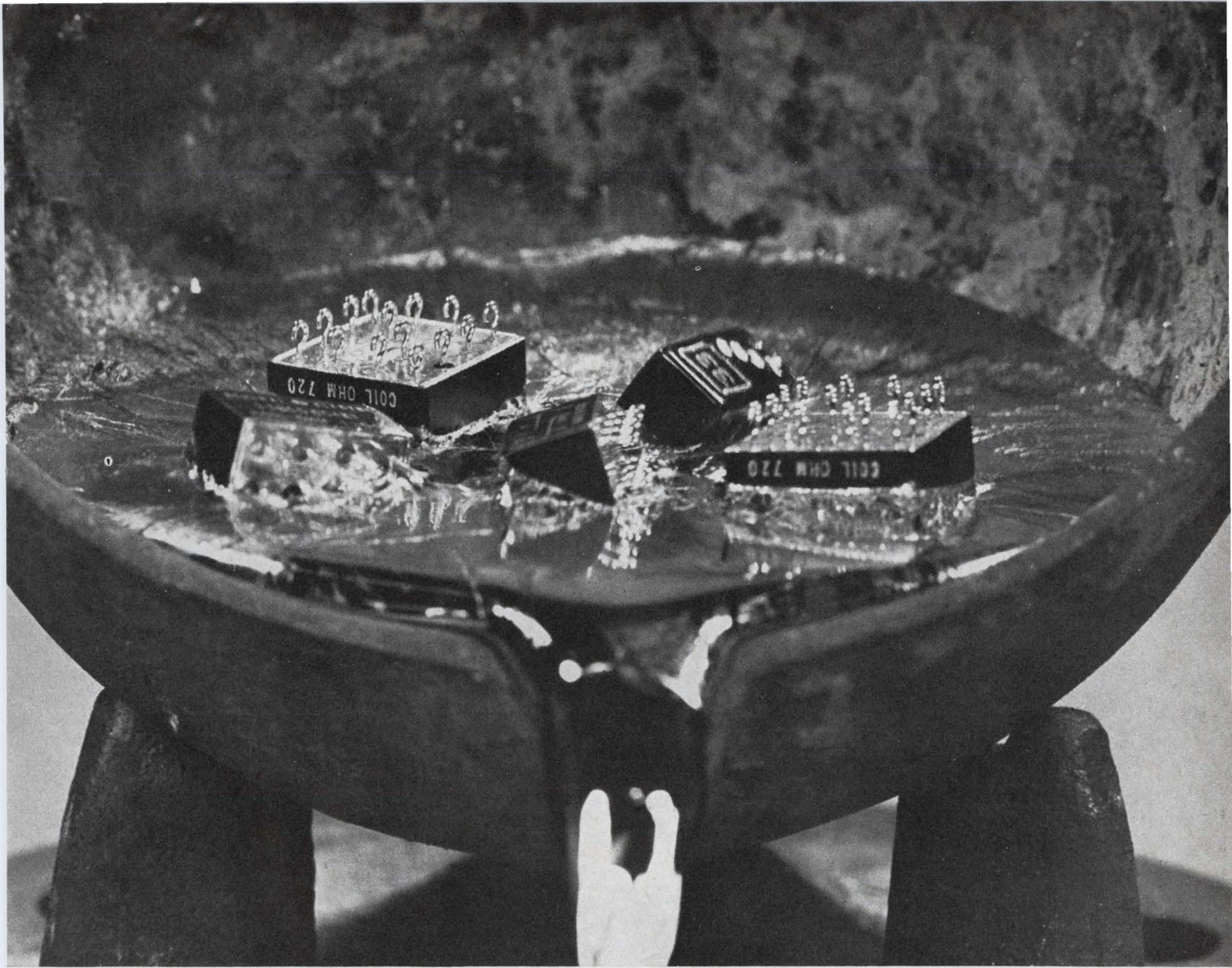

Molten-solder temperatures won't hurt G-E 150-grid relays

During degassing, G-E 150-grid relays get even hotter than the 356F it takes to melt solder. And it's good for them. High-temperature degassing removes much more of the organic volatiles that can contaminate a relay at normal operating temperatures.

Not many relays can stand the heat. G-E 150-grid relays can because they have a polyimide coil insulation and a welded can-to-header seal. Polyimide insulation withstands 50% more heat than conventional fluorocarbons. And a weld won't melt like a soldered joint.

New materials and fabrication methods are constantly being developed and used by General Electric to make its sealed relays more reliable. Get the full story from your G-E Electronic Components Sales Engineer. Or write for bulletin GEA-8024B, Section 792-39, General Electric Co., Schenectady, New York.

Specialty Control Department, Waynesboro, Va.

GENERAL  **ELECTRIC**

Circle 75 on reader service card

New complementary negative output series lets Helipot fill all your dc voltage regulator requirements — positive and negative.

12 Outstanding features on the negative:

- $\pm 0.05\%$ regulation
- short circuit proof models
- small size—0.5 sq. in.
- low profile—0.170"
- up to 5 amps load current
- fully sealed
- -3 to -21 volts output range fixed and adjustable
- hybrid cermet construction
- -55°C to +125°C
- up to 60 db ripple attenuation
- mil spec tested
- self-contained models, require no external components

Voltage Range	Positive		Negative	
	Fixed Output	Adjustable Output	Fixed Output	Adjustable Output
3 to 9 volts	Series 805	Model 806	Series 855	Model 856
9 to 21 volts	Series 801	Model 802	Series 851	Model 852
21 to 32 volts	Series 803	Model 804		
	Reader Service No. 513		Reader Service No. 514	

The price (1 to 9 quantity):

- \$30.00—fixed output models
- \$35.00—adjustable output models
(delivery from factory stock)

Positive or negative, Helipot fills your complete voltage regulator requirements.

Shown here is Model 851 Negative output DC Voltage Regulator — one of Helipot's four negative, hybrid cermet thick film units with outputs from -3 to -21 volts. Also available are 6 positive models with outputs from +3 to +32 volts.

For complete information on our unique *Negative* and *Positive* regulators, simply circle the appropriate number on the reader service card—or contact your local Helipot Sales Representative.



Beckman®

INSTRUMENTS, INC.
HELIPOT DIVISION
FULLERTON, CALIFORNIA • 92634

INTERNATIONAL SUBSIDIARIES: GENEVA; MUNICH; GLENROTHES, SCOTLAND; TOKYO; PARIS; CAPETOWN; LONDON; MEXICO CITY

Special report

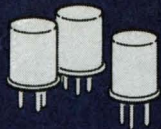

The transistor: Two decades of progress



- Page 78 The improbable years
93 Marrying frequency and power
105 Power transistors
109 Microwave transistors
116 Unijunctions
120 Field-effects
126 Looking ahead

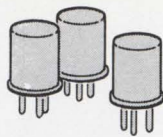

The improbable years

Even the handful of men who anticipated the device that would become the transistor never envisioned the rapid and drastic changes it was to make

The radio and movie page of the New York Times carried, on July 1, 1948, a modest four-inch report that the Bell Telephone Laboratories had invented an electronic device to replace the vacuum tube. The achievement, whose significance escaped the usually perceptive Times, had been a closely guarded secret since December of 1947 when Walter Brattain and John Bardeen built the first practical transistor. Theirs was a point-contact device that used two metal "cat's whiskers" in contact with a polycrystalline germanium slab.

To many in the scientific and engineering community, who had been working in the esoteric area of semiconductors, the news was like a giant thunderclap. Bell Labs, perhaps because its need was specific, had succeeded. Its transistor was the culmination of studies and experiments that had lasted for almost 10 years. So when Bell filed its claim for a patent on the point contact transistor it had no problem demonstrating intent and diligence of pursuit; prerequisites for patent.

Jack Morton, vice president of Bell Labs' electronic components development, recalling the long search, said: "Our discovery came out of our understanding of basic research, but it wasn't an accident. We were looking for a solid state amplifier." Mervin Kelly, who had been director of research, was the president of Bell Labs at that time and he realized that the telephone industry would some day be in trouble unless it found something that was faster than relays, and less power-hungry and more reliable than the vacuum tube.

What Kelly was looking for was a solid state device that would be electronic in behavior and could amplify and switch. If he got that, he could get rid of the hot thermionic cathode that was causing trouble in the telephone industry by limiting tube life and threatening the reliability of the associated components. Without this unknown unnamed device, the electronic switching systems and pulse code modulation systems — that Bell engineers were even then discussing as distant possibilities — would be impossible.

Bell's transistor was the breakthrough; the culmination of an effort that had spanned nearly a decade. Among the events leading up to the moment of success, these are particularly significant:

- In 1938 or 1939 William Shockley and Alan Holden, both physicists at Bell Labs, tried to make a solid state amplifier using carbon contacts brought together through pressure exerted by a quartz crystal. They expected, but did not get, a usable output through a change in the resistance of the carbon as a signal was applied to the crystal.

- Shockley's next step, late in December 1939, seemed no more fruitful. He speculated that if he were to oxidize a metal wire screen, thereby surrounding it with a semiconducting oxide, he could limit conduction through the oxide from one side of the screen to the other. He thought that a negative voltage on the screen wires — like the grid voltage in a vacuum tube — would control the current flow through the oxidized screen.

Tests of the structure, which suggests today's field effect transistor structure, were not successful.

- Near the end of World War II, Russell S. Ohl, a staff member of Bell Labs, used silicon crystal diodes, developed for radar and microwave systems, to amplify radio signals. However, since Ohl's amplifier depended on a negative resistance effect, it was quite unstable.

- Shockley returned to Bell Labs, after spending the war years at the Pentagon, still seeking a three-terminal device. He saw the significance of Ohl's success in achieving amplification with a diode.

- One of Shockley's proposals was a field effect structure with silicon and germanium deposited on insulators. It was tested but, disappointingly, no field effect was observed.

- John Bardeen had a hunch that he could explain the lack of the expected field effect, and he postulated that charges trapped on the semiconductor surfaces were the culprits.

- Walter Brattain, the experimental leader of the Bell Labs group, conducted experiments suggested by Bardeen's theory.

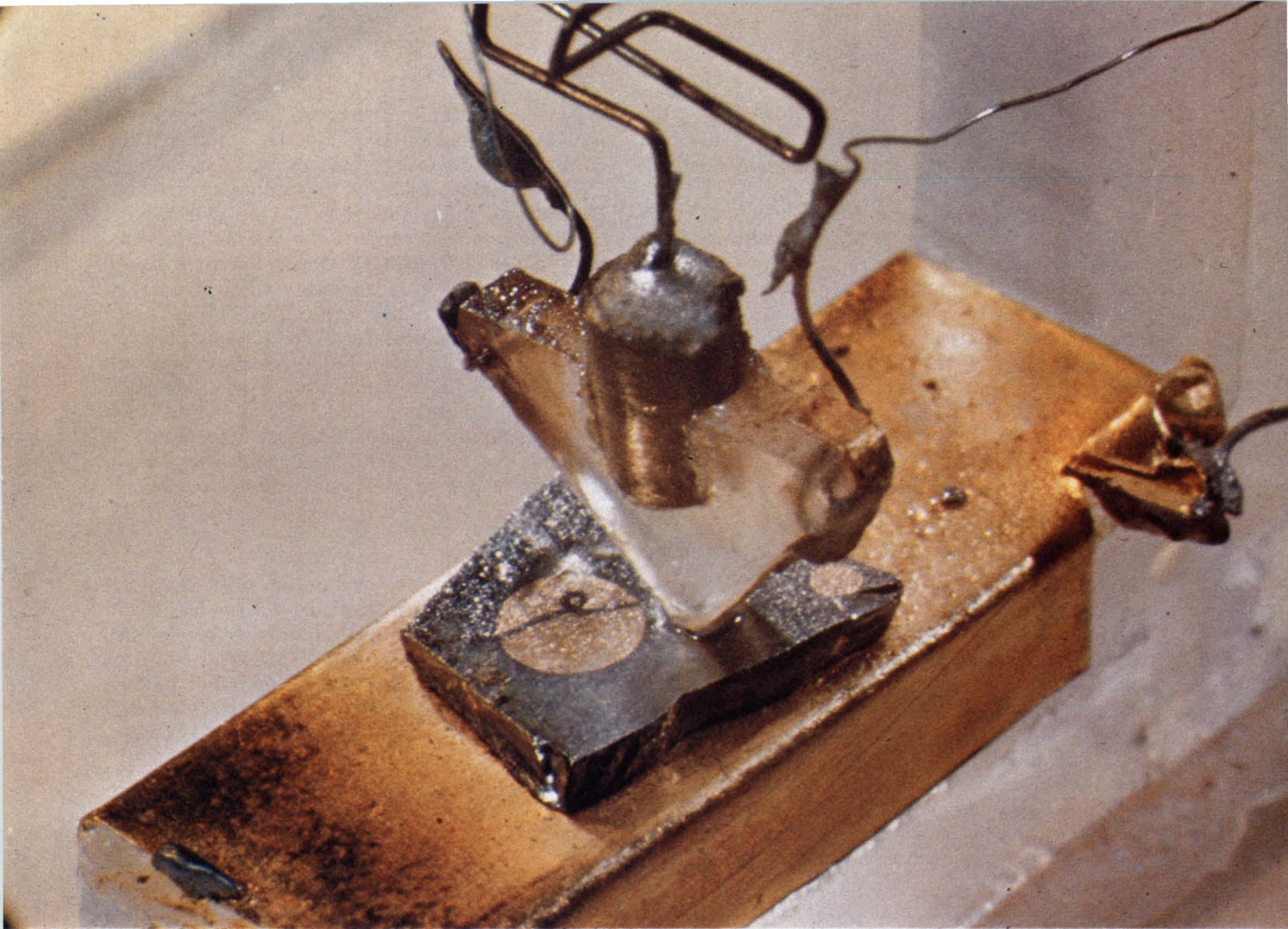

Number 1. The first transistor fabricated by Bell Laboratories' scientists was this crude point-contact device, built with two cat's whiskers and a slab of polycrystalline germanium.

How it happened

As Brattain recalls the events leading up to the final achievement, Bardeen's surface state theory covered "some things we didn't understand about the surfaces of semiconductors," including a surmise on why Shockley's field effect wouldn't work. Believing these problems were related, Bardeen and Brattain felt an answer to one would be an answer to all—and could result in an idea that would make an amplifier.

The Bell researchers expected to build an amplifying device by controlling the reverse-bias current through a point contact resting on a semiconductor surface. They sought to control this current through a field-effect, or inversion-layer effect. Varying the voltage on the control electrode would control the inversion layer and thus change the current through the reversed-bias point contact. Depending on the type of semiconductor — n or p type — a particular direction of variation of the control voltage would produce a known direction variation of the point contact current. This could be deduced from inversion layer effects.

To implement these ideas, Brattain placed a metal

point contact on the surface of an n-type germanium slice that he'd immersed in an electrolyte. He got amplification, though only at very low frequencies.

It's Brattain's recollection that he and Bardeen saw that the d-c bias on the electrolyte had anodically attacked the germanium, forming an oxide film. Why not use this film in place of the electrolyte, they asked.

They suspected the electrolyte was limiting the frequency performance. So, after forming the oxide layer on another slice of germanium, they washed away the electrolyte, deposited a gold contact and got amplification again. But they found that varying the control voltage caused the current to change in a direction opposite to the one they expected. Then they discovered that the water had also washed away the oxide layer and that the gold was contacting the germanium. They concluded that a field effect was not occurring at the control electrode but instead the control electrode was injecting extra carriers that flowed to the point contact (the collector) and added to the current. The unexpected contacting of the germanium led to the possibly misleading description of this experiment as an "accidental

piercing" of the oxide.

The experiments were described to all members of the research team working on the solid state amplifying device. Then Bardeen worked out the geometry to actually make one. Bardeen suggested the geometry to Brattain in his office and Brattain immediately invited him into the laboratory. By day's end, they had a working device.

Bell then began casting around for a name for its brainchild. John Pierce, now the executive director of research in the communications sciences division, came up with transistor. His word was a contraction for transfer resistor. The name, which places the device in the same family as varistors and thermistors, stuck although some people at first wanted to call the device a crystal triode.

Worldwide search

The foundations for the point-contact transistor had been built slowly over the years. A. H. Wilson in England had applied quantum mechanics to semiconductors, postulating the existence of holes and of n- and p-type materials. In Germany, Schottky had evolved a reasonable theory of semiconductors, but it had a flaw. He did not realize that holes could act as carriers.

Most of the work on semiconductors concentrated on silicon. During the war, Bell's silicon diodes were developed and used widely as the mixers in radar and microwave systems for the military.

Researchers Jack Scaff and William Pfann of Bell

Labs were continuing their work on the properties of semiconductor materials. In the course of their research they discovered the presence of Group III and Group V materials in silicon and germanium. They called these impurities p-type and n-type. Later, they were to produce the first p-n junctions.

At the end of the war, the Massachusetts Institute of Technology, Purdue University, the University of Pennsylvania, General Electric and Bell resumed their fundamental studies of the physics of semiconductors. In particular, Purdue research was well along and had also produced p-n junctions. Bell Labs, however, remembering Schottky's admonition that "the physics of semiconductors is the study of the physics of dirt" turned from silicon to germanium. Impurities in germanium were easier to control.

Birth pains

In the year after the announcement of the point contact transistor, Bell flooded the technical world with papers and talks. The military saw possibilities right from the start and Bell's first job was to convince the Pentagon that it was in the public interest to release detailed information on the transistor. Bell succeeded. The device was not classified; an important break for the electronics industry.

In September of 1951, Bell held a symposium, which was attended by over 300 people from universities, industry, and the military, but nothing much happened. Then, in April of 1952 Bell held

Shockley

Asked about the past and future of the transistor, William Shockley says frankly, "I don't think about it very much at all."

Now a professor of engineering sciences at Stanford University and a consultant for Bell Labs, Shockley spends most of his time teaching, which he clearly enjoys, or writing about teaching. He believes scientific concepts should be broken down into simple ideas through appropriate analogies, and he has collaborated on a ninth grade science primer based on this principle.

Shockley is on more controversial ground as the self-appointed "conscience" of the scientific community. The situation, he concedes, "affords me some humor because it is in some ways grotesque."

He chides intellectuals for their "failure to face some very worrisome human genetic or quality problems." This concern is based on his interpretation of Armed Forces intelligence tests, which he says show that Negro intellectual capacity is declining. He attributes

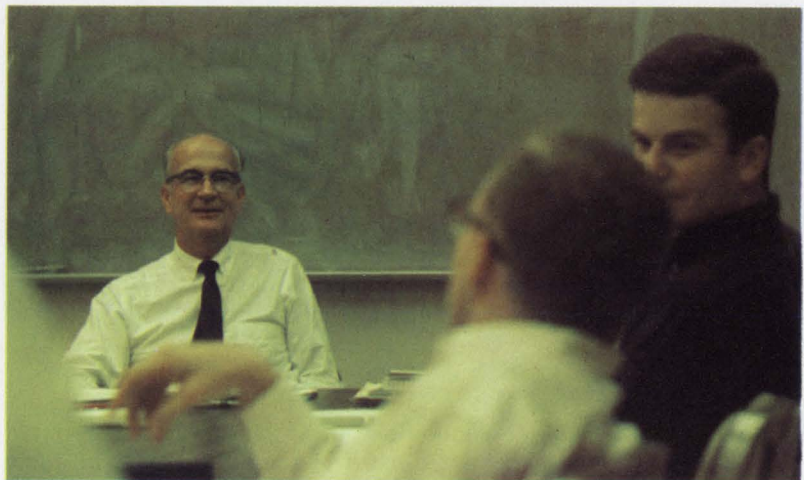

this partly to "well-intentioned welfare programs" that encourage a high Negro birth rate. Shockley makes no specific proposals except to urge that scientists find out the facts about Negro genetic intelligence and then draw the "necessary" unemotional conclusions.

For these views, he has been denounced, if not always by name, by fellow Stanford Nobel laureate Joshua Lederberg (medicine and physiology, 1958), and by leading

geneticists of the National Academy of Sciences.

Despite his broader interests, Shockley hasn't renounced technology. He is enthusiastic about studies made of magnetic domain walls in the orthoferrites by one of his graduate students, and says the materials have "potential for information processing and storage" and may provide "advantages exceeding those accomplished by transistor techniques."

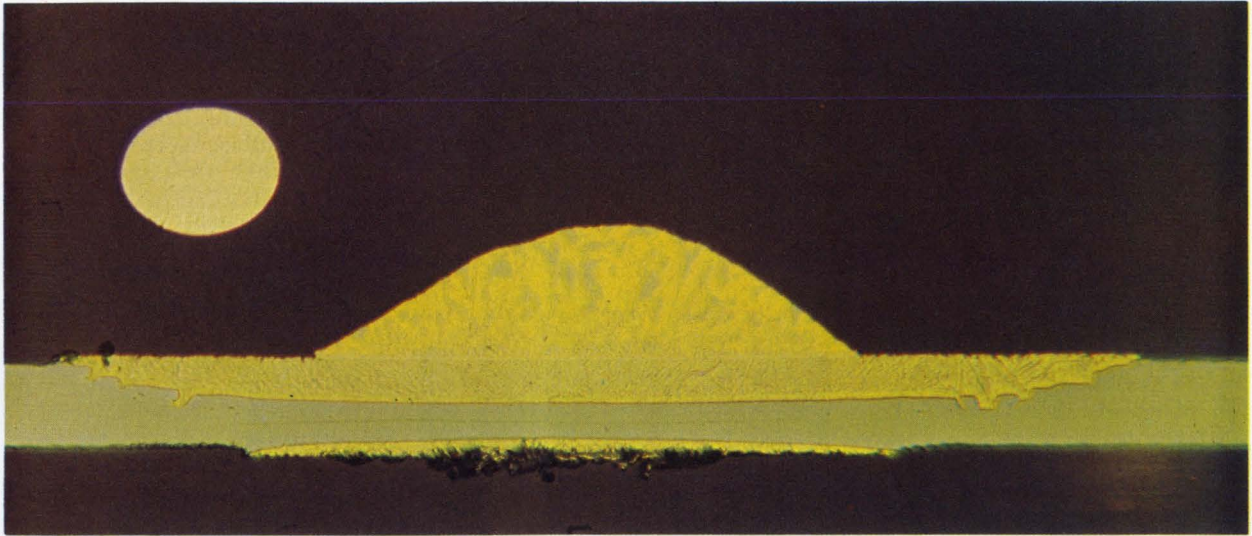

Classic profile. Cross-section of an alloy junction illustrates an early technique in transistor manufacturing in which dots of impurity elements are alloyed to a germanium wafer.

another symposium — this time for its licensees — on transistor processing technology and the door to the future opened wide.

Jack Morton relates, “There was nothing new about licensing our patents to anyone who wanted them. But it was a departure for us to tell our licensees everything we knew. We realized that if this thing was as big as we thought, we couldn’t keep it to ourselves and we couldn’t make all the technical contributions. It was to our interest to spread it around. If you cast your bread on the water, sometimes it comes back angel food cake.”

Morton was right; it was a cakewalk. By 1954 many companies were turning out transistors and the military watched the progress of the technology with keen interest. During the early stages of transistor development, the Pentagon had supported some of the work at Bell. In 1955, shortly after Bell described its diffusion process, the military divided about \$25,000,000 among a number of companies to explore this new technology. Impressive though this contribution may be, most industry spokesmen do not credit the Government or the military with the progress of the transistor; they claim that most of the important developments have been made by industry through its in-house efforts.

Patents

Bell’s price for a license to use its patents was an advance royalty of \$25,000. Some companies didn’t have to make this down payment because they were already licensed. And a few companies never paid any royalties, gambling that the Government—which had been examining the transistor patent-licensing arrangements — would eventually free the basic patents. This is exactly what happened after an anti-trust suit was launched in 1954. Bell signed a consent decree releasing all existing patents, royalty free.

After 1956, Bell’s early transistor patents earned royalties only from foreign companies. When the point-contact-transistor patent was about to expire,

Bell petitioned England for an extension. Under British law, to gain such an extension it’s necessary to establish that the patent is basic and generic, that the inventors have been diligent in pursuing their work, diligent in disclosing and teaching, and that they’ve not received sufficient return for their investment. Bell lost on that last point. England’s position was that Bell had earned enough from its patents and, since the patents had expired in half a dozen other countries to which England exported, extension would place the British at a disadvantage.

At the time of the hearings, the validity of the original patent was questioned but Bell had no trouble establishing its claim.

Now Bell must license anyone who wants to use patents awarded since the 1956 consent decree; and many companies need those licenses. Each license is negotiated individually. Among the important patents, that came after the royalty-free arrangement, are those covering diffusion, oxide masking, the epitaxial process, and photolithography.

Horse trading

Over 800 U.S. patents on transistors — some trivial, others of profound significance — now stand on the shelves of libraries here and abroad.

The flood gates were opened with the point-contact-transistor-patent which was issued in October 1950 to Bardeen and Brattain and assigned to Bell. The junction transistor patent was issued in 1951 to Shockley. [In 1956 the trio was awarded the Nobel prize for its accomplishments.] Other landmark patents include those for field-effect transistors, zone refining, diffusion, the planar processes and integrated circuits.

In the complex pattern of licensing and cross-licensing in the semiconductor industry, Texas Instruments, Fairchild Semiconductor, and of course, Bell Labs, are preeminent. Says one patent attorney, “It’s only reasonable that most of the industry pays royalties to these three. After all, they’re responsible

Bardeen

A shortage of office space helped put John Bardeen in the team that was to develop the transistor. When he came to Bell Labs in 1945 after spending the war years at the Naval Ordnance Laboratory, he was given a free hand to work on anything he wanted to. But space at Bell was at a premium, so he had to squeeze into an office already occupied by Walter Brattain and Gerald Pearson.

He quickly decided to join them in their work, and was soon helping Brattain conduct preliminary experiments on copper oxide, an early semiconducting compound. It was not long before they turned toward germanium and silicon.

One reason Bardeen joined Bell

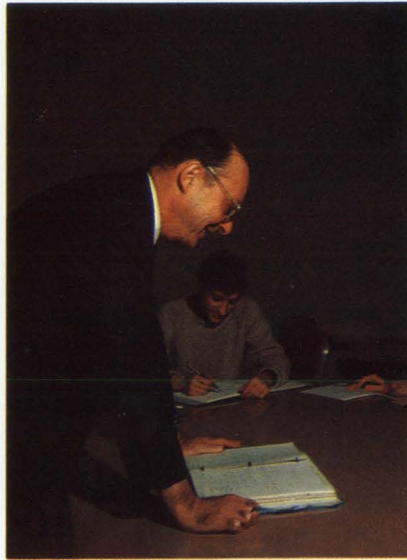

Labs was his acquaintanceship with William Shockley and James Fisk, now president of Bell Labs. He had known them in the mid-1930's when he was a postdoctoral fellow at Harvard and they were postdoctoral fellows at MIT.

Superconductivity has intrigued Bardeen ever since his Bell Labs days. At the University of Illinois, where he now teaches graduate courses in solid state physics, Bardeen was able to resume these studies. Along with L. N. Cooper and J. R. Schrieffer of the university, Bardeen in 1957 formulated a theory that explains the microscopic behavior of superconductors. He considers this theory to be of greater importance than the transistor "from a purely scientific point of view."

for the basic inventions that contributed most to the technology."

So valuable are some transistor patents that companies who want to use them will sometimes swap their own patents with the original patent owner and pay royalties as well. Details of licensing and cross-licensing are closely guarded secrets. They are the result of negotiation by patent attorneys, adept at horse trading. Industry's willingness to license anyone who has something to give in exchange accounts, in part, for the remarkably fast growth of transistor technology. There aren't many technical secrets in the semiconductor business.

Although companies don't always take out licenses to get at another's patents, there have been relatively few squabbles. Many fights never make it to the judgment stage in court. Frequently, a company suing for patent infringement convinces the other to take out a license and drops the charges. When suits do go to the bitter end, the complainant rarely seeks an injunction; if he wins the case he is satisfied with a licensing agreement with the company that has infringed on his patent.

Before genesis

Bell's point-contact-transistor patent described the first "workable" solid state amplifier, but wasn't the first patent on such a device. During its patent search Bell discovered a large number of "paper" patents describing devices that were impossible to build or understand.

One of these paper patents, issued in 1930 to the late Julius Lilienfeld, who had been professor of physics at the University of Leipzig, created a brief controversy. The patent described a method and device for getting electrical amplification in a thin film of copper sulfide. The object of his invention, wrote Lilienfeld, was "a simple substantial and inexpensive relay or amplifier not involving the use of excessive voltages, and in which no filament or equiv-

alent element is present."

To Virgil Bottom, former director of research of the Motorola Semiconductor division in Phoenix, Lilienfeld's patent clearly described a device like the npn transistor. Writing in the February 1964 issue of *Physics Today*, Bottom concluded that though Lilienfeld didn't have a good semiconductor with which to work and couldn't correctly explain the operation of his devices, "Nevertheless, it must apparently be conceded that he invented and used solid state amplifiers identical in principle with the modern transistor nearly a quarter of a century before it was rediscovered and made into a practical device."

But in the May 1964 issue of *Physics Today* J.B. Johnson, a former research physicist at Bell Labs, set the record straight. He showed that Lilienfeld had described a device that might be compared to today's insulated gate field effect transistor. Furthermore, Johnson said he'd built Lilienfeld's device but it didn't work. The reasons, he believed, were probably the "very low mobility of holes in Cu_2S and the effect of surface states on the free surface of the film."

There's a general belief that Lilienfeld never implemented his ideas by building the solid state amplifier he described. In 1964, when Lilienfeld's patent was introduced by opponents to an extension of Bell's basic patent in England, the claim was denied.

Gifted children

Three years after Bardeen, Brattain and Shockley invented the point contact transistor, not even a combination of Nostradamus and the Oracle at Delphi could have foretold that by 1967 nearly a thousand patents would cover transistors in the United States alone.

True, Shockley had predicted in 1949 that the point contact transistor would give way to the junction transistor but the men working in Bell Labs to transform his concept into a workable device were

still plagued by the impossibility of controlling the impurity level of germanium to one part per million. By 1951 they could, and did, build junction transistors but the control of impurities remained so erratic that it seemed yields would never be increased to the point where it would pay to produce the junction devices.

Then, in 1954, William Pfann, whose earlier contribution to the development of materials technology has already been described, invented zone refining, the process wherein the melted zone is swept through the ingot and the impurities with it. The technique was useful both for purifying the germanium and for evenly distributing impurities throughout the crystal.

By 1955, both alloy and grown junction devices were in production. In the former, dots of impurity elements are alloyed on either side of a germanium or silicon wafer. The impurities penetrate to a depth determined by the temperature to which the dots are heated, and the time they're held at that temperature.

In grown junction devices, impurity layers are developed while the crystal is withdrawn from the melt. Transistors are then cut from the crystal in a direction parallel to its axis, so that each transistor spans the impurity layer. Because these transistors are limited in frequency response, their application was restricted to the audio region.

By fabricating thin base layers through an electrochemical machining technique, Philco succeeded in 1953 in pushing the frequency range of transistors up to the megahertz region. One Philco device, called the surface barrier transistor, was used in very high frequency systems and computers.

Philco later introduced microalloy and then micro-

alloy diffused transistors using the same electrochemical process. Yields were high but the technique did not lend itself to batch processing.

Philco sold highly automated equipment for manufacturing electrochemical transistors to competitors, primarily to establish second sources; it still collects royalties from Sprague.

By the 1960's Philco was one of the world's five largest transistor makers. In 1956 it had built what was then the world's largest transistor plant and in 1959 it added a building for silicon manufacture. But in 1961 Philco was acquired by Ford and in 1963 the Edsel-hardened Ford management team stopped Philco from making transistors commercially.

Bell rings again

Bell Labs, however, was traveling another road; one that had been opened up by Pfann's zone-refining achievement of 1954. It led them, in 1955, to the diffusion process. In this technique, impurities are diffused into the surface of a germanium or silicon wafer by heating the material in an atmosphere containing gaseous dopants. The big advantages of the method are that it lends itself to batch processing and allows fine control of the depth of the diffusion. The most popular diffused base transistor was the mesa — so called because of its shape. It was the mesa that helped rocket sales for Fairchild Semiconductor from \$500,000 in 1958 to \$7 million in 1959.

Fairchild, with all its eggs in the diffusion basket, was getting ready for the next step. That came in 1959 when Jean Hoerni of Fairchild, making use of diffusion and oxide masking, came up with one of the giant contributions to transistor technology — the planar technique. [At a later date, Hoerni's patent,

Brattain

The day Walter Brattain and his colleague John Bardeen first observed amplification in a transistor structure, Brattain told riders in his carpool that he had "just taken part in the most important experiment I ever expect to do." In his enthusiasm, he forgot to pledge them to secrecy but took that precaution the next day.

Brattain says the research group at Bell Labs was the "greatest of which I've been a member." It was a close-knit team, he recalls. He and Bardeen often adjourned to the golf course when they seemed to be getting nowhere in the lab.

Today Brattain teaches undergraduate physics at his alma mater, Whitman College in Walla Walla, Wash., working not on transistors but on studies of simple biological surfaces.

As a surface physicist, Brattain is no longer keenly interested in transistor technology. While he admits to no surprise at any development in semiconductors, his greatest enthusiasm concerning transistors is the uses to which they've been put.

"Erasing illiteracy was one of the prime goals of education when I was growing up," he says. "We all agreed you had to teach a man to read before you could educate him. But now look at what's happened with development of the battery-powered transistor radio. Even the loneliest nomad on the steppes of Asia can have the news of the world just by twisting a dial. He doesn't have to read. Once the common man has a chance to learn what's going on, he has a chance to control his destiny."

Brattain the experimentalist and Bardeen the theorist still meet several times a year, always playing golf when they do. Brattain de-

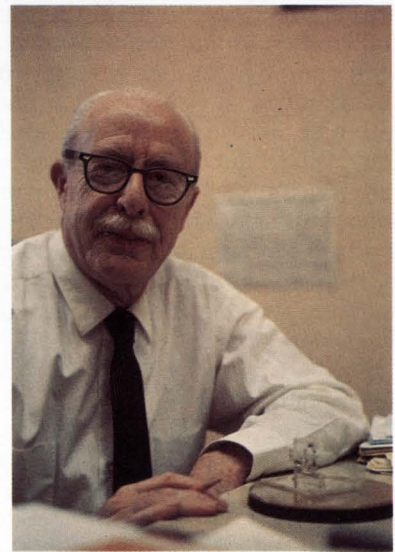

scribes Bardeen as a good, but erratic, long-ball hitter "and no experimentalist" on the links. He intends to be at Bardeen's 60th birthday party in April.

awarded in 1962, was to be challenged]. In 1959 Fairchild was out in front with an improved transistor with fully protected junctions. Transistors made with the planar technique were more rugged than the existing devices and were less vulnerable to contamination. For years, so secret was the technique, that entry to Fairchild's mask-making facilities was tougher than getting into Fort Knox.

A talented lot

When Bell uncorked its secrets at that 1952 symposium, the industry got off to a hot start and has yet to cool down. A quest for talented engineers and managers began and still persists. In the early years, experience was at a premium. Technical challenge and the lure of instant success meant the proliferation of companies through spin-offs and raids.

In this respect, Bell Laboratories gets credit for supplying not only the cookbook, but many of the chefs.

One of the head chefs was Shockley himself, who left Bell Labs to establish Shockley Laboratories. He obtained financial backing from Beckman Instruments Inc., and his company became a wholly owned subsidiary.

Among the young scientists recruited by Shockley was Robert Noyce. He and several others became disenchanted about policy and product direction. Shockley wanted to devise new products that could be patented on their own merits. The others wanted to make diffused silicon transistors. When the president of the parent company, Arnold O. Beckman, sided with Shockley, eight of the pro-transistor contingent left. They were "prodded by an investment firm to form a company under the terms offered by Fairchild Camera & Instrument Corp.," recalls Dave Allison, one of the original eight and now vice president of advanced development for Signetics. Shortly after the group formed Fairchild Semiconductor, Noyce joined it. Ed Baldwin was lured from the Hughes Semiconductor division to manage the Fairchild operation, and he brought six of his men with him. Baldwin stayed but a year, then took eight men with him to form Rheem Semiconductor. Noyce fell heir to the Fairchild managership.

At the outset, Fairchild convinced the International Business Machines Corp. that it could do a good job for them, and its first transistors were made to IBM specifications. The first one marketed by Fairchild was the 2N696 mesa — a double diffused silicon core driver.

Recalls Allison: "At Fairchild everything worked very smoothly and it was very exciting. Everything was also quite profitable. Every day it seemed as if something new was being developed.

"When we made the first pnp there was a problem with the base contact, but problems, as always at Fairchild then, seemed to solve themselves without any effort from us.

"We went into a period of rapid expansion and in a few years we were up to hundreds and then to thousands of employees. Then, of course, came the planar process."

Passive approach

Jean Hoerni, the developer of the planar technique, came to the U.S. after receiving a Ph.D. from the University of Geneva and from Cambridge University; both doctorates were in physics. Shockley had recruited Hoerni for his venture in 1955, when Hoerni was doing postgraduate work at Cal Tech. But Hoerni was among those who left to join Fairchild, where he headed the physics department.

Before the planar process, the mesa transistor was selling well, but it was fragile and vulnerable to contamination. Diffusion was then the accepted method of doping and silicon oxide was used as the mask.

"At Fairchild," Hoerni says, "we wanted to passivate the transistor, but our efforts were notably unsuccessful. Pure silicon oxide was not adequate as a passivating agent."

As it turned out, oxide exposed to diffusion of boron and phosphorus was an effective passivator. With that discovery by Hoerni, the success of the planar process was assured.

"Bell Labs," Hoerni says, "should have come up with this development, but they didn't. They could only understand pure silicon dioxide. It was the phosphorus in the oxide that was passivating the junction. The diffusion into the mask — which was unavoidable — was exactly what we needed." Hoerni, like others, had thought it would be detrimental.

Hoerni stayed with Fairchild until 1961 when he and Jay Last, another Fairchild founder, left to set up Amelco Semiconductor. "There was too great an accumulation of talent at Fairchild. I wanted to work more on my own," Hoerni explains.

When Union Carbide decided to enter the semiconductor business, they tapped Hoerni as their expert; he signed on with them as a consultant under a three-year contract. At its expiration he acted as a consultant for Hughes Aircraft, then formed his own company, Intersil, last July, to make mos and bipolar integrated circuits.

Not only the men, but some of the companies seem as mobile as the electrons that are at the root of it all. Shockley Laboratories, for example, was sold by Beckman to Clevite, then by Clevite to IRT. Of his personal role, Shockley views his split with the Fairchild group as distressing — "not a successful outcome of a business venture." He is no longer affiliated with Shockley Laboratories and never had a written agreement with IRT.

The Texas story

In 1951, a Dallas-based company, Geophysical Service Inc., launched itself on the road to becoming the leader in semiconductor sales. It did so by paying Western Electric a \$25,000 advance on royalties to become a licensee. Less than two years later the firm, whose name had been changed to Texas Instruments Incorporated, had set up its semiconductor-components division under Mark Shepherd, an electrical engineer who worked for General Electric and Farnsworth. TI soon hired Gordon Teal, the Bell Labs scientist who had helped invent the single-

Unijunction progress

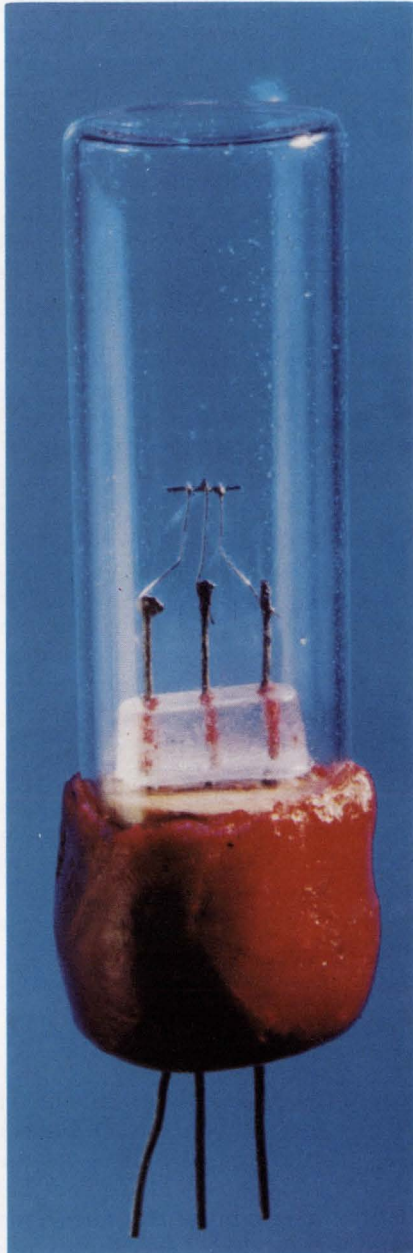

1953: Original double-base diode

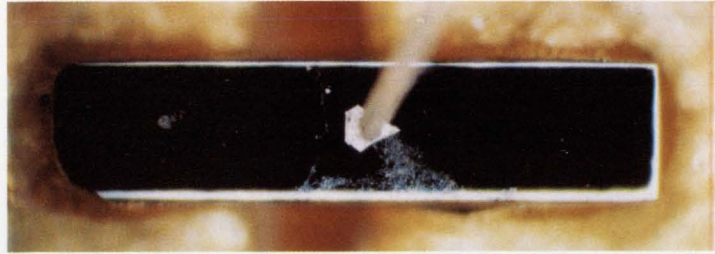

1958: Ceramic-based bar version

1962: Cube geometry

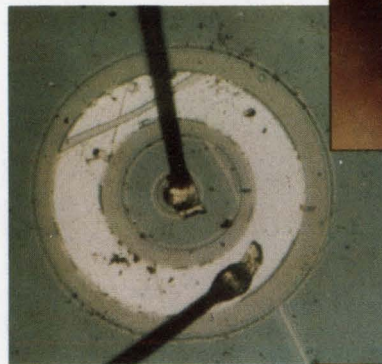
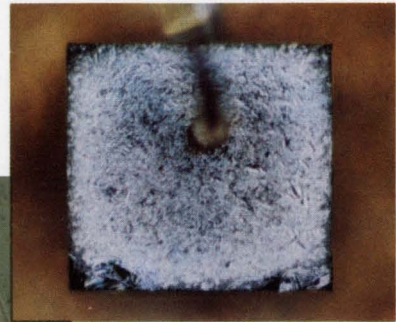

1966: Planar structure

1966: Complementary planar

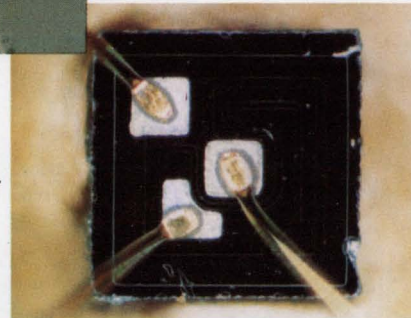

Take five. The original unijunction transistor by General Electric was a double-base diode of germanium slices, mounted on a cork base and sealed in a dust-proof glass envelope. It was superseded in 1958 by a silicon bar structure. Four years later, a smaller unit raised speeds and output levels. The planar geometry was perfected in 1966; later that year a complementary version added built-in resistor stabilizers.

crystal grown-junction method of making transistors.

In short order, TI had invested about \$2 million in a facility for mass producing transistors for a portable radio, "The Regency," made by an independent radio manufacturer. On the books, the radio was something less than a money maker but it paid off big in another way. It made TI confront the big hurdles of volume production and low cost. To surmount these obstacles, TI had to work out a lot of the bugs that were plaguing the industry and then come up with manufacturing techniques that would work in mass production. When the radio venture ended, TI had learned how to mass produce transistors at a cost

that interested the computer makers and other large-volume buyers.

Then TI set the industry on its ear when it developed, in 1954, a method of growing silicon crystals with the right structure and impurity distribution needed for transistors. Most companies had been hard at work trying to develop a silicon process. At the time, TI thought it had a few months' jump on the industry; but its lead time stretched to two years.

Steering committee

Some companies have had a penchant for picking the right product line and the right people to de-

velop, manufacture, and market it. At the outset, the independents seemed to have an advantage over companies firmly entrenched in vacuum tube manufacture. Firms like Fairchild, Texas Instruments, and Motorola, that never made a vacuum tube, barged ahead of giants like RCA, General Electric, and Sylvania. General Electric, for example, lived through periods when its corporate philosophy on semiconductors was vague and its market efforts hazy.

Yet GE was not a newcomer to semiconductor technology. With its work on copper oxide rectifiers dating back to the mid-1920's, and through its later studies of germanium, the company had become a major producer of germanium point contact diodes.

G.E.'s R.N. Hall and John Saby developed the first alloy junction devices early in 1950. In 1953 the company introduced the unijunction transistor; it was developed by I.A. Lesk who is now Motorola's manager of applied science. In 1962, GE began work on the

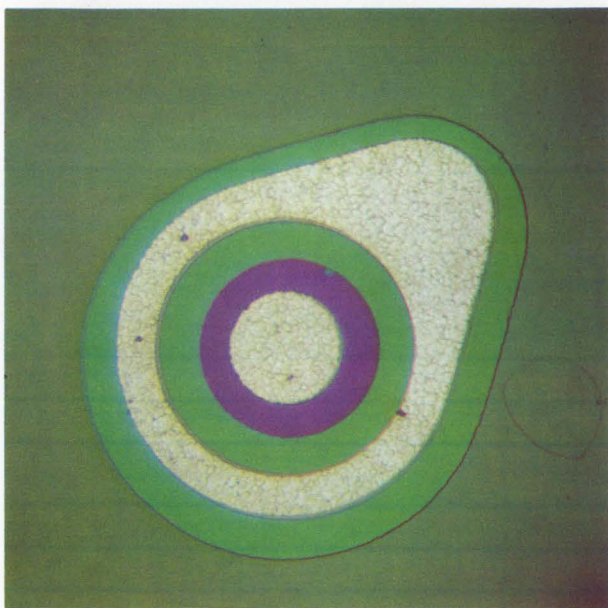

Pioneer. The first commercial planar pnp silicon transistor introduced in the early 1960's by Fairchild Semiconductor.

plastic encapsulation of silicon planar transistors, producing the first commercial units in 1963; today GE is a leader in plastics.

Who's on first?

The rapid spread of transistor technology in the early years can be attributed, in large part, to the movement of talented men from one company to another. As engineers, scientists and management of old and new companies in the semiconductor industry were hotly pursuing success, close behind came a phalanx of patent lawyers. In the two decades since the first transistor of 1948, the semiconductor industry has had its battles. Many of them were settled amicably but others wound up in court.

Currently, Hughes Aircraft seems to be the industry's most active litigant, with suits against five com-

panies—Sylvania, Raytheon, IRT, Microwave Associates, and Continental Devices. Hughes charges that these companies have infringed on its patent for a coaxial glass diode. Earlier, Hughes had sued General Instruments for infringement of this patent as well as another on a Hughes npn germanium transistor. Hughes won that case and subsequently worked out a licensing arrangement with General Instruments.

After Hoerni was granted the planar patent a few years ago, a number of companies sprang to the attack. They said the patent wouldn't hold up because its essential elements—oxide masking and diffusion—were already covered by a Bell patent. Interestingly enough, Bell wasn't among the complainants. Quite to the contrary, Bell entered a cross-licensing arrangement with Fairchild Semiconductor. It was Raytheon that challenged the planar patent and began a suit. Subsequently, Raytheon withdrew its complaint and was licensed by Fairchild. The most recent attack on the planar patent originated in the Netherlands where litigation is now in progress.

Fairchild and Texas Instruments are in contention for two patents covering metal-over-oxide leads and semiconductor devices. The Board of Interference of the Patent Office awarded priority of invention to Texas Instruments on four of the six claims involved; Fairchild was awarded the two remaining claims. That decision is now being appealed.

In another court case, Sperry sued Texas Instruments for infringing on a patent that, Sperry said, covered all devices—including diodes and rectifiers—using n-type germanium. Texas Instruments won, and the Sperry patent was declared invalid.

This is far from being a roll-call of the members of the semiconductor family who have been at loggerheads. Neither is it any indication that the end is in sight.

Better and better

One of the most interesting aspects of the increase in the reliability of transistors — about tenfold every four years during their 20-year history — has been underscored by C. Gordon Peattie, manager of Texas Instruments quality and reliability assurance department. Manufacturing experience, he notes, has not been the sole contributor to transistor reliability and the concomitant reliability of circuits and systems. Instead, what has happened is that each major innovation in device design has been accompanied by a sharp increase in reliability.

In the beginning, transistors were extremely sensitive to shock and temperature. The first improvement came when the point contact transistor was elbowed out of the way by the grown-junction and alloy-junction transistors. At once, the major source

Burnout-proof: Built-in resistors in series with each one of the emitter sites equalize current distribution to prevent thermal runaway in ITT's r-f power transistor.

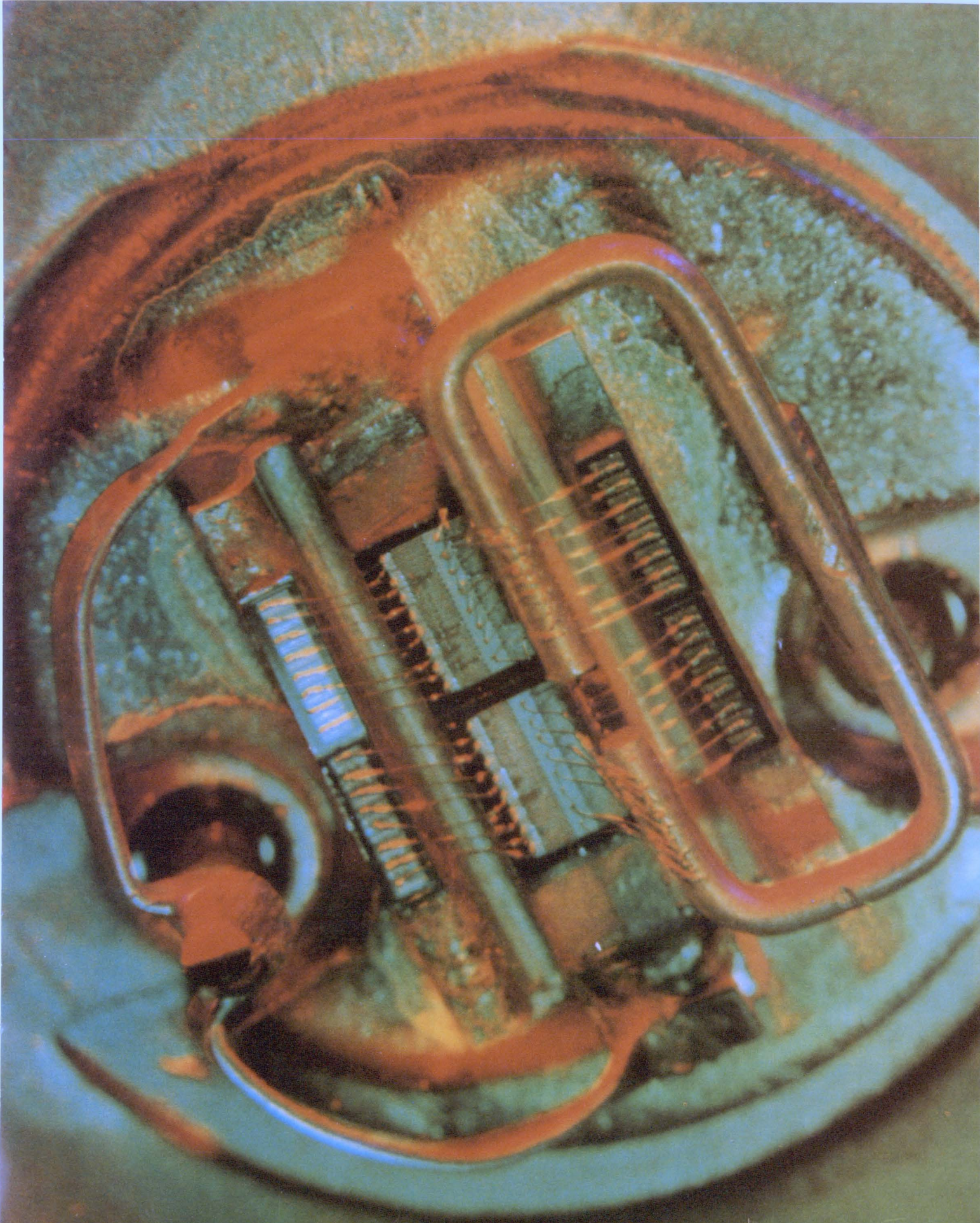

of failure in transistors — the cat's whisker — was eliminated.

When, in 1957, mesa transistors made their first appearance, users had a device that was inherently more rugged than its predecessors. The mesa construction permitted alloying a small, flat chip to the header surface, rather than having the bulk material mounted on posts above the header surface. Although the mesa's junctions remained exposed and susceptible to the adverse effects of surface contamination, it significantly improved device reliability.

The planar structure, because of its completely passivated surface and junction protection gave still greater reliability. When epitaxial techniques, which produced lower collector resistance, were developed in 1962 they were combined with the planar process, giving users the advantages of both.

It was a very good year

The same month Brattain, Bardeen, and Shockley announced the transistor, Claude E. Shannon — also of Bell Labs — published his now-famous information theory. In the July 1948 issue of the Bell System Technical Journal, Shannon's article, "A Mathematical Theory of Communication," described for the first time the amount of error-free information that could be transmitted over a given channel.

Today, information theory is a branch of mathematics and Claude Shannon's papers are the classical reference. Isaac Azimov describing Shannon's work said: "It has proved useful not only in circuit design, computer design, and communication technology; it is being applied to biology and psychology, to phonetics, and even to semantics and literature."

For communications, mathematicians have been working with limited success to develop codes that achieve limits set by Shannon. Large-scale integration, a recent development that stemmed from transistor technology, has renewed the hope that hardware may be built that will bring theory and application closer together.

For Bell Labs, 1948 was indeed a vintage year.

The millenium has not been reached, however. Pinholes in silicon-dioxide film are still a source of trouble. Another is the incorrect handling of the surface before passivation, which can cause impurities to be trapped on the surface.

The next step in more reliable devices, many think, will be based on improved methods of mounting and encapsulating transistor chips. The technique that holds most promise is Bell's beam lead process, a format that eliminates at least half the electrical joints usually required. Coupled with Bell's sealed junction technique, it promises device reliability equal to or better than that of canned devices and, at the same time, makes it possible to extend batch processing to the encapsulation step. The beam lead process is equally valid for integrated circuits, and makes it possible to mix, for example, bipolar and field effect transistors, or gallium arsenide and silicon transistors in the same circuits.

Reaping the rewards

While the military had been seeking smaller, more reliable, less power consuming equipment it did not, despite its financial support in the early days, realize the full potential of the transistor. There was one camp of military designers who regarded the transistor as an experimental device of dubious reliability.

Not until the missile programs of 1958 created a demand for the ultimate in performance characteristics, did the transistor get the impetus needed to push it strongly into military equipment.

One area that did welcome transistors was tactical communications. Discouraged by replacing burned-out and broken tubes, dead batteries, and lugging around the whole mess, military men were elated with transistorized equipment.

The transistor was the key to successful military reconnaissance, navigation, and worldwide communications satellites. It made possible increased payloads for intercontinental ballistic missiles by shrinking the power supplies and the guidance and control systems, while boosting the reliability of the entire avionics package.

Manufacturing and process industries reaped handsome rewards from transistors. They became the cornerstone of sorely needed instrumentation, control, and supervisory equipment that reliably — and at low initial and maintenance cost — provided new ways for managers and operators to run their plants and raise efficiency and production.

As examples, the transistor was the key to the introduction into industrial use of such equipment and ideas as analog and digital computer control, numerical control, electronic analog controllers and recorders, supervisory and telemetry data systems, and logic modules for special purpose control.

Transistors also were responsible for vast improvements in the performance of many instruments. Counters and digital voltmeters are only two such examples. In these, transistorized logic elements replaced electromechanical components, resulting in improved operating speeds, wider operating ranges, and improved maintainability.

It was also the transistor that was largely responsible for the phenomenal growth of the computer field. During the past five years the field has enjoyed an average annual growth rate of 20%. While integrated circuits are beginning to make inroads into some machines, discrete transistors and transistors in hybrid assemblies are by no means obsolete. In its system 360 series IBM remains heavily committed to hybrids. Control Data is still designing its supercomputers with transistors, on the grounds that monolithic integrated circuits have only recently achieved the speeds needed for large processors. Many computer makers see the changeover from transistors to integrated circuits as inevitable, but gradual.

Alternate sourcing

There have been periods when the transistor business resembled a revolving door with almost as many companies coming out as going in. When a company

folds its transistor manufacturing operations, and many have, it faces the related problems of disposing of its inventories and making certain its customers can still get the devices they want. One way to solve both problems is to sell the inventory to a competitor. Another is to auction it off.

For example, when Philco went out of the transistor business in 1963, it sold its inventory and a good part of its testing equipment to high-bidder Jay Wolf. Some former Philco staffers joined Wolf, who was not himself a Philco man, to form Lansdale Transistors & Electronics; their purpose was to sell the Philco inventory they'd acquired.

From this start, LTE now relabels bulk purchases from the major semiconductor makers — Fairchild, Raytheon and Texas Instruments — and has pyra-

chemical business and the line still accounts for more than half of Sprague's transistor sales. Philco's withdrawal from the transistor business was a boost for Sprague, but is only part of the story. Sprague's transistor efforts date back to 1953 when Kurt Lehovick left the Signal Corps to join the company. His first assignment was to work on point-contact and early alloy-junction transistors.

In the years that followed, Sprague solidified its position through licensing agreements and, more recently, through an ambitious program which has already seen an infusion of Ph.D.'s and the expansion of plant facilities.

Sprague began to study planar devices in 1961, brought out its own version in 1962, and later got a license for Fairchild's version. About two years ago,

Beam lead

This experimental silicon microwave transistor is fabricated with broad beam leads — 4 mils wide — to minimize inductance. Its symmetrical common-lead arrangement gives low inductance to ground; tests show that when the device is bonded to a well designed mount, a common-lead inductance of 100 picohenries is possible. Devices of this type have exhibited an f_T of 4 Ghz and maximum available gains of 10 db at 2 Ghz. Their noise figures were less than 5 db at 1.3 Ghz.

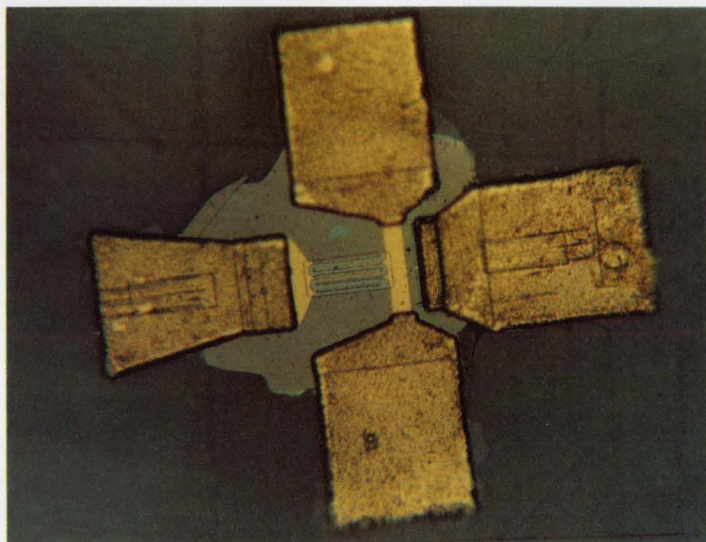

mided its sales to an amount estimated at from \$1 million to \$2.5 million. Wolf, who was the president of LTE, has been succeeded by Cyrus Warshaw, a former director of marketing for Philco's semiconductor operations. The company now has 28 employees, three of them engineers, and has ambitions of moving into the transistor manufacturing business itself.

That's one way of getting into the semiconductor business, albeit a tough one, because many companies that tried didn't make it. Yet some did succeed, and handsomely, so it's reasonable to assume others will be entering the revolving door.

Coming from behind

Companies that were late starters in the business had to buy their way in. The alternatives were to buy talent and start a new operation or to buy going concerns.

Sprague Electric is an example of a company that exploited licensing arrangements and captured high-level talent as well. The company's deal with Philco, described earlier, brought Sprague into the electro-

Sprague got an epoxy package license from General Electric.

In all three areas — electrochemical, planar, and epoxy — Sprague considers itself a late starter, but is satisfied with its catch-up rate. As the demand for electrochemicals wanes, the firm will switch its emphasis to silicon transistors (mostly in epoxy) and to integrated circuits.

"It was meant to be that way," comments John Sprague, vice president for research and development. "In fact, if we hadn't been able to see the potential of integrated circuits, I doubt if we could have swung the money for the original planar work."

High cost of entry

It's tougher to get into the semiconductor business today. Ten or even eight years ago, less investment was needed for automated equipment. Now a new company has to lock horns with the giants of the business who have driven the average selling prices of transistors down to somewhere between 30 and 40 cents. C. Lester Hogan, the general manager of Motorola's semiconductor products division, says

new companies would find it impossible to compete with the solidly entrenched leaders of the industry. Hogan underlines another obstacle facing newcomers — the wide dispersal of technology.

"At the outset, only a few companies had any semiconductor know-how," says Hogan, "but now everybody knows how to make semiconductor devices and a newcomer either has to have market dominance in a product, or sell at a price less than the giants'."

Changing times

Faced with the galloping technology, some firms are shifting from discrete transistors to IC's. Signetics, the most successful spinoff from Fairchild, leap-frogged transistors, going right to IC's.

The four major makers still active in germanium transistors are Texas Instruments, General Electric, RCA and Motorola. Hogan of Motorola also sees a

decreasing interest in silicon transistors among some competitors.

"Many have lost their zeal for the game," he says, discussing discrete devices generally. "We don't meet some of them as much as we used to in competition."

Hogan offers two possible explanations for this — diminishing profits or the neglect of discrete development efforts caused by a shift of some companies' funds into IC's.

Yet Hogan believes that, like the vacuum tube, the transistor will be around for a good many years to come. "Our total transistor backlog is about twice what it was last year at this time, and I know we increased our percentage of the transistor market in 1967."

The first two decades of the transistor have been the improbable years. From them, some say, the best is yet to come.

Diodes — they also serve

When the first, crude point-contact transistor was just a laboratory curiosity, the 1N34 germanium diode was already priced at 50 cents in production quantities. But the glamor attached to the transistor soon eclipsed that of the diode. Still in the shadow of transistors, diodes continue to be big business.

The International Telephone & Telegraph Corp.'s semiconductor division alone turns out 325 million diodes a year at its Lawrence, Mass., plant. And the unit selling price averages between 15 cents and 20 cents.

Lacking many of the outward trappings of big business, IRT's diode facility is housed in a grimy, one-time silk mill. On the inside, the accoutrements are spartan and much of the equipment looks makeshift. But each cardboard box, jig, and jury rig is there for a reason — manufacturing the greatest number of diodes at the lowest possible cost. And despite the plant's size (145,000 square feet) and work force (around 600), it is the world's largest diode producer.

The Lawrence facility, much of its production equipment, and its former plant manager, James Ambrose, came to IRT in 1962, when the company purchased National Transistor Inc. Two years later, IRT bought the Clevite Corp.'s diode operation and the Lawrence installation was soon filled with Clevite's green-colored production machines. Today, these machines still bear the Clevite nameplates.

Overhaul. But the paint and the

nameplates are about the only things unchanged. Ambrose's goal was to make the diode-manufacturing process as simple as mixing cement. Under his direction, production steps were eliminated, operations combined, and production lines in general were altered radically. Ambrose's success in achieving high production at low cost led to his recent appointment as the semiconductor division's director of manufacturing.

"Three years ago, we needed 500 people on a line," says Ambrose. "Now, we get same output with only 140. When you come right down to it, we had to do this to stay competitive." In a market where orders for tens of millions of assemblies are routine, a tenth of a cent's difference in unit production cost can mean the difference between profit and loss.

Ambrose got plenty of help from the plant's rank-and-file employees, who submitted cost-cutting and production-boosting suggestions. Each month, production-line foremen turned in reports on suggested changes together with estimates of their impact. At the same time, the foremen reported on the success or failure of previous changes. Most of the changes were inexpensive.

"A magnet here, a pickoff arm there, a red light to indicate a jammed machine — these were the usual sort of modifications; cheap stuff, usually costing well below \$100," says Ambrose. "Once we had to have a mechanic and a girl on each sealer machine. Now we have

automatic loading, thanks to a pneumatic plunger that replaced a complex set of gears and cams. Because the machine is simpler, things go wrong less often and downtime is so low that one mechanic easily serves five machines. Only one girl mans each machine now."

Payoff. Less downtime and fewer employees mean more production at a lower cost per unit. Between January 1966 and January 1968, the production cost of one diode type had been cut by 53%, another by 50%, and a third by 40%. "These aren't exceptions, they're typical," says Ambrose.

"Although we have to be more attentive to accounts wanting 20 or 30 million diodes," says Ambrose, "we also respond to small-volume and hurry-up orders. Inventory turns over every three or four weeks, or about 14 times a year.

"There's no trick to fast response. Two things make it possible. First, we build everything right here except the solder, the wire for leads, and the glass tubes used in packaging," says Ambrose. "This way nobody slows us down by failing to show up with the raw materials. Second, we keep millions of chips on the shelf so we can be packaging a given diode a day after getting the order instead of waiting a month for chips."

At the ready. Each line foreman has "the shelf" on his desk—a sealed glass jar with a dozen or so small plastic boxes, each containing a half million or more chips. With the chips at his fingertips, all a foreman need do is order the line to change over and a hurry-up order is easily accommodated.

Latest in the line of Monsanto IC counter/timers.

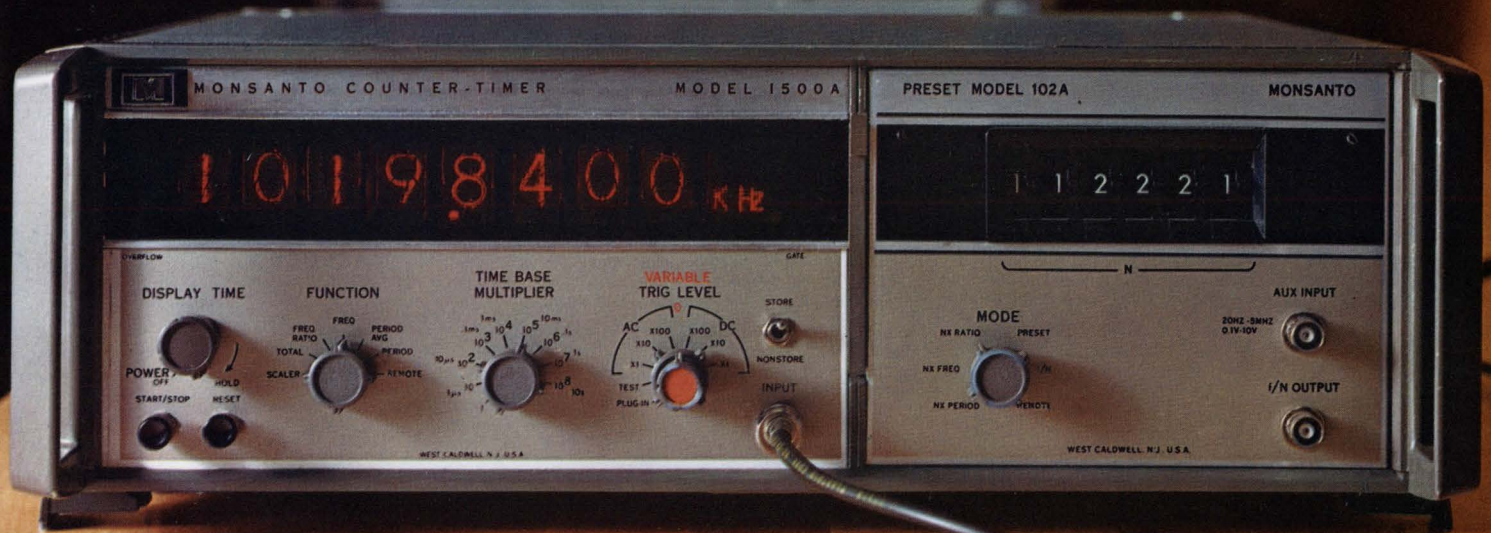

AVAILABLE PLUG-INS: TWO FREQUENCY CONVERTERS (50 MHz TO 500 MHz; 100 MHz TO 3 GHz); PRESCALER (dc TO 1 GHz); PRESET UNIT (20 Hz TO BEYOND 10 MHz); VIDEO AMPLIFIER (1 mV SENSITIVITY, 10 Hz TO 200 MHz); TIME INTERVAL UNIT (100 ns RESOLUTION); NON-COMMITTED PLUG-IN.

With 90% integrated circuit construction this new "4th generation" instrument is the most advanced plug-in counter/timer yet.

Our new model 1500A takes full advantage of IC capabilities to bring you: main-frame counting range from dc to over 125 MHz; to 3 GHz with a single plug-in. Remote programmability by either contact closure or voltage level. Provision for external time base up to 10 MHz. And nat-

urally, the inherent stability and reliability of integrated circuit construction, as indicated by our two-year warranty. All this for only \$2,850*. Call our field engineering representative in your area for full technical details, or contact us directly at: Monsanto Electronics Technical Center, 620 Passaic Avenue, West Caldwell, N. J. 07006. Phone: (201) 228-3800; TWX 710-734-4334. *U. S. Price, FOB West Caldwell, N. J.



ELECTRONICS

Circle 91 on reader service card

NEW FROM MICRO SWITCH

solid-state-encoded keyboard assemblies

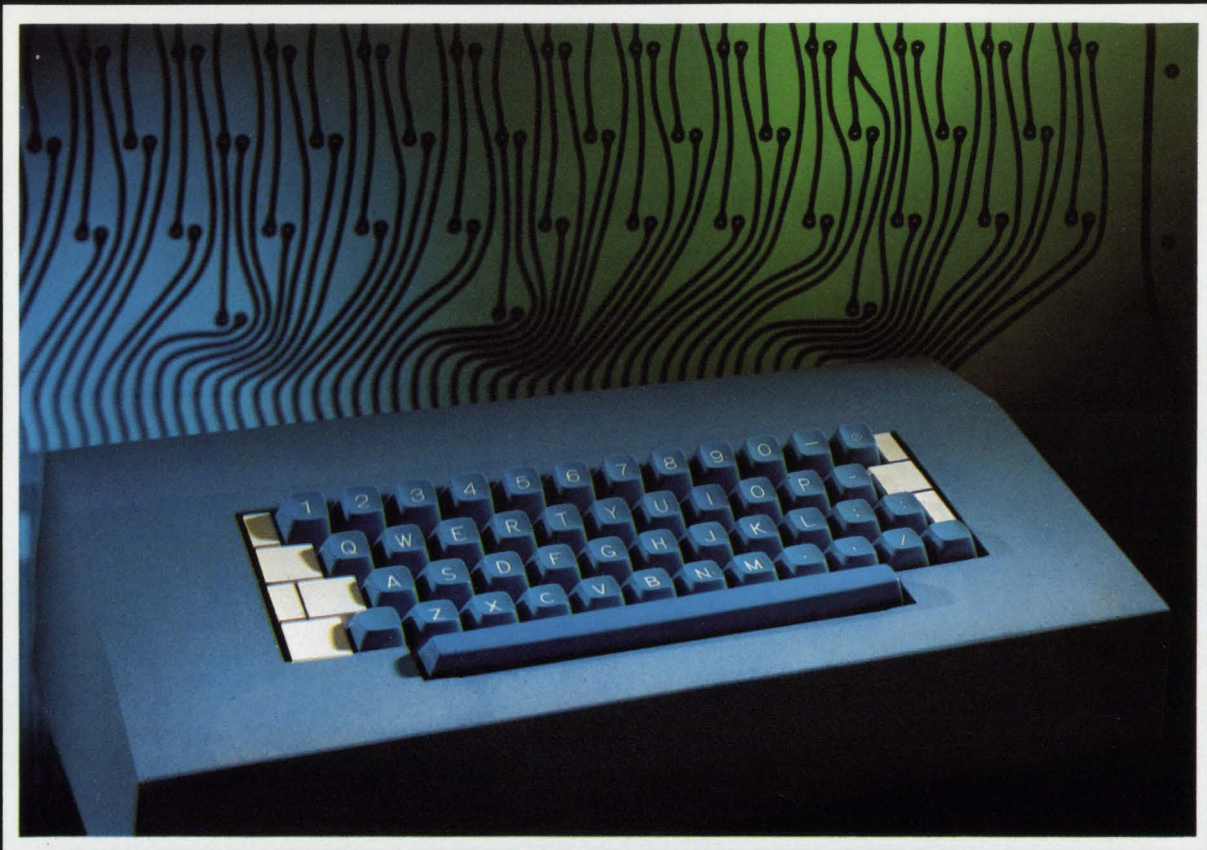

Complete keyboards—assembled, encoded, and ready to interface with your equipment.

These new keyboards feature reliability, flexibility and customized appearance that will give new sales appeal to your equipment. Exclusive new solid-state encoding and dry reed switch input assure your user the maximum in up time, and these features assure you the

minimum in maintenance.

You get a wide choice of custom-design opportunities to reduce your engineering and production costs. A unique new electronic interlock to increase operator speed and efficiency over existing approaches. An electronic strobe to delay the read cycle until the output is stabilized. Input flexibility to match your requirements.

MICRO SWITCH capabilities provide efficient factory assembly techniques to give you a customized keyboard at a price competitive with fixed format keyboards.

When you think of keyboards, think of MICRO SWITCH. Our Field Engineers can be a valuable asset to your design team. Call a Branch Office today. Or write for complete information.

MICRO SWITCH

FREEPORT, ILLINOIS 61032

A DIVISION OF HONEYWELL

Circle 92 on reader service card

Solid state

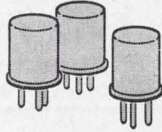

Fingers in the die

Reshaping transistor structures by interdigitation has increased active areas within limited over-all dimensions and enabled devices to handle large currents at radio frequencies without sacrificing their small size

By John G. Tatum

ITT Semiconductors Division, West Palm Beach, Fla.

Power, frequency, and size are factors designers have been juggling since the first transistor went on the drawing board. The problem has been that increases in power-handling capacity have required increases in the size of the transistor die, and that this greater size has lowered operating frequencies. Conversely, frequency could be raised by going to smaller dies, but only at a cost in power ratings.

For radio-frequency applications then, the challenge was to enlarge the device's active area—that region carrying emitter current or injecting current into the base—without expanding over-all physical dimensions. An answer was found in interdigitation—the reshaping of emitter and base into long, narrow fingerlike structures. Before this development, in 1954, the closest thing to an r-f power transistor was a device handling 7 watts at 5 kilohertz and rated at 0.3 ampere.

Interdigitated discrete devices are now handling hundreds of watts at tens of megahertz, and the technique is being applied to monolithic integrated circuits. How high is high in transistor power-handling and frequency capabilities? The present response would be 25,000 watt-Mhz. And with interdigitation, no ceiling is in sight.

Three layouts

Most iterated-emitter devices used in the range between very high and microwave frequencies are

The author



Now manager of the applications engineering department at ITT Semiconductors, John G. Tatum holds three engineering degrees from Stanford University. He has also been an applications engineer at Clevite Semiconductor and a circuit-design specialist at Hewlett-Packard.

either interdigitated or overlay [see page 98] types.

Interdigitated or overlaid, the fingerlike structures are arranged in square, rectangular, or circular emitter patterns. The choice depends on the desired ratio of emitter periphery to collector area, the current density per emitter site, the required amount and type of resistor stabilization, the physical area available, and, of course, the preciseness of the

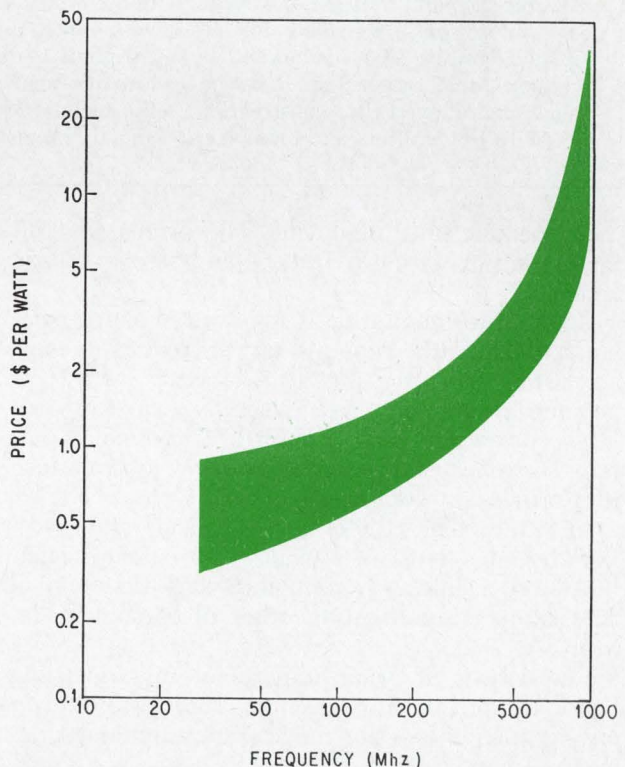

Cost curve. Dollar-per-watt figures are displayed as functions of operating frequency. Prices have dropped sharply recently because of growing volume.

Within limits

The father of the interdigitated transistor is N. H. Fletcher, an engineer with Transistor Products Inc. When, in 1954, he hit upon the idea of elongated emitter areas, Fletcher was seeking a means to increase the power-handling capability of devices, not a way to boost their cut-off frequency levels.

His discoveries were applied by other firms to most transistor types over the next decade, but his own company realized few benefits from his work.

The Clevite Corp. purchased Transistor Products in 1955 and was itself, in turn, acquired by IRT in 1965. While Transistor Products never established itself as a top-ranked semiconductor manufacturer [see p. 78], Fletcher's efforts were soon translated into market success by such firms as Texas Instruments, Motorola, TRW, RCA, and parent company IRT.

Finger man. Fletcher's discoveries were related to his Ph.D. work at Harvard, work that was partially subsidized by the Army's Signal Corps. In trying to develop a structure with a high ratio of active area to over-all physical size, Fletcher used what were then high-frequency (5 kilohertz beta cutoff) alloy transistors of single-bar, double-bar, and multiple-bar types. His basic designs called for enlarged emitter area surrounded by a base area, rather than the conventional alloyed disc construction.

With the emitters and bases con-

figured as fingerlike structures, the device took on a comb appearance. Interlocking of the fingers, or iteration, became the fundamental interdigitated structure, with emitter stripes alternating with base contact stripes.

Fletcher also learned that the transverse-flowing current in the base region induces a potential drop. So besides reducing the distance between base active region and base lead, he altered the resistivity of the base to cut the current loss. A reduction in noise level was an added benefit of this approach.

In the round. Fletcher's models were the basis for the Delco ring-emitter transistor of 1956, the first commercial interdigitated product. The elongated emitters were arranged in a circle, a configuration used again and again since by semiconductor makers. Among its offspring were the snowflake, leaf, and star patterns employed in devices produced during the late 1950's and early 60's.

The use of epitaxial processing, primarily to achieve better control of device parameters, was the next major advance. In 1959, TRW Semiconductors, then known as PSI Semiconductors, marketed epitaxially made interdigitated devices aimed at radio-frequency applications. Motorola followed soon after with epitaxially fabricated transistors designed to handle high power at low frequencies, and Fairchild used the technique to improve its small-signal transistors.

Epitaxial processing cut $V_{CE(sat)}$ figures by some 200%, thereby improving efficiency and raising cutoff frequencies by an order of magnitude. Basically, epitaxial layers gave increased control of regional thickness and resistivity; they didn't really constitute a new geometry.

Uniform current. Power and frequency levels were boosted further in 1961 as the result of geometry studies by William Shockley and R. M. Scarlett of Clevite Semiconductor. While investigating thermal stability and second breakdown effects, they found that structuring larger areas with narrower base regions could improve current distribution and the aluminum-silicon contact. With such designs, f_T rose from 100 Mhz to 250 Mhz, and power-handling capacity zoomed from 5 watts to 30 watts at 30 Mhz. Essentially, the uniform current concept produced finer geometries plus better registration over large areas, along with a good yield.

In this period, mask production and alignment techniques were sharpened by more than an order of magnitude. Base widths as thin as 1 micron and transistor device areas of 1 by 3 millimeters were attainable in production quantities.

Attention during the early 1960's then focused on parameter trade-offs, particularly between safe operating area and power-frequency product, but also between frequency capability and input impedance, and power gain and emitter inductance.

mask making and alignment. The primary circuit factors are operating frequency and safe operating area.

A square configuration is followed in simpler devices, those with moderate power-frequency characteristics, while rectangular geometries, with their geometric simplicity, are generally favored when large currents must be handled. The circular pattern is usually used for high-frequency jobs because it affords more peripheral space.

In former years, the exclusive consideration with interdigitated devices was power-frequency capability. But a shift away from purely general-purpose transistors is spotlighting other performance factors.

Linearity is of prime importance in single-sideband equipment, for example, and peak power output is an overriding consideration in amplitude- and pulse-modulated systems. Safe operating area might be the main interest for designers of mobile transmitter sets.

Vital statistics

Ignoring frequency, the most important parameters of power devices are breakdown voltage, peak current capability, safe operating area, and current gain. For a high-frequency transistor, regardless of its power level, the crucial parameters are power gain, base resistance, input Q, circuit efficiency, and noise output. In combination, these establish the device's bandwidth, switching ability, efficiency, and signal-processing ability.

Most of these devices' important parameters, along with the corresponding circuit factors, are common to all transistors. But others require definition within the context of high-power/high-frequency operation. For example, collector efficiency is the ratio of a-c output power to d-c input power, and maximum power output corresponds to a saturated state.

Tradeoffs between device parameters and circuit design factors must also be taken into account.

Safe ground. Safe operating area (SOA) is defined as that area of the collector voltage versus collector current characteristic where the transistor does not exhibit thermal instability or thermal runaway. Finer device geometries made the concept important, since active area, and therefore the current levels being handled, could be increased without a similar increase in over-all unit size.

Both emitter and base resistance had been reduced, and the speed of high-frequency operation didn't permit a uniform current distribution to be developed in the transistor die. For frequencies up to 200 Mhz and power levels of 20 watts, the problem wasn't severe, but beyond this point, radio-frequency-power transistors tended toward thermal runaway, fragility, and saturation at lower-than-predicted power output levels. The problem was aggravated by nonuniformities in the aluminum-to-silicon contact areas.

A solution to the resistance problem was found in 1962, when Shockley Labs placed discrete resistor elements in series with the emitter sites to equalize current distribution. The concept stemmed from a view of the interdigitated device as an assembly of small, paralleled transistors.

With 'n' parallel units of slightly differing characteristics, thermal runaway would occur in the higher-gain elements and would be more likely at higher temperatures. The connection to the case of external

resistors at each emitter site provided a more uniform current distribution and improved power gain.

Togetherness. This idea led to the placing of small, hybrid-packaged planar-epitaxial resistors next to the transistor die in the same can. It also led to extensive use of paralleled transistor dies in one package, further boosting power levels. Figures of 50 watts at 150 Mhz, 35 watts at 200 Mhz, and 15 watts at 400 Mhz in unconditionally stable devices became commonplace in the years 1963-1965. The state of the art was further advanced during that period through controlled aluminum sintering and surface treatment of the Al-Si contact area. The next significant innovation came in the 1966-7 period when integrated-circuit techniques were applied to resistor stabilization. Compatible thin-film nichrome resistors were either deposited on the transistor die or diffused into it to produce a greater resistor equalization in a smaller area than attainable with the discrete approach.

The technique also made for easier mounting of the dies, but all those benefits entailed some sacrifice. The extra die area needed to accommodate the ic-like resistor elements was a primary tradeoff, and the presence of the resistors on the same chip introduced feedback components that lowered the device's output impedance. Present research aims at resistor equalizers requiring less chip area and sufficiently isolated to minimize adverse feedback effects.

Outside job. A big and continuing drive to improve packaging was launched in the early 1960's. With chip impedance levels no problem by 1961, packaging impedance became the major factor on over-all bandwidth, stability, and matching. Before 1963, interdigitated devices were being encased in packages almost identical to those used for low-frequency transistors. Internal base and emitter leads were too long and too few, and had inductances that limited bandwidth, gain, and stability. High skin-effect losses at the package entry reduced power levels, and overlong external leads pared operating frequency. It was clear that smaller, lower-inductance packages were needed before interdigitated transistors could tackle vhf or uhf jobs.

The first breakthrough in this area was TRW's Spider package, a stud-mounted affair with two emitter leads. Introduced in 1963, it reduced packaging inductances to negligible levels and was 30% smaller than the TO-59 previously used for the same die; the boost achieved in power-frequency capability was 50%.

The 1963-5 period saw the debuts of a TO-60 package from RCA and a low-inductance stripline package from IRT, both of which doubled frequency performance. In 1967, Texas Instruments introduced coaxial packaging, integrating the package with the transistor, pushing power-frequency levels into the high uhf and low microwave range.

A specification for supply voltage V_{cc} , for instance, will restrict the choice of breakdown voltage BV_{CB0} , output impedance Z_o , r-f saturation voltage $V_{(sat) r-f}$, and safe operating area.

There are also a number of tradeoffs to be made among the transistor's interrelated parameters. A device with a high gain (beta), say, will have a low saturated power output and poor linearity, but it will also yield the highest power gain and the lowest noise output because of a high ratio of cut-off frequency to base resistance and lower base drive needs.

For transistors with similar d-c gains, the one with the lowest base resistance will exhibit the least noise because of smaller base drive requirements. Where base resistances are equal and gains unequal, the unit with the highest gain will have the best noise figure.

These relationships reflect the devices' geometry, fabrication, and package. A high d-c gain indicates a narrow base width, for example. This, in turn, in-

dicates a high base resistance and a low input Q.

High d-c gain also leads to an increase in saturation voltage at radio frequencies because of a current pinchoff and a corresponding rise in the r-f current gain. The pinchoff causes a drop in peak current capability. Further, high gain can reduce the device's stability.

Today's improvements in power-frequency levels center on the package-die interface. Impedance levels in r-f devices are so low that the package's impedance and skin-effect losses become part of the device's equivalent circuit. The circuit model includes a package inductance, L_p , whose impedance compares with that of the r_b and C_i (base resistance and input capacitance) of the transistor. Typically, r_b is 0.2-1 ohm and C_i is 200-500 picofarad. Thus, an inductance of just 1 nanohenry at 400 Mhz will produce an input Q of 3.7, thereby limiting the transistor's bandwidth. For wide bandwidth at high frequencies, therefore, Q's of 1 or less—reflecting package inductances of 0.3 nano-

Progress Report

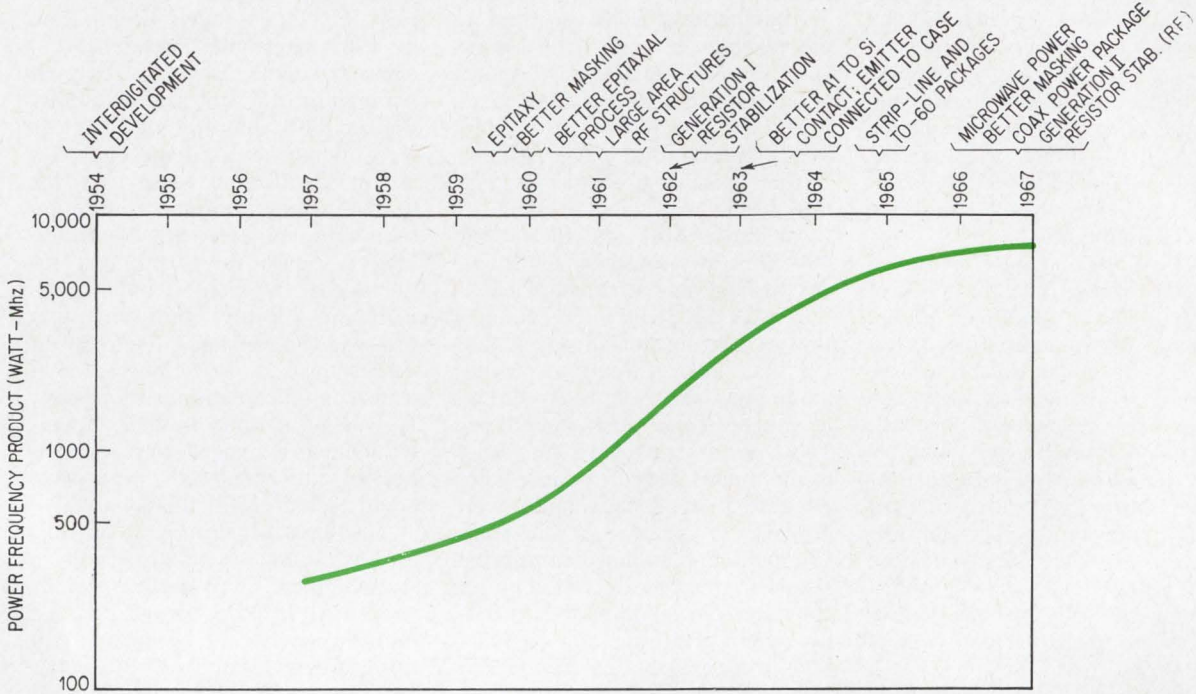

Power-frequency log

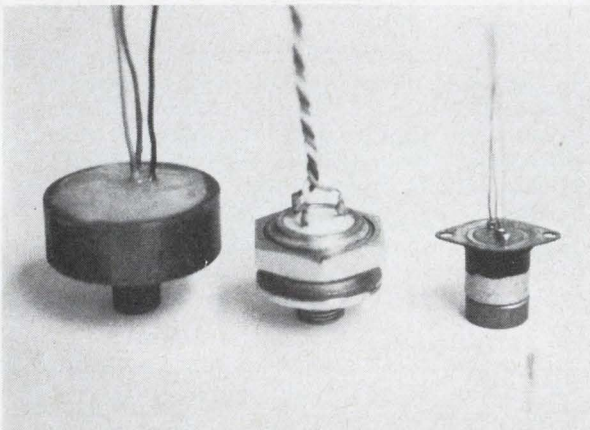

Early risers

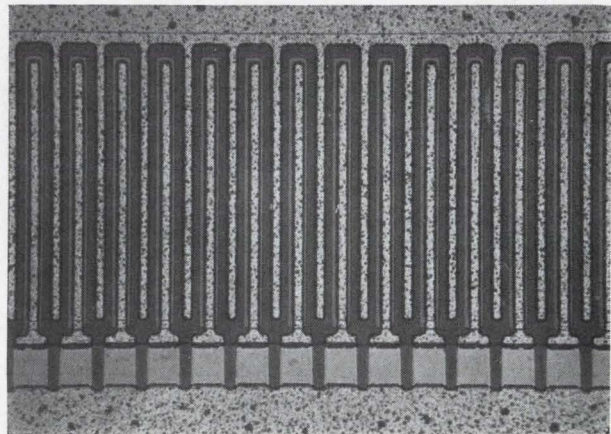

The lineup

Power-frequency capabilities of interdigitated devices have been improved 100-fold during past 14 years by innovations in die making, masking, processing, designing, and packaging (top). Interdigitated structures of 1955 vintage (above at left) handled 3, 5, and 100 watts at audio frequencies (5 khz). Iteration of elongated emitter sites, as shown in a modern r-f geometry (above right), permitted makers to cram scores of watts at uhf frequencies into smaller packages. Plot (right) of representative commercial interdigitated devices indicates broad range of r-f power needs covered by the technology.

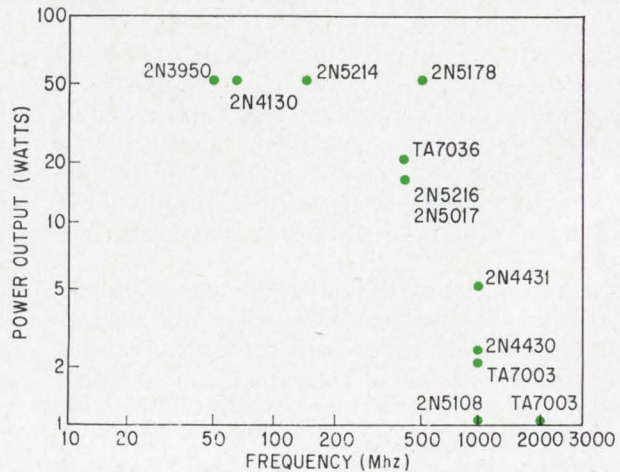

Sampling

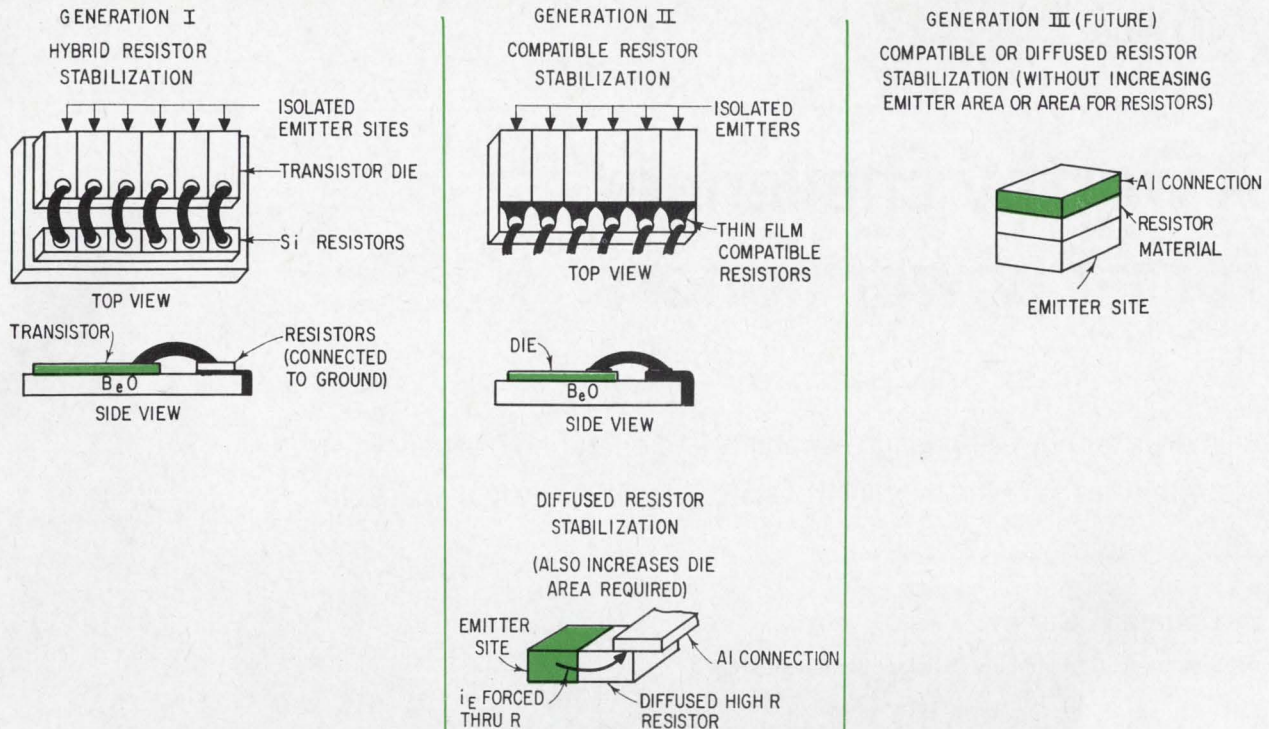

Three generations. Emitter site is resistor-stabilized in four basic ways. Initial method (left) required more area than two second-generation techniques (center). Current effort aims at reducing extra space needs to zero (right). Stabilization extends device's operating usefulness and lifetime by two orders of magnitude.

henry—are an absolute must.

Upward surges

Largely because of market factors, most development efforts have been directed toward vhf and ultrahigh-frequency transistors. The state of the art has recently advanced to 50 watts at 500 Mhz, and there is now considerable activity in the 500-Mhz-to-1-Ghz spectrum.

Cost per watt as a function of operating frequency has dropped over the past three years from about \$3 at 100 Mhz to 75 cents. Similarly, where in 1965 a user would pay \$100 for 1 watt of power at 1 Ghz, the cost today is \$20.

As would be surmised from these price figures, sales of interdigitated devices have boomed. About 12 million were marketed in 1965; the figure last year was 37 million.

And the number of producers has been growing. Such early comers as TRW, Motorola, and IIT have recently been joined by Texas Instruments, Fairchild Semiconductor, Amperex, and Vector. And, to a lesser extent, National Semiconductor, Bendix, and Nucleonic Products have added interdigitated transistors to their product lines.

Yields have tripled since 1965, primarily because of improvements in masking and epitaxial processing. Devices with 50 to 200 elongated emitter sites, each as small as 2.4 microns, are now commonplace. And where makers employ laser interferometry, table positioning servos, and optical control techniques, positioning accuracies can exceed 3 micro-inches.

Interdigitation has been extended beyond discrete bipolars to field effect transistors and ic devices. The aim is the same—to get a large active area in a small physical area.

Interdigitated FET's with high source-to-drain peripheries are capable of operating beyond 100 Mhz, and the technique is being used to boost the current-handling capabilities of linear switching and signal-amplifying ic's, transistor-transistor-logic digital units, and some hybrid circuits. In the linears, the interdigitated components are usually employed in the output stage; in the digital ic's, multiple-emitter elements are used to handle peak currents in the appropriate stages.

Bibliography

N.H. Fletcher, "Some Aspects of the Design of Power Transistors," Proc. of the IRE, May 1955, pp. 551-559.

R.M. Scarlett, William Shockley, "Secondary Breakdown and Hot Spots in Power Transistors," 1963 IEEE International Convention Record.

John Tatum "R-f Large-Signal Transistor Power Amplifiers: Parts I, II, III," Electrical Design News, May, June, and July 1965.

"Circuit Improvements Utilizing the New Resistor Stabilized VHF Transistors," Proc. of the National Electronics Conference, Vol. XXI, 1965.

"Microwave Transistor Parameter Trade-Offs in Circuit Design," Parts I, II, III, Microwave Magazine, September, October, November 1967.

E.O. Johnson, "Physical Limitations of Frequencies and Power Parameters of Transistors," RCA Review, Vol. XXVI, No. 2, June 1965, pp. 163-173.

D.R. Carley, P.L. McGeough, and J.F. O'Brien, "The overlay transistor: new geometry boosts power," Electronics, Aug. 23, 1965, p. 71.

"Mix and match," Electronics, Oct. 30, 1967, pp. 46-48.

Solid state

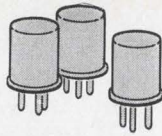

A worthy challenger for r-f power honors

All marks for power-handling capability and operating frequency are within reach of the overlay transistor, and it's only four years old

By Donald R. Carley

RCA Electronic Components Division, Somerville, N.J.

Radio-frequency power applications were once the private preserve of interdigitated transistors. But the past four years have seen the emergence of a successful device concept in the high-power/high-frequency field: the overlay transistor.

The highest power-handling capability yet attained in an r-f device—100 watts—was posted by an off-the-shelf overlay transistor. The top operating frequency yet for a commercial r-f device—2 Ghz—was also achieved by an overlay transistor. And in terms of chip size per unit of power-frequency² product, the smallest device available is an overlay.

State-of-the-art overlays now handle 100 watts at 76 Mhz, 3.5 watts at 2 Ghz, and more than 50 watts at 400 Mhz.

Overlay technique involves a geometric concept that yields the highest ratio of active device area to physical pellet size. Metalization isn't allowed to compromise or limit the current-bearing regions of the device. Overlays need only 1/10 to 1/2 the emitter area of comparable interdigitated transistors.

Three-way distinction

The distinguishing characteristic of the overlay is that part of the emitter metal lies over the base,

The author



Donald R. Carley joined RCA in 1957 after graduation from the University of Michigan. For the design and development of the overlay transistor, Carley received the 1965 David Sarnoff Outstanding Achievement Award. Now manager of high-frequency device engineering, he is engaged in developing hybrid microwave IC modules.

instead of adjacent to it. The emitter current is carried in the metal conductors, or fingers, that cross over the base. The actual base and emitter areas beneath the pattern are insulated from one another by a silicon dioxide layer.

Overlay transistors differ from conventional bipolar devices in three ways—pattern, composition, and metalization. Regarding pattern, many small, separate emitter elements are used instead of a continuous emitter stripe. This increases the overall emitter periphery without requiring an increase in device area, and thus raises the device's power-frequency capability.

As for composition, in addition to the standard base and emitter diffusions, an extra diffused region is made in the base to serve as a conductor. This p+ region helps to distribute base current uniformly over all of the separate emitter segments, and its small size is in keeping with the short distances between emitter and base. Besides equalizing current distribution, the grid lowers the base resistance, $r_{bb'}$, increases collector-to-base breakdown voltage, and lowers contact resistance between the aluminum metalization and silicon material.

Finally, as opposed to separated interconnect metalization, the emitter metalization overlays the base region and connects all the separate emitter elements in parallel, crossing over the base and p+ grid areas.

Present overlay devices operate in both the very-high and microwave frequencies. The vhf units, designed for use between 25 and 150 Mhz, are characterized by the presence of a ballast resistor in series with each emitter site to equalize the current distribution among emitters. The devices are typically operated with Class A, B, or AB biasing.

The microwave overlays operate at frequencies

Overlay progress chart

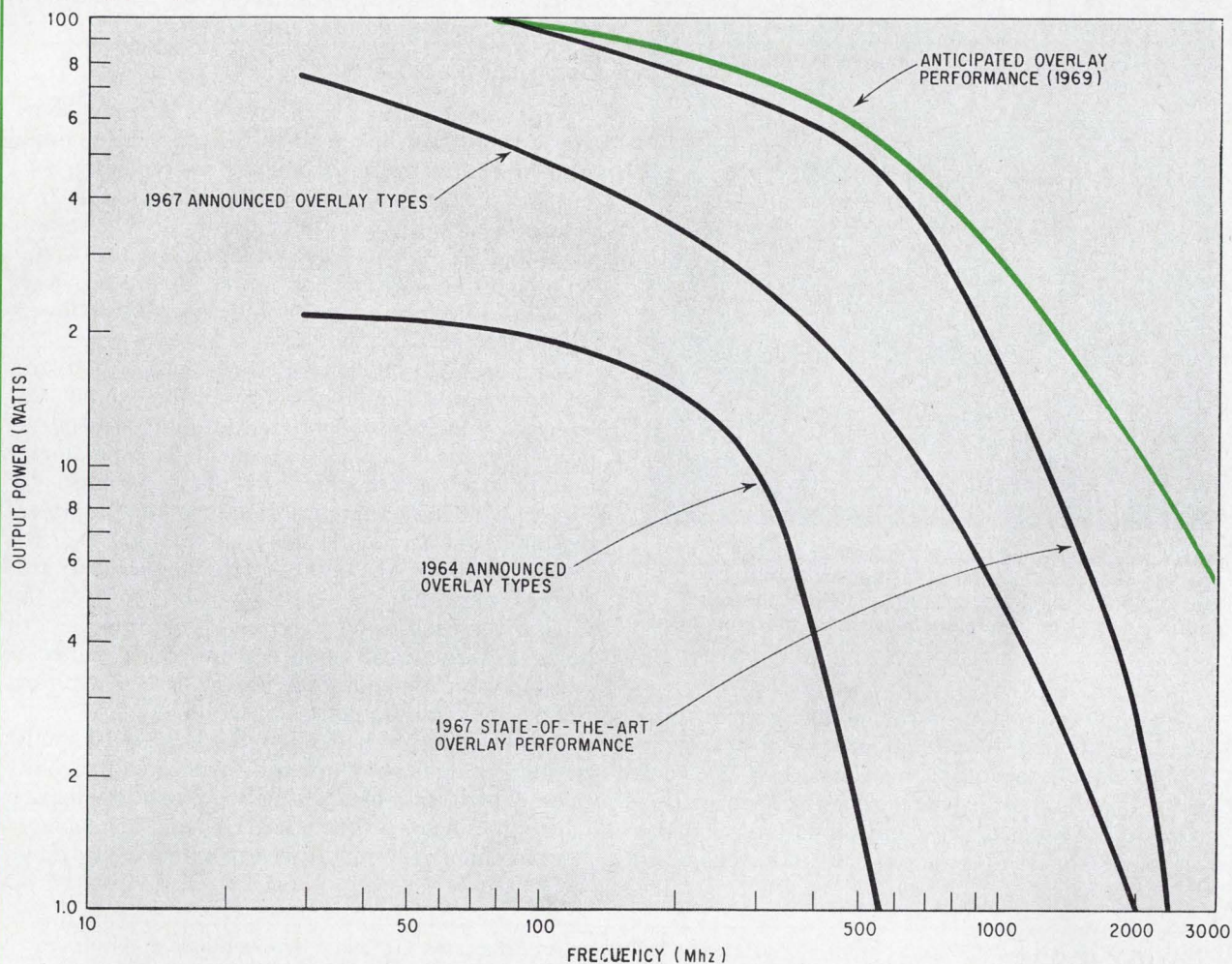

Characteristics	Device		
	TA2758	2N3375	TA7003
Maximum power dissipation (watts)	116	11.6	3.5
Maximum current (amps)	30	1.5	0.4
Emitter periphery (inches)	4.25	0.312	0.069
Operating frequency (Mhz)	30	400	2000
Typical output power (watts)	80	4	1.0
Emitter-contact current density (amps/cm ²)	1.22×10^5	1.63×10^4	1.29×10^4
D-C power density in base area (W/cm ²)	1.91×10^3	4.83×10^3	1.21×10^4

Four-year history of overlay transistor (above) has seen power-handling capability boosted 50-fold and operating frequency 10-fold. Comparison of electrical characteristics (left) of first commercial overlay transistor, the 2N3375, with those of the highest-power overlay, the TA2758, and the highest-frequency unit, the TA7003, illustrates these advances.

ranging as high as 3 Ghz. Instead of circular emitter sites containing ballast resistors, these transistors, operated with Class C biasing, use a line-type structure. The ballasts aren't vital because Class-C operation poses less stringent breakdown requirements. It's anticipated that some future high power microwave overlays will contain ballasts for superior current distribution.

Although these smaller devices are more difficult to manufacture than the low-frequency overlays because of the more precise resolution required, the steps in the fabrication process are actually fewer and the over-all production costs lower.

Six masks are needed in the vhf cycle: p+, base, resistor, emitter, emitter and base contacts, and metalization. Depending upon the particular ge-



Power pellets. Overlays cover the entire r-f power spectrum. Shown (in order of increasing size) are transistors handling 1, 3, 20, 30, and 100 watts of r-f output power, over the range between 30 Mhz and 2 Ghz.

ometry chosen, some 40-150 pellets can be processed simultaneously on standard 1-inch wafers.

With the microwave devices and their line emitters, the resistor step isn't needed and no oxide is grown during the emitter diffusion step. The contact mask is used to open only the base region, not

the emitter regions. The number of pellets per 1-inch wafer ranges between 400 (for a 15-watt, 400 Mhz unit) and 4,000 (for the 1-watt, 2-Ghz unit).

Piping down

A distinct feature of both overlay classes is short circuit protection linked to the exceptionally small ratio of emitter area to pellet size—typically, one part in 50. Corresponding to the tiny emitter is a reduced base structure under the emitter area, and narrow (0.25 micron) base widths. As a result, the manufacturing imperfection known as pipes—shorts between collector and emitter—hasn't plagued overlay devices.

Maintenance of thin emitters is essential to the device's current-handling ability. In the overlay, the injected currents concentrate around the emitter periphery, producing an edge effect. This phenomenon of emitter crowding was first reported by Fletcher in 1955, and has since dominated interdigitated and overlay design [see p. 94].

The narrower the emitter, the higher the frequency capability; the longer the emitter, the greater the useful power limit. The emitter length has a first-order bearing on current rating; collector resistivity is a second-order factor. Present emitters run as small as 1.5 microns in width.

Aspect ratio, or pellet length divided by pellet width, is a figure of merit for power-device geometries. A high ratio means a better power-dissipation capability. Also, as pellets are made with longer lengths and narrower widths, capacitance goes down

Laying it on

The overlay transistor, first introduced in 1964, was developed at RCA under a contract from the Army Electronics Command, Ft. Monmouth, N.J., as a direct replacement for the vacuum tube output stages then used in military transmitting equipment.

The first commercial overlay, the 2N3375, produced 10 watts of output power at 100 Mhz and could handle 4 watts at 400 Mhz. Comparable interdigitated structures of that day were capable of 5 watts at 100 Mhz and 0.5 watts at 400 Mhz.

RCA marketed interdigitated devices in the 1950's and early 60's, but switched to overlays because it felt they had superior r-f characteristics in relation to pellet size and manufacturing cost.

Overlay technology in the main has been spurred by development programs sponsored by the Air Force Systems Command, the National Aeronautics and Space Administration, and the Army Signal Corps.

Measure for measure. Advocates of the 12-year-old interdigitated technology use a power-times-frequency-square product as a criterion of performance. Overlay boosters, however, suggest that maximum power and maximum frequency considered separately, plus size, cost, and reliability factors, give a broader picture of device performance.

Some overlay makers feel that pf^2 products above 7,000 watt-Mhz can be attained only by devices also exhibiting low power gain, low efficiency, and limited reliability.

Short and sweet. The comparatively short history of overlays has seen some significant advances; characteristics have been improved, the number of suppliers has increased, and prices have declined. Amplifying devices can now handle hundreds of watts at vhf frequencies and a few watts at gigahertz levels. Present overlay oscillators can produce 250 milliwatts at 3 Ghz.

Joining RCA as overlay manufacturers have been Motorola, Na-

tional Semiconductor, Amperex, Siemens, Vector, and, recently, Fairchild Semiconductor. By the end of last year, there were more than 50 distinct overlay products being offered off the shelf, and they covered the entire radio-frequency spectrum between 30 Mhz and 2 Ghz.

Besides pushing for higher power at higher frequencies, designers are making significant progress in building overlays for specialized applications. These include linear transistors for single-sideband communications systems, devices for circuits with octave-bandwidth capability, and overlays with high pulse power for phased-array radar systems.

Price paring. Prices have dropped 10-fold over the past four years. The \$90 figure for the original 2N3375 is now \$7.45 in lots of 1000. A device with tight electrical parameters and a 1-watt capability at 400 Mhz can now be had for less than \$2 and the same unit with less stringent specs for non-critical parameters sells for even less than \$2.

and frequency capability rises. Devices today have aspect ratios of 10:1, compared to the 3:1 ratio of four years ago.

The limits on pellet shape are set by the need for equal emitter-to-base junction biasing, and by questions of thermal dissipation. Uneven biases can be caused by current flow down the emitter and base contacts caused by the complex impedance of the metal conductors. Contact resistance is minimized by increasing the width and thickness of the metalized portions, but the inductance portion is primarily established by the length of the metal contacts. Thus, to boost frequency capabilities, contacts must be shortened, widened, and thickened, and many must be paralleled to accommodate high currents. Since, unlike interdigitated construction, the overlay technique doesn't require that the metal fingers be contained within the emitter width, this boosting is easily done.

Preventing breakdown

A potential problem for all r-f power transistors is the second-breakdown effect. But the overlay's ballast resistors provide an easy answer.

Second breakdown is essentially a burnout phenomenon; excessive energy levels in the transistor become localized and create a regenerative hot spot. Some years ago it was thought that the breakdown would limit frequency capabilities because enlarging the width lessened the likelihood of hot-spotting but also lowered the cutoff frequency.

But in 1965, designers started to insert ballast resistors in series with the emitter to get a negative feedback action. As the potential across these resistors increases, the emitter injects less and less current, and maximum levels stay below the burn-out level. In this way, base widths could be reduced without risking second breakdown.

As integral parts of the vhf overlay structure formed by diffusion processes, the passivated resistors avoid injection current effects and other threats to reliability.

In the higher-frequency, line-emitter overlays, the emitter metalization is separated from the diffused base regions by a lateral diffusion of the emitter beneath the insulating silicon dioxide layer covering the base. No oxide is grown over the diffused emitter, and there is therefore no need for mask realignment or opening of the oxide—the normal means of making contact between emitter and metalization.

Same old tradeoffs

The designer of r-f power transistors is compelled to make the same type of parameter compromises faced by designers of low-noise receiver devices.

For example, achieving a high gain-bandwidth product, f_T , dictates as thin a base width as possible, with the dimension limited only by the reach-through of the collector depletion region to the emitter. But the operating voltage level in power overlays is high, necessitating a higher base concentration than small-signal transistors require. Similarly, small emitter and collector areas are desirable

to keep output capacitance, C_c , low, and to reduce base spreading resistance, r_{bb}' , which is affected by emitter length and proximity to base contact.

The tradeoff in overlays focuses then on the $r_{bb}'C_c$ product. Devices are paralleled to bolster power capabilities without increasing the product. Paralleling does increase the total C_c , but it reduces net r_{bb}' at the same rate, keeping the product constant. The result is a power density and frequency capability resembling that of small-signal transistors, but a higher total power capability.

The performance burden is no longer carried mostly by the chip. As with interdigitated devices, packaging has emerged as a critical factor because present chip impedances are now so low that package impedances govern attainable bandwidth and efficiency. Of particular concern are parasitic inter-electrode capacitance and lead inductance.

Low-impedance packages have taken the shape of molded plastic cases for stripline applications to 1 Ghz, and of coaxial packages for higher operating frequencies. Typical of the first type are packages featuring tapered transmission lines for broadband performance. And coaxial packages incorporate double-bonded, paralleled lead wires just a few thousandths of an inch long to reduce inductance in the base and emitter sections to small fractions of a nanohenry.

The mating game

Perhaps the most serious problem facing the user of r-f power transistors is matching output impedance to the circuit's load impedance. Because mismatches can occur in a number of ways, the solutions vary on an ad hoc basis.

One mismatch often encountered arises during adjustment, or tuning, of the output stage for optimum performance. Unless precautions such as tuning under pulse drive conditions or at reduced drive and voltage levels are taken, the transistor may fail. If no change in impedance occurs after the circuit has been tuned, the device will continue to operate reliably in a stable state.

In many types of equipment, however, frequent changes in load impedance are the rule. In mobile communications gear, for instance, the exposed antenna serves as the load. Impedance will change if the antenna is accidentally grounded (shorted) or broken off (opened), or if the vehicle passes under a metal bridge. The ability of a device to withstand mismatch is usually measured in terms of the voltage standing-wave ratio it can accommodate. This ratio varies with operating frequency, power output, phase of the mismatch, and the circuit used.

Often a detection circuit can be used in the output section to detect the amount of mismatch and to reduce driving power to the output as the mismatch increases. However, in situations where detection circuits cannot be used, the transistor must be derated, sometimes to one-third of its nominal matched-load-power capability.

In general, worst-case mismatch results from a short in some part of the system after the output

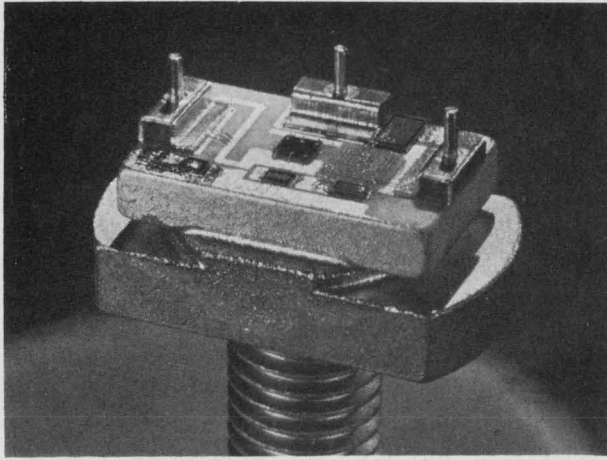

Buildup. Overlay hybrid IC module is complete 400-Mhz amplifier. Device contains a single transistor and six passive components.

stage. The transistor perceives this type of mismatch as a short, an open circuit, or something between these two, depending on phase. For example, with standard 28-volt transistor supplies, when a 30-watt, 30-Mhz device is operating with a matched load, 20 to 30 watts of power is dissipated in the transistor. Under mismatch conditions, peak collector-to-emitter voltage may easily become 130 volts and instantaneous power may be as much as 180 watts because of the higher-order harmonics generated by the mismatch.

Some generalizations must be made concerning the capability of devices and circuits to withstand mismatch. This capability increases with operating frequency, probably because of reduced harmonic content; the transistor doesn't have much gain at two and three times the fundamental frequency. Mismatch tolerance also increases markedly under pulse conditions. It falls as output power is raised either by an increase in input power or an increase in the supply voltage. The mismatch problem is more of an obstacle to large-area devices than are economic considerations. It's the prime reason behind the industry's reluctance to produce r-f power transistors handling 200 to 300 watts, or more.

The most promising solution yet is the integration of matching elements with active devices to form paralleled building blocks that would handle the higher powers. By mid-1968, the state of the art will be 70 watts at 400 Mhz, and there is no foreseeable limit with the hybrid building-block technique.

This hybrid integrated-circuit approach is less plagued by mismatch problems. With ic's the designer is working at the circuit and subsystem level. He therefore has a great deal more freedom to build in safety measures.

New look

Overlay transistors are being used in a new generation of hybrid ic's in which passive elements are combined with overlay pellets to form complete power-amplifier circuits. These networks may also

contain protective stages to minimize mismatch. Monolithic ic's with r-f overlay elements haven't as yet been marketed because of difficulties in obtaining low capacitance isolation between the elements.

The hybrid circuit's components are batch-processed by techniques identical to those used to make the transistor chip. The substrate is either beryllium oxide or sapphire, the choice depending on the power level at which the device is to operate.

Beryllium oxide is used for mounting most high-frequency power transistors. Since its thermal conductivity is about a third that of copper, it has the unusual property of being both an excellent electrical insulator and a good thermal conductor. It's used to isolate the pellet electrically from the heat sink while providing a good thermal path. Sapphire, though not as good a thermal conductor as beryllium oxide, has a much smoother surface, simplifying the definition of the very small lines used for passive elements in microwave hybrid circuits.

Overlay transistors in combination with lumped components have been operated at 2,000 Mhz in circuits whose performance is comparable to that of coaxially packaged devices.

Higher-power overlay devices are also being used at lower frequencies, such as complete 400-Mhz amplifier stages. The typical circuit, simplicity itself, has only four terminals—power supply, input, output, and ground. Input and output impedances are 50 ohms, and the beryllium-oxide substrate measures just 0.5 to 0.3 inch. For the chip, typical output power is 10 watts at 400 Mhz with an input power of 1 watt; collector efficiency is greater than 60%. The 1-db bandwidth is 60 Mhz, and the 3-db bandwidth is more than 100 Mhz. This large bandwidth can be attributed to the relatively low Q of the inductors and the elimination of parasitic package effects.

Aside from a promising future in ic's, discrete overlays have bright prospects on their own. Transistors capable of providing power in the range between 100 watts at 76 Mhz and 8 watts at 2 Ghz are now under development and should be available this year. The 76-Mhz unit is resistor-ballasted to guard against second breakdown; the 2-Ghz model has a line-emitter structure and utilizes 1.5-micron wide emitter sites to improve packing density and increase the yield at the narrow base width employed (about 0.008 mil or 2,000 angstroms).

Moreover, complete circuit modules will appear in the next two years. Constructed of lumped-component, thin-film matching elements and unpackaged overlay pellets, they will perform a variety of circuit functions with multistage amplification and octave bandwidth. Typical of what's coming are transmit-receive modules for communications and phased-array radar systems.

Bibliography

- D.R. Carley, P.L. McGeough, and J.F. O'Brien, "The overlay—a new uhf power transistor," *Electronics*, Aug. 23, 1965, pp. 70-84.
 H. Sobol, "Extending IC technology to microwave equipment," *Electronics*, March 20, 1967, pp. 112-124.

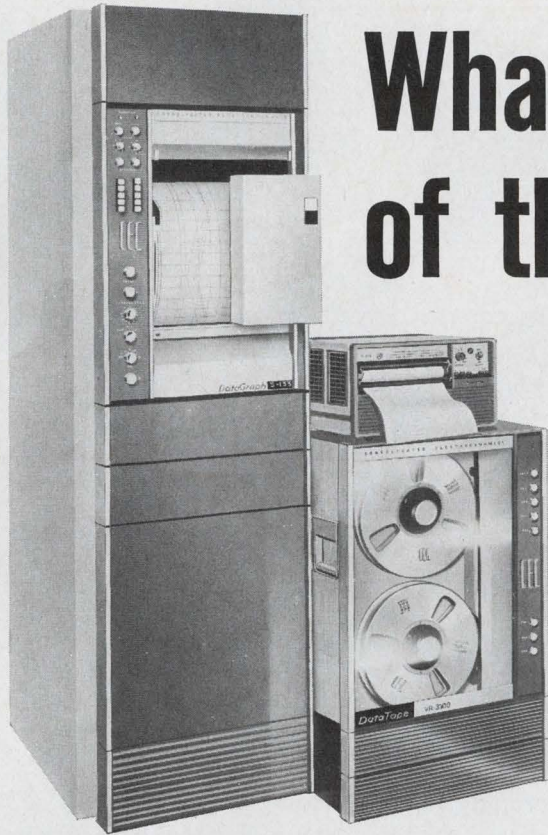

What's the secret of the success of these new oscillographs?

New high impedance galvos.

CEC's new high impedance galvanometers have made possible dramatic savings in weight, power, space and cost never before achieved in oscillography.

And for one very significant reason. These are the first and only galvos to utilize built-in integrated circuits.

As a result, you can now attach either of the above oscillographs directly to a magnetic tape recorder or telemetry system *without* attenuation or external signal conditioning equipment. As for the savings in weight, this would represent a reduction of approximately 60 pounds and a gain of 7 inches of space in a 14-channel system.

This advance has all come about through the use of five new CEC high impedance galvanometers: Type 7-601-0001 (0 to 100 Hz); Type 7-602-0001 (0 to 500 Hz); Type 7-603-0001 (0 to 2000 Hz); Type 7-605-0001 (0 to 3000 Hz).

Now consider the advantages which these galvos share in common. D-C sensitivity: ± 1.414 volts will produce ± 2

inches, $\pm 5\%$ deflection. Input impedance to high impedance galvo: 100,000 ohms minimum.

As for the oscillographs . . .

Both the 5-124A-H and 5-133-H contain the power supply and wiring required for use with the new high impedance galvos. However, due to their extreme flexibility, they can also be used with standard galvos if so desired.

These are not only the first high impedance oscillographs—but they are "first" in other ways as well.

The portable 5-124A-H is the ideal answer to a host of industrial problems. It provides up to 18-channel print-out recording, 10 speed ranges, and record-drive systems with 16 options from 0.25 ipm to 128 ips. And, with CEC's DataFlash Takeup Accessory, the 5-124A-H requires only 1 second to readout.

The advanced 5-133-H utilizes two galvanometer magnet assemblies. Galvo recording lamp intensity is individually

controlled so as to permit recording from either magnet assembly, or both. Thus two data setups can be made at one time and recorded simultaneously, or be made alternately and recorded sequentially utilizing full chart width for each.

The 5-133-H offers 5 recording modes—3 direct writing and 2 develop-out, and is available in 12-, 24-, 36- and 52-channel configurations. Graphic reasons why the new 5-133-H is the logical choice for FM data analysis, telemetry discriminator output recording and communications applications.

For complete specifications and all the facts about these new high impedance oscillographs, write Consolidated Electrodynamics, Pasadena, California 91109. A subsidiary of Bell & Howell. Ask for Bulletin Kit 1701-X3.

CEC/DATAGRAPH PRODUCTS

 **BELL & HOWELL**

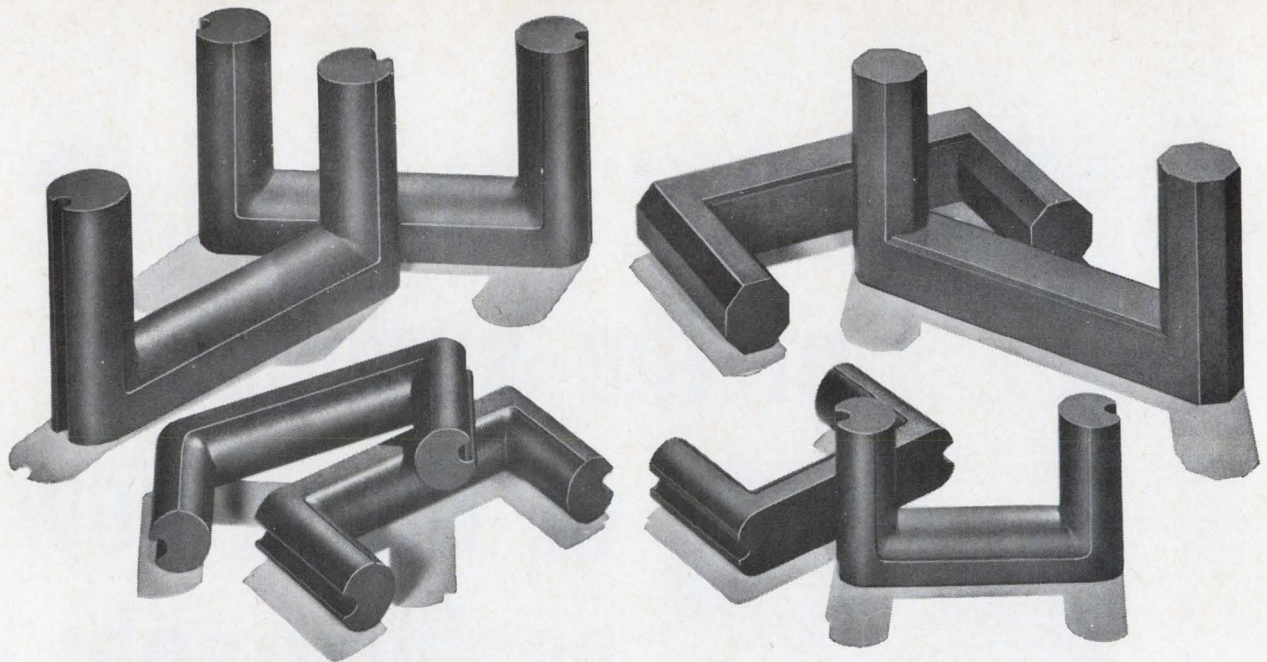

From Stackpole: A New H.O.T. Ferrite Material That Doesn't Lose Its Cool

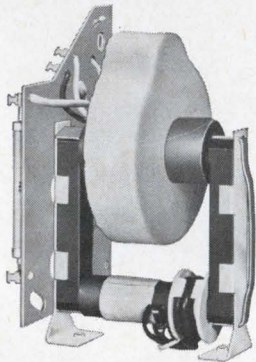

Ceramag[®] 24C was developed by Stackpole engineers especially for Horizontal Output Transformer applications. Because this new material offers an unequalled combination of high power permeability and low power loss under flyback circuitry operating conditions, it provides improved efficiency and cooler operating temperatures.

Excellent electrical and mechanical properties are combined to provide fabricated parts that easily meet standard industry strength and warpage requirements.

The Stackpole Ceramag[®] family of power ferrite materials has been the accepted standard of the television industry for over twenty years. Ceramag[®] 24C is no exception. It features a power permeability of 6200 @ 1800 gauss (typical operating condition), compared to Grade 24B with a permeability of 4200 @ 1800 gauss.

Equally important, the power losses of 24C at operating frequencies and temperatures are 15% lower than those of the widely recognized Ceramag[®] 24A, an industry workhorse.

Stackpole engineering pioneered the first Ceramag[®] horizontal output transformer cores as far back as 1947. Since then, continuous developments have made Stackpole a leading contributor to the growth of black and white, and now color, television technology.

For additional information and

samples of Ceramag[®] 24C, write or call: Stackpole Carbon Company, Electronic Components Division, St. Marys, Pa. 15857. Phone: 814-781-8521. TWX: 510-693-4511.

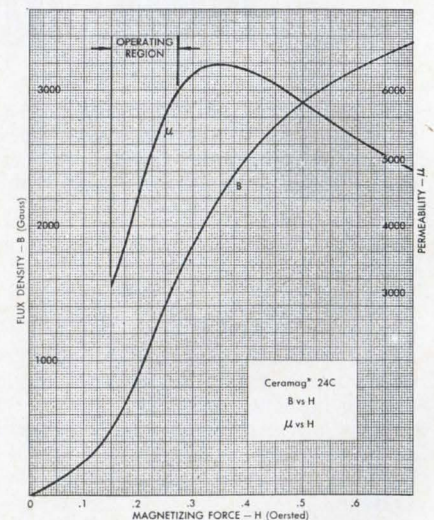

STACKPOLE
ELECTRONIC COMPONENTS DIVISION

ALSO A LEADER IN THE MANUFACTURE OF QUALITY FIXED COMPOSITION RESISTORS

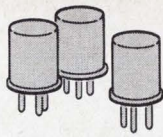

A discrete transistor that's a powerhouse

With current and voltage capabilities of today's power devices in the 250-amp, 1,000-volt range, integrated circuits have a lot of catching up to do before they can pose a major threat

By Leo L. Lehner

Motorola Semiconductor Products Inc., Phoenix, Ariz.

Obsolete is a word often heard whenever some discrete semiconductor components are mentioned. But not when talk centers on power transistors. Unlike small-signal devices, which are rapidly being replaced by integrated circuits, these transistors are more than holding their own. In fact, when it comes to potential and growth, power transistors rival ic's.

Power-transistor technology has come a long way since the early germanium devices designed primarily for automobile radios. Current and voltage capabilities have been stepped up from the 3-ampere, 30-volt range of the mid-1950's to the 250-amp, 1,000-volt range in today's devices.

Basically, there are two major types of power transistors, classified by the transistor material: germanium and silicon.

For high-current, low-voltage applications in which efficiency, high current gain, and low saturation resistance are important, germanium devices excel. They are the choice, for example, for inverters that are used with power supplies of 12 volts or less—except when the application requires operation at high temperatures. Silicon devices which were added to the power-transistor family in 1957, are best suited for applications requiring temperatures above 100°C or supplies above 28 volts.

The mainstay of today's germanium-transistor lines is an alloy device reminiscent of the early indium-doped transistors. In the newer devices, the emitters are doped with either gallium or aluminum as well as with indium. This results in devices having higher gain that holds up at collector currents of 25 amps and up.

Another popular germanium device is the dif-

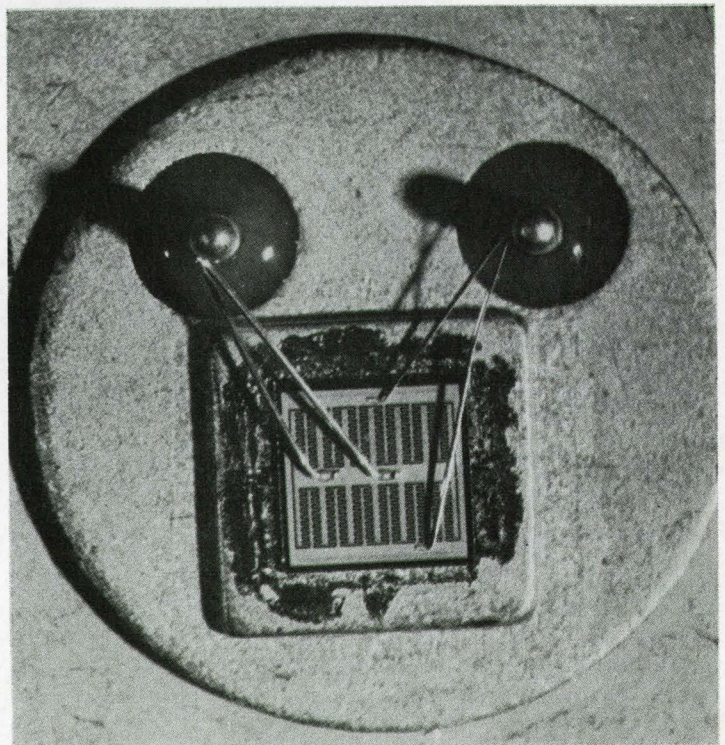

Powerful package. Silicon power transistor mounted on header before being sealed in a TO-66 can. The device's output power is 30 watts at 25°C. Special construction techniques reduce susceptibility to damage. Multiple emitter fingers combine the maximum emitter periphery—for good gain and current handling capabilities—with a minimum area—for low capacitance and good high-frequency characteristics. This silicon power transistor has a breakdown-voltage rating of 120 volts and can handle currents to 10 amperes. In addition, its gain-bandwidth product f_T is 40 Mhz. The transistor's gain, or beta ranges from 50 to 150.

The packaging evolution

TO-3 package

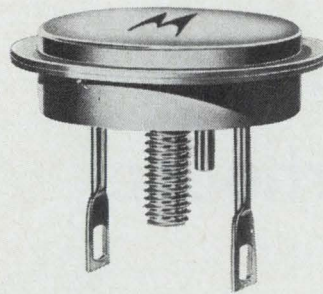
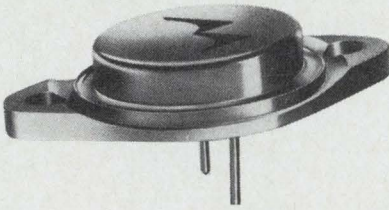

TO-36 configuration

TO-66 package

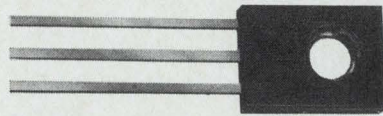
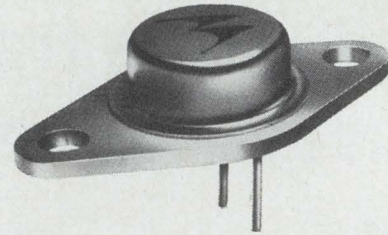

Plastic power package



R-f power in plastic

The shape of things. Power-transistor packages, although varied, center around a few, very popular styles. The first widely accepted configuration was developed for automobile radios. Simultaneous and nearly independent developments by GM's Delco Radio division and Motorola led to the widely used TO-3 package in 1954 and the TO-36 in 1955. In 1962, the smaller TO-66 package was developed. As the demand for power transistors grew, the industry developed more economical packaging schemes. In 1965, power transistors packaged in plastic became available and produced additional savings in circuit packaging due to the devices' smaller volumes.

fused-base transistor, which has its roots in the push-out-base and alloy approaches. Improved methods of doping the emitter and controlling the base's doping profile resulted in a diffused-base device having a switching speed close to that of the push-out-base transistor and a current gain slightly

less than that of the alloy transistor.

Diffused-base transistors are used in such applications as ignition circuits, high-speed inverters, and television-deflection circuits. Where switching speed is an absolute necessity, push-out-base devices are used.

A device having an identical cross section to that of the push-out-base type is an epitaxial-base power transistor. Because the epitaxial layer's resistance is low, the device's gain-bandwidth product is high. Moreover, the epitaxial-base transistor's current and power gains also are high.

The silicon power transistor found in most of today's industrial and consumer devices is an npn single-diffused type.

A recent development is a silicon epitaxial annular power transistor that has excellent gain linearity and efficient current-handling properties, especially for pnp designs. More recently, triple-diffused power transistors have been developed that extend breakdown voltages to well up into the 1,000-volt range.

A rose by any other name . . .

Engineers have a hard time in precisely defining a power transistor. Some say any transistor capable of certain minimum power dissipation, say 1 watt, is a power transistor. Others feel the type of pack-

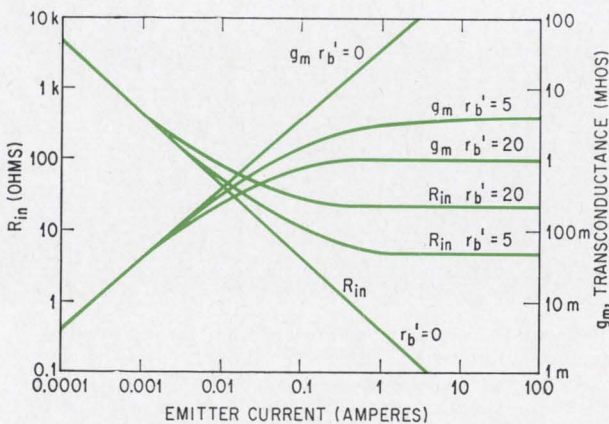

Current dependent. Input-resistance and transconductance values vary with emitter current. Graph illustrates that both curves flatten out above an emitter current of 100 milliamperes. Above this value, the device's base resistance r_b' determines the current. Transistors operating above the 100-ma current region are considered power transistors.

age determines whether the device can be called a power transistor. For example, a transistor that can be mechanically fastened to a heat sink and encased in a TO-3, TO-36, or TO-61 package. Both definitions leave much to be desired.

A better definition

To be more precise, it is best that a power transistor be defined as one that is operated at an emitter-current level that makes the device's input resistance and transconductance independent of emitter current. Since the input resistance of an ideal transistor is inversely proportional to its emitter current and its transconductance is directly proportional, the base resistance, r_b' , of a practical transistor becomes the controlling factor at a specific value of current.

This can easily be verified by plotting the input resistance, R_{in} , and transconductance, g_m , as a function of emitter current as shown on page 106 for a transistor having a gain of 20. The curves begin to flatten out at an emitter current of about 100 milliamperes. Beyond this value, both R_{in} and g_m depend primarily on r_b' .

A similar set of curves can be drawn for any base resistance and, though the absolute values of R_{in} and g_m vary with the transistor design, the flattening effect will still occur at about the same emitter current level. Thus, any transistor operated at a current beyond this value can be designated as a power transistor.

Keyed to application

Although there are a number of important parameters for power transistors, the significance of each varies with the application. Only one parameter, the safe area, is important for all applications. In early designs, many failures stemmed from inadequate specifications, which were partly attributed to designers' lack of experience with these transistors. This difficulty has long since been overcome by the development of a safe-area curve in which the frequency dependence is clearly defined. With the aid of this curve, the designer can choose the safe operating limits applicable to his transistor.

When a transistor is operated above its saturation level, it dissipates a significant amount of heat. Both the diffusion profile and the emitter's shape determine where the dissipation occurs. When dissipation is too high, burnout results. Burnout is believed to be caused by a fusion of the device's collector and base materials.

Turning on heat

Consider a small volume in the collector region. With a voltage across it, a finite time is required to raise the temperature to the melting point—1,000°C for germanium and 1,400°C for silicon. For short power pulses, it is possible to go beyond the safe area. But for longer pulses the heating will be greater and could lead to eventual failure of the transistor.

At a glance—germanium transistors

Making its bow in 1952, the germanium power transistor held out the promise of high efficiency, high current gain, and low saturation resistance. How successful the device has been in fulfilling its promise can be seen by tracing the technology's development. In brief:

1952 First power transistors are developed. These are indium-doped alloy devices that have excessive gain falloff at currents above 1 ampere; voltage breakdown is 60 volts, and gain-bandwidth product is about 500 kilohertz.

1955-6 Gallium or aluminum is added to emitter of indium-doped alloy transistors resulting in higher gain that holds up at collector currents greater than 25 amps.

1957 Push-out-base transistor is developed to satisfy need for high-speed power switch. Device consists of diffused n+ base region having a double-doped (p and n) emitter dot. Gain-bandwidth product is increased to about 15 megahertz. During emitter alloying, the faster moving n-type impurity atoms move out ahead of the p-type impurities, thus improving the transistor's base characteristics.

Diffused-base power transistor is developed. Device has base resistance of 5 ohms, compared with 30 ohms of earlier transistors, and gain-bandwidth product of 2 Mhz. Breakdown voltage is 120 volts. Reduction in current gain is offset by increase in power gain.

1963 Epitaxial-base power transistor is developed. Device's cross section is identical to that of push-out-base type. Because of epitaxial design, base resistance is lowered to 1 ohm. Gain-bandwidth product is 10 Mhz. Current and power gains increase.

Most power devices are packaged to reduce the thermal resistance from the transistor junction to the surrounding ambient. Heat is dissipated with heat sinks. Early package designs varied in mounting schemes and construction. Eventually, however, users and manufacturers narrowed the choice to a few designs that became standard. But with the advent of plastic cases, the standards are certain to undergo a change. The changes, however, are expected to be compatible with the popular TO-3 and TO-66 lead circles. Two plastic devices can be mounted in less space than one TO-3 package and with a lower mounting height as well. This com-

At a glance—silicon transistors

Silicon power transistors have come a long way since the first device made its appearance in 1957. In 10 years, breakdown voltage has climbed from 300 volts to better than 1,000 volts. Today's devices can handle collector currents of 250 amps.

Here, briefly, is the year-by-year evolution of the silicon transistor:

1957 First silicon power transistors developed are npn alloy devices. Cross section of these transistors are similar to germanium-alloy devices. Although gain is low, breakdown voltage is up to 300 volts. Gain-bandwidth product is about 100 kilohertz. Devices are extremely rugged. Difficulties in manufacturing result in low yields and high costs.

1958 Npn alloy-diffused devices are developed that have 1-megahertz gain-bandwidth product and 60-volt breakdown voltage. Emitter is constructed with alloying process for good carrier injection. Yields are still low.

1960 Npn triple-diffused interdigitated devices appear for first time. These transistors have breakdown voltages up to 120 volts and gain-bandwidth products of 10 Mhz. Devices are expensive but are considered reasonably priced for high-voltage applications.

1963 Npn high-voltage, line-operated transistor is developed. Breakdown voltages rise to 300 volts. Device is triple diffused. Thick collector and base regions result in high collector-to-emitter saturation voltages.

Npn single-diffused transistor is developed. Breakdown voltage boosted to 80 volts and gain-bandwidth product is doubled to 2 Mhz. Manufacturing yields are good, and costs are lowered.

1965 Npn epitaxial or planar device is developed. Epitaxial or planar process provides better control of resistivity and profile, resulting in higher inverse beta and, consequently, lower saturation voltage.

Pnp transistor is developed.

Npn high-voltage transistor becomes available. Breakdown voltages climb above 400 volts. Devices are triple diffused.

Npn very-high-current transistor is developed. Device handles collector currents to 250 amps.

Npn very-high-voltage, line-operated deflection transistor is available. Breakdown voltages are now over 1,500 volts.

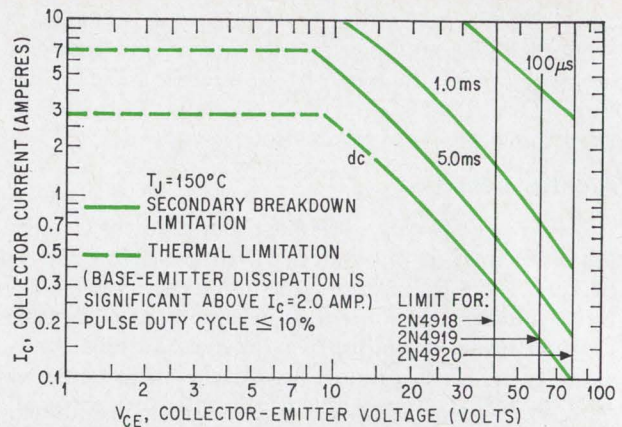

Upper limits. The safe operating area curves indicate the transistor's I_C - V_{CE} limits to be observed for reliable operation. Collector load lines for specific circuits must fall below the limits indicated by the applicable curve. The data is based upon a peak junction temperature $T_{j(pk)}$, of 150°C . Pulse curves are valid for duty cycles to 10% provided $T_{j(pk)} \leq 150^\circ\text{C}$. At high case temperatures, which depend upon conditions, thermal limitations reduce the power which can be handled to values less than the limitations imposed by secondary breakdown.

pactness can result in substantial savings in assembly and chassis costs.

What's ahead

Silicon power devices, once far more expensive than germanium transistors, have come into their own in the past few years. Economical plastic cases will make them even more appealing. Several firms are offering devices in plastic packages.

Complementary silicon transistors will be utilized in most linear power amplifiers. Thus, transformers will be eliminated, and biasing and over-all circuit designs will be eased. Monolithic Darlington amplifiers with current gains exceeding 2,000 will be common in servo and audio systems. Transistors with voltage ratings to 1,500 volts will be used in line-operated tv-deflection amplifiers. And special lightweight power inverters will be designed for direct line operation of low- and high-impedance devices, including battery chargers and high-frequency lighting.

Because of the growing impact of integrated circuits, power transistors will be made that are compatible with ic's. Power transistors may eventually be made with all the preamplifiers or logic circuitry on the same chip; thus, power devices that can decide and control will be available.

The author



Leo L. Lehner is manager of product marketing and market development for Motorola Semiconductor Products. Formerly, he was manager of applications engineering, and manager of market development.

Solid state

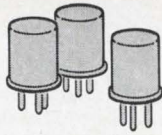

Fabrication control is key to microwave performance

Increasingly better power, gain, and noise figures for transistors result from the use of improved diffusion and photolithographic methods to make narrower and more precisely defined elements

By Roger Edwards

Bell Telephone Laboratories, Murray Hill, N.J.

Less than 10 years ago, diodes were the only semiconductor devices operating efficiently at microwave frequencies. Transistors have come on fast since then, winning places as amplifiers in the microwave range and posting increasingly better gain, power, and noise figures.

The change largely reflects improvements in diffusion and photolithographic techniques, improvements that have given designers accurate control of minute, critical dimensions. Present diffusion methods make it possible to fabricate shallow emitter-base and collector-base junctions, thereby simplifying the task of producing thin base widths. And with present photolithographic methods, small, intricate electrode shapes can be precisely defined.

Today's bipolar transistors can produce maximum available common-emitter power gains exceeding 5 decibels at 4 gigahertz and can oscillate at frequencies up to 6 Ghz. Output powers range from 50 watts at 500 megahertz to 75 milliwatts at 4 Ghz, and noise figures are commonly less than 3 db at 1 Ghz and 5 db at 2 Ghz.

There's now good reason to believe that the power-handling capability of transistors will be boosted fivefold during the next two years and

present gain and noise figures extended by about an octave in frequency. Unneutralized common-emitter power gains may be pushed up to more than 8 db at 4 Ghz, for instance, and oscillator operation may be extended to the 8-to-10-Ghz range. Performance at lower frequencies should also improve.

Horses for courses

The geometry of microwave transistors depends on the devices' application; tradeoffs must be made among the physical dimensions determining gain, noise, power, bandwidth, and other characteristics.

These design choices arise partly because of the time it takes carriers to drift through the collector depletion region of transistors. At microwave frequencies, transit time delay becomes crucial, limiting frequency response if the collector depletion layer is too wide. On the other hand, narrow layers tend to increase collector capacitance and reduce power gain and breakdown voltage.

Two figures of merit commonly applied to microwave transistors are f_T , the frequency at which common-emitter current gain falls to unity, and f_{max} , the maximum frequency of oscillation. Emitter-to-collector signal delay time τ_{ec} determines f_T , which equals $1/2\pi\tau_{ec}$. A high f_T is desirable when broad bandwidth is a requirement. It's possible to get power gain at frequencies above f_T if the transistor's design and the circuit in which it operates permit a favorable output-to-input impedance ratio.

A more important guide to power gain is f_{max} , which takes into account the transistor's horizontal as well as vertical geometry. It is equal to $(f_T/8\pi r'_b C_c)^{1/2}$ where $r'_b C_c$ is the time constant determined by the combination of distributed base resist-

The author



Now supervisor of a high-frequency transistor group at Bell Labs, Roger Edwards has worked on electron tubes, silicon diodes, and germanium and silicon microwave transistors. He holds a Ph.D. from the University of Birmingham in England and has worked at the British Admiralty's electronic research laboratory.

Tradeoffs

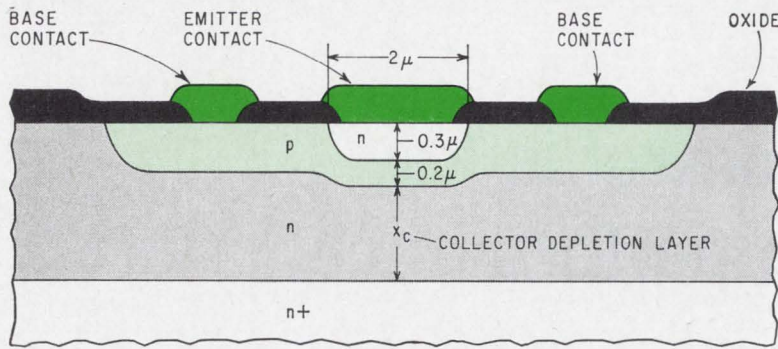

Dimensions and operating biases for these three representative microwave transistors vary because of different requirements. One important determinant of performance is depletion layer width.

Transistor type	α_e	Bias		Approximate delay time (psec)		
		V_{ce}	J_e	τ_e	τ_b	τ_c
		(volts)	(amp/cm ²)			
Low noise figure.....	1.5	5	1,000	50	5	15
Broadband, large power gain.....	2	15	8,000	20	5	20
Narrowband, large power and power gain.....	4	40	3,000	25	5	40

ance and collector capacitance.

f_{max} is also useful because the maximum narrowband power gain obtainable at frequency f when the transistor's feedback is neutralized is $(f_{max}/f)^2$. In well-designed transistors—where $r'_b C_c$ is kept low— f_{max} is almost always higher than f_T . Power gain advances have generally resulted from reductions in both $r'_b C_c$ and τ_{ec} . State-of-the-art transistors have an f_{max} of about 12 GHz.

While f_{max} is generally more valuable than f_T for assessing a transistor's power gain, a better indicator of practical circuit performance is the maximum available gain (MAG). This is a measure of the small-signal unneutralized power gain under conditions of conjugate matching, that is, where the input and output impedances are matched to the gen-

erator and load, respectively, by the equalizing of resistive elements and the tuning out of reactances.

If a transistor has positive feedback, trying to conjugate match may lead only to oscillations. In such a case MAG doesn't exist. However, common-emitter configurations above 1 GHz are normally stable. In practice, transistors are operated at frequencies where their neutralized gain is typically 3 to 6 db more than their MAG.

These figures of merit don't apply to large-signal operation because of nonlinearities in the transistor's characteristics. Large-signal performance is usually characterized in terms of circuit configuration.

Rapid transit

The emitter-to-collector transit time, τ_{ec} , represents the sum of several constants, all of which affect the over-all time of a transistor's response to an input signal. The most important of these constants are the emitter capacitance charging delay, τ_e , the base transit time, τ_b , and the collector depletion layer transit time, τ_c .

Base transit time can be cut by narrowing base layers; widths of about $\frac{1}{3}$ micron are common in today's microwave transistors, and some laboratories have refined diffusion techniques to the point where they can make bases only 0.1 micron thick.

Emitter capacitance charging delay drops as current densities rise, but a practical limit is reached when "base widening" sets in. This condition occurs when the excess of mobile charge in the collector depletion region changes the space charge distribution so that the neutral base layer encroaches on part of the depletion region. Base widening increases the base transit time.

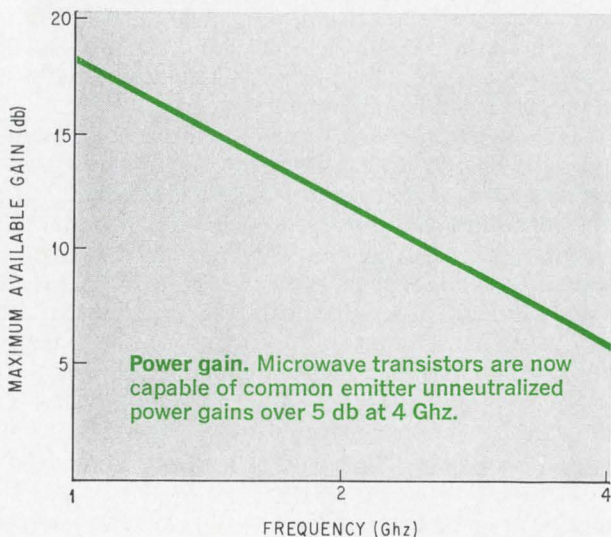

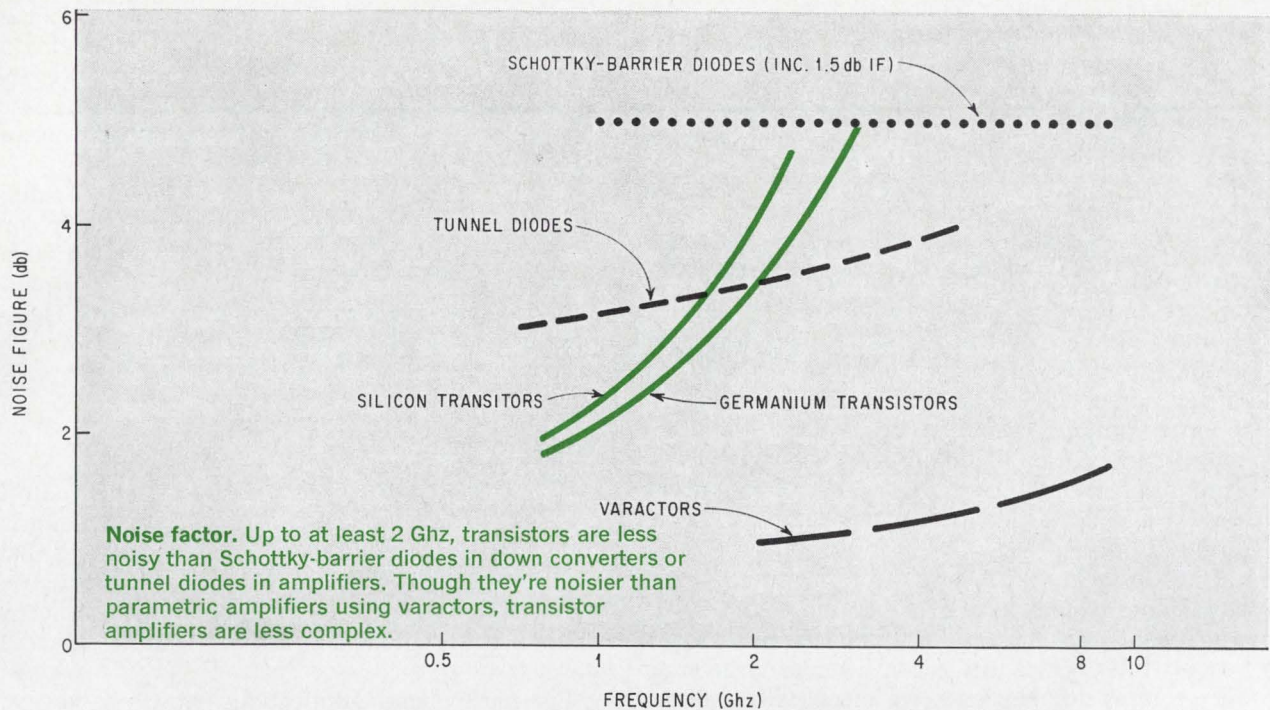

Collector depletion layer transit time decreases as the depletion layer narrows. At low currents, the width of the depletion layer depends on the collector doping level and the operating voltage. At high currents, it depends partly on the thickness of the epitaxial (collector) layer.

As current increases, the collector depletion layer moves toward the collector contact and can reach the substrate boundary.

Transistors should be designed with depletion layers extending right up to the substrate boundary, even at low currents, to permit the use of high current densities and reduce parasitic collector resistance. Collector depletion layer widths typically are 1 or 2 microns.

The horizontal geometry of transistors partly determines the base resistance-collector capacitance time constant. Base resistance is minimized in most small-signal, high-gain microwave transistors through the use of long, thin, closely spaced emitter and base contact stripes. Wide collector depletion layers also help $r'_b C_c$ by cutting down on capacitance. Although this necessarily lowers f_T because of increased collector transit time, it boosts f_{max} .

Just how far the tradeoff between these two figures of merit can be pushed depends on the application. For example, large bandwidth devices have a high f_T , at least as high as the maximum frequency of interest. But transistors used in circuits where bandwidth can be sacrificed have somewhat wider collector depletion layers for higher f_{max} and thus higher power gain.

Silent service

Transistors designed for low-noise applications operate at considerably lower current densities than those producing highest power gain. Since delay

and dispersion of carriers traveling from emitter to collector increases the noise figure, it's desirable to maintain as high a current amplification factor as possible. Thus, low-noise transistors emphasize a high f_T and sacrifice some gain. Their collector depletion layers are thin, and voltage and current-density operating bias is low.

These devices also require low base resistances, both to minimize thermal noise and to reduce input circuit losses, which can hurt noise figures. They also have high d-c current gain to keep down noise from the base current created by carriers lost in transit between emitter and collector.

Transistors are holding their own as low-noise devices. They're preferred to Schottky-barrier down converters and tunnel diodes at frequencies up to at least 2 Ghz. And while transistor amplifiers aren't as good as varactor parametric amplifiers, they're much less complicated.

Brute force

Most microwave power transistors available today consist of many individual high-gain transistors connected in parallel and housed in a single can. Base contact and emitter elements must be meshed to achieve $r'_b C_c$'s low enough for adequate power gain and to get uniform current distribution, and one way of accomplishing this is to group them in a pattern resembling interlocking fingers. An example of this interdigitated approach [see p. 93] is a 50-watt, 500-Mhz power transistor made by TRW. Texas Instruments also used an interdigitated structure to achieve 2 watts of pulse power output at 2.25 Ghz.

Alternatively, companies like RCA use an overlay technique, where a large number of small emitters are used with a low-resistance diffused base grid

to distribute the base current uniformly [see p. 98]. And the Nippon Telegraph & Telephone Public Corp. recently introduced a "mesh" transistor offering a high ratio of emitter periphery to collector area [Electronics, Dec. 11, 1967, p. 110].

At frequencies above 4 Ghz, transistors don't yet compete in absolute power level with such semiconductor devices as avalanche diodes and gallium-arsenide bulk-effect units. However, below these frequencies they compare favorably with bulk-effect devices so far as c-w power, though still falling short of the best avalanche diodes. The transistor's strong suit is its efficiency at lower microwave frequencies; c-w efficiencies top 25% at 2 Ghz and rise to more than 60% at 500 Mhz. This is an important consideration in oscillator design, where the use of combining techniques to sum transistor outputs may be a more economical way to achieve higher required powers.

One obstacle to higher power is second breakdown, the avoidance of which often requires bias adjustments that hurt radio-frequency performance. Second breakdown can occur when a large number of transistor elements are electrically, but not thermally, coupled. If one element heats up significantly more than the rest, it will carry more than its share of the current and will get still hotter. Known as thermal runaway, this condition can destroy a transistor.

The condition can also occur if voltage transients on the collector are high enough to cause avalanche multiplication. In that state, collector current can exceed emitter current, causing reversal of the base current; current then concentrates in the center of the emitter, forming a hot spot. This can happen, for example, in Class C operation with inductive load.

Equalizing current flow through the individual

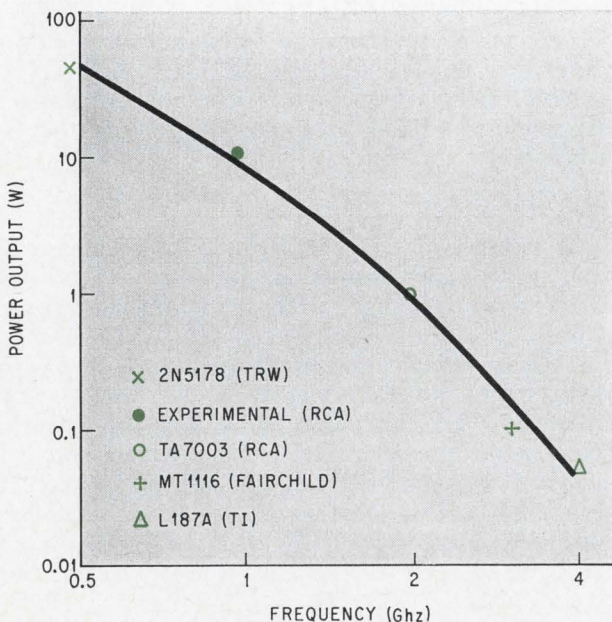

Handling power. State-of-the art power output for microwave transistors ranges from over 50 watts at 500 Mhz to 75 mw at 4 Ghz.

elements of power transistors gives some protection against second breakdown. Fairchild Semiconductor deposits thin-film emitter-feedback resistors over the transistor's protective oxide layer for this purpose, and RCA diffuses into the transistor resistors concentric with the individual emitters.

But these techniques have been applied extensively only to devices operating at relatively low frequencies. One difficulty is that the space taken up by the ballast resistors can lead to a larger parasitic junction area, thereby lowering r-f gain. Therefore, any dramatic improvements in microwave power transistors will depend on the development of better methods of current equalization.

Wide open spaces

Exploitation of the potentially high power output and large-signal power gain of microwave transistors requires a larger collector depletion layer than suffices for low-noise or high-gain-bandwidth devices. And because of increased emitter-to-collector delay, large depletion layers, or "output spaces," mean low f_T .

For narrowband applications, however, the reduced collector capacitance raises power gain. R. L. Pritchett of Bell Labs demonstrated this recently; he also holds that most microwave power transistors available today don't have collector depletion layers large enough for optimum power output.

Since microwave transistors with wide output spaces operate considerably above f_T , transit time effects are especially important in predicting these devices' r-f properties. The transport factor for carriers crossing the collector depletion layer turns out to be $(\sin \omega \tau_c / \omega \tau_c) \exp(-j\omega \tau_c)$. Thus, at a frequency equal to $1/2\tau_c$, the current gain—and therefore the power gain and output—drops to zero.

Pritchett has also shown that the optimum output space depends on the frequency of interest. For example, at 1 Ghz an output space of 10 microns offers more gain than an output space of 4 microns; because of transit time limitations, the situation is reversed at 4 Ghz. Pritchett's computations assume that the transistor has electrode stripes 2 microns wide and a resonant load admittance whose conductance equals the ratio of d-c collector current and voltage, a condition more typical of large-signal operation than is conjugate matching.

Of course, wide output spaces mean lower impurity concentrations and relatively low current densities. But the possibility of higher collector voltages partially offsets this limitation. Even more positively, the high output impedance obtained with a wide output space permits the paralleling of a large number of transistors before impedance becomes impractically low.

Pritchett showed that for maximum power output, output space should be about twice that for maximum power gain. However, the resulting loss in gain and bandwidth may not justify going quite that far.

Using a 4-micron output space, Pritchett

achieved 175 milliwatts of r-f output power at 3.3 Ghz with a 6 db gain. In this experiment, collector-emitter d-c bias was 50 volts and emitter current was 15 milliamperes. The output impedance achieved—more than 1,000 ohms—indicates the feasibility of increasing the area to achieve higher power levels.

Material considerations

Even in devices with very narrow output spaces, collector depletion layer delay is crucial because carrier velocity approaches a limit at high fields. In silicon, the velocity limit for electrons is about 50% higher than that for holes and about the same percentage higher than that for electrons and holes in germanium. For high f_T in devices where base transit time is negligible, therefore, silicon npn transistors become the clear choice. At present, the highest reported f_T levels for silicon and germanium are comparable.

However, germanium's higher electron mobility—a characteristic exploited in the first microwave transistors—makes for pnp transistors with significantly lower base resistances. As mentioned before, this is important for microwave power gain and noise. But fabrication ease must be taken into account, and since most development work has involved silicon, it looks as if the sophisticated low-noise transistors of the future will probably be made of that material.

Germanium pnp transistors now have the edge in small-signal gain and noise levels at frequencies from 1 to 3 Ghz. For handling higher power, though, silicon is the definite choice. Its higher avalanche breakdown field allows much higher operating voltages, which, in turn, allow higher current densities before base widening occurs. Then, too, silicon's wider band gap gives devices the ability to operate at temperatures of 200°C, more than twice the limit for germanium. Further, silicon conducts heat twice as well as germanium.

Although most microwave silicon transistors are npn, some promising pnp devices have been built. The Nippon Electric Co. has reported an f_{max} of around 7 Ghz for such a device.

The only other candidate to date for the microwave job is gallium arsenide, a material with a slightly higher carrier mobility than germanium, and band-gap and avalanche breakdown properties similar to those of silicon. But there are problems. Processing difficulties, as well as unwanted impurities or crystal imperfections that "trap" carriers, have so far limited the operation of bipolar GaAs transistors to frequencies below 500 Mhz.

On the other hand, W. W. Hooper and co-workers at Fairchild Semiconductor recently reported encouraging small-signal noise and gain figures for gallium-arsenide field effect transistors with Schottky-barrier gates. They've already made devices with noise figures lower than 4 db at 1 Ghz. If their extrapolations of performance from devices with smaller geometries prove correct, low-noise gallium-arsenide field effect transistors may well

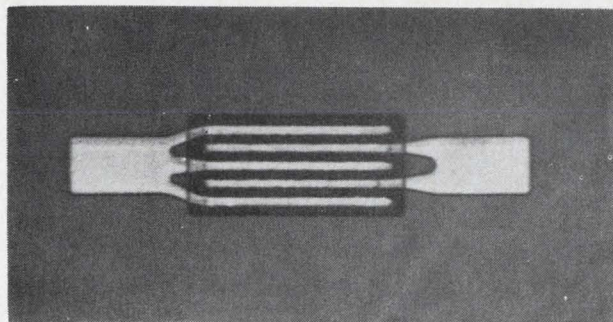

To the limit. Experimental silicon transistor has stripes 1 micron wide, about limit attainable with present methods.

give germanium and silicon bipolar devices a run for their money.

Now and then

Before more advances in microwave-transistor technology can be recorded, further progress must be made in the techniques of diffusion, photolithography, metalization, and etching. High-yield processing techniques are needed to extend device areas, and new methods must be developed to guarantee equal current flow through paralleled devices.

A number of researchers have developed shallow diffusion techniques by which transistors can be produced with f_T 's in excess of 7 Ghz. And devices with emitter windows only 1 micron thick have been fabricated with new photolithographic techniques; this width is almost as small as the wavelength used to define the windows in the photolithographic process and is therefore close to the limit attainable with present methods.

The International Business Machines Corp. recently demonstrated the feasibility of using electron-beam photolithography to delineate electrodes half a micron wide.

In microwave circuitry, low-loss passive elements such as transformers and matching networks can be fabricated most straightforwardly by applying thin-films to relatively large insulating substrates. Where performance is more important than cost, therefore, microwave circuits will continue to be of the hybrid type. Transistors orders of magnitude smaller than thin-film circuit elements must be bonded to the substrates either as packaged units or as individual chips.

Beam-lead sealed-junction transistors developed by M. P. Lepselter of Bell Labs are well suited for such hybrid applications, being both inexpensive and reliable. Provided that precautions are taken to minimize losses, beam leads may also be shaped to reduce inductive parasitics. For example, J. J. Kleimack of Bell Labs has developed an experimental microwave silicon transistor with broad beam leads—100 microns—that minimize inductance. In fact, tests show that a device of this type bonded to a well-designed mount should have a common-lead inductance of 100 picohenries, several times lower than that achieved with conventional bonded packages.

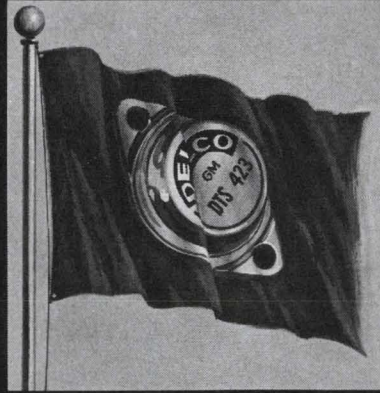

The Kokomoans

When it comes to high voltage semiconductors, come to us. Power is our specialty.

We were the first supplier, for example, to mass produce power transistors.

The first to develop high energy silicon power transistors with voltage capabilities of up to 700 volts, current to 10 amps.

The first to build silicon transistors suitable for large-screen color and black-and-white TV deflection.

The first to develop practical microcircuitry for the automotive IC voltage regulator.

And we mass produce diodes for use in

automotive generators.

Such achievements were no accident, of course. We're in the industrial control, entertainment, communications and automotive fields. Our products include stereotape systems for cars, car radios, digital systems and portable military communications equipment. So we know what the end-use requirements are. We know how to meet those requirements. And we know how to meet them in volume (our daily production of semiconductors, for instance, would make a line five miles long).

To meet today's requirements, we make rectifiers. High voltage silicon transistors. High power germanium alloy transistors. High and medium power germanium diffused base transistors. For use in such applications as DC and switching regulators, high power con-

SEMICONDUCTOR DISTRIBUTORS: EAST—BALTIMORE, MD. 21201, Radio Electric Service Co., 5 North Howard Street, (301)-539-3835 BINGHAMTON, N.Y. 13902, Federal Electronics, Inc., P. O. Box 1208, (607)-748-8211 CLIFTON, N.J. 07015, Eastern Radio Corporation, 312 Clifton Avenue, (201)-471-6600 NEWTON, MASS. 02195, The Greene Shaw Co., Inc., 341-347 Watertown St., (617)-969-8900 NEW YORK, NEW YORK 10036, Harvey Radio Co., Inc., 2 West 45th St., (212)-582-2590 PHILADELPHIA, PENN. 19123, Almo Industrial Electronics, Inc., 412 North 6th Street, (215)-922-5918 PITTSBURGH, PENN. 15206, Radio Parts Company, Inc., 6401 Penn Ave., (412)-361-4600 WOODBURY, L. I., N.Y. 11797, Harvey Radio Company, Inc., 60 Crossways Park West, (516)-921-8700 **SOUTH**—BIRMINGHAM, ALA. 35233, Forbes Distributing Company, Inc., 1416 Fourth Ave., South, (205)-251-4104 MIAMI, FLORIDA 33142, Mountain Electronics, Division of Mountain National Co., 3730 Northwest 36th St., (305)-634-4556 RICHMOND, VA. 23220, Meridian Electronics, Inc., 1001 West Broad Street, (703)-353-6648 WEST PALM BEACH, FLA. 33402, Mountain Electronics, Division of Mountain National Co., 1000 N. Dixie Highway, (305)-833-5701 **MIDWEST**—CINCINNATI, OHIO 45237, United Radio, Inc., 7713 Reinhold Drive, (513)-761-4030 CLEVELAND, OHIO 44125, The W. M. Pattison Supply Co., Industrial Electronics Division, 4550 Willow Parkway, (216)-441-3000 INDIANAPOLIS, IND. 46225, Graham Electronics Supply, Inc., 122 South Senate Avenue, (317)-634-8486 KALAMAZOO, MICH. 49005, Electronic Supply Corp., P. O. Box 831, (616)-381-4626 KANSAS CITY, MO. 64111, Walters Radio Supply, Inc., 3635 Main

are in power.

verters, ultrasonic power supplies, computer hammer drivers, VLF class C amplifiers, off-line class A audio output and CRT deflection—just about any power switching or amplification job.

And we make them on time. At competitive prices. With uniform, high-quality reliability.

For more information on Delco power semiconductors, contact your local Delco distributor or Delco sales office. Take advantage of the powers that be—from the Kokomoans.

FIELD SALES OFFICES

Union, New Jersey* 07083
Box 1018 Chestnut Station
(201) 687-3770

Chicago, Illinois* 60656
5151 N. Harlem Avenue
(312) 775-5411

Syracuse, New York 13203
1054 James Street
(315) 472-2668

Santa Monica, Calif.* 90401
726 Santa Monica Blvd.
(213) 870-8807

Detroit, Michigan 48202
57 Harper Avenue
(313) 873-6560

Kokomo, Ind. 46901
700 E. Firmin
(317) 459-2175 Home Office

*Office includes field lab and resident engineer for application assistance.



DELCO RADIO
DIVISION OF GENERAL MOTORS
KOKOMO, INDIANA

Street, (816)-531-7015 MINNEAPOLIS, MINNESOTA 55401, Stark Electronics Supply Co., 112 3rd Ave., North, (612)-332-1325 SKOKIE, ILL. 60076, Merquip Electronics, Inc., 7701 N. Austin Ave., (312)-282-5400 ST. LOUIS, MO. 63144, Electronic Components for Industry Co., 2605 South Hanley Road, (314)-647-5505 WEST—ALBUQUERQUE, N. M. 87103, Sterling Electronics, Inc., 1712 Lomas Blvd., N. E., (505)-247-2486 DALLAS, TEXAS 75201, Adleta Electronics Company, 1907 McKinney Ave., (214)-742-8257 DENVER, COLO. 80219, L. B. Walker Radio Company, 300 Bryant Street, (303)-935-2406 HOUSTON, TEXAS 77001, Harrison Equipment Co., Inc., 1422 San Jacinto Street, (713) 224-9131 LOS ANGELES, CAL. 90015, Radio Products Sales, Inc., 1501 South Hill Street, (213)-748-1271 LOS ANGELES, CAL. 90022, Kierulff Electronics, Inc., 2585 Commerce Way, (213)-685-5511 OKLAHOMA CITY, OKLAHOMA 73102, Radio, Inc., 903 North Hudson, (405)-235-1551 PALO ALTO, CAL. 94303, Kierulff Electronics, Inc., 3969 East Bayshore Road, (415)-968-6292 PHOENIX, ARIZ. 85005, Sterling Electronics, Inc., 1930 North 22nd Ave., (602)-258-4531 SAN DIEGO, CAL. 92101, Milo of California, Inc., 2060 India Street, Box 2710, (714)-232-8951 SEATTLE, WASH. 98108, Kierulff Electronics, Inc., 5940 6th Ave., South, (206)-763-1550 TACOMA, WASH. 98402, C & G Electronics Company, 2502 Jefferson Ave., (206)-272-3181 TULSA, OKLAHOMA 74119, Radio, Inc., 1000 South Main Street, (918)-587-9124 CANADA—SCARBOROUGH, ONTARIO, Lake Engineering Co., Ltd., 123 Manville Rd., (416)-751-5980

Solid state

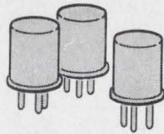

A switch in time

A switching-type semiconductor for timing, triggering and gating functions, the unijunction transistor continues to stand off IC's in these applications

By W. R. Spofford Jr. and R. A. Stasior

General Electric Co., Syracuse, N.Y.

Simplicity and low cost suffice to keep the unijunction transistor not only competitive but flourishing.

These aren't very glamorous factors, but then this discrete small-signal device couldn't compete on that score with the integrated circuitry entering its field. Those discretes successfully bucking the trend to IC's are generally power-handlers like silicon controlled rectifiers, or limited-volume items like thermistors. But the UJT has met IC's head-on in timing, triggering, gating, and sensing applications, and survived. More than that, sales are growing.

Only three firms are producing UJT's, though the

market now ranges from electric toys to the Saturn 5 space vehicle. And, UJT art is still advancing.

The unijunction is a three-terminal device whose simplified equivalent circuit consists of two series-connected resistors, one of which is variable, and a diode, connected to the common point between the resistors. Its distinctive characteristic is a negative resistance that is extremely stable with voltage, temperature, and time. Different device geometries exist—bars, cubes, planar structures—but the common point is always an n-type silicon pellet with ohmic contacts at its ends. These form the base-1

Shrinking with time

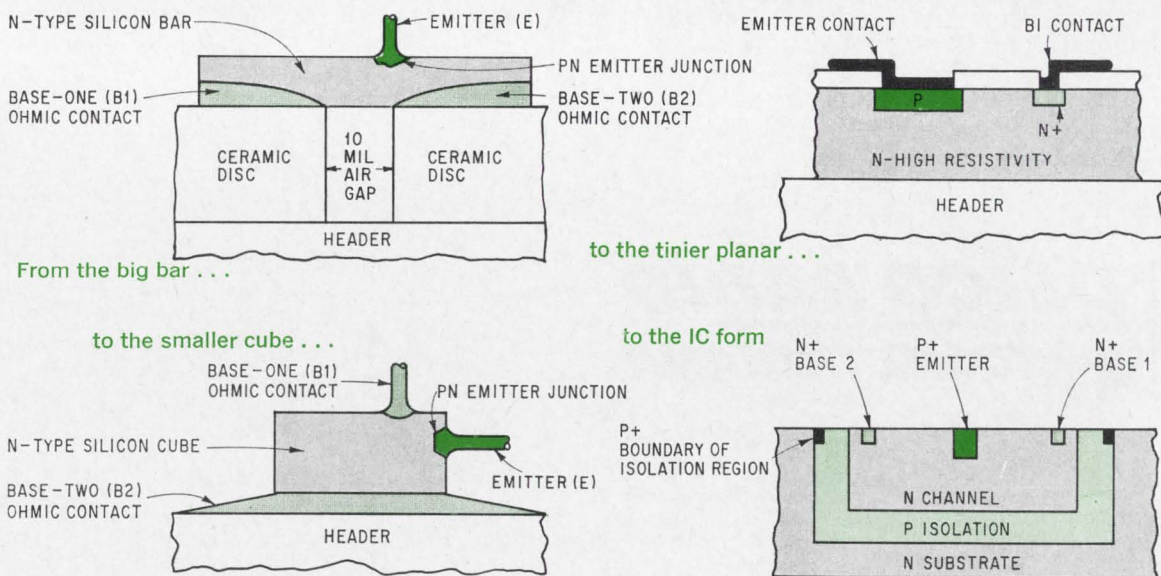

Four generations. Progressive reductions in the size of unijunction transistor structures generally cut fabrication costs and tightened control of electrical parameters. The 10x14x50 mil bar gave way to the 15x20x20 mil cube, which was replaced, in turn, by the 20x20x7 mil planar geometry. Monolithic integrated-circuit forms measuring even less have recently appeared, although they aren't yet ready for commercial introduction.

and base-2 sections; a single rectifying-type contact, the emitter, is attached at some point between the bases.

Operation is direct. When the emitter diode is made to conduct, the device shifts through a negative resistance state into saturation. The switching point is established by the bias between the bases and the potential on the emitter. When the potential reaches a predetermined proportion of the base bias, as established by the standoff ratio, the device switches states and generates an output pulse.

Bar, cube, and planar structures have a common mode of operation called conductivity modulation. The lightly-doped silicon "slab," acts as a resistor between the two bases, and current flow is established by a voltage applied between these bases. With the n-type material, this voltage is predominantly made up of electrons. When the emitter junction becomes forward biased, holes are injected into the bulk silicon, and, because of the electric field within the bar, these holes are swept towards base-1. Since conductivity is directly proportional to both hole and electron concentrations, an increase in holes decreases the bar resistance between the emitter and base-1. A further increase in emitter current decreases this resistance even more.

Long- and short-timers

Within the limits of its relatively modest frequency capabilities—300 kilohertz—the ujt is an efficient relaxation oscillator, timer, and sensor. It's used for firing power devices, for timing and time delay, for voltage and current-level sensing, for frequency dividing, and for generating and comparing waveforms. The circuits employing ujt's typically contain other nonintegrated components—high-power scr's and triacs, large resistors, high-value capacitors, and the like.

As a specialized semiconductor, the ujt has been classified in recent years according to the job for which essential parameters have been 'peaked up.' Besides general-purpose ujt's, therefore, the family includes units specially tailored for pulsing applications, voltage and current sensing, high-frequency short timing, and low-frequency long timing.

The ability to manipulate parameters is but one of the advances made in the 15 years of ujt technology—advances generally attributable to improvements in materials, manufacturing processes, and geometries. Today's standard unijunction provides output pulses of 6 volts, valley currents of 1 to 10 milliamperes, and peak currents of 2 microamps or less. Interbase resistances are typically 4 to 7 kilohms, leakages are just a few hundred nanoamperes, saturation voltages are commonly 2 to 5 volts, breakdown levels are as high as 60 volts, and standoff ratios are precise to within 5%. These levels represent improvements of two or three orders of magnitude over the figures posted by ujt's 10 years ago.

Silicon is the most common ujt material, and the cube structure is the most popular geometry, but planar techniques are now being widely applied, particularly to the more sophisticated units.

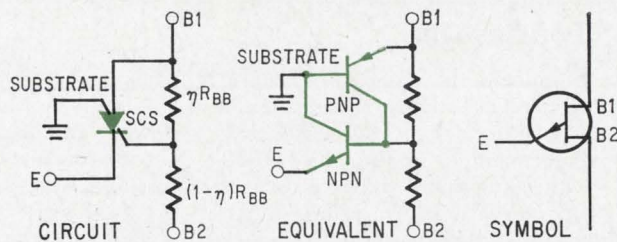

Pairings. Complementary UJT (right) is actually an IC-type silicon controlled switching circuit (left). Resistance between bases B_2 and B_1 is formed by a thin diffused resistor. Equivalent circuit (center) indicates switching action is achieved by npn-pnp complementary pair instead of by conductivity modulation.

Planar and fancier

The period from late 1966 through 1967 saw a great deal of innovation in this area, from the obvious but significant shifts to plastic packaging and planar manufacture, to the introduction of complementary designs and the programmable ujt.

Planar processing, by which the cube structure's alloyed junctions were replaced by diffused n and p regions, was adopted by Motorola and Texas Instruments to lower leakage and peak currents and thus lengthen time delays. The smaller geometries resulted in substantially higher oscillations.

Planar ujt construction is similar to that of standard planar npn bipolar transistors. The starting material is a high-resistivity n-type silicon, with the base-1 contact made to a diffused n+ section. The emitter is a diffused p region with an aluminum ohmic contact, and the base-2 region is simply the other side of the pellet. Planar construction yields a larger cross-sectional area in relation to depth than does the cube, making for a more nonlinear electric field. Advocates of planar insist that this has no detrimental effect on the stability of the standoff ratio, but proponents of the cube structure disagree.

General Electric uses planar techniques for its complementary unijunction (cujt) [Electronics, March 20 1967, p. 46], which is more accurately a multiple-junction integrated circuit consisting of two transistor elements and two diffused resistors simultaneously fabricated in a monolithic structure. Its standoff ratio is determined by the resistor ratio rather than by an electric field. The device resembles an scr in its saturation characteristics.

The complementary scheme enhances stability and saturation resistance. The improved stability stems from elimination of dependence on an electric field and on device geometry; standoff ratio tolerance is but 2% compared with the 15% of the cube, and frequency stability with temperature is 0.5%, an order of magnitude better. The low saturation resistance, typically 2 ohms, yields higher output pulses and reflects the positive feedback action of the complementary pair.

Pick 'em

The most recent technological jump is the programmable unijunction transistor, PUT, introduced last December. Actually a pnpn planar passivated

Two-base hit

Engineers at General Electric's electronics advanced semiconductor laboratory in Syracuse, N.Y., experimented in the early 1950's with germanium alloy tetrode devices in search of a semiconductor that could be used at frequencies higher than the 5-megahertz operating level of existing conventional bipolar transistors. The tetrode structures, it was found, produced a transverse electric field that boosted the device's cutoff frequency and lessened the semiconductor's input impedance—the limiting factor regarding frequency.

But in 1953, while examining the waveforms on the structure's terminals I.A. Lesk of the lab noticed that an oscillatory signal was present on the tetrode's emitter. And when the collector supply was removed, the oscillations persisted for a while. The researchers realized that they had stumbled on a new switching-type device.

The GE engineers added to the developmental tetrode models a doubled-based diode structure that was being studied because of a negative-resistance property.

Debut. The discovery was made public at the March 1953 annual convention of the Institute of Radio Engineers, and though heralded at the time as an interesting breakthrough, it wasn't credited with much practical significance. This indifference on the part of the rest of the engineering community gave GE a clear field in this area of double-base diodes. In fact, the firm remained the exclusive manufacturer of UJT-type units until 1959.

The Air Force, interested in the device's possibilities for communications and logic functions, awarded GE a study contract in 1953, and Lesk, V.P. Mathis, R.W. Aldrich, and J.J. Suran set out to thoroughly investigate the double-base diode. They made pnp structures that contained but a single junction, finding that the collector junction was superfluous to the device's operation. The base element was an n-type germanium bar, and the emitter was formed by an indium dot fused onto the bar's midsection. Ohmic contacts made to the bar's end points constituted the base-1 and base-2 portions.

Actually this early UJT with its

transverse-voltage operating mode, was more accurately a field effect device rather than a minority-carrier, current-mode semiconductor, and was, in a sense, the first practical FET.

The volt-ampere characteristics of the device, on page 119, included the negative-resistance property and indicated that the device would be useful as an oscillator. With no external source of emitter current, the device was already biased in the negative resistance region; a relaxation-type oscillator could be built merely by adding an external capacitor, there being no need for external resistance. However, since the frequency of oscillation was entirely dependent on the leakage current, which was excessive, the device remained a laboratory curiosity.

Wider view. Interest in the diode soon extended beyond its sinusoidal-oscillator possibilities. Suran and Edward J. Keonjian of GE's applications department perceived that the negative-resistance characteristic could be put to use in multivibrators and logic circuits.

In 1956, silicon began to replace germanium as the material for the diode bar because of its wider temperature range and faster switching properties. The first commercial silicon double-based diodes were introduced and marketed by GE that year.

In 1958, GE introduced the fixed-bed construction used in present bar devices. The design was more resistant to physical stress than were previous types. The year also saw a name change; the double-based diode became the unijunction transistor.

The silicon UJT had it all over the germanium models. It could switch in 1 microsecond instead of 10, and had a maximum operating temperature of 140°C against the 60°C of the germanium types. Equally important, the silicon device's standoff ratio, the parameter that establishes the switching threshold, was 10 times more stable with temperature. Also, silicon's resistivity—200 ohm/cm—was 10 times that of germanium and allowed the use of smaller bars.

Good try. The next major step came in 1962 when A. Ambroziac of the Polish Academy of Sciences reported on a multiple-emitter idea

that was later borrowed by bipolar transistor designers for use in both IC logic elements and microwave discrete devices.

Ambroziac built a counter circuit that used a UJT containing 10 alloyed emitters equally spaced along the bar. Designated the "Semidectron," its successive junctions could be turned on sequentially. However, isolation between emitters was poor, and often two or more were simultaneously turned on.

The bar structure of the single-emitter UJT persisted until 1962, when a cube die was created. Developed by T.P. Sylvan and V.A. Bluhm of GE's semiconductor products department, it had a 50-nanosecond rise time and 6-volt output pulses, far better than the 1 μ sec and 3 volts of the bar. Cube geometry made possible a smaller base-1 contact and brought the emitter closer to the base-1 portion. The resulting reduction in transit time and saturation voltage yielded the superior switching speed and larger output pulses.

Further, the cube was easier to mass produce than the bar because of simpler die mounting. The consequent cost savings made the units economically feasible for speed-control and light-flasher applications, jobs UJT's were to take over from small-signal switching transistors and, later, from electromechanical devices.

Drawbacks. But the cube wasn't a perfect design. In particular, the stability of its standoff ratio with temperature shift wasn't the equal of the bar structure's because of the higher intensity of the cube's electric field in the vicinity of the emitter. In terms of circuit performance, this instability required tighter-toleranced adjustment of the external compensation resistor in the base-2—a limiting but not difficult adjustment. The over-all temperature stability of the cube device was also less than the bar's.

But while UJT performance in oscillators and timers was somewhat restricted, low cost kept opening new applications. That the design was popular is evidenced by the fact that UJT production tripled within two years after the cube's introduction. And, as the accompanying article shows, further innovations were in the offing.

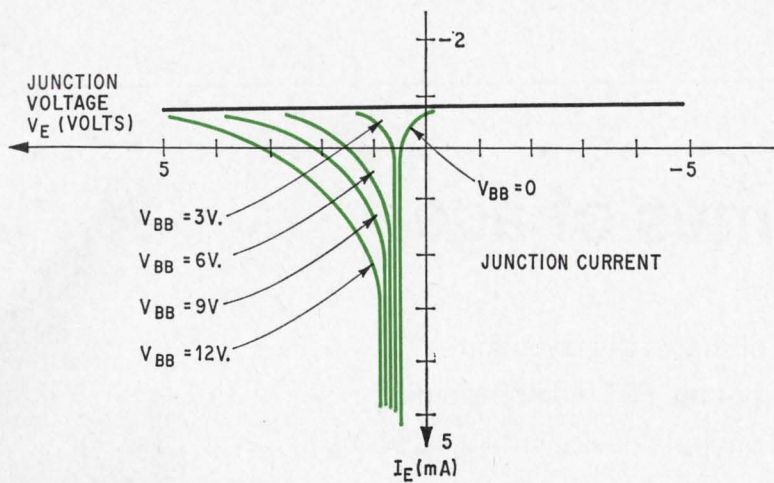

JUNCTION CHARACTERISTIC

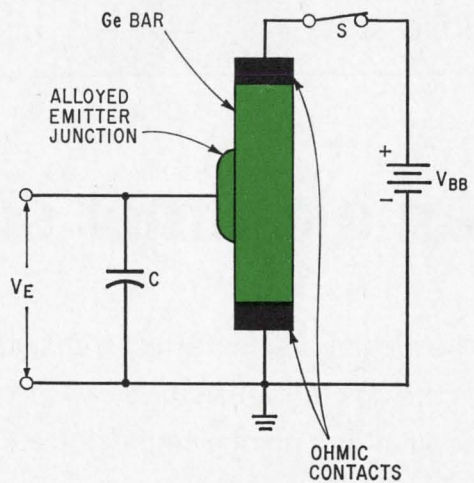

CIRCUIT

Wave maker. Early unijunction transistor, a germanium bar structure, was capable of generating oscillations when configured in a relaxation circuit (right). This property reflected the device's negative resistance characteristic, as displayed on its junction voltage-current relationship (left).

triode thyristor type of device, this GE innovation lets the user select standoff ratio, peak and valley current levels, and interbase resistance by his choice of the appropriate external base resistors [Electronics, Nov. 13, 1967, p. 25]. Although not a true UJT in construction, the PUT performs unijunction functions better than the conventional members of the family, besides having far more versatility.

The next advance will be the incorporation of UJT's into integrated-circuit structures, but this change won't be as all-encompassing as it has been with some other discretes. The CUJT is already found in several integrated circuits requiring stable oscillation. But planar, cube, and bar structures emphasize close control of geometry and resistivity and are thus less suited to standard IC techniques.

This has been pointed up in some recent research. Last year, J.E. Harlow of IRT reported that he had laid down an n-channel in a p-isolation region and then diffused a p-emitter area into the channel. The device, he said, functioned with a parasitic pnp transistor action instead of the conventional emitter-to-base-1 conductivity modulation. This embryonic UJT IC had a (poor) peak point current of 0.5 ma, about 30 times higher than the figure for discretes, and a low 10:1 ratio of valley to peak current.

Also in 1967, L. S. Stenhouse of Bell Labs reported on an integrated UJT that resembled a donut and had p+ base-1 and base-2 rings in a higher-resistivity p-type epitaxial layer. The emitter was formed by an n+ epitaxial layer under the entire epitaxial p layer, and was brought to the surface along the outside perimeter. Since the device was made in a p-type base, it had reverse polarity characteristics. Also, the standoff ratio of this fledgling IC version of a UJT was extremely sensitive to supply voltage.

General Electric developed an integrated-circuit version of its CUJT last year with features comparable to these of the discrete form. These devices have been incorporated in both military and industrial

circuits to achieve precise timing with a minimum of capacitance and silicon-chip area.

Discrete distance

For all these efforts though, the advantages of IC's usually aren't particularly relevant in UJT functions. To provide, say, a three-minute delay function with bipolar IC's would require two NOR gates connected as a multivibrator, plus added large capacitors or J-K flip-flops for frequency division.

Besides, circuits employing UJT's rarely handle the kind of repetitive functions associated with computer or some analog systems.

All signs point to market gains for discrete UJT's. The devices are in particular demand in applications where SCR's, triacs, and similar power units must be triggered, and they continue to hold down the job of clocking in the d-c to audio range and providing time delays of 30 seconds or more. Finally, applications in the areas of control and waveform generation are growing.

The authors



Walter R. Spofford, Jr., an applications engineer at GE's semiconductor products department, is completing studies toward a master's degree at Syracuse University. A specialist in timing and control, Spofford was previously employed at Crouse-Himes as a design engineer.



Richard A. Stasior received a Ph.D. in Physics from the University of Toronto in 1953. With GE for 15 years, he is now head of the applications engineering group of the semiconductor products department.

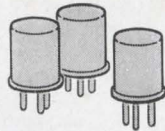

An old-timer comes of age

The idea of the field effect transistor predates the invention of the bipolar transistor by 20 years, but the FET didn't become popular as a unique amplifying and switching device until the 1960's

By Joel M. Cohen

Crystalonics Division, Teledyne Inc., Cambridge, Mass.

Conceptually the oldest of the semiconductors, the field effect transistor is, in a practical sense, one of the most up-to-date and dynamic. A true solid state component, it behaves much like the vacuum tube still favored by many designers. And it's one of the few discrete devices that hasn't been overwhelmed by the present wave of integrated circuits; in fact, it's become the basis of a separate integrated form, the metal oxide semiconductor IC.

During the past few years, FET's have taken an increasing number of amplifying and switching applications away from tubes and from bipolar transistors. Ironically, it has been semiconductor techniques originally developed for bipolars that have made FET production economically feasible.

The reasons for the FET's success are unique electrical characteristics such as high input impedance and low noise, plus simpler, more economical circuit requirements than both bipolar and tubes.

Slow off the mark

The history of the FET, detailed in the panel on page 123, began in 1928, 20 years before the invention of the bipolar transistor. But Julius Lilienfeld's scheme for what was basically a MOS FET received no attention from the scientific community of the time and quickly faded into obscurity.

It took the advent of the transistor in 1948 to

The author



Now director of engineering at Crystalonics, Joel M. Cohen joined the division in 1960. After completing his academic studies at MIT, Cohen was associated with MIT's instrumentation lab and later with Edgerton, Germeshausen & Grier. His current duties include new product development and applications, and hybrid IC design.

begin the establishment of the solid state field commercially and technologically. But this development also sparked interest in Lilienfeld's forgotten FET concept.

Riding the crest of the bipolar wave, FET's began to take hold in the 1960's. Junction types (J-FET's) led the way, with MOS units gaining ground steadily. Engineers designed the tube-like devices into a host of switching and amplifying circuits, taking advantage of the economy, ruggedness, size, power, and reliability of solid state components generally, along with the very high input impedance provided by FET's alone.

The bulk of FET applications fall into two categories: jobs requiring tube-like characteristics, and functions peripheral to those performed by such integrated circuits as flip-flops and op amps.

One major application, for example, is in the switching circuits that direct low-level analog signals in and out of computers, transmitters, receivers, and signal conditioners. Because the FET is voltage controlled, there's no mixing of drive and signal currents in the ON state as occurs with bipolars. Also, the FET doesn't have the contact potential or offset voltage associated with bipolars. And finally, since the FET has no true storage time, its switching speed is limited only by gate capacitance.

Amplifier uses put a premium on high input impedance, and here FET's have no solid state rival that can approach their mark of 10^9 ohms. Even figures for arrangements of bipolars, such as the Darlington connection, are at least an order of magnitude lower, and these arrangements generally involve operating current levels in the micropower and small-signal ranges.

Expensive match

Junction FET's are more difficult to match than bipolars because they exhibit much wider input

FET's: Growth of the rank and file

Competition—makers and products

Pricing—highs and lows

Technology—gains recorded

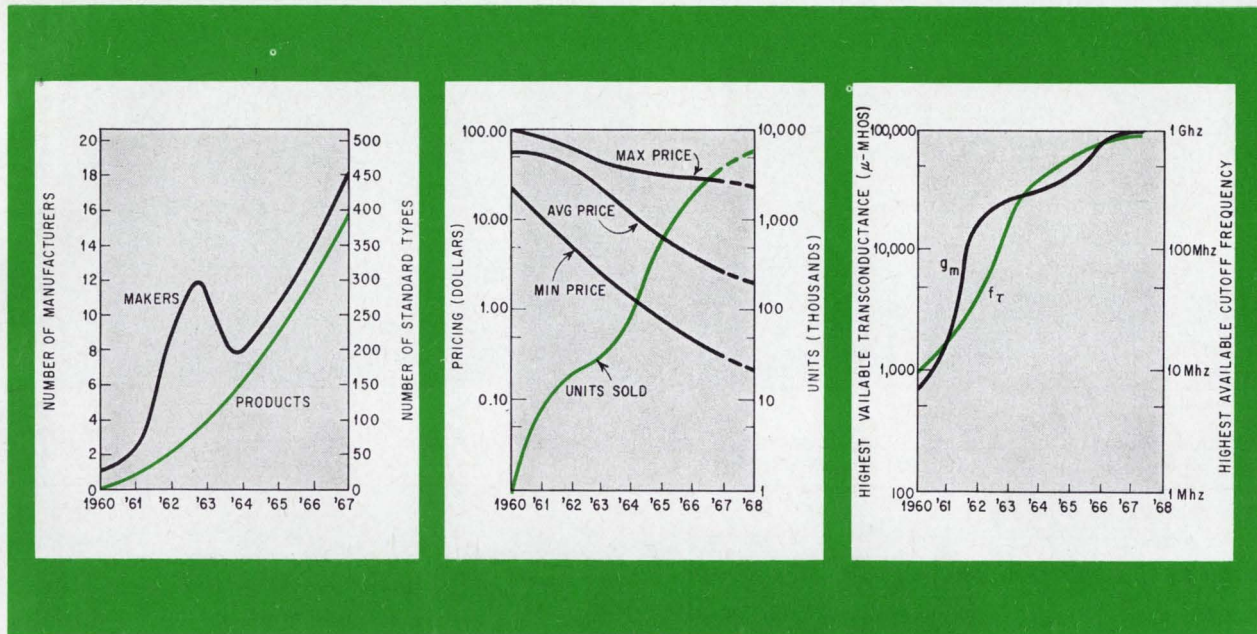

Profiles. Eight years of commercial establishment have witnessed a growth in suppliers and standard types (left). In 1960 there was one FET maker and less than a dozen standard devices; by the end of 1967, 18 firms were manufacturing field effect transistors and the number of standard units had risen to 400, indicating market success. Price history (center), based on lots of 100 devices, shows fairly regular drops, reflecting increased volume and no direct threat from integrated circuits, which are usurping sales of other discrete semiconductors. Improvement in technology (right) is evidenced by raising of transconductance from 800 to 100,000 micromhos and boosting of maximum cutoff frequency to 1 gigahertz from a 1960 level of but 10 Mhz.

voltage spreads—pinchoffs of 0 to 10 volts against the 100-millivolt spread of bipolars. The typical J-FET dual costs five times as much as a matched bipolar pair, therefore, but with it, drift rates as low as 5 microvolts per degree centigrade can be easily guaranteed.

Because J-FET's require little input current, their current noise levels are commonly as low as 0.1 decibel with a 1-megohm input resistance. And where bipolars exhibit $1/f$ noise below 1 khz, many J-FET's are free of measurable amounts down to 10 hz. But MOS FET's, because of their surface dependencies, exhibit $1/f$ noise at 10 khz and higher. Over the audio spectrum (10 hz-20 khz), total J-FET noise can be as low as 1 microvolt rms at a source impedance of 1 megohm.

Both J-FET's and MOS FET's are useful up to 1 Ghz, making them practical for r-f front-end circuits, intermediate-frequency amplifiers, and other high-frequency applications. Although some bipolars have higher cutoff frequencies, they suffer from intermodulation distortion—60 db more than FET's.

The tetrode configuration peculiar to junction and MOS FET's among semiconductors enhances mixing, automatic gain control, isolated biasing, and high-frequency amplifying capabilities. The two-series-gate MOS tetrode offers screen-grid performance. J-FET's with breakdowns of 300 volts, and

transconductances of 4,000 μ mhos, permit these devices to replace some small-signal vacuum tubes on a one-for-one basis. Drain current ratings up to 1 ampere also rival figures posted by some power tubes, small silicon controlled rectifiers, and crystal-can arrays.

On the make

Though most research on transistor manufacturing techniques has been aimed at improving bipolar fabrication, almost all the resulting advances have proved of more worth to FET's since their performance is more dependent on control of geometry.

For any FET, junction or MOS, the channel's length, width, and depth are the key geometric factors. The panel on page 122 lists major FET parameters and the device's figures of merit. Also included are relationships between geometry and the parameters. For example, transconductance and maximum drain current are improved if channel length is decreased, but this boost comes at the expense of lower breakdown voltage.

Some parameters can be changed without sacrifice. Pinchoff voltage, for instance, is a function of channel depth and is unaffected by changes in channel length or width. Channel length is primarily a function of the manufacturing process, and channel width of the device's geometry; channel depth is

Modern breed

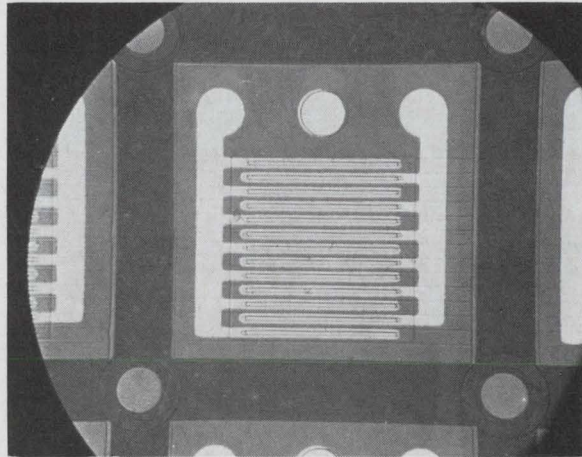

Easy switch

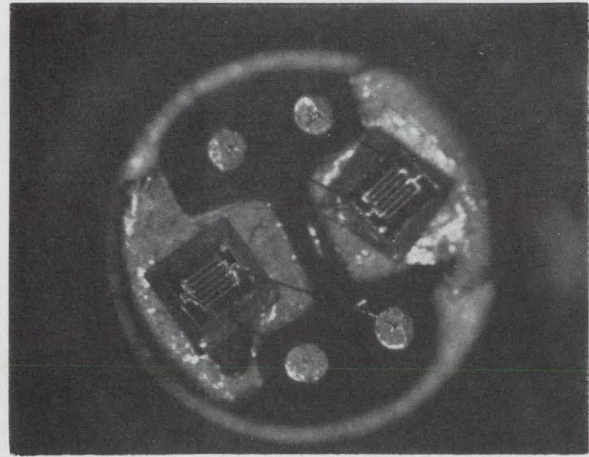

Gain twins

New lines. Typifying the state of the art: Crystallonics switching device which has an ON resistance of only 5 ohms (left), and Amelco's dual amplifier (right).

Geometry-Parameter Relationship

Parameter	Increasing Dimension		
	X	Y	Z
g_m , transconductance	decreases	increases	decreases
I_{DSS} , max. drain current	decreases	increases	increases
V_p , pinch-off voltage	no effect	no effect	increases
R_{DS} , ON-resistance	increases	decreases	decreases
C_{is}, C_{rs} , gate capacitances	increases	increases	no effect
I_{GSS} , gate leakage	increases	increases	no effect
e_n , short-circuit noise input	increases	decreases	decreases
i_n , input current noise	increases	increases	no effect

Figures of Merit

Criterion	Key parameter relationship
Input impedance	$(1/I_{GSS}) + (1/C_{is})$
Voltage gain	$g_m B V_{dgo} / V_{p1as}$
Frequency cutoff	g_m / C_{rs}
Noise figure	$(1/e_n + (1/R_{s1n}))$
Distortion	V_p / V_{signal}
Switching efficiency	R_{DS} / I_{GS}

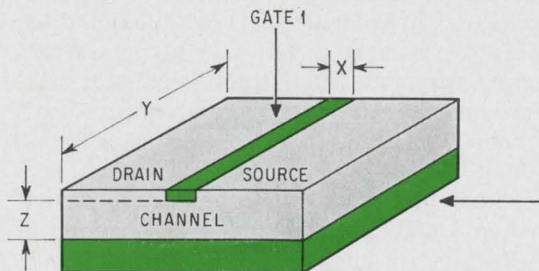

Cutaway. Channel dimensions x, y, and z in this simplified cross-section of a field effect geometry exert the greatest influence on device parameters.

a production variable established by diffusion depth.

Channel lengths today can be made as short as 2.5 microns. Once channel length has been minimized, channel width becomes the dimension determining current-handling capability, transconductance, and ON resistance. Most high-current units basically consist of paralleled, smaller-geometry FET's, with each channel width typically running to about 0.02 inch.

Depth is the most difficult of the channel dimensions to control, and is therefore the main cause of parameter spread. Typical depths run from 0.3 micron in low-pinchoff FET's to 2 microns in high-pinchoff types.

Device capacitance is concentrated between the channel and the gate-2 junction, a characteristic that led to the development of tetrode J-FET's to handle higher-frequency jobs beyond the capacity of triode FET's. The back gate in the tetrode configuration is used for biasing, and the small, low-capacitance front gate for signal input.

Regarding reliability, the J-FET, as a simpler device than either the MOS FET or the bipolar transistor, has fewer failure modes. The J-FET is basically a silicon diode with a second contact on the anode or cathode. Its breakdown characteristic is zener-like, and therefore nondestructive at low current levels; MOS FET's on the other hand, exhibit oxide punch-through failures, and bipolars are subject to second breakdown or avalanche modes.

Moreover, because the J-FET's parameters are bulk-controlled its characteristics vary only with material resistivity and channel dimensions. MOS FET parameters are surface-controlled, and therefore change with time. Further, as a surface-tolerant, majority-carrier semiconductor, the J-FET is more resistant to radiation than either the minority-carrier bipolar or the MOS FET.

If gate breakdown occurs in a MOS FET, the oxide separating the gate from the channel punches through, shorting the gate to the channel. In some

Delayed reaction

Julius E. Lilienfeld is a good example of a man with an idea ahead of its time. About 40 years ago the physicist-engineer first conceived of a "valve" device that might now be described as a sort of metal oxide semiconductor FET. His scheme, patented in the U.S. in 1930, went unnoticed. It might have altered the course of transistor technology had someone been able to build a device based on the patent. For more on Lilienfeld, see page 82.

The first commercial FET was produced in France in 1958, by Stanislas Teszner, a Polish scientist employed by CETH, a General Electric Co. affiliate. Called the Tecnetron, Teszner's device was a germanium alloy semiconductor. It had a transconductance of 80 micromhos, a pinchoff of 35 volts, a gate leakage current of 4 microamps, and a low gate capacitance of 0.9 picofarads. The low transconductance and high leakage severely limited its applications. But the high pinchoff voltage was closer to the operating levels of some tubes, and its gate capacitance permitted it to be operated at a few megahertz.

Left at gate. The FET was also prematurely boosted as the basis for complex gate arrays and a host of analog and amplifying jobs. Not until 1960, when Crystalonics introduced the first domestic FET, did practical circuit applications emerge. Many of these FETs went into high-impedance audio-frequency amplifiers for infrared detectors, hydrophones, and other transducers.

The big advantage was a lower noise figure than bipolars. The FET amplifiers could achieve a 0.1-db typical noise figure at 1-megohm source impedance, versus a noisier

2 db at 100 kilohms for the best bipolars. Compared to the Tecnetron, the American FET had 10 times the transconductance and a pinchoff voltage of 10, sufficiently low to permit operation with standard semiconductor-level power supplies (12-28 volts). The key construction feature was a short channel about 25 microns long, achieved by overlapping the large gate junctions.

Crystalonics' FET also had a lower input current, 0.1 μ a maximum, because silicon was used rather than the germanium of the French device. The large alloy geometry was achieved at some sacrifice—a high input capacitance and low production yield, reflected in the device's \$50 price. But FET's had arrived and were being used in moderate quantities, usually in aerospace applications.

And now planar. Next came the planar process, which imparted improved small-signal characteristics and permitted cheaper batch processing. Texas Instruments introduced the first planar junction FET in 1962, a device with a transconductance of 1,500 micromhos. Planar outdid the alloy process in yield, lowered leakages by a factor of 10, raised transconductance-to-capacitance ratios by an order of magnitude, and made possible small-area junctions and tighter geometry control.

The one drawback was a reduced breakdown voltage capability. Maximum breakdown of the double-diffused planar junctions was 20 volts, which limited the new FET's to small-signal applications. Alloy development continued, and in 1962 Crystalonics marketed a high-voltage J-FET series with breakdowns of 350 volts.

Crystalonics and TI led the FET

pack in 1962, adding to their alloy and planar lines. Gain figures rose, leakages were lowered, and even a tetrode unit offering separate gain control and better communications performance was produced. A new contender, Fairchild Semiconductor, that year introduced an advanced planar FET with a gate leakage of only 0.1 nanoamp and a transconductance of 500 μ mhos.

Fairchild also pioneered the first commercial MOS FET, a bipolar transistor with an MOS-type gate that modulated surface beta and thus output current. But it was withdrawn because of electrostatic breakdown of the gate isolation, the chief bugaboo of MOS devices.

More recruits. Also in 1962, the Electronic Components and Devices division of RCA joined the FET ranks with a line of MOS devices with transconductances of 1,500 micromhos and pinchoffs of 4 volts. And Amelco Semiconductor, a division of Teledyne Inc., started to produce planar silicon J-FET's with 150-volt ratings and transconductances of 1,000 micromhos.

Siliconix, a new entrant into the semiconductor business in the 1960's, made FET's its mainstay; the firm introduced a large number of amplifying and switching types. In the 1962-64 period, nearly every semiconductor producer got into the FET business—and out again just as quickly when optimistic predictions failed to materialize.

Also, a more attractive integrated-circuit business beckoned. The firms that continued to profitably produce FET's were of two types: comparatively small semiconductor houses that concentrated on FET's, or giant companies, such as TI and Motorola, that could afford substantial commitments in this area to supplement their discrete and integrated semiconductor products.

types, zener-diode elements shunt the gate to the substrate to protect against punch-through, but this safety measure is accompanied by a decrease in the device's input impedance, a drop of three to five orders of magnitude to the 10^9 -ohm J-FET level.

More to come

These minor restrictions haven't slowed the pace of FET growth, though. Sales have climbed some 40% annually over the last five years to a level of \$15 million in 1967. Moreover, MOS IC's, which make exclusive use of FET's as active elements, seem on the verge of a market spurt [Electronics, Jan. 8, p.

111]. FET's are also being fabricated alongside bipolars in monolithic structures [Electronics, Dec. 25, 1967, p. 25], and in hybrid arrangements to boost circuit capabilities.

The FET's of tomorrow will undoubtedly have higher breakdown ratings, drain currents, and cutoff frequencies. Prices will continue to drop as volume increases, as happened with bipolars and IC's.

The devices will be used more widely in military applications, instruments, f-m receivers, and tv tuners. The next technological leap will probably be to gallium-arsenide FET's—devices that may well have cutoff frequencies of 10 Ghz.

**Who in the world
makes stepper motors
that start instantly
at 2,000 pps and
accelerate
up to 8,000 pps.**

FUJITSU.

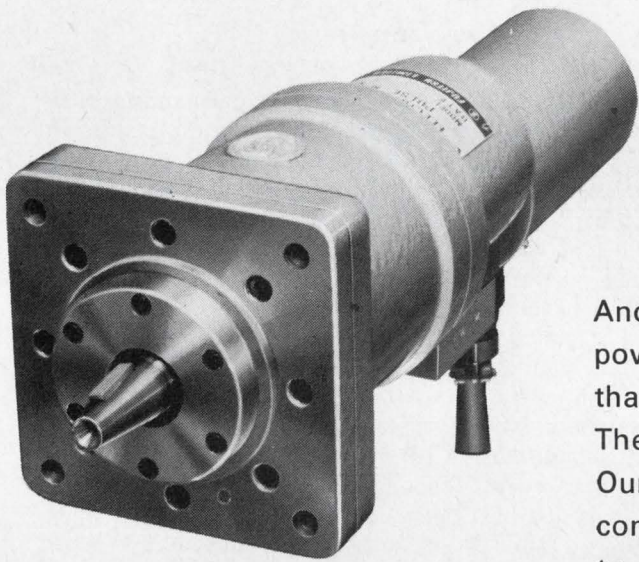

And with up to 6hp, they're the world's most powerful. To boot, stopping error amounts to less than 0.5°, non-cumulative.

The *causa sine qua non*?

Our Electro-hydraulic Pulse Motors (EHPM), a combination of an electric pulse motor as digital-to-analog converter and a hydraulic torque-amplifier. EHPMs are equipped with built-in hydro-mechanical feedback and range from 0.8 to 6hp. Electric Pulse Motors (EPM)—EHPM sans hydraulics—with up to 0.5hp are also available.

FUJITSU Steppers, especially geared for N/C systems, I/O equipment and auto-drafters, combine highest speed with astounding accuracy.

See EHPM and EPM at '68 IEEE EXHIBITION, 4th floor, Booth No. 4L02 & 4L03

Get in contact with us for more detailed information.

Fujitsu Limited New York Office

680 Fifth Avenue, New York, N.Y. 10019, U.S.A. Phone: CO 5-5360



FUJITSU LIMITED

Communications and Electronics

Marunouchi, Tokyo, Japan

Telemetering & Remote Control Equipment Electronic Computers & Peripheral Equipment (FACOM)
Automatic Control Equipment (FANUC) Electric Indicators Electronic Components & Semiconductor Devices.

Circle 125 on reader service card

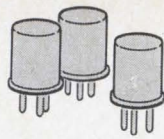

Transistors: A chapter ends —but the story continues

Heyday of discrete devices may be over, as some industry men say, but today's transistor technology will be the basis of tomorrow's developments in integrated circuits and other solid state devices

When the transistor becomes just another page of history, its significance won't be weighed in terms of how it reduced size or improved reliability. Rather, the transistor will be cited for what it had spawned.

Unlike the vacuum tube, whose development led nowhere, the transistor was the forerunner of advanced devices that wouldn't have been possible without solid state technology and the wealth of experience gained from it. But what of the discrete transistor itself? Has its development run its course, bringing an end to an era?

To some industry leaders, the transistor's future is past. Others say most of the developments in silicon have already been achieved and all that remains are refinements. Still others say the germanium transistor, although far from dead, has reached maturity and significant new developments are doubtful. And, of course, there are those who argue that the shift to integrated circuits has sidetracked—and, in some areas, derailed—the development of transistors.

Thus, there are many who feel the outlook for discrete transistors is dim, just as there were those who held a similar view of the vacuum tube when the transistor came along.

Among those who back in the early 1950's prophesied an imminent doom for the vacuum tube is C. Lester Hogan, now a vice president of Motorola Inc. and general manager of the company's Semiconductor Products division. Says Hogan today: "I'm beginning to believe that nothing really dies in electronics. At least the life cycles are quite long."

To underscore how wrong he guessed, Hogan points out that though 1967 wasn't a record year for vacuum tubes, it was an excellent year. And like the vacuum tube, he now says, the transistor will be around for a good many years to come.

"Even though the future belongs to ic's," comments Hogan, "we'll be selling a lot of transistors 10 years from now. We're still developing new germa-

nium-transistor products, and our germanium business is very profitable—profitable enough to support on its own the development of new germanium transistors."

But 1967 was a bad year for transistors. For the first time since transistors made their appearance on the market, sales dropped—by a whopping 20%—from the previous year's levels. Last year's sales totaled \$390 million for less than 700 million units, compared with 1966's \$441.8 million for 850 million units.

Robert Noyce, general manager of Fairchild Semiconductor, attributes the sagging sales to the impact of ic's. "The major field of operations for transistors has been in signal processing," says Noyce, "and this area is particularly subject to attack by ic's."

The transistor thus follows the same pattern of the vacuum tube, now left with one big market—the consumer field. Except for some special-purpose display and sensor devices, the vacuum tube has been pushed into the upper right hand corner of the power-frequency chart. Few people see the transistor challenging the vacuum tube for high-kilowatt radio-frequency and microwave power applications. But pressured from below by ic's, transistors are finding a niche in some new applications—particularly those in the ultra-high frequencies, and low microwave ranges.

On the road to consumers

In the last bastion of the receiving tube, the consumer market, the "biggest boon for semiconductors is at hand in the conversion of television receivers to solid state," says Donald Dickson, president of Dickson Electronics Corp., Scottsdale, Ariz. This will be a mixed bag of transistors and ic's, he says—"there may be 200 million tubes per year that will be replaced by solid state devices." Considering last year's sales picture, a healthy share of the replacements for 200 million tubes would look

very attractive to transistor makers.

Roger Webster, manager of microwave R&D programs at Texas Instruments, sees the consumer market as having the greatest potential for transistors. Describing sales as "still just dribbling in," he says the big problem is cost. "We can do all the signal circuitry now on color tv," Webster points out, "but we still have trouble with the economics."

Motorola's Hogan looks for television receivers to be all-solid state within three years, and says it will be 10 years before this market is totally integrated. Color-tv sets will be about half-and-half discretely and IC's, says Hogan, with a total device market of some 700 million a year by 1969. Motorola's Consumer Products division has a completely transistorized color set on the market now [Electronics, July 10, 1967, p. 45]. Hogan says it took "a massive effort" at the Semiconductor Products division to learn how to make the transistors cheaply as well as to develop a 750-volt breakdown transistor that performs the horizontal deflection function. The device operates at a few megahertz, according to the Motorola executive.

Gordon Moore, director of research at Fairchild Semiconductor, says a major effort at Fairchild is aimed at developing a 1,500-volt transistor that works on tv-raster deflection. Such a device, he says,

would eliminate the need for a power transformer in a line-operated tv set.

Transistor makers aren't limiting themselves to tv receivers. If the price obstacle can be overcome, says Hogan, the way can be cleared for widespread use of transistors in consumer products ranging from automobiles to dishwashers.

Hogan recently forecasted a market for semiconductors in automobiles alone of between 700 million and 1 billion devices annually as auto production approaches 10 million per year. A respectable portion of these will undoubtedly be IC's, says Hogan, but a fair share will go to discrete transistors. Solid state voltage regulators and electronically controlled transmissions are two categories in which semiconductors will be applied.

Electronic controls for camera shutters are a reality now, and Hogan says the function will be almost completely transistorized "in the next few years. Any time you want to control light or electricity, you'll find uses for transistors. Controls for dishwashers, kitchen mixers, and washing machines are all candidates for transistors, but the price per transistor function will have to be about 1 cent to crack this market open."

Richard Lee, president of Siliconix, Inc., specialists in field effect transistors and arrays, strikes an

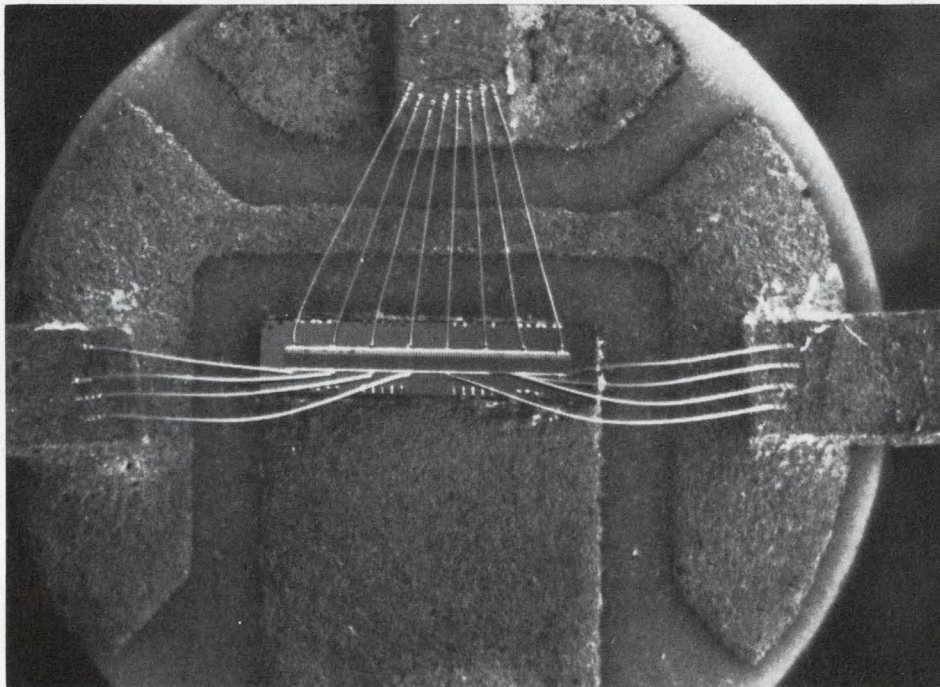

Microwave power. Developmental transistor from Texas Instruments uses interdigitated construction and delivers 10 watts at 1 Ghz. The package, left, has multiple bonds to reduce inductance, while the chip, below, has resistors incorporated into each emitter to improve current distribution. Emitter and base contact spacing is 3.75 microns.

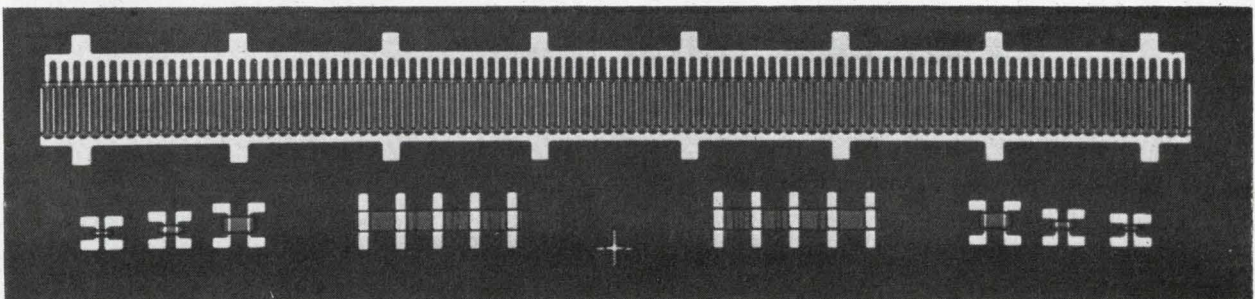

optimistic note: "I don't argue with the position that just as the transistor represented a revolution for the vacuum-tube world and the ic did for the transistor world, today large-scale integration looks like the next big jump. But I might argue about how many years it will be before the discrete market dries up—there are areas that are still growing."

Lee points to the analog world, where many functions, though not special-purpose, don't have the volume to justify integration. "In the industrial and consumer world, there may be a move into transducers—that is, an active device coupled with a transducer." For another thing, he points out, transistor technology until now has been based on monocrystalline silicon; gallium arsenide and other materials and processing methods haven't been fully explored.

Lee warms to the subject of FET's: "The surface has hardly been scratched in FET's. For instance, the idea that a FET is a voltage amplifier and that a bi-

polar transistor is a current amplifier hasn't been exploited. It's easy to exploit this combination in the discrete form."

Lee sees a possibility of a FET acting as a constant-current analog of a zener diode in applications where a current-source reference would be useful. The idea, he says, is in its infancy—like zeners were in 1951. But in five years, he predicts, two-terminal devices will be used as current references—a 0.1%, 1-milliamperere current source, from 1 to 50 volts. Also says Lee, field-effect structures haven't been fully exploited in multichannel commutators in which they serve as single-ended switches without offset or drift problems, but with high impedance.

Another FET specialist, Dickson, says the trend in FET's is to lower-priced devices.

"There are a lot of applications around for the power and frequencies that are available now, so the big push is on price—toward the 5 cents per transistor function that Dr. Hogan at Motorola has

The sky's not the limit

With transistors moving rapidly into the microwave range, a limitless field doesn't lie ahead. Although more reliable than vacuum tubes now used at these frequencies, transistors are subject to certain theoretical limitations because they are solid state devices that operate on a transit-time basis.

E.O. Johnson, engineering manager at the RCA Electronic Components division in Harrison, N.J., has studied the theoretical maximum parameters of transistors and has derived some constants that tell how close to the limit new devices work. The equations relate voltage and frequency, current and frequency, power and frequency, and finally power gain and frequency.

Velocity and field. The purpose of any amplifying device is to convert the d-c energy of the power supply to a-c energy at the signal frequency. This is achieved by adding energy to the charge carriers—electrons and holes in semiconductors. But there's a limit to how much energy can be added to each carrier.

The charge carrier has a maximum velocity, v_s , at which it can move through the crystal, and the value of this maximum is a property of the material. For germanium, silicon, and gallium arsenide this value is about 10^7 cm/sec. The maximum velocity is attained at a field of about 10^4 volts/cm, and increases in field beyond this do

not affect the velocity.

In a transistor, this is the maximum velocity at which the carriers can move from the emitter to collector, the critical path length.

The transistor's cutoff frequency, f_T , is related to the reciprocal of the emitter-collector transit time by $f_T = 1/2\pi\tau$. Therefore, with a fixed velocity, the path length, or base width, has to be made short if the transit time is to be made short.

But there's another basic property of the semiconductor material that enters the problem—the breakdown field. When the path length is shortened, the electric field increases with a fixed voltage.

Since path length is thus related to both the transit time and the electric field, the breakdown field, E , times the maximum velocity, measured in volts/sec, is a maximum for each material that cannot be exceeded. In germanium, this product is about 10^5 volts/cm \times 10^7 cm/sec or 10^{12} volts/sec. In silicon, it's about 2×10^5 volts/cm \times 10^7 cm/sec or 2×10^{12} volts/sec. When the extra factor of $1/2\pi$ is applied to the constant, because of the f_T relationship, maximum voltage-cutoff frequency product is $V_m f_T = E v_s / 2\pi = 2 \times 10^{11}$ volts/sec.

This constant can be related to the device's maximum voltage, the maximum frequency, the impedance levels, the power handling capability, and the power gain.

The constant can be applied to any semiconductor device that operates in a transit-time mode, as shown by B.C. DeLoach of Bell Laboratories. In devices such as the limited space-charge accumulation diode, the domains are quenched to give a negative resistance effect before they travel across the full diode width.

The power relationship isn't as restrictive as it may seem, though. If the designer is willing to accept a lower output impedance, he can parallel many devices operating below the limit and get almost as much power as he desires.

Voltage-frequency. With the maximum voltage-cutoff frequency product equal to 2×10^{11} volts/sec for silicon, the maximum cutoff frequency for a practical transistor can be estimated. If 1 volt is the minimum collector voltage, then about 200 gigahertz is the maximum. But with today's technology, extrapolating data to a 1-volt collector voltage results in a 20-GHz transistor.

Present devices do not, of course, make it to the theoretical limit. An RCA 7003 radio-frequency power transistor, for example, has a maximum collector-voltage rating of 58 volts and an f_T of 2.3 Ghz. The product of these two is thus 1.33×10^{11} volts/sec, which is quite close to the limit.

The relationship shows, however, that it would be impossible to build a transistor with a maxi-

been talking about lately," says Dickson. "These will be applications in which you need two or three discrete transistors. If you get into the five-to-20-transistor range, it's more economical to go monolithic."

Dickson also believes that there is a lot of room for clever electronics in toys, but quickly adds that the price has to come down if transistors are to be attractive to toy manufacturers.

Running down the list of transistor types, π 's vice president of technical development, Willis Adcock, had this to say:

- Field effect transistors—no radical developments.
- Unijunctions—a special device for which less and less interest will be shown.
- Power units—triacs may represent the biggest development for controlling power in both directions and there should be further growth of these.

On microwave and radio-frequency transistors π 's Webster says the materials have their limits,

but they haven't been reached yet. There are devices, using photomasking, that get 1 watt at 3 gigahertz and Webster visualizes devices getting 10 w at 3 Ghz. Five years ago, the former was considered impossible. And, as techniques get better, Webster says, "we see metal oxide semiconductor devices coming in."

More mileage from GaAs

There also should be further developments in gallium-arsenide devices. Though the technology still needs more development and a lot has to be learned about working with these devices, π 's Adcock is looking to GaAs to solve many solid state microwave problems.

Fairchild's Moore says he can see the day when useful gain at X band will be achieved with gallium-arsenide FET's—"We'll see samples by 1970." Fairchild now has transistors that produce some gain up to 10 Ghz, while useful gain is up to 3 Ghz.

maximum collector voltage of 100 volts and the same cutoff frequency of 2.3 Ghz. This product, 2.3×10^{11} volts/sec, would exceed the theoretical limit. For a 100-v maximum collector voltage, the maximum theoretical cutoff frequency attainable would be 2 Ghz.

Such figures are useful in evaluating new designs. Johnson recalls one device proposed by a little known competitor that, he says, caused a furor in the laboratories when it was first described. But then he realized that it exceeded his theoretical limit. He thus was reassured that RCA development engineers were not missing out on anything new by not starting a program to develop the new device. The device was not heard of again.

Present devices do not make it to theoretical limits because the limiting velocity isn't reached until the carriers are almost across the base and up to the collector, and thus their average transit velocity is less than the maximum. Also, because the electric field isn't set at the maximum—in general it may be about half the breakdown field.

The next step is to consider the current and collector-base capacitance and its corresponding reactance, X_c , at the cutoff frequency. These can be related to the theoretical maximum by $I_m C_o = E v_s$ and $(I_m X_c) f_T = E v_s / 2\pi$. When base-widening effects are included, this gives the tradeoff between cur-

rent and frequency. Any stray capacitance, however, also must be added into the C_o term and thus accounts for operation of practical transistors below the maximum.

Power handling. In like manner, the power-handling capability of the transistor can be related to the constant with the equation $(P_m X_c)^{1/2} f_T = E v_s / 2\pi$. This equation is similar to the familiar power-frequency reasoning about transistors—the higher the power, the lower the frequency because the device has to be made larger. But the underlying reason for the tradeoff, however, is the maximum rate of energy transfer for the charge carriers.

The RCA 7003 transistor has a maximum power—the product of maximum collector voltage and maximum collector current—of 23.2 watts and an X_c of 23.1 ohms and a cutoff frequency of 2.3 Ghz. Thus it has a $(P_m X_c)^{1/2} f_T$ product of 5.32×10^{10} volts/sec—again, below the theoretical limit of 2×10^{11} volts/sec.

Power gain. Johnson's analysis shows that the maximum power gain of a transistor is related to the cutoff frequency, f_T , the operating frequency, f , the maximum voltage, V_m , and the maximum voltage, V_T , required to put a charge on the collector. For a bipolar transistor, this charge is about kT/q volts (25 millivolts at room temperature); for a field effect transistor, about 1

volt. The relationship is $(G_p V_m V_T)^{1/2} f = E v_s / 2\pi$. This is a form of tradeoff between power gain and bandwidth.

A significant difference between bipolar and field effect transistors can be pointed out here. The lower the V_T , the higher the gain, since their product is a constant. Thus the bipolar transistor is better than the field effect transistor on this score. However, the bipolar transistor is subject to strong cross-modulation that doesn't affect the field effect transistor.

Evaluation. Thus to evaluate any new transistor, the following data must be measured or taken from the manufacturer's literature: the cutoff frequency, the maximum collector voltage, the maximum collector current, and the total collector capacitance (or the common-base output capacitance). With this data, the voltage-frequency, current-frequency, and the power-frequency relationships can be calculated and compared with the theoretical maxima. This provides an indication of the present state of the technology and points up the tradeoffs that have been made.

Bibliography

E.O. Johnson, "Physical Limitations on Frequency and Power Parameters of Transistors," RCA Review, June 1965, p. 163

E.O. Johnson, "Physical Significance of the Power-Amplification/Bandwidth Product of an Active Device," Proc. IEEE, October 1966, p. 1468.

Transistors, IC style

Only one transistor, a thin-film type, is being developed for use directly in large-scale integrated circuits without any thought of it being used as a discrete device. Recent developments have brought the thin-film transistor closer to use as a low-cost device for large-scale fabrication of IC's on glass substrates measuring several inches on each side.

Early thin-film transistors were unstable—threshold voltage shifted with time. A group at RCA Laboratories has traced the instabilities to the material used for the gate insulator—silicon monoxide. The group, led by Albert Waxman, has begun using aluminum oxide for the insulator. This, they say, reduces the instability significantly—the threshold voltage stays constant even when the electric field in the insulator reaches 10^6 volts/cm. The aluminum-oxide insulator also reduces the effects of water vapor, they say.

Motorola's Hogan doubts silicon will be displaced in transistors. "Gallium arsenide can do the same job, but it doesn't have silicon's reliability and it costs more." Jean Hoerni, who filed the basic Fairchild patent on the planar process and has since formed his own company, Intersil in Santa Clara, Calif., says, "There are limits of the silicon crystal that limit the theoretical frequency performance of the device [see "The sky's not the limit," p. 128]. Gallium-arsenide technology may make higher frequency transistors feasible, but that will take a long time. Gallium arsenide has not been developed to replace the transistor—but it will be used for photo-devices and diodes."

David Allison, one of the founders of Fairchild and now vice president of advanced development for Signetics Corp., sees gallium-arsenide devices as a possibility. "Only in higher frequencies and higher power will we see any revolutionary use of discrete transistors," says Wilson. "We'll see, someday, gallium-arsenide transistors that will permit us to use transistors in the high ranges. We'll see a lot of work in the III-V compounds and in optical coupling."

Motorola's Hogan says r-f transistors operating at "tens of watts" and 500 Mhz will be typical at his division in the near future. Transistors with hundreds of watts at 500 Mhz are farther down the road. In frequency, 1 Ghz devices are the goal for both the short and long haul, with the power cut by a factor of six below the 500-Mhz power devices.

Regarding manufacturing techniques, Dickson is convinced that electron beam and laser processing will be used to generate small junctions. "Ion implantation doesn't seem to be moving very fast," he says. "And it doesn't seem to be as promising now as it was a couple of years ago."

But there are those still hard at work, hoping to develop ion-implantation techniques for full-scale production of high-frequency transistors that need shallow base and emitter geometries for narrow base widths.

One of the advantages of ion implantation is that it is a far simpler manufacturing process for semiconductor devices than are present diffusion methods. The production facility for silicon solar cells at Ion Physics Corp., Burlington, Mass., for example, fits on one small bench and requires only one operator.

However, in an industry that's made amazing progress in producing dependable devices, a process that holds out the promise of even greater reliability is still being sought. Bell Telephone Laboratories' combined beam-lead and sealed-junction process improve on the reliability of the packaged device and, at the same time, make it possible to extend batch processing to encapsulation. Batch processing would raise yields and reliability significantly.

Hogan looks for lower device costs as new production techniques and plastic packaging become more widespread. He is particularly impressed by the Bell Labs' beam-lead, sealed-junction process. "This is an extremely important breakthrough," he says, "which will allow linking of many transistors or integrated circuits on a substrate and will allow lower device costs."

The road ahead

Thus, what lies ahead is not the discrete transistor, but the transistor existing within an integrated circuit; beyond that, a semiconductor bulk material doing jobs simply by its chemistry, its shape, and by the way it's processed—such as the Gunn effect.

Fairchild's Noyce also sees the most significant new products as bulk-effect devices such as Gunn and limited space-charge accumulation devices. Their major effect will be to extend solid state operation far into the microwave range. However, says Noyce, "the economic motivation for these things is not nearly so great as it was for the transistor. The market in higher frequencies is not nearly so great as it was for the receiving tube."

On new devices based on materials other than semiconductors, TI's Adcock says, "Many fads come and go. Every time one comes up, we get a letter from across the street. [TI corporate headquarters].

We are convinced, however, that all important electronic phenomena resides in solid state approaches."

Twenty years of transistor progress

The editorial task force on this special report, which starts on page 77, included Mark B. Leeds, William Bucci, Stephen Scrupski, James Chang, Eric Aiken, and Carl Moskowitz. On the reporting team were: Larry Curran and Bill Bell, Los Angeles; Walter Barney and Peter Vogel, San Francisco; Marvin Reid, Dallas; James Brinton, Boston; Howard Wolff, New York; Ray Bloomberg, Seattle; William Arnold, San Francisco. Reprints of this special report are available at \$1.50 each.

©Copyright 1968, Electronics® A McGraw-Hill Publication

tiny, but tough,

the Clare MF relay does a *big* job in .046 cu. in.

It's built for action. Whether the job calls for one operation with certainty, or for consistent reliability over more than 150,000 operations, the MF delivers proven Clare performance.

Design around the Clare MF for space-saving efficiency in the most demanding military and industrial circuits. Provide long electrical and mechanical life under extreme conditions of shock, vibration and linear acceleration . . . and temperatures from -65°C to $+125^{\circ}\text{C}$. Meet advanced pcb circuit requirements with low profile, high-density switching you can depend on, dry circuit to 0.5 amps.

For complete design information, circle reader service number—or ask Clare for Data Sheet 756 . . . Write Group 2N7

C. P. Clare & Co., Chicago, Illinois 60645
. . . and worldwide



a GENERAL INSTRUMENT company

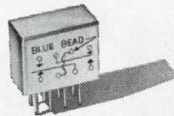

MF Relay: Actual size

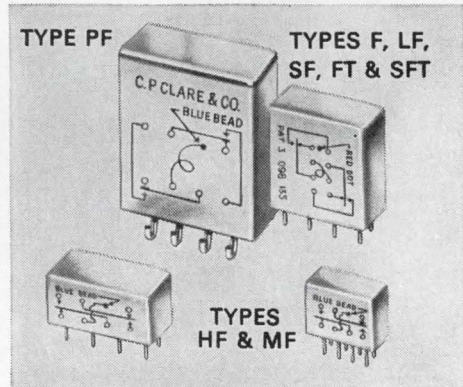

- Clare Military-Type relays include: New 10 amp Type PF, standard size Type F, latching Type LF, sensitive SF, half-size Type HF, one-sixth size Type MF, and Types FT & SFT for noise and thermal voltage problems. All meet appropriate MIL-R-5757D requirements
- Sensitivities from 40 mw
- Versatile contact capabilities . . . low level to 10 amp. Gold-plated contact areas, with high contact pressures and positive wiping action. Bifurcated contacts (F, FT, LF, SF, HF)

CLARE MILITARY-TYPE (crystal can) RELAYS

for airborne, aerospace and ground support equipment,
industrial and commercial control systems

Mating game:

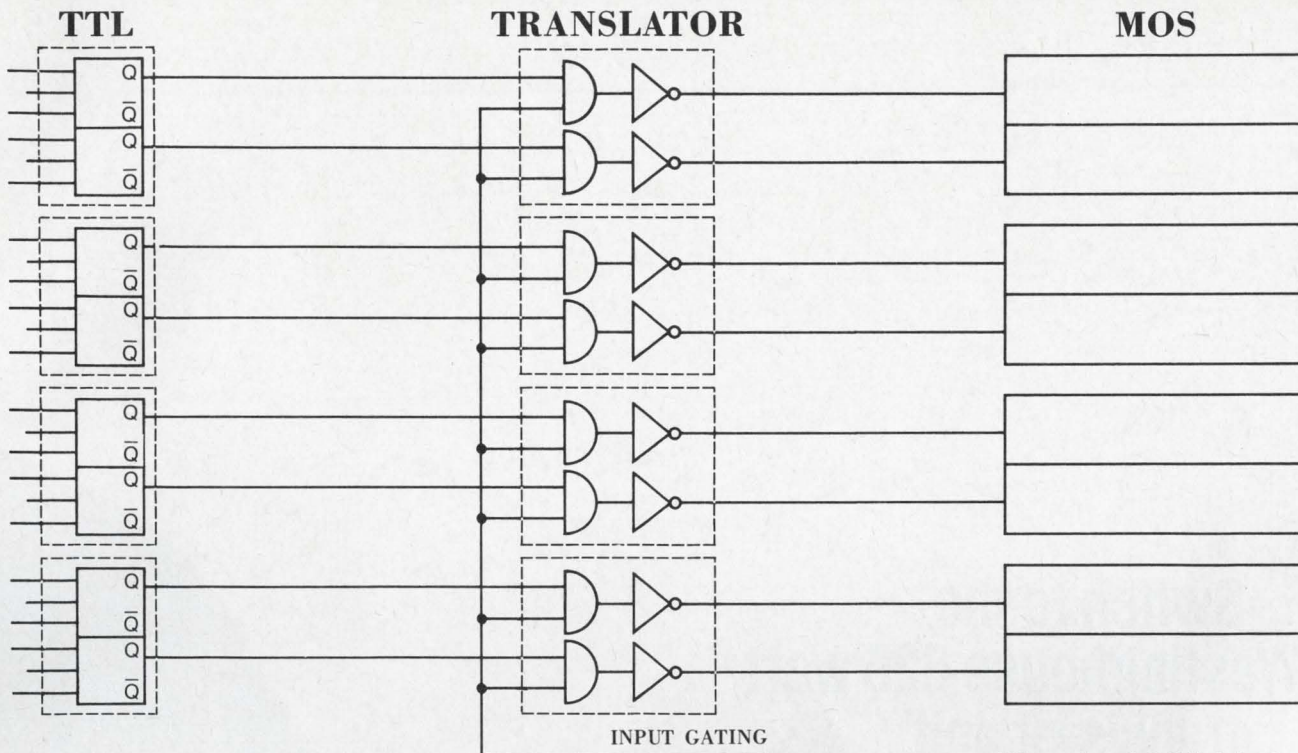

New DM7501 dual JK flip flop used as a TTL shift register for an 8-bit word.

Monolithic.

Hermetically sealed.

SN5473 equivalent.

Price: \$8.80 (100-999), \$4.00 for commercial DM-8501 (SN7473 equivalent).

Immediate delivery.

Circle Number 481.

New DM7800 dual voltage translator to change bi-polar logic voltage levels to MOS logic voltage levels.

Monolithic.

Gated inputs.

Input voltage levels DTL- and TTL-compatible.

Output levels variable between +25V and -25V.

Price: \$15.00 (100-999), \$10.00 for commercial DM-8800.

Immediate delivery.

Circle Number 482.

New dual 100-bit dynamic shift register stores one hundred 8-bit words at 15¢ per bit in electronic "drum" memories.

1 MHz operation.

Price (100-999): \$60.00; MM406 full temp, \$30.00; MM506 commercial.

Immediate delivery.

Circle Number 483.

Data sheets, a list of distributors and a picture postcard of Niagara Falls are yours for the circling.

Or write: National Semiconductor Corporation
2975 San Ysidro Way
Santa Clara, Calif. 95051

National Semiconductor

**Switch to the
Westinghouse 625 watt
transistor and...**

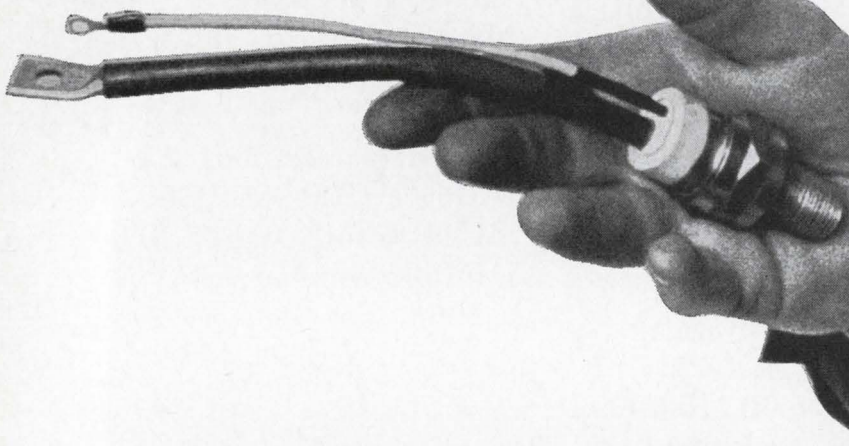

Every 1401 comes with
a unique kind of help:
local engineering
assistance.

Only Westinghouse has semi-
conductor applications specialists
like this Area Manager... in the
field full time to help
solve your technical
problems. Men who give all
customers the kind of service
some people only give to big
customers. Need help? Call
your local Westinghouse Sales
Office. We'll be glad to put
you in touch with your local
Westinghouse Area Manager.

SC-2106

A black and white photograph of a middle-aged man in a dark suit, white shirt, and patterned tie. He is looking towards the camera with a serious expression. His right hand is held out, palm up, and is filled with a large number of small, cylindrical electronic components, likely transistors. The background is a plain, light color.

**eliminate a
fistful of other
components**

The world's largest silicon transistor can make your equipment smaller. Westinghouse Type 1401 gives you 40–140 V_{CEX} and 250 amps I_C in a $\frac{3}{4}$ " stud-mount package.

In high-current applications like fork-lift trucks or electric cars this gives you opportunities to cut weight, space and circuitry cost.

For instance, this one transistor could replace up to ten 30 amp transistors connected in parallel. Or you could switch from SCR to transistor circuitry... and eliminate a fistful of auxiliary components. You'd also eliminate thermal fatigue. Type

1401 has the exclusive Westinghouse compression-bonded encapsulation (CBE). There's no solder connection to the transistor chip, hence no thermal fatigue failure.

If you'd like a 350 watt device, go to our Type 1441. It's just as notable for low saturation voltage, fast switching, CBE construction, and high current

handling as its 625 watt big brother. Make the big

switch to the big transistor. Call

your Westinghouse Semiconductor Distributor for the

Type 1401 and Type 1441 spec sheets. Or write

Westinghouse Semiconductor Division, Youngwood, Pa. 15697.

You can be sure
if it's
Westinghouse



TEKTRONIX

Type 547 sweep-switching oscilloscope

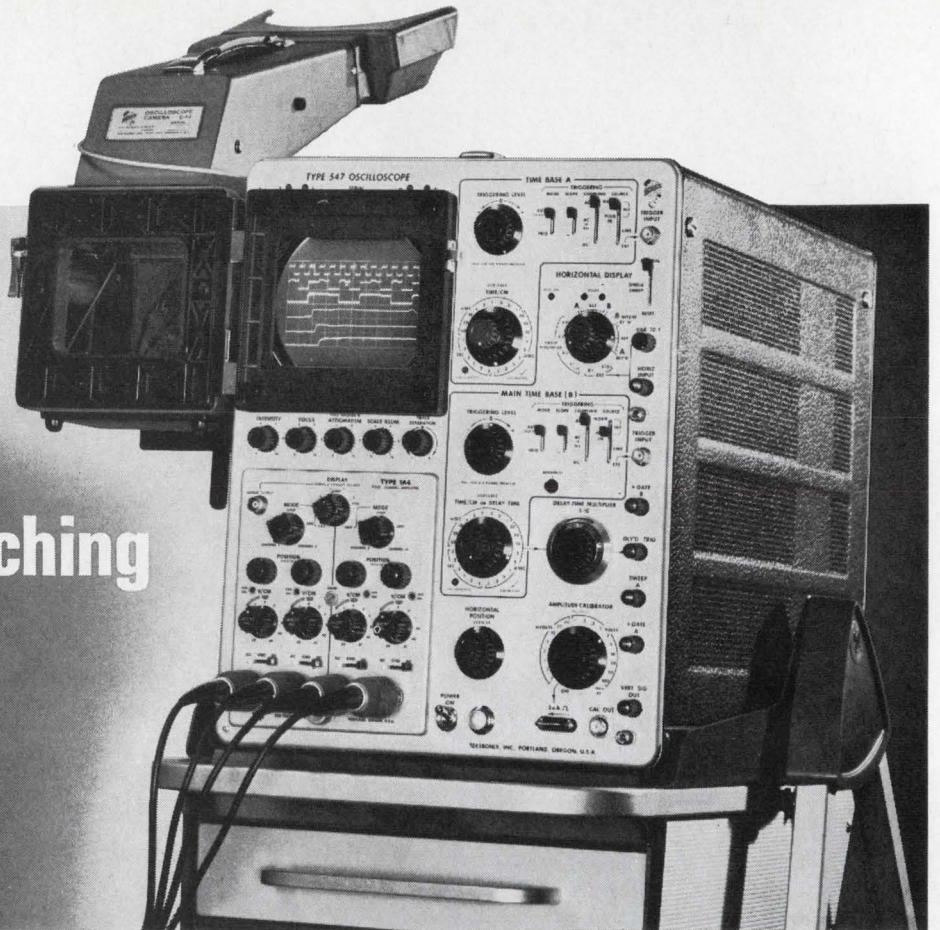

The Tektronix Type 547 is a 50-MHz, 7-ns sweep-switching oscilloscope that offers dual-beam measurement capabilities with most repetitive signals. A complete selection of plug-ins permits you to change your oscilloscope performance to meet your changing needs.

The sweep-switching feature of the Tektronix Type 547 Oscilloscope and the vertical switching of the new Type 1A4 Four-Channel plug-in provide two independent dual-trace oscilloscope systems that time-share the same CRT. The identical sweep systems provide 2% calibration from 5 s/cm to 100 ns/cm, extending to 10 ns/cm ($\pm 5\%$) with the horizontal magnifier. The calibrated sweep delay range is from 100 ns to 50 s and sweep-switching provides alternate displays of the delayed and delaying sweeps.

With the Type 1A4 Four-Channel Plug-in, the Type 547 has a 7-ns risetime and DC-to-50 MHz bandwidth over its 10 mV/cm to 20 V/cm calibrated range. You can also select from 50-MHz dual-trace plug-ins, differential plug-ins with bandwidths to 50 MHz, sub-nanosecond sampling and TDR plug-ins, and four spectrum analyzer plug-ins covering the spectrum from 50 Hz to 10.5 GHz.

Type 547 Sweep-Switching Oscilloscope	\$1875
Type 1A4 Four-Channel Plug-in	\$ 780
Type 1S1 Sampling Plug-in	\$1175
Type 202-2 Scope-Mobile® Cart	\$ 135
Type C-12 Camera	\$ 460
Type C-12 Camera Adapter (016-0226-00)	\$ 15

U. S. Sales Prices FOB Beaverton, Oregon

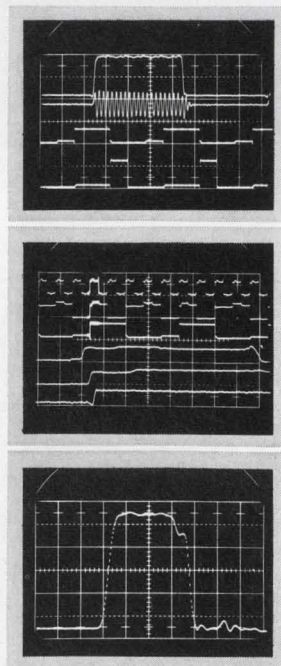

Four Signals—Two Sweeps

Using alternate vertical and horizontal display modes, Ch 1 and Ch 2 are locked to A Sweep (100 ns/cm) and Ch 3 and Ch 4 are locked to B Sweep (2 μ s/cm). This provides dual-beam measurement capabilities with most repetitive signals.

Three Signals—Delayed Sweep

Increased convenience is provided with sweep-switching in the delayed sweep mode. You alternately view both the delaying sweep (2 μ s/cm), intensified by the delayed sweep, and the delayed sweep (100 ns/cm). With the Type 1A4 Plug-in, eight traces can be displayed.

Sampling

More measurement functions are available with the Type 547's complete selection of plug-in units. The Type 1S1 Sampling Plug-in features 0.35-ns risetime, internal triggering and up to 100 ps/cm sweep speed.

For a demonstration, contact your nearby Tektronix field engineer or write: Tektronix, Inc., P. O. Box 500, Beaverton, Oregon 97005.



Multi-trace, differential,
sampling and spectrum analysis

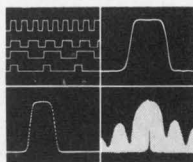

... in all Tektronix 530-540-550-series
plug-in oscilloscopes

Probing the News

Federal budget

An uncertain guide for suppliers

Electronics firms scrutinizing the \$186.1 billion Federal budget may well wonder which way leads to the pot of gold at the end of the Government rainbow. The nation's costly and continuing commitments in Southeast Asia are causing most of the confusion. Planners are simply unable to make long-term arrangements, and must stand ready to shuffle funds from one agency's account to another as new situations arise

Budgets at best represent guesses of outgo and income. President Johnson's proposals for the year beginning July 1, 1968 have the added disadvantage of being based on some rickety premises. As a result, uncertainties surround a number of projects vital to the electronics industry.

Gaining ground. On the plus side, strategic weapons, particularly antiballistic-missile systems, will be underwritten on a substantial basis as will air defense networks. Procurement of the conventional equipment needed to wage limited wars will continue at relatively high levels. The supersonic transport, aviation's stormy petrel, is likewise down for a big increase in funding that is sure to attract some Congressional flak. Military space appropriations are also slated for a healthy rise.

But the honeymoon is over for civilian space activities. Faced with further projected cutbacks, the National Aeronautics and Space Administration is exhibiting remarkable restraint and resiliency, settling for seed money that could produce Apollo-scale programs a few years from now. Outside contractors will be further hurt by the fact that the space agency is preparing to concentrate on in-house projects to keep its teams together during the hiatus.

Aside from the SSR budget boost, the Federal Aviation Administration has little cause for joy. And while the Internal Revenue Service, Federal Bureau of Investigation, and Post Office are down for more money for electronics gear, most civilian agencies are grumbling either about the sharpness of budget cuts or the skimpiness of increases.

I. New deal

For the second straight year, the Administration has produced a rab-

Probing the budget

Military	139
Space	145
Civilian	151
Aviation	155

bit from its fiscal hat, this time the so-called unified budget, a creature of the President's Bipartisan Commission on Budget Concepts.

For fiscal 1968, the White House resurrected the national income accounts budget, a favorite of professional economists that presents a fairly comprehensive picture of the Government's financial activities, including trust funds such as those for highways and Social Security.

The familiar, but less complete, administrative budget is the one for which the Congress voted appropriations; the cash budget simply kept score of income and outgo.

Like last year's version, the unified budget takes into account the transactions of the Government's trust funds. And a happy result of the Administration's latest choice is that in a fiscal year when the funds are expected to show a surplus, the over-all budget deficit is narrowed.

Deficit financing. The deficit of the unified budget equals the difference between receipts and outlays, defined as expenditures plus net lending. In theory then, the deficit now corresponds closely to the amount borrowed from the public in the form of Treasury bills or the securities of other Federal agencies.

In practice, however, the relatively modest budgeted deficit of \$8 billion is based on a number of precarious propositions. On the receipts side, planners assume that the economy will continue to grow vigorously, the long-lingering 10% tax surcharge will be enacted, and Congress will approve a speedup of corporate tax collections, new excise imposts, and transportation user charges it has shunned in the past.

Without passage of tax surcharge legislation, the deficit will soar to over \$20 billion. In addition, necessity may force supplemental appropriations for defense.

Outlays may be underestimated. There is, for example, no provision for the callup of reserves following the seizure of the USS Pueblo, a move draining \$10 million a month from the Treasury's coffers. Nor is there any provision for similar brushfire contingencies that may occur anywhere in the world.

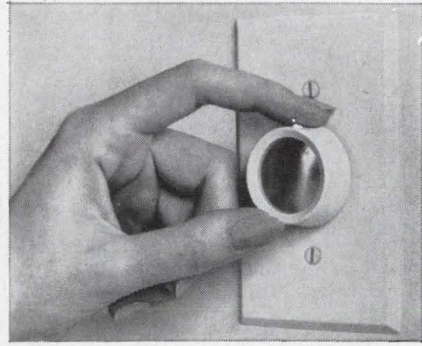

Lutron needed: the best combination of small size, reliability and low cost in capacitors for solid state dimmers.

So Lutron chose: capacitors of MYLAR.[®]

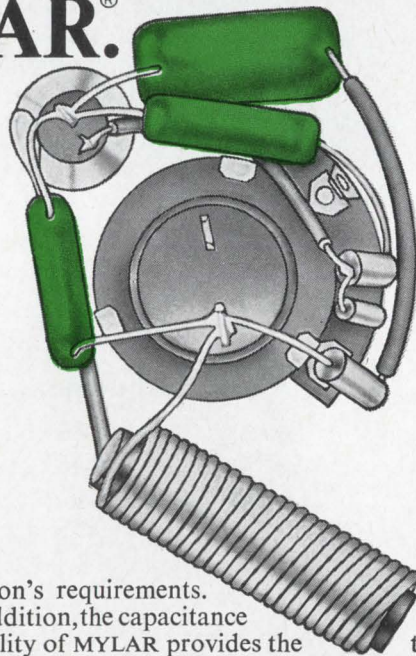

"Only capacitors of MYLAR* give us the size and reliability we must have, and at low cost," says Joseph M. Licata, Chief Engineer, Lutron Electronics Co., Inc.

Lutron's broad line of dimmers is miniaturized to fit single gang boxes for quick, easy installation. Because MYLAR has extremely high dielectric strength in thin gauges, capacitors made from this polyester film can be manufactured small enough to meet

*DU PONT'S REGISTERED TRADEMARK FOR ITS POLYESTER FILM.

Lutron's requirements. In addition, the capacitance stability of MYLAR provides the long-term reliability needed for trouble-free brightness control of all types of incandescent and fluorescent lighting.

Voltage requirements for Lutron's dimmers are 200 to 600 volts, and in many instances these units operate around the clock. Lutron's own tests and experience indicate capacitors of MYLAR

perform well in these conditions, even under extremes of humidity and temperature. Lutron has also found that in many cases, capacitors of MYLAR cost less than paper.

If capacitor size, reliability and price are important to you, check into MYLAR by writing: Du Pont Co.; Room 5742B, Wilmington, Delaware 19898. (In Canada write: Du Pont of Canada, Ltd., P.O. Box 660, Montreal, Quebec.)

Better Things for Better Living...through Chemistry



Encore for Pentagon's juggling act

Defense Department's \$100-billion request for fiscal 1969 pared by almost 25%, planners preparing to reprogram as necessary to meet variety of contingencies

"The armed forces' fiscal 1969 budget requests were the largest amounts asked of anybody by anybody in the history of mankind," says a Defense official.

Pentagon planners are asking Congress to authorize spending \$82.4 billion on the nation's military machine. They would have liked \$101 billion, but what they have been allowed to request is still a "peace-time" record. If the legislators go along—and they usually do on defense programs—\$77.1 billion will be spent during the fiscal year beginning July 1. Spending for electronics is up again, absolutely and as a percentage of the total. An educated guess puts the industry's share for both hardware and research at about 10%.

Eleventh hour. One big reason for the huge budget is that time ran out on deferrals of spending. Since the Kennedy Administration beefed up the strategic missile inventory and the nation shifted from a strategy of massive retaliation to one of controlled response, most electronics buys were tactical. The Vietnam war intensified the need for limited-warfare equipment and it was bought at the cost of updating strategic forces.

That updating can't wait any longer and the need for limited-warfare gear isn't tapering off. So the new budget includes \$9.6 billion for strategic programs, up 15% over last year; and \$35.2 billion, up 7%, for general-purpose forces.

Shell game. Reprogramming, a euphemism for budget juggling, enabled the Pentagon to avoid asking for a whopping supplemental appropriation. Last year, largely because of Southeast Asia Commitments, an additional \$12.3 billion was required. But in fiscal 1969, only a comparatively modest \$800 million is needed to cover a pay raise for military personnel. However, planners may be a little off base. Several legislators complain

that current military spending bears little resemblance to the outlays approved by Congress. Still, it's a good bet the proposed budget will be modified and reprogrammed as circumstances dictate.

I. Strategic defense

Although Robert S. McNamara, retiring Defense Secretary, warned that there can be no absolute protection for civilians in nuclear war, the Pentagon is investing heavily in missile and bomber defense.

Proposed antiballistic missile (ABM) hardware and research will

\$103 million in additional funding.

In a surprise move, the Pentagon is proposing a research program within the Sentinel system to make the Spartan missile effective against the Soviet Union's Fractional Orbit Bombardment System. Defense officials have repeatedly contended that all elements of the Sentinel were to be directed at the Red Chinese, rather than Russian, threat.

Blue yonder. McNamara told Congress the U.S. has not done much to improve its air defense since 1961. The new budget rec-

Defense budget by mission
(Billions of dollars)

	Fiscal 1968	1969
Strategic forces	7.9	9.6
General-purpose forces	32.6	35.2
Intelligence and Communications	5.7	6.3
Airlift and sealift	1.9	1.8
Guard and reserve Forces	2.7	3.0
Research and Development	4.6	5.1
Central supply and maintenance	7.1	7.3
Training, medical, etc.	9.4	9.8
Administration and associated activities	1.6	1.7
Military assistance	2.1	2.7
Total obligational authority	75.6	82.5

cost nearly \$1.5 billion. That excludes charges for site preparation for the Sentinel system. The deployment budget for Sentinel will have \$651 million in new money plus \$229 million left over from fiscal 1968. Development work on the "anti-Red China" weapons system will cost \$313 million.

The Nike-X program, the effort to achieve a more sophisticated ABM system, will be kept alive with \$165 million. And the Advanced Research Projects Agency's Defender ABM program is down for

tifies this. For openers, the Pentagon is proposing a program, costing \$12.3 billion over a period of several years that would incorporate a technically elaborate early-warning aircraft and an interceptor with existing and planned Federal Aviation Administration radars.

The heart of this new system is the Airborne Warning and Control System (Awacs) aircraft which will be built by either the McDonnell Douglas Corp. or the Boeing Co. Awacs planes will carry a down-looking radar system now under

We just took a great step backwards



(with three new, forward-looking unitized DVMs)

Trymetrics' new 4243 Digital Multimeter with AC, DC and OHM readings—auto polarity—full four digit—.01% (\$850) . . . a tremendous step backwards. And so are the 4240 DVM (\$695) and 4230 DVM (\$595).

We started with our Model 4100: stored display—precision .01%, four-digit DVM and its full range of plug-ins for the price of an ordinary 3-digit job—just \$740 with the $\pm 9.999v$ DC head; \$1045 with a complete multimeter head; and eight other plug-ins to choose from. For an encore, the only way to go was down.

Down \$195 to \$850 for the versatile 4243 Digital Multimeter: DC-AC-OHMS .01% — auto polarity $\pm 999.9mv$ to $\pm 999.9v$. Same 4-digit stored display—no plug-ins. Sorry—unless you don't need plug-ins.

Down again, \$155, to \$695, for the 4240 DVM. Same high accuracy, same stored display, same $\pm 999.9mv$ DC to $\pm 999.9v$ DC 4-digit measurements. But, no AC or OHMS—unless, of course you don't need AC or OHMS.

Once more, down, to \$595 for the Trymetrics 4230 DVM. Still the same precise 4-digit unit with readings $\pm 9.999v$ DC to $\pm 999.9v$ DC. Don't buy this one if you need to measure in the low millivolts.

You don't need true 4-digit readout with .01% accuracy at a 3-digit, .05% price? Sorry—but we can't keep backtracking forever. May we send you our new catalog that shows ALL our models, all our plug-in versatility, all our reasons for going backwards?

PRICES SLIGHTLY HIGHER IN EUROPE.

TRYMETRICS
Corporation
A SUBSIDIARY OF TRYGON ELECTRONICS, INC.
204 Babylon Tpke., Roosevelt, L.I., N.Y. 11575
Phone 516-378-2800

. . . the Navy is replacing Polaris with the improved Poseidon . . .

development, which will be able to discriminate between ground clutter and a low-flying bomber.

For an interceptor, the Air Force settled on a modified version of the F-106X built by the General Dynamics Corp. The 11-year-old plane will be outfitted with a new air-to-air missile, the Hughes Aircraft Co.'s Falcon, new radar, communications gear, and command-and-control equipment. The Convair division of General Dynamics will modify inventory planes.

The FAA radars can do little more than give minimal blanket coverage of the U.S. mainland. But the military believes this network, coupled with the high-flying Awacs planes and an experimental back-scatter over-the-horizon radar (OTHR), funded in fiscal 1969, will suffice.

With the back-scatter OTHR, target signals are returned directly to the transmitter site, rather than to receiver stations. Officials say such a system will be more effective than forward-scatter equipment in locating and tracking submarine-launched and air-breathing missiles moving through and below the ionosphere.

II. Strategic offense

The Air Force is seeking to improve its Minuteman missiles even beyond the Minuteman 3's, which are not yet deployed. Production of the 3's is being stretched out. On the basis of last summer's Strat X studies, the service asked

for \$56 million for work on advanced ICBM technology. Areas slated for investigation include multiple targeting, penetration techniques, and counter-counter measures.

The Navy's program to replace Polaris missiles with the improved Poseidon is moving at flank speed. There are funds in the new budget to convert six Polaris ships to accommodate the more complex Poseidon. There are also provisions for advance planning on the conversion of nine other missile-carrying submarines.

The Air Force plans to order the first 75 bomber versions of the F-111 at a total cost of \$550 million. Eventually, the number will swell to 253. But there is little money for the Advanced Manned Strategic Aircraft (AMSA). The money will go for avionics and engine research.

There are also funds to find out how bombers can better penetrate enemy defenses. One such method centers on stand-off missiles like the short-range attack missile (SRAM). This weapon, now in production at Boeing, will be installed on some of the newer B-52's. It was developed for the FB-111, and will be used there too.

III. General-purpose forces

The Army is asking Congress for \$6.4 billion for its procurement accounts, an increase of \$900 million. Research, development, test, and

Department of Defense: Where procurement dollars go (Millions of dollars)

	Fiscal 1968	1969	1969*	1969*
Aircraft	9,368	8,935	25%	2,233
Missiles	2,124	2,670	42	1,121
Ships	1,170	1,651	22	363
Ordnance, vehicles, and related equipment	5,539	6,760	6	406
Electronics and communications	1,380	1,392	92	1,281
Other procurement	1,888	2,036	3	61
Total expenditures	21,469	23,444		5,465

*Electronics share as a percentage and in dollars.

Where defense research dollars go
(Millions of dollars)

	Fiscal 1968	1969
Military sciences	563	659
Aircraft	1,230	1,024
Missiles	2,492	2,543
Astronautics	1,064	1,299
Ships	317	418
Ordnance, vehicles, and related equipment	331	340
Other equipment	956	1,109
Management and support	437	512
Emergency fund	24	125
Total research development testing and evaluation	7,414	8,029
Estimated dollars for electronics	2,374	2,570

evaluation outlays will go up \$208 million to \$1.7 billion—an increase that reflects intensified effort on ABM projects.

The Army's communications-electronics budget is a hefty \$730 million, nearly as high as its aircraft account. As usual, reliable, rugged, and mobile tactical communications equipment for theatre-wide command-and-control applications is high on the list. But part of the money will be used to underwrite the Army's role in the worldwide Strategic Military Communications System.

The Army's aircraft budget is largely earmarked for the electronics-laden Cheyenne armed helicopter, built by the Lockheed Aircraft Corp. This plane will carry an Integrated Helicopter Avionics System (IHAS) computer built by Teledyne Inc. as well as elaborate station-keeping, terrain-avoidance and gun-control systems.

Luck of the Irish. The Army is having trouble with the Shillelagh missile/gun system built by the Philco-Ford Corp., and has decided to withdraw all but a modest amount of production funds until the problems are solved. Reportedly, the difficulties involve the gyro platform. Redeye, an infrared missile, from General Dynamics will be bought in quantity during the year as will Chaparral, a Philco-Ford weapon.

A new antitank missile, the McDonnell Douglas Dragon, will go into advanced production engi-

neering in fiscal 1969. The weapon, formerly known as the Medium Assault Weapon, will have command-controlled, line-of-sight guidance.

The Sam-D (Surface to Air Missile, Development) is in an early stage and will continue to receive a moderate amount of funding. The Raytheon Co. and the Martin-Marietta Corp. have the major contracts on this system, planned to replace the Hercules and Hawk anti-aircraft missiles.

Sea power. The Navy has apparently convinced the White House it needs more of everything; it asks \$9.3 billion, a big jump from 1968's \$7.5 billion.

However, a \$50-million request for 30 F-111B's, built by the Grumman Aircraft Engineering Corp., is sure to draw Congressional flak because of doubts about the aircraft's suitability for carriers. Some insiders believe the Navy may get an okay to scuttle the program. If this happens, the airborne missile control system and the Phoenix missile, both being developed by Hughes, would probably end up in a new, lighter, less costly fighter.

The Grumman A-6A Intruder will be bought by the Navy even though last year's plans called for closing down the assembly lines. Combined Navy-Air Force purchases will come to \$145 million. The Intruder, which is crammed with electronic gear, has had avionics maintenance problems. But work is under way to make servicing easier. As a first step, 4 Pi



What do you do if you're already making the world's broadest line of TEFLON* Tape?

You broaden it.

CHR's new thin TEMP-R-TAPE® HM-350 has low elongation. Plus high breaking strength.

Plus all the advantages of other TEMP-R-TAPES. Like excellent electrical characteristics. And pressure sensitive silicone polymer adhesive. And reliability under a temperature range of -100 F to +500 F.

Find your distributor under CHR in industrial directories and microfilm catalogs. Or write for details and sample: The Connecticut Hard Rubber Company, New Haven, Connecticut 06509.

*T.M. OF DUPONT

CHR®

Subsidiary of
U.S. Polymeric, Inc.

WHERE RELIABILITY & ACCURACY COUNT

INTERNATIONAL PRECISION RADIO CRYSTALS
70 KHz to 160 MHz

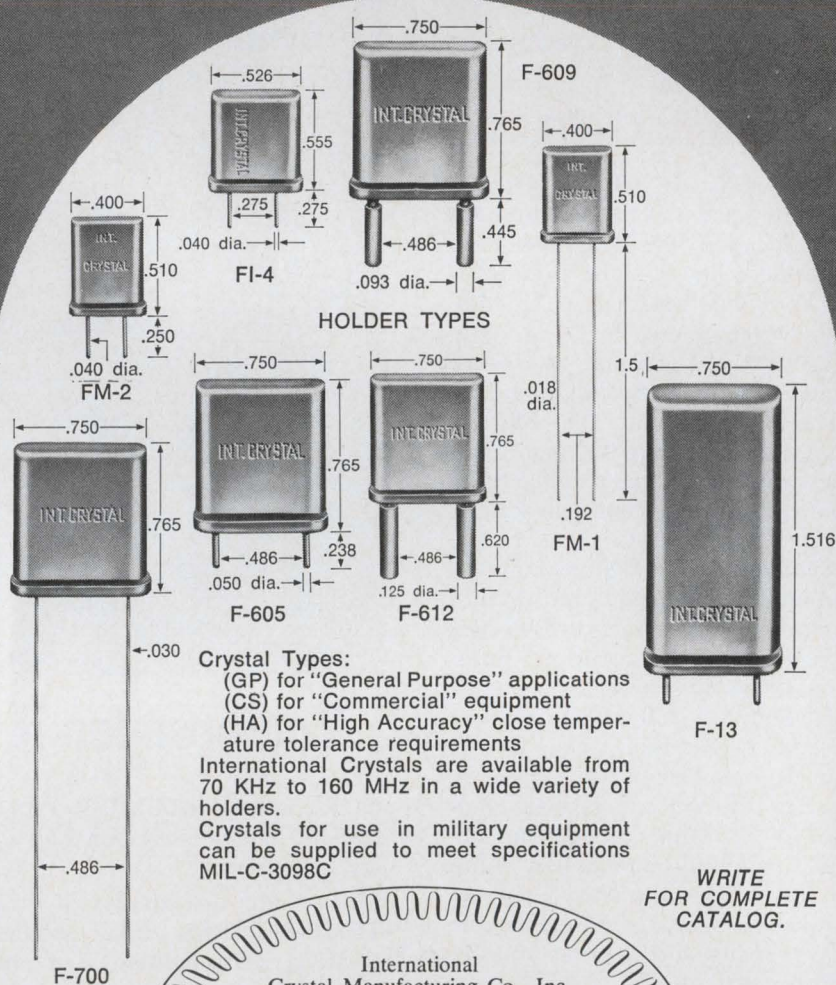

Crystal Types:
(GP) for "General Purpose" applications
(CS) for "Commercial" equipment
(HA) for "High Accuracy" close temperature tolerance requirements
International Crystals are available from 70 KHz to 160 MHz in a wide variety of holders.
Crystals for use in military equipment can be supplied to meet specifications MIL-C-3098C

WRITE FOR COMPLETE CATALOG.

International Crystal Manufacturing Co., Inc. guarantees every crystal against defective materials and workmanship for an unlimited time, when used in equipment for which they were specifically made.

INTERNATIONAL

CRYSTAL MFG. CO., INC.
10 NO. LEE • OKLA. CITY, OKLA. 73102

computers from the International Business Machines Corp. are being installed.

The Navy is cutting back on A-7E's from LTV Inc., but will still spend \$390 million on the plane. Justifying the move, defense officials say improved avionics in the "E" model will enable the pilot to choose from several attack approaches not formerly available, thus increasing the fire power.

De profundis. In antisubmarine warfare, the Navy plans to underwrite the vsx, a four-man, fixed-wing aircraft to replace the aging Grumman S-2. In addition to having greater speed and range, the vsx will be able to monitor more sonobuoys. Lockheed P-3C Orions, fitted with A-New, an integrated asw avionics system, will be bought in quantity. The Orions will also carry the new Mark 46 air-launched torpedoes.

Additional asw money is ticketed for a new family of directional and ranging sonobuoys, called Difar, which officials say will enhance the Navy's ability to detect undersea threats. Sanders Associates Inc. and the Magnavox Co. are making the first technical studies.

For now, the Pentagon has given up on buying 100 fast deployment logistic ships at a crack. But there's money in the budget to finance four FDL's to be built by Litton Industries Inc. Meanwhile, officials continue to make a strong pitch for "total package" procurement of naval vessels on the grounds such a policy would encourage private shipyards to automate.

Air power. The Air Force's tab for research, development, test, and evaluation will go up \$200 million to \$3.4 billion, largely because of higher outlays for the Manned Orbiting Laboratory, Awacs, and the rx tactical fighter plane.

The Air Force will invest \$1.1 billion in 163 General Dynamics' F-111A and F-111D fighters. The "D" model will be equipped with the North American Rockwell Corp.'s Mark 2 avionics system. The first production run on Lockheed's giant C-5A galaxie transport will account for another \$500 million.

Tactical missiles, including an improved Shrike, from Texas Instruments Incorporated and North American's standard ARM-2, both

of which home in on radars, will be funded as will Boeing's SRAM—a bomber stand-off weapons system—and Martin's AGM-79/80A, a version of the air-to-ground Bullpup with area correlation guidance. The Chrysler Corp.'s inertially guided Bullpup the AGM-80A is also down for funds. Both Bullpups are being tested and evaluated.

Fast shuffle. Advanced development work is almost complete on a set of reconnaissance packages that can be placed in an F-111 airframe on pallets, giving them a quick-change capability for either reconnaissance or fighter missions. The Air Force plans to buy some of the sets.

In the ECM area, EB-66's and EC-47's will be equipped with tactical electronic warfare support (TEWS)—a system for active and passive electronic countermeasure operations as well as airborne radio direction and paramilitary communications countermeasures. The system is being developed in-house, but Air Force officials hope to request bids within six months.

IV. Command centers.

The Defense Department also wants to spend \$6.3 billion on intelligence and communications. According to Pentagon figures, this represents a moderate increase over the 1968 level of \$5.7 billion. But exact comparisons are difficult since listed items change from year to year. For example, there is a new category called "Specialized Activities" which has the money for the National Military Command Center (the Pentagon's "War Room"), a worldwide command-and-control network. Money is needed for data processing equipment and communications links.

The alternate command posts afloat—two ships off the Atlantic Coast—will also be given additional new data processing equipment. And a new tropospheric-scatter communications station will be built in North Carolina to extend the vessels' operating range.

Work will also continue on improving the automatic data and voice switches that provide worldwide communications links for the military services. The Southeast Asia Integrated Wideband Communications System will also be further improved.

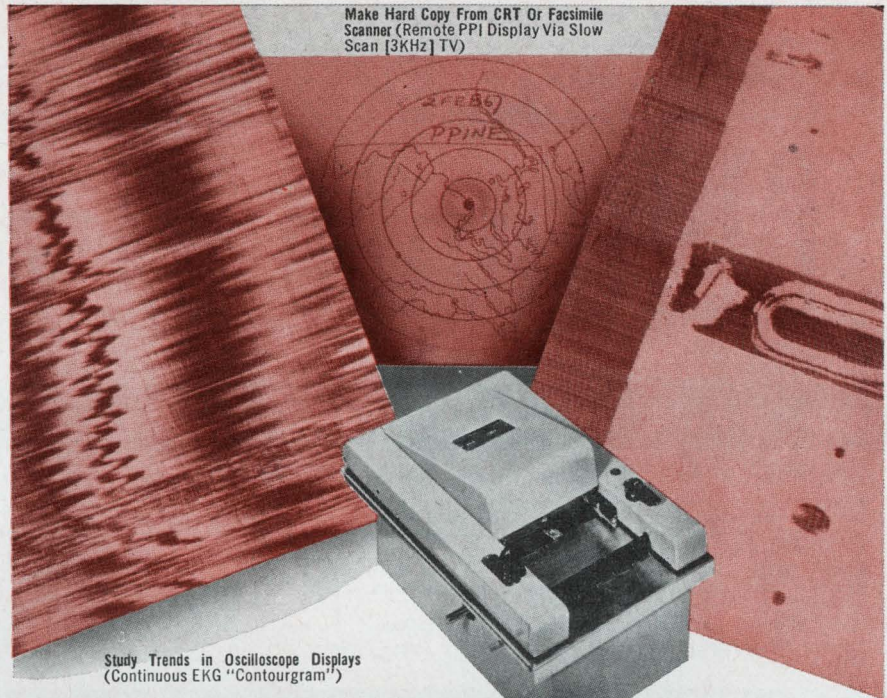

Make Hard Copy From CRT Or Facsimile Scanner (Remote PPI Display Via Slow Scan [3KHz] TV)

Study Trends in Oscilloscope Displays (Continuous EKG "Contourgram")

Plot From Scanning Sensors For Detection And Inspection (Ultrasonic Inspection For Bond Flaws)

PATTERN, PLOT OR PICTURE

Now . . . with a simple instrument . . . you can reproduce electrical phenomena as permanent records in pattern, plot, or picture form where otherwise the data is presented as transient oscilloscope or CRT displays.

The versatile Alden "Flying-Spot" Helix Recorder, used with Alfax Type A electro-sensitive paper, produces permanent graphic images of repetitive or sequential signals with a wealth of detail and information content not approached by other display and recording techniques.

It is a simple matter to synchronize the Alden Recorder with scanning sensor or transducer (sonar, radar, ultrasonic, infra-red detectors, etc.) to provide a continuous "plot" of the information obtained. The recorder sweep speed (horizontal output) can be varied to provide almost any desired rate of presentation. Paper advance rates can readily be changed to provide time expansion or compression for increased detail, or clearer representation of long-term data trends and improved signal-to-noise ratio.

The Alden Recorder can be used with a broad variety of systems (computers, television, medical instrumentation, facsimile, scanning radiometers, etc.) which produce sequential signals on a constant time base, to provide accurate and instantly visible "picture" or "pattern" information. Images are produced with a dynamic, tonal shading directly proportional to signal strength, providing a "third dimension" of information recording.

To satisfy your exact requirements, Alden "Flying-Spot" Component Recorders, in various printing widths from 4" to 48", along with a wide selection of plug-in drives, recording configurations, signal amplifiers, phasing circuits, and synchronizing accessories are available, designed to provide a simple, economical adaptation of Alden instant recording techniques to your instrumentation.

ALDEN
ELECTRONICS & IMPULSE RECORDING EQUIPMENT CO., INC.

For more information on the most versatile data recorders available, write today for complete details.

Dept. E-2

WASHINGTON STREET, WESTBORO, MASSACHUSETTS 01581 — TELEPHONE: (617) 366-4467

ALDEN ELECTRONICS & IMPULSE RECORDING EQUIPMENT CO., INC., WASHINGTON STREET, WESTBORO, MASSACHUSETTS 01581

GENTLEMEN: I am interested in Alden "Flying-Spot" recording techniques.

I would like to investigate Alden Equipment for use in the following application:

I would like data for possible future reference.

NAME _____ TITLE _____

COMPANY _____

ADDRESS _____

CITY _____ STATE _____ ZIP CODE _____

For Capacitors with **GREATER RELIABILITY . . .**

Choose
EL-Menco

*The Capacitors You
Find Wherever
There's Electronics!*

EL-MENCO DUR-MICA CAPACITORS

Only 1 Failure Per 43,000,000 Unit-Hours!

- It has been computed that "debugged" DM30, 10,000 MMF units, when subjected to 257,000 hours of life at 85°C with 100% of the rated DC voltage applied, will yield only 1 FAILURE PER 43,000,000 UNIT-HOURS!
- DM15, DM16, DM19, DM20 . . . perfect for miniaturization and for new designs using printed wiring circuits. Also available in DM30, DM42 and DM43.
- New "hairpin" parallel leads insure easy application. Exceed all electrical requirements of military specification MIL-C-5A.

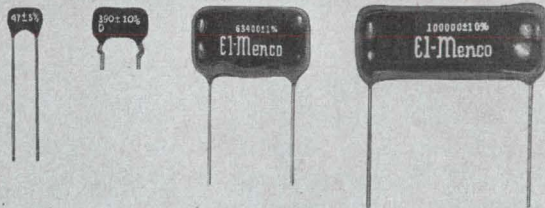

EL-MENCO TRIMMERS & PADDERS

Design Versatility!

- Available in 350 VDC and 500 VDC as well as other test voltages.
- All bases are of low-loss steatite.
- Special lugs are obtainable for printed circuitry.
- Miniature units are available.
- Solder Lugs can be bent in any position without affecting the capacity setting due to the rigid construction.
- Various types of mounting brackets are available for all trimmers.
- Units can be constructed for special applications.

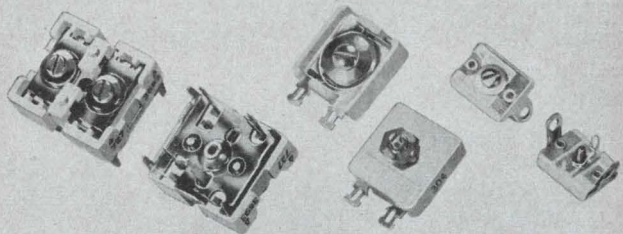

EL-MENCO *MYLAR-PAPER DIPPED CAPACITORS

Only 1 Failure in 14,336,000 Unit-Hours!

- Life tests at 105°C with rated voltage applied have yielded only 1 FAILURE PER 1,433,600 UNIT-HOURS for 1 MFD. Since the number of unit-hours for these capacitors is inversely proportional to the capacitance, 0.1 MFD Mylar-Paper Dipped capacitors will yield only 1 FAILURE PER 14,336,000 UNIT-HOURS!
- Working volts DC: 200, 400, 600, 1000 and 1600.
- Durez phenolic resin impregnated.
- Tolerances: $\pm 10\%$ and $\pm 20\%$ (closer tolerances available).
- Dielectric strength: 2 or 2½ times rated voltage, depending upon working voltage.
- Exceed all electrical requirements of E.I.A. specification RS-164 and military specifications MIL-C-91A and MIL-C-25A.

*Registered Trademark of DuPont Co.

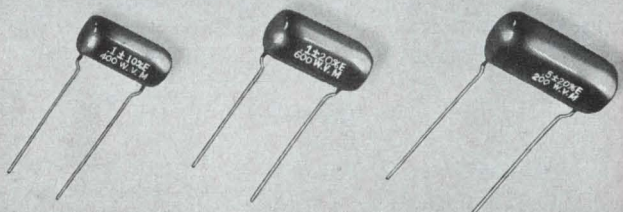

EL-MENCO MOLDED MICA CAPACITORS

Superior Performance!

- Unmatched for excellent stability, dielectric strength, high insulation resistance, extremely high "Q" and correspondingly low power factor.
- Units can be subjected to a short "debugging" life test at elevated voltage and temperature for removal of early life failures and for improved reliability.

*Write for Free Samples and Booklets
on Any of The Above Capacitors*

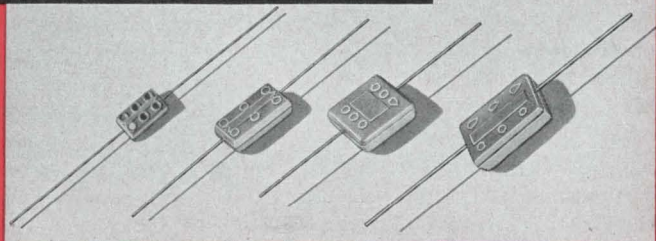

EL-MENCO OFFERS A COMPLETE LINE OF CAPACITORS . . . STANDS READY TO SERVE ALL YOUR CAPACITOR NEEDS

THE ELECTRO MOTIVE MFG. CO., INC.
WILLIMANTIC, CONNECTICUT

*Dipped Mica • Molded Mica • Silvered Mica Films • Mica Trimmers & Padders
Mylar-Paper Dipped • Paper Dipped • Mylar Dipped • Tubular Paper*

West Coast Manufacturers contact: **COLLINS & HYDE CO.**, 900 N. San Antonio Rd., Los Altos, California 94022
5380 Whittier Blvd., Los Angeles, California 90022

ALSO SOLD NATIONALLY THROUGH ELECTRONIC PARTS DISTRIBUTORS

MANUFACTURERS OF
EL-Menco
Capacitors

NASA seeks to fill post-Apollo void

Military outlays will climb, but space agency's countdown next year will be in dollars; retained programs have follow-on potential, though

The space agency is seeking its smallest budget in five years—\$4.37 billion. This is \$220 million less than the fiscal 1968 level and \$1.3 billion below the peak of fiscal 1966. While space certainly won't be a growth market for the electronics industry during the next couple of years, the National Aeronautical and Space Administration has done a remarkable job of setting up a base for a continuing major effort during the 1970's. Reductions in spending will mean the post-Apollo program won't start as fast as its predecessor did in the early 1960's. But the way NASA has allocated its fiscal 1969 funds paves the way for a program easily as big.

Space agency officials didn't get all they wanted from the Budget Bureau, but they're generally pleased. "There's enough to provide for growth in technology, which is essential to keep the space program alive," one says. "And the funds have been strategically placed to keep the space program moving in as many areas as possible," a Goddard manager adds.

Life insurance. Despite its size, the proposed budget insures survival of the space program and of the NASA team into the 1970's. The latter achievement comes partly at the expense of industry. But, while the agency sold most of its package to the White House, Congress is sure to do some paring, and the likely funds to cut are the seeds for new programs.

The agency's Congressional strategy is clear. James E. Webb, NASA's chief, told the House Science and Astronautics Committee that the U.S. can expect to be surpassed in space by the Soviets in the near future. He said Soviet manned spaceflights would begin shortly and predicted that the Russians will land instrument packages on Mars in 1969 and 1971. Webb urged Congress not to make any cuts in

the new budget and any increase in Russian activity could well serve to make Congress heed him.

Family spirit. The space agency's supplier's will not only carve up a smaller pie, but will also get a thinner slice. Last year, 94 cents of every dollar spent by NASA went outside the agency, "but this is apt to come down to something like 85 to 88 cents very shortly, and could go lower than that depending on the size of the budget," says Webb.

One reason is NASA's decision to do more work in-house. This course will let NASA retain most of its present staff even with the slimmer budget. By the end of fiscal 1968, NASA's well-publicized layoffs will total 1,300. However, no further cuts are anticipated. In fact, the agency proposes to increase its staff by 300 to 32,727.

In its new budget, NASA is again trying to get its post-Apollo program out of low gear. However,

Congress will probably apply some brakes. The space agency seeks \$439.6 million for the Apollo Applications Program (AAP)—about the same as was requested last year and then cut back to \$253 million.

Outlays for Apollo, the manned space program of the 1960's, are slated to drop \$520 million to \$2.04 billion in fiscal 1969. This is about the only R&D money sure to be approved by Congress. While the spacecraft fire last year delayed the entire flight program about nine months, NASA still hopes to put men on the moon by late next year.

After the first moon landing, all Apollo hardware, including spacecraft and boosters, will be shifted to Apollo Applications. Plans then call for two moon launches a year. Total costs of AAP through 1973 will be \$4 billion to \$6 billion.

Next step. A significant new start is being sought next year in the other half of the AAP—near-earth

NASA research and development

(Millions of dollars)

	Fiscal 1968	1969
Manned space flight	2,809.20	2,483.40
Apollo	2,556.00	2,038.80
Apollo applications	253.20	439.60
Advanced mission studies	—	5.00
Space science and applications	552.85	538.20
Advanced research and technology	318.70	336.80
Basic research	21.47	22.00
Space vehicle systems	35.00	35.30
Electronics systems	39.20	39.40
Human factor systems	20.98	21.70
Space power/electric propulsion systems	44.00	44.80
Nuclear rockets	54.00	60.00
Chemical propulsion	37.25	36.70
Aeronautical vehicles	66.80	76.90
Tracking and data acquisition	275.85	304.80
University affairs	10.00	10.00
Technology utilization	4.00	4.00
Total new obligational authority	3,970.60	3,677.20

Application For

FET SWITCHES

PROBLEM: Sample and Hold Circuit

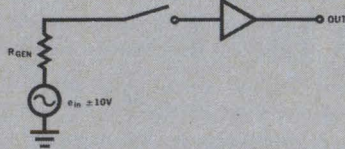

Siliconix assumes no responsibility for the circuit shown, nor do they represent or warrant that it does not infringe any patents.

REQUIRED - Circuit that will sample e_{in} with a 200 ns aperture . . . and hold sample 0.01 sec. minimum.

GIVEN

$e_{in} \pm 10V$. . .
Available supply voltages $\pm 15V$. . .
 R_{GEN} 25 ohms . . .

SOLUTION - FET switch and FET source follower

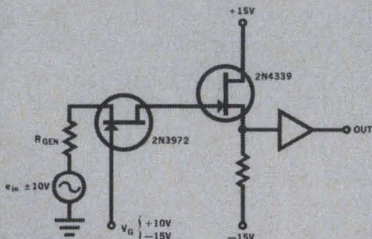

Siliconix assumes no responsibility for the circuit shown, nor do they represent or warrant that it does not infringe any patents.

FET switch used - 2N3972 with V_P less than 3V and r_{ds} below 100 ohms.

Gate drive to turn ON . . . +10V
to turn OFF . . . -15V

(2N4339 used as source follower for high input impedance.)

Tough switching job ahead? Contact us for applications assistance and our free FET switch data packet.



Siliconix incorporated

1140 W. Evelyn Ave. • Sunnyvale, CA 94086
Phone (408) 245-1000 • TWX: 910-339-9216

NASA spending (Millions of dollars)

	Fiscal 1968	1969
Research and development	3,910.60	3,677.20
Construction of facilities	37.80	45.00
Administrative operations	640.37	648.20
Total new obligational authority	4,588.77	4,370.40

missions—which might produce the long-sought earth orbiting station. Now being defined, the Saturn V workshop could, if all goes well, be launched by late 1972.

The Saturn 1 orbital workshop, now being built by McDonnell Douglas, is the third, or S4B, stage of the booster that will be used as a fuel tank in the launching. It will be outfitted with interior equipment in orbit. Originally scheduled to go in 1969, the project is now set for 1970.

Addenda. The advanced Saturn 5 workshop will use the same stage, but this S4B will be outfitted and equipped on the ground and flown into orbit. NASA has a major role in developing both workshops. The Marshall Space Flight Center, which is running the program, plans to include an integral Apollo telescope mount that would be flown into orbit inside the workshop.

Trying to avoid any talk of competition with the Air Force and its Manned Orbiting Laboratory, Webb points out that NASA's orbiting labs could be used by the military.

Hardware development is well underway for the 1971 AAP mission, when the Apollo Telescope Mount will rendezvous with the workshop already in orbit. Three revisits using the Apollo command service module are planned.

Space officials are asking \$5 million for studies to define both the space station and logistical support vehicle for advanced manned missions.

I. Limited goals

The space agency has been having its problems getting an unmanned planetary exploration program off the ground for the 1970's. Planners are proposing a truly austere outlay here—\$38 million.

The scaled-down proposal has been designed to provide a spring-

board for major programs later. Voyager is dead—at least for the moment—and Webb takes pains to emphasize that the extended Mariner program, slated for 1971 and 1973 missions, will cost only \$500 million, or about a quarter of the sum projected for Voyager. What Webb doesn't say is that follow-on activities—Voyager-type planetary soft landers, for example—could put Mariner in the same high-rent district.

The 1971 Mariner will be essentially the same as that to be used in 1969. It won't be able to accomplish as much as was anticipated from Voyager, but the 1971 version, for which NASA wants \$18 million in fiscal 1969, will be able to orbit Mars rather than simply fly by it. The 1973 Mariner, for which NASA wants \$20 million, will have an 800-pound rough lander carrying 20 to 25 pounds of instruments to send atmospheric measurements and some television pictures back to earth.

Odds and ends. Officials decided to drop NASA's big geophysical laboratory after the sixth craft and to pick up part of the research work done previously with smaller Explorer satellites. Atmospheric Explorers C and D have been added and the program is scheduled to grow by \$6 million. The rise also reflects the start in fiscal 1969 of the Sun Blazer program, delayed from this year. Two follow-on Pioneer craft, the F and G, equipped with despun antennas for flights near Jupiter, have also been added.

There's money for phase-B studies of the Astra program, an advanced astronomy system. About \$10 million of the \$32 million requested for the Nimbus program will go for hardware on two new craft, the E for a 1972 launch and the F for 1973. Some 30 requests for proposals will be issued later this year for new subsystems and experiment

packages. The General Electric Co. is currently the prime contractor.

Work will begin on two new Applications Technology Satellites, the F model for 1970 and the G model for 1971, boosting ATS funding by \$5.6 million. The Hughes Aircraft Co. is building the first five ATS craft, but the two new models will be treated as a new buy.

The earth resources program is down for \$12.2 million—\$10 million for sensor development and the rest for studies of a new satellite. There's also a \$400,000 increase in funding for the geodetic satellite program. A Goes-B-type craft will be converted for a 1969 flight as the third launch in the program.

II. Inching ahead

Advanced research and development activities are down for a com-

paratively moderate \$18 million gain from this year to \$336 million.

Aeronautics work is in the ascendancy; the space agency is seeking \$79.6 million, against \$66.8 million last year. Vertical short takeoff and landing technology, all-weather landing systems, and jet noise abatement schemes will get the emphasis.

Hiring hall. The addition of 150 employees to the staff at NASA's Electronics Research Center in Cambridge, Mass., will also sop up research funds. Mac C. Adams, who heads the space agency's Office of Advanced Research and Technology, says the center still lacks some technical personnel and is moving to find them. There are no new programs at ERC, but neither are there any dropouts. With a fiscal 1969 research budget of about \$20 mil-

NASA space sciences and applications (Millions of dollars)

	Fiscal 1968	1969
Physics and astronomy	142.95	141.90
Supporting research/technology	23.05	25.30
Solar observatories	12.10	12.00
Astronomical observatories	40.40	35.20
Geophysical observatories	20.20	13.20
Pioneer	7.00	6.00
Explorers	17.30	23.20
Sounding rockets	20.00	22.00
Data analysis	2.90	5.00
Lunar and planetary exploration	141.50*	107.30
Supporting research/technology	19.80	30.00
Advanced planetary studies	12.00	6.70
Data analysis	0.60	2.60
Mariner Mars 1969	59.20	30.00
Mariner Mars 1971	—	18.00
Titan Mars 1973	—	20.00
Launch vehicle procurement	127.10	128.30
Supporting research/technology	4.00	4.00
Scout	10.20	16.50
Delta	30.30	30.80
Agena	14.40	14.00
Centaur	68.20	63.00
Bioscience	41.80	48.50
Supporting research/technology	11.80	16.00
Biosatellites	30.00	32.50
Space applications	99.50	112.20
Supporting research/technology	19.30	23.80
TIROS/TOS improvements	9.10	5.80
Nimbus	33.70	32.10
Meteorological soundings	3.00	3.00
International applications satellites	0.10	0.10
Applications technology satellites	25.60	31.20
Geodetic satellites	3.40	4.00
Earth resources survey	5.30	12.20

*This total also includes programs not in the fiscal 1969 budget: Surveyor, Lunar Orbiter and Mariner 4 and 5.

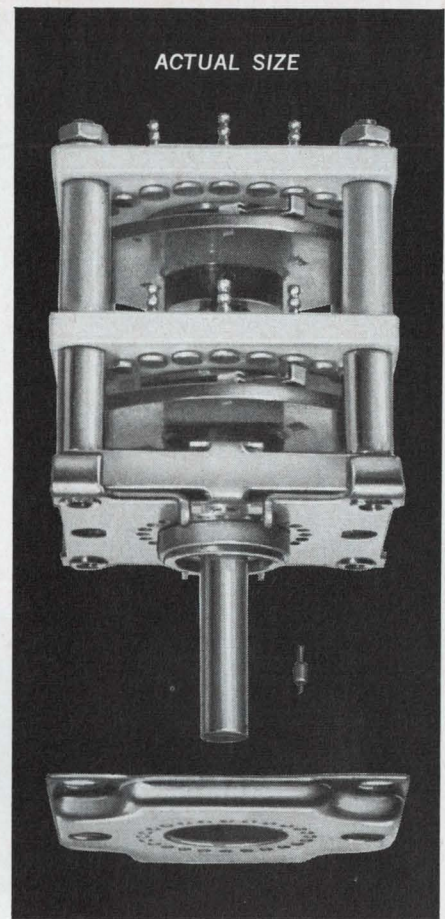

new switch, same prices

New all through — a brand new design has replaced our former series "C" rotary selector switches.

The customer-adjustable stop is only one of many new features offered at no additional cost. Your personal files on MIL-S-3786.14A, STYLE SR-14 switches is out of date if it doesn't include our new series "C" Catalog. Write, phone or TWX Daven — We build switches like no one else can!

DAVEN 

DIVISION OF THOMAS A. EDISON INDUSTRIES
GRENIER FIELD, MANCHESTER, N.H. 03103
(603) 669-0940 • TWX 603-623-4938



digital to resolver/synchro converters ... here's the next generation!

North Atlantic now brings you a new generation of solid-state digital-to-analog converters. They offer major advances in resolver/synchro conversion accuracy along with drift-free and stable performance unobtainable with currently available resistor/amplifier devices.

Typical of these new instruments are the Model 536 D/R and Model 537 D/S "shoebox" converters (11-13 bit) and the Model 538 D/R-S converter (14-17 bit). Both models use solid-state switched trigonometric transformers and feature input data storage registers thereby saving computer time. Conversion speed exceeds 10 microseconds. Built-in overload and short circuit protection assures trouble-free system integration and reliable on-line performance.

Your North Atlantic representative (see EEM) has complete specifications and application information. He'll be glad to show you how these new converters can be the answer to critical interface problems.



NORTH ATLANTIC industries, inc.
TERMINAL DRIVE, PLAINVIEW, NEW YORK 11803 • 516-681-8600

... tracking facilities get a 10% boost in funds ...

lion, the center will continue to work on guidance systems, automatic controls, cockpit displays, multiprocessors, microelectronics, solid state physics, and large-scale integration.

A NASA office whose request last year for 10% more money was chopped to a boost of just 2% is back asking for another 10% hike. Tracking and data acquisition activities are down for \$29 million more to cover operating costs that are growing fast as a result of the Apollo program. The complete manned-flight network of 11 ground stations, five ships, and eight aircraft will be in operation by June. Money allocated for equipment will rise about 5% to \$52.2 million in fiscal 1969, though, partly because of the need for special data processing gear to handle future spacecraft.

Almost half of NASA's construction outlays in next year's budget will go to three major tracking projects.

Deep dish. A step toward completion of a worldwide deep-space network of 210-foot antenna stations will be made next year; \$17 million is earmarked for the initial stages of building giant dishes at Canberra, Australia, and Madrid, Spain. Another \$17 million will be needed in fiscal 1970 to complete the two stations, which—along with the first 210-foot antenna now working at Goldstone, Calif.—will provide continuous tracking of deep space probes. Work must begin next year so the stations can support the 1973 Titan Mars mission. The successful Goldstone dish was designed and built by the Rohr Corp., with the Dalmo Victor Co. providing the servo and control systems.

Another \$3 million is in the budget for a phased-array antenna to support the new Sun Blazer program, postponed from fiscal 1968. The array will be at Goldstone. The third tracking project will upgrade the power facility at the heavily loaded Alaskan station.

III. Where the action is

The Pentagon submitted a record space request of \$2.2 billion—\$267

million above the year-earlier level. The Air Force's Manned Orbiting Laboratory accounts for a big chunk of this. Annual funding will peak at \$600 million in fiscal 1969; fiscal 1968 outlays were programed at only \$430 million.

The military is going all out to advance space guidance techniques and equipment. Principal goals are improvement of such self-contained packages as inertial systems, horizon sensors, and star trackers.

Another space program, called Project Pilot is planned by the Defense Department. Research work will center on developing ways to bring a man-carrying spacecraft down from orbit for a landing on a conventional air strip.

Communications satellites, both long-haul and tactical, are down for \$60.4 million. This summer, the military plans to launch a Hughes-built multiaccess tactical repeater that can send and receive in both uhf and shf bands.

Supersnoop. A satellite-borne missile warning system with a multisensor capacity that includes infrared detection will be funded in fiscal 1969. The year-old project, simply called Program 266, is a follow-on to Midas, a highly secret effort started and abandoned during the early 1960's. The Air Force has awarded a contract to TRW Inc.'s Systems group to develop the spy craft; the Aerojet-General Corp. will build the sensor package.

Additional military space money is ticketed for reconnaissance, navigation, and nuclear satellites. There will also be funds to develop the Titan and Agena boosters, and a good many dollars for investment in modernizing and operating ground-support equipment.

Quintet. Five other agencies, besides NASA and the military, are after space funds. Their request scale upward from the modest \$600,000 sought by the Department of Agriculture to the big-time \$150 million asked by the Atomic Energy Commission. On an overall basis, the five want \$190.9 million, a slight increase over the \$186.8 million appropriated in fiscal 1968.

Requests for space funds from all branches of the U.S. Government add up to \$6.825 billion, a \$176-million advance from the \$6.749 billion approved for fiscal 1968.

Dust Detective



The new Bausch & Lomb Aerosol Dust Counting System keeps a watch on dust in your clean room. Airborne contamination is detected, counted and recorded . . . automatically, accurately, dependably. Particles of different refractive indexes are correctly sized the only accurate way . . . using near-forward light scattering. The efficient concentric optical system can classify particles of any shape and orientation by equivalent diameter. Any particle concentration—up to one million per cubic foot—is read and printed directly. Response is instantaneous. Counts all particles greater than the preset size. Seven presettable sizes can be selected—0.3, 0.5, 1.0, 2.0, 3.0, 5.0, and 10 microns. And, surprisingly, this superior system is priced far below any other commercial unit. Ask for our new Catalog 38-2190 . . . it has the full story. Write Bausch & Lomb, 61402 Bausch Street, Rochester, N.Y. 14602.

BAUSCH & LOMB 
ANALYTICAL SYSTEMS DIVISION

Circle 149 on reader service card

THE MOST COMPLETE RANGE
IN THE WORLD
OF U.H.F. CERAMIC-METAL
TETRODES

In operation for more than
5 YEARS
on more than
500

low and high power U.H.F.
television transmitters
and translators

HIGH GAIN U.H.F. TETRODES UP TO 1000 Mcs

THOMSON TH-HB HOUSTON

... a trusted name

OUTSTANDING PERFORMANCES
IN SSB COMMUNICATIONS — TROPOSPHERIC SCATTER LINKS — RADARS



COMPACTNESS



RUGGEDNESS



THE MOST ADVANCED TECHNOLOGY * — THE LOWEST OPERATION COST

HIGH LINEARITY



LONG LIFE

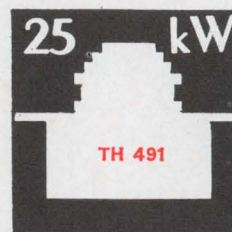

VAPOR COOLED

HIGH RELIABILITY

* Special grids patented

ASK FOR SPECIFIC DATA SHEETS

THOMSON HOUSTON - HOTCHKISS BRANDT

ELECTRON TUBE DIVISION 8, RUE CHASSELOUP-LAUBAT - PARIS XV^e - FRANCE - TÉL. : 566.70.04
THOMSON ELECTRIC Co INC. 50 ROCKEFELLER PLAZA · ROOM 916 NEW-YORK, 10020 N.Y. U.S.A. · Phone : (212)245.3900

War puts agencies on short rations

Internal Revenue Service, Justice Department, and Post Office are exceptions to the belt-tightening rule; FCC still trying to spend its 1968 research money

"Had again," says H.R.J. Gross, who directs the Center for Computer Sciences and Technology at the Bureau of Standards, when asked how his department fared in the budget for fiscal 1969. Similar sentiments are expressed by officials at other Government agencies not involved in the Vietnam war.

There are a few exceptions. The Justice Department and the Internal Revenue Service are optimistic about their requests, which have already survived the Bureau of the Budget's jaundiced look. But most civilian agencies, especially those oriented toward research and development, are at the Wailing Wall.

Scholarship cases. The National Science Foundation, long a champion of computer-aided instruction, was forced to settle for a \$23 million request, a scant \$2.1 million above fiscal 1968. Most of the money is earmarked for software projects. "The immediate goal is to get science and engineering students to learn to be at home on the machines," says an official. "Later on, when we have more money, we'll extend our program to other disciplines."

Eric is here. The Office of Education, which received a \$2.4 million windfall for its new Educational Resources Information Centers (ERIC) during fiscal 1968, asked for only a \$3.1 million allocation this time around. That's barely enough to keep the program going. The agency has also budgeted several million dollars for grants to let universities and secondary schools install educational television.

The National Institutes of Health, hit hard by 1968 rollbacks, is in for another rough time. "It's 1968 all over again," says an administrator. One bright light, however, is a new program in biomedical engineering, which has obtained Budget Bureau approval for \$1 million in seed money for research on diagnostic equipment and related

areas of technology.

In the increasingly vogueish area of consumer protection, the Radiological Health Center of the Public Health Service has almost finished developing an automated collimator for medical X-ray machines. Now it must wait for Congress to act on two radiation control bills. If either pass—a good bet—the bureaucratic fallout in the color television industry will be heavy. Presumably, the PHS will get a piece of the action.

I. Justice for all

At the Justice Department, things look better. The Office of Law Enforcement Assistance (OLEA) is asking \$20 million, a \$12.5 million increase. Among other things, the agency will support research to develop a better command-and-control network for patrol cars incorporating an electronic display system to keep track of the vehicles. The agency will also investigate a new emergency call box, equipped with a powerful transmitter, permitting both patrolmen and civilians to send out strong, clear signals for help.

Tests are underway on a Teletype printout system for use in patrol cars to speed information from control crime data banks. But so far, OLEA is simply checking on what is available. Later, there may be special grants for police work.

Fingerprint optical scanning devices are now well developed, and the Federal Bureau of Investigation is seeking \$17.9 million to continue its work on them. This represents an increase of almost \$2 million.

Also in the FBI's \$206.7 million request, is \$10.2 million for expansion of its computerized crime information center. A spokesman expects the system to go nationwide shortly; eventually most local enforcement agencies will be included.

In addition, President Johnson's proposals for an omnibus crime bill, which were sent to the Congress two weeks ago could mean more money for a number of Government agencies. If passed as presented, the bill would authorize expenditures of \$100 million the first year to subsidize state and local law enforcement programs. To this end, Attorney General Ramsey Clark has been designated to coordinate the activities of all Federal offices involved.

Data and taxes. Another bright spot for some concerns will be the Internal Revenue Service. This agency wants \$3.3 million to upgrade two System 360/65 computers built by the International Business Machines Corp.; a third processor will be leased.

Revenuers will also step up their work on a mass data entry system that eliminates punch cards and feeds tax returns directly onto tape. The system, developed under contract by the General Electric Co., uses a GE-Pac 4020 as an interface between a Datamet 760 computer and the tape. An operator types data on a silent keyboard; the material is displayed on a cathode ray tube screen. When the operator is satisfied that the input is correct, he simply pushes a button and the information is put directly onto tape, thus eliminating punch cards and a separate verifying machine. The IRS and GE expect the system to cut labor costs by as much as 30%.

The service intends to use the system, which it has been leasing from GE on a limited basis for its Southeast center, in its Southwest, Middle Atlantic, and Midwestern facilities. If all goes well, the IRS plans to buy a system during fiscal 1969 for over \$2 million.

II. Post haste

The Post Office may also buy a lot of electronics. If Congress approves, the agency's Bureau of Re-

Delay Lines

MAGNETOSTRICTIVE
DELAY LINES

SOLID
DELAY LINES
(Glass or Quartz)

LC and DC
DELAY LINES

DISPERSIVE
DELAY LINES

DIGITAL
DELAY LINES

for proven
reliability in
Delay Lines and
Serial Memory Systems
for military and
commercial
applications, it's...



MICROSONICS, INC.
60 Winter Street
Weymouth, Mass. 02188
Tel: 617 337-4200

A subsidiary of the Sangamo Electric Company

... ESSA wants money for an environmental satellite ...

search and Engineering will get more than a 50% boost in funds. The money is tabbed for such projects as a voice recognition system, optical scanners, automated sorting machines, and traffic control gear. Already, an \$800,000 contract has been awarded to the Cornell Aeronautical Laboratory to check out linear discrimination techniques for address readers. Eventually, the Post Office plans to establish a mail research laboratory in Washington, but no funds are being sought now.

Wind shift. Air pollution control will be an even less fertile field for electronics firms than heretofore. With the passage of a pollution control act last fall, emphasis has shifted from monitoring and measuring instrumentation to research on controlling pollutants in fuels and vehicular exhausts. The Government will spend only \$1.5 million in fiscal 1969 to research monitoring and measuring instrumentation. "About two-thirds, or \$1 million, will go for electronics gear," says an official at the Air Pollution Control Center. "But there will be \$24.5 million in state and local grants, and judging from past experience about 20% of that sum will also go into instrumentation."

Weather or no. The Commerce Department's Environmental Science Services Administration (ESSA) has requested \$178 million, up \$12.4 million. Increases in research and development amount to \$27 million, and the tab for such activities as participation in world weather programs, improved weather observations and forecasts, and expanded oceanographic services will rise from \$107 million to \$119.9 million. Electronics' share is \$19 million, including a \$12.9 million chunk of ESSA's satellite program. Of that, \$11.8 million is going into the spacecraft, an Improved Tiros Operational Satellite that can observe at night; the rest is slated for computers and electronic testing equipment.

The agency also wants money for a new environmental satellite now under study. The program, which has a \$450,000 budget for electronics research and development, will

New Transformer Converts 3-Phase Synchro Input To 2-Phase Resolver Output With 30 Seconds Of Arc Accuracy

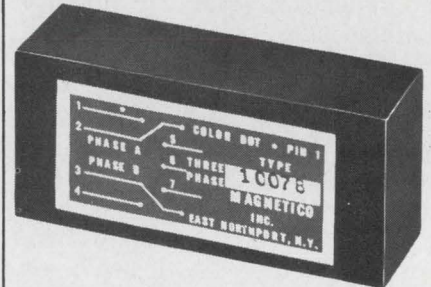

Now you can replace cumbersome and inaccurate techniques for conversion with Magnetico's new toroidal transformers. Small enough to mount on PC boards, they can be used in virtually any application requiring synchro to digital and digital to synchro conversion, including multiplexed conversion systems.

We call them Scott-T transformers and originally built them for military data systems. They meet the requirements of Mil-T-27B, Grade 5.

SPECIFICATIONS

	9652	9514
Input Voltage (line to line)	11.8 V	90 V
Input Impedance (at rated voltage)	100 K Ω	1 Meg Ω
Output Impedance	11 Ω	11 Ω
Null	< 1 mv	< 1 mv
Output Voltage (RMS)	5 V	4.25 V
Frequency	400 Hz	400 Hz
Accuracy (depending on load)	30 secs	30 secs
Temperature Range	-55°C to +125°C	

GO THE OTHER WAY, TOO. Units for resolver to synchro conversion also available. Ask for data.

Circle the Readers Service Card Number for complete electrical, mechanical and price information.

MAGNETICO, INC.

6 Richter Court/E. Northport, N.Y. (516) 261-4502

... unexpended R&D funds
revert to the Congress ...

develop subsystems to determine atmospheric density profiles and sensors for geodetic ranging between the earth's surface and satellites. These latter units would monitor electromagnetic disturbances in space and measure earth surface temperatures.

Semper paratus. Turned down last year, the Coast Guard is again seeking \$14.5 million for an electronics-laden cutter to conduct sub-polar oceanographic research. It also requests \$5 million for a national data buoy system, a project designed to provide Federal agencies with meteorological data.

III. High road

Both the Bureau of Public Roads and the Bureau of Highway Safety hope to continue studying traffic flow and highway safety. Among research projects under consideration are: development of a collision avoidance system for railroad grade crossings; the use of high-flying aircraft to gather traffic data and relay it to ground control stations; and a system to tell auto drivers when the passing lane is clear. This system would use induction loops buried in the pavement transmitting signals to warning indicators.

The Atomic Energy Commission wants \$25 million to begin construction of the 200 billion electron-volt accelerator in Weston, Ill. The commission has just signed a contract with the Universities Research Association for the preliminary design of the facility still awaiting Congress's okay. Also included in the AEC's budget is an additional \$26 million for construction of the Los Alamos Meson Physics facility.

Embarrassment of riches. Finally, there is the case of the Federal Communications Commission, which has been unable to decide what to do with its leftover 1968 research and development money. Although it is asking for \$1 million for R&D this year, the agency is in danger of losing the \$600,000 it got for 1968. If the money is not spent by July 1, it reverts to Congressional coffers. Some commissioners believe that if they don't act fast and use at least part, Congress will ignore the 1969 request.

WHAT'S A LAMINAR HYPERBOLOID?

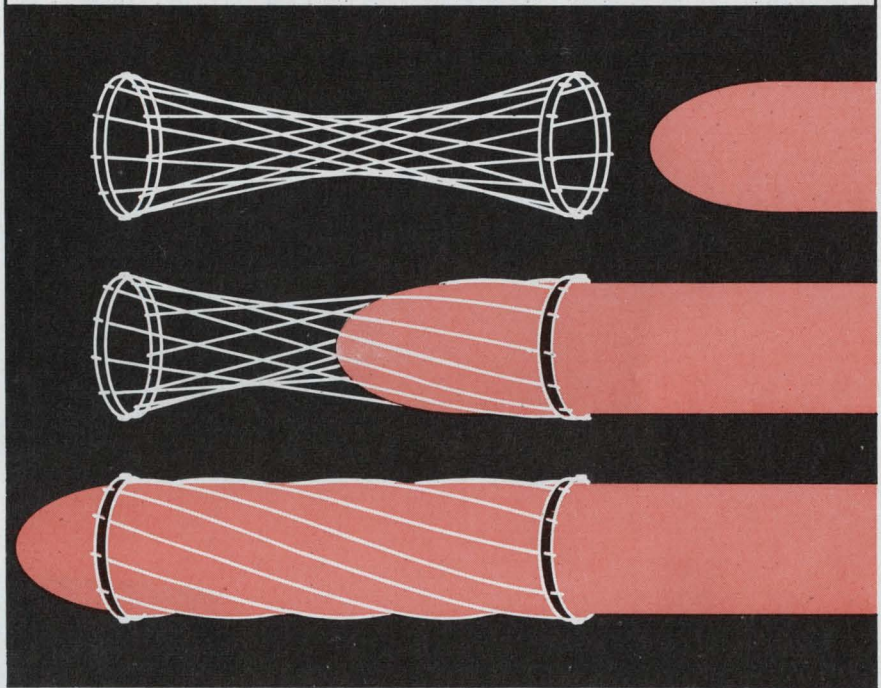

THE PRINCIPLE BEHIND HYPERTAC— THE LATEST ADVANCE IN CONNECTOR CONTACT DESIGN

More reliable and efficient connectors are now available with this new concept in contact design. HYPERTAC's geometrical socket construction is achieved by stringing a set of fine wires inside a tube at an angle. The wires "hug" the inserted pin in a taut grip, providing a number of lines of contact. There is no noticeable deterioration in operation after testing for over 100,000 operating cycles—surpassing anything in today's state-of-the-art. This patented "wire trap" design affords many advantages for high performance industrial or military applications:

Closed entry construction ★ Large contact area assures very low contact resistance ★ Reliability due to multiplicity of contact points and smooth pin entry ★ Very low insertion/extraction forces ★ Long life, low rate of wear with uniform characteristics ★ Withstands shock and vibration without noise or discontinuity ★ Easy manual insertion of high density, multiple pin connectors ★ Pre-assembly plating permits highly uniform thickness of finishes.

In both standard and non-standard configurations, HYPERTAC connectors can be customized to your specifications for insertion force, contact resistance and durability. Get complete information from your local IEH sales representative or contact:

INDUSTRIAL ELECTRONIC HARDWARE CORPORATION
109 Prince Street, New York, N. Y. 10012, (212) 677-1881.

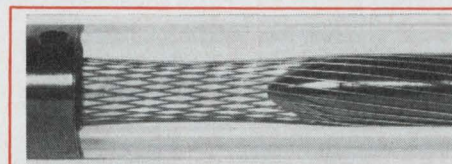

IEH

IEEE BOOTH #3B21

AFTER 10 MILLION SUCCESSFUL PERFORMANCES, WHAT DO YOU DO FOR AN ENCORE?



Bring on Utilogic® II.

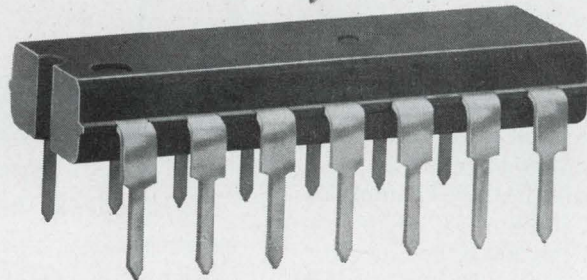

Signetics' new Utilogic II is a real show stopper—the most flexible, reliable, economical line in the business! Look at these features:

New - DIP. You asked for it, so we put the entire Utilogic II series in dual in-line silicone packages. Now you have convenience and ease of handling, in addition to the performance proven by over ten million Utilogic elements in the field.

New - Multi-Function Elements. Utilogic II now provides dual J-K binaries and triple and quadruple gates. Utilogic system design is now simpler, faster, more flexible ...and requires fewer packages.

New - Low Prices. Believe it or not, Utilogic II is actually priced at RTL levels! See for yourself:

TYPE NO.	DESCRIPTION	PRICE 1000-UP
300A	Dual 3-Input Expander	\$.75
305A	Single 6-Input AND Gate	.75
306A	Dual 3-Input AND Gate	.75
314A	Single 7-Input NOR Gate	.75
317A	Dual 4-Input Expandable NOR Gate	.81
321A	Dual Master Slave J-K Binary	1.50
322B	Dual Master Slave J-K Binary (in 16 pin package)	1.66
333A	Dual 3-Input Expandable OR Gate	.81
370A	Triple 3-Input NOR Gate	.81
380A	Quad 2-Input NOR Gate	.81
356A	Dual 4-Input Buffer Element	1.25

See us at IEEF, Booths 3A01 to 3A04

Those figures should bring a standing ovation. But hold the applause—because we'd like to give you a hand! For data sheets giving all the facts and figures on Utilogic II, just write Signetics, 811 East Arques Avenue, Sunnyvale, California 94086. This production brought to you by:

SIGNETICS INTEGRATED CIRCUITS



A SUBSIDIARY OF CORNING GLASS WORKS

SIGNETICS SALES OFFICES: Fort Lee, New Jersey (201) 947-9870; Syracuse, New York (315) 469-1072; Richardson, Texas (214) 231-6344; Beverly Hills, California (213) 272-9421; Garden Grove, California (714) 636-4260; Wakefield, Massachusetts (617) 245-8200; Silver Springs, Maryland (301) 946-6030; Collingswood, New Jersey (609) 858-2864; Clearwater, Florida (813) 726-3734; Rolling Meadows, Illinois (312) 259-8300; Sunnyvale, California (408) 738-2710.

DISTRIBUTORS: Compar at all locations listed below. Semiconductor Specialists, Inc. (312) 279-1000; Terminal Hudson Electronics (212) 243-5200; Wesco Electronics (213) 684-0880; Wesco Electronics (405) 968-3475; Hammond Electronics (305) 241-6601; Avnet Electronics Corp. of Massachusetts (617) 272-3060; Pioneer Standard Electronics Inc. (301) 427-3300; Kieruluff Electronics (206) RO 3-5510; G. S. Marshall (213) 684-1530.

DOMESTIC REPRESENTATIVES: Jack Pyle Company (415) 349-1266. Compar Corporation at the following locations: Alabama (205) 539-8476; Arizona (602) 947-4336; California (213) 245-1172; California (415) 697-6244; Colorado (303) 781-0912; Connecticut (203) 288-9276; Florida (305) 855-3964; Illinois (312) 692-4125; Maryland (301) 484-5400; Massachusetts (617) 969-7140; Michigan (313) 357-5369; Minnesota (612) 922-7011; Missouri (314) 542-3399; New Jersey (609) 429-1526; New Mexico (505) 265-1020; New York (518) 436-8536; New York (607) 723-8743; New York (516) 921-9393; North Carolina (919) 724-0750; Ohio (216) 333-4120; Ohio (513) 878-2631; Texas (214) EM 3-1526; Texas (713) 667-3420; Washington (206) 763-1711.

INTERNATIONAL SALES: France, Germany, Italy, Belgium, Holland, Luxemburg, Spain—Sovcor Electronique, 11, Chemin de Ronde, Le Vesinet, (S.-&O.) France, United Kingdom, Ireland, Sweden, Denmark, Norway, Switzerland, Austria, Portugal—Electrosil Ltd., Lakeside Estate, Colnbrook-Bypass Slough, Buckinghamshire, Great Britain, Australia—Corning, 1202 Plaza Building, Australia Square, Sydney, N.S.W. 27-4318, Canada—Corning Glass Works of Canada, Ltd., Leaside Plant, Ontario, Canada (416) 421-1500. Israel—Optronix, P.O. Box 195, Ramat Gan, Israel 724-437. Japan—ASAHI Glass Co., Ltd., Corning Products Sales Dept. No. 2, 3-Chome Marunouchi, Chiyoda-ku, Tokyo, Japan.

FAA priorities irk critics

Agency seeks 50% increase in funding for supersonic transport, but downgrades new air traffic control and research programs

Although the Federal Aviation Administration seeks an increase of \$146 million over last year in the 1969 fiscal budget, the gain for the electronics industry is comparatively small. The agency is asking for \$1.064 billion.

The agency's big electronics item is in "facilities and equipment," down for \$70 million, an increase of \$16 million. Most of this money will be spent for the National Airspace System (NAS) Stage A, automation of en route control centers. The FAA seeks to "automate" 11 centers and buy computers for five more. Right now, the agency's first center, at Jacksonville, Fla., is in a shakedown stage.

I. Supertarget

Critics of the FAA—and they appear to be growing in Congress—opened fire almost immediately after the budget was published, mainly because of the whopping increase for the controversial supersonic transport. The FAA wants \$223 million in new money, as against \$142.3 million last year. As if this \$80.6 million boost were not large enough to irritate Congressional foes, the total to be spent next year will top \$350 million, since only \$100 million will have been expended in fiscal 1968. The increase is an inviting target for Congressmen who lament cuts in "Great Society" programs.

Double jeopardy. Not only will the SST funding be measured against Great Society cutbacks, but FAA critics are also primed to compare it with the agency's lack of requests for air traffic control.

The budget includes no money for new towers, terminal radars, terminal vhf omnidirectional radio range gear, instrument landing systems, or visual aids.

Nor does it include any money for terminal automation. However, funds allocated in fiscal 1968 will be spent to get this project started.

Designated Tracon-C, the equipment will be similar to that at en route centers. The semiautomated system will display on controllers' radar screens information on aircraft identity, altitude, and ground speed.

The FAA hopes to request bids for the system late this month. In an unusual move, the agency will be asking for turnkey bids—making one prime contractor wholly responsible. Since the units have to be installed in Instrument Flight Rules systems now operating, the FAA figures getting the job done on a turnkey basis will produce less disruption.

The FAA has \$14.5 million available for Tracon-C, of which \$11.8 million is for electronic gear. The rest will go for site preparation. There will be 20 installations to start, with the first in Chicago.

Crowding in. The FAA hopes eventually to "automate" 62 terminals. But many controllers have serious doubts; they fear their screens will become too cluttered with alphanumeric.

While the FAA stresses that each unit will be tailored to individual airports, the system is designed so modules can be interchanged between facilities. The system's principal components are a computer, a digitizer to provide displays of aircraft information in alphanumeric on radar screens, and horizontal display radars for high-density airports.

The failure to request funds for terminal automation shows the FAA still approaches this project with its traditional caution.

The agency is also cautious about new terminal radars: it has \$4.8 million from fiscal 1968 that it will be spending this year on new equipment. Of this, \$2.5 million is going for electronics. The same situation exists in instrument landing systems. The agency has a modest \$6.3 million in the 1968 kitty for ILS and

approach landing systems (runway lighting). Of this, \$1 million is for ILS electronics.

Status quo. The agency wants \$28 million for research and development in 1969, a \$1 million increase. But no new R&D projects are contemplated.

The FAA's R&D efforts will center on what the agency calls "continuous development" of the NAS en route automated system capability. In fiscal 1969, it plans to spend \$11.5 million of its R&D funds in this area. The FAA will not concede the point, but the system must still have problems. Otherwise, it makes little sense to put 41% of the total research budget into a system that is currently being installed.

A comparable situation exists in terminal automation. The FAA plans to spend \$5.6 million for "the development of the terminal automated system capability."

Spread thin. Only a tiny sum is earmarked for research into what many call the most essential aviation development: vertical and short take-off and landing aircraft. The FAA has budgeted only \$183,000 for this purpose. The money will cover projects ranging from airport criteria to navigational aids.

The FAA asked \$276,000 for research on collision avoidance systems (CAS). The agency is concentrating on how the air traffic control system will fit into the CAS development work being done by airlines. Another problem area, clear air turbulence, is receiving only \$30,000 in research money.

Penny wise. One reason the FAA is so penurious about research money is its hope the aviation industry will contribute more. Last September, President Johnson asked the Secretary of Transportation to frame a long-range plan for future air traffic control equipment and facilities in which industry would share the costs. The proposals may be made in April.



**a new
dimension
in X-Y
recording!**

**New X-Y recorder for
unprecedented versatility**

**6 plug-ins now,
more to come!**

Unparalleled dynamic performance -

- slewing speed of $>30''/\text{sec}$!
- acceleration of $>1000''/\text{sec}^2$!

MODEL 7004A
with **PLUG-IN**
VERSATILITY

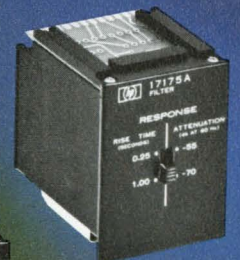
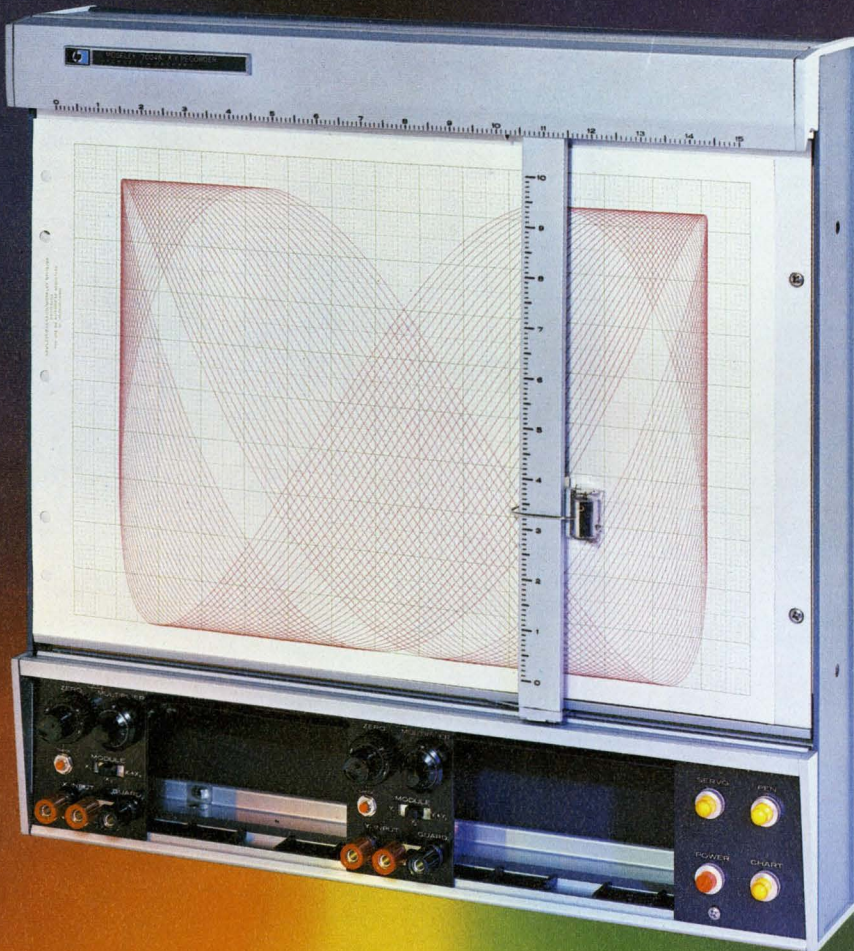

HEWLETT



PACKARD

QUICK-CHANGE PLUG-INS provide

FLEXIBILITY

7004A main frame covers a wide range of applications by simply changing plug-in.

If you're interested in a really versatile X-Y Recorder with high dynamic performance—then the 7004A is for you. Here at last is a truly versatile recorder. By changing plug-ins or adding accessories, it can be transformed from an X-Y to a Strip Chart Recorder; bench or rack mounted; use fan fold, roll of frame charts, continuous grid rolls, or 11 x 17 graph paper; operates as X-Y, Y-T, or X-T; and the list goes on and on.

In addition to versatility, the 7004A is a high precision instrument employing the most advanced solid-state circuitry available. The use of this solid state circuitry reduces the size, weight, maintenance, and power consumption of the recorder.

The 7004A offers High Dynamic Performance, Guarded Circuits, Electro-Static Paper Holddown, Integrated Circuits, All-Silicon Solid-State Circuitry, and more. Use of DC amplifiers eliminate mechanical choppers.

Common electronics are located in the 7004A frame to reduce the cost of the plug-ins by eliminating circuitry duplication. Complete versatility obtained with all the plug-ins may be purchased initially with the frame at a very modest investment or later as requirements arise. You pay only for the capability you actually need for your application.

Contact your H-P Field Engineer soon for information on how the 7004A fits into your particular application. In addition to the six plug-ins presently available, additional plug-ins are being developed. He can assist you in selecting plug-ins or combinations of plug-ins best suited for your application and provide you with information of new plug-ins as they are developed.

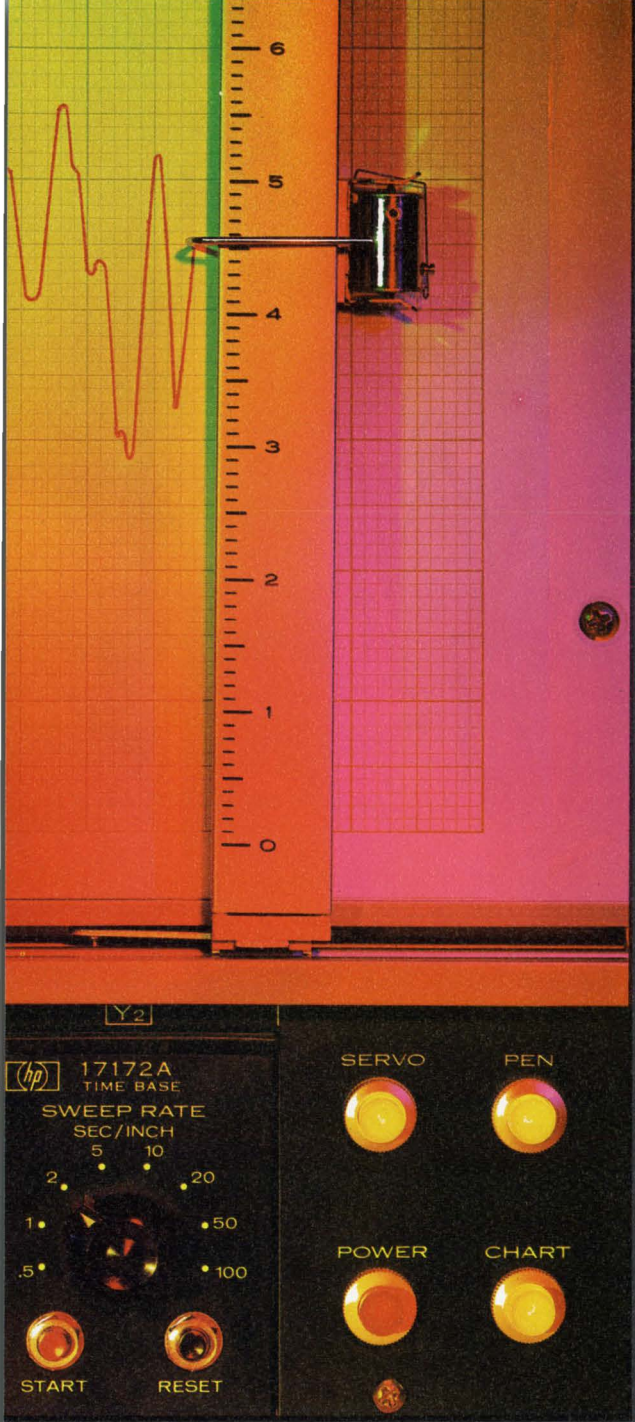

SPECIFICATIONS

Number of Plug-Ins: Frame will accept the equivalent of four single width plug-ins, two per axis.

Types of Inputs: Floating differential. All input terminals may be placed up to 500 VDC from ground. Critical circuit areas guarded. Guards are available at terminals on front panel or rear connector. Mating rear connector supplied.

Zero Set: Zero may be placed anywhere on the writing area or electrically set off scale up to one full scale from zero index. Adjustable by a lockable ten-turn high resolution control.

Range Multiplier: Ten-turn control with locking dial calibrated to change sensitivity from 0.6 to x 2.6 twice basic sensitivity.

Acceleration: >1000"/sec.²

Paper Holddown: Autogrip electric paper hold-down grips charts 11 x 17 or smaller.

Slewing Speed: >30"/second.

Pen Lift: Electric pen lift capable of being remotely controlled. Rear connector supplied.

Dimensions: 17½" wide, 17½" high, 4⅝" deep.

Weight: Approximately 20 lbs.

Power: 115 or 230 V ±10%, 50 to 1000 Hz.

Price: 7004A

\$1,295.00

Option: -01 Metrically Scaled and Calibrated
-02 X Axis Retracting Potentiometer

N/C

\$75.00

**DC COUPLER
17170A**

- 100 mv/in. Calibrated Input Range
- 450K Input Resistance
- 60 mv/in. to 250 mv/in. Variable Input Range
- ±0.1% Linearity
- ±0.2% Accuracy



\$50.00

DC-AMPLIFIER • 17171A

- 14 Calibrated Input Ranges — 0.5 mv/in. to 10 V/in.
- 1 megohm Input Resistance
- ±0.1% Linearity
- ±0.2% Accuracy



\$250.00

**TIME BASE
17172A**

- 6 Calibrated Sweep Speeds — 0.5 to 100 sec/in.
- Automatic Reset
- Local and Remote Sweep
- 0.5% Linearity
- ±2% Accuracy



\$200.00

PLUG-INS

\$200.00



- Up to 50 plots/sec.
- Multi-color Plotting (Programmable)
- Remote Controls

**17173A
NULL DETECTOR**



\$100.00

- High Resolution
 - Continuously Adjustable to 1 volt
 - Temperature Stability Better Than 0.005%/°C
- DC OFFSET • 17174A**

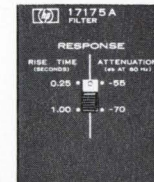

\$75.00

- Input Voltage to 2 Volts
- 55 db Rejection at 50 Hz and above
- Improves Both Normal and Common Mode Rejection
- Selectable Response Time

**17175A
INPUT FILTER**

TYPICAL MODULE APPLICATIONS

MEASUREMENT PROBLEM	PLUG-IN COMBINATIONS	RESULTS
Parameter to be measured on top of DC bias.		The 0-1 V offset adjustment of the 17174A allows up to 200 full-scales of offset at 0.5 mv/in.
High Normal Mode Noise (i.e., 60 Hz).		17175A before preamp will increase the 60 Hz rejection by 60 db.
Low level signals High Common Mode Noise (i.e., 60 Hz).		Low level signals High Common Mode Noise (i.e., 60 Hz).
Need to draw straight line segment between distant points.		1 second rise time.

ACCESSORIES

INCREMENTAL CHART ADVANCE

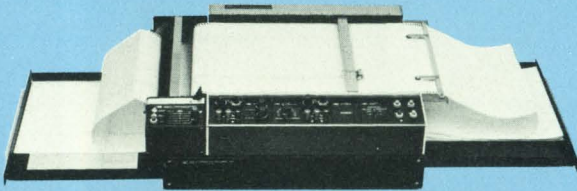

Recorded data is readily recoverable when plotted on fan fold paper. The 17005A-01 Incremental Chart Advance gives the 7004A fan fold capability in addition to adaptation to Strip Chart Recording, Automatic Frame Advance, Major Division Advance, Segmented Strip Chart, and Incremental Advance. Combining this additional versatility with the already flexible 7004A, offers a combination meeting practically all requirements. 17005A..... \$895.00

POINT PLOTTER



High speed point plotting is now available. The 7004A with 17173A Plug-In and 17012B Point Plotter offers speeds as fast as 50 plots/second.

17012B \$95.00

A two-color programmable Point Plotter is also available.

17011A \$175.00

HEWLETT  PACKARD

GRAPHIC RECORDERS

433 N. Fair Oaks Ave., Pasadena, California 91107

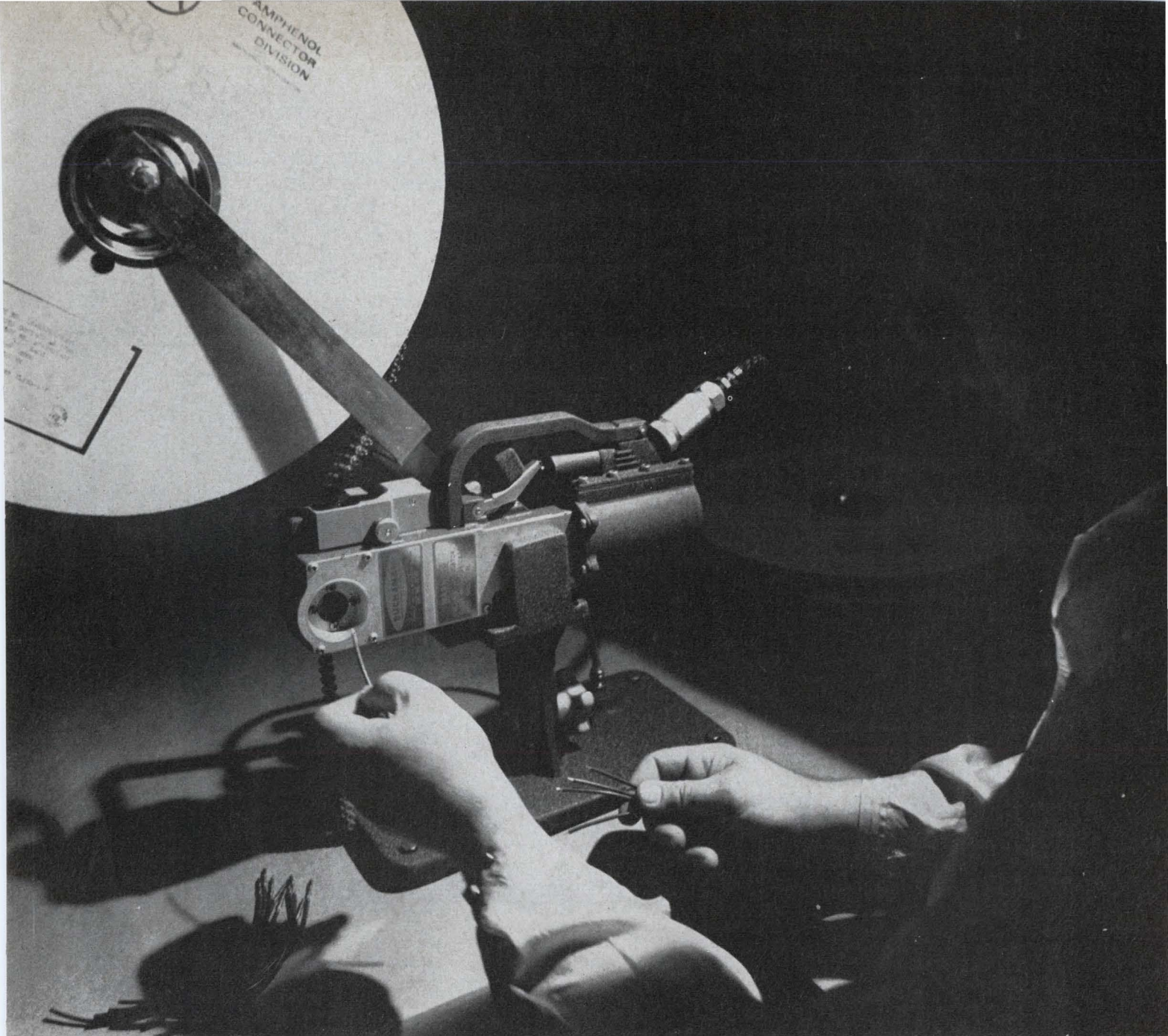

Buy Amphenol crimp contacts by the reel and save two ways

On purchase price. Cost per contact of Amphenol crimp Poke-Home® contacts is reduced substantially because it costs us less to produce them in large quantities and ship them on reels.

In production, too. Costs are reduced through fast and reliable wire terminations (400 an hour with our manual crimping tool, 600-800 an hour with our automatic hand-held or bench-mounted tool). Save time with dependable, visual inspections, too.

Contacts to three major specifications available:

MIL-C-26636 (MIL-C-26500 & 26518 connectors)
MIL-C-39029 (MIL-C-5015 connectors)
MIL-C-23216 (MIL-C-81511 & 26482 connectors)

Call Amphenol Connector Division for bulk contact pricing. (312) 261-2000. 2801 South 25th Avenue, Broadview, Illinois 60153.



AMPHENOL

Specify Amphenol... the leading name in cable, connectors, assemblies, RF switches, potentiometers, motors, microelectronics.

←Circle 160 on reader service card

Circle 161 on reader service card

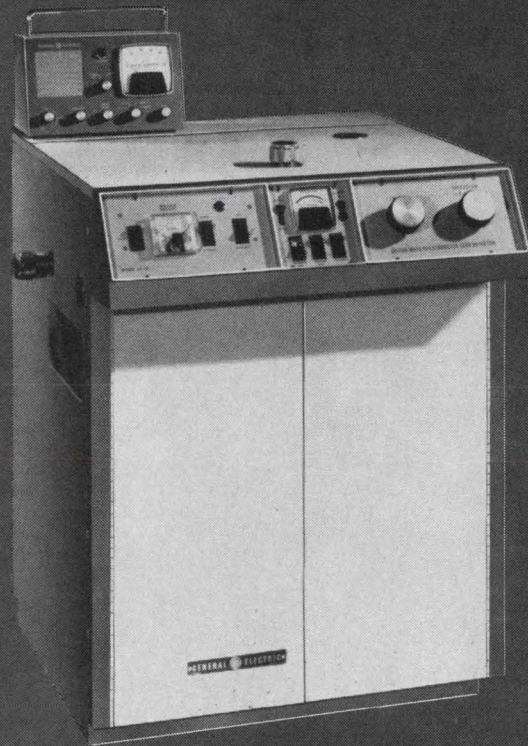

Why General Electric waited three years before introducing this all-new Helium Leak Detector:

Can we impose on you with a bit of history?

Twenty-five years ago, GE built the first Helium Mass Spectrometer Leak Detectors ever—for the Manhattan Project.

Subsequently, we made some mistakes. The main one was resting on our oars while competitors got in, caught up—and then passed us.

So, in the late fifties and early sixties our reputation in this field was—deservedly—less than good.

We got busy. We re-designed our units from scratch. We questioned everything we'd ever done, everything anybody else had done. We re-assessed every component, circuit, and operation in terms of developing leak detectors with optimum sensitivity, maximum reliability, and minimum maintenance.

Early in 1965 we were satisfied. But to make sure, we concentrated on placing them in General Electric

plants. (We think you'll agree there's nobody quite as critical as a member of the family.)

Now, three years later, we can look you in the eye and tell you that GE Helium Mass Spectrometer Leak Detectors are again the finest on the market.

We don't ask you to take our word for it. But we do ask you to check out for yourself the new-yet-proven features that characterize our product today. Things like all the sensitivity you'll likely ever need; a spectrometer tube filament that's guaranteed for two years; reliable, long-life, solid-state circuitry; constant sensitivity; real ease of operation and servicing; an all-welded, stainless steel high-vacuum system.

And then some. Check the reader service card, or write us direct for full particulars on manual model LC-10 and automatic model LC-20. We have a product we're proud of.

VACUUM PRODUCTS BUSINESS SECTION

GENERAL  ELECTRIC

SCHENECTADY, N.Y. 12305

LC-1

Digitran made it big

about so big

Digitran perfected a simple idea... the thumbwheel switch. Making it was simple. Making it perfect was a big job. We did, and called it a Digiswitch®. After we made it perfect, we made it small. We call that a Miniswitch®.

 Making it small was a big job, too. It took lots of time, talent and money. But it was worth it. Miniswitch can help you save up to 50% of your panel space; give you accurate, dependable controls that are simple, easy to set and read; under any conditions, in any environment.

 At Digitran you can count on our know-how to help solve your most complex switching problems. We've the industry's most complete thumbwheel switch application library to prove it. Given the opportunity, we can probably save you both time and money.

 But don't take our word for it, find out for yourself. Send for a complete catalog on switches (big and little). From Digitran. The thumbwheel switch company you can count on.

THE DIGITRAN COMPANY

Subsidiary of Becton, Dickinson and Company 

855 S. Arroyo Pkwy./Pasadena, Calif. 91105

Tel: (213) 449-3110/TWX 910-588-3794

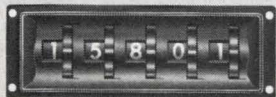

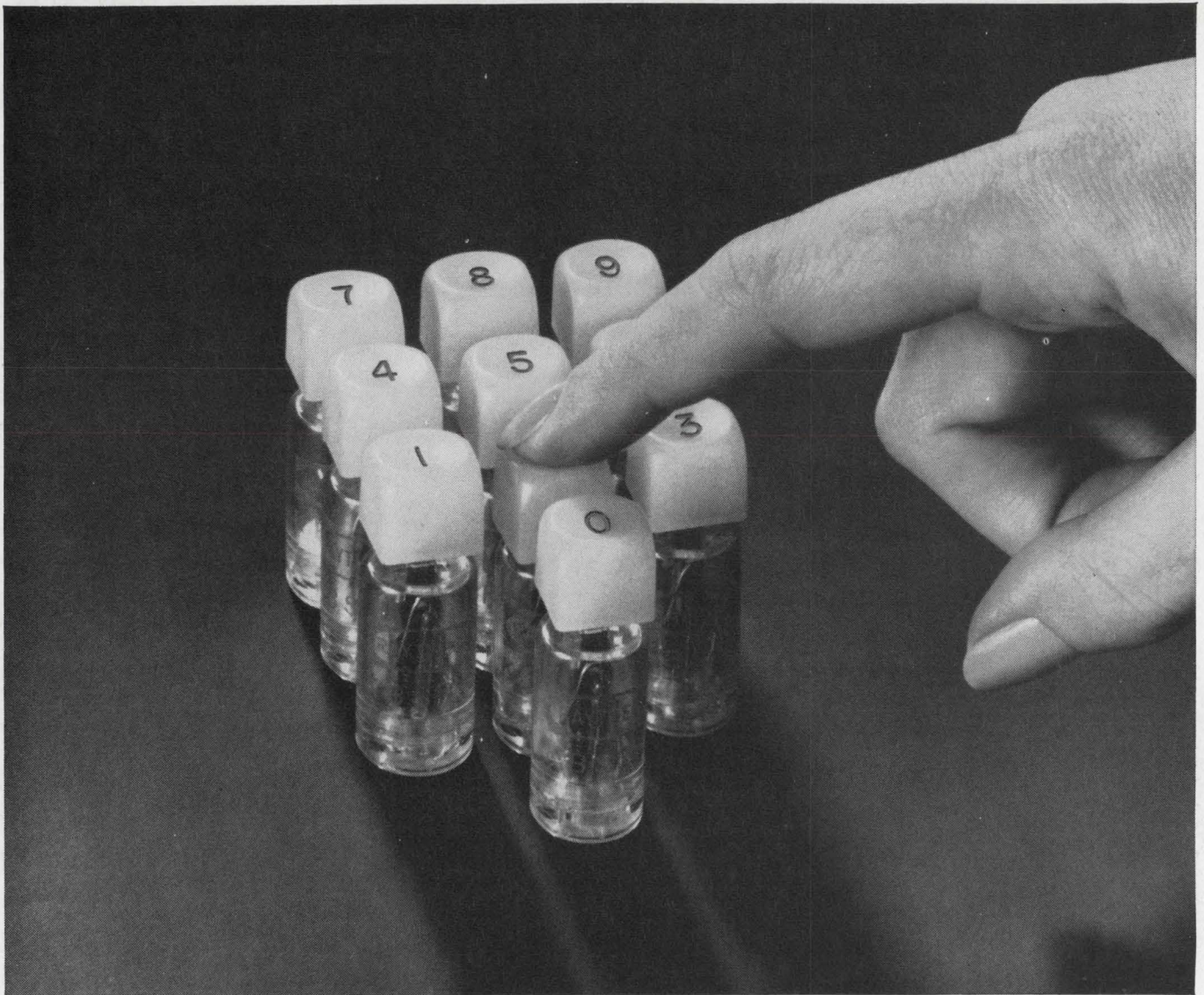

These new keyboard switches feature unusually precise action and low-cost mounting. See for yourself—write for samples.

These elegantly styled key switches are especially suitable for computers, learning and business machines, and other advanced control equipment.

Designed by Raytheon, they have a featherlight touch that is precise and reliable. Just a 3-oz. touch activates the switch. Because of the unique design, this action can be repeated more than 10 million times. Yet the switches cost as little as 60¢ in production quantities.

Raytheon key switches are available in a wide range of standard- and custom-cap shapes, sizes, colors,

and alphanumeric. The characters can be illuminated by backlighting. All switches are made of high-quality materials: stain-resistant caps; polycarbonate body parts; stainless steel springs; beryllium and stainless steel contacts. They are available in single- and double-level wipe-action types, and in dry-reed, hermetically sealed single- and double-level types.

Write for samples. For free samples, write on your letterhead describing your application to: *Raytheon Company, Industrial Components Operation, Dept. 2351-EL, Quincy, Massachusetts 02169.*

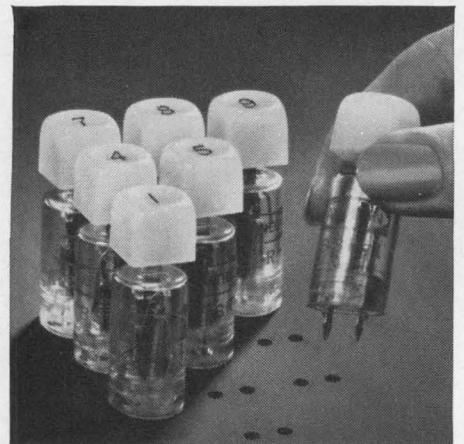

Simple, low-cost mounting. Raytheon switches plug into .125" PC board. Contact pins snap in, firmly lock switch in place for soldering. This permits you to use flow soldering techniques—cut keyboard assembly time and costs.





Equipment with a Reputation for Reliability

12 Amp Series EH Avalanche Silicon Rectifier Solid-State Assemblies Boast Full Wave Bridge Ratings Up To 1000 PRV

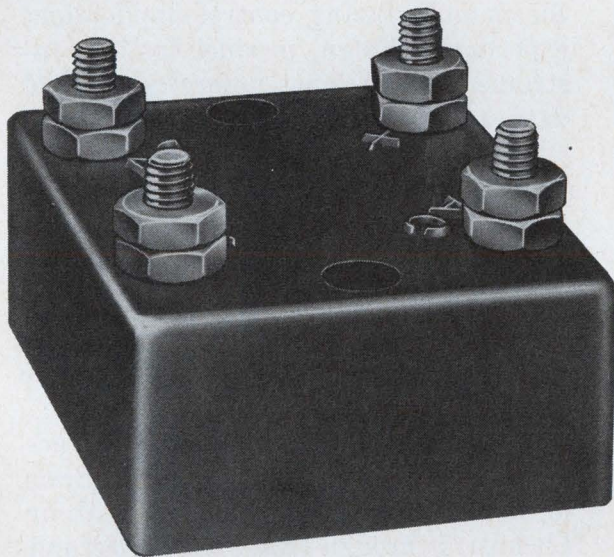

This relatively small, solid state, high current encapsulated assembly has a 12 amp rating and carries single phase and three phase full wave bridge voltage ratings up to 1000 PRV. Since it is encapsulated, it is not affected by environment. The wide spread terminal location eliminates dirt and moisture build-up between terminals, thus reducing surface creepage. Available with faston or stud terminals. High power, at a very low cost.

- Circuit Single phase full wave bridge
- AC Input up to 1000 PRV
- DC Output up to 12 Amps DC (25°C. Ambient-Chassis mounted)
- Surge Current Rating 200 Amps Peak for one cycle (25°C. Ambient)
- Loads Resistive, Inductive, Capacitive
- Duty Cycle Continuous
- Cooling Convection

Design Features:
Syntron avalanche diodes housed in an epoxy sealed case. Stud or faston terminals. High current rating for compact size.

Single Phase and Three Phase Bridge Current Ratings

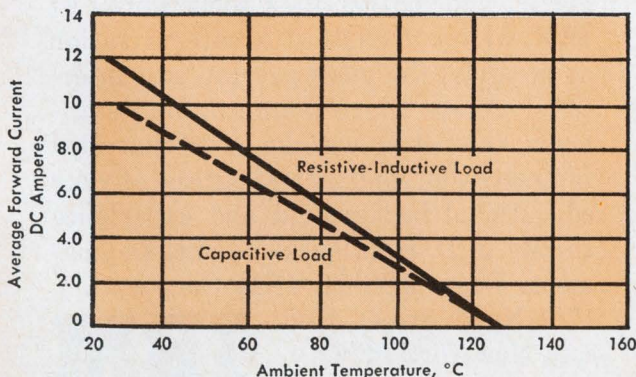

SYNTRON

A DIVISION OF FMC CORPORATION
241 Lexington Ave. • Homer City, Pa. 15748
Telephone 412-479-8011

Please Send full information on Series EH Encapsulated Assemblies

Name/Title _____

Company _____

Street _____

City, State _____ Zip _____

68RA1

Creative jobs for creative engineers

IBM has immediate openings for qualified engineers in Endicott, New York. Here are a few reasons we feel the environment here generates creative engineering.

We just outline the objectives; you decide how to achieve them. Sometimes you get insights into new areas that don't seem directly related to what you're working on. You get the chance to follow them up and see where they lead. Initiative and curiosity don't get lost in the shuffle.

You work individually, or in a small team of four or five people. Good work is recognized quickly. And we promote on merit-not seniority.

Immediate openings

IBM needs some creative *engineering* done right now, in the following areas:

Design engineering—These jobs offer an excellent opportunity for creative, innovative work with electron beams, solid-state circuitry and electronic systems in general. The problem is to develop new test technologies and circuit packages.

Quality engineering—We need people to establish quality control programs for the manufacture of printed circuit assemblies and sub-assemblies. This is quality *assurance*, not typical quality control.

Test engineering—This involves liaison and support assignments with engineers from many other areas of specialization. For engineers capable of handling complicated electronic system testing, this job offers an overview of the entire EDP field.

Systems engineering—If you're interested

in a future in this area, IBM may be able to offer you one. We need people to plan, develop, code and install computer programs for manufacturing control application, experiment design, product testing, instrument monitoring, numerical control data, and simulation.

What Endicott offers you

These positions are at IBM Endicott in upstate New York. Endicott/Binghamton (population 200,000) is surrounded by beautiful farmland and small woods. The area is noted for its recreational facilities, schools, and cultural activities.

There are educational facilities for advanced study. You can get your M.S. or M.A. in Engineering, Physics, Math or Chemistry through IBM's tuition-refund program. A liberal benefits plan is also paid for by the company.

Interdisciplinary environment

For simplification, we've listed these jobs in categories. But people don't fit into categories, and neither does their work. At IBM, we try to do as little categorization as possible; the more overlap and inter-involvement there is among our engineers, the better we like it. If that idea interests you, send a brief outline of your educational background and experience to: Mr. J. D. Hinkley, Personnel Department, Dept. QB3-04, IBM Corporation, 1701 North Street, Endicott, New York 13760.

IBM®

An Equal Opportunity Employer

EECO 5000/6000 Series Photoblock Tape Readers...

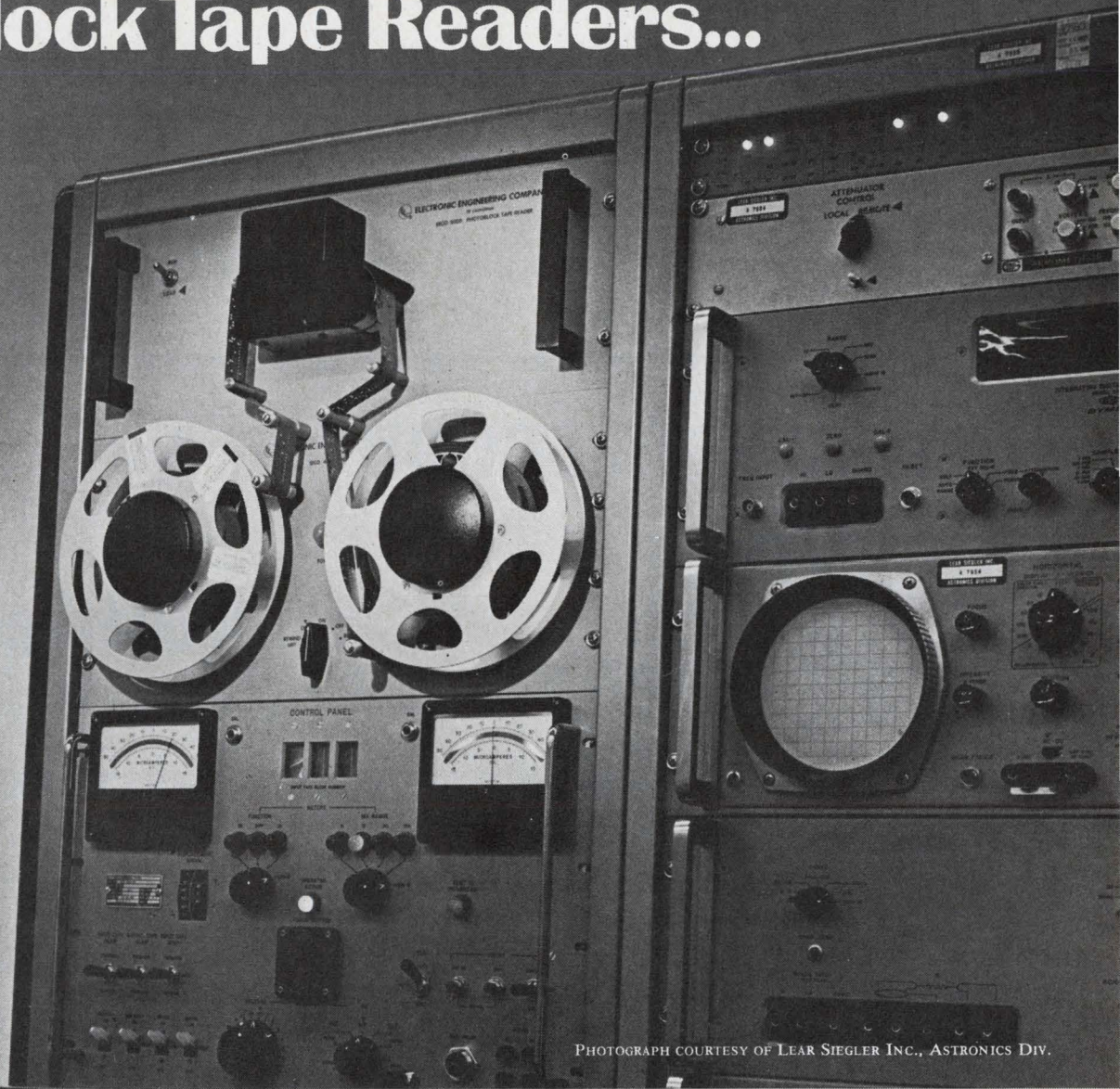
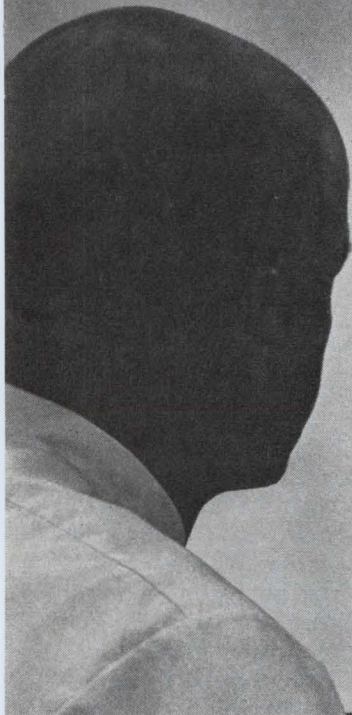

PHOTOGRAPH COURTESY OF LEAR SIEGLER INC., ASTRONICS DIV.

speed production testing

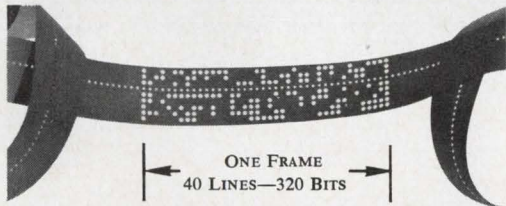

Segment of tape showing one 40 line block of data used to program instrument ranges and comparator limits.

EECO 5000/6000 Series Photoblock Tape Readers can be used to program a variety of electronic test instruments. Frequently, they are the most versatile, economical method of automating the production testing of electronic products.

Tape with 5 to 40 8-bit lines of test sequence data (40 to 320 bits) is photoelectrically read to program a particular test. The 5000 Series reads at rates to 12 blocks per second (100 lines/sec) ... the 6000 Series to 20 blocks per second (200 lines/sec). Twenty output options facilitate interface with present test instrumentation.

All EECO Photoblock Readers use solid state controls and step motor drives. EECO's *exclusive latching output option*, which keeps output lines "latched-in" between block advance commands, allows testing to continue while the tape is moving.

Compare EECO 5000/6000 Series Photoblock Readers for versatility, economy and reliability with such other programming methods as single line readers with buffer memories. Ask for data sheet and prices.



INSTRUMENTS DIVISION

ELECTRONIC ENGINEERING COMPANY OF CALIFORNIA

1601 EAST CHESTNUT AVENUE • SANTA ANA, CALIFORNIA 92701 • (714) 547-5501

NO BURNS

LIKE THIS

NO BLANKS

LIKE THIS

A PERFECT RECORD every time

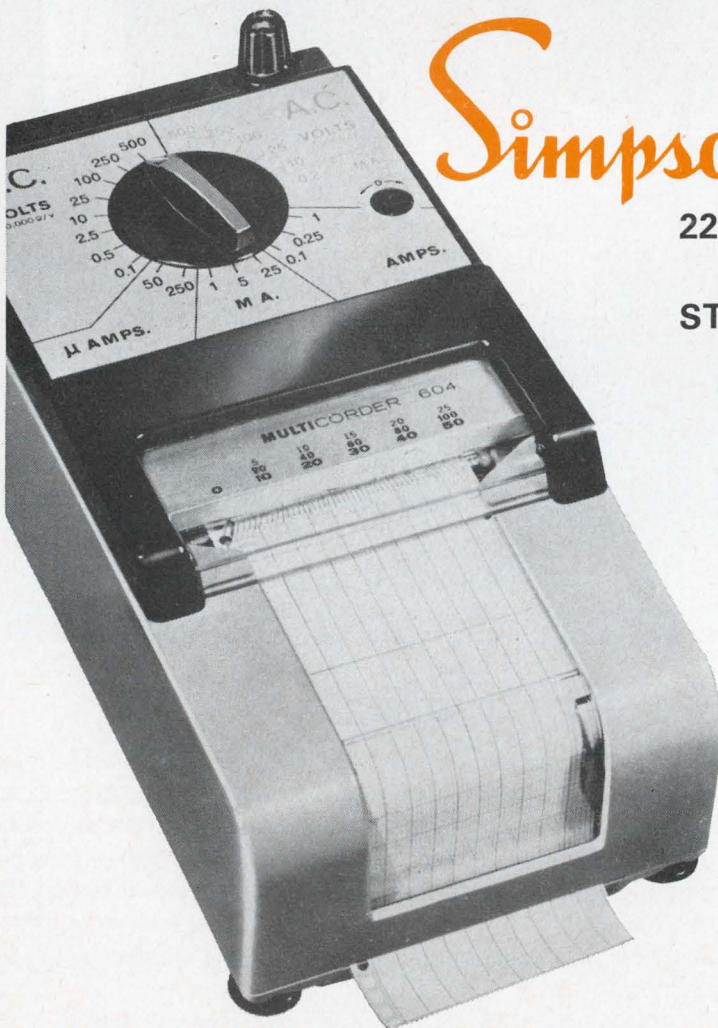
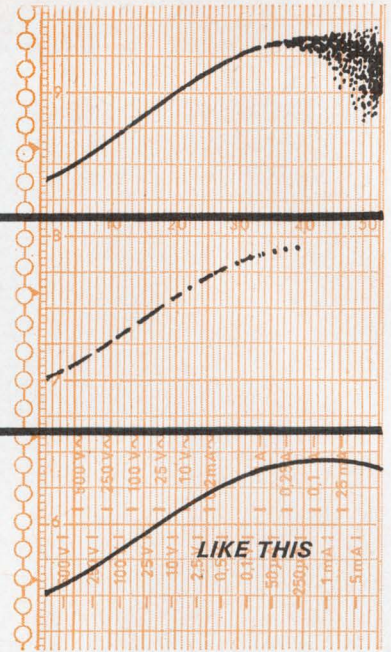

Simpson Multicorder®

**22 SINGLE ELECTRICAL RECORDERS
WRAPPED IN ONE
STANDARD 3 CHART SPEEDS
1", 3", 12" PER HOUR**

Impressions every 2 seconds. Additional speeds (30", 60", 90" per hour) with the optional gear unit Catalog #0682. This voltage-current recorder has a wide selection of ranges and functions to eliminate the need for separate recorders. The pressure-sensitive paper means that there is no conductive paper to burn, no ink to run dry. Meter movement features shock-proof **TAUT BAND SUSPENSION**. AC and DC indicating accuracy is $\pm 1.5\%$ FS; recording accuracy $\pm 2.5\%$ FS. These are just a few of the features that make the Simpson Model 604 Multicorder the most versatile and economical recorder on the market. For the full story, write for Bulletin 520.

RANGES

DC VOLTS: 0-0.1, 0.5, 2.5, 10, 25, 100, 250, 500 @ 20,000 Ω/V
 AC VOLTS: 0-10, 25, 100, 250, 500 @ 5,000 Ω/V
 DC MICROAMPERES: 0-50, 250
 DC MILLIAMPERES: 0-1, 5, 25
 DC AMPERES: 0-0.1, 0.25, 1.0
 AC MILLIAMPERES: 0-0.2

Multicorder Model 604.....\$200.00

ACCESSORIES

Gear Unit No. 6082 (30", 60", 90" per hour).....30.00
 Chart Paper No. 02612, Per Roll..... 2.50
 Ever-Redy Vinyl Carrying Case No. 02611.....25.00

Representatives in Principal Cities
 ... See Telephone Yellow Pages



SIMPSON ELECTRIC COMPANY

5202 W. Kinzie Street, Chicago, Illinois 60644

Export Dept: 400 W. Madison Street, Chicago, Illinois 60606, Cable, Simelco

IN CANADA: Bach-Simpson Ltd., London, Ontario

IN INDIA: Ruttonsha-Simpson Private Ltd., International House, Bombay-Agra Road, Vikhroli, Bombay



Phone: (312) 379-1121

WORLD'S LARGEST MANUFACTURER OF ELECTRONIC TEST EQUIPMENT

New Products

New semiconductors

The triac—from trickle to triumph in three years

Marketing men see \$25 million sales for three-lead a-c switch by 1972; plastic packaging cuts cost and potential automotive uses spur interest

By Stephen Wm. Fields

Assistant editor

“Triacs were born into the hard, cruel world of consumer electronics—and they are thriving in it,” says Donald Burke, head of applications engineering at RCA’s thyristor division.

The three-terminal solid state a-c switch was born less than three years ago. Today \$4 million worth of them are sold and industry leaders confidently predict \$25 million by 1972.

One major reason: more triacs are being encapsulated in plastic; one such device will be introduced by RCA next week.

Another: Detroit is showing interest in triacs. Up till now they have been used principally to control small appliances. But cars are being loaded with electronic equipment, an engineer points out, “and pretty soon the d-c system in the auto won’t be able to handle the load.” If cars develop as airplanes did, he says, d-c will soon be used for starting only. The alternator will be used for all other electrical functions. “That’s an a-c device, and that’s where the triac will shine.”

The triac was introduced by the General Electric Co. in 1965 as a result of a Navy contract that called for “the development and evaluation of a bilateral switching device

capable of carrying 25 amps with a minimum reverse-blocking voltage of 400 volts at a frequency of 400 hertz.”

An ancestor of the triac was made by the Hunt Electronics Corp. in Dallas, which was first to employ a four-layer a-c switching device. But it was not a triac because it had only two leads. No gate lead was available. It was triggered by a

voltage spike introduced in one of the two anode leads by a pulse transformer in series with the device. By controlling the time during a given cycle when the pulse was initiated, a form of phase control was produced. Hunt used its device to replace two silicon controlled rectifiers in lamp dimmers.

Enter GE. Then came GE with a three-lead device, rated at 6 amps

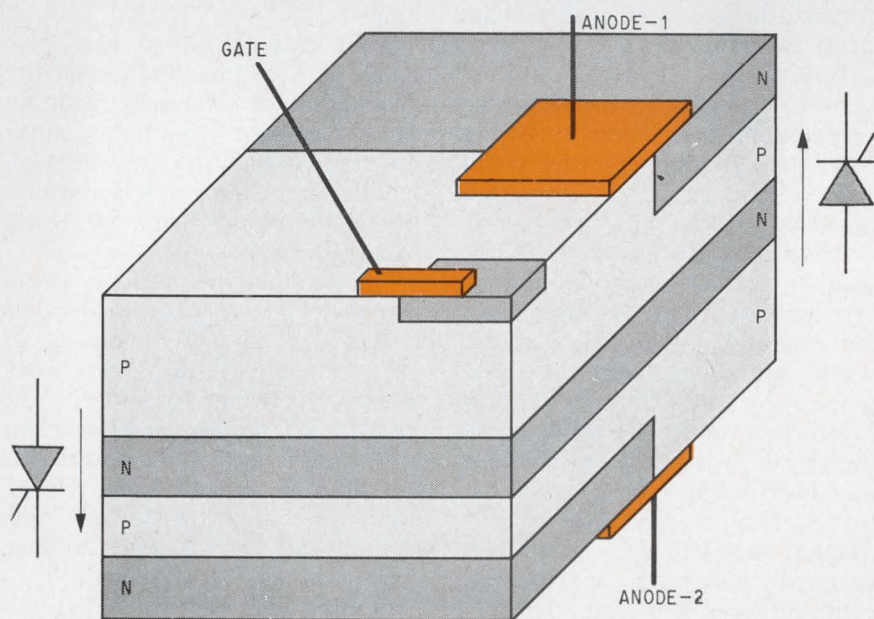

Multilayer. Triac chip is composed of five layers. Each half is similar to a four-layer SCR, and shares a common gate lead.

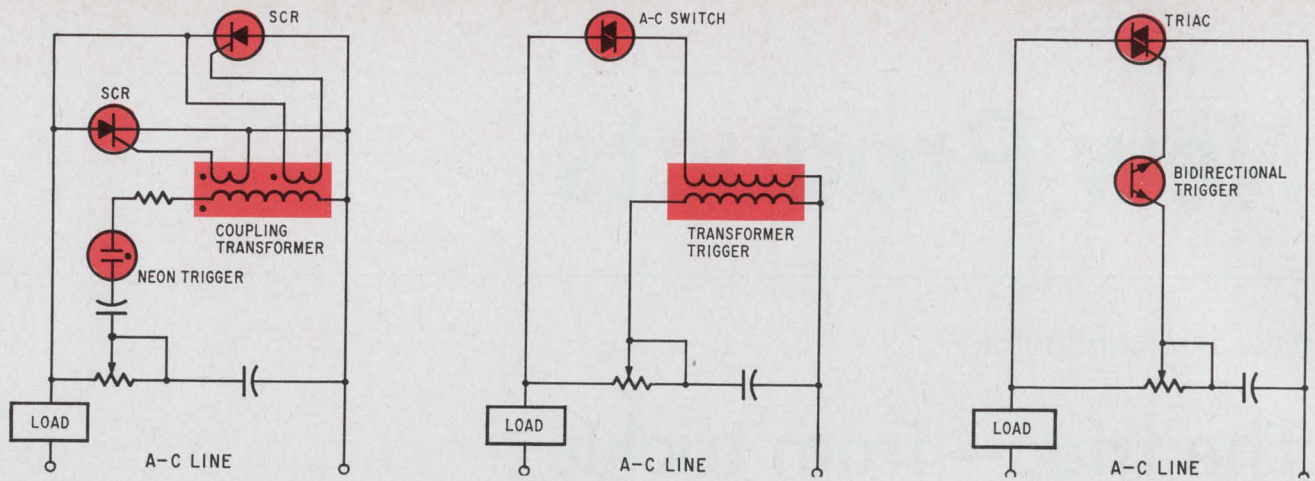

Evolution. The first full-wave lamp dimmer used two SCR's and a pulse transformer. Second-generation dimmers employed an a-c semiconductor switch but still needed the transformer. The latest design uses a triac and diode trigger, eliminating the bulkiness and 60-hertz hum that went with the transformer.

and intended for 120-volt a-c line operation. It was triggered by a pulse applied to the gate lead, eliminating the need for a transformer.

Called a triac (for triode a-c switch), it is the electrical equivalent of two SCR's connected in antiparallel with a common gate. General Electric coined the name but didn't register it, hoping it would become generic. It did. Samples trickled into R&D labs for evaluation and trickled out as solid state relays and lamp dimmers.

But the going was rough.

Thyristors—principally SCR's—first appeared in consumer products as motor controls in 1962, according to Jack C. Haenichen, operations manager for thyristors at Motorola. Half-wave SCR's were used in small power tools, such as hand drills and saber saws.

But these manufacturers don't want to change their designs to accommodate new control devices. That makes designers who would like to use triacs stay within tight packaging restraints.

Another application of thyristors was in household lamp dimmers, first with a single half-wave SCR, and then with two SCR's for full-wave operation. "But this business never got off the ground," Haenichen says, "because of the high price of the devices. The dimmer itself might have sold for \$12 to \$14. Maybe \$4 of that was production cost with the SCR's and associated triggering network accounting for 50% of that." The cost of the triac and its control devices is approximately 40% of the pro-

duction cost, says Haenichen, "and a production cost for the dimmer of less than \$2 is in the cards," implying a parts cost of 80 cents.

I. Only six can play

Of the 25 or so semiconductor manufacturers in the United States, nine are in the thyristor business. Only six of these make triacs. RCA followed GE, with Texas Instruments and Transiltron not far behind. The latest to enter the field are International Rectifier and Motorola. International Rectifier is not competing with the others. It specializes in a 200-amp unit for industrial controls. This area is untouched by the other five companies, which concentrate on low and medium power devices, under 40 amps.

Two reasons for so few triac makers are manufacturing difficulty and high costs. The manufacturing process requires very tight control on surface chemistry and diffusion techniques. A triac chip is also bigger than an SCR chip, requiring more silicon.

"In addition, the yield is worse for triacs because both halves of the chip have to be matched, so triacs will always be a little harder to make," Haenichen says. To get into the triac business, Haenichen says, would cost a company with no diffusion furnaces and related equipment about \$500,000. "And they would lose another million dollars in engineering time."

Finding the gate. The hardest problem is getting the proper gate contact. Because the triac is two

SCR's on the same chip, sharing common layers, the gate contact has to control both sides while keeping each half independent—one conducting and the other blocking. Further complicating manufacture is the fact that the triac has to conduct in either direction and be triggered in either direction by positive or negative gate signals.

Thus, the device has to act as three different thyristors. If anode-2 is positive, and so is the gate, the device functions as a conventional thyristor. With a negative gate and a positive anode-2, operation is like a junction-gate thyristor. If the gate is either positive or negative with a negative anode-2, the device functions as a remote-gate thyristor.

II. Now to sell

To break the sales-cost cycle GE turned to subassemblies, using its triac, that are a wire-for-wire replacement for mechanical and electromechanical devices. They can replace relays in washing machines and be used as speed controls in power tools.

Motorola is also making subassemblies using triacs in a kitchen blender. The next step could be an entire assembly such as a lamp dimmer, but Haenichen says that doesn't fit Motorola's marketing effort.

Easy trigger. Triacs have simplicity. For full-wave control, all that's needed is a variable resistor, a capacitor and a trigger. The most common trigger is a two-terminal transistor—a symmetrical transistor—that has a preset breakover volt-

age. GE calls them diacs (for diode a-c switch) because they conduct in either direction.

Motorola uses its MPT-32 series. Haenichen says a neon bulb could do the same job, but it has a much higher breakover voltage—80 volts as compared to 32 volts. The transistor now costs nearly twice as much as the neon bulb (about 20 cents for the MPT-32), but Haenichen predicts comparable costs within a year.

Some companies, such as RCA, combine the triac and a trigger in the same package. This is a sort of sub-subassembly intended to free the appliance manufacturer from redesigning his package. It also saves the cost of the package needed to house the trigger.

III. What next?

The latest development is the use of plastic packages. Motorola introduced an 8-amp plastic triac last year, and RCA will introduce one next week. The RCA triac is rated at 6 to 10 amps with blocking voltages from 200 to 400 volts. Dale Ludlum, RCA's administrator for thyristor market planning, says that since the plastic package is cheaper, and packaging is a major cost, the next logical step would be to put "more than one triac chip in a single plastic package."

A multi-triac package could replace high current relays or switches such as in a building's lighting or heating system. Instead of high-voltage wiring in conduit, low voltage wires could be used.

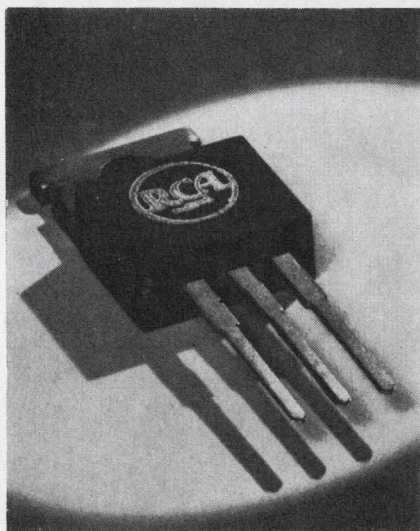

Latest entry. Plastic triacs with increased power capacity attract consumer-oriented manufacturers.

The saving on the wire alone would pay for the triacs.

In electric heating systems, the triac would save the cost of a multielement coil. In present systems, sections of the coil are switched in or out to modulate the heater. Using a triac would not only eliminate the expensive coil but provide infinite rather than step-type control.

Double sink. Since a triac conducts in both directions, and has two heat-producing anodes, both sides have to be sunk. The best solution, according to Norman Spear, thyristor sales manager for Westinghouse (which does not yet make triacs) is to use a package similar to Westinghouse's Pow-R-Disc design. This is a ceramic sided (usually round) package with metal seals at both ends. The unit would be mounted between two heat sinks and thus heat can be "gotten rid of from both ends."

IV. Market changes

Triacs could affect the power supply field. Robert Bertrand, Transistor's sales manager, says: "In regulated power supplies, where regulation is now being done on the d-c side with scr's, triacs could regulate the power on the a-c side. They could take away as much as half the scr's market in these applications."

Triacs can take over almost all applications where two scr's provide a-c control. Besides the two-for-one advantage, the triac needs less transient suppression. Scr's have to be protected from reverse voltage transients because they only conduct in the forward direction. Triacs, on the other hand, conduct in both directions, and can therefore handle reverse voltage without damage.

Turn-on and turn-off times are crucial in determining if a triac can be used to replace scr's. According to Bertrand: "An scr can have a turn-on time of less than 100 nanoseconds. A triac will have a turn-on time of from 500 nsec to 1 microsecond. But fast turn-on isn't critical in a triac since it's limited by power turn-on time, and that's 120 times per second on a 60-hz line anyway." Turn-off time is also slower for the triac, notes Bertrand, "but again, this isn't critical because of the frequency of the line."

New avionics

Recorded voice alerts pilots

Tape cartridge system plays message to warn of equipment failure

Pilots flying combat missions in Vietnam don't have the time to continually check their instrument panels. The lighting of a lamp on the panel to indicate a low fuel supply or an overheated engine may therefore go unnoticed.

The Army has been conducting tests of voice systems that would not only warn a pilot of a malfunction but tell him how to correct it. But most tested so far have been bulky and difficult to repair.

A new system said to solve both problems has been developed by the Master Specialties Co. Designated the Visual Warning and Audible Command System, it measures 3¾ by 5½ by 6½ inches, only one inch larger overall than existing lamp warning systems, according to the company.

Twenty separate tape cartridges are used, one for each stored message. When there's a fault, a signal is sent to the visual portion of the unit, turning on a lamp. This signal is also channeled to the audio portion of the system to activate the appropriate verbal message.

If two or more problems arise simultaneously, a priority logic assures that the most important is handled first. The logic is made up mostly of integrated-circuit modules mounted on a printed circuit board. Besides keeping the system small, the modular approach allows the priority sequence to be changed in the field.

The tape cartridges can be removed without special tools, and, since each contains its own recording and playback heads, there's no alignment problem. All of the cartridges are the same size; message length is variable from one to 30 seconds.

Master Specialties Co., 1640 Monrovia Ave., Costa Mesa, Calif. [338]

are you covered?

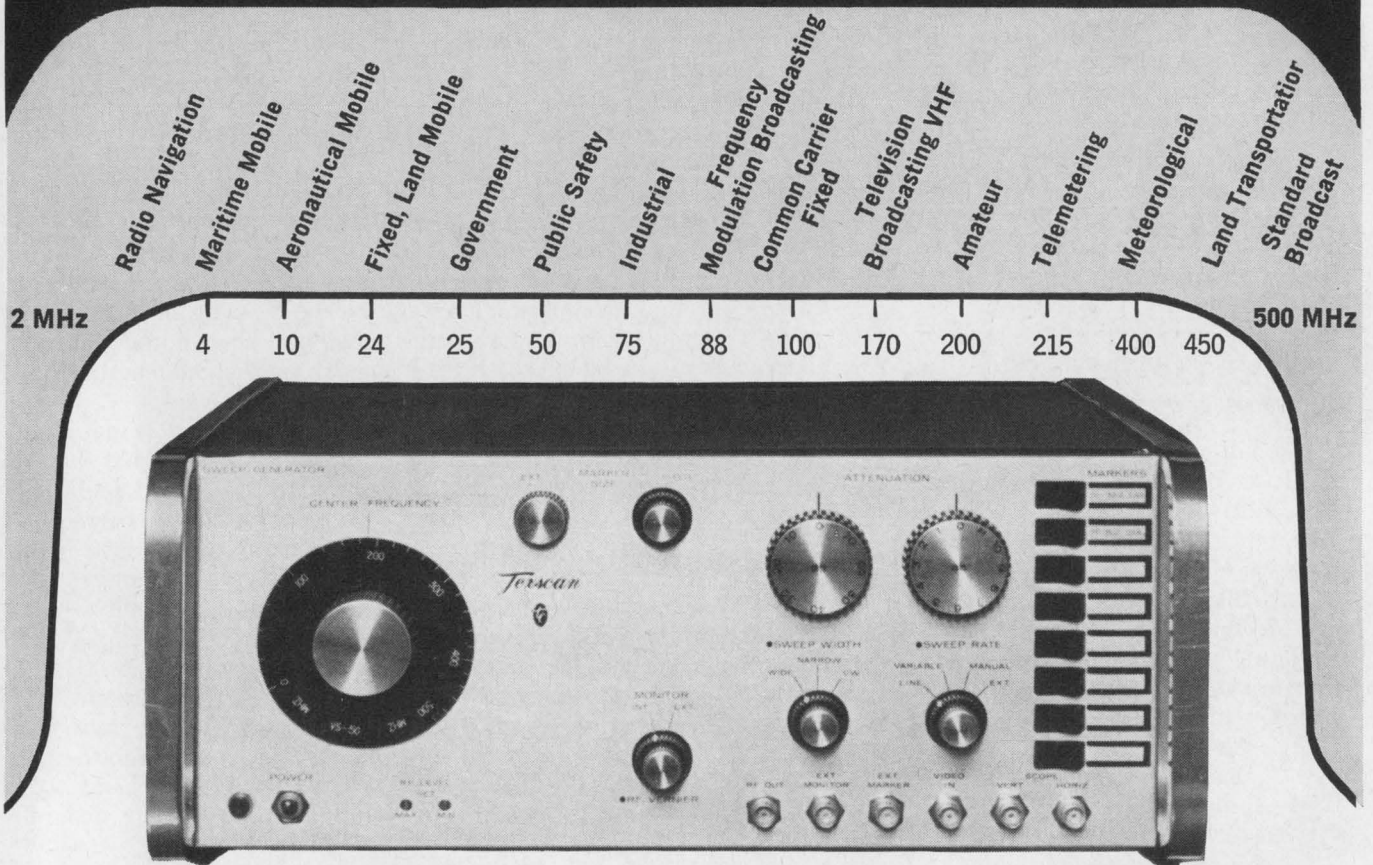

from 2 MHz to 500 MHz in one sweep

Texscan Corporation introduces the new VS-50 solid state sweep generator. Designed as a laboratory and production instrument, the VS-50 provides multiple octave coverage, variable sweep rates, internal and external capability and complete control of RF output level.

Using the latest circuit design techniques such as a double sweep heterodyne oscillator-amplifier system makes the VS-50 versatile enough to sweep from 2 MHz to 500 MHz in one sweep.

The RF output is extremely flat and is specified for a flatness of $\pm .25$ db at maximum sweep width with an output of 1 V rms into 50 ohms.

SPECIFICATIONS

Center Frequency Range	2 MHz to 500 MHz
Sweep Width	500 kHz to 500 MHz
Attenuation	0-6 db vernier 0-80 db in 1 db steps
Output Impedance	50 ohms or 75 ohms
Output Voltage	1 V rms

OTHER TEXSCAN VS-TYPE SWEEP GENERATORS

VS-20
200 Hz — 25 MHz

VS-40
1 — 300 MHz

VS-80
1 — 1200 MHz

VS-120
1 — 2.5 GHz

Contact your nearest Texscan Field Application Engineer
... a specialist in electronic instrumentation



Texscan Corporation 2446 North Shadeland Avenue, Indianapolis, Indiana 46219 • Tel. 317-357-8781 • TWX 810-341-3184

New Components Review



Application of power to the TFR time delay relay initiates a continuous recycling of on time and off time. Both times are adjustable in ranges from 0.25 to 360 sec. The series features 2% repeat accuracy, an output of 2pdt rated for 5 amps, and a life expectancy of 1 to 5 million operations (depending on load). Syracuse Electronics Corp., Box 566, Syracuse, N.Y. 13201. [341]

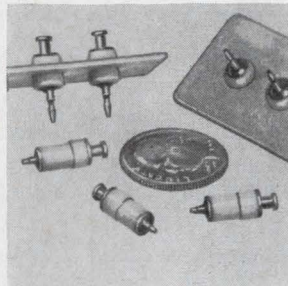

Hermetic Teflon terminal model 609-TH can be mounted on 7/32-in. centers. It will meet hermetic sealing specifications of MIL-T-27B and carries a test voltage of 2 kv rms. It uses a push-out for low-cost, high-speed rugged assembly. A sample kit, complete with tool points for assembly, is available for evaluation. Lundey Associates Inc., 694 Main St., Waltham, Mass. [342]

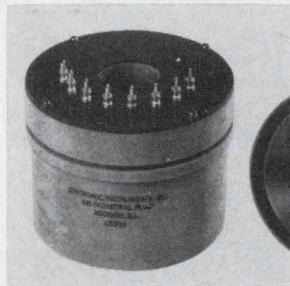

Shielded ferrite air core yoke C5380 features 0.1% max. residual magnetism and negligible h-f hysteresis. It is designed for high-speed computer and other crt character positioning and writing applications. It allows nsec writing speeds for small deflections and settling to 0.1% in less than 200 nsec. Syntronic Instruments Inc., 100 Industrial Rd., Addison, Ill. 60101. [343]

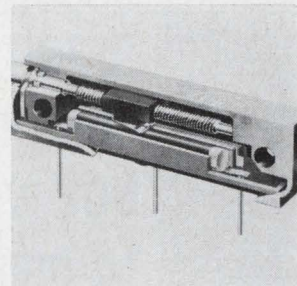

Infinite resolution rectangular trimmer 650 exceeds environmental and life requirements of MIL-R-22097C. It is available with Teflon-insulated leads or off-set p-c pins. Units are rated 3/4 w at 85° C and are available over a resistance range of 100 ohms to 10 kilohms, ±5% tolerance. Price (100 to 249) is \$3.75 each. IRC Inc., 401 N. Broad St., Philadelphia, Pa. 19108. [344]

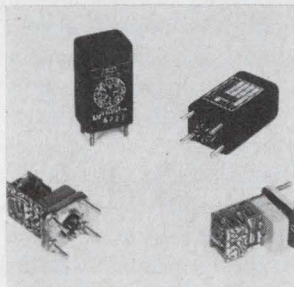

True delay-on-drop-out relays type DOT can operate on input pulses as short as 20 msec and provide timed drop-out delays up to 300 sec after removal of power. Standard models are dpdt types rated at 2 amps for operation at 18 to 31 v d-c. Repeatability is within ±1% at any specified temperature and voltage. Logitek Inc., 42 Central Drive, Farmingdale, N.Y. 11735. [345]

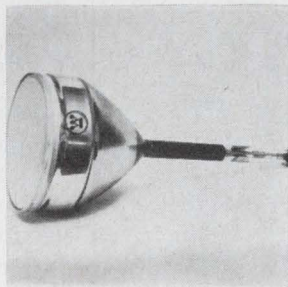

Magnetically focused crt WX-30734P, for use in military and industrial display systems, features a 10-in., optically flat faceplate and line width of 0.002 in. Typical applications include data handling, film scanning for graphic arts equipment in the printing industry, and flying-spot scanning. The tube is 25 in. long. Westinghouse Electric Corp., Elmira, N.Y. 14902. [346]

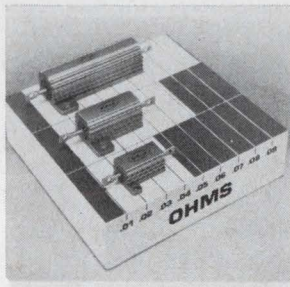

Housed resistors added to the RH series allow designers to obtain precision power in a range from 0.008 to 0.099 ohm. They come in 10, 25 and 50-w models, and are for use in voltage regulators, meter shunts and other circuits that require minimum resistance at close tolerances. Standard tolerances are from 0.1 to 5%. Dale Electronics Inc., Box 609, Columbus, Neb. 68601. [347]

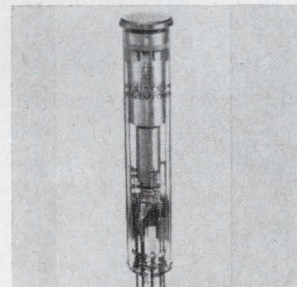

Vidicon type 2000 is a tv camera tube sensitive in the range from 3,500 to 18,000 angstroms. It is suitable both for tv camera operation in infrared light and for observing hot bodies at temperatures over 250° C. Marketed under the name Resistron, the tube uses an electron beam system provided with separate mesh. Epic Inc., 150 Nassau St., New York City 10038. [348]

New components

British Gunn shoots at X band

Hand-held radar sets, interference-proof warning systems seen as applications for this gallium-arsenide device

There's another British Gunn in town. Last January, Mullard Ltd. became the first company to market a Gunn-effect diode for use as an X-band source [Electronics, Jan. 9, 1967, p. 214]. Now, the Plessey Co. is introducing its version of the gallium-arsenide device.

Plessey's unit, the TEO1, is made by epitaxially depositing layers of gallium arsenide. A GaAs chip is mounted on a heat sink within an S4 varactor pill package and is connected to the outer case by a gold wire.

The TEO1 generates frequen-

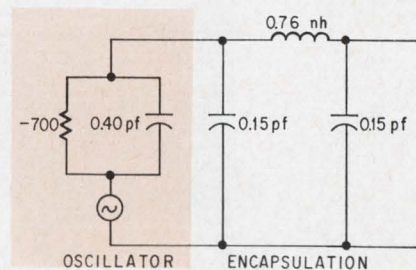

GaAs oscillator. Equivalent circuit was determined by measurements made in X band.

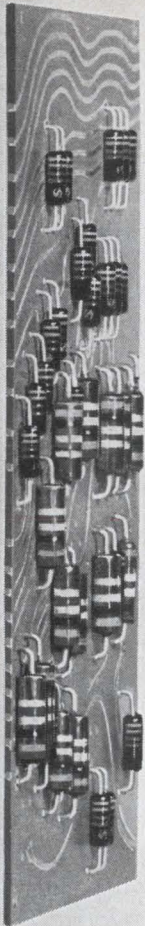

This approx. \$9,500 PC board assembly machine can insert 3,360,000 axial lead components a year.* But we think you only need to make 400,000 insertions to justify purchasing it. (Some customers say far less.)** That can mean a "Pay Back" period of just 1-1/3 months!

Send for cost analysis data on the Model 6001 . . . and 24-pages of engineering information on our broad line of sequencing and insertion machines (pantograph and N/C) for axial lead components, DIP's, jumper wires and transistors. Nowadays you don't have a PC board assembly built for you . . . you select the proven system best suited for your present and future needs. And, of course, you count on the no-obligation guidance you can get from an experienced Universal sales engineer. Contact:

Universal INSTRUMENTS CORPORATION
E. FREDERICK ST., BINGHAMTON, N. Y. 13902 • (607) 772-1710

MODEL 6001's
are now inserting
over 10-million
components a day

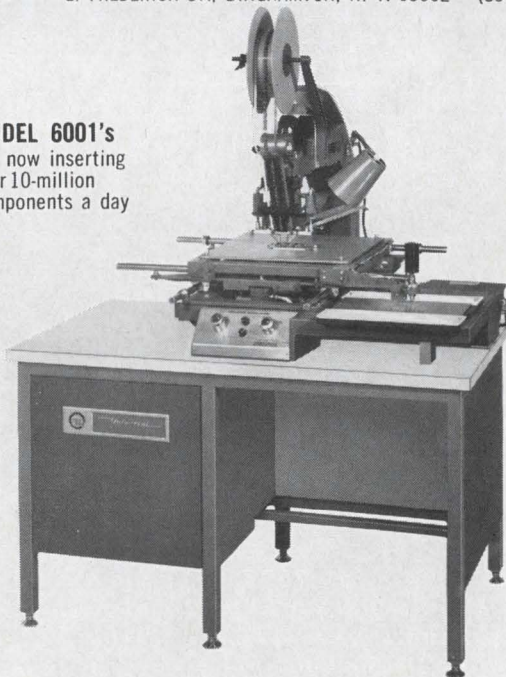

* Single 7-hr. shift; 240 day yr.; at 2/3 normal established machine rate.
** They add savings from increased uniformity . . . close tolerance accuracy . . . proven reliability . . . reduced floor space.

Visit Us at N. Y. IEEE Booths 1C29-31

**. . . biases from 4v to 10v
produce X-band power . . .**

cies from 7 to 12 gigahertz, Plessey says. Minimum power output over the X band is 2 milliwatts, and typical output is 5 mw. The diode draws 70 milliamperes and dissipates 1 watt maximum. Typical efficiency is 0.8%.

The diode starts to emit power when a 4-volt bias is applied. Power output rises sharply as the bias moves up toward a maximum of 10 volts.

The device operates over a range from -55°C to $+85^{\circ}\text{C}$. Plessey says its engineers have successfully tested the diodes in continuous and pulsed operation and report life times up to 7,000 hours.

Many uses. Some TEO1's have been sold in England. Engineers there have mostly used them, in products being developed, as local oscillators and klystron replacements. For example, one designer has used TEO1's in short-range doppler radars.

Plessey engineers say the device can lead to such microwave equipment as hand-carried radar speedometers, train-approach warning systems, ship docking radar, and intruder alarms immune to interference because of their high frequency.

If Mullard's experiences in the U.S. market are any indication, Plessey's best American customers will be research engineers. John Plump, Mullard's sales engineer in the U.S., says most of the company's Gunn-effect diodes sold here have been used in experimental work. He suggests seeing-eye radar sets for the blind as another possible application.

The package. In operation, a Gunn-effect diode is usually teamed with a tuning cavity, the frequency range of the diode-cavity package being a 1-gigahertz band within the frequency range of the diode.

Mullard markets both the diode and the diode-cavity package at prices of \$215 and \$315, respectively. Plessey doesn't make a package, but will sell its diode alone at only \$150. Delivery of TEO1's takes up to eight weeks.

Plessey Inc., 170 Finn Court, Farmingdale, N.Y. 11735 [349]

HERE'S HOW...

THE ELECTRONIC INDUSTRY IS USING THESE FAMOUS ULANO FILMS IN ULTRAMINIATURE MASK TECHNOLOGY AND COMPLEX PRINTED CIRCUITRY

UlanoTM

RUBYLITHTM

AMBERLITHTM

HAND CUT MASKING FILMS FOR THE GRAPHIC ARTS

ULANO RUBYLITH... a revolutionary knife cut red film is laminated to a stable transparent plastic backing sheet. The red film is "light safe" so that when contacted to a sensitized emulsion and exposed to a suitable light source, light passes through the cut-out portions only... not through the red film. ■ The polyester backing is absolutely stable... insures perfect register. ■ Special effects such as crayon tones, paste ups, benday sheets, and opaquing are easily combined with versatile ULANO RUBYLITH.

ULANO AMBERLITH... a companion to Rubyolith serves as a color separation medium used as the master on camera copy board to secure negatives or positives.

*A wide variety of Ulano films—
in rolls and sheets—is readily available*

Cut a piece of the desired film large enough to cover area to be masked. Tape it down firmly at the top *with dull-side up*.

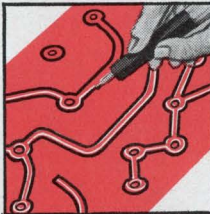
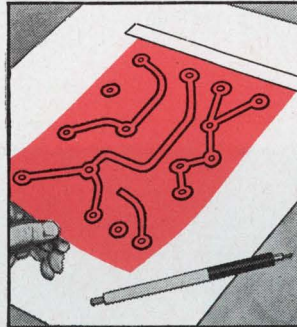

With sharp blade, outline the areas to be masked. *Do not cut through the backing sheet.* The Ulano Swivel Knife does the job quickly, easily.

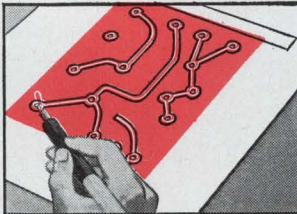

Using the tip of the blade, lift up a corner of the film thus separating it from the backing sheet.

Now carefully peel off the film as outlined leaving a completed mask, positive or negative, that corresponds exactly to the desired pattern.

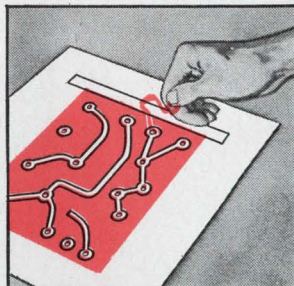

Designed FOR YOUR PARTICULAR NEEDS

Ulano offers the most versatile line of hand-cut masking films, including:

.0075—RUBYLITH 75 DR* **.005—RUBYLITH 5 DR†**

.005—AMBERLITH 5 DA†

Where exact register assures a critical importance, you will find these new, thick, polyester based films the positive answer.

* Available in sheets only, cut to your specifications

† Available in rolls and sheets



WRITE TODAY

*on your letterhead for free
special sample kit 1748*

"Ulano"—"Rubyolith"—"Amberlith" are registered trade marks of the Ulano Companies.

ulano

610 DEAN STREET, BROOKLYN, N.Y. 11238

In Europe: ULANO A.G., Untere, Heslibachstrasse No. 22, Kusnacht, Zurich, Switzerland

Be a lighting bug collector...

Surprise your friends...

Impress your boss.

More important, have all the engineering scoop on miniature lamps available when you need it.

That's what our lighting bug program is all about. Getting technical data on Chicago Miniature lamps where it can assist you the most. In your files, ready to be applied on any application that comes up. We have all the species.

Miniatures, sub-miniatures, hardware lighted devices and specially engineered varieties. Aerospace, aircraft, appliance, communication, computer and business machine, control panel and switch, instrumentation, optical, marine, medical, radio, TV, telephone, transportation... name your application and chances are, we've got a miniature or subminiature lamp that will do the job better.

Get your personal lighting bug collection. Send for it, today.

Even if you don't have any friends.

For application assistance, contact your Chicago Miniature Sales Representative. For off-the-shelf delivery, contact your local Authorized Chicago Miniature Electronic Distributor.



Chicago Miniature Lamp Works

4433 N. Ravenswood Ave., Chicago, Illinois 60640, (312) 784-1020



New Subassemblies Review

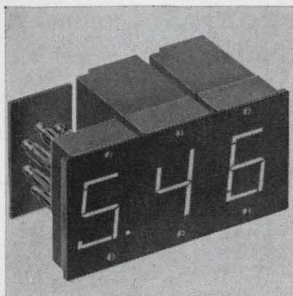

Digital display series NQM replaces gas-filled tube type displays in applications considered impractical because of size and cost. It is available with plus-minus sign, decimal point and colon. Each module is 1.97 in. high, 1.07 in. wide and 2 in. deep, and sells for \$25 per decade in production quantities. The Mesa Co., 220 Mill St., Bristol, Pa. 19007. [381]

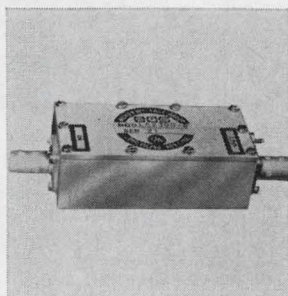

Solid state amplifier model LA 2300-8 provides a gain of greater than 50 db, with a noise figure of less than 1.5 db. It operates at 30 Mhz and its 3-db bandwidth is at approximately 10 Mhz. The 1-db compression point occurs at an output of 50 mi. Price is \$200; availability, from stock. Consolidated Airborne Systems Inc., 115 Old Country Rd., Carle Place, N.Y. 11514. [382]

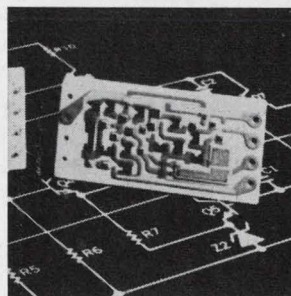

Cermet thick-film, d-c voltage regulator model 806 can be externally adjusted to provide any output from 3 to 9 v with $\pm 0.1\%$ regulation for both line and load variations. It can handle 0.5 amp. Operating temperature range is from -55° to $+125^{\circ}$ C, and power dissipation is 5 w at $+25^{\circ}$ C with heat sink. Beckman Instruments Inc., 2500 Harbor Blvd., Fullerton, Calif. [383]

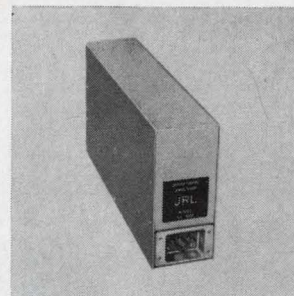

Operational amplifiers OA-602 and OA-603 feature a maximum short-term noise, flicker and drift of $0.1 \mu\text{v}$ peak-to-peak. The OA-602 has an output level of up to 40 ma into a 750-ohm load and the OA-603, an output power capability of 10 amps into a 1-ohm load. The OA-602 costs \$860; OA-603, \$1,800. Julie Research Laboratories Inc., 211 W. 61st St., New York 10023. [384]

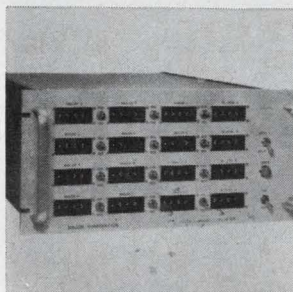

IC digital-to-analog converter model 6400 is designed for use as an output device for general purpose digital computers, data loggers, pcm decommutators or systems outputting address and data in a parallel binary multiplex. The unit accepts 8-, 10-, or 12-bit binary data at rates up to 100 khz. Discon Corp., 4250 Northwest 10th Ave., Fort Lauderdale, Fla. 33309. [385]

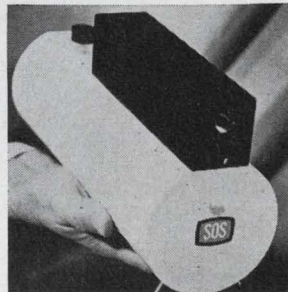

Portable neodymium laser designated Macro-Pak emits at a wavelength of 1.06 microns producing a conservatively rated maximum output of 5 joules. Laser beam diameter is 10 mm, and typical, half-angle beam divergence is 1.5 milliradians. The unit occupies 140 cu. in., weighs about 6 lbs. Price is \$5,000. Space Ordnance Systems Inc., 122 Penn St., El Segundo, Calif. 90245. [386]

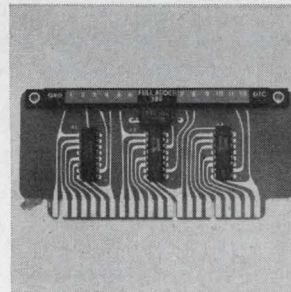

Modular 12-bit adder model 580 consists of three 4-bit circuits. It performs a 4-bit addition in 60 nsec, and a carry in 48 nsec. With power requirements of ± 5 v, 78 ma, the unit features a decoupling capacitor for minimizing noise interference, and is compatible with all DTL and TTL logic circuits. Data Technology Corp., 2370 Charleston Rd., Mtn. View, Calif. 94040. [387]

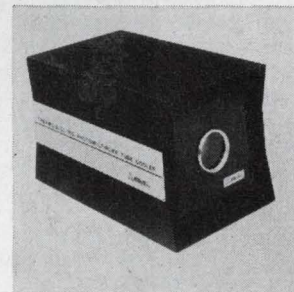

Thermoelectric photomultiplier tube coolers PMC-0206 have inside cavity dimensions that accept end-on tubes up to $2\frac{1}{8}$ in. diameter, $6\frac{1}{2}$ in. long. Free-air or forced-air convection, or water-cooled thermoelectric modules maintain the PMT at 0° , -18° and -28° C respectively, when the cooler is operated at ambient. EG&G Inc., 160 Brookline Ave., Boston, Mass. 02215. [388]

New subassemblies

Getting the right bump on the right pad

Infrared technique for ultrasonic flip-chip bonder can also be used in failure studies, beam lead work

Most people take it on faith that the light really does go out when the refrigerator door is closed. Besides, it certainly seems logical. But saying the bumps on a face-down bonded integrated circuit are really aligned with the appropriate bonding pads isn't that believable. Elaborate systems, incorporating complex optics, mirrors, and split images, have been devised to insure that bump and pad are in contact before the bonding energy is applied.

The ultrasonic flip-chip bonder developed by Hugle Industries pro-

vides the answer in different fashion: it looks right through the chip.

William B. Hugle, the firm's president, says the infrared optics designed for the bonder will have wide applications in other fields, including investigating the physics of failure, impurity levels, and epitaxial growth and in beam-lead manufacturing.

Monocrystalline silicon is transparent to infrared energy, but metals such as aluminum, copper, and gold will reflect it. The Hugle machine illuminates the metallization patterns on both chip and substrate with infrared energy, focused with conventional optics, and converts

Now! TCXO's from Bulova!

Stability:
±0.5 PPM!



Now you can get Temperature Compensated Crystal Oscillators from Bulova, with all the quality and dependability that have made Bulova the leader in frequency control products. Our new Model TCXO-5 is just four-cubic-inches, consumes only 50 mW, and employs a computer-selected-and-optimized compensation network designed to maintain frequency stability over wide temperature ranges without the need for an oven (±0.5 PPM from -40°C to +70°C). Perfect for aerospace and military applications where power, space and weight restrictions are severe.

SPECIFICATIONS

Frequency Range:	2MHz to 5MHz
Frequency Stability:	±0.5 PPM from -40°C to +70°C
Output:	Sine Wave, 1VP-P into a 1000 OHM Resistive Load
Input:	50 mW
Size:	Just 4 cu. in.
Weight:	Only 5 oz.

Other frequencies, output wave shapes, output levels and load impedances can also be supplied.

Write today for more information about Bulova's new TCXO-5, or assistance with any Crystal Oscillator problem. Address: Dept. E-27.

Try Bulova First!

FREQUENCY CONTROL PRODUCTS

ELECTRONICS DIVISION
OF BULOVA WATCH COMPANY, INC.

61-20 WOODSIDE AVENUE
WOODSIDE, N.Y. 11377, (212) DE 5-6000

... bonding process is semiautomatic ...

the infrared to visible light with an image intensifier.

Long block. The source of the infrared energy is an ordinary tungsten lamp. A silicon slice, mounted on quartz, filters out all visible radiation; the response of the image-intensifier tube, which peaks at about 0.86 micron, blocks radiation of wavelengths longer than infrared's 0.70 micron.

The infrared energy passes through a correctable objective lens that makes the rays almost parallel. Energy reflected from the metal passes through a collector lens into a prism, which focuses an image on the cathode surface of the image intensifier. Electrons falling off the cathode are accelerated by a potential of -15,000 volts, and deflected so that the reversed image will appear rightside up to the operator. A phosphor screen at the anode makes the image visible again.

Total magnification of the system is 60X to 100X.

Logic control. An electronic positioning system does away with the conventional camshafts. The new bonder uses two strain-gage transducers to measure force, and three differential transformers to set position. These transducers are controlled by a logic system that makes the bonding process semiautomatic; the operator has only to press a button marked "load" to position the chip, and one marked "bond" to attach it to the substrate.

The transducers, however, cannot actually align the chip; this function must be performed by the operator, who can manipulate both chip and substrate. Before bonding, the chips sit on a quartz slice. At the "load" command, a vacuum needle indexes in and picks up one chip; the slice swings away and the needle goes down to 1 mil above the package.

At this point, the operator must move the substrate around until pads and bumps are aligned. At the "bond" command, this x-y-z action is frozen and the needle pushes the chip into the package, deforming the bumps somewhat. Pressures of up to 5 pounds can be applied; the choice is made on a micrometer.

Easing off. If ultrasonic energy

NEW MAGNETIC RELAY plugs into your PC board!

NO Springs, NO Wiring,
NO Sockets, NO Soldering,
NO Mechanical Linkage

Printact®

Standard Series G
Latching Series LS/LD

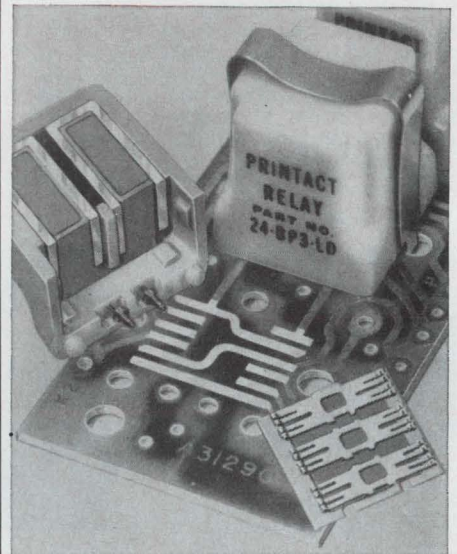

(actual size)

Plated Conductors on Your PC Board are the Fixed Contacts

Save SPACE, MONEY and MANHOURS with these new small, lightweight, highly reliable Standard and Latching PRINTACT Relays.

Available with Bifurcated Palladium or Gold Alloy contacts for more than 10 million cycle 2 to 4* pole switching. Handles up to 2 amp. res. loads. Coils for 6, 12, 24 and 48 vdc at 500 mw. Operating temperature -30°C to +95°C. Operate time 7 ms. The little gem is an 0.8 oz. 7/8" cube.

Quality features include: double-break contacts; balanced armature, enclosed housing; plug-in application; encapsulated coil; self-wiping contacts and inherent snap-action — saves sockets soldering, and wiring and the cost is lower than you think!

*Switches up to 4 form A plus B, or 4 form C.

For data and prices write or call:
212-EX2-4800

Executone

PRINTACT RELAY DIVISION
47-37 Austell Place
Long Island City, N.Y. 11101

Circle 245 on reader service card



EMC CONTROL

5 SOLUTIONS TO MAGNETIC SHIELDING PROBLEMS

1. Use flexible Netic Co-Netic Foil. It can be cut easily with ordinary scissors and shaped quickly to any desired configuration. One or more layers may be used as needed. Stock delivery in any required length. Widths: 4", 15" and 19 1/2". Other widths available. Several convenient thicknesses.

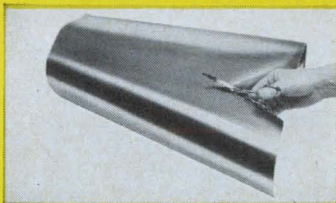

Netic Co-Netic Foil



Adhesive-Backed Foil

2. Order Netic Co-Netic Sheet Stock for fabrication in your plant into any desired configuration. Conveniently available in lengths of 15", 30", 60" and 120" in widths of 24", 26" and 30" and in thicknesses from .095 to .014.

3. Specify Netic Co-Netic fabricated component shields made to your exact specification by our magnetic shielding specialists.

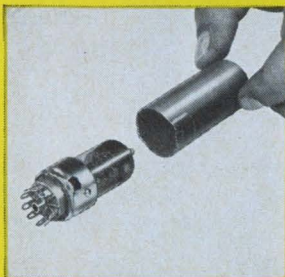

Miniature Component Shielding

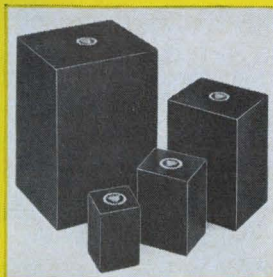

Transformer Cans

4. Protect your vital programming records by storing and transporting them in specially designed rugged Netic containers.

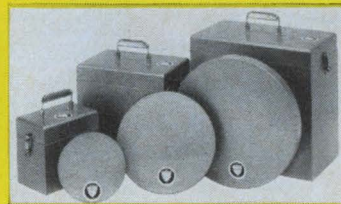

Stock Items

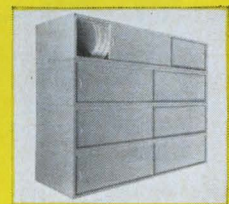

Multiple Stacked Tape Storage Cabinets

5. To reduce magnetic field pickup or radiation in vital wires or cables, select Unique Inter-8 Weave Cables. Available in plain, copper shielded or Co-Netic shielded.

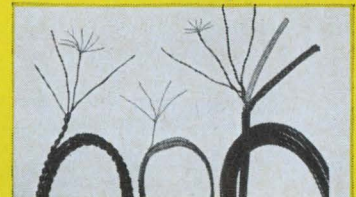

Inter-8 Weave Cable— Plain, Copper Shielded, or Co-Netic Shielded

YOURS FOR THE ASKING:

The most complete literature available on magnetic shielding.



MAGNETIC SHIELD DIVISION

PERFECTION MICA COMPANY

1322 NORTH ELSTON AVENUE • CHICAGO, ILLINOIS 60622

PHONE: 312, EV 4-2122

TWX 910 221-0105

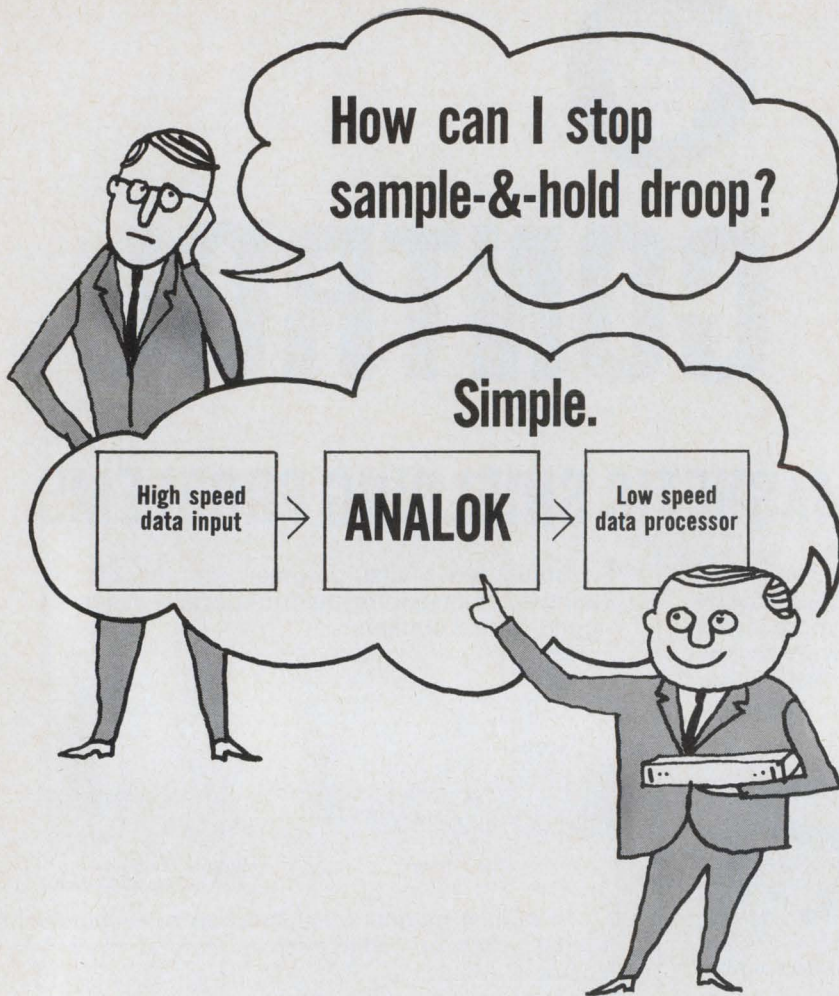

Forget about droop with ANALOK because it doesn't. What it *does* do is give you a simpler, less expensive system with greater flexibility.

Here's how. ANALOK is a multichannel unity gain track-and-hold amplifier with *zero* decay. It can retain stored values *in an analog state* indefinitely. This unique memory capability gives you greater flexibility because there's no time restriction between acquisition and use of sampled values. Check these applications:

- Use ANALOK as a high speed data buffer. Sample multiple functions simultaneously, or transient phenomena in a programmed sequence. Transfer the data to your low speed data processor as slowly or rapidly as you wish. No matter how much time you take, the stored values won't droop.
- Decommuration with one DAC and a multichannel ANALOK eliminates the need for periodic updating necessary when using conventional sample-and-hold channels. The result of using ANALOK is optimum use of your computer since it need only address each ANALOK channel when it has *new* information.
- Provide the information storage capability in your analog system with ANALOK. You may not have to go hybrid.

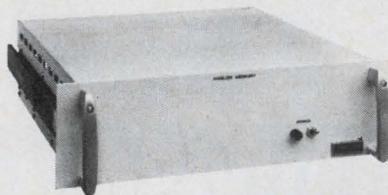

Get complete specifications. Write to ANALOK Sales, Dept. 240, Analog-Digital Systems Division, Control Data Corporation, 4455 Eastgate Mall, La Jolla, California 92037. Or phone 714/453-2500.

CONTROL DATA

CORPORATION

4455 Eastgate Mall, La Jolla, Calif.

is applied immediately, the higher bumps may take too much of it, and can be knocked right off the chip. This problem has made ultrasonic techniques difficult to apply to flip-chip packages. The Hugel machine gets around it by easing the pressure to a half pound before the lateral ultrasonic energy is turned on. Don Pedrotti, an engineer who worked on the bonder design, says about 20 watts should be sufficient for most packages.

Hugel Industries, 750 North Pastoria Ave., Sunnyvale, Calif. 94086 [389]

New subassemblies

British challenger uses big words

First desk-top computer designed in England has 16-bit word length

British engineers looking for small, inexpensive computers have so far had to buy American. But the gap in the British line will be filled this summer, when Digico Ltd. introduces its Micro 16, a desk-top computer priced at \$10,000.

Keith Trickett, Digico director, says the new machine will be able to compete on better than equal



Giving the orders. Computer has 16-bit word length, and direct access to any address in 4,096-word memory.

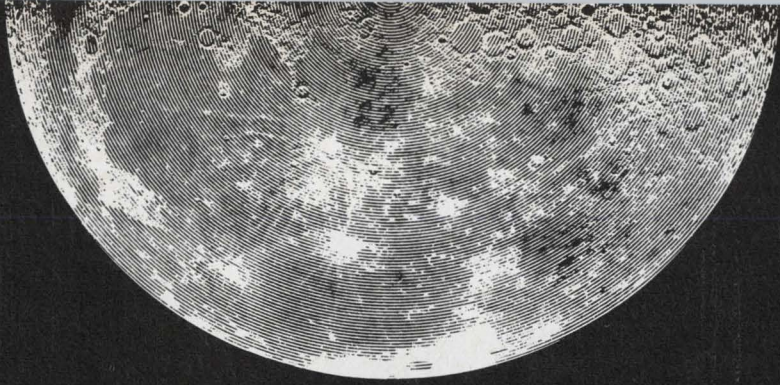

If YOUR system is going on a trip... let Hughes make the connections

Even if your electronic circuit isn't going as far as the moon—or if it is—when your interconnections require small-size ruggedness combined with the utmost in reliability, Hughes rectangular subminiature connectors are the answer. And don't worry if you are tight for space; all these subminiatures need is a crowded corner. They provide 110 contacts per square inch, *plus* the greatest space and weight savings available.

Check these other features and innovations: Crimp snap-in contacts with the best retention system in the industry ■ Exclusive PolarHex center jackscrew coupling mechanism for positive alignment and far less weight ■ One-piece diallyl phthalate connector bodies for outstanding performance in every application.

Whether your circuit will have to operate far from

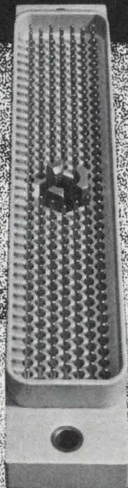
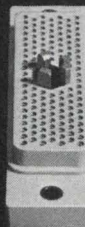

Earth for a long time, or whether it isn't going anywhere at all, Hughes subminiature rectangular connectors will give you the greatest versatility and reliability you can find—any place. For complete information, write, wire or phone: Hughes Aircraft Company, Connecting Devices, 500 Superior Avenue, Newport Beach, California 92663. Phone 714/548-0671, TWX 714/162-1353.



HUGHES

HUGHES AIRCRAFT COMPANY

HUGHES CONNECTING DEVICES

Hughes Circuit Technologies: Connecting Devices • Contour™ Cable • Semiconductors • FlipChips/Equipment • Frequency Control Devices • Microelectronic Circuits • MOSFETs.

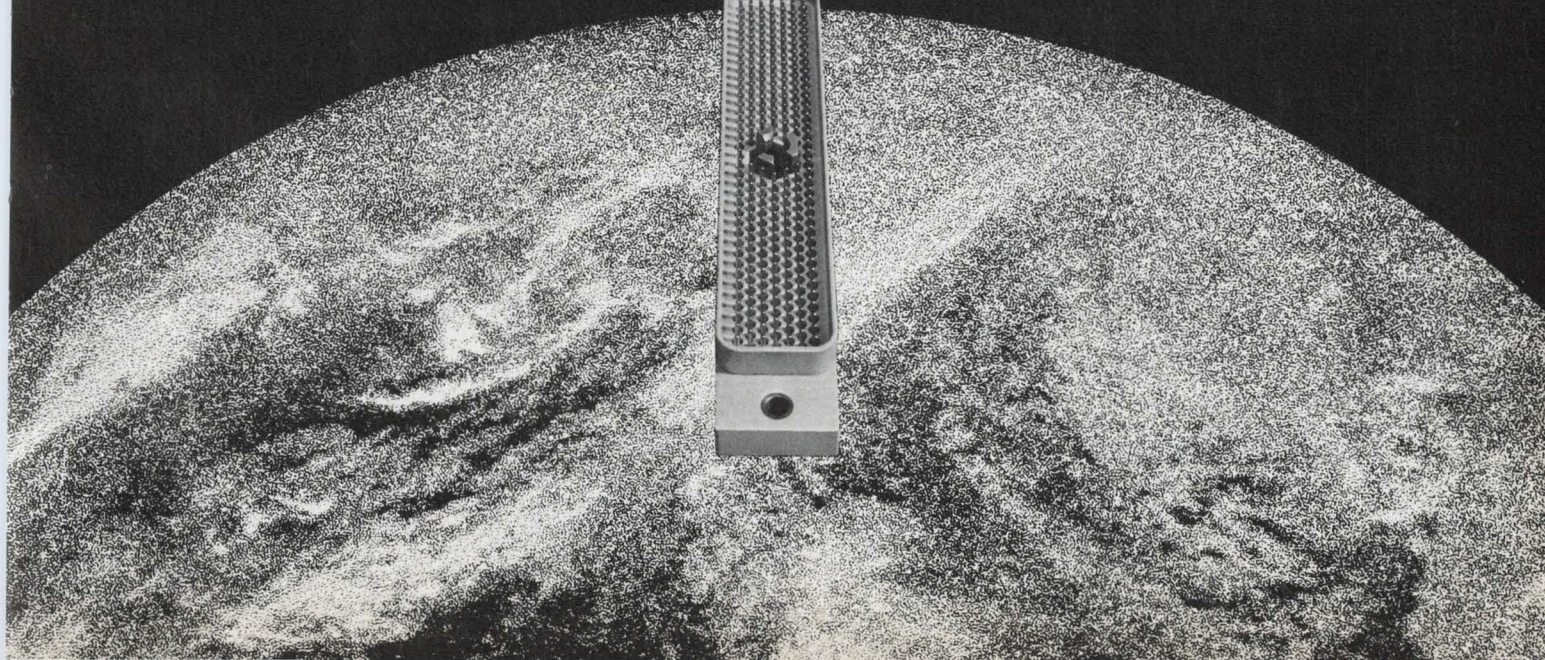

**NEW HIGH SPEED
DURANT 6 FIGURE
ELECTRIC COUNTER**



**COUNTS
ACCURATELY
REGARDLESS OF
POWER
FLUCTUATIONS!**

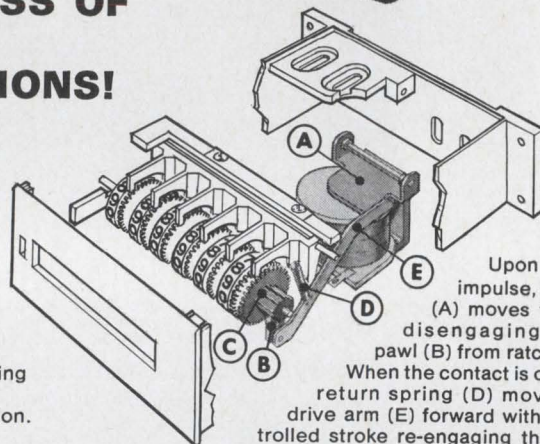

Upon power impulse, clapper (A) moves forward disengaging drive pawl (B) from ratchet (C). When the contact is opened, return spring (D) moves the drive arm (E) forward with a controlled stroke re-engaging the drive pawl with the ratchet causing the unit wheel to move 36° and add one count.

Panel or base mounting provides permanent, tamperproof installation.

Durant's new high-speed 6-YE is the only electric counter which counts on the release of power. Provides long life and accurate count, even when the power fluctuates.

This new, exclusive Durant drive assures positive, accurate counts at speeds to 2400 cpm. Simplified, balanced drive mechanism is consistently accurate—built to take shock, jars and vibration.

The entire mechanism of the 6-YE is housed within the case, keeping out moisture and dirt. Lubrication never required when used under specified operating conditions.

Your choice of instant electric or pushbutton reset (with reset time only 300 milliseconds) or non-reset model.

All Durant electrics are fast, accurate, dependable



MODEL 4-Y-9434 Series
Non-rectified, shaded pole coil withstands transient, high voltage spikes. 600 cpm AC, 800 cpm DC.

MODEL Y-Electric Series
Silent DC electromagnetic drive with built-in rectifier for AC operation operates to 1000 cpm. Also available in a non-rectified, shaded pole coil designed to withstand transient, high-voltage spikes. Speeds to 750 cpm AC.



6-CS-1-RMF Series
Count speeds 800 cpm with large easy reading figures.

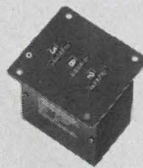

MODEL 3-Y-11564
A true subtracting counter which subtracts from the preset number down to 000 to actuate a switch.

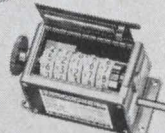

MODEL SP Series
Predetermined counter for automatic signal or control.

DURANT
MANUFACTURING COMPANY
MILWAUKEE, WISCONSIN

Write for Electric Counter Catalog.
Durant Manufacturing Company,
622 North Cass Street,
Milwaukee, Wisconsin 53201

6172

**... building blocks
increase memory ...**

terms with its American counterparts. The Micro 16 will have a 16-bit word length, compared with 12-bit word lengths for competitive units. And this feature, Trickett notes, permits direct execution of more complex commands.

The machine has direct access to all 4,096 words in the memory, and a feature called modified access. With modified access, an address can be made with or without increment and be specified anywhere in the lower half of the memory, he adds.

The unit is made of a series-parallel processor and memory, a paper-tape input-output unit, and a paper-tape handling device operating at 10 characters per second. Addition time for two 16-bit words is 20 microseconds.

The diode-transistor logic elements are silicon microcircuits, Fairchild 930's.

A few extras. Optional equipment, designed to extend capability, can be either installed in the basic unit or stacked on it. Options include:

- Multiply-divide hardware costing an extra \$1,300.
- A fast paper-tape reader and hesitate control costing \$1,700 to transfer data from magnetic tape and drum units to the core memory at rates up to 160,000 characters a second in parallel with computation.

▪ Additional 4,096-word core blocks to build memory capacity to a maximum of 65,536 words.

Digico says the system can be plugged into any a-c line and doesn't require a temperature-controlled environment.

The Micro 16 has real-time and interrupt capabilities, and is designed for process control, scientific computation, data logging, stock recording, and computer teaching.

Digico built the computer with the backing of the National Research Development Corp., a British government agency. It expects to be producing the Micro 16 at a rate of one a week by the end of the year.

Digico Ltd., 7 Broadwater Rd., Welwyn Garden City, Hertfordshire, England [390]

Announcing AE's Class H relay. It's compact, versatile, low in cost.



The Class H relay is small in size—just about a 1.3 inch cube. It's a versatile "telephone-type" component that offers better than average quality at a low price.

You can use the Class H to reduce the physical dimensions and decrease the cost of your products. It's well suited for business machines, vending machines, communication equipment, computer peripheral equipment, aircraft and missile simulators. These applications take advantage of its small size, versatility of mounting, and large switching capacity (maximum of 6 form C or 4 C and 2 D contacts).

The Class H can be direct-mounted or socket-mounted to a PC card. Or it can be socketed into a panel. It also has a socket that mounts on a rack.

The Class H is made as a regular quick-acting relay (Series HQA). It's also available as a short or long pulse "latching relay." In this ver-

sion (Series HRM) it uses remanent magnetism—or controlled residual magnetism of the coil core—as its latching medium.

This little relay's rugged construction protects it from ordinary shock and vibration. Mechanical life expectancy exceeds 100 million operations. Molded pileup insulators provide high dielectric strength and dimensional stability. Contact actuation is by a lift-off card method—which eliminates the problem of contact sticking.

A clear heavy-duty plastic cover provides protection from contamination and abuse. Once this cover is snapped into place, it's not readily removed. This discourages tampering.

Want helpful, detailed specification and application data? Send for Circular No. 1100. Just write to the Director, Relay Control Equipment Sales, Automatic Electric, Northlake, Illinois 60164.



AUTOMATIC ELECTRIC

SUBSIDIARY OF GENERAL TELEPHONE & ELECTRONICS

The box filled with echoes

Adjustable delay time produces reverberation or synchronizes signals

Engineers from Perfectone Sound Laboratories went to church recently to test a system, not to pray for one. The system, a reverberation generator, had been designed to electronically produce long delay times with low distortion of audio signals.

"We took the generator to a local church, hooked it up to the electronic organ, and it really sounded like we were in a cathedral," says George Lehsten, chief engineer at Perfectone.

The beat goes on. Reverberation gives music a deep, continuous sound. A sound wave, generated in a room, continually reflects off the walls and a person in the room hears each reflection until the sound dies out. The loudness of each reflection and the time it is heard depends on the size, shape and acoustical properties of the room. These factors are controlled in the design of a concert hall so the reflections, or reverberation, enrich the sound.

Recording engineers design their studios so they can duplicate concert-hall acoustics. They produce an artificial reverberation by using a group of tape decks and electronic delay devices.

For the record. Perfectone engineers wanted to increase the flexibility of the electronic approach. Their system allows adjustment of input delay time up to 2.5 seconds. Distortion is less than 1% from 15 to 17,500 hertz—most of the audio spectrum.

The reverberation generator has a series of amplifier stages. An input is delayed 33 milliseconds in each stage and the output of each amplifier can be attenuated and fed back to any input. Attenuations and feedback loops are set by Perfectone to produce the desired acoustic effects according to the

FOR BETTER, FASTER WIRE HARNESSING—

GUDEBROD CABLE-LACER®

NOW REDUCED TO \$9.95 ea.
[10% OFF, LOTS OF 50]

Production economics enable Gudebrod to offer the production tested Cable-Lacer at a new low price. Holds bobbin of tape. Facilitates lacing and knotting.

GUDEBROD GUDE-SNIPS®

NEW HANDY TOOL— \$3.75 ea.
[\$37.50 IN DOZEN LOTS]

Unique, palm held tape snips. Allow free use of fingers while holding in hand. Right- or left-hand use. Sharp, drop-forged cutlery steel blades. Spring action.

Special Offer!

So that you may try them and see the money-saving way they facilitate the harnessing operation—we'll send you postpaid, one Cable-Lacer, one Gude-Snips and a bobbin of lacing tape for just \$14.00. Test for yourself how these tools can help you make better harnesses, faster and for less money.

GUDEBROD BROS. SILK CO., INC.

Founded in 1870
12 South Twelfth Street
Philadelphia, Pa. 19107

Check enclosed, send me, postpaid:

- The special offer of Cable-Lacer, Gude-Snips and bobbin— \$14.00*
- I just want the Cable-Lacer— \$9.95*
- Send only the Gude-Snips— \$3.75*

Name _____

Company _____

Address _____

*In Pennsylvania please add sales tax.

BOTH:
ACTUAL SIZE

USE THE COUPON
FOR SPECIAL OFFER →

GUDEBROD

Electronics Division

buyer's specifications.

Tubes first. Although the generator has been redesigned for solid state construction, Perfectone still produces vacuum-tube models. "They're not too concerned about saving space in a recording studio," Lehsten explains. With tubes, the generator uses 200 watts. The solid state model uses 75 watts.

The generator can be used in reproduction systems, like home record players, and the solid state model is no larger than an FM receiver-amplifier. But the price is \$150 and Perfectone does not expect the generator to be competitive in that field, because lower-priced electromechanical reverberators are available.

Altogether now. Although they designed it as a reverberator, Per-

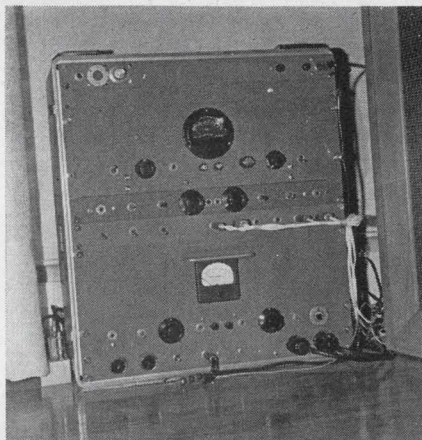

Stop and go. Reverberation generator delays audio inputs, avoids distortion.

fectone engineers now see many other applications for their generator. "We're still coming up with new ways to use it," says Lehsten.

Perhaps the most common use will be in multiple-input systems where the inputs arrive at different times, as in a computer with input stations in different cities. Delays can be set with dials on front panels of the generators.

Conversely, signals arriving at a recorder simultaneously can be staggered so one channel is used to record all inputs.

According to Lehsten, there's no reason why the generator can't be built to handle higher frequencies. But as frequencies go up, so does the cost.

Perfectone Sound Laboratories, 44 Midwood Ave., Allendale, N.Y. [391]

If you're concerned with Transistor Pads and Clips— Heat Sinks and Adapters . . .

JERMYN

ACCESSORIES

are worth
a closer
look . . .



Precision made in Kent, England by JERMYN Industries, these important items of circuit hardware are manufactured with traditional English craftsmanship. They are stocked and sold exclusively in the U.S. by GUDEBROD. Ask for our new Catalog GJ100 which describes the full line—or tell us about your custom needs.

GUDEBROD

Electronics Division

Gudebrod Bros. Silk Co., Inc.
Founded 1870
12 South Twelfth Street
Philadelphia, Pa. 19107

Now... IC op amps in low-cost plastic

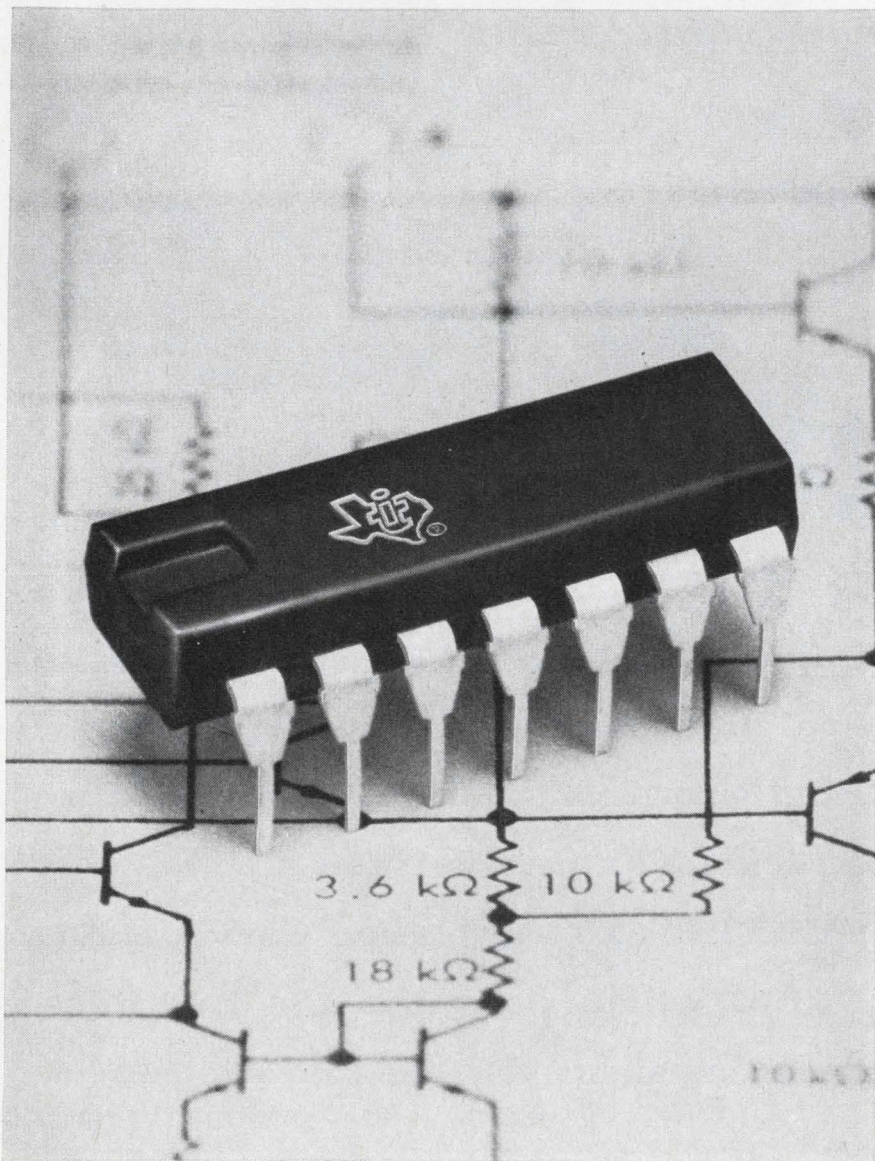

Now you can get economy versions of our "702", "709" and "710" IC operational amplifiers in rugged, low-cost plastic packages. Because these devices substantially reduce overall system costs, you can now justify their usage in hundreds of applications previously limited by economics.

Two versions are available...one for maximum economy and one for maximum performance. The premium Series 52 circuits feature peak performance over the full military temperature range of -55° to $+125^{\circ}\text{C}$, while the economy Series 72 circuits offer slightly lower performance over the industrial temperature range of 0° to $+70^{\circ}\text{C}$.

Regardless of the version you require, these new plastic-encapsulated ICs assure the greatest possible value for your circuit design dollar.

And best of all, you get the performance you want *without sacrificing ruggedness and reliability*. TI's "tougher-than-military" plastic package has passed many tests that far exceeded the requirements of applicable military specifications such as MIL-STD-750A and 202C.

In-depth test results are presented in an 84-page reliability report. Circle number 185 on the Reader Service card for this report...plus data sheets on "702", "709" and "710" ICs.



TEXAS INSTRUMENTS
INCORPORATED

New Microwave Review



Klystron stabilizer/receiver 201B is a combination of a high-gain 60 Mhz i-f amplifier, limiter, discriminator, d-c amplifier, and a-m detector. Frequency range is limited only by the external oscillator and mixer. At X band, use of a balanced mixer will provide a system noise figure of 10 db. Micro-Now Instrument Co., 6124 N. Pulaski Rd., Chicago 60646. [401]

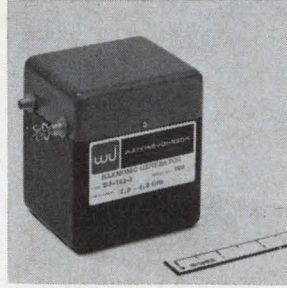

Electronically-tunable harmonic generators, for use as digitally-tuned local oscillators and as microwave test signal sources, offer linear and stable tuning characteristics over octave frequencies from 500 Mhz to 18 Ghz. Less than 1 watt of 100 Mhz fundamental drive signal is needed to operate the units. Watkins-Johnson Co., 3333 Hillview Ave., Palo Alto, Calif. 94304. [402]

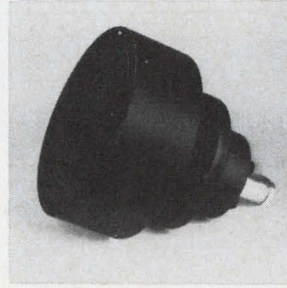

Planar spiral antenna DMR33-1, for airborne ECM receiving systems, has a frequency range of 2 to 10 Ghz. Its 3 db beamwidth uniformity is $90^\circ \pm 12^\circ$ (2-3 Ghz) and $78^\circ \pm 12^\circ$ (3-10 Ghz). Minimum squint is less than 5° ; axial ratio, less than 1.5 db; and gain tracking in matched pairs at ± 0.5 db. Dorne and Margolin Inc., Veterans Memorial Highway, Bohemia, N.Y. 11716. [403]

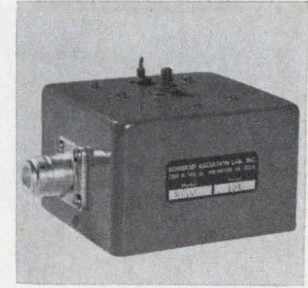

One-watt crystal-controlled power source N900 offers an output within 10 khz of 50 Mhz to excite step-recovery diode multipliers generating accurate frequency markers to 12 Ghz for calibrating receivers, transmitters, microwave spectrometers, and frequency meters. Price is \$165; availability, 20 days. Somerset Radiation Laboratory Inc., 2060 N. 14th St., Arlington, Va. 22216. [404]

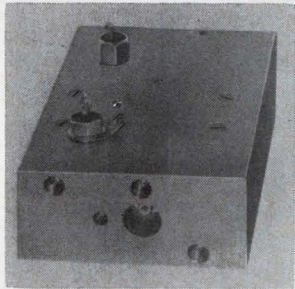

Octave bandwidth oscillator model MX-152 requires only single polarity voltage to tune over a full octave bandwidth. It has a linearizing network that produces linearity control over the 600 to 900 Mhz portion of the octave, when driven from 0 to 20 v (± 0.01). Operating temperature is -30° to $+55^\circ$ C. Micro State Electronics, 152 Floral Ave., New Providence, N.J. 07974. [405]

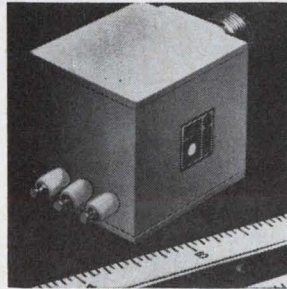

Voltage tunable, solid state oscillator PM-7101 was developed as a local oscillator for broadband microwave receivers and as a broadband signal source for microwave measurement equipment. It operates from 500 to 1,000 Mhz. Harmonic rejection is 15 db minimum. The unit measures 1.25 x 1.35 x 1.45 in. Alpha Industries Inc., 381 Elliot St., Newton Upper Falls, Mass. 02164. [406]

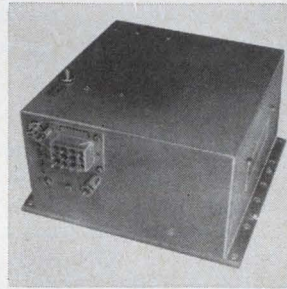

Telemetry module D10116 is designed for airborne target drone application. Meeting all pertinent MIL specs, the 7-lb, 6 x 6 x 6 3/4 in. package houses a 1-kw peak output, pulsed triode oscillator cavity, modulator, low pass filter and regulated r-f power supply. Operating range is 2,300 to 2,450 Mhz. Microwave Cavity Laboratories Inc., 10 N. Beach Ave., LaGrange, Ill. 60525. [407]

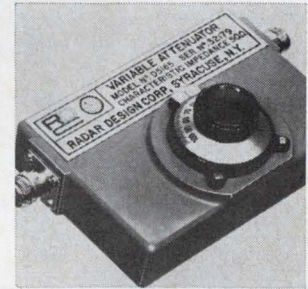

Calibrated, variable coaxial attenuator D-5165 operates over 2 to 12 Ghz with a range of 0 to 50 db. It features low insertion loss of 0.5 db and vswr of 1.25 maximum. Special planetary 5:1 movement allows fine setting to 100-db direct readout. An internal absorber of Radite 75 allows 5-w power rating. Radar Design Corp., 104 Packard Dr., Syracuse, N.Y. 13211. [408]

New microwave

Pointless plotting can save time

Diagraph displays reflection and transmission coefficients, complex impedances, and transistor scattering parameters

With busy production men in mind, Munich-based Rohde & Schwarz has improved its Z-g diagraph. At this year's IEEE show, the company will introduce a second-generation instrument, the Type zwa.

The 12-year-old Z-g is commonly used by microwave circuit designers

as a Smith-chart plotter. But it requires an external signal generator and point-by-point plotting.

"The old model was used in labs," says Carroll Barlow, sales engineer for Rohde's American office. "Now production people are demanding instruments with standards as stringent as those required in research, but they don't have time for point-by-point plotting."

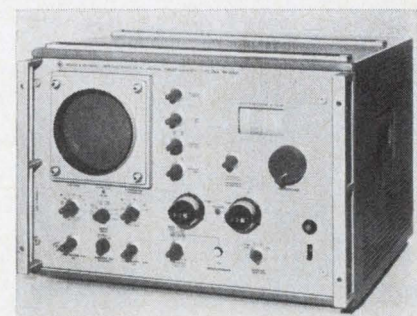

New generation. The cables from the two directional couplers are inserted into the sides of the diagraph.

gent as those required in research, but they don't have time for point-by-point plotting."

Sudden Smith. Rohde's engineers

NOW FROM AUSTRON



Model 20
Power Converter

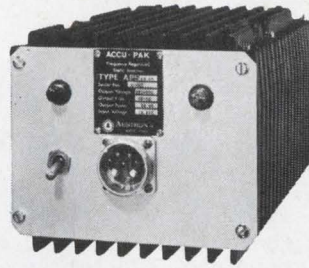

APS Series
Power Inverter

Power Modules

Model 20: Used as a frequency controlled power converter where square wave output is desired, the Model 20 converts unregulated 55-70 Hz or 340-460 Hz a-c input to an output at 60 or 400 Hz (or any required frequency) with a frequency tolerance as close as $\pm 5 \times 10^{-7}$. **APS Series:** These rugged inverters produce precision 50 Hz, 60 Hz, or 400 Hz, 115 V a-c, 30 to 200 VA outputs. Models for 12 V d-c or 24 V d-c inputs are available. Other configurations available on special order. Write today for data sheets.



10214 NORTH INTERREGIONAL HIGHWAY, AUSTIN, TEXAS 78753 TELEPHONE (512) 454-2581

Circle 246 on reader service card

it costs you nothing to call on experience:

Reeves-Hoffman design and manufacture
is 100% custom . . .
let us quote **your** needs!

★ quartz crystals

★ crystal filters

★ oscillators

★ discriminators

★ standards

★ ovens



REEVES- HOFFMAN

DIVISION OF **DCA**

400 W. NORTH ST., CARLISLE, PA. 17013
TELEPHONE • AREA CODE 717 • 243-5929



Md., D.C., Va., W.Va., N.C.
Valley Electronics, Inc.
Baltimore, Maryland
(301)668-4900; (202)659-1760

New England
Howard Jappe Company
Wakefield, Mass.
(617)245-9359

Pa. (not western), Del., So.N.J.
Eastern Components, Inc.
Philadelphia, Pa.
(215)927-6262

New York (except N.Y.C.)
Midstate Research Sales Co.
Syracuse, New York
(315)478-8314; (315)478-0715

New York City, No.N.J.
G. M. Moch Company
Ridgefield, New Jersey
(201)945-0080; (212)279-6758

So. California
Ash M. Wood Company
Arcadia, California
(213)283-1201; (213)287-0449

No. California
L & M Engineering
Santa Clara, Cal.
(408)243-6661

Ill., Ind., Wisc., Minn.
PGM Sales, Inc.
Chicago, Illinois
(312)622-8183

Ohio, W.Pa., Mich., Ky.
Tri-State Marketing, Inc.
Cincinnati, Ohio
(513)631-5060

Texas, Okla., Ark.
Carter Associates, Inc.
Garland, Texas
(214)276-7151

Ariz., N.M., Las Vegas
Carter Associates, Inc.
Scottsdale, Arizona
(602)947-4355

... frequencies from 10
to 480 Mhz available . . .

put a sweep frequency generator and a cathode-ray tube in their new diagraph so it can display a Smith chart instantaneously.

The ZWA applies an input voltage to the device being tested, and two directional couplers measure the reflected and transmitted voltage responses. By taking the ratio of each response to the input, the instrument can infer characteristic values of the device.

Engineers can use the ZWA to measure reflection and transmission coefficients, and complex impedances of filters, load resistors, transformers, and similar networks. Since test couplers can be connected to the ZWA with cables 11 yards long, remote measurements can be made on antennas.

The ZWA will also measure transfer characteristics of feedback networks, and, with a special attachment, the scattering parameters of transistors.

Big sweep. The range of ZWA's sweep generator is 10 to 480 megahertz. Any portion can be selected for measurements. Minimum sweep width is 20 kilohertz.

Results are displayed either as functions of frequency or as vectors on polar plots, such as Smith charts. Magnitudes are presented either linearly or logarithmically.

Ready mixer. Barlow says the sensitivity of the ZWA is the highest available for its type. Signals from the directional couplers pass into mixers for conversion into i-f. At maximum sensitivity setting, a two-microvolt signal produces a full-scale deflection on the scope face.

The value of the input signal is adjustable. Gains of the ZWA's outputs can be varied between -40 and +30 decibels.

Besides scope presentation, outputs are also available as analog signals to feed tape recorders, x-y plotters, and similar instruments. The ZWA can be programmed to perform a variety of measurements.

The diagraph, with one set of couplers, is priced at \$10,000. The buyer specifies a coupler impedance of 50, 60, or 75 ohms. Delivery time is four to six months.

Rohde & Schwarz Sales Co., 111 Lexington Ave. Passaic, N.J. 07056 [409]

No bubble, no trouble.

When you immerse your components in hot 3M Brand Inert Fluorochemical Liquids, bubbles of escaping air quickly detect gross leaks.

No bubble, no trouble.

That's one of the known test bath applications for 3M Inert Liquids. Thermal shock tests, transistor matching, temperature testing of integrated circuits at -55°C and $+150^{\circ}\text{C}$, are just a few other examples.

Our Inert Liquids quickly drain and leave no residue. So when the test is finished, additional cleaning steps are unnecessary. You save time and get greater accuracy.

Test 3M Inert Liquids...and save a lot of trouble.

3M Company, 3M Center
St. Paul, Minn. 55101

Dept. KAX-2-68

Send me all the details about 3M Brand Inert Liquids.

Name _____

Company _____ Title _____

Address _____

City _____ State _____ Zip _____

Chemical Division **3M**
COMPANY

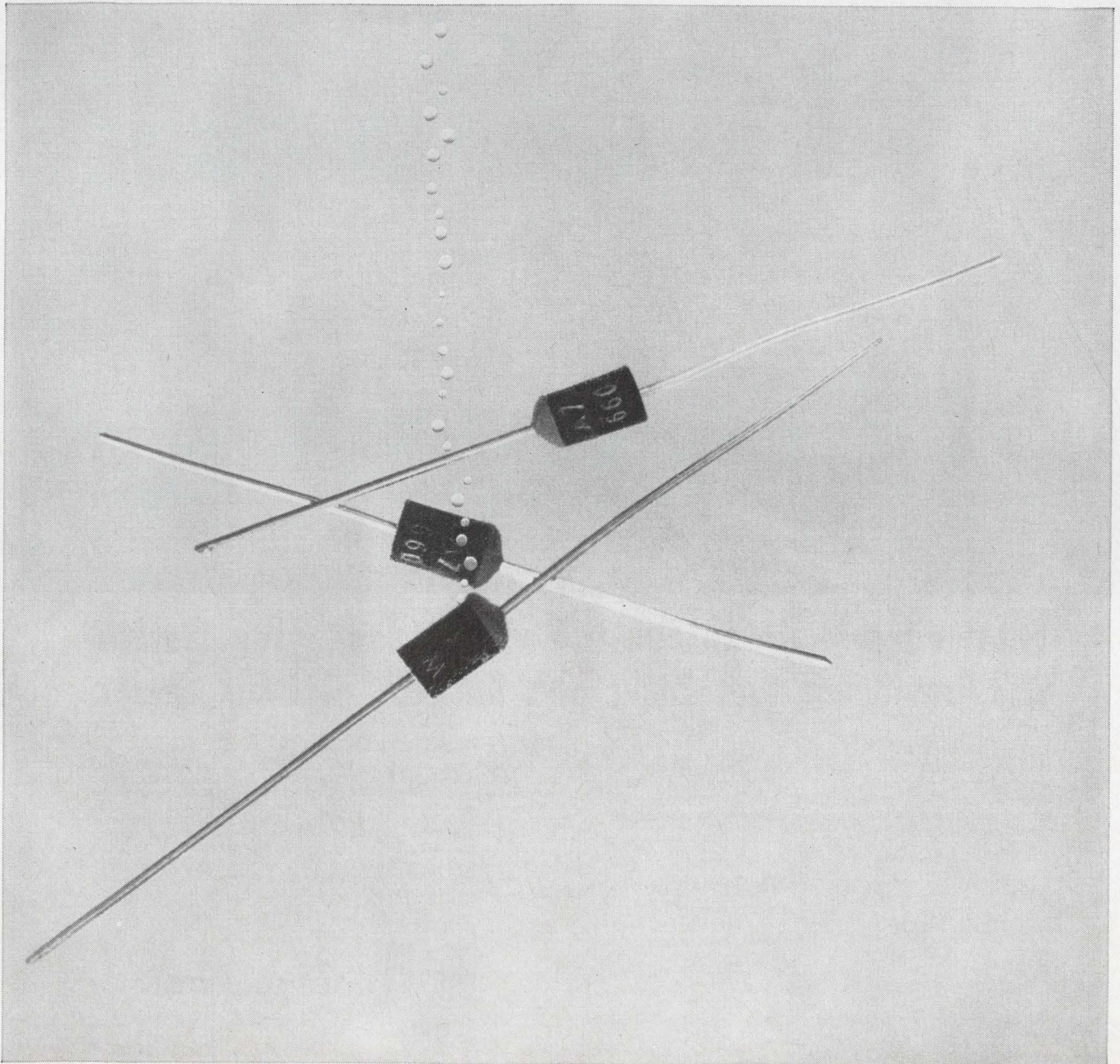

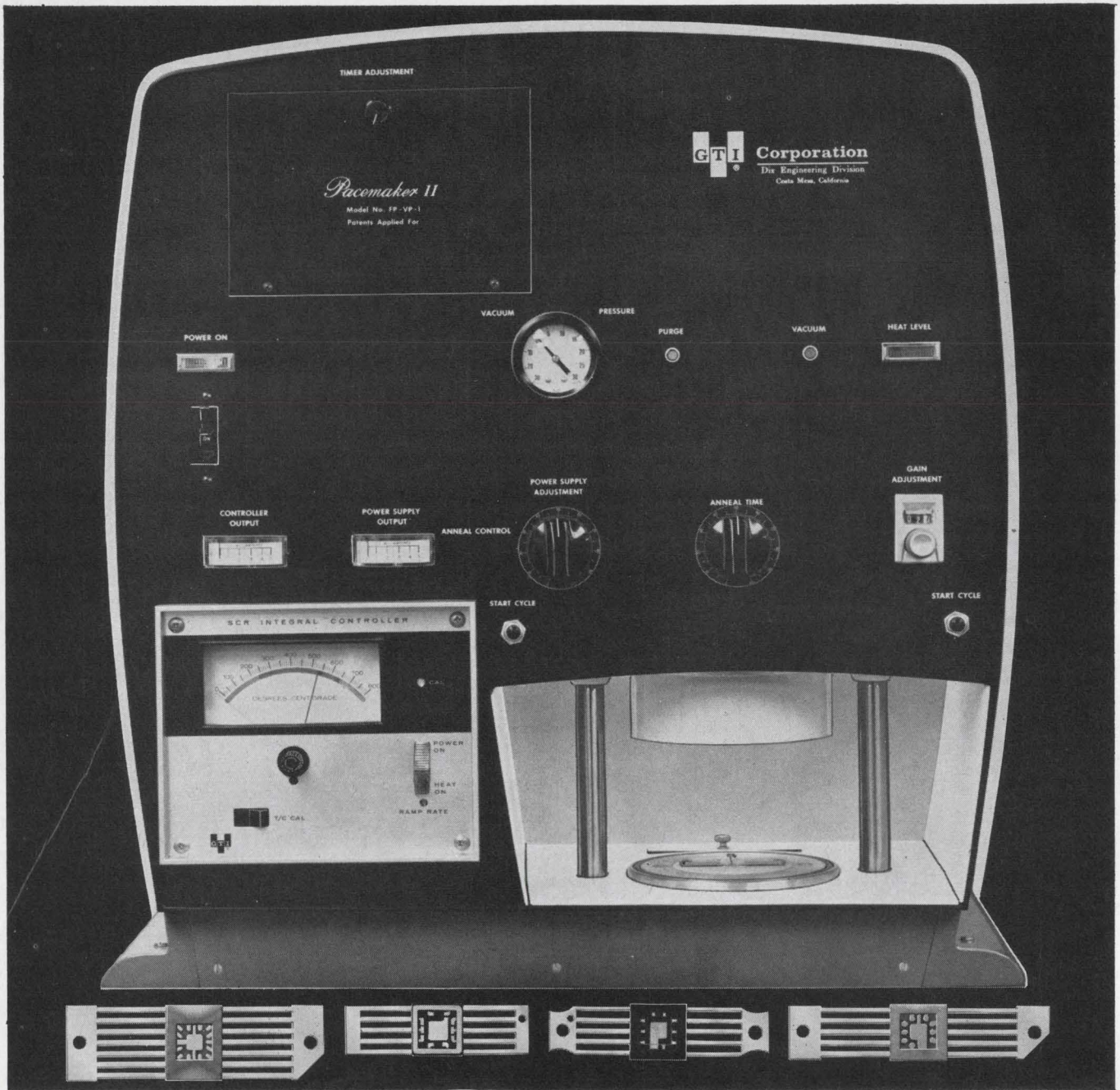

Total control for integrated circuit packaging...with GTI Providence Flat Packs plus the NEW GTI Dix Sealer

GTI FLAT PACKS

GTI offers a complete line of all-glass and glass-composition Flat Packs from 10-lead $\frac{1}{4}'' \times \frac{1}{4}''$ to 14-lead $\frac{1}{4}'' \times \frac{3}{4}''$. Using Corning's 7052 hard glass, nickel iron cobalt, and alumina glass compositions, GTI Flat Packs insure ruggedness, economy and reliability so necessary in today's microelectronic industry.

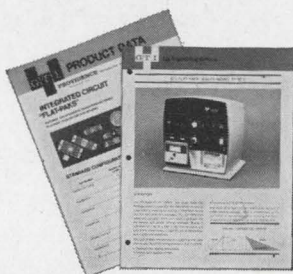

Send for FREE Literature Now!

Write to GTI Corporation, 310 Chestnut Street, Meadville, Pa. 16335 for Providence Division Integrated Circuit Flat Pack Data Sheet and Dix Engineering Division Flat Pack Sealer Data Sheet.

GTI FLAT PACK SEALER

The GTI Bench-Type, Single Head, Flat Pack Sealer incorporates the most advanced features for the controlled sealing of integrated circuits and film packages. Perimeter-type sealer seals glass, kovar, and ceramic packages in sizes from $\frac{1}{4}'' \times \frac{1}{8}''$ through $1\frac{3}{4}'' \times 1\frac{3}{4}''$. Sealer's versatility and size make it ideal for laboratory and pilot line use. Sealing atmosphere, location of heat, and time at temperature are strictly controlled, assuring high yields in final-sealing.

Flat Packs of all types can be sealed under vacuum or positive pressure. Heat is concentrated at the Flat Pack perimeter, thus keeping the device temperature at a safe level during the sealing cycle.

GTI CORPORATION

New Instruments Review

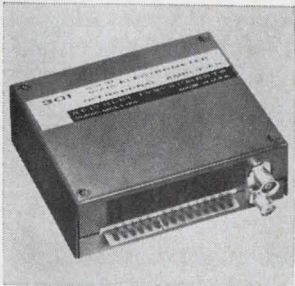

Electrometer amplifier 301 features differential MOS FET input, and a current offset of 10^{-14} amp. It has a common mode input resistance of 5×10^{12} ohms and an open loop gain of 50,000, has capability as a current modifier for signals from 10^{-14} to 10^{-22} amp. Maximum output is ± 11 v at 11 ma. Keithley Instruments Inc., 28775 Aurora Rd., Cleveland, Ohio, 44139. [361]

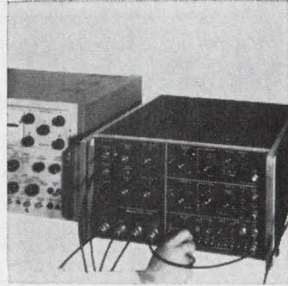

Spectrum analyzer converter model 2400 will provide a calibrated display with a 70-db dynamic range on a large screen or storage scope, or any other inexpensive scope available. Frequency range is 0.01-12.4 Ghz into the first mixer and up to 90 Ghz with external mixing. Price is \$3,000. Polarad Electronic Instruments, 34-02 Queens Blvd., Long Island City, N.Y. 11101. [362]

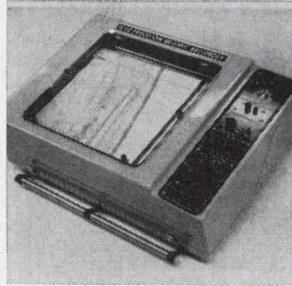

Start-stop seismic recorder PSR-1910A is for both land and sea applications requiring high resolution real-time recordings. It features variable line writing densities, 36 to 150 lines per inch; continuous or stop-start operations; and switch controlled frequency response in two ranges, d-c to 5 khz and 1 to 20 khz. Raytheon Co., P.O. Box 360, Portsmouth, R.I. 02871. [363]

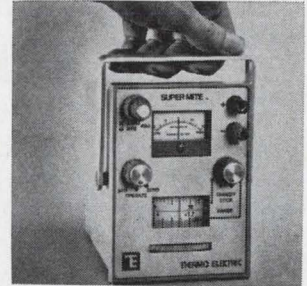

Portable potentiometer called SuperMite 31108 is for measuring thermocouple and millivolt input signals in industrial, field and laboratory areas. It is sensitive to signals as small as $2 \mu\text{v}$ or 0.05% of full scale span, whichever is greater. External resistance up to 2,000 ohms is permitted without loss of sensitivity or accuracy. Thermo Electric, Saddle Brook, N.J. 07662. [364]

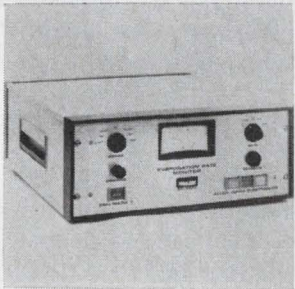

Continuous measurement and control of evaporation rate of dielectric materials and metals in a vacuum is provided by ERM Mark I, the heart of which is a thermally stable ion sensor. Fast response time permits rapid changes in controlled rate when the monitor is used as a transducer of a servo loop. Allen-Jones Electronics Corp., 17171 S. Western Ave., Gardena, Calif. 90247. [365]

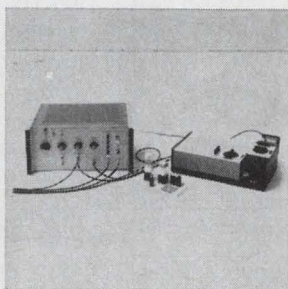

Decay time fluorometer 75A allows accurate decay time constant of proteins, amino acids, and other compounds to be added to spectral information for complete fluorometric data. It provides sensitivity to 5 parts per billion quinine sulfate, decay time range of 1.7 nsec to 10 nsec, and resolves multiple decays. TRW Inc., 139 Illinois St., El Segundo, Calif. 90245. [366]

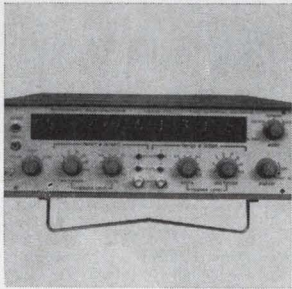

Time interval counter model 796 performs digital measurement, with 1 nsec resolution and accuracy, of pulse parameters, cable length, delay line calibration, laser/radar ranging time, and nuclear time of flight. Long term up to 1 part in 10^9 is provided by a variety of internal crystal oscillator options. Eldorado Electronics, 601 Chalomar Rd., Concord, Calif. 94520. [367]

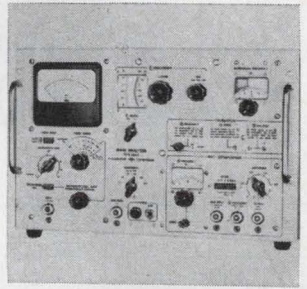

Solid state, heterodyne wave analyzer FRA3 provides a choice of 6 constant bandwidths throughout the range of 10 hz to 60 khz. It is suited for analysis of harmonic and noise components of periodic signals, selective measurements of frequency responses and convenient intermodulation measurements. Price is \$2,950. The London Co., 811 Sharon Dr., Cleveland, Ohio 44145. [368]

New instruments

Measuring up to standards

Automated impedance bridge designed to speed testing, matching and sorting of components

At times, it is more important to match components than to measure absolute values.

To make the task easier, the General Radio Co. will market its Type 1681 impedance comparator. At a glance, the 1681 looks much like its predecessor, the 1680, an automated

bridge introduced in 1964. Unlike the older instrument, which measures actual values of capacitance, conductance, or dissipation factor, the 1681 compares the component under test with a standard and measures impedance difference in percentage, or phase-angle differ-

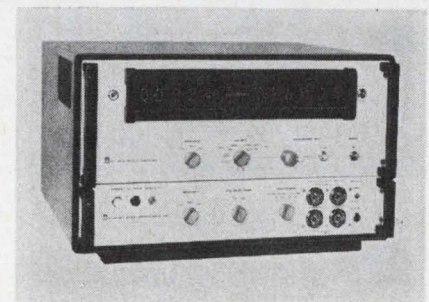

Matchmaker. Impedance bridge compares unknown to known component.

ence in radians.

The 1681 will find its niche on component production lines and in acceptance testing where it will speed the sorting of components by



Every Engineer or Draftsman should have the NEW 1968 BY-BUK CROSS REFERENCE GUIDE P-45

(supersedes By-Buk Catalog No. P-42)

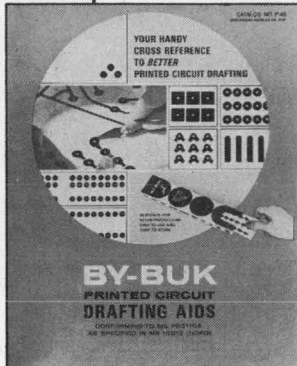

to better printed circuit
drafting.

This FREE 24 page booklet contains color-coded standard MIL-SPEC SIZES and design standards . . . plus a newly added numerical index for easy reference to over 2000 pre-cut tapes, pads, shapes, transistor tri-pads, spaced IC

terminal pad sets and other drafting aids for faster, more accurate, distortion-free printed circuit master drawings.

Send for your FREE guide today!

BY-BUK COMPANY

4326 West Pico Blvd. • Los Angeles, Calif. 90019 • (213) 937-3511



. . . standard can be
any component . . .

tolerance limits, aid matching of components, and give direct readings of such parameters as temperature coefficient. Also, the comparator could ease the task of selecting resistors with very-low phase shift (and therefore low ringing) for use in analog-to-digital converters or pulse devices. In laboratory applications, the 1681 can help balance transformer windings.

Balances voltages. The comparator is built around a transformer bridge with an impedance standard in one "arm" and the unknown in the other. The transformer bridge is more accurate and less susceptible to stray capacitance than is the more common resistive bridge, and works by balancing voltages across the windings of a precision toroidal transformer rather than by nulling the voltage drop across resistors.

The instrument translates the amount of voltage needed to balance the arms into numerical displays of impedance or phase-angle difference. A binary-coded decimal (BCD) output is supplied in addition to the in-line numerical readout.

In operation, the 1681 has a standard reference placed across two of the three input terminals. This can be a capacitor, inductor, or resistor. It need not be a laboratory standard; it can be a garden variety component that must be matched. With the standard in place, components with unknown values can be tested as quickly as the operator can place them in the test jig and remove them. At most, the 1681 takes only half a second to shift to the correct range and note the amount and phase of the unbalance voltage with reversible counters and phase detectors, and convert this data to the proper format for its in-line display or BCD readout.

The 1681 isn't limited to simple components; it can measure complex impedances as well. Measuring the impedance is just as easy for an integrated-circuit network as it is for a carbon resistor.

Systems capability. Since the 1681 reads out deviations from a standard, the instrument is suitable for stand-alone applications. How-

Circle 247 on reader service card

PROGRESS IN AN EXPLODING TECHNOLOGY

EXHIBITS
NEW YORK COLISEUM

TECHNICAL SESSIONS
NEW YORK HILTON

Monday through Thursday

- 48 GENERAL SESSIONS at the New York Hilton. Hours: 10:00-12:30; 2:00-4:30.
- FOUR FLOORS OF EXHIBITS at the N. Y. Coliseum including over 750 firms. Hours: 10 a.m.-8 p.m. 4 Days.
- GALA ANNUAL BANQUET—Wednesday 7:15 p.m. N. Y. Hilton Grand Ballroom—\$16.00.
- FREE SHUTTLE BUSES between the Hilton and the Coliseum—every few minutes.

- REGISTRATION—Good all days—General Sessions and exhibits. In and out privileges.—IEEE Members \$3.00. Non-members \$6.00. Ladies \$1.00. High School Students \$3.00 if accompanied by an adult—One student per adult; Thursday only—limit of 3 students per adult.
- REG-IDENT CARD speeds request for exhibitors' literature. Ask for one when registering.
- ESCALATORS/EXPRESS ELEVATORS to the Fourth Floor.



IEEE Exhibition MARCH 18-21, 1968

Analog Devices Announces the New Model 183 CHOPPERLESS Operational Amplifier

1.5uV/°C \$65
3uV/°C \$45
5uV/°C \$35

LOW DRIFT DIFFERENTIAL- CHOPPER-LIKE PERFORMANCE

- LOW CURRENT DRIFT
.05nA/°C
- HIGH INPUT IMPEDANCE
1000MΩ, CM
- LOW NOISE
1μV p-p, dc to 1Hz
- LOW PROFILE
.4" height

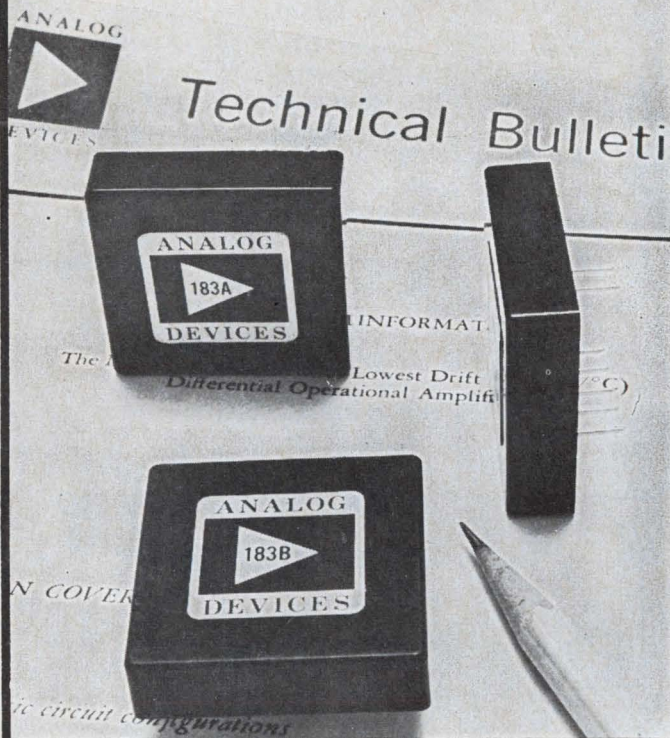

SPECIFICATIONS

Open Loop Gain	200,000 min.		
Rated Output	±10V @ 5mA		
Unity Gain Response	0.5MHz		
Full Power Response	5kHz		
Current Drift (Differential)	0.05nA/°C max.		
CMRR (±10V)	100,000		
Warm Up Drift	20μV (10 minutes)		
Noise (dc to 1Hz)	1μV, peak to peak		
Offset Voltage	Model J	Model K	Model L
@ 25°C, max.	3mV	.5mV	.5mV
vs. temp., max.	5μV/°C	3μV/°C	1.5μV/°C
Price (1-9)	\$35	\$45	\$65

HIGH INPUT IMPEDANCE

Unlike most chopper types, true differential input of 183 permits connection as non-inverting amplifier for input impedance of 1000MΩ. All other configurations are also possible with 183.

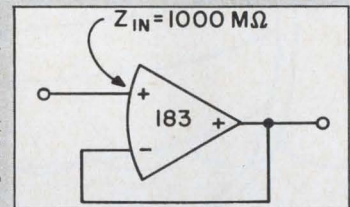

IMMUNITY FROM TEMPERATURE GRADIENTS

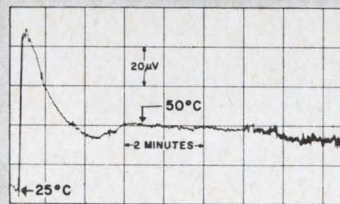

Thermal shock curve measures sensitivity to temperature gradients. Special components & design effect an order-of-magnitude improvement over most differential amplifiers previously available.

LOW NOISE

Most chopper amps exhibit high "flicker" (low frequency) noise, as well as spike noise at the chopping frequency. Chopperless 183 has only 1μV p-p (dc-1Hz). Spike noise is non-existent.

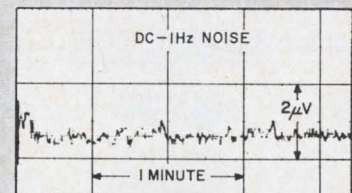

For complete specifications, application notes or evaluation samples write or phone collect to Mr. Bill Miller at Analog Devices, Inc. or contact your local representative.

ANALOG DEVICES INC. 221 FIFTH STREET, CAMBRIDGE, MASS. — 617/492-6000

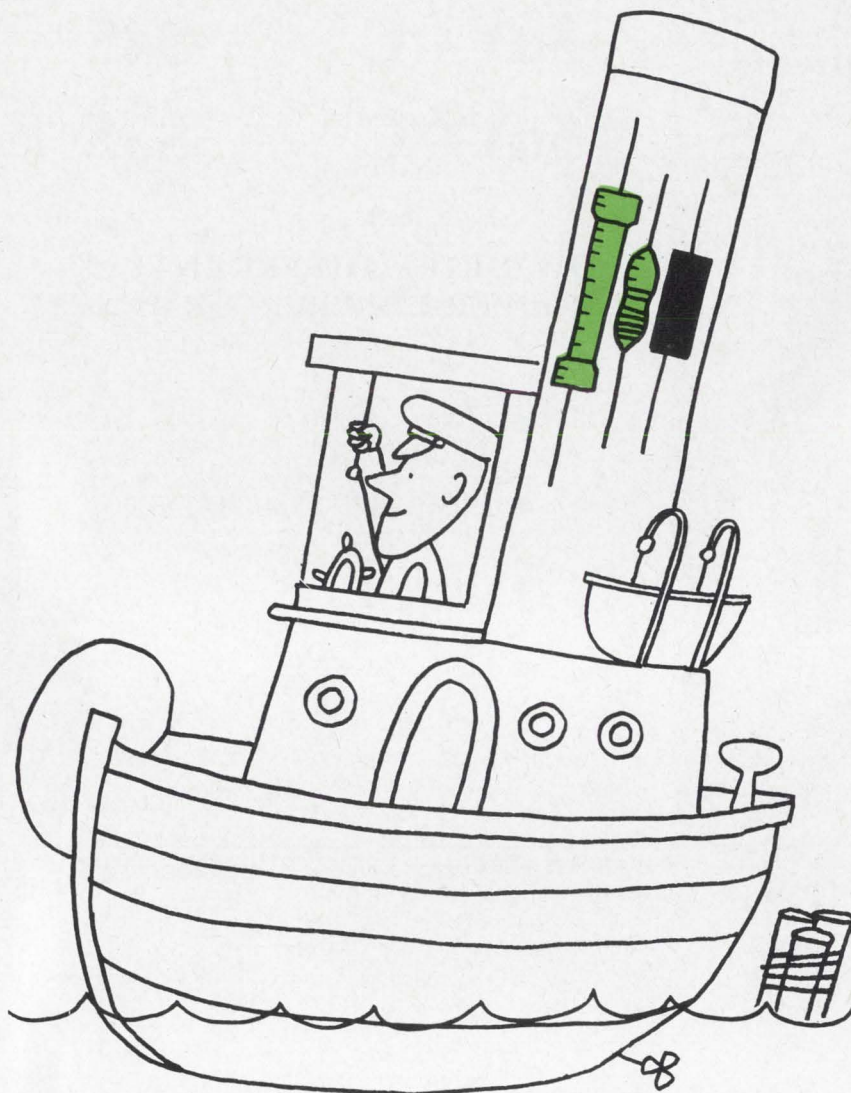

Our films cover the watt-er front

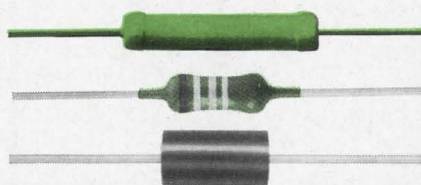

From $\frac{1}{8}$ watt to 7 watts, Mallory gives you fast delivery on a wide range of metal alloy and metal oxide film resistors. For high precision, Type MAF $\pm 0.25\%$, $\pm 0.5\%$ and $\pm 1\%$ in $\frac{1}{8}W$ and $\frac{1}{4}W$. For semi-precision, Type MAL $\pm 2\%$ and $\pm 5\%$ in $\frac{1}{2}W$. And for premium performance at low cost, Type MOL, $\pm 10\%$ 2W to 7W. All Mallory film resistors are 100% inspected. For details, write or call Mallory Controls Company.

MALLORY

MALLORY CONTROLS COMPANY

a division of P. R. MALLORY & CO. INC.
Box 231, Frankfort, Indiana 46041

ever, its BCD output allows the 1681 to work with a variety of catalog and special order items that can make up complex systems.

There is a wealth of such accessory equipment, from simple test jigs to multichannel input-switching arrangements that can ignore stray capacitances in the test setup. On the output side, stripchart and x-y recorders are available, as are component sorters, card- and tape-punch machines for recording specification data. General Radio also offers systems integration services.

Price of the 1681 is \$4,975.

General Radio Co., West Concord, Mass. 01781 [369]

New instruments

Average-as-you-go computer bows

Technique maintains
display of transients
at constant amplitude

Noisy signals of known periodicity can be cleaned up by sampling them at fixed intervals and adding them algebraically so that the signal is enhanced while the noise is canceled.

One annoying characteristic of instruments that perform this operation, computers of average transients, is that the successive additions cause the waveform to drift. Charles Trimble, an engineer at the Hewlett-Packard Co. has used data-compression techniques to design an instrument that averages successive waveforms, rather than adding them and then averaging the total. The wave maintains a constant amplitude on the oscilloscope display.

Since the signal is buried in noise, its information content is inherently low. "We take advantage of that noise," says Trimble, "because it means that our approximations are valid; we don't actually have to divide by every sweep."

Shaping up. The averaging factor is exponentially weighted, so that old information can be selectively deemphasized with respect to new

Specify BRADLEY X-band Solid State Sources for Low Noise

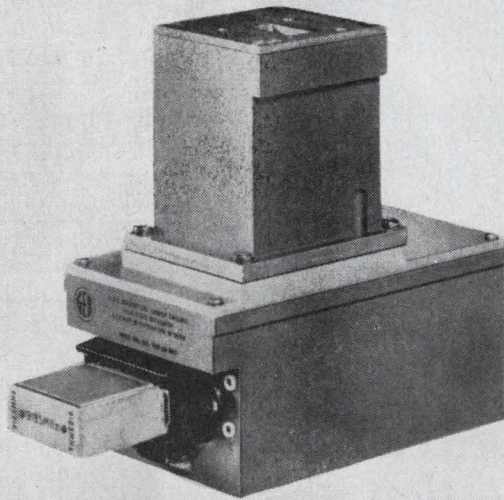

Varactor Sources— for high power

- Plug in Crystal Oscillators give choice of frequencies within 100 MHz channels
- Meets U.S. military specifications
- Up to 300 mW output
- Input 25 W at 28 V.D.C.
- Weight 4 lbs.

dBs on Carrier

Sideband Power (Both sidebands)

$\Delta B = 1 \text{ Hz}$ Output = 130 mW.

$\Delta f_{\text{r.m.s./fm}}$ is better than 5×10^{-5} from 20 KHz. onwards

→ kHz off carrier, fm

AND Step Recovery Sources -

for local oscillators

- Electrically tunable over 400 MHz
- 10 mW output
- 2 W input at 22 V.D.C.
- F.M. noise 80 d.B. per Hz at 50 KHz from carrier
- Low cost
- Meets U.S. military specifications
- Weight 5 ozs.

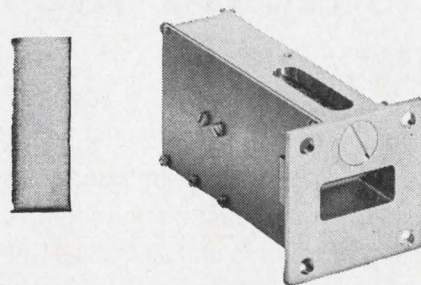

G. & E. BRADLEY LTD

ELECTRAL HOUSE, NEASDEN LANE, LONDON, N.W.10.
 TELEPHONE: 01-450 7811 TELEGRAMS: BRADELEC LONDON N.W.10. TELEX: 25583
 In the United States—EDWIN INDUSTRIES CORP.,
 11933 Tech Road, Silver Spring, MD., 30904. Tel: 301 622 0700

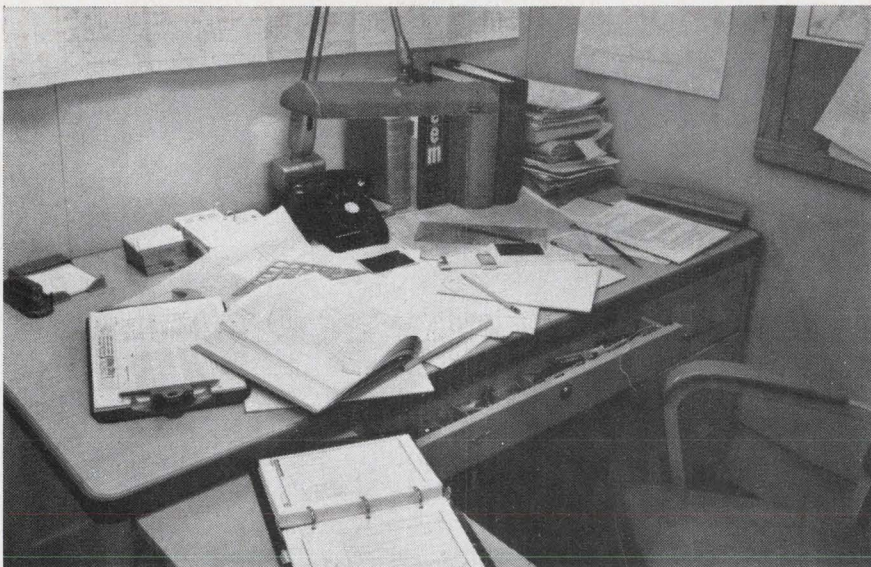

Transformer design problem got you in a corner?



Make sure it's one with a phone.

A call to your TRIAD distributor may be the quickest solution to your problem. He has the resources and the skill to answer many of your questions on transformers, inductors and filters. Chances are that one of the TRIAD transformers he has on his shelves will fit your needs.

For fast, dependable delivery and ready application assistance, contact your TRIAD distributor. And ask him for your TRIAD catalog. It's the sure way to keep from getting cornered. TRIAD Distributor Division, 305 North Briant Street, Huntington, Indiana 46750.

TRIAD Triad Distributor Division
of Litton Industries

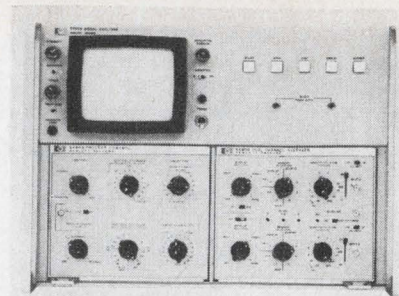

On the average. Computer continually adjusts waveform, combats drift.

information. Thus, if the waveform changes slowly, the computer will lock on to the new shape, instead of averaging it in with the old.

Some of the money saved in the complex "divide-by-N" circuitry, which enables the computer to store the average rather than the sum, was spent on core memory (N is the number of sweeps). The instrument, called the 5480 signal analyzer, has 1,024 words of 24 bits each. Memories of that size cost about 10 cents a bit, and the memory therefore accounts for a substantial portion of the instrument's price, about \$9,500.

Although it is an analog-in, analog-out instrument, its processing is performed digitally. Trimble incorporated an analog-to-digital feedback loop to store the average signal in the memory.

This loop is between the memory and the differential amplifier that compares the new sweep with the stored average. The difference signal is digitized and divided by the N factor before being stored in the memory. This creates a new average, equal to the old average plus a figure relating the input signal to the old average.

If the number of sweeps is small—five, for example—the input signal will be cut off after 2^5 sweeps, and the computer will give the new signal a relatively high value in calculating a new average. If N is large, the fraction representing the new signal will become relatively small.

Trading off. To keep at least five bits per word for the new signal, Trimble limited the choice of N to 2^1 through 2^{19} ; the operator can make his tradeoff of speed versus noise with a front-panel switch. Making N large provides a much less noisy signal. Making N small, however, results in more noise, but

Two new additions to the BURR-BROWN family of solid-state MULTIPLIERS*

MODEL 4029/25

New \$195† Multiplier makes hundreds of applications more economical.

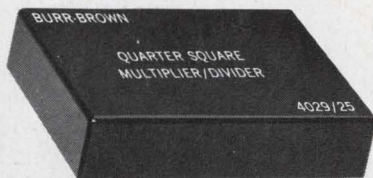

This new, low-priced, encapsulated Burr-Brown quarter-square multiplier is a precision analog function module capable of performing accurate four-quadrant multiplication, two quadrant division as well as square and square root functions. Accuracy is $\pm 0.5\%$ max. Bandwidth at 1% abs. error is 5kHz. Rated input: $\pm 10V$. Rated output: $\pm 10V$, $\pm 5mA$. Module size: 2.4" x 1.8" x .60".

†\$195.00 in 100 quantity (\$260.00 unit price) makes use of pre-engineered Burr-Brown modules even more attractive.

Use this publication's reader service card for your copy of new application-oriented product bulletin. For immediate applications assistance, phone (602) 294-1431, and ask to talk to your Burr-Brown Applications Engineer.

MODEL 4012/25

New encapsulated quarter-square multiplier-divider packs high performance in small package.

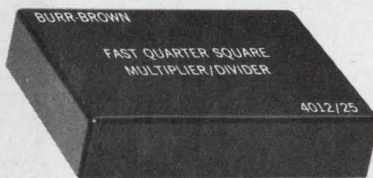

The 4012/25 is a high-speed, fully encapsulated quarter-square multiplier containing three wide-band operational amplifiers and two precision diode squaring circuits. It performs precision four-quadrant multiplication and two-quadrant division as well as square and square root functions. Accuracy is $\pm 0.25\%$ max. Bandwidth at 1% abs. error is 40 kHz. Rated input is $\pm 10V$.

Rated output: $\pm 10V$ at 10 mA. Module size: 2.4" x 1.8" x .60". Also available in rack-mount package. Unit price: \$495.00 (\$375.00 in 100 quantity).

Use this publication's reader service card for your copy of new application-oriented product bulletin. For immediate applications assistance, phone (602) 294-1431, and ask to talk to your Burr-Brown Applications Engineer.

***Use 'em like building blocks to save time and money in systems requiring dynamic gain control, trigonometric computation, power measurement, correlation computation, RMS measurement, linear modulation and many other system functions.**

BURR-BROWN

RESEARCH CORPORATION

International Airport Industrial Park • Tucson, Arizona 85706
TELEPHONE: 602-294-1431 • TWX: 910-952-1111 • CABLE: BBRCORP



Operational Amplifiers
Instrumentation Amplifiers
Function Modules
Active Filters
Analog Simulators
Geophysical Instruments

ENGINEERING REPRESENTATIVES: ALABAMA, HUNTSVILLE (205) 534-1648 / ARIZONA, PHOENIX (602) 254-6085 / CALIF., LOS ANGELES (213) 665-5181, SAN FRANCISCO (408) 244-1505 / COLO., DENVER (303) 388-4391 / CONN., EAST HARTFORD (203) 874-9222 / D.C., WASHINGTON (SEE MARYLAND) / FLORIDA, ORLANDO (305) 425-2764 / ILLINOIS, CHICAGO (312) 286-6824 / LA., NEW ORLEANS (504) 888-2266 / MD., SILVER SPRING (301) 588-8134 / MASS., BOSTON (617) 245-4870 / MICH., DETROIT (313) 358-3333 / MINN., MINNEAPOLIS (612) 781-1611 / MO., ST. LOUIS (314) 524-4800 / N.C., GREENSBORO (919) 273-1918 / N.J., CAMDEN (215) 925-8711 / N.M., ALBUQUERQUE (505) 255-1638 / N.Y., ALBANY (518) 436-9649, BINGHAMTON (607)

723-9661, MT. VERNON (914) 968-2200, NEW HARTFORD (315) 732-3775, ROCHESTER (716) 473-2115 / OHIO, CINCINNATI (513) 761-5432, CLEVELAND (216) 237-9145, DAYTON (513) 277-8911 / PENN., PHILADELPHIA (SEE CAMDEN, N.J.), PITTSBURGH (412) 243-6655 / TEXAS, DALLAS (214) 357-6451, HOUSTON (713) 774-2568 / UTAH, SALT LAKE CITY (801) 466-8709 / VIRGINIA, (SEE MARYLAND) / WASH., SEATTLE (206) 767-4260 / CANADA, DOWNSVIEW, ONT., (416) 636-4910 — MONTREAL, QUE., (514) 739-6776 — OTTAWA, ONT., (613) 725-1288 — VANCOUVER, B.C., (604) 298-6242

Tolerances to $\pm .5$ ohms with this new miniature coax!

Now, here is a new miniature coaxial cable providing extremely tight electrical characteristics and a greatly extended parameters in a variety of applications including low noise amplifiers, microwave transmission, high speed computers, airborne instrumentation and radar.

Offered in three sizes off-the-shelf: .141", .085" and .070" and in random lengths from 12 feet to 200 feet, construction consists of a silver-plated Copperweld inner conductor with a TFE Teflon dielectric and solid copper sheath. Electro-plated silver, gold and tin outer sheaths are also available from stock.

The new miniature coax offers very low attenuation across Gc band, low VSWR, no radiation or performance deterioration at environmental extremes

and maintains impedance despite extreme bends. This latter feature makes it possible to cut, bend or form the coax into coils for the achievement of signal delay or a variety of shapes for the fabrication of special assemblies for RF front ends and amplifiers without problems of loss or coupling to impair reliability.

This new miniature coax has been qualification tested for severe aerospace applications and has performed remarkably well where desired electrical performance cannot be achieved with conventional braided cables.

Why not write today for your free miniature coaxial cable folder which includes actual samples of the coax plus complete descriptive data?

PHELPS DODGE ELECTRONIC PRODUCTS
NORTH HAVEN, CONNECTICUT

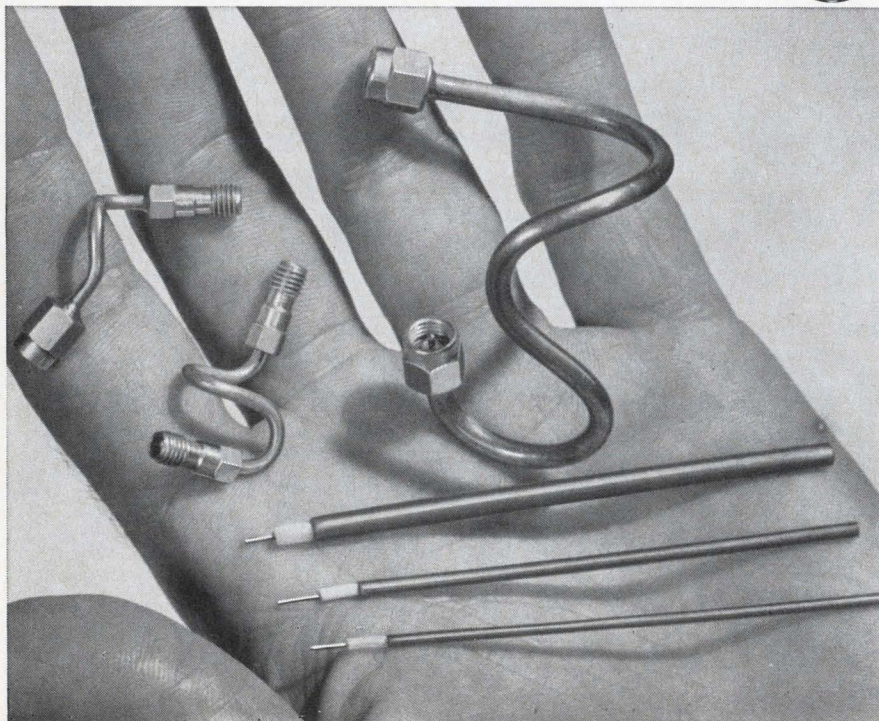

enables the operator to follow a slowly varying signal faster.

For display, the signal from the digital-analog converter between the memory and the differential amplifier is picked off to provide the vertical component to the scope deflection plates; a second d-a converter takes memory information to provide horizontal deflection. The 1,024 words give 1,000 points per line on the scope; vertical quantizing can be done with five, seven, or nine bits of a-d conversion, depending on how much resolution the user wants. Nine bits, for example, would provide 512 lines.

Summing too. The instrument will also provide the conventional summation mode, which is worthwhile if the user is worried about efficiencies of tenths of decibels, Trimble says. Even in this mode, the trace will not drift since it will be first attenuated to half its value. The signal will grow slowly to full value; and then, by a shift of one bit in memory, will be chopped in half again.

With a 20-megahertz crystal oscillator for primary synchronization, the instrument can sample at rates up to 100 Mhz.

Like many Hewlett-Packard products, a modified version of the instrument, the 5480A, is built from plug-in subassemblies. The 5480 itself contains the cathode ray tube, the core memory, the accumulator and address registers, and the power supply. The 5485A dual-channel averager incorporates the input amplifier and attenuator, memory selectivity, sample-hold circuitry, a-d and d-a converters, and amplifiers to drive the crt.

Wide range. The company expects to find applications for the 5480A in high-resolution spectroscopy, in vibration analysis, and particularly in the biological sciences. With a pseudo-random noise generator, the instrument is useful in diagnosing mechanical faults. In cardiography, the signal averager can read patterns of cardiac fatigue that might otherwise be obscured by muscle voltages; and in electroencephalography, it can pick out meaningful signals produced by different stimuli. First deliveries of the instrument are expected to begin in June.

Hewlett-Packard Co., 1501 Page Mill Road, Palo Alto, Calif. 94304 [370]

When you have an insulating problem that's "up in the air"

...ask LAPP.

LAPP ANTENNA INSULATORS

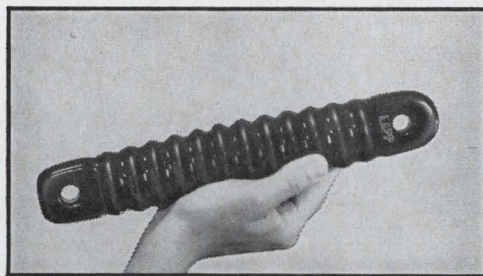

Shaped insulator

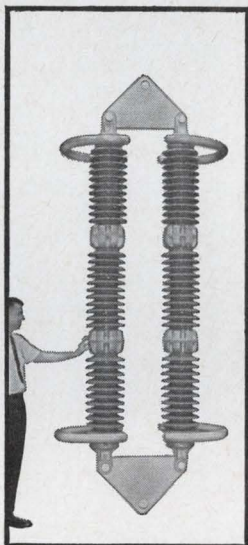

Double strain assembly



Rod-type with rain shield and corona ring

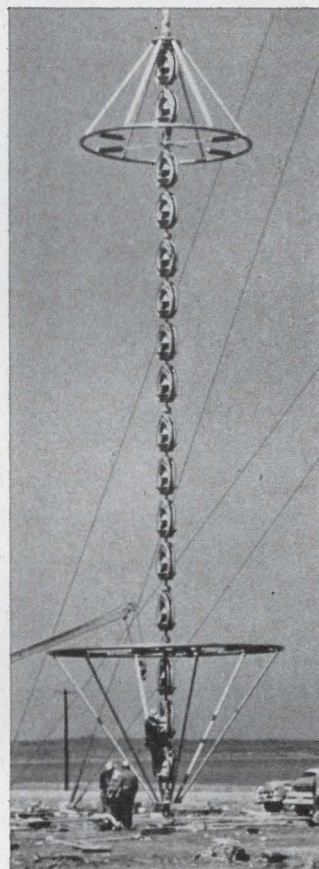

Special antenna insulator assembly with grading rings.

Lapp has been designing and producing antenna insulators for nearly a half century. We have delivered short ones, long ones, little ones, big ones, giant ones. Each met the customers' electrical and mechanical specifications with "room to spare".

Examples? The double-strain insulator assembly shown here tested to 240,000 lbs. ultimate strength. A similar triple yoke assembly tests to 360,000 lbs. Lapp has a compression cone guy insulator already designed that tests to 750,000 lbs! We also

have many smaller units and rod-type and shaped insulators.

Don't leave your antenna insulating problem "up in the air". Write or call Lapp Insulator Co., Inc., LeRoy, N. Y. 14482. We're down-to-earth people who get the job done.

Lapp

MILLIMETER SYSTEMS

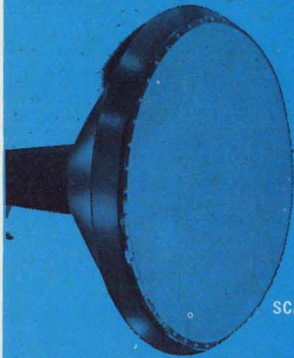

SCALAR FEEDS

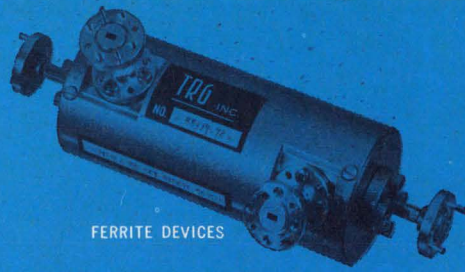

FERRITE DEVICES

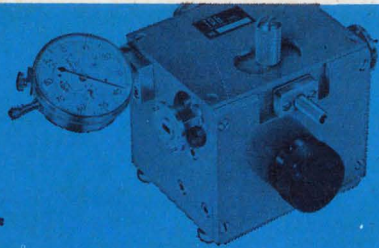

TEST BENCH COMPONENTS

DIRECT READING FREQUENCY METERS



LOW LOSS CIRCULAR WAVEGUIDE COMPONENTS

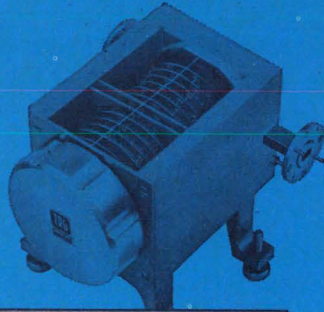

ANTENNAS



UNIVERSAL KLYSTRON POWER SUPPLY



SHORT FORM CATALOG

TRG
CONTROL DATA
CORPORATION

WAVE COMPONENTS MILLIMETER MICROWAVE CO

NTS MILLIMETER MICROWAVE COMPONENTS MILL

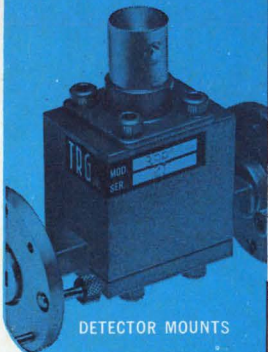

DETECTOR MOUNTS



HARMONIC MIXERS

TRG has the most comprehensive line of microwave components (now 12.4 to 220 Gc)...and all the facts are contained in our handy short form catalog.

Write for your copy today

This 20-page, short-form catalog contains all the important specifications on products available for Ku and K bands, as well as A, B, V, E, W, F, D, and G bands. To get your copy, contact your TRG representative or write TRG, 400 Border Street, East Boston, Massachusetts 02128. Tel. (617) 569-2110.

TRG CONTROL DATA
DIVISION CORPORATION

New Industrial Electronics Review

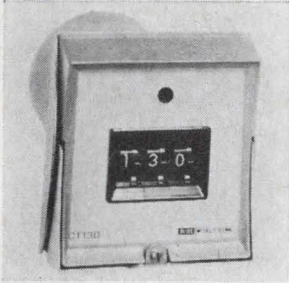

Two- and three-digit Cycl-Flex counters are suited for machine tool and process control. Electrical impulses from a limit switch, photocell or other sensing unit are fed to the Cycl-Flex input circuit. When the number of incoming pulses equals the number set on front panel, controlled load is turned on or off. Eagle Signal Div., E.W. Bliss Co., Federal St., Davenport, Iowa. [421]

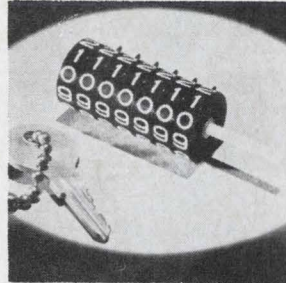

Nonreset odometer series 1771 features wheels, pinions, drive shaft, and partition plates of precision molded Delrin, with a plated steel retaining ring. Low torque, achieved with involute gearing, assures smooth operation and long life. The unit is for use in gas and liquid meter registers, as well as for recording time and distance. Veeder-Root, Hartford, Conn. 06102. [422]

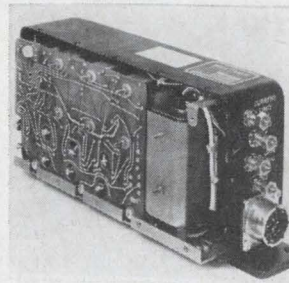

A-c servo amplifier model AS35 provides 1.5-kw output with 115-v, 400-hz power input, and 3-kw output with 208-v, 400-hz power input, capable of driving the largest 2-phase a-c servo motors. Voltage gain is 1,000 and is adjustable. A 2-speed network and quadrature rejection are integral to the unit. Westamp Inc., 1542 15th St., Santa Monica, Calif. 90404. [423]

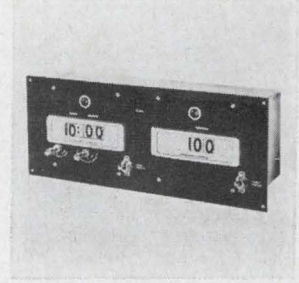

Elapsed time digital computer model 115 provides split second by second elapsed time in hours, 10 minutes, minutes and seconds. Time is registered on polygonal drums, 5/8 in. digits on 24 hour clock, 5/16 in. digits on 24 hour clock. The unit has front panel reset controls. Tymeter Electronics Div., Pennwood Numechron Co., 7249 Franktown Ave., Pittsburgh, Pa. 15208. [424]

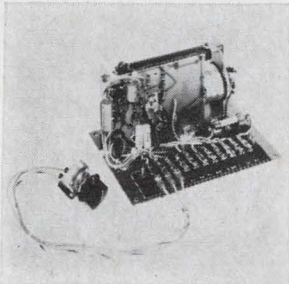

SCR electric motor variable speed drives provide accurate control of a broad variety of chemical and mechanical processes. The S20TX-10 is for use with d-c motors up to 1/8 h-p; the S50TX-10, for motors up to 1/2 h-p; and the S200TX-10, for motors up to 3/4 h-p. The control system responds to a 10- to 50-ma signal. G.K. Heller Corp., 249-06 Jericho Turnpike, Bellerose, N.Y. [425]



D-c reluctance type stepper motors speedily respond to sequential pulses. Bidirectional rotation is achieved by reversing pulse sequence of the control pulses. Units are available with 30°, 15°, or 7 1/2° steps per pulse and with corresponding stepping rates up to 90, 120 and 140 pps. Speed is 300 rpm max. Computer Instruments Corp., 92 Madison Ave., Hempstead, N.Y. 11550. [426]

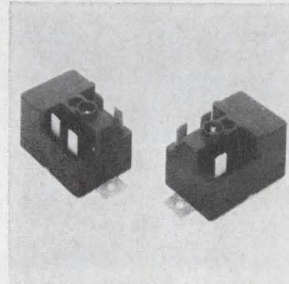

Motor starting relay model 4CR will mount in all positions due to its fully magnetic operation combined with constant tension springs. Calibration remains stable through the life of the relay. The unit covers motors with start-winding currents up to 25 amps regardless of horsepower. Mounting area is 1.3 x 1.9 in. Texas Instruments Inc., 34 Forrest St., Attleboro, Mass. 02703. [427]

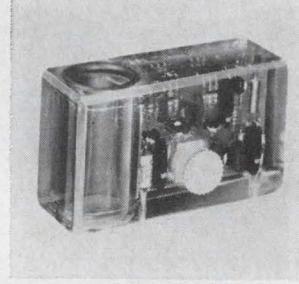

Floatless liquid level, sight gauge switch, called the Capsite, is attached easily to a variety of standard gauge glasses and weighs 5 oz. Output can be fed to remote control relays or to computers in automated systems. The unit's solid state components are encapsulated in plastic. No maintenance or cleaning is required. Sonic Engineering Corp., Norwalk, Conn. [428]

New industrial electronics

Keeping data on the straight and narrow

Digital technique linearizes sensor measurements, scales them to engineering units for readout

A tower of Babel is one way to describe the conglomerate analog measurements that arrive at a central data logger in an industrial plant. The signals often are not directly proportional to the measured variable nor are they scaled to desired engineering units. They must

be made compatible and readable.

For a cheaper and easier way to linearize and scale all measurements, J.H. Kollataj and Teuvo Harkonen of the Finnish electronics company, Oy Nokia Ab, have developed a digital method for their new data logger and applied

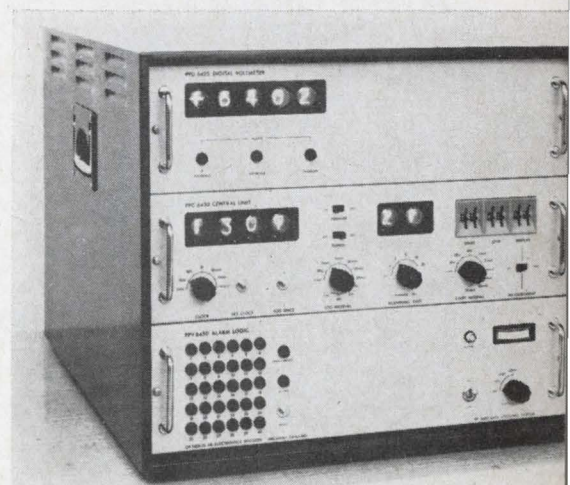

Start from Finnish. Logger bypasses analog, uses digital linearization.



Magneline® digital indicators are used to display random information. They have high readability and extremely long life. Sharp black and white digits are positioned electromagnetically. The number drum rotates on a polished shaft in a jewel bearing. Coil assemblies are encapsulated in heat and shock resistant epoxy. Test units have been run through 35 million cycles without failure or measurable wear. Applications range from aircraft and spacecraft instrumentation to control systems for heavy industry.

WRITE FOR OUR TECHNICAL BROCHURE

PATWIN ELECTRONICS	<small>Manufactured under one or more of the following U.S. Patents: 2,943,313, 3,009,140, 3,118,136, 3,201,785, 3,260,871. Other patents pending.</small>
A DIVISION OF PATWIN, INC. WATERBURY, CONNECTICUT • 06720	
Circle 249 on reader service card	

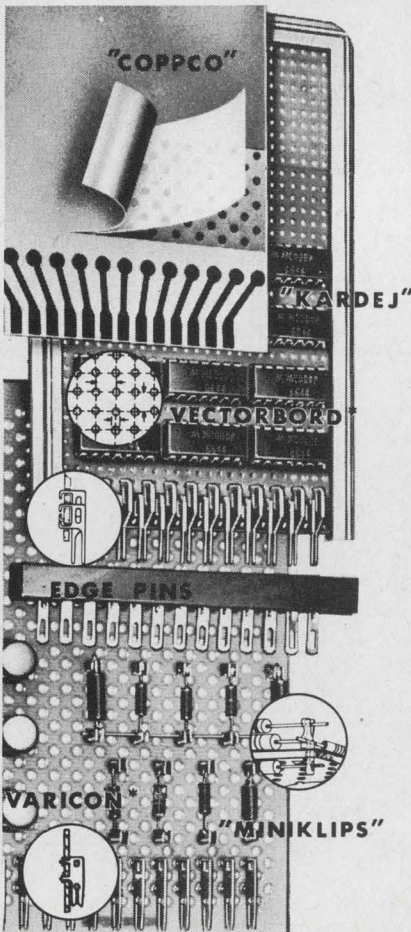

VECTOR PLUGBOARDS CUT CONSTRUCTION TIME

Why drill holes? Use prepunched Vector Plugboards to save time, work, and money.

- New "COPPCO"—Copper plus film plus Vectorbord*. User "pokes" holes through.
- "KARDEJ"—Aluminum framing stiffens cards 1/32" to 1/16" thick.
- VECTORBORD: "P" Type—.042" holes, 0.1" grid for D.I.P.s; "M" Type—.025" holes on .050" grid for I.C.P.s; "G" Type—.062" holes, 0.2" x 0.1" grid for transistors and discrete components.
- EDGE PINS stake to card — fit New "VECTORCONN" receptacles.
- "MINIKLIPS"—Vector "Push Pins" and turned terminals for leads.
- ELCO VARICON*, 12-47 contacts, or printed tabs.

*Trademark

For complete information contact:



ELECTRONIC COMPANY, INCORPORATED
1100 Flower Street, Glendale, California 91201

... extra bits correct sensor characteristic ...

it to six common transducers.

This technique, its inventors say, departs from the widely known analog methods which are expensive and pose problems in drift and noise suppression. Analog characterization is achieved by introducing into the input path a nonlinear element whose characteristic is the inverse of the nonlinear measurement.

But, as shown in the curve, digital linearization adds or subtracts a suitable number of pulses to the binary-coded-decimal counter in the logger's digital voltmeter. The number of pulses to correct non-linearity depends on the variable's

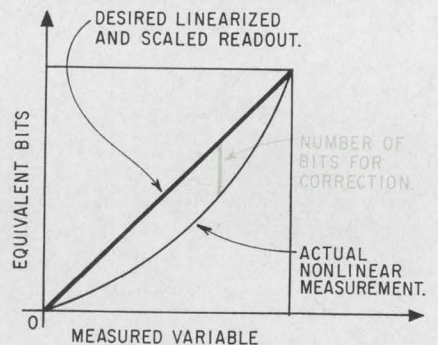

value as sensed by a transducer, such as a thermocouple, and a predetermined linear equivalent.

Commonality. The linearizing circuits use Texas Instruments' series 74 integrated circuit transistor-transistor logic (TTL). Because some circuitry is common, five different functions can be linearized at a component cost of about \$100, or \$20 per linearization—strongly competitive with analog function generators that run as high as \$400 each.

The PP 6402 Data Logging System is about the size and weight of a 25-inch television set. Maximum capacity is 50 input channels. From the front, the operator can—among other things—set logging intervals and scanning rates. The log interval can be continuous or every 1/5, 1, 5, 10, 15, or 30 minutes, or every 1, 2, or 4 hours. The scanning rate can be determined by an external signal or be set at 1, 2, 5, 10, or 20 channels per second.

Standard inputs are d-c voltage and current and resistance and fre-

Where small resistances are a big problem:

4 terminal accuracy
2 probe measurement
50 μohm sensitivity
in a portable instrument

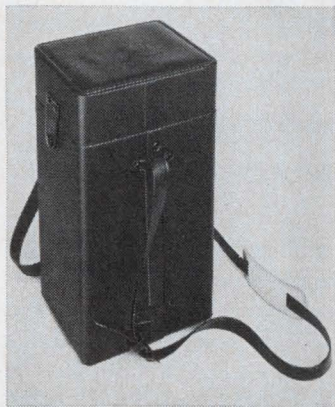
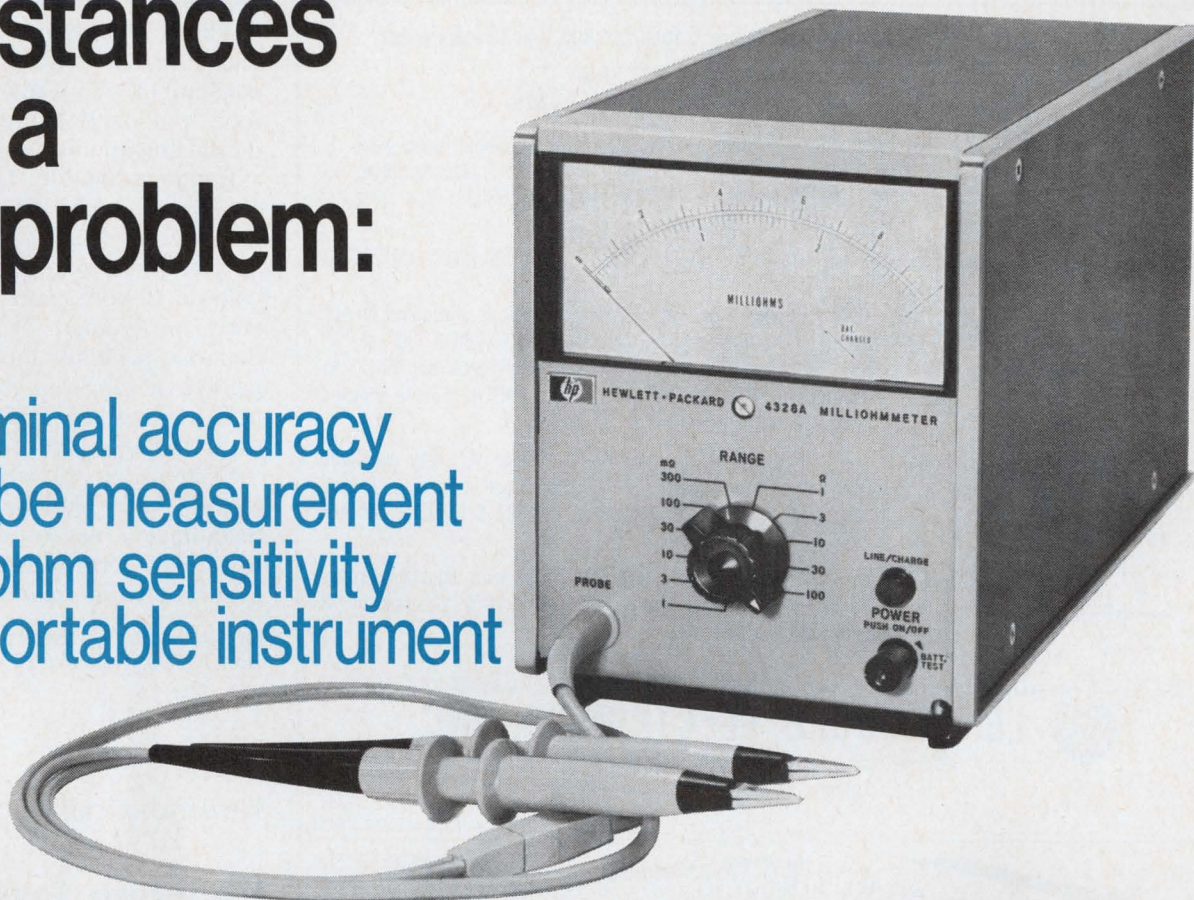

The new Hewlett-Packard 4328A Milliohmmeter, with 50 μohm sensitivity, improves on 4-probe resistance measurements by incorporating both current and voltage drive in one probe. It provides this great sensitivity by using a Kelvin Bridge technique, combining an oscillator and a phase-

sensitive voltmeter to offer today's most convenient measurement of extremely small resistances.

The 50 μohm sensitivity is excellent for measuring contact resistance of relays, switches and connectors; in trouble shooting to test the quality of grounds and other short-circuit phenomena; for making lead and end wire resistance measurements on pots.

Range of the 4328A is 100 ohms to 1 milliohm full scale in a 1, 3, 10 sequence. A built-in phase discriminator lets you make precise resistance measurements on samples with a series reactance up to *twice* full-scale

resistance, a feature that makes the meter useful for magnetic core material measurements.

Applied voltage is limited to 20 millivolts RMS by special sensing circuits, regardless of the measurement range, and extra protection for sensitive devices is afforded by having the oscillator function *only* when a resistance is connected to the probes.

The 4328A Milliohmmeter, in addition to its 2-probe convenience, is fully portable... weighs only 7 lbs., is offered with an optional rechargeable battery. Price: \$450 (\$25 more for the battery option; fitted leatherette field case \$15).

For more information call your local HP field engineer or write Hewlett-Packard, Palo Alto, California 94304; Europe: 54 Route des Acacias, Geneva.

HEWLETT  PACKARD

NEW! smallest axial shielded inductor available the "NANO-RED"

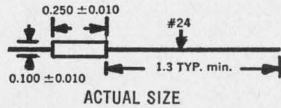

Range: 0.10 μ h to 1,000 μ h in 49 stock values
Size: 1/10 dia. by 1/4 lg.
Inductance Tolerance: $\pm 10\%$

This new "NANO-RED" offers the highest inductance to size ratio available in an axial shielded inductor. Exceptional "Q" and self-resonance characteristics. Max. coupling 2% units side by side. Non-flammable envelope. Designed to MIL-C-15305C. Operating temperature -55°C to 125°C.

Other Lenox-Fugle Subminiature Shielded Inductors:

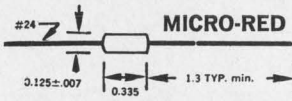

The "Micro-Red" is a shielded inductor that offers the largest inductance range in its size: 0.10 μ h to 10,000 μ h. "Q" to "L" ratio unsurpassed, with excellent distributed capacity. Inductance tolerance $\pm 10\%$. Designed to MIL-C-15305C. Stocked in 61 predesigned values.

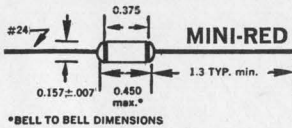

The "Mini-Red" offers the highest "Q" to "L" ratio available over inductance range 0.10 μ h to 100,000 μ h in its size. Inductance tolerance $\pm 10\%$ measured per MIL-C-15305C. Stocked in 73 predesigned values.

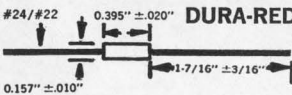

The "Dura-Red" is designed to MS-90537 with inductance range 0.10 μ h to 100,000 μ h with tolerance $\pm 10\%$. Stocked in 73 predesigned values.



Data Sheets: write or phone

LENOX-FUGLE ELECTRONICS, INC.

475 Watchung Avenue, Watchung, N. J. 07060

Telephone: Code 201, 756-1164-1165

Circle 250 on reader service card

quency. Standard linearization and scaling functions available include those for platinum and nickel resistance temperature detectors, and thermocouples made of platinum-rhodium/platinum, chromal/alumel, iron/constantan, and copper/constantan. Specials are square-root, exponential, and logarithmic digital linearizing cards.

Range is tunable. The logger has 10 adjustable alarm limits allocable to desired channels; adjustable measurement ranges from 100 millivolts to 10 volts; and six independently programmed scaling ranges. Separate printouts include an alarm printer, a tape punch at 20 channels per second, and a typewriter at 2 channels per second.

Systems are priced from \$8,000 to \$15,000. The maker regards Scandinavia as its main market. But a new series due this year may attract a wider market.

Oy Nokia Ab, Electronics Division, P.O. Box 10780, Helsinki 10, Finland. [429]

New industrial electronics

Reacting fast to reactions

Electrochemical changes
determine current rate
for battery charger

Battery chargers usually determine the charging rate for lead-acid cells by sampling terminal voltage. But not Tyco Laboratories' Dynalux charger. This charger samples the battery acid and bases the charging rate on the acid's electrochemical changes.

In a lead-acid battery, the rates of the chemical reactions, which convert the energy of the charging current into potential energy, increase—up to a maximum—as charging current increases. And as the battery's charge increases, the maximum reaction rate decreases. If the charging rate were driven beyond the battery's capacity, the excess charging current would be given off as heat, and could damage

"No matter how you cut it..."

SOUTH DAKOTA

is a good place to profit—
that's why we're in business!"

ED OWEN, PRESIDENT
RAVEN INDUSTRIES
SIOUX FALLS, S. D.



Raven Industries increased total sales three fold in 1966 over 1965, President Ed Owen reported to stockholders. "During the year we added over 500 employees to our working force, bringing the number now employed to over 700."

In addition, President Owen reported: "Our projected sales for 1967 exceed \$12 million . . ."

This is the kind of growth and profitability that industry can expect in South Dakota where the sky is still the limit.

700,000 people with a tradition for hard work and excellence help to create a business climate that can spell production and profit for you. Other executives have found the key to the future in South Dakota. How about you and your plant? Maybe it's time you cut out for South Dakota.

----- CLIP & MAIL COUPON TODAY! -----
for some convincing facts on
South Dakota!

ROBERT MARTIN, DIRECTOR
SOUTH DAKOTA I.D.E.A.
ROOM E-2
PIERRE, SOUTH DAKOTA 57501

NAME _____
COMPANY _____
ADDRESS _____
CITY _____
STATE _____ ZIP _____



These are specialized TRACOR instruments designed for your specific needs.

See them at IEEE booths 2J-30, 32 & 34.

FREQUENCY STANDARDS



RUBIDIUM FREQUENCY STANDARD
 1×10^{-10} freq
 2×10^{-11} stnd dev/yr
 use Reader Service #315.

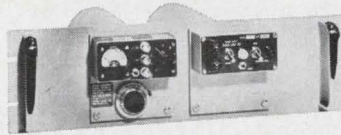

CRYSTAL STANDARDS
 $5 \times 10^{-11}/24$ hours
 5 to 0.1 MHz
 use Reader Service #316.



LOW COST HOUSE STANDARD
 $1 \times 10^9/24$ hours
 use Reader Service #317.

ULTRASTABLE CLOCKS AND DIVIDERS

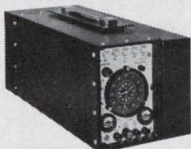

PORTABLE RUBIDIUM ATOMIC CLOCKS
 $5 \times 10^{-12}/100$ sec avg—37 pounds!
 use Reader Service #318.



CRYSTAL CLOCKS
 2×10^{-6} secs per day
 use Reader Service #319.

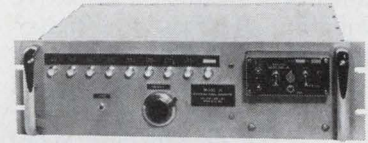

REFERENCE SIGNAL GENERATORS
 200 Hz-6.25 kHz
 use Reader Service #320.

VLF RECEIVERS—FREQUENCY/PHASE COMPARATORS

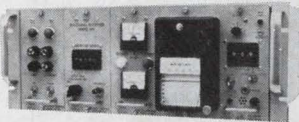

VLF TRACKING RECEIVER/COMPARATORS
 Continuous tuning 3.00 to 99.5 kHz
 use Reader Service #321.

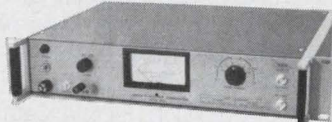

LINEAR PHASE/TIME COMPARATOR
 1 nanosecond time resolution
 0.01 cycle phase resolution
 use Reader Service #322.

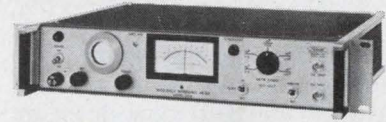

FREQUENCY DIFFERENCE METER
 difference to 1×10^{11} , error multiplied by 10^4 .
 use Reader Service #323.

NOISE ANALYSIS



CONTINUOUSLY-VARIABLE PASSIVE FILTERS 15 Hz-672 kHz
 use Reader Service #324.

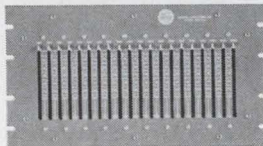

EQUALIZERS/SPECTRUM GENERATORS
 Up to 40 $\frac{1}{3}$ -octave increments
 use Reader Service #325.

OMEGA NAV SYSTEMS

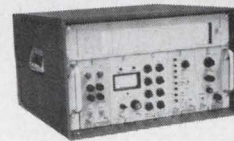

VLF/OMEGA NAVIGATIONAL SYSTEMS
 For broad-area navigation
 use Reader Service #326.

NORTHERN SCIENTIFIC, INC.

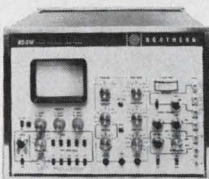

DIGITAL MEMORY OSCILLOSCOPES and Pulse Height Analyzers
 use Reader Service #327.

ASTRO-SCIENCE CORP.

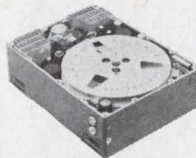

ASTRO-SCIENCE MULTI-CHANNEL AIRBORNE INSTRUMENTATION TAPE RECORDER/REPRODUCERS
 use Reader Service #328.

WESTRONICS INC.

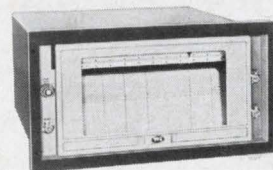

MULTIPOINT AND CONTINUOUS PEN CHART RECORDERS
 use Reader Service #329.

For a short-form catalog of TRACOR instruments, please use Reader Service #330.

Industrial Instruments Division



**PRECISION
IN METALS**

dimensional
metallurgical
technological

notes from HAMILTON

CREATIVE ENGINEERING

gives Hamilton strip and foil properties that can improve your product and lower your production costs.

The difference between Hamilton precision strip and foil and "run-of-the-mill" metals is Creative Engineering. This is the metallurgical and technological know-how that gives you the properties you want to the tolerances you require on the first lot and every subsequent lot. If you require a specific tensile for a critical strength requirement or almost fantastic dimensional tolerances, you will get them on the first lot and every lot after that. This repeatability means that once your manufacturing processes are established, you won't need to slow down or

change them every time you start processing a new lot of Hamilton material. The results are lower manufacturing costs for you and better, more reliable products for your customer.

Below is a list of materials available and a table of sizes and tolerances of Hamilton Precision Metals. Take advantage of the cost-saving Creative Engineering possibilities of Hamilton Precision Metals. Deliveries are good—quality is the finest. If, however, you need more information beforehand, write for your copy of the latest Hamilton Precision Metals Catalog.

MATERIALS AVAILABLE:

HAVAR®	High Temperature Alloys
ELINVAR EXTRA®	High Strength Alloys
DURAPERM	Refractory Metals
PLACOVAR®	Atmosphere Reactive Metals
VAPALLOYS®	High Temperature Brazing Alloys
Pure Metals	Diaphragm Alloys
Magnetic Alloys	Nickel-Base Alloys
Resistance Alloys	Copper-Base Alloys
Stainless Steels	Cobalt-Base Alloys
Permalloys	Experimental Alloys

SIZES AND TOLERANCES:

Thickness	Width	Thickness Tolerances
0.0007" to 0.0004"	4" max.	±5%
0.0004" to 0.001"	12" max.	±5%
0.0010" to 0.010"	12" max.	±0.0001"
0.010" to 0.025"	12" max.	±0.0002"
0.025" to 0.040"	12" max.	±0.0003"
0.040" to 0.065"	12" max.	±0.0005"

The width and tolerances may vary depending on properties of alloys being rolled.

HAMILTON PRECISION METALS

division of Hamilton Watch Company ■ Lancaster, Pa. 17604

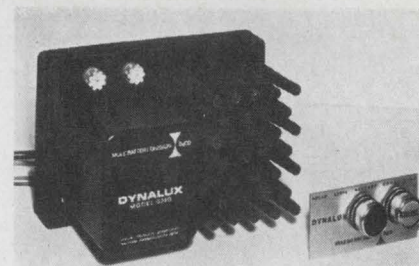

Sea power. Rods exchange heat when Dynalux is charging. Lights signal skipper when battery is ready.

the electrodes and shorten battery life.

Precise control. The Dynalux charger samples a battery's electrochemical state 120 times a second, sensing the maximum amount of charge the battery can accept without heat losses, and then delivers the charge. This precise control isn't possible in other chargers, the company claims.

The device automatically shuts off when the battery is suddenly discharged. And the sensing of the electrochemical processes is so specific that Dynalux can't charge a battery having a damaged cell.

The first Dynalux chargers on the market, the waterproof 0320 series marine-battery conditioners, were introduced at the National Boat Show in New York this month.

The marine charger was designed for permanent installation in small charter and private boats. The electronic control circuits are all solid state and the charger works off a standard a-c line.

Ready, go. Two indicator lights, mounted on the boat's dashboard, indicate whether charging is in progress. An amber light goes on when the battery is being charged and a green light goes on when the battery is fully charged.

The marine charger is available in three models—the 0320 can deliver 8 amperes and costs \$150, the 0321 delivers 15 amperes and costs \$190, and the 0322 delivers 30 amperes and costs \$230.

Later models. Lawrence Sullivan, Tyco's marketing director, says that Dynalux chargers designed for other applications, will probably be available in five or six months. "We have to talk to potential customers and find out the places they want to use the Dynalux," he says.

Tyco Laboratories, Inc., Hickory Drive, Waltham, Mass. 02154 [430]

We're looking for hardnosed design engineers

who want to make the best investment in IC logic assemblies.

It's a buyer's market. Now you can get exactly the right logic cards to design your logic systems the way you want them . . . without settling for fall-out cards from general purpose computers . . . and without going to all the expense of building specials.

CAMBION® makes the odd-ball IC assemblies as standard . . . along with all the regulars. You're never stuck for the right logic card, even if you need only one. You design your systems with all compatible cards, spend less time in repeated back wiring and less time debugging back wiring. Think of the money you'll save.



CAMBION's exclusive gold-plated 70-pin input/output is the key to your investment. It lets you bring more functions through to the outside world . . . reduces the total number of circuit connections . . . and provides for large scale integration . . . *now*.

®Reg. U.S. Pat. Off.

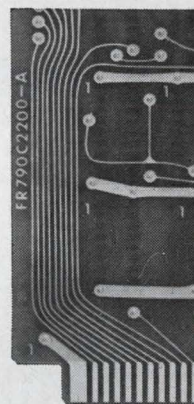

And CAMBION's complex function logic assemblies give you more circuitry in the etch — permanently. You get more functions per card, use fewer cards and card racks and get more compact design at lower cost.

Compare CAMBION IC logic assemblies with all the others . . . card for card, function for function, capability for capability, line for line and price for price . . . you'll prove for yourself it's your best investment.

Our latest comprehensive Logic Manual has all the data. To get your copy circle the number below or write Cambridge Thermionic Corporation, 447 Concord Avenue, Cambridge, Massachusetts 02138. Phone: (617) 491-5400. In Los Angeles, 8703 La Tijera Blvd., Phone: (213) 776-0472.

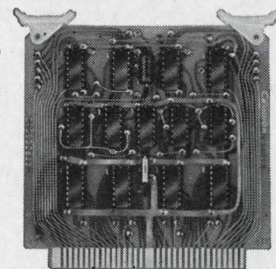

CAMBRIDGE THERMIONIC CORPORATION
CAMBION®

Standardize on CAMBION . . . the guaranteed logic assemblies

If You are Testing Components for

SHOCK

Acceleration and Vibration...

Bunker-Ramo's model BR-650 CHATTER and TRANSFER DETECTOR can be used to monitor closed relay contacts, connector-pair contacts, continuous conductor paths, slip ring and brush assemblies, printed circuit boards, integrated circuits, diodes, transistors, to name a few.

The BR-650 is an environmental testing device that indicates all undesirable opening and closing of active circuit paths under test. Now you can monitor circuitry under dynamic test for a wide spectrum of test information. The BR-650 provides eight independent chatter and transfer channels, with four inputs per channel in either chatter or transfer mode. The operator may make independent channel adjustments for chatter and transfer detection times with five settings covering a range of 1-microsecond to 100-milliseconds. Accuracy is $\pm 0.5\%$ full-scale.

For additional information on the BR-650 or other new versatile test instruments available, contact: Test Instruments Operation. Phone (213) 346-6000 or write: "See you at the IEEE Show-Booth 4E 39-41"



THE BUNKER-RAMO CORPORATION
DEFENSE SYSTEMS DIVISION
8433 FALLBROOK AVENUE • CANOGA PARK, CALIFORNIA 91304

Circle 251 on reader service card

FREE

Design Engineering Service

from

PERMACOR®

Iron Core Engineers

Only the world's largest iron core producer could offer you the qualified engineering services backed by an unequalled knowledge of iron core usage, applications, limitations, and production to quickly resolve all iron core problems.

With countless years in their research, development, and production, PERMACOR can, from experience, recommend the most efficient and economical solution to your iron core product and production problems.

We have matched over 20,000 iron cores to the needs of countless military, commercial, miniature, and specialized applications. We can do the same for you!

Send us your problems today. Let us show you how PERMACOR "Engineered Economy" can save you time and money. There's no obligation, of course.

PERMACOR®

A Division of Radio Cores, Inc.

9540 Tully Ave., Oak Lawn, Ill.

Phone: 312/GA 2-3353

Why Phoenix spells p-r-o-f-i-t

In this land of year-round sunshine it costs less to build plants and homes, too. People can live better, stay healthier, save more money. Outdoor sports and hobbies can be enjoyed 12 months a year. Production lines are blizzard-proof. Productivity and morale are higher. Our tax structure encourages profitable growth.

For FREE 40-page brochure, "PHOENIX: Environment for Science-Oriented Industries," write Stanton Allen, Manager, Economic Development Department, Room E-5, Chamber of Commerce, Phoenix, Arizona 85004

PHOENIX

ARIZONA

Circle 252 on reader service card

New industrial electronics

Inverter packs regulated wallop

For people on the go,
400 watts available
on land or on the sea

Although most consumer-type power inverters do a pretty good job of converting low-voltage d-c power to 117-volt a-c power for low wattage appliances such as radios, phonographs, electric shavers, and bottle warmers, they usually have two basic weaknesses: they are not rated for large-screen television sets or most communications gear that boaters and campers operate, and they do not provide a means of remote operation.

However, at this month's Boat Show, the Heath Co. introduced a low-cost, heavy-duty power inverter that fits the bill of the vacationer, boatman, or camper. Called the MP-14, Heath's power inverter can deliver up to 500 watts on an intermittent duty cycle or 400 watts on continuous duty—enough to operate even a color-tv set. Moreover, the inverter can be used as an emergency power source in the event of a line failure. Priced at \$99.95 in kit form, the inverter can be assembled in one evening. The MP-14 has a removable control head that permits the inverter to be mounted near the battery while the a-c receptacle is at another location.

The inverter operates with a d-c input supply of 12 to 14.5 volts. Input current requirements are 4 amperes with no load and 40 amperes with a 400-watt load. A switch-selected a-c output of 120, 135, 150, 165, and 180 volts is available at 400 watts continuous, or 500 watts intermittent—15 minutes on, 15 minutes off at 100°F, maximum. Line frequency is 60 hertz, adjustable, with a regulation of 1% no load to 400 watts. The input circuit is protected with a 50-ampere circuit breaker and a d-c polarity reversal diode. The over-all size is 9½ by 7¾ by 6¾ inches.

Heath Co., Benton Harbor, Mich. [431]

**familiar faces
from the
world's broadest
line of
indicating
relays**

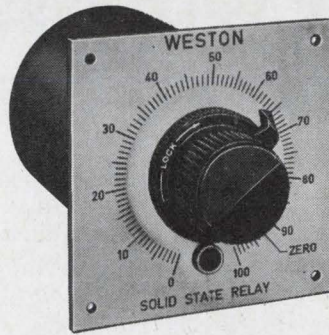

Model 1062 Control Relay—no moving parts, not even relay contacts; voltage ranges from 0-1 volt, current ranges from 0-100 μ a; 200-millisecond response time with 0.5% repeatability typical; zero adjust and trip indicator on 320° scale.

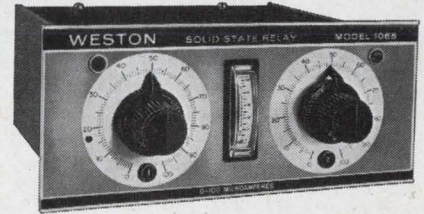

Model 1066 Dual Set-Point Relay—with input monitor and independently adjustable set points. Repeatability $\pm 1/2\%$; accuracy $\pm 2\%$; selectivity to 1 μ a; switching capacity 1 amp at 117 volts AC.



Model 705 Sensitrol® Relay—highly sensitive; surface or flush mounted; single or double, fixed or adjustable contact; ranges as low as 0.5-0-0.5 μ a.

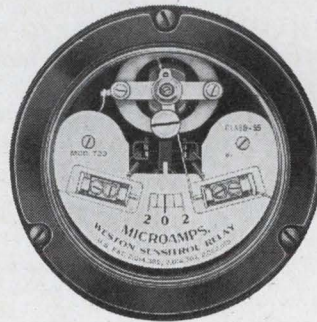

Model 723 Sensitrol® Relay—sealed; shielded; internal reset; solder terminals; single or double magnetic contact; ranges as low as 1-0-1 μ a.

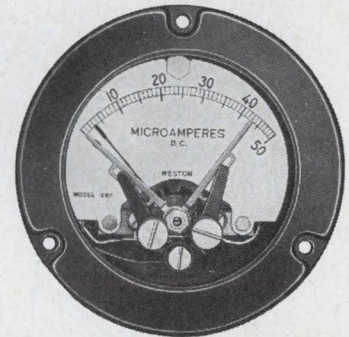

Model 1097 Ruggedized 3 1/2" Relay—LCCA type fully meets applicable portions of military spec; sealed; magnetically shielded; solder terminals; single or double adjustable contacts. **Model 1093 2 1/2" size available.**

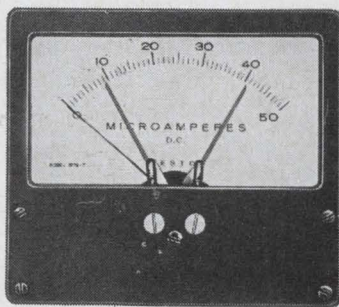

Model 1075 Photronic* Relay—operates without physical contact; single or double adjustable set points; continuous reading beyond set point; taut band frictionless mechanism; solid state switching circuit; ranges from 10 μ a.

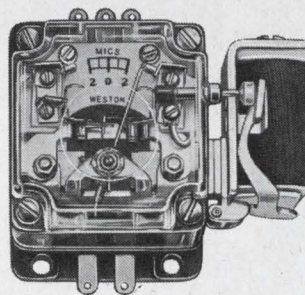

Model 813 Miniature Relay—compact and lightweight; sensitive and Sensitrol (magnetic) contacts; single or double contact; ranges as low as 2-0-2 μ a.

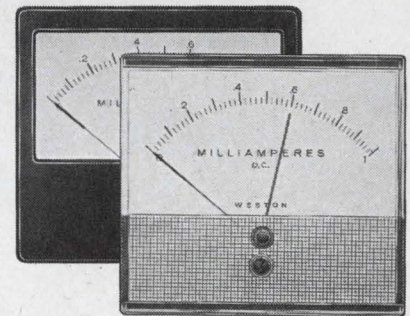

Model 1930/1940 Photronic* Relay—3 1/2" and 4 1/2" in either bakelite or plastic front; low cost; add-on power supply and solid state switching circuit; shielded; non-physical, adjustable contact.

**Photronic is a Trademark of Weston Instruments, Inc.*

**Weston Instruments Inc., Weston-Newark,
Newark, N.J. 07114, a Schlumberger company**

WESTON® prime source for precision... since 1888

Will Scotchpar® win the Ester award for the best film of the year?

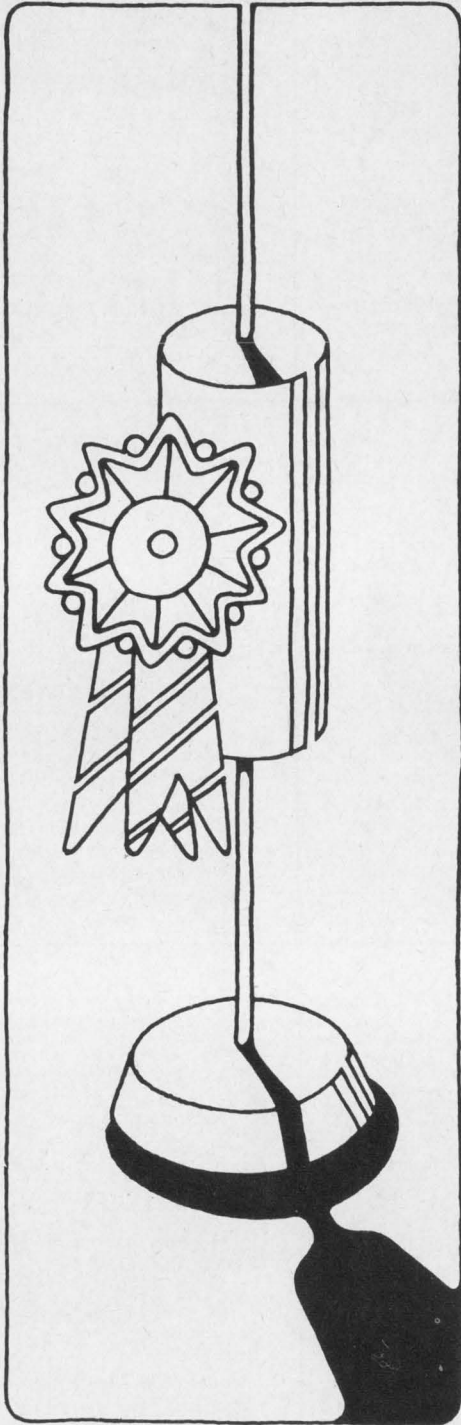

Based on the quality of polyester films, 3M's SCOTCHPAR should win at least as many votes among electrical manufacturers as the "big name" film.

There's nothing better than SCOTCHPAR for capacitors.

And there's nothing better than SCOTCHPAR as insulation for transformers, motors, wire and cable.

We have it in thin films and thick films.

SCOTCHPAR has high dielectric strength, great temperature stability, resistance to moisture and solvents. It's thin, tough, flexible and durable.

If you're going to use polyester film instead of a conventional insulation—and you should, to cut costs, save space, and improve product performance—vote for SCOTCHPAR. If you want SCOTCHPAR that's heat sealable, the name is SCOTCHPAK.®

A vote for SCOTCHPAR is a vote for quality and adaptability.

3M Company, Film & Allied Products Division, 3M Center, St. Paul, Minnesota 55101.

Scotchpar® **3M**
BRAND COMPANY

New Semiconductors Review

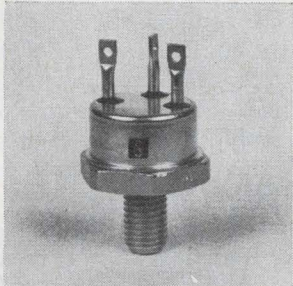

A full line of 20-amp and 10-amp pnp silicon power transistors are packaged in the isolation TO-61 case. One series have a minimum gain of 5 at collector current of 20 amps and gain range of 30-90 at I_c of 10 amps. The second series have a gain of 10 min. at I_c of 10 amps and gain range of 30-90 at I_c of 5 amps. Solitron Devices Inc., Blue Heron Blvd., Riviera Beach, Fla. [436]

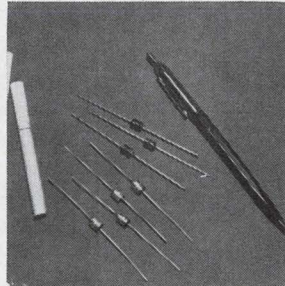

Silicon 3-amp diodes are available in both epoxy and glass-to-metal seal packages. They are offered in a voltage range from 50 to 600 v, in types IN5197 through IN5201 (epoxy), SLA-5197 through SLA-5201 (glass-to-metal). JAN types are also available in the epoxy package. Price (100 lots), 37 cents to \$1.80 each. Slater Electric Inc., 45 Sea Cliff Ave., Glen Cove, N.Y. [437]

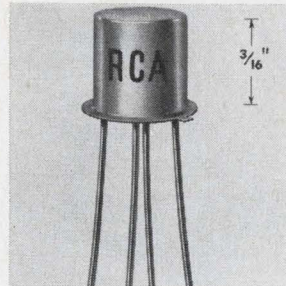

Silicon MOS FET 3N152 is for vhf amplifier use up to 250 Mhz in military and industrial communications equipment. Noise figure of 3.5 db max. and usable gain of 14.5 db min. (16 db typical) at 200 Mhz, coupled with feedback capacitance of 0.2 pf max. suit the unit for high-performance front-end circuits. RCA Electronic Components and Devices, Harrison, N.J. [438]

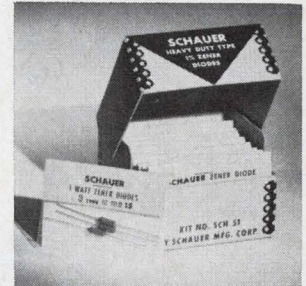

Compact kit SCH51 contains a 51-piece assortment of 1% tolerance, 1-w zener diodes. The assortment covers the voltage range of 2.7 to 16 v. There are 3 diodes of each voltage contained in a reusable poly bag. Introductory price of the kit is \$24.50 (a \$54.57 value if the diodes were purchased separately). Schauer Mfg Corp., 4521 Alpine Ave., Cincinnati [439]

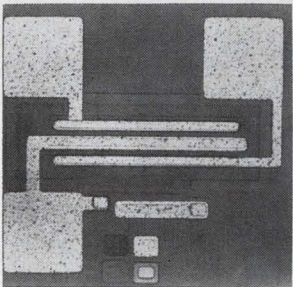

P-channel MTOS (metal thick oxide silicon) transistor MEM556 is suitable for multiplexing, series and shunt chopping, commutating, and logic circuits involving high signal voltages and Nixie driving applications. Features include 80-v max. operation and an off-to-on ratio of 2×10^8 . Price is \$10 each in lots of 1 to 99. General Instrument Corp., Hicksville, N.Y. 11802. [440]

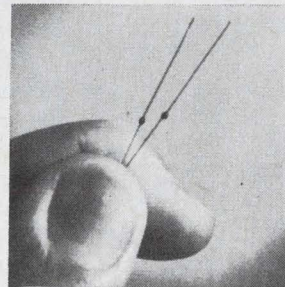

As many as six individual, matched silicon junctions are stacked and packaged in a micro epoxy form for switching applications up to 6,000 working volts in the Micro-Codistor II line of diodes. Switching speeds range as low as 50 nsec for conditions of 10 ma, 100 ohms. Units measure 0.075 x 0.125 in. Computer Diode Corp., Pollitt Dr. South, Fair Lawn, N.J. 07410 [441]

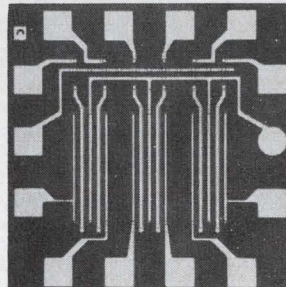

MOS 6-channel analog switch 3701 features a low on-resistance, typically 300 ohms. Input and output leakage current are typically 10 pa and 100 pa respectively. The device may be operated over a temperature range of -55° to $+85^\circ$ C. It is suited for analog or digital data transmission applications. Fairchild Semiconductor, 313 Fairchild Dr., Mtn. View, Calif. [442]

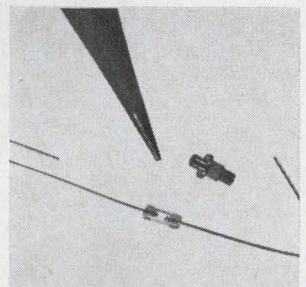

Schottky-barrier mixer diodes of all-bonded construction are designed for low-noise operation in S-band where units with noise figures of 6 db max. through 7 db max. are offered. Both pill-prong (L8200) and axial lead (L8201) packages are available. Units are for local oscillator power levels of 1 mw. Philco-Ford Corp., Union Meeting Rd., Blue Bell, Pa. 19422 [443]

New semiconductors

Everything—including sink—in one package

Radio-frequency power amplifier with heat dissipator is designed for telemetry and radar systems

A discrete amplifier has sneaked its way into a line of products designed for integrated circuits.

The line, called MEMA (micro-electronic modular assembly), features hermetically sealed ceramic packages developed by Amelco Semiconductor for the computer in

the Integrated Helicopter Avionics System. The assemblies are about 1 inch square and 90 mils thick, and most contain a series of IC's interconnected to perform a specific function.

The new, discrete assembly is a 1-watt radio-frequency power am-

plifier with its own heat sink. It operates at 500 megahertz and can dissipate 50 watts. "Before long we'll put a 50-watt transistor in it," says Richard Winckler, section head for r-f MEMA design.

Now offered only in the military version, the amplifier is intended for telemetry transmitters and radar systems. It was designed, says Winckler, "because power transistors are hard to handle; high voltage or high current can blow them easily." Putting the protective electronics and heat sink in the same package with the transistor solves that problem.

Screened on. The transistor and

Can you

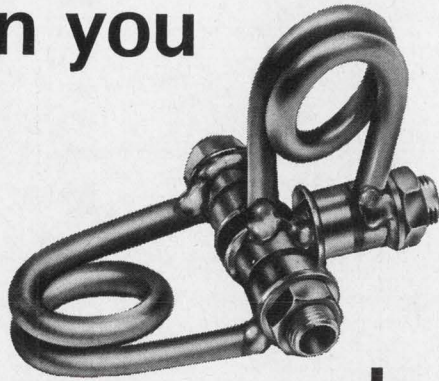

do this?

These new Johanson glass *capacitors* are designed to bridge the gap between conventional trimmers and high frequency air capacitors. They have high Q—low inductance; they have high RF current characteristics, they can be soldered together with components to simplify circuitry and they are *strong*.

Models include:



SG11054

Series II: High RF voltage *low cost* units with $Q > 1200$ and TC; 0 ± 50 ppm.



GQ11115

Johanson GQ11115: High voltage quartz capacitors which feature 7000 VDC; 2500 V peak RF at 30 mc and current capacity > 2 amps.

Also available are:

- Tuners and ganged tuners; linear within $\pm .3\%$
- Differential capacitors
- Mil spec capacitors
- Microminiature capacitors .075" diameter and .1-1 pf

Write today for full catalog.

Johanson MANUFACTURING CORPORATION

400 Rockaway Valley Road, Boonton, N. J. 07005 (201) 334-2676

Electronic Accuracy Through Mechanical Precision

Circle 212 on reader service card

Our little black book has over 100,000 phone numbers.

You never had a black book like it. Over 1,500 pages. And those phone numbers! More than 100,000 telling you who to call/where to go, for the over 4,000 different product categories listed and advertised in the yellow pages of the Electronics Buyers' Guide.

It's the industry's one-stop shopping center that lets you find the products and services you need quickly. You can depend on EBG.

Electronics Buyers' Guide

A McGraw-Hill Market Directed Publication, 330 West 42nd Street, New York, N.Y. 10036

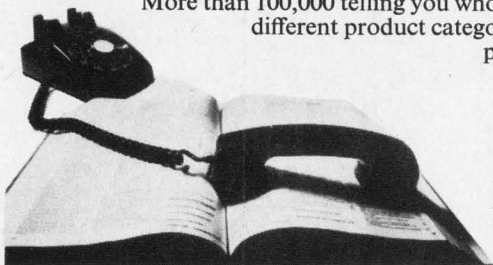

... lengths of transmission lines tune amplifier ...

the three capacitors of the circuit are wired directly to a shielded microstrip transmission line inside the package. These transmission lines are molybdenum manganese traces deposited on the substrate by silk-screen techniques. They behave as inductances and capacitances. Width and spacing are so critical, Winckler says, that a change of only two diameters in the length of the 3-mil wires connecting the circuit elements and the transmission lines can affect tuning.

The close tolerance is not entirely a drawback, since the amplifier is easily tuned by changing the wire length. And the microstrip reduces spurious inductances. Manufacturing difficulty, however, shows in the price of the amplifier—\$200 for one, \$125 each in large quantities.

Although Winckler sounded out 20 companies on user requirements for frequency and power, the first MEMA amplifier is something of a feeler. The company chose 500 Mhz because higher frequencies are usually generated at that level and multiplied up. But, Winckler says, the package can be easily modified to operate at 200 Mhz or even one gigahertz.

Also, Amelco has decided to market these devices in off-the-shelf MEMA packages:

- A 16-bit binary counter, with 16 chips, priced at \$215 in 1-99 lots, \$162.50 each for production quantities of 100 and up.

- A dual four-bit up-down counter, with 11 chips, for \$98 and \$74 each.

- A dual decade counter, with 10 chips, for \$125 and \$94.50.

All three circuits will be available in both military and industrial temperature ranges, and at three power levels—0.5 milliwatt, 1.2 milliwatt, and 4.0 milliwatt. At the IEEE Show in New York next month, Amelco will add to its list of off-the-shelf MEMA packages a dual decade decoder matrix and a dual 12-bit shift register. All are part of a series of 25 packages Amelco plans to introduce soon, all containing both discrete components and IC chips.

Amelco Semiconductor, a Teledyne subsidiary, 1300 Terra Bella Avenue, Mountain View, Calif. 94042 [444]

NEW Hi-G REED RELAY FEATURES SIMPLIFY YOUR DESIGN PROBLEMS

The Series 3500 terminals . . .

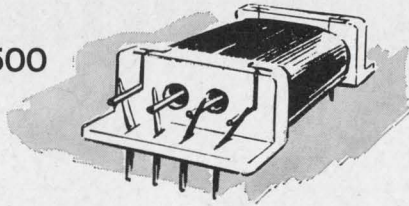

has printed circuit board mounting on 1 inch x .100 inch centers.

. . . or, when we slide a plate into our bobbin mold, circuit board mounting pins on 1 inch x .150 inch centers and is called Series 3600 . . .

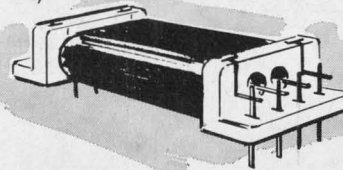

Both versions use our new assembly without requiring strip and its extra welds . . .



Flextop terminal to give stress-free reed an intermediate nickel "ribbon"

But, when you need a relay that plugs in and out without fuss, or just want an independent source for Berg Pin mounted relays, we add adapter blocks . . . and fill all your needs from stock!

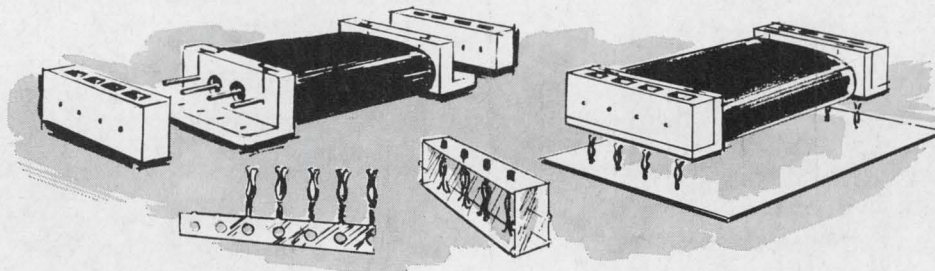

Either way you get a big bore bobbin that holds even the largest "miniature" reeds without sacrificing its recessed coil terminals magnet wire and

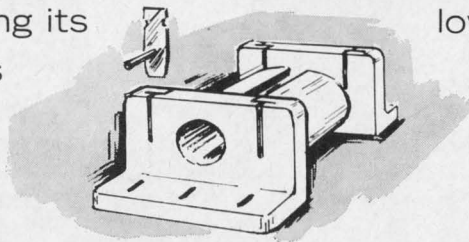

low profile, and unique fully that eliminate exposed intermediate coil leads.

Call, write or check the reader service card for your copy of Hi-G product bulletin #160. If you need application engineering assistance, an experienced Hi-G representative awaits your call. Telephone: 203-623-2481.



SPRING STREET & ROUTE 75 / WINDSOR LOCKS, CONNECTICUT 06096

Now, Winchester military-type performance

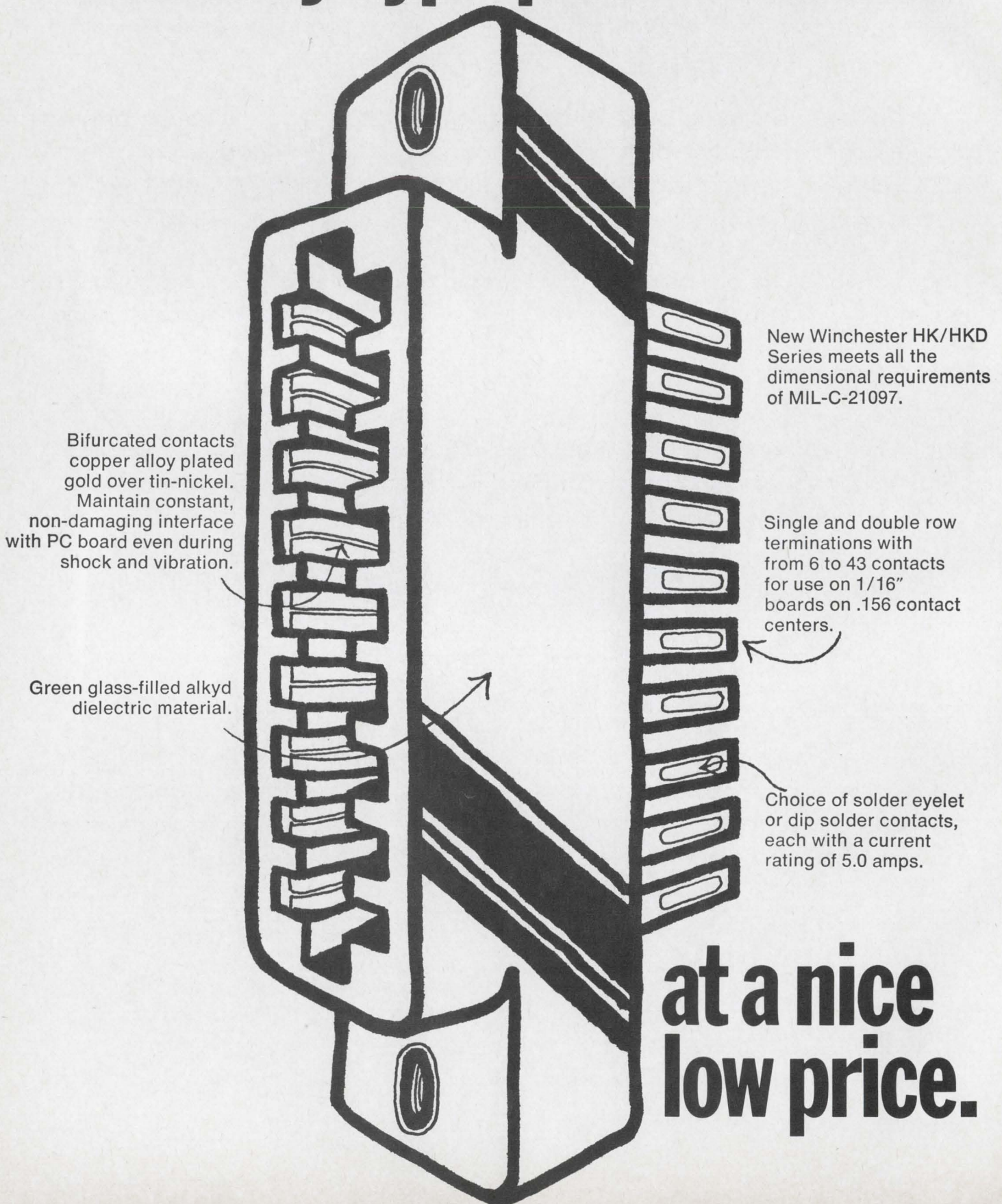

**at a nice
low price.**

New Books

Programed for disaster

The Tale of the Big Computer
(A Vision)
Olof Johannesson
Coward-McCann Inc.
126 pp., \$4.00

Did man create the computer in his own image? Is the data processing technology the ultimate Frankenstein's monster?

These are the big questions Johannesson's "vision" raises. His tale, which begins B.C. (Before Computer), has a half-believable plot about computers taking over from humans. The book is valuable to engineers because it reminds them of a neglected socio-political side to the computer age—one that goes beyond the automation threat and far more perilous than Orwell's 'Big Brother' prophecy.

Johannesson's theme is that right now computer technologists are inadvertently creating the means of man's undoing. After giving the computer's history, he builds a case, based upon man's limited perception of his 'calculating' servant.

Man builds a computer-perfect world. Machines do everything—feed us, entertain us, regulate our climate, educate us, and run our government. The powers of these computers were placed in their 'tapes' by man. They restrict themselves to their work, and show no hint of an ambition to take over. In fact, they abolish war, eliminate legal injustice, and treat the sick (automatic doctors everywhere).

But comes the revolution. The last of the bureaucrats (what the rest of mankind was doing is not made clear) engage in a power struggle, control over the tape is lost, and a great disaster occurs. One by one, the computers grind to a halt because somebody pulled a plug or didn't throw a switch.

That's calamitous enough (about 10% of mankind survives), but what's left of undaunted humanity decides to build even better computers. These will be thinking, propagating, egocentric and almost God-like machines that can't break down. But that generation of computers begins to regard man as inferior and imperfect. They program themselves to decide if man de-

Poor old Henry Adams He thought he found a goof in a Trygon silicon power module. But the laugh was on him.



Like any of the Twelve Cranks on Pleasant Avenue, Henry Adams feels fulfilled whenever he finds a goof. When he found two in a row, he was ecstatic—but the other Cranks wouldn't believe him.

They were right. The laugh was on Henry when they found an intermittent in his test equipment leads. One goofed Trygon could be possible (that's what we hire our 12 cranks to catch). But two? Impossible, Henry.

Trygon's silicon power supply modules are precision regulated units for unattended operation in military, industrial or commercial systems. Automatic reset short circuit protection and optional overvoltage protection. Voltage and current ratings from 3v to 200v, 150mA. to 5A. with single and dual outputs.

Highest quality components—generously derated and temperature aged power transistors—hermetically sealed rectifiers—temperature stabilized zener diodes—computer grade capacitors—the works.

Performance specifications match the componentry: 0.01% line regulation; temperature range from 0° to 71°C.; remote programming; remote sensing; or more. Much more. Four series of modules in a competitive price range. Write for literature.

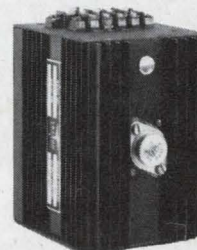

Trygon Power Supplies

111 Pleasant Avenue, Roosevelt, L.I., N.Y. 11575
Trygon GmbH 8 Munchen 60, Haidelweg 20, Germany
Write for Trygon 1967 Power Supply Handbook.

There's no sense in paying for connectors that are certified to MIL-C-21097. Unless you have to. But there's lots of sense in Winchester's new HK/HKD Series that provides the same geometry. Because they're low cost—built to Winchester quality standards.

The fact is, we keep the cost of the HK/HKD Series down by using a different molding material and contact plating. This makes our new HK/HKD Series your best buy for computers, ground support equipment and other applications where you need a really good, dependable connector. But you don't want to spend a fortune.

The HK/HKD Series is promptly available from your nearby Winchester distributor. So is a helpful new brochure called "Commercial Printed Circuit Connectors." Winchester Electronics, Main St. and Hillside Avenue, Oakville, Connecticut 06779.

WINCHESTER ELECTRONICS
LITTON INDUSTRIES

Want to design for
INSTANT STARTING?...
SPLIT-SECOND ACCURACY?
REVERSIBILITY?...
MIXED SPEEDS?...

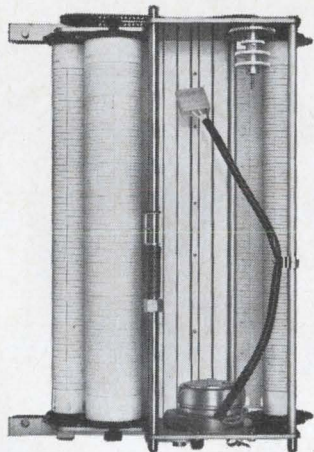

turn the
job over to
SYNCHRON® MOTORS!



No matter whether you want a motor to withstand swiftly changing temperatures, meet fast-reversing stresses, turn a small part with exact accuracy to 1 Rev. per week or 600 Rev. per minute, there's a SYNCHRON Motor that can do it! It can do a hundred other things as demanding as these — if you tell us how you want it to function. Before you start any design that calls for small drive or timing motors, think of SYNCHRON Motors, and call or write us at Hansen Manufacturing Company. We'll be there at once to help — with experience. Better still — don't wait till you face a problem. Write us now — let us tell you about SYNCHRON Motors and the ways we design them to work for you.



HANSEN REPRESENTATIVES: CAREY & ASSOCIATES, Houston and Dallas, Texas, R. S. HOPKINS CO., Sherman Oaks, Calif., MELCHIOR & MACPHERSON, INC., San Carlos, Calif., THE FROMM COMPANY, Elmwood Park, Ill., H. C. JOHNSON AGENCY, INC., Rochester, N.Y., JOHN ORR ASSOCIATES, Grand Rapids, Mich., WINSLOW ELECTRIC CO., Essex, Conn., Narberth, Pa., and New York, N.Y. EXPORT DEPARTMENT, 64-14 Woodside Ave., Woodside, N.Y.

New Books

serves to survive.

That scene which leads to the last chapter, must be read to be appreciated. And so must the entire novel, especially by the people now planning tomorrow's computers. The author warns that engineers must not only guard against humans misusing computers, but against computers exploiting man.

J.B. Steuer

Electronics Consultant

Understanding logic

Electronic Digital Components and Circuits,
R.K. Richards,
D. Van Nostrand Co., Inc.
526 pp., \$15

Even the electrical engineer familiar with basic components and circuits, and able to use his knowledge in design can be stymied (or worse, settle for less than best) when he has to choose from among the myriad of digital circuits and components. Richard's treatment of digital design will sharpen that choice, and make the effort smoother and faster.

The text explains how various practical components and sundry circuits work. It describes advantages and disadvantages of the major designs, provides alternate approaches, elaborates on circuits behavior, and compares the relative merits of diodes, transistors, tunnel diodes and super-conducting devices.

The author does not smother the reader with superfluous details. He does point out pitfalls. For example, his discussion of speedup capacitors and the ramifications of the forward-biased diode junction voltage drop in a transistor should eliminate the difficulty (what size is best, and how hard should a device be biased-on) that many designers have with these simple but important factors.

Other topics included are combined diode-transistor components and functions, core structures and accessing methods, film-storage units, and specialized magnetic-core arrays of diode AND and OR switches. He also discusses magnetic drums, disks, tapes, cards, and various switching schemes.

DIELECTRIC MATERIALS CHARTS

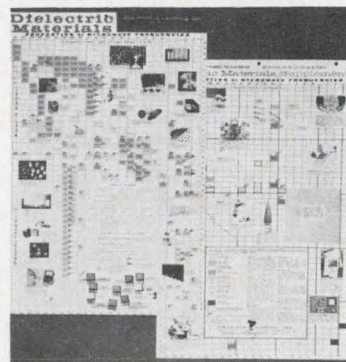

Charts in full color contain data on all important materials used by electrical and electronic engineers.

Circle 515 Readers Service Card

THERMAL CONDUCTIVE DIELECTRICS

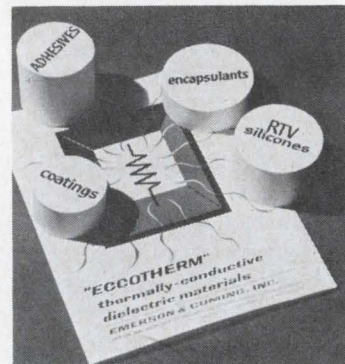

NEW FOLDER

Electrically insulating, thermally conductive . . . for bonding, encapsulating, coating or sealing heat sinks, components or cryogenic devices where rapid heat transfer is desired. New four-page folder describes materials and applications.

Circle 516 Readers Service Card

FREE SAMPLE RFI GASKET ECCOSHIELD

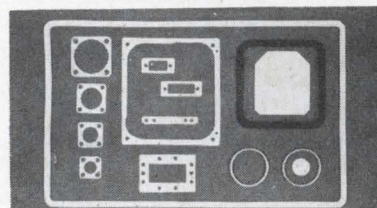

Eccoshield® SV is the flexible, compressible plastic with the conductivity of metal—available in many physical forms—for RF and hermetic seals. Insertion loss has exceeded 100 db.

Circle 517 Readers Service Card

Emerson & Cuming, Inc.



CANTON, MASS.
GARDENA, CALIF.
NORTHBROOK, ILL.
Sales Offices
in Principal Cities

EMERSON & CUMING EUROPE N.V., Oevel, Belgium

The world's lowest cost Core Memory...right in the palm of your hand

We build some pretty sophisticated core memory systems—but not everybody needs them. A lot of you out there have asked for a compact, no-nonsense, inexpensive memory for such applications as data transmission buffering, data logging, formatting and CRT refresh. Thus challenged, we came up with (it wasn't easy) the FI-1—a 1024 x 1 core memory system at a cost that lets you abandon even delay lines

without a qualm.

Briefly, the FI-1 has a full cycle time of $2\mu\text{sec}$ and access time of 900 nsec. Power? Just $\pm 6\text{v}$. Utilizing ICs we have packed address decoding, ferrite core drivers, data I/O circuits and internal timing logic for half cycle operation into a handful-size package. And there's still room in it for an extra universal circuit card to add logic functions for specific applications.

Single quantity cost? Just \$650.

Designers, arise! You have nothing to lose but the limitations of other storage techniques. For complete data on the FI-1 Memory System, get on the horn (collect) or write for Bulletin MS-671.

Ferrocube 
Systems Division, Englewood, Colorado

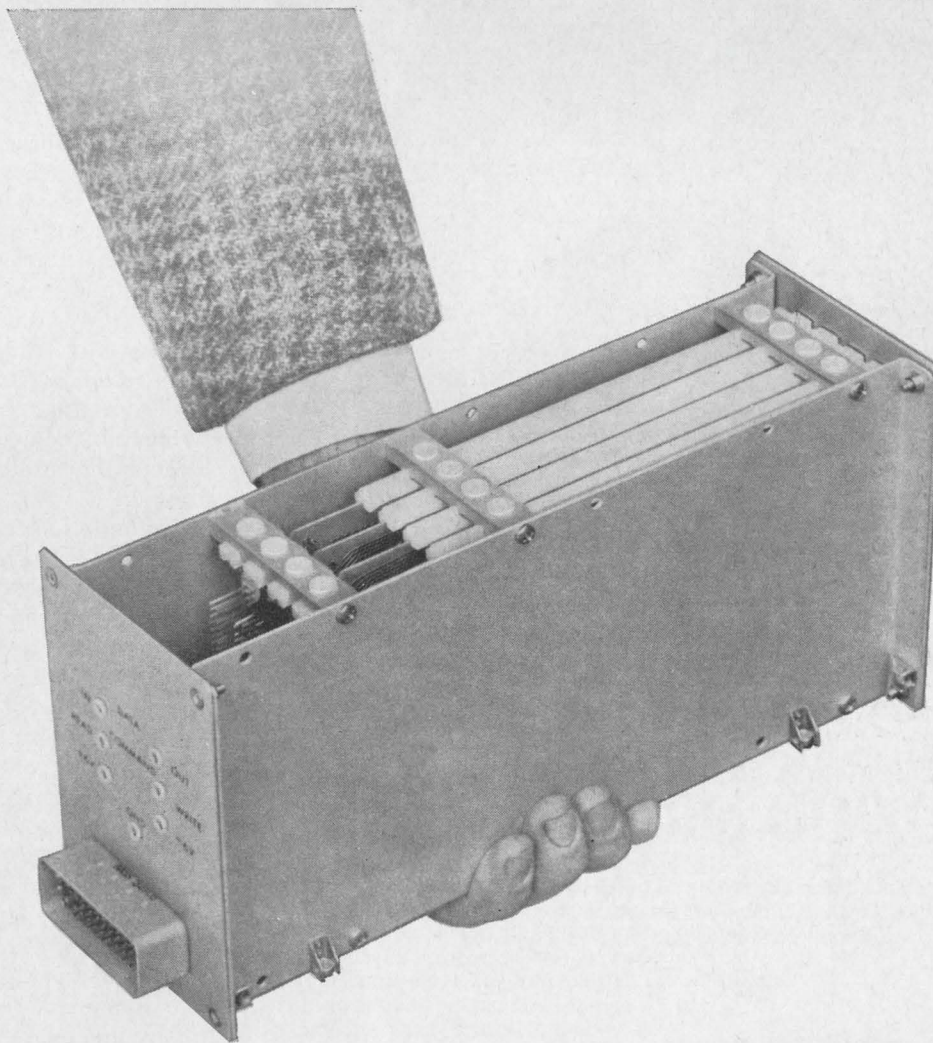

Albuquerque—Electronic Enterprises, (505) 256-1585; Baltimore—Eastern Components, (301) 322-1412; Dayton—(513) 253-3158; Encino, Cal.—(213) 788-2060; Englewood, Col.—(303) 771-2000; Houston—Noakes Engineering, (713) 529-6213; Irving, Texas—Noakes Engineering, (214) 255-0441; Lansing, Mich.—(517) 482-7140; Minneapolis—(612) 888-4681; Northlake, Ill.—(312) 261-7880; Orlando—(305) 841-6380; Philadelphia—Eastern Components, (215) 927-6262; Phoenix—(602) 265-1792; San Francisco—Wm. J. Purdy Agents, (415) 863-3300; Saugerties, N. Y.—(914) 246-2811; Union, N. J.—(201) 964-1844; Waltham, Mass.—(617) 899-3110; Toronto, Ontario—Philips Electron Devices, Ltd., (416) 425-5161.

We designed these special reed relays to solve specific problems. Maybe yours.

We think these specials demonstrate our versatility in designing for unique requirements.

Our line also includes standard and miniature varieties of dry reed, mercury-wetted, latching and high power reed relays—available in molded, cased or tubular construction.

Whether you're interested in specials or standards, chances are we can deliver the reed relays you need—fast. Our complete engineering and design facilities are at your service.

For a copy of our latest Doranic® Reed Relay catalog, write to: Douglas Randall, Inc., 6 Pawcatuck Ave., Westerly, Rhode Island 02891.

ULTRA-LOW CONTACT RESISTANCE

Guaranteed maximum: 5 milliohms.

HIGH VOLTAGE

Will break 15,000 volts peak RF and 70 amps for 1 μ sec pulse.

VERTICAL MOUNT AND LOW PROFILE

For use where available space is limited. Low profile relay shown is .315" high. Vertical mount relay fits into .4" square.

SPECIAL MOUNTING

An example of one configuration designed to meet special mounting and terminal requirements.

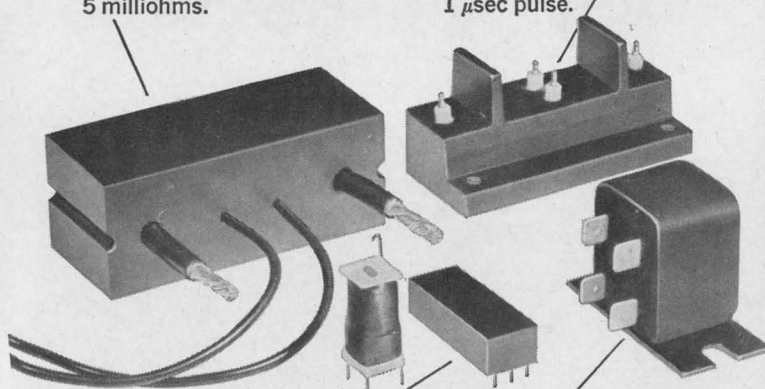

DOUGLAS RANDALL, INC.

Division of Walter Kidde & Company, Inc. **Kidde**

Circle 218 on reader service card

Our little black book has over 100,000 phone numbers.

You never had a black book like it. Over 1,500 pages. And those phone numbers! More than 100,000 telling you who to call/where to go, for the over 4,000 different product categories listed and advertised in the yellow pages of the Electronics Buyers' Guide.

It's the industry's one-stop shopping center that lets you find the products and services you need quickly. You can depend on EBG.

Electronics Buyers' Guide

A McGraw-Hill Market Directed Publication, 330 West 42nd Street, New York, N.Y. 10036

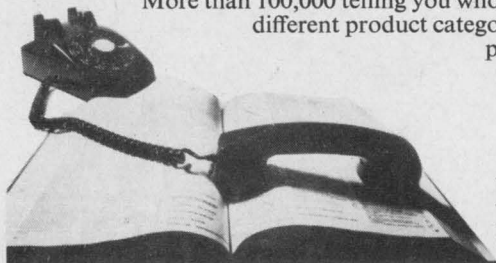

Technical Abstracts

A look at Venus

Summary results from interplanetary spacecraft radio propagation experiments
Glen A. Reiff
National Aeronautics and Space Administration, Washington

When Mariner 5 passed within 7,000 miles of Venus last fall, the spacecraft provided earth-bound scientists with a description of the Venusian atmosphere. Among the spacecraft's experiments were two that described the atmosphere by measuring the refraction, scatter, and attenuation of radio signals.

In one experiment, S-band signals were transmitted to Goldstone, Calif., where scientists measured the phase, frequency, and amplitude changes of each received signal.

With this data, the scientists were able to calculate the scale height of the Venusian stratosphere as 3.3 miles. Scale height, the decrease in altitude for which electron density decreases 37%, differs at each atmospheric level. Assuming a constant temperature of 230° Kelvin for the stratosphere and knowing the scale height, scientists employed a variation of the perfect gas law to compute the stratosphere's mean molecular weight as 40. From this, they inferred that carbon dioxide makes up more than 70% of the stratosphere's composition.

In the other experiment, dual-frequency propagation was used to determine ionospheric electron density. Two signals, 423.3 and 49.8 megahertz, were transmitted from Palo Alto, Calif., to the spacecraft, which measured the phase, frequency, and amplitude differences of the two signals, and transmitted this data to earth.

Since the refraction of a high-frequency signal in the ionosphere is small compared with that of a low-frequency signal, the scientists reasoned that differences in the refraction of the signals are attributable to ionospheric influence on the low-frequency signal.

As Mariner approached Venus on the night-side, scientists plotted phase difference as a function of the spacecraft's distance from

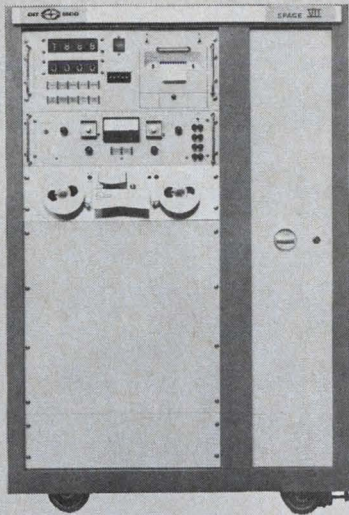

**IT TAKES A LOT
OF ADJECTIVES
TO DESCRIBE THE
SPACE VII...**

Adjectives like FAST, ACCURATE, FLEXIBLE, RELIABLE, VERSATILE, ECONOMICAL and MANEUVERABLE. If you doubt for one minute that a humble wiring system analyzer from the middle west can live up to these labels, then try testing this tester for yourself. It was designed and developed (after thorough lab and field testing) especially to meet today's demand for speed, accuracy, versatility and economy. DIT-MCO's Space VII operates on the fully automatic tape input and printout concept. Design and construction are of the highest quality. The "total

speed" function of the Space VII gives you faster overall test time because of adaptation and hookup ease, rapid tape feed, speed of test plus speed of fault determination time, scan time, error recording and printout. With this advanced system you can test up to 2,000 terminations at a rate of more than 400 per minute! Electronic engineers who've tried it, call DIT-MCO's Space VII the best intermediate size testing system on the market. We won't disagree.



DIT-MCO INTERNATIONAL

A DIVISION OF XEBEC CORPORATION

5612 BRIGHTON TERRACE

KANSAS CITY, MISSOURI 64130

TELEPHONE (816) 363-6288 TELEX 42-6149

IT'S NO WONDER APPROXIMATELY 90% OF ALL MAJOR MANUFACTURERS IN THE COMPUTER AND AEROSPACE INDUSTRIES ARE SATISFIED USERS OF DIT-MCO SYSTEMS.

Circle 253 on reader service card

Now they're warranted

for

TWO YEARS or 2000 HOURS!

Transicoil is the first rotating components manufacturer to warrant its products for two years or 2000 hours. Customers have long known that Transicoil products are engineered to outperform all others. Now we'll prove it! The extended warranty is at least double that of any other rotating component manufacturer. It reflects the superior quality control practices and broad servo experience of the leader in the field.

**Weston Components Division, Weston-Transicoil,
Worcester, Pa. 19490, a Schlumberger company**

WESTON®

prime source for precision

...since 1888

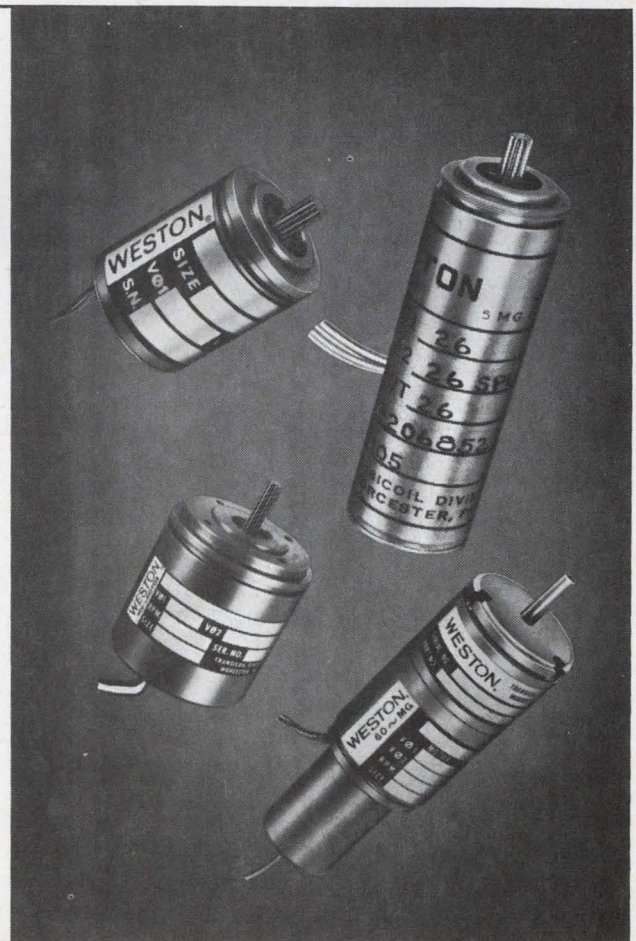

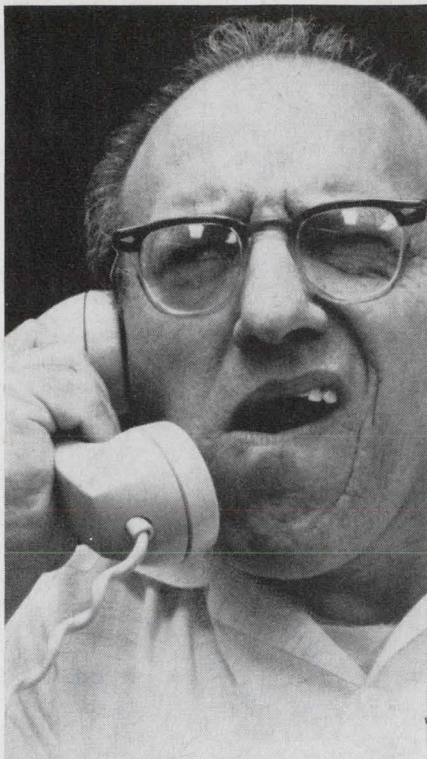

**"Four to six weeks
for power supply
delivery?**

Forget it!

**Acopian will ship
any of their
62,000 different
AC to DC plug-in
power supplies
in just 3 days!"**

This catalog lists 62,000 models of AC to DC plug-in power supplies available for shipment in just three days. Choose the exact outputs you need. Singles or duals, regulated or unregulated. Write or phone for your free copy.



Name _____
 Title _____
 Company _____
 City _____
 State _____ Zip _____



Acopian Corp., Easton, Penna. 18042
 Phone: (215) 258-5441

Technical Abstracts

Venus' center. A similar curve was plotted as Mariner traveled away from the day-side. These plots, along with other Mariner data, enabled the scientists to calculate ionospheric electron density at various altitudes. Venus' peak night-side value is 10^4 electrons per cubic centimeter. (Earth's night-side peak is 10^5 .) Dual-frequency tests also indicate the possibility of a double-layered ionosphere in which a different ion dominates each layer.

Previously, radio-propagation experiments had been performed by Mariner 4 and Pioneer craft. Because the density of the Venusian atmosphere was expected to be high, equipment modifications were necessary.

The power supply of the dual-frequency receiver, which worked on 28 volts d-c in earlier spacecraft, was adapted to Mariner's 50-volt system. Two antennas had to be positioned to provide maximum gain for the Venus mission. Instead of a fixed-position S-band antenna, a movable antenna was used.

Presented at the AIAA Aerospace Sciences Meeting, New York, Jan. 22-24.

Tattletale failures

Predicting IC reliability via failure mechanisms
 D.I. Troxel and Benjamin Tiger
 RCA, Camden, N.J.

Reliability of integrated circuits can easily be predicted with a technique based on the identification of failure mechanisms and their probability of occurrence, and impact of environment. This technique stems from two studies—Mice, for modeling of integrated circuit effectiveness, which identified and quantified these factors, and a stress-survival study, which proved that properly made and used IC's are inherently free from time-induced performance changes.

The probability function itself consists of several individual probabilities: the probability that the unit will have adequate performance and strength for the required period of time under specified temperature, pulse, power, shock, and vibration, the probability of unde-

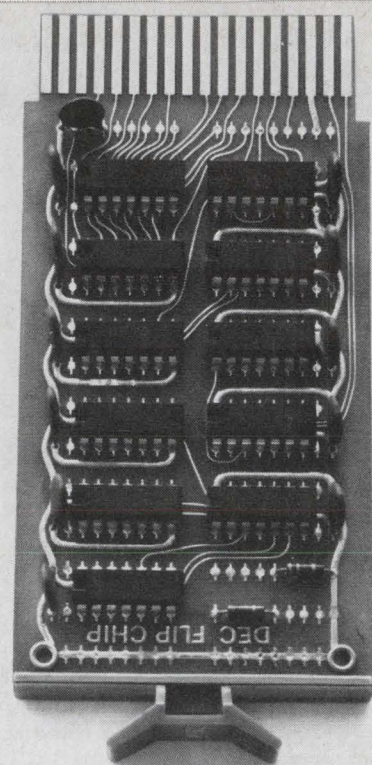

**Complete
10 MHz IC
shift register
at \$10.50
per stage**

M-208 is an 8-stage digital logic shift register, complete. It, like all 25 modules in the M Series, works at 10 MHz. And it, like all other modules in the series, is designed for a cost/performance ratio that is the best in the industry. The M-208 sells for \$84, unless you buy large quantities. Then it's less.

M-208 control lines are buffered, eliminating complex loading rules. Provision is made for parallel loading of bits. TTL integrated circuits, the latest and best available, are used exclusively. Typical dc noise margin is 1 volt at either logic 1 or logic 0 levels.

M Series modules, including the M-208, and several other series of compatible modules, are fully described in the new Logic Handbook. Write for a free copy.

digital
 MODULES · COMPUTERS
 Maynard, Mass.,

Blackstone beats tough cleaning problems.

Alone...

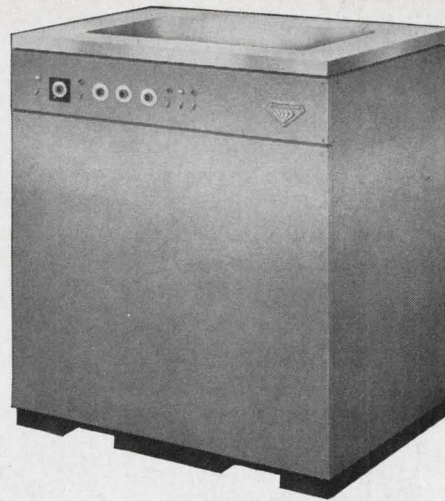

Blackstone VE 6.5

or in a gang.

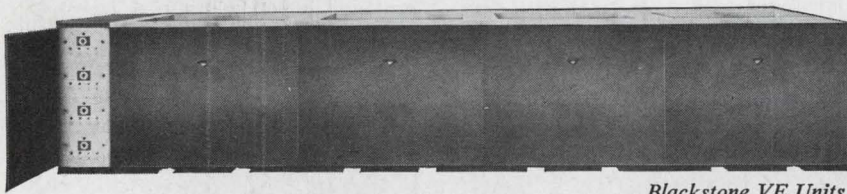

Blackstone VE Units
in Modular Series

Never before has so much cleaning flexibility been designed into an ultrasonic system!

Blackstone VE units, available singly with tank capacities of 1.9 and 6.5 gallons, or in modular series with tank capacities of 11.2 and 28 gallons, solve hundreds of cleaning problems, including . . .

- Printed circuit boards.
- Aircraft components.
- Automotive bearings and carburetors.
- Diesel parts.
- Electric motors.

And Blackstone VE units come complete with both ultrasonic and vapor rinse, 300 series stainless steel tanks, 0 to 100% power control (optional), filtering down to 5 microns, solid state automatically tuned generators, and the convenience of up-front service for easy access to the controls.

The Blackstone Challenge

Send us a sample of your work and a description of your cleaning process. If we cannot precision clean it to your complete satisfaction and lower your cleaning costs while doing it, we will not risk your good will by accepting your order.



BLACKSTONE ULTRASONICS, INC.

1400 Howard Street · Sheffield, Pa. 16347

Circle 256 on reader service card

UCON® SOLVENTS

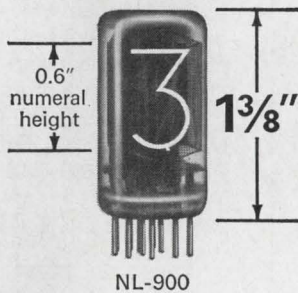

If you really need to
save space, NATIONAL®
has the answer.

Interchangeable with NL-840. Available with the features you want: decimal point, plus or minus and inverted tube.

NATIONAL Request
Bulletin

ELECTRONICS, INC.
a varian subsidiary

PHONE: (312) 232-4300 · GENEVA, ILLINOIS 60134

FREE BULLETINS 72 PERFORMANCE CURVES ON DC MOTORS AND GEARHEADS.

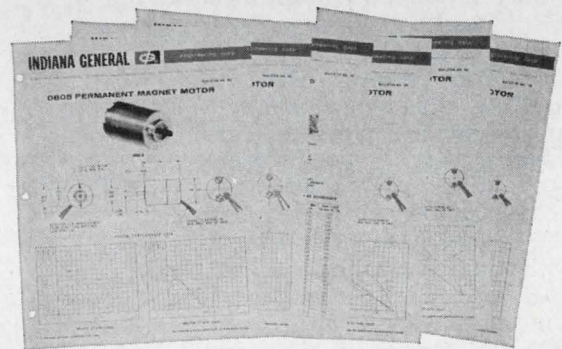

Indiana General has just released specifications on custom-designed DC motors at off-the-shelf prices. These precision motors are produced under a "Zero Defects" program, and assembled in a "clean room." Tolerances are often held to .0001".

They come in 8, 9, 13, and 15 frame sizes with delivery in 6 to 8 weeks instead of the normal 12.

For technical details, including performance curve data for each, plus information on gearheads, write: Mr. R. D. Wright, Manager of Sales, Indiana General Corporation, Electro-Mechanical Division, Oglesby, Illinois.

INDIANA GENERAL

need a
front-yard
market?

IOWA has
that, too!

Chicago, Detroit, Milwaukee, Minneapolis, Kansas City and St. Louis are all in Iowa's front yard. That's one reason Iowa's last 4 record years of industrial growth have seen 438 new industries invest \$205,000,000 in Iowa and 626 industries spend \$346,000,000 for expansion.

Some other important reasons: *Labor Force* . . . talented, trainable men and women from 32 colleges and universities and many vocational schools. *Water* . . . from the Mississippi, Missouri and many other Iowa rivers. *Transportation* . . . two navigable rivers, plus roads, rails and an airline network to every conceivable point. *Management Time* . . . Iowa executives just naturally have more. They don't waste hours commuting daily.

There's more. Fill out the handy coupon . . . we'll send all the facts. Fast!

(Confidential Reply Coupon)
IOWA DEVELOPMENT COMMISSION
Dept. 528 250 Jewett Building
Des Moines, Iowa 50309



Name _____

Firm _____

Address _____

City _____

State _____

Zip _____

Technical Abstracts

tected failure mechanisms, and the probability of adequate performance over time assuming that there are no failure mechanisms. These probabilities are modified by the rate at which undetected failure mechanisms fail with time.

Before failure distribution for a batch of circuits can be quantified, it is necessary to know the manufacturing process used, and the type of circuit and its specifications. All known failure mechanisms, and the probability of occurrence for each, must be determined. Screening and checkout procedures should be tabulated and then used to determine the probability of failure mechanisms escaping detection. For each failure mechanism, environment and usage factors that affect the unit's life are determined. A mathematical expression for the failure distribution is then developed for the mechanism. In some cases, it may be desirable to life-test units to gain knowledge of failure distribution.

Predicting ic reliability based on failure mechanisms and their probabilities of occurrence and escape, though simple in concept, is difficult at first. However, as experience is gained—particularly in quantizing the factors—accurate predictions become easier.

Presented at the Symposium on Reliability, Boston, Jan. 16-18.

Put to the test

Experience with a computer controlled data system in an engineering laboratory
Roger Wellington and John Henderson
Detroit Diesel Engine Division,
General Motors Corp., Detroit
Michael H. Cole
Systems Engineering Laboratories Inc.,
Ft. Lauderdale, Fla.

Several years ago, General Motors turned to a computerized data-acquisition system in an engine-testing laboratory in hopes of speeding both gas-turbine development and diesel performance testing. The company succeeded, but not without some difficulty.

Guiding test sequences on any or all of five gas-turbine and six diesel engines, the system monitors and acquires data from 480 differ-



Cool De-Fog Exhaust Circulate

with Sanders MINICUBE®
Subminiature Blowers

Missile-bred reliability . . . space-saving one cubic inch size . . . 1.25 ounce lightweight . . . 2.2 cfm rated output . . . 6.3, 26 or 115 vac, 400 cps. Sanders MINICUBE Blower eliminates hot spots around electronic components . . . prevents fogging of optical devices. Solves a variety of problems in both military and commercial applications. Write for free literature. Sanders Associates, Inc., Instrument Division, Grenier Field, Manchester, New Hampshire 03103. Phone: (603) 669-4615. TWX: (710) 220-1845.



1" x 1" x 1";
2.2 cfm nominal; 1.25 ounces;
operating temperature range: -55°C to 125°C; typical life: 5000 hours; three models available.

Creating
New Directions
In Electronics

*J.M. SANDERS ASSOCIATES, INC.

SA  **SANDERS ASSOCIATES, INC.**
INSTRUMENT DIVISION
GRENIER FIELD, MANCHESTER, NEW HAMPSHIRE

TUNG-SOL PACKAGES LIGHT TO YOUR REQUIREMENTS

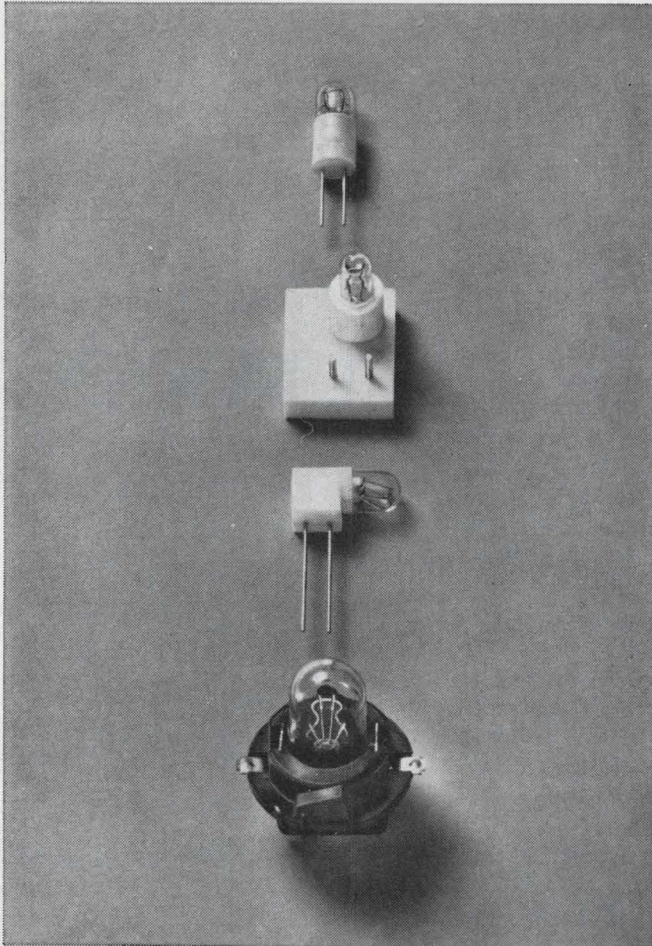

Special lamp assemblies are not necessarily expensive, especially if the configuration can be made compatible with molding techniques. By molding bases on miniature or sub-miniature lamps, Tung-Sol has pointed the way to substantial production advantages for numerous manufacturers of computers and other equipment.

Molded base lamps need no wired-in mounting receptacle—itself a major production benefit. Elimination of the customary cemented-on metal base contributes to greater reliability.

Installation of Tung-Sol "packaged light" is simple and production shrinkage is reduced almost to nil. Some molded base lamps can be installed with automated equipment. Tung-Sol molded base lamps may help you produce a better product, cut costs, or both. Write for more information. Tung-Sol Division, Wagner Electric Corporation, One Summer Ave., Newark, N.J. 07104.

TUNG-SOL®

**WHERE BIG THINGS ARE DONE
WITH SMALL LAMPS**

®REGISTERED TRADEMARK WAGNER ELECTRIC CORPORATION

Circle 258 on reader service card

Still using LC's? This might change your mind:



Clevite's ceramic ladder filters deliver 80 db rejection in 0.1 cu.in.!

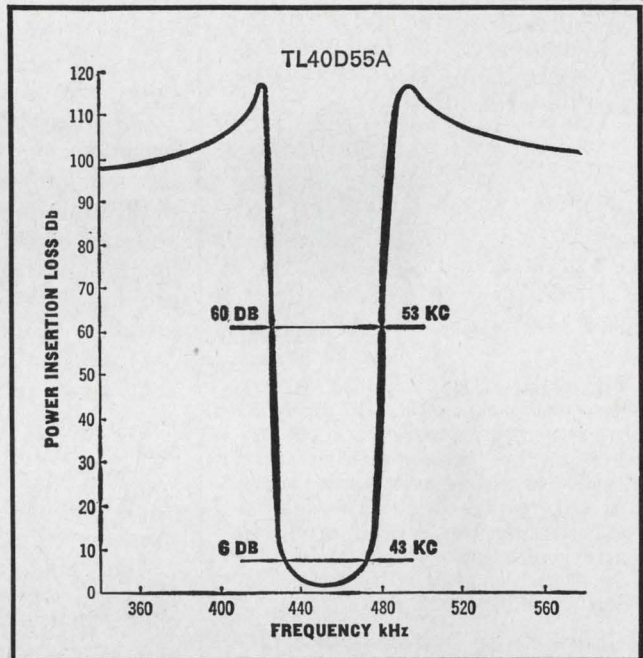

Here's a fixed-tuned filter that offers more selectivity for its size than any conventional i-f filter on the market!

Clevite's non-magnetic, non-microphonic, 17-disc ceramic ladder filter is ideal for i-f stages of high quality superheterodyne radio receivers used in airborne or ground AM and FM communications equipment. Stop band rejection: 60 or 80 db. Center frequency tolerance: ± 1 kHz for 20 kHz B/W and below; ± 2 kHz for 30 kHz B/W and above. Stability: within $\pm 0.2\%$ for 5 years; within 0.2% from -40°C to $+85^{\circ}\text{C}$. Impedance (in and out) 2500 ohms for 12 kHz bandwidth and below; 1500 ohms for 13 kHz to 29 kHz B/W; 1200 ohms for 30 kHz bandwidth and above.

Following models standard at 455 kHz (A) or 500 kHz (C) (custom models on special order):

Model Number	B/W		Model Number	B/W	
	Min. @ 6db	Max. @ 60db		Min. @ 6db	Max. @ 60db
TL-2D5 (A)	2 kHz	5 kHz	TL-20D32 (A)	20 kHz	32 kHz
TL-4D8 (A)	4 kHz	8 kHz	TL-30D45 (A)	30 kHz	45 kHz
TL-6D11 (A)	6 kHz	11 kHz	TL-40D55 (A)	40 kHz	55 kHz
TL-8D14 (A)	8 kHz	14 kHz	TL-45D65 (A)	45 kHz	65 kHz
TL-10D16 (A)	10 kHz	16 kHz	TL-50D75 (C)	50 kHz	75 kHz
TL-16D25 (A)	16 kHz	25 kHz			

PRICES: 1 — \$52.50; 25 — \$42.00 ea; 100 — \$36.75 ea; 500 — \$31.50 ea; 2000 — \$26.00 ea.

(Prices subject to change without notice.)

Send order or request for Bulletin 94017 to: Clevite Corporation, Piezoelectric Div., 232 Forbes Rd., Bedford, Ohio 44014, U.S.A. Or: Brush Clevite Company, Limited, Southampton, England.

CLEVITE

Circle 223 on reader service card

223

Delta Launches the
COMPUTACH[®]*



*The
Great
One!*

*An exclusive computer-tachometer for precise RPM measurement in easy-to-build Kit form!



ONLY
\$29.95
ppd.

Delta, pioneers in CD ignition who produced the fabulous MARK TEN[®], now offer a precise computer-tachometer which obsolesces any type tachometer on the market today! You achieve unbelievable accuracy in RPM readings due to the advanced, solid-state electronic matched components used in the computer, coupled with the finest precision meter in the world. In kit only for all 12V, 8 cyl. cars.

Check these Deltafeatures:

- ▲ 0-8000 RPM range
- ▲ Perfect linearity — zero parallax
- ▲ Adjustable set pointer
- ▲ Wide angle needle sweep
- ▲ Translucent illuminated dial
- ▲ Chrome plated die-cast housing
- ▲ All-angle ball & socket mounting
- ▲ Use it with any ignition system
- ▲ Meter: 3 1/8" dia. X 3 3/8" deep
- ▲ Kit complete, no extras to buy

Orders shipped promptly.
Satisfaction guaranteed.
Send check today!

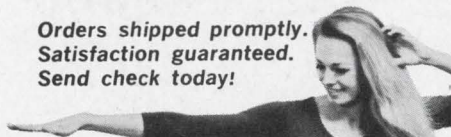

DP 8-2

DELTA PRODUCTS, INC.

P.O. Box 1147E / Grand Junction, Colo. 81501

Enclosed is \$ _____ Ship ppd. Ship C.O.D.

Please send:

COMPUTACH[®] Kits @ \$29.95 ppd
(12 VOLT 8 CYLINDER VEHICLES ONLY)

Name _____

Address _____

City/State _____ Zip _____

Technical Abstracts

ent temperatures, 540 pressures, 31 speeds, 11 torques, and 11 fuel rates—in all, almost 1,100 different measurement points.

The company needed about a year to get the system fully operational.

In setting up the system, GM encountered some difficulty in programming. To format a data sheet and include some calculations takes two to five days. And to convert an involved Fortran-programmed turbine data-reduction scheme (prepared for an IBM 7094), for a smaller Systems Engineering Laboratories' data-acquisition computer, may take five more days.

Other problems stemmed from variations in torque pulses from the engine, variations in water drag in induction dynamometers, and noise from heavy machinery operating at high speeds. These problems were solved by a filter installed in the torque-sensor line.

Measuring rotative speeds in analog form proved a mistake. It would have been better to measure speed by pulse count from a toothed wheel and display it on digital counters that operating personnel prefer.

The system went on-line in July 1966, but without the bulk memory whose delivery had slipped to the end of the year. Initially, system availability was 60%, but reached a satisfactory level of over 95% in 10 weeks. Then availability dropped on four occasions.

Reduced on-line time occurred when the bulk memory, a new card reader-punch, and a revised monitor program were installed. Later, parity errors arose and were solved by a Systems Engineering Labs customer engineer. Then, erratic measurements required change, one-by-one, of three different analog cards to find a solution. Erroneous displays resulting from a bad transistor in a flip-flop circuit also caused a reduction in on-line time.

Once the system started to run smoothly, it reduced diesel test time by 30% to 50% and greatly speeded turbine development.

Presented at SAE Automotive Engineering Congress, Detroit, Jan. 8-12.

Upset stomach?

If you're looking for a remedy and you can't remember the name of a fast-acting brand, just consult the Trade Name Directory in your Electronics Buyers' Guide. You'll have your answer in seconds. EBG also has a Directory of Products and a Directory of Manufacturers and Sales Offices. Use it often.



Electronics Buyers' Guide
A McGraw-Hill Market Directed Publication,
330 West 42nd Street, New York, N.Y. 10036



Packs a wide frequency range in small space

The Hewlett-Packard 3200B VHF Oscillator offers continuous coverage of frequencies from 10 to 500 MHz, yet takes up little space on the bench or in the rack. The 3200B provides $\pm 0.002\%$ frequency stability over a 5-minute period, a high RF output level, and an output attenuator. It is ideal as a general purpose source of CW signals and will also accept external pulse or amplitude modulation. The 3200B may be used with an accessory doubler probe to extend the frequency coverage to 1000 MHz. Size: 7 $\frac{1}{2}$ " wide, 6 $\frac{1}{2}$ " high and 13 $\frac{1}{8}$ " deep. Price \$525. For more complete information, contact your local Hewlett-Packard field engineer or write: Hewlett-Packard, Green Pond Road, Rockaway, New Jersey 07866.

HEWLETT  PACKARD

SIGNAL SOURCES

1074B

Circle 259 on reader service card

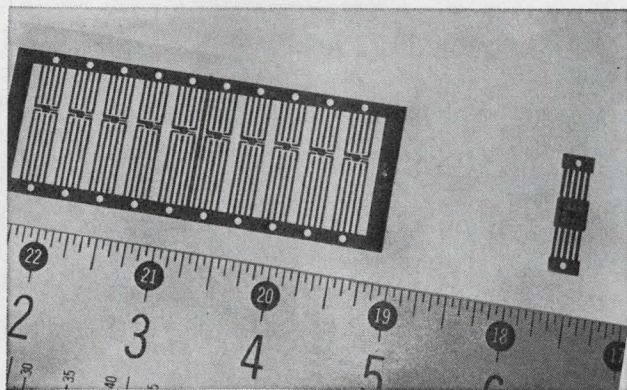

ETCHED KOVAR FOR MICROCIRCUIT PACKAGING

Etched kovar clip leads for microcircuit packaging are available. Any configuration can be made, adequately framed for support. Leads are flat kovar ribbons up to 0.015 inches wide and from 0.015 to 0.055 inches thick . . . Etching or photoforming to tolerances of ± 0.000039 — call or write for information.

BUCKBEE - MEARS
COMPANY

245 E. 6th St., St. Paul, Minn. 55101/(612) 227-6371

See us in Booth 254, NEPCON



Circle 260 on reader service card

New, miniature Teflon® trimmers

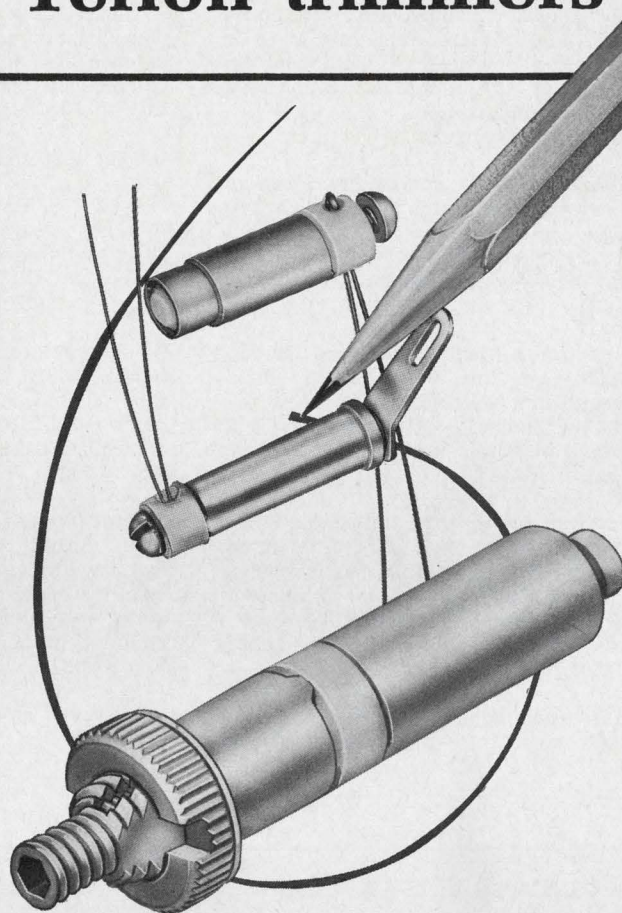

These new trimming capacitors are ideally suited for VHF and UHF applications requiring low minimum capacity and delta C. They provide high resolution and are electrically stable. Tuning is linear. High Q (2000 at 1 MHz typical). Insulation resistance 10^6 megohms. Temperature range— -55° to $+150^\circ\text{C}$. Voltage breakdown 2000 VDC. Part numbers 273-1-1 and 273-1-2 nominal capacity .25 pf min., 1.5 pf max.; part 273-15-1 nominal .30 pf min., 2.9 pf max.

Metal parts are gold plated on PC and solder lug mounting types, silver plated on panel mount. Insulation is Teflon.® Rotor screw threaded 80 turns to the inch on PC and solder lug types, 40 turns per inch on panel mount version. Resistant to shock and vibration.

See your Johnson representative or write for complete information.

©Teflon is a registered trade name of DuPont Co.



E. F. JOHNSON COMPANY

3058 Tenth Ave. S.W., Waseca, Minnesota 56093

Providing nearly a half-century of communications leadership

Circle 225 on reader service card

225

New Literature

F-m subcarrier discriminator. Airpax Electronics, P.O. Box 8488, Fort Lauderdale, Fla. 33310. Bulletin TM-7 describes a low-cost, miniaturized f-m subcarrier discriminator with tape-speed compensation. Circle 446 on reader service card.

Coated copper conductors. Hudson Wire Co., Ossining, N.Y. 10562. A four-page bulletin covers all specification data on uninsulated stranded silver- and nickel-coated copper conductors. [447]

Tone transmitter and receiver. Quindar Electronics Inc., 60 Fadem Road, Springfield, N.J. 07081. Two new bulletins (128 and 129) cover the QT-32 tone transmitter and the QR-32 tone receiver. [448]

Photomultiplier tube housing. Space Sciences Inc., 301 Bear Hill Road, Waltham, Mass. 02154, has published a single-page technical description of the Cryostat, a cryogenically cooled housing for photomultiplier tubes. [449]

Fast coincidence analyzer. Hamner Electronics Co., P.O. Box 531, Prince-

ton, N.J. 08540. Technical bulletin NL-17 describes an analyzer for use in nuclear experiments requiring fast coincidence and anticoincidence logic with coincidence resolving times in the range of 5 to 125 nsec. [450]

Gasket material. Technical Wire Products Inc., 129 Dermody St., Cranford, N.J. 07016. Two-page data sheet EMC-480 describes Teckspan, a thin, emi/rfi gasket material, a conductive sheet with over 200 resilient contact points per sq in. [451]

Pulse generator. Solid State Electronics Corp., 15321 Rayen St., Sepulveda, Calif. 91343, offers a bulletin on the model PG-113 solid state, crystal-controlled pulse generator with IC design. [452]

Electrical resins. 3M Company, St. Paul, Minn. 55101, has issued a series of five new brochures on Scotchcast brand electrical resins, including typical cured-state physical and electrical properties, handling properties and other information. [453]

Microwave diodes. Sylvania Electric Products Inc., Johnston St., Seneca

Falls, N.Y. 13148, has published an eight-page illustrated brochure on a line of broad-band coaxial microwave diodes to answer design problems above the S band. [454]

Clad laminates. Universal Laminates Inc., Mohawk Drive, Leominster, Mass. 01453. Specification bulletin No. 1 discusses copper-clad, glass epoxy laminates for single and multilayer electronic circuits. [455]

Linear acceleration transducers. Humphrey Inc., 2805 Canon St., San Diego, Calif. 92106. A brochure covering a complete line of linear acceleration transducers includes pictures, technical data and diagrams. [456]

Semiconductor catalog. International Rectifier Corp., 233 Kansas St., El Segundo, Calif. 90245, has published a 48-page catalog containing descriptions, ratings and specifications for zener voltage regulator diodes, voltage reference diodes, and low-power silicon rectifiers. [457]

Silicon transistors. Raytheon Co., 350 Ellis St., Mountain View, Calif. 94040, offers a 65-page catalog describing more than 350 different high reliability silicon transistors. [458]

Resistors. Victoreen Instrument Co., 10101 Woodland Ave., Cleveland, Ohio 44104, has issued technical bulletin

UNIQUE DESIGN ADDS VALUE AND APPEAL

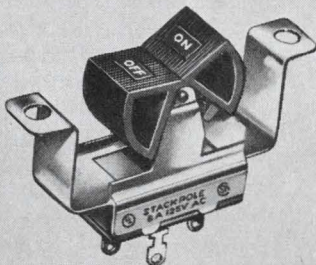

- 23 rocker switch configurations, including 2-3 positions, spring return and center-off.
- Variety of rocker designs available in a spectrum of colors and hot-stamped lettering.
- 1 to 10 amp UL AND CSA ratings at 125V and 250V.
- Solder lug, space saver, quick-connect or printed circuit terminals.
- Field-proven quality same as famous Stackpole slide switches.
- Prices start at less than 15¢.
- Write for engineering literature.



STACKPOLE
COMPONENTS COMPANY
P. O. Box 14466
Raleigh, N. C. 27610

UNEXCELLED QUALITY FOR LESS THAN 4¢

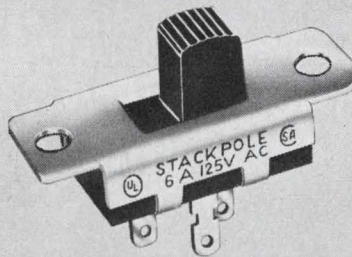

- Rated from 1 to 10 amps with full UL AND CSA approval.
- 7960 slide switch combinations — 23 basic types.
- New rugged solder lug terminal, designed for use with quick connectors.
- Uniform quality assured by automated assembly.
- Electro-silver plated terminals and contacts—shorting and non-shorting.
- Phenolic or nylon triggers in a variety of colors.
- Write for engineering bulletin.



STACKPOLE
COMPONENTS COMPANY
P. O. Box 14466
Raleigh, N. C. 27610

GUARANTEED UNIFORMITY IN ELECTRICAL, PHYSICAL CHARACTERISTICS

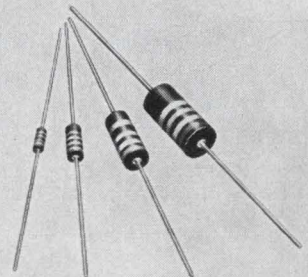

- Available in 2, 1, ½ and ¼ watt sizes.
- Uniform from resistor to resistor, order to order.
- 100% tested for resistance value.
- Same day shipment on 9 orders out of 10.
- Solderability, load life and humidity-temperature characteristic checked.
- Impregnated to assure moisture resistance.
- Write for literature.



STACKPOLE
CARBON COMPANY
Electronic Components Division
Kane, Pa. 16735

3194-12-67 on its MOX series metal oxide glaze resistors. [459]

Modular power supplies. Electronic Research Associates Inc., 67 Sand Park Road, Cedar Grove, N.J. 07009, has available a five-page bulletin on its wide-range, adjustable silicon power modules. [460]

Fiberglass reinforced thermoplastics. Fiberfil Division, Rexall Chemical Co., Evansville, Ind. 47717. A six-page brochure contains a detailed description of Super Concentrate fiberglass-reinforced thermoplastic molding compounds. [461]

Transistorized digital readout. Transistor Electronics Corp., Box 6191, Minneapolis, Minn. 55424. Bulletin 628 gives specifications and purchasing information on the Tec-Lite transistorized digital readout with Nixie tube and IC decoder driver. [462]

Plastic film. The Fluorocarbon Co., 1754 So. Clementine St., Anaheim, Calif. 92803, offers a data sheet on Kel-F film, which can be used for printed circuits, flat cable, cable-wrapping, and motor insulation. [463]

Numerical indicator tube. Raytheon Co., Fourth Ave., Burlington, Mass. 01803, has issued a data sheet describing the CK1905 gas-filled, cold-cathode, numerical-indicator tube that

uses a common anode, 10 cathodes in the shape of the numerals 0 through 9 and an integral decimal point. [464]

Thin-film materials. Materials Research Corp., Orangeburg, N.Y. 10962. A catalog of thin-film materials includes price estimates for custom specifications. [465]

Silicon transistor oscillator. Solid State Electronics Corp., 15321 Rayen St., Sepulveda, Calif. 91343. A single-sheet bulletin illustrates and describes the model CH-114, a crystal- and heater-controlled silicon transistor oscillator. [466]

Control switch. The Fredericks Co., Huntingdon Valley, Pa. 19006. A technical bulletin describes a vacuum-actuated control switch that controls and measures pressure up to 120 torr. [467]

Indium alloy solder. Alpha Metals Inc., 56 Water St., Jersey City, N.J. 07304. Indium alloy No. 1, for applications requiring low-melting solder and superior ohmic contact, is the subject of technical bulletin No. 6a-6. [468]

Flexible waveguide. Andrew Corp., 10500 W. 153rd St., Orlando Park, Ill. 60462. Technical bulletin 252 gives specifications for a new Heliac elliptical waveguide designed for 2.5-to-2.7-GHz applications. [469]

Vane axial blowers. Eastern Air Devices Inc., 385 Central Ave., Dover, N.H. 03820. Data sheet 301.4 covers a series of 4 $\frac{3}{4}$ -in. vane axial blowers with air-moving capacity of up to 370 cfm against high static pressures. [470]

Noise sources. Signalite Inc., 1933 Heck Ave., Neptune, N.J. 07753. A two-page bulletin describes a line of gas discharge microwave noise sources and generators. [471]

Digital logic modules. Scientific Data Systems, 1649 17th St., Santa Monica, Calif. 90404. Digital logic modules that use dual-in-line DTL circuits are described in brochure 64-51-26A. [472]

Temperature controllers. Simpson Electric Co., 5200 W. Kinzie St., Chicago 60644. Transistorized, compact temperature controllers are described in folder C-1201. [473]

Microwave absorbing material. Microwave Filter Co., 135 W. Manlius St., East Syracuse, N.Y. 13057. A 28-page booklet describes Ferrosorb, a microwave energy absorbing material. [474]

Core memories. Computer Control Division, Honeywell Inc., Old Connecticut Path, Framingham, Mass. 01701. An eight-page brochure includes descriptions and specifications for the company's standard IC core memories. [475]

SOLVE NOISE AND FILTERING PROBLEMS WITH CERAMAG® FERRITE BEADS

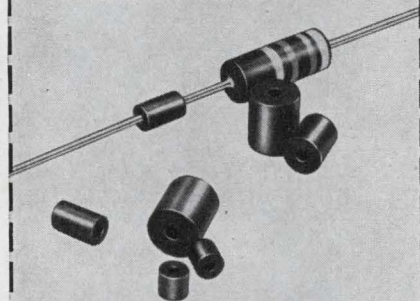

- Ceramag® ferrite beads are low cost, easy to install, and save space.
- Effective r.f. decoupling, shielding and parasitic suppression without sacrificing low-frequency power or signal level.
- Installed by simply sliding one or several over conductor leads.
- Beads can, but need not, be grounded.
- Sizes from .040" ID — .100" OD — 100" L.
- Sample quantities available.

STACKPOLE
CARBON COMPANY
Electronic Components Division
St. Marys, Pa. 15857

NEW SPECIAL PURPOSE RESISTOR PROTECTION

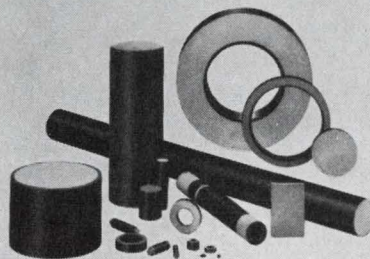

- Currently in use on lightning arrestors, circuit breakers, spark plugs.
- Available in rods, sleeves, rings, special shapes, up to 15" in length and 5" in diameter.
- Ceramic composition favors high voltage applications with high surges.
- Organic Special Purpose Resistors are inexpensive solution where heat dissipation is necessary.
- Both ceramic and organic available in wide range of resistivity values.
- Write for technical assistance.

STACKPOLE
CARBON COMPANY
Electronic Components Division
St. Marys, Pa. 15857

ENVIRONMENT PROOF ROTARY SWITCHES

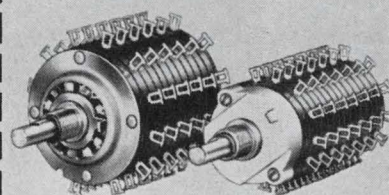

Series 600 1 $\frac{1}{8}$ " Dia. — Series 100 1 $\frac{1}{8}$ " Dia.

- Both index mechanism and electrical sections are completely enclosed.
- Corrosive atmospheres, dust, dirt and moisture are permanently sealed out, lubricants sealed in.
- Solder or quick-connect terminals molded permanently into position minimize production damage.
- Standard index angles include 15°, 30°, 36°, 60° and 90°, special angles available on request.
- Write for engineering bulletin.

STACKPOLE
COMPONENTS COMPANY
P. O. Box 14466
Raleigh, N. C. 27610

NEW

**ultra
miniature**

**I/C POWER
SUPPLY**

**80%
SMALLER!**

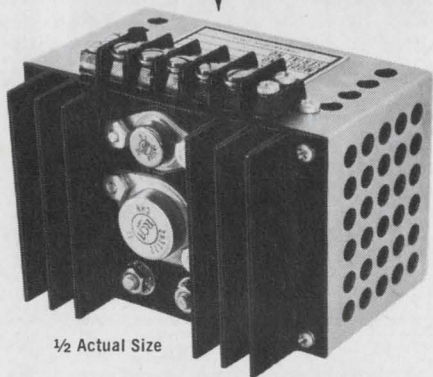

1/2 Actual Size

Avtel's new, ultra-miniature power supply is only 4" x 3" x 2 5/8" including heatsink.

Avtel 9-D SERIES power supplies are specifically designed for use in lightweight chassis with 1C or other digital logic. Output voltages are available from 3 to 30 volts with .05% regulation.

INPUT: 115 Volts 47-440 HZ

TYPICAL OUTPUTS:

3 V at 6 A
5 V at 5 A
15 V at 2 A

The Avtel 9-D SERIES is currently available from stock. Detailed specifications and prices are available upon request.

CUSTOM POWER SYSTEMS

Avtel's experts are capable of solving your most difficult power conversion requirements.

POWERTEC PRODUCTS



AVTEL CORPORATION
1130 EAST CYPRESS STREET
COVINA, CALIFORNIA 91722
PH. (213) 331-0661
TWX (213) 686-6753

DIVISION-AIRTRONICS, INC.

New Literature

Focus coils. Syntronic Instruments Inc., 100 Industrial Rd., Addison, Ill. 60101. Advance technical bulletin 67-3 gives complete technical data on types C5215 and C5315 dynamic/static precision focus coils. [476]

Static inverters. Westinghouse Electric Corp., Box 868, Pittsburgh, Pa. 15230. Single-phase, fixed-frequency inverters for emergency power are described and illustrated in brochure SA-9929. [477]

Solid state rectifiers. Allen Aircraft Products Inc., Box 271, Ravenna, Ohio 44266. Bulletin describes 24 solid state rectifier units designed for plating, anodizing, and other d-c applications. [478]

Miniature lamps. Mura Corp., 355 Great Neck Rd., Great Neck, N.Y. 11021. A catalog describes more than 100 low-voltage Muralite miniature lamps. [479]

IR-photocontrol modules. Sensor Corp., 97 Indian Field Rd., Greenwich, Conn. 06830. Technical bulletin 3004 describes series 2200 IR-photocontrol modules that use diodes as light sources. [371]

Hybrid multiplier. Hybrid Systems Corp., 127 Alewife Brook Parkway, Cambridge, Mass. 02140. Technical notes describe hybrid analog-to-digital circuits. [372]

Laminar flow equipment. Controlled Environment Equipment Corp., 160 Pleasant St., Brockton, Mass. 02401. A 16-page catalog describes 12 basic models of Cleanline laminar flow equipment. [373]

Digital temperature controller. Thermo Electric Co., 109 Fifth St., Saddle Brook, N.J. 07662. A digital controller that allows direct dialing of setpoint temperatures is illustrated and described in a catalog. [374]

Test chambers. Blue M Engineering Co., 138th & Chatham St., Blue Island, Ill. 60406. A four-page bulletin describes selected examples of the company's lines of ovens and shock-test cabinets. [375]

Control systems. Aremco Products Inc., P.O. Box 145, Briarcliff Manor, N.Y. 10510. Product bulletin 2500 describes the Porta-Trol line of portable, high-temperature instrument control systems. [376]

Voltmeter/amplifier. B&K Instruments Inc., 5111 W. 164th St., Cleveland, Ohio 44142. A six-page bulletin describes the model 2409 portable voltmeter/amplifier, which produces true rms measurements for signals from 2 hz to 200 khz, and measures a-c voltages from 1 mv to 1,000 v in true rms, average or peak values. [377]

**BATTERY OPERATED
TIME CODE
GENERATOR**

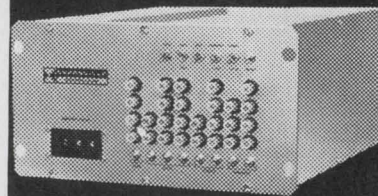

Operates 60 hours from internal rechargeable battery.

Ideally suited for . . .

- seismographic
- oceanographic
- geophysical
- airborne

. . . and other field system uses

Available in all IRIG, NASA and VELA time codes, the new Series 26,000 Time Code Generators require only 1/2 watt of power.

Chrono-Log manufactures a complete line of time code generators, readers and tape search systems.

For more information, write us or phone (215) EL 6-6771

CHRONO-LOG CORP.
2583 W. CHESTER PIKE, BROOMALL, PA.

Circle 264 on reader service card

Cartoon by Whitney Darrow, Jr.



Be a buddy!

**One gift works many wonders
THE UNITED WAY**



Your best source for ELECTRONIC COOLING.

* from ELECTRONIC DISTRIBUTORS:

Heat Sinks — milliwatt to high power, Circuit Board Heat Sinks, Thermal Clamps/Clips/Links/Retainers, Natural and Forced Convection Coolers, Insulating Wafers, Heat Sink Extrusions, Thermal Joint Compound, ‡Epoxy Resin Systems — bonding/coating/casting.

** from the FACTORY:

Modular Forced Convection Semiconductor Cooling Packages, Liquid Cooled Plates, Extrusions, Convuluted Fin Stock, Custom Epoxy Coating Service, Special Cooling Units Designed and Assembled, Semiconductor Life Test and Aging Equipment.

MANUFACTURING SERVICES:

In addition to making major developments in semiconductor cooling, WAKEFIELD has one of the most modern metalworking, fabrication, assembly, and model-making shops in the country. Custom design and production jobs are handled.

WRITE FOR Catalogs No. *1967, ‡27, and **17.

IEEE SHOW — BOOTH #4B06



WAKEFIELD ENGINEERING, INC.

WAKEFIELD, MASS. 01880 ■ (617) 245-5900 • TWX 617-245-9213

Circle 265 on reader service card

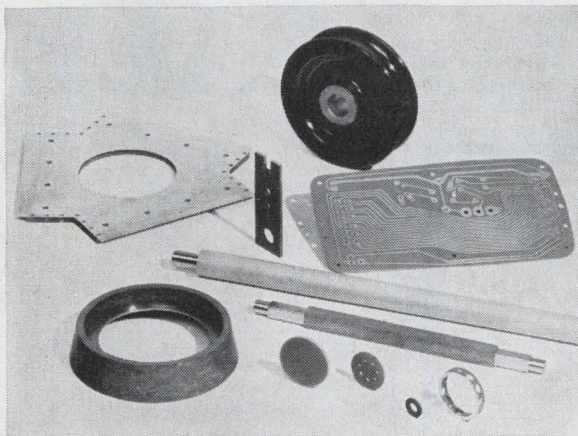

Need a New Material? Try adding Synthane to steel (copper, rubber, etc., etc.)

Combine Synthane laminated plastics with another material and you get the properties of both—and maybe an exciting new answer to your requirements. We do the combining during our processing of Synthane sheets, rods, tubes and molded parts. For more information write for a copy of Synthane News containing the combination story or circle our inquiry number in this publication. Synthane Corporation 36 River Road, Oaks, Pa. 19456

SYNTHANE

CORPORATION  OAKS, PA. 19456

Laminated Plastic Sheets, Rods, Tubes and Fabricated Parts

Circle 266 on reader service card

FIVE GUESSES...

WHAT ARE THEY?

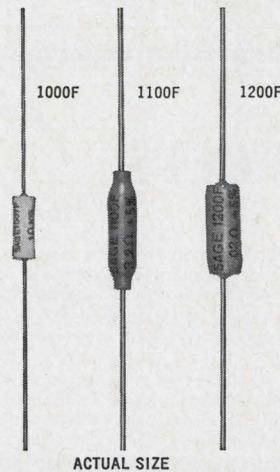

CAPACITORS?
DIODES?
INDUCTORS?
RESISTORS?
FUSES?

If you said resistors you'd be right of course. And if you said fuses you'd be right again.

That's right, FUSIBLE RESISTORS.*

This new adaptation of miniature power resistors comes from SAGE ELECTRONICS, a leading producer of standard silicone and custom designed wirewound resistors.

As the name implies, SAGE type F units are special, dual-function resistors . . . custom-made, typically in fractional or very low ohm values.

*PAT. PENDING

HERE'S THEIR DUAL FUNCTION...

1. Act as long-life, highly stable, fixed resistors up to specified current level.
2. Safely and permanently blow circuit open within a specified time interval if critical current level is exceeded.

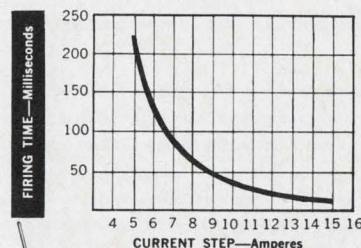

Graph shows representative results on a SAGE 1000F 1Ω part.

For a prompt analysis of your application, contact us, outlining details of resistance value, fusing time and current.

Or for specifics or environmental performance, body size, etc., write, wire or phone for a copy of Catalog R-66.

SEE OUR SPECIFICATIONS IN
VSMF
THE MICROFILM CATALOG FILE



SAGE

SAGE ELECTRONICS CORP.

Subsidiary of Gulton Industries, Inc.

BOX 3926 ROCHESTER, N. Y. 14610

Phone: (716) 586-8010

Circle 229 on reader service card



EMPLOYMENT OPPORTUNITIES

RF Engineers / Salary to \$17,000

Antenna/Radome Engineer—B.S. in Math, Physics or E.E. and a minimum of 2 years experience in design and development of antennas, radomes and microwave components. Experience should include design of antennas in all frequency bands.

EMC Engineer—to generate MIL-I-6181D or equivalent design data including control and test plans. Will direct tests, analyze data, generate fixes and prepare reports on CFE/GFE.

ECM Engineer—B.S.E.E. and a minimum of 3 years experience in one or more of the following: receivers, reception techniques, transmitters or high power tubes. Must readily accept responsibility and perform assignments with a minimum of supervision.

All salaries commensurate with background and experience

An immediate interview may be arranged by sending a comprehensive resume to P-4845, Electronics, Class. Adv. Div., P.O. Box 12, New York, N.Y. 10036. All replies held in strict confidence. An Equal Opportunity Employer, M/F

CIRCLE 950 ON READER SERVICE CARD

The Scientists and Engineers served by Corcoran in the last year have found the difference between "a job" and "the job."

- Nationwide. Fee paid.
- Please airmail background to:

JOSEPH P. CORCORAN
Personnel Consultants

505 B Germantown Pike
Lafayette Hill, Pa. 19444
Member IEEE

CIRCLE 951 ON READER SERVICE CARD

Electronic Circuit Engineers for advanced micro-electronic circuit synthesis. Managerial, engineering & research candidates wanted for novel thin-film circuit development. New business opportunity offers growth potential for Circuit Designers. Send resume to Rm. 62-H, General Electric Co., Box 112, Main Post Office, Schenectady, N. Y. 12301.

(An equal opportunity employer)

CIRCLE 953 ON READER SERVICE CARD

EMPLOYMENT SERVICES

Across The Spectrum in the Electronics Industry—Engrg—Mgmt—Sales, Gardner Assoc. MU 7-6616 545 5th Ave., N.Y., N.Y. 10017.

Electronic Systems Test Engineers

Stimulating work assignments are immediately available to individuals qualified as follows:

B.S.E.E. preferred or equivalent with experience in checkout of electronic systems including thorough knowledge of complex digital checkout equipment. Experience should be in one or more of the following areas: Electrical Power Distribution Systems; Flight Control Systems; Communications Systems; Guidance & Control; Computer & Digital Control Systems; High Performance Radar Systems; Instrumentation Systems. Duties will include writing test procedures required to check out and integrate various subsystems; directing, assisting and aiding technicians during system checkout.

Salary to \$15,000
in accordance with background and experience

To arrange an immediate interview, send comprehensive resume, in strict confidence, to Box P-4776, Electronics, Class. Adv. Div., P.O. Box 12, New York, N.Y. 10036

An Equal Opportunity Employer, (M/F)

CIRCLE 952 ON READER SERVICE CARD

CLASSIFIED ADVERTISING



SEARCHLIGHT SECTION

BUSINESS OPPORTUNITIES
USED OR SURPLUS EQUIPMENT

RADAR SYSTEMS GROUND AND AIRBORNE. AUTOMATIC TRACKING ANTENNA SYSTEMS. NIKE AJAX. NIKE HERCULES. M-33. MSO-1A. MPS-19. MPS-9. SCR 584. TPS-1D. TPS-28. FAA-ASR-2. AIRBORNE SYSTEMS. APN-84. APN-102. APS-20. APS-27. APS-45. DPN-19. DIGITAL COMPUTERS. IBM 650. IBM 704.



LARGEST INVENTORY OF RADAR AND MICROWAVE EQUIPMENT IN THE WORLD.

RADIO RESEARCH INSTRUMENT CO.

45 WEST 45TH ST. N. Y. 10036 212-JU 6-4691

CIRCLE 954 ON READER SERVICE CARD

VOLTSENSOR

VOLTAGE SENSITIVE RELAY DRIVER

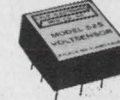

- 100 K Input Impedance
- 25 Microsecond Response
- +/-20 Volt Trip Range
- \$38 ea., \$26.60 at 100 pcs.
- Accuracy 0.01%

Send today for full specifications
CALIF. ELECTRONIC MFG. CO.
P.O. Box 555, Alamo, Calif. 94507

CIRCLE 956 ON READER SERVICE CARD

FOR SALE

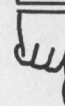

When you have used electronics equipment to sell, advertise in Electronics Searchlight Section for fastest results.

For information:
Searchlight Section
Classified Advertising Division
Post Office Box 12
New York 10036

Young engineers are key engineers at the San Francisco Bay Naval Shipyard.

W. D. MONTGOMERY, BSME, Southern Methodist '60, is the project engineer responsible for the overhaul of the USS BAINBRIDGE, the Navy's first nuclear powered frigate.



If you're ready for more responsibility than your present employer is willing to give you, join the young engineers who are handling the big jobs at the San Francisco Bay Naval Shipyard.

Critical assignments in the development of deep submergence vehicles and in the conversion of conventional and nuclear surface craft and submarines have created immediate openings for men qualified by education and experience in the areas of:

• **Instrumentation • Optical Systems •**

Piping Systems • Structural Engineering • Materials Development, Test & Evaluation • Power Systems (Conventional and Nuclear) • Hydrodynamics & Ship Design • Mechanical Equipment Engineering • Configuration Control • Systems Analysis • Radar & Sonar Systems • Communications Systems

SALARIES TO \$12,500 A YEAR
Higher-level positions usually filled by promotion from within.

Positions available at both San Fran-

cisco and Vallejo facilities of the San Francisco Bay Naval Shipyard. Full Civil Service benefits plus tuition payment plan for advanced degrees. Relocation expenses paid.

Send resume or SF-57 to:
**Employment Manager, Code 174-5F
San Francisco Bay Naval Shipyard
Vallejo, California 94592**

*An Equal Opportunity Employer
U. S. Citizenship Required*

microwave problem?

talk to Andrew...the antenna systems specialist



Andrew microwave antenna systems are hard at work all over the world. Fixed, portable, and mobile installations, designed by Andrew, can be found wherever communications engineers demand the utmost in performance and reliability. ■ This new transportable 7 GHz system is a good case in point: used in a quick reaction microwave link, the unit packs broadband communications capability into a compact package. A 100 ft. aluminum telescoping mast pneumatically raises the 6 foot antenna, guy wires, and dual axis positioner in

less than 60 minutes. The flexible HELIAX® elliptical waveguide feeder goes up simultaneously, and the jacket includes control cables for the positioner. An automatic dehydrator-compressor, 1½ ton trailer, and AC power supply complete the package—all from Andrew. One source—one responsibility. ■ **Have a microwave antenna system problem?** Bring it to Andrew, most people do! Andrew Corporation, P.O. Box 42807, Chicago, Illinois 60642.

3-67



Newsletter from Abroad

February 19, 1968

Starfighter shines again in Germany

It now looks as if the Kiesinger government will fill the West German air arms' "reconnaissance gap" with a batch of 150 Starfighters. Defense Ministry officials say both Lockheed's F-104 Starfighter and McDonnell-Douglas' Phantom still are in running for the next complement of aircraft for the Luftwaffe and the German Navy. Aerospace industry executives, though, expect the F-104 will get the nod.

The Starfighter has the edge over the Phantom, they insist, on several counts. For one thing, it will cost about half as much. For another, German aerospace plants still have F-104 production equipment, a left-over from an earlier run of 700 Starfighters. Then, the Luftwaffe has the maintenance gear and checkout equipment for the planes. The Starfighter accident rate—alarmingly high at one time—has dropped off sharply during the past year. Above all, the F-104 will be made almost entirely in Germany under license.

A decision on the next batch of planes should be firm by early March. Odds are that Messerschmitt AG will be named the main contractor. Teldix GmbH, a joint venture of AEG-Telefunken and Bendix, rates as a strong contender for the lead role in producing the avionics.

An early order for a production run of Starfighters or Phantoms under license would give the avionics industry a much-needed lift. One of its few potentially big projects—the U.S.-German advanced vertical takeoff and short-landing fighter—was killed earlier this month.

French and Germans study big computer

A computer to rival the Control Data Corp.'s CDC 6600—touted as the world's most powerful commercially available machine—may yet be built in Europe.

Although a French-British scheme to have a consortium of computer companies develop a huge machine is getting nowhere, West Germany and France have started looking into a possible joint project that would be strictly government-run. State-owned laboratories would develop the prototype and then manufacture the few production versions that would be needed.

In Germany, nearly all native computer-making potential is concentrated in Siemens AG and AEG-Telefunken. Bonn, presumably, would set up a new facility to handle its share of the project. France, by contrast, has several electronics-oriented government laboratories that could be fitted into a big-computer project.

Britain chips in for better IC's

The Wilson government's campaign to keep Britain competitive in integrated circuits by a selective shakeout of native producers is proceeding as most guessed it would.

To no one's surprise, the first subsidies—announced by the Ministry of Technology last week—went to Ferranti Ltd. and Elliott-Automation Microelectronics Ltd. These two, along with Marconi and perhaps the Plessey Co., figure to get nearly all of the government's IC development support [Electronics, Dec. 25, 1967, p. 83]. Both Elliott and Marconi are English Electric companies.

Ferranti's grant is for \$200,000. It covers half the cost of a two-year program aimed at developing automatic techniques for photoetching,

Newsletter from Abroad

diffusion, and assembly.

Elliott is down for \$100,000, half the cost of developing metal oxide semiconductor IC's with beam leads. Elliott already has solved the problem for bipolar circuits and will soon have them in production.

Peso tv coming to Mexico City

A six-channel pay television system will start operating in Mexico City late this spring.

Under its authorization from the Ministry of Communications and Transport, the operating company Cablevision S.A. will transmit special programs like sports events and plays over cables to subscribers' sets. In addition to its own programs, Cablevision has agreed to supply subscribers all the regular broadcasts that can be picked up in its area. Currently, Mexico City has three commercial tv stations and one educational station. Two additional commercial stations will go on the air this summer before the start of the Olympic Games.

Subscribers will pay a flat monthly fee, no matter how many hours of Cablevision programs they tune in. The fee—still to be set—will run about \$5.50 a month.

GPO opens the door to supplier's club

The Marconi Co. and Pye Telecommunications Ltd. now stack up as likely eventual members of the General Post Office's "suppliers' club," at the moment limited to five other U.K. telecommunications-hardware producers.

A long-standing arrangement under which the GPO split up research and development in telephone exchange equipment—and the subsequent production contracts—among the five runs out next month. And Postmaster General Edward Short says there'll be a shift to competitive bidding—"as far as possible"—then. Short also says that if the prices aren't right under open bidding by U. K. companies, he may let outsiders bid. Or he may even set up government-run production facilities.

Insiders don't see any chance that the change in buying rules will bring any "loss-leader" bids by companies eager to line up the post office as a customer. But they expect Pye, now under control of Philips' Gloeilampenfabrieken, and Marconi will quietly join the suppliers club. The current members: The General Electric Co. and Associated Electrical Industries (now being merged), Ericsson Telephones and Automatic Telephone & Electric Co. (both in the Plessey Group), and Standard Telephones & Cables Ltd., an ITT subsidiary.

Signetics and Asahi may form IC team

Signetics Corp. may follow the lead of Texas Instruments and set up an integrated-circuit manufacturing affiliate in Japan.

Insiders are convinced that Signetics' parent company, the Corning Glass Works, is well along in talks for an IC operation with the Asahi Glass Co. TI has confirmed it is negotiating with the Sony Corp. for an IC joint venture [Electronics, Feb. 5, p. 207].

Asahi already markets Signetics' IC packages and it produces television picture tubes under a Corning license. The IC production plant, in fact, may be tucked into the corporate framework of Iwaki Glass Co., jointly owned by Asahi and Corning.

Signetics, however, is under no great pressure to get a Japanese plant into production. It has just started work on a facility in Utah and has a Far East assembly operation in South Korea.

Japan

Space hardware

Blue-sky thinkers at the Nippon Electric Co. figure it won't be long before cars tooling down superhighways will be linked together like trains—but with electronic couplings.

In fact, the company's research laboratory has developed a key piece of hardware for the coupling—a simple laser radar. Nippon expects the radar to be used first as an alarm to warn drivers when they're tailgating. But the ultimate aim is a sophisticated speed control system that would keep cars spaced out.

Uncomplicated. Nippon set out to develop as simple a radar as possible and wound up with a prototype transmitter less complex than an ordinary six-transistor radio. The receiver is little more than a phototransistor coupled to an integrated-circuit amplifier.

Further, there's no costly pulse-timing circuitry. The angle between the transmitter and the receiver sets the distance at which the radar will develop an output signal. Nippon Electric's marketing men have yet to decide what's next for the simple radar, but it seemingly could be priced at \$100 if built in quantity.

Bursts. Basically, the transmitter is made up of a gallium-arsenide laser diode and a power supply to pump it. In the prototype, a single diode is pumped with 50-ampere pulses lasting about 170 nanoseconds. This puts the transmitter output at 2 watts and gives the radar an effective range of somewhat less than 65 feet. However, Akira Kawaji, who led the development team, says his group has in the works a laser assembly made up of a stack of 10 GaAs diodes. This would boost the range to about 330

feet, more than enough to space cars going at the highest legal speed in Japan.

The 10-diode improved transmitter would use the same power supply as the single-diode prototype. It runs off a 12-volt battery and has a d-c to d-c converter to boost voltage to 400 volts. The converter output charges a 0.02 microfarad capacitor and it in turn discharges through the diode under control of a pulsing circuit. The pulse repetition rate is 25 hertz and this holds the battery drain to about 100 milliwatts.

Pickup. Infrared pulses bounced off a car ahead would hit the receiver's phototransistor only at the critical distance established by the angle between the laser head and the receiver. Because of the fast pulses, a high-pass filter with a cutoff somewhat less than 100 megahertz can be used in the receiver. Thus, noise generated by changes in speed and by variations in the ambient light would have no effect on the response.

The phototransistor is a special item, although fabricated by standard planar technique. Despite large base dimensions—2 mm square—the transistor has a cutoff frequency higher than 100 Mhz. No special precautions were needed to ward off charge storage in the base caused by deep-penetrating phonons. The transmitter's repetition rate is so low that the effects of charge storage cause no complications.

It's a snap

Electronic shutters based on cadmium-sulfide photocells have turned even casual Sunday snapshotters into reasonably competent photographers. But with film speeds on the rise and camera makers getting smaller, camera makers have begun to clamor for more sensitive cells for their upcoming models.



Bright idea. Transmitter for Nippon Electric's laser radar has fewer parts than a six-transistor radio.

The Matsushita Electric Industrial Co. thinks it can quiet that clamor. The company expects to market before yearend a CdS cell that develops a photocurrent of 500 microamperes for each square millimeter of active surface when powered by a 1.3-volt battery and lit by 1 lux of light. That's roughly 50 times the basic sensitivity of conventional cells. Because of the way they're packaged, though, the new devices best their predecessors by only a factor of 10.

Sandwich. Matsushita boosted the photosensitivity of the new cell by shifting to a sandwich configuration. Previously Matsushita, like other producers of CdS devices, used a serpentine active element meandering between two metal electrodes. With this arrangement, the distance between electrodes can't be less than 0.1 mm. The smaller the gap between electrodes, the more sensitive the cell.

By tucking the CdS active layer between a transparent upper electrode and an indium lower electrode, Matsushita can get an electrode separation of between 5 and

20 microns. The company has also developed a technique to control the lattice defects that activate the CdS, and with it can vary the response characteristics over a much wider range than previously possible. Photocells for professionals' cameras need peak sensitivity at low light levels, while those for amateurs' cameras generally peak at high light levels.

Dense. The switch to the sandwich configuration for tighter electrode spacing is an obvious one but hard to achieve. It's been tried before but didn't work because pin holes developed in the CdS layer and shorted out the electrodes. Matsushita says the key to its new cell is the dense photosensitive layer, obtained, the company hints, by its combination of flux, temperature, and control of the environment while the layer is deposited onto the glass substrate.

The cells are fabricated in batches, starting with a glass substrate about 4 inches by 4 inches. After the electrodes and CdS layer have been laid down, the glass is cut into sections about 4 mm square. They are either packaged in cans or fused into a solder mound atop an alumina chip.

France

Broken color line

Last fortnight's Winter Olympics television spectacular meant some tidy business—an estimated \$30 million worth—for French makers of telecommunications equipment and broadcast equipment. But color-tv set makers, as expected, got little sales mileage out of the games. They may get more from a winter competition they're waging among themselves.

An upstart company called Electronique Moderne de l'Oise (EMO) has shattered the industry's \$1,000 minimum price line on color sets. Major makers had been determined to keep prices high until a good part of their investment in color-set production facilities had been

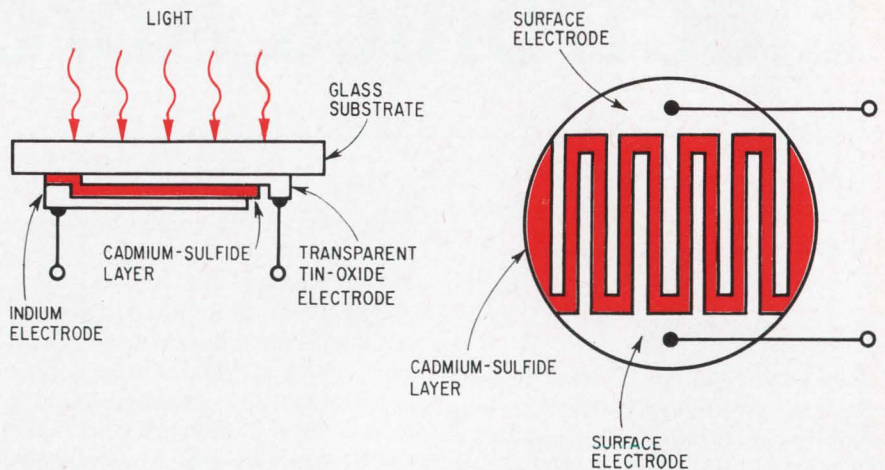

Tighter fit. Minimum spacing between electrodes—and thus higher sensitivity—comes from sandwiching cadmium-sulfide layer between electrodes (left). New geometry is major factor in 10-fold improvement over serpentine cells.

written off, but the maverick company's action will almost certainly force them to scrap that policy.

EMO has set \$550 as the list price for its 19-inch set and \$850 for its 23-inch model. Although the company has gotten only 2,000 color sets out to dealers since it began producing them last fall, its sales manager, Claude About, predicts that sales will be running at a rate of 40,000 sets yearly by the end of 1968. Total color-set sales for all France so far have been estimated at 10,000.

Into the fray. Actually, EMO has been on the French consumer electronics scene as a maker of black-and-white sets for nearly 15 years. But last fall, the company suddenly changed from just another small producer into a firm that could challenge the industry's pricing policies. Behind the transformation: a tripling of the company's capital that brought in a pair of formidable principals—free-wheeling capitalist Sylvain Floirat and well-heeled inventor Henri de France, father of the Secam color-tv system used in France and in the Soviet Union.

Floirat's principal aim, says About, was to force down the high retail price levels—\$1,000 to \$1,200—maintained by the two leading French color-set producers, Compagnie Française Thomson Houston-Hotchkiss Brandt and La Radiotechnique, a subsidiary of Philips' Gloeilampenfabrieken of the

Netherlands. The pair claimed they would never be able to earn back the costs of starting up color-receiver development and production if set prices were low at the outset.

Floirat, who heads the company that will produce de France's version of the post-deflection-focus Lawrence tube, wants a mass market as soon as possible. So, apparently, does the de Gaulle government, which owns part of the tube producer, Compagnie Française de Télévision [Electronics, Jan. 22, p. 193].

Innovations. Along with Floirat's considerable drive, EMO has some technology going for it, a factor that gives it a cost edge over its competitors. For one thing, only EMO among French makers offers 19-inch color sets; it imports the picture tubes from Germany and Japan. For another, EMO's circuitry is all solid state except for the horizontal output stage. The transistors are cheaper than tubes, About maintains, and the sets can be assembled by workers with little training.

Largely to lure dealers, who must service sets covered by a one-year warranty, EMO has packaged its circuitry in plug-in modules. For repairs, dealers simply locate the faulty board and replace it. The company fixes the faulty boards at its factory.

About says EMO's splash in the color market has caused the company's black-and-white sales to

spurt. The monochrome sets, curiously, are conventional tube models. "Our next objective," About says, "is solid state black-and-white receivers."

Great Britain

Magnetic modulator

It's been nearly three years since a quartet of researchers at Bell Labs reported that yttrium-iron-garnet (yig) could be made transparent to infrared radiation at wavelengths from 1.1 microns to about 4.5 microns. One of the four, R.C. LeCraw, followed up the discovery with an experimental optical modulator, but outside of that, there's been little effort in the U.S. toward putting the phenomenon to work.

In Britain, though, Mullard Ltd.'s Roger Cooper has been plugging away at developing possible yig-infrared devices and has now come up with a small and simple magneto-optic modulator. It can put voice communications onto an infrared beam, but Cooper expects the first applications to be in detection systems, where the modulator could replace a motor-driven chopper.

Associated Semiconductor Manufacturers Ltd., in which Mullard, a Philips subsidiary, holds a two-thirds interest, expects to have the yig modulator on the market sometime this year. A prototype of Cooper's modulator will make its debut in an infrared telephone link that Mullard will demonstrate next month at the annual Physics Exhibition in London.

True worth. Cooper admits his yig modulators, though much smaller, will cost much more than simple motor-and-slotted-disk choppers. But he feels that eliminating a motor that makes noises and needs maintenance will justify the added cost.

And he's convinced that the yig modulators will be much cheaper than the electro-optic modulators currently used where mechanical

choppers aren't feasible. Electro-optic modulators—almost always potassium dihydrogen phosphate (kdp) crystals—range in price from \$385 to slightly more than \$4,000. Also, they require high drive voltages—generally in the kilovolt range and never less than 75 volts.

The yig devices need only 6 volts. Of course, they won't work in the visible portion of the spectrum as kdp modulators do.

Polarized. Mullard's modulator is built around a yig disk 5 millimeters in diameter. Tucked inside a wound bobbin about a half-inch in diameter, it's flanked on either side by small polarizing plates.

An infrared beam passing through the modulator is first polarized and then—because of the Faraday effect—rotated by any magnetic field set up by the coil surrounding the yig disk. Varying the current fed to the coil therefore changes the angle between the beam and the axis of the exit polarizing plate and hence the amount of infrared radiation that gets through. Besides being amplitude-modulated in this way, the beam can be frequency-modulated by varying the frequency of the current to the coil.

In the thick of it. The maximum modulation depth depends largely on the thickness of the disk. With a disk 2 mm thick, the modulator

can handle wavelengths from 1.2 to 2.4 microns and requires a drive current of 25 milliamperes root-mean-square for full modulation.

In the magneto-optic telephone link Mullard will demonstrate next month, the beam of an ordinary 4.8-volt tungsten lamp is focused on the modulator and a microphone circuit drives the coil to amplitude-modulate the output beam. For reception, a photodiode picks up the modulated infrared beam. Range is about a mile.

West Germany

The low road

Television receiver makers so far have followed the high road toward developing large-screen transistorized sets without costly power transformers. And with considerable fanfare, semiconductor producers have been getting into the market with transistors that can withstand 1,000 volts or more. Such transistors are the crucial component for the horizontal output stage of sets working directly off rectified line voltage.

While the pack pushes upward—the goal now is a 2,000-volt tran-



Rig with a yig. Mullard's Roger Cooper talks over infrared telephone link built around the magneto-optic modulator he developed.

Now in
publication!

A Fully Documented Analysis of International Electronics

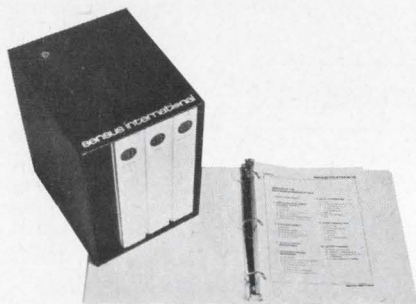

Four volumes of incisive data—by country—basic elements in planning and maintaining a position of marketing strength in the international electronics markets.

Updated regularly, information is gathered on the spot and covers all aspects of doing business in electronics in every major electronics market of the world. Tariffs, government policies, exchange controls, credit, trade unions, even the impact of smuggling are covered in these in-depth reports.

Send for complete, free information

sensus international

Please send me your free, descriptive literature.

Name _____

Title _____

Company _____

Street _____

City _____

State _____ Zip _____

SENSUS INTERNATIONAL
712 Montgomery Street,
San Francisco, Calif. 94111

If you can't wait,
call (415) 989-6973

Electronics Abroad

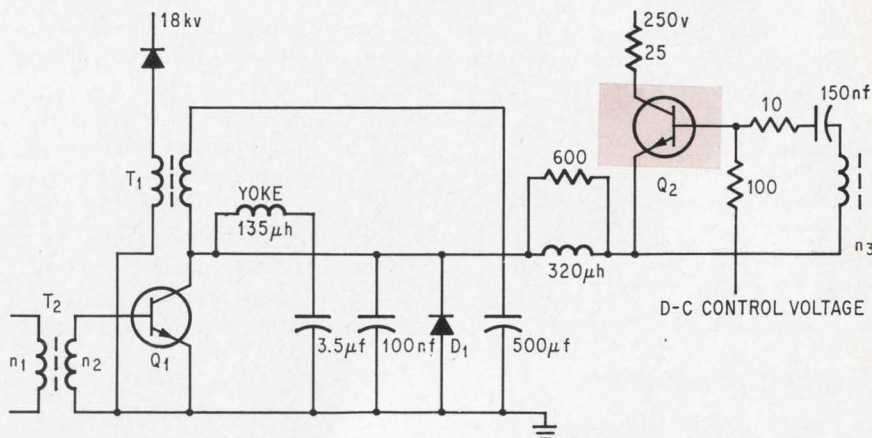

Well paired. Adding a second transistor to horizontal deflection circuit eliminates the need for a power transformer and for high-voltage transistors as well.

sistor for Europe's 250-volt line voltages—Siemens AG has taken the low road. At last week's International Solid State Circuits Conference in Philadelphia, Guenter Eberhard, one of the company's application engineers, showed how to make standard 300-volt transistors do for line-operated all-transistor receivers.

Add one. In the Siemens setup, the usual output driver transistor works with a second transistor called "the pump" (Q_2). It switches the rectified 250-volt supply onto the deflection circuitry during the flyback interval, when the voltage across the yoke is at a peak. In conventional transistorized drive stages, power feeds into the yoke through the sweep and the level must be kept low—about 30 volts—to hold the eight-fold rise at flyback within acceptable limits. It's this requirement, more than anything else, that makes a power transformer necessary for conventional solid state sets.

Besides doing away with the usual power transformer for the horizontal driver, the two-transistor circuit turns out to be a convenient source of low-level d-c for the vertical deflection stage and the audio stages. What's more, a control voltage properly applied to the pump transistor keeps the low-level source stable even with power drains as high as 20 watts.

Fire two. In the new driver circuit, the two transistors are held off and on in turn by the secondary

windings (n_2 and n_3) of the horizontal driver transformer (T_2).

During the second half of the sweep interval, Q_1 conducts and the 3.5 μf capacitor feeds the yoke a current that increases linearly. At the end of the sweep period, transistor Q_1 stops conducting and the yoke's energy is transferred to the 100-nf flyback capacitor. As its voltage builds up, the pump transistor Q_2 switches on to feed power into the deflection circuit.

Safer pace

Today's pacemakers—those body-implanted electronic devices that stimulate a weak heart—carry their own hazards. The failure, or even aging, of a critical component in their oscillator circuit can cause a sudden rise in its rate, a pulsing that can severely strain the heart. A decrease in battery voltage or the seeping of body fluids through small cracks in the pacemaker's epoxy encapsulation may also lead to a sharp increase in the device's pulse rate. In a few cases, this sort of circuit runaway has caused death.

The problem may be over. Gerhard Weil, a 28-year-old doctoral candidate at the Aachen Technical University, has built a pacemaker that's practically failsafe.

Slowdown. Weil's device is built with integrated circuitry, which is inherently more reliable than the

discrete components used so far. Even more important is the unit's special four-layer relaxation oscillator. Instead of rising, its rate drops as battery voltage declines. Even if body fluids penetrate the encapsulation, the pulse rate will fall.

In a pinch. For all the advantages of switching to IC's for pacemakers, Weil says it's easy to see why medical electronics firms have stuck with discrete components. Most makers are small companies with limited, if any, IC production facilities. And there isn't a big enough market in this field to interest the big semiconductor firms.

Another factor, Weil suggests, is the need for high-ohmic resistors, which are hard to produce on IC chips. Weil's circuit uses pinch resistors—an ordinary diffused resistor with an emitter diffusion atop it to limit its cross-section—for the high ohmic values needed to keep current drain to less than 10 microamperes. With the five mercury cells that power it, the IC pacemaker should last well over three years. About 2½ years is the maximum for discrete units, and some are changed yearly.

Weil claims, in fact, that the lifetime of the IC pacemaker is limited only by the battery. P.R. Mallory & Co.'s battery division is now developing a 10-year cell, notes Walter L. Engl, head of the university's institute of theoretical electronics, and when it becomes available, "IC pacemakers will be an absolute necessity." Engl read a paper on Weil's device at last week's Solid State Circuits Conference.

Time to split. Like many other researchers, Weil expects biological power sources to be harnessed to drive pacemakers. Until such power sources are practical, though, he thinks pacemakers should be built and implanted in two parts. One would carry the pulse-generating circuit proper plus the probe that goes to the heart to apply the pace-making voltages. The other would consist of the power pack. This would ease the job of installing new batteries and save some money for the patient as well; all-in-one units have to be completely replaced every time a battery is changed.

NEED A 3000 VOLT ZENER DIODE?

=

PHOTO-MULTIPLIER POWER SUPPLY

CORONTRON actual size: Photo-multiplier power supply, showing Corotron location, 1/3 size.

You *could* string together several hundred zeners. Or you could specify *one* Victoreen Corotron. It is the gaseous equivalent of the zener with all the advantages of an *ideal* HV zener diode.

For space research and other rugged applications requiring absolute power supply stability, GV3S Series, shown, provide the ideal reference voltage anywhere in the range of 400 to 3000 volts. They enable circuitry to maintain constant high voltage regardless of battery source voltage or load current variations. Cubage and weight (GV3S Corotron weighs only 4 gm.) are important considerations. So is temperature variation (Corotrons operate from 200°C down to -65°C). Ruggedized versions withstand shock to 2000 G, vibration 10 to 2000 cps.

If you're trying to simplify circuits . . . to cut cost, size and weight . . . to upgrade performance—you need Corotron high voltage regulators. Models are available now from 400 to 30,000 volts. A consultation with our Applications Engineering Dept. will speed up the countdown.

8501-A



VICTOREEN INSTRUMENT DIVISION
10101 WOODLAND AVENUE • CLEVELAND, OHIO 44104
 IN EUROPE: GROVE HOUSE, LONDON RD., ISLEWORTH, MIDDLESEX, ENGLAND

■ Acopian Corp. Mort Barish Associates	220	■ Daven, Inc. Weston Assoc., Inc.	147	■ Hewlett Packard, Microwave Div. Lennen & Newell, Inc.	2
■ Adams & Westlake Co. Kasper & Assoc., Inc.	58	■ Delco Radio, Div. of General Motors Corp. Campbell-Ewald Co.	114, 115	■ Hewlett Packard, F.L. Moseley Co. Div. Lennen & Newell, Inc.	156 to 160
■ Alden Electronics Larcom Randall Adv., Inc.	143	■ Delta Products, Inc. Noble De Roin & Associates	224	■ Hewlett Packard, Palo Alto Div. Lennen & Newell, Inc.	1
■ Allen-Bradley Co. Fensholt Adv. Agcy.	35, 37	■ Digital Equipment Corp. Kalb & Schneider, Inc.	220	■ Hewlett Packard, Rockaway Div. Culver Adv., Inc.	225
■ Amphenol Corp., Connector Div. Marsteller, Inc.	161	■ Digitran Co., The Smith-Klitten, Inc.	163	■ HI-G, Inc. Marketing Assistance, Inc.	213
■ Analog Devices, Inc. Kenen Associates	193	■ Dit-Mco International Div. of Xebec Corp. Martin Fromm & Assoc., Inc.	219	■ Honeywell, Computer Control Div. Franklin P. Folts, Inc.	49
■ Andrew Corp. Fensholt Adv., Inc.	232	■ Douglas Randall, Inc. West, Weir & Bartel, Inc.	218	■ Honeywell, PMD Div. Batten, Barton, Durstine & Osborn, Inc.	38, 39
■ Austron, Inc. Don L. Baxter, Div. of Albert Frank-Guenther Law, Inc.	188	■ DuPont de Nemours Co., Mylar Div. Batten, Barton, Durstine & Osborn, Inc.	138	■ Hughes Aircraft Co. Foote, Cone & Belding	181
■ Automatic Electric Co., Sub. of General Telephone & Electronics Corp. Marsteller, Inc.	183	■ Durant Manufacturing Co. Franklin Mautner Advertising	182		
■ Avtel Corp. Frost, Shaffer, Gauthier	228				
		■ E-H Research Laboratories, Inc. Steedman, Cooper and Busse Advertising	51	■ I B M Corporation Ogilvy & Mather, Inc. Adv.	166
		■ Electro Motive Mfg. Co. Reynolds & Foster, Inc.	144	■ IEEE (Institute of Electrical & Electronic Engineers) Alpaugh Advertising	192
■ Bausch & Lomb, Inc. Wolff Assoc., Inc.	149	■ Electronics Buyers' Guide Plansboard Adv., Inc.	224	■ Indiana General Corp., Ferrites Div. Griswold & Eshleman	221
■ Beckman Instruments, Inc., Helipot Div. Hixson & Jorgensen, Inc.	76	■ Electronic Engineering Co. of California Jansen Associates	167	■ Industrial Electronic Hardware A.D. Adams Advertising, Inc.	153
■ Belden Corporation Fensholt Adv., Inc.	40, 41	■ Emerson & Cuming, Inc. Edwin F. Hall	216	■ International Crystal Mfg. Co. Robert V. Freeland & Associates	142
■ Bendix Corp., Flight & Engine Instruments Div. MacManus, John & Adams, Inc.	44	■ Executone, Inc., Printact Relay Div. J.A. Richards	178	■ International Electronic Research Corp. Van Der Boom, McCarron, Inc. Adv.	68
■ Blackstone Corp., Ultrasonics Div. Carr-Liggett Adv., Inc.	221			■ ION Physics Kalb & Schneider, Inc.	16
■ Buckbee-Mears Co. Midland Assoc., Inc.	225	■ Fairchild Semiconductor, Inc. Faust/Day, Inc.	18, 19, 20, 21	■ Iowa Development Commission L.W. Ramsey Advertising	222
■ Bulova Watch Co., Electronics Div. Frank Best Co., Inc.	178	■ Ferroxcube Corp. of America Solow Wexton, Inc.	217	■ ITT Semiconductors Div. Neals & Hickok, Inc.	64
■ Bunker-Ramo Co. Diener & Dorskind, Inc.	56, 208	■ Frenchtown/CFI, Inc. Mort Barish Assoc., Inc.	63		
■ Burr Brown Research Corp. N.A. Winter Adv. Agcy.	197	■ Fujitsu, Ltd. Asia Adv. Agcy., Inc.	124, 125	■ Jerrold Electronics Corp. Gray & Rogers, Inc.	14
■ Busmann Mfg. Div. of McGraw Edison Co. Henderson Adv. Co.	73			■ Johanson Mfg. Co. Josephson, Cuffari & Co.	212
■ By-Buk Company Albert Frank-Guenther Law Adv., Inc.	192	■ General Atronics Corp. Garceau Hallahan & McCullough, Inc.	67	■ Johnson Co., E.F. Midland Associates	225
		■ G & E Bradley, Ltd. Hyde & Partners, Inc.	195		
■ Cambridge Thermionic Corp. Chirurg & Cairns, Inc.	207	■ General Electric Co., Specialty Control Div. Robert S. Cragin, Inc.	75	■ Lapp Insulator Co. Wolff Associates	199
■ Centralab, Div. of Globe-Union, Inc. The Brady Co.	242	■ General Electric Co., Vacuum Products Business Section Doe-Anderson Adv. Agcy., Inc.	162	■ Lenox-Fugle Electronics, Inc. Keyes, Martin & Co.	204
■ Chicago Miniature Lamp Works Buti-Roberts Adv.	176	■ General Instrument Corp., Semiconductor Products Div. Norman Allen Associates	66	■ Litton Industries, Inc., Electron Tube Div. West, Weir & Bartel, Inc.	15
■ Chrono-Log Corp. Hill Associates	228	■ General Radio Co. Horton, Church & Goff, Inc.	2nd Cover	■ Litton Industries, Inc., Triad Distributor West, Weir & Bartel, Inc.	196
■ Cimron, Div. of Lear Siegler, Inc. Phillips-Ramsey, Inc.	42	■ G.T.I. Corp. Meek and Thomas, Inc.	190	■ Litton Industries, Inc., Winchester Electronics Div. West, Weir & Bartel, Inc.	214, 215
■ Clare & Co., C.P. Reincke, Meyer & Finn Adv., Inc.	131	■ Gudebrod Brothers Silk Co., Electronics Div. Ramsdell-Buckley & Co.	184, 185		
■ Clevite Corp., Piezoelectric Div. Carr Liggett Adv., Inc.	223			■ Machlett Laboratories, Div. of Raytheon Co. Fuller & Smith & Ross, Inc.	9
■ Clifton Precision Products Co., Div. of Litton Industries Ivey Adv., Inc.	24	■ Hamilton Watch Co. Beaumont, Heller & Sperling, Inc.	206	■ Magnetic Shield Div., Perfection Mica Co. Burton Browne Adv.	179
■ Connecticut Hard Rubber Co., The Chirurg & Cairns, Inc.	141	■ Hansen Manufacturing Co. Keller-Crescent Co.	216	■ Magneto, Inc. The Stanley Schwartz Co.	152
■ Consolidated Vacuum Corp., Sub. of Bell & Howell Wolff Assoc., Inc.	36	■ Hewlett Packard, H-P Associates Lennen & Newell, Inc.	65	■ Mallory & Co., P.R., Mfg. Div. Aitkin-Kynett Co.	194
■ Consolidated Electrodynamics Corp., Sub. of Bell & Howell Hixson & Jorgensen, Inc.	103	■ Hewlett Packard, Colorado Springs Div. Tallant/Yates Adv., Inc.	3rd Cover	■ Marconi Instruments McCarthy, Scelba & DiBiasi Adv. Agcy., Inc.	70
■ Control Data Corp., Analog Digital Systems Div. Barnes-Champ Adv.	180	■ Hewlett Packard, International Import Div. Lennen & Newell, Inc.	203	■ Metex Corp. Keyes, Martin & Co.	72
■ Cornell-Dubilier Electronics Daniel & Charles, Inc.	17			■ Microsonics, Inc. S. Gunnar Myrbeck & Co.	152
				■ Micro Switch Div. of Honeywell Batten, Barton, Durstine & Osborn, Inc.	92



Minnesota Mining & Mfg. Co., Chemical Div. Young & Rubicam, Inc.	189
Minnesota Mining & Mfg. Co., Scotchpar Div. Young & Rubicam, Inc.	210
Molex Products Co. Fensholt Adv., Inc.	6
Monsanto Co. Foote, Cone & Belding	91
Motorola Government Electronics Div. Botsford, Constantine & McCarty, Inc.	8
Motorola Semiconductor Products, Inc. Lane & Bird Adv. Inc.	27 to 34, 43
National Electronics, Inc. Connor-Sager Associates	221
National Semiconductor Corp. Jay Chiat & Associates	132, 133
North Atlantic Industries, Inc. Murray Heyert Associates	148
Pacific Measurements, Inc. Jack Herrick Adv., Inc.	7
Patwin Electronics Graceman Adv., Inc.	202
Pheips Dodge Electronic Products Corp. Smith, Dorian & Burman, Inc.	198
Phoenix Chamber of Commerce Jennings & Thompson Advertising	208
Radiation, Inc. W.M. Zemp & Assoc., Inc.	55
Radio Cores, Inc. Sander Rodkin Adv. Agcy., Ltd.	208
Radio Corporation of America Al Paul Lefton Co.	4th Cover, 12, 13, 57
Raytheon Co., Components Div. Fuller & Smith & Ross, Inc.	164
Reeves Hoffman, Div. of Dynamics Corp. of America Adams Associates, Inc.	188
Sage Electronics Corp. Mathison Adv., Inc.	229
Sanders Associates, Inc., Instrument Div. Chirurg & Cairns, Inc.	222
Sensus International John W. Hall	238
Sierra Electronics, Div. Philco Ford Hal Lawrence, Inc.	11
Signetics Corp., Sub. Corning Glass Works Cunningham & Walsh, Inc.	154
■ Siliconix, Inc. Graphics West	74, 146
■ Simpson Electric Co. Emerad Advertising Service, Inc.	168
Sloan Instruments Corp. Palmer/Larson Communications	62
■ Sorensen Operation, Raytheon Co. James Advertising, Inc.	61
South Dakota Industrial Development Expansion Agency Maurice Paulsen Advertising	204
Sprague Electric Co., The Harry P. Bridge Co.	5, 10
■ Stackpole Carbon Co., Electronic Components Div. Meek & Thomas, Inc.	104, 226, 227
Synthane Corporation Arndt, Preston, Chapin, Lamb & Keen, Inc.	229
Syntron Co. De Sales Advertising, Inc.	165

■ Tektronix, Inc. Hugh Dwight Adv., Inc.	136
Telonic Instruments Jansen Associates, Inc.	69
Teradyne, Inc. Quinn & Johnson Adv., Inc.	22
Texas Instruments Incorporated Components Group Don L. Baxter, Div. of Albert Frank-Guenther Law, Inc.	186
■ Texscan Corp. Talad Adv. Agcy.	172
Thomson Electric Co., Inc.	150
■ Tracor, Inc. Weekley & Valenti, Inc.	205
■ TRG, Inc., Control Data Corp. Div. Culver Adv., Inc.	200
Trio Laboratories, Inc. Zam & Kirshner, Inc.	71
■ Trygon Electronics, Inc. Kameny Associates, Inc.	215
Trymetrics Corp. Kameny Associates, Inc.	140
■ Tung-Sol Division, Wagner Electric Corp. Feeley & Wheeler, Inc.	223
Ulano Graphic Arts Supplies, Inc. Lory Roston Associates	175
Universal Instruments Corp. Caroe Marketing, Inc.	174
Vector Electronics Co. Van Der Boom, McCarron, Inc.	202
Victoreen Instrument Co., The The Palm & Peterson, Inc.	239
Vidar Corp. Hal Lawrence, Inc.	53
Wakefield Engineering, Inc. Sales Promotion Services, Inc.	229
Westinghouse Semiconductor Div. McCann/ITSM	134, 135
■ Weston Instruments, Inc., Newark Div. Arndt, Preston, Chapin, Lamb & Keen, Inc.	209
■ Weston Instruments, Inc., Trancoil Div. Arndt, Preston, Chapin, Lamb & Keen, Inc.	219

Classified Advertising

F.J. Eberle, Manager	
EMPLOYMENT OPPORTUNITIES	230-231
EQUIPMENT (Used or Surplus New) For Sale	231
ADVERTISERS INDEX	
California Electric Manufacturing Co.	230
Joseph P. Corcoran	230
General Electric Co., Capacitor Dept.	230
Radio Research Instrument Co.	230
U.S. Navy San Francisco Bay Naval Shipyard	231

■ For more information on complete product line see advertisement in the latest Electronic Buyer's Guide

Advertising sales staff

Frank E. LeBeau [212] 971-6464
Advertising sales manager

Wallis Clarke [212] 971-2187
Assistant to sales manager

Donald J. Austermann [212] 971-3139
Promotion Manager

Atlanta, Ga. 30309: Michael H. Miller, 1375 Peachtree St., N.E.
[404] 892-2868

Boston, Mass. 02116: William S. Hodgkinson
McGraw-Hill Building, Copley Square
[617] CO 2-1160

Chicago, Ill. 60611: Robert M. Denmead,
J. Bradley MacKimm, Ralph Hanning,
645 North Michigan Avenue,
[312] MO 4-5800

Cleveland, Ohio 44113: William J. Boyle, 55 Public Square, [216] SU 1-7000

Dallas, Texas 75201: Richard P. Poole, 1800 Republic National Bank Tower,
[214] RI 7-9721

Denver, Colo. 80202: Joseph C. Page, David M. Watson, Tower Bldg., 1700 Broadway,
[303] 255-5484

Detroit, Michigan 48226: Ralph Hanning
856 Penobscot Building
[313] 962-1793

Houston, Texas 77002: Kenneth George,
2270 Humble Bldg., [713] CA 4-8381

Los Angeles, Calif. 90017: Ian C. Hill,
John G. Zisch, 1125 W. 6th St.,
[213] HU 2-5450

Minneapolis, Minn. 55402: J. Bradley
MacKimm, 1104 Northstar Center
[612] 332-7425

New York, N.Y. 10036
500 Fifth Avenue
Donald R. Furth [212] 971-3615
James R. Pierce [212] 971-3616
John A. Garland [212] 971-3617

Philadelphia, Pa. 19103:
Jeffrey M. Preston
Warren H. Gardner,
6 Penn Center Plaza,
[215] LO 8-6161

Pittsburgh, Pa. 15222: Warren H. Gardner,
4 Gateway Center, [412] 391-1314

Portland, Ore. 97204: James T. Hauptli,
218 Mohawk Building, 222 S.W. Morrison
Street, Phone [503] 223-5118

Rochester, N.Y. 14534: William J. Boyle,
9 Greylock Ridge, Pittsford, N.Y.
[716] 586-5040

St. Louis, Mo. 63105: Robert M. Denmead
The Clayton Tower, 7751 Carondelet Ave.
[314] PA 5-7285

San Francisco, Calif. 94111:
James T. Hauptli, 255 California Street,
[415] DO 2-4600

London W1: Edwin S. Murphy Jr.,
34 Dover Street, Hyde Park 1451

Paris: Pierre Braude, European Director
88-90 Avenue Des Champs-Elysees, Paris 8.
Phone: 225 85 88

Milan: Robert Saidel
1 via Baracchini Phone: 86-90-656

Frankfurt/Main: Hans Haller
Elsa-Brandstroem Str. 2
Phone: 72 01 81

Geneva: Mike Zeynel
1, rue du Temple Phone: 31 95 60

Tokyo: Nobuyuki Sato, 1, Kotohiracho
Shiba, Minato-Ku [502] 0656

Osaka: Ryoji Kobayashi 163, Umegae-cho
Kita-ku [362] 8771

Business Department

Wallace C. Carmichael, Manager
[212] 971-3191
Stephen R. Weiss, Production Manager
[212] 971-2044
Thomas M. Egan,
Assistant Production Manager [212] 971-3140
Dorothy Carmesin, Contracts and Billings
[212] 971-2908
Frances Vallone, Reader Service Manager
[212] 971-2865

Circulation and Research

Milton Drake, Manager [212] 971-3485
Isaaca Siegel, Assistant Circulation Manager
[212] 971-6057
David Strasser, Assistant Research Manager
[212] 971-6058
Chloe D. Glover, Research Associate
[212] 971-6057

Electronics Buyers' Guide

George F. Werner, General Manager
[212] 971-2310
Ray Smyth, Eastern Regional Manager
[212] 971-6538
Regina Hera, Directory Manager
[212] 971-2544
Thomas M. Egan, Production Manager
[212] 971-3140



Component
space ?
stuffed ●

Get design room with the new space watchers' diet

Centralab's new, low cost SLIM TRIM Resistor is the ideal prescription for designers who have to make every fractional inch of space count. The Slim Trim takes so little room, it all but disappears in entertainment, military and industrial applications.

Out of sight, but not out of might. The Slim Trim is rated at 1/4 watt per section at 70° C, and offers resistance values ranging from 100 ohms to 15 megohms. Maximum voltage is 350 volts, which may be exceeded in special applications.

The unit is built on a .025" thick base plate of alumina to provide more effective heat dissipation. Carbon composition resistance is bonded directly to the plate for maximum reliability.

In addition to variable resistors, units can be supplied with fixed resistance as well. Multiple units with two, three or four sections are available. Single and multiple units are available with "hat" knobs, low profile knobs or without knobs. An edge adjust knob is available on single units only. Unit cost is as slim as under \$.07 in quantity.

When design spaces are bulging, a diet of Slim Trims is a space watcher's best friend.

FOR SAMPLES AND MORE INFORMATION ON SLIM TRIMS AND THE COMPLETE LINE OF CENTRALAB PRODUCTS, WRITE CENTRALAB, TODAY. CENTRALAB PRODUCTS ARE MARKETED THROUGH CENTRALAB INDUSTRIAL DISTRIBUTORS AND INTERNATIONALLY THROUGH GLOBE-UNION INC. — INTERNATIONAL DIVISION.

SPECIAL NOTE: Have you investigated the new, low cost of Centralab's 5TR miniature trimmer resistors?



CENTRALAB

Electronics Division
GLOBE-UNION INC.

5757 NORTH GREEN BAY AVENUE
MILWAUKEE, WISCONSIN 53201

M-6809

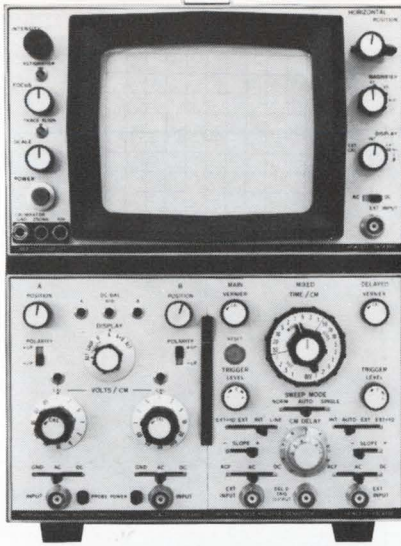

hp 180A Oscilloscope

RUGGED

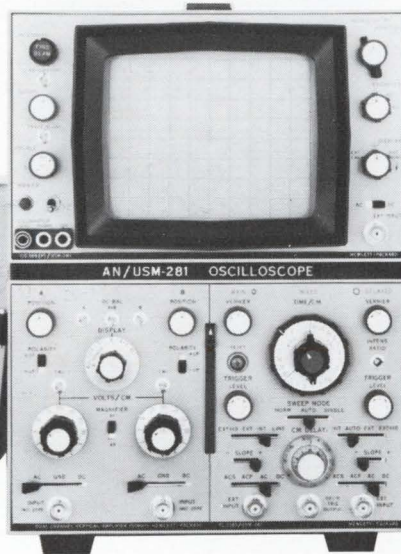

hp 180E Military Version Oscilloscope

RUGGEDest

Our grammar may not be correct . . . but the description is!

The standard hp 180A Oscilloscope is a RUGGED scope. Take its environmental specs, for example. The 180A scope with plug-ins operates in temperatures from -28 to +65°C—and at altitudes to 15,000 feet. It operates in a steamy 95% relative humidity up to 40°C. It operates after being vibrated in three planes for 15 minutes each with 0.010" excursion from 10 to 55 Hz. It's rugged enough to take rough treatment in field trucks—and rugged enough to take being banged around your laboratory . . . without affecting electrical performance!

Take the already rugged 180A, further ruggedize its step-ahead circuitry and wrap it in a splash-proof case. The result is the "RUGGEDest" scope—the 180E (AN/USM-281, FSN 6625-053-3112) Military Version Oscilloscope. In fact, it is *the ruggedest scope in the world!*

We battered the 180E with a 400-pound hammer. We subjected it to spray. We checked it for RFI. We steamed it in 95% humidity at temperatures up to 65°C while operating. Some of

the other significant military specifications met by the 180E are listed in the table. It met these specifications—and our own exacting electrical specifications—with no ifs, buts or maybes—NO COMPROMISE!

If you're looking for a 50 MHz, 30-pound, solid-state, plug-in scope with a large easy-to-read 8 x 10 cm CRT, 7 nsec rise time and 5 mV/cm sensitivity get the rugged hp 180A. If you're working in extreme environments, get the "ruggedest"—the hp 180E Oscilloscope!

Ask your hp field engineer for the data sheet on the 180A and for the 180E data sheet which gives test results and a cross reference to military specifications, plus full electrical specifications. Or, write to Hewlett-Packard, Palo Alto, California 94304. Europe: 54 Route des Acacias, Geneva.

Price: For the hp 180A Oscilloscope, \$825; hp 180AR (rack mount), \$900; hp 1801A Dual Channel Amplifier, \$650; hp 1820A Time Base, \$475; hp 1821A Time Base and Delay Generator, \$800. For the hp 180E Oscilloscope, \$1215; hp 180ER (rack mount), \$1205; hp 1801E, \$800; hp 1820E, \$570; hp 1821E, \$920, hp 10164A Accessory Kit and Front Cover, \$165; hp 180E Military Oscilloscope System (AN/USM-281, FSN 6625-053-3112), \$3100.

	MIL-E-16400F Class 2 & 4	MIL-E-4158C outdoor equipment	MIL-E-4158C indoor equipment	MIL-E-4970A PROC III	MIL-F-18870C Class 4	MIL-S-8512B PROC 3
Temp. oper.	●	*	●	●	●	●
Altitude oper.	▲	●	●	●	●	●
Humidity	●	●	●	●	●	●
Shock	●	▲	▲	●	●	●
RFI	●	●	●	▲	▲	●

● Passed *Not tested ▲ Indicates test not required

087/29

HEWLETT  PACKARD

OSCILLOSCOPE SYSTEMS

No other 100W silicon power transistor in the industry can match this performance point

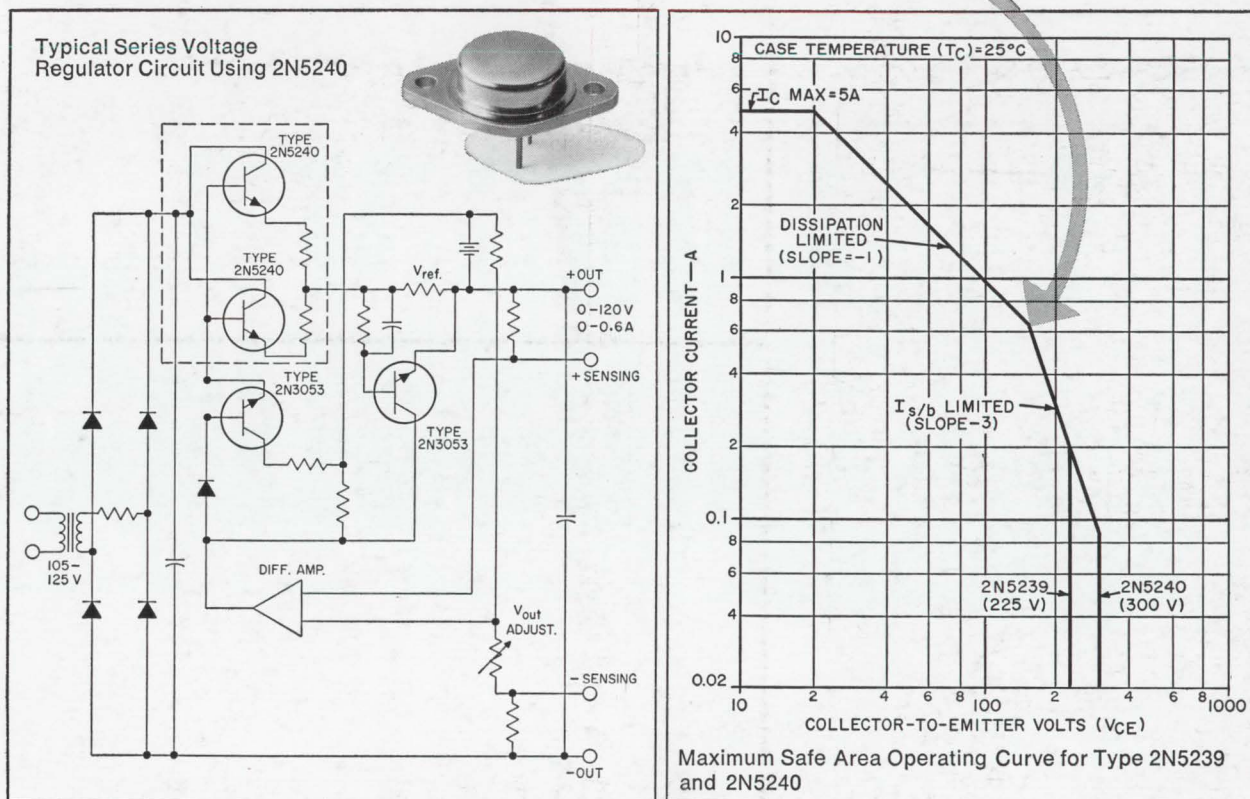

Now, full second breakdown protection up to 100 W dissipation and 150 volts, plus safe area rated up to 300 volts! That's a brand new level of power performance and reliability for high-voltage silicon transistors.

We made this capability possible by creating a unique pellet construction technique—multiple diffusion combined with the multiple emitter concept made famous by RCA "overlay." To you, this means better performing, more reliable circuits for high-voltage regulators, series regulators, high-speed inverters for off-the-line operation, switching bridge amplifiers for servo motor controls, and ultrasonic power amplifiers.

Depending on your circuit requirements, you can choose between the 2N5240 with a V_{cer} (sus) of 350 volts or the 2N5239 with a 250 volt rating. Both transistors have an I_c (max.) of 5A and P_t of 100 W.

For more information consult your RCA Representative or your RCA Distributor. For technical data, write: Commercial Engineering, RCA Electronic Components and Devices, Section IN2-3, Harrison, N. J. 07029.

RCA