

Sonic technique for nonvolatile memory 90

Design failures made easy 112

Active filters with nonlinear elements 116

\$1.00 A McGraw-Hill Publication

April 14, 1969

Electronics®

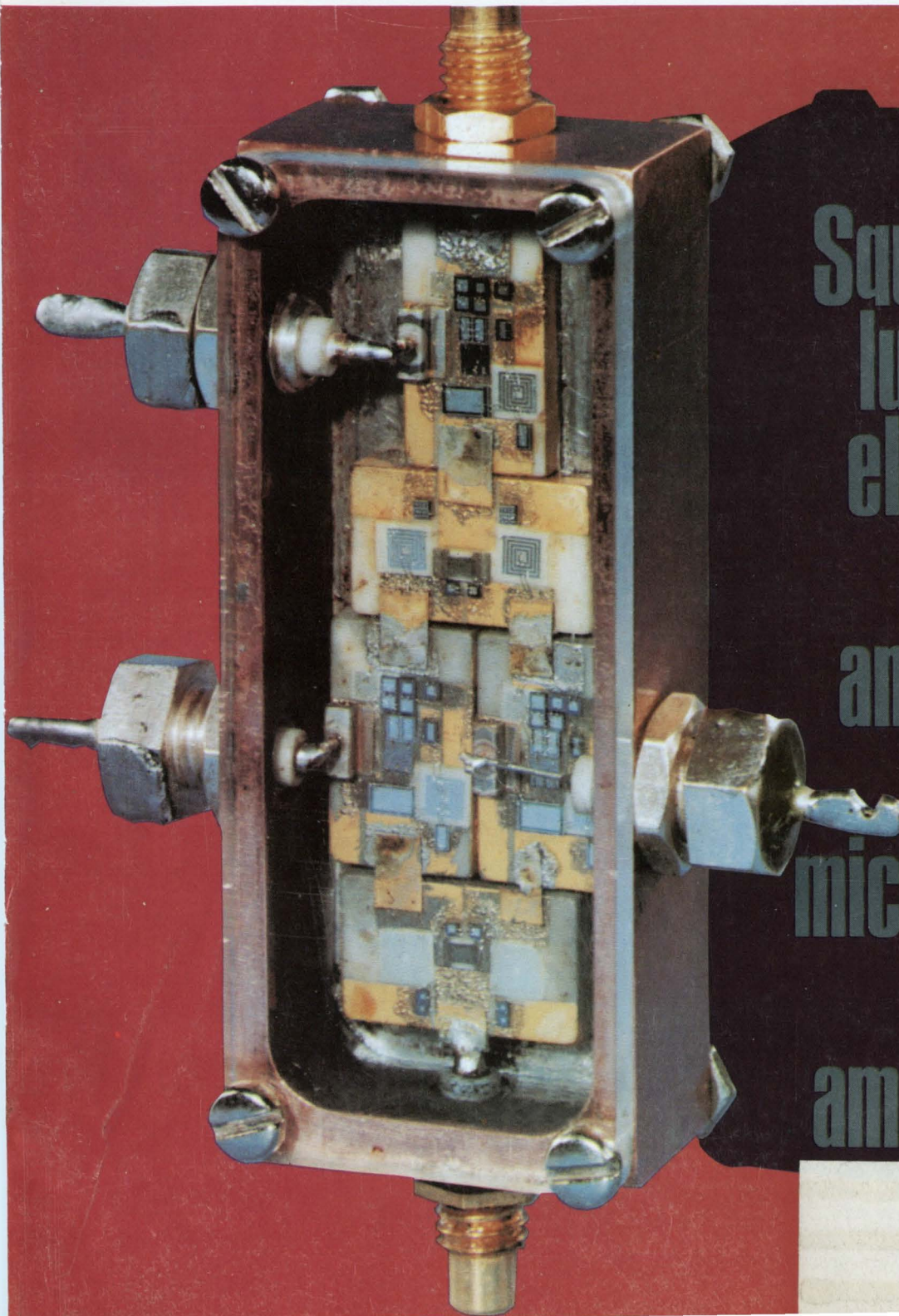

Squeezing
lumped
element
size
and cost
for
microwave
IC
amplifiers

New random-noise generator with flat output from 20 Hz to 20 MHz

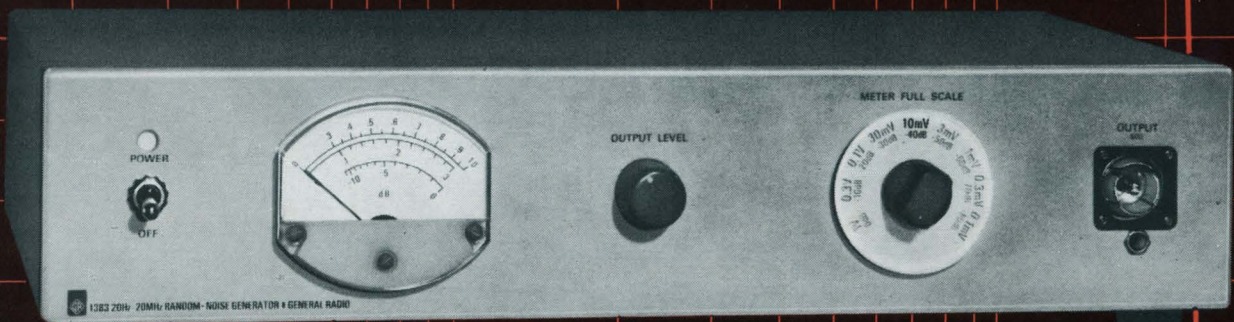

Wide frequency range, calibrated output, and carefully specified Gaussian amplitude distribution are the key features that distinguish this new random-noise generator from others available. The 1383 generates white noise of uniform spectrum level out to 20 MHz, particularly useful for tests in video- and radio-frequency systems. It is also an ideal broad-band, high-level noise source for use in amplifier testing, noise measurements, tests of signal-detection schemes, distortion measurements, and signal modulation to produce noise sidebands at higher frequencies. The 1383 contains a temperature-limited thermionic diode as a noise source, semiconductor amplifiers, an output meter, an 80-dB attenuator, and power supply, all enclosed in a convenient cabinet for bench use or rack mounting.

Frequency Range. The spectrum is flat (constant energy per hertz of bandwidth) ± 1 dB from 20 Hz to 10 MHz, ± 1.5 dB from 10 to 20 MHz.

Calibrated Output. The maximum output is one volt, open circuit, from a 50-ohm source impedance.

Carefully Specified Gaussian Distribution. The noise source provides symmetrical Gaussian amplitude distribution, specified to $\pm 3 \sigma$ as measured with a "window" of 0.2σ .

Price: Bench model, \$775; rack model, \$795.

Prices apply only in the USA. All GR products are subject to a quantity discount ranging from 3% for 2-4 units to 20% for 100 units. For complete information, write General Radio Company, W. Concord, Massachusetts 01781; telephone (617) 369-4400. In Europe: Postfach 124, Ch 8034 Zurich 34, Switzerland.

Other true random-noise generators:

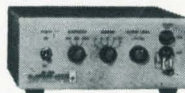

- 1381**
- 2 Hz to 2, 5, or 50 kHz
 - Gaussian distribution
 - adjustable clipping
 - 3-V rms output
- Price: \$375, bench model
\$398, rack model



- 1382**
- 20 Hz to 50 kHz
 - white, pink, or USASI spectra
 - Gaussian distribution
 - 3-V rms output, balanced, unbalanced, or floating
- Price: \$375, bench model
\$398, rack model



- 1390-B**
- 5 Hz to 5 MHz
 - 30- μ V to 3-V output
 - ± 1 -dB audio-spectrum-level uniformity
 - white spectra, and pink (with filter)
- Price: \$375; \$50 for pink-noise filter

GENERAL RADIO

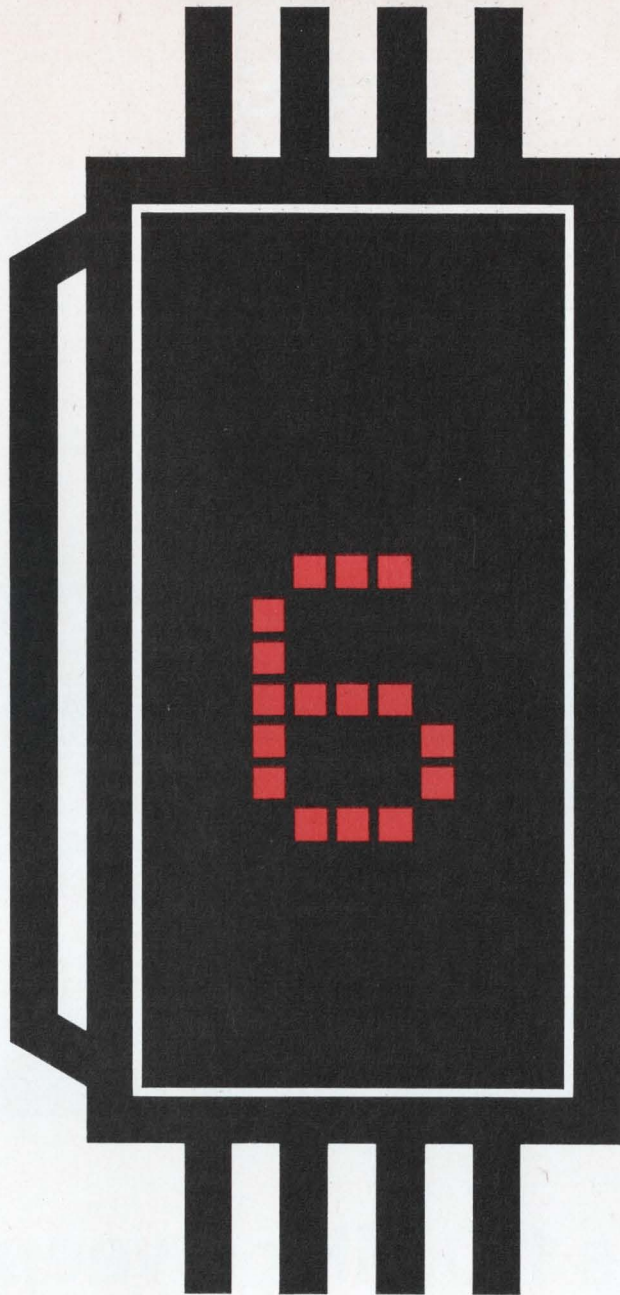

Surprise package (1" x 1/2" x 1/10")

It's a completely new way to display digital information. The Hewlett-Packard solid state numeric display packs everything in one, small unit only 1" x 0.5" x 0.16". Gallium arsenide phosphide diodes and an IC driver/decoder chip deliver bright red numerals—bigger than life, visible for yards.

This new "total package" also gives you the edge on cost. You don't have to buy driver elements, or anything else. No special interfacing is needed. Only four line 8-4-2-1 BCD input and less than five volts to drive it. The modules are available in three-character packages, too.

The Hewlett-Packard solid state numeric display is ideal for instruments requiring smaller, tighter display panels. Or any ap-

plication demanding either low power or resistance to shock and vibration, without catastrophic failures.

Get more information about the new technology for numeric indicators. Call your local HP field engineer or write Hewlett-Packard, Palo Alto, California 94304; Europe: 1217 Meyrin-Geneva, Switzerland.

HEWLETT  PACKARD

SOLID STATE DEVICES

01902

Digital frequency dialing accurate to 1% of frequency

0.01% calibration check at 5 MHz intervals.

Sweep speeds and triggering versatility for all applications.

Monitor frequency to 110 MHz with low-cost 10 MHz counter—HP 5321.

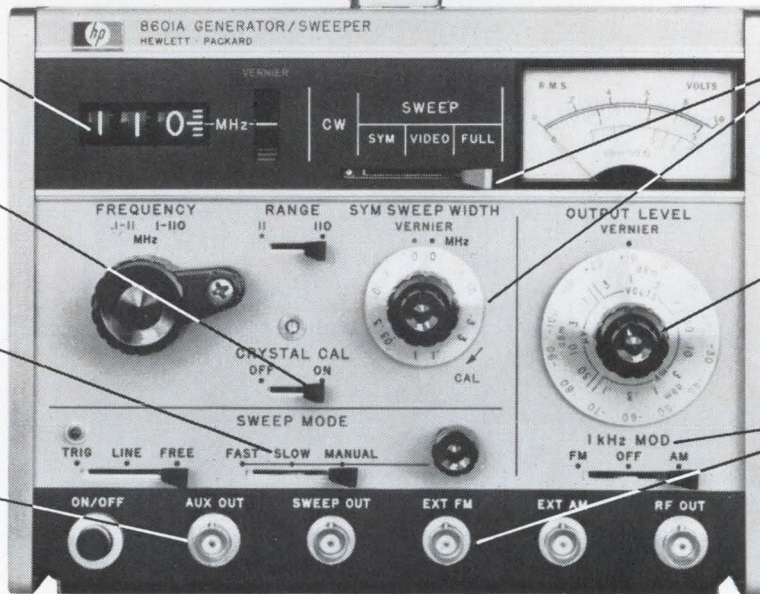

3 sweep functions, each with 0.5% linearity. Go from broad to narrow sweep with the flick of a switch.

± 1 dB output accuracy from 10 dBm to -110 dBm; flatness is ± 0.25 dB from 0.1 to 110 MHz.

Modulation: AM or FM, internal or external. (Internal: 30% AM and 75 kHz deviation FM.)

This 110 MHz sweeper is so accurate you can forget about markers

...and it doubles as a signal generator

Covering 100 kHz to 110 MHz, this all-solid-state 21 lb. instrument is a natural for both lab and production use. Price is \$1975. Call your HP field engineer for complete details on the 8601A Generator/Sweeper. Or write Hewlett-Packard, Palo Alto, California 94304; Europe: 1217 Meyrin-Geneva, Switzerland.

HEWLETT  PACKARD

SWEEP SIGNAL GENERATORS

Circle 2 on reader service card

News Features

Probing the News

- 139 **Manpower:** For EE's the party's over in employment demand
147 **Companies:** German company's electronics kit leaves the toy box

U.S. Reports

- 47 **Computers:** Illiac 4 program forced to drop medium-scale IC's
48 **Components:** Motorola to sell Sentinel program fallout—beam lead IC's
50 **Memories:** Nonvolatile, alterable semiconductor memory
52 **Consumer electronics:** Tape machine using Dolby effect
54 **Government:** NASA nervously eyes post-Apollo void
56 **Lasers:** Scanning system used by military has commercial possibilities
56 **Military electronics:** TI's discretionary wiring heads for the wild blue yonder
60 **For the record**

Electronics International

- 221 **France:** Helicopter radar spots high-tension lines
222 **Great Britain:** Yig-based systems check auto exhaust gases and transmission-line currents
222 **West Germany:** Siemens helps light Apollo spacecraft; ferrite substrates improve microwave IC's
223 **Japan:** "Fine-stripe" memory packs the bits in; fluorescent billboard makes a moving display

New Products

- 159 **In the spotlight**
159 Digital signal processors to bow at computer show
165 **Components review**
165 Fillets hold parts for soldering
167 Switch has lever action
171 **Data handling review**
171 Core memory with low profile
174 Terminal prints fast, quietly
179 **Instruments review**
179 Detector spots fast-rising spikes
182 Digital panel meter is versatile
184 Adapter widens analyzer's tasks
189 **Semiconductor review**
189 Two MOS read-only memories
191 Vidicon uses diode array as target
193 Transistors are radiation-tolerant

Technical Articles

Memory technology 90

Sonic film unit is a sound bet
Sonic film memories are nonvolatile, provide nondestructive readout, and don't require mechanical bearings and linkage
Rabah Shahbender, RCA Laboratories

Circuit design 95

Designer's casebook
▪ Transformerless d-c voltage converter is 70% efficient
▪ One-shot multivibrator yields division up to 12
▪ Pick-hold coil driver recovers quickly
▪ Photomultiplier's gain is temperature compensated
▪ Low-frequency waveform generator uses three op amps

Microwaves 100

Designing lumped elements into uhf and microwave amplifiers (cover)
RCA engineers are now turning out passive elements so small that distributed effects aren't critical in high-frequency applications. The devices are being used in hybrid power amplifiers that are smaller than conventional units and promise worthwhile cost savings
Martin Caulton and Walter E. Poole, RCA Labs

Opinion 112

Want to be a good loser? Go about it systematically
Design failures—equipment that looks fine in the lab and bombs out in the field—can be assured by following easy-to-learn, time-tested guidelines to disaster
Matthew W. Slate, Sedco Systems

Design theory 116

Active filters part 9: Applying nonlinear elements
Design engineers confronted with high-temperature or radiation-affected environments can resort to magnetostrictive and Hall-effect assemblies for filtering or frequency-tuning
Velio A. Marsocci, New York State University, Stony Brook

Departments

- | | | | |
|----|--------------------------|-----|--------------------------|
| 4 | Readers Comment | 48 | Index of Activity |
| 8 | Who's Who in this issue | 69 | Washington Newsletter |
| 14 | Who's Who in electronics | 196 | New Books |
| 22 | Meetings | 201 | Technical Abstracts |
| 31 | Editorial Comment | 211 | New Literature |
| 33 | Electronics Newsletter | 219 | International Newsletter |

Electronics

Editor-in-Chief: Donald Christiansen

Senior staff editors

Technical: Stephen E. Scrupski
News: Robert Henkel
International: Arthur Erikson

Managing editor: Harry R. Karp
Art director: Gerald Ferguson

Senior associate editor: Joseph Mittleman
Assistant managing editors: Eric Aiken, H. Thomas Maguire, Howard Wolff
Senior copy editor: James Chang

Department editors

Advanced technology: William Bucci, Richard Gundlach
Communications: John Drummond, Raphael Kestenbaum
Computers: Wallace B. Riley, George Weiss
Design theory: Joseph Mittleman
Instrumentation: Owen Doyle, Walter Barney
Military/Aerospace: Alfred Rosenblatt; William F. Arnold (Military); Paul Dickson (Aerospace)
New products: William P. O'Brien
Solid state: George Watson, Stephen Wm. Fields

Domestic bureaus

Boston: James Brinton, manager; Gail Farrell
Chicago: Frederick Corey, manager
Los Angeles: Lawrence Curran, manager
San Francisco: Walter Barney, manager; Peter Vogel
Washington: Robert Skole, manager; Paul Dickson, William F. Arnold

Foreign bureaus

Bonn: John Gosch
London: Michael Payne
Tokyo: Charles Cohen

Copy editors: Larry Miller, Edward Flinn
Staff writer: Peter Schuyten

Assistant art director: Kenneth L. Dix
Production editors: Susan Hurlburt, Arthur C. Miller

Editorial research: Anne Mustain

Editorial secretaries: Lorraine Longo, Claire Goodlin, Barbara Razulis, Vickie Green, Bernice Pawalk

McGraw-Hill News Service

Director: Arthur L. Moore; Atlanta: Fran Ridgway; Chicago: Robert E. Lee
Cleveland: Arthur Zimmerman; Dallas: Marvin Reid
Detroit: James Wargo; Houston: Barbara LaRoux
Los Angeles: Michael Murphy; Pittsburgh: Louis Gomolak
San Francisco: Margaret Drossel
Seattle: Ray Bloomberg; Washington: Charles Gardner, Daniel B. Moskowitz, Herbert W. Cheshire, Seth Payne, Warren Burkett, William Small, William D. Hickman

McGraw-Hill World News Service

Bonn: Robert Dorang; Brussels: James Smith; Hong Kong: Wes Perry;
London: John Shinn; Mexico City: Gerald Parkinson; Milan: Ronald Taggiasco, Jack Star;
Moscow: Jack Winkler; Paris: Robert E. Farrell, Stewart Toy
Rio de Janeiro: Leslie Warren; Tokyo: Marvin Petal
Reprints: Susan Nugent
Circulation: Isaaca Siegel

Publisher: Gordon Jones

Assistant to the publisher: Wallace C. Carmichael

Electronics: April 14, 1969, Vol. 42, No. 8

Published every other Monday by McGraw-Hill, Inc. Founder: James H. McGraw 1860-1948.
Publication office 99 North Broadway, Albany, N. Y. 12202; second class postage paid at Albany, N. Y.

Executive, editorial, circulation and advertising addresses: McGraw-Hill Building, 330 W. 42nd Street
New York, N. Y. 10036. Telephone (212) 971-3333. Teletype TWX N.Y. 710-581-4235. Cable address:
MCGRAWHILL N.Y.

Subscriptions solicited only from those professionally engaged in electronics technology. Subscription rates: qualified subscribers in the United States and possessions and Canada, \$8.00 one year, \$12.00 two years, \$16.00 three years; all other countries \$25.00 one year. Non-qualified subscribers in the U. S. and possessions and Canada, \$25.00 one year; all other countries \$50.00. Air freight service to Japan \$50.00 one year. Single copies: United States and possessions and Canada, \$1.00; all other countries, \$1.75.

Officers of McGraw-Hill Publications: Joseph H. Allen, President; J. Elton Tuohig, Executive Vice President; David J. McGrath, Senior Vice President-Operations; Vice Presidents: John R. Callahan, Editorial; Paul F. Cowie, Circulation; John R. Emery, Administration; John M. Holden, Marketing; David G. Jensen, Manufacturing; Jerome D. Luntz, Planning & Development; Robert M. Wilhelmy, Controller.

Officers of the Corporation: Shelton Fisher, President and Chief Executive Officer; John L. McGraw, Chairman; Robert E. Slaughter, Executive Vice President; Daniel F. Crowley, Donald C. McGraw, Jr., Bayard E. Sawyer, Senior Vice Presidents; John J. Cooke, Vice President & Secretary; Gordon W. McKinley, Vice President & Treasurer.

Title ® registered in U.S. Patent Office; © Copyright 1969 by McGraw-Hill, Inc. All rights reserved. The contents of this publication may not be reproduced either in whole or in part without the consent of copyright owner.

Subscribers: The publisher, upon written request to our New York office from any subscriber, agrees to refund that part of the subscription price applying to copies not yet mailed. Please send change of address notices or complaints to Fulfillment Manager; subscription orders to Circulation Manager, Electronics at address below. Change of address notices should provide old as well as new address, including postal zip code number. If possible, attach address label from recent issue. Allow one month for change to become effective.

Postmaster: Please send form 3579 to Fulfillment Manager, Electronics, P.O. Box 430, Hightstown, New Jersey 08520

Readers Comment

Domestication

To the Editor:

In your international edition, you published a story on a new Telefunken optical mask aligner (with optics from Carl Zeiss) for projecting precise patterns on silicon wafers [Feb. 17, p. 13E].

The article describes a second-generation machine that offers a 1:1 reproduction ratio and also provides faster exposure times than the first-generation machine. Of the earlier machines, 90% were sold in the U.S., and I feel you would do your U.S. readers a favor by telling them about this new mask aligner.

Bernd K. Knoerr

AEG-Telefunken
Schenectady, N.Y.

■ Readers who want to know more about the machine can write to *Electronics* for a free reprint of the article. Kulicke & Soffa, Fort Washington, Pa., is the U.S. sales agent.

One spelling lesson

To the Editor:

As a manufacturer's rep for the Semtech Corp., I was not too flattered to see the company listed with other suppliers of voltage triplers as "Sempeck" [Jan. 6, p. 137].

Jack E. Sweet

Scott Electronics
Fort Wayne, Ind.

... and another

To the Editor:

Regarding your story "Phased-array satellite antenna pops up when orbit is reached" [Feb. 17, p. 53], the correct spelling of Radiation Inc.'s dish antenna feed system is "dielguide"—a contraction of "dielectric waveguide"—and not "Dialoguide."

Also, the maximum efficiency of such a system approaches 80% for main reflector diameters in the vicinity of 200 wavelengths. Effi-

MODULINE[®] Memory-drive Hybrid Circuit Modules combine miniaturized inductive elements with thick-film ceramic-based technology.

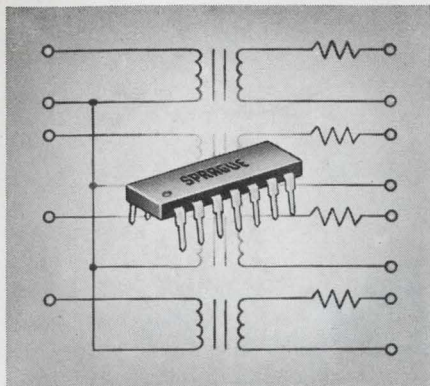

You get pulse transformers and resistors (diodes and capacitors can also be included) in a circuit tailored to your specifications.

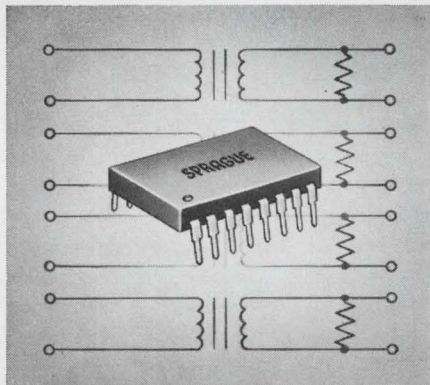

A single module may contain up to four identical circuits. They're particularly useful in memory systems where a similar repetitive pattern exists.

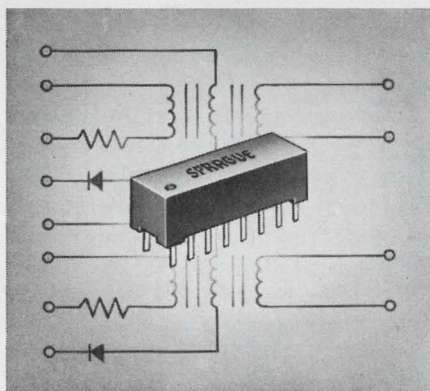

Flexibility offered by modular concept simplifies specific designs.

3 package styles: standard dual in-line, jumbo dual in-line, molded case with pin leads. They're all compatible with conventional in-line circuit layout.

High component density permits substantial size and cost reduction.

For complete technical data, write
for Engineering Bulletin 22210 to:
Technical Literature Service, Sprague Electric Co.,
35 Marshall St., North Adams, Mass. 01247.

THE BROAD-LINE PRODUCER OF ELECTRONIC PARTS



*Sprague' and '®' are registered trademarks of the Sprague Electric Co.

Clip this ad and cut delivery time on Heinemann circuit breakers

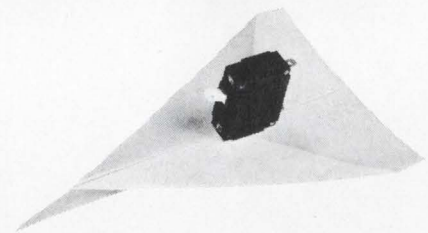

Authorized Heinemann Stocking Distributors:

Alabama
Electro-Tech, Inc.
Huntsville
(205) 539-1250

Arizona
Kierulff Electronics, Inc.
Phoenix
(602) 273-7331

California
Wesco Electronics
Los Angeles
(213) 685-9525

Wesco Electronics
Palo Alto
(415) 968-3475

Wesco Electronics
San Diego
(714) 279-3471

Colorado
Kierulff Electronics, Inc.
Denver
(303) 343-7090

Connecticut
MarLe Company
Stamford
(203) 348-2645
Grand Light & Supply Co.
New Haven
(203) 777-5781

Florida
McDonald Distributors
of Florida Inc.
Fort Lauderdale
(305) 563-1255

Industrial Electronics
Associates, Inc.
West Palm Beach
(305) 848-8686

Parts Service Corp.
Winter Park
(305) 647-5343

Georgia
Electro-Tech, Inc.
Hapeville
(404) 758-7205

Illinois
Electric Supply Corp.
Chicago
(312) 263-5225

Hall-Mark Electronics
Rosemont
(312) 299-6602

Kansas
Hall-Mark Electronics
Kansas City
(913) 236-4343

Kentucky
E & H Electric Supply Co.
Louisville
(502) 587-0991

Marine Electrical
Apparatus & Sales Co.
Louisville
(502) 587-6511

Louisiana
Poulan's Electrical Co.
Monroe
(318) 323-7701

Hall-Mark Electronics
New Orleans
(504) 242-7581

Maine
Stanley J. Leen Co., Inc.
Portland
(207) 774-6266

Maryland
Lee Electric Co.
Baltimore
(301) 752-4080

Pyttronic Industries, Inc.
Baltimore
(301) 727-5100

Massachusetts
Apparatus Service Co.
Allston
(617) 787-1300

Electrical Supply Corp.
Cambridge
(617) 491-3300

T. F. Cushing, Inc.
Springfield
(413) 788-7341

Mississippi
Ellington Electronic
Supply, Inc.
Jackson
(601) 355-0561

New Jersey
Hamilton Electro Sales
Cherry Hill
(609) 662-9337

Federated Purchaser, Inc.
Springfield
(201) 376-8900

New Mexico
Kierulff Electronics, Inc.
Albuquerque
(505) 268-3901

New York
Federal Electronics Inc.
Vestal
(607) 748-8211

F-J-R Electronics, Inc.
Hicksville, L.I.
(516) 433-5530

North Carolina
Electro-Tech, Inc.
Charlotte
(704) 392-7451

Ohio
Midwest Equipment Co.
Cincinnati
(513) 821-1687

Radio & Electronic Parts
Cleveland
(216) 881-6060

Oklahoma
Hall-Mark Electronics
Tulsa
(918) 835-8458

Oregon
Platt Electric Supply
Portland
(503) 222-9633

Pennsylvania
West Chester Electric
Supply Co.
West Chester
(215) 696-7500

Rhode Island
William Dandreta & Co.
Providence
(401) 861-2800

Texas
Cummins Supply Co.
Amarillo
(806) 373-5379

G. E. Jones Electric Co.
Amarillo
(806) 372-5505

Priester-Mell Co., Inc.
Austin
(512) 452-7634

Warren Electric Co.
Beaumont
(713) 833-9405

Hall-Mark Electronics
Dallas
(214) 231-6111

Nelson Electric Supply
Dallas
(214) 741-6341

Hall-Mark Electronics
Houston
(713) 781-0011

Warren Electric Co.
Houston
(713) 225-0971

Messner Electric Supply
Longview
(214) 753-4484

The Perry Shankle Co.
San Antonio
(512) 223-1801

Virginia
Dominion Electric Supply
Arlington
(703) 536-4400

Washington
Kierulff Electronics, Inc.
Seattle
(206) 725-1550

HEINEMANN ELECTRIC COMPANY  **Trenton, New Jersey 08602**

Readers Comment

ciencies greater than 75% have been achieved on at least one production system. The 70% figure you give is for a reflector diameter of about 20 wavelengths, which is, admittedly, more in line with satellite design.

R.J. Fratello

Sperry Gyroscope Division
Sperry Rand Corp.
Great Neck, N.Y.

... and yet another

To the Editor:

Please note that in your coverage of our tunable transmission reference cavity [Feb. 3, p. 157], the text loses much of its significance because the word "setability" is rendered as "stability." Also note that the stability is called out earlier in that sentence as being ± 250 Ghz over the temperature range from -15° to $+65^\circ\text{C}$. The significant part of the specification is that frequency can be set with great accuracy.

George E. Tirone

Frequency Engineering
Laboratories
Farmingdale, N.J.

Color mixup

To the Editor:

I want to call your attention to some technical discrepancies in your article "Logic circuits improve

tv color mix" [Feb. 17, p. 169].

One can almost overlook your placement of the article in the new subassemblies section instead of under new instruments; or your headline, in view of the fact that the logic circuits' primary advantage is the pattern stability they provide, not their control over color mix; or your misplaced emphasis on tv production applications when the instrument was designed for color tv servicing. But the statement "use of logic circuitry to improve reproduction of the National Television System Committee color standards" cannot remain unchallenged.

The Heath IG-28 color-bar and dot generator produces the service standard offset carrier rainbow display, not the NTSC color television standards.

Also, it's understandable that the block diagram of the instrument required reduction for convenient publication, but errors occurred in the process. The most harmful of these was your designation of the 3.56-Mhz oscillator as a 3.58-Mhz unit. This error lends credence to the earlier NTSC misstatement. Further, the IG-28 produces 12 patterns, not 13, and only the dot, cross-hatch, and gray-scale patterns can be operated in nine-by-nine and three-by-three modes. The color-bar vertical lines and horizontal lines, on the other hand, are either nine or three.

E.C. Fiebich

Heath Co.
Benton Harbor, Mich.

New from the **SPEC-TROLL!**



A 10-TURN INDUSTRIAL WIREWOUND POT WORTH BLOWING OUR HORN ABOUT!

Selling for only \$4.39 in quantity, our new Model 532 features "designed-in" reliability to give you top pot performance at bargain prices. The 532 offers:

- Longer element for "tighter" resolution.
- Precious metal contacts for minimum noise characteristics.
- Improved vibration-resistant slider design and dual slip ring contacts.
- Rugged mechanical stops for dependability.
- Passivated stainless steel shaft.
- A tough industrial design that can handle most of the requirements associated with MIL-R-12934.

Brief Specs

Size:	$\frac{1}{8}$ " diameter
Resistance Range:	15 ohm to 180K
Resistance Tolerance:	$\pm 5\%$
Independent Linearity:	$\pm 0.25\%$
Power Rating:	3 watts @ 40°C

The model 532 is available through your local Spectrol distributor. For full specs, circle the reader service number. Qualified respondents may obtain a sample *free of charge* through their Spectrol representative.



Spectrol Electronics Corporation
A subsidiary of Carrier Corporation
17070 East Gale Avenue
City of Industry, Calif. 91745
Phone: (213) 964-6565
TWX: (910) 584-1314

SUBSCRIPTION SERVICE

Please include an Electronics Magazine address label to insure prompt service whenever you write us about your subscription.

Mail to: Fulfillment Manager
Electronics
P.O. Box 430
Hightstown, N.J. 08520

To subscribe mail this form with your payment and check new subscription renew my present subscription

Subscription rates: qualified subscribers in the U.S.: 1 year \$8; two years, \$12; three years, \$16. Non-qualified: 1 year \$25. Subscription rates for foreign countries available on request.

CHANGE OF ADDRESS

ATTACH
LABEL
HERE

If you are moving, please let us know five weeks before changing your address. Place magazine address label here, print your new address below.

name

address

city

state

zip code



Caulton

Poole

Physicist Martin Caulton, coauthor of the cover story on lumped elements that starts on page 100, has both academic and practical credentials. The holder of a doctorate from Rensselaer Polytechnic Institute, he was a 1954-55 Fulbright scholar at the Imperial College of Science and Technology in London. Following his return to the U.S. he was a member of the technical staff at Bell Labs, researching low-noise microwave tubes. Caulton left Bell to become assistant professor of physics at Union College in 1958. Two years later he joined RCA Labs where he's been doing extensive research in the microwave field. Caulton has not, however, turned his back on the educational world; he's written a textbook on physical electronics, and is adjunct professor of electrical engineering at Drexel Institute.

Caulton's collaborator on the cover article, Walter E. Poole, has also moved in two worlds. Before signing on with RCA, he was for two years an instructor in the physics department at Drexel, where in 1964 he had earned his bachelor's degree. At RCA, Poole has been responsible for the design and fabrication of various uhf and microwave integrated amplifiers, as well as thin-film passive elements for different applications.

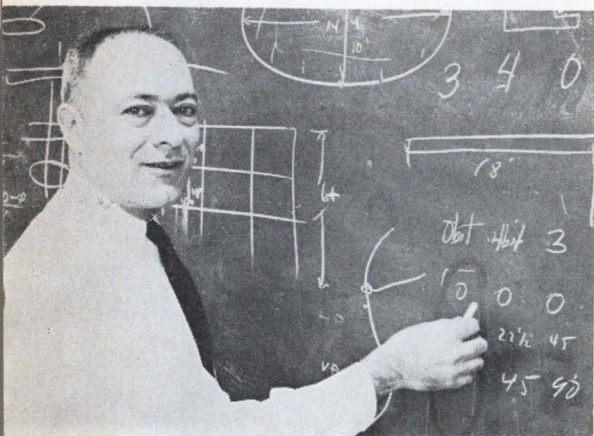

Slate

Experience, bitter and otherwise, may well be the key to Matthew W. Slate's grasp of how to facilitate design failures—a subject he discusses with wryness and relish in the article beginning on page 112. Recently named manager of electronics development at Sedco Systems, he has held responsible executive posts at such firms as Blass Antenna, Loral, Maxson, Dumont Labs, and Hazeltine. Slate earned a bachelor's degree (cum laude) from the City College of New York and a master's at Columbia.



Marsocci

Cairo-born Rabah Shabbender, author of the article on sonic film memories on page 90, began his career doing seismic exploration in Middle-East oil fields. He later switched to electrical engineering and earned a Ph.D. at Illinois in 1951. Following a stint at Honeywell, he joined RCA in 1955.

Dividing his time between a classroom and a research lab at New York State University's Stony Brook campus, Velio A. Marsocci somehow finds time to write articles like the rundown on nonlinear elements in active filters beginning on page 116. Marsocci holds a doctorate from New York University.

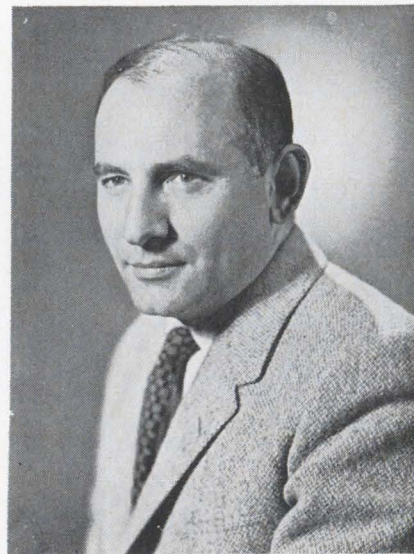

Shabbender

Here's the RF spectrum of an "ideal" synthesizer

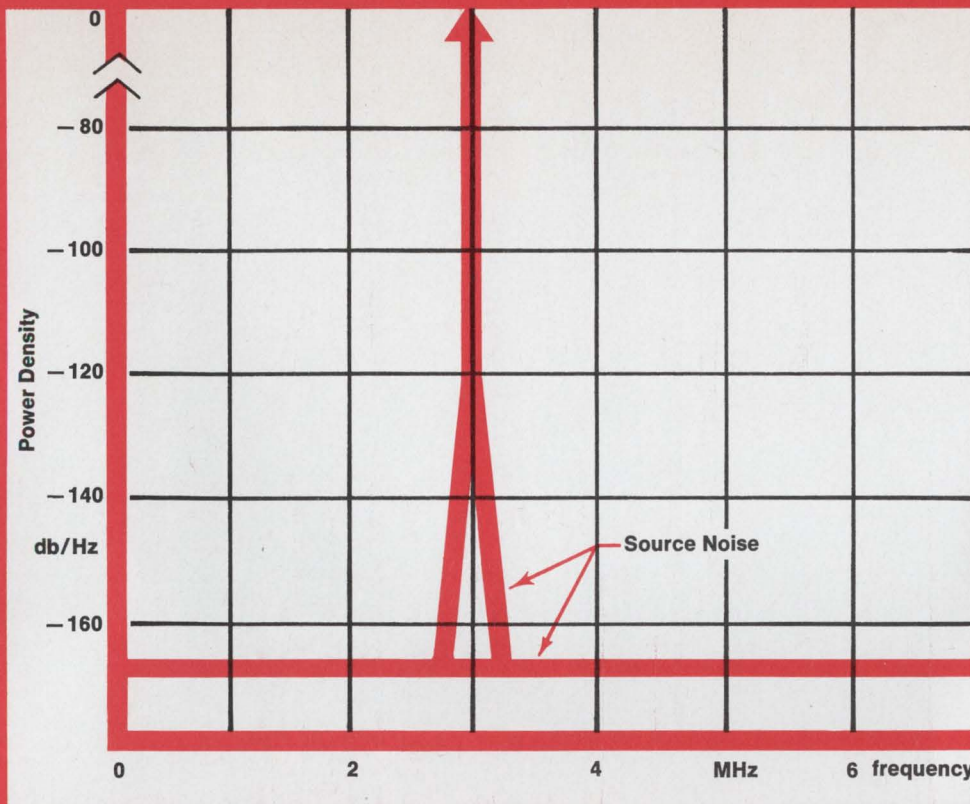

and the closest thing to it!

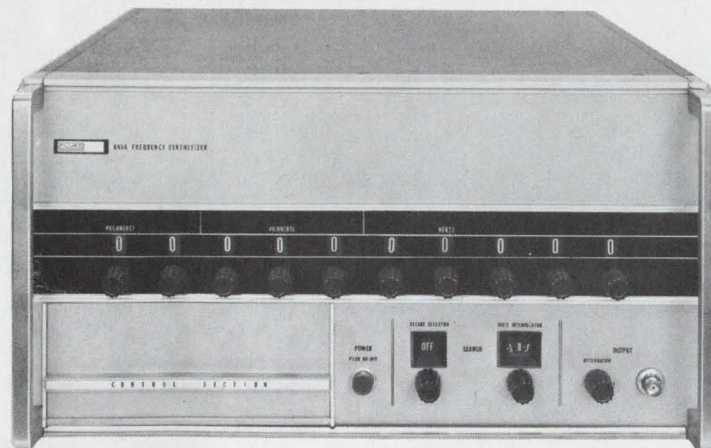

The new Fluke 645A!

The Fluke 645A features symmetrical search oscillator and built-in sweep-marker generator for filter and resonator testing. Automatic remote output leveling for systems applications. Twenty microsecond switching from remote decimal, or BCD program source. Modular design simplifies special configurations to meet your particular needs.

Key Specifications

FREQUENCY: DC to 50 MHz
INCREMENTS: 0.01 Hz
SPURIOUS CONTENT: <100 db
HARMONIC CONTENT: <30 db
NOISE FLOOR: <135 db/Hz at 5 KHz
CLOSE-IN NOISE: <100 db/Hz at 10 Hz offset
PRICE: \$13,500.

Fluke, Box 7428, Seattle, Washington 98133. Phone: (206) 774-2211, TWX: 910-449-2850.
In Europe, address Fluke Nederland (N.V.), P.O. Box 5053, Tilburg, Holland.
Phone: (04250) 70130. Telex: 884-50237. In the U.K., address Fluke International Corp.,
Garnett Close, Watford, WD2 4TT. Phone: Watford, 27769. Telex: 934583.



Circle 9 on reader service card

MECL III is still
twice as fast
as the fastest.

fastest

- where the priceless ingredient is care!



Now, 12 **MECL III** circuits are available in production quantities

350 MHz Flip-Flops head list of devices in three systems-oriented MECL families

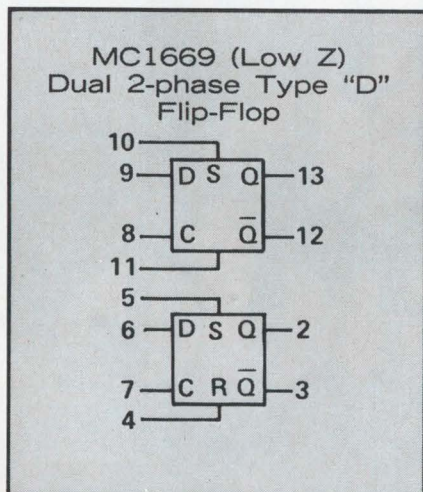
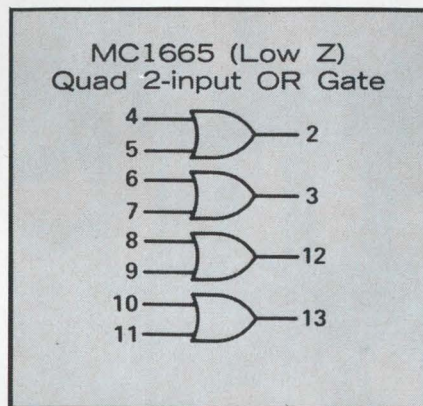

Your counter or logic system is still only half as fast as it could be — if you're not using MECL III — the World's fastest, most advanced form of integrated circuit. Now you have nine new functions including one-nano-second gates and a variety of flip-flops with toggle/shift frequencies of 350 MHz — with either high or low impedance inputs. And, they're all available in production quantities, with still many other types in the development stages. Here are the 9 new types:

- MC1661S (Low Z) Dual 4-input OR/NOR Gate
- MC1663S (Low Z) Quad 2-input NOR Gate
- MC1664S (High Z) Quad 2-input OR Gate
- MC1665S (Low Z) Quad 2-input OR Gate
- MC1666S (High Z) Dual, 2-phase R-S Flip-Flop
- MC1667S (Low Z) Dual, 2-phase R-S Flip-Flop
- MC1668S (High Z) Dual, 2-phase, Type "D" Flip-Flop
- MC1669S (Low Z) Dual, 2-phase, Type "D" Flip-Flop
- MC1671S (Low Z) Dual, Single-phase, Type "D" Flip-Flop

A new "Advance Information" brochure is now available to assist you with your MECL III designs. Send for it.

Circle 508 on reader service card

Compatible MECL II... still faster than saturated logic!

You may not need or want quite as much speed for other sections of your digital system. So, there's

a MECL series that offers 4 nS propagation delay and approximately 100 MHz toggle/shift frequencies. That's MECL II. And, now there are more than 65 devices in this unique series, counting the four new ones below:

- MC1028L Dual 4 nS, 4-Channel Data Selector. (The first low-cost multi-layer metal circuit that is commercially-available.)
- MC1039L Quad Level Translator.
- MC1040L Quad Latch.
- MC1043L 3-Bit Binary to One-Of-Eight Line Decoder.

Circle 509 on reader service card

Watch for the introduction of these additional 2 nS MECL II Circuits!

- MC1062 Quad 2-Input NOR Gate
- MC1064 Quad 2-Input OR Gate
- MC1061 Quad Twisted Pair Line Receiver.
- MC1063 Quad Twisted Pair Line Driver. (OR/NOR outputs)
- MC1066 Triple 2-Input Gate With OR/NOR outputs.

All MECL III types (MC1600 series) are currently available from distributor stock in the 14-pin flat pack with stud (for heat sinking).

The MECL II types (MC1000 series) are in the 14 and 16 pin dual in-line ceramic packages. For complete specification data and applications information, circle the reader service number or write to the address below.

Circle 510 on reader service card

MOTOROLA Integrated Circuits

Motorola Semiconductor Products Inc./P. O. Box 20912/Phoenix, Arizona 85036

**Codex
introduces
a modem
that transmits
9600 bps
over one
voice grade
line!**

“Unbelievable!”

“Unbelievable!”

But true.

The new Codex Model AE-96 modulator/demodulator can make 1 leased line do the work of 4, by transmitting and receiving data at 9600 bps over lines previously utilized at 2400 bps or 4800 bps at the most. Accuracy is as good as with 2400 bps equipment.

“Tell me another”

It has an Automatic Equalizer (“AE”) that conditions the 9600-bit data to travel smoothly on one voice grade Type 3002, C-2 conditioned line. You just push a button for initial equalization, which takes a mere 3½ seconds. The equalizer then monitors and optimizes performance 8 times per second to compensate for line changes. No hours of manual tweaking.

“You’ve struck a nerve”

Codex’s 9600 bps Modem is in use and on the production line. It meets RS 232B Interface Standard (full duplex) of EIA, and MIL Std. 188B.

“O.K. Send me the whole story”

For literature, test results and full details, contact Richard Young, Marketing Manager, Data Transmission, Codex Corporation, 150 Coolidge Ave., Watertown, Mass. 02172. Phone: (617) 926-3000
TELEX: 922-443.

If you’re not familiar with Codex (until now we’ve concentrated in military markets) . . . we have some real eye-openers to show you!

codex
corporation



PUTTING CURRENT-LIMITER DIODES TO WORK

PROBLEM: How to provide a low noise voltage reference with only two components?

SOLUTION: A Siliconix CL diode in series with a resistor.

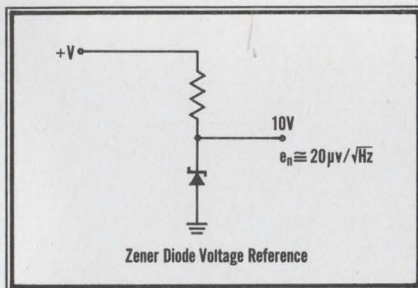

The zener diode voltage reference circuit has a typical noise voltage of $20 \mu\text{v}/\sqrt{\text{Hz}}$.

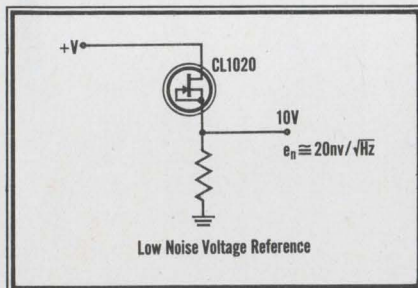

This CL diode circuit results in a 60 dB reduction in noise voltage—from $20 \mu\text{v}/\sqrt{\text{Hz}}$ to $20 \text{nv}/\sqrt{\text{Hz}}$ at 100 Hz.

For further information and immediate applications assistance, call the number below. Ask for extension 19.

Siliconix Incorporated

1140 W. Evelyn Ave. • Sunnyvale, CA 94086
Phone (408) 245-1000 • TWX: 910-339-9216

* Applications power . . . a broad product line, an in-depth applications team at your service!

Who's Who in electronics

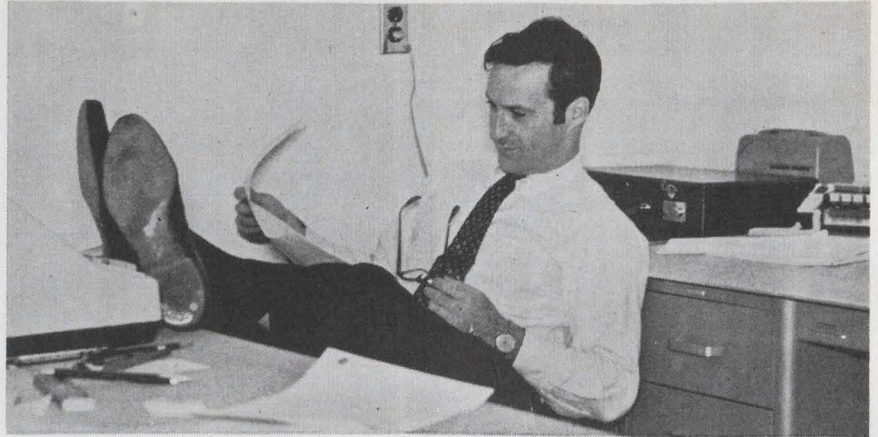

Kass

A continental commuter, Hal Kass has been making regular trips between Hillside, N.J., and Sydney, Australia—not to watch tennis matches but, rather, to get to the post office. As newly appointed manager for automated postal systems at the Plessey Airborne Corp., at Hillside, Kass has been studying the operation of the Redsern Mail Exchange, Sydney's completely automated post office.

Although postal automation is a new line for Plessey Airborne, a subsidiary of Britain's Plessey Co., it shouldn't be surprising; the Redsern installation was built by Plessey's Australian subsidiary.

Import. Plessey Airborne, which before its acquisition last year was known as the Airborne Accessories Corp., initially intends to import from Australia and sell the Plessey Letter Mail Sorting System. In operation, says Kass, the system automatically sorts each piece of mail according to a destination number encoded on the back of the envelope. The number is determined when clerks, sitting at remote consoles, interrogate a computer for the destination code. The code is then printed in a special ink on the back of the envelope. Once the letter or package is encoded, the system, via a series of conveyors, sends the material to the appropriate carrier.

Although competition for postal automation contracts in the U.S. becomes stiffer as more and more firms enter the field, Kass is confident that Plessey Airborne is assured of success because it already

has a proven product. In fact, Kass hints, several contracts already are being negotiated.

Another sign of Plessey Airborne's confidence is a new manufacturing facility recently opened in Hillside to eventually produce the letter-sorting systems.

Kass, who came to Plessey Airborne from the Intertype Co., where he was involved with automated typesetting equipment, feels another advantage to the Plessey system is that it's modular in design. Thus it can accommodate even the largest mail volumes simply with the addition of more modules.

Everyone who's been in the Army can recall at least one supply or administrative snafu, whether it was getting tomatoes when tent pegs were ordered or finally receiving tires after five tries only to discover they were the wrong size. The Army has long been conscious of the problem, but it wasn't until the recent refinement of automated data processing that it felt it could do anything about it.

Now the service has created a Computer Systems Command to oversee the design and development of systems for its various administrative and support operations. Commanding is Brig. Gen. Wilson R. Reed, formerly in charge of the Automatic Data Field Systems Command, which forms the nucleus of his new command.

"We're basically a management information shop," says the veteran

winning form

from the
form-factor
specialists
at Damon

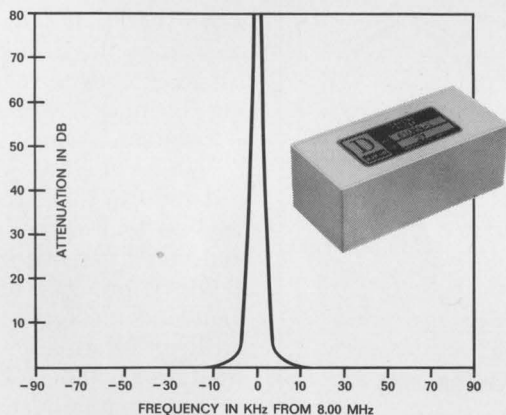

When your system calls for an ultra-sharp attenuation "spike" . . . specify a **Damon Model 6108A Band-Reject Crystal Filter**. Operating from a known source into a low-noise amplifier, the Damon Model 6108A filter rejects local oscillator and related feed-through—but preserves the system noise figure. With unwanted signals rejected before amplification, it also improves the system's dynamic range and reduces intermodulation from vibration and shock.

The Model 6108A has a center frequency of 8.00 MHz. Attenuation: not less than 75 db ± 240 Hz from f_r , and 11 db ± 4 db at -3 kHz and $+3$ kHz from f_r . Operates over -40°C to $+85^\circ\text{C}$ range with vacuum tube, transistor, or MOSFET amplifiers.

Whatever your signal-shaping need—from a narrow band-reject "spike" to a broad band-pass—you can rely on the form-factor specialists at Damon. Write: Electronics Division, Damon Engineering, Inc., 115 Fourth Avenue, Needham, Mass. 02194, or call (617) 449-0800.

 **DAMON**

Circle 15 on reader service card



The Grayhill "Excellent 50's"

Here is an entirely new generation of miniaturized rotary switches that allows you to select your own specifications from all these options:

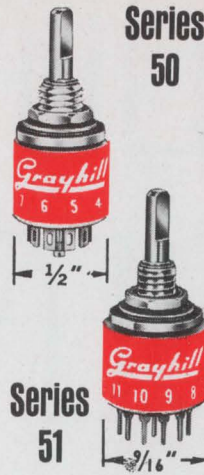

NUMBER OF POLES:

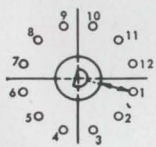

1 pole

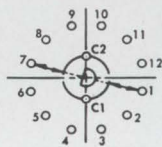

2 poles

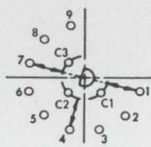

3 poles

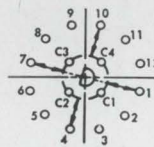

4 poles

ANGLES OF THROW:

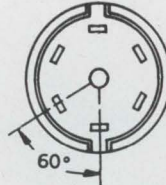
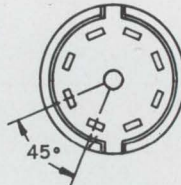
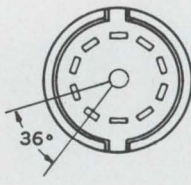
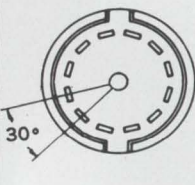

TERMINALS:



Solder Lugs



Printed Circuit

CONTACTS:



Shorting or Non-Shorting



STOPS:

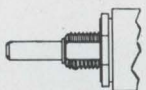

Factory Set

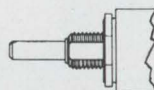

Adjustable

SEAL OPTIONS: Shaft and Panel

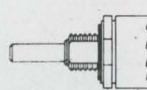

Sealed

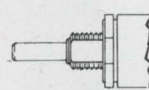

Unsealed

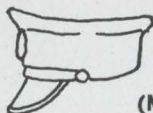

Military
(MIL-S-3786/20)



Commercial

Write for "Excellent 50's" technical data — Switches are available from stock — contact your Grayhill Representative or local Distributor.



523 Hillgrove Avenue
LaGrange, Illinois 60525
Area Code 312, Phone 354-1040

... the Difference Between Excellent and Adequate

Who's Who in electronics

of 32 years' service. "We'll be managing contracts and guiding contractors right away. We hope to be able someday to develop programs in-house, but it's a long way off."

Under way is a program to develop unified data processing systems for the 40-odd Army posts in the U.S. Up to now, Reed explains, there's been little uniformity in the way these posts have been run. Under the new program, such administrative functions as finance, personnel, and supply have been broken into "packages" and developed separately for data processing. Half of the 10 packages planned are now ready to go, Reed says.

What this program means is that the Army will be able to cross-check its inventories and spot irregularities. It may discover that one stateside tank battalion is using more sparkplugs than another, and may trace the discrepancy to a local maintenance regulation requiring changes every four months.

Progress. And, says Reed, "Whereas before you may have ordered five times to get Jeep tires, you do that with the new system and you'll get five sets of tires."

Other projects under his command include Tacfire (an automated artillery information system made by Litton), the tactical operations system, an intelligence collator, and the combat service support system (a transportable bookkeeping system undergoing extensive tests at Fort Hood, Texas.)

Besides the post-level systems, the new command will take over an experimental system for field armies called centralization of Supply Management Operations (Cosmos) and now being tested at the Sixth Army headquarters at the Presidio in San Francisco. One future problem will be to interface the Army-level and post systems, Reed notes.

Reed stresses that even though the systems at Fort Hood and the Presidio are developmental, they can't be taken out when the trials are over. For one thing, commanders get used to them. "As one general told me the other day," Reed says, "you can't take it out. If you do, I'm dead."



Desk-type hp 9100A programmable calculator. Provides dynamic range from 10^{-99} to 10^{99} with resolution to 10 significant figures, and a memory which accommodates 196 program steps. Printed circuit board from calculator shows extensive use of Allen-Bradley hot-molded resistors.

"We specify Allen-Bradley hot-molded resistors for quality, reliability, price and delivery"

Hewlett-Packard

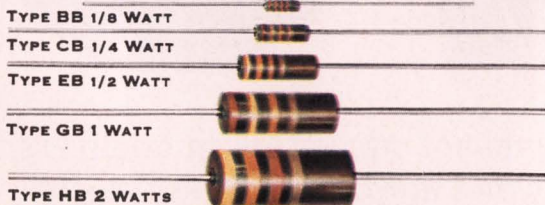

A-B hot-molded fixed resistors are available in all standard resistance values and tolerances, plus values above and below standard limits. A-B hot-molded resistors meet or exceed all applicable military specifications including the new Established Reliability Specification at the S level. Shown actual size.

The computer-like capabilities in this compact hp Model 9100A Calculator have placed severe demands on component performance. Reliability must be of the highest level.

Allen-Bradley hot-molded resistors completely meet the challenge. This is shown by the fact that they satisfy the requirements of the latest MIL-R-390008A Established Reliability Specifications at the *highest* level—the S level. This is true for all three ratings—the 1 watt, ½ watt, and ¼ watt—over the *complete* resistance range from 2.7 ohms to 22 megohms!

The unsurpassed performance of A-B resistors results from an exclusive hot molding manufacturing technique. The equipment is fully automatic—developed and used only by Allen-Bradley. The "built-in" precision control ensures the highest uniformity from resistor to resistor—year after year. Physical properties are constant. Performance is predictable.

For complete specifications on this quality line of hot-molded resistors, please write to Henry G. Rosenkranz and request Technical Bulletin 5000. Allen-Bradley Co., 1201 S. Second St., Milwaukee, Wis. 53204. Export Office: 1293 Broad Street, Bloomfield, N. J., U.S.A. 07003. In Canada: Allen-Bradley Canada Limited.

Circle 17 on reader service card



ALLEN-BRADLEY
 QUALITY ELECTRONIC COMPONENTS

5 revealing questions to ask hybrid manufacturers:

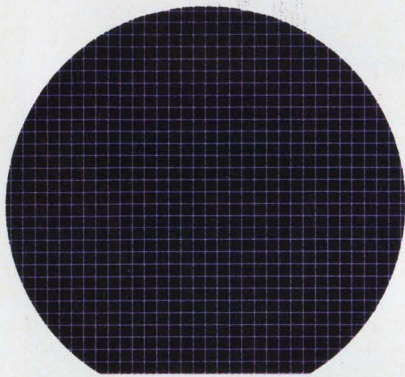

1 Do you manufacture your own chips? Fairchild does. We're the only manufacturer that manufactures, tests and stores our own chips. We test over three million dice in our hybrid facility every month. And we store over 10 million dice, ready to be used right now. Response to any demand is quick and in volume. From Fairchild.

2 How large is your selection of hybrid components? Back to the Fairchild stores, where we've got those 10 million dice. They include everything from simple diodes to complex LSI functions. If you need it, you can get it right now. From Fairchild.

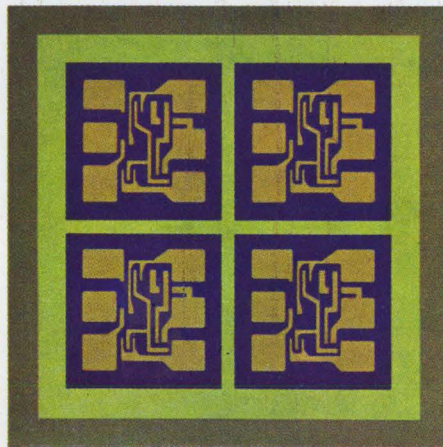

3 Can you offer computer-aided design? Fairchild not only offers, but delivers. If those 10 million single chips in our facility won't do your job best, we give your problem to our CAD group. With our new computer-aided design technology, the whole design procedure

—choosing the logic elements to implement your function, generating diffusion and metalization masks, even setting up functional and electrical test sequences for checking out the completed device—is all handled by the computer. It's just one of the things that

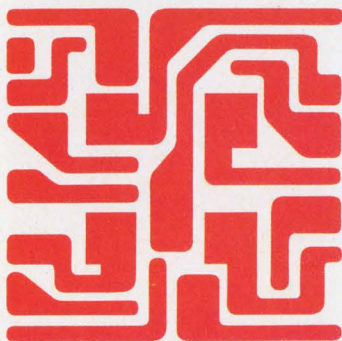

makes our prices the lowest in the industry. Your special functions are available fast and economically. From Fairchild.

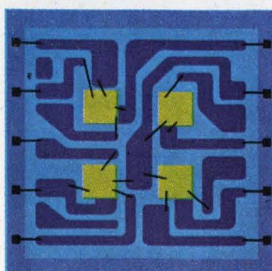
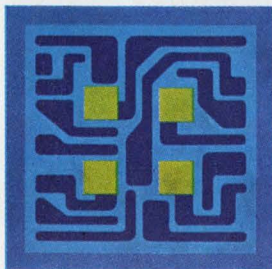
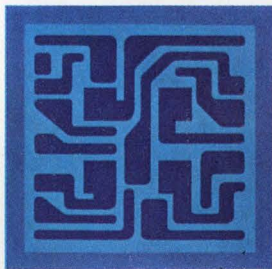
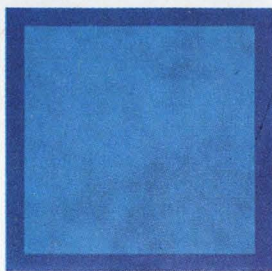

4 Are you limited to any specific technology? Not at Fairchild. We use the technique that's best for you. Thick film for economy. Thin film for accuracy and radiation resistance. Thin film on silicon if the function calls for a lot of active devices—discretes, MOS or LSI—and few passive ones. Whatever's right. From Fairchild.



5 Can you make hybrids in production quantities? At Fairchild, we make so many hybrids we've even got a line of standard hybrid functions priced like discretes. Hybrid production is on an assembly line basis, with the lines split according to the complexity of the functions being manufactured. Skills and equipment are matched exactly to the products. The products are right on price, performance and reliability. From Fairchild.

When all the answers are in, you'll find that Fairchild is the only manufacturer that qualifies as a complete hybrid source. For everything. Packages. Products. Substrates. Volume.

If there are more questions, you can get one brochure that has all the answers. Only from Fairchild. Write for it today!

FAIRCHILD
SEMICONDUCTOR

Fairchild Semiconductor / A Division of Fairchild Camera and Instrument Corporation
313 Fairchild Drive, Mountain View, California 94040 (415) 962-5011 / TWX: 910-379-6435



Anacondability is five men finding

What is Anacondability? It is the application engineering and coppermetal technology that helped Professor Johannson wire Canadian geese for sound, to plot their migratory habits.

For a couple of years, Professor Johannson had been equipping the wild birds with transmitters. Time and again, the antennas broke off the tiny transmitters, strapped to the birds' legs. They weren't heard from any more . . . just as the trip got interesting.

Professor Johannson called in Anaconda. Known for their solutions to the metals industry's most critical problems, Anaconda's applications engineers showed him how fatigue, from vibrations set up in flight, was causing antenna failure. The answer: antennas of a special Anaconda phosphor bronze alloy with high fatigue strength, proper electrical characteristics for radio transmission and excellent resistance to corrosion under a wide variety of environmental conditions.



a better way to track birds

Bird migration may not be your problem but Anacondability may have just the answer for you. Write for Anaconda's new Data Pack, a unique information system that could provide you with the answers to questions concerning copper alloys—quickly, completely and intelligibly.

Anaconda American Brass, 414 Meadow Street, Waterbury, Connecticut 06720. In Canada: Anaconda American Brass Ltd., Ontario.

Circle 21 on reader service card

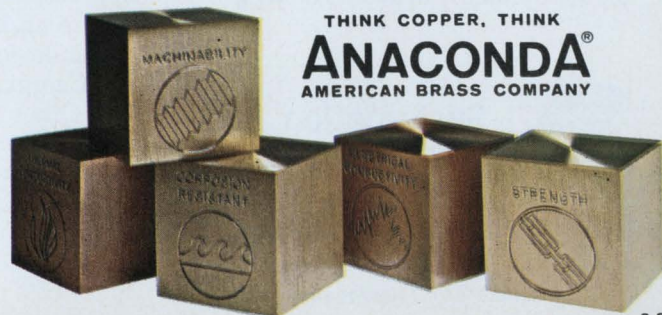

Wonder where the yellers went?

The "yellers" stop when you build a reputation for reliability. Yelling consumers become enthusiastic, time-&-again customers. Dealers stop yelling; management stops yelling. Engineering, production and quality control stop yelling and pointing fingers at each other.

High speed F·I·X·I·T builds reputations for incredible product quality and performance.

This plugboard-programmed, inspection test system checks mass-produced electronic circuit boards component by component. By the use of new, advanced, *in-circuit* test techniques, it identifies manufacturing errors and faulty components.

High-speed F·I·X·I·T is extraordinarily fast; up to 300 tests per program at an average of 30 tests per second. Checks each connection, each lead, every component individually (including IC's).

High-speed F·I·X·I·T is equipped with dual fixtures for maximum output—provides a "go/no-go" print-out for each board tested. You know instantly where trouble is: which production line operation needs correction, which supplier's components are out-of-spec.

To learn how High-speed F·I·X·I·T can improve product quality, build your reputation for incredible product reliability and stop all the "yellers", write or phone. . . .



Systemation Inc.
140 ERIE BLVD./SCHENECTADY, N. Y. 12305
TEL. 518/393-3638

Manufacturers of F·I·X·I·T, GUARDOHM®, APAC®, Consultants in and manufacturers of electronic, mechanical and optical engineering products and systems. Name it; we'll automate it.

Meetings

Diversity marks International Microwave Symposium

If quantity is any indication, this year's International Microwave Symposium should be almost twice as good as last year's. The 1969 edition will offer 83 technical papers in 12 sessions, against 49 papers in 1968. Topics will range from the emerging technology of micro-sound to the established disciplines of precision measurements and components. The meeting, to be held in Dallas, May 5 to 7, will present seven papers from overseas—including two from Russia—and two from Canada, plus several invited papers.

There will be two sessions on microwave integrated circuits, one covering multistage transistor amplifiers, digital phase shifters, low-noise microwave mixers, interdigitated strip-line quadrature hybrids, and wave propagation in micro-strip; the other will concentrate on amplifiers and oscillators. Papers will describe a 200-watt uhf amplifier, parametric amplifiers with impatt-diode pumping, yig-tuned transistor oscillators with amplifier buffering, a hybrid integrated transistor amplifier for high-volume production, and a hybrid microwave integrated circuit telemetry transmitter and command receiver.

Sound of the waves. The session on microwave acoustics features two invited papers: Ernest Stern of MIT's Lincoln Laboratory, a pioneer in microsound technology, will review the state of the art, while B.A. Auld of Stanford University will give a tutorial paper on acoustic-wave analysis using microwave concepts. Other papers will touch on the more advanced aspects of this technology.

Millimeter-wave systems and components will be discussed at two sessions, one of which will feature an invited paper on planar ferrite devices by G.P. Rodrigue of the Georgia Institute of Technology. Other subjects include yig filters, vhf and uhf junction circulators, a low-cost latching ferrite phaser fabrication technique, a thin-film lumped-element circula-

tor, slot-line techniques, and coplanar waveguide for nonreciprocal gyromagnetic devices. And there'll be a paper from the Soviet Union on six-port phase-type circulators and switches.

The single session on solid state circuits and devices will take up the design of highly stable and efficient varactor multiplier chains, broadband frequency doublers using charge-storage diodes, and all-transistor, 1-kilowatt, high-gain uhf power amplifier, radar duplexers, and high-power pulse limited space charge accumulation gallium arsenide devices.

Confrontation. Concerning diodes, the symposium will give equal time to two opposing camps. One session will be devoted to Gunn-effect devices, another to avalanche types. Among the Gunners, L.F. Eastman of Cornell University will review the state of the art, a Japanese paper will be given on c-w Gunn diodes in composite structures, and a British paper will discuss the effect of temperature on LSA oscillations between 26 and 40 Ghz.

At the avalanche-diode session, Prof. Bernd Höfflinger of Cornell will describe his work on high-efficiency avalanche resonance pumped amplification, and researchers from Raytheon and Bell Labs will talk about a 1-watt c-w oscillator, or power amplifier, and circuits for high-efficiency oscillators.

A session on computer-oriented microwave techniques rounds out the agenda. In an invited paper, A. Wexler of the University of Manitoba will survey the new directions being taken in computer field analysis. Two other papers at that session will cover the application of computer-aided design to broadband low-noise microwave amplifiers and three-port waveguide junction circulators.

For further information contact J.B. Horton, Texas Instruments, P.O. Box 5012, Dallas, Texas 75222.

(Continued on p. 24)

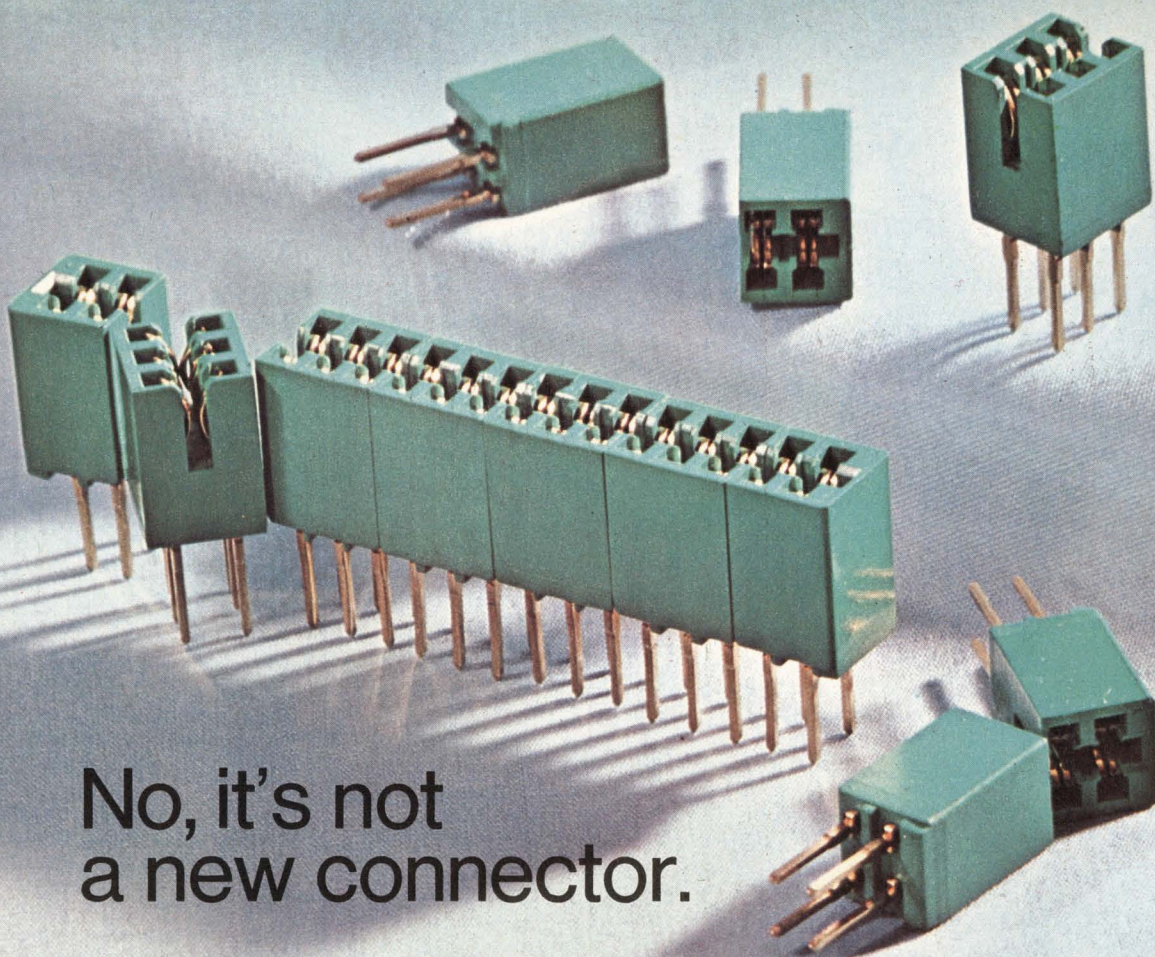

No, it's not
a new connector.

It's a new kind of connecting.

The little connectors above are really one connector. You take as many pieces as you need, mix them together, and use them to connect any size of p.c. board to a mother board.

That's not spectacularly new. Connector modules for use in bread-boarding have been around for a while.

But these new Mojo™ Series 6308 p.c. connector modules* are not just for bread-boards and prototypes.

Not hardly.

When used with plated-through holes on the mother board, they are one of the slickest production tricks to come along in quite a while. Contact tails combine a square wire-wrapping post with a specially designed locking feature which, when press-fitted into a plated-through hole, provides a gas-tight and reliable electrical connection.

No, you don't have to solder.

Yes, you can wire-wrap if you want.

And, yes, you'll save time and money in moving from prototype into production. Because connectors

of virtually any size can be built up economically from just two sizes of modules, you don't need a large inventory. Or custom connectors. And you only have to insert modules where connectors are required, saving a few more pennies.

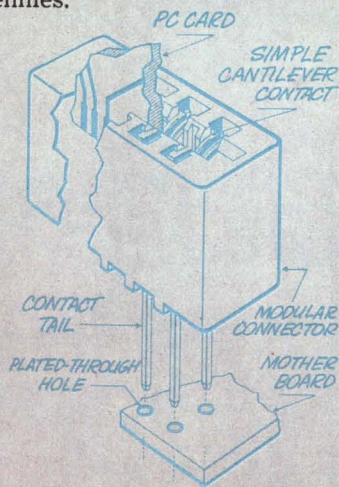

And, no, you don't give up a bit of connector reliability. The exclusive swaged single-beam design of the dual-readout contact provides optimum spring rate and deflection characteristics. A preload applied

to the contact nose in the insulator makes sure that the contact really holds on to the card, while keeping the contacts well apart when the card is removed from the connector.

Mojo™ p.c. connector modules:
Specs in brief

Material

Glass-filled DAP

Contacts

Cantilevered-beam, dual read-out, bifurcated nose. .150" centers. Center modules have 6 contacts. End modules have 4 contacts, molded-in card guide.

Tails

.031" square wire-wrapping type

Mounting

Press fit, in .048" dia. plated-through holes, 3/32" to 1/8" thick board.

For more information, write, wire, call, or TWX us for our Mojo™ p.c. connector module data sheet. Elco Corporation, 155 Commerce Drive, Fort Washington, Pa. 19034. (215) 646-7420; TWX 510-661-0.



Circle 23 on reader service card

ELCO Mojo™ p.c. Connectors

* Patent pending



Temp-R-Tape® T

One of a series of self-adhering tapes of skived Teflon* TFE. High elongation provides excellent conformability for tight wraps around irregular surfaces.

Temp-R-Tape HM

A series of self-adhering tapes of skived Teflon TFE with lower elongation and higher breaking strength. 2¼ mils to 6½ mils. Good conformability.

Temp-R-Tape C

Extruded Teflon FEP film has extremely high electric strength, highest of all Temp-R-Tapes. Transparent for easy read-through. Excellent conformability.

Temp-R-Tape Kapton*

Made from a polyimide film. Has outstanding thermal endurance. Retains physical and electrical properties at elevated temperatures. *T.M. OF DUPONT

Temp-R-Tape GV

Closely woven glass cloth. Good conformability and flexibility. Strong. Puncture and tear resistant. Excellent abrasion resistance and thermal stability.

Temp-R-Glas®

Glass fabric coated with Teflon TFE. Four thicknesses. Resists Teflon cold flow. Strong. Puncture and tear resistant. Also available without adhesive.

WE MAKE SIX DIFFERENT TYPES OF WIDE TEMPERATURE RANGE ELECTRICAL TAPES.

THAT WAY WE'LL HAVE ONE THAT'S JUST RIGHT FOR YOUR APPLICATION.

Temp-R-Tape is operational from -100 F to +500 F, has excellent electrical and physical characteristics. Pressure sensitive silicone polymer adhesive. Stocked by a national network of distributors capable of technical assistance and fast delivery. Look under CHR in industrial directories or micro-film catalogs. Or write for details and sample. The Connecticut Hard Rubber Company, New Haven, Connecticut 06509.



Subsidiary of U.S. Polymeric, Inc.

Meetings

(Continued from p. 22)

Calendar

International Geoscience Electronics Meeting, IEEE; Twin Bridges Marriott Hotel, Washington, April 16-18.

American Power Conference, Illinois Institute of Technology; Sherman House, Chicago, April 22-24.

Documentation and Debugging, Control Data Corp.; Sheraton-Silver Springs Hotel, Washington, D.C., April 28-30.

Aluminum Strip Conductor Symposium, Electrochemical Society; New York City, May 4-9.

Rocky Mountain Bioengineering Symposium, University of Wyoming; Laramie, May 5-6.

Electrical and Electronic Measurement and Test Instrument Conference, IEEE; Skyline Hotel, Ottawa, Ontario, May 5-7.

Instrumentation Symposium, Aerospace Industry Division of the Instrumentation Society of America; Frontier Hotel, Las Vegas, May 5-7.

Design Engineering Conference, American Society of Mechanical Engineers; Waldorf-Astoria Hotel, New York, May 5-8.

International Congress on Instrumentation in Aerospace Simulation Facilities, IEEE; Polytechnic Institute of Brooklyn, Farmingdale, N.Y., May 5-8.

International Microwave Symposium, IEEE; Marriott Motor Hotel, Dallas, May 5-8.

Digital Communications Symposium, IEEE; Los Angeles, May 6.

Conference on Power Thyristors and their Applications, IEEE; London, May 6-8.

Congress on Nuclear Electronics, IEEE; EURATOM Lab., Ispra, Italy, May 6-8.

Frequency Control Symposium, Electric Components Laboratory, Army Electronics Command, Shelburne Hotel, Atlantic City, N.J. May 6-8.

Pattern Recognition, Postal Department's Bureau of Research and Engineering and Systems Science and Cybernetics Group of the IEEE; Statler-Hilton Hotel, Washington, D.C., May 6.

Second National Conference, Association for Precision Graphics; (Continued on p. 26)

This Sierra L-F wave analyzer costs \$2,295.

(For about the same money, others can give you a fraction of its accuracy: ± 1 Hz).



(...and about half its range of 20 Hz to 110 kHz)

Short of spending another \$2,000, you cannot buy the accuracy of a Model 301B L-F Wave Analyzer. Nor its broad tunable coverage of the low-frequency spectrum. Nor its convenience and all-around usefulness.

Consider, for example, the benefits of up-to-date readout techniques. Model 301B displays tuned frequency on a five-digit counter, driven by solid-state circuitry. A second digital display presents the algebraic sum of the two attenuator settings, doing away with calculations. A lighted pointer on direct-projected meter scales gives you parallax-free readings of voltage and dBm.

As a wide-range wave analyzer, Model 301B delivers precise data on individual components of complex signals. You can accurately measure fundamental frequencies, harmonic voltages, intermodulation products, and other noise and signal voltages too small to be indicated by other means.

Built-in signal generator

By looping pulse outputs back to the 301B input, you can produce a harmonic signal every 100 Hz or 1 kHz (READ or TUNE position). A built-in 1-MHz clock frequency assures the accuracy of all generated pulse harmonic frequencies in this mode. By tuning the set to any harmonic frequency and locking on AFC, you can operate it as a frequency synthesizer throughout the entire range. In this function, it provides a restored sig-

nal of high frequency accuracy at the restored output terminals.

Among other Model 301B features: dual-selectable bandwidths of 10 and 100 Hz; a meter recording output; an optional bridging line transformer (Model 129-600) that makes measurements of true dBm on 600-ohm lines possible with only 0.1 dB bridging loss.

Product File 369 discloses everything about this remarkable economic development. Write Philco-Ford, 3885 Bohannon Drive, Menlo Park, California 94025. Or call (415) 322-7222, ext. 329.

SUMMARY SPECIFICATIONS

Frequency	
Range	20 Hz to 110 kHz
Accuracy	(20 Hz to 110 kHz) ± 1 Hz ± 1 count
Input Level Range	
Voltage (Full scale).....	30 μ v to 300 v in 1, 3, 10, 30 sequences
dBm (ref 600-ohm line and 0 dB on meter scale).....	+50 to -90
Input Level Accuracy.....	± 0.5 dB
Selectivity	
Narrowband	10 Hz (6-dB points) 60 Hz (60-dB points)
Wideband	100 Hz (6-dB points) 600 Hz (60-dB points)

PHILCO 

PHILCO-FORD CORPORATION
Sierra Electronic Operation
Menlo Park, Calif. • 94025



We warned the industry that we planned to go over their heads.

Way over.

We started out by guaranteeing that all CEC digital recording heads would record perfectly for 2,000 hours. Then discovered that in actual use they've been averaging better than 12,000 tape passing hours. And achieving a peak head life of 16,000 hours.

How come? Tougher materials and an advanced head design which produce a smoother, harder contact surface. Which, in turn, assures the lowest cost-per-hour for heads and maximum protection for tape. And superior head-to-head uniformity.

Of course, CEC digital recording heads offer some other important advantages, too. Such as 3200 FRPI (1600 BPI) performance. The fact that they are fully IBM compatible. And that they are available for any specific requirement—when you need them.

Now aren't you glad we didn't go through channels?

For all the heady facts, call our nearest office. Or write Bell & Howell, Pasadena, California 91109. Ask for Bulletin Kit 3308-X1.

CEC/DATA INSTRUMENTS DIVISION



BELL & HOWELL

Meetings

(Continued from p. 24)

University of Southern California, Los Angeles, **May 7-8.**

Annual Symposium & Equipment Exhibit, American Vacuum Society; International Hotel, Los Angeles, **May 7-9.**

Textile Engineering Conference, American Society of Mechanical Engineers; Sheraton-Sir Walter Hotel, Raleigh, N.C., **May 7-8.**

International Joint Conference on Artificial Intelligence, IEEE; Statler Hilton Hotel, Washington, D.C., **May 7-9.**

Short courses

Recent advances in engineering mathematics, University of California at Los Angeles; **June 16-27**; \$375 fee.

Electromagnetic science series of short courses, University of Colorado, Boulder; **July 7-18**; \$300 fee.

Digital process control systems, Purdue University, Lafayette, Ind.; **Sept. 15-24**; \$350 fee.

Call for papers

Annual Technical Conference, Metallurgical Society of the American Institute of Mining, Metallurgical, and Petroleum Engineers; Statler-Hilton Hotel, Boston, August 24-27. **May 1** is deadline for submission of abstracts to D.P. Seraphim, IBM Components Division, Bldg. 300, Hopewell Junction, N.Y. 12533.

Symposium on Reliability, IEEE, American Society for Quality Control, The American Society for Nondestructive Testing, and the Institute of Environmental Sciences; Ambassador Hotel, Los Angeles, January 27-29, 1970. **May 1** is deadline for submission of papers and abstracts to W.R. Abbott, Program Chairman, Lockheed Missiles & Space Co., Dept. 60-01, Bldg. 104, P.O. Box 504, Sunnyvale, California 94088.

Symposium on Switching and Automata Theory, IEEE and Dept. of Applied Analysis and Computer Science; Waterloo, Ontario, October 15-17. **May 16** is deadline for submission of abstracts to Professor John E. Hopcroft, Department of Computer Science, Cornell University, Upson Hall, Ithaca, New York 14850.

Ultramation is here.

The Honeywell 316 computer: new dimension on the path to ultimate efficiency . . . That's Ultramation

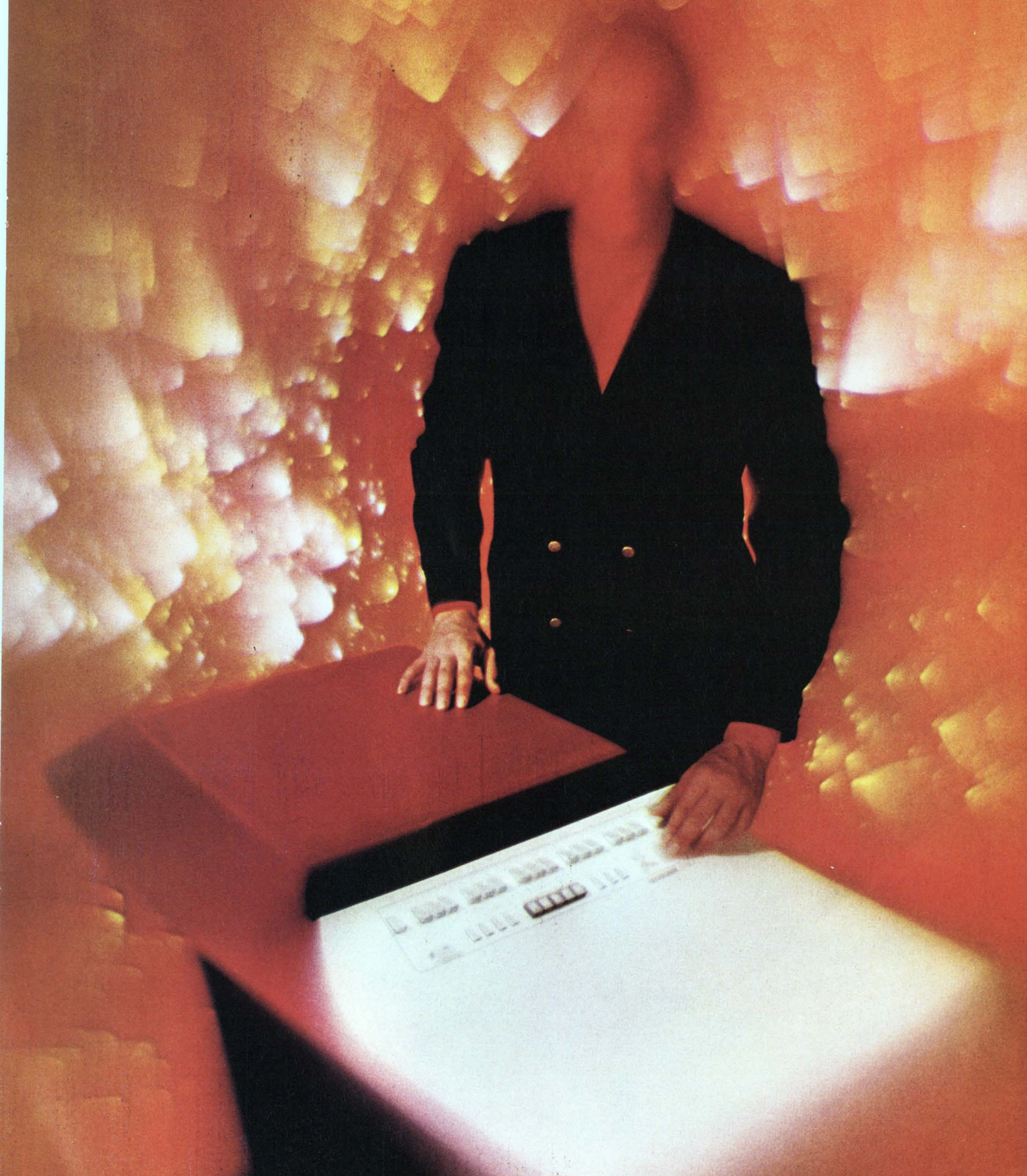



H316 is the first under-\$10,000 16-bit computer with the backup you deserve

When Honeywell hangs an under-\$10K price tag on a computer, you get something you've never had before at this price: big-computer-company backup. This means on-time delivery for one H316 or hundreds . . . world-wide support . . . a full line of proven peripherals.

The H316 comes in three versions — each a full-scale digital computer — with the rack-mountable model priced under \$10,000. Newest and smallest member of the Honeywell Series family (116, 316, 416, 516) of computer systems, the H316 is logically identical to the DDP-516 — same organization, instructions, interface characteristics.

Result: over 500 programs you know will work; peripherals and options you can count on; experience that means better results for you; growth to larger Series 16 computers without costly reprogramming.

The H316 could be just the small computer you're looking for. Typical applications are: industrial and mil/aero control systems, research, scientific data acquisition, hybrid, data storage and retrieval, and communications. Actually, Series 16 computers do real-time tasks so efficiently, they've been teamed as high-performance front ends with computers made by other manufacturers.

Find out how much more Ultramation offers you in an under-\$10K computer backed by thousands of Honeywell people around the world . . . first to deliver 16-bit computers.

The specs on the following page might help you make your decision to head for Ultramation . . .

Honeywell
A U T O M A T I O N

Move up to Ultramation. Reserve your H316s.

SPECIFICATIONS

TYPE — Stored program, single address, 16-bit, binary, parallel, general-purpose, two's complement.

MEMORY — Type: Four wire, coincident current, magnetic core

Size: 4,096 words, expandable in same increments to 16,384

Cycle time: 1.6 μ secs

Add time: 3.2 μ secs

INSTRUCTION COMPLEMENT — 72

REGISTER COMPLEMENT (all 16-bit) — A-Accumulator, B-Accumulator Extension, P-Program Counter, M-Memory Information, Y-Memory Address, X-Index Register

POWER FAILURE INTERRUPT — Power failure causes an interrupt through a unique location in memory to store contents of registers in memory.

INDEXING — By hardware index register, adds no time to instruction execution. Index register addressable directly and/or as memory location Zero.

SENSE SWITCHES — Four switches on control panel are capable of being tested by programmed instruction.

INPUT/OUTPUT — Word parallel. Programmed via A Register, or, optionally,

automatic to/from memory under control of Direct Multiplex Control Unit.

I/O CHANNELS — Up to 20 individually addressable channels or interfaces on the I/O bus. Multiple devices per interface or channel.

PRIORITY INTERRUPT — Basic machine has capability for up to 16 individually maskable priority interrupts. 48 additional interrupt lines optionally available.

TEMPERATURE — Room ambient.

HUMIDITY — 0-90% relative humidity with no condensation.

POWER — 475 watts at 115 volts AC $\pm 10\%$, 60 cycle, ± 2 cycles, single phase. Input current, 5.5 Amps.

CONFIGURATION — The basic 316 is supplied as a rack-mountable unit complete with power supply and control panel. This unit requires 14 inches of panel height in a 19" rack. Table-top and pedestal configurations also available.

DIMENSIONS — 17.88" wide x 24.5" deep x 14" high. This unit can contain the central processor, 16K of memory, real-time clock, high speed arithmetic, Teletype interface and logic for several other internal options and/or device interface.

WEIGHT — Approximately 150 pounds.

PLEASE RESERVE _____ H316(s) AND
number
CONFIRM APPROXIMATE DELIVERY DATE.

- Send more information by return mail. Hold this delivery date for me for 15 days so I can make a final decision and get my P.O. to you.
- Don't reserve an H316 for me yet. I need more facts. Send me your H316 brochure.
- I think I need a more powerful computer. Send me your DDP-516 brochure.

NAME _____

TITLE _____

COMPANY _____

STREET _____

CITY _____ STATE _____ ZIP _____

The application I have in mind is:

Attach this coupon to your letterhead and mail to: Honeywell, Computer Control Division, Dept. 20, Old Connecticut Path, Framingham, Mass. 01701.

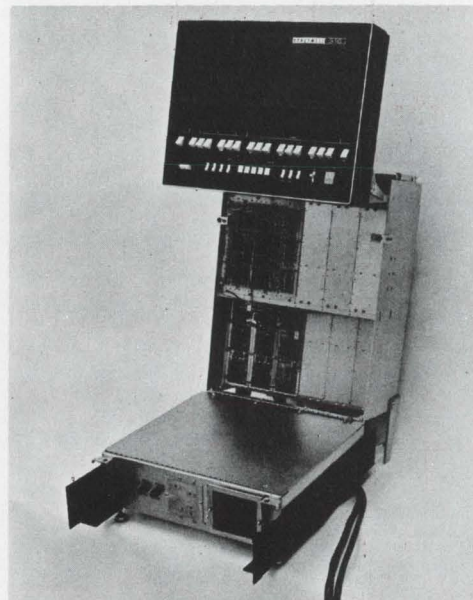

For easy maintenance purposes, access to the unit is implemented by a front pull-out and tilt mechanism.

Honeywell
AUTOMATION

Editorial comment

A tale of two cities

The Paris electronics exhibition (Salons Internationaux des Composants Electroniques et de l'Electroacoustique), coming as it did this year on the heels of the IEEE International Convention and Exhibition in New York, provided an interesting opportunity to compare the two shows. Both are truly international and both must be adjudged successful in terms of attendance (IEEE, 60,000; Paris show, 170,000). On the other hand, the managements of both exhibitions can learn by noting what the other does best, and the visitor to either show may find his attendance next year more productive and enjoyable if he keeps in mind the character of the two shows.

The Paris show is at some disadvantage in that it tries to cover all the ground that's divided among several conventions in the U.S. For example, it devotes a large section (really a separate show) to audio components, and it also accommodates a group of exhibitors who sell to the original-equipment market in the consumer field. For this reason, critics have called the show a hodgepodge.

Nevertheless, more than a thousand exhibitors were able to display their wares this year in the spacious, well-lighted, and well-appointed exhibition hall at the Porte de Versailles. In contrast, the IEEE show's biggest problem was cramming 720 exhibits into New York's odd-shaped Coliseum. (The visitor to IEEE sometimes gets the feeling he's missed a cubbyhole full of exhibits, if not an entire mezzanine.)

The visitor to the Paris show is impressed by the way its sponsors cater to its international clientele. For example, the management made interpreters and secretaries available to exhibitors and visitors alike, and Credit Lyonnais and La Banque Nationale de Paris had offices on the exhibition floor to change foreign currency. Furthermore, every booth was clearly marked with the exhibitor's name and nationality, a practice the IEEE show would do well to follow.

The Paris show has matured in its 30 years, but the decision of its management to keep it open over the weekend must be questioned. Hardware exhibits were virtually deserted on Saturday and Sunday, and even Texas Instruments' "Miracle Mile" was accorded scant attention.

Weekend visitors were in a holiday mood, gravi-

tating to the audio exhibits, where clashing sounds and flashing lights delighted them. Others fiddled with knobs at the instrument booths, and a small crowd surrounded Hewlett-Packard's blackjack-playing computer. Some visitors brought tots and teenagers, who amused themselves by collecting data sheets and eating popsicles.

It was not until the work week began that the serious visitors arrived. As one executive put it, "They're here to do business, not drink champagne." Most exhibitors had conference rooms built right into their booths, and that's where the orders were written (and, admittedly, a modicum of wine was consumed). At least one customer brought a sketch of a custom metalization mask to the TI booth and asked the company to begin immediately to convert it into a finished mask. Visitors returned the compliments of the exhibitors, saying that the technical competence of booth personnel was outstanding. Rarely were visitors (language barriers notwithstanding) given only partial answers, as so often happens at IEEE.

Neither show has enjoyed a reputation as a showplace for significant technical papers, but the Paris program was primitive by U.S. standards. Only a handful of the 33 papers drew audiences of more than 200 people, and several were presented to fewer than a dozen. The most popular papers were those dealing with developments in integrated circuitry.

One of the most important impressions a visitor comes away with from the Paris exhibition is that the Europeans intend to mount their challenge to the U.S. by extending their "leapfrog" tactic to bypass those technologies in which they never gained a foothold. An indication that the maneuver has already paid off was found in an observation made in Paris by TI. Advanced TTL circuits account for only 50% of the U.S. logic IC market, the company noted, but the figures are 70% in France and 90% in West Germany.

The end is not in sight, either. Visitors to the Paris exhibits considered transistor-transistor-logic technically passé. They were interested in large-scale integration, metal oxide semiconductor technology, emitter-coupled logic, advanced linear integrated circuits, optoelectronics, and sophisticated instrumentation.



New, more versatile scribing . . . identical operation

Changes have been made in the new Model "C." Tempress Automatic Scribing Machine, but only where they matter . . . to increase operating flexibility and to incorporate improved components where they will contribute to the efficiency, dependability, or longevity of the machine. Follow the same set-up procedures; press "actuate," and you are scribing any rectangular or triangular pattern from .001" to .399", with incremental resolution to .001". How versatile? Choose a model to scribe either 1½" or 2" wafers, decimal or metric indexing, extended range, 50 or 60 cycle operation, without affecting Circle 32 on reader service card



TEMPRESS

Tempress Research Co., 566 San Xavier Ave., Sunnyvale, Calif. 94086

price. The only option for which you pay extra is a binocular optical system. Third generation of the machine that brought low-cost, automatic scribing to the semiconductor industry, the new Model "C" meets the Tempress Standard of Excellence, your assurance of precision when you purchase any member of the growing family of Tempress miniature assembly tools and production machines.

Electronics Newsletter

April 14, 1969

Burroughs appears sour on thin film

After ballyhooing thin-film memories for several years, and putting them in several of its computers—notably the giant B-8500 series—Burroughs is said to have lost interest in the technology and returned to the old reliable ferrite-core arrays. In fact, one report says a 650-nanosecond core memory will be installed in the B-8502, now a partially constructed engineering model at the company's laboratories near Philadelphia.

Even more significant, the company is said to be taking a hard look at the buffer-memory concept that IBM is pushing hard [*Electronics*, March 17, p. 51]. This buffer, which IBM calls a "cache," would be a monolithic or hybrid semiconductor array. This new interest apparently reflects a feeling at Burroughs that semiconductor costs are rapidly dropping to the level that make thin films economical, and that semiconductors won't present the kind of technical problems now plaguing films.

Although Burroughs representatives are presenting a paper at Intermag in Amsterdam this week on the Illiac 4 thin film memory, only an engineering version exists and there's no production contract [see p. 47].

Equipment makers moving into MOS

Major commercial equipment makers are moving fast to build up a prototype capability in metal-oxide-semiconductor integrated circuits. Development laboratories at some companies are deep into this work. National Cash Register and Xerox, for example, have labs working very actively in MOS. Xerox is aiming to get MOS from three or four suppliers and has built up its MOS test lab "to keep suppliers honest."

Xerox definitely is going to MOS circuits; only the timing is in doubt at this point. The firm plans to introduce an all-IC machine next spring, but the decision on whether the circuits will be bipolar or MOS has not yet been made. More complex electronic subsystems than those now being used in Xerox machines are slated for prototype next year.

Two MOS circuit suppliers working with and supplying chips to Xerox are Fairchild Semiconductor and General Instrument.

Military eyes wideband receivers for surveillance

The military seems to be taking a longer look at wide-open type surveillance receivers for reconnaissance missions. Until now, the money generally has gone to frequency-scanning rather than wideband varieties.

The services have issued at least three requests for proposals for wideband receivers in the last three weeks. "We haven't seen such interest for some time," says Donald L. Margerum, executive vice president at Raven Electronics of Burbank, Calif.

The wide-open approach had two drawbacks: it could measure frequencies only to within a general band, and it had low sensitivities. But, says Margerum, the wide-open approach looks more promising because it now can pinpoint frequencies more accurately than scanners and has sensitivities approaching -65 dbm.

Raytheon jumps into op-amp race

Raytheon's semiconductor operation will introduce next month a proprietary operational amplifier it hopes will take some of the play away from the hottest "second-generation" op amps around—National Semiconductor's LM107 and uncompensated LM101A and Fairchild Semi-

Electronics Newsletter

conductor's 741. Raytheon claims that its new entry, the RM4131, has higher gain at lower voltages than these competitors, plus faster slew rate and more bandwidth.

Silicon nitride passivation, a technique Raytheon has already applied to beam-leaded integrated circuits, provides voltage gains of up to 50,000 with supplies as low as ± 3 volts. Slew rate is 1.5 volts per microsecond and bandwidth is 4 megahertz. With a new design for current regulation, the 4131 can produce a nearly flat 225 microamperes at from 2 to 45 volts.

The circuit is internally compensated. Raytheon, which second-sources just about every op amp on the market, describes the 4131 as only the first in a series of proprietary linear circuits.

Autonetics forms microelectronics unit

Autonetics officials, who just signed a \$30 million contract to provide MOS LSI arrays to Japan's Hayakawa Electric Co. for a pocket calculator, have served further notice on the industry that they're in the commercial LSI business for keeps. All the company's microelectronics activities have been spun off into a new Microelectronics Products division. R.S. (Sam) Carlson, a vice president, has been named general manager of the new unit, while Alvin Phillips, formerly director of microelectronics planning, is director of operations, Earl Schaefer is chief engineer, and Charles Kovac is director of market development and program management.

Pair of TI aces form MOS company

The two men most responsible for getting Texas Instruments into the commercial MOS business have resigned and formed their own company. They are L.J. Sevin, head of TI's metal-oxide-semiconductor operation and one of the pioneers in MOS design, and Louis Sharif, head of MOS manufacturing. Sharif is the man who discovered the aluminum-gold bonding phenomenon—known as purple plague—during the old Minuteman program; he joined the MOS group two years ago and helped bail it out of some manufacturing difficulties.

Reportedly, Sevin and Sharif left because they were unwilling to move to Houston, as they were called upon to do under TI's recently announced plan to broaden its production base.

Sevin and Sharif are said to be planning an MOS manufacturing company, to be situated in Dallas.

U.S. airlines eye British navigator

U.S. airlines are taking a hard look at a British navigation system, and at least one, Eastern Airlines, may place an order soon. The carrier has been testing an area-coverage land and sea navigation system made by Decca Ltd. for the past 18 months; if it buys, other airlines can be expected to follow. The lines may find the system all the more attractive now that ITT has bought Decca's U.S. distributor, Decca Systems Inc., because the new setup can provide nationwide service.

Addendum

Systems engineering for some of the avionics on the Navy's F-14A attack fighter craft will be done for Grumman Aircraft—the prime contractor—by Sperry-Rand. Under a \$500,000 contract, Sperry-Rand will carry out analysis and simulation studies in the swingwing plane's weapons delivery, navigation, and gunnery systems. First report is due in July.

The Case for a *Driftless* Op-Amp

Almost all op-amp applications suffer in one way or another from the effects of offset and drift. Changes in ambient temperature of only a few degrees (or even just the passage of time) can cause drift errors . . . errors which can completely obliterate small signals in circuits built around conventional amplifiers. Now you can forget the whole troublesome problem! Our new model 232 is almost driftless . . . Voltage drift low as $0.1\mu\text{V}/^\circ\text{C}$ and $1\mu\text{V}/\text{month}$ is practically negligible. (In fact, long term tests show drift will never exceed $5\mu\text{V}$!)

Drift performance like this (coupled with only $15\mu\text{V}$ offset to begin with) means that you can forget balance pots (and periodic adjustments) forever. Of course, chopper stabilized amplifiers have been available for some time, but **never** at these prices. The 232 J at just \$54 in OEM quantities means that now all of your designs can be "driftless".

One more thing, this incredible amplifier is in a new "flat pack" case . . . perfect for P.C. card racks.

Check the complete specs on the back, then use the attached "instant action" reply card to request an evaluation sample. No obligation to buy, of course.

\$54

(232 J, 100 lot)

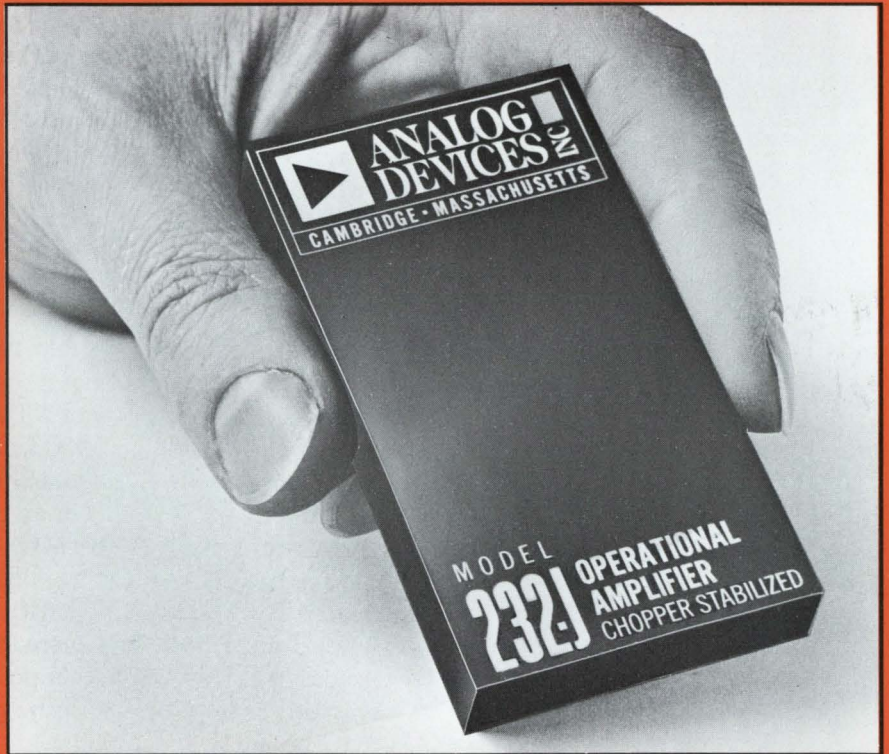
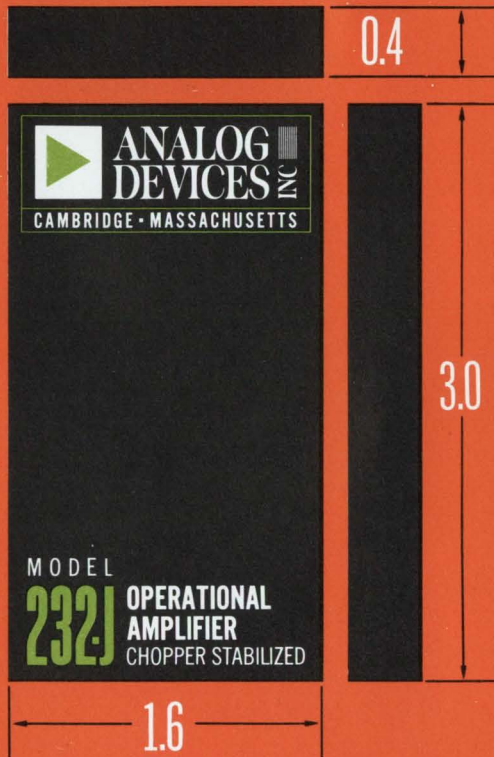

Instant action card
Use for Detailed literature, new 1969 catalog, evaluation samples.

BUSINESS REPLY MAIL
NO POSTAGE STAMP NECESSARY IF MAILED IN THE UNITED STATES

FIRST CLASS
Permit No. 39342
Cambridge, Mass.

POSTAGE WILL BE PAID BY



221 FIFTH STREET • CAMBRIDGE • MASSACHUSETTS 02142

Specifications: Model 232

All specifications typical @ 25°C and nominal supply voltage unless otherwise specified.	MODEL 232 (NEW)	
	J	K
OPEN LOOP GAIN		
dc, rated load, min	10 ⁷	
RATED OUTPUT, min	-10V @ 4mA*	
FREQUENCY RESPONSE		
Unity gain, small signal	500kHz	
Full power response, min	3kHz	
Slew rate, min	.2V/μsec	
INPUT OFFSET VOLTAGE @ 25°C, max.	±15 μV	±10 μV
Average vs. temp 10 to 60°C, max.	±.25 μV/°C	±.1 μV/°C
vs. supply	±.1μV/%	
vs. time	±1μV/mo	
INPUT BIAS CURRENT @ 25°C, max	±100pA	±50pA
Average vs. temp 10 to 60°C, max	±1 pA/°C	±.5pA/°C
INPUT IMPEDANCE		
Differential	300kΩ	
INPUT NOISE		
Voltage .01Hz to 1Hz p-p	1.5μV	
5Hz to 50kHz rms	5μV	
Current .01Hz to 1Hz p-p	10pA	
PRICE		
1-9	\$64.	\$99.
10-24	\$58.	\$90.

*For 25 mA output specify model 231

LONG TERM STABILITY

Actual Test Data, 5 units

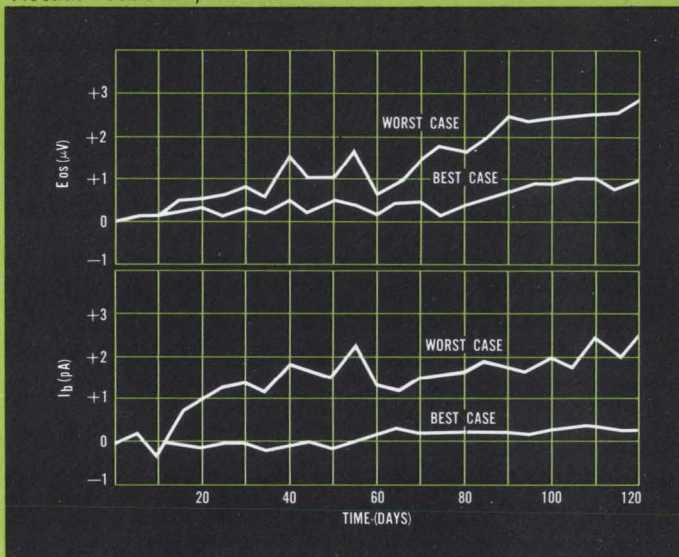

LOW VOLTAGE AND CURRENT NOISE

1Hz Noise Bandwidth

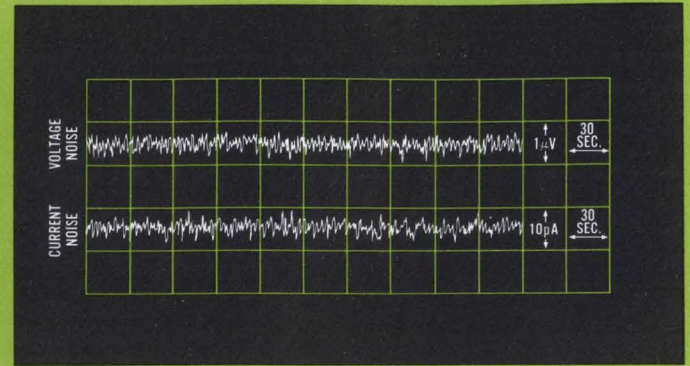

INITIAL OFFSET AND WARM-UP DRIFT

Typically Less Than 1μV

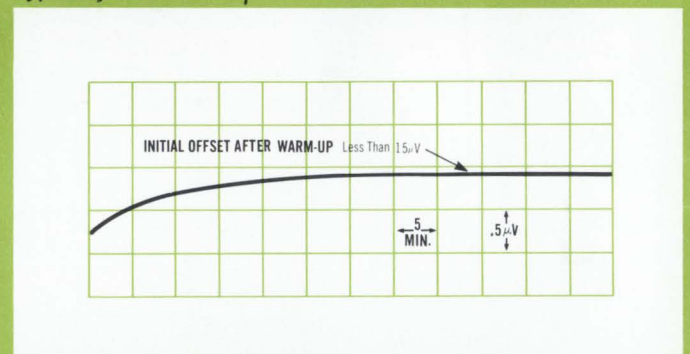

WHY USE CHOPPER STABILIZED AMPLIFIERS?

Some I.C. op-amps (and amplifiers built with "heated substrate" input stages) can yield low voltage drift characteristics, at least as regards temperature drift. The shortcomings of this approach show up in two areas:

- (1) Long term drift (over a period of months)
- (2) Bias current offset and drift (important for high impedance circuits)

For high performance applications the I.C.'s just don't measure up. A chopper stabilized op-amp is the only way to get low voltage and current drift and long term stability. Until now, chopper stabilized amplifiers were large, costly, and suffered somewhat higher noise levels than conventional amplifiers. The new 232 cures all these problems.

MAKE US PROVE IT!

Evaluation samples are now available . . . Use the attached "instant action" card or phone your local representative.

221 FIFTH STREET • CAMBRIDGE • MASSACHUSETTS 02164 • (617) 492-6000 • T W X: (710) 320-0326

INSTANT ACTION REQUEST

Please send 1969 catalog

Please send literature on Model 232J 232K

My interest is for:

231J 231K

Information only

Please send Evaluation Sample 232J 232K

Immediate application

231J 231K

Anticipated application

For 25 mA output specify model 231

Name	Title
Company	
Dept./Mail Station	Phone
Address	
City	State Zip

FREE
NEW
1969
CATALOG

This new 32 page catalog features 19 brand new products, includes detailed specs and application information on our complete op-amp line. Get your copy free . . . use the INSTANT ACTION card.

Well?

Gas discharge tube



Digivac S/G

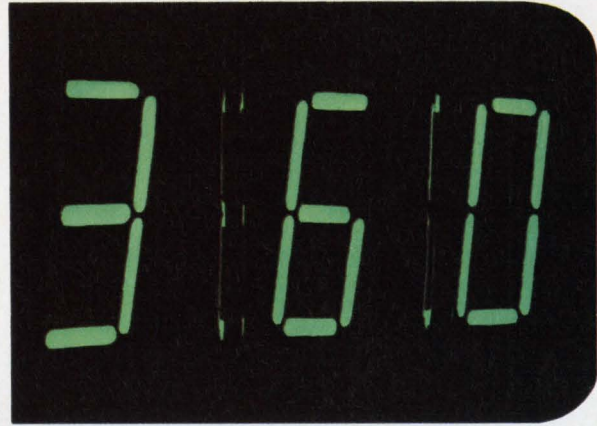

How's This for an Angle?

Parallax problems encountered when side-viewing gas discharge readout devices are eliminated by the design of the Tung-Sol Digivac S/G vacuum fluorescent readout. The segmented character is up front and the display is in a constant plane. The crisp, blue-green color of Digivac S/G is in sharp contrast to the "bloodshot eye" effect of the gas discharge tube. Legibility is consistently distinct, even at wide viewing angles. How wide? We say 150°, and we like to be conservative. For complete information, write for bulletin T436 which describes all the features of Digivac S/G readouts.

TUNG-SOL DIVISION / WAGNER ELECTRIC CORPORATION

630 W. MT. PLEASANT AVENUE, LIVINGSTON, N.J. 07039 TWX: 710-994-4865 PHONE: (201) 992-1100

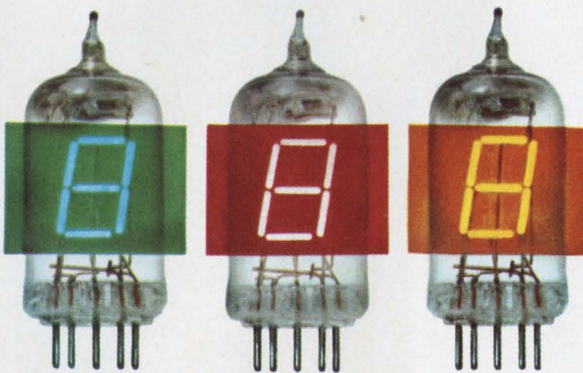

CHOICE OF COLOR WITH FILTERS

Simple filtering provides an almost unlimited choice of colors for identifying individual readout arrays.

TUNG-SOL[®] DIGIVAC S/G[™]

...the newest state
of the readout art

This, the second in a series of Licon heroics, bears little resemblance to the first episode.



Caution: Although Licon's Type 63 environment free sealed switch is rated at 60,000 feet, most angels are ineffective at such heights.

A Licon blimp at 3500 feet. Pity, the Hindenburg was not equipped with Licon switches.

Shown above, the Incredible Wazuma, master of disguise, cleverly camouflaging a Licon toggle switch

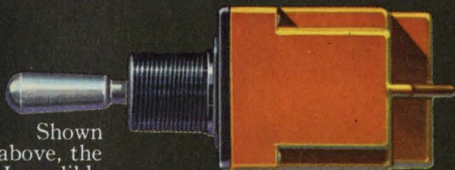

An incredible free offer is hidden somewhere on this page. Hint: look for a fish.



Actual size Type 18 double break sub-miniature switches with oak leaf cluster.

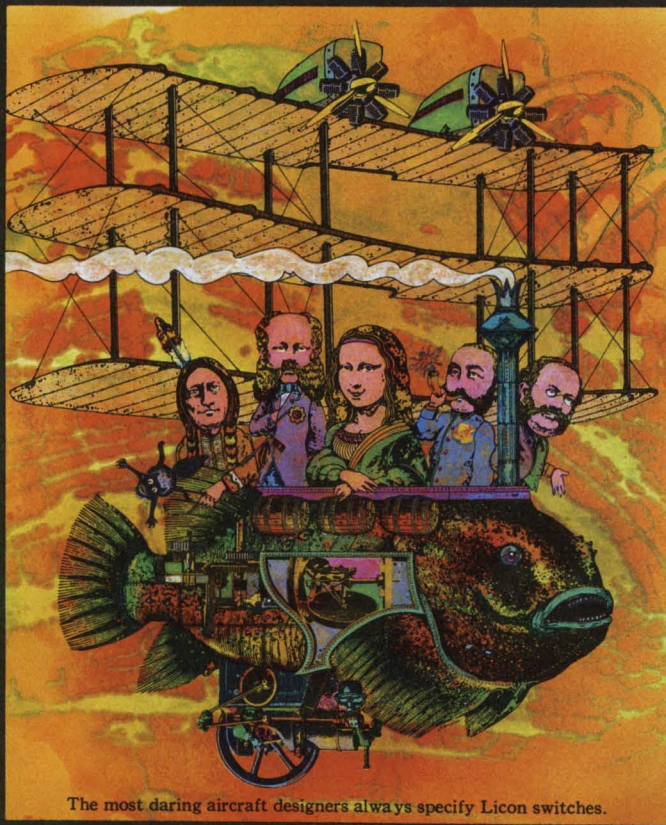

The most daring aircraft designers always specify Licon switches.

Free! Life size poster of the most amazing aircraft yet designed (shown here immediately before take-off). To get your very own space craft, write on your letterhead to: Licon Division, Illinois Tool Works Inc., 6615 West Irving Park Road, Chicago, Illinois 60634. Or circle No. 491 on the response card in the rear of this magazine.

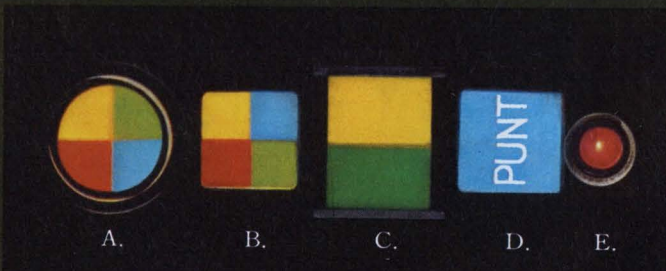

A. Licon's original Fly By Night Switch. The multi-colored Type 44 illuminated indicator.
B. Type 04 Four Lite illuminated pushbutton switch in actual use on the battlefield.
C. A Type 02 illuminated pushbutton switch shot in the dark.
D. Type 04 illuminated pushbutton switch in dress blue.
E. The tiny 01-700 lighted switch. (Toughest little fella in the squad.)

Licon's butterfly double break switches have a greater capacity than you could ever imagine—20 million mechanical cycles.



"For what military machines do we make Type 65 hermetically sealed switches?"
"Tanks."
"You're welcome."

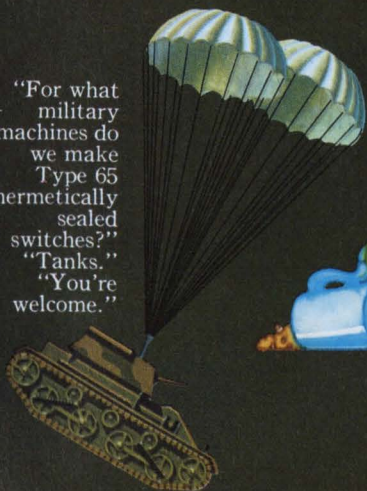

LICON
Division Illinois
Tool Works Inc.

MAGNETICS



The Bettmann Archive Inc.

BY ARNOLD

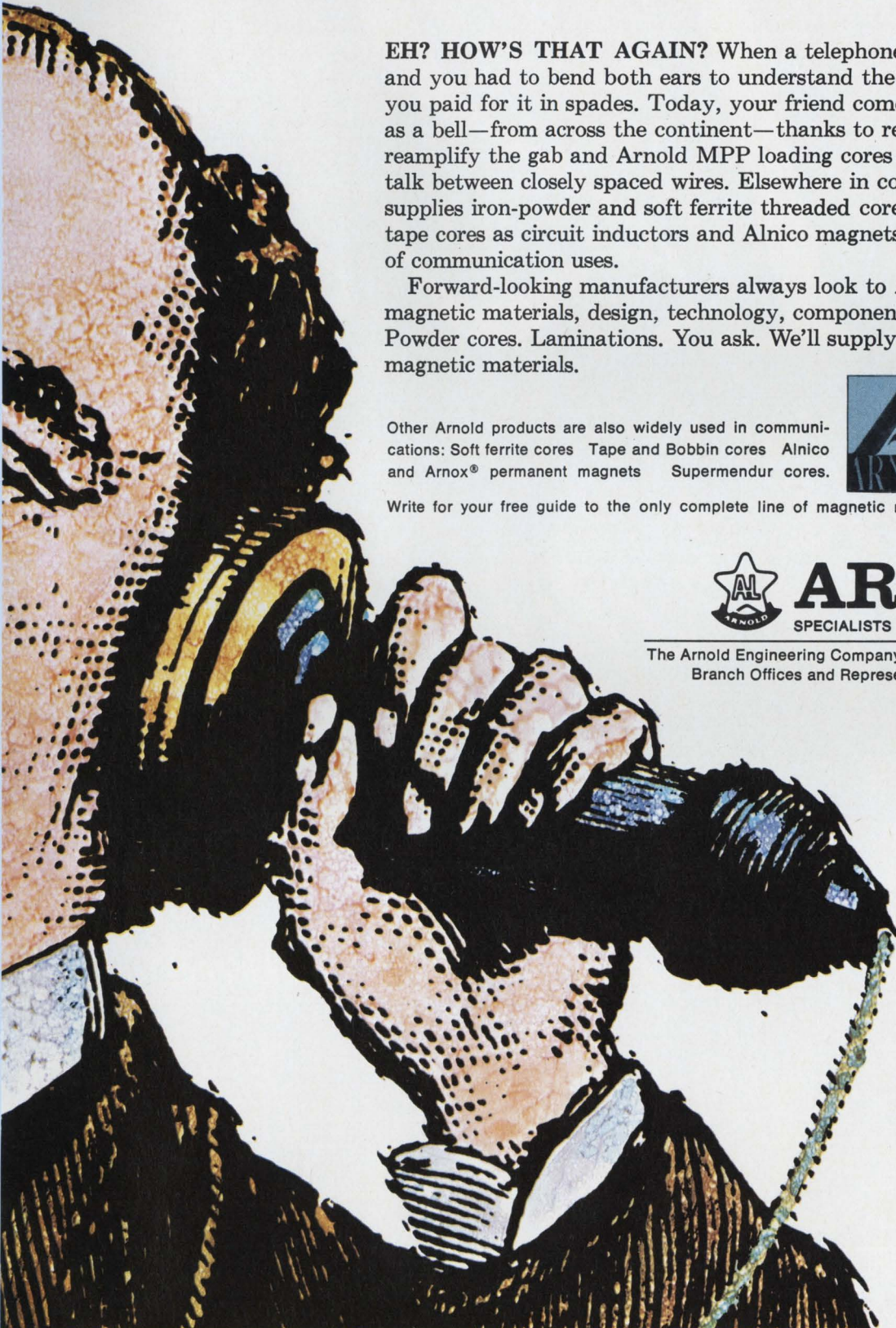

EH? HOW'S THAT AGAIN? When a telephone was truly a luxury and you had to bend both ears to understand the guy on the next block, you paid for it in spades. Today, your friend comes through clear as a bell—from across the continent—thanks to repeater coils that reamplify the gab and Arnold MPP loading cores that eliminate cross talk between closely spaced wires. Elsewhere in communications, Arnold supplies iron-powder and soft ferrite threaded cores for radio/TV, tape cores as circuit inductors and Alnico magnets for a host of communication uses.

Forward-looking manufacturers always look to Arnold for high-quality magnetic materials, design, technology, components. Magnetic cores. Powder cores. Laminations. You ask. We'll supply. The best in magnetic materials.

Other Arnold products are also widely used in communications: Soft ferrite cores Tape and Bobbin cores Alnico and Arnox® permanent magnets Supermendur cores.



Write for your free guide to the only complete line of magnetic materials.



ARNOLD

SPECIALISTS IN MAGNETIC MATERIALS

The Arnold Engineering Company, Main Office: Marengo, Ill.
Branch Offices and Representatives in Principal Cities



12

Ways to Solve

Cermet

POTENTIOMETER

PROBLEMS

*...All with TC of 150 PPM/°C Standard**

Model 3009

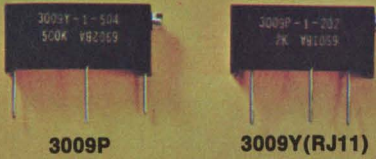

- Low Cost Industrial (RJ11 Pin Configuration)
- Power 0.75 watt at 25°C
- Resistance: 10Ω to 1 Meg.

Model 3069



- Low Cost Industrial
- Mil-Spec Immersion
- Power 0.75 watt at 25°C
- Resistance: 10Ω to 1 Meg.

Model 3282

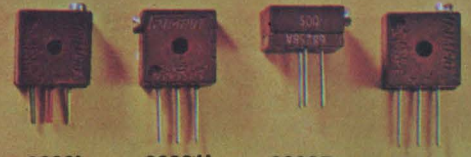

- Meets requirements of MIL-R-22097
- Power 0.5 watt at 85°C
- Resistance: 10Ω to 1 Meg.

Model 3012

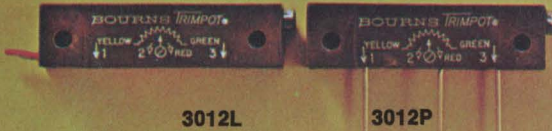

- Meets or exceeds MIL-R-22097, Style RJ11
- Power 1.0 watt at 70°C
- Resistance: 10Ω to 1 Meg.

Model 3052



- Meets or exceeds MIL-R-22097, Style RJ12
- Power 1.0 watt at 70°C
- Resistance: 10Ω to 1 Meg.

Model 3262

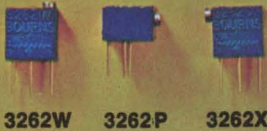

- Meets or exceeds MIL-R-22097
- Power 0.25 watt at 85°C
- Resistance: 10Ω to 1 Meg.

Model 3252

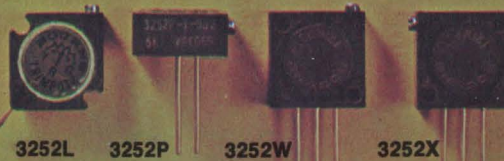

- Meets or exceeds MIL-R-22097, Style RJ22
- CRV 1.6% over entire resistance range
- Power 1.0 watt 70°C
- Resistance: 10Ω to 2 Megs.

Model 3099



- First Dual In Line Cermet Available
- Std DIP size (TO-116)
- Sealed to meet MIL-R-22097 Immersion
- Power 0.75 watt at 25°C
- Resistance: 10Ω to 1 Meg.

Model 3059

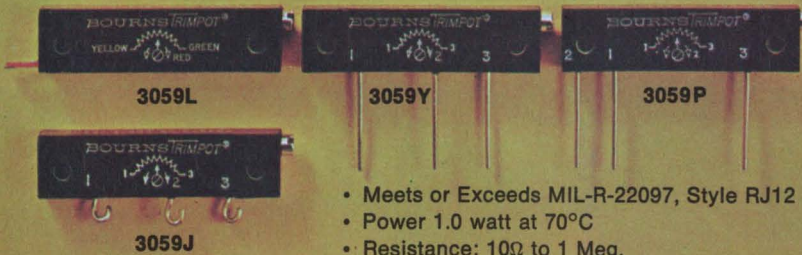

- Meets or Exceeds MIL-R-22097, Style RJ12
- Power 1.0 watt at 70°C
- Resistance: 10Ω to 1 Meg.

Model 3292

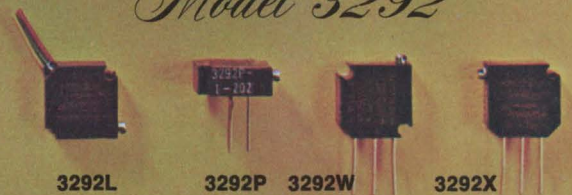

- Meets or exceeds MIL-R-22097, Style RJ24
- Power 0.5 watt at 85°C
- Resistance: 10Ω to 1 Meg.

Model 3082

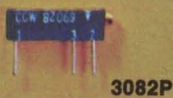

- Only .10" x .15" x .50"
- Power 0.3 watt at 85°C
- Resistance: 10Ω to 1 Meg.

Model 3329



- First Commercial single turn to meet or exceed MIL-R-22097
- Only 0.25" dia. x 0.18" high
- Power 0.5 watt at 70°C
- Resistance: 10Ω to 1 Meg.

For a detailed package of technical data on the entire line of TRIMPOT® cermet potentiometers write or call the factory, your local field office or representative!



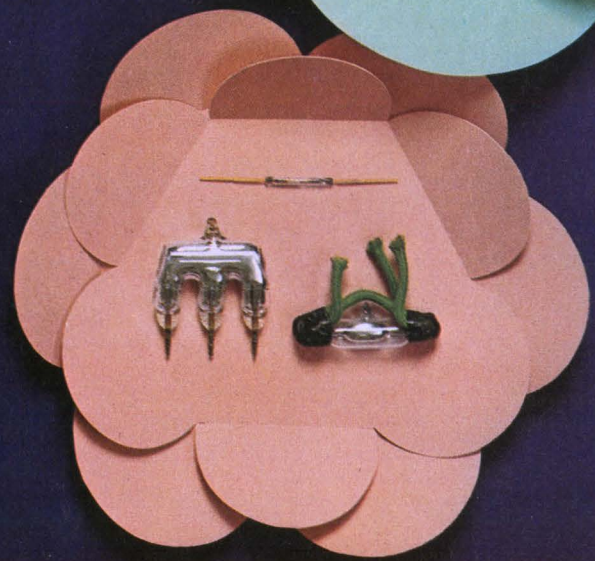
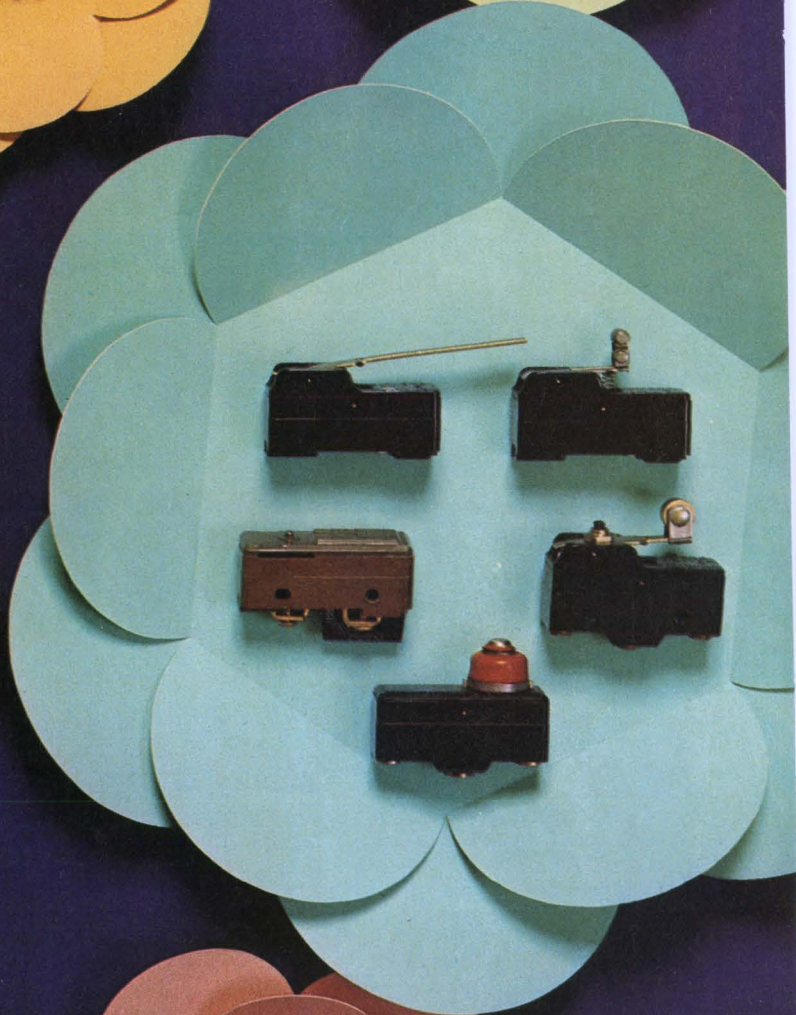
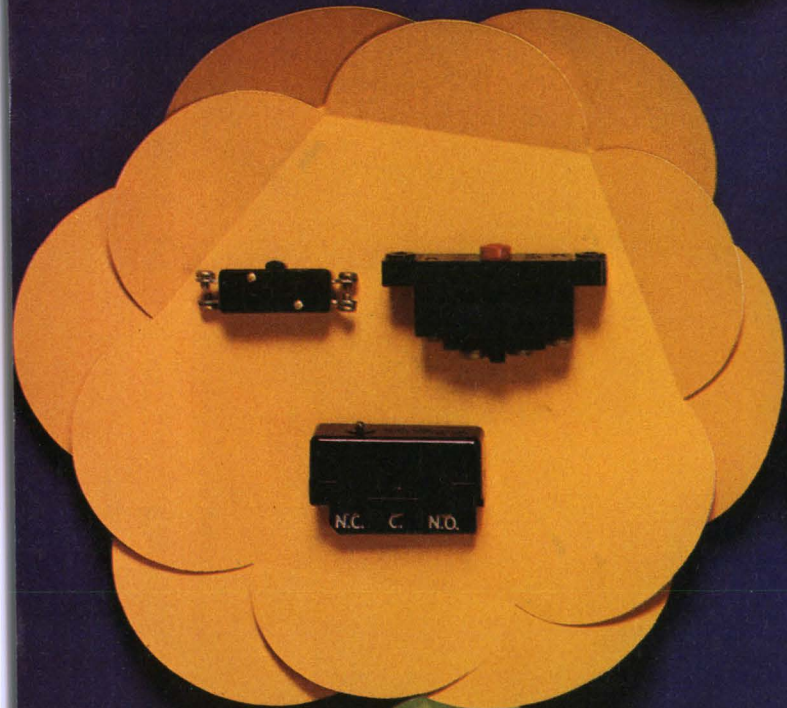
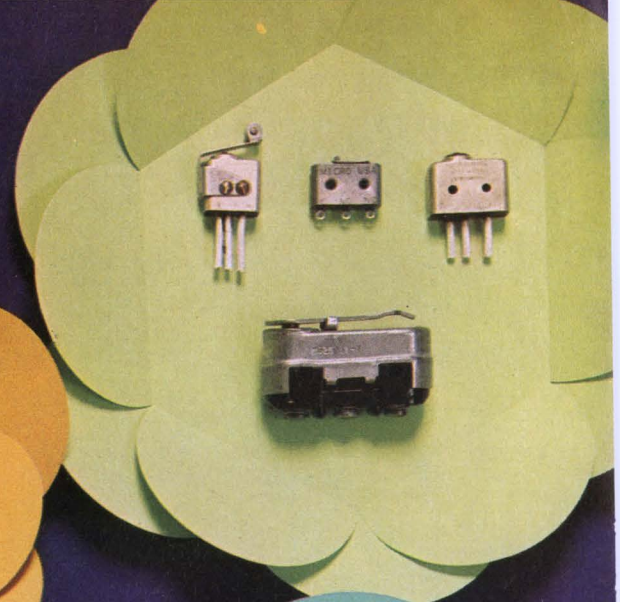
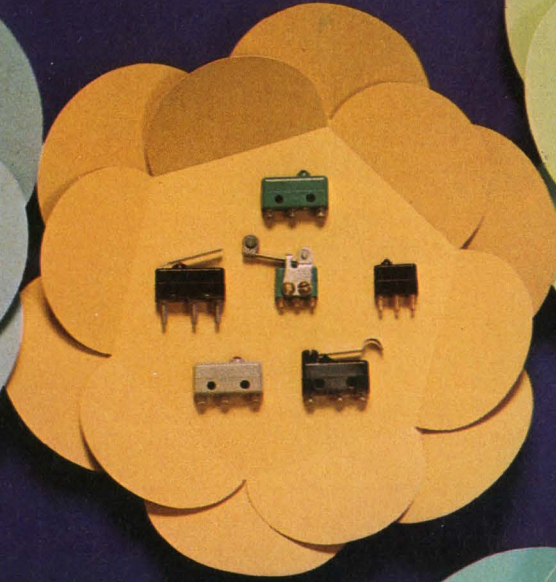
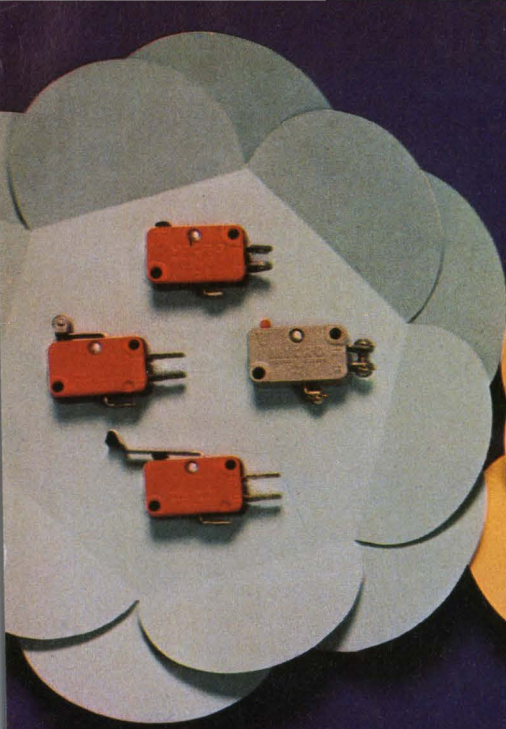

Basic Switches?

Go where you can pick from the whole blooming family.

You won't miss out on the latest in basic switches when you come to MICRO SWITCH. Here you can make your selection from the world's largest family. Thousands of subtle variations help you meet any combination of requirements—size, weight, circuitry, electrical capacity, actuation, termination and environmental resistance.

For example, there are switches especially sealed to do the job in highly contaminated environments; switches that operate efficiently at temperatures as severe as +1000° or -320°F; electrical loads from milliamp to 25 amps, 125 vac, or 10 amps, 125 vdc. A large number meet military specifications.

But you can expect much more when you come to MICRO SWITCH. For instance, extra assurance of consistent quality throughout a large quantity run. Or

the certainty that a switch will deliver precise operating characteristics throughout a long life. Perhaps what's essential to you is the convenience of local distributors with complete selections on the shelf—or, on the other hand, world-wide availability! If on-time deliveries are critical to you, you'll be interested in our computer-controlled ordering, inventory and production control system. Finally, should you have special design problems, our engineering field service—the largest in the industry—specializes in coming up with the right solutions.

Shown at left and described below are just a few members of our ever-blooming family of basic switches. For additional information, call a Branch Office or Distributor (Yellow Pages, "Switches, Electric"). Or write for Catalogs 50 and 52.

A. Type V3 Basic Switches—Small, versatile precision switches. Over 500 standard designs, including many actuator and terminal variations. Operating force as low as 10 grams, differential travel as small as .002 inch. Rating up to 15 amps 125 vac. SPDT, SPNO or SPNC. Temperature range up to 600° F. Military listed. Case size 1.09 x .62 x .40 inch.

B. Subminiature Basic Switches—Precision operation with minimum space and weight. Variety of actuators, terminals and characteristics. Silver or gold contacts, and bifurcated contact design for reliable low energy operation. Military listed. Type SM: Case size .78 x .35 x .25 inch, up to 10 amps 125 vac. Type ISX: Case size .50 x .35 x .20 inch, 7 amps 125 vac.

C. Sealed Basic Switches—Small switches for reliable military/aerospace use and other applications requiring environmental protection. Types XE and SE are classed watertight (Symbol 3, MIL-S-8805), with a corrosion-resistant metal housing, molded silicone rubber plunger seal, and terminals encased in epoxy resin. Types HM and HS feature true hermetic sealing (Symbol 5, MIL-S-8805), with metal-to-metal and glass-to-metal fusion. Solder or leadwire termination.

D. Special Circuitry Basic Switches—Simplify circuit design and eliminate extra wiring. Type "DT": DPDT. Type TB: 2-Ckt and 4-Ckt Double-Break. Type MN: 2-Ckt Double-Break. Also dual SPDT assemblies, make-before-break, pulse operation, and sequential action types.

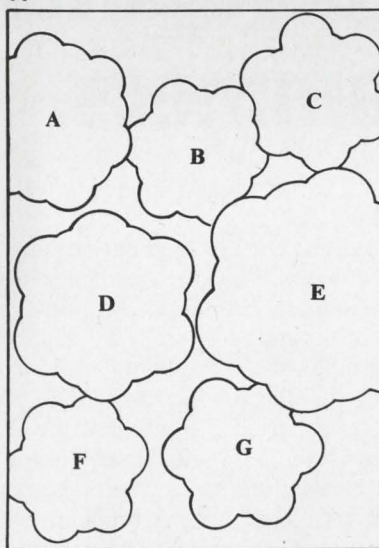

E. Standard Basic Switches—The maximum in precise operation, accurate repeatability, long life and high electrical capacity. Thousands of proven designs available. Variety of actuators and terminals. Case size: 1.94 x .95 x .68 inch. SPDT, SPNO or SPNC. Momentary or maintained contact. Type Z: 15 amps; Type A: 20 amps; Type M: 22 amps; Type E: 25 amps; each at 125 vac. Type MT: 10 amps 125 vdc.

F. High Temperature Basic Switches—Type HT switches withstand +1,000°F and -321°F. Available with panel-mount push-plunger or roller-plunger, or side-mount with auxiliary actuators. Corrosion and shock resistant.

G. Glass-Enclosed Switches—Hermetically sealed contacts for extra reliability and long life. Modern automatic equipment assures product uniformity in large quantity production. Type AS mercury switches: low force, tilt operation; SPST, SPDT, or 2-Ckt; rating up to 70 amps 30 vac; variety of operating characteristics. Type CS miniature reed switches: Form A or Form C; outstanding long life/high capacity combination—up to 100,000,000 cycles at 10 watts; and high reliability on micro-volt or micro-ampere circuits.

MICRO SWITCH

FREEPORT, ILLINOIS 61032

A DIVISION OF HONEYWELL

HONEYWELL INTERNATIONAL: Sales and service offices in all principal cities of the world. Manufacturing in United States, United Kingdom, Canada, Netherlands, Germany, France, Japan.

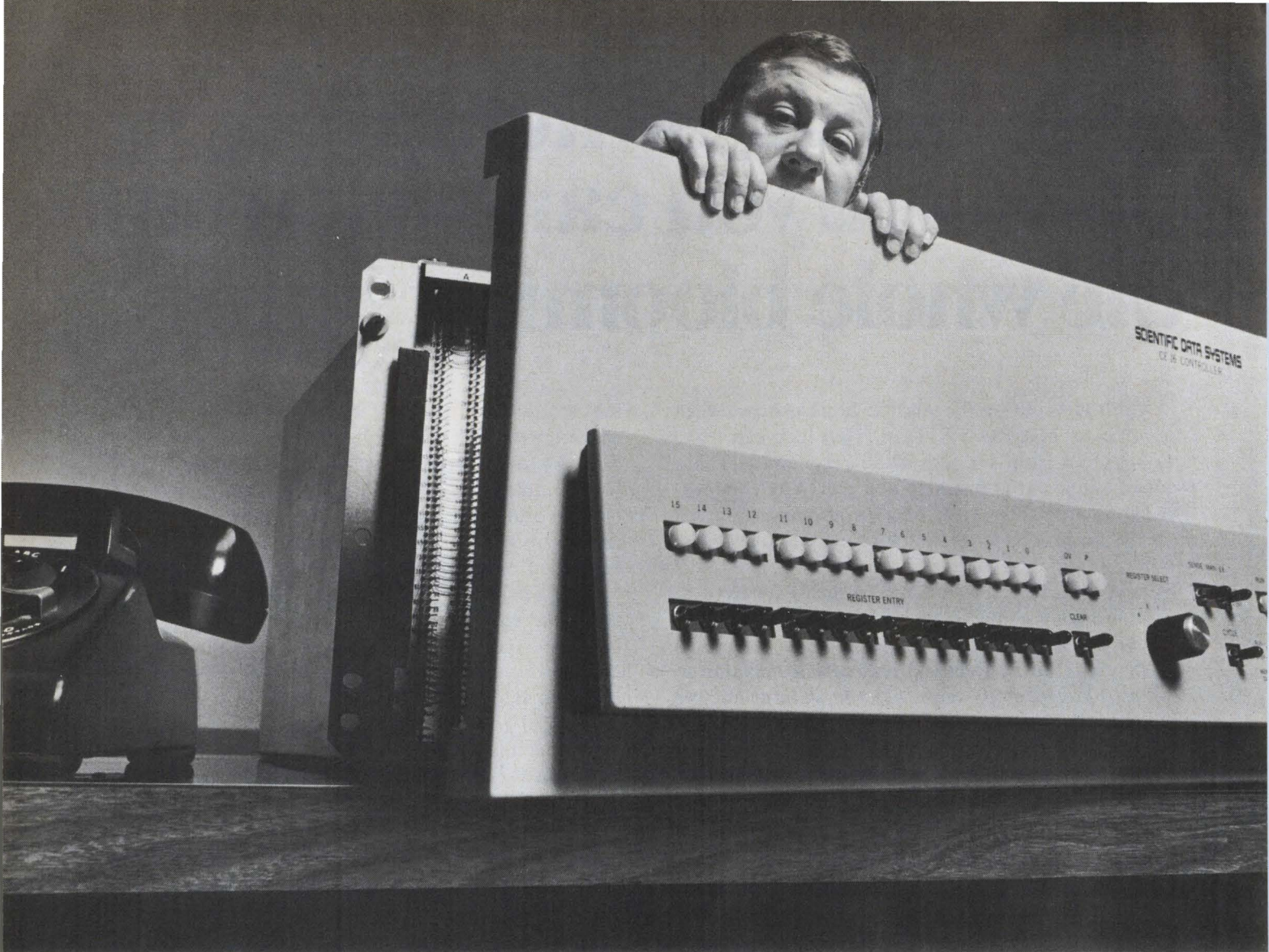

Our new mini-computers have built-in programmers.

Most small computers are designed for programmers. Ours are designed for people.

Just tell our 16-bit machines what you want done. The CE16 and CF16 will do it, because their "built-in programmers" (a comprehensive set of sophisticated instructions) let any engineer use them with ease. For example, the single instruction "scan memory" makes our machines compare a given number with the contents of the entire memory.

The CE16 and CF16 have 125 other heroic instructions that specify comprehensive maneuvers. So you give fewer instructions and use far less core memory than with any other small computer. Problem run times are shortened and Input/Output operations are simplified.

The CE16 and CF16 are designed to control and exchange information with a large number of external devices while doing related computation. Their "automatic I/O" enables them to talk back and forth between memory and a group of interrupting peripherals, in order of priority,

without needing attention from the on-going program.

Automatic I/O isn't a high priced option. Neither is a teletype, nor three priority interrupts, one of which is indefinitely expandable. They're all standard. The only thing you might pay extra for is speed. The CF16 can do a fully signed software multiply in 42 micro-seconds. But it costs a little more than the CE16 which takes 126 micro-seconds (which isn't bad) for the same job.

Don't take our word for all this. Drop us a line asking for:

- A brochure with straight from the shoulder specs so you can compare.
- A representative with more information than could fit in a brochure.
- Or a meeting between our sales engineer and one from any competitor you want, at your office. The competition can even bring a programmer along. We won't have to.

SDS
Scientific Data Systems,
El Segundo, California

Short circuits snag Illiac 4 program

Medium-scale IC's, ordered from TI, have been dropped from Illinois' supercomputer; size and cost problems loom as Burroughs shops for second source of standard IC's

Illiac 4, the University of Illinois' supercomputer designed to execute up to a billion instructions per second, may never get up to speed. As a matter of fact, it's now possible that the system may follow its predecessor, Illiac 3, into partial oblivion [*Electronics*, Oct. 14, 1968, p. 56]—although no one directly connected with the project is quite this pessimistic.

While Illiac 4 has been tagged all along by some as a technological white elephant [*Electronics*, May 15, 1967, p. 141], its current woes stem from skyrocketing costs and some unexpected difficulties experienced by Burroughs, the prime contractor, and its subcontractor, Texas Instruments, with the medium-scale integrated circuits from which the huge parallel-processing system was to be built.

Illiac's speed was to be obtained by simultaneously putting as many as 256 conventional machines to work on different portions of the same problem. For smaller problems, the array would be divided into 64-processor quadrants and a single control unit.

Inflationary spiral. The MSI circuits originally planned are now out and it is the shift to standard IC's that some people believe may make the billion-per-second execution rate unattainable. Moreover, money problems could conceivably kill the complete 256-processor system. Already, costs have risen from the initial estimate of \$14 million for the entire system to \$26 million for the single quadrant (64 processors) section—the only part of the project that's been funded so far. Simply extending this figure would push the total system price to over \$100 million.

The three remaining Illiac 4 quadrants, which are not yet

funded, could well be casualties, even though a top official in the Pentagon's Advanced Research Projects Agency, which is footing the bill, believes the entire system is still a "perfectly viable program."

In the lurch. Much to the dismay of Burroughs and Illinois, TI dropped the MSI project altogether; then early this year, the decision had to be made to eliminate MSI from Illiac 4. The original contract called for TI to furnish complete 80-pin packages which were made up

of several MSI chips on a single substrate. TI will say only that "the work stopped because of time, schedule, and cost requirements for the program. All of this was not compatible with what was required to develop the technology."

Burroughs adds to that: "It recently became evident that MSI of the very high-speed logic would not be available economically on a schedule compatible with planned completion of Illiac 4." Nevertheless, the company admits that the "circuit change has resulted in a delay in delivery and resulting increase in development cost."

Burroughs wanted emitter-coupled logic, for which TI had a well-established and growing capability. But TI, according to one report, didn't deliver a single MSI circuit to Burroughs. The company reportedly shipped some standard ECL IC's for breadboarding, but these had a failure mode. This source says TI's MSI problems were threefold: yield, test, and the substrate. TI denies any problems with testing, saying "the job never got to the test stage." Other sources say that the company couldn't cope with the circuit's power dissipation or had difficulty with multilayer interconnections.

Another observer in the semiconductor industry claims the circuits were so badly designed to start with that when an open bidders' conference was held a few months ago in the hopes of getting a second source for the TI design, he doubted that anyone bid to such a spec.

Solo. A computer industry source says the big reason TI got the Illiac 4 contract from Burroughs was because it was the only bidder. This man, who is not with Fairchild, notes Fairchild Semiconductor tried to convince Burroughs to

Into the breach?

In an attempt to recoup some of the lost space and speed on Illiac 4, as well as to cut costs, Burroughs and the University of Illinois are seriously considering going to semiconductor memories in place of the magnetic thin-film units that were originally planned.

Burroughs put out a request for quotes several months ago for up to 256 semiconductor memories of 2,048 words (64 bits), one for each processor. Five companies were said to have responded, including TI, National Semiconductor, and Fairchild Semiconductor. The Fairchild entry is a large bipolar memory with some complementary transistor logic in the peripheral circuitry. Cycle time is 200-250 nanoseconds.

Going to semiconductor memories would, it is hoped, offset part of the higher costs resulting from the use of standard ECL IC's rather than MSI. The move would also help take some of the curse away from increase in system size that will stem from going to standard ECL circuits.

For some time now, Burroughs has been telling bidders that the award was "imminent," but so far, none has been made.

U.S. Reports

switch to its complementary transistor logic—conventional NAND/NOR logic with an emitter-follower output stage using both pnp and npn transistors.

Burroughs is now pushing ahead as well as it can, using off-the-shelf ECL logic in dual-in-line packages. Because a given amount of logic takes a lot more room to package in standard IC's than in MSI, Burroughs is having to redesign the logic. Aside from being a costly proposition, this rework tends to slow down the entire machine. Moreover, going the "discrete IC" route means that the size of the Illiac 4 processors will be boosted by as much as from 15% to 20%.

TI says it is now delivering to Burroughs custom ECL circuits with "complexities that approach

MSI." However, a knowledgeable insider says these dual-in-line packages are really discrete IC's with a complexity of about three gates.

Solicitations. There's no question that Burroughs and Illinois will finally decide on two sources, particularly in the light of their experience with TI. And some months ago, another request for quotes went out to industry on the ECL IC's. The field has now been narrowed down to three or four companies, and a decision on procurement is expected within the next week or two. As it happens, however, there's also little doubt that TI will be one of the suppliers.

Daniel L. Slotnick, head of the Illiac 4 project at the university, won't comment on current problems or delays. But scheduling on

the program has certainly slipped. Although he originally expected to have his system running this year, Slotnick won't get it, at best, until late next year.

Components

Taking the (beam) lead

Although some firms, Raytheon and Signetics among them, are either shipping beam-lead integrated circuits to selected customers or at least promising to do so soon, very little has been heard about the commercial beam-lead IC plans of the three companies funded by Western Electric to develop such circuits for the Sentinel Safeguard ABM program: Motorola, RCA, and Texas Instruments.

However, Motorola is now taking the wraps off its plans to market the commercial fallout from its Safeguard effort. James Newton, operations manager for the program at the firm's Semiconductor Products division, says Motorola will be the first of the three firms to introduce standard commercial IC's based on the Bell Labs' process that puts gold on silicon-nitride-passivated chips [*Electronics*, Nov. 25, 1968, p. 72]. Motorola expects to announce some new members of a transistor-transistor logic family before year's end, and will probably introduce at least one beam-lead linear integrated circuit at the same time.

Newton won't say which of the TTL lines Motorola makes—Sylvania's SUHL families, TI's 5400 or 7400 series, or its own MTTL 3—will be the first chosen for beam-lead treatment. "The only special processing required is to make the beam leads and put on the silicon nitride," Newton says, "so we can choose any of the basic TTL diffusions."

Easy choice. He explains that TTL was tapped for beam leading because of its popularity and because Motorola engineers expect to encounter power-dissipation problems when beam leads are put on the emitter-coupled logic lines. Newton is quick to add that the seriousness of this problem isn't

Electronics Index of Activity

April 14, 1969

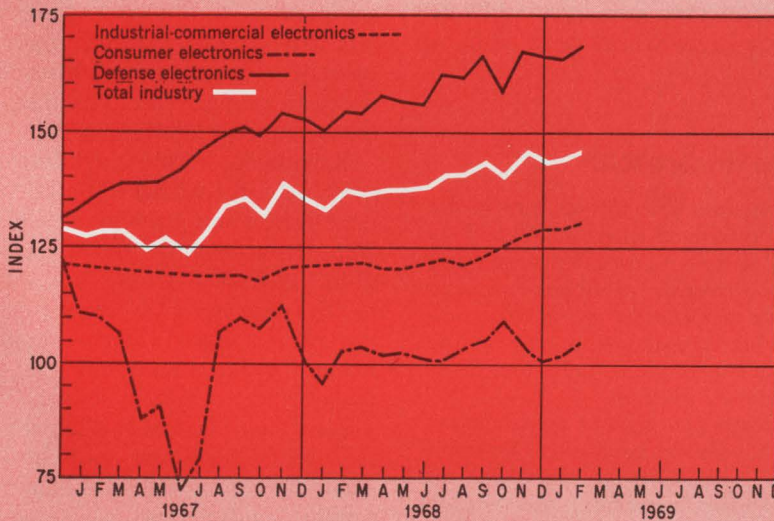

Segment of industry	Feb. 1969	Jan. 1969*	Feb. 1968
Consumer electronics	105.1	102.1	103.2
Defense electronics	168.2	165.9	155.3
Industrial-commercial electronics	130.5	129.0	121.3
Total industry	146.4	144.2	136.5

The index of production inched up 1.5% (2.2 index points) in February from January and 7.3% (9.9 points) from February 1968. The January figures were revised sharply downward because of a reduction in defense production. Each of the three major sectors contributed to the over-all gain. Consumer output rose 3% (3 points) from the previous month, while defense gained 1.5% (2.3 points) and industrial-commercial 1% (1.5 points). Industrial-commercial volume is expected to continue to advance over the next several months; private and Government surveys of plant and equipment expenditures indicate significant gearing up in this field.

Indexes chart pace of production volume for total industry and each segment. The base period, equal to 100, is the average of 1965 monthly output for each of the three parts of the industry. Index numbers are expressed as a percentage of the base period. Data is seasonally adjusted.
* Revised

Only one man in a thousand needs this kind of flexibility in an angle position indicator...

(the other 999 relax knowing it's there.)

Available with single or dual synchro/resolver inputs, 2-speed synchro input, multi-frequency inputs, and retransmit components (synchro, resolver, potentiometer or shaft-encoder).

Half-rack configuration, designed to MIL-T-21200. Servo amplifier, power supply, and optional signal-conditioning circuitry are supplied as plug-in modules for easy field maintenance.

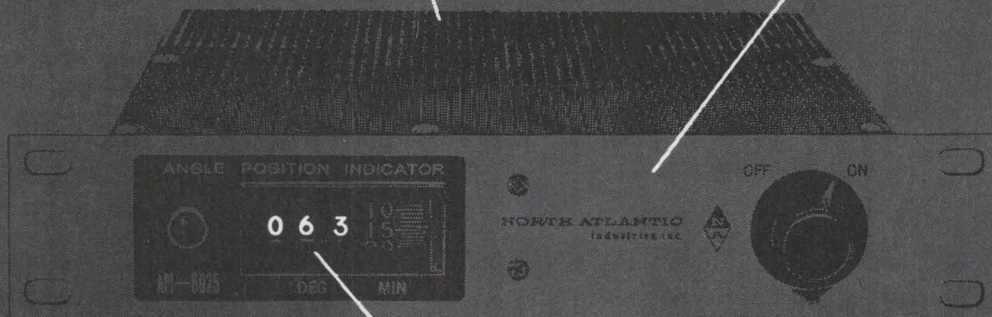

Provides continuous 0° to 360° digital readout of remote synchro or resolver shaft angle with 30-second resolution and repeatability. Accuracy 6-minutes. Servo slew speed 25°/second.

The North Atlantic Model API-8025 Angle Position Indicator is another example of the versatile and elegant concepts from North Atlantic Industries in instrumentation and control systems.

For additional, rewarding details call a field-engineering representative (see EEM), use the reply card or call or write North Atlantic Industries, Inc., Terminal Drive, Plainview, Long Island, N.Y. 11803. (516) 681-8600.



NORTH ATLANTIC
industries, inc.

U. S. Reports

yet known because it's difficult to measure dissipation on the beams. "We may be able to get around it by using wider beams," the manager says.

The TTL devices will be offered in quarter-inch-square flatpacks and in chip form, and will be aimed at customers making high reliability military equipment and those in the multichip hybrid business. "The main thing we'll be offering," says Newton, "is the reliability of the silicon-nitride and all-gold system. We'll be selling a chip with the equivalent reliability of a hermetically sealed package, and the multichip people working with large arrays may be forced to beam leads because it's difficult to obtain hermeticity in the large packages they use.

"We're satisfied that the technology does what it sets out to do," he continues. "We do 300°C back-bias tests on a few dice from each wafer after they've been sprayed with salt water. The devices take it quite nicely. The nitride-and-gold arrangement largely escapes the electrolytic effects and plague of two-metal systems. The only problem is that it's expensive."

Keeping abreast. A finished beam-lead IC in a flatpack will be competitive in price with similarly packaged high-reliability components without beam leads, according to Newton. As for chips, he predicts that the price will be about the same as customers would pay for a standard device in a flatpack that had undergone extra testing. He expects Motorola to sell more unpackaged devices than packaged ones at the outset because of the interest expressed in beam leads by multichip users.

Motorola has its sights on about \$1 million worth of business in commercial beam-lead IC's next year, but Newton considers that a conservative target. He estimates that volume could grow to \$20 million by 1975. What device types the company introduces after its initial beam-leaded TTL circuits will depend on how low costs can be held. If they can be kept low enough, Newton says, Motorola may then market a device family that can go in plastic packages.

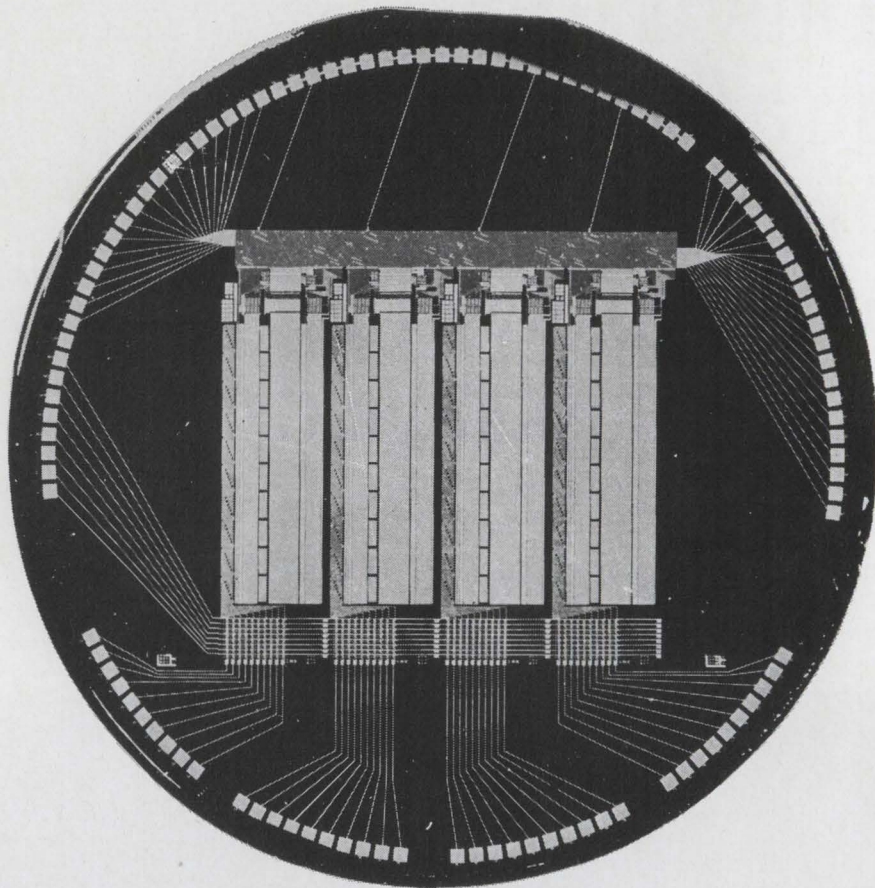

Dish. Litton's 1.5-inch wafer has about 20,000 MOS FET's storing 10,000 bits. IC drivers are across top, selection circuitry at bottom.

Memories

Digging in data

Nonvolatile semiconductor memories—memories that don't lose their data during a power interrupt—are unusual. There are some read-only types, but officials at Litton Industries' Guidance and Control Systems division believe they have the jump in developing a first in semiconductor storage—a nonvolatile and alterable unit.

Litton does it by applying a layer of silicon nitride as a gate dielectric to the wafer containing the metal oxide semiconductor field effect transistors. The nitride acts as both insulator and storage medium. William L. Patterson, manager of semiconductor research in the Applied Research Laboratory, says the nitride insulator has roughly the same electronic structure as a semiconductor, except that the nitride's conduction and valence bands are much farther apart. Between the

bands are discrete centers, or traps, that store one or two electrons.

"Once trapped," says Patterson, "these electrons stay in the trap. And with silicon nitride, their willingness to stay in the traps for periods of years is the basis for the long-term storage mechanism." Patterson explains that when an electric field of 3×10^6 volts per centimeter (an external voltage of 20 to 40 volts) is applied to the nitride, "there's a dramatic increase in the probability that the trapped electrons will leave the trap by tunneling into the bulk silicon."

Two of three. This means that a field greater than 3×10^6 volts per centimeter is needed to write data into the memory by tunneling, which is why the phenomenon is called "tunneling" or "charge storage" memory. Whether a 1 or a 0 is written is determined by whether the charge is moving into or out of the nitride traps; that, in turn, is dictated by the polarity of the charge. Negative voltages are used

Pick the
BEST IC
for the job

Problem: Four DC to 30 kHz signals from high impedance sources must be summed into a $2k\Omega$, 100 pF load. The output is to be a guaranteed minimum ± 12 volts over the full frequency and military temperature range. The logical choice would be a Radiation RA-909. But amplifier offset current drift must not exceed $2 \text{ nA}/^\circ\text{C}$. Pick the Best IC for the job.

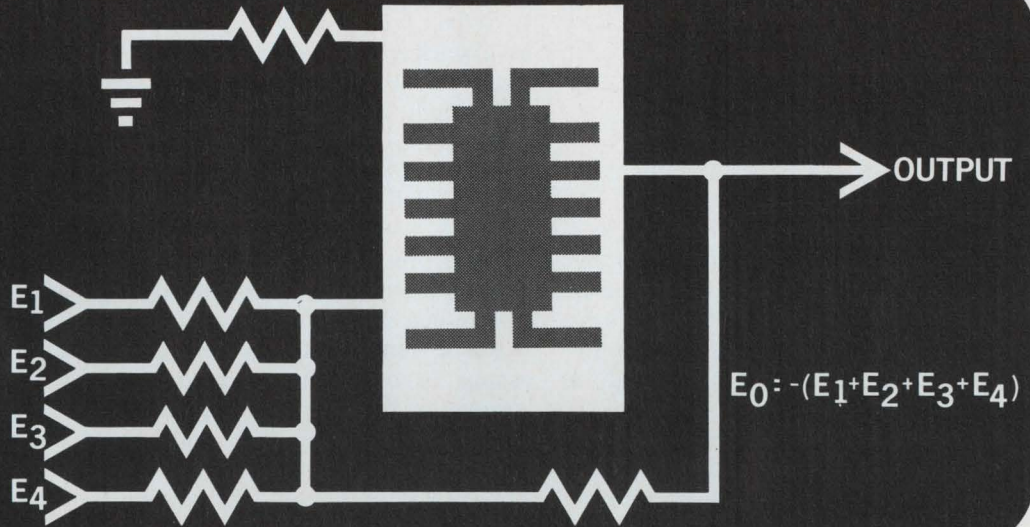

the **BEST** Solution:

THE NEW RA-909A COMPENSATIONLESS OPERATIONAL AMPLIFIER

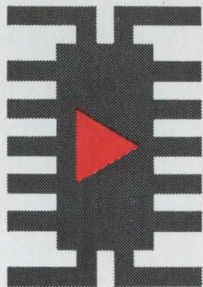

Drift error is very low in the new dielectrically isolated compensationless RA-909A. Between -55°C and $+25^\circ\text{C}$ offset current drift is a low $2 \text{ nA}/^\circ\text{C}$. From $+25^\circ\text{C}$ to $+125^\circ\text{C}$... an even lower $0.5 \text{ nA}/^\circ\text{C}$! And Radiation guarantees less than $15 \mu\text{V}/^\circ\text{C}$ offset voltage drift over the military temperature range. Compare this performance with any 709 type op amp over this extremely wide operating frequency range. You'll pick the Best op amp for the job. The RA-909A.

Like the RA-909, no external compensation is needed. Dielectric isolation and good circuit design eliminates the need for compensation. The RA-909A is in both a TO-99 package and a TO-86 flatpack configuration. A direct replacement for 709 type op amps.

Contact your nearest Radiation sales office. Let us help you pick the Best IC for the job.

WE MAKE THE **BEST** IC FOR THE JOB



RADIATION
INCORPORATED

SUBSIDIARY OF HARRIS-INTERTYPE CORPORATION
MICROELECTRONICS DIVISION

RADIATION SALES OFFICES: P. O. Box 476, Lexington, Mass. 02173, (617) 862-1055 • 600 Old Country Road, Garden City, N.Y. 11530, (516) 747-3730 • 2600 Virginia Ave. N.W., Washington, D.C. 20037, (202) 337-4914 • 6151 W. Century Blvd. Los Angeles, Calif. 90045, (213) 670-5432 • Saratoga, Calif., (408) 253-5058 • P. O. Box 37, Melbourne, Fla. 32901, (305) 727-5430 • International Sales: Marketing Department, P. O. Box 37, Melbourne, Fla. 32901, (305) 727-5412

U. S. Reports

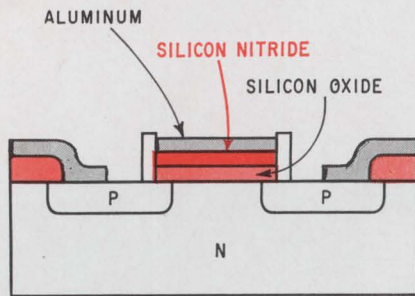

Hero. Typical MOS FET in Litton tunneling memory.

to write data into the memory; a positive voltage applied between the gate and substrate will clear all the bits in one line of the memory.

The amount of the charge determines the transistor threshold. A transistor in the 0 state has a threshold of -3 volts; a device in the 1 state has a threshold of -10 volts. The memory can be interrogated by applying a gate voltage about midway between the two, or -6 to -7 volts. This level will turn on a transistor in the 0 state but not in the 1 state. Thus, the binary value of the stored information can be determined when a bit location is sensed.

Patterson says that silicon nitride alone or nitride with an undercoating of silicon dioxide is used in wafer processing, "depending on which part of the read-write-retention tradeoff you want to optimize. You can have any two of them. You can write and read fast if you settle for a short retention time. You can write fast and retain data for long periods if you read slowly, or you can read fast and retain for long periods if you're willing to write slowly."

The tradeoff considerations suggest two kinds of applications for a tunneling memory: an alterable read-only memory for microprograms in general business machines—initially in peripheral computers—into which data is written slowly, can be retained for long periods, and read quickly; or a scratchpad for a general-purpose computer with a short retention time but fast read and write capabilities. The retention time could be that required for an airborne mission—about a week, Patterson says.

Although Litton researchers have

written individual bits in as little as 0.25 microsecond, the minimum time for writing or reading in a 100-word memory will be about 1 μ sec because of the use of all-MOS address circuitry to keep costs down. Litton has outside funding to deliver within a year a prototype of a packaged memory with a capacity of 20,000 to 40,000 bits per cubic inch that works at MOS computer logic levels of -6 to -27 volts. After that, Patterson says, extension of the technology to a million bits per cubic inch "is pretty straightforward and we'll pursue it as soon as the present commitment is completed."

For 2 cents fancy. Wafer processing is a simple extension of conventional MOS processing techniques. Reading, writing, and addressing circuitry are all on the same piece of silicon. "There's no problem putting nitride gates and oxide gates on the same chip as long as the nitride is kept away from the bulk silicon," says Patterson.

The Litton researcher estimates that the tunneling memory will cost twice as much as conventional MOS memory—or about 2 cents per bit even for small memories—in two years or so. He says this is about a fifth the cost of magnetic nonvolatile memories and adds that Litton test results going back more than two years indicate that data can be retained for days to years.

Litton isn't alone in developing this type of memory. Patterson says both Sperry Rand and Westinghouse have been funded for similar efforts, but he believes Litton has an advantage over Sperry based on published data showing that 83 volts applied for 10 μ sec as a writing pulse produced a threshold shift of 5 volts; Patterson says Litton gets the same shift in the same time with just 29 volts. He points out that IC drivers can't handle 83 volts but will accommodate 29, so he feels Litton is ahead in large arrays that need integrated read-write electronics on the same chip with the memory elements. Patterson says he has no basis for comparison with Westinghouse because he hasn't seen any published Westinghouse data.

Consumer electronics

Stretch

Nearly two years after the first announcement, a tape machine has arrived which is not only aimed at making recordings quiet, but also at obtaining a nearly professional performance at 3.75 inches per second. The machine is the Model 40 built by the KLH Research and Development Corp., and it uses the so-called Dolby system, developed in 1966 by Ray M. Dolby, an American engineer working in England. Basically, the system reduces noise.

Talks between KLH and Dolby started in 1967 [*Electronics*, June 12, 1967, p. 40], but a management shakeup at KLH, some disagreement over licensing terms, and redesign of the basic system slowed development. Not only that, but KLH's plan to also offer a Dolby "black box" for connection to existing machines has been shelved. The Model 40 is to sell for \$600.

Ever since the 1950's, 7.5 ips has been the most used home tape recording speed. Slower speeds long have been available, but signal-to-noise ratios were poor and bandwidth was limited. Speeds of 15 ips still are used by professionals to maximize bandwidth and minimize noise.

Option. Though it was possible to get extended frequency response at 3.75 ips, high frequencies also brought unwanted tape hiss—thus most tape deck makers opted for either hissy highs or quiet, narrow-band performance.

"We wish to make 3.75 ips respectable for the serious recordist," says Andrew G. Petite, KLH's manager of product planning and market development, "and the key is our use of the Dolby."

The Dolby reduces noise on tape recordings by amplifying weak sounds during recording and by attenuating the same frequencies—and attendant tape noise, or hiss—during playback. In the Model 40 this amplification and attenuation reaches 8 to 10 decibels, and so does the improvement in signal-to-noise ratio.

At 3.75 ips using quarter track heads, the Model 40 achieves a

How to
CHARGE-
CONTROL
A PULSE
-AND FAST.



New, from Microwave Associates (West) – a P²S picosecond pulse diode characterized for speed. The MA-4B200 is the first of a series which, by using advanced techniques of surface passivation and junction profile control, offer unmatched switching speed, and guaranteed pulse performance over wide temperature ranges. For variable pulse delays, pulse sharpening, impulse generation, very wide band pulse counting discrimination and amplification. Compatible with TTL circuits.

Pulse shape
Pulse delay
Pulse amplify
Pulse generate

Model Number	Minimum Breakdown Voltage (V)	Total Capacitance	Turn Off Time
MA-4B200	70	3 pF min. 5 pF max.	300 ps. max.

Write or call Microwave Associates (West),
999 East Arques Avenue, Sunnyvale, California
(408) 736-9330

P²S Diodes for pulse conversion,
MA – West Style



MICROWAVE ASSOCIATES

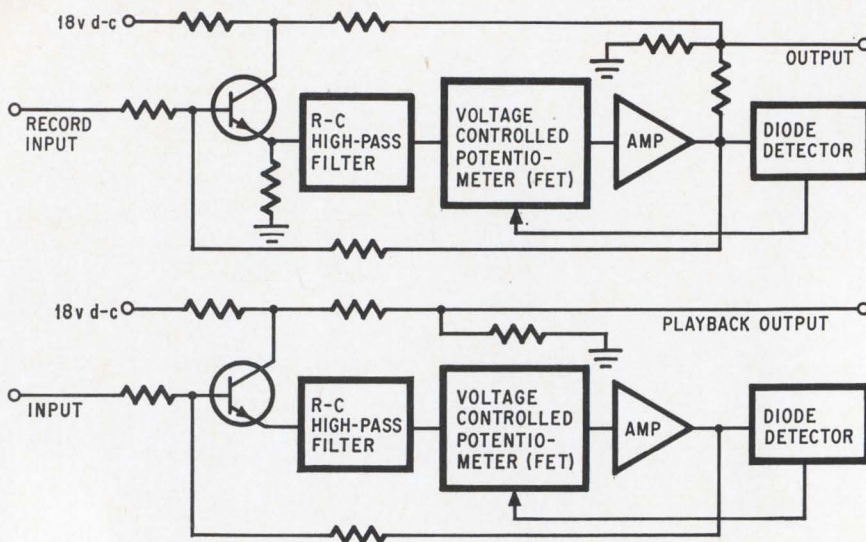

The stretcher. KLH's Model 40 tape machine utilizes this noise-reduction system developed by Ray M. Dolby to raise quality of 3.75 ips operation.

signal-to-noise ratio of 68 db or more, an impressive figure compared with most home recorders claims of 50 to 55 db.

With this reduction in noise, KLH engineers were able to design the Model 40 for broadband performance; thus the deck has a frequency response of 45 to 15,000 hertz ± 2.5 db at 3.75 ips.

Fast company. In dealer demonstrations the \$600 Model 40 is being compared with a \$3,500 ampex AG440 deck, a professional machine using half track heads and a tape speed of 15 ips. Petite claims that the only audible difference is less hiss in the Model 40's playback.

The original Dolby unit divided the audible frequency range into four bands, treating each separately to reduce noise. But this approach was uneconomical for a consumer product. Thus Dolby designed a new unit after consultation with KLH to operate in one band from about 1,700 hz to about 20,000 hz. KLH reasoned that almost all of the extraneous annoying sounds, such as hiss, would occur within this range of frequencies. Thus, the Dolby circuit for home use was far simpler and less costly than a professional Dolby even though the former retains the most audible advantages of the circuit.

During the design stage, Petite and others had the opportunity to map a marketing strategy perhaps as different as their electronics.

Petite feels that the 7.5 ips speed may have held back growth of home records. "The common 1,200-foot tape reel gives only a little more than a half-hour of recording time at 7.5 ips. Longer tapes are available, but cost more—in fact the 10.5-inch reel demands three times the price for twice the tape. More costly long thinner tapes can 'print through,' break, or stretch, too. Also, it's necessary to edit frequently, to waste tape and so on. At best, the average classical recording at 7.5 ips costs more than fine records. Together with the higher price of tape equipment, records seem more economical.

"One gets twice the recording time at 3.75 ips, and thus cost is about \$1 per recording. Side advantages include the ability to standardize on a single tape length (1,200 feet or about one hour)." But the primary advantage lies in the reduced cost of tape recordings that KLH hopes will revitalize the market for reel-to-reel tape recorders despite cartridges and cassettes.

"We realize that at \$600 we will sell relatively few machines," says Petite, "but our hope is that other companies will follow our lead to improve the quality of home recorders, and that perhaps prerecorded tapes might be made using the Dolby approach." Thus, while KLH is presently Dolby's sole licensee, it hopes to be joined by other firms.

Government

Emptiness of space

The message has finally sunk in at the National Aeronautics and Space Administration: unless something happens soon, the 1970's will not see the kind of vast expenditure for manned space flight seen in the 1960's. That message started coming across when NASA's first two budget requests for fiscal 1970 were slashed by the Bureau of the Budget. Some \$425 million was sliced out of the request for manned flight before it was even presented to Congress.

Now, with the lunar landing in sight, the message has all the more relevance. NASA must come up with some acceptable encores—and encores are not possible with the slightly over \$2 billion that NASA will receive for manned space flight if the present 1970 budget is approved. Trying to turn the tide, NASA's administrator for manned space flight, George E. Mueller, has already asked the House Science and Astronautics Committee for an additional \$100 million to pay for development of scientific packages to accompany the fifth through the tenth lunar landings. As it now stands only four manned landings are planned after the first; Mueller and others at NASA are lobbying for 15 to 18. The request for the packages is just the start. According to an insider in the Manned Spaceflight Office, "Congress is not going to give up an extra \$100 million easily and we're going to have to fight for it."

A small team. Meanwhile, Presidential science adviser Lee DuBridge has put together a small team which, between now and Sept. 1, will come up with the flight plan for the second decade in space. The group is composed of DuBridge, NASA Administrator Thomas O. Paine, Vice President Spiro Agnew, and Air Force Secretary Robert Seamans, formerly of NASA.

DuBridge advocates "a really solid, many-faceted program." Seamans and Paine are clearly behind an ambitious program for the 1970's, which would include a national space station, establishing a

CROWBAR...?

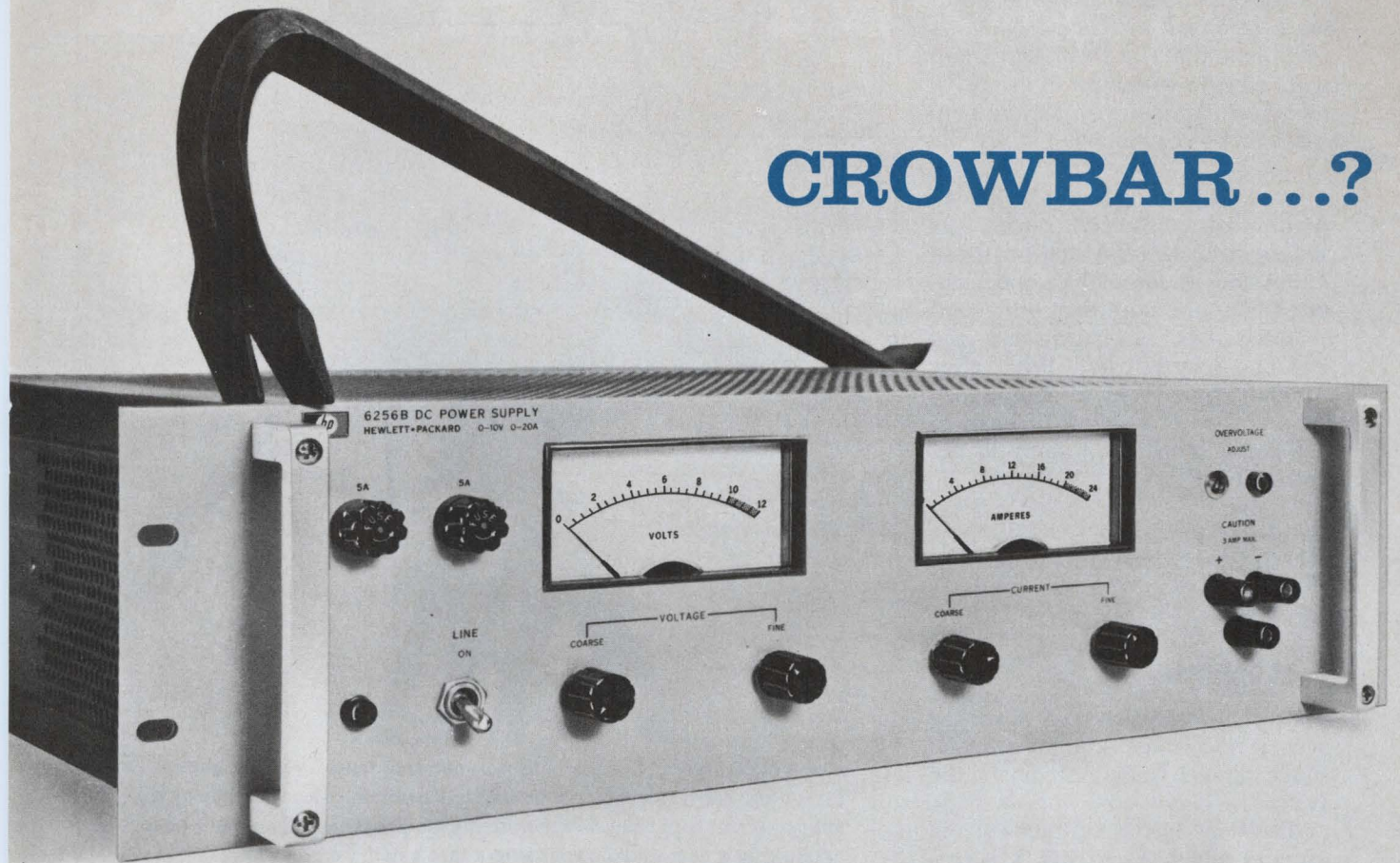

The One Inside is FREE

Not so many years ago, the prudent transmitter engineer discharged a high voltage capacitor bank by dropping a shorting "crowbar" across its terminals. Today's "crowbar" is a protective overvoltage circuit found on DC power supplies — usually at extra cost. Now HP includes a crowbar as standard on its recently updated series of low-voltage rack supplies . . . at no change in price.

Long established as preferred system supplies for component aging, production testing, and special applications, these supplies have now been redesigned and expanded to meet the stringent demands of today's power supply user. Advantages include low ripple (peak-to-peak as well as rms), well-regulated constant voltage/constant current DC with outputs to 60 volts and 100 amps.

Where loads are critical and expensive, the extra pro-

tection — say, against inadvertent knob-twiddling — from a crowbar is invaluable. On all internal crowbars in this series, the trip voltage margin is set by screw-driver at the front-panel.

Pertinent specifications are: triggering margins are settable at 1V plus 7% of operating level; voltage ripple and noise is 200 μ V rms/10mV peak-to-peak (DC to 20 MHz); current ripple is 5 mA rms or less depending on output rating; voltage regulation is 0.01%; resolution, 0.25% or better; remote programming, RFI conformance to MIL-I-6181D.

Prices start from \$350. For complete specifications and prices, contact your local HP Sales Office or write: Hewlett-Packard, New Jersey Division, 100 Locust Avenue, Berkeley Heights, New Jersey 07922 or call (201) 464-1234 . . . In Europe, 1217 Meyrin, Geneva.

HEWLETT  PACKARD
POWER SUPPLIES

Additional data sheets available upon request

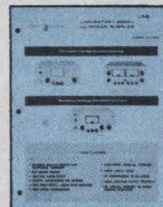

LAB SERIES
smaller package,
lower power,
optional crowbar



CROWBARS
A Technical
Discussion

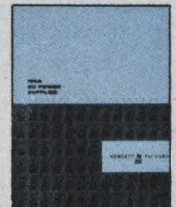

**1969 Power
Supply Catalog**
— includes total
HP power supply line.

U.S. Reports

permanent base on the moon, space shuttles, and other ambitious hardware oriented programs. NASA is optimistic that the DuBridge group will come up with a set of extensive recommendations with certain concessions to economy to mollify the Congress.

According to a Manned Spaceflight official, a definite concern has settled in at NASA which has been intensified as more than one Congressman and more than one noted scientist has observed that the question may not be, "What after Apollo?" but, "Why after Apollo?" Clearly, NASA is going to have to get going soon if it's going to get going at all.

Lasers

Fast bounce

That high-resolution laser scanning system now transmitting reconnaissance photos from Vietnam to the Pentagon is expected to have wide applications in digital data recording and retrieval systems. The reason: high scanning speed and information-packing density. Officials at CBS Labs, where the equipment was developed, think they can sell the setup to news media, hospitals, and weather forecasting organizations.

The Air Force Electronics Systems division is barely willing to admit that the laser system exists, let alone detail its operation. But a milliwatt-range helium neon (red) laser system based on the same technology, and demonstrated by CBS Labs, has a resolution of 20,000 elements per scan line with a bandwidth exceeding 50 megahertz. By comparison, the standard 525-line tv system allows for about 400 elements and 4 Mhz. The practical bandwidth capability of a laser scanning setup like the one demonstrated by CBS is said to be in the hundreds of megahertz with resolution capability limited only by the bandwidth of the transmitting data link.

Determination. Scanning is by a facet on the spinner. The size of the facet, which determines the lens

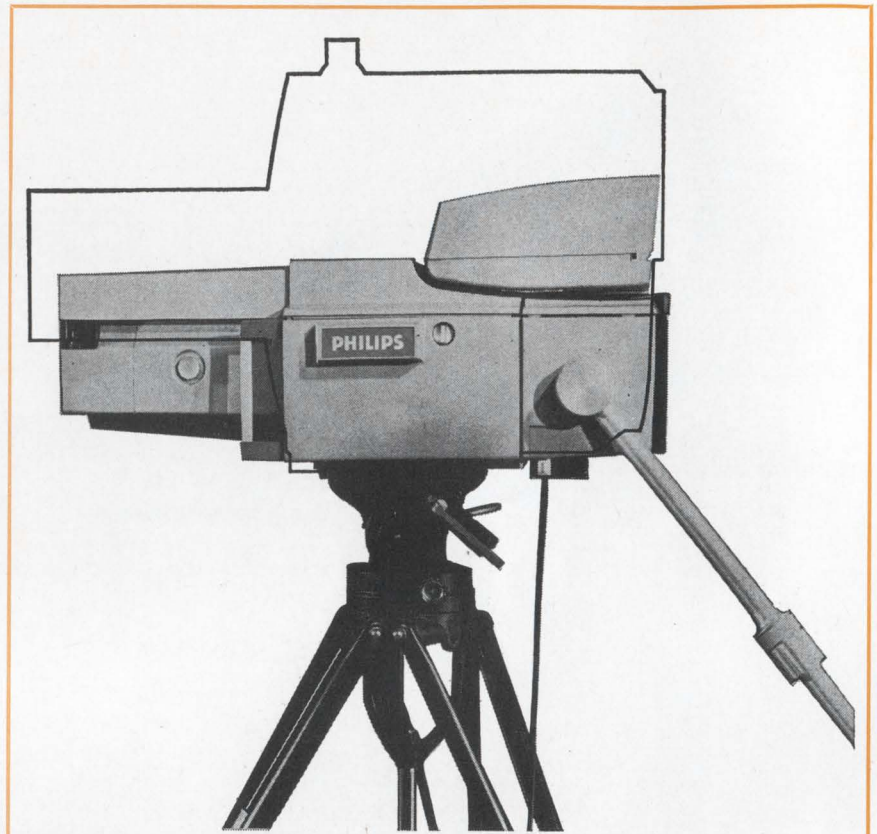

Going digital. Portable color television cameras have made life easier for remote crews, and now something has been done for the guys in the studio. At the NAB show last month, Philips Broadcast Equipment Corp. announced a new studio color camera that's half the size of present units and weighs 40 pounds less. Designated the PC-100, the camera uses digital multiplexing techniques. All signals between the camera and the control console, including power, video, color, and setup, are sent through a thin triaxial cable. Up to a mile of this cable can be used without line repeaters. The camera, which sells for \$84,850, has been ordered by the CBS and ABC networks and independent stations across the country; deliveries are scheduled for early 1970.

aperture, also ultimately determines the quality or resolution of the scanned picture. Therefore, to achieve the highest possible resolution, the highly concentrated laser beam is first expanded so it can illuminate the entire facet. After passing through the scanning optics, the beam is modulated by the film to produce a light signal; that signal is transformed to an equivalent electrical signal by the photomultiplier, amplified, and passed on to a data transmission system. Hence the spinner provides the horizontal line scan synchronization while the film transport provides the vertical synchronization which makes the lines merge into a

picture.

In the laser recorder at the receiving end, the video signal modulates the laser beam, which is then expanded. Scanner optics concentrate the beam into a fine moving point.

Military electronics

LSI takes off

What the Air Force regards as the first piece of equipment employing bipolar large-scale-integration will be delivered to the Avionics Laboratory at Wright-Patterson AFB,

MIL-STD-883



STEWART-WARNER 930 DTL's...

FIRST IN CIRCUITS...FIRST IN QUALITY... AND FIRST IN THE HEARTS OF MILITARY MEN!

By now everyone knows that Stewart-Warner has the broadest line of 930-type DTL's in the industry. But why is this line the preferred choice of military users?

First, there's our new policy for Group B environmental testing. We are now testing to the tough Class A level of MIL-STD-883 by subjecting all military-type production lots to this strict new IC standard on a continuous 6-week sampling basis.* But if you think that's enough, we don't.

So we also put our products through an exclusive triple testing program that ensures the uniform high quality of the line: 100% DC parameter tests at the wafer stage; another 100% classification testing after assembly and mechanical screening; and, at no extra cost, a third 100% testing prior to shipping.

What more could anyone want, except perhaps low price and good delivery? Well, just try us on price; and, for immediate off-the-shelf product delivery, call your local Stewart-Warner Micro-

circuits Distributor. Or for more information on our 930-type products and our hi-rel program, contact us or our local sales representative.

**Except for Reverse Bias Burn-in and Moisture Resistance Vibration.*

STEWART-WARNER SYMBOL OF
COMPANIES **SW**
EXCELLENCE

STEWART-WARNER MICROCIRCUITS, INC.
730 EAST EVELYN AVENUE, SUNNYVALE, CALIFORNIA 94086
PHONE 408/245-9200 TWX 910-339-9210

U.S. Reports

Ohio, this month by Texas Instruments. The Air Force already is satisfied that the general-purpose avionics computer [*Electronics*, June 24, 1968, p. 47] demonstrates the feasibility of using LSI and TI's discretionary wiring approach.

The TI development effort was far enough along a year ago to prompt the Avionics Lab to award a contract to the Burroughs Corp. for a multiprocessor computer using discretionary wiring. "Other companies, such as Hughes and Raytheon, are looking into discretionary wiring or modifications of it for their computers," reports Robert Werner, a project engineer in the Avionics Laboratory.

Wright-Patterson is now evaluating proposals for development of a digital filter using LSI; this is intended to provide experience in solving the problems of LSI in communications and radar systems. Discretionary wiring is under consideration for this program too.

Still around. However, the Air Force has certainly not abandoned fixed wiring. At the start of its program with TI, Wright-Patterson started a parallel program with RCA for an LSI computer using fixed-wired emitter-coupled logic instead of the discretionary-wired transistor-transistor logic used by TI. The chips are somewhat less complex in RCA's approach, however; although some arrays contain over 200 gates, the average density is about 144 gates per chip. The chips used in the TI computer have about 250 gates each.

RCA's program will be completed

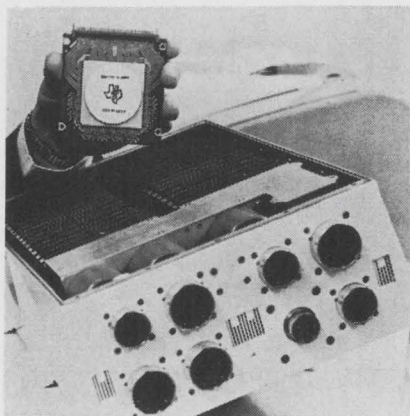

Handy. New TI airborne computer is about half size of old version.

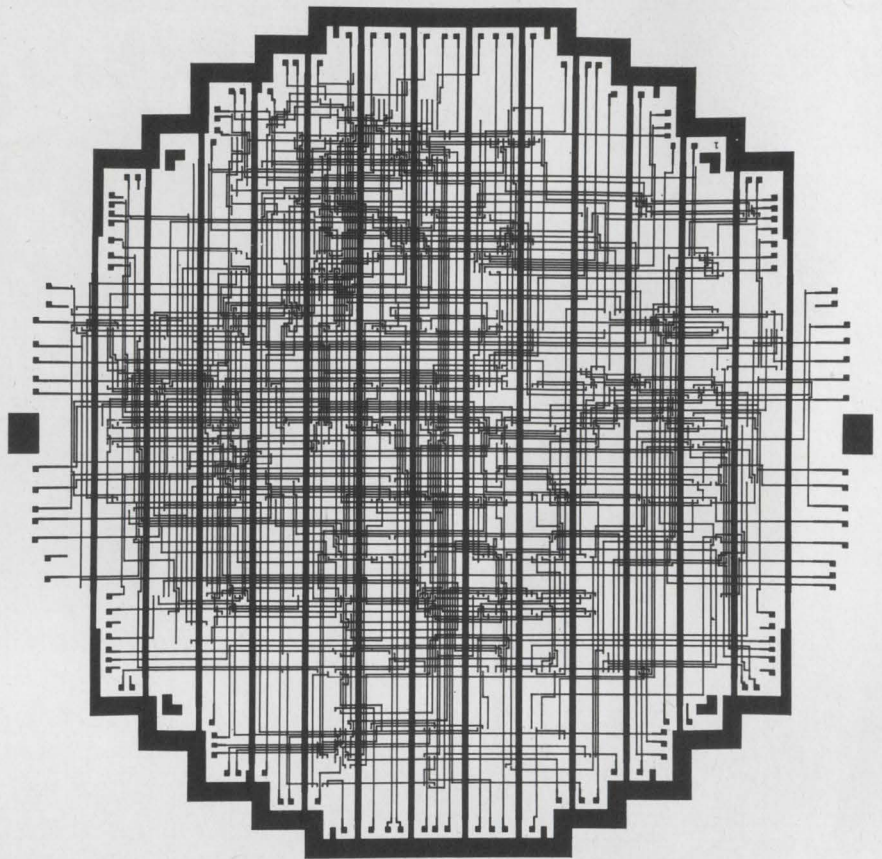

All lined up. A composite of the two masks for a typical circuit in the computer. CRT traces the hundreds of paths in just 132 seconds.

next month, on schedule, according to Werner. With TI, the Air Force also asked for a three-year program, but TI engineers felt they could do it in two. As it turned out, they had to ask for a year's extension. "It did take longer than we anticipated," says TI's Jack Kilby, "because of the difficulty of getting all the technologies to work together." Kilby is referring to the combined problems of partitioning, computer routing of interconnections, mask making, multilevel metalization, and packaging.

TI plans to exploit commercially the techniques it developed during the program. The company will introduce in the next few months such discretionary-wired LSI circuits as a digital differential analyzer, a 1,000-bit shift register, and an eight-bit adder.

As far as the TI's LSI computer effort, the Air Force wasn't too concerned about the piece of equipment used to prove LSI feasibility, according to Werner. "We just

wanted one that would present the realistic problems in the development of the circuit and the partitioning of the arrays—getting the right logic on the chip." The computer was "just a convenient vehicle" to demonstrate discretionary-wired LSI, he noted.

Solution. TI, the prime advocate of the discretionary wiring technique, views it as a solution to the yield problem in LSI. Instead of using a fixed metalization pattern to interconnect the 100-or-more circuits on the chip, TI uses a computer to do the metalization layout. The computer remembers where the defective circuits are and avoids them when it designs the interconnection pattern. Although critics regard discretionary wiring as overly complex, expensive, and—at best—an interim solution, TI now points to actual hardware as a vindication of its technique.

The computer uses 34 LSI arrays of 14 different types. The arithmetic section uses 16 of one type,

KEPCO'S 2000V OP-AMP

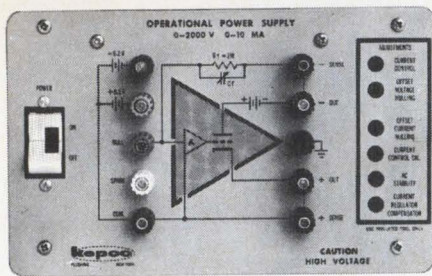

Model OPS-2000

The scope photos show the effects of varying the feedback capacitance (adjustable from 100 pF to 1000 pF). The fastest response, of course, is with the 100 pF feedback capacitor, the other values are available to shape the response or to accommodate reactive loads. As the photos dramatically illustrate, the overall response can be varied at will to suit the task.

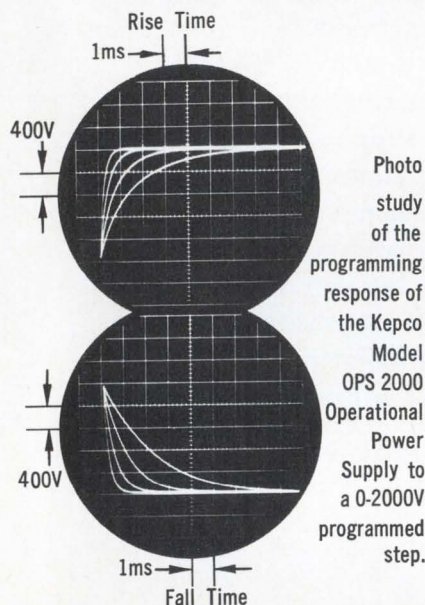

The fastest programming speed or slewing rate for this instrument, measured as the chord of the exponential to its first time constant, is about $3.7V/\mu\text{sec}$. . . the spec is $1V/\mu\text{sec}$.

The other specs and the performance of our 0-2000 volt, 0-10 mA self powered Op-Amp are equally impressive. Write to Dept. CC-14, we'll send you a nice spec. sheet.

**with KEPCO
IT'S CONTROL!**



131-38 SANFORD AVE. • FLUSHING, N.Y. 11352
(212) 461-7000 • TWX # 710-582-2631

U. S. Reports

the input-output section uses six of another type, and the control section uses 12 arrays, each different. The computer package occupies 0.37 cubic feet and weighs 25 pounds, half the size and 34% lighter than the previous version of the computer, which used 1,754 conventional IC's. TI engineers are quick to point out that the size and weight could have been cut even more, but this was not one of the goals of their program.

As for the computer, it will be put to work, even though it was intended to be only a demonstration. It will be used for compensating phasing and for range calculation in the MERA (Molecular Electronics for Radar Application) radar that TI is building.

For the record

Laird's lard. Under the pressure of inflation and demands for urban reform, the Nixon Administration called on the Pentagon to do its share of budget pruning, but the \$1.1 billion in fiscal 1970 "cuts" recently announced by Defense Secretary Laird add up for the most part to paper exercises. No big programs are canceled and much of the "savings" come from deferring some buys until 1971.

The Safeguard/Sentinel ABM system would be reduced by \$997 million from the \$1.8 billion asked by the Johnson Administration, but the Pentagon still pegs the over-all cost of the revised system at about \$7 billion. Laird would also postpone the \$326 million procurement of the SRAM missile—which doesn't work yet. And by cutting the FB-111 program to 60 planes, the Pentagon would save \$428 million during fiscal 1969 and 1970.

At the same time, Laird would add \$23 million to the Advanced Manned Strategic Aircraft (AMSA), which the Air Force dearly wants, so that engineering development can begin in fiscal 1970.

Among other significant changes: \$43 million more for an expanded satellite early-warning system, \$15 million less for the Airborne Warning and Control System (AWACS), and \$55 million less for the "McNa-

mara Line" in Vietnam. Also, the Navy's Dash reconnaissance helicopter program is being dropped [*Electronics*, Jan. 20, p. 50] for a saving of \$8 million, and a stretched-out acquisition schedule will shave Minuteman 3 by spending \$135 million.

A look before baking. A backscattering thickness gage is helping to keep turbine blades off the scrap heap. Jet-engine makers bake an aluminum-silicon coating onto the blades, and if the coating is too thick or too thin, the blade has to be scrapped. Now the thickness can be checked before the coating is baked on. The backscattering gage, made by the General Nuclearonics division of Tyco-Laboratories Inc., shoots beta particles from a krypton-85 source at the coated blade and counts those that bounce back. The number of back-scattered particles is proportional to the thickness of the coating. The gage, built to the specifications of a large jet-engine maker, checks out one blade every 15 seconds.

Original cast. Julius Blank, one of the eight founders of what has become the Fairchild Semiconductor division and the last to hold a position at the division, has resigned to join Gordon Ness Associates, a Palo Alto, Calif., venture capital firm. Not a scientist, Blank served as business manager in the early days at Fairchild. He had lately been concerned with long-range planning and the selection of new plant sites.

Ties that bind. Eugene G. Fubini, who is leaving his post as corporate vice president and group executive at IBM to become a private technical consultant, has already signed up one of his first clients—IBM. Fubini joined the company in 1965 after a stint as Assistant Secretary of Defense and deputy director of defense research and engineering. At IBM, he was in charge of the Research and Advanced Systems Development division.

Subtracting color. Early detection of cancer of the pancreas is the aim of subtract and dual-chan-

nel color scanning techniques now in use at the Hines, Ill., Veterans Administration Hospital just outside of Chicago. The Picker Nuclear Corp., which has modified a scanner to accommodate the subtract and color circuitry developed by researchers at the hospital, is marketing the unit for about \$30,000. Four have been delivered thus far, including the prototype at Hines.

Adapted to a Polaroid camera, the scanner provides printouts—color photographs of the scans appearing on the unit's oscilloscope—showing the liver, which obscures the pancreas, in two contrasting colors. Scanning information is stored on a four-channel tape recording, with one channel each for horizontal and vertical information, and two for the system's color information.

Two isotopes are used in the scanning—radioactive gold for the liver and selenomethione for both the liver and pancreas. Thus, when the gold image is subtracted from the liver scan, the liver image is eliminated altogether from the printout, and the pancreas can be examined.

Sheriff's helper. The Ampex Corp. has sold its Videofile information system to the Los Angeles County Sheriff's Department. Described as the first application of the Videofile concept to law enforcement, the system combines videotape recording and computer technologies for the storage of visual records. Key features are file compression, rapid access, and flexibility for updating.

To be installed in 1970, the \$5.6 million system will store law enforcement records, including fingerprints and photographs, on videotape in a master file and make them immediately viewable at 15 sheriff's substations throughout Los Angeles County. Equipped with filing consoles, tv monitors, and printers, these stations will be able to enter fingerprints and other documents into the master file remotely, and retrieve documents as tv images or printed copies. The sheriff's department figures it will save \$1.5 million annually in record-keeping costs by going to the Ampex system to store its visual information.

A MULTI-ACTION AIRBORNE RECEIVING SYSTEM FOR ANTENNA PATTERN ANALYSIS

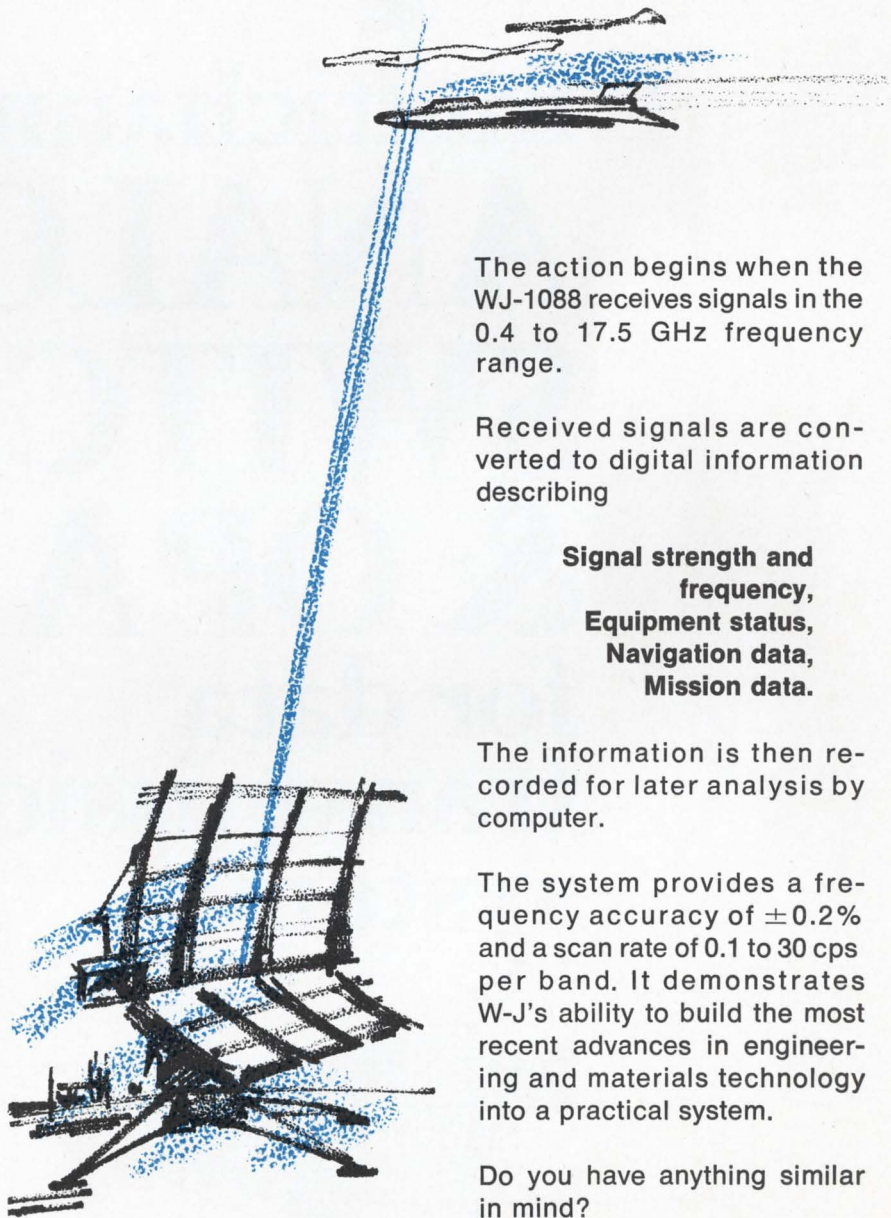

The action begins when the WJ-1088 receives signals in the 0.4 to 17.5 GHz frequency range.

Received signals are converted to digital information describing

**Signal strength and frequency,
Equipment status,
Navigation data,
Mission data.**

The information is then recorded for later analysis by computer.

The system provides a frequency accuracy of $\pm 0.2\%$ and a scan rate of 0.1 to 30 cps per band. It demonstrates W-J's ability to build the most recent advances in engineering and materials technology into a practical system.

Do you have anything similar in mind?



WATKINS-JOHNSON

3333 HILLVIEW AVE., STANFORD INDUSTRIAL PARK, PALO ALTO, CALIF. 94304 • (415) 326-8830

Circle 61 on reader service card

61



multichannel
**ANALOG
SWITCHES
& OP AMPS**
for data
transmission
systems

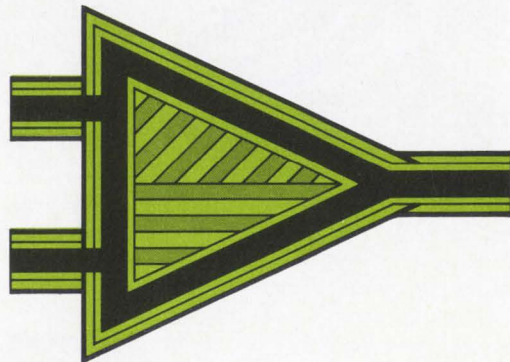

* Applications Power: A wide variety of driver/FET switch combinations and an in-depth applications team waiting to serve you!

Siliconix offers over 32 integrated driver/switch combinations particularly suited to data transmission systems. Choose from a wide variety of junction or MOS FET switches, depending on your system requirements. These, combined with a Siliconix OP AMP, can be applied to a great variety of data transmission requirements.

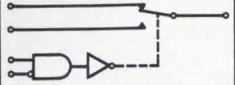
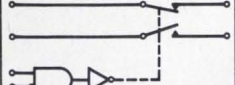
Functional Description	Type	Max. $r_{DS(ON)}$ (ohms)	Switch Type
 SPDT 1-CHANNEL	DG136	600	PMOS
	SI3002	600	NMOS PMOS
 SPDT 1-CHANNEL	DG113	600	PMOS
	143	80	N
	144	30	N
	146	10	N

A number of switches with the ON resistance ranges best suited to your application are available from Siliconix. These driver-switches accept standard DTL, RTL, and TTL logic control inputs.

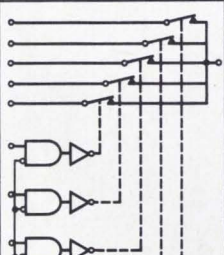
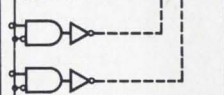
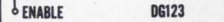
Functional Description	Channels	Type	Max. $r_{DS(ON)}$ (ohms)	Switch Type		
 	2	DG102	100	N		
		103	100	N		
		104	100	N		
		110	600	PMOS		
		111	600	PMOS		
		112	600	PMOS		
		133	30	N		
		134	80	N		
		141	10	N		
		147	600	PMOS		
		148	40	PMOS		
		 	4	DG116	600	PMOS
				118	600	PMOS
 	5	DG123	600	PMOS		
		125	600	PMOS		

System requirements will dictate which of the above combinations are best for your multiplexer combination.

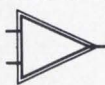
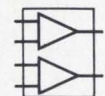
SILICONIX OP AMPS	Max. input offset voltage -55 to +125°C	Max. input current	Min. open loop gain	Output voltage swing	Slew rate	
 LM 101 LH 101 (Internally compensated)	6 mV	200 nA	50K	±12V	.25V/μsec.	<ul style="list-style-type: none"> • Operation from ±5 to ±20V power supplies • Low current drain • Continuous short circuit protection • Same pin configuration as 709 amplifier
 L 120	200 mV	50 pA	100	±12V	20V/μsec.	<ul style="list-style-type: none"> • Low input leakage • High slew rate • Unity gain stable • Ideal for sample and hold, integrating and fast voltage comparisons

Working on data transmission? Write today for complete information on all Siliconix FET switch combinations and OP AMPS.

For instant applications assistance, call the number below. Ask for Extension 19.

 **Siliconix incorporated**
 1140 West Evelyn Ave. • Sunnyvale, Calif. 94086
 Telephone (408) 245-1000 • TWX 910-339-9216

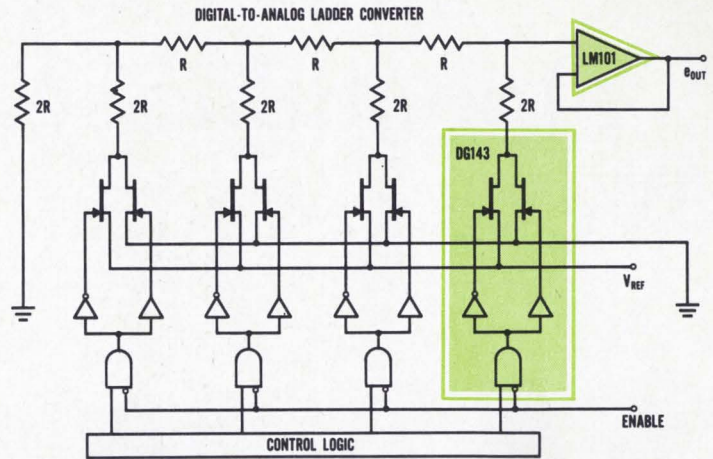

We recommend Junction FETs for this popular digital to analog converter, but if you prefer MOS FETs, we have them, too.

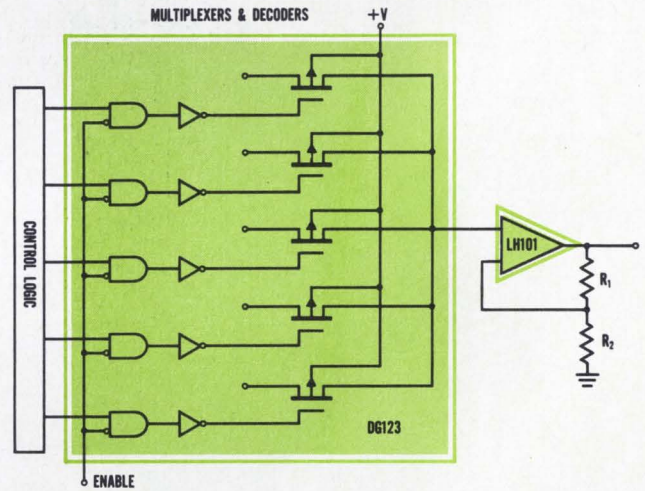

Only one TO-86 package is required to accomplish the above switching functions. Packages include switch drivers that accept standard DTL, RTL, or TTL logic signals.

Monolithic logic today.
Monolithic systems tomorrow.
We've got ideas to deliver.

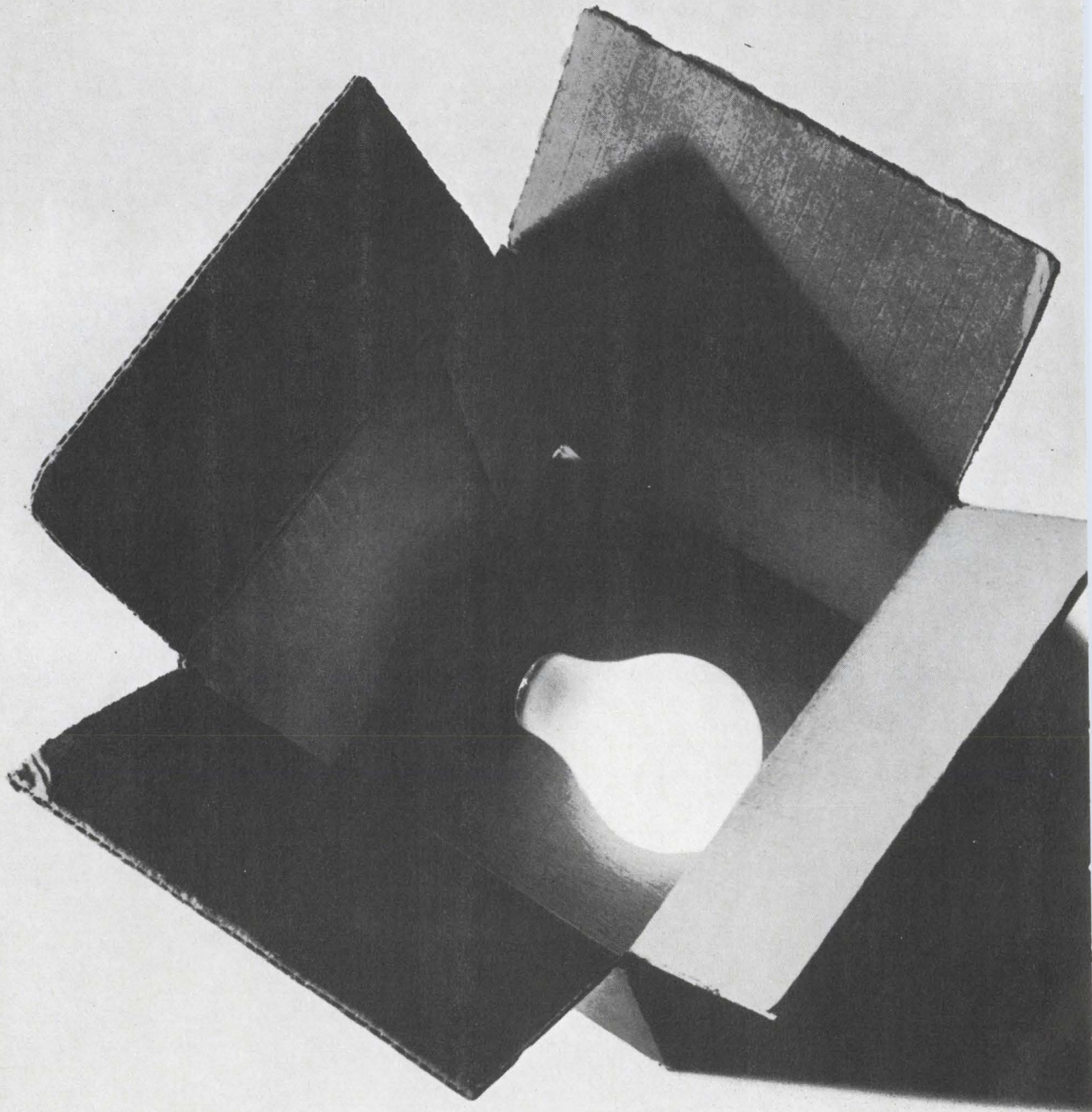

Many wafers ago Raytheon drafted a blueprint for success in the semiconductor industry. It's drawn around some very sharp idea men to nudge the state-of-the-art ever forward. Plus a production line that can turn ideas into products and pour them out en masse and on time. Here's a roll call of results, delivered and on the way.

Products for now

DTL: Over 95 circuits in Series 200, 930 and 1000.

TTL: More than 100 circuits in our industry's-fastest Ray III, and our SUHL-equivalent Ray I and II.

MSI: We're booming in TTL types, with 18 production circuits based on Ray I and II, 54/74 and 64/84 logic. And more coming fast.

Linears: Industry's broadest line of popular types. 17 circuits, including standard and 'A' versions of 100, 4100, 700 and 4700 Series.

Transistors: More than 400 standard and high-rel mil types. Switches, drivers, choppers. And amplifiers—general purpose, low level, high frequency, differential, dual and Darlington.

Diodes: 1800 types of switching and general purpose diodes, ranging from IN91 to IN4308, at speeds down to 1.0 nanoseconds.

And ideas for tomorrow

But the best is yet to come. Here's what's cooking for delivery within one year. Beam lead, of course. Plus 2-layer metal interconnects. 64-bit random access memories. 256-bit read-only memories. Multi-chip memory arrays. Very high speed logic. High speed NPN and PNP single and quad core drivers. Monolithic diode arrays. RF transistors.

And we've got even brighter things docketed for a little more distant delivery. Advanced packages—up to 78 leads, using beam lead and multi-layer substrates. Bipolar and MOS LSI. Computer-controlled LSI design. Radiation hardened circuitry. Low power ECL MSI.

Just promises? Not so. We're working on everything on that list, logging day-by-day progress toward production. So keep your eye on us. Because we intend to be getting the ideas—and delivering them—for a long time to come.

Browse through one of our detailed, just-completed catalogs. Yours for the asking. Raytheon Semiconductor, Mountain View, California, (415) 968-9211.

RAYTHEON

BELDEN...new ideas for moving electrical energy

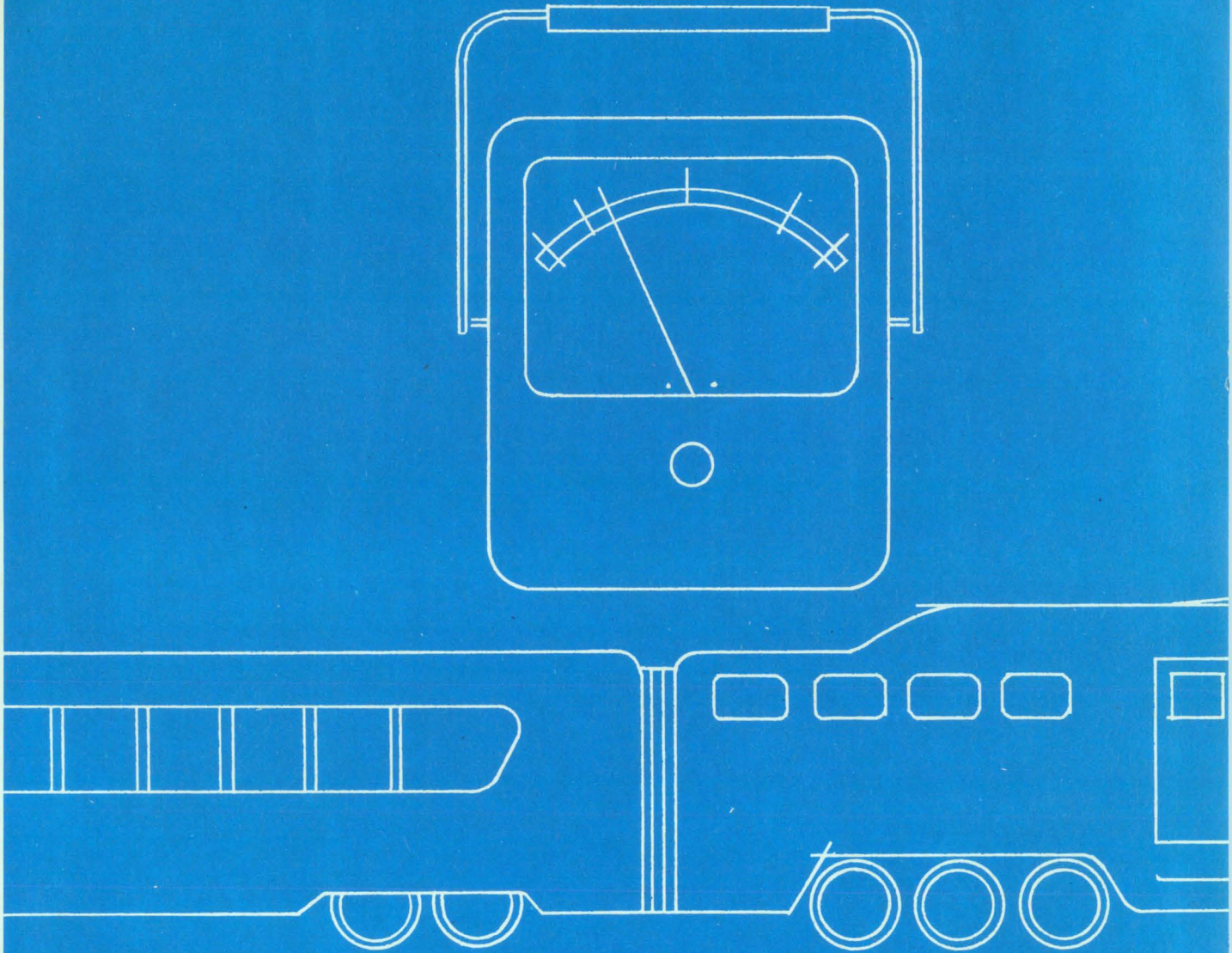

Belden's systems savvy is

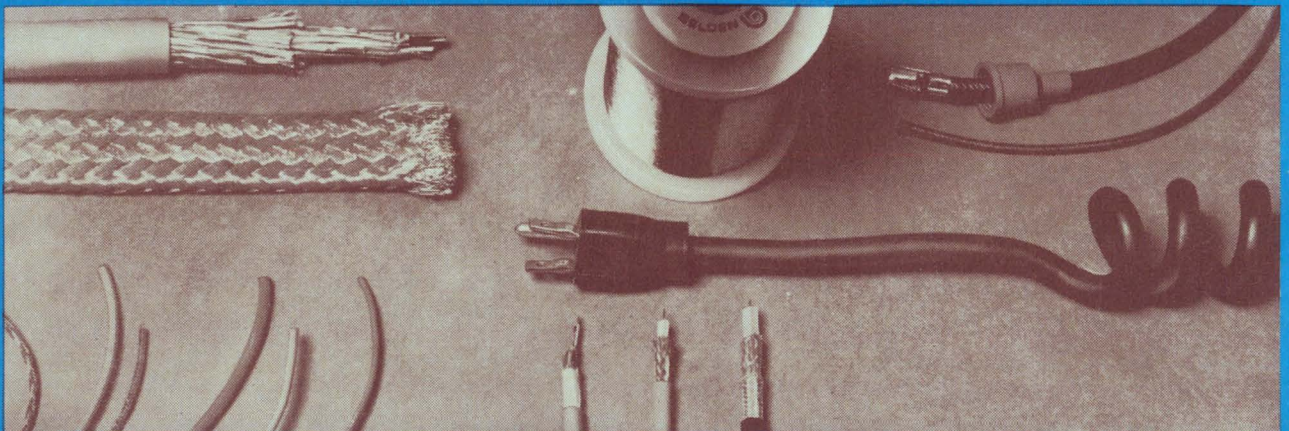

BELDEN

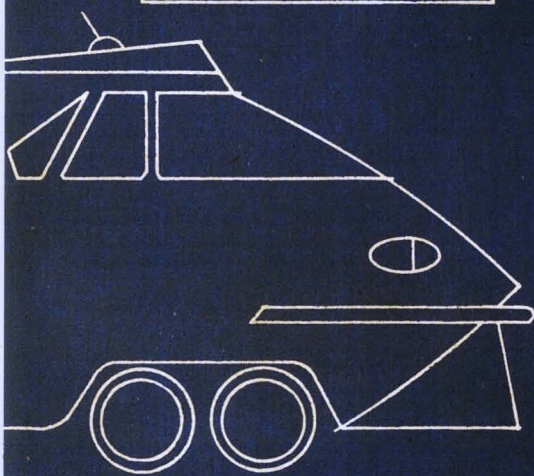
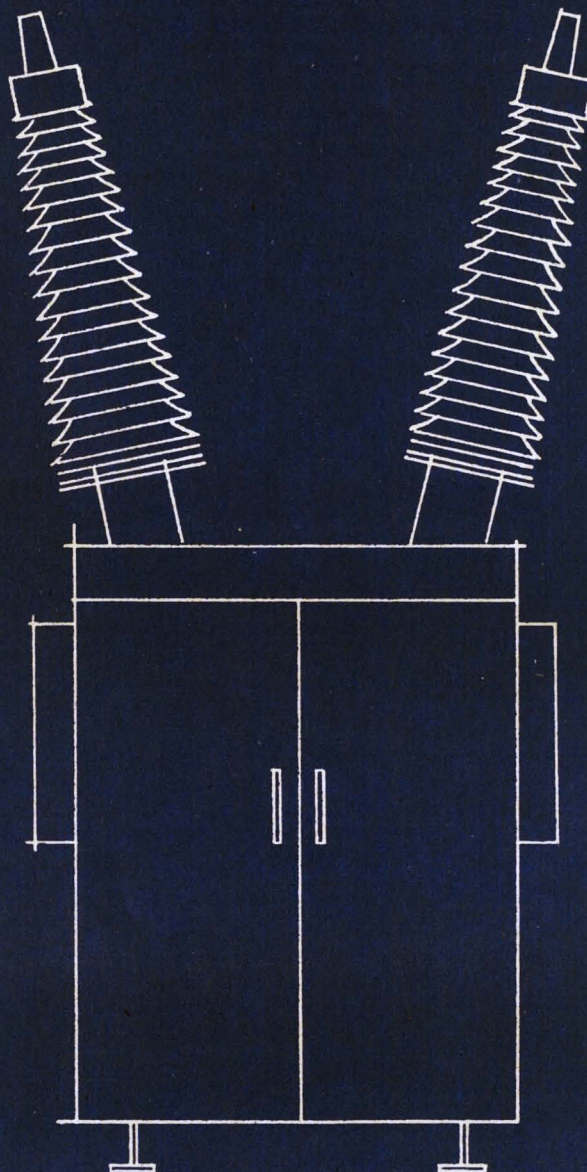
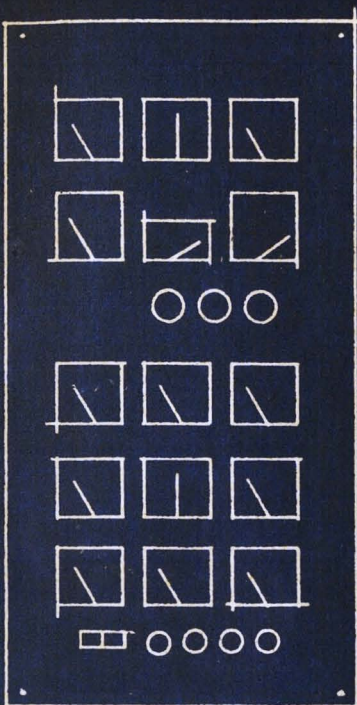

no big deal

It's a lot of little deals, that add up to something big. Like lower costs. Fewer production headaches. Enhanced product reliability. By poking and probing into your product's electrical system and the way it's manufactured and used, Belden Wire Systems Specialists may be able to suggest a wire or cable that costs less. Or that lasts longer, or that takes up less space*. Or maybe they'll suggest a different put-up that saves you assembly time. Or a solution to a stripping problem. They'll also offer you one responsible source for all your wire needs. Because we're the

people who make all kinds of wire for all kinds of systems. So if you're making plans or having problems, get yourself a good deal. Call or write: Belden Corporation, P.O. Box 5070-A, Chicago, Illinois 60680. And ask for our catalog, and the reprint article, "Key Questions and Answers on Specifying Electronic Cable."

*For example: Beldfoil® shielding in Belden cable. It isolates conductors better than anything yet. And it's thinner. You can pack more conductors into a conduit . . . hold down size and weight.

G-2-8

MICROWAVE

...dimensions that make Andrew's antenna systems capability unique

We sell more microwave antennas than anyone. Two or three times as many. It's this, plus a unique "degree of completeness" that makes Andrew the better buy. It's antennas. *And* waveguide or coaxial cable. Made to work together. *All* the hardware you need. Plus *all* of the software necessary to guarantee performance as specified. It's technical assistance *on an international basis*. Help all the way through the installation if you need or want it. Anywhere in the free world. Like to know more? Communicate with Andrew.

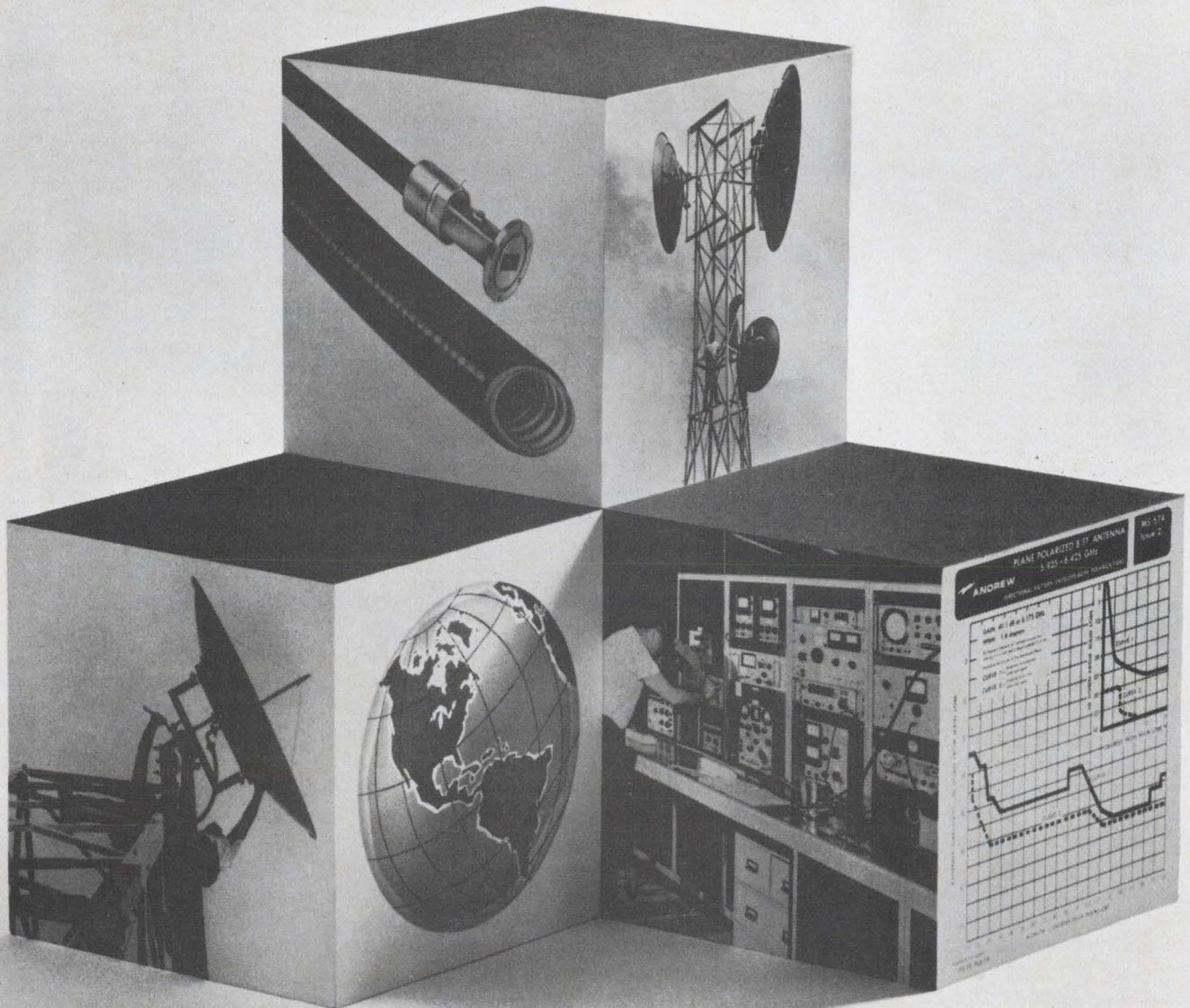

ANDREW

Washington Newsletter

April 14, 1969

Army takes to IC's in plastic packages

With all the hullabaloo these days over whether plastic packages for integrated circuits are reliable enough for military applications—the makers saying yes and the services, particularly Rome Air Development Center, still saying no—one Army project has quietly been using plastic-encapsulated IC's operationally for several months.

In a highly-classified research and development program, plastic-packaged IC's have been designed into a fuze. And since last year, small lots—1,500 to 2,000 rounds—of shells using the fuze have been employed in Vietnam. Apparently, the results have been highly successful. A large buy is expected, possibly this month.

The overriding factor in favor of the plastic-package was its shock resistance. This benefit overruled any misgivings that the Army might have had about the plastic packages' moisture resistance.

FCC seeks a study of microwaves ...

Within the next few weeks the Federal Communications Commission will request proposals for a comprehensive analysis of microwave-spectrum allocation. The contract will be awarded in June. According to a high-ranking engineer at the FCC, the study will concentrate on the techniques now used to determine the assignment of microwave frequencies, and on ways in which new technology can permit more effective use of these frequencies.

Meanwhile, the FCC is considering a follow-on effort to implement the results of a land-mobile-spectrum study the Stanford Research Institute is just completing. The commission would like to keep outside contractors working in this area, but it faces the question of where the funds will come from.

... and expert advice on black-box tariff

Watch for the "Carterphone case" tariff to get hot again at the Federal Communications Commission. The tariff, as set up by Bell Telephone, requires a "black box"—supplied by Bell for \$2 a month—between foreign attachments and telephone lines. Manufacturers of foreign attachments are starting to complain loudly about it. The FCC will be pressured to drop the tariff and allow customer-supplied devices to be directly joined to the lines. Common Carrier Bureau Chief Bernard Strassberg will soon call informal conferences on the question. The conference has been held up until the selection of a "prestigious" advisory panel is completed.

Meanwhile, the new tariff has enabled the Xerox Corp. to offer long-distance transmissions of copies of documents at prices sometimes competitive with telegraph rates, and the FCC is starting to think about how this will affect Western Union and its domestic telegraph monopoly.

Plan data systems at 40 Army posts

Later this year, the Army is expected to decide what system and software components it wants for COCOAS, Continental Army Command Class 1 Automatic System. Now undergoing prototype evaluation at Fort Sill, Okla., the computer system would completely automate about 12 post administrative and bookkeeping functions, such as finance, supply, and personnel. An IBM 360/30 is being used in the evaluation but won't necessarily be the final main frame. The Army wants to put the system in about 40 U.S. posts [see page 14].

Washington Newsletter

Project overruns face triple threat

Watch for increased Pentagon and Congressional attention into the problem of cost overruns on military contracts. Defense Secretary Melvin R. Laird acknowledged before Congress this month that he's "uncovered" overruns amounting to \$1.8 billion in current programs such as the Army's Cheyenne helicopter, the Air Force's C-5A (both made by Lockheed) and F-111 A/E/D aircraft (made by General Dynamics), and Navy shipbuilding programs. Contractors whose projects are not in trouble might also put pressure on Congress to act. These contractors are understood to be worrying that their own projects might get cut back or squeezed out because of money diverted to pay for overruns.

Packard may be kept muzzled after falling into a credibility gap

Some observers expect Defense Secretary Laird to keep his deputy, David Packard, under wraps for a while. Packard embarrassed the Pentagon twice recently in testimony on the Safeguard/Sentinel system before Senate questioners. Once, when asked if he'd consulted with any scientists outside the Defense Department on the ABM program, he named a man who later told the Senators that his contact with Packard was limited to a brief, casual conversation at an airport. Moreover, the scientist turned out to harbor some "serious engineering criticism" of the program. In the other instance, Packard tried to discredit another expert by referring to him as an opponent of the Polaris missile program; this the man vehemently denied.

NASA succeeding in long-range sell for space station

While there are no major funds in the fiscal 1970 NASA budget request for a national space station, NASA officials are using House and Senate budget hearings to "presell" the mammoth mid-1970 program. In spelling out details, NASA is dwelling at length on the valuable applications. The national space complex would be planned for 10 years of continuous operation, requiring highly reliable subsystems as well as design provisions for maintenance and repair. The complex would be composed of separately launched modules—such as laboratory systems, crew quarters, and storage modules—which would be added to expand the size of the basic station. Thus far, the trial balloon has not hit any snags and Congressmen seem more interested than skeptical. Initial cost estimates are about \$10 billion for R&D, administration, and initial operation.

Addenda

The Government appears to be backing down in its battle with the Allen-Bradley Co. over the Milwaukee firm's Negro hiring practices [*Electronics*, Jan. 20, p. 48]. Secretary of Labor George Schultz has asked that the original three-man panel meet April 17 to try to work out a program for hiring more Negroes. In the past, Allen-Bradley insisted it was not willing to agree to any programs that might give Negroes an advantage over whites. Labor Department lawyers handling the case have maintained that Allen-Bradley has had plenty of time to comply with regulations applying to Federal contractors. They sought to bar Allen-Bradley from Government contracts until the firm complies, but Schultz wants to avoid a showdown. . . . William Scranton, ex-Governor of Pennsylvania, has been named to succeed Ambassador Leonard Marks as head of the United States delegation to the International Telecommunications Satellite Consortium. With the lackluster showing of the U.S. in the first round of Intelsat negotiations, Scranton has been handpicked by the President to bolster the U.S. position in the 68-member Consortium.

2760 watts and 7" panel height?

Yes! With the Sorensen DCR Series

\$900⁰⁰

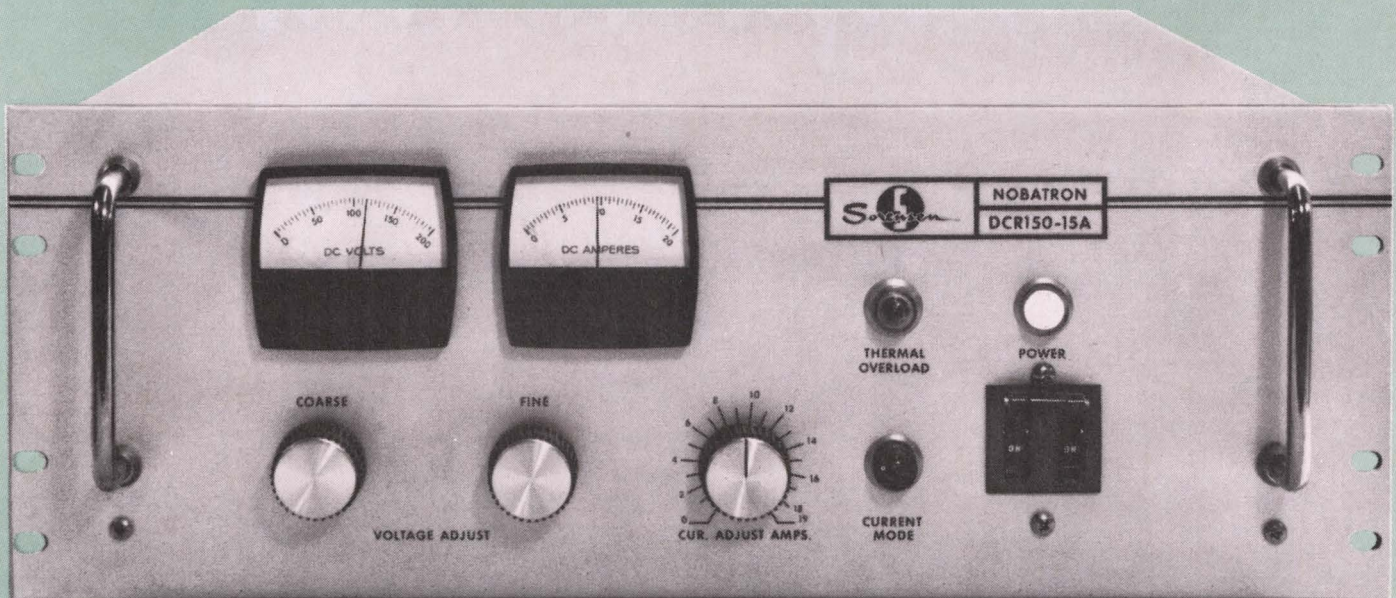

The multi-temperature rated DCR Series (115% I_o @ 30°C/100% I_o @ 55°C/65% I_o @ 71°C) contains eleven models which are available from stock in the 7" high package utilized by model DCR 150-15A. They cover the voltage ranges of 0-20, 40, 60, 80, 150 and 300Vdc at currents to 144A.

Features include: ■ $\pm 0.075\%$ voltage regulation and current regulation with automatic crossover ■ optional overvoltage protection ■ compliance with MIL-I-26600 and MIL-I-6181D ■ 25,000 hour MTBF.

The versatile and proven performance

of these models make them ideal for industrial or scientific applications such as: life testing or production aging of semiconductor devices, forming electrolytic capacitors, controlled charging and discharging of batteries, precision electroplating and controlling magnetic devices.

For more information contact your local Sorensen representative or; Raytheon Company, Sorensen Operation, Richards Avenue, Norwalk, Connecticut 06856.

Tel: 203-838-6571;

TWX: 710-468-2940;

TELEX: 96-5953

RAYTHEON



Monolithic Voltage Regulators

the complete works

now in paperback

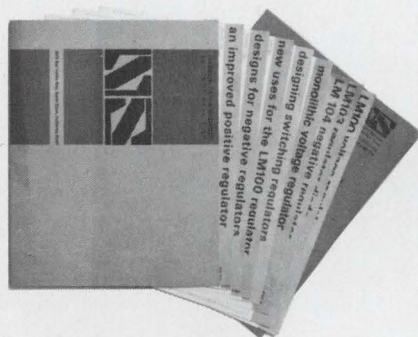

Five voltage regulator application notes including two just published; 60 pages of design information on positive and negative voltage regulators. Sixteen pages of specification information including significant graphs of performance characteristics. An eight page Reliability Report encompassing Production Processing, Quality Control, Screening, Life Testing, Environmental Testing and Design Philosophy. The most complete set of design aids in print for monolithic voltage regulators. You can see the performance; send for the book. National Semiconductor Corporation, 2975 San Ysidro Way, Santa Clara, California 95051 (408) 245-4320
TWX: 910-339-9240 CABLES: NATSEMICON

National/Linear

National Semiconductor
2975 San Ysidro Way
Santa Clara, California 95051

Send my copy of your Monolithic Voltage Regulator Library to:

Name _____

Title _____

Company _____

Street _____

City _____

State _____ Zip _____

Mail Station _____

My application is _____

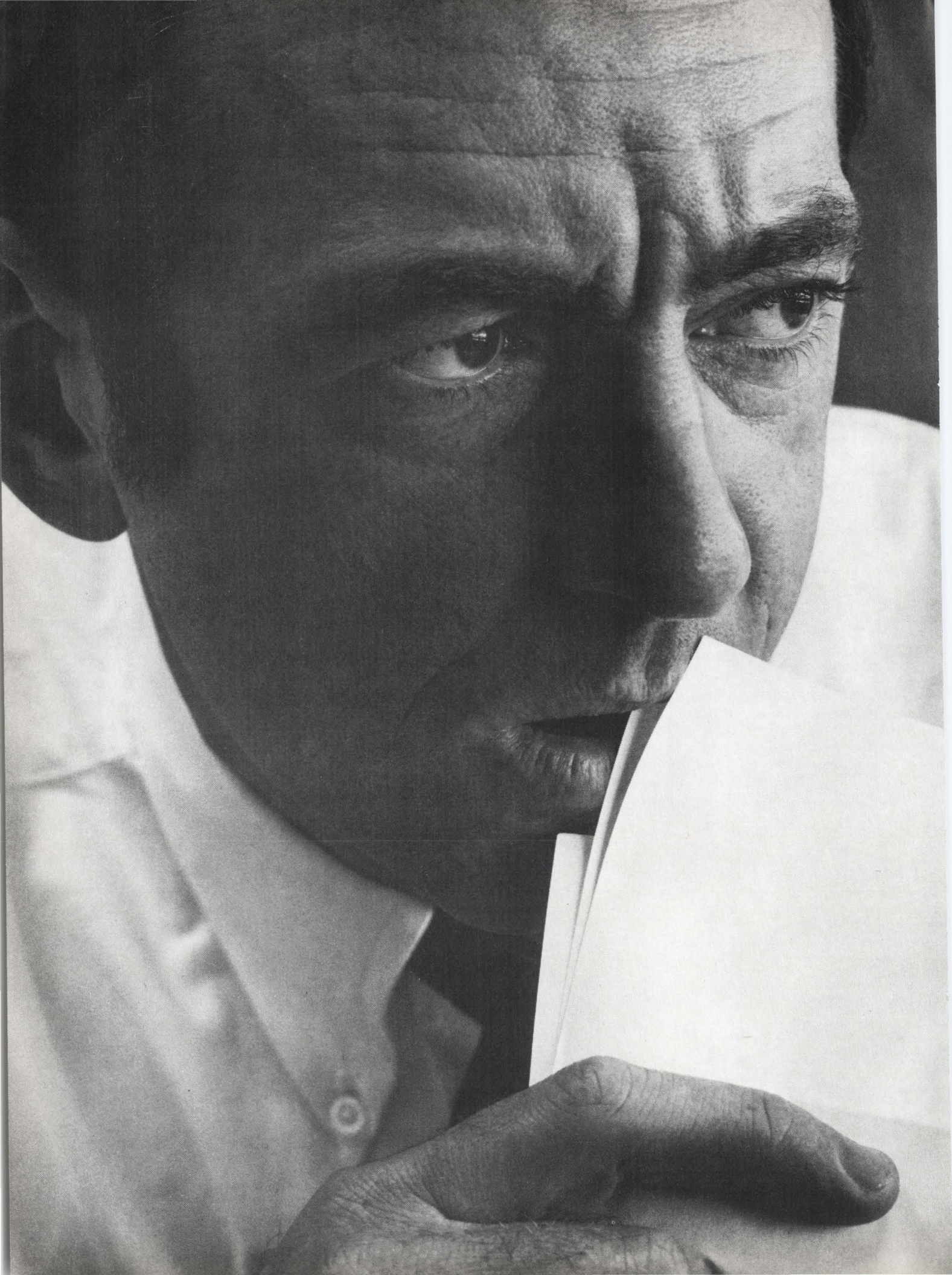

If your time-share bill runs over \$2,300 a month

you're being had!

Forget about mounting rental bills. You'll save hard cash with *your own* HP 2000A System.

You can have up to 16 terminals going simultaneously. Your users can program the computer in simple conversational BASIC... and unlike most computers it checks every entry step-by-step. No busy signals; no wait messages. And you can even forget about expensive repairs and computer down-time. The 2000A System keeps on working... while others are being worked on. *Time and money saved*, that's what you can count on with the extraordinary HP 2000A System.

Sound good so far? Here's one better. HP can have your 2000A Time-Share System installed and running in a matter of months — not years. So give your local HP computer specialist a call. He's got all the details. Or write Hewlett-Packard, Palo Alto, California 94304; Europe: 1217 Meyrin-Geneva, Switzerland.

HEWLETT  PACKARD

DIGITAL COMPUTERS

22913

Circle 75 on reader service card

first it was MOS...
then it was MIOS...

now it's...

The Nitride "Sandwich"

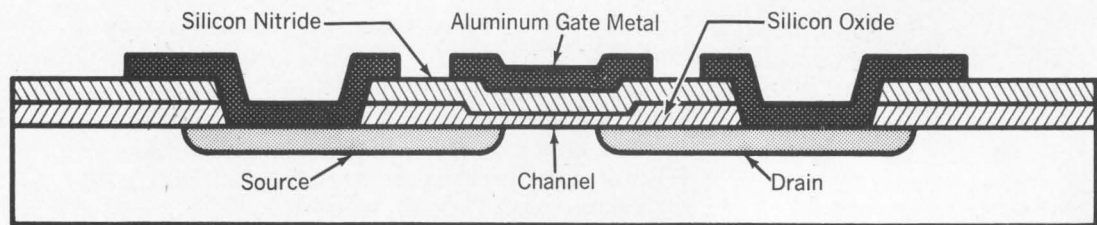

Cross-section of MTNS device

General Instrument's MTNS (Metal-Thick Oxide-Nitride-Silicon) represents the latest stage in the development of Large Scale Integration that began with MOS and continued with MIOS. The exclusive Silicon Nitride process signifies the achievement of goals General Instrument has intensively pursued since pioneering in this technology... constant improvement in reliability, performance and cost reduction in LSI.

At the basis of this latest advance in the technology is the Nitride "sandwich." The low threshold voltages achieved (typically 2 volts) allow General Instrument LSI circuits to be directly compatible with existing TTL, DTL circuits — ie, they can be driven from and are capable of driving bipolar ICs. The importance of eliminating the interface circuitry usually required in any given system can hardly be stressed enough in terms of the resulting systems' cost saving, performance and reliability. Several good things happen right off.

- First, there is a reduction in the number of system power supplies required. The -27 volt supply is eliminated completely. The existing 5 or 6 volt supply used for the bipolar devices can be used as one of the nitride device supplies. The only other supply needed is -12 volts which is often available in the system.

- Second, elimination of the interface circuits, which often cost more than the LSI circuit they interface, eliminates additional propagation delays which degrade system performance.

- Third, the reduced parts count and reduced number of interconnections enhance system reliability.

The silicon nitride used in the gate structure of the device has some very desirable qualities. One of these is a high dielectric constant. It is, in fact, this feature which makes possible the low threshold voltage. The high dielectric constant also manifests itself in an electrical parameter called k' , increasing it by

MTNS

An exclusive Nitride process that makes General Instrument LSI circuits directly compatible with bipolar ICs (without input-output interfacing)

50%. (k' is the gain factor of the device.) The increased k' makes possible both faster circuits and lower "on resistance" devices.

Another property of the silicon nitride is its extremely good passivation characteristics. Silicon nitride is virtually impervious to sodium ion migration at temperatures in excess of 200°C. This has impact on cost in that devices may be encapsulated in inexpensive plastic packages . . . and impact on reliability in that in a hermetically sealed package this characteristic gives added protection against contamination.

The gate structure of these devices is actually a sandwich of silicon oxide and silicon nitride. These two materials are incorporated in the structure by two different kinetic processes which tend to compensate each other in that pinholes introduced by the one process are eliminated by the second. This reduces that normal occurrence of short circuits caused by pinholes in gate areas, raises yield and results in lower cost.

Increased Operating Temperature

An important property of the nitride process relates to high temperature operation. With proper engineering design, circuits can be made to operate at 125°C. The nitride passivation qualities eliminate concern for contamination migration at elevated temperature and therefore, MTNS devices are typically rated at 125°C. Another consideration in this rating is that the low voltage circuits typically dissipate less power than the standard voltage circuits and therefore have less internal heating which keeps junction temperatures nearer to the ambient temperature.

Reduction In Power Dissipation

One of the more dramatic results of the nitride process is the reduction of power dissipation of dc and two phase circuits. Reducing the V_{dd} supply from the usual 12 volts to 6 volts reduces power by a factor of 4 for the same operating speed.

Increased Operating Frequency

When driving into a TTL circuit, the operating frequency of the device is usually increased. This comes about because MTNS devices are typically frequency-limited by the output stage, being much faster internally. Limiting the output voltage swing to less than 4 volts by driving into TTL then raises the frequency limit.

General Instrument has been delivering thousands of MTNS circuits for selected military applications over the past six months, where particular advantage has been taken of their unique properties. A standard product line for general use will be available from distributors beginning in 60 days.

MTNS not only sets significantly higher standards of performance and reliability, but it also affords a degree of flexibility of design and application previously unattainable. General Instrument engineers are ready and anxious to assist you in exploring the vast and intriguing possibilities both in standard and custom circuits.

Write to General Instrument Corporation, Microelectronics Division, 600 West John St., Hicksville, L. I., New York. (In Europe, to General Instrument Europe S.P.A., Piazza Amendola 9, 20149 Milano, Italy.)



GENERAL INSTRUMENT CORPORATION • 600 WEST JOHN STREET, HICKSVILLE, L. I., NEW YORK

**TEFLON: all by itself
the most thoroughly proven,
high-reliability
insulation**

**But look at the
extra performance
you can get
with TEFLON plus
mineral fillers**

Insulations of Du Pont TEFLON fluorocarbon resins have proven their reliability for more than 20 years, particularly in demanding aerospace applications. But did you know there are also mineral-reinforced constructions of TEFLON, whose extra toughness and abrasion resistance protect against cut-through and installation damage?

These mineral-reinforced insulations of TEFLON are available in a wide range of colors and are rated for use over a wide temperature range—up to 260°C. They offer the nonflammability, resistance to chemical corrosion and the optimum dielectric quality you expect from insulations made with TEFLON.

Consider composite insulations of TEFLON plus mineral fillers (or composites using polyimides or polyvinylidene fluorides plus TEFLON) for your next design.

For additional information, write us and let us know about the specific application you have in mind. Write: Du Pont Company, Room 7296B, Wilmington, Del. 19898.



TEFLON[®]
fluorocarbon resins

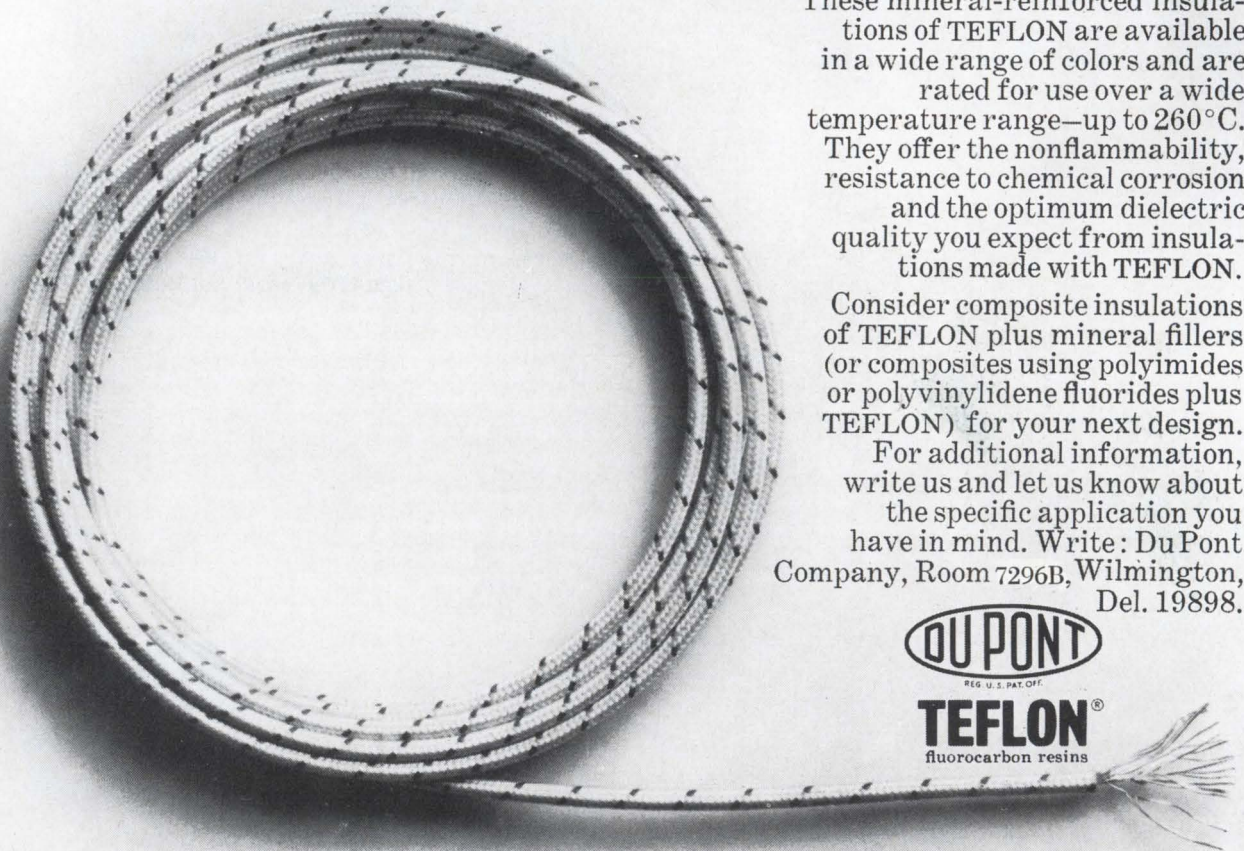

Component Engineers and Physicists

For:
Application • Design
Reliability • Evaluation
Failure Analysis
Phenomena Studies

The Components and Materials Laboratory of Hughes Aircraft Company in Southern California has immediate needs for Engineers and Physicists to fill challenging, permanent positions in the following fields:

Microelectronics Engineers. To evaluate integrated and hybrid devices, analyze failure modes, investigate effects of environments and materials on device characteristics and determine application criteria.

Component Engineers. Will coordinate component-equipment requirements, provide technical consultation, select vendors, determine evaluation programs and initiate procurement documentation.

Component Application Engineers. Will provide technical consultation and liaison to design activities, assist in selection and application

of component parts and participate in design reviews.

Magnetic Designers. To design static magnetic components, develop new magnetic devices, initiate evaluation tests, investigate and apply new design concepts.

Reliability Engineers. To coordinate reliability programs, conduct component failure analyses, define and direct experiments, establish mathematical models and investigate component performance.

Physicists. Will investigate component performance, analyze failure mechanisms, conduct phenomena studies and experiments.

Component Development Engineers. To develop components using advanced techniques, investigate new design concepts, study component phenomena, direct experiments and design evaluations.

Supervisors. In addition to requirements for both junior and senior engineers for these positions, several supervisory openings are available.

Requirements. BS, MS or PhD degree in Physics or in Electrical/Mechanical Engineering. (Openings are also available for non-degreed engineering personnel.) Assignments are available in the following and associated technical fields:

Microelectronics • Electron Tubes • Potentiometers • Connectors • Microwave • Capacitors • Crystals • Relays • Instruments • Mechanical • Filters • Motors • Semiconductors • Resistors • Switches • Reactors • Resolvers • Transformers.

U. S. Citizenship Is Required

For immediate consideration, please airmail your resume to:

Mr. Robert A. Martin
Head of Employment
Dept. 93
11940 W. Jefferson Blvd.
Culver City, Calif. 90230

HUGHES

HUGHES AIRCRAFT COMPANY
AEROSPACE DIVISIONS

An equal opportunity
employer — M & F

LK series high-current power supplies all silicon, convection cooled—bench or rack

For test equipment
and lab use—
0-20, 0-36, 0-60 VDC
from 0-4.0 amps.
to 0-66 amps.

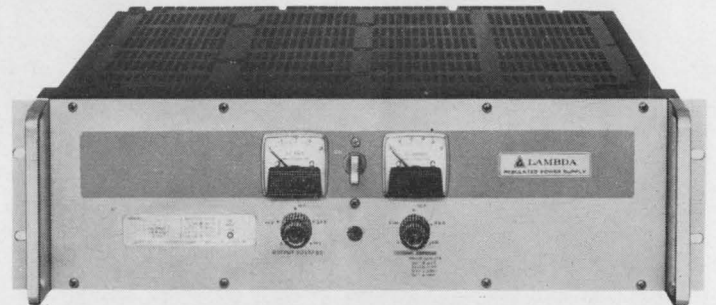
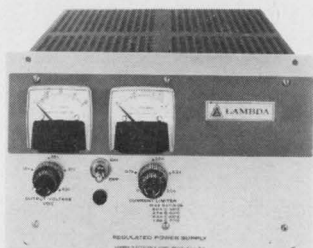
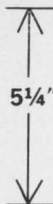
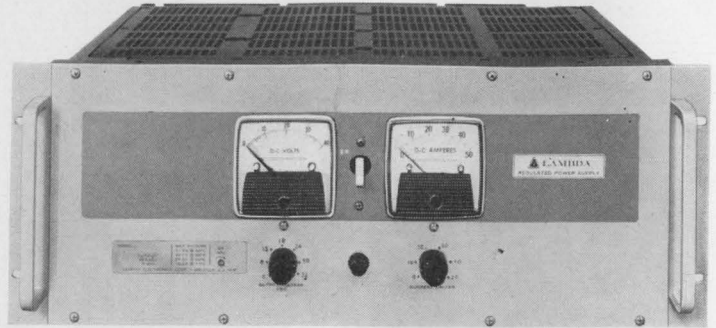
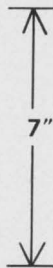

**ONE
DAY
DELIVERY
ALL
MODELS**



LK Series metered 1/2-rack

LK Series metered full-rack

Features and Data

- All silicon-designed for maximum reliability
- Convection Cooled—no blowers, no external heat sinks.
- Regulation—.015% or 1 mV (line or load)
- Ripple—500mV RMS
- AC Input—105-132 VAC, 57-63 Hz. LK7 "series" 188-238 VAC, 57-63 Hz (derate current 10% at 50 Hz.)
- No Voltage Spikes or Overshoot on "turn on", "turn off" or power failure
- Temperature coefficient—0.015% + 0.5mV/°C.
- Series/Parallel Operation

- Completely Protected—short circuit proof—Continuously adjustable automatic current limiting
- Constant Voltage/Constant Current
- Remotely Programmable
- Meet Mil. Environment Specs.
Vibration: MIL-T-4807A
Shock: MIL-E-4970A Proc. 1 & 2
Humidity: MIL-STD-819 Meth. 507
Temp. Shock: MIL-E-5272C (ASG) Proc. 1
Altitude: MIL-E-4970A (ASG) Proc. 1
Marking: MIL-STD-130
Quality: MIL-Q-9858

LK Series full-rack models		Size 7" x 19" x 18 1/2"				
Model ²	ADJ. VOLT. RANGE VDC	CURRENT RANGE AT AMBIENT OF: ¹				Price ²
		40°C	50°C	60°C	71°C	
LK-360 FM	0-20	0-66A	0-59A	0-50A	0-40A	\$995
LK-361 FM	0-36	0-48A	0-43A	0-36A	0-30A	950
LK-362 FM	0-60	0-25A	0-24A	0-22A	0-19A	995

LK Series full-rack models		Size 5 3/16" x 19" x 16 1/2"				
Model ²	ADJ. VOLT. RANGE VDC	CURRENT RANGE AT AMBIENT OF: ¹				Price ²
		40°C	50°C	60°C	71°C	
LK-350	0-20	0-35A	0-31A	0-26A	0-20A	\$675
LK-351	0-36	0-25A	0-23A	0-20A	0-15A	640
LK-352	0-60	0-15A	0-14A	0-12.5A	0-10A	650

LK Series 1/2-rack models		Size 5 3/16" x 8 3/8" x 16 1/2"				
Model ²	ADJ. VOLT. RANGE VDC	CURRENT RANGE AT AMBIENT OF: ¹				Price ²
		40°C	50°C	60°C	71°C	
LK-340 A	0-20	0- 8.0A	0- 7.0A	0- 6.1A	0-4.9A	\$330
LK-341 A	0-20	0-13.5A	0-11.0A	0-10.0A	0-7.7A	385
LK-342 A	0-36	0- 5.2A	0- 5.0A	0- 4.5A	0-3.7A	335
LK-343 A	0-36	0- 9.0A	0- 8.5A	0- 7.6A	0-6.1A	395
LK-344 A	0-60	0- 4.0A	0- 3.5A	0- 3.0A	0-2.5A	340
LK-345 A	0-60	0- 6.0A	0- 5.2A	0- 4.5A	0-4.0A	395

OVERVOLTAGE PROTECTION ACCESSORIES			
For Use With	Model	Adj. Volt Range	Price
LK-340A, 341A	LH-OV-4	3-24 VDC	\$35
LK-342A, 343A	LH-OV-5	3-47 VDC	35
LK-344A, 345A	LH-OV-6	3-70 VDC	35
LK-350-352	OV-70	Overvoltage Protection up to 70 VDC as a built-in option for full-rack models. To order, add suffix (-OV) and add \$90.00 to price of models LK-350-352, add \$120.00 for models LK-360-FM-362-FM.	
LK-360 FM-362 FM			

NOTES:

- 1 Current rating applies over entire voltage range.
- 2 Prices are for non-metered models. For metered models, add suffix (-FM) and add \$30.00 to price. Models LK-360-FM, LK-361-FM, and LK-362-FM which are metered models not available without meters.
- 3 Chassis Slides for full rack models: Add suffix (-CS) to model number and add \$60.00 to the price, except for models LK-360-FM-LK-362-FM, for which add \$100.00.

Prices F.O.B. factory, Melville, N. Y. All specifications and prices subject to change without notice.

 **LAMBDA**
ELECTRONICS CORP.
515 BROAD HOLLOW ROAD, MELVILLE, L. I., NEW YORK 11746
TEL. 516-694-4200. TWX: 510-224-6484 CABLE: VEECOVAC PLAINVIEW NY

LP/LPD series general purpose power supplies for test equipment and lab use—bench or rack



LP Series — single output

ONE DAY DELIVERY ALL MODELS

- Twice the voltage (up to 500 VDC) with outputs in series.
- Twice the current (up to 3.4 amps) with outputs in parallel.

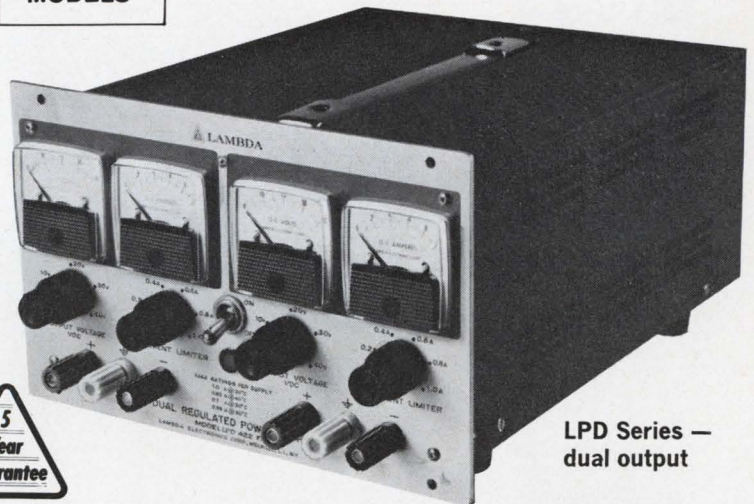

LPD Series — dual output

Features and Data

- 5 LPD Models with two independent DC outputs offer widest choice—Up to ± 250 VDC, up to 1.7 amps. Either output may be + or -, or both outputs may be + or -.
- Series/Parallel operation with LPD Series, both outputs yield *two times* the voltage or *two times* the current—up to 500 volts or up to 3.4 amps.
- Regulation (line or load)—0.01% + 1mV.
- Ripple—500 μ V RMS, 1.5 mV p-p. Models LP-415 and LP-425-FM only—1mV RMS, 3mV p-p.

LP Series 1/4-rack models		Size: 5 $\frac{3}{16}$ " x 4 $\frac{3}{16}$ " x 10"				
Model	Voltage Range VDC	MAX. AMPS AT AMBIENT OF: ¹				Price ²
		30°C	40°C	50°C	60°C	
LP-410*	0-10	0-2A	0-1.8A	0-1.6A	0-1.4A	\$129
LP-411*	0-20	0-1.2A	0-1.1A	0-1.0A	0-0.8A	119
LP-412*	0-40	0-0.70A	0-0.65A	0-0.60A	0-0.50A	114
LP-413*	0-60	0-0.45A	0-0.41A	0-0.37A	0-0.33A	129
LP-414	0-120	0-0.20A	0-0.18A	0-0.16A	0-0.12A	149
LP-415	0-250	0-80mA	0-72mA	0-65mA	0-60mA	164

LPD Series 1/2-rack models		Size: 5 $\frac{3}{16}$ " x 8 $\frac{3}{8}$ " x 10 $\frac{5}{8}$ "				
Model	Voltage Range Per output/Outputs in series VDC	1 MAX AMPS AT AMBIENT OF: ⁽¹⁾ Per output/Outputs in parallel				Price ⁽³⁾
		30°C	40°C	50°C	60°C	
LPD-421-FM*	0- ± 20 /0-40	1.7A/3.4A	1.5A/3.0A	1.3A/2.6A	0.9A/1.8A	\$325
LPD-422-FM*	0- ± 40 /0-80	1.0A/2.0A	0.85A/1.7A	0.7A/1.4A	0.55A/1.1A	260
LPD-423-FM*	0- ± 60 /0-120	0.7A/1.4A	0.6A/1.2A	0.5A/1.0A	0.4A/0.8A	325
LPD-424-FM	0- ± 120 /0-240	0.38A/0.76A	0.32A/0.64A	0.26A/0.52A	0.20A/0.40A	325
LPD-425-FM	0- ± 250 /0-500	0.13A/0.26A	0.12A/0.24A	0.11A/0.22A	0.10A/0.20A	350

NOTES:

- * Overvoltage Protection available as an accessory. Each output requires separate OV accessory—add \$35.00 for each output.
- 1 Current rating applies over entire voltage range. Ratings based on 57-63 Hz operation.
- 2 Prices of LP series are for non-metered models. For metered models, add suffix (-FM) and add \$10.00 to price.
- 3 Prices of LPD series are for metered models. LPD Series models are not available without meters.

- AC Input—105-132 VAC 47-440 Hz (ratings based on 57-63 Hz operation). For operation at 205-265 VAC, add suffix "-V" to model numbers. No change in price.
- Temperature coefficient—0.015% + 0.5mV/°C.
- Auto Series/Auto Parallel with Master-Slave tracking
- All silicon-designed for maximum reliability
- Convection cooled—no blowers, no external heat sinks.
- Constant voltage/constant current.
- Designed to meet RFI per MIL STD 826A.
- Remotely programmable.
- Remote sensing.
- Fungus Proofing Option—Add suffix "R" to model number and add \$15.00 to price.

Accessories

Rack Adapter LRA-1 Price \$60.00 • 5 $\frac{1}{4}$ " H x 16 $\frac{1}{2}$ " D

Rack Adapter LRA-2 Price \$35.00 • 5 $\frac{1}{4}$ " H

OVERVOLTAGE PROTECTION ACCESSORIES			
For Use With	Model	Adj. Volt Range	Price per Output
LP-410; (0-10VDC)	LH-OV-4	3-24V	\$35
LP-411; LPD-421-FM (0-20VDC)	LH-OV-4	3-24V	35
LP-412; LPD-422-FM (0-40VDC)	LH-OV-5	3-47V	35
LP-413; LPD-423-FM (0-60VDC)	LH-OV-6	3-70V	35

Prices F.O.B. factory, Melville, N. Y. All specifications and prices subject to change without notice.

 **LAMBDA**
ELECTRONICS CORP.
515 BROAD HOLLOW ROAD, MELVILLE, L. I., NEW YORK 11746
TEL. 516-694-4200. TWX: 510-224-6484 CABLE: VEECOVAC PLAINVIEW NY

LR series high-performance power supplies

regulation—0.0005%, ripple—35 μ v

For test equipment and lab use—rack or bench
0-20, 0-40, 0-120, 0-250 VDC, from 60 ma. to 1.8 amps.

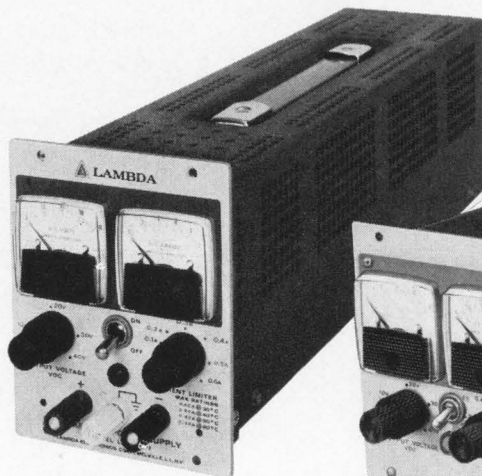

1/4 rack models

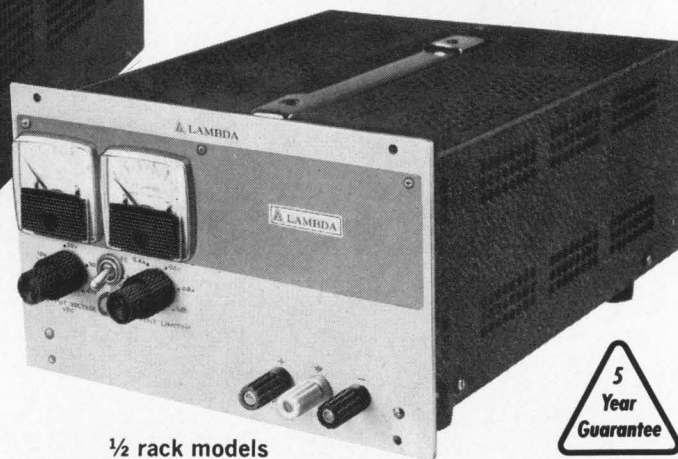

1/2 rack models

ONE DAY DELIVERY ALL MODELS



Features and Data

- 0.0005% plus 100 μ regulation.
- 35 μ V rms, 100 μ p-to-p ripple.
- AC Input: 105-132 VAC, 47-440 Hz (Ratings based on 55-65 Hz; derate current 10% at 50 Hz.) 205-265 VAC on request at no extra charge ("V" option).
- 2 meters monitor both voltage and current simultaneously and continuously.
- Accuracy—0.01% plus 1mV
- Stability—0.001% plus 100 μ V for 8 hours
- Temperature coefficient—0.001% plus 10 μ V/ $^{\circ}$ C
- Multi-Current-Rated.

- Guaranteed for 5 years. The only 5-year guarantee that includes labor as well as parts. Guarantee applies to operation at full published specifications at end of 5 years.
- Only 5 1/4" high. Convenient 1/4 and 1/2 rack sizes for rack or bench use.
- All silicon-designed for maximum reliability.
- Convection Cooled—no blowers, no external heat sinks.
- Auto Series/Auto Parallel with Master-Slave tracking.
- Constant Voltage/Constant Current
- Completely protected—short-circuit proof—continuously adjustable, automatic current limiting.
- Overvoltage protection available for all models up to 70 VDC.
- Remotely Programmable

LR Series 1/4-rack models		Size: 5 3/16" x 4 3/16" x 15 1/2"				
Model	Voltage Range	MAX. AMPS AT AMBIENT OF: ¹				Price
		30 $^{\circ}$ C	40 $^{\circ}$ C	50 $^{\circ}$ C	60 $^{\circ}$ C	
LR-602-FM	0-20 VDC	1.1	.95	.80	.64	\$265
LR-603-FM	0-40 VDC	.60	.50	.42	.33	265
LR-605-FM	0-120 VDC	.23	.20	.17	.14	295
LR-606-FM	0-250 VDC	80ma	72ma	65ma	60ma	310

LR Series 1/2-rack models		Size: 5 3/16" x 8 3/8" x 10 5/8"				
Model	Voltage Range	MAX. AMPS AT AMBIENT OF: ¹				Price ²
		30 $^{\circ}$ C	40 $^{\circ}$ C	50 $^{\circ}$ C	60 $^{\circ}$ C	
LR-612-FM	0-20 VDC	1.8A	1.6A	1.3A	1.1A	\$305
LR-613-FM	0-40 VDC	1.0A	0.9A	0.75A	0.6A	305
LR-615-FM	0-120 VDC	0.33A	0.29A	0.25A	0.21A	320
LR-616-FM	0-250 VDC	100ma	90ma	80ma	70ma	340

NOTES:

- 1 Current rating applies over entire voltage range. Ratings based on 55-65 Hz operation. Derate current 10% for 50 Hz input.
- 2 Prices are for metered models. LR Series models are not available without meters.

Accessories

- Rack Adapter LRA-1 Price \$60.00 • 5 1/4" H x 16 1/2" D
Rack Adapter LRA-2 Price \$35.00 • 5 1/4" H

OVERVOLTAGE PROTECTION ACCESSORIES

For Use With	Model	Adj. Volt Range	Price
LR-602-FM, LR-612-FM	LH-OV-4	3-24 V	\$35
LR-603-FM, LR-613-FM	LH-OV-5	3-47 V	35

Prices F.O.B. factory, Melville, N. Y. All specifications and prices subject to change without notice.

 **LAMBDA**
ELECTRONICS CORP.
515 BROAD HOLLOW ROAD, MELVILLE, L. I., NEW YORK 11746
TEL. 516-694-4200. TWX: 510-224-6484 CABLE: VEECOVAC PLAINVIEW NY

HYBRIDS

bridge the op amp generation gap

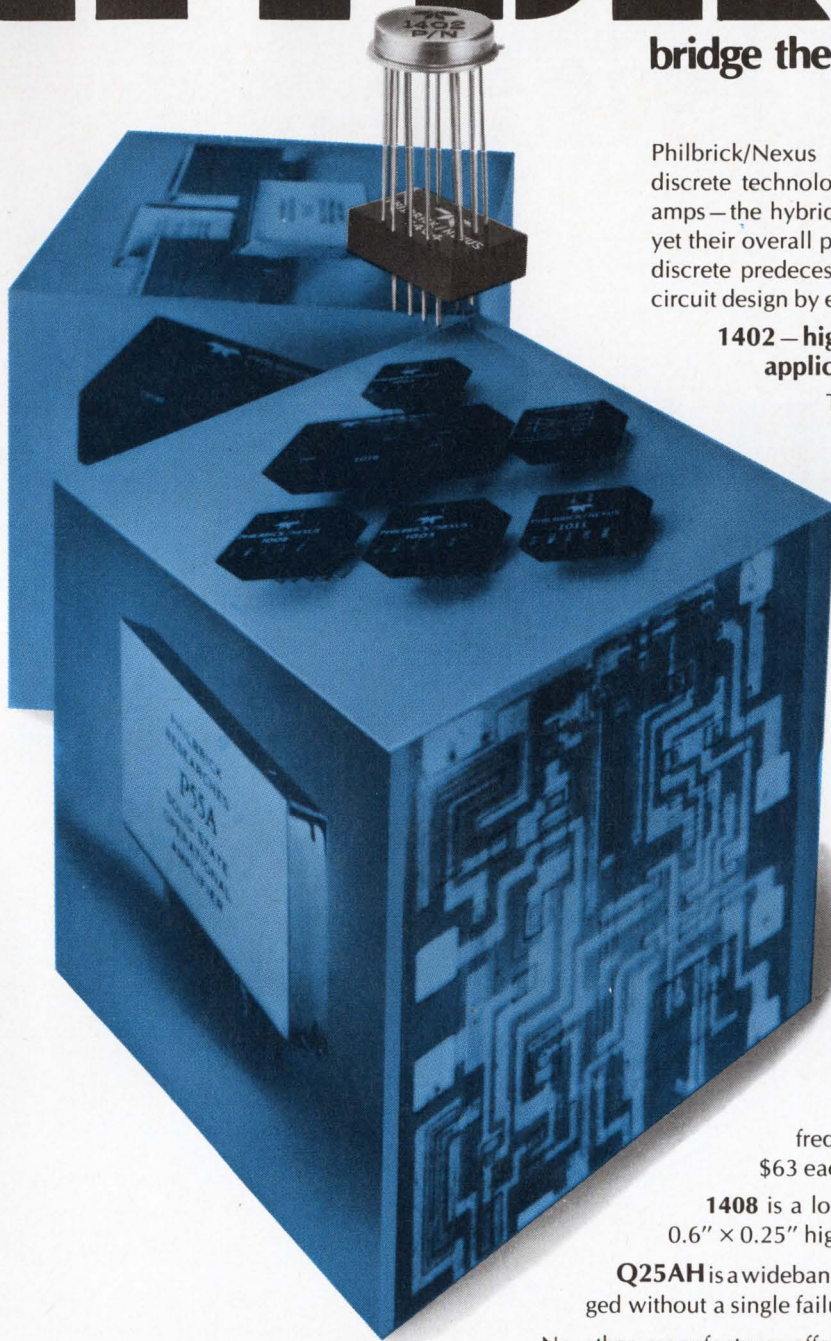

Philbrick/Nexus combines the best of monolithic and discrete technologies to create the now generation of op amps—the hybrids. They're micro-miniature and low cost, yet their overall performance is equal to or better than their discrete predecessors. And, built-in stabilization simplifies circuit design by eliminating external components.

1402—high performance FET for battery applications

The 1402 features a quiescent current drain of only $500\ \mu\text{A}$ with a power supply voltage range of $\pm 4\text{V}$ to $\pm 24\text{V}$, full output frequency of 80 KHz and output capability of $\pm 14\text{V}$ at $\pm 5\text{mA}$ with $\pm 15\text{V}$ power supply. TO-8 case; 0.5" diameter, 0.14" high. Price: \$75 each in 1-9 quantity.

Other hybrids offering interesting performance characteristics:

1404 offers the lowest power drain ($50\ \mu\text{A}$) of any general purpose hybrid on the market. ± 2.5 to ± 15 volt operation. Produces 1 mA output. Size: $0.75" \times 0.45" \times 0.20"$ high. Price: \$58 each in 1-9 quantity.

1406 is a small (TO-8 case) fast general purpose op amp. Price: \$36 each in 1-9 quantity.

1407 is a low cost high performance FET which features a gain bandwidth product of 30 MHz. Full output frequency is 100 KHz. TO-8 case. Price: \$63 each in 1-9 quantity.

1408 is a low cost differential FET input. Size: $0.6" \times 0.6" \times 0.25"$ high. Price: \$30 each in 1-9 quantity.

Q25AH is a wideband, high reliability FET. 1,000,000 hours logged without a single failure. TO-8 case. \$180 each in 1-9 quantity.

No other manufacturer offers as wide a variety. Ability to innovate, design and manufacture will continue to provide a greater variety of hybrids from Philbrick/Nexus than you'll get from any other single source.

For complete specifications and technical assistance, contact your Philbrick/Nexus field-engineering representative or write, Philbrick/Nexus Research, 22 Allied Drive at Route 128, Dedham, Mass. 02026.



PHILBRICK/NEXUS RESEARCH

A TELEDYNE COMPANY

Low-cost motion control is here...

and PMI has the precision motor!

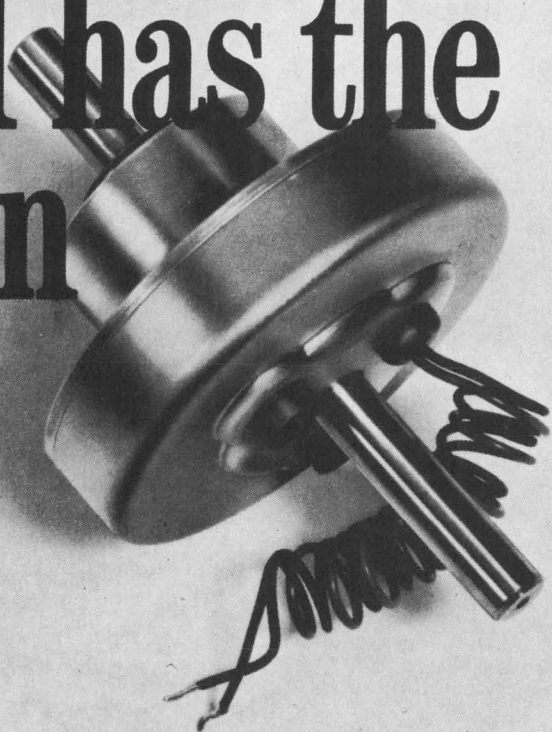

When your motion needs accurate controlling, call your PMI Applications Specialist. Our experience in fast response actuators has helped us to design a new low cost version with the best performance per dollar in the industry. The same proven reliability found in our standard line is built into these lower cost motors.

The U9M4F is the first of the new servo series which will be used for low cost EDP peripheral equipment, fast stop-start applications for industrial use and low cost video and tape recorders.

This motor will also be available with our new integral tachometer.

Motion control is our prime concern... a field in which we are constantly innovating. This new DC servo motor is another example of our interest in helping you solve your precision control problems. We have a broad line of fast response actuators and an extensive free application assistance program to help you with your special requirements. Write or call us (516-676-8000) for all the details.



PRINTED MOTORS, INC. GLEN COVE, NEW YORK 11542

Engineering, Manufacturing and Sales by: PHOTOCIRCUITS CORPORATION, Glen Cove, New York 11542



Another First...

FOR THE FIRST TIME, A HANDSIZE*, ALL SOLID-STATE (F.E.T.) V-O-M

Triplet's super-sensitive tester—Model 310-FET—features dynamic design, unprecedented performance, $\pm 3\%$ DC accuracy, $\pm 4\%$ AC, taut suspension movement. It ushers in an exciting new breed of miniaturized measurement mightiness.

1. All Solid-State (F.E.T.) with 10 Megohm input resistance, Battery operated.
2. High sensitivity (300 mV DC fs) for transistor bias measurements, resistance measurements to 5,000 Megohms.
3. Handsize with single selector switch and provision for attaching AC clamp-on adapter.

AN ADDITION TO THE FAMOUS TRIPLETT 310 SERIES

SEE YOUR TRIPLETT REPRESENTATIVE OR DISTRIBUTOR FOR A FREE DEMONSTRATION!

*Photo Actual Size

SUGGESTED U.S.A. USER NET PRICE \$70.00



THE TRIPLETT ELECTRICAL INSTRUMENT COMPANY • BLUFFTON, OHIO 45817

Certified mix & match



With the Winchester MRAC series you can intermix power, shielded signal and signal circuitry in the same connector, plus polarizing pins. To match your own termination requirements. And our adaptable, easily installed, readily removed contacts are available in crimp, solder, or wire-wrap, to match your production methods.

All certified—hoods, blocks and contacts—to MIL-C-22857.

Which means our MRAC series is not only adaptable and versatile, but highly dependable. And recommended for such applications as computers, shipboard equipment, radar and ground support equipment.

Let us send you specifications and details. Including how our removable contacts offer substantial savings in time and labor. And, great flexibility in your choice of circuitry. Write to: Winchester Electronics, Main St. and Hillside Ave., Oakville, Conn. 06779.

WINCHESTER ELECTRONICS 
LITTON INDUSTRIES

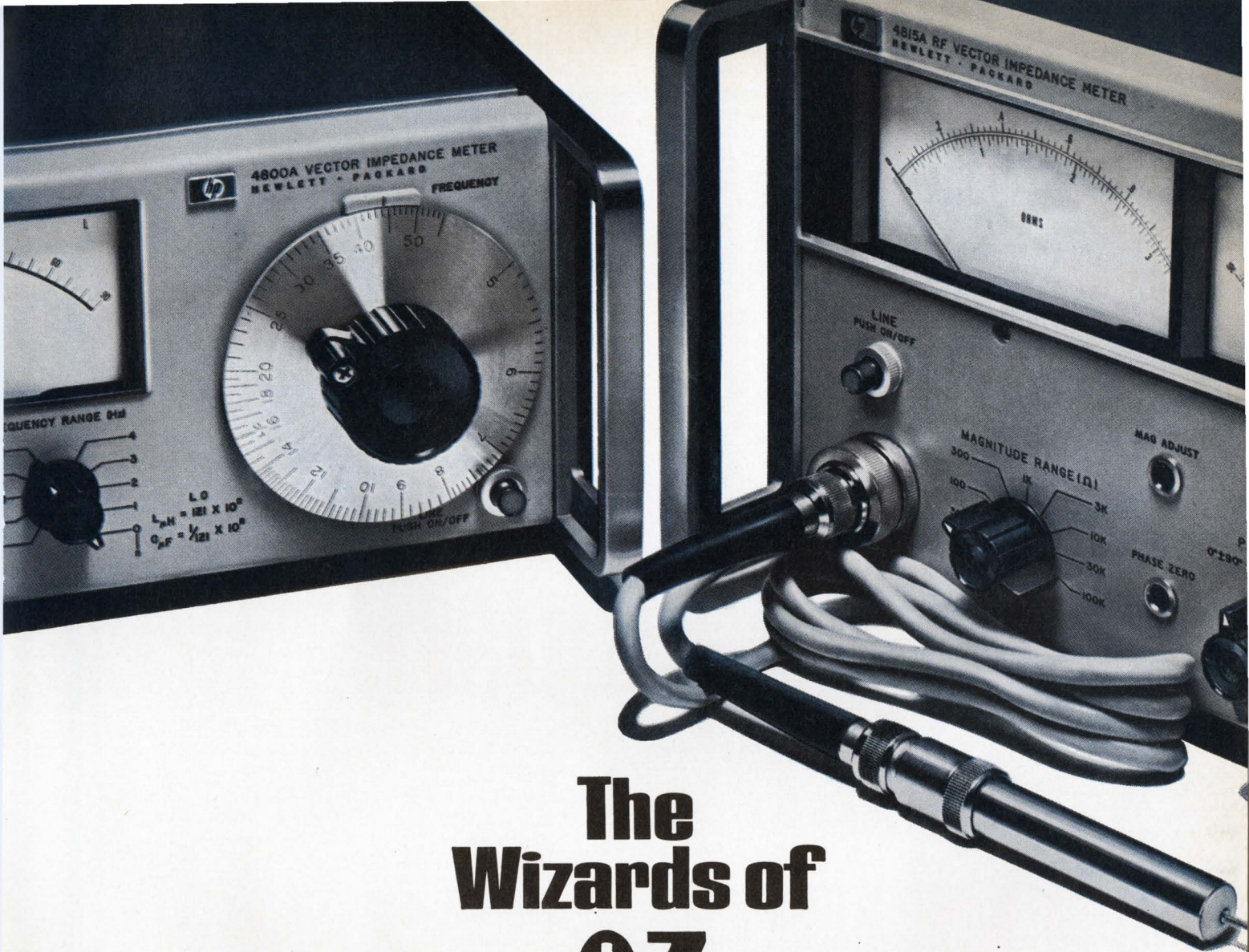

The Wizards of θZ

Like magic . . . vector impedance instruments read out complex impedance in an instant.

With the HP impedance meters, measurements involving impedance magnitude, Z , and phase angle, θ , no longer require tedious test procedures. These measurements are now as easy to make as voltage readings. No nulling . . . no balancing . . . no calculations to make. The wizardry of these HP instruments provides direct readout of Z (in ohms) and θ (in degrees) over a continuous frequency range.

HP 4800A Vector Impedance Meter covers the 5 Hz to 500 kHz range. You set the frequency, select

the impedance range and read: Z from 1 ohm to 10 Megohms, and θ from -90° to $+90^\circ$. \$1650.

HP 4815A RF Vector Impedance Meter covers 500 kHz to 108 MHz. Measures, via a probe, active or passive circuits directly in their normal operating environment. Z from 1 ohm to 100 K ohms; θ from 0° to 360° . \$2650.

Application Note 86 describes many applications of the 4800A and the 4815A Vector Impedance Meters including the measurement of Z , R , L , and C . For your copy and complete specifications, contact your local Hewlett-Packard field engineer or write: Hewlett-Packard, Green Pond Road, Rockaway, New Jersey 07866. In Europe: 1217 Meyrin-Geneva, Switzerland.



HEWLETT  PACKARD
IMPEDANCE INSTRUMENTS

What this country
needs is a good
nickel cigar...
and a $\frac{3}{8}$ " square
industrial
cermet
trimmer.

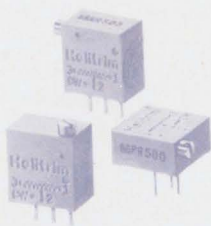

Helipot has the trimmer for \$3.50 list...

now available in local stock.

(But you'll have to find the cigar.)

Beckman

INSTRUMENTS, INC.

HELIPOT DIVISION

FULLERTON, CALIFORNIA • 92634

INTERNATIONAL SUBSIDIARIES: AMSTERDAM; CAPE TOWN; GENEVA; GLENROTHES,
SCOTLAND; LONDON; MEXICO CITY; MUNICH; PARIS; STOCKHOLM; TOKYO; VIENNA

Technical Articles

**Sonic film memory
is a sound bet
page 90**

The sonic film memory combines some of the characteristics of planar thin-film units, sonic delay lines, and magnetic drums. But unlike these others, it's capable of nondestructive readout, is nonvolatile, and doesn't require mechanical bearings and linkages. The sonic film memory takes advantage of an anisotropic thin film's magnetostrictive properties to change its magnetic state or generate a readout pulse as a strain wave propagates through the substrate.

**Designing lumped
elements into uhf and
microwave amplifiers
page 100**



Circuit designers have generally avoided lumped passive elements for high-frequency jobs because of distributed reactance effects. As a rule, microstrip has been used to interconnect active devices with matching, filtering, and biasing circuitry. Now, however, RCA engineers, using photoresist techniques originally developed for transistor technology, are turning out pas-

sive elements so small that distributed effects aren't critical factors in performance. The company is putting these devices in hybrid power amplifiers operating at uhf and microwave frequencies. The amps perform as well as conventional assemblies, are smaller, and promise cost savings since the passive circuitry can be batch processed. On the cover is 40-watt amplifier built by RCA with lumped elements; it has a 16-decibel gain at 350 megahertz.

**Want to be a good loser?
Go about it systematically
page 112**

Design failures—equipment that looks fine on the drawing board and works well in the lab but which bombs out when produced and sold in volume—may occasionally occur by chance. In most cases, however, the designer has dutifully followed some or all of these easy-to-learn, time-tested guidelines to disaster.

**Active filters: part 9
applying nonlinear
elements
page 116**

When faced with the task of filtering or frequency-tuning in high-temperature or radiation-affected environments, designers can turn to offbeat devices like magnetoresistive and Hall-effect assemblies, which also afford space savings.

**Systems engineering—
myth and methodology**

Coming

For better or worse, systems engineering—a concept still in search of a consensus definition—is being applied to large-scale projects in the hope of saving time, money, and effort. The verdict on its efficacy, particularly with regard to engineering creativity, is still in doubt.



Sonic film unit is a sound bet

A strain wave moves along a substrate under an isotropic magnetic film in experimental memory that reads and writes, is nonvolatile, and isn't saddled with mechanical contrivances

By Rabah Shahbender

RCA Laboratories, Princeton, N.J.

Strain waves interacting with magnetic film elements form an unusual memory—the sonic film. In the technique, which RCA Laboratories has been investigating for several years, strain waves travel at the speed of sound along a substrate under an anisotropic magnetic film, taking advantage of the latter's magnetostrictive properties to record data in it. The aim is to produce a block-oriented random-access memory (Boram), in which blocks of data are accessible randomly at electronic speed but from which data can be retrieved only a whole block at a time, not in individual words.

It's still an experimental technique; current work is primarily in improving ways to launch the strain wave and in measuring its characteristics. This research will probably continue for at least another year, after which a program must be undertaken to develop methods to deposit the film, make the transducer, package the unit mechanically, and so on—probably one or two years' more work. At that point the technique may become suitable for a commercial product, depending on the status of competitive techniques, its prospects now are bright.

Like those of the planar thin-film memory, the sonic film memory elements are a series of thin-film spots or strips deposited on a substrate of glass or similar material. But the sonic film memory is capable of nondestructive readout; whereas planar thin-film memories, in general, have destructive readout—that is, all information taken from them must be regenerated if it is to be available for later reuse. [Cylindrical thin films, or plated wires, are also capable of nondestructive readout; see *Electronics*, Nov. 11, 1968, p. 124.]

Like the sonic delay line, the sonic film depends on a piezoelectric element from which high-frequency mechanical pulses propagate through a substrate. But the sonic film memory is nonvolatile, whereas the data stored in a sonic delay line van-

This is the eighth installment in *Electronics'* continuing series on memory technology, which began in the Oct. 28, 1968, issue.

ishes when power is shut off.

Like the electromechanical disk or drum unit, the sonic film memory can transfer data from individual blocks or tracks at very high rates. But the sonic film memory isn't saddled with mechanical supports, linkages, drive motors, and the like, and it doesn't have to wait an average of several milliseconds, as does the mechanical unit, before it can start reading from a particular block. Furthermore, it's capable of much better volume utilization. That is, bits can fill up every cubic inch of memory instead of being scattered about on the surface.

The simplest configuration for a memory block is a series of continuous strips of anisotropic magnetic film deposited on one surface of a glassy substrate, similar to a biologist's microscope slide, as shown on page 91, top. The best results are obtained with a substrate of fused silica. The film's anisotropy creates a much larger remanent flux in a particular direction, called the easy axis, than at right angles to that direction—the hard axis. An ultrasonic transducer of lead zirconate-titanate or similar material is attached to one end of the substrate, and an ultrasonic absorbing medium is attached to the other, to prevent echoes from generating spurious outputs. Two conductors on opposite sides of a plastic sheet are put over the magnetic film strips. One conductor is the bit line, parallel to the film's hard axis; the other is a sense line, parallel to the easy axis. One of these has a zigzag pattern; which one depends on the orientation of the film relative to the direction of strain wave propagation and on whether a longitudinal or shear wave is

Boram block. Ultrasonic transducer launches strain wave in substrate; moving deformation creates magnetostrictive changes in this magnetic film to store or retrieve data. The two windings shown on the plastic overlay can be combined into one if the magnetic film is properly deposited.

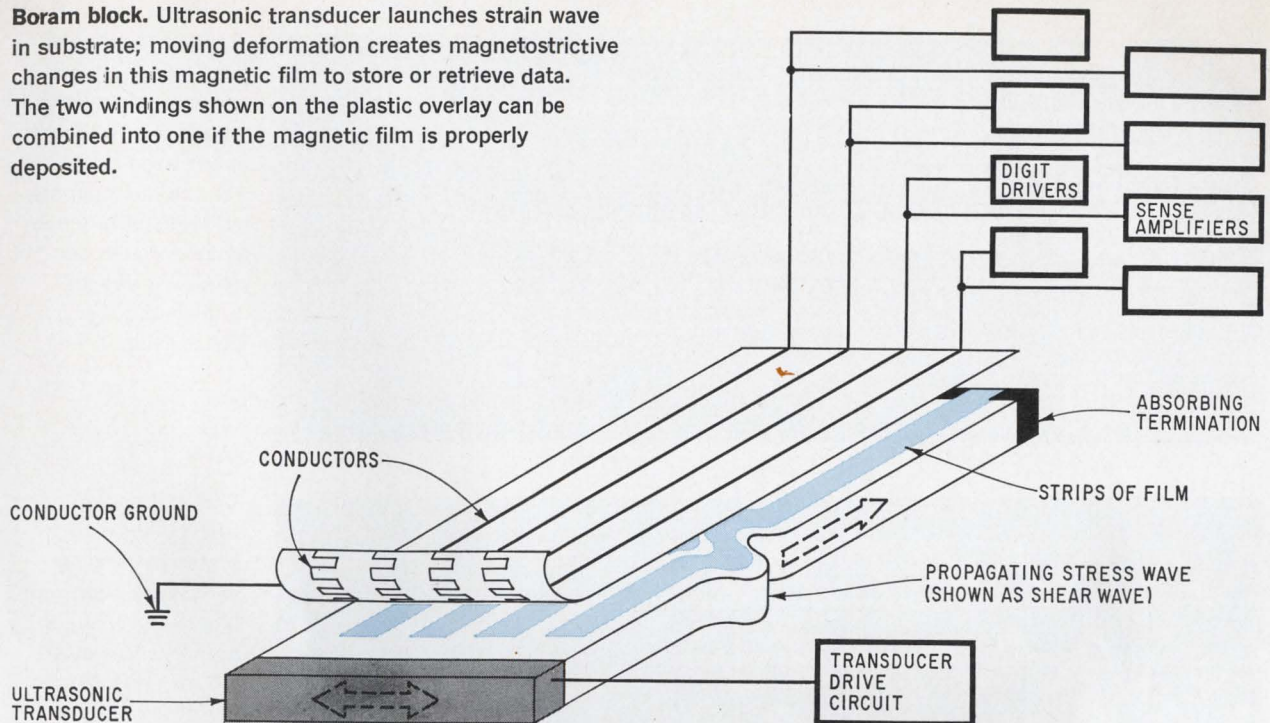

used. For the longitudinal wave, the direction of propagation is parallel to the direction of strain; for a shear wave, the two are perpendicular, with the strain parallel to the plane of the film. Any of these configurations works, but a shear wave gives the best results.

To enter data into the block, the ultrasonic transducer launches a strain wave that propagates along the glass at the speed of sound—3,760 meters per second in fused silica. For a strip 30 centimeters long, this strain wave would arrive at the absorbing medium 80 microseconds after it was launched. As it passes each bit position on its way along the substrate, the strain wave reduces the switching threshold of the film at that position, because of the film's magnetostrictive properties. Pulses of current in the bit line can reverse the magnetization of the strained regions of the film without affecting that of the unstrained regions; properly timed pulses can therefore write data in the film as the strain wave moves along the substrate.

Likewise, as a strain wave passes a given region of the film in the absence of a writing pulse, the film's magnetization rotates slightly but doesn't reverse; this rotation generates a voltage in the sense winding. The polarity of the induced voltage depends on the remanent state of magnetization corresponding to the stored data.

This description is somewhat oversimplified. Actually, either rotation of the easy axis or reduction of the anisotropy field, or a combination of both, can be used for either writing or reading. But in any case, a single sequence of bits can be serially stored in the film, and serially read out again. Data can be processed several bits at a time—in characters or full computer words, for example—by using

the necessary number of film strips on the substrate, each with its own digit and sense line and its own drive and sense circuits.

The diagrams and oscilloscope traces on page 92 show the results of tests on a sonic film memory device. These particular tests were performed on a substrate lacking an absorbing termination at the end opposite the ultrasonic transducer, so that echo signals are present. Also, the substrate had discrete film spots, measuring 20 by 50 mils, as shown below, instead of a continuous strip of film, and it had a large round patch of film in the center for testing the film's B-H loop. Other tests have shown that a continuous film strip is feasible for this memory. If

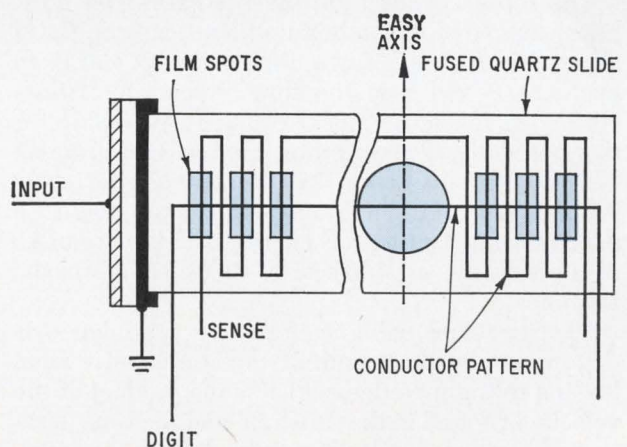

Test blocks. Initial tests were performed on this unit using individual patches of film and two separate conductors. The round spot is for testing the film's B-H loop. Later tests showed that continuous film and one conductor are feasible.

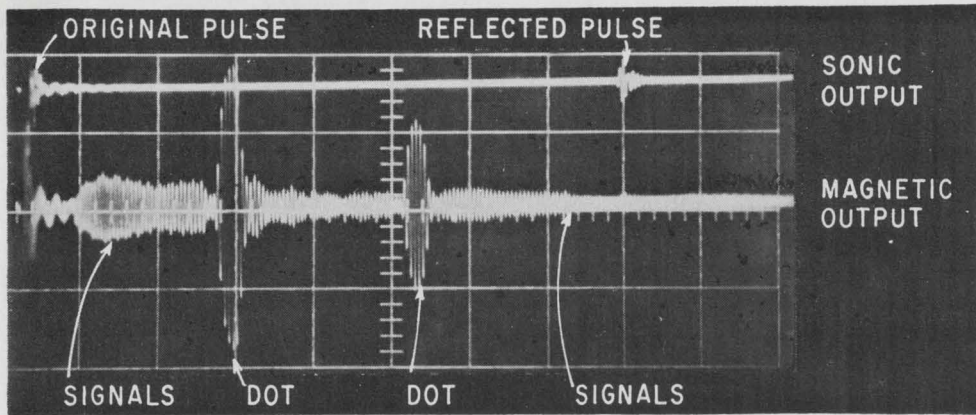

Composite signals. Upper trace shows original and reflected pulses in transducer; lower trace is signals read from film spots as sonic pulse propagates through substrate. Scales are 1 mv and 5 μ sec per division.

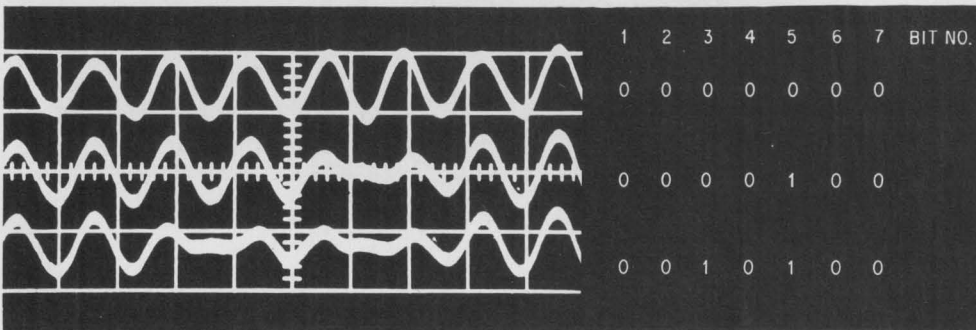

Data pulses. In one test, pulses generated by passing sonic wave represent binary 0's; where a 1 no pulse. Scales are 0.5 mv and 0.2 μ sec per division.

the film's easy axis is at an angle to the strain wave's direction of propagation, the sense and digit functions can be combined in a single winding.

The oscilloscope trace of the composite sense signal, in the top photo, also shows in its upper trace the original driving pulse and the pulse generated by the sound wave reflected from the far end of the substrate. On the lower trace are the outputs from the individual magnetic spots and a large blip generated by the round center patch. Both of these are duplicated in reverse, with reduced amplitude, as the echo pulse returns.

The sense signals from seven adjacent bit positions, expanded in the bottom photo, include 0's in all seven positions, a single 1 in position 5, and 1's in positions 3 and 5 in the three traces. A distinct change in the sense signal character is visible for the stored 1's. The encoding used in this example generated a pulse for a 0 and essentially no pulse for a 1. The reverse coding, of course, could be used instead. Timing for a series of missing pulses in succession is established by strobe signals in the amplifier.

The length of a bit in inches or centimeters is determined by the length of the strain pulse from leading to trailing edge, which is the product of the velocity of sound in the substrate and the time duration of the strain pulse. To enter data in the memory, a strained magnetic region must switch completely in less than the time required for the strain wave to pass that region.

If bits are packed onto the film at 20 per centimeter—much less than the tightest feasible packing

in this technology—the strain pulse must be no more than 0.5 millimeter long. If the wave travels at 3,760 meters per second, its duration is about 125 nanoseconds, and it therefore passes a particular point in 125 nsec. Then the magnetic film must switch in less than 125 nsec—considerably less, because higher densities are more practical and there must be a margin for error. This implies a switching time of about 10 nanoseconds.

Furthermore, the current pulse that causes this switching cannot have much overdrive, or it will switch unstrained bit positions as well as the one that is strained. The switching threshold is reduced to about half its unstrained value as the strain wave passes; the current pulse should be just strong enough to clear the strained threshold reliably without affecting any unstrained part of the film.

Densities, in general, are determined by transducer characteristics. If the density is too high for a particular kind of transducer, pulse crowding will occur between adjacent bits as they interfere with one another. To a certain extent, this interference can be overcome by appropriate encoding techniques, such as phase modulation. These techniques, which guarantee at least one phase change in every bit position regardless of whether it is a 1 or a 0, are similar to those that permitted bit packing densities on magnetic tape to increase from the 556 bits per inch that was standard only a few years ago to the 3,500 or so commonly found today.

Of the various parameters of a magnetic film, the most important ones entering into the sonic film's operation as a memory are the anisotropy field, H_k ,

the coercive field along the easy axis, H_c , and the direction of the easy axis relative to the direction of the strain, ϕ .

The anisotropy field expresses numerically the tendency for the magnetization to lie along one of the two axes in the film. It's shown graphically in the hysteresis loops measured in the two directions, drawn below. An ideal material for the sonic film memory, when unstrained, would have a perfectly square loop in the easy direction and no loop at all in the hard direction, and these directions would interchange when the material was sufficiently strained. The best films for this purpose approach the ideal quite well. They are made from about 60% nickel, 25% iron, and 15% cobalt.

The coercive field, of course, is simply half the width of the hysteresis loop along the easy axis. It's the field necessary to reduce the remanent magnetization to zero.

Both the anisotropy field and the direction of the easy axis are affected by strain. The easy axis tends to line up with the direction of the strain—discontinuously so, if the strain is great enough and applied at right angles to the original easy axis. And the anisotropy field can increase or decrease with strain, depending on the strain's magnitude and whether it is tensile or compressive. Both the anisotropy direction and the anisotropy field as functions of strain have been derived analytically; the graphs on page 94 are plots of these derivations.

In the first graph at left, the rotation of the magnetization θ_r is plotted against the normalized strain, with the angle ϕ between the unstrained easy axis and the direction of strain as a parameter. The easy axis can be established in any direction when the film is deposited in a suitably oriented magnetic field. The normalized strain is the ratio of the actual strain to the strain that produces the discontinuous rotation at $\phi = 90^\circ$; for highly magnetostrictive nickel-iron films the latter is 10^{-4} .

This graph shows that if the strain is applied parallel to the easy axis ($\phi = 0^\circ$), the easy axis doesn't rotate at all. On the other hand, if the strain is applied at right angles to the easy axis, the axis jumps suddenly through 90° to align itself with the strain when the latter reaches the critical value $K = 1$, or 10^{-4} . (Of course, this is only a theoretical result, based on the analytical derivation. Truly discontinuous rotation in the mathematical sense is physically impossible. In practice, because of microscopic variations in the substrate material, the strain isn't at exactly right angles to the easy axis at every point in a sample, even a small one, nor is it exactly the same value everywhere in the sample. As a result, the easy axis rotates quickly—not discontinuously—through *about* 90° when the normalized strain is *about* 1.)

In the second graph, at right on page 94, the normalized anisotropy field, H_k , is plotted against normalized strain, again with ϕ as a parameter. Normalized anisotropy field is the ratio of the actual field to the field existing in the absence of strain. Positive strain is tensile, and negative strain is com-

pressive; either one can increase or reduce the anisotropy field, depending on its direction relative to the unstrained easy axis. The graph shows that for positive values of K greater than 1, and with $\phi = 90^\circ$, the anisotropy field appears to become negative. This is a result of the discontinuous rotation of the easy axis under these conditions.

These theoretical predictions apply also to cylindrical thin films, although the details are different, of course. The predictions have been checked out experimentally.

PZT transducers

There are many piezoelectric materials, but not many that are suitable for a sonic film memory. One of the few both suitable and commercially available is lead zirconate-titanate, known as PZT from the chemical symbols for its components, Pb, Zr, and Ti. PZT transducers with a resonance frequency of 4 megahertz are readily available and are easily bonded to the ends of fused-quartz substrates; they generate ultrasonic pulses that propagate almost ideally. Unfortunately, the bit density for which this frequency is suitable is only about 25 bits per inch.

For a density of 100 bits per inch the resonant frequency is 16 Mhz. PZT transducers at this frequency are also available, but they're harder to handle, and the pulses they generate tend to travel through the substrate with velocities that are a function of frequency. Since a square pulse contains many frequencies, its shape deteriorates as it travels under these conditions, to the detriment of the output signal. The pulses are also likely to convert to other modes, analogous to the various electric and magnetic modes in a waveguide; these modes propagate at widely differing velocities, and thus produce spurious signals.

For still higher densities, up to 200 bits per inch, transducers of cadmium sulfide are being developed. These transducers are evaporated onto the substrate in somewhat the same way that the thin films are evaporated. Their resonance frequencies are in the range of 20 to 50 Mhz. These transducers, and the characteristics of the strain pulses that they generate, are the principal subjects of present in-

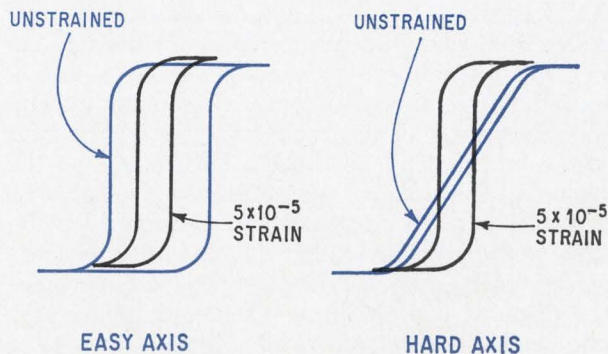

Toward isotropy. Sonic film's operation depends on the difference between the magnetic hysteresis loops in the easy and hard directions and the effect that strains has on them—narrowing one and widening the other.

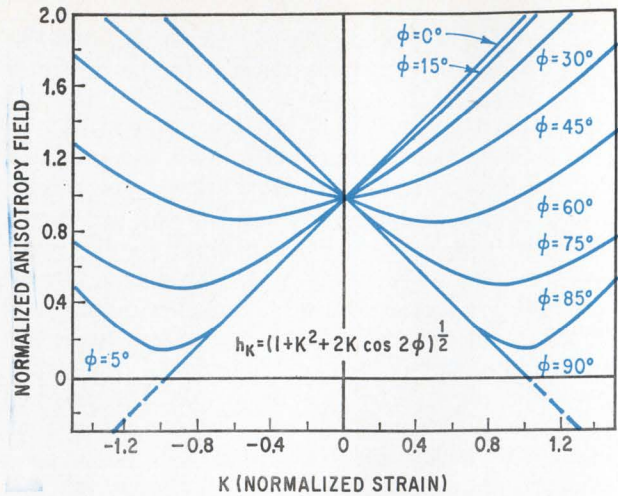
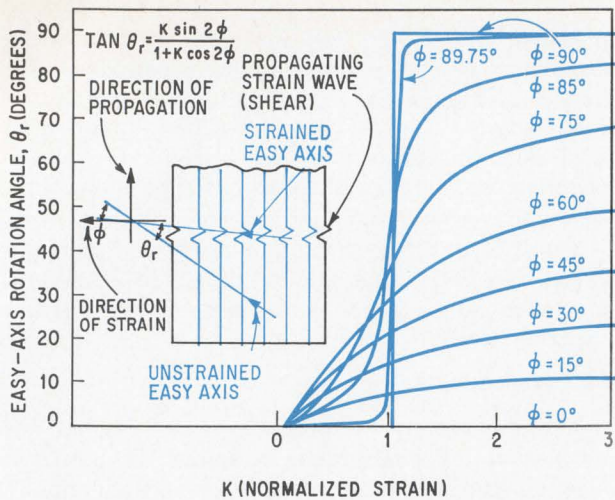

Twist, push, and pull. Amount of easy-axis rotation caused by strain wave depends on strain's magnitude and angle relative to original easy axis, plotted at left. Inset defines the angles. Diagram at right shows how strain diminishes difference in magnetic properties between the film's easy and hard axes.

vestigations in the sonic film technology.

A sonic film memory system would comprise a large number of substrates, each carrying several film strips storing information. Each strip is equivalent to a data track, containing a number of bits depending on the bit density and the track length. These parameters in turn are limited by the resonant frequency of the driving transducers, as described above, and the attenuation of the ultrasonic pulse as it propagates in the substrate. This attenuation is not excessive in a substrate 10 inches long; if the density is 200 bits per inch, each track could hold 2,000 bits. As many as 50 tracks could be deposited on a single substrate and driven by a single transducer, resulting in a capacity of 100,000 bits per substrate. Each track would require its own digit-sense conductor with associated circuitry. Because readout is nondestructive, a small number of sense-digit circuits could be shared by a large number of tracks; data read from unselected tracks need not be sensed for regeneration.

Only 10 such substrates would provide storage for a million bits. Capacities of many megabits would thus be available in a relatively small number of substrates. In such a system the access time is determined by the speed of the circuits that select the transducers—presumably about a microsecond. After a transducer was selected and a strain wave launched along a substrate, the bit transfer rate would depend on the bit density and on the velocity of sound in the substrate—typically 32 megabits per second at 200 bits per inch density.

As mentioned previously, the sonic film memory's performance is similar to that of an electromechanical magnetic disk or drum system; its bit transfer rate is similar, but the sonic film's access time is much faster—a microsecond, compared to the drum's 30 to 40 milliseconds. In the electromechanical system the bit transfer rate depends on the bit density and on the relative velocity between the

storage medium and the recording head. The velocity is limited by mechanical considerations to a few hundred feet per second, so that megabit transfer rates are obtained by packing the data at high density. In the sonic film memory, the velocity is that of sound, many thousands of feet per second, permitting high bit rates at modest densities.

From a device point of view, the sonic film memory resembles a fast thin-film memory. But, the latter's word-selection circuits are replaced by the ultrasonic transducers, each of which provides access to many more bits than the usual circuits.

Writing and reading in a sonic film memory cannot be interleaved; once a track has been selected all of it is loaded with new data, or all the old data is retrieved. This bypasses the digit transient recovery problem of other high-speed memories.

Without these transients, the sense amplifiers need not discriminate against much noise. In fact, the only noise present is the thermal noise in the amplifier itself. Because of this, even though the sonic film is block-oriented, its performance is almost as good as the performance of a wholly random-access memory. ■

Bibliography

- J.A. Rajchman, RCA Technical Note No. 346, 1959.
- E.N. Mitchell, G.I. Lykken, and G.D. Babcock, "Compositional and angular dependence of the magnetostriction of thin iron-nickel films," *Journal of Applied Physics*, April 1963, p. 715.
- H.L. Pinch and A.A. Pinto, "Stress effects in evaporated permalloy films," *Journal of Applied Physics*, March 1964, part 2, p. 828.
- H. Weinstein, "Static and dynamic stress effects on cylindrical ferromagnetic films," *Journal of Applied Physics*, March 1966, p. 1,003.
- H. Weinstein, L. Onyshkevych, K. Karstad, and Rabah Shahbender, "Sonic film memory," *American Federation of Information Processing Societies, Conference Proc. Vol. 29 (Fall Joint Computer Conference)*, 1966, p. 333.
- L. Onyshkevych, "Strain-sensitive thin magnetic films," *Journal of Applied Physics*, February 1968, p. 1,211.

Designer's casebook

Transformerless d-c voltage converter is 70% efficient

By Kees Van der Geer

Jutphaas, Netherlands

Replacing a standard multivibrator by a complementary one in a d-c voltage converter consisting of a multivibrator, a coupling network, and a standard diode-capacitor voltage multiplier increases the converter's efficiency from 1% to 70%. The complementary, unlike the standard multivibrator, has no collector resistance dissipating useful power and is therefore more suitable as the driver of the multiplier.

The multiplier, in turn, rectifies and multiplies the multivibrator's output.

The complementary multivibrator has two timing capacitors, is symmetrical, and consists of transistors Q_1 through Q_4 . Q_3 and Q_4 act as collector resistances of Q_1 and Q_2 . Little power is dissipated in these "resistances" because the voltage dividers $R_1 - R_3 - R_5$ and $R_2 - R_4 - R_6$ in conjunction with zener diodes D_1 and D_2 are designed so that when Q_1 or Q_2 is on, Q_3 or Q_4 is off and vice versa. This condition is met by adjusting potentiometers R_3 and R_4 .

If R_3 and R_4 are too low, the multivibrator will not oscillate. If they are too high, the power dissipated can be very high and the transistors may burn out. The multivibrator does not restart itself. It can be started with a push-button in the d-c input line.

With the values shown the frequency is about 10 kilohertz. With an input voltage of 10 volts, the output voltage is about 100 volts. Power output is 280 milliwatts making the circuit about 70% efficient.

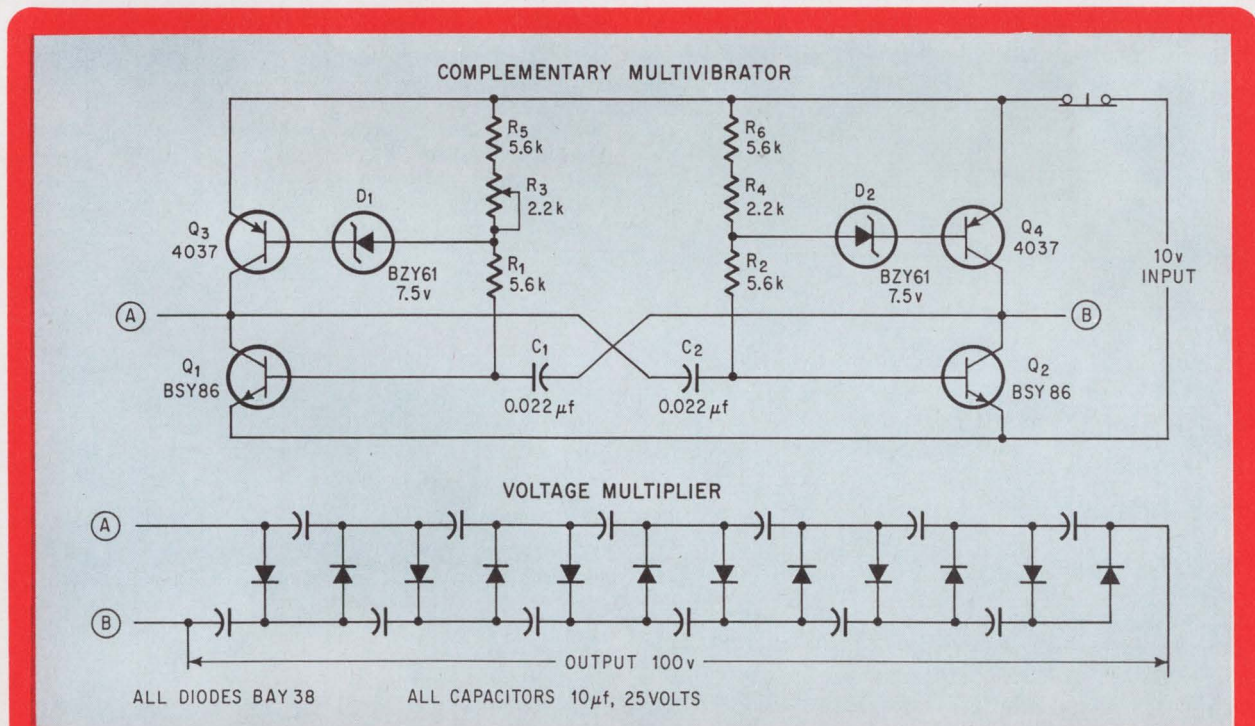

Conversion. The multivibrator's square-wave output is fed into a diode-capacitor network which rectifies the wave and multiplies the amplitude according to the number of its stages. Either voltage polarity can be obtained at the output by merely reversing the connections of the diodes and capacitors.

One-shot multivibrator yields division up to 12

By Virgilio Mosca

Electronics Consultant, Milan

One-shot multivibrators have an advantage as frequency dividers over the more common blocking oscillators and astable multivibrators: division that can be stopped or started instantly. Precise division up to 12 was obtained with this circuit, and the generated pulse could be stopped with any positive edge of the clock pulse.

When the circuit is idle, Q_2 conducts, Q_1 is cut off, D_2 is forward-biased, and D_1 is reverse-biased. The first input pulse—a differentiated positive spike—turns Q_1 on. The circuit then behaves like an ordinary one-shot multivibrator, except that the biases on the diodes reverse. The positive spikes now are delivered to Q_2 's base, adding to the discharging waveform through the timing capacitor. When Q_2 's base is driven sufficiently positive, it starts conducting again and the cycle ends.

A minimum value of C is chosen and the potentiometer is adjusted to achieve a fixed division factor. The circuit shown boxed is added to generate neatly squared pulses that can be used to synchronize another divider stage.

Division up to 1,000 with a 0.01% accuracy can be obtained with the aid of a self-controlled input gate and a 1-megahertz crystal-controlled clock feeding three such cascaded circuits. The output pulse width is 1 millisecond.

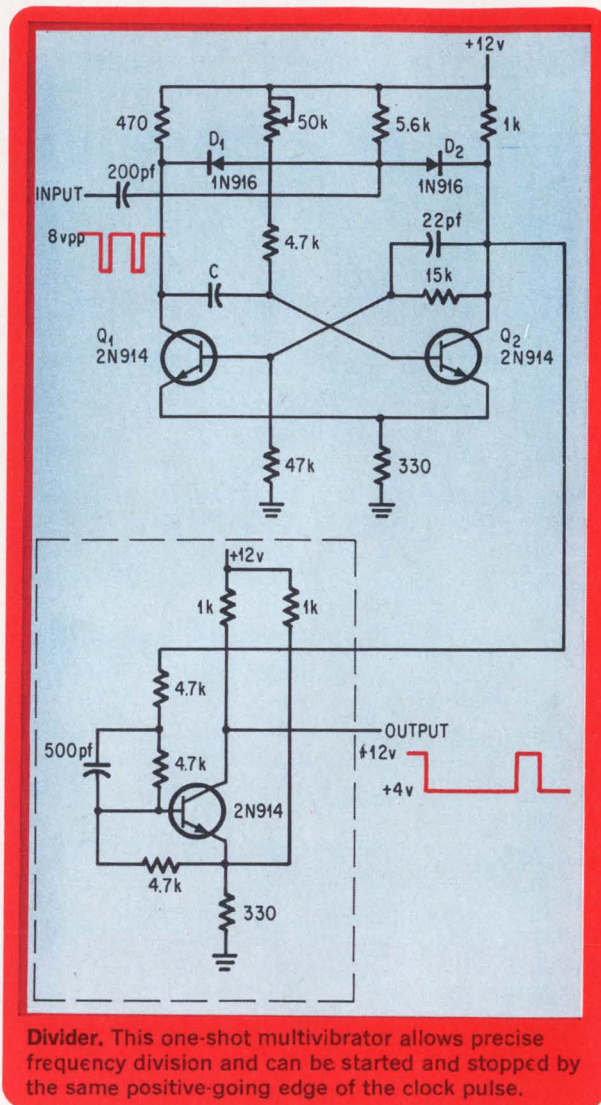

Divider. This one-shot multivibrator allows precise frequency division and can be started and stopped by the same positive-going edge of the clock pulse.

Pick-hold coil driver recovers quickly

By F.E. Mueller

International Business Machines Corp., San Jose, Calif.

Solenoid-operated devices need large currents to excite the coil if the device is to be activated quickly. The usual method is to charge a capacitor to a high voltage through a series resistor and then discharge it through the load. The capacitor supplies the energy surge for accelerating the mass, the resistor supplies the holding current. The dis-

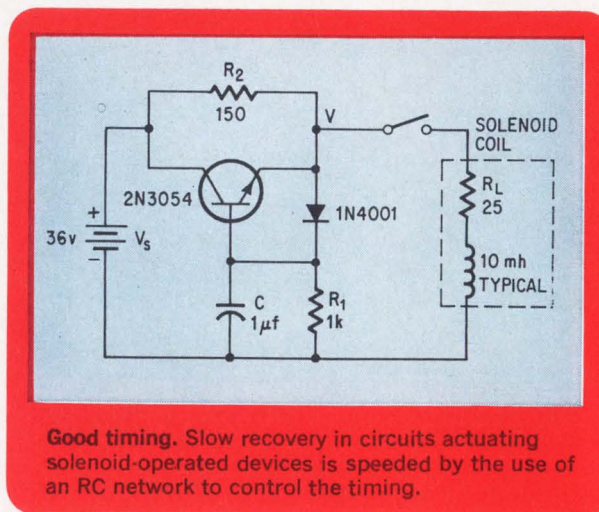

Good timing. Slow recovery in circuits actuating solenoid-operated devices is speeded by the use of an RC network to control the timing.

advantage of this circuit, however, is the slow recovery while charging the capacitor. But using an RC network for timing rather than storage, avoids this problem and speeds recovery.

Before the solenoid is operated, the switch is opened and the capacitor is charged until the voltage, V , equals the supply voltage. The transistor is now reverse-biased from the diode drop.

To activate the device, the switch is closed and load current causes the emitter voltage to drop until the base-emitter junction of the transistor is forward biased. This reverse-biases the diode. The capacitor discharges through R_1 with time constant R_1C . V drops to a final value: $R_L V_s / (R_L + R_2)$.

When the switch is opened, the capacitor is charged by R_2 with time constant $R_1 R_2 C / (R_1 + R_2)$.

Photomultiplier's gain is temperature compensated

By Alexander E. Martens

Bausch & Lomb Inc., Rochester, N.Y.

Frequent recalibration of equipment is a nuisance; but an engineer may find it necessary during the initial warmup if he's using photomultiplier tubes. As the ambient temperature increases, these tubes decrease in gain. However, a relation was found to exist between the temperature of the base pins and the gain of the photomultiplier.

A simple circuit using a thermistor takes advantage of this relation. The circuit provides automatic temperature compensation of the gain over a limited but usually adequate range. This circuit eliminates the need for expensive temperature stabilization devices.

The thermistor, located on the tube's socket close to the connecting lugs, forms one leg of a bridge consisting of resistors R_2 , R_3 , R_4 , and potentiometers R_5 and R_6 . The voltage across the bridge is derived from the photomultiplier's high voltage supply and is stabilized by the zener diode.

The potential difference between the dynodes, as determined by the resistor values in the voltage divider, control the photomultiplier's gain. Varying the voltage on the last dynode compensates for temperature.

As soon as the equipment is turned on, the engineer feeds in constant intensity light pulses. In response to these, he balances the bridge by adjusting R_5 in such a way that moving the wiper of R_6 between its end points, A and B, produces no change in the output of the photomultiplier.

About an hour after the equipment has been stabilized at its operating level, R_6 is adjusted to restore the output pulse amplitude to its original level. R_5 is left untouched during this final adjustment. As the temperature increases, point B becomes less negative with respect to ground because of the negative temperature coefficient of the ther-

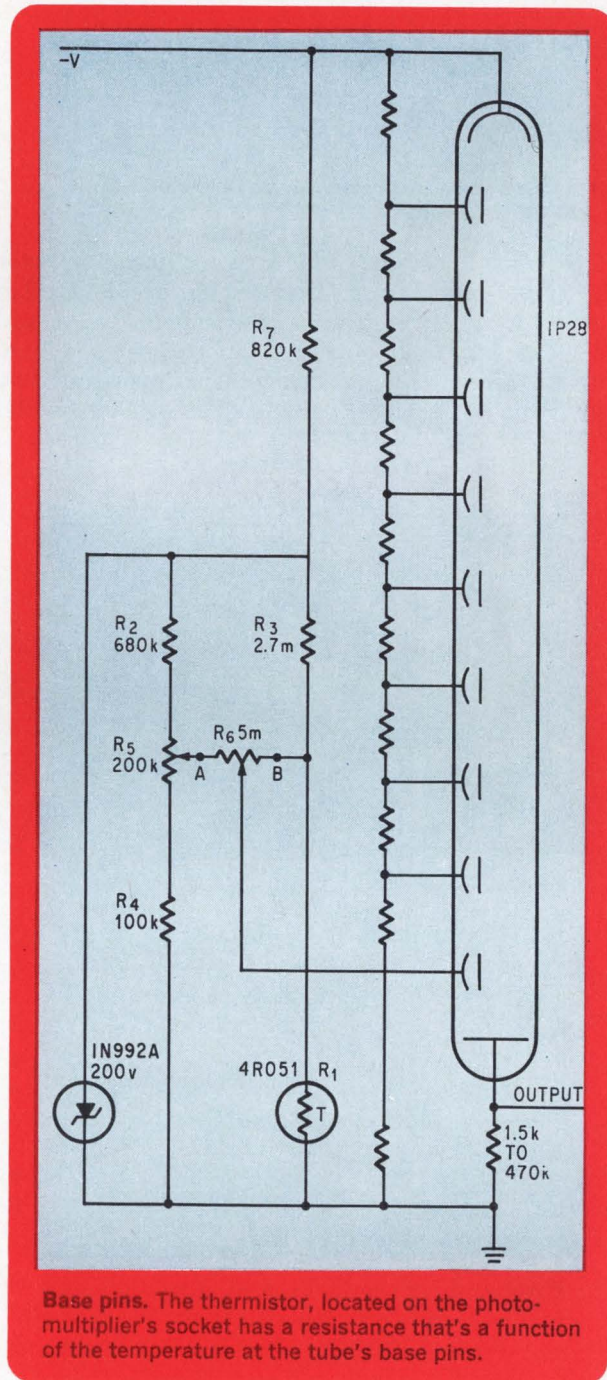

Base pins. The thermistor, located on the photomultiplier's socket has a resistance that's a function of the temperature at the tube's base pins.

mistor, thus increasing the potential difference between the last and the preceding dynode. The setting of R_6 controls the rate of the voltage change and reaches the maximum when the wiper is at B.

The output pulse height varied less than 2% over a temperature range from 24° to 40° centigrade when gain compensation was used. Without compensation this variation was four times greater.

Low frequency waveform generator uses 3 op amps

By Arthur D. Delagrange

Naval Ordnance Laboratory, White Oak, Md.

Small modifications added to a linear inverter and two integrators produce an oscillator that can deliver a square wave, a triangular wave, and a parabolic waveform that approximates a sine wave. The circuit consists of a clipper and two inverters and oscillates at a frequency of .004 hertz.

The output of the clipper is fed back to its non-inverting input resulting in hysteresis that sustains the oscillations. The hysteresis acts as a phase lag which decreases as amplitudes increase. The amplitude stabilizes when the phase shift equals 360° around the loop at the frequency of oscillation. The potentiometer adjusts the wave's amplitude by controlling the hysteresis.

Each integrator uses a resistor in parallel with the feedback capacitor to fix the d-c gain of the stage at 20 and maintain a low Q. The time constant for the second integrator is shorter than the first, the amplitude of the sine wave is about the same as for the triangular wave. Normal oscillations begin when power is turned on. There are no large starting transients.

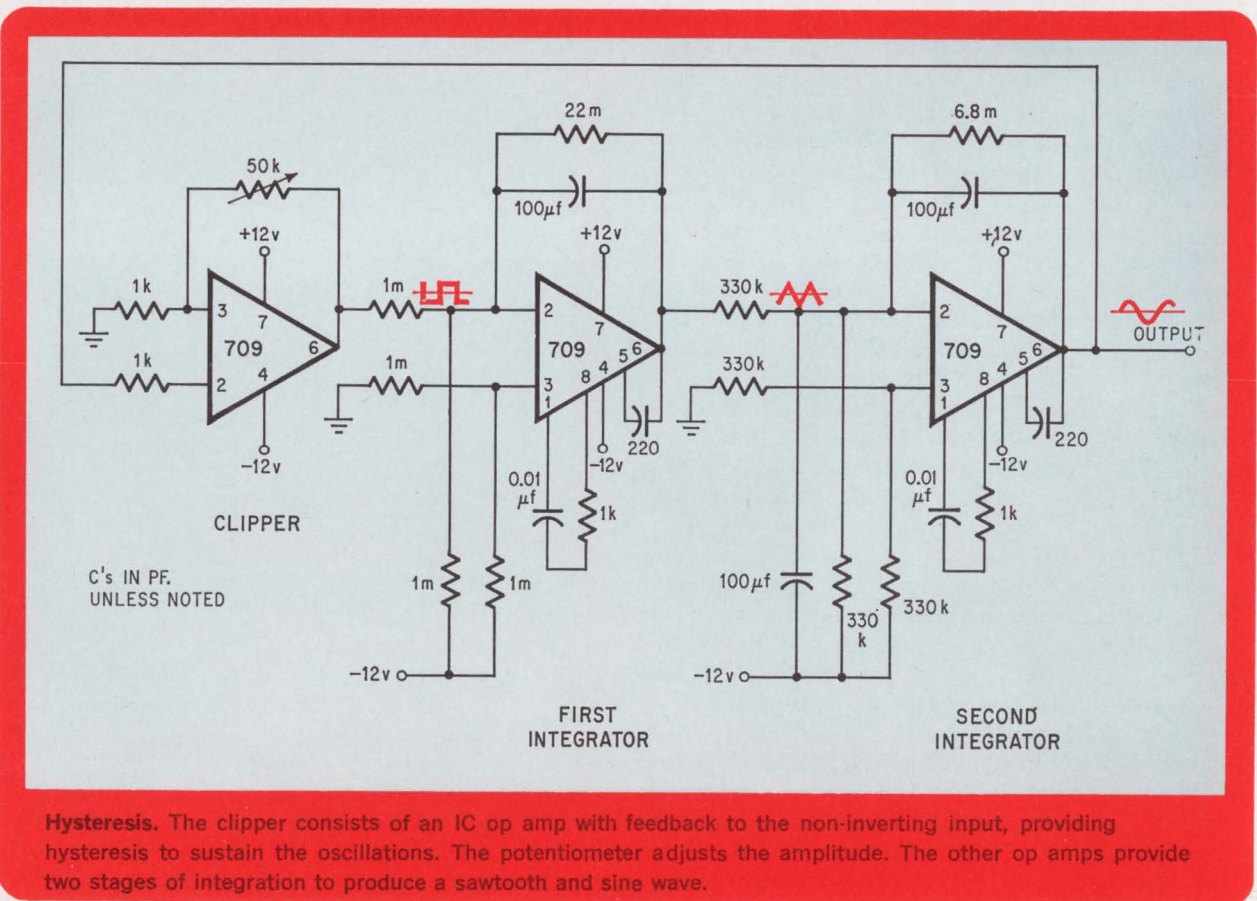

Hysteresis. The clipper consists of an IC op amp with feedback to the non-inverting input, providing hysteresis to sustain the oscillations. The potentiometer adjusts the amplitude. The other op amps provide two stages of integration to produce a sawtooth and sine wave.

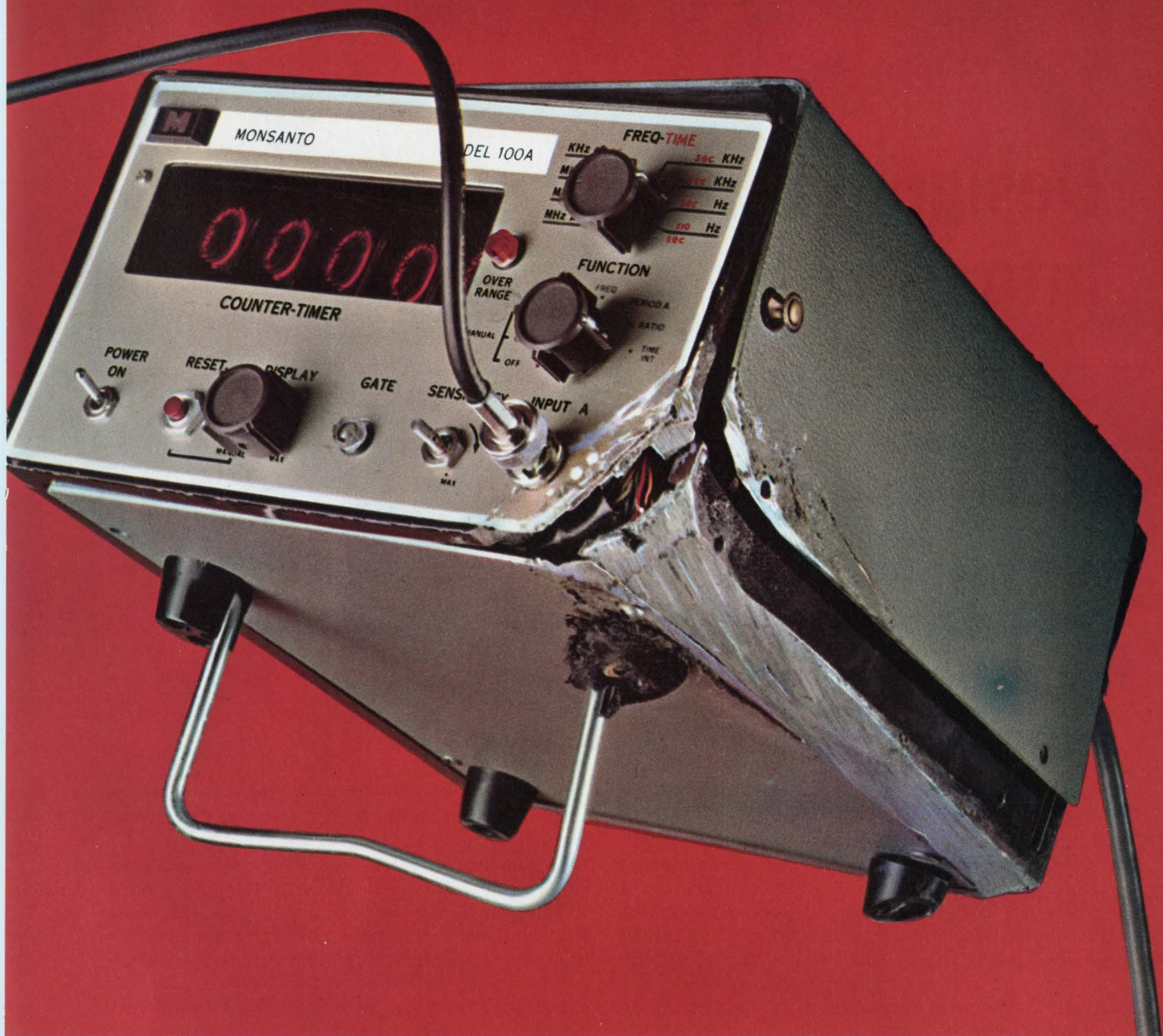

**This counter fell off a plane.
It didn't need service
(but when one does, we're ready).**

This Model 100A Counter-Timer was enroute to a customer. A freight handler laid it on the wing of the airplane—and forgot it. The package finally slid off as the wheels left the runway. Instantly freed of its container, the “Small Wonder,” as our customers sometimes call it, chased the plane for about a hundred yards, then ground-looped.

Our nearby Service Center, bored with inaction, brightened at the thought of a real challenge when it was brought in. But they were disappointed: electrically, the “Small Wonder” picked up right where it left off in Final Inspection. (Of course, *mechanically* there were a few abra-

sions to take care of, as you can see.)

Please help us keep our 37 Service Centers with their factory-trained technicians alive and well. Call the one nearest you anytime you feel that a Monsanto instrument requires service or calibration... or even verification of its performance. In addition to their expertise and factory specified test equipment, all carry a complete stock of spare parts. If there should be a defect in materials or workmanship during the 2-year warranty period, it won't cost you anything.

Monsanto Company, Electronic Instruments, West Caldwell, New Jersey 07006.

Designing lumped elements into microwave amplifiers

Tiny thin-film inductors, capacitors, and resistors can be used to construct hybrid IC power amplifiers that are far smaller—and potentially cheaper—than conventional microstrip types

By Martin Caulton

RCA Laboratories, Princeton, N.J., and

Walter E. Poole

RCA Electronic Components Division, Somerville, N.J.

Power amplifiers for ultrahigh-frequency and microwave operations need no longer be built of distributed microstrip structures. Instead, they can be made with lumped passive elements—thin-film inductors, capacitors, and resistors—designed as if they were to operate at lower frequencies where distributed reactances can be ignored. This means circuits can be much smaller than the microstrip variety—and with a more conventional design. Because their small size permits batch-processing on a single wafer the costs should be lower.

With the photoresist techniques developed for transistor technology, lumped elements can be made so that their size is only a very small fraction of the operating wavelength. Thus, no distributed reactances show up along the length of the inductors and resistors or in the dielectric of the capacitor. It was to apply these effects at high frequencies, rather than try to overcome them, that microstrip techniques were developed in the first place. But now, with thin films, an inductor behaves strictly like an inductor, a capacitor like a capacitor, and a resistor like a resistor at the higher frequencies.

Batch-fabricated hybrid IC amplifiers using lumped elements for matching and filtering have operated at frequencies ranging from 0.2 to 2 gigahertz. Their performance is comparable to that of conventional amplifiers; power levels have been as high as 75 watts at uhf and 1 watt in the microwave region, and higher levels are expected as transistors improve. The upper frequency limit depends only on how small the elements can be

made. However, the size difference between lumped-element and microstrip circuits narrows as frequency goes up.

Ultimately, complete amplifiers—with active-device chips and lumped elements integrated on a substrate—will be supplied in packages only slightly larger than those now used for discrete transistors. And functional units covering the important frequency bands will be available, so that equipment manufacturers will be able to work with matched amplifiers instead of with devices requiring complex and costly matching networks. And with these small and integrated amplifiers, the parasitic coupling effects found in conventional circuits will be minor and readily controlled.

Conventional microwave circuits use waveguide, microstrip, or coaxial transmission lines for matching. Lumped elements such as inductors are normally avoided because when the wavelength approaches the size of the element, the element radiates energy. A good rule of thumb is to keep the size of the lumped elements to about $\frac{1}{100}$ of a wavelength at the operational frequency. For example, at 400 megahertz (wavelength 3 inches), the outer diameter of a typical inductor would be 0.1 inches; at 2 GHz (wavelength 0.6 inch), the size should be approximately 0.05 inch.

At these high frequencies, only small tuning inductances and capacitances are needed. The inductors can be built within the size limits set by the operating wavelengths. For example, tuning inductances at 400 Mhz are generally less than 25 nanohenries; at 2 GHz, they're less than 8 nh. Em-

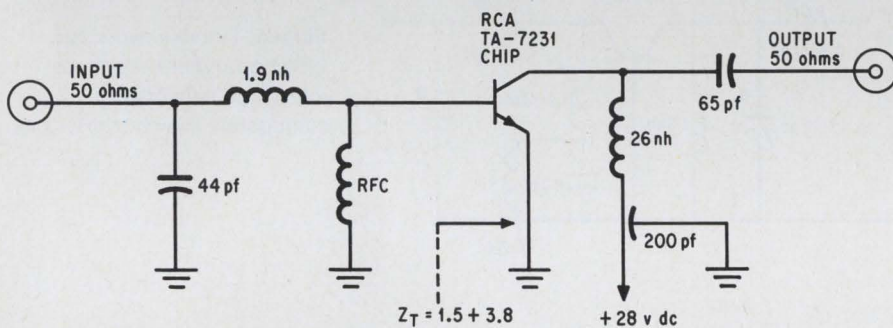
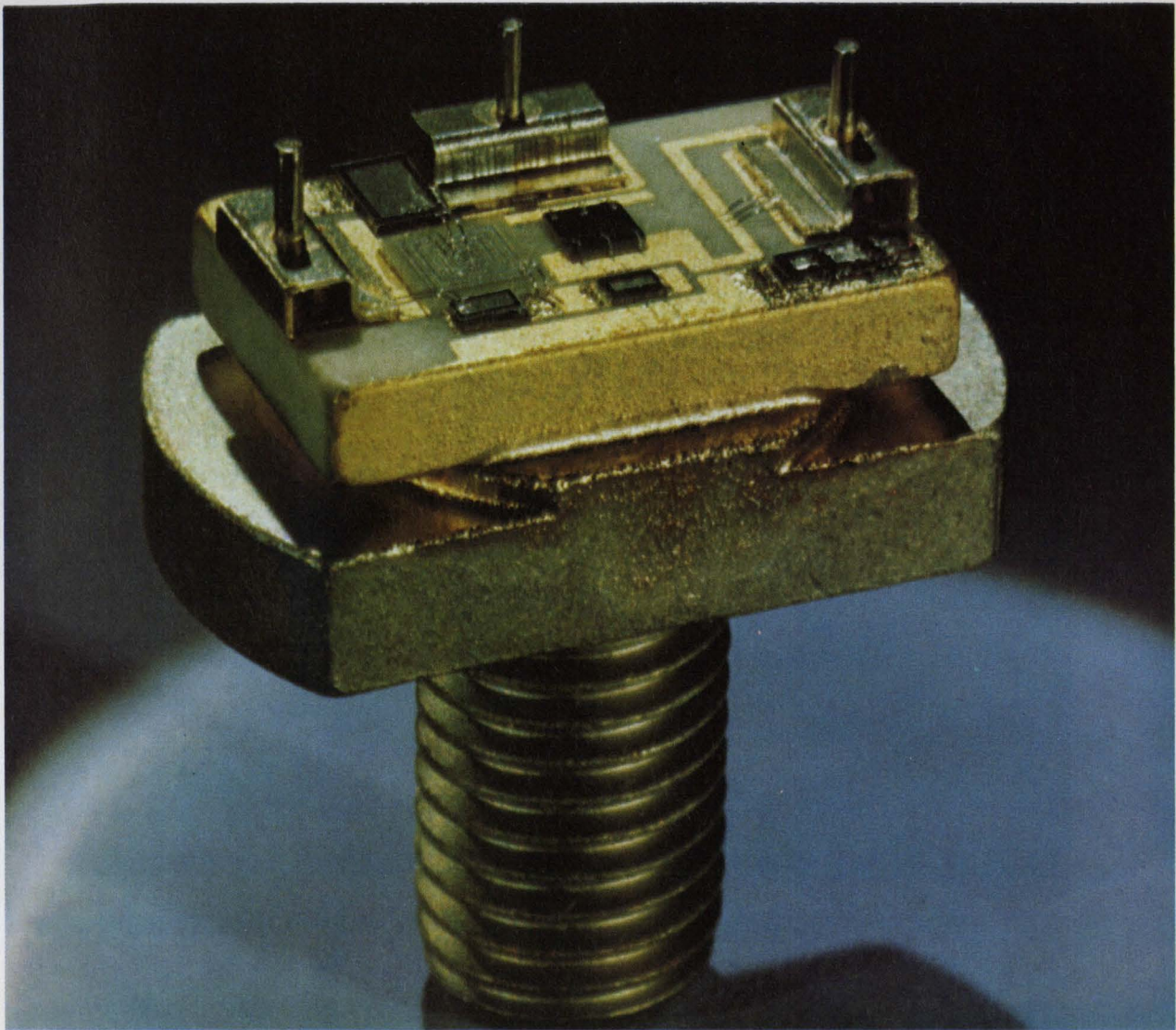

On top of things. In its breadboard stage, the 400-Mhz lumped-element power amplifier at left produces 10 watts and fits into a three-terminal module measuring 0.36 by 0.65 inches. The simple L-section networks in the schematic at the left transform input and output impedances.

ploying IC photolithographic techniques, a 25-nh inductor with a fairly high Q can be built in a spiral ribbon less than 75 mils square. An 8-nh inductor fits in a 50-mil-diameter coil. Inductor widths on the order of mils are easy to make, and the separation between turns can be as small as a half-mil.

The values of thin-film capacitors at these frequencies generally run from a half-picofarad to tens of picofarads.

Lumped-element IC's are typically 10 times smaller than distributed circuits in microstrip. And more than 20 identical single-stage amplifiers, with biasing elements, have been built in a batch on a

single $\frac{3}{4}$ by 1-inch sapphire wafer.

The very smallness of the lumped-element circuits, though, presents some important problems. For one thing, it's difficult to attach them to the outside world and to measure their parameters. For another, performance limits are established whenever energy is stored in a very small volume. It's hard to get sharp tuning—Q's greater than 1,000—in this case, because performance is proportional to the ratio of volume to surface.

Q's of the thin-film elements are moderate, running to about 100 for the tuning inductors and to about 50 for the tuning capacitors. (The quality

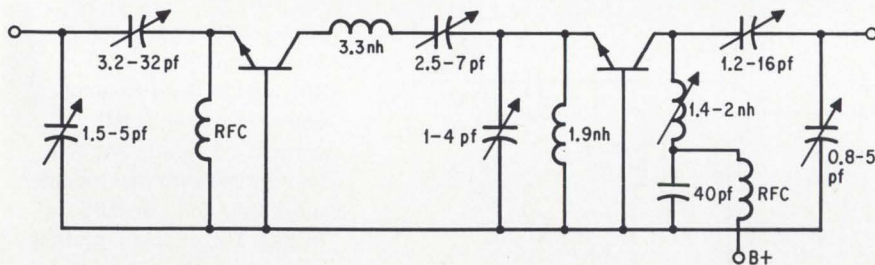
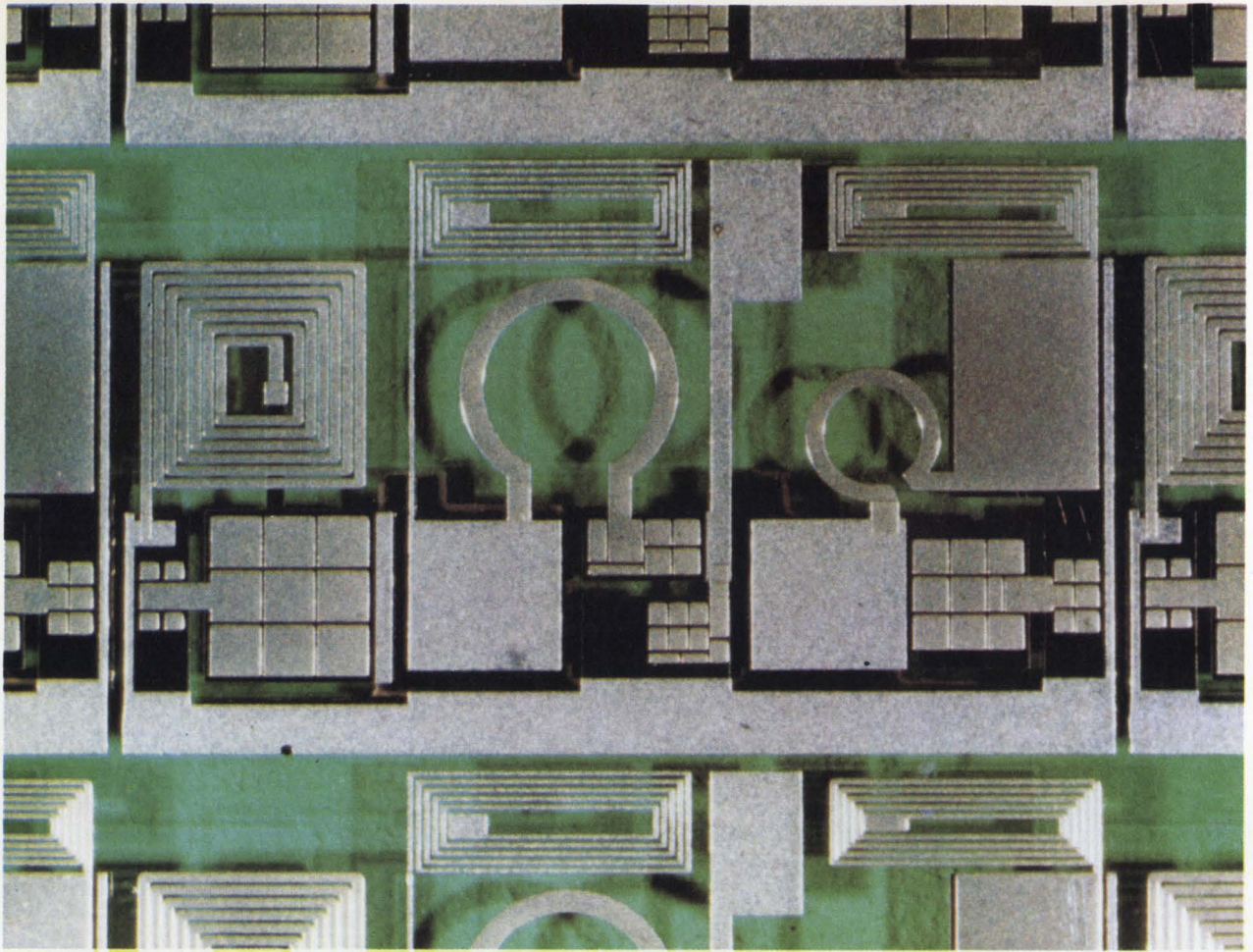

Staged. Tunable two-stage 2-GHz amplifier uses these interstage networks to conjugately match transistors.

factors of r-f chokes and bypass capacitors are unimportant and present no problems). However, effective matching circuits can be built with these elements in efficient high-power amplifiers. But with active-device gains still fairly low at about 10 decibels, special attention has to be paid to keeping losses down.

Once one of these circuits has been designed, a thin-film hybrid breadboard should be made before the design is committed to batch processing. The approach taken to breadboarding depends on the intended operating frequency of the circuit. In the range up to 1.5 GHz, bond wire reactances can be reasonably accounted for, and the design can be evaluated on a breadboard in which thin-film

inductors, capacitors, resistors, and transistor chips are processed separately and then connected by wire bonds on a common substrate. Such a breadboard approximates closely the conditions of the final integrated structure with respect to coupling, interconnection reactances, and thermal dissipation.

After the design is optimized on the breadboard, the values of the passive elements are modified to account for any parasitics that exist, and the final thin-film circuit is fabricated on a single substrate.

In circuits designed to operate above 1.5 GHz, on the other hand, the interconnecting leads alone may do the tuning; the chip-type breadboard is difficult to work because of critical parasitics. The designer often uses a tunable thin-film breadboard.

The networks can be capacitively tuned by paralleling portions of the deposited capacitor elements; inductive tuning is achieved by shorting portions of the deposited inductors. The final thin-film circuit is then obtained by slightly modifying the breadboard masks.

To design the matching circuits, the transistor chips must be characterized under actual large-signal class-C operating conditions. The input-impedance transforming network must match the relatively low impedance of the transistor to the impedance of the generator.

As with breadboarding, two techniques are used—depending on operating frequency—to obtain the class-C parameters. Above 1 Ghz, the transistor is mounted in the actual physical structure of the final hybrid amplifier so that residual parasitics are included in the measurements. The chip is then bonded to short 50-ohm microstrip lines brought directly up to its edge. Bias is supplied, generally with an external bias tee, and input- and output-stub or slide-screw tuners are set for the desired performance levels.

With the input assumed to be conjugately matched, the transistor's impedance is the conjugate of the stub impedance transformed along the 50-ohm line to the end of the chip bond wires. And the impedance of the output stub, transformed back to the collector terminal of the chip, represents the load required for the given output power.

The other technique is used at the lower uhf frequencies (0.2 Ghz to 0.5 Ghz), where parasitics are less critical. Here, the transistor is bonded to metalized areas on a small beryllium oxide block, which, in turn, is connected through a 50-ohm coaxial air line to the end of a slotted line. When a variable load is applied to the d-c biased collector through a stub tuner, the chip is driven to the desired operating level by the generator directly through the slotted line, and the output is simultaneously tuned for maximum output power. The voltage standing-wave ratio and phase position detected in the slotted line determine the device's effective input impedance.

The optimum output load at the collector is found by a separate slotted-line measurement of the impedance looking back from the collector into an output stub tuner. This technique isn't suitable for higher frequencies due to high vswr's.

Measuring the impedance of the individual thin-film elements used in the circuit breadboard also requires care, particularly because of the elements' small size. There are two direct measurement techniques, and the choice—once again—depends on operating frequency. Below 500 Mhz, the element is put across a 14-mm coaxial air line at the end of a slotted line. To reduce parasitics at frequencies above 500 Mhz, the element is bonded to a 50-ohm microstrip that's connected to the slotted line.¹

Recently, an indirect method—a resonant-circuit substitution technique—has been employed to measure high-Q elements at frequencies to X-band.² The resonant measurement is made with a micro-

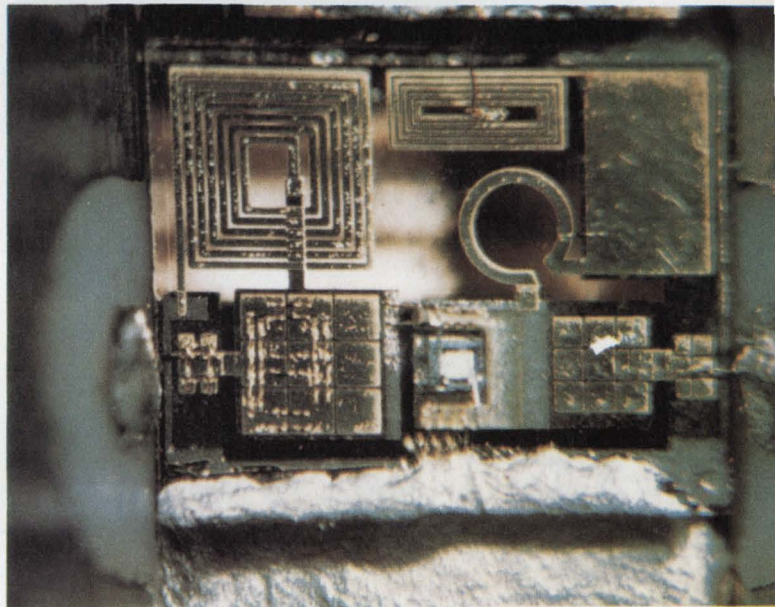
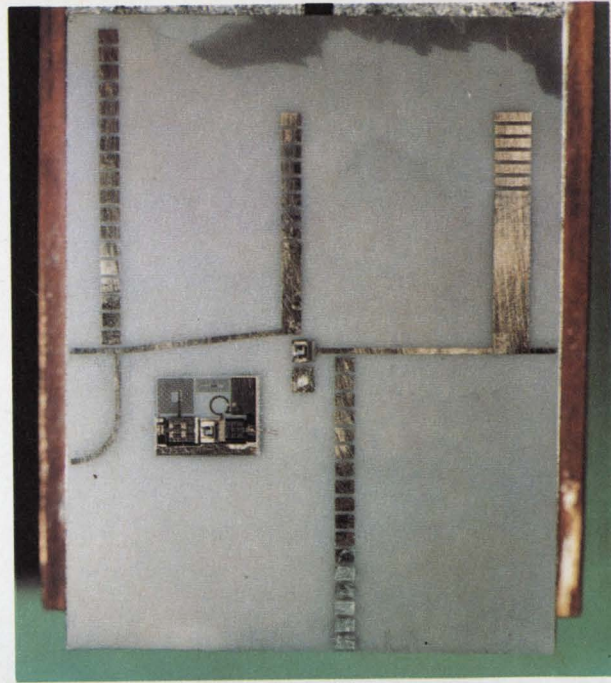

Big shrink. Breadboard version of hybrid 2-GHz amplifier with lumped elements is almost 1/40th the size of an equivalent unit made of conventional $\frac{3}{4}$ x1" microstrip.

strip transmission line—either a ring or straight section—that's open-circuited at one end. At the other end, the reactive element is inserted between the line and ground, and the resonant frequencies measured. A short circuit is then substituted for the element and the resonances again measured.

The reactance of the element is determined by the difference between the two corresponding resonant frequencies. The element's Q is determined by the value of Q when the line is short-circuited and the system's Q when the element is in place.

Once the transistor's characteristics are known, it's fairly simple to design matching networks. In

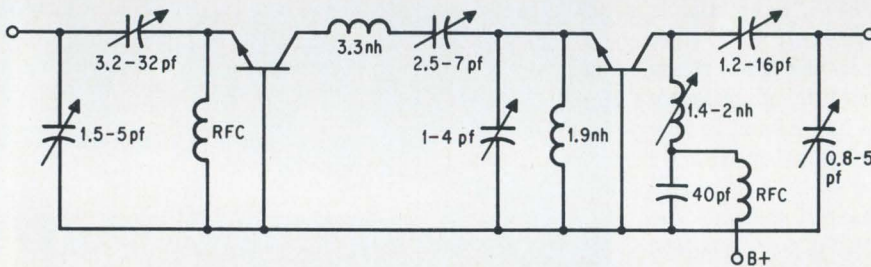
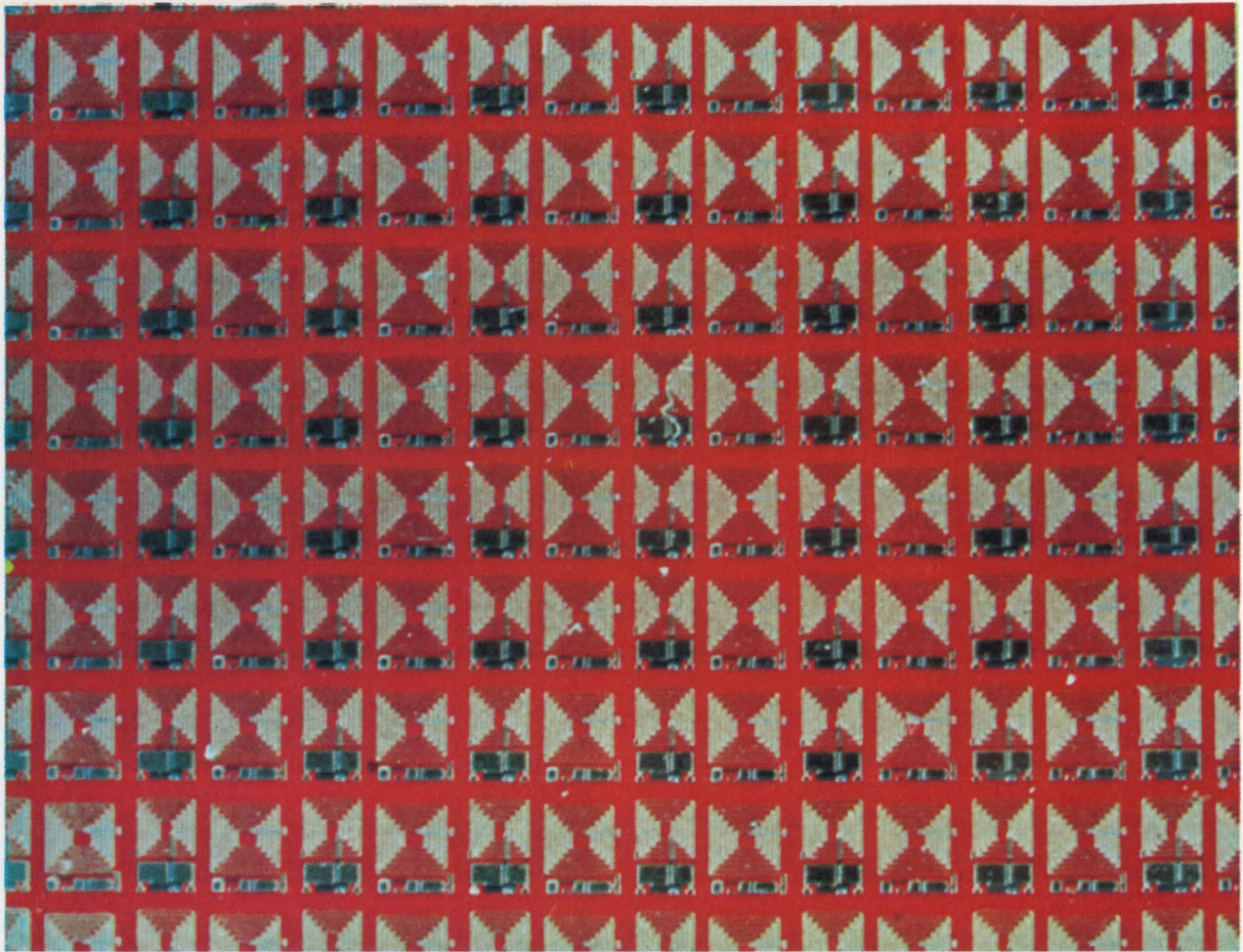

Lumped and batched. Passive elements of a 1-watt, 400-Mhz amplifier can be batch processed. Some 160 circuits fit on a 1-inch-square substrate.

the single-stage, 10-watt, 400-Mhz amplifier shown on page 101, a simple L-section input network transforms the low input impedance of the chip transistor to the 50-ohm resistance of the generator. Measured under class-C conditions, the transistor has an input impedance, Z_1 , of $1.5 + j3.8$. The L-section network consists of a series 1.9-nh inductor and a shunt 44-pf capacitor. An L-section output is also used to provide the optimum load impedance. The complete amplifier includes thin-film r-f bypass capacitors and r-f chokes.

In an optimized hybrid form, the 400-Mhz amplifier on a beryllium oxide substrate fits into a three-terminal module 0.36 by 0.65 inch. The actual area occupied by transistor, input and output matching networks, choke, and bypass capacitor is 0.3 by 0.2 inch. The small input series inductor is a wide-ribbon conductor formed directly on the substrate.

A thin-film nichrome resistor in the input circuit prevents parasitic oscillations.

The 400-Mhz amplifier is one of four breadboard single-stage amplifier modules that have been developed for operation in the uhf region. Their performance is equivalent to that of similar units using packaged transistors and conventional circuitry—lumped or distributed.

Power output ranges from 1.5 to 20 watts, with gains as high as 9.5 decibels. Each amplifier is of class-C design, and is housed in the 0.56-by-0.65-inch three-terminal module, which includes a 50-ohm input, a 50-ohm output, and a d-c bias lead. The module is grounded through the case.

The 10-watt amplifier's 1-db bandwidth of 16% (65 Mhz) for a 1-watt input can be substantially increased by using broad-band matching networks. For example, a 1-db bandwidth of 41% was

obtained with the same input power, the same transistor, and a three-section Chebyshev input network. Although not optimized completely, the input reflects 25% or less of the input power over the entire 225-to-400-Mhz band. The resulting output is 7.6 watts flat to ± 0.5 db from 265 Mhz to 400 Mhz, with better than 50% efficiency across the band at a drive of 1 watt.

From this breadboard, the design moves on to thin-film integrated form. For the higher-power uhf amplifiers, the transistor is mounted on a beryllium oxide block, and the matching networks are deposited on a glass or sapphire substrate.

The 1.5-watt, 9.5-db amplifier, for example, occupies an area 135 by 80 mils, about 300 times less space than is taken up by an equivalent amplifier with conventional components. Input and output matching networks, shown on page 104, are fabricated together in an area 90 by 50 mils.

Gain and output power significantly greater than what's available with a single module can be had by combining modules at their 50-ohm-impedance input and output terminals. For example, a three-stage, 40-watt c-w module with a 16-db gain at 350 Mhz results when two 20-watt modules are paralleled through an input power divider and output power combiner and are driven by a 10-watt stage. The complete module measures 2 by 0.8 by 0.4 inches. The lumped-element power combiner/dividers used in this structure are made with thin-

film inductors and capacitors and a chip resistor.

And by paralleling two of the 40-watt modules, as shown on page 105, one can get 76 watts out (50% duty cycle) for a 2-watt input at 350 Mhz.

The performance limits of passive elements and chip transistors are of greater importance in microwave power amplifiers than in devices operating at lower frequencies. Because the transistor is operating close to its cutoff frequency in the microwave range, the amplifier must have a relatively narrow band to supply any gain and power. But the narrow band makes it harder to design matching networks for the transistor, whose impedance varies with power levels. To compensate for the impedance shifts, the amplifier is designed to be tunable as previously described.

An example of a microwave amplifier built with the hybrid, lumped-element approach is the 2-Ghz unit, shown on page 103, along with a similar but conventional device. This hybrid, actually an integrated breadboard, includes d-c blocking and biasing components. An impedance-admittance Smith chart was used to match tunable input and output networks to a range of transistor class-C dynamic impedances with minimum loss. The networks also permit operation in forward-biased class-A and -B operation.

Twenty-five such single-stage microwave amplifiers have been processed simultaneously on a single polished sapphire substrate measuring 0.75

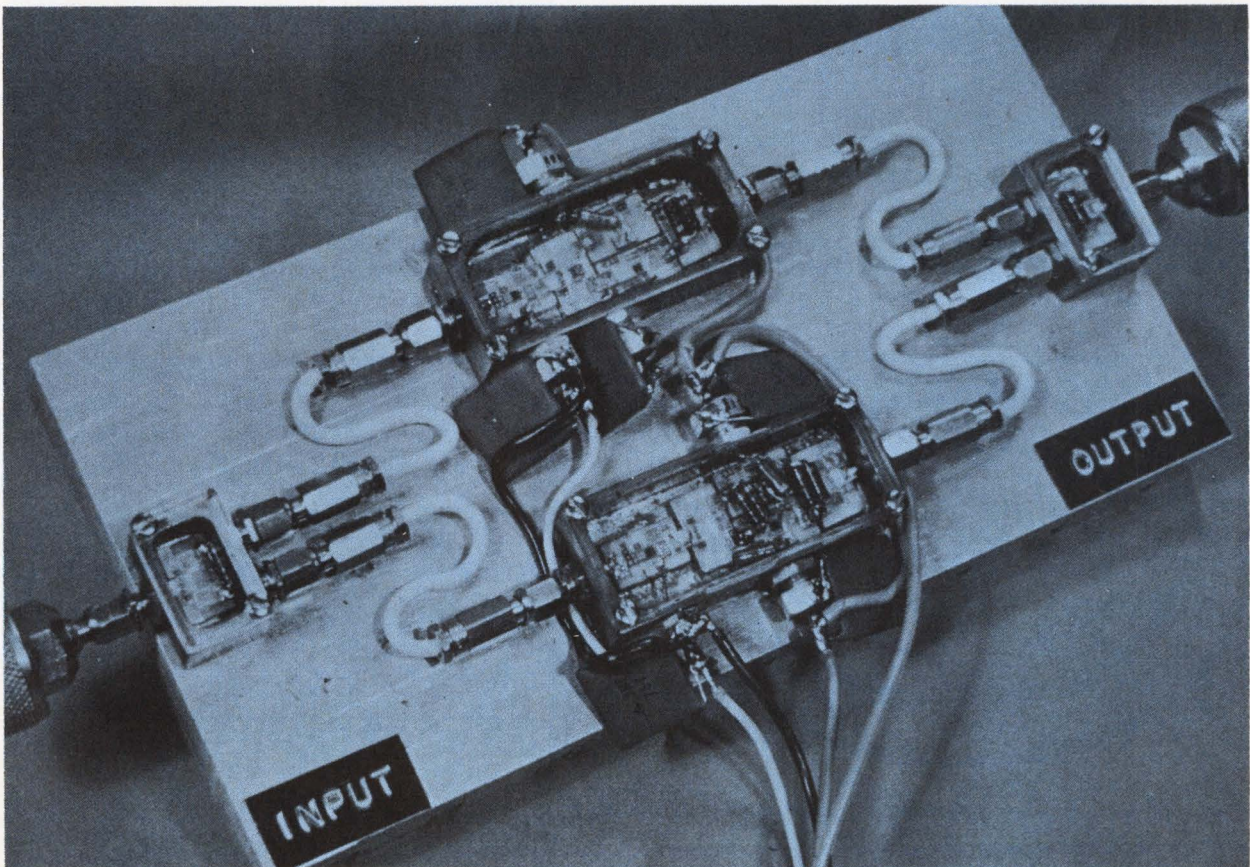

Doubling up. Paralleling of two 40-watt amplifier modules yields 76 watts and a gain of 15.8 db at 350 Mhz.

Lumped elements

The inductive reactance required in a circuit operating at uhf and microwave frequencies can be obtained from a simple rectangular ribbon of width W , thickness h , and length l . The low-frequency inductance, L_R , of this ribbon is given by:¹

$$L_R = 5.08 \times 10^{-31} \left(\ln \frac{l}{W+h} + 1.193 + 0.223 \frac{W+h}{l} \right) \quad (1)$$

where L_R is in nanohenries; all dimensions in mils.

Inductance measurements at lower frequencies agree with the values predicted by this equation, and they are only slightly lower at high frequencies. A 2-nh inductor, for example, with an l/W ratio of 20 (typical of 2 GHz and higher), must be about 100 mils long and can be fabricated in a $3/4$ -turn circle about 40 mils in diameter.

The Q of this inductor can be easily calculated. Assuming that current flows within a skin depth, δ , of the surface, and defining Q as $2\pi f L_R / R_{ac}$, where f is the frequency in hertz and R_{ac} is the a-c skin resistance of the inductor, the Q_R per nanohenry inductance of the ribbon inductor is:

$$\frac{Q_R}{L_R} = \frac{2.15 \times 10^{12}}{K} \frac{W}{l} \left(\frac{\rho(\text{Cu})}{\rho} \frac{f(\text{Ghz})}{2} \right)^{1/2} \quad (2)$$

where ρ is the d-c resistivity of the metal, $\rho(\text{Cu})$ is the d-c resistivity of copper (1.7×10^{-6} ohm-cm), and K is the factor between 1.3 and 2 that accounts for the current crowding at the corners of the ribbon. This expression is plotted below.

For the 2-nh inductor with l/W of 20, used for the one-turn inductor in the circuits shown on page 103, the product KQ is 200, corresponding to a measured Q of 100. Q 's greater than this can be achieved with wide-ribbon (l/W about 15) inductances of 1 nh or more.

Flat spiral. Inductors larger than about 4 nh can be made with flat planar spirals, as shown below. The inductance of such a coil is given to within a few percent by:

$$L = \frac{a^2 n^2}{8a + 11c}$$

where n is the number of turns, $a = d_o + d_i/4$; $c = (d_o - d_i/2)$, and d_o and d_i —the outer and inner diameters of the coil—are in mils.

The Q of the spiral inductance can be obtained from the expression:

$$\frac{Q d_o^{1/2}}{L^{1/2}} = \frac{1.3 \times 10^2 W}{K} \left(\frac{f(\text{Ghz})}{2} \frac{\rho(\text{Cu})}{\rho} \right)^{1/2}$$

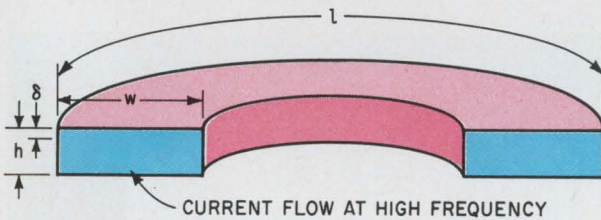

In shape. As at lower frequencies, the values of a ribbon inductor are determined by its physical dimensions.

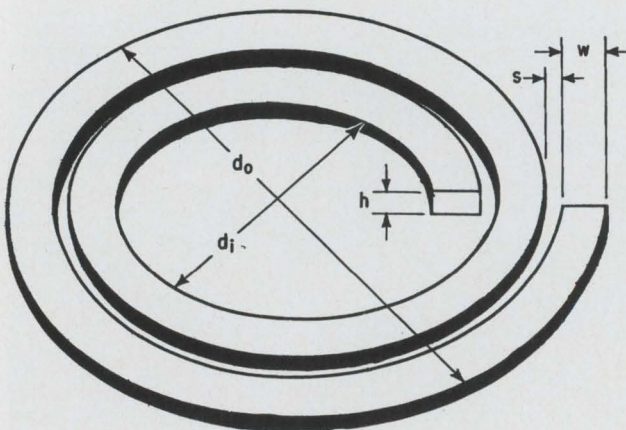

The worm turns. Flat planar spirals are used for inductors with values larger than 4 nh.

It's assumed here that current flows on the top and bottom surfaces and that the ratio of outer to inner diameter, d_o/d_i , is 5 to maximize Q .

Q increases with the width of the ribbon. To keep d_o small for a higher Q , the separation between turns should be as small as possible. However, the increase in parasitic capacitance with a small separation between turns can cause the resonance of a large inductance—generally with a higher Q .

For the same outer diameter, a circular spiral will

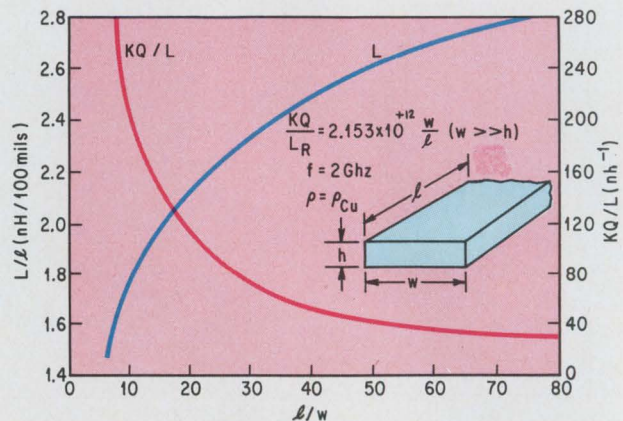

Inductance plot. Values of L and Q for a ribbon inductor can be found by plotting the relevant equations.

have about a 10% greater Q than a square spiral, although the inductance is about 20% less. Circular spirals are thus preferred for tuning inductors, while square and rectangular spirals are more suitable for r-f chokes.

Metal choice. Only four metals—silver, copper, aluminum, and gold—have been considered for the thin-film inductors because their a-c sheet resistance, R_s —which determines the Q directly—is very low. The four have R_s values within 30% of one another.

For higher Q's, the inductor should be reasonably square and at least three skin depths thick, and have straight sides and smooth surfaces. Such a device is fabricated either by selectively plating metal up through a thick photoresist mask on a thin layer of chrome-copper or chrome-gold, as shown below, or by evaporating 10 microns of aluminum, gold or copper on a substrate and then etching through a photoresist pattern. Plating produces a squarer cross-section but yields a higher d-c resistivity than does the evaporation-etching technique. The resistivity of the evaporated metal is close to its bulk value. However its been found experimentally that plated and evaporated coils of the same size and material have almost equal Q's.

Measurements on different circular spiral coils show that Q varies very nearly with the square root of frequency and the width of metalization as predicted by the previous equation.² These coils were fabricated by

plating several skin depths of smooth copper through a photoresist mask and topping the plating with 1 micron of gold. Measured Q's are about 60% of the values calculated for pure copper. When the current crowding factor and the d-c resistivity of the plated metal are accounted for the calculated values generally match the measured ones.

In films. The Q of a thin-film capacitor can be found by considering the capacitor as a short length of an open-circuit ac transmission line. Then,

$$\frac{1}{Q_{cap}} = \frac{1}{Q_c} + \frac{1}{Q_d}$$

where Q_c is due to the conductor metal and Q_d to the dielectric loss.

$$Q_c = \frac{3}{2\omega R_s C}$$

where C is the capacitance of a square capacitor ($l = W$) and R_s is the surface resistance of the metal. Q_d is given by:

$$Q_d = \frac{1}{\tan \delta}$$

where $\tan \delta$ is the dielectric loss tangent.

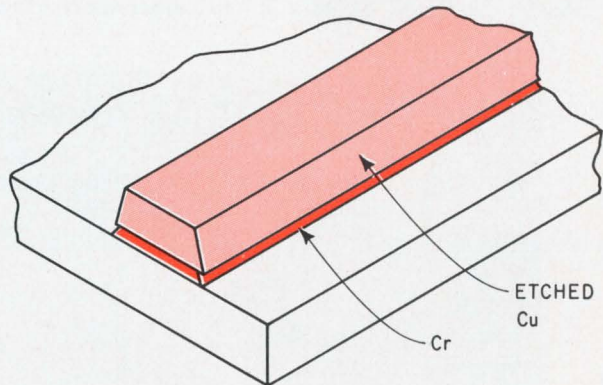
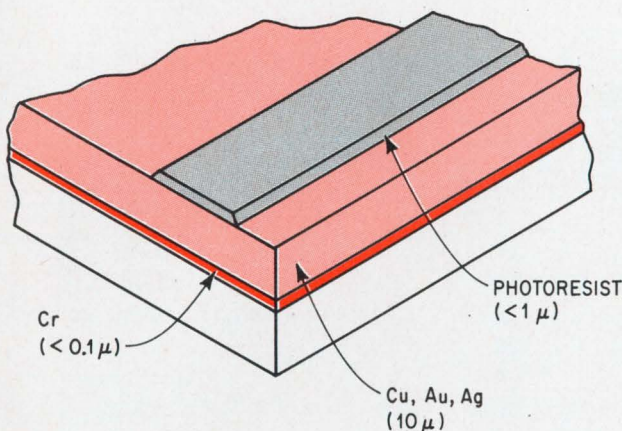
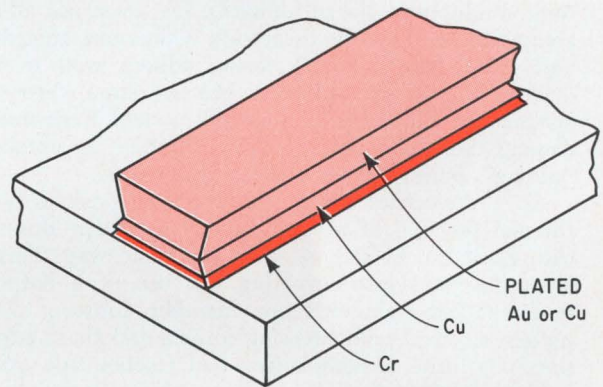
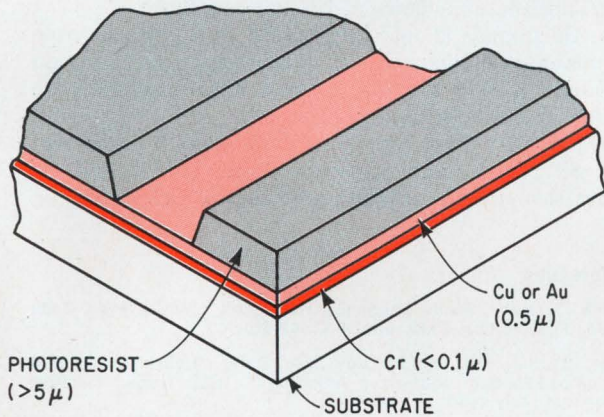

Two routes. Inductors are made either by plating metal down through a thick photoresist mask, top, or depositing metal on the substrate and then etching it away, bottom.

At 2 Ghz, the Q_c of most metals is greater than 500; the value varies as $f^{-3/2}$ and should be greater than 500 at 400 Mhz. The Q_d for pure thin-film SiO_2 is unknown, but that of bulk fused quartz is 10,000.

In a typical thin-film capacitor made of a metal-oxide-metal sandwich, conductor thickness is one or two skin depths, or about 4 microns at 400 Mhz and about 2 microns at 2 Ghz. The capacitance is given by $\epsilon A/h$, where ϵ is the permittivity and A is the area (Wl). For a 1-micron-thick dielectric of SiO_2 with a dielectric constant of about four, capacitance is around 0.023 picofarads per square mil. Capacitances per unit area can be increased with thinner dielectrics; silicon dioxide layers as thin as a half-micron have been used.

Choice of sandwich. Two types of capacitors have found extensive use, one a metal-oxide-silicon sandwich and the other a metal-oxide-metal sandwich. The former, which usually employs silicon with very low resistivity as one electrode, thermally grown or deposited SiO_2 as a dielectric, and aluminum in its top electrode, is used for breadboarding because it's easy to fabricate. Capacitors with values from 2 to 200 pf have been fabricated.

Metal-oxide-metal capacitors have been built from several of the metals listed in the table shown below, where the d-c resistivities given are normalized to copper's. They all have a resistance low enough so that their conductivity doesn't limit Q . However, not all are compatible with oxide dielectrics. Aluminum, tungsten, and molybdenum, for instance, adhere well to the oxides. Nickel also adheres, but its large sheet resistance prohibits its use at microwave frequencies. Among the other metals, chrome acts as an excellent "gluing" buffer between metal and oxide.

As a dielectric, silicon dioxide is deposited by a thermal reaction of oxygen and silane, SiH_4 .³ Borosilicate glass can be deposited in the same way. This is a simple procedure involving the use of a hotplate at 450°C and a glass reaction chamber. Growing to the bottom electrode and covering corners and sharp edges, the SiO_2 forms a pinhole-free and fraction-free oxide.

Heat treatment. The resulting glasses aren't very dense; their atoms can move in an r-f field, and the material has a large loss factor. The oxide can be made denser by heating it at temperatures varying

from 450° to 1,000°C, but only tungsten and molybdenum will withstand temperatures above 600°C. R-f sputtering has yielded lower loss SiO_2 , but vapor-deposited oxides are more easily fabricated.

The Q 's of silane-deposited SiO_2 capacitors, measured from 0.3 to 2.5 Ghz, vary from 40 to 60, with a slight drop at 2.5 Ghz; the low Q 's result from the flexible bonds of the unspattered SiO_2 . Capacitors with heat-treated or r-f sputtered silicon dioxide have Q 's of 100 at 2 Ghz.

Thin-film lumped resistors are built much like the inductors. They must be placed reasonably far from the ground plane so that their characteristic impedance will be large and they won't behave like rc transmission lines. For all practical purposes, monolithic diffused resistors with junction isolation can be ruled out at microwave frequencies. The only alternative, then, is the thin-film metallic resistor.

As for circuit layout, the designer should remember:

- Place inductors at least one diameter from metal.
- Grounding metalization on the same plane as the tuning inductor has a negligible effect on inductance.
- In general, the use of lumped-element inductors implies that the distributed reactance to ground is negligible. The inductor is treated as part of a very-high-impedance transmission line, and the ground plane must be so far away underneath the inductor that the characteristic impedance of the line is infinite.
- All grounds should be brought to a common area to minimize inductances. If a connecting metalization is longer than it is wide, its inductance will play an appreciable role in tuning.
- Thin-film capacitors have little field leakage and can be placed near other elements, but should be wider than long to minimize parasitics and losses.

References

1. F.E. Terman, "Radio Engineers Handbook," McGraw-Hill Book Co., First edition, 1943, pp. 34-37, 47-60.
2. M. Caulton, S.P. Knight and D.A. Daly, "Hybrid Integrated Lumped-Element Microwave Amplifiers," IEEE Trans., Electron Devices, July 1968, pp. 399-406.
3. N. Goldsmith and W. Kern, "The Deposition of Vitreous Silicon Dioxide Films from Silane," RCA Review, vol. 28, March 1967, pp. 153-165.

Metals for lumped elements

Material	d-c Resistivity, ρ (relative to Copper)	Skin depth, δ , at 2Ghz (micron)	Surface resistivity, $R_s \cdot 10^7/f^{1/2}$ (ohms/Sq)	Coefficient of thermal expansion, $\alpha \cdot (10^6)$	Adherence to dielectrics ++ good -- poor	Deposition technique
Silver	0.95	1.4	2.5	21	—	Evap.
Copper	1.0	1.5	2.6	18		Evap.
Gold	1.36	1.7	3.0	15	--	Evap.
Aluminum	1.6	1.9	3.3	26	++	Evap.
Tungsten	3.2	2.6	4.7	4.6	+	Sputt, vapor
Molybdenum	3.3	2.7	4.7	6.0	+	Sputt
Nickel	5.1	0.31	55.0	15	+	Evap.
Chromium	7.6	4.0	7.2	9.0	++	Evap.

by 1 by 0.010 inch. Each amplifier measures 0.12 by 0.16 inches and is bonded to a transistor on an RCA 5-mil-high glass-metal chip carrier.

In production the amplifier's size can be more than halved by eliminating the tuning, using a SiO₂ dielectric a half-micron thick instead of 1 micron, and omitting the extra large collector metalization.

RCA TA7003 transistors mounted on the individual 2-GHz amplifier circuits can be tuned to achieve either maximum power gain or maximum output. Because of the nonlinear behavior of power transistors in class-C operation, these objectives cannot be gained simultaneously.

Maximum gain of an amplifier is 6 db with approximately 0.5 watts output at 26% collector efficiency. Gains of more than 7 db with power outputs greater than a half-watt have been achieved with other transistors, however. Maximum output of the two-stager is 1 watt with a gain of 4 db and an efficiency greater than 30%. In coaxial circuits, similar transistors have produced a power gain of 6.3 db with greater than 30% collector efficiency and an input of 0.2 watt.

A 2-GHz class-A amplifier yielding more than 13 db of gain at low power levels has been built by breaking the emitter-base d-c return and applying a forward bias. This unit also uses a TA7003 transistor, but its low-power linear characteristics give it a stable gain only for a 50-ohm load; the circuit oscillates with mismatched loads.

A cascaded class-A and class-C amplifier has yielded better than 17 db of gain with 0.6 watt of output. And two cascaded class-C stages have yielded 11 db at 2 GHz with more than 0.8 watt.

Further, a 1.8-GHz amplifier composed of class-AB, class-B, and class-C stages has been assembled from basic amplifier-chip circuits. This unit operates stably and gives a gain of more than 21 db while supplying more than 0.6 watt. The 1-db bandwidth is greater than 70 Mhz. A 2.1 GHz amplifier has been similarly constructed that supplies one watt of power with a gain of more than 20 db.

All of these high-gain amplifiers were built by cascading the same basic IC shown on page 103 which was tunable to the different frequencies and power levels.

Match game

In a tunable two-stage amplifier, interstage networks shown on page 102 were designed to conjugately match the output of one transistor directly to the input of the other without going through a 50-ohm level. The network has a series as well as a shunt inductor. Tuning is aided by capacitors.

Loss in the higher-frequency circuits must also be considered, of course. If the unloaded Q's of the elements are about 50 and the transistor is tuned to match the loads, the calculated intrinsic losses for the input and output networks of these amplifiers are 0.5 and 0.8 db, respectively. (Intrinsic loss is that power lost in a one-way transmission with no reflections at input and output terminals.)

It remains to be seen just how feasible these

lumped-element designs will be as frequencies climb. As noted earlier, microstrip circuits themselves shrink as frequency increases; at some point—probably above C band—the size advantage of lumped-element units becomes insignificant.

For example, the lumped-element 2-GHz tunable network is much smaller than the comparable microstrip circuit shown on page 103. At this frequency, a tuning network in microstrip is about a quarter-wavelength long—a half inch in high-purity alumina. The lumped element circuit with two tuning networks is only about 0.125 inch. But although the microstrip doesn't have any r-f bypass networks, it could be made smaller by bending the shorted and open stubs closer to the signal path. And at X band (9 GHz), the quarter-wavelength microstrip is about 0.125 inch—just a bit longer than the comparable lumped-element amplifier at that range.

Although an inductor's ratio of Q to L increases with the square root of frequency, the required inductance values decrease. Thus, fairly constant Q's can be achieved throughout the range.

Capacitor Q's of 500 are theoretically possible, but dielectrics must be improved. With Q's of 100 or less, losses in individual matching networks transforming 10 to 1 impedance ratios will be 0.4 db or greater, and this limitation probably won't be pared by more than a factor of 2 in the near future.

Loaded question

The Q limits present a problem with low-gain devices where high loaded Q's are needed, or with networks that have to transform widely different impedances. The moderate unloaded Q of lumped elements prevents their use in narrow, high-Q tuning circuits. For low, loaded Q's such as in high-power but relatively low-gain uhf amplifiers, lumped elements are fine. Indeed, microwave lumped-element IC's appear to have no fundamental power limitation so long as the elements and the devices have a good heat sink.

Integrated L-band amplifiers with outputs of tens of watts will be possible as higher-power transistors are produced. Single-amplifier modules will soon be available with 20-watt outputs flat to 1 db over the 225-to-400-Mhz band. At the microwave frequencies, better transistor chips will make possible single-stage amplifiers with the same gain the cascaded circuits now have. Output powers will hit 5 watts or more at 2 GHz.

The use of lumped elements, as noted before, eases design. But lumped-element microwave circuits involve a more complicated fabrication process than do their distributed microstrip counterparts. Four separate depositions of dielectric and metal are required, and more if plating steps are used. Microstrip, on the other hand, only requires single depositions on the two sides of the substrate, though hybrid elements—passive as well as active—must still be added.

A fully integrated thin-film microstrip circuit may have as many components as its lumped-element equivalent. Although lumped-element circuitry

Triple-decker

Lumped-element thin-film circuits are fabricated in a three-step process that results in a deposited metal-oxide-metal sandwich, as shown below. The choice of a metal depends on the function performed by each layer. The capacitor's plates are formed by both of the metal layers, while the inductors can be formed in either top or bottom layer.

Capacitors can be made from most of the metals listed in the table on page 108 because conductor loss is small compared to that of the dielectric. On the other hand, only the metals with the lowest resistivities are used for the inductors, as noted before.

The fabrication process begins with the evaporation of the bottom, or main, metalization layer onto the substrate to a thickness of about one and a half skin depths. Additional thin layers of chromium or aluminum, for instance, can be added to top and bottom to improve the main metal's adhesion to the substrate and oxide. Standard photoresist techniques are then applied to define and etch this layer.

Next, a dielectric material—usually silicon dioxide—is deposited over the entire substrate, and finally, the top metal layer is evaporated, defined, and etched. Additional metal could be plated through a photoresist mask to increase Q. Gold can be used

to protect the exposed metal areas.

Some of the combinations used include: aluminum—SiO₂—aluminum; chromium, copper, gold, chromium—SiO₂—chromium, copper, gold; chromium, gold, chromium—SiO₂—chromium, gold; chromium, molybdenum, gold—SiO₂—chromium, copper, gold.

As for the substrate, the material chosen should have a high bulk resistivity and low dielectric loss tangent, a very flat surface, high thermal conductivity, and a low dielectric constant.

Although glass is easy to scribe and has good electrical properties, its low thermal conductivity restricts its usefulness. Sapphire dissipates about 0.5 watt per square mil—40 times better than glass. This means that transistors that produce up to 5 watts can be mounted on it. The actual cost of sapphire is still quite high, but the cost per circuit is low and should further decrease with additional usage.

High-resistivity silicon and beryllium oxide find limited usefulness as a substrate. However, the high thermal conductivity of beryllium oxide makes it a suitable mount for high-power transistors. Polished alumina hasn't been used because its surface pits can affect processing yields.

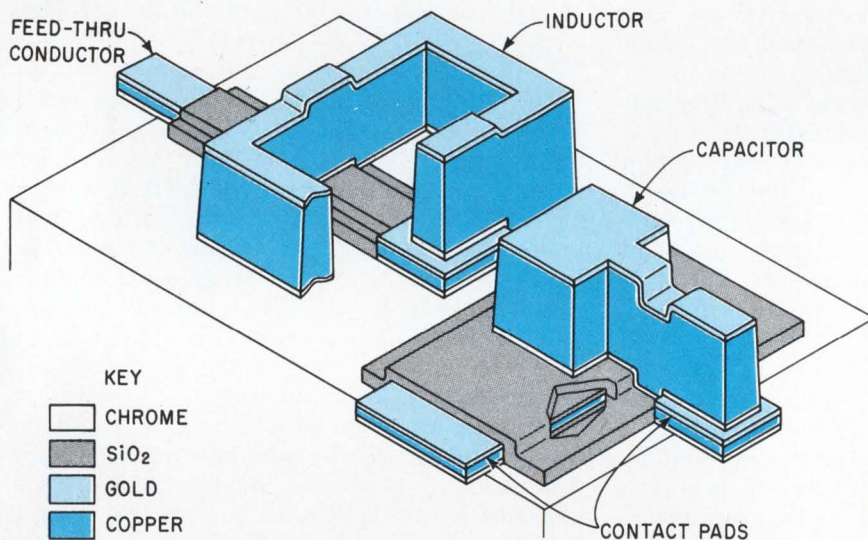

Sticking together.

Lumped elements are built in metal-oxide-metal structures with metals such as chrome or nickel added to help the materials adhere. Vertical scale exaggerated.

often requires finer detail and definition, the same kind of capital equipment can be used to produce both types of amplifier.

Integrated amplifiers are not the only beneficiaries of the lumped element approach. Lumped-element low-pass filters with 2.8 GHz cutoff frequencies have already been fabricated that yield performance equal to that of much larger microstrip units. Lumped elements will eventually be used in other circuits, such as couplers, hybrid combiners, matching networks in parametric diodes, and in such lower frequency nonreciprocal devices as circulators and isolators.

The uhf work reported here was supported by

the Air Force Avionics Laboratory, Research and Technology Division, Air Force Systems Command, Wright-Patterson Air Force Base, Ohio, Contract No. AF33(615)3202 and AF33(615)-5370. The microwave work was supported in part by the U.S. Army Electronics Command, Fort Monmouth, N.J., Contract No. DAAB07-68-C-0296 and RCA Laboratories, Princeton, N.J. ■

References

1. D.A. Daly, S.P. Knight, M. Caulton, R. Ekholdt, "Lumped Elements in Microwave Integrated Circuits," IEEE Trans., Microwave Theory and Techniques, December 1967, pp. 713-721.
2. M. Caulton et al (to be published) Paper at May, 1969 IEEE Microwave Theory and Techniques Symposium, Dallas, Texas.
3. W.E. Poole, "Uhf Integrated Power Amplifiers, International Solid State Circuits Conference, Philadelphia, February 1968, pp. 126-127.

Test your logic.

a) Suppose you designed the DCL MSI 8260, world's fastest adder, and its logic diagram looked like this:

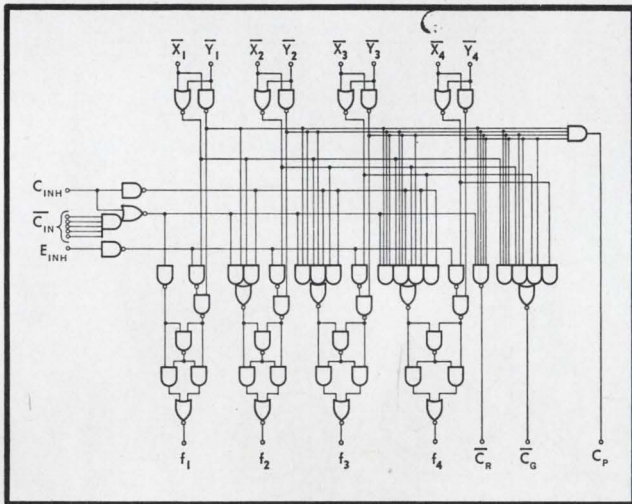

b) And it gave a speed and package count, which beat any other IC family, like this:

No. of Bits	Package Count			Addition Time per Bit (ns)	Total Addition Time Input to Output (ns)
	8260	8261	Quad 2-Input NAND Gates		
16	4	1	—	3.3	52
24	6	3	—	3.3	52
32	8	3	—	2.0	64
48	12	6	1	1.3	64
64	16	7	1	1.2	76

c) Next, suppose you came up with eleven new MSI elements—all perfect fits with the 8260, our other MSI elements, and the entire DCL family—like this:

8230	8-Input Digital Multiplexer
8232	8-Input Digital Multiplexer
8241	Quad Exclusive-OR
8242	4-Bit Comparator
8266	2-Input, 4-Bit Multiplexer
8267	2-Input, 4-Bit Multiplexer with Bare Collector
8268	Full Adder
8275	Quadruple Latch
8276	8-Bit Shift Register with Clock Inhibit
8284	4-Bit Binary Up/Down Counter
8285	BCD Up/Down Counter

d) Now then: wouldn't you logically buy a full-page ad to tell the world in Electronics? And wouldn't you sign it like this:

Signetics DCL

Signetics Corporation/811 E. Arques Ave., Sunnyvale, Calif. 94086/A subsidiary of Corning Glass Works

Logical afterthought: For written proof that Signetics is right in the middle of MSI, send for our DCL handbook. It's 120 pages—and free!

Want to be a good loser? Go about it systematically

Turning out gear that doesn't work shouldn't be a hit-or-miss affair or the exclusive job of production people; failure can be assured from the very start if the designer follows a few simple rules

By Matthew W. Slate

Sedco Systems Inc., Farmingdale, N.Y.

Rules of thumb go hand in hand with engineering. The designs of the future reflect the distilled and codified experience of the past. Therefore, if a designer is going to produce a failure, it's pointless for him to go about the job in a haphazard way. Not when he can fail by the numbers. The guidelines were laid down long ago and have been tested countless times. If the designer conforms to them, the results are guaranteed.

First, let's be clear that when we talk of a design "failure," we're talking about equipment that looks good on paper and works properly in the lab but bombs out when it's produced and sold in volume. Its production costs far outrun original estimates, its performance is unsatisfactory, or it's subject to excessive downtime when it finally gets into the field.

Such equipment may occasionally be turned out by chance, but in most cases the designer has dutifully followed one, several, or all of the following easy-to-learn rules. Names have been withheld to protect the guilty, but few engineers can deny that at one time or other they didn't accept at least one of these rules as true.

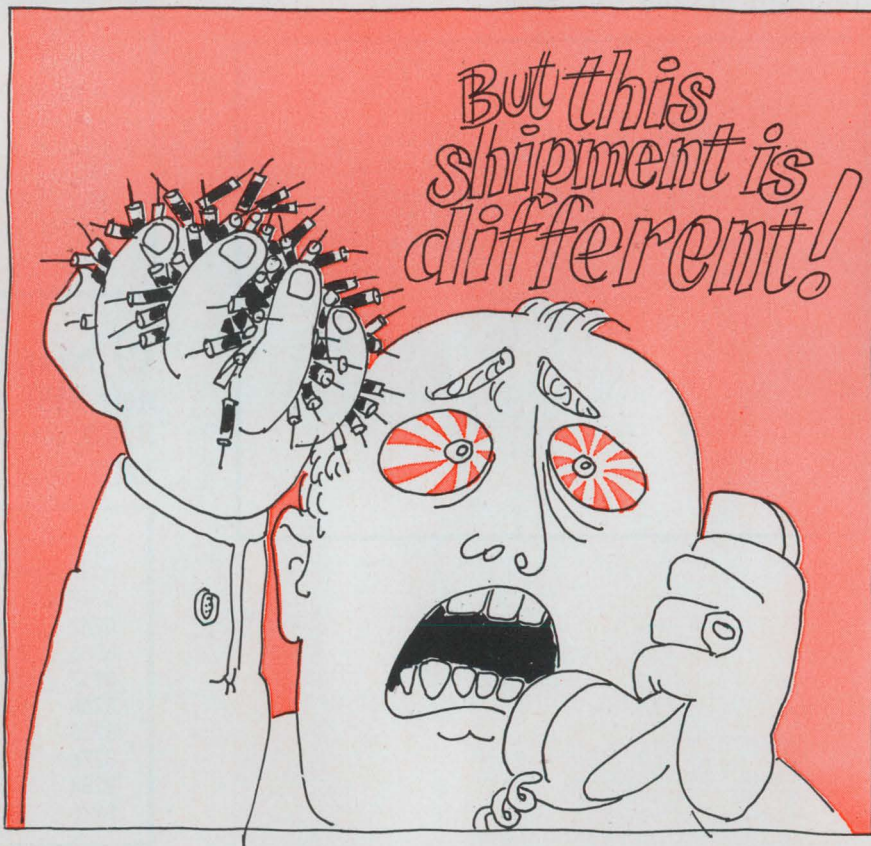

**Rule 1:
Components are components**

If the breadboard works—amplifier gain and rise time meet specifications—don't waste time analyzing the expected gain distributions or frequency response of the transistors and integrated circuits.

Naturally, the myriad of components you buy next year when the

vendor has his new production line going will be no different from the samples his sales representatives delivered to you.

So what if the samples were very close to the lower limit of the capacitance distribution; the production components you get won't be any more widely distributed. And there's no need to worry about your production circuits oscillating be-

cause the transistor, with a guaranteed minimum f_T of 10 megahertz—your sample was actually 15 Mhz—might next year average 30 Mhz, with some as high as 60 Mhz. You carefully, though experimentally, eliminated all feedback paths within the frequency response of your sample.

**Rule 2:
Take tolerances literally**

Doesn't every 1,000-ohm, 5% resistor have a resistance somewhere between 950 and 1,050 ohms? Of course it does when the manufacturer tests it before shipping it. But after it's been shipped and stored, and the leads clipped, bent, soldered, or welded, and after it has been operated under load and temperature cycling, all bets are off. Now, at time $t = 800$ hours, when the equipment is at maximum operating temperature, the resistance of this 1,000-ohm device is actually 1,175 ohms and your equipment's performance has just gone out of spec.

It's not your fault. You don't have to estimate the reversible and irreversible variations caused by internal and external heating. That requires some calculations and involves reading the footnotes on the data sheet, or even calling the manufacturer. All that's time-consuming. Besides, that technically astute sales rep said his components never go out of tolerance—well . . . hardly ever.

**Rule 3:
Take ratings literally**

Obviously that 200-volt rating stamped on a capacitor means that you can put 200 volts on it—forever. After all, the equipment has to operate for only 400 hours, so the 20 bypass capacitors you hung on the +200-volt line can be rated at 200 volts; there's no need to pay for a higher voltage rating. When you put the equipment into environmental tests, you chuckle to yourself about how much money you've saved. And you keep on chuckling until the unit fails.

You have no idea why it failed. There's no temperature rise you can trace to internally generated heat that might be caused by a-c current passing through a capacitor is there? You remember that there was something about that in either

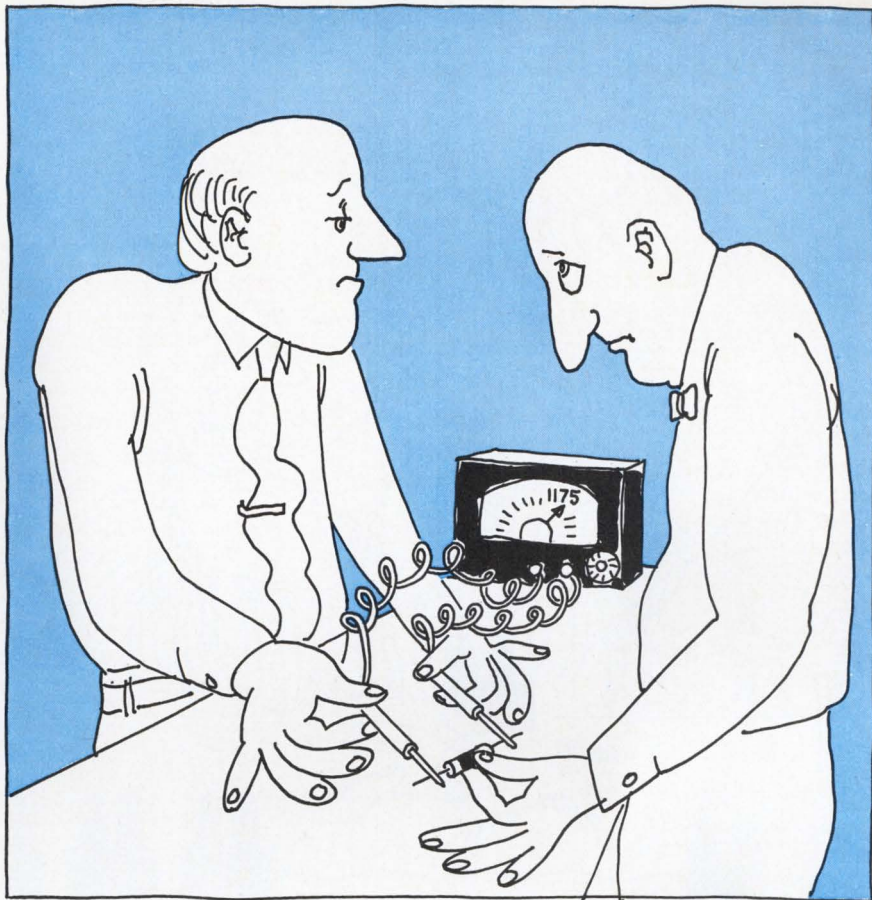

MIL-STD-198 or MIL-STD-199, but those specs were much too tiresome to read.

Of course, most component manufacturers have data with which mean life, or performance degradation with time, can be related to operating conditions, but to get this information would have taken a long-distance phone call, and your operation can't afford that any more than it can afford a reliability engineer.

**Rule 4:
Stay out of production**

If an amplifier or digital module works on the bench when hooked up to a laboratory power supply, it follows that four of them will work from one common power supply in the final product. You could, of course, calculate what filtering would be required to isolate each unit unconditionally, but these calculations might take an hour. Besides, you might even have to calculate the frequency at which two capacitors that bypass a common line resonate with the inductance of the lead connecting them.

You would then have to determine what gain, signals, and noise exist at this frequency and what damping, if any, is needed. You can see how all this snowballs. Your job could turn out to be as difficult as specifying the ground connection of a group of IC's to maintain common-impedance coupling at an acceptable level.

But if you think a bit—after all, that's why you went to engineering school—you can save yourself a lot of work. Why not wait until the prototype is delivered to you with all the components potted? Then you can have your technician do the job the easy way. It should only take him a minute to determine if the prototype oscillates, and probably just a few minutes more to determine the exact frequency of oscillation.

**Rule 5:
Don't redesign**

Don't fret about production. The technician who carefully put together your breadboard, who painstakingly laid out and mounted all components, and who aligned that



Finally, after many months of sweat, you're ready to release the equipment for production but have decided that it might be a good idea to show the president how well it works. Just as you finish telling him what a great job you've done, your technician inadvertently drops a screwdriver near the equipment. You, the president, and everyone else watch the oscillator's frequency change as though Con Edison were modulating the a-c power line.

Now the heretofore ignored mechanical designer suggests that you use a dielectric support, but the only accessible location at this stage of the game happens to be a high-impedance point of the oscillator circuit. You know he's right, but you also know that with the added capacitance of the support, the oscillator won't cover the required range unless you completely redesign the tuning circuitry. And if you redesign, you'll slip your schedule.

Well, restrain yourself. Don't redesign anything; people might think you're incompetent. Instead, take your chances on shock and vibration. Most likely you can get a waiver, or a new job.

**Rule 7:
Don't sweat temperature**

If the highest operating temperature specified for a piece of equipment is $+50^{\circ}\text{C}$, rate all the components for $+50^{\circ}\text{C}$ and give the matter no further thought. Of course it may be that the equip-

breadboard with a mother's loving care will also nurse each production unit right into the shipping crate.

In his 20 years of experience he's worked for engineers even more careless than you; he knows what clearance is needed to stand off 1,000 volts, so he'll take an extra hour to dress the leads carefully and position the resistor precisely. He'll also take two hours to align the amplifiers, remembering just how much each adjustment upset earlier alignments.

So get out of the loop fast! It doesn't pay to waste your valuable time improving designs to make production-line jobs easier. That's the production engineer's responsibility anyway.

**Rule 6:
Skip the details**

Say you've developed and proven a layout with the breadboard. The high-frequency oscillator works. When you told your technician how to mount the tuning elements to

achieve a maximum circuit Q, the mechanical designer was in the next room but you didn't bother to ask his advice on how to support them. You were too busy, he was too busy, and besides, it was really an electrical problem.

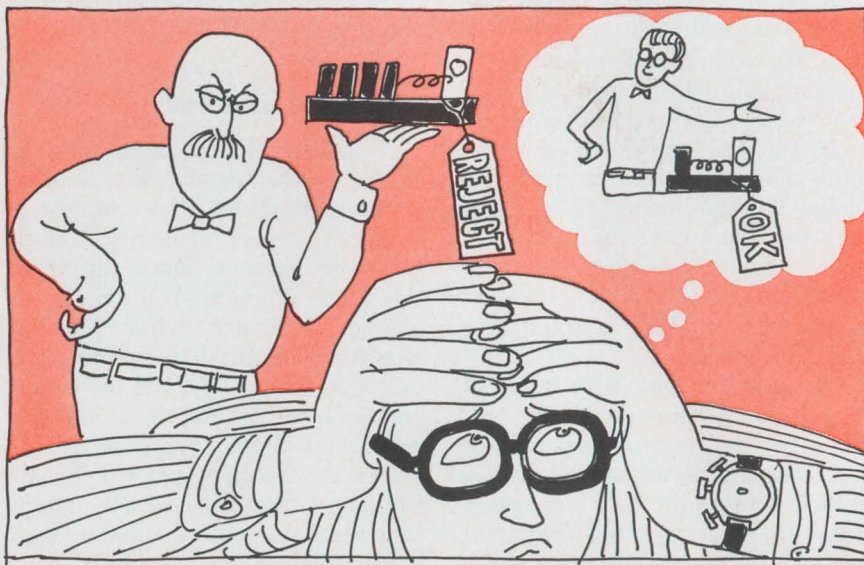

ment itself will generate some heat. And it's true that you could calculate the average temperature rise above ambient, but who remembers those thermodynamics courses. But simple common sense will tell you that those high-dissipation components you grouped together for electrical reasons will block each other's air circulation. The actual temperature in certain areas may rise as much as 50°C above ambient, which could heat nearby components to 40° above ambient. Now if the operating temperature is 50° and the equipment generates enough heat to cause an additional 50° rise, those components rated at 50°C may find it hot.

But you have enough problems to worry about; don't add to the list. Anyway, it's easier to build the equipment and see what burns up. Your customers will tell you.

**Rule 8:
If you can't measure it, forget it**

The first two production models of your uhf variable-tuned receiver have just failed; sensitivity is out of spec by 2 decibels. How could that be? Initially, the breadboard was 4 db better than required. After you finished the breadboard, you installed limit transistors and the sensitivity margin dropped to 1.5 db. You also allowed for component degradation, which accounted for another 0.5 db. Of course, it would have been better if you had considered all this at the beginning of the design effort, but half a loaf is better than none, and you had a 1-db margin anyway. However, somewhere between breadboard and production line an additional 3 db were lost, and you're wondering where.

Well, here's what happened. When the mechanical designer suggested a support, your technician soldered in a metallized ceramic type. You didn't care what grade of ceramic was used, because when the technician checked the support in the breadboard he found no significant reduction in gain. How could he? Who can measure degradation of 0.2 db in a single circuit? Of course, you could have calculated the actual loss by looking up the dissipation factor of the ceramic, measuring the capacitance, and computing the effect of the equivalent shunt resistance. If this



loss was high, you could then have selected a better grade of ceramic to reduce it.

Also, at two points in each tuned circuit of the breadboard you used a mica feedthrough capacitor with a resin seal. However, someone suggested using a newer hermetically sealed type for improved reliability. And since the Q of both types is identical at 1 Mhz, it's natural to assume that there would be no difference at uhf. But being very thorough, you tested one in a mockup and it looked okay. In reality, though, these new capacitors turn out to have additional losses—0.1 db for the low r-f current locations and 0.2 db for the high.

Remember the sample capacitor used in the breadboard? You know, the one with a silver-plated brass terminal all the way through. Well, the newer one has a kovar terminal

that's gold flashed after assembly, and this increases its r-f series resistance at uhf by several times that of the capacitor used in the breadboard. Of course, had you measured the capacitor's Q at the operating frequencies, this would have been apparent.

What else could go wrong? For one thing, the coupling capacitor was originally optimized near the extreme high-impedance end of the transmission line. But to make the capacitors easier to install in production, you repositioned them 1/8 inch down the line. Again you had the revised circuit tested, and again you couldn't measure the difference. And you were absolutely right not to concern yourself further. After all, it was only 0.2 db.

**Rule 9:
Assume this list is complete ■**

Active filters: part 9

Applying nonlinear elements

Magnetoresistive and Hall-effect devices can be the answer for engineers who must worry about the effects of high temperatures or radiation on either conventional semiconductors or integrated circuits

By Velio A. Marsocci

State University of New York, Stony Brook

Unconventional active elements such as Hall-effect and magnetoresistive devices can be used to good advantage as linear amplifiers in converters or gyrators. Previous articles in this series discussed the use of conventional assemblies, for example, transistors and integrated circuits, as active elements in resistor-capacitor filters. Their employment as amplifiers, negative-impedance converters, or gyrators in combination with RC networks avoids problems of bulkiness (in comparison with equivalent RLC networks) and losses in the passband. But offbeat componentry can prove helpful, particularly in applications where size is a factor or where temperature and radiation could impair the performance of a conventional device.

The magnetoresistive amplifier is one application for an unconventional element in an active RC filter network. A magnetic field is modulated by an input signal current, with an active element placed in the field. As the field changes so does the resistance of the element. The resultant variation becomes the output current.

Such amplifiers have been classified into two groups. The first comprises conventional magnetoresistive devices fabricated by placing a material that exhibits a large magnetoresistive effect in the gap of a ferromagnetic core. The second is made up of cryotrons biased to operate in the resistive transition region—that lies between the superconducting and normal resistance states of the gate element. For conventional devices, the magnetic field is varied by input signal currents applied to windings on the core. A schematic and matrix representation of a linear equivalent circuit for this type of device is shown at the bottom of the facing page. (Discussion of matrix occurs later in this article.)

The resistance, R , for the active element is

$$R = R_0(1 + \alpha_m B^n)$$

where R_0 is the value of the resistance when the field is zero; B is the magnetic induction, and α_m is the magnetoresistance characteristic for the active element material. The fractional change in resistance, referred to as the zero-field value, for a varying magnetic field is expressed by

$$\frac{(R - R_0)}{R_0} = \frac{\Delta R}{R_0} = \alpha_m B^n$$

The values of α_m and n are determined by measuring $\Delta R/R_0$ for several values of B and then using analytical or graphical techniques to obtain the numbers. In most materials n equals 2, and thus a square-law relationship holds between the magnetoresistance factor, $\Delta R/R_0$, and the magnetic field.

The maximum power gain of the magnetoresistance amplifier can be expressed in the form

$$A_{pm} = K_1(S/R)^2$$

where K_1 depends on the physical characteristics of the active element, the geometry of the magnetic core and its windings, the flux density in the core, and the d-c power dissipated by the active element; S equals dR/dB .

Factors $(S/R)^2$ and K_1 are affected by the field biasing; however, plotting $(S/R)^2$ and A_{pm} against the applied field shows that the variation in A_{pm} follows that in $(S/R)^2$ very closely. Magnetoresistance amplifiers are useful as components of such devices as mixers, d-c to a-c inverters, and transducers (pressure sensors, displacement sensors, and accelerator elements).

Although magnetoresistive devices have limited bandwidth and require relatively large magnetic fields, they offer good d-c isolation between the input and the output terminals. The output signal's polarity is then determined by the arrangement of the biasing batteries.

For the second group a typical cryotron element and a cryotron amplifier are depicted at the right. In linear operation, an input current applied to the control element, produces a varying magnetic field that modulates the resistance of the gate element in the transition region.

The linear output characteristics of the cryotron are derived by considering that the resistance of the gate, for operation in the transition region, is described by

$$R_g = K(ai_G + i_C - I_0)^n, \quad 0 < K(ai_G + i_C - I_0)^n < R_n$$

where R_n is the normal resistance of the gate element, I_0 is a constant, i_G is the total instantaneous value of gate current, i_C is the total instantaneous value of control current, and K , a , and n are constants. A typical family of such curves is shown at the bottom of the next page together with the load

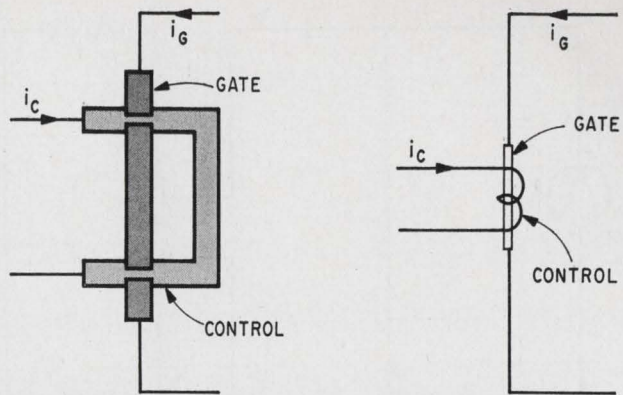

Cryotron amplifier. Current, i_C , is applied to the control element of a thin-film cryotron amplifier and produces a fluctuating magnetic field. The field modulates the resistance of the gate element. Current through the gate is designated i_G .

line set by R_L , the load resistor.

If the cryotron's operation is restricted to small regions about a point in the linear region of the output characteristics, then the variation in the gate voltage can be written as

$$de_G = \left(\frac{\partial e_G}{\partial i_G} \right) di_G + \left(\frac{\partial e_G}{\partial i_C} \right) di_C$$

where e_G and e_C are the total instantaneous values of the gate voltage and control voltage, respectively. If these incremental quantities are replaced by symbols for small-signal variations in the voltages and the currents, and if a dynamic gate resistance, r_g , and a transresistance, r_m , are defined as

$$r_g \equiv \frac{\partial e_G}{\partial i_G}, \quad r_m \equiv \frac{\partial e_G}{\partial i_C}$$

then e_g can be written in the form

$$e_g = r_g i_g + r_m i_c$$

The input circuit of the cryotron can be represented as a short-circuit, since the control element is always in the superconducting state. Several small-signal equivalent circuits for linear operation that can be used to characterize the cryotron are shown at the right of page 119. These representations are referred to as the common-point, common-control, and common-gate connections. They are analogous to the three connections possible with a transistor, namely common-base, common-emitter, and common-collector, respectively.

If the cryotron amplifier is represented in terms of the linear equivalent circuit of the common-point type with a load resistance, R_L , attached to the output terminals, the current gain of the device is derived as

$$K_i = \frac{R_m}{r_g + R_L} = \frac{\alpha}{1 + (R_L/r_g)}$$

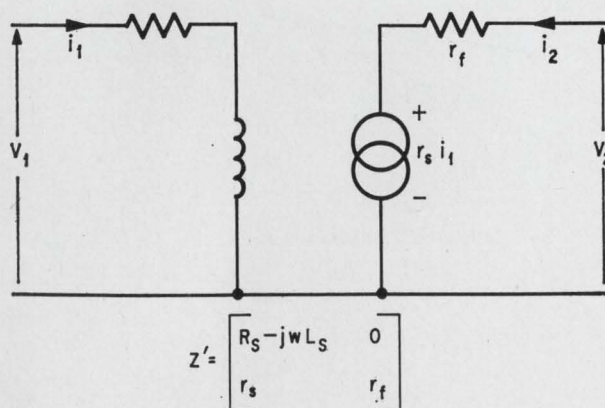
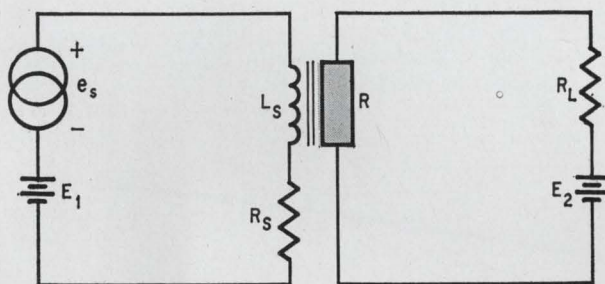

Magnetoresistive amplifier. Current i_1 , through inductor, L_s , sets up a magnetic field that is sensed by magnetoresistive element, R . Equivalent circuit for the amplifier shows the result as a voltage source, $r_s i_1$.

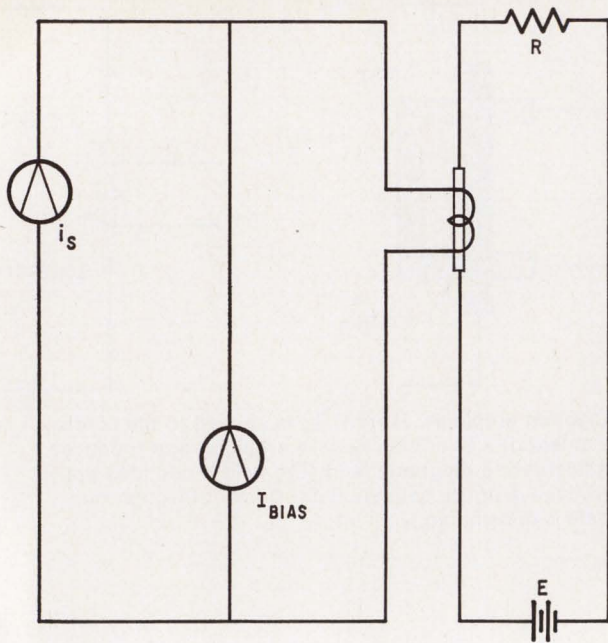

Current mix. In the linear cryotron amplifier, current i_s and i_{BIAS} combine and flow through the coil, setting up a magnetic field. Output current is then induced in the gate and flows through resistance R .

where α is defined by $\alpha = -\partial g/\partial c/$ and by $\alpha = r_m/r_g$. The maximum current gain is achieved for $R_L = 0$, which is the condition for a cascaded stage in the common-point connection.

The polarity of the output depends upon the polarity of the bias generators. A reversal of the bias batteries reverses the sign of α . Current gain of the amplifier in the common-control connection is given by

$$K_i = \frac{\alpha}{1 - \alpha + R_L/r_g}$$

which has a maximum value, for $R_L = 0$, of

$$K_i = \frac{\alpha}{1 - \alpha}$$

Thus, in this connection K_i can take on a large value even when α is less than unity. In the common-gate connection, the current gain is described by

$$K_i = \frac{1 + \alpha}{1 + R_L/r_g}$$

with the maximum value of

$$K_i = 1 + \alpha$$

being achieved for $R_L = 0$.

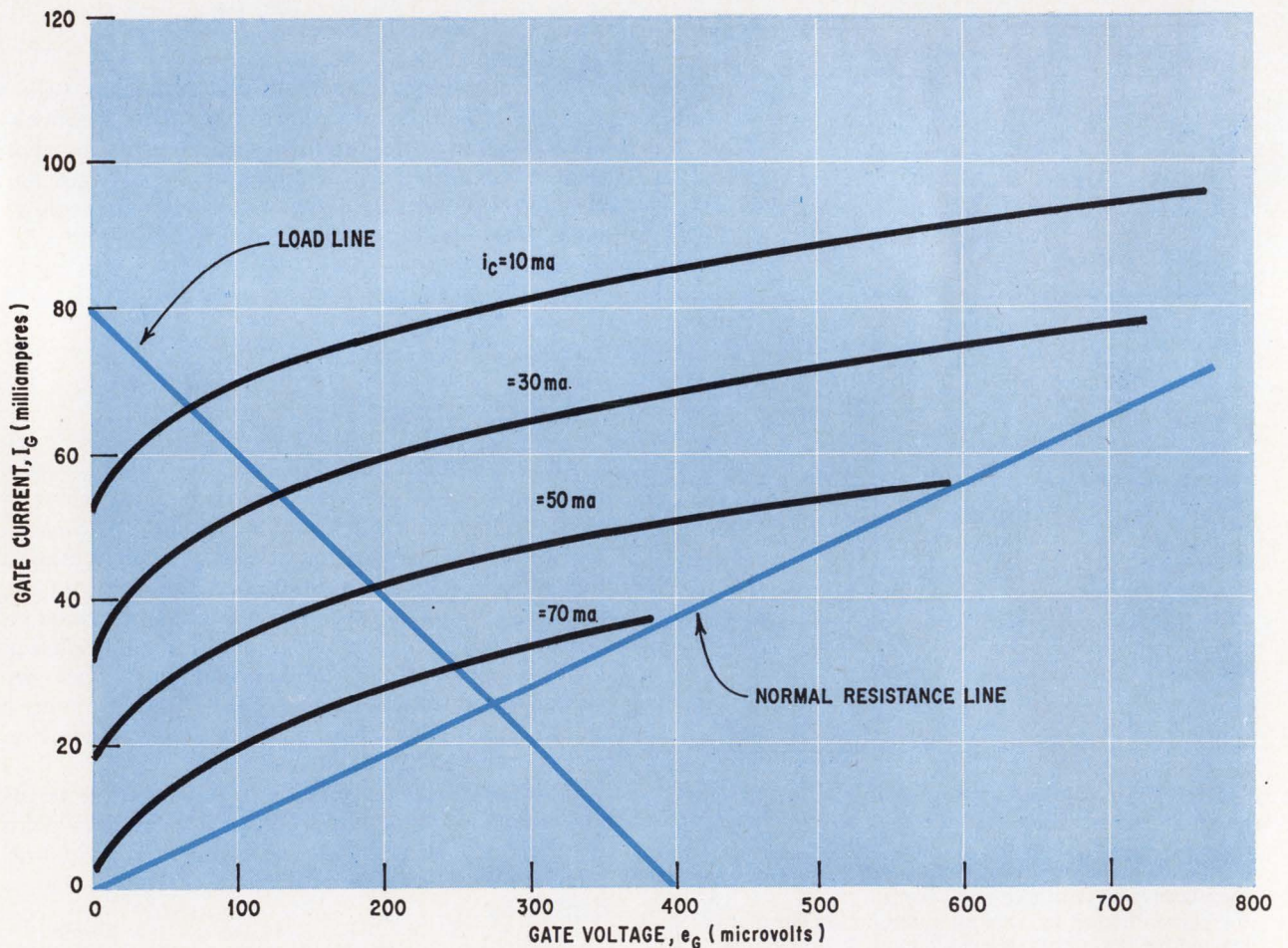

Getting an output. These are typical output characteristics of a cryotron operated in the resistive transition region.

The major advantages of cryotrons are ruggedness, high reliability and wide bandwidth, as well as the large packing densities that are possible.

If a conducting specimen is placed in a magnetic field that is perpendicular to the direction of current in the plate, the deflection of the charge carriers in the specimen produces a Hall voltage. This voltage is perpendicular to the plane set by the current and magnetic fields. A typical Hall-effect plate is depicted at the top of page 120. The effect has been used in such devices as magnetometers, isolators, transducers, circulators, resolvers, function generators, detectors, multipliers, and modulators.

A linear power gain greater than unity can be achieved with the device if a d-c current is supplied to bias the sample. The gain is measured from the input to the magnetic field to the output at the Hall-voltage terminals. Like that of the magnetoresistance amplifier, the gain-bandwidth of this device is limited.

Gyrator circuits have been developed using any one of the several network techniques and active devices [*Electronics*, June 10, 1968, p. 114]. One drawback of gyrators is that the input and the output impedances that result are not low enough for truly efficient action.

One way to obtain these low impedance levels is with cryogenic magnetoresistive devices. The conventional and the cryogenic magnetoresistive devices also produce the gyrator characteristics with only one negative-resistance element.

Almost all other gyrator configurations require two negative resistance elements. With transistor circuit configurations, these may be intrinsic in the design. With the magnetoresistive devices, the single negative-resistance element can be achieved either by using two such devices in combination or by using the conventional method for gyrators.

The gyrator is a two-port network that can be characterized by the z-parameter matrix

$$\begin{bmatrix} z_{11} & z_{12} \\ z_{21} & z_{22} \end{bmatrix} \equiv \begin{bmatrix} 0 & \pm R \\ \pm R & 0 \end{bmatrix}$$

R is an impedance developed by the network (z') in the drawing at the top of page 121 together with the external elements Z, Z_1 , and Z_2 . If the over-all network is to produce the ideal gyrator, conditions must be such that

$$Z = -(z_{12}' + z_{21}')/2$$

$$Z_1 = -(z_{11}' + Z), \quad Z_2 = -(z_{22}' + Z)$$

If the network (z') is to be implemented with a cryotron operating in the linear mode, then the gyrator matrix is achieved from the common-point connection—with $R = +\frac{1}{2}r_m$ —and the external impedances chosen as

$$Z = -\frac{1}{2}r_m, \quad Z_1 = \frac{1}{2}r_m, \quad Z_2 = -r_g + \frac{1}{2}r_m$$

Thus, if $r_m \geq 2r_g$, the gyrator characteristics are indeed achieved with one negative-resistance element. This condition requires that

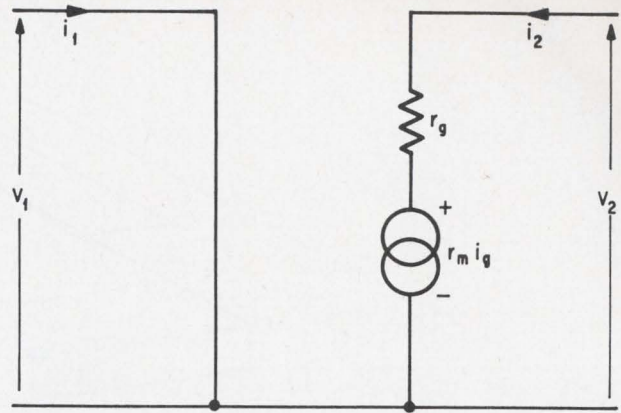

(a)

$$z' = \begin{bmatrix} 0 & 0 \\ r_m & r_g \end{bmatrix}$$

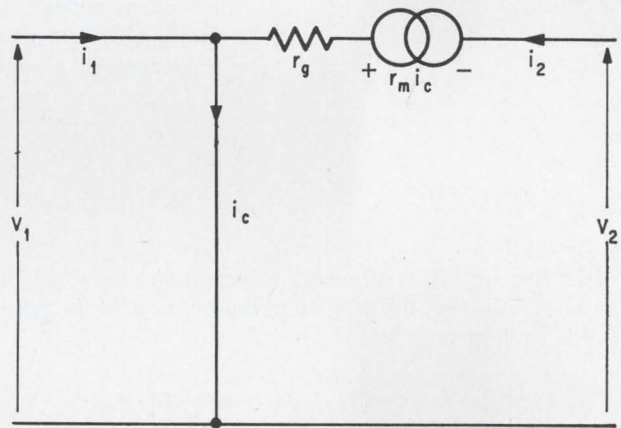

(b)

$$z' = \begin{bmatrix} 0 & 0 \\ -r_m & -r_m + r_g \end{bmatrix}$$

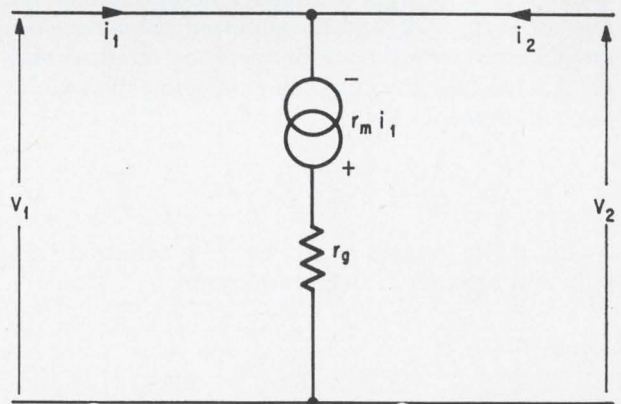

(c)

$$z' = \begin{bmatrix} -r_m + r_g & r_g \\ -r_m + r_g & r_g \end{bmatrix}$$

Cryotron equivalent. A cryotron amplifier is connected in a common-point (a), common-control (b), or common-gate (c), configuration.

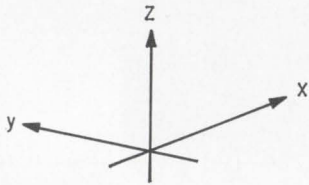
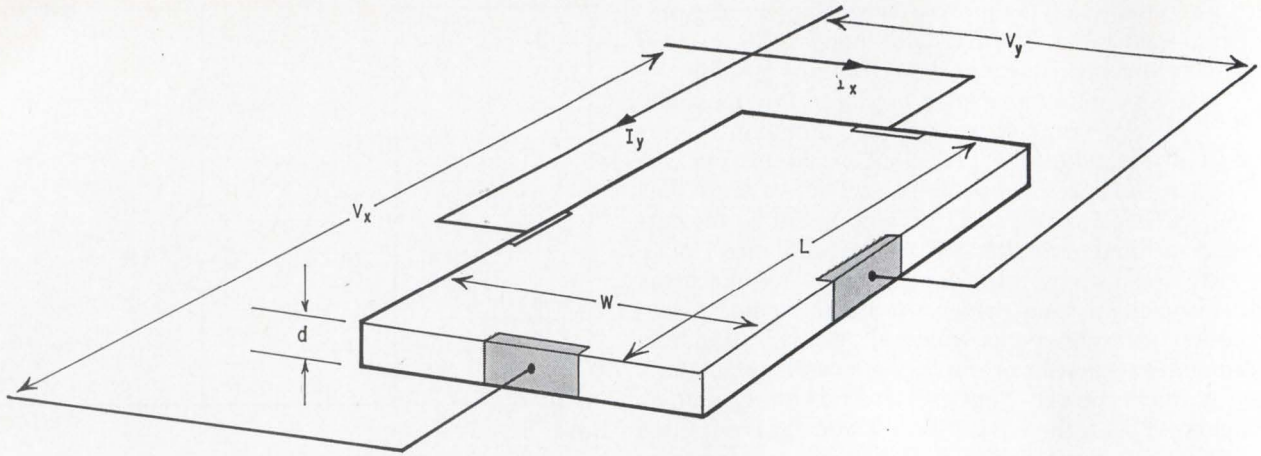

Study the boundaries. With a d-c magnetic field applied to a Hall plate, a voltage V_y develops if current, i_x , flows. If the d-c field is removed, no voltage appears for V_y . If the open-circuit impedance matrix is measured with the d-c field present, symmetrical contact location leads to $z_{12} = z_{21}$. If the contacts are not symmetrically located, z_{12} will not equal z_{21} .

$$\alpha \equiv \frac{r_m}{r_g} \geq 2$$

If the cryotron is used in the common-control connection the gyrator impedance matrix is produced when

$$Z = \frac{1}{2}r_m, \quad Z_1 = -\frac{1}{2}r_m, \quad Z_2 = r_g - \left(\frac{3}{2}\right)r_m$$

Therefore, the gyrator characteristic is still achieved with a single negative-resistance element if

$$\alpha \equiv \frac{r_m}{r_g} \leq \frac{2}{3}$$

This is a much less stringent condition than the one for $r_m/r_g \geq 2$, and these output characteristics are achieved over the entire operating range. A similar analysis for the common-gate connection yields the requirements that

$$Z = -r_g + \frac{r_m}{2}, \quad Z_1 = \frac{r_m}{2}, \quad Z_2 = -\frac{r_m}{2}$$

Again, if the gyrator matrix is to be achieved with only one negative-resistance element,

$$\alpha \equiv \frac{r_m}{r_g} \geq 2$$

A magnetoresistive device can be operated with either polarity at its output signal. The conventional device, however does not provide the low impedance levels obtained with the cryotron.

In the linear equivalent circuit, shown for the conventional magnetoresistive device, elements R_s and L_s represent the impedance of the field-producing coil to which the input signal is applied. The impedance parameters provided by this net-

work, when used to obtain the (z') portion of the over-all network, are

$$z_{11}' = R_s + j\omega L_s, \quad z_{22}' = r_f, \quad z_{12}' = 0, \quad z_{21}' = r_s$$

and the gyrator matrix can then be achieved, with $R = r_s/2$, if the external elements are designed as

$$Z = -\frac{r_s}{2}$$

$$Z_1 = -(R_s + j\omega L_s) + \frac{r_s}{2}, \quad Z_2 = -r_f + \frac{r_s}{2}$$

The presence of the $j\omega L_s$ term for Z_1 indicates that the gyration resistance, R , is achieved at only one frequency. The design of the magnetic circuit of the device must aim toward minimizing L_s so as not to make the useful bandwidth too low. Therefore, the gyrator characteristics are achieved with one negative-resistance element provided that

$$r_s \geq 2R_s$$

$$r_s \geq 2r_f$$

The magnetoresistive device can be connected in the corresponding three ways as the cryotron. For instance, the connection just analyzed corresponds to the common-point connection for the cryotron. If the magnetoresistive device is arranged in a common-control connection then the following inequalities must be observed:

$$r_s \geq 2R_s$$

$$r_s \geq 2r_f$$

In the arrangement corresponding to the common-gate connection, however, the gyrator is achieved with one negative-resistance element if the sole criterion

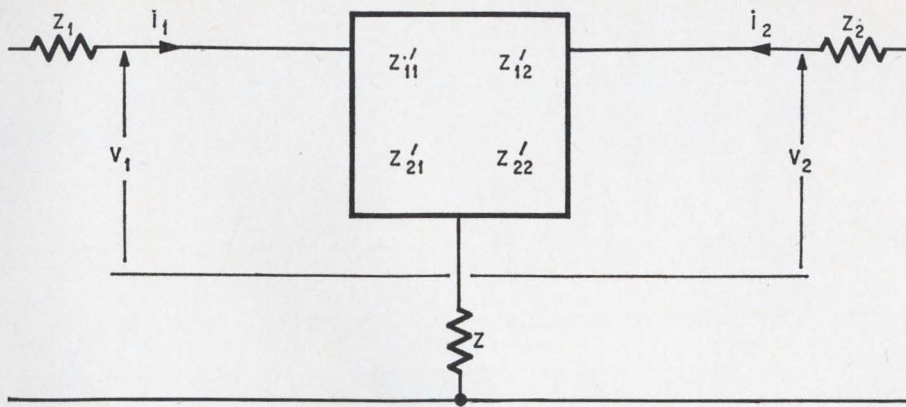

Modeling a gyrator. A typical gyrator is represented by its z matrix and series resistive elements.

$$r_s \geq 2R_s$$

is satisfied.

Thus, a cryogenic device does provide very low input and output impedances for the gyrator network, but the magnetoresistive device can operate both at room temperature and reduced temperatures. How well the two devices compare with other methods in approaching the ideal gyrator characteristics can be seen by comparing the ratios R/z_{11} and R/z_{12} for each case. The input and output impedances are not zero in practice, and the impedance criteria for α and r_s are satisfied only for the inequality.

Experimental results for the magnetoresistive device indicate that the condition $r_s \geq 2r_t$ is easily achieved, whereas the more restrictive statement $r_s \geq 2R_s$ requires that the input circuit be designed to minimize the real part of the input impedance.

Hall-effect gyrators

The Hall-effect devices have been used to achieve gyrator characteristics, but the device introduces network parameters that cause the input and output impedance to vary from zero. However, to control this limitation, the Hall-effect device is connected with one negative-resistance element.

The two-port network equations for the Hall-effect plate are written as

$$\begin{aligned} V_x &= z_{xx}I_x + z_{xy}I_y \\ V_y &= z_{yx}I_x + z_{yy}I_y, \quad z_{xy} = z_{yx} \end{aligned}$$

where z_{xx} and z_{yy} represent the internal impedances of the device. The parameters z_{xy} and z_{yx} are also functions of the Hall coefficient and of the applied magnetic induction. An equivalent set of admittance equations based on the geometry and the conductivity have been derived as

$$\begin{aligned} I_x &= (\sigma_{xx}Wd/L)V_x - (\sigma_{xy}d)V_y \\ I_y &= (\sigma_{xy}d)V_x + (\sigma_{xx}Ld/W)V_y \end{aligned}$$

Comparing the coefficients V_x , V_y , I_x , and I_y yields

$$\begin{aligned} z_{xx} &= (\sigma_{xx}L/DdW) \\ z_{yy} &= (\sigma_{xx}W/DdL) \end{aligned}$$

$$z_{xy} = -z_{yx} = (\sigma_{xy}/Dd)$$

where $D = \sigma_{xx}^2 + \sigma_{xy}^2$. Therefore, the impedance matrix for the Hall-effect device can be written as

$$\frac{1}{Dd} \begin{bmatrix} (\sigma_{xx}L/W) & \sigma_{xy} \\ -\sigma_{xy} & (\sigma_{yy}W/L) \end{bmatrix}$$

This situation also represents a departure from ideal gyrator characteristics in that z_{xx} and z_{xy} may not be relatively low impedances. However, the ideal situation can be approached if the Hall plate is fabricated so that $W \ll L$, which tends to reduce z_{yy} to a low value. The success achieved by constructing the plate in this way depends on how z_{xy} and z_{yx} are affected by variations in the geometry. Although the parameters appear to be affected only by the dimension, d , the Hall coefficient also depends on the geometry of the plate. Thus, since σ_{xy} and σ_{yx} are related to the Hall coefficient, the unbalance produced in z_{xy} and z_{yx} must be considered from the physics of the device.

Bibliography

- H.J. Thuy, "Der Galvanomagnetische Verstärker," Arch. Elek. Übertragung, vol. 8, May 1954, pp. 217-222; June 1954, pp. 269-278.
- M. Green, "The Gaussistor, A Solid-State Electronic Valve," IRE Transactions Electron Devices, vol. ED-3, July 1956, pp. 133-141.
- V.A. Marsocci and P.M. Chirlian, "Optimization of the Dynamic Properties of the Controlled Superconductor," IRE Transactions Component Parts, vol. CP-9, June 1962, pp. 74-77.
- P.M. Chirlian and V.A. Marsocci, "A Cryotron Linear Amplifier," IEEE Transactions Component Parts, vol. CP-10, December 1963, pp. 144-146.
- B.A. Shenci, "Practical Realization of a Gyrator Circuit and RC-Gyrator Filters," IEEE Transactions Circuit Theory, vol. CT-12, September 1965, pp. 374-380.
- M.S. Ghausi, "Principles and Design of Linear Active Networks, McGraw-Hill Book Co., 1965.
- L.T. Yuan, "Magnetoresistive Transducer," Solid-State Electronics, vol. 9, pp. 497-502, May 1966.
- V.A. Marsocci, "Optimal Biasing In Magnetoresistance Amplifiers," IEEE Transactions on Magnetics, Vol. MAG-2, pp. 744-747, December 1966.
- V.A. Marsocci, "Realization Of A Magnetoresistive Gyrator Circuit," IEEE Journal of Solid-State Circuits, vol. SC-2, pp. 44-46, June 1967.



ZELTEX Model 830, the FIRST fet 'op amp' in a dual-in-line package...

try that on for size

The big news in miniature amplifiers is the ZELTEX 830—the industry's first in a DIL package—and the first in a new ZELTEX family of DIL analog functions. What's more, the 830 is fully compensated and short circuit-proof. Performance? The spec's tell the story. ■ Voltage gain is 300,000 ■ $20\mu\text{V}/^\circ\text{C}$ drift ■ input



WHERE THINGS ANALOG ... HAPPEN!

bias current of 15 pA ■ $6\text{V}/\mu\text{sec}$ slew rate ■ 10 volt common mode voltage, and ■ output of 10 volts at 5 mA. Available from stock, too. Size up the 830 now. Write for complete data and prices. ■ 1000 Chalomar Rd., Concord, Ca. 94520. Phone (415) 686-6660.



Here are four Acopian power supplies... two singles and one dual.

Where your equipment or system requires more than one regulated DC output, you can save space, weight and cost by using Acopian duals. Acopian duals consist of two independent regulated power supplies housed in a single plug-in case. They occupy less space than two separate modules, require only one socket instead of two, and cost less, too. Whether you need two identical outputs, such as required for powering operational amplifiers, or two different voltages, Acopian offers you a choice of 80,000 combinations.

Acopian duals also save you time. Shipment is guaranteed within three days after receipt of order. For information on the complete line, ask for the brand new Acopian 1969 catalog. Write Acopian Corp., Easton, Pa. 18042 or call (215) 258-5441.



YOU'RE LOOKING AT THE THREE FINEST INSTRUMENTATION PORTABLES MADE TODAY

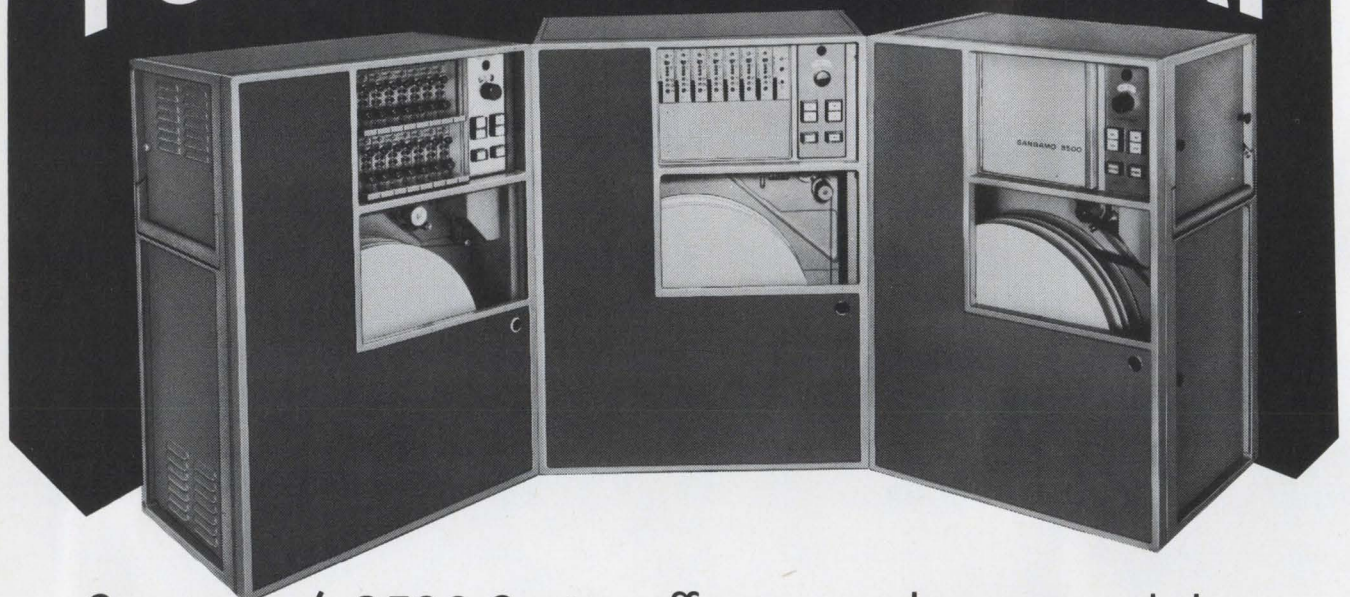

Sangamo's 3500 Series offers complete tapeability with Low Level, Wideband, and Midband models

These portable recorder-reproducers outperform all other portables . . . even most laboratory models. They're first to employ a light mass, fast response, bi-directional drive system; first with an exclusive inertial dampening system. They offer highest long term speed accuracy, highest servo correction range and rate . . . plus lowest flutter, time base error and skew.

The midband and low level portables offer up to six electrically selectable speeds, the wide band model offers seven.

Operating advantages include:

LOW LEVEL Differential input with high common mode rejection and sub-millivolt input sensitivity. Suitable for medical and other low level transducer applications.

WIDEBAND Seven automatically selectable speeds with amplitude and phase equalized direct record. Frequency response of up to 2 MHz direct and DC to 500 KHz FM. 16-inch reels for longer record time of high frequency data.

MIDBAND High accuracy and long record time in a portable configuration with integrated circuit reliability.

Please contact Dept. E-4 for complete performance data and the low price of these great performers.

SANGAMO
Information Systems
Springfield, Illinois

The innovators
in tape
instrumentation

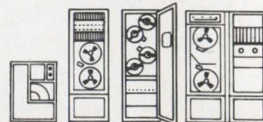

DS-691

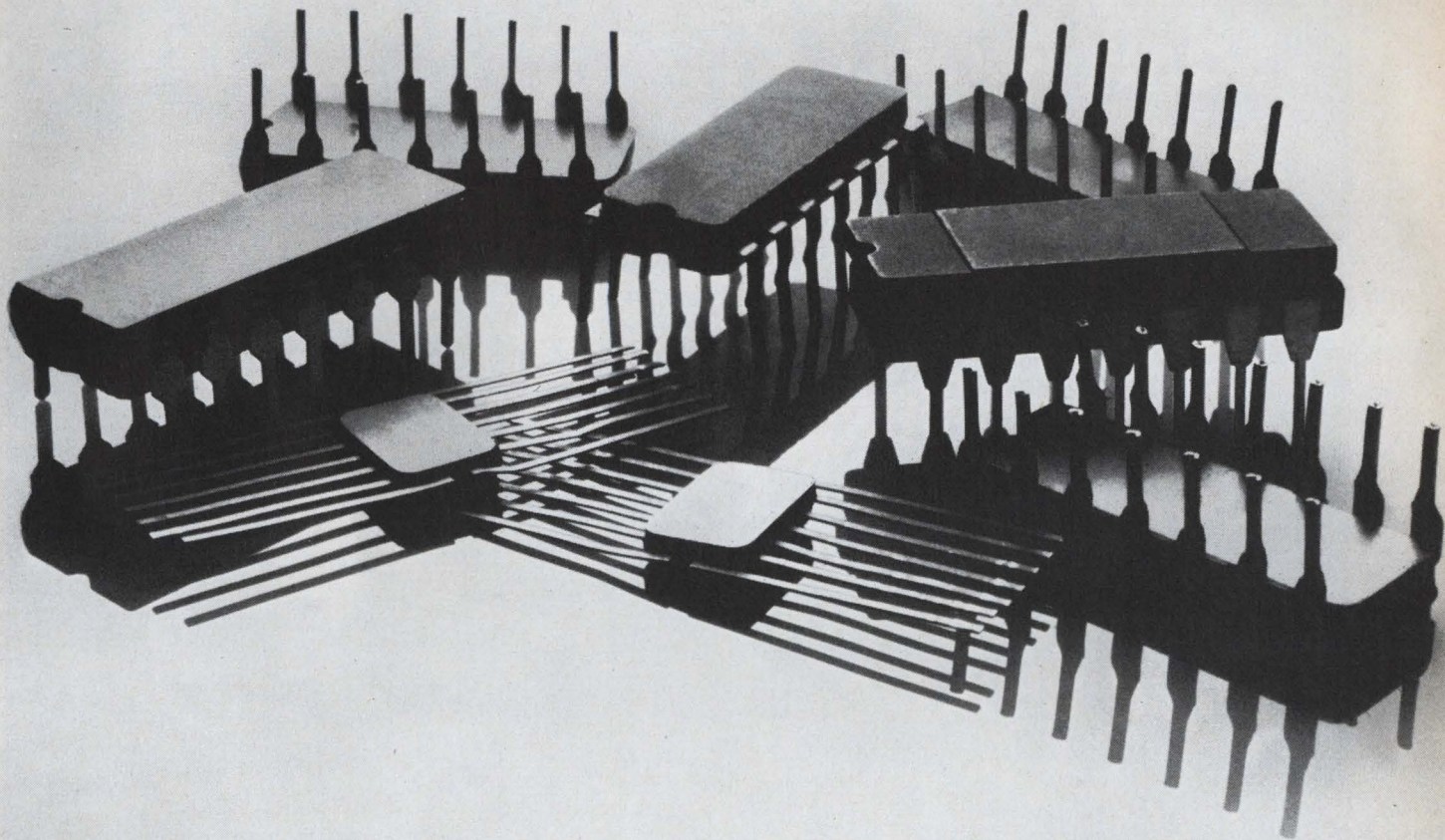

Sylvania presents eight good imitations.

The only way our competitors could match Sylvania SUHL integrated circuits was to copy them.

They're good imitations but we think our circuits are still better.

For instance, we use aluminum bonding wires where others use gold. This eliminates the chance of "purple plague" and gives better reliability, too.

The lower mass of aluminum wire also improves shock and vibration characteristics.

We are the only maker that performs 100% DC tests at temperature extremes. Of course, we make 100% AC tests, too.

We use a metal-to-metal seal for better hermeticity. We've been told that we have the best package on the market, based on tests by large-

scale users.

Our entire SUHL circuit line is available in both flat packs and dual-inline packages.

And we have the broadest SUHL circuit line in the marketplace. And that includes MSI.

All Sylvania MSI are completely compatible with SUHL circuits. Which means, if you are thinking of going the MSI route, Sylvania MSI is the only way to go.

So why settle for good imitations when you can get the real thing?

Sylvania Electronic Components,
Semiconductor Division, Woburn, Mass. 01801.

SYLVANIA
GENERAL TELEPHONE & ELECTRONICS

SOME PEOPLE CONSIDER THIS THE MOST TROUBLESOME TEMPERATURE/ HUMIDITY CHAMBER EVER BUILT



(THEY'RE OUR COMPETITORS)

You'd feel the same way if you were trying to sell against what is acknowledged as the finest unit of its kind on the market. Put yourself in their place.

First off, you'd be probably trying to peddle an out-moded on-off type control. Not only is performance poor, but you'd be saddled with explaining how a maze of complicated mechanical linkages between the programmer and recorder can possibly work. This is doubly hard because it *doesn't* work — unless someone attends it constantly.

(Blue M uses the patented POWER-O-MATIC 60® Saturable Reactor Proportioning Control System. It provides unquestionably the finest performance, yet is so simple to run that a child can operate it.)

Then there's the compressor. You'd be selling a system that slams on and cuts off, causing a noticeable variation in chamber conditions every time. And you'd have to try to explain high maintenance.

(Blue M's compressor operates continuously for longer life. Performance is geared exactly to the operating temperature needs of the chamber at all times.)

Almost every chamber manufacturer has his own water system: spray, steam injection, etc. They *do* get water into the chamber, but often it's in the form of mist or drops — hardly humidity. And every one needs constant attention.

(Imagine trying to sell one of them against Blue M's reliable solid-state water leveling system and exclusive vapor-pressure system.)

And finally, there's construction. You would probably be selling a unit built to a price — skimpy, if not actually shoddy.

(Blue M Temperature/Humidity Chambers are built to last. They'll run for years, assuring the maximum number of tests per dollar invested. We even include an elapsed time meter to record the actual number of hours the cabinet operates. We haven't a thing to hide.)

But the biggest point you'd have to sell against is the fact that Blue M Temperature/Humidity Cabinets *work as specified*. They easily meet every current MIL Humidity Spec, for example, plus a host of even tougher industrial requirements. They've been designed to provide the lowest cost per test — all with a minimum of trouble and fuss to you. We're prepared to prove it with actual performance charts, operating data and demonstrations any time you say.

Blue M builds the finest temperature/humidity chambers in the country. We challenge anyone to show us (or try to sell you) a better one. For full information, write: Blue M Engineering Company, A Division of Blue M Electric Company, Corporate Headquarters, Blue Island, Ill. 60406.



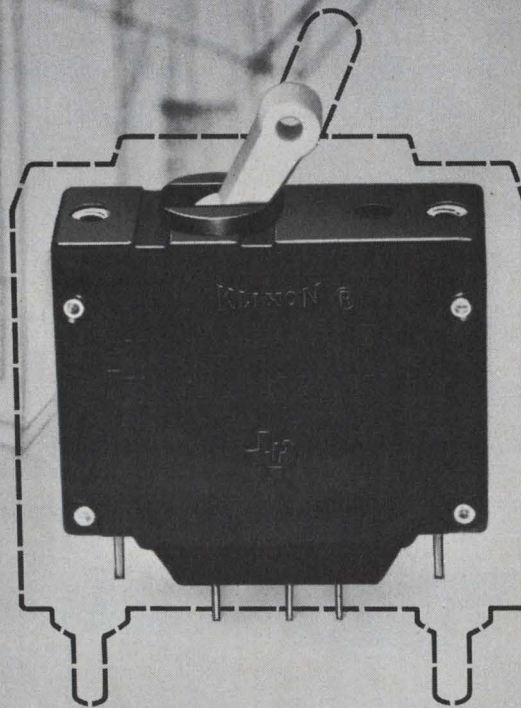

The paradoxical circuit protector.

It's a brand new TI product. Yet, it offers you the benefits of a 5-year history of success. How come?

Very simple. Our new 51MC magnetic circuit breaker is the low-cost miniature version of our 4MC which advanced the state of the art five years ago with its smaller, lighter, simpler mechanism.

Our design engineers took that time-tested mechanism and

squeezed it into a 25% smaller package without affecting its superior operating characteristics. Faced with the same miniaturization problem, other manufacturers started from scratch.

Because of its predictable performance, we can guarantee that our new miniature 51MC . . . rated at 0.020 to 50 amps . . . will reliably perform in computers, power sup-

plies, business machines, communication equipment and allied electronic applications.

Bulletin CIRB 35 contains all the data on our new 51MC Series magnetic circuit breakers. Write for your copy today to TI Control Product Division, Attleboro, Massachusetts 02703, or phone (617) 222-2800.



TEXAS INSTRUMENTS
INCORPORATED

Electrical Engineers:

At IBM Lexington, the biggest electronic challenges come in small packages.

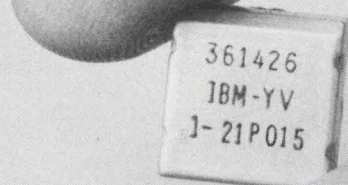

Like this solid logic circuit package, a key memory device in IBM's new Composer. The Composer electronically sets, justifies and corrects type for printing. It was developed at IBM Lexington, Kentucky, and is just one example of the electronic challenges and opportunities you'll find here.

What you'd do

We have immediate openings for electrical engineers with a B.S. or M.S. degree. If you qualify, there are opportunities in several areas:

Semiconductors: You'd work with solid state semiconductor devices, optimizing their capabilities in practical applications.

Design: You would be involved with logic design, logic circuit design, analog and digital circuit design, and digital logic design.

Testing: You would test electronic and electro-mechanical equipment—both manufactured products and the test equipment itself.

Grow with IBM

At IBM Lexington we produce a line of sophisticated office products: electric typewriters, dictating equipment, printers. And the line is constantly growing. In fact, we develop one major new product at Lexington about every 18 months.

Progress like this has made IBM a leader in the world's fastest growing major industry—information processing. Maybe your ideas can help solve some of the problems we face in electronics, and you can grow with us.

Write to us now

If you're interested, send your resume to Dave Evans, IBM Corporation, Department CD 1062, New Circle Road, Lexington, Kentucky 40507.

An Equal Opportunity Employer

IBM®

build with ... ALCOSWITCH

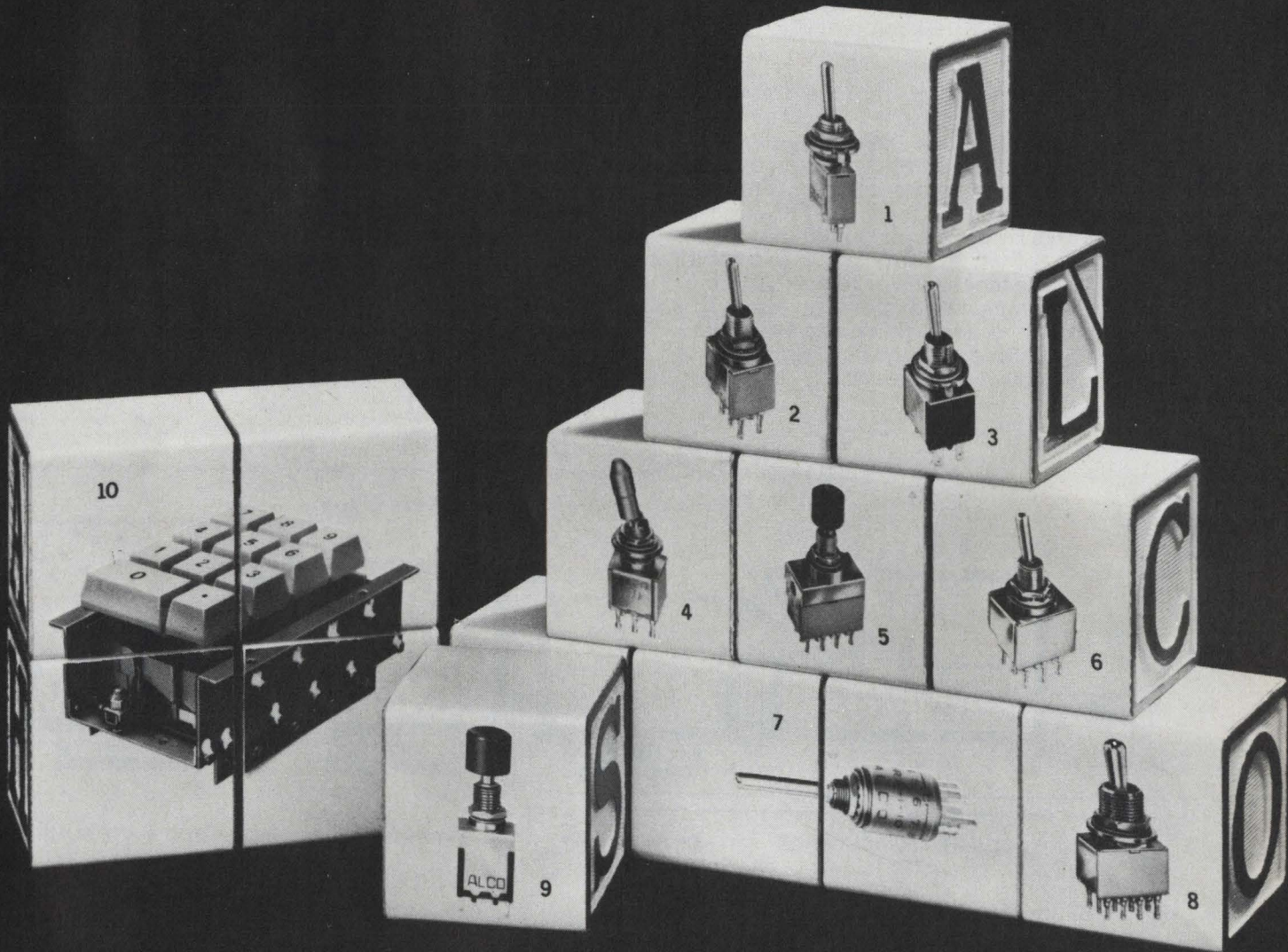

Build quality and reliability into your equipment with a top performing miniature Alcoswitch. Here are typical miniature switches from the many families of Alcoswitch which you can select: 1—SPDT "A" Series Toggle Switch, 2—DPDT "E" Series Toggle Switch, 3—DPDT "MST" Series Toggle Switch, 4—DPDT Locking Toggle Switch, 5—4PDT "E" Series Push Button Switch, 6—

3PDT "E" Series Toggle Switch, 7—"E" Series Waterproof Rotary Switch, 8—4PDT "Mustang" Toggle Switch, 9—DPDT "MST" Series Push Button Switch, 10—Reed Switch Operated Keyboard Assembly. Whatever your design problem or production budget, there is a miniature switch to fit your needs from Alcoswitch ... the No. 1 choice in the U.S.A.

ALCO[®] ELECTRONIC PRODUCTS, INC. • LAWRENCE, MASS.

Circle 129 on reader service card

Announcing the "Freon" Solvent Drying System.

Dries water-wet parts spot-free at 118°F...in 3 easy steps.

1. Lower the parts into the drying sump containing FREON® T-DA 35 solvent boiling at 118° F. Low-temperature boiling eliminates water spotting caused by the evaporation of water. (This system, using the high density of FREON, works by the displacement of water, rather than its evaporation.) No spotting of parts means fewer rejects. And the low-temperature operation also helps to protect delicate parts. The system is compatible with most plastics, elastomers and metals.

2. Remove the parts and allow the excess solvent to drain back into the drying sump. (The solvent is re-usable—no need to discard the solvent because it is saturated with water.) After draining, lower the parts into the first rinse sump containing FREON TF.

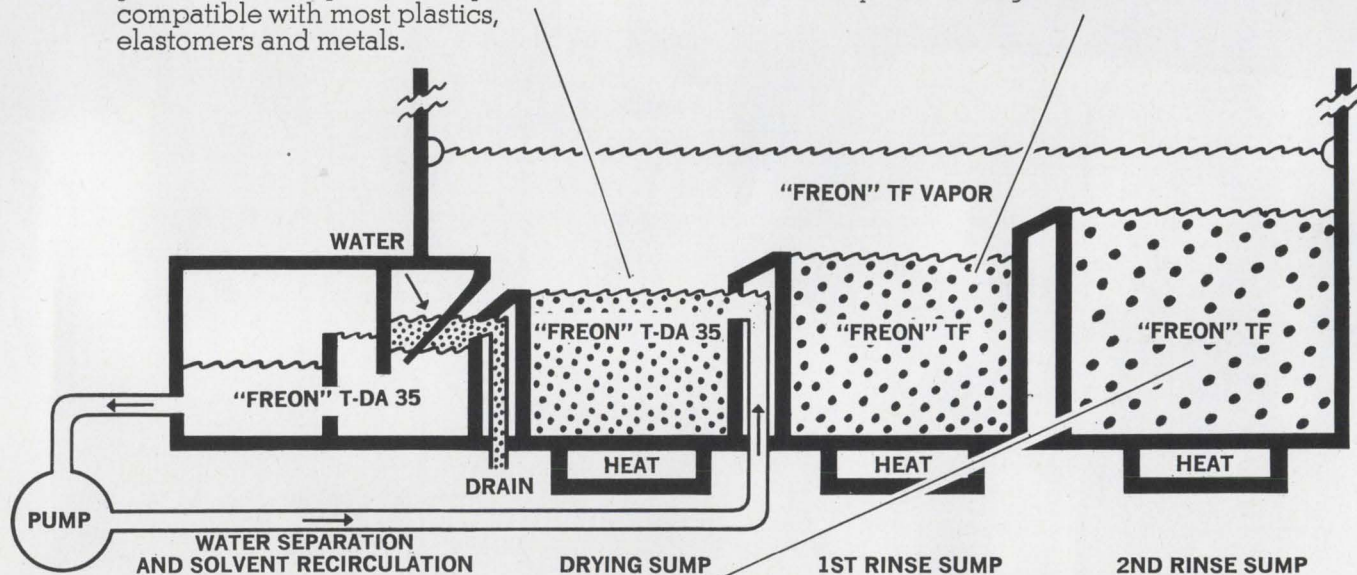

3. Remove the parts from the first rinse sump. Allow to drain and then place in the second rinse sump. Remove the parts and hold them in the vapor zone above the sump. When the dripping stops, remove the parts from the drying system. Parts will be completely dry, spot-free and immediately ready for further processing.

The whole, remarkably simple operation takes only a few short minutes. Furthermore, it is completely safe. FREON solvents are nonflammable, nonexplosive, nonirritating and low in toxicity. **For further information on the efficient, economical FREON Solvent Drying System, write: Du Pont Company, Room 7304 Wilmington, Delaware 19898.**



®Du Pont registered trademark for its fluorocarbon cleaning agent.

Last year, we sent some of our hybrids into outer space. This year, we've come down to earth.



We started producing hybrids because we had to be 101% sure about the ones we put into aerospace projects. (There are no retakes in outer space.)

Guess what happened then.

We solved the tough circuitry problems Hughes engineers gave us. Lived up to their rigid reliability standards. And met their often-impossible deadlines.

The word got around. Demand for Hughes hybrids kept growing. Most of all, in inner space.

We're reasonable people. So here we are—a down-to-earth company, ready to do business with you.

We're well established in MOSFETs and flip chips. We make all the other components that go into custom circuits. We'll assemble, package and test whatever you need.

Bring us your problem, and we'll deliver a guaranteed solution. Or, if you like, we'll work with you on an à la carte basis...

We'll provide thin or thick film substrates. Or substrates masked and etched with capacitor, conductor and resistor patterns. Multilayer circuits. Or whatever.

Big order or small order, we offer some pluses.

Experience in handling the knottiest aerospace problems. Plenty of practice living up to the highest reliability levels. The research resources of a leader in electronics and the manufacturing facilities for big jobs.

We'd like to share all this, and the hybrids themselves. But first, let us send our brochure. Just address: Hughes Hybrid Integrated Circuits, 500 Superior Ave., Newport Beach, California 92663.



Scans and Logs Signals Without an Operator

3 0 1 4 2 7
 3 0 1 4 2 7
 3 0 1 4 2 4
 3 0 1 4 2 5
 3 0 1 4 2 6
 3 0 1 4 2 4

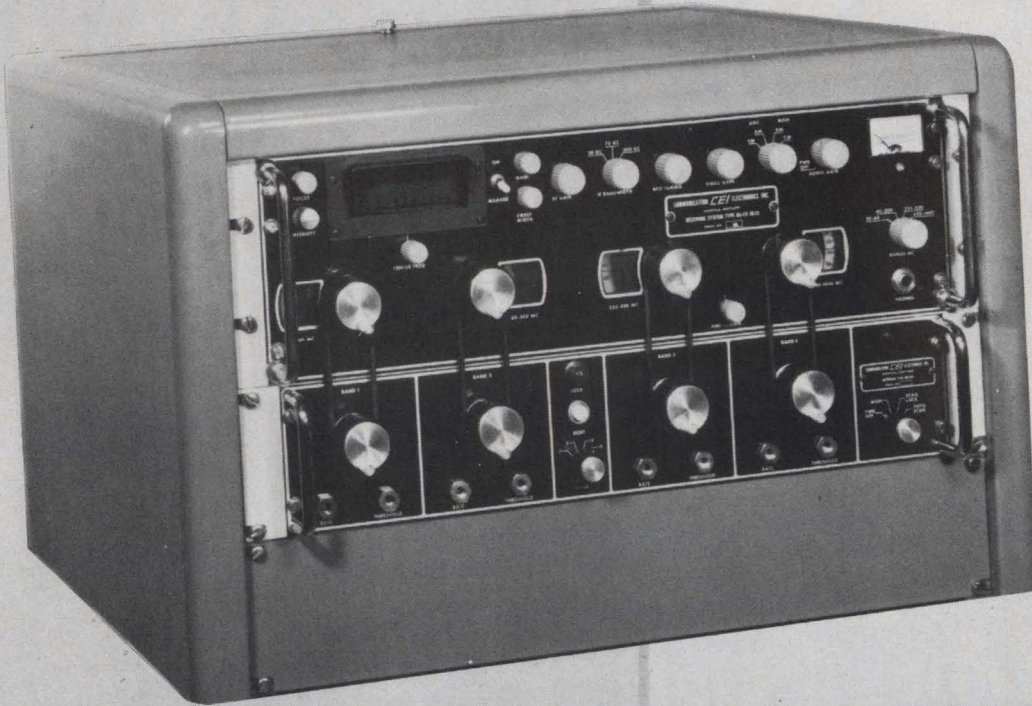

NEW MD-104 AUTOSCAN FROM WATKINS-JOHNSON

The MD-104 converts the Type RS-111-1B-17 VHF-UHF Manual Receiving System into a scanning Receiving System. It externally drives the tuning knobs on the receiver at rates from 4 to 34 rpm and provides commands to a tape recorder for storing information. The autoscanner has four channels, each channel controlling one pulley, and features variable scan speed and variable threshold level adjustments for each channel.

The MD-104 (1) Scans for a signal. (2) Upon finding a signal stops and fine tunes itself to the selected signal. (3) Commands the associated counter to measure the frequency of the selected signal. (4) Commands print out of measured frequency. (5) Monitors the selected signal for a predetermined time and supplies signal to an external recorder or other monitor. (6) Repeats the operations.

The RS-111-1B-17 Receiving System is the latest version of the performance-proved RS-111-1B Series Receivers and has been modified especially for use with the MD-104. It receives AM, FM and CW signals, in the 30-1000 MHz range and tunes the range in four bands. It features digital automatic frequency control capability when used with an ancillary counter.

A modification kit is available for field conversion of any RS-111-1B Series Receiving System into an RS-111-1B-17.



CEI DIVISION
 6006 Executive Blvd.
 Rockville, Md. 20852

World's largest selection of receiving equipment for surveillance, direction finding and countermeasures.

Circle 133 on reader service card →

If you don't see what you want here...



ask for it.

We make all kinds of recorders, including Unicon[®], first practical laser recording system. Result? We're able to recommend the recorder (or recorder system) that's best for you—objectively, professionally. Just send the coupon below. Or, call us at 3170 Porter Drive, Palo Alto, California 94304; (415) 321-5615.



**PRECISION
INSTRUMENT**

TO: Precision Instrument Company
3170 Porter Drive, Palo Alto, California 94304

OK. Help me select the recorder that's best for my application.

Name _____

Company Organization _____

Address _____ Phone _____

City _____ State _____ Zip _____

I'M INTERESTED IN:

- Digital
- Analog
- Video

FOR USE:

- in aircraft
- in lab
- in field
- in land vehicle
- on board ship.

When it comes to manpower...



Colorado is choice country for a growing boy.... or a growing business

That's because 750,000 Coloradans work hard, whether they're skilled laborers trained in Colorado's new community college system or celebrated scientists performing sophisticated research. Their State offers a wide choice of recreational activities that are well worth working for. Maybe that's why companies with multi-state facilities say their Colorado employees are more stable and more productive. The State's unemployment and compensation rates are among the lowest in the country.

But that's not all. Coloradans are well educated. The average employee in the 25 and older age group has

better than a high school education. In the same age group, 10.7% have 4 years of college, the highest percentage in the country. And Colorado ranks third in the nation for percentage of scientists in its population.

Find out about choice Colorado sites for your expansion or relocation. Write for a complimentary copy of our 66 page "Industrial Colorado." Address inquiries to William C. Hacker, Director of Industrial Research & Development, State of Colorado Division of Commerce and Development, 1052 State Capitol Annex, Denver, Colorado 80203.

Make Industrial Colorado Your Choice

Facts.

The Mark 260 delivers more of them...with less fuss, bother and cost...than any other oscillograph you can buy.

Facts start with accuracy.

And the Mark 260 is about as accurate as you can get. We *guarantee* 99½%. So when you're looking at the chart of a Mark 260, what you see, is fact. We owe it all to a fool-proof position feedback system that enforces pen position all the way across the chart. There are no springs, no strings. Or any of the other tricky mechanisms that you'll suffer with in other recorders.

Those traces you see are a lot more than just accurate. They're crisp and clear and reliable from one edge of the chart to the other. They won't smudge or smear. (And you can chalk that up to a patented pressurized ink-

writing system that puts the trace into the paper and not just on it.)

You can forget about recalibration problems, too. We took care of that little nuisance at the factory. So change those settings to your heart's delight. The Mark 260 will keep right up with you. And save you piles of time and piles of chart paper in the bargain.

That's what you get with a Mark 260. It's the go-anywhere, do-anything 6-channel recorder by Brush. At a price per channel that will surprise you.

More facts. Less fuss, bother and cost.

Ask your Brush representative for a demonstration. Or write for Mark 260

Bulletin 942-2: Clevite Corporation, Brush Instruments Division, 37th and Perkins, Cleveland, Ohio 44114. We'll include one of the most comprehensive handbooks on signal conditioning you'll ever find.

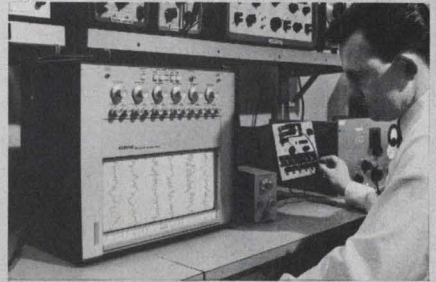

CLEVITE BRUSH

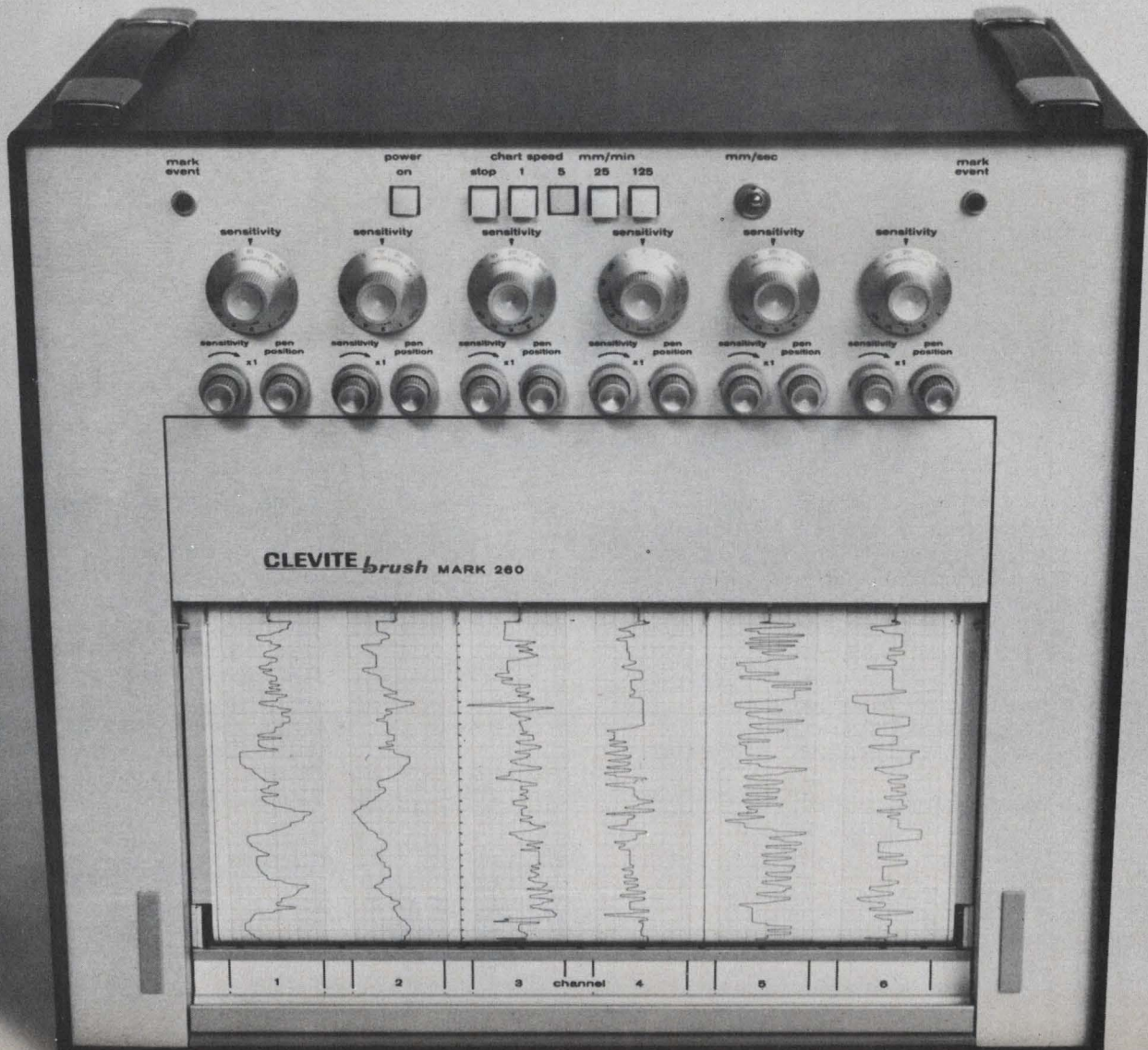

Bendix Autosyn 08 Synchros.

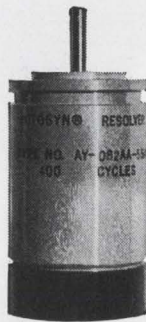

For weight-conscious engineers.

The average weight of Bendix® size 08 Autosyn® synchros is only 1.3 ounces. And their maximum diameter is 0.750". That's a great combination for trimming down servo systems.

There are 16 standard 08 units to choose from. Some are radiation-resistant. Some will perform accurately at sustained temperatures up to 800°F. All have flexible 12" leads, corrosion-resistant construction and aluminum housings.

Stainless-steel housings are avail-

able too. So are hundreds of other Autosyn types in 10, 11, 15 and 22 sizes. As well as Mil-Spec synchros up to size 37. You're almost certain

From Catalog 25	Function	Voltage	Max. Error
AY080AA-40-A1	Transmitter	26/11.8	7'
AY080AA-42-A1	Receiver	26/11.8	—
AY080AA-36-A1	Control Transformer	11.8/22.5	7'
AY083AA-43-A1	Control Differential	11.8/11.8	7'
AY082AA-53-A1	Resolver	26/11.8	7'

to find exactly what you need. And if you don't, we can design one for you. We've been doing it for 40 years. No wonder so many engineers rely on Bendix synchros for performance and dependability. And why you find them in the 747, C-5A and F-111, to name a few. There's no better value anywhere. Ask for our catalog and see for yourself. The Bendix Corporation, Flight & Engine Instruments Division, Montrose, Pennsylvania. Phone: (717) 278-1161.

Bendix
**Aerospace
Products**



Any surface, curved or flat, can be checked with bands of light that never damage the tested part.

Measure surface roughness and coating thickness to one millionth of an inch or less

The exclusive ZEISS Interference Microscope gives instant quality control checks—without physical contact of any kind. The possibility of damaging tested parts is completely eliminated.

Bands of interference light, either white or monochromatic, profile the tested surface which is viewed at magnifications from 60 to 480x or higher. Roughness measurements are based on deviations in the pattern of the interference bands; the thickness of coatings by the shift of the bands.

The ZEISS Interference Microscope is compact (6x6x9½") and simply operated (no special training necessary). A tiltable cross-stage quickly and accurately aligns the surface of any tested part in upright or horizontal position.

And as tests are made, a 35mm camera or 3¼ x 4¼ Polaroid attachment can be used to simultaneously take photos for your proof-of-inspection records.

For complete information, write Carl Zeiss, Inc., 444 Fifth Ave., New York City 10018. Complete service facilities available.

ZEISS

THE GREAT NAME IN OPTICS



ATLANTA, BOSTON, CHICAGO, COLUMBUS, DENVER, DURHAM, LOS ANGELES, ST. LOUIS, SAN FRANCISCO, SEATTLE, WASHINGTON, D. C.

Circle 137 on reader service card

plug-in

- multi-trace
- differential
- sampling
- spectrum analysis

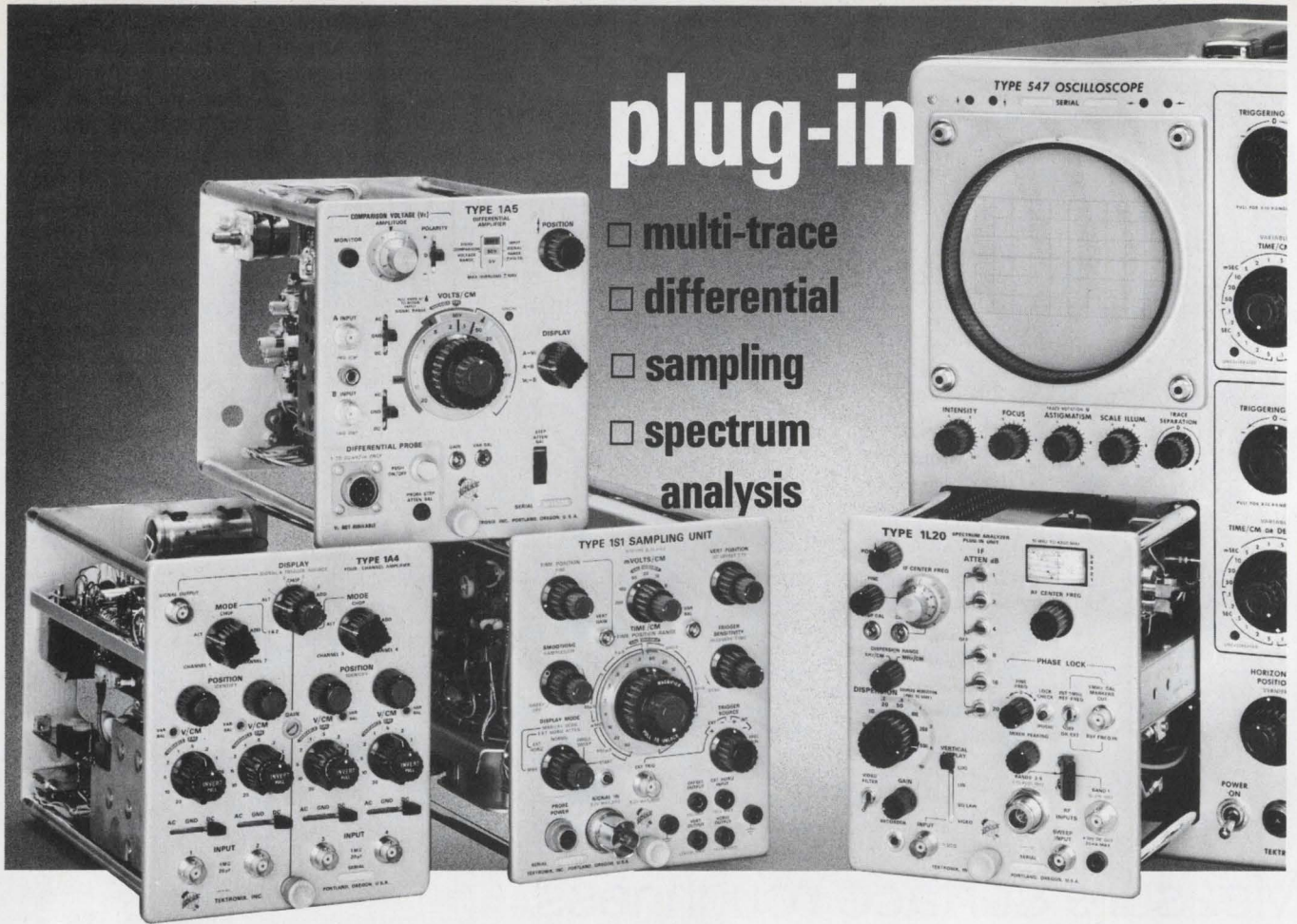

Tektronix 530, 540 and 550-series plug-in oscilloscopes offer a wide range of performance, designed to meet your changing measurement needs. Select the performance and measurement functions you need from multi-trace, differential, sampling and spectrum analyzer plug-ins.

For multi-trace applications, the new Type 1A4 Four-Channel amplifier offers constant DC-to-50 MHz bandwidth and 7-ns risetime capabilities over its 10 mV/cm to 20 V/cm deflection factor range. Operating modes include alternate or chopped four channel, dual channel differential, and 2, 3, or 4 channels added or subtracted. Two dual-trace plug-ins are also available, the Type 1A1 with 28 MHz at 5 mV/cm (50 MHz at 50 mV/cm) and the Type 1A2 with 50 MHz at 50 mV/cm.

Type 1A1 Dual-Trace Plug-in	\$625
Type 1A2 Dual-Trace Plug-in	\$350
Type 1A4 Four-Trace Plug-in	\$825

For differential applications, the new Type 1A5 Differential amplifier features 1 mV/cm deflection factor, 1,000:1 common-mode rejection ratio at 10 MHz, ± 5 V comparison voltage and 50 MHz bandwidth with 7-ns risetime at 5 mV/cm. The low-cost Type 1A6 Differential plug-in with 1 mV/cm deflection factor, 10,000:1 CMRR and 2-MHz bandwidth and the high-gain Type 1A7A Differential plug-in with 10 μ V/cm deflection factor, 100,000:1 CMRR and 1 MHz bandwidth are also available.

Type 1A5 Differential Plug-in	\$575
Type 1A6 Differential Plug-in	\$250
Type 1A7A Differential Plug-in	\$450

For sampling applications, choose from two high performance plug-ins, the Type 1S1 general purpose sampling plug-in and the Type 1S2 TDR sampling plug-in. The Type 1S1 features internal triggering, 0.35-ns risetime, DC-to-1 GHz bandwidth and calibrated sweep speeds from 100 ps/cm to 50 μ s/cm. The Type 1S2 is a time-domain reflectometer with a system risetime of 140 ps, 0.005 p/div deflection factor and sweep rates from 100 ps/div to 1 μ s/div. With its 90-ps risetime, 5 mV/div deflection factor and built-in triggering, the Type 1S2 can be used in many other sampling applications.

Type 1S1 Sampling Plug-in	\$1275
Type 1S2 TDR Plug-in	\$1400

Four spectrum analyzer plug-ins covering the spectrum from 50 Hz to 40 GHz convert your oscilloscope to a high-performance spectrum analyzer. The plug-ins cover the following frequency bands: Type 1L5 from 50 Hz to 1 MHz with 10 μ V/cm deflection factor; Type 1L10 from 1 MHz to 36 MHz with -110 dBm sensitivity; Type 1L20 from 10 MHz to 4.2 GHz with -110 to -90 dBm sensitivity; and Type 1L40 from 1.5 GHz to 40 GHz with -110 to -70 dBm sensitivity.

Type 1L5 Spectrum Analyzer Plug-in	\$1025
Type 1L10 Spectrum Analyzer Plug-in	\$1175
Type 1L20 Spectrum Analyzer Plug-in	\$1950
Type 1L40 Spectrum Analyzer Plug-in	\$2150

U.S. Sales Prices FOB Beaverton, Oregon

For a demonstration, contact your nearby Tektronix field engineer or write: Tektronix, Inc., P.O. Box 500, Beaverton, Oregon 97005

Tektronix, Inc.

committed to progress in waveform measurement

For EE's the party's over

In all but a few critical specialties, the supply of engineering talent exceeds demand; nonetheless, salary scales continue their upward spiral

By Peter J. Schuyten

Staff writer

Demand for electrical engineers far exceeded the supply as recently as a year ago. Fledgling EE's, fresh out of school, could pretty much pick and choose what they wanted to do professionally and for whom they wanted to do it. But as the song suggests: "The times they are a-changin'." And as an official at a large aerospace concern in the Philadelphia area puts it, "This is the year of the employer."

One of the big reasons for the changed situation involves constraints in the Federal budget. Cutbacks in projected outlays for space projects and stretchouts of key defense programs are having a profound impact on the employment picture for EE's. An East Coast electronics company, for example, reports having laid off 1,000 or more of its technical staff over the last 10 months. And across the country, college placement officers and corporate executives confirm the fact that this firm's experience is not an isolated case.

John Love, employment director for Lockheed Missiles and Space division, for example, reports his company's need for new personnel is so slight that he's had to cancel interviews at a number of colleges because "we just didn't feel right taking up people's time needlessly." Lockheed recently gave pink slips to a substantial number of EE's following the completion of the research and development phase of the Poseidon contract. And a spokesman for the Page Communications division of the Northrop Corp. says that the overall supply-and-demand picture, coupled with the company's need for experienced

personnel, has caused it to drop—temporarily at least—its campus recruiting program.

Neither the National Aeronautics and Space Administration nor the Department of Defense expects to be doing very much hiring this year. A spokesman for NASA reports that due to the size of cutbacks in the agency's funds, there are few spots for engineers, or anyone else for that matter. In fact, layoffs at NASA and certain military agencies—for example, the Office of Naval Research—will be more common this year than ever before.

College placement directors, like Dale Barbee of Case-Western Reserve University in Cleveland, find it's tougher to slot graduates in choice spots. Barbee reports that while there are 16% more recruiters arriving on his campus this year, the number of actual job offers is off by about 50%. He attributes this drop partly to the fact that Case-Western Reserve traditionally attracts a large number of recruiters from R&D companies where the money pinch has been particularly acute.

Feeling a draft. The elimination of draft deferments for graduate study hasn't helped the situation any, either. Many EE's who would otherwise be going on for advanced degrees are joining the ranks of those shopping around for occupational deferments. Thomas Martin, dean of engineering at Southern Methodist University in Dallas, notes that nationally, new admissions to electrical engineering graduate schools have dropped 25%. SMU has experienced about a 15%

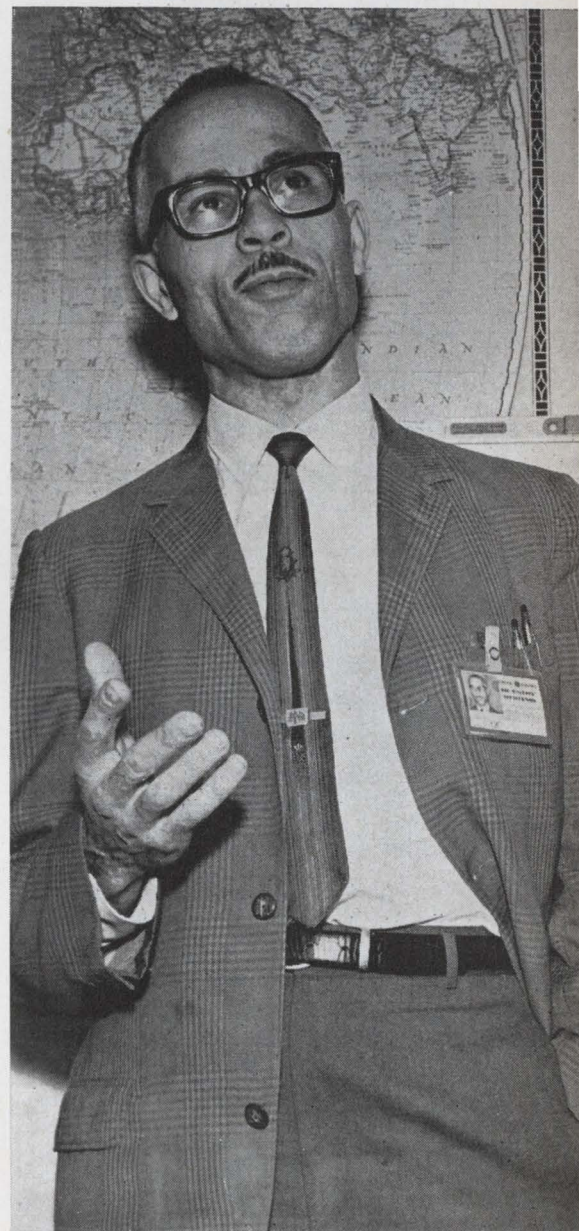

Wanted men. Though sought after, Negro engineers like Ernest Bouey, a veteran value-engineering specialist with GE, are still relatively rare in industry.

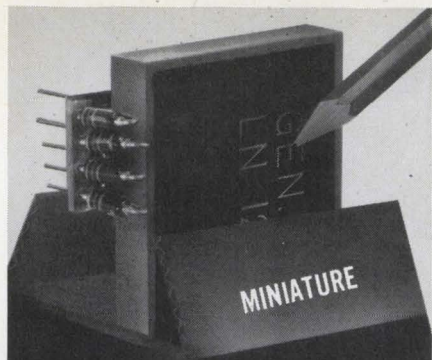

LADDER NETWORKS FROM STOCK

- 8 to 17 Bits
- 1/2 LSB Accuracy
- Switch Impedance Compensated
- Military / Commercial
- 1" x 1.40" x 0.2"
- 30 Volt Input
- R/2R, Binary, Mod. Binary
- \$15 to \$110*

*f.o.b. Mt. Vernon, N.Y., domestic

Write or 'phone for complete technical data.

General Resistance, Division of Chronetics,
500 Nuber Avenue, Mt. Vernon, N.Y. (212)
292-1500. In Europe: 39 Rue Rothschild,
Geneva, Switzerland (022) 31 81 80.



Executive suite

Forget about next year's raise; think about becoming an executive, where the real money is. That's the advice San Francisco management consultant Jack R. Yelverton gives EE's. Along mahogany row, salaries are going up much faster, proportionately, than at the low end of the scale, he finds. "The tax structure makes that almost imperative," says Yelverton, a vice president of Wilkinson, Sedgwick, and Yelverton Inc.

"To give a meaningful increase to a man at the \$25,000 level, you can't just give him a couple of thousand dollars. On his bimonthly paycheck, that's the price of a good dinner," he asserts. A large part of his firm's business involves executive search—headhunting. "We find," Yelverton says, "a technical manager's slot that paid \$25,000 in 1965 will pay \$34,000 today."

How does one attain these levels? Yelverton is leery of generalizing. But he says that, allowing for the inevitable exceptions, the president of an average electronics company is likely to have been educated as an electrical engineer, to have worked his way up in manufacturing or engineering, and, at some point, acquired some marketing exposure—either as a product or division manager, but not as a marketing manager. "In the electronics business, the chips are down on understanding the technology, not the market," he explains. "When it comes to picking a president, a board of directors is more likely to choose the man with the manufacturing background than the marketing type."

Careering. The first step up the ladder from the engineering ranks is likely to be as a project engineer. "At that time, the engineer is in his late twenties and making around \$10,000, perhaps less," Yelverton says. "In very few instances will he get a raise, but he may move along a little faster in the normal salary progression." The project engineer may have \$15,000 to spend on developing an instrument; the quality that his employers look for is good judgment. They ask if he's a rational, mature person who thinks things through and expresses his frustrations back to management, Yelverton continues. Some neophytes think that they can do anything, don't realize when they have a problem, and get into trouble, he adds.

The next step is as a section unit manager; the titles vary but the engineer has a permanent assignment that entails planning and supervising the work of others. He's about 30, and he may be making \$13,000 or \$14,000—in some cases as much as \$18,000.

Five years or so later, the budding manager is in demand. "At 35, with solid experience, he can begin to think about some form of delayed or extra compensation such as stock options or bonuses," says Yelverton. But he can't press his luck; the offer will have to come from the company. "If he's changing jobs, he may bargain for a little more money," says Yelverton, "but after a few years, compensation evens out. And the guy who negotiates too hard may become suspect."

Bonuses are likely to be based on corporate performance. A typical stock option may be for 1,000 shares at current market price, 500 of which may be bought in two years, the rest over the next two years. A company seldom has much flexibility in this matter, Yelverton points out, because "there is just so much pie to cut. The man who wants four times his share may put himself out of contention."

Moment of decision. At this point, the engineer has a number of options. "He's no longer just an engineer," Yelverton notes, "he's a manager. He'll probably get some rotational assignments for example, being made a plant manager or being asked to find a subsidiary to acquire and then to manage it—and if he's well-known, he becomes of interest to the investment community." It's at this point that some of the more successful managers begin peeling off to start their own companies, and they have less and less trouble finding the backing.

Yelverton says that some large companies are beginning to feel the pinch of these defections, either to smaller companies or to new firms. "The big outfits have a backlog of talent, but there is a siphoning off of people in whom they have a big investment in education," he continues. "To combat it, they may have to decentralize decision making, and figure out ways to make a man's earnings a function of his contribution to profit."

—Walter Barney

decline in its own enrollment. "The situation here is somewhat unusual," says Martin. "We're in a location where many of our students can go to school, and work in critical jobs at defense plants as well."

At Carnegie-Mellon University in Pittsburgh, J. Dennis Ryan, assistant placement director, confirms that more and more students prefer to take their chances at getting an occupational deferment rather than go on to grad school. In 1967, for instance, 45% of CMU's engineers went on for an advanced degree; last year only 32% did so. This year the figure promises to be even lower.

Employers are not altogether unhappy about the draft situation since it gives them a wider range of top graduates to choose from. Richard Blue, placement director at Tufts University near Boston, says, "For the first time, recruiters are getting a chance to talk to the A student, with some prospect of success for hiring him."

Ten grand

Oddly enough, while this year's graduate may not be wholly satisfied with the job he gets, his monthly check should go a long way toward cheering him up. And much the same holds true for his more experienced colleagues in industry. Although a definite buyer's market exists, the employment picture for the electrical engineer hasn't become so dark as to adversely affect salaries. As a matter of fact, the inflationary spiral continues unabated.

"This year, for the first time, graduating EE's will have a shot at a \$10,000 starting salary," says Georgia Institute of Technology's placement director Neil DeRosa. And although the \$10,000-a-year-plus graduate will be more the exception than the rule, the average EE can look forward to an unusual starting salary of \$9,600—about \$1,000 higher than he would have made last year.

Starting pay is now determined less by a man's class standing or the prestige of his school than by what the engineer did with his summers. At Litton Industries' Guidance & Control Systems division, for example, where starting salaries range from \$9,000 to \$10,-

Billy Helms is just one of the 42,146 highly skilled workers trained in state-sponsored technical schools last year.

Trained absolutely free for South Carolina industry.

Trained for the very machines they'll be using.

Trained and ready to go on opening day.

Before you decide where and when that opening day will be, you'll want to know more about plant sites, construction, transportation, electric service, tax rates and Billy Helms.

Find out more.

Mail the coupon today.

Mr. R. H. Kennedy, Vice President,
Area Development
South Carolina Electric & Gas Co.
Box 764
Columbia, South Carolina 29203

He's got the facts.

Name _____

Address _____

City _____

State _____

Zip _____

SOUTH CAROLINA OFFERS YOU IDEAL PLANT SITES, LOW CONSTRUCTION COSTS, GOOD TRANSPORTATION FACILITIES, ECONOMICAL ELECTRIC SERVICE, LOW TAX RATES, AND BILLY HELMS.

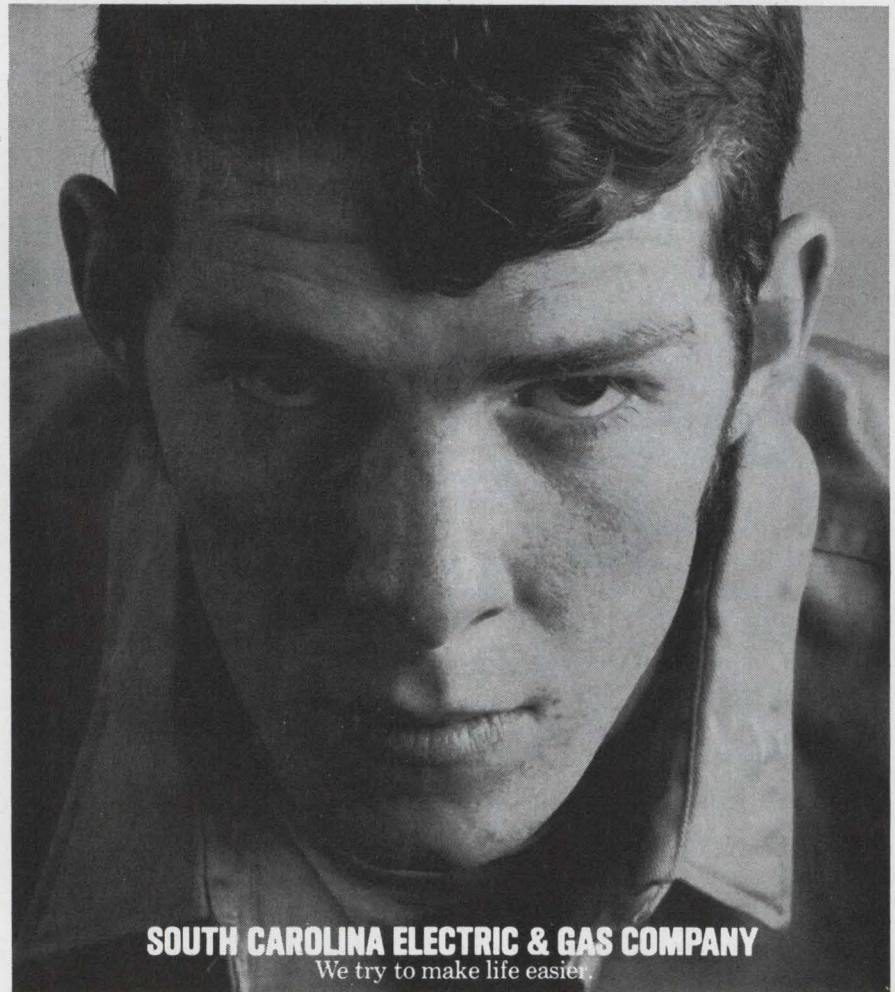

SOUTH CAROLINA ELECTRIC & GAS COMPANY

We try to make life easier.

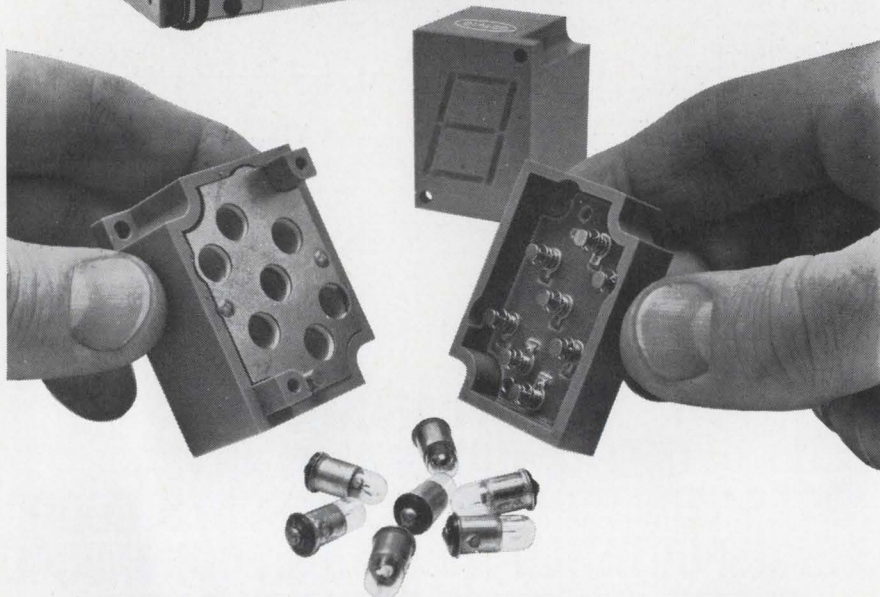

What makes low-cost Dialight readouts so reliable and easy-to-read?

Reliable because of simple module construction and long life lamps. Designed for use with neon or incandescent lamps to meet circuit voltage requirements. Easy-to-read from any viewing angle. 1" high characters are formed by unique patented light-gathering cells, and may be read from distances of 30 feet. Sharp contrast makes for easy viewing under high ambient lighting conditions.

Dialight Readout Features

1. Operate at low power.
 2. 6V AC-DC, 10V AC-DC, 14-16V AC-DC, 24-28V AC-DC, 150-160V DC or 110-125V AC.
3. Non-glare viewing windows in a choice of colors.
 4. Available with RFI-EMI suppression screen.
5. Available with universal BCD to 7 line translator driver.
 6. Can be used with integrated circuit decoder devices now universally available.
7. Caption modules available; each can display 6 messages.

Send for catalog

Catalog-folder contains complete specifying and ordering data on numeric and caption modules, translator drivers, mounting accessories. Dialight Corporation, 60 Stewart Avenue, Brooklyn, New York 11237. Phone: (212) 497-7600.



DIALIGHT

DT-126

500, the grad who has done something applicable during vacations commands the top dollar, according to employment manager Frank McCarter.

California dreaming. The geographical location of the company also plays a part in the salary game for both beginning and experienced engineers. Georgia Tech's DeRosa notes that graduates who opt for jobs in California can expect to get "slightly more" than those who stay in the Southwest or Southeast. The Northeast, especially the Boston area, follows the West Coast in terms of monetary rewards. DeRosa, among others, ascribes this situation more to regional cost-of-living differences than anything else.

More significant than locale, however, is the sector of industry in which the beginning—or experienced EE, for that matter—chooses to work. Without exception, aerospace firms offer the highest salaries. There, beginning EE's have a chance to start at the \$10,000-plus level, says an engineer at Westinghouse Electric's Aerospace division. But along with the high salaries comes a high degree of insecurity. Says this source: "I had a friend who made piles of money designing a spaceship noselift. But when the contract ran out so did he. He couldn't get another job at a comparable salary because his experience was too specialized and all but useless. Finally he had to start at the bottom with a new firm."

Compensation. Discounting the occupational deferment factor, job security is often a more important consideration for the beginning engineer than salary, points out Roy Holm, corporate employment manager for Beckman Instruments. Starting rates at Beckman are somewhat below the national average, about \$8,100, but Holm says that his recruiters have no trouble in securing the people they want. "In fact, we're almost like kids in a candy store," he adds. Holm attributes Beckman's good fortune in attracting personnel to the non-defense character of the company's principal product lines.

Electronics firms in the consumer sector also attract top EE graduates with little difficulty, even though their starting salaries run about 5%

below the national average. Here too, the lure of built-in job security apparently outweighs monetary considerations.

Toward the low end of the salary scale are research-oriented organizations like MIT's Lincoln Laboratory. One former Lincoln Lab engineer says, "When I was hired, I was told very frankly that I could make more money elsewhere but that nobody would sit on me for eight hours a day as they do at a big company. Sure, I made less money—about \$1,000 less. But I could come and go almost as I pleased, the supervision was so minimal."

Most wanted

Engineering specialties play an equally important part in determining the salary ranges. But as is the case with clothing styles, there seems to be a new vogue every year. According to Litton's McCarter, circuit designers are among the most sought-after specialists at the moment. But, he says, the time is coming when companies like Litton will replace circuitry designers with catalog items and start scouring around for systems engineers instead.

Over at Hughes Aircraft, industrial relations manager Paul Bigelow adds package designers and microwave engineers—especially those with a competency in solid state discrete power sources—to the wanted list. "Microwave specialists are so hard to find these days, that when we spot a man who is qualified, we literally go out and buy him," admits Anglos Lindsey, salary administrator for Philco-Ford's WDL division in Palo Alto, Calif.

Black is beautiful. Although most companies won't admit it, it doesn't hurt to be a skilled Negro these days. Says one college placement director: "Many recruiters have actually come to us and asked for leads on getting black engineers. And the market is so tight that they'll pay almost any reasonable salary." Litton's McCarter adds that at Howard University the recruiters actually outnumber the prospects; most predominantly black campuses in the South are literally crawling with representatives from large aerospace and electronics firms [*Electronics*, July 8, 1967, p. 135]. John Harris, head of Harris Associates, a technical em-

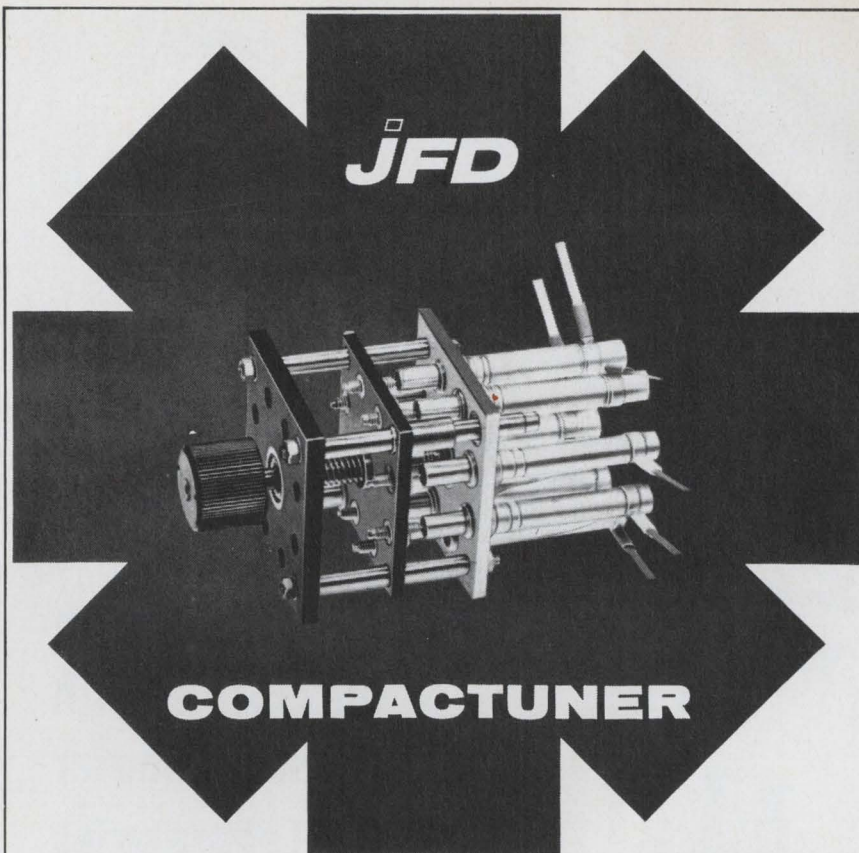

(Illus. .65 actual size)

MINIATURE MULTIGANG MODULAR TUNERS

JFD is pleased to announce a new line of miniaturized Long Life Multigang Modular Tuners, for both straight line capacitance and straight line frequency applications.

JFD has always featured a line of specially designed and built tuners to meet custom applications. Now available is a standardized tuner designed with all the versatility of the custom built units. This is made possible by two new mechanical packages that allow up to eight independent capacitor elements to be tuned simultaneously. This standardization results in a high quality, precision tuner at moderate cost.

Two basic models are available both featuring ten full turns of adjustment for precise tuning and excellent resolution. One model will accommodate up to four cylinders; the

other from five to eight cylinders. These cylinders are available in a wide choice of dielectric materials and metalized patterns allowing almost unlimited design freedom. They can all be made as straight line capacitance, straight line frequency, special function, split stator, differentials, etc. or any combination can be specified on a single tuner.

The use of solid dielectrics with their inherent stability and high voltage ratings allow tuners to be built in smaller sizes than have ever been achieved before. Wide capacitance ranges or frequency ratios can be achieved in packages that will withstand the severe environmental conditions that today's equipment requires.

For additional information, write for catalog LLT-68.

"TODAY'S COMPONENTS BUILT FOR TOMORROW'S CHALLENGES"

JFD JFD ELECTRONICS CO. / COMPONENTS DIVISION
15th Ave. at 62nd St. • Brooklyn, N.Y. 11219 / Phone 212-331-1000

Offices and subsidiaries in principal cities, world-wide.

How much does the
ground tilt...

when the moon passes overhead?*

You can
measure it with
this tiltmeter

by Rockland Laboratories



BIAXIAL TILTMETER Model 2162, Resolution .0005 arc sec, Base Price \$2750

The Rockland Laboratories Model 2162 Tiltmeter is a sensitive, two-axis tilt indicator consisting of a sensor and an indicator electronics console. The sensor is a pendulum, with two degrees of freedom, equipped with orthogonal capacitor displacement transducers for simultaneous measurement of tilt about two perpendicular axes. Solid state electronic circuitry provides visual meter readouts and analog outputs for continuous recording. Operation is AC or DC.

Full scale settings of 1 arc sec, 10 arc sec, 1 arc min and 10 arc min are selectable by front panel switch. In the most sensitive scale setting, the tiltmeter resolution is .0005 arc sec which is adequate for recording earth tide or long-term tilts associated with tectonic crustal deformation. Such measurements can provide basic data for earthquake prediction studies and related geophysical investigations. The lower sensitivity scales are suitable for recording tilts of gyro test piers, launch pads, dams, buildings, etc.

Options and ancillary equipment available on special order include: integral motor drives for remote leveling; insulating covers for thermal control; automatic caging and uncaging for remote deployment; motor-driven gimbal mounting for borehole or ocean bottom applications; calibration system; internal battery pack; 2-channel recorder console; and a variety of special purpose casings for adaptation of the system to various environmental conditions, e.g., recording on the ocean bottom or in boreholes.

*.02 to .04 arc sec p-p.



ROCKLAND LABORATORIES, INC.

POST OFFICE BOX 57 • TAPPAN, NEW YORK 10983 • TEL: 914-359-1818
Precision instruments for engineering and the physical sciences

ployment agency in the San Francisco area, says that although companies don't come right out and say "find us a Negro," it's implied, along with an emphasis on phrases like "equal opportunity employer."

Advance to the rear

Defense cutbacks and the general surplus of engineering talent are making things tougher for those with the master's and doctoral degrees trying to get a job for the first time. In past years the holder of an MS would start in the same salary range as an EE with from three to five years experience—\$10,000 to \$13,000—says E.W. Moore, a vice president at Cadillac Associates, a Chicago employment agency that handles engineers. "Having a doctorate would boost his salary another \$2,000," Moore adds.

But while starting salaries for the beginning BS winner have risen between 4% and 7% over the past year, those for the holders of advanced degrees have remained relatively static, according to Georgia Tech's DeRosa. "There's just not the great demand there once was for graduate degrees because of the heavy cutbacks in R&D funds," he concludes.

Company they keep. Once in the corporate fold the average engineer can expect to get a raise about once a year. At Litton, for instance, the average annual increment approximates 7%. But in common with other firms Litton rewards exceptional individual performance, reviewing men outside the annual schedule, says McCarter.

"Of course the raise situation changes the more time an engineer puts in at a company," says an official at a Boston-based firm. "On the lower end, salaries are reviewed every 12 months. But as the pay scale gets higher, say \$15,000, a man will be reviewed only every 15 months, and at \$18,000, every two years. In other words, the growth rate for young engineers is much steeper than for the man with 10 to 15 years experience. This is due, in part, to pressure at the bottom since college grads are getting proportionately higher salaries each year."

Tufts' Richard Blue believes that spiraling starting salaries are beginning to create a problem within the industry. Says Blue, "Although

... moving into management can prove to be a gamble ...

a good increase is about 10% a year, it's not enough to guarantee an engineer with three years experience that he won't be making the same as a beginner. Discontent within the industry over this situation has now reached the point where more and more men are starting to move from company to company."

Indeed, George Morse, president of George C. Morse & Associates, an employment agency in Boston, says, "EE's have to move to get substantial raises. If an engineer stays with one company he will get gradual raises of about \$1,000 a year, or about 10%—not a substantial increase today. That's one reason why they're on the move and the market's flooded."

The big money. While it's true that moving around guarantees between 15% and 20% more money at a clip, many engineers prefer to take the plunge into management and sales, eschewing the intercompany game of musical chairs.

At Beckman Instruments, for example, a nonsupervisory engineer could make as much as \$25,000 a year, but most don't get there, says salary administrator Richard Sears. Even with 15 to 18 years experience most purely technical men top out around \$20,000, he adds. A majority of industry sources agrees. The engineer who stays in the technical end foregoes a shot at the big money," says Hughes' Bigelow.

Moving into management, however, can be something of a gamble. Many engineers take a shot at executive-hood to make more money faster, but find to their sorrow that their technical abilities are greater than their administrative prowess, says Litton's McCarter. "It isn't all that easy to leave the drawing board and become a big success," agrees a source at a large semiconductor house.

At consumer electronics firms engineers are encouraged to move into management because of the increasing emphasis on customer service. But there again, notes Wells-Gardner Electronics Corp.'s engineering vice president, Chad Pierce, "You can lose a good engineer and gain a poor manager."

Small wonder!

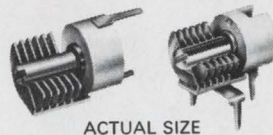

ACTUAL SIZE

New air variable capacitors only 0.310" in diameter for vertical or horizontal tuning.

Johnson introduces these new Type "T" subminiature air dielectric capacitors for trimming applications that call for small size (0.310" diameter), high Q (greater than 1500 at 1 MHz), low TC, and low cost. Mounting dimensions of vertical mount "T" are identical to common 3/8" diameter PC mount ceramic disc trimmers.

Nominal capacities available range from 1.3 pF minimum to 15.7 pF maximum. Minimum voltage breakdown is 250 VDC. End frame is 95% alumina, grade L624 or

better, DC200 treated. Metal parts are silver plated and Iridited to inhibit discoloration.

Plates are precision machined from brass extrusions and offer exceptional uniformity, stability, and absolute freedom from moisture entrapment. Temperature coefficient is plus 30 ± 15 ppm/°C. Retrace characteristics are excellent. Outstanding stability during vibration from 10 to 2000 Hz. These new capacitors meet or exceed EIA-RS 204 and MIL Standard 202C Methods 204A and 201A.

- Please rush a sample of your new Type "T" capacitors, detailed specs and prices.
 Include Catalog 701 covering the entire E. F. Johnson component line.

NAME _____ TITLE _____

FIRM _____ ADDRESS _____

CITY _____ STATE _____ ZIP _____



E. F. JOHNSON COMPANY

3004 Tenth Avenue S. W., Waseca, Minnesota 56093

Providing nearly a half-century of communications leadership



"we are not that Oh La La people any more

monsieur"

French women are glamorous.
French champagne glitters, French Cognac is... hmm!
Frenchmen wear berets.

Sure? No. France is slightly different.

We have got a know-how for other little things.

One example: this "unique au monde" VHF generator.

Its name: Artus 411. Born French. But France is

too small for it (Artus has provided 95% of the French market). Europe? Just large enough (we have sold Artus 310 in most of the European countries). The (New) World then: why not?

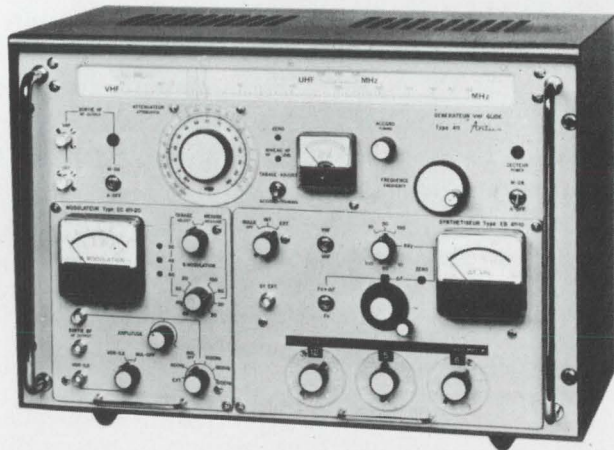

V.H.F. - GLIDE GENERATOR TYPE 411
Frequency range: 75-160 MHz - 320-340 MHz.
Frequency synthesizer with internal or external 1 MHz crystal-control.
Continuously adjustable interpolation range: -10 to +100 KHz.
Output level: 2 VEMF (50 ohms) with automatic level control.
Amplitude modulation from 0 to 100% with linear modulation characteristics (at $m = 85\%$ $d \leq 1,5\%$).
Internal modulation: Marker, identification.
External modulation possibility: 20 Hz - 15,000 Hz VOR, ILS.
High precision modulation measurement.
Built in internal AM - depth standards.
Operates on 50 - 60 Hz mains supply.

AUDIO FREQUENCY HIGH PRECISION I.L.S. GENERATOR TYPE 310

Continuous attenuation of 90 or 150 Hz from 0 to 20 dB with a 0 to 1 dB interpolator (graduations: 0,01 dB).
Amplitude stability: 10^{-4} .
Continuous phase shift from sinus to cosinus.
Variation of frequencies (90 and 150 Hz) = $\pm 3\%$.
Precision: 10^{-1} .

Operates on 50 to 400 Hz mains supply.

AUDIO FREQUENCY I.L.S. GENERATOR TYPE 302

Continuous attenuation of 90 Hz or 150 Hz from 0 to 20 dB (dial with 0,1 dB graduations).
Constant S.D.M.

Phase position: sinus.

Operates on 50/60 Hz mains supply.

AM MODULATION METER TYPE 510

High precision AM measurement (ARTUS patent).

HF input range from 7,5 to 460 MHz.

Sensitivity: from 1 mV to 5 volts on 50 ohms.

Uses I.C. technology.

Operates on 50 to 400 Hz mains supply.

AUDIO FREQUENCY V.O.R. GENERATOR TYPE 105 B

9,960 \pm 480 Hz - 30 Hz FM - VOR signal (amplitude 2 V).

30 Hz variable phase signal from 0° to 360° \pm 0,2° (amplitude 2 V).

30 Hz fixed phase signal (amplitude 5 V).
Operates on 50 or 60 Hz mains supply.

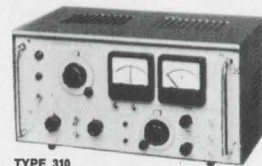

TYPE 310

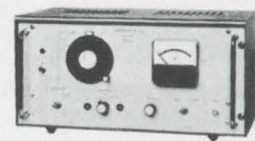

TYPE 302

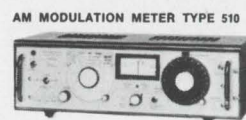

AM MODULATION METER TYPE 510

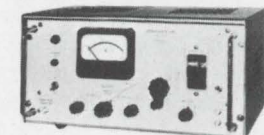

TYPE 105 B



OTHER PRODUCTS

V.H.F. crystal-controlled generator for LOC - VOR - M.B. application (Type 401 A).
Zero Indicator for V.O.R. (Type 501).
High precision ILS - LOC receiver (Type 320).
DC - DC and DC - AC Converters.
DC - AC motors and blowers (from 1 cubic-inch to 10 KW).

2901 publicité alan pernaud

ARTUS Electronique 25,rue Ganneron PARIS 18^e - call 387 59-89 - LÉ BOURGET international aeronautical exhibition :Hall CI Stand 27

Electronics kit leaves the toy box

German firm's fast-selling plastic componentry blocks, designed for children, are attracting interest from companies training apprentices and research labs

By John Gosch

Associate editor

Making child's play of electronics has proved rewarding for a West German kit maker and its American marketing affiliate. The companies, Munich-based Deutsche Lectron GmbH and the Macalaster Scientific Co., a division of the Raytheon Education Co., located in Waltham, Mass., are selling easy-to-assemble sets of plastic componentry blocks, with which literally hundreds of working experiments can be done. Though originally designed with school-age children in mind, the kits have, during their short life span, proved increasingly popular in Germany at least for apprentice training and basic laboratory work.

A Lectron set includes see-through plastic blocks with one or more components—transistors, diodes, resistors, capacitors, and the like—and a metal base plate. The blocks are simply placed next to one another, domino fashion, on the plate, to form electronic circuits; small magnets keep the blocks together and provide electrical interconnections among components.

Simplicity and ease of assembly are the Lectron blocks' big selling points. Amateur experimenters and electronics novices don't have to bother with such tools as cutters, strippers, pliers, or soldering irons. Moreover, they don't have to worry about shorts, broken wires, or heat-damaged parts. And since each block is plainly labelled with an electronic symbol for what's inside there's no problem with matching components to sometimes confusing circuit schematics.

Just by following simple instruc-

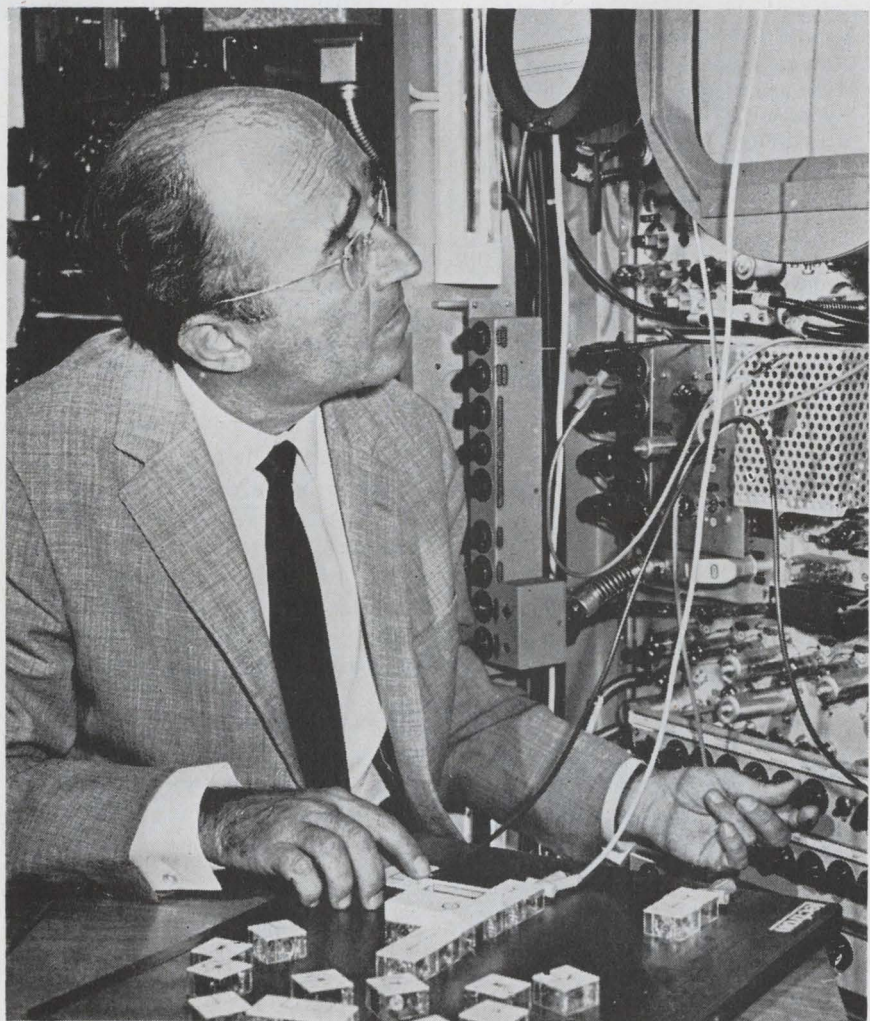

Master builder. Georg Greger, inventor of Lectron blocks and the managing director of the company making them, is always at work on advanced units.

tions in the instruction booklet that comes with each kit, the neophyte can, for example, observe the effects of light hitting a photocell, determine how a diode or transistor works, and build a morse-code oscillator, moisture indicator, and

even a three-transistor radio with loudspeaker. The more imaginative can devise a number of circuits that go beyond those described in the instructions.

But amateur experiments appear to be just the beginning of what

Advanced Instrumentation



Synchro-to-Digital Converters

A simple, reliable, accurate method of high resolution conversion with resolution and accuracy to 18 bits. Available with straight binary code or BCD code outputs. Ideally suited for use as an interface between analog pickoffs and digital computers or off-line equipment.



Digital-to-Synchro Converters Digital-to-AC Analog Converters

ASI Converters accept and register digital angles in binary or BCD code and convert these inputs to the equivalent synchro or resolver voltages. Single-speed resolution and accuracies are available up to 18 bits.

Miniature Solid-State Airborne Units

All solid-state converters featuring high density packaging and ultra-reliability. Available as: Digital-to-Synchro Converters; Synchro-to-Digital Converters; Digital-to-AC Analog Converters; AC Analog-to-Digital Converters.



asi Advanced Instrumentation
astro systems, inc.

6 Nevada Drive, New Hyde Park,
New York 11040 • (516) 328-1600

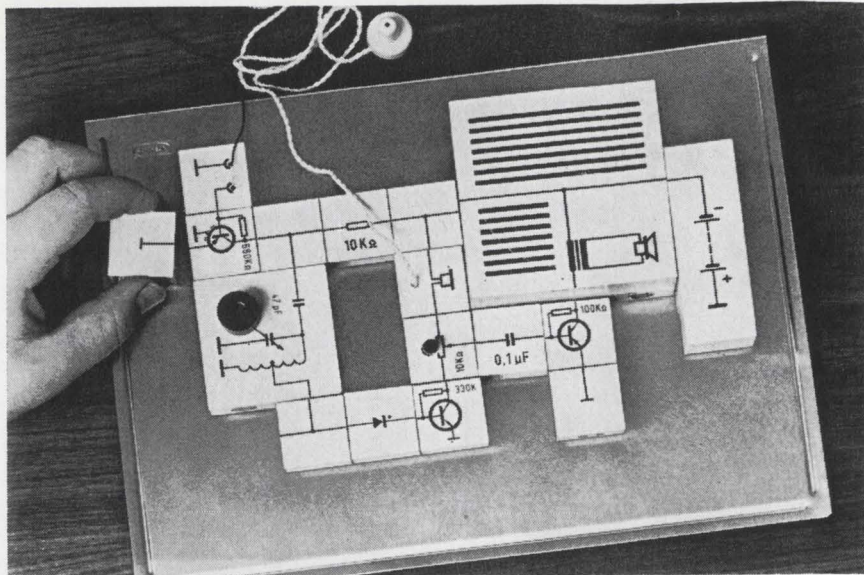

Broadcast band. Among the projects that amateur experimenters can build with their Lectron kit blocks is this three-transistor radio with loudspeaker.

can be done with Lectron's magnetic blocks. Already on the German market are kits for building such digital circuits as AND, NAND, OR, and NOR gates; shift registers; and counters. In the wings are low-voltage oscilloscope, Geiger counter, and microelectronics kits.

Success story

With its existing kits, however, Lectron has already carved out a comfortable niche in the worldwide market for small educational aids. From mid-1966 when the firm, then known as Eggerbahn GmbH, switched production from model railroads to electronics kits, business has expanded rapidly. Last year set sales rocketed to \$890,000—no small amount for a 100-man company in Europe. About \$640,000 worth was sold to Raytheon; the balance went to Germany's Braun AG, distributor of Lectron kits in Europe. West Germany accounted for 90% of European sales, and Austria and Switzerland the balance. Lectron estimates its business will grow by at least 10% to 15% a year.

This record is a personal triumph for Georg Greger, 46, the company's managing director. He invented the magnetic building blocks and recognized their potential as an educational tool. "From a pedagogical point of view I have always been interested in simple representations of complex technical processes," Greger says. He recalls ex-

perimenting as a boy with crystal radio sets in the early 1930's. "In those days you could see what you were doing, observe the effects of putting a lead here, or changing a component there. Everything was so simple then." That simplicity, he notes, gradually disappeared as electronics became more and more complex. "Systems can now no longer be recognizeably demonstrated, and many people, especially the young, have lost touch with down-to-earth, practical electronics," Greger says. Essentially, he wanted to make electronic experimentation uncomplicated again.

Omissions. To that end, the "learn-by-doing" methods in Lectron instruction books skip theory—formulas, equations, derivations, and the like—that often makes once-eager students lose their zest. "Rather than telling a new experimenter all about Ohm's law, I want him to see what happens to the current in a circuit when a resistor is changed," Greger explains.

At least from an educational point of view, Greger deplores assembly schemes in which one is told, in cookbook fashion, to connect a wire from point one to point two or to stick a resistor between points three and four. "It's not that high-quality, functioning equipment can't be built that way," he says. "It can. But what has a person learned about electronics?"

He himself seems to have followed the dictum of "learn-by-

doing" throughout his life. Though he comes across as a college professor, he's been a working engineer all his adult life. World War II prevented him from getting a university education, but in 1943, Greger was recalled from active military duty to work as an electrical engineer at Dornier, an aircraft manufacturer. After the war he did audio acoustical engineering for several West German motion picture producers. At Munich-based Constantin Film, where he concentrated on the technology of sound-synchronizing for foreign films, Greger suddenly got the idea for his magnetic building blocks. The prototype kits he developed were so well received at various toy and educational-aid fairs in Europe that Constantin decided to mass-produce them at its affiliate Eggerbahn, a maker of model railroads. Eggerbahn, now Deutsche Lectron, put the first kits on the German market in September 1966.

Going partners

Raytheon officials first became aware of Lectron kits at the 1967 Nuremberg Toy Fair. They checked the U. S. market potential and made a sales agreement with Lectron later in the year. The \$640,000 order was signed in January 1968, and Lectron delivered loose build-

ing blocks worth that amount between February and October of last year. Additional orders are in the works.

Macalaster, which packages the blocks into kits that vary somewhat from those sold in Europe, has distribution rights throughout the Western Hemisphere. Lectron in 1967 turned over German distribution rights to Braun, a maker of consumer electronics goods with a large domestic and foreign sales organization. So far, sales in Europe have been limited to German-speaking countries—West Germany, Austria, and Switzerland. But Braun, an affiliate of the Gillette Co., is now translating instruction books and readying sets for French and Belgian outlets. Eventually the firm plans to tackle the Scandinavian countries, Italy, and The Netherlands. Just who will handle Great Britain and Japan is still up for grabs.

Promotional push. In West Germany, Lectron is getting a lot of unsolicited advertising for its kits, with the biggest boost coming from the Bayerische Rundfunk which runs Bavaria's regional television network. On BR's Telekolleg, a sort of "university-of-the-air" show, Lectron blocks especially designed for tv presentation, are used in a 13-lecture basic electricity course. Many of the program's 220,000 viewers buy Lectron kits to do their homework and for further study. As a result, a new 23-block version, selling for about \$12, has been put on the German market. Later this spring, another regional tv network, the Hessischer Rundfunk—Radio Hesse—will start airing the Telekolleg program, probably providing another boost for kit sales.

Among the electronics companies and research organizations using Lectron kits for apprentice training are Siemens AG, Grundig Werke GmbH, and the German Post Office. Kits are also used in some electronic development labs, and the company has put together a 100-block set selling for around \$105, to cash in on this development.

Other outlets with potential include teacher training colleges and technical trade schools. At a computer programming school at Ulm, for example, digital circuit kits are used as aids for teaching Boolean

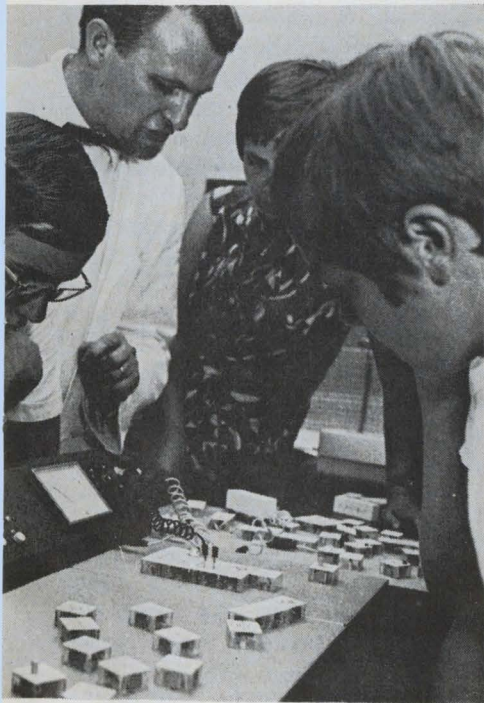

Plus. Though designed for children, Lectron blocks appeal to adults too.

LOW COST AUTOMATION takes many forms

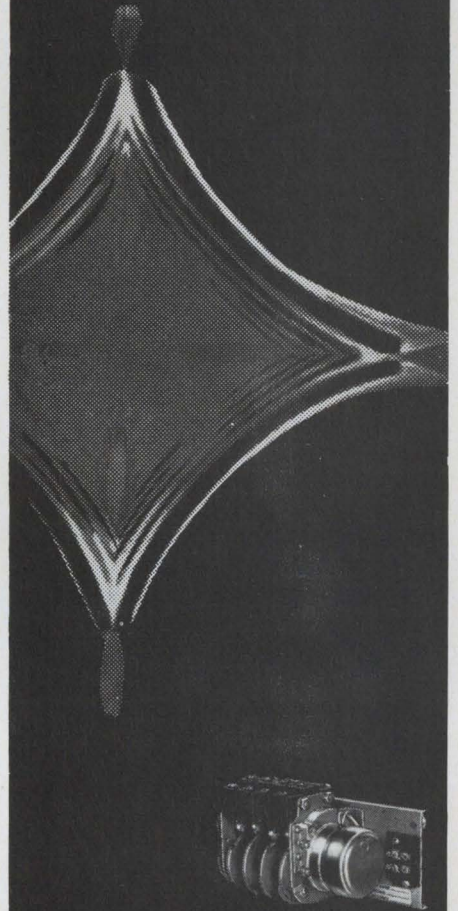

Our MP Repeat Cycle Timers inexpensively control up to 12 SPDT, 10 amp 120 VAC circuits from a common time base. Catalog 15 explains this and 560 other forms of low-cost automation. Send for it.

GW Eagle Signal Division
E. W. Bliss Company
 Davenport, Iowa 52803
 A GULF + WESTERN COMPANY

Service-In-Depth...
 Local Engineering, Stock, Repair

Choose from 44 styles of film capacitors... There's one to meet your exacting requirements

HERMETICALLY-SEALED METAL CASE TUBULAR CAPACITORS



BARE METAL CASE

Style LP8, metallized polycarbonate film
Style LM8, metallized PETP-polyester film
Style LS8, metallized polystyrene film
Style AP8, polycarbonate film
Style AM8, PETP-polyester film
Style AS8, polystyrene film
Style AF8, PTFE-fluorocarbon film

METAL CASE WITH INSULATING SLEEVE

Style LP9, metallized polycarbonate film
Style LM9, metallized PETP-polyester film
Style LS9, metallized polystyrene film
Style AP9, polycarbonate film
Style AM9, PETP-polyester film
Style AS9, polystyrene film
Style AF9, PTFE-fluorocarbon film

CIRCLE 511 READER SERVICE CARD

EPOXY-CASE RECTANGULAR CAPACITORS

AXIAL-LEAD

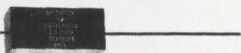

Style LP7A, metallized polycarbonate film
Style LM7A, metallized PETP-polyester film
Style LS7A, metallized polystyrene film
Style AP7A, polycarbonate film
Style AM7A, PETP-polyester film
Style AS7A, polystyrene film

RADIAL-LEAD

Style LP7S, metallized polycarbonate film
Style LM7S, metallized PETP-polyester film
Style LS7S, metallized polystyrene film
Style AP7S, polycarbonate film
Style AM7S, PETP-polyester film
Style AS7S, polystyrene film



CIRCLE 512 READER SERVICE CARD

WRAP-AND-FILL ROUND TUBULAR CAPACITORS



Style LP66, metallized polycarbonate film
Style LM66, metallized PETP-polyester film
Style LS66, metallized polystyrene film
Style AP66, polycarbonate film
Style AM66, PETP-polyester film
Style AS66, polystyrene film

CIRCLE 513 READER SERVICE CARD

WRAP-AND-FILL OVAL TUBULAR CAPACITORS



Style LP77, metallized polycarbonate film
Style LM77, metallized PETP-polyester film
Style LS77, metallized polystyrene film
Style AP77, polycarbonate film
Style AM77, PETP-polyester film
Style AS77, polystyrene film

CIRCLE 514 READER SERVICE CARD

HERMETICALLY-SEALED METAL CASE RECTANGULAR CAPACITORS



Style CML, high voltage paper/
PETP-polyester film, inserted tab
construction.

CIRCLE 515 READER SERVICE CARD

HERMETICALLY-SEALED CERAMIC CASE TUBULAR CAPACITORS



Style SML, high voltage paper/PETP-polyester
film, inserted tab construction.
Style SML E, high voltage paper/PETP-poly-
ester film, extended foil construction.

CIRCLE 516 READER SERVICE CARD

HERMETICALLY-SEALED GLASS CASE TUBULAR CAPACITORS



Style GML, high voltage paper/PETP-poly-
ester film, 85 C
Style GTL, high voltage paper/PETP-polyester
film, 125 C

CIRCLE 517 READER SERVICE CARD

EPOXY CASE RECTANGULAR CAPACITORS



Style EFX, high voltage paper/PETP-poly-
ester film.

CIRCLE 518 READER SERVICE CARD

For engineering bulletins on the capacitor styles
in which you are interested, write to Dearborn
Electronics, Inc., Box 530, Orlando, Fla. 32802.

Dearborn Electronics, Inc.

(a subsidiary of the Sprague Electric Company)

FOREMOST IN FILM CAPACITORS

1D-0100

algebra. The prime business, however, comes from sales to home experimenters. Kits are sold mainly in radio and do-it-yourself stores. There are also many toy stores and some book stores in Germany that sell Lectron kits.

Production unit. The blocks are turned out in a rather nondescript factory that's a far cry from the shiny electronics production facilities which have sprung up in and around Munich. The Lectron factory, located in the Southwestern portion of the Bavarian capital, is a former field hospital that was located in downtown Munich and moved to its present site soon after the war. Since then, cement sidings have been added but they don't much improve the building's general appearance. Eventually, Greger says, production will be moved to new quarters that can accommodate more workers than the present crew of 100 or so.

"Labor is a big problem," Greger says. "With Siemens practically next door, it's tough to find workers." Still, no big production bottlenecks have been hit so far, although at times minor delivery delays have occurred because components didn't arrive in time.

Cottage industry. To keep up with the demand Lectron resorts to a practice that was once fairly common with many small manufacturers in Germany's labor-short economy. It sends out component parts to people's homes for further assembly. The company has about 20 such home-based, part-time assemblers, some of whom are employed full-time at Lectron during regular working hours.

Among the 100-odd workers at the Lectron plant, around 60, including some female Gastarbeiter—foreign workers—from Italy and Sweden, do the assembling. Twelve others man injection molding machines. The rest are employed in the shipping and accounting departments.

Producing the magnetic building blocks is a relatively simple, three-step affair. First, the plastic housings are made in an injection-molding process. Then, the electronic components and the magnets are installed. Finally, white covers with appropriate symbols are put on top of the housings. The components and magnets come largely from

For REALLY DIFFICULT APPLICATIONS



Vidicon



Image
intensifier

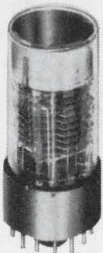

9536



9594



9578



9603

Specify



Photosensitive Devices

EMI offers photomultipliers with various photocathodes, and all dynode configurations in sizes from 1/2" to 12", many with fused silica windows.

Now available: four stage image intensifier and 1/2" vidicon.

Write for catalog, or call for specific information.

Whittaker
CORPORATION
GENCOM DIVISION

80 Express St., Plainview, L. I., N. Y.
516-433-5900 TWX 516-433-8790
*EMI ELECTRONICS, LTD.

West German outfits. But companies in Japan supply loudspeakers and earphones. "Pricewise the Japanese can give us the best deal on such items," Greger says.

Keeping pace. Greger himself, aided by two assistants at Lectron and occasionally by outside consultants, toils away in his lab and office designing the blocks. "I try to keep up with the latest trends in electronics," he says. Now that the low-voltage oscilloscope and Geiger counter kits are in the bag, Greger is concentrating on micro-electronic blocks. They should hit the German market by Christmas and will make possible advanced types of digital and other circuits. Another one of Greger's current projects is developing blocks with MOS field effect transistors in them.

One idea Greger says he'll probably pursue is a kit for tv circuit instruction. Essentially, this one will be based on the oscilloscope kit, which will be adapted for use with tv circuits like line and test-pattern generators.

So far, there are a half dozen different types of Lectron kits on the German market. They range in price from \$12 for an 18-block mini-system up to \$105 for the 100-block set. The digital circuits kit, which can be used for as many as 100 different experiments was introduced at Didacta 68, a fair for educational aids held at Hanover last year. The oscilloscope and Geiger counter kits, presented at the Nuremberg Toy Fair in February, will soon go into mass production.

Commonality. A unique feature of the Lectron kits is that the blocks are standardized. Each has a base area of 27-by-27-millimeters and is 16 millimeters high. Since a block's sides are transparent, beginning experimenters can see what a transistor, a diode, etc. looks like.

The ferrite magnets keeping the blocks together are shaped like discs and installed in round indentations in the block's sides and bottom. A 12-by-12-mm nickel-silver contact plate covers each magnet. The plate is shaped in such a way that it also holds the magnet in place. In addition, the plates provide a means for attaching and soldering component leads during block manufacture.

A standard block can have a maximum of five magnets, one on

LOW COST AUTOMATION takes many forms

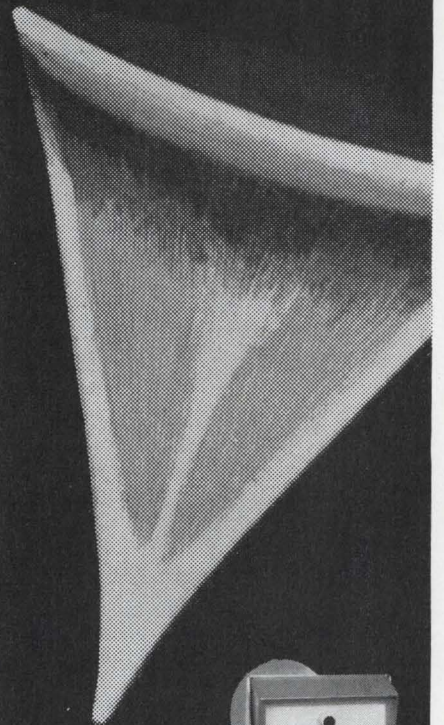

New plug-in Cycl-Flex 2 & 3 digit totally solid state I/C counters. 100% accurate. Up to 1200 counts per minute. Available in higher count rates. Easy-to-set thumb wheels.

Get Catalog 15, describing these and 560 other forms of low-cost automation.

GW Eagle Signal Division
E.W. Bliss Company
Davenport, Iowa 52803
A GULF + WESTERN COMPANY

Service-In-Depth ...
Local Engineering, Stock, Repair

Now you
can count
up, down,
and sideways
for only
\$895!



Atec's new Model 2400 Bi-Directional Counter lets you count in any direction...and at a modest price.

The Model 2400 is

VERSATILE: It has six operating modes. It counts *up and down* from 0 to 10 MHz. It counts *sideways*: in A quad B mode, input signals are added or subtracted depending on phase relationship. And it offers these other outstanding features:

- BCD output ■ Operating power for sensing lamps and amplifier circuits ■ Manual or remote programming ■ Input sensitivity from 0.01 V RMS to 125 V ■ One megohm input impedance ■ Four decimal digits (to seven, optionally) ■ Only 1 $\frac{3}{4}$ " high in a standard rack mount.

RELIABLE— Jitter-free, coincidence-free circuitry, all solid-state modular design, extensive use of ICs, and a motherboard to minimize wiring.

ECONOMICAL— all this for only \$895!

For complete specifications or a free demonstration call your local Atec engineering-sales representative or write directly to us. A brief description of other Atec instruments is available in the 1969-70 EEM, in section 2200.

Atec, Inc.

1125 Lumpkin Street, Houston, Texas ■ Phone (713) 468-7971
Mailing Address: P. O. Box 19426, Houston, Texas 77024

the bottom and up to four on the sides, depending on the number of component leads inside the block. Blocks are kept snug on the base plate by a bottom magnet, strong enough to hold them in place even when the mounting board is tilted or hung on a wall.

In addition to the 27-by-27-mm blocks, there are bigger units which have a base area that is a multiple of the standard types. This kind of dimensioning facilitates circuit assembly and makes for a clean, uncluttered look in finished equipment. The larger blocks include, for example, an indicator, a loudspeaker, and other devices that don't fit into the standard housings. For better viewing in the case of the indicator or better operation in the case of the loudspeaker, the larger-size blocks are also a little higher. As a rule, such blocks have more magnets than the standard versions.

Fillers. Some blocks contain just a piece of wire for extending connections between component blocks. The wire runs either between two opposite sides or at a 90° angle between adjacent sides. Some wire-blocks also feature branched leads, and others provide a ground connection through the bottom magnet to the plate.

A nine-volt, 50-milliamperere dry battery, also housed in a block, is the power supply for most kits. For the oscilloscope and Geiger counter kits, however, a six-volt, 200-ma unit is used because of different circuit requirements. In the oscilloscope setup, the six volts is changed to a-c in a transistorized converter circuit. The voltage is then stepped up to 250 volts in a block housing a transformer. By means of a diode-based voltage-doubling circuit, the 500 volts for the oscilloscope tube is obtained. The voltage for the Geiger counter is similarly achieved. Since all voltage processing occurs in closed plastic blocks, the danger of shocks is eliminated.

By the book

Generally, the experiments in the instruction books for the large kits fall into three main categories. The first involves studying the functions and operating principles of transistors, diodes, resistors, potentiometers, and other circuit elements.

**YOUR
FREE COPY
IS READY!**

**NEW 1969
NEWARK
INDUSTRIAL ELECTRONICS
CATALOG**

★ The one-source buying guide ★ Over 70,000 items—500 major brand lines.

★ 700 pages

★ Over \$7,000,000 industrial electronic inventory

NEWARK HAS IT NOW, THE COMPLETE LINE OF



PRECISION POTS

Wirewound, single and multi-turn, linear and non-linear, diameters from 1/2" to 3".



TRIMMER POTS

Wirewound and non-wirewound, to 1 Megohm. Single, 15, 25, 42 turn, square, round, rectangular and TO-9 case size.



**TURNS—COUNTING
DIALS**

Digital or concentric readout.

Immediate delivery from stock—factory OEM prices
—fast efficient service from 11 Newark warehouses.



New Main Office & Warehouse

NEWARK ELECTRONICS CORPORATION

500 North Pulaski Chicago, Illinois 60624
(312) 638-4411

WAREHOUSES IN

- | | | |
|----------------------------------------|--------------------------------------------|---|
| ★ Minneapolis, Minn.
(612) 331-6350 | ★ Los Angeles Area
(213) 678-0441 | ★ |
| ★ Cincinnati, Ohio
(513) 421-5282 | ★ Grand Rapids, Michigan
(616) 452-1411 | ★ |
| ★ Denver, Colorado
(303) 757-3351 | ★ New Orleans, Louisiana
(504) 834-9470 | ★ |
| ★ Detroit, Michigan
(313) 548-0250 | ★ Dallas, Texas
(214) 271-2511 | ★ |
| ★ New York City
(212) 255-4600 | ★ Houston, Texas
(713) 782-4800 | ★ |

In the next, the knowledge gained from preliminary work is reinforced by the building of functional circuits. These range from simple light-operated detection circuits and tone generators through amplifiers and a tuned transistor radio. The final stage involves methods of testing individual components, particularly semiconductors.

One interesting feature of Lectron kits is that individual blocks can easily be removed and substituted without having to take the whole circuit apart. This allows for "designing" a completely different circuit within a few seconds. It's a feature that comes in handy when kits are used in electronics development labs.

Since it's possible to buy blocks individually just as, for example, pieces of track can be bought for a model railroad, experimenters can build a stock for experiments not described in the instruction books. Lectron also provides component-less blocks that only have small sockets into which any size resistor or capacitor not normally part of the assembly kits can be inserted.

The 100 different experiments outlined for the digital circuit kit also break down into three groups. The first deals with the basic differences between analog and digital techniques. To demonstrate the difference, a binary system and a bistable multivibrator are built. The second involves basic logic circuits such as AND, NAND, OR and NOR gates. The experimenter learns basic operating principles by means of switches and relays. He then investigates these principles with semiconductor switching elements. In the third group, knowledge is put to use in building such complex circuits as a decoder, a Schmitt-trigger, circuit-based pulse shaper, and the like.

Once the microelectronic blocks are on the market, the range of circuits that can be built will be greatly extended. A typical 81-by-81-mm microelectronics block that Greger is now developing contains an integrated circuit incorporating the functions of three transistors and four resistors. External passive devices can be connected to that block by way of its ten outside contacts. With this one block as a basis up to 35 different experiments can be performed. ■

**LOW
COST
AUTOMATION
takes
many
forms**

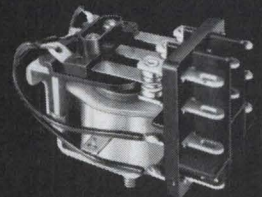
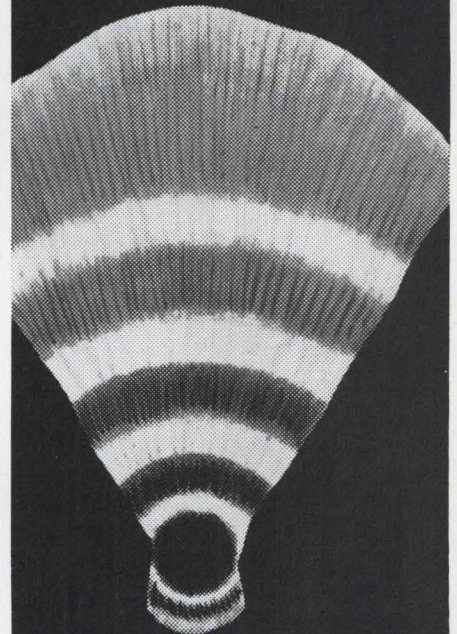

EAGLE control relays last longer! There are over 3000 models in our catalog RGC-1, ready to prove their superiority in your application. See them all. Send for your copy.

GW Eagle Signal Division
E.W. Bliss Company
Davenport, Iowa 52803
A GULF + WESTERN COMPANY

**Service-In-Depth...
Local Engineering and Stock**

We're not handing you the biggest line in the industry.

We're selling it.

Everything from 14-inch Vertical Coaters to 72-inch Horizontal Coaters. Pumping systems that provide total performance—the optimum blend of cleanliness, speed, repeatability. Completely automatic, semiautomatic or manual control. You decide. All you have to do is tell us your requirements. There's a CVC coater to do exactly the job you want done.

And that's an important point. When you have so many coaters to choose from, you won't fall into the trap of buying more efficiency than you need. Or less.

You'll get the most out of your budget allocation.

But the thought we'd really like you to hold, when you're checking out high-vacuum equipment, concerns CVC experience. We've been a leader in this field ever since high vacuum became a science. That's how we became the single source for everything you need.

Total systems, pumps, components and accessories. How can we help you? Write: The Bendix Corporation, Scientific Instruments and Equipment Division, 1775 Mt. Read Blvd., Rochester, New York 14603.





THE MEMORY SQUAD. YOURS FOR THE ASKING.



You're looking at the senior engineering staff of ELECTRONIC MEMORIES. And, if you're designing computer or memory systems, they're all yours for a day. Free.

They'll give you a one-day seminar on memories and memory systems in your plant. Or even your office. On everything from memory basics to system configuration, implementation and final checkout and test. When they're done, you'll be checked-out on everything you need to know to make your systems perform the way you expected them to when you bought the hardware.

Write for them now, though, because we're limiting the number of seminars. We need these guys, too.

Phil Harding, Manager, Systems Development, investigates new system concepts and develops product line hardware. Harding has been granted 13 memory-related patents, has six more on file and another two disclosures in process. When he investigates, he investigates.

Tom Gilligan manages our Commercial Memory Engineering Department. He designed the first sub-microsecond 2½D memory system and has participated in the design and manufacture of stacks and systems that run the gamut from "small and slow" to "large and fast." He's responsible for every commercial memory system or stack that goes out our doors. And that's a lot.

Robert Johnston is our plated wire specialist. We're keeping this quiet at the moment. Keeping competition off guard. You know how it is. But we'll tell you more at the seminar.

Brian Rickard manages our Military Magnetics operation. He implements the design of core memory stacks specifically for severe environments and has built hardware for Pioneer, Lunar Orbiter, Advanced IRLS and other spacecraft.

Max Van Orden performs the same kind of function as Rickard in our Commercial Division. As Manager of Commercial Magnetics, he's responsible for the implementation of all commercial magnetic arrays, assemblies and stacks.



Daniel Brown is our resident core expert. He carries through from R and D on magnetic materials to pilot production and has developed a broad spectrum of cores, from wide-temperature range cores for military programs to fast-switching cores for commercial computers.

Part of this group developed our Nanomemory 2650; maybe that's why it's selling as fast as we can build it. It has a cycle time of 650ns, uses $2\frac{1}{2}D$ magnetics, IC electronics and comes with an optional self-tester. All this is built into a $2\frac{5}{8}$ cubic foot module, designed for easy use and easy maintenance. The entire memory is built on plug-in cards and can be stripped down to its

case and power supply in six minutes flat. But we've built it so you'll never even have to open the case.

They also developed our Micro-memory 1000 giving you storage at less than 6.5¢ / bit for commercial systems. For this price, you can get up to 32K bits of storage with a cycle time of $2.5\mu s$. This memory is designed for OEM use and consists of a stack and five cards of electronics which all plug into a mother board for easy maintenance. A single connector provides the interface to your system.

So whether you're looking for hardware or are still on the drawing board, write us. We'll see that you get just what you need.

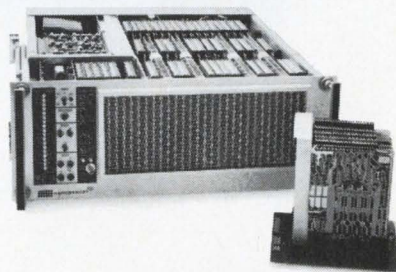

EM ELECTRONIC MEMORIES
12621 Chadron Avenue
Hawthorne, California 90250

It's so tempting. You already have the equipment. You can get the space. Just move around some talent, allocate some money, pick up some of those nifty new IC's and you'll be in business.

Maybe.

Module making takes an awful lot of time, effort, money, equipment, patience, test facilities, and know-how. We've made over 1,600 types, many for our computers. So we know.

Yet sometimes it's worth the hassle. We've learned that, too. And we're willing to tell you when. Ask a Digital sales engineer to look over your electronic circuits. He's there to help you. And if you should make your own, he'll be the first to tell you so.

Before he arrives, get a quick briefing about what the world's largest manufacturing supplier of modules has learned while making 2 million modules every year.

It's all in our booklet, Make or Buy. Write for it.

Caution: Module making may be hazardous to your health.



digital
COMPUTERS · MODULES

Digital signal processors go to market

New company to introduce fast Fourier analysis machine at Spring Joint Computer Conference in Boston; Raytheon's widens its computers' applications

"The difficult we do immediately—the impossible takes a little longer." If a motto were needed for digital signal processors, it might well be this one borrowed from the military. The systems represent a potentially inexpensive way of doing many things that are nearly—if not downright—impossible in today's laboratories. They can present the Fourier components of complex signals in real time, or close to it. They can deduce not only the characteristics of the filter through which a signal has passed, but the signal's original characteristics. And they can simulate a filter with infinite Q , even at very low frequencies—a feat impossible with analog techniques.

But digital signal processors are still rare items in the marketplace. Many firms have built machines capable of fast Fourier and other processing schemes, but most are still in the lab. Until now, the Time/Data Corp.'s model 100, a relatively straightforward machine that's programmed through knobs and dials on its front panel, has been the only widely available processor of this type [*Electronics*, April 15, 1968, p. 126].

The situation is changing, though. Two firms plan to unveil digital signal processors at the Spring Joint Computer Conference in Boston, May 14 to 16 [*Electronics*, March 31, p. 35]. Computer Signal Processors Inc., a new company based in Waltham, Mass., will introduce the CSS-3, a processor capable of three kinds of fast Fourier analysis, auto- and cross-correlation, convolution, amplitude histograms, averaging, and filter and modem simulation.

And Raytheon will introduce a peripheral processor called the ATP (for array transform processor) and

designed for use with the firm's small 16-bit computers, designated the 703 and the 706.

Co-founder and president of Computer Signal Processors is Edmund U. Cohler, formerly a scientist at the advanced research lab of Sylvania Electronic Systems and designer of one of the first specialized digital signal processors, the ACP-1. Sylvania is apparently making such processors for in-house use only.

Responsive audience

"I frankly don't know all the areas into which digital signal processing can penetrate," Cohler says. "I originally expected to find such applications as communications research, electronic intelligence, speech studies, sonar research, and so on. But we are also attracting interest in the medical community,

which would use the machines in studies of body sounds and electroencephalograms. Even less expected was the interest shown by engineers doing vibration analyses of structures as exotic as rocket engines."

Along with the basic CSS-3, he continues, "we provide a fast 16-bit general-purpose computer, sampling inputs, a cathode-ray-tube display, and a teletypewriter input-output channel." But Cohler feels that what will attract buyers is the system's "apparently simple" software. "We make digital signal processing relatively easy for neophytes," he says.

Easy does it. For example, a user can request a histogram of an input signal simply by typing "hist" on the teletypewriter. He can then sit back and watch the graph of phase versus amplitude grow on the



Analyze and display. The CSS-3 processing system includes crt display and teletypewriter printout of the signal components.

TRYGON HAS THE POWER

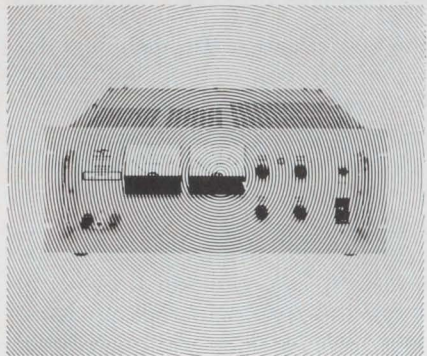

**to deliver wide
range constant voltage
constant current
performance for
every lab and system
application.**

- All silicon design—precision performance
- Wide voltage ranges—currents to 100 amps
- Positive convection cooling—no derating
- Overvoltage and ultra-high stability options
- Automatic load share paralleling
- Priced from \$575.

Super-Mercury from TRYGON . . . the competitively-priced series of fully programmable wide-range power supplies, power and value packed.

Super-Mercury: Designed for bench or rack installation with slide provisions at no extra cost . . . in ranges up to 160 volts and up to 100 amps. Regulation of 0.005% and 0.015% stability are standard (0.005% stability optional) as is MIL Spec, RFI-free performance. Total ripple and noise: less than 1 mV RMS; Master-slave tracking, auto-load share paralleling and remote sensing and programming also standard. Write for the full TRYGON power story.

TRYGON DOES HAVE THE POWER!



TRYGON POWER SUPPLIES

111 Pleasant Avenue, Roosevelt, L.I., N.Y. 11575
Trygon GmbH 8 Munchen 60, Haidelweg 20, Germany
Write for Trygon 1968 Power Supply Handbook.
Prices slightly higher in Europe.

Swimming with the stream

If the Pueblo had been able to contact Japan when the intelligence ship was first harassed by North Korean torpedo boats, it might not have been taken. But poor radio propagation conditions apparently made it impossible for the vessel to synchronize its electronic crypto communications gear with the equipment back at its base.

According to Marvin Z. Frank, marketing manager for data terminals at the Codex Corp., Watertown, Mass., "the TM-15 could have made it easier." The TM-15 is a time-division multiplex-demultiplex system capable of packing up to 15 full-duplex or 30 half-duplex teletypewriter channels, either encrypted or 'clear,' into a voice-bandwidth, 1,200-bit-per-second stream. It will be introduced during the SJCC next month.

"Radio transmission is prone to fading, noise, and breakdown," Frank says, "but in the TM-15 we can be pretty sure that no bits will be added or dropped out of a stream. A redundant error-correcting supervisory code accompanies each 'word' and identifies its channel. Also, if a transmission line or radio channel fails completely, almost exact synchronization with the transmitter multiplexer is retained by clock circuits in the TM-15. These clocks hardly drift, so that the TM-15 can resynchronize itself even after hour-long outages.

Pulling together. Not only does a TM-15 keep itself synchronized with other TM-15's but it helps keep secure systems properly slaved to each other. Encrypting and decrypting devices, as learned in the Pueblo hearings, usually must be synchronized with one another around a nominal clock rate.

The TM-15 can tolerate clock-rate drifts of up to 104 parts per million, absorbing bits that enter the stream too quickly in small buffer stores, and slowing its bit rate to accommodate slower decrypting devices.

It also uses a code-conversion scheme to translate asynchronous codes (like teletypewriter or ASCII into synchronous form. "We lop off the Baudot Code's 'letter start' and 'letter stop' bits, retaining the five bits that indicate which letter is being transmitted and adding a data control bit," Frank explains. The rest is just a matter of seeing that the bits are transmitted at an even clock rate."

Codex Corp., 150 Coolidge Ave., Watertown, Mass. 02172 [340]

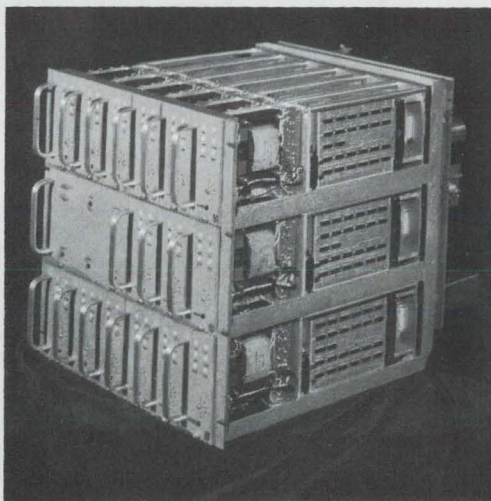

It's accommodating.

Unlike most time-division multiplexers, which sample and digitize incoming data at a fixed rate, the TM-15 adjusts to the bit stream, accelerating or decelerating transmissions to suit its throughput.

CSS-3's Tektronix display screen. After waiting long enough to get the desired resolution, the operator can flip a switch to either freeze the display, store the data in the computer's memory, or request a printout on the teletypewriter.

Cohler won't give out details on on the CSS-3's software, but he does

note that it's loaded into the computer through paper tape—a system he deems more flexible than front-panel controls, especially when it's used in combination with keyboard controls and almost infinitely variable control of such parameters as sampling duration and rate.

The standard processes, or pro-

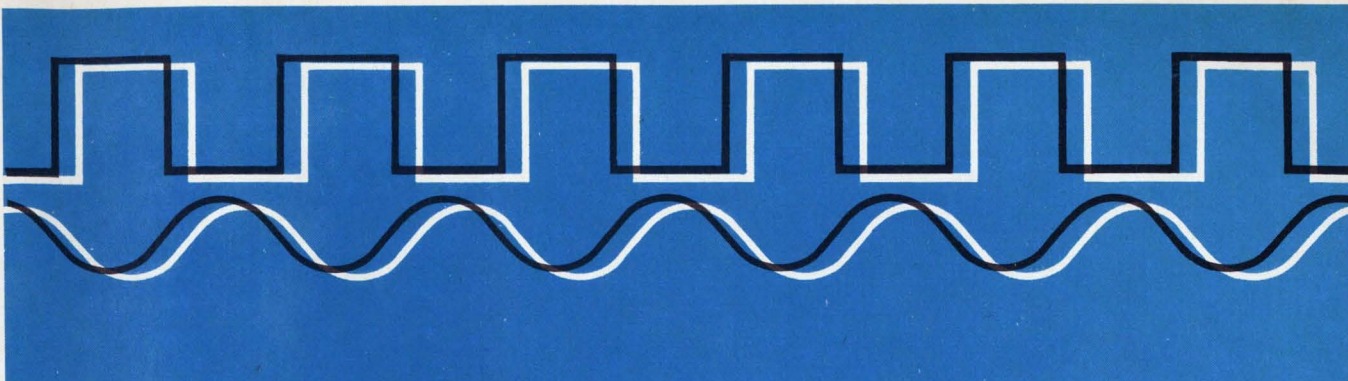

a function generator
with the
accent on

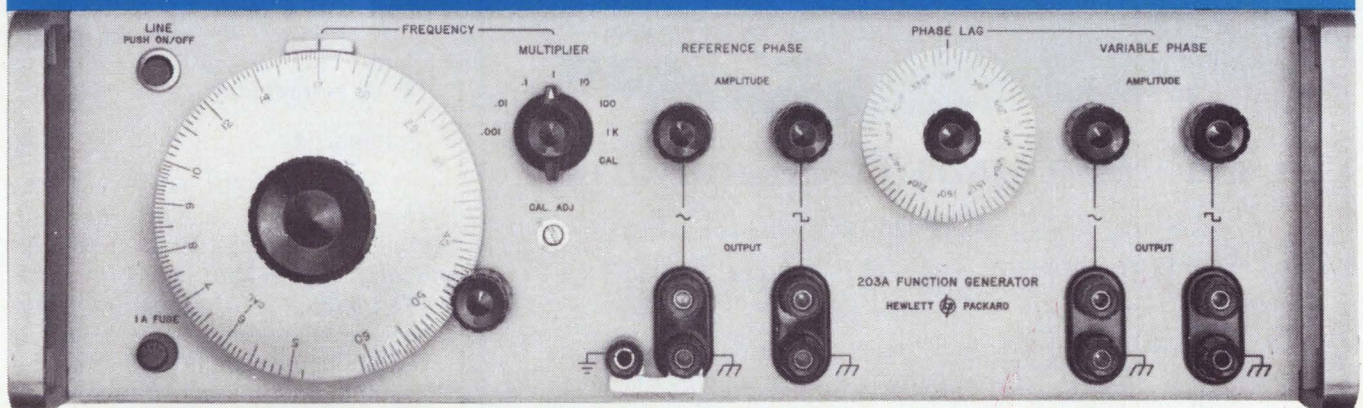

FUNCTION

The array of features on the Hewlett-Packard 203A Variable Phase Function Generator make it one of the most useful and versatile function generators available. It's a fast, practical way to get high-quality test signals for a variety of field and lab applications.

First, the 203A gives you simultaneous sine and square waves from 0.005 Hz to 60 kHz. Or from 0.00005 Hz with optional bands for tests at extremely low frequencies. Two additional outputs give you a continuously variable phase shift of each signal from 0° to 360°. Yet total harmonic distortion is less than 0.06%.

Second, you get 1% frequency accuracy from a dial

calibrated in 180 divisions and precision vernier drive. All four outputs float with respect to the power line, and each has a 40 dB continuously adjustable attenuator. With all its features, the solid-state 203A fits neatly and economically into medical, geophysical and servo applications as well as audio and vibrations testing. Price: \$1250 (options 01 and 02 for lower frequency decades, \$50 and \$150, respectively.)

For complete details on each and every function, call your local HP field engineer, or write Hewlett-Packard, Palo Alto, California 94304; Europe: 1217 Meyrin-Geneva, Switzerland.

HEWLETT  PACKARD
SIGNAL SOURCES



Generation Gap

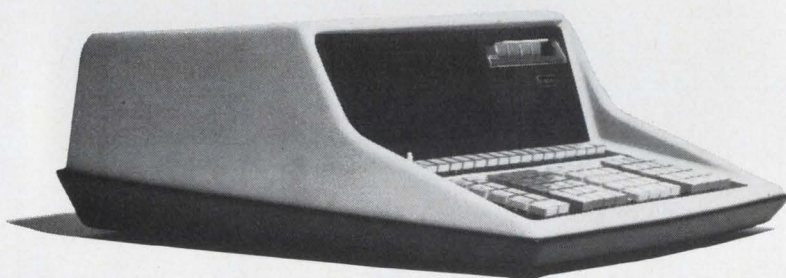

The Wang 700 Calculator is a whole lot smarter than its predecessors.

It's the first of a new breed, a third generation programmable calculator. The difference is more revolutionary than evolutionary. It's ten times faster and more powerful than the best of the 2nd generation machines. It handles far longer programs (learns on a built-in 8192-bit core and stores permanently up to 10 blocks of 960 steps each on snap-in magnetic tape cassettes), has many more data storage registers (up to 120), and provides more hardware operations (like logs to base e and base 10, π , e^x , 10^x , etc.), than any existing calculator or so-called desk-top computer.

Execution speeds for various functions range from 300 μ sec for + and - to 250 msec for trig functions. A dual Nixie-type display produces 12 digit answers plus 2-digit (-98 to +99) exponents each register.

The Wang 700 has commands for loops, branches and subroutines, unmatched power for matrix and array operations. Exclusive integrated circuit design concentrates all these capabilities into a self-contained, convenient desk-top package. It's the logical heir to Wang leadership in high performance problem-solving.



Dept. 4H, 836 North St., Tewksbury, Massachusetts 01876 • Tel. 617 851-7311

Call today

for immediate trial:

(201) 241-0250	(216) 333-6611	(313) 278-4744	(502) 426-1116	(608) 244-9261	(714) 234-5651
(203) 223-7588	(301) 588-3711	(314) 727-0256	(504) 729-6858	(612) 881-5324	(716) 381-5440
(203) 288-8481	(301) 821-8212	(315) 463-9770	(505) 255-9042	(615) 588-5731	(717) 397-3212
(205) 881-5360	(303) 364-7361	(317) 631-0909	(512) 454-4324	(616) 454-4212	(801) 487-2551
(206) 622-2466	(304) 344-9431	(402) 341-6042	(513) 531-2729	(617) 542-7160	(805) 962-6112
(212) 682-5921	(305) 563-8458	(404) 633-6327	(517) 835-7300	(617) 851-7311	(816) 444-8388
(213) 278-3232	(305) 841-3691	(405) 842-7882	(518) 463-8877	(702) 322-4692	(817) 834-1433
(214) 361-7156	(309) 674-8931	(412) 366-1906	(601) 234-7631	(703) 595-6777	(901) 272-7488
(215) 642-4321	(312) 297-4323	(414) 442-0160	(601) 982-1721	(713) 668-0275	(916) 489-7326
		(415) 692-0584	(602) 265-8747	(713) 668-3753	(919) 288-1695

... speed traded
for flexibility ...

grams, offered with the CSS-3 include: spectrum analysis; buffered (real time) and unbuffered fast Fourier analysis; so-called zoom-FFT (which Cohler recommends for "a fine-grain look at a small section of a frequency spectrum"); correlation, convolution, and cepstrum by Fourier transform; amplitude histogramming; signal averaging (to pull a weak signal out of random noise); and recursive digital filtering (including simulation of Butterworth, Chebyshev, Bessel-function, low-pass, high-pass, and bandpass filters).

Optional software provides for simple and Fourier-transform cross-correlation of two inputs; multi-channel input modules are required for these functions.

Trading off

Cohler says the CSS-3 isn't the fastest digital signal processor available because speed has been sacrificed for the sake of flexible programming and operation; thus, the machine performs the repetitive multiplications of fast Fourier, for example, in its own arithmetic unit rather than in the hardwired logic used by specialized processors. Still, Cohler declares, because of the speed of the small computer (a slightly modified Varian 620-I) and some software tricks, the CSS-3 is only 10 times slower than specialized machines and is still "as much as five to 10 times faster than general-purpose machines using the Cooley-Tukey algorithm."

The CSS-3 is limited to audio-frequency analysis. Its maximum sampling rate is about 50 kilohertz, and since a sampling rate of twice the highest important mode or frequency is required for Fourier analysis, the upper frequency limit is about 25 khz.

To the core. The duration of each sample is 100 nanoseconds, and signals can be sampled repetitively over infinite periods of time. The samples are converted into 10-bit words and are stored in the computer's core memory. Since a 4,096-word memory is standard in the Varian machine, and since some of this capacity must be devoted to

software, a maximum number of 2,048 samples can be stored. An 8,192-word memory is a \$7,200 option, and magnetic-tape and disk memories are available for additional storage.

The first CSS-3 is to be delivered in early May and 60-day deliveries will be quoted afterward. The price is \$44,850 for a basic, already programmed machine.

On the other hand

In contrast to the CSS-3, the ATP from Raytheon's Computer division is a high-speed hardwired system designed to perform fast Fourier functions and other tasks as an adjunct to the company's model 703 and 706 computers.

Raytheon says it's not yet ready to sell the ATP but may be able to arrange first deliveries by autumn. Nor is it clear how the ATP will be sold; Raytheon is talking about combined ATP-model 703 systems, but it also is possible that signal processors with the necessary software would be sold separately to owners of 703's and 706's. The price of a computer plus the ATP are also sketchy, but the company claims that with the peripheral processor, fast Fourier runs can be performed about 80 times faster than with an unaided 703. This would make the ATP roughly 10 times faster than the CSS-3.

The capabilities of the machine are similar to those of other such specialized processors — convolution, auto- and cross-correlation, and averaging, for instance.

Partnership. The ATP takes advantage of its computer's memory in an apparently flexible manner with a resulting increased sample capacity. Arrays of data points are stored in the memory and transferred to and from the ATP over a direct-access channel. The signal processor uses a 16-bit floating point format that conserves memory storage space.

Through software in the computer, the ATP can be set up to run simultaneously with other peripheral gear and with the computer's mainframe.

Computer Signal Processors Inc., 176 Second Ave., Waltham, Mass. 02154 [338]
Computer Division, Raytheon Co., 2700 S. Fairview St., Santa Ana, Calif. 92704 [339]

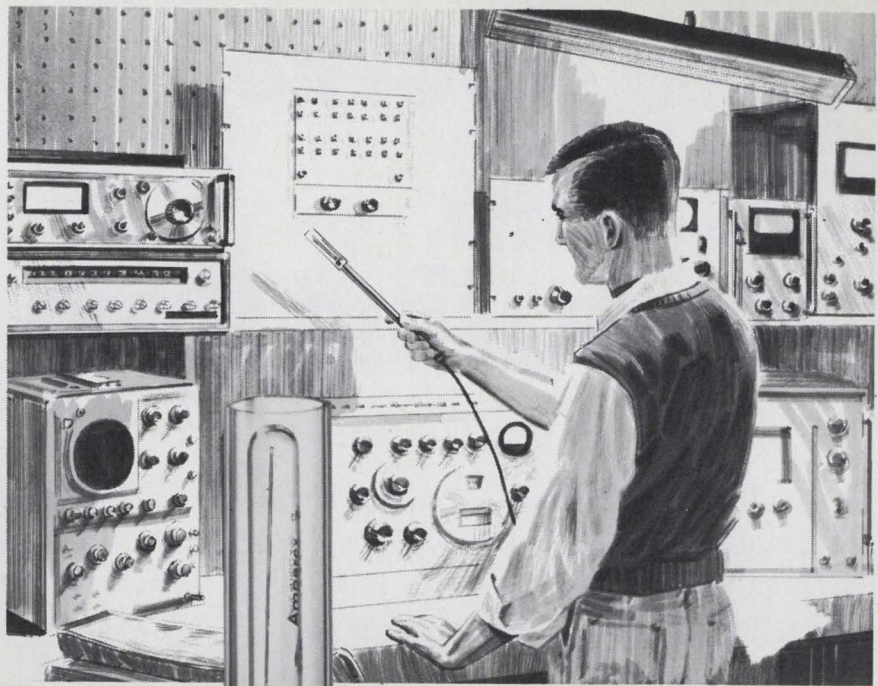

Play it

SAFE! check
microwave radiation hazards

with International's Microlite-287

This handy test light provides an instrument for safety checks in the laboratory or other areas where microwave radiation may be a hazard. The Microlite-287 was designed for testing radiation from microwave ovens at 2450 MHz. In this service it indicates fields of 10 MW/CM² or more. It may be used for testing other ranges of radiation and can be calibrated to indicate glow level. Connect to nearest 115 vac outlet and it's ready to use. Store in drawer or tool box. Unit shipped complete with instructions.

\$29.95 f.o.b. Oklahoma City

Same as above except with certified field intensity for glow ignition at 2450 MHz.....**\$45.00**

Note: Microlites may be recertified at any time by forwarding the unit to International. Price of recertification.....**\$15.00**

Manufacturers of electronic products for industry and the home. Write for catalog.



CRYSTAL MFG. CO., INC.
10 NO. LEE • OKLA. CITY, OKLA. 73102



NEW! Reeves Mini-RIG[®] Integrating Gyro

...a major breakthrough in reliability and cost reduction. Now, Reeves has developed the Mini-RIG—a subminiature, heaterless integrating gyro that lives up to its claims!

Through new production techniques Reeves has made a major advance, in both cost reduction and reliability, in the field of subminiature high-volume inertial sensors.

Mini-RIG is the first of a new generation of modular-design, fluid-filled, fully-floated gyros and accelerometers. Only one inch by two inches in size, it furnishes stability, guidance and control to missiles, aircraft and aerospace vehicles. It operates in either platform or strap-down systems.

High Performance. The heaterless Mini-RIG provides excellent control of gyro gain and damping over the whole military temperature range. Damping is compensated and transfer function controlled to a tolerance of $\pm 20\%$ from -65°F to $+200^{\circ}\text{F}$. For shorter temperature ranges, such as 0°F , to 180°F , $\pm 10\%$ tolerance is maintained.

Reliability. Reeves new balanced-line automated assembly makes it pos-

sible to perform the final assembly of a Mini-RIG unit in **less than one work day**. This reduces to the barest minimum the possibility of contamination during manufacture.

Low Cost. Reeves new manufacturing techniques have reduced the number of assembly operations and hand labor, relying on mechanical fixturing and electrical welding. Detail parts are interchangeable and the same stainless steel outer housing can be used for many versions. This means low-cost design modification for a wide range of applications.

Reeves, working by the Total Systems Concept, can package the Mini-RIG for any specialized need you may have. For important programs, we will provide Mini-RIGS on 60-day consignment. "Let them prove to you, what we claim for them"! All we ask is prompt, competent evaluation.

For complete data and application information, call or write Component Group, Reeves Instrument, Garden City, New York 11530.



Reeves[®] INSTRUMENT DIVISION
DYNAMICS CORPORATION OF AMERICA | GARDEN CITY, NEW YORK 11530 

Cone-shaped fillets hold parts for soldering

Metallic liners grip components in fixed position on printed-circuit boards without need for bending leads

The big bottleneck in assembling printed-circuit boards is the difficulty in keeping components in uniformly fixed positions up to and during the soldering operation. Companies have tried various schemes: forming the component leads before they're inserted into the printed-circuit board, or bending the leads after they are pushed through the holes. Printed-circuit

board liners to hold the leads have also been tried. While some of these schemes resulted in increased production, in general there was still considerable misalignment of the components, and quality was therefore not improved.

An additional and important drawback of the lead-bending technique is that whether the leads are formed by hand or by machine, the

components must be held securely against the p-c board and this subjects the components to maximum heat transfer during the soldering operation. Therefore, unless these components are protected by thermal spacers, they could be seriously damaged.

Of course, semiautomatic machines are available which can do the job. Such a machine will cut

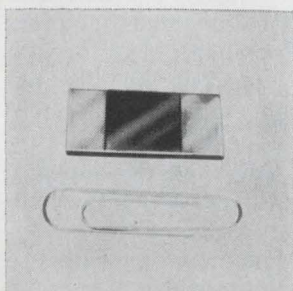

Thick film chip resistor CR05 was developed for hybrid circuit applications. Element size is 0.050 x 0.050 x 0.012 in. Resistance range is 1 ohm to 2 megohms. Temperature coefficient is -55° to 125° C, ± 200 ppm. Dissipation is 1/10 w at 125° C. Unit has a glass seal overcoat, while land areas are platinum-gold. EMC Technology Inc., 1300 Arch St., Philadelphia 19107. [341]

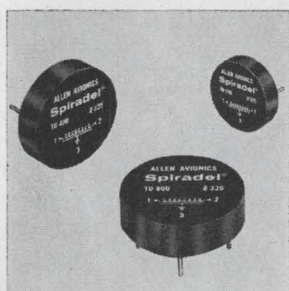

Distributed constant, fixed delay lines called Spiradel are compact and encapsulated for maximum environmental protection. Time delay to rise time ratios of over 20 to 1 can be achieved, with excellent temperature stability and pulse fidelity. Units cover a delay range of 100 to 1,000 nsec. Standard impedance is 325 ohms $\pm 10\%$. Allen Avionics Inc., E. 2nd St., Mineola, N.Y. [342]

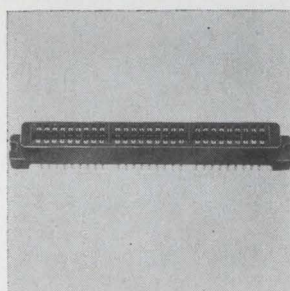

P-c connector series 600-121-27 is a 27-dual contact unit (54 terminals) with 0.100 in. center-to-center contact spacing. A choice of dip solder or solder lug terminations is available in gold plated beryllium copper. Glass reinforced diallyl phthalate molding type GDI-30 per MIL-P-19833 has 3 integral polarizing barriers. Continental Connector Corp., Woodside, N.Y. [343]

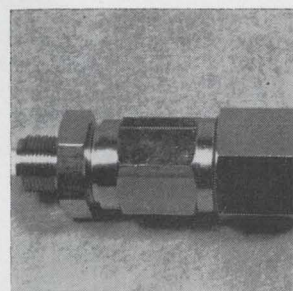

High voltage connectors series KV are less than 1 inch in diameter and will withstand 30 kv in a mated or unmated condition. They are available for various cable sizes—both flexible and semi-rigid—up through 3 inches. The connectors offer a pulse reflection coefficient of less than 1% maximum. General RF Fittings, Connector Division, Cove Road, Port Salerno, Fla. 33492. [344]

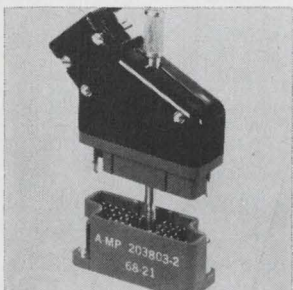

High density rectangular connector series HDR in 54-contact size features crimp-and-insert contacts on a 100-in. square grid pattern. Size 20 contacts are rated at 7.5 amps and come in two wire range sizes, 20-24 and 24-30 Awg. Contact plating is gold over nickel, selective gold, or tin. Housings are black phenolic or blue diallyl phthalate. AMP Inc., Harrisburg, Pa. [345]

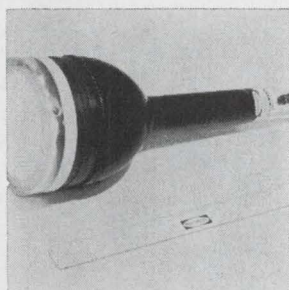

Cathode-ray projection tube CK1459P- is for video presentations on screens up to 10 to 20 sq ft in size. Television, radar, or computer-generated electronic information can be displayed. It uses a special face panel with high thermal conductivity to obtain a marked increase in light output, resolution, and tube life. Raytheon Co., 465 Centre St., Quincy, Mass. 02169. [346]

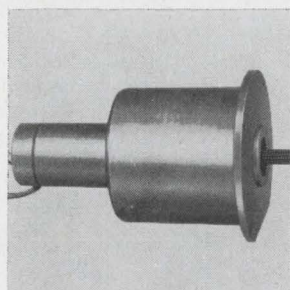

Servomotor tachometer size 23 is for use in power servo actuators. The 8-pole motor has a stall torque of 16 oz. in., and a free speed of 5,000 rpm. The tachometer produces an output of 2 v $\pm 1\%$ per 1,000 rpm, has a phase shift of $0^{\circ} \pm 1^{\circ}$, and linearity of $\pm 7\%$, and requires 5w of power. Operating temperature is -55° to $+132^{\circ}$ C. Weston-Transicoil, Worcester, Pa. [347]



Compact reed relay GB811, in a 14-pin dual-in-line package, is completely compatible with IC logic components and p-c board pin spacing. Input is 5 v d-c for direct transistor logic drive, with the package containing both a reed relay and a diode to suppress back emf. Unit has a contact rating of 3 w. Grigsby-Barton Inc., 107 N. Hickory, Arlington Heights, Ill. 60004. [348]

This 10 amp relay meets the AC grounded case requirement.

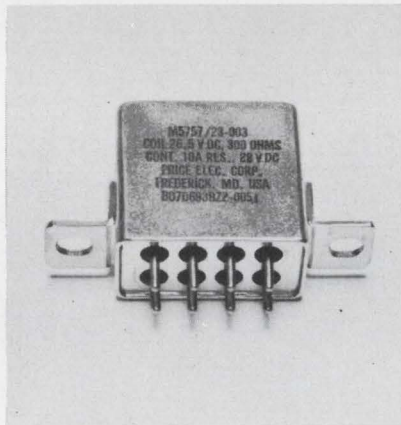

The Conelco Style 7 DPDT 10 amp relay meets the following specifications: MS 27245, MS 27247, MIL-R5757/23.

You can't get a better 10 amp relay for your money than the Conelco Style 7. It was developed specifically for the aerospace industry.

So it's durable and dependable. For 3-phase AC requirements, an arc chamber is used to assure trouble free operation to 100,000 times, minimum. And all welded construction makes it absolutely reliable for the most stringent avionic applications. Independent tests have proven that the Style 7 Relay stands up against the effects of altitude, vibration and temperature extremes.

We've got a Style 7 Relay designed specifically for your needs. Send for our exclusive Select and Specify Chart.

FEATURES:

All welded construction for positive contamination control.
20% smaller than similar relays.
Arc chamber: -10 amp AC rating 115 volts single and three phase with case grounded.

CHARACTERISTICS:

DPDT 10AMP 28VDC/115VAC res.
Coil: 565 MW typical: 26.5VDC 300 ohms
Ambient temp: -65 to +125 C
Vibr: 20G up to 2000 Hz
Shock: 50G 11msec
Mil-Spec: MS 27245 MS 27247 MIL-R 5757/23

PRICE ELECTRIC COMPANY

A Division of North American Philips Corporation
relays and electromechanical devices / Conelco switching devices
Frederick, Maryland 21701 / (301) 662-5141 / TWX (710) 826-0901

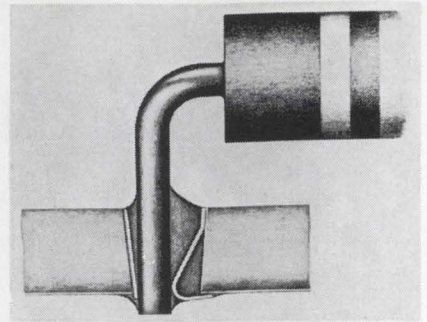

Gripping. Component lead is firmly held by springlike tension on fillet.

the leads of the tape-fed components to the desired length, form them, and install them in the printed-circuit boards at rates of up to 1,600 insertions per hour per operator. While this method markedly increases production and quality, the cost of the required automated equipment is rather high and can only be justified where large production operations are involved.

Popularity. Many manufacturers prefer to solve the problem through the use of a metallic liner to hold the components while they're being soldered. And AMP, a Harrisburg, Pa., based firm, has developed a conical shaped fillet which the company says offers all of the advantages of liners now in wide use throughout the industry.

The fillet requires only that 0.055-inch diameter holes be drilled or punched out of the circuit board. In addition, it permits center-to-center hole spacing as close as 0.110 inch nominal on the printed-circuit board. The fillet also firmly grips the component leads in standard 1/16-inch thick printed-circuit board until all the components can be assembled, at which time soldering takes place.

Less heat. The firm grip of the fillets eliminates the need to bend or form the leads either before or after they are inserted in the board. This provides the added bonus of minimizing heat transfer during soldering, since heat sensitive components can be positioned above the board. In addition the fillets ease components replacement during servicing without damaging the board.

The fillets are installed by a machine that puts either 356 fillets into a 10.8-by-12.25-inch printed circuit board or 500 fillets into a 7.8-by-11.8-inch board in less

than one minute.

The bench-mounted machine inserts the fillets by the vibration and multiple punch technique which substantially increases production volume.

AMP Inc., Harrisburg, Pa. 17105 [349]

New components

Switch has lever action

Flip of the finger puts operating wheel through 10 detent positions

Lever-action design permits fingertip control of a new switch, called Leverwheel by the manufacturer, the Cherry Electrical Products Corp. Unlike a conventional 10-position thumbwheel device in which the operating wheel requires a full 360° rotation to complete the cycle, a Leverwheel unit needs only a 60° movement. By flipping the lever its full 60° arc, an operator effectively turns the operating wheel carrying the lettering 160°, or through 10 detent positions.

Quick reset. The new switch can be reset quickly. "Instantly" is the way the company puts it: "With a single sweep of the hand, a bank of six or seven of these units can all be automatically reset." It really isn't quite that simple. A single downward movement returns all the levers to the full down position, or zero setting. It's from this point that resetting can be quickly achieved.

Some manufacturers of thumbwheel switches offer a solenoid-operated reset feature as an option, an expensive one. Cherry's Leverwheel eliminates the need for such an option.

When going from, say, four to nine, the conventional thumbwheel switch operation requires the slow plunking or thumbing through five-six-seven-eight before reaching nine. And unless the operator is careful, he can go beyond.

Beats thumbing. With the lever action, the operator can go either

Soliton RF Power

Covers the Spectrum!

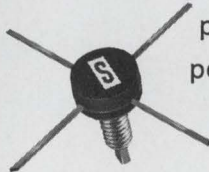
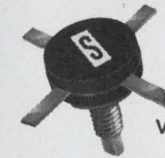

Soliton's wide range of RF power transistors can provide the right devices for your required applications. These transistors cover a useful frequency range from 40 to 1000 MHz and output power levels of 1 to 30 Watts. All popular package types are available.

Take your pick from Soliton's power frequency spectrum and contact us today.

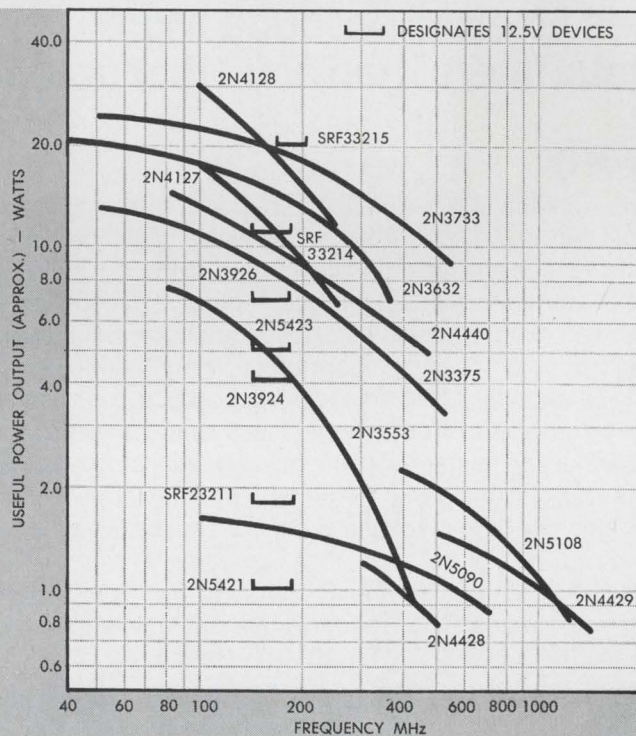
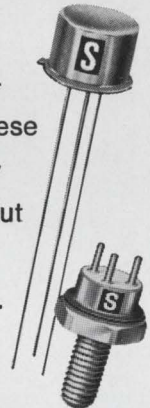

Dial 1-800-327-3243 for a "No Charge" telephone call and further information

Soliton

DEVICES, INC.

1177 BLUE HERON BLVD. / RIVIERA BEACH, FLA / TWX: (510) 952-6676

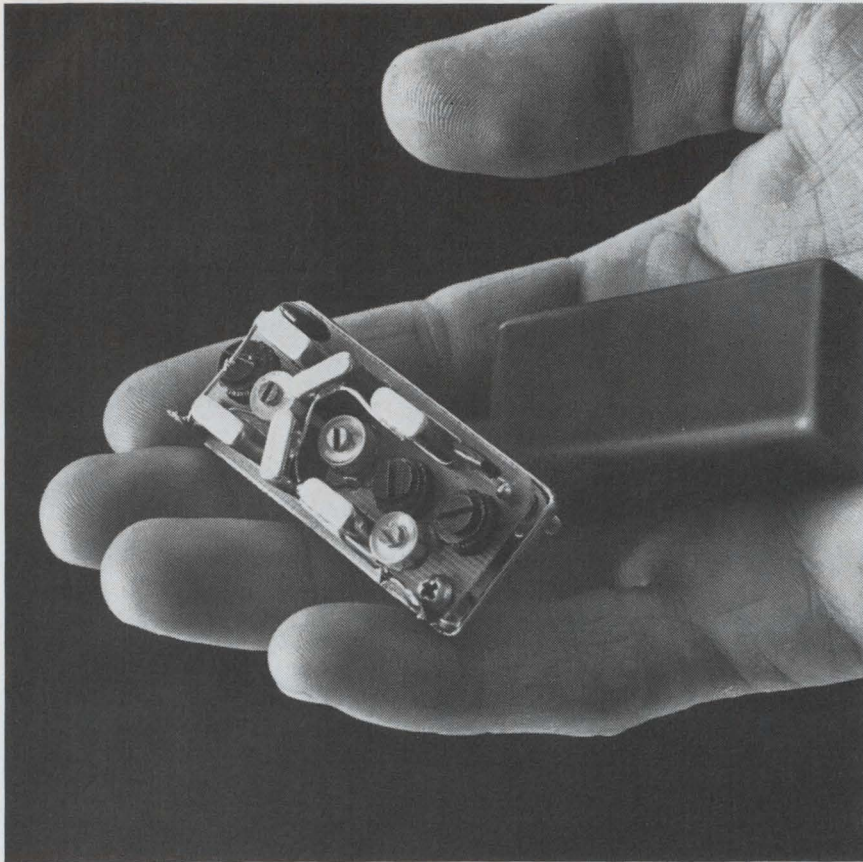

Does Sherold produce more crystal filters than any other source?

Clearly.

In fact, we're the largest single independent source for both crystal filters and discriminators. And we've built more PRC and VRC filters than any other company. Plus, we've got the widest range of models in production. But . . . biggest doesn't necessarily mean best, although it's a good indication. Sound out our crystal technology capabilities and you'll find Sherold has a solid reputation for being able to produce top-quality frequency selection devices in the full range from 1 to 150 megahertz. For commercial and military applications. The real proof, though, is to let Sherold tackle your frequency selection application. Send us the electrical and mechanical characteristics of your problem and we'll put our Filter Technology Department to work on it. Quickly. Write Sherold Crystal Products Group, Tyco Laboratories, Inc., 1510 McGee Trafficway, Kansas City, Missouri 64108. Or phone (816) 842-9792. TWX 910-771-2181.

tyco

full up to one for full down to zero and start from this point. Either way, the lever action is faster than thumbing the way through.

Cherry offers the Leverwheel switches in two sizes: the L11 miniature series available in both front and back mounting, and the L20 subminiature series in back mounting only.

The printed-circuit boards are mounted in the rear and on the side opposite the lever. The housing is molded from a polycarbonate material for impact strength and can be plated to minimize radio interference.

Standard codes available in both the miniature and subminiature series include 10-position decimal, binary coded decimal, bcd complement, bcd plus even parity, octal, and bcd plus odd parity.

With the 10-position decimal code, for example, a five in the read-out window indicates that the common input terminal is connected to the No. 5 output terminal.

The switch has an operating force of from seven to 10 ounces,

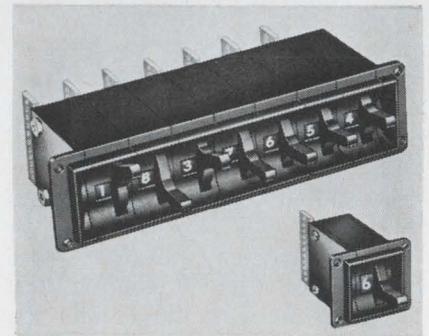

Leverage. The switch, used singly or in a bank, can be quickly reset by a flip of the finger.

contact resistance of 0.1 ohm max., insulation resistance of 1,000 megohms, dielectric strength of 1,000 volts a-c, vibration 15G, and shock 50G. Maximum electrical rating is 200 volts a-c or d-c, 0.5 amp (12 watts) per output circuit, and 1 amp (12 watts) total of output circuits.

In 10-position decimal codes and in lots of 50, the switch will be priced at \$7.80, in lots of 100 at \$7.60, and in lots of 1,000 at \$6.45. Price continues to decrease in larger quantities.

Cherry Electrical Products Corp., Highland Park, Ill. [350]

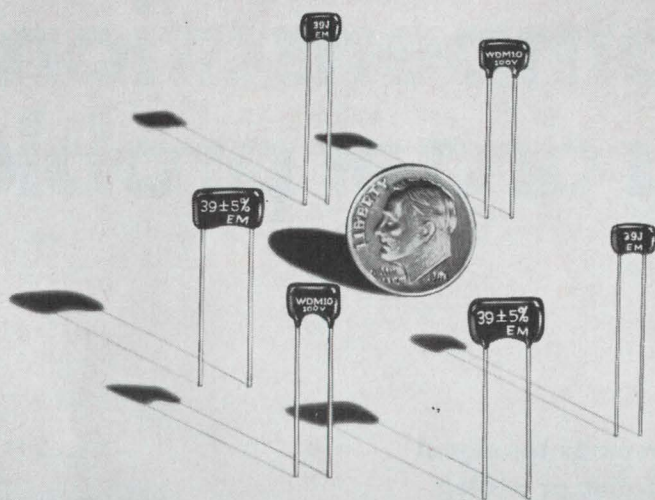

They're Small and Reliable*

EL-MENCO DM5 — DM10 — DM15 — ONE COAT DIPPED MICA CAPACITORS

STYLE	WORKING VOLTAGE	CHARACTERISTIC	CAPACITANCE RANGE
DM5	50VDC	C	1pF thru 400pF
		D, E	27pF thru 400pF
		F	85pF thru 400pF
DM5	100VDC	C	1pF thru 200pF
		D, E	27pF thru 200pF
		F	85pF thru 200pF
DM10	100VDC	C	1pF thru 400pF
		D, E	27pF thru 400pF
		F	85pF thru 400pF
DM15	100VDC	C	1pF thru 1500pF
		D, E	27pF thru 1500pF
		F	85pF thru 1500pF
DM5	300VDC	C	1pF thru 120pF
		D, E	27pF thru 120pF
		F	85pF thru 120pF
DM10	300VDC	C	1pF thru 300pF
		D, E	27pF thru 300pF
		F	85pF thru 300pF
DM15	300VDC	C	1pF thru 1200pF
		D, E	27pF thru 1200pF
		F	85pF thru 1200pF
DM10	500VDC	C	1pF thru 250pF
		D, E	27pF thru 250pF
		F	85pF thru 250pF
DM15	500VDC	C	1pF thru 750pF
		D, E	27pF thru 750pF
		F	85pF thru 750pF

Where space and performance are critical, more and more manufacturers are finding that El-Menco miniaturized dipped mica capacitors are the reliable solution. The single coat is available in three sizes: 1-CRH, 1-CRT and 1-CE.

The 1-CRH DM "space savers" easily meet all the requirements of MIL and EIA specifications, including moisture resistance. The 1-CE and 1-CRT units also meet the requirements of MIL and EIA specifications, except that they have less moisture protection because of their thinner coating; these capacitors, therefore, are ideally suited where potting will be used. Note: DM10 and DM15 units are still available in the standard 4-CR size.

Specify "El-Menco" and be sure . . . the capacitors with proven reliability. Send for complete data and information.

*Normally, El-Menco 39 pF capacitors will yield a failure rate of less than 0.001% per thousand hours at a 90% confidence level when operated with rated voltage and at a temperature of 85°C. Rating for specific applications depends on style, capacitance value, and operating conditions.

THE ELECTRO MOTIVE MFG. CO., INC.

WILLIMANTIC, CONNECTICUT 06226

Dipped Mica • Molded Mica • Silvered Mica Films • Mica Trimmers & Padders
Mylar-Paper Dipped • Paper Dipped • Mylar Dipped • Tubular Paper

West Coast Manufacturers contact: **COLLINS & HYDE CO.**, 900 N. San Antonio Rd., Los Altos, California 94022
5380 Whittier Blvd., Los Angeles, California 90022

ALSO SOLD NATIONALLY THROUGH ELECTRONIC PARTS DISTRIBUTORS

Preamp temperature compensation isn't a circuit problem.

If you've been using preamps for signal conditioning, instrumentation or analog computation, you've been paying for circuit solutions to temperature stability problems. Paying in dollars and paying in space, weight and design time. The new Fairchild $\mu A727$ Temperature-Controlled Differential Preamp solves the problem on the chip. No more FETs, choppers or ovens. Offset voltage drift is $0.6\mu V/^{\circ}C$, offset current drift is $2pA/^{\circ}C$, while long term drift is $5\mu V$ per week. All specifications apply over the full military, temperature range from $-55^{\circ}C$ to $+125^{\circ}C$.

Our Second Generation Linear technology gives you this premium performance with no premium on the price. The $\mu A727$ has a built-in temperature regulating circuit that ensures accurate operation whatever your needs. Besides the low drifts, it has an input impedance of $300M\Omega$,

a common mode rejection ratio of 100 dB and a low frequency noise output of only $3\mu V$ rms. Here are three ways to use it. Our data sheets and application notes list a few more.

To order the $\mu A723$, ask your Fairchild distributor for:

PRECISION COMPARATOR

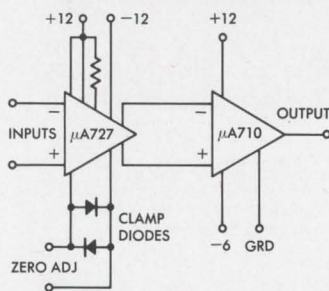

Input Resistance: $300M\Omega$
 Differential Input Voltage: $\pm 10V$
 Input Voltage Range: $\pm 8V$

LONG PERIOD INTEGRATOR

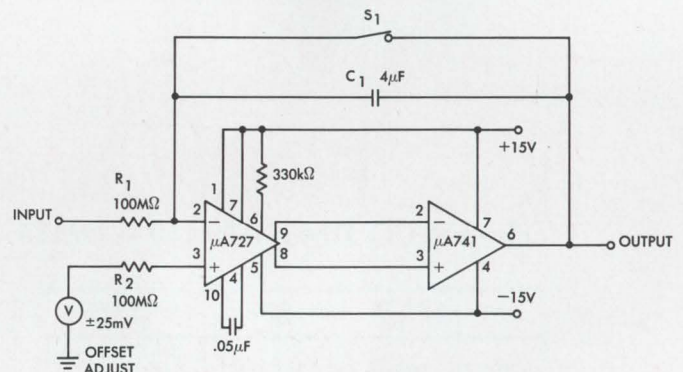

Error accumulation rate: 0.05% / minute

TRANSDUCER AMPLIFIER

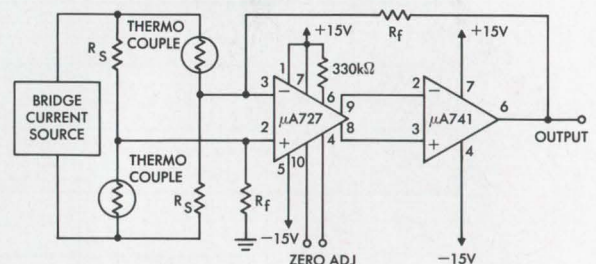

Accuracy: 0.01%
 Input impedance: $300M\Omega$
 Open-loop gain: 140dB

PART NUMBER	PACKAGE	TEMPERATURE RANGE	PRICES		
			1-24	25-99	100-999
U5J7727312	TO-5	$-55^{\circ}C$ to $+125^{\circ}C$	\$50.00	\$40.00	\$34.00
U5J7727333	TO-5	$-20^{\circ}C$ to $+85^{\circ}C$	22.50	18.00	15.00

FAIRCHILD
SEMICONDUCTOR

160-kilobit core memory has low profile

Storage unit plus piggyback power supply fits into 5¼-inch-rack space; three-wire, three-dimensional organization helps trim costs

Most core memories with storage capacities up to 4,096 words by 40 bits and submicrosecond full-cycle times require a power supply that's as high as the memory itself—5¼ inches—and stacks atop the memory. Not so with Varian Data Machines' Versastore IV, to be introduced at the Spring Joint Computer Conference in Boston May 14-16. A "piggyback" power supply

mounts on the rear of the cabinet, making the entire unit fit a standard rack space that's 19 inches wide, 5¼ inches high, and 24 inches deep. Andy Lucero, project engineer for the Versastore IV, says he knows of no other memory with comparable capacity and speed that doesn't double the height when a power supply is added.

The unit has a full-cycle time

(read-restore) of 900 nanoseconds, a 600-nsec half-cycle time and a 35-nsec access time. It can do a read-modify-write operation in 1 nsec. The previous best in the Varian line, the Versastore III, had a 1- μ sec full-cycle time, not including time to modify the data.

While Varian officials will say only that the price will be "compatible" with that of the Versastore

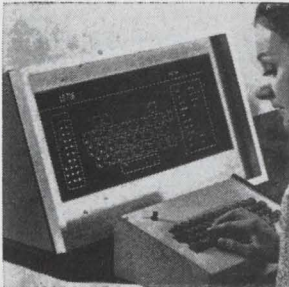

Data entry console LC-728 features a standard IBM 029 key-punch configuration on a movable keyboard. It functions as a general purpose terminal to provide two-way communications with a computer. It is designed as part of the LC-720 data entry system which permits data to be entered on magnetic disk or tape from several terminals. Logic Corp., Euclid Ave., Haddonfield, N.J. [421]

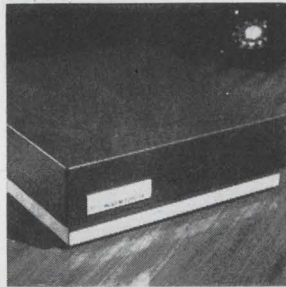

Data set called Modem 2200/24 transmits 2400 bps data over either dial-up or dedicated leased telephone lines. It is compatible with most existing four-phase units such as the Western Electric 201B. It includes circuit techniques formerly exclusive to the company's eight-phase data sets. Price is \$2,350. International Communications Corp., 7620 N.W. 36th Ave., Miami, Fla. [422]

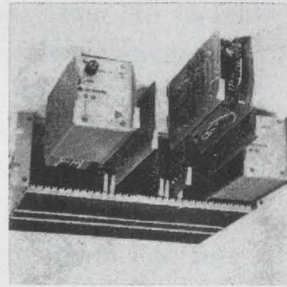

Catalog-standard core memory system FI-3 has a capacity of 4096 words by 20 bits per word. It offers a 3- μ sec full cycle time (2- μ sec half-cycle time) and access time of 1 μ sec maximum. The system utilizes integrated DTL circuits and silicon semiconductors mounted on p-c cards. Price is \$4,300; availability, less than 60 days. Ferroxcube Corp., Box 359, Saugerties, N.Y. [423]

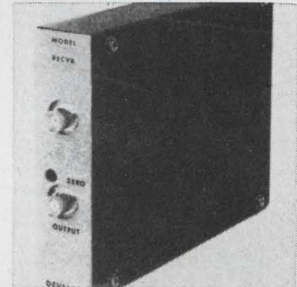

Light-coupled data amplifiers models 6110 and 6120 employ fiber optics to transmit data via a light pipe. Major system features include: common mode rejection greater than 100 db at 50 Mhz; frequency response d-c to 50 Mhz direct, or 20 to 80 khz f-m; 500,000 v common mode voltage isolation available. Develco Inc., 2433 Leghorn St., Mountain View, Calif. [424]

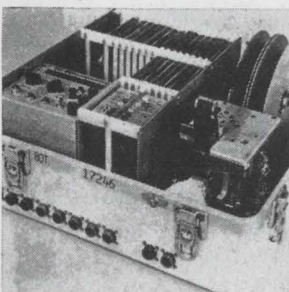

Portable data logger model 801 is designed for completely automatic operation in plant or outdoors. At preset time intervals, it samples 10 independent voltage channels over the range -9.99 to +9.99 v, displaying data on a decimal readout and simultaneously recording them in standard code on punched tape. Towner Systems Co., 1829 Clement Ave., Alameda, Calif. [425]

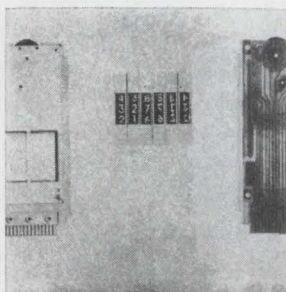

Commutator count modules are single digit pulse advance units for printing or reading. They also signal the position to which stepped by a rotated brush location against a commutator board. The printing or indicating wheel can be instructed to stop at any desired position when continually pulsed. Code is either 1 out of 10 or 12. Practical Automation Inc., Shelton, Conn. [426]

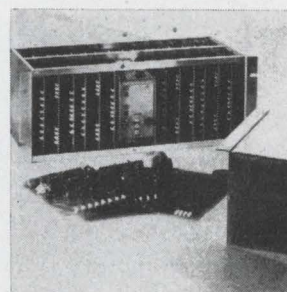

Data set FM-18 is available for dial-up data communications networks. It is a low speed frequency shift keyed modem intended to link peripheral units such as crt displays or card and tape terminals to a central processor. It will operate at any speed up to 1800 bps, when used as an asynchronous modem. Rixon Electronics Inc., 2120 Industrial Parkway, Silver Springs, Md. [427]



Word generator 3903 combines push-button controls, optional plug-in repeat controls and data generators. Up to 9 plug-ins, each providing a serial word of data from 1 to 16 bits, and up to 4 repeat controls are available. With 4 repeat controls, the 3903 can deliver up to 16,320 bits. Price of the basic 3903 is \$2,150. Lear Siegler Inc., Morena Blvd., San Diego, Calif. [428]

Micro-Sensitive Relays

Solid State Sensitivity . . . Load Isolation

- ON-OFF and Latching Models
- Operate Levels as Low as 1 μ A
- Silicon Solid State
- Reed or Relay Contacts
- Negligible OFF-Mode Drain



Models 16, 17, S16, S17

With sensitivity that far exceeds that of the most sensitive electromechanical relays, Sensitak® Models 16 through 21 combine the best features of solid state and conventional relays. Their isolated load contacts operate on

signals as low as 0.7 volts dc and/or 1 microampere. Highly stable and with negligible off-mode drain, they are available in ON-OFF and latching types. Each encapsulated module combines a silicon solid state amplifier with either dry reed or electromechanical load relays for complete input-to-output isolation.

Use these new generation relays in alarm circuits, for fault detection, frequency selection, memory and multiple-gate logic, pulse stretching, time delay, and in many other applications. For typical application circuits and detailed specifications, send reader service card to request Data Bulletin B/10616.

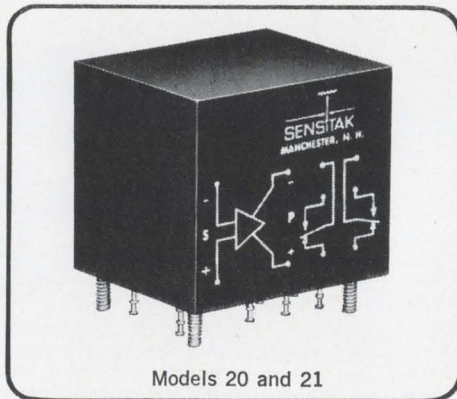

Models 20 and 21

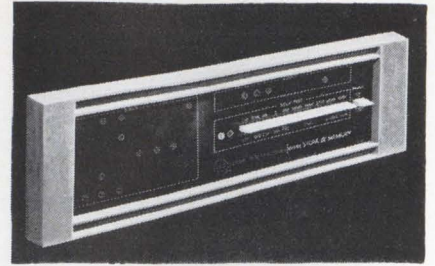

Compact. Core memory fits in standard rack space. The front panel includes self-test switches and indicators.

III, they indicate that the slight speed improvement and greater capacity (4,096 words-by 36 bits for the Versastore III) have been offset in price by adoption of a three-wire, three-dimensional organization instead of the four-wire, 3-D configuration of earlier units. Use of only three wires cuts threading costs through the 20-mil-diameter cores.

New features. Lucero says that in the past, in order to change a unit from 4,096 words by 40 bits to 8,192 words by 20 bits, data partitioning was required that assigned the first 20 bits to the first 4,096 words and the remaining 20 bits to the second 4,096 words, and this could be done only in the half-cycle mode. The Versastore IV can be partitioned into 8,192 words by 20 bits full- or half-cycle, he points out. "We also offer partitioning down to eight-bit increments," Lucero notes, "so that the customer can get 16,000 words by eight bits or he can buy 4,000 words by 32 bits and partition down in eight-bit increments." This eight-bit increment capability is available in full cycle only.

Two other features that distinguish the Versastore IV are an "extendable" front panel and a customer option to buy memory cards only—without the cabinet or power supply. The front panel has all data, address, and self-test indicators, plus self-test switches. Its ability to be extended means that if a customer has a number of memories in cabinets, he need buy only one fully instrumented front panel and can pull it off to test any of his memories without disturbing the performance of the unit from which it was removed.

While most core memory suppliers offer a "cards-only" option, the cards are made to order for the



SENSITAK INSTRUMENT CORP.

A WHOLLY-OWNED STRUTHERS-DUNN SUBSIDIARY
531 Front Street, Manchester, N.H. 03102

Telephone: 603-669-5922

The Great Panel Discussion over Honeywell's new VT-100 digital meter...

... a discussion that's making the VT-100 one of the most talked-about panel meters around!

The VT-100 3½-digit panel meter calls a halt to the expensive problem of service and stocking different meters for different functions. And this deserves discussion.

Now, you need only the low-cost VT-100 with its plug-in card feature. Change its range and function to any one of 20 different configurations — AC and DC volts, AC and DC current and resistance parameters with three-five ranges each — by simply changing the input card. Or, use your own input card for scale factoring, readout in engineering units, etc. Spare plug-in cards provide immediate, on-the-spot repair.

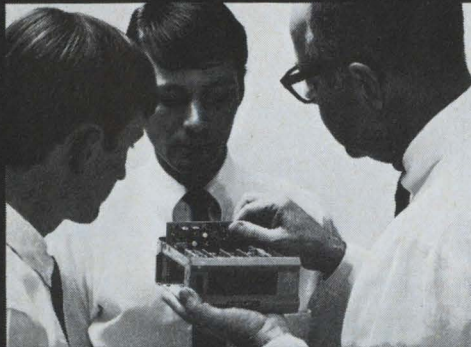

You get quick, accurate, full-scale calibration and automatic zero. It also provides 100% over-range with an overrange digit reading to 1999 (4000 count option to 3999), BCD outputs, remote encoding, print command and an accuracy of .2% of reading ± 1 digit.

Innovative? Yes. Practical? Definitely. At only \$245. (quan. of 1-24 units)

Order your VT-100's today! Call Don Anderson (collect) at (303) 771-4700.

Or write for more information to Mail Station 222, Honeywell, Test Instruments Division, P. O. Box 5227, Denver, Colorado 80217.

Honeywell

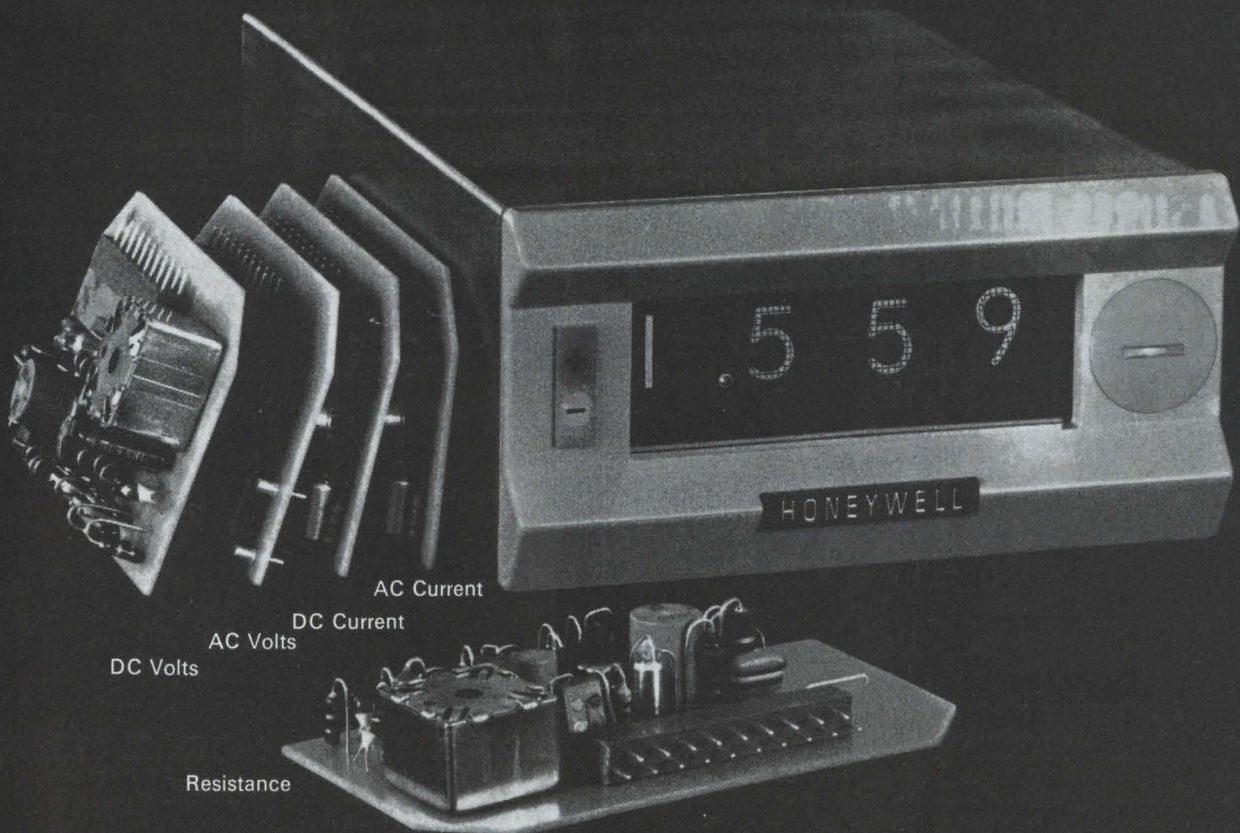

Honeywell engineers sell solutions

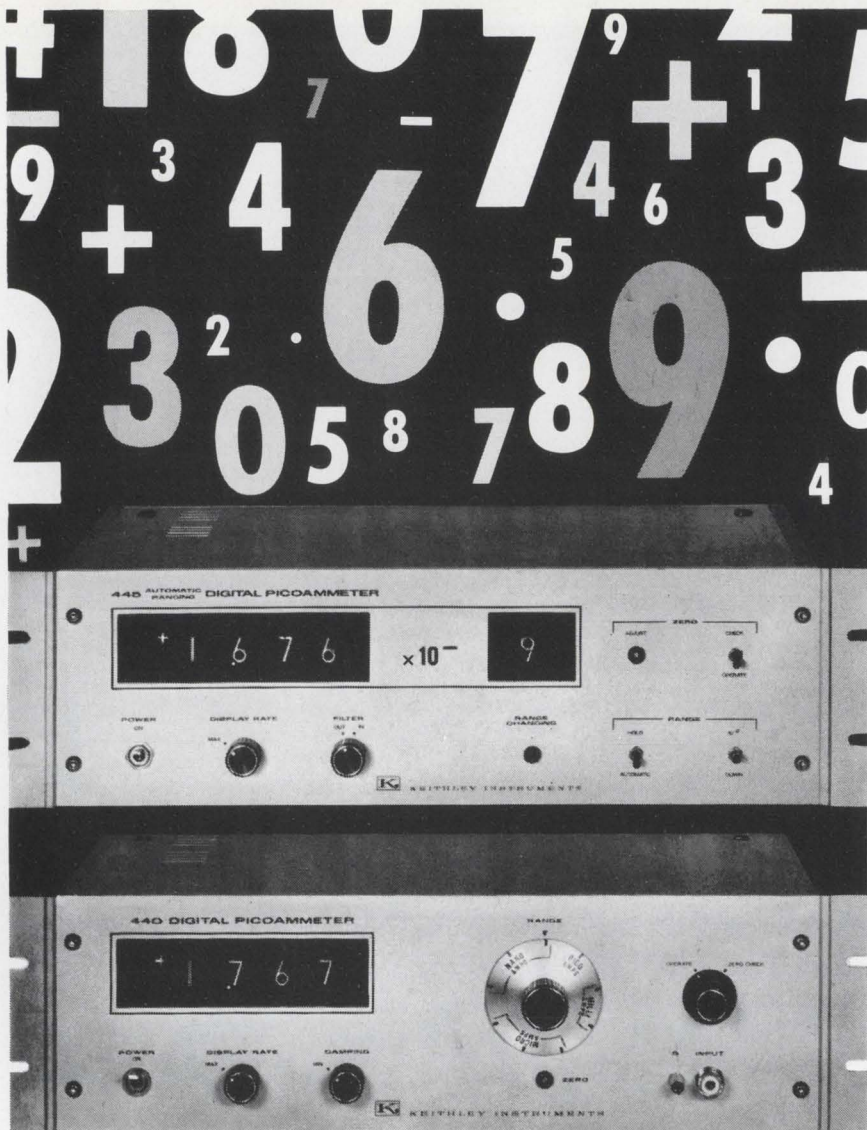

MEASURES MILLIAMPERES TO PICOAMPERES AND NARROWS THE GAP BETWEEN PRICE AND PERFORMANCE

See the first digital picoammeter above? It's our new \$1495 autoranging Model 445. It simplifies measurements from 10^{-2} ampere f.s. to 10^{-9} ampere and provides both analog and BCD outputs. The second is the Model 440, new too. At \$995, it features 10^{-2} to 10^{-10} ampere f.s. current ranges, has an analog output and an option for BCD.

Both picoammeters are packed with convenience features designed to minimize operator error and maximize performance. Stable to 0.5% of full scale per week, they make low level measurements accurate to 0.2% almost routine. And provide variable display rate to 24 readings per second. But isn't that what you'd expect from a firm with years of analog picoammeter design experience? And an industry-wide reputation for quality? Like Keithley.

See if you don't agree we have the best digital approach to picoampere level measurements. Call your Keithley Sales Engineer for demonstration and details. Or contact Keithley Instruments, Inc., 28775 Aurora Rd., Cleveland, Ohio 44139. In Europe: 14 Ave. Villardin, 1009 Pully, Suisse. Prices slightly higher outside the U. S. A. and Canada.



KEITHLEY

customer; Varian will supply the same units in card or packaged form, and will supply either a wired motherboard or the required wiring list for the customer to do his own interconnections with the cards-only version.

The Versastore IV will be compatible with standard diode-transistor logic voltage levels on the output and will be designed for DTL or TTL input levels. It will operate from 0 to 50°C and will have three address possibilities: random-access register (standard), random sequential access, or sequential interlace access. The last two are options. Input power required is 800 watts maximum. The memory will be available in production quantities by the end of this summer.

Varian Data Machines, 2722 Michelson Dr., Irvine, Calif. 92664 [429]

Data handling

Terminal prints fast, quietly

Data communications
machine is designed
for 'front office'

High speed and low noise—those are the principal design features of a data-communications terminal developed by the General Electric Company.

The TermiNet 300 will be marketed for computer time-sharing systems and for terminal-to-terminal communications.

Through use of a special printing technique, speeds of 10, 15 or 30 characters per second can be achieved. These rates are controlled by a switch on the front of the terminal. Type characters are rotated horizontally in front of a bank of hammers. Two sets of 94 type characters are included to allow upper and lower case printing. The hammers are activated, and they in turn drive the desired character against the paper through the ink ribbon. Left-to-right printing is thus employed without the need



Dissecting the critical moment

There are many applications far too fast for conventional data acquisition systems. Studying impact and shock tests where masses of data come in a single burst; characterizing transient response of servo systems; or analyzing complex signals in vibrations and acoustics.

For these high-speed measurement applications, Hewlett-Packard gives you sampling rates up to 100 kHz and aperture times down to 50 nanoseconds. Plus the

ability to record, process and display the data... and perform closed-loop control. HP has all the system modules you need. Fully-specified analog front ends—digital computers—peripherals for printout, storage, display, interface and control.

Ask your HP field engineer for our brochure, "Computer Systems for Data Acquisition and Control." Or write Hewlett-Packard, Palo Alto, California 94304; Europe: 1217 Meyrin-Geneva, Switzerland.

HEWLETT  PACKARD

DATA ACQUISITION SYSTEMS

06829

Why Make A Big Thing Of It?

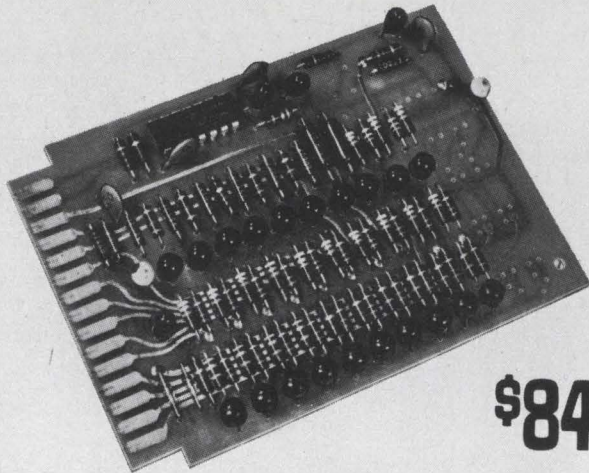

\$84.40*

This 10-Bit D/A Converter is Small. And Small-Priced.

It also features very small power consumption. And small output impedance. You probably could build it yourself. But why bother, when Computer Products can make it better, smaller, faster, and at less cost to you?

This is one of Computer Products' new DA025 series — 18 variations of D/A converter units with 8, 10 or 12-bit resolution, packaged on printed circuit cards measuring only 2.75 x 4 inches. Six analog output ranges to ± 10.24 V into 1K ohm load (10.24 MA); output can drive up to 300 feet of twisted pair cable.

Up to 16 converters and all necessary DC power supplies can be packaged in a standard 19-inch chassis, requiring only 3.5 inches vertical rack space.

LOW PRICES

QUANTITY	1-3	4-9	10-29	30-99	100-up
DA225A thru F (8 bits binary)	\$89.40	\$79.60	\$70.40	\$66.30	\$63.20
DA025 Series DA425A thru F (10 bits binary)	\$103.90	\$93.60	*\$84.40	\$79.30	\$75.20
DA625A thru F (12 bits binary)	\$117.90	\$107.60	\$98.40	\$93.30	\$89.20

Write or call for complete information and specifications. We'll also be glad to send you full details on our DA231 Series of 8-bit D/A converters with internal storage. Ask for bulletins PL005-025 and PL005-231A. Shipment 3 weeks ARO.

Computer Products, Inc., 2801 E. Oakland Park Blvd.
Fort Lauderdale, Fla. 33306 • Phone: 305/565-9565



**COMPUTER
PRODUCTS™**

FORT LAUDERDALE



Table model. Data terminal is typewriter-size and portable.

for a moving carriage.

Through extensive use of electronic circuitry, the number of mechanical parts and functions is reduced to a minimum, thus making the terminal relatively quiet. GE designers stressed this approach so that the machine could be used in an office environment and not be relegated to a special room because of noise.

The terminal is also designed to fit into front-office decor. It is self-contained, with all the electronics necessary for receiving and transmitting in a unit that is about the size of an office typewriter.

An integrated-circuit logic module, mounted inside the terminal for quick access and service, is designed to make the terminal functions and options modular.

Light touch. The keyboard of the TermiNet 300 uses magnetic coupling to generate codes, and special circuitry permits rapid operation while making the keyboard light to the touch.

The terminal can be connected to telephone lines by using GE or Bell System data sets. Optional features include a photoelectric tape reader that can read at 10, 15, or 30 characters per second and can send data at 120 cps. A paper tape punch is available, and it also operates at 10, 15, or 30 characters per second. The punch, solenoid-driven to reduce noise and wear, is located in a sound-suppressing cabinet. A horizontal-tabulation option gives the user additional flexibility in formatting his output data. From a remote location or from the local keyboard, the user can set tabs at every print position on the print line. Moving from one tab position to another takes less than one character time.

GE Specialty Control Dept., Waynesboro, Va. [430]

You don't need a degree to test op amps.



Signetics' new Model 1410 is the most comprehensive, definitive, easy-to-use op amp tester on the market. And we can prove it.

Rather than shout about its many features, let us just tell you how it works and what it does:

First, you simply insert a program board (manufacturer's spec or your own) for the op amp to be tested. Plug in the device. All operations are now performed by pushing illuminated test buttons. Push the top left button and the lights immediately indicate what tests will be performed. Next, push the "Test" button. If all tests are passed all button lights go out and the "PASS" indicator lights up. If any test is failed, the button corresponding to that test stays lit and the fail light comes on.

Now, if you want to know to what degree a given parameter passed or failed its test, just push the button corresponding to that specific test. The

answer is read out immediately as a percentage of the specified test limit.

We call this real "decision language."

There are fourteen tests: power consumption overrange (greater than 200%), power consumption (less than 200%), offset voltage (source resistance zero ohms), offset voltage (source resistance programmed), + supply sensitivity, - supply sensitivity, common mode rejection, bias current, offset current, gain (programmed light load), gain (programmed heavy load), noise and oscillation. And for the first time there are tests you won't find on testers selling for ten times our price: + *slew rate*, - *slew rate*.

The Model 1410 has no knobs to turn or meters to interpret. Your secretary could learn to use it in about one minute. Optional input/output boards allow you print-out or data log complete

parameter measurement.

And there's more. But suffice it to say for now that we believe the 1410 represents a major breakthrough in linear testing. Many who have wanted to test op amps can now afford to do so because the 1410 makes op amp testing practical and cost-efficient.

We know that there are some prospects out there who could profit by paying eighty or ninety thousand for this tester.

We're happy to say that the price will not be more than a tenth of that. Plus tax.

SIGNETICS CORPORATION
MEASUREMENT/DATA
A subsidiary of Corning Glass Works

For detailed information or a demonstration write Signetics, Measurement/Data, 811 E. Arques Ave., Sunnyvale, Calif. 94086, or contact one of the following:

AUTHORIZED SIGNETICS REPRESENTATIVES (Measurement/Data) □ Alabama and Tennessee Col-Ins.-Co., Inc., Huntsville (205) 539-1771 □ California L and M Engineering, Inc., Inglewood (213) 678-5409; Santa Clara (408) 243-6661 □ Connecticut Datech Associates, Inc., New Haven (203) 624-7291 □ District of Columbia (see Silver Spring, Maryland) □ Florida Col-Ins.-Co., Inc., Orlando (305) 423-7615 □ Georgia Col-Ins.-Co., Inc., Marietta (404) 422-8327 □ Illinois Carter Electronics, Inc., Chicago (312) 776-1601 □ Indiana Carter Electronics, Inc., Indianapolis (317) 293-0696 □ Maryland OED Electronics, Inc., Silver Spring (301) 588-8134 □ Massachusetts Datech Associates, Inc., Newtonville (617) 969-9710 □ Minnesota Carter Electronics, Inc., Minneapolis (612) 869-3261 □ Mississippi/Louisiana Col-Ins.-Co., Inc., St. Louis (504) 833-1116 □ New Jersey OED Electronics, Inc., Camden (215) 925-8711 □ New York OED Electronics, Inc., Mt. Vernon (914) 664-0080 □ J. A. Reegan Co., Inc., Albany (518) 489-4777; Binghamton (607) 723-9661; Newburgh (914) 561-4510; Syracuse (315) 471-7274; Utica (315) 732-3775; Rochester (716) 473-2115 □ North Carolina Col-Ins.-Co., Inc., Winston-Salem (919) 765-3650 □ Ohio WKM Associates, Inc., Cleveland (216) 885-5616; Dayton (513) 434-7500 □ Pennsylvania WKM Associates, Inc., Pittsburgh (412) 892-2953 □ Michigan WKM Associates, Inc., Detroit (313) 892-2500 □

Time Delay

which

FITS YOUR REQUIREMENTS?

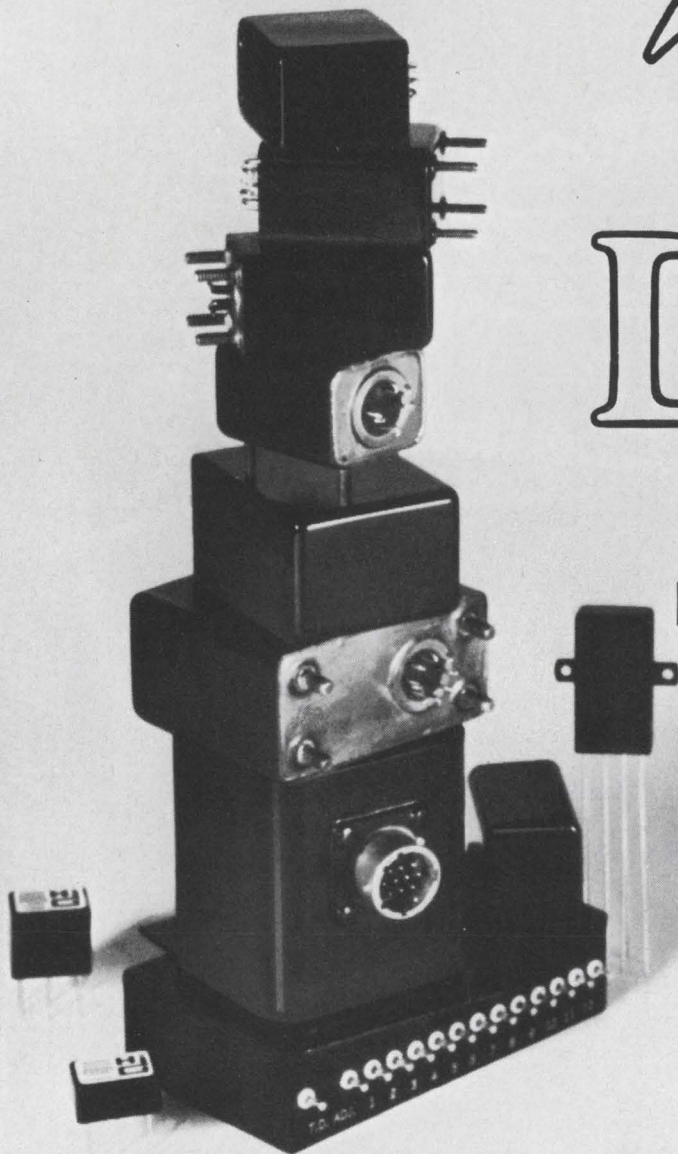

Hi-G time delays come in many packages.
In addition to the series 2400 crystal can type highlighted below, our electronics line includes:

Fixed and Adjustable Time Delays

Up to 300 seconds delay. Contact ratings up to 10 amps. Special variations available to accomplish delay-on-break and interval timing.

Solid State Timing Modules

Solid state reliability offers flexibility in choice of secondary switching capability.

Voltage Sensors

DC and AC level sensing provides precise switching logic over the temperature range of -55 to $+125^{\circ}\text{C}$. Interface with transducers to sense heat, light, and pressure.

Phase Sequence Relays

To protect phase sensitive loads against phase reversal, open or grounded phase.

The spotlight is on Hi-G's 2400 series time delay relays, which combine *solid state timing circuits* with dependable *half-size electromechanical relays* in packages only slightly longer than a standard crystal case.

Results? Small size (0.4 x 0.8 x 1.5 inch), lightweight (1.2 ounces). High current carrying capacity (see below) and the rugged performance of Hi-G electro-mechanical relays. Long life and fast response of hybrid circuits.

Hi-G 2400 series relays operate on 18 to 31 volts unregulated and need no external resistance or capacitance to obtain maximum timing.

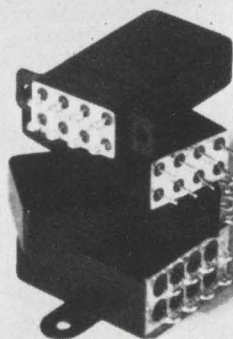

SPECIFICATIONS:

Delay Times:

50 milliseconds to 100 seconds on make.

Delay Time Tolerance:

$\pm 10\%$ (5% on special request).

Contact Rating:

2 amps resistive @ 30 VDC.

1 amp @ 115 V, 400 Hz.

Temperature Range: -55°C to $+125^{\circ}\text{C}$.

Vibration: 20 G, 10 to 2000 Hz.

Shock:

50 G, 11 ± 1 milliseconds duration.

Call, write, or check the reader service number for more information. If you want application engineering assistance, an experienced Hi-G representative awaits your telephone call.



SPRING STREET AND ROUTE 75 • WINDSOR LOCKS, CONN. 06096 • 203-623-2481

Detector spots fast-rising spikes

Three delay lines let instrument measure amplitude from 25 to 2,500 volts; it also determines transient's rise time and width; over-all accuracy is 5%

They make memories forget, logic circuits work illogically, and recording pens fly off scale. But because voltage spikes come in a wide variety of shapes and sizes, they're hard to detect, let alone analyze. And with the increasing use of high-speed switching devices such as silicon controlled rectifiers and thin-film diodes, the chances of electronic equipment

being spiked are also increasing. Engineers at Gralex Industries Inc. don't have a solution for the spike problem, but they can give a clear picture of the villain.

Gralex's Voltage-Spike Detector and Analyzer measures amplitudes, rise times and widths of spikes with amplitudes between 25 and 2,500 volts, plus or minus. The rise-time range is 10 nanoseconds to 10 mi-

croseconds, and the width range is 100 nsec to 100 μ sec. All three measurements are done with an accuracy of 5%.

And the instrument detects spikes whose amplitudes are as low as 2.5 volts. However, between 2.5 and 25 volts amplitude, it can't measure rise time and width.

Triple play. Gralex vice president Paul Lenoble says the big fea-

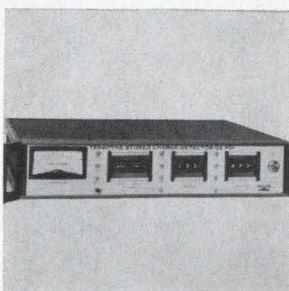

Stored-charge detector QS901 is a solid state instrument for use in high-speed automatic diode testing. High and low limits are set on front-panel digit switches, and results are indicated by pass-fail lamps and by an electrical output at the rear panel. Stored charge is also indicated on a front-panel meter. Price is \$3,850. Teradyne Inc., 183 Essex St., Boston, Mass. [361]

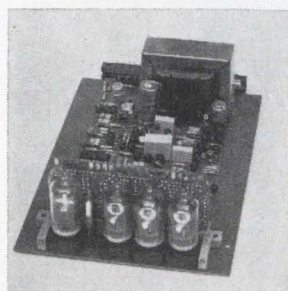

Digital panel meter model 3300 is available in any one of 4 standard voltage ranges from 0.1999 to 1999.9 v d-c; 8 current ranges from 0.1999 to 1.999 amps; and 7 resistance ranges from 199.9 ohms to 19.99 megohms. Accuracy is $\pm 0.1\%$ of reading ± 1 digit over 20°C range from 0° to 50°C . Prices start at \$175. Electro-Numerics Corp., 2191 Ronald St., Santa Clara, Calif. [362]



Crystal controlled frequency source model SS400 provides precise synchronizing pulses at 200, 400, 800, 1600, and 9600 hz. Frequency stability and accuracy of 0.005% are achieved. Unit is designed for laboratory use to synchronize RC oscillators at these fixed frequencies. It is priced at \$98 and available from stock. Polyphase Instrument Co., Bridgeport, Pa. [363]

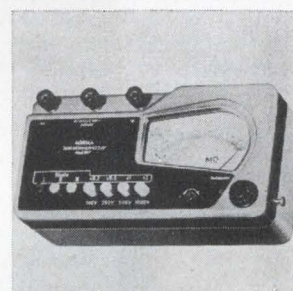

Portable megohmmeter type 667 is battery operated and suited for making accurate insulation tests of motors, wiring, appliances and other electrical equipment. Four test voltages are available: 100, 250, 500 and 1,000 v d-c with a resistance range from 0 to 10,000 megohms at 500 v d-c. Price is \$175. Freed Transformer Co., 1718 Weirfield St., Brooklyn, N.Y. 11227. [364]

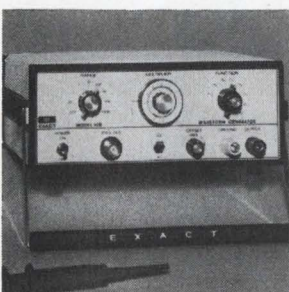

Waveform generator model 100 features miniature size (7.38 x 2.85 x 8.50 in.) and handle/tilt-stand. Frequency range is continuously variable from 0.001 hz to 3 Mhz, with square and triangle outputs to 5 Mhz. Output signal amplitude is ± 5 v peak for positive and negative square-waves, 20 v p-p for all others, into a 600-ohm load. Exact Electronics, Hillsboro, Ore. [365]

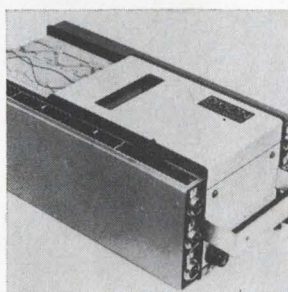

Direct-recording oscillograph recorder called Visigraph-P is compact and portable. Paper speeds from 0.2 to 40 ips are offered in the 6-channel unit which writes at 2,400 ips using a choice of 5 galvanometer ranges with frequencies of from 100 hz to 2,000 hz. Timing lines are recorded on the margin of the 3 $\frac{5}{8}$ in. wide paper every 0.1 sec. Dixon Inc., Grand Junction, Colo. [366]

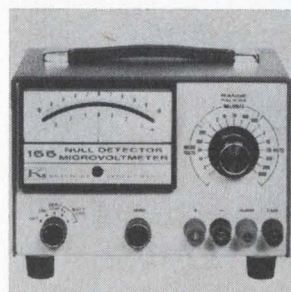

Combination null detector/micro-voltmeter model 155 offers 1 μ v full scale sensitivity to 1000 v range. It features less than 150 nv noise, greater than 140 db common mode rejection ratio, and greater than 100 db normal mode rejection ratio, and greater than 10^{12} ohms isolation from ground. Price (1-4) is \$325 each. Keithley Instruments Inc., 28775 Aurora Rd., Cleveland. [367]



Counter/timer model 1605, for general lab and shop use, measures frequency from d-c to 25 Mhz. Features include input signal conditioning, gate times from 10 msec to 10 sec, 5-digit display with storage and automatic decimal positioning and an internal crystal oscillator with stability of 1 part in 10^6 /month. Eldorado Electronics, 601 Chalomar Rd., Concord, Calif. [368]

SPACE SAVERS!

**BARNES 041 SERIES
PRODUCTION-MOUNTING
SOCKETS FOR MAXIMUM
"TO" TRANSISTOR
PACKING DENSITY**

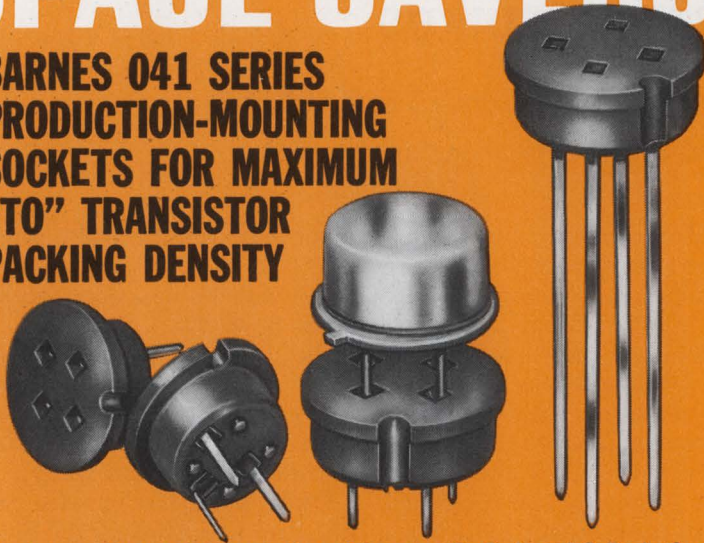

Want to socket-mount your transistors on P. C. boards? Pack them tightest with the new Space Savers from Barnes. These miniature production-mounting sockets feature extremely low profiles and small diameters for maximum packing density. Double wiping contacts assure reliable electrical contact, positive device retention. Temperature ranges from -55°C to 150°C . The low-cost Space Savers from Barnes: Write or call for free samples and more data.



Lansdowne, Pa. 19050 • 215/MA2-1525

barnes / THE FIRST WORD IN CARRIERS, CONTACTORS AND SOCKETS FOR I.C.'S

Circle 233 on reader service card

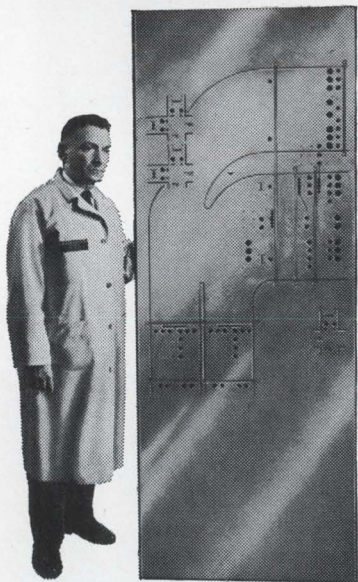

think BIG

(also small)

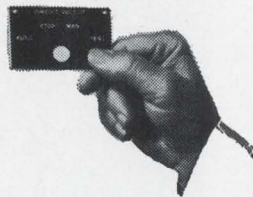

Now engrave anything from 6 ft. panels to tiny nameplates

Engravograph tackles them all. Right in your own shop, effortlessly, speedily — ideal for unskilled workers. Adjustable ratio engraves 21 different sizes.

Write for illustrated catalog # 114

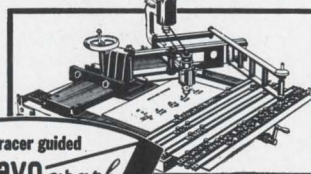

the tracer guided
Engravograph

new hermes engraving machine corp.

20 Cooper Square, New York, N.Y. 10003. Chicago, Atlanta, Los Angeles, Dallas, Montreal, Toronto, Mexico City

... spike is found by
selecting proper tap ...

ture of the detector is its wide range. And this, he says, results from the use of three delay lines instead of one.

According to Lenoble, before a detector can measure rise time, it must first measure the spike's amplitude. So a detector needs some sort of memory—usually a delay line. Lenoble says detectors with one line either have poor accuracy because of signal distortion in the delay line or have a small dynamic range.

The delays of the three lines in the Gralex detector are 200 nsec, 2.5 μsec , and 10 μsec , respectively. The lines are connected in series, with a tap at the end of each of the lines.

The 200-nsec line is a coaxial cable 130 feet long. The other two delay lines are made of discrete components.

When a spike occurs, it flows into the first delay line. Inside the instruments are two identical gated peak detectors, one to look at one 100-nsec portion of the spike, the other to look at the next 100-nsec portion. If the output of the second detector is higher than the output of the first, the spike peak hasn't yet occurred, and the gating sequence continues.

If the output of the first peak detector is higher, the gating sequence stops. A logic circuit finds the spike by selecting the proper tap in the delay line, and then rise time, width, and amplitude are measured.

On the move. The detector comes in measurement and control-and-display sections. The measurement unit is plugged into the power line, and can be pulled out at any time and connected to some other line.

In addition to companies that want to keep an eye on voltage coming in, Gralex hopes to sell the detector to utility companies that want to know about voltages they're sending out.

The detector's price is around \$10,000, and delivery time is three months.

Gralex Industries Inc., 28 DiTomas Court, Copiague, N.Y. 11726 [369]

the state-of-the-art resistor tester

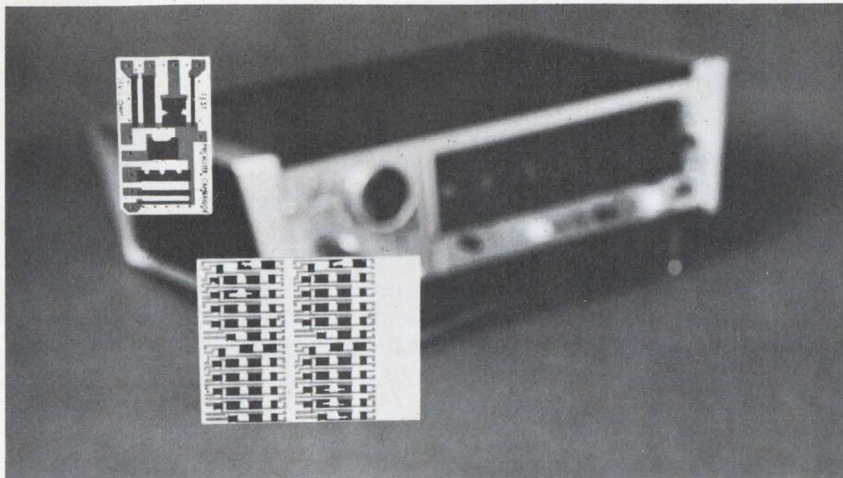

State-of-the-Art resistors require comparable test equipment. This is why Biddle produced the Model 803. It is the only precision resistance tester geared specifically for today's critical applications—limit testing, precision trimming and measuring, both absolute and ratio. Until now this has required a complexity of instruments and a compromise in performance. The 803 changes all that. This single instrument does the work of what is now a subsystem, and it does it more accurately, reliably, economically and faster.

Operation. The test resistor is connected directly to the 803, and compared against the desired value. A visual, interpreted indication of whether it is high, low or within preset tolerances is given, and, to control trimming and handling equipment, corresponding electrical signals appear on appropriate output lines.

Precision. The 803 is the only complete 5 digit resistance tester available. In addition,

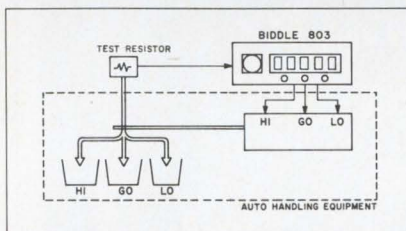

tion, it has a 10% overrange, and at the lower end, tolerances can be set beyond the fifth digit. In the 100 Ω range, for instance, the 803 can look at a $\pm 60\mu\Omega$ tolerance window.

Accuracy. The 803 is exceptionally accurate in all modes of operation. Each unit is factory calibrated to 10 PPM and rated at 60 PPM for thirty days. Yearly accuracy is within 150 PPM without calibration.

Deviation Accuracy. Limit testing and trimming require tolerance ranges and automatic decision. This imposes a critical

need for deviation measurement—the accuracy with which tolerance limits can be recognized. The 803 provides these advantages:

1. With the precise divider network of the 803, deviation resistances are perfectly linear, whereas conventional bridges have substantial non-linearity at wide limits.
2. Tolerance limits in the 803 are set with a ten turn pot rather than marked off on a meter scale.
3. All decision circuitry is solid state. It doesn't have the drift or tracking problems of a meter, and it is free from human error and the inaccuracies of hanging photo-devices on a meter scale.

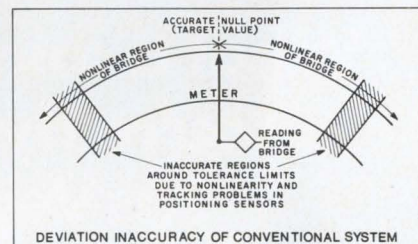

Speed. Testing speed is limited only by the handling equipment. For precision trimming, the 803 will respond in milliseconds, and in completely automatic systems it can comfortably test better than 1800 resistors an hour.

Versatility. The standard 803 has six ranges from 100 Ω to 11 M Ω . In addition, the options are almost unlimited: 10 Ω range; direct reading temperature coefficient; BCD output; etc. In fact, no matter how special your problem is, in all likelihood, the 803 can be adapted to solve it. Why not call us and see?

JAMES G. BIDDLE CO.
Plymouth Meeting, Pa. 19462
(215) 646-9200



\$2,240



**What a coincidence!
You're flying to
Las Vegas
for the
National Electronics Week
and the 1969 New Show
May 21-23.
So are we.**

And many of your fellow conventioners
will be going with us.
You'll enjoy it more if you fly with
your friends.

TWA

Our people make you happy.
We make them happy.

New instruments

Meter maker goes digital, but . . .

Triplett introduces dpm,
also shows way to improve
analog meters' performance

The entrance of a new digital meter onto the market usually pushes analog meters further into the shadows. But when the Triplett Electrical Instrument Co. recently introduced its first digital meter, the company backed up its line of a-c analog meters by also introducing an amplifier that extends the analog meters' ranges down into the nanoamp region.

Triplett is going digital with a 3½-digit panel meter, called the Model 5000. Priced at \$350 in small quantities, the 5000 costs almost twice as much as most of the newer dpm's. This, says the company, is offset by the 5000's versatility. Less expensive meters offer optional features that are standard on Triplett's dpm.

"We held up a year before coming out with this instrument," says executive vice president Norman Triplett. "We wanted to make sure that the 5000 has everything an engineer could want."

During the next few months, though, Triplett will start offering the 5000 in stripped-down versions, priced—says the company—in line with other dpm's.

Among the 5000's features are 100-millivolt sensitivity, automatic polarity indication, both binary-

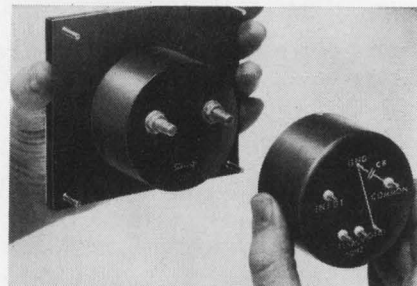

A joiner. The amplifier allows analog meter to measure a-c in the nanoamp region.



TRW
Metallized
Mylar Capacitors

are different

The little things set them apart.

Things like superior electrical properties. Better environmental properties, too.

Things like variety. Tape-wrap, epoxy or hermetically sealed. Axial or radial leads. Voltages from 50 volts to 600 volts. Values from .001 mfd. to 10.0 mfd. And

tolerances to 1%.

And not so little things like unequalled experience in metallized mylar*. And the technical know-how to meet special requirements. They all add up to a big difference!

Contact any TRW distributor, or TRW Capacitors, Box 1000

Ogallala, Nebraska. Phone (308) 284-3611. TWX 910-620-0321. *TRW Capacitors is a Division of TRW INC.* *DU PONT REGISTERED TRADEMARK

TRW[®]

The Thousand Dollar \$375

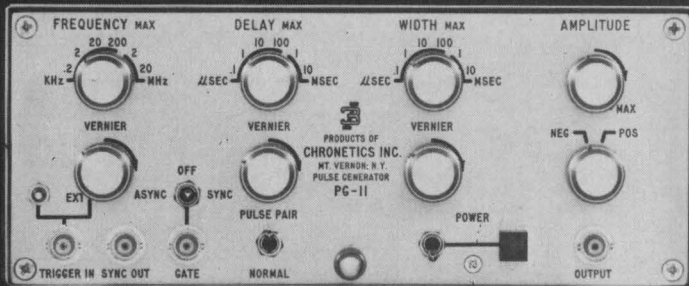

PULSE GENERATOR

MODEL PG-11 provides the performance you would normally expect to find only in pulsers costing nearly three times as much.

To wit: Rep rates from 10 Hz to 20 MHz, ± 15 volt output, 3 ns typical rise time, single or double pulses and one-shot, synchronous or asynchronous gating, triggering DC to 20 MHz, externally gated pulse bursts, continuously variable rep rate, width (25 ns to 10 ms), delay (20 ns to 10 ms), amplitude (0 to ± 15 volts).

Rise time is specified at 5 ns at full output amplitude, not at some reduced amplitude favorable point; it is typically better than 3 ns at full amplitude and amplitude is

± 15 volts at any rep rate, up to and including maximum.

The Model PG-11 is all solid state. With rack adapter RA-11/2 you can mount two PG-11's side by side in 3-1/2". The portable (bench) model is 4" h x 8-1/2" wd x 9-1/2" d. Net weight 7 pounds.

Our thousand dollar pulse generator costs \$375 f.o.b. factory, domestic. It is available from stock. Write or phone for technical literature, a prompt demonstration or both.

Chronetics, Inc. 500 Nuber Avenue, Mt. Vernon, N.Y. (914) 699-4400. In Europe: 39 Rue Rothschild, Geneva, Switzerland. (022) 31 81 80.



coded-decimal and decimal outputs, automatic zeroing, display-hold circuitry, and a balance control that insures equal positive and negative readings. The meter's resolution is 100 microvolts, its accuracy is 0.1%, and its input resistance is 1,000 megohms.

The meter delivers a print-command pulse, so the user can connect it to a printer without going through any interface circuitry.

Built into the 5000 is a self-regulating power supply which puts out 8 watts. The supply's common-mode rejection is 80 decibels and its series-mode rejection is 40 decibels.

The 5000 comes as a d-c or a-c voltmeter in ranges from 100 mv to 1,000 volts, or as a d-c ammeter in ranges from 1 microamp to 10 amps. Its dimensions are 2 5/8 by 4 3/8 by 5 5/8 inches and it weighs 3 1/2 pounds.

The backup. Triplet's analog-meter attachment, called the 300 Meter-Amp, is an amplifier, packed into a cylindrical case 2 3/4 inches in diameter and 2 5/8 inches high. The package fits on the back of Triplet's G-series panel meters and can be connected in a couple of minutes.

The 300 boosts the meter's impedance to 10 megohms, and enables it to make full-scale readings as low as 3 nanoamps or 30 millivolts. The 300's response range is 50 hertz to 50 kilohertz. The price is \$70.

Triplet Electrical Instrument Co.,
286 Harmon Road, Bluffton, Ohio
[370]

New instruments

Analyzer adapts to impedance

Sweep generator and detector with new adapter measures magnitude and phase angle

It always could measure the amplitude and phase of sinusoidal voltage; now Hewlett-Packard's 675A/676A network analyzer has an additional talent. Thanks to a

NEW...!

FROM TRACOR/GTC,
the most experienced producers of
RUBIDIUM FREQUENCY STANDARDS
THE NEW MODEL **304-D**

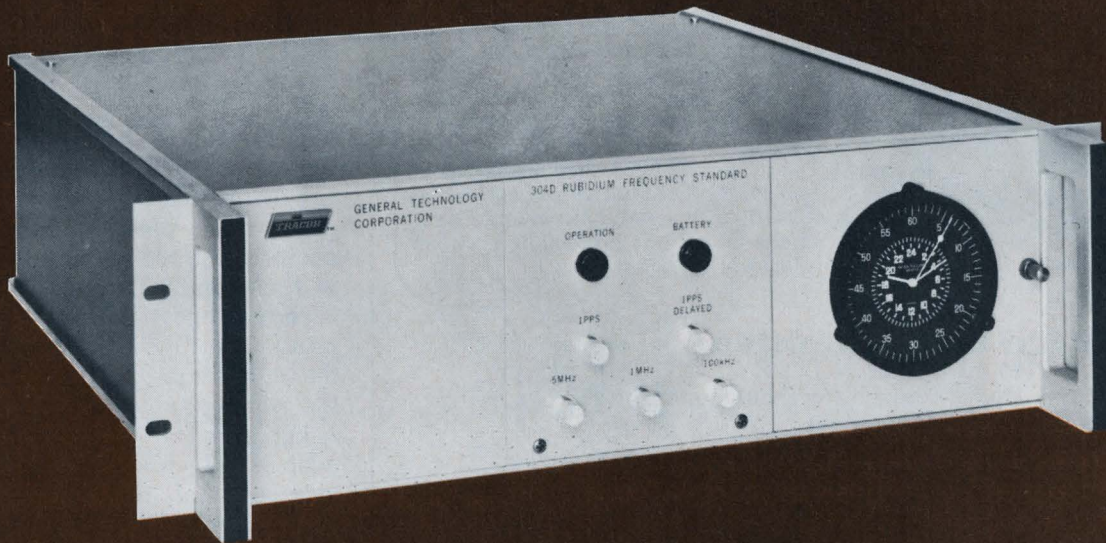

Developed from space environment designs at the General Technology Corporation, this new Atomic Standard combines state of the art circuitry with GTC's unmatched Rubidium Frequency Standard technology.

- Superior Long Term Stability
- Internal Standby Battery†
- Internal Clock system†
- \$7,300.00* with internal time scale selector.

Write for specifications on the new 304-D to
TRACOR
INDUSTRIAL INSTRUMENTS
6500 Tracor Lane, Austin, Texas 78721
AC 512/926-2800

*FOB Los Angeles †optional

Specialized instruments to meet your specific needs

TRACORTM

IA-124

The geniuses who perfected the Dalic selective plating process certainly had electronic manufacturers in mind.

If Sifco's Dalic process of electroplating had just one reason for existence, one might say it was to make life pleasanter for electronic manufacturers, their operations more profitable. ■ Pleasanter, because the Dalic process is designed to be an integral part of the electronic manufacturer's setup, ready for plating jobs anytime. ■ Profitable, too, because—being portable—it saves masking, dismantling and processing time . . . saves sending parts out and waiting for them to come back. ■ With Sifco's exclusive Dalic process, makers of electronic equipment can spot-plate gold, silver,



rhodium or other metals directly onto conductive surfaces . . . without disturbing the assembled components. ■ The Dalic electroplating process consists of power pack, tools and electrolyte solutions. Applying metal coatings with this "package" is easily mastered with a minimum of training and no previous experience. ■ The thickness of deposited metals can be accurately controlled to as fine as 0.000010 inches. ■ Additional information on the Sifco Dalic process for electronic equipment sent on request.

Sifco Metachemical
935 East 63rd St. • Cleveland, Ohio 44103
Phone 216/881-8600 and 216/431-0306
TWX 810-421-8464

DIVISION OF
SIFCO
INDUSTRIES, INC.

Circle 234 on reader service card

new attachment, called the 11138A Impedance Adapter, the analyzer measures impedance, both magnitude and phase, at frequencies from 10 kilohertz to 32 megahertz. The range of the analyzer-adapter combination is 0.3 ohm to 3 kilohms at phase angles from -90° to $+90^\circ$, and measurements can be made on any two-port network.

The analyzer itself consists of a sweep generator and a detector. The sweeper sends outputs along two channels to a pair of devices—one is usually a reference—and the detector measures their outputs.

The detector's outputs are proportional to the phase difference between the outputs of the devices being tested, the log of the amplitude of each of these outputs, and the log of the amplitudes' ratio.

Usually, a two-trace oscilloscope displays the phase difference and one of the three amplitude signals as functions of frequency.

New connection. The setup for measuring impedance is similar to the setup for measuring amplitudes; the difference is that the devices being tested are connected to the adapter, which is connected to the sweeper and the detector. The sandwich-sized adapter converts the sweeper's output into a pair of identical constant-current signals, one for each device.

The voltages across these devices, which are proportional to the devices' impedances, are amplified and sent to the detector. The adapter also puts out a d-c signal proportional to the phase difference between the two signals.

The detector's outputs are one phase signal, two impedance-magnitude signals, and one impedance-ratio signal.

Restricted. One way to measure impedance with the adapter is to use a resistor as a reference and display the magnitude and absolute phase angle of the device being tested. Accuracy depends on how precisely the resistance of the reference is known, and ranges between 1% and 15%.

But these impedance measurements are only for those owning the \$3,500 network analyzer. According to H-P, the adapter doesn't work with any other company's analyzer.

The adapter's price is \$175.

Hewlett-Packard Co., 815 Fourteenth St. SW, Loveland, Colo. [371]

Vector

Vector systems help you CUT BREADBOARDING TIME

SOLDERLESS
U-CLIP TERMINAL

Choose the type that meets your needs.

1. Mount D.I.P.'s, Transistors, Round Can Integrations, directly to board or in sockets. Patch cord hook-up available.
2. Solderable push-in terminals for .042", .062" or .093" holes.
3. Handsome new extruded aluminum rails that make into expandable circuit cases or chassis in virtually any size and shape. Hardware for mounting in plug-in racks or chassis.
4. Pre-punched Copper-Clad Cards for do-it-yourself etching. Also solderless spring terminals.

May we send you complete information including sample Vectorbord® and terminals? There is no obligation.

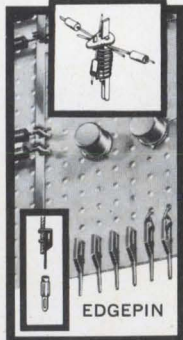

EDGE PIN

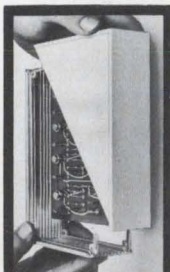

CASES
AND
CHASSIS

4 WAYS

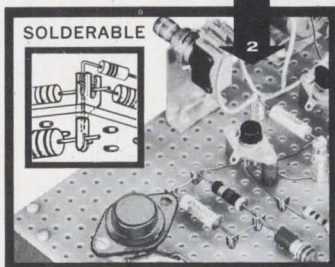

SOLDERABLE

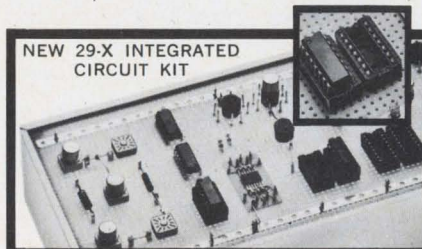

NEW 29-X INTEGRATED
CIRCUIT KIT

Vector ELECTRONIC COMPANY, INC.
12460 Gladstone Ave., Sylmar, Calif. 91342



Monotherm® homes in.

An infantryman has only one shot at an enemy plane with the Army's infrared homing missile, the Redeye. So he expects 100% reliability. Every time. And he gets it.

One reason is that General Dynamics specified a Riegel Monotherm® flexible laminate of copper and Type H Kapton® for the Redeye's three rugged printed circuits.

This Monotherm laminate withstands 550°F soldering without delaminating or circuit swimming. It won't support combustion, being non-

Monotherm® - registered trademark of Riegel Paper Corporation for its laminations of conductive and dielectric materials.
Kapton® - registered DuPont trademark.

flammable and self-extinguishing. It is unaffected by repeated soldering (30 re-soldering operations per connection on the Redeye).

It can be bent 360 degrees in any direction. It can be subjected to high pressure multi-layering and the circuit won't swim or rupture. Yet for all its strength, its weight is one-third that of conventional wire circuits and it requires a third of the space—a great advantage in the world's smallest guided missile.

In 2½ years of Army use, The Riegel

Monotherm laminate used in the Redeye has proven to be 100% reliable.

For more information, mail the coupon today.

.....
TAYLOR CORPORATION
Valley Forge, Pennsylvania 19481
Please send me Kapton®/copper data sheets
and the Conductor and Dielectric Guide for
Riegel Monotherm®.

Name _____

Company _____

Street _____ City _____

State _____ Zip _____



EXCLUSIVE U.S. DISTRIBUTOR OF RIEGEL MONOTHERM IN SHEETS AND ROLLS.

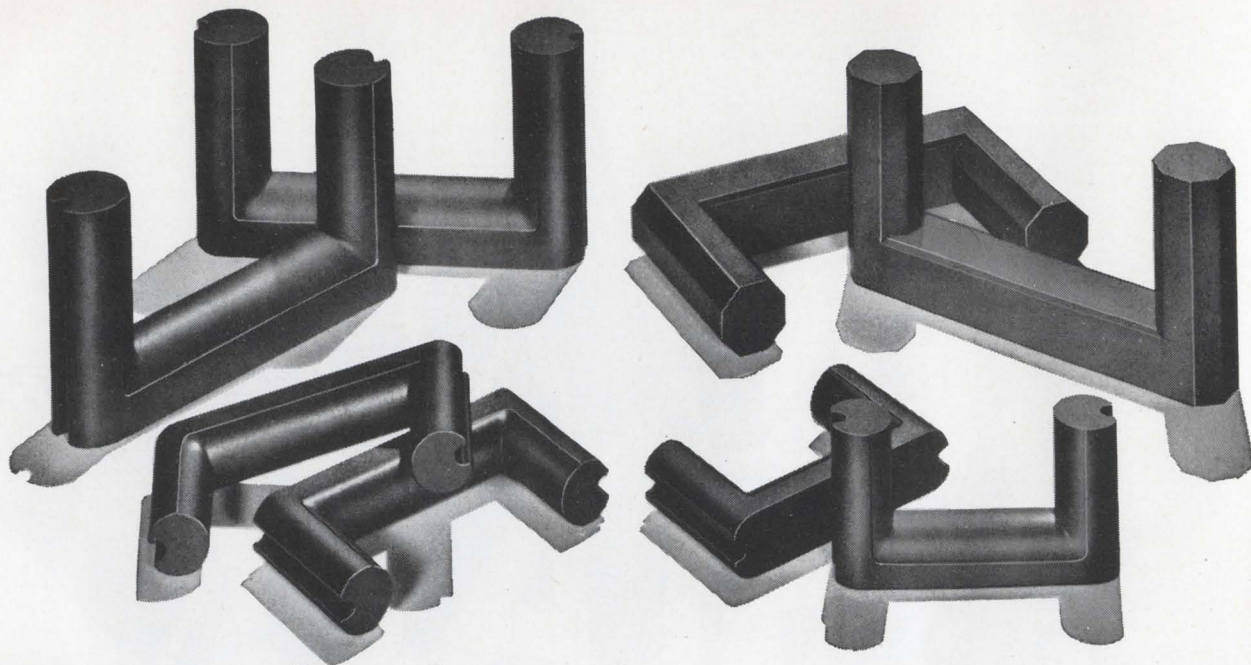

From Stackpole: A New H.O.T. Ferrite Material That Doesn't Lose Its Cool

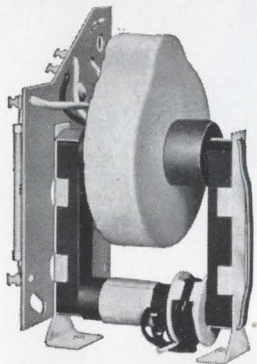

Ceramag[®] 24C was developed by Stackpole engineers especially for Horizontal Output Transformer applications. Because this new material offers an unequalled combination of high power permeability and low power loss under flyback circuitry operating conditions, it provides improved efficiency and cooler operating temperatures.

Excellent electrical and mechanical properties are combined to provide fabricated parts that easily meet standard industry strength and warpage requirements.

The Stackpole Ceramag[®] family of power ferrite materials has been the accepted standard of the television industry for over twenty years. Ceramag[®] 24C is no exception. It features a power permeability of 6200 @ 1800 gauss (typical operating condition), compared to Grade 24B with a permeability of 4200 @ 1800 gauss.

Equally important, the power losses of 24C at operating frequencies and temperatures are 15% lower than those of the widely recognized Ceramag[®] 24A, an industry workhorse.

Stackpole engineering pioneered the first Ceramag[®] horizontal output transformer cores as far back as 1947. Since then, continuous developments have made Stackpole a leading contributor to the growth of black and white, and now color, television technology.

For additional information and

samples of Ceramag[®] 24C, write or call: Stackpole Carbon Company, Electronic Components Division, St. Marys, Pa. 15857. Phone: 814-781-8521. TWX: 510-693-4511.

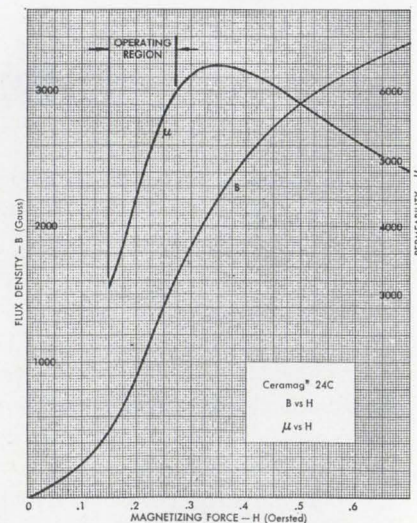

STACKPOLE
ELECTRONIC COMPONENTS DIVISION

ALSO A LEADER IN THE MANUFACTURE OF QUALITY FIXED COMPOSITION RESISTORS

Two firms enter MOS read-only memory race

Union Carbide, National Semiconductor market static 1,024-bit capacity units; applications mushroom in code conversion, logic control, character generation

Read-only memories are getting a lot of attention these days, and with good reason. They're versatile devices, lending themselves to such functions as code conversion, random logic control, table lookup, character generation, and arithmetic subroutines. Two manufacturers are taking advantage of the ROM's popularity by introducing static MOS ROM's with 1,024-bit capacity.

The National Semiconductor Corp. is offering the MM521, arranged in 256 four-bit words, and the MM522, which is identical except that it can also be organized in 128 eight-bit words.

The Electronics division of the Union Carbide Corp., now in its new plant in San Diego, is offering the ROM1k in four organizations: 128 × 8, 256 × 4, 512 × 2, and

1,024 × 1. The Union Carbide product has a typical access time of 1.5 microseconds. The National unit is somewhat faster—its access time is typically 600 nanoseconds — but power dissipation is higher (220 milliwatts vs. 160 mw for Union Carbide's).

Users prefer a static ROM because its output is valid as long as a given address is sensed. (In a

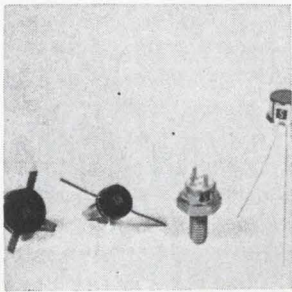

Silicon r-f power transistors and kits, including the 2N5421, 2N5423 and 2N5424, are for 12.5 v operations. The kits consist of 3 to 5 devices and are capable of delivering up to 40 w of output power from a parallel pair of outputs at a frequency of 175 Mhz. Applications include Class A, B and C r-f amplifiers. Solitron Devices Inc., Blue Heron Blvd., Riviera Beach, Fla. [436]

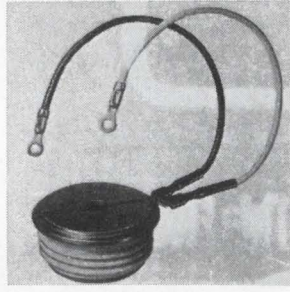

Full capacity thyristor type 282, designed to replace parallel scr's, permits upgrading of equipment with a minimum of external protection. When the device is water cooled, its rms current is 850 amps. Turn-on time is typically 5 μsec. I²T is 200,000 amps squared seconds, and forward and reverse voltages range up to 1,500 v. Westinghouse Semiconductor, Youngwood, Pa. [437]

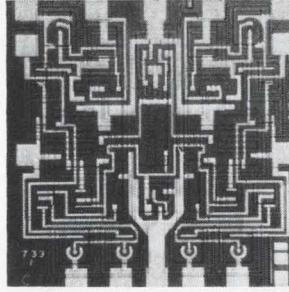

Dual operational amplifier #A739 is a linear IC that achieves high packing density with a 14-lead dual in-line package, which contains 2 identical op amps on a single silicon chip. Stable gain is maintained over a supply voltage range of ±4 to ±15 v. Power supply rejection is 50 μv/v. Slew rate is 1 v/μsec. Fairchild Semiconductor, 313 Fairchild Dr., Mtn. View, Calif. [438]

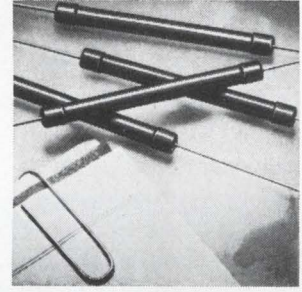

Universal high voltage selenium rectifier S-926 will withstand 2 ma forward current at 4,600 v rms input and is usable at higher potentials at reduced current. Electrical characteristics at 60 hz are: piv, 7800 max.; input voltage, 5.5 kv rms; d-c output, 2450 v at 1.8 ma max. continuous into a resistive load. Sarkes Tarzian Inc., 415 N. College Ave., Bloomington, Ind. [439]

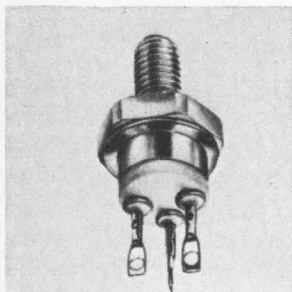

Isolated-collector, stud-mounted silicon transistors 2N5346-9 are medium-power npn devices with minimum f_T's of 30 Mhz. V_{CEO} ranges from 80 to 100 v. Minimum beta at a collector current of 2 amps ranges from 30 to 60. Units are housed in a TO-59 package. Prices are between \$24 and \$34.95 in quantities of 100. Motorola Semiconductor Products Inc., Box 20924, Phoenix. [440]

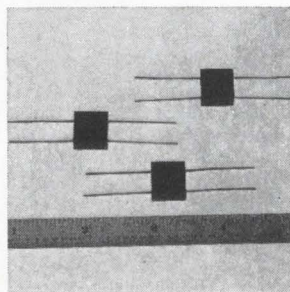

Single-phase, full-wave rectifier bridges are 2-amp units featuring controlled avalanche and reverse recoveries from 50 to 400 nsec. Each leg has a double glass seal for hermeticity. Units meet or exceed applicable reliability provisions of MIL-S-19500 and MIL-STD-202. Prices start at \$1.86 each in 250 lots. Micro Semiconductor Corp., 11250 Playa Court, Culver City, Calif. [441]

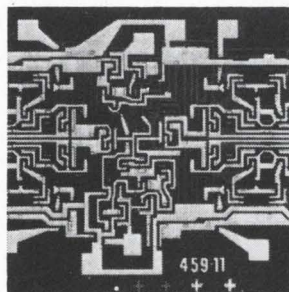

Parity generator/checker series SM120 are MSI arrays that replace the equivalent of 13 IC packages. The devices perform digital logic functions, normally requiring multiple NAND gates, with typical low over-all power dissipation of 125 mw. Delay time per gate function is as low as 22 nsec per gate. Sylvania Electric Products Inc., 100 Sylvan Rd., Woburn, Mass. [442]

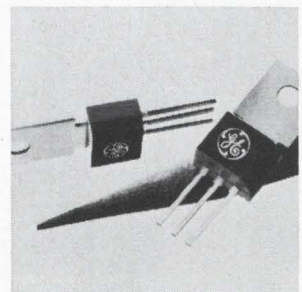

Complementary silicon power tab transistors are designated D27C and D27D. The former is encapsulated with red silicone for identification as an npn device; the latter, with green silicone, to show it as a pnp unit. Both offer low saturation voltages in the 3-ampere range. Prices (100,000 lots) are in the 40 to 50 cent range. General Electric Co., Syracuse, N.Y. [443]

NEW

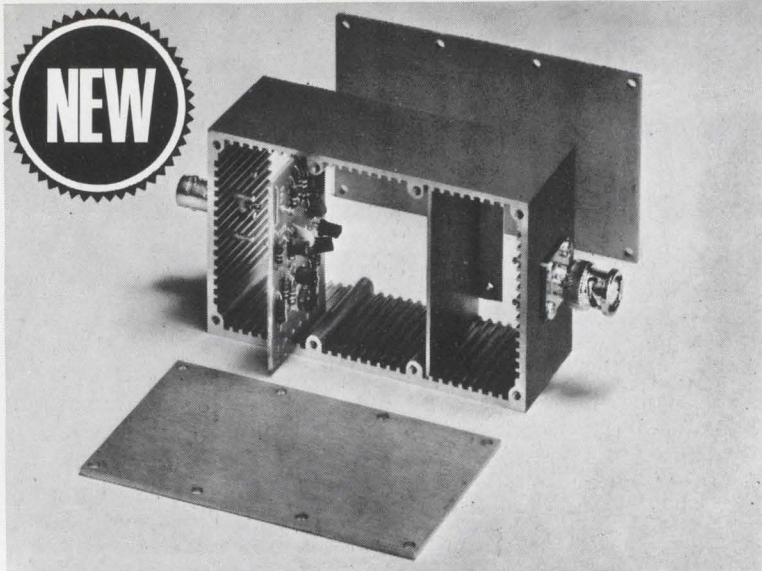

SHIELDED BOXES with CARD GUIDES

Rugged die-cast aluminum boxes, slotted to accept 1/8" circuit boards and shielding dividers. Excellent for packaging electronic circuitry. Boxes have removable top and bottom covers. Useable inside space: 4"x2"x1 1/2". Several models with various connectors.

"Write for 1969 Catalog"



POMONA ELECTRONICS CO., INC.
1500 E. Ninth Street, Pomona, California 91766

Circle 235 on reader service card

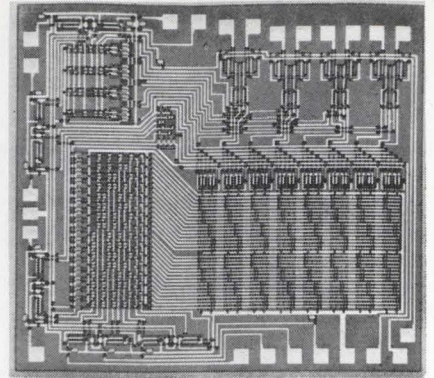

Compatible. Union Carbide's memory can connect directly with TTL IC's.

dynamic ROM, the output remains valid only for a certain time after the data location has been clocked.) According to Robert Goldin, who designed Union Carbide's ROM, "It's easier for a customer to use a static memory and easier for us to specify. We specify the access time and the customer knows the output will be valid without the need to clock the unit."

For the Union Carbide circuit, the typical drain-supply voltage is -12 volts and the gate supply is typically -25 volts, both at 25° C. Union Carbide specifies a chip-inhibit response—the time required to float or to enable the output drivers after the chip-inhibit signal is switched—at 1 μsec typical and 2 μsec maximum.

For National's circuit, drain- and gate-supply voltages are +15 and -15 volts, respectively. A logical 1 is 3 volts maximum and a 0 is 9.3 volts minimum.

Direct coupling. The ROM's of both manufacturers are "bipolar compatible," that is, they can interface directly with transistor-transistor-logic IC's. However, the National Semiconductor device requires external resistors on the input and output to adjust the circuit to TTL voltage levels; the Union Carbide version requires a resistor only on the input. Dale Mrazek, an applications engineer with National Semiconductor, recommends an input pullup resistor value of 3 kilohms; this value provides high speed operation, he says. At the output, the resistor value is determined by whatever supply voltage is convenient; it should be equal to this supply voltage divided by 1.6 milliamperes.

Goldin says that when the de-

Scissors
Out The Cost Of Printed Circuits

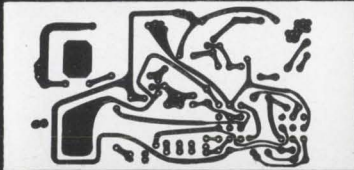

Our new production techniques and rapid service saves you delay time and research cost.

We can produce single and small quantity orders extremely economically. Our quality is unsurpassed, and orders are usually processed within three days from receipt of the order. Large quantity orders receive the same fast service.

HOW TO ORDER

Layout your circuit board to scale in exact proportion to the size you desire. We can enlarge or reduce the copy to your specifications. Copy can be an ink drawing or laid out with the new circuit tapes. NOTE: The board we produce can only be as accurate as the copy we receive; so be sure to **double check**. Specify rigid or flexible board.

SEND FOR FREE SAMPLE OR QUOTATIONS TODAY - NO OBLIGATION

American Engraving Inc.

MANGUM, OKLAHOMA 73554

190

Circle 189 on reader service card

ECONOMICAL Thin Film!

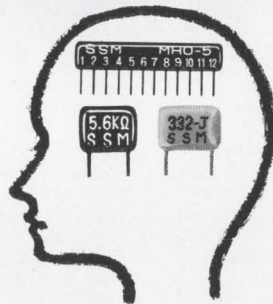

What's needed for memory system is everlasting high accuracy. SSM's components are the very ones satisfying superior reliability.

- Plate-ohm: evaporated metal film resistor
- Pla-module: thin film modulated C-R circuit
- Pla-con: organic thin film capacitor by plasma reaction

SUSUMU INDUSTRIAL CO., LTD.

Minami Bldg. 1-12 Ebisuminami
Shibuya-ku, Tokyo, Japan
TEL: Tokyo (03) 712-5990
TELEX: No. 246-6270

Circle 190 on reader service card

Electronics | April 14, 1969

cision was made to design the ROM1k, he felt more confident using silicon material with a crystal orientation of 1-1-1, but he expects to have an improved version of the ROM by midyear, with 1-0-0 silicon. He predicts that this will make the device compatible with TTL and diode-transistor logic without external resistors on either input or output. Goldin adds, "We think we'll be able to match National's access time with that circuit."

Maskmaking. Union Carbide's military-grade ROM1k (operating from -55 to $+125^{\circ}\text{C}$) costs \$103.50 for quantities between 1 and 24, \$95.40 for 25 to 99, and \$82 for 100 to 999. A commercial version (0° to $+70^{\circ}\text{C}$) costs \$47.50 for 100 to 999. Minimum order is 50 units, and there is a maskmaking charge of \$400 for orders of fewer than 100.

National Semiconductor's MM521 costs \$54 for 25 to 99, and \$45 for 100 to 999. The military version (called the MM421) costs \$86.40 and \$72 in the same quantities. National requires a minimum order of 10 units, and adds a \$1,000 maskmaking charge, which is waived on an order of 100 or more.

Union Carbide Corp., Electronics Division, 8888 Balboa Ave., San Diego, Calif. 92123 [444]

National Semiconductor Corp., 2950 San Ysidro Way, Santa Clara, Calif. 95051 [445]

New semiconductors

A solid look for vidicons

Tube with silicon target has high sensitivity for CCTV applications

Closed-circuit television systems have been plagued by two problems. The cameras, consisting of electron beam guns and glass targets covered with antimony trisulfide, burn out either when exposed to bright lights or from raster scanning. Secondly, their sensitiv-

less than \$180 per function...



HEATH Universal Digital Instrument

Now you only need one instrument, the Heath EU-805A, to perform all these functions: Frequency, Period, Time Interval, Events count, Ratio, Integrating DVM, and Voltage Integrator. Combining in one package a DC-12.5 MHz Multi-Purpose Counter/Timer with a 0.05% accuracy Digital Voltmeter, the new Heath/Malmstadt-Enke UDI offers you unmatched versatility at less than \$180 per function! An original modular design based on TTL IC's plug-in cards protects the instrument from obsolescence.

The UDI features convenient fast cycling on slow time bases, continuous summing function, memory, 0.1 s to 30 s display time, 6 digit readout plus over-range.

The identical high-sensitivity (10 mV) input comparators provide $1\text{ M}\Omega$ impedance, complete range of trigger controls (including Automatic Mode), oscilloscope monitoring of triggering point and four levels of input attenuation. Input pulse resolution is better than 50 ns. Time bases range from 1 μs to 10 s and short term stability is better than 5 in 10^9 . Accuracy ± 1 count.

DVM section has Automatic Polarity, $5 \times 10^9 \Omega$ input impedance on separate 1 V range (10 M Ω on the others), four ranges from 1 V to 1000 V, 10 μV resolution, 0.1 s to 10 s integrating time and V-F output available at rear panel.

The UDI is obviously the instrument you need and it is obviously priced right: \$1250. Less DVM order EU-805D at \$940. DVM conversion pack costs \$340.

Many cards from the UDI may be used in the Heath/Malmstadt-Enke Analog Digital Designer EU-801A:

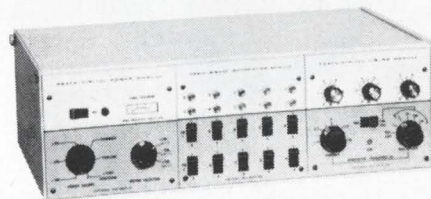

The ADD permits the design of various analog and digital circuits and instruments, by plugging-in logic cards into its power, binary and timing modules. Solderless connections are made with ordinary wire and components leads.



For full information send for the **FREE NEW Scientific Instrumentation Catalog. An abridged Manual is available for \$3.50.**

**HEATH COMPANY, Dept. 580-04
Benton Harbor, Michigan 49022**

In Canada, Daystrom Ltd.

- Please send Free New Scientific Instrumentation Catalog.
- Please send Manual EUA-800A, a special 250 pg. condensation of the manuals which accompany Heath Digital equipment ... \$3.50.

Name _____

Address _____

City _____ State _____ Zip _____

Prices & specifications subject to change without notice. EK-264

NEW THERMOCOUPLE REFERENCES WITH 25 CHANNELS ONLY \$299.00!

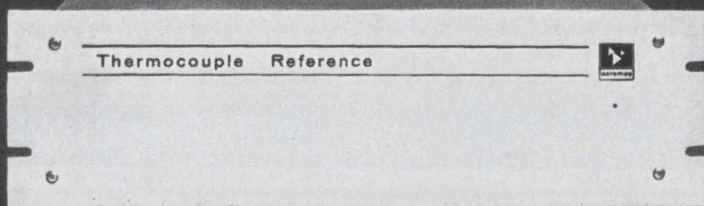

Now — ACROMAG Series 330 Thermocouple References with 25 channels of 0°C ice-point compensation for only \$299.00, including **ALL 25** thermocouples! Uniformity 0.05°C, one-second warmup, easy to use. Ideal for scanned TC systems, DDC, and laboratory use. Series 340 References (150°F oven-type) with 25 channels for \$299.00! Both Series stocked in ISA Types, J, K, T, R & S. Others to order.

Request Technical Data 3-001

ACROMAG
INCORPORATED

30765 Wixom Road • Wixom, Michigan 48096
Phone (313) 624-1541

Makers of Precision Instrumentation and Controls



Circle 236 on reader service card

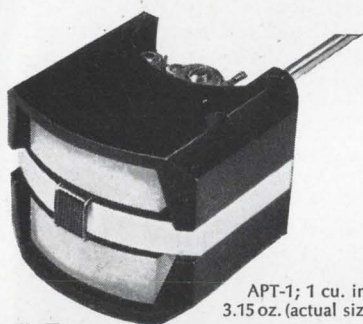

APT-1; 1 cu. in.,
3.15 oz. (actual size)

More torque, Less weight in moving coil mechanism

Highly stable, linear and accurate mechanism for indicating, control or recording systems. 18-0-18° linearity is 1%. Coil design with over 75% of winding "working" in high energy, uniform field air gap assures greater accuracy. Coil system weighs 0.85 gm, develops 26.4 mmg of torque; 31:1 T/W. Mechanism offers negligible vibration pivots and jewels — custom damping — wide range of sensitivities.

AMMON

AMMON INSTRUMENTS, INC.
345 Kelley St., Manchester, N.H. 03105

See GRC at the Design Show • Booth #1540

FASTENERS FROM



DIE CAST
ZINC ALLOY



MOLDED
NYLON &
DELRI

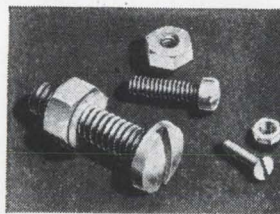

NYLON SCREWS AND NUTS

also available in Delrin

MACHINE SCREWS from miniature #0 thru 1/4" in wide range of lengths and head types.

Also SET SCREWS, NUTS from #2 thru 5/16".

GRC's exclusive methods—die casting zinc alloy or molding Nylon and Delrin fasteners in one high speed automatic operation—assure high quality at lowest possible cost.

Write, wire, phone TODAY for SAMPLES, prices, your copy of GRC's NEW INDUSTRIAL FASTENER CATALOG



GRIES REPRODUCER CO.

Division of Coats & Clark Inc.

World's Foremost Producer of Small Die Castings
151 Beechwood Ave, New Rochelle, N.Y. • (914) 633-8600
Plants in: New Rochelle, N.Y.; Warren, R.I.; Toccoa, Ga.

... can't be damaged
by exposure to light ...

ity is too low for some applications. For example, a camera, positioned in a bank, can be damaged by light; and it may not pick up a usable picture when installed in a dimly lit factory.

But now RCA is marketing a camera tube that uses an array of silicon diodes for the target, thereby increasing sensitivity and removing the possibility of burn-out. Quantum efficiency of the unit is greater than 50% in the visible region of the spectrum and about 40% at 0.85 micron (in the gallium arsenide emission region) and 50% at 1.06 microns (in the neodymium-doped laser region). Sensitivity is 580 microamperes per lumen with infrared light filtered out, compared to 150 μ amps per lumen for comparable conventional vidicons. Moreover, the tube can't be damaged by its own electron beam or by exposure to intense light.

Estimated reliability of the tube equals that of conventional vidicons under ideal conditions—over 10,000 hours. But most vidicons aren't run under ideal conditions and can be damaged by light. Thus, the RCA unit should last longer.

Light spots. Picture defects from faulty diodes that show up as light spots on the RCA unit are comparable to those of other units used for closed-circuit applications. RCA says that improvements should make it possible to eventually market solid target vidicons for both black and white and color applications.

The new unit is designed to sell for \$1,000 in small quantities. RCA won't swing into large-scale production before the end of the year. The price is some \$800 more than antimony-trisulfide-covered units, but the company says that the higher sensitivity and freedom from burnout will attract buyers. On the other hand, it's less costly than other solid target vidicons—for example, a Texas Instruments unit that sells for \$6,500. And the RCA unit has the highest resolution of any solid target vidicon; its amplitude response to a 400-television-line square wave pattern is 30%.

Similar optics. The new tube, known as the C23136, uses electron

beam optics similar to those in RCA's 8541A standard tube, and a target that consists of several hundred thousand individual photodiodes. The C23136 is one inch in diameter, uses magnetic-focus and magnetic-deflection techniques, and has a low-power, 0.6 watt "dark heater."

Other advantages are its small lag and small dark currents. After the third field, lag is only 8% compared with 20% in conventional tubes. The subjective effect is to eliminate after-images. It is also interchangeable with standard vidicons. However, since the target voltage, 5 to 10 volts, is lower than the 20 to 40 volts used in conventional tubes, some cameras may require modification.

RCA Electronic Components, Harrison, N.J. 07029 [497]

New semiconductors

Transistors are radiation-hard

Military-spec devices have betas of 10 and 12 after neutron bombardment

The growing market for radiation-tolerant devices has matured to such an extent that the first such transistors made to a military specification have been introduced. Texas Instruments' 2N5332 and 2N5399 complementary devices have a specific post-radiation minimum gain. After exposure to a neutron fluence of 10^{15} neutrons per square centimeter, the pnp 2N5332 has a worst-case h_{FE} , or gain, of 10 at 10 milliamperes, and for the npn 2N5399, it's 12.

The two transistors have small-signal characteristics and are designed for general-purpose switching and amplifier use. They have a gain-bandwidth product, or f_T , between 800 and 1,500 megahertz, and each is enclosed in a TO-46 package.

The 2N5399 is unusual because of its low degradation of h_{FE} after exposure to the rated neutron bom-

Free.

Information on how to get more out of water.

It's Barnstead's new comprehensive catalog containing detailed information on water purification, demineralizing, and water storage equipment for laboratory-scale applications. Send in this coupon . . . you'll get a lot out of it.

(PLEASE PRINT OR TYPE)

Name _____

Title _____

Company _____

Address _____

City _____ State _____ Zip _____

BARNSTEAD COMPANY
225 Rivermoor Street, Boston, Mass. 02132

 **BARNSTEAD**
SYBRON CORPORATION

New Norden Encoder with internal electronics



Binary and BCD encoders—for systems with DTL and TTL computer logic—have built-in “wired-or” configuration for multiplexing, high fan-out capability, and provision for latching information which allows use as a parallel register. Also offer parallel non-ambiguous output, independently generated digit and complement for absolute reliability checking, and a 7½ million turn life. Sizes 18 and 23. Write Norden, 1475 Barnum Ave., Bridgeport, Conn. 06610.

Norden

DIVISION OF UNITED AIRCRAFT CORPORATION
**U
A**[®]

bardment. Its pre-radiation h_{FE} ranges between 30 and 90 (typically 50) at a collector current of 20 ma. Pre-radiation h_{FE} for the 2N5332 is 20 to 80 (typically 40) at the same current level.

Collector-base-breakdown voltage, or V_{CBO} , is 20 volts for the npn unit and 25 volts for the npn device. Collector-emitter-breakdown voltage, or V_{CE} , ratings are 12 and 15 volts for npn and npn units.

To obtain the 10^{15} neutrons/cm² radiation tolerance—reportedly the highest for complementary-pair devices of this kind—TI also uses ultrasonic bonding, which is much more reliable in a radiation environment than the more conventional thermal compression bonding.

In 100 to 999 quantities, prices are \$9.40 for the 2N5332 and also for the 2N5339. Delivery time is 30 days.

TI is also marketing two new radiation-tolerant power transistors. These devices have a typical post-radiation h_{FE} degradation of only 3 to 1, in contrast to the 8-to-1 degradation common in other radiation-tolerant power transistors. The TIXP39 and TIXP40 differ only in collector-emitter voltage ratings—80 volts and 70 volts respectively. Guaranteed minimum h_{FE} is 10 for both after exposure to 10^{14} neutrons/cm².

Before and after. Prior to radiation exposure, the power transistors are rated at 10 amps collector current, dropping to 5 amps after exposure. Typical saturation voltage is 0.4 volt at 10 amps collector current. Minimum f_T is 120 Mhz.

Small orders for these transistors can be filled from stock, the manufacturer says; average delivery time is four weeks for quantities of 100. Price is \$49.80 for the TIXP39 and \$29.80 for the TIXP40 in 100-999 quantities.

IC versions. Like several other manufacturers, TI has introduced off-the-shelf radiation-tolerant integrated circuits [*Electronics*, Feb. 3, p. 137]. These are essentially versions of standard diode-transistor-logic and linear circuits with dielectric isolation and thin-film nickel-chromium resistors to provide radiation tolerance. TI uses light from a neodymium laser to simulate gamma radiation and predict IC performance.

Texas Instruments, Dallas [498]

business trips rule out evening classes?



here's a practical way to update your knowl- edge of electronics

Are irregular hours, travel and family obligations keeping you from attending classes—even though you worry about becoming technically obsolescent? Check into the Special Programs in Electronics for Engineers developed by CREI, the Home Study Division of the McGraw-Hill Book Company.

These are not simply courses, but comprehensive programs in advanced electronics offering major electives in such fields as:

Communications Engineering, Aeronautical and Navigational, Television Engineering, Automatic Control Engineering, Missile and Spacecraft Guidance, Radar and Sonar Engineering, Nuclear Instrumentation and Control, Computers.

Industry-recognized CREI Programs make it possible for you to catch up on new developments in electronics through study in your own home, at your own pace,

your own schedule. Free book gives complete information and details of technical material covered. For your copy, mail coupon below or write: CREI, Home Study Division, McGraw-Hill Book Company, Dept. 1860H, 3224 Sixteenth St., N.W., Washington, D.C. 20010.

Founded 1927



Accredited Member of the National Home Study Council



CREI, Home Study Division, McGraw-Hill Book Company
Dept. 1860H, 3224 Sixteenth St., N.W.
Washington, D.C. 20010

Send me free brochure describing CREI Programs in Electronics for Engineers.

NAME _____ AGE _____

ADDRESS _____

CITY _____ STATE _____ ZIP CODE _____

COMPANY _____

TITLE _____

now!

acoustic and vibration data acquisition...

New 450 series amplifiers:

- Wideband with very low intrinsic noise
- Selectable frequency response
- 100 db gain range, in precise steps.

MODEL 451



hear!

accurately



Operationally proven 100 series preamplifiers for high impedance transducers:

- Premium noise, FET input
- Precise control of gain and bandwidths
- Custom modifications readily available.

MODEL 143L

this!

automatically

New 440 series Auto-Gain* amplifiers for fully automatic Data Acquisition/Recovery:

- 450 series performance with automatic gain ranging
- Over 120 db dynamic range automatically
- Gain status recorded for up to 32 amplifiers on a single tape track.

MODEL 442

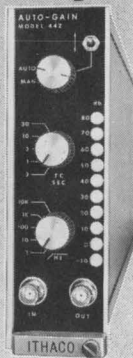

Related new products:

- Wideband hydrophones
- Computer controlled amplifiers
- Differential preamplifiers
- High speed log/AGC amplifiers

*trade-mark pending

For complete specifications and information contact:

607-AR2-7640

ITHACO INC.

413 TAUGHANNOCK BLVD., ITHACA, N.Y. 14850

New Books

A first

Introduction to Large-Scale Integration
Adi J. Khambata
John Wiley & Sons, 196 pp., \$9.95

This book, the first to address itself exclusively to the subject of LSI, is quite properly called an introduction. The technology is moving so fast that any book that tried to go further would be obsolete the day after the author submitted it to a publisher—or the day before.

What should be expected from a book bearing this one's title? Well, the package should include some historical background to put LSI in perspective; a fairly good technical description of semiconductor processing; a description of mask making; a rundown on computer-aided design and automated steps in IC production; discussions of array testing, the logic partitioning problem, and the interface between systems house and semiconductor maker; coverage of discretionary wiring techniques, custom IC's, and LSI chip packaging; a look at the MOS-versus-bipolar question; a list of applications; a timetable for future developments; and, finally, some comments on the approaches being taken by various companies.

The author serves up all this, and more. Of course, none of these subjects can be pursued extensively in a book this size, but what is said about each subject is succinctly stated and worth reading.

Khambata himself views the field from a particularly good vantage point. Now systems manager at the Univac Data Processing division of Sperry Rand, he can see not only the needs of the computer manufacturer but what the semiconductor manufacturers are doing to come up with solutions. He also has a background in semiconductors, having had the prime responsibility for development and design of the original IC's used in Univac's first microelectronic computers.

In discussing performance versus costs, he points out that the price per bit of 256-bit MOS memory arrays in quantities of 100 was between 25 and 30 cents in the second half of 1968. In quantities of

DC Meters

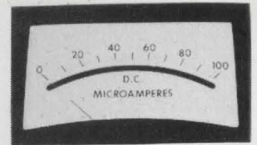

Mod Meters

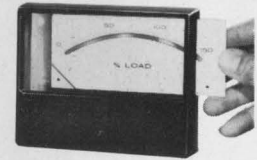

Pick your panel meter

from

VU Meters

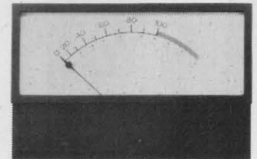

API's exclusive combination

Pyrometers



These API panel meters offer you a unique choice of styles, features and functions:

DC meters—standard 1% tracking and taut-band construction in 20 to 100 μ a ranges, at no extra charge. Optional 0.5% tracking at published prices. Stocked in 15 models with clear plastic, recessed-mounting and black phenolic case styles.

Mod Meters—with interchangeable scales for measuring different variables. Many meters for the price of one.

VU meters—for recording and broadcasting applications. Most stylish in the industry. Stocked in 12 models.

Pyrometers—widest selection available anywhere, including ruggedized type shown above.

For detailed specifications, ranges and prices, ask for Bulletin 47.

api

INSTRUMENTS CO.
Chesterland, Ohio 44026
(216) 729-1611

New Books

10,000 arrays, the price went down to 8 to 10 cents per bit. In 1970, he predicts, the price will have dropped to 3 to 5 cents per bit for 100-unit quantities, and to 1 or 2 cents for lots of 10,000.

One of his key forecasts, now being borne out in the industry, is that although LSI will have a considerable effect on the operations of semiconductor manufacturers, it will have an even more dramatic impact on equipment manufacturers—an impact that in many cases will be “extremely severe.” LSI will generate major perturbations in the area of user-vendor relationships as it brings with it a whole new concept of systems organization and design. The future design teams for computers won't consist solely of logic and systems designers, Khambata says. Programmers and even marketing men will exercise a considerable influence—and influence reaching down even to the semiconductor processing level.

Khambata's chapter on the hardware-software relationship is one of his best. He presents the problem of rising software costs and tries to evaluate the effectiveness of LSI in reducing these costs, as well as those of hardware. With estimates that software accounts for anywhere from 50% to 80% of the over-all expense of owning a system, he reasons that LSI may present little, if any, real cost advantages to the user.

LSI can help, though, with some of the housekeeping functions that impose an extra load on programming requirements. Khambata feels that some mathematical functions that might lend themselves to hardware implementation are binary-to-decimal conversion, scaling operations, subroutines such as trigonometric functions, square-roots, and table-lookup operations.

Returns are in

Principles of High-Resolution Radar
August W. Rihaczek
McGraw-Hill Book Co., 498 pp., \$19.50

This book is not one that can be read casually. Though the author does his best to describe the sub-

If your electronics problems are... **PEOPLE, PRODUCTION, and PROFITS** **UTAH** has the answers

Utah offers you GUARANTEED BRAINPOWER . . . an inventory of more than 4000 hard-to-find specialists, experienced people of all kinds, eager to work for you in Utah.

An adequate and stable labor force of women and trainable people with the vocational training facilities to prepare them to meet YOUR needs.

One major electronics firm now in Utah reports:

Increased productivity 2.5 to 3 times.

Decreased labor turnover $\frac{2}{3}$ to $\frac{3}{4}$.

. . . and that spells PROFITS . . .

That is why such firms as Univac, Litton, Sperry, General Instrument, Signetics, and others are sold on the fact that “This Is the Place” for profitable electronics operations.

In addition to an unlimited source of low cost raw materials, Utah offers you:

- Many trained people in the electronics field.
- An outstanding and stable labor supply at reasonable wages.
- Training aid and research help.
- Low-cost plant sites.
- Favorable freight rates.
- Freeport-Export Exemption laws.
- An ideal distribution location in the middle of a market of 30 million.
- Recreation, culture, scenery . . . a wonderful place to live and work.

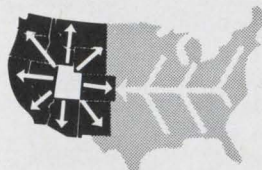

Win the WEST . . . from

UTAH!

For information write:
UTAH INDUSTRIAL PROMOTION BOARD
167 Social Hall Avenue,
Salt Lake City, Utah 84111 Dept. 119

Name.....

Company.....

Type of Business.....

Address.....

City.....

State..... Zip.....

HANSEN'S NEW 900 SERIES

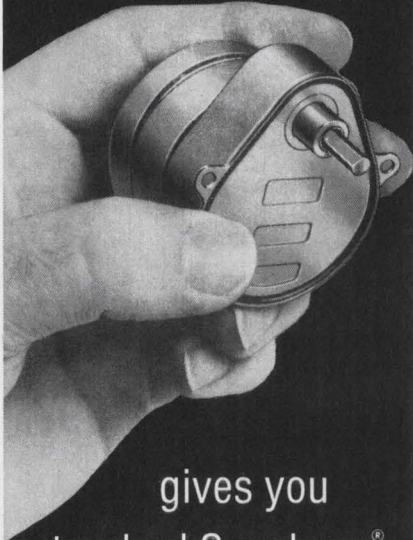

gives you
standard Synchron®
reliability with up
to 98 oz.-in. torque

Now, without sacrificing compact size, you can get high torque even at higher speeds—from 1 to 900 RPM. Synchron® 900 Series has thick, wide gears, specially designed to give the added gear strength that makes full use of its power increase. Highest quality instrument gear train for all speeds below 900 RPM.

The new self-starting hysteresis motor has positive direction of rotation—right or left hand. Plus extra heavy phenolic first gear for low noise level. It can be stalled continuously without electrical or mechanical damage.

Added strength in both the rotor and gear train enables 900 Series to handle your toughest timing and control jobs. Because of its compact dimensions, it is often interchangeable with motors of lower torque. To find out what 900 SERIES can do for you, write or phone today to have a representative contact you.

VISIT BOOTH No. 3133,
DESIGN ENGINEERING SHOW



HANSEN MFG. CO., INC.
Princeton, Indiana 47570

HANSEN REPRESENTATIVES: CAREY & ASSOCIATES, Houston and Dallas, Texas; R. S. HOPKINS CO., Sherman Oaks, Calif.; MELCHIOR ASSOCIATES, INC., San Carlos, Calif.; THE FROMM CO., Elmwood Park, Ill.; JOHN ORR ASSOCIATES, Grand Rapids, Mich.; H. C. JOHNSON AGENCY, INC., Rochester, N.Y.; WINSLOW ELECTRIC CO., Essex, Conn.; Villanova, Pa., and New York, N.Y.

EXPORT DEPARTMENT: 2200 Shames Drive, Westbury, N.Y. 11590

New Books

ject without resorting to high-level mathematics, the problem he deals with is basically one of waveform analysis, which means that complex exponential functions and integrals must be included.

Primarily intended for practicing engineers, the book could be used as a college text. However, there are no problems for solution by students.

Coverage ranges from basic waveform analysis with single-target measurements, matched-filter radar, and pulse compression waveforms, up to radar mapping of distributed targets, target detection in clutter, and synthetic aperture radar.

Working from a general definition of resolution as the capability of recognizing a particular target in the interference from all other targets, the author then can separate the problem of detection from that of resolution.

In most of the book he ignores the effects of antenna pattern by assuming that the targets are either being illuminated with the same signal strength or not at all. With the problems of antenna sidelobes thus being of secondary importance to the resolution, he can separate the antenna design from the waveform design. Primary concern is for those cases where the interaction between waveform and antenna pattern occurs because of a high signal bandwidth combined with a large antenna.

The author is a senior scientist at the Technology Service Corp. in Santa Monica, Calif.

Recently published

An introduction to Electrical Engineering, Allen E. Durling, Macmillan Co., 480 pp., \$10.95

This book provides electrical engineering students with a review of concepts they'll study in depth later in the curriculum. Topics include elementary circuits and theorems, system response, superposition, circuit models, linear and nonlinear circuits, and energy conversion. While the reader should know calculus, a previous course in differential equations isn't necessary.

ECCOFOAM® PLASTICS/CERAMICS FOAM CHART

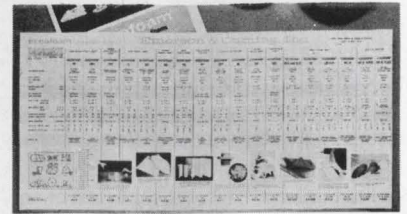

Complete physical and electrical data are displayed for eighteen foams—liquids, powders, sheet stock—plastics, ceramics and even artificial dielectrics. Fold-out chart in full color for notebook or wall mounting is yours.

Circle 505 on reader service card

CRYSTAL CLEAR EPOXY CASTING RESIN



Several transparent Stycast® resins are offered for making display embedments or castings. A convenient chart is available to aid in selection of the most appropriate system. It is yours for the asking.

Circle 506 on reader service card

CONDUCTIVE SILVER COATING IN AEROSOL SPRAY



Eccocoat CC-2 and Eccoshield ES coatings produce surface resistivities below 0.1 ohm per square. Silver particles are plastic bonded to form a tough film which adheres to most materials.

Circle 507 on reader service card

Emerson & Cuming, Inc.



CANTON, MASS.
GARDENA, CALIF.
NORTHBROOK, ILL.
Sales Offices
in Principal Cities

EMERSON & CUMING EUROPE N.V., Oevel, Belgium

SCIENCE/SCOPE

The largest and most powerful communications satellite launched to date was put into synchronous orbit February 9 over the Pacific. Built for the U.S. Department of Defense by Hughes Aircraft Company, the 1600-pound experimental giant is two stories tall and more than eight feet in diameter. It is so powerful its signals can be received by all types of ground terminals, including those with antennas as small as one foot in diameter. It will be used by the U.S. Army, Navy and Air Force to determine the feasibility of using synchronous satellites for tactical communications with small mobile ground stations, aircraft, and ships at sea.

A small, speedy, fourth-generation computer, designed to meet highly sophisticated military command-and-control requirements in the 1970s and beyond, is being built by Hughes under a multi-million-dollar company funded program. Basic size is only 4½ cubic feet. It will handle up to five million operations a second and store up to 256,000 words in its memory, and is designed for modular expansion in both hardware and software to meet changing requirements.

Brazil's first satellite communications ground station, which was inaugurated February 28, was built by Hughes under contract with Embratel, Brazil's telecommunications agency. The station will handle 120 two-way broadcasts via Intelsat satellites currently in operation over the Atlantic. Other services available include telegraph, facsimile, and telex. The Brazilian station is expected to be integrated into the 64-nation communications satellite system of the International Telecommunications Satellite Consortium (INTELSAT).

An advanced forward-looking radar system built by Hughes for the U.S. Air Force's Advanced Development Program 698 DF represents a broad spectrum of sensor and system technology: radar, electro-optical, reconnaissance, navigation, and weapon delivery. System has completed a series of successful flight tests.

NASA's Project Viking plans to softland an unmanned spacecraft on Mars in 1973. The U.S. project calls for two 5,000-lb. spacecraft consisting of a Surveyor-type softlander and a Mars/Mariner orbiter, and will use a Titan 3D-Centaur launch vehicle. One of the softlander's missions will be to determine whether extraterrestrial life exists. Hughes, member of the Project Viking industrial team formed by Boeing, designed and built the five Surveyor spacecraft that landed on the moon to pave the way for Apollo astronauts.

A high-level Intelsat IV task force for scientists and engineers representing international management of the commercial satellite program visited Hughes recently. Four of the huge satellites will be built by Hughes and 12 subcontractors from countries which are members of the International Telecommunications Satellite Consortium. Program is directed by Comsat, which acts as manager for the consortium.

HUGHES

HUGHES INTERNATIONAL
HUGHES AIRCRAFT COMPANY
CULVER CITY, CALIFORNIA, U.S.A.

Circle 199 on reader service card



**Do you have
the question
to this**

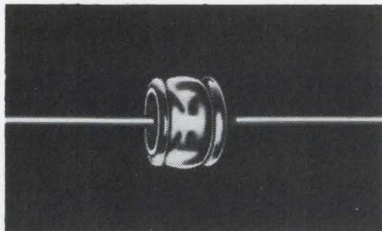

answer?

The only limits to the questions answered by the Siemens Gas-filled Surge Voltage Protector are your needs, and your imagination.

Tiny, lightweight, a handful can protect a ton of sensitive electronic equipment, especially supersensitive solid state circuits. They give you tailor-made protection in hundreds of applications. With current carrying capacities up to 5,000 amps. With DC striking voltages from 90V to 1000V. With reaction speeds in the nanosecond range. And with a cost of less than \$1 in quantity.

Lightning strokes, static charges, internal switching, short circuits—all these transient dangers are guarded against by these tiny, tireless sentries—Siemens Gas-filled Surge Voltage Protectors. If you've got a protection question, call Siemens America Incorporated for immediate protection delivery.

Send us your questions!

SIEMENS AMERICA INCORPORATED
350 Fifth Ave., New York, N. Y. 10001
(212) 564-7674

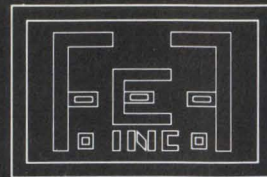

**MICROANALYSIS
of
MICROCIRCUITS**

Problems

- ▼ CONTAMINATING PARTICLES & FILMS
- ▼ MECHANICAL DEFECTS & DAMAGE
- ▼ FAULTY LEADS & BONDS
- ▼ PLATING & METALLIZING FLAWS
- ▼ PASSIVATION & DIFFUSION DEFECTS
- ▼ CONTACT IRREGULARITIES

Techniques

- ▲ LIGHT MICROSCOPY
- ▲ METALLOGRAPHY
- ▲ SCANNING ELECTRON MICROSCOPY
- ▲ REPLICATION ELECTRON MICROSCOPY
- ▲ ELECTRON & X-RAY DIFFRACTION
- ▲ ELECTRON MICROPROBE ANALYSIS



ERNEST F. FULLAM, INC.

P.O. BOX 444, SCHENECTADY, N. Y. 12301
TELEPHONE 518 785-5533

Write for brochure

Circle 239 on reader service card



FASTENER KNOW-HOW

Here's complete design and application data on self-tapping TAP-LOK® inserts . . . the quickest, most practical and economical way to put strong threads in soft materials. Get your copy of this helpful 12-page catalog by writing: Groov-Pin Corporation, 1121 Hendricks Causeway, Ridgefield, N.J. 07657, WH-5-6780.

FASTENER DIVISION

GROOV-PIN CORP.

"For Creative Cost Saving Ideas, See Us at Booth 2117,
Design Engineering Show, May 5-8, N.Y.C."

Technical Abstracts

Surface ripples

Acoustoelectric surface-wave amplifiers
K.M. Lakin
W.W. Hansen Laboratories of Physics
Stanford University
Palo Alto, Calif.

The surface-wave acoustic amplifier may provide some competition for transistors in the not-too-distant future. The high gain that's achieved without interstage networks, high input-output isolation, and simple fabrication techniques make this kind of amplifier an intriguing item. And interest increases when you also consider that the amplifier can be used as a mixer at high signal levels—or as a variable attenuator when the drift field is varied—and that phase changes less than 30° for a gain change of 30 decibels.

Amplification, as in bulk-wave acoustoelectric devices, is provided by the traveling-wave interaction between drifting carriers in semiconductor material and a slow transverse-magnetic wave produced by the acoustic wave in piezoelectric material. With this type of amplifying mechanism, any geometry that efficiently couples such a slow wave to the drifting carriers can be used.

A surface-wave amplifier built at Stanford had lithium niobate as the acoustic medium and a thin silicon epitaxial film as the drift current region. The bidirectional transducer consisted of 20 electrode pairs fabricated by normal photo-etch techniques and matched to a 50-ohm line with pi networks.

This amplifier produced 6 db of stable terminal gain—the actual electronic gain minus transducer loss—with a continuous drift current operation of 3.5 milliamperes at 1.8 kilovolts. No acoustic noise buildup or oscillations due to multiple reflections were observed. The reason: these noise components were outside the transducer's pass-band and were absorbed rather than reflected by the acoustic terminations. Also, triple-transit signals were greatly reduced due to the nonreciprocal property of the amplifier.

Much higher gain can be

Pert Mag, the PERMAG girl, says:

"Separating is simple with Magnets!"

And Permaga has just the right magnet for your separating or sorting problem. Permaga, the world's largest stocking distributor of magnetic materials, offers permanent magnets, assemblies, electrical alloys, flexible magnets, soft magnetic materials and ferrites. Also, special precision grinding and cutting. And full magnetizing and engineering facilities.

Your No. 1 source for all magnetic materials.

PERMAG PACIFIC CORP.

5441 WEST 104th ST., LOS ANGELES, CALIFORNIA 90045
Telephone Area Code (213) 776-5656 TWX [910] 328-6547

PERMAG SOUTHWEST CORP.

2720 TAYLOR STREET, DALLAS, TEXAS 75226
Telephone Area Code (214) 748-6909

PERMAG CENTRAL CORP.

1213 ESTES AVE., ELK GROVE VILLAGE, ILL. 60007
Telephone Area Code (312) 956-1140

PERMAG MAGNETICS CORP.

formerly EMPIRE MAGNETICS
3130 SOUTH AVENUE, TOLEDO, OHIO 43609
Telephone Area Code (419) 385-4621

PERMAG NORTHEAST CORP.

50 THAYER ROAD, WALTHAM, MASSACHUSETTS 02154
Telephone Area Code (617) 484-0550

PERMAG CORP.

88-06 VAN WYCK EXPRESSWAY, JAMAICA, N.Y. 11418
Telephone Area Code (212) 657-1818 TWX [710] 582-2952

Circle 252 on reader service card

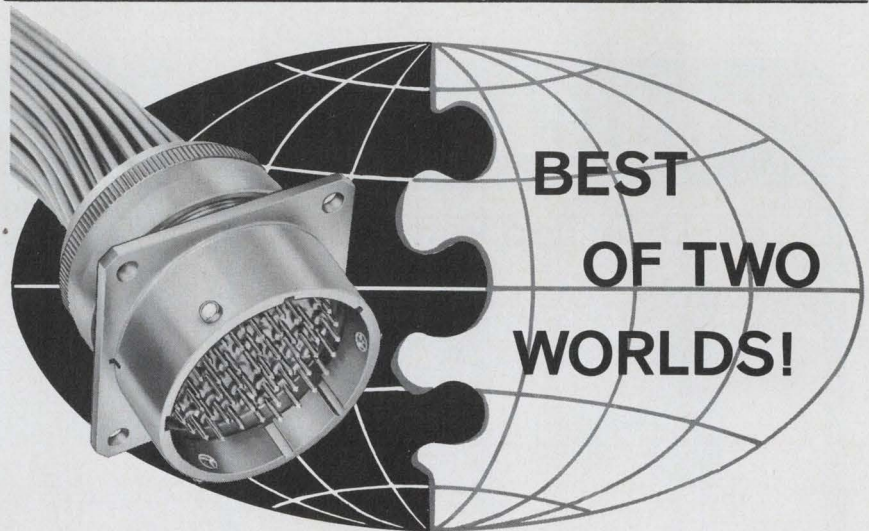

Deutsch 460 series connectors combine the best of two worlds. They offer a low-cost Tri-Kam, bayonet-lock coupling, designed to MIL-C-26482, plus the high-reliability of silicone inserts constructed to NAS 1599. **Positive lock... rear release!** You get them both when you plan your designs with Deutsch 460 series connectors. The 460 family is completely compatible with all the Deutsch components that comprise the Deutsch Integrated Termination System (ITS). The 460 series is adaptable to standard MS accessory hardware and is intermateable and interchangeable with existing MIL-C-26482 bayonet locking connectors. Write for your 460 Data File or contact your local Deutschman.



DEUTSCH

ELECTRONIC COMPONENTS DIVISION

Municipal Airport • Banning, California 92220 • Telephone: Area Code 714 • 849-6701

COPYRIGHT, 1969 DEUTSCH ELECTRONIC COMPONENTS DIVISION

These NEW Bench Supplies will make you smile 3 ways!

- 1** Excellent regulation .01% and —ripple only 250 mv!
- 2** Same Day Shipment. No annoying wait
- 3** Low Price. You can buy several

The BP-89 and BP-118 both give you a regulation of supply within 0.01% and ripple is 250 microvolts. Silicon differential amplifiers and stable voltage references result in excellent stability. They are short circuit and overload protected, and feature MIL spec performance. At such low prices, you can afford to have several of these fine power supplies available. Stop waiting in line to use the more expensive one, and smile!

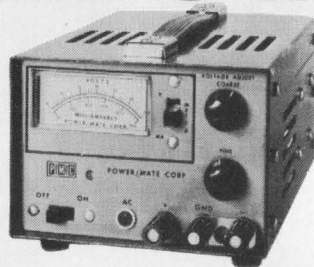

BP-89
0-34 volts at 0.5 amps for **\$89**



BP-118
0-34 volts at 1.5 amps for **\$118**

SPECIFICATIONS

OUTPUT: 0-34Vdc, BP-89 — 0-500mA BP-118 1.5Amp
INPUT: 105-125Vac, single phase, 50-400Hz
LOAD REGULATION: Less than $\pm 0.01\%$ plus 1mV output voltage change for a load current change equal to the current rating of the supply.
LINE REGULATION: Less than $\pm 0.01\%$ output voltage change for a change in line voltage from 105 to 125 (or 125 to 105) volts at any output voltage and current within rating.

RIPPLE AND NOISE: Less than 200 μ V RMS/1mV p-p
TEMPERATURE COEFFICIENT: Output voltage change per degree centigrade is less than 0.02% plus 1mV after 30-minutes warmup.
STABILITY: The total drift for 8 hours (after 30 minutes warmup) at a constant ambient is less than 0.1% plus 5mV.
CONSTRUCTION: All metal case with baked enamel finish.

PIMIC **POWER/MATE CORP.**
 163 Clay Street • Hackensack, N.J. 07601
 (201) 343-6294 • TWX (710) 990-5023

SAME DAY SHIPMENT

Circle 242 on reader service card

INDICATORS

Unlimited Variety

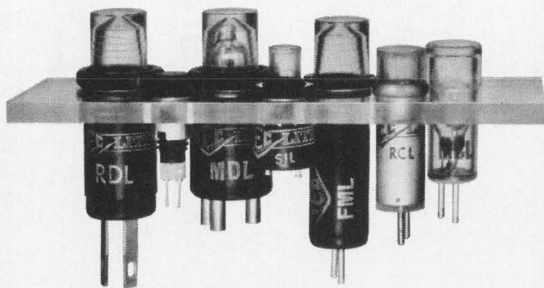

What's your need? TEC has it . . . electrically designed to cover most supply voltages. Neon or incandescent lamps; wide choice of options including integral switch. Some so compact they mount on $\frac{1}{4}$ " centers. For information about TEC's complete line of indicators and switches • readouts • display panels • data entry keyboards • CRT display terminals, call (612) 941-1100 or write:



**Transistor
 Electronics
 Corporation**

Box 6191 • Minneapolis, Minnesota 55424

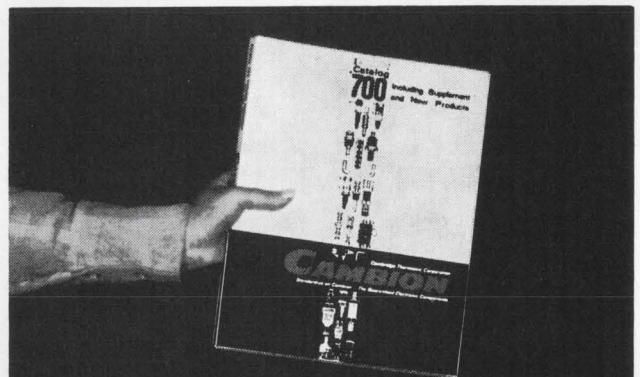

**This free catalog
 will tell you more about
 electronic components...
 than you'll ever need to know**

Design features, performance data, construction details, application ideas, and much, much more. CAMBION's new Catalog 700 makes it easy to select the best coil or coil form; the most practical pin or connector; you choose from the largest variety of solder or insulated terminals; RF chokes and panel hardware to meet your circuit design requirements. Catalog 700 has it all. And with 700 by your side, you'll have the widest selection of guaranteed electronic components in the industry. To get your copy, call or write Cambridge Thermionic Corporation, 467 Concord Avenue, Cambridge, Massachusetts 02138. Phone: (617) 491-5400. In Los Angeles, 8703 La Tijera Boulevard, 90045. Phone: (213) 776-0472.

Standardize on

CAMBION®

The Guaranteed Electronic Components

Technical Abstracts

achieved with a pulsed drift field because of the lower average power dissipation. With an amplifier active region of only 1 centimeter, the terminal gain can be varied over 100 db (-50 to +50 db) by varying the drift field from -2 kv to approximately +5 kv. To reduce the high drift field requirements, the amplifier can be cut into segments; each of these tiny amplifiers can then be operated in parallel at much lower voltages. The segments' gains can be added directly, and gains of 30 db at 185 volts have been achieved.

The maximum power output for the silicon sample used was about 1 milliwatt, or 0 dbm; however, other samples gave as high as +15 dbm. The lowest input level was -80 dbm, but this was due to the noise limitation of the test receiver, not to the amplifier.

Presented at the 1969 IEEE International Convention, New York, March 24-27.

CAM's grow up

On Integrated Associative Memory Element

R.F. Herlein and A.V. Thompson,
American Micro-systems Inc.,
Santa Clara, Calif.

For many years computer people have wanted a memory from which they could retrieve information without having to keep track of its precise location—retrieval purely in terms of the information itself. Until recently, such memories, called associative or content-addressable memories (CAM's), haven't been economically feasible, because each storage cell requires logic associated with it. But the advent of large-scale integrated circuits lowers the cost of such complex units to a point where they are of more than academic interest to the engineering community.

One such array has recently been developed at American Micro-systems, Inc. It contains eight words of eight bits each, organized for parallel access and designed to operate at 1 megahertz. It contains 1,799 p-channel metal oxide semiconductor transistors on a single substrate measuring 156 by 144

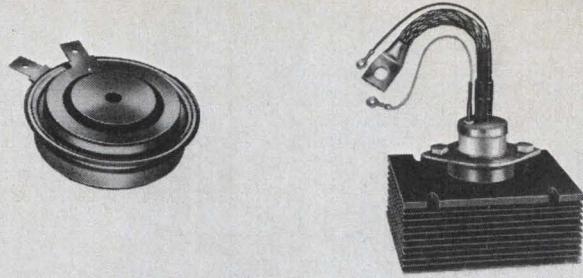

175 amp, 235 amp, 470 amp Regenerative Gate* SCRs

Regenerative Gate SCRs operate with lower switching losses and higher continuous di/dt than any other SCR. Low power gate drive. No sacrifice required in any other characteristic.

Continuous Rating at 60 Pulses Per Second, 90°C**

rms Current Rating	Pulse Width	Peak On-State Current
235 amp	100 μ sec.	3300 amps
470 amp	150 μ sec.	6000 amps

**Verified by long-term life test.

Also available in 55 amp and 110 amp. Request Bulletin.

NATIONAL
ELECTRONICS, INC.

a varian subsidiary
GENEVA, ILLINOIS 60134
PHONE (312) 232-4300

*A National® exclusive.
Patent Pending.

Circle 244 on reader service card

You can put

500

high-performance
electrical contacts

in this space, and...

**TAKE THE WORRY
OUT OF BEING CLOSE!**

Check 'em out! You'll find Deutsch high-density, **rectangular** connectors stack up best from any angle. No other group of connectors can handle as many contacts in so little space. Yet they're easy to work with and provide perfect dielectric separation. One of many components in the Deutsch Integrated Termination System (ITS), these rectangulars are ideal for modular instrumentation packages. Center jackscrew provides visual indication of proper lock and assembly. Also available with center guide pin for rack and panel installation. Environmental and non-environmental models available. Five shell sizes. Many insert arrangements. Write for your Deutsch Data File on rectangulars.



DEUTSCH ELECTRONIC COMPONENTS DIVISION

Municipal Airport • Banning, California 92220 • Telephone: Area Code 714 • 849-6701

COPYRIGHT, 1969 DEUTSCH ELECTRONIC COMPONENTS DIVISION

NEW

**Low Cost
Compact
Proximity
Sensing
System**

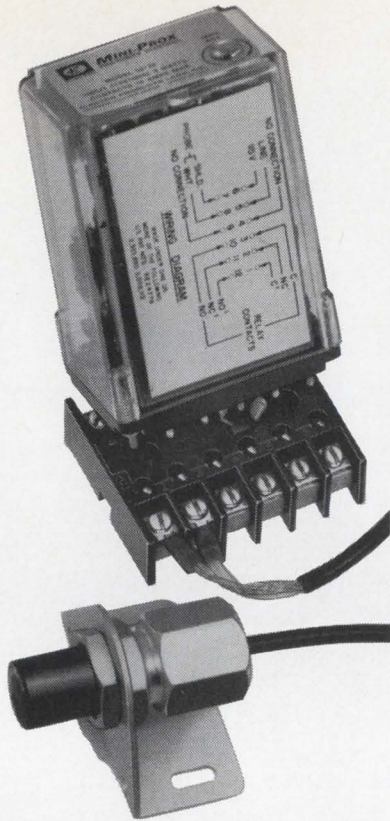

Model 55125
Mini-Prox with
Model 41060
plug-in socket
and 85001
sensing head.

★TEMPERATURE-STABLE

MINI-PROX

For Non-contact Detection and Control

★ Mini-Prox accuracy of sensing distance can be depended upon in any environment; heat to +160°F or cold to -30°F at *either probe or control* in the detection of ferrous and nonferrous metals.

Plug-in design and unitized construction eliminates soldering, also wiring of sensing controls. Operations up to 600 per minute. (Electronic output models for higher speeds are available.) Five standard sensing heads provide sensing ranges from .050" to 1.000".

ELECTRO representatives are experienced in assisting with proximity switch applications. Most carry local stock to service your requirements immediately.

Write for bulletin giving complete specifications and the name of your nearest EPL representative.



ELECTRO
PROXIMITY SWITCHES

ELECTRO PRODUCTS LABORATORIES, INC.
6125 West Howard St., Chicago, Ill. 60648 • 312/647-8744

**±1/4° F control
(SCR solid state)
-120°F to +350°F range**

**with improved Tenney Jr.
"Hermeticool"
refrigerated
bench-top
test chamber**

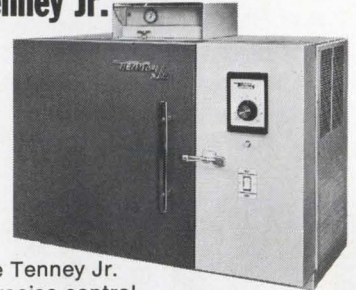

Better than ever! The Tenney Jr. now features more precise control while providing 40% expanded work space and faster cooling. Inside area has been enlarged to 1 1/4 cu. ft. without increasing outside dimensions. New, faster pull-down is from +75°F ambient to -100°F in just 35 minutes. Delivered for immediate 115 volt plug-in operation, Tenney Jr. requires no special piping, no accessories.

Write or call today for complete details.

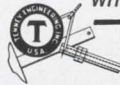

Tenney
ENGINEERING, INC.

Only \$1080
Available immediately
from stock

1090 Springfield Rd., Union, N. J. 07083 • (201) 686-7870
Western Div.: 15721 Texaco St., Paramount, Calif. 90723

479 B

Circle 245 on reader service card

For the Computer Industry

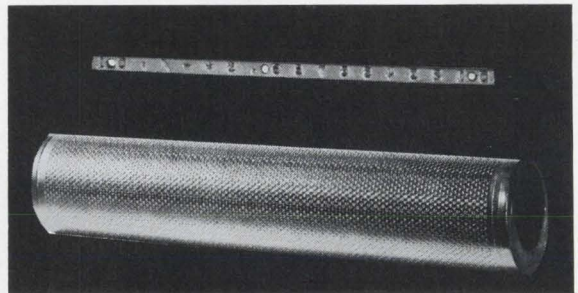

Print Bars and Drums

At Buckbee-Mears we etch the entire drum in one operation. Costly assembly problems are eliminated because there are no segments to line up. We are also geared to etch print bars faster at lower costs. Our print drums and bars are made of hardened tooled steel for extra long life.

For more information, see your nearest Buckbee-Mears representative. Or contact Bill Amundson, our industrial sales manager. You'll be glad you did.



**BUCKBEE - MEARS
COMPANY**

245 E. 6th St., St. Paul, Minn. 55101 / (612) 227-6371

Technical Abstracts

mils and is mounted in a 40-lead dual in-line package.

A new kind of MOS circuit was developed to achieve the memory's high packing density, high speed, and low power. Like conventional four-phase clocked logic, it relies on temporary storage in distributed capacitances, but it uses only three clock phases, so that its propagation delay is reduced. Furthermore, the circuits' output impedances are low when their outputs are positive, producing good noise immunity. The clock pulses are the source of power to the circuits.

Three kinds of circuits are used in the memory: an isolating inverter, a minimum delay inverter, and a noninverting gate. The memory cells that actually store the information are each made of two isolating inverters that recirculate a bit back and forth. A minimum-delay inverter generates the complements of the address bits; NOR logic made from the isolating inverters decodes the address.

An associative memory's most critical function—that of generating flag bit outputs for words that match the unmasked portions of an input data word—is implemented here with the noninverting gate.

The new associative memory would have been difficult or impossible to build without these new circuits, which promise to be useful in many future applications as well.

Presented at the International Solid State Circuits Conference Philadelphia, Feb. 19-21.

Gain in translation

Millimeter-Wave Up-Converter With Gain Using Germanium Avalanche Diodes
S. Kita,
Nippon Telegraph and Telephone Public Corp., Tokyo

Crucial to the reliability of experimental millimeter wave systems are the solid state devices that regenerates pulses in repeaters. Usually, Schottky-barrier diodes or diffused diodes are used as varistors and varactors respectively. These diodes don't amplify the intermedi-

MDS MODEL 2110R . . . THE LOW-COST TAPE PUNCH THAT DELIVERS HIGH-QUALITY SERVICE

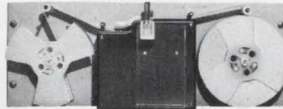

MDS 2110R Paper Tape Punch

The low-cost Paper Tape Punch that makes no compromise with quality

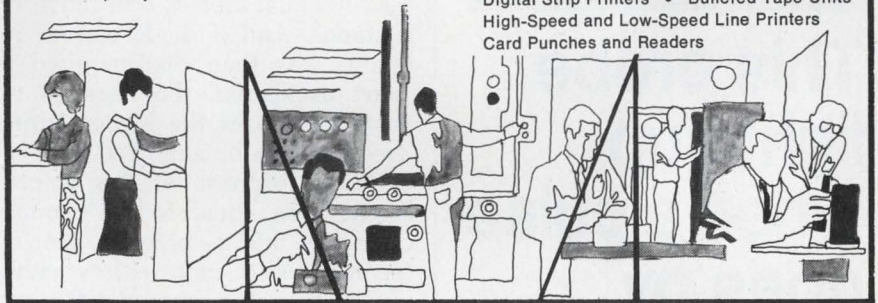

MOHAWK ^{MS} DATA SCIENCES CORPORATION OEM MARKETING

122 E. Ridgewood Ave. • Paramus, N.J. 07652

Telephone 201/265-7333

Every MDS Office is an OEM Marketing Office

Digital Strip Printers • Buffered Tape Units

High-Speed and Low-Speed Line Printers

Card Punches and Readers

Circle 247 on reader service card



the Solderless Hermetic!

Up to now, hermetic connectors meant soldered contacts. Solder meant smoke, and — **more important** — operator training, time, uninspectable connections, the danger of unreliability, and high costs. Now . . . Deutsch brings you the solderless rear-release hermetic connector! Not only can you now insert and remove contacts in seconds, but also without any of the old problems of precision soldering. Meets Mil Spec performance requirements. Compatible in contact crimping, terminating, installing and tooling techniques with all components of the Deutsch Integrated Termination System (ITS). Why not break your smoking habit. Write for your Hermetic Data File or contact your local Deutschman.



DEUTSCH

ELECTRONIC COMPONENTS DIVISION

Municipal Airport • Banning, California 92220 • Telephone: Area Code 714 • 849-6701

COPYRIGHT, 1969 DEUTSCH ELECTRONIC COMPONENTS DIVISION

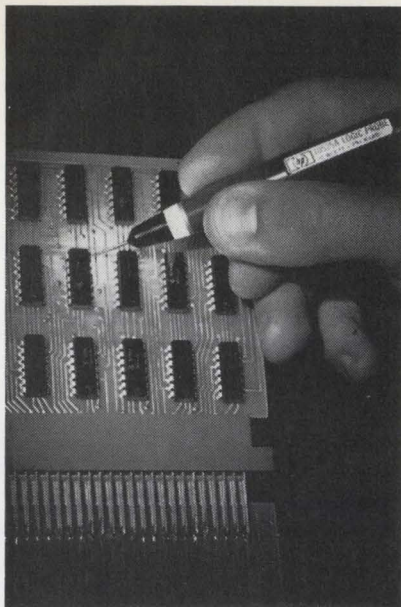

This probe lights up when a pulse goes by.

Even a pulse as short as 30 ns—positive or negative—will cause this logic indicator to flash a signal. You can trace pulses, or test the logic state of TTL or DTL integrated circuits, without taking your eyes off your work. In effect, the probes act like a second oscilloscope at your fingertips.

No adjustments of trigger level, slope or polarity are needed. A lamp in the tip will flash on 0.1 second for a positive pulse, momentarily extinguish for a negative pulse, come on low for a pulse train, burn brightly for a high logic state, and turn off for a low logic state.

The logic probe—with all circuits built into the handpiece—is rugged. Overload protection: -50 to +200 V continuous; 120 V ac for 10 s. Input impedance: 10 k Ω . Price of HP 10525A Logic Probe: \$95, quantity discounts available.

Ask your HP field engineer how you could put this new tool to work in logic circuit design or troubleshooting. Or write Hewlett-Packard, Palo Alto, Calif. 94304; Europe: 54 Route des Acacias, Geneva.

02825A

HEWLETT  PACKARD

Technical Abstracts

ate frequency as they convert it to the higher output frequency.

However, an experimental millimeter up-converter using avalanche germanium diodes translates a 4-gigahertz signal to a 46.5-Ghz output signal—and amplifies the signal up to 3 decibels.

When this diode is used in the avalanche region the 42.5-Ghz local frequency and the -4 Ghz intermediate frequency are efficiently converted to the 46.5-Ghz output frequency by a parametric effect. Keeping both the optimum and output frequencies of the diode nearly equal creates a negative resistance. And if diode current remains less than that required to start oscillation, the negative resistance causes the higher output frequency to be amplified.

Pulse response of the up-converter was equal to the requirements of millimeter wave pcm repeaters. When input pulses with a 4-Ghz frequency and a 400-mega-bits-per-second rate were applied, the rise and fall times of the output pulses were about 1 nanosecond.

Diode current and output power increased rapidly beyond negative bias voltages of 8 volts, reaching a maximum of -11 volts. Current at that point was about -10 milliamperes. A maximum output power of 5.1 dbm was obtained at a local oscillator power of 10 dbm and a signal power of 14 dbm.

Experiments were done with germanium silver-bonded diodes consisting of n-type germanium and a silver whisker doped with a small amount of gallium.

Presented at the 1969 IEEE International Solid State Conference, Philadelphia, Feb. 19-21.

Decisions, decisions

One view of automation for patient clinical care
George N. Webb, N.S., and
Richard S. Johns, M.D.
Johns Hopkins School of Medicine
Baltimore, Md.

Automating various phases of hospital operation is one way to improve health care. But before a hospital turns to automation, it should precisely define the problems it's



NORTON[®] MAGNETIC HEADS

MULTITRACK ERASE RECORD PLAY

Send now for complete technical literature.

NORTON
ASSOCIATES, INC.

10 Di Tomas Court, Copiague, N.Y. 11726
Phone: 516 598-1600

Circle 248 on reader service card

Make your own break.

You can take a lot of the chance out of your future by including yourself in the Electronics Manpower Register.

When you do, your experience and talents become part of a nationwide computerized placement service.

Our computer is programmed to give every registrant the same look for every opening. With your prior approval, you'll be considered for every opportunity that matches your resume.

All you have to do is send one to:

Electronics Manpower Register
Electronics
330 West 42nd Street
New York, N.Y. 10036

TRANSTECTOR

CIRCUIT PROTECTOR



prevents transients from causing "unexplainable" circuit failures.

Don't blame circuit failures on bad luck.

Voltage transients can cause circuits to fail or suffer undetected and progressive damage.

Transtector* circuit protector, a new solid state device, senses transients within nanoseconds, absorbs the surge and resets itself. Gives continuous protection for tubes, transistors, diodes and integrated circuits.

Find out about Transtector Systems from M&T Chemicals Inc., 3025 W. Mission Rd., Alhambra, California 91803.

*Trademark of M&T Chemicals Inc.

M&T Chemicals Inc.
SUBSIDIARY OF AMERICAN CAN COMPANY



Circle 249 on reader service card

FREE!
CATALOG ON
SEMI-CONDUCTOR
PROCESSING
EQUIPMENT

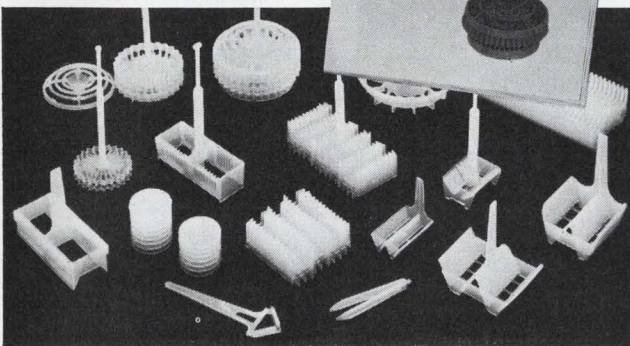

Get full information on a wide variety of products for handling substrates, wafers, and crystals. Fluoroware carriers, baskets, and trays are precision-molded from FEP Teflon*, a material that is almost 100% inert and useable at extreme temperatures.

Write for the "Semi-conductor Processing Equipment Catalog," including information on the new Fluoroware spin dryer.

*DuPont Trademark

FLUOROWARE.
Chaska, Minnesota 55318 • Phone 612-448-3131

Circle 250 on reader service card

What price performance in a quality filter?

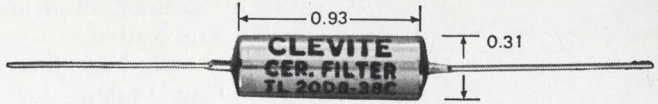

less than \$15
with Clevite's compact ceramic ladder filter.*

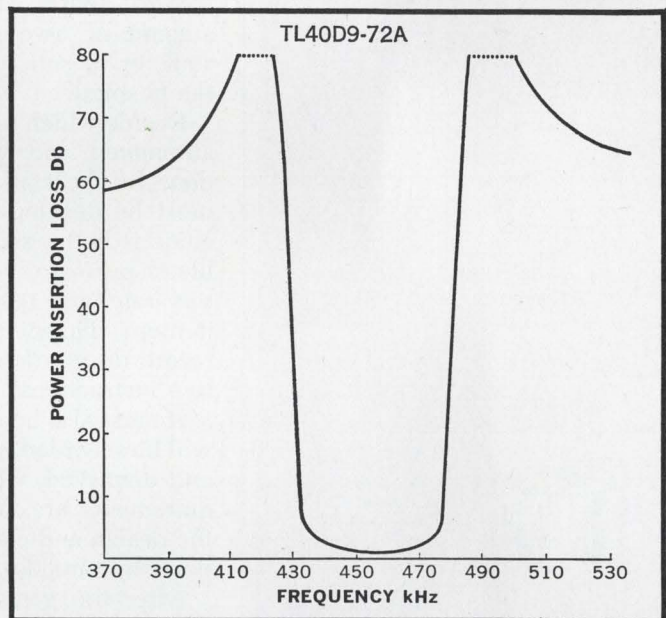

Here's the smallest (less than 0.07 cu. in.), most rugged fixed-tuned filter on the market today!

Clevite's 9-disc miniature filter is packaged in a hermetically-sealed cylinder, exceeds all military environmental specifications, is ideal for transistorized i-f amplifier circuitry in AM and FM sets plus many other applications that call for a fixed-tuned filter. Stop band rejection: 50 db. Center frequency tolerance: ± 3 kHz. Stability: within $\pm 0.2\%$ for 5 years; within 0.2% from -40°C to $+85^{\circ}\text{C}$. Impedance (in and out) 2000 ohms for B/W less than 12 kHz; 1000 ohms for broader bandwidths.

Following models standard at 455 kHz (A) or 500 kHz (C) (custom models on special order):

Model Number	min. @ 6db	B/W	max. @ 60 db
TL10D9-20 (A or C)	10 kHz		20 kHz
TL16D9-32 (A or C)	16 kHz		32 kHz
TL20D9-38 (A or C)	20 kHz		38 kHz
TL30D9-57 (A or C)	30 kHz		57 kHz
TL40D9-72 (A or C)	40 kHz		72 kHz

*PRICES: 1—\$25 ea; 25—\$20 ea; 100—\$17.50 ea; 500—\$15 ea; 1000—\$13.75 ea; 2500—\$12 ea.

(Prices subject to change without notice)

Send order or request for Bulletin 94021 to: Clevite Corporation Piezoelectric Div., 232 Forbes Rd., Bedford, Ohio 44014, U.S.A. Or: Brush Clevite Company, Limited, Southampton, England.

CLEVITE

Circle 207 on reader service card

207

FOR 8-TRACK RECORDING ON 1/4" TAPE

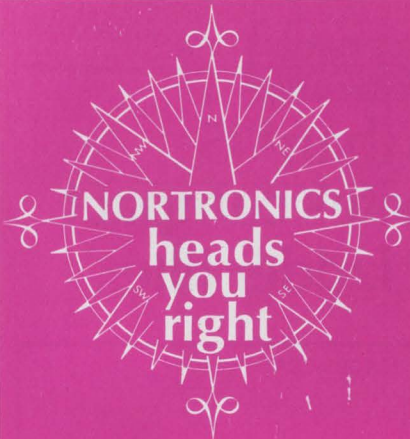

Since we pay a lot of attention to everybody's magnetic recording needs, we can readily understand both how and why yours are different. That's why we offer not only a tremendous range of tape heads, but also the expert counsel that guides you to the most effective specifications.

Study our technical literature on these 8-track heads (available free on request):

MODEL B2L



The basic head of the 8-track stereo industry, for record and/or playback. Response through 15Khz at 3.75 ips.

MODEL ZJ2L



First Combo head for 8-track stereo. Record, playback, and erase in a single unit. Eliminates assembly tolerance, track alignment and pressure pad problems. Simplify circuitry; internal automatic biasing.

MODEL P-BQL



For duplicating or instrumentation applications. Maximum information storage at minimum cost. Four in-line tracks. A staggered pair provides 8 tracks on 1/4" tape.

Which one fits your needs? Nortronics, the world's largest tape head manufacturer, has what it takes to analyze your requirements and to recommend the right head... for any audio or instrumentation application.

When you have a tape head need, head for Nortronics. We'll head you right.

Nortronics
COMPANY, INC.

8101 Tenth Avenue North
Minneapolis, Minnesota 55427
Phone—(612) 545-0401

Sales Offices throughout the world

Technical Abstracts

trying to solve. And this defining requires the cooperation of physicians and engineers, because all the skills of the systems engineer are called into play in the design and installation of an automated hospital system.

The design of a cardiac monitoring system, for instance, requires adherence to the following stringent guidelines:

Define specific goals for the system before anything else is done. Examine the reason for going to an automated system. Is it to improve patient care at any cost, to reduce medical costs, to increase the amount of care provided by the staff, or to satisfy status needs of the hospital?

Decide which functions are to be automated and which are to be done by the staff. For example, it must be decided if man or a machine is better suited to measuring blood pressure, heart and respiratory rate, and temperature. And is it more efficient for a machine to record drug orders and administrative instructions?

It must also be decided how data will be recorded, processed, stored, and displayed, what the safety requirements are, and what part of the design and construction will be done by outside contractors.

After the goals have been laid down, run a pilot study. Get all the hospital personnel involved at this stage so that later complications can be avoided. And set up training programs for all affected employees of the hospital.

Budget a fixed percentage of projected costs to pay for outside consultation.

And budget at least 10% of projected hardware costs for inhouse maintenance and modification. With the exception of one device from Hewlett-Packard, all the electronic instruments bought in the past year for a system at Johns Hopkins either required a major repair or had to be returned to the maker within three months of purchase. And this isn't to let H-P off the hook because the other equipment from them failed.

Presented at 1969 IEEE International Convention, New York, March 24-27.

NEW

MINIATURE REMOTE CONTROLLED ATTENUATOR

0-10db
1db steps
DC-2000 Mhz
\$275.00

0-100db
10db steps
DC-1200 Mhz
\$350.00

0-110db
1db steps
DC-1200 Mhz
\$450.00

Now Available: A new line of motorized programmable step attenuators. Twelve (12) models cover the attenuation range of 0-110db in increments of 0.1db, 1.0db and 10db.

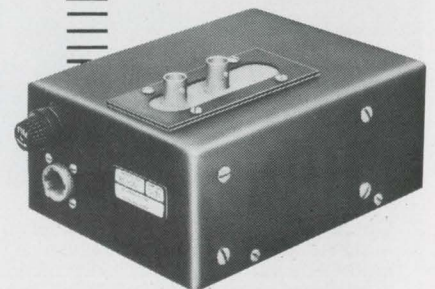

TEXSCAN
CORPORATION
2446 N. Shadeland Avenue
Indianapolis, Indiana 46219
Telephone (317) 357-8781
TWX: 810 - 341 - 3184

PHILIPS

the strongest european group in integrated circuits is expanding their activity

Challenging opportunities Physicists

for development and design of new digital and linear monolithic IC's

Engineers

for solid state diffusion and production of integrated circuits

requirements:

at least B.S. degree in physics or electrical engineering
experience in integrated circuits or semiconductors readiness to work in
our facilities in Germany (VALVO GmbH, Hamburg)

please mail your resumé to:

Dr. Schilling, PHILIPS Germany, 7 Mönckebergstrasse, Hamburg 1 - Germany.

Circle 253 on reader service card

FREE!

CLAMP Design Manual



72 pages of engineering data!

The most complete work of its kind, this manual features 72 pages of prints, illustrations, tables, specifications and installation tips for any clamp situation. Whether of aluminum, titanium or stainless steel, from 1/8" to 6" diameter, for hot or cold temperature insulation . . . for any situation, you'll find the best way to "clamp down" clearly shown in this booklet. ■ Over 41,000 clamp designs at your fingertips, ready for shipments now, at big off-the-shelf savings. Also shows blocks, brackets, line supports and related items. BEFORE YOU DESIGN OR BUY, CHECK WITH TA FIRST! Write or phone today for a quotation. ■ Send for your free clamp manual today!

TA MFG CORP  A DAYCO COMPANY

4607 Alger Street, Los Angeles, California 90039 ■ Phone 213-245-3748/
TWX 910-497-2065 L. A./WUX CAT L. A., Calif.

Circle 254 on reader service card

INTRODUCING! THE UNRELAY?

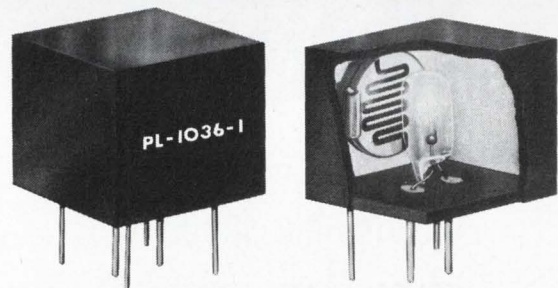

New PL-1036-1 Photocell Lamp
Assemblies from National feature:

- 10 volt — 15 MA Lamp
- 400 volt — .25 watt photocell
- Photocell ON resistance —
400 ohms max
- OFF Resistance — 100 Megohms
Min

NATIONAL SEMICONDUCTORS LTD.

MANUFACTURERS OF PHOTOELECTRIC CELLS

331 Cornelia St. Plattsburgh NY 12901 Tel. 518-561-3160
In Canada: 2150 Ward St. Montreal Que Tel. 514-744-5507

Circle 209 on reader service card

209

The Complete Line of Fuses For The Protection of Semi-Conductor Rectifiers

TRON Rectifier Fuses

Provide extremely fast opening on overload and fault currents, with a high degree of restriction of let-thru current. Many types and sizes available. Ampere ratings from 1/2 to 1000 in voltage ratings up to 1500.

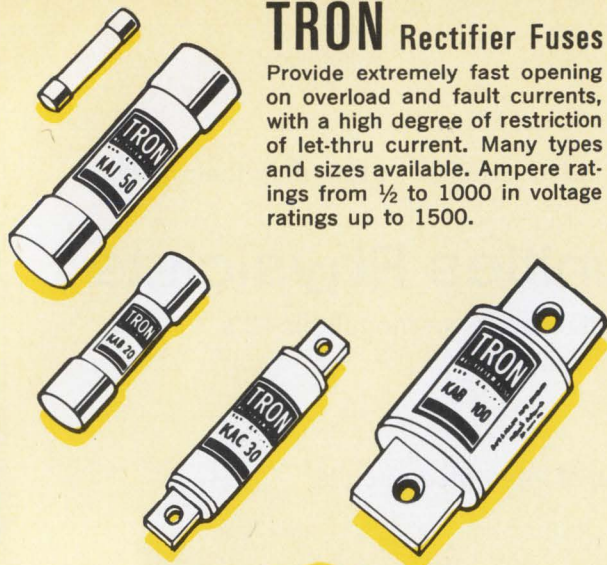

Write for BUSS Form SFB



BUSSMANN MFG. DIVISION, McGraw-Edison Co. St. Louis, Mo. 63107
Circle 255 on reader service card

The Complete Line of Signal-Indicating Alarm-Activating Fuses

For use on computers, microwave units, communication equipment, all electronic circuitry.

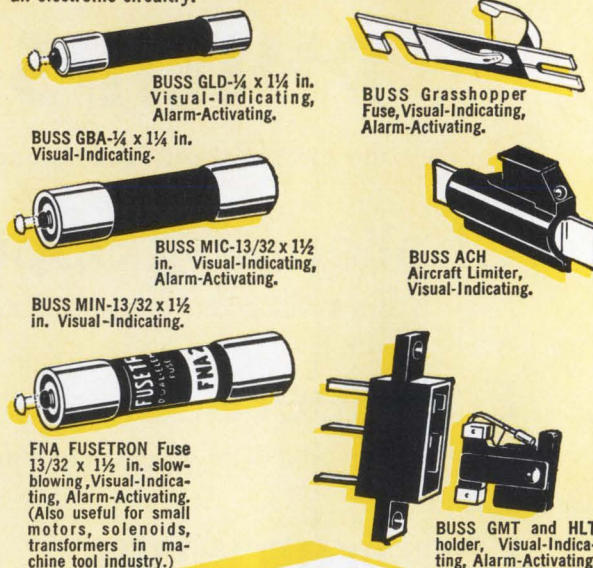

Write for BUSS Form SFB



BUSSMANN MFG. DIVISION, McGraw-Edison Co. St. Louis, Mo. 63107
Circle 255 on reader service card

BUSS: The Complete Line of Fuses and . . .

**WANTED:
ELECTRONICS
MANUFACTURER**

who desires to fill a dependable supply of government contracts

Excellent opportunity for growth-minded electronics manufacturer to locate in Texas and help meet the needs of the government and the third fastest-growing state. Stable, productive labor. Incomparable tax advantages. Lowest living costs. For 1968 Texas Fact Book, write or call the:

TEXAS INDUSTRIAL COMMISSION
Central Information Source for all of Texas
Box JJ-E, Capitol Station
Austin, Texas 78711
Telephone 512/475-4331

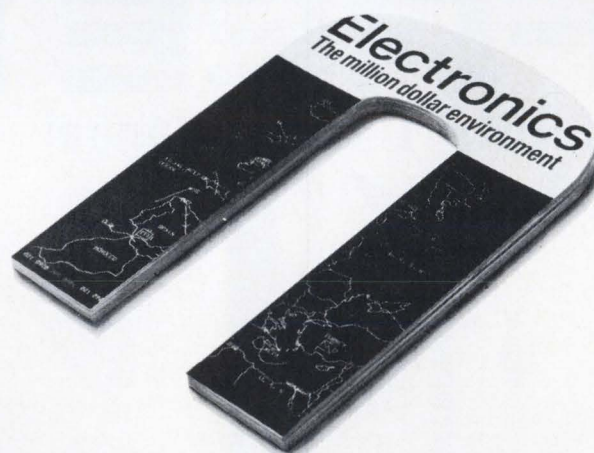

Every year, ELECTRONICS attracts requests for over 125,000 editorial reprints.

They're like interest payments on our million-dollars-a-year editorial principles.

That's how much we spend annually to produce timely, authentic, and useful articles like those listed on the reader service card as reprints currently available.

Investment and interest make both ELECTRONICS and its readers more meaningful to its advertisers.

New Literature

Instrumentation. Sybron Corp., 95 Ames St., Rochester, N.Y. 14601. A four-page folder on Quick-Scan 400 series instruments describes the line's controllers, recorders, process indicators, manual loading stations, and cascade switching stations.

Circle 446 on reader service card

I-R analytical accessories. Barnes Engineering Co., 30 Commerce Rd., Stamford, Conn. 06902, has published a 36-page handbook on its complete line of i-r spectrophotometer cells and accessories. [447]

Counter/timer. Monsanto Electronic Instruments, 620 Passaic Ave., West Caldwell, N.J. 07006. Characteristics and capabilities of the model 110A, a 50-Mhz programable counter/timer, are outlined in a six-page brochure. [448]

Power transducers. Esterline Angus Division of Esterline Corp., P.O. Box 24000, Indianapolis 46224. A-c power transducers that are virtually maintenance-free are described in a 12-page catalog. [449]

Tone receiver. Quindar Electronics Inc.,

60 Fadem Rd., Springfield, N.J. 07081. Two-page product data sheet PDS-1-4 describes the QR-30 frequency-shift tone receiver. [450]

Frequency sources. Frequency Sources Inc., P.O. Box 159, North Chelmsford, Mass. 01863, has just released its new 1969 catalog describing a broad line of microwave solid state sources. [451]

High-current rectifiers. KSC Semiconductor Corp., KSC Way (Katrina Rd.) Chelmsford, Mass. 01824. A six-page bulletin lists characteristics and application conditions for a series of high-current rectifiers. [452]

Displacement transducers. Research Inc., Box 6164, Minneapolis 55424. Bulletin 508.5 covers a line of displacement transducers for remotely measuring linear motion, displacement, deflection or separation. [453]

Discrete devices. Fairchild Semiconductor, Box 1058, Mountain View, Calif. 94040. The 1969 transistor and diode condensed catalog gives a complete listing of the company's discrete devices. [454]

Electron-beam evaporation. Airco Temescal, Division of Air Reduction Co., 2850 Seventh St., Berkeley, Calif. 94710. A 12-page brochure outlines applications of electron-beam evaporation for producing optical and electronic thin-film devices. [455]

Automatic testing control. Theta Instrument Corp., 22 Spielman Rd., Fairfield, N.J. 07006. Bulletin 67-10 describes digital systems with primary applications in the automatic control of testing sequences. [456]

Voltage regulator sockets. Electronic Molding Corp., 40 Church St., Pawtucket, R.I. 02860, offers bulletin FS-11 on a nine-pin molded socket for packaging TD-66 flanged-type voltage regulators. [457]

Diode test equipment. Teradyne, 183 Essex St., Boston 02111, has published a 12-page brochure on its line of automatic test instruments for diodes [458]

High-vacuum pumps. Nelson Vacuum Pump Co., 2133 Fourth St., Berkeley, Calif. 94710, has released catalog No. 20 giving up-to-date details on a full line of high-vacuum pumps and acces-

Fuseholders of Unquestioned High Quality

THE COMPLETE LINE OF *Small Dimension* FUSES

For The Protection of All Types of Electronic and Electrical Circuits and Devices . . .

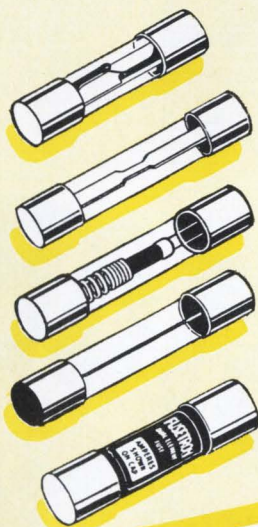

. . . includes dual-element "slow-blowing", single-element "quick-acting" and signal or visual indicating types . . . in sizes from 1/500 amp. up.

For special fuses, clips, blocks or holders, our staff of fuse engineers is at your service to help in selecting or designing the fuse or fuse mounting best suited to your requirements.

Write for BUSS Form SFB

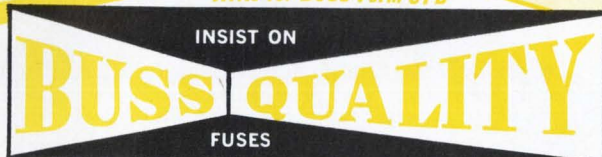

BUSSMANN MFG. DIVISION, McGraw-Edison Co. St. Louis, Mo. 63107

Circle 211 on reader service card

SUB-MINIATURE FUSES

Ideal for space tight applications, light weight, vibration and shock resistant. For use as part of miniaturized integrated circuit, large multi-circuit electronic systems, computers, printed circuit boards, all electronic circuitry.

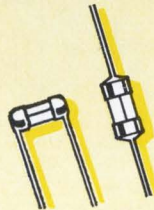

TRON Sub-miniature Pigtail

Fuses — Body size only .145 X .300 inches. Glass tube construction permits visual inspection of element. Hermetically sealed. Twenty-three ampere sizes from 1/100 thru 15.



BUSS Sub-miniature GMW Fuse and HWA Fuseholder

Fuse size only .270 X .250 inches. Fuse has window for visual inspection of element. Fuse may be used with or without holder. 1/200 to 5 amp. Fuses and holders meet Military Specifications.

Write for BUSS Form SFB

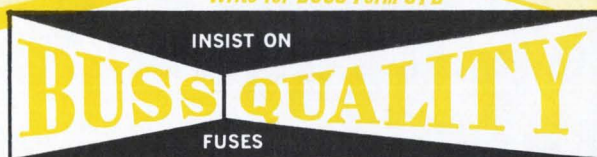

BUSSMANN MFG. DIVISION, McGraw-Edison Co. St. Louis, Mo. 63107

Circle 211 on reader service card 211

New Literature

sories for laboratory and field uses. [459]

Ribbon cable and assemblies. Spectra-Strip Corp., P.O. Box 415, Garden Grove, Calif 92642. Bulletin 070 describes Spectra-Sil flat ribbon cable and harness assemblies made of individual round conductors insulated with sicilone rubber. [460]

Quartz crystal and ovens. Erie Technological Products Inc., 644 W. 12th St., Erie, Pa. 16512. A 16-page brochure describes Hunt quartz crystals and ovens for accurate and reliable control of frequency response. [461]

Power supply. EMD Components Inc., Wickliffe, Ohio 44092, offers a bulletin describing the operating and performance characteristics of a new adjustable frequency power supply. [462]

Delay lines. Engineered Components Co., 2134 W. Rosecrans Ave., Gardena, Calif. 90249, has published catalog NS-16 on its miniature lumped-constant nanosecond delay lines. [463]

Sputtering sources. Semi-Elements Inc., Saxonburg Blvd., Saxonburg, Pa.

16056, has available a catalog dealing with high purity sputtering sources. [464]

Time division multiplexing. Rixon Electronics Inc., 2120 Industrial Parkway, Silver Spring, Md. 20904, has issued a four-page bulletin on its model TDX time division multiplexing terminals. [465]

Avalanche diodes. Computer Diode Corp., Pollitt Drive, Fair Lawn, N.J. 07410. A four-page illustrated technical bulletin describes the company's line of general-purpose, low-voltage avalanche diodes. [466]

Thermal switches. Standard Controls Inc., 2401 South Bayview, Seattle, Wash. 98144. Technical bulletin TSP-169 provides a quick reference for a complete family of probe type, bimetallic snap acting thermal switches. [467]

Ultrasonic cleaning. Phillips Mfg. Co., 7334 N. Clark St., Chicago 60626, has published an eight-page booklet on the principles of ultrasonic cleaning. [468]

Frequency synthesizers. Hewlett-Packard Co., 1501 Page Mill Road, Palo Alto,

Calif. 94304. A 26 page application note No. 96 describes the principles of operation and applications of fast-switching, direct-type frequency synthesizers. [469]

Wire lacing. Gudebrod Bros. Silk Co., 12 S. 12th St., Philadelphia 19107, has issued an eight-page bulletin illustrating and describing two lacing systems for electronic gear. [470]

Governed d-c motors. A.W. Haydon Co., 232 N. Elm St., Waterbury, Conn. 06720. Bulletin MM801 provides detailed data on chronometrically governed reversible d-c motors. [471]

Voltage stabilizers. English Electric Valve Co., Chelmsford, Essex, England. A four-page leaflet contains data for a full range of voltage stabilizers and reference tubes. [472]

Power supplies. Velonex Division of Pulse Engineering Inc., 560 Robert Ave., Santa Clara, Calif. 95050. A 12-page bulletin V-50 covers a complete line of d-c to d-c power supplies. [473]

Molded inductors. San Fernando Electric Mfg. Co., 1501 First St., San Fer-

CTS series 750 cermet resistor networks with snap-in formed leads . . .

for either automatic insertion or hand mounting.

- Available in 3 sizes and an infinite number of circuit combinations.
- Extremely good environmental specifications.
- 5 lbs. pull strength on leads.
- Available with or without active devices.

Delivery: 2 weeks for prototypes; 4-6 weeks for production quantities.

Order from: CTS of Berne, Inc., Berne, Indiana 46711. (219) 389-3111.

CTS CORPORATION

Founded 1896

Series 750	4-pin 3 resistors	6-pin 5 resistors	8-pin 7 resistors
1,000 piece price	29.6c ea.	40.6c ea.	50.9c ea.
10,000 piece price	15.5c ea. (5.2c/ resistor)	21.0c ea. (4.2c/ resistor)	26.1c ea. (3.7c/ resistor)

These prices are based on $\pm 5\%$ tolerance. $\pm 300\text{ppm}/^\circ\text{C}$ standard TC, and 50 ohms thru 100K ohms resistance range with all resistance values being within a 10:1 ratio per side.

CERMET RESISTOR

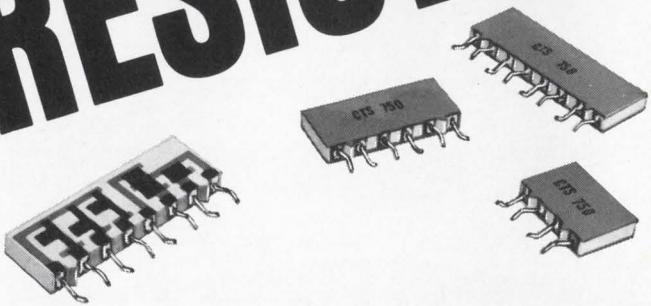

nando, Calif. 91341. A 32-page brochure details one of the industry's largest lines of molded inductors. [474]

Laser plasma tubes. University Laboratories Inc., 733 Allston Way, Berkeley, Calif. 94710. Twelve helium-neon laser tubes are described in bulletin 1009. [475]

Pushbutton switches/indicators. Dialight Corp., 60 Stewart Ave., Brooklyn, N.Y. 11237. Catalog L-169D provides complete data, drawings, and ordering information for the 513 series pushbutton switches. Data is also given for 183 series matching indicator lights. [476]

Digital tachometers. Airpax Electronics, P.O. Box 8488, Fort Lauderdale, Fla. 33310. Preliminary bulletin DS-1 describes a line of digital tachometers, industrial devices that accept and count the signals over a given time interval. [477]

Fluidic limit switch. Corning Glass Works, Corning, N.Y. 14830. Operation, performance characteristics, and a physical description of a fluidic limit switch are provided in a data sheet. [478]

Metal plate connectors. Elco Corp., 155 Commerce Dr., Fort Washington, Pa. 19034. A 32-page design manual contains complete information for metal plate back-panel interconnecting systems. [479]

Ceramic capacitors. Sprague Electric Co., 35 Marshall St., North Adams, Mass. 01247. Type 7C radial-lead, Monolithic ceramic capacitors are described in engineering bulletin 6202, available upon letterhead request.

Soldering equipment. Ideal Industries Inc., 5180 Becker Pl., Sycamore, Ill. 60178. Soldering equipment, designed to handle the miniature and subminiature job, or the large soldering and brazing project, is described in four-page bulletin No. 7. [480]

Microwave diodes. Microphase Corp., 35 River Road, Cos Cob, Conn. 06807, has released an eight-page catalog listing more than 100 types of germanium and gallium-arsenide mixer, video-detector, oscillator, switching, and amplifier diodes. [481]

Optical components. Spectra-Physics, 1250 W. Middlefield Road, Mountain

View, Calif. 94040. A six-page short-form catalog includes detailed characteristics of more than 250 optical components for laser-oriented products and systems now in use. [482]

Ribbon cable. Berkshire Technical Products Inc., P.O. Box 60, Reading, Pa. 19607. Bulletin 102 details properties and advantages of new flat-bonded, round-conductor ribbon cable for aerospace, military, and industrial applications. [483]

Frequency synthesizer. Micro-Power Inc., 25-14 Broadway, Long Island City, N.Y. 11106, has available a bulletin on the model 300A microwave frequency synthesizer with 12.4-Ghz signal capability. [484]

Crystal controlled oscillators. McCoy Electronics Co., Mt. Holly Springs, Pa. 17065. Thirty-two miniature, precision crystal controlled oscillators are described in a 12-page catalog [485]

Laser plasma tubes. University Laboratories, 733 Allston Way, Berkeley, Calif. 94710. Twelve helium-neon laser plasma tubes for systems use are described in bulletin 1009. [486]

NETWORKS

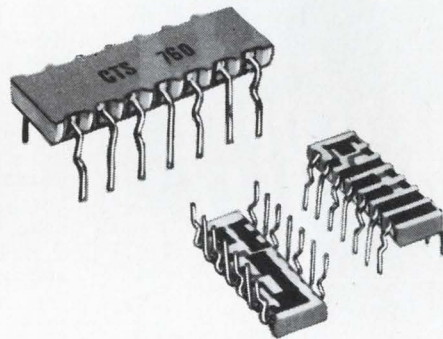

CTS Series 760 cermet resistor network or thick film hybrid circuit is mechanically compatible with standard 14 lead dual-in-line package . . . simplifying automatic insertion

and reducing assembly costs accordingly. The networks can also be easily hand mounted.

Series 760 provides:

- Up to 13 resistors per module with an infinite number of circuit combinations.
- Extremely good environmental specifications.
- 5 lbs. pull strength on leads.

Delivery: 2 weeks for prototypes; 4-6 weeks for production quantities.

Order from: CTS of Berne, Inc., Berne, Indiana 46711. (219) 589-3111.

Series 760	9 resistors	11 resistors	13 resistors
1,000 piece price	82c ea.	86c ea.	90c ea.
10,000 piece price	41c ea. (4.5c/resistor)	43c ea. (4c/resistor)	45c ea. (3.5c/resistor)

Prices shown are based on $\pm 5\%$ tolerance, $\pm 300\text{ppm}/^\circ\text{C}$ standard TC, and 50 ohms through 100K ohms resistance range with all resistance values within a 5:1 ratio per side.

CTS CORPORATION



AMPERITE

GLASS ENCLOSED Thermostatic DELAY RELAYS

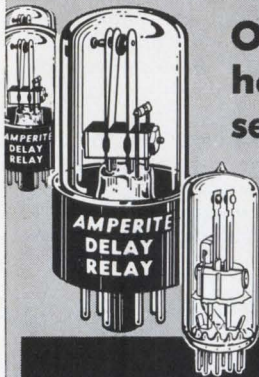

Offer true
hermetic
sealing—

— assure
maximum
stability
and life!

Delays: 2 to 180 seconds

Actuated by a heater, they operate on A.C., D.C., or Pulsating Current... Being hermetically sealed, they are not affected by altitude, moisture, or climate changes... SPST only — normally open or normally closed... Compensated for ambient temperature changes from -55° to $+80^{\circ}$ C... Heaters consume approximately 2 W. and may be operated continuously. The units are rugged, explosion-proof, long-lived, and inexpensive!

TYPES: Standard Radio Octal and 9-Pin Miniature... List Price, \$4.00
PROBLEM? Send for Bulletin No. TR-81.

AMPERITE

BALLAST REGULATORS

Hermetically sealed, they are not affected by changes in altitude, ambient temperature (-50° to $+70^{\circ}$ C.), or humidity... Rugged, light, compact, most inexpensive.

List Price, \$3.00

Write for
4-page
Technical
Bulletin
No. AB-51

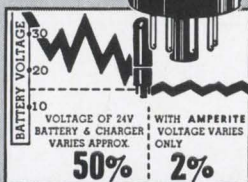

AMPERITE

600 PALISADE AVE., UNION CITY, N.J.

Telephone: 201 UNION 4-9503

In Canada: Atlas Radio Corp., Ltd.,
50 Wingold Ave., Toronto 10

New Literature

Miniature circular connectors. Viking Industries Inc., 21001 Nordhoff St., Chatsworth, Calif. 91311. A 12-page catalog provides design, performance, and assembly data on Snap-Lock (standard) and Snap-E-Lock (environmental) miniature circular connectors. [487]

Reed relays. Wheelock Signals Inc., 273 Branchport Ave., Long Branch, N.J. 07740, has available a 24-page catalog covering over 160 of its complete family of reed relays. [488]

Components. Cambion Electronic Products Ltd., Cambion Works, Castleton, Sheffield, England, offers a revised 1969 edition of catalog 700 featuring miniature plugs and jacks among the 22,000 electronic components described. [489]

Tachometers. Dynalog Corp., 4107 N.E. Sixth Ave., Fort Lauderdale, Fla. 33308. Series T2000 solid state tachometers are described in Dynaform 2000. [490]

Copper foils. Circuit Foil Corp., 23 Amboy Road, Bordentown, N.J. 08505. Copper foils for circuits and the company's capability for production of special treated foils are discussed in a six-page brochure. [491]

Instruments. Sencore Inc., 426 W. Westgate Dr., Addison, Ill. 60101. A 12-page catalog, Form No. 458, features five new test instruments, including a sweep and marker generator, combination oscilloscope/vectorscope, color generator, and two transistor/FET testers. [492]

Readouts and decoder/drivers. Discon Corp., 1150 N.W. 70th St., Fort Lauderdale, Fla. 33309. Two illustrated brochures provide descriptive information and specifications for the DiGiCator line of numeric readouts and IC decoder/drivers. [493]

Instrumentation recorder. Newell Industries, 795 Kifer Road, Sunnyvale, Calif. 94086. Complete specifications of the AV-15000R instrumentation magnetic recorder are featured in a six-page brochure. [494]

Power spectral density system. Federal Scientific Corp., 615 W. 131 St., New York 10027. Bulletin 682 describes a fully automatic, real-time power spectral density system for fast, inexpensive analysis of vast quantities of noise, vibration, and other low frequency data. [495]

Vacuum equipment. Hughes Aircraft Co., 2020 Oceanside Blvd., Oceanside, Calif. 92057, has available two data sheets, one on a series of molecular sieve type foreline traps, and the other on eight different high-vacuum valve models. [496]

High Voltage Rectifiers

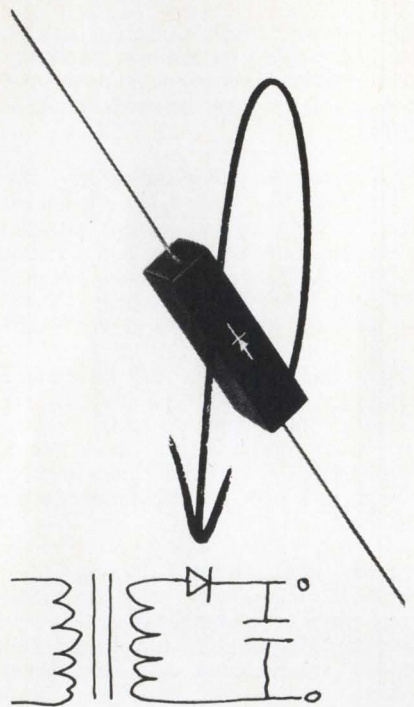

New! From Varo.

Silicon Rectifiers At Selenium Prices!

At last, economical high voltage silicon rectifiers. Ideal for use in all high voltage, low current applications.

- 5,000-40,000 Volts
- 5, 10, 25 milliamp ratings
- Standard and Fast Recovery
- In $\frac{1}{4}$ " square package.

These are the high voltage rectifiers that make completely solid state television circuits possible. Equally well suited for use in other cathode ray tube applications, electrostatic power supplies and voltage multipliers.

Only \$1.32

10,000V, 5mA rating. Quantity of 1,000. Complete details, applications, and price list available.



SEMICONDUCTOR DIVISION
2203 WALNUT STREET, GARLAND, TEXAS 75040
(214) 272-3561

Looking for a better job?

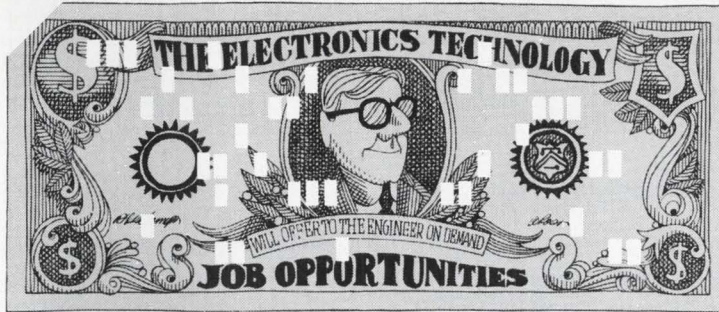

Ask Electronics' computer all about it

Electronics magazine feels an obligation to help its readers find positions in the electronics technology which will make the greatest contribution to their profession and to society — jobs in which electronics men themselves will be happiest.

Electronics has joined with a nation-wide talent search company—National Manpower Register, Inc.—to form the computerized Electronics Manpower Register. Your qualifications and job requirements will be pro-

grammed into a GE 265 computer, direct-linked to the Manpower Register's offices in New York. The computer, once your resume form (bottom of page and following page) is received, will continuously compare all your data with the specific manpower needs of electronics companies. When a match is made, you will be contacted directly or through an affiliated agency. The company and you will be brought together on a confidential basis.

Continued on next page

<p>Resumes acceptable only from applicants residing within the United States</p>	<h3>Electronics Manpower Register</h3> <p>It is important that your information be complete and that you type or print legibly</p>	<p>Resumes acceptable only from applicants residing within the United States</p>																														
<table style="width: 100%;"> <tr> <td style="width: 50%;">IDENTITY</td> <td style="width: 50%;">PRESENT OR MOST RECENT EMPLOYER</td> </tr> <tr> <td>Name _____</td> <td>Date _____</td> </tr> <tr> <td>Home address _____</td> <td>Parent company _____</td> </tr> <tr> <td>City _____ State _____</td> <td>Your division or subsidiary _____</td> </tr> <tr> <td>Zip _____</td> <td>Location (City/State) _____</td> </tr> <tr> <td>Home phone _____</td> <td>Do you subscribe to Electronics <input type="checkbox"/> or see a library or pass-along copy <input type="checkbox"/></td> </tr> </table>			IDENTITY	PRESENT OR MOST RECENT EMPLOYER	Name _____	Date _____	Home address _____	Parent company _____	City _____ State _____	Your division or subsidiary _____	Zip _____	Location (City/State) _____	Home phone _____	Do you subscribe to Electronics <input type="checkbox"/> or see a library or pass-along copy <input type="checkbox"/>																		
IDENTITY	PRESENT OR MOST RECENT EMPLOYER																															
Name _____	Date _____																															
Home address _____	Parent company _____																															
City _____ State _____	Your division or subsidiary _____																															
Zip _____	Location (City/State) _____																															
Home phone _____	Do you subscribe to Electronics <input type="checkbox"/> or see a library or pass-along copy <input type="checkbox"/>																															
<p>GEOGRAPHICAL PREFERENCE (Check appropriate boxes and complete all blanks)</p> <p>I will NOT relocate <input type="checkbox"/> I will consider opportunities in: <input type="checkbox"/> North East <input type="checkbox"/> Mid Atlantic <input type="checkbox"/> South <input type="checkbox"/> Midwest <input type="checkbox"/> Southwest <input type="checkbox"/> Calif. <input type="checkbox"/> Northwest</p> <p>Prefer: <input type="checkbox"/> Metro. area <input type="checkbox"/> Medium town <input type="checkbox"/> Rural area Other: _____</p>																																
<p>EDUCATION</p> <table style="width: 100%;"> <tr> <td style="width: 25%;">Degree _____</td> <td style="width: 25%;">Major field _____</td> <td style="width: 25%;">Year _____</td> <td style="width: 25%;">College or University _____</td> </tr> <tr> <td> </td> <td> </td> <td> </td> <td> </td> </tr> <tr> <td> </td> <td> </td> <td> </td> <td> </td> </tr> </table>			Degree _____	Major field _____	Year _____	College or University _____																										
Degree _____	Major field _____	Year _____	College or University _____																													
<table style="width: 100%;"> <tr> <td style="width: 60%;">EMPLOYMENT INFORMATION</td> <td style="width: 20%; text-align: center;">FOR OFFICE USE ONLY</td> <td style="width: 20%;"></td> </tr> <tr> <td>Position desired _____</td> <td style="text-align: center;"> <table border="1" style="display: inline-table; border-collapse: collapse;"> <tr> <td style="width: 15px; height: 15px;"> </td> <td style="width: 15px; height: 15px;"> </td> <td style="width: 15px; height: 15px;"> </td> <td style="width: 15px; height: 15px;"> </td> <td style="width: 15px; height: 15px;"> </td> <td style="width: 15px; height: 15px;"> </td> </tr> </table> </td> <td style="text-align: center;"><input type="checkbox"/></td> </tr> <tr> <td>Present <input type="checkbox"/> or most recent <input type="checkbox"/> position _____</td> <td style="text-align: center;">REGISTRATION NUMBER</td> <td style="text-align: center;">INITIAL OF LAST NAME</td> </tr> <tr> <td>From _____ To _____ Title _____</td> <td></td> <td></td> </tr> <tr> <td colspan="3">Duties and accomplishments _____</td> </tr> <tr> <td colspan="3"> </td> </tr> <tr> <td colspan="3"> </td> </tr> <tr> <td colspan="3"> </td> </tr> </table>			EMPLOYMENT INFORMATION	FOR OFFICE USE ONLY		Position desired _____	<table border="1" style="display: inline-table; border-collapse: collapse;"> <tr> <td style="width: 15px; height: 15px;"> </td> <td style="width: 15px; height: 15px;"> </td> <td style="width: 15px; height: 15px;"> </td> <td style="width: 15px; height: 15px;"> </td> <td style="width: 15px; height: 15px;"> </td> <td style="width: 15px; height: 15px;"> </td> </tr> </table>							<input type="checkbox"/>	Present <input type="checkbox"/> or most recent <input type="checkbox"/> position _____	REGISTRATION NUMBER	INITIAL OF LAST NAME	From _____ To _____ Title _____			Duties and accomplishments _____											
EMPLOYMENT INFORMATION	FOR OFFICE USE ONLY																															
Position desired _____	<table border="1" style="display: inline-table; border-collapse: collapse;"> <tr> <td style="width: 15px; height: 15px;"> </td> <td style="width: 15px; height: 15px;"> </td> <td style="width: 15px; height: 15px;"> </td> <td style="width: 15px; height: 15px;"> </td> <td style="width: 15px; height: 15px;"> </td> <td style="width: 15px; height: 15px;"> </td> </tr> </table>							<input type="checkbox"/>																								
Present <input type="checkbox"/> or most recent <input type="checkbox"/> position _____	REGISTRATION NUMBER	INITIAL OF LAST NAME																														
From _____ To _____ Title _____																																
Duties and accomplishments _____																																
<p>HAVE YOU REGISTERED WITH THIS SYSTEM PREVIOUSLY? Yes <input type="checkbox"/> No <input type="checkbox"/></p>																																
<p>CONTINUED ON OTHER SIDE</p>																																

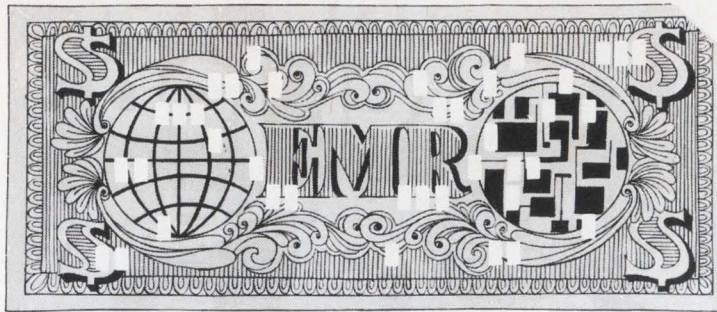

The cost of all this to you? Absolutely nothing. No fees or charges at any time.

Other advantages of EMR:

- Your resume is sent only to those companies that have a genuine requirement for your particular skills.
- There is no general "broadcasting" in the hope "someone will be interested."
- Your identity is protected because your name is released only according to your prior instructions. Your name can be deleted on request.
- EMR's service is nationwide. You may be considered for job opportunities anywhere in the U.S.

The Electronics Manpower Register is a powerful tool and should be considered when you are seriously seek-

ing a new position. And, although you may be reasonably happy in your present position, chances are that you might have that ideal job in mind.

This is why EMR makes good sense for you. If that job does turn up, you'll be there.

To get your name in the EMR file, just fill out the resume form and return to:

Electronics Manpower Register
330 West 42nd Street
New York, N. Y. 10036

Please enclose a copy of your resume if you have one. A detailed brochure further describing EMR will be sent to you.

Electronics Manpower Register A computerized employment opportunity service

CONTINUED FROM OTHER SIDE					
Previous Position	Employer	City/State	From	To	
Duties and accomplishments					
Previous Position	Employer	City/State	From	To	
Duties and accomplishments					
GENERAL INFORMATION (Summarize your over-all qualifications and experience in your field. List any pertinent information not included above.)					
Current annual base salary	Total years of experience	Date available (within four months)	U.S. Citizen <input type="checkbox"/>	Non U.S. Citizen <input type="checkbox"/>	
My identity may be released to:	Any employer <input type="checkbox"/>	All but my present employer <input type="checkbox"/>	Have you security clearance?	Yes <input type="checkbox"/> No <input type="checkbox"/>	If yes, What level
Mail (with a copy of your resume, if you have one) to:					
Electronics Manpower Register ELECTRONICS 330 West 42nd St. New York, N. Y. 10036			NO FEES OR CHARGES		EMR-14



**ELECTRONIC
RECRUITING
SPECIALISTS**

San Francisco Openings

Let us work on your behalf, in a confidential, professional, personal manner, to find you the right position in the beautiful and exciting SAN FRANCISCO BAY AREA. We will keep you informed weekly of all efforts expended and results achieved! There is no cost to you.

IF YOU ARE INTERESTED IN:

- San Francisco Bay Location
- Superior Salaries
- Young Growth Firms
- Professional Advancement

AND HAVE HAD EXPERIENCE IN:

- Circuit/Device Design
- IC's—MOS—LSI—Microwave RF
- Systems Design and Analysis
- Communications—Computers
- Test and Test Equipment Design
- Quality and Reliability Engineering

THEN CALL OR WRITE IMMEDIATELY:

EXECUTIVE ACTION INC.

525 University Avenue
Palo Alto, Calif. 94301
415-325-5915

A Professional Placement Agency

CIRCLE 966 ON READER SERVICE CARD

This ad is not for men who love their jobs.

It's for the man who's found his job has become a chore.

If that man is you, then you're the man we want to talk to.

We're Management Recruiters — the matchmakers. We've got 80 offices across the country and in Canada.

Call us. And the next time you see this ad, you'll be able to pass it by.

**Management
Recruiters**
The matchmakers

CIRCLE 967 ON READER SERVICE CARD

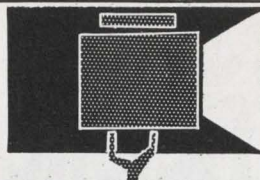

SEARCHLIGHT SECTION

- CLASSIFIED ADVERTISING • BUSINESS OPPORTUNITIES
- USED OR SURPLUS EQUIPMENT

AUTOTRACK MOUNT

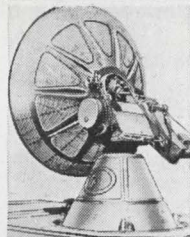

360 degree azimuth, 210 degree elevation sweep with better than 1 mil. accuracy. Missile velocity acceleration and slewing rates. Amplidyne and servo control. Will handle up to 20 ft. dish. Supplied complete with control chassis. In stock—immediate delivery. Used world over by NASA, USAF, MP-61-B. Type SCR 584. Nike Ajax mounts also in stock.

PULSE MODULATORS

MIT MODEL 9 PULSER 1 MW—HARD TUBE
Output 25kv 40 amp., 30kv 40 amp. max. Duty cy. .002. .25 to 2 microsec. Also 5 to 5 microsec. and .1 to .5 microsec. Uses 6C21. Input 115v 60 cycle AC. Mfg. GE. Complete with driver and high voltage power supply. Ref: MIT Rad. Lab. Series, Vol. 5, p. 162.

2 MEGAWATT PULSER
Output 30 kv at 70 amp. Duty cycle .001. Rep rates. 1 microsec 600 pps. 1 or 2 msec 300 pps. Uses 5948 hydrogen thyratron. Input 120/208 VAC 60 cycle. Mfr. GE. Complete with high voltage power supply.

250 KW HARD TUBE PULSER
Output 16 kv 16 amp. Duty cycle .002. Pulses can be coded. Uses 5D21, 715C or 4PR60A. Input 115 v 60 cy. AC \$1200 ea.

18 MEGAWATT PULSER
Output 150KV at 120 amps. Rep rate: 50-500 PPS. Pulse length: 5 msec. 15KV 120 amp. into pulse transformer. Rise time 1.5 msec. Filament supply 5V 80 amp. incl. 17.5KV 1.5 amp DC power supply. Input: 220V 60 cy AC.

INDICATOR CONSOLES

AN/SPA-4A, PPI 10", range to 300 ml.
VJ-1 PPI 12", Range to 200 ml.
VL-1 RH1 12" to 200 ml. 60K ft.

SCR 584 AUTOTRACK RADARS

Our 584s in like new condition ready to go, and in stock for immediate delivery. Ideal for telemetry research and development, missile tracking, satellite tracking. Fully Desc. MIT Rad. Lab. Series, Vol. 1, pps. 207-210, 228, 284-286. Comp. Inst. Bk available \$25.00 each.

40 KW TRANSMITTER

4 to 21 MHZ. 40 kw Telegraphy, 30 kw Voice, can be SSB. New condition. Two systems in stock. Excellent rf source, broadcast or point-to-point.

ADDRESS BOX NO. REPLIES TO: Box No. Classified Adv. Dept. of this publication. Send to office nearest you.
NEW YORK, N. Y. 10036; P. O. Box 12
CHICAGO, Ill. 60611; 645 N. Michigan Ave.
SAN FRANCISCO, Cal. 94111; 255 California St.

EMPLOYMENT SERVICES

Florida/Nationwide EE's ME's IE's needed Electronics fields. Aerospace, Industrial Manufacturing. \$9-18,000. Tech. Div., Brodeur Personnel Service Inc., 3947 Blvd. Center Dr., Jacksonville, Fla. 32207.

BUSINESS OPPORTUNITIES

Capital Contacts—Before you try Public or Private Placements to Underwriters, Investment Banking Houses, write for free helpful information to Confidential Consultant, 817 51st St., Brooklyn, N.Y.

Don't forget

THE BOX NUMBER

when answering the classified advertisements in this magazine. It's our only means of identifying the advertisement you are answering.

ANTI-AIRCRAFT GUN MOUNT

Will handle 6,000 lbs. rapid slew through 360° azimuth, 180° elevation. Mobile.

MICROWAVE SYSTEMS

200-2400 mc. RF PKG

Continuous coverage, 30 Watts Cw nominal output. Uses 2C39A. Price \$575.

L BAND RF PKG.

20 KW peak 990 to 1040 MC. Pulse width .7 to 1.2 micro sec. Rep. rate 180 to 420 pps. Input 115 vac incl. Receiver \$1200.

200-225 mc RADAR SYSTEM

1 Megawatt output. 200 nautical mile range for long range detection of medium and high altitude jet aircraft as well as general search. AN/TPS-28.

SURVEILLANCE DRONE RADAR SYSTEM

X-Band tracking system with plotting boards. Type AN/MPQ-29. Drone also in stock.

5 MEGAWATT C-BAND

Klystron RF package delivering nominal 5 megawatt pulse RF. Complete with pulser and power supply.

500 KW L BAND RADAR

500 kw 1220-1359 msc. 160 nautical mile search range P.R.I. and A scopes. MTI. thyratron mod 5326 magnetron. Complete system.

AN/GPG-1 SKY-SWEEP TRACKER

3 cm. automatic tracking radar system. Complete package with indicator system. Full target acquisition and automatic tracking. Input 115 volts 60 cycle New. In stock for immediate delivery. Entire System 6' long, 3' wide, 10' high. Ideal for Infrared Tracker, Drone Tracker, Missile Tracker, R. & D.

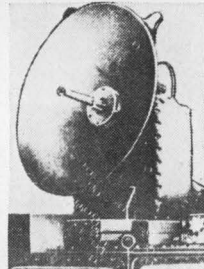

C Band Autotrack

1 Megawatt 10 ft. Parabola. Sperry.

RADAR SYSTEMS GROUND AND AIRBORNE. AUTOMATIC TRACKING ANTENNA SYSTEMS. NIKE AJAX. NIKE HERCULES. M-33. MSO-1A. MPS-19. MPS-9. SCR 584. TPS-1D. TPS-28. FAA-ASR-2. AIRBORNE SYSTEMS. APN-84. APN-102. APS-20. APS-27. APS-45. DPN-19. DIGITAL COMPUTERS. IBM 650. IBM 704.

LARGEST INVENTORY OF RADAR AND MICROWAVE EQUIPMENT IN THE WORLD.
RADIO RESEARCH INSTRUMENT CO.
45 WEST 45TH ST. N. Y. 10036 212-JU 6-4691

CIRCLE 968 ON READER SERVICE CARD

ELECTRON TUBES

KLYSTRONS • ATR & TR • MAGNETRONS
SUBMINIATURES • C.R.T. • T.W.T. • 5000-6000 SERIES
• SEND FOR NEW CATALOG A2 •
A & A ELECTRONICS CORP.
1063 PERRY ANNEX
WHITTIER, CALIF.
696-7544

CIRCLE 969 ON READER SERVICE CARD

WELDING HAND TOOL

TW 17 A
\$ 48.00



Replaceable Tips—Adjustable Pressure
AC and Stored Energy Power Supplies

EWALD Instruments Corporation

Kent, Conn. 06757

CIRCLE 970 ON READER SERVICE CARD

VACUUM PENCIL



PHILIP FISHERMAN COMPANY
7 CAMERON ST. WELLESLEY, MASSACHUSETTS

CIRCLE 971 ON READER SERVICE CARD

Remember . . .
MAIL MOVES THE COUNTRY
but . . .
ZIP CODE MOVES THE MAIL

Precise control... high spectral efficiency...long life...

the reasons David W. Mann Co. chose EG&G Xenon Flashtubes for new IC photomask production system.

David W. Mann Co., a division of GCA Corporation and a leader in the production of precision IC photomask equipment, uses an EG&G pulsed Xenon Flashtube in their new Type 1480 Photorepeater. The EG&G Xenon Flashtube is the only one that meets the stringent operating requirements demanded by the Mann system. It provides precisely controlled variable intensity and flash duration needed for accurate exposure. It assures high spectral efficiency and energy balance to aid in razor-sharp edge definition. And, EG&G pulsed Xenon Flashtubes are designed to provide the longest, most reliable life.

EG&G specializes in the design and manufacture of complete pulsed Xenon Flashtubes for use in such diverse applications as laser stimulation, phototypesetting, flash photolysis, photocopying, stroboscopy, warning beacons, oscillograph recorders, and medical research. EG&G pulsed Xenon Flashtubes are available in linear, air and liquid cooled, helical, U-shaped, and coaxial type designs. Envelope materials are quartz, soft glass, or hard glass. Energy inputs range from 0.1 to 25,000 watt-seconds with operating voltages from 400 volts to 3.5 KV. Light output encompasses the entire visible spectrum and extends into UV and IR ranges.

EG&G also supplies chokes, trigger transformers, power supplies, and trigger modules. We'll even design any special flashtube circuitry your application may require.

If you'd like more information on EG&G pulsed Xenon Flashtube Systems, or for that matter on any of our products, such as thyatron, krytron, spark gaps, transformers, chokes, trigger modules, photodiodes, or light instrumentation, write: EG&G, Inc., 166 Brookline Avenue, Boston, Massachusetts 02215. Telephone: 617-267-9700. TWX: 617-262-9317. On west coast telephone 213-464-2800.

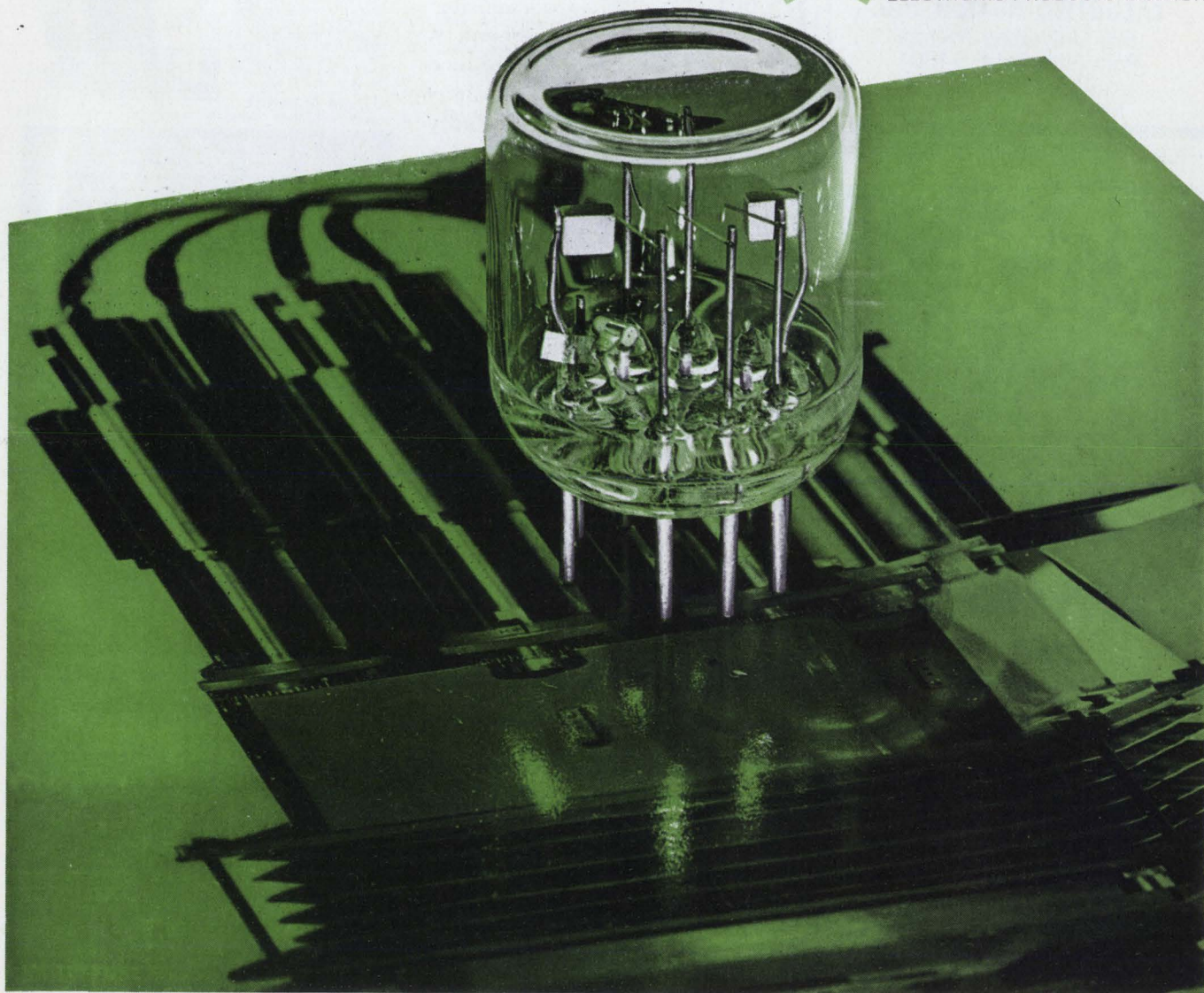

International Newsletter

April 14, 1969

'Plan Calcul' firm set for a shakeup

France's government-backed computer maker, Compagnie Internationale pour l'Informatique (CII), may be taken over by the big Thomson-Brandt group.

If that happens, a major management shakeup is sure to follow. CII is having major problems getting its state-subsidized computers into production. And its sales effort is lagging because, as one executive puts it, "we have nothing to sell."

A Thomson-Brandt takeover of CII would be a back-door result of the complex negotiations now going on to restructure France's heavy electrical equipment industry in the wake of the Westinghouse Electric Corp.'s attempt to take over the industry's second biggest firm, Societe Jeumont-Schneider.

A plan now under study calls for Thomson-Brandt to turn over its 18% holding in Societe Alstom—the country's leading maker of heavy electrical equipment—to Compagnie Generale d'Electricite (CGE) in exchange for CGE's 30% interest in CII and probably some of its other electronics interests. Thomson-Brandt, by adding this block to its present 30% share in CII, would gain majority control of the firm. The plan, heartily endorsed by the government, would concentrate French electrical equipment and electronics producers in two strong groups.

Production of CII's first all-French computer, developed under the government's "Plan Calcul," is reportedly several months behind schedule. That machine, the Iris 50, was due for first delivery by the end of this year. A military Plan Calcul computer, the Iris 35, is to be shown for the first time at the Paris Air Show in May. A third machine, the Iris 80, will be unveiled at next fall's Sicob business machines show.

Desk calculator makers in Japan face a shakeout . . .

Look for a thinning-out over the next year or two of the crowd of Japanese companies vying for shares of the desk calculator market.

Some 20 companies are in the business. But the leaders have started to produce in quantities that will make it unprofitable for small producers to stay in the market. Industry-leading Hayakawa Electric Co., for example, has tooled up for a 20,000-monthly output of the new miniature LSI calculator it will add to its line [*Electronics*, Feb. 17, p. 215].

Already there's been a dropout. The Uchida Yoko Co. phased out production of its three low-priced machines this month. Uchida, though, will continue with a high-priced machine that has programed operation. Insiders are convinced that Uchida is just the first of several companies that will opt out of an increasingly competitive market.

. . . as Sanyo tries to top Hayakawa with battery pack . . .

Much of the competition will center on technological innovations that pay off doubly: first in lower cost, second in an exclusive sales feature.

Sanyo Electric Co. is counting on an LSI miniature calculator with a built-in power pack in an effort to gain ground on Hayakawa. Sanyo says it will start sales this fall, just a few months after Hayakawa goes to market with its LSI—but line-powered—machine.

The battery pack—four nickel-cadmium rechargeable "C" cells—can run the calculator for three hours before it needs a recharge. Power drain is a mere two watts—1.2 watts for the two-phase logic circuits and 0.8

International Newsletter

watt for the display and its drives, according to Sanyo.

Sanyo's cordless machine has 13 different MOS arrays in its logic circuits, plus four transistors, eight resistors, and four capacitors in the clock circuits. The company stoutly insists it will produce the MOS packages itself; insiders in the semiconductor business, though, maintain that Sanyo has had trouble producing bipolar IC's at a reasonable cost and almost certainly will have to turn to U.S. suppliers for MOS arrays.

... and Hayakawa plans power pack plus new display

Sanyo won't have the cordless calculator market to itself for long.

Hayakawa is pressing development of a power-pack accessory for its LSI miniature calculator, which draws 4 watts. The company expects to have a prototype ready by September. It will be a nickel-silver-cadmium type and will run the calculator for eight hours between recharges. With both Sanyo and Hayakawa selling cordless calculators, other producers will be forced to follow suit.

Along with a power pack, Hayakawa has another improvement in the works for competitors to fret over—a low-voltage, eight-decade Digitron display tube. The tube, being developed for Hayakawa by Ise Electronics, will operate on a 12-volt supply, compared with 25 volts for the discrete Digitrons now used. Ise will pack the eight decades in a single flat envelope 8 by 4 by 2 centimeters in size. The single tube will be cheaper than the eight discrete tubes it will replace.

Giant computer lures EEC firms

Five of Europe's big electronics companies apparently have heeded a call of the European Economic Community's commission—the executive arm of the six-nation Common Market—and may join forces to develop supercomputers for the 1970's and 1980's. Reportedly discussing the idea are Siemens and AEG-Telefunken of West Germany, Philips' Gloeilamp-enfabrieken of the Netherlands, Italy's Olivetti, and France's Compagnie Internationale pour l'Informatique.

The EEC has two projects in mind, spearheads of a campaign to narrow the technology gap between its member countries and the U.S. One involves a very large computer that would be based on existing technology and be ready for the market around 1975. The other would be based on LSI-and-later techniques and follow the first by five years.

Ceiling lifts for Germany's avionics makers

West Germany avionics makers face their brightest prospects in years. Now that France and West Germany have informally agreed to build the A-300B European airbus [*Electronics*, March 31, p. 177], there's a strong chance that a European combat jet will get off the ground as well. The go-ahead, which could come as early as May or June, would dispel much of the gloom that's pervaded the German avionics scene in recent years.

The project, first proposed by the Germans 18 months ago and at that time called the NKF aircraft, now involves Britain, Italy, and the Netherlands as well. The plane, rechristened the multi-role combat aircraft (MRCA), would be a successor to the current standard NATO jets, the F-104 Starfighter and the Fiat G.91.

Detailed negotiations haven't yet begun, but German aerospace companies are speculating that development costs will come to between \$400 million and \$500 million, with a production run of something like 1,000 planes costing about \$2.5 million each. Avionics would account for 20% to 35% of the total expenditure.

Sensitive radar keeps helicopters in the clear

System developed in France spots high-tension wires 1,500 yards off; a twin-antenna layout eliminates "dead" time of single-dish units

There's mixed news at Electronique Marcel Dassault (EMD) these days for low-flying French helicopter pilots.

EMD, the electronics arm of the well-known French aircraft maker Dassault, has readied an obstacle-avoidance radar system so sensitive it can spot high-tension wires. Helicopters equipped with the system, called Saiga, could cruise in confidence even in bad weather at ground-skimming altitudes.

But for the moment, there's no plan to produce the radar, even though two prototypes built for the French army have performed admirably in tests. Saiga was developed to go with a new personnel-carrying helicopter whose costs have climbed to the point where the austerity-minded French government has had to eschew the radar. The helicopter in question is the Sud-Aviation 330, which Sud

developed jointly with Britain's Westland Aircraft.

Despite this domestic setback, EMD still has hopes of finding military customers for Saiga in Britain, West Germany, and Sweden. U.S. officers are scheduled to get a look at the system this spring, but chances of a sale to them look very slim.

Whirling. Crucial to Saiga's performance are its 1.3° pencil beam and its twin-antenna layout. Instead of sweeping back and forth with a single dish, Saiga uses a pair of dishes mounted back-to-back in a gimbal that spins at 11 revolutions per second. This eliminates the "dead" time that's inevitable with a single dish, which has to stop at the end of a sweep before starting back in the opposite direction.

As they spin, the antennas are switched onto the radar's signal-

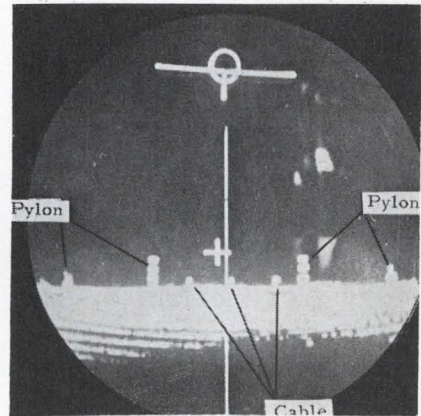

Good show. Pylons and high-tension lines stand out on scope of French helicopter radar. Cross in center indicates course.

processing circuits to get a horizontal coverage of 160°. The vertical scan covers a 20° angle.

Saiga operates at a wavelength of 8 millimeters.

Guidance. The radar proper is paired with a special computer so that pilots can "fly blind" with the system. For one thing, the computer switches the field of view every time the helicopter's course changes by 60°. For another, it supplies inputs showing where the helicopter is and where obstacles are.

Actually, the pilot has two kinds of displays on the radar's scope. One is close to conventional, with obstacles showing up as pips against range markers. A special marker-line in this display indicates the braking distance—telling the pilot whether he can safely stop in midair or whether he must veer off to avoid a collision.

The second display is a television-like scan of 22 lines. It shows the azimuth and elevation rather



Bulbous. Obstacle-avoidance radar adds a big nose to test helicopter.

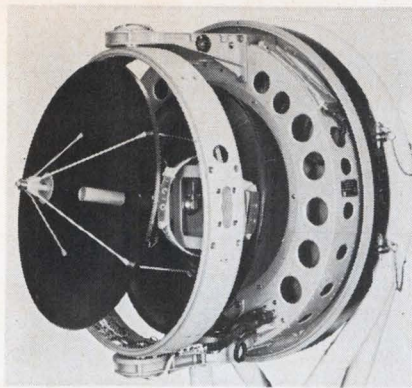

Dervishes. Antenna dishes spinning back-to-back do away with the "dead" time that occurs when a single dish sweeps back and forth.

than azimuth and range.

A computer-generated course marker superimposed on this display shows if there's a danger of hitting an obstacle. By flying to keep the marker in the clear, the pilot will clear obstacles by anywhere from 100 feet to 1,000 feet, depending on the radar's setting.

On the line. Saiga's tour de force so far has been spotting high-tension lines up to 1,500 yards away. The cables show up on the radar's scope as three dots.

This was a surprise, according to Gerard Collot, chief of EMD's radar department. It was first thought that the 8-mm output of the radar would bounce back from a single point on transmission lines. But apparently because the cables are twisted and the wavelength of Saiga's beam is short, there's an interference effect that gives three equally strong returns.

Great Britain

Rigged with yig

Like a lot of other companies, Mullard Ltd. is high on yttrium-iron-garnet. Just how high will become eminently clear later this week at the International Conference on Magnetics in Amsterdam.

At Intermag, researchers from Mullard and its parent company, Philips' Gloeilampenfabrieken, will tell about two prototype systems they've worked out. Both exploit

the transparency of yig—under the right conditions—to infrared radiation at wavelengths from 1.1 to 5.5 microns. But the systems have entirely different end uses. One checks the pollution content of automobile exhausts; the other operates as a contactless ammeter for high-voltage electric transmission lines.

Twin beams. The pollution checker is a joint effort of Herman van Heek of Philips' Eindhoven research facility and Roger Cooper of Mullard. Its principle: the three main pollutant gases in auto exhausts are heavy absorbers of the radiation that yig will pass.

A beam of polarized light then, can be shifted by the Faraday effect in a yig modulator to pass alternately through an inert-gas sample and an exhaust-gas sample. By comparing the radiation levels picked up by an indium-antimonide detector after the light passes through each sample, the pollution content can be precisely measured—down to 10 parts per million.

Van Heek thinks that the lab setup could one day be realized in a production unit that would be no more than 20 inches long. This package would be paired with remote electronics.

Untouchable. Mullard's second yig system is a step toward a lightweight instrument that can measure current flow in electric transmission lines. The job is currently done by means of fairly bulky transformers.

The system, largely the work of Cooper and his colleague, Ron Pearson, puts a yig crystal a few inches—precise positioning is a must—from the line. The current flowing through the line sets up a magnetic field that makes the yig crystal rotate a polarized infrared beam passing through it. The amount of rotation, then, depends on the current in the transmission line.

Cooper has proved out this system in low-voltage lines. For his experimental yig ammeter, he uses a 12-volt, 55-watt quartz-iodine lamp and a germanium photodiode. This setup measured currents up to 500 amps with an accuracy of 2%, which is as good as conventional ammeters can do. A fully engineered yig ammeter, Cooper thinks, would be accurate to about 0.1%.

West Germany

Lighting the way

You'd hardly expect the designers of U.S. spacecraft to run to overseas companies for electronics hardware, but they do from time to time.

A triode made by Siemens AG flew deep into space on Mariner 4 five years ago. And Siemens has found a small niche for itself—albeit indirectly—in NASA's man on the moon Apollo program.

An electroluminescent material Siemens developed is going into readout panels that Lear Siegler Inc. makes, including some for the Apollo 11 command capsule. The Siemens material—a copper-doped zinc sulfide—will also light up the flight attitude indicator in the lunar excursion module, the craft that will carry two astronauts to a touchdown on the moon.

Siemens, of course, uses the material in its own hardware and particularly for solid state X-ray image converters.

Sandwich. The Apollo lighting panels are built up on a substrate of Nesa glass less than 3 millimeters thick (Nesa is a coated glass produced by PPG Industries Inc.). One side of the glass has a transparent coating of antimony-doped tin oxide, a semiconductor material that serves as one electrode for the panel. This layer is less than 1 micron thick and has a low resistance, 100 ohms per square.

Covering the tin oxide is the luminescent copper-doped zinc sulfide, embedded in an organic binder. This layer is from 1 to 2 mils thick and is topped by a white reflecting layer.

The sandwich is completed by printing silver bars on the reflecting layer. They form numbers, letters or symbols. These bars, actually, serve as small individual electrodes and are energized selectively by transistor circuits to get the desired display. The panel emits light only where there's an energized bar. The voltage used for the panel is 115 volts, 400 hertz.

Added ingredient. In Siemens' own electroluminescent-image converters, there's a high-resistance

layer of semiconductor material sandwiched between the luminescent layer and the back electrode. The semiconductor layer changes its resistance when hit by X-rays, and there's a subsequent rise in the voltage at the luminescent layer in the areas involved. They light up while other areas on the panel stay dark. Because of the persistence of the luminescent material, the image is stored for a short time.

Siemens is using image converters like this experimentally in its X-ray engineering work.

Curie-point cure

Today's substrates for microwave integrated circuits are good, but far from ideal. For one thing, the substrates—usually hard-to-machine aluminum oxide—need holes drilled in them to hold ferrite elements like circulators, isolators, and sometimes directional couplers. For another, the bonds between the ferrites and the substrates often cause unwanted reflections in the circuit.

The cure for these mechanical and electrical problems is a ferrite material with a Curie point well below freezing, reports the Philips Research Laboratories at Hamburg. At operating temperatures from -30°C to $+70^{\circ}\text{C}$, substrates made from these ferrites are nonmagnetic and make an admirable match for normal magnetic ferrites in microwave IC's. The magnetic and "nonmagnetic" ferrites can be sintered together for a homogeneous, nonreflecting bond.

Using this new approach, Philips researchers have already developed microwave subsystems such as X-band radar front ends, X-band doppler radar components, and phase shifters. Some of these subsystems, particularly the doppler radar, are seriously being considered for production. Peter Holst and Martin Lemke, the two Philips scientists mainly responsible for the technique, will pinpoint their progress to date at Intermag later this week at Amsterdam.

Take a powder. To fabricate the ferrite IC's, preheated ferrite bulk material is first ground to a fine

powder. This powder is then mixed with a small amount—about 5% by weight—of a polyester resin so that it can be easily shaped. After that, the nonmagnetic and magnetic types are packed into a die that has the geometry wanted for the IC. Subsequently, the ferrites are pressed and sintered to form a monolithic unit.

The technique gives a high-density ferrite chip with a vacuum-tight transition between the two different ferrite materials. Its porosity—less than 5%—is about the same as that of the original bulk material. Holst says the ferrite substrates can be machined and polished more easily than aluminum oxide substrates. This, he says, is important when it comes to low-loss devices.

Choices. Two kinds of ferrite crystal structures can be used: a spinel structure consisting essentially of an iron oxide and any one of the transition elements, or a garnet crystal structure such as an yttrium-iron-garnet. To make a spinel-type ferrite nonmagnetic, its zinc content must be higher than usual. And to obtain a garnet-type nonmagnetic material, its aluminum content must be made higher than usual.

The work done by the Philips researchers indicates that electrical properties like loss tangents, dielectric constants and Q factors are roughly the same for both ferrite and aluminum-oxide substrates. Also, the average power-handling capability of ferrite substrates is

more than enough for most microwave IC's.

A ferrite substrate 30 by 30 millimeters square, for example, can carry the circuitry for an X-band doppler radar. The substrate has an integrated magnetic zone for the circulator.

The system's 15 milliwatts are generated by a Gunn oscillator. About one-fifth of that is fed directly into a balanced mixer that acts as a local oscillator. The remaining energy goes through the broadband circulator formed by a metal disk on aluminum-substituted yig and a small permanent magnet embedded in the ground plane below.

Japan

A powerful memory

Squeezing nearly 100 memory bits into the same minuscule space that a bit now takes up in a magnetic memory seems impossible, but a research team at the Kokusai Den-shin Denwa Co. (KDD) thinks it can be done.

KDD is Japan's overseas cable and radio company and its memory research team has some impressive credentials in magnetics. The team leader, Shintaro Oshima, did the work that led to plated-wire memories in Japan. And it's Oshima who's giving the invited paper on Japanese memories at Intermag.

Combination. The way to pack the bits in, say the KDD men, is to combine fabrication techniques developed for magnetic memories with the photoetching techniques used to produce integrated circuits. The combination results in magnetic-stripe memory elements so fine and so close together they can connect directly to drive-circuit elements on an IC.

Because of the way the element looks, KDD calls its store a fine-stripe memory. There's still considerable development work to be done, but KDD can build memories with a density of 5,000 bits per square centimeter, against the 3,300 bits per cm^2 in an MOS memory. By the time MOS memories are avail-

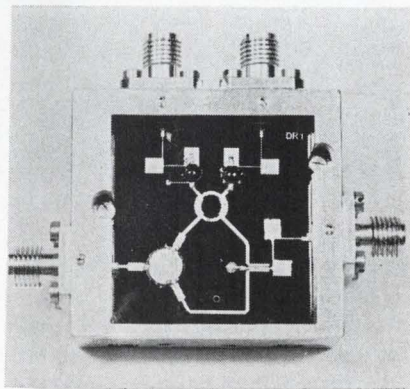

Of a piece. Front end for X-band doppler radar is all on ferrite IC. Circulator (lower left) is built on yig disk sintered into substrate.

able with a bit density of 10,000 per cm², Oshima predicts, the fine-stripe memories will be up to 17,000.

And, being magnetic, the fine-stripe memory has other advantages over MOS. Two of the more important ones: the store isn't lost if there's a power failure, and there's less heat generated.

On deposit. To build a fine-stripe store, KDD starts by vapor-depositing a thin film of Permalloy on a glass substrate. This film—about 2,000 angstroms thick—has aligned domains since it's put down in the presence of a magnetic field.

Atop the Permalloy goes a 3,000-angstrom copper layer, followed by a coating of photoresist. This is exposed to get a digit-line pattern of stripes—aligned in the easy direction of magnetization—25 microns wide on a 50-micron pitch. Because this IC technique can be accurate to about 1 micron, digit lines with a width of 10 microns on a 15-micron pitch may be practical.

To finish the digit-line layout, the stripes are electroplated so that the copper stripes end up completely surrounded by Permalloy. The magnetic domains are oriented so that the easy direction of magnetization is circumferential as in conventional plated-wire memories.

Wordy. Word lines are conductors in grooves scribed on a ferrite sheet. The sheet is placed—grooves up—against the digit-line plate, with the word lines at right angles to the digit lines. No insulation is needed; the ferrite acts as its own insulator. Return connections for the word lines can be put on a separate substrate on the other side of the digit-line substrate.

Signed up

Engineers at the Matsushita Electric Industrial Co. expect one day to do away with cathode-ray tubes in tv sets and instead use solid state matrix displays. So does just about everybody else in the business. But Matsushita, unlike most of the others, also foresees an eventual demise of the neon tube in large outdoor signs. The company is well along with its candi-

date for a successor—a fluorescent mosaic display.

Matsushita already has built a prototype that would make a respectable billboard—about 11 feet by 5½ feet. The display has 288 picture elements, each 8.7 inches square. They flash on and off—in any of 16 colors—under tape control to show fixed or moving patterns like advertising slogans or animated cartoons.

Big show. Matsushita doesn't see the mosaic as a gigantic tv display. The frame rate is 3 or 4 per second, compared with 25 or 30 frames per second for normal tv transmission. But for signs, the frame rate is fast enough and the mosaic displays have a potentially big edge over made-to-order neon signs. For one thing, the picture elements will be mass-produced standard modules. For another, the mosaic panels can change their colors and patterns if their control tapes are changed.

A good size for an outdoor display, Matsushita thinks, would be between 5,000 and 10,000 elements.

And the company has plotted its way to a full-fledged sign. Later this year, it expects to install an 800-element sign, probably to huckster its own wares at the Osaka International Airport. Next year, the schedule calls for a sign put together from about 5,000 elements, this one near New York.

On the panel. No matter how large the signs, they'll be made up of standard four-lamp panels. For the prototype, the panel size is 22 centimeters square; but it's possible to whittle this down to 10 cm on a side. The lamps—red, green, blue, and white—lie behind a diffusing panel. They can be left off or switched on separately, in combination or all together.

For each lamp, there's a thyristor-control circuit for turn-on and a transistor circuit for turn-off. Both the thyristor and the transistor work with an AND gate so that both x and y signals have to be present to switch the lamp. The control signals are stored on a six-track audio-tape recorder.



Comfortably close. The Mitsubishi Electric Corp. is right up with the pack in the effort to develop flat-screen tv. Spurred, apparently, by a mid-March report on Matsushita Wireless Research Lab's electroluminescent panel [*Electronics* March 17, p. 114], Mitsubishi had one of its own to show at the International Convention of the Institute of Electrical and Electronic Engineers in New York last month. Both Mitsubishi's and Matsushita's panels sandwich an electroluminescent layer between a layer of x-axis electrode strips and a layer of y-axis strips. Coincident points during an x-y scan, then, become picture elements that emit different levels of light to form images. Mitsubishi's screen has a resolution of 80 lines and its size is slightly less than 3 by 4 inches.

Electronics advertisers

April 14, 1969

■ Acopian Corp. Mort Barish Assoc.	123	Damon Engineering, Inc. L.K. Frank Co., Inc.	15	■ Hewlett Packard, Rockaway Div. Culver Adv., Inc.	87
Acromag, Inc. Watkins-Rogers, Inc.	192	Dearborn Electronics, Inc., Sprague Electric Co. Div. Harry P. Bridge Co.	150	HI-G, Inc. Marketing Assistance, Inc.	178
□ Adret Electronique Perez Publicite	30E	Deutsch Co. Smith & Hemmings Avd.	201, 203, 205	□ Hoboken Honeywell, Computer Control Div.	26E 27 to 30
□ Alcatel Agence Rehe Sicard	11E	Dialight Corp. Michel Cather, Inc.	142	■ Honeywell Test Instruments Div. Creamer, Trowbridge Case & Basford, Inc.	173
Alco Electronic Products, Inc. Marktronics Adv.	129	Digital Equipment Corp. Kalb & Schneider, Inc.	158	■ Hughes Aircraft Co. Foote, Cone & Belding	79, 131, 199
Allen-Bradley Co. Fensholt Adv. Agcy.	17	DuPont de Nemours & Co., Freon Div.	130		
American Engraving, Inc. Page-Lacy Agcy.	190	DuPont de Nemours Co., Teflon Div.	78		
■ Ammon Instruments, Inc. Culver Adv., Inc.	192	Batten, Barton, Durstine & Osborn, Inc.			
■ Amperite Co. H.J. Gold Co.	214				
Anaconda American Brass Co. Wilson, Haight Welch, Inc.	20, 21	■ Eagle Signal Div. of E.W. Bliss Co.	149, 151, 153	■ IBM Corporation Ogilvy & Mather, Inc. Adv.	128
■ Analog Devices, Inc. Kenen Assoc.	35, 36	Feeley & Wheeler, Inc.		■ International Crystal Mfg. Co. Robert V. Freeland & Assoc.	163
Andrew Corp. Fensholt Adv., Inc.	68	E G & G, Inc. Culver Adv., Inc.	218	■ Ithaco, Inc. Hart-Conway Co., Inc.	196
■ A.P.I. Instruments George Z. Griswold Adv.	196	Elco Corp. Schaefer Adv., Inc.	23	ITT Wire and Cable MacManus, John & Adams, Inc.	228
Arnold Engineering Co. Buchen Adv., Inc.	40, 41	■ Electro Motive Mfg. Co. Reynolds & Foster, Inc.	169		
Artus Alain Perraud	146	□ Electronique Applique Electro Products Laboratories, Inc., Transducer Div.	14E 204		
Astrosystems, Inc. Don Alt and Assoc., Inc.	148	Electronic Memories Chiat/Day, Inc.	156, 157	■ J F D Electronics Co., Components Div. Delphi Adv., Inc.	143
Atec, Inc. Helme Assoc., Inc.	152	Emerson & Cuming, Inc. Edwin F. Hall	198	Johnson Co., E.F. Martin Williams Adv.	145
		Ernest F. Fullam, Inc.	200		
■ Barnes Corp. Industrial Public Relations, Inc.	180			Keithley Instruments, Inc. Bayless-Kerr Co.	174
■ Barnstead Co. Div. of Sybron Corp. Creamer, Trowbridge, Case & Basford, Inc.	193	Fairchild Semiconductor Inc. Chiat/Day, Inc.	18, 19, 59, 170	■ Kepco, Inc. Weiss Advertising	60
■ Beckman Instruments, Inc., Helipot Div.	88	□ Ferisol Agence Domenach	20E		
Hixson & Jorgensen, Inc.	66, 67	■ Fluke Mfg. Co., John Bonfield Associates	9	■ Lambda Electronics Corp. Michel Cather, Inc.	80, 81, 82
Belden Corporation Fensholt Advertising, Inc.	26	Fluoroware Colle & McVoy Adv. Agcy., Inc.	207	Licon Div., Illinois Tool Works, Inc.	38, 39
Bell & Howell, Electronic Instrumentation Group-CEC/Transducer Div. Hixson & Jorgensen, Inc.	136			Hurvis, Binzer & Churchill, Inc.	
Bendix Corp., Flight & Engine Instruments Div. MacManus, John & Adams, Inc.	154, 155	□ G & E Bradley, Ltd. Hyde and Partners, Ltd.	27E	Litton Industries, Inc., Winchester Electronics Div.	86
Bendix Corp., Scientific Instruments & Equipment Div. MacManus, John & Adams, Inc.	16E	Gencom Division—Whittaker Corp. A.D. Adams Adv., Inc.	151	□ LTT Promotion-Vente-Publicite	24E, 25E
□ Bernard Golay S.A. Langel Publicite	181	■ General Instrument Corp., Semiconductor Products Div. Norman Allen Associates	76, 77	□ Marconi Instruments, Ltd. Taylor Adv., Ltd.	13E, 22E
Biddle, James G. Co. A.A. Blundi, Inc.	126	General Radio Co. Horton Church & Goff, Inc.	2nd Cover	■ Micro Switch Division of Honeywell N.W. Ayer & Son, Inc.	44, 45
■ Blue M Electric Co. South Suburban Adv.	42, 43	General Resistance, Div. of Chronetics J.S. Lanza & Assoc.	140	Microwave Assoc., Inc. Kalb & Schneider, Inc.	53
Bourns, Inc., Trimpot Div. The Lester Co.	18E	■ Grayhill, Inc. Merchandising Adv., Inc.	16	Mohawk Data Sciences Corp./OEM Marketing MacFarland Assoc., Inc.	205
Brush Instruments, Div. of Clevite Corp. Carr Liggett Adv., Inc.	135	Gries Reproducer Co. Harold Marshall Adv.	192	Monsanto Co. Michel Cather, Inc.	99
■ Buckbee-Mears Co. Midland Assoc., Inc.	204	Groov-Pin Corp. Feeley & Wheeler, Inc.	200	□ Morgan Group, The Scientific Adv. & Marketing, Ltd.	15E
□ Burr-Brown Research Corp. N.A. Winter Adv. Agcy.	210, 211	■ Guardian Electric Mfg. Co. K & A Adv.	3rd Cover	■ Motorola Semiconductor Products, Inc. Lane & Bird Adv., Inc.	10, 11
■ Bussmann Mfg. Div. of McGraw Edison Co. Henderson Adv. Co.	210, 211			M & T Chemicals, Inc. Marsteller, Inc.	207
Cambridge Thermionic Corp. Chirurg & Cairns, Inc.	137	■ Hansen Mfg. Co. Keller-Crescent Co.	198		
Carl Zeiss Michel-Cather, Inc.	184	■ Heath Co., Sub of Schlumberger, Ltd. Advance Adv. Service	6	■ National Electronics, Inc. Connor-Sager Assoc.	203
Chronetics, Inc. J.S. Lanza & Assoc.	207	Heinemann Electric Co. Thomas R. Sundheim, Inc.	1	National Semiconductor Corp. Hall Butler Blatherwick, Inc.	72, 73
■ Clevite Corp., Piezoelectric Div. Carr Liggett Adv., Inc.	12, 13	■ Hewlett Packard, H.P. Assoc. Lennen & Newell, Inc.	206	National Semiconductors, Ltd. Newark Electronics Corp.	209 153
Codex Corp. Creamer, Trowbridge, Case & Basford, Inc.	134	■ Hewlett Packard, Frequency & Time Div. Lennen & Newell, Inc.	161	Stral Adv. Co.	
Colorado State of, Industrial Development Div. Buchen Adv., Inc.	176	■ Hewlett Packard, International Div. Lennen & Newell, Inc.	2	■ New Hermes Engraving Machine Corp. Lester Harrison Adv., Inc.	180
■ Computer Products, Inc. Grenman Assoc., Inc.	24	■ Hewlett Packard, Microwave Div. Lennen & Newell, Inc.	55, 227	Norden Div. of United Aircraft Corp. Cunningham & Walsh, Inc.	194
Connecticut Hard Rubber Co. Chirurg & Cairns, Inc.	127	■ Hewlett Packard, New Jersey Div. McCarthy, Scelba & DiBiasi Adv. Agcy. Inc.	74, 75, 175	North Atlantic Industries, Inc. Ross Roy of New York Inc.	49
Control Products Div., Texas Instruments Incorporated Horton, Church & Coff, Inc.	17E	■ Hewlett Packard, Palo Alto Div. Lennen & Newell, Inc.		■ Norton Assoc., Inc. J.J. Coppo Co.	206
□ C.R.C. IRP	195			■ Nortronics Co., Inc., OEM Div. Stral Adv. Co., Inc.	208
CREI, Home Study Div. of the McGraw-Hill Book Co. Henry J. Kaufman & Associates	212, 213				
■ CTS Corporation Reincke, Meyer & Finn, Inc.	226			□ Onan Div. of Studebaker Corp. Campbell Mithun, Inc.	19E
Cyclo-Tronics, Inc. Bernard J. Hahn & Assoc.					

**ETCH YOUR OWN
P C BOARDS
AUTOMATICALLY**
(in less than 5 minutes)

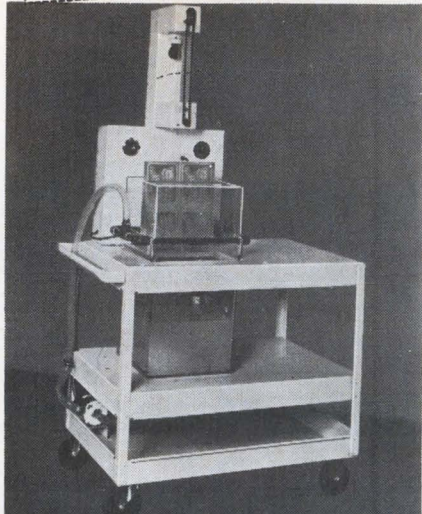

Model No. 201 (illus.), etches two 11" x 14" one-sided boards or one 11" x 14" two-sided board: **\$795**
Pat. applied for

from this →
to 11" x 14"
Shown Actual Size

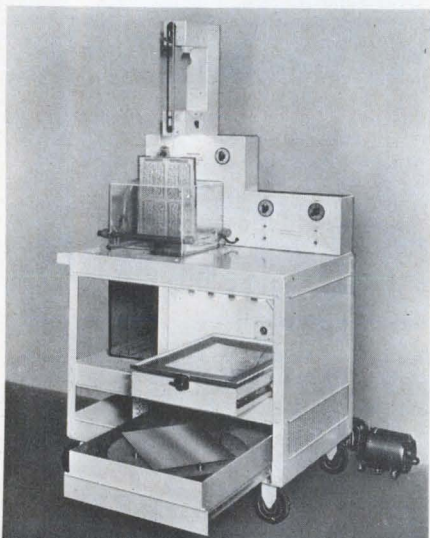

Model No. 205 (illus.) P.C. Processing Lab. has everything but the chemicals. **\$1495**
Pat. applied for

Includes etcher, whirler, infra-red drying oven, vacuum frame and pump, ultra-violet exposure—all assembled into 24"x36" mobile cart. Complete photo processing instructions. \$1495

Model No. 204 Resist Processing Lab. Includes all of above except etcher. \$750

CYCLO-TRONICS, INC.
3858 N. CICERO — CHICAGO, ILL. 60641
TELEPHONE: (312)-282-6141

■ Permag Corp. 201	□ Tranchant Electronique 1E, 2E
Schneider, Allen, Walsh, Inc.	Publebitec
■ Philbrick Nexus Research 83	Transistor Electronics Corp. 202
Culver Adv. Inc.	Steverson & Assoc., Inc.
Philco Ford Corporation	Trans World Airlines, Inc. 182
Sierra Electronics Operation	Wells Rich, Greene, Inc.
Hal Lawrence Inc.	Triplett Electrical Instrument Co. 85
■ Philips Eindhoven, Nederland 209	Burton Browne Adv.
Media International	TRW Electronics, Capacitors Div. 183
■ Photocircuits Corporation 84	Fuller & Smith & Ross, Inc.
Duncan Brooks Inc.	■ Trygon Electronics, Inc. 160
■ Pomona Electronics Company 190	Kameny Assoc., Inc.
Buxton Advertising Agency	■ Tung-Sol Div., 37
■ Power/Mate Corporation 202	Wagner Electric Corp.
Caroe Marketing Inc.	Feeley & Wheeler, Inc.
■ Precision Instrument Co. 133	Tyco Laboratories, Inc.,
Hal Lawrence Inc.	Sherold Crystal Products Group 168
■ Price Electric Corporation 166	Kenyon & Eckhardt, Inc., Adv.
Schaefer Advertising Inc.	

Radiation Inc. 51	
W.M. Zemp & Associates Inc.	
■ Radio Corporation of America 4th Cover	
Al Paul Lefton Company	
■ Raytheon Semiconductor 64, 65	
Botsford Constantine & McCarty Inc.	
■ Reeves Instrument Division 164	
Duncan Brooks, Inc.	
■ Rockland Laboratories Inc. 144	
J.J. Curran Inc.	

■ Sangamo Electric Company 124	
Winius-Brandon Company	
□ Schlumberger Ltd. EMD 4E	
□ Schlumberger SIS 6E	
Sodipa	
□ Schneider R.T. 29E	
Noirclerc Publicite	
Scientific Data Systems 46	
Doyle, Dane, Bernbach, Inc.	
Siemens America 200	
Clinton E. Frank, Inc.	
■ Sifco Metachemical 186	
The W.N. Gates Co.	
■ Signetics Corp., Sub. 111, 177	
Corning Glass Works	
Cunningham & Walsh, Inc.	
■ Siliconix, Inc. 14, 62, 63	
Graphics West	
□ Sogle 21E	
Etudes et Creations Publicitaire	
□ Solartron Electronics Group, Ltd. 5E	
T.P. Brown, Ltd.	
■ Solitron Devices, Inc., 167	
Transistor Div.	
Haselmire Pearson Adv., Inc.	
■ Sorensen Operation Raytheon Co. 71	
Urrutia & Hayes, Inc.	
■ South Carolina Electric & Gas Co. 141	
Cargill, Wilson & Acree, Inc. Adv.	
■ Spectrol Electronics Corp. 7	
J M R, Inc.	
□ S.P. Elettronica 7E to 10E	
Studio Sergio Rosata	
■ Sprague Electric Co., The 5	
Harry P. Bridge Co.	
■ Stackpole Carbon Co., 188	
Electronic Components Div.	
Meek & Thomas, Inc.	
■ Stewart Warner Microcircuits, Inc. 57	
Jones, Maher, Roberts, Inc.	
■ Struthers Dunn, Inc. 172	
Harry P. Bridge Co.	
■ Susumu Industrial Co., Ltd. 190	
Kyokuto Kikaku Co., Ltd.	
■ Sylvania Electric Products, Inc., 125	
Electronic Components Group	
Doyle Dane Bernbach, Inc.	
■ Systemation, Inc. 22	
Barlow/Johnson, Inc.	

TA Mfg. Corp. 209	
Bear Adv., Inc.	
■ Taylor Corp. 187	
Gray & Rogers, Inc.	
■ Tektronix, Inc. 138	
Dawson, Turner & Jenkins, Inc.	
■ Tempress Research Co., Inc. 32	
Hal Lawrence, Inc.	
■ Tenney Engineering, Inc. 204	
Keyes Martin & Co.	
■ Texas Industrial Commission 210	
The Pitluk Group	
■ Texscan Corp. 208	
Burton Browne Adv.	
■ Tracor, Inc., 185	
Industrial Instruments Div.	
Winn-McLane Assoc., Inc.	

Utah Industrial 197	
Promotion Commission	
David W. Evans & Assoc.	
■ Varco, Inc. 214	
Tracy-Locke Co., Inc.	
■ Vector Electronic Co., Inc. 186	
Packard Adv., Inc.	

Wang Laboratories 162	
Impact Adv., Inc.	
■ Watkins-Johnson Co. 12E, 61, 132	
William C. Estler Advertising	

Zeltex, Inc. 122	
Helme Assoc., Inc.	

Classified & Employment Advertising
F.J. Eberle, Manager
212-971-2557

EMPLOYMENT OPPORTUNITIES 215-217
Executive Action Inc. 217
Management Recruiters 217
EQUIPMENT (Used or Surplus New) For Sale
A & A Electronics Corp. 217
Ewald Instruments Corp. 217
Fishman, P. Co. 217
Radio Research Instrument Co. 217

■ For more information on complete product line see advertisement in the latest Electronics Buyer's Guide
□ Advertisers in Electronics International

Electronics Buyers' Guide

George F. Werner, General Manager
[212] 971-2310
Robert M. Denmead,
Midwest Regional Manager
[312] MO 4-5800
William A. Capuzzi,
New York, New England District Manager
[212] 971-3793
Regina Hera, Directory Manager
[212] 971-2544
Thomas M. Egan, Production Manager
[212] 971-3140

Circulation Department

Isaaca Siegel, Manager [212] 971-6057

Research Department

David Strassler, Manager [212] 971-6058

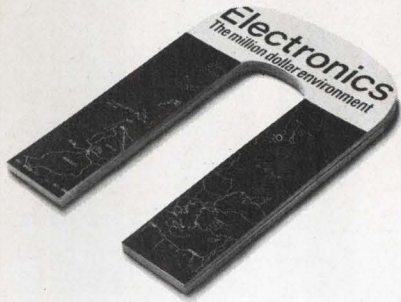

ELECTRONICS attracts requests for over 125,000 editorial reprints every year.

They're like interest payments on our million-dollars-a-year editorial principle.

That's how much we spend annually to produce timely, authentic, and useful articles like those listed on the reader service card as reprints currently available.

Investment and interest make both ELECTRONICS and its readers more meaningful to its advertisers.

Want to be unique in our memory?

It's easy. Enter the Electronics Manpower Register.

We'll feed your professional background into the talent memory of our nationwide computerized recruitment service.

Our computer will match your unique profile against every opening being programmed into it by a long list of electronics companies. You'll automatically be qualified for every logical career opportunity. But we'll only release your availability to those companies you approve.

To enter, send us your resume.

Electronics Manpower Register

Electronics
330 West 42nd Street
New York, N.Y. 10036

Advertising Sales Staff

Frank E. LeBeau [212] 971-6464
Advertising Sales Manager

Wallis Clarke [212] 971-2187
Assistant to sales manager
Donald J. Austermann [212] 971-3139
Promotion Manager

Warren H. Gardner [215] LO 8-6161
Eastern Advertising Sales Manager

Atlanta, Ga. 30309: Michael H. Miller, 1375
Peachtree St., N.E.
[404] 892-2868

Boston, Mass. 02116: William S. Hodgkinson
McGraw-Hill Building, Copley Square
[617] CO 2-1160

Cleveland, Ohio 44113: William J. Boyle, 55
Public Square [216] SU 1-7000

New York, N.Y. 10036
500 Fifth Avenue
James R. Pierce [212] 971-3615
John A. Garland [212] 971-3617
Michael J. Stoller [212] 971-3616

Philadelphia, Pa. 19103:
Jeffrey M. Preston
Warren H. Gardner,
6 Penn Center Plaza,
[215] LO 8-6161

Pittsburgh, Pa. 15222: Warren H. Gardner,
4 Gateway Center, [412] 391 1314

Rochester, N.Y. 14534: William J. Boyle,
9 Greylock Ridge, Pittsford, N.Y.
[716] 586-5040

Donald R. Furth (312) MO 4-5800
Midwest Advertising Sales Manager

Chicago, Ill. 60611: Kenneth E. Nicklas
Ralph Hanning 645 North Michigan Avenue,
[312] MO 4-5800

Dallas, Texas 75201: Richard P. Poole, 1800
Republic National Bank Tower,
[214] RI 7-9721

Houston, Texas 77002: Robert Wallin,
2270 Humble Bldg. [713] CA 4-8381

Detroit, Michigan 48226: Ralph Hanning,
856 Penobscot Building
[313] 962-1793

Minneapolis, Minn. 55402: 1104 Northstar
Center [612] 332-7425

St. Louis, Mo. 63105: Kenneth E. Nicklas,
The Clayton Tower, 7751 Carondelet Ave.
[314] PA 5-7285

James T. Hauptli [415] DO 2-4600
Western Advertising Sales Manager

Denver, Colo. 80202: Joseph C. Page David
M. Watson, Tower Bldg., 1700 Broadway
[303] 255-5484

Los Angeles, Calif. 90017: Ian C. Hill,
John G. Zisch, 1125 W. 6th St.,
[213] HU 2-5450

Portland, Ore. 97204: James T. Hauptli,
Thomas McElhinny, 218 Mohawk Building,
222 S W Morrison Street,
Phone [503] 223-5118

San Francisco, Calif. 94111: James T. Hauptli,
Thomas McElhinny, 255 California Street,
[415] DO 2-4600

Pierre Braude Tel: 225 85 88: Paris

European Director

Paris: Denis Jacob
88-90 Avenue Des Champs-Elysees, Paris 8
United Kingdom and Scandinavia

London: Oliver Ball, Tel: Hyde Park 1451
34 Dover Street, London W1

Milan: Robert Saldel
1 via Baracchini Phone 86-90-656

Brussels: F.I.H. Huntjens
27 Rue Ducale Tel: 136503

Frankfurt/Main: Hans Haller
Elsa-Brandstroem Str. 2
Phone 72 01 81

Geneva: Denis Jacob
1 rue du Temple Phone: 31 95 60
Tokyo: Takeji Kinoshita, McGraw-Hill
Publications Overseas Corporation,
Kasumigaseki Building 2-5, 3-chome,
Kasumigaseki, Chiyoda-Ku, Tokyo, Japan
[581] 9811

Osaka: Akihiko Kamesaka, McGraw-Hill
Publications Overseas Corporation, Kondo
Bldg., 163, Umegee-cho Kita-ku [362] 8771

Business Department

Stephen R. Weiss, Production Manager
[212] 971-2044

Thomas M. Egan,
Assistant Production Manager [212] 971-3140

Dorothy Carmesin, Contracts and Billings
[212] 971-2908

Frances Vallone, Reader Service Manager
[212] 971-2865

your best buy in D.C. . . .



from any angle

For the mini-price of \$90, you can choose from three compact, well regulated, constant voltage/current limiting laboratory power supplies. And, for only \$25 more, 3 additional models are available with constant voltage/constant current. We call them BENCH supplies.

These stable battery substitutes are packaged in molded, high-impact plastic cases with an interlocking feature for stacking. They can be rack mounted with an accessory kit.

Check the following specs for proof of quality at no sacrifice in performance.

Outputs 0-10V @ 0-1A, 0-25V
@ 0-.4A, 0-50V @ 0-.2A
Regulation 4 mV, Load or Line
Ripple 200 μ V rms/1mV p-p
(DC to 20 MHz)
Stability 0.1% +5 mV for 8 Hours
Size 3 1/4" H x 5 1/4" W x 7" D

HEWLETT  PACKARD

POWER SUPPLIES

112 Locust Avenue
Palo Alto, California 94304

IRRAVINTM

INSULATED WIRE



**Fights
solder-iron damage,
cost, carelessness.**

Send for a sample. We'll prove that IRRAVIN insulated hook-up wire fights accidental damage from hot solder-iron contact, ambient heat up to 115°C. There's no melting, shrinkback or flowing.

IRRAVIN hook-up wire costs less, too. It saves up to two-thirds that of other high temperature wires. Fact is, there is no other wire available that is so universal in use—so low in cost. And what's important, IRRAVIN insulated wire has superior abrasion and cut-through resistance. It's available in long continuous lengths, is U.L. Listed and conforms to MIL-W-16878. With advantages like that there's not much to complain about.

Convinced you ought to have a sample? Write ITT Wire and Cable Division, Surprenant Products, International Telephone and Telegraph Corporation, Pawtucket, Rhode Island 02862.

In Europe contact: ITT Europe-Components Group, Wire and Cable Division, Lister Road, Basingstoke Hants, England.

IRRAVIN—the wire
that stops the grumbles.

WIRE AND CABLE **ITT**



Two best sellers with the same silly problem

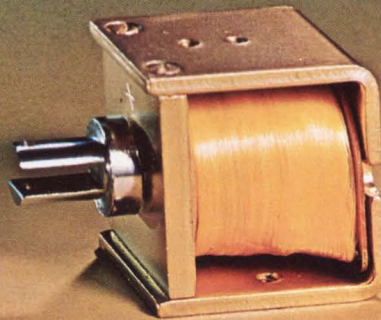

When your 1969 model looks the same as your 1968 model—getting across the engineering advances and improvements that are on the *inside* is a problem.

For instance, in 1966 we started using fully-annealed Armco steel for all Guardian Solenoid plungers . . . an "inside" improvement. Then, to compound the problem, we covered up this improvement with copper/nickel plating.

In 1968 we did it again. We took those

long-life plungers and started running them in a cavity lined with low-friction phenolic. This alone increases operating life by maybe half a million operations.

And there's more: The new acetate-yarn-sealed coil cover that's standard this year means better protection, complies with U/L construction at no extra cost.

Our "bug" changes. Inside. Where an engineering advance makes for a better solenoid. Write for Bulletin G2, TS.

NEW! TUBULAR SOLENOIDS

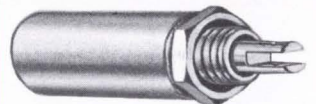

Eleven new Guardian Tubular Solenoids to fit every application. Practically install themselves. Just insert threaded bushing through installation hole and tighten furnished nut.



GUARDIAN[®]
ELECTRIC

MANUFACTURING COMPANY 1550 W. Carroll Ave., Chicago, Illinois 60607

Circle 901 on reader service card

First 200 MHz IC Amplifier Array

RCA-CA3049 for -55° to 125°C operating temperature, \$1.95 (1,000 units)

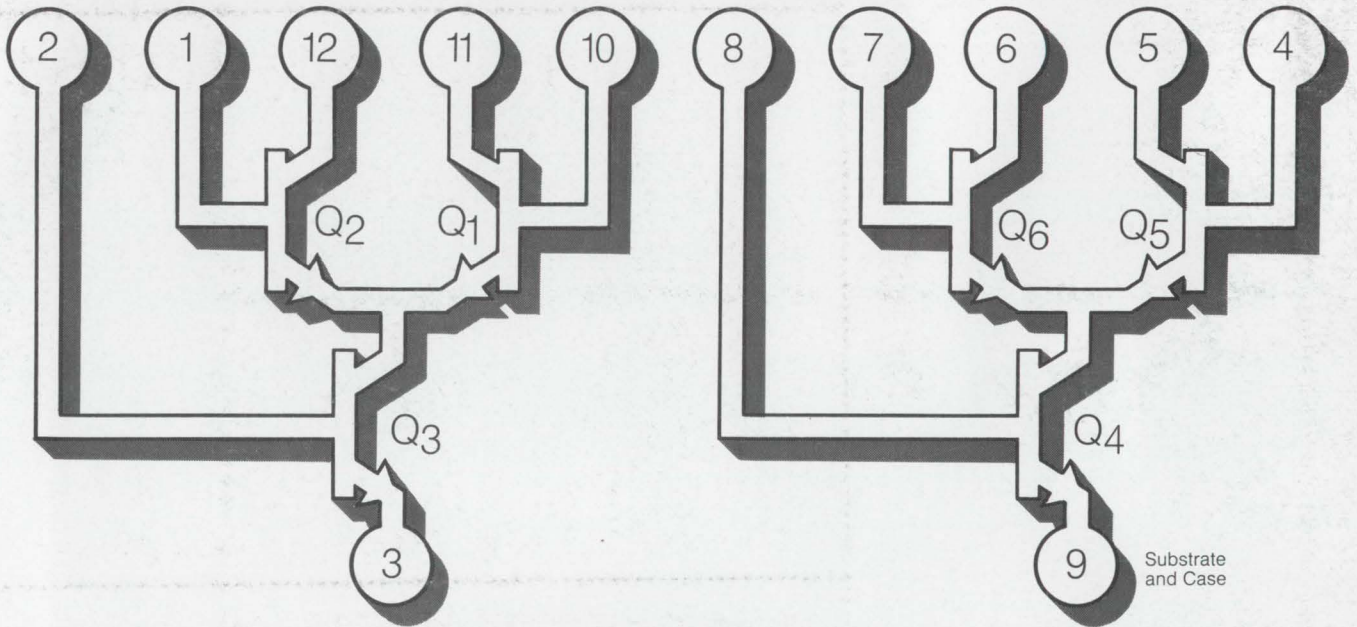

Substrate
and Case

Here's another of RCA's growing family of "building block" IC's—usable as high-speed sense amplifiers, low noise IF and RF amplifiers, balanced mixers, wideband amplifiers, oscillators, and many more.

It's the RCA-CA3049—a pair of differential or cascode amplifiers on a single chip. Each amplifier provides a transducer power gain of 23 dB (typ.) in a cascode connection at 200 MHz with a current of only 2 mA. This unit—useful to 500 MHz—marks another "first" for RCA stemming from new high-frequency IC design and production techniques.

Ask your local RCA Representative or your RCA Distributor for details. Or for complete technical information, write RCA Electronic Components, Commercial Engineering, Section ICN 4-1, Harrison, N. J. 07029.

RCA Linear Arrays for Design Flexibility

RCA-CA3018	Two isolated transistors plus Darlington pair	\$.98 (1000 units)
RCA-CA3018A	Same unit with performance characteristics controlled from $10\ \mu\text{A}$ to $10\ \text{mA}$	1.35 (1000 units)
RCA-CA3026	Dual independent diff amps for DC to 120 MHz	1.25 (1000 units)
RCA-CA3045	3 isolated transistors and 1 diff pair for -55° to $+125^{\circ}\text{C}$ operation, DC to VHF (DIC package)	1.50 (1000 units)
RCA-CA3046	Same as CA3045 but in dual-in-line plastic package (0°C to $+75^{\circ}\text{C}$ operation)	.98 (1000 units)
RCA-CA3050	Two Darlington-connected diff amps with diode bias string: -55° to $+125^{\circ}\text{C}$, DC to 20 MHz operation (DIC)	2.25 (1000 units)
RCA-CA3051	Same circuit for 0°C to $+75^{\circ}\text{C}$ operation (DIP)	1.65 (1000 units)

RCA
Integrated
Circuits