

- 98 Special report: shared computer networks gain in popularity
- 110 Current steering packs 1,024 bits into bipolar RAM
- 126 Preview of the National Computer Conference

Electronics®

Powerful mini design
based on 4,096-bit memory chip

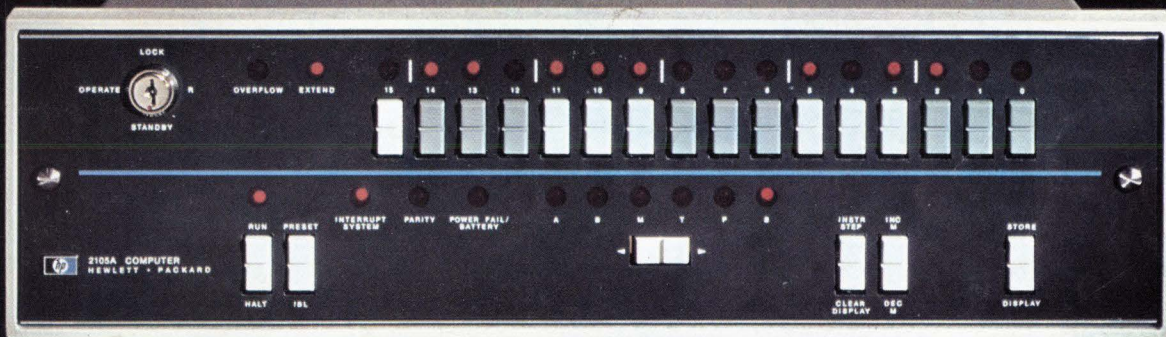

STATE TECHNICAL INSTITUTE
LIBRARY PERIODICALS 14585
5963 MACON COVE
MEMPHIS TN 38134

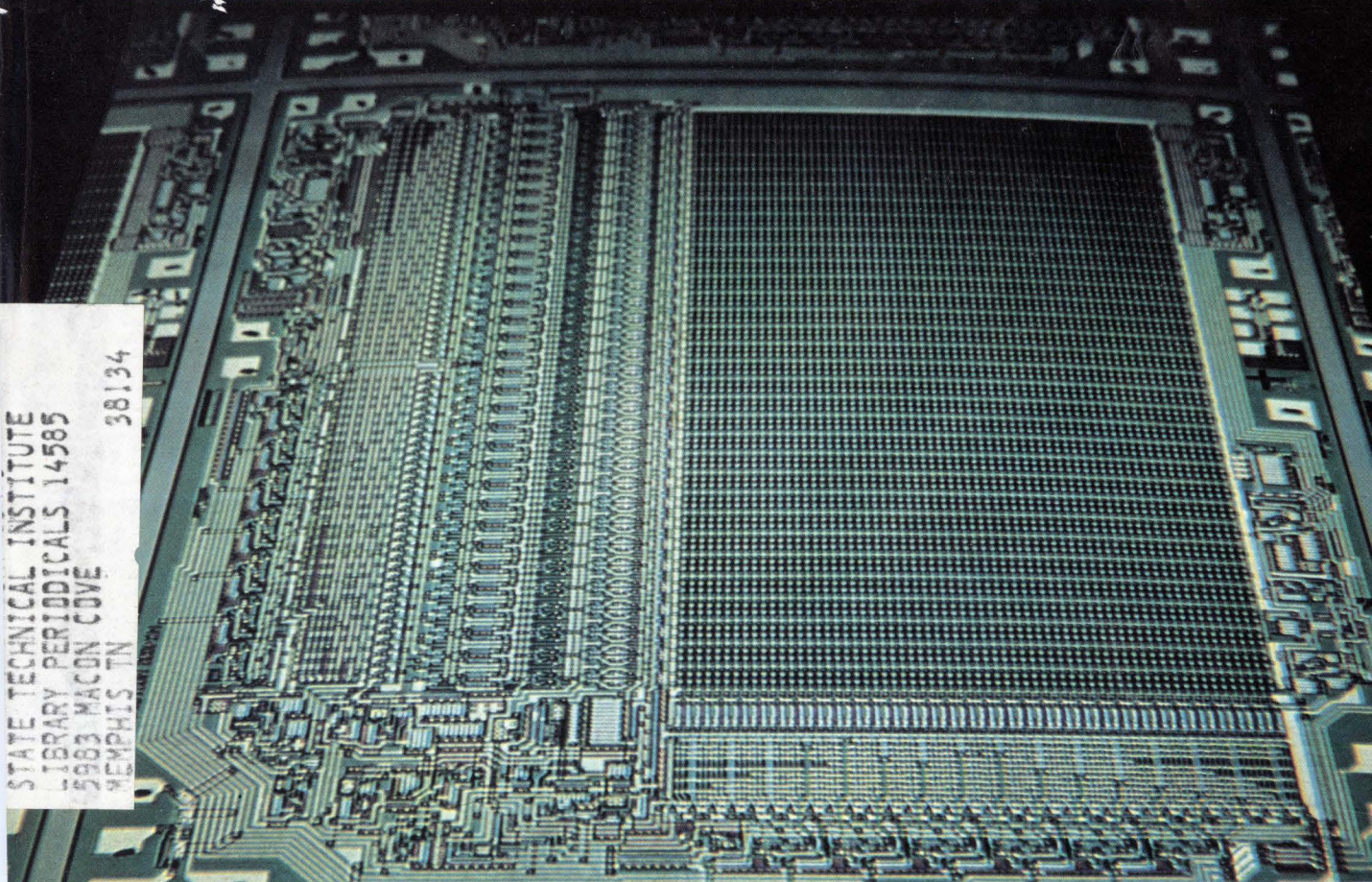

Dialight sees a need:

(**Need:** Single source supply for all indicator lights.)

See Dialight.

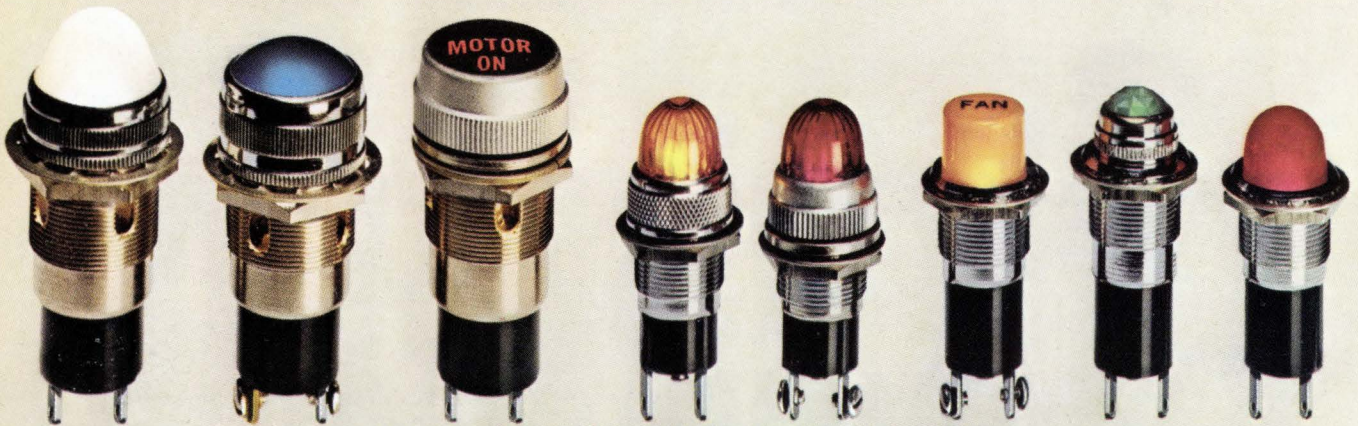

INCANDESCENT OR NEON MINIATURE AND LARGE INDICATORS

Designed to accommodate either incandescent (2-250V) or neon (105-250V) lamps for panel mounting in 11/16" or 1" clearance holes. Units meet or exceed MIL-L-3661 requirements; all are listed in Underwriter's Recognized Components Index. Wide selection of lens shapes, colors,

finishes and terminations. Many lenses may be hot stamped, engraved or offered with film legend discs. Oil-tight units with unique "O" ring construction make them oil, water and dust tight on the face of the panel. Available off the shelf for prompt delivery.

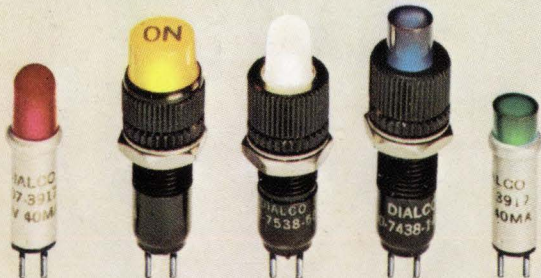

LED, INCANDESCENT OR NEON ULTRA-MINIATURE DATALITES®

Meet or exceed MIL-L-3661. Replaceable plug-in cartridges for 1.35-125V operation. Indicators mount as close as 1/2" centers; available with red, green, amber, blue, white translucent, light yellow or colorless lenses in wide range of lens shapes, legends and finishes. Off-the-shelf.

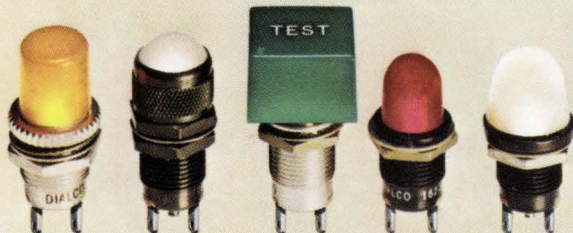

INCANDESCENT OR NEON SUB-MINIATURE INDICATORS

Meet or exceed MIL-L-3661. Mounts in 15/32", 1/2" or 17/32" clearance holes. Incandescent for 1.35-28V; neon has patented built-in current limiting resistor. Choice of cylindrical, faceted, convex, flat, square and round lens shapes, colors, finishes, legends. Off-the-shelf.

Circle 900 on reader service card

DIALIGHT

Dialight, A North American Philips Company
203 Harrison Place, Brooklyn, N. Y. 11237 (212) 497-7600

SEND ME FREE INDICATOR LIGHT PRODUCT SELECTOR GUIDE.



Spectrum analysis made easy

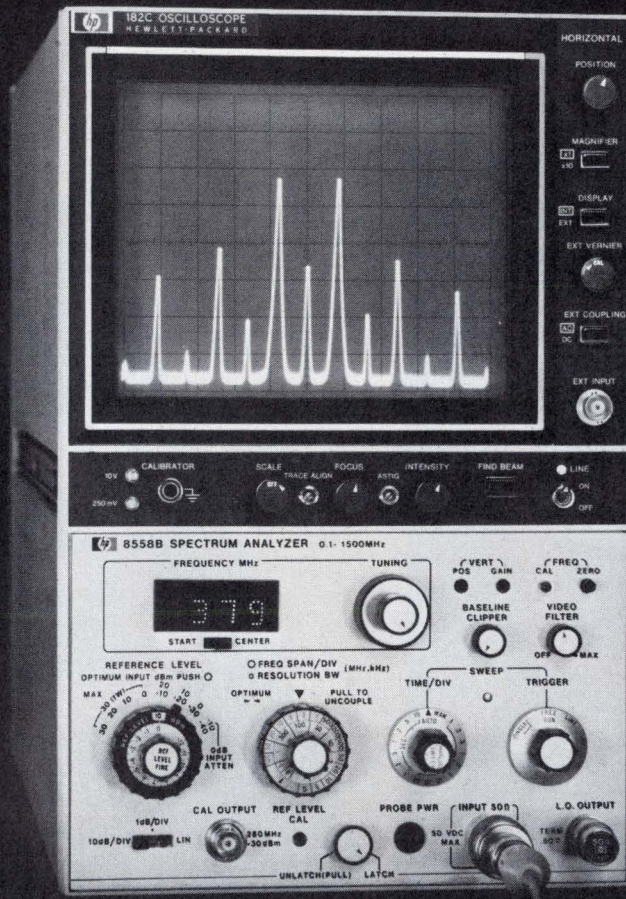

A new 1500 MHz plug-in for HP 180 series Scopes

Three Controls Do It. The 8558B Spectrum Analyzer makes most measurements with three simple settings: tuning frequency, frequency span and amplitude reference level. Resolution bandwidth and sweep time are automatically optimized, and LED's digitally display frequency. Panel markings guide you to the settings that minimize the possibility of errors from signal overloads.

Lab Grade Performance. Compare the 8558B's frequency and amplitude accuracy against any other analyzer and you'll quickly see how good it is. Frequency response over the full 0.1-1500 MHz range is ± 1 dB, and its frequency accuracy is ± 5 MHz. Distortion-free dynamic range exceeds 70 dB. Signal levels from +30 dBm to -117 dBm can be measured. Resolution bandwidths from 1 KHz to a wide 3 MHz are provided.

Domestic USA prices only.

Just \$3900. The 8558B Spectrum Analyzer plug-in is priced low enough to make it practical for every workbench; no need to "timeshare" the expensive analyzer. And since it's part of the HP 180 Scope family, the mainframe can do double-duty using the wide array of other 180 plug-ins.

For full information on this tremendous value in spectrum analysis, call your nearest HP field office. Or write.

HEWLETT  PACKARD

Sales and service from 172 offices in 65 countries.
1501 Page Mill Road, Palo Alto, California 94304

SURPRISE!

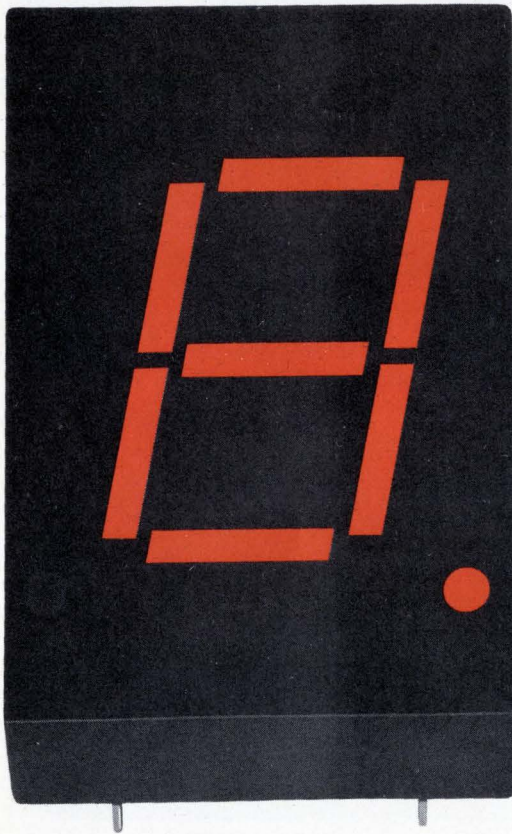

HP's new 5082-7750 series

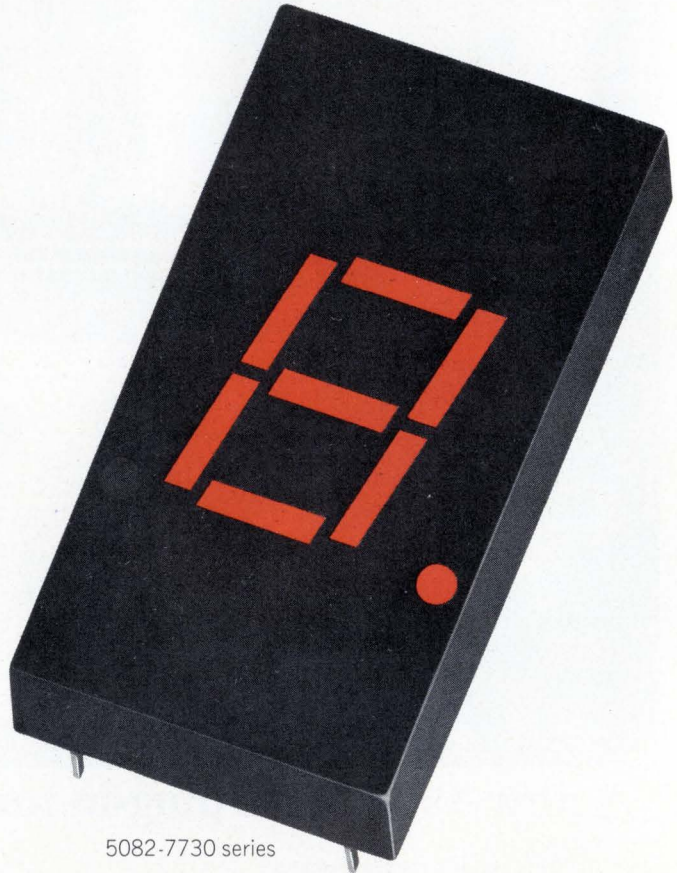

5082-7730 series

HP displays are bigger than ever!

Now you can get a big, readable 0.43 inch LED display without sacrificing the simplicity and economy of single chip per segment design.

Bright enough to clearly see 20 feet away. HP's 5082-7750 series display features the same wide viewing angle, excellent readability and the same pin configuration as our 0.3 inch 5082-7730 series displays.

Just \$3.50 each in 100 quantities*.

Contact Schweber, Hall-Mark or the Wyle Distribution Group for immediate delivery. Or, write us for more details. This is one display you won't want to miss.

HEWLETT  PACKARD

Sales and service from 172 offices in 65 countries.
1501 Page Mill Road, Palo Alto, California 94304

01403A

*Domestic USA price only.

33 Electronics Review

AVIONICS: MOS computer to vie for spot on new minuteman, 33
DISPLAYS: GaP under GaAsP brightens LED colors, 34
INSTRUMENTATION: Laser triggers 8-MV test jolt, 35
COMPUTERS: Speedy printer is electrostatic, 35
COMMUNICATIONS: Optical and mm-wave links have promise, 36
MILITARY ELECTRONICS: Schlesinger wants to save Sanguine, 38
INDEX OF ACTIVITY: 40
GOVERNMENT: Contractors seek more IR&D freedom, 40
NEWS BRIEFS: 42
MEMORIES: "Bulk" hologram uses organics, 44

57 Electronics International

JAPAN: Piezoelectric polymer finds transducer jobs, 57
AROUND THE WORLD: 57

69 Probing the News

SATELLITES: ATS-F poised to set records, 69
COMPANIES: Pacing the paperless parade, 72
PACKAGING & PRODUCTION: Printed-circuit makers go additive, 77
COMPUTERS: HIS completes its consolidation, 81

87 Technical Articles

COMPUTERS: Microprogramability lets user tailor minicomputer, 87
DESIGNER'S CASEBOOK: Schottky diode pair stabilizes detector, 94
Crowbar protection circuit senses load voltage directly, 95
Simple gating circuit marks both pulse edges, 96
DATA COMMUNICATIONS: Nets are taking on complex computations, 98
SOLID STATE: Current steering simplifies 1k bipolar RAM, 110
ENGINEER'S NOTEBOOK: Measuring access time of bipolar ROMs, 115
Eliminating stray signals in remotely gain-switched op amps, 116

126 Special Report

Expanding market augurs well for National Computer Conference, 126
Highlights of new products debuting at NCC, 129

135 New Products

IN THE SPOTLIGHT: Fluke adds to low-cost multimeter line, 135
COMPONENTS: Photovoltaic detector uses heterojunction, 137
INSTRUMENTS: Ac standards reach 1 gigahertz, 140
DATA HANDLING: Simplicity built into card reader, 149
PACKAGING & PRODUCTION: Wafer processes are automated, 159
SUBASSEMBLIES: Lead-acid cell finds its niche, 164

Departments

Publisher's letter, 4
Readers comment, 6
40 years ago, 8
People, 14
Meetings, 24
Electronics newsletter, 29
Washington newsletter, 53
Washington commentary, 54
International newsletter, 59
Engineer's newsletter, 118
New literature, 172

Highlights

Cover: Microprogramable mini exploits 4k RAM, 87

A family of general-purpose minicomputers is the first production series to profit from the low power and high density of the new 4,096-bit random-access-memory chips. Greater microprogramability gives the user more freedom to adapt his machine to changing applications.

Success of 6th satellite in ATS series likely, 69

Due for launch on May 30, the sixth and last of the applied technology satellites promises to advance long-distance communications techniques and could help improve usage of the communications spectrum.

Computer networks give users more scope, 98

By pooling such data-processing resources as data bases and sophisticated programs, computer networks handle large and complex tasks very fast. But research into their potential continues even as commercial nets grow in number and popularity.

NCC aims at computer builders and users, 126

A recordbreaking 119 technical sessions at the National Computer Conference cover every aspect of data processing, from technological advances to its rapidly diversifying applications.

And in the next issue . . .

The film-carrier approach to high-volume IC assembly . . . measurement and control using programable calculators . . . how readers evaluate EE evaluation.

EDITOR-IN-CHIEF: Kemp Anderson

EXECUTIVE EDITOR: Samuel Weber

MANAGING EDITORS: Lawrence Curran, *News*;
Arthur Erikson, *International*

SENIOR EDITORS: John Johnsrud,
H. Thomas Maguire, Laurence Altman
Ray Connolly, Stephen E. Scrupski

ART DIRECTOR: Fred Sklenar

ASSOCIATE EDITORS: John N. Kessler,
Howard Wolff, Gerald M. Walker

DEPARTMENT EDITORS

Aerospace: William F. Arnold
Circuit Design: Lucinda Matterna
Communications & Microwaves:
Stephen E. Scrupski
Components: Joel DuBov
Computers: Wallace B. Riley
Consumer: Gerald M. Walker
Instrumentation: Michael J. Riezenman
Military: Ray Connolly
New Products: H. Thomas Maguire
Packaging & Production: Stephen E. Grossman
Solid State: Laurence Altman

COPY EDITORS: Margaret Eastman,
Everett C. Terry

ASSISTANT EDITOR: Marilyn Offenheiser

ART: Charles D. Ciatto, *Associate Director*
Patricia Cybulski, *Assistant Director*

PRODUCTION EDITOR: Arthur C. Miller

EDITORIAL SECRETARIES: Janet Annunziata,
Julie Gorgoglione, Penny Roberts

FIELD EDITORS

Boston: Gail Farrell
Los Angeles: Paul Franson (Mgr.)
Midwest: Larry Armstrong (Mgr.)
New York: Alfred Rosenblatt (Mgr.)
San Francisco: Bernard Cole (Mgr.)
Judith Curtis
Washington: Ray Connolly (Mgr.),
William F. Arnold
Frankfurt: John Gosch
London: Michael Payne
Paris: Arthur Erikson
Tokyo: Charles Cohen

McGRAW-HILL WORLD NEWS

Director: Ralph R. Schulz
Bonn: Robert Ingersoll;
Brussels: James Smith;
London: Marvin Petal;
Milan: Peter Hoffmann, Andrew Heath;
Moscow: Axel Krause;
Paris: Michael Johnson, Richard Shepherd;
Stockholm: Robert Skole;
Tokyo: Mike Mealey

PUBLISHER: Dan McMillan

DIRECTOR OF MARKETING: Pierre J. Braudé
ADVERTISING SALES SERVICE MANAGER:
Wallis Clarke

BUSINESS MANAGER: Stephen R. Weiss

CIRCULATION MANAGER: Nancy L. Merritt

MARKETING SERVICES MANAGER:
Tomlinson Howland

RESEARCH MANAGER: Margery D. Sholes

You'll find a preview of the National Computer Conference starting on page 126. Our two-part coverage of the conference opens with a report on the record number of 119 technical sessions, which cover a broad range of technology and applications. Then, on page 129, we take a look at some of the significant products that are being introduced at the show.

Al Rosenblatt, our New York bureau manager, who prepared the technical-session preview, says that the technical program "reflects the move of information processing into a host of newer businesses, such as data communications, point-of-sale systems, and computer networks."

Indeed, the shift in emphasis toward attracting the non-computer professional, which was first made by NCC management a year ago, illustrates, once again, how pervasive electronics technology has become. More and more, the computer user is someone who did not start out as an expert in computer usage. Instead, his data requirements are pushing him into harnessing the power of electronic technology.

Also illustrating that trend are six special sessions. They will cover such broad social topics as computers and personal privacy and energy in an evolving society.

Risk is certainly one of the most challenging elements of the electronics business. And our cover story this issue is, partly, the story about a risk successfully taken. To ready their new minicomputers for market, designers at Hewlett-Packard had to take the risk that 4,096-bit random-access memories would be ready, too.

As the article that starts on page

87 points out, the first breadboards were based on core, even though the design was committed to semiconductor memory long before the costs came down to ferrite-core levels. Then came the jump to 1,024-bit devices—and the decision that 4k RAMs of high reliability would reach competitive cost levels in time.

The story of how the design progressed—even to the point of adding the ability to accept 4k RAMs of a variety of characteristics from several sources—is fascinating. What's more, it shows that the calculated risk—which pushes technology forward in the process—is one of the elemental forces that keeps electronics so strong.

Resource sharing is just about the most significant trend in computer technology today. Tie together a number of computers into a network, and you have a system that has a computational power far greater than the mere summing of the parts might indicate.

As Wally Riley, our Computers Editor, brings out in his special report (see p. 98), networks not only offer shared computational resources—including data bases, special equipment, and sophisticated programs—they offer advantages peculiarly their own. "They show the way to low-cost, high-performance computing systems," he says, "since for some jobs a network of smaller systems can duplicate the capability of one large expensive system at lower total cost."

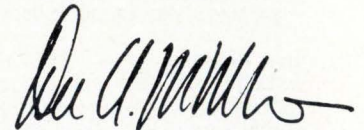

May 2, 1974 Volume 47, Number 9

93,602 copies of this issue printed

Published every other Thursday by McGraw-Hill, Inc. Founder: James H. McGraw, 1860-1948. Publication office: 1221 Avenue of the Americas, N.Y., N.Y. 10020; second class postage paid at New York, N.Y. and additional mailing offices.

Executive, editorial, circulation and advertising addresses: Electronics, McGraw-Hill Building, 1221 Avenue of the Americas, New York, N.Y. 10020. Telephone (212) 997-1221. Teletype TWX N.Y. 710-581-5234. Cable address: MCGRAWHILL N.Y.

Subscriptions limited to persons with active, professional functional responsibility in electronics technology. Publisher reserves the right to reject non-qualified requests. No subscriptions accepted without complete identification of subscriber name, title, or job function, company or organization, including product manufactured or services performed. Subscription rates: qualified subscribers in the United States and possessions, Canada, and Mexico \$9.00 one year, \$18.00 three years; all other countries \$25.00 per year, except Japan \$50.00 per year, Brazil \$40.00 per year, Australia and New Zealand \$60 per year, including air freight. Limited quota of subscriptions available at higher-than-basic rate for persons outside of field served, as follows: U.S. and possessions and Canada, \$25.00 one year; all other countries \$50.00. Single copies: United States and possessions and Canada, \$1.00; all other countries, \$1.75.

Officers of the McGraw-Hill Publications Company: John R. Emery, President; J. Elton Tuohig, Executive Vice President-Administration; Gene W. Simpson, Group Publisher-Vice President; Senior Vice Presidents: Ralph Blackburn, Circulation; Walter A. Stanbury, Editorial; John D. Hoglund, Controller; David G. Jensen, Manufacturing; Gordon L. Jones, Marketing; Jerome D. Luntz, Planning & Development.

Officers of the Corporation: Shelton Fisher, President; Wallace F. Traendly, Group President, McGraw-Hill Publications Company and McGraw-Hill Information Systems Company; Robert N. Landes, Senior Vice President and Secretary; Ralph J. Webb, Treasurer.

Title registered in U.S. Patent Office. Copyright © 1974 by McGraw-Hill, Inc. All rights reserved. The contents of this publication may not be reproduced either in whole or in part without the consent of copyright owner.

Subscribers: The publisher, upon written request to our New York office from any subscriber, agrees to refund that part of the subscription price applying to copies not yet mailed. Please send change of address notices or complaints to Fulfillment Manager; subscription orders to Circulation Manager, Electronics, at address below. Change of address notices should provide old as well as new address, including postal zip code number. If possible, attach address label from recent issue. Allow one month for change to become effective.

Postmaster: Please send form 3579 to Fulfillment Manager, Electronics, P.O. Box 430, Hightstown, N.J. 08520.

New function generator programs faster— functions better, longer.

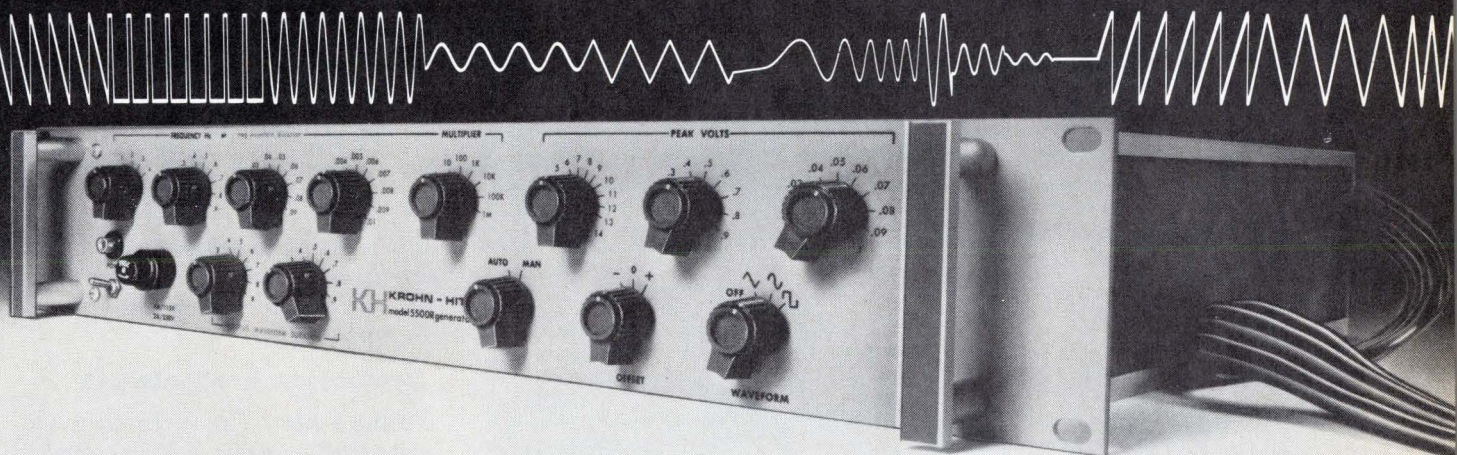

The 5500R Programmable Function Generator utilizes high-speed FET switches for greater reliability and generates functions automatically in less than 100 μ sec.

There are no relays to break down. And optical coupling assures high isolation between system and logic drive. Frequency range is 0.0001Hz to 5MHz. Sine, square, triangle, pulse and sawtooth waveforms, as well as frequency, amplitude, DC offset and pulse width control functions, can all be selected auto-

atically or manually. And the 5500R programming interface is compatible with DTL, RTL, TTL logic and relay closures. It's ideally suited for automatic calibration and test systems. For fast action, call (617) 491-3211, TWX 710 320 6583, or contact your local KH representative listed below.

**KH KROHN-HITE
CORPORATION**

580 Massachusetts Avenue, Cambridge, Massachusetts 02139

SALES OFFICES: ALA., Huntsville (205) 534-9771; ARIZ., Scottsdale (602) 947-7841; CAL., Santa Clara (408) 243-2891, Inglewood (213) 674-6850; COLO., Denver (303) 934-5505; CONN., Glastonbury (203) 633-0777; FLA., Orlando (305) 894-4401; HAWAII, Honolulu (808) 941-1574; ILL., Des Plaines (312) 298-3600; IND., Indianapolis (317) 244-2456; MASS., Lexington (617) 861-8620; MICH., Detroit (313) 526-8800; MINN., Minneapolis (612) 884-4336; MO., St. Louis (314) 423-1234; N.C., Burlington (919) 227-3639; N.J., Haddonfield (609) 795-1700; N.M., Albuquerque (505) 299-7658; N.Y., E. Syracuse (315) 437-6666, Rochester (716) 328-2230, Vestal (607) 785-9947, Elmont (516) 488-2100; OHIO, Cleveland (216) 261-5440, Dayton (513) 426-5551; PA., Pittsburgh (412) 371-9449; TEX., Houston (713) 621-0040, Richardson (214) 231-2573; VA., Alexandria (703) 354-1222; WASH., Seattle (206) 624-9020; CANADA, Montreal, Quebec (514) 636-0525, Toronto, Ontario (416) 444-9111, Stittsville, Ontario (613) 836-4411, Vancouver, British Columbia (604) 688-2619.

Circle 5 on reader service card

FLAT INTERCONNECTS YOUR COMPLETE SOURCE

Ribbon Cable / IC Interconnects / Custom Harnesses

You're sold on flat cable, now buy it at its best. Precise, compact cable packages to fit your specifications perfectly, computer-loomed for unmatched versatility by Woven Electronics.

Handling ease of independent non-bonded leads speeds production, cuts cost, while technical characteristics outrank other flat cable forms.

Make Woven your source for jumpers, continuous rolls, special harnesses, all your interconnect needs.

WOVEN ELECTRONICS

P.O. Box 189 Mauldin, South Carolina 29662

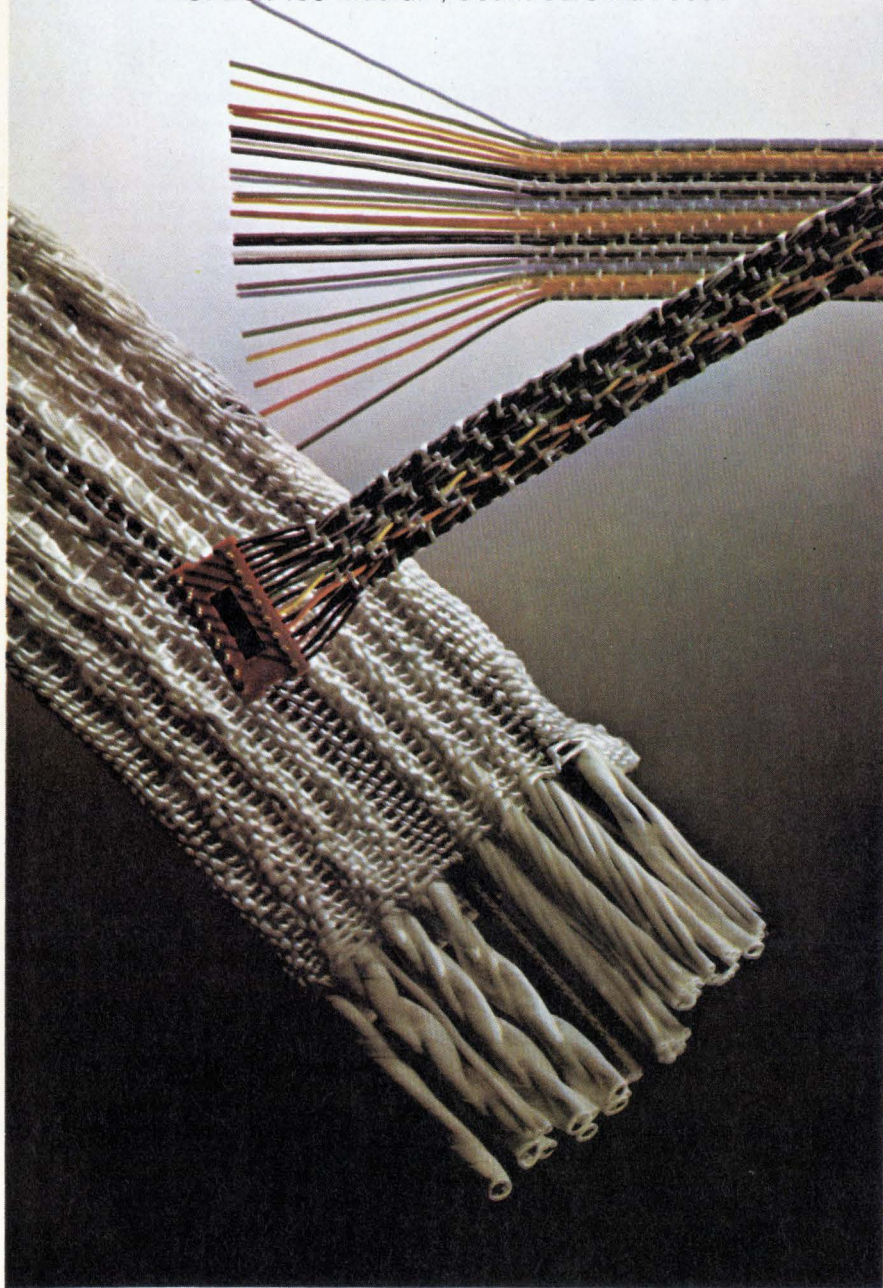

Readers comment

Crediting IBM 1k RAM roles

To the Editor: My article, "Pinch-load resistors shrink bipolar memory cells," [*Electronics*, March 7, p.130] has resulted in some confusion on the relative role of the Boeblingen, Germany, and Burlington, Vt., IBM locations in developing the 1,024-bit random-access memory used in the 370 models 135 and 145.

My work consisted of the invention and early experimental investigations of cells employing pinch-load resistors [U. S. Patent No. 3,693,057]. The application of these and other inventions in the development of the 1,024-bit chip and its subsequent reduction to practice was accomplished in the Burlington facility, where that 1,024-bit chip is currently in production. The product is also being produced in Corbeilles-Essonnes, France.

S. K. Wiedmann
IBM Deutschland GmbH
Boeblingen, Germany

■ *The article appearing on p. 110 of this issue describes the design of the memory module, as worked out in Burlington.*

Tone encoder won't interface

To the Editor: The [Frequency Devices Inc.] tone encoder described in the New products section [*Electronics*, March 21, p. 167] won't interface with the Bell System tone receivers using the upper oscillator set of frequencies listed.

The frequencies should be 1,209, 1,336, 1,477, and 1,633 hertz to be compatible with Bell System frequencies. The error in the first frequency looks like a transposition by your typesetters. The 1,477 Hz has a longer error background.

It appears that a typesetting error in Table 14 on page 30-22 of the fifth edition of the [ITT] "Reference Data for Radio Engineers" caused the 1,447 Hz to get propagated in various subsequent articles. Table 6 on page 2-14 of "Reference Data" has the correct frequency set. I hope this letter will alert the engineering-design community that 1,477 Hz is the correct upper frequency for push buttons 3, 6, 9, and #.

E. G. Baldwin
Winston-Salem, N. C.

Knute had his Four Horsemen. HiNIL has its MSI.

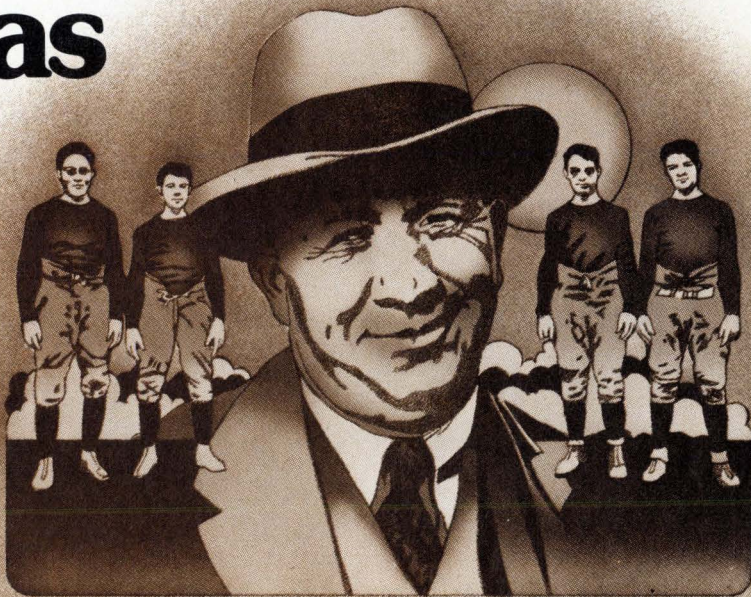

Knute Rockne's Four Horsemen of Notre Dame crushed the opposition every time they ran onto the field. A lot like HiNIL's four new MSI circuits. Our high noise immunity logic circuits will crush the biggest noises and make them just whispers when you use them in industrial control applications. Here's the lineup:

367 Quad Schmitt Trigger—Line Receiver. Deaf as a doornail with a typical D.C. noise margin of 5.5V and 2.5V during switching. The 367 eliminates false counts due to contact bounce on switches, relays, etc. and has a 4.5V dead zone to eliminate noise problems occurring on long lines. The 367 directly interfaces with CMOS and the 368 open collector version with TTL.

375 4-bit Shift Register. A universal shift register and storage element that can be used in serial in, serial out, parallel in and parallel out modes. For increased flexibility, the 375 has both parallel entry enable and master reset pins. For serial entry, we've provided J and K inputs as well as Q and \bar{Q} outputs. Worst case noise margin is 3.5V and typical shift rate is 3MHz.

383 BCD to 7-segment Decoder/Driver. Decodes binary to 7-segment code. Drives LEDs (like the MAN-1) and gas-filled seven segment tubes. Has blanking and lamps test inputs.

347 Dual Retriggerable Monostable Multivibrator (One Shot). Has both inverting and non-inverting trigger inputs and active pull-up complementary outputs. Isn't sensitive to power transients. Output pulse times are determined by an external capacitor making them independent of input-trigger pulse width. Can be used as a free-running one-shot by inhibiting retrigger capability.

So there they are. Like all 40 of our HiNIL devices, guaranteed noise margin is 3.5V without shielding, filter capacitors or spot regulators. They operate at either 12 or 15 volts with regulation to $\pm 1V$. They interface with TTL, DTL, MOS or CMOS. And they come handily packaged in ceramic or molded silicone DIPs attached to a very modest price tag. Available from Teledyne, reps or distributors.

Our HiNIL literature describes the entire team and shows you how to lead the way in industrial controls. And it's free. For your copy just give us a yell.

 **TELEDYNE**
SEMICONDUCTOR

1300 Terra Bella Avenue Mountain View, California 94043
(415) 968-9241 TWX: 910-379-6494 Telex: 34-8416

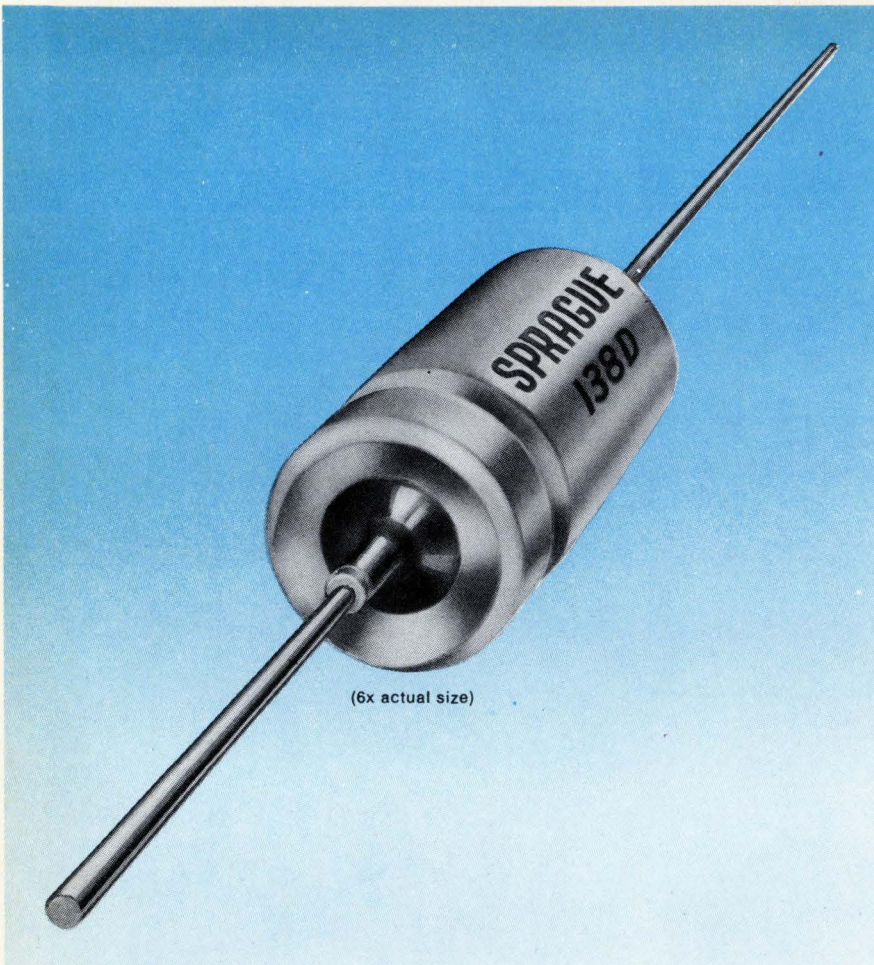

seal of improval

Improved reliability through the use of a glass-to-tantalum true hermetic anode seal is the prime feature of new Type 138D gelled-electrolyte sintered-anode Tantalex® Capacitors. This new construction eliminates all internal lead welds while retaining the strength of conventional internal lead-welded parts. In addition, the new construction offers outstanding resistance to extensive temperature cycling.

Type 138D Tantalex Capacitors are designed to meet or exceed

the environmental and life test requirements of MIL-C-39006. The gelled-electrolyte employed in these new capacitors gives premium performance for all capacitor parameters with respect to frequency and temperature variations.

Originally developed for use in aerospace applications, this capacitor design is now available for general industrial and aviation use where the utmost in component performance and reliability are primary necessities.

For complete technical data, write for Engineering Bulletin 3704A to: Technical Literature Service, Sprague Electric Co., 35 Marshall St., North Adams, Mass. 01247.



THE BROAD-LINE PRODUCER OF ELECTRONIC PARTS

40 years ago

From the pages of Electronics, May 1934

Microphones in the cemetery

Many persons are pursued by an unreasoning fear that they may some time undergo a temporary coma simulating death, and be actually buried alive, only to "wake up" and find themselves interred in a coffin five feet underground.

One victim of this fear of being buried alive, has made advance arrangements with his undertaker and cemetery, by means of which a sensitive microphone will be installed inside the coffin and connected with loudspeakers in the cemetery caretaker's dwelling nearby. This microphone circuit is to be kept continuously energized for at least a year after interment, during which year it is to be regularly tested by sounding a small gong in the coffin.

Guarding a \$1 million painting

When the famous painting, Whistler's "Mother," was on view at Dayton, Ohio, the million-dollar canvas was guarded by a series of electronic protection devices, installed under the direction of Gilbert D. Bossard, president of the General Kontrolar Company, of Dayton.

A system of infrared "black light" beams, with all generating and light-sensitive equipment installed in the walls, made it impossible for anyone to approach or disturb the canvas without sounding several alarms, including a police siren that could be heard for several blocks.

Sam Browne belt radio

A miniature radio receiving set has been invented by Ralph O. Gordon of Los Angeles, to be worn by patrolmen. The set is worn on a Sam Browne belt with an earphone attached to the cap, the whole weighing less than three pounds.

Associate Press facsimile

Newspapers of the Associated Press have approved the plan to transmit pictures by wire facsimile, using the A.T.&T. process. Pictures up to 11 by 17, half a newspaper page, will be sent at average rates of 11 square inches per minute.

Why pay

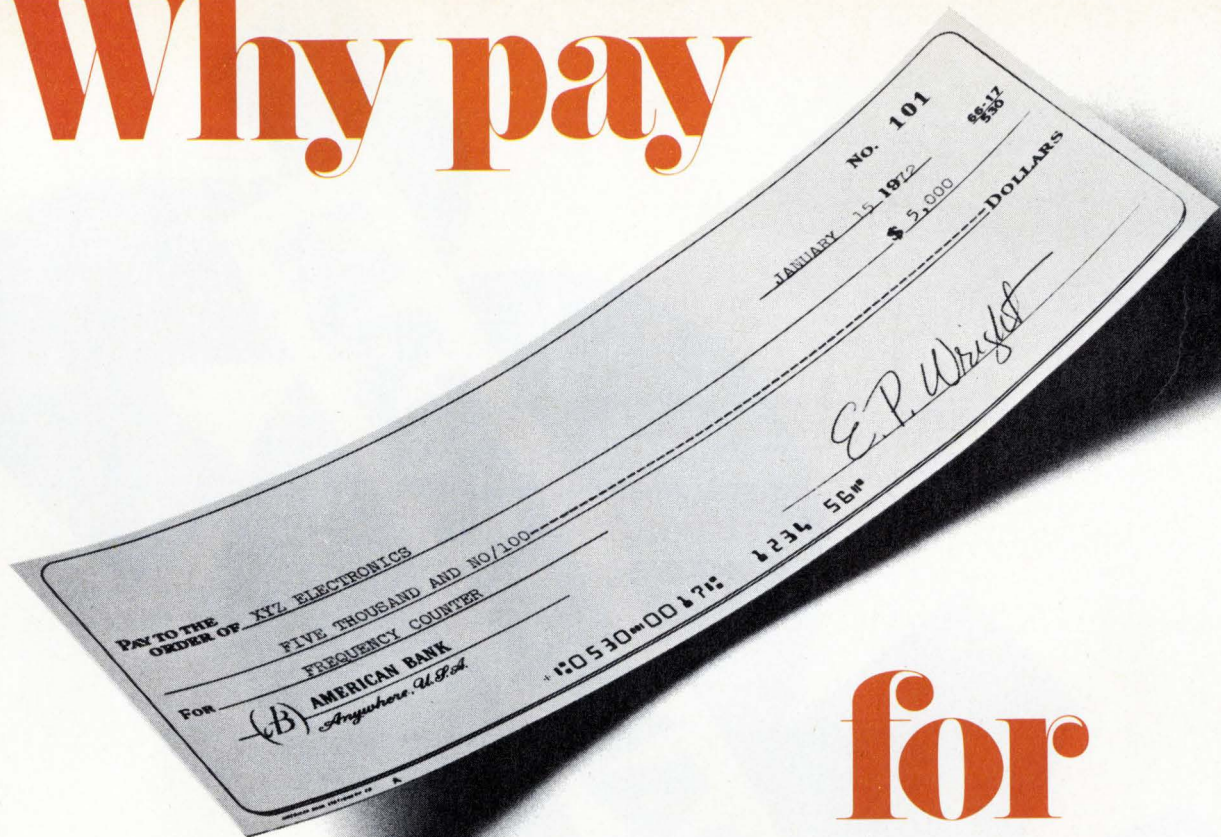

for CW only?

You're looking at the only self-contained single instrument capable of measuring virtually any microwave signal from 20 Hz to 18 GHz. It's Systron-Donner's 6057 frequency counter, which combines S-D's Automatic Computing Transfer Oscillator (ACTO®) with an advanced manual T.O. system.

CW and AM measurements are fully automatic from 20 Hz to 18 GHz—simply connect the input and read the final answer. FM and pulse modulated carriers are measured using a simple 3-step operation which yields direct readout answers, even with pulse widths as short as 0.1 μ sec.

A full nine digit readout with automatic decimal point and annunciator is standard. Resolution down to 1 Hz is selectable from front panel pushbuttons. Options include digital outputs, remote programming, and a complete selection of extended stability time base oscillators.

The 6057 is priced at only \$5,450, which is just about what you'd expect to pay for comparable instruments **without** FM and pulsed RF capability. However, with S-D you pay for only what you need. If it's CW only you need to measure, then choose our Model 6016 at \$4,875, or for only \$3,695 you get a Model 6092 manual T.O. measuring system.

For details, a demo or 5-day delivery, call your Scientific Devices office. Or call collect S-D's Quick Reaction Line (415) 682-6471. In Europe: Systron-Donner-Munich, W. Germany; Leamington Spa, U.K.; Paris (Le Port Marly) France. In Australia: Systron-Donner-Melbourne.



For only \$5,450
you can get the
one **18GHz** box
that measures
everything: **FM**,
pulsed RF
and **CW**.

**5-DAY
DELIVERY!**

SYSTRON  DONNER

KIDS

MAINSTREAM

AMD/MOS/MAY ONE

| | | | |
|---|--------------------|---|--------------------|
| Dual 128-Bit Static Shift Register | Am1002 | 512-Bit Dynamic Recirculating Shift Register | Am2805 |
| 256-Bit Random Access Memory | Am1101A | 1024-Bit Dynamic Recirculating Shift Register | Am2806 |
| 256-Bit Random Access Memory | Am1101A1 | 512-Bit Dynamic Recirculating Shift Register | Am2807 |
| Quad 256-Bit Dynamic Shift Register | Am1402A | 1024-Bit Dynamic Recirculating Shift Register | Am2808 |
| Dual 512-Bit Dynamic Shift Register | Am1403A | Dual 128-Bit Static Shift Register | Am2810 |
| Single 1024-Bit Dynamic Shift Register | Am1404A | Dual 128-Bit Static Shift Register | Am2814 |
| 512-Bit Dynamic Recirculating Shift Register | Am1405A | 64 x 4-Bit FIFO Memory | Am2841 |
| Dual 100-Bit Dynamic Shift Register | Am1406/1506 | Quad 128-Bit Static Shift Register | Am2855 |
| Dual 100-Bit Dynamic Shift Register | Am1407/1507 | Dual 256-Bit Static Shift Register | Am2856 |
| 1024-Bit Static Random Access Memory | Am2102 | 512-Bit Static Shift Register | Am2857 |
| 512-Bit Dynamic Recirculating Shift Register | Am2505 | Dual 128-Bit Static Shift Register | Am3114 |
| 1024-Bit Dynamic Recirculating Shift Register | Am2512 | 64 x 4-Bit FIFO Memory | Am3341 |
| 10 MHz Quad 256-Bit Dynamic Shift Register | Am2802 | Quad 128-Bit Static Shift Register | Am4055/5055 |
| 10 MHz Dual 512-Bit Dynamic Shift Register | Am2803 | Dual 256-Bit Static Shift Register | Am4056/5056 |
| 10 MHz Single 1024-Bit Dynamic Shift Register | Am2804 | 512-Bit Static Shift Register | Am4057/5057 |

(To be continued...)

More than two dozen mainstream MOS parts, all in one place: Advanced Micro Devices.

Every one is silicon gate. Every one is available in military temperature range. Every one is built to MIL-STD-883 at no extra charge.

And one is N-Channel. The 2102. A 1024-bit Static Random Access Memory.

Every MOS part we make is guaranteed to be as good or better than the original. Every part is available for immediate delivery.

If you're getting into MOS, if you want spec sheets or app notes or a thousand parts, talk to Advanced Micro Devices, the next giant.

Advanced Micro Devices

Corporate offices are at 901 Thompson Place, Sunnyvale, California 94086. Telephone (408) 732-2400/Southern California office: Beverly Hills (213) 278-9700/Mid-America: Des Plaines, Illinois (312) 297-4115/Edina, Minnesota (612) 835-4445/Eastern United States: Roslyn Heights, New York (516) 484-4990/Baltimore, Maryland (301) 744-8233/Lexington, Massachusetts (617) 861-0606/Britain: Advanced Micro Devices, Telephone Maidstone 52004/West Germany: Advanced Micro Devices, Munich, Telephone (089) 53 95 88.
Distributed nationally by Hamilton/Avnet and Cramer Electronics.

10K ECL.

Where to get 1024-bit memory and 37 logic devices right now.

Talk to Fairchild.
You want 10K ECL for speed.
And at Fairchild we've got it for you right now.

Lots of logic. And more memory than anyone else today.

37 of the logic devices you want most. All off-the-shelf.

Check our list of available logic, and you'll find all the basics are there.

Including some handy items you won't find anywhere else—like our F10000 4-Bit Shift Register, our F10010 Decade Counter and our F10016 Binary Counter.

Plus 15 other helpful devices available very soon.

Where else can you get 1024-bit 10K ECL memory in stock? Nowhere.

Or, where else can you get immediate quantities of 256-bit 10K ECL memory?

Nowhere. Except from the leader in ECL memory—Fairchild.

And, of course, we have all the 128-bit memory you need, too.

Complete compatibility.

How does Fairchild's F10K ECL play with other ECL brands? That's easy to answer. All the way.

And for many applications, better.

For new ECL designs, some new competitive advantages.

Of course, if you're designing a new system using 10K ECL logic and memory, you'll be decidedly ahead of your competitors by designing with *voltage-compensated* F10K ECL circuits from Fairchild.

ECL 1024-BIT MEMORIES IMPROVE SYSTEM PERFORMANCE
Read-Modify-Write Cycle (Worst case over 0-75°C)

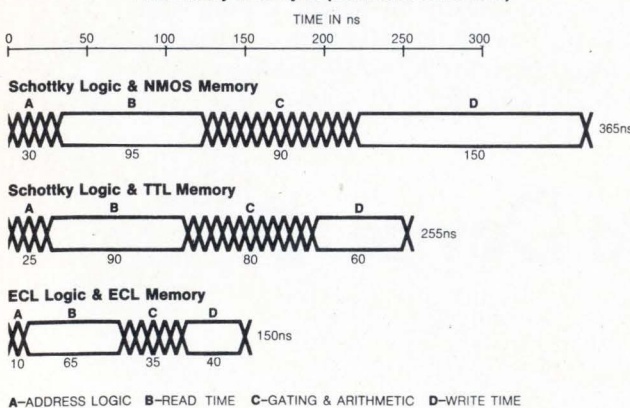

F10K ECL Logic in Stock

| Device | Description | Price 100-999 |
|--------|----------------------|------------------|
| 10000 | 4-Bit Shift Register | 12.10 |
| 10010 | Decade Counter | 12.10 |
| 10016 | Binary Counter | 12.10 |
| 10101 | Quad OR/NOR | 1.67 |
| 10102 | Quad NOR | 1.67 |
| 10103 | Quad OR | 1.67 |
| 10105 | Triple OR/NOR | 1.67 |
| 10106 | Triple NOR | 1.67 |
| 10107 | Triple Exc. OR/NOR | 2.09 |
| 10109 | Dual OR/NOR | 1.67 |
| 10110 | Dual 3/3 OR | 2.09 |
| 10111 | Dual 3/3 NOR | 2.09 |
| 10114 | Triple Line Receiver | 2.09 |
| 10115 | Quad Line Receiver | 1.67 |
| 10116 | Triple Line Receiver | 1.67 |
| 10117 | Dual 2 W AOI | 2.09 |
| 10118 | Dual 2 W OA | 2.09 |
| 10119 | 4 W OR/AND | 2.09 |
| 10121 | 4 W AOI | 2.09 |
| 10124 | TTL To ECL | 4.50 |
| 10125 | ECL To TTL | 4.50 |
| 10130 | Dual D Latch | 4.46 |
| 10131 | Dual D Flip-Flop | 5.65 |
| 10132 | Dual MUX-Latch | 5.02 |
| 10133 | Quad Latch | 6.19 |
| 10134 | Dual MUX-Latch | 5.02 |
| 10160 | 12-Bit Parity | 6.84 |
| 10161 | 1-8 Demux/Decode (L) | 5.42 |
| 10162 | 1-8 Demux/Decode (H) | 5.42 |
| 10164 | 8-1 MUX | 5.42 |
| 10170 | 9 + 2 Bit Parity | 6.84 |
| 10171 | Dual 1-4 Demux (L) | 5.42 |
| 10173 | Quad MUX-Latch | 6.19 |
| 10174 | Dual 4-1 MUX | 5.42 |
| 10175 | Quint Latch | 7.33 |
| 10179 | Look Ahead | 6.84 |
| 10180 | Adder/Subtractor | 18.00 |

F10K ECL Logic Available Soon

| Device | Description |
|------------------|---------------------------|
| 2nd Quarter 1974 | |
| 10014 | Active Terminator |
| 10104 | Quad AND Gate |
| 10141 | 4-Bit Shift Register |
| 10153 | Neg Clock 10133 |
| 10172 | Dual 1-4 Demux/Decode (H) |
| 3rd Quarter 1974 | |
| 10135 | Dual JK Flip-Flop |
| 10136 | Binary Counter |
| 10137 | Decade Counter |
| 10176 | Hex D Flip-Flop |
| 10210 | High-Speed 10110 |
| 4th Quarter 1974 | |
| 10145 | 16 x 4-Bit RAM |
| 10165 | Priority Encoder |
| 10166 | 5-Bit Comparator |
| 10181 | 4-Bit ALU |
| 10186 | Hex D Flip-Flop/Reset |

F10K ECL Memories in Stock

| Device | Description | Price 100-999 |
|--------|------------------|------------------|
| 10405 | 128 x 1-Bit RAM | \$15.00 |
| 10410 | 256 x 1-Bit RAM | \$21.00 |
| 10415 | 1024 x 1-Bit RAM | \$70.00 |

Our F10K is virtually immune to voltage variation, ripple and gradients. And holds noise immunity constant.

So if you want almost anything in 10K ECL today, you'll certainly want to talk to Fairchild soon.

Send for complete information on prices and delivery or contact your local Fairchild Sales Office or Distributor.

**MADE IN
FAIRCHILD**

Semiconductor Components Group, Fairchild Camera & Instrument Corp.,
464 Ellis St., Mountain View, CA 94040. Telephone (415) 962-5011. TWX: 910-379-6435.

The new 420L offers everything but the pedestal you'll want to put it on.

The pedestal's optional, but the broad frequency coverage of 100 kHz to 280 MHz and a power output up to 20 watts are standard in this state-of-the-art RF power amplifier.

Linear Class A circuitry will faithfully reproduce input modulations including AM, FM, SSB, TV and pulse with minimum distortion. Completely solid-state, the 420L will supply full power output into any load impedance (from an open to a short circuit).

Driven by any signal generator, frequency synthesizer or sweeper, the 420L is a flexible and versatile source of RF power for general laboratory work, RF/EMI testing, signal distribution, RF transmission, laser modulation and ultrasonics.

The new 420L. Offering everything but the pedestal you'll want to put it on, at \$2950.

For further information or a demonstration contact ENI, 3000 Winton Road South, Rochester, New York 14623 (716) 473-6900 or TELEX 97-8283

ENI

The world's leader in solid state power amplifiers

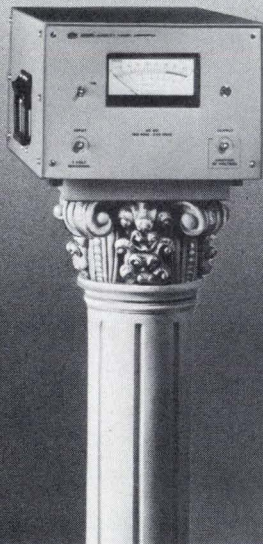

People

NDC's Thorpe spreads his wings

When does a former Air Force colonel volunteer to give up some of his command? In the case of National Data Corp.'s president George W. Thorpe, the time was this year when the company reached a value of \$30 million and set out to double its size.

The Atlanta-based computer/communications systems house, which specializes in electron-funds-transfer programs (see p. 72), has been under Thorpe's command ever since he organized it in 1967, three years after he retired from the Air Force. He had the idea that a lot of what he learned while heading the Strategic Air Command's intelligence-data-processing centers could be applied to credit-card authorization and other money-managing services.

The concept worked. By now, company growth has prompted Thorpe to reorganize, to take some of the day-to-day management load off his shoulders, and to rev up the corporate engines for another growth spurt.

Thorpe's Air Force experience is reflected at NDC in other ways. For example, he picked up an aversion to paperwork while in the military and still does much of his executive memo-writing on the back of envelopes.

Another aversion that survives from his military days is over-staffing. "Having too many people on top is bad—in fact, it's worse than not having enough personnel," he observes. "That's why we have limited the recent changes to four functional responsibilities and just two staff positions."

Between his Air Force retirement and the formation of NDC, Thorpe spent three years with the Southern Railway System where he set up the railroad's data-processing and communication operations.

Thorpe, who has a BS degree in engineering from the U.S. Air Force Institute of Technology, believes that NDC can influence point-of-sale system technology not by building its own hardware but by culling the



SAC style. George W. Thorpe has applied his Strategic Air Command training to National Data Corp.'s operations.

best from present manufacturers. With a new management organization in place, NDC will be set to prove this contention during 1974 as the company begins to install the first of specially designed authorization terminals recently ordered from Addressograph-Multigraph and National Cash Register Co.

One thing that won't change is Thorpe's penchant for working himself and his executives on weekends. After all, credit authorization—just like SAC—is a seven-day-a-week operation.

Lucus heads Xynetics after it acquires his firm

The president of a small company acquired by a larger one is not always happy about the arrangement, but Gerald E. Lucas probably won't complain. A year ago, he was president of Electroglas Inc., a maker of production equipment for integrated circuits, when it was acquired from Electronic Memories & Magnetics by Xynetics Inc. But now, because the Electroglas subsidiary performed better than the parent Xynetics, Lucas has been promoted to the presidency of Xynetics itself.

Xynetics, which is moving to Santa Clara, Calif., from Canoga Park, Calif., sells a high-speed, high-accuracy X-Y positioner that uses linear motors.

Electroglas, which has been in Santa Clara, Calif., makes wafer probers and scribes. "Electroglas

"On May 16, 1974 every scan conversion system in the world becomes obsolete."



—Dr. Steven R. Hofstein, President,
Princeton Electronic Products, Inc.

The second revolution in image storage technology begins with the advent of the Lithocon® II.

The first revolution began five years ago when our company introduced the Lithocon silicon storage tube—the first practical medium for storing, processing and scan-converting electronic images. These advances culminate in Lithocon II.

On May 16, 1974, you can see CRT displays with extraordinary improvements in image fidelity, gray scale and retention time, using Lithocon II Scan Converters or scan conversions by our new Lithocon II systems.

These new performance levels make Lithocon II systems more versatile. They extend the use of low-cost image systems to new and more demanding image processing applications. Indeed, no matter what your application may be, look first to the Lithocon II storage tube for your imaging technology.

Like electronic "photograph". You won't believe you're looking at a picture from an image storage tube. It will have the gray scale, the dynamic range, that you would normally expect from a high-resolution video camera. A picture so smooth, so uniform, that visitors who have seen prototypes in our laboratory have said, "It looks like a photograph."

This electronic "photograph," however, can be erased and re-used through thousands of video "exposures" without damage or deterioration.

No other technology approaches Lithocon II systems in performance, or in answering so wide a range of application requirements. For example, in medical, diagnostic and clinical environments, the doctor can count on consistent, reproduceable X-ray, ultrasonic or nuclear camera images, reproduced by the Lithocon II's wide dynamic range (64 gray levels) and high resolution. These same features make practicable X-ray baggage inspection at airports.

With Lithocon II's unique features, you no longer have to make a trade-off between editing speed, retention time and erase speed. Our new Lithocon II system lets you have over two hours storage time with the ability to store TV images, and still get single-frame erase—full screen in 33 milliseconds. These are the features you need for such applications as remote industrial process monitoring, computer-aided design, medical electronics and cable and closed-circuit television systems.

At the other end of the scale, for slow-scan applications, the same Lithocon II system is operated in a manner which reproduces high quality images independent of writing speed. This capability comes at no cost to the user in dynamic range, erase time (33 msec.) or retention time (greater than two hours).

In short, look to Lithocon II for your low-cost, high-quality scan conversion. With a guaranteed long life cycle. And the sharpest resolution available today.

Lithocon II—for stored images that don't look stored.

Phone or write us today about your application. We'll put the answer right before your eyes.



PRINCETON ELECTRONIC PRODUCTS, INC.

P.O. Box 101, North Brunswick, New Jersey 08902
(201) 297-4448

AMPEREX DOT MATRIX PRINTERS

*Fast, Quiet, Versatile, Low Cost -
And they're a breeze
to integrate into your system!*

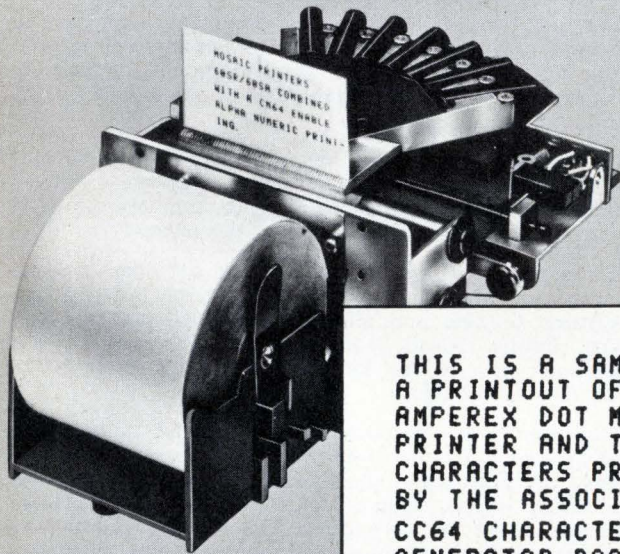

MODEL 60SA

THIS IS A SAMPLE OF
A PRINTOUT OF THE
AMPEREX DOT MATRIX
PRINTER AND THE
CHARACTERS PRODUCED
BY THE ASSOCIATED
CM64 CHARACTER
GENERATOR BOARD.
ABCDEFGHIJKLMNQRST
UVWXYZ < . / ; - : ! " £
\$ % & ' () * = ? +
1234567890

If you're designing equipment that must print hard copy, Amperex has the Printer for your system.

With an Amperex Printer and the available Amperex Electronics you have all the tools you need to produce at low cost—and on very short notice—high quality medium-speed printout.

Amperex Printers, Models 60SR and 60SA, offer full dot matrix character flexibility and print up to three copies of 20 characters per line data on 2¼ inch paper. Intermittent operation of the (no-clutch) motors guarantees long life, quiet operation and reliability for such applications as POINT OF SALE TERMINALS, PROCESS CONTROL MONITORS, MEDICAL DATA SYSTEMS AND DIGITAL METERS.

OUTSTANDING FEATURES

THE PRINTERS

- **LOW POWER CONSUMPTION:**
(no standby power; no clutches)
Motors: 8.5 watts; Head: 40 watts
- **LONG LIFE:**
10 million lines (frame)
- **MEDIUM SPEED:**
1 20-character line per second
- **LIGHT WEIGHT:**
only 4.4 pounds
- **LOW COST (100 Quantity)**
Model 60SR (with ribbon): \$185.
Model 60SA (without ribbon): \$170.

THE ELECTRONICS

- **FULL 64 CHARACTER, ASCII FORMAT**
- **DTL/TTL COMPATIBLE INPUT**
- **LOW POWER CONSUMPTION:**
less than 1 watt
- **EASILY INTEGRATED
INTO YOUR SYSTEM**
- **HEAD SOLENOID DRIVER**
- **LOW COST (100 Quantity)**
Model CM64:
Complete Electronic
Control Package: \$135.

For complete data and information on available applications assistance, write: Amperex Electronic Corporation, Hicksville Division, Hicksville, New York 11802.

Amperex®

TOMORROW'S THINKING IN TODAY'S PRODUCTS

Sold through
North American Philips Electronic Component Corporation

People



Lead acquisition. Within a year Gerald E. Lucus moved into the presidency of the firm that had acquired his own company.

and Xynetics made an excellent fit says Lucus. "Electroglas gave Xynetics an outlet in the fast-growing and important semiconductor industry, and the Xynetics positioner gave Electroglas' products a leg up on competition using other types of positioning." Among other features, the positioner can move in two axes at once—an impossibility with other positioners that do comparable tasks.

Xynetics, which has been in business about five years, has doubled its sales every year since shipping started. Recently, however, Xynetics has been overshadowed by Electroglas, whose sales last year were \$17 million.

Lucus thinks that much growth can still come in the semiconductor industry, but he expects to penetrate at least two additional market areas per year. "We've just signed an agreement with Boeing for government applications, for example, and there are probably 20 different industries other than semiconductors in which the positioning stage can be applied." He's also looking at a number of acquisitions, but notes "the end-user business is much more difficult over the long term than OEM marketing." To OEMs, multiple orders can be sold with little more effort than it takes to sell one user, so he's looking hardest in this direction.

The wide, wide world of AMP Circular Plastic Connectors.



No matter where you go, you won't find a more versatile line of circular plastic connectors. AMP has a variety of design options. From mating plugs to panel-mount or free-hanging receptacles. From square flange to feed-thru pressure bulkhead receptacles. They're available with many types of contacts and arrangements. And in popular shell sizes: 11, 17, 23. What's more, there are sealing boots, strain relief/shield components, posted or solder contacts, plus standard or splashproof models.

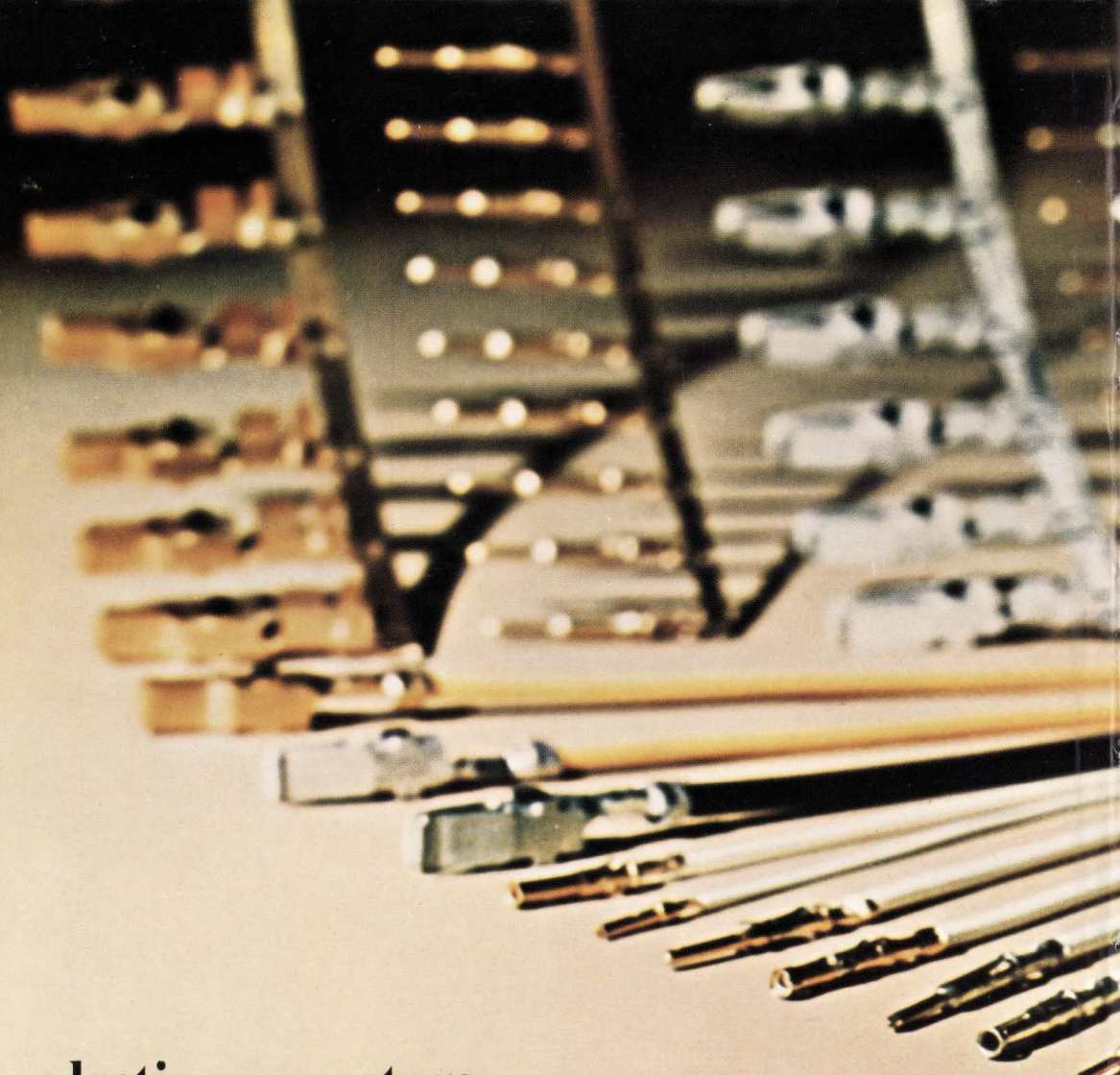

Why plastic connectors are better than metal ones.

Besides offering greater versatility, AMP gives you high-strength, glass-filled nylon connectors that are as reliable as metal ones—but cost much less. In some ways, they're even more rugged. Because AMP Circular Plastic Connectors are resilient. Yet, up to 50% lighter. And nonconducting.

Contacts to fit every need.

AMP supplies a great variety of contacts for #8AWG to #28AWG wires. The pins and sockets are stamped and formed from top-quality copper alloys, and are available

with either a gold or tin finish. And with AMP, you pay only for the contacts you use.

AMP automatic machines. For high-speed termination.

The contacts are supplied in continuous strip form. So termination is possible at volume production rates. And at the lowest possible cost to you. To be certain that you'll be able to take full advantage of these savings, AMP worldwide has over 1,000 field service and sales engineers to assist you with design and production applications. No matter where in the world you're using AMP commercial connectors.

Features that lead to more savings.

Built-in pin and socket protection. Quick connect/disconnect capability. Thread-assist coupling ring with positive detent locking. 5-key polarization is built in to assure proper connector mating.

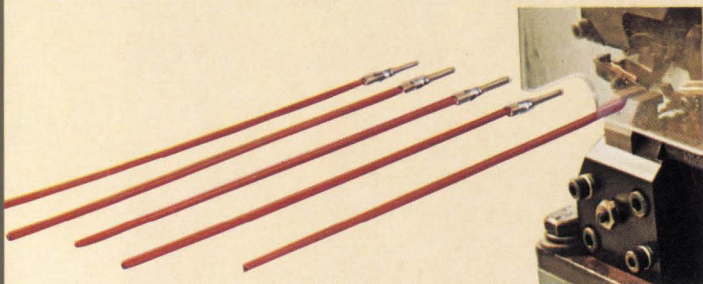





**AMP is at the core
of reliable circular
plastic connectors.**

**No matter what
industry you're in.**

Aircraft

Office Equipment and
Business Machines

Computers and
Peripheral Equipment

Automotive

Space Vehicles

Appliances and Home
Entertainment Products

Industrial Equipment
Instruments

AMP has some 100 manufacturing plants, warehousing facilities and sales offices worldwide. So we can handle virtually all your circular plastic connector needs no matter where you're doing business. Call (717) 564-0100. Or write AMP Incorporated, Harrisburg, Pa. 17105.

AMP
INCORPORATED

AMP is a trademark of AMP Incorporated.

*Here's a dependable, quick-delivery source
for Zero Defect*

High Voltage Silicon Rectifiers

- MEETS STRINGENT ENVIRONMENTAL REQUIREMENTS.
- HIGH TRANSIENT VOLTAGE RATINGS.
- EXTREMELY LOW LEAKAGE.
- WORKING VOLTAGE RANGE . . . 200V. THROUGH 50kV.

If you're looking for on-time delivery of miniature and microminiature High Voltage Silicon Rectifiers, look no further than ERIE. You simply can't beat our zero defect rectifiers since these units were first designed for high reliability night vision, lunar and aerospace applications. Their small size makes ERIE rectifiers ideal for thick film substrates, miniature power supplies, airborne displays, CRT displays, color TV, microwave ovens and other industrial and commercial applications where small size, reliability and superior performance are critical. All ERIE High Voltage Silicon Rectifiers feature conservative voltage ratings, fast recovery time, fast turn-on time, wide operating temperature range, high transient voltage ratings, low reverse leakage and unsurpassed reliability.

ERIE also offers double sealed, miniature Full Wave Bridge Rectifiers . . . perfect for P.C. use, with ratings up to 1000 volts per leg. So think ERIE for your High Voltage Silicon Rectifiers. Write TODAY for our new 24-page catalog . . . High Voltage Components and Devices.



ERIE TECHNOLOGICAL PRODUCTS • Erie, Pennsylvania 16512

From CPU 8080 Microcom

Intel's new 8080 n-channel microcomputer is here—
incredibly easy to interface, simple to program and with up
to 100 times the performance of p-channel
MOS microcomputers.

Best of all, the 8080 is real—in production
at Intel and available in volume quantities,
today. It's also available through distributors
along with a growing line of peripheral
circuits and a new version of the
Intellec 8, a program and hard-
ware development
system for the 8080,

all supported with software
packages, design documenta-
tion and manuals, and backed
by more than 100 man years
of microcomputer expertise.

The 8080 is the inevitable
successor to complex custom
MOS and many large discrete
logic subsystems. It is the
industry's first general purpose
n-channel microcomputer and
the first high performance
single-chip CPU, with extremely
simple interface requirements and
straightforward programming. It runs a
full instruction cycle in 2 microseconds.

As such, the 8080 extends the economic
benefits of Intel's p-channel microcom-
puters to a new universe of systems that need
fast, multi-port controllers and processors. These
systems include intelligent terminals, point of sale
systems, process and numeric controllers, advanced

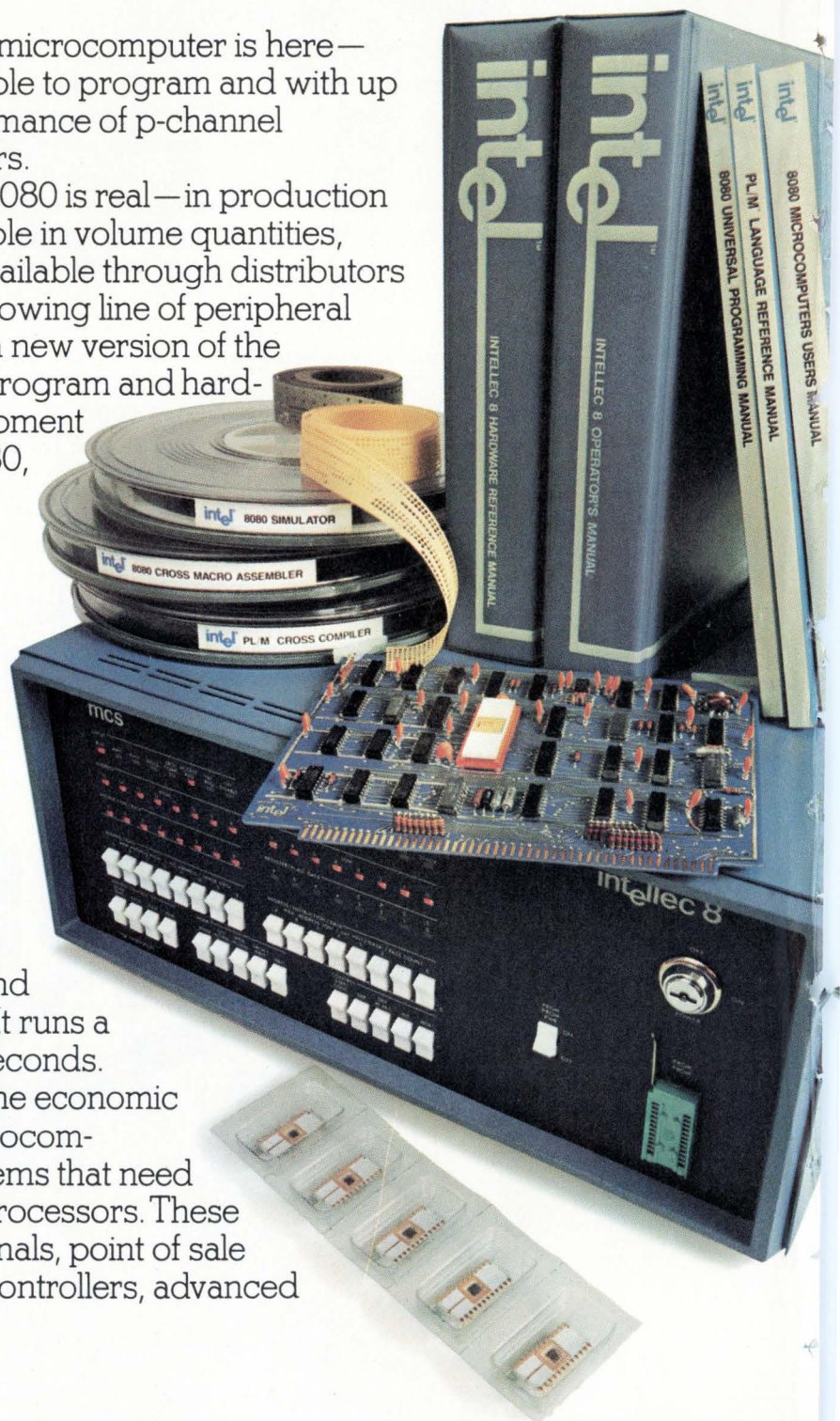

to software, the puter is here.

calculators, word processors, self-calibrating instruments, data loggers, communications controllers, and many more.

You can use 256 input and 256 output channels, handle almost unlimited interrupt levels, directly access 64 kilobytes of memory, and put many satellite 8080 processors around a single memory.

Interfacing is minimal and design is easy with the 8080 because all controls are fully decoded on the CPU chip itself and inputs and outputs are TTL compatible. There are separate data, address and control buses.

The 8080 microcomputer has 78 basic instructions, including the 8008 set plus new ones that make possible such features as vectored multi-level interrupt, unlimited subroutine nesting and very fast decimal and binary arithmetic.

Program development for the 8080 can be done either on a large computer using the Intel software cross products (PL/M systems language compiler, macro-assembler and simulator), or on an Intellec 8 development system with a resident monitor, text editor and macro-assembler.

The new 8080 product family includes performance matched peripheral and memory circuits configured to minimize design effort and maximize system performance. Large, low cost RAMs, ROMs, PROMs and I/O devices are available now and we will soon announce other 8080 LSI support circuits.

The 8080 is easier to use and more economical than any high performance microcomputer in sight. It's here now, in volume, from the inventors of the micro-computer and the people who lead the industry in production and design support.

Intel Corporation, 3065 Bowers Avenue, Santa Clara, California 95051.
(408) 246-7501.

| | | | |
|------------|---------------------------|--------------------------------|------------|
| INTEL 8080 | RAM MEMORIES | | |
| | 8101 | 256 x 4 STATIC | AVL: 3RD Q |
| | 8111 | 256 x 4 STATIC WITH COMMON I/O | AVL: 3RD Q |
| | 8102 | 1024 x 1 STATIC | AVL: NOW |
| | 8107 | 4096 x 1 DYNAMIC | AVL: NOW |
| | ROM MEMORIES | | |
| | 8308 | 1024 x 8 | AVL: 3RD Q |
| | 8316 | 2048 x 8 | AVL: NOW |
| | PROM MEMORIES | | |
| | 8702 | 256 x 8 | AVL: NOW |
| | 8704 | 512 x 8 | AVL: 4TH Q |
| | 8604 | 512 x 8 | AVL: 4TH Q |
| | PERIPHERAL CIRCUITS | | |
| | 8205 | 1 of 8 DECODER | AVL: NOW |
| | 8210 | 4K RAM CLOCK DRIVER | AVL: NOW |
| 8212 | 8 - BIT I/O LATCH | AVL: NOW | |
| 8216 | BI-DIRECTIONAL BUS DRIVER | AVL: 3RD Q | |
| 8201 | COMMUNICATIONS INTERFACE | AVL: 4TH Q | |

INTEL 8080 PRODUCT FAMILY

intel® Microcomputers. First from the beginning.

Grayhill quality in 1/4 amp lighted switches



- Self-cleaning wiping contacts for logic circuits
- Momentary and alternate actions—SPST, SPDT, and DPDT circuitry—operates in any position or attitude.
- Shown actual size—decorator-designed for compact panels—wide color choice—matching unlighted switches and indicator lights.
- Choice of mountings— front panel bezel, sub-panel or bushing.

Not all lighted push-button switches are created equal! Grayhill's low-level lighted switches are designed for applications where *switch* quality is what really counts. They out-perform butt contact or snap action switches... yet offer the style and appearance options you need, competitively priced. Write for complete technical data on these switches, and consult EEM for data on other Grayhill switches.



561 Hillgrove Avenue • LaGrange, Illinois 60525
(312) 354-1040

Meetings

International Instruments, Electronics, and Automation Exhibition, Olympia, London, England, May 13-17.

International Magnetics Conference (Intermag) '74, IEEE, Four Seasons Sheraton Hotel, Toronto, Canada, May 14-17.

Society for Information Display International Symposium, Town and Country Hotel, San Diego, Calif., May 21-23.

International Instrumentation Symposium, Instrument Society of America, Hilton Inn, Albuquerque, N. M., May 21-23.

Semicon/West '74, SEMI, San Mateo Fairgrounds, San Mateo, Calif., May 21-23.

International Symposium and Technical Exhibition on Electromagnetic Compatibility, Swiss Federal Telecommunications Authority, Montreux, Switzerland, May 23-29.

Microwave Power Symposium, International Microwave Power Institute, Marquette University, Milwaukee, Wis., May 28-31.

Consumer Electronics Show, EIA, McCormick Place, Chicago, Ill., June 9-12.

Power Electronics Specialists Conference, IEEE, Bell Laboratories, Murray Hill, N. J., June 10-12.

Quantum Electronics International Conference, IEEE, Hyatt Regency, San Francisco, June 10-13.

Utilities Telecommunications Council Annual Meeting, UTC, Chalfonte-Haddon Hall Hotel, Atlantic City, N. J., June 16-20.

International Microwave Symposium, IEEE, Atlanta, Ga., June 12-14.

1974 Government Microcircuit Applications Conference, Dept. of Defense, NASA, AEC, University of Colorado, Boulder, Colo., (confidential clearance required), June 25-27.



Your closest SIGNETICS distributor is...

ARIZONA
Phoenix: Hamilton/Avnet Electronics (602) 275-7851
Phoenix: Kierulff Electronics (602) 273-7331

CALIFORNIA
Culver City: Hamilton Electro Sales (213) 870-7171
El Segundo: Liberty Electronics (213) 322-8100
Los Angeles: Kierulff Electronics (213) 685-5511
Mountain View: Hamilton/Avnet Electronics (415) 961-7000
Palo Alto: Kierulff Electronics (415) 968-6292
San Diego: Cramer Electronics (714) 565-1881
San Diego: Hamilton/Avnet Electronics (714) 279-2421
San Diego: Kierulff Electronics (714) 278-2112
Sunnyvale: Cramer Electronics (408) 739-3011

CANADA
Downsview: Cesco Electronics (416) 661-0220
Downsview: Cramer Electronics (416) 661-9222
Montreal: Cesco Electronics (514) 735-5511
Montreal: Hamilton/Avnet Electronics (514) 735-6393
Ottawa: Cesco Electronics (613) 729-5118
Ottawa: Hamilton/Avnet Electronics (613) 725-3071
Quebec City: Cesco Electronics (418) 524-3518
Vancouver: Bowtek Electric Co. Ltd. (604) 736-7677

COLORADO
Denver: Cramer Electronics (303) 758-2100
Denver: Hamilton/Avnet Electronics (303) 534-1212

CONNECTICUT
Hamden: Arrow Electronics (203) 248-3801
Georgetown: Hamilton/Avnet Electronics (203) 762-0361
North Haven: Cramer Electronics (203) 239-5641

FLORIDA
Hollywood: Hamilton/Avnet Electronics (305) 925-5401
Hollywood: Schweber Electronics (305) 927-0511
Orlando: Hammond Electronics (305) 241-6601

GEORGIA
Atlanta: Schweber Electronics (404) 449-9170
Norcross: Hamilton/Avnet Electronics (404) 448-0800

ILLINOIS
Elk Grove: Schweber Electronics (312) 593-2740
Elmhurst: Semiconductor Specialists (312) 279-1000
Schiller Park: Hamilton/Avnet Electronics (312) 678-6310

INDIANA
Indianapolis: Semiconductor Specialists (317) 243-8271

KANSAS
Lenexa: Hamilton/Avnet Electronics (913) 888-8900
Lenexa: Hall-Mark Electronics (913) 888-4747

MARYLAND
Hanover: Hamilton/Avnet Electronics (301) 796-5000
Rockville: Pioneer Washington Electronics (301) 424-3300
Rockville: Schweber Electronics (301) 881-2970

MASSACHUSETTS
Burlington: Hamilton/Avnet Electronics (617) 273-2120
Newton: Cramer Electronics (617) 969-7700
Waltham: Schweber Electronics (617) 890-8484

MICHIGAN
Detroit: Semiconductor Specialists, Inc. (313) 255-0300
Livonia: Hamilton/Avnet Electronics (313) 522-4700
Troy: Schweber Electronics (313) 583-9242

MINNESOTA
Edina: Hamilton/Avnet Electronics (612) 941-3801
Minneapolis: Semiconductor Specialists (612) 854-8844

MISSOURI
Hazelwood: Hamilton/Avnet Electronics (314) 731-1144
St. Louis: Hall-Mark Electronics (314) 521-3800

NEW MEXICO
Albuquerque: Cramer Electronics (505) 265-5767
Albuquerque: Hamilton/Avnet Electronics (505) 765-1500

NEW YORK
Buffalo: Summit Distributors (716) 884-3450
Farmingdale, L.I.: Arrow Electronics (516) 694-6800
Rochester: Schweber Electronics (716) 328-4180
Syracuse: Hamilton/Avnet Electronics (315) 437-2642
Westbury: Hamilton/Avnet Electronics (516) 333-5800
Westbury: Schweber Electronics (516) 334-7474

NORTHERN NEW JERSEY
Cedar Grove: Hamilton/Avnet Electronics (201) 239-0800
Saddlebrook: Arrow Electronics (201) 797-5800

SOUTHERN NEW JERSEY AND PENNSYLVANIA
Cherry Hill, N.J.: Milgray-Delaware Valley (609) 424-1300
Moorestown: Arrow/Angus Electronics (609) 235-1900
Mt. Laurel, N.J.: Hamilton/Avnet Electronics (609) 234-2133

CENTRAL NEW JERSEY AND PENNSYLVANIA
Somerset, N.J.: Schweber Electronics (201) 469-6008

NORTH CAROLINA
Greensboro: Hammond Electronics (919) 275-6391

OHIO
Beechwood: Schweber Electronics (216) 464-2970
Dayton: Hamilton/Avnet Electronics (513) 433-0610
Cleveland: Arrow Electronics (216) 464-2000
Cleveland: Pioneer Standard Electronics (216) 587-3600
Kettering: Arrow Electronics (513) 253-9176

TEXAS
Dallas: Cramer Electronics (214) 350-1355
Dallas: Hamilton/Avnet Electronics (214) 661-8661
Houston: Component Specialties (713) 771-7237
Houston: Hamilton/Avnet Electronics (713) 526-4661

UTAH
Salt Lake City: Alta Electronics (801) 486-7227
Salt Lake City: Hamilton/Avnet Electronics (801) 262-8451

WASHINGTON
Bellevue: Hamilton/Avnet Electronics (206) 746-8750
Seattle: Cramer Electronics (206) 762-5722

Open up your options in Linear ICs.



What you need, to free up your buying power, is a good strong alternative to single-source linear supplies. Because nothing breaks you out of most price/delivery binds, like that simple basic: freedom of choice.

The key to Buyers' Lib is Signetics. With a major commitment in linear products. For years we've been established in the linear business, in a big, broad-line way.

Volume we've got—our production capacity's doubled in the past year. And variety that just won't stop. A solid line of standard devices to back up a wide range of purchasing requirements. To help you cut delays, wipe out stoppages, and get your system delivered (and paid for) sooner.

But maybe the biggest spread between Signetics and other so-called "single" sources is—

service. First, a nationwide network of linear-wise distributors—every region with at least one office within easy call. Second, the industry's most thorough cataloging and applications material. Plus on-the-spot assistance from our traveling platoon of technical specialists—always on the road, for on-site problem solving.

Straight goods, straight talk. And that means anytime we get a sudden run, putting a specific device in short supply, you'll get realistic commitments. Probably the most important option you can pick up from any supplier, when you lift the phone to source linear from Signetics.

Signetics Corporation, a subsidiary of Corning Glass Works, 811 E. Arques Ave., Sunnyvale, California 94086, (408) 739-7700.



Available through your local distributor. Now.

| | | | | | |
|-------------------------|-----------------------------|------------|----------------|---------------------------|-----------------|
| Comparators | 7520 | 75451 | Op Amps | MC1556 | PLL's |
| μ A710 | 7521 | 75452 | μ A709 | NE510 | NE560 |
| μ A711 | 7522 | 75453 | μ A740 | NE511 | NE561 |
| NE526 | 7523 | 75454 | μ A741 | NE515 | NE562 |
| NE527 | 7524 | μ A733 | μ A747 | NE531 | NE565 |
| NE529 | 7525 | 75S107 | μ A748 | NE536 | NE566 |
| NE522 | 75S207 | 75S108 | LM101A | Voltage Regulators | NE567 |
| NE521 | 75S208 | DM8880 | LM201A | μ A723 | |
| Memory Interface | NE521 | DM7820 | LM301A | NE550 | Consumer |
| 3207 | NE522 | DM8820 | LM107 | | NE540 |
| 3207-1 | Peripheral Interface | DM7830 | LM207 | Timers | NE546 |
| 3207A | 75450 | DM8830 | LM307 | NE555 | ULN2111 |
| 3207A-1 | | NE501 | LM308 | NE556 | PA239 |
| | | NE592 | MC1456 | | MC1496 |

signetics

Growing with the

Amphenol connectors help assure correct weight in new automatic weighing system.

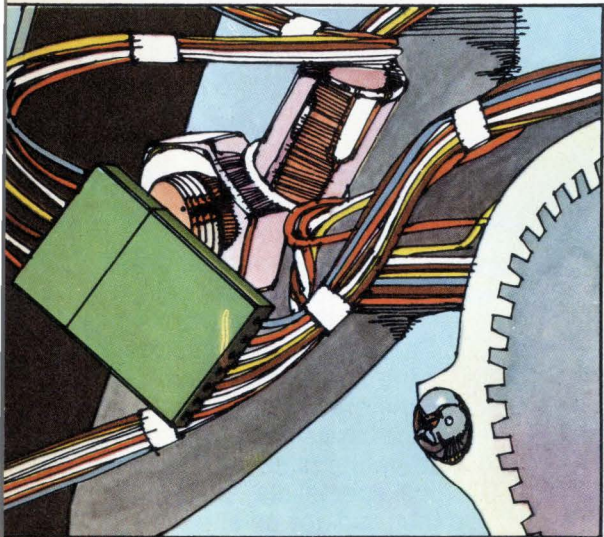

Meat merchandising has taken a big step forward with advanced solid state circuitry. The system includes a scale, mini-computer, and a printer in an integrated modular package that can weigh and price meat in seconds.

Amphenol 221 Series micro-miniature connectors share the responsibility for transmitting weight and price data to the mini-computer. Their low cost, sturdy design, and high-reliability contact configuration make them ideal for this application.

The 221 Series does the same kind of reliable work in a variety of equipment in the electronic data processing, telecommunications and home entertainment industries.



new electronics

Amphenol connectors help transmit computer data in new high speed printer.

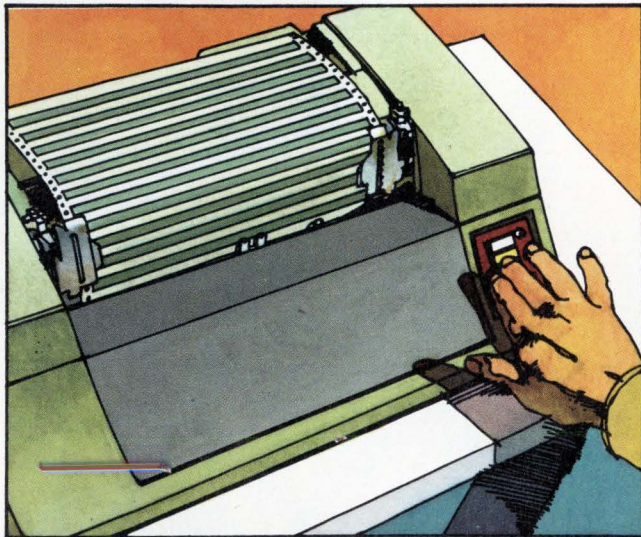

Amphenol assembly services help produce new credit card verifier.



A unique modular matrix printer was recently developed to interface with mini-computers, medium-speed batch terminals, and other installations requiring high speed data output. Data is received at up to 75,000 characters per second. The data is then carried through PC cards to a printing head with an output of up to 165 characters per second.

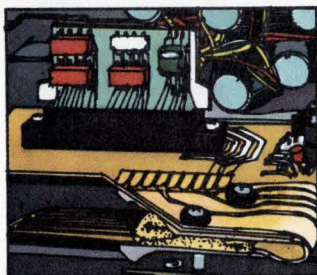

Precise signal input and data output depend on consistent and accurate information flow. That's why this peripheral systems manufacturer specifies Amphenol 225 Series PC connectors and 6034 Series trimmers. They also rely on Amphenol connectors as an important link to the power supply portion of the printer.

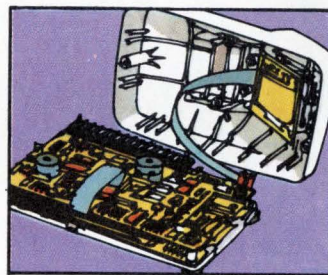

A major computer corporation recently developed a new computerized credit system. To eliminate a costly invest-

ment in production equipment and inventories, they turned to the Amphenol Cadre Division.

All assembly and material supply is now handled by Amphenol people including component preparation, stuffing and wave soldering of printed circuit boards, hand wiring, and mechanical assembly. In addition, unique quality control tests are carried out.

Over 500 units have already been produced with excellent turnaround time and high product quality. They are now in use by a nationwide resort and restaurant chain for added customer convenience and man-hour savings.

BUNKER RAMO AMPHENOL

For more information, contact these manufacturing/sales facilities. **United States:** Amphenol Components Group, 1830 S. 54th Av., Cicero, IL 60650 **Canada:** Amphenol Canada Ltd., 44 Metropolitan Rd., Scarborough, Ont. **Great Britain:** Amphenol Ltd., Thanet Way, Tankerton, Whitstable, Kent, England **West Germany:** Amphenol-Tuchel Electronics GmbH, 8024 Deisenhofen bei Munchen, West Germany **France:** Usine Metallurgique Doloise, 92a98 Avenue de Gray, 39100—Dole, France **Australia:** Amphenol Tyree Pty. Ltd., 10-16 Charles St., Redfern, N.S.W. 2016, Australia **India:** Amphetronix Ltd., 105 Bhosari Industrial Area, Box 1, Poona 26, India **Japan:** Daiichi Denshi Kogyo K.K., 20, 3-Chome, Yoyogi, Shibuya-ku, Tokyo, Japan 151

Introducing the new standard of quality in cermet film fixed resistors.



Now Allen-Bradley quality is available in cermet film fixed resistors. We coupled 40 years of know-how in reliable fixed resistor mass production with 15 years of experience in metal film resistive elements.

The result will change your thinking about film resistor suppliers.

Features? Capless design that does away with problems associated with end cap construction. And an alumina core with superior thermal characteristics and physical strength to resist fractures. Solderable/weldable leads. Even dual markings that are easy to read.

Now available in preferred number values from 10 ohms to 1 meg; 1% tolerance; $\frac{1}{4}$ watt at 70°C, $\frac{1}{8}$ watt at 125°C; Size 0.250 L. by 0.090 D. Approved to MIL-R-10509 for style RN55, characteristic D. With tape reel packaging if you prefer.

For complete technical information on the Type CC cermet film fixed resistor, write Allen-Bradley Electronics Division, 1201 South Second St., Milwaukee, Wisconsin 53204.

There's more to resistors than resistance.

Circle 28 on reader service card

Actual Size

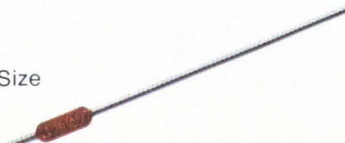

EC68



ALLEN-BRADLEY
Milwaukee, Wisconsin 53204

TI is to ship minis that use its own 4,096-bit RAM . . .

One customer apparently unworried by Texas Instruments' difficulties in making 4,096-bit MOS random-access memories [*Electronics*, March 21, p. 70] is TI's own Digital Systems division. Not only did the division begin last December to ship systems using the part to Ramada Inns, **but it will introduce a commercial version plus a new minicomputer—**both using the RAM—at the National Computer Conference, May 6 to 10. The 960B computer, a second-generation model in TI's 960 series, contains new error-detection and correction circuitry. The minicomputer is priced at \$3,915 in quantity.

As for the 4k production problems, TI appears to be getting a handle on the process. **The company will begin discussing delivery schedules with customers** "in the near future," a spokesman says, "and we expect that significant shipments will be made in the second half."

. . .and another maker considers supply adequate

Although some potential customers for 4,096-bit MOS RAMs have been hesitant to commit to them, Prime Computer Inc., a three-year-old minicomputer manufacturer in Natick, Mass., **feels it can get enough parts.** So Prime has introduced a memory board built around 4k RAMs, to be offered with its models 100, 200, and 300 computers (see p. 129). The new memory system has 32,000 words, with 16 bits and 2 parity bits per word, on a 16-by-18-inch pc board.

The company is using chips from TI and Intel, but Joseph Cashen, director of engineering, says, **"We are not limited by pinout."** Accommodating chips with different pinouts would mean different board configurations. But, says Cashen, "We don't have a hangup about having more than one board." Prime says that because its logic is micro-programmed, the cost of designing a second board is minimized.

TTL crunch easing, say distributors

Distributor supplies of transistor-transistor logic are catching up with demand. But for factory orders, don't look for lead times to drop below 18 weeks. Peary A. Nelson, marketing vice president at Semiconductor Specialists Inc. in Elmhurst, Ill., says, "As for production coming in from suppliers, some areas have opened up. **We even have on the shelf again 7400-series devices** that were hard to get a couple of months ago."

Nelson says his company can ship almost any TTL device out of stock on orders up to 5,000 or 10,000 pieces, and inventory on some parts is in six figures. But on large quantities of hard-to-get parts, the distributor must place a new order with semiconductor manufacturers, and the makers are still quoting 18- to 40-week lead times.

Simple gates have been hardest to get, Nelson points out, "but now that supply is catching up with demand, manufacturers are producing gates in large quantities. A major Eastern distributor agrees. Seymour Schweber, president of Schweber Electronics, Westbury, N. Y., says TTL simple functions, in short supply for months, are coming in stronger now. Deliveries are better than they were three months ago, he says.

At least one major TTL supplier challenges the distributor claims. **National Semiconductor's Gene Carter says gates and flip-flops are not in large supply.** In fact, some vendors have tried to overstock distributors with higher-price MSI, he maintains. Carter is director of marketing for the Microcircuits division.

IC-fault tester makes use of microprocessor

Microprocessors are finding their way into instruments for testing integrated circuits via a small Titusville, Fla., company called Testline Instruments. What the firm has done in its AFIT (automatic fault-isolation tester) is to use **a brute-force in-circuit test, controlled by a microprocessor, to pinpoint both IC and board failures.** This is a departure from the usual technique of resorting to ever more powerful computerized diagnostic schemes in which elaborate procedures are applied to a board's input/output connector.

The simplicity of Testline's system saves time and money, claims president Roger Boatman. Use of a microprocessor instead of a mini-computer means that Testline **can sell its AFIT for \$8,800, compared with around \$25,000** for computer-controlled machines, he says. And even though a clip must be moved from IC to IC, says Boatman, the Testline method is faster because each test is performed so quickly, and faults are isolated down to specific ICs.

Two U.S. firms vie for Swedish police contract

The interest of police departments in digital communications [*Electronics*, April 18, p. 68], has spread to Europe, and now two American companies are bidding to provide equipment for tests to be run by the Swedish national police. **Competing with European terminal makers are Kustom Electronics Inc. of Chanute, Kan., and E-Systems Inc. of Dallas.**

In what is believed to be the first such tests to be conducted outside the U.S., the Swedes plan to install a display and keyboard in an unspecified number of patrol cars. The screen would be capable of handling eight 40-character lines. However, a police official says that any mass purchases of digital communications equipment would have to wait until prices are lower.

General Radio, in first public report, tells of comeback

General Radio Corp., the old-line Massachusetts instrument firm, has made a financial comeback. It had been beset in 1972 by difficulties resulting from unprofitable acquisitions and heavy expansion commitments undertaken just when the 1970-71 recession hit. **In its first publicly released annual report,** the firm, which is almost wholly owned by its employees, shows a turnaround from a net loss of more than \$2 million in 1972 to a net income in 1973 of \$1,157,000 on sales of \$45 million. In making public its annual report, the company is paving the way to go public "in a few years."

Addenda

Hard on the heels of its new Series 60 computer systems (page 81) and its high-speed electrostatic printer (page 35), **Honeywell Information Systems plans to expand its Series 16 line of minicomputers,** probably in June. It'll be a new version of the two-year-old H-716, at lower price and with better peripheral equipment. . . . Watch for core memory maker Fabri-Tek Inc. to **enter the computer market with a 12-bit microprocessor** at the National Computer Conference. The \$990 unit has a TTL processor, nonvolatile core memory of 4,096 words by 12-bits, and requires a single 5-volt power supply.

Fast enough for the fastest transistors.



Unitrode ESP Power Rectifiers to 150V give you the switching speeds you need for today's high performance power supplies: reverse recovery times as low as 15ns and very fast forward recoveries with low overshoot voltages. Forward voltage drops are as low as 0.8V at 20A.

Unitrode's ESP Power Rectifiers make your power supplies more efficient. There's less power dissipation . . . even in the highest speed switching application. With fewer heat problems you can simplify heat sinking and increase package density and reliability.

Unitrode ESP Rectifiers.

In fact, only Unitrode Power Rectifiers have the *Efficiency, Speed and Power* you need to design high current, high frequency power supplies with low diode losses. That's why we call them ESP rectifiers.

Three discrete Series now available as 1N5802 through 1N5816. You can also order them as high efficiency assemblies, center tap rectifiers, bridges, or higher current modules. Send for our latest ESP literature. Or for faster action, call Fred Swymer collect at (617) 926-0404.

| Type | PIV | Maximum Average D.C. Output Current | Non-Repetitive Sinusoidal Surge (8.3ms) | Maximum Forward Voltage Drop | Leakage Current @ PIV 25° C | Maximum Reverse Recovery Time | Package |
|--------|-----|-------------------------------------|---|------------------------------|-----------------------------|-------------------------------|----------------|
| | V | A | A | V @ A | μA | ns | |
| 1N5802 | 50 | | | | | | |
| 1N5803 | 75 | | | | | | |
| 1N5804 | 100 | 2.5 | 35 | 0.875 @ 1 | 1 | 25 | Axial leaded |
| 1N5805 | 125 | | | | | | |
| 1N5806 | 150 | | | | | | |
| 1N5807 | 50 | | | | | | |
| 1N5808 | 75 | | | | | | |
| 1N5809 | 100 | 6 | 125 | 0.875 @ 4 | 5 | 30 | Axial leaded |
| 1N5810 | 125 | | | | | | |
| 1N5811 | 150 | | | | | | |
| 1N5812 | 50 | | | | | | |
| 1N5813 | 75 | | | | | | |
| 1N5814 | 100 | 20 | 250 | 0.900 @ 10 | 10 | 35 | Stud-mount D04 |
| 1N5815 | 125 | | | | | | |
| 1N5816 | 150 | | | | | | |

See Electronic Buyers' Guide Semiconductors Section for more complete product listing.

Circle 31 on reader service card

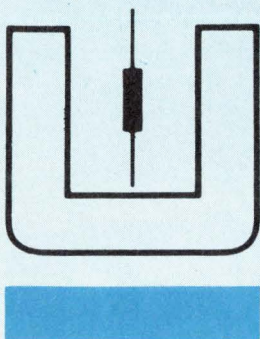

UNITRODE

580 PLEASANT STREET, WATERTOWN, MA 02172

Power Thyristors for Phase Control

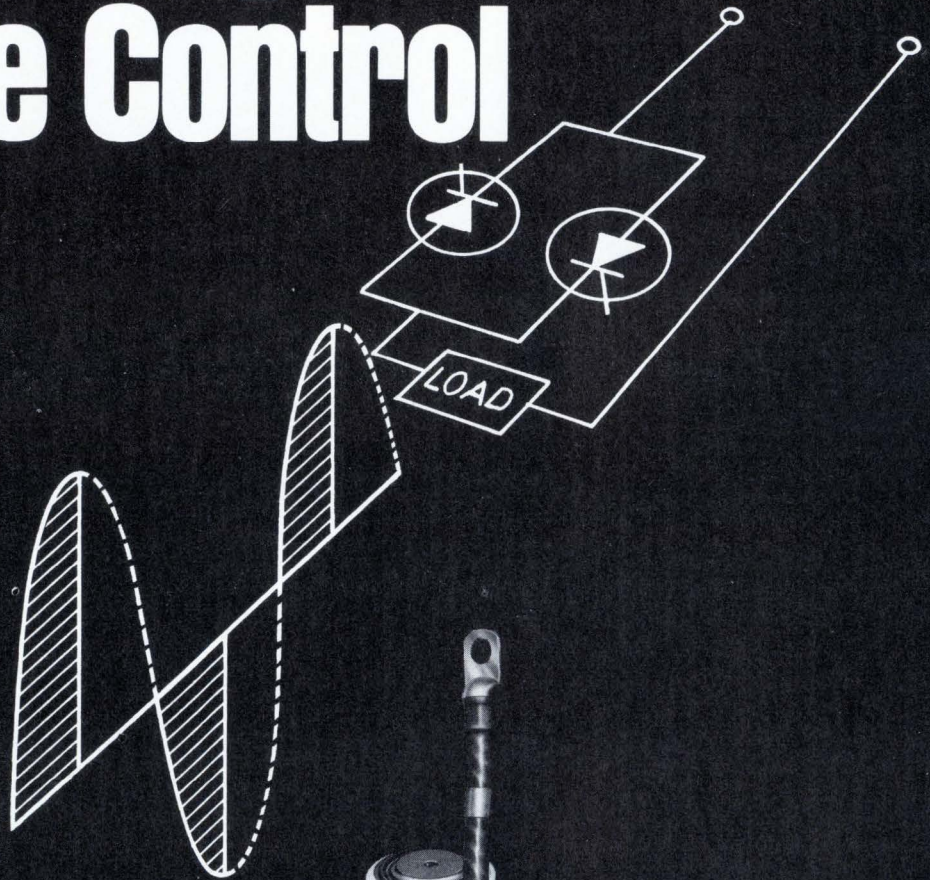

New C701 from General Electric incorporates 53 mm pellet... offers 1950A RMS, up to 1800V, 18,000A surge rating, 800A/ μ sec di/dt. Amplifying gate and 12% lower Θ_{j-c} with new Press Pak.

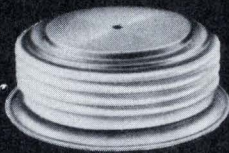

C280, C380 series offers choice of flat mount or Press Pak, 400A RMS, up to 1800V and years of field proven operation.



C390 features 850A RMS, and up to 1300V.

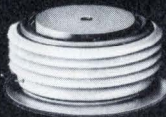

New C147 operates 15% cooler than competitive types, 63A RMS, up to 1200V, 1000A pk one cycle rating, 200V/ μ sec dv/dt.



For more information contact
General Electric Semiconductor, Electronics Park 7-49
Syracuse, N.Y. 13201

GENERAL  ELECTRIC

Electronics review

Significant developments in technology and business

MOS computer vies for spot on new Minuteman

Rockwell p-MOS version is demonstration model designed to attract funds for one that uses SOS

The Air Force is studying follow-ons to its Minuteman III intercontinental ballistic missile, and the Autonetics division of Rockwell International Corp. hopes to prod the service into funding a radiation-resistant solid-state replacement for the Minuteman III guidance computer.

Autonetics has built a demonstration computer that uses 32-bit p-channel MOS and a nonvolatile metal-nitride-semiconductor (MNOS) memory. This machine, the advanced ballistic computer (ABC) is an order of magnitude faster than Autonetics' high-performance bipolar D37D, first designed in 1967, which has a disk memory and is used in the Minuteman III.

However, the ABC is only a demonstration unit that Rockwell hopes will persuade the Air Force to fund a computer that makes use of the company's silicon-on-sapphire technology to guide the forthcoming Minuteman-X. The C-MOS-on-sapphire technology will provide an even higher level of speed and require less power than the p-MOS model, plus better resistance to radiation.

Although Rockwell isn't predicting publicly how much better performance its dream computer will deliver, the company implies some expected advantages through a comparison of its ABC with the D37D. The ABC is much smaller

and lighter than the older machine, requires less power, and appears to be even more reliable. Apparently the ABC also would be much less expensive.

Comparison. The D37D is a 24-bit-per-word bipolar computer with 13,568 words of disk memory. The ABC has 16,000 words of memory, mostly nonvolatile MNOS. Add speed is 2 microseconds vs 78 μ s for the D37D; it occupies 0.13 cubic foot, compared with 0.6 ft³, and it weighs 16 pounds, vs 42 lb. In addition, the ABC requires less than half the power of the older machine—160 watts vs 380.

That's only the start, however. The new computer also has such functional features as hardware floating-point arithmetic, including multiplication and division, and microprogrammed organization. Speed is 22 μ s for 32-bit floating-point multiplication.

Reliability is also an important

Test model. Three modules—power supply, central processor, and input/output—make up advanced ballistic missile computer designed with Minuteman-X in mind. One chip has a whopping 92 beam-type leads.

factor. The dramatic reduction in the number of semiconductor devices and the elimination of the rotating electromechanical disk memory has increased calculated failure rates from 0.06% per 1,000 hours to 0.01%. Component cost should also be reduced dramatically, with \$20 MOS devices replacing some \$1,400 worth of bipolars.

The four-phase central-processing unit of the advanced computer is

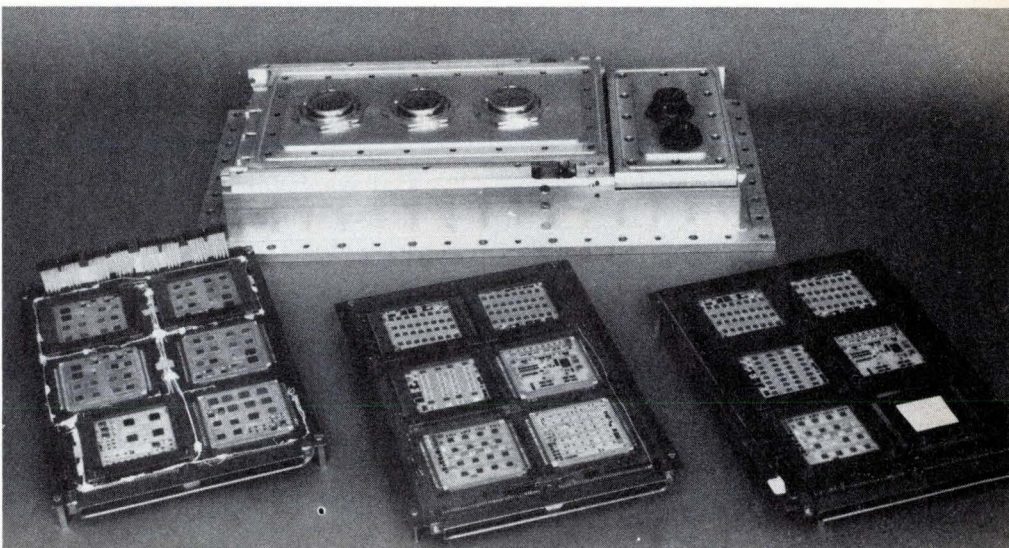
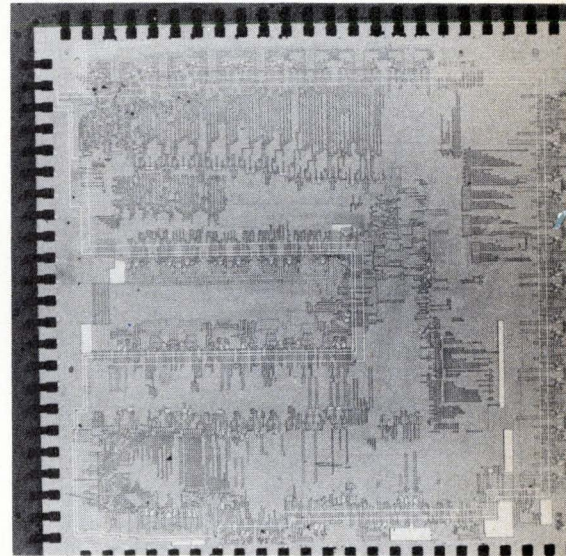

made up of p-MOS LSI. Most of it is fabricated by the Rockwell Microelectronic Device division, Anaheim, Calif., but it was designed by the Autonetics Components and Microelectronics Laboratory under Thomas Gunckel. The CPU contains 57 chips of 10 types, plus six micro-programmable read-only-memory chips.

The input/output section contains 14 MOS chips of three types (one common to the CPU), and the memory contains three types of MOS chips: 2,048 bits of MOS random-access scratchpad memory, 2,048 bits of MNOS electrically alterable read-only memory (Earom), and 12,288 bits of MNOS RAM. The Earom is made by National Cash Register Co., but was designed by Rockwell. The other MNOS is from the Rockwell Microelectronics group. Bipolar devices are used in the clocks, memory timing, control, and power supply, as well as for drivers and receivers.

All semiconductor devices are in chip form and mounted by beam leads on multilayer thick films deposited on 2-by-2-inch ceramic substrates. The devices, which have up to 92 pins, typically measure 250 mils on a side. The hybrid substrates themselves have 348 leads and can be plugged into connectors for testing or in lead frames for flight use.

Most of the beam leads are actually gold ribbons that Rockwell has added to finished, nitride-passivated MOS and bipolar devices. A full complement of beam-lead parts is not available, points out Gunckel, but "the parts look and act like true beam leads after the ribbons are attached." He also says they can meet military standards. The parts are wobble-bonded to the substrate. □

Displays

GaP under GaAsP brightens LED colors

Gallium-phosphide diodes that emit green or yellow light cost more and are usually dimmer than red LEDs

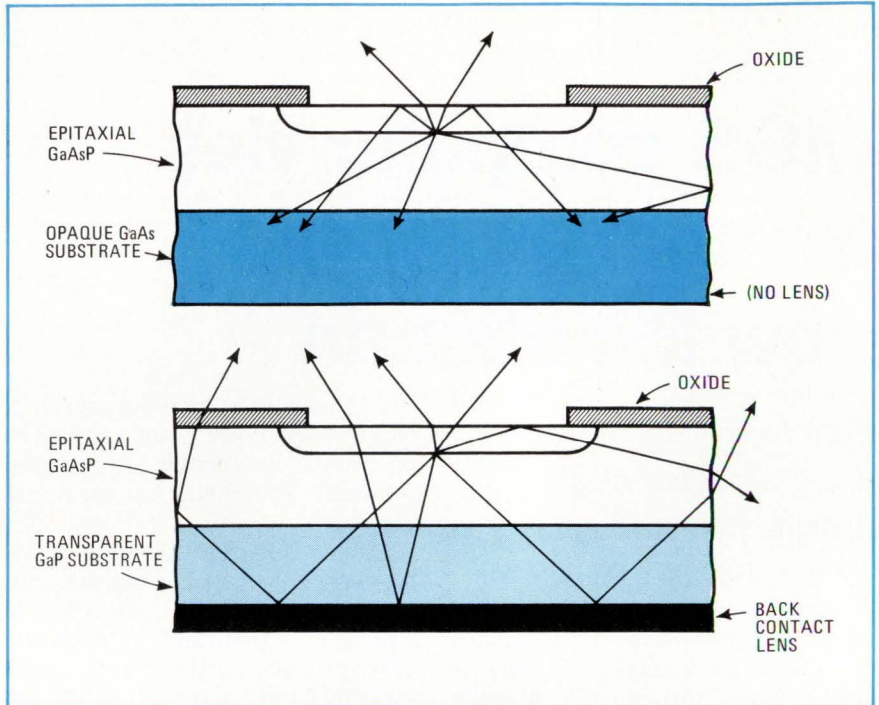

Bright idea. New LED has a GaAsP pn junction on a transparent GaP substrate that transmits a maximum amount of light. Old GaAsP on GaAs substrate is less efficient because the substrate is opaque. Output of the new structure is higher than is straight GaP.

made of gallium-arsenide-phosphide because it's difficult to manufacture high-bandgap, short-wavelength GaP material with good enough yields and output efficiencies. But workers at the HPA division of Hewlett-Packard Co. now appear to have the problem licked.

HPA obtains efficient high-bandgap emission by combining the easier-to-manufacture GaAsP pn junction with a GaP substrate. Using this system, the division plans to introduce discrete LED lamps in yellow, green, and high-efficiency red by the end of the month and to follow them with 0.6-inch-high digits in the same colors.

The success of the new structure derives from GaP's transparency to light emitted by a GaAsP junction—as opposed to its opaqueness to the shorter wavelengths emitted by GaP junctions. When the GaAsP-on-GaP combination is backed by a reflecting lens, a much greater fraction of light can be collected at the output cavity, and the resulting colors appear brighter and clearer than is the case with GaP-only systems.

Rick Kniss, product marketing manager at HPA, claims that be-

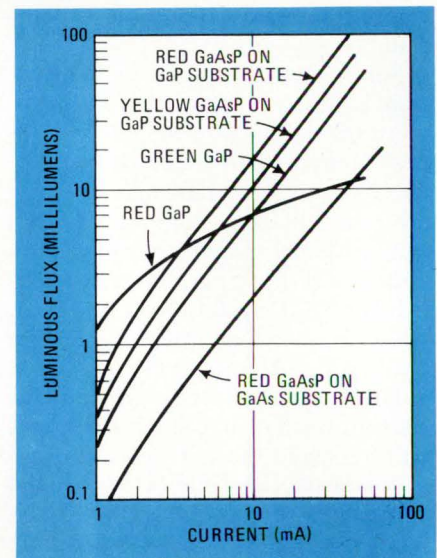

cause of the transparent substrate and lens system, the lamps have an 180° viewing angle of near-constant intensity, in contrast to many other yellows and greens that have narrow viewing angles. Equally important, Kniss points out that "although GaP junctions emitting at yellow and green wavelengths may be more efficient at low currents, it saturates at about 20 milliamperes, while GaAsP remains linear." This

is important in high-current strobe systems, where a high drive current, say 50 mA, is needed to power the lamps in parallel. GaP lamps will saturate, but GaAsP-on-GaP lamps won't. □

Instrumentation

Laser triggers 8-MV test jolt

An 8-megavolt discharge that simulates the electromagnetic pulse (EMP) of a nuclear blast is being triggered by a laser signal carried by fiber-optic cables. These blasts are designed to test the effects of EMP on electronic systems in aircraft at the Air Force Weapons Laboratory, Kirtland AFB, Albuquerque, N.M. The fiber-optic transmission system, which is 100 feet long, is needed to isolate the sensitive triggering and

be in flight when undergoing tests.

This facility, scheduled for completion early in 1976, is as long as three football fields. One trestle is for testing horizontal components of the EMP wave, and the other tests the vertical ones. Each trestle is large enough to handle aircraft the size of a Boeing 747.

The pulse that simulates the nuclear blast is generated by triggering an 8-MV pulse in 10 nanoseconds through an antenna near the aircraft. Maxwell Laboratories, San Diego, has a \$4.2 million subcontract to supply the high-voltage pulse generator. American Laser Systems, a small Santa Barbara, Calif., firm is supplying three subsystems: a dielectric trigger link with 350-picosecond rise time, usable with a maximum of 200 feet of fiber-optic cable, an optical transmission set that uses an LED transmitter and avalanche photodetector coupled by fiber optics, and a monitor for the output switch that han-

four separate light pipes to avalanche-diode photodetectors 100 feet away. These fast-acting detectors—the delay in the trigger must be less than 1 ns—then trigger four Marx generators. These generators employ a well-known technique for generating high voltage by charging capacitors in parallel and discharging them in series.

On the receiving end, the photodetector is followed by a wide-band preamplifier and threshold detector that can drive a 50-ohm load to more than 100 v with a rise time of 2 ns. Extremely low jitter is vital, since the four units must drive the separate Marx pulse modules, points out American Laser's president, Duncan Campbell. The jitter is held to less than 250 picoseconds.

The 8-MV pulse travels down antenna wires placed on either side of the aircraft. The two sides form a transmission line so that the plane is, in effect, inside a parallel-plate line that has an impedance of about 108 ohms. To prevent ringing, the plates are terminated in sea-water with a resistance of that value.

The American Laser system also includes two other fiber-optic links. One link transmits data that's been monitored to show the performance of the electronic equipment involved in the test. It consists of a LED transmitter, another 100-foot fiber-optic link, and an avalanche photodetector. The second link is placed next to one of the firing switches that helps to discharge the Marx generators. A fiber-optic cable carries the switch signal to a detector as a zero-time base for the monitored data. □

Test site. Fiber-optic light pipe triggers 8-megavolt blast at Air Force test facility.

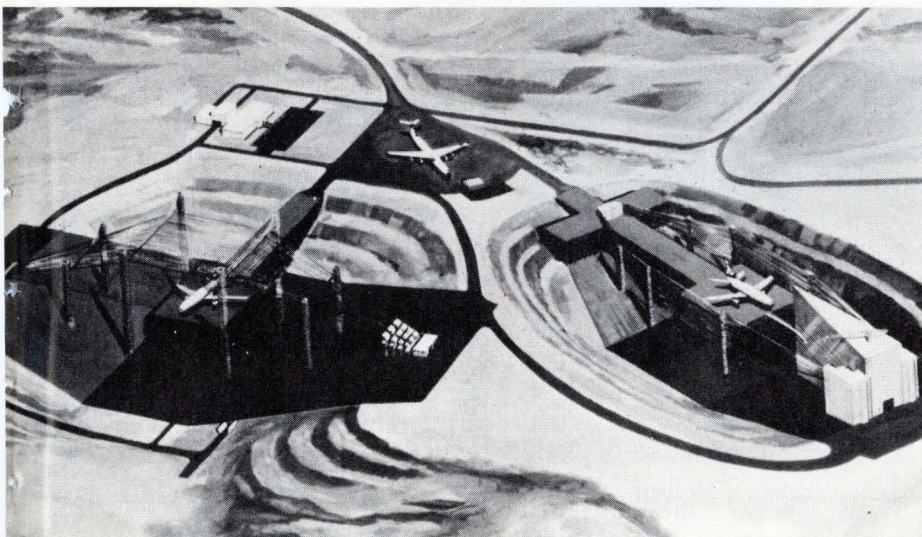

monitoring equipment from the 8-MV bang. Fiber-optic pipes are used to transmit the test measurements, and to detect the time of firing.

McDonnell Douglas Astrionics Co. is prime contractor for the \$19.5 million Trestle, so-called because the nonmetallic trestle-like structures that hold the aircraft are built entirely of wood, held together with nonconducting nylon screws and epoxy so that the aircraft appears to

dles the high voltage.

Optical coupling. To prevent dangerous feedback, optical coupling is used to trigger the 8-MV pulse. The trigger, which consists of a gallium-arsenide laser actuated by a 5-v input pulse, has been operating since last November at a Maxwell Laboratories test site in San Diego.

Using low-loss fiber-optic cables [*Electronics*, March 21, p.89], the light is carried from the laser via

Computers

Speedy printer is electrostatic

In introducing its new series of computers, Honeywell Inc. (see p. 81) has also brought to market what is likely to be the world's fastest commercially available computer-output printer. It is an off-line electro-

static machine that can print as many as 210 pages per minute, equivalent to 18,000 lines per minute with up to 132 characters. This is three or four times as fast as the fastest output printers—also electrostatic units—available until now.

The first two printers have been shipped to Lawrence Livermore Laboratory in Livermore, Calif. The laboratory is replacing its 10-year-old Radiation Inc. electric-arc printer, a one-of-a-kind machine that produces 30,000 lines per minute. [*Electronics*, July 19, 1971, p. 32; Nov. 6, 1972, p. 44]. The printers will be programed for graphics and run with Livermore's vast Octopus

square electrodes connected to drive circuits through closely spaced etched wiring or through tightly packed cables—all of which present relatively high-capacitance loads to the drive circuits. At conventional speeds, this capacitance is only a minor problem, but in the Honeywell printer, the high printing speed requires narrow pulses with fast rise times, for which a capacitive load is formidable.

So, to reduce the capacitance, the electrodes were put in two well-spaced rows; they were made rectangular, with the closest spacing between the shorter sides of the rectangles; and the etched connections

charged, resulting in a solid vertical line 5 mils wide, such as the left side of the letter E.

For a single 5-mil-square dot, which would be nearly invisible, the 1-mil-wide electrode would be left on long enough for 5 mils of paper to go by—approximately 160 microseconds at 30 inches per second. For a solid horizontal line, several adjacent electrodes in one row would be turned on long enough to produce a series of dashes of the desired width; then, when the paper is under the second row, electrodes would be turned on to fill in the gaps between dashes.

The system is controlled by a Honeywell 716 minicomputer, which also translates data, if necessary, from the magnetic-tape input code to Ascii for the printer's character generator. Tape drives are available for either 7- or 9-track tapes or both. Honeywell has also designed a drive to handle both formats. This dual-drive system has two heads, of which only one operates at a time.

The system uses coated electrographic paper in roll form, either 8½ or 11 inches wide, on which it prints characters spaced 12.56 to the inch horizontally and 10 to the inch vertically, compared to 10 and 6 per inch in conventional printers.

The printer's standard character generator accepts the 96 printable characters in Ascii; the set can be expanded to as many as 512 by substituting the proper character generator. Unlike most conventional printers, expanding the character set in this way doesn't slow down the printer. □

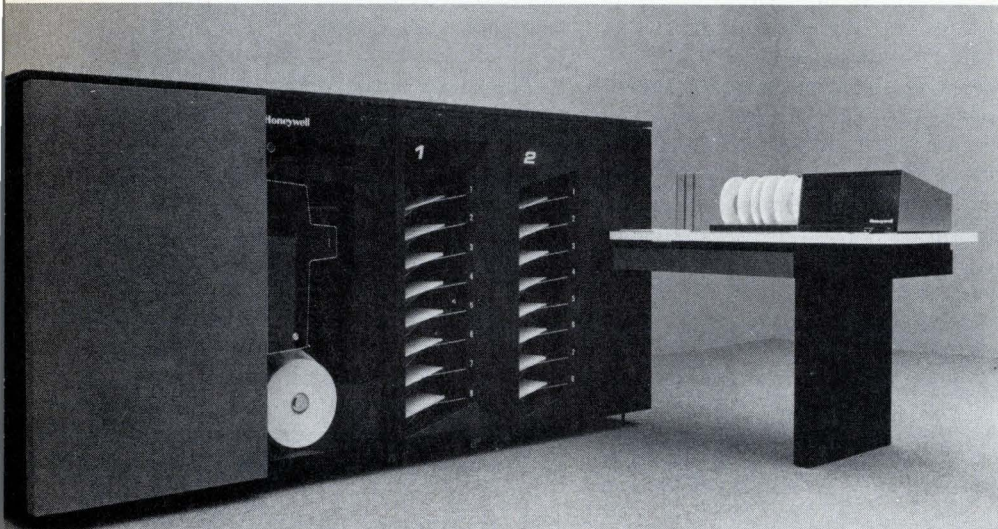

Speed champ. Electrostatic printer from Honeywell spews out 18,000 lines of up to 132 characters each per minute on 8½- or 11-inch-wide paper.

computer network. The machine can print a fixed form along with variable data, and can collate up to 32 copies printed in succession.

Costs of the systems are high—the 210 page per minute machine is priced at \$193,620, while a slower model that handles 140 pages per minute is priced at \$162,120. However, Honeywell believes the machines will find their niches in other large-scale data-processing centers.

Electrode design. The design of the electrodes is a key point in the over-all design of the printer. These electrodes deposit the static charges for fixing the toner, or "ink," on the paper in an electrostatic machine. Most other electrostatic printers use a single row of either round or

to the drive circuits fan out widely to well-separated connectors that plug directly into the boards carrying the drive circuits.

The electrodes consist of 2,112 etched-copper rectangles in two rows on a flexible substrate. Each rectangle measures 1 by 5 mils, with the long dimension in the direction perpendicular to the paper motion. The rectangles in each row are 5 mils apart. The second row of electrodes is staggered so that its electrodes lie exactly opposite the gaps in the first row.

Raster. A raster-scan technique places a voltage of about 500 v on selected electrodes in the array; as long as this voltage remains, the surface of the paper passing nearby is

Communications

Optical, mm-waves offer promise

The wideband systems that will be transmitting large volumes of data at high speeds in the 1980s will combine optical and millimeter-wave links. That's the prediction of a study recently completed for the Air

another handful ... with more measurement solutions

THIS 5 MHz PORTABLE ADDS EXPANDED BANDWIDTH TO THE TEKTRONIX LINE OF MINIATURE OSCILLOSCOPES

You've got to keep your computer installation running; downtime is too costly to treat lightly. When it happens, you must get there with the proper troubleshooting equipment, find the problem and quickly correct it. The 221 from Tektronix will help get the job done.

At 5 MHz bandwidth, 5 mV/div sensitivity, and 1 μ s/div sweep, this battery-operated miniscope displays the waveforms encountered in today's computer environment.

Many operator conveniences save set-up time and make the display easy to interpret. The integral 1 M Ω probe is always there when you need it. Deflection factors are easy to read. Trigger level and slope are simplified in one rotary control. AUTO trigger mode automatically triggers the scope trace from its input signal. And in AUTO mode, a bright reference trace eliminates confusion. Rotate the switch out of AUTO mode and you can select any combination of trigger slope and trigger level. With all this, you carry just 3½ pounds.

In its 3" x 5¼" x 9" package, the 221 has rechargeable batteries. It can be operated and charged from practically any power source from 90 to 250 V, 48 to

62 Hz AC, or 80 to 250 V DC without switching. Double insulation protects the operator while making elevated voltage measurements. Its impact-resistant case absorbs the rough treatment you expect in field maintenance.

221 Portable Oscilloscope, including batteries and probe ... \$775
Other 200-Series miniscopes offer 500 kHz bandwidth in single- or dual-trace, or dual-trace storage models.

Call your nearest field office for a look at the 221. Or write Tektronix, Inc., P.O. Box 500, Beaverton, Oregon 97005. In Europe, write Tektronix Ltd., P.O. Box 36, St. Peter Port, Guernsey, C. I., U. K.



TEKTRONIX®
committed to
technical excellence

For a demonstration circle 36
on reader service card

Circle 37 on reader service card



Force's Rome Air Development Center by Martin Marietta Aerospace, Orlando, Fla.

The Air Force commissioned the study as an aid to planning future intrabase communications between rapidly deployed command posts and a central headquarters unit. But the authors say much of the report applies equally well to commercial intracity links.

The major conclusion is that optical links are superior to mm-wave links only for distances of 1 kilometer or less, according to Terry Duffield, Martin Marietta staff engineer. In a paper being presented this week at IEEE Southeastcon in Orlando, Duffield says that the cost and performance studies performed by RADC show that the two types of systems are about equal between 1 and 3 km, but that millimeter waves take over at longer distances. In a related paper, Martin Marietta's H.B. Muench adds that today's optical systems are ready for serious consideration as short links.

Duffield's study, which projected cost and performance figures through the late 1970s and into the 1980s, centered on systems with information bandwidths greater than 500 megahertz and all-weather reliability of 99.9%. The millimeter wave systems were solid-state sys-

tems using bulk-effect devices for sources. The optical systems used light-emitting diodes for the short links, gallium-arsenide lasers for links in the 2- to 3-km range, and carbon-dioxide and neodymium-doped yttrium-aluminum-garnet lasers for the longer links.

The recent price reductions for gallium-arsenide lasers is the basis for Muench's conclusion that they could be used in communications today. Lasers that were selling for more than \$100 six months ago, he says, now are available for less than \$20. In his paper, he quotes a recent Army (Fort Monmouth, N.J.) estimate of a \$1,000 cost per terminal for a gallium-arsenide system operating at 10 megabits per second. Muench says that this cost may be achieved by early next year.

With such a system operating at 1.5 megabits per second, Muench points out that it could be useful for setting up short links in a telephone system to avoid the need to lay cables for a T1-type link, the Bell System designation for equipment that multiplexes 24 voice conversations on one wire pair. Muench says that such a system could be useful in, say, new housing developments to bring voice signals to a central switching office, or for setting up emergency communications. □

Military electronics

Schlesinger wants to save Sanguine, despite Navy's decision to suspend it

Secretary of Defense James R. Schlesinger reportedly wants to save the controversial Project Sanguine. He is convinced that the secure, extremely-low-frequency transmission system for the Navy's fleet ballistic missile force is indispensable. Schlesinger's views—linking Sanguine to his doctrine of precise targeting and limited use of submarine-based ICBMs—were being circulated by Pentagon officials following the Navy's April disclosure that it was suspending work on the project for the remaining two months of the

fiscal year. The reason: a 42% overrun on Sanguine's \$8.3 million budget for fiscal 1974.

Sanguine's public problems and its priority among Pentagon programs have resembled a wildly bouncing ball in the five years since the Naval Electronic Systems Command began serious work on it. The transmission system, which is to be based in the continental United States, is designed to provide a secure means of ordering submarine missile launches. Last December, the decision to appropriate 50% of

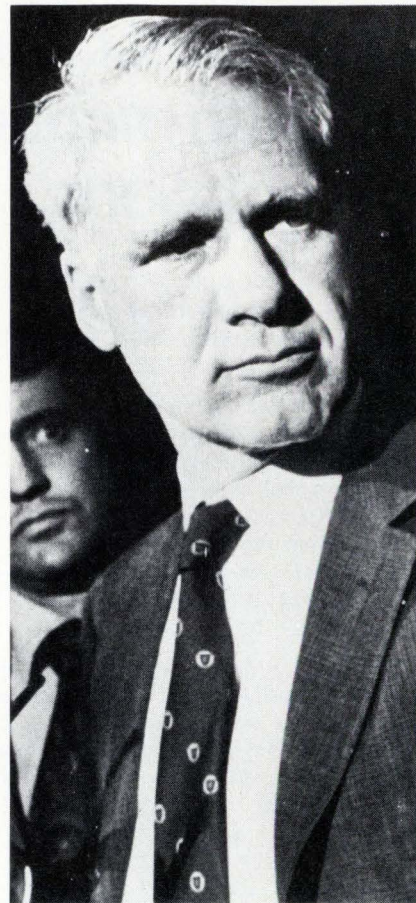

Adamant. DOD's Schlesinger considers Sanguine vital for sub-launched missiles.

the Navy request for fiscal 1974 proved a last-minute compromise by a House-Senate conference committee, after the House had eliminated the \$16.7 million sought and had ordered the program terminated [*Electronics*, Dec. 6, 1973, p. 59]. This year, Navelex is asking \$13.2 million in the fiscal 1975 budget now before Congress.

DOD officials say the Navy again is unlikely to get the full fiscal 1975 request, but they note that Schlesinger is prepared to fight for the program, even at a lower funding level.

The Defense Secretary is described as convinced that Sanguine is essential to give the U.S. the capability to launch selected missiles at enemy military targets in the event of "a limited nuclear exchange" with the Soviet Union. By giving Sanguine the capability of transmitting weather and other data affecting missile trajectories, along

Don't stick your neck out. Get the clear picture from Hughes.

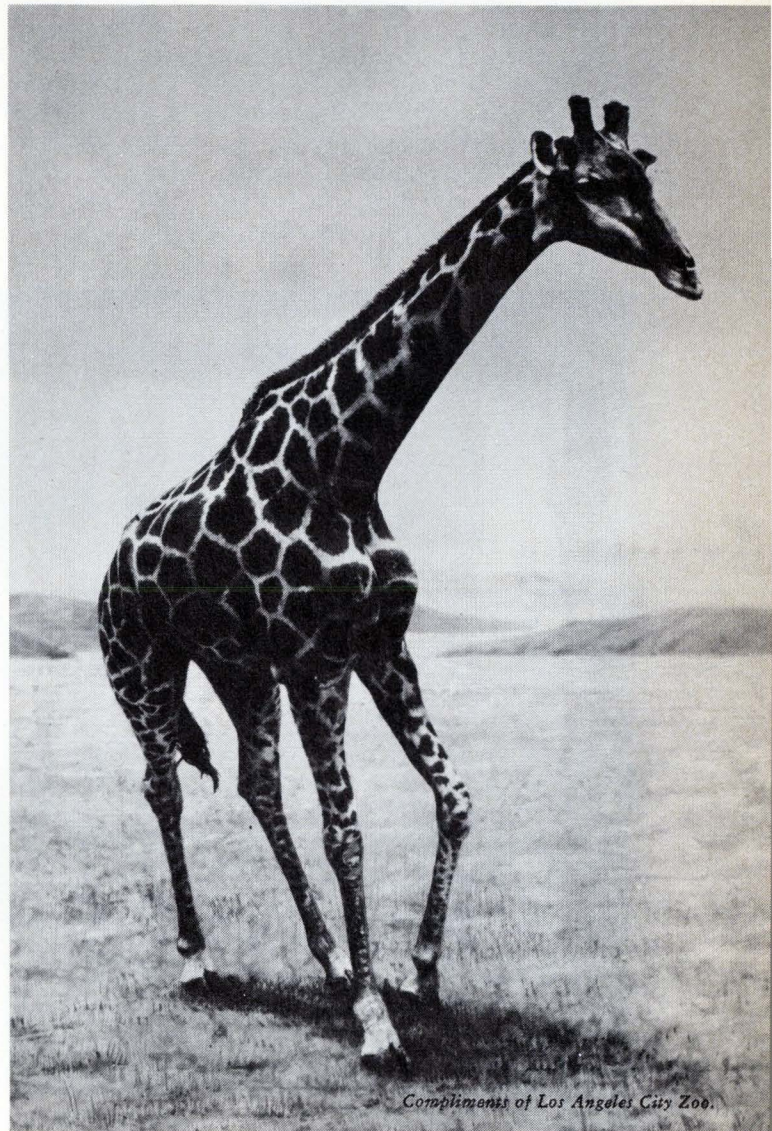

Compliments of Los Angeles City Zoo.

Hughes image storage equipment gives you more detail per dollar than any other image storage technology.

Pictures come out clear, clean and bright. In ten different shades of gray.

Hughes memories will store slow-scan pictures, graphics, and random vectors then replay the complete assemblies. Scan rates can be changed and storage time selected.

Whatever your application, you

don't have to pay for more storage than you need. Model 639 with optional 3000 TV lines limiting resolution (diagonal measure) and standard Model 639

(2100 TV lines limiting) are both compatible with TV displays of any scan line format from 525 to 1229.

Model MSC-1 is a natural for 525 scan line systems.

And for TV "frame grabbing," Model TVS-1 is unequalled for simple, silent, reliable television storage.

Like what you see? Pull your neck in and write: 6855 El Camino Real, Carlsbad, CA 92208. Or call (714) 729-9191.



HUGHES
HUGHES AIRCRAFT COMPANY
INDUSTRIAL PRODUCTS DIVISION
IMAGE DEVICES

Creative Image Processing.

Circle 39 on reader service card

with an attack order, U.S. submarines could then adjust missile guidance systems to compensate for such factors and could aim their weapons with greater precision at smaller military targets, instead of being limited to targeting large industrial urban areas.

The Navy has spent \$73 million overall on Sanguine so far. Estimates of what it would cost to complete the program initially ran between \$800 million and \$1.2 billion, but the Navy said it determined last year that it could halve the radiated

power from 300 to 150 amperes at a likely carrier frequency of 45 or 75 hertz and still have a satisfactory system costing \$100 to \$400 million, exclusive of R&D.

Dispute. Sanguine site locations, in which a checkerboard-like grid of cables ranging from 40 to 80 miles square, must be built into massive nonconductive rock strata, have been a matter of controversy almost from the beginning [*Electronics*, Nov. 24, 1969, p. 48]. Opposition to the first site proposed, at Chequamegon National Forest in Wis-

consin, came largely from environmentalists and local residents. Similar groups objected to alternative sites in northern Texas and the upper Michigan peninsula.

The site issue, compounded by Sanguine's need for a large nonconductive rock formation to contain its buried cable grid, is expected to be as much a problem for Secretary Schlesinger as the project's costs. Nevertheless, DOD is expected to push hard for continuing the project. One approach to the Congress being considered is to hold the program in low-profile studies "for another year," according to military sources, and to use that time to persuade opponents to the program of its importance in strategic policy, as well as its environmental safety when operated at the reduced powers now being contemplated.

Suspension of the Sanguine effort came before the award of two parallel development awards later this year but after completion of design validation proposals by three contractors. They were GTE Sylvania Electric Products Inc., Waltham, Mass., RCA Communications Systems, Camden, N.J., and TRW Systems Group, Redondo Beach, Calif. Other studies had been performed by MIT's Lincoln Laboratory and the Naval Underwater Systems Center, Newport, R.I. □

Government

Contractors seek more IR&D freedom

Full reimbursement of independent research and development costs and bid and proposal costs, the elimination of cost ceilings, and elimination of the requirement for "potential military relationships" for IR&D is being urged on the Congress by a three-association committee of Government electronics and aerospace contractors. The recommendations, developed jointly by the Electronic Industries Association, the National Security Industrial Association, and the Aerospace Industries Associ-

Electronics Index of Activity

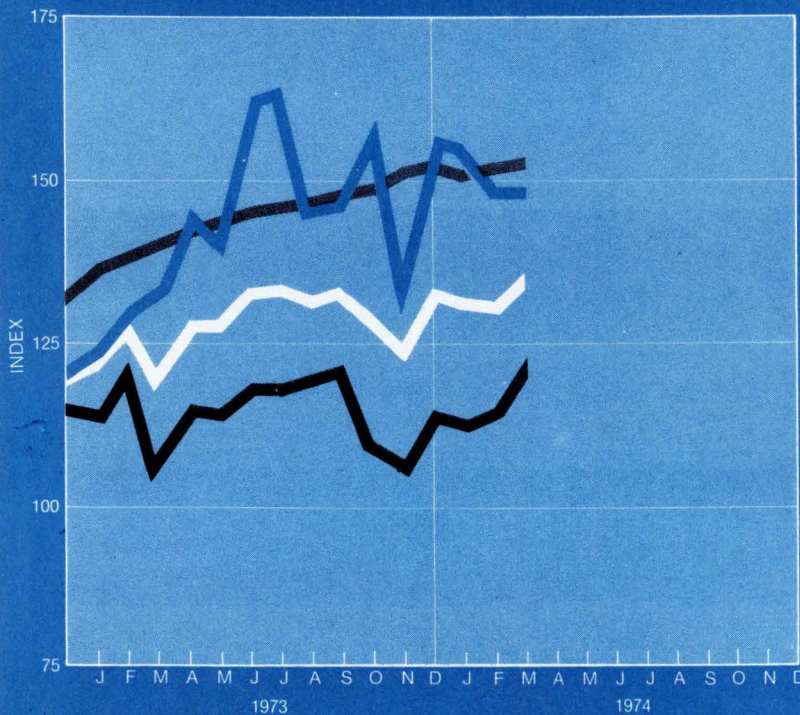

| Segment of Industry | Mar. '74 | Feb. '74* | Mar. '73 |
|-----------------------------------|----------|-----------|----------|
| Industrial-commercial electronics | 148.6 | 148.6 | 141.5 |
| Consumer electronics | 122.4 | 114.4 | 117.9 |
| Defense electronics | 153.0 | 152.7 | 140.4 |
| Total industry | 136.1 | 131.7 | 128.8 |

The index registered its fourth straight monthly increase, rising 3.3% in March and bucking a declining national trend. The largest gainer was the defense component, which climbed 7.0% from February's level. The industrial-commercial sector inched up 0.2%, but was 9.0% higher than a year ago. Consumer electronics was unchanged.

Indexes chart pace of production volume for total industry and each segment. The base period, equal to 100, is the average of 1965 monthly output for each of the three parts of the industry. Index numbers are expressed as a percentage of the base period. Data is seasonally adjusted. *Revised.

You know what kind of Function Generator you need.

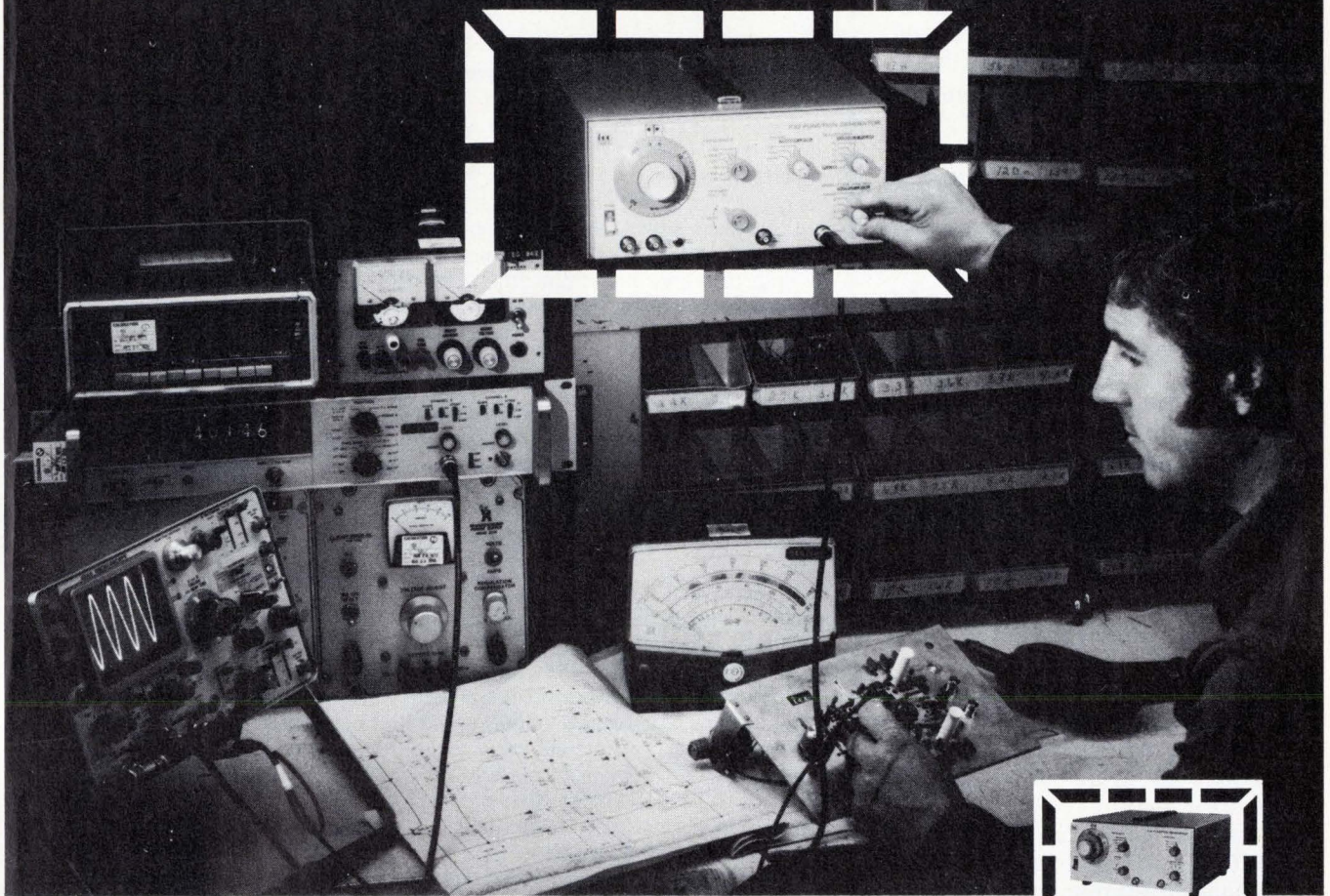

So does INTERSTATE.

Our comprehensive Series 30 includes a function generator with your special requirements — PLUS more capability and time-saving features that we believe give you a better *price/performance value* than any competitive model. Capabilities like: 3MHz frequency range; clean sine, square, triangle, sweep, adjustable d-c, and variable width pulse waveforms; and trigger, gate, tone burst, and sweep operating modes. Time-saving features such as a well-organized front panel, our direct-reading Sweep Limit Control, and an unbeatable Instruction Manual.

The "\$495 Comparison" lets YOU be the Judge.

You can find out exactly how INTERSTATE outperforms a competitor like Wavetek. Check the number below to receive the "\$495 Comparison: Interstate F34, Wavetek 134 Function Generators" and a new Specifier Guide that outlines cost and capability right down both model lines.



Purchase an INTERSTATE function generator and use it for 15 days. If you're not totally satisfied, return it to us for a full refund of the purchase price — no explanations necessary.

Take us up on our offer. Call John Norburg, collect, at 714/772-2811.



IEC INTERSTATE ELECTRONICS CORPORATION Subsidiary of A-T-O Inc.

Dept. 7000, Box 3117, Anaheim, CA. 92803: TWX 910-591-1197 TELEX 655443 & 655419

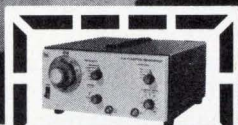

F31 \$295

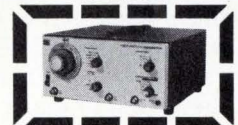

F32 \$345



F33 \$395



F34 \$495

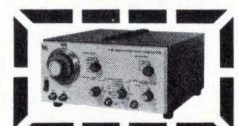

F35 \$595



F36 \$645

Our function generator will perform better than you expect, or we'll take it back.

ation, were disclosed near the end of April in response to renewed congressional interest in the reimbursement of IR&D and bid and proposal costs by Defense Department, NASA, and the Atomic Energy Commission.

In disclosing the recommendations of their *ad hoc* committee, the three trade groups said they had developed their position in response to 22 questions on IR&D posed to the General Accounting Office last October by Sen. William Proxmire (D., Wis.), chairman of the Senate subcommittee on priorities and economy in Government, and Sen. Thomas J. McIntyre, (D., N.H.), chairman of the research and development subcommittee of the Armed Services Committee. The senators' joint queries to the GAO have produced a full-scale investigation of the IR&D and bid and proposal issue by the congressional watchdog agency.

GAO officials say the study is expected to be complete near the end of the year, although an interim report may be available to the two senators in May.

Funds. At stake is an annual Federal fund of approximately \$400 million for IR&D reimbursement and an estimated \$300 million more in bid and proposal costs, according to the industry associations. Citing one DOD study last year summarizing statistics from 77 major contractors, the group notes that "in 1972, DOD obtained access to \$776 million of IR&D work, while accepting only \$400 million as its share of the costs" to the contractors.

In a 34-page summary position paper, the three associations contend that "IR&D and B&P expense allocated to defense contracts has modestly increased in recent years. While absolute dollars increased from \$685 million in 1968 to \$704 million in 1972 because of inflation and the new Government requirement to burden the direct man-hour base, man-hours of effort have actually declined by approximately 28%."

Challenging the view that these costs are insufficiently controlled, the contractors contend that

News briefs

Motorola asked to find new buyer

Motorola Inc.'s sale of its TV receiver business to Matsushita Electric Industrial Co. [Electronics, April 18, p. 40] raises "antitrust questions," according to the U.S. Dept. of Justice. The proposed sale has therefore been ordered postponed until May 28. In that period, Motorola has agreed to make "a good faith effort" to find another buyer. The Department said it would not block the sale if Matsushita's purchase were "the only means of retaining Motorola's TV business as a viable competitor," but called on Motorola to entertain any offer from other companies regardless of how the offer compares to Matsushita's. Motorola says it has retained the brokerage firm of Goldman Sachs & Co. to try and find an alternate buyer.

AT&T and GTE join forces . . .

AT&T and GTE Satellite have announced that they will join their proposed domestic satellites into a \$90 million system using three GTE and four AT&T earth stations and the three satellites that AT&T will lease from Comsat. Pending FCC approval, AT&T has agreed to suspend a lawsuit filed last fall aimed to overturn an FCC decision that provided that both communications companies could provide the same service in the same areas.

. . . while AT&T suffers a setback

The FCC has ordered AT&T and its Bell System affiliates to cease and desist the removal of interconnection services to MCI Communications Corp. customers. Prior to this order, Bell companies had disconnected nine MCI customers. MCI had filed a suit against AT&T. The FCC order came on the heels of a Federal Appeals Court ruling that turned jurisdiction back to the FCC and overturned a lower court ruling that ordered AT&T to service specialized carriers [Electronics, Jan. 10, p. 30]. AT&T has gone to court to have the FCC decision reviewed.

Comsat, Solarex dispute

Communications Satellite Corp. has sued Solarex Corp., Rockville, Md., [Electronics, Oct. 11, 1973, p. 14] claiming that Solarex partners Joseph Lindmayer and Peter Varadi are using "violet" solar-cell techniques [Electronics, May 22, 1972, p. 30] developed while they were with Comsat. Comsat is asking injunctive relief and about \$1 million in damages. Solarex has countersued for \$35 million stating that Comsat's suit, based on false charges maliciously interferes with Solarex's business and acquisition of solar cell producer Centralab [Electronics, March 7, p. 40]. Solarex also says its charter is violated by Comsat's interest in terrestrial solar cells.

Philco-Ford wins ground-station contract . . .

A \$96.3 million contract has been awarded to Philco-Ford Corp. to build a worldwide network of 21 AN/MS-60 ground terminals for the U.S. Defense Department's second generation Defense Satellite Communications System. The company's Western Development Laboratories, which won an \$8 million development contract in June 1970, will build the terminals.

. . . and Westar is tested

Western Union's Westar, the first U.S. domestic communications satellite, launched April 13, is in stationary orbit over the equator, almost due south of Dallas, Texas. Western Union is now testing Westar's 12 transponders and will continue to do so until the satellite is put into operation in June, at the launching of Westar II for backup.

Allen promoted to defense research deputy

John L. Allen, former associate director of research for electronics at the Naval Research Laboratory, has been appointed Deputy Director of Defense Research and Engineering for research and advanced technology. Allen is a specialist in antennas and radar-systems research.

SIEMENS

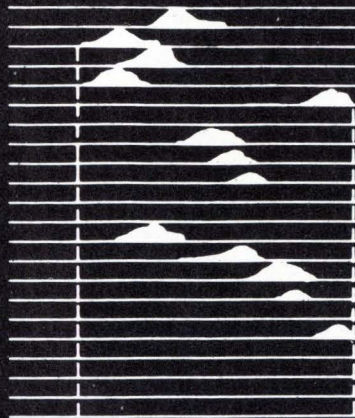

Seizure of Nominal Value Deviations – considering previous events

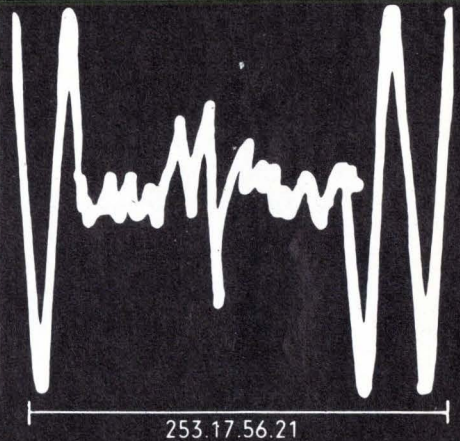
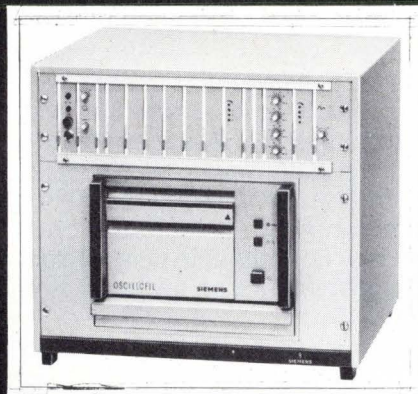
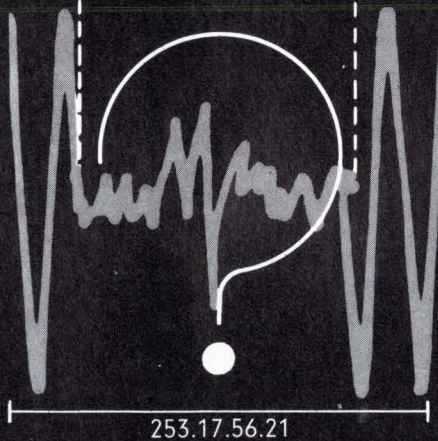

What caused the anomaly? Which variable quantities are effected? How long does the nominal value deviation last? What eliminated it eventually? – Questions, needing answers to make an exact fault analysis possible. OSCILLOSTORE® helps you to answer such questions. Because OSCILLOSTORE can monitor all continuous processes which can be represented through electrical signals up to 10 kHz. OSCILLOSTORE simultaneously registers, depending on task, up to 32 measurement values for milliseconds or minutes.

OSCILLOSTORE reacts as soon as the monitored measurement value exceeds its limits: A connected recording device is switched on to record the delayed measurement value – a few undisturbed periods, then the process of the entire disturbed measurement value and finally the recurrence of the nominal value.

Would you like to know more about OSCILLOSTORE? Where this modular system has been applied successfully in electrical power stations or processing systems?

Please write to:
Siemens Aktiengesellschaft,
ZVW 133,
7500 Karlsruhe 21,
Postfach 21 1080.

in USA to:
Siemens Corporation,
186 Wood Avenue South, Iselin,
New Jersey 08830

in Canada to:
Siemens Canada Limited,
7300 Trans-Canada-Highway,
Point Claire 730, Québec

with the OSCILLOSTORE by Siemens

Circle 43 on reader service card

Mod Squad

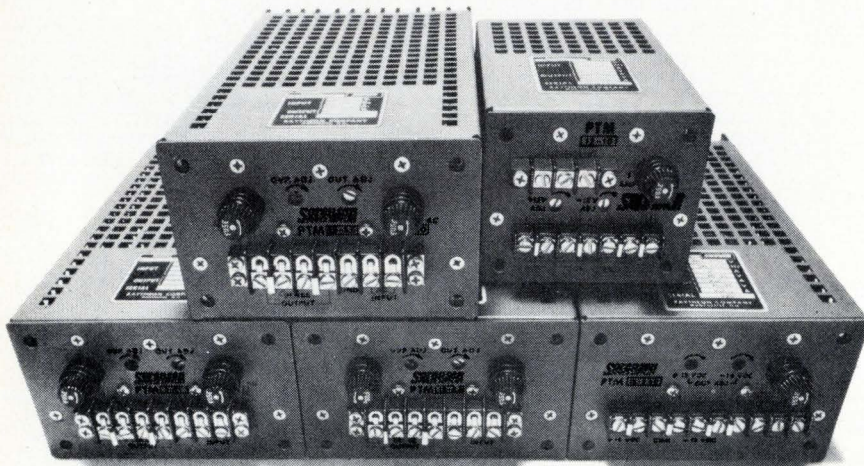

Sorensen's new generation of modulars—PTM series pass DC power supplies in both single and dual output versions. Now 33 models in the squad—and every one packs *more* power into *less* space than comparable modulars—at low, low cost per watt. New outputs ranging from 12 to 170 watts (2.8 to 29 volts) . . . built-in overvoltage protection . . . low noise and ripple . . . automatic current limiting . . . exceptional operating reliability are the major PTM features. For complete data, contact the Marketing Manager at Sorensen Company, a unit of Raytheon Company, Manchester, N.H. 03103. (603) 668-4500.

Representative Specifications—PTM

| | |
|-----------------------------------|---|
| Regulation (comb. line & load) | 0.05% + 5 mV (single) 0.02% (dual) |
| Ripple (PARD) | rms: 1 mV p-p: 5 mV |
| Temp. Coefficient | 0.01%/°C or 1 mV/°C whichever is greater |
| Prices | \$85 - \$190 |

Sorensen
POWER SUPPLIES

Electronics review

“present regulations tend toward over-control and inhibition of IR&D and B&P.” In addition to calling for full reimbursement of Government contractors and the elimination of both cost ceilings and the required military relationship for IR&D, the associations also:

- Oppose establishment of line items in agency budgets for IR&D and bid and proposal costs “as though these efforts were commodities to be priced. These are indirect costs, part of industry overhead, and as such, are appropriately included in product or contract estimates.”
- Oppose creation of a new Federal agency responsible for operational aspects of IR&D and bid and proposal costs, but favor establishment of a common Federal policy and practice for all agencies.
- Want Congress to “specifically express positive support for IR&D and B&P and correct the current motivation to continually reduce this effort.” □

Memories

‘Bulk’ hologram uses organics

By using organic materials in an optical memory, researchers at Battelle Memorial Institute, Columbus, Ohio, expect to achieve a bit density 10 times greater than has been yielded in holograms made of such single-crystal inorganics as lithium niobate. Chemically classed as stilbenes, colored powders used in the manufacture of textile dyes, the material can store 100 million bits per square centimeter by stacking as many as 100 holograms per millimeter of material depth.

Although organic materials have been tried for surface holograms, this is the first reported use in a volume hologram, meaning that storage is in the bulk of the material, claims Battelle chemist Richard A. Nathan. Prototype material to demonstrate the storage ability will be delivered to NASA's Langley Research Center this month, and “we

estimate that we could have an optimized, fully complete memory within two years," says Nathan. Moreover, based on the laboratory experiments conducted so far, he continues, the concept shows promise for meeting most of the requirements set by NASA for optical-memory systems.

Storage relies on differences in the index of refraction of two stable isomers—materials with the same molecular formula but different geometric structures—of selected stilbenes; the change from one isomer to another is triggered by a laser.

"We've found that we can store a lot more information per unit volume than we can with single-crystal inorganics," Nathan continues. These inorganics also rely for information storage on differences in indexes of refraction. However, with the stilbenes, "the difference in the change in the index is two or three times greater. This permits us to superimpose up to 100 holograms, instead of the five or 10 possible with inorganic materials.

Stacking. Different holograms are stacked by changing either the angle or the wavelength of the incident light. Holograms are sorted out by reading data out at the same angle at which it was recorded.

At a particular incident angle, writing requires one wavelength, and erasing, another. Reading is done with a third wavelength that does not cause the material to be converted from one isomer to another. "In this class of materials, we can find materials that isomerize with high efficiency from one form to another at wavelengths produced by small economic lasers," Nathan explains. "We'd like to have the three wavelengths sufficiently close together so that we could use a single, tunable laser."

While all materials have limiting properties, he points out, the ability to tailor the organic compounds far exceeds that of single-crystal inorganics, and organic materials are generally more economical. Also, isomerization of organics requires less energy, permitting the lasers to be compact and inexpensive. □



the first production Serial Analog Memory

RETICON
SAM-64

"SAM™ DID IT."

The SAM™64 is the first of a family of monolithic Serial Analog Memory devices to be introduced by RETICON. It provides 64 independent capacitive memory cells, each of them individually addressable by two independent shift registers. The Read-in register sequentially time samples the analog input signal and stores it in the memory cells. The Read-out register then reconstructs the stored information to its original form. Any desired delay may be achieved by simply delaying the initiation of the Read-out register or by varying clocking rates while maintaining constant relation between the initiation of Read-in and Read-out.

Time base correction (or delay as shown in the photo) to compensate for wow and flutter of recording systems can be easily achieved. Other applications include real time Fourier transforms, digital filtering, drop-out correction, bandwidth/time compression or expansion, analog FIFO, chirp Z transforms and many others.

Several devices may be cascaded to store a complete TV line. Over 10 MHz sampling rates and 50 dB S/N ratio have been achieved.

The SAM-64 comes in a 16 lead ceramic/gold dual-in-line package, available from inventory. Call for more information.

RETICON®

Reticon Corporation • 450 E. Middlefield Rd. • Mt. View, California 94043
(415) 964-6800 HOTLINE (415) 964-3033 TWX 910-379-6552

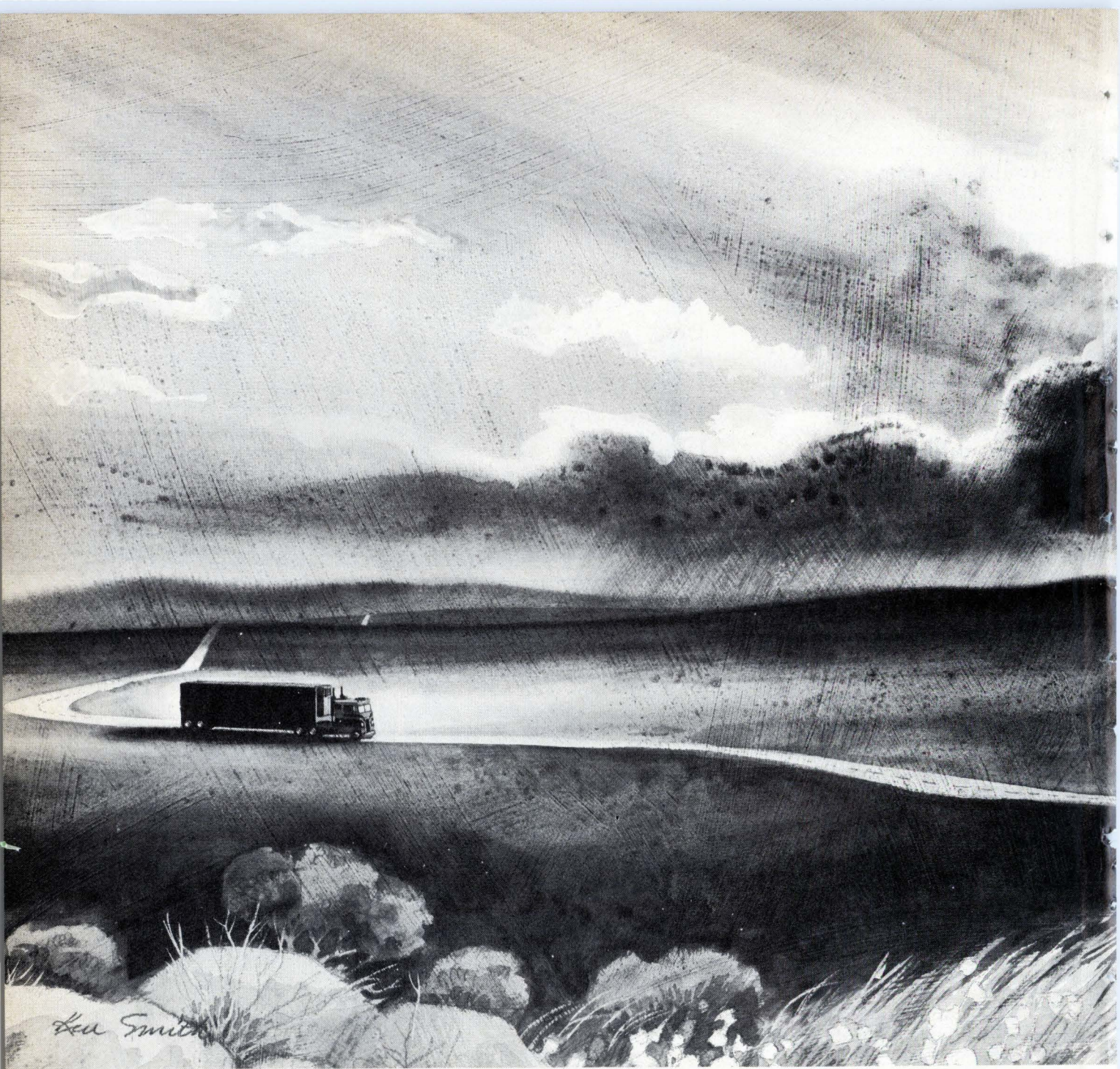

Ken Smith



The world's biggest little black box is coming your way

It's a unique display of TRW Electronic Components' newest, most exciting products, circuit applications and ideas. A walk-through exhibit of TRW state-of-the-art technology, coming right to you.

And its form is every bit as unique as its content!

Picture a typical electronics chassis, grown to mammoth proportions. In fact, to the size of a 40-foot tractor-trailer; far and away the world's *biggest* "little black box." Inside are scale models of all the most familiar components, but looking like nothing you've ever seen before—because the scale is *giant*. Five feet high for some.

Our technical experts will be on hand to answer specific questions. And you'll get a close-in view of more than 1000

life-sized products. They represent the 14 separate divisions that, together, form TRW Electronic Components—a single entity that can be the source for all your electronic component needs. That's why it takes the world's biggest little black box to show-and-tell our story of electronic components from A (actuators) to Z (Zener diodes).

And the show is on the road right now—right into your plant's parking lot, or somewhere nearby. We're zig-zagging our way across country, stopping at 155 plants in 27 states.

Watch for announcements of when we'll be in your area. TRW's little black box is where electronics is, and we're bringing it to where you are.

Because we *are* TRW.

TRW ELECTRONIC COMPONENTS

10880 Wilshire Boulevard, Los Angeles, CA 90024

Connectors • Resistors • Semiconductors • Capacitors • Motors • PC Boards • Potentiometers • Transformers • Coils and Inductors • Wire and Cable

**INTERDATA
ANNOUNCES
THE INDUSTRY'S
FIRST 32-BIT
MINICOMPUTER
FOR UNDER
\$10,000.**

WITH UP TO A MILLION BYTES OF DIRECTLY ADDRESSABLE MEMORY.

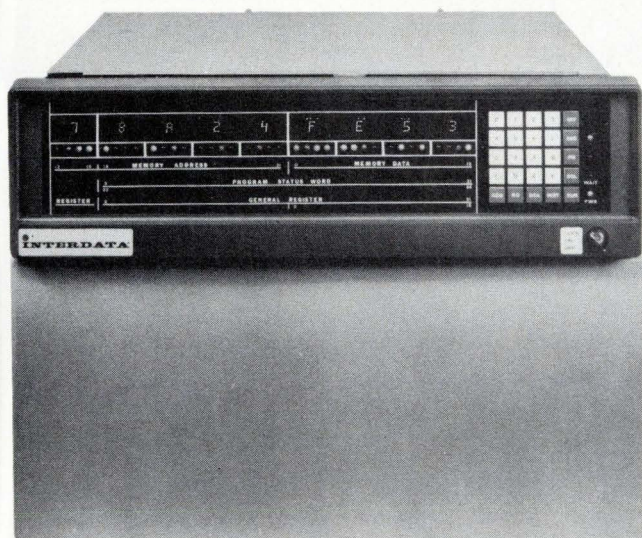

Minicomputer myths you can live without:

1. There's no such thing as a 32-bit minicomputer.
2. Minicomputers have an absolute 64K addressing limit.
3. The only way to even access more is to resort to some sort of hardware kluge with a hairy software scheme that'll cost you an arm and a leg.

All wrong.

Because now there's the Interdata 7/32 – a powerful new 32-bit minicomputer with main memory expandable up to a million bytes and direct addressing up to 16 million bytes.

Big it is. But hairy it isn't.

Because it's simple, straightforward and efficient. And it's the industry's first uncomplicated extended-memory software environment.

Backed up by a lot of hardware muscle like thirty two, 32-bit registers, 1024 I/O interrupts with automatic vectoring, 239 instructions. And a lot more. All of which would lead you to expect to pay a lot more money, right? Well, that's also a myth.

| Performance | 7/32 | Nova 840 | PDP-11/40 |
|--|-----------|----------|-----------|
| Word length | 32 | 16 | 16 |
| Memory speed (nanoseconds) | 750 | 800 | 900 |
| Maximum memory capacity (bytes) | 1,048,576 | 262,144 | 262,144 |
| Addressing range (bytes) | | | |
| Direct | 1,048,576 | 512 | 65,536 |
| Relative | ±16,384 | ±256 | ±32,768 |
| Indexed | 1,048,576 | 65,536 | 65,536 |
| Double indexed | 1,048,576 | No | No |
| General-purpose registers | 32 32-bit | 4 16-bit | 8 16-bit |
| Index registers | 30 32-bit | 2 16-bit | 8 16-bit |
| Vectored interrupt levels | Yes | No | Yes |
| Minimum interrupt overhead time (usec) | 6.5 | 47.5 | 46.5 |

| Price | 7/32 | Nova 840 | PDP-11/40 |
|----------------------|----------|---------------|---------------|
| 32 KB processor | \$ 9,950 | \$12,930 | \$15,345 |
| 64 KB processor | 14,450 | 19,330 | 26,925 |
| 128 KB processor | 23,450 | 35,630 | 44,725 |
| 256 KB processor | 41,450 | 61,230 | 80,825 |
| 1 Megabyte processor | 171,650 | Not available | Not available |

Source: Data General Price List, 5/15/73. DEC PDP-11/40 Price List, 6/73. DEC OEM & Product Services Catalog, 1972. Auerbach Minicomputer Characteristic Digest, June, 1973. "How to use Nova Computers", 1973.

The software muscle is all there, too. A new FORTRAN V compiler. An optimizing assembler called CAL. And the first extended operating system that's both powerful and simple – OS/32. Plus all the other field-proven Interdata software – it's all compatible.

The new Interdata 7/32.

We put our muscle where their myth is.

INTERDATA®

2 Crescent Place, Oceanport, New Jersey 07757 (201) 229-4040.
 Boston – (617) 890-0557. Washington – (703) 525-4806. Philadelphia – (215) 436-5579.
 Orlando – (305) 851-6962. Chicago – (312) 437-5120. Detroit – (313) 356-5515.
 Dayton – (513) 434-4193. Kansas City – (913) 384-1606. Houston – (713) 783-3060.
 Dallas – (214) 238-9656. Denver – (303) 758-0474. Los Angeles – (213) 640-0451.
 Phoenix – (602) 968-2477. San Diego – (714) 565-0602. San Francisco – (415) 969-1180.
 Seattle – (206) 455-0680. Toronto – (416) 677-8990. Tokyo – (270) 7711.
 Sydney – 439-8400. London – Uxbridge 52441. Munich – 0811-8543887.

INTRODUCING MONO-GLASS

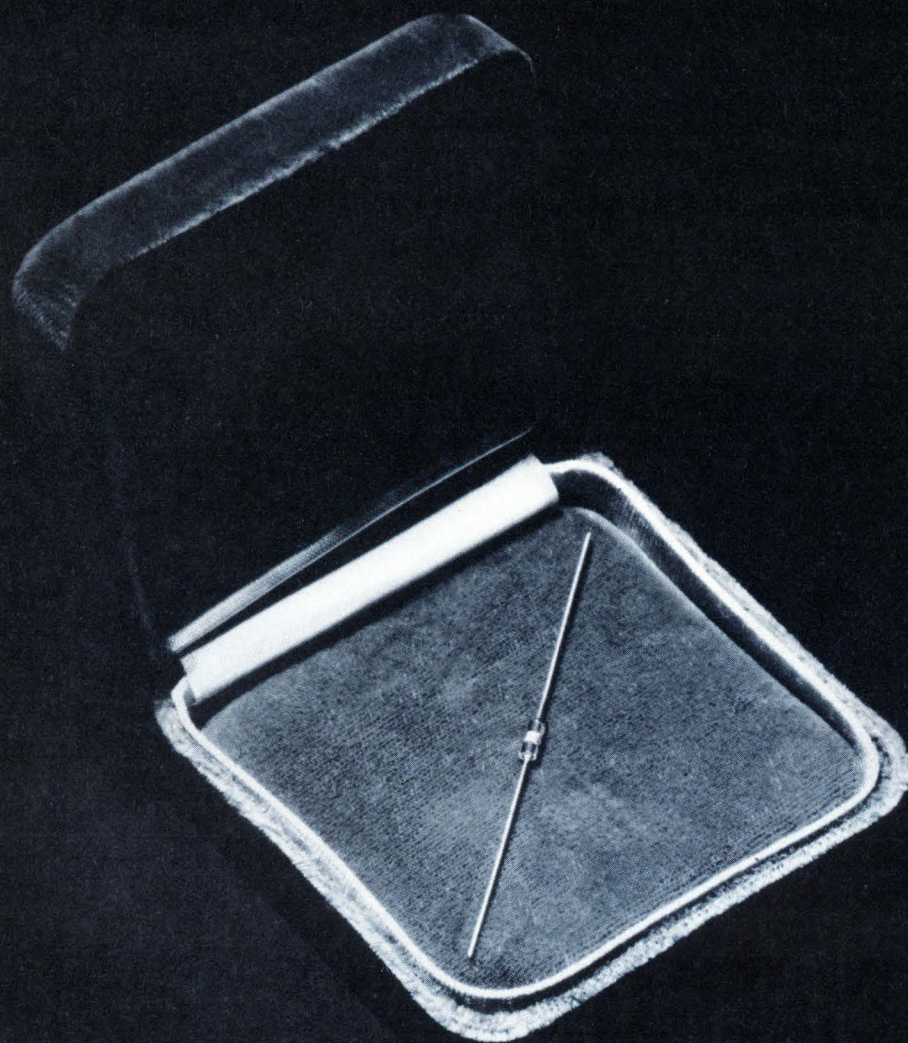

A JEWEL OF A CAPACITOR

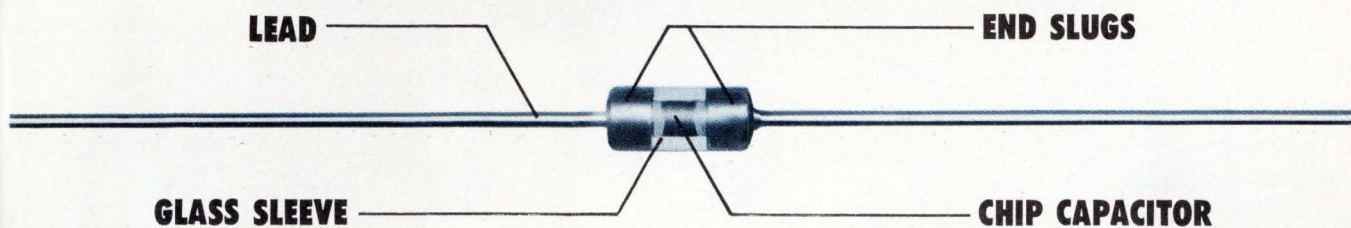

U.S. Capacitor Corp. has done something elegant for high volume capacitor users . . . MONO-GLASS.

This glass encapsulated monolithic ceramic capacitor offers something special: for the Design Engineer looking for cost reduction and dependability; for the purchasing agent looking for low price with fast delivery; for the incoming Q.C. inspector who is looking for reliability.

DURABILITY:

Our hermetically sealed, glass-to-metal construction offers these advantages: solderless internal contacts that won't reflow in your wave-soldering process; no glass fracturing during lead forming—stress is transferred to the end slugs rather than the glass sleeve.

RELIABILITY:

USCC is the proven leader in state-of-the-art, demonstrated on N.A.S.A. life support and guidance systems. Commercial as well as military aerospace applications benefit from the high reliability features of our products—the best available.

MONO-GLASS is our lowest priced ceramic axial lead capacitor, offering a new quality capability for communications, navigation and guidance, computer business machines or anywhere that high volume, low price is required.

Write or call for an evaluation sample, more technical data or applications help for your special requirements. Remember, USCC-Centralab.

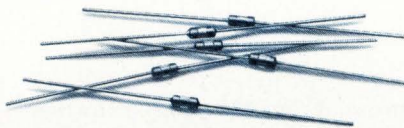
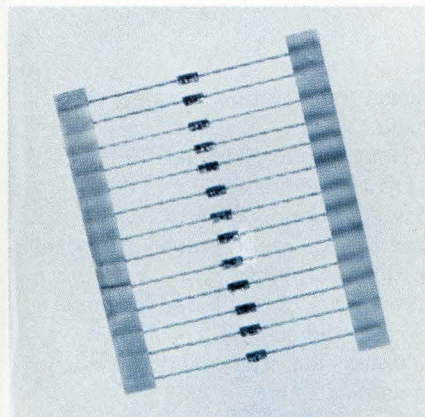

HIGH VOLUME; LOW PRICE

USCC's production capability for chip capacitors is second to none. MONO-GLASS is produced by a simple assembly technique. Combine these two and you get the best possible delivery for high quantity requirements, at a budget price.

WIDE SELECTION:

Four case sizes are available200 x .100; .250 x .100; .300 x .150 and .400 x .150. The 50 and 100 WVDC units offer up to .01 mfd in COG dielectric, to .18 in X7R and up to 1.0 mfd in the Y5V dielectric.

AUTOMATIC INSERTION:

If you use it, you know the substantial savings in time and cost. MONO-GLASS is designed for automatic insertion with the same equipment used for diodes and resistors. Reel packed and ready for your machines.



USCC/Centralab

Electronics Division ■ Globe-Union, Inc.



2151 North Lincoln Street ■ Burbank, California 91504

(213) 843-4222 ■ TWX: 910-498-2222

The world of temperature and resistance... Applications open up endless possibilities

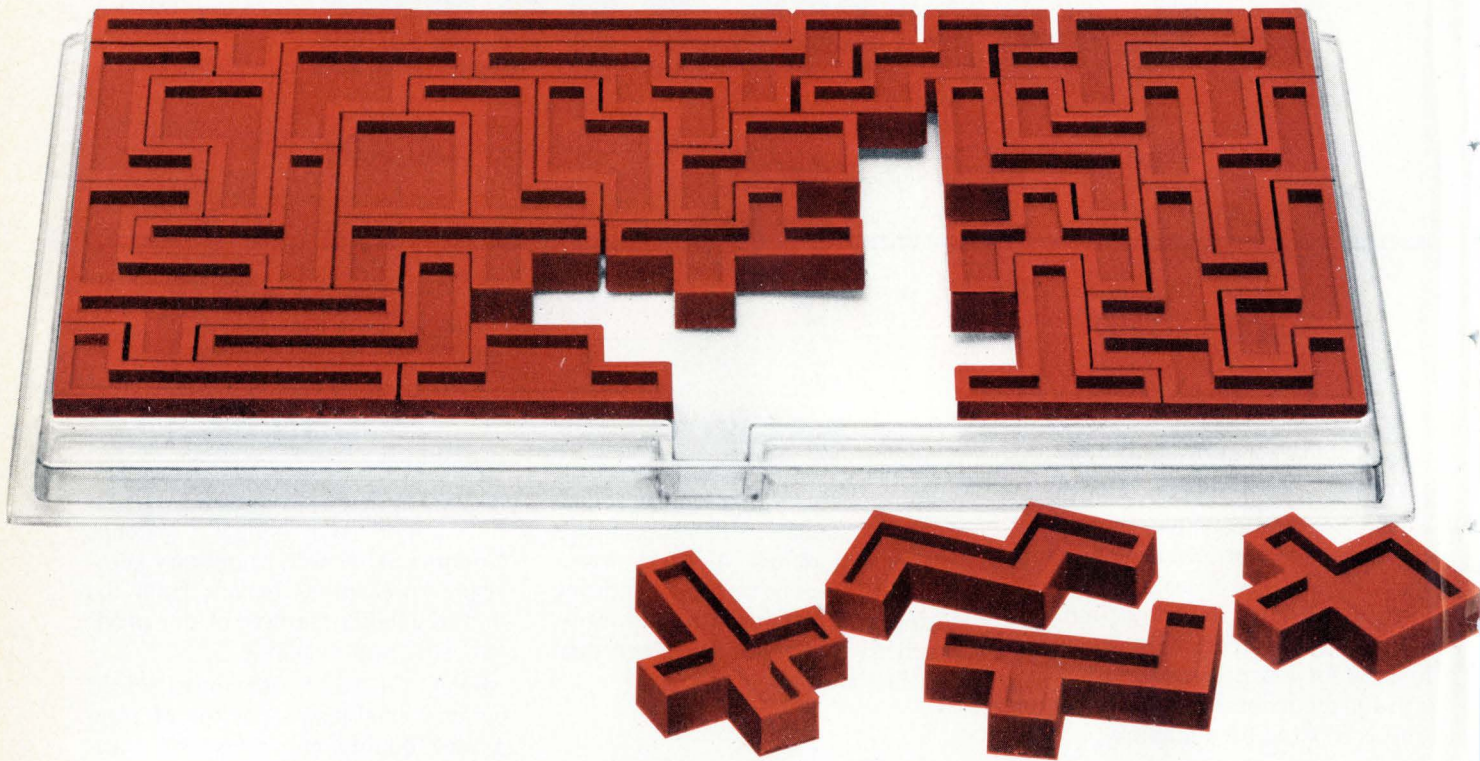

Resistance variation ratio of over 10^7 , 20°C value. Optimally selectable curie temperature, the point where resistance changes sharply, from -50°C to $+190^\circ\text{C}$. Sharp resistance variation characteristics. How these advantages can be put to work depends on you. The TDK PTC thermistor possesses outstanding characteristics not found in any other competing products, giving it a wider and greater range of possibilities never dreamed possible before.

Already, the PTC thermistors are being utilized for many applications, ranging from household appliances to industrial equipment, including automatic degaussing of color TV CRT, constant-heat generation, over-current protection, circuit protection, heat sensing, liquid level detection, etc.

The PTC thermistor, non-contact thermoresistor, is the valuable aid in the circuit which you may have under design or one which you may want to

improve. From this small extra consideration, great benefits can be derived. TDK stands ready to help you. What are your needs? You will find TDK happy and able to meet them.

Here are some typical performance building-blocks obtained from TDK PTC thermistors:

Current limiting characteristic

Constant-temperature heating characteristic

Constant-current characteristic

On-Off characteristic

Delaying action

Capacity to take large transient onrushing current

Thermal cut-out and reusable temperature fuse applications

Restorable and semi-permanent due to non-contact element

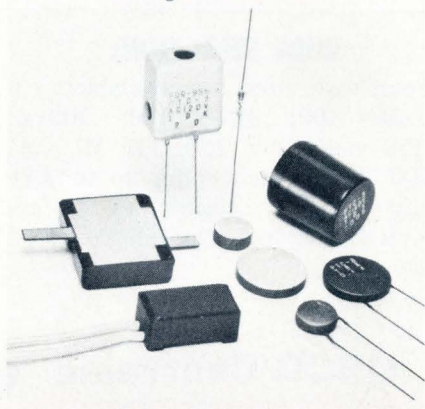

TDK®

TDK ELECTRONICS CO., LTD.

14-6, 2-chome, Uchikanda, Chiyoda-ku, Tokyo 101, Japan

Telex: J24270, J26937 (TODENKA)

Cable: TDKCORE TOKYO

TDK ELECTRONICS CORP.

LOS ANGELES BRANCH

931 South Douglas Street, El Segundo, California 90245

Phone: (213) 644-8625

Telex: WUD 653-456 (TODENKA ELSD)

CHICAGO BRANCH

2906 West Peterson Avenue, Chicago, Illinois 60659

Phone: (312) 973-1222

Telex: TWX 910-221-4211 (TDK CHGO)

FCC reorganizes Common Carrier Bureau . . .

Watch for a summer upswing in Federal Communications Commission telecommunications activity now that a number of key house-keeping chores have been completed. Most important among them are **the restructuring of the Common Carrier Bureau under its new chief, Walter R. Hinchman**, and the permanent assignment of Kelley E. Griffith to the position of bureau deputy chief. Griffith replaced Asher Ende, who resigned earlier this year when not promoted to chief.

Under the reorganization, the bureau will have five, instead of seven, divisions, plus two staff units reporting directly to Hinchman. The divisions include: Economics, to handle accounting, depreciation, economic analysis, and rate issues; Facilities, responsible for technical issues and international matters; **Tariffs, including a new interconnection branch;** Mobile Radio, to be spun off from the old Domestic Radio Facilities division, plus an unchanged Hearing and Legal unit. The two new staff groups include a special unit for coordinating division work and another to research and evaluate new projects and programs.

. . . as four commissioners act on 900-MHz docket

Despite three vacancies on its seven-man panel, **the Federal Communications Commission has quietly decided Docket 18262, and so opened up 115 megahertz of space** in the 900-MHz region for expansion of land-mobile communications [*Electronics*, May 10, 1973, p. 29]. The mid-April vote **made good on chairman Richard E. Wiley's promise to push for early action** on the docket [*Electronics*, March 21, p. 49]. FCC sources point out that it would not have helped to wait for the seating of commissioner James H. Quello, the retired Detroit broadcaster approved by the Senate without dissent on April 22, because "he is not familiar with the issues" in the complex docket.

In its allocation **the FCC set aside an initial 12.5 MHz for wireline carriers' development of high-capacity land-mobile telephone service using "cellular" techniques**, and it left another 27.5 MHz in reserve for later allocation as common carrier demand requires. There will be a general reserve of 12 MHz, and the rest goes to multi-user systems, industrial-scientific-medical systems, and private radio systems.

Speed up approval of export licenses, WEMA tells Senate

More money, more export specialists, more precise legislative language, and a computer data bank are needed by the Department of Commerce if the U.S. is to compete successfully in exporting electronics to eastern Europe and mainland China, the U.S. Senate has been told by WEMA. The trade association, representing western U.S. electronics and information technology companies, urged the Senate subcommittee on international finance to incorporate these and similar amendments in S. 3282, the bill to extend 1969's Export Administration Act till 1977.

Speaking for WEMA, Ampex president Arthur Hausman recommended seven changes in the extension, including **more department money, to speed export licensing** by adding "an adequate number of well qualified licensing officers," and a computerized data bank, to replace the present manual system. He also called for: **more precise definition of exports with "military potential," in order to facilitate export control decisions;** representation of six specific Government agencies on the technical advisory committees; wider dissemination of the reports of these committees, and greater staff support for them.

AT&T's march on Congress

Competition that its chairman decries as "selective" and "contrived" is abhorrent to the telephone company. Yet it is an issue on which American Telephone & Telegraph Co. has lost battle after battle with Federal regulators who administer the laws. So now AT&T and its affiliates are taking their case against competition to those who write the laws. "Unfortunately, the Congress is the one place where they might win," says one industry communications specialist in the capital. "They have lost before the Federal Communications Commission, and they are losing in the courts. Where else can they turn?"

Lobbying the Congress has never been a Bell System specialty, but there is increasing evidence that AT&T chairman John D. deButts means to remedy that inadequacy quickly. As he wrote the company's shareholders earlier this year: "Eventually it may fall to the Congress of the United States to decide where the public interest lies and to determine once and for all whether the goals of the Communications Act of 1934—'to make available . . . to all the people of the United States a rapid, efficient, Nationwide . . . communications service at reasonable charges'—would be better served by modes of competition or, as we believe it would, by a reaffirmation of the common carrier principle that has governed the development of telecommunications in this country thus far."

In that message last year, deButts devoted half of his text to the issue of competition. AT&T, he said, will "oppose it with all the energies we can command."

Management's priorities

Any question about deButts' determination to place the Bell System's case before the Congress was dispelled near the end of April when a Washington daily newspaper published the text of some of the chairman's remarks to a private meeting of the presidents of AT&T's operating affiliates last summer. There deButts declared "how important I believe it is that every man in this room take upon himself personally the responsibility for assuring that our case is understood by the people who may come to decide it eventually. I mean your senators and congressmen."

The chairman then went on to make clear his belief that not only had the chiefs of the Bell System companies flunked this requirement in the past but that he expected that situation to change. "I must tell you, however, that again and again I have been disappointed to dis-

cover—usually too late—that we have no more than a superficial acquaintance, if any, with legislators whose understanding turned out to be critical to us," he said. And he called it "a basic responsibility of a chief executive officer to represent his business to the people whose views have a significant bearing on its future. I consider this to be a top priority. . . ."

In its new drive to find friends in the Congress, AT&T is, of course, doing nothing more than many industries have developed into a fine art through years of practice. There is not a hint of anything illegal in lobbying when it is done correctly. And deButts made clear to his managers that he was "not talking about ITT-type influence-peddling or arm-twisting." What does concern communications-equipment manufacturers, however, is the size of the resources at AT&T's disposal. Says one equipment maker's Washington lobbyist, "I am frankly afraid. With the size of their staff—all those economists, engineers, and lawyers—they can kill us. It will be like racing a kiddy car against a Rolls."

Should Bell lobby?

Only time can tell how successful deButts' turn to lobbying the Congress will be. But some of his competitors believe the AT&T chairman's concern about competition is overdrawn. As MCI Communications Corp. chairman William McGowan sees it, "Competition from MCI and other specialized carriers impacts only one small area of AT&T's total service offerings—a market served by AT&T Long Lines, and one that currently comprises only \$1 billion of the Bell System's total annual revenue of over \$25 billion. As a consequence, the effect on the local telephone companies and their exchanges' customers should be negligible. Competition may, in fact, even have a beneficial effect on the local companies' revenues, since MCI pays for all interconnection facilities leased from them."

However correct the MCI argument may ultimately prove to be, it is unlikely to produce any split in the ranks of the Bell System management. Today, Ma Bell is going forward in a determined drive to get the Congress to take another look at—and perhaps rewrite—the Communications Act of 1934. Nevertheless, that action raises a related issue that the Congress may want to address first: is congressional lobbying a legitimate endeavor for a company that claims the title of "a natural monopoly," one that is subject to Government regulation?

—Ray Connolly

Centralab perspectives

FOR USERS OF ELECTRONIC COMPONENTS



CENTRALAB

Electronics Division

GLOBE-UNION INC.

5757 NORTH GREEN BAY AVENUE
MILWAUKEE, WISCONSIN 53201

Centralab Distributors now have twice as many monolithic capacitors in stock.

To provide a wider selection of monolithic ceramic capacitors, Centralab doubled its line. Distributors now have 288 standard chip, axial and radial lead capacitors -- all ready for off-the-shelf delivery.

If you're specifying or buying monolithic capacitors, you know that the last few years have produced its share of headaches. The use of these devices has expanded so rapidly that problems of availability and delivery have been more the rule than the exception. Recognizing your needs, Centralab, in 1973, initiated a program that today gives you a broader selection of monolithics competitively priced and with no waiting for delivery.

There's no compromise in the Centralab line of standard monolithic ceramic capacitors. It now includes chip, axial and radial lead types. They are available in 288 standard values — that's twice the number previously offered. And 244 values are directly cross referenced to major competitive units, making them not only an excellent first choice but an ideal second source.

In the new broad Centralab line you can select from 58 values of Ceramolitic® chip capacitors in 100 VDCW types, rated from 10 pf to .039 mf with COG (NPO) and X7R temperature characteristics, and tolerances of $\pm 5\%$ and $\pm 10\%$.

Tubular axial lead types are available in 84 values for 100 VDCW, rated 1 pf to .1 mf with COG (NPO) and X7R temperature characteristics and tolerances of ± 0.5 pf or $\pm 10\%$.

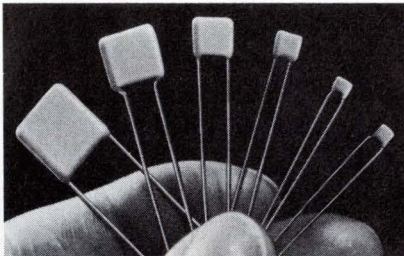

The radial lead, epoxy coated Mono-Kap™ is offered in general purpose, temperature stable and

ultra stable types. You can select from 50 or 100 VDCW with COG (NPO), X7R, and Y5V characteristics. Tolerances include ± 0.5 pf, $\pm 10\%$, $\pm 20\%$ or $+100 -0\%$ (GMV).

But breadth of line is only one reason you can count on Centralab for monolithics. Availability is another. Every Centralab Distributor has this comprehensive line available for immediate delivery. Long the source of highly reliable ceramic disc and special purpose capacitors, he is also the man to see for superior, top performing monolithics. Ask him for the new catalog that gives complete technical details on 288 values and our cross reference for major competitive monolithics. Then see why Centralab standard monolithics are the best headache remedy in the business.



In addition to stocks of monolithic ceramic capacitors at Centralab Distributors, this 20,000 square foot warehousing facility in Milwaukee maintains an extensive back-up inventory exclusively for distributor orders.

Circle 55 on reader service card

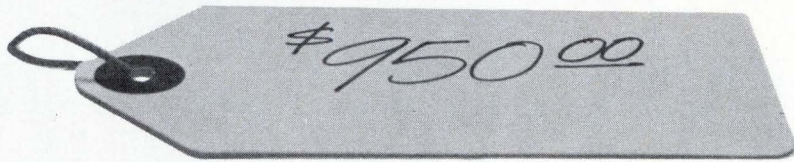

SENSITIVITY AND ACCURACY AREN'T THE ONLY THINGS WORTH KNOWING ABOUT OUR COUNTERS

We know sensitivity is important. So we designed our frequency counter to measure a wide range of signals:

10mVrms from 100Hz to 550MHz (or 100mVrms at 10Hz to 100Hz).

We know you want accuracy too.

Therefore, a 5×10^{-8} day aging rate, delivered from a temperature-compensated crystal oscillator (and nine digits to resolve all that accuracy). We figured you might also

like cleaner signals, so we devised an automatic noise suppressor. Then, to guarantee your interest, we worked

in an appealing price: Consider \$950.00 in single units (greater quantities get lesser prices, of course).



The complete package is called *the 5108*. We honestly believe you can't find a better combination of sensitivity, accuracy, quality and price in any other frequency counter.

However, if your needs run along the line of universal counters, look to our 5104 and 5106 models.

The 5104 has a frequency range to 50MHz, and is sensitive to 50mVrms.



It measures time interval, period, totalizes events and has a price tag of \$590.00. *The 5106* has a higher range: 70MHz. A better sensitivity: 10mVrms. It measures both chattering and burst mode signals. It costs \$1250.00.

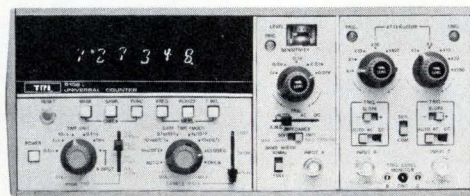

T.R.I. is a company which represents two decades of progress in digital test equipment, instruments and pricing.



T.R.I. CORPORATION

505 West Olive Avenue, Sunnyvale, CA 94086
(408) 733-9080

Piezoelectric polymers aimed at audio transducer jobs

Quality audio speakers that are as thin as picture frames are among the goals of researchers at Japan's Pioneer Electronic Corp., which this year will introduce transducers utilizing piezoelectric high-molecular materials. Pioneer plans to introduce headphones, a tweeter, a phonograph cartridge, and a microphone containing the polymer transducers, while research continues on adapting the piezoelectric material to low-frequency speakers.

Takeo Yamamoto, managing director and general manager of Pioneer's Acoustical Engineering Research Laboratory, says the piezoelectric devices that will be introduced over the next year will include the first ever used as an output transducer in commercial audio equipment. He adds that, once engineers are able to reduce voltage requirements for the polymer in low-frequency equipment, they can make speakers that take up little more room than a wall painting.

Film. The polymer developed by Pioneer is made of polyvinylidene fluoride in film form that ranges from 8 micrometers thick for headphones to 30 μ thick for use in tweeters. Aluminum electrodes are attached to each side of the film, producing a poling effect that causes the film to behave like an ideal pulsating-sphere radiator. Polyurethane backing serves as a damper.

Yamamoto says that, in addition to the structural simplicity of transducers constructed with the new piezoelectric material, the polymer does not react to humidity conditions as do condenser and electret-type transducers. Moreover, the total actuation offered by the film gives better directional qualities. Distortion of the tweeter that will be built with the new material is rated at 0.3%. Overall, Yamamoto says, smooth, flat frequency responses up to 25,000 hertz have been recorded in tests on the piezoelectric transducers now being developed.

A 1-to-10 step-up transformer is used with the tweeter, and 4 volts is applied at the primary source. With low-frequency speakers, the necessarily large stroke requires transformers too large to be commercially feasible in audio equipment. Researchers are attempting to lower the low-frequency voltage requirements for the polymer.

Pioneer developed the polymer in cooperation with Japan's Kureha Chemical Industry Co., and Yamamoto says that because the poly-

mer is being produced in small quantities at present, its cost is higher than that of the equipment it replaces in conventional transducers. However, Pioneer plans to use piezoelectric tweeters in both medium and high-priced speaker sets in the hope that, by using the film in such quantities, material price will drop. Piezo electric headphones will be introduced this month, the tweeters and microphones toward year-end, and the cartridge next spring. □

Around the world

Cassette recorder aimed for military

Backed by some \$600,000 in development money from the French army, Schlumberger Instruments and Systems (SIS) has readied a ruggedized digital-tape cassette recorder that meets French and international military standards. The first units will go to the French army for a battlefield artillery computer system. The French navy has also ordered these recorders for the data-processing systems for a new class of ships. All told, there's an immediate 1974 market of several hundred recorders, estimates Alain Piro, who heads the company's equipment department. But, since SIS so far is the only European company to offer a ruggedized tape-cassette recorder, Piro estimates that unit sales could add up to several tens of thousands over the next decade.

Right now, the ruggedized recorder carries a price tag of \$5,000 or more. However, Piro predicts that the price will edge down to about \$2,000 within five years if the company lands enough orders to warrant reasonable production runs. SIS, which calls the cassette recorder the PS 6020, guarantees an accuracy within one bit per million under military operating conditions. Capacity of the cassette is 600 feet of half-inch, eight-track tape, enough to handle 30 million bits of data without gaps. The top data rate that keep accuracy within 10^{-6} bits is 20,000 bits per second, but 60,000 b/s are possible when an error rate of 10^{-4} is acceptable.

Remote video terminals control mail-sorter

Faced with the task of handling some 30 million letters every day, West Germany's Post Office is increasingly turning to electronically controlled equipment for its letter-sorting operations. The latest addition to its arsenal is its highest-capacity automatic sorting system, a computer-controlled installation that will have a throughput of 72,000 letters an hour. Built by AEG-Telefunken, it features remote video coding stations.

In the sorter, video pick-up devices scan the letters' addresses. The various gray shades are then converted into digital data, which is stored in a special memory. At the remote video coding stations, the complete address of the next letter to be routed is automatically retrieved from the memory and displayed in its original, but enlarged, form on a television screen. On a keyboard, the operator punches in the four-digit postal-area code. The main advantage of video coding stations is that such equipment can be installed at a distance from the noisy printing and letter-sorting machinery. Also, these stations make for better use of the mechanical equipment and do away with the need for intermediate letter-stacking gear. Letter-stacking is, in effect, replaced by storing addresses in the memory.

REI has one question for people who buy electronic test equipment.

Why?

When you need it fast . . . rent it. Purchasing equipment usually involves long delivery lead times. When you rent your electronic equipment from REI it's a safe bet that you can get what you need within 36 hours of the time you call in your order, sometimes sooner. This fast service is possible because we maintain 9 Instant Inventory Centers throughout the U.S. and Canada, stocking millions of dollars worth of equipment.

When you need it for only a short time . . . rent it. Need equipment for a short-term project? Rent it from REI. When you don't need it any more, return it to us. It's the easy, low-cost way to use the equipment you need for just the time that you need it.

When you care about what it costs . . . rent it. Renting from REI can be less expensive than purchasing. There's no capital investment to adversely affect your company's cash flow. This means you'll get more mileage from your equipment budget. And, since you can treat your monthly payments as an expense in most situations, you'll also achieve tax advantages from renting.

All REI rental equipment is guaranteed to meet manufacturers' specifications and is operationally checked out prior to shipment. Routine maintenance is provided free of charge. Certification and calibration are available upon request. Our flexible arrangements include rental, rental-purchase and leasing packages to give you the use of equipment from one week to three years or more.

Get your free copy of our 1974 catalog that lists virtually every item in our rental inventory. Use reader service card, or write Rental Electronics, Inc., 99 Hartwell Ave., Lexington, MA 02173. For immediate information, call your local REI Instant Inventory Center listed below. Once you rent from REI, you may never buy electronic test equipment again.

Rental Electronics, Inc.

A **PEPSICO** LEASING COMPANY

Burlington, MA (617) 273-2770 • Gaithersburg, MD (301) 948-0620 • Oakland, NJ (201) 337-3757 • Ft. Lauderdale, FL (305) 771-3500
Des Plaines, IL (312) 827-6670 • Dallas, TX (214) 661-8082 • Mountain View, CA (415) 968-8845 • Anaheim, CA (714) 879-0561
Rexdale, Ontario (PLC Leasing Ltd.) (416) 677-7513



Think about renting. It's the smart way to go.

International newsletter

Overseas investments pushed by Japan's electronics giants

Japan's major electronics producers will invest an estimated \$33 million in overseas ventures this year to help offset rising production costs at home. Nearly all the investments will be for production of consumer electronics ware, and will include establishment of sales subsidiaries. **Sony Corp. will spend approximately \$20 million** to expand its color-TV manufacturing plant in San Diego, while **Matsushita has earmarked an estimated \$60 million for overseas investments**, including its purchase of Motorola's Consumer Products division.

TV data service comes closer with British agreement

British television-set makers and the two broadcasting authorities—British Broadcasting Corp. and Independent Broadcasting Authority—have agreed to a technical format for alphanumeric data service. Both broadcasting authorities have been working independently on such a viewer service for some time. **Four lines per frame will be used for carrying the data in digital form—lines 17, 18, 330, and 331, all off the screen and at present unused.** The data will be coded in non-return-to-zero binary form and transmitted at a bit rate fractionally under 7 megabits a second. That rate is a lot faster than the experimental systems, but it means that one TV line can carry all the data needed for housekeeping and a complete row of 40 Ascii-coded alphanumeric characters. Using a maximum of 24 rows of characters per page of data on the screen, 99 pages can be cycled through in about 25 seconds. Therefore, if a viewer selects for freezing a page that has just gone, he doesn't have to wait too long for it to come around again. **For the IBA—a commercial organization—it also means more space for advertising.**

Though BBC and IBA still have to decide that an operational service is worthwhile, and the government has to authorize it, it's more likely than not that a service will start—because it can be done inexpensively. Ultimately, reception equipment in TV sets is likely to be a half-dozen LSI circuits costing no more than \$100 or so. The most expensive equipment item at the transmission end is the small computer that digitizes the data and inserts it in the video signal. **So far, BBC has started experimental transmissions on the new format, and IBA hopes to start in the fall.** TV-set component makers Texas Instruments Ltd. and Mullard Ltd., as well as major set-maker Rank Radio International Ltd., are building test demodulators, which are part linear, part digital.

Color TV still paces Germany's consumer-gear sales

By all appearances, 1974 is shaping up like another banner year for West Germany's entertainment-electronics industry. After a successful first quarter for color-TV sets, the industry **expects above-average sales to keep up, with the prime stimulant coming from the world soccer championship games in Germany this summer.** Following that event, demand will slacken somewhat but should still rise at a 15% nominal growth rate until the end of this year. That rate should put the country's total market for entertainment-electronic products—including radio receivers, tape recorders, disk players, and stereo equipment—well above the \$2.8 billion level. Sales in 1973 were \$2.4 billion.

Japan's computer sales led by minicomputers

Japanese computer sales climbed a healthy 18% in fiscal 1973, thanks mainly to a boom in minicomputers, sales of which skyrocketed 50% to 60%, to total 60% of the 10,531 computers now in use. Growing capac-

ity and refinements in ICs that permit manufacture of easy-to-handle computers at small costs are cited as major reasons for growing popularity of minicomputers. The sales boom is typified by Nippon Electric Co.'s NEAC System 100. Sales of the system have passed the 500-units mark, even though it was only put on the market in the middle of the year. Other big minicomputer sales gains were reported by Takachiho Burroughs Co., a 50-50 joint venture, and by Mitsubishi Electric Corp. **Takachiho Burroughs sales of small computers have topped 8,000 units since their introduction six years ago.**

AEG-Telefunken goes East to up output

To avoid production bottlenecks at home, West Germany's AEG-Telefunken is quietly expanding its semiconductor operations in the Far East. The firm's latest move in that area is the foundation of a Philippine semiconductor company in which Manila-based Stanford Micro-Systems Inc. is an equal partner. **The new company, Telefunken Semiconductors Philippines Inc., will begin device assembly around the middle of this year, with machinery and know-how to be supplied from West Germany.** Using parts from AEG-Telefunken's Heilbronn facilities, TSP will put together low- and high-frequency silicon transistors, as well as bipolar and MOS integrated circuits for reexport to West Germany or for shipment to other markets. One of the prime reasons for the move, AEG-Telefunken officials say, is **to take some of the load off their domestic facilities, where production capacity is severely strained by high market demand.** The company's semiconductor sales increased by more than 50% annually during the last two years.

Ericsson chalks up more orders for computer-run exchanges

L M Ericsson has strengthened its position as supplier of computer-controlled telephone exchanges by **racking up \$20 million worth of contracts recently.** The orders include new exchanges for Rotterdam, Aarhus in Denmark, and Guadalajara, Mexico, as well as extensions of earlier contracted exchanges in Aabo, Finland and Monterrey, Mexico. The new orders **bring to 29 the number of computer-controlled trunk exchanges that Ericsson has in use or on order in nine countries.** The exchanges, designed for national, international, and intercontinental traffic, use multiprocessors. The total capacity of Ericsson exchanges in use and on order is 220,000 trunk lines, which is equal to 1.3 million subscriber lines.

Addenda

The pocket TV set with 2-inch-diagonal screen that Sinclair Radionics Ltd. has said it will announce this summer won't appear before next year at the earliest. Managing director Clive Sinclair says that he can't find a tube maker prepared to make the tube in quantity. The set is intended to have the vast majority of the circuitry integrated onto four chips. . . . **Norwegian shipboard-computer maker Noratom-Norcontrol A/S has landed one of its biggest single orders:** 10 DataBridge navigation systems for Mobil oil tankers. Most of the 21 orders received so far this year have come from Amoco, Exxon, and Mobil. The systems use computers made by A/S Norsk Data-Elektronik. . . . **In a \$25 million deal, Iran** will get an electronics and optical production facility designed and equipped by Hughes Aircraft Co. The installation will be called the Electro-Optical division of Iran Electronics Industries.

now...

RESISTOR NETWORKS

from
BOURNS

The Leader in resistive component technology now brings you a line of thoroughly tested and qualified DIP and SIP Resistor Networks . . . that live-up to their specifications, stand-up to your applications. BOURNS® Resistor Networks are available off-the-shelf in a selection of standard configurations to replace the most popular Allen-Bradley, Beckman, Dale, Sprague, CTS, Centralab, and Mepco part numbers.



CONSIDER WHY BOURNS IS BETTER:

- Proven thick-film production expertise
- Proprietary resistor ink system provides $\pm 100\text{ppm}/^\circ\text{C}$ tempco through all resistances . . . from 33Ω to $220\text{K}\Omega$
- Better power handling characteristics
- Design qualified and life tested to meet or exceed tough Mil-Standards.

Inquiries for special values, schematics and specifications invited.

Your local Bourns representative has complete specs, cross-reference data and order forms at the ready. Call him today . . . or the factory direct.



BOURNS, INC., TRIMPOT PRODUCTS DIVISION
1200 COLUMBIA AVENUE
RIVERSIDE, CALIF. 92507

Circle 61 on reader service card

BOURNS

TRIMPOT®
PRODUCTS

ADJUSTMENT POTENTIOMETERS
PRECISION POTENTIOMETERS
CONTROLS/VARIABLE RESISTORS
RESISTOR NETWORKS



TRIMPOT® P
ALLST
PRE

TRIMPOT PRODUCT





digital

DECkit

digital
dec products

Interface your PDP-11 with a screwdriver.

Attention all you PDP-11 owners out there.

We've been watching you.

And a lot of you are doing the same kind of interfacing.

Hooking up standard peripherals. Converting analog signals to serial ASCII. Directly accessing storage memory. Hooking up remote instruments and custom peripherals that have BCD outputs. Doing the same thing over and over.

Hold it.

Our new DECKits can save you a lot of time and frustration.

DECKits are instant interfaces — basically just a few modules and a PDP-11 systems unit.

Just plug the modules into the systems unit, screw the unit into the PDP-11, and attach the connectors. Your equipment is interfaced.

There's no design time. No breadboarding.

No wirewrapping. The modules and design for each kit have been pretested and fully documented and are ready to solve your interface problem.

Start your interface now. Pick up your pencil and circle our number on the readers service card. We'll send you a complete description of all the DECKit interfaces now available.

We're Digital Equipment Corporation, Logic Products Group, Maynard, Massachusetts 01754. (617) 897-5111, extension 2785. In Canada: P.O. Box 11500 Ottawa, Ontario, K2H 8K8. (613) 592-5111. In Europe: 81 Route de l'Aire, 1211 Geneva 26. Telephone: 42 79 50.

**We think interfacing is so important,
we've devoted an entire department to it.**

digital

Cooling, lifting, holding, pulling, damping, drying...

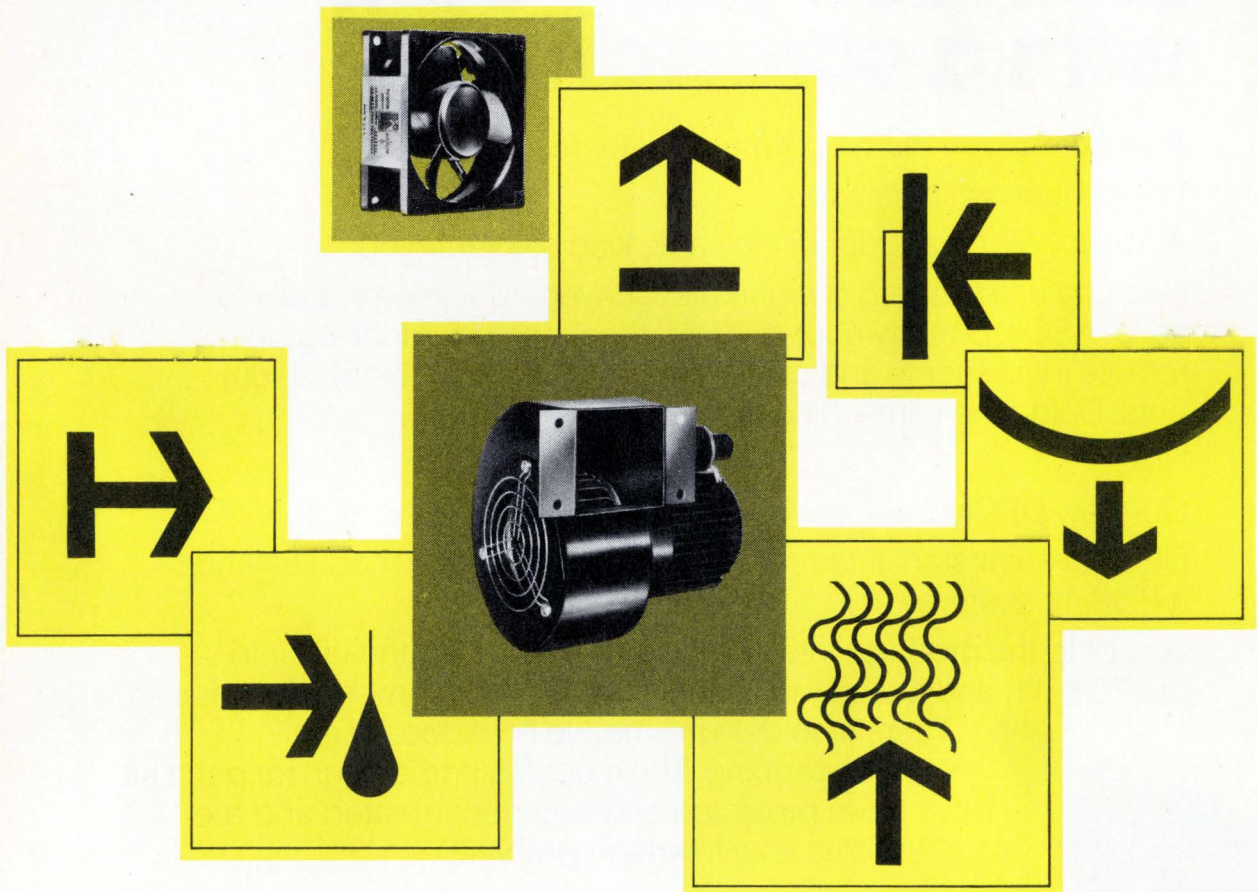

Rotron has a way...with air

Air, in the hands of the world's most advanced manufacturer of precision air moving devices, has a potential for doing things that designers and manufacturers are beginning to appreciate.

Forced convection cooling of electronic equipment—providing for more densely packaged components with equal or even greater system reliability—is just one of the jobs air, by Rotron, performs so well.

In buffer columns and tape hold downs and a dozen other non-cooling applications within the electronics industry alone, air moving devices from Rotron simplify system design, increase both efficiency and reliability.

Rotron's extensive line of air movers require an absolute minimum of space (as little as 1 cu. inch). They're quiet. (As low as NC 20). They consume surprisingly little power (a low of 5 watts). And they are exceptionally reliable. (Ten years and more of continuous duty without maintenance.)

Learn more about the Rotron line of fans and blowers, with pressures to 165" wg., flows to 2600 cfm. Contact your local Rotron representative or distributor or write us directly.

Why settle for less when the best costs no more.



ROTRON INC.

Woodstock, N. Y. 12498 □ 914 • 679-2401 □ TWX 510-247-9033

Pacific Div., Burbank, Cal. 91506, 213•849-7871 • Rotron B.V., Breda, Netherlands, Tel: 79311, Telex: 844-54074

Cinch has the extras in .100" PC edge connectors

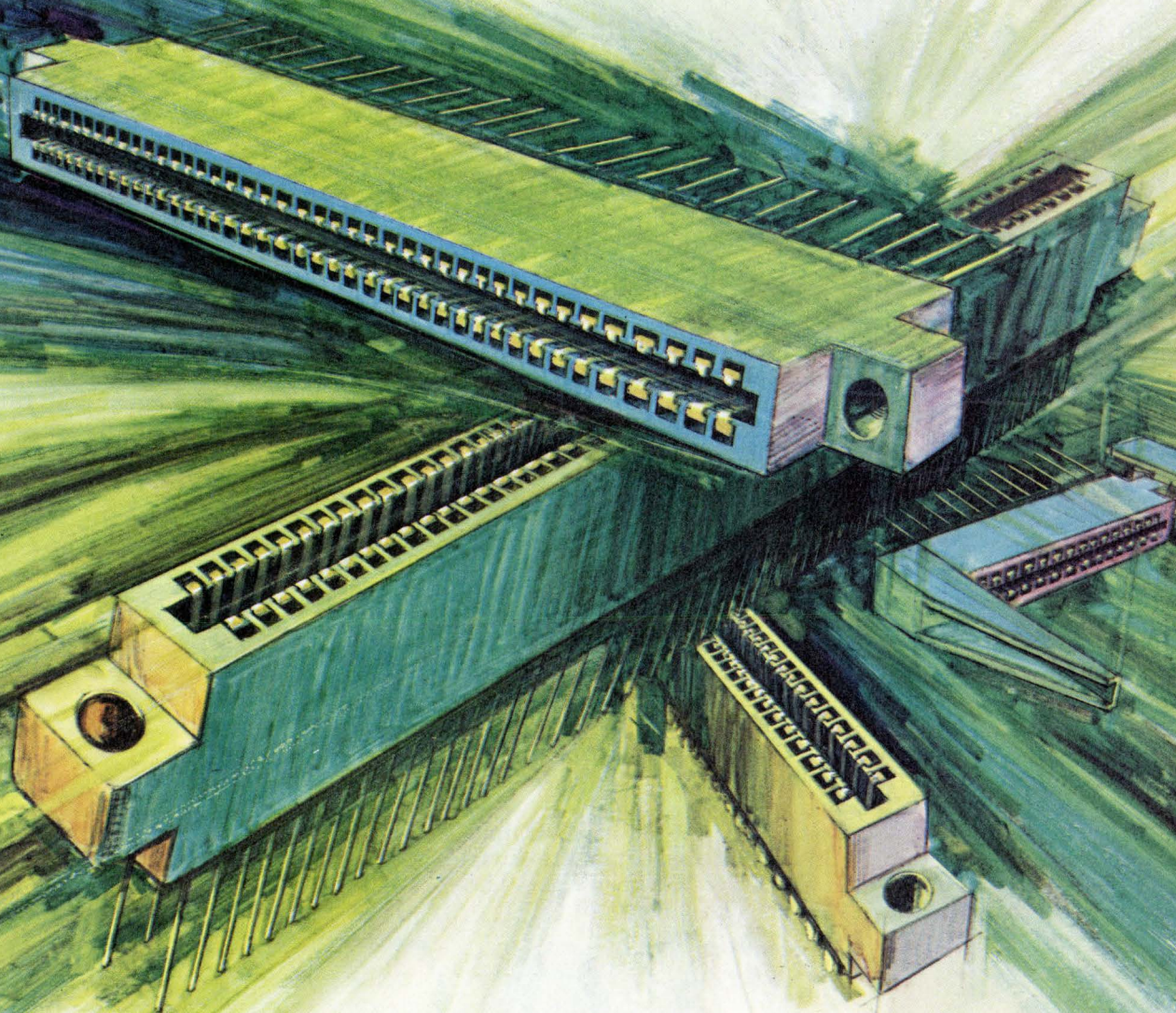

Extras that result in higher reliability, wider availability, and greater economy are integral to these TRW/Cinch edge connectors:

- Gold-plated contact reliability at a lower cost through Cinch selective plating (30 microinches on board contacting areas and 10 microinches on non-contacting areas).
- Cantilevered contact construction results in gap uniformity and controlled insertion and withdrawal forces, due to preloading of bifurcated contacts against insulator stop.
- Available in 16 sizes, from 10 to 50 double readout contact positions, with choice of wire wrap*, dip solder

or solder tab terminations, and detachable card guides, for added versatility.

- Nation-wide stocking by TRW/Cinch distributors of six popular sizes (15, 22, 36, 40, 43, and 50 positions) for off-the-shelf availability.

For additional information, see detailed listings in EEM, contact your nearest TRW/Cinch sales office, or dial toll-free (800) 645-9201 for the name of your nearest TRW/Cinch distributor. Or write for Catalog C-24, describing the complete line of printed circuit edge connectors, to TRW/Cinch Connectors, an Electronic Components Division of TRW Inc., 1501 Morse Avenue, Elk Grove Village, Illinois 60007; phone (312) 439-8800.

*T.M. Gardner-Denver

CM7404

DIVA'S COMPUTROLLER BEGAT AND...



An Episode in the True Chronicle of the DIVAS, Proudest Peripheral Family in the Computerworld.

Forever stored in the computerworld memory is that incredible marriage four years ago, immortalized by this painting, of mini processor technology to DIVA controller — a marriage that united distinguished minicomputer families with great storage capacity disc drives of the IBM 2311 and 2314 types.

Once again, the elite of the computerworld find themselves at what appears to be a joyful celebration. They had been summoned here by a mysterious masked messenger who said only that they must come to witness an astonishing event. Marvel at the great throng! DEC, Data General, TI, Interdata — all of those with whom DIVA controller has interfaced in the past are here. A driving murmur fills the hall as all speculate upon the possible reason for this grand assemblage. Bits of conversation issue from the minis.



"They say mini processor and DIVA controller are now proud parents. They say we are here to see the spin off."
 "No, no," unwinds another mini. "Another marriage is my input. DIVA plans a bold coupling that will further maximize us minis. That's the way I read it."
 "Saving money. A million dollars saved on the purchase of a DIVA system, as compared with a comparable IBM system. That's news. That's why we're here."

On and on minis calculate. Discs and tapes drive and search. Output increases rapidly. Information is being transferred at fantastic rates — up to 624K bytes/sec by a DIVA Disc Drive 30 system alone. The combined interchange of data reaches din-like proportions.

BUT WHAT HAS HAPPENED?

Two awful, blinding electronic flashes coupled with ear-piercing, supersonic cracks of sound reveal a shrouded figure holding up the DIVA medallion. Instantaneously all eyes focus upon this commanding sight. A shuddering gasp sweeps the hall, followed by electric silence. The newcomer steps forward and a sonorous pronouncement issues from deep behind royal purple robes.

"I am DIVA COMPUTROLLER here to tell you of my mighty workings."
 COMPUTROLLER? COMPUTROLLER? All units go into search mode.

"Nor will you find me in your memories. I was not.

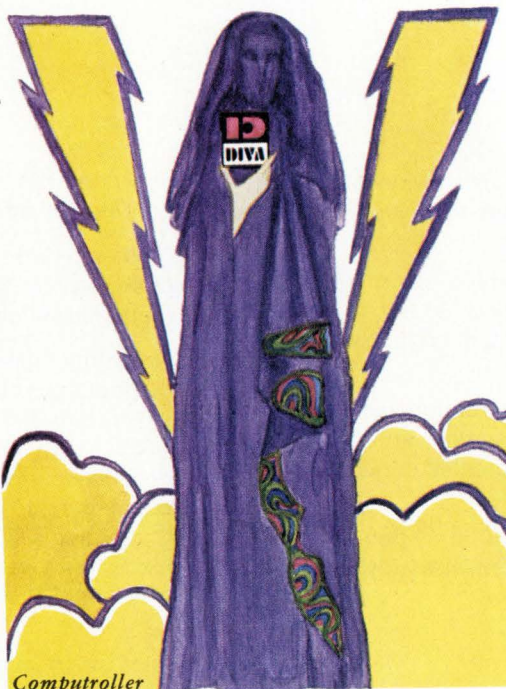

I am NOW. Born full-blown of mini processor and DIVA controller. Brought to maturity by expanded research facilities and a rapid growth curve. I was begat to interface all minis with IBM compatible 3330 type drives."

A tumultuous spontaneous exclamation of surprise and joy thunders from the throng. Mesmerized by this magnetic figure, they see he is a DIVA in every way: powerfully-built, solid-state throughout, capable of simultaneous control of up to eight disc drives in either mini or IBM formatting.

Holding up his medallion for silence, COMPUTROLLER speaks again. "Today I take a mini bride. Come rejoice with me. Learn how greatly I expand the memory and speed of my chosen one."

DIVA'S COMPUTROLLER, PDP 11, AND 3330 TYPE DISC DRIVE UNITE. AN INCREDIBLE MARRIAGE.

An Episode in the True Chronicle of the DIVAS, Proudest Peripheral Family in the Computeworld.

The computeworld stares in awe at the incredible wedding scene which has unfolded before them. The bride is minicomputer PDP 11, offspring of the illustrious maxi-computer clan, begat of Abacus. The bridegroom is DIVA COMPUTROLLER, scion of this proud, most respected peripheral family. Officiating at the ceremony is Duke DIVA Disc Drive, direct descendant of IBM compatible 3330 type disc drives.

Realizing the great impact this interfacing will have on the computeworld, our happy guests monitor the wedding with joyous solemnity.

"Mated," Interdata 70 whirrs, "PDP 11 will have access to 100 million bytes of data on a single spindle or 200 million bytes on a dual spindle disc drive unit within an average access time of 32 msec."

"And with COMPUTROLLER providing a buffering sector, data will be transferable at the rate of 645,000 bytes/sec," marvels Nova II.

"And keep in mind," interrupts a breathless TI 980A, "that with COMPUTROLLER controlling eight drives, mini will have access to 1.6 billion 8-bit bytes of data!!"

But, hush! Listen to Duke DIVA repeating those always-inspiring words: "With the data stored in me, and with provided interconnecting cables and distribution panel, I now pronounce you linked in holy matrimony."

Resounding cheers befitting the occasion arise from the crowd. "A toast! A toast! A toast!" they roar. As is the custom, the proud parents, mini processor and DIVA controller, propose the toast to the dazzling couple: "To the most splendid and significant union in all our memories."

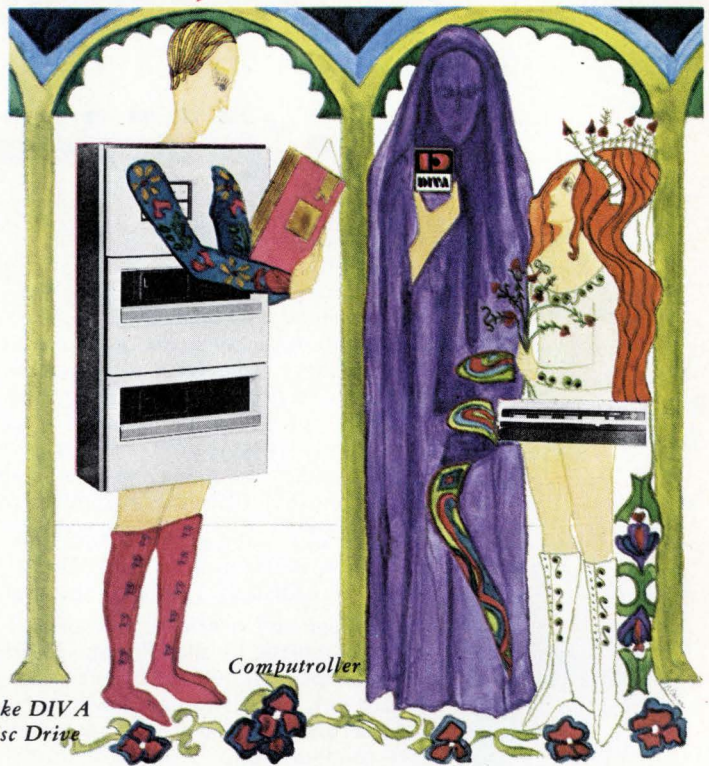

Duke DIVA Disc Drive

Computroller

Mini PDP 11

"Vive, DIVA! Vive, DIVA! Vive, DIVA!" Everyone unwinds.

But even as we listen to the clink of ceremonial glasses and the exuberant laughter, we sense an underlying sadness. Those unchosen minis — do they count for nothing now? Will they not be able to enter the world of high speed data storage/access and low cost/bit performance? And why — throughout this entire festivity — has COMPUTROLLER remained hidden under his purple robe? Is there more to

COMPUTROLLER than meets the eye? Be sure to join us for the next episode in the True Chronicle of the DIVAS when we will hear the horrendous accusation: "Bigamy! BIGAMIST!"

In the meantime, learn COMPUTROLLER'S inside story. Find out about the free implementation and training courses, the software packages, and warranties that go with each disc system. All you PDP 11 users call George Roessler at 201-544-9000 for cost and delivery information. Or write: DIVA, Inc. 607 Industrial Way West Eatontown, N.J. 07724 TWX 710-722-6645.

REGIONAL SALES OFFICES:
 CT: 203-526-3222
 CA: 415-349-3482
 Wash. DC: 703-370-5211.
 GSA CONTRACT NO. GSS-OOC-00159.

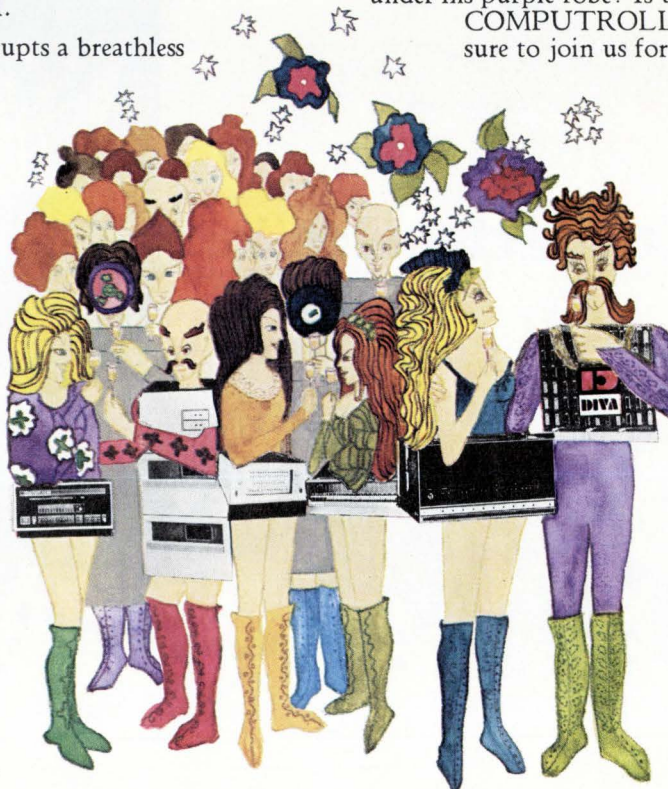

ACDC ANNOUNCES THE GRAND OPENING OF OUR NEW HIGH EFFICIENCY POWER SUPPLY.

We've opened it up to give you an inside look at things like the modular construction that adds to reliability and simplifies circuit check out...the low voltage drop, high speed rectifiers that combine the best elements of reliability, speed and low forward voltage drop...the low impedance output capacitors that reduce high frequency ripple to about 5mV peak-to-peak...and the sealed input EMI filter that minimizes conducted RFI.

These 20KHz inaudible switchers operate from 115/230VAC, 47-63Hz or from 150VDC with 70% efficiency and 0.1% regulation. (100VAC also available).

Overvoltage and overload protection is standard and EMI is minimized by shielding and filtering. (We even offer an optional built-in filter for compliance with Mil-Std 461, CE03). You get low inrush on turn on for soft start and can parallel up to six switchers in master-slave configuration.

There are 10 models in this new series. Five 300 watt models range from 5V at 60A to 24V at 14A. Five 500 watt models range from 5V at 100A to 24V at 23A. They're all in our new brochure. Just circle the reader service number and we'll get a copy to you right away. However, if you would like a copy of our 64-page catalog containing technical data on our complete line, fill-out the coupon company letter-

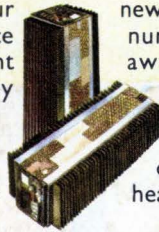

Name _____

Company Name _____

Address _____

City _____

State _____

Zip Code _____

acdc electronics inc

Oceanside Industrial Center Oceanside, CA 92054 (714) 757-1880

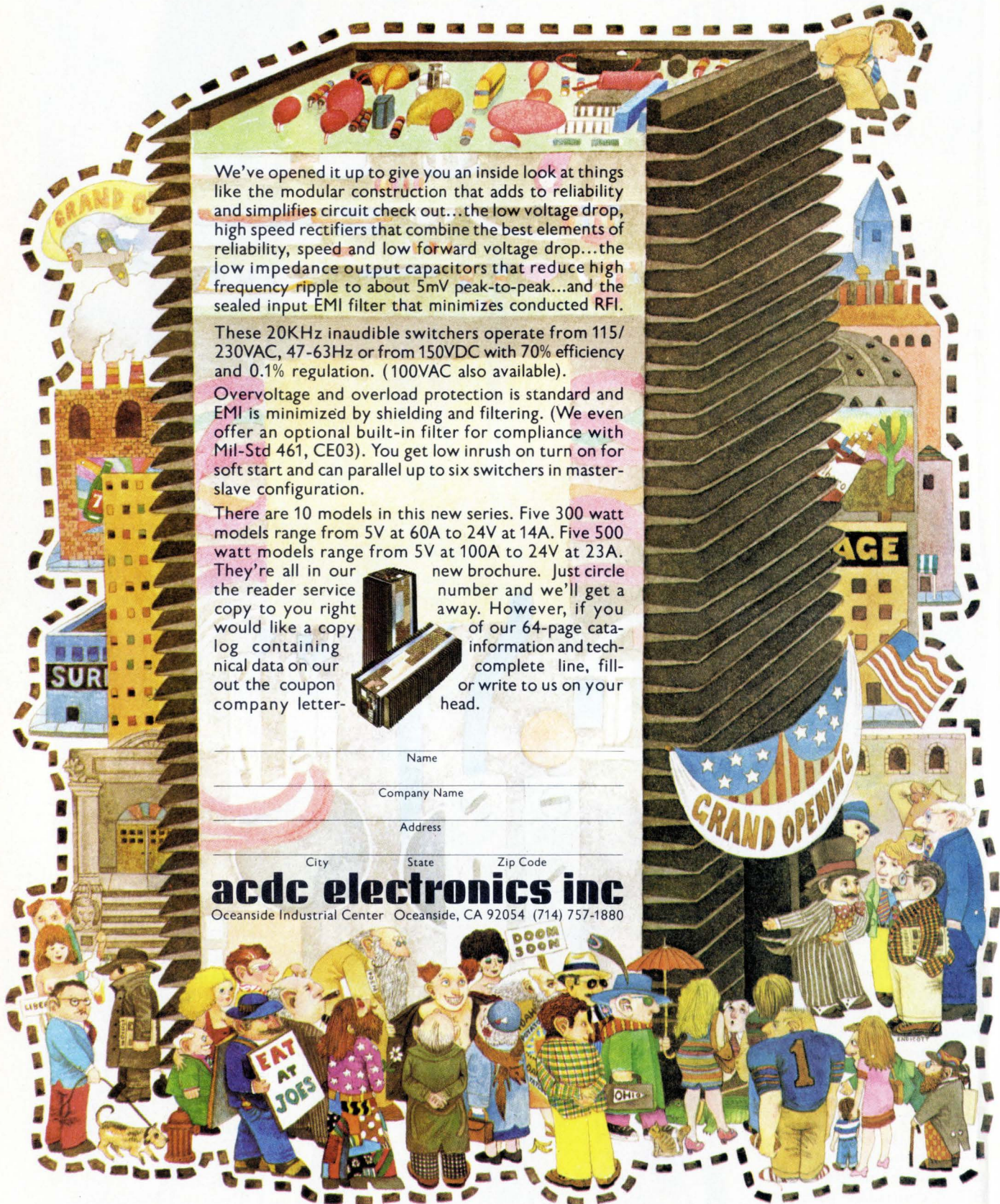

ATS-F poised to chalk up firsts

\$200 million package, designed to advance satellite communications, will experiment with tracking, data relay, enlarged spectrum

by William F. Arnold, Aerospace Editor

The sixth, and last, applied technology satellite may be the most exciting one in the series. ATS-F promises to open a new dimension in satellite-communications technology when it is launched the morning of May 30.

The experimental spacecraft will carry a host of sophisticated electronic gear designed to test and extend long-distance communications techniques on an international basis for education, plane and ship tracking, and data relay between earth and other spacecraft. But it also will conduct experiments on high-frequency propagation and interference that may enlarge the communications spectrum.

If successful, ATS-F will provide more communications uses to serve mankind and foster production of new equipment to service additional markets. The \$200 million program should bear rich fruit. For example, the spacecraft may, through its high-resolution radiometer to detect cloud fronts, help increase the yield of rice for the hungry millions in India. Since rice must be planted within a precise time before the onset of the monsoon season, the radiometer will spot the buildup of monsoons in time for successful planting.

Key ATS experiments are:

■ **Educational and health TV experiments.** Sponsored by the Department of Health, Education and Welfare, these tests will seek to deliver health and

educational services to millions of Americans in remote regions of the Rocky Mountain states, Alaska, and Appalachia. Voice, color-video, and data signals will be used. Each of ATS's two high-powered transmitters operating in the 2,500-megahertz range will bounce a beam off the parabolic reflector to produce a pair of almost tangential beams covering 1,000 by 300 miles. The TV programs can be simultaneously broadcast in four languages, tied in with local microwave or cable systems, and be sent to individual receiving stations. A 10-foot fiberglass receiver antenna will operate from -50°C to $+70^{\circ}\text{C}$ and cost about \$5,000 each, says Albert A. Whalen, the health education telecommunications coordinator at NASA, Goddard.

■ **Position-location and aircraft-communications experiment.** Involving both the Federal Aviation and the Maritime Administrations, this C-band test will seek ways of more

economic and efficient routing by providing continuous communications and navigation information between ships, planes, and ground stations.

■ **Tracking and data-relay experiment.** To prove the capability of transferring data from an out-of-sight satellite through another one to the ground, this experiment will use ATS to relay weather data from NASA's Nimbus F to ground receivers when the weather bird is out of sight of earth stations.

■ **Radio-frequency-interference experiments.** These experiments will enable experts to measure the mutual interference between satellite and earth communications systems, the results of which should affect the design of future systems.

■ **Millimeter-wave-propagation and radio-beacon experiments.** Also important for future communications design, these tests will be used to define the way millimeter waves are propagated from space to earth,

help determine how radio waves in specific bandwidths are affected by rain and other climatic conditions, and investigate the effect of ionospheric particles on radio propagation and the affects of atmosphere layers on radio-wave reflection.

After the experiments on the far side of the world, the spacecraft will be brought back so that it can transmit across the U.S. However, since the specified performance life is two years, but the design goal is at least

Teahouse. That's what the fully deployed ATS-F suggests, with its 48 radial ribs and antenna. The satellite will weigh 3,080 lbs.

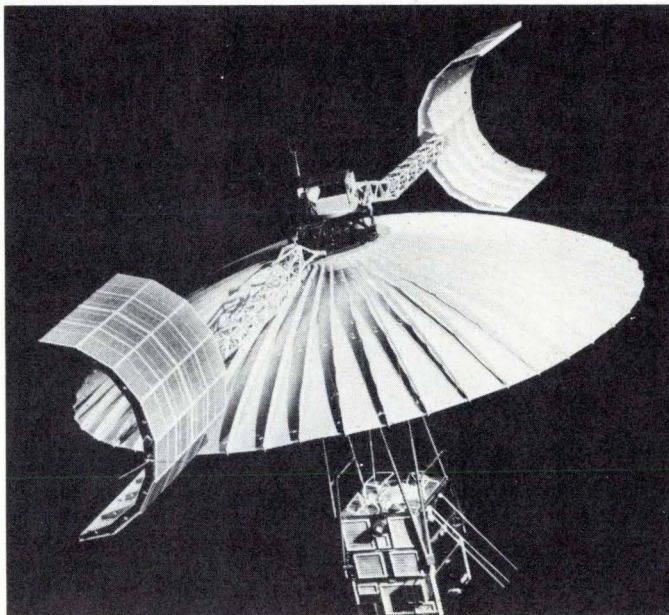

up
your
density
per dollar

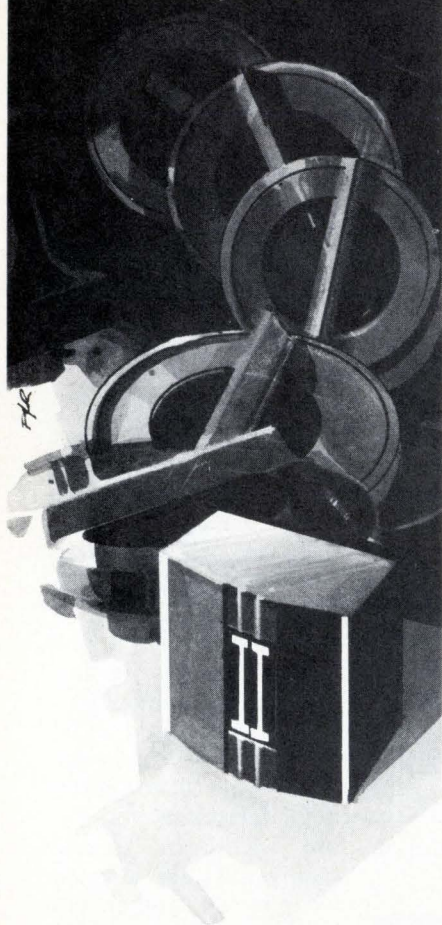

To 6250 bpi.
That is four times as
much data as you
presently store . . . yet
in the same volume, at
one fourth the cost.

We have the head, our
6250. You have the
system.

Let's put it all together.



Company, Inc.
8101 Tenth Ave. North, Minneapolis, Minn. 55427
Telephone (612) 544-0381

Probing the news

five years, ATS isn't booked up for the rest of its time. The remaining five to six years are as yet unplanned.

Teahouse transmitter. Weighing 3,080 pounds at launch, ATS, about the size of an Intelsat-4 satellite, will be launched into a synchronous orbit to conduct experiments over the U.S. From its geostationary perch 22,300 miles high, the spacecraft will resemble a teahouse delicately supported by a giant parasol suspended from two booms. The teahouse, called the earth-viewing module, contains the "antenna-feed farm" on top, the communications module, the service module for altitude, command and telemetry control, and the experiment module housing earth-viewing experiments within a package that's 4.5 by 4.5 by 5 feet.

The parasol is a huge 30-foot parabolic reflecting antenna made of 48 flexible radial ribs covered by a dacron mesh. The large antenna is primary to the spacecraft's tremendous potential because it provides a vast area to reflect beams. But, unfurling the antenna from its doughnut-shaped ring hours after launch will be a tricky and key part of the complicated process to get the bird on station and in operation. At the end of the booms are curved paddles containing 21,600 solar cells that will provide 470 w of power at

the end of their life. The booms and paddles are 54.8 feet across.

As prime contractor, Fairchild used several electronic subcontractors. Philco-Ford Corp.'s Western Development Laboratories built the communications subsystem which will operate over a range of 17 uhf, vhf, L-band, S-band, and C-band frequencies ranging from 136 MHz to 6 gigahertz. Lockheed Missiles and Space Co. fabricated the 180-pound reflector, which has a contour precise enough to handle a top frequency of 10 GHz. IBM's Federal Systems division built the orbital-attitude and receive- and decode-command equipment. Honeywell's Aerospace division made the attitude-control system, the first all-digital spacecraft-control system.

Firsts. Fairchild and NASA officials boast of many unique features aboard the craft. William A. Johnston Jr., Fairchild program manager, claims that, for the first time, ATS will use a graphite composite structure for the support cage, deploy its 30-foot reflecting antenna, use a completely digital computer in the altitude-control system, use a new system of heat pipes to lower and dissipate the heat profile, use solid-state transmitters to achieve the highest power yet in space—more than 100 watts of rf power in some experiments. And the effective radiated power, the intensity of the beam received on earth, will be 200,000 w. □

ATS-F sails along

From a turbulent history, the ATS-F has sailed into a clear course lately. In fact, it is passing all its preflight tests with such high grades that the sophisticated spacecraft should have a very successful career in orbit, surmises Richard B. Marsten, communications program director in NASA's office of applications. "I've never seen a spacecraft program go so well," he says, adding that he had been involved with about 70 satellites when he was with RCA.

It wasn't always so. ATS was born in controversy when NASA first awarded the contract for the program to the General Electric Co. in April 1970. Fairchild protested and was upheld by the General Accounting Office and two NASA committees. The agency then reversed itself and gave the spacecraft job to Fairchild in September 1970.

Delays in getting the mission defined and lagging subsystem contractors threw the program into funding and timetable problems [*Electronics*, Feb. 14, 1972, p. 49]. Consequently, the follow-on ATS-G was scratched, and F's 1973 launch was postponed a year. Fairchild bore down and encountered only a six-week delay in launch because NASA wanted to check out some "suspect" transistors in the power supply.

COS/MOS is Power Conscious

Plagued by expensive power supplies and cooling systems? Having a rough time trying to cram too many system functions into a mini-package? Heat causing a reliability problem?

"Yes" to any of these problems means you have a need for RCA COS/MOS IC's.

COS/MOS power dissipation is negligible at dc and increases linearly with frequency. Since many logic elements in a digital system are idle much of the time, or switch at lower rates than the maximum clock frequency, a substantial net power saving can be achieved with COS/MOS in comparison with other logic families whose dissipation remains constant with frequency.

For example, a Digital Clock with 21 COS/MOS IC's takes only 6.3 milliwatts for the countdown from a 262 KHz crystal and the logic to drive an hours, minutes and seconds display. A comparable TTL

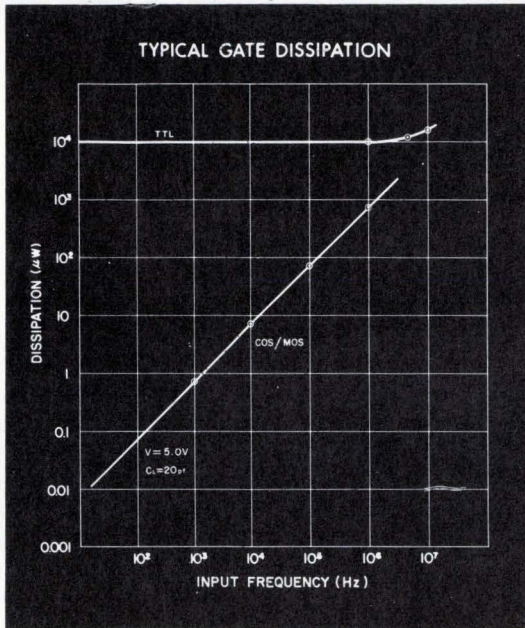

system will consume 600 milliwatts—a difference of almost 100 to 1 in power cost savings with COS/MOS.

Power conscious? You bet it is. But ultra-low power consumption is not the only great feature you get.

□ COS/MOS circuits

work from 3 to 15 volts, eliminating expensive regulators.

□ COS/MOS noise immunity is among the highest of any technology (typically 45% of supply voltage).

□ COS/MOS features stable transfer characteristics—less than 3.0% change over the full temperature range of -55°C. to +155°C.

It all adds up to ease of use and cost-effective designs. Try it. You'll

be convinced that the digital world is a COS/MOS world.

Send for your guide to the ever-growing COS/MOS Product Family. Write: RCA Solid State, Section 70E 2,

Box 3200, Somerville, N.J. 08876.

Or phone: (201) 722-3200, Ext. 2565.

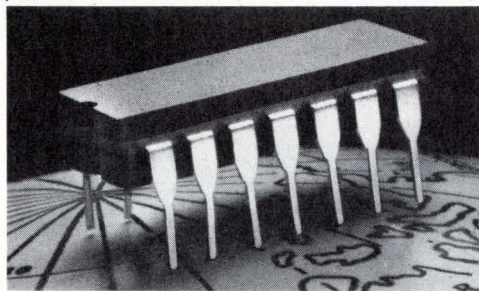

RCA Solid State

Pacing the paperless parade

National Data Corp. is developing computer/communications systems that have led the march toward the all-electronic transfer of funds

by Gerald M. Walker, Consumer Editor

Electronic funds-transfer systems—the basis of a “cashless society”—are gaining momentum in retailing, banking, and other consumer transactions. Riding the crest of the wave is seven-year-old National Data Corp., which is in a position to be a data middleman for a widening range of users in need of nationwide authorization and billing networks.

But back in 1967, this concept didn't seem too promising, particularly since National Data had nothing tangible to offer—no hardware manufacturing of its own, no experience in credit authorization, and no proof that a real-time net was necessary.

Founded by eight retired Air Force officers and a couple of civilians under the leadership of a former Strategic Air Command intelligence deputy, what National Data did offer was computer/communications know-how. Most of it was gained in the Air Force well in advance of developments for commercial firms.

The man in command, George W. Thorpe, the retired colonel from SAC, got the company off the ground by using the now-familiar strategy

of applying defense-industry techniques to civilian endeavors. National Data's first two targets were the credit-card system of the petroleum industry, which is the granddaddy of card issuers, and the trucking industry's freight records. The petroleum venture flew, but the trucking program didn't.

Today, National Data has several systems up and running; all are clustered around some form of electronic funds-transfer. For one, it announced early this year that it would begin installing 25,000 point-of-sale terminals in a nationwide credit authorization system over the next three years. Its hardware arsenal consists of a large-scale Burroughs B6700 computer, Univac 494 equipment plus backup, RCA communications gear, and numerous Digital Equipment Corp. mini-computers, as well as modems and cathode-ray-tube terminals numbering in the hundreds.

Credit-card authorization, which now serves 28 petroleum companies in the U.S. and Canada, last year accounted for more than 29 million transactions. Banks offering both big credit-card plans, Inter-

bank/Master Charge and National BankAmericard, have hooked into the system. So have airline credit-card issuers and one of the travel and entertainment-card plans. In all, approximately \$80 million in credit purchases may be in process at any given time inside National Data's Atlanta headquarters.

Another fast-growing portion of National Data's business is a bank-deposit-reporting system that was started in 1970 and now numbers some 350 subscribers linked to about 75 banks. This service involves the concentration of funds collected by users into banks via a deposit-transmission-information link from National Data's central computer. The company does not actually handle any of the \$1 billion to \$1.5 billion a day transferred by the users; it concentrates these funds so that companies have virtually on-line use of their cash, rather than having to wait for incoming payments to be sifted through the paper-clogged banking apparatus. Receipts at all user locations are reported to the National Data EDP center, then retransmitted to the banks.

Influence. Although National Data has not built its own hardware, the company has developed enough clout to influence the design of the terminals now on order. Addressograph-Multigraph Corp. has included alterations that were suggested by National Data equipment to its AmCat-I terminals, and Na-

Credit Influence. Senior vice president Joseph A. Mattes demonstrates one of the Addressograph-Multigraph credit-authorization terminals ordered by National Data and altered to NDC's own specifications.

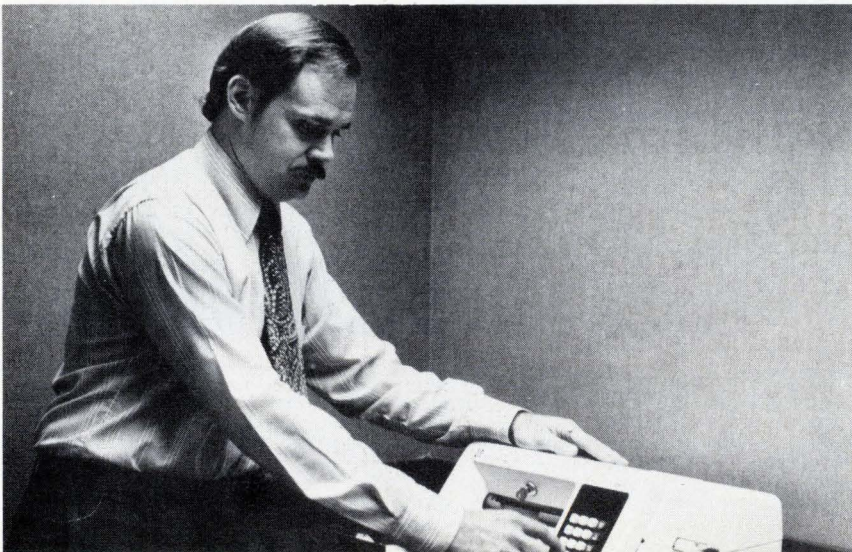

Seven ways to tell a Darlington that's great from a Darlington that's merely good.

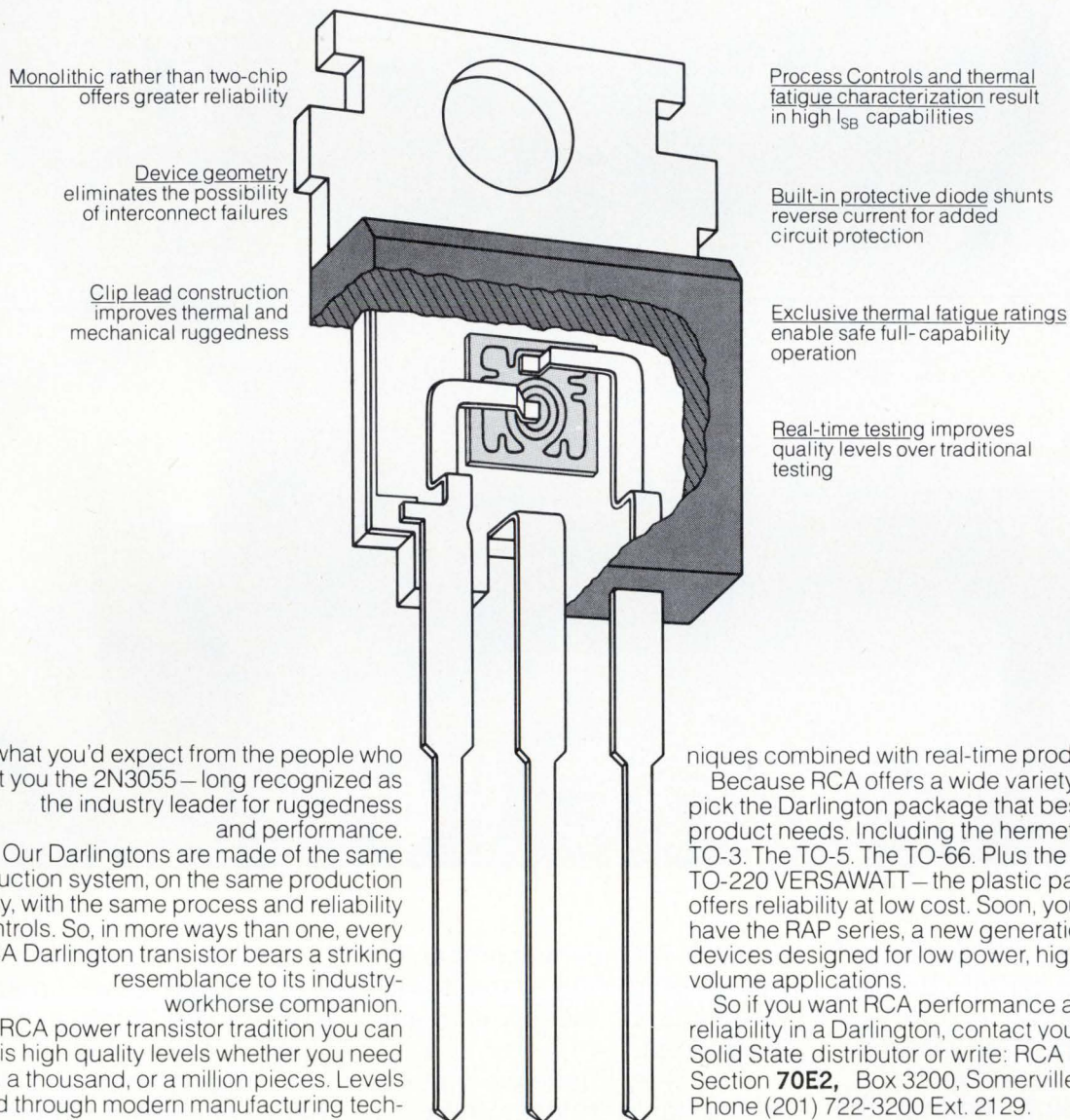

Monolithic rather than two-chip offers greater reliability

Device geometry eliminates the possibility of interconnect failures

Clip lead construction improves thermal and mechanical ruggedness

Process Controls and thermal fatigue characterization result in high I_{SB} capabilities

Built-in protective diode shunts reverse current for added circuit protection

Exclusive thermal fatigue ratings enable safe full-capability operation

Real-time testing improves quality levels over traditional testing

It's what you'd expect from the people who brought you the 2N3055 — long recognized as the industry leader for ruggedness and performance.

Our Darlings are made of the same construction system, on the same production facility, with the same process and reliability controls. So, in more ways than one, every RCA Darlington transistor bears a striking resemblance to its industry-workhorse companion.

Another RCA power transistor tradition you can look for is high quality levels whether you need a hundred, a thousand, or a million pieces. Levels achieved through modern manufacturing tech-

niques combined with real-time product control.

Because RCA offers a wide variety, you can pick the Darlington package that best suits your product needs. Including the hermetic steel TO-3. The TO-5. The TO-66. Plus the RCA TO-220 VERSAWATT — the plastic package that offers reliability at low cost. Soon, you'll also have the RAP series, a new generation of devices designed for low power, high volume applications.

So if you want RCA performance and reliability in a Darlington, contact your RCA Solid State distributor or write: RCA Solid State, Section 70E2, Box 3200, Somerville, N.J. 08876. Phone (201) 722-3200 Ext. 2129.

RCA Solid State

International: RCA, Sunbury-on-Thames, U.K., or Fuji Building, 7-4 Kasumigaseki, 3-Chome, Chiyoda-Ku, Tokyo, Japan.
In Canada: RCA Limited, Ste. Anne de Bellevue 810, Canada.

Brain Trust.

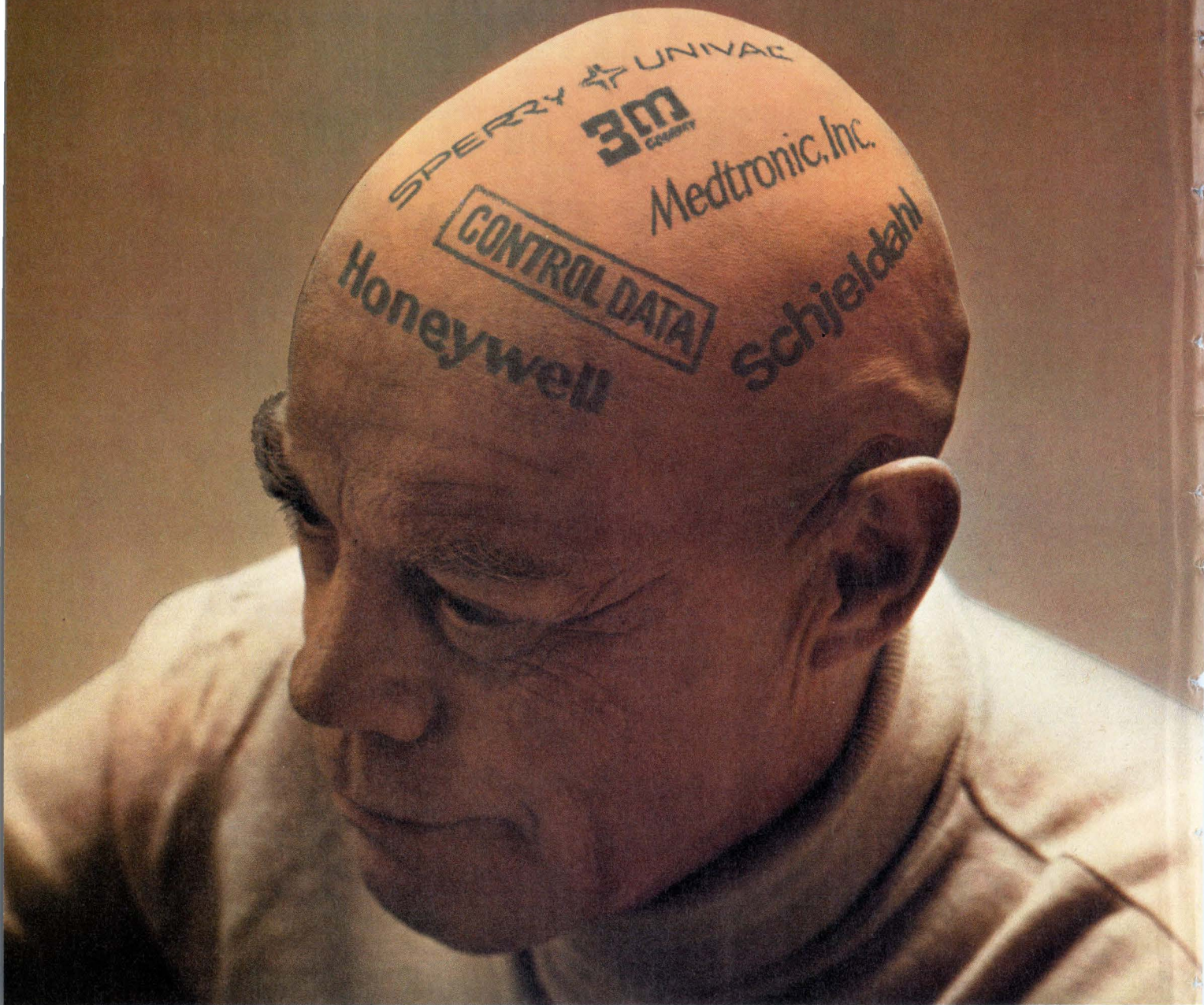

These leading "knowledge" firms have a bright idea for you. Minnesota.

By "knowledge," we mean the scientific-technical kind.

The kind behind the growth of 3M, Medtronic, Control Data, Schjeldahl, Honeywell, Sperry Univac and hun-

dreds of Minnesota companies who depend on the most current state of the art in many disciplines.

They'll tell you why it's so profitable to locate here.

More scientists in the labor force. More dollars invested in research. More em-

phasis on education.

Plus other resources that equate with a superior Quality of Life.

Write and we'll tell you more. Minnesota Department of Economic Development. 480 Cedar Street, St. Paul, Minnesota 55101. (612) 296-5021

It's good to be in Minnesota.

Probing the news

tional Cash Register Co. has built a credit-authorization terminal to National Data specifications.

The reason for this cooperation is that National Data considers itself a marketing company for other people's hardware. And, of course, credit-authorization terminals at the point of sale now represent a big market. Thorpe estimates that there's a potential need for 700,000 terminals in the continental U.S. and Canada, but only 700 are actually in place.

In addition, the company is a big user of the mails (the Atlanta office has its own zip-code number) and more importantly, the telephone. The possibility of more than 750,000 of its own terminals hanging out at the ends of Bell's telephone lines has caused National Data considerable concern. So, along with the design work the firm has done on the authorization terminal, it has been forced to concentrate on remote test and maintenance of the terminals around the country.

National Data recently built its own computer-based terminal-diagnosis system. The program, run off a minicomputer, not only checks out point-of-sale terminals in the field, but in effect, it peers over Bell's shoulder to ensure proper data transmission.

Finding the trouble. The first stage of the plan monitors the frequency portion of transmission from the terminals. It analyzes distortion and indicates the source—the terminal or the transmission system. The reason for this approach, says Joseph A. Mattes, senior vice president for planning and development, is to anticipate a communications failure before the user detects it and to know immediately if any repairs are necessary.

"We want to be able to have our maintenance man arrive at the user's place of business and tell him there's something wrong with the terminal, rather than have him crying for help after a breakdown," Mattes explains. As the number of terminals on line grows, it will be necessary to sweep the entire network, then troubleshoot on an exception basis, he adds. □

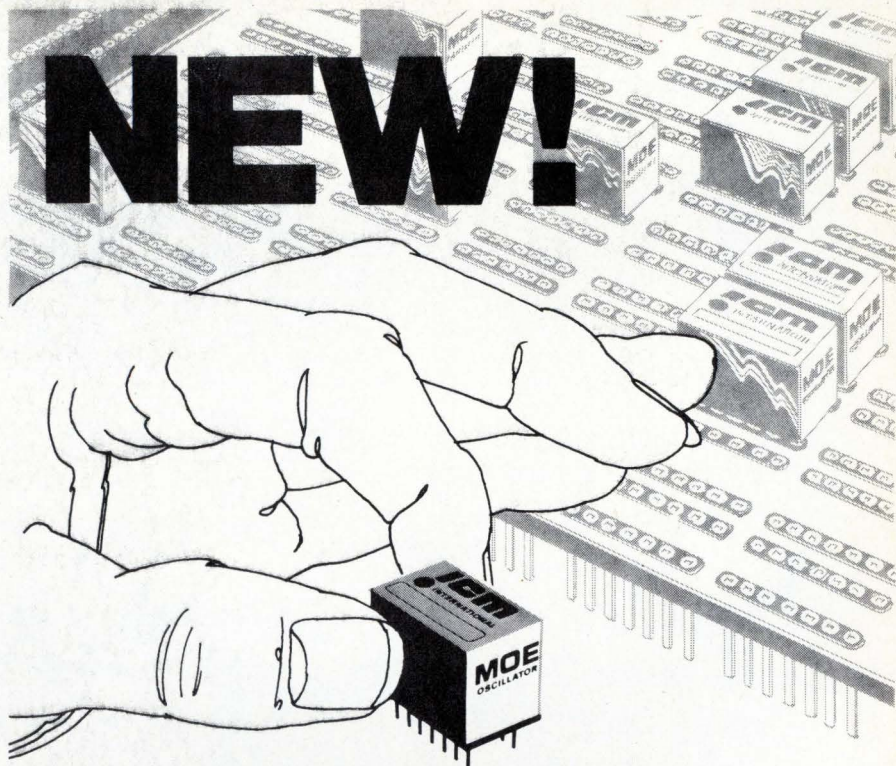

INTERNATIONAL'S MOE Crystal Oscillator Elements provide a complete controlled signal source from 6000 KHz to 60 MHz

The MOE series is designed for direct plug-in to a standard dip socket. The miniature oscillator element is a complete source, crystal controlled, in an integrated circuit 14 pin dual-in-line package with a height of 1/2 inch.

Oscillators are grouped by frequency and temperature stability thus giving the user a selection of the overall accuracy desired. Operating voltage 3 vdc to 9 vdc.



INTERNATIONAL
CRYSTAL MFG. CO., INC.
10 NO. LEE • OKLA. CITY, OKLA. 73102

| TYPE | CRYSTAL RANGE | OVERALL ACCURACY | 25°C TOLERANCE | PRICE |
|--------|------------------|---------------------------|-----------------|---------|
| MOE-5 | 6000KHz to 60MHz | + .002% -10° to +60°C | Zero Trimmer | \$35.00 |
| MOE-10 | 6000KHz to 60MHz | + .0005% -10° to +60°C | Zero Trimmer | \$50.00 |

Domestic or Professional YOUR potentiometer is here

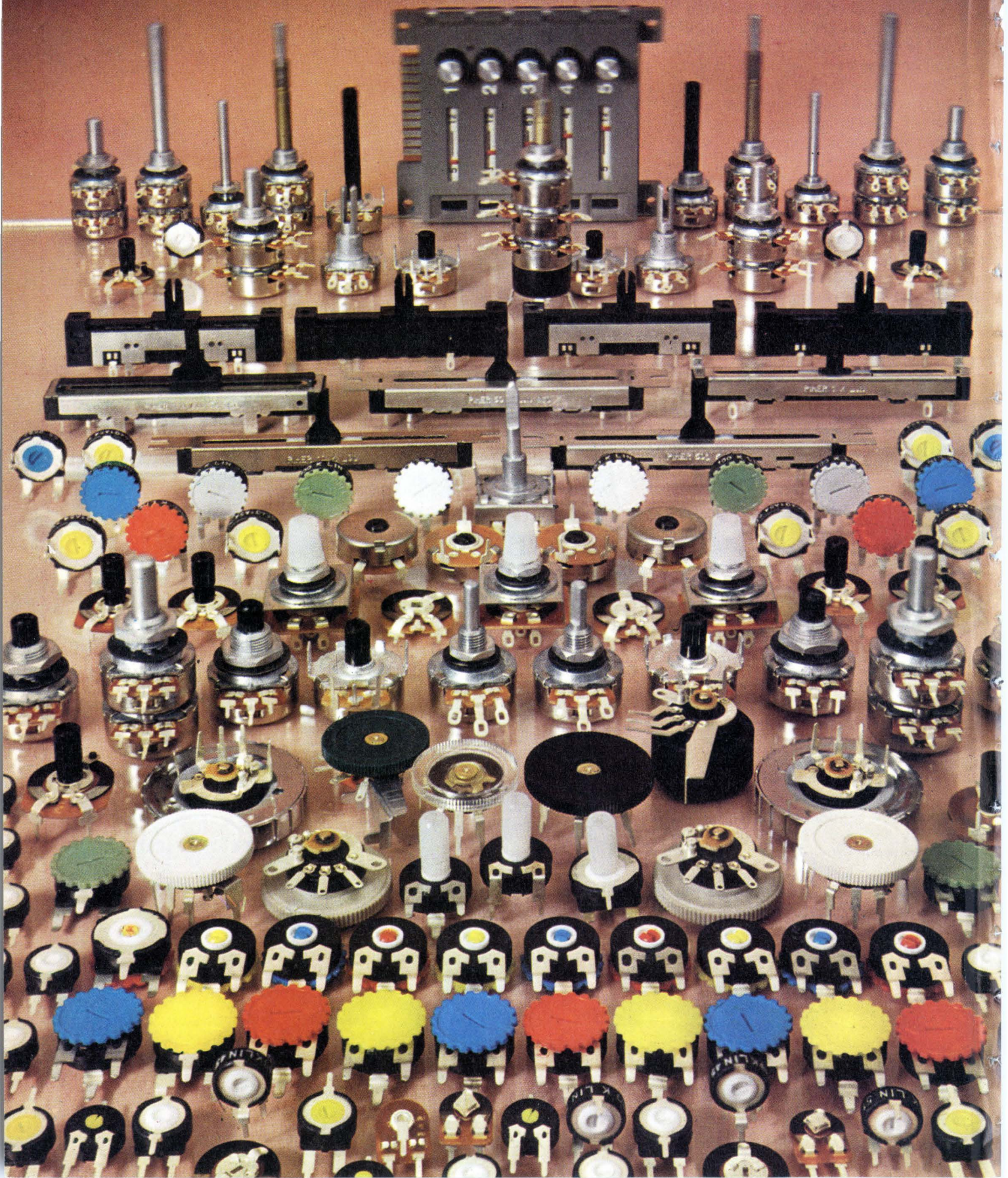

With our range of preset, rotary spindle, slider and rectilinear potentiometers – all designed round the prime requirements of noise-free operation and long life – we have brought new standards of quality and reliability to the potentiometer market for domestic or professional use.

In a technology not normally associated with dramatic breakthroughs we have introduced new ideas to component design and manufacture.

Like our Series PT preset pots which are fully enclosed in flame retardant plastic for protection from environmental factors. And the new PL40 slider pot, with its enclosed track and specially designed wiper movement that eliminates jitter, giving ultra-smooth operation.

Of course we also provide the usual options, like matched pairs for stereo applications, various terminal arrangements, earth screening and mains switches.

There's also the new PL25, a 20-turn rectilinear preset control for radio and tv varicap tuning applications.

In short, in any situation calling for high quality potentiometers, the discerning engineer should turn to Piher.

Write or ring for full details.

U.K. – PIHER International LTD.,
Romar House, The Causeway,
Staines, Middlesex, England.
Tel: Staines 56157. Telex 934167.

U.S.A. – PIHER International Corp.,
4239 Rand Road, Des Plaines,
Illinois 60016, U.S.A.
Tel: 312 297 1560. Telex 282154.

Germany – PIHER International GmbH,
85 Nurnberg, Tuchergartenstrasse 4,
W. Germany.
Tel: 0911 533 051. Telex 623354.

France – PIHER International SARL,
83, Rue Etienne Dolet, 94230,
Cachan, France.
Tel: 656 26 07. Telex 27107.

Italy – PIHER International S.P.A.,
Via Censio 34, 20154 Milan, Italy.
Tel: 314532/316213.

Head Office – Riera Cañado,
s/n Apartado de Correos 53,
Badalona (Barcelona), Spain.
Tel: 389 03 00. Telex 59521.

 **PIHER**

Circle 77 on reader service card

Probing the news

Packaging & Production

Printed-circuit makers take additive route

Plating copper on, rather than etching it away, cuts costs in latest breed of double-sided plated-through boards

by Stephen E. Grossman, Packaging & Production Editor

The additive approach to making printed-circuit boards is gaining a firm foothold, thanks to mounting automotive and consumer market demands for high-volume, low-cost boards—and heightened competition between the process's promoters. Already boards made by the additive process account for about 8% of worldwide pc-board production, and that share may climb to 25% by 1975.

Making boards the additive way means building up copper where it's required, instead of taking it away where it's not wanted—as in tradi-

tional, selective-etch processing. In the highly cost-conscious pc-board field, the innovation represented by the additive approach holds out the promise of shaving precious pennies from manufacturing costs.

Indeed, in double-sided, plated-through boards, the additive approach can save pc-board makers anywhere from 15% to 25%. What's more, additive boards can deliver copper-to-laminate peel strengths as good as, and solderability probably better than, subtractive boards.

Start up. In the early 1950s, printed-circuit pioneers had no

Two routes. Additive-pc-board making (left) starts with uncoated board. Masking protects areas where copper is not wanted, instead of where it is wanted, as in the traditional subtractive approach (right). Both ways give same finished board.

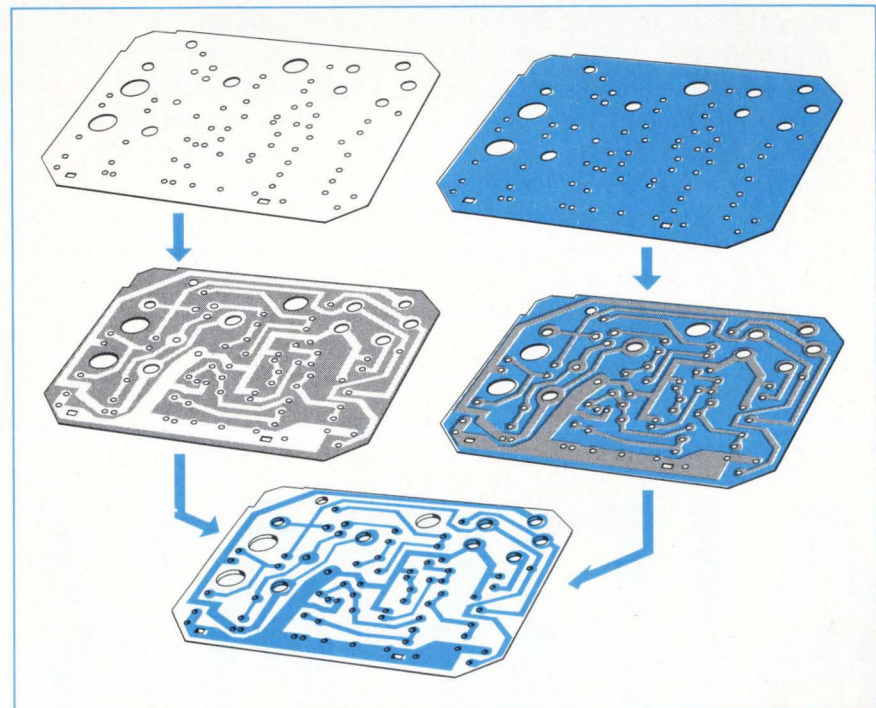

NEW
FROM
AIRPAX



The
New
Design

Edge-reading Control Meter the ER-35

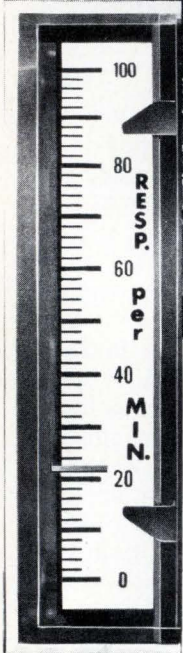

The solid state AIRPAX "Parkermeter"® Series ER 35 Control Meter . . . the finest ultra-compact, contactless, edge-reading meter available today . . . improved switching . . . more reliable meter movement . . . extremely rugged precision-molded case . . . state-of-the-art manufacturing throughout. The ER-35 is available with one or two set points and provides four control switching configurations . . . is only 7/8" thick . . . can be panel mounted or stacked in any quantity as required . . . horizontal or vertical displays available. Truly the most modern and dependable of all.

For detailed information write for Catalog 0200G.

AIRPAX Controls Division P.O. Box 8488
Fort Lauderdale, Florida 33310 Phone: 305/587-1100

AIRPAX™

Probing the news

choice between additive and subtractive processing because no one had mastered the technique of plating thick, ductile copper onto an insulated board. What they could do was to attach a sheet of copper to an insulated board with an adhesive. After masking to protect the regions where copper was wanted, the board was bathed in an etchant to remove the unneeded copper.

Ten years. A decade ago, the Photocircuits division of Kollmorgen Corp., Glen Cove, N.Y., began additive production by figuring out how to plate on an intermediate adhesive. Then, in 1971, MacDermid Inc., Waterbury, Conn., a leader in the plating of plastics, introduced its version, which differs from the Photocircuits approach by plating directly onto the board.

Today, Photocircuits and MacDermid are battling it out in the marketplace. Says A.J. Siegmund, product-marketing manager at MacDermid: "It used to be that everyone tried additive, but nobody bought it. But now the printed-circuit industry is more cost-conscious than ever, and the evidence is building that additive can save money."

Convinced of its advantages, some large companies with captive shops switched to additive in the past few years—RCA in 1971 and IBM in 1968. Now the contract shops, which produce about 30% of the industry's boards, are also turning to the additive method.

For example, Circuit-Wise Inc., North Haven, Conn., went to additive processing in 1972 for electronic-ignition boards, which now account for 100,000 of the 400,000 boards the company turns out a month. Says Jack Mettler, Circuit-Wise vice president: "Making boards by the additive method promised labor costs one-fifth that of the subtractive boards."

What's more, he says, in the past two years the company has brought the copper price down to 85 cents per mil-foot² from \$1.35. And he expects the cost to fall to 50 cents per mil-ft², or about 5 cents below the present cost of copper for subtractive boards. Now that the Government has taken the price lid off cop-

per, prices for copper-clad laminate and copper anodes—the basic ingredients of a subtractive board—are expected to jump 25%. On the other hand, electroless copper, the heart of the additive process, is a high-profit item for its suppliers, and they are expected to soak up most of any price rise.

Concludes Mettler: "I recommend that manufacturers handling 10,000 pieces or more per month try additive on 500 to 1,000 pieces. Then they can decide if they want to commit themselves to the additive process."

Competition. Photocircuits has licensed its CC-4 process to 31 companies—including Western Electric, Hitachi, IBM, and Motorola—to make additive boards. The license route with companies having large captive operations is particularly attractive to Photocircuits because there is little likelihood that they will compete with Photocircuits' own pc-production capability.

However, it has also licensed a competitor. Methode Electronics Inc., Chicago, signed up with Photocircuits in 1973 and is going on stream with a 22,500-square-foot additive plant. William J. McGinley, president of Methode, says that additive is about 30% less expensive than subtractive for two-sided plated-through circuitry. "Since yields are better with the additive process, there is a price advantage for very dense boards," he adds.

"Finer spacings of lines is possible because there's no undercutting, as there is in subtractive etching." For the pc board in its simplest form—the single-sided board—subtractive remains less costly than additive, he points out.

MacDermid introduced the Plaid II version of its additive printed-circuit technology in May 1972 and has attracted Circuit-Wise and Litton Advanced Circuitry division in Springfield, Mo., among others. "While there's always going to be more room for subtractive two-sided plated boards," says Neal Hales, marketing vice president at Litton, "we look for additive to be big in automotive and consumer-electronic applications." Hales estimates that additive-board volume will reach \$6 or \$8 million in 1975.

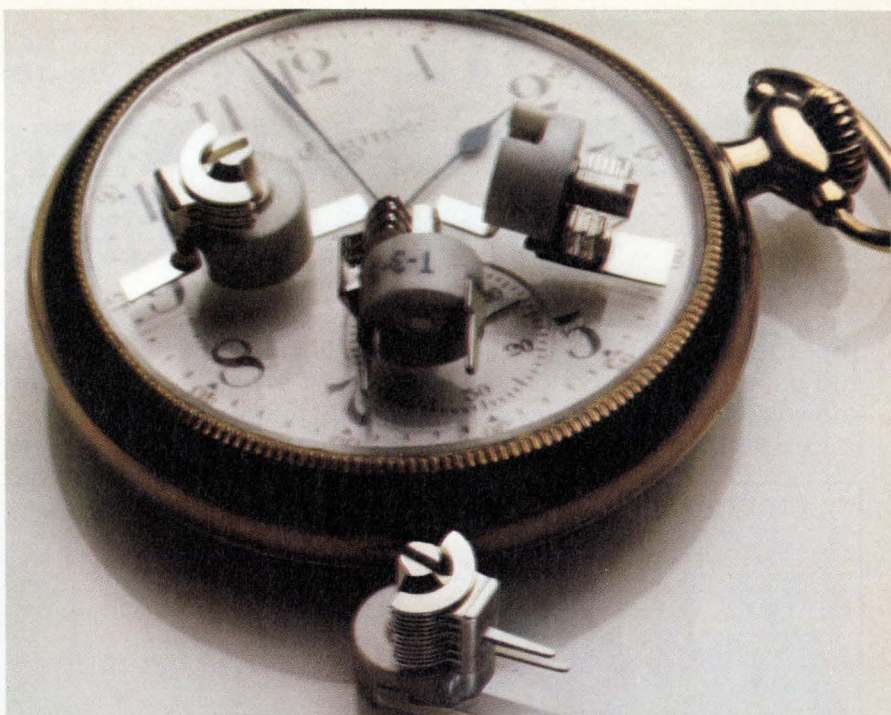

We can deliver the world's smallest 180° air variable capacitors. On time.

And since we're nice people, we don't even charge much for them. So if you have an application that calls for a sub-miniature capacitor that you can "tweak" to a specific frequency, these Johnson trimmers are ideal.

You can choose from either PC or stripline mount, either vertical or horizontal tuning. These Type "T" capacitors are about one-third the size of the familiar type "U" capacitors, so you can save space, cut costs and insure improved performance in the most compact electronic equipment.

Rotors and stators are precision-machined from solid brass extrusions, resulting in exceptional stability and uniformity. High Q—typically 2000 at 150 MHz. Temperature coefficient is a low plus 30 ± 15 ppm/°C. High torque (1½ to 8 oz./inches) holds rotor securely under vibration. They're designed to meet or exceed EIA-RS 204 and MIL Standard 202C Methods 204A and 201A.

In short, these capacitors may be just what you've been looking for. It'll only cost you a stamp to get more information. And if you give us your phone number, we'll call you and send free samples after we have clarified your application.

E. F. JOHNSON COMPANY
3005 Tenth Ave. S.W. / Waseca, MN. 56093

- Please send me technical information on the type T.
 Also, include information on your entire line of variable capacitors.
 I want test samples. Please call me at _____
 NAME _____
 TITLE _____
 FIRM _____



ADDRESS _____
 CITY _____ STATE _____ ZIP _____

E. F. JOHNSON COMPANY

The new Keithley Model 168 autoranging DMM... ...vive la différence!

There really is a difference in Digital Multimeters, and once you've experienced Keithley's 168 you'll know why we say *vive!* If you're tired of "general-purpose" promises that turn into run-of-the-mill

performances; if you want that bit extra that'll make your job easier, then *vive la différence*... here's the DMM for you! Send for our DMM Selector Guide or call us for demo now. Phone (216) 248-0400.

AC VOLTS
DC **AMPS**
OHMS

5 functions
100 μ V to 1000 V dc
100 μ V to 500 V ac
0.1 μ A to 1 A dc
0.1 μ A to 1 A ac
100 m Ω to 20 M Ω

price
Enough said? Order one... or two... or three now!

\$299⁰⁰

two-terminal input

Simple to connect. You can't get it wrong. Eliminates the word "whoops" from your vocabulary. Saves temper, too.



hi-lo ohms

Select either of two voltage levels, 1 V or 100 mV, for ohms measurements. You can have your PN junctions either way you want 'em... on or off.

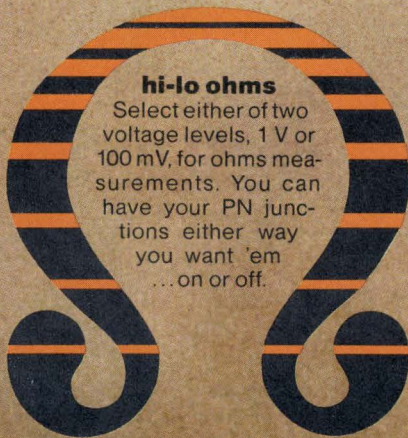

options & accessories

Rechargeable batteries that you can install anytime. An RF probe for high frequencies. Test leads. A 50-amp current shunt too.



automatic ranging

You just connect the signal and push the function. The decimal point pops into position automatically and the display is direct reading. That does save time!



KEITHLEY INSTRUMENTS
U. S. A.: 28775 AURORA ROAD, CLEVELAND, OHIO 44139
EUROPE: 14, AVENUE VILLARDIN, 1009 PULLY, SUISSE

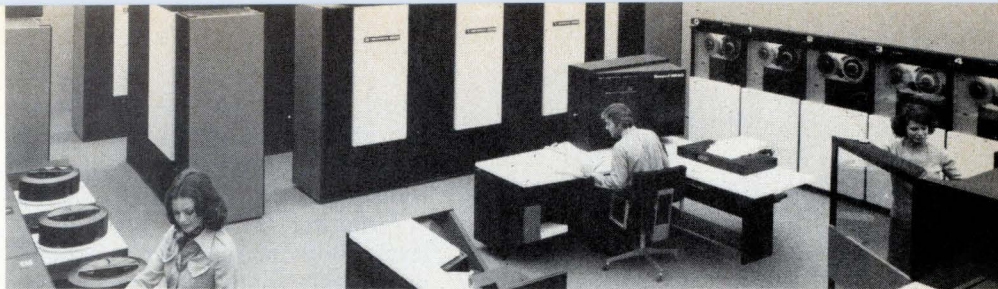

Computers

HIS completes its consolidation

New Series 60 fully integrates at last the former Honeywell and GE machines into a single multilevel line with semiconductor memories

by Wallace B. Riley, Computers Editor

Three and a half years after buying out General Electric's computer-manufacturing business, Honeywell Information Systems Inc. has introduced a new line. Called the Series 60, it ranges all the way from mini-computers to supercomputers and represents the final step in consolidating the GE and Honeywell product lines.

Technologically, the Series 60 has some innovations that are new to Honeywell, but not to the industry:

- All levels of the series use semiconductor memory. Honeywell has used semiconductor memory before, but never to the extent that it has in the Series 60.

- A few of the largest models use high-speed buffer (cache) memories in front of the relatively slow main memories. IBM introduced the cache concept in its big machines five or six years ago and has used it repeatedly since then, but, until now, no other computer manufacturer has followed suit.

- A high-speed non-impact printer that can produce 18,000 lines per minute of hard copy was announced at the same time as the Series 60. The printer can be used as a Series 60 peripheral, but because it is an off-line device it is essentially a separate development.

Series 60 will appear on five levels, called the 61, 62, 64, 66, and 68, in order of increasing size. Each model is optimized for a particular class of user, but offers a modular growth path so that users can graduate easily to larger systems as their needs increase. In general, several models are available at each level. The basic models are compatible

with each other, but the successive levels are not cross-compatible, although all can be upgraded to higher levels.

Semiconductor main memory in the new machines is built with 1,024- and 2,048-bit MOS packages in all models at every level. Capacities range from 64,000 to 8 million bytes in various models. Before the Series 60, Honeywell had used MOS only in its top models of the 6000 series.

Cache memory. The MOS main memory has an access time of 750 nanoseconds, while the much smaller cache, made of bipolar cir-

cuits, can produce data in less than 200 ns. Whenever the processor calls for a word from the main memory, the system transfers a much larger block of data into the cache, including the requested word. This ensures that data needed by the processor is nearly always in the cache, and thereby makes the machine run as if its entire memory were producing data at the rate only the cache can achieve.

Virtual memory is available in the larger models. The smaller versions have something Honeywell calls integrated data store, which is a method of data-base management—

A new standard for the data quantum?

Despite the industry standard of 8-bit bytes plus parity, the largest models in the Honeywell Series 60 are built with 9-bit bytes plus parity. This choice is based on the computer's 36-bit word, a legacy of the 6000 and GE 600 series, dating back to the early 1960s. Honeywell's large computers have always kept this word length because it permits superior single-precision floating-point arithmetic. Too much accuracy is lost with a 32-bit word, the IBM standard, and when accuracy is restored with double-precision computation, the speed decreases sharply. For data communications and character-oriented processing, the 36-bit word can be easily divided into 9-bit segments, but not into 8-bit segments.

The extra bit also allows instant conversion between today's two "standard" data codes, ANSI'S ASCII and IBM'S EBCDIC. Needless to say, the two codes are incompatible. A ninth bit in a byte could be useful as a flag to indicate which code is represented by the other 8 bits, thus permitting the two codes to be mixed in a single system.

Unstated—officially, at any rate—is the rumor circulating through the computer industry that the 9-bit byte may be adopted by IBM in its next major computer announcement, expected in 1975. This change would enable IBM computers to use ASCII when communicating with outside networks, while retaining EBCDIC internally. It would improve the accuracy of single-precision floating-point arithmetic. And it would upstage those competitors who try to be IBM-compatible but aren't geared up to switch quickly to a 9-bit byte.

Thus, by going to 9 bits in its new large computers, Honeywell seems to have jumped well ahead of the rest of the industry.

Probing the news

sort of a poor man's virtual memory.

All the logic in the new machines is TTL, most of it off-the-shelf standard products in medium-scale integrated circuits. A few custom parts, including some using Schottky TTL, are used, especially in the larger models. "We found TTL available in

larger volume and therefore more cost-effective than ECL," says Ugo O. Gagliardi, director of the HIS technical office.

Firmware control is used at all levels, both in mainframes and in peripheral controllers. Honeywell has used firmware (microprograms) in a few of its older machines, but never across the board. Basic firmware is in fast read-only memories in all models and in the in-

put/output controls; in the smaller machines, other microroutines that are not time-dependent or critical in over-all performance are in a read/write control memory made with the same technology as the main memory.

A new line of peripheral equipment is also being produced for use with the Series 60. This includes three new disk-storage units, two families of magnetic-tape drives and controllers, and two new belt printers that run at 1,200 and 1,600 lines per minute, as well as the high-speed page printer. Many of the peripheral controllers, especially in the smaller models, are integrated with the mainframe, eliminating the need for a raised floor in the room where the computer is installed.

James A. Synk, director of advanced-marketing planning, says, "Our data on user trends shows that most new applications for computers of all sizes are being programmed in high-level languages. Therefore, in the Series 60, we are emphasizing high-level language capability at all levels"—including a new version of Cobol recently issued formally as a standard by the American National Standards Institute, a new ANSI Fortran, now being developed but not yet formalized, and a report-program generator (RPG) derived from the version supported by IBM for its small System/3 computer. Because ANSI has not begun to consider a formal standard for RPG, the IBM version offers the most convenient *de facto* standard. All software for the Series 60 will be separately priced.

Levels listed. Level 61, which includes the models 61/58 and 61/60, is being sold only in Europe. It represents an evolution of the Honeywell 58, a product of Honeywell Bull, in France.

Level 62 consists of only the 62/60 in the United States and of two models, 62/40 and 62/60, in Europe. They are intended for customers starting to use computers for the first time and for users of the smaller models of Honeywell's older 200 and 2000 series in the U.S. or of the G-10, a product of Honeywell Italia, in Europe, who want to switch over to the new series. Compatibility with these two different lines is through simulation. The new

8 CASES FOR SWITCHING TO NATIONAL[®] SCRs



16-1600 Amperes rms
25-1700 Volts
Power and Inverter SCRs
Patented Regenerative Gate

Call or write for full details



NATIONAL ELECTRONICS

a varian division

geneva, illinois (312) 232-4300

The All-In-One, Voltage Invariable, Self-Regulating, Constantly Bright, Money Saving, LED Lamp System.

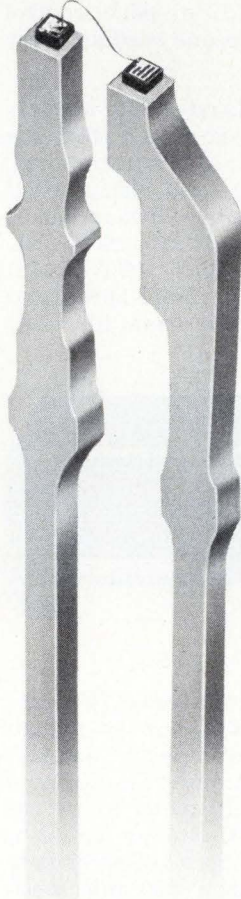
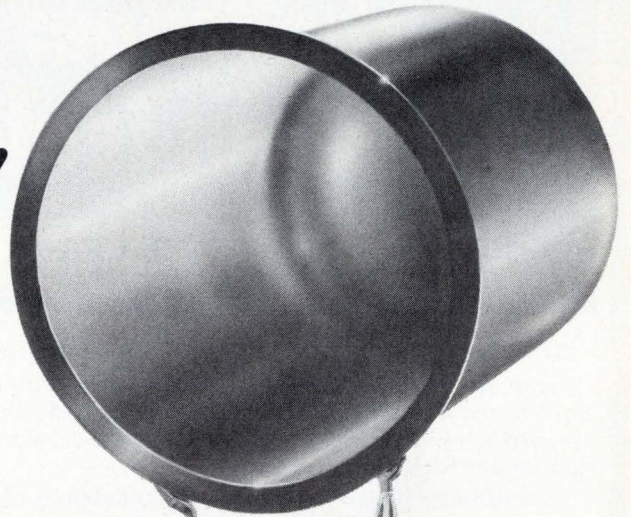

Under the dome of every Red-Lit series LED lamp is a bipolar IC current regulator that holds the LED's brightness constant through a supply voltage range as wide as 4.5 to 16 volts.

This revolutionary design eliminates current-limiting resistors, individual drive circuits and even supply regulators. That's why you'll save far more than the few pennies the Bright Guys charge for adding the regulator IC. You'll save on design costs, components, board assembly and supplies.

Some neat savings in inventory and spares can be made, too. Since these lamps shine the same at different voltages, there's no need to use different

types in panel circuits operating at different voltages.

Customer satisfaction is another benefit. When power supplies fluctuate or batteries droop, these LED lamps don't.

Three types are available: RLC-200 with a constant brightness of 1.2 mcd; RLC-201 at 0.7 mcd; and RLC-210 at 0.6 mcd. The RLC-200 and RLC-201 come in T-1 $\frac{3}{4}$ lamp size and cost 50¢ in 1K quantity. The RLC-210 in a miniature T-1 package costs 60¢ in 1K quantities.

At these prices, why put all the parts together? Get your all-in-one LED lamp systems at reps and distributors, or right from us.



litronix

Litronix, Inc. 19000 Homestead Road, Cupertino, California 95014
(408) 257-7910 TWX: 910-338-0022
European Headquarters: Litronix, Inc. Bevan House, Bancroft Court
Hitchin, Hertfordshire SG5 1LW England Tel: 2676 Telex: 825-497

The Hickok challenge: match our features, beat our price.

Most people know that the Hickok line of Digital Multimeters is one of the best performing on the market. The hard fact is, you can spend a lot more for a Multimeter and still not get all the features we offer. That's why, spec for spec, Hickok is your best all-around dollar investment.

All of our 3400 series Digital Multimeters come with 4¾ digits, an optional 300% overranging that enables you to read to 39999 on all five functions, an accuracy of .01%, a front panel control to vary the reading rate from 2 per second to one reading every five seconds and a solid 3-year warranty.



The Standard 3400 Multimeter is priced at just \$595. It's a rugged, non-tempermental, hard-working tool with a 10 μ V resolution built-in. It handles DC voltage from 10 μ V-1200V; AC voltage from 10 μ V-1000V RMS; resistance from 10m Ω -20M Ω and DC/AC current from 10nA-2A.

The 3410 Microvolt Multimeter is priced at \$695. It offers full Multimeter capability with 1 μ V and 1m Ω resolution. It has 10 times more sensitivity for low-level measurements. A built-in guard box virtually eliminates errors due to ground loops and power line hum and provides for additional operator safety.



The 3420 Multimeter/Counter costs \$750. There is enough measurement capability in this one compact unit to replace a four-digit multi-meter as well as a five-digit frequency counter. Time base is from 100 seconds to 10 milliseconds; 100 mV sensitivity at 20 MHz.



So remember, with Hickok your dollars will go as far as they can. Send for our 3400 Series Data Sheet for complete specifications on our digital Multimeters.

HICKOK
the value innovator

Instrumentation & Controls Division
The Hickok Electrical Instrument Co.
10514 Dupont Avenue - Cleveland,
Ohio 44108
(216) 541-8060 - TWX: 810-421-8286

Probing the news

level 64 consists entirely of one model at present, the 64/20, but compatibility is optional with the larger 2000s in the U.S. and with G-100 in Europe.

Four models constitute the level 66. They are the 66/20, 66/40, 66/60, and 66/80—all compatible with various versions of Honeywell's current 6000 series, and compatibility with the 2000 series is optional.

At the top of the new line is the level 68, which again consists of only one model, the 68/80. It is a replacement for the present Honeywell 6180, built specifically for the Multics time-sharing system. Multics was developed jointly by GE and Massachusetts Institute of Technology around a souped-up General Electric 635 computer that became known as the GE 645; the Honeywell 6180 is an improved version of the 645.

None of the older machines is being discontinued. "We find that 80% of our business comes from former customers," says Synk. "We don't want to force them to convert to the new series, so we're continuing to support the older ones to permit the user to move up in either the old line or the new."

GE plants. Although the distinction between the Honeywell and GE computer lines is now disappearing, most of the new line will be made in former GE plants. Levels 61 and 64 will be made by Honeywell-Bull in France, formerly known as GE-Bull; levels 66 and 68 will be built in Phoenix, and peripheral equipment in Oklahoma City—both former GE facilities. Level 62 will be made primarily by Honeywell Italia, which was at one time part of the Olivetti organization. Most other Honeywell plants will continue with the same equipment as before—for example, the series 16 minicomputers in Framingham, Mass., 200/2000 in Brighton, Mass., which also will build levels 62 and 64, 6000 in San Diego, Calif., and both new and old peripheral equipment in Lawrence, Mass. Framingham's 716 minicomputers are used in the non-impact printer and in the Datanet front-ends that go with the level 66 in a data-communications net. □



Now you can get a foreground/background system for less than \$25,000. And that's before discounts.

Now there's a foreground/background disk-based system available for thousands of dollars less than any other hardware/software combination. And it offers more performance than has ever been available before.

It's based on RT-11, Digital's new F/B operating system, and the PDP-11E10. (RT-11 is also available on other PDP-11 systems.) And you can run the single job version with just 8K words of memory and a dual DECTape drive for less than \$18,500.

RT-11 is designed for the on-line user who is involved in program development and/or

real-time applications. It's a fast, low-overhead (less than 3K resident) system. And you don't have to be a computer scientist to use it... or even to modify it.

New, high performance, extended versions of Dartmouth-compatible BASIC and ANSI-Standard FORTRAN IV are available. Both offer high level language support of sequential and direct access files, chaining, overlays, A/D's, D/A's, clocks, digital I/O, graphics, plotting, signal processing... And there's more coming. And the minimum FORTRAN and BASIC are supported on just 8K of memory.

These are just some of the features that make RT-11 the highest performing on-line system with the lowest price in the market.

For additional details on RT-11 performance, write Digital Equipment Corporation, Maynard, Mass. 01754 (617) 897-5111, Ext. 2083. European headquarters: 81, route de l'Aire, 1211 Geneva 26. Tel: 42 79 50. Digital Equipment of Canada Ltd., P.O. Box 11500, Ottawa, Ontario K2H 8K8. (613) 592-5111.

digital

“We expected the quality. What floored us was the throughput.”

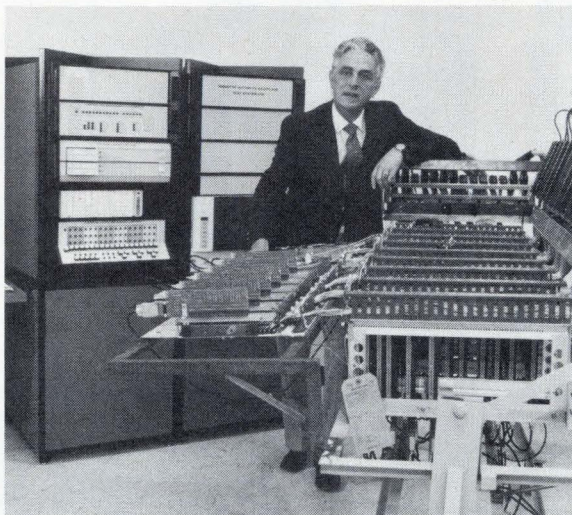

Walter H. Canter, Jr.
Vice President of Manufacturing
Industrial Nucleonics Corporation

In a fast-growing company like Industrial Nucleonics, there's constant pressure for increased productivity. But Walter Canter, IN's VP of Manufacturing, knows that product quality has to come first, and his job is to increase production without sacrificing that quality. If he can find a way to boost both quality *and* throughput, he's way ahead of the game—the game in this case being backplane wiring.

“The backplanes that go into our large AccuRay process automation systems run from a few hundred points to eight or nine thousand. Like most people, we used to manually inspect the wiring. That took time. Worse, it was subject to the same kind of human error it was supposed to uncover.”

The answer was a Teradyne N151 Computer-Operated Backplane Test System, which now *completely* checks the wiring on a 6,000-point

backplane in about 15 seconds. With no programming to worry about. The N151 learns the wiring either from a known good backplane or from the same program used to control the wiring.

What all this means to Walter Canter is this: “We save money on backplane inspection time, and we save money later in the final testing of systems. The N151 paid for itself here in 10 months. Best of all, our N151 works two shifts a day, six days a week, with no downtime to speak of.”

Find out more about Teradyne's N151, the system that has literally revolutionized backplane testing. Write Teradyne, 183 Essex Street, Boston, Massachusetts 02111. In Europe: Teradyne Europe S.A., 11 bis, rue Roquépine, 75 Paris 8^e, France.

TERADYNE

Chicago (312) 298-8610 / Dallas (214) 231-5384 / New England (617) 458-1256 / New York (516) 364-9797 / Sunnyvale (408) 732-8770
London (093-28) 61111 / Paris 265 72 62 / Rome 59 47 62 / Munich (0811) 33 50 61 / Tokyo (03) 406-4021.

Microprogramability lets user tailor new minicomputer to his requirements

A new family of general-purpose minicomputers that meet custom needs is also one of the first production series to exploit the high density and low power dissipation of 4,096-bit semiconductor chips

by John Stedman, Hewlett-Packard Co., Cupertino, Calif.

□ Today's minicomputer must be flexible enough to fit readily into individual applications without bringing with it the performance tradeoffs that "general purpose" often implies. Yet, a mainframe tailored to solve a specific problem should have the ability to expand its capabilities as requirements increase.

The first two members of a family of user-micro-programable minicomputers, the Hewlett-Packard 2105A and 2108A, have been developed with these goals in mind. With user-microprogramability, the minicomputer maintains its versatility and yet adapts readily to users' custom requirements. The new machines are also among the first in full production to use 4,096-bit semiconductor memory chips in their main memories. Furthermore, many new instructions are available in the new machines, which nevertheless remain compatible with previous models.

Semiconductor memories give the new machines a number of advantages—such as high density, low power dissipation, and potential improvements in speed and reliability. Furthermore, with 4,096 bits per chip, they seem to have reached the stage of costing less than ferrite-core memories.

Nevertheless, the design was committed to semiconductor memory long before the cost decreased below the level of ferrite-core memory. The new units were breadboarded with core, but the change to semiconductor random-access memories—1,024-bit devices first—was made soon thereafter. During this period, the designers' contact with semiconductor suppliers made them confident that 4,096-bit RAMs of high reliability would become available in adequate

quantity for 1974 equipment production. The design centered around these devices very early, and the risk had to be taken that costs would come into line.

Volatility is no problem

The advantages of semiconductor memory, of course, are accompanied by disadvantages. An important one is volatility, or loss of stored data in the event of a power failure. But accepting this disadvantage wasn't difficult. Power failure has always been an important hazard to computers, even those with core memories. Some core-based computers commonly go into power-fail routines upon the absence of as little as a single cycle of main line power.

Because of the semiconductor memory's special characteristics, the design of the power module of the new minis received special consideration. The design study included ways to build in immunity to low or high power-line voltage and line-frequency variations, as

Small. First of new user-microprogramable minicomputers from Hewlett-Packard, the 2105A comes with 16,384 or 32,768 16-bit words in its memory and has four input/output channels. Memory is assembled from 4,096-bit MOS chips and is among the first to use these components extensively.



Architecture for microprogramability

The control logic of the computer, through microprograms stored in the control memory, executes all machine-code instructions. Because of its use of microprograms, the control logic is sometimes called a microprocessor. (But note that this term is also used to refer to one-chip large-scale integrated-circuit processors, which are not used in H-P computers). Because much of the hardware of the control logic is used commonly by many instructions and is available for future instruction-set enhancements, much less hardware is required than where some is dedicated to each individual instruction.

In the H-P 2105A and 2108A, the primary bus is the S-bus, a three-state transistor-transistor logic bus that interconnects most of the machine's registers and the arithmetic-logic unit (ALU). The ALU implements functions such as ADD, SUBTRACT, COMPLEMENT, AND, inclusive-OR, exclusive-OR, INCREMENT, and DECREMENT. It is made from commercially available medium-scale-integration products. Its input comes from the latch register, a 16-bit register loaded from the S-bus. The latch register holds one operand for the ALU, while the

other operand is supplied directly via the S-bus.

The 16-word register stack is put together from fast 64-bit read-write memory ICs. This "memory" contains twelve 16-bit scratch registers, two index registers, the program counter, and the switch register.

When an instruction is read from the main memory under control of the microprogram, it is passed into the transfer register, onto the S-bus, and then into the instruction register. Instruction-register outputs consult several look-up tables to generate a control-memory address. This goes to the read-only-memory address register to locate the particular microcoded execution routine for that instruction.

The routine is found among 4,096 24-bit microinstructions in the control memory. Outputs of the control memory are loaded, one word at a time, into the ROM instruction register, a 24-bit register that is divided into five fields: op-code, ALU, S-bus, store, and special. A separate decoder serves each of these fields. The signals they generate, and the operations performed by the processor, depend on the coding of each field in the microinstruction.

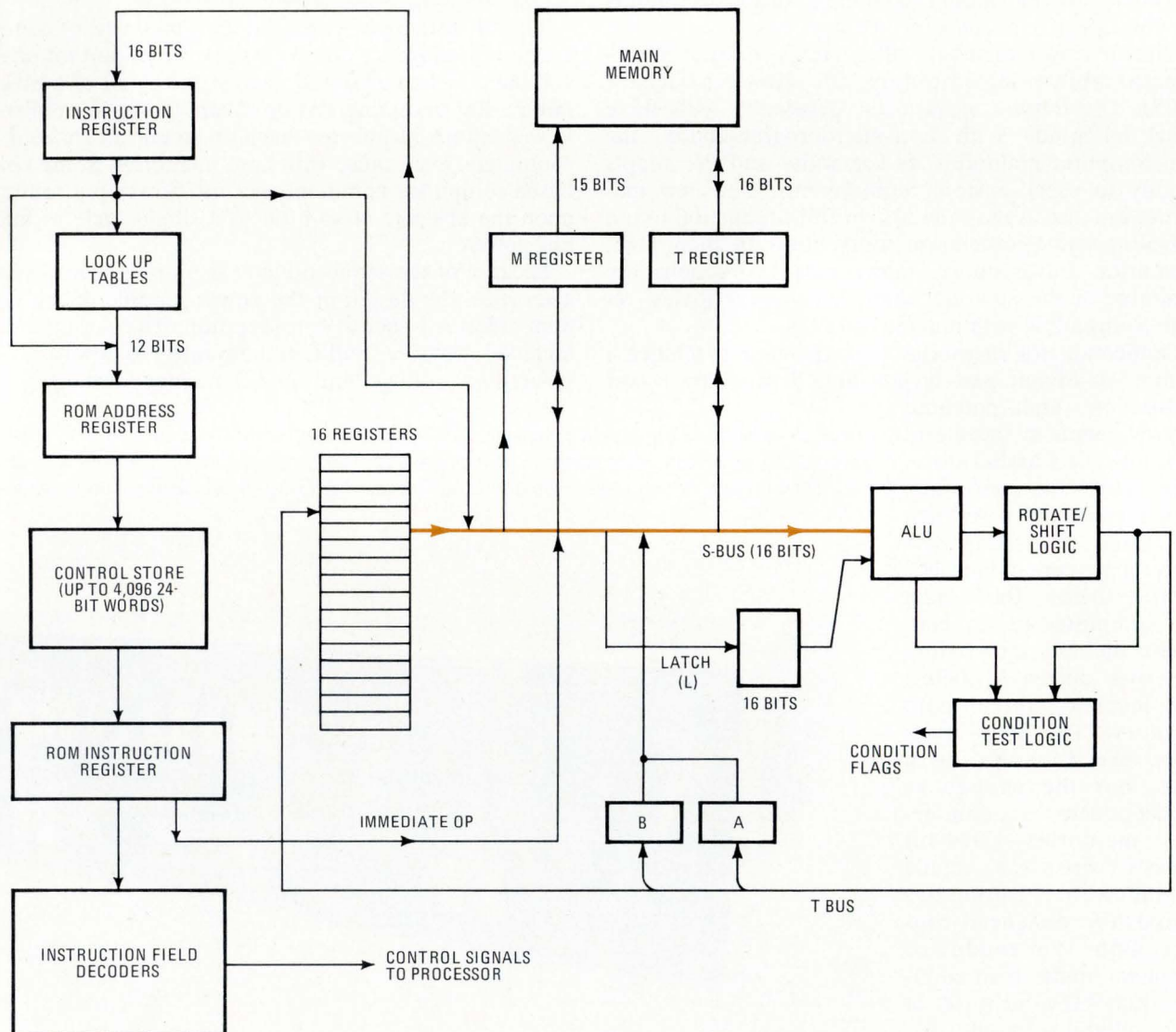

well as from outright power loss. Such precautions were necessary because the family was intended for use even in environments traditionally hostile to computers. The machines had to tolerate brownout conditions and unstable sources of power, such as auxiliary generators, without sacrificing performance. Providing battery standby protection for the volatile semiconductor memory was only one of many design decisions related to these special characteristics.

Perhaps the most appealing advantage of semiconductor memory is reliability. A large part of the project effort was devoted to testing memories from all suppliers, and results indicate that mean time between failures will be at least twice that of core memories. An improvement of 15 times may well be established. This improved reliability is particularly important in the larger memory capacities.

The cost of semiconductor memory already has fallen to about 10% below that of equivalent core memory. As more vendors of semiconductor memory enter the field, and as they gain more experience with the manufacturing processes involved, the price of 4,096-bit RAMs is certain to drop even further. Meanwhile, core-memory making is a well-established art, so that further large reductions in core cost seem unlikely.

Semiconductor-memory technology is not the exclusive province of any single manufacturer, and none could be ignored. From the beginning of the project, therefore, relationships were established with all U.S. manufacturers who were willing to be considered potential suppliers. Their cooperation has been most gratifying. Designs differ, of course, but the project included accommodation to all those differences at the printed-circuit-board level, and every plan included the ability to make these differences invisible to the processor. Thus, as the new minis go into production, memories from any of the suppliers can be used. Texas Instruments, Motorola, and Mostek have delivered the memories in quantity, and all will be represented in the new machines. Several others have supplied promising samples, which are now being tested.

The design of other parts of the minicomputers were also affected by the decision to use solid-state memory. For example, the interface between the memory and the processor was designed to be as flexible as possible to allow for memories from various sources. The design also allows for various memory cycle times, various refresh intervals in dynamic MOS memories, and even the absence of refresh cycles in static memories.

Microprogram is key

Microprogramed control is a basic element in the design. The control-memory capacity now is 4,096 words, of 24 bits each; approximately 250 of these words emulate the entire instruction set of earlier HP-2100 minicomputers. The remainder is available for new instructions introduced with these machines, for options, and for user-defined microprograms. The 2100 control memory had a capacity of 1,024 words, of which 256 words implemented only part of the basic instruction set, leaving the remainder to be hard-wired. The earlier unit is thus emulated by the new one, executing 2100 programs with comparable performance.

In any microprogramed processor, source-code instructions are interpreted in the instruction register as pointers to microprocessor programs that emulate the particular instruction set being executed. In the conventional approach, on the other hand, each instruction is decoded and executed with specific control logic wired into the machine. The conventional method sometimes has an advantage in speed over microprogramed control, but it requires that the hardware and the instruction set be fixed at an early stage in the design of the system. Thus it is inflexible, and adding new capabilities is often difficult and expensive.

The total user-microprogram approach used by H-P differs from other levels of microprogramming that are not quite as basic as hard-wired control logic. In the first microprogramed computers, microprograms were stored in read-only memories. The whole memory or a large part of it, however, had to be replaced when a change or an improvement was to be installed. Many microprograms are still implemented this way—including the basic portions of H-P microprograms—but semiconductor read-only memories are much smaller and more amenable to change than the older arrays of capacitors or transformers.

More recently, some microprograms have been realized in memories in which changes can be written without physically replacing anything. However, these microprograms are carefully protected from access by the user through the use of a reloading mechanism that permits only the computer manufacturer to specify the control information to be loaded. On the other hand, as in the H-P machines, when the user can specify what he wants loaded into his control memory, he can completely specify what he wants his machine to do and how it does it, and thus tailor it more closely to the application than is possible with wired logic, read-only programs, or any other means of control.

No hybrid design

In the microprogramed processor, as used in the 2105A and 2108A, every source code instruction is executed via a microprogram, allowing great commonality in processor hardware. For example, most processor operations utilize the central arithmetic and logic unit. In the conventional hard-wired approach, some instructions require unique hardware. This commonality, together with the recent availability of many new types of medium-scale integrated circuits—64-bit fast read-write memories for registers and fast arithmetic-and-logic-unit packages, as examples—significantly reduce the number of components in the processor, compared with previous machines.

The basic portion of the microprogram is stored in fast read-only memories, with 60-nanosecond access time. Read-write and programable read-only memories store the custom portions of the microprogram. Microcode words are 24 bits long, permitting a microinstruction to specify more parallel machine operations than is possible with a single 16-bit word in the source program. These relatively long microinstructions can be executed in less time than source-code instructions, which also adds to the machine's performance.

The processors in the 2105A and 2108A include a set

of sixteen 16-bit registers, two of which are reserved for use as a switch register and a program counter. Two others are used as index registers, leaving 12 available to the source programmer. But all 14 are available to the microprogrammer, for storing temporary or intermediate results during arithmetic operations. With fewer memory references, correspondingly faster program execution is obtained, and less main memory is required to solve the problem.

Microcode packages

A user-microprogrammable computer has other advantages besides instruction-set enhancements. For example, single-precision floating-point arithmetic, optional on some minicomputers and not available at all on others, is standard on both the 2105A and the 2108A, and is implemented in firmware. Other options are continually being developed, such as the Scientific Instruction Set, which executes many common subroutines in microcode instead of assembly language, taking advantage of improved cycle time and flexibility of the microprogram control logic. Speed increases of more than 28:1 are sometimes achieved in executing these routines.

This microprogramming technique is accessible by the user to increase the performance of the 2105A and 2108A processors for a specific application. The basic instruction set, as in many other microprogrammed machines, is stored in a standard read-only memory that comes as part of the machine. Some optional instructions are also coded in special read-only memories that are installed at the customer's request when the machine is purchased.

But the user may also put the most commonly used subroutines in his particular application programs into microcode. In microcode, these subroutines speed up the machine because the microinstructions are executed

more quickly and the program spends a lot of time in these subroutines. Several options support this practice. One option, a writeable control store (WCS) plus a micro-assembler and editor/debug package, enables the user to write, edit, and test his microcode routines easily in his system at full system speed. Once the routines are tested, the user's system software can load the microcode routines into the WCS through the input/output channel at the beginning of the run. To obviate reloading the micro-routine for every run, the user can store his microcode in firmware, but he needs an optional writer for the programable read-only memory and an associated software package.

All in the family

The new design, for cost-effectiveness, is for a family of minicomputers, rather than a single "all-purpose" design. All users need some capabilities, but they differ in their need for main-memory capacity and input/output channels. The smaller of the initial machines is the 2105A. Only 5¼-inches high, it can contain within its mainframe as many as 32,768 16-bit words of main memory and four powered input/output channels. The larger 2108A, 8¾-in. high, has nine powered I/O channels and 32,768 words of memory, extendable further without loss in speed. The memory cycle times of some minicomputers lengthen by as much as 150 nanoseconds when the memory is expanded beyond the restrictions imposed by the mainframe. The extra time is imposed either by extra cycles or by hardware that, in effect, maps the extended portion of the memory onto the basic portion. The hardware includes a register that is loaded in advance with a "pointer" that shows where the mapping process is to begin. The H-P scheme uses mapping, too, but it is implemented with fast circuits that impose little or no extra delay on the system.

With a family of mainframes, the memory capacity,

Packing 300 W on two pc boards

The power supply for the new H-P minicomputers includes several features made possible by recent technological advances such as inexpensive transistors that can switch 600 volts at 8 amperes in 500 nanoseconds, 25-ampere Schottky-barrier rectifiers, photo-isolators, and various new types of ferrite cores, capacitors, and printed-circuit boards.

Electrically the power supply consists of a high-voltage, high-frequency switching preregulator, two dc-to-dc converters, and several series-pass final regulators. It has over-voltage and over-current protection for all output voltages, as well as a battery-powered standby system to protect the contents of the semiconductor memory if line power fails. The total available output power is 300 watts at eight different voltages.

Physically, this power supply assembly consists of two main eight-layer printed-circuit boards, plus three smaller boards that provide the battery standby system. This method of assembly reduces the cost of initial assembly and testing and makes field service easier than many older designs of computer power supplies.

The preregulator and the dc-to-dc converters operate at 20 kilohertz, an unusually high frequency. Because of

this, all power transformers and other magnetic components are small and light enough to be mounted directly on the pc board. Likewise, all power-handling stages are highly efficient, so that heat sinks have minimal volume and all power semiconductor devices are mounted on the board, instead of on a metal chassis.

Placing the power supply's main energy-storage capacitors ahead of the preregulator and rating them at twice the rectified line voltage (for 115-volt operation) results in both smaller size for the capacitors and increased energy storage. Since the volume occupied by an aluminum electrolytic capacitor is proportional to the voltage while the energy stored is proportional to the square of the voltage, the advantages of using a relatively high voltage for energy storage are obvious. As a result, this power supply maintains its regulated output power at full load even though line power is interrupted for 2½ cycles at 60 hertz. Stored data is kept for up to 10 cycles.

The preregulator stage, controlled by feedback from the +5-volt output, maintains a nearly constant input voltage for the converter, even with ±20% variation in power line voltage. Other memory and input-output voltages are regulated by small series-pass regulators.

number of I/O channels, and selection of options can be closely matched to individual user requirements. To keep down the cost of giving the user so much flexibility, special efforts were made to modularize the design, and to use as many common assemblies as possible. All members of the family are program- and I/O-compatible, too, and although they include many new features, they are upward-compatible with all previous H-P minicomputers, thus protecting the investment users have made in more than 8,000 minicomputers belonging to the series.

The entire processor is on a single printed-circuit board, which is common to all members of the minicomputer family. The single board requires fewer connectors and between-board cables and thus accounts for part of the cost savings. This p-c board has multiple layers, which improves reliability because the internal interconnections are less subject to noise.

Many new instructions have been added as standard features to all members of the family. For example, several bit and byte manipulation instructions have been added, for use in data-communications and data-acquisition applications. These include instructions to set, test, and clear single bits in a given data word, instructions that load or store individual bytes of data, and instructions that compare two strings of bytes and determine whether a less-than, equal, or greater-than condition exists.

Two hardware index registers and 28 instructions that use them help relocate blocks of data brought in from mass storage—an increasingly useful function in disk-based systems. For more efficiency, several new data-movement instructions are included to move bytes, words, or blocks of data with a single instruction. These are helpful in manipulating data in information-management applications.

Protection from accidents

The family is designed for use with operating-system software, and incorporates several features to protect the integrity of the operating system from accidental modifications—as can sometimes happen when the system is time-shared. Memory protect, one of these options, has a “fence” register that effectively divides the memory space into a system area and a user area. The operating system, which must maintain control of the computer even though several users may be executing programs at different times, loads this fence register with an address corresponding to the upper bound of the control program—the part of the operating system that is always in the memory. Users’ programs are kept above the fence. If one of the user’s programs inadvertently tries to obtain access to any address below the fence, the operating system interrupts the attempt, taking back control from the user’s program.

A similar interrupt also occurs if one of the users’ programs attempts to execute an I/O instruction, since all input/output is under the operating system’s control. In addition, the memory-protect option safeguards the system from some common programming errors. For example, “infinite indirects” are permitted to repeat themselves only three times before the operating system takes over control to correct the situation.



Large. Beefed-up cousin, the H-P 2108A, appears here at the top of the rack in a typical disk-based system. It has a 32k-word memory and nine I/O channels. Both machines are among the first large-scale applications of 4,096-bit MOS memories.

An infinite indirect is the improper use of an indirect address, by which an instruction tells the processor to perform an operation on data found, not in a location whose address is specified in the instruction, but in a location whose address is specified in another location specified in the instruction. In some computers, several levels of this indirect addressing are possible. If the instruction specified a location that contains its own address, or two locations each of which contains the other’s address, the computer can oscillate indefinitely, always looking for useful data but finding only more addresses, unless external means are provided to stop it. In the 2105A and 2108A, the operating system can continue with as many levels of indirect addressing as it wants to, unhindered by the hardware, but the user is limited to three levels.

Memory protect also interrupts any operation in which a parity error is detected, and stores the memory address in a violation register, which can be read later by a diagnostic program. Without the memory-protect option, a parity error stops the computer.

Parity detection is standard on all family members, as it was on the earlier 2100 minicomputer, with a 17th bit in every word in main memory. Parity is automatically checked on every word read from memory, including

data transferred via the dual-channel port controller. This feature is considered essential for reliable operation of any complete system, no matter what size, to assure program or data integrity.

Although memory protect is a standard feature on the 2100, it is not required for many applications. Therefore, it was made an option for the new minicomputers, allowing an additional cost saving to those who do not need this capability.

Several branch-on-test microprogram instructions are also available, allowing more efficient programing than if only skip-on-test instructions were available. Normally, of course, in any computer program, instructions and microinstructions are executed in sequence. Skip-on-test instructions look for a specified condition. If that condition exists, the program skips the next instruction, and goes to the third instruction in sequence, which initiates a routine that reacts to the condition.

Obviously the skipped instruction must be an unconditional branch, so that if the tested condition does not exist, the program can bypass the conditional routine. But branch-on-test instructions cause the program to go to a specified location for its next instruction if the condition exists, so that in its absence—which may be most of the time—the program can continue in its normal sequence without any unnecessary unconditional branches. In the new minicomputers, the conditions include the presence of a carry, a zero result, a particular bit, or one of several front-panel settings.

Access by the user

To take advantage of these powerful microprocessor features, a programmer must have access to them from his assembly language program. This access is built into the basic instruction set—one of the key differences between these user-programmable minicomputers and other microprogrammed computers. In addition to the 80 instructions in the basic set, 512 instructions, called "macros," are available for microprogram routines.

The use of macros is an old trick to programmers in as-

sembly or higher-level languages. In writing a long program relatively free of conditional or unconditional branches, the programmer may find himself writing the same small sequence of instructions many times with only minor variations. When that happens, he can define a macro—short for macroinstruction—which gives an arbitrary name to that small sequence and specifies any variables it may include. Then, while writing his program, when he encounters a need for that sequence, he simply specifies the name of the macro. The assembly program, when it translates his program listing into machine language, replaces the name with the actual sequence of instructions.

Likewise, in the new H-P machines, a user can take advantage of macros to define new microprogram routines tailored to his own custom requirements. When he assembles his program with the standard assembler, the writable control store or the PROM writer can produce a minicomputer to match his particular needs.

Overlapped processing and I/O

Another useful feature is the dual-channel port controller, an option both on this new family of minicomputers, and on the 2100. This option, which offers direct memory access (DMA) also includes all control logic, memory address registers, and word count registers for two channels, which the program can assign to any I/O devices. When it is installed, data can be transferred directly between an I/O device and the memory, without passing through the processor, and thus without interrupting what the processor may be doing, permitting processing and I/O operations to overlap. Other machines with DMA capability require this hardware or its equivalent to be duplicated in each controller that must have direct memory access.

An important performance specification of a machine's direct-memory-access capability is the DMA latency time, defined as the maximum time from the device request to the initiation of the DMA transfer to or from the device, in the absence of any higher priority

Safety in numbers—of sources

From very early in the project to develop the new family of minicomputers, Hewlett-Packard has worked closely with all the potential producers of 4,096-bit MOS memories, including Texas Instruments, Motorola, and Mostek. It now appears that Mostek will be the first to deliver, but Hewlett-Packard can take chips from any supplier who can deliver them.

Mostek and TI use a 16-pin package for their memory chips, while American Microsystems Inc. and Motorola use 22 pins; thus the two circuits are not compatible. Anticipating these differences, H-P designed modules for each configuration, so that any of them can be used in any machine. However, they won't all look alike to the customer: more 16-pin than 22-pin packages will fit into a given space, and the computer that uses the 16-pinnings will cost a little more than one with the larger packages.

Dick Conrad, standard product marketing manager for AMI, says that his company is shipping the 4,096-bit memories to H-P in sample lots only, but nobody seems

to be delivering in any quantity. "Nobody's got anything wrapped up yet," says Conrad. "We have 12 major customers who want to buy our entire 1974 production—the same customers everyone else is talking to"—which means Univac, Burroughs, and Control Data, to name just a few.

Right now, Conrad says, the semiconductor people are all running pilot lines and telling each other how good things will be in the fourth quarter—but nobody has any substantial number of circuits in stock. That could cast a shadow on Hewlett-Packard's plans to begin delivering the new machines on schedule next month, but H-P spokesmen insist that the company has what it needs initially, although it can use more.

So, with plenty of customers signed up, the question now is one of delivery. Probably, no matter who delivers in bulk first, the rest will be able to pick up some business, perhaps with the same customer list.

—Walter Barney

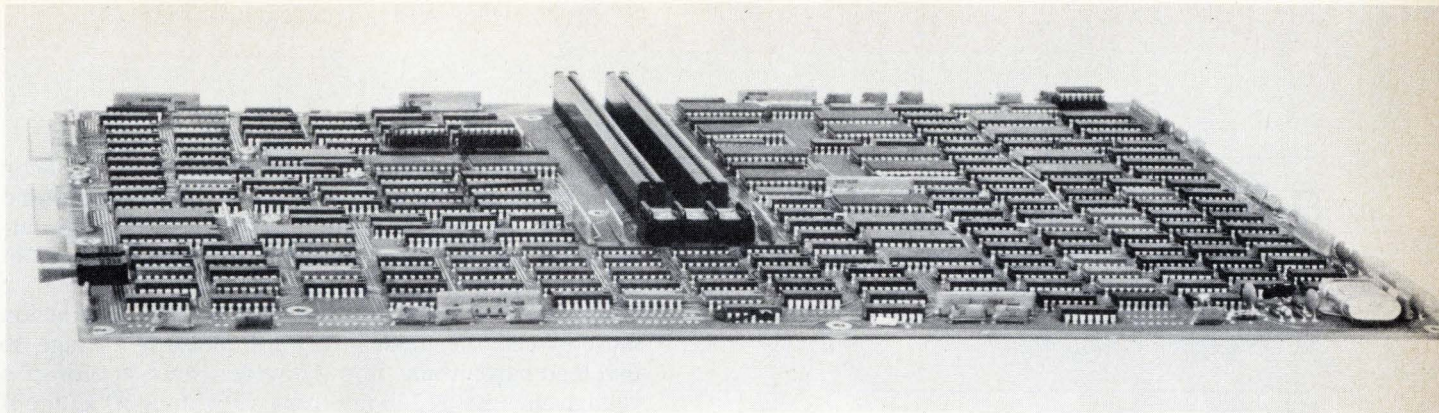

Processor. Both new minicomputers, and all future models in the family, use identical processors on one board. Plug-in connections in the center ease assembly and trouble-shooting. Multilayer board enhances noise immunity of on-board interconnections.

operation in progress or pending. The maximum DMA latency for the new family is 1.625 microseconds, compared with 2-5 μ s maximum latency time on some other minicomputers. This is another important characteristic in data-acquisition or sensor-based applications where quick response to a device's request to transfer a word of data is essential. All I/O channels have this minimum DMA latency time.

Included in the standard instruction set are other capabilities not offered in many other minicomputers. One of these is the ability to perform logical or arithmetic operations on data in memory locations. For instance, to add the number in a memory location Y to a register A, one executes the single 16-bit instruction, ADA Y. The step requires only two memory cycles—one to fetch the instruction and one to execute it—and one word of memory. Other machines without this capability might require the following:

LOAD REGISTER B with Y

ADD REGISTER A to REGISTER B

each of which requires three memory cycles and two words in memory. This feature is invaluable because less memory is used to solve the problem, specifically in applications where many logical or arithmetic operations are to be performed on large amounts of data.

"Cold loading" of programs or data—as, for example, when the memory is completely empty—is easy with the front panel arrangement and "bootstrap" feature. Up to four different 64-word loader programs can be stored in read-only-memory chips included as part of the processor. A user can very easily select, load and execute any of these programs from the front panel of the machine.

The selected program is transferred to the upper 64 words of main memory from the ROM and configured for the address of the peripheral unit containing the rest of the program. The main program is then read from that peripheral unit and may begin to be executed as soon as it is fully loaded. All of these tasks, and most other front panel operations, are controlled by special routines in the microprograms. This allows a very simple and very reliable front panel.

All the front panel switches and light-emitting-diode indicators and a small amount of logic are mounted on a single printed-circuit board. The switches are an adaptation of a novel design developed for the HP-35 pocket calculator. These are strips of beryllium-copper

with a dimple at each switch location. Pushing the switch causes the dimple to touch a circuit-trace beneath it. The "oil can" or "cricket" principle gives a snap action to the switch and provide definite feedback to the user that contact has been made.

Wide applicability

The last few years have seen a large increase in the use of minicomputers. With continual improvement they are now able to perform routinely tasks that only a few years ago would require large, expensive computer systems. Moreover, their rising computational power and falling price are continually opening new applications that cannot be met by microcomputers or programmable calculators.

The specific uses to which predecessors of the new machines have been put may point to their first applications. The HP 2100 has been widely employed in time-shared systems for computer-aided instruction and design. In disk operating systems, it is used for batch-oriented problem-solving in scientific and other situations. More recently, with new software, many were used for dedicated, on-line terminal systems for database management and business transaction processing. The 2100 is a part of many data-acquisition, or sensor-based systems, for monitoring large amounts of measurement information in a real-time environment. Other 2100-based systems are used in Fourier analyzers, gas chromatography, electron spectroscopy, microwave spectrum analyzers, network analyzers, cardiac medicine, and nuclear medicine. The goals of the new family are to provide a more cost-effective processor for all of these uses, and to introduce new features with which designers of these systems can enhance performance.

With improvements in environmental immunity, ability to function on unstable power sources, and established long mean time between failure, applications should open in previously unserved functions. Computer control of operations on an oil-prospecting ship in rough North Sea waters is under serious consideration, for example. Small size can be important, as in a satellite navigation system now under construction. Such minicomputers are beginning to be used for control purposes on large supertankers, where resistance to the effects of vibration is an important consideration. □

Schottky diode pair makes an rf detector stable

by Roland J. Turner
AEL Communications Corp., Lansdale, Pa.

If broadband rf detection is to be efficient at low signal levels, detection thresholds must be stable—a design goal achievable with a pair of matched Schottky diodes. The diode-stabilized circuit shown here, for instance, maintains a detection stability of ± 0.06 decibel over a temperature range of -20°C to $+90^{\circ}\text{C}$ for an rf drive level that is a 10th of that of a conventional detector.

With such a circuit, the amount of rf circuitry required can be much reduced because accurate stabilized detection thresholds can be set for low rf drive levels. Also, the circuit's temperature stability and detection efficiency permit the realization of a sensitive receiver—one that can have a high video gain as well as a low rf gain.

Normally, it is hard to achieve high detection efficiency at a low rf drive level while keeping detection efficiency constant over a wide temperature range. This is because of the nature of the forward blocking voltage of

a diode. For example, at room temperature, a silicon diode has a forward voltage of about 500 millivolts and a temperature coefficient of $2\text{ mV}/^{\circ}\text{C}$, so that the forward voltage will vary considerably—from 370 mV at 90°C to 590 mV at -20°C .

The rf drive level needed to start the detection action must exceed the diode's forward blocking voltage so that load current may flow. However, since the forward voltage changes by 220 mV from -20°C to $+90^{\circ}\text{C}$, the rf drive level required must vary accordingly to maintain detection action. The inherent detection efficiency, therefore, is low and strongly dependent on temperature, limiting the maximum video gain that may follow the detector.

The rf detector depicted here, though, solves these problems. The two Schottky diodes, D_1 and D_2 , are matched to within 5 mV from 0.1 to 0.5 milliamperes and are connected in a half-wave rf detector configuration. The dc bias developed across diode D_2 and resistor R_1 serves as an arming bias for the detector diode, D_1 , establishing temperature tracking between the two diodes.

The voltage drop across resistor R_1 establishes a reverse offset bias on diode D_1 , in this way setting a known rf threshold that the rf drive level must exceed before detection action takes place. And the voltage drop across diode D_2 acts as a temperature-dependent forward arming bias on diode D_1 . The level of this arm-

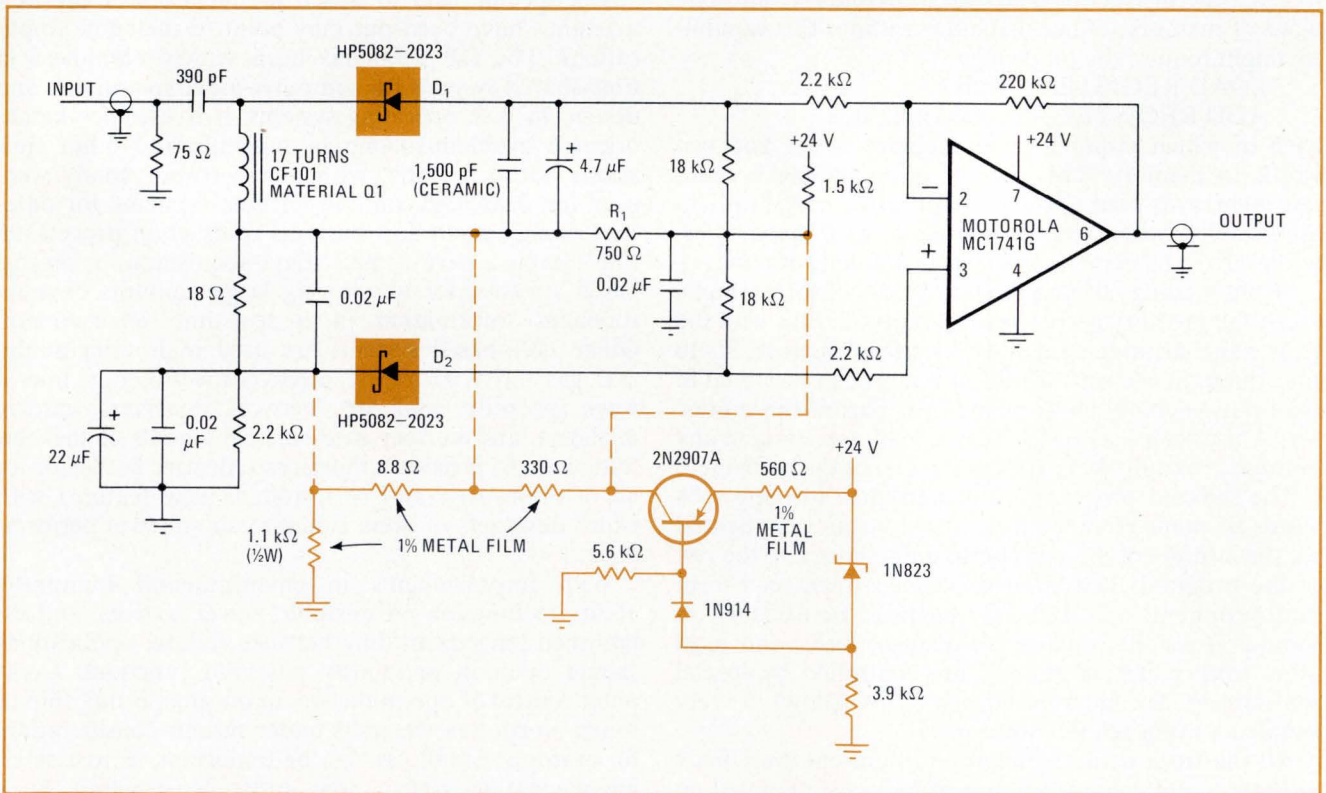

Temperature stabilized. High-efficiency rf detector operates at low input drive levels over a wide temperature range. Matched Schottky diodes (D_1 and D_2) and a fixed rf threshold bias (via resistor R_1) permit the circuit to hold voltage detection stability to ± 0.06 dB from -20°C to $+90^{\circ}\text{C}$ for a 55-mV input. Sensitivity to supply-voltage changes can be minimized by adding colored network (and omitting R_1).

ing bias tracks the forward blocking voltage of diode D_1 as the temperature changes.

Because of this temperature-compensating arming bias, it is possible to realize constant detection efficiency over a wide temperature range, in addition to a constant rf threshold detection level. For a constant rf input of 55 mv, the detection voltage developed by the circuit varies only 1.8 mv between -20°C and $+90^\circ\text{C}$. Rf peak voltages as large as 80 mv can be detected quite efficiently.

The operational amplifier at the output of the circuit senses the detection voltage and translates it to a 12-volt

level. This output voltage varies only 2.1% from -20°C to $+90^\circ\text{C}$ for a constant rf input drive. Here, the op amp's gain is 40 dB, a figure that can be safely increased to 50 dB without adversely affecting the output stability of the circuit.

The circuit's performance will be further enhanced if the detector is made insensitive to variations in supply voltage. This can be done by adding a current source (shown in color in the diagram). The current source keeps the rf threshold voltage constant, despite supply variations of ± 0.5 v. In connecting this source, resistor R_1 must be omitted. □

Crowbar protection circuit senses load voltage directly

by Thomas E. Skopal
Acopian Corp., Easton, Pa.

The triggering point of the overvoltage-protection crowbar circuit for a power supply can be decreased without increasing the circuit's sensitivity to transients. The trick is to have the crowbar circuit sense the voltage across the load, rather than the output voltage of the power supply, as is usually done.

To provide maximum protection, a crowbar circuit is generally set reasonably close to the operating voltage required by the load. Typically, a compromise setting of about 15% above the load's operating voltage is chosen, because commonly encountered transients may cause spurious crowbar triggering and interfere with normal system operation if a tighter differential is used.

However, when voltage drops in the supply's output

wiring exceed 2% or 3% of the output voltage—a common occurrence with low-voltage, high-current logic supplies—the system designer is faced with a dilemma. If he compensates for these drops with an increase in power-supply output voltage, the differential will be reduced and the crowbar's sensitivity to transients increased. And if crowbar setting is increased to maintain the same differential, load protection is degraded.

This conflict can be resolved by using the four-terminal crowbar circuit shown in the figure. It senses the voltage across the load, much as a supply's remote-sensing connections may be used to automatically compensate for voltage drops caused by long wires.

The crowbar's triggering point is a function of the voltage seen by the load, as opposed to the output voltage of the supply, and it is unaffected by the amplitude of the wiring voltage drops. Since the sensing connections of the crowbar share the sense lines of the supply's regulator, no additional system wiring is required.

The diode in the circuit provides temperature compensation for the transistor. The component values given are appropriate for power supplies having outputs of 4 to 10 volts and of up to 20 amperes. □

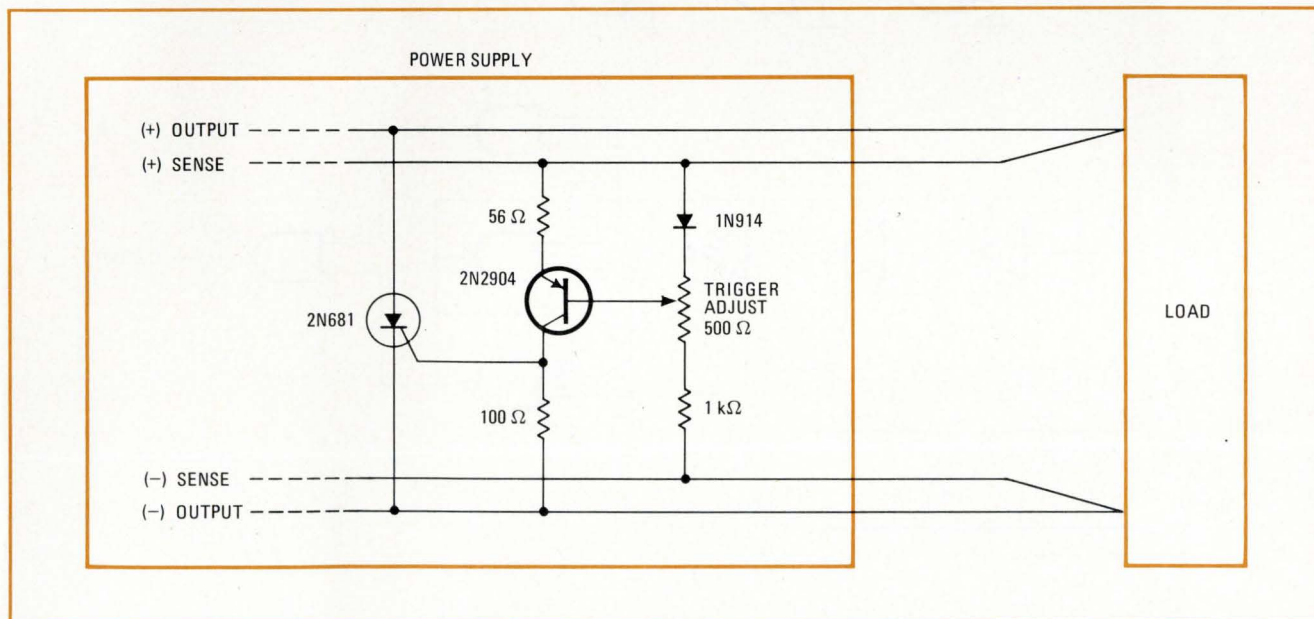

Better protection. Crowbar circuit protects a power supply from overvoltages by sensing the voltage across the load, instead of the supply's output voltage, which is the usual approach. This means that overvoltage sensing will not be affected by wiring voltage drops, nor will there be an increased sensitivity to voltage transients. The components shown here are for a power supply of 4 to 10 volts at up to 20 amperes.

Simple gating circuit marks both pulse edges

by Ralph Tenny
Texas Instruments, Central Research Laboratories, Dallas, Texas

A bidirectional edge detector can be built from only two integrated-circuit packages—or with only one package if exclusive-OR gates are used. Applications for the circuit include triggering for event counters and frequency doubling for digital data communications.

The configuration for the standard edge detector is drawn in black in (a). If NAND gates are used, as indicated here, the circuit responds to positive-going edges. If NOR gates are used, it detects negative-going edges.

When the input signal is low, the output of gate G_4 will be high. And when the input becomes high, G_4 's output goes low one gate propagation delay later. Meanwhile, the input signal ripples through gates G_1 ,

G_2 , and G_3 , causing G_3 's output to go low after three gate delays. The output of G_4 then become high again one gate delay later. This means that G_4 's output is a negative pulse that is three gate delays wide. The four gates, therefore, mark the positive-going edges of the input.

Adding three NOR gates to this standard circuit, as shown in color in (a), enables the circuit to mark both positive and negative edges. Gate G_5 , together with gates G_1 , G_2 , and G_3 , form a negative-edge detector. Gate G_6 simply inverts the output from gate G_4 , while gate G_7 simply sums and inverts the detected edges.

The same dual edge detection can be obtained from a single quad exclusive-OR gate package when the gates are connected as indicated in (b). Or, an equivalent circuit can be constructed by hooking up three inverters and four NAND gates, as in (c).

The timing diagram shows the key waveforms for all the circuits. □

Designer's casebook is a regular feature in Electronics. We invite readers to submit original and unpublished circuit ideas and solutions to design problems. Explain briefly but thoroughly the circuit's operating principle and purpose. We'll pay \$50 for each item published.

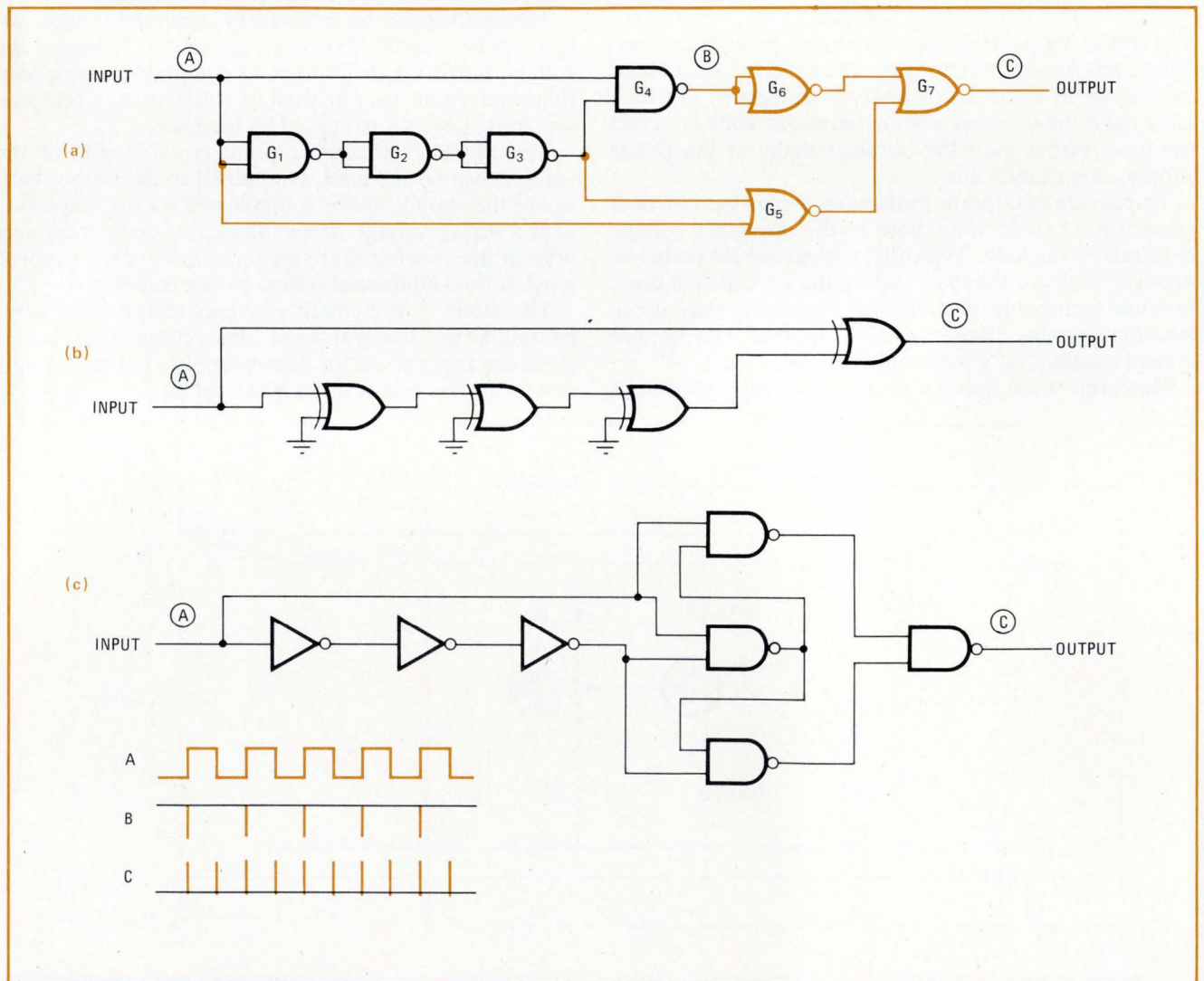

Noting each pulse-edge direction. Both positive and negative pulse edges can be detected with the same circuit by adding the three gates drawn in color in (a) to a standard unidirectional edge detector (drawn in black). If exclusive-OR gates are used, as in (b), the bidirectional edge detector requires only one IC package. Inverters and NAND gates, as in (c), can also provide the same circuit function.

A New Standard For Accuracy!

3½ Digit A/D Converter

The LD110/LD111 A/D converter sets the pace for accuracy with a specification of 0.05% of reading, ± 1 digit. The set consists of two ICs, and with the addition of a reference voltage and clock becomes a full 3½-digit analog-to-digital conversion system. LD110/LD111 features and specifications make the converter set an ideal choice for digital display processors in

- DPMs
- DVMS
- Controllers
- Instrumentation
- Thermometers
- Scales
- Tachometers

Specifications

- Accuracy of 0.05% of reading, ± 1 count
- $Z_{IN} > 1000 \text{ M}\Omega$
- 4 pA typical input bias current (25°C)
- 100 μV resolution (200.0 mV range)
- 40 dB NMRR @ 60 Hz

Features

- Auto-zero minimizes effect of offset, drift and temperature
- Auto-polarity
- Sampling rates from 1/3 to 12 samples/second
- Two voltage ranges: 2.000V and 200.0 mV
- TTL-compatible outputs
- \$28.60 per set (100-set price)

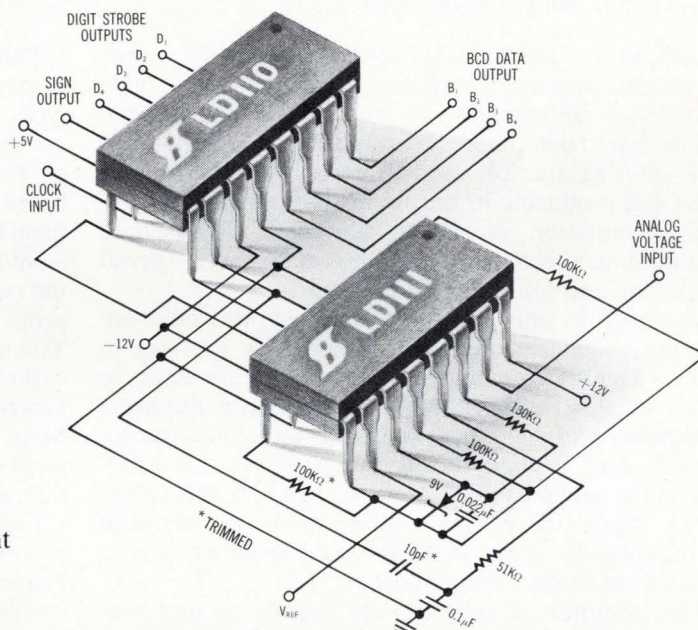

The unique conversion technique uses a single reference and a single full-scale adjustment to achieve a highly-accurate strobed 3½-digit output of up to 3100 counts plus sign. LD111 analog processor employs monolithic PMOS/bipolar construction and interfaces directly with the LD110 digital processor, which has a monolithic PMOS structure. For further information

write for data

IC Applications: (408) 246-8000, Ext. 120



Siliconix incorporated

2201 Laurelwood Road, Santa Clara, California 95054

Computer networks are taking on the heavyweight computations

The most significant trend in computer technology today is the growth of resource sharing—the linking of big and little computers by leased and dial-up communication lines into centralized or distributed networks

by Wallace B. Riley, *Computers Editor*

□ Computer networks today are the wave of the future, just as time-sharing was, a few years ago. In a sense, networks are an extension of the time-sharing concept. A time-shared computer is merely accessible from a distance, offering multiple users more or less simultaneous access and producing its output faster than a batch-processing computer. Networks, however, offer shared computational resources, including data bases, special equipment, and sophisticated programs.

But networks and network technology also offer advantages peculiarly their own. They show the way to low-cost high-performance computing systems, since for some jobs a network of smaller systems can duplicate the capability of one large expensive system at lower total cost. And beyond this is the possibility of interconnecting networks of the new microprocessors [*Electronics*, April 18, p. 81] into networks of powerful computational systems at what would seem by today's standards to be microscopic cost.

Some commercial networks are already off and running—notably General Electric's Mark III system and the Tymnet operated by Tymshare Inc. Both of these are direct outgrowths of commercial computation services that were based on time-sharing.

Other networks, still in development, will go into commercial operation within the next few months or in 1975, the fruition of recent research projects. Examples are the networks of Telenet Communications Corp. and of Packet Communications Inc., both of which are based on technology developed in the Defense Department's Advanced Research Projects Agency.

Still others are services operated primarily by and for the research community without the intent of turning a profit on an investment—such as the network of the Triangle Universities Computation Center, one of the earliest to become operational; the Octopus network at Lawrence Livermore Laboratory in California; the Merit network, serving three universities in Michigan; and the network at Carnegie-Mellon University in Pittsburgh, Pa.

Finally some networks are the basis for research into how they can extend computer capability. Examples are Prime and DCS (for distributed computer system) at two campuses of the University of California, and ongoing research in Arpanet, which was set up for this purpose but today operates largely as a research service.

While the technology of computer-to-computer communication, on which computer networks are based,

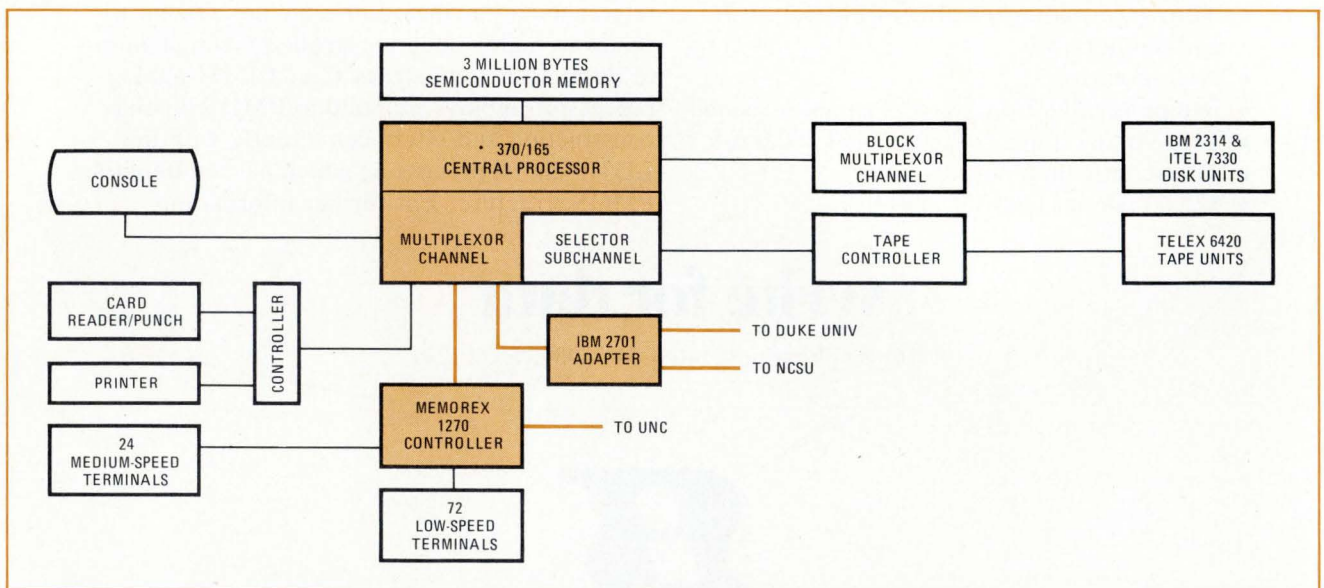

1. **TUCC.** One of the earliest networks to begin operation was TUCC at Triangle Universities Computation Center in North Carolina. Today it has been expanded with modern equipment to serve, not only the original three universities, but other sites statewide.

dates back in its most embryonic forms into the early 1960s, only after some time had elapsed did the concept gain a foothold in practice. One of the earliest networks to begin actual operation, for example, was started in 1966, with the establishment of the Triangle Universities Computation Center. TUCC (pronounced tuck) was set up to provide computational capability for the University of North Carolina, Duke University, and North Carolina State University, located respectively in Chapel Hill, Durham, and Raleigh.

More needed

All three institutions needed extra computing capability in the mid-1960s. They saw this extra capability available in the IBM System 360, which was just then appearing on the market. They also saw that larger models of the 360 had extensive communication capability plus attractive price/performance ratios. But because these models were beyond the needs and means of the individual universities at the time, there arose the idea of utilizing the communication capability to connect all three campuses to a single computation center.

"We were guinea pigs," says Leland H. Williams, director of TUCC. "But we had to make the idea work because it was the only way all the schools could get the computation they needed, and because the remote location depended heavily on data communication."

Both the center and the three individual campuses have continued to grow in their computational needs and in the kind of equipment they use. Today, an IBM

370/165 is the network's single source node. All terminals communicate with it more or less directly, but not with each other. The network topology is therefore the "star" type (as opposed to the "ring" type, which is discussed later). But the network contains no unusual hardware—with one possible exception (see page 149).

Connected to the TUCC 370/165, as shown in Fig. 1, are a 370/135 at Duke, a 360/75 at UNC, and a 360/40 at NCSU, as well as 72 low-speed terminals operating at 110 to 1,200 bits per second and 24 medium-speed terminals operating at 2,000 to 9,600 b/s. These terminals permit TUCC to communicate directly with the three main campuses and also with the campuses of small colleges around the state. These obtain from TUCC, through the North Carolina Educational Computing Service, computational power on a scale they could not otherwise afford.

At present the TUCC network contains no minicomputers. But that situation may change shortly. Since the capacity of the controller for low-speed terminals is fully utilized, plans are being made to attach a minicomputer to the controller and to add 32 more low-speed lines to the system through the minicomputer. Conceivably, at some later time, another minicomputer may be added in one of the North Carolina cities containing multiple nodes in the TUCC network. A likely choice would be Charlotte, where two colleges and 10 high schools are already using the system.

Contrasting with university-oriented networks like TUCC are commercial networks, of which an example is

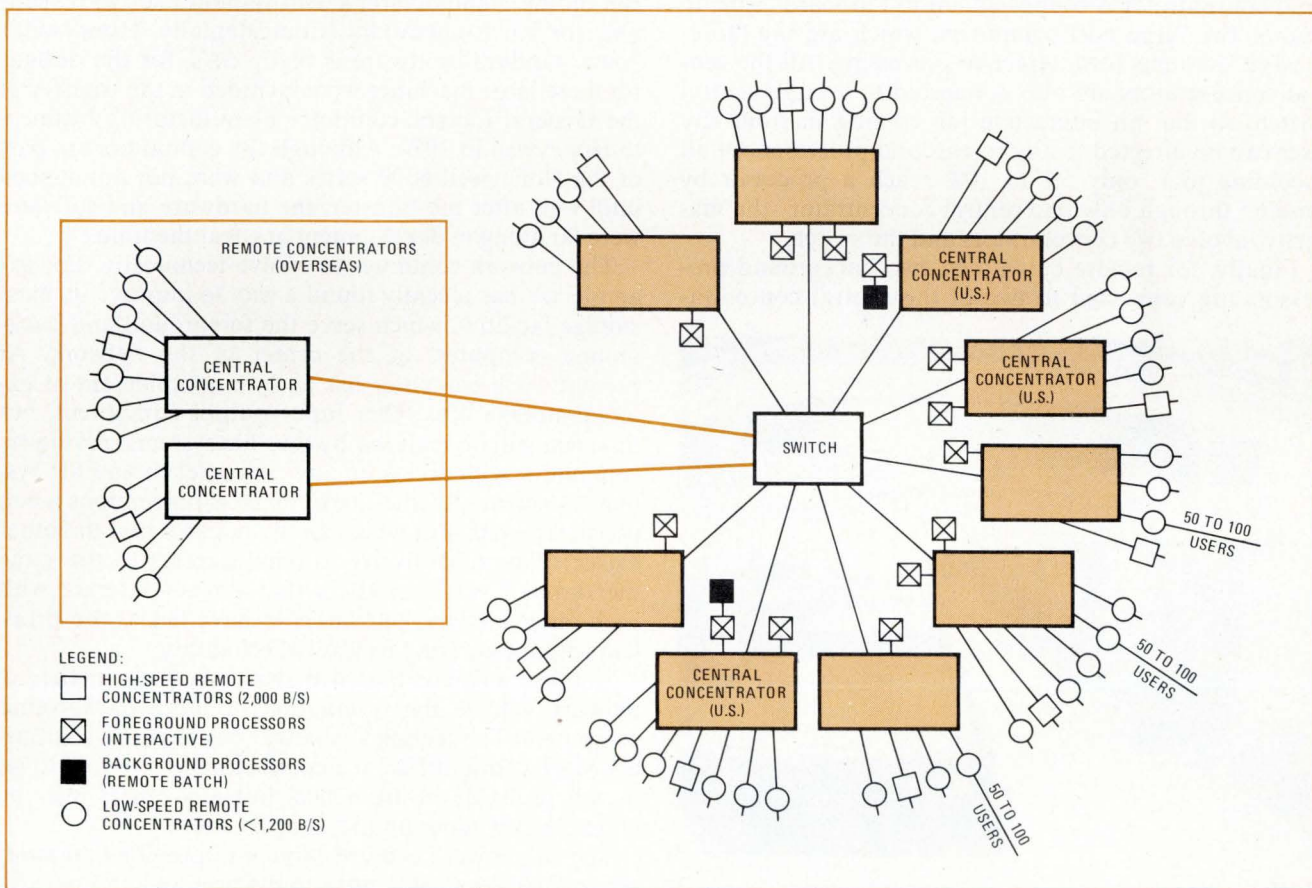

2. Mark III. General Electric's commercial network is probably the largest in operation today and reaches more than halfway around the world. Everything in the network is doubled, providing 100% redundancy and therefore an extremely reliable operation.

General Electric Co.'s Mark III system (Fig. 2), probably the largest network in operation today. Through its Information Services division, GE offers computational services to a wide variety of users. The network is basically the "star" type, like TUCC's, and the equipment is conventional, for the most part. The system covers more than half the globe, and two of everything provide 100% redundancy for reliability.

Terminal access only

The GE network, which began operation in 1969, comprises over 100 computers of various sizes, including some very large models. But these are accessible to the user only through a terminal on the network—whether interactively or for a remote batch job. In interactive use, the customer "converses" with the network asynchronously at 110 to 1,200 b/s. In remote batch, transmission is synchronous at 2,000 to 4,800 b/s.

The customer normally makes his connection by dialing a local telephone number in his own city. This connects him to what GE calls a remote concentrator in that city, or occasionally, over a foreign-exchange or leased multiplex line, to a remote concentrator in a nearby city. Each remote concentrator can handle 50 to 100 customers interactively or five to 10 for high-speed remote job entry.

Up to eight remote concentrators are connected, over leased telephone lines, to a central concentrator. Sixteen central concentrators—14 in Cleveland, Ohio, and two in Europe—form the heart of the network. Each Cleveland concentrator is connected, on its "inboard" side, to one or two large host computers, which are the "foreground" systems for interactive processing. All the central concentrators are also connected to a large central switch, so that an interactive job coming in from any user can be directed to any foreground processor. Of all incoming jobs, only 5% to 10% reach a processor by passing through only one central concentrator—the majority involve two concentrators and the switch.

Finally, for remote batch jobs, two background processors are connected to two of the central concentra-

tors. These are very large computers that chew away at big jobs and are not required to produce immediate outputs. They may finish a job in a few minutes, or they may work overnight, either directly on a problem or on a queue of big problems, before producing outputs.

Double without trouble

For reliability, everything in the system is duplicated, and all the interconnections are made by dual lines through different exchanges. Both lines are in use all the time, at half capacity, but if one line goes down, the other can immediately assume the full load. Even the second line can go down for as long as 10 seconds without imposing any burden on the user. If a remote concentrator goes down, users have access to a second one, usually in the same city. The 14 central concentrators in Cleveland offer a similar backup. The two European concentrators are connected to the Cleveland center by two links—undersea cable and satellite. With this degree of redundancy, obviously, failure of the whole network is highly unlikely, although individual parts give trouble from time to time.

All the machines—remote concentrators, central concentrators, switchers, and foreground and background processors—are themselves computers of various sizes. The 15 foreground units (Fig. 3) are large-scale Honeywell systems running on GE's own special operating-system software, designed for the particular requirements of the interactive network operation. Likewise, the two backgrounders are large Honeywell systems, but they run on the manufacturer's own standard software, suitable for batch operation. (Coincidentally, Honeywell's "own standard" software is really GE's, for the designs for these large machines were included in the transfer of the General Electric computer manufacturing business to Honeywell in 1970. Although the computers are part of the Honeywell 6000 series and were not announced until well after the transfer, the hardware and software were far along in development at GE at the time.)

The network continues to evolve technically. For example, GE has recently found a way to improve its mass storage facilities, which serve the foreground and background computers at the center of the network. At present, each computer has its own complement of external storage plus other input/output equipment, but this soon will be replaced by four file systems serving six computers, with access by any computer to any file system. Conceptually, the interference is horrendous when two users, neither of which knows or cares that the other exists, simultaneously try to obtain access to the same file through two computers that do not interact with each other directly. GE claims to have licked the problem without lowering its level of reliability.

Another advance that will shortly appear in the GE network will be the installation of more background computers. The technical challenge is that the computers will be from different manufacturers—the first to go in will probably be from IBM, but any others may be added later without undue complications.

The GE network evolved largely to provide computer service at a reasonable price to the user and at a reasonable profit to GE. That the service is provided by a network is incidental.

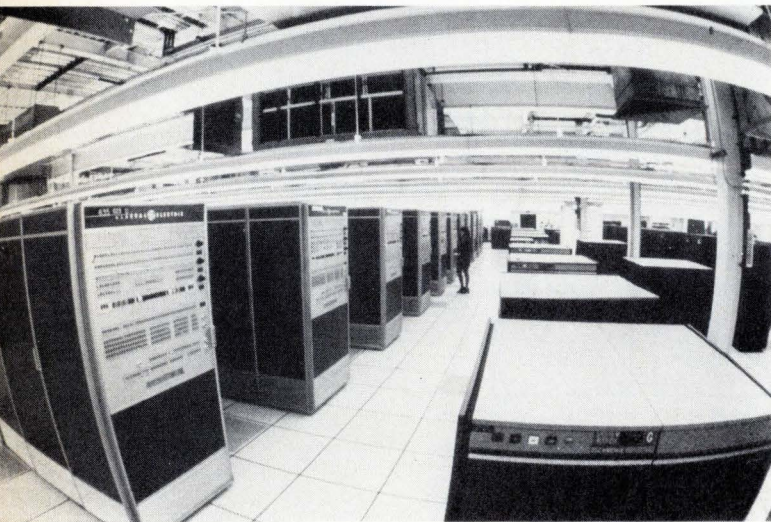

3. Network center. Large-scale Honeywell computers in Cleveland, Ohio, constitute the 15 foreground and two background computers to which the world-wide GE network is connected.

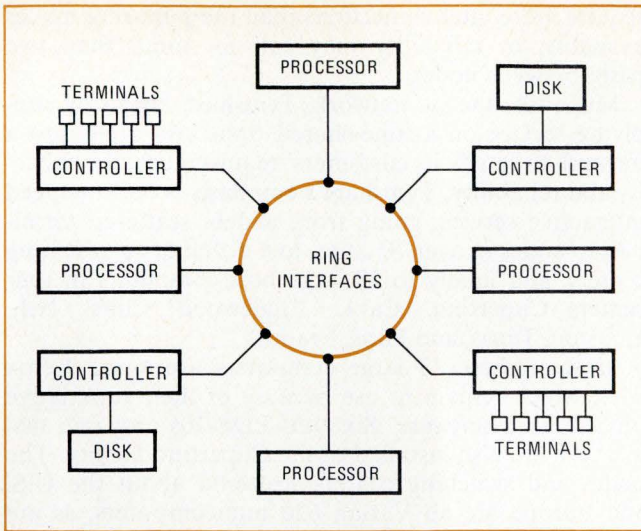

4. California's DCS. Collection of processors and input/output devices bid on jobs submitted by the user. Selected unit can subcontract its job to other processors if work load demands it.

Nevertheless, the network concept raises a number of questions that are best answered in a research environment, where customer service and income production are not the primary considerations. For example, how can a system adapt itself most readily to a variety of tasks? How can it reconfigure itself into a working system, at a lower level of performance, if some of its components fail? Can this reconfiguration occur without affecting availability too much? How can privacy and security for multiple users best be achieved? Are networks the best means to these ends?

Network research

Questions like these are being studied at the University of California at Irvine, for example, where David J. Farber is developing a distributed computer system, or DCS. His interest is in adaptability and reconfiguration. He regards his system as functioning at different times as a very large and complex machine, or as a network of smaller machines, or as something in between.

Such a system, Farber argues, should not have any supervisory element, because the failure of the supervisor would cause the entire system to go down, canceling the requirement for soft failure. As a result, the system is based on a ring configuration—as distinguished from TUCC's and GE's star configuration (Fig. 4). In a pure ring, the various nodes are arranged around the rim of a circle, with each computer connected only to those on either side of it. All data transmitted from any computer to any other except its immediate neighbors has to pass through all the intervening nodes en route. (Practical implementations of ring networks are usually not this simple, and will be described later.)

The configuration is more reliable than the basic star configuration in this respect: if one link in a star network fails, the nodes outboard of that link are isolated from the center (unless GE's dual-channel approach is used), but if one link in a ring network fails, nodes that normally communicate through that link can still communicate around the ring in the opposite direction.

In the absence of a supervisor, particular tasks are as-

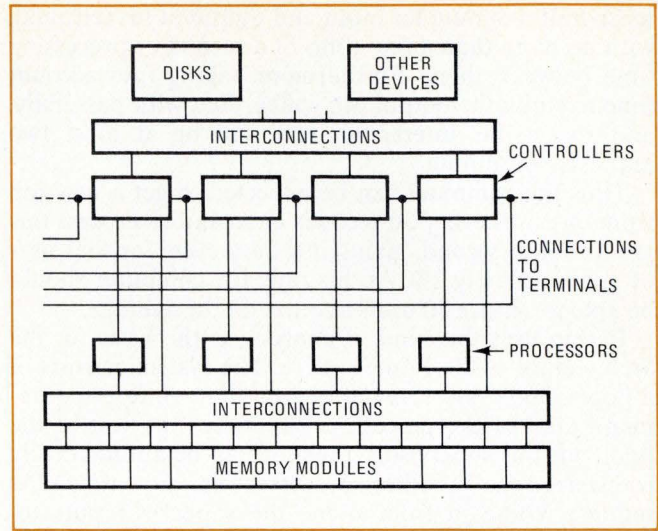

5. Prime. Designed specifically for users, not computer experts, this network consists of a pool of resources from which a supervisory processor puts together what's needed to do a user's job. High bandwidth in the path between primary and secondary memories, a characteristic of this network, is important for high performance.

signed to particular elements of the system through a process of bidding. A user describes the job he wants done through a terminal connected to some element of the system. His request goes around the ring picking up bids from any elements that can do the job and, on completing the circuit, displays the list of bids to the user. The user picks one, and the system goes to work. However, unbeknownst to the user, the system configuration may change while his job is in progress, so that it is not necessarily completed by the same machine that started it.

At the moment, four minicomputers are connected into the DCS at the University of California. Three of them are Lockheed's SUE computers, and the other is a Varian 620i. Interfaces between these computers, each of which has its own complement of peripherals, have been built from standard TTL integrated circuits at a component cost of about \$1,000 each. Farber estimates, however, that the design could be implemented with two LSI packages for perhaps \$40, plus design cost.

Eventually many other machines at Irvine and other southern California campuses may be connected to the network. But by that time Farber feels that DCS will no longer be a research activity, and he will turn it over to an operating authority.

Another research project, called Prime, is also at the University of California but on the Berkeley campus, some 400 miles north. It is under the direction of Herbert Baskin. Although Baskin is a computer expert working among other computer experts, he is putting together a continuously available, high-performance system designed for computer users as distinct from computer experts. "Experts are unusual," says Baskin. "They write their own programs, and if the programs don't work or if the hardware fails, they fix it. But the great bulk of computer users are like the bulk of motorists—when something goes wrong with the vehicle, they yell for help."

Baskin sees the ordinary computer user taking quar-

ter to half a minute for input and output at his terminal, with no more than a few 10ths of a second of processing time between them. Furthermore, taking into account time to study the output, sip coffee, chat with passersby, and so on, his interaction rate will be at most two requests per minute.

Thus the computer can be expected to get a new job from one user every 30 seconds or so and to process this job in half a second, giving it a duty cycle for that user of approximately 2%. At this rate, the computer should be able to service 50 users at once, on the average.

Baskin uses this kind of analysis as the basis for the architecture of the Prime system. The system consists of a pool of processors, memory, and input/output equipment. One of the processors supervises the rest of the pool, but this supervisory function can be automatically transferred to another processor at any time. As requests come in from users, the supervisor puts together a small computer from elements of the pool. The computer thus assembled processes the request until it is finished, generally in a fraction of a second, and will not be disturbed during this time unless the system receives a request when its pool is exhausted of one or more kinds of elements. Even so, the job will only terminate if the computer has had it for some time.

Wide-band link

The Prime network aims for high performance by establishing interconnections of exceptionally high bandwidth between the primary and secondary memories. This is the path taken by data during "swapping" operations, when the currently active portion of one program or block of data is replaced by another. Since most requests from the ordinary user cause file manipulation or computation related to file manipulation, swapping is a large part of the work done during the half-second that the processor is serving a particular user. A high bandwidth in the swapping path keeps the job from getting bogged down in swapping, and also can permit several different users' programs to swap all at once. This, together with the fact that secondary memory (a magnetic drum or disk) is likely to have an access time of tens or hundreds of milliseconds, implies that many, parallel, wideband paths between secondary and primary memories are necessary. A single path is quickly bogged down and remains a bottleneck even if the capacity of secondary storage is enormous.

Baskin's group is currently putting together a network (Fig. 5) containing five processors, 26 memory modules, and 15 high-speed disk drives in the pool. The processors are Meta 4 computers from Digital Scientific Corp. and include general-purpose emulators—Digital Scientific's stock-in-trade—that run programs written for the Xerox 940. Later, other emulators for the DEC PDP-10 and other computers will be added.

Four-center network

Ring networks are not limited to university research projects, for Tymshare Inc. operates a distributed network of computers commercially. Called Tymnet, it is a practical version of the basic ring shape, which usually has to become a distributed network to cope with specific applications. For example, traffic conditions may

require more interconnections than the pure ring makes available, or reliability may call for more than two paths between nodes.

Much like the GE network, Tymshare began by supplying service on a time-shared basis and grew into a network to satisfy its customers' requirements for capacity and reliability. Tymshare's emphasis is on low-speed interactive service, going from widely scattered terminals to nodes in over 70 cities, to a dozen or so switching centers, and finally to 33 large host computers in four centers—Cupertino, Calif., Englewood Cliffs, N.J., Houston, Texas, and Paris, France.

Most of these 33 large computers are aging Xerox 940s, which remain in use because of their superlative time-sharing software. Six DEC PDP-10s and one IBM 370/158 are also installed in the Cupertino facility. The nodes and switching centers scattered about the U.S. and Europe are all Varian 620 minicomputers, as are the small front-end computers that interface the network and the large central computers (Fig. 6).

Both GE and Tymshare networks can incorporate a customer's own computer, affording it access to remote facilities for special purposes and giving access to it to other network users. Tymshare, in particular, has 19 such connections with nine different customers. One is the National Library of Medicine, whose Medline data base is accessible from the Tymnet. Subscribers to the library can, for example, look up unusual combinations of symptoms, as an aid to diagnosis, or the specifications of rare drugs and medicines and their sources. One of Medline's outstanding files is on toxicology, which provides information on the symptoms and antidotes for a wide variety of poisons.

Other networks

In Michigan, three universities are interconnected over a network called Merit. Although the University of Michigan, Michigan State University, and Wayne State University have different computing requirements, the network lets their students and faculty share resources, augmenting one another's capabilities and avoiding duplication of effort.

Wayne State in Detroit and the University of Michigan in Ann Arbor, 35 miles west, each have an IBM 360/67. Michigan State, in East Lansing, 60 miles northwest of Ann Arbor, has a Control Data 6500. The interface between each computer and the leased 4,800-b/s line that interconnects the network is a DEC PDP-11 computer. Eventually the network may be extended to other institutions in Michigan, in much the same way that TUCC serves the state of North Carolina.

In Pennsylvania, a rather diversified network has grown up at Carnegie-Mellon University in Pittsburgh. It began several years ago with the installation of a relatively simple link between the university's IBM 360/67 and its Univac 1108, both large-scale computers. A more flexible yet less expensive connection was later made through a DEC PDP-11/45, which also allows ports to be added to the connection at low cost, and by now a second 11/45 has been tied to the first. The two 11/45s share a common memory and serve 90 teletypewriter and similar terminals scattered around the campus, plus two minicomputers in the departments of

psychology and biotechnology, plus four other time-shared machines at various research centers in the U.S. and Canada. All of these have access, through an 11/45, to both the 1108 and the 360/67. Besides, in the department of physics, a PDP-8 is used as a remote job entry terminal to the 1108 alone, over a private connection.

This network is operated by the university's computation center. In addition, the department of computer science maintains a connection to the Arpanet, described later. The computation center network is not connected to the Arpanet node at present, although it may be in the future.

In California, a network called Octopus provides an impressive level of computing capability to the personnel of the Lawrence Livermore Laboratory, which has an exceptionally large and highly concentrated computer center to simulate nuclear reaction experiments that cannot actually be performed. The network's name comes from its original configuration—a single large switching unit connected to an array of worker computers on one side and to a collection of mass storage units on the other. But by now it's a cross between an octopus and a hydra, since to improve reliability, the single switch was replaced by five concentrators, with more to be added in the near future. (Another network, at Los Alamos Scientific Center, is called Hydra.)

All the worker computers—presently four Control Data 7600s and one CDC 6600, and shortly to include CDC's giant Star-100 (Fig. 7)—are connected in general to all the concentrators, each of which is itself a computer of substantial capability. For example, the one that controls the data files for the system is a large Digital Equipment Corp. PDP-10. Originally the "head" of the octopus, it now also maintains a time-sharing system of its own and controls raster-scan terminals that

display graphic data in conjunction with Teletypes. Other concentrators handle interactive terminals, remote job entry terminals, and a subnetwork of data-collection devices. New concentrators are planned for additional peripheral equipment—notably the new Honeywell high-speed printers [*Electronics*, Nov. 6, 1972 p. 44, and in *Electronics Review*, this issue].

A borderline case

Both research and commercial networks are obviously going propositions. Moreover, one very impressive network, the Arpanet, built as a basic research project in its own right, seems to be turning into a commercial operation or at least a research service. It even seems to be spawning several purely commercial enterprises patterned after it (see "Commercial Arpanets," p. 105).

The Arpanet is a project of the office of information processing techniques in the Defense Advanced Research Projects Agency of the U.S. Department of Defense. Over the years, Darpa has also provided much of the funds for MIT's Project MAC, for Illiac 4, and for work on many other computer-related research projects—as well as advanced projects in space, seismology, and other fields.

The Arpanet interconnects about 30 or so research organizations, working under contract to Darpa. It permits people at any one of these laboratories to obtain access to a computer at any other. Its overwhelming advantage is that every node has access to all the computing resources of all the nodes, including special data bases, special programs, and unusual equipment.

At each host computer is an interface message processor (IMP), which translates the hardware and software idiosyncrasies of the particular computer at that node—

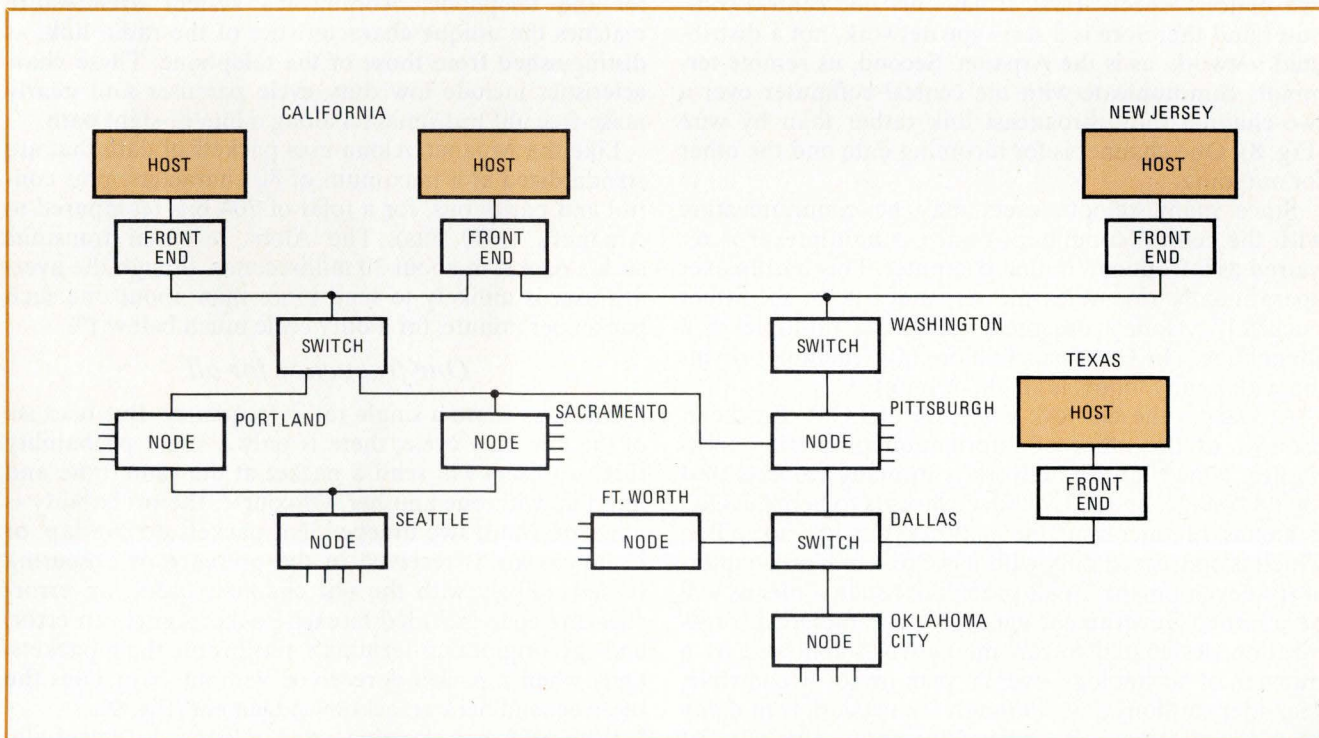

6. **Distributed commercial network.** Tymnet offers service from four centers (three shown here) through switching centers and concentrators in various locations such as those named, interconnected to provide alternative paths in the event of localized failures.

such as interface requirements, cycle time, word length, and operating system—into the requirements for data transmission over the network. The IMP also performs the reverse translation for incoming data. All data is transmitted over the network in the form of “packets” of a maximum of 1,000 bits, with an address on each packet that indicates its destination and its position in a larger block, if any.

Packet switching permits a message to be sent over the network without having a path established for it in advance. This is unlike telephone switching, where a customer has the exclusive use of a circuit during his call. Voice communication is essentially continuous, whereas computers tend to talk in bursts and use as little as 1% to 10% of a continuous channel capacity. But routing can change from moment to moment, depending on traffic, equipment failures, and so on, so that the packets may arrive at the destination in a different order from the one in which they were sent—this is why the address includes packet-ordering information.

Not all nodes in the Arpanet have host computers. Some rely on terminal IMPs, or TIPS, which give them access to the network but provide no service to other users of the network.

Packets by radio

Another packet-switching project is the Aloha system centered at the University of Hawaii and linking computer centers and terminals in the islands that constitute the state of Hawaii. Aloha was initiated as a separate project but, under the direction of Norman Abramson, has become part of the Arpanet, through a satellite link to the mainland via Intelsat.

Although Aloha's packet-switching approach is much like the Arpanet's, it does differ from the Arpanet in two major respects. First, it has only one central computer and therefore is a star-type network, not a distributed network, as is the Arpanet. Second, its remote terminals communicate with the central computer over a two-channel radio broadcast link rather than by wire (Fig. 8). One channel is for incoming data and the other for outgoing.

Since many remote users may be communicating with the central computer at once, a multiplexer is required as a front end to that computer. This multiplexer operationally resembles the Arpanet's IMPs, so, rather pockishly, Aloha's designers called the multiplexer a Menehune. (In Hawaiian folklore, a menehune, rhyming with penny loony, is an elf, or imp.)

At Darpa, the network is in care of J.C.R. Licklider, director of the office of information processing techniques. Now that the network is in many respects past the R&D stage, one of Licklider's tasks is to help develop a means of operating the network outside his office, which is concerned only with basic research and exploratory development. In all probability such a means will be another Government agency or a commercial organization designated to run the network, followed by a transfer of technology over a year or so. Meanwhile, Licklider cautions that, although the network is in many ways a service now, much developmental work remains that can be suitably done within his office.

For example, the network isn't as reliable as some

users would like it to be. One critic, whose organization has a host computer at one node, says that he uses it only a couple of times a month, generally just to send messages to colleagues at other nodes—“and even then it's often shut down when I want to use it,” he says.

Certainly a weak spot in the network is that IMPs in general are on the same site as their hosts. As a result, when host personnel shut down their computer for the weekend or for any other reason, they sometimes shut down the IMP, too, so that it can't handle packets passing through to another destination.

Licklider points out another weakness—the nonredundancy of the IMPs at source and destination, and of the connections from the IMPs to their respective hosts. As originally envisioned, the IMPs were to be linked to the host by no more than 200 feet of straight wire. But experience has shown that sometimes cables as long as 2,000 feet are needed between an IMP and its host, calling for the installation of line drivers and receivers. In a few cases, the hosts have been so far away that the only feasible connection between the IMP and its host was to add another modem and a common-carrier line. The alternative in these cases was relocating the wideband line of the network itself.

Licklider also cites work going on toward increasing the throughput of the network itself. For example, present 50,000-b/s lines could be replaced by lines with a capacity of a megabit or more. Alternatively, satellite connections could be used between nodes.

Abramson's experience with the Aloha network is germane to this issue. He chose the radio links for the network, partly as a research exercise, and partly to overcome technical problems that occur with telephone-line links (telephone cables *do* exist between the islands of Hawaii). But instead of merely substituting the radio for the telephone, Abramson's system architecture matches the unique characteristics of the radio link, as distinguished from those of the telephone. These characteristics include low duty cycle per user and nearly noise-free uhf transmission along a line-of-sight path.

Like the Arpanet, Aloha uses packets of data that are standardized at a maximum of 80 characters, plus control and parity bits, for a total of 704 bits (compared to Arpanet's 1,000 bits). The Aloha terminal transmits such a packet in about 30 milliseconds, though the average user is unlikely to send more than about one such packet per minute, for a duty cycle much below 1%.

One frequency for all

All users share a single radio frequency. But because of the low duty cycle, there is only a slight probability that two users will send a packet at the same time and interfere with one another. Of course, the probability is not zero. But if two independent packets do overlap, or if any packet is received in the presence of obscuring noise (unlikely with the uhf channels used), an error-checking code included in each packet signals an error, and the originating terminals retransmit their packets. Only when a packet is received without error does the receiver send back an acknowledgement (Fig. 9).

With uhf broadcasting, transmission is essentially only along the line of sight. Consequently, all the terminals of the Aloha network installed so far are on the is-

Commercial Arpanets

The technical success of the Arpanet has led to the formation of two commercial enterprises, Telenet Communications Corp. and Packet Communications Inc., which each have close links to the parent project. Both have been boosted by the reluctance of the Defense Department to operate the Arpanet as a service and by certain deficiencies in the network that have become apparent from experience with it. Both are value-added networks (VANs), which means that both will lease wide-band communication lines from a common carrier (AT&T), add terminal, computer, and interface facilities, and resell the package. Both are expecting patronage from banks, credit bureaus, and other large organizations of all kinds that need data communications in bulk, and that now must build their own networks to get the service they need.

Lawrence G. Roberts, who was director of the Defense Advanced Research Projects Agency's information processing technology office from 1969 to 1973 and a special assistant to the director from 1967 to 1969, is now the president of Telenet Communications Corp. He made the move from Darpa to Telenet because, he says, the technology had gone about as far as it could within the Government agency. "It had to become a commercial service to demonstrate its real value and to continue its development. It's also attractive, both in a business sense and because it provides a needed service."

Roberts plans to have a seven-city network in operation by next January and to expand the network to 18 cities during 1975. Each city will have an interface message processor (IMP)—something like Arpanet's—in a Telenet-owned facility, reachable by local subscribers over 4,800-b/s dial-up lines, and connected between cities by 50,000-b/s leased lines, or by 1½-million-b/s satellite channels. The land lines will be better for short messages, because they are not subject to the quarter-second delay imposed in satellite transmission by the satellite's high altitude. But large blocks of data can go by satellite because the bandwidth of the channel is larger and hence the cost is less.

"The satellite links will also be very effective in a broadcast mode," says Roberts, "when you have a block of data that must go to many nodes at once. To do that with land lines would require moving it step by step across the country, with larger capacity on each of the segments en route."

Telenet's IMPs will be duplexed at each node and concerned only with forwarding messages that pass through; local connections will be handled by duplexed terminal interface processors (TIPs). The duplexing will provide a degree of reliability not enjoyed by Arpanet users. Telenet's IMPs and TIPs ("I invented the words, so I'm going to use them," says Roberts) will be dual-source machines from Honeywell and from Prime Computer Corp.; the two are compatible. Arpanet's IMPs are Honeywell 516s and 316s.

The other Arpanet spinoff, Packet Communications Inc., has Lee R. Talbert for its president. Talbert was formerly an employee of Bolt, Beranek & Newman Inc., the prime contractor for the IMPs and other Arpanet hardware. His task was to study the commercial opportunities offered by the company's work with the Arpanet. He found BB&N unwilling at the time to make the investment he thought would be necessary, so he decided to make the attempt independently, starting PCI in July, 1972.

(Paradoxically, just a few months later, BB&N backed the establishment of Telenet, of which Larry Roberts eventually became president. Today BB&N owns 54% of Telenet's stock.)

The level of investment Talbert is talking about is shown by the size of network he says is necessary for economical operation. To transmit 1,500 packets per second, none of which is delayed by more than 0.2 second in reaching its destination, would require about 13,000 terminals connected to 50 to 100 large computers. However, to ease the financial problems of getting started, Talbert and his associates have decided to back off from immediate implementation of these specifications—most notably in the delay from source to destination of 0.2 second. If a full second is allowed, PCI would have five times as long to get a packet onto a line, and the network can break even with fewer terminals and computers.

"Therefore, our initial offering will be on lines running at 9,600 bits per second and costing that much less than the faster lines," says Talbert. "We'll grow into the faster lines with correspondingly better service as our business increases." PCI will begin selling its service this month, and hopes to begin operation in 18 cities during the summer of 1975.

PCI's network will resemble those of Darpa and Telenet in many ways, but will have some important characteristics of its own to escape some of the problems of the Arpanet. "Darpa's experience with the IMPs gives about 200 to 400 hours mean time between failures," says Talbert. "We want something like 10,000 hours. And we don't like the idea of adding redundancy, because it creates new problems with interfacing." When interviewed, Talbert hadn't made any commitment to a particular vendor, but felt that General Automation was out in front as a likely source for the computers, which will be called packet switching processors and terminal access processors—PSPs and TAPs—corresponding to Darpa's IMPs and TIPs.

One problem that both Telenet and PCI face is the unwillingness of commercial network customers to adapt the software in their computers to work with the network. The Arpanet's users are research laboratories whose people are able to tackle the software modifications—"but in the commercial world they're not about to do that at all," says Roberts. Talbert emphasizes that his network processors provide the host—any kind of host—with an interface exactly like the one the host works with in its own data communications. This standardized (to the host, anyhow) interface removes the need for a network control program, which the Arpanet requires, but still lets the design of the network processor evolve.

Roberts

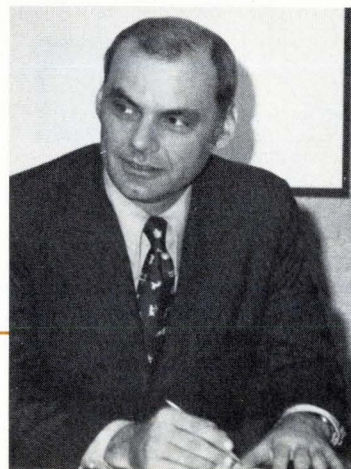

Talbert



land of Oahu, where the university's main campus is, and on Maui, 100 miles southeast. Conventional repeaters are used in the link between the two islands, which passes over the island of Molokai.

These repeaters, however, are quite unsuitable for a packet-switching system. Designed for use with voice-transmission and similar analog channels, they receive a signal on one carrier frequency, remodulate it onto a different frequency, and retransmit it. The frequency shift is necessary to prevent the repeater from picking up its own continuously transmitted signal. When many different repeaters are being used in a single system, careful choice of frequencies is necessary, together with filtering, to avoid interference.

Abramson's group is developing a new kind of repeater, one that can store an incoming packet and retransmit it at the same frequency—separating the incoming and outgoing messages in the time domain. A single frequency could then be used for the entire system. The storage presents no problem, Abramson points out, since a 1,000-bit storage module can be hand-held.

The radio link is also encouraging the group to develop a portable terminal—a much simpler task with radio transmission than with telephone lines. Abramson expects a prototype requiring plug-in power to be ready this month. Later, an even smaller battery-operated unit will be developed, he thinks.

European networks

Networks, of course, are not the monopoly of the United States. Arpanet, General Electric, and Tymshare have links to Europe and Japan, and Europe has some impressive networks of its own.

In West Germany, some networks link banks with one another, and others store and exchange data on wanted persons between computers at state and federal police centers. One network, undergoing continual expansion, links the stock exchanges in Düsseldorf and Munich, is now adding the Berlin exchange, and will link up with the Stuttgart bourse shortly.

In Scandinavia, 1,600 savings banks with 5,200 offices in four countries are to be interconnected through a network now being installed by Saab-Scania AB of Sweden. It consists of teller terminals at individual bank windows, local minicomputers in each bank branch, larger computers coordinating all the banks in a given district, and finally large central computers. Machines from several different manufacturers are included in the network. Saab has also sold a similar system to the Central Savings Bank in New York.

Sweden's two largest commercial banks, Svenska Handelsbanken and Skandinaviska Enskilda Banken, have also installed their own networks linking about 500 branches apiece throughout the country. The Handelsbanken system is being installed by Svenska Philips AB, a subsidiary of Philips Gloeilampenfabrieken of Holland, which is also putting in a network to link 750 of Sweden's largest post offices. The system will handle a variety of postal operations, from registering letters and handling payments, to printing receipts. It includes 570 minicomputers (some shared by nearby offices) and large central computers in Stockholm.

French ambitions

Right now France is lagging behind its European neighbors in installed computer networks, but by next year at least two government-backed packet-switching networks will be operating on a more than experimental scale. The government's plans are very ambitious. To meet its target of 110,000 terminals installed by the end of 1977, the growth rate will have to exceed 100% a year, since only about 8,250 are installed now.

One of the planned networks, called Cyclades, will interconnect the country's main government research bases and will permit a dialog between scientists or between data banks in different computers. Various sizes and types of computers will be included, ranging from the IBM 360/67 and Control Data 6600 down to the Hewlett-Packard 2100 and the Philips 1100. The network will resemble the Arpanet in the U.S. in many

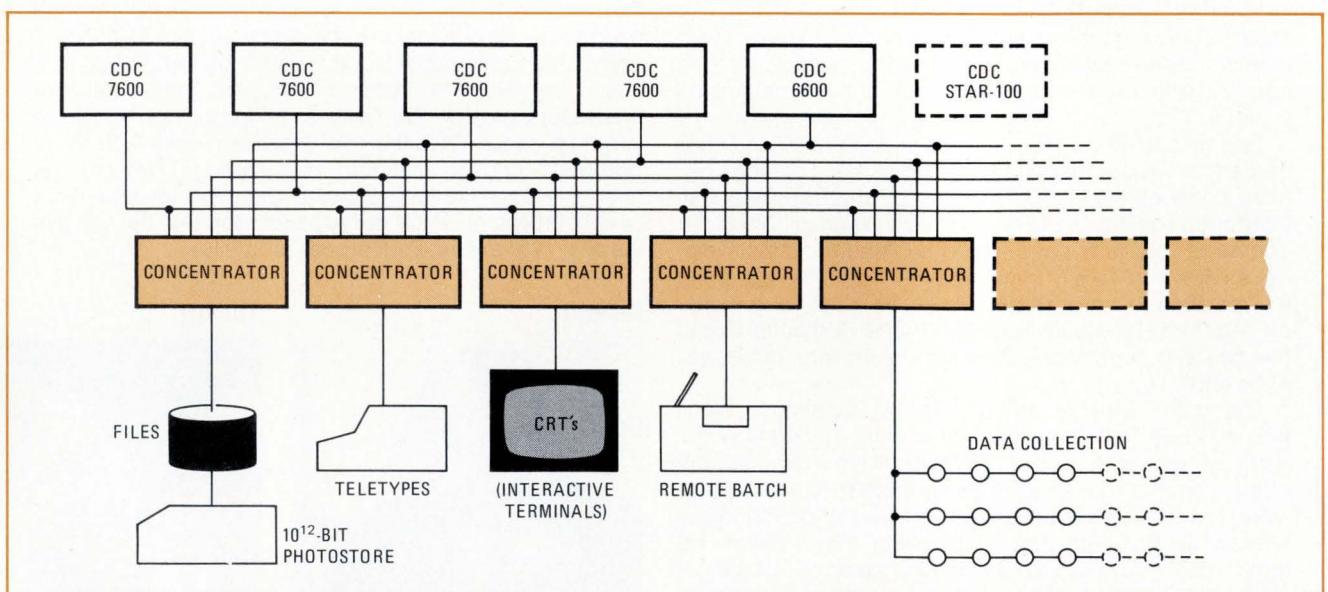

7. Octopus. At Lawrence Livermore Laboratory a variety of high-powered computers is interconnected with bulk storage units, data collection devices, and remote terminals. The network can simulate complex nuclear experiments that cannot be carried out in the real world.

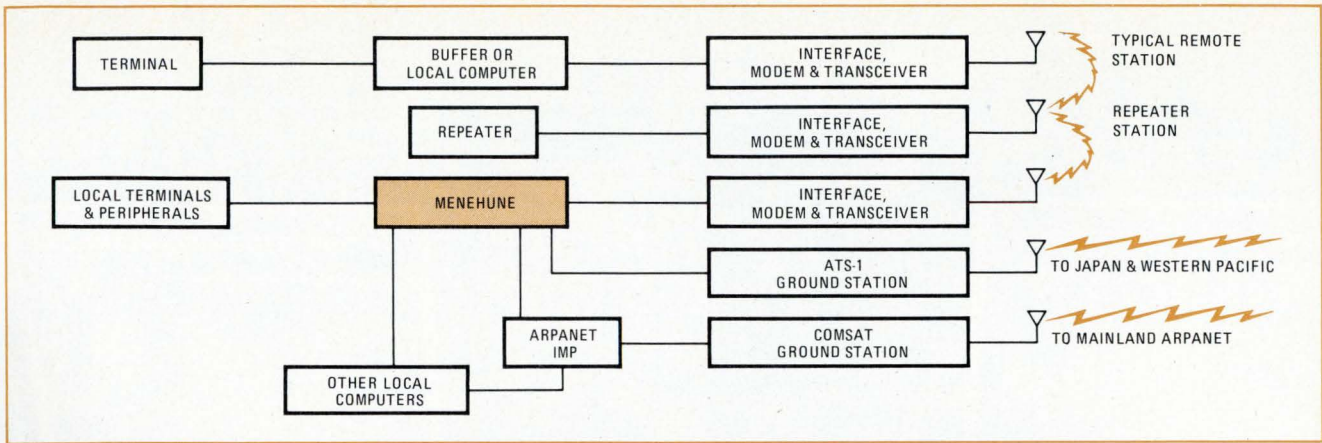

8. Through the air. In Hawaii, several remote stations are connected to a central host computer with radio links instead of the usual telephone line. Similar links are maintained between this Aloha network and the Arpanet, in mainland U.S., and western Pacific computers.

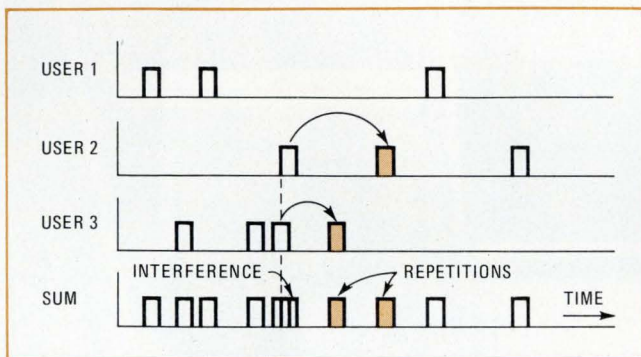

9. Low interference. Because each user occupies an Aloha data channel much less than 1% of the time, two users are unlikely to transmit simultaneously. But if neither message will be acknowledged by the receiver, and both will therefore be repeated.

ways: the function of Arpanet's IMPs will be carried out by small Mitra 15 computers built by Compagnie Internationale pour l'Informatique (CII).

Another network, for commercial applications, will be the RCP, for Réseau de Commutation par Paquets, being developed by the French Post and Telecommunications Ministry Research Laboratories [*Electronics*, March 7, p. 52]. At one time RCP was to be combined with the general telephone network, but the authorities now have lowered their sights to achieve an extensive packet-switching network on its own set of leased telephone lines.

The Russians are planning computer networks as well. The OGAS program, which stands for All-Union Automated System for Planning and Management when translated, will link a system of regional computer centers to Moscow and to local computer rings in each region, all as part of a long-range effort to bring management of the economy up to date. The Soviet Union has signed an agreement with Control Data Corp. under which CDC will provide technical assistance and perhaps two large CDC computers for use as part of the network, which would be patterned after CDC's Cybernet system in the U.S. The network would also include IBM-360-like Russian Ryad computers.

However, the agreement is not final, pending clearance by the U.S. Government under existing regulations that restrict the export of militarily significant

computers and computer technology to the Soviet Union. Such clearance is not expected for some time. Even if it is granted, the Soviet network is not slated to begin operation before 1990.

Nontechnical problems

Many university research networks are or have been supported in part by the National Science Foundation, whose principal interest has been in the sharing of resources, computer-based or otherwise. According to Donald D. Aufenkamp, head of computer applications in research, in the division of computer research at NSF, one of the foundation's major recent projects was to fund several star networks that would let a major university share its computational facilities with a dozen or so other colleges in the area.

The biggest problem turned out to be the missionary work that was necessary to make that kind of resource-sharing useful. "It's not enough just to hook up all the computers and buy terminals for people," says Aufenkamp. "You need a mechanism to facilitate the use of the resources. In some cases you need instructional material. You have to make it easy for people to use the system, and that depends on the level of sophistication they have to begin with."

Other problems arise over the transferring of funds between institutions. Sometimes a small college with its own computer center may suffer some dislocation because an on-campus terminal also offers access to a major center on another campus, a bright light some miles away. That may generate a lot of resentment. Or if the local campus has access to the Arpanet, it may save money on hardware and communication costs, but it may lack the expertise needed to productively use the network's broader expanse of machines and services. Indeed, the local college may have to increase its own staff, offsetting some of the hardware savings.

"Many subtle issues and considerations are involved in determining what savings and over-all costs may accrue to an institution when it is tempted to join a network," Aufenkamp concludes. "Furthermore, determining the total cost alone doesn't consider the effect on the individual groups that contribute to that cost. Even if the dollar cost is reduced, what do you do if the results are unsatisfactory in some way?" □

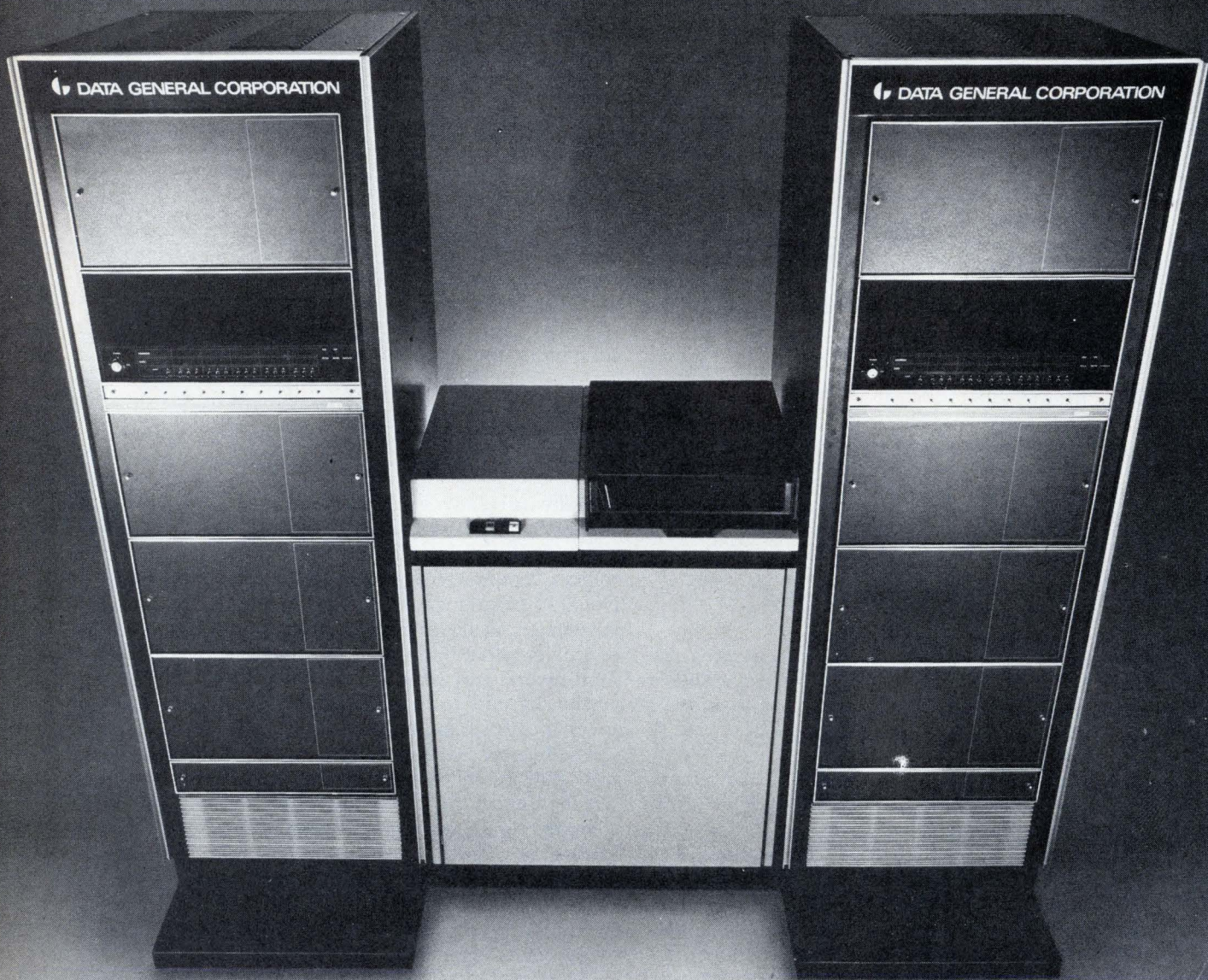

**Data General introduces the first
stereo computer system.**

This computer not only looks like a music system.
It works in stereo.

Two separate computers play off the same disc.
It's called the Dual Nova.

The Dual Nova is a standard off-the-shelf product. Which means it's fully supported by the operating system. You just plug it in and go to work.

Which is the first time you've been able to do that on a small dual processor system.

If you want to do load sharing, the disc gives you a huge storage area that both computers can use. So both computers can share the same datafiles and programs.

And if you want to use the Dual Nova as a redundant system, the backup computer won't just sit there. You can put it to work on computation, data reduction, or what have you.

And if one of the computers happens to go down, the other one will keep going. One can't hurt the other. Because they're totally separated. Electrically. Mechanically. And physically.

There's three discs to choose from: the quick access Novadisc, a cartridge disc, or big capacity disc pack.

You can use any two computers made by Data General.

And as it turns out, every Dual Nova computer has a foreground to do one thing. And a background to do something else.

Just in case you want to go quad.

DataGeneral

The computer company you can understand.

• Data General Corporation Southboro, Massachusetts 01772, (617) 485-9100.
Datagen of Canada Ltd., Hull, Quebec (819) 770-2030/Data General Europe, Paris, France 504-23-44.

Circle 109 on reader service card

Current steering simplifies and shrinks 1k bipolar RAM

Steering a current through the decoder matrixes simplifies circuitry and eliminates the many resistors needed by voltage-mode TTL devices; moreover, a single circuit can perform an entire logic function

by John E. Gersbach, IBM Corp., Essex Junction, Vt.

□ To pack 1,024 bits of random-access memory on a single bipolar chip requires a combination of processing advances and innovations in circuit design. IBM's 1,024-bit RAM, introduced in 1973 into the System /370 and System /7 computers, is no exception.

The processing advances used to obtain smaller chip size and better performance included self-aligning emitter contacts and thin (3.5-micrometer) epitaxial layers, while double-layer metalization eliminated the need for conductive underpasses in silicon that would have added to parasitic capacitance. The use of emitter-over-base pinch resistors also reduced both the size and the power dissipation of the individual memory cells [Electronics, March 7, p. 130]. The new circuit approach was to access each cell, not with the voltage-mode circuits of TTL, but with current-steering circuits, which afford space and power savings.

The current-steering approach also made it possible to perform entire logic functions in single circuits, rather than in an assembly of such separate circuits as AND gates and inverters. Essentially, the logic design was worked directly into the circuit design.

The 1k RAM is organized in a 32-by-32 array. To access individual cells, five bits of the 10-bit address code steer an 8-milliampere current through decoders to one of the 32 lines in the X direction (called word lines), while the other five address bits steer another 8-mA current to one of the 32 Y lines (or bit lines).

The use of current-steering circuits has many advantages over the use of TTL voltage-mode circuits:

- Small size—for the same power and performance, total resistance is two to three orders of magnitude lower than in TTL circuits, increasing packing density.
- Low power—only small voltage swings (± 400 milli-

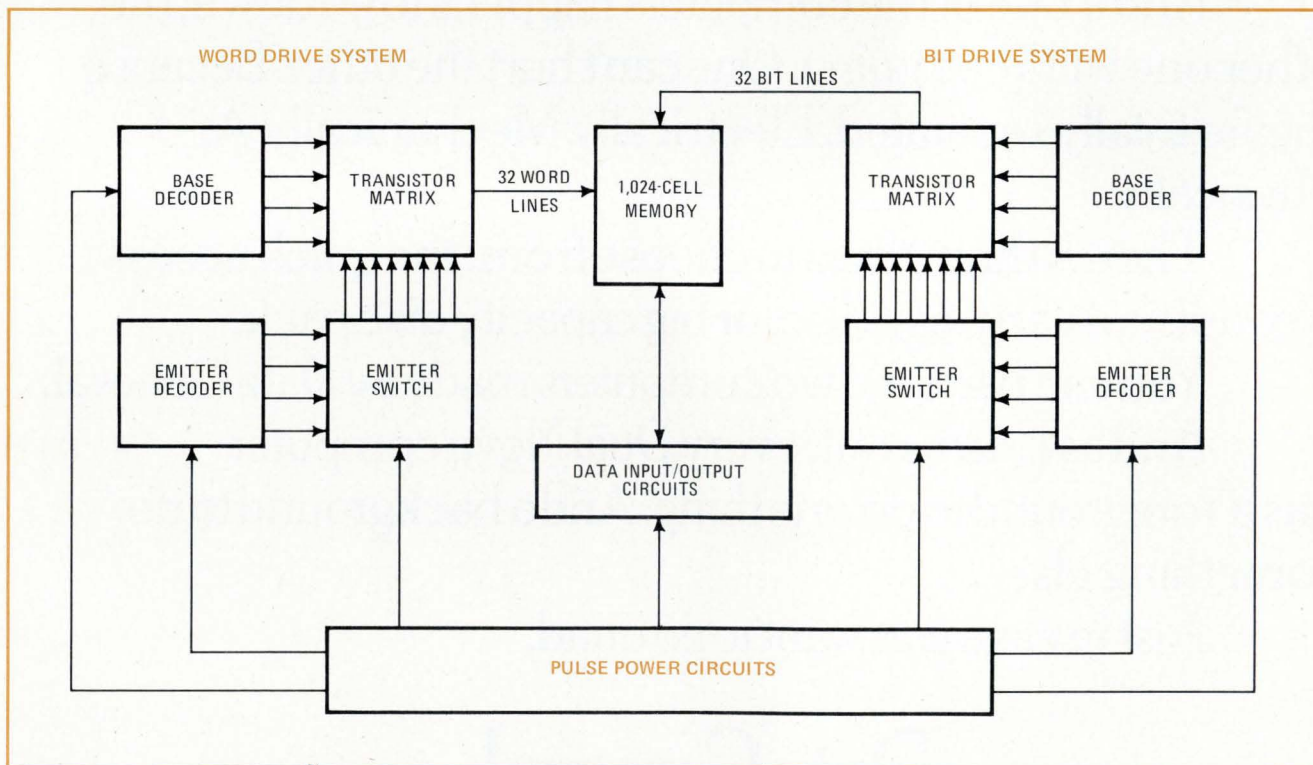

1. Complete memory. Currents are steered by address bits through decoders (emitter switches, base decoders, emitter decoders, and transistor matrixes) to word and bit lines to gain access to one of 1,024 cells. Output from the cell appears on data bus and is switched to data out line. Pulse-power circuits generate currents used throughout the memory.

volts) are required to steer just one current, performing many functions, through many circuits.

- Light loading of driver circuits—only base currents are required to drive inputs.
- Wide design margins—performance depends not on the absolute but the relative tolerances of resistors and diodes. Since these are inherently good in integrated circuits, yields rise and costs drop.
- Simplicity—powering the circuits with pulsed power is easily accomplished, and it takes relatively few transistors to steer a current. Packing density is thus increased. In addition, the power-performance product can be dramatically improved by such circuit simplification as “collector-AND” functions (connecting collectors together to perform AND operations) and cascoding (so that the drive current is used only for on-devices, and none is used to keep off-devices off).

Performance and power

The memory basically consists of address decoders and drivers for the word and bit lines, the memory cells, the data input/output circuits, and the pulse-power circuits (Fig. 1). In the IBM applications, the chips are packaged four to the module. Only one of the four is powered at any one time, during which period chip-select pulses gate the decoder circuits.

The access time over the path that goes from the chip-select inputs through the power gate and decoder matrices to the data I/O circuit is typically 20 nano-

seconds, and cycle time is 50 ns. These two figures could be reduced to 12 ns and 40 ns, respectively, if the power gate circuits remained on continuously. (This would be done by disconnecting the -3(P)V terminal in the power gate circuit, shown later in Fig. 5.)

Chip standby power is 58 milliwatts, and, while the chip is selected, power is 425 mW. This power, however, is reduced because of the duty cycle and is distributed among the chips of a large matrix, so that the average chip power is close to the standby value.

To understand how the circuit operates, take the example of an address input of all logic 0s. Logic 0s are negative voltages of about 400 mV (logic 1 is +400 mV).

First, consider the word-drive system (Fig. 2). This system comprises an emitter switch that decodes the fifth bit of the address code (ADR 5), an emitter decoder, which decodes ADR 1 and ADR 2, a base decoder similar to the emitter decoder, but which decodes ADR 3 and ADR 4, and a transistor matrix, which finally steers the current to the proper word line.

In the emitter decoder, a negative input at ADR 1 causes the input transistor to turn off and thus turns off transistors Q₁ and Q₂, too. Transistors Q₃ and Q₄, however, turn on since their corresponding input transistor has its input grounded. The two transistors thus draw 1 mA each through their respective 250-ohm load resistors, which are connected to output lines +2 and +3. Likewise, ADR 2 causes Q₅ and Q₆ to conduct, drawing 1 mA through the resistors for lines +1 and +3. Thus,

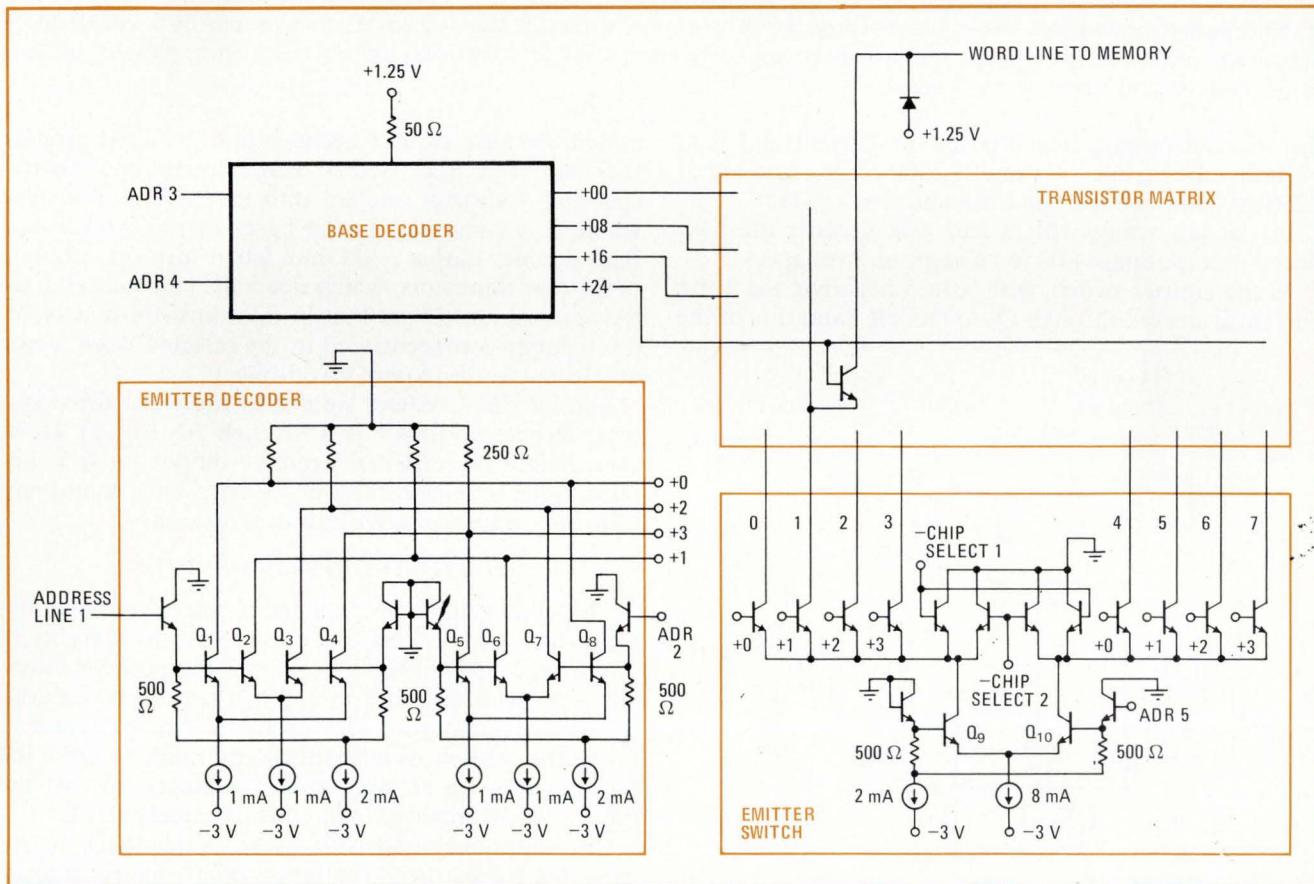

2. Word drive system. Negative and positive inputs on the address lines (ADR) switch transistors on or off, steering current provided by current reference circuits through the emitter switch (as determined by the emitter decoder output) and through the transistor matrix (as determined by the base decoder output) to one of 32 word lines. Nonselected matrix transistors need no power.

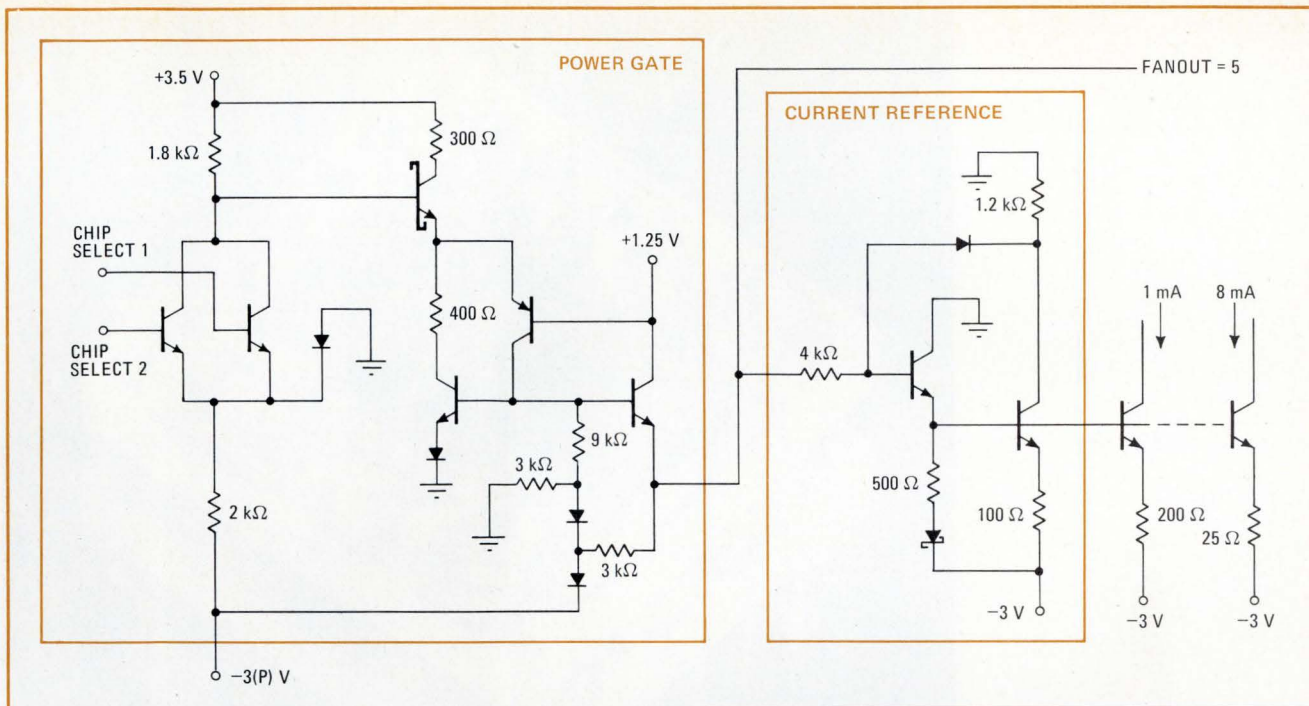

5. Pulse-power circuits. Power gate circuit, turned on by simultaneous occurrence of two logic level selection pulses, drives current reference circuits for rest of memory. If the $-3(P)V$ terminal is left unconnected, access and cycle times are reduced.

further drive to the off state at the end of the chip selection pulse, the current in the bit emitter switch is diode "OR-ed" to all pnp collectors. The point at which the feedback transistor turns on is set by the bit base decoder's reference voltage of +2.5 v.

The memory cell (Fig. 3) is a diode-gated flip-flop with 15-kilohm load resistors (the pinch resistors described in the March 7 article). In the standby condition, each cell draws about 20 microamperes from the 3.5-v supply through the conducting half of the flip-flop and then through the 200-ohm resistor connected from the word line through a diode to the +1.25-v supply. The offset voltage between the conducting and nonconducting halves thus is about 300 mv, and standby power is about 45 microwatts.

The flip-flop transistors are shown as "Schottky" transistors since they have Schottky diodes (not shown) clamping the collector-base junctions out of saturation. Once a cell is selected by the negative 8-mA pulse on the word line and the positive pulse on the bit line, the information appears as a differential voltage across the bit output lines and, through the two diodes, on the data bus.

When the bit lines go positive, both Schottky coupling diodes turn on. If, for example, the right-hand transistor is conducting, its collector would be about 400 mv lower than the other collector, making the bit 0 line more positive than the bit 1 line. Since the Schottky diodes are conducting at about the same currents, they have about the same voltage drops, so that the differential voltage is also about the same as the voltage difference across the internal cell collector nodes.

In the data I/O circuit (Fig. 4), during a read operation, a negative voltage is applied at the +write/-read terminal. With the chip-select inputs negative, the 8-mA current source flows through transistor Q_1 and divides

between the 40-ohm resistor and the diode—6 mA through the resistor and 2 mA through the diode. The OR diodes that connect to the bit lines and the translation diodes are biased on by the 2-mA current. The 6-mA current flows to the "data out" pad or to the 3-v supply, depending on the stored data.

For a write operation, the +write line is positive, causing the 8-mA current to flow through Q_2 . If the "data in" line is negative (to write in a logic 0), the 8-mA current is further steered through the left-hand ("data-in") current switch transistor to hold the bit 0

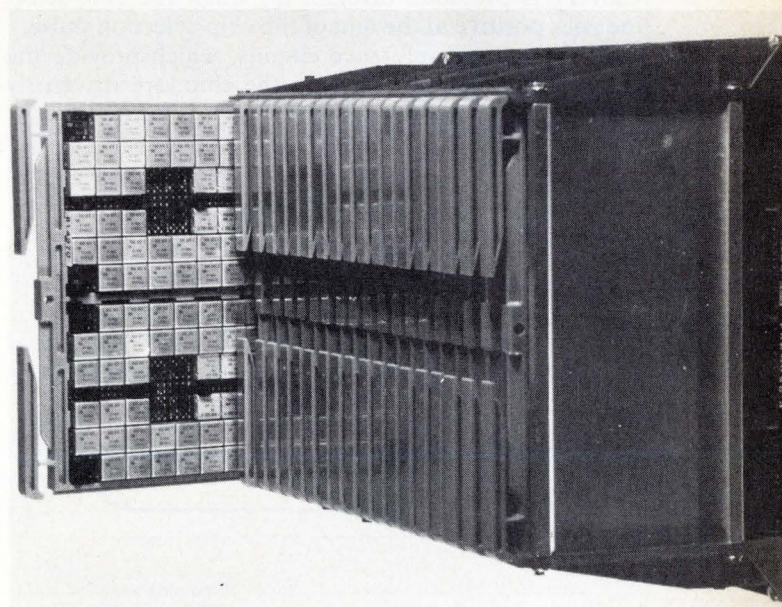

6. Rack-up. Memory modules mount cards which plug into a board 13 inches wide (holding 36 cards). Each card contains 128-k bits; total capacity is about 0.5 megabyte (a byte is nine bits).

7. Double-decker. Two ½-inch-square ceramic substrates each hold two 1-k RAM chips, to make the four-chip module used in IBM's System/370 and System/7 computers.

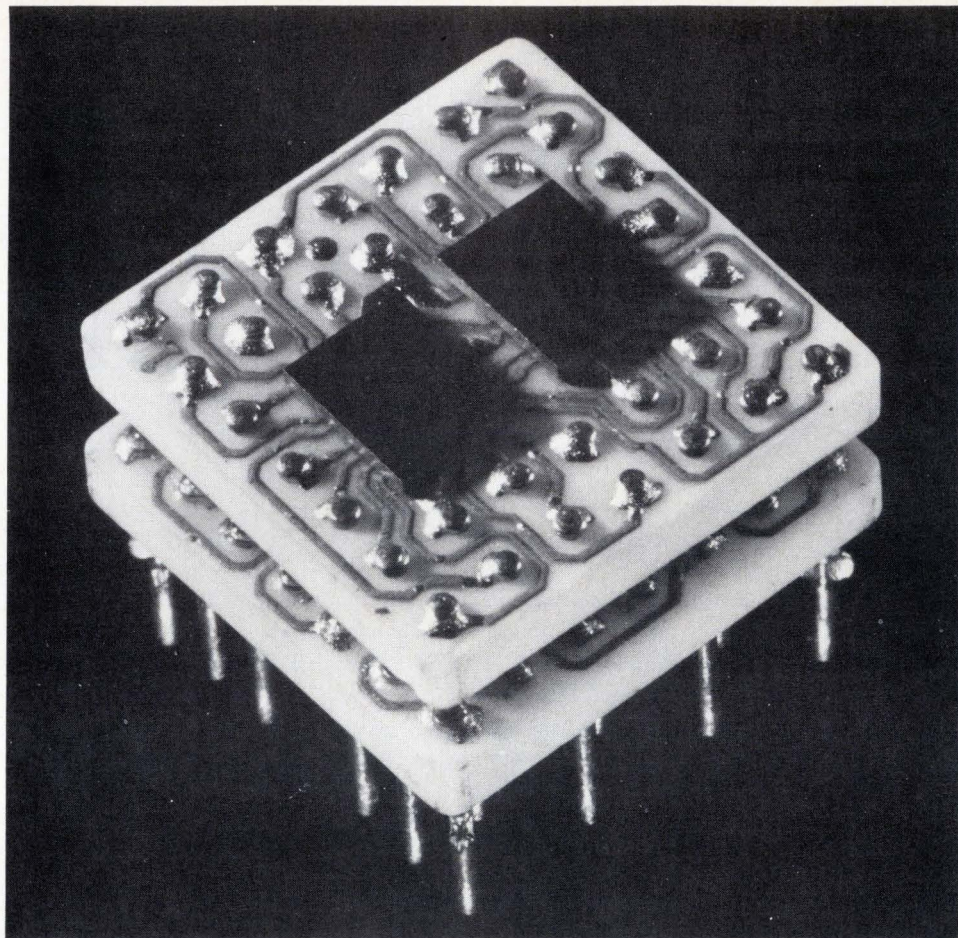

line negative before the cell is selected. When the bit line goes positive, only the memory cell's right-hand Schottky diode will conduct, pulling up the collector of the left-hand transistor, turning the right-hand transistor off and turning on the left-hand transistor. Bit line recovery is provided through Q_3 when the chip-select line goes positive at the end of the chip-selection pulse.

All the current reference circuits, which provide the many current sources used on the chip, are driven by

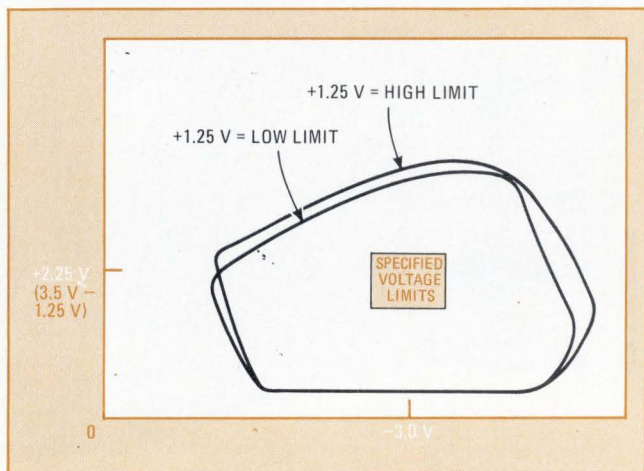

8. Wide margins. The "Shmoo" plot for a 128-kilobit memory card shows significant range between the specified limits on the three power-supply voltages (-3 V, $+2.25$ V, and $+1.25$ V) and the edge of the plot, which represents the limit of proper memory operation.

the power-gate circuit (Fig. 5). This circuit turns on with the coincidence of two logic level selection pulses. For voltage translation, the power gate also uses a lateral pnp transistor that here, too, is driven on hard and has its turn off hastened by feedback.

The big picture

Large memories are built using a 3.25-by-4.5-inch card (Fig. 6) that contains 128 kilobits of storage as a basic building block. Every card is populated with 32 four-chip modules (Fig. 7), plus 10 single-layer modules for buffering, decoding, and sensing. A board containing 36 such cards can package up to 0.5 megabytes of storage (a byte is nine bits). The boards, which are 13 inches wide, 8 in. high, and 6 in. deep for a density of 7,562 bits per cubic inch, can be stacked vertically and cooled by forced convection.

The memory will operate over a wide range of variations in the three power supplies, as shown in the "Shmoo" plot for a 128-kilobit card (Fig. 8). There are wide margins between the specified tolerances on the power-supply voltages and the edges of the plot. This means that chips with defects, which fail near the voltage specification limits and are likely to fail in the field, can be screened out without any testing loss of chips that are defect-free. □

ACKNOWLEDGMENT

The author is indebted to IBM's Adolf Zehle and Joseph Maslack for the chip layout; Roy Flaker for the cell analysis; Robert McMahan and Paul Zerr for the peripheral circuit analysis; Paul Steiner for management of the design into manufacturing; and Siegfried Wiedmann for early work on the pinch resistor.

Measuring the access time of bipolar read-only memories

by Joseph J. McDowell
Monolithic Memories Inc., Sunnyvale, Calif.

The access time of a semiconductor memory, particularly that of a bipolar read-only memory, can be difficult and time-consuming to measure. But here's a tester that makes this measurement quickly and does not require the data pattern stored in the ROM to be known. There is one condition, however. The ROM must be tested first for its dc parameters.

Memory access time is considered to be the maximum address-to-output delay from any address to any output. For bipolar ROMs, access time typically ranges from 30 to 150 nanoseconds, and storage capacities can be as large as 8,192 bits. Conventional testing techniques require a single-shot time-interval measurement for each bit, since each address and output of the ROM

generally has a different delay time. The maximum delay measured in this way is recorded as the access time.

Single-shot time-interval measurements, however, have two major drawbacks. Each reading requires about a millisecond, which can add up if the memory is a large one. And the Schmitt-trigger discriminators, which are used to establish the start and stop times, rely on a specific transition direction (either high to low or low to high) through a voltage threshold to implement the start or stop.

This last condition is a problem because the transition direction cannot be predicted for a ROM, unless the data pattern in the ROM is stored in a random-access memory. The problem then becomes one of finding a RAM that is as large and as fast as the ROM being tested to tell the measurement system what to expect. Even if such a RAM can be found, spikes can appear prior to the access time and can trigger the discriminators.

Another measurement technique is to compare the ROM with a RAM that is loaded with ROM data. But again, there is the problem of finding a RAM as fast as the ROM to be tested.

The tester in the figure uses a totally different ap-

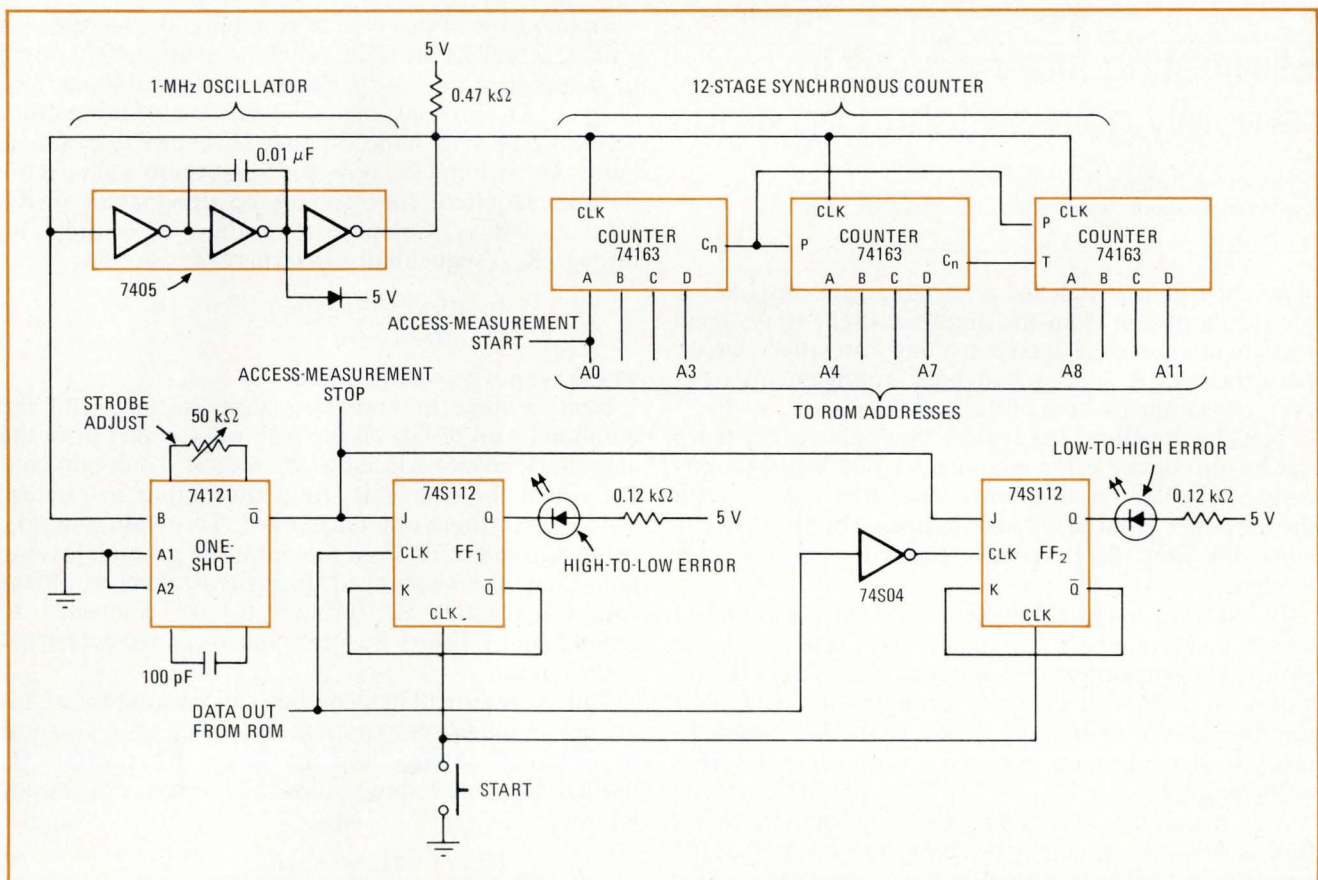

Time-saving tester. This circuit checks out the access time of a bipolar read-only memory by regarding any transition occurring at the memory output after the allowable access time as an error. The counter string changes all of the ROM's addresses at the same time. The one-shot acts as a strobe whose timing cycle is set to the allowable access time. A pair of Schottky-TTL flip-flops monitors each ROM output line. If a high-to-low transition error occurs, FF₁ lights its LED; if a low-to-high transition error occurs, FF₂ lights its LED.

proach. It looks for transitions after the expected access time, and defines any transition from this access time until the next address change as an error. This method takes advantage of the fact that the memory reaches a steady-state value before the access time, and the data outputs should not change again until the address is changed. Although the data pattern stored in the ROM does not have to be known, the unit must first be checked for dc parameters, since a package without a chip inside will pass the test.

In the test circuit, 4-bit totally synchronous counters are used to count through all the addresses of the ROM, guaranteeing that all the addresses change at the same time. These address transitions define the start of the access measurement. The counters are driven by a 1-megahertz oscillator, which is constructed with logic inverters. Two Schottky-TTL J-K flip-flops are employed to look for transitions after the access time—FF₁ looks for high-to-low transitions, while FF₂ looks for low-to-high transitions.

The one-shot stops the flip-flops from watching for transitions prior to the access time by holding each one's J input low until the access time is reached. This prevents the flip-flops from changing state. They remain

in their initially cleared condition, with their Q outputs low and their \bar{Q} outputs high.

After the one-shot completes its timing cycle, the J input of each flip-flop goes high. If a high-to-low transition now occurs on the memory output line, flip-flop FF₁ changes state—its \bar{Q} output goes low, and its Q output goes high, turning on the error-indicating light-emitting diode. The flip-flop, and therefore the error, remain latched because the unit's \bar{Q} output is tied to its K input. (Depressing the START button will clear the error.)

Flip-flop FF₂ operates identically, but turns on its error-indicating LED for a high-to-low transition on the memory output line. This scheme can be expanded to monitor n memory outputs by adding 2n flip-flops to the test circuit. (A pair of flip-flops is required for each memory output.)

The tester can be calibrated by attaching a pulse generator or delay line of known duration between the access-measurement start and stop inputs to the circuit. This simulates the memory access time, so that the one-shot strobe can be adjusted until a failure just occurs for a set GO/NO-GO limit. The tester can accurately measure an access time to within an accuracy of ± 4 ns. \square

Eliminating stray signals in remotely gain-switched op amps

by Ernest J. Kacher & Forrest Fox
The Methodist Hospital, Texas Medical Center, Houston, Texas

When the gain switch for a variable-gain amplifier is physically distant from the amplifier itself, stray signal pickup and/or capacitance loading can affect circuit performance. A special switching arrangement, however, can eliminate both of these problems.

The circuits drawn in (a) show how cable capacitance can be introduced at the amplifier's input. While the circuits of (b) show where noise generators appear when the amplifier input leads remain open. (In all these circuits, the amplifier is connected in its non-inverting mode.)

In contrast, the switching arrangement illustrated in (c) has no current paths through unused resistors, and it eliminates switching at the amplifier input. All of the resistors are used with each gain configuration, and all of the lines to the switch are always connected either directly to signal ground or to the low-impedance output of the amplifier.

The maximum allowable cable capacitance, therefore, is now determined by the capacitance load that the amplifier can tolerate, rather than the signal phase shift. Another advantage of this switching arrangement is that the circuit's bias-current compensation remains optimum for each gain, as long as the correct value is selected for resistor R₀.

To make use of this type of switching, the resistors required, as well as the right switching arrangement, must be determined for the specific set of desired gains: G₀, G₁, . . . , G_n. First, arrange the gains in ascending order according to magnitude (so that G_i is less than G_{i+1}), but let G₀ = 1 and G_{n+1} = ∞ . Since there will be n + 1 resistors required, they should be designated as R₁, R₂, . . . , R_{n+1}. Compute the values of resistors R₂ through R_{n+1} sequentially, in terms of resistor R₁:

$$R_{i+1} = \frac{G_{i+1}(G_i - G_{i-1})R_1}{G_{i-1}(G_{i+1} - G_i)}$$

where i varies between 1 and n.

Next, arrange the switch so that, starting with the minimum gain of G₀, all the resistors connect from the amplifier's inverting input to the output. To obtain gain G₁, switch the end of R₁ from the output to ground, leaving everything else unchanged. To obtain gain G₂, switch the end of R₂ from the output to ground, leaving everything else unchanged. In general, then, to obtain gain G_i, resistors R₁ through R_i are connected to ground, and resistors R_{i+1} through R_{n+1} are connected to the output.

This same switching technique can be used for an inverting amplifier configuration. However, gain G₀ must be set equal to zero, and the values for resistors R₂ through R_{n+1} are found sequentially in terms of resistor R₁ from:

$$R_{i+1} = \frac{(G_{i+1} + 1)(G_i - G_{i-1})R_1}{(G_{i-1} + 1)(G_{i+1} - G_i)}$$

where i again varies between 1 and n.

Resistor R₀ can be computed as the parallel combination of all the gain resistors, R₁ through R_{n+1}. Or, for

the non-inverting amplifier, it can be determined by:

$$R_0 = [(G_1 - 1)/G_1]R_1$$

And for the inverting amplifier, the value of R_0 is:

$$R_0 = [G_1/(G_1 + 1)]R_1$$

Circuits (d) and (e) give the resistor values for producing gains of 2, 5, and 10 when $R_1 = 1$. Amplifier (d) is noninverting, while amplifier (e) is inverting. □

Engineer's notebook is a regular feature in Electronics. We invite readers to submit original design shortcuts, calculation aids, measurement and test techniques, and other ideas for saving engineering time or cost. We'll pay \$50 for each item published.

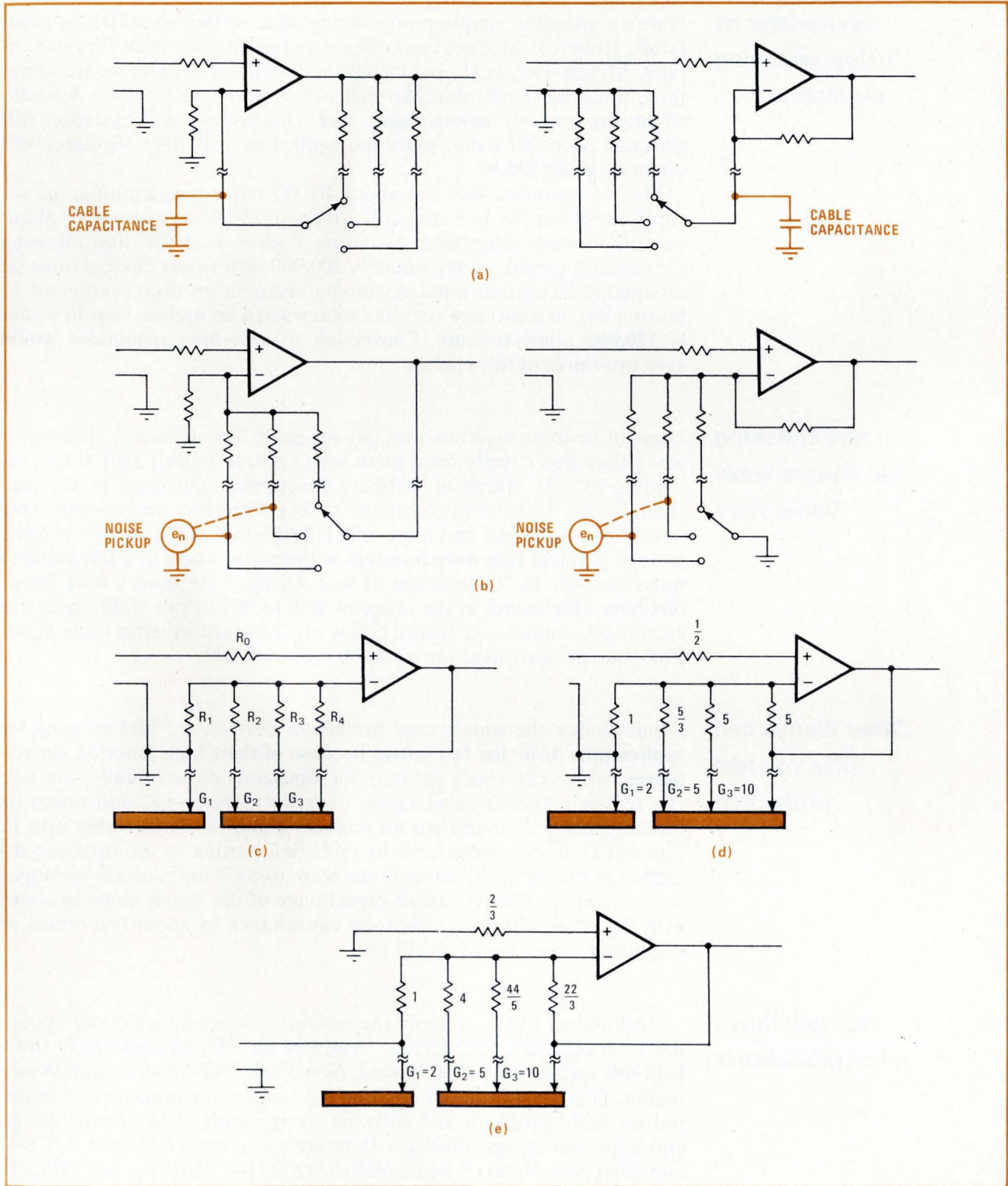

Switched-gain amplifiers. Remotely switched variable-gain amplifiers can suffer from the capacitance loading (a) of long wires or can pick up noise (b) through unused resistor paths. The switching arrangement of (c) doesn't have these problems because all of the switched points have low-impedance paths to ground. The noninverting (d) and inverting (e) amplifiers given here provide gains of 2, 5, and 10.

Save power by using switching regulators . . .

Here's a great but simple power-saving idea: **switch to switching regulators.** Robert J. McCue, marketing manager for Sorensen Power Supplies, Manchester, N.H., points out that switching regulators are about three times more efficient than their series-pass counterparts. **A 5-volt, 50-ampere ac-to-dc power supply that uses series-pass regulation will dissipate over 500 watts, while the equivalent switching regulator will dissipate about 135 w.**

McCue estimates that the about 40,000 series-pass modular power supplies sold in the U.S. annually dissipate 250 w on average or about 10 million watts altogether. Assuming a seven-year life, and allowing for demand growth, approximately 200,000 series-pass devices must be dissipating 50 million watts. Assuming again an on-time average of 10 hours a day in a 240-day year, the total **wasted on useless heat in a year is 120,000 kilowatt-hours. Conversion to switching regulators would save two thirds of this energy.**

. . . and checking out square-wave generators

Users of dc-to-ac inverters who pay for good, low-distortion sine waves when they don't really need them waste power as well as dollars. According to J. L. Harris of Wilmore Electronics, Durham, N. C., who should know because his company makes both sine- and square-wave generators, a cheaper and more efficient square-wave generator is often enough. **Typical sine-wave inverters in the power range of a few hundred watts are 60% to 70% efficient at best. Comparable square-wave inverters have efficiencies in the range of 85% to 90%.** Price differences are even more dramatic—a typical 500-watt sine-wave inverter costs about \$900, but an equivalent square-wave is about \$200.

Zener diodes can give you fast protection

Zener diodes, the widely used protection devices, are **just no good for applications involving fast pulses because of their high junction capacitances,** which can easily get into the thousands of picofarads. But you can reduce a zener's capacitance, improve its response, and retain its limiting function, if you **put an ordinary signal diode in series with it.** The signal diode should have its junction oriented in the opposite direction to that of the zener, as if you were using it to thermally compensate the zener. **The very small capacitance of the signal diode in series with the zener will reduce the total capacitance by about two orders of magnitude,** down to around 10 pF.

Get with those microprocessors

Feeling lost trying to apply the new microprocessors to your system design specs? Another series of **seminars on microprocessors is to be held this spring in Atlanta, Boston, New York, Philadelphia, and Washington.** These last from one to three days and cover introductory material on both hardware and software, programing, and system design and applications, specifically with reference to Intel's MCS-4, MCS-8, and 8080, and National Semiconductor's IMP-8, IMP-16, and GPC/P. **Fees are \$125 to \$350,** depending on the material covered and the length of the seminar. Contact Microcomputer Technique Inc., 11227 Handlebar Road, Reston, Va. 22091, or call (703) 620-9676.

THE MICRO- PROCESSORS

THE CHIPS

Microprocessors for do-it-yourselfers. From National Semiconductor. On distributors' shelves now.

Our chips are two P-MOS/LSI circuits that can be slapped together like building blocks to yield computer systems ranging from simple 4-bit processors for control functions to a powerful 32-bit system that handles complex calculations.

National's building blocks are the Register and Arithmetic Logic Unit (RALU) and Control and Read-Only Memory (CROM). Together they contain all the gates and flops you used to have to wire together to build your own processor.

The thing that does the work.

RALU.

A 4-bit slice of the Register and Arithmetic portion of a general purpose computer.

In one 24-pin package using standard +5V and -12V supplies

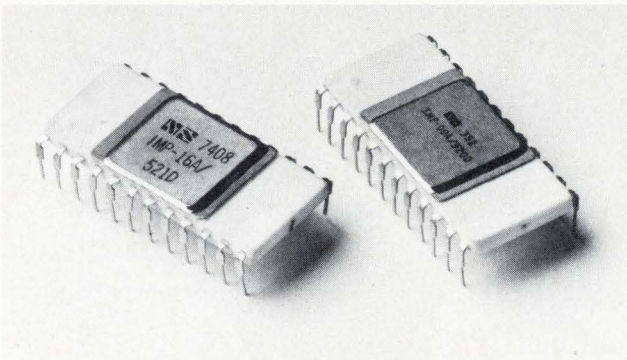

we've crammed all of the following: seven general-purpose registers, a status flag register, an arithmetic

logic unit, an I/O multiplexer, and a 16-word LIFO stack that improves speed and performance while conserving main memory. The RALU number is IMP-00H/520D.

The thing that tells the other things what work to do.

The only trouble with RALUs is that they don't understand English. Or even the zeros and ones that you feed into the microprocessor.

CROMs do understand zeros and ones.

They're souped-up ROMs that translate your binary instructions into operational commands. A single instruction to the CROM triggers a series of commands to the RALUs.

CROMs are currently available in three varieties:

A standard-instruction 16-bit CROM, IMP-16A/521D, with 43 instructions.

An extended-instruction 16-bit CROM, IMP-16A/522D, that speeds up processing with 17 additional powerful instructions including divide, multiply, double precision add/subtract, etc.

And an 8-bit CROM, IMP-8A/520D with 38 instructions.

You can buy the RALUs and CROMs in these set numbers: IMP-16A/500D: 16-bit standard set; IMP-16A/502D: 16-bit extended set; IMP-8A/500D: 8-bit standard set.

THE CARDS

For people who want to save time, National offers its "ready-mades."

Complete, fully-debugged 8 and 16-bit microprocessors on 8½ by 11 inch p.c. cards ready for your application program.

Our big ones.

The IMP-16C is a 16-bit microprocessor built around four RALUs and one or two CROMs.

The one-CROM version has a standard-instruction-set CROM and

with a Direct Memory Access bus controller and multi-level interrupts.

Our little one.

IMP-8C, 8-bit microprocessor. Small, but oh my!

A flexible, low-cost, self-contained processor and controller containing two RALUs, an IMP-8A/520 CROM, and provisions for the addition of a second CROM to expand the instruction set.

If 8-bits is your thing, you'll find

some things here to turn you on: 8 addressable control flags—control jump multiplexer provides 16 programmable branch conditions. Eight-bit buffered-data-out bus. Memory addresses 16 bits wide to provide a memory address range of 65,536 bytes. On-card memory expandable to 2304 bytes, consisting of 256 bytes of read/

write memory and up to 2048 bytes of read-only memory (ROM/pROM).

But whether you go for 8-bit or 16-bit, cards or chips, the question is, what are you going to do with them once you've got 'em?

Please turn the page.

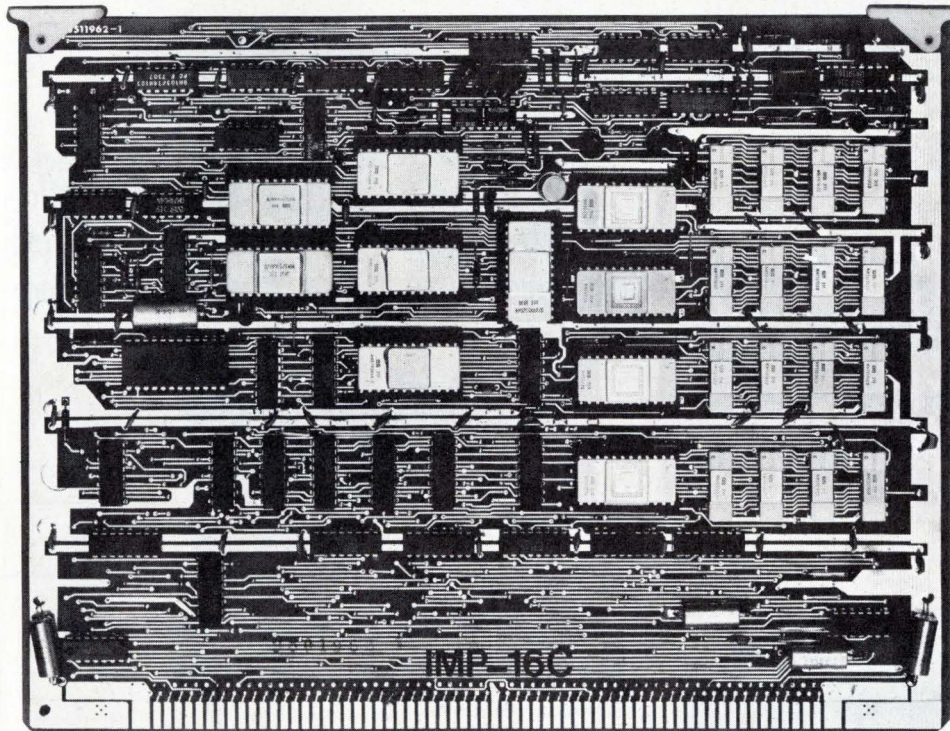

an empty socket for another (IMP-16C/200). Add the extended instruction-set CROM and you've got the IMP-16C/300.

The IMP-16L/300 card is similar to the 16C/300, but we optimized it for high performance applications

THE BOXES

The advantages of the whole microprocessor thing lies in the fact that it is standard hardware designed and built for you to *program* to your specific application.

Our boxes help you do that.

They're program debugging and prototyping systems, providing everything you need to develop and test both the interfaces and application programs.

Each box includes a microprocessor card, programmers control panel, peripheral interfaces, memory, power supply and chassis.

Box #1

The IMP-16P.

A microcomputer for use with the IMP-16C microprocessor cards. With a Teletype®, the IMP-16P provides all equipment necessary for the immediate evaluation and use of the IMP-16C (both 200 and 300) cards and chips.

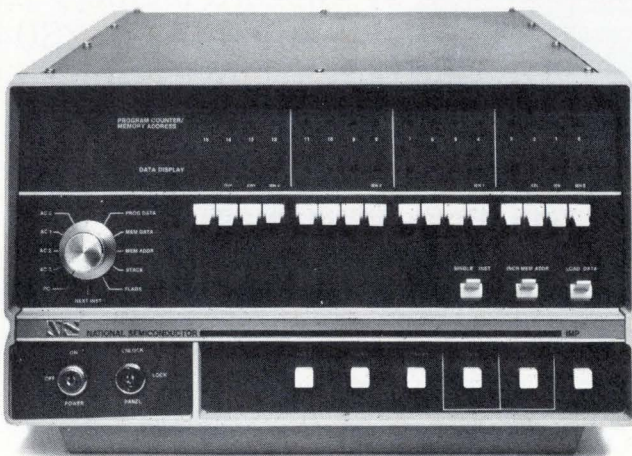

Box #2

The IMP-16L.

A prototyping system for the IMP-16L/300 card. (And if you're starting to get confused by all the different numbers, the chart on this page should help unconfuse you.)

The basic IMP-16L and options provide an unusually versatile tool for developing a variety of OEM equipment, software, and full-scale processing systems.

Box #3

The IMP-8P.

For 8-bit fans this is the prototyping tool for the IMP-8C card. Like the others, IMP-8P puts all you need for hardware and software development all in one box.

What goes with what.

| | CROM Types: | # of RALUs | Cards: | Boxes: |
|--------------------------|------------------------------|------------|-------------|-------------|
| standard 16-bit | IMP-16A/521D | 4 | IMP-16C/200 | IMP-16P/204 |
| extended 16-bit | IMP-16A/521D IMP-16A/522D | 4 | IMP-16C/300 | IMP-16P/304 |
| extended 16-bit with DMA | IMP-16A/521D IMP-16A/522D | 4 | IMP-16L/300 | IMP-16L/304 |
| 8-bit | IMP-8A/520D | 2 | IMP-8C/200 | IMP-8P/208 |

So that's our basic hardware. Our boxes, our cards, and our chips. But we're not quite through yet...

THE WORKS

National wouldn't leave you out on a limb. We support our hardware with software, firmware, and accessories that help make the whole thing easier to apply.

The assemblers.

What we have here is a communications problem.

RALUs don't understand what binary instructions are talking about (so we have CROMs to act as interpreter). And CROMs don't understand what human beings are talking about.

What's needed in the latter case is an assembler, which is a computer program that automatically converts English to binary language (something CROMs can understand). You just feed the program language and the assembler program into the computer and out pops the computer language.

We offer three kinds of assemblers, in both 8 and 16-bit versions. A self-assembler that needs no "outside" computer if you have one of our prototyping systems...a cross-assembler for use on your in-house IBM 360/370 computer... and a cross-assembler for use on a timesharing utility.

Other goodies.

We offer a strong software support package. Things that help you write the program you need, and check it out. Application, interfacing

and programming manuals...extensive diagnostic programs for hardware testing...loader programs...soft-

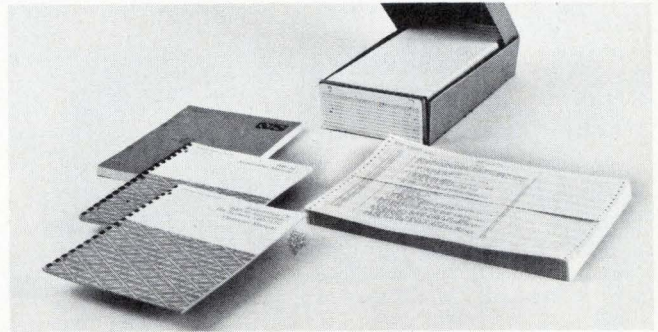

ware debug routines...utility routines, etc.

And there's also a passel of support hardware such as card cages, memory cards, extender cards, prototyping cards, peripherals, plus training courses to make you an expert in a hurry.

In other words...the works.

For further information use the coupon or call us at (408) 732-5000.

NATIONAL SEMICONDUCTOR
2900 Semiconductor Drive, Santa Clara, California 95051

Please send me the following literature:

- 16-bit Microprocessor Product Descriptions
- 8-bit Microprocessor Product Descriptions
- GPC/P Microprocessor Chip Product Data Sheets
- National Training Courses
- Have a salesman call.

Name _____

Title _____

Company _____

Address _____

City _____ State _____ Zip _____

Phone _____

4

NATIONAL

See us at Booth #753 National Computer Conference in Chicago.

Turn to page 7. Important? Sure...

By the time the office copy of ELECTRONICS gets to you, there's nothing left of page 7. It happens. Too often.

How often has ELECTRONICS wound up on your desk dog-eared and abused, with articles clipped out and ripped out? Or days, even weeks late?

How often has ELECTRONICS

never even made it to your desk?

You should be getting your copy of ELECTRONICS right off the press. You need it. Because it's important to stay on top of what's happening in your field. And ELECTRONICS is on top. ELECTRONICS is the Source. It's packed with up-to-date info, the breaking news of the electronic industries in the U.S. and worldwide.

You can get ELECTRONICS where you can find the time to read it—at home. Go to *the Source*, today. Fill out the subscription card enclosed in this issue, and send it off.

Electronics 
IS THE SOURCE.

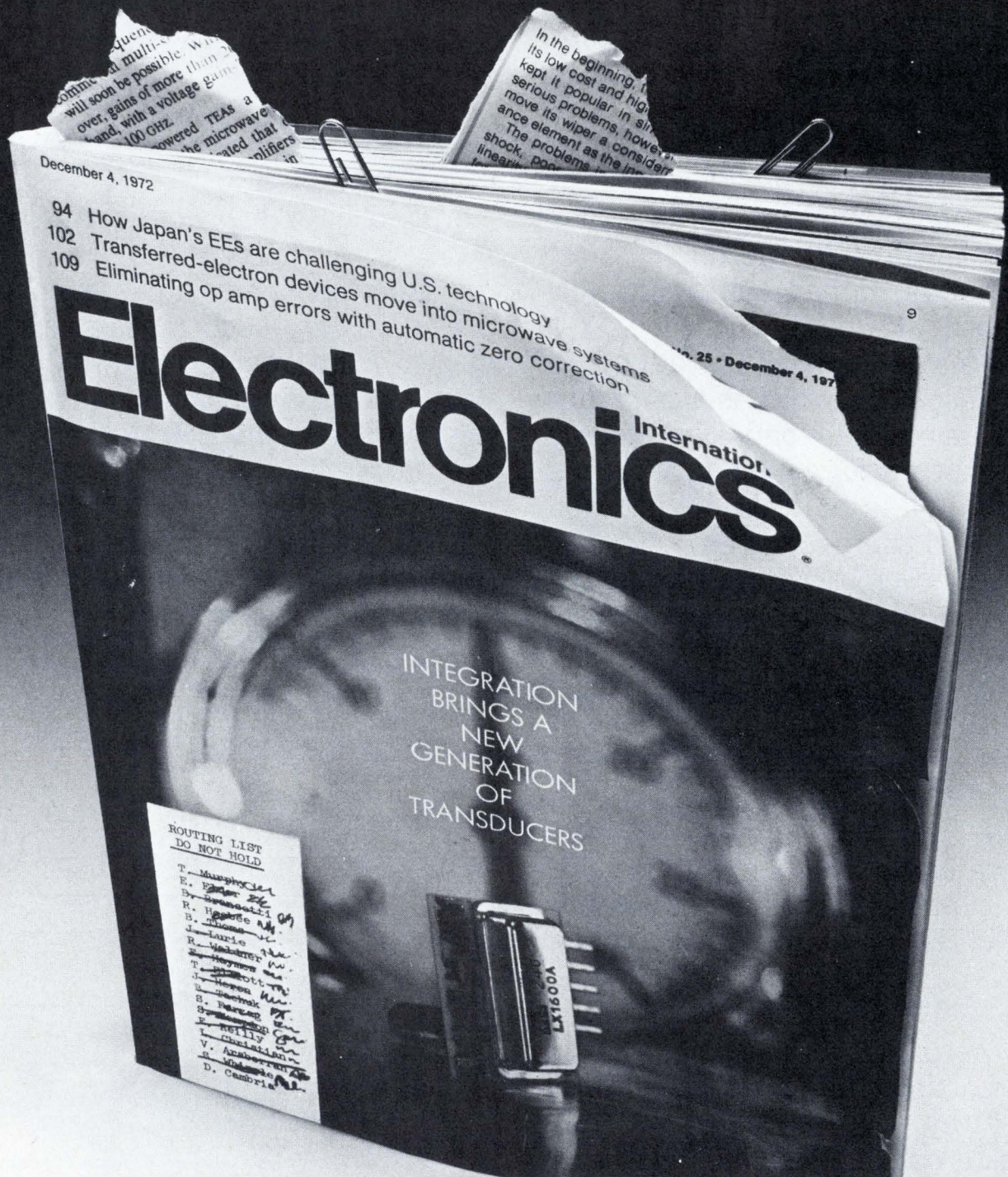

What you can't see can hurt you.



Unless you have mass, atomic-absorption, infrared and X-ray spectrographs, scanning and transmission-electron microscopes, scanning electron microprobes, X-ray fluorescence. Or us.

New independent analytical service.

Airco's new Analytical Services provides a full line of services for industrial, scientific and educational applications. We offer full gas analyses including calibration gas, gas identification and gases in metals and ceramics. We also provide environmental, organic and inorganic analyses. And we have portable instrumentation to conduct on-site analyses for many areas.

As a major supplier of industrial and rare and

specialty gases, we have an experienced staff and fully equipped lab to handle any analysis problem. They'll provide a complete gas analysis from any supplier (you don't even have to tell them who it's from) and they won't hesitate to tell you when a gas isn't as pure as it should be, even if it's ours.

For complete information, write or call Hank Grieco, Airco Industrial Gases, 575 Mountain Ave., Murray Hill, New Jersey 07974 (201)464-8100.

AIRCO
Industrial Gases

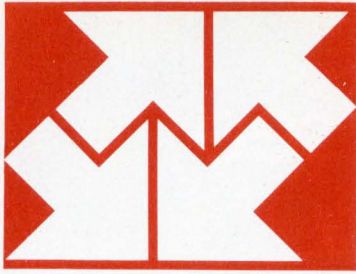

Expanding marketplace augurs well for 1974 National Computer Conference

Technical sessions to cover a broad range of technology and applications for users, as well as the EDP industry

by Alfred I. Rosenblatt, *New York bureau manager*

□ With both computer technology and applications sharing the spotlight, the technical program at next week's National Computer Conference in Chicago offers a record number of 119 sessions. That figure reflects the move of information processing into a host of newer businesses, such as data communications, point-of-sale systems, and computer networks.

As it did last year in New York, the NCC management is trying, especially through its technical program, to attract the "so-called non-computer professional who, because of his data requirements, actually winds up as the eventual computer user," explains Thomas C. White, director of communications for the sponsor, the American Federation of Information Processing Societies. "Appealing to the data-processing manager alone, as the Afips conferences did in the past, is just tunnel vision," he adds.

Accordingly, the program is divided into 10 major industry and business categories and five areas of computer science and technology. These represent, says general chairman, Stephen S. Yau, chairman of the Computer Sciences department at Northwestern University, "the most comprehensive analysis ever undertaken of the U.S. data-processing field."

The industry categories include communications and data-network systems, health care and biotechnology, education, manufacturing, retailing and distribution, government, finance, industrial-process control, and transportation. The science and technology areas deal with architecture and hardware, software systems, computer networking, and information-management systems.

And, finally, six special sessions will cover topics of general interest to computer professionals. Included is a review of computers and personal privacy, a three-part session marking the 10th anniversary of the inauguration of the computer time-sharing system at Dartmouth College, an overview of energy in an "evolving society," plus discussion of computer communications in a regulatory environment, computer development and applications outside of the United States, and computing and mathematics in society.

As in past years at Afips conferences, computer design and technology will receive major attention. Eleven sessions from next Monday through Thursday will deal with various aspects of computer hardware and architecture. All are aimed at either updating some of the most recent work or looking into what the future may bring.

In recognition of the number of large-scale data-processing installations and mass-memory systems increasing throughout the country, two sessions are devoted to discussing how the systems are designed and

PRODUCT PREVIEW

**Using 4,096-bit MOS RAMs,
single memory board for
computer mainframes
packs in 32,768 words**

Though interest in 4,096-bit MOS random-access memories is running high, start-up problems with yield and performance have kept them from being used in many systems. But Prime Computer Inc., which has committed itself to semiconductor memories since its founding in 1971, feels it can get a good enough supply of 4k MOS with good enough performance to let it introduce a new memory board built around 4k MOS RAMs.

The new board, which will be offered with Prime 100, 200, and 300 computers, has 32k words, with 16 bits and two parity bits per word—the most MOS memory ever packed onto a 16-by-18-inch printed-circuit board, the company says. This density will allow users to build systems with up to 256k of main memory in a single 21-inch chassis.

Prime is now using 22-pin Intel and Texas Instruments chips, but director of engineering Joseph F. Cashen says, "We are not limited

by pinout." Accommodating chips with different pinout would require a differently etched board but "we don't have a hangup on having more than one etch board," he says. Prime says that because its logic is microprogramed, the cost of designing a second etch board is minimized, and even that cost is offset by the advantage of being able to use more parts.

Cashen feels that, so far, the 4k chips that Prime has worked with are better than 1k chips were at a similar stage in their product life. He notes that problems are often found in new products, but so far Prime has found none in its 4k chips.

The principal benefit that 4k MOS contributes is lower price; a Prime 300 with 32k of 1k MOS memory costs \$26,000; with 32k of 4k memory, it costs \$19,000. While 4k chips are more expensive than 1k chips, they enable the component count to be substantially decreased, reduce supporting circuitry, and allow the unit to fit into a smaller chassis—with 1k MOS, Prime fits 8k words on one pc board. And since 4k MOS is still relatively new, Prime projects cost reductions as the price of the chips drops.

However, use of 4k MOS results in a tradeoff in speed: Prime's fastest 300 has a cycle time of 600 nanoseconds, while cycle time with 4k MOS is 750 ns. Prime expects that speed will increase in the future, and notes that since basic control for the memory is on the central-processor board, the microcode can be adjusted to different memory times as new products become available.

Use of 4k MOS makes a large amount of main memory available to the small-computer user, says Cashen, allowing him to be less dependent on slower mass storage and to save software costs of trying to squeeze his programs into smaller memories. In the Prime 300

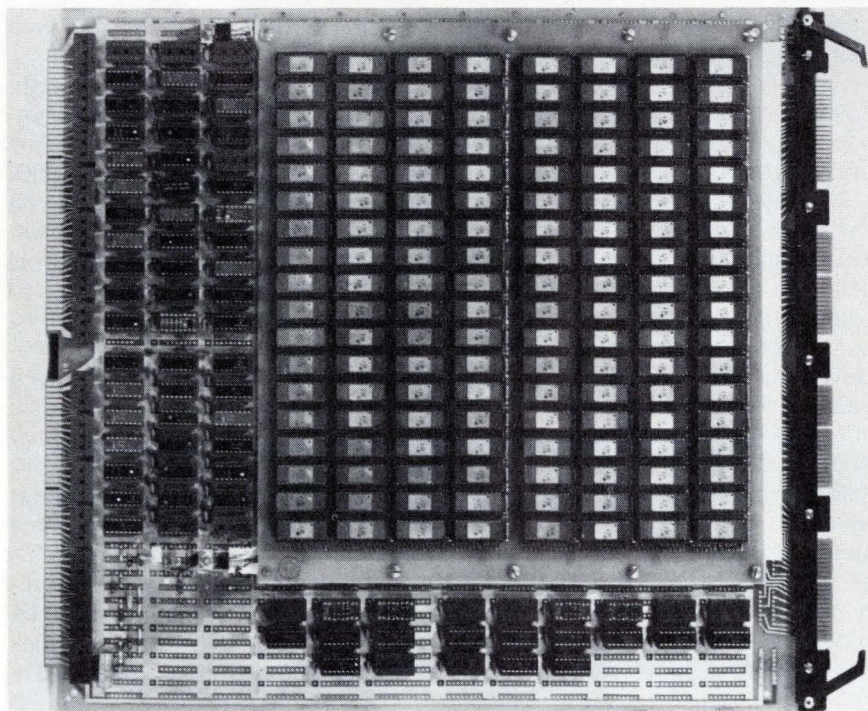

TYPE - 256 x 1 Static SOS/CMOS Ram

NUMBER - INS4200

READ CYCLE TIME - 180 nS

WRITE CYCLE TIME - 140 nS

QUIESCENT POWER DISSIPATION - 40 μ W @ 10 V

INPUT CAPACITANCE - 6.5 pF

SUPPLY VOLTAGES - 5 to 15 volts

OUTPUT - Three-state TTL compatible, full address
decoding and bipolar compatible pin-outs.

PACKAGE - 16 pin dual-in-line

PRICE - Mil Range (100-999) \$38.00

Comm. Range (100-999) \$21.00

**256X1
CMOS
RAMS**

Only Inselek makes the lowest power, highest speed 256x1 Static SOS/CMOS RAM currently available. And the price is only \$38.00 in the military range and \$21.00 for the commercial version (100-999).

Excellent prices when you consider the added benefits you're getting with our proven SOS technology ... exceptional reliability, high speed and low power. With an Inselek INS4200

Ram, a minimum number of additional components are required due to the 3 chip select inputs, especially when employed with large memory arrays. For the applications minded engineer or manager, you'll be glad to know that they're perfect for use in point-of-sale systems, mini & micro computers, computer peripherals, calculators & portable electronic systems. One more point. The Inselek INS4200 Ram is fully compatible with other CMOS and TTL devices. Check the specs above and then contact Bob Burlingame, your applications engineering specialist at

Inselek. Bob will be glad to discuss your specific requirements. Call Bob collect at (609) 452-2222, or write him at INSELEK, Inc., 743 Alexander Road, Princeton, New Jersey 08540.



SALES OFFICES IN:
CONCORD, MASS. (617) 369-5298
LOS ANGELES, CALIF. (213) 889-2788

DISTRIBUTORS

West Coast - WESTATES (213) 341-4411 • New England - GREEN SHAW (617) 969-8900 • Mid-Atlantic - WILSHIRE ELECTRONICS (609) 786-8990

New products

Fluke adds to low-cost multimeter line

4½- and 5½-digit instruments for bench use and field service employ a custom IC for economical dual-slope a-d conversion

by Michael J. Riezenman, Instrumentation Editor

Building on the success of its 3½-digit model 8000A multimeter [*Electronics*, Aug. 28, 1972, p. 100], the John Fluke Manufacturing Co. has decided to complete its coverage of the low-cost multimeter market by bringing out two new instruments—the 4½-digit (20,000-count) model 8600A, and the 5½-digit (200,000-count) model 8800A. But there's a difference: though the approach taken in the new units and the 8000A is the same—high reliability and no gimmickry—the means have changed.

Dual slope. Instead of the 8000A's voltage-to-frequency converter, which is incapable of the accuracy needed by higher-precision units [*Electronics*, Sept. 11, 1972, p. 102], the new models use dual-slope conversion—the process owned by Schlumberger, which recently licensed Fluke to use it. And to keep the costs of the dual-slope converter down, most of its circuitry has been implemented in a custom-designed IC.

Like their predecessor, the new meters feature LED displays, automatic zeroing, automatic polarity

detection, and rugged cases molded of high-impact plastic. Unlike it, the new instruments have autoranging in addition to manual range selection. Prices of the new meters are \$595 for the 4½-digit unit and \$995 for the 5½-digit machine.

Though meant for bench and field use, they can be given a systems orientation by an optional, isolated printer output for data-logging applications. Prices of this option are \$100 for the 8600A and \$150 for the 8800A. An option available for the model 8600A only is a rechargeable battery pack, priced at \$95.

Protection. A basic design consideration was adequate overload protection. The 8600A can withstand overloads of up to 1,200 volts dc or 1,700 v peak ac on all its voltage ranges. Its ohms ranges are protected up to 250 v rms or dc, and its current ranges are all protected by a 2-ampere fuse which is accessible from the front panel.

The 8800A is protected up to 1,000 V dc or 1,700 v peak ac on its dc voltage ranges, and up to 1,200 V rms on its ac ranges. Ohms protection is the same as on the 8600A;

the 8800A has no current ranges.

The 4½-digit 8600A has five ac and dc voltage ranges, five ac and dc current ranges, and six ranges of ohms. The voltage scales range from 200 millivolts full scale to 1,200 v, while the current scales run from 200 microamperes full scale to 2 A. The resistance ranges run from 200 ohms full scale to 20 megohms. Maximum error on the 2-, 20-, and 200-v dc ranges is $\pm(0.02\%$ of input + 0.005% of range). Input resistance is greater than 1,000 megohms on the 200-mv and 2-v ranges, and 10 megohms on the others.

The 5½-digit 8800A has essentially the same ranges, except it has no 100-mv ac voltage range.

Under the best of conditions, over a 24-hour period, at a stable temperature of $23^{\circ}\text{C} \pm 1^{\circ}\text{C}$, the worst error in measuring dc voltage is only $\pm(0.005\%$ of input + 0.002% of range). More realistically, over a 90-day period, in the temperature range from 18 to 28°C , the maximum error is $\pm(0.01\%$ of input + 0.003% of range).

The John Fluke Manufacturing Co., P. O. Box 7428, Seattle, Wash. 98133 [338]

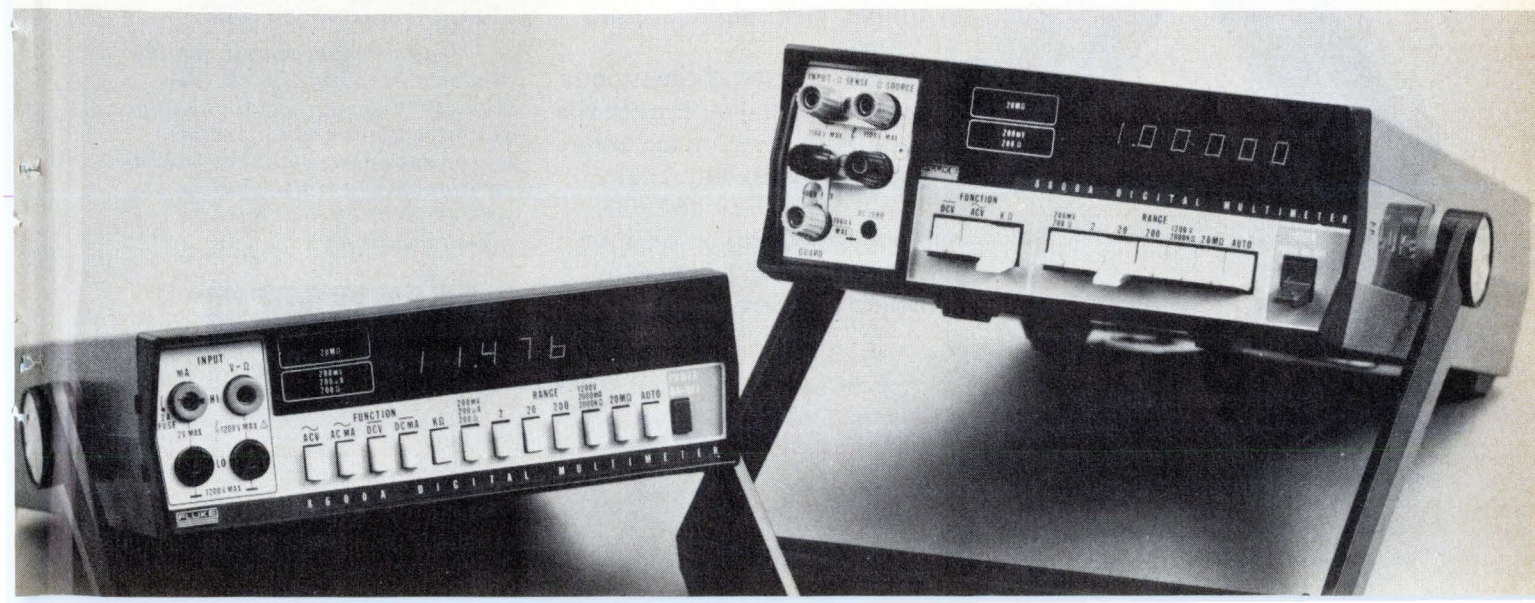

Some of the best things about our new Digivac[®] 1000 are what you can't see.

When you look at our vacuum fluorescent readout, you won't see the low voltage requirements making it directly compatible with available MOS IC logic packages.

You won't see the exclusive mica substrate which supplies mechanical strength and helps emphasize lighted segments through a desirable halo effect.

You won't see the low cost, lower than competing readouts with fewer customer advantages.

Of course, there are things about our Tung-Sol[®] Digivac 1000 you can see.

Like the Digivac 1000's brightness. 50% more brightness and greater uniformity than ever before.

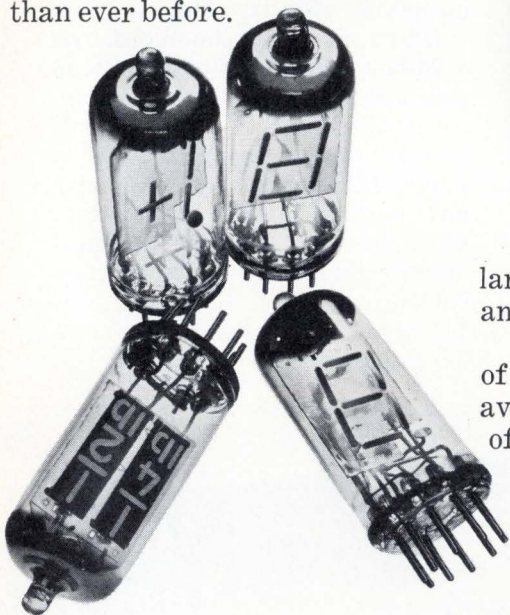

You can see the flexible language with alpha, numerical and symbolic figures.

You can see the wide range of colors, including white, available with common types of filters.

And because of the unique construction, you can see the accurate viewing assured from virtually any angle.

With the Digivac 1000 readout, whether you see it or you don't . . . it's still nice to know it's all there.

For additional information on the Digivac 1000, write to: Tung-Sol Division, Wagner Electric Corporation, 630 W. Mt. Pleasant Avenue, Livingston, New Jersey 07039.

Wagner makes other quality products in volume for the electronics industry, including bridges, power supplies and subsystems, silicon rectifiers, resistors, miniature lamps and status indicators. And Wagner offers contract manufacturing.

WAGNER[®]

We've got a lot more riding for you.

®Trademarks Wagner, Tung-Sol and Digivac, Reg. U.S. Pat. Off. and Marcos Registradas

New products

Components

Detector uses heterojunction

Technique in photovoltaic unit is said to increase current output, sensitivity

A new heterojunction photovoltaic detector supplies 30% to 50% more output current than can be obtained from conventional light-sensitive silicon devices, its manufacturer claims. The detector, fabricated by the Innoductor division, Innotech Corp., Norwalk, Conn., uses a pn heterojunction consisting of semiconducting glass and silicon. This is formed when a thin layer of a specially developed n-type glass is deposited on a layer of p-type single-crystal silicon.

Moreover, because the glass is basically transparent to visible light, the detector is sensitive to the blue-violet portion of the light spectrum. Ray Pennoyer, Innoductor general manager, points out that this sensitivity opens up the possibility of designing the new detectors into color-sensitive applications. In conventional photodetectors, these frequencies are absorbed before they can reach the electron-emitting pn junction formed between p- and n-type layers of silicon, Pennoyer says.

Intended applications include use in light detectors, card readers, op-

tical character-recognition equipment, industrial counting and measuring devices, level sensors, and punched-tape readers. The company also wants to use the device in solar cells for converting light to electricity on a commercial scale. Because of their greater output current, the new devices offer a greater signal-to-noise ratio than conventional parts, and, in a complete system, they can be followed by less critical circuitry.

The first detector in the family of devices, the model PVDO90F, has a typical short-circuit current of 165 microamperes when using a 500-foot-candle standard incandescent tungsten light source. The light-sensitive area measures .090 by .090 inch. Open-circuit voltage is a minimum of 200 millivolts.

Sensitivity of the devices is 13 microamperes per milliwatt per square centimeter at 7,500 angstroms, which is the red wavelength emitted by a gallium-phosphide light-emitting diode, for example. This is 70% higher than the output obtained from standard silicon units, says Pennoyer. At 5,000 Å in the green, the device's sensitivity level is $8\mu\text{A}/\text{mw}/\text{cm}^2$ —three to four times the sensitivity of a purely silicon photodetector, Pennoyer claims.

The PVD090F is packaged in a TO-5 low-profile flat-glass windowed case. Sample quantities are available from stock at \$20 each, and the price tails off to \$5 each in quantities approaching 500. Custom-chip sizes are also being offered, and other packages, as well as mul-

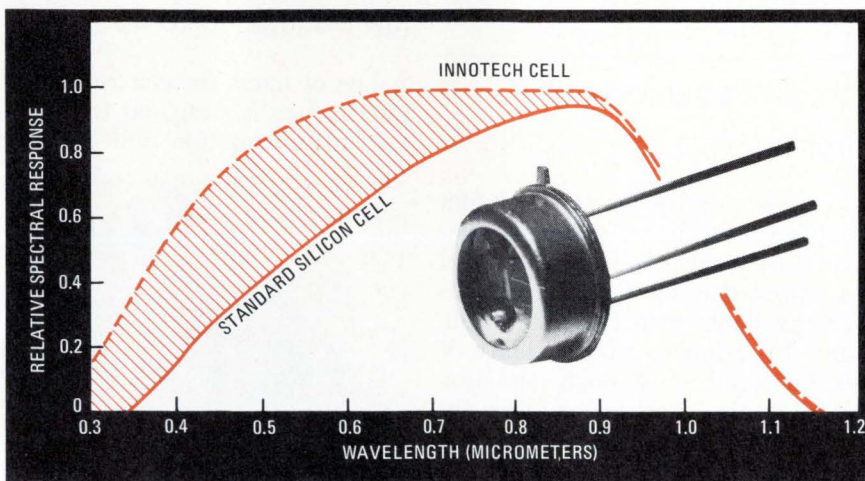

THE LINE PRINTER FOR THE LONG RUN



OEMs select it because users prefer it.

This line printer is designed for the long runs—applications where printing is measured in hours instead of minutes. It's a line printer. Full 132 columns, 200 lines per minute. That means 200 lpm regardless of line length!

It's reliable. Quiet. Quality print. No duty cycle limitations. A one year warranty to back it up.

Drive it as hard as you want. Over a thousand Tally Line Printers in the field and not a single mechanical failure! As an OEM, that means Tally printers won't eat you alive in service calls.

Tally has the data processing printer. A printer with all the data processing features your user expects. Eight channel VFI. 64 character set. 96 character upper and lower case option. Various fonts. Foreign languages.

Enhance your computer system with this super reliable, long run line printer. Find out all the features. Write or call Tally Corporation, 8301 So. 180th Street, Kent, Washington 98031. (206) 251-5647.

TALLY®

If
you
think all card
readers
are alike...

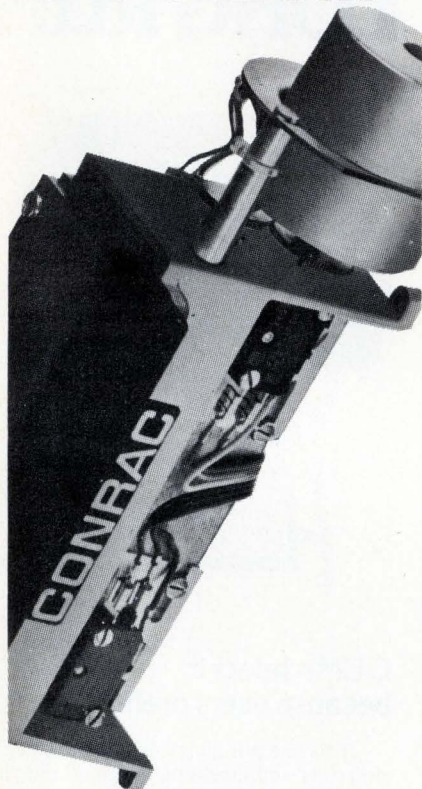

take a look
at
CONRAC

Take a good, long look before you specify... check and compare all the features offered by the CONRAC A-31 Series Magnetic Card Reader. Here are only a few: • Read or write on Standard Magnetic Cards • Industry Compatible Credit Cards— IATA, ABA, THRIFT, NTT • Card remains stationary and visible at all times—minimizing chances of card loss, damage or jamming • Card-in-place switch—insures proper insertion of card before operation • USA designed and made for OEM applications requiring rugged, long life • All this plus more and it's one of the lowest priced. ⁵⁰⁰

Write For Descriptive Literature.

CONRAC CRAMER DIVISION
CORPORATION

Mill Rock Road, Old Saybrook, Conn. 06475
(203) 388-3574

tiple units on 100-mil centers, will be offered in about a month.

Innotech Corp., 181 Main St., Norwalk, Conn. 06851 [341]

LC filters offer 51.2-MHz center frequency

A line of crystal filters includes an LC filter designated the model 6918LA. Specifications include a center frequency rated at 51.2 megahertz, a 3-decibel bandwidth (28.4 MHz minimum), an operating temperature range of -10°C to $+65^{\circ}\text{C}$, and a price of under \$50 in quantities of 100. The LC filters are also available in low-pass, high-pass, bandpass, band-reject, and combination configurations.

Electronics Division, Damon Corp., 80 Wilson Way, Westwood, Mass. 02090 [339]

Microwave capacitors range from 5 to 125 picofarads

Small capacitors for use in microwave integrated circuits are designed for volume production in such specific applications as by-pass capacitors, bias current capacitors, and blocking capacitors. The line offers a wide range of capacitances, starting at 5 picofarads and extending to 125 picofarads. Blocking voltages offered are dc, 70 or 50 volts. Five models are available in the VCC series.

Varian, Solid State East Division, Salem Rd., Beverly, Mass. 01915 [345]

Thick-film networks offer from three to nine resistors

A series of single in-line thick-film networks designated series CSP provides from three to nine resistors in a flame-retardant package. Models are available with four, six, eight, and 10 terminals with a choice of 0.100- and 0.125-inch spacing. Lead-frame construction provides built-in standoffs to facilitate board washing and wave soldering. The

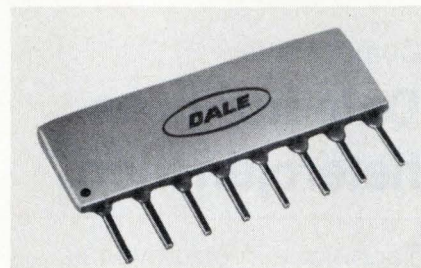

networks are designed to operate in the temperature range of -55 to $+150^{\circ}\text{C}$, and they have a resistance range of from 10 ohms to 1 megohm with a temperature coefficient of ± 200 ppm.

Dale Electronics Inc., Box 609, Columbus, Neb. 68601 [343]

Linear filters range from 400 Hz to 50 MHz

Linear phase lowpass resistance-capacitance filters are offered in Bessel, Gaussian, equal-phase, and transitional types. Frequency range extends from 400 hertz to 50 megahertz with impedances from 50 ohms to 20 kilohms. The filters offer low phase and delay distortion in passband and very low pulse distortion. At 50 MHz, attenuation is typically 70 decibels, and delay is 100 nanoseconds. The units are encapsulated in epoxy or sealed in metal cans.

Allen Avionics Inc., 224 E. 2nd St., Mineola, N.Y. 11501 [346]

Emi filters have low leakage current

A line of filters for electromagnetic interference is designed for use in test instrumentation and computer



peripherals. They meet UL specifications for equipment requiring a detachable power line, and to minimize shock hazards, they offer a low leakage current. Frequency range is from 150 kilohertz to 100 megahertz. The filters accommodate a three-conductor line cord and withstand a variety of environmental hazards.

The Potter Co., Box 337, N. Highway 51, Wesson, Miss. 39191 [344]

Power relay offers 3 contact materials

A miniature printed-circuit-board power relay, called the model V23027, is offered with three different contact materials, silver-gold flashed, silver-nickel, and silver-cad-

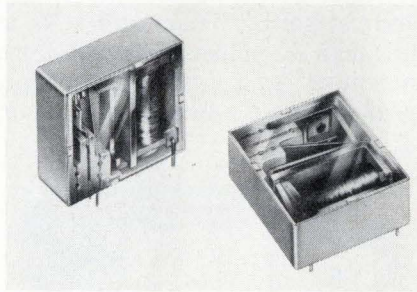

mium-oxide. The unit provides resistive, lamp, and inductive loads up to 8 amperes continuous or 15 A switching. The relay is designed for mounting on a 0.1-inch grid, and typical applications include automotive, consumer electronics, process control, and data processing. Price is about \$1.92 in 500-lots.

Siemens Corp., Special Components Dept., 186 Wood Ave. South, Iselin, N.J. 08830 [348]

Voltage protector lasts beyond 900 operations

The model CG-350 transient voltage protector, when subjected to a current pulse of 500 amperes, exhibits a typical life beyond 900 shots, or 250 operations at 1,000 A. When the half-width duration of a transient surge exceeds 500 to 750 micro-

seconds, however, appropriate life tests must be performed by the user. Applications are in telecommunications, instruments, control systems, intrusion detection, and traffic control.

Signalite, 1933 Heck Ave., Neptune, N.J. 07753 [347]

Plastic pots range from 100 ohms to 4 megohms

The series 7PT precision conductive plastic potentiometers are intended for commercial and industrial applications. These include medical instrumentation and sound systems for radio and TV. Life expectancy is a minimum of 3 million revolutions. The pots are available in ranges from 100 ohms to 4 megohms.

Sigma-Netics Inc., 1 Washington Ave., Fairfield, N.J. 07006 [350]

Resistor flatpacks offer varied ratings

The series 889-1 and 889-3 resistor networks are designed for applications requiring low package profile and ribbon lead terminations to the circuit board. The flatpacked networks are particularly suited for high-density applications. The 889-1 is a 13-resistor unit rated at 0.15 watt for each resistor, and the 889-3 is a seven-resistor unit with each device rated at 0.25 watt. Power rating at 25°C for the package is 0.6 watt. Maximum resistance tolerance is $\pm 2\%$, and maximum resistance shift is 0.25% over the operating temperature range of from -55 to +125°C. Price in 1 to 9 quantities is \$7.50 for both series.

Beckman Instruments Inc., 2500 Harbor Blvd., Fullerton, Calif. 92636 [349]

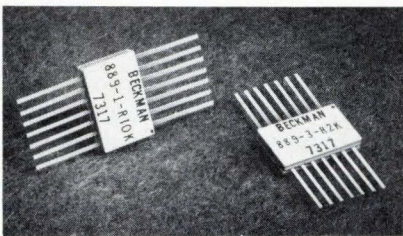

We've made a great tape transport a lot better.

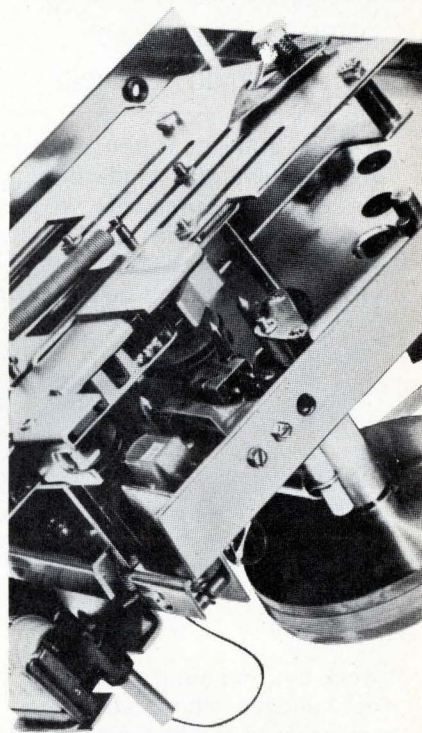

take a look at CONRAC

Now, there's no reason for you to "trade-off" when specifying an audio cassette tape transport...not if you specify the Conrac CAS-4. Here are only a few reasons why: • USA designed and manufactured • 3 motor design • No mechanical clutches or brake bands required • Designed for remote control • OEM priced. 501

Write for descriptive brochure

CONRAC CRAMER DIVISION
CORPORATION

Mill Rock Road, Old Saybrook, Conn. 06475
(203) 388-3574

Instruments

Ac standards reach 1 GHz

Thermal voltage converters compare ac voltages with precision dc levels

It being difficult, at best, to build an ac equivalent of a standard cell, precision ac measurements are necessarily derived from ac-dc transfer standards. These standards are devices for calibrating ac meters and

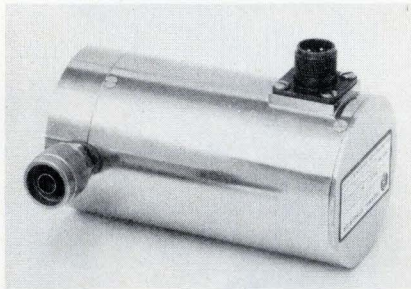

work by comparing ac voltages with dc voltages whose accuracies are traceable to the National Bureau of Standards.

Until now, the highest frequency that could conveniently be covered with NBS certification was 100 megahertz. Now Ballantine Laboratories is producing a thermal converter, based on an NBS design, that covers the frequency range from 100 MHz to 1 gigahertz. The new converter comes in three different models, each of which spans a different voltage range, and all three of which cover the full frequency range. The model 1386A-1 spans the voltage range from 0.25 volt to 1.0 v; the 1396A-2.4 goes from 1.0 to 2.4 v; and the 1396A-7 covers 2.4 v to 7.0 v. Price of the two lower-voltage models is \$475; the 7-v unit costs \$530.

The heart of the thermal converters is a small vacuum element containing a fine heater wire to which a tiny thermocouple is attached. In operation, an unknown ac voltage, after passing through a frequency-

compensated attenuator, is applied to the heater wire while a Lindech potentiometer is used to null out the dc voltage generated by the thermocouple. Then, leaving the potentiometer alone, the ac signal is removed and replaced with an adjustable dc supply. The dc voltage is adjusted until the potentiometer is again balanced, at which point the dc voltage is equal to the rms value of the ac voltage. The dc level, of course, can be read on a high-accuracy dc voltmeter.

The thermal converters are supplied with calibration charts giving the measured differences between the dc and rf voltages at different frequencies. The maximum error in the rf-dc differences is 1%, and the Ballantine standards against which the measurements are made can contribute as much as another 1% error, so that total worst-case error is 2%. This uncertainty can be reduced to 1% by having the units calibrated by NBS, but at about \$80 per frequency point, NBS certification can easily cost more than the converters themselves.

Ballantine Laboratories Inc., P.O. Box 97, Boonton, N. J. 07005 [351]

Wave analyzer offers built-in counter

Single-frequency measurements can be made quickly with the model 3581A wave analyzer. A built-in counter displays the tuned frequency with 1-Hz resolution on an LED readout. Signal amplitude is read on a four-scale analog meter. Two scales are for log displays of 90 dB and 10 dB (expanded), and the other two are linear with 1 or 3 full scale. Amplitude can be read to better than 0.1 dB on the meter's expanded 6-inch 10-dB scale. Automatic frequency control is used for locking onto drifting signals, and afc pull-in is rated at 800 Hz.

A communications version, model 3581C, is designed for analysis of telephone voice channels, both single and up to 12 channels multiplexed. The unit can also be used to pinpoint interference on data chan-

nels, detect spurious tones, and analyze levels of transmitted tones. Specifications of both the 3581A and 3581C are identical, except the latter has some modifications to make it compatible with telephone systems.

Sensitivity of both units is 100 nanovolts full scale. This low-level measurement capability is especially valuable in sonar. Maximum input to the models 3581A/C is 30 volts. Dynamic range is 85 dB, and minimum bandwidth is 3 Hz. Price starts from \$2,600.

Hewlett-Packard Co., 1501 Page Mill Rd., Palo Alto, Calif. 94304 [353]

Triac-SCR tester operates in less than 30 milliseconds

A tester that automatically checks and categorizes Triacs and SCRs in less than 30 milliseconds measures: repetitive peak off-state voltage, peak off-state voltage, maximum



on-state voltage, rms on-state current, gate trigger current, gate trigger voltage, and dc holding current. Devices are tested to determine the on-state current rating and then are tested at gate current levels programmed for the on-state current rating. Price is \$3,350.

Bailey Engineering Co., 2206 Michael, Box 621, Garland, Texas 75040 [355]

Modular instrument line is for control applications

The 520 series of modular instruments has been expanded to include units that accept the output of standard thermocouples, resistance bulbs, radiation pyrometers, and

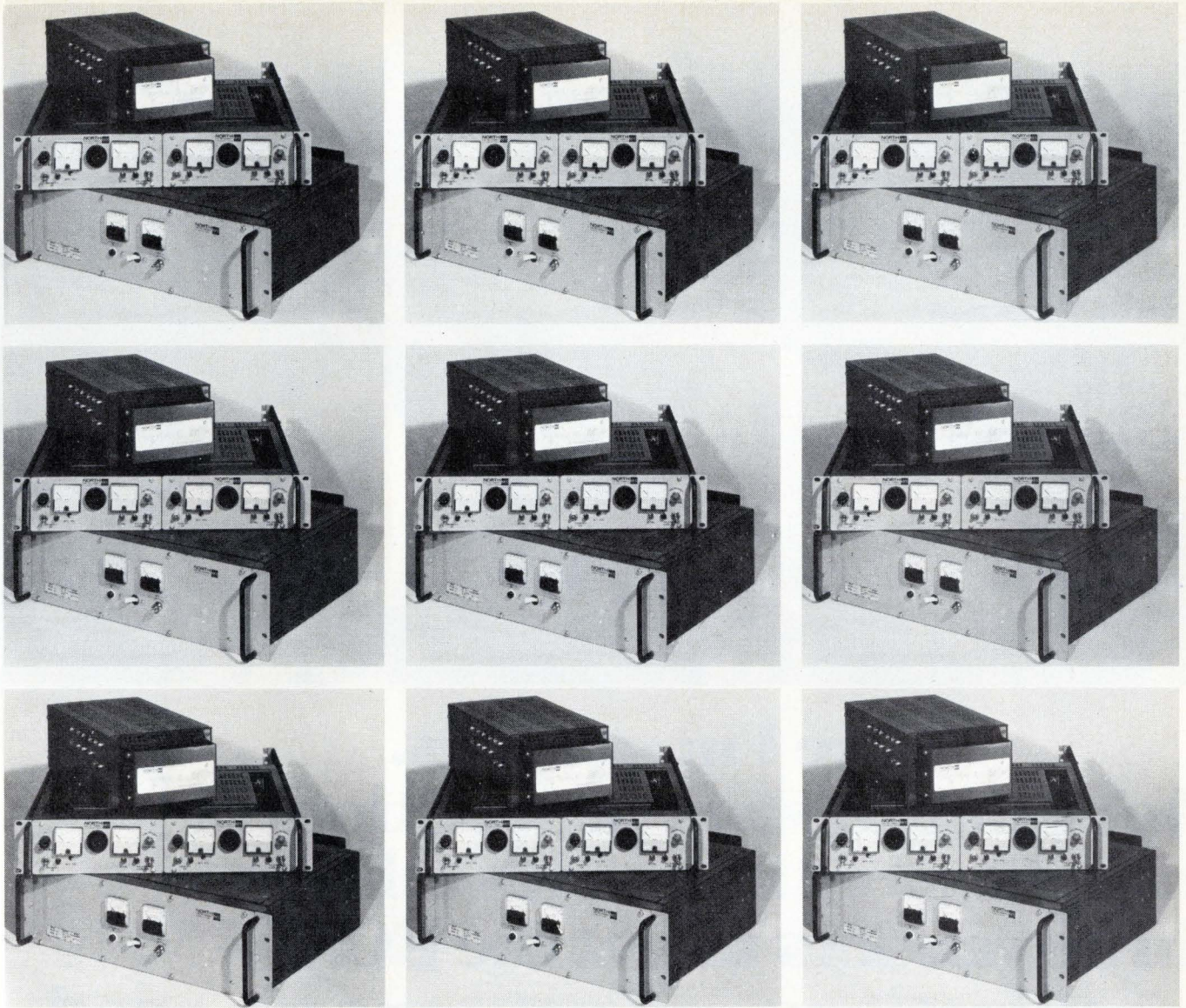

Whether you buy one's, two's or multitudes North delivers power reliability!

The performance of your business machine products should never depend on anything less than reliable power supplies. It just doesn't make sense to risk the valuable reputation of a major piece of equipment over a minor component—especially, when the cost difference is so little.

Many O.E.M.'s are beginning to agree with this point of view, and if you're one of them, we'd like to quote your next power supply order. Whether you need one unit—or one hundred, North Electric has both the product selection and the production capacity to deliver more "reliability" for your power supply dollar.

And, to back it up, we offer the industry's finest technical specialists and more than 40 years experience as the leader in custom power supplies.

SP-15

Send for a product catalog today, or for service information call your North Standard Product Manager at 419/468-8874.

| MODEL | 10000 |
|-------|-------|
| VDC | AMPS |
| 0-7.5 | 2.10 |
| 0-16 | 1.25 |
| 0-25 | 0.85 |
| 0-33 | 0.68 |

| DUAL OUTPUT SUPPLIES | |
|----------------------|--------|
| MODEL | N03052 |
| VDC | AMPS |
| +15-12 | 400MA |
| MODEL | N60052 |
| VDC | AMPS |
| +15-12 | 1.0A |

Listed here are the more popular models—many other voltages are available.

| MODEL | 11000 | 12000 | 13000 | 14000 | 15000 | 16000 | 17000 | 18000 |
|-------|---------|-------|-------|-------|-------|-------|-------|-------|
| VDC | AMPERES | | | | | | | |
| 5.0 | 3.9 | 5.3 | 11.3 | 13.0 | 20.0 | 32.5 | 49.0 | 82.0 |
| 12.0 | 2.8 | 4.2 | 8.0 | 10.5 | 15.0 | 23.0 | 36.0 | 58.0 |
| 15.0 | 2.4 | 3.7 | 7.5 | 9.5 | 14.0 | 20.5 | 27.0 | 47.0 |
| 18.0 | 2.1 | 3.3 | 6.0 | 8.0 | 13.0 | 18.0 | 26.0 | 40.0 |
| 24.0 | 1.5 | 2.8 | 4.2 | 7.0 | 11.0 | 15.0 | 21.0 | 33.0 |
| 28.0 | 1.4 | 2.4 | 4.0 | 6.3 | 9.0 | 14.0 | 20.0 | 29.0 |
| 36.0 | 1.2 | 2.2 | 3.1 | 5.6 | 8.0 | 11.0 | 14.0 | 23.0 |
| 48.0 | .95 | 1.8 | 2.6 | 4.2 | 6.0 | 8.0 | 10.0 | 18.0 |

NORTH 
ELECTRIC COMPANY

North Electric Company / Galion, Ohio 44833 / A United Telecom Co.

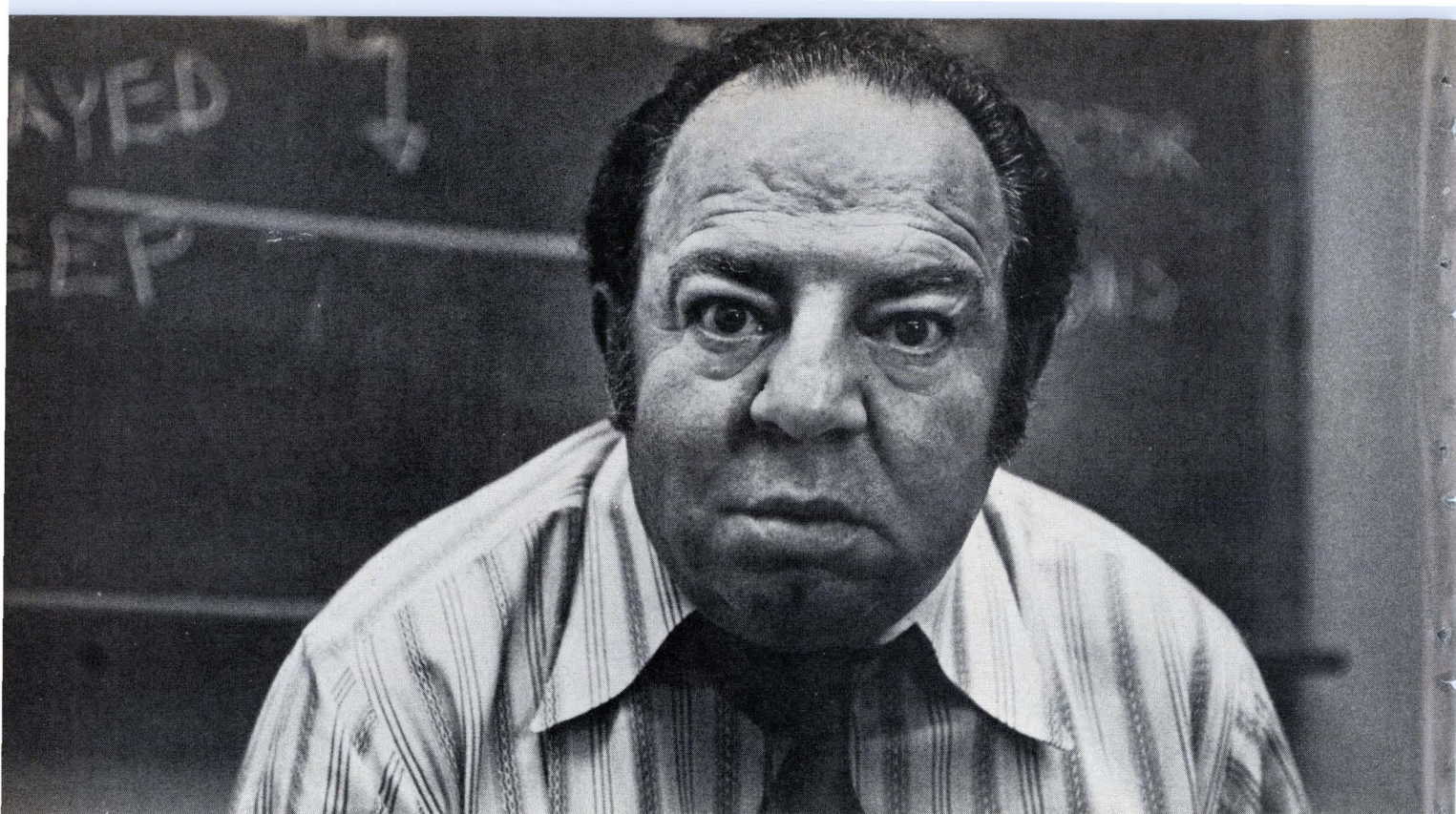

**“Sure I’m nervous.
We’re due to start production
in eight months and it’s taking
three vendors to get the ROM
organizations and patterns we need.
“If any one of them
falls through, we’re up the creek.”**

Give him the good news:

You don't have to gamble any more. At AMI, we can design and produce all your ROM patterns—and run them in parallel. So you don't have to worry about compatibility, whether you need a 4K x 4, 512 x 10, 2K x 4, or a 64 x 9 x 7 character generator. And being the Number One MOS company, you don't have to sweat out the prototyping and production of that final ROM, because we finish them up at the same time. On time. For further information, write to AMI, 3800 Homestead Road, Santa Clara, CA 95051.

Phone (408) 246-0330.

Or ask your distributor.

AMI

AMERICAN MICROSYSTEMS, INC.

It takes a lot of ROMs to make them right.

We've been building ROMs for over four years. In that time, we've developed 1500 individual ROM patterns—more than anyone else in the business.

As the Number One MOS ROM company in terms of volume and product variety, we can handle all your ROM needs. We cover all the bases, whether your application is for code conversion, microprogramming, or character generation.

And we give you other advantages, like the best data rate in the industry (2MHz), the densest circuits (up to 16K), TTL compatibility and a choice of dynamic or static, custom or standard.

So the next time you're planning a product that needs plenty of ROMs and no production delays, remember this: if we didn't deliver, we wouldn't stay on top. And that's where we intend to stay.

Some typical ROM specifications from an untypical MOS company.

| P/N | Size | Organization | Power Supply (V) | Data Rate (MHz) | Access (ns) | Power (mW) | Directly Replaces |
|-------|-------|--------------|------------------|-----------------|-------------|------------|-------------------|
| S8457 | 1536 | 128X12 | + 5, -12 | 1.0 | 1000 | 1000 | |
| S8499 | 2240 | 64X5X7 | +13, -13 | 0.5 | 2000 | 400 | TMS 4100 |
| S8564 | 4032 | 64X9X7 | + 5, -12 | 2.0 | 450 | 1000 | |
| S8614 | 2560 | 512X5 | + 5, -12 | 2.0 | 450 | 1000 | |
| S8771 | 5120 | 512X10 | + 5, -12 | 2.0 | 450 | 1000 | |
| S8772 | 4096 | 512X8 | + 5, -12 | 2.0 | 450 | 1000 | |
| S8773 | 2560 | 256X10 | + 5, -12 | 2.0 | 450 | 1000 | MK 2400 |
| S8865 | 8192 | 2048X4 | + 5, -12 | 0.5 | 1.3 | 600 | SIG 2580 |
| S8866 | 4032 | 64X7X9 | + 5, -12 | 2.0 | 450 | 1000 | |
| S8996 | 16384 | 4096X4 | + 5, -12 | 0.6 | 1400 | 300 | SIG 2580 |
| S8996 | 16384 | 2048X8 | + 5, -12 | 0.5 | 1800 | 300 | |

AMI

Circle 143 on reader service card

New products



other millivolt sources. Process variables such as temperature or pressure can be monitored by a deviation meter, or an analog process meter, or a digital process meter. For control as well as measuring applications, four control modes are available: on-off, proportional, proportional plus integral, and proportional plus integral plus derivative. The on-off mode is available only on the single output on-off models.

Barber-Colman Co., Industrial Instruments division, Rockford, Ill. 61101 [354]

Monitor-breakout panel is for data communications use

The model 60 interface monitor and breakout panel is a pocket-sized test set providing access to all 25 conductors of the EIA RS232 interface for data communications applications. Twelve LEDs are used to monitor the status of the source of 12 primary signals, and two additional digits are provided for display of plus or minus voltage levels greater than ± 3 v. The conductors can be interrupted, allowing isolated testing and observation of terminal

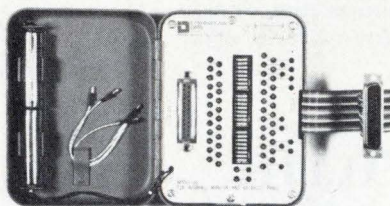

The pollution problem.

Maybe your engineers deserve a little help.

The engineers will be the ones to find the technical solutions to pollution problems. There's no doubt about it.

But pollution is a people problem, too. And the engineers' technological approach to pollution isn't going to solve people problems.

Maybe this booklet can help. It lists some of the things all people can do to fight pollution. And with all the people supporting your engineers we'll have a better chance of winning the fight.

For a free copy or a list of bulk rates write to Keep America Beautiful, Inc., Box 1771, Radio City Station, New York, New York 10020.

Keep America Beautiful

Advertising contributed for the public good



People start pollution.
People can stop it.

Easy Access At Newest Plant Site In Rochester, New York

The Outer Loop Industrial Park is right next to a freeway system that connects you with the New York State Thruway and the World. Expressways also lead you straight to the profitable Rochester market.

Neighboring companies know the benefits of this fine location on Rochester's west side. Some of them are Eastman Kodak, Bendix Corporation, 3M Company, General Motors, and Ragu Foods.

Railroad service is available on-site and an airport served by three major airlines is minutes away via the freeways. The Port of Rochester, a few miles to the north, has deep water accommodation for ocean-going vessels.

For more information, contact Robert J. Hall, Director of Area Development, Rochester Gas and Electric Corporation, 89 East Avenue, Rochester, New York 14649 or call (716) 546-2700, ext. 2466.

We know more about sites in our nine-county area than just about anyone else. Contact us for information on available facilities from 10,000 to 800,000 square feet.

RGE ROCHESTER GAS AND ELECTRIC
89 EAST AVENUE, ROCHESTER, N. Y. 14649 • 546 2700

Circle 144 on reader service card



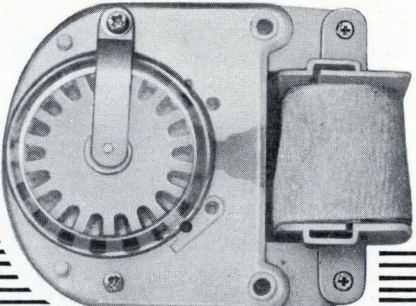

Electric Clock Motors

Increase your sales potential with compact, ultra-thin motors that deliver an amazing 150 gr-cm at only 6 rpm!

Just compare the following features:

- More power for your money.
- Compact construction means easy design.
- Low speed increases lifetime and eliminates noise.

NIKKO SEIKI CO., LTD.

4-25, 2-chome, Azuma-cho, Ageo-shi, Saitama, Japan Tel: 0487-71-2450

144 Circle 190 on reader service card

New products

modem signals. Price is \$135.
International Data Sciences Inc., 100
Nashua St., Providence, R.I. 02904 [356]

Noise meter measures
to 115 decibels

A noise meter for personal use is designed to measure brief doses of noise, mainly in factories. Engineered to meet OSHA requirements,

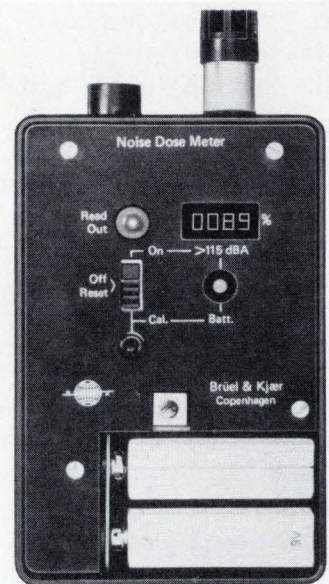

the meter offers a dynamic range of 90 to 115 decibels. An alert light for readings over 115 dB is provided, as well as a built-in condenser microphone and a remote microphone with optional preamplifier. Called the model 4425, the unit cuts off below threshold.

B & K Instruments Inc., 5111 W. 164th St.,
Cleveland, Ohio 44142 [358]

Probe station handles
to 900 circuits/hour

A manually operated probe station, called the model MP-0200-PCH, offers a fixed-point probe-card holder for use with the company's fixed-point probe cards. The unit checks resistors and other devices used for thick- and thin-film hybrid circuit applications. An automatic

ENDING THE CONVERTER PARADOX

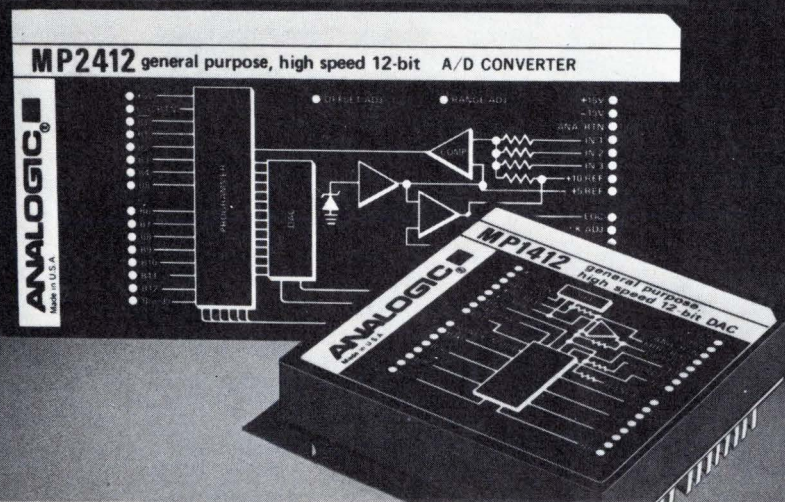

You always had to pay high prices for high performance. Now, Analogic gives you complete 12 bit performance at 10 bit prices. (available off the shelf)

Yes, immediate delivery in OEM quantities. At the lowest current prices for 12-bit computer-grade A/D and D/A converter modules.

How did we cut the cost of these high-speed converters without cutting corners or compromising on specification integrity? By using everything our staff has learned about circuit and package optimization in 200 man-years of converter engineering. By using modern, field-proven MSI technology to minimize the number of components even by comparison to "so-called" monolithic converters. And by using circuit and thermomechanical configurations that preserve generous safety margins under worst-case conditions . . . and cut production costs, too.

Tightly disciplined design pays off. You see it in every specification.

In high accuracy, linearity and monotonicity, maintained at computer-compatible data throughput rates. In unusually high time/temperature/power supply stabilities, maintained over wider-than-usual ranges. And, *true* computer-grade reliability, fully supported by worst-case design validation, by premium-grade components, and by exhaustive, computer-programmed testing that begins at the component level.

Call or write for the comprehensive data sheets on these remarkable converters—or order one (or a thousand) for quick delivery, Analogic, Audubon Rd., Wakefield, Mass. 01880; phone (617) 246-0300.

SPECIFICATIONS

| MP1412 12-BIT DAC | MP2412 A/D CONVERTER |
|--|--|
| \$39 | \$75 |
| in 100 quantities | in 100 quantities |
| Settling time 4 μsec | Throughput to 50 kHz |
| Linearity 0.012% | Linearity 0.012% |
| Reliability 200,000 hours MTBF | Reliability 100,000 hours MTBF |
| Stability 15 PPM/°C. | Stability 20/PPM/°C. |

Northeast, 617-235-2330, 203-966-2580, 315-466-0220, 201-652-7055, 212-947-0379

Mid Atlantic, 215-272-1444, 215-687-3535, 703-790-5666, 301-252-8494

Midwest, 314-895-4100, 913-362-0919, 216-267-0445, 513-434-7500, 313-892-2500, 412-892-2953, 312-283-0713, 414-476-1500, 317-844-0114

South, 713-785-0581, 214-620-1551, 305-894-4401, 919-227-3639, 205-534-9771, 305-773-3411, 813-867-7820

West, 303-744-3301, 505-523-0601, 602-946-4215, 505-292-1212, 714-540-7160, 415-398-2211, 206-762-7664, 503-643-5754

Canada, 613-836-4411, 604-688-2619, 416-499-5544, 514-636-0525, 902-434-3402

ANALOGIC
... The Digitizers

Circle 145 on reader service card

NEW! Build and test circuits as fast as you can think! No soldering or patch cords!

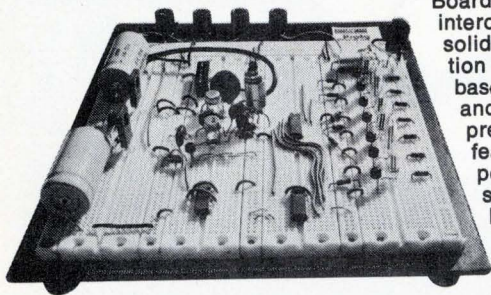

Four new Continental Specialties Proto Boards let you make all circuit and power interconnections with common #22 AWG solid hook-up wire, while power distribution buses make wiring a snap. Aluminum base plates offer solid work surfaces and perfect ground plane. Rubber feet prevent scratching. Each Proto Board features one or more 5-way binding posts to tie into system or power supply gnd. All are compatible with ICs (digital or linear), in TO5s, DIP packs and discrete components. Each is completely assembled, ready-to-use.

PAT. PENDING

| Proto Board Model No. | 14 Pin DIP Capacity | Size (L"xW") | Price (U.S. only) |
|-----------------------|---------------------|--------------|-------------------|
| 101 | 10 | 5.8"x4.5" | \$29.95 |
| 102 | 12 | 7.0"x4.5" | \$39.95 |
| 103 | 24 | 9.0"x6.0" | \$59.95 |
| 104 | 32 | 9.5"x8.0" | \$79.95 |

Order today — or send for free selection guide, with applications, photos, specs and more.



Continental Specialties Corp.
325 East St., Box 1942
New Haven, CT 06509
Telephone (203) 624-3103

CANADA: Available thru Len Finkler, Ltd., Downsview, Ontario
Circle 146 on reader service card

FREE METRIC TO ENGLISH SLIDE RULE
Convert lengths, area, weight, volume instantly. Yours FREE with each Proto Board order!

New products

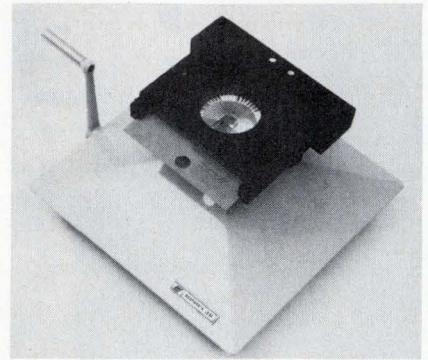

vacuum system holds substrates in place and comes with an interchangeable chuck, which can be tooled for any substrate measuring up to 2¼ inches square. Production rate is from 700 to 900 circuits per hour, depending upon test time.

Wentworth Laboratories Inc., Rte. 7, Brookfield, Conn. 06804 [357]

High-performance counters are low in price

Two counters using high-stability crystal time bases and offering a sensitivity of 25 mV make ratio as well as frequency measurements. Model 5381A is priced at \$249, model 538A at \$450. The former is an 80-MHZ, seven-digit counter, the latter a 225-MHZ, eight-digit machine. Resolution for both instruments is 10 hertz at 0.1-second gate time, 1 Hz at 1 second, and 0.1 Hz in 10 seconds. The units are also available with a high-stability temperature-compensated oscillator, which adds \$100 to the price.

Hewlett-Packard Co., 1501 Page Mill Rd., Palo Alto, Calif. 94304 [359]

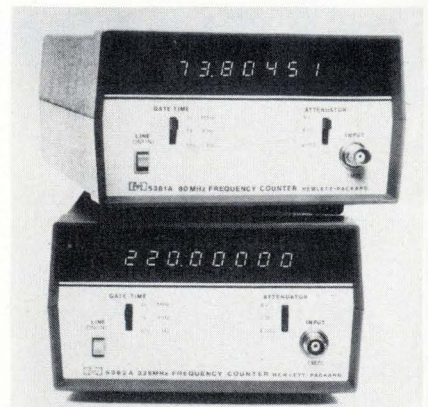

Circle 147 on reader service card →

ELECTRONIC PRESSURE CONTROL SYSTEMS



The Series CP-400 electronic pressure module and sensor can react in milliseconds. Automatic control, inspection and test can be accomplished by unskilled personnel directly on site or from a remote station. Instantaneously the electrical signal; precisely proportional to the pressure; can be filtered, rectified, compared, selected, rejected or a computer operation performed before the final controlling action is completed.

COLUMBIA RESEARCH LABS., INC.
Call or Write: Woodlyn, Pennsylvania 19094
Telephone: (215) 532-9464

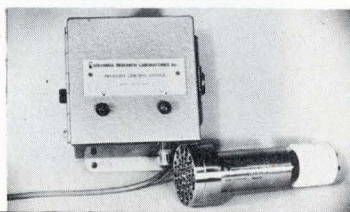

columbia first for transducers and control

146 Circle 191 on reader service card

WHY WAIT?

CALL YOUR SCANBE DISTRIBUTOR NOW!

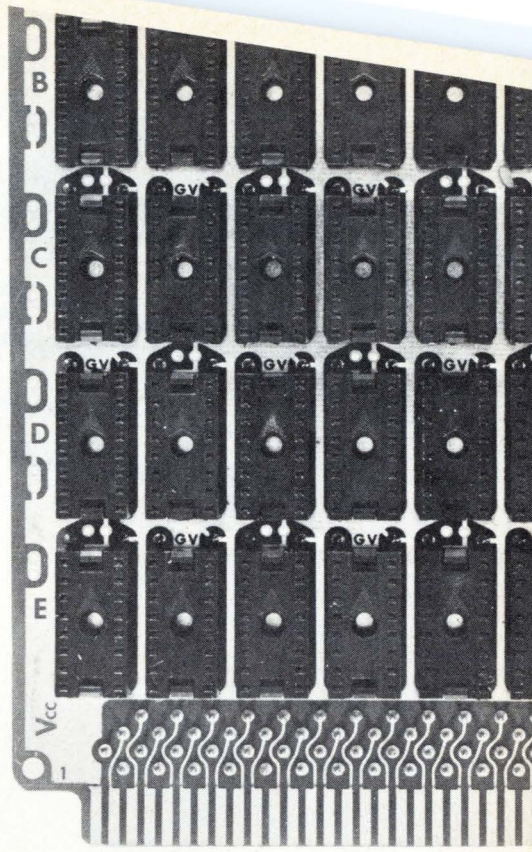

If you're facing an IC packaging problem, the solution is as near as your telephone. Simply phone the Scanbe distributor in your area and start getting *results* instead of promises.

SERVING EVERY PACKAGING NEED

Scanbe's IC packaging hardware offers the widest range of packaging problem-solvers in the industry... along with Scanbe quality and economy. Most important, when you select the Scanbe line, you are ensuring yourself the very highest in performance and reliability. And these aren't just words. We can back them up with our own record of success in the packaging field.

PROVEN PACKAGING PRODUCTS

Each year approximately ten million Scanbe ME-2 sockets are sold separately as well as in standard cards and panels. Imagine, then, the number of Scanbe packaging products already in use... already *proven dependable* in actual on-line systems throughout the industry.



DESIGNED AND PRICED TO SAVE

As to cost, we invite you to compare Scanbe's low-cost standard IC packaging systems with expensive "pin-in-the-board" techniques. You'll find that you not only save initially by choosing Scanbe, but that there is a great deal more to be saved through Scanbe's reliable delivery and consistent quality.

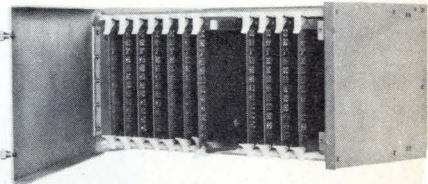

SO... DON'T WAIT.

Standard IC packaging products are on your Scanbe distributor's shelf now. Ready for delivery. Today!

Call your Scanbe distributor for a complete Catalog, or contact Scanbe directly.



SCANBE
CANOGA INDUSTRIES

3445 Fletcher Avenue/El Monte, California 91731
Telephone: (213) 579-2300/TWX: (910) 587-3437

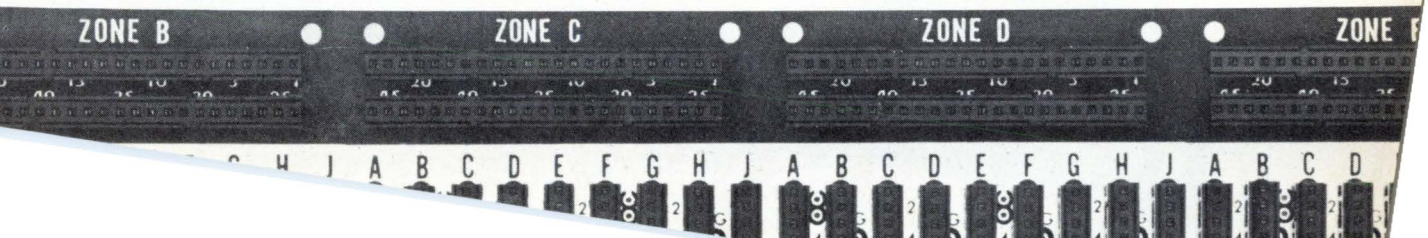

WHY BUY EMM
MEMORY?

JUST ASK OUR SALES MANAGER

"**Reliability**, for one thing," says Don Miller. "We started in the military memory business where reliability is the name of the game. And we still have 80% of that market because we put reliability first... first in military, first in commercial, first in all our products.

"**Versatility** is important, too. We make everything from cores and chips to complete memory systems. Commercial, industrial, or military. If you have a requirement for memory, you can get it from us.

"**Standardization** is another key idea. While our custom capability is second to none, we can usually meet custom requirements with standard products. That means quick turn-around and delivery — anywhere in the world, because we have worldwide facilities. That goes for service and engineering support, too. If you have a problem, we'll be there. It's as simple as that.

"So you can take your choice. If you want commercial core memory, talk to us about our MICROMEMORY product line. We can give you any capacity from 1K x 8 to 256K x 40. If you are thinking of semiconductor memory, take a look at our MICRORAM family of NMOS memories. And if you have a military memory requirement, we're the best equipped to handle that, too.

"Like I said, EMM is **The Memory Company**."

If you'd like to hear our answers to your specific memory needs, contact your local EMM office.



**ELECTRONIC MEMORIES &
MAGNETICS CORPORATION**

12621 Chadron Ave., Hawthorne, Calif. 90250



New products

Data handling

Simplicity built into card reader

Optical data units handle up to 800 punched or marked cards per minute

Card readers aren't the most exciting of computer peripherals, but a line of inexpensive card readers developed by True Data could be called elegant in their simplicity. Each reader has a single 4-inch cap-

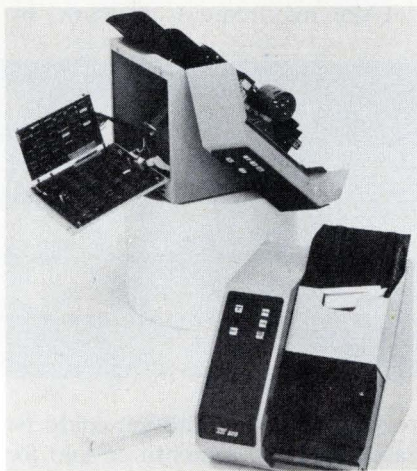

stan that picks up the cards, transports them past a fiber-optic read head, and then stacks them. The readers have only half the number of parts of most competitors, and only three bearings are used, instead of the 40 of older designs, thus improving reliability and lowering the price.

The True Data readers are modular in design. The basic deck is upgradable in the field or factory from 200 to 800 cards per minute, and it can be adapted to punched or optical-mark cards. For OEM buyers, this means that a single basic line of readers can be stocked, and simple changes can meet differing customer requirements. Modularity also simplifies stocking of spare parts, documentation, and service. The readers weigh 55 pounds and are 17 inches high, 14 in. wide, and 21 in. deep.

James McKee, president of True Data and developer of the mechanism, says that the transport permits the reader to handle damaged, mis-registered, oily, and colored cards as easily as clean cards. It can select a single card at a time and separate interlaced webs, as well as handle cards with damaged leading edges, he says. Card flutter and skewing are avoided because the transport mechanism eliminates the track commonly used for the passage of cards.

The readers have built-in self-diagnostic capability, and checks are provided for such errors as loss of synchronization, extinguished light, and feeding jams. Data output is 12-bit parallel in serial columns. Switch-selectable input/output polarities and standard TTL outputs are provided. The model 400 has a 1,000-card hopper and 500-card stacker, and the 800 has a capacity of 1,000 in each. Cards can be added or removed during operation.

For servicing, hinged panels can be opened to expose the electronic and mechanical subassemblies. Little maintenance is required; the read head is automatically brushed each time a card passes.

In OEM quantities of more than 5,000 units, the basic decks, providing speeds of 200 to 1,200 per minute, sell for as little as \$500 each. Complete with all electronics and packaging, the decks are priced at \$2,095 each in single quantities for the model 400 ODR, which operates at 200 or 400 cards per minute, and \$2,395 for the 800 ODR, which processes 300 to 800 cards per minute. OEM discounts are available. Delivery time is 30 days.

True Data Corp., 2701 Halladay St., Santa Ana, Calif. 92705 [361]

Remote-batch terminal plugs gap in market

As Triangle Universities Computation Center in North Carolina expanded its services beyond its three constituent institutions to small colleges throughout the state (see page 98), it encountered a problem in

There's an EMM office near you.

WESTERN REGION

Regional Office

SAN FRANCISCO
(408) 247-9711

LOS ANGELES AREA
(213) 644-9881

ORANGE COUNTY AREA
(714) 639-5811

MINNEAPOLIS AREA
(612) 941-2404

PHOENIX AREA
(602) 968-2492

DALLAS AREA
(214) 231-7207

EASTERN REGION

Regional Office

BOSTON
(617) 861-9650

CHICAGO AREA
(312) 297-7090

WASHINGTON, D.C. AREA
(703) 941-2100

NEW YORK AREA
(516) 423-5800

CLEVELAND AREA
(216) 842-8920

International OFFICES

European Headquarters

BELGIUM
(03) 76.69.75

UNITED KINGDOM
(01) 751-1213

WEST GERMANY
(0811) 74.30.40

Far East Headquarters

JAPAN
(03) 404-8520

EMM ELECTRONIC MEMORIES & MAGNETICS CORPORATION.

12621 Chadron Avenue
Hawthorne, Calif. 90250
(213) 644-9881

New

MICRO-VECTORBORD AND D.I.P. PLUGBORDS ARE HERE!

Save time — Save work — Save money

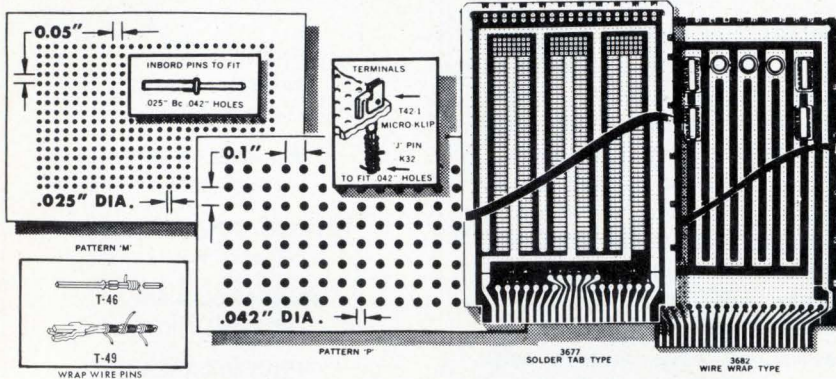

WIDE SELECTION OF SIZES AND MATERIALS

MICRO-VECTORBORD "P" .042" holes match D.I.P. leads. Epoxy glass or paper, cop. cld. also 1/64" to 1/16" thk.

MICRO-VECTORBORD "M" .025" holes match Flat-Paks, 1/32" Epoxy glass, cop. cld. also or .007" Mylar.

NEW SOLDER-PAD D.I.P. PLUGBORDS — 3677 Series Epoxy glass, "P" pat., 1/16" thick with 44 etched plug contacts (2 side total) power, ground

busses, pads for up to 24 D.I.P.'s (14's). Also 21 units 16-leads D.I.P.'s, T-O's and discretes.

NEW WRAP WIRE D.I.P. PLUGBORDS — 3682 Series Similar to above but closely spaced bus lines for higher density. Up to 48 D.I.P. 14 lead wrap wire sockets mountable or T-O's and discretes.

TERMINALS — Micro-Klips, Mini-Wire-Wraps, Rd. Pins, Patch Cords, etc., available.

Vector

Send for complete literature

ELECTRONIC CO., INC.

12460 Gladstone Ave., Sylmar, California 91342

Phone (213) 365-9661 • TWX (910) 496-1539



28-73-3

Circle 150 on reader service card

A wild card.

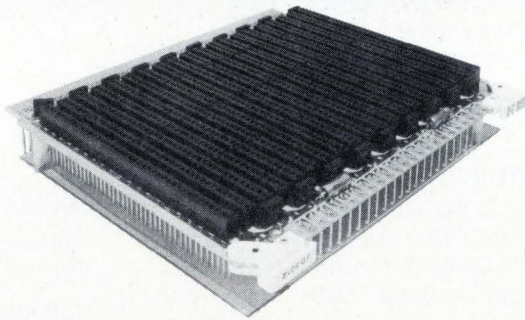

This unusual card can be almost anything you want it to be. It gives you a maximum of design freedom with a minimum of restriction on your design thinking. You can breadboard 14- and 16-pin ICs right next to each other, and plug in virtually anything. You can ignore noise problems because we've taken them out for you. This is our 3-D Dual-in-Line Socket Card, and it comes in a choice of configurations, along with a complete line of mounting hardware. Write for our catalog. Also available from G.S. Marshall.

EECO

1441 East Chestnut Avenue/Santa Ana, California 92701/Phone 714/835-6000

150 Circle 192 on reader service card

New products

specifying the terminals to be installed on the distant campuses.

TUCC found that applying such terminals as the IBM 1050 in a remote-job-entry mode was possible at a very low price—in the neighborhood of \$100 a month—but that the data transmission rate of a few hundred baud, at most, was too slow. Terminals with faster rates generally cost too much—in the neighborhood of \$800 a month.

A TUCC manager mentioned the existence of this gap in the market structure to Joel V. Perry, president of Perry Electronics Inc., a small company in Raleigh concentrating on the production of printed-circuit boards. As a result, Perry and his associates produced a terminal that met the requirements of TUCC by

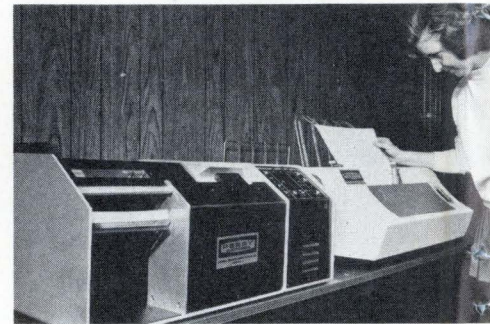

working at 1,200 baud yet could be leased for \$370 a month or sold for \$10,750.

The unit has an OEM-supplied printer and card reader and a Perry-built controller. It works at any rate over the range of 110 to 1,200 baud, converting the Hollerith card code to parallel Ascii, and then to serial form for transmission, and converting the incoming serial data to parallel form for the printer. On unconditioned lines, it runs at 1,200 baud asynchronously but it can do 1,800 baud, also asynchronously, if the lines are conditioned—that is, carry loading coils to compensate for phase delay.

Perry Electronics installed its first terminal at TUCC in September 1972. Since then, it has been busy perfecting the design and installing units elsewhere in the TUCC network, while maintaining its principal pc card business. It hopes to expand into educational installations

Electronics/May 2, 1974

IS ONE BRAND OF FUSE
AND FUSEHOLDER AS
GOOD AS ANOTHER?

DON'T BET ON IT.

BET ON BUSS®

There are some good reasons for being brand-conscious. Here are three of them:

1. **ACCEPTANCE** — Without question, BUSS® is the best known and most widely accepted name in fuses and fuseholders of all types. There's no need for introductions or explanations. When it's BUSS, no questions are asked.
2. **QUALITY** — You can take BUSS quality for granted, because BUSS doesn't. Not only are BUSS fuses manufactured to exacting quality control standards, but **every one** is electronically tested.
3. **SPECIALIZATION** — All BUSS resources are focused solely on manufacturing quality fuses and fuse mounting hardware. Such a concentration of undivided attention automatically results in a superior product.

So be brand-conscious —

YOU'LL ALWAYS BE AHEAD WITH BUSS.

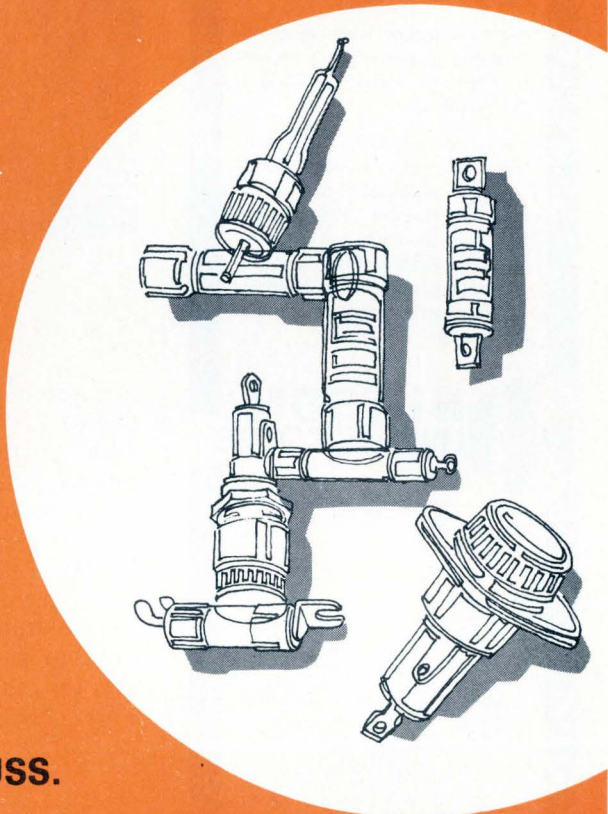

BUSSMANN MANUFACTURING
a McGraw-Edison Company Division
St. Louis, Missouri 63107



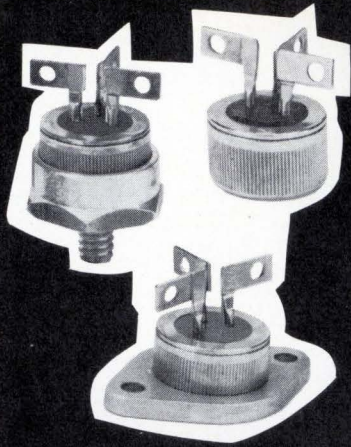

triacs

3/4" PRESS-FIT Series (IT(RMS)) to 600 Volts

Ideally suited for solid state switches, motor speed controls, lighting, heating and cooling controls.

Hutson's power triac series is available in hermetically-sealed 3/4" Press-Fit, STUD MOUNT, and TO-3 packages.

If you need a TRIAC or SCR, Hutson's state-of-the-art technology assures reliability and economy. All Hutson TRIAC's and SCR's are available as void-free, glass-passivated chips or in all popular package configurations. Call or write Hutson for complete information.



Box 34235 • 2019 W. Valley View
Dallas, Tex. 75234 (214) 241-3511
TWX 910-860-5537

Distributors:

New York City 201/399-4350. Seattle 206/454-0300. Los Angeles 213/240-3151. Dallas 214/231-6181. Baltimore 301/944-8262. Denver 303/757-7679. Ft. Lauderdale 305/772-5100. Chicago 312/286-1500. Detroit 313/499-0188. Syracuse 315/699-2671. Indianapolis 317/888-2260. Atlanta 404/427-0241. Canada 416/638-1322. Beaverton 503/643-1644. Dayton 513/433-2511. Phoenix 602/968-9037. Minneapolis 612/866-3035. Waltham 617/890-8040. Kansas City 816/765-2998.

Distributors:

Elizabeth 201/345-2420. Los Angeles 213/240-3151. Denver 303/934-5505. Chicago 312/323-9670. Canada 416/635-9880. Rochester 716/454-7800. Belgium 02362135. Brussels 02352135. Denmark (01) 295622. Norway 472702272. Spain 234-62-62. Sweden 08-28-5940. Switzerland 051-852201.

New products

in neighboring states soon, as well as into other applications.

Perry Electronics Inc., 2323 Campbell Street, Raleigh, N.C. 27605 [362]

Core-memory modules have 16,384 or 32,768 words

A family of 20-bit memory modules, designated the 1600 series, offers capacities of either 16,384 or 32,768 words. Designed for OEM users, the core memories are priced at 0.5 cent per bit. Each module is comprised of a single double-sided printed-circuit board and a plug-in stack. Access times range from 300 to 650

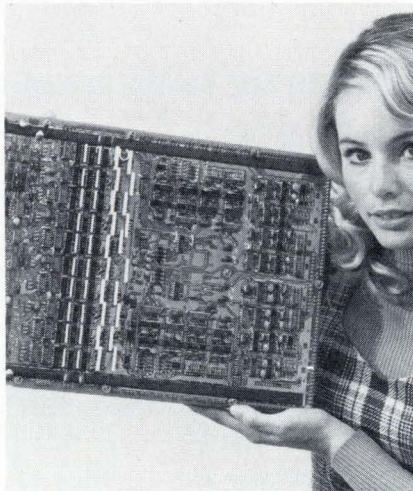

nanoseconds, and cycle times from 650 to 1,500 nanoseconds. Further, word lengths of 20, 18, 16, and 10 bits are available. Up to eight series 1600 modules can be combined to provide either 128,000 words using 16,000-word modules or 256,000 words using 32,000-word modules. Temperature-independent cores are used to provide stable operation over the range from 0 to 55°C.

Ampex Corp., 401 Broadway, Redwood City, Calif. 94063 [363]

Printer operates at 600 lines per minute

Designated the model 2260, a printer can operate at 600 lines per minute using a 64-character set or at

How to ship small packages in a big hurry.

DELTA'S DASH

DELTA AIRLINES SPECIAL HANDLING

On DASH shipments Delta guarantees delivery on the flight or routing you specify between most Delta cities.

Packages accepted up to 50 lbs. with length plus width plus height not to exceed 90" total, with only one dimension exceeding 30".

Deliver to Delta's ticket counter or airport air freight terminal at least 30 minutes prior to scheduled departure time. Shipments may be picked up at either location 30 minutes after flight arrival.

Delta's exclusive "Dashboard" control procedure insures constant tracking of your shipment from delivery to pick-up.

DASH charges are nominal. Check Delta reservations for charges between specific points. Pay in cash, by company check, most general-purpose credit cards, special credit arrangements or on government shipments by GBL. **DELTA** The airline run by professionals

Rate examples (Tax included)

| | |
|-----------------------------------|---------|
| Atlanta-Washington | \$21.00 |
| Boston-Miami | \$26.25 |
| Cincinnati-Louisville | \$21.00 |
| Cleveland-Phoenix | \$26.25 |
| Los Angeles-New Orleans | \$31.50 |
| Dallas-Los Angeles | \$26.25 |
| San Francisco-Atlanta | \$31.50 |
| Philadelphia-Houston | \$26.25 |
| New York-Tampa | \$26.25 |

For details, call Delta reservations.



Delta is ready when you are.

Norplex multilayer laminates—the heart of today's high-density circuitry.

In applications where space is critical, multilayer circuits can replace two or more single boards, allowing you to increase circuit density without sacrificing finished exterior dimensions.

Norplex glass laminates and prepregs are available with either epoxy or polyimide resin. They continually meet (and generally exceed) *all* customer specifications. We provide not only the materials but the technical services to go with them,

working closely with you to attain maximum benefits for your product line and increased finished product yield.

We have a separate group devoted exclusively to the manufacture of multilayer materials, working with specialized Norplex-designed equipment for optimum production capability and quality assurance.

No one else can offer you the in-depth experience and technical

expertise of Norplex, where laminate manufacture has been our only business for more than 25 years.

Send coupon for our new brochure which explains the advantages of Norplex multilayer laminates. Or phone: 608/784-6070.

Norplex® laminates
by **UOP**

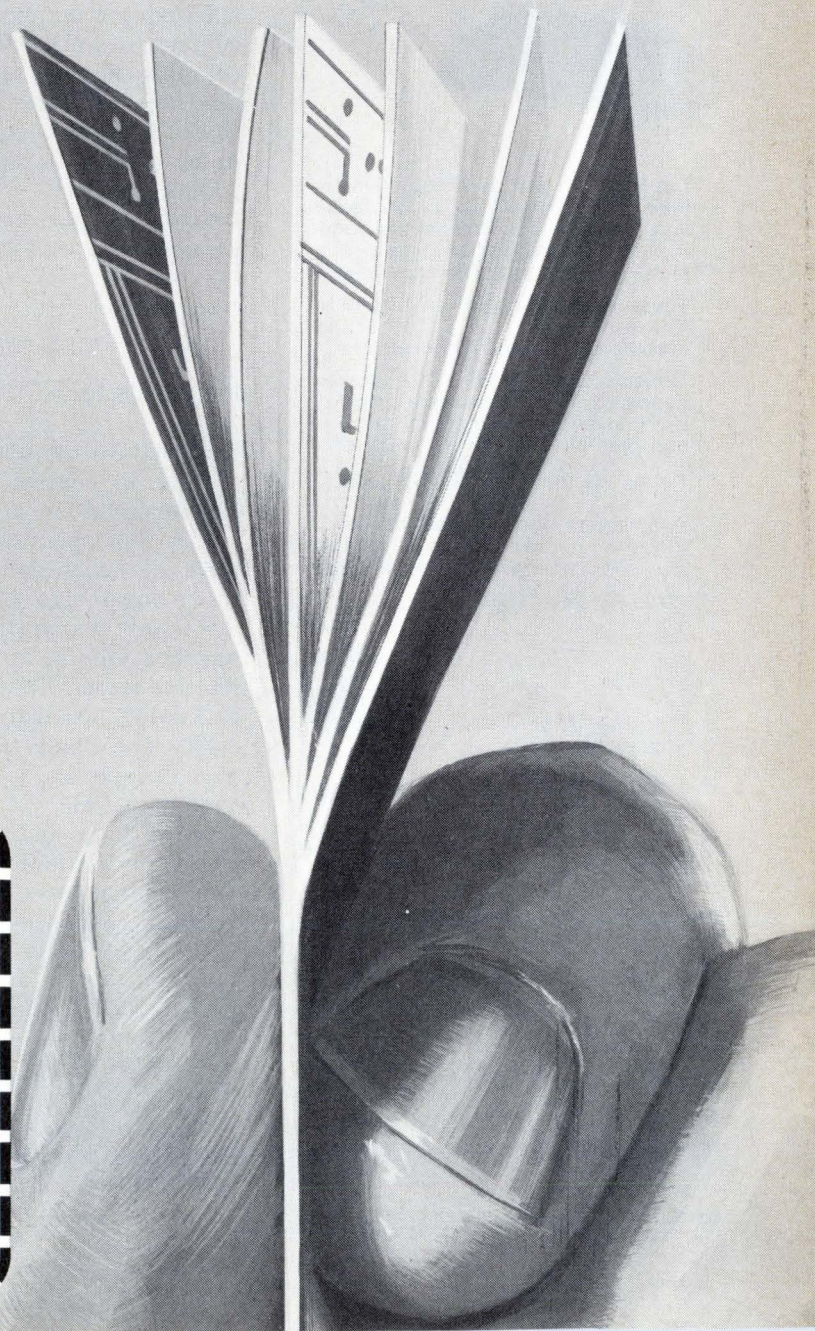

Circle 153 on reader service card

© 1974 UOP

Norplex Division, UOP
(Universal Oil Products Company)
Norplex Drive,
La Crosse, Wis. 54601

Please send me your brochure on
multilayer laminates.

Name _____

Title _____

Company _____

Address _____

City _____ State _____ Zip _____

High Voltage Diffused Silicon Rectifiers

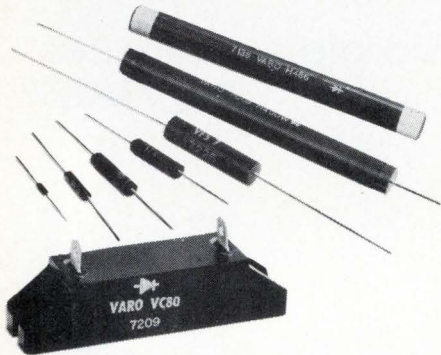

Six series in a wide range of minimum size packages with low leakage currents for commercial and industrial applications requiring high reliability at economical cost.

These devices feature 1kV to 40kV V_{RRM} with 5mA to 2A, I_o . All series available in fast recovery versions.

Typical applications: CRT power supplies, RF transmitters, microwave ovens, electrostatic copiers and precipitators and TV receivers.

Series VG; 20kV V_{RRM} **\$1.49** (1000).

Rectifiers for medical and industrial X-Ray equipment and high voltage multipliers also available from Varo.

Write for free catalog.



**Design us in —
We'll stay there**

VARO SEMICONDUCTOR, INC.

P.O. BOX 676, 1000 NORTH SHILOH,
GARLAND, TEXAS 75040
(214) 272-4551 TWX 910-860-5178

Distributed by:

ALLIED ELECTRONICS, Chicago, Ill. 312/421-2400. **THE ALTAIR CO.**, Houston, Tex. 731/781-5300; Richardson, Tex. 214/231-5166. **BELL INDUSTRIES**, Menlo Park, Cal. 415/323-9431; Skokie, Ill. 312/965-7500; Bellevue, Wash. 206/747-1515. **BRIDGEFIELD SUPPLY**, Chesterland, Ohio 216/729-9451. **CRAMER ELECTRONICS**, Nationwide; Newton, Mass. 617/969-7700; 303/266-3755. **MILGRAY ELECTRONICS**, Freeport, N.Y. 516/546-6000; Hyattsville, Md. 301/864-1111; Cherry Hill, N. J. 609/424-1300. **WESTATES ELECTRONICS**, Chatsworth, Calif. 213/341-4411.

In Canada:

ELECTRO SONIC, Toronto, Ont. 416/924-9301. **R.A.E. IND. ELECTRONICS**, Vancouver, B. C. 604/687-2621.

New products

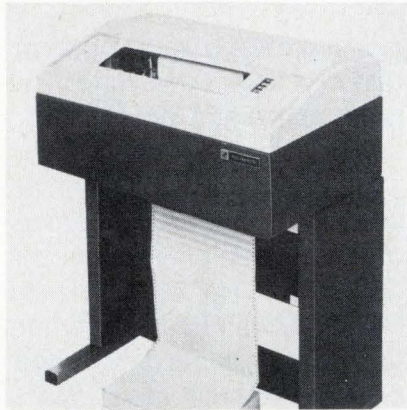

480 lines per minute using a 96-character set. Format is 136 characters per line, 10 characters per line horizontal, and 6/8 line per inch vertical. When used at a speed of 600 lines per minute, the printer accommodates a 9,600-bit-per-second communications rate. Single-line advances and slew rates are in excess of 20 inches per second. Price is under \$8,700, with quantity discounts available.

Dataproducts Corp., 6219 De Soto Ave., Woodland Hills, Calif. 91364 [364]

Punched-tape reader transmits to 3,000 b/s

Designed for transferring data from remote to central locations, the Teleterminal is a punched-tape reader that operates on a desktop, table, or bench with any standard telephone-line modem. Teleterminal transmits data from punched tape at up to 3,000 serial bits per second. Rate may be specified as 110, 300, 600, 1,200, 2,400, or 3,000. The reader has an integral power supply and is TTL-, DTL-, and RTL-compatible. It operates with strip or loop and, by use of an adapter, with fanfold applications. Teleterminal uses matched LED/phototransistor sets that read all 5-, 6-, 7-, and 8-level tapes. Price is

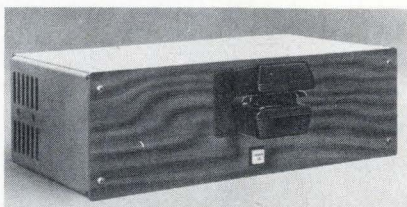

FROM BREADBOARD TO FINAL PACKAGING HARDWARE...

ALL AVAILABLE FROM ONE SOURCE

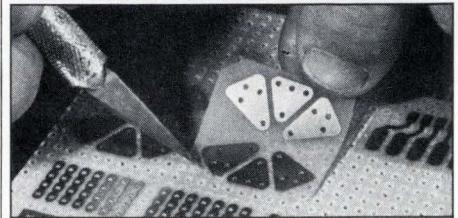

★ ADHESIVE BACKED CIRCUIT SUB-ELEMENTS

(Over 200 Pre-Drilled component mounting patterns available "off-the-shelf.")

★ EPOXY GLASS BOARD MATERIALS

- 76 Standard "Off-the-Shelf" Boards.
- Including Unclad, Copper Clad, Cut & Peel Copper Clad, Pre-etched "X-Y" Pattern and Plated thru Hole Copper Clad.
- .100" Grid Hole Pattern or Undrilled.

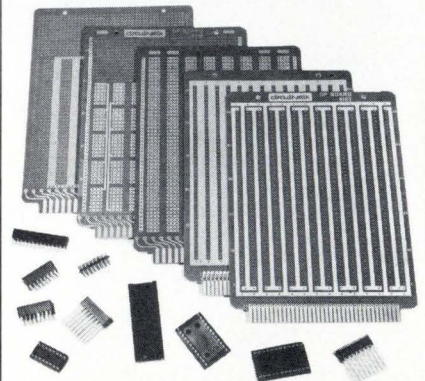

★ GP CIRCUIT BOARDS and ACCESSORIES

- Highest Quality — Choose from 74 "Off-the-Shelf" Boards.
- Sockets — Low & Standard Profile, P.C. and Wire Wrap. • Highest Quality Gold Contacts.
- Adapter plugs • Connectors
- Card Pull Handles.

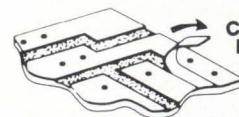

CIRCUIT-STIK'S NEW CUT & PEEL BOARDS

SEND FOR OUR NEW CATALOGS #502 & #801

circu-stik®

P.O. BOX 3396 • Torrance, California 90510
Phone (213) 530-5530

FUJI

Non Volatile, Low Cost & High Reliability

SMALL CAPACITY **RAM** PERFECTION

POS TERMINAL, CASH DISPENSER, MICRO PROCESSOR, CREDIT CARD CERTIFIER, ELECTRONIC CASH REGISTER

It has been generally assumed that MOS IC memory systems are less expensive and more suitable to use than a ferrite core memories to employ in a field of small-capacity random access memories whose capacities are smaller than 8K bytes.

However, today this assumption shall be contradicted. FUJI's new series of memories, Small-capacity Ferrite Core Memory Modules, incorporated with Hybrid integrated circuit as its peripheral circuits, offering a more economical price and better reliabilities rather than MOS IC memories.

Everyone knows that volatility and reliability of stored information is the most important factor in handling of cash transactions at banking system as well as operating cash registers, POS terminal machines, and on-line devices. Consequently, at least the last digits of calculation must be nonvolatile.

Which do you think is more rational... a system designed by a MOS IC memory with the last calculated digits to be stored by a nonvolatile core memory or a whole entire system simply designed with a nonvolatile core memory? Answer is clear, that is FUJI Core Memory!

STANDARD MODELS

A wide variety of standard models are available over a wide range of memory capacities from 128 words-4 bits to 8K words-9 bits. Furthermore, we are ready to design and manufacture special systems with quick delivery service, according to your requirements.

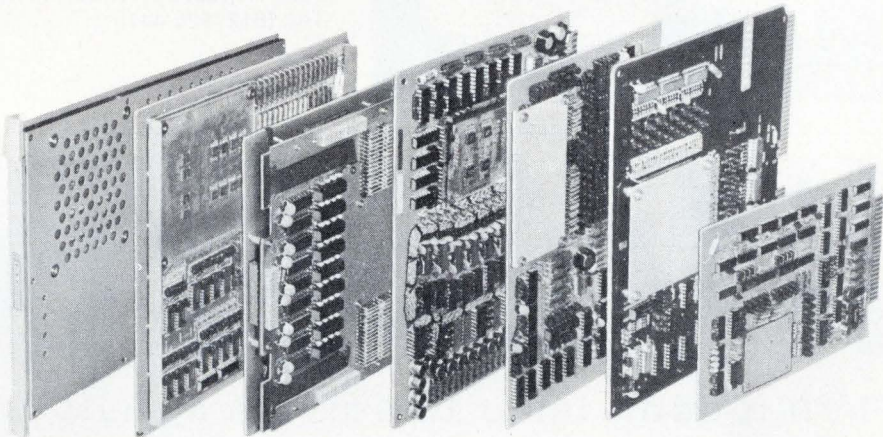

| MODEL | CAPACITY | CYCLE TIME | POWER | DIMENSIONS (size in inch) |
|----------|-----------------------|-------------|-----------------|---------------------------------|
| CMS2101A | 128W-4B | 3 μ s | $\pm 5V$ | 5.8 \times 8.7 \times 0.5 |
| CMS2101B | 256W-4B | 3 μ s | $\pm 5V$ | 5.8 \times 8.7 \times 0.5 |
| CMS2112 | 512W-4B | 3 μ s | +5V | 6.0 \times 8.0 \times 0.5 |
| CMS2113 | 1024W-4B | 3 μ s | +5V | 6.0 \times 8.0 \times 0.5 |
| CMS2114 | 2048W-4B | 3 μ s | +5V | 8.0 \times 10.0 \times 0.5 |
| CMS2115 | 4096W-4B | 3 μ s | +5V | 8.0 \times 10.0 \times 0.5 |
| CMS2116 | 1024W-9B or 512W-18B | 1.5 μ s | $\pm 5V$, +24V | 9.8 \times 11.8 \times 0.6 |
| CMS2201A | 1024W-10B | 1 μ s | $\pm 5V$ | 9.5 \times 10.5 \times 0.5 |
| CMS2201B | 2048W-10B | 1 μ s | $\pm 5V$ | 9.5 \times 10.5 \times 0.5 |
| CMS2107 | 1024W-18B | 1.5 μ s | $\pm 5V$, +24V | 7.4 \times 8.3 \times 1.4 |
| CMS2401 | 4096W-18B or 8192W-9B | 1 μ s | $\pm 5V$, +15V | 10.0 \times 15.0 \times 0.5 |
| CMS2403 | 4096W-18B or 8192W-9B | 1.5 μ s | +5V | 10.0 \times 15.0 \times 0.6 |

FUJI ELECTROCHEMICAL CO.

Head Office: Hamagomu Bldg., 5-36-11, Shinbashi, Minato-ku, Tokyo, Japan
TEL: 434-1271

Overseas Office: New York, TEL: (212) 532-5630
Los Angeles, TEL: (213) 620-1640
Dusseldorf, TEL: (211) 89031

TAD. ISHIZUKA
SAM. YOSHINO
TAD. KOMURO

FUJI**MEMORIES**

JUST TOUCH.

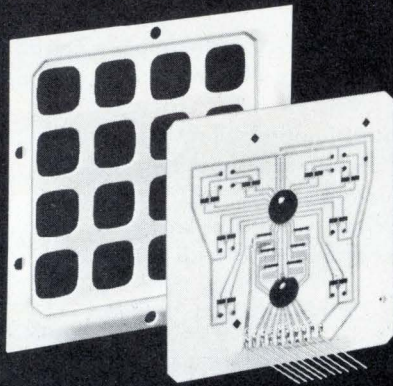
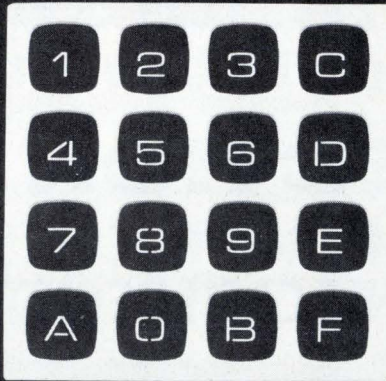

DON'T PUSH!

Just the touch of a finger operates a Magic Dot solid-state keyboard. You don't 'push' because there are no moving parts. There's also no arcing, jamming, sticking, contact corrosion or contact bounce to limit reliability. The result? Simplicity, flexibility and reliability that's truly unparalleled.

Magic Dot's new 12 and 16-button touch-operable keyboards operate on a capacitance principle, are totally sealed and have low profile 1/4" height. They provide maximum flexibility when interfacing to a variety of customer applications. The heart of this flexibility is two custom integrated circuits which sense the finger's touch and cause a coded output. Standard encoding is BCD at MOS levels with two additional strobe lines. They can also be interfaced to TTL.

We'd like to tell you more than this space permits. Contact your nearest Magic Dot representative today or write or call.

*Magic*TM
Dot

3361 Republic Avenue / Minneapolis, Minnesota 55426
Tel: (612) 925-4410

Circle 156 on reader service card

it takes more

Then a neon lamp to solve a circuit problem like this...

NEON LAMP REGULATES VOLTAGE IN COPY MACHINES...

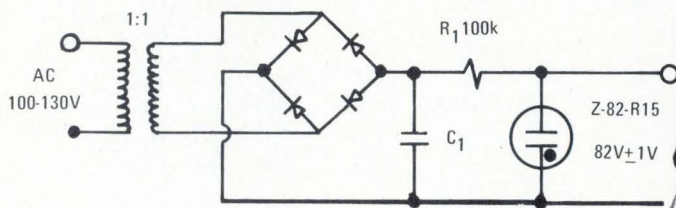

The Signalite Z-82-R15 neon, regulates within ± 1 volt over a current range of $500\mu\text{a}$ to 15ma and takes a maximum current of 17ma without damage. When operated at an average current of 2ma, life is in excess of 30,000 hours average. The voltage regulator circuit utilizing a Signalite reference tube provides an $82\text{V} \pm 1\text{V}$ regulated reference voltage for all variations of line voltage over a wide operating temperature range.

It takes application help from a group of gas discharge specialists...
...yours for the asking!



SIGNALITE DIVISION
GENERAL INSTRUMENT CORP.

Contact us at 1933 Heck Ave.,
Neptune, New Jersey 07753
(201) 775-2490

cc 2

156 Circle 196 on reader service card

Electronics/May 2, 1974

New products

\$945. Delivery time is 8 weeks.
Electronic Engineering Co. of California,
1441 E. Chestnut Ave., Santa Ana, Calif.
92701 [366]

Push-button switches are
rated at 2 A or 100 mA

The S190 series of lighted push-but-
ton switches for terminals and key-
boards, offer DPDT operation in mo-
mentary action, priced at \$1.62
each, and in alternate action at
\$1.92 each in quantities of 1,000
pieces. Employing dual wiping con-
tacts, switch capability is 100,000
cycles at 2 amperes resistive, and

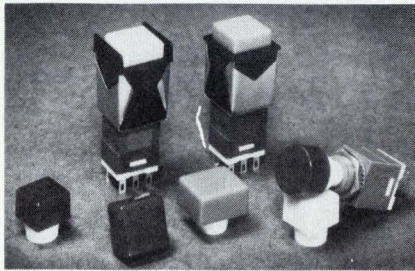

250,000 cycles at 100 mA resistive.
Widely spaced silver-inlaid termi-
nals accept either two #22 AWG sol-
dered wires or 0.110-inch quick-con-
nect receptacles. Neck bushings are
provided for subpanel installations,
and front-panel mounting is accom-
plished with any of five adapters.
Clare-Pendar Co., Box 785, Post Falls,
Idaho 83854 [367]

Serial printer handles
30 characters per second

An asynchronous serial printer,
called the Mark II, includes a split
platen, which independently drives
two forms. Other features include
tabulation to any one of 64 posi-
tions. Printing speed is 30 characters
per second, with 192 characters in
one line. The printer can produce
up to five copies, and offers red and
black printing. Its adjustable pin-fed
tractors provide flexibility in the use
of forms.

Litton ABS, OEM products division, 34
Maple Ave., Pine Brook, N.J. 07058 [365]

1200 VA, \$625
AC LINE CONDITIONERS
FOR DIGITAL SYSTEMS

- 75V TO 130V REGULATION $\pm 3\%$
- ISOLATION 120dB
- NOISE SUPPRESSION 120dB

Deltec IVACON™ AC line conditioners give you regulated transient-free power at low cost and provide maximum common mode isolation to computer and instrumentation systems. The IVACON eliminates brownout problems and reduces line transients caused by down-line equipment such as SCR's, solenoids, and other switching devices.

For more information, call or write:
DELTEC, 3849 Gaines Street,
San Diego, CA 92110
Phone (714) 297-4466

DELTEC
CORPORATION

Circle 157 on reader service card

EFRATOM'S
RUBIDIUM FREQUENCY STANDARD

A new generation in time and frequency systems.

- Low cost
- Stability: 2×10^{-11} /month
- Size: 4 x 4 x 4½ inches
- Warm up time: <10 minutes
- 3 year warranty

Model FRK

For complete specifications and prices,
write or call today.

EFRATOM CALIFORNIA, INC. 3303 Harbor Blvd., E1, Costa Mesa, CA 92626 ^{E5-2}
(714) 556-1620, Telex 685635

Name _____ Title _____
Company _____
Address _____
City _____ State _____ Zip _____

Europe: Efratom Elektronik GmbH, 8000 München 90
Telephone: (0811) 64 71 38; Telex: 841-529701 (EFRAD)

16Kx18 =

more core in Fabri-Tek's reliable 600 Series

We have an addition to our 600 Series! It's the Model 686 Core Memory System with a basic module capacity of 16K x 18. Like all 600 Series models, the 686 combines off-the-shelf availability with reliable performance and minimum cost.

Modular constructed, ferrite core memories permit operation of up to eight modules in a single enclosure. Developed for a wide variety of data storage applications, the entire 600 Series is completely compatible with TTL logic. So, check the specifications, then specify the 600 Model that best fits your application.

The 620 Core Memory System

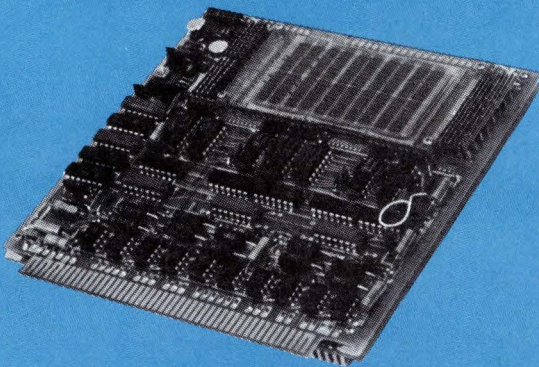

Capacity of 1,024 words by 10 bits on a single card. Planar 3-D, 4-wire configuration measures 6.0 x 6.4 inches. Expandable. Access time: 350 nanoseconds. Full cycle time: 1.0 usec.

The 684 Core Memory System

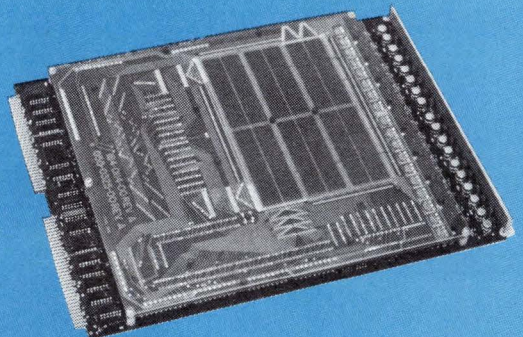

Basic module capacity of 8,192 words by 18 bits on a single card. Expandable to 32K x 36, 64K x 18 or 128K x 9 bits. Planar 3-D, 3-wire configuration measures 11.0 x 14.75 inches. Access time: 300 nanoseconds. Full cycle time: 650 nanoseconds. System options include: enclosures with printed circuit back panels, power supplies and test exerciser, and 250 nanosecond access time option.

The 686 Core Memory System

NEW



Basic module capacity of 16,384 words by 18 bits on a single card. Expandable to 64K x 36, 128K x 18 or 256K x 9 bits. Planar 3-D, 3-wire configuration measures 11.625 x 20.0 inches. Access time: 350 nanoseconds. Full cycle time: 750 nanoseconds. System options include: enclosures with printed circuit back panels, power supplies and test exerciser.

The 688 Core Memory System

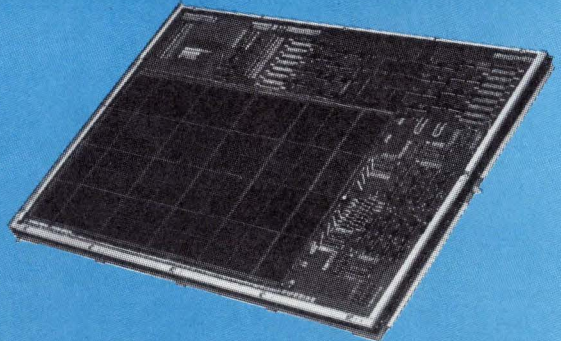

Basic module capacity of 32,768 words by 20 bits on a single card. Expandable to 128K x 40, 256K x 20, or 512K x 10 bits. Planar 3-D, 3-wire configuration measures 15 x 21.5 inches. Access time: 500 nanoseconds. Full cycle time: 1.2 microseconds. System options include: enclosures with printed circuit back panels, power supplies and test exerciser.

FABRI-TEK INC.
COMPUTER SYSTEMS

5901 South County Road 18 • Minneapolis, MN 55436 • (612) 935-8811
Leader in Memory Technology for Over a Decade

SALES OFFICES IN:

| | | | | | | |
|---------------------------|--------------------------|------------------------------|---------------------------|-----------------------------|------------------------|--------------------------------------|
| Boston (617) 969-5077 | Dallas (214) 661-3155 | Long Beach (213) 420-2493 | Orlando (305) 857-1050 | Sunnyvale (408) 739-4780 | Hong Kong K-331383 | Tokyo (03) 432-6901 |
| Chicago (312) 437-4116 | Denver (303) 753-0631 | New Jersey (201) 964-4770 | Phoenix (602) 266-4448 | Toledo (419) 865-6693 | Munich 089-755-8298 | United Kingdom Maidenhead 37321-4 |

See us at booth #345 National Computer Conference

Packaging & production

Wafer processes are automated

Photoresist, other modules complete automatic front-end fabrication systems

A continuing goal of semiconductor manufacturers is to increase production and yield while decreasing time and costs in the wafer-fabrication process. The key, of course, is automation. And now the Cobilt divi-

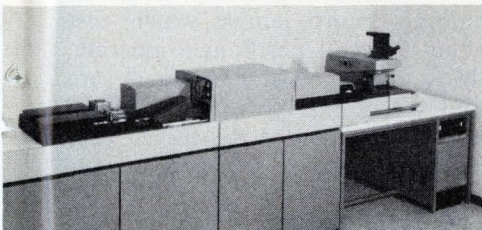

sion of Computervision Corp. has developed three additional processing modules that make possible a series of in-line front-end fabrication systems, designated Autofab, for about \$100,000.

Designed modularly to allow semiconductor makers to phase gradually into fully automated fabrication, the major individual components of Autofab include:

- The model 1501 single-track coat/bake or develop/bake processor, a stand-alone unit that automates the processes of wafer coating (or developing) and either soft or hard baking.
- The model AF 1101 single-track coater/developer, containing a proprietary new spinner for coating wafers with photoresist or dispensing developers.
- The model AF-1201 single-track baking oven, a compact oven with 50-wafer capacity in an over-all length of only two feet.

Multiple-track units of each model contain up to four independent processing tracks mounted side by side in the same cabinet. Combining these components with two

other Cobilt products on the market—the Autolign automatic mask-alignment/exposure system and the AF-520 Autoload load/unload system—make possible a fully automatic in-line fabrication system.

Cobilt offers this system in two configurations: the model AF-2100, a straight-through system combining a load station, spin-coater, soft-bake oven, Autolign mask aligner, spin developer, hard-bake oven, and unload station, in addition to the model AF-2200, a “U-track” system that performs the same functions as the AF-2100, but which has the develop/bake track in the same cabinet as the coat/bake track. This forms the “U” configuration: wafers travel from left to right as they approach the Autolign and return to the unload station from right to left.

In initial tests of the system, Cobilt engineers report substantially higher throughput than present techniques provide. Typical rates are 100 to 150 an hour and as many as 180 wafers an hour occasionally. The system is designed to process wafers up to 4 inches in diameter.

Cobilt offers substantial yield improvement, depending on the stability and refinement of the rest of the wafer-fabrication process. While good yield averages are hard to pin down, Cobilt officials say that a company with an already dependable production capability can expect improvements of 8% to 20% by using the Autofab process.

The new four-foot long oven in the Autofab offers consistent baking uniformity because of a special rotary transport design, plus high density—as many as 50 wafers in process at any given time. Power demand is 300 to 600 watts.

The coater/developer, equipped with its own solid-state controller, is designed for fully automatic operation while applying various solutions to the wafer surface. It provides complete flexibility of process control—variable acceleration spin speeds as high as 10,000 revolutions per minute and the ability to program up to three solvent sprays and two applications of photoresist. Total length is four feet.

The coat/bake or develop/bake

processor consists of seven major assemblies: a solid-state control module; load and unload stations for standard 23-wafer carriers; a new spinner for dispensing solvents, photoresists or developers; a bake oven with a capacity of 50 wafers, and a storage buffer for emptying the oven during downstream slowdowns. It is seven feet long.

Cobilt officials expect the Autofab line to be in full production during the first quarter of 1975 and say that, when in production, the entire system could be sold for about \$100,000. Stand-alone subsystem prices are expected to range from \$20,000 to \$45,000.

Cobilt division of Computervision Corp., 1135 E. Arques Ave., Sunnyvale, Calif. 94086 [391]

Socket panel permits close board-to-board spacing

A single-sided wire-wrap socket panel is available on a custom design basis so that any size and configuration is possible. Board-to-board center spacing is as small as 12.7 mm or 0.500 inch. The unit is

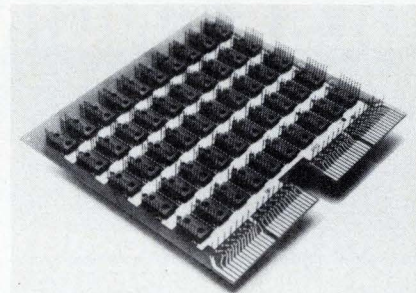

compatible with two-sided printed-circuit-board centers, permitting direct interface with existing back panels.

Augat Inc., 33 Perry Ave., Attleboro, Mass. 02703 [394]

Side-brazed DIP designed to house 2k and 4k RAMs

A 22-lead side-brazed DIP with an extra large rectangular cavity of 0.220 by 0.285 inch is designed for

New products

housing 2,048-bit and 4,096-bit MOS RAMs. The package is formed from layers of 94% alumina tape, metalized in the green state, then laminated and high-temperature-fired to produce a rugged, monolithic, ceramic body. Hermeticity of 1×10^{-8} cubic centimeters per second of helium is achieved because all metalized feedthroughs from internal cav-

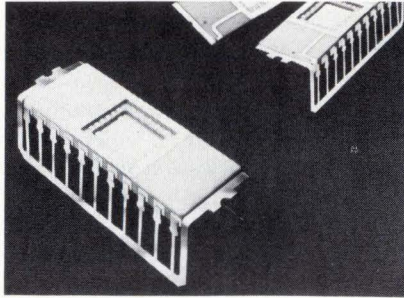

ity to external braze pads are buried within the body walls. Kovar or alloy-42 leads are supplied as standard. The package is available spot-plated, with gold applied only to such critical areas as dice-attach pad, wire-bonding fingers, and cover-seal ring. This is accomplished by recently developed selective gold-plating equipment.

Metalized Ceramics Corp., Huntington Industrial Park, Providence, R.I. [393]

DELAY LINES

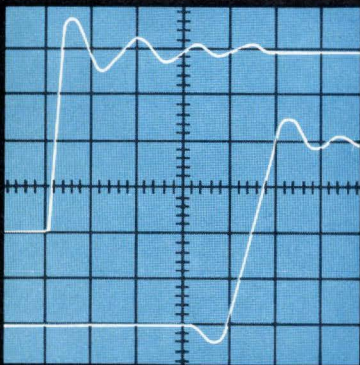

**60 OFF-THE-SHELF
DIP MODELS... TO
250 NSEC...
THOUSANDS OF
SPECIALS
SHIPPED
MONTHLY BY**

PULSE ENGINEERING!

Choose from our broad standard line or let us build to your specifications. We're geared to large volume production and delivery.

Write for complete information
or send your specifications for quote-

**DELAY LINES • MICROELECTRONICS
MINIATURE MAGNETICS**

Call your nearest regional office:

ABINGTON, PA.
(215) 887-4343

BOCA RATON, FLA.
(305) 391-3803

SANTA CLARA, CALIF.
(408) 248-6040

WALTHAM, MASS.
(617) 894-0950

CHICAGO, ILL.
(312) 992-3720

STUDIO CITY, CALIF.
(213) 872-0735

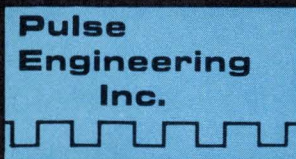

A Varian Subsidiary

Pulse Engineering

P.O. Box 12235 • San Diego, Calif. 92112
Phone 714-279-5900 • TWX 910-335-1527

Laser trims resistors
at low operating cost

A laser that trims resistors to desired tolerances uses air-cooled tungsten-halogen pump lamps, which cost about 10 cents per hour to operate. (Most laser resistor-trimmers are said to require \$1-per-hour Krypton lamps.) Designated the model 607, the unit produces 1¼ watts of out-

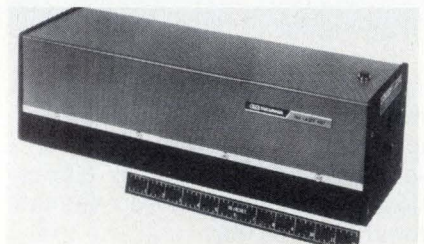

put power, single traverse mode, at a 5-kilohertz repetition rate when Q-switched. Continuous-wave output is 1½ w, transverse electromagnetic mode, and 10 w multimode. Price is less than \$5,500 for the cw version and under \$10,000 with Q-switching.

GTE Sylvania, Laser Products Department,
Box 188, Mountain View, Calif. 94042 [398]

Wafer developer can also
be used as an etcher

The model K-1124X is designed especially for developing silicon wafers at high production rates. One feature of the system is a balanced fan-spray aspirator, which provides a uniform pattern over all the wafers. Other features include explosion-proof components, Teflon

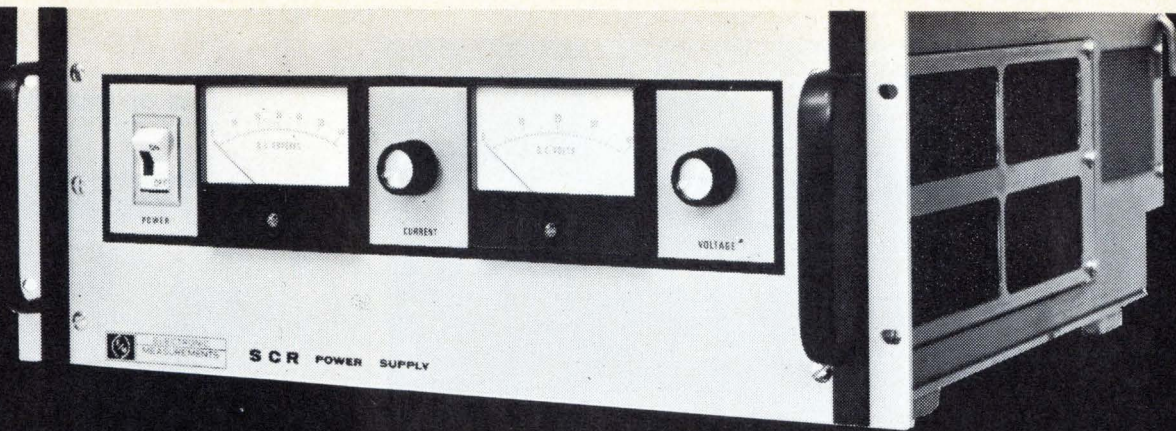

POWER SUPPLIES

Electronic Measurements has designed and built many power supplies to solve a wide range of applications. Design reliability has been field proven since 1968. We have a wealth of application experience, and the flexibility to help solve your power supply problems. Call us.

The table shows the 0.1%-regulation SCR models and 1%-regulation EM models, but Electronic Measurements has a full line, bench-type and modular, with single and multiple outputs, from 5V to 500V and from 2.5A to 650A.

And there's more: remote sensing and programming, automatic E/I crossover, stability within 0.05%, full overload protection, rugged construction that's easy to service, and a five-year guarantee.

In Power Supplies, the best is Engineer Power, from Electronic Measurements. For a short-form catalog, use the Reader Service card, or contact Electronic Measurements.

| Rating | Price | |
|-----------|---------|---------|
| | EM | SCR |
| 6V-600A | \$1,900 | \$2,200 |
| 7.5V-300A | 1,200 | 1,400 |
| 10V-250A | 1,200 | 1,400 |
| 10V-500A | 1,900 | 2,200 |
| 20V-125A | 1,100 | 1,300 |
| 20V-250A | 1,500 | 1,800 |
| 20V-500A | 2,300 | 2,700 |
| 30V-100A | 1,100 | 1,300 |
| 30V-200A | 1,500 | 1,800 |
| 40V-60A | 1,100 | 1,300 |

| Rating | Price | |
|----------|---------|---------|
| | EM | SCR |
| 40V-125A | \$1,400 | \$1,700 |
| 40V-250A | 2,100 | 2,500 |
| 50V-200A | 2,300 | 2,700 |
| 80V-30A | 1,100 | 1,300 |
| 80V-60A | 1,400 | 1,700 |
| 100-100A | 2,300 | 2,700 |
| 120V-20A | 1,100 | 1,300 |
| 120V-40A | 1,400 | 1,700 |

| Rating | Price | |
|----------|---------|---------|
| | EM | SCR |
| 160V-15A | \$1,100 | \$1,300 |
| 160V-30A | 1,400 | 1,700 |
| 160V-60A | 2,100 | 2,500 |
| 250V-10A | 1,100 | 1,300 |
| 250V-20A | 1,500 | 1,800 |
| 250V-40A | 2,300 | 2,700 |
| 500V-5A | 1,400 | 1,600 |
| 500V-10A | 1,900 | 2,200 |

19" Rack, 20" depth. Voltage and current adjustable over wide range.

See EEM Vol. 1, Pages 673, 674, 675 for additional product information.

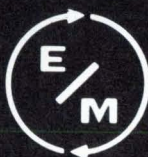

ELECTRONIC MEASUREMENTS INC.

405 Essex Road, Neptune, N. J. 07753

Phone: (New Jersey) 201 - 922-9300 • (Toll-Free) 800 - 631-4298

Specialists in Power Conversion Equipment

DigiTec introduces another product in the **HT SERIES** *(a breakthrough in High Technology)* **4½ digit Panel Meter.**

DigiTec's new 4½ digit Panel Meter, Model 2780, is another of the HT Series (High Technology) instruments. Capable of measuring voltage or current, this low cost, bi-polar panel meter delivers accuracy and versatility heretofore unequaled in the instrument market. Automatically sampling at a rate of 4 times/Sec. the unit can be programmed to hold the last reading or take a single sample. The Model 2780 delivers the highest level of reliability and serviceability in accordance with the basic design standards of the HT Series. DigiTec's new, revolutionary conversion technique, coupled with the use of proprietary LSI has significantly reduced component count, yielding high reliability. The 4½ digit display of large, easy-to-read Monsanto MAN 72 LED's ensures trouble free operation and long life. Plug-in IC's, LED's and circuit boards enable quick / easy maintenance. Operates from 115, 230 VAC or 5VDC. Attractively styled to enhance your instrument panel.

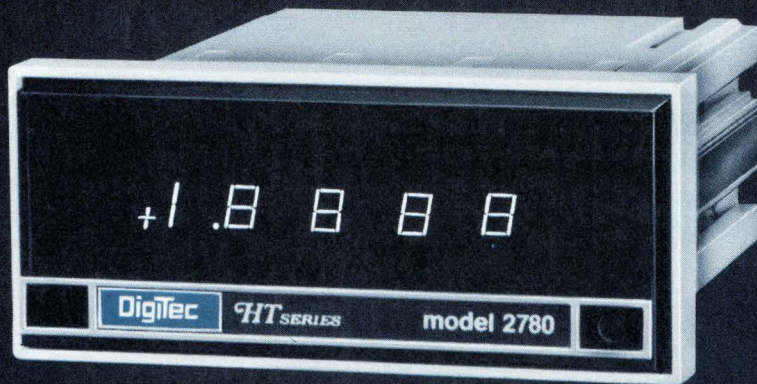

Model 2780 Panel Meter

\$219.

Features: Four voltage ranges / Five current ranges / accuracy 0.01% rdg. / 4½ digit, easy-to-read LED display / automatic sampling / programmable sample and hold / operates from 115,230 VAC or 5 VDC / mounts in 3.75"W x 1.75"H panel cutout / optional BCD output / off-the-shelf delivery / generous OEM quantity discounts.

UNITED SYSTEMS CORPORATION
918 Woodley Road, Dayton, Ohio 45403
Ph (513) 254-6251 Twx. (810) 459-1728
a subsidiary of

Monsanto

DigiTec®

New products

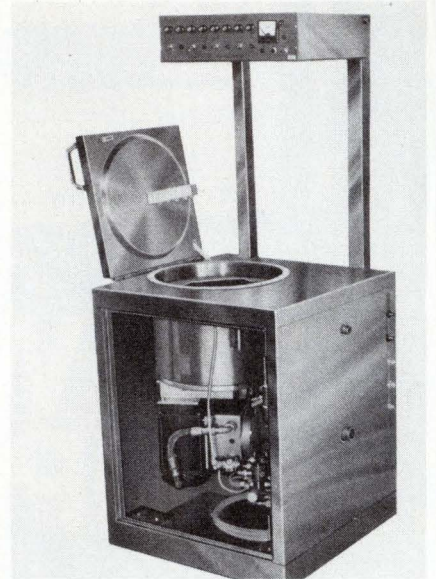

valves, solution delay, cycle overlap, and a choice of turntables. A 10-cycle programmable controller is standard, with a four-cycle controller available as an option. With modifications, the K-1124X can also be used as an etcher.

Fluoroware Systems Corp., 335 Lake Hazeltine Dr., Chaska, Minn. 55318 [397]

Ultrasonic etch system uses very hot bath

Designed for semiconductor process applications, the model 24 ultrasonic etch system uses a hot bath for hydrofluoric etching of wafers. In other systems, where acid reaches the silicon, the hydrogen outgassing that occurs could affect the uniformity of the etch process, but model 24 drives out hydrogen bubbles and provides full control over etching uniformity. The use of ultrasonics also permits the slope of the etch to be controlled.

Collins Machinery Corp., 2565 Cloverdale Ave., Concord, Calif. 94520 [399]

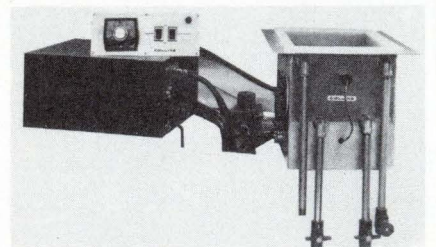

An outstanding storage tube for Oscilloscopy: Our TH8902

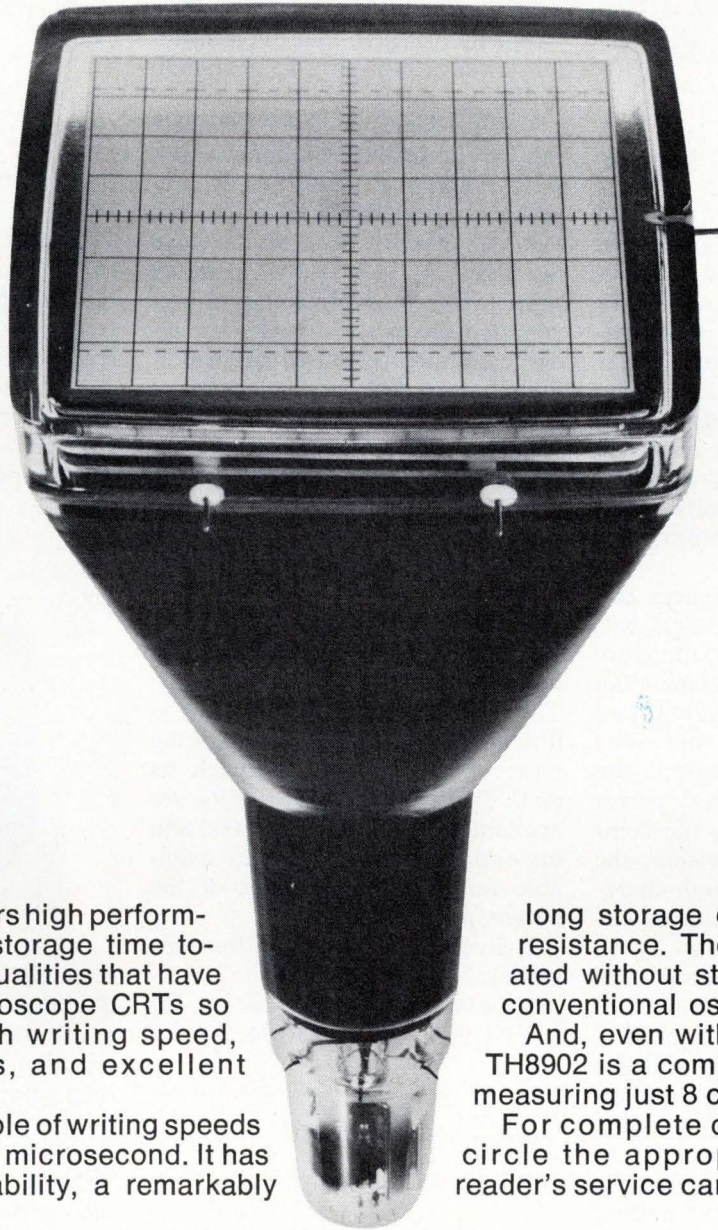

Our new TH8902 offers high performance and adjustable storage time together with the same qualities that have made our other oscilloscope CRTs so successful: ultra high writing speed, superior brightness, and excellent resolution.

The TH8902 is capable of writing speeds in excess of 100 cm per microsecond. It has superb half-tone capability, a remarkably

long storage capacity and high burn resistance. The TH8902 can be operated without storage if you wish, as a conventional oscilloscope CRT.

And, even with all these features, the TH8902 is a compact rectangular design measuring just 8 cm x 10 cm.

For complete details on the TH8902, circle the appropriate number on the reader's service card or contact us directly.



THOMSON-CSF

MARKETED IN NORTH AMERICA BY DUMONT ELECTRON TUBES & DEVICES, CLIFTON, N.J. / TEL (201) 773-2000

France - THOMSON-CSF Groupement Tubes Electroniques/8, rue Chasseloup-Laubat/75737 PARIS CEDEX 15/Tel. 566 70.04
Germany - THOMSON-CSF Elektronenröhren GmbH/Am Leonhardsbrunn 10/6 FRANKFURT/MAIN/Tel. 70 20.99
Italy - THOMSON-CSF Tubi Elettronici SRL/Viale degli Ammiragli 71/ROMA/Tel. 638 14.58
Japan - THOMSON-CSF Japan K.K./Kyosho Building/1-9-3 Hirakawa-cho/Chiyoda-ku/TOKYO/1102/Tel. (03) 264.6341
Sweden - THOMSON-CSF Elektronrör AB/Box 27080/S 10251 STOCKHOLM 27/Tel. (08) 22 58.15
United Kingdom - THOMSON-CSF Electronic Tubes Ltd./Bilton House, Uxbridge Road, Ealing/LONDON W 5 2TT/Tel. (01) 579 55.11/Telex: 25 659

SEE US AT
THE SID SHOW
MAY 21ST-23RD.
SAN DIEGO,
CALIFORNIA

"See us at SID, Booth # 106-107.

Subassemblies

Lead-acid cell finds its niche

Charging, supply circuitry make battery suitable for portable instruments

Despite long shelf-life, low cost, and high ampere-hour capacity, modern sealed and gelled lead-acid batteries have not caught on with makers of portable instruments and communications equipment. Yet they appear to fit well in the applications niche between nickel-cadmium cells, which are appropriate for relatively short discharge intervals, and disposable carbon-zinc cells, best suited for low-drain or intermittent usage.

Engineers at Seven Sciences Inc. think they know why lead-acid batteries have not caught on: there are problems in properly interfacing the batteries with both charging and power-supply circuitry. And they think they have a solution—the CellMate 1000 cyclic battery power supply. Manufactured by the company's new CellMate division, the CellMate 1000 includes both charging circuitry and power-supply circuitry.

The charging circuitry accepts ac voltages from 105 to 125 v and 210 to 250 v at any frequency from 48 to 440 hertz, as well as dc voltages from 18 to 36 v. To minimize recharging time without damaging the battery, the charging proceeds in three stages: constant-current charging at a current of about three times the 20-hour discharge current; constant-voltage charging during which 14 v is placed across a 12-v battery to rapidly finish the charging while cleansing the cells of impurities that might damage the plates if not removed; and a float stage, during which a voltage of 13.2 v keeps the battery fully charged without damaging it.

The power-supply circuitry, which regulates the output of the

battery, includes a dc-to-dc converter for generating either ± 12 or ± 15 v dc. In addition to the ± 12 - or ± 15 -v supplies, the CellMate can provide a supply of +5 v and an auxiliary +9-v supply, or +6 v with an auxiliary +11-v supply. The CellMate comes in four different total-power ratings—1.5, 4.5, 9, and 20 watts.

Various features of the CellMate can be eliminated to minimize size, weight, and cost. The dc-to-dc converter can be eliminated, as can the auxiliary output. This would leave the basic +5- or +6-v regulated supply. Overload protection to prevent damage to all outputs, even under continuous short-circuit conditions, is standard on all models, the company points out.

Special overvoltage protection, to prevent damage to load circuitry, is optional. Finally, the capability of running off ac can be eliminated, when it is known that dc recharging power will always be available to the user.

Because of the large number of options, pricing can vary widely. The cheapest system can cost as little as \$59 in single units, and the most expensive one as much as \$207. Discounts as high as 55% are available for quantities of 1,000 and up, and smaller discounts are available for smaller quantities of the battery power supply.

Delivery time is 30 days for most models.

CellMate Division, Seven Sciences Inc., 933 Kifer Rd., Sunnyvale, Calif. 94086 [381]

Voltage sources are digitally programed

Two modular, digitally programed voltage sources are designed to be used in automatic computer-controlled test equipment and process control systems, as well as in laboratory applications. Designated the models 4800 and 4801, the units are compatible with most minicomputers. They combine a d-a converter with a high-power output stage, digitally programable current limit and output ranges, storage resistors,

current sense output, and digital output flags to indicate current limiting and voltage setting. Small-quantity price is \$650. Delivery is from stock to four weeks.

Burr-Brown Research Corp., International Airport Industrial Park, Tucson, Ariz. 85706 [386]

Op amp provides 200-MHz gain-bandwidth product

The model 9829 operational amplifier provides a 200-megahertz gain-bandwidth product and unity gain frequency at a power-supply current level of less than 7 milliamperes on ± 15 -volt supplies. The device is designed for use in portable, battery-operated equipment, where differential input, wide bandwidth, and a

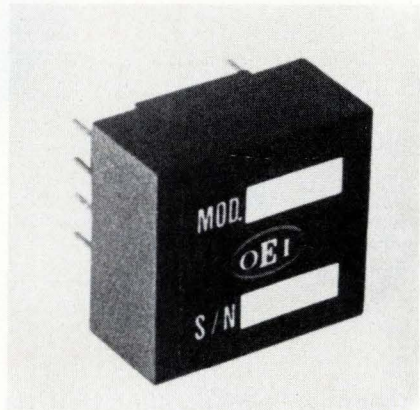

moderately fast slewing rate are required. Other specifications include a 110-dB minimum common-mode rejection, an 80-dB minimum open-loop gain, and a temperature range from -55 to $+100^{\circ}\text{C}$. Price ranges from \$46.50 to \$57.50, depending on quantity.

Optical Electronics Inc., Box 11140, Tucson, Ariz. 85734 [384]

Power supply is designed for self-scan displays

Meant for use with the Burroughs Corp. self-scan displays, the model 9760-PS power supply operates a 16- or 32-character array, with or without memory, and also powers

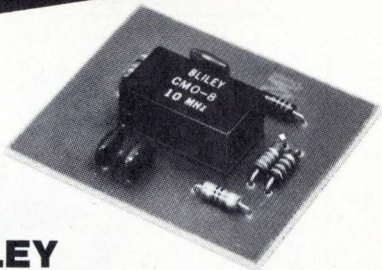

BLILEY CLOCK OSCILLATORS

OFFER:

- DIP or PC board adaptability
- Frequency Range: up to 30 MHz
- Stability: (Std.) ± 50 ppm 0° - 50° C or (Optional) ± 25 ppm 0° - 70° C
- Output/Supply:
DTL/TTL logic with +5 Vdc.
CMOS logic with +5 to +15 Vdc.
(Optional) Triple output @ 1, 2 & 4 MHz
- Size: .820 x .480 x .370 max.

Complete Crystal Oscillator Data Sheets
Available On Request

Bliley if you buy quality

BLILEY ELECTRIC COMPANY
2545 West Grandview Boulevard
Erie, Pennsylvania 16512

Circle 197 on reader service card

The Brush recorder module. It gives your system the competitive edge.

OEM recorder modules give you design flexibility along with all the Brush exclusives.

Choose single or dual channel, low profile or vertical models. There's a wide range of chart speed options.

Plus Brush exclusives like pressurized ink writing and Metrisite® servo loop feedback system that assures 99.5% linearity.

Write Gould Inc., Instrument Systems Division, 3631 Perkins Avenue, Cleveland, Ohio 44114. Or Kouterveldstraat Z/N, B 1920 Diegem, Belgium.

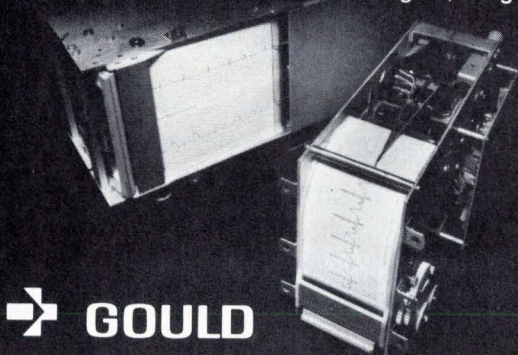

GOULD

Circle 198 on reader service card

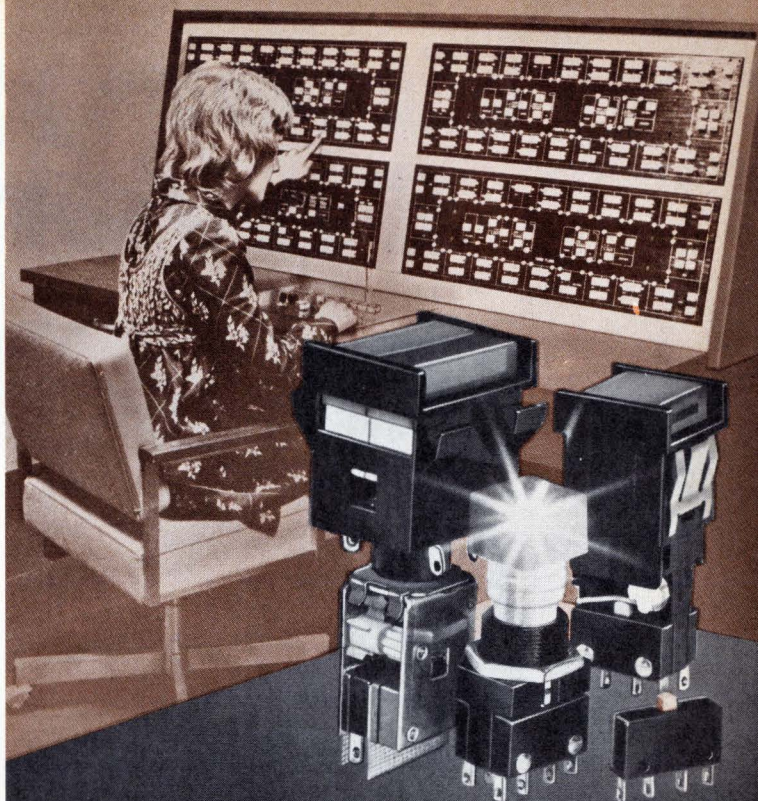

In medical electronics, Licon® switches go where the action is.

Medical electronic equipment demands precision reliability. Licon provides it. With proven double-break, double-reliable Butterfly® switches. They work 'round the clock in X-ray machines, communications systems, automated examining tables, sample oxidizers/synthesizers and more.

Licon saves design time, too: as a single source for a broad selection of lighted and non-lighted pushbuttons, basic miniature and sub-miniature snap-action and limit switches.

Want to individualize? Replace several switches with one? Or meet a multi-functional requirement in a standard way? You can, with "added value" from Licon.

Licon switches: where the action is in medical electronics, computer systems, business machines, industrial controls. Check your Licon rep or distributor for full details. Or write for literature.

LICON®

Division Illinois Tool Works Inc.
6615 W. Irving Park Rd., Chicago, Ill. 60634
Phone (312) 282-4040 TWX 910-221-0275



LICON

puts ideas to work
in electronics

The Innovative Electronic Group of ITW...
LICON • EMCON • PAKTRON

© ILLINOIS TOOL WORKS INC. 1974

Circle 165 on reader service card

Energy Saver



NEW ELECTRONICS BUYERS' GUIDE... EASY-TO-USE, SINGLE VOLUME SOURCE FOR:

- Information on over 4,000 products.
- Over 6,000 company listings and phone numbers — both home and field offices.
- **EBG EXCLUSIVE:** quick access to over 800 helpful catalogs through a timesaving Direct Inquiry service.
- More than 1,400 pages of data.

Here is the international world of electronics at your fingertips. Find suppliers... fast... accurately... and locally! Don't have a copy? Use coupon below, today.

Electronics Buyers' Guide

A McGraw-Hill Publication
1221 Ave. of the Americas, New York, N.Y. 10020

Yes, send me _____ copies (copy) of the energy saving Electronics Buyers' Guide. I've enclosed \$15.00 (USA and Canada only; elsewhere send \$25.00). Full money back guarantee if not satisfied.

NAME _____

COMPANY _____

STREET _____

CITY _____

STATE _____ ZIP _____

New products

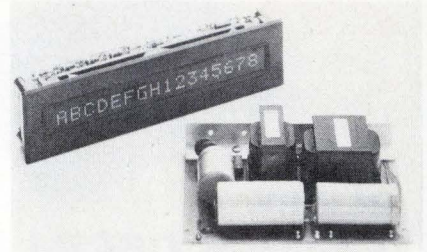

additional TTL or MOS circuitry. Output voltages are 250 v dc at 30 mA, -12 v dc at 200 mA and 5 v dc at 1 A. An optional -5 v dc output is also available. All output voltages are regulated within 5% for an input of 105 to 125 v ac. Price is \$96.

Texas Digital Systems Inc., Box 3701, Bryan, Texas 77801 [385]

Cascadable amplifiers are rated from 5 to 500 MHz

The models A5 and A7 cascadable amplifiers, rated at from 5 to 500 megahertz, are stable for any source and load condition. The integrated devices cascade up to four stages to

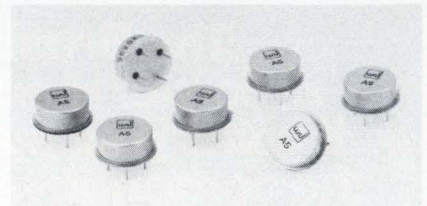

achieve a typical gain of 58 decibels and a typical flatness of ± 0.5 dB. The application of either 15 v dc to the A5 or 24 v dc to the A7 produces a gain of 14.5 dB and a gain flatness of less than ± 0.3 dB, in addition to a VSWR of less than 1.2 (input) and less than 1.5 (output). Price of the A5 is \$99; and of the A7, \$109.

Watkins-Johnson Co., 3333 Hillview Ave., Palo Alto, Calif. 94304 [387]

Active transformer links electrically isolated circuits

For applications in which a conventional magnetically coupled transformer cannot provide adequate

MOS 16K ROM 450ns



Our New Arrival



To Provide:

- Direct Feedback from output to input for:
 - Sequential logic
 - ∞ Programs with loops and jumps
 - Arithmetic operations, etc.
- Wire-or and chip select for expansion
- Simplified interface and on-chip address decoding
- Dynamic or Quasi-Static operation

For These Applications and More:

- N/C Processors
- Combinatorial logic trees
- Function Generators
- Encoders
- Look-up tables
- Microprocessors
- Pattern Generators
- Decoders

HEADQUARTERS — Applications Mgr.: Mr. Julius Hertsch;
MOS Technology, Inc., Norristown, Pa. 19401

CENTRAL REGION — MOS Technology, Inc., 838 S. Des Planes St.,
Chicago, Illinois 60607 • (312) 922-0288

EASTERN REGION — Mr. William Whitehead, Suite 307 — 88 Sunnyside
Blvd., Plainview, N.Y. 11803 • (516) 822-4240

WESTERN REGION — MOS Technology, Inc., 2172 Dupont Dr., Suite 221,
Patio Bldg., Newport Beach, Calif. 92660 • (714) 833-1600

MOS high speed ROM family

| Organization | Part Number | 10K Price |
|----------------------------|-------------|-----------|
| 2048 x 8 | MCS 2026 | \$24.75 |
| 1024 x 8 | MCS 2023 | \$16.50 |
| 7 x 9 x 128 | MCS 2022 | \$16.50 |
| 9 x 7 x 128 | MCS 2024 | \$16.50 |
| 10 x 768 (10 x 12 x 64) | MCS 2025 | \$16.50 |
| 7 x 9 x 64 | MCS 2017 | \$11.00 |
| 10 x 12 x 32 | MCS 2018 | \$11.00 |
| 7 x 10 x 32 | MCS 2020 | \$11.00 |

WE'VE TURNED A TECHNOLOGY INTO A COMPANY



MOS TECHNOLOGY, INC.
VALLEY FORGE CORPORATE CENTER, NORRISTOWN, PA. 19401 (215) 666-7950

a proud affiliate of ALLEN-BRADLEY





Some Delevan designs are very special...

THEY'RE NOT MADE YET.

Applications for inductive devices are virtually unlimited... and not even Delevan's broad line of *standard* designs can fit every requirement. That's where Delevan's Application-Engineering capability comes in! No matter how unusual or highly-specialized your application may be... Delevan can provide a custom-engineered design to meet the most demanding specifications, the most unique applications.

At Delevan, the design of inductive devices is far more than an art... it is a highly-sophisticated science. State-of-the-art techniques in winding and molding, the instant availability of computerized data, and utilization of new materials and procedures... combined with the proven expertise of Delevan engineers... equals unmatched capabilities. If you have the application, Delevan can provide the design.

Delevan
Division



AMERICAN
PRECISION
INDUSTRIES INC.

270 QUAKER RD./EAST AURORA, N.Y. 14052
TELEPHONE 716/652-3600 TELEX 091-293

OTHER DIVISIONS OF AMERICAN PRECISION INDUSTRIES INC.:
BASCO • DUSTEX

New products

performance, the model AT200 solid-state transformer links electrically isolated circuits, solves both gain and impedance problems, and passes 360-kilohertz signals. Moreover, the unit performs these functions with a low harmonic intermodulation distortion, immunity to



interference, high input impedance, and differential or single-ended operation. The transformer handles signals down to dc levels and is priced at \$200 each.

Burwen Laboratories Inc., 209 Middlesex Turnpike, Burlington, Mass. 01803 [389]

Differential multiplier uses eight pairs of analog switches

The model MMD-8 differential multiplexer consists of eight pairs of analog switches. Each pair is switched simultaneously through two buffer amplifiers into a true differential-input, singled-ended output amplifier. The output pair from the analog switches, the inputs and outputs of the two buffer amplifiers, and the differential amplifier are all brought out to the pins. The analog switches and amplifiers can be used separately if desired. In addition,

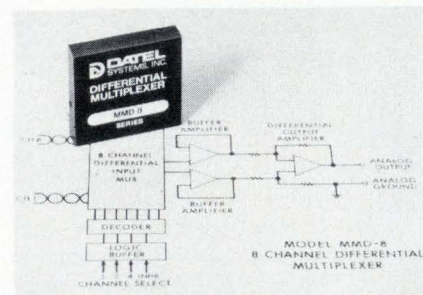

"When we were evaluating Augat panels, we had to be absolutely sure they would withstand the shock and vibration of a hard-working storage system.

"Now we're sure."

Chuck Bates
Senior Development Engineer
Clark Equipment Company, Storage Systems

"Clark automated storage systems utilize a computer directed stacker crane. The heart of the system is a Clark-designed electronic logic package, built around Augat plug-in socket panels.

"When we were designing the system, we of course looked for density and design flexibility. And at the same time we found the cost of wire-wrapped panels attractive.

"What concerned us was if the socket panel concept could withstand shock and vibration with a high degree of reliability. Clark storage systems often work 24 hours a day. We found that Augat's unique machined socket contact stood up very well in test

Testing control box featuring Augat panels.

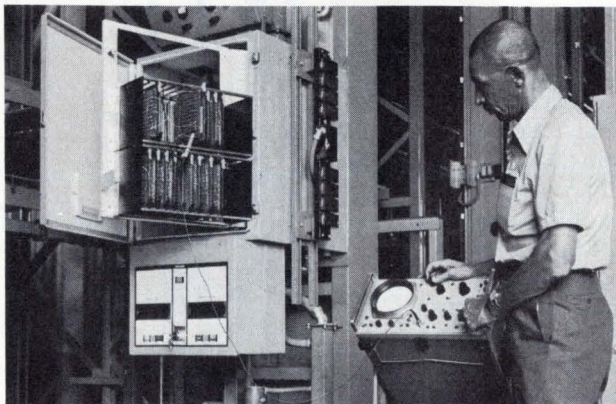

"See us at Nepcon East, Booth # 4332"



Chuck Bates

and in the field as well.

"Augat gave us an interconnection system which met our requirements from a cost, reliability and design standpoint."

All of which just might tell you why Augat has become the world's leading producer of wire-wrapped socket panels and other IC interconnection products. But Augat has more to offer than just hardware. Augat's technical experience is ready to help you meet your interconnection requirements.

Call or write to us today. We'll send you our free brochure and complete product information. Augat, Inc., 33 Perry Avenue, Attleboro, Massachusetts 02703. Represented and distributed internationally.

AUGAT

Circle 169 on reader service card

Europe—Augat International, Inc., Boulevard A. Reyers, 103, 1040 Brussels, Belgium, Tel. (02) 36-93-99.

Japan—Kyokuto Boeki Kaisha Ltd., New Otemachi Bldg., 2-1, 2-Chome Otemachi, Chiyoda-Ku, Tokyo 100-91, Japan, Tel. (03) 244-3788.

AMERICAN MADE

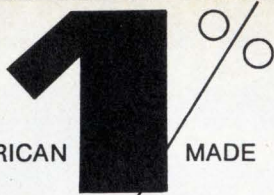

Tolerance SCHAUER 1-Watt ZENERS

Immediate Shipment Low Prices

ANY voltage from 2.0 to 16.0

| Quantity | Price each |
|-----------|------------|
| 1-99 | \$1.07 |
| 100-499 | .97 |
| 500-999 | .91 |
| 1000-4999 | .86 |
| 5000 up | .82 |



All welded and brazed assembly

No fragile nail heads

Gold plated leads

Write for complete rating data and other tolerance prices.

Buy the kit- Save a lot



Kit contains a 51-piece assortment of SCHAUER 1% tolerance 1-watt zeners covering the voltage range of 2.7 to 16.0. Three diodes of each voltage packaged in reusable poly bags. Stored in a handy file box. Contact your distributor or order direct.

A \$54.57 value for
ONLY \$24⁵⁰

Semiconductor Division

SCHAUER

Manufacturing Corp.

4514 Alpine Ave. Cincinnati, Ohio 45242
Telephone: 513/791-3030

New products

the MMD-8 offers good transfer characteristics with high-speed break-before-make switching. A channel select inhibit (all channels off) is provided so that two MMD-8s can be stacked to provide 16 channels of differential analog multiplexing. Differential input signals up to ± 10 volts can be accepted by the MMD-8. Without the amplifiers, switching time is typically 500 nanoseconds, while the output settling time of the amplifier is 4 microseconds. Price is \$169.

Datel Systems Inc., 1020 Turnpike St., Canton, Mass. 02021 [388]

Subminiature filter handles peak power up to 30 watts

A series of subminiature filters of .01-dB Chebyshev design offers center frequencies from 200 to 600 MHz and handles peak powers of 1 to 30 watts. Designated model TSA, the new filter is constructed with a magnetically coupled resonator design and may be specified with two to eight sections, depending on bandwidth and other characteristics de-

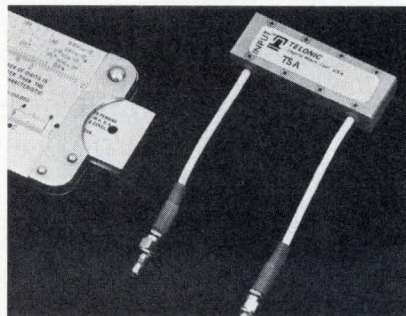

sired. In cross-section, the filter measures $\frac{1}{8}$ in. by $\frac{11}{16}$ in. and is 2 to 3- $\frac{1}{2}$ in. long, length being a function of the number of sections and pass bandwidth. Input and output connectors may be specified as Seallectro, or OSM, or any combination, and may be located at ends or sides. Minimum 3-dB bandwidths range from 1:0 to 15%, also depending on the number of sections. Price ranges from \$150 to \$300.

Telonic Industries Inc., Box 277, 21282 Laguna Canyon Rd., Laguna Beach, Calif. 92652 [390]

Procond

Synthetic film capacitors
Electrolytic capacitors
Filters
Push Buttons

PROCOND S.p.A.
32013 Longarone (Belluno) Italy

telephone (0437) 76145 / 76355
telex 44029

Quadrangolo

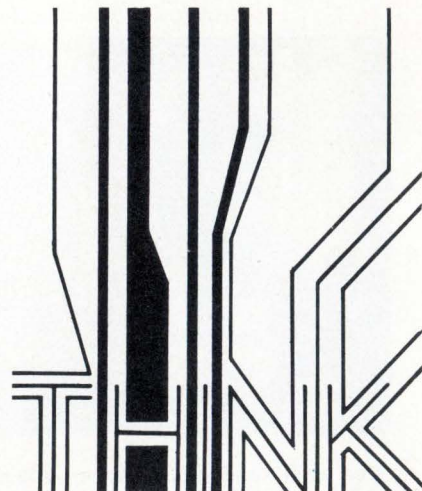

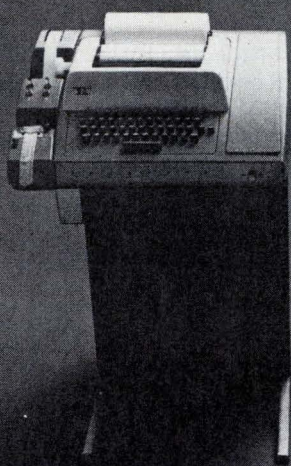

The model 33 is so good you'll never believe its price.

Underneath the cover of the model 33 is a data terminal that offers the most in reliability and versatility at a very economical price.

In fact, you can't buy a terminal that offers as much as the model 33 does—for as little as the model 33 costs.

That was true when we introduced the model 33. And it's still true today. Although the terminal we're selling today is hardly the terminal we started with. That's because over the years we've had a crack team of engineers assigned to the model 33. And their only job is to search out ways to improve it.

Some of their improvements have made the model 33 more

reliable and rugged. Others have kept the cost down.

But as improved as the model 33 is, the changes haven't outmoded previous model 33's. So the oldest unit still putting in a hard day's work is compatible with the units coming off our assembly lines right now.

However, there is one small part of the model 33 we're trying to keep as old-fashioned as possible. That's the price. We want to make sure our customers get more than a data terminal. By making sure they also get a bargain.

It takes more than manufacturing facilities to build the terminals Teletype® Corporation offers. It also takes commitment. From people who think service is as important as sales. In terminals for computers and point-to-point communications.

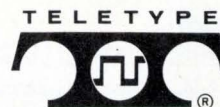

The computercations people.®

For more information about any Teletype product, write or call: TERMINAL CENTRAL, Teletype Corporation, Dept. 53T, 5555 Touhy Avenue, Skokie, Illinois 60076. Phone 312/982-2500. Teletype is a trademark registered in the United States Patent Office.

Circle 171 on reader service card

CONTROL—precise
SIZE—fits
SUPPLY—fast
PRICE—fine

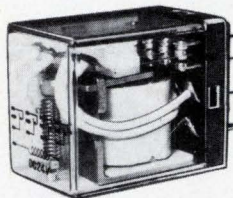

**Miniature
Relay Type
MPM-100**

- Available for various voltages AC & DC.
- Both 4PDT and DPDT contact switching requiring minimum driving power is available.
- Highly economical.
- Incorporates anti insulation fatigue device which prevents short-circuits.
- Uses UL-approved resin bobbin.

Digital Line Printer LP-108

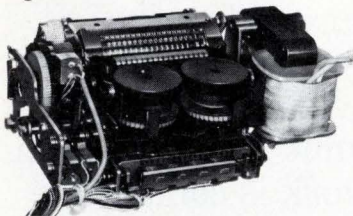

- Compact size with simplified mechanism.
- Up to 18 columns.
- 14 characters per column.
- High reliability.
- Red/black printing.
- Print rate of 2.5 to 3.0 lines/sec.
- Low cost

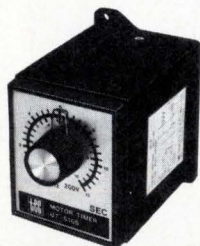

**Miniature
Motor Timer
Type UT-500**

- Smart surface design. Plug-in type terminal.
- Economical due to simplified pointerless mechanism.
- Available in a variety of types ranging from 10 seconds to 24 hours, surface-mounted or flush-mounted.

Whichever way you take the measure of TEC control instruments you're getting top value. They work longer; give you more reliable performance for your money.



TOKYO ELECTRIC CO., LTD.

14-10, 1-chome, Uchi-Kanda, Chiyoda-ku,
Tokyo, Japan

New literature

SCR gate drives. Vectrol Inc., 1010 Westmore Ave., Rockville, Md. 20850, has issued a four-page catalog covering the Phasetrol series of SCR gate drives and regulator control modules. The line includes feedback amplifiers, current limiters, lockout circuits, and current-voltage regulators, all offered in either plug-in or panel-mounted versions. Circle 421 on reader service card.

Test equipment. A 64-page catalog describing electronic test equipment, including oscilloscopes, pulse generators, and voltmeters, has been published by Baynton Electronics Corp., 2709 N. Broad St., Philadelphia, Pa. 19132. Specifications, prices and general information are given. [422]

Laminates. Dynthane-Taylor, Valley Forge, Pa. 19482. A 12-page brochure gives details of a line of glass-base laminates that can be used with any method of circuit manufacture. [423]

Power supplies. A technical bulletin from Induction Process Equipment Corp., 32251 N. Avis Dr., Madison Heights, Mich. 48071, describes the Statiron line of heating inverter power supplies that convert low-frequency ac line current to rf ac current. [424]

Breadboarding equipment. A 20-page catalog of circuit design and breadboarding equipment from E&L Instruments Inc., Derby, Conn., features the ADAM modular breadboarding system, two op-amp signers, socket boards, and equipment. [425]

Microwave products. Texas Instruments Incorporated, Box 512, MS-84, Dallas, Texas 75222 Bulletin CB-161 describes a line of beam-lead microwave semiconductors, which include p-i-n switching diodes, Schottky barrier mixer diodes, and capacitors with Jedec values. [426]

Silicon rectifiers. International Rectifier Corp., Semiconductor division, 233 Kansas St., El Segundo, Calif.

LOW-COST TRANSPORTATION
FOR ALL LIFE-STYLES

**Get a
VESPA!**



VESPA CIAO
(pronounced
Chow)

Vespa Ciao is the vehicle for everybody who enjoys getting 168 miles per gallon. Pedal it like a bike or enjoy the motor. The Ciao has automatic transmission, is whisper quiet, and weighs just 74 pounds.

Check Yellow Pages for Vespa dealer or write to:

MR. SHORT

WESTERN SCOOTER DISTRIBUTORS

1599 Custer Ave. • San Francisco, Ca. 94124



The fun way to go!

Circle 200 on reader service card

Cost Cutter

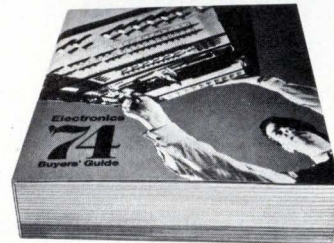

**New Electronics Buyers' Guide ...
Easy-to-use, single volume
source for:**

- Data on over 4,000 products
- Over 6,000 company listings and phone numbers
- **EBG EXCLUSIVE:** quick access to over 800 catalogs through a Direct Inquiry Service.

The international world of electronics at your fingertips. Find suppliers...fast...accurately...and locally! For your copy send \$15.00 (USA and Canada only; elsewhere send \$25.00) to address shown below.

**Electronics
Buyers' Guide**

A McGraw-Hill Publication
1221 Ave. of the Americas, New York, N.Y. 10020

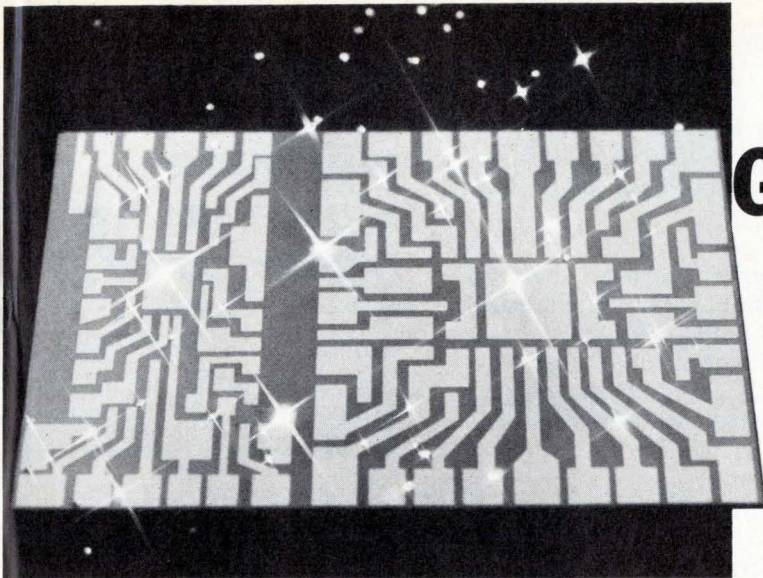

Good Reasons Why You Should Buy 1 oz. of Platinum+. Today.

1. Platinum+ is fritless. No glass. Nothing to add resistance.
2. Platinum+ bonds super strong. The wire will break or the chip will break before you can break the bond.
3. Platinum+ allows for fully automated production. No other thick film can say that.
4. Platinum+ circuits have less noise. No glass, less noise. Simple.
5. Platinum+ requires no conversion of processing equipment. You can start using it now.
6. Platinum+ has a leach resistance equivalent to or exceeding palladium/silver compositions.
7. Platinum+ wets quickly. No time wasted building on the foundation.
8. Platinum+ helps you build better equipment. Better conduction; better transmission.
9. Platinum+ costs less than comparable palladium/silver conductors. Substantially less.
10. If you do buy 1 oz. of Platinum+, and your own tests do not confirm reasons 1-9, we'll refund your money. No questions asked.

TRY AN OUNCE TODAY
YOU MAY WANT A
TON TOMORROW

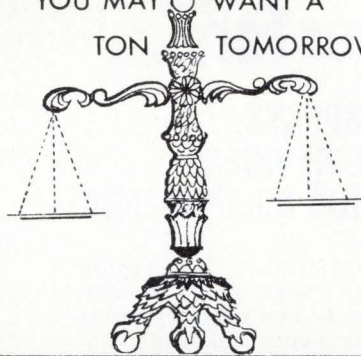

| SPECIFICATIONS | | |
|-------------------|---|---|
| TEST | TEST CONDITIONS | U.S.A. |
| ADHESION | Pull strength using 50 mil sq. pads | > 6,000 P.S.I. |
| LEACH RESISTANCE | 2 min. @ 230° C.—40 mil line | No evidence of leaching |
| PEEL STRENGTH | 100 Hours 80 mil sq. pad— 150° C. 0.035 Cu wire | 7-10 pounds |
| ACCELERATED AGING | 10 Min. @ 225° C. reflow solder 20 Min. @ 225° C. reflow solder 30 Min. @ 225° C. reflow solder | 7-10 pounds 6- 9 Pounds 4- 8 Pounds |
| SHEET RESISTIVITY | | 0.00095 Ohms/Sq/Mil |

OK. We'll try an ounce of Platinum+ for \$44.95. (\$24.95 in 1000 oz. quant.) We understand that if it doesn't live up to everything you say, you'll return our money.

Company Name _____

Name _____

Address _____

City _____ State _____ Zip _____

PLATINUM+™

A genuine breakthrough in conductive thick film

Electro Oxide Co., Inc.

... current technology runs in our family.

3896 Burns Rd., Palm Beach Gardens, Florida 33403.
Telephone 305/622-1235

U.S. and Foreign Pat. applied for.

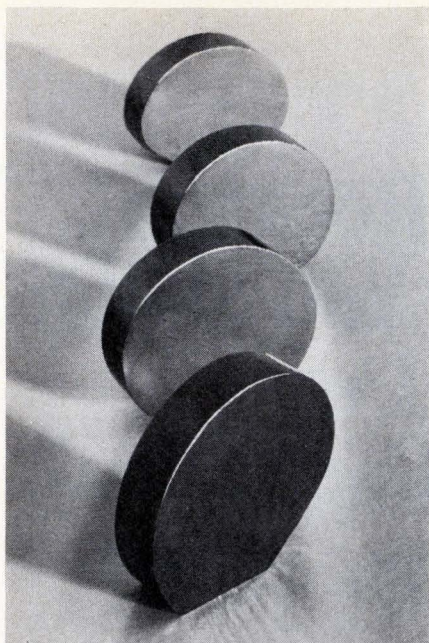

Our compounds are your right answer for...

DIODE DISPLAYS, INFRARED DEVICES, ELECTRONIC COMPONENTS

Asarco Intermetallics Corporation offers a wide range of III-V compounds used in the production of light emitting diodes (LED) and photoluminescent displays.

We provide gallium arsenide, gallium phosphide and indium phosphide in both polycrystalline and single crystal form. All polycrystalline materials are available as ingots. Gallium phosphide and indium phosphide are also available in granular form.

Gallium arsenide single crystals are boat grown with typical cross-sections of 19mm x 47mm for a (111) orientation and 33mm x 47mm for a (100) orientation.

You can order single crystals of our III-V compounds as ingots or slices, as cut or polished.

All materials are furnished in small quantities for evaluation or in large volume for production use. For more information contact us at 120 Broadway, New York, N.Y. 10005. Or call 212-732-9500.

ASARCO INTERMETALLICS CORPORATION

174 Circle 174 on readerservice card

New literature

90245, has issued a data sheet describing three versions of a 6-ampere medium-power silicon rectifier. [427]

Transducers. Technical bulletin 1001A from Schaevitz Engineering, Box 505, Camden, N.J. 08101, provides information and a selection guide for ac- and dc-operated linear variable differential transformers. [428]

Film deposition. Scientific Gas Products Inc., 513 Raritan Center, N.J. 08817. Information is provided in a technical bulletin on the deposition of silicon-nitride and silicon-dioxide films on prepared gallium-phosphide substrates. The bulletin also describes how to achieve fast growth rates at low temperatures. [429]

Ceramic capacitors. Republic Electronics Corp., 176 E. 7th St., Paterson, N.J. 07524, has made available catalog K-1, which describes the line of Mucon subminiature ceramic capacitors. [430]

Digital panel meters. A package of updated data sheets describing the 11 series of digital panel meters is obtainable from Electronic Research Co., Box 913, Shawnee Mission, Kan. 66201. [432]

Oscilloscopes. Nicolet Instrument Corp., 5225 Verona Blvd., Madison, Wis. 53711. "The General Purpose, High Precision, Digital Oscilloscope" is the title of a 12-page technical brochure that discusses design, operation, midsignal trigger, display capabilities, accuracy, resolution, and interfacing techniques when digital electronic components are used in oscilloscopes. [433]

Microwave diodes. Unitrode Corp., 580 Pleasant St., Watertown, Mass. 02172, lists the specifications of a line of microwave diodes in a six-page catalog. [434]

Converter modules. A two-page data sheet describing digital-to-synchro converter modules is available from Astrosystems Inc., 6 Nevada Dr., Lake Success, N.Y. 11040. [435]

Is equipment service squeezing your profit?

RCA Service Company can supply comprehensive maintenance, emergency and installation service coast-to-coast, for electronic or electro-mechanical industrial and commercial equipment marketed by you. We're specialists on communications, control and data processing equipment maintenance for the large user, and account of the manufacturer.

- Stop the profit squeeze.
- Compare price and benefits.
- Eliminate service headaches.
- Decrease down-time.
- Lower overall service costs.

Write or phone for details:

B. L. Grossman, Building 204-2
RCA Service Company
A Division of RCA
Camden, New Jersey 08101

RCA

Circle 201 on reader service card

FLATPACK

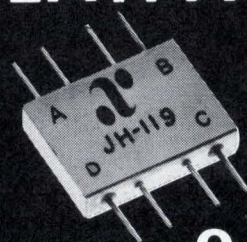

90°

HYBRID

MODEL JH-119

- 80-160 MHz Frequency Range
- 3 Degree Phase Tracking
- 1/2" x 3/8" x 1/8"
- \$75/Stock Availability

anzac
ELECTRONICS



39 Green Street, Waltham, Mass.
(617) 899-1900 • TWX 710-324-6484

Circle 202 on reader service card

AUTOTRACK MOUNT

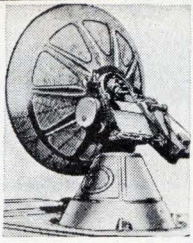

AUTOTRACK

SCR-584 RADARS

360 degree azimuth, 210 degree elevation sweep with better than 1 mil. accuracy. Missile velocity acceleration and slewing rates. Amplidyne and servo control. Will handle up to 20 ft. dish. Supplied complete with control chassis. **ALSO** in stock 10 cm. van mounted radar system. Conical scan. PPI 6 ft. dish. Ideal for S band telemetry, weather, balloon trk, missile trk, rocket trk, ECM range. Write for complete data: 600 pg. instr. bk. avail. at \$25 ea.

1 MEV LINEAR ACCELERATOR

Dual Mode, Ion or Electron. RF Drive, 300 KHZ at 45 KW. Includes control console, RF unit, accelerator, etc.

MOD IV HIGH RESOLUTION TRACKER

Instrumentation radar; freq. 8.5-9.6 GHz, Pwr: 250 KW, 1 mil tracking accuracy, 6' Fresnel lens antenna with 4 horn monopulse feed. Tracking range 50 or 200 miles. Formerly used as range safety radar at Cape Kennedy.

PULSE MODULATORS

245 KW LINE PULSER Output 16 KV at 16 amp. .25 μ s at 4000 PPS.

405 KW FLOATING DECK PULSER Output 20 KV at 20 amp. 1 μ s to 10 milisecond pulse.

500 KW LINE PULSER Output 22 KV at 28 amp. .4/1.75/2.25 μ s at 2500/550/300 PPS.

1 MW HARDTUBE MIT MODEL 9 Output 25 KV at 40 amp. .25-2 μ s at .002 D.C.

2.0 MW LINE PULSER Output 30 KV at 70 amp. 1/2 μ s at 600/300 PPS.

3 MW LINE PULSER Output 39 KV at 75 amp. .25/1 μ s at 500 PPS.

10 MW LINE PULSER Output 76 KV at 135 amp. 2.5 μ s at 350 PPS.

17 MW LINE PULSER Output 17 KV at 1000 amp. 2-5 μ s at 150-200 PPS.

HV POWER SUPPLIES

6.3 KV @ 5 Amps; 20KV @ 1.3 Amps; 35KV @ 1.5 Amps; 28KV, 70MA; 12KV @ 800MA;

18KV @ 2.25 Amps; 17.5KV @ 1.8 Amps.

RECON DRONE CONTROL RADARS

X Band systems autotrack and search complete with plotting boards. Fully mobile van mounted. Gives PPI, slant range, altitude data. Ground to air control links and beacons also in stock. AN/MPQ-29 & AN/UPW-1

RADAR DATA MICROWAVE LINK

Freq. 7.1-7.9 GHz, Pwr. 100 mw., 4 channels. Transmits video, pulse, synchro, and voice information. Mfr: Motorola.

SPARE PARTS IN STOCK

Nike Ajax, Nike Hercules, M-33, MPS-19, TPS-1D, TPS-10D, FPS-6, SPS8, SCR-584, HIPAR.

RADAR & RF PKGS.

34ghz 40kw Pulse RF pkg

24ghz 40kw Pulse bomb toss system

16ghz 130 kw Pulse B-58 search radar system

X BAND SEARCH 40 KW PULSE WEATHER RADAR

X BAND AUTOTRACK 250KW PULSE M-33

compl w / plot boards

X BAND BEACON 400 W PULSE AN/DPN-62

X BAND AUTOTRACK 50KW PULSE B-47

fire control complete

C BAND WEATHER RADAR 250 KW PULSE

C BAND HEIGHT FINDER

AN/FPS-26 5 megawatt output.

AN/TPS-37, 1 megawatt output.

C BAND 1 MEGAWATT AUTOTRACK

10ft dish mortar locator MPQ-21

C BAND 285KW PULSE Search AN / SPS-5

S BAND AUTOTRACK 500 KW PULSE 10' DISH

S BAND 1 MEGAWATT COHERENT AN / FPS-18

S BAND 1 MEGAWATT PULSE NIKE ACQ.

S BAND 5 MEGAWATT HEIGHT FINDER AN/FPS-6

S BAND BEACON 1 KW PULSE

L BAND 500KW PULSE AN / TPS-1D / E

L BAND 5 to 20KW PULSE

400mhz 1KW CW AN / FPS-23

225mhz 1 MEGAWATT PULSE AN/TPS 28

2-30mhz 100KW PULSE

CW 950-5ghz 150 WATTS

CW 1.5mhz-10.5ghz 5 WATTS

CW 7.4GHZ 2 KW

AN / GPG-1 SKYSWEEP TRACKER

3 cm. auto. tracking radar system. Comp. pkg. w / indicator sys. Full target acquisition & auto. tracking. Input 115v 60 cy. new.

In stock for immed. del. Entire sys. 6' x 3' x 10'. Ideal for infrared tracker, drone tracker, missile tracker. R & D.

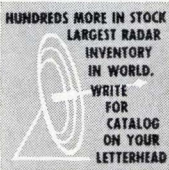

CLASSIFIED ADVERTISING

SEARCHLIGHT SECTION

BUSINESS OPPORTUNITIES
USED OR SURPLUS EQUIPMENT

EUROPE

We are specialists in helping you to get established on the European Market, thru our services tailored to your requirement:

MARKET ANALYSIS,

defining your products' potential, competition and Market trends.

MARKETING PLAN,

providing you with detailed recommendations on Sales methods and channels to be used to sell your products effectively.

DISTRIBUTION,

selecting and setting-up complete Distribution Network, giving optimum coverage and results.

REPRESENTATION,

monitoring, coordinating and supervising your established distributors.

Please write for further details to:

FURRER MARKETING

P.O. Box 99
CH-6300 Zug 2, Switzerland

CIRCLE 607 ON READER SERVICE CARD

SAME DAY SHIPMENT Minis & Peripherals

PDP SPECIALISTS 8, 8I, 8L & 11

NEW 300 LPM PRINTERS

PDI CARD READERS

BRPE PUNCHES

\$750 Minis

TELETYPE 35 & 37 DEC & HONEYWELL Modules 617/261-1100

Send for Free Report "Maintenance of Computers"

AMERICAN USED COMPUTER CORP.
P.O. Box 68, Kenmore Sta., Boston, MA 02215
member COMPUTER DEALERS ASSOCIATION

CIRCLE 602 ON READER SERVICE CARD

free catalog

POTTING APPLICATORS MANUAL OR AIR OPERATED

2 1/2cc 6cc 12cc 30cc
FOR POTTING, ENCAPSULATING ETC.

PHILIP FISHMAN CO., INC.
7 CAMERON ST. WELLESLEY, MASS. 02181

CIRCLE 603 ON READER SERVICE CARD

FREE CATALOG

HARD-TO-FIND PRECISION TOOLS

Lists more than 2000 items—pliers, tweezers, wire strippers, vacuum systems, relay tools, optical equipment, tool kits and cases. Also includes ten pages of useful "Tool Tips" to aid in tool selection.

JENSEN TOOLS
4117 N. 44th Street, Phoenix, Ariz. 85018

1974 BOOK CATALOGUE

Over 2500 titles. A wide range of authors writing on every conceivable subject from Abbott: *Flatland* to Zwicker: *Advanced Geometry of Plane Curves*. List includes more than 500 Scientific and Technical paperbacks at prices you can afford.

H. SHPRENTZ CO., Box 83EB, Irvington, NY 10533

CIRCLE 606 ON READER SERVICE CARD

EMPLOYMENT OPPORTUNITIES

Send New Ads to:
Electronics
Class. Adv. Dept.
P.O. Box 900, N.Y., N.Y. 10020

POSITIONS VACANT

Positions Available—Electrical & Electronic Eng's. Over 1000 US client co's pay our fees for selected technical referrals. Est. 1959. Send resume with pres. sal. Atomic Personnel, Inc., Box L, 1518 Walnut St., Phila., Pa. 19102.

Q. Whom do I contact or call to renew my classified ad or make corrections?

A. Write Electronics, Class. Adv. Dept., P.O. Box 900, NY, NY 10020 or call: (212) 997-6585 or 6586. Give full company name, size of ad. & date or dates it is scheduled to appear.

Flameless
Compressed-Air
Heat Torches —
Lightweight and
portable for
pinpoint
intense heat
performance.

Heat Blowers — Built for
continuous 24-hour duty.

New! Master-Mite™ Gun
— Lightweight
versatility
with three
interchangeable
nozzles and
heat ranges.

U. L.
Approved

Standard
Heat Gun —
Compact
and
economical,
die-cast
aluminum
housing.

250° to 1,000° F

Chrome Heat Gun — Designed for
labs, R & D, and professional use.

A flameless heat tool for every need: Master makes them all

Master offers you the world's most complete line of flameless heat tools. Each one is precision built for rugged dependability and versatile performance. And every Master heat tool features a complete line of attachments for every production need.

Heat Guns and Blowers are available in U.L. and L.A. approved models.

CSA approved in Canada. In Canada, contact Martin Industrial Sales, P.O. Box 576, 4445 Harvest Road, Burlington, Ontario.

Send for your free 12-page catalog and price list on the world's most complete line of flameless heat tools.

For information on our exciting 1974 Rio de Janeiro Incentive Travel Program, write now for our special brochure.

MASTER
appliance corporation

Racine, WI 53403

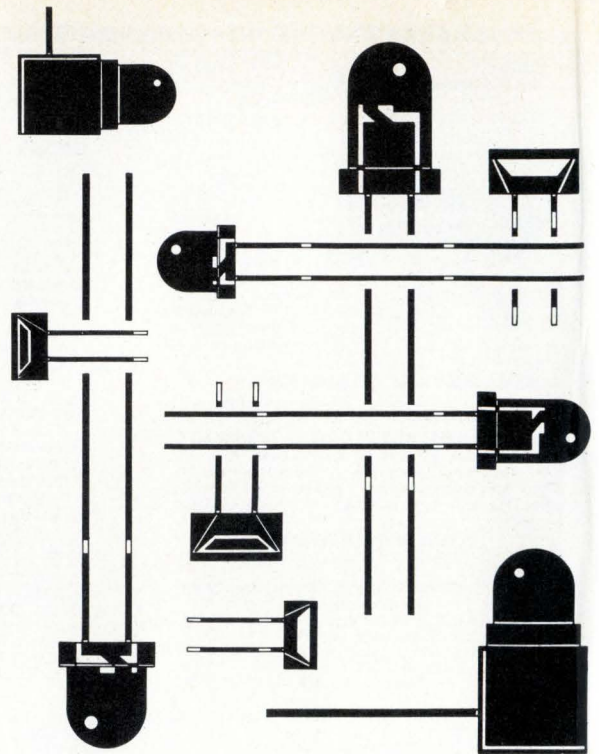

“LEDs?
That's a stock item,
We can
ship tomorrow...”

Words you don't hear very often anymore, unless you're talking to a National Semiconductors Ltd. representative. He can tell you about our complete line of low current high efficiency gallium phosphide LEDs, and their multi-colour capabilities. He'll also tell you (and he's right) that we have the most uniform and high efficiency LEDs in production.

He might even mention our full range of photocells, photodiodes, phototransistors, optocouplers, optoelectronic arrays and customized optoelectronic devices.

All this, and low prices too. Give us a call and let us convince you.



NATIONAL SEMICONDUCTORS LTD.

331 Cornelia St., Plattsburgh, N.Y. 12901 Tel.: (518) 561-3160
2150 Ward St., Montreal, Quebec H4M 1T7 Tel.: (514) 744-5507
TWX 610-421-3362

Electronics advertisers

May 2, 1974

| | | | | | |
|---|-----------|---|---------|---|---------|
| ■ ACDC Electronics, Inc. Rose Associates Advertising & Public Relations | 68 | Gould, Inc./Instrument Systems Div. Carr Liggett Adv., Inc. | 165 | Signetics Corp., Sub. of Corning Glass Works Hall Butler Blatherwick, Inc. | 24-25 |
| Advanced Micro Devices Keye/Donna/Pearlstein | 10-11-11E | ■ Grayhill, Inc. Stral Advertising Company, Inc. | 24 | Siliconix Robertson West, Inc. | 97 |
| ■ Airco Industrial Gases Gimbel, Hammond, Farrell & Walsh, Inc. | 125 | ■ Hewlett-Packard Richardson, Seigle, Rolfs & McCoy, Inc. | 2 | ‡ Sorensen Company, A Unit of Raytheon Company Provandie Eastwood & Lombardi Inc. | 44 |
| ■ Airpax Electronics, Inc. Robert B. Walker & Associates, Inc. | 78 | ■ Hewlett-Packard Richardson, Seigle, Rolfs & McCoy, Inc. | 1 | * Spectrol Reliance Limited J M R Advertising | 14E-15E |
| Allen Bradley Company Hoffman, York, Baker & Johnson, Inc. | 28 | ■ Hickock Electrical Instrument Co. Carr Liggett Advertising, Inc. | 84 | Sprague Electric Company Harry P. Bridge Company | 8 |
| American Smelting and Refining Company Clyne Maxon, Inc. | 174 | Hughes Aircraft Company Foote, Cone & Belding | 39 | State of Minnesota Chuck Ruhr & Assoc. Agency | 74 |
| American Microsystems Inc. Wilton Coombs & Colnett Inc. Advertising | 142-143 | Hutson Industries Greene, Webb Associates, Inc. | 152 | Systron Donner Concord Instruments Fred Schott & Associates | 9 |
| Amperex Electronic Corp. Sam Groden, Incorporated | 16 | Inselek Ambrose & Borrie Advertising | 134 | Tally Corporation Bonfield Associates | 137 |
| ■ AMP Incorporated Aitkin-Kynett Co., Inc. | 17-20 | Intel Corp. Regis McKenna, Inc. | 22-23 | Tau-Tron, Inc. Billings & Reece, Inc. | 178 |
| Ampheno Components Group Bunker Ramo Corp. Marsteller, Inc. | 26-27 | Interdata Shaw Elliott, Inc. | 50-51 | ‡ T.D.K. Electronics Co., Ltd. Chuo Senko Advertising Co., Ltd. | 52 |
| Analogic Corporation Sommer Agency, Inc. | 145 | International Crystal Mfg., Co. Robert V. Freeland & Associates | 75 | * Tekelec Altronic S.P.F.D. | 19E |
| Anzac Electronics Ken Puleo Advertising | 174 | ■ Interstate Electronics Corp. Chris Art Studio Inc. | 41 | ■ Tektronix Inc. McCann Erickson, Inc. | 37 |
| Applied Computing Technology | 179 | * Invest Export-Import Interwerbung | 61 | * Teledyne Relays S. Michelson Advertising | 52 |
| ■ Augat Creamer, Trowbridge, Case & Basford, Inc. | 169 | ■ Johnson Company, E.F. Martin Williams Advertising | 79 | Teledyne Semiconductor Regis McKenna, Inc. | 7 |
| Billiey Electric Company Barber/Drullard Division of Barlow/Johnson | 165 | Keithley Instruments, Inc. Chagrin Valley Marketing Associates | 80 | Teletype N.W. Ayer & Son, Inc. | 171 |
| ‡ Bourns, Inc. Marlborough Assoc., Inc. | 61 | * Kennedy Co. R.L. Thompson Advertising | 151 | Teradyne, Inc. Quinn & Johnson, Inc. | 86 |
| ‡ Bussman Mfg. Division of McGraw-Edison Co. Henderson Advertising Company | 151 | Krohn-Hite Corp. Impact Advertising, Inc. | 5 | Thomson CSF/Dumont Ranieri, Saslaw, Mohr and Associates, Inc. | 163 |
| ■ Centralab Electronics Div., Globe-Union Inc. Action Communicators | 55 | LICON Division Illinois Tool Works Inc. Post Keyes Gardner Inc. | 165 | Toko, Inc. Hakuhodo, Inc. | 180 |
| ■ Chicago Dynamic Industries, Inc. Burton Browne Advertising | 179 | Litronix Inc. Regis McKenna, Inc. | 173 | Tokyo Electric Co., Ltd. PAL, Inc./Export Advertising | 72 |
| ■ Cinch Connectors, Operation of TRW Electronic Components Stral Advertising Company, Inc. | 65 | ■ Magic Dot, Inc. Allan & Alan, Inc. | 156 | ‡ T.R.I. Corporation Kassler/Noble Advertising | 56 |
| Circuit-Stik, Inc. Haaga Advertising | 154 | Master Appliance Hoffman, York, Baker & Johnson, Inc. | 176 | ■ TRW, Electronic Components Division The Bowers Company | 46-47 |
| Columbia Technical Publications | 146 | MOS Technology, Inc. Henry S. Goodsett Advertising, Inc. | 167 | * Ultra Dennis Dolling Limited | 17E |
| ■ Continental Specialties Corp. Robert A. Paul | 146 | * Motorola Semiconductor Graham & Gillies Limited | 56 | United Systems Corp., A Sub. of Monsanto Co. Advertising & Merchandising, Inc. | 162 |
| * Cooke Engineering Furrer | 12E | National Electronics Lea Advertising | 82 | ■ Unitrode Corporation Culver Advertising, Inc. | 31 |
| * Computer Components, Inc. | 20E | ■ National Semiconductor Corp. Chiat/Day, Inc. Advertising | 119-123 | Universal Oil Products, Norplex Division Campbell Mithun, Inc. | 153 |
| Cramer Division of Conrac McCarthy, Scelba, DeBlasi | 138-139 | ■ National Semiconductors Limited Griener Harries Maclean Ltd. | 176 | U.S. Capacitor Corp. S. Michelson Advertising | 48-49 |
| ■ Dale Electronics, Inc., A Sub. of the Lionel Corporation Swanson, Sinkey, Ellis, Inc. Advertising | 4th Cover | Nikko Selki Co., Ltd. General Advertising Agency, Inc. | 144 | Varo Semiconductor, Inc. Warren-Guild | 154 |
| Data General Corporation Scall, McCabe, Sloves, Inc. | 108-109 | North Electric Co.—Electronetics Div. Marc Associates | 141 | Vector Electronic Company, Inc. Communications Management Company | 150 |
| ■ Datel Systems, Inc. John Donlan Advertising | 3rd Cover | Nortronics Company, Inc. Allan & Alan, Inc. | 70 | Vespa James Plessas Inc. Advertising - Public Relations | 172 |
| ■ Delevan Division, American Precision Industries, Inc. Comstock Advertising, Inc. | 168 | * Oxy-Metal Starter | 18E | ■ Wagner Electric Corporation Coordinated Communications, Inc. | 136 |
| Delta Air Lines Burke Dowling Adams, Inc. | 152 | * Phillips N.V. PII/T & M Division Brookies Communications Systems SA | 58 | Weston Instruments, Inc. APCL&K | 60A-60B |
| Deltac Manning/Bowen and Associates | 157 | Piherr International Ltd. Scott MacTaggart Advertising | 76-77 | Wiltron Company Frank Burkhard Company | 178 |
| ■ Dialight Corporation Michel-Cather, Inc. | 2nd Cover | * Plessey Semiconductors Creative Workshop Ltd. | 7E, 9E | ■ Woven Electronics Prentiss Court Advertising | 6 |
| Digital Equipment Corporation Creamer, Trowbridge, Case & Basford, Inc. | 85 | Princeton Electronic Products, Inc. Mort Barish Associates, Inc. | 15 | | |
| Digital Equipment Corporation Schneider Parker, Inc. | 62-63 | Procond S.p.A. QUADRAGONO | 170 | | |
| Diva, Inc. Halloff & Caine | 66-67 | Pulse Engineering Manning/Bowen and Associates | 160 | | |
| * Ebauches SA | 10E | * R 2 E Sagha | 2E-3E | | |
| EECO The Greer Agency | 150 | RCA Service Company Al Paul Lefton Company, Inc. | 174 | | |
| Efratom of California, Inc. Capital Communications Company | 157 | RCA - Solid State Division Marsteller, Inc. | 71, 73 | | |
| Electro Oxide Ads & Ends, Inc. | 83 | ■ Rental Electronics, Inc. Humphrey Browning MacDougall, Inc. | 58 | | |
| * Electro Scientific Industries Com/Mark Communications Group | 44 | Reticon Corporation The House Agency | 45 | | |
| Electronics Measurements, Inc. Hill Advertising Agency | 161 | Rochester Gas & Electric Corp. Ad Group Hutchins/Darcy Inc. | 144 | | |
| Electronics Memories and Magnetics Corporation S. Michelson Advertising | 148-149 | * Rohde & Schwarz | 1E | | |
| ■ Electronics Navigation Industries Hart Conway Co., Inc. | 14 | Rotron Incorporated Black-Russell-Morris | 64 | | |
| ■ Erie Technological Products, Co., Inc. Altman Hall Associates Advertising | 21 | Scanbe Manufacturing Corp. Warren C. Wilson & Associates | 147 | | |
| Fabri-Tek Inc. Midland Associates, Inc. Marketing and Advertising Services | 158 | Schauer Manufacturing Corp. Nolan, Keelor & Stites | 170 | | |
| Fairchild Semiconductor, Inc. Carson/Roberts, Inc. Adv., Division of Ogilvy & Mather, Inc. | 12-13 | * Sescosem Bazaine Publicite | 4E | | |
| Fuji Electrochemical Co., Ltd. General Advertising Agency, Inc. | 155 | * Showa Musen Kogyo Co. Ltd. General Advertising Agency, Inc. | 16E | | |
| ■ General Electric Co., Semiconductor Products Department Advertising & Sales Promotion Syracuse Operation | 32 | Siemens AG Linder Presse Union GmbH | 43 | | |
| | | Signal Transformer Russell Technical Services, Inc. | 178 | | |
| | | Signalite, Inc. McCarthy, Scelba, DeBlasi Advertising Agency, Inc. | 156 | | |

Classified & Employment Advertising

F. J. Eberle, Manager 212-971-2557

| | |
|---|-----|
| EQUIPMENT (Used or Surplus New) For Sale | |
| Employment | 175 |
| American Used Computer Corp. | 175 |
| Furrer Marketing | 175 |
| Jensen Tool & Alloys | 175 |
| Radio Research Instrument Co. | 175 |
| H. Shprentz Co. | 175 |

■ For more information on complete product line see advertisement in the latest Electronics Buyer's Guide
* Advertisers in Electronics International
‡ Advertisers in Electronics domestic only edition

IMMEDIATE DELIVERY!
IN STOCK

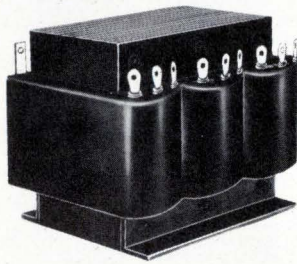
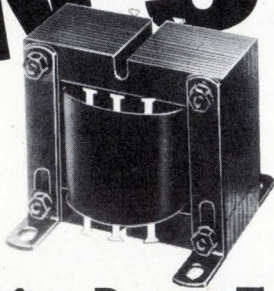

Rectifier Power Transformers and Chokes

SIGNAL HAS THE LARGEST SELECTION OF OUTPUT RATINGS AVAILABLE.

- Most Economical—No Minimum order Requirement.
- Ideal for Single or Dual DC Supplies.
- Wide Diversity of Ratings—5 to 300V, 0.1A to 200 Amp.
- Very High Current Units Up to 1000 Amps, Single and 3 Phase.

**Signal
transformer co. inc.**

1 Junius St., Brooklyn, N.Y. 11212
 Telephone (212) 498-5111

Send for Free Catalog also listing extensive lines of Printed Circuit Plug-In Transformers, Flat Plug-Ins and Constant Voltage Transformers.

Advertising Sales Staff

Pierre J. Braudé New York [212] 997-3468
 London 01-493-1451
 Director of Marketing

Atlanta, Ga. 30309: Joseph Lane
 100 Colony Square, 1175 Peachtree St., N.E.
 [404] 892-2868

Boston, Mass. 02116: James R. Pierce
 607 Boylston St. [617] 262-1160

Chicago, Ill. 60611:
 645 North Michigan Avenue
 Robert W. Bartlett (312) 751-3739
 Paul W. Reiss (312) 751-3738

Cleveland, Ohio 44113: William J. Boyle
 [716] 586-5040

Dallas, Texas 75201: Charles G. Hubbard
 2001 Bryant Tower, Suite 1070
 [214] 742-1747

Denver, Colo. 80202: Harry B. Doyle, Jr.
 Tower Bldg., 1700 Broadway
 [303] 266-3863

Detroit, Michigan 48202: Robert W. Bartlett
 1400 Fisher Bldg.
 [313] 873-7410

Houston, Texas 77002: Charles G. Hubbard
 2270 Humble Bldg. [713] CA 4-8381

Los Angeles, Calif. 90010: Robert J. Rielly
 Bradley K. Jones, 3200 Wilshire Blvd., South Tower
 [213] 487-1160

New York, N.Y. 10020
 1221 Avenue of the Americas
 Warren H. Gardner [212] 997-3617
 Michael J. Stoller [212] 997-3616

Philadelphia, Pa. 19102: Warren H. Gardner
 Three Parkway,
 [212] 997-3617

Pittsburgh, Pa. 15222: Warren H. Gardner
 4 Gateway Center, [212] 997-3617

Rochester, N.Y. 14534: William J. Boyle
 9 Greylock Ridge, Pittsford, N.Y.
 [716] 586-5040

San Francisco, Calif. 94111: Don Farris
 Robert J. Rielly, 425 Battery Street,
 [415] 362-4600

Paris: Alain Offergeld
 17 Rue-Georges Bizet, 75 Paris 16, France
 Tel: 720-73-01

Geneva: Alain Offergeld
 1 rue du Temple, Geneva, Switzerland
 Tel: 32-35-63

United Kingdom & Scandinavia: Keith Mantle
 Tel: 01-493-1451, 34 Dover Street, London W1

Milan: Robert Saidel
 1 via Baracchini, Italy Phone 87-90-656

Brussels: Alain Offergeld
 23 Chaussee de Wavre
 Brussels 1040, Belgium
 Tel: 13-73-95

Frankfurt/Main: Fritz Krusebecker
 Liebigstrasse 27c, Germany
 Phone 72 01 81

Tokyo: Tatsumi Katagiri, McGraw-Hill
 Publications Overseas Corporation,
 Kasumigaseki Building 2-5, 3-chome,
 Kasumigaseki, Chiyoda-Ku, Tokyo, Japan
 [581] 9811

Osaka: Ryji Kobayashi, McGraw-Hill
 Publications Overseas Corporation, Kondo
 Bldg., 163, Umegae-cho Kita-ku, Japan [362] 8771

Australasia: Warren E. Ball, IPO Box 5106,
 Tokyo, Japan

Business Department

Stephen R. Weiss, Manager
 [212] 997-2044

Thomas M. Egan,
 Production Manager [212] 997-3140

Carol Gallagher
 Assistant Production Manager [212] 997-2045

Dorothy Carter, Contracts and Billings
 [212] 997-2908

Frances Valone, Reader Service Manager
 [212] 997-6057

Electronics Buyers' Guide

George F. Werner, Associate Publisher
 [212] 997-3139

Regina Hera, Directory Manager
 [212] 997-2544

Circle 204 on reader service card

High-Accuracy Phase Meters

0.5 Hz to 2 MHz

Digital or meter
readouts

As low as \$1050



930 E. Meadow Dr. Palo Alto, Ca. 94303
 (415) 321-7428

Circle 205 on reader service card

Do you Create and Control Waveshapes?

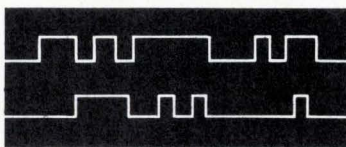

Our flexible systems can help you with: *PCM Communications Testing:* Bit and block error rate test measurements up to 1000 MHz. *Data and Word Generators:* Serial data generators to 500 MHz; Parallel words to 100 MHz. *Pulse Shaping:* Digital control with 200 picoseconds accuracy.

tau-tron inc

11 Esquire Road, North Billerica, Mass. 01862
 Tel: (617) 667-3874

Circle 101 on reader service card

Thinking about Microcomputers?

After selecting the microcomputer for your job, how are you going to integrate it into your product or system?

Applied Computing Technology's series of ASSEMBULATORS (assembler-simulators) offer a complete stand-alone microcomputer development capability. Applied Computing Technology builds ASSEMBULATOR development systems for the Rockwell International and Intel series of 4 bit and 8 bit microcomputers.

The ASSEMBULATOR features real-time microcomputer simulation including ROM simulation up to full system capacity. A resident assembler transcribes machine language directly into the ROM simulator memory from mnemonic instructions inputted via the teletype.

A resident utility system allows quick display and change of simulated ROM and RAM. Input-Output channels within the ASSEMBULATOR provide for interface with external electronics.

Integral programmers allow direct memory transfer to Programmable-Read-Only-Memories.

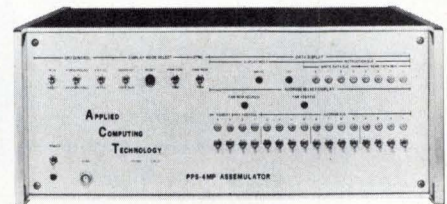
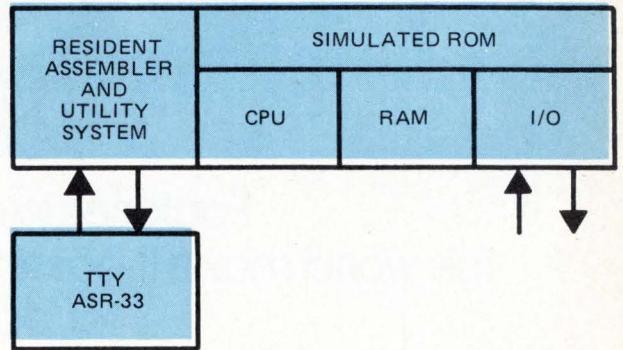

17961 Sky Park Circle
Irvine, CA 92707

(714) 557-9972

Circle 179 on reader service card

CDI CREATES THE BETTER LINEAR SWITCH

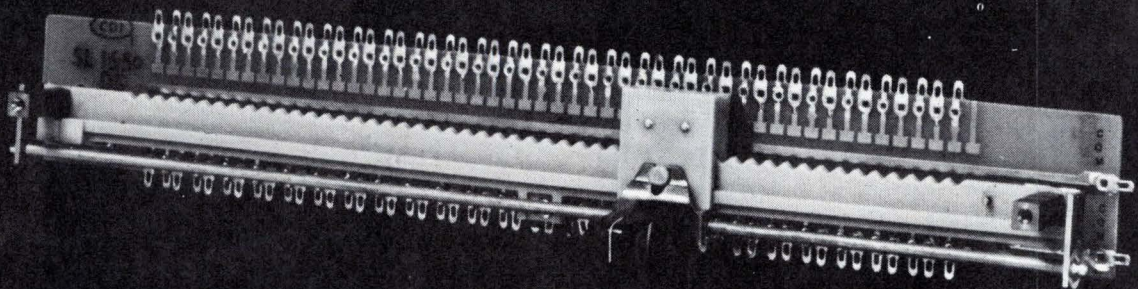

CHOOSE ANY NUMBER OF POSITIONS UP TO 100 (UNIQUE)

Series SL Linear Slide Switch (Patented)

APPLICATIONS: CONTROL FUNCTIONS REQUIRING RAPID POSITION SELECTING

- CATV channel selecting
- High & Low limit switches
- Process equipment controls
- Computers & peripherals
- NC applications
- Many others

OTHER REMARKABLE FEATURES:

Mounts EITHER left/right OR up/down (versatile) • Single or multiple position selectors • Solder lugs or dip solder termination for p.c. use • 1 or 2 Poles, or coded outputs available.

ELECTRICAL CHARACTERISTICS:

200 megohms min. insulation • 1000 volts min. dielectric strength • 2 amps @ 115 VAC current carrying capability • 125 ma @ 115 VAC current breaking capability.

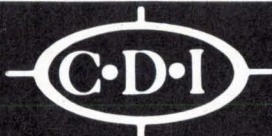

CHICAGO DYNAMIC INDUSTRIES, INC.

PRECISION PRODUCTS DIVISION

1725 Diversey Blvd., Chicago, Illinois 60614, Phone (312) 935-4600 TELEX 25-4689

TOKO

high-quality parts for the electronics industry

Factories in major cities around the world make it possible for us to supply local needs for parts in a hurry.

Type 10K Coil

Toko's 10K coil has a wide range of application—10.7 MHz radio, SIFT, TV set VIF, CHROMA circuits, acoustic and communication equipment. Amazingly stable and reliable.



Ceramic Filter Type: CFR-107M

The CFR-107M is a high-performance filter developed by TOKO to achieve adjustment-free FM IF circuits.

A new-type super-miniature ceramic filter with superior selectivity characteristics.

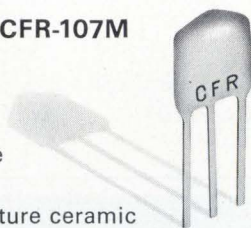

HS-200S II-HIGH-SPEED LARGE-CAPACITY MEMORY SYSTEM

A high-speed, large-capacity, low-cost memory bank designed for use as the main memory in medium-to-large computers and various data processing systems. Access time operating speed, 200ns; cycle speed, 350ns. Memory capacity, 65k bytes. Memory capacity readily increased by combining as many HS-200S II units as desired.



Polyethylene Capacitor

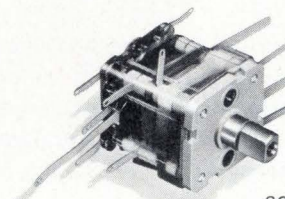

The CY2 Series polyethylene variable capacitor is highly stable and only 20mm square. It was developed by challenging the limits of parts precision and by making radical improvements over all existing products.

Pulse Transformer Dual In-Line

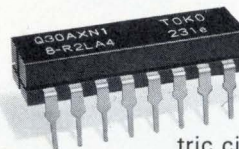

IC circuits are currently replacing all other electric circuits. There is also an increasing demand to combine active as well as activated elements into identical IC packages. In particular, the Dual In-Line Package (DIP) is gradually becoming the standard for IC packages. Used in electronic computers and other electronic machinery.

EXCELLENT SET WITH TOKO PARTS



TOKO, INC.

Head Office: 1-17, 2-chome,
Higashi-Yukigaya, Ohta-ku, Tokyo,
Japan

Toko America Inc.
350 Fifth Avenue, New York, N.Y. 10001 U.S.A.
Tel: 212-565-3767 Cable: "NEWTOKO" Telex:
224114 NEWTOKO

Toko America Inc., Los Angeles Branch
3440 Wilshire Boulevard Los Angeles, California
90010 U.S.A. Tel: 213-380-0417 Telex: 0674873
LA TOKO

Toko America Inc., Chicago Branch
3601 West Devon Avenue, Chicago, Illinois, 60659,
U.S.A. Tel: 312-267-8855

Toko Elektronik GmbH
4000 Düsseldorf, 1, Grafenberg Burgmuellerstr. 7,
F.R. Germany Tel: 0211-682281~3 Telex: 8582643
TOKO D

Toko U.K. Ltd.
Shirley Lodge, 470 London Road Slough, Bucks,
England Tel: Slough 48444 Telex: 847185 WWT
SLOUGH

Toko, Inc. Hong Kong Branch
49, Hoi Yuen Road, 3rd Fl., Kwun-Tong, Kowloon,
Hong Kong, Tel: 3-428131-6 Telex: HX 3820
TOKOMFG

11 factories and 9 branch offices world-wide