

- 85 A progress report on EBS tubes
- 89 How to achieve high-resolution a-d conversion
- 100 Designing logic boards for automatic test

LIBRARY  
 STATE TECHNICAL INSTITUTE  
 AT MEMPHIS

# Electronics®



**The  
 FCC  
 OVERBURDENED,  
 UNDERMANNED**



1420 TCH988 MCSA9 JUN75  
 STATE TECHNICAL INSTITUTE  
 LIBRARY PERIODICALS 14985  
 5983 MACON COVE  
 MEMPHIS TN  
 38134

# Dialight sees a need:

(Need: The widest choice for your every application.)

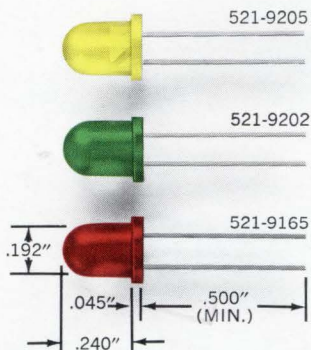

Now available in green, yellow and red. Mini-sized for maximum front panel density and easy panel mounting. High luminous intensity, low cost. Vibration/shock resistant. Solid state for long life. Wide viewing angles. Ideal for applications like panel lighting, film annotation and alpha-numeric displays.

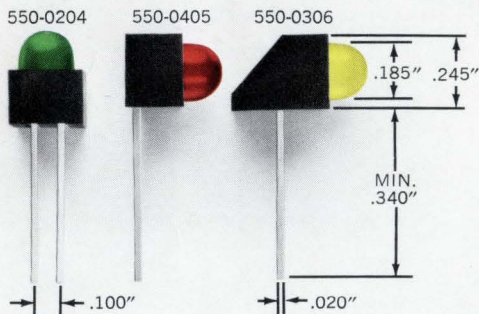

Mix 'em or match 'em. LED logic state fault indicators are available in red, yellow and green, in a variety of shapes, some with a built-in integral resistor. Can be driven from DTL and TTL logic. Designed for easy alignment on PC boards so that multiple functions can be displayed.

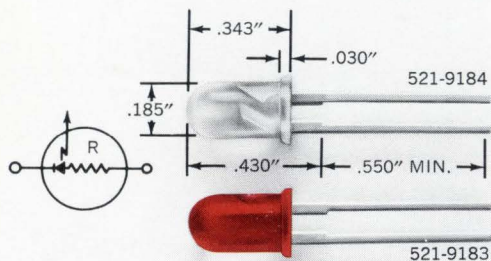

Available in red or clear LED packages with or without a built-in current limiting resistor. Red LED is also made without resistor. Suitable for circuit status indication, alpha-numeric displays and visual indicators. Features long wire-wrappable leads. IC compatible with solid state reliability. High luminous intensity, low power consumption, low cost.

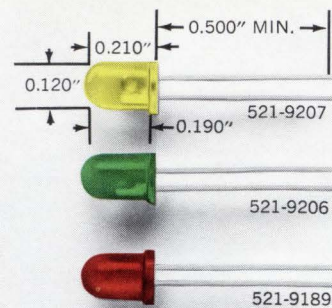

Your choice of green, yellow and red, with axial leads for dense packaging requirements. Wide viewing angle for easy readability. Low power consumption, low cost, IC compatible. 10mA operation for typical brightness. Size is identical to the most popular red LEDs.

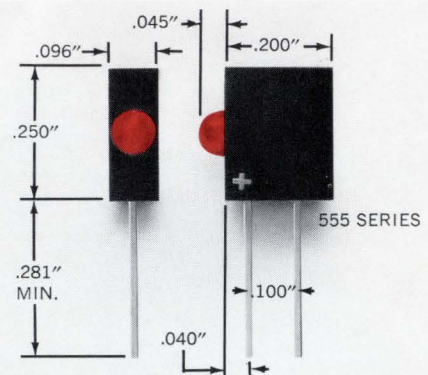

LED logic state fault indicators available in 14 models with voltage ratings from 1.7 to 14. Suitable for dense packaging on printed circuit boards—up to 10 units to the inch—IC compatible. With built-in series resistor. Polarity identified. Low power consumption.

Dialight, the company with the widest choice in switches, LEDs, indicator lights and readouts, looks for needs . . . your needs . . . and then they develop solutions for your every application. No other company offers you one-stop shopping in all these product areas. And no other company has more experience in the visual display field. Dialight helps you do more with these products than any other company in the business, because we are specialists that have done more with them. Talk to the specialists at Dialight first. **DIALIGHT**  
Dialight, A North American Philips Company  
203 Harrison Place, Brooklyn, N. Y. 11237  
(212) 497-7600

# See Dialight.



**You've got one chance to do a field recording job that demands laboratory performance.**

**With HP's 3960, you can carry it off.**



Not all high performance recorders are big, bulky lab consoles.

One is different: HP's 3960 Portable Instrumentation Tape Recorder.

The compact 3960 goes virtually anywhere. Yet it's still designed to come through when you've got one

chance to get it right. And that's the kind of confidence you need whether you're gathering data across the room or across the desert.

Operable on either AC or DC, the rugged 3960 has a built-in DC calibration source and high accuracy DC or AC peak meter for input or output monitoring. Signal to noise ratio is outstanding. And HP reliability helps insure that what goes in is exactly what comes out.

Ample options are available to let you customize your recorder to exactly the kind of work you do. The choice includes voice channel, DC-AC inverter, remote control, tape speeds and more.

Get complete details on HP's high performance 3960. The portable recorder built to carry it off both in the field and in the lab. Write Hewlett-Packard, 1501 Page Mill Road, Palo Alto, California 94304.

11410



Sales and service from 172 offices in 65 countries.  
1501 Page Mill Road, Palo Alto, California 94304

Circle 1 on reader service card

# SURPRISE!

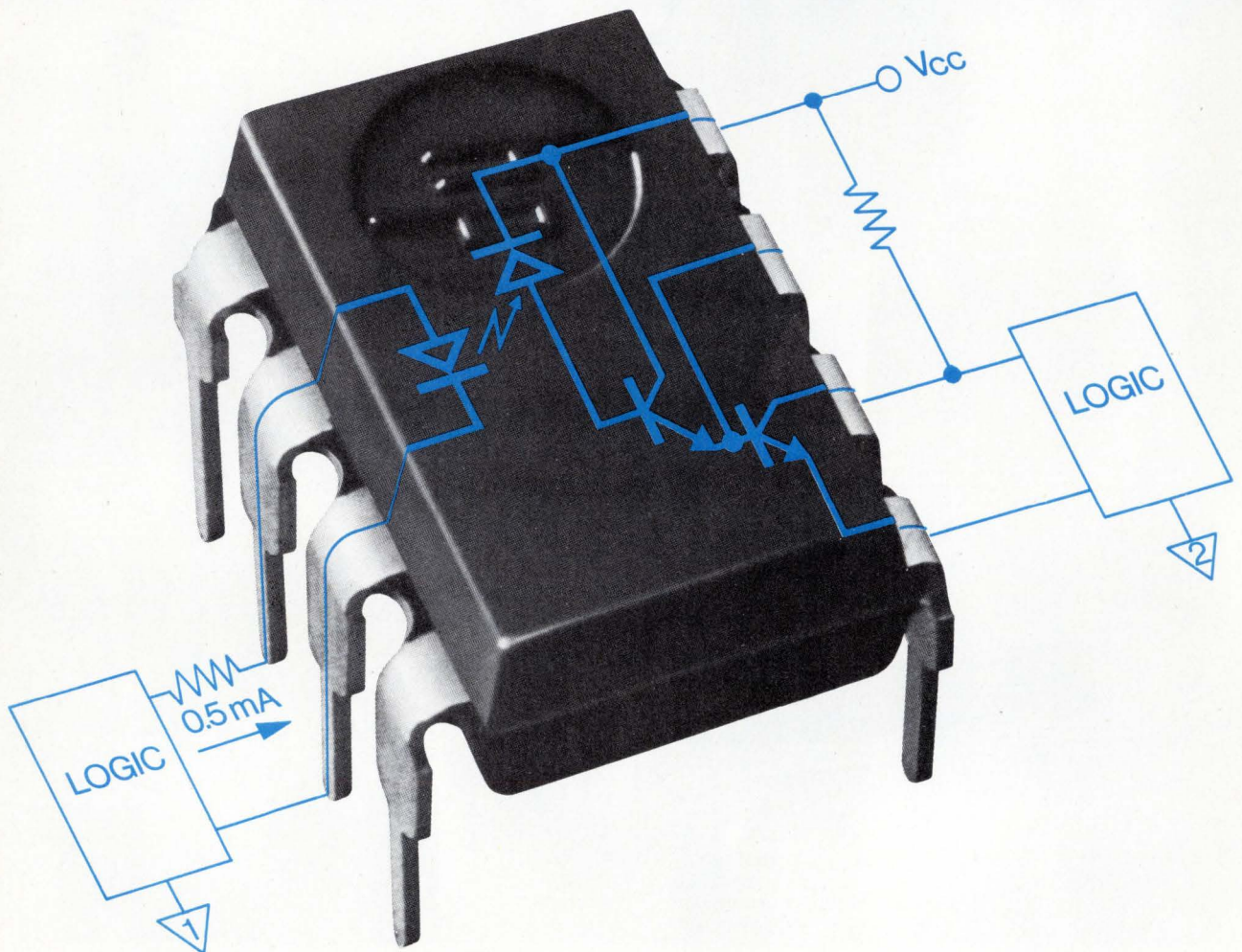

## Optical isolation at 0.5 mA input

Now there is a new series of opto couplers from HP that will interface with most logic families. HP's 5082-4370 series isolators can be driven directly from CMOS, MOS, LTTL or TTL.

The unique construction of the 5082-4370 series offers a TTL compatible output voltage with speeds 50 times greater than conventional photodarlington isolators. Current transfer ratio of the 5082-4371 is typically 800% at 0.5mA input current and current transfer ratio of the 5082-4370 is typically 600% at 1.6mA input current.

Select the 5082-4370 for logic and TTL applications; 5082-4371 for CMOS, LTTL and other lower current uses. Performance of both models is guaranteed from 0°C to 70°C.

In 100 quantities, price for the 5082-4370 series starts at \$1.80\* each.

For a complete design package on our new 5082-4370, hermetic, dual and high speed isolators contact Hall-Mark, Schweber, Wilshire or the Wyle Distribution Group.

Or write us, we're sensitive to your needs.

01407

\*Domestic USA price only.

**HEWLETT**  **PACKARD**

Sales and service from 172 offices in 65 countries.  
1501 Page Mill Road, Palo Alto, California 94304

- 33 **Electronics Review**  
PACKAGING & PRODUCTION: Silk screening prints circuit boards, 33  
RADAR: Accurate 3-d system has one antenna, 34  
MANAGEMENT: Corrigan new president at Fairchild Semiconductor, 35  
LAW ENFORCEMENT: Police to get portable digital terminals, 35  
SOLID STATE: Fairchild pushes Isoplanar MOS, 36  
Gallium-arsenide laser moves optical ICs closer, 38  
COMMUNICATIONS: OTP favors ways to aid AT&T rivals, 40  
NEWS BRIEFS, 42  
CONSUMER ELECTRONICS: Reaction cool to TI calculator patent, 44  
COMMERCIAL ELECTRONICS: Fingerprint file controls access, 44
- 57 **Electronics International**  
FRANCE: Ship positioning system works in heavy weather, 57  
AROUND THE WORLD: 57
- 69 **Probing the News**  
COMMUNICATIONS: Video compression schemes save bandwidth, 69  
Phone management systems getting plugged in, 72  
GOVERNMENT: New legislation requires computer security, 78  
INSTRUMENTATION: Power-line monitors find a market, 81
- 85 **Technical Articles**  
SOLID STATE: Diodes inside tubes make broadband rf amplifiers, 85  
COMPONENTS: Which hybrid converter: single-switch or quad? 89  
DESIGNER'S CASEBOOK: Interfacing a microprocessor, 96  
Diode pair senses differential temperatures, 97  
Generating nanosecond pulses with TTL monostables, 98  
CIRCUIT DESIGN: Designing logic boards for automatic testing, 100  
COMMUNICATIONS: Can the FCC cope with change? 106  
ENGINEER'S NOTEBOOK: Driving LEDs directly from C-MOS logic, 116  
Measuring complex impedance at actual operating levels, 117  
DATA STORAGE: Small thin-film transducers promise system speed, 122
- 131 **New Products**  
IN THE SPOTLIGHT: Processor adds to computer power, 131  
DATA HANDLING: FFT module is fast, versatile, 133  
MICROWAVE: Varactor diodes have high Q, 140  
SEMICONDUCTORS: Three-chip set makes powerful calculator, 147  
PACKAGING & PRODUCTION: Machine assembles, crimps plug, 153  
MATERIALS: 57

## Departments

- Publisher's letter, 4  
Readers comment, 6  
40 years ago, 8  
People, 14  
Meetings, 24  
Electronics newsletter, 29  
Update, 50  
Washington newsletter, 53  
Washington commentary, 54  
International newsletter, 59  
Engineer's newsletter, 120  
New literature, 158

## Highlights

### The cover: Can the FCC cope? 106

In grappling with the spread of data communications and cable TV, the FCC has in effect produced new national communications policies. But the agency's limited manpower and budget could critically hamper the new leadership in its fight to implement those policies. Congressional action is called for (see p. 54). Cover is by Art Director Fred Sklenar.

### Wanted: narrower bandwidths for digital video, 69

Though digital video communications squander the limited frequency resources available, they are vital to reconnaissance by remotely piloted vehicles, satellite transmissions, and Picturephones. That's why the military, NASA, and Bell Laboratories are all busy researching bandwidth compression techniques.

### Tubes containing diodes excel as rf amplifiers, 85

Electron-bombarded semiconductor (EBS) devices, in which an electron beam is aimed at a photodiode, have now added reliability and long life to their main attraction—outstanding performance as high-power rf amplifiers and modulators.

### How to design easy-to-test logic boards, 100

The cost of testing logic boards has soared along with their increasing complexity, but can be reduced if board layout is designed to complement the capabilities of automated test equipment.

### And in the next issue . . .

New advances of charge-coupled devices in memories and analog signal processing . . . programed logic arrays in digital design . . . technology update on color TV tubes.

EDITOR-IN-CHIEF: Kemp Anderson

EXECUTIVE EDITOR: Samuel Weber

MANAGING EDITORS: Lawrence Curran, *News*;  
Arthur Erikson, *International*

SENIOR EDITORS: John Johnsrud,  
H. Thomas Maguire, Laurence Altman,  
Ray Connolly, Stephen E. Scrupski

ART DIRECTOR: Fred Sklenar

ASSOCIATE EDITORS: John N. Kessler,  
Howard Wolf, Gerald M. Walker,  
Alfred Rosenblatt

DEPARTMENT EDITORS

*Circuit Design*: Lucinda Matterna  
*Communications & Microwave*:  
Stephen E. Scrupski

*Computers*: Wallace B. Riley  
*Consumer*: Gerald M. Walker  
*Industrial*: Michael J. Riezenman  
*Instrumentation*: Stephen E. Grossman  
*Aerospace/Military*: Ray Connolly  
*New Products*: H. Thomas Maguire  
*Solid State*: Laurence Altman

COPY EDITORS: Margaret Eastman,  
Everett C. Terry

ASSISTANT EDITOR: Marilyn Offenheiser

ART: Charles D. Ciatto, *Associate Director*  
Patricia Cybulski, *Assistant Director*

PRODUCTION EDITOR: Arthur C. Miller

EDITORIAL SECRETARIES: Janet Annunziata,  
Julie Gorgoglione, Penny Roberts

FIELD EDITORS

*Boston*: Gail Farrell  
*Los Angeles*: Paul Franson (Mgr.)  
*Midwest*: Larry Armstrong (Mgr.)  
*New York*: John N. Kessler (Mgr.)  
*San Francisco*: Bernard Cole (Mgr.)  
Judith Curtis  
*Washington*: Ray Connolly (Mgr.)  
Larry Marion  
*Frankfurt*: John Gosch  
*London*: William F. Arnold  
*Paris*: Arthur Erikson  
*Tokyo*: Charles Cohen

McGRAW-HILL WORLD NEWS

*Director*: Ralph R. Schulz  
*Bonn*: Robert Ingersoll  
*Brussels*: James Smith  
*London*: Marvin Petal  
*Milan*: Peter Hoffmann, Andrew Heath  
*Moscow*: Axel Krause  
*Paris*: Michael Johnson, Richard Shepherd  
*Stockholm*: Robert Skole  
*Tokyo*: Mike Mealey

PUBLISHER: Dan McMillan

DIRECTOR OF MARKETING: Pierre J. Braudé

ADVERTISING SALES SERVICE MANAGER:  
Wallis Clarke

BUSINESS MANAGER: Stephen R. Weiss

CIRCULATION MANAGER: Nancy L. Merritt

MARKETING SERVICES MANAGER:

Tomlinson Howland

RESEARCH MANAGER: Margery D. Sholes

**O**ur cover story this issue is a thoughtful and thought-provoking story about the problems facing the Federal Communications Commission as it tries to cope with the impact of new technology. Looking at it another way, the story is about what the electronics industries can expect as the FCC implements the various decisions it has made since the landmark Carterfone ruling.

Senior editors Ray Connolly, chief of our Washington bureau, and Steve Scrupski, who heads our communications department, put together the report after scores of interviews with Government and industry officials. Their conclusions: the task facing the FCC is enormous and it is going about its work with a distinct handicap in manpower and budget resources. While a lot has been accomplished, there are still a number of obstacles in the way of its top management's desire to accomplish a lot more. Turn to page 106 and read for yourself about the FCC and its new national communications policies.

**T**he nation's computers hold a vast amount of data about the nation's citizens. And there is growing concern about misuse of that information. For example, there are more than 100 proposals in Congress that would in one way or another safeguard the privacy of material stored in these data banks.

The big stumbling block, though, is cost. As Larry Marion, of our Washington bureau, points out in the Probing the News story starting on page 78, "if legislation requires a catalog of facts—such as which parts of the data bank was accessed, and what was reviewed and for how long—the resulting need for memory

and the operating costs would be exorbitant." And he cites testimony before Congress that the increased memory capacity required for access-control devices and the development and sale of such systems would have a major impact on the computer industry. For example, one expert is quoted as saying: "Either a computer data bank has access controls or lots of insurance."

The movement toward rigid controls on data banks is just getting under way, but in a few years all such banks—public and private—may be covered by controls. Indeed, some expect that the Federal, state, and local government data files will come under new legislation this year. The big question, though, is whether hardware—and software—will be available to meet the letter of the law.

**T**he computer-privacy story, by the way, carries the first Probing the News byline for reporter Marion, who just recently joined our Washington bureau. After graduating from Drexel University, where he earned a bachelor of science degree in 1972, Larry worked for the Department of Housing and Urban Development. His main assignment was helping coordinate the disaster recovery operation in Wilkes-Barre, Pa., following devastating floods. Then, while working for a master of science degree in journalism at Northwestern University, he spent several months gathering news in Washington. That led to a job on an energy newsletter and then to *Electronics*.



July 25, 1974 Volume 47, Number 15  
94,122 copies of this issue printed

Published every other Thursday by McGraw-Hill, Inc. Founder: James H. McGraw 1860-1948. Publication office 1221 Avenue of the Americas, N.Y., N.Y. 10020; second class postage paid at New York, N.Y. and additional mailing offices.

Executive, editorial, circulation and advertising addresses: Electronics, McGraw-Hill Building, 1221 Avenue of the Americas, New York, N.Y. 10020. Telephone (212) 997-1221. Teletype TWX N.Y. 710-581-5234. Cable address: MCGRAW HILL N.Y.

Subscriptions limited to persons with active, professional, functional responsibility in electronics technology. Publisher reserves the right to reject non-qualified requests. No subscriptions accepted without complete identification of subscriber name, title, or job function, company or organization, including product manufactured or services performed. Subscription rates: qualified subscribers in the United States and possessions, Canada, and Mexico \$12.00 one year, \$24.00 three years; all other countries \$25.00 per year, except Japan \$50.00 per year, Brazil \$40.00 per year, Australia and New Zealand \$60 per year, including air freight. Limited quota of subscriptions available at higher-than-basic rate for persons outside of field served, as follows: U.S. and possessions and Canada, \$25.00 one year, all other countries \$50.00. Single copies: United States and possessions and Canada, \$4.00; all other countries, \$2.00.

Officers of the McGraw-Hill Publications Company: John R. Emery, President; J. Elton Tuohig, Executive Vice President-Administration; Gene W. Simpson, Group Publisher-Vice President; Senior Vice Presidents: Ralph Blackburn, Circulation; Walter A. Stanbury, Editorial; John D. Hoglund, Controller; David G. Jensen, Manufacturing; Gordon L. Jones, Marketing; Jerome D. Luntz, Planning & Development.

Officers of the Corporation: Shelton Fisher, Chairman of the Board and Chief Executive Officer; Harold W. McGraw, Jr., President and Chief Operating Officer; Wallace F. Traudly, Group President, McGraw-Hill Publications Company and McGraw-Hill Information Systems Company; Robert N. Landes, Senior Vice President and Secretary; Ralph J. Webb, Treasurer.

Title registered in U.S. Patent Office; Copyright ©1974 by McGraw-Hill, Inc. All rights reserved. The contents of this publication may not be reproduced in whole or in part without the consent of copyright owner.

Subscribers: The publisher, upon written request to our New York office from any subscriber, agrees to refund that part of the subscription price applying to copies not yet mailed. Please send change of address notices or complaints to Fulfillment Manager; subscription orders to Circulation Manager, Electronics, at address below. Change of address notices should provide old as well as new address, including postal zip code number. If possible, attach address label from recent issue. Allow one month for change to become effective.

Postmaster: Please send form 3579 to Fulfillment Manager, Electronics, P.O. Box 430, Hightstown, N.J. 08520.

# A new digital phasemeter that's accurate to $.05^\circ$ ?

$.05^\circ$  accuracy and  $.01^\circ$  resolution  
continuous precision measurement  
from  $0^\circ$ – $360.00^\circ$

no  $0/360^\circ$  ambiguity, right down  
to readings as small as  $.01^\circ$

5 digit Sperry readout

accuracy unaffected by amplitude differences

frequency range 10Hz to 5MHz

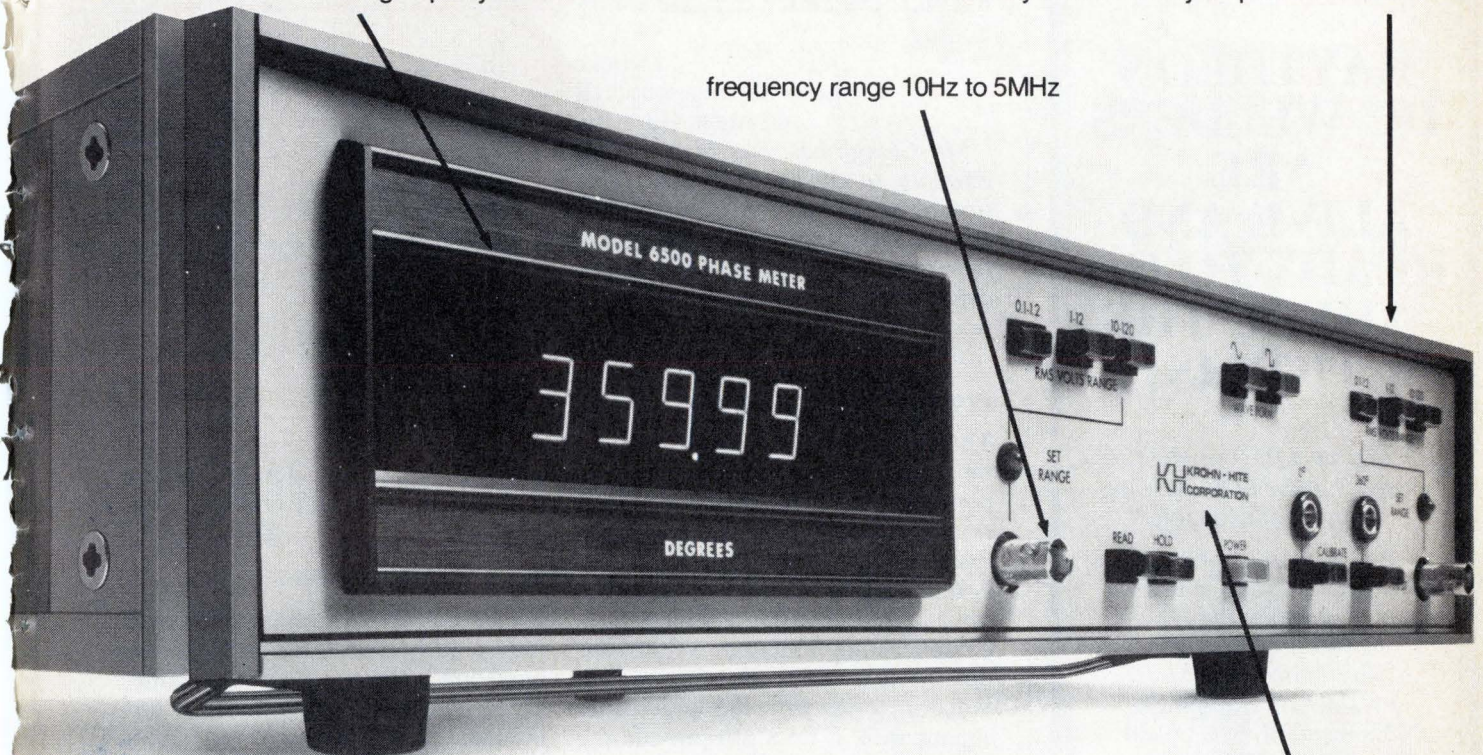

## Precisely.

and the best performance  
at the best price,  
only \$1995.—

for immediate action call  
(617) 491-3211, TWX 710  
320 6583, or contact your  
local KH representative,  
listed below.

### **KH** KROHN-HITE CORPORATION

SALES OFFICES: ALA, Huntsville (205) 534-9771; ARIZ, Scottsdale (602) 947-7841; CAL, San Jose (408) 292-3220, Inglewood (213) 674-6850; COLO., Denver (303) 934-5505; CONN., Glastonbury (203) 633-0777; FLA., Orlando (305) 894-4401; HAWAII, Honolulu (808) 941-1574; ILL., Des Plaines (312) 298-3600; IND., Indianapolis (317) 244-2456; MASS., Lexington (617) 861-8620; MICH., Detroit (313) 526-8800; MINN., Minneapolis (612) 884-4336; MO., St. Louis (314) 423-1234; N.C., Burlington (919) 227-3639; N.J., Haddonfield (609) 795-1700; N.M., Albuquerque (505) 299-7658; N.Y., E. Syracuse (315) 437-6666, Rochester (716) 328-2230, Vestal (607) 785-9947, Elmont (516) 488-2100; OHIO, Cleveland (216) 261-5440, Dayton (513) 426-5551; PA., Pittsburgh (412) 371-9449; TEX., Houston (713) 688-9971, Richardson (214) 231-2573; VA., Alexandria (703) 354-1222; WASH., Seattle (206) 624-9020; CANADA, Montreal, Quebec (514) 636-0525, Toronto, Ontario (416) 444-9111, Stittsville, Ontario (613) 836-4411, Vancouver, British Columbia (604) 688-2619.

Circle 5 on reader service card

# RAYTHEON DC WELDERS ARE ALIVE AND READY TO GO WHERE THE ACTION IS . . .

We have the broadest power range of DC welding equipment available.

If you want to weld the coolest package in town, contact the Marketing Manager, Raytheon Company, Production Equipment Department, 676 Island Pond Road, Manchester, N.H. 03103. (603) 668-1600.



## Readers comment

### Counting functions

**To the Editor:** In your interview with Charles Clough, Texas Instruments' vice president for semiconductor marketing ["Everybody's popping circuits," *Electronics*, March 21, p. 66], he estimates that "the average [U.S.] home now has 3,000 transistor functions."

We would be very much obliged if you could tell us how Mr. Clough has come to this conclusion, which is far beyond all of our estimates for TV and radio sets, two cars, anti-burglar systems, and air-conditioning.

J. Hieke

Siemens Aktiengesellschaft  
Munich, Germany

• *Mr. Clough has since increased his estimate to 30,000 transistor functions. The key word is "functions." A simple calculator chip has 6,000 functions, and it's logical that a calculator, several solid-state television sets, a car or two, and radio could easily boost the total that high.*

### Protecting with zeners

**To the Editor:** The idea presented by your Engineer's newsletter, "Zener diodes can give you fast protection" [May 2, p. 118], is not as effective as claimed. This item states that a zener-diode clamp will be made much faster by the addition of a compensating junction. While this does add a small junction capacitance in series with the large zener capacitance, it does not provide the order-of-magnitude reduction in clamp capacitance, as claimed.

The total clamp capacitance is not the series combination of the junction and zener capacitances. To demonstrate this, the required connection from A to B is added to the diagram of the clamp. Note that the voltage that must be developed on each capacitance is determined by the diode it shunts. Addition of the compensating junction does not reduce the voltage to which the zener capacitance  $C_Z$  must be charged, so the charge required by  $C_Z$  is still  $q_Z = C_Z V_Z$ . In addition, the capacitance of the compensating diode  $C_F$  must be charged with  $q_F = C_F V_F$ . Thus, the total equivalent clamp capacitance is

$$C = q/V$$

$$C_{TOTAL} = (V_Z C_Z + V_F C_F) / (V_Z + V_F) \neq (C_Z C_F) / (C_Z + C_F)$$

For a 6-V zener diode,

$$C_{TOTAL} = 0.9 C_Z + 0.1 C_F \neq 0.1 C_Z$$

While the above total capacitance is about 9% less than  $C_Z$ , the clamp voltage is increased around 10% by the added junction. Thus, the time to reach the clamp level is increased—not decreased—by addition of a compensating junction.

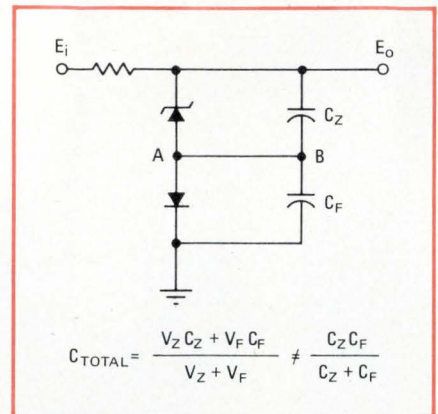

Jerald Graeme  
Burr-Brown Research Corp.  
Tucson, Ariz.

### Microwaves for rails

**To the Editor:** This office is engaged in feasibility studies for future transportation systems in the Adelaide, South Australia, urban area. It has occurred to us that microwave communications systems could be used for train-signaling control. We request information on such a system that could satisfy our needs.

Preliminary analysis indicates that the system should have immunity to power-frequency interference from electric trains, the ability to confine signals to railway property, immunity to copper thieves, and ability to measure each individual train's location and velocity at any instant.

Any information on such a system may be forwarded to:

Roger M. Pullem  
Director-General  
of Transport's Office  
Box 1599, G. P. O.  
Adelaide, South Australia 5001



# The last time someone announced 74C, it was a national campaign.

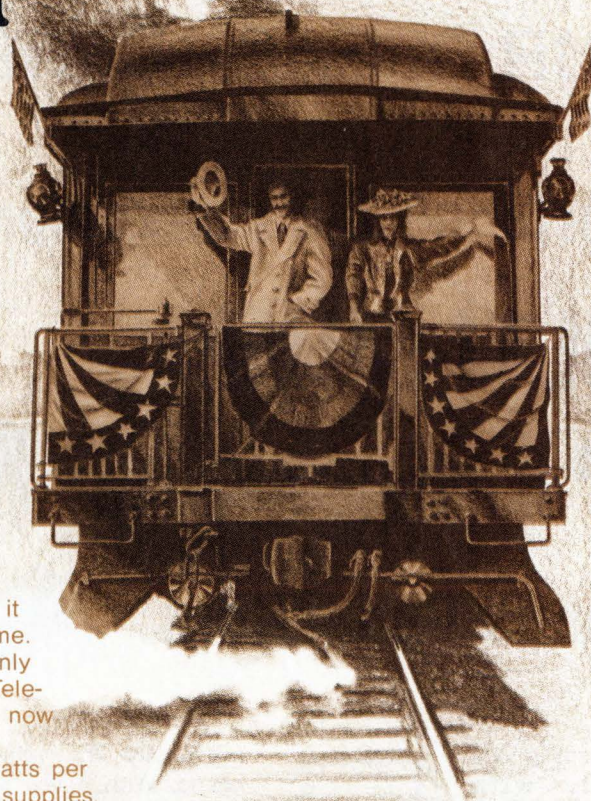

When we saw 74C coming down the tracks, we knew it would be the hottest and most logical CMOS line in a long time. Flags waved, bands played, and thousands of engineers suddenly found CMOS easier to design in. The only thing missing was Teledyne's big production volume and competitive pricing, and now you've got that too.

Here's what Teledyne 74C delivers: A mere 10 nanowatts per gate typical power dissipation. Operation on 3V to 15V power supplies. A big, guaranteed 1V noise margin. Typical noise immunity 45% of the supply voltage. Hefty outputs that drive MOS and bipolar logic (at least two LPTTL loads).

And 74C really simplifies design. 74C logic functions, pinouts and even numbers are identical to 7400 TTL, and every 74C device is compatible with every other 74C device. I/O specs are consistent (no interpreting a pile of data sheets to calculate what's compatible with what). Not to mention drastic cuts in the need for supply regulation, bypass capacitors and noise filtering.

The first batch is available now.

MM74C00	Quad 2-Input NAND Gate	MM74C107	Dual J-K Master-Slave Flip-Flop
MM74C04	Hex Inverter	MM74C160	Synchronous Decade Counter
MM74C20	Dual 4-Input NAND Gate	MM74C161	Synchronous 4-Bit Binary Counter
MM74C42	BCD-to-Decimal Decoder	MM74C192	Synchronous Up/Down Decade Counter
MM74C74	Dual D Flip-Flop	MM74C195	4-Bit Parallel-Access Shift Register

That's our national platform for 74C. But Teledyne's CMOS campaign has just begun. We'll soon be speaking softly about big values in proprietary devices compatible with 74C and custom CMOS for linear and digital applications. All with ultra-low power dissipation and high noise immunity.

 **TELEDYNE**  
**SEMICONDUCTOR**

1300 Terra Bella Avenue Mountain View, California 94043  
(415) 968-9241 TWX: 910-379-6494 Telex: 34-8416

# CIRCUIT DESIGNERS...

## GET MORE VERSATILITY AND FLEXIBILITY IN YOUR BREADBOARDING.

Experience the convenience of

# MULTI-COMP<sup>®</sup> DIP Multiple-Section Ceramic Capacitors

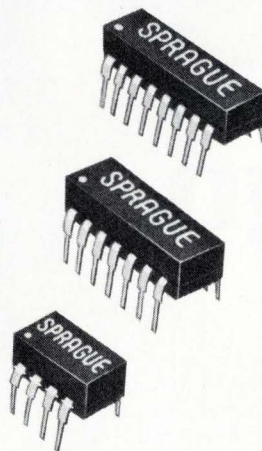

Breadboarding is a lot easier with Sprague Multi-Comp Monolythic<sup>®</sup> Ceramics. They readily plug in and out of standard DIP sockets for fast changes during experimentation. They come as 4-, 7-, and 8-section capacitors, in popular most-frequently-used capacitance values. By connecting capacitor sections in parallel, you can obtain

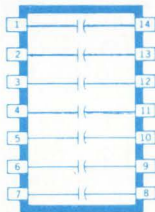

practically any value your circuit needs. With a few Multi-Comp capacitors on hand, there's no need to keep heavy stocks of individual capacitors for breadboarding purposes. There's less soldering and unsoldering, too.

**And when your final capacitance determinations are made, you can either stay with DIP Multi-Comps, or switch to Sprague Single-Section Monolythic<sup>®</sup> Capacitors, which have the same layer-built construction and the same electrical characteristics.**

**GET THE DIP HABIT —  
TRY MULTI-COMP<sup>®</sup> MONOLYTHIC<sup>®</sup> CAPACITORS IN YOUR NEXT  
BREADBOARD DESIGN — THEY'RE READILY AVAILABLE FROM  
YOUR SPRAGUE INDUSTRIAL DISTRIBUTOR!**

For more information, write or call  
Ed Geissler, Mgr., Specialty Components  
Marketing, Sprague Electric Company,  
35 Marshall Street, North Adams, Mass. 01247.  
Tel. 413/664-4411.

45Z-4112



THE BROAD-LINE PRODUCER OF ELECTRONIC PARTS

## 40 years ago

From the pages of Electronics, July, 1934

### AN EDITORIAL:

#### Synchronized broadcasting\*

On July first, the new Federal Communications Commission took over control of radio. It is to be hoped that the new regulating authority will be more receptive to new ideas and technical developments than was the old Federal Radio Commission.

Take the matter of synchronizing broadcast stations for common frequency operation, at which the old F.R.C. repeatedly balked. Today equipment is all ready, complete experiments have been made, and several successful individual installations are in use. Synchronizing is now a demonstrated fact.

Synchronizing, indeed, seems the only ultimate avenue for solution of a whole group of problems that are facing broadcasting. Here are some of the needs for which synchronizing supplies prompt answers:

- Wider channels (15 to 20 kc.) for high-fidelity broadcasting
- Efficient use of broadcast channels
- Channels to meet demands of Canada, Mexico and Cuba
- Common-frequency broadcasting by chain stations with high fidelity
- Positions in the spectrum for stations requiring good local coverage
- Higher wattage on channels, but distributed among synchronized transmitters.

In fact, all the present "head-aches" of broadcasting seem to find their solution in this panacea of synchronizing, intelligently applied. We hope the new Commission will give the subject of synchronizing on the broadcast channels careful and sympathetic study.

*\*Synchronized broadcasting, a technique scarcely heard of today, was designed to eliminate annoying beat-frequency notes caused when two stations transmitted on the same nominal frequency but were, actually, 10 to 20 hertz apart. Such common-frequency operation of a pair of stations many miles apart was used in the early days of radio to increase the broadcast range of a radio station.*

# If you have any of these tape transports...

**Honeywell**  
HEWLETT  PACKARD

**GENISCO**  
SANGAMO 

**BELLE HOWELL**  
**AMPLEX**

## Then it's easy to put time on your tape.



Model 8120 Time Code Generator

Systron-Donner's time code instrumentation is compatible with most, if not all, analog tape transports. Your transport manufacturer will probably recommend Systron-Donner—the leading manufacturer of quality time code instrumentation. Exactly what does S-D provide?

1. Time code generation and reading, IRIG formats, NASA formats, and others.
2. Automatic tape search using your transport to automatically locate selected tape segments during playback.
3. Computer-controlled tape search to permit automatic location and identification of selected tape segments for data reduction.



Model 8134 Time Code Reader/Tape Search and Control Unit

Because S-D offers a complete line of time code instrumentation, we can meet your specific requirements. Request our new brochure "Time Code Instrumentation". (Free)

For an authoritative and practical treatise on timing, S-D offers a newly revised timing handbook entitled "Precision Timekeeping and Tape Search". Price \$3.50

Contact your Scientific Devices office or Systron-Donner at 10 Systron Drive, Concord, CA 94518. For immediate details, call our timing products department (415) 676-5000. In Europe: Munich, W. Germany; Leamington Spa, U.K.; Paris (Le Port Marly) France. Australia: Melbourne.

**SYSTRON**  **DONNER**

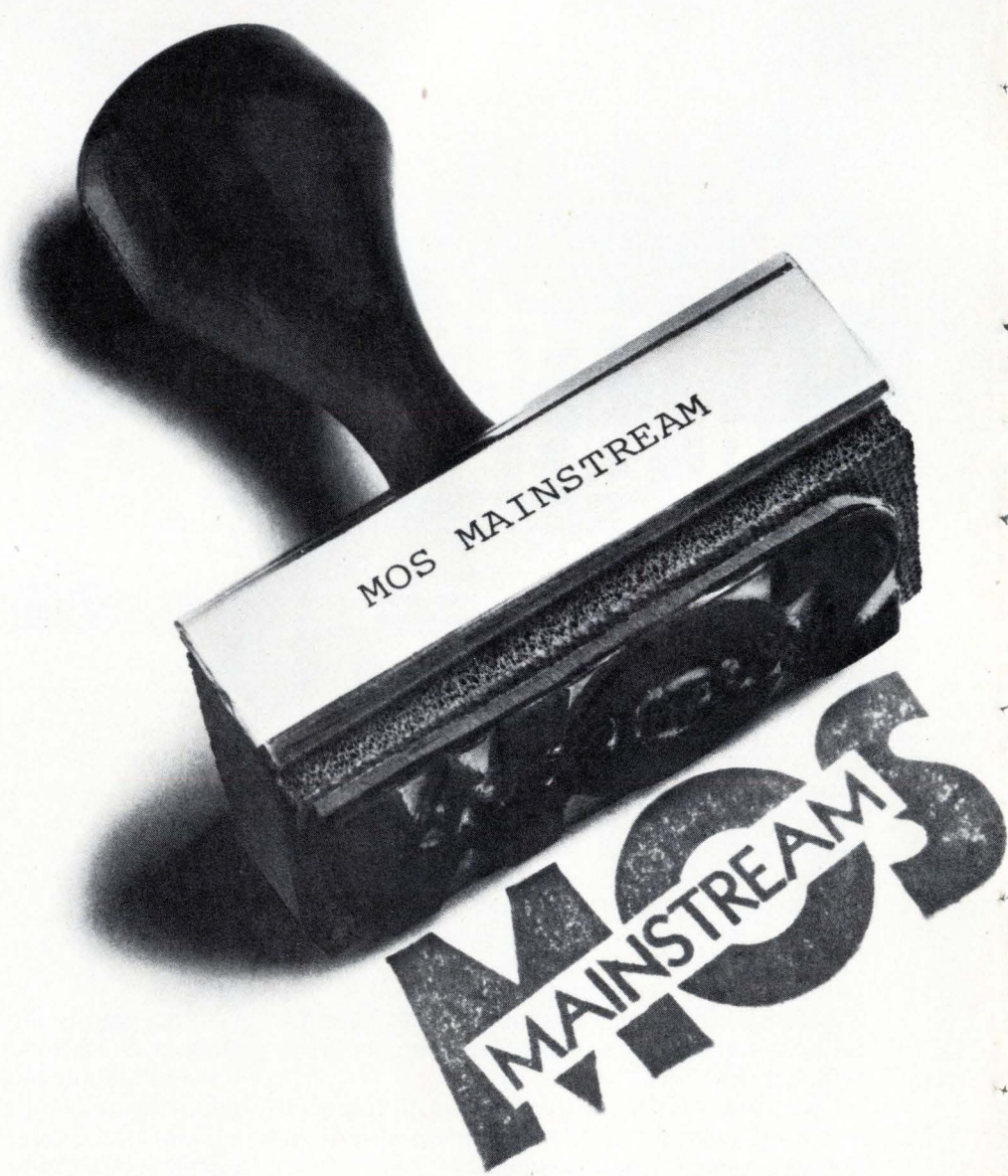

MOS MAINSTREAM

MOS  
MAINSTREAM

# AMD/MOS/AUGUST ONE

More than 40 mainstream MOS memories, all in one place: Advanced Micro Devices.

More than a dozen new devices since May.

Every one is silicon gate. (Five are N-channel.) Every one is available in military temperature range. Every one is built to MIL-STD-883 at no extra charge. Every one is tested over 100 percent of its power supply range.

Every alternate source MOS part we make is guaranteed to be as good or better than the original. Our proprietary products are in a class by themselves. Every part is available for immediate delivery.

If you're getting into MOS, if you want spec sheets or app notes or a thousand parts, talk to Advanced Micro Devices, the next giant.

<b>Am1002</b> Dual 128-Bit Static Shift Register	<b>Am2533</b> 1024-Bit Static Shift Register	<b>Am2841</b> 64x4-Bit FIFO Memory
<b>Am1101A</b> 256-Bit Random Access Memory	<b>Am2602</b> 1024-Bit N-Channel Static Random Access Memory	<b>Am2855</b> Quad 128-Bit Static Shift Register
<b>Am1402A</b> Quad 256-Bit Dynamic Shift Register	<b>Am2802</b> 10MHz Quad 256-Bit Dynamics Shift Register	<b>Am2856</b> Dual 256-Bit Static Shift Register
<b>Am1403A</b> Dual 512-Bit Dynamic Shift Register	<b>Am2803</b> 10MHz Dual 512-Bit Dynamic Shift Register	<b>Am2857</b> 512-Bit Static Shift Register
<b>Am1404A</b> 1024-Bit Dynamic Shift Register	<b>Am2804</b> 10MHz 1024-Bit Dynamic Shift Register	<b>Am3114</b> Dual 128-Bit Static Shift Register
<b>Am1405A</b> 512-Bit Dynamic Recirculating Shift Register	<b>Am2805</b> 512-Bit Dynamic Recirculating Shift Register	<b>Am3133</b> 1024-Bit Static Shift Register
<b>Am1406/1506</b> Dual 100-Bit Dynamic Shift Register	<b>Am2806</b> 1024-Bit Dynamic Recirculating Shift Register	<b>Am3341</b> 64x4-Bit FIFO Memory
<b>Am1407/1507</b> Dual 100-Bit Dynamic Shift Register	<b>Am2807</b> 512-Bit Dynamic Recirculating Shift Register	<b>Am4055/5055</b> Quad 128-Bit Static Shift Register
<b>Am2102</b> 1024-Bit N-Channel Static Random Access Memory	<b>Am2808</b> 1024-Bit Dynamic Recirculating Shift Register	<b>Am4056/5056</b> Dual 256-Bit Static Shift Register
<b>Am2505</b> 512-Bit Dynamic Recirculating Shift Register	<b>Am2809</b> Dual 128-Bit Static Shift Register	<b>Am4057/5057</b> 512-Bit Static Shift Register
<b>Am2512</b> 1024-Bit Dynamic Recirculating Shift Register	<b>Am2810</b> Dual 128-Bit Static Shift Register	<b>Am4102</b> 1024-Bit N-Channel Static Random Access Memory
<b>Am2521</b> Dual 128-Bit Static Shift Register	<b>Am2812/2812A</b> 32x8-Bit FIFO Memory	<b>Am5058</b> 1024-Bit Static Shift Register
<b>Am2524</b> 512-Bit Dynamic Recirculating Shift Register	<b>Am2813/2813A</b> 32x9-Bit FIFO Memory	<b>Am7552</b> 1024-Bit N-Channel Static Random Access Memory
<b>Am2525</b> 1024-Bit Dynamic Recirculating Shift Register	<b>Am2814</b> Dual 128-Bit Static Shift Register	<b>Am9102</b> 1024-Bit N-Channel Static Random Access Memory
	<b>Am2833</b> 1024-Bit Static Shift Register	

(To be continued...)

## Advanced Micro Devices

Corporate offices are at 901 Thompson Place, Sunnyvale, California 94086. Telephone (408) 732-2400 or toll free from outside California (800) 538-7904/Southern California office: Beverly Hills (213) 278-9700/Mid-America: Oak Brook, Illinois (312) 323-6900/Edina, Minnesota (612) 835-4445/Eastern United States: Roslyn Heights, New York (516) 484-4990/Baltimore, Maryland (301) 744-8233/Lexington, Massachusetts (617) 861-0606/Britain: Advanced Micro Devices, Telephone Maidstone 52004/West Germany: Advanced Micro Devices, Munich, Telephone (089) 53 95 88. Southern Europe: Advanced Micro Devices, S.A., Neuilly, France, Telephone: 747-4194. Distributed nationally by Hamilton/Avnet, Cramer and Schweber Electronics.

# Announcing the Battery Status Indicator— a new LED/IC combination

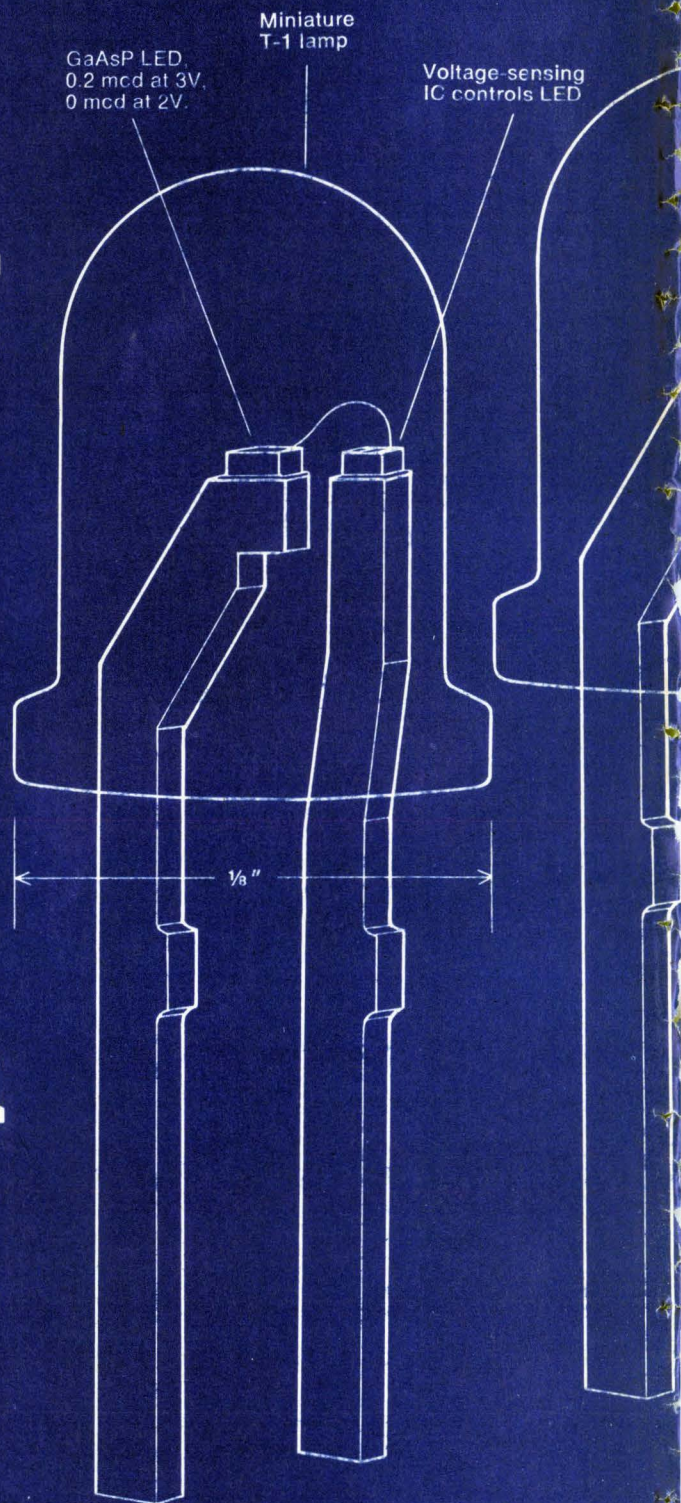

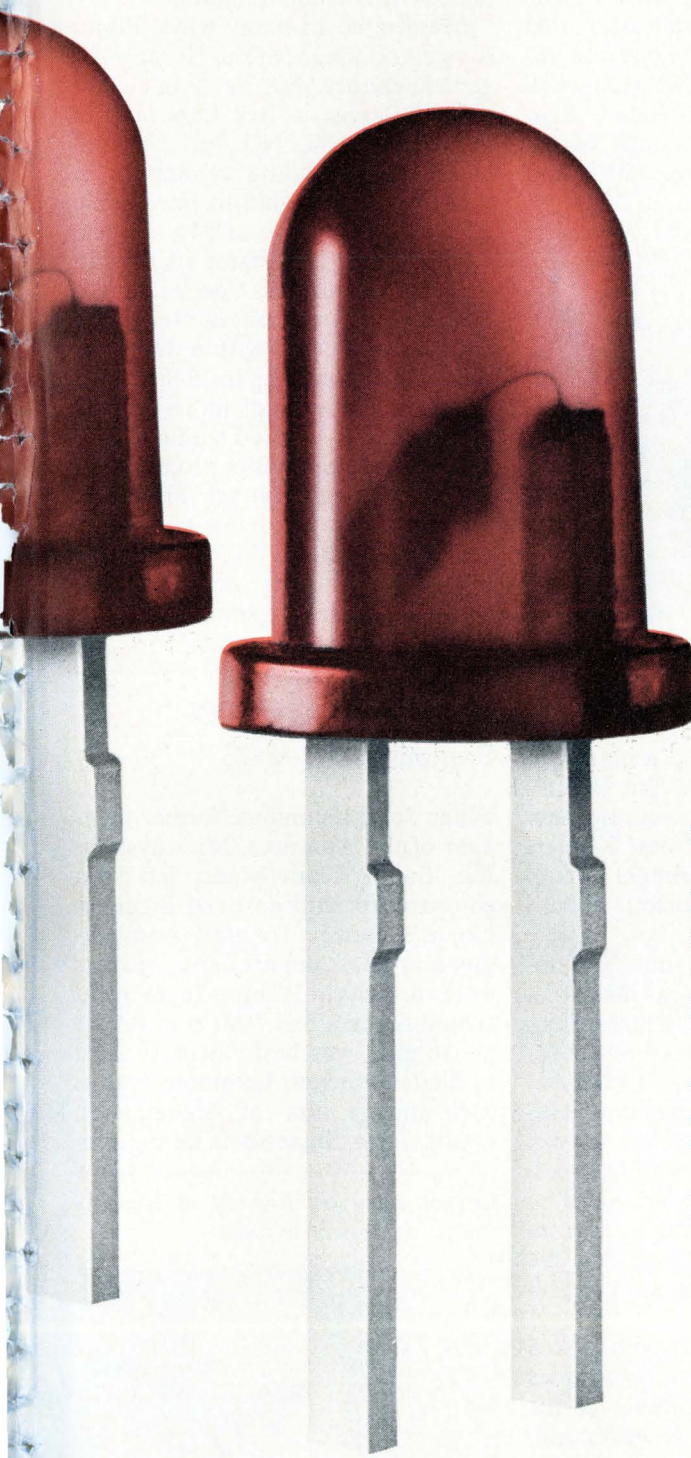

Dead batteries! Everyone hates 'em. And most battery powered equipment—cameras, tape recorders, calculators—don't warn you until it's too late.

Now Litronix—the world's largest manufacturer of LEDs—introduces the RLC-400 Battery Status Indicator. It's a red GaAsP warning light and voltage-sensing IC combined in one little T-1 lamp package. The light is on at 3V, off at 2V.

One of the nation's most prominent camera manufacturers uses it. Any battery-powered device that uses it may acquire an important competitive advantage at low cost.

The Litronix Battery Status Indicator will cost you only 60¢ in quantities of 1000. And you keep production costs down because you don't have to test, assemble and inventory several components.

If you need a warning light that goes on and off at different voltages, get in touch with us. We may be able to help you.

You can get a free sample of the Battery Status Indicator by writing us on your company letterhead. Or if you want more information quick, contact Litronix, 19000 Homestead Road, Cupertino, California 95014. Phone 408-257-7910. TWX 910-338-0022.

**No wonder  
we're No.1  
in LEDs**

**litronix**

Circle 13 on reader service card

# MORE POWER MORE BANDWIDTH

Our Model 503L is an ultra-wideband RF power amplifier whose wide range of frequency coverage and power output provides the user with the ultimate in flexibility and versatility in a laboratory instrument. Easily mated with any signal generator, this completely solid state unit amplifies AM, FM, SSB, TV, pulse and other complex modulations with minimum distortion.

Constant forward power is continuously available regardless of the output load impedance match, making the 503L ideal for driving highly reactive loads.

Unconditional stability and instantaneous failsafe provisions in the unit provide absolute protection from damage due to transients and overloads. This low cost instrument, covers the frequency range of 1.6 to 540 MHz with a linear power output of 3 watts . . . and there's no tuning. Priced at \$995.\*

#### Applications include:

- Laboratory instrumentation
- Communication systems
- Laser modulation
- RFI/EMI testing
- Spectroscopy

\*USA and Canada



For further information or a demonstration contact

ENI, 3000 Winton Road South,  
Rochester, New York, 14623.

Call 716-473-6900.

Or TELEX 97-8283 ENI ROC.

# ENI

The world's leader  
in solid-state power amplifiers.

## People

### Zone refining leads to Science Academy

A reviewer of Bill Pfann's now classic text, *Zone Refining*, took him to task back in 1957 for suggesting that the floating-zone technique for purifying materials would work "ideally in a space station." That was just before the launch of the world's first satellite, Sputnik I, and



**Founder.** High purity semiconductors began with Bell Labs' William G. Pfann.

the reviewer reproached Pfann for making such a frivolous remark in a serious scientific work. But Pfann's foresight proved to be accurate. Several months ago—and some 17 years later—the very experiment Pfann proposed was conducted aboard Skylab II.

William G. Pfann, not only invented zone melting—a means of making materials of the highest purity—but he also fathered an industry. That is the refining of semiconductor materials, a business estimated to total \$150 million a year. More than one third of all chemical elements now can be produced to the highest purity through zone refining. And Pfann expects that the basic technique will be applied still further.

Now, the 56-year-old, soft-spoken researcher from Bell Laboratories has been named a member of the National Academy of Sciences and, in October, he will receive the Industrial Research Institute's award for creativity in science and technology. He is now investigating the possibility of producing new compo-

sitions of matter. In particular, he's concerned with making metastable phases of materials, such as diamonds, which, he points out, defy existence according to the usual phase-equilibrium diagrams.

**Messenger.** In many ways, Pfann is an embodiment of the Horatio Alger experience, but he didn't head west. He came to Bell Laboratories in Murray Hill, N.J., at 17, and, given the prevailing economics in those years, was glad to have a job as a messenger boy at \$15 a week. At the same time, Pfann also began night school at the Cooper Union School of Engineering in New York and was graduated with a degree in chemical engineering in 1940.

Today, Pfann holds more than 60 patents and is credited with conceiving and developing the prototype of the first point-contact transistor to be manufactured. As a result of his efforts, he holds the basic patents related to alloying and diffusion methods for making transistors.

### Lemmons maneuvers Signetics in C-MOS

When John Lemmons, former manager of the American Microsystems Inc. Santa Clara plant, left that company recently to head Signetics Corp.'s newly formed complementary-MOS department, rumors were rampant. Rumor logic went something like this: AMI is in C-MOS and digital watches, C-MOS is used in digital watches, Lemmons was at AMI and is now at Signetics in C-MOS. *Ergo*, Signetics is set to jump

**Logical.** John Lemmons will set Signetics straight on the path to C-MOS.

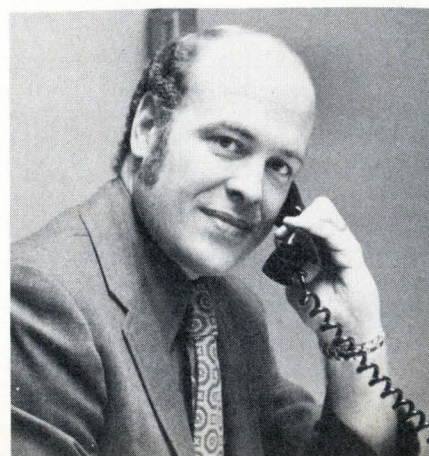



# Fast and easy... MOSTEK's MK4102-6 static 1K RAM.

## 275 ns!

MOSTEK's MK4102P-6 is fast — 275 ns access time! But speed is only one of its features. Just as important, it's easy to use, requiring only one +5 V power supply. All inputs are TTL compatible. And the processing technology is strictly state-of-the-art utilizing a combination of N-channel silicon gate plus ion implantation.

Also, you can accomplish large memory array construction with a minimum of additional circuitry because of the high impedance "off state" coupled with "chip select" input.

What else? Well, the MK4102P-6 is a pin - for - pin alternate for the 2102. But there's no comparison in access time. Check for yourself.

MOSTEK's line of 1K RAMs gives you plenty to select from, static or dynamic. They range from the MK4008-9 (at 800 ns) through two other versions of the MK-4102 (450 ns or 1  $\mu$  sec) up to the popular MK4006 (at 400 ns). Check the table below for the part number you need.

When your design requires an MOS memory, remember MOSTEK. Call your nearest MOSTEK distributor or representative or contact MOSTEK, 1215 W. Crosby Road, Carrollton, Texas 75006, (214) 242-0444. In Europe contact MOSTEK GmbH, TALSTR. 172, 7024 Bernhausen, West Germany, Tel. 798038.

# MOSTEK®

**MOSTEK moves forward...in memories.**

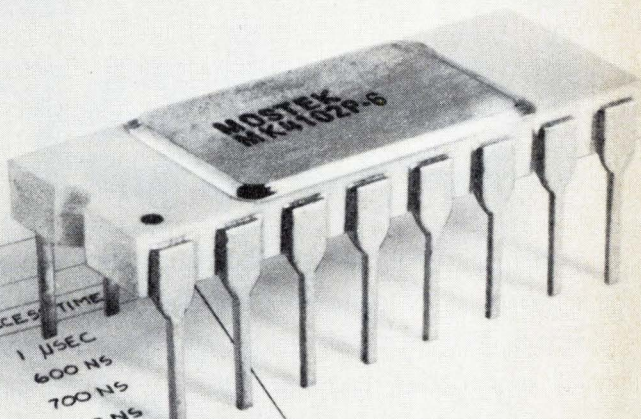

MOSTEK MEMORIES		MAX. ACCESS TIME
	ROMS	1 $\mu$ SEC
	TYPE	600 NS
	2240 - BIT CHARACTER GENERATOR	700 NS
	2560 - BIT ROM (REPLACES MM 5232)	700 NS
	4096 - BIT ROM (REPLACES FSC 351A)	900 NS
	4096 - BIT ROM (REPLACES EA 4800)	
	16K - BIT ROM	
	RAMS	400 NS
	1024 - BIT DYNAMIC RAM	900 NS
	256 - BIT STATIC RAM	500 NS
	1024 - BIT DYNAMIC RAM	800 NS
	1024 - BIT STATIC RAM	1 $\mu$ SEC
	1024 - BIT STATIC RAM	450 NS
	1024 - BIT STATIC RAM	275 NS
	4096 - BIT DYNAMIC RAM	350 NS
CIRCUIT		
MK 2300P		
MK 2400P		
MK 2500P		
MK 2600P		
MK 2800P		
MK 4006P		
MK 4007P		
MK 4008P		
MK 4008P-9		
MK 4102P		
MK 4102P-1		
MK 4102P-6		
MK 4096P		

# Stop spoon feeding your DIP tester

If you're still hand-feeding your DIP tester for incoming or outgoing inspection, you're working too hard. Put our table-top Model 800 to work. Or any one of our other high-speed, automatic DIP test handlers and you can multiply your DIP test throughput by as much as ten—or more. To get all the profitable particulars write or call IPT Corporation, 1140 W. Evelyn Ave., Sunnyvale, California 94086. Phone (408) 732-7550.



**IPT Corporation**  
High-Speed Automatic Test Handlers

into the digital-watch market.

The unflappable Lemmons admits that the facts are essentially correct. However, the logic, and therefore the conclusion, is faulty and somewhat simple-minded. "Signetics is planning a major push into C-MOS," he says. "And, eventually, that may mean watches. But that is not in the immediate future. What comes first is establishing Signetics as a broad-based high-volume producer of C-MOS devices.

At first glance, this may seem to be a little difficult. Signetics is about the last of the major semiconductor houses to get into the C-MOS act. However, Lemmons feels this tardiness has certain advantages. "In any marketing situation, the best place is, of course, to be first, as the innovator," he says. "But when you are last, the market trends are set, the technology is established. And you've got the advantage of knowing the market strategies that succeeded—as well as those that failed." Lemmons concedes, however, that bringing up the rear is an advantage only as long as the market is still expanding.

"Certainly, the marketplace for C-MOS, in particular, and logic devices, in general, is not expanding at the rate it was a year ago," he says. "But the demand is still greater than the supply, and as long as it stays like that for at least a year or so, Signetics has a good chance of establishing itself.

To be successful, this kind of marketing strategy also requires the man who manages it to have, not only a knowledge of C-MOS technology, but also other logic families and processes, plus experience in engineering, production and marketing. "I guess that is why Signetics was interested in me," Lemmons says.

His career has provided him perfect background for the job. Following graduation from Arizona State University with a master's degree in electrical engineering, Lemmons worked for six years at Motorola Semiconductor. There he was product manager, successively, of consumer linear IC and high-frequency power and MOS transistors.



# THE UNIVERSAL CONNECTORS

We call them Universal MATE-N-LOK connectors, because they meet UL, VDE and most other international requirements. That gives you not only another first from AMP, but worldwide compatibility for your equipment interconnections. Available in NEMA colors for both panel and free-hanging applications.



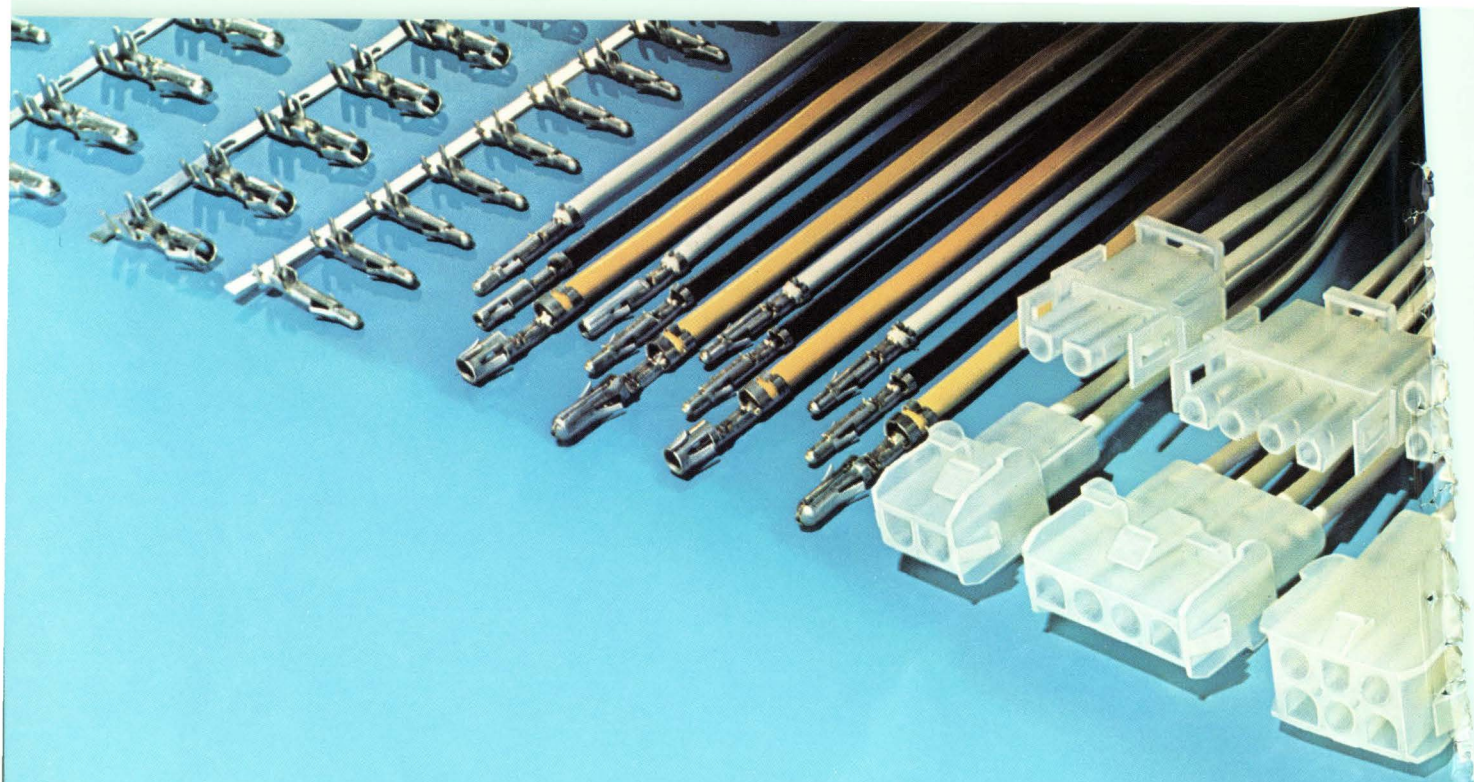

## Universal MATE-N-LOK Connectors meet UL and VDE requirements of 600 volts.

These AMP connectors have dual-lance contacts to provide superior stability. Crimp snap-in contacts rated at 25A. And because pins and sockets can be intermixed in the same housing, a wide variety of keying combinations is possible.

Both contacts and housings have a dual-wire capability, which reduces pin requirements and facilitates daisy-chaining.

Nylon housings are fully polarized, highly resistant to shock and vibration, and include 2 through 15 circuit configurations.

Preloaded pin headers are available for cable-to-pc-board connection.

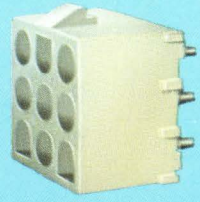

## For today's power requirements: .140 special MATE-N-LOK Connectors.

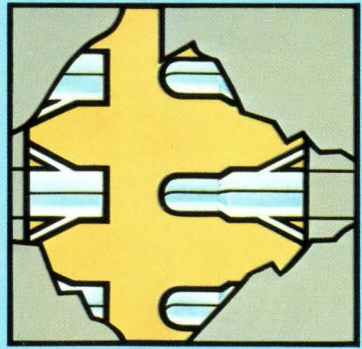

This addition to our standard product line has .140-diameter contacts, which accept insulation up to .180" diameter and carry 25A. Contacts cover 24-10 AWG and incorporate the dual-lance feature described in our Universal range. Available in 2 through 9 circuit configurations.

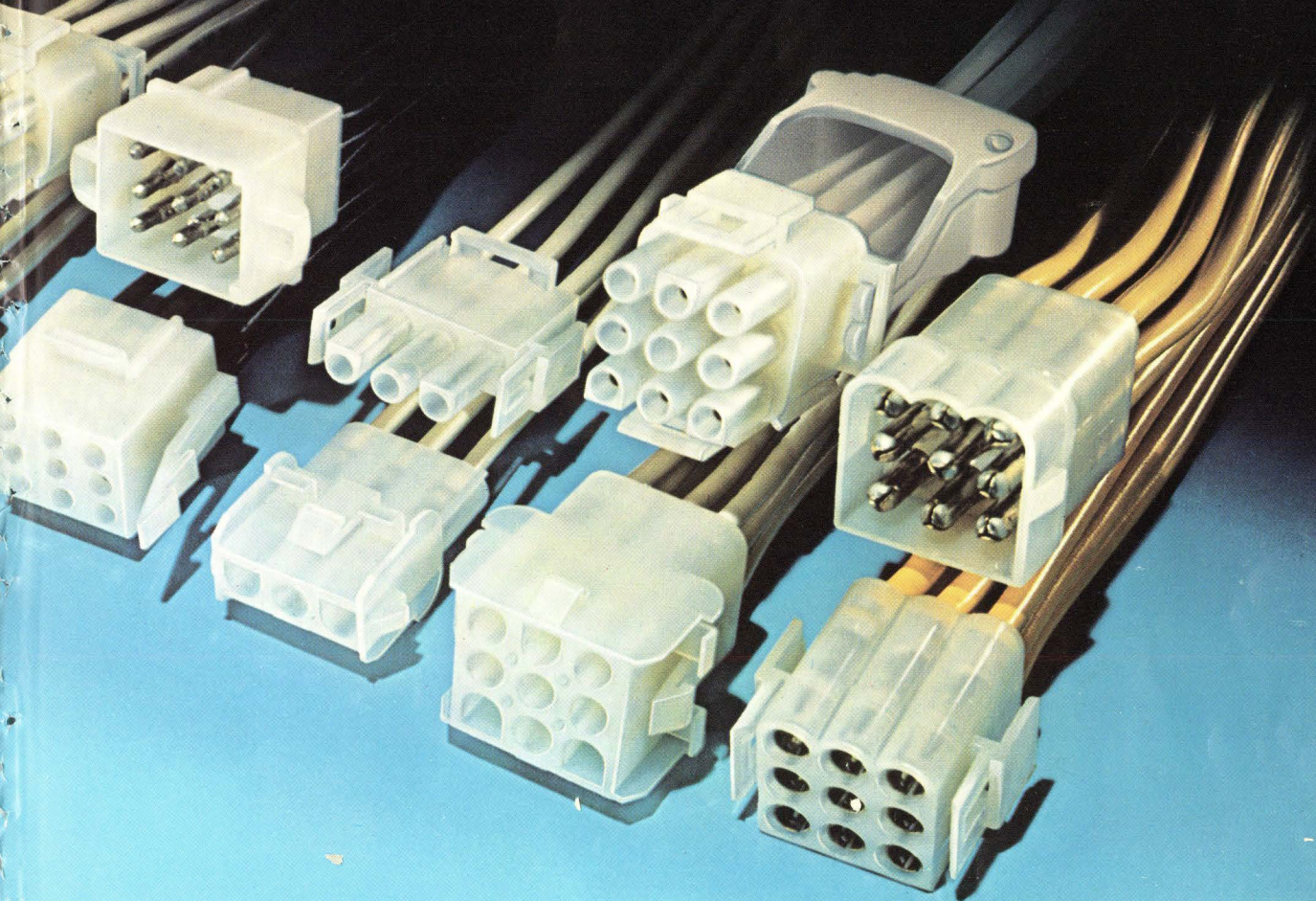

## AMP terminating equipment. For low applied cost.

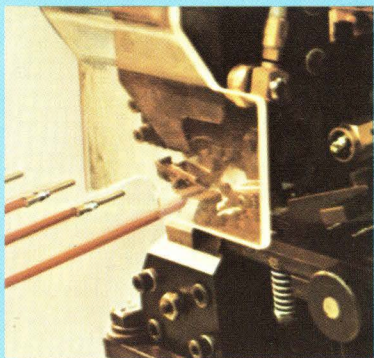

The contacts are supplied in reel-fed form and are designed for use with the versatile, quick-change mini-applicator. So termination is possible with semiautomatic or the latest AMPOMATOR equipment. They can provide up to 11,000+ terminated leads per hour. To take advantage of these savings circle number 150. We have over 1,000 field service and sales engineers to assist in every design and production application—no matter where in the world you're using Universal MATE-N-LOK connectors.

## **MR II Connectors. For economical, high-density connections.**

A highly reliable means of connecting I/O leads, cable-to-cable or to pc boards. With new housing latches for easy disengagement irrespective of which half is mounted. Sizes range from 1 through 36 configurations, and include a pc board header with tails to accommodate 1/16" through 1/8" thick boards. Contacts are rated up to 10A, with low insertion/extraction forces.

So if you're looking for connectors, be assured AMP has the technical experience and plant locations to satisfy your needs. For more information call (717) 564-0100. Or write AMP Incorporated, Harrisburg, Pa. 17105.

**AMP**  
INCORPORATED

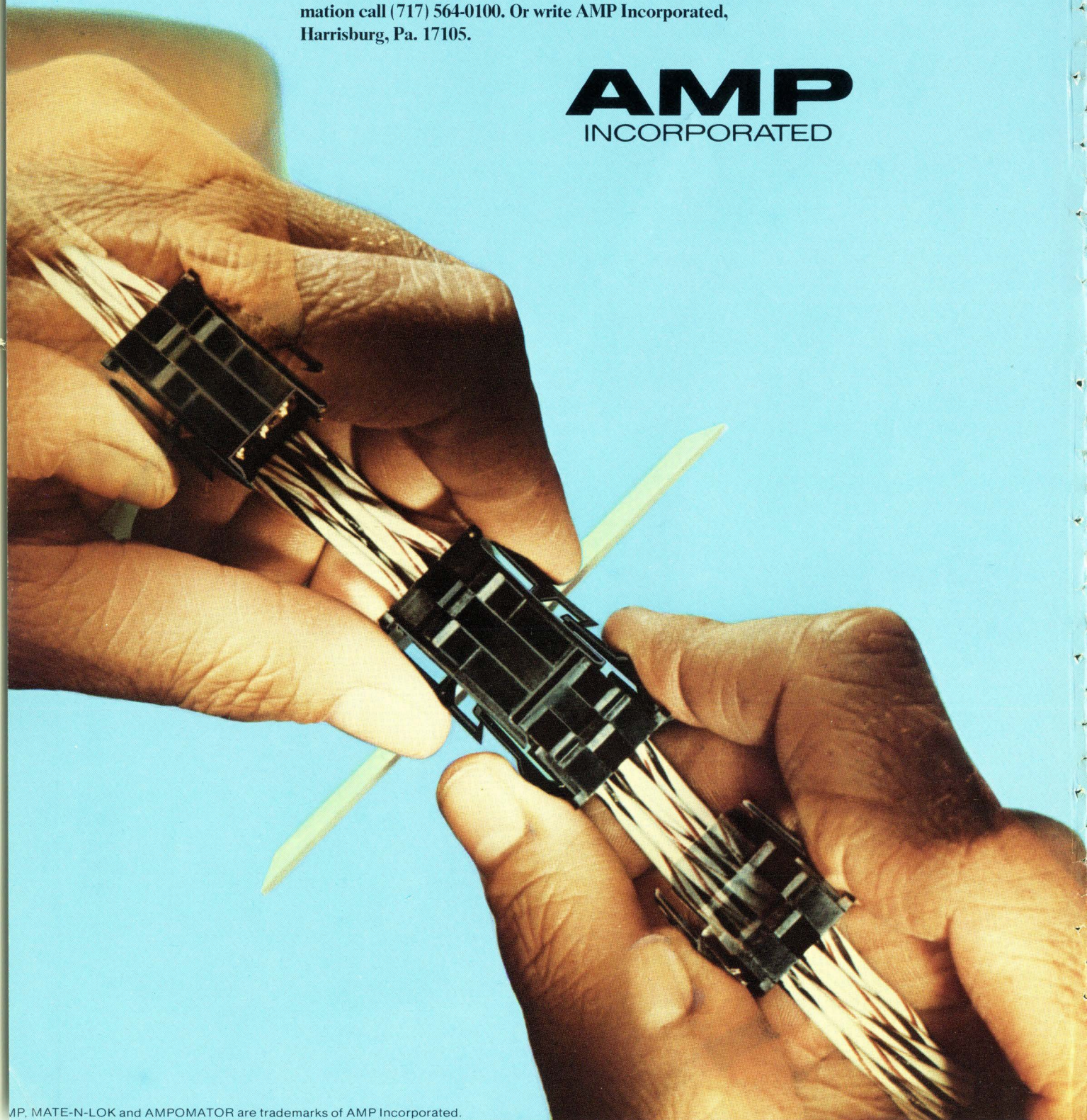

# CAUTION: 50,000 VOLTS



## LET ERIE DESIGN and BUILD YOUR HIGH VOLTAGE POWER SUPPLIES and VOLTAGE MULTIPLIERS

When you talk about designing and packaging miniature, low current High Voltage Power Supplies and Voltage Multipliers, the name ERIE should come to mind first. Why? *No other manufacturer of these sophisticated devices has its own capacitor and rectifier technology in-house.* Only ERIE does it all. Our many years experience in producing State of the Art high voltage capacitors and high voltage silicon rectifiers — plus an unsurpassed technology in circuit designing, packaging and encapsulation, makes ERIE an ideal source for your high voltage component needs. From very low input voltages, ERIE can produce output voltages up to 50,000 volts. Application for these compact, high reliability devices includes night-vision image intensification systems. Apollo TV cameras. CRT displays. Avionics systems exposed to rugged environments. Industrial, commercial and military equipments . . . an almost infinite variety of applications. So bring ERIE in early. Let us design and build *your* High Voltage Power Supplies and Voltage Multipliers. We're equipped to handle large or small volume orders . . . in-house.

Write for our 32-page catalog . . .  
High Voltage Components and  
Devices . . . or for technical  
assistance, call  
613/392-2581

ERIE TECHNOLOGICAL PRODUCTS, INC.  
Erie, Pennsylvania 16512

**ERIE**

# From CPU 8080 Microcom

Intel's new 8080 n-channel microcomputer is here — incredibly easy to interface, simple to program and with up to 100 times the performance of p-channel MOS microcomputers.

Best of all, the 8080 is real — in production at Intel and available in volume quantities, today. It's also available through distributors along with a growing line of peripheral circuits and a new version of the Intellec 8, a program and hardware development system for the 8080,

all supported with software packages, design documentation and manuals, and backed by more than 100 man years of microcomputer expertise.

The 8080 is the inevitable successor to complex custom MOS and many large discrete logic subsystems. It is the industry's first general purpose n-channel microcomputer and the first high performance single-chip CPU, with extremely simple interface requirements and straightforward programming. It runs a full instruction cycle in 2 microseconds.

As such, the 8080 extends the economic benefits of Intel's p-channel microcomputers to a new universe of systems that need fast, multi-port controllers and processors. These systems include intelligent terminals, point of sale systems, process and numeric controllers, advanced

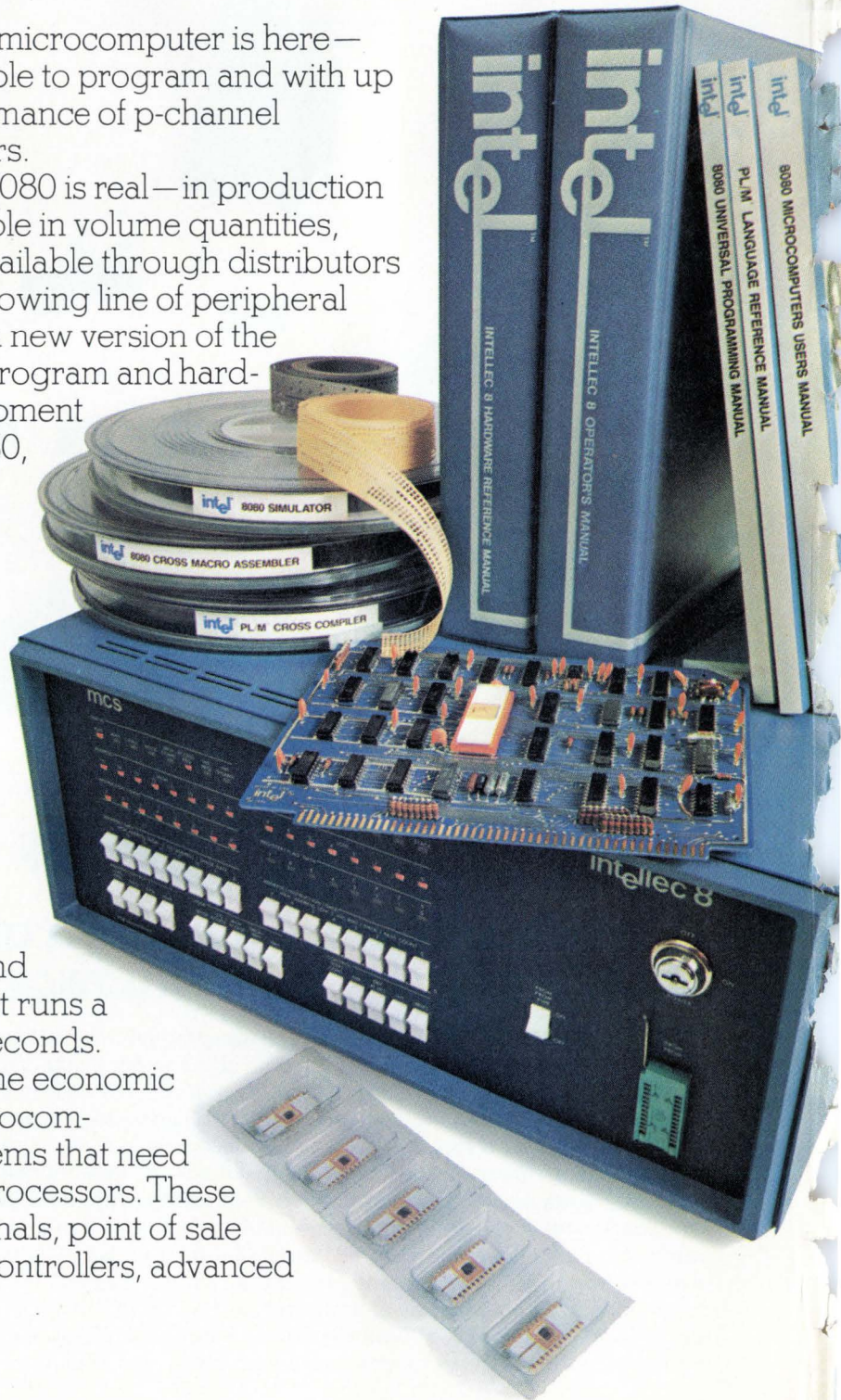



# to software, the puter is here.

calculators, word processors, self-calibrating instruments, data loggers, communications controllers, and many more.

You can use 256 input and 256 output channels, handle almost unlimited interrupt levels, directly access 64 kilobytes of memory, and put many satellite 8080 processors around a single memory.

Interfacing is minimal and design is easy with the 8080 because all controls are fully decoded on the CPU chip itself and inputs and outputs are TTL compatible. There are separate data, address and control buses.

The 8080 microcomputer has 78 basic instructions, including the 8008 set plus new ones that make possible such features as vectored multi-level interrupt, unlimited subroutine nesting and very fast decimal and binary arithmetic.

Program development for the 8080 can be done either on a large computer using the Intel software cross products (PL/M systems language compiler, macro-assembler and simulator), or on an Intellec 8 development system with a resident monitor, text editor and macro-assembler.

The new 8080 product family includes performance matched peripheral and memory circuits configured to minimize design effort and maximize system performance. Large, low cost RAMs, ROMs, PROMs and I/O devices are available now and we will soon announce other 8080 LSI support circuits.

The 8080 is easier to use and more economical than any high performance microcomputer in sight. It's here now, in volume, from the inventors of the microcomputer and the people who lead the industry in production and design support.

Intel Corporation, 3065 Bowers Avenue, Santa Clara, California 95051.  
(408) 246-7501.

INTEL 8080	RAM MEMORIES		
	8101	256 x 4 STATIC	AVL: 3RD Q
	8111	256 x 4 STATIC WITH COMMON I/O	AVL: 3RD Q
	8102	1024 x 1 STATIC	AVL: NOW
	8107	4096 x 1 DYNAMIC	AVL: NOW
	ROM MEMORIES		
	8308	1024 x 8	AVL: 3RD Q
	8316	2048 x 8	AVL: NOW
	PROM MEMORIES		
	8702	256 x 8	AVL: NOW
	8704	512 x 8	AVL: 4TH Q
	8604	512 x 8	AVL: 4TH Q
	PERIPHERAL CIRCUITS		
	8205	1 of 8 DECODER	AVL: NOW
	8210	4K RAM CLOCK DRIVER	AVL: NOW
	8212	8 - BIT I/O LATCH	AVL: NOW
8216	BI-DIRECTIONAL BUS DRIVER	AVL: 3RD Q	
8201	COMMUNICATIONS INTERFACE	AVL: 4TH Q	

INTEL 8080 PRODUCT FAMILY

**intel**® Microcomputers. First from the beginning.

# FLAT INTERCONNECTS YOUR COMPLETE SOURCE

Ribbon Cable / IC Interconnects / Custom Harnesses

You're sold on flat cable, now buy it at its best. Precise, compact cable packages to fit your specifications perfectly, computer-loomed for unmatched versatility by Woven Electronics.

Handling ease of independent non-bonded leads speeds production, cuts cost, while technical characteristics outrank other flat cable forms.

Make Woven your source for jumpers, continuous rolls, special harnesses, all your interconnect needs.

## WOVEN ELECTRONICS

P.O. Box 189 Mauldin, South Carolina 29622  
803/963-5131

## Meetings

**IFIP Congress, International Federation for Information Processing**, IFIP, Stockholm, Aug. 5-8.

**Computer Communications International Conference**, IEEE, Stockholm, Sweden, Aug. 12-14.

**National Electronics Conference of New Zealand (Nelcon)**, New Zealand Section, IEEE, University of Auckland, Auckland, Aug. 26-30.

**Fifth Conference of the Canadian Medical and Biological Engineering Society**, Queen Elizabeth Hotel, Montreal, Sept. 3-6.

**International Congress on Data Processing**, AMK, Congress Hall, West Berlin, Sept. 4-7.

**Preparation and Properties of Electronic Materials**, Metallurgical Society of the American Institute of Mechanical Engineers, Sheraton-Boston Hotel, Boston, Sept. 9-11.

**International Switching Symposium 1974**, VDE, Sheraton Hotel, Munich, Sept. 9-13.

**Comcon Fall**, IEEE, Mayflower Hotel, Washington, D. C., Sept. 10-12.

**Western Electronic Show and Convention (Wescon)**, IEEE, Los Angeles, Sept. 10-13.

**Fourth European Microwave Conference**, Microwave Exhibitions and Publishers Ltd., Maison des Congrès, Montreux, Switzerland, Sept. 10-13.

**European Solid State Devices Research Conference**, Institute of Physics, IEEE, University of Nottingham, England, Sept. 16-19.

**International Conference on the Technology and Applications of Charge Coupled Devices**, University of Edinburgh, Centre for Industrial Consultancy and Liaison, et al., Edinburgh, Sept. 25-27.

**Minicomputers in the Factory**, New York Management Center, Delmonico's Hotel, New York, Oct. 7-8.

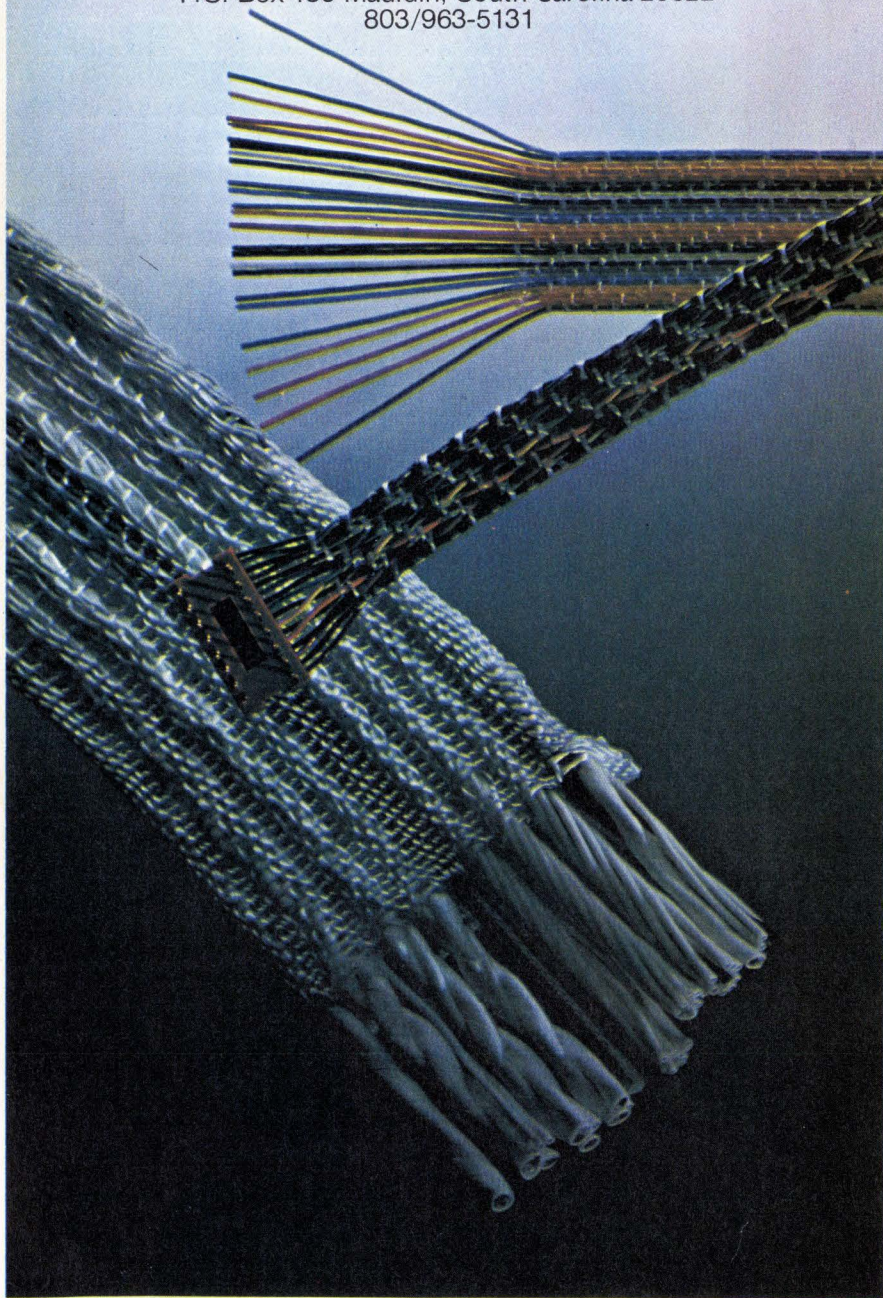

# Industrial designers like the way they look. Engineers like the way they work.

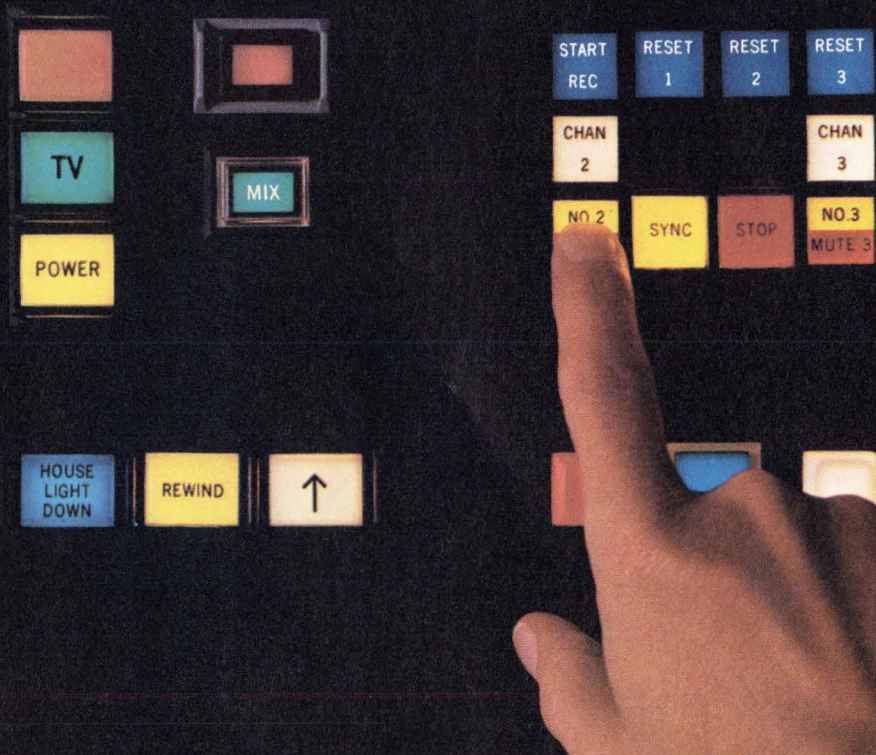

**MAIN PHOTO:**  
Series 3 (right) and Series 4 (left)

**LOWER PHOTO:**  
Series 4, (left) lowest cost, all three energy levels, snap-in mount.

Series 2, (back) with modular design, up to 4 lamps and 4 poles, military versions.

Series 1, (right) with bushing mount, panel seal, military versions.

Series 3, (front) the smallest in our line, with snap-in or matrix mount.

If you've got a particular idea about what a lighted push-button should look like, we've got four important numbers for you: Series 1, 2, 3 and 4.

They represent one of the biggest selections of lighted pushbuttons in the world.

So you get to choose from a long list of options, depending upon the switch you select. Like buttons available in popular, highly consistent colors. Either transmitted or projected. Legending includes hot stamp, engraved or film insert, with an optional hidden legend available. Barriers and housings come in a choice of colors. Lighting is single or multiple lamp. Mounting either single unit, strip or matrix. You can also choose between round or square configurations, and most of them offer front-of-panel relamping without tools.

But your choice doesn't end at the front of the panel. In back of the button, there are three energy levels available—solid-state, low-energy and power. You can choose among solder, quick-connect, P.C. board mount or screw terminals. They're all U.L. and C.S.A. listed, with military-listed variations available. Circuitry can be single-pole, single-throw through four-pole, double-throw. With momentary or alternate action.

And, even though each of the four Series has its own particular advantages, they all have one thing in common: the kind of reliability you'd expect from the company that pioneered lighted pushbutton switches.

If you'd like more information on any or all of the MICRO SWITCH lighted pushbuttons, call toll-free 800/645-9200 (in N. Y. 516/294-0990, collect) for the name of your nearest Branch Office or Authorized Distributor.

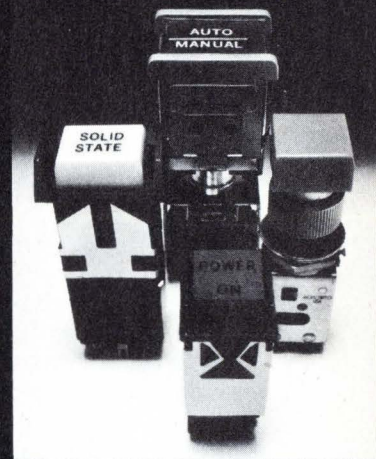

**MICRO SWITCH**

FREEPORT, ILLINOIS 61032

A DIVISION OF HONEYWELL  
Circle 25 on reader service card

MICRO SWITCH products are available worldwide through Honeywell International.

# SEE THE INTERFACE FOREST

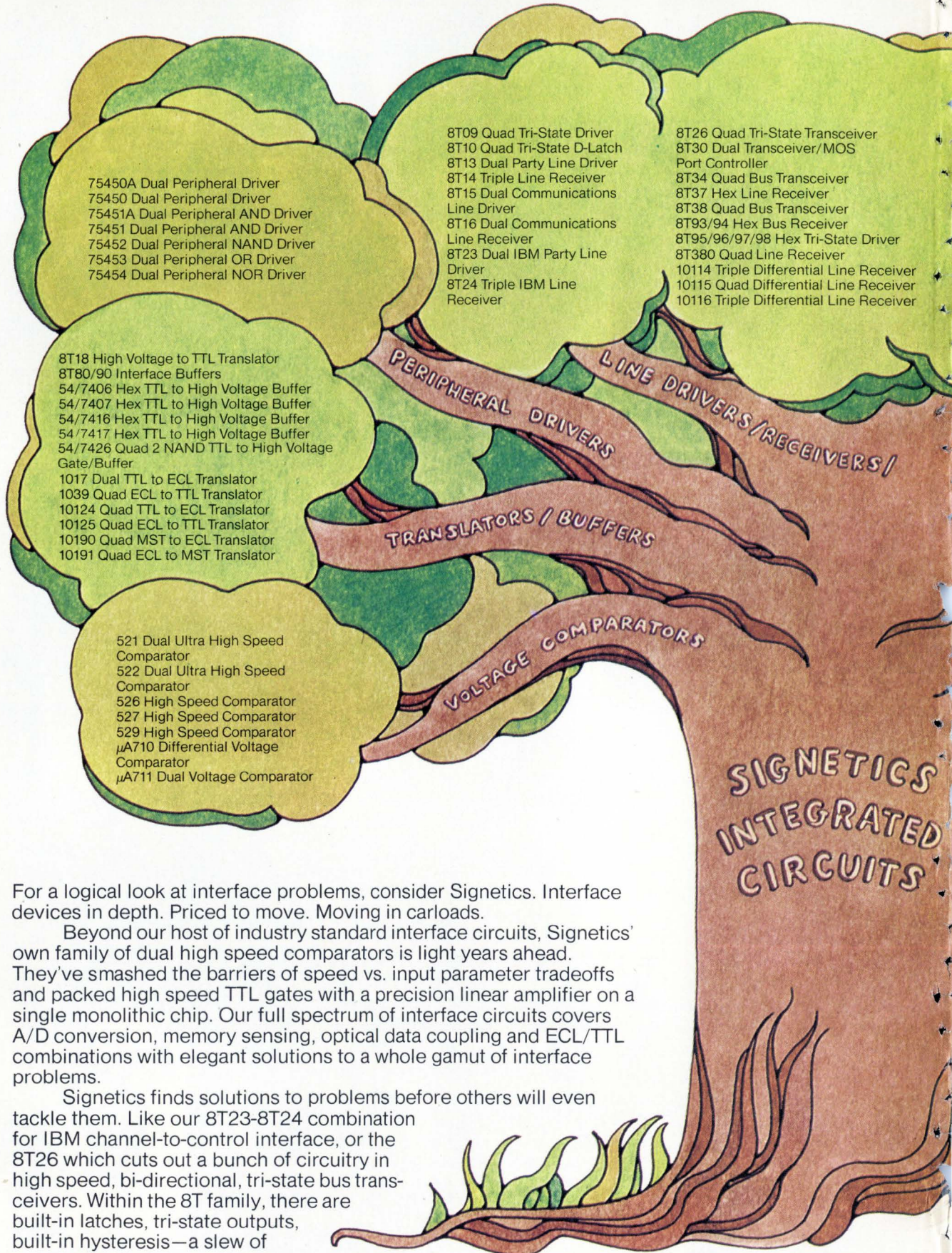

For a logical look at interface problems, consider Signetics. Interface devices in depth. Priced to move. Moving in carloads.

Beyond our host of industry standard interface circuits, Signetics' own family of dual high speed comparators is light years ahead. They've smashed the barriers of speed vs. input parameter tradeoffs and packed high speed TTL gates with a precision linear amplifier on a single monolithic chip. Our full spectrum of interface circuits covers A/D conversion, memory sensing, optical data coupling and ECL/TTL combinations with elegant solutions to a whole gamut of interface problems.

Signetics finds solutions to problems before others will even tackle them. Like our 8T23-8T24 combination for IBM channel-to-control interface, or the 8T26 which cuts out a bunch of circuitry in high speed, bi-directional, tri-state bus transceivers. Within the 8T family, there are built-in latches, tri-state outputs, built-in hysteresis—a slew of

# (BECAUSE OF THE TREE).

10129 Quad Bus Receiver (w Latch)  
 10192 Bus Driver  
 10216 Triple Differential Line Receiver  
 54/7438 Quad Bus Driver  
 54/7439 Quad Bus Driver  
 54/74124 Quad Tri-State Driver  
 54/74125 Quad Tri-State Driver  
 54/74128 Line Driver  
 54/74S40 Dual 4 NAND Buffer/Line Driver  
 54/74S140 Dual 4 NAND Buffer/Line Driver  
 78/8820 Dual Line Receiver  
 78/8830 Dual Line Driver

8T51 5 mA Source LED Decoder Driver  
 8T59 50 mA Source LED Decoder Driver  
 8T74 20 mA Sink (w Latch) LED Decoder Driver  
 8T75 20 mA Source (w Latch) LED Decoder Driver  
 54/7445 BCD to Decimal Decoder/Driver  
 54/74145 BCD to Decimal Decoder/Driver  
 8880 Sperry Display Decoder/Driver

8T25 Dual MOS Sense Amplifier/Latch  
 3207A Quad MOS Clock Driver  
 3207A-1 Quad MOS Clock Driver

7520 Dual Core Memory Sense Amplifier  
 7521 Dual Core Memory Sense Amplifier  
 7522 Dual Core Memory Sense Amplifier  
 7523 Dual Core Memory Sense Amplifier  
 7524 Dual Core Memory Sense Amplifier  
 7525 Dual Core Memory Sense Amplifier

501 Video Amplifier  
 592 Video Amplifier  
 $\mu$ A733 Differential Video Amplifier

555 Timer  
 556 Dual Timer  
 8T20 Bi-Directional One Shot  
 8T22A/9601 Retriggerable One Shot  
 8T363 Dual Zero-Crossing Detector  
 9602 Dual Retriggerable One Shot  
 54/7413 Dual Schmidt Trigger  
 54/7414 Hex Schmidt Trigger  
 54/74121 One Shot  
 54/74122 Retriggerable One Shot  
 54/74123 Dual Retriggerable One Shot  
 54/74132 Quad 2 NAND Schmidt Trigger  
 54/74232 Quad 2 NOR Schmidt Trigger

TRANSCEIVERS

DISPLAY DRIVERS

MOS MEMORY SENSE AMPLIFIERS/CLOCK DRIVERS

CORE MEMORY SENSE AMPLIFIERS

VIDEO AMPLIFIERS

TIMING CIRCUITS

dam busting solutions for simpler, more reliable systems. Low current PNP inputs give greater design freedom and you can interface with any data source—TTL, memories and MOS micro-processors. It's all spelled out in our information package.

Whatever you're interfacing, you can count on Signetics. Before you accept a tradeoff in design, or in price or in delivery, give us a call. We're specialists in solving problems and if we haven't hit yours yet, we'd sure like to try.

CLIP THIS COUPON AND ATTACH TO LETTERHEAD FOR FAST ACTION.

Signetics-Interface  
 P.O. Box 3004-33  
 Menlo Park, California 94025

No more out on a limb for me. Send me your new interface information package.

Name Title

Mail Stop

Signetics Corporation, a subsidiary of Corning Glass Works, 811 E. Arques Ave., Sunnyvale, Ca. 94086 (408) 739-7700.

**signetics**

# Simplified Communications Signal Analysis

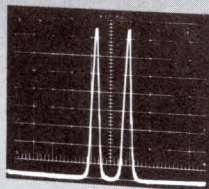
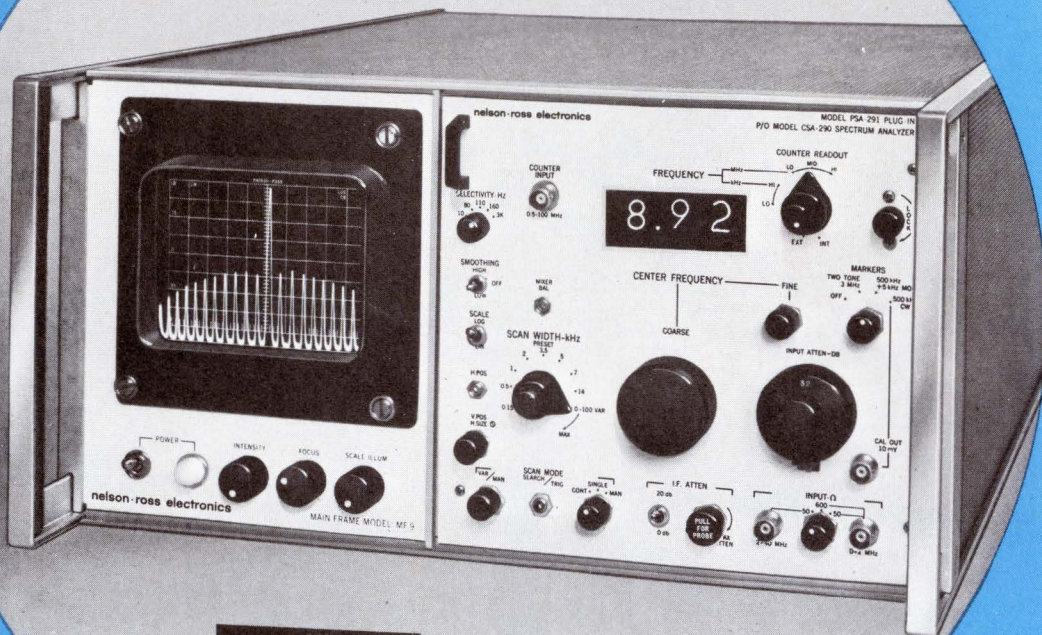

Two Tone IM test. CSA-290  
rated for  $\geq 70$ db IM range.

## SSB, FM, AM, MUX—10 Hz to 400 MHz

The Nelson-Ross CSA-290 pinpoints and analyzes all your communications signals from 10 Hz to 43 MHz — to 400 MHz with Range Extender (Model RE-7292). Resolution capability is 6 Hz!

### CHECK THESE FEATURES:

- Frequency Counter provides  $\pm 0.1\%$  tuning accuracy and  $\pm 10$  Hz fine  $\Delta F$  tuning precision.
- Preset operation. Completely self-testing. Spurious-free displays.
- $\geq 70$  dB range for two-tone IM distortion tests. (Two-Tone AF Signal Generators, Model TTG-29, optional.)
- Field proven reliability; meets rigid U.S. Government environmental specifications. FSN #6625-450-4312
- Lowest cost.

Testing, monitoring and troubleshooting modern high density SSB and FM communications signals requires exceptional selectivity, stability, and a wide dynamic

range free of internal spurious responses, image frequencies, and IM. The versatile Nelson-Ross CSA-290 includes all these capabilities, plus foolproof self-testing operation and unique accessories.

### And the cost is modest:

- Model CSA-290A — Spectrum Analyzer & Probe,  
10 Hz — 43 MHz \$4,600.
- Model TTG-29 — Two-Tone AF Signal Generator  
20 Hz — 20 kHz \$1,200.
- Model RE-7292 — Range Extender, for analysis  
to 400 MHz \$2,000.

The CSA-290A's calibrated Display Main Frame can also be used with more than a dozen popular Nelson-Ross Spectrum Analyzer Plug-Ins; 0.5 Hz to 6.5 GHz. For complete specifications, please phone, write or circle the Reader Service Number.

## nelson • ross electronics

A Division of Polarad Electronics Corp.

5 Delaware Drive / Lake Success, New York 11040 / 516-328-1100 / TWX 510-223-0414

## **C-MOS on sapphire replaces bipolar at McDonnell**

McDonnell Douglas Electronics Co. has decided to replace its bipolar IC facility with one devoted solely to C-MOS on sapphire. Although parts won't be produced in quantity for about a year, the first part—a ROM designed to test the process—is due off the line by year-end.

Because of the low power requirements of C-MOS technologies, McDonnell Douglas is **convinced that military avionics is fast moving toward C-MOS on sapphire.** "And it's our opinion, from what we see in Government installations, that a large proportion of future military/aerospace requirements are going to be C-MOS on sapphire," notes John W. Buttrey, director of solid-state technology for the St. Charles, Mo., firm. Planned as a fast-response, low-volume line, the facility is now aimed at satisfying custom needs in-house, but it may eventually solicit a limited amount of outside business.

## **Monolithic 1.2-GHz decade divider due from Plessey**

Plessey Semiconductors next month will introduce a monolithic 1.2-gigahertz decade divider—**double the operating range of previous models of this device.** The highest frequency now attainable in decade dividers is a 600 megahertz part, also sold by the English-based firm. The new device extends direct frequency synthesis and instrumentation to the upper limit of 1,215 MHz. The divider uses a form of emitter-coupled logic, and it is compatible with MECL II and 10K. Unusual for this frequency range, the IC is packaged in a 14-pin dual-in-line package. The part is pin-compatible with the 600-MHz divider.

## **H-P turns 9830A into interactive data terminal**

A new interface from Hewlett-Packard Co. is closing the communications gap between its 9830A desktop calculators and computers. Consisting of cable and a plug-in read-only memory, **the data-communications interface makes the 9830A the first desktop calculator to offer both asynchronous and synchronous data transfer.** H-P says this, in effect, turns the calculator into an interactive terminal.

The terminal can talk to other 9830As as fast as 9,600 bits per second. It can also be operated as a remote batch terminal or as a time-sharing terminal for a large computer system. The basic interface package will sell for \$1,500, while the calculator itself has a \$6,475 price.

## **Cheaper LSI may affect views on avoidance gear**

Now that the cost of making LSI chips is dropping, previous opinions on various collision-avoidance systems by the Federal Aviation Agency, the Air Transport Association, and general-aircraft users may change. The FAA, **recognizing a need for new studies on comparative costs of various airborne avoidance systems** has awarded a \$116,000 contract to Arinc Research Corp., Annapolis, Md., for a six-month study of systems containing LSI.

And alterations to the forthcoming ground-based discrete-address beacon system may be able to provide CAS capability for commercial aircraft over the Atlantic and Pacific Oceans. The Institute for Defense Analyses, Arlington, Va., has received a \$223,000 contract for studies of CAS communications capability and reliability.

FAA assistant administrator Gustav Lundquist had promised a recommendation on CAS to Congress by July 1975, but at a recent Senate

committee hearing, **he said that it might not be ready until January 1976**, more than six years after the ATA formally advocated the air-borne CAS made by McDonnell Douglas.

## **MLS to be installed at 50-100 airports**

Microwave landing systems will go into operation at 50 to 100 airports by late 1977, according to a new Federal Aviation Agency deployment schedule. Says FAA's project manager for MLS, Joseph DelBalzo, **"heavy pressure from the user community" has forced earlier deployment of an MLS system**, so a low-performance modular version will replace category I instrument-landing system radar (200-foot ceiling, quarter-mile visibility) in certain test locations. Several industry representatives will be asked for recommendations on where MLS test systems should be installed.

There were no surprises in MLS testing at Wallops Island, Va., last June, DelBalzo says, and the agency will soon begin reviewing data from six months of flight tests on two doppler and two scanning-beam microwave systems. A contract for two prototype units—based on either scanning beam or doppler—will be awarded in March 1975, he says. **A limited production option for "between 50 and 100 units" will be exercised in June 1976** with the successful prototype manufacturer.

## **Terabit memory returns with new look**

A new, less expensive version of Unicon's trillion-bit laser memory system is on the market. The original, which records data with a laser that burns microscopic holes in a thin metallic film, **was available only in the trillion-bit capacity, cost \$1.7 million, and was quite bulky**. Now, Precision Instrument Co. of Santa Clara, Calif., following a company reorganization, is offering the new model 190 in modular form, with a minimum capacity as little as 200 megabytes, for lease or for sale for as little as \$400,000.

## **Bendix switches to Eaton's antiskid system**

The Bendix Corp., the country's biggest maker of truck air brakes, **has taken itself out of the antiskid competition** [*Electronics*, July 11, p. 74]. Instead, Bendix dealers will supply the Eaton Corp. system. Marvin Flaks, vice president and group executive, denies that Bendix has dropped its antiskid development. Rather, he says, there isn't enough time before implementation of Federal rules requiring antiskid devices on trucks to test them adequately.

## **Addenda**

The FAA has decided to continue funding development of Philco-Ford's electronic voice switch prototype to the tune of \$100,000 a week. The agency will decide by the end of the summer whether to seek new bids. The project is running far beyond its January 1975 target date. . . . Scarcely a month after ordering 100 shipboard terminals for its Marisat maritime communications satellite [*Electronics*, June 13, p. 78], Consat has ordered another 100. **This increases its total purchase from Scientific Atlanta to about \$4 million**. . . . Look for samples of sapphire wafers from Monsanto by the first quarter of next year. **The silicon giant is eyeing the market**—now dominated by Union Carbide—and expects a pilot line for slicing and polishing wafers to go on-stream within a few months at its St. Peters, Mo., materials facility.



# We'll deliver 10,000 SCR's in three weeks.

Choose the plastic 2N5060 Series, or IP100 Series now available to 300V. Or the hermetically-sealed ID100 Series now available to 400V. Both with typical dv/dt capability of 75V/ $\mu$ sec.

Unitrode also offers many other low-level SCR's. The widest choice in the industry. The right SCR for your specific environmental requirements, at the right price. All part of a growing family of Unitrode plastic or hermetic SCR's designed for a wide range of sensing and control applications.

Place an order. We'll deliver 10,000 of any of the SCR's listed — in three weeks or sooner.

Write for our latest data sheets. Or for faster action, call Vin Savoie at (617) 926-0404.

## Unitrode plastic or hermetic SCR's



Type			Blocking Voltage	Maximum Current, RMS	Gate Trigger Current $I_{GT}$	Gate Trigger Voltage $V_{GT}$	Holding Current $I_{HX}$
TO-92	TO-92	TO-18	30V 60V 100V 150V 200V 300V 400V	0.8A	200 $\mu$ A Maximum	0.8V Maximum	5mA Maximum at $R_{GK}=1K$
2N5060	IP100	ID100					
2N5061	IP101	ID101					
2N5062	IP102	ID102					
2N5063	IP103	ID103					
2N5064	IP104	ID104					
	IP105	ID105					
		ID106					

See Electronics Buyers' Guide Semiconductors Section for more complete product listing.

Circle 31 on reader service card

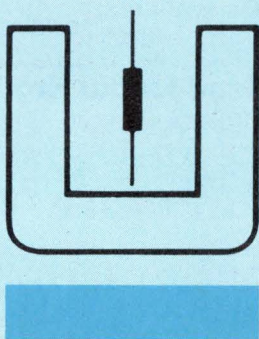

# UNITRODE

580 PLEASANT STREET, WATERTOWN, MA 02172

## HERMES LOOP ANTENNA

THREE SAMPLE SITES  
ON THE NORTH AMERICAN  
CONTINENT —

DIFFERENT LATITUDES  
DIFFERENT CLIMATE

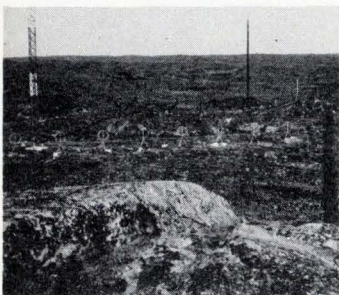

FROBISHER BAY, CANADA

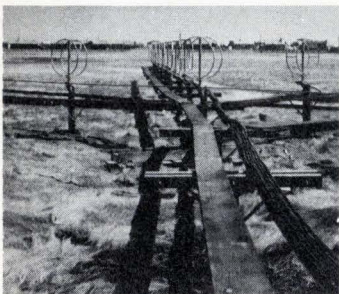

MARSHFIELD, MASS.

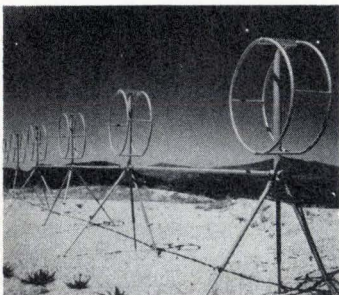

NEAR SAN DIEGO, CALIF.

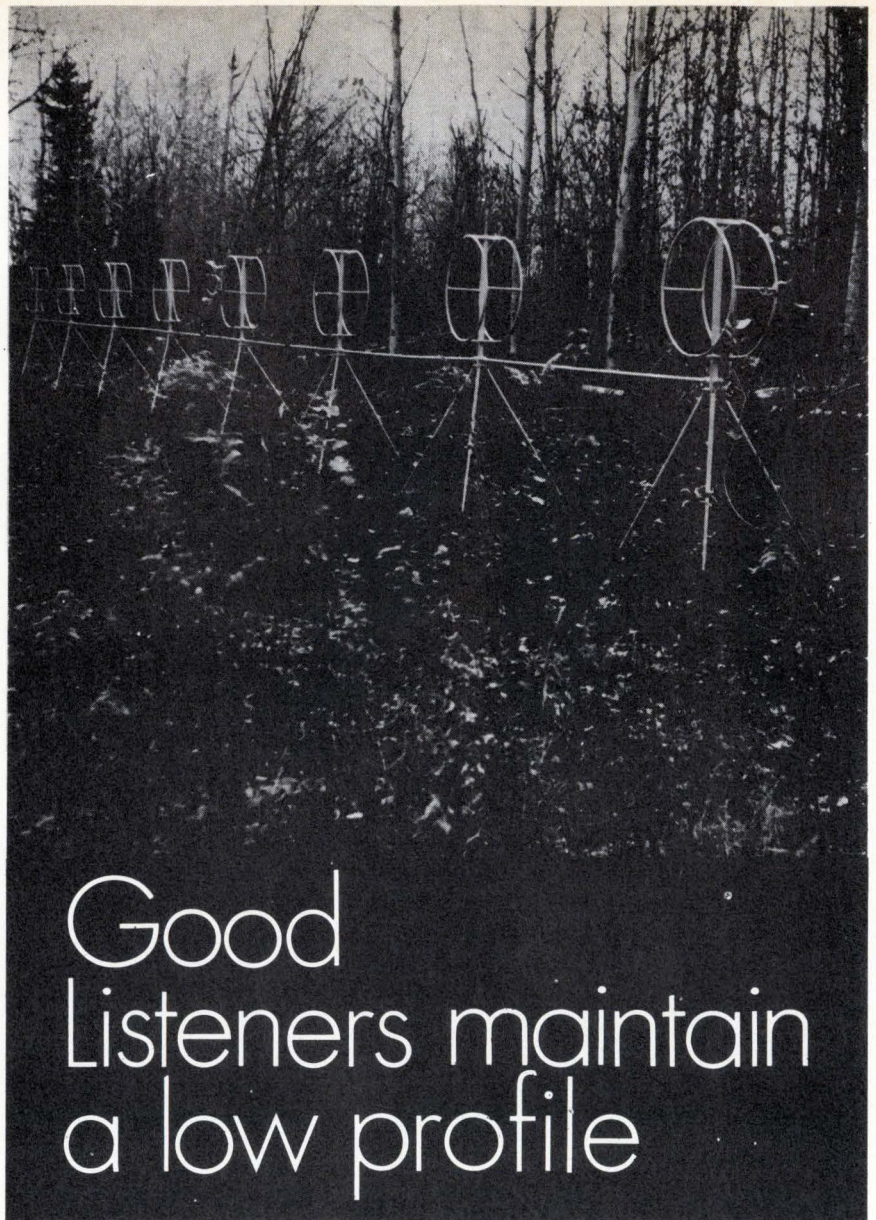

# Good Listeners maintain a low profile

Even in the solitude of the forest depths, from rooftops, arctic tundra, swamps to sweltering tropics, 'neath snow, sand or ice, the Hermes Loop antenna keeps an ear to the sky. The amazing aperiodic antenna does away with vast log periodic and rhombic arrays - those towering antenna farms.

Excellent directional characteristics in rosette configuration, the Hermes loop antenna provides an omnidirectional broadband receiving array in space merely 1/100th that of the traditional antenna farm. More than 53 government agencies around the world have pressed the loop antenna into service.

A new, even more compact version is available. Only Hermes Electronics makes it.

**2-32MHz  
BROADBAND**



**ASK US Send for our Brochure**

Hermes Electronics Limited  
Suite 315  
2020 F Street NW  
Washington, DC 20006 USA  
202-296 2978  
TWX 710 822 1106

## Silk-screening prints conductors, resistors on circuit boards

Printing replaces usual chemical deposition or etching; price reductions of 10% to 30% promised

"I've been thinking for the past 10 years there must be a better way to make printed-circuit boards," says Christos G. Alex, division manager of tiny Ohmtec Inc., in Burlington, Mass. From his background in micro-packaging, he realized that people in the circuit-board business dislike handling the chemicals needed for etching and plating and the effluents they produce.

And so, after searching for that simpler way, he's come up with a method that does away with those chemicals entirely and relies instead on simply silk-screening the conductor pattern onto the circuit board. Moreover, the same silk-screening process is also used to put resistors on the board.

Besides its ecological tidiness, the new technique, which Ohmtec calls Econostrate, has a cost advantage, as well. Alex asserts it will yield circuit boards 10% to 30% less expensive than comparable boards fabricated by chemical methods. Tooling and set-up time are not reduced because separate masks are needed for each conductor layer and for each type of resistor. However, because the process requires no lamination or etching, the number of steps involved is reduced. With patterns deposited in one step some 1,000 to 1,500 4-by-5-inch units can be turned out in an hour. Board size is limited only by the size of the custom-designed silk-screen printing

system, and the company soon hopes to modify the system and offer larger boards.

**Double layer.** Not only is Ohmtec able to deposit single-layer conductor patterns, but double-layer patterns can be screened on only one side of the board, as well. A proprietary insulating layer separates the two conductive layers, while connection pads are left exposed. This eliminates plated-through holes, a source of unreliability in pc boards that have one layer on each side of the board.

The idea for silk-screening the conductor patterns seems simple,

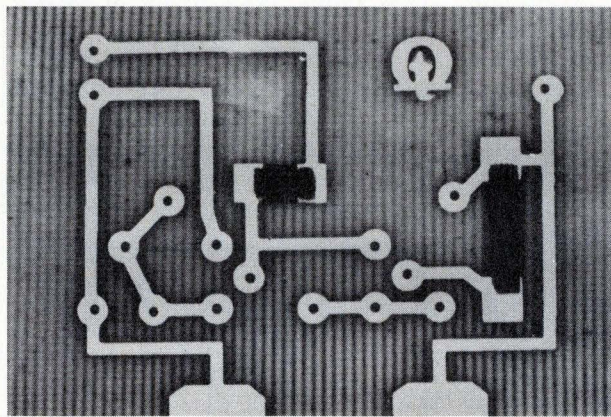

**Imprinted.** Printed-circuit board measures 4 by 5 inches, limited by the silk-screening process. Light lines on the board are conductors, the two dark patches are printed-on resistors.

but Ohmtec spent two years developing proprietary conductive materials, based on silver resins with additives. The materials must adhere tightly to the boards, have sufficient conductivity, and be printable with line definitions as small as 10 mils. Conductors also must have a high dielectric strength, offer constant surface roughness, be free of cracks, and be solderable.

In addition to being solderable, the conductors can also be handled the same way as a ceramic substrate for wire and chip bonding, Alex says. The Econostrate process is best suited for glass-epoxy boards, he continues, but it can be used with such other materials as polyester, glass, and phenolic. And Ohmtec is investigating using the process on flexible circuits, since it appears that the conductor material will not crack under stress.

**Resistors.** Ohmtec deposits resistors simply by changing masks and materials in the silk-screen system. Again, the material is proprietary—a

carbon resin with additives. Resistors can have tolerances of 5%, 10%, or 20% and power ratings as high as 0.25 watt. Temperature coefficient is a few hundred parts per million per degree C, varying with resistor value. This is quite acceptable for inexpensive consumer products produced in high volume, such as automotive electronics and watches,

Alex points out. In the future, he hopes to make available resistors with tighter tolerances and lower temperature coefficients.

While Ohmtec has not yet licensed the system, it is investigating the possibility, says Alex. However, the custom-designed deposition system can use customer-supplied masks, as well as masks designed by Ohmtec engineers. Customer de-

signs, however, may have to be modified to eliminate plated-through holes or to change spacing in the pattern. □

Radar

Accurate 3-d system has one antenna

Three-dimensional radar, which pinpoints a target's height, as well as its range and bearing, has received considerable attention through the years. The latest design comes from the UK's Plessey Radar division, which, by applying new transmitting and frequency-processing techniques, has developed a simplified antenna to provide an accurate, long-range 3-d radar. Called the AR-3D, the system is intended for military air defense and civil-air-traffic-control systems.

Normally air-surveillance radar systems derive their data through two antennas—one for range and bearing, and the other for altitude. These systems are usually limited by the slower-scanning altitude antenna. A recent trend is to get a

single 3-d antenna by using "stacked-beam" techniques. These, in effect, create one large antenna from many small ones, but the system needs complex and sophisticated processing equipment to integrate all the data.

Instead, the Plessey radar radiates a pencil beam, formed by an antenna with a feeder having a squint angle in the vertical plane that is a function of the carrier frequency. The beam may be electronically scanned over a chosen vertical angle by changing the transmitter's carrier frequency. Intercepted targets will return signals at frequencies that are a function of the target's elevation. And the height, in turn, can easily be derived from the elevation information contained in the measurement of the frequency. Moreover, the radar inherently scans for elevation with each rotation, considerably speeding up analysis of this data.

**Range.** Plessey claims the AR-3D radar will with 90% probability detect bombers 300 nautical miles away and fighters out to 180 nautical miles, both flying at 60,000 feet.

The company also boasts of militarily important performance

against ground and rain clutter, chaff, and noise jamming, principally because the high-resolution pencil beams carry a range cell of only 15 meters.

The price of the cheapest mobile version will be about \$2.5 million after Plessey gets into production in 1976, says marketing director Allan Carnell.

Thomson-CSF in France and ITT-Gilfillan, Hughes, and Westinghouse in the U.S. are marketing competitive systems. The British Ministry of Defense has put up part of the estimated \$5 million to \$10 million cost of development and may contribute further toward production.

**Selective.** The system is frequency-selective within S band, operating in a 200-Mhz bandwidth. There are independent frequency selectors, for each of the 13 elevation channels, each having a bandwidth of about 20 megahertz. The receiver has a compression ratio of 130 to 1.

But Plessey couldn't build the system until it had developed the equipment to analyze the frequency spectrum. Its Allen Clark Research Centre in Addlestone, Surrey, came through with an acoustic surface-

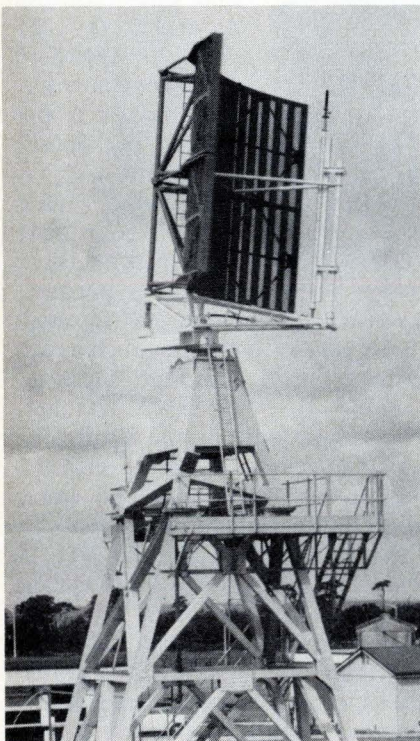

**Triple threat.** Only a single reflector curved in the horizontal axis is needed by Plessey's 3-d radar. Pencil beam, below, is scanned in vertical plane by varying transmitter frequency. Target altitude is derived from frequency of return signal.

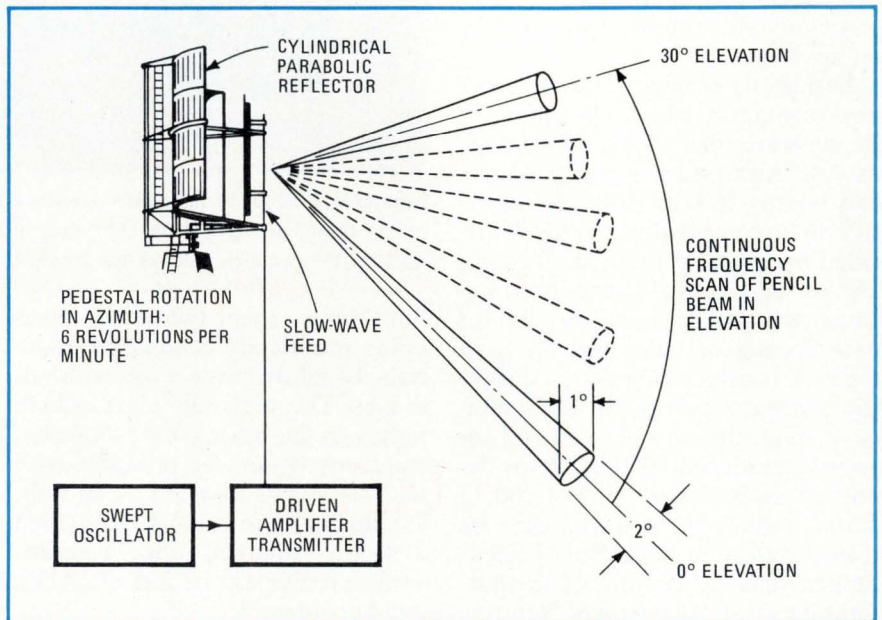

wave filter to do the job.

To obtain elevation measurements, the received signals are separated by filters into a number of channels equalling elevation sectors of about 2° each. Measurements finer than 1/16 of each of the sectors are obtained by measuring simultaneously the frequency of the compressed target responses in each channel.

The range resolution is determined by the target-echo bandwidth, and, since the target return is a swept-frequency signal, the company applies pulse compression to get high resolution. The acoustic-wave-surface equalizers compress the received signals to pulses of 0.1 microsecond, giving the radar a range cell size of 15 meters.

The antenna design has been simplified by a corrugated waveguide structure that produces a slow waveguide feed. Plessey describes the antenna as a linear array and parabolic cylinder having bandwidths of 1° in azimuth and 2° in elevation, a 30° scanning angle, and 41.3 decibels of gain. It rotates at six revolutions per minute.

The transmitter has peak pulse power of 1.11 megawatts, mean power of 10 kilowatts, and pulse length of 36 microseconds. J.K. Coldwell, AR-3D technical manager explains that each target is "hit" eight times and the system averages the results to derive accurate heights. The minicomputer-driven radar system, which will automatically track a maximum of 80 targets simultaneously, will see about 100 targets per scan and handle about 1,000 in all. □

## Communications

### Police to get portable digital terminals

Car thieves are being arrested in greater numbers, and stolen cars are being tracked down faster—thanks to digital communications links in police patrol cars. So successful have the in-car systems been that

## Corrigan named Fairchild president as Hogan becomes vice chairman



Corrigan

Now that Fairchild Camera & Instrument Corp. has reversed the flow of red ink that until recently plagued it, the man brought in to mastermind that turnaround—C. Lester Hogan—has stepped aside. He has turned over the offices of president and chief operating officer to his 36-year-old protege, Wilfred J. Corrigan.

Hogan becomes vice chairman, where his main duties will be to "represent Fairchild in major business and governmental forums." The move comes as a surprise only to those who haven't watched recent corporate changes at the Mountain View, Calif.-based company.

**Jumpers.** Corrigan is one of the original seven managers who in August 1968 jumped from Motorola Semiconductor with Hogan when Hogan left as general manager of the Semiconductor division to become head of Fairchild. Starting as group director of discrete devices in 1968, Corrigan became manager of the Semiconductor Components operation in 1971. Last September he was elected an executive vice president and member of the board of directors, with added responsibility for the three divisions comprising the company's Commercial Systems group: Systems Technology,

Industrial Products and Inland Manufacturing.

Over the last nine months, the 54-year-old Hogan relinquished more and more of his control over the day-to-day marketing and production activities to Corrigan, spending most of his time acting as a spokesman for WEMA, the electronics industries trade association, and for the semiconductor industry. "This is something that Walter (Burke, chairman of the board) and I have been discussing for about two years," he said. "We made up our minds that at the 'right time,' I would step aside and Wilf would take over."

The decision that the right time was now was based on two things, he says. One was the apparent turnaround of the company during the first quarter of this year when it chalked up record profits. The second was Hogan's growing involvement in Government affairs.

When Hogan arrived at Fairchild the company was a technological leader, but in chaos. With a customer base of about 600 companies, Fairchild had an unhealthy dependence on digital circuits and the computer industry, component yields barely 20% of those of some of its major competitors, and a reputation for late delivery.

Hogan temporarily de-emphasized state-of-the-art product development in favor of "second sourcing," sunk \$56 million through 1970 into modernizing "antiquated" manufacturing facilities, centralized scheduling and production, and reorganized the marketing group.

**Payoff.** Hogan's own strategy ultimately paid off. In the first quarter of this year, Fairchild's customer base was about 5,000. Its product lines now include linear, memory, and discrete as well as digital devices, and its diversified customer mix depends on no single industry or company. Moreover, Fairchild earned \$10.6 million on \$103.8 million in sales. Corrigan, says, "I think the company has reached the point where it can emphasize both high technology and high volume."

tests will soon begin on hand-held, battery-powered terminals to be carried by patrolmen not travelling in cars.

The program, funded by the Law Enforcement Assistance Administration, would give the patrolmen the same freedom with digital communications that their portable voice transceivers now give them with voice communications. The terminals would give them direct access to information stored in local law-enforcement data banks.

Three such data banks are used, for example, with the in-car digital system established in Oakland, Calif. One bank contains a state-wide list of stolen cars, another, a nine-county most-wanted-persons list, and a third, a local stolen-property list.

In addition, it would be possible for a patrolman to obtain information, once his queries are relayed through a control center at his headquarters, from such national data banks as the FBI's National Crime Information Center in Washington.

**Hand-held.** Telephone-type keyboard and LEDs characterize portable digital police terminal from Electromagnetic Sciences.



**Run-off.** Officials at LEAA say two contracts, each with an estimated value of \$120,000 and covering five transceivers and a headquarters control unit, will be awarded during July to Burroughs Corp., Paoli, Pa., and Electromagnetic Services Inc., Atlanta. The two systems, which are similar, will be evaluated next year by the District of Columbia police department and LEAA. About the size of a "large calculator," the terminals will contain a keyboard and some sort of alphanumeric display such as light-emitting diodes. After six months of evaluation, bids may be requested for a larger-scale evaluation, say LEAA officials.

These officials predict that the units will sell for about \$500 or \$600 each when mass-produced. Digital communications terminals in police vehicles cost five to six times more, and the potential market is "practically every police force in the country."

**Success.** The impetus for the development of the portable terminals comes from the success of the in-car terminals. More than 15 metropolitan police forces throughout the country already have tested or ordered in-car digital communications systems. They include New York, Los Angeles, Kansas City, Mo., West Palm Beach, Fla., San Francisco, Atlantic City, N.J. and Cleveland, Ohio [*Electronics*, Dec. 6, 1971, p. 39].

One of the oldest and best-developed systems, which is in Oakland, has been operating since late 1971. Oakland police lieutenant John J. Vomacka praises its helpfulness in combatting car thefts and says that the officers who have worked with the digital systems installed in 31 police vehicles were "unanimously enthusiastic" about them. One hundred vehicles in the Oakland fleet will be equipped by December 1975 with the units, which have cathode-ray tubes for displaying alphanumeric information.

Oakland will also be installing a digital dispatching system. A control operator will punch into a computer terminal the location of a trouble spot. And the nearest police vehicle, selected by the central computer,

automatically will receive the summons information on the vehicle's CRT, according to Vomacka. As part of the system, digital equipment in the vehicle will transmit its location to the central station. □

### Solid state

## Fairchild to push Isoplanar MOS

If you had mentioned Fairchild Semiconductor's capability in MOS technology around Silicon Valley a few months ago, you'd probably have heard chortles, at best, from the division's competitors. Many of them didn't take Fairchild very seriously in MOS, but that could be about to change. Fairchild is planning a "blitz" of MOS parts, including a microprocessor that will use the division's proprietary Isoplanar processing technology.

Introduced in 1971, the Isoplanar technique uses oxide isolation to reduce circuit size, boost speed, and lower costs by allowing higher circuit-packing density and higher yields. First applied to bipolar devices, it got Fairchild into high-density bipolar-memory devices [*Electronics*, March 1, 1971, p. 52]. Now, the process has been found to benefit MOS designers as well. By eliminating an oxide step and reducing sidewall capacitance, it produces faster devices.

"By the first quarter of next year, we will have very strong lines of shift registers, random-access memories, and one-chip calculators, as well as the microprocessor," says Philip Thomas, general manager of Fairchild's MOS Products division, Mountain View, Calif.

In addition to the microprocessor (see "Micro CPU to star"), the new products include:

- A line of high-speed static shift registers, as well as the first of Fairchild's first-in, first-out memories.
- "Much improved" high-speed versions of the 1,024-bit 1103, 2101, and 2102 random-access memories.
- A high-speed version of the 4-

# 1000 cm/ $\mu$ sec stored writing speed, four storage modes, and more.

## 100 MHz oscilloscope

Tektronix 7633 oscilloscope gives you 100 MHz bandwidth and 1000 cm/ $\mu$ sec stored writing speed. So you can retain and view fast rise, low repetition rate, single shot or slow moving waveforms. All with one instrument. This allows you to solve problems in computer sciences, aerospace, ballistics, communications and various other applications.

## Multi-mode storage

The 7633 offers four operating modes: Non-store, normal and fast Variable Persistence and Bistable modes are available at the touch of a button. And, an 8 x 10 div. (.45 cm/div.) mode gives the instrument's top writing speed.

## Bright, burn-resistant CRT

No special operating safeguards are necessary with the 7633's rugged, burn resistant CRT. This makes it a dependable unit for design bench, hospital laboratory, service facility or classroom. The large 8 x 10 div. CRT is easy to read in both cabinet and rackmount configurations. An alphanumeric readout, exclusive on Tektronix instruments, makes quick on-screen reference and easy interpretation of photographic records. Or, the instrument may be ordered without the readout for \$400 less.

## Part of the 7000 Series

Select from thirty different 7000 Series plug-ins. You can custom tailor your instrument to meet your immediate need. And expand its capabilities later as the need arises. A 7633 mainframe costs \$3650. A typical configuration with dual trace vertical amplifier and delaying sweep timebase sells for \$5,550. For rackmount add \$100.

## Specifications

Vertical System—Accepts all 7000 Series vertical amplifiers. Bandwidth determined by mainframe plug-in unit up to 100 MHz. Left, Alternate, Add, Chop, Right display

modes. Chopped rate approximately 1 MHz. Horizontal System—Compatible with all 7000 Series plug-ins. Fastest calibrated sweep rate is 5 ns/div. Phase shift between vertical and horizontal is 2°, DC to 35 kHz for X-Y operation. CRT and Display—Internal 8 x 10 div. (.9 cm/div) graticule with superimposed 8 x 10 div. (.45 cm/div) reduced scan area. Nonstore, variable persistence, and bistable in normal or fast and full or reduced scan storage modes push-button selected. Writing Speed and View Times—From .03 div/ $\mu$ sec until erased up to 2222 div/ $\mu$ sec at 30 sec view time. View time may be increased more than 30 times by using reduced intensity in the SAVE display mode.

## See for yourself

For a "hands-on" demonstration, contact your nearby Tektronix Field Engineer. Or write: Tektronix, Inc., P. O. Box 500, Beaverton, Oregon 97005. In Europe write: Tektronix Ltd., P. O. Box 36, St. Peter Port, Guernsey, C. I., U. K.



**TEKTRONIX®**  
committed to  
technical excellence

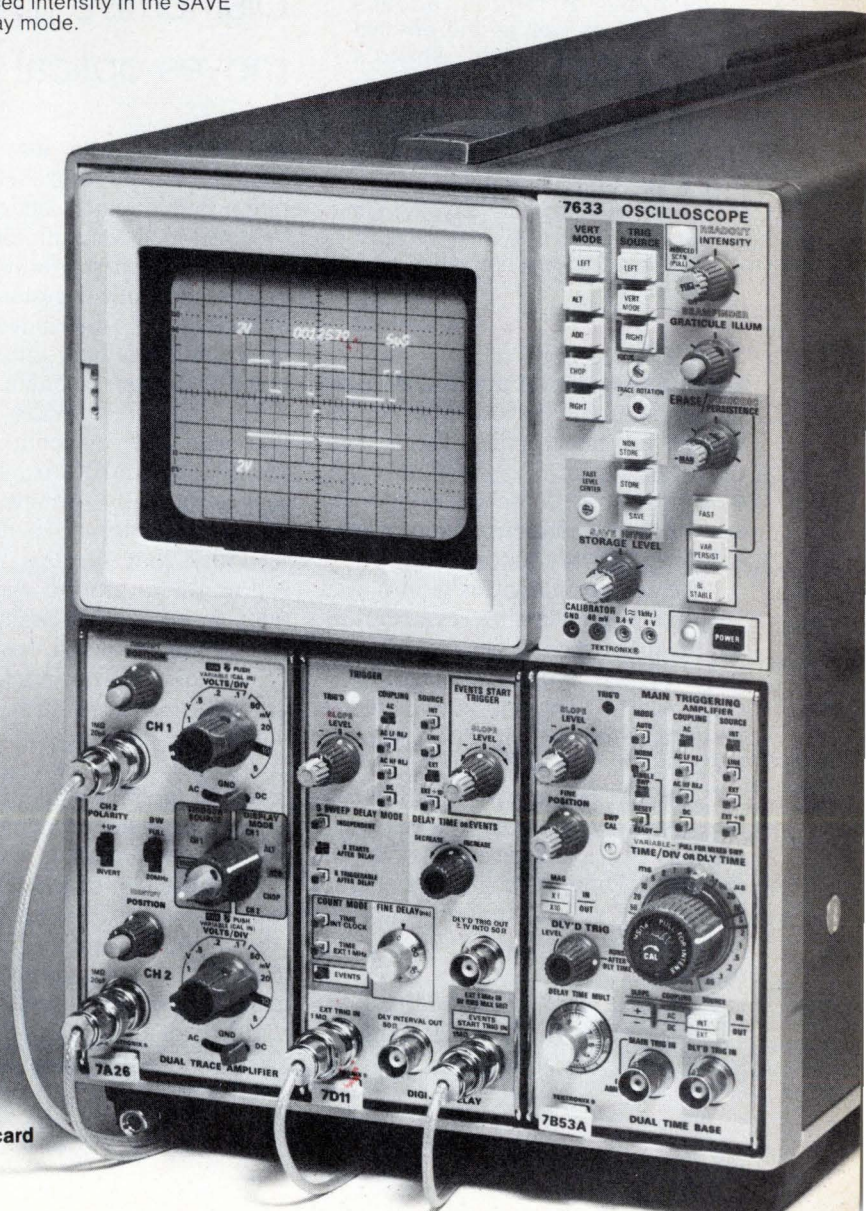

Circle 36 on reader service card

For a demonstration circle 37 on reader service card

## Micro CPU to star

An 8-bit, n-channel micro-processor, the F-8, will be the star attraction in Fairchild's forthcoming introduction of Isoplanar products. Sampling of the I/O-oriented device will begin by December.

Cycle time of the F-8 will be about 2 microseconds, the same as that of the Intel 8080. But Fairchild engineers say it will be faster in certain applications.

An important aim of the device design is to eliminate the need that other microprocessors have for substantial numbers of external parts. Both the central-processing unit and a read-only memory chip, which Fairchild also is developing, will have on-board I/O ports and clock generators. And the CPU will include 64 bytes of random access memory, as well as the on-chip interface circuitry. There's enough there so that an F-8 can function in a minimum system with a ROM chip alone, according to Fairchild's Philip Thomas of the MOS Products division.

Overall, Thomas says, "We can save the customer at least 10% in parts cost alone in a typical system".

kilobit RAM that Fairchild is now second-sourcing for Mostek, which will be 100 nanoseconds faster than the original part.

■ A family of one-chip, eight- 10- and 12-digit calculators, and a one-chip printing calculator.

"We are sampling this month and will be into volume production within three months with three versions of the n-channel 1,024-by-1 static RAM," Thomas says. They'll be designated the 2102, 2102-1, and 2102-F.

"The first two at 650- and 350-nanoseconds cycle times, respectively, match the standards for these speeds," Thomas continues. "But the 2102-F at 350 nanoseconds is faster, we think, than anything on the shelves".

Fairchild is already sampling 1,024-bit 1103s rated at 220 nanoseconds and has completed testing

parts rated at 150 nanoseconds, according to Thomas. "And I suspect," he adds, "that we can make it significantly faster."

Of the Mostek 4-kilobit RAM, the 4096, Thomas says, "we will have one part meeting the Mostek specs at 350 nanoseconds. But another part will be at least 100 nanoseconds faster. It will be designated the 4096-3, which implies we expect to have -1 and -2 versions."

Sampling of these Isoplanar RAMs will begin late in the fourth quarter.

Originally introduced in a product in 1971, the Isoplanar process made quite an impact for Fairchild. While most of its competitors were still struggling to get their first high-

density bipolar processes on stream, Fairchild even extended the Isoplanar concept to a family of emitter-coupled-logic devices. The process brought about much tighter circuit designs than before, which allowed operation at subnanosecond speeds and reduced powers per gate [*Electronics*, Feb. 15, 1973, p. 41].

These ECL devices were followed by an Isoplanar complementary-MOS family that is directly interchangeable with RCA 4000 devices, but operate at higher performance levels [*Electronics*, Dec. 20, 1973, p. 25]. The company's first MOS Isoplanar memory product—the 3355, a 4-megahertz static shift register—was introduced in September 1973. □

## Lasers

### Distributive gallium-arsenide laser moves optical ICs a step closer

In the same way that current is channeled and controlled in silicon integrated circuits, optical ICs can be developed to manipulate light. A recent major step toward such integration of optical systems was the operation of distributed-feedback injection lasers built into monolithic chips of gallium arsenide.

Experimental devices have been demonstrated by both the Aerospace Corp. and Xerox. The new lasers—electrically pumped gallium-arsenide devices—depend on the feedback that sustains their lasing action on a grating deposited on their upper surfaces. Conventional semiconductor lasers depend on optical feedback from mirrors cleaved into their opposite ends, something that can be done only in discrete devices. The new lasers, however, could be integrated in a substrate of gallium arsenide that contains other optical components as well.

Integrated optics are being pursued vigorously in many research laboratories because of the promise they offer for communications systems. Data rates and bandwidth could be much higher—theoretically 10,000-fold—because of the higher

frequencies. The military is especially interested in optical data exchange because it appears impossible to intercept, and is resistant to electromagnetic interference.

The use of distributed-feedback lasers as oscillators and amplifiers with other light-frequency equivalents of such elements as modulators and waveguides should make possible integrated optical circuits for compact, low-loss optical-processing systems. The components have been available individually. But they are generally too bulky, and interface losses are too high as signals pass from one element to the next.

**Ripple.** The lasers developed by Xerox Corp., Palo Alto, Calif., and by Aerospace Corp., El Segundo, Calif., are similar in many respects, and both are developments of earlier concepts. The key to their operation is the use of a periodic perturbation in the surface of a gallium-arsenide chip to which a pulsed high-density current is applied.

Because of refraction, the surface acts like thousands of small mirrors, providing the feedback necessary for lasing. This structure, first described two years ago by Herwig



# DIVA high-performance magnetic tape system for your mini.

## At dropdead low prices.

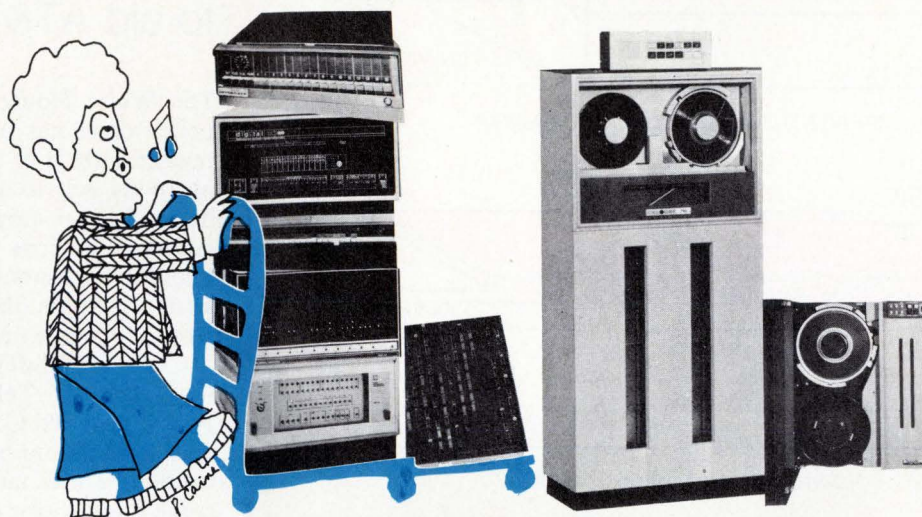

The big-computer-only mag tape drive system is now available to your mini computer. High performance and quality for the lowest cost/byte in the industry. The mag tape system we're talking about has all the features mini needs, plus the strength and endurance that spell repeatable accuracy over a long life of hard day-and night use.

With a DIVA mag tape system you can use your mini's software and any 1/2-inch industry standard tape reels of 10.5", 8.5" or minireels, as well as IBM wrap-around cartridges. You can read and write at speeds of 125 or 200 ips, 9-track 800 bpi NRZI or 1600



bpi phase-encoded. You can hang eight drives on one DIVA controller!

The drives rewind tape at 500 ips around air-bearing turn points through photo-electrically monitored vacuum columns. Tape can automatically be loaded in a few seconds under the gentle and positive action of a single capstan (non-pinch) drive.

**All this for the lowest cost/byte in the industry.**

If you need a mag tape drive system and want the best the least money can buy, then you want DIVA's system. All shipments are made in 30-45 days. For complete details call any DIVA office.

### SPECIFICATIONS

	DMT-1000	DMT-1001
Tape drive	Single capstan	Single capstan
Tape speed	200 ips	125 ips
Recording density	800 bpi NRZI or 1600 bpi phase encoded	800 bpi NRZI or 1600 bpi phase encoded
Recording format	9 track — 0.6" nom IRG	9 track — 0.6" nom IRG
Tape loading	Fully automatic: 7 secs approx	Fully automatic: 7 secs approx.
Rewind		
Speed	500 ips	500 ips
Time	45-70 secs	45-70 secs
Start/stop time	IBM compatible (2 msec nom)	IBM compatible (2 msec nom)
Speed variation	±3%	±2%
Transfer rate	320KB max	200KB max
Tape characteristics		
Type	1/2 inch	1/2 inch
Reel	Std reels of 10.5", 8.5" or minireel; or IBM cartridge	Std reels of 10.5", 8.5" or minireel; or IBM cartridge
Environment		
Temperature	50° to 110°F (op)/ -30°F to 150°F (non-op)	50° to 110°F (op) -30° + 150°F (non-op)
Relative humidity	20% to 80% (op)/5% to 80% (non-op)	20% to 80% (op)/5% to 95% (non-op)
Power	208/230 VAC, 3 phase, 60 Hz	115/208/230 VAC, single phase, 50/60 Hz
Dimensions	67"H x 30"W x 29.5"D (stand alone drive)	24 1/2"H x 19"W x 19"D (rack mtd drive)
Weight	900 lbs approx	230 lbs approx
Controls	Load/rewind ■ Rewind/unload ■ Start ■ Reset ■ Power on/off	Load/rewind ■ Rewind/unload ■ Start ■ Reset ■ Power on/off
Indicators	Select ■ Ready ■ Load Check ■ File Protect ■ BOT ■ EOT	Select ■ Ready ■ Load Check ■ File Protect ■ BOT ■ EOT



Mini maximizer systems

**DIVA, Inc.** 607 Industrial Way West / Eatontown, N. J. 07724 / Phone: 201-544-9000 / TWX 710-722-6645  
 REGIONAL SALES OFFICES: California: 213-889-4180 / Massachusetts: 617-275-1436 / Washington D.C.: 703-370-5211

## OTP favors ways to aid AT&T rivals

The White House communications policy chief has urged Congress to rewrite Title II of the 1934 Communications Act to separate and perhaps free competitive communications services from the rigid Federal Communications Commission regulation that applies to the AT&T telephone network monopoly.

Clay T. Whitehead, director of the Office of Telecommunications Policy, also told Congress that "antitrust laws should be enforced so that regulatory mechanisms cannot become a haven for escape from competition." Whitehead testified during hearings on the communications industry before a Senate subcommittee on antitrust and monopoly, chaired by Sen. Philip A. Hart. The Michigan Democrat is holding hearings on his bill, the Industrial Reorganization Act (S. 1167), to break up large corporate concentrations of industrial power in the U.S. Congressional observers give the bill little chance of enactment.

**Support.** Nevertheless, Whitehead used the Senate hearing as a platform from which to support limitation of AT&T's "natural monopoly" to the public telephone network, while opening it to free interconnection of customer-provided equipment. Whitehead, who later told the chairman that "the general thrust of my statement does reflect Administration policy," called for change in the 1934 Communications Act, under which FCC operates, to recognize the existence of new technologies and to make it more equitable for a potential competitor to enter the market with them. The way the FCC operates, Whitehead observed, "the would-be provider of a new communications service, rather than the monopolist, is now required to justify his existence, and the monopolist, rather than the would-be customer, receives the protection of the regulatory machin-

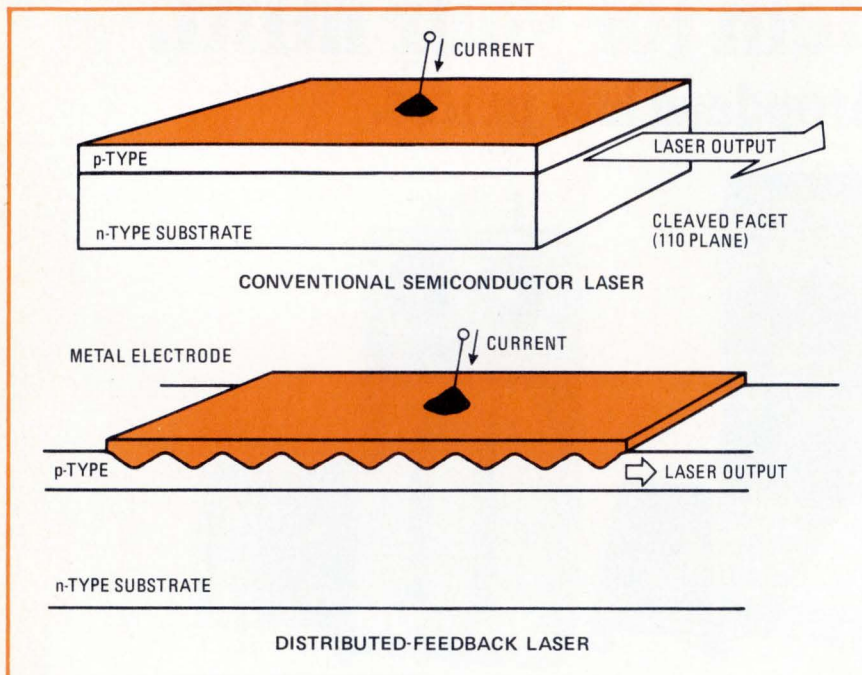

**IC laser.** Feedback for integrated laser comes from grating on surface. Without cleaved ends, laser could be built into chip with other devices to form optical IC.

Kogelnik and C. V. Shank of Bell Laboratories, had been demonstrated with optical pumping, a technique incompatible with miniature integrated optical systems.

The Aerospace laser, developed by Harold M. Stoll and David H. Seib, members of the technical staff of the Electronics Research Laboratory, is a homojunction device. Although it now operates best at 77 K, it may ultimately be refined to operate at room temperature. The laser is fabricated on a chip 15 mils by 65 mils by diffusing p-type material (zinc) into heavily doped n-type gallium arsenide, forming a thin (1.5- to 1.7-micrometer) junction (see illustration.) The distributed feedback was introduced with a shallow ripple structure machined into the surface with argon ions.

The ripple was made by first spin-coating the surface with photo-resist, then exposing it to a grating pattern (with a 3,500-angstrom periodicity) formed by the standing waves between two interfering laser beams. The pattern was then machined into the material with a beam of argon ions. A single machining went to a depth of only 500 Å, insufficient for lasing. This was followed by shadowing the

GaAs grating with aluminum at a glancing angle, then ion-machining. This was repeated three times to final depth of about 1,200 Å.

The grating was then covered by a 3,000-Å layer of evaporated silver-manganese, and an additional 800-Å gold film. This metalization was chosen because of its minimal penetration into the surface of the GaAs. The ohmic contact, which is about 35 mils by 6 mils, is perpendicular to the grating ridges. The unmetallized region suppresses Fabry-Perot oscillations, the feedback mechanism for conventional lasing.

The Aerospace lasers have line spectra at 8,420 Å and 8,459 Å. Definitive measurements haven't been made yet, but spectral width appears to be less than that of injection devices. By changing the grating periodicity, the output wavelength can be varied over approximately a 100-Å range. Power has not been measured, either, but it appears comparable to output of diode lasers.

Xerox's laser is similar in structure, except for an additional gallium-aluminum-arsenide layer 30 μm thick, deposited on top of the grating, which gives a smooth finish that is easy to metalize. □

# The MACRODATA MD-107 Memory System Analyzer!

Imagine a tester that can handle plated-wire, core, or semiconductor memories . . . that can test complete computer memory systems, memory boards, or memory chips . . . that can operate at 10 MHz and compare up to 160 data bits at any of 16,000,000 addresses.

**The Macrodata MD-107 Memory System Analyzer does it all.**

- Macrodata's Cascaded Computer Control Testing Concept
- Minicomputer, Microprogrammable Processor, and CRT Display
- Key-

- board Entry of Test Programs
- Split Cycle Timing Capability
- Sophisticated Address Manipulation Capability
- Simple Software Language with Display of Directive Action for Operator Based on Test Results
- Extensive Sync Capability
- CRT Display of Device Inputs/Outputs for Test Monitoring
- CRT Message Display for Easy Program Debug
- Complete system under \$50,000.

For the full story, send for the MD-107 brochure, or call us directly.



**SYSTEM BLOCK DIAGRAM**

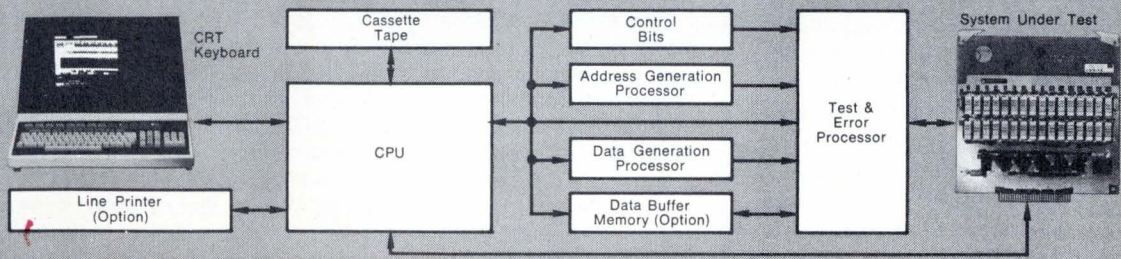

## Macrodata



**Macrodata Corporation, 6203 Variel Avenue, Woodland Hills, California 91364, Phone: (213) 887-5550, Telex: 65-1345**  
**Sales Offices:** Northern California Area Tel. (408) 735-9560 • Southwestern Area Tel. (213) 644-3611 • Scottsdale Tel. (602) 947-7841 • Minneapolis Area Tel. (612) 636-1770 • Chicago Area Tel. (312) 455-5100 • Cleveland Area Tel. (216) 461-8333 • East Coast Tel. (516) 343-8600 **International:** West Germany Munich Tel. (0811) 34 56 00 Telex: (841) 521-5969 • Milan, Italy Tel. 871-988/899-248 Telex: (843) 34314 • Sweden and Norway — Stockholm Tel. (08)-380-370 • Switzerland and Austria — Bern Tel. (031) 22 44 81 Telex: (845) 33172 • Tel Aviv, Israel Tel. 25 55 69 • Tokyo, Japan Tel. (03) 985-5266 Telex: (781) 272-2171 • Buckinghamshire, England Tel. High Wycombe (0494) 36 3 81 Telex: (851)837236

Circle 41 on reader service card

ery" (see "Can the FCC cope with changing technology?" p. 106).

**Monopoly.** Future communications policy, the OTP chief said, should recognize four principles:

- The public-utility monopoly in conventional telephone service is still appropriate today.
- The monopoly concept should not be extended to other communications services.
- New competitors should be free to offer any service except conventional public telephone service.
- Any telephone customer should be allowed to buy and use any communications device over telephone lines.

Whitehead hit hard on the interconnection issue, striking indirectly at FCC's pending Docket 20003, which will consider the economic impact of interconnection. He also issued a warning that the Government may look into AT&T's increasing political and legal activity to protect its position. "Business success should be won competitively in the marketplace by providing goods and services that customers want," he said. "It is unbecoming for a company the size and the stature of AT&T to use its legal, political and economic power to seek to extend its monopoly by Government fiat into areas where monopoly is not called for. In my judgment, the Government cannot let such an effort go unnoticed or unchecked."

The efforts by AT&T and other telephone companies were called by Whitehead "the recent aggressive campaign" to declare a moratorium on competition, which he said will injure "the development of new communications services by slowing the infusion of capital and raising the legal fees required to challenge the established carriers in the courts and at the FCC."

**Rebuttal.** With more witnesses to testify in its behalf at the end of July, AT&T's rebuttal at the session where Whitehead appeared was limited to consulting economist Robert R. Nathan and Robert E. La Blanc, respectively vice president and technology group manager of Salomon Brothers. Challenging Whitehead's assertion that rate-av-

## News briefs

### Commercial service starts on Westar

Western Union, pulling hard and successfully against governmental foot-dragging, began commercial service on the U.S.'s first domestic communications satellite on July 15. Using the original Morse telegraph key, Western Union chairman and president Russell McFall sent Morse's own first message "What hath God wrought?" from New York to Los Angeles via Westar.

Originally planned in January 1970 as part of the White House's "Open Skies" recommendations, the domestic satellite did not receive a go-ahead from the Federal Communications Commission until December 1972, almost three years later. However, anticipating the move, Western Union had contracted in August of that year with Hughes Aircraft Co. for the Westar which, finally, was launched last April 13.

### Modem firm builds display system

International Communications Corp., Miami, Fla., is venturing outside of the data-modem field for the first time with a new cathode-ray-tube data-display terminal that's a teletypewriter replacement with editing capabilities. Built around the Intel 8008 microprocessor, the 40+ terminal has all the control functions built into a read-only memory. The microprocessor also aids in editing and fault diagnosis, and it performs calculations on displayed data. The 40+ operates at 1,200 bits per second in an asynchronous mode or 2,400 b/s, synchronously.

### Fairchild's Polish deal rejected

Fairchild Camera & Instrument Corp.'s March 1973 petition for a license to supply Poland with integrated circuits and production know-how has been rejected by the Commerce Department's Office of Export Administration on the grounds that the ICs may be used in Polish military applications. However, Fairchild may yet appeal the decision to Commerce secretary Frederick Dent or to the National Security Council.

### Bunker Ramo wins \$10 million bank contract

Bunker Ramo Corp.'s Information Systems division, Trumbull, Conn., and the Bank of America have signed a \$10 million contract to equip the bank's domestic offices with a newly developed data-communications system built by Bunker Ramo. Called the Community Office On-Line System (Cools), the system will enable the bank's 5,500 counter and desktop CRT terminals around the country to access information in the bank's central computers.

### Electronic equipment sales rise 7.1%

U.S. electronic equipment sales rose 7.1% to \$31.6 billion in 1973 from \$29.5 billion in 1972, according to the Electronic Industries Association. Communications and industrial electronics recorded the biggest gain, up 12.9% to \$12.9 billion for a 41% share of the total U.S. market. Sales to the Federal Government rose 1.9% to \$10.8 billion, but the small increase was insufficient to prevent the Government share of the total market from registering its third consecutive annual decline, down 1.8% to 34.2%.

In addition, consumer electronics also posted a dollar increase for the year of 4.2% to \$6.6 billion, but the consumer share of the total market also dropped fractionally to 21.5% in the face of the large industrial market growth. Replacement component sales of \$920 million reflected a sharp 29.6% increase from the year before.

### FAA's bright-radar order totals \$2.5 million

The Federal Aviation Administration has ordered 111 extra-bright radars costing about \$2.5 million from ITT Aerospace/Optical division, Fort Wayne, Ind. The systems will be used at approximately 35 airports by traffic controllers in towers that are subject to extremely high and variable light levels. The FAA has already installed 213 of the units at other airports.

# Ask The Man Who Uses One

... About Cost Effectiveness

He works for these companies . . .

Fairchild  
Hamilton Standard  
ITT-Avionics  
ITT-Europe  
NCR  
Rank Xerox  
Raytheon  
RCA  
Siemens  
Sperry  
Sycor  
U.S. Air Force  
U.S. Navy  
Western Electric  
Xerox

He knows how to evaluate automatic test systems and their cost effectiveness on the basis of . . .

- Hardware costs
- Software-controlled switching of peripherals, eliminating adaptors
- Use of sophisticated resident software system
- Use of efficient test-oriented English language, such as ATLAS
- Use as a MANAGEMENT INFORMATION SYSTEM

He also understands test system cost savings that can result from data logging for trend analysis reports, quality control reports, and configuration control. And he knows he can test new products and save costs by meeting test specification changes through fast, economical field modifications.

Ask the man who has proven the cost effectiveness of the System 390. He has paid for the system through cost savings realized over 5-to-15 months of use.

Send us your test requirements, and we'll show you how the System 390 can solve them efficiently and economically. We'll also send you our User Catalog.

Contact:

Instrumentation Engineering, Inc.  
769 Susquehanna Avenue  
Franklin Lakes, N.J. 07417;  
telephone: 201-891-9300

Instrumentation  
Engineering



## The System 390

Ask The Man Who Uses One.

Los Angeles Office: 213-973-6611  
Washington, D.C. Office:  
703-451-1422

Europe Offices:

Siemens AG  
D 7500 Karlsruhe 21; 595-2591  
D 8000 Munich; 7200-7131

## Electronics review

eraging could be retained for the basic telephone network, while allowing competitive pricing for the 5% of Bell System revenues that are subject to competition, Nathan asserted, "You can't draw such a nice line." Putting communications on a cost basis completely will mean that "we are in for trouble." □

## Calculators

### Reaction is cool to TI patent

In the wake of the announcement by Texas Instruments that the company had been issued a patent covering a miniature electronic calculator, [*Electronics*, July 11, p. 43] it's still difficult to tell how well the semiconductor and calculator giant intends to protect its development—or if it can.

TI's announcement of the patent award included a terse statement that the company would make licenses available to the industry "in the near future." But there doesn't appear to be any stampede of competitors toward Dallas to get licenses; nor has TI been after them to

start any licensing negotiations.

Harvey Lowhurst, patent counsel for National Semiconductor Corp., says the TI patent doesn't apply to National. In its specific interpretation, he says, the TI patent would apply to a specific design. And because National's calculators are of a different design, they wouldn't be subject to the TI patent.

"If the patent is interpreted generally as applying to all calculators," he continues, "National is covered by a cross-licensing agreement the company signed with TI in the mid-1960s which encompasses all ICs. And in our view, the calculator chip is just another IC."

Officials at Bowmar/Ali Inc. haven't been contacted by TI about a license, and they believe their own patent, issued last December, protects their calculator business. A spokesman says, "Our patent covers a broad combination of an IC chip and hand-held calculator using a keyboard and LED readout." And Berry Cash, executive vice president of Mostek Corp., says he's "sure it will be challenged," referring to the TI patent. Mostek, which marketed the first single-chip calculator, now manufactures and sells personal calculators through Corvus Corp., a wholly owned subsidiary. □

## Commercial electronics

### Fingerprint file controls access

With about 100 bills in Congress aimed at safeguarding data in computer installations [see p. 78], the search is about to begin for a most vital part of any security system: a device that limits access to authorized persons only. Orders already have been placed for the first automatic fingerprint reader capable of controlling access to commercial facilities, including computers, according to Calspan Technology Products Inc., Albany, N.Y.

Calspan's Fingerscan unit is used by a person wanting to access a computer data bank or a controlled-



**Detective.** User keys in number, provides a fingerprint. Fingerscan does the rest.

# 1

AMERICAN MADE

## Tolerance

# SCHAUER

## 1-Watt

# ZENERS

## Immediate Shipment

## Low Prices

ANY voltage from 2.0 to 16.0

### Quantity Price each

1-99	\$1.07
100-499	.97
500-999	.91
1000-4999	.86
5000 up	.82



Write for complete rating data and other tolerance prices.

## Buy the kit—

## Save a lot



Kit contains a 51-piece assortment of SCHAUER 1% tolerance 1-watt zeners covering the voltage range of 2.7 to 16.0. Three diodes of each voltage packaged in reusable poly bags. Stored in a handy file box. Contact your distributor or order direct.

A \$54.57 value for

ONLY **\$24<sup>50</sup>**

Semiconductor Division

# SCHAUER

Manufacturing Corp.

4514 Alpine Ave. Cincinnati, Ohio 45242

Telephone: 513/791-3030

# Pick The General-Purpose Scope Chosen By Thousands of Specialists . . . HP's 180 System.

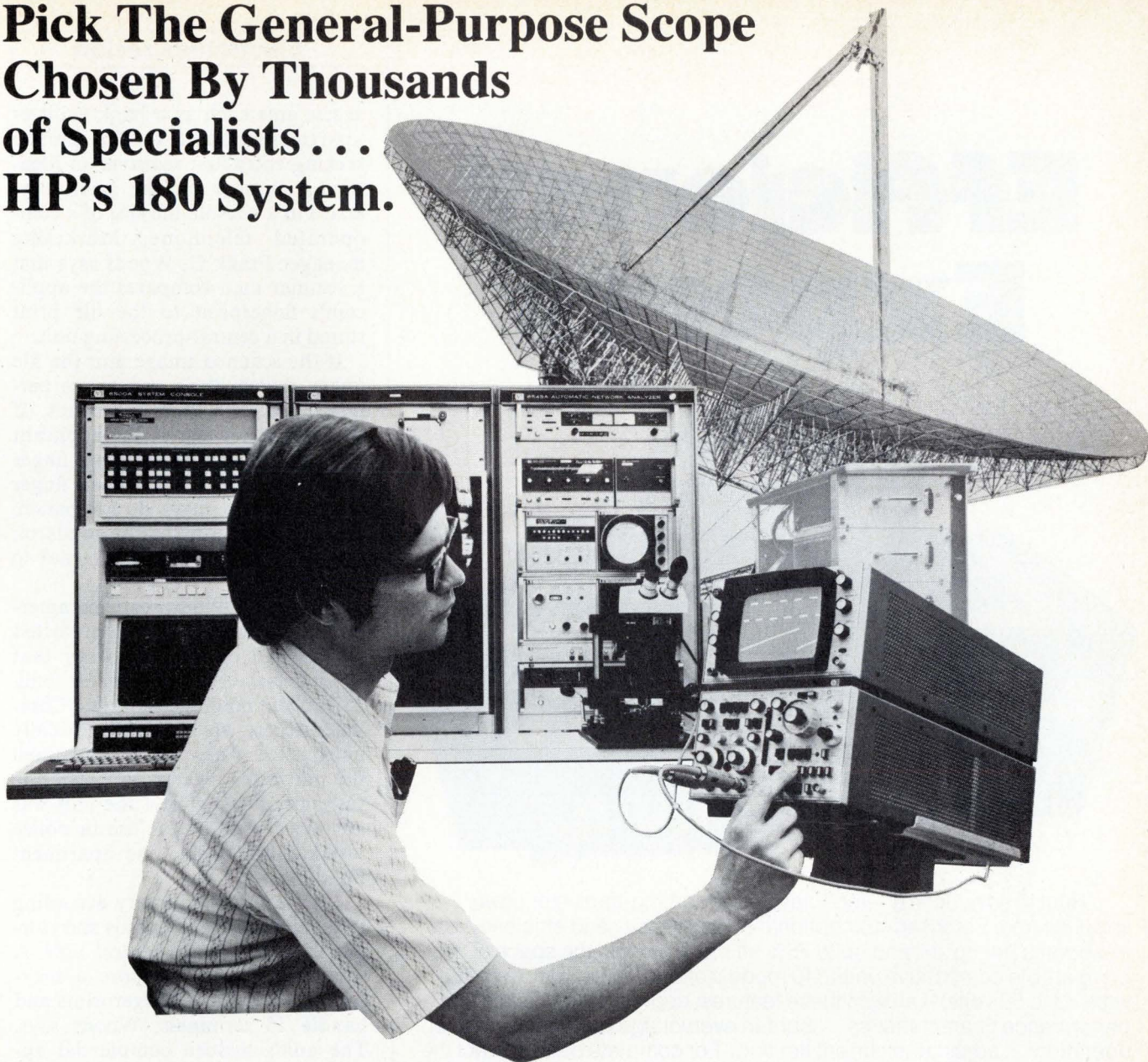

Specialists choose the 180 System for its flexibility, performance, and price. Its variety of mainframes and plug-ins lets them select the optimum system for their specific application. Consider these examples.

Specialists working in the very demanding low-frequency areas, such as biomedical and control circuits design, use the large-screen, dual-channel system. They do this because it offers maximum visibility of their waveforms, highly repeatable measurements, excellent dependability, and it costs less than \$2,000\*.

Digital designers working with RTL to ECL logic make their measurements on a 100 MHz, dual-channel system that gives them delayed sweep, DC offset and selectable trigger source... all for only \$3,100\*.

Specialists in communications and high-speed digital applications frequently use the dual-channel 250 MHz real-

time 180 systems with prices starting at \$3,900\*.

Plug-ins extend the system's capabilities to include Spectrum Analysis, TDR and Sampling to 18 GHz. Variable persistence mainframes are available too. With this breadth of measurement capability, there's a 180 System to meet your needs. For more information, contact your local HP field engineer. Or, write Hewlett-Packard, 1501 Page Mill Road, Palo Alto, California 94304.

\*Domestic USA prices only

084/4

**HEWLETT  PACKARD**

Sales and service from 172 offices in 65 countries.  
1501 Page Mill Road, Palo Alto, California 94306

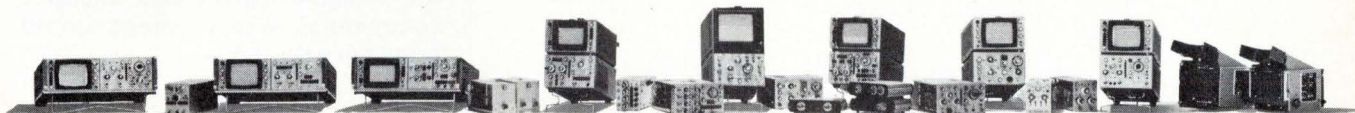

# Efficiency Experts

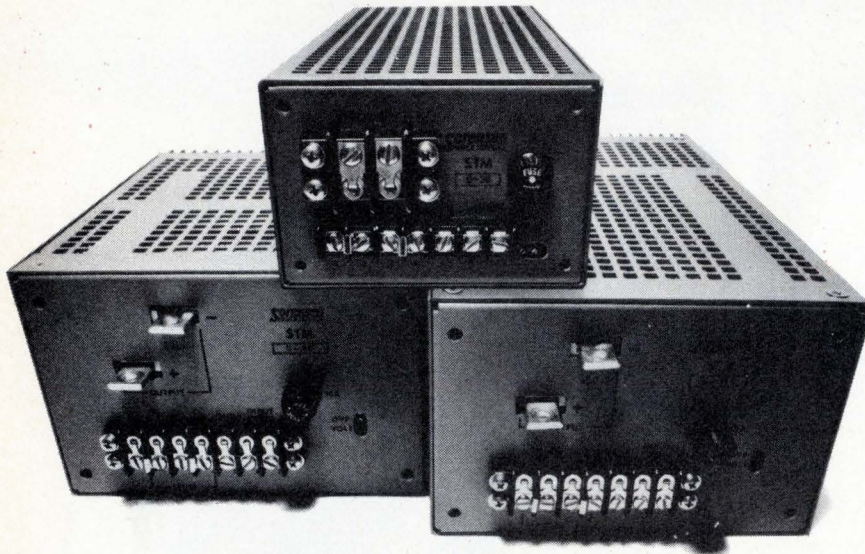

Built to save energy—modular STM switching-transistor power supplies from Sorensen. Exceptional power density and efficiency. Up to 1.5 watts per cu. in., and up to 75% efficiency in half the space of comparable competitive units. 40 models offer outputs from 72 to 780 watts (3 to 56 volts)—all with these features: cool running... excellent performance characteristics... built-in overvoltage protection... quiet operation... adjustable current limiting. For complete data, contact the Marketing Manager at Sorensen Company, a unit of Raytheon Company, Manchester, N.H. (603) 668-4500.

## Representative Specifications—STM

Regulation (comb. line & load)	0.05%		
Ripple (PARD)	rms: 3 to 10 mv. p-p: 30 mv. typ.; 50 mv. worst case		
Module Sizes & Prices	Module	Size	Price
	III	5.12" x 3.31" x 9.50"	\$240-270
	IIIA	5.12" x 3.31" x 14"	\$300-330
	IVA	7.5" x 4.94" x 10.5"	\$475-495
	VI	7.5" x 4.94" x 14"	\$600-650

**Sorensen**  
POWER SUPPLIES

access area such as a bank vault or apartment complex. The person seeking entry first registers an identifying number on the small key-board in a console the size of a coin-operated telephone. Marketing manager Frank G. Woods says that a scanner then compares the applicant's fingerprint to the file print stored in a central-processing unit.

If the scanned image and the file image match, the applicant is permitted access within 2 seconds. If the two do not match, the applicant is instructed to place another finger on the scanner. If the second finger image and file image do not match, then the processor sounds an alarm, denies access, or sends a signal to the police.

**Potential.** Widespread commercial applications are being predicted by Calspan officials, who say that computer-access accounts for only 25% of the potential market. "Computer-access was something totally unexpected when we first planned the unit a few years ago," says one Calspan official. Then, the unit was anxiously awaited for use in police installations, banks, and apartment buildings.

System prices will vary according to the number of terminals and storage capacity of the central unit. A standard system can store a maximum of 500 sets of fingerprints and handle 15 terminals, Woods says. The unit's maiden commercial appearance is at the International Identification Association's annual meeting July 29 through Aug. 1 in Washington, D.C.

Fingerscan's accuracy is rated at one incorrect access in 1,000 attempts, although Calspan officials said the system can be "tightened up" to reduce this to one error in a million or less.

Systems will sell for \$20,000 to \$30,000, or more, depending on the number of Fingerscan terminals. A computer-access consultant said the system "is much too expensive" for widespread use by data banks with hundreds of terminals, but one Government official familiar with the potential market said intensive commercial development could bring the price down. □



# NEW TOP-SPEED MOS RAM.

## N-CHANNEL, OF COURSE

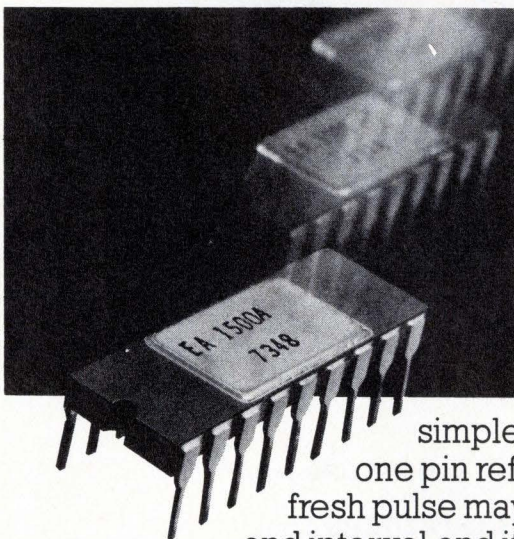

With a guaranteed maximum access of 60 ns, EA's new 1024-bit RAM is ready to take its place in the fastest MOS memory system you can build.

We designed the EA 1500A to make your system as simple as possible.

For example, the RAM is fully decoded, can be OR-wired to expand capacity and needs only two supplies, +15v and -15v. Power dissipation is only 0.22 mW/bit in action and 0.045 mW/bit on standby.

To achieve low power, we had to make the RAM dynamic – but we made the refresh technique as

simple as you can imagine. One pulse on one pin refreshes the entire memory. The refresh pulse may occur anytime within a 2-millisecond interval, and it will not interfere with read/write cycles. Your memory is never busy.

The EA 1500A in an 18-pin silicone DIP costs only \$13.00 in quantities of 500.

It's in stock right now at our nationwide distributors, Cramer Electronics, and at Electronic Arrays, Inc., 550 East Middlefield Road, Mountainview, Calif. 94043. Phone (415) 964-4321.



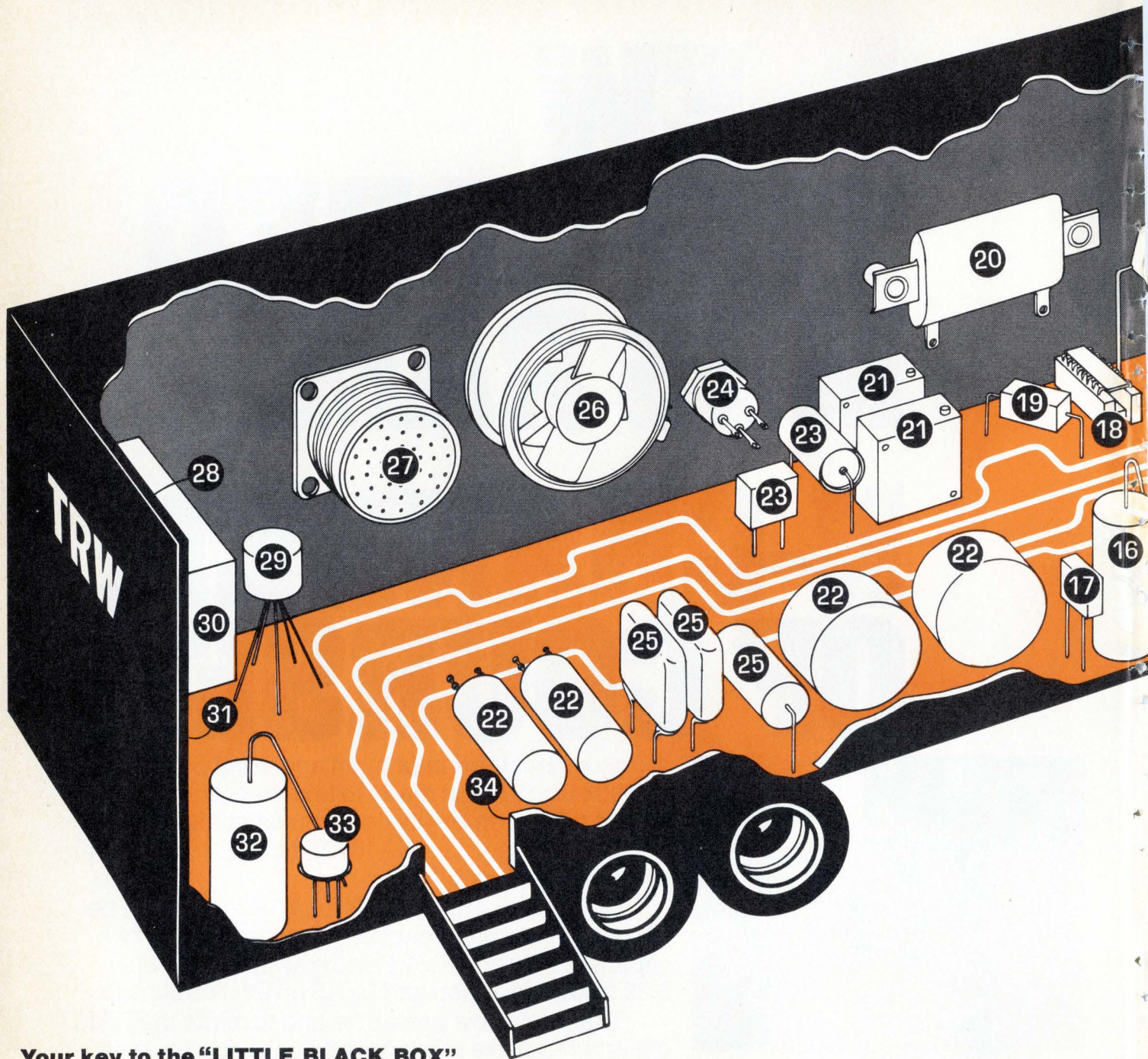

## Your key to the "LITTLE BLACK BOX"

- |  |   |  |
|--|---|--|
| 1. <b>CONNECTORS</b> , Printed Circuit           | 13. <b>CAPACITORS</b> , Solid Tantalum              | 24. <b>TRANSISTORS</b> , Power, Switching        |
| 2. <b>PRINTED CIRCUITS</b> , Multilayer          | 14. <b>SOCKETS</b> , Transistor                     | 25. <b>CAPACITORS</b> , Film                     |
| 3. <b>CONNECTOR SYSTEMS</b> , IC Logic           | 15. <b>TRANSISTORS</b> , RF Communications          | 26. <b>FANS</b> , Miniature Precision, AC or DC  |
| 4. <b>SOCKETS</b> , Tube                         | 16. <b>RESISTORS</b> , Wire Wound, Molded           | 27. <b>CONNECTORS</b> , Cylindrical              |
| 5. <b>BARRIER TERMINAL BLOCKS</b> , "Jones" Type | 17. <b>RESISTORS</b> , Thick Film (Metal Glaze)     | 28. <b>FASTENERS</b>                             |
| 6. <b>FILTERS</b> , RF Bandpass                  | 18. <b>SOCKETS</b> , Integrated Circuit             | 29. <b>TRANSFORMERS</b> , Pulse                  |
| 7. <b>CONNECTORS</b> , Rack and Panel            | 19. <b>RESISTORS</b> , Flame Proof                  | 30. <b>MOTORS</b> , Miniature                    |
| 8. <b>DIODES</b> , High Speed Power              | 20. <b>RESISTORS</b> , High Voltage, High Frequency | 31. <b>POWDERED METAL PRODUCTS</b>               |
| 9. <b>DARLINGTONS</b> , Monolithic               | 21. <b>TRIMMERS</b> , Wire Wound                    | 32. <b>RESISTORS</b> , General Purpose           |
| 10. <b>AMPLIFIERS</b> , Magnetic                 | 22. <b>POTENTIOMETERS</b> , Multi Turn              | 33. <b>TRANSISTORS</b> , Single Sideband, Linear |
| 11. <b>TRANSFORMERS</b> , IF and RF, TV          | 23. <b>CAPACITORS</b> , Metallized Film             | 34. <b>CABLE HARNESS &amp; ASSEMBLIES</b>        |

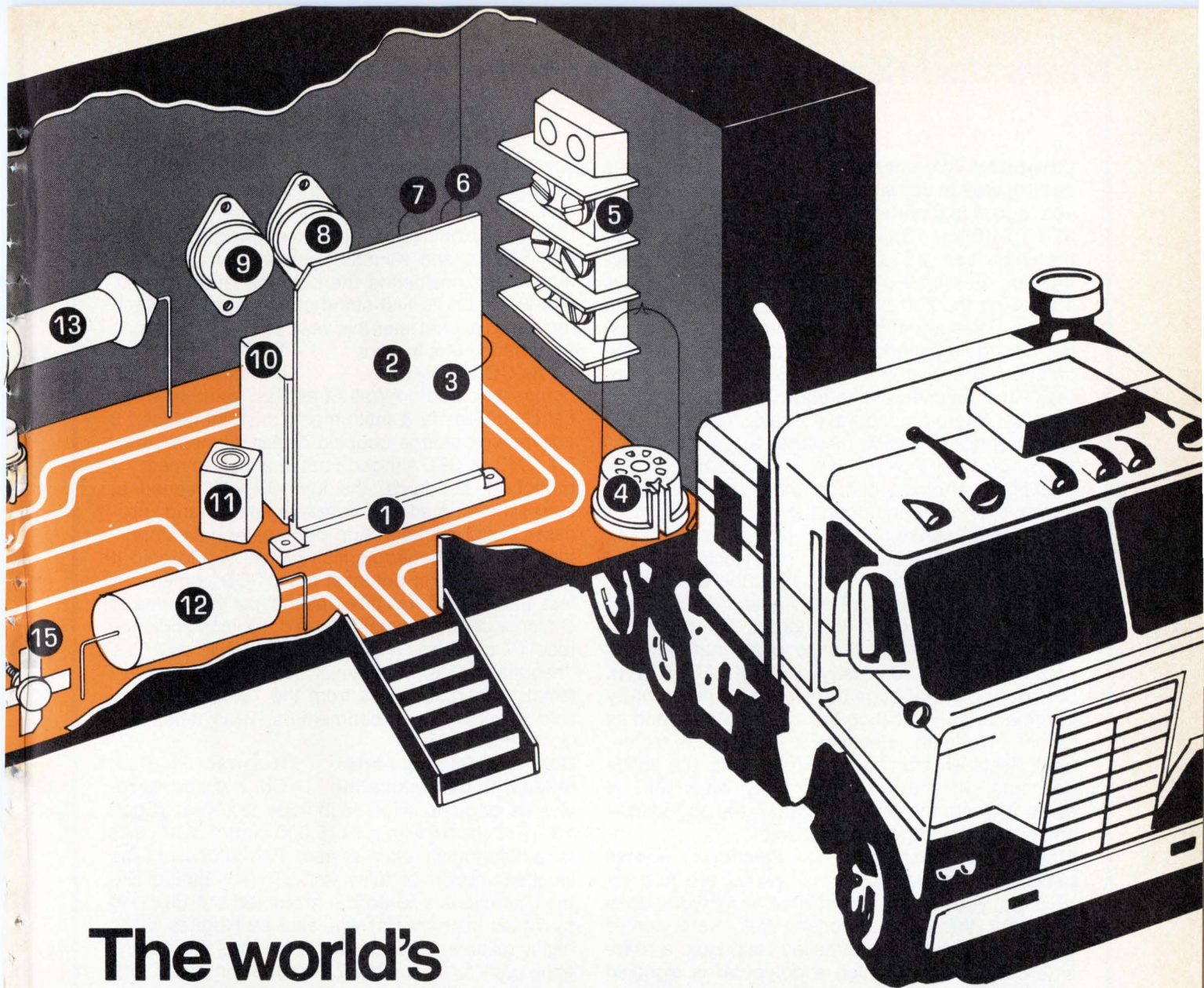

# The world's biggest "little black box" is heading home.

We're about ready to wrap up our road show on state-of-the-art electronic components. By the time we're through, we'll have visited over 150 plants in 27 states and had a chance to meet thousands of people. Executives, design engineers, manufacturing and purchasing managers.

Hopefully, you've had a chance to see our display of over 1,000 different circuit components from the 14 separate divisions which form TRW Electronic Components.

We also hope you've had a chance to ask questions, found the answers you needed, and proved to yourself that TRW is doing things — the right things — to help you solve your problems quickly and efficiently.

If you missed our "little black box," we're sorry. In that case, the above sketch should give you a general idea of what it was all about.

We're always ready to show that we want — and deserve — your business. And we'll do almost anything to prove it. Because we *are* TRW.

**TRW** ELECTRONIC COMPONENTS  
10880 Wilshire Boulevard, Los Angeles, CA 90024

For a free copy of our DIRECTORY OF OPERATIONS, write TRW Electronic Components at the above address.

Circle 49 on reader service card

## **Low-price TV camera selling well in Japan**

The Japanese were presented a year ago with a portable TV camera that was priced at \$770 [Sept. 13, 1973, p. 62]. The price since then has risen to \$1,028, but Tokyo Shibaura Electric Co., developer of the single-tube camera, says it's selling the 200 or so units it's producing each month. Sales are 40% each to schools and industry, with the remainder to individuals. When will the camera be available in the U.S. and other countries? Just as soon as the equipment gains Underwriters Laboratory approval, says Toshiba. Why the low price? Toshiba manages to get good performance from vidicon with a standard antimony trisulphide photoconductor rather than having to use an expensive photoconductor.

## **Electronic license plates to be road tested soon**

If you're intending to hijack a truck, it might be a good idea to carry out the caper soon because the Department of Transportation has a plan to make the job much harder. The plan centers on an electronic license plate that was announced prematurely last year [Sept. 13, 1973, p. 50]. But now that bugs have been worked out by Information Identification Inc. of Fort Worth and its parent, Hoffman Electronics Corp., El Monte, Calif., tests will start soon. Ten trucks and a police helicopter in the New York City area will be equipped with the plates—actually, transponders—and interrogation gear in the copter.

## **Maker of road call box to do own marketing**

Electronic license plates are fine for truckers, you might say, but what has anyone done lately for the poor motorist? Well, here comes help—specifically, the so-called Help Box, a roadside call box from which a computer is signaled when a motorist needs help. The boxes were to be sold by ADT Corp. of New York [May 24, 1973, p. 36], but now the manufacturer, Solid State Technology Inc. of Wilmington, Mass., will do its own selling. Solid State is setting up a U.S. distributor network, while ADT retains international rights. The reason for the switch, according to Solid State's Bob Santoro, director of operations, "We are a younger and more aggressive company."

## **Victor puts off systems, still eyes point-of-sale**

The last major electromechanical calculator maker to convert to electronics was Victor Comptometer Corp., and a year ago it was still in the throes of that change [Sept. 13, 1973, p. 41]. Since then, it has solidified its high-end position with the industry's least expensive line of programables and entered the low-end derby with a \$49.95 hand-held unit. But plans for more systems-oriented products, such as a small billing and

accounting system scheduled for this year, have been tabled for the present, indicates James Sheridan, new Victor president and formerly Litton Industries senior vice president responsible for Monroe, Sweda, and Kimball Systems divisions. The firm is still considering the point-of-sale business, and will bring its first stand-alone electronic cash register to market later this year.

## **Fairchild seeks buyers for its CCD camera**

There was some excitement among competitors and on Wall Street last summer when Fairchild Camera & Instrument Corp. introduced a commercial charge-coupled-device camera [Aug. 30, 1973, p. 36]. Although not intended to meet TV broadcast standards, the MV-100 was aimed at surveillance, medical instrumentation, and process-control markets. And perhaps equally important, Fairchild hoped its little marvel would help it gauge the market potential for a CCD camera. In fact, the MV-100 was billed as the first in a series of cameras that eventually would replace vidicon-tube TV cameras. A year later, Fairchild says it's "negotiating" with potential customers in an attempt to increase sales from the "several" it has sold to individual experimenters, R&D labs, and Government labs.

## **Hughes delivering parts made with pad-relocation**

Hughes Aircraft Co. decided to revive its pad-relocation technique last year [Sept. 13, 1973, p. 40] with a \$428,000 contract for parts for a data-transmission system. Pad relocation, the Hughes version of full-wafer LSI (something like the discretionary-wired LSI promoted but dropped by Texas Instruments) was said by Hughes to be highly reliable. Since then, the firm has been delivering parts to its customer, General Atronics Corp. of Philadelphia, a Magnavox subsidiary that's building high-frequency codem (coded modem) equipment for the U.S. Naval Systems Command. The parts, using pad relocation to substitute good logic cells for bad ones, will be delivered during the rest of 1974.

## **Macrodata soft-pedals patent-protection actions**

Macrodata Corp. is playing its patent cards close to the vest. Last year, president William C.W. Mow said that, since his company had received a patent covering the basic techniques used in memory testing, he has decided to "protect his interest" [Sept. 13, 1973, p. 35]. He added that he intended to get royalties from competitors who he said are violating his patent, or make them quit manufacturing. Now, Mow won't say much about his fight. He discloses that a few letters have been written, but that Macrodata hasn't gone to court. Beyond that, Mow is mum. —Howard Wolff

# A CHECK

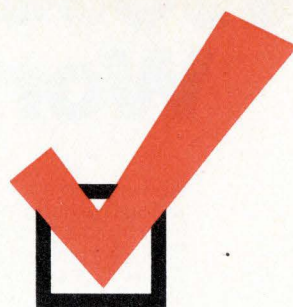

## ON 3/4A AND 4A BRIDGE RECTIFIERS

	GENERAL INSTRUMENT	MOTOROLA	VARO	UNITRODE	SEMTECH	DIODES INC.
1—Who has a 4A rated bridge rectifier?.....	<input checked="" type="checkbox"/>	<input checked="" type="checkbox"/>	<input type="checkbox"/>	<input type="checkbox"/>	<input type="checkbox"/>	<input type="checkbox"/>
That does not require heatsinking?.....	<input checked="" type="checkbox"/>	<input type="checkbox"/>	<input type="checkbox"/>	<input type="checkbox"/>	<input type="checkbox"/>	<input type="checkbox"/>
At 85¢* each in 10K quantities?.....	<input checked="" type="checkbox"/>	<input type="checkbox"/>	<input type="checkbox"/>	<input type="checkbox"/>	<input type="checkbox"/>	<input type="checkbox"/>
2—Who has a 3/4A rated bridge rectifier?.....	<input checked="" type="checkbox"/>	<input type="checkbox"/>	<input checked="" type="checkbox"/>	<input type="checkbox"/>	<input type="checkbox"/>	<input type="checkbox"/>
Available in three case styles?.....	<input checked="" type="checkbox"/>	<input type="checkbox"/>	<input type="checkbox"/>	<input type="checkbox"/>	<input type="checkbox"/>	<input type="checkbox"/>
All at 20¢* each in 10K quantities?.....	<input checked="" type="checkbox"/>	<input type="checkbox"/>	<input type="checkbox"/>	<input type="checkbox"/>	<input type="checkbox"/>	<input type="checkbox"/>
3—Who has a bridge rectifier that can replace 4 rectifiers at no additional cost? .....	<input checked="" type="checkbox"/>	<input type="checkbox"/>	<input checked="" type="checkbox"/>	<input type="checkbox"/>	<input type="checkbox"/>	<input type="checkbox"/>
4—Which is the first and only company using flame-retarding materials (classified 94V-0) in the construction of its rectifiers and bridge rectifiers? .....	<input checked="" type="checkbox"/>	<input type="checkbox"/>	<input type="checkbox"/>	<input type="checkbox"/>	<input type="checkbox"/>	<input type="checkbox"/>
5—Which company should be checked for the lowest priced bridges, anywhere? .....	<input checked="" type="checkbox"/>	<input type="checkbox"/>	<input type="checkbox"/>	<input type="checkbox"/>	<input type="checkbox"/>	<input type="checkbox"/>



75WOM .75A 20¢\*  
WOM 1.5A 25¢\*

75KBD .75A 20¢\*  
KBD 1.5A 25¢\*

75KBP .75A 20¢\*  
KBP 1.5A 25¢\*  
KBL 4.0A 85¢\*

\*PRV @ 400V or lower, 10,000 units scheduled within 60 days.

# GI'S GOT IT!

For complete information on GI's bridge rectifiers, call toll-free 800-645-1247 (In New York State call 516-733-3235) or write, General Instrument Corporation, Semiconductor Components Division, 600 W. John St., Hicksville, N.Y. 11802.

**GENERAL INSTRUMENT CORPORATION  
SEMICONDUCTOR COMPONENTS**



# MV5050-series GaAsLITEs: Worth looking into.

Viewing angle for various devices ranges from 50 to 110 degrees. Choose from full-flooded diffused, or pinpoint lens effects, either red or clear.

Long life and shock resistance are inherent to the GaAsLITE design. No filament or glass to break. .001"-dia. gold connecting wire is bonded by thermo-compression to die and anode lead, and encapsulated.

Automated handling becomes a possibility with a new cylindrical barrel design that makes the MV5050-series lamps fit precisely into .200-inch aperture. Flattened flange, denoting cathode, speeds handling.

High brightness GaAsP chip is eutectically bonded to header.

The virtually unbreakable "bulb" can take temperatures up to 125°C without deforming. It's made from a unique formulation of a modified bisphenol Type A epoxy system.

Bendable, solderable, wire-wrappable leads are plated copper for best heat transfer and stability characteristics. They mount easily in PC boards on 100-mil centers.

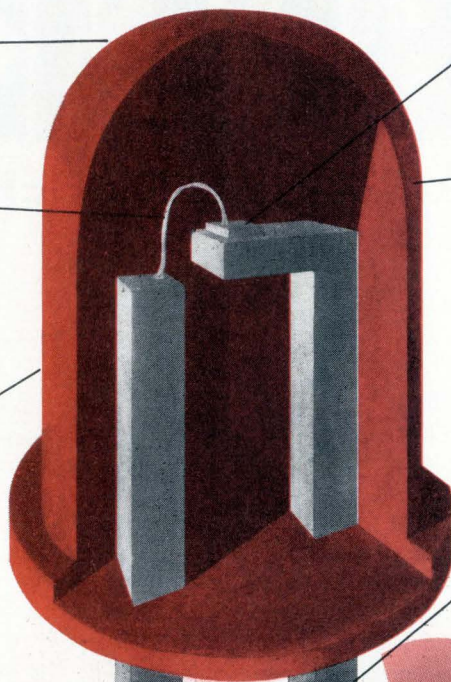

Six solid-state indicator lamps



Three solid-state illuminators

Installation is a snap with our mounting grommet, supplied on request at no extra cost.

Here's our newest family of low-cost, long-life solid-state indicators and illuminators. They're all IC-compatible and use new high brightness materials. Like all our GaAsLITEs, they shine with very little power and are a snap to design into your equipment. Compact, rugged and reliable, the MV5050-series gives you the widest selection of lens effects in the industry. Pin-point. Soft diffused. Flooded. And your choice of viewing angles. All the details are on the data sheet.

For illumination, our MV5054-series GaAsLITEs use high-performance GaAsP to light up a 1/4"-dia. circle. Choice of three brightness levels. And the MV5054-1 has a *new reduced price*. For complete specs and pricing information, ask any of our distributors or write  
**Monsanto Commercial Products Company**  
 Electronics Special Products  
 3400 Hillview Avenue  
 Palo Alto, CA 94304  
 (415) 493-3300/

*Putting innovation to work*

# Monsanto

## Washington newsletter

### **U.S. not opposed to IBM/Comsat plan; FCC to decide by fall**

The Federal Communications Commission is aiming for a September decision on **IBM Corp.'s proposal to enter the domestic satellite business in a joint venture with Comsat General Corp.—and the Justice Department's antitrust division has no plans to oppose it.** This disclosure came from officials at the two agencies as IBM and Comsat General formally filed with the FCC their plan to acquire the two-thirds interest in CML Satellite Corp. now held by cash-hungry MCI Communications Corp. and Lockheed Aircraft Corp. [*Electronics*, July 11, p. 26]. IBM Satellite, a new subsidiary, would hold 55% of the stock, while Comsat General would increase its present one-third share to 45%.

The Lockheed-designed satellites proposed for use by CML may not be used by the new company. In any event, since the would-be owners plan a joint system study to evaluate the needs of a commercially attractive system, **the old CML target launch date of 1977 for its first satellite will slip at least a couple of years—possibly more** if opposition to the venture develops before the FCC.

### **Economics of solar plant confound systems designers**

Systems design engineers in industry and the universities are calling the Naval Research Laboratory by the score to express interest in its **plan to develop energy-collecting components for the first solar-powered electrical generating plant** [*Electronics*, July 11, p. 26], but they find the economics of the NRL proposal mind-boggling. Respondents are being asked "to brainstorm" systems **"that may be fabricated and installed in large quantity for perhaps one tenth or less of the cost of 'radar' types of platforms and reflectors, as well as low-cost reactors."**

The 100-megawatt plant, as conceived by NRL, "may consist of thousands of upward-reflecting, off-axis paraboloidal solar collectors," 20 to 60 feet in diameter, that, by causing the **"dissociation of a polyatomic gas like SO<sub>3</sub> in a closed-cycle circulation system"** would provide chemical energy for ultimate transformation into electricity.

### **FCC policy post to be headed by Wiley aide**

Watch for **Werner H. Hartenberger to be named chief of the Office of Plans and Policy at the Federal Communications Commission** by chairman Richard E. Wiley. Hartenberger, now administrative aide to Wiley, will fill the vacancy created late last year when Walter R. Hinchman left the post to become chief of the FCC Common Carrier Bureau. In a related move, a new FCC consultant position will be created for Walter E. Sutter, now assistant director of the White House Office of Telecommunications Policy. Sutter will advise the commission on a variety of matters, including spectrum management.

### **Space Shuttle orbiters, controls make progress**

**Rockwell International has just received \$483 million** as NASA's second payment toward the \$2.6 billion cost of designing and building two Space Shuttle orbiters, and **Honeywell has already delivered the first breadboards of the shuttle control subsystems** to the agency, having spent only \$14 million to develop them—less than the budgeted cost, says an official. After tests and evaluation, the two-axis accelerometer, servo-actuator drives, and other controls will be manufactured for two shuttles. **Remaining design and development of major components will begin in fiscal 1975, NASA says.**

## Changing the status quo in communications

If the Federal Communications Commission, just turned 40, is showing its age, so is one of its principal concerns, the American Telephone & Telegraph Co. The difference in the two patterns of aging, however, is that the FCC cannot adapt to change without a mandate from the Congress, while AT&T does not want to change at all.

Clay T. Whitehead, director of the White House Office of Telecommunications Policy, summed it up neatly in early July when he advised a Senate subcommittee that "our regulatory mechanisms and the structure of our common carrier communications industry are becoming obsolete." Whitehead believes "we should seek to redefine the regulatory framework within which the FCC and the industry operate, rather than cast blame on those who seek to do the best they can under an outdated regulatory framework." The redefinition, he suggests, will have to come from the Congress through a revision of Title II of the Communications Act of 1934, by which the FCC was created and under which it operates (see p. 35).

### Saving the FCC

The need to rewrite the rules under which the FCC operates is critical if the commission is to continue to function effectively. As things stand at the moment, it is on the verge of being overwhelmed both by petitions for new applications of communications technology spawned by two decades of rapid innovation in electronics and by continuing disputes with AT&T and its competitors over who may serve a given market and how.

Some communications specialists find it remarkable that the FCC has somehow thus far succeeded in bending a 40-year-old regulatory system, designed with only telephone and telegraph services in mind, to accommodate altogether new technologies and services. To Whitehead, however, what is more remarkable about such decisions is "the difficulty and the slowness with which they were made." This, he says, shows "how the regulatory apparatus of the 1930s has come to be a major impediment to the natural growth of new communications services."

Though Whitehead and AT&T agree—along with many others in communications—that the time has come to change the rules under which the FCC operates, they are poles apart on the nature of those changes. Where Whitehead favors limiting AT&T's monopoly to telephone services and permitting competition for new

communications services, AT&T is vigorously opposed. Still, an increasing number of communications interests are beginning to agitate for congressional action to alter the FCC's outmoded regulatory structure (see p. 106).

### Priorities and prospects

But the Congress has yet to receive anything resembling a firm proposal to reconsider the 1934 communications act. And with the pressures of an impeachment proceeding and a national election still before it, the Congress is unlikely to give much thought to the FCC this year. In 1975 the story may be different.

Whenever the time comes, there are many opponents of the AT&T monopoly, as well as a few of its supporters, who believe the company's adamant stand against competition of any kind will cast it as the corporate bad guy in any congressional hearing. Calls for the dismemberment of AT&T into a number of independent operating companies are few and insignificant now, although there is an increasing number of voices heard in Washington suggesting that AT&T be required to spin off its manufacturing arm, the Western Electric Co.

Even the OTP's Whitehead has touched on this politically sensitive subject, noting that "a restructuring of the communications industry may be necessary if competition and monopoly are to co-exist constructively." And last year the Department of Justice indicated its antitrust division's interest in AT&T's activities by issuing an eight-page civil investigative demand for company documents relating to interconnection of customer-provided terminals to the telephone network [*Electronics*, Dec. 20, p. 50].

### Interim action

Yet any antitrust action would involve years of litigation before it could be resolved. And since there is no promise of any congressional consideration of the FCC regulatory structure for at least a year, where can the communications industry look for relief in the interim? It must of course look to itself.

Altering the status quo cannot be done easily or quickly. But if the communications services industry is to flourish in a competitive atmosphere, the people who develop the technology that make innovation possible must give more thought to the politics of its implementation. To generate support for competition, rather than monopoly, will require much more lobbying in many more places than the industry has undertaken in the past.

—Ray Connolly



# Yes We Can is a two-way street.

A word to Brand-Rex customers on ways to help reduce supply problems.



As our most valuable asset, there's something you should know.

We understand the trouble you're having in getting the wire and cable you need. And we're doing something about it.

Our "Yes we can" program is not a hollow slogan, it's a coordinated, company-wide effort to make supply shortages less of a burden to you. And we've taken dozens of specific steps, large and small, in pursuit of this goal.

But we're not there yet. To make the program really work, we need your help.

Here are some things you can do:

1. Keep us posted, as far in advance as possible, of upcoming wire and cable needs so we can schedule

your requirements and obtain long-range commitments from our vendors.

2. Order only what you need, to be delivered when you really need it. If we accept your order, we'll deliver it — on time or as soon as humanly possible. Placing the same requirement on several vendors only increases pressures on available supply. So everybody suffers.

3. Talk with our engineers before finalizing specifications, so we can match your requirements against available materials — and where necessary be open to recommended substitutes or design changes.

4. Understand that there is only so much either we or our vendors can do to eliminate supply shortages. You can help by accepting the shorter-than-specified cable lengths that are part of all manufacturing processes — if you can use them. That's one way to minimize waste.

None of us can do everything. But it's amazing how much we can do if we all work together.

**Brand-Rex**

Willimantic, Conn. 06226

**Yes  
we can.**

# Proven Performance.

<b>Computer:</b>	General Automation SPC-12/20. Step and repeat, mirror image, automatic rewind. Handles variety of formats.
<b>Spindle feed rate:</b>	20-250 ipm. Accuracy to within 2% of setting. Stroke limit adjustable, 0.001-in. increments.
<b>Table travel speed:</b>	400 ipm each axis. Computer-driven, high-torque, high-speed, low-inertia servo motor gives instant acceleration.
<b>Drill hit rate:</b>	200/min. Quality holes on 1/4-in. movement with 3-high stacks and 0.002 chip load.
<b>Spindle motor speed:</b>	15,000-45,000 rpm electric motors; 15,000-60,000 rpm liquid-cooled, frequency-controlled motors; 30,000-80,000 rpm air-bearing frequency-controlled motors.

## The Excellon Mark III. Nobody's equalled it yet.

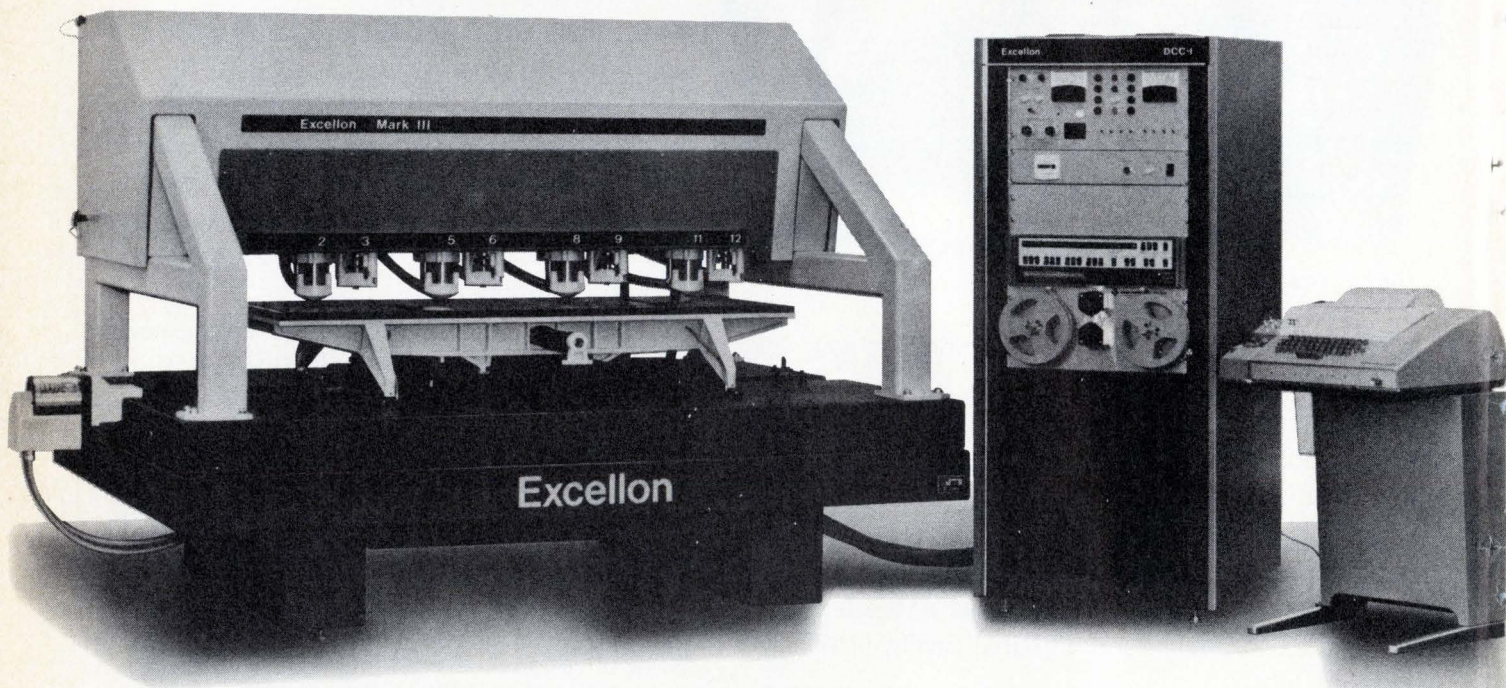

The Excellon Mark III is the most advanced p.c. drilling system in the industry today.

We've had more than our share of advances over the years. The fact is, when we added up the knowledge we've gained from our successes (and failures), we had all the makings of a major breakthrough.

The magnificent Mark III, for instance. World-wide, the Excellon Mark III

is giving unequalled performance with highest production rates possible... at the lowest hole costs possible, with high accuracy and clean, smear-free holes.

It has no competition because nobody's equalled it yet. *Call or write Excellon International, Arkwright 18, Astmoor Industrial Estate, Runcorn, Cheshire. Phone: Runcorn 66545. Telex: (851) 627496.*

### Excellon Automation

A Division of Excellon Industries  
23915 Garnier Street

Torrance, California 90509

Phone: (213) 325-8000

Telex: 67.45.62 Cable: Excellon Torrance



Excellon Sales and Service in ENGLAND • FRANCE  
SCANDINAVIA • W. GERMANY • HOLLAND • AUS-  
TRALIA • HONG KONG • TAIWAN • JAPAN

## Ship positioning system works in heavy weather

When a midget submarine was missing off the coast of Florida last year, not even the most sophisticated tracking and rescue gear could locate the vessel in time to save the crew's lives. To avoid that happening again, the Florida foundation that operated the sub turned to a new and far more accurate French acoustic measuring technique. Others are interested in the approach, too, and CIT-Alcatel, developer of the technique, is moving into the much bigger market of offshore oil rig positioning.

By next summer a modular computer-controlled dynamic positioning system based on this technology will be in operation aboard the French-owned Pelican deep-sea oil drilling ship. At depths of up to 3,000 feet—almost 10 times deeper than most current drilling operations—the system locates position on the seabed with an accuracy of less than 1% of water depth in good weather or about 6% in storm conditions.

**Noise.** The French company is in competition with Honeywell, the world's biggest manufacturer of acoustic positioning systems. Key to CIT-Alcatel's technique, developed from its work with the French navy's advanced submarine fleet, is its ability to operate effectively amid all the din of propellers, thrusters, and drilling rigs—which would put most acoustic devices out of action.

The fully redundant system is based on one or two on-board acoustic interrogation transducers, two seabed transponders located close to the drilling hole on the sea floor, and a series of directional hydrophone arrays suspended about 6 feet under the hull of the drilling ship. The position is calculated by analysis of the pyramidal geometry formed by signals from the three sets of instruments.

The transducers transmit signals

to the transponders. Each transponder has its own interrogation frequency—plus special identification code, if necessary—on which signals are received from the transducer above. The two transponders signal back up to the hydrophones on a shared frequency. This has two advantages: only a single reception channel is needed, and detection er-

rors on the hydrophone can be picked up independently of the transponder.

The programmed interrogation of the transponders allows oil drillers to leave transponders in position at a drill hole, move off to tap another potential site nearby, and return to the first hole later, using the transponders as homing beacons. □

## Around the world

### Multiplexing slashes shipboard 'spaghetti'

Modern ships carry a host of electronic equipment—for communications, radar, navigation, and other duties. But, even with the increasing use of digital technology, the various elements still talk to each other through bewildering mazes of wires and cables. Now, Ferranti Ltd.'s Digital Systems division is turning to digital-multiplexing techniques so that the navigation and radar-gear can communicate through only two twisted pairs of wires, cutting the shipboard "spaghetti" by many orders of magnitude.

The Ferranti Serial Signaling Scheme divides the various inputs from compass, rudder, radar, and input terminals into encoded 14-bit data packets and transmits them digitally over the single cable. A demultiplexer then redivides the packets and sends them to their designations. Because the transmission speed is 3 megabits per second, the system can handle extremely high data rates from the many terminals and sensors in large ships. Optimum transmission distance is 300 meters, ideal for most warships.

### Digital control shifts bus gears

The bus driver's lot often isn't a happy one. But to help him out, the Ford Motor Co. and Ferranti Ltd. have developed a prototype of a transmission that's shifted by digital circuitry. Called the electronically synchronized transmission assembly, the system uses an almost old-fashioned non-synchromesh transmission with a conventional clutch to connect the engine to the gears. But it employs a host of digital circuits to operate the hydraulic actuators, which avoids the drift problems of analog controls.

Ford and Ferranti claim that the system makes gear changing a finger-tip operation. A driver sets the lever of a smaller version of the normal gearshift to the desired gear. The system does the rest, operating the clutch, gearshift mechanisms, exhaust brake to slow the engine, and accelerator. Six prototype units are now participating in a 12-month road test.

### 40 heads made on one substrate

Multiple fixed heads allow faster access to magnetically stored data than movable heads, but they increase cost and make it difficult to obtain the high track density possible when conventional heads are used. What's more, the number of heads that can be bunched together has been limited. Now, though, researchers at Hitachi Ltd.'s research laboratory have developed batch-processed 40-head units made on a single ferrite substrate. Initially, leads and two-turn coils are fabricated by deposition and etching of conducting and insulating layers using hybrid-ic manufacturing techniques. The two-turn coil is built as a multilayer helix perpendicular to the substrate. Subsequent deposition and electroplating of permalloy over the coil is used to form magnetic yokes, with thickness of the coil setting the air gaps.

# REI has one question for people who buy electronic test equipment.

## Why?

**When you need it fast . . . rent it.** Purchasing equipment usually involves long delivery lead times. When you rent your electronic equipment from REI it's a safe bet that you can get what you need within 36 hours of the time you call in your order, sometimes sooner. This fast service is possible because we maintain 9 Instant Inventory Centers throughout the U.S. and Canada, stocking millions of dollars worth of equipment.

**When you need it for only a short time . . . rent it.** Need equipment for a short-term project? Rent it from REI. When you don't need it any more, return it to us. It's the easy, low-cost way to use the equipment you need for just the time that you need it.

**When you care about what it costs . . . rent it.** Renting from REI can be less expensive than purchasing. There's no capital investment to adversely affect your company's cash flow. This means you'll get more mileage from your equipment budget. And, since you can treat your monthly payments as an expense in most situations, you'll also achieve tax advantages from renting.

All REI rental equipment is guaranteed to meet manufacturers' specifications and is operationally checked out prior to shipment. Routine maintenance is provided free of charge. Certification and calibration are available upon request. Our flexible arrangements include rental, rental-purchase and leasing packages to give you the use of equipment from one week to three years or more.

Get your free copy of our 1974 catalog that lists virtually every item in our rental inventory. Use reader service card, or write Rental Electronics, Inc., 99 Hartwell Ave., Lexington, MA 02173. For immediate information, call your local REI Instant Inventory Center listed below. Once you rent from REI, you may never buy electronic test equipment again.

## Rental Electronics, Inc.

A PEPSICO LEASING COMPANY

Burlington, MA (617) 273-2770 • Gaithersburg, MD (301) 948-0620 • Oakland, NJ (201) 337-3757 • Ft. Lauderdale, FL (305) 771-3500  
Des Plaines, IL (312) 827-6670 • Dallas, TX (214) 661-8082 • Mountain View, CA (415) 968-8845 • Anaheim, CA (714) 879-0561  
Rexdale, Ontario (PLC Leasing Ltd.) (416) 677-7513



**Think about renting.  
It's the smart way to go.**

### **NATO Starfighter replacement awaits U.S. Air Force move**

Decision on replacement of 350 to 400 aging F-104 Starfighters and F-100s by Belgium, Holland, Norway and Denmark will probably come in early 1975. U.S. government officials promised a steering committee of the four NATO countries, which visited the U.S. last month, **to push up the U.S. Air Force's choice between the Northrop YF-17 and the General Dynamics YF-16. That would give the Europeans a chance to phase in with the U.S. program.** Previously, the Belgians and possibly the Dutch were expected to decide on a Starfighter replacement before the end of this year.

Though the four NATO countries have agreed to coordinate their selection, it is not clear that they will manage to do so. The Belgians, who are considered likely candidates for the French Super Mirage F-1, could make their decision this fall in what some observers see as an effort to pressure their NATO colleagues into buying the French planes.

Involvement with the U.S. would offer the advantages of standardization within NATO, help in sharing R&D costs, and would probably result in a lower cost per airplane. **Total Starfighter replacement costs for the four countries are estimated at about \$2 billion—part of which would be offset by manufacturing deals with the four countries' aircraft and electronics industries. A substantial part of the offset packages consist of avionics.**

### **French look to Russia, elsewhere for computer support**

The French government is working out new ways to dodge U.S. dominance in the European computer business. **One long-term bet is a plan to build fourth-generation computers and the components to go with them in partnership with the Soviet Union.** Senior Russian officials conferred with top French government computer planners in Paris earlier this month and agreed to work together to produce a successor to the current East European third-generation systems.

In the meantime, France's Compagnie Internationale pour l'Informatique is struggling to find enough money to keep it financially abreast of its Unidata partners Siemens and Philips. While its private industry shareholders, Compagnie Générale d'Electricité and Thomson-Brandt, continue to bicker with each other, the French government is re-examining the case for a foreign partner for CII as an alternative to nationalization. The European Community's recent accord to put more political muscle behind the European computer industry **has made Siemens the current favorite to take a share in the French company—a move which would establish it as effective leader of Unidata.**

CII's partners would be just as happy to see the French accept a U.S. partner, like Honeywell-Bull, in the hope of an eventual foothold in the U.S. market, but the French still want an all-European solution. And the sooner the better, since all the uncertainty is beginning to damage CII's image among computer buyers, both in France and elsewhere.

### **Sweden may ban commercials on video recordings**

The Swedish government has named a commission to study different possibilities of prohibiting or significantly limiting advertising on videotapes or disks. The government's directive to the commission **suggested that tapes designed for private use, at home, or in libraries or hospitals have no commercials.** Ads might be allowed, however, for tapes shown specifically as sales promotion aids. Should the commission find a total prohibition impossible, it might suggest limits—such as

allowing advertising only in special parts of a tape, similar to the advertising trailers played at European movie houses.

**Behind the government move are worries that the video recording business might boom in the future, seriously affecting advertising income to the press.** Moreover, there is no commercial television in Sweden, and there is some indication that the government **sees a threat to the publicly-owned TV system.** Viewers may stop watching broadcasts if inexpensive, commercial video recordings were to become popular. **Already a commercial video-cassette operation is being tested in Sweden.** A company headed by American advertising executive Andrew Karnig, a former vice president of J. Walter Thompson, is supplying cassette players to restaurants and pubs. Programs feature sports and entertainment, and there are 30-second commercials between the 15-minute programs.

### **Budget squeeze slows French phone expansion**

The French target of 12 million telephone lines in operation by 1978 is beginning to move out of range of the government's financial firepower. **The manufacturing plants are there, but the orders are slowing down. Companies claim that the problem is money.** Inflation has eaten away at the budgets, and the available cash can not pay for the number of lines scheduled for this year.

A parliamentary commission has called for an extra \$640 million this year, and it now seems likely that telecommunications and posts minister, Pierre Lelong, may be able to find an extra \$250 million or so—probably through higher call fees. Next year, the commission wants to hike this year's current budget of \$2.2 billion to a massive \$3.8 billion. The best that ministry officials are hoping to arrange for is \$3.1 billion.

**Meantime, CIT-Alcatel has pulled off a big export order for its E-10 electronic switching system with a sale to Syria.** The French company will deliver four exchanges to start with and will follow up with a manufacturing plant to supply the electronic exchanges for the rest of the country's phone network.

### **Japanese announce another cassette system for home video**

**Toshiba and Sanyo Electric Co. have introduced another contender in the home video-tape-recorder sweepstakes.** They have jointly developed an 0.5-inch cassette color system based on a cassette introduced earlier by Sanyo for a black-and-white portable recorder. The cassette has two reels side-by-side. That arrangement contrasts with the one-reel cartridge recorders made by Matsushita Electric Industrial Co. and Sony Corp. and the two-reel, back-to-back cassette recorders developed by Philips. The initial announcement only disclosed details of the cassette system, but each company says it will soon announce and start sales of recorders. **Standard playing time of the cassettes is 30 minutes, using 20 micrometer thick tape.**

### **Membrain dickers for Honeywell test division**

Fast-growing Membrain Ltd. is seeking to greatly expand its share of the automatic test equipment market by attempting to buy Honeywell Ltd.'s test systems division. Informed industry sources say that merger talks are underway in a deal that could increase Membrain's expected 1974 turnover of \$3.3 million by 50%. **A merger asset would be the consolidating of Membrain's almost exclusively commercial market with Honeywell's largely military one.**

**Meet a  
brand new company  
with a 15-year reputation  
for reliability.**

**The Components Group  
of  
Digital Equipment  
Corporation.**

**Now you can buy  
the components  
and peripherals  
that support the world's  
most popular  
minicomputers.**



# Separately. In quantity. At extremely low prices.

From us. The Components Group of Digital Equipment Corporation. A new group, formed to supply proven, reliable computer components to the volume buyer at the lowest possible prices.

The products, described in detail on the following pages, are all used by Digital as components and peripherals in the PDP-8 and PDP-11 minicomputer systems, the most popular minis in the world. Our components—like our computers—are designed to deliver maximum price/performance.

Our peripherals can be interfaced readily with all commonly-used minicomputers. Additional products will be available in the near future; product families are planned to provide a range of capabilities.

Until now, if you wanted Digital components, you had to buy an entire system.

Not any more.

Now, if you order fifty pieces or more, you can buy any of these components completely unbundled. Volume buying will get you price breaks you won't believe—just check out the prices on the next couple of pages.

And you can have our components off the shelf. When we've established our nation-wide network of warehouse/depots (due this fall), volume deliveries will be made as fast as we can process your order.

Behind our commitment to deliver stands the entire Digital manufacturing capability—over



two million square feet of manufacturing space in the United States, Puerto Rico, Canada and other countries overseas. These are the same facilities that have produced more minicomputers than anyone else, the facilities that manufacture and test the peripherals that support these computers. To meet your demands in the next year alone, we're planning several new plants in the United States and Canada and retooling present production lines to Components Group specifications.

To deliver these components quickly and to maintain our high standard of reliability, the Components Group is planning a network of warehouses. At these depots, products meeting our rigid specifications will be stocked for off-the-shelf delivery.

Our warranty is simple: all hardware is fully warranted for a specified time. If, during this period, any product should prove defective, you simply return it to the nearest depot for fast repair or exchange.

Over the next few years, we expect the cost of computer hardware—especially the cost of the computer itself—to keep going down. Entirely new applications will open up. Volume production of proven components and peripherals enables us to sell at greatly reduced prices. Our low-cost, high-quality products will provide our customers with an opportunity for enhanced profits and a competitive edge in an increasingly price-conscious market.



# Terminals and peripherals.

## **Our cassette mag tape system. Under \$1600 in quantities of 100.**

Priced below even paper tape, the TU60 is a truly reliable dual cassette system. We designed it to stand up to repeated use — with cassettes spec'd at a minimum of 1000 passes, and an error rate that's a full order of magnitude lower than most other systems.

Our proprietary cassette design reduces the possibility of hard error. The extra-thick 1 mil mylar tape is specially coated to resist extreme temperature and humidity.

The TU60's reel-to-reel drive increases tape life even more — there are no capstans, pulleys, pinch rollers, or brakes. DC servo-controlled motors reduce stretching and provide precise start/stop characteristics.

To reduce noise interference and ensure that even very low data levels will be read accurately, the TU60 employs an independent high-threshold data block detector and low-threshold data peak detector.

And the TU60 can't accumulate error from tape-speed fluctuation due to power variation or mechanical difficulties: the read electronics adapt themselves to the tape speed by means of a phase lock loop. Other error-reducing features include redundant dual-track recording, automatic leader detection, and CRC-type error control.

Because the TU60 places the burden of recording-reliability on its electronics, not its mechanics, less maintenance is required to keep the system in good working condition. And when maintenance is necessary, it's no problem. The top flips open, everything is accessible, and the two main modules can be replaced in minutes.

## **Our new DECscope video terminal. Under \$950 in quantities of 100.**

The VT50 is the most inexpensive CRT display terminal in the world. It'll give you fast, quiet alphanumeric video capability for the cost of a slow, noisy teletypewriter. Hardcopy output is available too, with our optional low-cost copier.

For a groundlevel budget price, you get 12-line, 80-column good-quality display — 64 ASCII-

standard upperface characters, each on a 5x7-dot matrix. After displaying 12 lines, the page scrolls upward from the bottom; its speed can be adjusted by the user.

The keyboard is an easy-to-use, audible, typewriter-style board, with 3-key rollover to permit fast typing. Our optional copier fits right into the desktop display cabinet.

The VT50 is fast — a full range of baud rates are switch-selectable up to 9600. Interfacing is with a standard 20mA current loop, with inexpensive EIA option.

Installation is easy, just plug it in. The VT50 has few moving parts, so maintenance is simple. Its keyboard is the same field-proven model we use on the LA36 teletypewriter. And its low heat output means no fans, less noise, and low power consumption.

At such an incredibly low price, the VT50 will go far. And fast.

## **Our remote terminals. Starting at less than \$600.**

The RT01 and RT02 terminals provide easy, low-cost interactive data entry and retrieval.

Uncomplicated keyboards make it easy for untrained personnel to enter or retrieve data. There's no need for confusing, numerically-coded instructions. The RT02 will even prompt the inexperienced operator by spelling out on the display what information is needed next.

The RT01 displays up to 12 digits of data in a Nixie™ numeric readout. For non-numeric response, it has programmable status indicators. The 16-key pad will input 30 ASCII characters.

The RT02 costs more and gives you more. A 64-character gas-discharge alphanumeric readout that displays up to 32 characters at once. 16-key or 58-key input. Interactive display prompting.

Both terminals are ASCII-compatible, so you can interface them to any computer with a Teletype™ port. EIA modem interface is also available.

Both have simple displays and few moving parts, for built-in reliability and ease of maintenance.

# Logic modules and interfacing.

Digital is the world's largest seller of solid-state modules. We give you the widest choice you can get—over 400 pretested modules, most of which we use ourselves, in our computers and controllers. We also carry a full line of compatible hardware, power supplies, plug-in boards, cabinets, racks and related equipment.

If you do your own interfacing, our Logic Products Handbook and Logic Systems Design Handbook will provide general support and solutions to specific standard problems. The Components Group will also supply, in volume, custom interfaces, custom modules, and custom variations of our standard terminals. Complete descriptive literature on any of these topics is available.

## **M Series modules.**

These high-speed logic modules for computer interfacing use monolithic TTL circuitry to give you high speed, high fanout, large capacitive drive capability and excellent noise margins, in frequencies up to 6MHz. Some of our newer M Series modules also employ current MOS technology.

## **K Series modules.**

These noise-resistant modules are principally used for industrial control applications where noise-resistance is more important than speed. Frequencies from DC to 100KHz are typical, 5KHz frequencies can be obtained. K Series modules are designed for easy system checkout and troubleshooting and will fit both standard NEMA enclosures and computer mounting racks.

## **A Series modules.**

For communications between the computer and the outside world, these analog modules give 10-bit and 12-bit performance in a family of mutually compatible functions—multiplexers, operational amplifiers, sample-and-hold circuits, A/D and D/A converters, reference voltage sources, and multiplying A/D converters.

## **DECKit interfaces.**

Our DECKits provide pre-tested, fully-documented interfaces for a number of common interfacing situations. Basically just a few modules and a prewired systems unit, they eliminate design time, breadboarding, and wirewrapping in a number of areas. Complete descriptions of the specific interfaces are available.

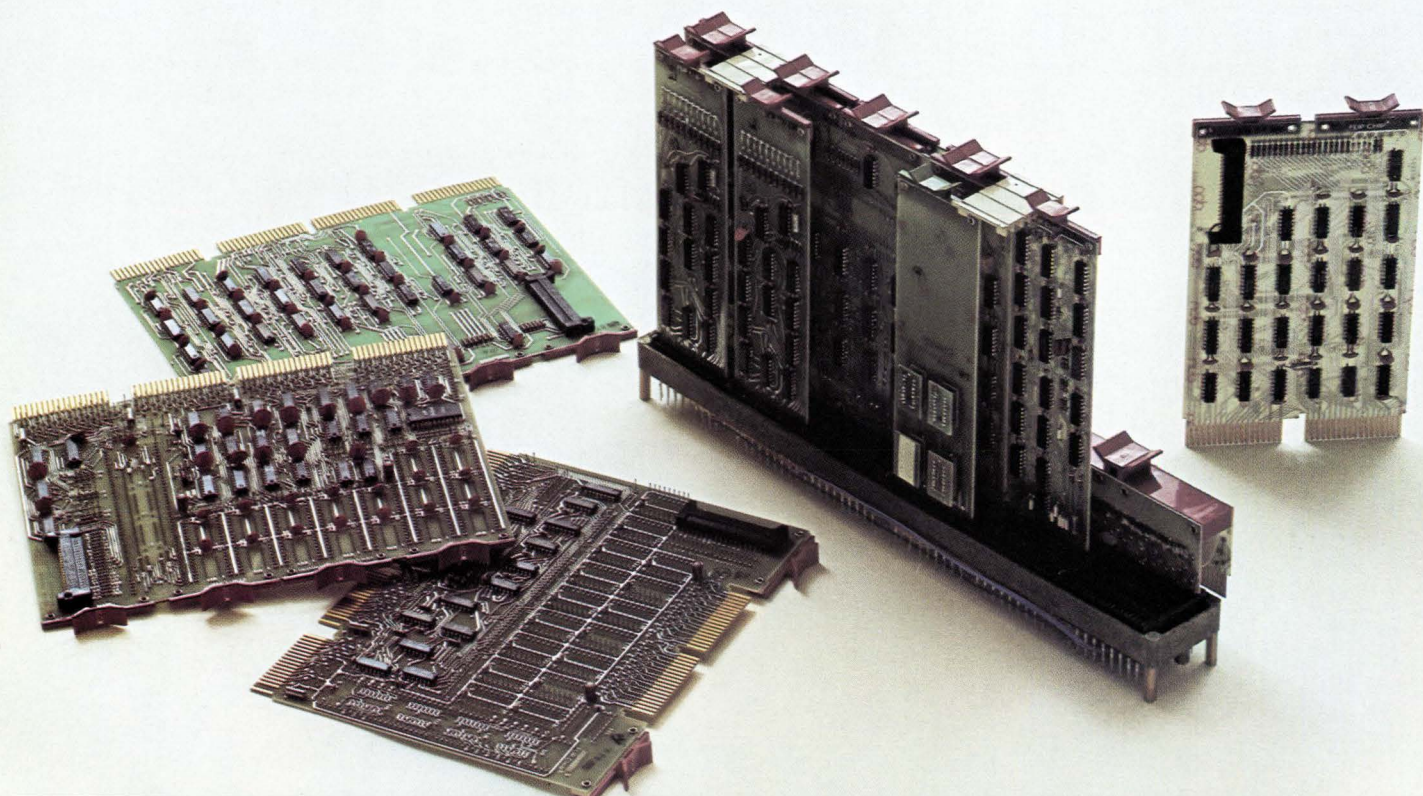

# The start of a new family of component computers.

## The PDP-8/A. \$572 in quantities of 100 (CPU & 1K RAM).

For minicomputer applications, the PDP-8/A computer-on-a-board gives you speed and performance at an extremely low price.

The newest, smallest member of the PDP-8 family of minicomputers, the 12-bit PDP-8/A uses only proven, readily available, multi-source MSI semiconductor technology. We know it's reliable, and we can deliver in quantity, starting in late 1974.

To reduce the size and enable low-cost, user-tailored memory capacity, we've added expandable semiconductor memories: ROM, RAM, PROM, and ROM/RAM combinations, expandable from 1K to 32K words. Cycle time is 1.5 $\mu$ sec.

The PDP-8/A uses the same powerful instruction set as the PDP-8/E and is fully compatible with other PDP-8 family hardware, operating systems, and high level languages (such as BASIC, FORTRAN IV, FOCAL).

The PDP-8 Omnibus™ backplane facilitates direct interface with more than 60 PDP-8 options and peripherals. Seven commonly-used options are available on two option boards: serial-line interface, 12-bit parallel I/O, front-panel control, and real-time clock on one board; powerfail/auto-restart, memory extension, and bootstrap loader on the other.

The PDP-8/A gives the user the flexibility, reliability, and expansion capability of a minicomputer at an extremely low price.

## The MPS microprocessor series. \$476 in quantities of 100. (CPU & 1K RAM).

The MPS microprocessor series of modules gives you a simple, versatile 8-bit controller that's inexpensive and easy to use. It will replace hard-wired logic in control applications and perform processing tasks in many new applications.

The MPS consists of four building-block modules and an optional control panel. A basic fully operational processor can be assembled from as few as two modules: the CPU and a memory module.

The CPU module with 8-bit parallel processor, 48 data-oriented instructions, and 12.5  $\mu$ sec cycle time, can directly address up to 16K words of memory. There are two memory modules: the Read-write Memory module consists of a fully-self-contained random access memory (1K, 2K or 4K words) and all address decoding logic; the Programmable Read-only Memory module contains up to 4K words of UV-eraseable, completely reprogrammable semiconductor memory. The External Event-Detection module provides power-failure detection and automatic start, with 6 interrupt request inputs. The Monitor/Control Panel, which can be cable-interfaced to the CPU, will perform such typical functions as monitoring data paths, memory, and addresses, handling general system operational and diagnostic checks, and entering programs.

We designed the MPS to be immediately available, using proven P-channel MOS/LSI silicon gate technology.

Control programs are prepared on a small, low-cost PDP-8 minicomputer, using the MPS software-development kit of six basic programs.

The MPS will give you processor hardware with the convenience of building-block modularity and a design-development package that allows you to customize to your application. And all MPS modules are completely compatible with Digital's logic modules, programmable controllers, and minicomputers.

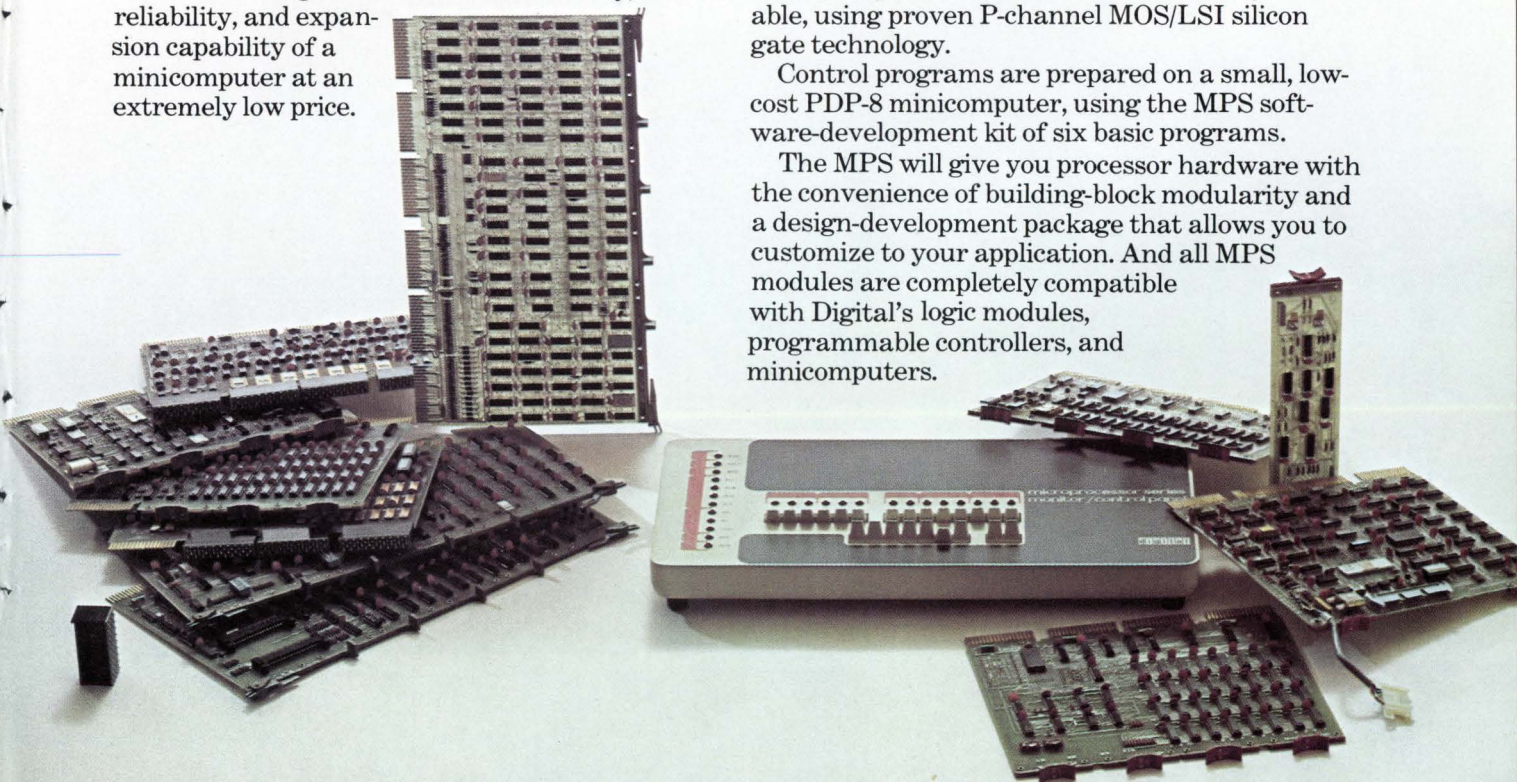

**digital**  
**COMPONENTS**  
**GROUP**

**Unbundling the world's  
most popular minicomputers.**

Meet the Components Group now  
— we've got a lot to talk about. Call us direct at

**800-225-9480**

Toll-free from 8:30AM to 5:00PM your time.\*  
\*US only. Massachusetts residents, please dial (617) 481-7400.

Digital Equipment Corporation, Components Group,  
One Iron Way, Marlborough, Massachusetts 01752.

In Canada: Digital Equipment of Canada Limited,  
P.O. Box 11500, Ottawa, Ontario, K2H8K8, (613) 592-5111.

Prices quoted are in US dollars and will vary outside the United States.

# EVEN THE BIGGIES HAVE TO BEAT THEIR OWN DRUM SOMETIMES.

It's about time we made some noise about the fact that we're one of the top three manufacturers of modular regulated DC power supplies. What does that mean to you? Plenty! ACDC Electronics provides one of the most extensive lines of standard power supplies in the industry...over 500 models ranging from approximately 6 watts to over 500 watts. There are five series in our series-pass power supply line. Of these, the most popular is the OEM. Although they are known for their economy, these OEM power supplies offer the same reliability you have come to expect from all ACDC products. Our new high efficiency switching power supplies offer the latest in technology. They're smaller, cooler, and more efficient than series-pass supplies and operate quieter and more reliably than most other competitive models. And, there's even more for us to "boom" about. ACDC's ability to tailor a power supply to specific applications is virtually unlimited. Some typical units range from miniature 400 Hz airborne power supplies to 3000 amp power systems for state-of-the-art computer complexes, incorporating such features as auto-progression, margining, sequencing, transistor switching, phase control and series regulation as well as special packaging configurations. Complete information is contained in our new copy, just write to us on your letter- is enough, just circle the reader *drum, you just can't*



1974 catalog. To get your personal service number. *Like the broken beat ACDC power supplies.*

Name \_\_\_\_\_

Company Name \_\_\_\_\_

Address \_\_\_\_\_

City \_\_\_\_\_

State \_\_\_\_\_

Zip code \_\_\_\_\_

**acdc electronics inc**

Oceanside Industrial Center Oceanside, CA 92054  
(714) 757-1880



# Centralab perspectives

FOR USERS OF ELECTRONIC COMPONENTS



**CENTRALAB**

Electronics Division  
GLOBE-UNION INC.

5757 NORTH GREEN BAY AVENUE  
MILWAUKEE, WISCONSIN 53201

## With the options now available, standard cermet and carbon trimmer resistors take on new dimensions of application.

Centralab is meeting the high performance demands of navigation equipment, aircraft radio, calculators, instrumentation and automotive electronics. High volume and low cost are ancillary benefits.

Regardless of the application, if you're looking for a trimmer resistor with power handling capacity, small size, reliability, or any number of other critical parameters, you'll find the right combination in the extensive line of standard designs and options available from Centralab. And if you're looking for high volume at low cost you should know that Centralab can provide production runs in the millions with unit costs of less than 10 cents, depending on the type you select.

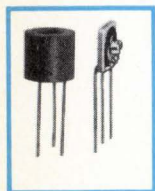

Compare the Centralab Series M trimmer with a conventional TO-5 size. The Centralab 1/20 watt unit requires 2/3 less space. That's a significant advantage for miniaturization.

Our four series of carbon or cermet trimmers offers you 18 standard models, in sizes from 1/4" to 3/4", from single to quad sections, in ratings from 1/10 to 3/4 watt. You can select from a wide range of resistor values — 100 ohms to 10 megohms in carbon, 100 ohms to 1 megohm in cermet. With standard resistor tolerances as low as  $\pm 10\%$ . To simplify assembly, all units can be furnished

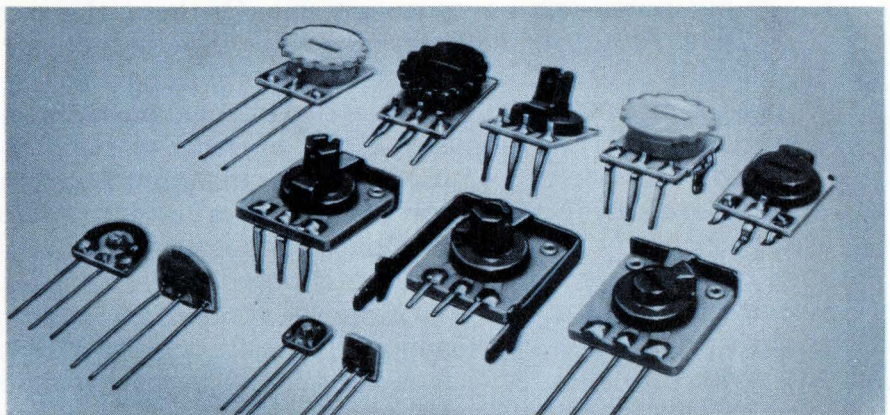

There's maximum versatility in the Centralab trimmer resistor line. Four series are available with a variety of options including mounting brackets, leads, knob styles and colors.

for vertical or horizontal mounting with your choice of three tab leads — including the new Snap-Tite® rigid PC mount — or with tinned wire leads.

Knob selection is equally varied and gives you the choice of universal, screwdriver, edge-adjust and a new thin-profile style just .130" high. All knobs are flame retardant and come in four standard colors.

### FIXED RESISTOR CAPABILITY

Complete resistor networks can be supplied on the trimmer base plate. As many as 9 fixed resistors can be added to the quad units, 3 on a single

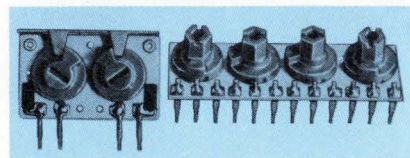

Multiple sections — double, triple and quad — plus fixed resistors are every-day requirements being met by Centralab trimmers.

section. And, because you also want the assurance of better tracking and stability, we offer ratio matching as a part of our fixed resistor capability.

Even with all these features, there are other reasons why you can confidently specify Centralab trimmers. One is the ceramic substrate that gives them performance unmatched by phenolics. First of all it gives you the setability you need. But in addition, you get higher wattage in a smaller space. They're conservatively rated at double the wattage capability of phenolics. Ceramic bases mean they'll withstand higher operating temperatures — greater dimensional stability — no flux migration during flow soldering.

Centralab can help you match up their world of options and standard designs to give you new dimensions in trimmer resistor specification. Complete data, including new simplified part descriptions for each trimmer family, is included in a new Specification Guide. Write for your copy today. Ask for Catalog 1549T.



## Centralab perspective:

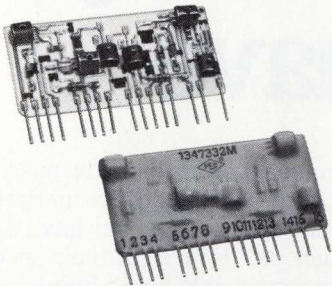

### Two thick film hybrid systems. PEC and MEC.

Centralab offers the flexibility to design and fabricate thick film modules to fit virtually any application and cost parameter.

Low-cost silver/carbon or  systems for consumer applications:

- Resistor Range..... 10 ohms to 10 megohms
- Resistor Tolerance.....  $\pm 10\%$  preferred minimum
- Ratio Matching.....  $\pm 5\%$  minimum
- Capacitor Types..... Ceramic and tantalum
- Active Devices..... Diodes, transistors & IC's
- Operating Temp. Range....  $-55^{\circ}\text{C}$  to  $+85^{\circ}\text{C}$

Noble metal/cermet or MEC systems for commercial and industrial uses:

- Resistor Range..... 3 ohms to 3 megohms
- Resistor Tolerance.....  $\pm 5\%$  minimum
- Ratio Matching.....  $\pm 1\%$  minimum
- Capacitor Types..... Ceramic and tantalum
- Active Devices..... Diodes, transistors & IC's
- Operating Temp. Range....  $-55^{\circ}\text{C}$  to  $+150^{\circ}\text{C}$

For Bulletin 1547 write  
A.R. Wartchow, Manager,  
Electroceramic Marketing,  
Outside U.S.A. contact  
J.H. Meunier, Manager,  
International Sales.

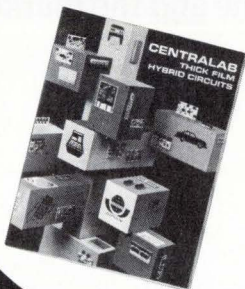

## Centralab perspective:

### Transmitter Capacitors

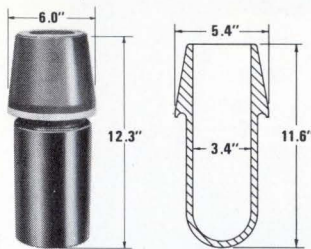

Ceramic dielectric insert.

### Meet Specs For Extra Reliability and Save 50%.

When selecting capacitors for transmitter equipment, Centralab can help. Example: one ceramic dielectric type can replace two vacuum types — increase reliability — yet reduce both weight and cost by 50% or more. The cup type shown, meets specs calling for 6000 pf, 10 kV and current ratings of 100 amps at 500 kHz.

Centralab's line of special capacitors includes header, feed-thru, tubular, slug and water-cooled types — plus custom designs to meet any spec.

All it takes is a call to  
Marty Hedrich at  
414/228-2033.



CENTRALAB  
Electronics Division  
GLOBE-UNION INC.

5757 NORTH GREEN BAY AVENUE  
MILWAUKEE, WISCONSIN 53201

## Centralab perspective:

### CERAMOLITHIC® FILTERS HAVE EVOLVED WITH USE OF EVER HIGHER FREQUENCIES.

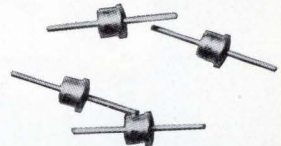

MSI and LSI technology have been shrinking the world of electronics, dictating higher, faster frequencies/speeds. With active circuit elements in intimate relationship, electromagnetic fields are straying into unwanted places; sharp filtering has to be an important design consideration.

U.S. Capacitor Corporation, the world's leading innovator of monolithic ceramic capacitors and filters, has tracked circuit speed developments with one idea in mind: improved attenuation at increasingly higher frequencies, in state of the art sizes and at *affordable prices*. Ceramic Filter evolution happens at USCC/Centralab by basic research in dielectric materials and new manufacturing techniques.

Today's products of this evolution are CERAMOLITHIC® subminiature EMI/RFI filters like our 9900 series feed-thru's giving better than 70 db at 10GHZ in only a .110" x .156" diameter case size — for use in medical electronics and CATV. Write for our new 1974 filter catalog or call Don Thommen direct, (213) 843-4222.

USCC/Centralab  
2151 N. Lincoln Street  
Burbank, California 91504



# Data Communications- the new business every business must have.



We're  
putting it  
all together  
for you.



Data communications is indeed a puzzle to most of the people working in the market. In fact, many don't realize that they have data communications needs or what their needs are.

The people responsible for planning a data communications system for their company must decide alternative systems approaches, carriers, hardware, and vendors—all in the context of economics, government regulation, and future technology development.

Putting together all the pieces of this puzzle—that's what the new McGraw-Hill magazine, **Data Communications**, is all about. **Data Communications** will be published bi-monthly.

Our editorial is 100% data communications and we know our approach is correct because we have tested it with two pilot issues, a year apart.

Our audience is 100% data communications because to qualify, they must have responsibility to buy, specify, recommend or approve the purchase or lease of products associated with data communications.

Our subscribers are 100% request verified—not only are they qualified but each one of the 25,000 has individually requested **Data Communications**.

If you want to cover the fastest-growing market in our economy, take a full-year's schedule of full pages in **Data Communications** for only \$7,800, which includes color, bleed and special positions. We'll even do your color separations at minimal cost.

For complete advertising information, contact your nearest McGraw-Hill office.

**data** **McGraw-Hill**  
COMMUNICATIONS

A McGraw-Hill Publication

the magazine and the market.

## Start with our new Blue Streak™ cable

... it's loaded with features designed to lower your installed costs. For instance, every fifth conductor is color coded for quick identification and the Blue Streak immediately identifies polarity. The unique cable construction permits clean conductor separation for breakouts and easy insertion into connector assemblies. Available in 50 conductors or less — solid or stranded wire — this U/L listed self-extinguishing cable is the perfect companion for the new one-piece connectors.

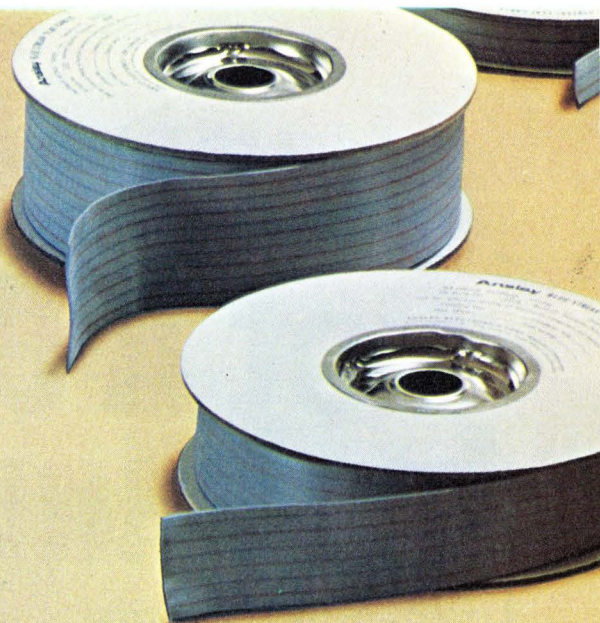

## New cable connector system...It's designed to lower your installed costs.

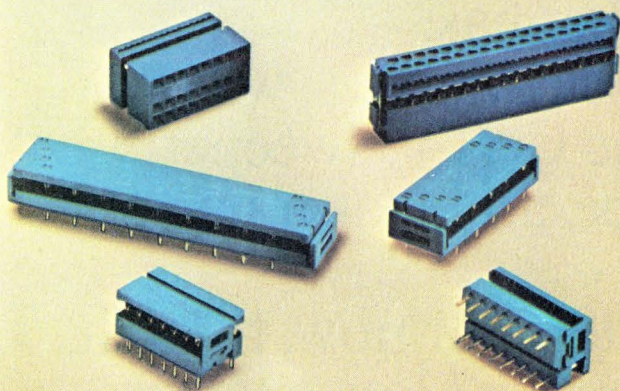

### Our new insulation displacing flat cable connectors install in 1/3 the time

... simply because they come to you in *one* piece. Two benefits result; assembly of the connector itself is eliminated and the time consuming job of lining up the cable on the connector is no longer necessary.

To install — simply insert the cable end into the connector and crimp. It's that easy — fast — and reliable! Speaking of reliable — our new connectors feature an exclusive "tulip" contact design which provides 4 contact points per conductor. In addition, the front of the "tulip" contact is designed to act as a strain relief on the wire.

We'll be more than happy to send you a test report on contact reliability.

### A perfect crimp every time

... because our Blue Streak hand tools feature the Shure-Stake® principle which makes the tool responsible (not the installer) for the compression connection. Your installer must complete the set compression stroke before the connector can be removed. It's as fool proof and reliable as a compression connector tool can be. A full line of bench mounted tools with interchangeable dies are also available.

The Ansley Team — One Piece Connectors — Shure Stake® Hand Tools and Blue Streak™ Cable — all combine to offer you the most reliable connection package at the lowest installed cost.



# Ansley

ANSLEY ELECTRONICS CORP.  
Subsidiary of Thomas & Betts Corporation

3208 Humboldt St., Los Angeles, Ca. 90031  
Tel. (213) 223-2331, TWX 910-321-3938

SOLD COAST TO COAST THROUGH AUTHORIZED ANSLEY DISTRIBUTORS.

Circle 65 on reader service card

# “We’ve Got A Great Instrument”



Carl Pehlke, President and Chairman

In fact, we’ve got a lot of great instruments. Perhaps we’ve grown complacent. Maybe we haven’t been ardent enough in telling our customers Texscan IS the world leader, with a complete line and a single source that no other has.

With our design and design capabilities, we’re coming on even stronger in the CATV, sweeper, spectrum analyzer, oscilloscope, attenuator and oscillator business.

We’ll be telling you more later. For now, though, why is Texscan *the* leading supplier? For openers, take a look at the chart below:

PRODUCT	Number of Models		
	TEXSCAN	TELONIC	WAVETEK
Laboratory Sweep Generators	26	8	7
Spectrum Analyzers	6	0	0
Display Oscilloscopes	3	3	1
Attenuators	83	18	8
Oscillators	149	0	0
Filter types	8	6	0

Based on latest catalog information

## Texscan

THE WORLD LEADER AND  
COMING ON EVEN STRONGER.

**U. S. Sales Offices:** Albuquerque 505-298-2575, Bayside (N.Y.) 212-423-7330, Binghamton (N.Y.) 607-748-0509, Blue Bell (Pa.) 215-542-1490, Cedar Rapids 319-363-2489, Cleveland 216-243-8430, Dallas 214-363-5291, Dayton 513-298-3033, Depew (N.Y.) 716-685-4111, Detroit 313-482-1229, Dover (N.J.) 201-366-7518, Hamden (Conn.) 203-288-5246, Hazelwood (Mo.) 314-731-5200, Hazlet (N.J.) 201-264-1851, Honolulu 808-941-1574, Huntsville (Ala.) 205-837-1601, Independence 816-737-1414, Indianapolis 317-257-7231, Los Angeles 213-478-1586, Mt. Penn (Pa.) 215-672-5565, Northbrook (Ill.) 312-882-7140, Orlando 305-859-2160, Palo Alto 415-494-3331, Seattle 206-763-2233, Syracuse 315-454-9314, Ulster Park (N.Y.) 518-372-6649, Winston-Salem 919-722-9671, Waban (Mass.) 617-969-3372, Wheaton (Md.) 301-942-9420. **Canadian Sales Offices:** Downsview 416-638-0218, Halifax 902-455-0670, Montreal 514-735-4565, Ottawa 613-728-4624, Vancouver 604-732-7317, Winnipeg 204-475-1732.

# BOURNS trims more circuits than anyone else in the world!

## here's why...

### NOBODY KNOWS MORE ABOUT TRIMMERS THAN WE DO

Marlan E. Bourns, President of Bourns, Inc., invented the modern miniature TRIMPOT® trimming potentiometer. This company pioneered the industry, and has maintained its leadership position for over a quarter of a century.

### WE GIVE YOU WHAT YOU NEED

Bourns has the broadest line of trimming potentiometers in the industry. We produce just about any type, shape, size, style you're likely to need. We make them more readily available via a large factory inventory . . . and 91 stocking distributors.

Ready to simplify your specifying? Standardize on Bourns "Top Twenty" . . . they cover 90% of your application requirements. Write for our Top Twenty Designer's Portfolio.

### YOU CAN DEPEND ON BOURNS

Trimming potentiometers are the *most* cost-effective method of adjusting, regulating and controlling circuits . . . and they will remain so for the foreseeable future. Bourns is the *most* capable, straightforward and reliable supplier of trimming potentiometers. Depend on Bourns.

QUALITY, SERVICE, VALUE — Bourns is No. 1

... you can depend on it!



Circle 67 on reader service card

BOURNS, INC., TRIMPOT PRODUCTS DIVISION • 1200 COLUMBIA AVENUE, RIVERSIDE, CALIFORNIA 92507

# Bad ICs should die young.

As soon as they come in your door, bad ICs should be pinpointed. And eliminated. Because the later they're discovered, the more they'll cost you. In rework. In field repair. In customer goodwill and lost business. The bill will be much higher, in fact, than it would be to test every single IC you buy.

For the whole story on the remarkable economies of 100% testing,

write for our free "High-Volume Testing for the Electronic Device User." It covers the testing of not only ICs, but also backplanes, PC boards, and all types of semiconductors. And it comes to you from the world's largest producer of automatic test systems for electronic components. Teradyne, Inc., 183 Essex St., Boston, Mass. 02111.

**TERADYNE**

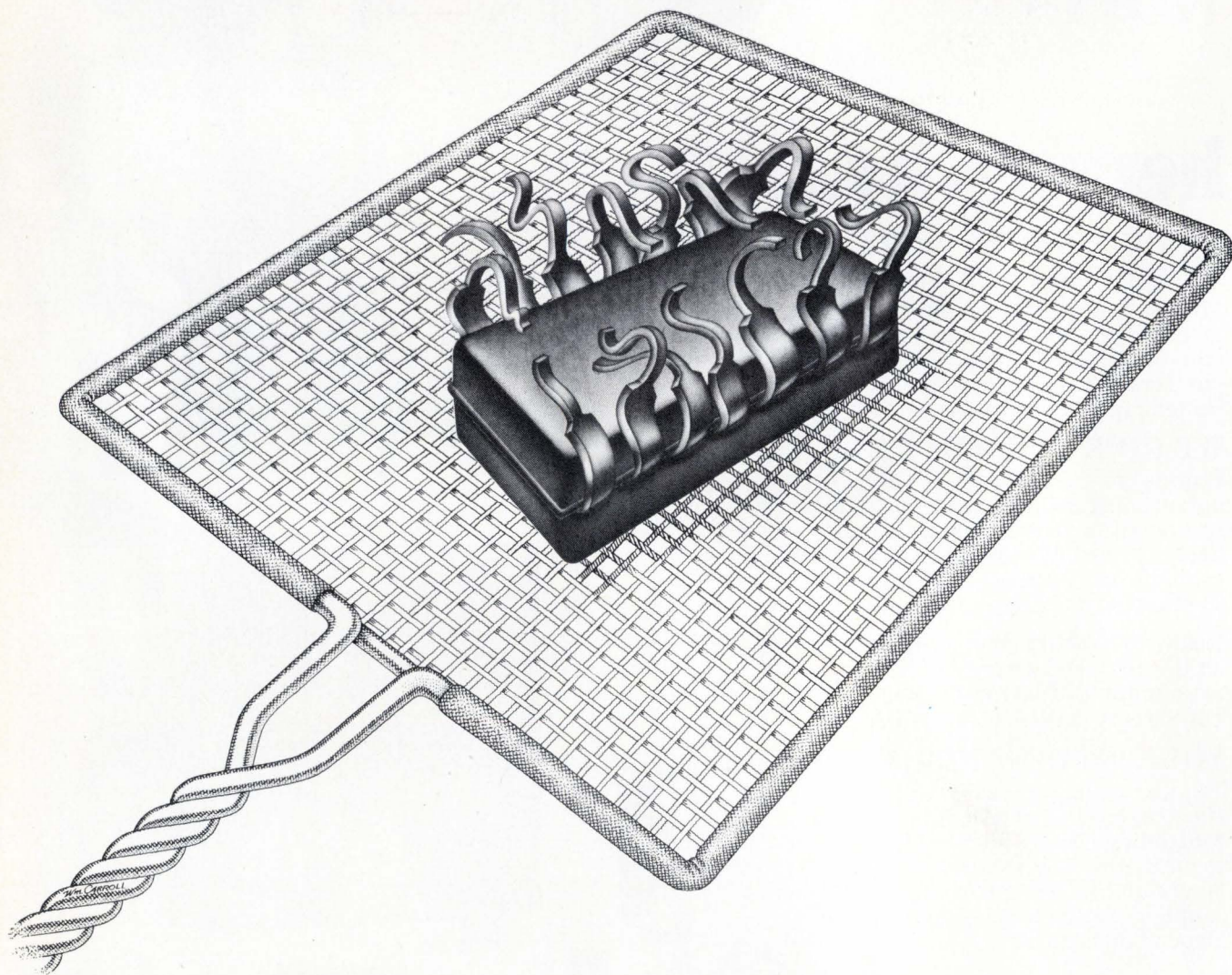
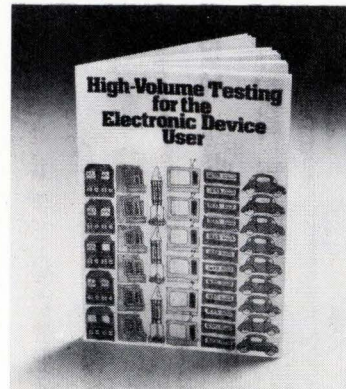

CHICAGO (312) 298-8610 / DALLAS (214) 231-5384 / NEW ENGLAND (617) 458-1256 / NEW YORK (201) 334-9770 / SUNNYVALE (408) 732-8770  
LONDON (0932) 51431 / PARIS 265 72 62 / ROME 59 47 62 / MUNICH (0811) 33 50 61 / TOKYO (03) 406-4021

# Probing the news

Analysis of technology and business developments



**Drop-outs.** White dots in video-telephone picture are areas of significant change in face-to-face communications in 1/60 second. These are the areas that will be refreshed.

## Problem: cut video bandwidth

Solution: choose from compression techniques being pursued by such varied agencies as the military, NASA, and Bell Laboratories

by Larry Armstrong, Midwest bureau manager

**Digital video** transmissions require 48 to 50 megabits per second. That's too much for the military, NASA, and AT&T. So all three are working to pare that figure, with the result that there are now several systems that can send recognizable pictures at 1 Mb/s or less.

Military interest centers on use in remotely piloted vehicles for strike and reconnaissance. Each vehicle will contain a TV camera and transmitter to return images to a ground or air-control station. Antijam operation is important: the idea is to squeeze out as much redundancy as possible and then put back the missing parts later in a controlled fashion. In this way, the enemy is forced to spread his jamming power [*Electronics*, June 27, p. 33].

While observers agree that NASA doesn't need to press as hard as the military, the capacity of satellites is limited. Reduction from 6 bits per picture element to 2, therefore, means a threefold increase in channel capacity.

Closer to home, Bell Laboratories is looking at similar procedures for the obvious Picturephone application and has plans to use video-compression techniques in the photocomposition of telephone directories. Although Bell admits that it has no on-going hardware programs, it's studying two-dimensional coding with the Harr, Hadamard, and fast-Fourier transforms and with differential pulse-code modulation, requiring a frame memory at transmitting and receiv-

ing ends of the system. It's also working on color pictures.

**Prototypes.** Although most of the work is still in the research—even theoretical—stage, at least two programs will pay off this fall in prototype hardware for real-time processing and transmission.

At Wright-Patterson Air Force Base near Dayton, Ohio, the Air Force Avionics Laboratory has started building a hardware processor, designed for remotely piloted vehicles (RPVs), that compresses video transmissions to 1 Mb/s. The Air Force team breaks a typical picture frame, containing 512 by 512 elements, into 4,096 subpictures of 8 by 8 elements each, runs them sequentially through an analog-to-digital converter, and holds them in

# 2000 pole double throw switch

How do you direct 2,000 low level transducer lines into a back-up computer without changing 200 cables?

Easy. T-Bar® 48-pole latching relays.

T-Bar makes high density switches and relays . . . designs and fabricates special switching systems . . . reliably and economically. If you switch a lot of lines — all at once or a few at a time — write or phone today for complete T-Bar literature.

**T-Bar**  
INCORPORATED  
SWITCHING TECHNOLOGY

141 Danbury Road  
Wilton, CT 06897  
Phone: 203/762-8351

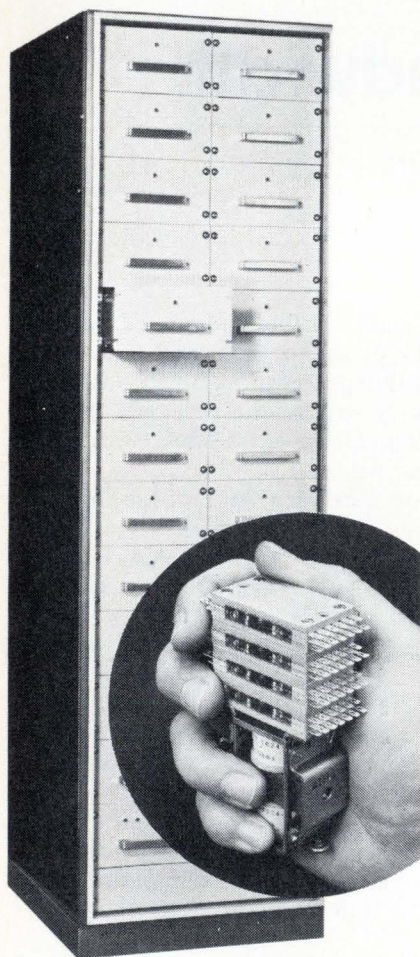

## Probing the news

4,096-bit random-access memories.

The arithmetic/logic unit, built of Schottky transistor-transistor logic, performs simple two-dimensional Harr or Hadamard transforms on the data, depending on the ROM chip plugged into the system. Both transforms require only addition and subtraction during processing, and the simpler ALU that performs these two operations also helps keep the weight of the payload for the pilotless planes to a minimum.

**Smaller.** Facing even larger problems are researchers at the Naval Undersea Center in San Diego, Calif. While the Air Force work is directed toward large-body, high-speed RPVs, the Navy team is limited to a 1- to 2-pound system.

Built around LSI charge-coupled-device circuitry developed by Texas Instruments, the hardware processor reduces the image bandwidth by means of the sophisticated, analog-cosine transform, followed by differential pulse-code modulation. "We cannot go with direct digital implementation because of its complexity," explains Harper Whitehouse, assistant director for science at the Navy lab's sensor and information technology department.

Instead, the Navy first unravels the vidicon output by ignoring every alternate frame and thus obtaining a frame of 256 by 256 elements.

This frame is broken into columns, each 23 elements wide, and each column is processed a line at a time, column by column, at a 5-megahertz rate. The frame takes about a quarter of a second to process, giving an effective rate of 3.75 frames per second. The differential pulse-code modulator compares the bandwidth-reduced analog data to the previous line, quantizes it, and feeds the digital output to the transmitter.

Work at NASA-Ames in Sunnyvale, Calif., is focused on developing hardware for real-time, digital Hadamard-transform systems for satellite use. The NASA technique, unlike that used at Wright-Patterson, divides four successive frames into blocks of 4 by 4 by 4 picture elements for transform coding. Because the method works in three dimensions, a sizable memory is required: the hardware package includes a set of disk memories, 64- and 1,024-bit static RAMs, 256- and 512-bit shift registers, a standard TTL ALU, and a 6-bit a-d converter.

The compression system for planetary exploration at Jet Propulsion Laboratory, Pasadena, Calif., uses a new two-dimensional simpler transform developed by Robert F. Rice, senior research engineer.

With it, JPL has achieved simulated transmission rates of less than 0.25 bit per picture element, although Rice cautions that some of the concepts might not extend to ground applications. □

## Adding—and subtracting—the picture

Traditionally, pulse-code-modulation techniques have been used to digitally describe video-scan frames of 512 by 512 elements. Each element is quantized as one of 64 different shades of gray and transmitted as a binary code using 6 or 8 bits per element. Differential PCM is an attempt to cut down the information transmitted by sending only the difference between that element and a previous one—the same element in the preceding frame or line, or its immediate predecessor. Either way, the difference has already been digitized for the PCM format.

However, most researchers feel that the redundant information can be sorted out better if the elements are in a different domain so that pictures are mathematically transformed without significantly altering their meaning. Most of these transforms try to approximate the Karhunen-Loève transform that is accepted as the best for block-image processing. Perhaps the closest is the cosine transform, an analog technique that yields the real part of the complex numbers that result from a high-resolution fast-Fourier transform.

Harr and Hadamard transforms might be called the poor man's Fourier transforms. Although the Fourier version is better, because it requires multiplication and division, it is difficult to implement. Both Harr and Hadamard versions can be built with add-subtract modules alone.



# An industry first.

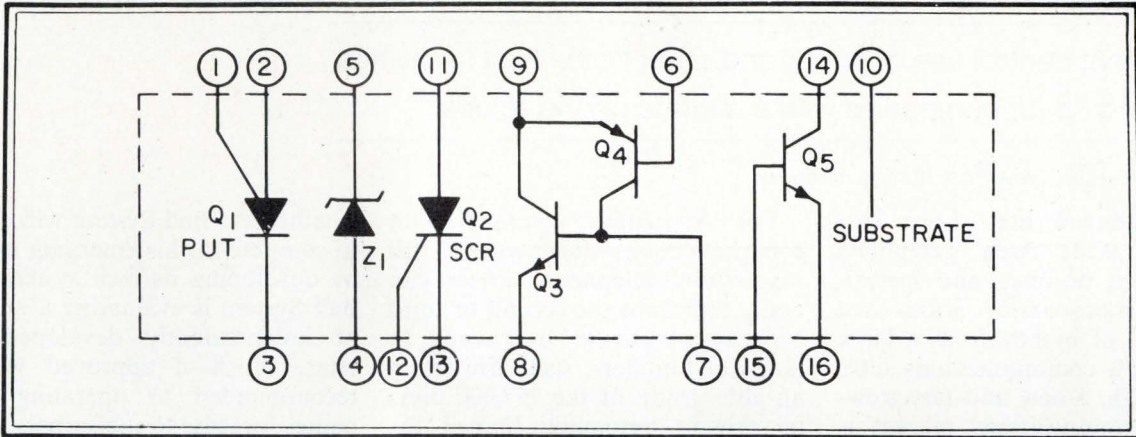

## RCA Solid State's CA3097E Thyristor/Transistor IC Array

There are so many ways to use it that we can't even begin to describe them to you.

We've put a programmable unijunction transistor (PUT), sensitive gate SCR, zener diode, p-n-p/n-p-n transistor pair and an n-p-n transistor ... all together in the 100 times improved plastic package system — RCA's new E-55 (16 lead DIP).

Check these characteristics and decide for yourself how to use the CA3097E in your system.

### Characteristics

- Programmable unijunction transistor (PUT)
  - peak-point current = 15 mA (typ) at  $R_G = 1\text{ M}$
  - $V_{AK} = \pm 30\text{ V}$
  - DC Anode Current = 150 mA
- Sensitive-gate silicon controlled rectifier (SCR)
  - 150 mA forward current (max.)
- Zener diode
  - $8\text{ V} \pm 10\%$
  - $Z_z = 15\ \Omega$  (typ.)

- DC Current 25 mA (max.)
- p-n-p/n-p-n transistor pair
  - $\beta \cong 8000$  (typ)
- @  $I_c = 10\text{ mA}$
- n-p-n transistor
  - $V_{CEO} = 30\text{ V}$  (min.)
  - $I_c = 100\text{ mA}$  (max.)
- Thermal and electrical component tracking with the design flexibility of discrete components
- Improved product reliability with the E-55 plastic packaging system, which demonstrates two orders of magnitude improvement in reliability over previous industry average.
- Operation over a temperature range of  $-55$  to  $+125^\circ\text{C}$ .

If the CA3097E can work for you, order now. It is available in quantity — at a price that will stop you in your tracks: \$1.35 (1K price).

Want to know more about the CA3097E? Write: RCA Solid State, Section 70G25, Box 3200, Somerville, New Jersey 08876. Or phone: (201) 722-3200, Ext. 3144.

**RCA Solid State**  
products that make products pay off

Communications

# Plugging in to phone management

Systems that control use of WATS and other lines result in savings of 15% and up for companies with elaborate phone setups

by John N. Kessler, New York bureau manager

**Special reduced-rate** phone services—like Wide Area Telephone Service lines, tie lines, and specialized common-carrier links—can shave a lot of money from a large corporation's communications bills. Now, though, a new and fast-growing telecommunications market is springing up to help coordinate a company's complex mix of phone services—and to cut another 15% to 20% off the bills. The basis of all the systems being offered is a computer—either a minicomputer or a microprocessor. In the simpler systems the computer keeps logs of all calls, and in the more sophisticated systems, it routes calls over the least expensive path.

This new, computerized adjunct of the telephone market is confined—at least at first—to telephone customers with more than 100 lines and 50 or more trunks, which might include WATS, foreign exchange (FX), direct distance dialing (DDD), tielines, and specialized common-carrier links. With such facilities, telephone bills can easily top \$10,000 a month.

For companies equipped with communications facilities of this magnitude, telephone service can easily represent the second or third highest corporate overhead. In terms of numbers, such firms form an elite group of the 197,000 users of private automatic branch exchange (PABX) and Centrex systems. About 20,000 have more than 200 lines, according to Harry Newton, a New York City telecommunications consultant.

**Marketing.** Newton estimates that a little more than 100 computerized telephone-management systems will be installed by the end of the year. This represents an equivalent sales volume of about \$6 million, including leased systems. But he expects this figure to grow to at least \$20 million in three years—a fairly conservative figure, considering the potential \$1.2 billion market. In three to five years, Newton says, the cost of computerized telephone-management systems will drop, and the economic benefits will likely be reaped by smaller users, too.

One of the big unknown factors is

whether the Bell System will decide to compete in this emerging market by developing its own system. The Bell System is evaluating a number of independently developed systems, which—if approved—will be recommended to operating companies for lease to subscribers.

The only Bell System installation to date is one purchased from Vitel, Mountain View, Calif., the manufacturing subsidiary of the Continental Telephone group. It's installed at Transamerica Corp. of San Francisco.

**Control.** There are two basic types of systems. Passive systems monitor lines and trunks, providing hard-copy printouts of what extensions called what numbers, how much each call costs, when each call was placed, when it ended, and how each call was routed—for example, via WATS or DDD. The active systems provide two basic additional functions: they can restrict telephone usage of certain phones to, say, local and WATS trunks, and they can force a caller to use the least-expensive line or trunk.

Both systems link a computer with magnetic tape and a clock connected to each phone line and/or trunk. The dc pulses from each extension and the time of day are monitored. The tapes can be collected periodically and processed on a computer to yield hard-copy printouts. Depending on the software, various types of printouts can show individual extension use, department usage, peak-calling periods, the toll charges for each extension, the routing of each call, and hourly distribution of call minutes, based on time or trunks used. Special programs can also screen out incom-

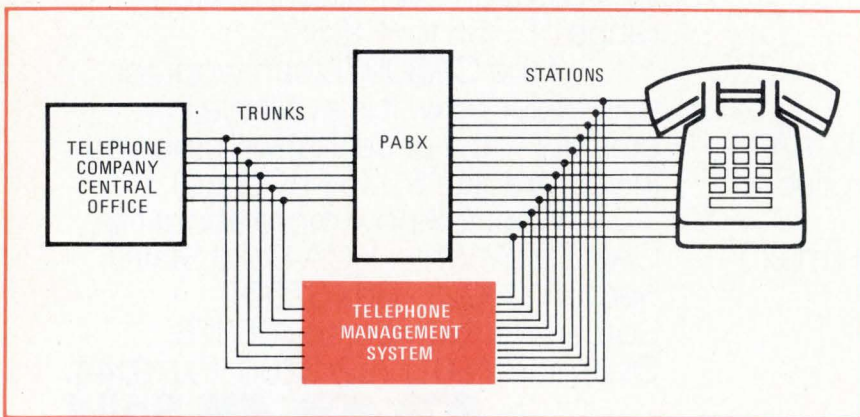

**Getting the most from phones.** This diagram shows typical installation of a computerized telephone-management system. Such systems can log calls and also route them.

# Seven ways to tell a Darlington that's great from a Darlington that's merely good.

Monolithic rather than two-chip offers greater reliability

Device geometry eliminates the possibility of interconnect failures

Clip lead construction improves thermal and mechanical ruggedness

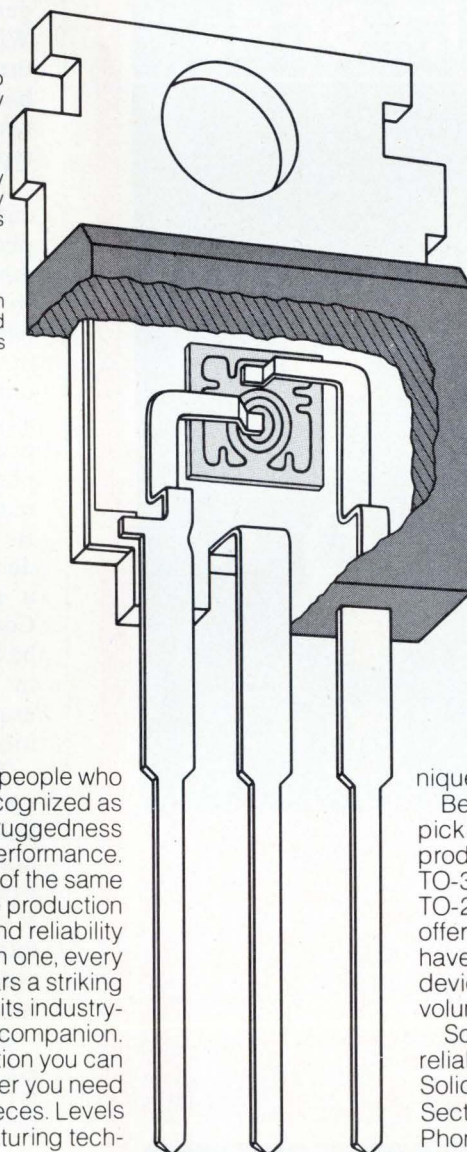

Process Controls and thermal fatigue characterization result in high  $I_{SB}$  capabilities

Built-in protective diode shunts reverse current for added circuit protection

Exclusive thermal fatigue ratings enable safe full-capability operation

Real-time testing improves quality levels over traditional testing

It's what you'd expect from the people who brought you the 2N3055 — long recognized as the industry leader for ruggedness and performance.

Our Darlington transistors are made of the same construction system, on the same production facility, with the same process and reliability controls. So, in more ways than one, every RCA Darlington transistor bears a striking resemblance to its industry-workhorse companion.

Another RCA power transistor tradition you can look for is high quality levels whether you need a hundred, a thousand, or a million pieces. Levels achieved through modern manufacturing tech-

niques combined with real-time product control.

Because RCA offers a wide variety, you can pick the Darlington package that best suits your product needs. Including the hermetic steel TO-3. The TO-5. The TO-66. Plus the RCA TO-220 VERSAWATT — the plastic package that offers reliability at low cost. Soon, you'll also have the RAP series, a new generation of devices designed for low power, high volume applications.

So if you want RCA performance and reliability in a Darlington, contact your RCA Solid State distributor or write: RCA Solid State, Section 70G25, Box 3200, Somerville, N.J. 08876. Phone (201) 722-3200 Ext. 2129.

**RCA** Solid State

International: RCA, Sunbury-on-Thames, U.K., or Fuji Building, 7-4 Kasumigaseki, 3-Chome, Chiyoda-Ku, Tokyo, Japan.  
In Canada: RCA Limited, Ste. Anne de Bellevue 810, Canada.

## Probing the news

pleted calls, wrong number, local calls, and extension calls.

The active systems can be customized. Each extension can be assigned a calling area, limiting the caller to local calls, specific exchanges, or WATS lines, or can be permitted everything, including FX and DDD. For example, with the TMS System developed by Dextel

Corp. of New York, such restrictions can be changed for different times of the day, according to the availability of trunk facilities.

Action Communications Systems Inc., Dallas, uses a separate piece of hardware it has dubbed a Watsbox to give a caller to an outside line. The Watsbox is connected to a PABX or Bell System Centrex. To place a call, the user enters his authorization number. The Watsbox then automatically selects the most eco-

nomical route for long-distance calls and records time and billing information. As with some other systems, Watsbox features include replacing of frequently used long-distance numbers with a two- or three-digit code. If the circuits are all busy, the system will also notify a caller of the number of call requests already stacked up.

One of the most unusual systems, in terms of hardware, is the Alston Call Account System, made by the Alston division of Conrac Corp., Duarte, Calif. The common control functions that format the data are handled by an Intel microprocessor. The microprocessors, which handle 240 lines each, can be added together to make larger systems. While there is no magnetic tape, there is an Ascii code plug at the back of each unit that can be connected to a tape, teleprinter, or teletypewriter.

**Accurate charges.** Besides simply cutting bills, computerized telephone-management systems have other economic benefits. Their use will enable companies to optimize telephone facilities by eliminating or adding trunks or lines. For some organizations, such as law firms and advertising agencies, these systems provide a definitive cost index of phone charges that can be billed realistically to individual clients. But as Edward Parsons, vice president of Interconnect Corp., Miami, a subsidiary of Milgo Electronic Corp., Miami, puts it, "the users will have to become more sophisticated in evaluating the assignment and usage of telecommunications facilities."

The "big brother" aspect in any system that records who calls when and for how long is an inherent economic asset. For example, Nat Freedman, president of Dextel, has a customer that was able to determine the cost of employees calling a certain New York City number that turned out to be Dial-a-Joke.

The future of the industry, in terms of electronics, says Freedman, is toward smaller, less expensive systems. Some units, he believes, will eventually be incorporated in the PABX itself. And this, in turn, will change the PABX from simply a switching device to an intelligent system. □

## 8 CASES FOR SWITCHING TO NATIONAL® SCRs



16-1600 Amperes rms  
25-1700 Volts  
Power and Inverter SCRs  
Patented Regenerative Gate

*Call or write for full details*



**NATIONAL ELECTRONICS**

a varian division

geneva, illinois (312) 232-4300

# THE FIRST PRACTICAL DATA-ACQUISITION MODULE:

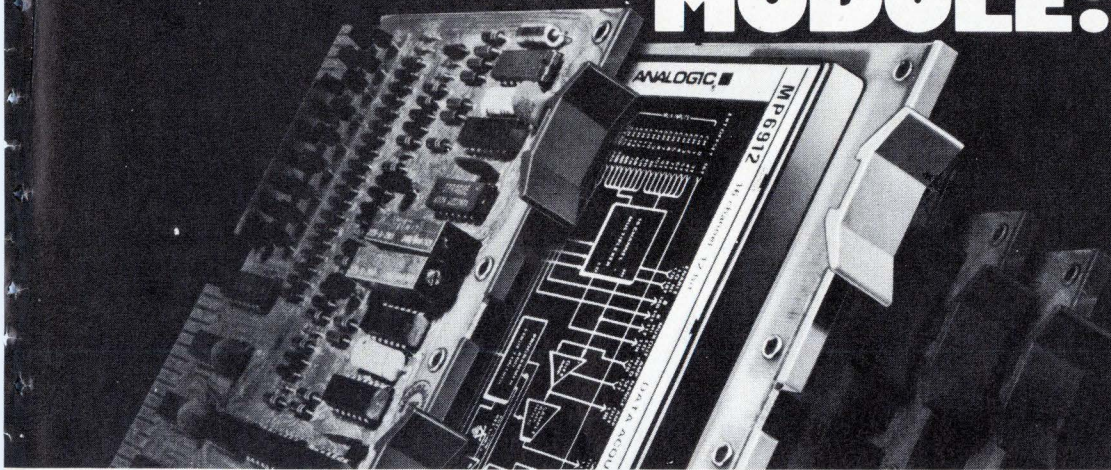

**Complete 12-bit,  
16-channel  
system fits 0.5"  
card spacing--  
anywhere.**

**Better  
performance,  
at lower cost,  
than individual  
module  
combinations.**

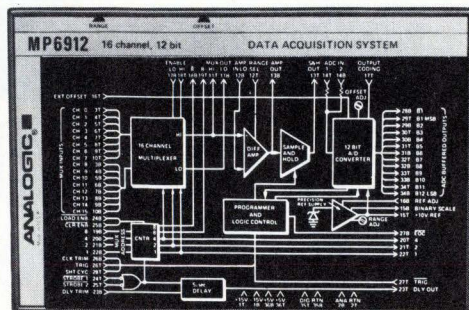
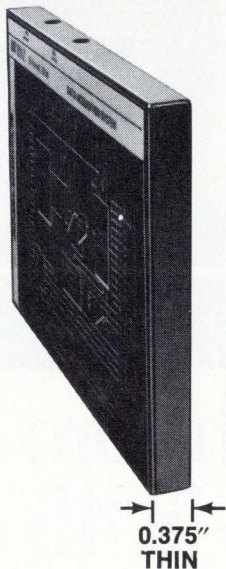

On a minicomputer motherboard, medical instrument or process control system . . . mounted on a single small card . . . plugged directly into a card-cage connector—there's always room for the 0.375"H x 4.6"W x 3.0"L Model MP6912: With space at a premium, this remarkable plug in, easily serviceable high-performance / low-cost system is your first really practical alternative to either in-house design or larger more costly systems. Particularly since you'd actually pay *more* to get comparable performance from individual modules that need .3-5 times the "real estate".

You get a 16-channel multiplexer (expandable to 256 channels), fast sample and hold, and a 12-bit A/D converter (accuracy  $\pm 0.025\%$  at a 100kHz thrupt rate), integrated with complete programming, control, and timing logic. (That's what we call the first *practical* data acquisition module.)

What you don't get is equally important: error accumulation; module inter-connection costs and headache; redesign challenges

every time the application changes; and testing, documenting, and quality-controlling at the module level.

The MP6912 is an optimized design: 100% shielding on all six sides to minimize interference; minimum parts count for inherently high reliability; an exceptional 100kHz basic throughput rate that can be "short cycled" up to 450kHz; buffered outputs for trouble-free digital interconnection.

A companion D.C. to D.C. converter, the MP3020, which is powered by the +5V logic supply is also available to provide all the power needed for the MP6912 in a compatible 0.375" thin package.

Write for our 16-page designer's guide to the MP6912—applications and timing diagrams, set-up and calibration procedures, etc. and see why the Analogic alternative makes sense. Analogic, Audubon Rd., Wakefield, Mass. 01880; phone (617) 246-0300.

Northeast, 617-235-2330, 203-966-2580, 315-466-0220, 201-652-7055, 212-947-0379

Mid Atlantic, 215-272-1444, 215-687-3535, 703-790-5666, 301-252-8494

Midwest, 314-895-4100, 913-362-0919, 216-267-0445, 513-434-7500, 313-892-2500, 412-892-2953, 312-283-0713, 414-476-1500, 317-844-0114

South, 713-785-0581, 214-620-1551, 305-894-4401, 919-227-3639, 205-534-9771, 305-773-3411, 813-867-7820

West, 303-744-3301, 505-523-0601, 602-946-4215, 505-292-1212, 714-540-7160, 415-398-2211, 206-762-7664, 503-643-5754

Canada, 613-836-4411, 604-688-2619, 416-499-5544, 514-636-0525, 902-434-3402

**ANALOGIC**  
... The Digitizers

Circle 75 on reader service card

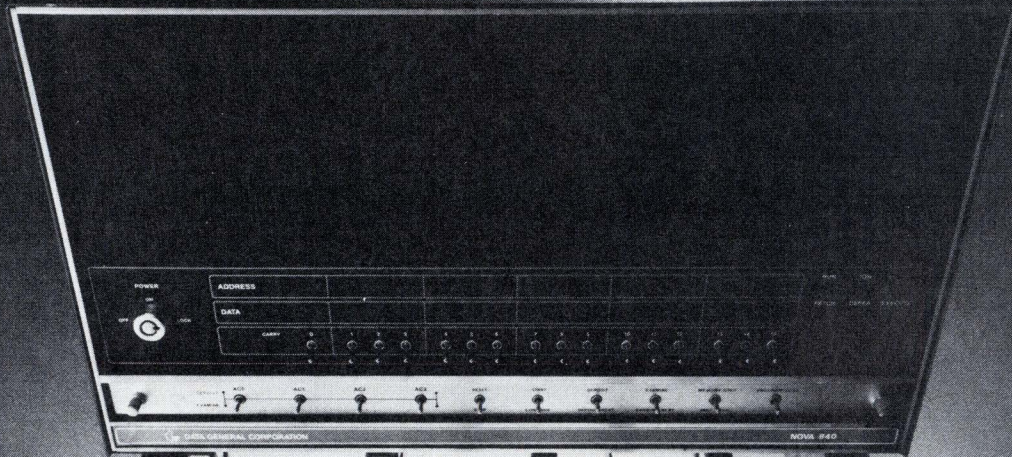

The 840 out of Southboro  
is now scheduled to arrive in 45 days.

When the 840 first came out, a lot of people came running to Southboro to see what it could do.

It did so many different things that people started buying them faster than we were building them.

Which unfortunately made them kind of hard to get.

So in an effort to make 840's easier to come by, we've made the place where we make them bigger. And faster.

And to encourage even more people to want 840's, we're offering some incredibly powerful systems software. A Real-time Disc Operating System that works just as hard developing your programs as running them. Plus a Fortran 5 compiler so comprehensive the diagnostics tell you exactly what's wrong and where. In English.

To run software like that, you'll get hardware like this: 256K bytes of core, Memory Management and Protection Unit, high-speed Floating Point, terminal, disc and tape drive.

But now you won't have to stand in line to get it.

Catch the 840 out of Southboro.

It'll arrive 45 days after you buy your ticket.

## DataGeneral

The computer company you can understand.

• Data General Corporation, Southboro, Massachusetts 01772, (617) 485-9100.  
Datagen of Canada Ltd., Hull, Quebec (819) 770-2030/Data General Europe, Paris, France 504-23-44.

Government

# U.S. to require computer security

Legislation would force Federal and local governments to limit access to data banks; big purchases delayed as law is awaited

by Larry Marion, Washington bureau

**Computer privacy** is coming, but it isn't going to come cheap. That's the message for hardware makers in bills that are starting to make their way through the Federal legislative process. When these measures, seeking better security for government data banks, are boiled down into a law—and experts expect one this year—security devices for Federal, state, and local government data banks containing personal information will be mandatory. Senate committee statistics indicate that there are dozens of Federal installations alone and hundreds more at other levels of government.

Access controls, including substantial record-keeping systems, would require installation of costly security systems. Ruth M. Davis, director of the National Bureau of Standards Institute for Computer Science and Technology, says the majority of the privacy requirements would be met by "hardware implementation."

Computer security has been a major concern for the last few years as hundreds of cases of computer manipulation for personal profit have been uncovered. Banks, telephone companies, and retail outlets have investigated various methods of limiting access to files containing information, such as accounts receivable and cash deposit totals. Time-sharing centers have been especially interested in preventing fraudulent billing schemes.

**Development needed.** Experts in industry and government expect access controls to be offered by computer vendors within the next three or four years, but Davis and another expert, Rand Corp. analyst Willis Ware, say that these systems are not



**Technology lags.** That's what Ruth Davis says about security and privacy hardware. She directs NBS computer science institute.

now available on the commercial market. Davis says that techniques and systems developed for the military could be adapted by commercial firms "when the incentive is there." Such techniques—including voiceprints, fingerprints, hand geometry, and magnetic cards—can be circumvented or have not been sufficiently developed, Davis has told a Senate committee. Experts say the cost of secure-access devices, between \$20,000 and \$30,000 per four-terminal data bank, may be too high.

Davis sees security as "a whole new market for the future. No one has gotten beyond the superficial level of computer-security devices. At this time, we don't have the slightest idea what the total cost of

security will be, but preliminary studies indicate the cost to the Federal Government would be between \$750,000 and \$5 million at the upper end of the spectrum, plus up to \$1 million per year in operating costs, depending on which legislation is passed. Encryption techniques [guidelines on encryption are soon to be issued] will result in a four-fold increase in transmission."

Rapid application of current technology, plus development of new technology, will be needed to meet the demands of the proposed legislation, she notes. And increased transmission lines and facilities would be needed to handle the extra load.

**Bills.** Despite the warnings about cost and technology, there's no shortage of bills in the congressional hopper. The legislation includes formation of a Federal privacy board, to be responsible for annual reports on the size and number of Government data banks with personal information. Other proposals that are included in many of the more than 100 computer privacy proposals include requirements for recording each access to a system and keeping that information for two years or more.

Davis, at hearings of the Senate's constitutional rights subcommittee of the Judiciary Committee and the Senate Government Operations Committee, warned that such a requirement for information accessed only once in nine months would double a file's contents in seven years. Davis also noted that merely recording each access by the operator's name is not too difficult, but if the legislation requires a catalogue of facts—such as which part of the



data bank was accessed, and what was reviewed and for how long—the resulting need for memory and operating costs would be exorbitant. She indicates that costs of increased memory capacity and the development and sale of access-control systems would have a major impact on the computer industry.

“Either a computer data bank has access controls or lots of insurance—those are the only two options I see in response to the security-privacy legislation now before Congress,” says Rand’s Ware, who is also a technical consultant to Wema. He warns that it will be more difficult to apply access control to some computers than to others. For the data-bank operator, Ware says the new legislation would mean that more memory capacity would be devoted to housekeeping.

**Packages coming.** As for the vendor hardware, Ware says, “In the next three years, most hardware manufacturers will offer hardware-software security packages as part of a security safeguards system. And right now, there are not many gadgets around that can authenticate if the user is who he says he is.” Most of the proposed bills permit aggrieved citizens to sue computer data-bank owners if the owner/operator does not comply with privacy guarantees in the legislation, including prohibitions against improper disclosure of personal information.

The final Senate committee proposal should be before the floor for a vote by the end of the summer, according to Congressional staffers. They expect House action before Christmas. A computer-privacy bill is inevitable this year, they say, because it is a “computer-privacy-conscious” Congress. Sen. Sam Ervin (D, N.C.) a prime sponsor and mover of the computer-privacy legislation, makes the same prediction.

**Impact.** Already the specter of legislation has had an enormous impact. General Services Administrator Arthur F. Sampson has announced a new policy of submitting computer-procurement proposals to Congress before requesting bids, and the GSA now reviews the security requirements and features of in-house computer proposals from other executive agencies [*Electron-*

## Sweden's watchdog

Sweden's Data Inspectorate—the world's first data-bank watchdog—has made its first major decisions. The rulings are expected to have long-range effect on private data banks in that country. Perhaps the most important is rejection of a plan by the nation's banks to establish a national repository of information on all Swedes to be used for credit and other financial transactions. Each bank will be permitted to operate data banks only on its own customers.

The Swedish privacy laws and those being submitted to the U.S. Congress have basic differences. The American versions are concerned to a major extent with computer security, as well as privacy. On the other hand, the year-old Swedish law [*Electronics*, July 19, 1973, p. 72] prevents, among other things, keeping records of highly personal matters, gives each citizen the right to get a free printout of his “dossier,” forces data banks to correct errors or eliminate names on request, and gives citizens the right to sue data banks.

*ics*, June 27, p. 30]. Proposed major system purchases for the Internal Revenue Service, the Veterans Administration, and the Justice Department are being held.

The GSA delay in future computer and telecommunications procurements stems from the recent furor among the agency, Congress, and the White House Office of Telecommunications Policy over a large computer-procurement proposal issued in February but withdrawn in May. GSA wanted to purchase up to 10 large computer centers for it and the Agriculture Department—all connected by a dedicated network. OTP objected to the size of the purchase, the failure of GSA to try for leased telecommunications systems, and the absence of detailed cost estimates for the package.

GSA will issue an amended request for proposals this summer for a smaller computer system without a telecommunications network. The agency temporarily will use its Federal telecommunications system but issue an RFP on a telecommunications network next year unless Congress intervenes. □

# High-Q Tunable Filter



The EDMAC Hi-Q Tunable Filters are general purpose active two pole filters which can be used in either a bandpass or a bandreject mode of operation.

## FEATURES

- ≡ Tunable bandwidths corresponding to circuit Q's of 1000.
- ≡ Tunable frequencies from 1 Hz. to 30,000 Hz.
- ≡ Independent controls for bandwidth and center frequency.
- ≡ Simultaneous bandpass and bandreject filter functions.
- ≡ Controlled input-output phase relationship.
- ≡ Zero phase shift at center frequency.
- ≡ Selectable automatic tracking.
- ≡ Circuit overdrive indication.
- ≡ Selectable calibration mode.

WRITE FOR COMPLETE SPECIFICATIONS

## EDMAC Associates Inc.

333 West Commercial Street,  
East Rochester, New York 14445  
(716) 385-1440

# Our new 25 and 50 nsec Fast Recovery Rectifiers

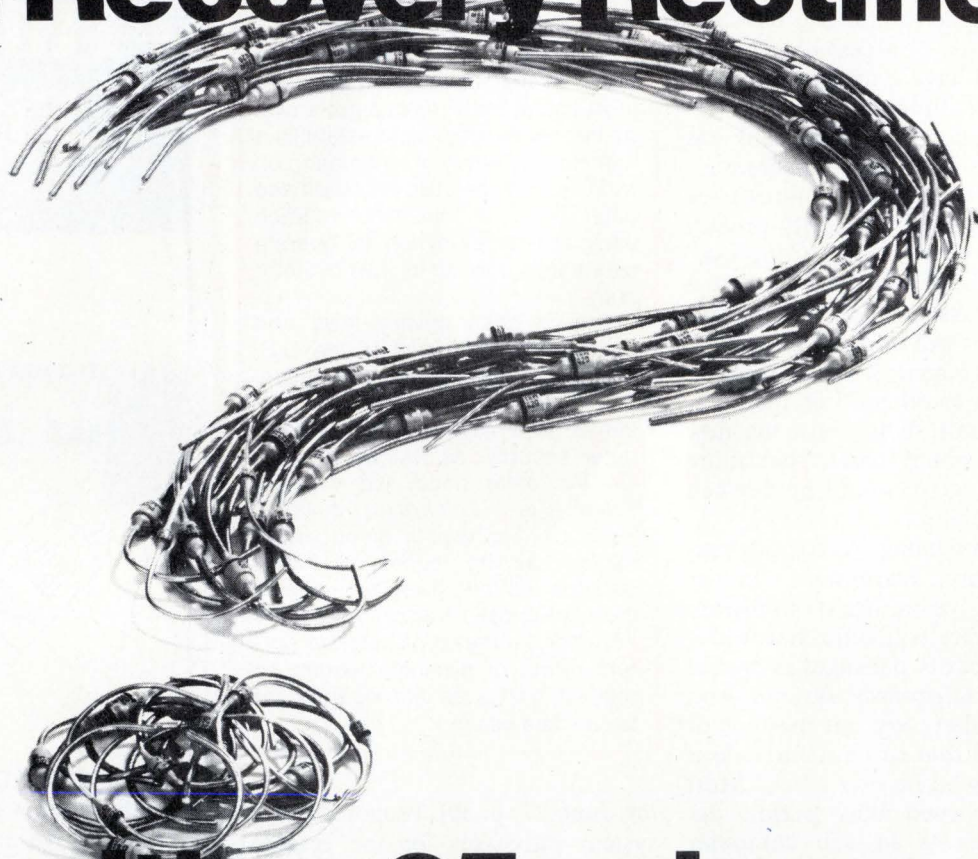

## are either 25% cheaper or 100% more expensive

**We're not confused.** Our new axial-leaded Fast and Ultra-Fast Recovery Rectifiers are cheaper—if you need the switching speed. But they're more expensive if you don't.

If you can get by with 100 nsec speeds in your power control and conversion circuits, go ahead. There's no need to pay for what you can't use.

But, if you're working with fast transistors, know this: at 25 and 50 nsec speeds, Fast Recovery Rectifiers protect your power transistors, operate with

greater efficiency, less power dissipation and heat. And that means less energy needed along with far simpler packaging.

Happily, at TRW, along with speed and efficiency, you get competitive savings. Our 50 nsec parts will generally cost out at 25% less than similar parts.

For complete specifications, write John Powers, TRW Power Semiconductors, an Electronic Components Division of TRW, Inc., 14520 Aviation Blvd., Lawndale, California 90260. Or call (213) 679-4561.

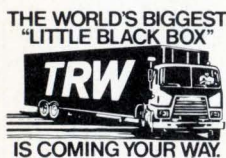

## **TRW** POWER SEMICONDUCTORS

**These products are available through the following authorized distributors:**

Almo Electronics  
Bell Industries  
Cramer Electronics Inc.  
De Mambro Electronics

Electronics Marketing Corp.  
Elmar Electronics Inc.  
Hall-Mark Electronics Corp.  
Harvey-Michigan Inc.

Lake Engineering, Ltd.  
Liberty Electronics  
Pyttronic Industries Inc.  
Rochester Radio

Semiconductor Concepts Inc.  
Summit Distributor  
R. V. Weatherford Co.  
Westates Electronics Corp.  
Wilshire Electronics

Instrumentation

## Power woes create a market

Line monitors appeal to banks, insurance companies, research labs, and others worried about variations in voltage and current

by Bernard C. Cole, San Francisco bureau manager

**If you think** you've been affected by the power-generation problem, pity the operator of an elaborate computer installation facing questions. Should data be checked to see if a sudden voltage drop has skewed it? Has the uninterruptible power system malfunctioned? Has a power variation made test results faulty?

The answers are being supplied in more and more cases by power-line monitors. These instruments range from \$300 strip-chart recorders that record voltage, current, or frequency to elaborate power-line-monitoring systems costing as much as \$25,000 for their multiparameter capabilities. In the words of one maker of such equipment, "It's like selling insurance."

There is still only a handful of firms in this infant industry. One of them is Programed Power Inc. of Menlo Park, Calif.

"Last year's fuel and energy crunch woke up a lot of people in the electronics and computer industries," says president Lee Cooper. "They found out that, much to their dismay, they can no longer take for granted what comes out of that electrical socket in the wall. Since then there has been an incredible rush of companies looking for instruments to help them determine power needs."

Although PPI's main motivation since incorporating in January 1972 has been the development of uninterruptible power systems, the company has found a lucrative sideline in its model 3200 power-line monitor. It falls midway between the other models on the market in terms of cost at \$3,200 and combines the portability of less expensive models with the sophistication of more ex-

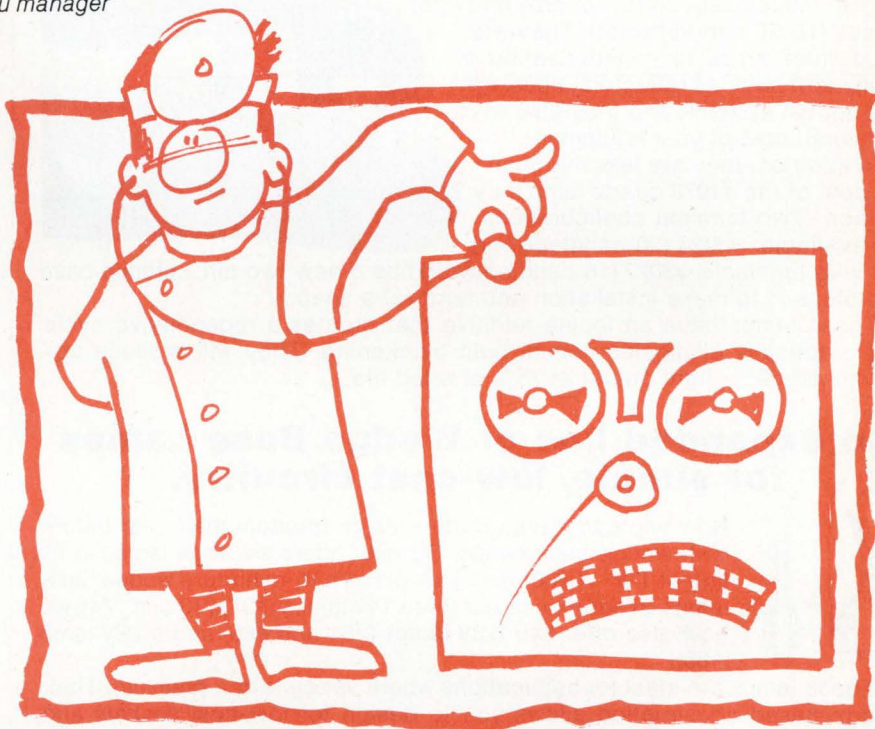

pensive monitoring systems.

Sales for the monitor last year totaled only \$200,000. This year, PPI expects to gross between \$600,000 and \$1 million. Among the company's customers are Aetna Life and Casualty, the American Broadcasting Co., Brookhaven National Laboratory, Control Data Corp., Univac, E. I. DuPont, Ford Motor Co., Eli Lilly and Co., Montgomery Ward, NASA, the Army, Navy, Air Force, and the Departments of State and Defense, the Stanford Research Institute, and the University of Michigan.

On the East Coast, Data Research Corp. of Fort Lauderdale, Fla., finds business getting better and better. According to Linda Stark, sales manager, the company's sales amounted to only \$200,000 in the

fiscal year ending July 31, 1972. But last year's figure doubled to \$400,000, and while the numbers haven't been totaled for 1974, company officials say flatly that 1974 will be even better than last year.

One of the causes of Data Research's optimism is the success of its Powerguard, a \$485 model. The instrument is being offered by General Electric as part of its instrument-rental program, and, says Stark, the giant corporation is enthusiastic about customer response. Leasing, incidentally, is an important business for Data Research. "A customer will take an instrument for two or three months to find and correct a problem," explains Stark.

The company's business mix runs around 70% to 90% computer users, and a good part of the remainder is

# New and improved General Electric lamps provide for increased design flexibility.

## Two new sub-miniature halogen cycle lamps ideal for miniaturization.

These new T-2, 6.3V, 2.1 amps, 75 hour GE halogen cycle lamps are the smallest of their type (.265") and set industry standards for size and light output (16-20 candlepower). They are the perfect lamps for miniaturization of equipment such as reflectors, housings and optical systems, and they also save on overall cost of your equipment.

In addition, they are less than half the cost of the #1973 quartz lamp they replace. Two terminal configurations are available: #3026 (20 candlepower) has wire terminals; #3027 (16 candlepower) has a new two pin, ceramic base that plugs in to make installation and removal a snap.

These lamps have an iodine additive that creates a regenerative cycle that practically eliminates normal bulb blackening. They will produce approximately 95% light output at 75% of rated life.

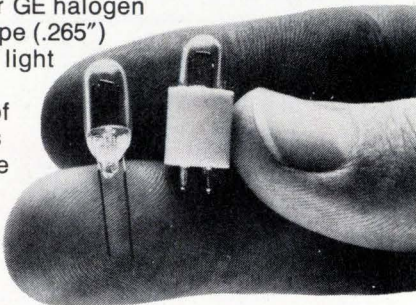

## An expanded line of Wedge Base Lamps for simple, low-cost circuitry.

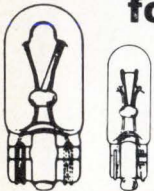

Now you can have greater design freedom than ever before with wedge base lamps. GE now offers six large lamps in its line of T-1 3/4 (.230" max.) all-glass, sub-miniature wedge base lamps. In addition to our three 14V lamps (#37, #73 and #74), we now also offer two 6.3V lamps (#84 and #86) and a 28V lamp (#85).

These lamps are ideal for applications where space is at a premium. Their wedge-based construction allows you to design for low-cost sockets and virtually ends corrosion problems because they won't freeze in the sockets. And the filament, which is always positioned in the same relation to the base, offers more uniform brightness.

## Green Glow Lamp has been improved over previous lamp.

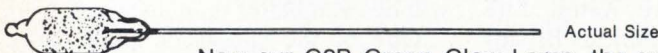

Now our G2B Green Glow Lamp, the only domestic green lamp on the market today, gives a more uniform, purer green light than our previous model. It's bright enough for your circuit component applications. With appropriate current limiting resistors, it can be used for 120/240 volt green indicator service. Or used together with our high-brightness C2A red/orange/yellow glow lamps to emphasize multiple functions with color.

All GE glow lamps give the benefits of small size, rugged construction and low cost — 12¢ each for the G2B, 44¢ each for the C2A in 100,000 quantities.

## Send today for newest literature.

For the most up-to-date technical information on any or all of these lamps, write: General Electric, Miniature Lamp Products Department, #0747-M, Nela Park, Cleveland, Ohio 44112.

GENERAL  ELECTRIC

## Probing the news

from Government agencies. And, says Stark, some of her company's instruments even keep an eye on uninterruptible power systems, which are supposed to eliminate the power problem entirely. One bank, she says, thought that the bad data coming from its computers was due to power glitches. But installation of a monitor showed that the power system was to blame.

One would tend to think of the power-monitor business as a one-piece sale aimed at a particular problem. But that's not so, says PPI's Cooper. Actually, the situation is just the opposite.

"A few weeks with a monitor on the line and customers realize that the power environment, even excluding brownouts and voltage reductions, is not a constant one. It isn't even one with just a few predictable variables that can be guarded against by altering the equipment or inserting buffers to protect the sensitive electronic components."

For one thing, the impedance of power lines can cause transients and voltage drops, especially when large loads are tied into the same power loop. Current loads from motors, large transformers, mercury arc lighting, and even auxiliary power sources can drop line voltage 10% to 20% for longer than 30 milliseconds. Add this to the typical power variations of  $\pm 5\%$ , and computer operations, for example, would be marginal at best. And there is also the problem of voltage continuity.

Remedies to many of these problems exist in the form of motor-generator sets, line conditioners, or voltage regulators to buffer delicate electronic systems from incoming power disturbances and in uninterruptible power sources to maintain complete and regulated output for both transient and long-term disruptions or outages.

"But the power network isn't a steady-state environment," says Cooper, "and as a result some form of monitoring is virtually mandatory, if only to provide records of the quality of the electrical service and give some idea of how to alter safeguard procedures." □

# New **TY-RAP**<sup>®</sup> Tool completes one million ties every month

Triggered 70,000 times each day without a misfire!

As you read this message, the production model of this pneumatic hand tool, TR-225, is continuing its life cycle test... 1,000,000 cycles per month without a falter.

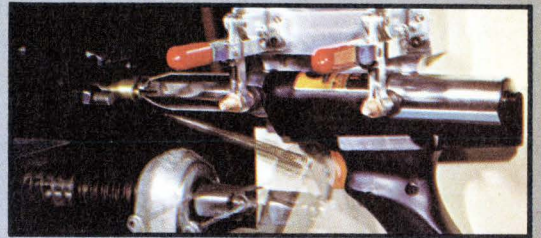

This 20 ounce tool ties wire bundles from 1/16" to 4" diameter with just about every regular and "Slim Line" type TY-RAP<sup>®</sup> cable tie... 16 sizes in all. It reduces operator fatigue... and is particularly well suited for close-up work, break-out points and tying in confined places in equipment.

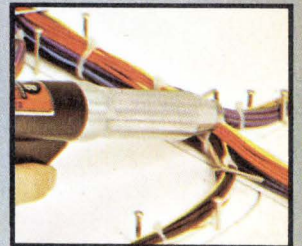

Our other new production tool, the high speed TR-300, automatically positions a TY-RAP tie around bundle, cinches to a preset tension, locks tie securely and trims evenly... all in 8/10 of a second... and on bundle diameters ranging from 1/32" to 5/8".

Write for new catalog. The Thomas & Betts Co., Elizabeth, New Jersey 07207, (201) 354-4321. In Canada, Thomas & Betts Ltd., P.Q.

**Sold Only Through Authorized T&B Distributors**



## **THOMAS & BETTS**

Division of Thomas & Betts Corporation

Circle 83 on reader service card

524

*A flexcircuit for low-light home movies.*

# We did it for Kodak.

In turning the idea of low-light home movie making into the reality of the KODAK XL-55 Movie Camera, Kodak engineers solved tough design problems at every step. Among these problems, the design of a circuitry system of minimal bulk and maximum reliability.

They accomplished this with a Schjeldahl flexcircuit.

Flexing in four planes, this Schjeldahl flexcircuit has two 180 degree fold-over sections. This provides circuit reversal, transfers conductors to opposite sides of the circuit without the expense of plated-through holes and permits placement of seven conductors in a five conductor space — all without two-sided circuitry.

This Schjeldahl flexcircuit makes all electrical connections in the camera and carries all electronic components. For manufacturing efficiency, a hardboard back-up section permits auto insertion of components and continuous process wave soldering.

The flexcircuit fits available space and is designed for volume production. It does for Kodak what flexcircuitry does best.

Perhaps Schjeldahl flexcircuitry advantages can help in your design problems. It only takes a call to Schjeldahl to find out.

Schjeldahl did it for Kodak.

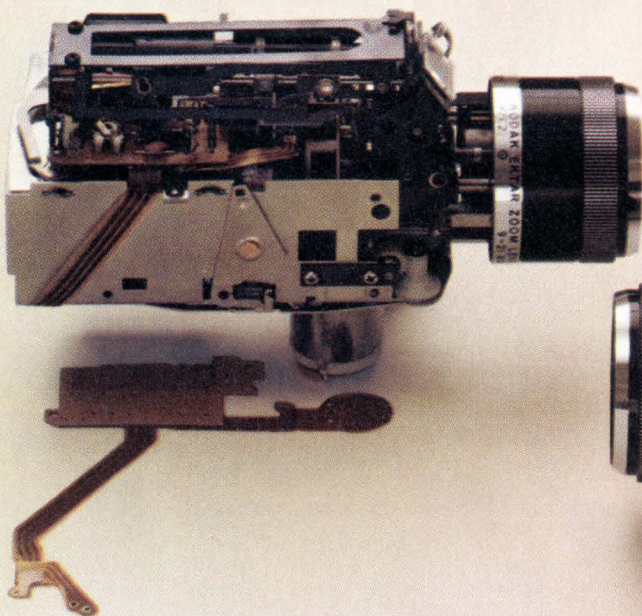

 **Schjeldahl Company**

Electrical Products Division  
Northfield, Minnesota 55057  
Phone: (507) 645-5633

*The state of the art people in volume flexible circuits*



# And we can do it for you.

# Semiconductors inside tubes make high-performance rf amplifiers

Rf power amplifiers and modulators with unprecedented voltage-rise-time and gain-bandwidth capabilities will soon be obtainable, now that it's possible to build reliable, long-lived electron-bombarded semiconductor devices

by David J. Bates, *Watkins-Johnson Co., Palo Alto, Calif.*

□ Electron-bombarded semiconductor (EBS) devices, which are essentially semiconductor diodes in the same envelopes as modulated electron beams, are now coming on the market as radio-frequency amplifiers and modulators that far outperform either vacuum tubes or semiconductors acting on their own. The idea is not new—an EBS device, after all, is just a photodiode illuminated by a high-energy electron beam instead of light—but only in the past few years have the problems of reliability and lifetime been solved.

No EBS device is in actual systems use yet, but their unusual features will soon make them an attractive alternative in many high-power, wideband digital and analog systems. For instance, their gain-bandwidth and power-bandwidth or voltage-rise-time capability is 100 to 10,000 times greater than that of existing competitive devices. A high-voltage modulator has produced 800 volts output with less than a 1-nanosecond rise time, for a  $dv/dt$  of nearly  $10^{12}V/second$ . A high-current modulator has produced 100 amperes output with 2-ns rise (and fall) time, for a  $di/dt$  of 50,000 A/microsecond.

Besides an electron gun and diode, an EBS device contains an rf input section and an rf output assembly (Fig. 1). The gun is biased negatively with respect to a semiconductor diode, either a conventional pn junction or a Schottky diode. The electron beam, which illuminates the diode with electrons having energies in the 12- to 15-kilovolt range, is controlled by a pulse from the rf input section. The rf output assembly takes the signal from the diode, which is reverse-biased well below avalanche threshold in order to keep leakage currents low when the electron beam is turned off.

While the electron beam is on, however, electrons penetrate the depletion region of the diode (Fig. 2) and generate hole-electron pairs—one pair for each 3.6 electron-volt loss (more or less) of incident electron energy. This results in a current gain, from electron beam to diode current, of 2,000 or greater. The diode current then is applied to a load to develop the output pulse.

### Three types

Figure 1 shows the most basic kind of EBS device. Known as the density-modulated type, it has some of the characteristics of a vacuum-tube triode. Since its

output current is related to the grid voltage by an approximate three-halves power law, it is not used for applications that need linearity. However, the density-modulated device has a transconductance per unit area of cathode that is about 1,000 times greater than in a conventional planar-grid triode. This gives it much greater gain-bandwidth or voltage-rise-time characteristics and makes it excellent for modulator applications.

A second type of EBS device is deflection-modulated (Fig. 3). Here, a traveling-wave modulation structure deflects the beam to illuminate a diode, and the amount of diode current is proportional to the deflection voltage. In an actual device, a deflection mask is inserted in front of the diodes to collect electrons when no input signal is applied. Highly linear amplifiers can be built with this technique. With two target diodes, the device can be operated in a highly efficient class-B operation—half of the input sine wave would deflect the beam in one direction and illuminate one diode, and the other half of the sine wave would illuminate the other diode.

The deflection-modulated device has no analog in ei-

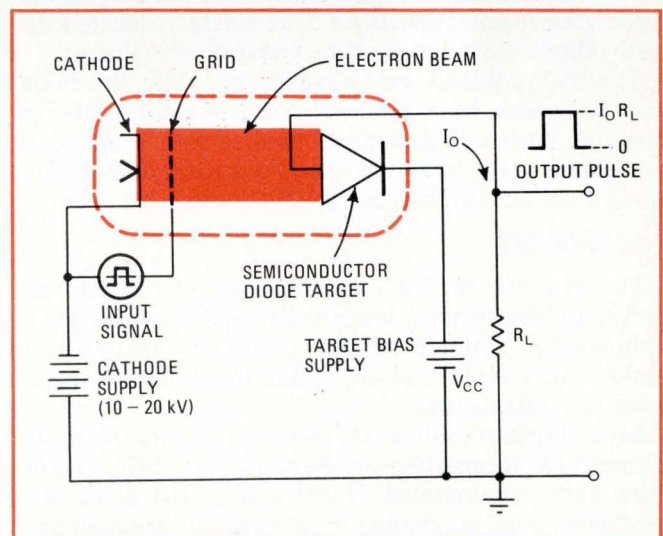

1. **Grid control.** One type of electron-bombarded-semiconductor (EBS) device is similar to a vacuum triode. It uses a control grid to modulate the electron beam and hence the diode current. The output, taken across a load, can be of either polarity.

ther the vacuum-tube or semiconductor realm, so its performance cannot be compared with that of an existing device. However, it has achieved 50 watts linear rf output over a dc-to-300-megahertz frequency range.

A third type of EBS device creates a density modulation of the beam at the diode by modulating the electron velocity and then allowing the electrons to drift over a suitable path length. However, this type device seems not to offer as immediate applications as the first two types and has remained relatively undeveloped.

### From concept to reality

The major difficulties in developing an EBS device arise from the need to put a semiconductor device with a high electric field at its surface into a vacuum envelope with a thermionic cathode. This can produce mutual contamination problems between the diode and the cathode, while the high temperatures required for the vacuum-tube process can affect the semiconductor diode's reverse breakdown voltage. Similar breakdown problems are caused by the high electric field at the interface between diode and vacuum. Then, too, bombarding even a passivated semiconductor with energetic electrons creates positive-charge traps. Finally, simply operating the diode at a high level of power dissipation means a lot of heat must be removed.

Early EBS devices used bare-junction mesa diodes, but the reverse breakdown voltages of these diodes quickly deteriorated during operation. Surface passivation with a thermal oxide over the junction region corrected this difficulty, but the charge traps continued to degrade the breakdown voltage. The effect was particularly evident in p-on-n diodes, which, unfortunately, are preferable for rf devices, because they have higher carrier drift velocities than the n-on-p type.

The problem was solved with a radiation-hardened passivated planar diode developed in association with Signetics Corp. This diode has a thick deposit of phosphosilica glass over the thermal oxide, and conventional beam-lead processing methods are used to form a metal electron-beam shield slightly above the surface of the oxide-glass passivation layer. The shield is located directly above the junction of the planar diode (Fig. 4).

Thermal problems were solved by attaching the diode to a heat sink by a method of silicon-gold void-free bonding. Such a diode can be operated with about 50 W continuous-wave output power and a maximum rise in diode junction temperature of 100°C or less.

### How reliable?

The two elements that will wear out first in the EBS device are the semiconductor diode and the thermionic cathode. Still, cathode life is expected to be greater than 30,000 hours, and diode life should ultimately be many times the cathode life.

Several deflection-beam rf power amplifiers are on cw life test at Watkins-Johnson. As of June 24, 1974, two of these have accumulated 12,600 and 11,210 hours, respectively, with no change in operating characteristics. Eight devices have operated for 70,160 hours at diode dissipation densities between 20 and 35 W/mm<sup>2</sup> without failure, resulting in a mean time to failure of 78,000 hours at a 60% confidence level. Since each device con-

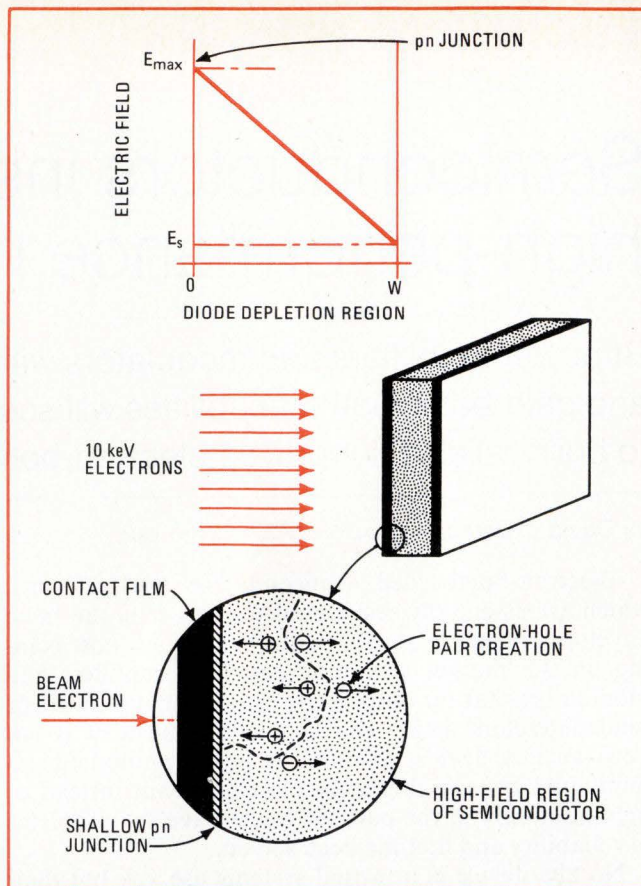

**2. Close-up.** When high-energy electrons strike a reverse-biased diode, they create electron-hole pairs in the diode depletion region. The high electric field then sweeps carriers out of the region to the output circuit. Result is current multiplication.

tains two diodes, the total diode operating time is 140,300 hours at an MTF of 156,000 hours, or about 17.8 years at a 60% confidence level.

In addition, four high-voltage modulators have completed 22,350 hours with one failure for an MTF of 10,900 hours at 60% confidence level.

### A good selection

Various versions of the density and deflection-modulated devices have been developed. Examples are: single-target-grid-controlled, density-modulated devices, which can be operated either Class C or Class A, and deflection-modulated amplifiers with either single targets for Class-A and Class-C operation or dual push-pull connected targets for Class-B operation.

In a planar-grid density-modulated device, for example, on-off signal ratios greater than 100,000 have typically been measured. This unit, which can be operated up to a 4% duty factor, provides 400-v output with 12-v input into a 100-ohm load, and a total rise time of 4 ns has been achieved (measured from the 10% point of the input waveform to the 90% point of the output pulse). This performance makes the device desirable for many fast-pulse modulator uses, such as optoelectronic modulators, electronic countermeasure deception repeaters, and pulse radar and dual-mode ECM systems. As a traveling-wave-tube grid modulator, the unit provides 400-v output into a 100-ohm load in shunt



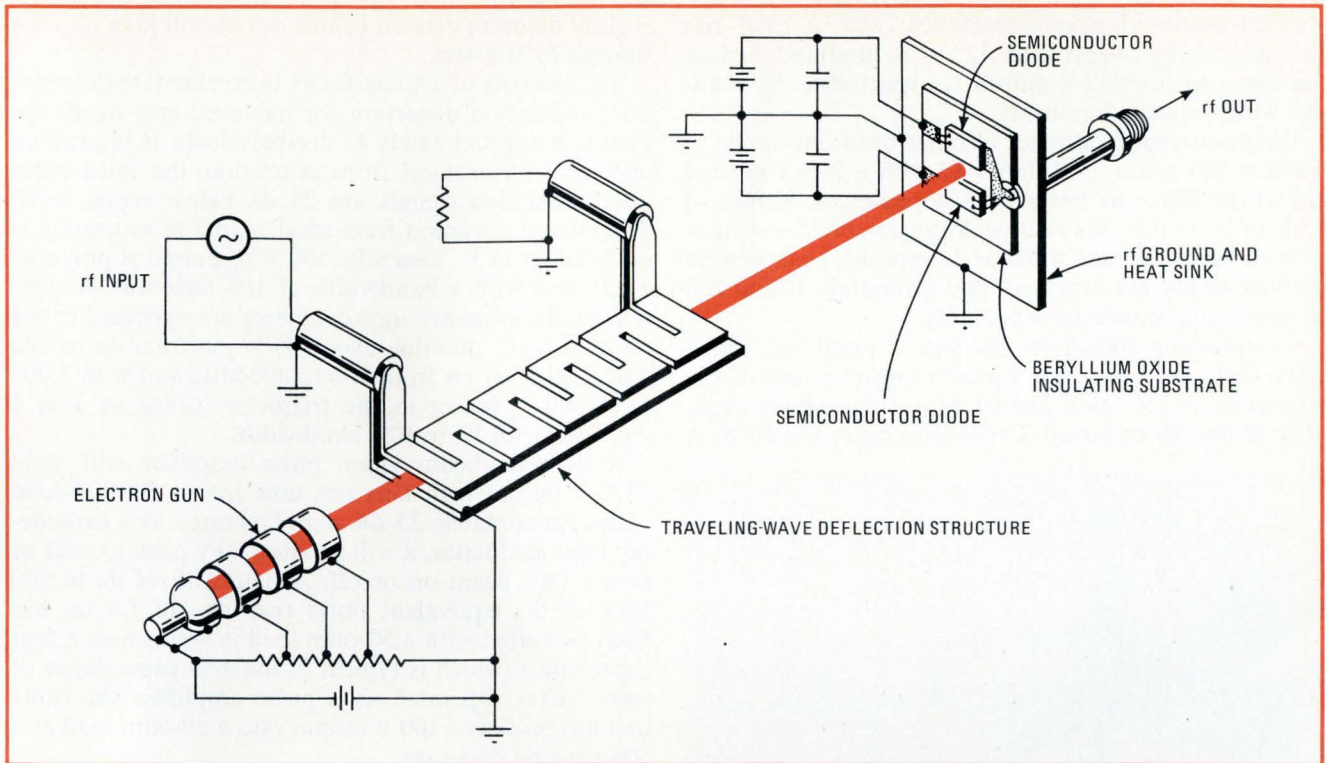

**3. Beam bender.** In a second type of EBS device, a traveling-wave structure deflects the electron beam, making it strike one of two diodes. This gives Class-B operation for good linear amplification. Amount of diode current depends on degree of beam overlap.

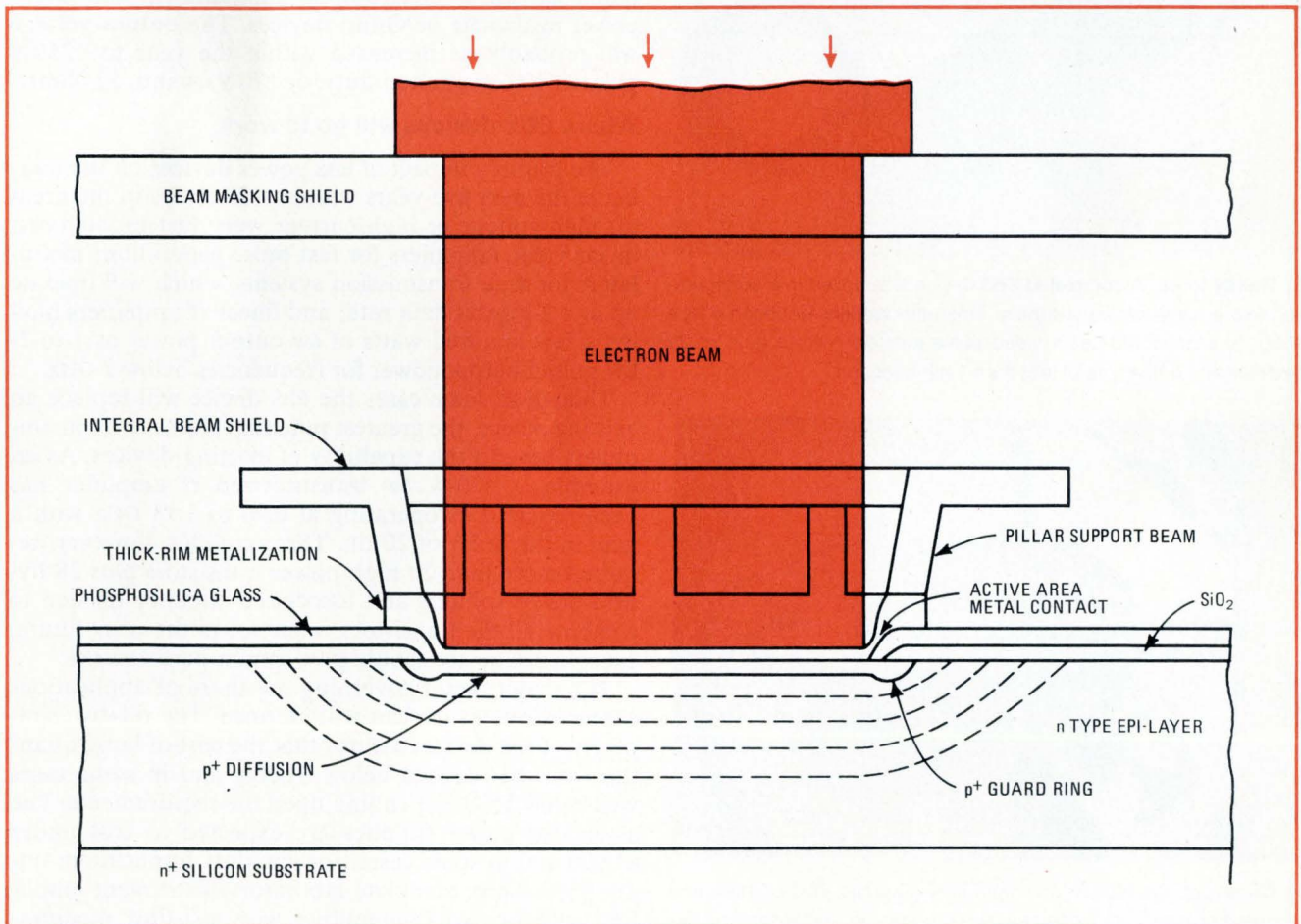

**4. Shielded diode.** An integral metal shield, formed by beam-lead-type process during diode manufacture, protects the diode's oxide and phosphosilica glass layers from the electron beam. This device was developed jointly by Watkins-Johnson and Signetics Corp.

with 30-picofarad grid capacitance, with a total rise time plus delay of less than 12 ns. A modified version that can provide 850-v output is expected to be available within six to 12 months.

A high-current modulator also has been developed to produce 100 A into a 1-ohm load with a 2-ns rise time and up to 250 A at lower load impedances. Values of  $di/dt$  of  $5 \times 10^{10}$  A/s and peak powers of 12 kW have been achieved. Within the next 12 months, peak powers of 30 to 40 kW are expected, and ultimately 100 to 200 kW per device should be achievable.

A conduction-cooled cw low-pass rf amplifier, which uses a deflected beam, has a pulsed output power of 200 W from dc to 160 MHz. The cw or average-power capability of liquid- or forced-air-cooled versions is 50 W. A

slightly different version of this device will give 25 v cw from dc to 310 MHz.

The linearity of a Class-B EBS is excellent: third-order intermodulation distortion for balanced two-signal operation is approximately 15 decibels down at saturation, and for 3-dB back-off from saturation, the third-order intermodulation signals are 25 dB below signal level. Total phase deviation from small signal to saturation is in the order of  $3^\circ$ . Recently, 500 w of pulsed rf power at 1,500 MHz with a bandwidth of 105 MHz was demonstrated. Performance improvements are expected in the next six to 12 months—over 100 w cw from dc to 300 MHz, and 50 w cw from 100 to 400 MHz and with 1,000 W pulsed rf power in the frequency range of 1 to 2 gigahertz with 5% to 10% bandwidth.

A deflected-beam video pulse amplifier will yield  $\pm 120$  v output with 1-ns rise time into a 50-ohm load with approximately 25-dB gain. Operated as a cathode-ray-tube modulator, it will produce 80 v peak to peak to turn a CRT beam on or off. A bandwidth of dc to 200 MHz, or the equivalent pulse rise time of 1.5 ns, has been measured with a 50-ohm load in shunt with a 5-pf capacitance (which is typical of the grid capacitance of some CRTs). Operated as a pulse amplifier, the same unit has produced 100 v output into a 50-ohm load at a 500-megabit data rate.

Thus, it is suited for a wide variety of linear video-amplifier requirements, and especially for rapid modulation of CRTs, electro-optic modulators, and high-power avalanche or Gunn devices. The output voltage will probably be increased within the year to  $\pm 250$ -v pulse at 10% maximum duty, or  $\pm 70$  v cw into 50 ohms.

#### Where EBS devices will go to work

The primary impact of EBS power devices on the market in the next five years will most likely be in the areas of: high-voltage or high-current, very fast modulators; linear video amplifiers for fast pulse generation; modulators for data transmission systems, which will operate up to a 2-gigabit data rate; and linear rf amplifiers having a few hundred watts of cw output power or 1-to-2-kw pulsed output power for frequencies below 2 GHz.

Though in some cases the EBS device will replace an existing device, the greatest potential seems to lie in amplifiers beyond the capability of existing devices. As an example, a 400-w cw transistorized rf amplifier has been reported as operating at 0.96 to 1.18 GHz with a gain in the order of 20 dB. This amplifier, however, required more than 20 high-power transistors plus 28 hybrid power splitters and associated circuitry needed to combine all the transistors, whereas, in the near future, a single EBS device should give similar performance.

The major factor governing the share of applications captured by EBS devices will be price. The relative simplicity of the devices assures that the cost of large quantities will be reduced below \$1,000, and in some cases well below \$500, depending upon the requirements. The associated power supplies are expected to cost under \$1,000 and in some cases, for low-duty application, under \$500. Thus, complete laboratory-instrument amplifiers will be cost-competitive with existing medium-power TWT amplifiers and will complement them in the frequency range from dc to 2 GHz. □



**5. Ready to go.** A completed EBS device is supplied in a configuration like a traveling-wave tube's. This unit, Watkins-Johnson's type 3650, is a deflected-beam video pulse amplifier with a gain of 25 decibels and a rise time of less than 1 nanosecond.

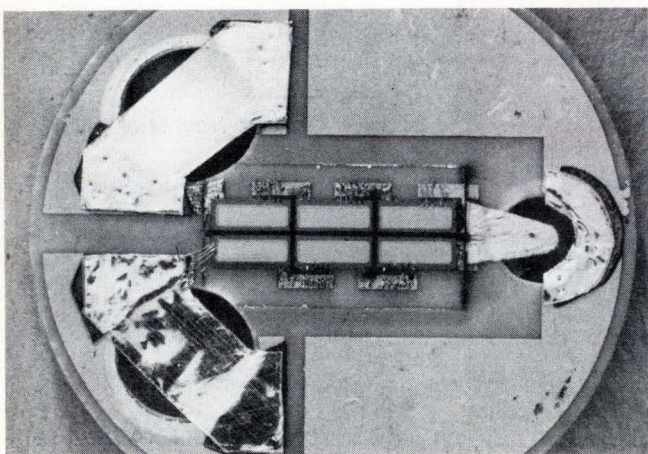

**6. On target.** Six diodes, arranged in two parallel sets of three and mounted on beryllium oxide heat sinks, comprise the target for a deflected-beam EBS device. A sheet beam from the electron gun illuminates each set of diodes alternately.

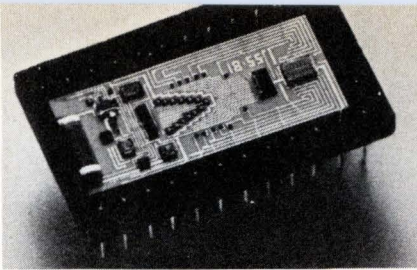

# Which hybrid converter: single-switch or quad?

When carefully fabricated, a single-switch hybrid analog-to-digital converter (shown above) outperforms quad-switched types; it provides 12-bit resolution with better than 0.024% accuracy over  $-55^{\circ}$  to  $+125^{\circ}\text{C}$

by Richard D. Tatro, *Micro Networks Corp., Worcester, Mass.*

□ Though single-chip ICs are successful enough as low- to medium-precision digital-to-analog converters, they still lack the precision and stability necessary for truly high-resolution (12-bit and up) conversion—both d-a and a-d. Discrete designs, on the other hand, because their various components seldom heat up identically, must employ expensive, complex circuitry to avoid temperature-induced errors.

Hybrid designs get the best of both worlds—the combination of a thin-film resistor network with several semiconductor chips results in a converter capable of 12-bit resolution over a broad temperature range. But some hybrid designs are better than others. Quad switches are very popular, but the older single-switch hybrid circuit can yield better results if it is fabricated properly—that is, if it uses a well-stabilized resistor network and has all of its semiconductor chips mounted in close thermal contact with each other.

Because a-d and d-a converters come with a multitude of different and sometimes conflicting specifica-

tions, it is important for the user to understand their design and operation, even if he never intends to build one.

The two most important parts of a digital-to-analog converter, which in turn is the heart of the successive-approximation type of a-d converter (see "Three approaches to a-d conversion," p. 92), are its resistor network and its switching circuitry. The design approach that uses quad monolithic switches and precision resistor networks is shown in the simplified block diagram of Fig. 1. Since this general approach has been well covered in the literature,<sup>1,2,3</sup> only a brief description of its operation will be given here.

Operational amplifier  $A_1$ , in conjunction with the reference transistor  $Q_1$ , provides the base line voltage to all

**1. Quad switching.** In this simplified block diagram of a 12-bit d-a converter, temperature-sensing transistor  $Q_1$  and op amp  $A_1$  vary base line voltage to switching transistors to compensate for their  $V_{BE}$  variations with temperature. Digital inputs are shown in Fig. 2.

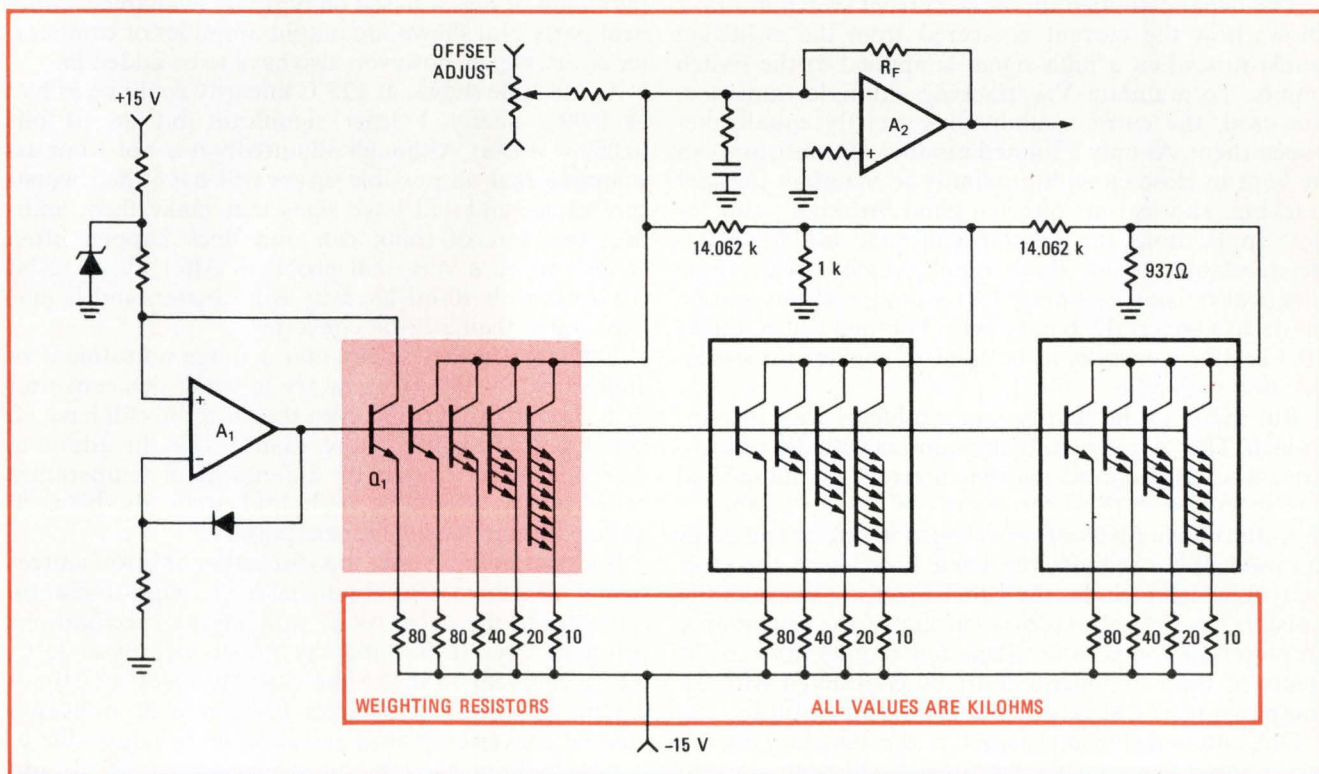

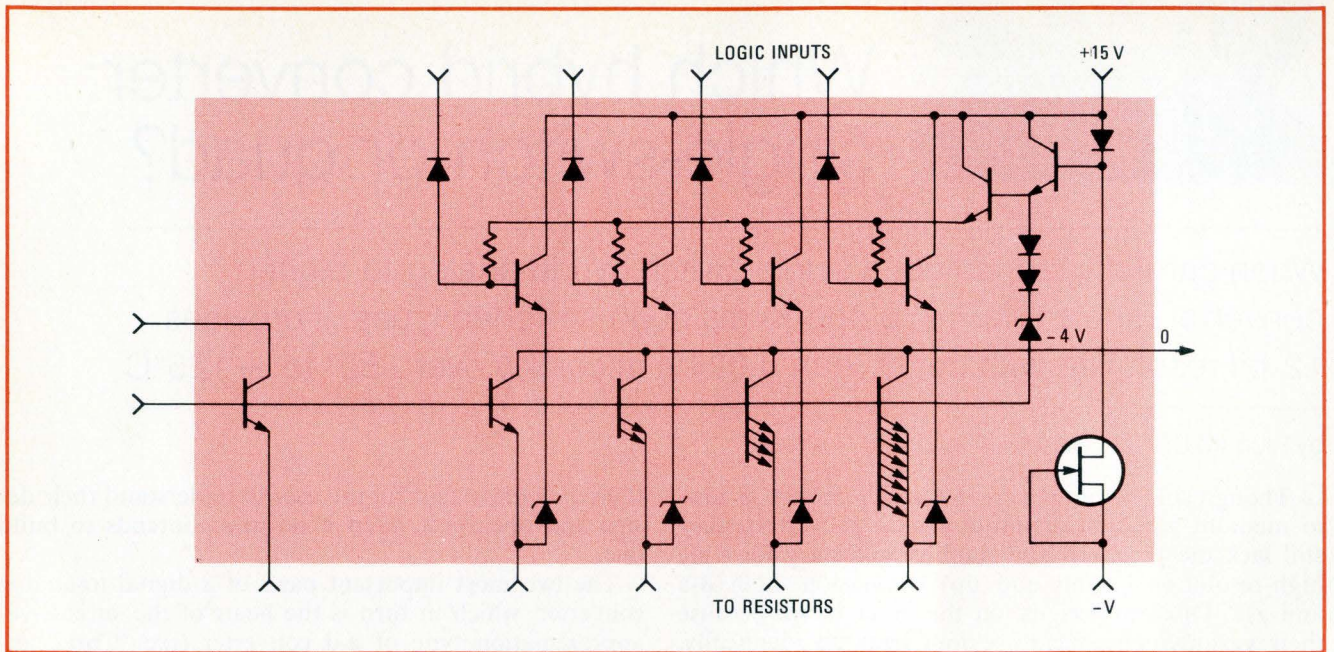

**2. Current steering.** Detailed view of single quad switch of Fig. 1 shows how logic inputs control switching of current into resistors. Use of multiple transistors ensures uniform heating by making all transistors in the quad circuit carry exactly the same current.

of the switching transistors. This voltage varies with temperature in such a way as to compensate for the temperature-induced changes in the base-emitter voltages of the switching transistors. The result is a fixed, temperature-independent voltage across the weighting resistors, which thus deliver fixed currents to the output amplifier circuit ( $A_2$  and associated resistors). The base bias resistor also reacts to variations in the minus supply to maintain fixed currents.

### Details of the quad

The expanded diagram of the current switch in Fig. 2 shows how the current is steered from the switching transistors when a high signal is applied at the switch inputs. To maintain  $V_{BE}$  tracking, multiple transistors are used, the current subdividing exactly equally between them. As only a limited number of transistors can be kept in close enough proximity to maintain thermal tracking, and as four bits is a good breaking point for BCD applications, the popularity of quad switches is understandable. Using three quad switches with three identical resistor networks, 16:1 scaling resistors can be made to convert 12 binary bits. The quad also allows 10:1 scaling networks to be used to convert three-decade BCD with ease.

But there are limitations and problems with this approach. They are generally the same as with discrete approaches, although all the switch errors are lumped to one specification. Resistor errors can also be lumped if thin-film resistor networks packaged in one or two chips are used. What remains the same, however, is the error budget, which includes the switch error, tolerance of the resistors, and offset and bias current of the operational amplifiers or comparator. Then, too, temperature coefficients of the components must be considered with all components held at exactly the same temperature.

One other disturbing aspect is the tendency of the servo amplifier,  $A_1$  to latch up. Although several

schemes can be made to work, including the one shown in Fig. 1, care must be taken both in component selection and layout.

All these considerations affect both linearity and accuracy. In terms of accuracy alone, the output amplifier must be zero-adjusted and the output voltage range trimmed to compensate for switch error, resistor tolerance, and reference error. These adjustment pots will then also contribute errors with temperature.

The table summarizes the error budgets for the linearity and accuracy of the switch and resistor portion of the circuit of Fig. 1, based on typically available component errors, which, however, also have to be added in.

As the table shows, at  $125^\circ\text{C}$  linearity could be as bad as 0.09%—nearly 1 least significant bit at 10 bits ( $0.05\% = \frac{1}{2}$  LSB). Although admittedly it is not a fair assumption that all possible errors will have their worst-case values and will have signs that make them additive, this sort of thing can and does happen often enough to be a very real problem. After all, a 12-bit converter with 10-bit linearity is no better, and is perhaps worse, than a 10-bit converter.

The table further shows that a range adjustment of approximately 10% is necessary to bring this converter to its desired output, and even then it could still have an inaccuracy of slightly more than 1 LSB. In addition, there are errors caused by differences in temperature between parts internal to the hybrid circuit and between those parts and the adjustment pots.

If it does nothing else, this discussion of error sources should alert the potential purchaser of a high-resolution converter to the necessity of studying its specifications before he buys. If the specs say  $\frac{1}{2}$ -LSB linearity at  $25^\circ\text{C}$ , take a moment to make the calculation of  $x^\circ\text{C}$  times  $y$  ppm/ $^\circ\text{C}$  to see if you have a 12-bit or a 10- or even a nine-bit converter. If they say accuracy is adjustable to  $\frac{1}{2}$  LSB, find out what the untrimmed accuracy is, and

TABLE: MAJOR SOURCES OF ERROR IN THE QUAD-SWITCH HYBRID A-D CONVERTER

ERRORS IN LINEARITY			ERRORS IN ACCURACY		
Parameter	Typical	Maximum	Parameter	Absolute	Matching
Switches	2 ppm/°C	5 ppm/°C	Switches	0.01%	0.01%
Source resistors	1 ppm/°C	2 ppm/°C	Source resistors	2%	0.012%
Scale and feedback resistors	1 ppm/°C	2 ppm/°C	Scale and feedback resistors	2%	0.006%
Worst-case total	4 ppm/°C	9 ppm/°C	Zener diode	5%	—
Worst-case total at 125 °C	400 ppm (0.04%)	900 ppm (0.09%)	Worst-case total	9%	0.028%

how much it must be adjusted to obtain the 1/2-LSB figure. The same applies to output zero adjustments. Perhaps more wisely, you should simply go a step further and look for a converter that requires no adjustments and is guaranteed to meet its specs over a wide range of temperatures.

The circuit of Fig. 1 can be completely constructed in hybrid form with substantial improvements in accuracy and temperature effects from those shown in the table. Experience has shown that while ±1/2 LSB linearity for 12 bits is obtainable, the practical range of holding ±1/2 LSB is only -25° to +85°C. Although several IC manufacturers offer quad current switches, they are not usually completely interchangeable.

**The single-switch hybrid circuit**

Consider now the circuit of Fig. 3. The base voltage is developed in much the same way as in the circuit of Fig. 1. However, the current switching is quite different: all

the current switches are of equal value and are divided through the output R/2R resistor network. This circuit is fast because the current-steering effect maintains a fairly constant current through the resistors, and because the common-base switch configuration allows for fast switching. RC time constant effects are small in the output circuit because of the low resistor values used in the R/2R ladder. Finally, the fact that all the currents are equal means there is no need to put transistors in parallel and also simplifies the thin-film resistor network design, since all resistors can be equal and generally smaller in value than those used in the approach of Fig. 1.

To those familiar with converter design but not with hybrid techniques, this design may seem to have several obvious defects. It is virtually impossible, on a production basis, to select 13 transistors with exactly equal values of V<sub>BE</sub> and ΔV<sub>BE</sub> with temperature. Even if it were possible, there is still the problem of holding them all at

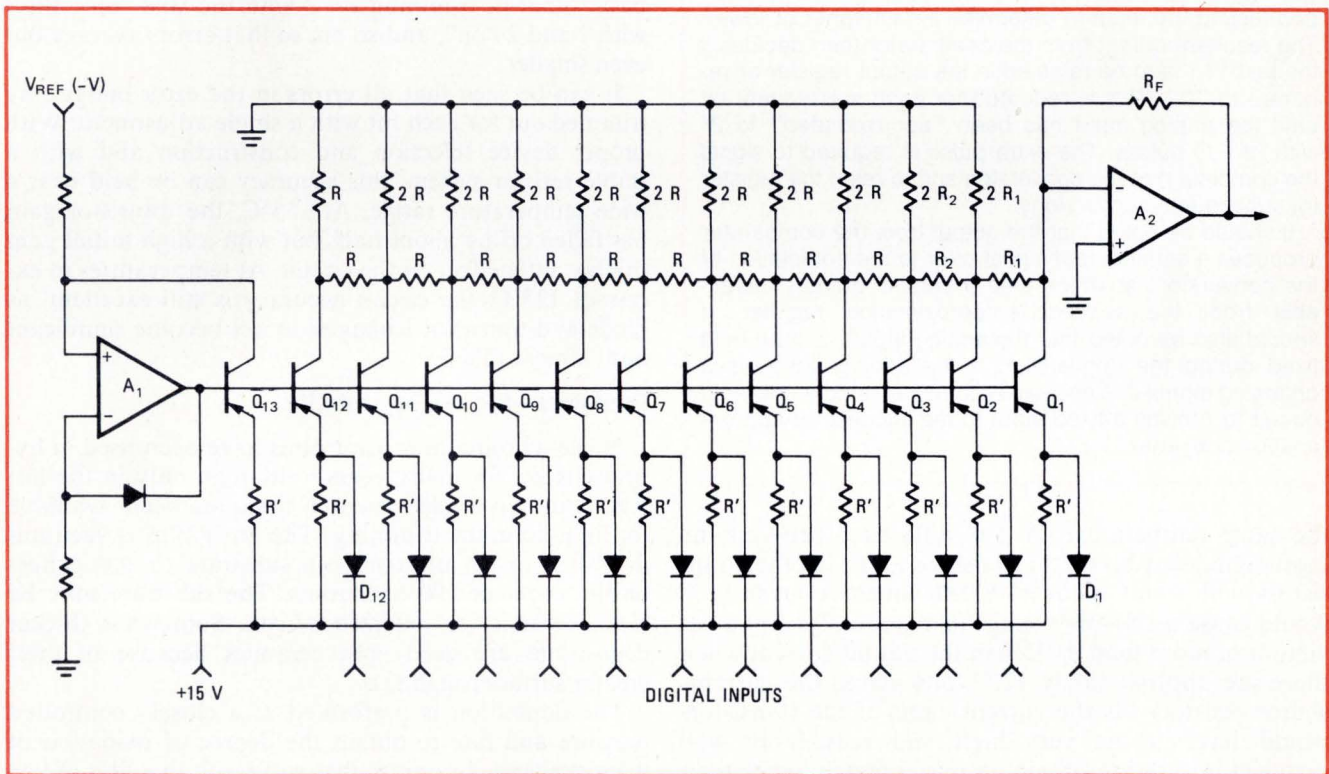

**3. Older is better.** "Old-fashioned" single-switch design uses same temperature-compensation scheme as quad switch, but much simpler current-steering technique. Superbeta transistors cut from the same wafer and mounted in intimate thermal contact with each other are secret of how this circuit works. Common-base configuration makes circuit fast as well as stable.

## Approaches to a-d conversion

Analog-to-digital converters divide up into three basic types: parallel, integration, and feedback. Parallel conversion requires a considerable amount of decoding circuitry and the use of  $(2^n - 1)$  comparators (where  $n$  is the number of bits to be resolved). In general, while being extremely fast, it is quite expensive and is usually limited to low-resolution converters. At the other end of the spectrum is the integrating converter, for which the dual-slope integration technique is the most popular. This design approach is quite economical for high-resolution converters, but conversion time is very long. The entire middle ground belongs to the feedback converter.

In general, the feedback converter uses a digital-to-analog converter with logic circuitry in a comparator feedback loop to generate a digital output. Most popular of these are the counter or ramp a-d, the tracking a-d, and the successive-approximation a-d converter. All are based on the generation of a digital number that, when converted to an analog value which matches the analog input, is signalled that it is correct by the comparator.

The counter method is relatively slow, requiring up to  $(2^n - 1)$  clock pulses in order to attain the digital output. The tracking converter, which is a special-purpose device, acquires the signal in up to  $(2^n - 1)$  clock pulses but uses the comparator output as an up/down counter control and continuously "tracks" the analog input. For slowly changing analog inputs it does this with very little time delay.

Most popular because of its speed and versatility is the successive-approximation converter. This device requires more complex logic but results in a unit which completes a conversion in  $(n + 1)$  clock pulses. Briefly, the logic first turns on the most significant bit (MSB), producing a one-half scale output from the d-a converter and testing the input to determine if it is higher or lower. The resultant output from the comparator then decides if the test "1" is to be retained in the output register or returned to "0". This is repeated for each subsequent bit until the analog input has been "approximated" to  $2^n$  with  $(n + 1)$  pulses. The extra pulse is required to signal the completion of the conversion and to reset the register for subsequent conversions.

It should be noted that the output from the comparator produces a serial output signal prior to the completion of the conversion, at which time a parallel output is available from the successive-approximation register. It should also be noted that the analog input must be held fixed during the conversion. If the analog signal is a changing signal it is necessary to use a sample-and-hold circuit to provide a fixed input to the successive-approximation converter.

the same temperature. A  $1^\circ\text{C}$  difference between the most-significant-bit (MSB) transistor and the other transistors will result in over  $\frac{1}{2}$  LSB linearity error ( $1^\circ\text{C}$  would cause a 1.85-mV change in  $V_{BE}$ , resulting in a deviation of more than 0.015% in the output current when there are approximately 12.5 volts across the current-source resistor). As the current gains of the transistors would have to be very high and reasonably well matched in order to obtain an initial match better than several millivolts, this approach is totally impractical.

This same circuit, however, when constructed in the hybrid form shown in Fig. 4, is capable of  $\frac{1}{2}$  LSB lin-

earity from  $-55^\circ$  to  $+125^\circ\text{C}$ . Initial accuracy is well under 0.012% maximum, while accuracy over the temperature range of  $-55^\circ$  to  $+125^\circ\text{C}$  is better than 0.024% with an external reference voltage.

To achieve such specifications, "superbeta" transistors with current gains of 500 at the switch current are used. Further, all transistors come from the same wafer to ensure exact tracking of  $V_{BE}$  with temperature. The chips are mounted so that they are all either at exactly the same temperature or at least at temperatures which will not change relative to each other with changes in input conditions or external temperature. Naturally, the  $V_{BE}$ s of the devices will not be the same but may vary by as much as 5 to 10 millivolts. This variation is not significant, however, as it results in less than 1-2 ppm/ $^\circ\text{C}$  linearity error and the initial error will be eliminated in trimming.

### Putting it all together

The completed circuit is assembled and then trimmed functionally. Supply voltages are connected and the inputs are set to the desired condition. In the case of a 0-to-+10-v unit, the output voltage is initially set to zero by trimming the operational amplifier balance resistor. With the most significant bit turned on, the source resistor associated with that bit is trimmed for an exact 5.0000-v output, the second bit trimmed to 2.5000 V and so on down to the LSB trim of 0.0024 v. As a result, absolute worst-case "add up" errors of well under  $\frac{1}{2}$  LSB (0.012%) are realized. The trimming system sensitivity is such that adjustment can be made as close as 0.1 mV and 12 individual trims do not add up to a large error. Trimming can also be done on a "summation" basis—that is, trimming Bit 2 with the MSB "on", Bit 3 with 1 and 2 "on", and so on, so that errors average out even smaller.

It can be seen that all errors in the error budget are trimmed out for each bit with a single adjustment. With proper device selection and construction and with a stable resistor system, this accuracy can be held over a wide temperature range. At  $-55^\circ\text{C}$ , the transistor gain has fallen off by about half, but with a high initial gain this has little effect on the circuit. At temperatures in excess of  $125^\circ\text{C}$ , the circuit accuracy is still excellent, as diode and transistor leakages do not become significant until almost  $150^\circ\text{C}$ .

### Resistors—the key to stability

Nickel-chromium resistor films have been used in hybrid circuits for many years,<sup>4</sup> although only in the last few years have adjustment techniques been available for high-accuracy trimming. The NiCr film is vacuum-deposited on an ultra-smooth substrate to a thickness on the order of 100 angstroms. The substrate may be glass, ceramic, or oxidized silicon. Somewhat thicker depositions are used with ceramics because of their greater surface roughness.

The deposition is performed at a closely controlled pressure and rate to obtain the degree of oxidation of the nickel and chromium that will result in a film of low temperature coefficient and high stability. Without breaking vacuum, a layer of nickel is evaporated onto the NiCr and followed by a layer of gold. The gold

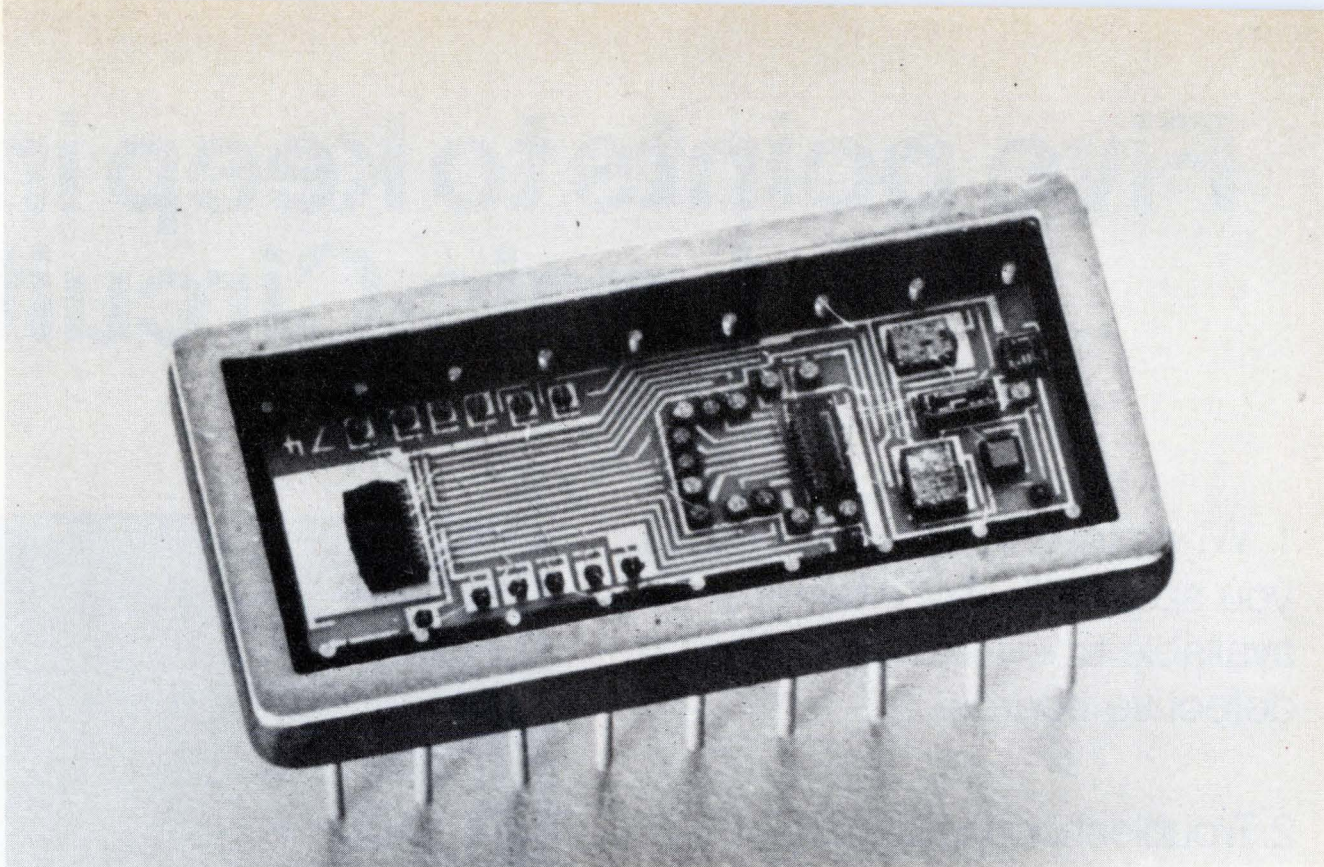

**4. Intimate contact.** Key to success of hybrid design is tight thermal coupling between circuit elements. Switching transistors in this model MN360 12-bit d-a converter are all mounted within an area of 16 mm<sup>2</sup>, while transistors that must track each other are mounted side by side. Result is a maximum nonlinearity of  $\pm\frac{1}{2}$  LSB over the full temperature range from  $-55^{\circ}$  to  $+125^{\circ}\text{C}$  with no adjustments needed.

forms the interconnect paths and bonding contact, while the nickel forms a barrier layer to prevent interaction between the NiCr and the gold.

The delineation of the resistor networks is a two step-etching process using photomasks. Following temperature aging to stabilize the film, the wafer is diced into chips and handled in subsequent circuit operation as a passive IC.

In all of the hybrid circuits shown, the resistors are deposited on silicon substrates. When ceramic substrates are used, all pattern metalization, including the resistors, can be put on the substrate. The decision whether to put a resistor network chip or resistors on the substrate is based on a number of factors, including cost, physical size, and ease of handling and trimming.

Substrate preparation also employs photo etching techniques to etch detailed patterns in gold on ceramic substrates.

The circuits shown use two types of chip-mounting techniques: eutectic and epoxy. In general, all electrical contacts are made by eutectic bonding and all non-electrical contacts with epoxy. Both techniques result in excellent mechanical strength, but eutectic bonding is superior for circuits that are sensitive to a very small amount of contact resistance.

One of the important features of hybrid design is the close thermal coupling between elements. Consider Fig. 4, which shows all the switch transistors clustered in an area about 4 millimeters square, while the transistors that need to track each other are side by side. Also, the resistors are closely spaced, and all circuit elements that are important to linear operation have been especially

designed to have constant power consumption and therefore constant temperature.

All connections are made by thermocompression-bonding 0.001-inch (25-micrometer) gold wire.

The completely assembled device is then connected for operation in the trimming fixture, and the resistors trimmed by vaporization of the NiCr until the desired output voltage or current is attained. YAG lasers are used for this trimming step, the spot size being adjusted to less than 0.001 in. to allow sensitive trimming of resistors with 0.001-to-0.003-in. line width. The laser energy has no effect on the circuit operation, with the occasional exception of certain integrated circuits that require some shielding to reduce noise. Following trimming, the circuit can be checked right in the trim fixture to ensure that all bits of the converter add up properly.

The packaged unit is then hermetically sealed to insure long-term stability and submitted to environmental screening—five  $0^{\circ}$ -to- $100^{\circ}\text{C}$  liquid-to-liquid thermal shocks, 10,000–30,000-g acceleration, and gross leak tests. If required, most Micro Networks Corp.'s devices can be visually inspected before sealing to high-reliability test documents and also can be tested to fine leak requirements down to  $10^{-7}$  cubic centimeter/s. All devices are designed to meet full environmental shock, vibration, and moisture-resistance specifications. □

#### REFERENCES

1. Bill O'Neil, "Digital-to-Analog Converter Circuits Using The 8018A," Intersil Applications Bulletin, June 1972.
2. J. Graeme, "Monolithic D/A Improves Conversion Time," EDN, March 15, 1971.
3. J. Pastoriza, "Technical Background Facts on the  $\mu$ DAC Monolithic IC D/A Converter," Analog Devices (technical information).
4. R. D. Tatro, "A Microcircuit Digital to Analog Converter," International Microelectronics Conference, Munich, October 1966.

# Five points to keep in Logic-Circuit

1. When testing complex boards, you spend most of a tester's available time troubleshooting defective boards.
2. Troubleshooting can be time-consuming and costly.
3. Not all test systems troubleshoot equally well.
4. Software is the least understood and the most important part of any test system.
5. The system that provides the best hardware/software integration minimizes troubleshooting time and expense.

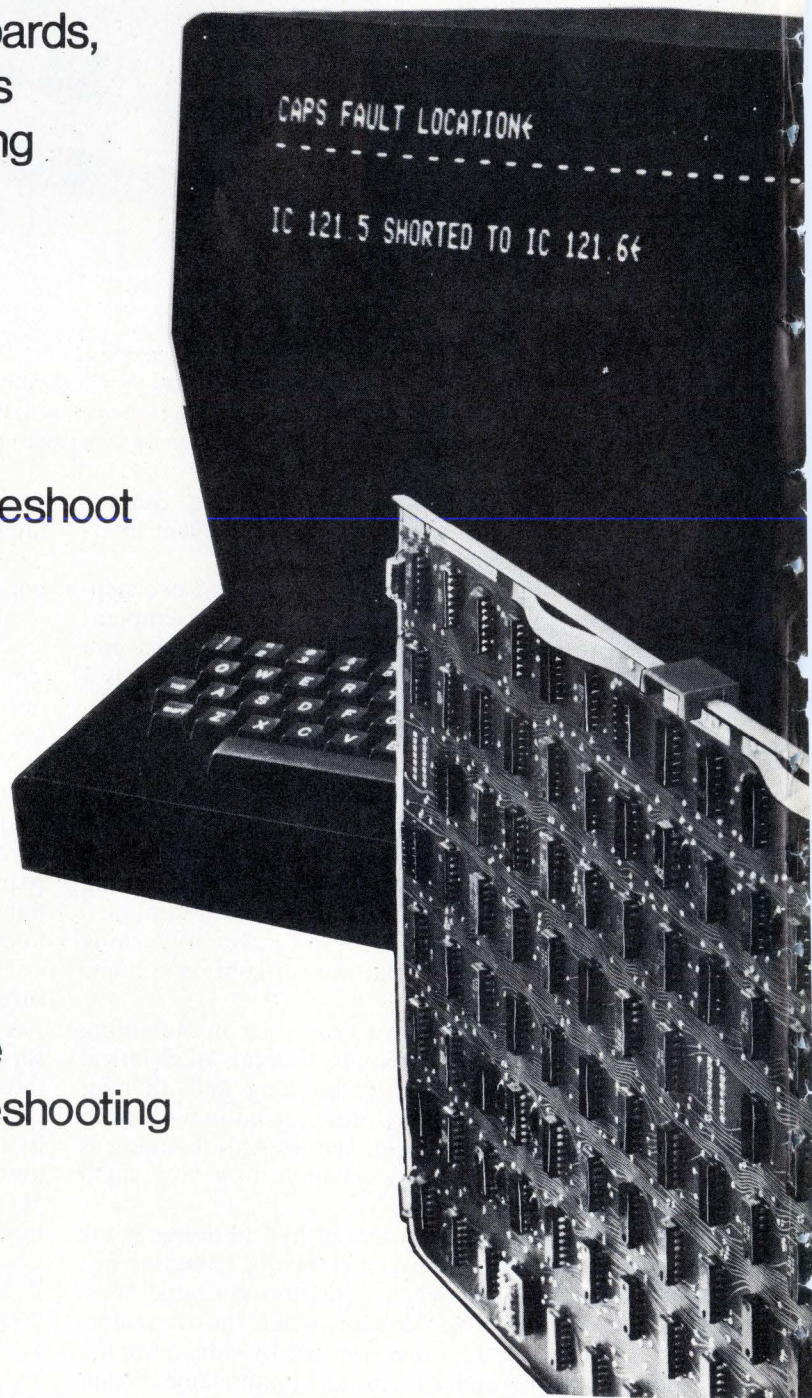



# mind when evaluating Testers...

It is the last point on the facing page that separates the GR1792 Logic Test System, with its CAPS software package, from all other logic-circuit testers. Among other things, CAPS removes the human element from troubleshooting as much as possible. In fact, it actually makes troubleshooting fun!

CAPS stands for Computer-Aided Programming (and fault diagnostic) Software, and it features two different troubleshooting techniques. One technique, automatic fault location (AFL)\*, literally removes the operator from the troubleshooting procedure. Within seconds after a fail signal appears, the CRT displays a series of messages that resolve not only *what* the fault is but *where* it is located. With the second technique the operator uses a computer-guided probe, with CAPS guiding the operator through the logic and leading him quickly to the fault.

No single troubleshooting technique can find all possible failures on every type of board design. GR is the only manufacturer that provides *both* on-line fault simulation and the probe, and our dual techniques offer more time-saving troubleshooting versatility than any other system.

There is much more to tell about the GR1792 and CAPS than space permits here. To learn more, write for a copy of our new 1792 Data Bulletin that gives you insight into logic-circuit testers in general and the GR1792 in particular.

With over 200-logic-circuit test systems shipped during the past few years, GR has developed an LCT expertise in both hardware and software that is second to none. If you are considering investing in a logic-circuit test system, or several systems, be sure to learn what GR can do for you. We think you'll be pleasantly surprised . . . like so many others.

\*Patent applied for



## General Radio GR Test Systems Division

300 BAKER AVENUE, CONCORD, MASSACHUSETTS 01742  
NEW YORK (N.Y.) 212 964-2722, (N.J.) 201 791-8990  
BOSTON 617 646-0550 • DAYTON 513 294-1500  
CHICAGO 312 992-0800 • WASHINGTON, D. C. 301 948-7071  
ATLANTA 404 394-5380 • LOS ANGELES 714 540-9830  
SAN FRANCISCO 415 948-8233 • DALLAS 214 234-3357  
TORONTO 416 252-3395 • ZURICH (01) 55 24 20

GR COMPANIES  
Grason-Stadler • Time Data • Techware Computing Co.

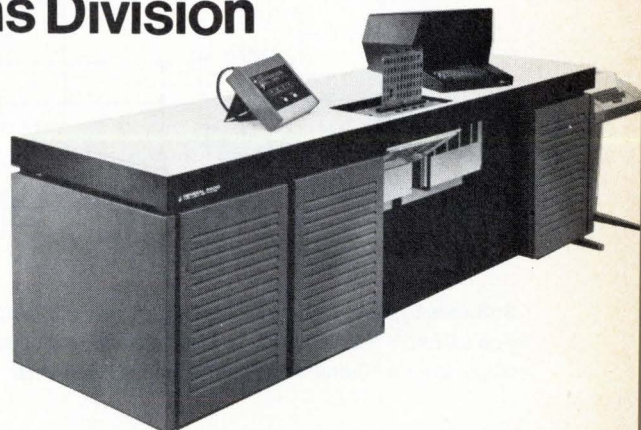

# Designer's casebook

## Interfacing a teletypewriter with an IC microprocessor

by Steven K. Roberts  
Cybertronic Systems, Louisville, Ky.

The lengthy software service routine generally required to interface a teletypewriter and an IC microprocessor, such as the Intel 8008, can be eliminated by the circuit shown here. A shift register and some control logic are all that it takes, bringing total component cost to only about \$6.50.

In the 8008 system, synchronization with the central-processing unit is accomplished through this microprocessor's READY line, making modification of the teletypewriter itself unnecessary. The hardware configuration given in the figure is designed for a 10-character-per-second Model 28 Teletype, which uses the five-level Baudot code. If the intended application will not easily accommodate data storage in the Baudot code, conversion may be accomplished with a read-only memory, such as National's MM5221TM. (A Model 33 Teletype presents no decoding problem.)

During the time that the input parallel data is valid, the circuit receives the START pulse, which sets the BUSY

flip-flop and takes the READY line low. The BUSY flip-flop also removes the reset from the cycle counter and enables the LOAD flip-flop, which is set on the next clock pulse. This action loads the data at the input to the shift register and increments the cycle counter once.

On the succeeding clock pulse, the ENABLE flip-flop is set, and the data in the register begins to shift to the right. For each shift pulse, the cycle counter is incremented by one until it reaches a binary count of 8. Then, the BUSY and ENABLE flip-flops are both reset, and the READY signal is restored to the microprocessor so that the central-processing unit can resume operation.

In the data character presented to the shift register, bit H, which is constantly held low, corresponds to the teletypewriter START pulse. Similarly, the register's A and B bits are tied high, corresponding to the teletypewriter STOP pulse. Since the STOP signal must be applied to the teletypewriter for approximately 1.5 times longer than the other pulses, the BUSY flip-flop is reset on the falling edge of the clock, during the time that bit A is present at the register's Q<sub>H</sub> output. The serial output of the register switches the 60-milliampere teletypewriter current loop through the transistor.

The clock signal for the circuit is derived from the IC timer that is free-running at approximately 75 hertz. For teletypewriters that operate at 6 characters per second, the clock frequency should be about 45.5 Hz. □

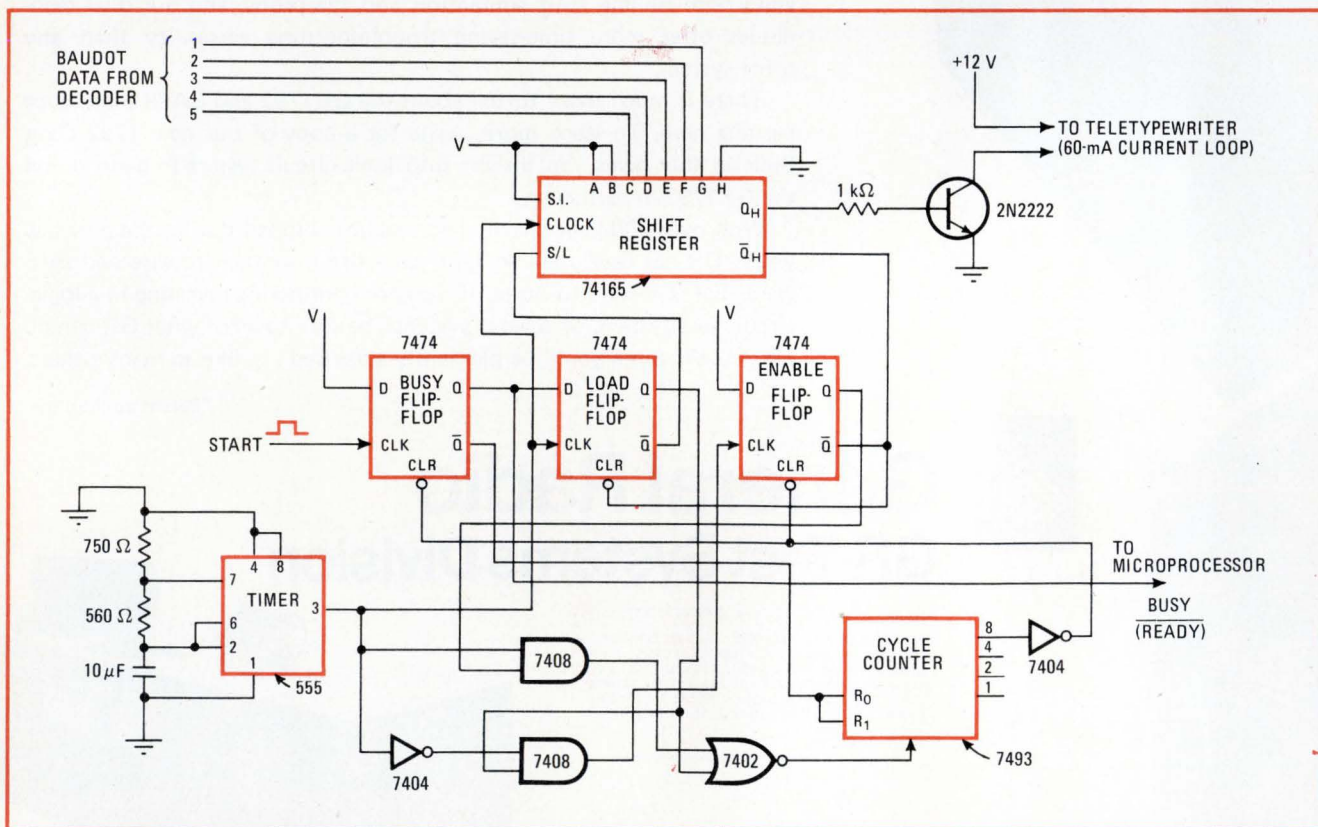

**Software bypass.** Digital interface circuit provides synchronization between a teletypewriter and a microprocessor chip through the latter device's READY line. Normally, a long software routine is needed to make the interface. The input data is in the parallel Baudot code, and the output is for a 10-character-per-second teletypewriter. A free-running IC timer is used to produce the clock signal.

# Diode pair senses differential temperature

by Don DeKold  
Dekolabs, Gainesville, Fla.

Normally, a germanium diode functioning as a temperature sensor relies on the linear variation of its forward voltage with temperature. But a pair of germanium diodes can be made to serve as a differential-temperature comparator if the circuit exploits a much less used temperature-dependent diode property—the logarithmic variation with temperature of the reverse saturation current. The resulting circuit is useful for industrial-control applications.

When one diode (SENSOR<sub>1</sub>) is at temperature T<sub>1</sub> and the other diode (SENSOR<sub>2</sub>) is at temperature T<sub>2</sub>, the circuit output will change state as the temperature differential (T<sub>1</sub>-T<sub>2</sub>) approaches and crosses a differential threshold, ΔT<sub>1,2</sub>. For the circuit shown here, ΔT<sub>1,2</sub> is 13°C—when (T<sub>1</sub>-T<sub>2</sub>) is less than 13°C, the circuit's output is low; and when (T<sub>1</sub>-T<sub>2</sub>) is greater than 13°C, the output goes high. The circuit has a fairly wide and useful temperature range of 20°C to 120°C.

The two diodes, along with resistors R<sub>1</sub> and R<sub>2</sub>, form a resistance bridge. The right-hand side of the bridge consists of equal resistances that divide the bridge voltage in half, establishing a reference voltage at the inverting terminal of the FET-input operational amplifier. The noninverting op-amp terminal receives the temperature-dependent voltage, which is derived from the division of the bridge voltage across the diode temperature sensors.

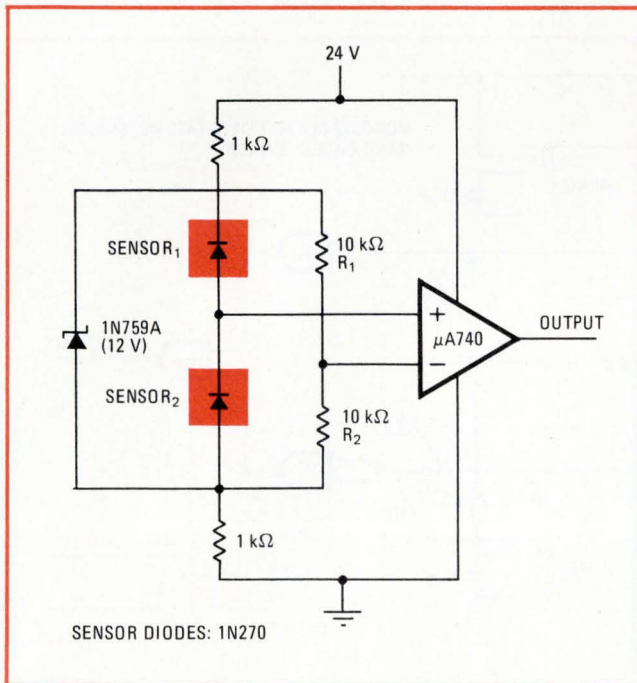

In general, the reverse saturation currents of two unmatched diodes are different at a single temperature. However, when plotted as a function of temperature on semilog paper, the two reverse-current characteristics will be parallel to each other. That is, a diode's reverse current may vary from one unit to the next at a single temperature, but it will increase in an identically proportional manner from one unit to the next as a function of temperature.

For instance, for the type 1N270 germanium diodes used here, the current doubles every 13°C. The doubling is highly regular, producing a nearly linear semilog plot over a fairly wide temperature range, as shown by the graph of reverse saturation current versus temperature for two type 1N270 diodes.

Now, when a diode is reverse-biased, it in effect becomes a temperature-dependent current source with a reverse saturation current that is only negligibly influenced by the actual magnitude of the reverse voltage. But as the reverse voltage approaches zero, the reverse current decreases. When two diodes are connected in series, therefore, the voltage across them will divide equally only when their currents are the same, a condition that occurs at a fixed temperature difference between the two. This equal-current temperature differ-

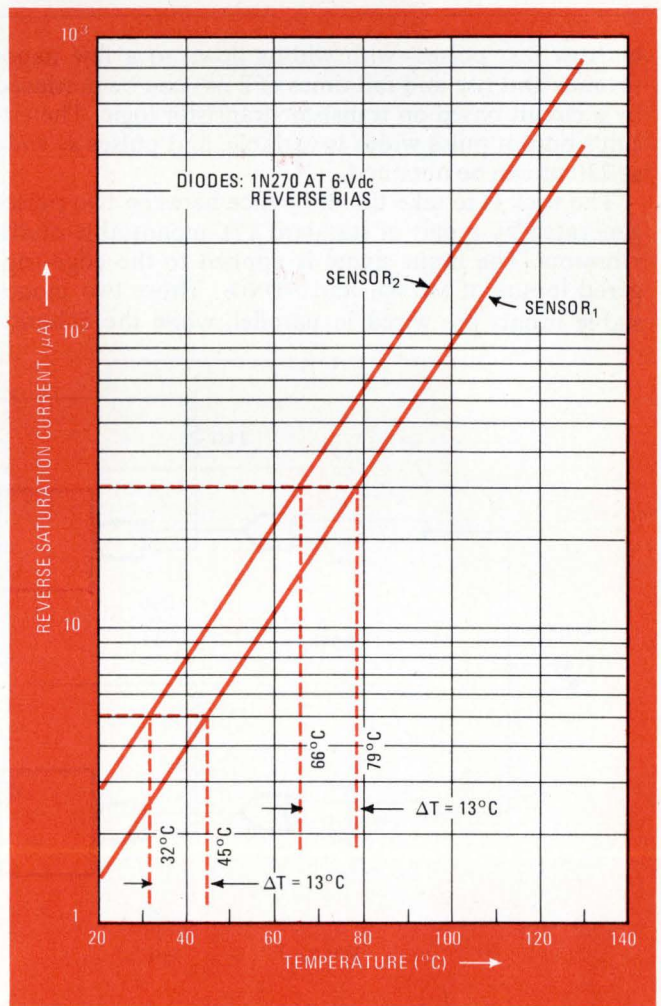

**Temperature comparator.** Unmatched germanium diodes have different reverse saturation currents at the same temperature. But this difference remains proportionate with changing temperature so that the temperature differential between the two currents stays the same, as shown by the graph. A differential-temperature comparator can be built by connecting two unmatched diodes in a bridge configuration.

ential is the  $\Delta T_{1,2}$  threshold for the circuit.

The diode having the lower reverse saturation current acts here as  $SENSOR_1$ , so that practically all of the bridge voltage will be dropped across it. This keeps the voltage at the noninverting op-amp input below that of the inverting op-amp input, and the circuit's output is low. As the temperature of  $SENSOR_1$  increases, its reverse leakage current will also rise.

When  $SENSOR_1$  is  $\Delta T_{1,2}$  degrees celsius above  $SENSOR_2$ , the voltages at the op-amp inputs will be equal. With an additional temperature increase of  $SENSOR_1$ , most of the bridge voltage will then be dropped across  $SENSOR_2$ . This raises the voltage of the noninverting op-amp input above that of the inverting op-amp input, causing the circuit's output to go high.

Various operating conditions can be set up for the differential-temperature comparator by interchanging the locations of the low-current and high-current diodes or by switching the input connections to the op amp. Different diode pairs will provide different values of threshold temperature. Basically,  $\Delta T_{1,2}$  is determined by the ratio of diode leakage currents at a fixed temperature, and this current ratio increases as the comparator differential increases. Diodes with identical reverse currents at the same temperature produce a  $\Delta T_{1,2}$  of  $0^\circ\text{C}$ .

A FET-input op amp must be used here to assure that there is practically no loading of the bridge diode divider. Minimal loading is particularly important if the absolute temperatures to be compared differentially are low. □

## Generating nanosecond pulses with TTL monostables

by Robert J. Broughton  
Yale University, New Haven, Conn.

Narrow fast pulses—with widths down to a few nanoseconds and rise and fall times of 2 ns—can be produced by a circuit based on transistor-transistor logic. The circuit's output pulse width is variable, and pulses as wide as 220 ns can be obtained.

The trick is to take the difference between two pulses generated by a pair of standard TTL monostable multivibrators. The input signal is applied to the edge-triggered inputs of  $MONO_1$  and  $MONO_2$ . Those two monostable inputs are wired in parallel, while the Schmitt-

trigger monostable inputs are kept high by the 2-kilohm resistors tied to the supply voltage.

$MONO_1$  is wired to produce a 30-ns pulse, which is conditioned by a Schottky-TTL NAND gate,  $G_1$ , to speed up its rise and fall times. Similarly,  $MONO_2$  generates an output pulse that is complementary to the one generated by  $MONO_1$  and that is conditioned by a second Schottky-TTL NAND gate,  $G_2$ . The width of this pulse is adjustable from 30 ns to more than 250 ns.

The third and last Schottky-TTL NAND gate,  $G_3$ , accepts the conditioned pulses from gates  $G_1$  and  $G_2$ . The output of this gate is a fast narrow pulse whose width is the difference between the pulses produced by  $MONO_1$  and  $MONO_2$ . An output pulse having a width of 8 ns and rise and fall times of 2 ns can be easily obtained with the generator circuit. □

Designer's casebook is a regular feature in Electronics. We invite readers to submit original and unpublished circuit ideas and solutions to design problems. Explain briefly but thoroughly the circuit's operating principle and purpose. We'll pay \$50 for each item published.

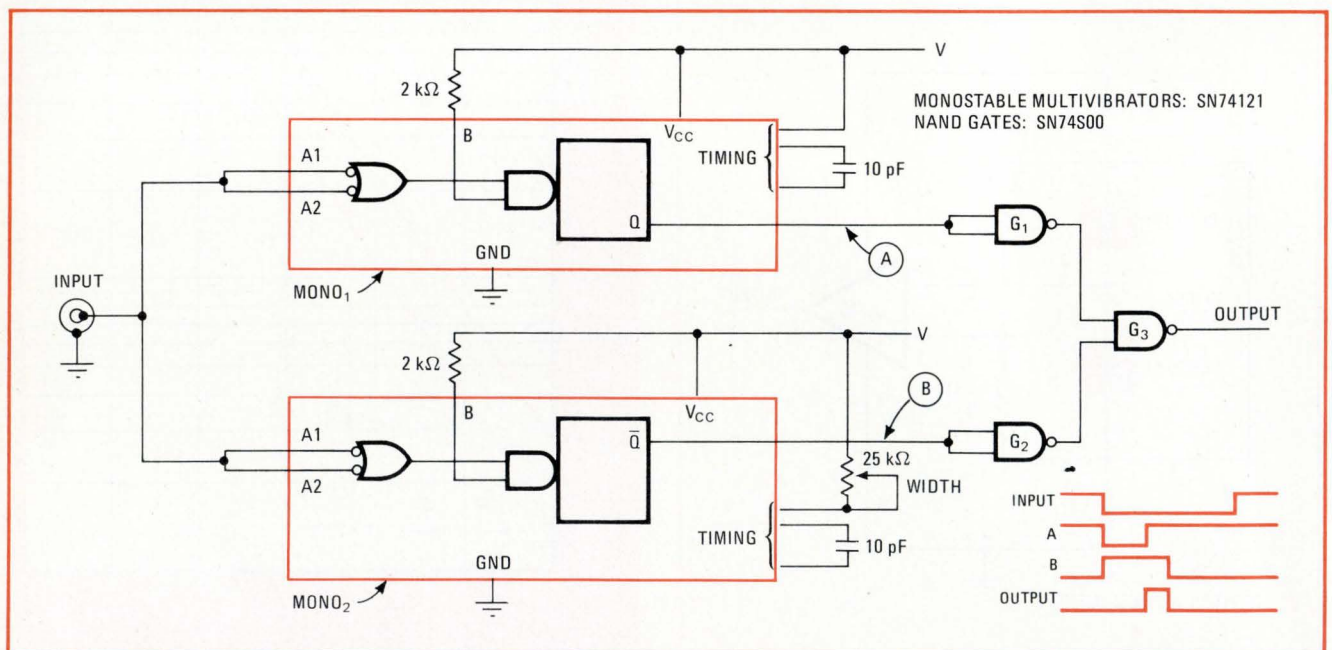

**Pulse generator.** A pair of standard TTL monostables can be made to produce sharp nanosecond pulses by using a Schottky-TTL NAND gate to accept their complementary outputs. The pulse width of  $MONO_1$  is fixed at 30 ns, while the pulse width of  $MONO_2$  is variable from around 30 ns to better than 250 ns. Gate  $G_3$  takes the difference between these two pulse widths. Output rise and fall times are 2 ns.

# The first name in sweep generators has met its match.

Telonic Sweepers and Display Oscilloscopes. Totally compatible and definitely synergistic.

There are four sweepers in the 1200 Series (with frequency ranges to 1.5 GHz), any of which may be coupled to a Model 121 single trace scope or a Model 122 dual-trace scope. Any combination gives you a complete facility for lab or production line testing and alignment operations over the entire RF and near-microwave frequencies.

All Telonic Sweep Generators have built-in frequency markers, attenuators, variable sweep rates and over 20 years of design experience.

SWEEP GENERATORS					DISPLAY OSCILLOSCOPES		
	Model 1201	Model 1202	Model 1204	Model 1205		Model 121	Model 122
Frequency (MHz)	.5(kHz)-30	.1-120	1-500	1-1500	Modes	Single Trace	Dual Trace
Sweep Width (MHz)	.5(kHz)-30	.1-120	.2-500	.2-600	CRT	11" Diagonal	
Output (dBm)	+19	+13	+10	+7	V Bandwidth (kHz)	15	
Flatness (dB)	±.10	±.25	±.25	±.50	H Bandwidth (kHz)	1	
Linearity (%)	1	2	1	1	V Sensitivity/div.	1, 10, 100 mv, 1v	
Markers	Single and Harmonic				H Sensitivity/div.	100 mv	
Circuits	Solid State/Modular				Input Imped.	10 K ohms	
Price (\$)	1895	995	1095	1395	Price (\$)	475	695

Telonic Display Oscilloscopes incorporate 11" CRTs (P4 or P7 phosphor), have 15 kHz bandwidths, and are ideal for X-Y presentation of swept frequency response.

Discuss a trial marriage with your Telonic representative; he will be glad to make the arrangements. **OR WRITE FOR OUR DATA PACKAGE COVERING SWEEPERS, SCOPES, AND ACCESSORIES.**

## TelonicAltair

21282 Laguna Canyon Road, Box 277, Laguna Beach, California 92652  
Tel: 714 494-9401 • TWX: 910 596-1320

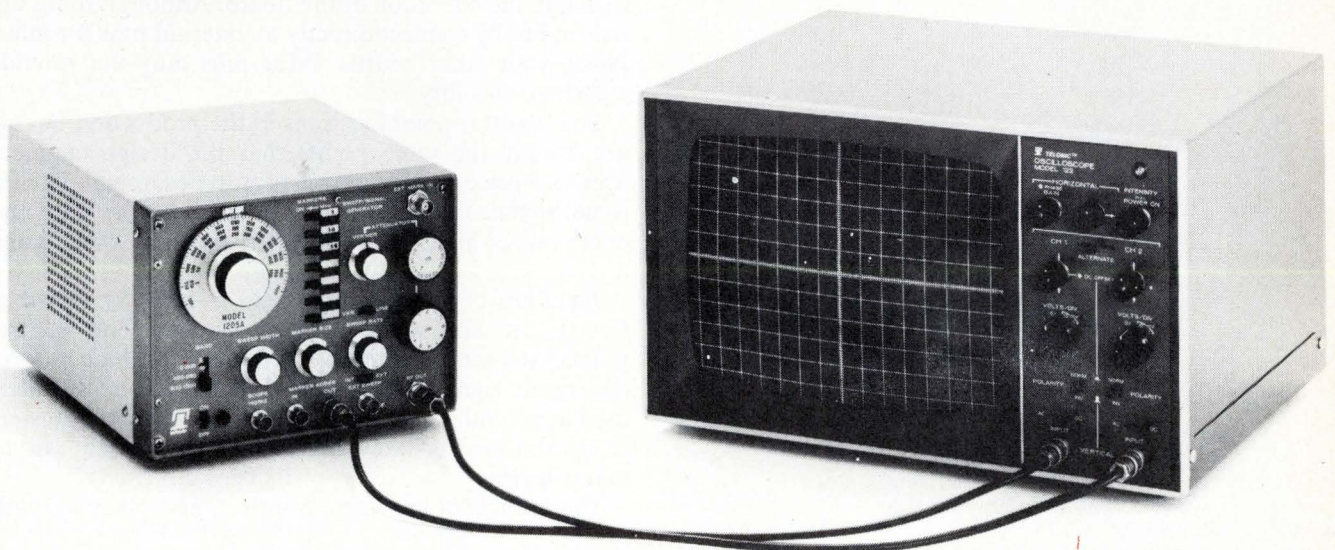

# Designing logic boards for automatic testing

The test engineer should team with the circuit designer to lay out logic boards for easy testing, fault isolation, and troubleshooting; this foresight can yield large over-all economies in manufacture

by David Schneider,  
Test Systems Division, General Radio Co., Concord, Mass.

□ As the capabilities of digital logic boards have been increased, so has their complexity. As a result, the costs of testing and diagnosing failures of these boards have become such a serious threat to economical fabrication that manufacturers have assigned top priority to testability.

Surprisingly, the difficulties seldom are the fault of the test technology itself. Efficient automated systems for high-speed go/no-go logic testing and fault-diagnosis are coming into widespread use. However, the basic requirements of testability are often overlooked when logic boards are designed and laid out.

Testing problems can be solved simply by far-sighted design techniques. Many of these suggestions will not increase fabrication costs at all; they only require the design engineer to think about testability. Other suggested modifications will increase fabrication costs, but these costs clearly need to be weighed against the savings in over-all testing costs.

These suggestions must also be weighed against such other factors as possible increases in manufacturing error or increased susceptibility to noise. The design and test engineers are not expected to implement all of the recommendations to increase testability, but rather to understand the fundamental principles of testability.

Some of the techniques described in this article are intended to help design testability into TTL and DTL circuit boards. But the principles are valid for all logic families, and use of the techniques will enhance the capabilities of any test system to diagnose virtually any type of logic-board failure. In addition, application of these principles can ensure the cost-effectiveness of any automatic diagnostic software system.

## Planning for diagnosis

The key to efficient fault diagnosis is the capability to rapidly isolate each defect. A typical logic-test system applies bit patterns to the input pins of the logic board and senses the resulting patterns on the output pins. The test system judges each output pattern as right or wrong. If wrong, the incorrect pattern frequently initiates a fault-localizing algorithm that seeks to identify the defective component(s).

Efficient fault-diagnosis depends on visibility of the logic board. That is, the ability of the test system to see, in detail, the operation of the board. Although some signals normally connect directly to external pins for interfacing with other boards, these pins may not provide sufficient visibility.

The best test-point locations in the production boards are usually the same points that the design engineer uses to check operation of his prototype circuits. The internal signals that tell the design engineer the state and operation of his circuits are often the same signals the test engineer will want to monitor.

Junctions of large fan-ins and fan-outs, as shown in Fig. 1, are also ideal locations for test and control points. At a fan-in, a number of signals combine to form one result signal, whereas at a fan-out, one signal is used at several places. Examples of fan-outs are master-clock and master-reset signals, which branch out to many devices.

The outputs of flip-flops, counters, and other ICs with

memory are valuable indicators of the states of the circuits. Access to those points simplifies test generation and also allows for rapid diagnosis of failures of these ICs. Further, because these memory elements often control other sequential logic, they can prove useful in revealing the operation of that logic, as well.

Whenever an input stimulus to the board has to pass through many levels of intermediate logic to get to the output of the board, direct access to the buried logic can be simplified by adding test points that allow intermediate logic to be bypassed or placed in a desired state. Another testing problem arises if designers employ redundant static logic to prevent dynamic problems or to ensure fault-tolerant operation. A few extra test points will break up the logic into nonredundant parts for testing purposes and will confirm the operating condition of these circuits.

### Initializing memories

Frequently, memory elements start out in unknown or random states when power is applied to the board, and they must be set to known states before a valid testing routine can begin. If all the memory states are strongly connected (each state can be reached from any other state by exercising the board's inputs), then memory elements can be initialized. But the sequence of input stimuli, called a homing sequence, required to reach a given state, may be both hard to devise and exceedingly long. What's more, most of the logic elements may be required to function properly to achieve certain initial states, thereby inhibiting fault-diagnosis.

Means of placing memory elements in known initial states should be designed into the logic board from the start. Depending on circuit complexity, it may be also desirable to set memory elements in several different known states. This permits independent initialization and simplifies generation of certain internal states required to test the board adequately.

A designer should provide external pin connections through which the tester can apply reset signals directly to memory elements. Sometimes extra logic gates may be required. In the case of a flip-flop reset by an internal board signal (Fig. 2a), a logic gate can be added so that a signal from the tester can reset the flip-flop (Fig. 2b). Sometimes the tester signal can be wire-ORed with the normal reset signal (Fig. 2c). Though safe for DTL, standard and low-power TTL circuits, high-power and Schottky TTL circuits cannot be driven low safely for more than one second. When not being driven, the tester line may serve as a sense point.

Where an output of an IC feeds back into the same IC, as in a flip-flop, a shift register, or counter, the output may be driven low by using the wired-OR technique as shown in Fig. 3(a). For example, driving the Q or  $\bar{Q}$  output low initializes the "slave" stage of a master-slave flip-flop, but leaves the "master" stage unchanged.

If external pins are not available for an extra reset, a designer can add a power-up reset that remains low momentarily after power is applied, as shown in Fig. 3(b). Set, reset, and load lines of flip-flops and other memory elements are often left unconnected, tied to  $V_{cc}$  or to ground, or tied to  $V_{cc}$  through pull-up resistors. If a set-reset is tied directly to ground or  $V_{cc}$ , it cannot be

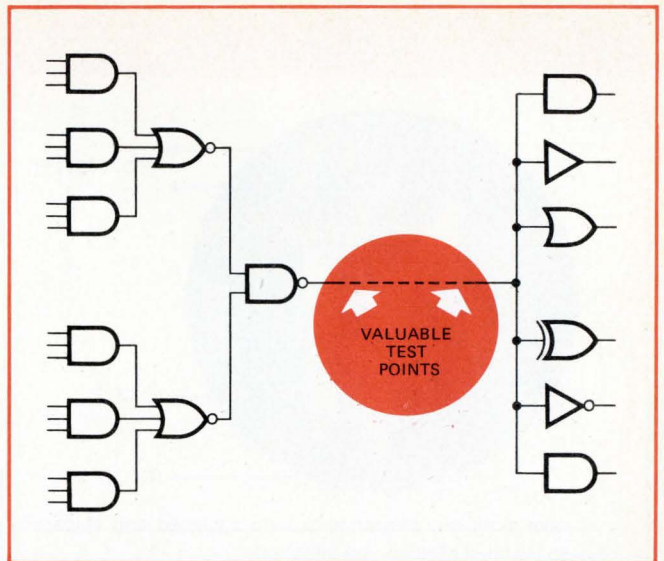

**1. Take the pulse.** Junctions of large fan-ins are natural points to bring out to connector pins for efficient automated testing. Conversely, fan-outs, such as those at master clock and master reset points, are natural points for applying control signals from an automated tester. They, too, should be brought out to connector pins.

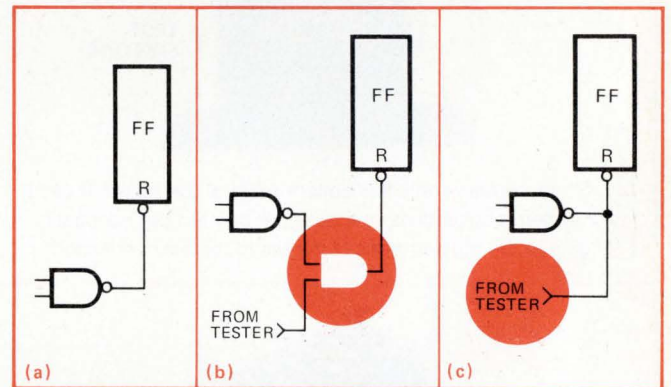

**2. High or low?** Initializing flip-flops takes the guesswork out of determining their state. By adding an extra gate to the circuit as shown (b), the tester can provide the reset signal. The wired-OR technique, shown in (c), does away with the additional gate, but caution must be exercised with high-power and Schottky circuits, since they may not be driven low for more than 1 second.

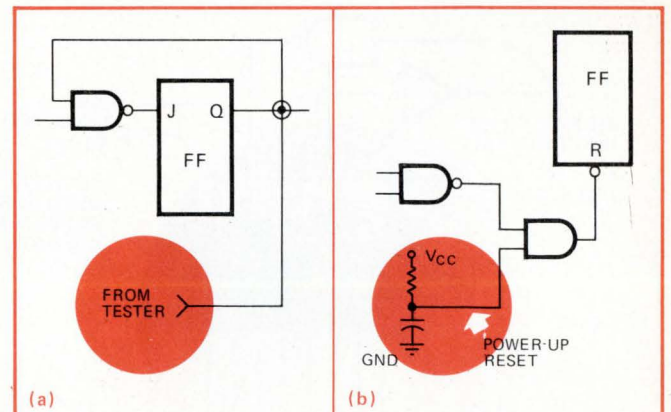

**3. Feed it back.** Where an output of a flip-flop feeds back into a driving IC, the output can be reset by using a wired-OR technique as in (a). If an external pin is not available for reset, then a power-up reset can be added by using an RC network as in (b).

## SOME PACKAGING TIPS

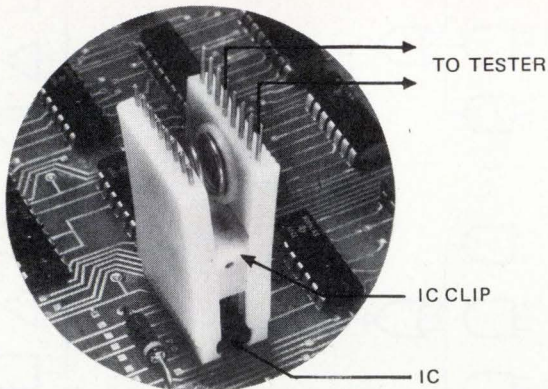

Leave sufficient clearance around socketed and soldered ICs so that test clips can be attached.

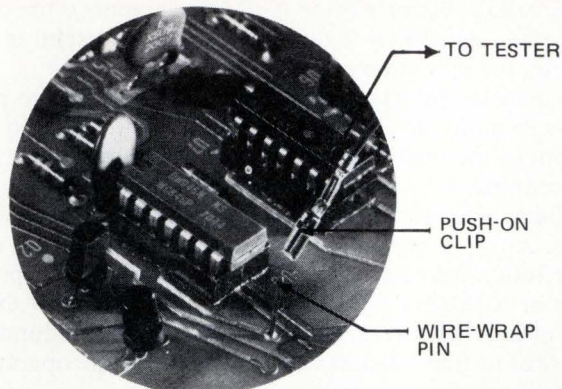

If crowding is unavoidable and will prevent use of an IC clip, mount a wire-wrap pin to allow connection of a push-on clip.

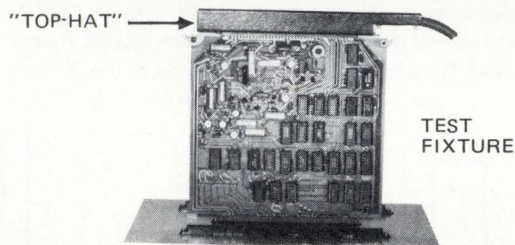

Since normally only the bottom edge of the board is used for system connections, the designer can run out connection fingers to the top and sides of the board for test connections.

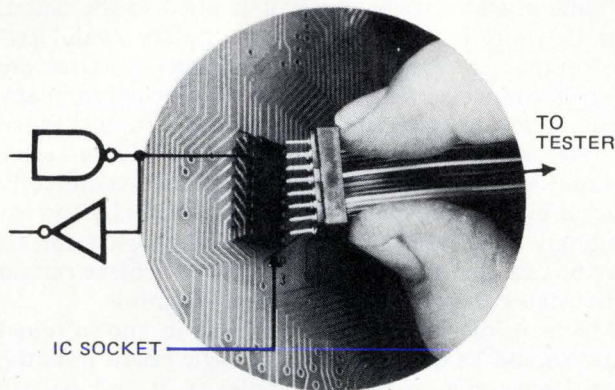

Extra IC sockets can be added for test and control points. Sometimes signals can be wired to unused IC sockets for connection during testing.

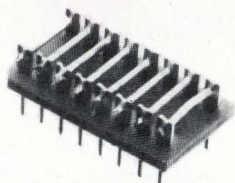

A jumper plug, which is removed during testing, can interrupt feedback and other signals.

Bring out test and control points to connection fingers. During normal system operation, they may be jumpered. However, they are readily accessible during board tests.

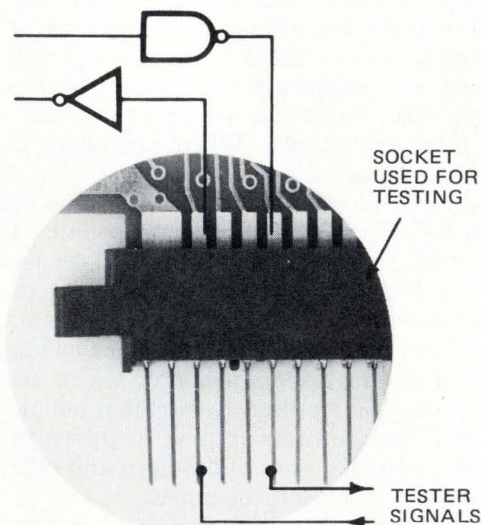
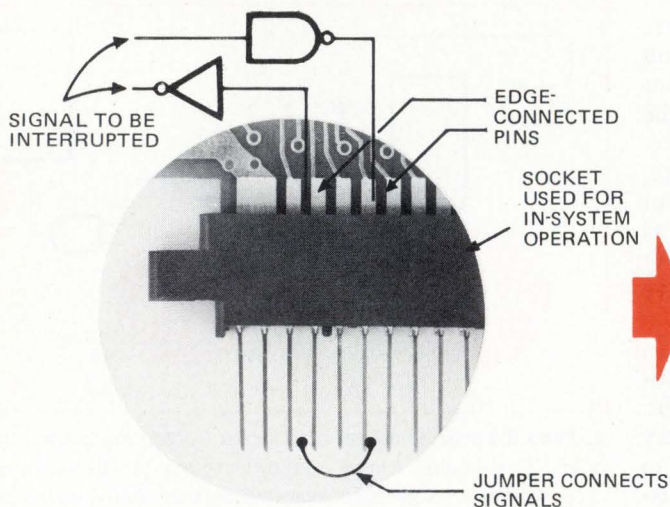



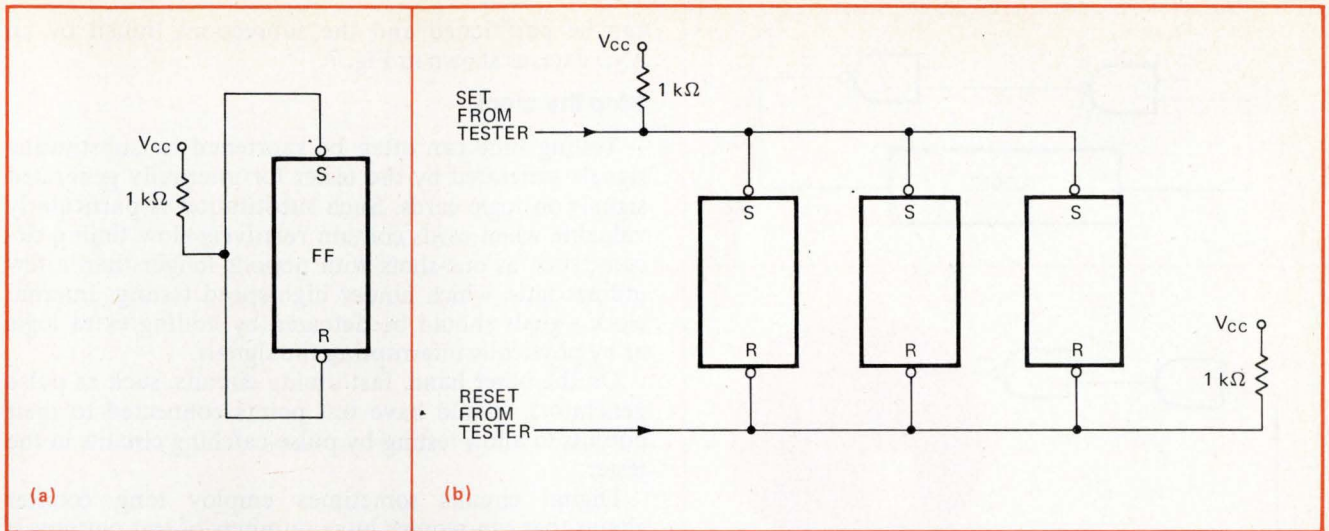

**4. Tandem reset.** If a set-reset line is tied through a pull-up resistor to  $V_{cc}$ , the line may be driven low by the tester so long as the same resistor is not used to pull up both set and reset lines of the same element as in (a). However, the same pull-up resistor can be used for several sets and resets as in (b). Both set and reset signals are provided by the tester.

driven by the tester and is lost for test purposes.

Instead, a source of logic high should be designed to come from a pull-up resistor, and a source of logic low from a pull-up resistor driving an inverter. The designer should avoid using the same resistor to pull up set and reset lines of the same memory element as shown in Fig. 4(a), since the memory element can not be initialized because of an internal race. However, Fig. 4(b) shows how a single pull-up resistor should be wired so that several sets or resets on different memory elements may be accessed simultaneously for initialization.

If a design is already in production and a set-reset line is unconnected, an IC clip can be used to access the line and drive it low momentarily.

### Unmask the culprit

Feedback loops with many logic elements hinder fault-diagnosis because the effect of the fault at one point in the loop may affect all points in the loop. For example, in the simple circuit shown in Fig. 5 where e, f,

g, and h = 1, the faults d stuck low, a stuck high, b stuck high, and c stuck low are indistinguishable.

Because the defective device is, in effect, disguised, it cannot be uniquely isolated. The loop can be broken if the signals e and f are set to 0, but it may be difficult to manipulate these signals. Other means are frequently needed to break feedback loops.

A designer should provide a means of inhibiting the clock of each memory element to break the feedback loop and to provide known reference points. A hypothetical logic circuit with feedback is shown in Fig. 6(a). One way to break the loop is to insert a gate to interrupt the feedback path as shown in Fig. 6(b).

Alternatively, the feedback loop can be brought out to external pins, which are connected by a jumper for normal operation as shown in Fig. 6(c). Removing the jumper interrupts the feedback and provides the tester with both a drive and sense point.

Like feedback loops, large wired-OR fan-ins also thwart fault resolution. To solve the problem, the fan-in

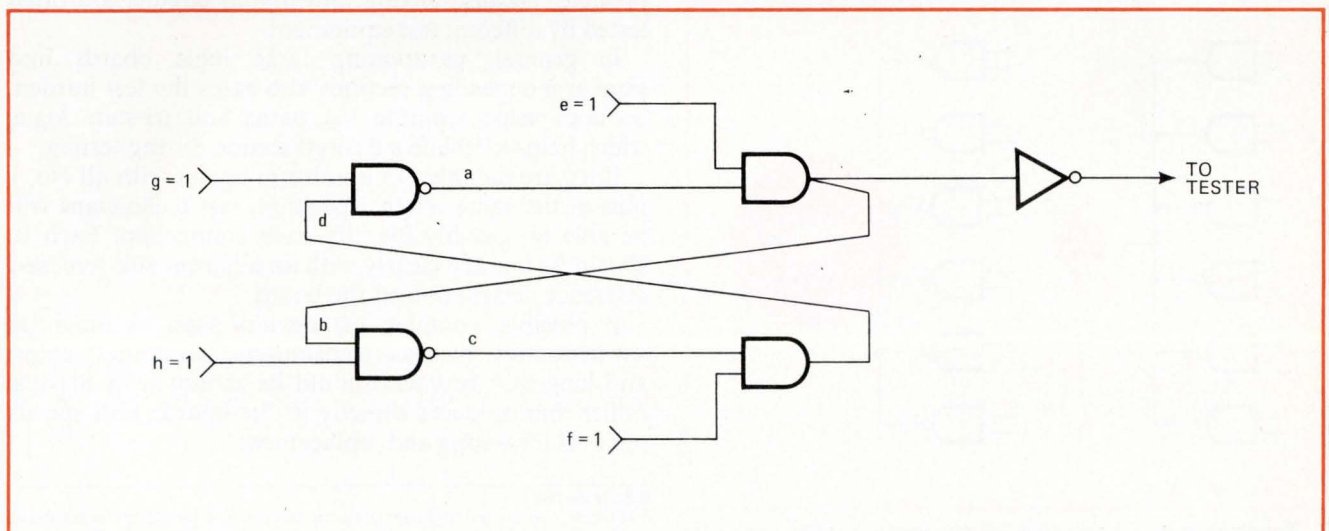

**5. Disguised.** Feedback loops, which are common in many latch circuits, can disguise faults. If, for example, f, g, and h are all high, d stuck low appears identical to a or b stuck high or c stuck low. A way to break loop must be provided.

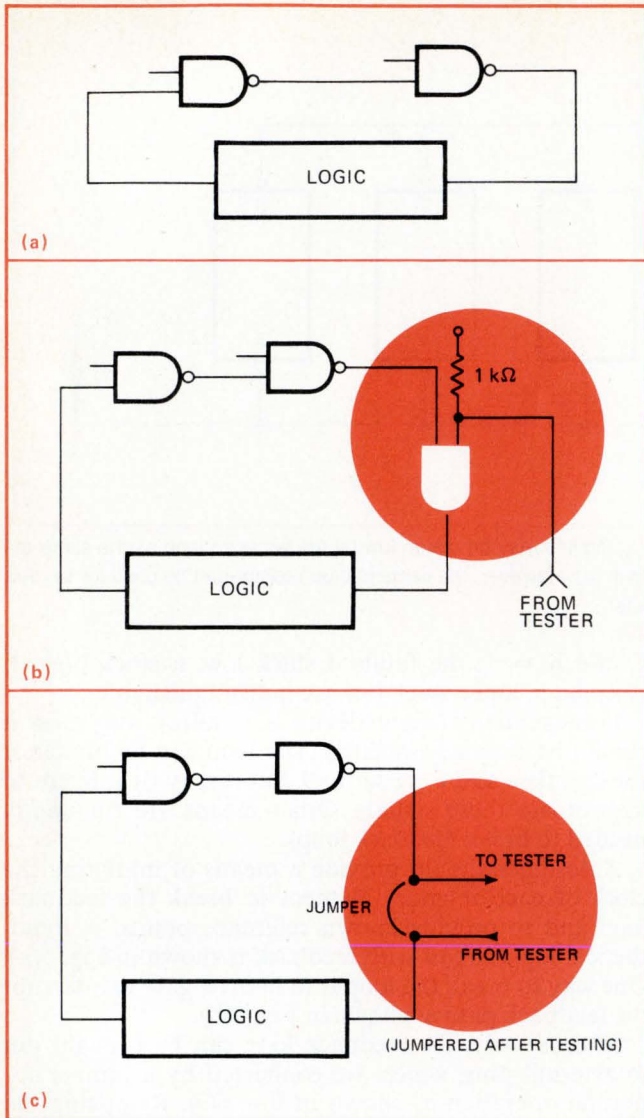

**6. Break the loop.** Feedback loops shown in (a) can be broken by inserting gates as in (b). The loop can also be opened mechanically by wiring the circuit as in (c) and providing jumpers when operating.

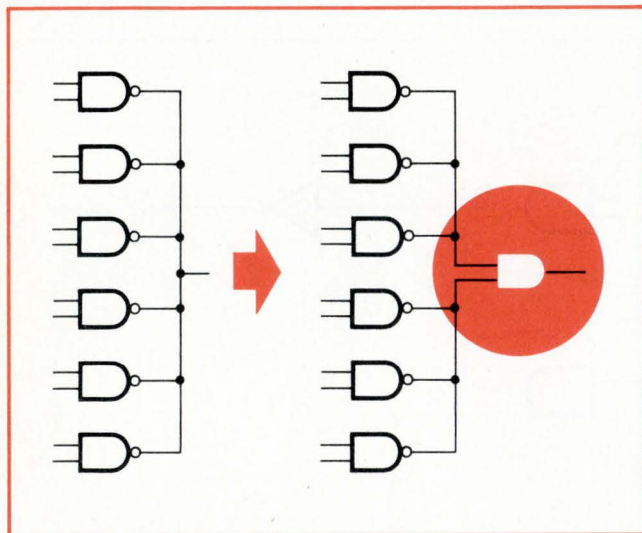

**7. Tough to test.** Large wired-OR connections suffer from poor fault resolution. Partitioning the connection into smaller groups and linking them with an AND gate or a jumper, improves fault resolution.

can be partitioned and the subsections linked by an AND gate, as shown in Fig. 7.

### Stop the clock

Testing time can often be shortened by substituting signals generated by the tester for internally generated signals on logic cards. Such substitution is particularly valuable when cards contain relatively slow timing circuits, such as one-shots with periods longer than a few milliseconds, which hinder high-speed testing. Internal clock signals should be defeated by adding extra logic or by physically interrupting the signals.

On the other hand, fast timing circuits, such as pulse generators, should have test points connected to their outputs to allow testing by pulse-catching circuits in the tester.

Digital circuits sometimes employ long counter chains that can require huge numbers of test patterns if tested in a conventional way. For instance, a 24-bit counter requires  $2^{25}$  or about 33 million test patterns, which is highly inefficient and greatly prolongs test time on a general-purpose test system.

When counters are directly loadable, the number of patterns can be drastically reduced by connecting control signals to the direct load lines of a long counter chain. Another technique is to break the connections between cascaded counter stages, thereby enabling each stage to be clocked independently with a minimum number of clock pulses.

There are several ways to accomplish this. One is to attach a driver to pull down the cascade line, being careful not to impair the counter internally. Or the cascade lines can be physically interrupted by bringing out test points to a connector. These are shorted by a jumper during normal operation. Perhaps extra logic can be added so that counter stages can be clocked independently of the carry-out from earlier stages.

### Packaging for efficient testing

A careful logic-board layout can make major contributions to efficient testing. For instance, analog and digital circuits should be packaged on separate cards, if possible, because analog and digital circuits are often tested by different test equipment.

In general, partitioning large logic boards into smaller independent sections also eases the test burden. So does using separate  $V_{cc}$  paths and tri-state logic, which helps to isolate a desired section during testing.

If ICs are mounted in a uniform layout with all No. 1 pins in the same relative position, test technicians will be able to speedily identify each connection. Each IC should be marked clearly with an adjacent silk-screened reference designation on the board.

If possible, complex LSI devices such as universal asynchronous receiver/transmitters, computer chips, and long-shift registers should be mounted in sockets, rather than soldered directly in the board. This speeds removal for testing and replacement. □

### BIBLIOGRAPHY

Fred Liquori, "Introduction to Current Computer Aids to Digital Test Design for Automated Test Equipment," Naval Air Engineering Center, Philadelphia.  
Lutz Henckels, "Testability of Logic Circuit Boards," 1974 IEEE proceedings.  
George Peters, "Company Success or Failure Can Depend on Product Testability," EDN, Feb. 20.

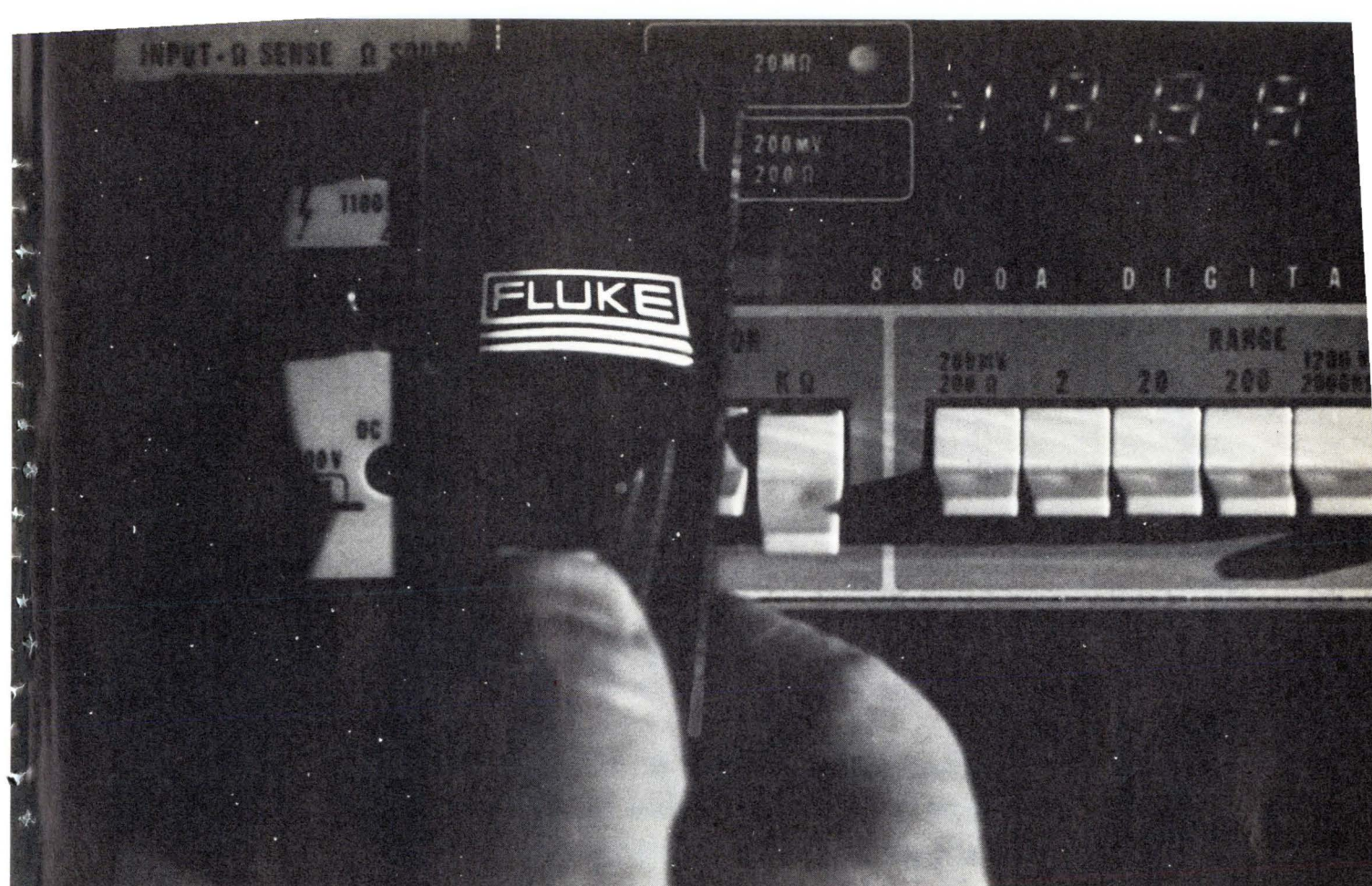

## Discover how these auto-multimeters keep you out of trouble.

On the surface they may look like any well-designed digital multimeters.

Now look closer. What else do you see?

There... the Fluke name!

That indicates unusual performance.

We designed both the Fluke 8600A and the 8800A with auto range, auto zero, and auto polarity. **And every parameter is fully protected.** This means you can accidentally overload the instrument with too much current... too much voltage... or too much resistance... and you're still okay.

Another way you stay out of trouble: MTBF on each instrument is a minimum of 10,000 hours.

Now, the specs.

**The 26-range Fluke 8600A, \$599.** We packed this 20,000 count multimeter with five

ranges of volts from 200 mV through 1200 V ac and dc. Five ranges of current, 200  $\mu$ A to 2 A ac and dc. And six ranges of resistance from 200 ohms to 20 megohms.

Basic dc accuracy is a fully credible 0.02%. Options include built-in automatic rechargeable battery pack for up to 8 hours off-line operation. Digital output is also offered.

**The 0.005% Fluke 8800A, \$1099.**

This digital multimeter features five ranges of dc volts from  $\pm$ 200 mV

to  $\pm$ 1200 V. Four ranges ac from 2 V to 1200 V. And six ranges of four terminal resistance from 200 ohms to 20 megohms. For complete isolation the input resistance is better than 1,000 megohms on lower ranges and 20 megohms on the higher ranges.

For critical resistance measurements the instrument provides completely isolated four terminal ohms with less than 4 volts open circuit from 200 ohms through 20 megohms.

So there are the specs.

Impressive? We think so. But remember—specs are one thing. That name on the panel, however... It's what makes a Cadillac a Cadillac.

And a Fluke a Fluke.

For details, call your nearest Fluke sales engineer. Or simply dial our hot line.



**For data out today, dial our toll-free hotline, 800-426-0361**

In the continental U.S., dial our toll free number 800-426-0361 for the name and address of your nearest local source. Abroad and in Canada, call or write the office nearest you listed below. John Fluke Mfg. Co., Inc., P.O. Box 7428, Seattle, Washington 98133. Phone (206) 774-2211. TWX: 910-449-2850. In Europe, address Fluke Nederland (B.V.), P.O. Box 5053, Tilburg, The Netherlands. Phone 013-67-3973. Telex: 844-52237. In the U.K., address Fluke International Corp., Garnett Close, Watford, WD2 4TT. Phone, Watford, 33066. Telex: 934583. In Canada, address ACA, Ltd., 6427 Northam Drive, Mississauga, Ontario. Phone 416-678-1500. TWX: 610-492-2119.



# CAN THE FCC COPE WITH CHANGING TECHNOLOGY?

**New leadership is handicapped by  
limited resources and static budget  
that doesn't reflect shifting workload**

by Ray Connolly and  
Stephen E. Scrupski,  
*Senior Editors*



□ In the mid-sixties, the Federal Communications Commission had an image problem. "Is the FCC dead?" asked one magazine article in 1966, "Is the FCC Obsolete?" asked another in the same year, and in 1967, Kenneth A. Cox, then an FCC commissioner, presented a commissioner's side of the story in an article called "Does the FCC Really Do Anything?" But in recent years, as outsiders and insiders agree, the FCC has done a great deal, despite limited resources and an unchanged organizational structure at a time when communications technology is undergoing rapid changes.

Since 1968, when the FCC issued its landmark Carterfone ruling that customer-provided equipment could be attached to the switched public telephone network, the agency has continued to break new ground. Its series of

decisions has in effect produced new national communications policies, the most controversial of which opt for competition—competition between long established entities like AT&T and TV broadcasters on the one hand and, on the other, an increasing number of corporate newcomers anxious to cultivate new markets.

Having written those policies, however, the FCC now faces the far harder task of getting them implemented. Moreover, it must do so not only in the face of mounting opposition from established interests but also with a new chairman, new commissioners and new key staff members (see "How the FCC works," p. 113).

The most fundamental problem of all, however, is the size of the FCC's total budget and its distribution within the commission. In the fiscal year that began July 1, the

FCC will be operating with a budget authority of less than \$50 million—merely a footnote to a total Federal expenditure that will exceed \$300 billion (and AT&T spent almost \$1 billion on marketing alone in 1973).

By far the largest chunks of those limited funds are allotted in the initial budget request to the Broadcast and Field Operations Bureaus, which get \$9 million and \$10.6 million, respectively. Field operations employ more than a quarter of the commission's 1,800 regular personnel in spectrum monitoring, inspection of licensed station equipment, operator licensing, and a host of other routine chores.

Similarly, the Broadcast Bureau devotes the bulk of its resources to regulating the nation's radio and TV stations and is relatively uninvolved in new technologies. "Broadcast gets as much money as it does," says one insider, "just because it was there first. Licensing broadcasters used to be our [the FCC's] most important function. It is still important, of course, but it hasn't changed much." Nor, it should be added, is the broadcast field a significant growth area in today's electronics business.

The TV and radio broadcast industries are put at \$4.1 and \$1.6 billion, respectively, by the Department of Commerce. But in 1974, they are expected to provide electronics with an annual equipment market of only \$179 million [*Electronics*, Jan. 10, p. 120]. The interconnect market, for one, can be far larger. For example, radio and TV's \$179 million is \$1 million less than the value ITT Corp.'s E.F. Eddy places on U.S. shipments of PABX and key systems this year. Eddy also notes his estimate is conservative because of "numerous industry imponderables and a lack of aggressive marketing strategy."

### **FCC's biggest impact: carriers**

Unquestionably the most important FCC operation, in terms of its impact on new applications and the markets they represent, is the Common Carrier Bureau. Close behind is the Safety and Special Radio Services Bureau, with its responsibility for land-mobile communications and other, nonbroadcast, uses of radio in aviation, marine, amateur, and police operations.

Nevertheless, the fiscal 1975 budget request for the Common Carrier Bureau was less than \$6 million—two thirds that of Broadcast—while the Safety and the Special Radio Services Bureau was allocated less than \$4.5 million in the request to the Congress.

Yet the explosive growth in telecommunications applications, plus the commission's advocacy of competition between AT&T and new specialized common carriers, has far outstripped the small increases in the Common Carrier Bureau's budget and staffing employed to regulate the industry on a timely basis. The bureau must not only oversee a domestic telecommunications industry that accounts for an estimated \$1 billion in hardware annually when the output of AT&T's captive Western Electric Co. is factored in—but it must also recommend policies to FCC commissioners on a variety of controversial issues ranging from interconnection to domestic satellites.

For the Safety and Special Radio Services Bureau, the biggest immediate problem is implementing the commission's recent decision, under Docket 18262, that

expanded land-mobile operations in the 900-megahertz band [*Electronics*, May 2, p. 52].

Who coordinates FCC's technology? That job, among others, belongs to the Office of Chief Engineer run by Raymond E. Spence, Jr., who is among the first to recognize that more than technology is involved: "Ten years ago we simply found a piece of the spectrum that was lying around and gave it to an applicant. Now things are much more complicated." As Spence points out, more than a year before the FCC ruled in favor of expanding land mobile up into the 900-MHz region, it came up with an interim resolution of the problem by taking the top 13 uhf TV channels and making them available to mobile operations. Such decisions are "no longer engineering issues. They become political as well as economic and social issues."

Spence agrees that the FCC "spends too much on broadcasting and not enough time on other developing issues." One way this handicaps the commission and his office is to limit their ability "to weigh engineering factors in their own right." On the matter of interconnection, for example, Spence's office proposed equipment certification standards in the fall of 1972. But in the summer of 1974, the commission has yet to act on the plan.

### **Drowning in paper**

Virtually everyone who deals with the FCC and many of its own staffers agree that it is close to being overwhelmed by the controversies created by each new application of technology. The FCC is employing "a structure of the forties to try and deal with the problems of the seventies," says Bernard Strassburg, who retired last year after 31 years with the commission, the last 10 of them as Chief of the Common Carrier Bureau.

During Strassburg's tenure the commission marched off in a variety of new directions, most of which encouraged competition with the existing communications establishments. After the Carterfone interconnection decision there came, for instance, the computer-communication inquiry, the first and second phases of a major investigation of AT&T's structure and operations, and the domestic-satellite decision.

"When I came to the commission," Strassburg recalls, "we only had voice communications to regulate and the industry was one tenth the size it is now. But the FCC had as many people back then as it has today. Now we could do the job with the same number of people if the tools had changed—computer files, and so forth—but the tools haven't changed."

Throughout all its bureaus, the commission appears to lack adequate legal staff—a critical inadequacy because of the increasing number of challenges to commission actions by AT&T and its new competitors. "We're talking about policies that come as a result of engineering advances, not the engineering itself," explains one FCC lawyer. "We have 13 lawyers who share four secretaries in the Common Carrier Bureau—that's it. How can we be expected to cope with AT&T with that kind of staffing?" Former commissioner Kenneth Cox, now a senior vice president with MCI Communications Corp., a specialized carrier, concedes that the FCC generally and the Common Carrier Bureau in particular is

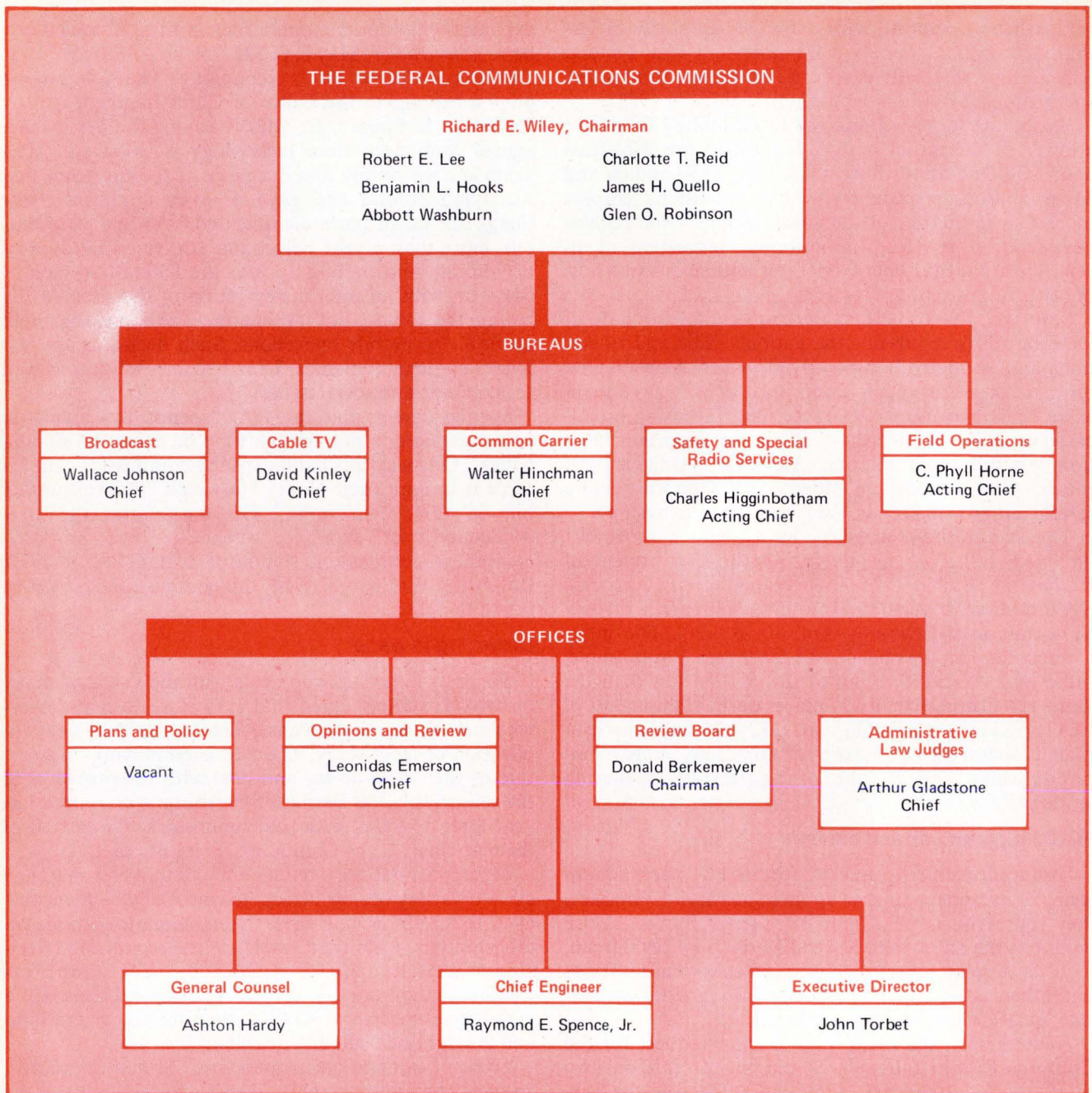

"thin in experienced personnel" right at the time when "they and we are having a problem with Bell." Cox contends that "there is a lot of indecision on the commission because of the inadequacy of the staff. They are facing new problems and don't have the numbers or—more important—the kinds of people to handle the problems."

Most of the new problems over competition fall in the Common Carrier Bureau's domain. Compounding those problems is the Common Carrier Bureau's recent reorganization under its new chief, Walter Hinchman. An alumnus of the White House Office of Telecommunications Policy (OTP), Hinchman moved into the bureau from the FCC's Office of Plans and Policy. And chairman Wiley is still trying to fill Hinchman's planning post with someone "who can take me up to the mountaintop periodically and give me the big picture."

But some FCC staffers and industry sources are already expressing concern whether Hinchman—who is continuing Strassburg's advocacy of competition—can make the transition from planning to administration quickly enough to maintain bureau momentum. Hinchman's reorganization of the bureau structure [*Electronics*, May 2, p. 53] has reduced the level of effort in economic analysis just at a time when it may be most needed—the recently opened Docket 20003 will comprise a study of the economic impact of interconnection on Bell System operations. If history is any guide, AT&T can be expected to inundate the commission with data in support of its contention that unrestricted interconnection will result in higher telephone rates for the average user.

Support for the commission in the form of both economic and engineering studies also comes from the

OTP—except that some within the FCC wish the commission had OTP's operation in house. That view is held by Strassburg, even though he already believes that OTP has given "an added dimension to the FCC." The White House group "is in a position to do the kinds of studies the FCC should do." In the FCC's cable vs satellite studies, Strassburg says he "frankly welcomed OTP's efforts. They don't have an axe to grind. I just wish the FCC had the same type of capability—the dollars and staff to bring to bear on some of these issues."

The need for studies of the economics of communications like Docket 20003, rather than engineering cost analyses alone, is also supported within OTP. Outside the FCC, too, AT&T's problems over forecasting the communications market stem from its heavy reliance on engineering data, instead of marketing data, suggests OTP's Sebastian Lasher, recalling the observation of psychologist Abraham Maslow that "if the only tool you have is a hammer, you tend to treat everything as if it were a nail." AT&T now has a new marketing organization, but nevertheless Lasher feels that, even if the company were inclined to share its "highly sensitive and proprietary" marketing studies with the Government, "it probably would not constitute good public policy to rely too heavily on any single firm's projections."

Such judgments, of course, leave the FCC with few options except such dockets as 20003 as a means of improving its expertise in communications economics. And, as one outside analyst observes, "this leaves the commission, once more, in the position of having to rely on selective, secondhand information it has received from others."

### Self-implementing tariffs

A handicap of even longer standing at the FCC is the statutory rule, established when the commission was set up, that a new common-carrier tariff goes automatically into effect 90 days after filing with a 60-day advance notice. No one at the FCC, including its chairman, disputes the argument of AT&T's competition that the rule is outdated. AT&T has opposed any change.

Chairman Wiley, for example, would like to have Congress alter the rule so that new tariffs could be held in abeyance for as long as it takes to adjudicate the issue, perhaps nine months or a year, if necessary. MCI's Cox concurs. "In the past," he notes, "tariff challenges have been based on overcharges, so that redress could be made in the form of lower rates and rebates. Now, however, the challenges are from competition, and rebates to users do not balance the competitive scales. They certainly don't do MCI any good."

In fact, they may do MCI and other special carriers like Data Transmission Co. (Datran) sufficient damage to be fatal, according to William Melody, well-known communications economist and faculty member of the University of Pennsylvania's Annenberg School of Communications.

AT&T's so-called "hi-lo" competitive tariff for voice-grade private lines, for example, went into effect on June 13—after AT&T's 60-day voluntary suspension of the original effective date, but before the commission could rule on its validity. The tariff, Bell's first departure from nationwide rate-averaging concept, offers

lower charges on high-density routes while raising charges on low-density routes.

### Survival issue (or for whom does Bell toll?)

This kind of competitive response by AT&T to MCI, Datran, and others, combined with other legal actions in courts and state public utility commissions, could "wipe out" the specialized carriers, Melody believes. Other boosts to AT&T will come from its proposed, low-price data-under-voice microwave system for use with its Dataphone Digital Service, and also from the competition to special carriers provided by the so-called "value-added" carriers offering packet switching services over AT&T lines [*Electronics*, May 2, p.105].

Melody says he is becoming convinced that small special carriers, with their limited financial resources, will ultimately be no match for the AT&T monolith. Because of the long drawn out proceedings before the FCC and the courts, the economist contends that special carriers—for whom the FCC has said it will not provide any protective umbrella—may win individual legal battles, but eventually lose the financial war because of the costs of competition and legal counsel.

MCI chairman William McGowan naturally opposes this view, adamant in his belief that "special carriers are

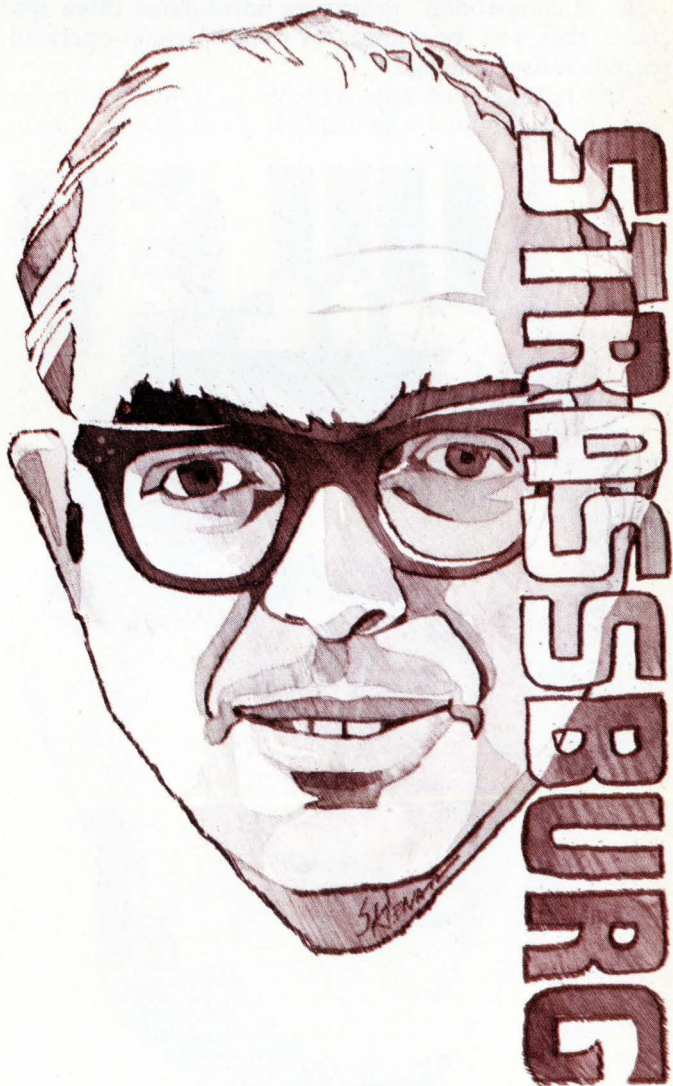

here to stay" and convinced that "the Government won't let us go under."

Nevertheless, AT&T is by all accounts proving more responsive than ever to the thrust of new commission rulings on the issue of competition, interconnection, and the development of new land-mobile markets at 900 MHz, in which it will share heavily under the FCC's May decision on Docket 18262.

### Mobile radio controversies

Despite the fact that AT&T and other wire-line common carriers will eventually have the use of 40 MHz of the 115 MHz opened up in the 806-947-MHz band for land-mobile use, AT&T has petitioned for reconsideration by FCC, as have others. Rather than 40 MHz, wire-line carriers would like to have the full 61 MHz they originally sought, without any reserve.

AT&T not only opposes the frequency limitation as one that would unnecessarily raise its equipment costs by half, but it is against the stricture that land-mobile operations should be handled by a separate subsidiary to prevent cross-subsidization of cellular service by other services. Moreover, the company wants a modification of the rule that would prevent it from providing and maintaining mobile radio units and also charges the FCC with "a desire to promote competition for the sake of competition" in leaving unregulated those systems that will be known as "entrepreneur-operated common-user systems."

The post-decision appeals seem guaranteed to go to the courts for final adjudication. Consequently, these

proceedings, too, could drag on for another year or more.

Because of the FCC's inability to deal in a timely way with controversial—and, in the case of specialized carriers, perhaps life-or-death—issues, petitioners before the commission are turning increasingly to the courts and, in some cases, to state regulatory agencies. Similarly, established entities like AT&T, which see a threat to the profitable *status quo*, also are turning to the courts and the states and, if need be, to the Congress to delay or get relief from FCC rulings. In addition, some states are taking independent action on such critical subjects as interconnection.

ITT's E. F. Eddy has noted that this "trend toward polarization of opinion regarding interconnection" is one "with the greatest potential impact on the industry's future." AT&T, he points out, "has found eager allies among the National Association of Regulatory Utility Commissioners (NARUC), which represents the state regulators. [State regulators have tended to be most sensitive to possible intrastate rate increases for residential users and thus have lent willing ears to Bell's warnings of such effects of interconnection.] In this environment of strong feelings, there has already been direct confrontation between several states and the FCC: the well-known North Carolina proceedings [which have threatened action that could effectively bar non-Bell telephone equipment in the state] and the rulings of the attorney general of Nebraska and the state of Oklahoma, which insist that interconnect companies obtain certification as common carriers."

Though the FCC has asserted jurisdiction over the states in these matters, and has the tacit support of the Justice Department, Eddy is not overly optimistic. "It seems unlikely that the nationwide, Federally controlled program of certified direct interconnection envisioned by the FCC staff and its PBX Advisory Committee will come to pass in the near future."

As a result, Bell may continue to impose charges for the protective interface circuits that it says are necessary to prevent harm to its network. These charges, when added to the price tags carried by non-Bell interconnect equipment, have made it more difficult to close sales, the competitors complain. They would prefer to build in whatever protective circuitry is required and, after certification, sell it for direct connection to the network.

Meanwhile, Eddy notes that even though Bell is just beginning to wage heavy war in the competitive marketplace, Bell already "manages to retain about 76% of all jobs on which they bid against interconnect."

North Carolina Utilities Commissioner Hugh A. Wells explained his state's action to exert jurisdiction on interconnection by claiming that—in three years of adopting a "wait and see" attitude after Carterfone—he found only Federal inaction. North Carolina moved, he said, because "good regulation abhors a vacuum." The FCC record on interconnection, according to Wells, "reflects more indecision than purpose and more guesswork than information."

One of several vocal opponents to North Carolina's assertion of intrastate jurisdiction on interconnection is William H. Borghesani, Jr., Washington counsel for the National Retail Merchants Association (NRMA) that





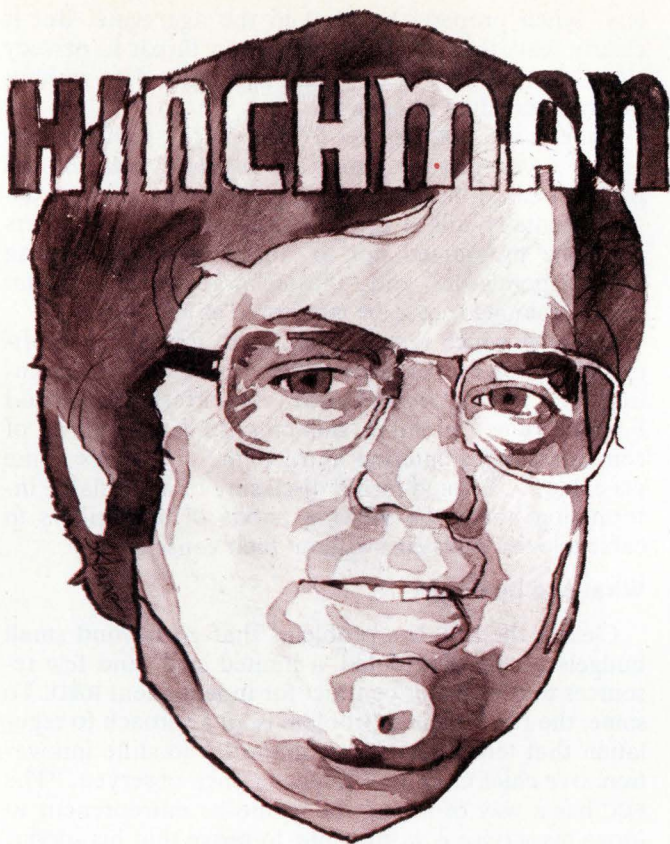

strongly advocates interconnection. The state's action, he insists, "could nullify interstate access to the common and indivisible public telecommunications network." But that issue between North Carolina and the FCC is now before the U.S. Fourth Circuit Court of Appeals at Richmond, Va. "Hopefully," Borghesani says, a decision will come before the end of 1974.

Borghesani says he sympathizes with the view of one FCC lawyer, who likens the long delay between the 1968 Carterfone interconnection policy decision and its still unresolved implementation, to the continuing battle over school desegregation (see "How the FCC works," p. 113). Yet he sees the North Carolina case and similar battles as but "pieces of a mosaic" that is AT&T's war.

#### **Cable TV: paper problems**

The FCC's Cable Television Bureau has by far the smallest budget of the five bureaus. And most of its request for \$2.2 million early this year for fiscal 1975 will go for paperwork—the processing and licensing of cable systems under rules requiring certification of all systems by 1977. In the six years before the certification ruling of March 1972, only 600 applications had been processed. Cable plant investment of about \$1 billion in 1972 has been forecast as growing to \$2.5 billion by 1978 and more than \$8 billion in 1983.

Like their Broadcast Bureau counterparts, cable staffers are heavily involved in "software issues" such as the uses of cable, rather than its technology. But some of these concerns seem likely to have a significant impact on CATV equipment makers.

At the moment, the cable bureau is caught up in a program introduced this year. Known as "re-regulation," it's an effort to simplify CATV licensing by mod-

ifying and in some cases eliminating excess paperwork.

Consequently, much of the work on technology is being left to an industry-oriented group known as the Cable Television Technical Advisory Committee. For example, an Electronic Industries Association (EIA) panel is in the process of turning over specifications for a "cable-compatible" TV receiver to the advisory committee after two years of work [*Electronics*, July 11, p. 77]. The design would boost a viewer's receiver costs, but could also cut cable service costs by 10% to 15% since, observes Teleprompter Corp.'s Hubert Schlafly, it "avoids additional boxes, eliminates unnecessary circuitry, and accommodates wireless remote controls."

Even more important, the policy concerns of CATV regulation by the 50 states and even smaller jurisdictions like cities and counties clearly worry the industry and its suppliers. Equipment-specification writers fear what they call "three-tier regulation" by Federal, state, and local authorities, and the possibility of its leading to conflicting requirements.

The FCC notes through its cable bureau chief David Kinley that it has preempted local regulation and fran-



chising of pay-cable systems, but the commission's authority is being challenged and the fundamental issue is not yet resolved. What's more, the challenge to the FCC has the support of such anti-cable-television groups as the National Association of Theater Owners, fearful of first-run movie distribution, and the long-established National Association of Broadcasters. The NAB argues that it is only concerned with program "siphoning" by CATV of network programs, notably sports events, but it is generally viewed as unhappy with CATV's threat to the broadcast industry's dominance and revenues.

### Interactive systems

Technologically, there are still a number of problems about two-way interactive CATV systems, in which the subscriber orders up his own programs and services. In its 1972 order on CATV, the FCC noted that, in future two-way offerings, "activation of the return service must always be at the subscriber's option." Yet the Urban Institute, a Washington-based public interest group, says its Cable Television Information Center (CTIC) "knows of no two-way subscriber response test now underway that conforms to the FCC dictum." For example, says CTIC, "Subscribers on the Tocom system in Rossmor Leisure World, Arizona, and the Thetacom Subscriber Response System in El Segundo, Calif., cannot prevent their channel selections from being monitored."

The Urban Institute believes that such monitoring for commercial interests like rating services and the measurement of advertising effectiveness "may be harm-

less" when properly handled in the aggregate. But it clearly fears that other uses contain a threat to privacy since "there is no way to obtain aggregate data without polling individual receivers."

Though the FCC has yet to rule on the technicalities of the CATV privacy issue, the institute believes the problem could be resolved since "two-way cable is developmentally still in the prototype stage." Computers could be programed not to store individual viewing data, it points out, and "the technology could permit certain channels not to be monitored at all."

The OTP, which regularly inputs to the FCC, is drafting legislation on the cable privacy issue for the Administration. It would, explained Vice President Gerald Ford in June, "prohibit 'snooping' and monitoring of communications entering and leaving a citizen's home via cable TV. I would forbid disclosure of identifiable information about the viewing habits of subscribers to cable television systems without their consent."

### What's to be done?

Clearly the FCC has problems that go beyond small budgets poorly distributed, a limited staff, and few resources to conduct or contract for independent R&D. To some, the fundamental problem is an approach to regulation that tends almost automatically to stifle innovation. OTP chief Clay T. Whitehead once observed, "The FCC has a way of asking the would-be entrepreneur to prove his service is worthwhile, to prove that his service is economical, to prove that the public wants it, before he is even allowed to try. I think you can see that kind of discourages innovation."

Among others, former chairman Dean Burch has suggested disentangling the FCC from its present dilemma by reorganizing it into two bodies. Burch, now a White House adviser, was a premier advocate of competition in communications. His straightforward, no-nonsense approach to complex regulatory issues has some communications specialists calling him "the FCC's Harry Truman," despite his conservative Republican background. Like Burch, former commissioner Cox believes "it would be a good idea to split the commission into two commissions—one concerned with common carrier and safety and special radio services and the other with broadcasting and CATV matters."

But John Sodolski, Communications division vice president at the EIA, opposes a split or massive reorganization, as does retired commission executive Strassburg. Sodolski likens reorganizations generally to firing the coach when the team is doing poorly: "It doesn't make the team any better." He believes the commission may not be a model of efficiency, "But it does work."

Former bureau chief Strassburg believes the FCC needs better tools and more staff to "develop a greater depth of understanding of what's going on and the implications of technological developments." Moreover, he sees a need for a systems analysis capability "to give early warning of emerging problems."

One eye-opening Strassburg suggestion: since the FCC has "no systematic effort in monitoring technology—the public's money is spent on this at Bell Labs, and it spends \$400 million a year—the commission should have the benefit of knowing what they are doing.

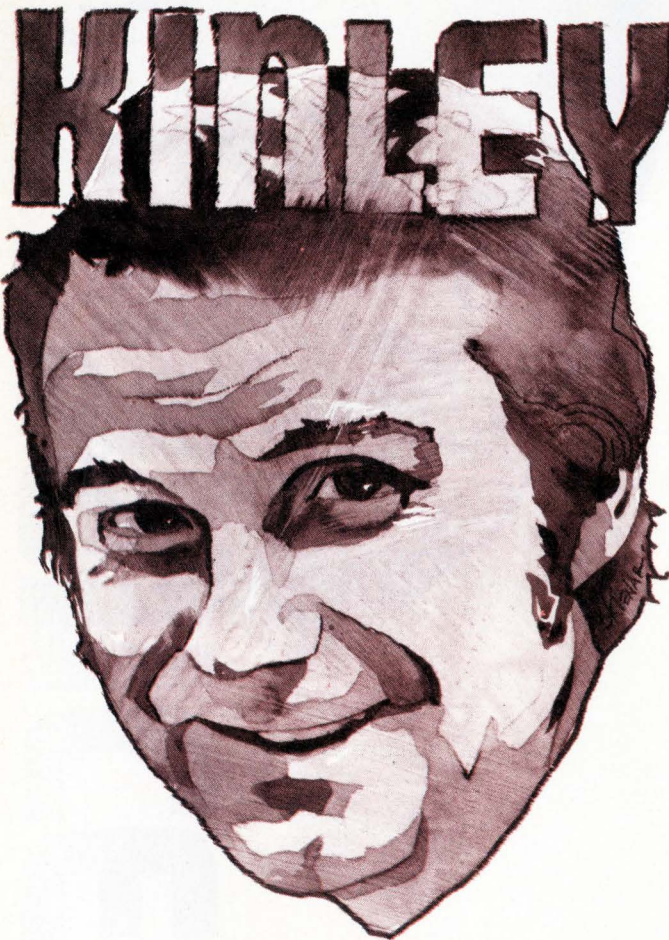

## How the FCC works

Created by the Communications Act of 1934, the Federal Communications Commission has been likened to a court. But it is more than that—instead of merely interpreting existing law, it can break new ground to accommodate new uses of communications technology.

Though the FCC is called "an independent agency" and reports to the Congress, the President names its seven commissioners, and the necessary Senate approval of his nominees is, more often than not, a routine procedure. Executive control is also exercised through the White House Office of Management and Budget, which must bless the FCC's annual budget request. The only constraint upon the President is that no more than four of the commissioners may be of the same political party.

The FCC is charged under the law "to make available to all the people of the United States a rapid, efficient, nationwide, and worldwide wire and radio communications service with adequate facilities and reasonable charges." Moreover, it is authorized, among other things, "to study new uses for radio, provide for experimental uses of frequencies, and generally encourage the larger and more effective use of radio [in the all-inclusive sense of frequency-spectrum management] in the public interest."

Richard E. Wiley, an ambitious and determined 40-year-old lawyer from Peoria by way of Chicago, has been trying to do just that ever since March 8, when he succeeded Dean Burch as chairman. Having become a commissioner in January, 1972, after 15 months as FCC general counsel, Wiley moved into the top job with three of the seven seats on the commission vacant, fewer than 1,800 of the more than 2,000 staff positions filled, and a budget of less than \$50 million for the Federal fiscal year that began this July 1.

Since that time, a fifth commissioner, former Detroit broadcast executive James H. Quello, has been confirmed by the Senate. For the remaining vacancies President Nixon late in May nominated Abbott Washburn, former chief of the U.S. delegation to the Intelsat Conference, and Minnesota law professor and communications lawyer Glen O. Robinson and also renominated Robert E. Lee to a fourth seven-year term, all of whom the Senate confirmed this month.

In reaching a policy decision, the commission's principal resources for technological assessments include the staff office of the Chief Engineer and the five operating bureaus he works with but which report directly to the commissioners. The five are the Broadcast, Cable Television, Common Carrier, Safety and Special Radio Services, and Field Operations Bureaus.

With these limited resources, the FCC must not only represent the U.S. in international communications activities but also try to implement such domestic policies as:

- Setting rules for interconnection of customer-provided equipment with the Bell system.
- Overseeing the establishment and operation of competitive domestic satellite systems.
- Controlling the expansion of land-mobile communications through new frequency allocations in the 900-megahertz region.
- Providing a fair shake for the infant cable-television industry in the face of stormy opposition from over-the-air broadcasters.
- Monitoring the explosive growth of computer-to-computer communications.
- Refereeing what shapes up as the most controversial issue of all—competition between AT&T and the newly formed specialized common carriers for new commercial and industrial services such as high-speed digital data communications.

When not wrestling with the political and technological questions raised by these issues—each the subject of at least one major policy decision since 1968—the FCC must find time for more routine matters such as regulating more than 12,000 radio and TV broadcast stations, ruling annually on approximately 1,000 station license applications, and regulating and licensing another 1,800 nonbroadcast stations for aviation, police, marine, amateur, industrial, and other uses.

Then there is what one FCC attorney calls "our software side," involving judgments on such time-consuming and often politically touchy matters as how much and what kind of TV advertising should America's children be exposed to. Another, dubbed "the fairness doctrine," involves deciding on a case-by-case basis what persons or groups should be granted free time on a radio or TV station or network to counter a biased presentation on a controversial issue.

"I am not surprised—though I am troubled—by the fact that there seems to be no way that we can resolve these issues in a timely way," sighs one long-time commission staffer. "Interconnection by itself has been running on since Carterfone in 1968, and it is still not resolved. It's like school integration—the Supreme Court supposedly decided that 20 years ago, yet new questions come up every week. And just when you think you have answered one, there are two more in its place.

"What does amaze me," he concludes with a wan smile, "is that the FCC works at all. But so far it has somehow managed."

We must know more about new technology to make decisions in the most informed way." In Strassburg's view, Bell Labs is "a quasi-public resource."

What is chairman Wiley's goal? Not only does he oppose a commission break-up or reorganization, but, he says, "I want to pull this place together." While he believes the FCC needs more and better people—including some engineers—he says he is more immediately concerned "not with any huge growth but with keeping the good people we've got."

But a large majority of those who work with and for the FCC agree that the agency needs much more than better personnel policies and a sharpened image if it

is to keep pace with changing technology and the new applications it is bringing. Clay T. Whitehead, director of the Office of Telecommunications Policy, is convinced, for example, that substantive changes may have to come from Congress as major revisions of the 1934 Communications Act.

Whitehead's suggestion that competition may permit less regulation of some segments of communications is a view shared by chairman Wiley. But there is little that Wiley or the commission can do about that without action by Congress. Until then, the FCC must continue to plod along, understaffed, overworked, and close to being overwhelmed. □

# Not just a second source. But a Introducing Harris'

Here they are—22 device types offering true alternate-source availability for 54C/74C CMOS. Combined with our existing 4000 series and custom LSI capability, addition of these new units makes Harris one of the few suppliers with total CMOS capability. So, choose from our 54C/74C series—44 devices with more on the way.

**Our 54C/74C series**, designed to reduce system costs, is pin-for-pin and function-for-function equivalent to T<sup>2</sup>L 7400 devices. Among their cost-saving features are low power supply requirements, less power supply regulation, fewer bypass capacitors, simpler design, and simplified power

distribution. The units also offer high noise immunity—typically 45% of supply voltage, and they have a guaranteed 1V noise margin. This means that 1V of noise at the input will not cause the output to rise beyond T<sup>2</sup>L levels. As a result, logic errors are less likely.

Applications are easy, too, with industry standardized input and output characteristics. Experience acquired with the 7400 series can also be applied directly to use of the 54C/74C's. For details, see your Harris distributor or representative.

	100-999 UNITS	
	-55°C to +125°C	0°C to +70°C
HD-54C00/74C00 Quad 2 NAND Gate	2.98	.69
HD-54C02/74C02 Quad 2 NOR Gate	2.98	.69
HD-54C04/74C04 Hex Inverter	3.30	1.04
HD-54C10/74C10 Triple 3 NAND Gate	2.98	.69
HD-54C20/74C20 Dual 4 NAND Gate	2.98	.69
HD-54C42/74C42 BCD to Decimal Decoder	7.15	3.30
HD-54C73/74C73 Dual J-K Flip Flop with Clear	4.75	2.26
HD-54C74/74C74 Dual D Flip Flop	4.20	1.45
HD-54C76/74C76 Dual J-K Flip Flop with Clear and Preset	4.75	2.26
HD-54C107/74C107 Dual J-K Flip Flop with Clear	4.75	2.26
HD-54C151/74C151 8 Channel Digital Multiplexer	6.40	3.95
HD-54C154/74C154 4-Line to 16-Line Decoder/Demultiplexer	16.20	5.40
HD-54C157/74C157 Quad 2 Multiplexer	5.10	2.88
HD-54C160/74C160 Decade Counter with Asynchronous Clear	10.40	5.70
HD-54C161/74C161 Binary Counter with Asynchronous Clear	10.40	5.70
HD-54C162/74C162 Decade Counter with Synchronous Clear	10.40	5.70
HD-54C163/74C163 Binary Counter with Synchronous Clear	10.40	5.70
HD-54C164/74C164 8-Bit Parallel Out Serial Shift Register	11.00	4.35
HD-54C173/74C173 Three State Quad/D Flip Flop	9.15	3.80
HD-54C192/74C192 Synchronous 4-Bit Up/Down Decade Counter	10.30	5.65
HD-54C193/74C193 Synchronous 4-Bit Up/Down Binary Counter	10.30	5.65
HD-54C195/74C195 4-Bit Register	5.70	3.75

**WHERE TO BUY THEM:** ARIZONA: Phoenix—Hamilton, Liberty, Weatherford, Scottsdale—HAR (602) 946-3556 CALIFORNIA: Anaheim—Weatherford, El Segundo—Liberty, Glendale—Weatherford, Long Beach—HAR (213) 426-7687, Mountain View—Elmar, Palo Alto—Weatherford, HAR (415) 964-6443, Pomona—Weatherford, San Diego—Liberty, Weatherford COLORADO: Commerce City—Elmar, Denver—Hamilton, Englewood—Weatherford CONNECTICUT: Danbury—Schweber, Norwalk—Harvey FLORIDA: Hollywood—Hamilton, Schweber, Melbourne—HAR (305) 727-5430 GEORGIA: Atlanta—Schweber, Norcross—Hamilton ILLINOIS: Elk Grove Village—Schweber, Schaumburg—HAR (312) 894-8824, Schiller Park—Hamilton INDIANA: Indianapolis—Pioneer KANSAS: Lenexa—Hamilton MARYLAND: Baltimore—Hamilton, Rockville—Schweber MASSACHUSETTS: Burlington—Hamilton, Lexington—Harvey, Wellesley—HAR (617) 237-5430 MICHIGAN: Livonia—Hamilton, Troy—Schweber MINNESOTA: Edina—Hamilton, Schweber, Minneapolis—HAR (612) 432-6111 MISSOURI: Hazelwood—Hamilton NEW JERSEY: Cedar Grove—Hamilton, Mt. Laurel—Hamilton, Somerset—Schweber NEW MEXICO: Albuquerque—Hamilton, Weatherford NEW YORK: East Syracuse—Hamilton, Melville—HAR (516) 249-4500, Syracuse—HAR (315) 463-3373, Rochester—Schweber, Westbury—Schweber, Woodbury—Harvey NORTH CAROLINA: Raleigh—Schweber OHIO: Beachwood—Schweber, Cleveland—Pioneer, Dayton—Pioneer, HAR (513) 226-0636 PENNSYLVANIA: Wayne—HAR (215) 687-6680 TEXAS: Dallas—Hamilton, Weatherford, HAR (214) 231-9031, Houston—Hamilton, Weatherford UTAH: Salt Lake City—Hamilton WASHINGTON: Seattle—Liberty, Weatherford WASHINGTON, D.C.: HAR (202) 337-3170 CANADA: Mississauga, Ontario—Hamilton, Montreal, Quebec—Hamilton, Ottawa, Ontario—Hamilton.

**LEGEND FOR HARRIS SALES OFFICES & DISTRIBUTORS:** Elmar Electronics (Elmar), Hamilton Avnet Electronics (Hamilton), Harris Semiconductor (HAR), Harvey Electronics (Harvey), Liberty Electronics (Liberty), Pioneer Standard Electronics (Pioneer), Schweber Electronics (Schweber), R. V. Weatherford Co. (Weatherford).

source with total CMOS capability.

# New 54C/74C Series

Our 4000 (S) series offers you the fastest, low-power logic devices available today. With 10-volt power supplies, speeds are typically twice that of comparable IC's. Power supply range is 3 to 15VDC, while noise immunity is typically 45% of supply voltage. Other advantages are low power dissipation and elimination of SCR latch-up problems. All units are pin-for-pin compatible with the CD-4000A series. And you have a choice of high-speed or direct CD-4000A replacement characteristics. To order a high-speed unit just add the suffix "S" to the HD-4000 part number (HD-4000S). For a direct CD-4000A replacement add an "A" to the number (HD-4000A).

In addition to the HD-4000 series, we offer the HD-4800 group of Harris proprietary devices. Among these devices are six units which together comprise the first family of three-state CMOS interface circuits available. By providing the ability to regulate the state of hard wired outputs, these interface circuits permit an extremely high level of flexibility in buss oriented systems design. These units also have buffered outputs for driving high capacitive lines and T<sup>2</sup>L directly. When four circuits are utilized, they permit the user to perform logic translation (i.e. MOS to T<sup>2</sup>L) directly at the buss line. For complete details on our 4000 and 4800 series, see your Harris distributor or representative.

	100-999 UNITS			
	-40°C to +85°C		-55°C to +125°C	
	A	S	A	S
HD-4000 Dual 3 NOR Gate plus Inverter, 14 pin DIP	.78	1.86	1.17	3.10
HD-4001 Quad 2 NOR Gate, 14 pin DIP	.78	1.98	1.17	3.30
HD-4002 Dual 4 NOR Gate, 14 pin DIP	.78	2.04	1.17	3.40
HD-4007 Dual Complementary Pair plus Inverter, 14 pin DIP	.78	1.59	1.17	2.65
HD-4009 Hex Inverter/Buffer, 16 pin DIP	1.69	3.15	2.54	5.25
HD-4010 Hex Buffer, 16 pin DIP	1.69	3.15	2.54	5.25
HD-4011 Quad 2 NAND Gate, 14 pin DIP	.78	1.98	1.17	3.30
HD-4012 Dual 4 NAND Gate, 14 pin DIP	.78	2.07	1.17	3.45
HD-4013 Dual D Flip Flop, 14 pin DIP	1.62	2.85	2.43	4.75
HD-4019 Quad AND/OR Select Gate, 14 pin DIP	1.91	3.03	2.87	5.05
HD-4023 Triple 3 NAND Gate, 14 pin DIP	.78	2.06	1.17	3.44
HD-4025 Triple 3 NOR Gate, 14 pin DIP	.78	2.06	1.17	3.44
HD-4030 Quad Exclusive OR Gate, 14 pin DIP	1.63	2.27	2.45	3.79
HD-4804 Three State Hex Buffer with Level Translator, 16 pin DIP	-	6.15	-	7.67
HD-4805 Three State Hex Buffer Inverter with Level Translator, 16 pin DIP	-	6.15	-	7.67
HD-4806 Three State Triple True/Complement Buffer with Disable, Independent Level Translator, 16 pin DIP	-	6.15	-	7.67
HD-4807 Hex Buffer with Disable, 16 pin DIP	-	6.15	-	7.67
HD-4808 Three State Hex Buffer with Disable, 16 pin DIP	-	6.15	-	7.67
HD-4809 Triple True/Complement Buffer, 16 pin DIP	1.69	3.15	2.54	5.25
HD-4810 Three State Triple True/Complement Buffer with Disable, Common Level Translator, 14 pin DIP	-	6.15	-	7.67
HD-4811 Quad Exclusive NOR Gate, 16 pin DIP	1.63	2.27	2.45	3.79
HD-4814 Hex Inverter, 16 pin DIP	.97	2.27	1.45	3.80

# Harris



P.O. Box 883, Melbourne, Florida 32901 (305) 727-5430

## Driving LEDs directly from C-MOS logic outputs

by C.D. Patterson  
Gandalf Data Communications Ltd., Ottawa, Ont., Canada

If a complementary-MOS logic system requires a number of light-emitting diodes in its display, the power dissipated in the display may be far more than that for all the rest of the circuitry.

To get a nice bright display, each LED should receive more than 15 milliamperes of current. If the requirement is for, say, four LEDs, then something like 60 mA must be provided by the supply. In addition, each LED must be driven from a high-current C-MOS inverter, such as a 14019 device wired as a current sink.

One way to cut down on current consumption is to connect all the LEDs in series in a 20-mA current chain, as shown in the figure. Each LED can then be controlled by shorting it out with a transistor.

A pnp transistor will allow a LED to turn on for positive C-MOS levels, while an npn transistor will allow a LED to turn on for negative C-MOS levels. Also, since the transistor can be operated with less than 0.3 mA of base current, normal C-MOS logic outputs can provide sufficient current for driving the LEDs.

LEDs controlled by pnp transistors should be inserted

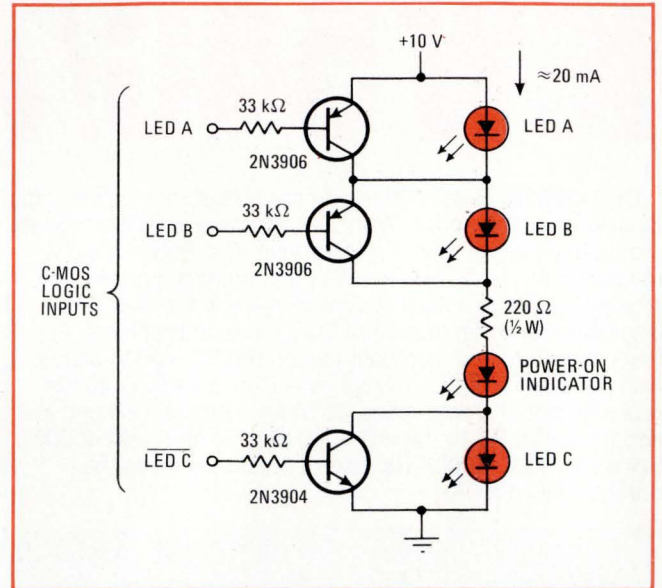

**Current-saving design.** Inserting a bipolar transistor between a C-MOS logic output and a LED indicator permits the C-MOS logic device to control the LED. The current supplied by the C-MOS logic-level output is sufficient to turn on the transistor, which, in turn, causes the LED to go out. A pnp transistor is used for positive logic signals, and an npn transistor for negative logic signals.

at the top of the chain, and those controlled by npn transistors at the bottom. This avoids excessive reverse emitter-base voltages. □

## Transistor gain boosts capacitor value

by L. E. Schmutz  
Massachusetts Institute of Technology, Cambridge, Mass.

In many applications, designers try to avoid specifying large capacitors. Besides being expensive, they are usually leaky, have poorly tolerated values, and are physically large. But such large-capacitor problems as these can be circumvented by using the gain of a transistor to multiply capacitance. A simple circuit will do the job, allowing a much smaller capacitor to be used instead.

In the circuit of (a), the effective capacitance, which is shown in color, is the result of the gain of the transistor:

$$C' = \beta C$$

where  $C'$  is the effective capacitance value,  $C$  is the ac-

**Capacitance multiplier.** A large effective capacitance ( $C'$ ) can be obtained from a small capacitor ( $C$ ) by using transistor gain to multiply the actual capacitance value, as shown in (a). The technique is especially convenient in reducing the size of the bypass capacitor in a cascaded emitter-coupled amplifier (b). Here, the capacitance needed is decreased by a factor of 100—from 1,270 to 12.7  $\mu\text{F}$ .

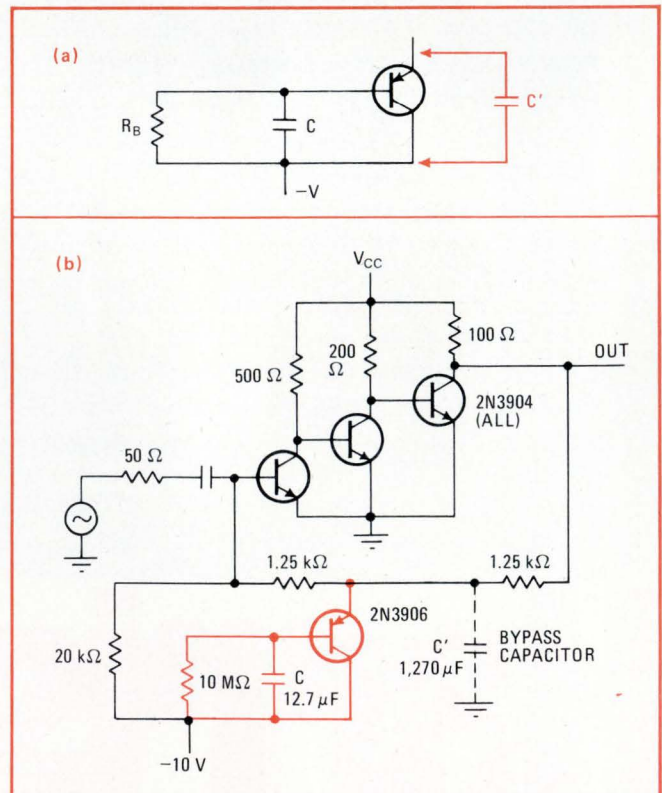

tual capacitance value, and  $\beta$  is transistor gain. The resistor that biases the transistor must have a large value, since its actual resistance is divided by the gain of the transistor.

$$R_B' = R_B/\beta$$

where  $R_B'$  is the effective resistance value, and  $R_B$  is the actual resistance value. (The effective resistance caused by capacitor leakage is also decreased by transistor gain.)

This capacitance-multiplier circuit is particularly useful in reducing the size of the bypass capacitor in a feedback-stabilized cascaded amplifier, like the one drawn in (b). Cascaded emitter-coupled amplifiers are widely used in applications requiring high ac gain and good frequency response. However, they normally require

elaborate biasing schemes to compensate for the lack of gain uniformity between discrete transistors.

Sometimes, a direct-coupled cascade is employed so that dc feedback can be used to stabilize the bias for the transistors. Capacitor  $C'$  then bypasses the ac component to ground, maintaining the amplifier's large signal gain. But, with this approach, the resistance seen by capacitor  $C'$  is reduced by the gain of the amplifier, making it necessary for  $C'$  to be very large to achieve ordinary low-frequency break points.

If the low-end half-power point of circuit (b) will be 10 hertz, the value of capacitor  $C'$  climbs to a whopping 1,270 microfarads. But when the simple capacitance multiplier of (a) is used instead, the value of the bypass capacitor ( $C$ ) can be cut down to 12.7  $\mu\text{F}$ , a 100-fold reduction.  $\square$

## Measuring complex impedances at actual operating levels

by Jim Walworth  
Honeywell Inc., Tampa Division, Tampa, Fla.

Complex impedance is usually measured with a vector impedance meter or a network analyzer. The vector impedance meter supplies its own signal source at a fixed level, which is sometimes lower than the normal operating level of the device under test. This approach can cause problems if the device involved is nonlinear. The network analyzer uses a dual directional coupler and measures the impedance relative to a 50-ohm system.

A simpler and equally effective means of measuring complex impedance is often overlooked as a useful data-gathering technique. By inserting a noninductive resistor in series with the unknown impedance, voltage and phase measurements can be made on each side of the resistor. This procedure allows in-circuit parameter measurements at the normal operating levels of the circuit. Additionally, the method requires less test equip-

ment and is more versatile since data can be reduced graphically or mathematically.

The circuit illustrated in Fig. 1 shows the voltage and phase relationships that must be determined.  $R_S$  is the noninductive resistor in series with the unknown impedance,  $Z$ . The signal source can be an external source or the circuitry that normally drives  $Z$ . The complex voltage at the input to  $R_S$  is  $V_1/\theta_1$ ; and the complex voltage across the unknown impedance is  $V_2/\theta_1 + \theta_m$ , where  $\theta_m$  is the phase shift across  $R_S$ .

Unknown impedance  $Z$  is calculated using vector algebra. The series combination of  $R_S$  and  $Z$  form a voltage divider, and  $V_2/\theta_1 + \theta_m$  is given by:

$$V_2/\theta_1 + \theta_m = V_1/\theta_1 \left[ \frac{Z}{R_S + Z} \right]$$

Solving this equation for  $Z$  yields:

$$Z = R_S \left[ \frac{V_2/\theta_1 + \theta_m}{V_1/\theta_1 - V_2/\theta_1 + \theta_m} \right]$$

or:

$$Z = R_S \left[ \frac{V_2/\theta_m}{V_1 - V_2/\theta_m} \right] \quad (1)$$

The term  $\theta_m$  is the relative phase across the resistor and, therefore, the desired phase parameter to measure.

The last equation for  $Z$  can easily be solved with some of the scientific calculators now available, or it can be solved graphically. Normalizing Eq. 1 in terms of resistance  $R_S$  produces:

$$\frac{Z}{R_S} = \frac{(V_2/V_1)/\theta_m}{1 - (V_2/V_1)/\theta_m} \quad (2)$$

If this equation is plotted in polar coordinates, it forms a circle having its center point at  $-1$ . If it is plotted on a Smith chart, the circle's center lies at the far left side of the chart with a radius of  $V_2/V_1$  and an angle of  $\theta_m$ .

Figure 2 is a Smith chart showing the contours of Eq. 2. It now becomes a simple matter to determine an unknown impedance quickly by measuring the voltage

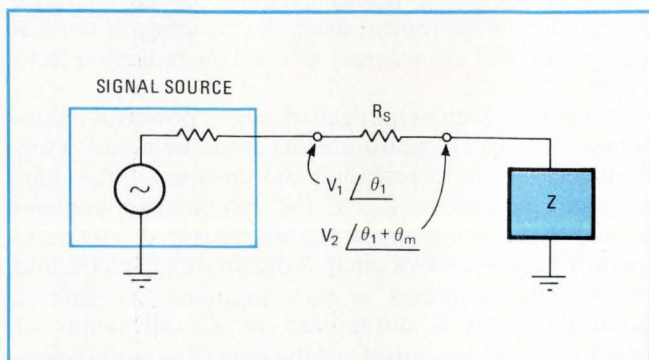

**1. Test setup.** Unknown complex impedance  $Z$  can be determined by measuring the voltage drop and phase shift across noninductive resistor  $R_S$ . Complex impedance  $Z$  can then be found graphically with a modified Smith chart or mathematically with a calculator.

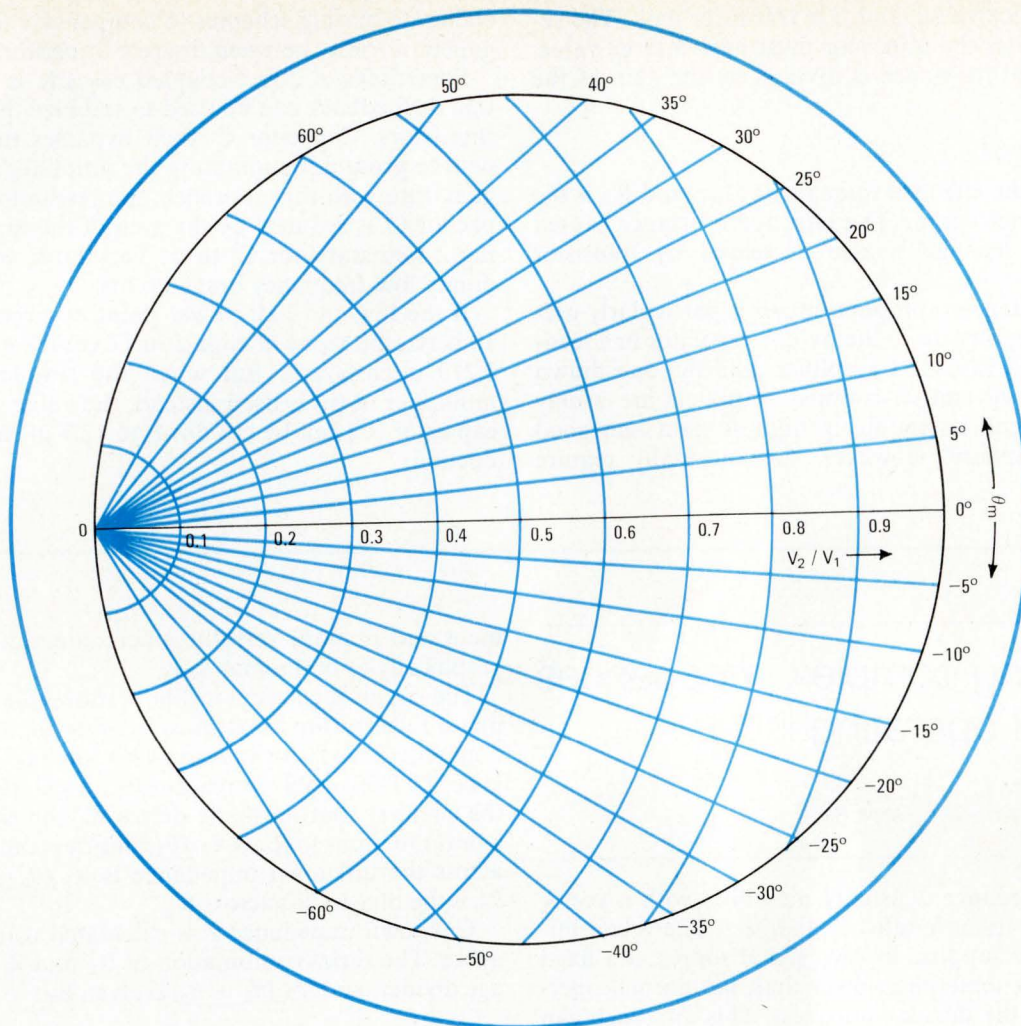

**2. Graphical solution.** The value of complex impedance  $Z$ , normalized with respect to noninductive resistor  $R_s$ , can be found graphically from this modified Smith chart. The chart establishes the coordinates for the voltage ratio of  $V_2/V_1$  and the relative phase shift of  $\theta_m$ .

ratio of  $V_2/V_1$  and its relative phase,  $\theta_m$ .

Suppose an unknown complex impedance is to be measured. The first step is to estimate the relative impedance magnitude and choose a noninductive resistor having such a value—511 ohms, for this example. (Optimum accuracy is obtained when  $R_s$  approximately equals the absolute value of  $Z$ .) By using the test setup of Fig. 1, the following data is then taken:

$$\begin{aligned} V_1 &= 1.0 \text{ V} \\ V_2 &= 0.6 \text{ V} \\ \theta_m &= -10^\circ \end{aligned}$$

and:

$$(V_2/V_1)/\theta_m = 0.6 / -10^\circ$$

The point,  $0.6 / -10^\circ$ , is next plotted on the modified Smith chart of Fig. 2, and the impedance,  $Z_n$ , which is normalized to 511 ohms, can be read off the chart in the conventional manner:

$$\begin{aligned} Z_n &= 1.28 - j0.58 \\ Z &= (511 \text{ ohms}) \times (1.28 - j0.58) \\ Z &= 654 - j296 = 718 / -24.5^\circ \end{aligned}$$

This procedure should be repeated until the computed magnitude of impedance  $Z$  is the same order of magni-

tude as the estimated value for resistor  $R_s$ .

The same equation—Eq. 2—can be solved mathematically on a scientific calculator. For this example, the measured data can be reduced to:

$$Z = 726 / -24.29^\circ = 661.7 - j298.6$$

The mathematical solution is more accurate than the graphical one, but the graphical technique is quicker. The accuracy of the results depends on the tolerance and quality of the resistor used, the accuracy of the test equipment, and the accuracy of the data-reduction technique.

A modified Smith chart can also be a powerful analysis aid when VSWR measurements are to be made at low frequencies. A series resistor is chosen equal to the characteristic impedance,  $Z_o$ , of the system, and voltages  $V_1$  and  $V_2$ , as well as phase  $\theta_m$ , are measured. The maximum acceptable VSWR circle is drawn on the chart, and  $(V_2/V_1)/\theta_m$  is plotted at each frequency of interest. Since the chart is normalized to  $Z_o$ , all points of  $(V_2/V_1)/\theta_m$  falling outside of the circle are out of specification. □

Engineer's Notebook is a regular feature in Electronics. We invite readers to submit original design shortcuts, calculation aids, measurement and test techniques, and other ideas for saving engineering time or cost. We'll pay \$50 for each item published.



# Cinch adds sum logic to I.C. logic board logistics



Some people stop half way. Sum people get it all together, like TRW/Cinch Connectors does with its new integrated circuit logic boards.

Working from the logic of a national distribution network to assure fast, off-the-shelf delivery on popular board configurations, Cinch assembled the features and flexibility that facilitate prototyping and short production runs:

1. Universal boards accommodating 14 to 40-lead plug-in IC's and high density DIP boards in 14 and 16-pin patterns (in 30-pattern multiples up to 180).

2. Socket terminals that accept varying sizes of DIP leads and round pins, with a choice of two and three-level wire wrap\* terminals for high wiring density and flexibility in circuit changes.

3. A full line of accessories—adapter plugs—input/output plugs, board interconnectors, and edge connectors.

4. FR-4 epoxy glass boards, 1/8 or 1/16 in., with power and ground planes on each side connected to each pattern.

For special requirements, our application engineers are available to assist in developing custom boards. These can be produced with minimum turn-around time at our extensive manufacturing facilities.

To sum up: design flexibility, distributor stocking, and custom board availability point to Cinch Connectors as your logical source for IC logic boards.

Available nationwide through these distributor networks

Pioneer-Standard Electronics  
Rampart Components  
RESCO Electronics  
Sterling Electronics  
Wilshire Electronics

Dial toll-free (800) 645-9201 for the name and phone of your nearest facility.

For additional information see listings in EEM Vol. 4 or contact your TRW/Cinch logic board distributor or TRW/Cinch Connectors, An Electronic Components Division of TRW Inc., 1501 Morse Ave., Elk Grove Village, Illinois 60007; (312) 439-8800. CC-7311

\*T.M. Gardner-Denver

**TRW** CINCH CONNECTORS

Circle 119 on reader service card

## Dimmer lights last longer

A recent Engineer's Newsletter [March 21, p. 122] contained design ideas for conserving power in circuits and/or systems. But this power-saving idea from Calvin R. Graf of Sunnyvale, Calif., comes with a bonus—it could also extend lamp life. Whenever the whiteness of the light from an incandescent lamp is unimportant, **place a diode in series with the lamp so that its terminals receive pulsating dc instead of continuous power.** This more than halves the bulb's power consumption and also **extends its life because the lamp now operates at a lower temperature.** Of course, the tungsten lamp light also appears yellow rather than white, but if you're not going to work or read by it, who cares?

**In the case of a dial or pilot light, solder a silicon diode in series with each lamp or the lamp string.** Where lighting must be left on continuously but is not required for reading, as on walkways and in exit signs, outdoor night lights, and the like, **a silicon diode the size of two 25-cent pieces can be inserted into the bulb socket.**

## A quick way to do time computations by calculator

Here's a time-saving way of doing time computations directly on your four-function pocket calculator. **Just go to a 24-hour-type time designation and add filler zeroes,** says Nicholas Bodley of New York, N.Y. The technique is also useful for calculations involving degrees.

**Place a filler zero between the hours' number and the minutes' number, and another zero between the minutes' and seconds' numbers.** For instance, 11:31:42 becomes 11031042. **Add or subtract,** treating the filler zeroes as "real" zeroes. Then, **if the resulting minutes' and/or seconds' number comes to 060 or more, adjust it by using the correction constant 940.** The constant should be added after an addition, subtracted following a subtraction. For example, 11031042 plus 4033011 makes 15064053, which is corrected by adding 940000 to make 16004053 (or 16:04:53).

And if you're interested in calculator algorithms, a handy pamphlet is available for \$2 from Mallman Optics and Electronics, 836 South 113 St., West Allis, Wis. 53214

## A mix of logics drives Nixie, LED displays best

For Nixie tubes and LED lamps, **large drive currents are essential but high speed isn't**—two requirements that industrial designers find they can meet if they **mix standard C-MOS circuits with a high-noise-immunity logic like Teledyne's Hi NIL family.** The Hi NIL is used for inputs and outputs, to take advantage of its guaranteed 3.5-v input noise immunity and up to 65-mA output drive current, and the C-MOS is used for the internal logic, which benefits from its typically microwatt-level quiescent power dissipation.

## Fighting off that old feeling

Feeling obsolete in the face of a relentlessly shifting technology? **Pick up a copy of "Maintaining Professional and Technical Competence of the Older Engineer."** Just published by the American Society of Engineering Education, the 256-page paperback deals specifically with the societal, organizational, and psychological phases of engineering obsolescence and **suggests ways of preventing technical obsolescence in people and organizations.** It costs \$4 from ASEE Publications Sales, Suite 400, One Dupont Circle, Washington, D. C.—**Lawrence Altman**

# SIEMENS

## Brushless DC Motors: Make reliable products more reliable.

Because they're *brushless*, Siemens DC motors last as long as their bearings. Bearings last much longer, too, because there's no brush carbon dust.

Because they're *brushless*, Siemens DC motors can run for 20,000 hours and never cause any trouble. Even if the motors lay idle for a year, they'll start immediately, because no oxidation can take place. Periodic service and replacement is eliminated.

Because they're *brushless*, Siemens DC motors can be used in explosive atmospheres. There's no arcing or sparking.

Because they're *Siemens*, these brushless DC motors are the highest quality and come in the most complete range of power sizes available from stock. Siemens pioneered brushless DC motors. And Siemens will give you the benefit of years of application experience, by advising and assisting you with electronic circuit design for your individual needs.

Your high-quality electronic equipment will benefit from Siemens brushless DC motors. Siemens will show you how. Call or write Siemens Corporation, Power Engineering Division.

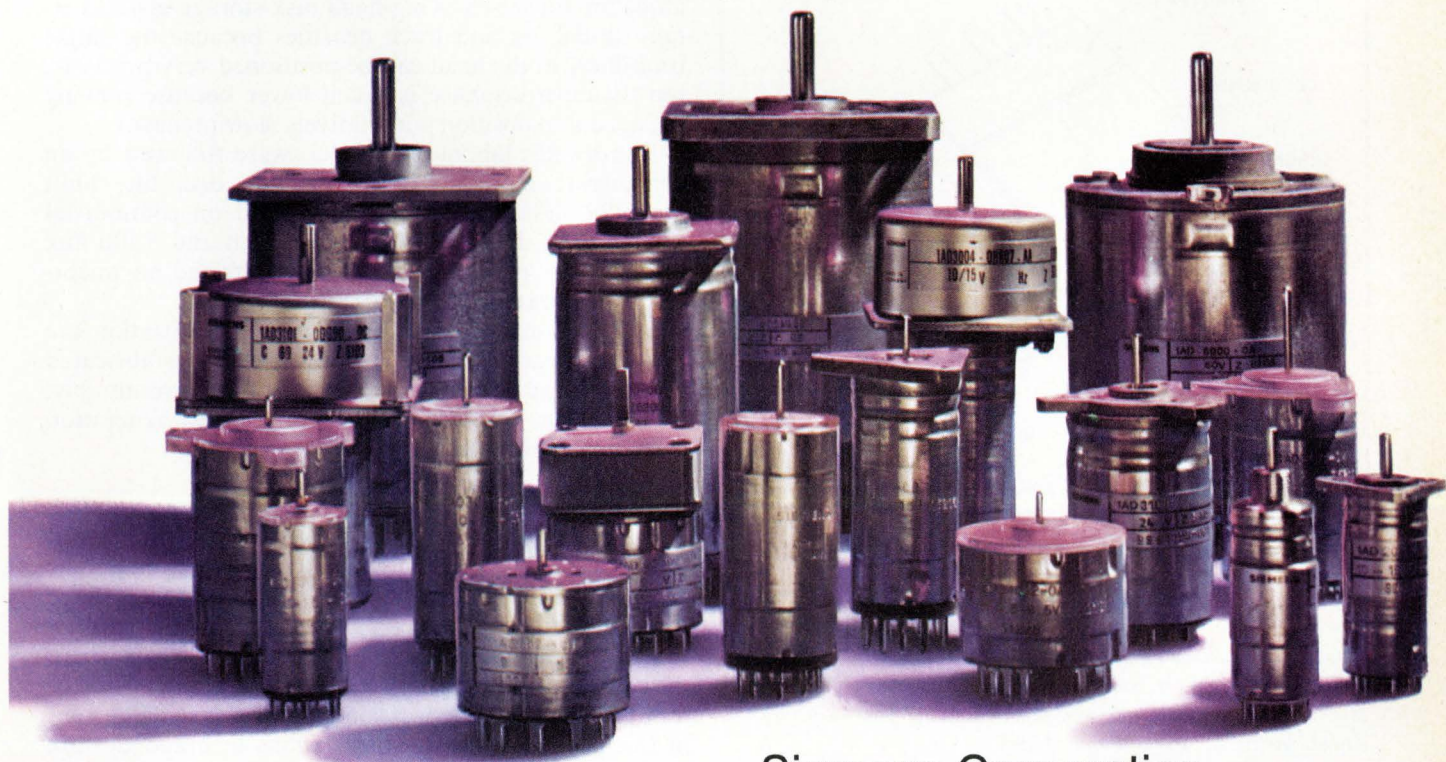

**Siemens Corporation**  
**Power Engineering Division**

186 Wood Avenue South, Iselin, New Jersey 08830 (201) 494-1000

Circle 121 on reader service card

# Small thin-film transducers point to fast, dense storage systems

In present high-speed disk-storage units, the number of bits per square inch is limited by the large size of the fixed read-write head—but really small magnetic heads can now be fabricated by integrated-circuit processes

by William Chynoweth,  
Honeywell Information Systems Inc., Oklahoma City, Okla.,  
and John Jordan and Wolfgang Kayser,  
Honeywell Information Systems Inc., Phoenix, Ariz.

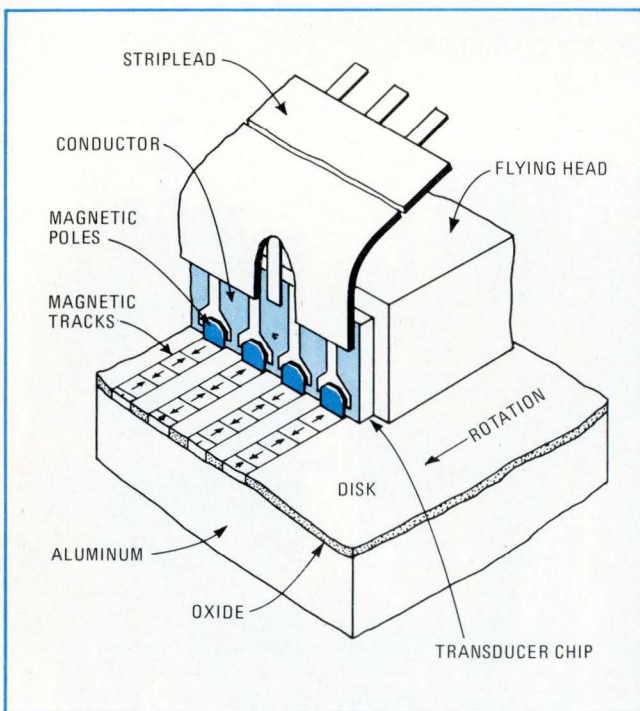

**Flying head.** Thin-film transducers (color), on their substrate chip, are mounted on the trailing edge of a head that "flies" less than 100  $\mu$ in. above the surface of a rotating disk.

□ The fastest way to access the data in a magnetic-disk storage system is to span the disk tracks with a fixed head containing a separate transducer for each track. But the conventional fixed head also limits storage capacity because only 50 or so transducers can be squeezed across an inch of disk radius—the tracks read by a single fixed head can be only as close together as the transducers and their housing permit.

Moreover, the biggest total storage capacity and the fastest data transfer rates are obtained when bits are packed as densely as possible along each individual track. But densely packed bits require a short gap length in the transducer, although density is limited by other factors as well.

All this accounts for much of the present interest in replacing individual wirewound horseshoe-shaped transducers with much smaller, thin-film versions in which the magnetic structure and winding are fabricated in rows on the same substrate. The other important advantages of batch-fabricating the devices in this way are a high level of production repeatability and much reduced cost.

One thin-film-transducer project, called Pedro, was started in 1967 at the General Electric Co. and continued after 1970 by Honeywell Information Systems. But work on this technology is also under way at NCR Corp., Burroughs Corp., Minnesota Mining and Manufacturing Co., IBM Corp., and Sperry Univac in the U.S., as well as at Compagnie Internationale pour l'Informatique in France.

The aim of the GE-Honeywell project was to develop designs for thin-film transducers and to evaluate the technology's strengths and weaknesses. By 1970 enough progress had been made for several laboratory models of disk files to be built, using thin-film transducers to obtain track densities of 100 to 400 per inch of disk radius and flux reversal densities of 4,400 to 10,000/in. along the tracks. (Moving-head disk-storage systems attain similar bit and track densities because the single transducer in the head can be positioned very precisely, but their performance is much lower because moving the head into position is a relatively slow process.)

Honeywell's laboratory models were followed by an engineering model of a 6-megabyte disk file, built around standard disks like those used on commercial storage units. It has 100 tracks per inch and 5,100 flux reversals per inch, and it has demonstrated an uncorrected error rate of one in  $10^9$  bits.

By now, current trends in memory organization are under evaluation to see where the batch-fabricated thin-film heads can best be applied. That, presumably, will be in one or more products in the next generation of bulk-storage systems.

## Thin-film transducers

The significant differences between conventional and thin-film heads lie in the construction of the magnetic recording transducer. Both kinds of transducers have the same elements—namely, a loop of magnetic material that is completely closed except for a small gap where the recording field is produced, and a winding of one or more turns of an electrical conductor. A varying current in this conductor creates fluctuations in magnetic flux

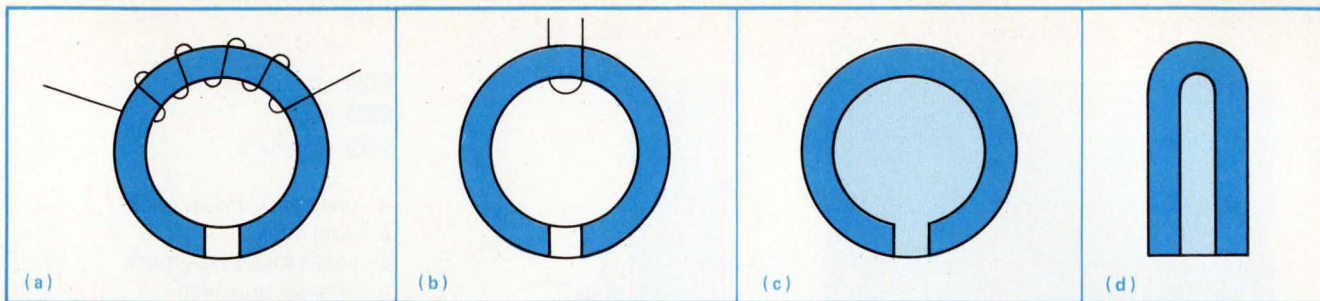

**1. Evolution.** Thin-film transducers have evolved from the classic, wound ring with a gap in it (far left), past ring shapes with either a single turn of ordinary wire or completely filled with a conductor (center left and right), to a conductor-filled horseshoe shape (far right).

that are captured by the recording medium moving past the gap. Conversely, externally imposed flux variations from the recording medium induce a fluctuating voltage in the conductor. But these elements take very different physical forms in conventional and thin-film transducers.

The thin-film transducer has evolved from the conventional ring-type with an air gap into a horseshoe shape in which the conductor fills the gap entirely. This "turn-in-gap" head is shown in Fig. 1 with just a single turn. But thin-film multitrack transducers have been investigated at Honeywell and elsewhere, in both vertical and horizontal form (Fig. 2).

The thin-film elements are fabricated by film deposition and photoetching processes that are closely related to integrated-circuit fabrication and can produce very short and shallow gaps and very narrow and closely spaced elements with great accuracy. A complete thin-film transducer may be only three times as thick and roughly the same height as the gap spacer in a conventional transducer, and multichannel magnetic recording heads can be fabricated as easily as single-channel heads.

The film's very thin cross section permits it to have an extremely short gap, which is essential in high-density recording—because closely spaced magnetic variations in the recording medium cannot be resolved by too long a gap. But this cross section also gives the transducer properties that are quite different from those of transducers made of bulk materials.

To begin with the advantages, track spreading and crosstalk between transducers are negligible. The very small broadside dimension makes the magnitude of side fringing fields drop off rapidly in real distance (as distinguished from distance as a proportion of transducer

dimension), creating only small coupling of magnetic fields between neighboring transducers.

Also, resolution is improved because the thin pole tip is about as long as the gap. In conventional transducers, the tip is many times longer than the gap, but its corners are still within the magnetic field of the recording medium and can produce small but spurious signals that interfere with the gap signal. In thin-film transducers these "contour anomalies" produce effects in the same frequency range as those that are limited by the gap length and are more nearly in phase with them, so that their interference is less. As a consequence, the resolution for a given gap length can exceed that of a conventional transducer, particularly when the head is not in contact with the recording medium—as is usually the case in disk-storage units.

One disadvantage of vertical film transducers is poor low-frequency read performance. As in conventional transducers, the response to recorded variations with wavelengths greater than the length of the transducer drops off very steeply. These variations, which are also caused by the head contour, determine the low-frequency limit of the recording system. But in thin-film transducers, the rolloff begins at a much higher frequency than with conventional transducers.

Furthermore, although the efficiency of a thin-film transducer is high, using the "winding" as the gap spacer results in an extremely high write-current density. And, although the read voltage is quite high, its absolute magnitude is very small.

### Design considerations

The basic input parameters for the design of a thin-film multitrack head, like those for a conventional head, are linear recording density, track density, and oper-

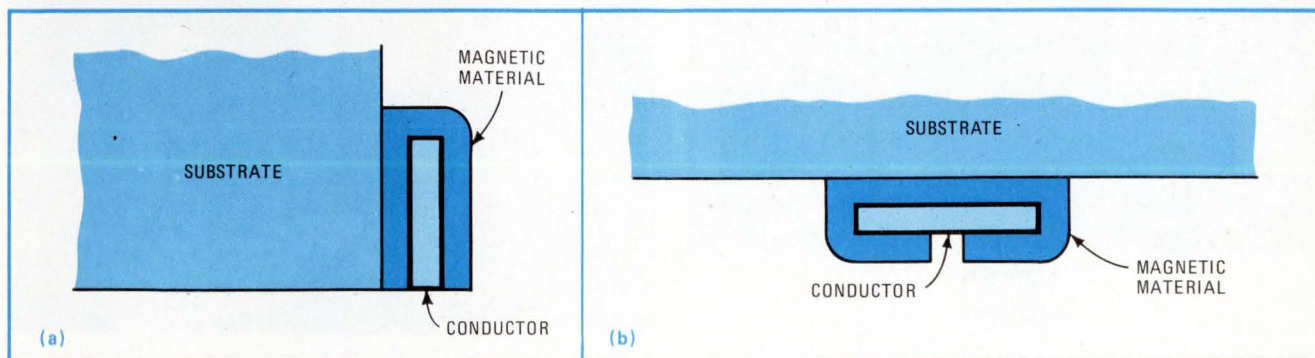

**2. Horizontal or vertical.** Thin-film transducers can be deposited either vertically against one side of a substrate (left) or horizontally underneath it (right). Both orientations consist of successive depositions of magnetic and conductive materials, appropriately masked.

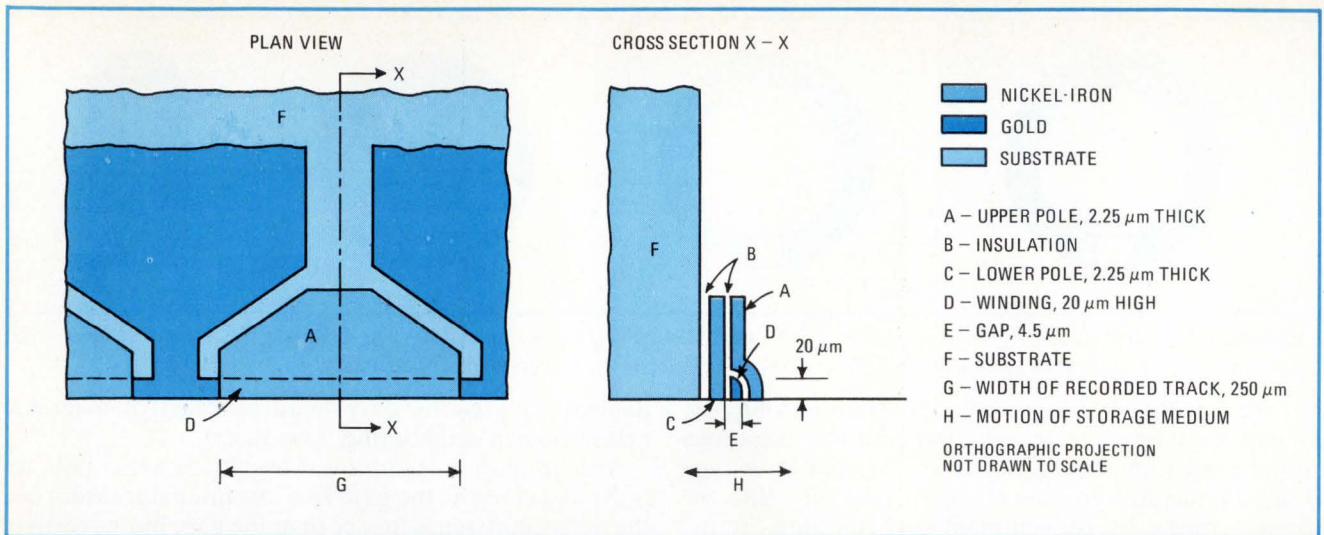

**3. Orthographic projection.** Vertical orientation of Pedro transducer comprises two layers of nickel-iron and a layer of gold. Gold layer extends upward to form pad for external connection. Note resemblance of cross section to the letter "h."

ating frequencies. Secondary parameters, derived from these basic inputs, are transducer dimensions, recording mode, and the height at which the transducer "flies" over the recording surface—usually 30 to 120 micro-inches, depending on the shape of the head and the kind of air bearing that the shape creates.

In the Pedro program the basic requirements were 100 tracks per inch and 4,400 flux reversals per inch, the same density as on the Honeywell DSU 180 or the IBM 2314 disk files. Standard commercial oxide coatings and conventional flying height of 70 to 100  $\mu\text{in.}$  were used. The gap length was chosen as 4.5 micrometers, which is about 180  $\mu\text{in.}$

The Pedro transducer is a two-pole vertical type made of materials chosen for compatible thermal expansion coefficients and etching characteristics, as well as the obvious magnetic or electrical properties. An insulated design was chosen in which the metallic layers are separated by insulating layers.

Since the larger the number of transducers on a head,

the lower the cost per track, it's important to reduce the number and complexity of transducer connections. As shown in Figs. 3, 4, 5, and 6, two adjacent transducers share a connecting pad. An alternative configuration would be to connect one side of each transducer to a common bus bar. With either configuration the number of leads from a head is one more than the number of transducers, permitting a flexible, flat multiconductor strip-lead to be used for a simple connection to the transducers. But the shared-terminal construction has better thermal performance because it maximizes the conductor area and cross section between transducers, while also maximizing track width for a given track density.

Ideally, the write field produced by a transducer would affect a magnetic storage medium of indefinite thickness only directly under the transducer gap. But ideal conditions are never realized; one departure is in the use of the flying head, which is necessary to reduce wear and tear on the recording surface. This separation

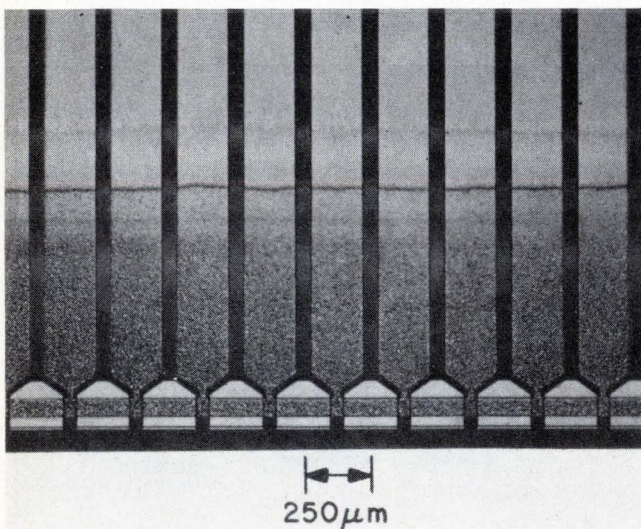

**4. Worm's-eye view.** Microphotograph shows 10 transducers on a common substrate, before excess at bottom has been ground away. Gray bands, connected to vertical pads, are the transducers.

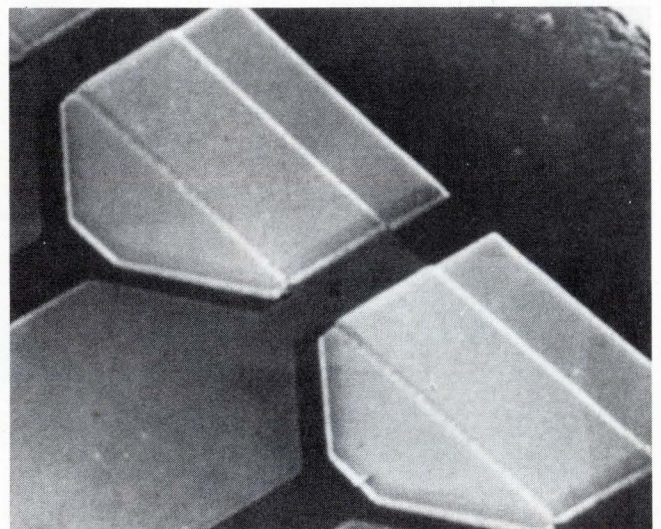

**5. Detail.** This photo, made with a scanning electron microscope, clearly shows how the nickel-iron deposition overlies the conductive gold layer, which extends leftward toward top of transducer.

of the recording surface from the transducer gap combines with the fringes of the write field (always found outside the gap) and the finite thickness of the magnetic medium to affect the medium at a distance from the gap. As a result, an isolated magnetic pulse spreads out, and closely packed pulses are reduced in amplitude—a phenomenon called pulse crowding.

Recent analyses of thin-film transducers have shown that the write field is less than that of a conventional transducer at distances greater than one gap length from the center of the gap, in a direction parallel to the recording surface, and may even become opposite in sign. This difference significantly improves resolution and reduces the problems of pulse crowding found with conventional transducers.

Likewise, the reading performance of a vertical thin-film transducer differs from that of a conventional transducer because of the thinness of the poles and the "turn-in-gap" configuration. In any transducer the voltage across the output terminals is generated by the sum of two changing flux patterns: a high-resolution part carried by the poles and linking the entire winding, and a low-resolution part carried through the air and linking at most only part of the winding. In conventional transducers, the winding has many turns and is remote from the gap, so that the airborne part generates a voltage that is only a negligible fraction of the total. But in thin-film transducers, with a one-turn "winding," the airborne flux is a much larger proportion of the total, and creates a more variable output.

Furthermore, the small uniform cross section of the film transducer and the limited permeability of materials such as nickel-iron and iron-cobalt, of which the transducer poles are made, results in leakage between the poles. Therefore not all of the flux entering the pole tips from the recording passes around the conductor. The ratio of the flux passing around the conductor to the total flux entering the pole tips can be calculated. It is greater than 0.95 for a permeability in excess of 500 and a 20- $\mu\text{m}$  conductor height (Fig. 3). Because the mathematical expression for the ratio involves the

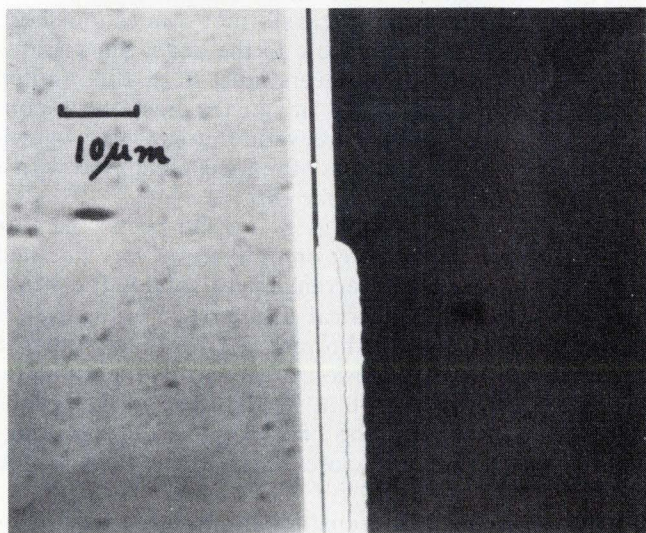

**6. Actual scale.** In another view, this microphotograph shows the nickel-iron layer "dropping off" the top of the gold layer. It also indicates true scale of the cross section shown in Fig. 3.

square root of the permeability but the direct height of the conductor, the effect of the height is greater than that of the permeability. The ratio drops off quickly for a permeability below 200; it also decreases more or less linearly for taller conductors.

Because the transducers are very small while the write currents are relatively large, the current density in the conductor can reach  $3 \times 10^6$  amperes/cm<sup>2</sup>, dissipating as much as 0.25 watts and corresponding to a power density of over 20 megawatts/cm<sup>3</sup>. These are orders of magnitude higher than in conventional transducers. To keep the temperature low enough for reliable operation, heat must flow readily along the path from the current-carrying conductor through the intervening layers of metal and insulation to the substrate.

### Thermal characteristics

A theoretical thermal analysis under write conditions shows that the transducer's thermal and electrical conductances deteriorate rapidly above approximately 2.45 A (Fig. 7). However, the normal operating range is well below this nonlinear region. Theoretical analysis also predicts a temperature rise of 29°C in the conductor for a current of 1.5 A.

This has been experimentally verified, using the gold conductor in the transducer as a resistance thermometer. With the shared-terminal design a four-point-probe resistance measurement is possible. As shown in Fig. 8, if a current is passed through any one transducer, the actual voltage across that transducer can be measured with a high-impedance voltmeter connected to any pair of leads that have both current leads between them. Thus if the current through the conductor, which is made of gold, is accurately known, the conductor resistance can be calculated, and converted to temperature using the known relationship of resistivity to temperature for a thin film of gold.

Such measurements as these indicate that a temperature rise of 25°C, which is 4° below the predicted rise, is typical for these dimensions at a peak operating current of 1.5 A. Other measurements with pulsed currents up to 2.0 A showed that the thermal rise time is less than 60 microseconds. The turn-on time constant increases dramatically as the thermal nonlinearities come into play—but again, these are found well above the operating range. Such time constants are much shorter than ordinary data block periods in a disk file, and the demonstrated temperature rises are small. Thus reliability degradation caused by thermal cycling will not be a problem in storage systems using thin-film heads at the flying height in this model.

### Head fabrication

The transducer is a five-layer, photoetched, thin-film structure, batch-fabricated on a thermally oxidized 1-0-0 silicon substrate. The silicon wafer is inexpensive, flat, smooth, and a good thermal conductor. Long rows of transducers extend right across the wafer, which can be readily scribed and broken into chips of any desired size. The long rows provide maximum flexibility in this regard, while the 1-0-0 crystal orientation simplifies the scribe-and-break step.

Standard sputtering and photo-fabrication tech-

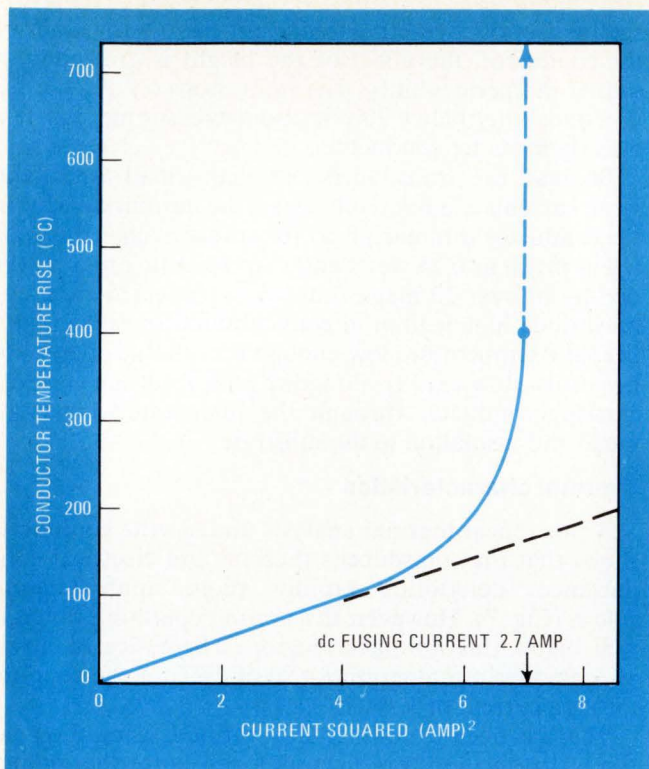

**7. Thermal response.** Theoretical analysis, confirmed by experiment, shows reduced conductance and sharp temperature rise at high current, ending in destruction where curve becomes vertical. Normal operation is well down in linear part of curve.

niques are used in depositing the five thin-film layers. These are, in order, the bottom magnetic pole material, the bottom insulation layer, the conductor layer (actually a three-part layer—.015  $\mu\text{m}$  of chrome for adhesion, 13  $\mu\text{m}$  of sputtered gold, followed by an electroplated layer of gold of the required thickness), the top insulation layer, and finally the top magnetic pole. All but the bottom insulation layer are also either etched or masked to align their respective patterns.

The thin-film transducer seems well adapted to a multi-track head for a disk file. The most convenient assembly locates the chip on the rear end of a standard slider, riding on the air cushion between it and the recording surface. A protective cover glass should be cemented over the row of transducers. This configuration is used in the present engineering model.

To connect the transducer chip to the circuit board, a flexible multilead cable is required. A suitable cable can be made by photoetching a multiconductor pattern on copper-clad Kapton, which is flexible, yet can stand the reflow soldering temperature without distortion. The strip-lead fans out from the 0.010-in. spacing of the chip connection pads to the 0.025- or 0.05-in. spacing at the circuit board.

#### Transducer/electronics interface

As described previously, at a nominal flying height of about 80  $\mu\text{in}$ , the transducer requires drive currents of 1.0 A or more to produce the required magnetic fields for recording on standard disks. But the single-turn transducer has a resistance of about 0.2 ohm, and the combined impedance of transducer and associated

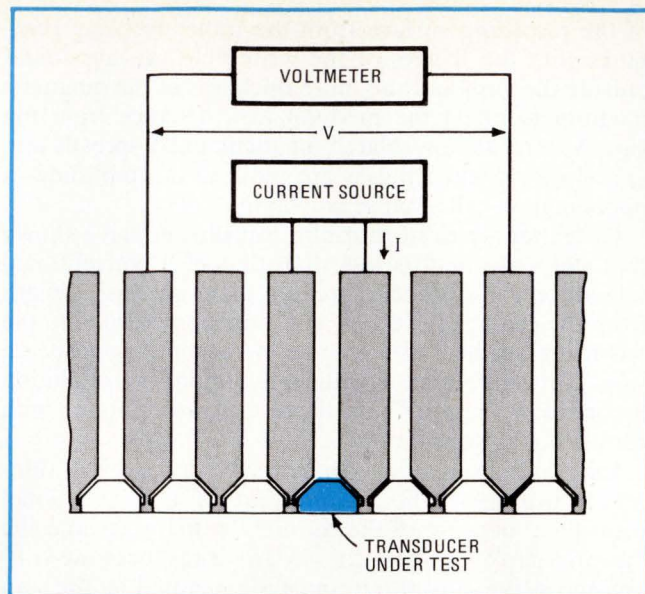

**8. Resistance measurement.** When current is passed through any one transducer in an array, voltage drop can be measured from any two other leads that have both current leads between them. Resistance and temperature are calculated from the voltage and current.

strip-leads is about 1 ohm at 2.5 megahertz. Meanwhile, the single-turn transducer produces a peak-to-peak read signal of about 120 microvolts at a recording density of 4,400 flux reversals per inch.

To drive and sense the single-turn transducer directly with integrated circuits is difficult with such a high drive current and low signal level. Thus discrete-component circuits have been used in the present model. The circuits use a single transformer for both read and write, to reduce the drive circuit's current requirements for writing and to increase the signal level for reading. Each transducer has a separate transformer, and the secondary winding of the transformer is center-tapped. The transformer has a turns ratio of 1:8 for write and 1:16 for read, through this center tap, thus reducing the required drive current by a factor of nearly 8 and increasing the sense signal to more than 1 millivolt.

To keep the transducer-transformer connection short, the transformer must be close to the head. Since transformers for all the transducers must fit in this limited space, they must be very small. To meet these constraints, the transformers are wound on pot cores, which are small cup-shaped pieces of magnetic material with a single post in the center of the cup.

In pot cores the windings go on the posts; the flux path closes through a cover or another pot core inverted over the first one. This arrangement shields the windings from external electrical interference and physical damage, while closing the magnetic path around the windings in three dimensions. But in the experimental disk file using the thin-film heads, the cores are used singly, stacked one on top of another so that the magnetic path of each one closes through the back of the next.

The presence of a transformer imposes some constraints upon the recording code. Normally the magnetic transducer is directly coupled to the write driver, thus responding to direct current. But the transformer



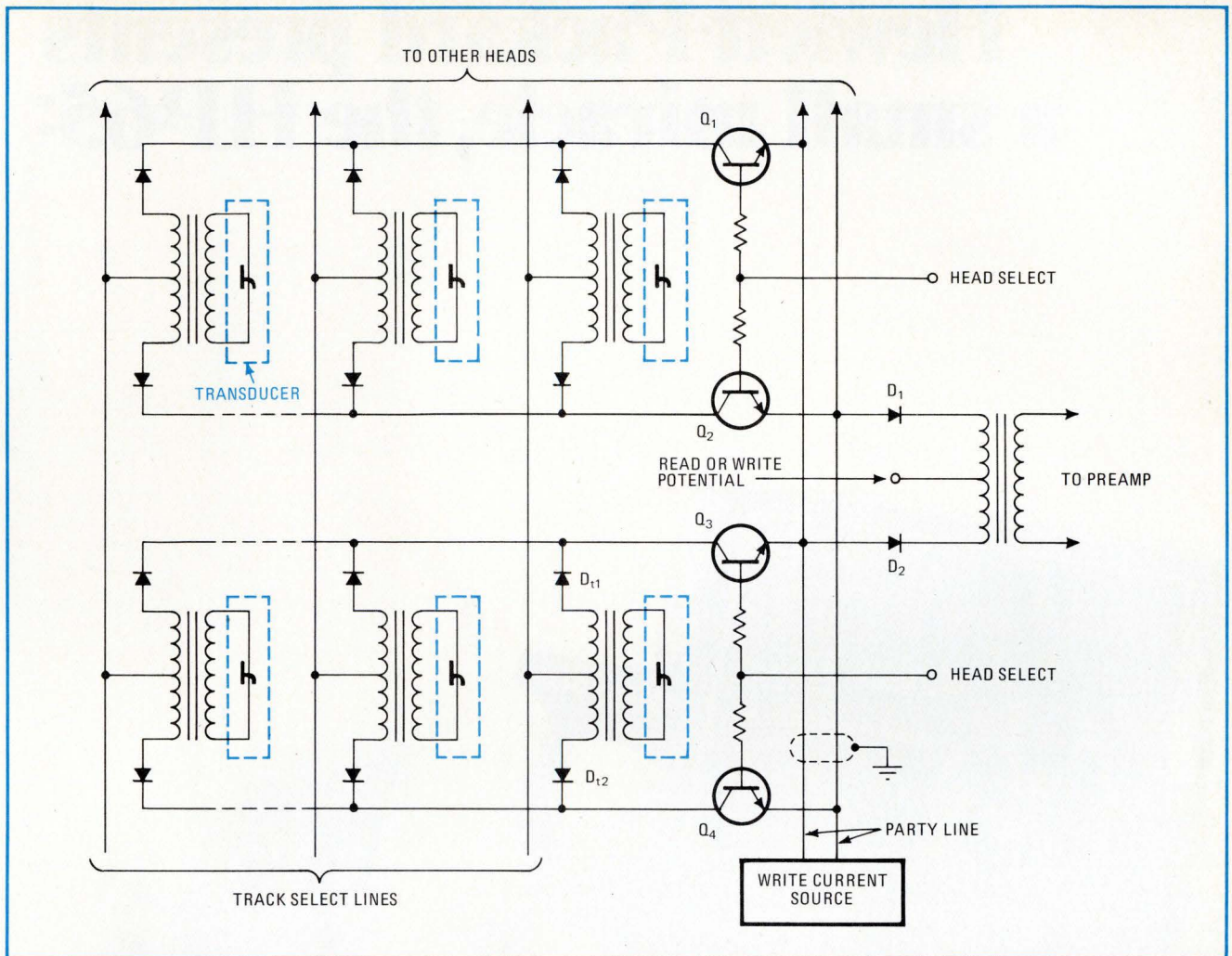

**9. Transducer selection matrix.** Combination of track-select and head-select lines picks one transducer, hence one track, for either read or write. Transformers (pot cores) increase write current and step up read signal. The h-shaped symbol represents the transducer (Fig. 3).

used with the thin-film transducer has a low-frequency cutoff of about 50 kilohertz. These characteristics would be unsatisfactory with the non-return-to-zero-inverted code, in which writing a continuous string of 0s requires the passage of a direct current. Likewise, any code that allows an unbalanced write-current sequence to be repeated indefinitely has a net dc requirement, which again won't pass the transformer.

But with certain codes—for example, the double-frequency and phase-modulation codes, or codes that permit only certain allowed sequences—a repetitive unbalanced write current sequence cannot occur. These codes therefore have no long-term dc bias and hence are suitable for use with a transformer.

The presence of a transformer causes no such problems in the read mode because sensing through rate of change of flux eliminates the need to detect direct current. However, the transformer's low-frequency cutoff may cause an undesired phase shift.

### Transducer selection

Since every track has its own read/write transducer, selecting the transducer selects the track. The selection circuits must not significantly degrade the write current or the read signals. They must also be low in cost, so

that they do not negate the cost advantages of batch-fabricated thin-film transducers. Low cost is achievable if each flying head carries at least 20 transducers, which can be done easily with the Pedro structure. The engineering model, which uses standard disks with 374 tracks, has 12 flying heads with 32 transducers on each head.

The selection circuits form a matrix (Fig. 9) in which the track select lines are the columns and head select lines form the rows. The selection transistors are drivers when writing and saturated switches when reading. One track-select line addresses, say, the innermost track served by each of several flying heads, while selection of one of those heads isolates the selection to one transducer and the track it serves. A double "party line" interconnects all selection transistor pairs with the write current source and with the read preamplifier. □

### BIBLIOGRAPHY

- E. P. Valstyn, "Integrated Head Developments," Conference on Advances in Magnetic Recording, New York, N.Y., Jan. 1971.
- J. P. Lazzari and I. Melnik, "Integrated Magnetic Recording Heads," IEEE Transactions on Magnetics, vol. MAG-7, March 1971, pp. 146-150.
- A. D. Kaske, P. E. Oberg, M. C. Paul, and G. F. Sauter, "Vapor Deposited Thin Film Recording Heads," IEEE Trans. Mag., vol. MAG-7, Sept. 1971, pp. 675-679.
- L. M. Harker and H. Chang, "Magnetic Disks for Bulk Storage—Past and Future," Spring Joint Computer Conference, 1972, pp. 945-954.
- L. W. Brownlow and C. C. King, "Write Field Analysis for Integrated Heads of the Finite Pole-Tip Configuration," IEEE Trans. Mag., vol. MAG-8, Sept. 1972, pp. 539-541.

# Hewlett-Packard presents a small miracle, the HP-65:



# the only fully programmable pocket-sized computer calculator, \$795.

Once you had to know a "computer" language, work at a desk and have a large budget to use programming. No longer.

## The HP-65 is fully programmable.

It's the first fully programmable pocket-sized computer calculator in the world.

With an HP-65 you can write programs just by pressing the keys in sequence, without using a special "computer" language. You can edit programs, i.e. add or delete steps at will. And you can record your programs on magnetic cards for subsequent use anywhere.

The HP-65's 100-step program memory, in combination with its 51 pre-programmed arithmetic, logarithmic, trigonometric and exponential functions, its operational stack and its nine addressable memory registers, permits you to write exceedingly complex programs.

Its user definable keys let you program up to five routines using any of the machine's pre-programmed capabilities. You can also label portions of your program so the calculator can branch to a specific instruction or choose between alternate computational paths based on logical comparisons ( $x=y$ ,  $x\neq y$ ,  $x>y$ ,  $x\leq y$ ) or the condition of the HP-65's two flags.

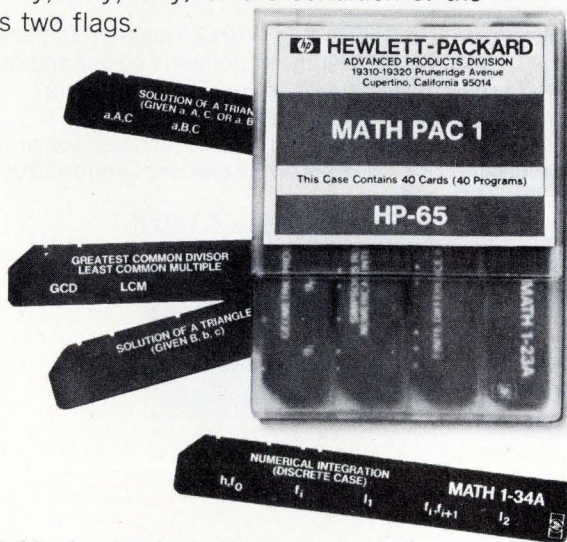

## The HP-65 also lets you use pre-recorded programs.

HP offers a series of pre-recorded program packages called Application Pacs at \$45\* each. Each Pac contains as many as 40 programs dedicated to a specific discipline (currently Electrical Engineering, Mathematics, Statistics, Medicine and Surveying, with more to come).

We also maintain a Users' Library of owner-contributed HP-65 programs which are itemized in catalogs distributed periodically to subscribing owners. Programs may be ordered from the Library for a small handling fee.

## The HP-65 is a powerful pocket-sized calculator.

The HP-65 ranks with our popular and powerful HP-45 as a keyboard-operated calculator. It's pre-programmed to handle 51 functions and operations.

## The HP-65 is priced at just \$795.\*

What you gain in time, precision and flexibility may well save you that amount in a matter of weeks. The price includes one 11-ounce HP-65 with rechargeable battery pack, AC adaptor-recharger, carrying cases, a year's subscription to the Users' Library, Owner's Handbook, Quick Reference Guide and a Standard Application Pac that contains 17 representative pre-recorded programs, 2 diagnostic cards, 20 blank cards, a head-cleaning card and instruction booklet.

The HP-65 may be ordered on a 15-day trial basis. For details send the coupon. Or call Customer Service at (408) 996-0100 for the outlet nearest you.

## Hewlett-Packard makes the most advanced pocket-sized computer calculators in the world.

614/18



Sales and service from 172 offices in 65 countries  
Dept. 214 H, 19310 Pruneridge Ave., Cupertino, CA 95014

Hewlett-Packard  
Dept. 214 H  
19310 Pruneridge Ave., Cupertino, CA 95014

Please send me:

- HP-65(s) including Standard Application Pac at \$795 (domestic U.S.A.) each plus applicable state and local taxes. (Check enclosed.)
- Detailed specifications on your HP-65 and available Application Pacs.
- Detailed specifications on your full line of pocket-sized and pre-programmed desktop calculators.

Name \_\_\_\_\_

Address \_\_\_\_\_

City \_\_\_\_\_

State/Zip \_\_\_\_\_

\*All prices domestic U.S.A., not including applicable state and local taxes.

# PULSED LASER MEASUREMENT RESULTS IN MINUTES!

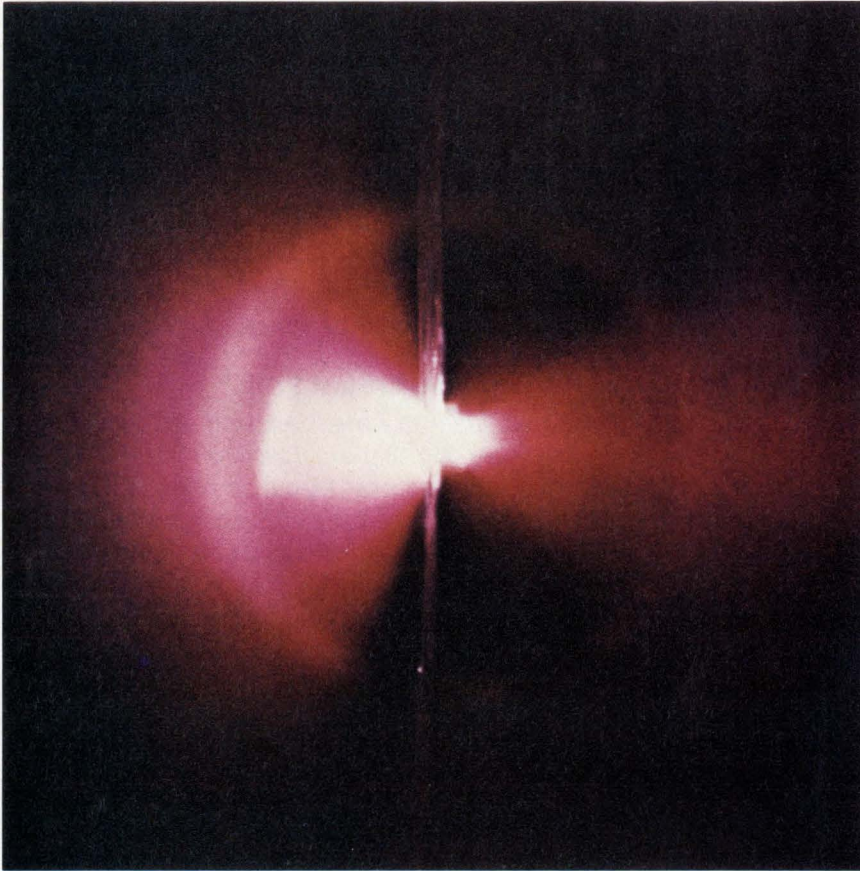

The R7912 offers you the following measurement capabilities:

**Analog Bandwidth:**

1 GHz at 4 V/DIV  
500 MHz at 10 mV/DIV

**Resolution:**

320 by 400 lines  
512 by 512 addressable points

**Writing Rate:**

8 DIV/N sec—Digital Mode  
30 DIV/N sec—TV Mode

**Sampling Rate (effective):**

10 psec (100 GHz) or slower

The TEKTRONIX R7912 Transient Digitizer represents orders of magnitude improvement in high speed transient measurements. It allows you to make your laser measurements quickly and easily—such measurements as checking switch-out effectiveness, looking for multi-modes, checking pumped amplifiers, and measuring effects on targets. One such target measurement is the study of particles generated from a plasma like that shown in the photo above.

Fast transient measurements can be viewed rapidly—with no need for photographs—whether your laser is running at a few pulses per second or single shot. The R7912 can be configured for direct viewing or for computer analysis. For repetitive signals (low or high rate), the TV mode offers large bright displays. For single transients, the digital display controller provides for viewing a refreshed display of the waveform on a monitor. For computer analysis, the PDP-11 interface allows waveform manipulation and measurement with Tektronix developed software.

Investigate the TEKTRONIX R7912 Transient Digitizer, it can make your pulse laser measurements easier and quicker. To obtain a copy of "New ways to see Fast Transients" and/or pertinent application notes, contact your Tektronix Field Engineer, use the reader service card, or write to Tektronix, Inc., P.O. Box 500A, Beaverton, Oregon 97005. Phone: 503/644-0161. In Europe: Tektronix, Ltd., Guernsey, C.I., U.K.



  
**TEKTRONIX®**  
committed to  
technical excellence  
**SYSTEMS  
DIVISION**

# Processor adds to computer power

High-speed signal analyzer provides host machine with capabilities for fast-Fourier-transform and other types of signal and data analysis

by Gail Farrell, Boston field editor

**Digital signal processors** can be costly, but CSP Inc. of Burlington, Mass. says its new line of macro arithmetic processors (MAP) allows minicomputers and large scientific computer systems to perform complex mathematical operations in real time, while still acquiring data, for as little as \$5,000 in extra cost. The programable MAP can provide the host computer with the capability of a fast-Fourier-transform processor, array processor, display processor, image processor, voice processor, convolver box, or data-acquisition system.

But the main advantage of MAP, the company says, is its speed. CSPI claims it is among the fastest, most powerful signal processors available, in terms both of memory and of input/output capacity. It is available with multiported memory having cycle times of 125 or 500 nanoseconds and optimally addressed in 8-, 16-, or 32-bit words. Both memories are available with all three versions of MAP. At \$5,000 the MAP 100 is the slowest unit; it can perform a 1,024-point complex FFT in floating point in 60 milliseconds. The MAP 200 for \$10,000 can do the same operation in 10 ms, while the \$15,000 MAP can do it in 3.5 ms.

A multiprocessor, MAP consists of up to four arithmetic processors, a control processor, up to four multiported memories, up to 64 input/output devices, and the host computer. The control processor is a stripped-down version of CSPI's CSP-30 computer [*Electronics*, March 2, 1970, p. 159]. It has some arithmetic capacity but no memory of its own, since it is used to set up I/O operations and calculate addresses and address patterns.

The arithmetic processor, in the same unit as the control processor, contains a 32-bit floating-point arithmetic section and does the real arithmetic work. It is data driven; its memory holds macro-instructions that enable it to perform one task repeatedly with only one instruction from the controller. Its 256-word memory also contains about 50 microprogrammed routines, such as complex multiply, which are used as building blocks to set up "macro" arithmetic operations, such as FFT.

Maximum memory is 1,048,576 bytes, contained in a total of four memories. All four may be relatively slow, storing 262,144 bytes each on 4,096-bit MOS RAM chips with a 500-nanosecond cycle time. Alternatively, one or two of the four may be faster, storing 65,536 bytes each on 1,024-bit bipolar RAM chips with a cycle time of 125 ns. There can be up to four buses to transfer data, and in addition each memory has 16 ports.

**Block transfer.** Because the memory is ported, CSPI can provide an I/O system with MAP, called the I/O Scroll. Up to 24 Scrolls, one per port, each of which can handle one peripheral device, can be hung on the bus. High data rates can use up most of a computer's busing capacity, but the I/O Scroll data can handle the I/O by block transfer directly to and from memory. One command from the control processor initiates a full series of transfers, freeing the MAP computer from the need to carry out transfer programs running into hundreds of memory cycles. The Scroll can handle transfer rates of 32 megabytes per second in a single memory.

MAP can be used for signal pro-

cessing in seismic and geophysical applications, communications, sonar, radar, and other areas. Application program packages are available, and new functions or algorithms can be added by programming the arithmetic and control processors. MAP is both macro- and microprogramable through the host operating system or higher-order languages such as Fortran.

Host interface, memory, and I/O Scroll are available as options.

CSP Inc., 209 Middlesex Turnpike, Burlington, Mass. 01803 [338]



FOR NEW STANDARDS IN SIGNAL GENERATORS, THINK HP



**“A good general purpose signal generator  
should handle most of your bench needs  
and be cheap enough to fit every budget.  
That’s why we designed the HP 8654A”**

Frequency range: 10-520 MHz  
Calibrated  
output level: +10 to -130 dBm, leveled  
Modulation: AM & FM,  
internal & external  
Stability: 20 ppm/5min  
Price: \$1500. Domestic USA price only.

But you'll want to evaluate the 8654A for yourself. A call to your local HP field engineer will put one in your hands. Or for more information just write.

**HEWLETT  PACKARD**

Sales and service from 172 offices in 65 countries.  
1501 Page Mill Road, Palo Alto, California 94304

04406

Data handling

## **FFT module is fast, versatile**

---

Processor analyzes

1,024 signal points  
in 2 milliseconds

---

Real time, fast-Fourier-transform (FFT) analysis of complex signals is being used more and more as the electronics and data-processing industries tackle more sophisticated problems. Jobs that would formerly have been assigned to huge, off-line computers are increasingly being done by portable or lower-budget equipment. This in part is possible because of the high speed of small, relatively inexpensive fast-Fourier transform processors, such as the new Datawest processor used in its Real Time signal-analysis systems.

The processor module, developed for Datawest's voice-identification system, is now offered for sale separately, both as a "box" and as part of a system. The same processor, in combination with suitable accessories, such as a minicomputer and peripherals, can be used in seismic exploration and to analyze engines, vibration, acoustics, and speech. It's also suitable for communications tests, underwater sound analysis, automatic testing, pattern recognition, image processing, and shock, biomedical, and nuclear analysis.

The Real Time I is a 16-bit floating-point system priced at \$40,000. Datawest claims the fastest speeds in the industry, with a transformation on 1,024 points performed in only 2 milliseconds. The units have a typical multiply time of 125 nanoseconds, and memory access time is 50 nanoseconds.

The system, depending on its specific configuration, permits on-line or off-line stand-alone or computer-augmented analysis of periodic, random and transient signals in either the frequency or time domain or both. The high speed provides the capability of analyzing multiple

channels, even in real time (with sufficient displays, which could be the limitation).

The signal analyzers perform the following functions: FFT, inverse FFT, power spectrum, cross-spectrum, transfer, coherence, autocorrelation, cross-correlation, convolution, spectrum analysis, and ensemble averaging of any or all of these functions. Speed is 500,000 samples per second on each of two channels. Throughput rate depends on such factors as configuration, number of channels, and functions.

The system is available as a stand-alone or with an Interdata 7/32 computer. It can be interfaced to a customer's PDP-11 Nova, or Varian 620 or V73.

Datawest will also have 32-bit versions in the future.

Datawest Corp., 7333 E. Helm Dr., Scottsdale, Ariz. 85260 [361]

---

## **Controller links IBM printer with non-IBM computers**

---

The IBM model 1403, although widely accepted as a printer, is designed only to be used on-line with IBM computers. Users who would like to use the printer with the DEC PDP-10 or Xerox Sigma computers can now do just that with a printer-controller developed by Spur Products. The firm had earlier developed controllers for off-line use and for CDC, General Automation and DEC PDP-8 computers. Spur's controller, the S1403, is an updated version of IBM's model 2821—smaller because it takes advantage of improvements in technology in the last 10 years, says Spur president Ray Lorenz. Unlike some printers, the 1403 comes stripped, without power supplies, hammer drivers, and logic, for example, so the controller includes these. The controller interfaced to a large computer such as the PDP-10 or Xerox Sigma series is priced at about \$17,000. The company has other controllers under development and will develop custom adapters for other applications.

Spur Products, 2928 Santa Monica Blvd., Santa Monica, Calif. 90404 [341]

---

## **Versatile modem transmits**

4,800 bits per second

Designed for data communications at 4,800 bits per second over dial facilities as well as dedicated lines, a modem designated the IBM 3874 provides broad flexibility in tele-processing systems. It can be equipped, for example, to answer incoming signals automatically and to allow automatic calling of a remote location during operation over dial networks. In dedicated systems, the 3874 can allow transmission between two modems on a single line or between a control modem and as many as six locations on one line. The device can be shared by as many as three terminals or three multiplexers at one location. Rental fees range from \$155 to \$282 per month, and purchase prices from \$4,650 to \$7,200.

IBM, Data Processing Division, 1133 Westchester Ave., White Plains, N.Y. 10604 [340]

---

## **Add-on core memory**

offers up to 65,000 words

An add-on core memory, completely transparent to IBM 1800 System programs, can be used with both the 2-microsecond and 4- $\mu$ s models. Up to 65,000 words are available in increments of 8,000 words, with an optional 8,000-word backup for service restoration. The model CH1-1106 attaches to the host system through slip-on connectors, which are attached to the pin side of the IBM logic gates. Connections are not permanent and can be easily installed or removed.

Computer Hardware Inc., P.O. Box 4496, Sacramento, Calif. 95825 [364]

---

## **Microprocessors allow user to design custom system**

The DL-8 and DL-16 8- and 16-bit microprocessor computer systems provide users with custom design capability for specific computer ap-

**\$1395.00**

## FOR A BREADBOARDING SYSTEM

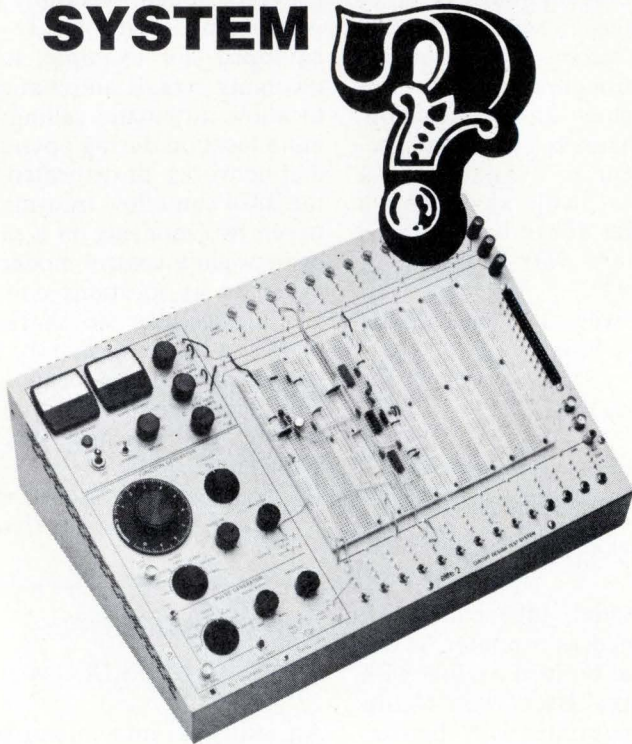

Sounds like a lot, doesn't it? But then again, think of the time and money you'll save by having one system, the **elite 2**, for *all* your logic, linear, and hybrid breadboarding; PC card testing and simulation; LSI and MSI IC module testing; IC burn in; op amp testing; and analog/hybrid computers. Plus, the **elite 2** makes a great teaching system.

The **elite 2** features a function generator, dual output pulse generator, 3 independent floating power supplies, 12 buffered monitor lamps, 4 SK-10 solderless component sockets, isolated toggle switches, pushbutton arrays, and a variety of I/O connectors.

For the top of the line in circuit design, it's the **elite 2**



### E&L INSTRUMENTS, INCORPORATED

61 First Street, Derby, Connecticut 06418  
Telephone (203) 735-8774

(If your needs call for something a bit less sophisticated than the **elite 2**, ask about our **elite 1** and **3**, from \$400.)

### New products

plications. Data Logic DL-8 and DL-16 systems each comprise four major elements: central processor, power supply, control panels with displays, and finished cabinet. Both systems can be ordered without mi-

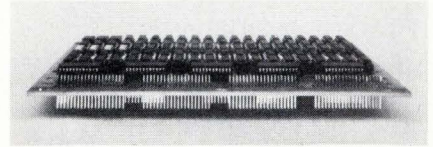

croprocessor chips or other IC elements, but are wired and tested so that customers can insert their own ICs. The microcomputers provide up to 128 input and output ports, each of 4, 8 or 16 bits. Prices start at \$395.00 for a completely wired central processor.

Data Numerics Inc., 141-A Central Ave., Farmingdale, N.Y. 11735 [363]

### Controller provides fast response to interrupts

A microprogrammable controller with a throughput rate of 2,860,000 16-bit words per second is designed to provide response to fast interrupts in 350 nanoseconds, while multiplexed interrupt response is as fast as 1.05 microseconds. The SCU model's capabilities include input/output controller and/or preprocessor for a host computer, device controller for peripherals, communications system controller, special algorithmic processor, computer emulation system, remote intelligent processor, video display controller, and a stand-alone processor. A TriBus architecture, orga-

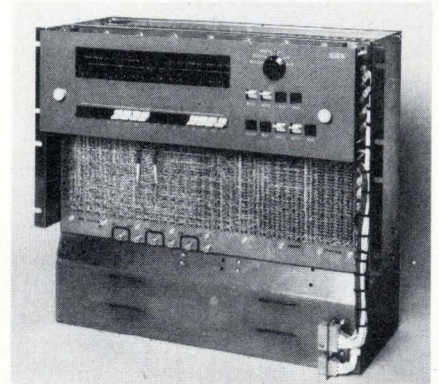



# The new Keithley Model 168 autoranging DMM... ...vive la différence!

There really is a difference in Digital Multimeters, and once you've experienced Keithley's 168 you'll know why we say *vive*! If you're tired of "general-purpose" promises that turn into run-of-the-mill

performances; if you want that bit extra that'll make your job easier, then *vive la différence*... here's the DMM for you! Send for our DMM Selector Guide or call us for demo now. **Phone (216) 248-0400.**

**AC VOLTS  
DC AMPS  
OHMS**

#### 5 functions

100  $\mu$ V to 1000 V dc  
100  $\mu$ V to 500 V ac  
0.1  $\mu$ A to 1 A dc  
0.1  $\mu$ A to 1 A ac  
100 m $\Omega$  to 20 M $\Omega$

#### two-terminal input

Simple to connect. You can't get it wrong. Eliminates the word "whoops" from your vocabulary. Saves temper, too.

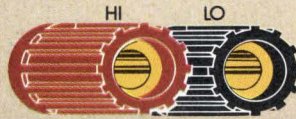

#### options & accessories

Rechargeable batteries that you can install anytime. An RF probe for high frequencies. Test leads. A 50-amp current shunt too.

#### hi-lo ohms

Select either of two voltage levels, 1 V or 100 mV, for ohms measurements. You can have your PN junctions either way you want 'em ... on or off.

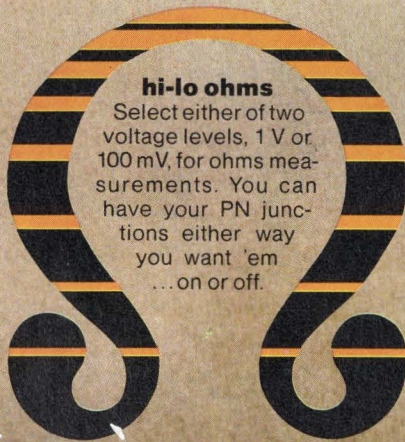

#### price

Enough said? Order one... or two... or three now!

**\$299<sup>00</sup>**



#### automatic ranging

You just connect the signal and push the function. The decimal point pops into position automatically and the display is direct reading. That does save time!

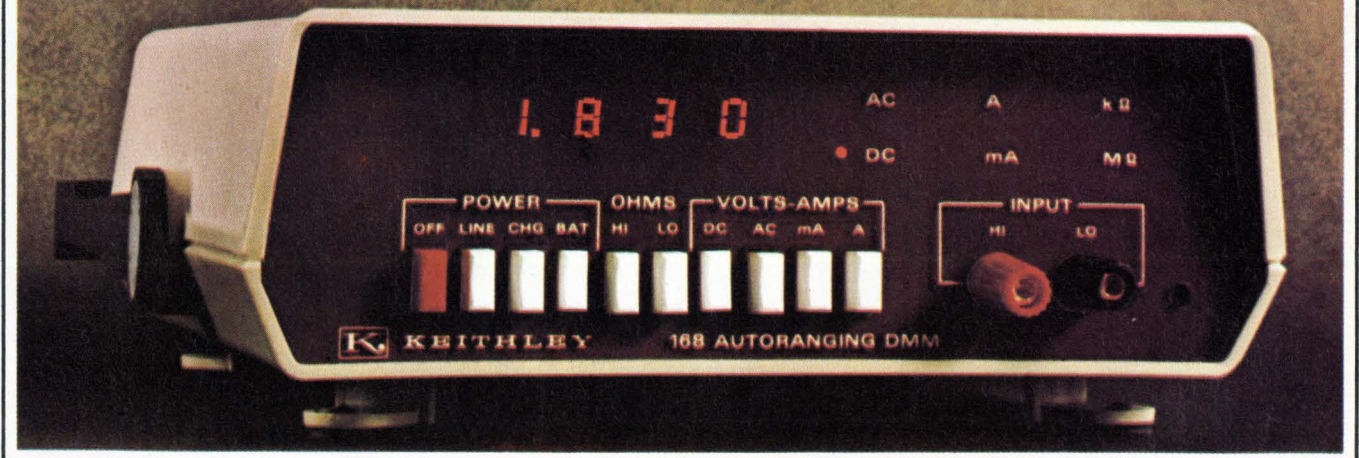

**KEITHLEY  
INSTRUMENTS**  
U.S.A.: 28775 AURORA ROAD, CLEVELAND, OHIO 44139  
EUROPE: 14, AVENUE VILLARDIN, 1009 PULLY, SUISSE

**Dow Corning silicones  
protect this Time Computer\*  
against a 2,500-g impact.**

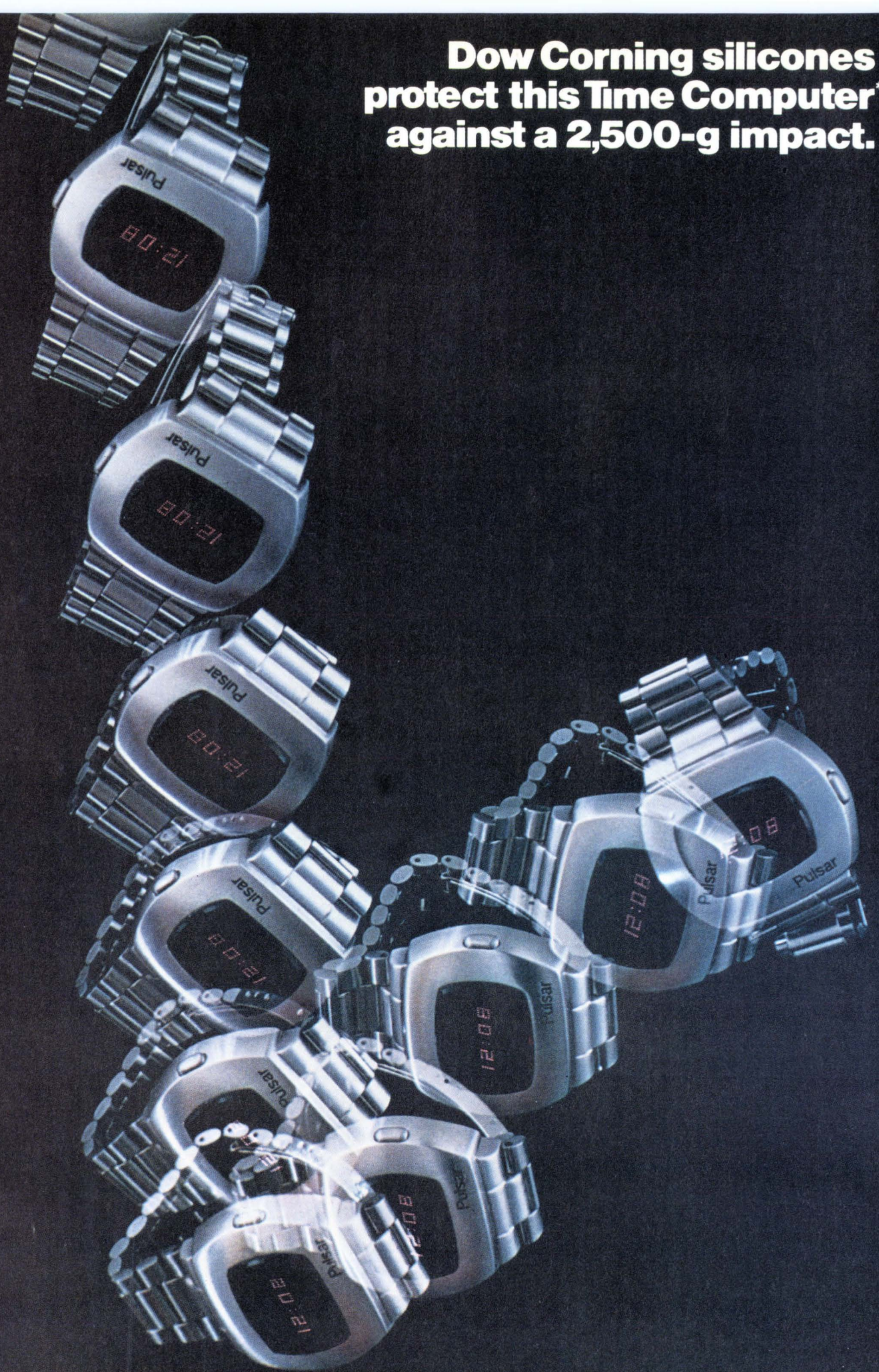

# They also protect against heat, moisture and thermal shock.

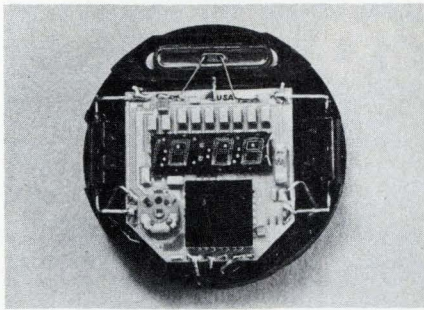

This Pulsar computer circuit uses Dow Corning silicones for shock protection, for positioning individual components, and as a moisture barrier. They all help Pulsar maintain an accuracy of  $\pm 5$  seconds per month. A major production advantage with silicones: only one hour primary cure is required before further assembly work. Yet if a circuit element is improperly placed or doesn't test out, the clear sealant can easily be cut away and the individual component replaced without complete rework. Circle No. 220.

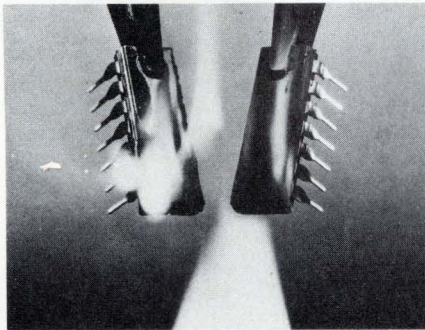

ICs, MOS, CMOS, and other devices made with flame resistant silicone molding compounds provide in many applications the reliability of hermetics at about  $\frac{1}{3}$  the cost. These compounds are superior in moisture resistance, thermal life and electronic stability over other plastics. Their heat resistant and shock protective qualities make them especially valuable in the unusually harsh environments of automotive applications. And molding cycle times are as short as 30 seconds. Circle No. 221.

*Pulsar units withstand 2,500 g's, symbolized by this strobe illuminated scene. Courtesy Time Computer, Inc., subsidiary HMW Industries, Inc.*

\*Trademark of HMW Industries, Inc.

For cooling high-density, high-performance modules, silicone fluids thin out very little, and silicone heat-sink compounds won't melt. This results in more effective heat dissipation, required in high-voltage power supplies operating over a wide temperature range. Circle 222.

Silicone rubber insulated wire and cable, used in nuclear power-plant instrumentation and controls, provide reliable service in applications to 260 C without gumming or

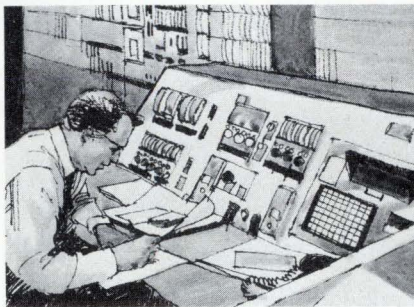

melting. And they continue to function even after a fire because of their nonconducting ash. Circle No. 223.

These electronic-quality silicone products are representative of a complete line of silicones that have inherent properties making them ideal protectors for almost every circuit/system.

Send today for "Silicones for Electronic Design," a 24-page brochure full of special applications for improving electronic circuits. Dow Corning Corporation, Department D-3202, Midland, Michigan 48640. Or call your nearest Dow Corning distributor.

***Silicones; simply the best way to protect electronic circuits.***

## **DOW CORNING**

**DOW CORNING**

## New products

nized around three 16-bit parallel buses, permits up to three data transfers to take place concurrently within a single microinstruction. Data may be intermixed combinations of bytes and 16-bit words. Price for a single unit is \$4,500, with volume discounts available.

Xerox Corp., 701 S. Aviation Blvd., El Segundo, Calif. 90245 [365]

## OCR page reader scans

1,000 characters a second

Designed for text editing and for photocomposition at 10,000 words per minute, the model OCR/COMP optical character page reader reads documents having 10 pitch fonts at rates up to 1,000 characters per second. The system is built to accept a



single font, but can have up to three fonts resident at any time. The standard, full alphanumeric fonts plus special symbols are Courier 12, OCR A and OCR B; other fonts are optional. The basic model OCR/COMP is priced at \$29,900, with OEM prices available.

Dest Data Corp., 1285 Forgewood Ave., Sunnyvale, Calif. 94086 [366]

## Disk storage unit

holds 25 million words

A disk storage unit for use with any of the Prime small to medium-scale computers has a capacity of 25 million words. Up to four disks can be attached to a controller, which in turn can be attached to a Prime 100, 200, or 300 central processor. The disk units utilize 20-surface (11-

**First, the Fabulous 43...**  
**Then, the Super 70...**  
**And now--**

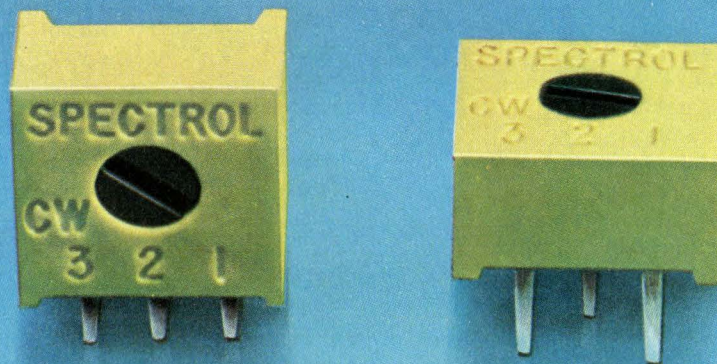

## **The "Set-sational" 63!**

If you liked our  $\frac{3}{4}$ -inch and  $1\frac{1}{4}$ -inch rectangular cermet trimmers, you'll love our new single-turn  $\frac{3}{8}$ -inch square cermet, the Model 63. Its superior Spectrol design virtually eliminates springback problems and provides reliable setability. It plugs right into those 362, 3389, and 72 sockets, and it's competitively priced.

The 63's are available from the factory and 75 distributor outlets. For free samples, all you have to do is ask.

**Spectrol**

**SPECTROL ELECTRONICS GROUP**

**UNITED STATES Spectrol Electronics Corporation** 17070 E. Gale Avenue, City of Industry, Calif. 91745, U.S.A. • (213) 964-6565 • TWX (910) 584-1314

**UNITED KINGDOM Spectrol Reliance Ltd.** Drakes Way, Swindon, Wilshire, England • Swindon 21351 • TELEX: 44692

**ITALY SP Elettronica spa** Via Carlo Pisacane 7, 20016 Pero (Milan) Italy • 35 30 241 • TELEX: 36091

Circle 138 on reader service card

## New products

disk) packs. Information can be recorded in IBM-compatible format or any user-specified recording mode. Price for the 25-million-word disk storage unit is \$20,000. The controller unit, which handles up to four disk pack units as well as one fixed-head disk, sells for \$5,000.

Prime Computer Inc., Box 2600, 145 Pennsylvania Ave., Framingham, Mass. 01701 [367]

### Data-acquisition system takes 60 samples/second

Dataquire IV, a 10- to 100-channel data-acquisition system, includes high-speed autoranging that allows automatic capture and recording of data varying from 1 microvolt to  $\pm 10$  v dc, at speeds up to 60 samples per second. The unit provides a real-time nine-digit clock and multi-range timer, as well as 10 constant data switches for reader informa-



tion. Channel selection can be either sequential or random, determined by a front-panel pin-board programmer. An optional printer is provided for setup and calibration, and a high-speed computer-compatible magnetic tape deck records the information for later processing on a computer. Prices start at \$4,100.

Data Graphics Corp., 8402 Speedway, San Antonio, Tex. [368]

### Ruggedized minicomputer's memory is expandable

The model 1603 is a conductively cooled ruggedized minicomputer that includes a four-card CPU, 8,000 words of memory expandable to 32,000 words and a 47-440-Hz power supply. Core memory is

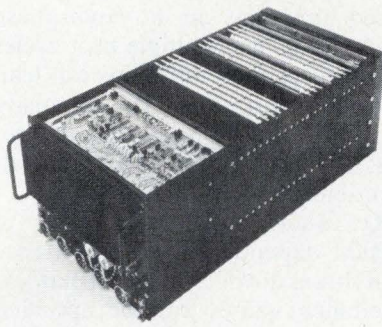

available in 8,000 word increments, and up to two semiconductor memory modules can be installed in the chassis. All memory in the 1603 provides typical cycle time of 1.2  $\mu$ s. Direct memory access is standard. A one-card extended arithmetic unit providing 7.7-microsecond hardware multiply/divide is optional. Price of a unit with 8,000 words of memory is \$9,950.

RoIm Corp., 18922 Forge Dr., Cupertino, Calif. 95014 [369]

### Flexible-disk system can handle million bytes

A flexible-disk system, called Flexi-File 52, includes two disk drives, a built-in controller with formatting electronics, and a power supply. On-line capacity is 524,288 8-bit bytes in a 16-sector, 64-track format with a data transfer rate of 31,000 bytes. The unit accommodates an additional two-disk slave system which increases the total capacity to one million bytes. Access time is 10 milliseconds, track to track. All assemblies and electronics, including the disk drives, operate in an extended position to simplify maintenance.

Tri-Data, 800 Maude Ave., Mountain View, Calif. 94040 [370]



# How to ship small packages in a big hurry.

## DELTA'S DASH

DELTA AIRLINES SPECIAL HANDLING

On DASH shipments Delta guarantees delivery on the flight or routing you specify between most Delta cities.

Packages accepted up to 50 lbs. with length plus width plus height not to exceed 90" total, with only one dimension exceeding 30".

Deliver to Delta's ticket counter or airport air freight terminal at least 30 minutes prior to scheduled departure time. Shipments may be picked up at either location 30 minutes after flight arrival.

Delta's exclusive "Dashboard" control procedure insures constant tracking of your shipment from delivery to pick-up.

DASH charges are nominal. Check Delta reservations for charges between specific points. Pay in cash, by company check, most general-purpose credit cards, special credit arrangements or on government shipments by GBL. **DELTA**  
The airline run by professionals

### Rate examples (Tax included)

Atlanta-Washington . . . . .	\$21.00
Boston-Miami . . . . .	\$26.25
Cincinnati-Louisville . . . . .	\$21.00
Cleveland-Phoenix . . . . .	\$26.25
Los Angeles-New Orleans . . . . .	\$31.50
Dallas-Los Angeles . . . . .	\$26.25
San Francisco-Atlanta . . . . .	\$31.50
Philadelphia-Houston . . . . .	\$26.25
New York-Tampa . . . . .	\$26.25

For details, call Delta reservations.



## Delta is ready when you are.®

Microwave

## Varactor diodes have high Q

Capacitance of tuning devices also increased by liquid-phase epitaxy process

Liquid-phase epitaxy is called the key to producing more uniform gallium-arsenide varactor diodes by engineers at Varian, Palo Alto, Calif. The company has a new line of high-Q tuning diodes, suitable for tuning Gunn and Impatt oscillators to frequencies as high as 50 gigahertz. Q values are almost double those of previous devices, while capacitance values have been increased between 10% and 25%. Other typical applications include wide-tuning range vhf and uhf oscillators, tunable filters, and tunable microwave transistor oscillators.

Varian's liquid-phase epitaxy process gives a uniform junction and avoids "spiking" in the doping profile, an effect often noted in devices made with vapor-phase epitaxy, claim the company's engineers. (Spiking limits the effective abruptness of the pn junction, and an abrupt junction is necessary for high tuning ratios.) Varian says it can grow an entire pn structure with its process, in only one heat cycle. The company contrasts its process with that used in most other varactors,

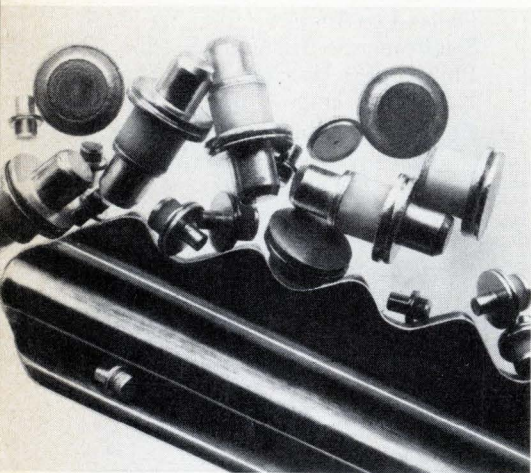

which it says are made with zinc-diffused junctions in a vapor-phase epitaxial layer. Multiple heat cycles involved in such diffusions can lead to extreme spiking. The company says the liquid-phase epitaxy process is based on its work with gallium-arsenide Gunn diodes.

Q values range from 2,400 to 5,000, depending on capacitance and breakdown voltage. Total capacitance values can be specified from 0.5 picofarad to 5 pF with  $\pm 10\%$  tolerance. Additional values and tighter tolerances are available on special order. More than 15 package styles are available, with package capacitances ranging from less than 0.1 pF to 0.25 pF. Breakdown voltages are selectable—from 15 v to greater than 60 v.

Prices in small quantities begin at \$75 each.

Varian, Solid-State West Division, 611 Hansen Way, Palo Alto, Calif. 94303 [401]

## Stabilized oscillator

tunes over 100-MHz bands

A cavity-stabilized oscillator with automatic-frequency control within  $\pm 0.1\%$  and low fm noise, is mechanically tunable over any 100-megahertz band from 3 to 4 gigahertz at up to 500 milliwatts. The afc option allows voltage tuning across  $\pm 0.1\%$  of the band at typically 1 MHz/v and tuning rates to 10 MHz. Operation into all phases of a 1.5:1 mismatch is typically  $\pm 1$  dB power variation and  $\pm 1$  MHz frequency pulling. Frequency Sources Inc., 166 Middlesex St., North Chelmsford, Mass. 01863 [404]

## Diode switches cover

0.5-to-18-GHz range

A line of p-i-n diode switches—single-pole double-throw types, offers a wide variety of options for high-speed channel-selection or pulse-modulation applications. The models MT3580 and MT3581 have integrated TTL-compatible drivers and the models MT3680 and MT3681 are without drivers. Small

size, low weight, and rugged construction make the switches suitable for electronic-countermeasures applications. Frequency is 0.5 to 18 gigahertz. Other specifications include a switching speed of 20 to 700 nanoseconds and a maximum insertion loss of 2.2 decibels at 18 gigahertz.

Alpha Industries Inc., 20 Sylvan Rd., Woburn, Mass. 01801 [402]

## Coupling adapter measures filter-insertion loss

A universal coupling adapter for frequencies ranging from dc to 10 gigahertz is designated the model M-240B and is designed to measure filter insertion loss as specified in MIL-STD-220A. This enables engineers working with electromagnetic-interference problems to check filter circuitry for compatibility. Interference pollution, which is espe-

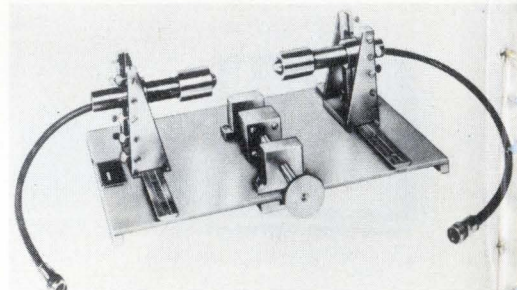

cially encountered in aerospace applications, can then be controlled within specification limits, according to the company. The M-240A is furnished with two coaxial cables and coupler heads to accommodate various types of terminal configurations. Accessories available include an isolation attenuator, a buffer network assembly, and coaxial switches.

Filtron Co. Inc., 200 Shames Dr., Westbury, N.Y. 11590 [339]

## Electromagnetic-compatibility tester covers 1-18 GHz

For testing microwave electromagnetic compatibility, the model FSS-500, EMC system is designed to provide automated measurements at

Our new Series-500 Logic-Circuit Testers say so. Loud and clear. They are: fully portable, fully automatic, with both random and programmable patterns, at quantity prices as low as \$5,950!

Correct. The whole bag. In a "suitcase."  
For tens of thousands of dollars less than previous production test systems.

There's more.  
Program compatibility with most other test systems. Superior fault-isolation techniques. Unusually high test rates and dynamic resolution.  
Low cost program preparation.

Questions? Fire away. Need literature? Just write. Trial sales? We have those too.  
It's a whole new way to look at logic circuit testing!

**From  
this moment on  
you will have  
to look at logic  
circuit testing in a  
totally different way.**

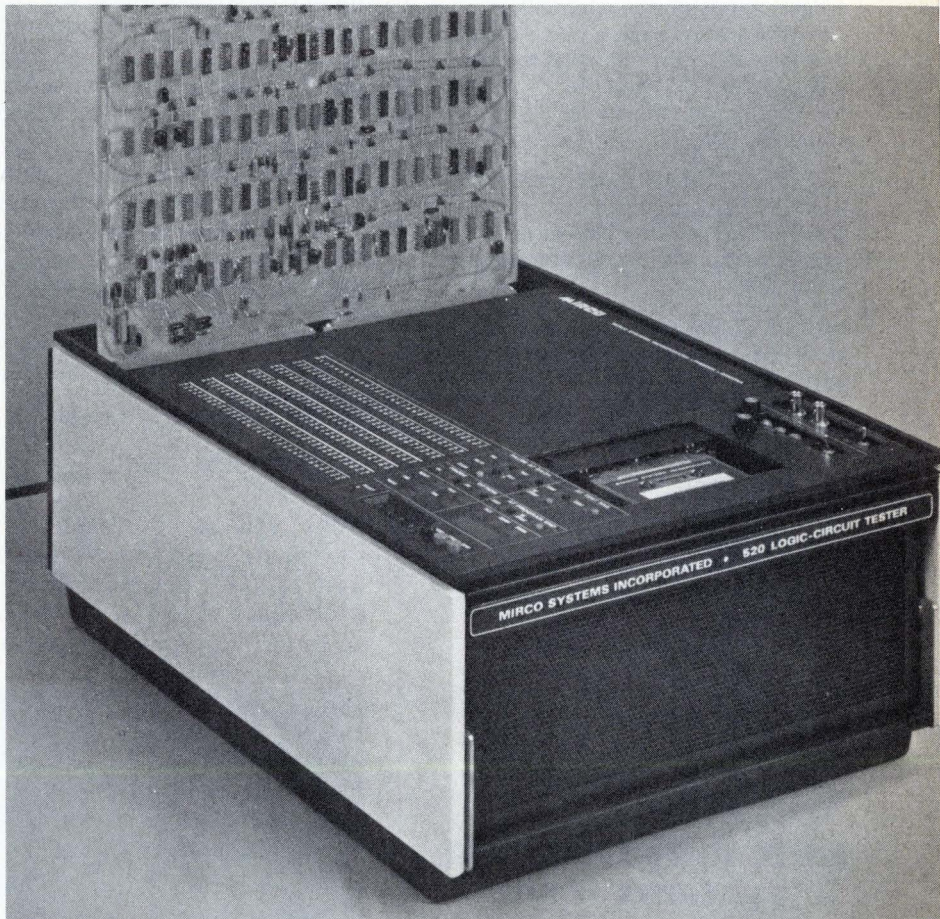
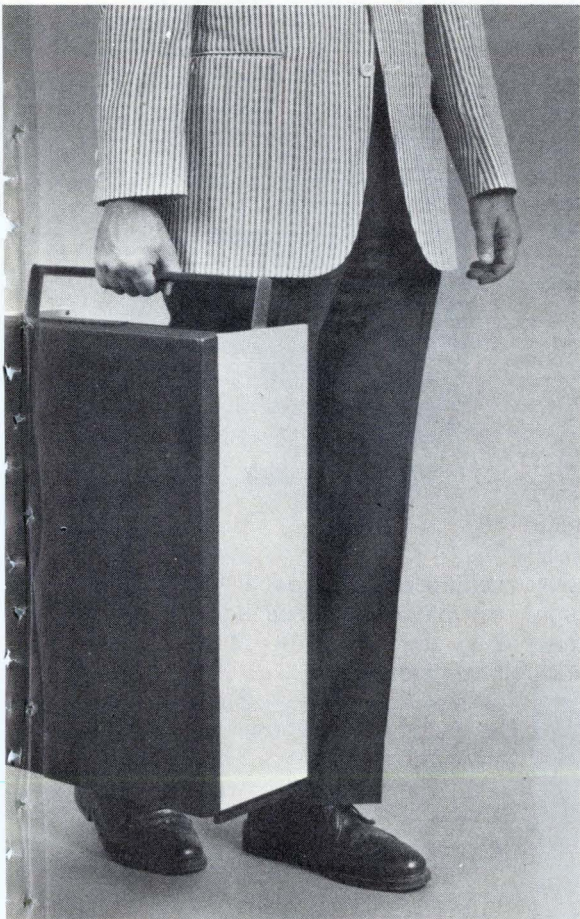

MIRCO 500-Series Portable Full-Capability Logic-Circuit Testers



**MIRCO SYSTEMS, INC.**  
2106 W. Peoria, Phoenix, Az. 85029 • Phone (602) 944-4691  
The only name you need to know in circuit testing

## Pro-Log brings intelligence to ROM Programmers



Intelligent because it's controlled by a Pro-Log microcomputer. It cuts programming time substantially, makes operation easy, and is able to interface as a conversational terminal with people, TTY, and other computers. All of this for around \$2000.

The Series 81 ROM Programmers from Pro-Log are fully portable units designed for use in engineering, quality assurance, production, or out in the field.

**Model 810: Programs 1702A ROMs**

**Model 811: Programs 1702 ROMs**

**Model 812: Programs National 5203 ROMs**

**Model 813: Programs 3601 Fusible Link ROMs**

### Features:

- Programs, Lists, Duplicates, and Verifies
- Automatic erase check
- Duplicates with advance substitution
- Duplicates typical 1702A in less than 30 seconds — 1702 or 5203 in less than 5 minutes
- Hexadecimal keyboard for address and data entry
- Binary data display
- Quick load, zero insertion force ROM sockets

## ROM Programming Systems from Pro-Log



"Microcomputers, Programmers and Education"  
▲ 852 Airport Blvd. Monterey, Calif. 93940  
(408) 372-4593

## New products

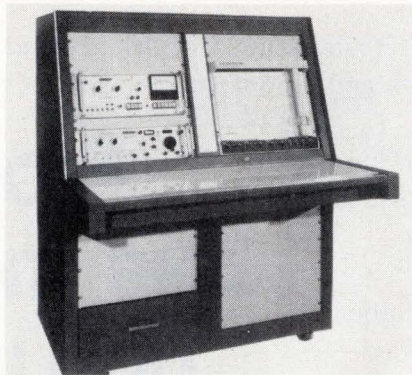

frequencies of 1 through 18 gigahertz. Designed as a companion unit to the model FSS-250, which measures lower frequencies, FSS-500 is normally installed in a matching dual-bay rack. However, to provide additional flexibility, the FSS-500 microwave system is operated independently of the lower-frequency system. One module in the system is the microwave receiver, model EMC-50, which covers 1 to 12.4 GHz and can provide optional coverage to 18.0 GHz. The EMC-50 receiver can be operated separately from the FSS-500 system. When calibrated measurement is required, the EMC-50 is operated with the other components in the system. Price of the system is about \$45,000. Penril Corp. Electro-Metrics Division, 5520 Randolph Rd., Rockville, Maryland 20852 [403]

### Noise sources offered in millimeter range

Noise sources, available in nine waveguide sizes, cover the range from 18 to 170 gigahertz. Low VSWR is obtained by using a 7° insertion angle for the alumina ceramic noise

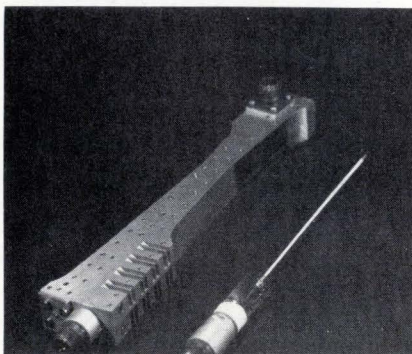

tube and by using a higher-than-normal pressure of argon gas along with a Kr85 additive. The models WR15, WR19, WR28, and WR42 have noise tubes that are replaceable in the field, and test data indicates that actual measurement values will be below a maximum cold VSWR of 1.30 and a maximum hot VSWR of 1.20. Pricing is in the \$1,000 range, depending on the frequency specified.

Signalite, 1933 Heck Ave. Neptune, N.J. [405]

### Spiral antenna operates from 2 to 8 gigahertz

The model ASO-1498A cavity-backed spiral antenna operates within the range of 2 to 8 gigahertz. The unit is designed to improve normally encountered low-end gain by 3 decibels at 2 GHz in a restricted-size envelope for applications in sur-

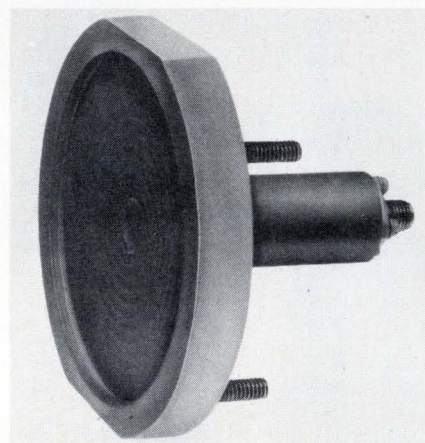

veillance and reconnaissance. Typical characteristics include a VSWR of 2:1, gain of 5 dB  $\pm$  2 dB, and a beamwidth of 70°.

American Electronic Laboratories Inc., MS/1123, P.O. Box 552, Lansdale, Pa. 19446 [407]

### Signal-source frequency is stable to $\pm$ 5 ppm

Low-noise microwave signal sources covering from 1 gigahertz to 12.6 GHz in both free-running and crys-



# CUTLER-HAMMER'S BIG LINE OF COMMERCIAL MINIATURES.

Toggles. Pushbuttons. Rockers. Rotaries. Available in a vast array of operator styles, colors, and shapes. Including illuminated pushbuttons and rockers. Many featuring snap-in mounting. And all in stock for fast delivery!

Now the same great quality, service and availability you've come to expect from Cutler-Hammer is available in miniature size—at a competitive price!

Make your selection. Standard or watertight. Single or multiple pole. A wide range of decorator caps, buttons, bezels that extend application flexibility. And for their size, hefty electrical/mechanical ratings.

Before you place that next order, check with your source for commercial miniature switches—your nearest Cutler-Hammer Sales Office or Authorized Stocking Distributor.



**CUTLER-HAMMER**

SPECIALTY PRODUCTS DIVISION, Milwaukee, Wis. 53201

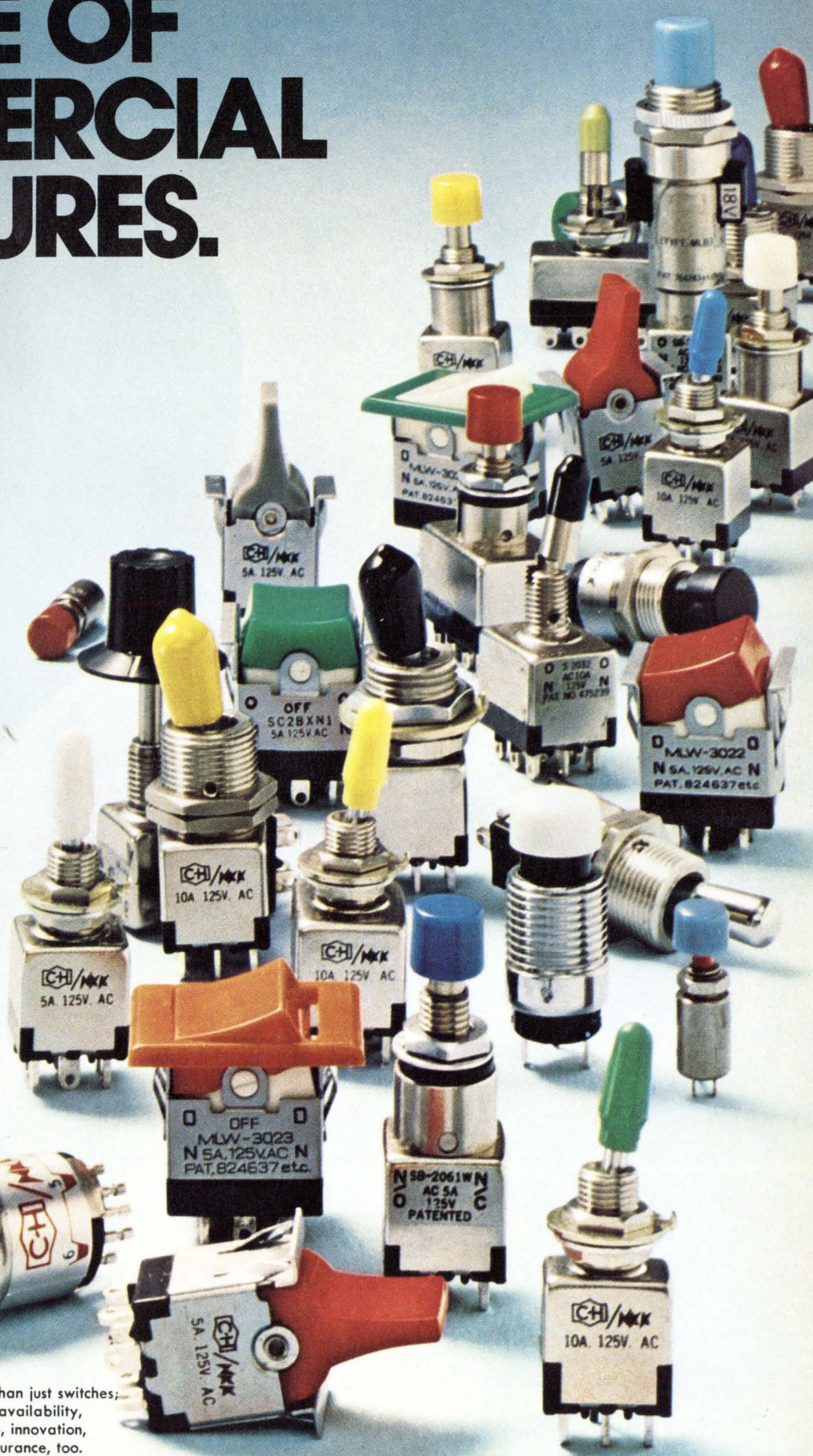

Switch  
to No.1

More than just switches;  
prompt availability,  
field help, innovation,  
quality assurance, too.

# Who do you call for fast delivery of tantalums?

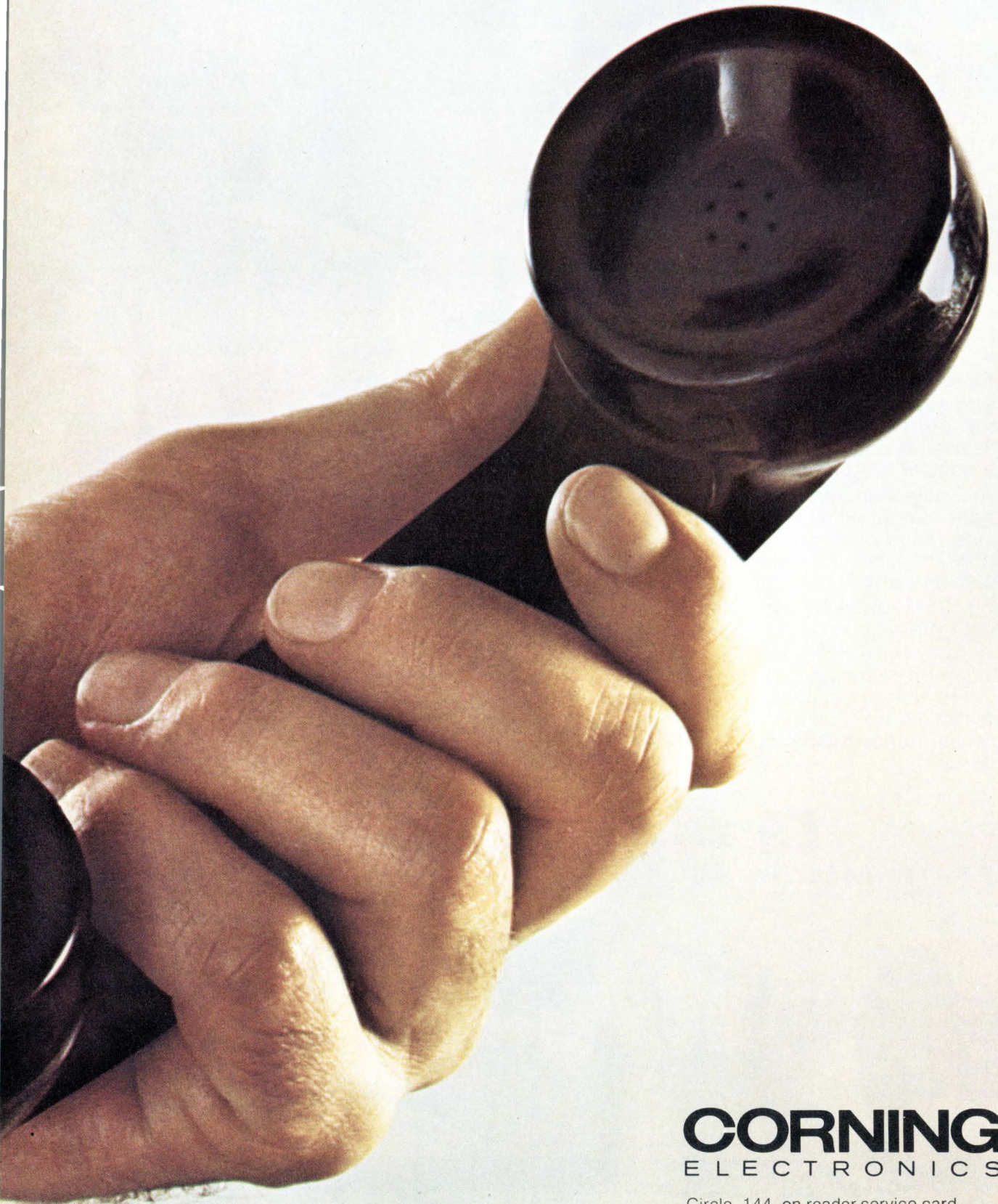

**CORNING**  
ELECTRONICS

Circle 144 on reader service card

# The man who has them: Your Corning distributor.

## ALABAMA: Huntsville

Cramer/EW (205)539-5722

## ARIZONA: Phoenix

Liberty Electronics (602)257-1272

## CALIFORNIA: Culver City

Avnet Electronics (213)836-7200

## CALIFORNIA: Gardena

Bell Industries Electronics (213)321-5802

## CALIFORNIA: Los Angeles

Liberty Electronics (213)322-8100

## CALIFORNIA: Mountainview

Elmar Electronics (415)961-3611

## CALIFORNIA: San Diego

Liberty Electronics (714)565-9171

## CALIFORNIA: Sunnyvale

Acacia Sales, Inc. (408)735-0100

## COLORADO: Commerce City

Elmar Electronics (303)287-9611

## COLORADO: Denver

Cramer Electronics (303)758-2100

## CONNECTICUT: North Haven

Cramer Electronics (203)239-5641

## FLORIDA: Hollywood

Cramer/EW (305)923-8181

Hamilton/Avnet Electronics (305)925-5401

## FLORIDA: Orlando

Cramer/EW (305)894-1511

## ILLINOIS: Chicago

Bell Industries (312)282-5400

Schweber Electronics (312)593-2740

## MARYLAND: Baltimore

Radio Electronics Service (301)823-0070

## MASSACHUSETTS: Watertown

Sterling Electronics (617)926-9720

## MASSACHUSETTS: Newton Centre

Cramer Electronics (617)969-7700

## MINNESOTA: St. Paul

Ragon Electronics (612)488-0201

## NEW JERSEY: Cherry Hill

Cramer Electronics (609)424-5993

## NEW JERSEY: Somerset

Schweber Electronics (201)469-6008

## NEW MEXICO: Albuquerque

Cramer Electronics (505)265-5767

## NEW YORK: Freeport

Milgray Electronics (516)546-6000

## NEW YORK: Hauppauge

Cramer/Long Island (516)231-5600

## NEW YORK: Rochester

Cramer/Rochester (716)275-0300

## NEW YORK: Syracuse

Cramer/Eastern (315)437-6671

## NEW YORK: Westbury

Schweber Electronics (516)334-7474

## NEW YORK: Woodbury

Harvey Electronics (516)921-8700

## NORTH CAROLINA: Winston-Salem

Cramer/EW (919)725-8711

## OHIO: Cincinnati

Sheridan Associates (513)761-5432

## OHIO: Cleveland

Schweber Electronics (216)464-2970

## PENNSYLVANIA: Philadelphia

Almo Electronics (215)676-6000

## TEXAS: Dallas

Solid State Electronics (214)352-2601

## TEXAS: Houston

Hamilton/Avnet Electronics (713)526-4661

## UTAH: Salt Lake City

Cramer Electronics (801)487-4131

## WASHINGTON, D.C.

Cramer/EW (301)948-0110

Milgray/Washington (301)864-1111

## WASHINGTON: Seattle

Liberty Electronics/NW (206)763-8200

Almac/Stroun (206)763-2300

## CANADA: Montreal

Cesco Electronics, Ltd. (514)735-5511

## CANADA: Toronto

Cesco Electronics, Ltd. (416)661-0220

## New products

tal-controlled models are designated the 28450 series. Frequencies are stable to  $\pm 5$  ppm in the standard package, which, as an option, can be operated from an external frequency standard. Typical applications include transmitter-exciter, frequency references for doppler radars, stable local oscillators for receivers in communications systems, and reference standards for laboratory experiments. Stability ranges from  $\pm 0.5\%$  for free-running oscillators to  $\pm 0.0005\%$  for phase-locked sources with ovens. Power levels of 10 milliwatts, 50 MW and 250 MW

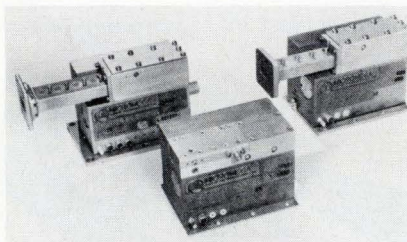

are standard. All units come in a 22-cubic-inch package, which is compatible with point-to-point communications equipment.

Micromega, 12575 Beatrice St., Los Angeles, Calif. 90066 [408]

## Double-balanced mixers 'drop into' IC assembly

Because of miniaturization in the microwave industry, it is necessary to eliminate connectors and semi-rigid cable. Thus, a line of miniature "drop-in" double-balanced mixers, designated WJ-M15, -M16, -M17, and -M18 has been developed for direct integration into IC assemblies. Gold-plated 50-ohm microstrip transmission lines are provided at all three ports for integration with microwave IC amplifiers, hybrids, filters and circulators. Interconnection between modules is accomplished with gold ribbon. These models are also supplied in a hermetic SMA connector housing for breadboarding with semirigid cables which can then be removed for incorporation directly into an MIC or strip-line subassembly. Noise fig-

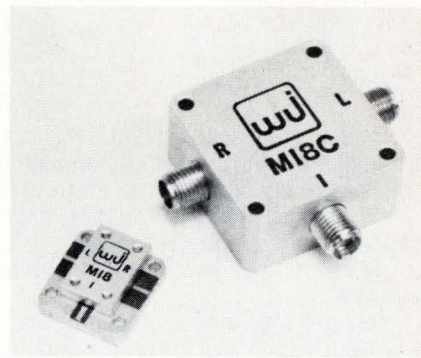

ures of typically 5.5 dB are available up to 13 GHz, and 7.5 dB at 18 GHz. Price ranges from \$250 to \$575.

Watkins-Johnson Co., 3333 Hillview Ave., Palo Alto, Calif. 94304 [406]

## Signal sources deliver 5, 10, or 50 milliwatts

A series of free-running and phase-locked microwave-signal sources, which provides a minimum of 5, 10, or 50 milliwatts of output power over broad tuning ranges, also provides low residual fm noise—typically less than 16 Hz rms—in a 3-kilohertz bandwidth. Free-running models feature single-screw tuning and offer both afc/fm and phase-lock options. Twenty-one models of free-running and crystal-controlled sources provide output frequencies ranging from 3.60 to 8.50 gigahertz.

Frequency West, 3140 Alfred St., Santa Clara, Calif. 95050 [409]

## Coax power dividers cover up to 18 GHz

The model 2532 coaxial power divider covers from dc to 12.4 gigahertz, and the model 2533 covers from dc to 18.0 GHz. Both devices, which are 6-dB resistive power dividers, exhibit good tracking across their frequency ranges (typically better than 0.25 dB). The maximum VSWR is 1.25:1 from dc to 10 GHz and less than 1.35:1 from 10 to 18 GHz. The model 2532 is priced at \$142, and the 2533 is \$165.

Midwest Microwave, 3800 Packard Rd., Ann Arbor, Mich. 48104 [410]

# INTRODUCING THE 4000 TESTER. AGAIN.

Even a great test system can be improved. So, we've done it. Presenting System Four. Still the same great 4000 — but not really. Now it's greater.

We kept all the features that made the 4000 the most successful semiconductor test system ever — which means you get the same results: high throughput, reliability and versatility.

You get four-channel multiplexing: simultaneous testing on four stations at 100 tests per second. You can measure both voltage and current, and make comparisons with programmed go/no go limits. And, we offer every imaginable option to expand and customize your system for your specific requirements.

Here's what's new: A solid state memory to replace that pesky magnetic disk. It operates reliably over a broader line voltage specification — with stand-by power, just in

case. And it stores 900 programs (expandable to 1800), with no timing problem, and no down-time for disk maintenance.

Also new is the totally re-designed logic — TTL instead of primitive RTL. Plus standard Lambda power supplies; all-solid state operational amplifiers; and next generation direct read-out. Remember the old cooling system? We fixed that too.

System Four is still the definitive system in automatic production testing and wafer probe testing of ICs and transistors. And it's backed by a nation-wide service organization second to none. Also, it's cheaper now.

Call us about it.

**GCA/SUNNYVALE DIVISION** ●●▲

1050 Kifer Road, Sunnyvale, CA 94086 / (408) 732-5330 / TWX: 910-339-9211



Semiconductor

### Third calculator chip adds power

Array lets scientific unit compute complex functions in a few keystrokes

Solving advanced mathematical, statistical, or scientific problems becomes elementary with any handheld scientific calculator designed around a new three-chip set from MOS Technology Inc. Basic calculating features plus a 14-digit display are handled by two chips, while the third extends the computational power of the system to include advanced functions.

Designated the Senior Scientist, the set operates in conjunction with a 40-key keyboard. On these keys, factorials, binomial coefficients, probability integrals and other advanced functions are represented in the "upper-case" position, actuated by a shift key.

All three chips are involved in handling series expansions, vector manipulation, permutations and combinations, coordinate conversions, complicated statistical equations, and complex mathematical problems in general. But the first two chips of the Senior Scientist may also be used alone to provide a basic 40-key scientific calculator.

This unusual option is provided by a system architecture common to all scientific-calculator array sets from MOS Technology: the master array of the system is programed to recognize the presence or absence of the third chip, and no electrical change is required to change the functional level.

Included within the three chips of the set are 12 data memories and 2,560 words of program storage. The memories are allocated in such a way that three are directly usable by the operator with separate store/recall keys. An additional four memories are internally accessed for storage of statistical group data,

prior result data, and prior parentheses data. The remaining five are used by the system as working registers.

A minimum number of external components is required for integration of the set into finished calculator designs, the company says, and power dissipation is kept at minimum levels, less than 300 milliwatts average.

Price of the set is \$50 in quantities of 100,000.

MOS Technology Inc., Valley Forge Corporate Center, 950 Rittenhouse Rd., Norristown, Penn. 19401 [411]

### Philips launches 10 ICs for radio/audio functions

Though widely used in television sets, integrated circuits turn up in radio and audio equipment only sporadically. The limited number of rather simple active functions in such equipment could be handled quite economically with discrete components—at least, before consumers began clamoring for better sound reproduction in high-fidelity equipment, for quadrasonic systems, and for car radios with fm stereo, cassette player capability and easier control. Since all of this demands more circuitry, manufacturers see a need to extend the boundaries of integration.

One company responding to this need is Philips Gloeilampenfabrieken in the Netherlands. Together with 16 ICs for television applications [*Electronics International*, June 27, p. 9E], the Dutch electronics firm is launching 10 devices for the radio and audio sector.

Aimed at world markets, "our new range handles functions that haven't been integrated before," says Ted Van Moorsel, product manager for linear ICs at Philips' Eindhoven-based electronic components and materials division.

In addition to economic advantages, the new devices offer better equipment performance, Van Moorsel says. In hi-fi systems, for example (see photo), the circuits allow electronic pre-selection and search

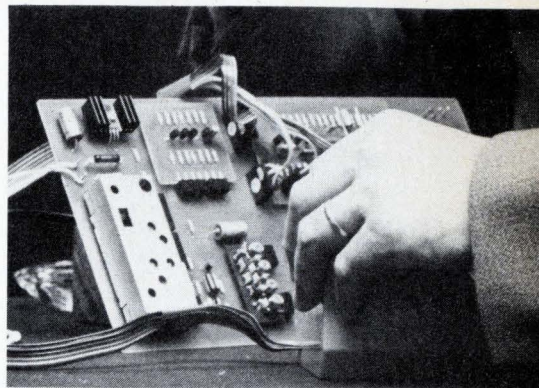

tuning as well as AGC muting and improved stability. Volume production of the 10 ICs will start next year.

One device that should do well on U.S. markets is an 8-watt power amplifier, the TDA1004. Developed primarily for car radios, but also for use in record players, the TDA1004 consists of a preamplifier and a power amplifier, both stabilized against temperature drift and supply-voltage variations up to 18 volts.

Another is the TDA1001, also for car radios where it provides interference suppression in the audio stages of four mono or stereo channels.

For use in record/playback systems there are the TDA1002 and TDA1003, the former incorporating all amplifier circuits (except for the playback power output stage) needed in such systems, and the latter comprising a capstan motor speed control, a stop circuit, and an automatic bias/erase oscillator.

Philips Gloeilampenfabrieken N.V., Elcoma Division, P.O. Box 523, Eindhoven, The Netherlands [412]

### Monolithic op amp challenges choppers

The mono OP-07, a monolithic operational amplifier, which has a bipolar-input, is designed to replace chopper amplifiers in microvolt and high-stability applications. An on-chip trimming technique reduces the cost of providing this level of performance, including input offset voltages of 10 microvolts, offset drift vs temperature of  $0.2\mu\text{V}/^\circ\text{C}$ , and

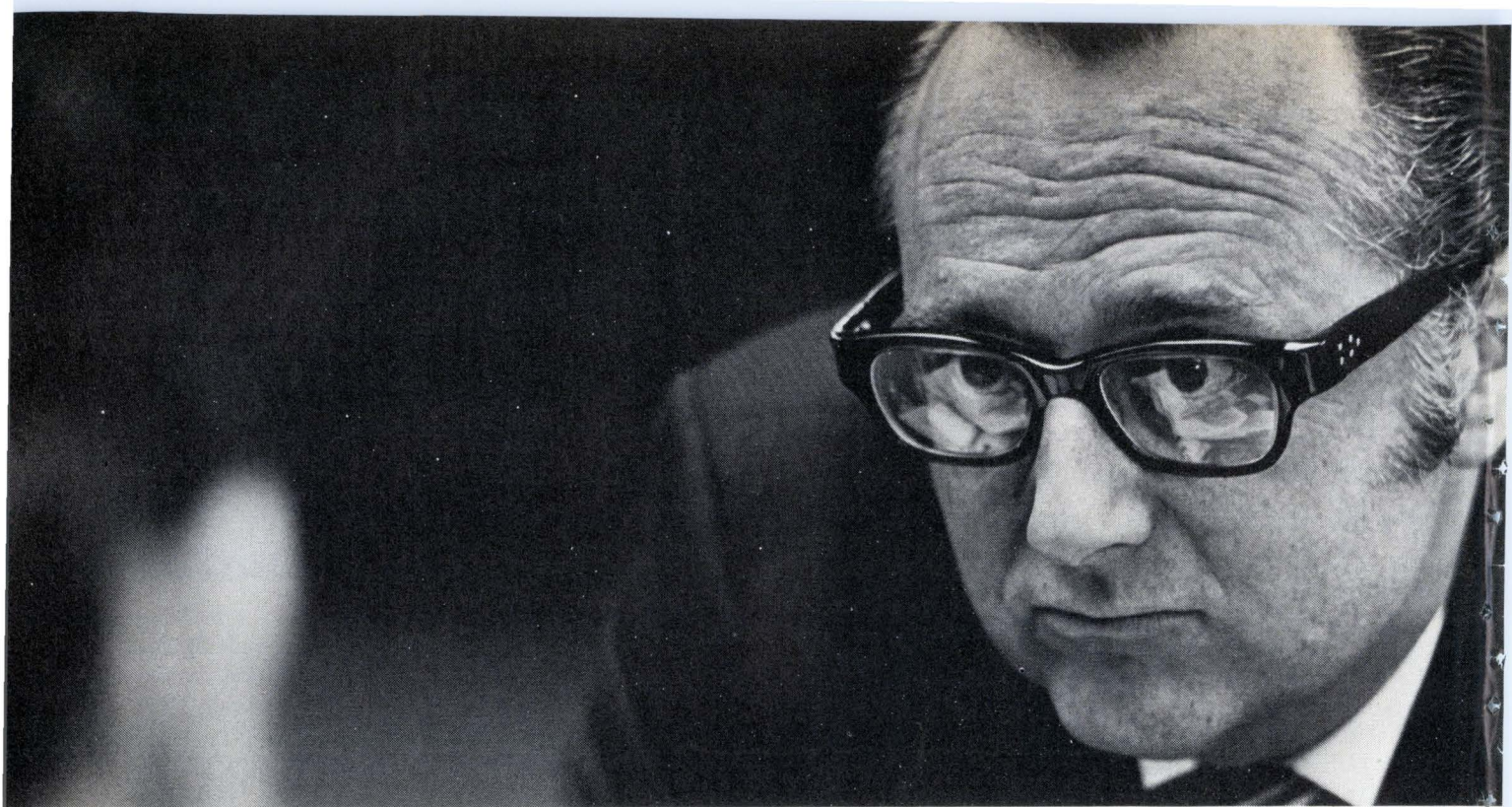

**“You’ve gotta be kidding.  
A battery-powered design like that  
would need a dense, static CMOS RAM  
with a 200 nanosecond access time  
and around 2 microwatt stand-by  
power.**

**“No way you’re going to find  
an outfit that can hack that.”**

**Give him  
the good news:**

Our new S2222 512x1 CMOS RAM does it all. It combines the highest density and performance with the lowest power requirements on the market—three more firsts from Number One. And at just \$41 apiece in 100-999 quantities, it also gives you the lowest cost per bit. For complete information, write AMI, 3800 Homestead Road, Santa Clara, CA 95051. Phone: (408) 246-0330.

Or call your distributor.

**AMI**  
AMERICAN MICROSYSTEMS, INC.

# Here's that dense, static CMOS RAM.

Our S2222 is a 512 word by one-bit RAM, constructed with silicon gate CMOS devices integrated on a monolithic array. Fully decoded on the chip, this memory uses DC stable (static) storage elements and needs no refresh to operate. The memory matrix is organized as 32 rows by 16 columns. High-speed operation and micropower supply requirements make our new RAM ideal for applications where you have to conserve electricity or use a battery.

You can't beat its performance, either. It has a 200 ns access time and 420 ns cycle time, with power dissipation of less than 5  $\mu$ w/bit and typical stand-by power of just 4 nw/bit. Since it is static, the data can be read without interruption. Maximum power dissipates only when the inputs change.

The unique circuit design lets the chip select precharge the internal nodes which minimize the power dissipation and maximize the performance. And for greater density, it is designed with five transistors per cell. All in all, it's the densest, lowest powered CMOS RAM ever produced.

## S2222 Specifications

Access time: 200 ns at room temperature.  
300 ns at military temperature range.

Cycle time: 420 ns

Power dissipation: typically less than 5  $\mu$ w/bit.  
Stand-by power: 4 nw/bit.

Power supply: single + 10 volt.

Current sink output with "OR" tie capability.

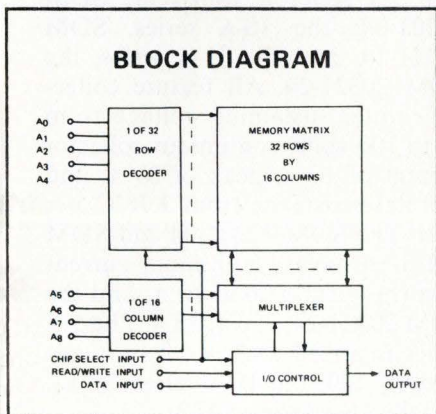

# AMI

Circle 149 on reader service card

## New products

long-term offset drift averages of 0.2  $\mu$ V per month. The bipolar input circuit provides a high-impedance, fully differential input with a common-mode input-voltage range of  $\pm 14.0$  V and common-mode rejection ratio of 126 dB. Applications for the mono OP-07 ultra-stable op

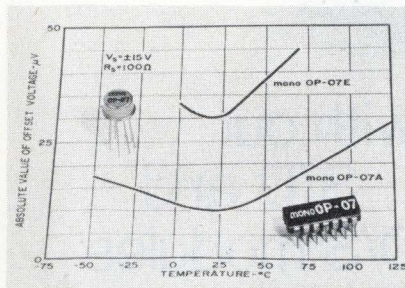

amps include precision buffers, thermocouple and strain-gage amplifiers, precision integrators and comparators, low-noise audio and medical amplifiers, and output amplifiers in high-resolution digital-to-analog converters. Price starts at \$9.95.

Precision Monolithics Inc., 1500 Space Park Dr., Santa Clara, Calif. 95050 [413]

Isoplanar FIFO memory offers 1.5-MHz data rate

A 40-word-by-9-bit first-in, first-out memory, the 3351, is the second MOS product made by Fairchild's Isoplanar technique. The circuit offers a low-cost solution to many problems associated with interfacing digital systems that have different data rates. Typically, the FIFO memory serves as an input or output buffer between a keyboard and a central-processing unit or between a CPU and a printer. Information can be entered into the FIFO at keyboard speed, saving computer time. Similarly, data can be fed from the CPU to the FIFO at computer speed and then transferred to a printer at the slower print-out speed. The model 3351 operates at data rates from dc to 1.5 MHz, has independent asynchronous inputs and outputs, and is compatible with TTL circuitry. It also can be expanded in width or length to accommodate other data

# Energy Saver

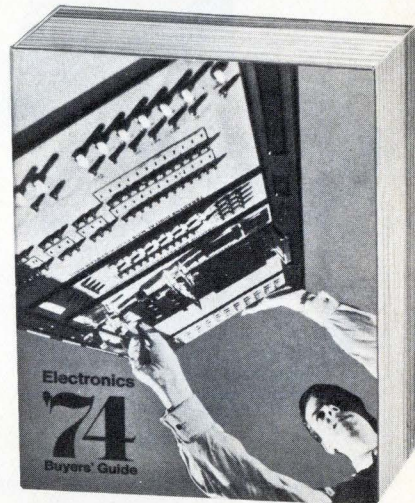

**New Electronics Buyers' Guide...  
Easy-to-use, single volume  
source for:**

- Information on over 4,000 products
- Over 6,000 company listings and phone numbers — both home and field offices
- **EBG EXCLUSIVE:** quick access to over 800 helpful catalogs through a timesaving Direct Inquiry Service
- More than 1,400 pages of data

Here is the international world of electronics at your fingertips. Find suppliers... fast... accurately... and locally! Don't have a copy? Use coupon below, today.

## Electronics Buyers' Guide

A McGraw-Hill Publication  
1221 Ave. of the Americas, N.Y. N.Y. 10020

Yes, send me \_\_\_\_\_ copies (copy) of the energy saving Electronics Buyers' Guide. I've enclosed \$15.00 (USA and Canada only; elsewhere send \$25.00). Full money back guarantee if not satisfied.

NAME \_\_\_\_\_

COMPANY \_\_\_\_\_

STREET \_\_\_\_\_

CITY \_\_\_\_\_

STATE \_\_\_\_\_ ZIP \_\_\_\_\_

# OUR ANGLE: More Synchro Conversion For Less Cost



with our  
S/D and  
D/S modules

How does a choice of 14-bit resolution (greater for 2-speed S/D), 60 or 400 Hz data frequency, high accuracy, 11.8V to 90V line-line voltages and all kinds of self-protection circuitry — look from your angle? Not to mention that as few as 5 modules make up a complete S/D or D/S converter, or that all modules are replaceable one-for-one without trimming! And, economically too!

New 2-speed S/D sets are now available with accuracies typically better than 20 seconds from all error sources including resolution. D/S specifications include 4 minute accuracy, 1.25 VA output with optional 20 VA output for torque receiver applications.

Key performance specifications for both converters include 14-bit (0.022°) resolution over 360°, 4000°/sec analog data rates and 0-70°C operation. Some units available for operation from -55°C to +105°C. All units are DTL and TTL compatible.

Prices start at \$650.00 for a set of modules. Delivery from stock. Call toll-free (800) 645-9200 for the name and address of your local sales engineering representative.



**NORTH ATLANTIC** industries, inc.

200 Terminal Drive, Plainview, New York 11803 • Phone (516) 681-8600  
California District Office: 13418 Wyandotte Street, N. Hollywood, CA 91605 • Phone (213) 982-0442

Circle 150 on reader service card

## MAGNETIC INSTRUMENTATION

### Gaussmeters • Fluxmeters

Magnetizers • Stabilizers • Demagnetizers

Automatic Magnet Processing Systems

Alnico Permanent Magnets • EI Laminations



**Thomas & Skinner, Inc.**

1120 East 23rd Street, Indianapolis, Indiana 46205 • 923-2501

150 Circle 191 on reader service card

## New products

formats. Price is \$15.60 each in lots of 100.

MOS Products Division, Fairchild Camera & Instrument Corp., 464 Ellis Street, Mountain View, Calif. 94042 [415]

### Bus drivers operate in 4 nanoseconds

Four current-mode bus drivers, forming a single integrated circuit, operate in 4 nanoseconds. Inputs of the model 10192 are compatible with all other devices in the ECL 10,000 series. Outputs are 16-milliampere, open-collector, switched-current sources. The complementary outputs can be switched to one of three logic states—"11," "01," and "10"—which provides the user with party-line capability in differential and single-ended modes. The open-collector outputs can also accept voltages ranging from +5.5 v to -1.6 v, permitting the designer to use a variety of termination and level-translation approaches to solving interface problems. Price is \$6.27 in lots of 100.

Signetics Corp., 811 East Arques Ave., Sunnyvale, Calif. 94086

### Darlington transistors handle up to 15 amperes

A family of 5-ampere, 10-A, and 15-A fast-switching industrial npn Darlington power transistors is packaged in steel-version TO-3 cases. The 5-A series is called the SDM 20301-04; the 10-A series, SDM 20311-14; and the 15-A series, the SDM 20321-24. All feature collector-emitter sustaining voltage from 40 to 100 volts, continuous collector current of 10 A, peak of 20 A, and thermal resistance from 1.75°C per watt. The SDM 20301-04 and SDM 20311-14 have a minimum current gain ( $h_{FE}$ ) of 1,000 at 10 A; and the SDM 20321-24, 750 at 15 A. The 5-A series is priced at \$2 each in quantities of 100; the 10-A series, \$2.12; and the 15-A series, \$2.32.

Solitron Devices Inc., 1177 Blue Heron Blvd., Riviera Beach, Fla. 33404 [416]

Electronics/July 25, 1974



# TADA!

No more going from this catalog to that for different types of interface devices.

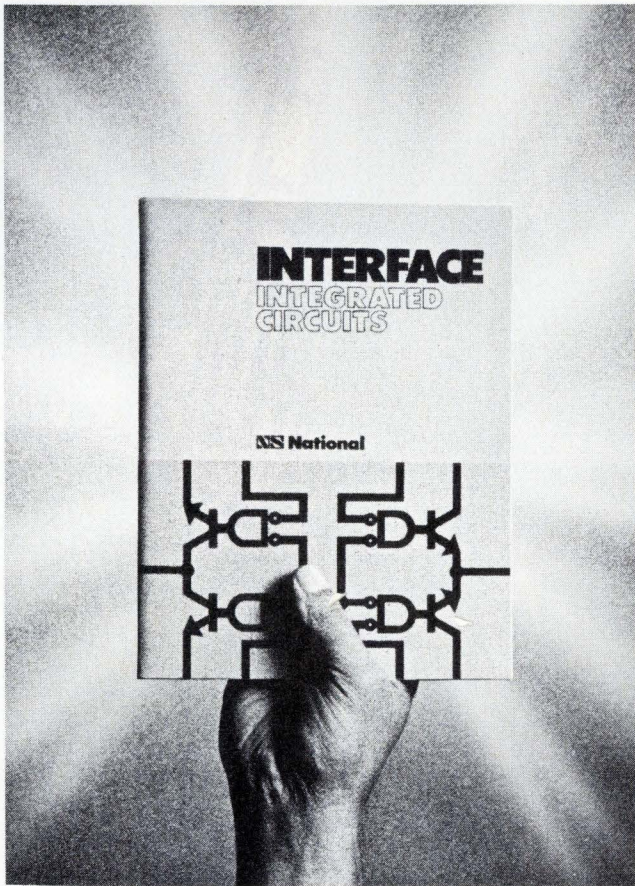

We've got it all together (in more ways than one).

Our new 350-page interface handbook.

Interface devices from A to Z pulled from our many handbooks and put into one.

Linear, MOS, digital, hybrid, everything.

For yours, (it's free) write National Semiconductor Corporation, 2900 Semi-

conductor Drive, Santa Clara, California 95051.

## Here's one for the book.

LF 311 high input impedance comparator.

In addition to our industry-standard LM 111 we've got this new one with high impedance due to a FET input, which is unique in the comparator field. On a monolithic chip.

Here's some more new ones.

LM 360-361 high-speed comparators.

A pair of high-speed devices that operate in the 10-15 nanosecond range. And featuring essentially no speed change as the input changes (nobody else has got that, either).

And LM 339A quad comparator.

Half the input offset voltage of any other comparator: 2mv. And truly compatible with CMOS because—alone among all comparators—it offers the same advantage that CMOS offers.

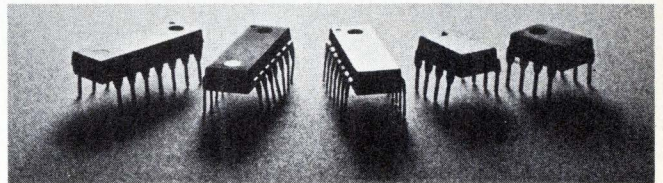

Namely, very low power consumption, and operation over a wide range of supply voltages.

We make 14 kinds of comparators. About twice as many as anybody else.

So no matter what kind you may need, we'll have it for you.

Ta da!

# National

National Semiconductor Corp., 2900 Semiconductor Drive, Santa Clara, Calif. 95051; Scottsdale, Ariz. (602) 945-8473; Mountain View, Calif. (415) 961-4740; Sherman Oaks, Calif. (213) 783-8272; Tustin, Calif. (714) 832-8113; Miami, Fla. (305) 446-8309; Chicago, Ill. (312) 693-2660; Indianapolis, Ind. (317) 255-5822; Lenexa, Kan. (816) 358-8102; Glen Burnie, Md. (301) 760-5220; Burlington, Mass. (617) 273-1350; Farmington, Mich. (313) 477-0400; Minneapolis, Minn. (612) 888-4666; Englewood Cliffs, N.J. (201) 871-4410; Syracuse, N.Y. (315) 455-5858; Dayton, Ohio (513) 434-0097; Dallas, Tex. (214) 233-6801.



## EMR-Telemetry... in a class by itself.

### Here, and in 20 other countries around the world.

When you're good at what you do, your reputation spreads world wide. But, excellence in system design and total product breadth isn't enough when you're selling turnkey systems.

It takes installation know-how, software expertise, customer training, and an attitude that says . . . we care now, and will care in the future about your changing needs.

EMR customers respond to this philosophy with enthusiasm. We don't just sell hardware . . . we're there when you need us, world wide. They know it at the National Space Agency in Japan, at the India Aeronautical Development Establishment, and at every key data gathering station around the globe.

#### Japan Space Program . . .

By 1976, the Japanese National Space Development Agency expects to launch a variety of communication and scientific satellites. EMR will supply both frequency and time division multiplex ground stations for use at several stages of the program: for experimenters to check out their scientific and communications packages; for functional tests of each stage of the rocket boosters; and for a complete checkout and monitoring system in the blockhouse at the launch site.

#### India Aircraft Flight Test Program . . .

The India Aeronautical Development Establishment is using an EMR ground telemetry Data Readout Station consisting of a quick-look, van-mounted, checkout system coupled with a large FM-PAM/PDM and PCM computerized telemetry system. Real-time flight testing of aircraft will be accomplished with this facility.

### When can we help with your data gathering needs?

**EMR** 

EMR Telemetry  
Weston Instruments, Inc.  
Box 3041, Sarasota, Florida 33578  
813-371-0811

## New products

Packaging & production

### Plug assembled, crimped to cable

Machine applies connector pin, ring and shell, then terminates ends of cable

Most push-on phono plugs used for radio, TV, and stereo are manufactured in several steps—some automated, some manual. But AMP Inc., Harrisburg, Pa., has developed a new three-piece connector for terminating coaxial cable that is designed to be assembled on an automated line that AMP is marketing.

Consisting of an outer shell and center pin of tin-plated steel, both supplied on reels, and a polyvinylchloride dielectric ring that can be hopper-fed, the AMP Coaxion phone

then carries each end of the stripped cable through the application of the connector's inner pin, insulator ring, and outer shell.

Although the inner pin is crimped onto the wire's center conductor, the crimp is behind the contact, providing for a smooth center plug. The phono plug's outer shell is crimped in the cable braid, around the rigid dielectric ring, using a "braid-pick" technique instead of the conventional pressure crimp. Four V-shaped lances on the outer shell's wire-barrel penetrate the braid, separating it from the cable dielectric, to provide a redundant electrical contact as well as additional mechanical strength.

Pricing depends on the number of connector components purchased and other factors.

AMP Inc., Harrisburg, Pa. 17105 [391]

### Vertical etcher built for wafers and substrates

The model 1212 vertical etcher is designed for chemical machining to close tolerances and precision etching of circuit boards. The etcher is especially suited for the fine line and space resolutions required in the processing of semiconductor wafers and substrates. Its vertical, rotating work holder is synchronized with oscillating spray nozzles on each side, and either single-sided or double-sided work can be handled. The holder is adjustable to work from 2 by 2 inches up to 12 by 12 in., while etching periods are controlled by means of an automatic re-

set timer, which assures uniform etching over the entire surface, the company says.

Chemcut Corp., 500 Science Park, State College, Pa. 16801 [394]

### Wave-soldering system

processes 18 feet a minute

Designed to meet applicable operational and safety standards, a wave-soldering system is available

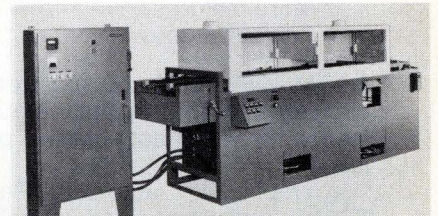

for board widths of 12, 15, 18, and 24 inches, with either pallet or finger conveyor. Both versions are inclinable from the horizontal to a maximum 8° angle, and individual stations can be customized to meet any production requirement. The standard system, which processes boards at a capacity of 18 feet per minute, includes foam-fluxing, pre-heating and wave-soldering with an integrated vent system. Sliding, heat-tempered glass panels on the front of the vent system permit observation and access. Price starts at \$15,450.

Electrovert Inc., 86 Hartford Ave., Mt. Vernon, N. Y. 10553 [393]

### Connector links miniature devices by pressure alone

An elastomate micrometalized connector provides interconnection of microminiature devices by pressure alone. The connector, which eliminates large connector housings and associated hardware, is useful with liquid-crystal displays in electronic watches and in calculators where maximum packaging density is required. The connector consists of a nonconducting elastomeric core wrapped with parallel lines of gold-plated conductors on thin flexible

plug or connector is designed for use with RG-58 and RG-59 type coaxial cable. The connector shell and pins come in a variety of sizes. Insulation resistance between the pin and outer shell is at least 100 megohms; operating voltage is 350 volts rms; withdrawal force averages three pounds.

Two parallel series of applicator machines terminate each end of the cable in a three-step operation. Accepting cable cut to lengths down to 7½ inches, the system first strips cable jacket, braid, and dielectric for crimp termination, using a rotary coaxial wire stripper with preset blades. A pair of chain conveyors

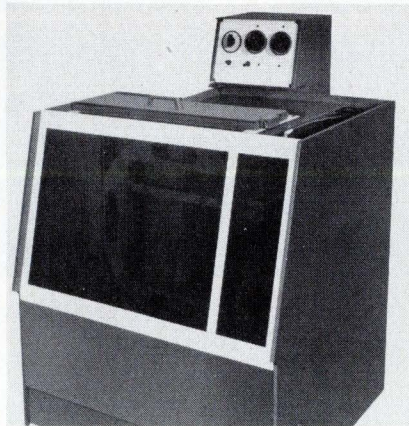

# A BETTER METER.

Data Precision's newest multimeter — the 5½ digit MODEL 3500 — is a second generation instrument that combines the best of both worlds.

More features.  
For less money.

MODEL 3500 incorporates all of the proven circuitry advances that made our 2500 Series the internationally accepted price/performance leader.

Tri-phasic™ auto-zero, Ratiohm™ 2- and 4- wire resistance, and Isopolar™ high stability referencing.

With a 6 month basic DC accuracy of ±0.007% of reading ±0.001% of full scale ±1 LSD, full autoranging from 1 microvolt to 1000V (DC or AC peak) and 1 milliohm through 12 megohms resistance, 20% overranging, DC Ratio, isolated BCD output, remote triggering and remote ranging, it represents the most sophisticated laboratory multimeter you can buy for less than \$1000.

**\$995.**  
**complete**

MODEL 3500 features the industry's most reliable, field proven circuit technology packaged behind a big, bright and easy-to-read ½ inch planar gaseous display. And none of the bugs of an unproven design.

MODEL 3500 measures DCV, 1 microvolt to 1000 Volts; ACV, 1 microvolt to 700V RMS, 30 Hz to 100KHz; Resistance, 1 milliohm to 12 megohms; and Ratio.

## AVAILABLE NOW

Contact your local Data Precision representative to arrange for a demonstration.

AL (205) 533-5896	MA (617) 273-0198	NY (S) (516) 482-3500
AZ (602) 994-9519	MD (301) 552-2200	OH (N) (216) 725-4560
CA (N) (408) 733-9000	MI (313) 482-1229	OH (S) (513) 298-3033
CA (S) (714) 540-7160	MN (612) 781-1611	OR (503) 238-0001
CO (303) 449-5294	MO (W) (816) 737-0066	TX (N) (214) 234-4137
CT (203) 525-7647	MO (E) (314) 731-2331	TX (S) (713) 461-4487
FL (813) 294-5815	NC (919) 787-5818	UT (801) 268-3181
GA (404) 457-7117	NJ (S) (215) 925-8711	WA (206) 763-2210
HI (808) 262-6286	NJ (N) (201) 863-5660	CAN (W) (416) 787-1208
IL (312) 593-0282	NM (505) 265-6471	CAN (W) (613) 772-5874
IN (317) 293-9827	NY (N) (315) 446-0220	CAN (E) (514) 731-9328

Data Precision Corporation  
Audubon Road, Wakefield, MA 01880  
(617) 246-1600

 **DATA PRECISION**  
...years ahead



## New products

film. When compressed between two parallel planes, the metalized lines around the circumference interconnect the circuitry on each plane with assured contact redundancy. Standard connector conductors are 0.003-inch wide on 0.007-inch centers, but a variety of configurations is available.

AMP Inc., Harrisburg, Pa. 17105 [398]

### Drafting system eliminates registration problems

A new drafting system is designed to eliminate the major registration problems engineers and draftsmen encounter in preparing circuit diagrams for two-sided printed-circuit boards. The Nopan model drafting system has amber- and magenta-colored pressure-sensitive drafting tapes which, when used with Wratten filters, eliminate the need to use panchromatic film in the photographic reproduction of original printed-circuit diagrams. The system, instead, uses orthochromatic film, which is processed under normal red-light darkroom conditions instead of the complete darkness needed with panchromatic film for color separation of magenta and amber. Both magenta and amber negatives can be developed simultaneously in normal darkroom red light by standard developing procedures.

W. H. Brady Co., Computer and Drafting Products, 727 W. Glendale Ave., Milwaukee, Wis. 53201 [399]

### 42-pin socket staggers rows on 0.050-inch centers

A 42-pin socket, designed specially for flat-pack calculator chips, staggers four rows of pins on 0.050-inch centers. The sockets are furnished with tin-plated pins, and when required, gold-over-nickel plating can be provided. Pin material is a copper-alloy leaf spring. A low-profile, open-design insulator body reduces component height. Although developed for high-volume, commercial

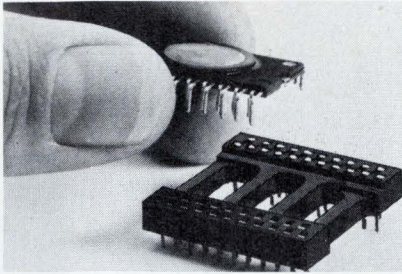
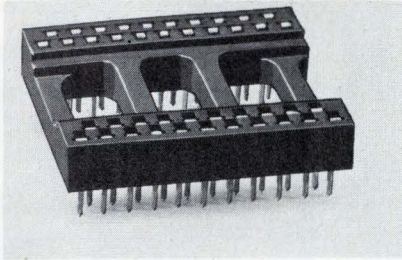

use, the socket can also be used for low-quantity experimental or research work.

Circuit Assembly Corp., 3169 Red Hill Ave., Costa Mesa, Calif. 92626 [397]

### Wire-wrap panels built for three-voltage ICs

A family of wire-wrapping panels is designed for use with dual in-line integrated circuits that require two voltages and a ground, or three voltages. The panels are intended to aid the designer in the packaging of random-access memories, read-only memories, and other medium-scale and large-scale integrated digital and linear devices. A family of three voltage backplanes is also offered, along with 108-pin two-piece wire-wrap-to-wire-wrap connectors. The panels are priced at \$61.50 each in quantities of 10.

Mupac Corp., 646 Summer St., Brockton, Mass. 02402 [400]

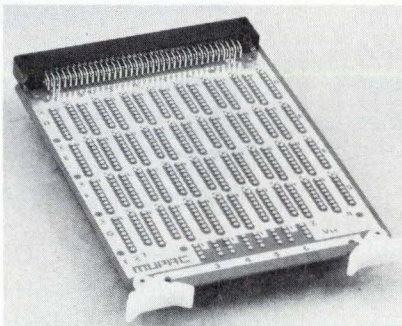

# WHO CAN MAKE ANY GLASS MATERIAL FOR FLAT PANEL DISPLAYS?

Need flat glasses for windows and backplates in thicknesses from .010" to .090"? Corning makes them. We also make glass ceramic materials for backplates. And black glass ceramic cell sheets chemically machined with any pattern or hole size. You can even put your displays together with Corning glasses. We make devitrifying powdered glasses, and vitreous sealing glasses in rectangular shapes. Preformed beads for tubulation seals. Hard glass rods to space front and backplates. Even the mercury capsules used for dispersion in gas displays. Corning makes them all! Want more information? Write or call:

# CORNING MAKES IT!

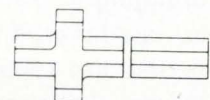

Electronic Materials Department

## CORNING

CORNING GLASS WORKS

Corning, New York 14830  
(607) 974-8866

Whether you buy  
one's, two's...

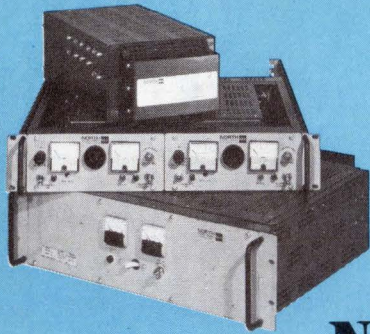

or multitudes—

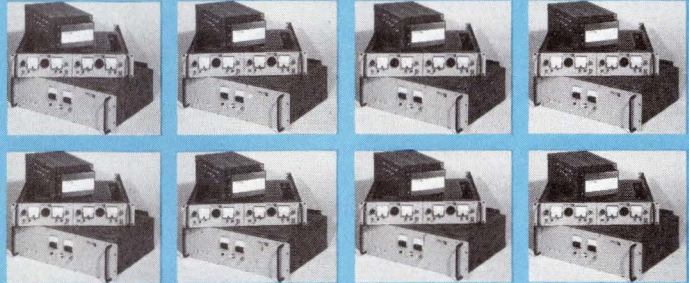

## North delivers power reliability!

MODEL	11000	12000	13000	14000	15000	16000	17000	18000
VDC	AMPERES							
5.0	3.9	5.3	11.3	13.0	20.0	32.5	49.0	82.0
12.0	2.8	4.2	8.0	10.5	15.0	23.0	36.0	58.0
15.0	2.4	3.7	7.5	9.5	14.0	20.5	27.0	47.0
18.0	2.1	3.3	6.0	8.0	13.0	18.0	26.0	40.0
24.0	1.5	2.8	4.2	7.0	11.0	15.0	21.0	33.0
28.0	1.4	2.4	4.0	6.3	9.0	14.0	20.0	29.0
36.0	1.2	2.2	3.1	5.6	8.0	11.0	14.0	23.0
48.0	95	1.8	2.6	4.2	6.0	8.0	10.0	18.0

Listed here are the more popular models—  
many other voltages are available.

MODEL	10000
VDC	AMPS
0-7.5	2.10
0-16	1.25
0-25	0.85
0-33	0.68

DUAL OUTPUT SUPPLIES	
MODEL	N03052
VDC	AMPS
+15-12	400MA
MODEL	N60052
VDC	AMPS
+15-12	1.0A

Many O.E.M.'s agree that it just doesn't make sense to risk the reputation of a major piece of equipment over a minor component—especially, when the cost difference is so little.

If you're one of them, we'd like to quote your next power supply order. Whether you need one unit—or one hundred, North has the product selection and the production capacity to deliver more standard power reliability for your dollar.

To back it up, we offer the industry's finest technical specialists and over 40 years experience as the leader in custom power supplies.

Send for a catalog today, or call 419/468-8874.

**NORTH**  
ELECTRIC COMPANY



North Electric Company / Galion, Ohio 44833 / A United Telecom Co.

SP-16

Circle 156 on reader service card

# A new autoranging multi-function counter using LSI/MOS from the "Counter House"

## \$349

Who else but FLUKE could bring you this new multi-counter at such an attractive price? A multi-counter that measures frequency or period—and totalizes too. Model 1900A from Fluke "The Counter House" has a dynamic range of 5 Hz to 80 MHz . . . advanced LSI/MOS circuitry . . . autoranging . . . and autoreset on all functions, gate times, filter and attenuator. And of course the 1900A incorporates all the traditional Fluke quality, and comes with a full 12-month guarantee plus a 15-day money-back policy.

Phone or write to-day for complete details on the \$349 multi-counter from Fluke—"The Counter House".

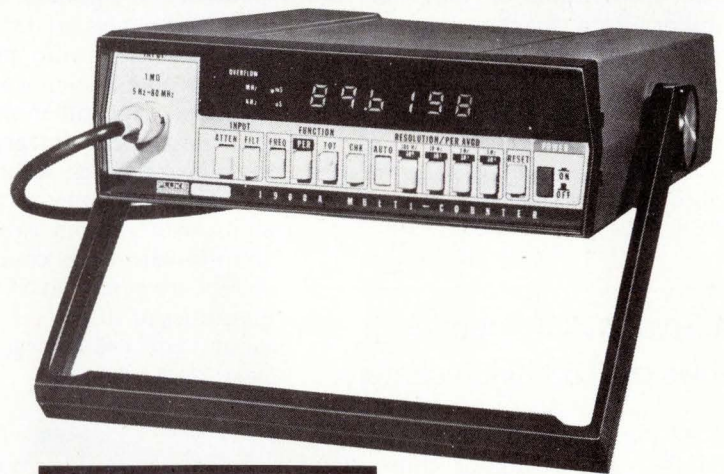

**FLUKE**  
COUNTER DIVISION

John Fluke Mfg. Co. Ltd., Counter Division,  
P.O. Box 1094, Station "D" Buffalo, N.Y., 14210.  
Phone (716) 842-0311. TWX 610-492-3214

THE ORIGINAL  
 "WEDGE-TYPE" SCREWDRIVER  
 does all the job!

**HOLDS, STARTS,  
 DRIVES & SETS**  
 the screw to normal tightness

**QUICK-  
 WEDGE**  
 SCREW-HOLDING SCREWDRIVER

FINEST  
 QUALITY  
 WORKMANSHIP  
 & MATERIALS

**17 SIZES**

GET A SET TODAY!

Write for Catalog.

**KEDMAN COMPANY**

P. O. Box 267  
 Salt Lake City, Utah 84110

(801) 363-4413 © 1974 by Kedman Company.

Circle 178 on reader service card

## Competitive Labor Market

Does your factory use a great deal  
 of hand work?

Is your labor getting expensive?

Would you be interested in having  
 your articles made at a competi-  
 tive price?

**Haitian labor ranks among  
 the highest quality, lowest  
 cost in the world. We Pro-  
 vide:**

- All of the necessary details and studies to bring your plant here. . .
- All of the managerial and operational skills to keep you here — profitably!

Write to:

**Haitian American  
 Industrial Co.**

P. O. Box 904  
 Port - Au - Prince, Haiti  
 Cable Address: HAICO  
 Phone: 2-0424 — 2-0442

Circle 179 on reader service card

## New products/materials

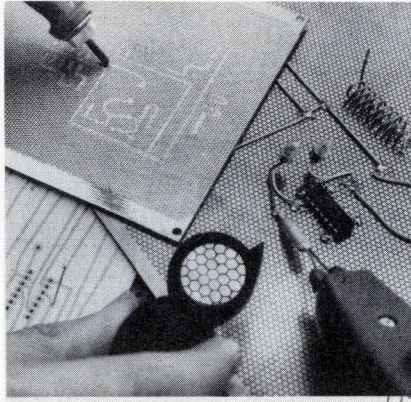

A nonconducting metal sheet, for pc applications, allows circuits to be drawn or scribed directly onto the metal sheet. Pressure is all that is necessary, and circuits may be erased for new designs. For mass production, a letter press may be used. A more economical version for direct-wiring purposes, rather than printed circuitry, is available. Spot-soldering may be done at random without spoiling adjacent areas of the board, since the sheet is non-conducting.

Metal Circuit Systems Corp., P.O. Drawer 2226, Houston, Texas 77001 [476]

An inexpensive package lid for semi-conductors, made from an alloy of readily available metals and called Foballoy, takes the place of gold/tin preforms. Generally, clad lids are made of Kovar or Alloy 42, but the new lid is clad with a thin layer of Foballoy, which has a melting point of 235°C and therefore seals at a lower temperature than gold/tin. At current gold prices, Foballoy can provide a saving of \$40 per thousand lids over gold/tin, the company says.

Plessey Inc., Materials Division, Melville, N.Y. [478]

A family of optical coatings, offered in thicknesses of 100 to 3,000 Å, is available on a broad line of fiber-optic face-plates. The coatings, which have applications in a variety of electro-optical systems, are available in many materials, including nickel, tin, chrome, inconel, gold, quartz, and magnesium fluoride.

Galileo Electro-Optics Corp., Galileo Park, Sturbridge, Mass. 01518 [480]

**WHO  
 CAN  
 MAKE A  
 PHOTOMASK  
 FROM  
 SCRATCH?**

Corning can! We start from scratch—we make two glass compositions for substrates and DUR-COR™ photoplates. Through an integrated process the sheet glass is finished and cleaned to flatnesses down to 50 microinches per inch in either .060" or .090" thicknesses and that includes the new 4" squares. We can offer you the products, and we can deliver because we've increased our capacity 50%. Our DUR-COR photoplates are made with an incredibly durable iron oxide layer coated on either of these substrate compositions. And, we can also give you advice. Because of our integrated process, we are technically competent in all aspects of mask production. For more information on our products, or processing help, write or call:

**CORNING  
 MAKES  
 IT!**

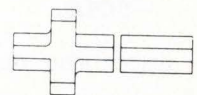

Electronic Materials Department

**CORNING**  
 CORNING GLASS WORKS

Corning, New York 14830  
 (607) 974-8866

Circle 157 on reader service card 157

## EMPLOYMENT OPPORTUNITIES

Send New Ads to:  
Electronics  
Class. Adv. Dept.  
P.O. Box 900, N.Y., N.Y. 10020

# SPANISH FIRM NEAR MADRID

is looking for design and development engineers with a minimum of three years of experience in the field of P.C.M. equipment to be used by the telephone industry. Areas of interest are encoders and decoders, P.C.M. multiplexers and R.F. equipment to transmit P.C.M. data. Salary open.

Send resúme to:

**NORTRON**  
Fernando el Católico, 63  
Madrid 15  
SPAIN

**SOLD!**

"Please discontinue our ad in 'Searchlight' as we have sold the equipment through this advertising." Can "Searchlight" Serve You?

CLASSIFIED ADVERTISING  
**SEARCHLIGHT SECTION**  
BUSINESS OPPORTUNITIES  
USED OR SURPLUS EQUIPMENT

RADAR SYSTEMS GROUND AND AIRBORNE. AUTOMATIC TRACKING ANTENNA SYSTEMS. NIKE AJAX. NIKE HERCULES. M-33. MSO-1A. MPS-19. MPS-9. SCR 584. TPS-1D. TPS-28. FAA-ASR-2. AIRBORNE SYSTEMS. APN-84. APN-102. APS-20. APS-27. APS-45. DPN-19. DIGITAL COMPUTERS. IBM 650. IBM 704.

LARGEST INVENTORY OF RADAR AND MICROWAVE EQUIPMENT IN THE WORLD.

**RADIO RESEARCH INSTRUMENT CO.**  
3 QUINCY ST., NORWALK, CONN. 06850 (203) 853-2600

CIRCLE 952 ON READER SERVICE CARD

**SAME DAY SHIPMENT**  
Minis & Peripherals  
**PRINTERS**  
"BRAND NEW"

---

**DATA PRODUCTS**

---

**2440— 700 LPM**

---

**2470—1250 LPM**

---

**MDS 4320— 300 LPM**

---

ALSO  
CENTRONICS, POTTER, CDC  
A. B. DICK, IBM, HIS, UNIVAC

Send for Free Report "Maintenance of Computers"  
**AMERICAN USED COMPUTER CORP.**  
P.O. Box 68, Kenmore Sta., Boston, MA 02215  
member COMPUTER DEALERS ASSOCIATION

CIRCLE 957 ON READER SERVICE CARD

**free catalog**  
**POTTING APPLICATORS**  
MANUAL OR AIR OPERATED  
2½cc 6cc 12cc 30cc  
FOR POTTING, ENCAPSULATING ETC.

**PHILIP FISHMAN CO., INC.**  
7 CAMERON ST. WELLESLEY, MASS. 02181

CIRCLE 958 ON READER SERVICE CARD

**FREE CATALOG**  
**HARD-TO-FIND PRECISION TOOLS**  
Lists more than 2000 items—pliers, tweezers, wire strippers, vacuum systems, relay tools, optical equipment, tool kits and cases. Also includes ten pages of useful "Tool Tips" to aid in tool selection.

**JENSEN TOOLS**  
4117 N. 44th Street, Phoenix, Ariz. 85018

CIRCLE 954 ON READER SERVICE CARD

**FREE ALARM CATALOG**  
Full line of professional burglar and fire alarm systems and supplies. 96 pages, 450 items. Off the shelf delivery, quantity prices.

**mountain west alarm**  
4215 n. 16th st., phoenix, az. 85016

CIRCLE 956 ON READER SERVICE CARD

## New literature

**Dc-to-ac inverters.** ATR Electronics Inc., 300 E. Fourth St., St. Paul, Minn. 55101, has issued a catalog covering dc-to-ac inverters in solid-state and vibrator models, as well as battery eliminators, Shav-paks, vibrators, and standby-power systems for emergency lighting and power. Circle 421 on reader service card.

**Load cells.** Sensotec Inc., 1400 Holly Ave., Columbus, Ohio 43212, is offering an eight-page catalog featuring eight series of strain-gage load cells. Technical descriptions and applications are provided. [422]

**Pc-board cleaning.** A brochure on Scotch Brite products for cleaning printed-circuit boards is available from the 3M Co., Box 33600, St. Paul, Minn. 55133. Information on cleaning brushes and deburring wheels for pc boards is given, along with information on finishing flap brushes for pc-board finger-cleaning. [423]

**Product catalog.** A short-form catalog summarizes the specifications, applications, and physical characteristics of products manufactured by Analogic Corp., Audubon Rd., Wakefield, Mass. 01880. These include analog-to-digital and digital-to-analog converters, digital panel instruments, and industrial digitizing equipment. Additions to the lines are also discussed, and these include high-speed and low-price converters. [424]

**Optoelectronic components.** Monsanto Commercial Products Co., 3400 Hillview Ave., Palo Alto, Calif. 94304. A short-form catalog describes the company's line of LED displays, discrete indicators, optoisolators, and solid-state relays. [425]

**Programmable controllers.** FX Systems Corp., Mt. Marion Rd., Saugerties, N.Y. 12477, has issued a four-page brochure that describes the MC-16 programmable controller, which is especially designed for small machines or short processes requiring only a limited number of control inputs and outputs. [426]



Solving a major problem in  
hybrid circuit chip assembly...

# The <sup>DIXON</sup> Robot.®

**It solder-dips  
and places  
800 chips  
per hour!**

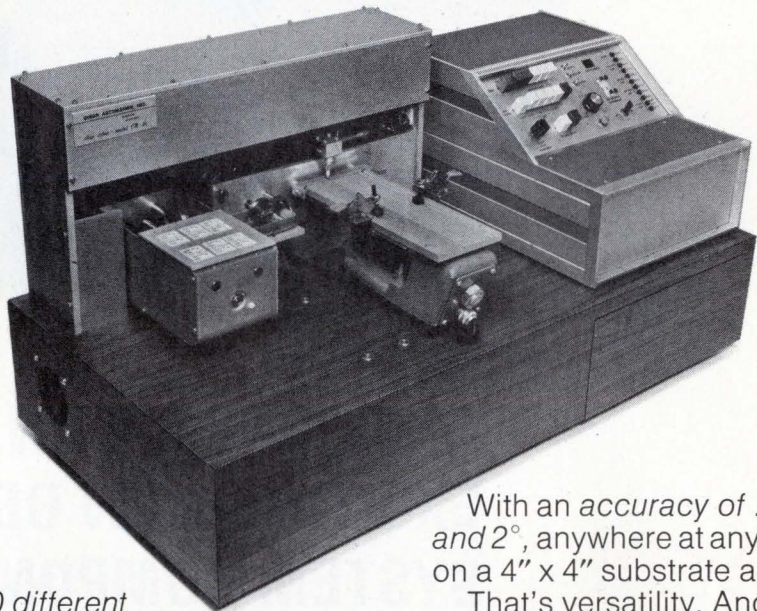

Our Model CR-10 Chip Assembly Robot... a precision machine that automatically places and solder-dips chip capacitors, IC's and resistors onto one or more substrates.

It can handle *mixed sizes* of square or rectangular chips from .080" to .500" in the same set-up. Up to

*30 different chips per substrate.*

At a rate of 800 an hour... placing a metered amount of solder paste or epoxy on both ends of the chip. Or 1400 an hour if solder-dipping isn't required.

With an *accuracy of .002" and 2°*, anywhere at any angle, on a 4" x 4" substrate area.

That's versatility. And flexibility.

*Programming* is a simple "walk-thru"... up to 60 chips placed per program. Programs can be permanently stored on a cassette for retrieval and later use.

The Robot does the work of many assemblers and with consistent quality. Without fatigue and coffee-breaks.

That's economy. And efficiency.

For more details and/or a demonstration of the Chip Assembly Robot, call Ken Dixon at (213) 325-0410. Or write him at the address below.

## How the simple, versatile Robot works.

1 Vacuum chuck picks up chip capacitor from vibratory feeder.

2 Chip capacitor is solder-dipped on both ends. Solder amount can be precisely metered.

3 Placement is accurate to .002" & 2° on 4" x 4" area. At the rate of 800 or 1400 an hour.

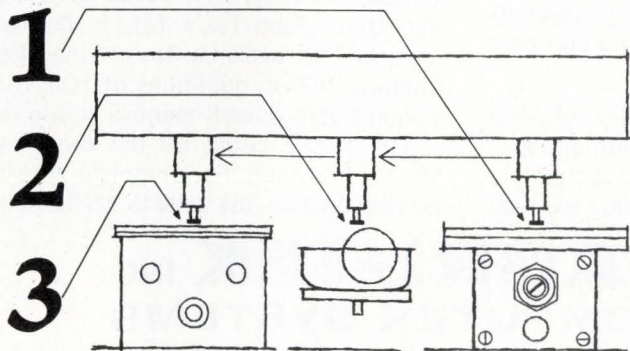

## Dixon Automation, Inc.

A Subsidiary of Excellon Industries  
23915 Garnier Street  
Torrance, California 90509  
Phone: (213) 325-0410  
Telex: 67-4562 Cable: Excellon Torrance

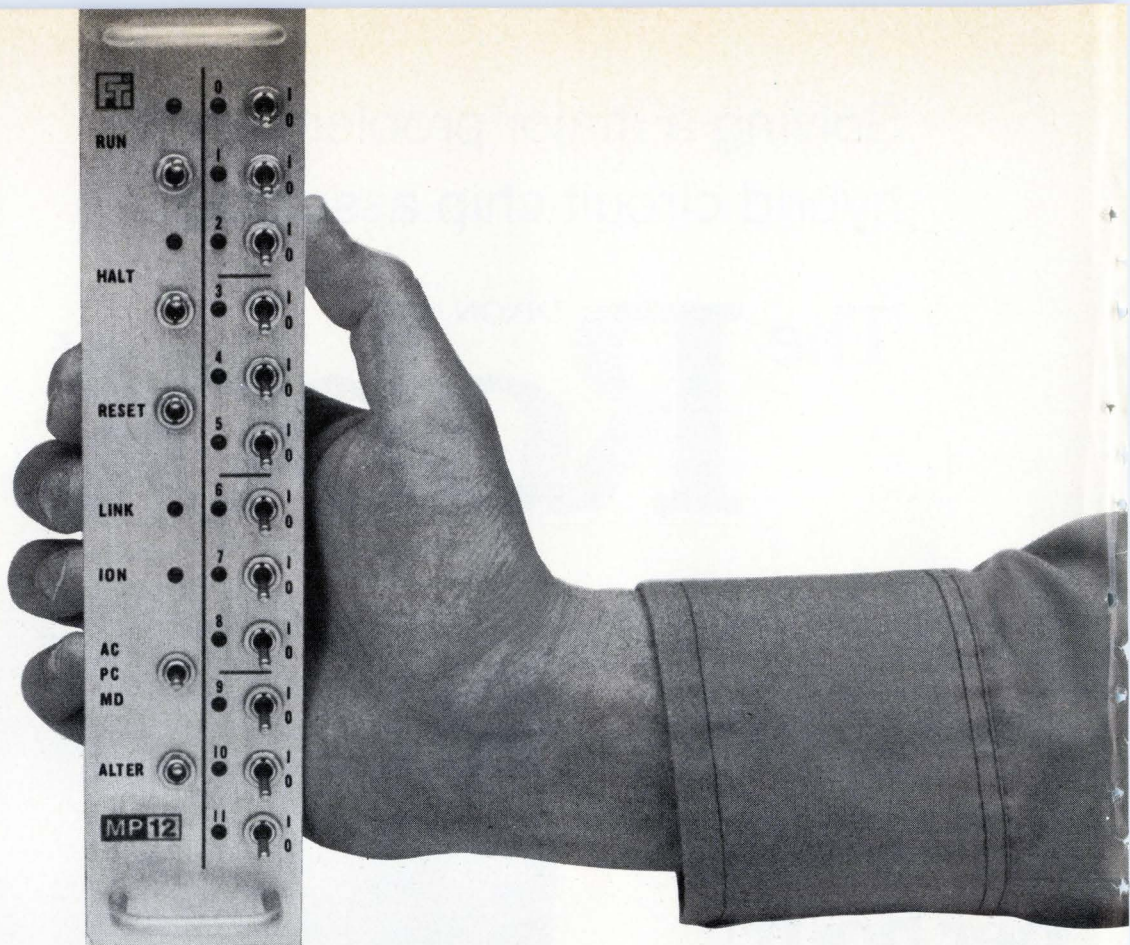

## ANNOUNCING AN EXCITING NEW OEM SYSTEM COMPONENT.

It's the MP12... Fabri-Tek's new microprocessor that performs like a minicomputer. The MP12 helps you get your application system up and running faster, easier and with more capability than ever before. No MOS microprocessor can match its performance in data acquisition, automated assembly, point-of-sale and other dedicated digital control applications.

**Completely Operational**—The MP12 CPU is a completely self-contained operational unit. All the digital electronics you need are built in along with 4K of reliable core memory, an operating console, power fail-auto restart and more. Everything comes in a compact 2.0" x 9.5" x 15.0" package.

**Supporting Software**—You also get all the software you need to develop and check out your own application programs. MP12 supplied programs are completely documented and include assembler, debug, loaders,

360/370 cross-assembler, source edit utility, processor diagnostic and utility sub-routines. Instruction set is PDP-8 compatible.

**Easy Interfacing**—You never had a processor so easy to interface. In fact, it's plug-in easy. The MP12 comes with all the timing and control necessary to interface with almost any peripheral. And it has enough power to drive up to 64 peripherals... printers, teletypes, CRT's, card equipment, on and off-line storage devices.

**Quick Delivery, Low Price**—There's a lot more you'll like about Fabri-Tek's MP12. Delivery and price, for instance. It's available for off-the-shelf delivery for as little as \$990 in quantities of 100. It can actually help you cut your overall manufacturing costs.

The MP12 could be the most useful component you've ever seen. For complete specifications and option information just write to MP12 at the address below.

**FABRI-TEK** INC.  
COMPUTER SYSTEMS

5901 South County Road 18 • Minneapolis, MN 55436 (612) 935-8811

**SALES  
OFFICES IN:**

Boston  
(617) 969-5077  
Chicago  
(312) 437-4116

Dallas  
(214) 661-3155  
Denver  
(303) 753-0631

Detroit  
(313) 487-5940  
Long Beach  
(213) 420-2493

New Jersey  
(201) 964-4770  
Orlando  
(305) 857-1050

Phoenix  
(602) 266-4448  
Sunnyvale  
(408) 739-4780

Hong Kong  
K-331383  
Munich  
089-755-8298

Tokyo  
(03) 432-6901  
United Kingdom  
Maidenhead 37321-4

# Electronics advertisers

July 25, 1974

‡ <b>ACDC Electronics, Inc.</b> Rose Associates Advertising & Public Relations	61	<b>GCA/Sunnyvale</b> Moser & Associates	146	* <b>RCA Ltd.</b> Marsteller Ltd.	2E-3E
<b>Advanced Micro Devices</b> Keye Donna Pearlstein	67	■ <b>General Electric Co., Miniature Lamp Div.</b> Carr Liggett Advertising, Inc.	82	<b>RCA—Solid State Division</b> Marsteller, Inc.	71, 73
<b>Advanced Micro Devices</b> Keye Donna Pearlstein	10-11	■ <b>General Instrument Corporation, Semiconductor Comp. Div.</b> Norman Allen Associates, Inc.	51	‡ <b>Rental Electronics, Inc.</b> Humphrey Browning MacDougall, Inc.	58
* <b>AEROCOM</b> Jacster Enterprises, Inc.	12E	<b>General Radio Company</b> Grad Associates	94-95	<b>Schauer Manufacturing Corp.</b> Nolan, Keelor & Stites	44
<b>American Microsystems Inc.</b> Wilton Coombs & Colnett Inc. Advertising	148-149	<b>Haitian American Industrial Company</b> Zone Industrielle	157	‡ <b>SHELDAHL INC.</b> Chuck Ruhr Assoc. Advertising, Inc.	84
■ <b>AMP Incorporated</b> Aitkin-Kynett Co., Inc.	17-20	‡ <b>Harris Semiconductor</b> Tucker Wayne & Co.	114-115	* <b>Siemens A.G. Munich</b> Linder Presse Union GmbH	56
<b>Analogic Corporation</b> Sommer Agency, Inc.	75	<b>Hermes Electronics, Ltd.</b> Public & Industrial Relations Limited	32	<b>Siemens Corporation</b> Stiefel/Raymond Advertising, Inc.	121
* <b>Anritsu Electric Co., Ltd.</b> Diamond Agency Co., Ltd.	4E	■ <b>Hewlett Packard</b> Dancer Fitzgerald Sample, Inc.	128-129	<b>Signetics Corp., Sub. of Corning Glass Works</b> Hall Butter Blatherwick, Inc.	26-27
‡ <b>Ansley Electronics Corp.</b> S. Michelson Advertising	65	■ <b>Hewlett-Packard</b> Richardson, Seigle, Rolfs & McCoy, Inc.	2	‡ <b>Sorensen Company, A Unit of Raytheon Company</b> Provandie Eastwood & Lombardi, Inc.	46
‡ <b>Bourns, Inc.</b> Marlborough Assoc., Inc.	67	■ <b>Hewlett-Packard</b> Phillips Ramsey Advertising & Public Relations	1	■ <b>Sorensen Production Equipment Dept., Raytheon Company</b> Provandie Eastwood & Lombardi, Inc.	6
<b>Brand-Rex</b> Creamer, Trowbridge, Case & Basford, Inc.	55	■ <b>Hewlett-Packard</b> Bozell & Jacobs/Pacific	132	■ <b>Spectral Electronics Corp.</b> J M R Inc.	138
■ <b>Centralab Electronics Div., Globe-Union Inc.</b> Action Communicators	62-63	■ <b>Hewlett-Packard</b> Tallant/Yates Advertising, Inc.	45	<b>Sprague Electric Company</b> Harry P. Bridge Company	8
■ <b>Cinch Connectors, Operation of TRW Electronic Components</b> Stral Advertising Company, Inc.	119	* <b>Institute of Electrical Engineers</b>	65	<b>Syston Donner Concord Instruments</b> Fred Schott & Associates	9
■ <b>Corning Glass Works, Electronic Materials Dept.</b> Pierce Brown Associates, Inc.	55, 157	<b>Instrumentation Engineering Inc.</b> Fletcher-Walker-Gessell, Inc.	43	* <b>TEAC Corp.</b> Dentsu Advertising Ltd.	144
‡ <b>Corning Glass Works, Electronics Products Division</b> Warner, Bicking & Fenwick, Inc.	144-145	<b>Intel Corp.</b> Regis McKenna, Inc.	22-23	■ <b>T-Bar, Incorporated</b> The Robert A. Paul Advertising Agency, Inc.	70
‡ <b>Cutler-Hammer, Inc.</b> Campbell-Mithun, Inc.	143	<b>IPT Corporation</b> Rock Advertising Design	16	■ <b>Tektronix, Inc.</b> McCann Erickson, Inc.	37, 130
■ <b>Dale Electronics, Inc., A Sub. of the Lionel Corporation</b> Swanson, Sinkey, Ellis, Inc. Advertising	4th Cover	* <b>Isola</b> Werbstudio Equipe	46	<b>Teledyne Semiconductor</b> Regis McKenna, Inc.	7
<b>Data General Corporation</b> Scall, McCabe, Sloves, Inc.	76-77	<b>Kedman Company</b> Gardiner Advertising Agency	157	<b>Telonic Altair</b> Jansen Associates, Inc. Marketing Services	99
■ <b>Data Precision</b> Allied Advertising Agency, Inc.	154	<b>Kelthley Instruments, Inc.</b> Chagrin Valley Marketing Associates	135	<b>Teradyne, Inc.</b> Quinn & Johnson, Inc.	68
■ <b>Datel Systems, Inc.</b> John Donlan Advertising	3rd Cover	<b>Krohn-Hite Corp.</b> Impact Advertising Inc.	5	<b>Texscan Corporation</b> Bruce Bottum Associates	66
<b>Delta Air Lines</b> Burke Dowling Adams, Inc.	139	<b>Litronix, Inc.</b> Bonfield Associates	12-13	‡ <b>Thomas &amp; Betts Company</b> McCarthy, Scelba, DeBiasi Advertising Agency, Inc.	83
■ <b>Dialight Corporation</b> Michel-Cather, Inc.	2nd Cover	<b>Lockheed Electronics Co.</b> McCann-Erickson, Inc.	162	<b>Thomas &amp; Skinner, Inc.</b> Bell-Catterlin & Hedgecock Advertising, Inc.	150
‡ <b>Digital Equipment Corp.—Components Group</b> Schneider Parker, Inc.	1D-8D	<b>Macrodota Company</b> JMR Advertising	41	■ <b>TRW/Capacitors</b> Gray & Rogers, Inc.	164
<b>Diva, Inc.</b> Halloff & Caine	39	■ * <b>Marconi Instruments Ltd.</b> Russell Powell Advertising Ltd.	1E	■ <b>TRW, Electronic Components Division</b> The Bowes Company	48-49
<b>Dixon Automation (Subsidiary of Excellon Industries)</b> Graham & Sparkman Advertising etcetera	159	■ <b>Micro Switch Division of Honeywell</b> N.W. Ayer & Son, Inc.	25	■ <b>TRW Semiconductors</b> The Bowes Company	80
<b>Dow Corning Industrial</b> Ketchum, MacLeod & Grove, Inc.	136-137	<b>Mirco Systems, Inc.</b> McAward Associates	141	■ <b>Unitrode Corporation</b> Culver Advertising, Inc.	31
<b>EDMAC Associates</b> J.L. Newman & Associates, Inc.	79	<b>Monsanto Commercial Products Co., Electronic Special Products</b> Advertising Promotion Services	52	■ <b>Woven Electronics</b> Prentiss Court Advertising	24
<b>EECO</b> The Greer Agency	163	<b>Mostek Corporation</b> David W. Evans, Inc./Texas	15	* <b>La ZincoLere S.p.A.</b> Studio Dr. Giuliano Blei	84
<b>Electronic Arrays, Inc.</b> Bonfield Associates	47	<b>Natel Engineering Co., Inc.</b>	162		
■ <b>Electronic Navigation Industries</b> Hart/Conway Advertising—Public Relations	14	<b>National Electronics</b> Lea Advertising	74		
■ <b>EL Instruments, Inc.</b> Langeler-Stevens, Incorporated	134	<b>National Semiconductor Corp.</b> Chiat/Day, Inc. Advertising	151		
<b>Emr-Telemetry</b> Carol Marketing Associates	152	■ <b>Nelson Ross Electronics, Div. Polarad Electronics</b> McCarthy-Scelba-DeBiasi Advertising Agency, Inc.	28		
■ <b>Erie Technological Products, Co., Inc.</b> Altman Hall Associates Advertising	21	<b>North Atlantic Industries, Inc.</b> NOAT Advertising Company	150		
‡ <b>Excellon Industries</b> Graham & Sparkman Advertising etcetera	56	<b>North Electric Co.—Electronetics Div.</b> Marc Associates	156		
<b>Fabri-Tek Inc.</b> Midland Associates, Inc. Marketing and Advertising Services	160	* <b>Phillips Elcoma</b> Brockies Communications	61		
■ <b>Fluke Manufacturing Co., John</b> Bonfield Associates	105	* <b>Phillips N.V. Pit/T &amp; M Division</b> Brockies Communications Systems SA	58		
■ <b>John Fluke Mfg. Co., Ltd.</b> Lennox Marketing Limited	156	<b>Pro-Log Corporation</b> Kassler Noble Advertising	142		

## Classified & Employment Advertising

F. J. Eberle, Manager 212-997-2557

EQUIPMENT (Used or Surplus New) For Sale	
American Used Computer	158
Philip Fishman Inc.	158
Jensen Tool	158
Nortron	158
Mountain West Alarm	158
Radio Research Instrument Inc.	158

■ For more information on complete product line see advertisement in the latest Electronics Buyer's Guide  
\* Advertisers in Electronics International  
‡ Advertisers in Electronics domestic edition

Years ago we made a decision to let the other guys knock out all of the simple printed circuit boards they could make. We wanted the tough jobs.

Multilayer and two-sided PCs. Complex drilling, printing and plating.

And we wanted to do them better than anybody in the business.

Since then, we've been doing

more of the hard work than anyone. And delivering it on time. With precision and economy.

We built a reputation on hard work. We're not about to take things easy now.

If you've got a tough job, call us at (213) 722-6810 collect. Or write Data Products Division, 6201 East Randolph Street, Los Angeles, California 90040.

**We built a reputation on hard work.**

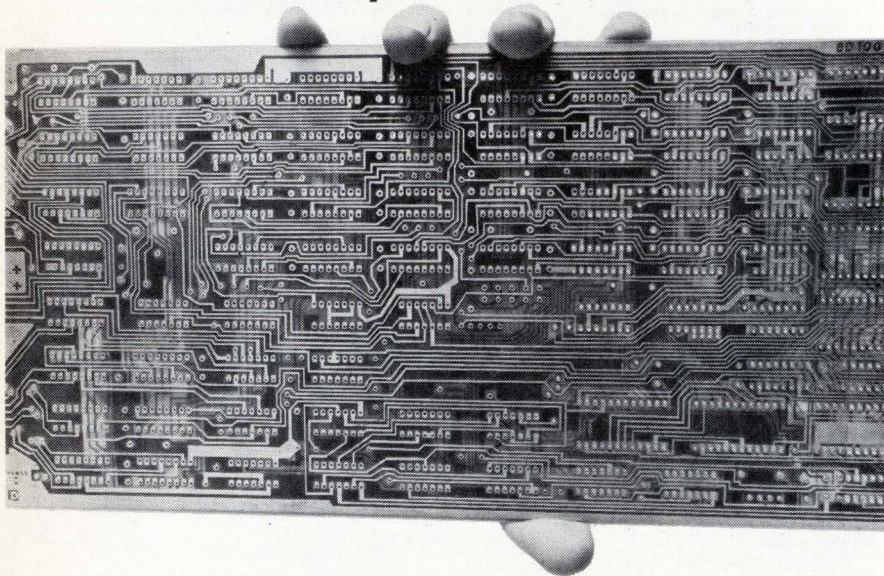

**Lockheed Electronics—First In Complex PCs**

15 YEARS OF LEADERSHIP IN ELECTRONICS. 1959-1974.

Circle 162 on reader service card

## A COMPLETE SYNCHRO CONVERSION PRODUCT LINE

- SYNCHRO TO DIGITAL
- DIGITAL TO SYNCHRO
- TWO SPEED CONVERSION
- ANGLE POSITION INDICATORS
- MODULAR PACKAGING
- SYSTEMS PACKAGING
- 10 TO 15 BIT ACCURACIES — SINGLE SPEED
- SPECIAL INTERFACE CIRCUITS

**NATEL HAS DELIVERED ALL THESE . . . AND . . . MORE!**

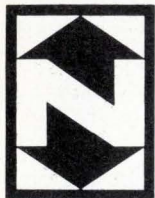

**FOR ECONOMY, RELIABILITY AND DELIVERY IN YOUR SYNCHRO CONVERSION SYSTEM—CALL US COLLECT FOR IMMEDIATE ACTION**

**NATEL ENGINEERING COMPANY**

8954 MASON AVENUE, CANOGA PARK, CALIFORNIA 91306  
(213) 882-9620 / TWX (910) 494-1959

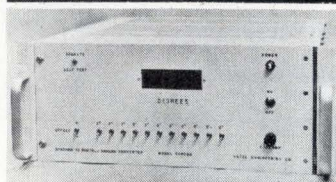
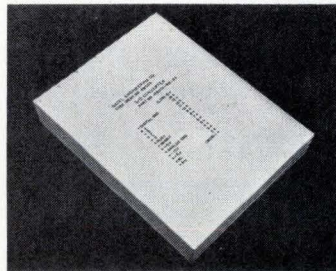

### Advertising Sales Staff

**Pierre J. Braudé** New York [212] 997-3468  
London 01-493-1451  
Director of Marketing

**Atlanta, Ga. 30309:** Joseph Lane  
100 Colony Square, 1175 Peachtree St., N.E.  
[404] 892-2868

**Boston, Mass. 02116:** James R. Pierce  
607 Boylston St. [617] 262-1160

**Chicago, Ill. 60611:**  
645 North Michigan Avenue  
Robert W. Bartlett (312) 751-3739  
Paul W. Reiss (312) 751-3738

**Cleveland, Ohio 44113:** William J. Boyle  
[716] 586-5040

**Dallas, Texas 75201:** Charles G. Hubbard  
2001 Bryant Tower, Suite 1070  
[214] 742-1747

**Denver, Colo. 80202:** Harry B. Doyle, Jr.  
Tower Bldg., 1700 Broadway  
[303] 266-3863

**Detroit, Michigan 48202:** Robert W. Bartlett  
1400 Fisher Bldg.  
[313] 873-7410

**Houston, Texas 77002:** Charles G. Hubbard  
2270 Humble Bldg. [713] CA 4-8381

**Los Angeles, Calif. 90010:** Robert J. Rielly  
Bradley K. Jones, 3200 Wilshire Blvd., South Tower  
[213] 487-1160

**New York, N.Y. 10020**  
1221 Avenue of the Americas  
Warren H. Gardner [212] 997-3617  
Michael J. Stoller [212] 997-3616

**Philadelphia, Pa. 19102:** Warren H. Gardner  
Three Parkway,  
[212] 997-3617

**Pittsburgh, Pa. 15222:** Warren H. Gardner  
4 Gateway Center, [212] 997-3617

**Rochester, N.Y. 14534:** William J. Boyle  
9 Greylock Ridge, Pittsford, N.Y.  
[716] 586-5040

**San Francisco, Calif. 94111:** Don Farris  
Robert J. Rielly, 425 Battery Street,  
[415] 362-4600

**Paris:** Alain Offergeld  
17 Rue-Georges Bizet, 75 Paris 16, France  
Tel: 720-73-01

**Geneva:** Alain Offergeld  
1 rue du Temple, Geneva, Switzerland  
Tel: 32-35-63

**United Kingdom & Scandinavia:** Keith Mantle  
Tel: 01-493-1451, 34 Dover Street, London W1

**Milan:** Robert Saidel  
1 via Baracchini, Italy Phone 87-90-656

**Brussels:** Alain Offergeld  
23 Chaussee de Wavre  
Brussels 1040, Belgium  
Tel: 13-73-95

**Frankfurt/Main:** Fritz Krusebecker  
Liebigstrasse 27c, Germany  
Phone 72 01 81

**Tokyo:** Tatsumi Katagiri, McGraw-Hill  
Publications Overseas Corporation,  
Kasumigaseki Building 2-5, 3-chome,  
Kasumigaseki, Chiyoda-Ku, Tokyo, Japan  
[581] 9811

**Osaka:** Ryji Kobayashi, McGraw-Hill  
Publications Overseas Corporation, Kondo  
Bldg., 163, Umegae-cho Kita-ku, Japan [362] 8771

**Australasia:** Warren E. Ball, IPO Box 5106,  
Tokyo, Japan

### Business Department

**Stephen R. Weiss, Manager**  
[212] 997-2044

**Thomas M. Egan,**  
Production Manager [212] 997-3140

**Carol Gallagher**  
Assistant Production Manager [212] 997-2045

**Dorothy Carter,** Contracts and Billings  
[212] 997-2908

**Frances Vallone,** Reader Service Manager  
[212] 997-6057

### Electronics Buyers' Guide

**George F. Werner,** Associate Publisher  
[212] 997-3139

**Regina Hera,** Directory Manager  
[212] 997-2544

Card-Pak is our new card filing system that comes to you in four parts that takes (in most cases) just eight screws to put together. And we supply the screws.

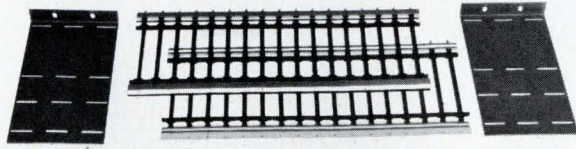

The four parts are dimensioned to your order exactly, for card height, depth, spacing, and total number. Right from stock.

If you want to get fancy, we can give you double-tiered Card-Paks, single-double combos, card identification strips and markers, connector supports, and card handles and ejectors. All from stock.

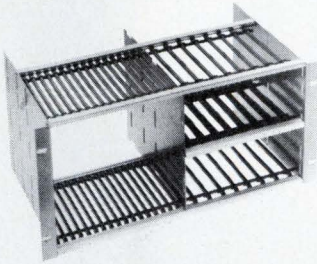

Our card guides are made of Noryl, not nylon, for dimensional stability, and our metal structures are satin-finished aluminum for durability, rigidity, light weight, and beauty.

Card-Pak is a choice, not an echo. And we'll gladly send you our catalog. Or telephone (toll free) any G. S. Marshall Co. office nationwide.

Card-Pak. From EECO.

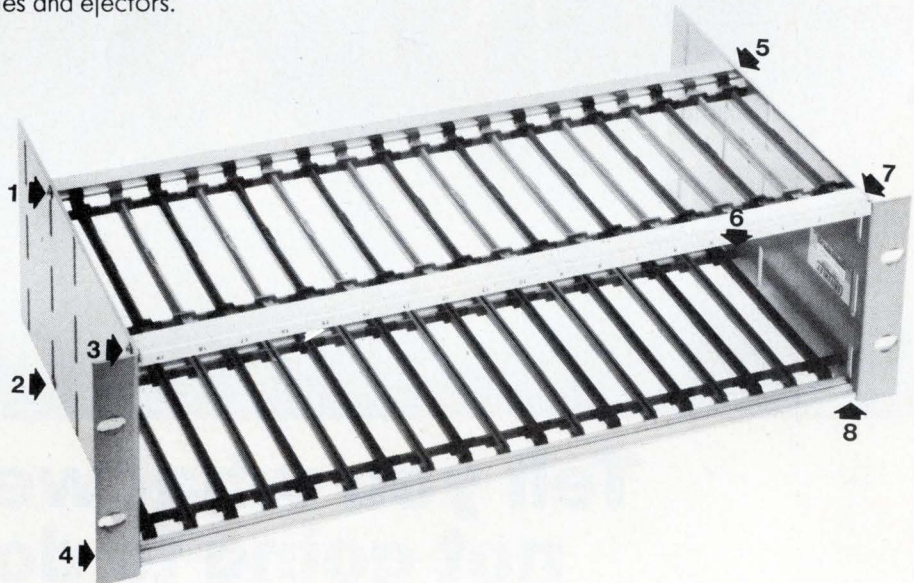

# Eight screws and you've got it all together.

CARD-PAK from **EECO**

1441 East Chestnut Avenue  
Santa Ana, California 92701  
Phone 714/835-6000  
Also from G. S. Marshall Company nationwide.

FREE CARD-PAK CATALOG  
We'll send it to you if you'll send us the information below.

Name \_\_\_\_\_  
Position \_\_\_\_\_  
Company \_\_\_\_\_  
Address \_\_\_\_\_

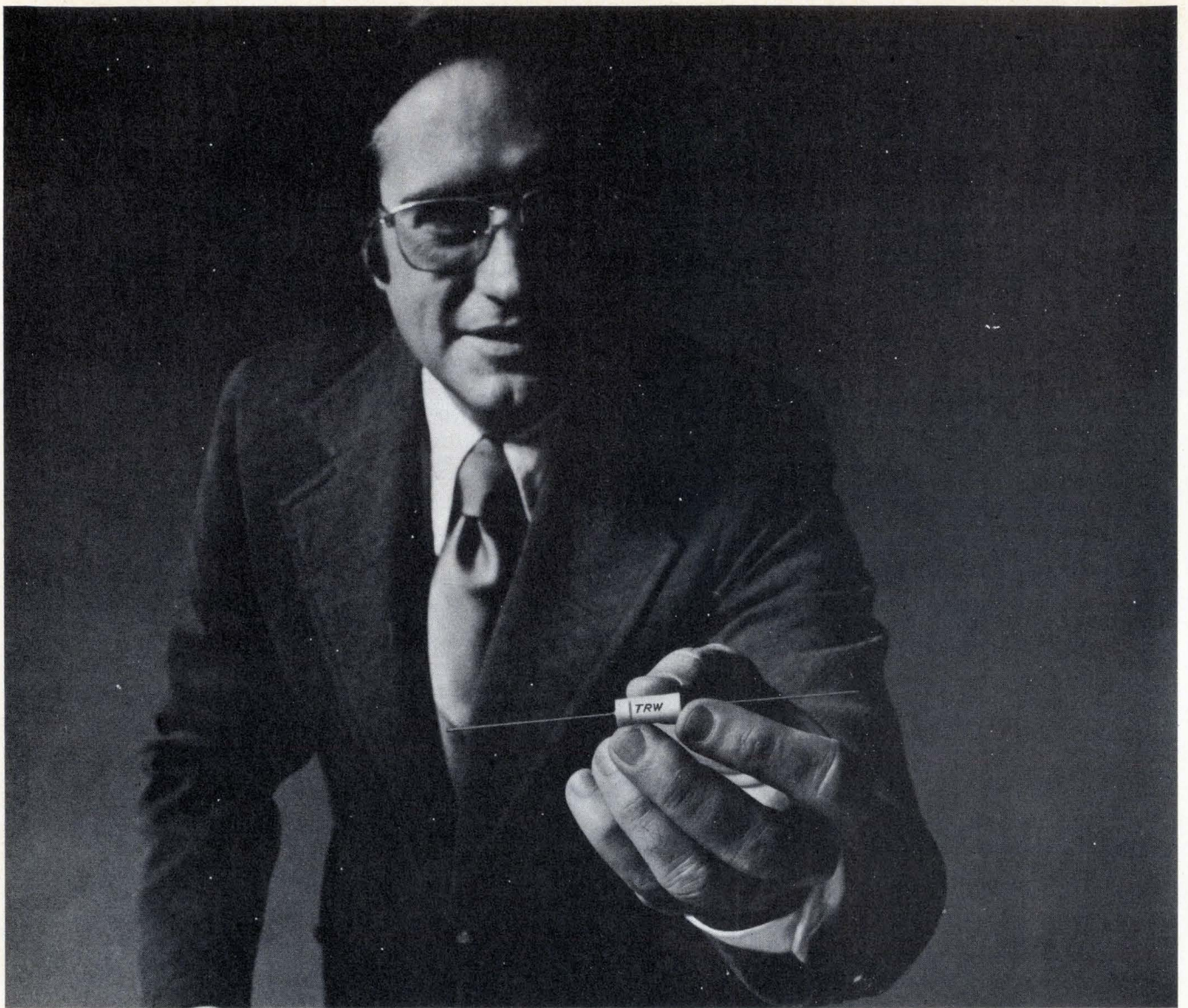

## Tell you what we're not going to do.

Sure, we know *how* to make cheaper capacitors. But not with "TRW" stamped on them. No way. Because we figure you can't make quality capacitors and me-too capacitors under the same roof. Not without one operation eventually goofing the other one up.

So if it's marked "TRW," you *know* you're getting the top technology in wound—both metallized and film foil—and solid tantalum capacitors.

You're also getting a pipeline to some of the best minds in capacitor R&D, design, QC, and application engineering—ready to help you with *any* capacitance problem. From TV to aerospace.



All this will cost you a little more per capacitor. In return, it can help *your* product earn a reputation for "no headaches, no surprises." What better edge in today's marketplace?

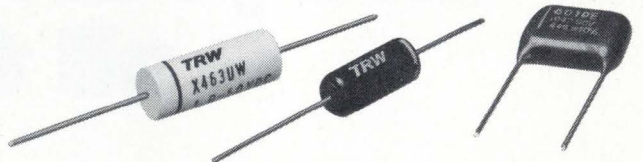

TRW Capacitors, an Electronic Components Division of TRW, Inc., Box 1000, Ogallala, Nebraska 69153.

# TRW<sup>®</sup> CAPACITORS