

# Mini-Micro Systems

A CAHNERS PUBLICATION

APRIL 1983

Focus on 16- & 32-bit minis  
New fail-safe multiprocessor

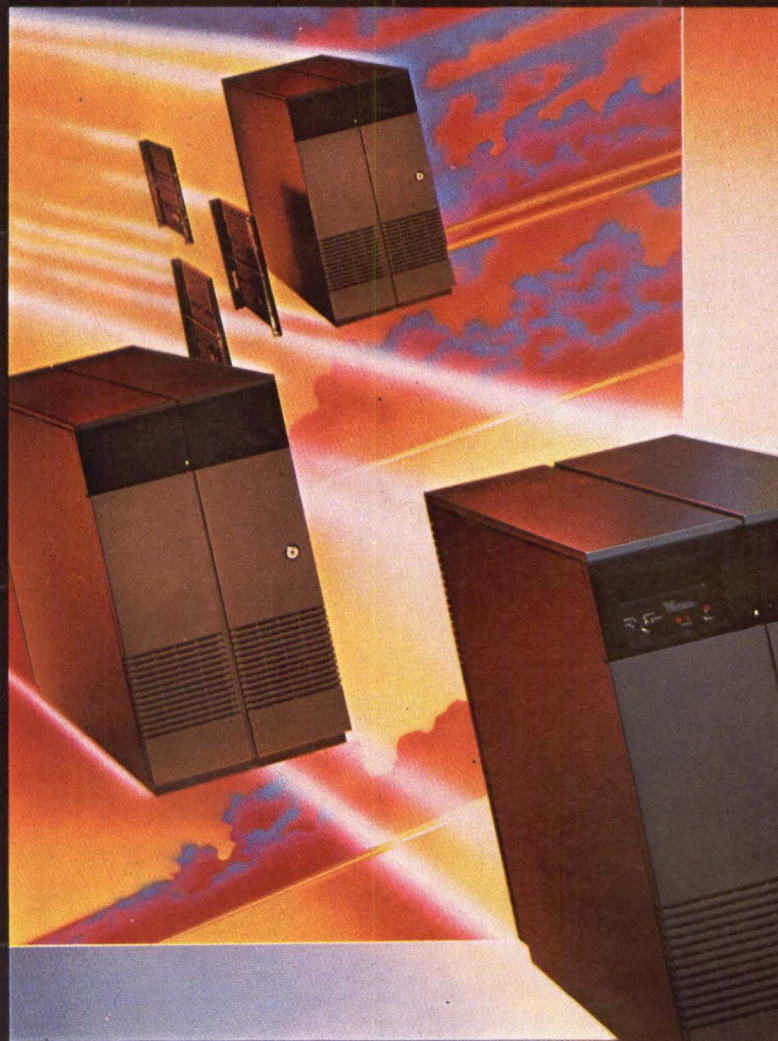

435 645 0009 04/ 01  
0782 11 2 F 3 JHI 05210  
RHELLENTHAL ASST PROF  
BIOLOGY DEPT  
UNIV OF NOTRE DAME IN 46556  
NOTRE DAME

Convergent tries multiple parallel processors

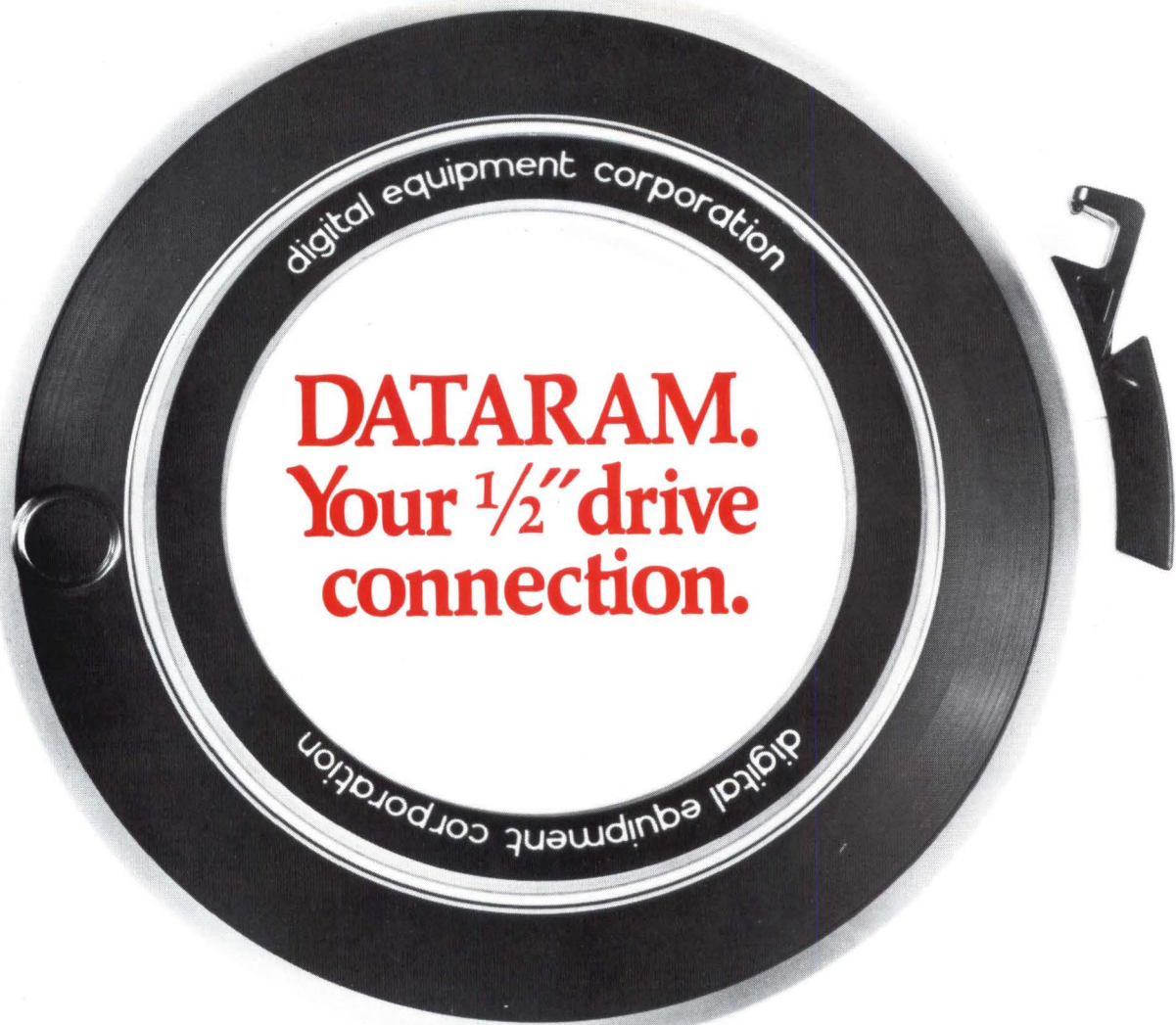

## It's easy to interface your 1/2" drive to a DEC computer. When you have connections.

Dataram provides tape drive connections to your host LSI-11, PDP-11, or VAX computer, with a family of couplers/controllers that operate in NRZI, PE, or GCR modes. Dataram's couplers/controllers operate with 1/2" tape drives from all major manufacturers. As slow as 25 ips — or as fast as 125 ips. 200 BPI to 6250 BPI. With TM11 and TS11 emulations.

Start-stop or streaming. Efficient streaming is supported by a unique RSX-11M utility, FASTSAVE-11M, which provides optional backup and save capability for Dataram's streamer coupler. A full one-year warranty is standard.

For more information about 1/2" drive connections, call (609) 799-0071. We'll help you make the connection you need!

STANDARD AND STREAMER		GCR
AMPEX	KENNEDY	STC
CIPHER	PERTEC	TELEX
CDC	S. E. LABS	
DATUM	TANDBERG	
DIGI-DATA	TDX	

**Dataram Corporation.** Princeton Road.  
Cranbury, NJ 08512. (609) 799-0071.

LSI-11, PDP and VAX are registered trademarks of Digital Equipment Corporation.  
FASTSAVE is a trademark of Computer Systems Advisors.

# DATARAM

CIRCLE NO. 2 ON INQUIRY CARD

# The new COMPAQ Portable Computer. IBM compatibility to go.

**S**imple, isn't it? The COMPAQ™ Portable Computer can do what the IBM® Personal Computer does. To go.

It runs all the popular programs written for the IBM. It works with the same printers and other peripherals. It even accepts the same optional expansion electronics that give it additional capabilities and functionality.

There's really only one big difference. The COMPAQ Computer is designed to travel.

Carry the COMPAQ Computer from office to office. Carry it home on the weekend. Or take it on business trips.

If you're a consultant, take it to your client's office.

If you use a portable typewriter, you can use the COMPAQ Computer as a portable word processor instead.

If your company already uses the IBM Personal Computer, add the COMPAQ

you'd probably need to buy an additional display screen because the built-in screen is too small for certain tasks, like word processing. The COMPAQ Computer's display screen is nine inches diagonally, big enough for any job, and it shows a full 80 characters across. And the built-in display offers high-resolution graphics and text characters on the same screen.

The bottom line is this. The COMPAQ Computer is the first uncompromising portable computer. It delivers all the advantages of portability

In the standard configuration, the COMPAQ Computer has three open slots for functional expansion electronics as your needs and applications grow. It accepts standard network and communications interfaces including ETHERNET™ and OMNINET™.

If you're considering a personal computer, there's a new question you need to ask yourself. Why buy a com-



puter that isn't portable?

For more information on the COMPAQ Portable Computer and the location of the Authorized Dealer nearest you, write us. COMPAQ Computer Corporation, 20333 FM149, Houston, Texas 77070. Or call 1-800-231-9966.

without trading off any computing power capability.

And what do those advantages

cost?

Nothing.

The COMPAQ Portable sells for hundreds less than a comparably equipped IBM or APPLE® III. Standard features include 128K bytes of internal memory and a 320K-byte disk drive, both of which are extra-cost options on the IBM. Memory and additional disk drive upgrades are available options to double those capacities.

Portable as a mobile unit that can use the same programs, the same data disks, and even the same user manuals.

There are more programs available for the COMPAQ Computer than for any other portable. More, in fact, than for most non-portables. You can buy them in hundreds of computer stores nationwide, and they run as is, right off the shelf.

With most other portables



## COMPAQ™

PORTABLE COMPUTER

The most computer you can carry

# Mini-Micro Systems

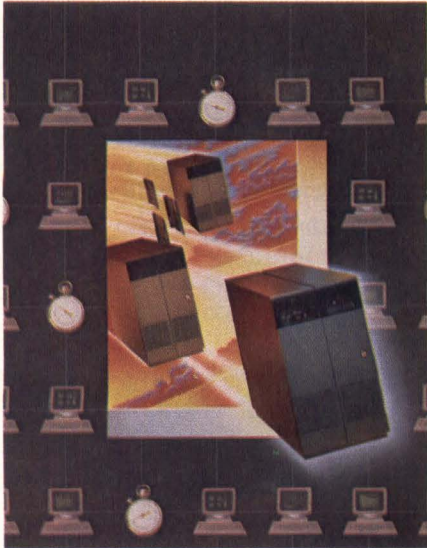

p. 157 (art direction by Blankenship-Taveres, Inc., airbrushing by Mark Ericson and Bill Ehart, photo by Sollecito Photography)



p. 17... DG claims an advantage.

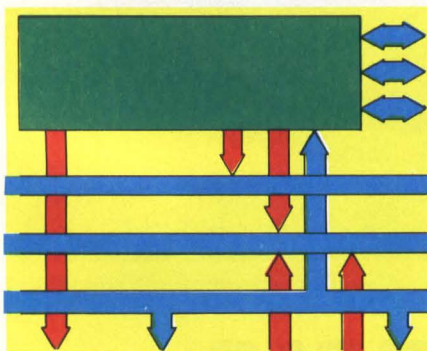

p. 71... Array processors are gaining ground.

## MINI-MICRO WORLD

### News

DG doubles performance with new supermini (p. 17)... Tektronix lower price strategy brings three terminals (p. 20)... TI enters 'professional' CPU market with Intel 8088/MS-DOS system (p. 22)... IBM's 4-in. microfloppy turns heads as standard debate rages (p. 24)... Televideo seeks to strengthen market lead with two new terminals (p. 30)

### International

Mainframe software vendor transports accounting package to Perkin-Elmer, other superminis (p. 41)

### Corporate and financial

Market Barometer (p. 49)

### Shows and conferences

NCC preview (p. 57)

## INTERPRETER

71 Array-processor vendors calculate on market growth, product diversity

91 Start-ups rush to establish high-capacity 5¼-in. drives

## SYSTEMS IN MANUFACTURING

107 Programmable controllers take on new role in automated factory

119 Workstation optimizes plant design software... CAE system combines layout, simulation functions

**FEATURES**

**129 Highlights**

- 133 32-bit minis press down from above . . . will they squeeze out 'traditional' 16-biters?**
- 145 The 16-bit mini holds on . . . despite the micro challenge, this mini still packs an OEM punch.**
- 157 'Megaframe' aims at mainframe performance . . . Motorola- and Intel-based system allows field upgrades to 128 users.**
- 165 Multiprocessor architecture ensures fault-tolerant transaction processing . . . Synapse's entry into the 'continuous processing' system market uses software-protection spheres.**
- 175 Micro-Winchester market awaits micro-diskette standards . . . five different types of diskettes have been proposed.**
- 176 Video cassette recorders for disk backup . . . Although slow, VCRs are reliable.**

**DEPARTMENTS**

- |                   |                            |
|-------------------|----------------------------|
| 4 Editorial staff | 221 Mini-Micro Marketplace |
| 7 Breakpoints     | 223 Classified Advertising |
| 49 Box Score      | 224 Career Opportunities   |
| 184 Calendar      | 232 Index to Advertisers   |
| 189 New Products  |                            |

MINI-MICRO SYSTEMS (ISSN 0364-9342) is published monthly (with additional issues in spring and fall) by Cahners Publishing Company, Division of Reed Holdings, Inc., 221 Columbus Avenue, Boston, MA 02116. Norman L. Cahners, Chairman; Saul Goldweitz, President; Ronald G. Segel, Financial Vice President and Treasurer. MINI-MICRO SYSTEMS is published by the Cahners Magazine Division; J. A. Sheehan, President; William Platt, Executive Vice President; H. Victor Drumm, Group Vice President. Circulation records are maintained at Cahners Publishing Co., 270 St. Paul St., Denver, CO 80206. Second class postage paid at Denver, CO 80206 and additional mailing offices. Postmaster: Send address changes to MINI-MICRO SYSTEMS, 270 St. Paul St., Denver, CO 80206. MINI-MICRO SYSTEMS is circulated without charge by name and title to U.S. and Western Europe based corporate and technical management, systems engineers, and other personnel who meet qualification procedures. Available to others at the rate of \$45.00 per year in the U.S.; \$50.00 in Canada and Mexico; \$65.00 surface mail in all other countries; \$100 foreign air mail (14 issues). Single issues \$4.00 in the U.S.; \$5.00 in Canada and Mexico; \$6.00 in all other countries.

© 1983 by Cahners Publishing Company, Division of Reed Holdings, Inc. All rights reserved.

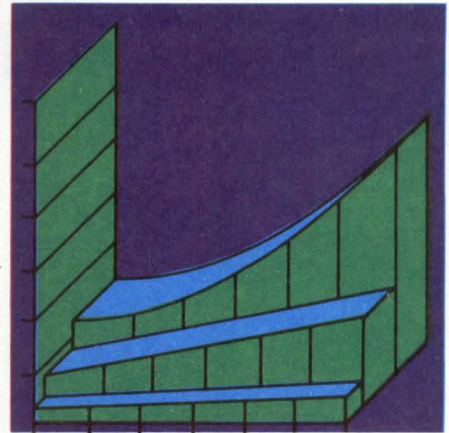

*p. 145. . . 16-biters hold their own.*

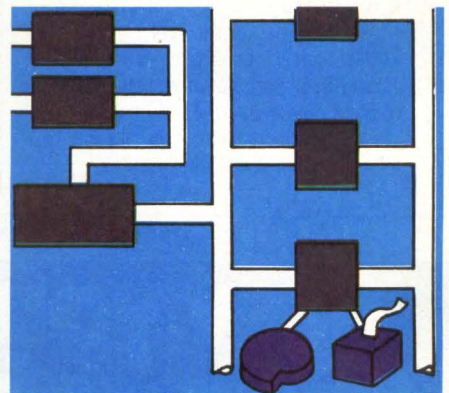

*p. 165. . . Multiprocessor architecture is fail-safe.*

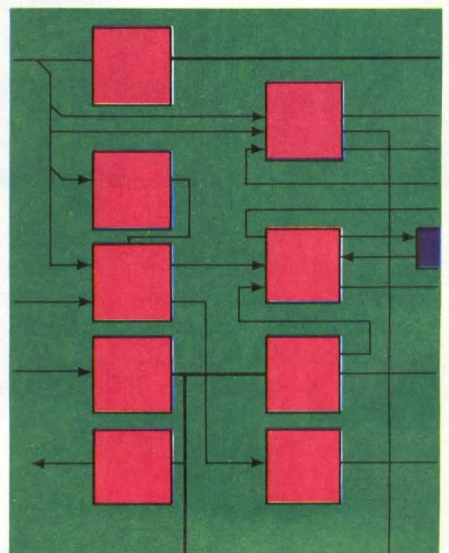

*p. 176. . . VCR backup is slow but reliable.*



## LOW COST EXTRA PAGE MEMORY FOR YOUR CRT

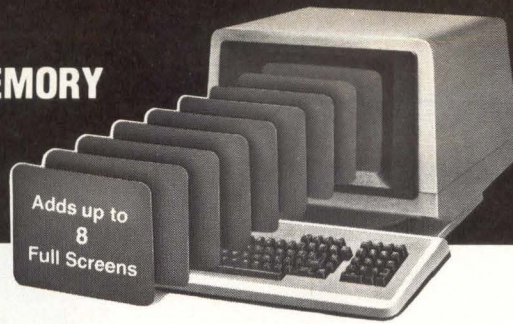

### DataQwik®

- Easy "dial-up" of CRT screen formats or commonly used data.
- Convenient store and forward communications.
- Off-line data editing.
- Adds up to 99 programmable function keys.

Connect *DataQwik* to your dumb or intelligent terminal and instantly add 16,000 characters of memory for storing CRT screen formats, Telex or TWX messages, demo programs, form letters or any data you wish to store and use often.

### HIGHLIGHTS

- 16K battery-backed memory.
- "User friendly" commands.
- Dual RS232 ports for inline connection.

Data is stored in 99 "Data Bins" which are assigned numbers and can be called up by the terminal or by using the *DataQwik* keypad.



*DataQwik* plugs inline between almost any RS232 Terminal and its Modem or Computer, so data can freely pass between the two ports. *DataQwik* can be configured to send to the Terminal, Modem or both.

Call toll free for more information today!

**wte: western telematic inc.**

2435 S. Anne St., Santa Ana, CA 92704 • (714) 979-0363  
Outside California call toll free (800) 854-7226

CIRCLE NO. 5 ON INQUIRY CARD

# now you can run DIBOL software on UNIX powered systems!

Any microcomputer with a Unix™ operating system, now has access to the thousands of professional quality DIBOL™ software packages. *SIBOL™*, a new portable language system, makes it all possible. It combines the price/performance and portability features of Unix with the proven and tested advantages of DIBOL, DEC's most widely used business language.

The *SIBOL* system, like DIBOL, gives you a compiler, a run-time interpreter, a symbolic debugger and a library of external utility subroutines. The entire package is written in the "C" language that is standard on all Unix systems. And *SIBOL* is ready today with easy-to-use documentation.

See this new product at COMDEX/SPRING, Atlanta.

**Software Ireland Limited**

A member of the National Westminster Bank Group

Software Ireland Representatives, Inc., 100 Wall Street, New York, NY 10005 Tel. (212) 509-0363  
West Coast Rep.: Yates Ventures, 4962 El Camino Real, Suite 111, Los Altos, CA 94022 Tel. (415) 965-0103  
Offices in Ireland: Belfast Tel. 247433 Dublin Tel. 780088

DIBOL is a trademark of Digital Equipment Corporation. Unix is a trademark of Bell Laboratories.  
SIBOL is a trademark of Software Ireland Ltd.

CIRCLE NO. 6 ON INQUIRY CARD

## STAFF

Vice President/Publisher  
**S. Henry Sacks**

Managing Editor  
**George N. Bond III**

Editorial Departments  
Features

Executive editor: **Alan R. Kaplan**  
Senior editor: **Patrick Kenealy**  
Associate editor: **David H. Freedman**  
New products editor: **Steven F. Frann**  
Contributing editors:  
**Walter A. Levy**, data communications;  
**Efrem Mallach**, computer architecture;  
**Malcolm L. Stiefel**, product profiles

Interpreter/Systems in Manufacturing  
Senior editor: **Dwight B. Davis**  
Associate editors: **Frank Catalano**, **Sarah Glazer**

### Mini-Micro World

Boston: **Lori Valigra**, senior editor, news;  
**David Bright**, reporter (617-536-7780)  
San Jose: **Robert A. Sehr**, **Kevin Strehlo**,  
associate editors (408-243-8838)  
Los Angeles: **Edward S. Foster**, associate  
editor (213-826-5818)  
New York: **Geoff Lewis**, associate editor  
(212-949-4446)  
Washington, D.C.: **Stephen J. Shaw**,  
contributing editor (202-320-2273)  
London: **Keith Jones**, European editor  
(011-44-1-661-3040)

### Editorial Production

Associate editor: **Frances T. Granville**  
Production editor: **Mary Anne Weeks**  
Word processing: **Elizabeth Kress**

### Art Staff

Art director: **Vicki Blake**  
Assistant art director: **Mark Fallon**  
Artist: **James Wiley**

### Editorial Services

**Phyllis Anzalone**, **Adrienne DeLeonardo**,  
**Laura Downey**, **Jeanne Howat**, **Robin Sheehan**

### Production Staff

Supervisor: **William Tomaselli**  
Production services: **Noel Boulanger**  
Composition: **Diane Malone**

Executive VP/Group Publisher  
**H. Victor Drumm**

VP/Group Editorial Director  
**Roy Forsberg**

Director of Graphics  
**Lee Addington**

Vice President, Production  
**Wayne Hultzky**

Vice President, Research  
**Ira Siegel**

Assistant to the Publisher  
**Linda L. Lovett**

Group Circulation Manager  
**Sherri Gronli**  
(303) 388-4511

Marketing/Promotion Staff  
**Richard B. Dalrymple**, Mktg. Director  
**Susan Rapaport**, Promotion Director  
**Elizabeth Gotoff**, Promotion Coordinator  
**Wendy Whittemore**, Promotion  
Coordinator

### Editorial Offices

**Boston:** 221 Columbus Ave., Boston, MA  
02116. **Los Angeles:** 12233 W. Olympic  
Blvd., Los Angeles, CA 90064. **San Jose:**  
3031 Tisch Way, San Jose, CA 95128. **New  
York:** 205 E. 42nd St., New York, N.Y. 10017.  
**London:** IPC Business Press, Quadrant  
House, The Quadrant, Sutton Surrey, SM2  
5AS, England.

# Open the door to a new UNIX™ performance environment.



Exciting new doors are opening up for UNIX™ users. The Gould CONCEPT 32/87 is the key. Now there's a powerful alternative for the VAX-bound user. Running the authorized version of Bell Laboratories' UNIX operating system, the Gould CONCEPT 32/87 benchmarks at triple the performance of the VAX 11/780\*. This new processing power can make you more productive. Whether you are dealing with VLSI design, molecular modeling, or simulation processing, the 32/87 has the versatility and performance you need for increased productivity.

Now Gould S.E.L. minicomputers offer a comprehensive ICSC-Ada\*\* language translator to open new doors into the state-of-the-art DOD

language environment. The ICSC-Ada translator operates in conjunction with the C compiler under UNIX to enable users of Gould computers to learn Ada and to develop programs to satisfy emerging Ada requirements of military and scientific computer applications.

Let us open new doors to performance and productivity in your compute-bound UNIX environment. Just call or write.

**Gould Inc., S.E.L. Computer Systems Division,**  
6901 West Sunrise Boulevard,  
Fort Lauderdale, Florida 33313 1-800-327-9716.

™UNIX is a trademark of Bell Labs

\*™VAX 11/780 is a trademark of Digital Equipment Corporation

\*\*ICSC-Ada is a proprietary software product of Irvine Computer Sciences Corporation. Ada is a trademark of the U.S. Department of Defense.

 **GOULD**

*Electronics & Electrical Products*

CIRCLE NO. 7 ON INQUIRY CARD

## Model 6455 Cartridge Tape System

# Loaded with Features — Loaded with Benefits.

Kennedy products have always provided innovative new features. And these features have always provided added benefits and convenience for the user. For instance, our Model 6455 offers these features and benefits:

**Feature:** Start/Stop Operation

**Benefit:** Drive can emulate a 1/2" tape drive by providing the ability to perform selective file back-ups, file-restructuring, journaling and software updates.

The drive is effectively a 1/2" Tape Drive in a smaller package.

**Feature:** Hard Read Error Spec. of 1 in 10" bits.

**Benefit:** Best data reliability of any tape cartridge drive. Gives the user confidence in the integrity of the back-up medium.

**Feature:** On-board Diagnostics

**Benefit:** Drive can be tested off-line with no test equipment required. Use of S.A. also lowers the MTTR.

**Feature:** Cartridge Jam Protection

**Benefit:** Protects the cartridge from damage if cartridge jams. This is accomplished by sensing a current surge and then disabling the motor. Thus insuring that the cartridge will not be damaged.

**Feature:** High Density Recording

**Benefit:** Storage capacity of 23 MB on a single cartridge.

**By now you can see what we're driving at. Model 6455 is full of unique features and benefits for you. For the complete story, write or call us today.**

## **KENNEDY**

*An Allegheny International Company*

1600 Shamrock Ave., Monrovia, CA. 91016  
(213) 357-8831 TELEX 472-0116 KENNEDY  
TWX 910-585-3249

### **KENNEDY INTERNATIONAL INC.**

U.K. and Scandinavia  
McGraw-Hill House  
Shoppenhangers Road  
Maidenhead  
Berkshire SL6 2QL England  
Tel: (0628) 73939  
Telex:  
(851) 847871 KEN UKS G

### **KENNEDY INTERNATIONAL**

Koningin  
Elisabethplein, 8  
B-2700 Sint-Niklaas  
Belgium  
Tel: (03) 777.1962  
Telex: 71870 KEN CO

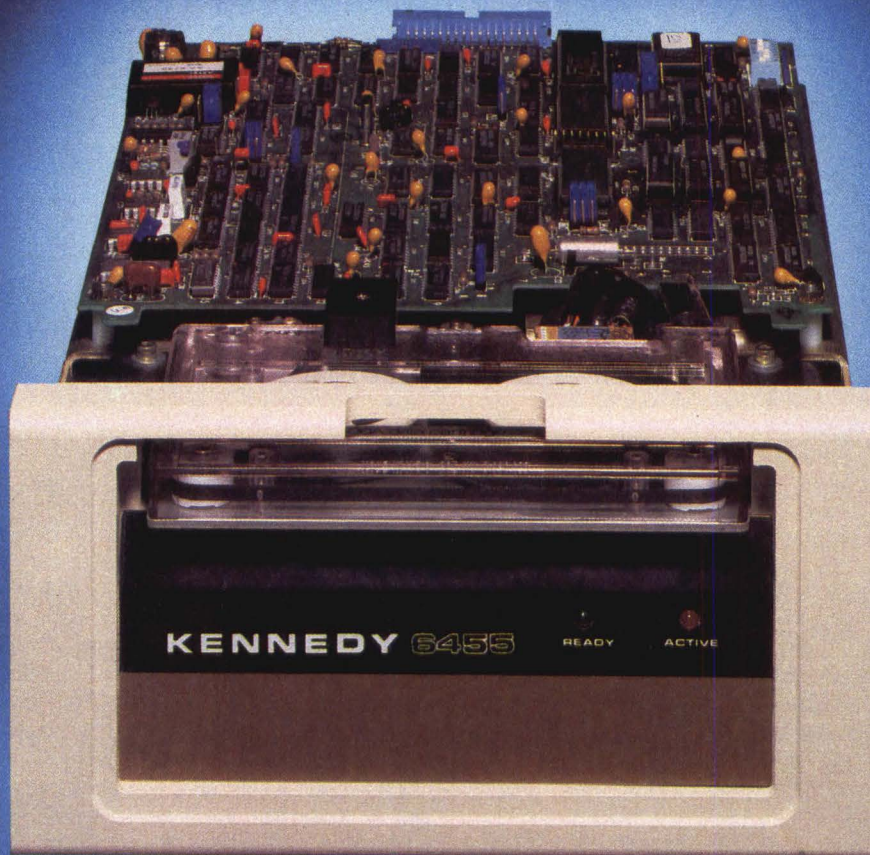

# **KENNEDY • QUALITY • COUNT ON IT**

CIRCLE NO. 8 ON INQUIRY CARD



# Breakpoints

---

## **HP READIES INSTRUMENT CONTROLLER, UNIX FOR SERIES 200 MICROS**

The desk-top computer division of Hewlett-Packard Co., Fort Collins, Colo., has packaged a version of its MC 68000-based Series 200 computers as a modular instrument controller designed for harsh environments. The HP model 20 is a rack-mountable box with 15 option slots and an optional 128K-byte bubble memory or 256K-byte EPROM cards. An add-on CRT-terminal keyboard, mass storage and the BASIC and Pascal languages are available for the model 20, as is a custom keypad interface card to facilitate design of simple keypads for unskilled operators. The model 20 is compatible with the entire Series 200 line, and can share data and peripherals with the BASIC operating-system version of the HP 9000 32-bit microcomputer via the Shared Resource Management network. Expected in June for all Series 200 computers is the UNIX operating system, including a real-time version for the new model 20, which will enhance the line's upward compatibility with the HP 9000.

## **DURANGO'S POPPY MICROCOMPUTERS TAKE ON IBM PC**

When Durango Systems Inc. launches its new product line at Comdex this month it will be taking shots at both the IBM Personal Computer and the IBM rose featured in PC advertising. The Durango products, dubbed the Poppy family, are based on the Intel 186 and 286 16-bit microprocessors. A series of teaser ads has sprung up on Silicon Valley billboards in recent weeks showing the orange Icelandic poppy in anticipation of the official introduction. The series will start with a \$3995 dual-floppy disk, stand-alone system based on the 186 and running the MS/DOS operating system. The products will extend upwards to a 12-terminal configuration with 1M byte of main memory, a 60M-byte Winchester disk and Microsoft's XENIX. The 286-based high-end model will be \$35,935 with terminals. The 186-based system can be ordered with XENIX as an option and can support four terminals. The 186-based Poppy can be upgraded to a 286-based Poppy II.

## **DIABLO EXPANDS TECHNOLOGY OFFERINGS WITH THERMAL TRANSFER PRINTER**

Diablo Systems Inc. was scheduled late last month to introduce its first thermal transfer printer. The new printer is said to be able to produce integrated text and graphics on plain paper at a speed as high as 6 pages per min. Resolution will be 200 x 200 dpi, with a virtually unlimited selection of fonts through host controls. The expected end-user price of the unit is less than \$5000. At the same time, Diablo planned to announce enhancements to its existing line of dot-matrix printers and several new paper-handling devices.

## **FOUR TOUCH TERMINALS AVAILABLE FROM ANNAPOLIS START-UP**

Two-year-old Touch Technology Inc., Annapolis, Md. is bringing its first four products to market. Expected to be introduced and available late last month were touch monitors using capacitance technology. The monitors plug into the Apple II, the IBM PC and other microcomputers. A touch monitor with a green 12-in. screen, cables, software, documentation, a demonstration disk, a video-tape interface and an interface card for placement in the microcomputer sells for \$1450 in single-unit quantities and \$999 each in quantities of more than one. A 12-in. composite color monitor with the same components sells for \$1550 in single-unit quantities and \$1300 each in quantities of more than one. A 12-in. RGB screen sells for \$1950 in single-unit quantities and \$1850 each in quantities of more than one. A 19-in. RGB monitor sells for \$1850 in single-unit quantities.

## **BACK TO THE SOFTWARE DRAWING BOARD AT CAPRO**

After a brief fling in the hardware market, Capro Inc. has abandoned plans to sell an Intel 8086-based system with the Pro IV programming system (MMS, December, 1982, p. 21). Citing the flood of lower priced products onto the market since the company began planning its Dimension One two years ago, Capro officials have withdrawn the \$50,000 system. Instead they will concentrate on marketing Pro IV implementations on Intel iAPX family processors and work on a version that will run on Intel and CP/M-86 systems.

# Breakpoints

---

The company plans to offer the program-generating package to hardware manufacturers, system houses and high-volume end users. On the hardware OEM front, Capro is looking at several Intel 186 and 286 implementations. It is also considering expanding its base to systems running XENIX.

## **START-UP OFFERS UNIX PACKAGE FOR IBM PC**

Microsoft's public statements to the effect that it will soon offer its XENIX version of UNIX for the IBM PC has not daunted start-up LANtech Systems Inc., Dallas. The new company expects to beat Microsoft to the market and to underprice XENIX as well. LANtech's Unetics package should be available this month and is priced at \$100 including a PC-DOS emulator. LANtech is concentrating on OEM contracts and is understood to have its foot in the door at both IBM's Boca Raton Fla., PC headquarters and at Texas Instruments Inc., from which an 8088-based PC recently emerged. The LAN portion of LANtech refers to a UNIX local-area networking scheme called Unet that is designed to run with Ethernet and Omninet hardware.

## **TELETYPE INTRODUCES DOT-MAPPED DISPLAY BASED ON BELL 32-BIT CHIP**

Teletype Corp. planned to make one of its most comprehensive product introductions—four CRT terminals—early this month. Perhaps the most noteworthy is a dot-mapped unit aimed at programmers and CAD/CAM applications. It uses Bell's heralded 32-bit single chip. Dubbed the 5620, the terminal has 100 pixels per sq. in., 48K bytes of ROM, 256K bytes of RAM and is compatible with UNIX Version V. The 5620 can run at data rates as high as 19.2K bps, and has as many as seven windows that can function simultaneously.

## **INTERMETRICS PLANS TO ANNOUNCE PASCAL, C CROSS COMPILERS**

This month, Intermetrics Inc., Cambridge, Mass., plans to introduce Pascal and C cross compilers designed for software development on embedded microprocessor systems. InterPas and InterC, initially aimed at the Motorola MC68000 and Intel 8086 processors and resident on VAX superminis, also will be supported on PDP-11 systems. Soon to come are assemblers for the MC68000 and 8086, as well as extensions of InterPas and InterC to other microprocessor target hosts. Intermetrics' goal is to allow the embedder to change the processor at will without finding a cross compiler in an acceptable language or adjusting code. InterPas and InterC for the MC68000 and the 8086 run on the VAX computer under Berkeley 4.1 UNIX or VMS. They are being scheduled for availability on the PDP-11 under RSX-11M and UNIX this summer.

## **TEKTRONIX TO ANNOUNCE COLOR INK-JET PRINTER**

Tektronix Inc. will announce an ink-jet printer this month that will serve as a low cost alternative to the 4691 color graphics copier. The new model 4695 will be priced at less than \$2000 and will produce color graphics in seven shades. Primarily intended for terminal-dedicated, rather than host-driven use, the 4695 lacks the resolution and speed of the more expensive 4691. Its dot placement will be 120 x 120 dpi at a speed of 2 to 3½ min. per page. The 4695 will have a Centronics-like parallel interface and will be able to produce copies on paper and transparencies.

## **TECHFILES: A quick look at industry developments**

**Graphics Files: Precision Visuals Inc.'s** DI-3000, a full-blown mainframe and supermini implementation of the device-independent CORE graphics system in FORTRAN subroutines, has been transported to run under the UNIX operating system on the MC-68000-based computer due from Cosmos Computer. Thus, object code for complex graphics applications—including 3D transformations, dynamic color selection and use of pick and segmentation functions—can be moved transparently from a company's mainframes to its microcomputers. Precision Visuals is said to be negotiating with OEMs to transport the software to other MC68000-based UNIX machines....**Hewlett-Packard Co.**

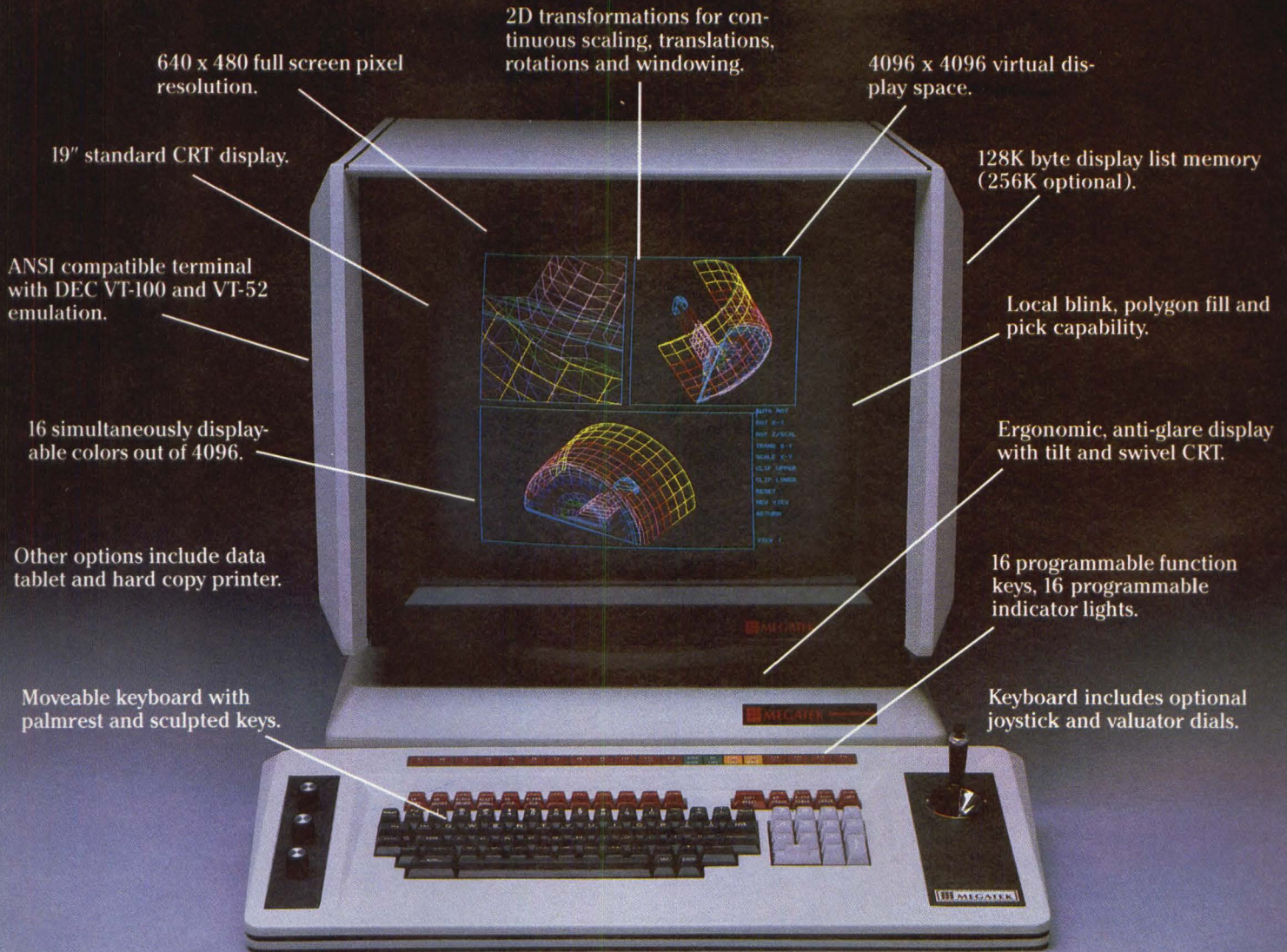

640 x 480 full screen pixel resolution.

2D transformations for continuous scaling, translations, rotations and windowing.

4096 x 4096 virtual display space.

19" standard CRT display.

128K byte display list memory (256K optional).

ANSI compatible terminal with DEC VT-100 and VT-52 emulation.

Local blink, polygon fill and pick capability.

16 simultaneously displayable colors out of 4096.

Ergonomic, anti-glare display with tilt and swivel CRT.

Other options include data tablet and hard copy printer.

16 programmable function keys, 16 programmable indicator lights.

Moveable keyboard with palmrest and sculpted keys.

Keyboard includes optional joystick and valuator dials.

# Thaumaturgy.\*

Graphics miracles right on your desk. Our latest Whizzard.™ The 1650 desk top design terminal. Now, anyone can afford the power and performance of our more expensive Megatek Whizzards. Your own design station right at your fingertips. Another product of Megatekknology.™

Finally. Everything an engineer or designer could want in desk top computer graphics. Convenience. High quality and powerful performance. VT-100 compatibility.

Functionality. Greatly increased productivity. Shouldn't every desk top design terminal offer this?

Tomorrow's graphics technology on your desk top today... thanks to Megatekknology.

\*Thaumaturgy (thō'ma tūr jē), n., the performance of miracles.

**Making History out of State-of-the-Art.**



World Headquarters · 3985 Sorrento Valley Blvd., San Diego, CA 92121 · 619/455-5590 Telex: 910-337-1270

MINI-MICRO SYSTEMS/April 1983

CIRCLE NO. 9 ON INQUIRY CARD

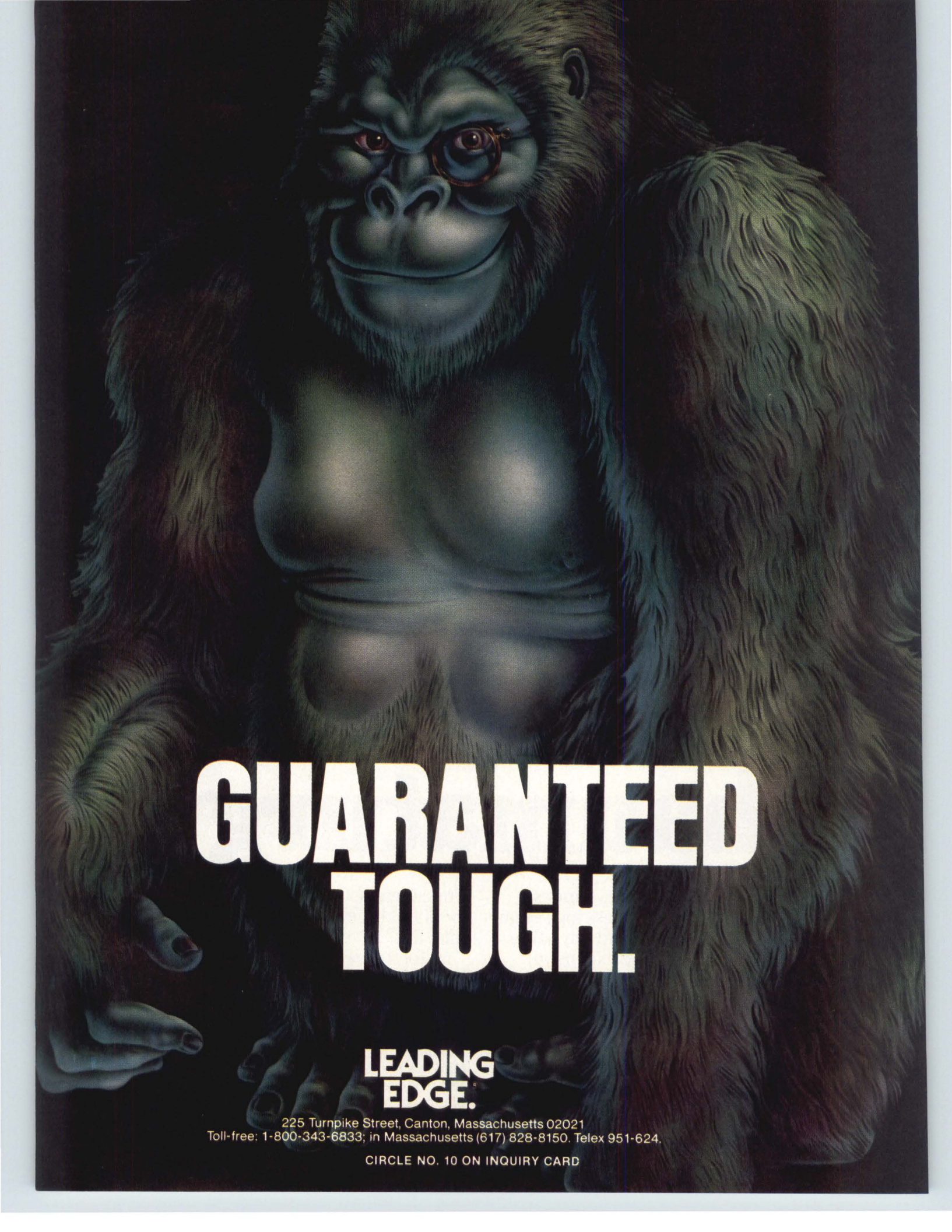

**GUARANTEED  
TOUGH.**

**LEADING  
EDGE.**

225 Turnpike Street, Canton, Massachusetts 02021  
Toll-free: 1-800-343-6833; in Massachusetts (617) 828-8150. Telex 951-624.

CIRCLE NO. 10 ON INQUIRY CARD

# Breakpoints

is adding 512 × 390 resolution, 16-color graphics to its MC68000-based Series 200 model 36 desk-top computer and calling it a computer-aided-design workstation. With HP's BASIC 2.1 and Pascal 2.1, which offer high-level graphics extensions, two 5¼-in. floppy disk drives and 0.5M bytes of main memory, the model 36C is priced at \$17,660, approximately \$3000 more than a similarly configured, monochrome model 36B.

**Random Disk Files: Despite the recent entry of IBM Corp.'s 4-in. form factor microfloppy drive into the sub-5¼-in. controversy, there is strong backing for the industry-committee-proposed 3½-in. floppy drive standard.** The 3½-in. form factor has received the continued support of Tandon Corp. despite efforts by Seagate Technology and Tabor Corp. to convince the industry's largest manufacturer of low-end floppy drives to back the 3¼-in. form factor. The 3½-in. drive has also received the support of Control Data Corp. and is now expected to prevail in a letter ballot being distributed to ANSI's X3B8 committee members. The results of the ballot will be revealed at a meeting to be held during Comdex this spring.... The biggest push for the 3½-in. form factor has come from rigid drive manufacturers. So far, two sub-5¼-in. Winchester drives have been revealed. Both fit the dimensions of the committee's proposed floppy standard. **CDC**—which until now has concentrated on the high-end, high-performance market—is **expected to take off the wraps of a 3½-in. Winchester drive at NCC next month. The 6M-byte drive will have a single platter and reportedly will be the first to use thin-film-head technology on a small drive.** CDC, which uses its own thin-film head on its 3380-compatible drive, expects to have better luck with the new technology than Seagate, which announced a thin-film-head 5¼-in. drive in 1981, only to withdraw it a short time later because it could not obtain heads in production volumes.... With the Reagan Administration, Democrats and others jumping on the high-tech bandwagon, can network television sitcom be far behind? **Access Corp.**, a portable computer start-up in San Jose, has found a marketing gimmick that might push it towards its goal of \$100 million in sales for its first year. **The firm's Access computer, with built-in thermal printers and modems, will be featured along with comedienne Madeleine Kahn in a new "romantic comedy" about computer programmers, scheduled for the ABC television network next fall...** **Andy Roman**, former president of Roman Associates, a Newark, Calif., market research and consulting firm, **has become vice president of marketing for Cogito Systems, a start-up that manufactures half-height, 5¼-in. Winchester drives.** The drive's capacity is 6.3M bytes on one platter and 12.7M bytes on two platters, unformatted. OEM prices are \$725 each in quantities of 500 for the low-end model and \$825 each in quantities of 500 for the high-end model. The three-month-old company is expected to begin shipping evaluation units this spring. The company was privately funded through Ching Fong Investments, a Hong Kong conglomerate that also recently purchased thin-film-head manufacturer Magnex Corp. from Exxon.... **Cybernex Corp.**, San Jose, has denied charges in a suit filed by IBM Corp. that Cybernex stole thin film head trade secrets. Cybernex, which was formed in 1981, claims the technologies it uses for the heads are "public domain."

**Printer Files: C. Itoh Electronics** is expected to introduce two enhanced versions of its 8510 Pro/Writer dot matrix printer at this month's Comdex. The 8510S will feature a 160-cps high-speed draft mode and a 30-percent increase in throughput. Another enhanced model, the 8510C, will offer the same speed characteristics as the 8510S plus color capabilities employing a three-color ribbon to produce a seven-color spectrum.

**Micro Files: Altos Computer Systems** is putting its money where its mouth is to support the advancement of UNIX in the 16-bit microcomputer market. Concerned over the dearth of application software in that market, Altos is launching an application-distribution program that will funnel packages to dealers at discount prices. In addition, the company will support software developers with discounts on Altos hardware, UNIX/XENIX licenses and supported languages. The San Jose-based company will also hit the road with monthly training programs for UNIX dealers.

# Breakpoints

**NCC Look Ahead: CompuPro Systems**, which introduced its first packaged Intel 8088/8085-based systems at last year's NCC, plans to expand its line at this NCC with a multi-user office system. The new model, which departs from CompuPro's traditional S-100 bus orientation, will include an Intel 8086 master processor with four 8-bit slave processors, yielding a four-user system. A built-in floppy/hard disk controller supports high-density minifloppies and ST-506-compatible Winchester drives. A basic system will start at \$3000, and a configuration with dual half-height minifloppies, 20M bytes of Winchester disk capacity and 2M bytes of main memory is expected to sell for less than \$7000. Although the 8086- and Z80-compatible, 8-bit processors are installed on a single board, CompuPro says, each 8-bit workstation processor will have its own memory and I/O. This system will run MP/M and MS/DOS....The **Pixel** division of Instrumentation Laboratories plans to use its NCC exhibit to show a new graphics workstation system that is scheduled for introduction at this month's Comdex show in Atlanta. The Pixel 80G is based on the MC68010 microprocessor with virtual memory and features what Pixel officials claim is one of the highest resolutions in the industry—1728 × 2810 pixels. At a list price of \$18,000, the system includes 1M byte of main memory, 38M bytes of 5¼-in. Winchester disk storage and UNIX System III....Expect **Perkin-Elmer Corp.** to feature one or two groups of low-end 32-bit systems....**Cincom Systems, Inc.**, Cincinnati, Ohio should spotlight a database-management system for Digital Equipment Corp. VAX minicomputers. Cincom offers Total, a database-management system for DEC PDP-11s running under R/SX-11M. A Cincom spokesman says the product for VAC may be announced before NCC....**Rosscomp Corp.** expects to highlight a 160M-byte streaming-tape drive called the "Evaluator" that will interface with both SA1000 and SMD controllers....**NEC Information Systems's** 8-in. Winchester disk line should be expanded with a 167M-byte model....**Seagate Technology** should show its three-platter ST 425 drive. The 5¼-in. drive is expected to store more than 18M bytes, unformatted....**Dataram Corp.** is expected to feature its A22 LSI-11/23-based system that includes an 8-in. RX02-compatible floppy disk drive and a 10.4M-byte RLO1/RLO2 compatible Winchester drive. A minimum configuration with the LSI-11/23 microcomputer, 245K bytes of memory, and the two drives is \$9800. ....Although portable computer manufacturer **Compaq Computer Corp.**, Houston, is expected to have a new offering, the company may have trouble getting exhibit space at NCC. At press time, a Compaq spokesperson said the company was number 60 on the waiting list....Look for **Qume Corp.** to have a variety of new printers at NCC. A 70-cps daisy-wheel printer is said to be in the works and will likely be ready for introduction at next month's show. Potential OEM customers may also get a look at a cut-sheet feeder product designed to be built into the printer in an effort to make rapid feeding more affordable in word-processing systems. Certain to be introduced at NCC are a cut-sheet feeder priced at less

than \$1000, and an IBM PC plug-in interface module for the Sprint 11 printer....**Nissei Sangyo America Ltd.**, Wellesley Hills, Mass., is expected to demonstrate several new printers, disk drives and CRT monitors at NCC. The two graphics printers, which are manufactured by Hitachi Koki, can be programmed to overlap dots anywhere on a page to produce logos and bar codes in near-letter-quality, output, according to the company. OEM prices are approximately \$3700 for the 300-lpm printer and \$5000 for the 600-lpm unit. Four Shugart-compatible, 5¼-in., half-height floppy disk drives to be shown have capacities ranging from 250K bytes to 1M byte. Prices for OEM quantities of 500 range from \$112 to \$170 each. Several 3-in. and 2½-in. floppies will also be shown. The line of color and monochrome, medium- and high-resolution CRTs features a high-contrast, "direct-etch" picture tube....**Although next month's NCC once seemed as though it would be a showcase for 3½-in. Winchester drives, most of the expected announcements have been delayed.** Only Scotland-based Rodime Ltd. and Control Data Corp. have confirmed they will show the next generation of Winchesters at NCC. Seagate Technology, and Miniscribe have delayed plans to introduce their 3½-in. Winchesters....**Maxtor Corp.**, a start-up that dazzled last fall's Comdex Show attendees with a 144M-byte, 5¼-in. drive, has planned an encore at NCC with a family of 5¼-in. drives with capacities nearing 400M bytes. Although the company has just begun to ship evaluation units of the 144M-byte drive, **the new drives are a product of the enhanced ST-506 interface recently negotiated by Maxtor and a few other companies.** The enhanced interface will double the data-transfer rate from 5M to 10M bits per sec. The new drives use the same proprietary spindle motor as the original drive and will hold as many as eight platters. By using enhanced recording densities and run-length-limited code, the company hopes to more than double its previous record-setting capacity. Despite Maxtor's continued efforts to make the enhanced small disk interface a universal high-performance standard, skeptics such as Xebec Corp., Micropolis Corp. and ST-506 inventor Seagate Technology hesitate to embrace the interface, which may affect the ultimate acceptance of Maxtor's new products....**Quality Micro Systems Inc.**, Mobile, Ala., is scheduled to show its new intelligent graphics controller for non-impact printers at NCC. The QMS QUIC-RIP System enables non-impact printers to do letter-quality printing, industrial graphics and bar coding, bit-mapped graphics, intermixed fonts, multiple forms printing and line printing at speeds as high as 100 pages per min. Available interfaces include RS232 and current loop with various protocols, Centronics, Dataproducts, IBM System 34 and 38, Wang VS and Ethernet. The controllers will be sold as part of various printer packages. Prices will start at \$24,995 for a Xerox 2700 12-page per min., non-impact printer with the QUIC-RIP controller. Availability is planned for the first quarter of 1984....For a peek at more products expected at NCC, see page 57.

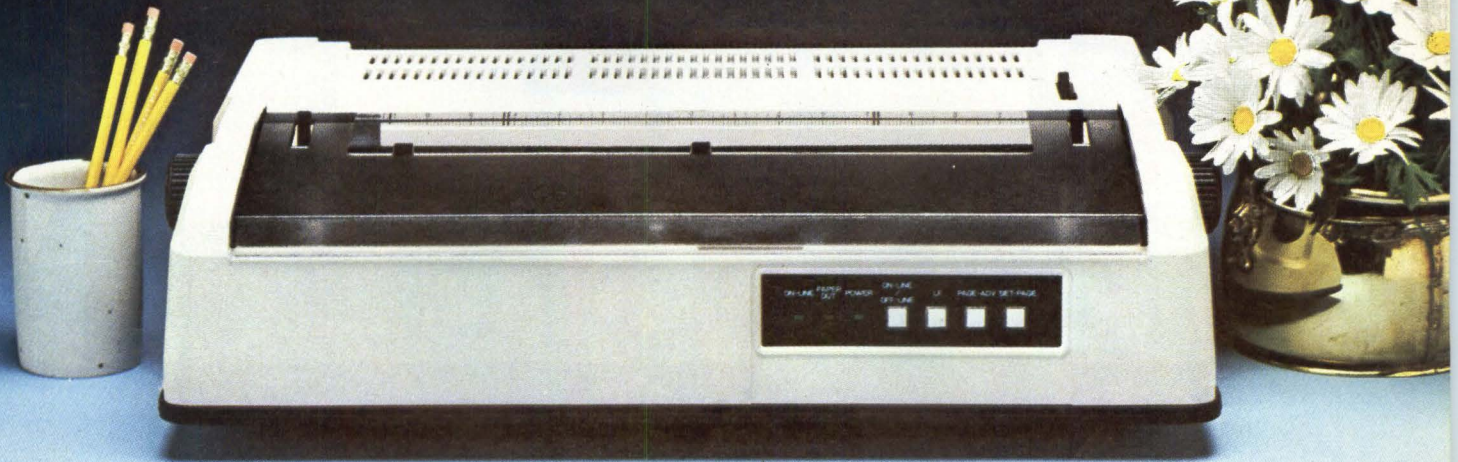

C. Itoh's F-10 Daisy-wheel printer is the compact beauty you can easily get attached to. Just look at all the useful features you get.

1. Small footprint, low-profile design (only 6" high) fits easily into your system.
2. Downloading wheel and impact sequences allow use of a variety of unique wheels and permit OEM's to tune the printer to specific needs.
3. Comes in two Shannon-text-rated speeds. 40 CPS and 55 CPS.
4. Industry-standard parallel or RS 232-C interfaces and ETX/ACK, XON/XOFF protocols provide maximum OEM flexibility and installation ease.
5. Extensive, built-in word processing functions allow easy adaptability and reduced software complexity.
6. Uses mono and dual-plastic wheels. (Unlike metal wheels, dual-plastic provides superior print quality over the entire life of the wheel.)
7. Field proven, firmware intensive technology for increased reliability.
8. Cast aluminum base plate with high quality metal parts provide lasting dependability.
9. Low-noise operation is ideal for office environment.
10. Choice of friction feed or bidirectional tractor feed for precise print positioning of tabular and graphics data.
11. Uses industry-standard wheels and ribbon cartridges available from multiple sources at low prices.
12. Universal power supply is standard and allows worldwide power source compatibility.
13. FCC approved and under 50 lbs. in weight for fast shipments and sales.
14. Easy-to-load wheels with tested and proven method of wheel support (spring loaded with positive detent).

We could go on. But quite frankly, once you see the F-10 perform, you'll never look at another Daisy.

The F-10 is fully backed by C. Itoh's warranty and complete support organization. Contact C. Itoh Electronics, Inc. 5301 Beethoven St., Los Angeles, CA 90066 (213) 306-6700.

 **C. ITOH  
ELECTRONICS, INC.**  
One World of Quality



**HOW DO I LOVE YOU?  
LET ME COUNT THE WAYS.**

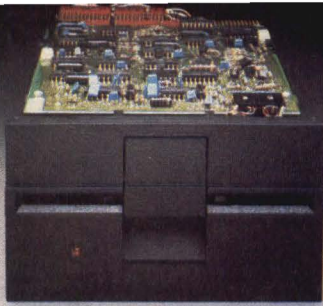

TM100-1 5 1/4" Floppy  
48TPI 250KB

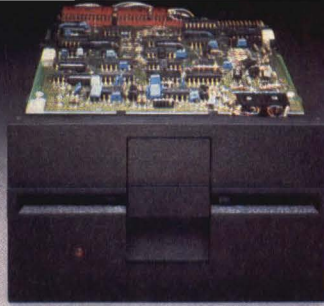

TM100-2 5 1/4" Floppy  
48TPI 500KB

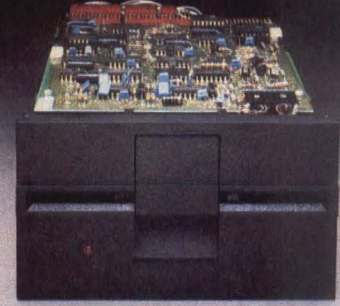

TM100-3/3M 5 1/4" Floppy  
96/100TPI 500KB

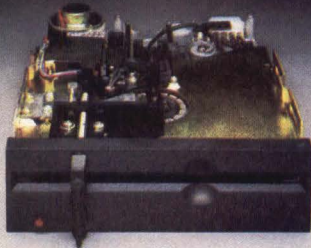

TM50-1M 5 1/4" ThinLine Floppy  
48TPI 250KB (Mechanics)

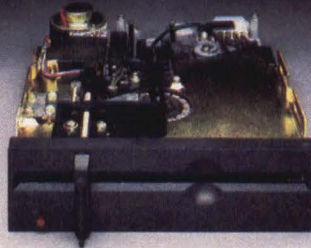

TM50-2M 5 1/4" ThinLine Floppy  
48TPI 500KB (Mechanics)

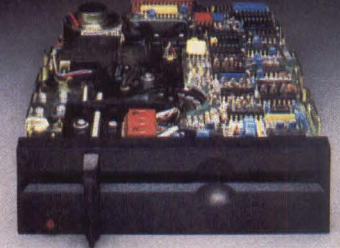

TM50-1 5 1/4" ThinLine Floppy  
48TPI 250KB

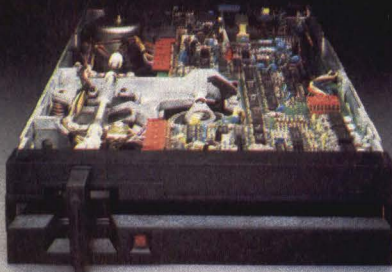

TM848-1 8" ThinLine Floppy  
48TPI 800KB



TM848-2 8" ThinLine Floppy  
48TPI 1.6MB

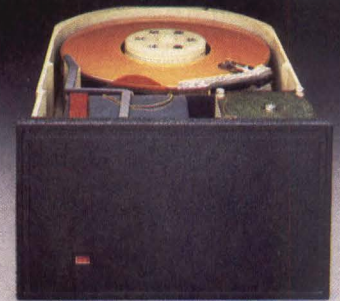

TM501 5 1/4" Winchester  
6.4MB

# TANDON IS THE LAST WANT TO BUY.

Because once you buy from Tandon, you'll realize there's no reason ever to buy from anyone else.

We're the world's number one source for 5 1/4" floppies, 8" ThinLine™ floppies, and 5 1/4" Winchesters. For three very good reasons: our three producing divisions.

Each of our divisions is a specialist in its field. That means they can concentrate their energies on producing what they know best. It's as if we owned three disk drive

companies. All named Tandon. All with the same stable financial backing and forward-thinking corporate direction. All a world leader in their particular product line.

Tandon's 5 1/4" floppy division is the world's largest producer of 5 1/4" floppies. They produce more drives every month than anyone else. For some of the biggest names in the computer industry.

We introduced the 8" ThinLine drive to give you traditional 8" storage capacity in

ThinLine is a trademark of Tandon Corporation. Tandon Corporation, 20320 Prairie, Chatsworth, CA 91311, (213) Atlanta (404) 934-0620 • Chicago (312) 530-7401 • Dallas (214) 423-6260 • Irvine (714) 675-2928 • Sunnyvale (408) 745-6303 • Frankfurt, West





TM100-4/4M 5¼" Floppy  
96/100TPI 1MB

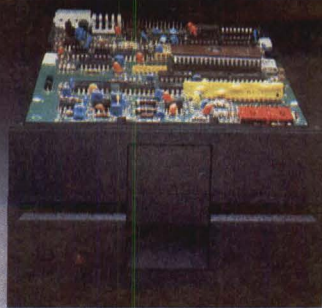

TM101-4\* 5¼" Floppy  
96TPI 1MB

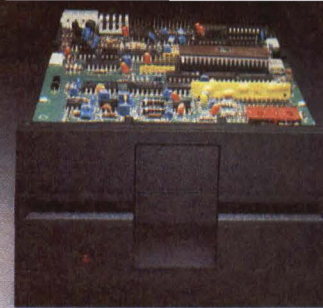

TM102-2\* 5¼" Floppy  
96TPI 2MB



TM50-2 5¼" ThinLine Floppy  
48TPI 500KB



TM55-2\* 5¼" ThinLine Floppy  
48TPI 500KB



TM55-4\* 5¼" ThinLine Floppy  
96TPI 1MB



TM502 5¼" Winchester  
12.8MB



TM503 5¼" Winchester  
19.2MB

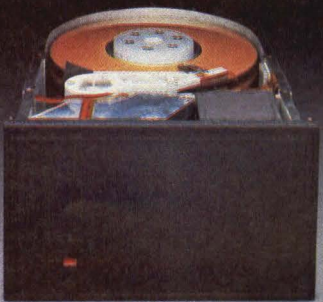

TM703 Winchester  
30MB (Closed-Loop)

# PLACE YOU'LL EVER A DISK DRIVE.

half the space. Our 8" ThinLine division is by far the world's largest producer of these popular drives.

Our Winchester division is now delivering 5¼" drives in both open-loop and high performance closed-loop models. They have current capacity to produce 40,000 drives a month.

All our divisions share Tandon's dedication to constant improvements in technology,

productivity, and efficiency. With a degree of vertical integration no other company even approaches. That means higher quality control and lower costs to you.

That's the Tandon story. It's made us the most successful disk drive companies you ever heard of. And the last place you'll ever have to go to buy a disk drive.

## Tandon

**THE MOST SUCCESSFUL DISK DRIVE COMPANIES YOU EVER HEARD OF.**

993-6644, TWX: 910-494-1721, Telex: 194794. Regional Sales Offices: Boston (617) 938-1916 • New York (201) 449-7720  
Germany 6107-2091, Telex 411547 • London, England (0734) 664-676 Telex: 848411. Distributors: Hall-Mark, Kierulff, Schweber. \*Microprocessor Controlled

MINI-MICRO SYSTEMS/April 1983

CIRCLE NO. 12 ON INQUIRY CARD

# CUSTOM MODEMS WHILE YOU WAIT!

(well, almost)

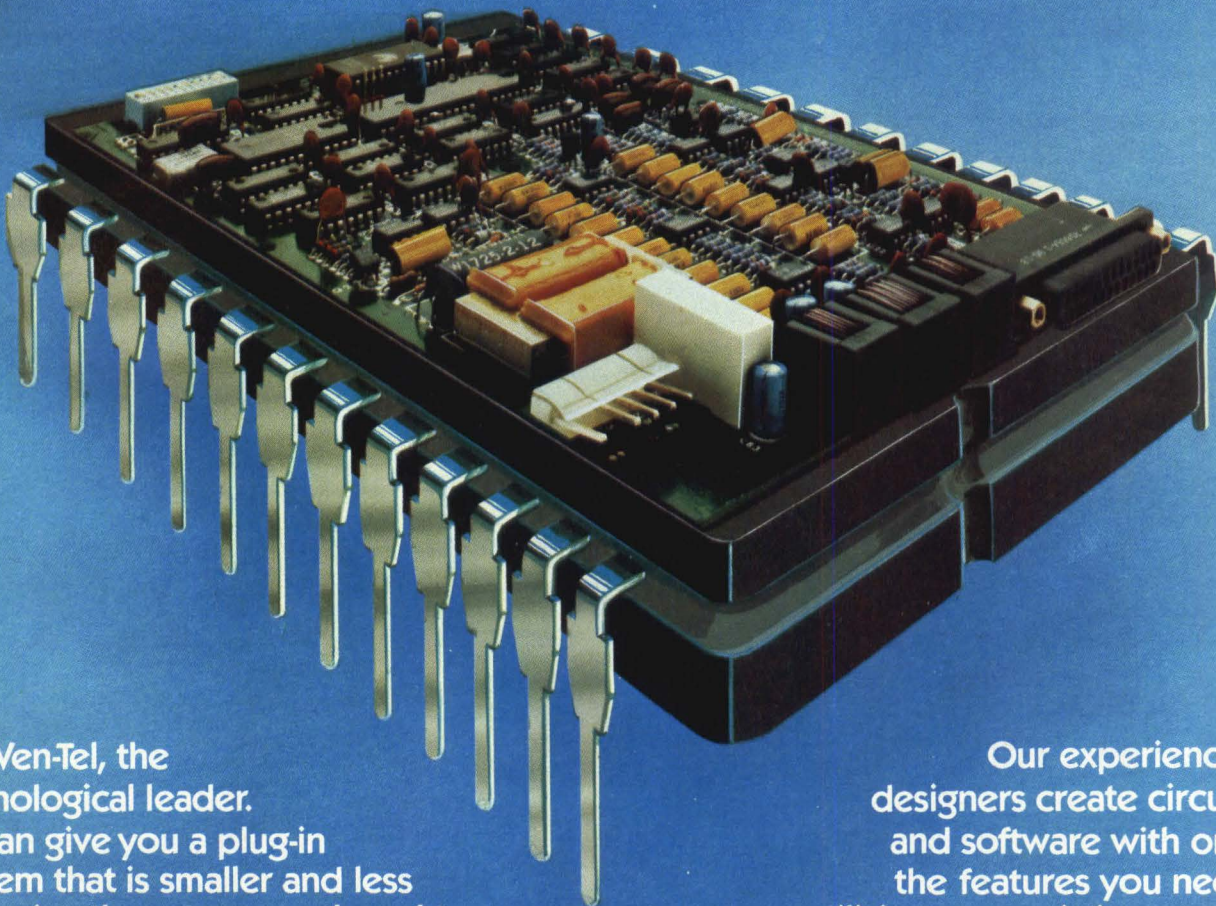

Join Ven-Tel, the technological leader. We can give you a plug-in modem that is smaller and less expensive than you ever thought possible. Our custom modems have been field-proven in over 10,000 installations. They take up a remarkably small space and add the value your product needs to stand out from the crowd.

Our experienced designers create circuits and software with only the features you need, utilizing your existing power supply and interfaces. We use CAD/CAM technology to produce your custom modem in as little as 60 days ARO.

For all the exciting details phone Dick Bessey, Vice President, Custom Products: 800-538-5121, or write him c/o Ven-Tel, Inc., 2342 Walsh Avenue, Santa Clara, CA 95051 (408) 727-5721.



**VEN-TEL**™

CIRCLE NO. 14 ON INQUIRY CARD

# Mini-Micro World

NEWS

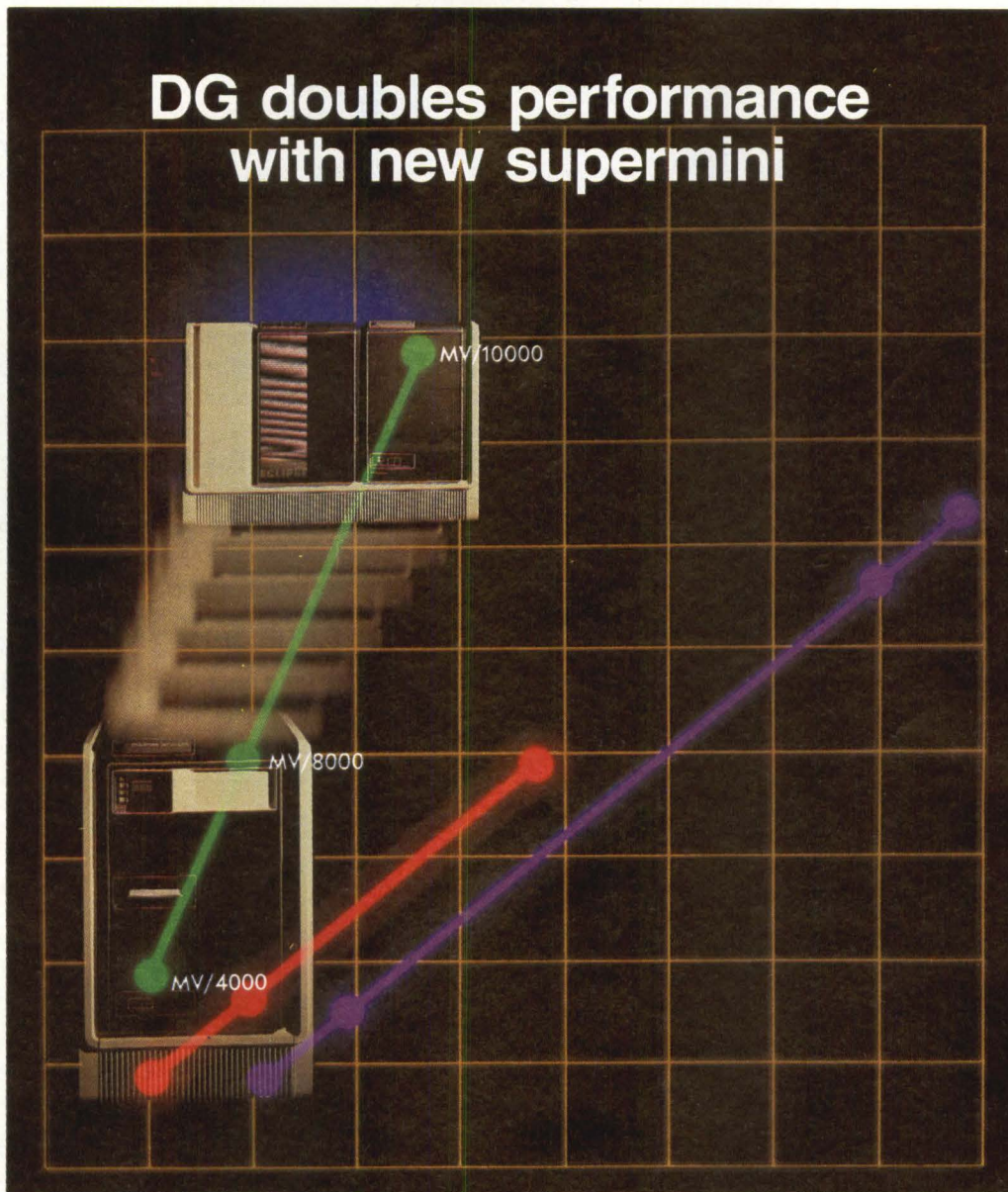

For the first time since it entered the 32-bit minicomputer market, Data General Corp., Westboro, Mass., has seized the initiative from its rival, Digital Equipment Corp., with a high-end system it claims will deliver twice the performance of DEC's VAX-11/780. The DG advantage may be short-lived with a rumored VAX-11/790 on the horizon, but DG officials hope to carve a permanent position with their MV/10000—especially in technical markets.

The MV/10000 is designed to deliver twice the performance of the MV/8000 by extending the basic MV/ architecture with an advanced Schottky processor, a board-level floating-point processor, an address generator board and faster RAMs in the instruction, data and address translation caches. MV/10000 engineering project leader Bob Beauchamp attributes most of the improvement to the address generator, which enables the system to load and store instructions in one

cycle instead of the two cycles required on earlier MV/ models. The MV/10000 boasts a 140-nsec. cycle time versus 220 nsec. for the MV/8000. The MV/10000 supports as many as 256 simultaneous processes and 196 users. The MV/8000 supports 256 processes and 128 users. The MV/10000 can address 18M bytes of memory compared to 12M bytes on the MV/8000.

Other MV/10000 performance features include the expansion of microcode instructions from 80 to

# Mini-Micro World

NEWS

104 bits each, a dual-ported memory bus with an aggregate bandwidth of 57.2M bits per sec., a burst multiplexer supporting connections of as much as 18.5G bytes of disk storage, a microNova-based intelligent asynchronous communications controller, an Intel 8086-based intelligent synchronous controller and a new two-board floating-point unit. The floating-point unit uses two identical boards, one of which is assigned single-precision operations and the other double-precision operations.

The result is a system DG officials say delivers 2500K single-precision Whetstones and 1988K double-precision Whetstones. This compares with 1240K Whetstones in single-precision math for the MV/8000 and 1133K Whetstones for the VAX-11/780.



**DG's highest performance superminicomputer, the MV/10000, is targeted at industrial automation. A variety of graphics workstations can be used on the system, including a new Dasher G500 medium-resolution terminal (foreground) and a high-resolution GW/4000 workstation (middle and left), which is driven by an MV/4000 supermini.**

A basic MV/10000 configuration including 1M byte of memory, a 147M-byte disk, a tape drive, a 16-line multiplexer, a console and the AOS/VS operating system license is list-priced at \$204,100. In

comparison, a VAX-11/780 with 2M bytes of memory, a 121M-byte Winchester disk drive, a tape drive, a console and an eight-line multiplexer lists for \$189,000. With the MV/10000 introduction, DG has cut the prices of MV/8000 packages by \$20,000 to \$34,000 each for a maximum reduction of about 16 percent. An MV/8000 configuration similar to the MV/10000 quoted above, for example, dropped from \$190,000 to \$157,700.

The basic MV/10000 configuration is implemented on 12 boards including a 1M- or 2M-byte memory board. The system includes an arithmetic-logic unit, an instruction-processor unit, a system-control processor, an address-translation unit, the address generator, a microsequencer, two floating-point processor boards, a

## DG ADDS 16-BIT MINICOMPUTERS

At the same time Data General Corp. was topping off its MV/10000 32-bit minicomputer line, it was also expanding its 16-bit Eclipse line with a high-end model for technical and commercial OEMs.

The system is based on third-generation high-density bipolar Schottky logic components and is said to have a 150-nsec. cycle time. It has a 4K-byte cache, a 288K-bit control store and supports from 0.5M to 2M bytes of main memory. The basic CPU also includes an asynchronous I/O controller and a programmable interval timer.

For technical OEMs, DG's Technical Products Business Unit offers the system as the s/280 with options such as a \$6000 floating-point unit and a \$1500 burst multiplexer channel. With the floating-point unit, the system is said to achieve 900K Whetstones. The s/280, which is said to provide a 50-percent performance boost over the s/250, overlaps the low end of the 32-bit line, the MV/4000, introduced last fall (MMS, December, 1982, p. 17). The MV/4000, which starts at around \$30,000, has a 600K Whet-

stone rating. The s/280 starts at \$30,000 in a 512K-byte version in a 16-slot rack-mount cage. A packaged version with a floating-point unit, a 25M-byte Winchester disk drive, a floppy disk drive and an operating system is \$46,220, and a high-end configuration with 2M bytes of main memory, a 73M-byte disk, a floating-point unit, a 1600-bpi streaming tape and an operating system is \$72,535. The s/280 can be ordered with the AOS, RDOS or MP/AOS operating system.

The commercial version from the Small Business Systems Business Unit is the Series 200C, which differs from the s/280 in the availability of floating-point and burst-multiplexer options, which are not offered on the commercial system. A configuration with 512K bytes of main memory, a 50M-byte Winchester disk, a 1600-bpi tape, a 16-line asynchronous terminal interface, a dual-bay cabinet, a Dasher 200 console and the RDOS operating system license sells for \$57,130.

A high-end package with 2M bytes of main memory, a 147M-byte

Winchester disk, a 1600-bpi tape, a 16-line terminal controller, a cabinet, a D200 terminal and an AOS operating system license is \$83,630.

With the Series 200C introduction, DG cut prices on other commercial systems and upped the memory limit to 2M bytes on the Series 100 and Series 200B. The price cuts, attributed to the introduction of 64K-bit memory technology, amounted to \$3000 for a 100 with 512K bytes of main memory, \$700 on a 256K-byte 100 and \$6600 on a packaged Series 200B with a 1M-byte main memory. Upgrade fees were reduced on the cs/10 model 3, which can be upgraded from a three-terminal system to a Series 100 system supporting 16 terminals for \$9650. A cs/30 can now be upgraded to a Series 100 for \$7750.

The company has also added a 15M-byte cartridge-tape drive and a 50M-byte Winchester disk for the cs line. The tape unit, which is available on the 100 and 200 series, is list-priced at \$5500, and the 50M-byte disk, which is restricted to the 200, is \$10,500.

memory-controller board and an I/O controller board. The system uses the 64K-bit RAMs that were added to the upgraded MV/8000 a year ago. And, in addition to the diagnostic "sniffing" technique pioneered in the MV/8000, the MV/10000 has a "fail-soft" capability intended to disable faulty physical-memory locations. The system control processor, which oversees the internal diagnostics of the system, is designed to continue operating with a minimum of one I/O board functioning.

The optional writable control store, which was expanded recently in the low-end MV/4000 introduction, is being offered with the MV/10000 in a 4096- × 104-bit word package for customers who wish to optimize their systems through custom microcoding.

Although DG officials decline to make direct comparisons with systems designed for real-time applications such as Perkin-Elmer Corp.'s 3200 series and Gould S.E.L.

Concept/32s, the company is pitching the MV/10000 system directly to industrial end users and OEMs. DG officials claim the MV/10000 is the fastest virtual-memory 32-bit minicomputer on the market. Don McDougall, director of DG's Technical Products Business Unit, says, "Industrial automation is our focus with this system." He sees the market divided into end-user sales for computer-aided engineering, system OEM sales for turnkey CAD and CAM products and hardware OEMs for process-control.

With the MV/10000, DG hopes to build on the CAE base that it has been building with the MV/8000. While the MV/8000's biggest industrial market has been time-shared, general engineering applications, says senior marketing specialist Bob Andrews, the MV/10000 will provide the performance for computation-intensive simulation and modeling applications as well. To address the engineering and design

markets, DG has announced the availability of the Anvil 4000 drafting package from Manufacturing Consulting Services and Ease2, a finite-element analysis package from Wessco, Elk Grove, Calif.

"In the design market," McDougall says, "people are moving from turnkey systems to independent software." DG allows customers who develop their own applications to write programs in the AOS/VS environment and run them under the real-time RT/32 operating system.

On the commercial side, Information Systems division vice president J. David Lyons predicts that the MV/10000 will take the CEO office-automation package into large-scale installations in which mainframe-based systems have previously been used. Lyons claims the economies of scale on the MV/10000 will reduce the price per workstation to about \$7500.

—Geoff Lewis

## DG SUPPORTS GKS STANDARD WITH OEM GRAPHICS TOOLS

Shunning the turnkey CAD/CAM systems market for itself, Data General Corp. is offering its technical OEMs a set of tools to configure their own CAD/CAM systems. The company has added a \$70,000 GW4000 design system incorporating the MV/4000 32-bit minicomputer and GDC/1000 workstation, and is offering the workstation separately for incorporation in 16-bit Eclipse systems. The GDC/1000 color workstation, including two Eclipse boards and a data channel interface, is approximately \$19,000 with a 768- × 576- × 8-dot resolution and \$23,000 with a 1280- × 1024- × 8-dot resolution.

Both workstation options support the proposed Graphical Kernel Software standard now before the International Standards Organization and covering two-dimensional graphics subroutines. The GDC/1000 workstation has a bit-sliced display controller and a z8000-based com-



**Data General's high-resolution GW/4000 workstation system, which is driven by a 32-bit MV/4000 minicomputer, can display 256 colors simultaneously.**

mand processor. It is said to provide 40 bits per pixel of information—24 bits for color definition and 16 bits for depth definition. As many as 256 colors can be selected from a 16.7-million color palette. Each of eight planes of memory can be addressed separately. Agnes Imregh, product manager of graphics languages and tools, says the terminal

can draw at 1 million pixels per sec.

Imregh predicts DG will be able to deliver higher performance this year when 60-MHz monitors become available. The current system uses a 30-MHz monitor, but Imregh says DG will sell the GKS graphics controller without a monitor.

In addition to the high-resolution color graphics products, DG has added a Dasher G500 medium-resolution graphics display. The G500 has a 15-in. bit-mapped display, 640 × 480 resolution, a Centronics-compatible parallel printer port and an RGB port. The G500 is controlled by a Motorola MC68000 microprocessor and includes its own 0.5M-byte memory for "displayless" storage, which enables the G500 terminal to draw a shape based on a description of the logical shape transmitted from the host, instead of relying on the host to transmit the entire pattern.

# Mini-Micro World

NEWS

## Tektronix's lower price strategy brings three terminals, graphics microcomputer

With the April introduction of the 4100 "Unicorn" family of three-color raster terminals, anchored by the \$3995 list-priced 4105, as well as a companion less-than-\$6000 4170 local graphics-processing unit and less-than-\$2000 eight-color ink-jet printer, Tektronix Inc. hopes to reestablish a reputation for quality at low prices. Additionally, the 4170 may signal Tektronix's "shy" move into the stand-alone graphics micro-computer market.

In 1971, Tektronix introduced the 4010 direct view storage tube terminal, which at \$3995 was an order of magnitude less expensive than previous graphics terminals of similar resolution. The company thus acquired a reputation for quality at low prices, and that reputation made it a leader in the emerging market for computer graphics. Over the years, Tektronix's reputation for quality rose, but so did prices, until the industry perceived Tektronix's quality to come only at a premium.

Now, the company is focusing on high-volume, price-competitive products aimed at engineering executives and office users. "The low-cost [4105] terminal coupled with the 4695 ink-jet printer bring Tektronix strongly into the high-volume end of graphics," says Gary Laroff, marketing manager for San Diego, Calif., Integrated Software Systems Corp. (ISSCO), a leading vendor of computer graphics software that has written a device driver for its display presentation graphics software to run on the new terminal.

Thomas Clarkson, president of Tektronix spin-off Graphics Software Systems, Wilsonville, Ore., concurs. "The 4105 terminal is a



**Tektronix's \$3995 4105 terminal and the less-than-\$2000 4695 color graphics ink-jet "copier" are intended for technical and professional users. The 4695 provides 120-dot-per-in. resolution and six-color images. The 4105 has a 480- × 360-pixel resolution, a 64-color palette and displays 16 colors simultaneously.**

price/performance breakthrough for Tektronix," he says. "The only near equivalents might be the DataMedia Colorscan with retrographics or Envision Technologies' 220," he says. Both go for about \$1000 more.

The 4105 offers 480 × 360 resolution in a CRT the size of a 15-in. monochrome display. The CRT is built around Intel Corp.'s 80186 16-bit chip, which integrates many on-chip support component functions (MMS, August, 1982, p. 19). Users can define a palette of 64 colors interactively using the hue, saturation and lightness model. Eight separate colors are available for graphics and text annotation, respectively. Refresh is noninterlaced at 60 Hz to minimize flicker, while a finely etched screen and a bright Panasonic shadow mask tube alleviate glare. Primitives for solid and dashed lines, plus polygon fill-in of solid colors, color shading and a variety of patterns, are accom-

plished in firmware, as is support for a variety of text sizes and text rotation in 90-degree increments. A coordinate space of 4096 × 4096 is dot addressable.

The omission of support for local segments, pan and zoom and coordinate transformations is not significant for the low-end market at which the 4105 is aimed, claims Clarkson. "But performance is, and clever firmware and byte-per-pixel architecture make the 4105 fast."

The two other 4100 Unicorn members are the less-than-\$7000 4107, which has the pan and zoom and coordinate transformations omitted on the 4105, as well as 640- × 480-dot resolution, and the top-of-the-line 4109, a 19-in. screen version with the same resolution as the 4107 but with the added graphics capability and more memory and priced at less than \$10,000. All models can run with the 4170 local graphics-processing unit,

## UNICORN: A DESIGN FOR QUALITY AT LOW COST

Dave Squires, who headed Tektronix Inc.'s Unicorn terminal family design team, says the study of Japanese manufacturing methods was a major factor in getting the list price of the low-end 4105 color graphics terminal down to \$3995. One result was the formation of close relationships with suppliers, with particular attention to improving the suppliers' quality-assurance procedures. The result: Tektronix neither inspects incoming parts nor does burn-in of the Unicorn terminals, yet quotes a mean time between failure of 10,000 hours for the 4105.

"A lot goes into that MTBF," says Squires. One key is use of Intel's 80186, a chip that integrates many functions normally performed by a CPU and a number of support components, which results in decreased internal heat buildup. Another bonus is decreased manufacturing costs: Squires estimates Tektronix

saved \$400 per unit by choosing the 186 over the 8086. The 4100 family was designed for automated assembly, Squires says. "There's only 10 min. of labor in each 4105," he claims.

Finally, the team saved money by rejecting Tektronix's typical "Baskin Robbins approach" to marketing in favor of plain vanilla products. That way, no time is spent explaining various product flavors, and standard products need not be removed from the box, opened and retooled to incorporate additional features. If the 4105 does not meet a customer's needs, a salesman merely shows the higher capability 4107 or 4109.

One last key to the 4105's low price is one that involves a gamble. "We're counting on high-volume [sales]," says Jon Reed, general manager of the Interactive Display Division of Tektronix, "and the jury is still out on whether we'll get them."

which essentially turns the combination into a stand-alone, 8086-based graphics microcomputer running CP/M-86.

Another important plus for the new family of Unicorn terminals, observers agree, is their independent alphanumeric dialog area, which uses an SMC 7002 controller to run ANSI X3.64 screen-handling codes at rates as high as 19.2K baud. The dialog area can be expanded interactively from the bottom two 80-character lines to the full 30-line display, and can write over or hide the graphics image.

Achieving a small footprint without sacrificing both graphics and alphanumeric capabilities was one of the goals of the 4100 design team, says Jerry Ramey, general manager of the Unicorn family project. Also important were ergonomic features.

Clarkson and other observers agree that the low-end 4105 will be attractive as a terminal to attach to

host computers, particularly Digital Equipment Corp. minicomputers. Tektronix's product marketing manager for the Unicorn terminals, Bob Anundson, points out that the Unicorn's price is no more than that of the DEC VT125 monochrome graphics terminal. And the availability of 4105 device drivers for ISSCO's Disspla and Tel-A-Graf software and SASgraph software from the SAS Institute Inc., which together account for most presentation-graphics work done in Fortune 500 companies, also indicates the Unicorn terminals will find their way outside of the normal Tektronix sphere of scientists and engineers.

But several observers question whether the Unicorn introduction adequately addresses the trend toward local programmability, despite the importance that an internal study that led to the new Tektronix products attached to off-loading host computers. Graph-

ics Software Systems' Clarkson lauds the presence of the Intel 8087 floating-point co-processor in the 8086-based 4170 locally programmable graphics unit. He says the 8087 improves performance on typical graphics functions such as rotations about 10 times. And Tektronix plans to upgrade the 4170 by replacing the 8086 and 8087 with the faster 80286 and 80287 processors when they are available in volume will make the local programmability unit "a real screamer," he says. "But when you add the cost of the 4105 terminal, you've got a \$10,000 computer, and that might be high."

Russ Weeks, marketing manager for Digital Research Inc.'s graphics products, agrees. He sees the new Tektronix combination competing with microcomputers such as the NEC Information Systems Inc. Advanced Personal Computer, which offers 640 × 480 resolution and eight colors for less than \$5000. "The 4170 runs CP/M-86, and there are a lot of people writing software—graphics and otherwise—for that operating system, but will Tektronix fully leverage it?"

Merle Smith, product manager for the 4170, says Tektronix will do everything possible to encourage the creation and use of third-party software on the new stand-alone graphics processor. He says the greatest strengths of the 4170 are the large base of Tektronix Plot-10 software that runs on the 4170 and the upward migration path available to a 4170 user via a low-level terminal interface the 4170 shares with the earlier Tektronix 4110 line, including the new \$25,000, top-of-the-line, 1280 × 1024 resolution, 256-color 4115. "But it is our intention to add Digital Research's GSX graphics system extension for CP/M-86, thus tapping that growing base of graphics applications as well," he says. —Kevin Strehlo

## TI enters 'professional' CPU market with Intel 8088/MS/DOS system

Texas Instruments Inc. has made its move into the office personal-computer market with a package patterned on the IBM Personal Computer, but with some significant departures from IBM Corp.'s model, such as a voice-recognition/telephone-management option.

Like the IBM PCs and the raft of IBM-like systems that have appeared on the market in the past year, the TI Professional Computer uses the Intel 8088 microprocessor, 320K-byte floppy drives and Microsoft's MS/DOS operating system. It diverges from the IBM fold in both its higher resolution graphics and in its five-slot expansion chassis, four of which are available even with high-resolution color graphics. Although TI officials have promised to keep the system "open" for TI-compatible third-party add-ins, not all add-ins designed for the IBM bus will fit the TI machine. The TI bus has a card interface similar to IBM's, but the TI cards are slightly longer. "Some option cards (designed for IBM) have been proven to work, and some haven't," a TI spokesman reports. A parallel printer port is standard. An asynchronous/synchronous communications card is available for \$225.

Software compatibility with IBM is also hazy. Like many other 8088/MS/DOS vendors, TI claims its machine is media and data-file compatible with IBM's. This means users can expect to run some IBM programs as-is, while other packages that use system capabilities beyond the operating system must be modified. However, TI has already lined up an array of software that will run on its system including Ashton-Tate, Digital Research, Lifeboat, Micropro, Peach-



*The natural-language package, an option for TI's Professional Computer scheduled for release this year, enables non-programmers to construct database inquiry and other basic applications by selecting appropriate terms from a multi-window screen.*

tree, Softech, Software Publishing, Sorcim and VisiCorp products. Digital Research CP/M packages can run under a Xedex Z80 soft-card option. CP/M-86 is offered as an alternate operating system—along with UCSD p-System—on the 8088. Digital Research's Logo is also supported. TI has agreements to supply VisiCorp's forthcoming Visi<sup>On</sup> package, with Lotus Development Corp. to supply 1-2-3 and with Relational Software to supply the Oracle database-management system.

The basic TI configuration is a \$2595 package with 64K bytes of main memory, a single 320K-byte floppy, a detachable keyboard, a 12-in. monochrome monitor and documentation. The same configuration with a 13-in. color display is \$3145. A high-end configuration with TI's Seagate-licensed 5M-byte Winchester drive and 256K bytes of RAM is \$5490, and a similar hard disk model with the 13-in. color display is \$6185.

TI executive vice president Jerry Junkins says, "We believe being a major contributor in this market is strategically critical for TI." He emphasizes the ways in which TI has broken out of the IBM-clone mold. On the surface, the most dramatic departure is in the TI system's graphics capabilities. A single CRT controller has been designed to handle monochromatic or color monitors with a resolution of 720 × 300 pixels. IBM's requires separate controllers for those two functions. The controller has 2K bytes of RAM.

For hard-copy output, TI has introduced a companion low-end, dot-matrix printer that can produce graphics and text at speeds as high as 150 cps. In another departure from IBM, TI provides expansion memory through a separate memory bus that accommodates 64K-, 128K- or 192K-byte boards for a maximum main memory of 256K bytes.

TI hopes to distinguish itself most strongly from the crowd, however, with a voice-recognition/telephone-management option and a "natural-language" programming package, both due this year and as yet unpriced. The voice option is based on a piggybacked, dual-card package that will occupy a single expansion slot in the system. The package includes a TI TMS320 signal-processing chip, a TMS7000 microprocessor with I/O control functions, 32K bytes of RAM and 1K byte of ROM. The option is expected to be used as a telephone-management system for answering-machine, automatic-dialing, dictation and automatic-host-computer dial-up functions. It can also be used to implement voice store-and-forward applications, according to



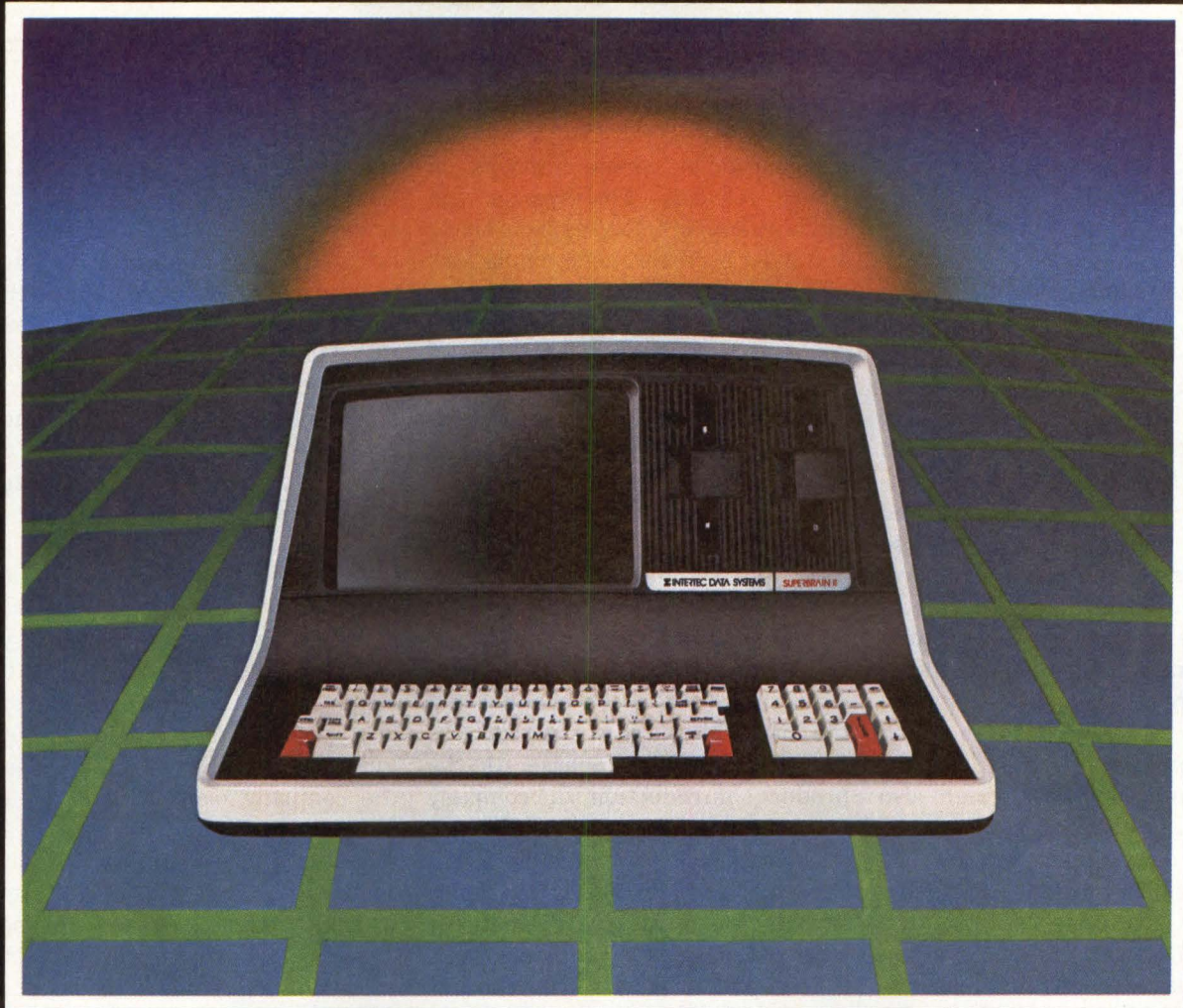

# THE PERSONABLE BUSINESS COMPUTER™

Intertec announces what may well be the industry's first *personable* microcomputer—SuperBrain II.™

What's a *personable* computer? It's a computer with business application versatility at personal computer prices. It's a computer powerful enough to tackle even your toughest business jobs, yet at a price that won't put you out of business. But most importantly, it's a computer you can put to use right out of the box. That's because SuperBrain II™ boasts the industry standard CP/M\* operating software. So whatever your business application, SuperBrain II can handle it. There are literally hundreds of ready-to-run business applications available "off-the-shelf".

Unlike many microcomputers, the SuperBrain II™ is time-tested and field-proven. It's built and backed by a company that's been around as long as the industry itself. A company you can count on for product support and customer satisfaction.

\*Registered trademark of Digital Research.  
†Microsoft is a trademark of Microsoft Corporation.

## STANDARD FEATURES

- Dual 5¼" disk drives
- 350K/750K/1.5 MB disk capacities
- 64K RAM
- Twin Z80A microprocessors
- An easy-to-read 12-inch non-glare screen
- An 18-key numeric keypad
- 10 MB disk expansion capability (Optional)
- Microsoft† Basic

When you think about it—price, performance, and the reputation of the manufacturer—it's no wonder so many discriminating microcomputer users have become "personal" friends with our new SuperBrain II™—the industry's one and only *personable* desktop microcomputer.



CORPORATE HEADQUARTERS: 2300 BROAD RIVER ROAD • COLUMBIA, SOUTH CAROLINA 29210 • (803) 798-9100 • TWX 810-666-2115

CIRCLE NO. 15 ON INQUIRY CARD

# Mini-Micro World

NEWS

TI officials. On the voice-recognition side, it can be "trained" to recognize multiple sets of 36 words each. A "transparent keyboard" feature is designed to enable users to substitute voice commands for keyboard commands without rewriting an application program.

The natural-language option, which was developed at TI on machines running the Lisp artificial-intelligence system, is intended for non-programmers who wish to perform simple application programming. It includes a series of connectors, nouns, qualifiers, comparisons and attributes and features a split-screen format from which users can select words to build programming sentences.

The natural-language system also automatically eliminates syntax errors. The first application for the package will be a database-inquiry facility for extracting data from the Dow Jones News Retrieval system. TI officials expect the natural-language package and the voice options to be used by outside vendors for their applications.

TI plans to release an internal 300- or 1200-bps modem option this year and will have IBM 3270 SNA and

bisynchronous communications in future releases. The system will initially support TTY asynchronous and 3780 bisynchronous emulations written by TI. The company has also disclosed plans to make Corvus's Omninet local network available.

Distribution of the TI Professional Computer, which began in February, will be through retail computer stores, office-equipment dealers, system houses and directly to large end users. In developing the computer retailing channel, TI is going directly to individual stores in a one-step distribution program that thus far circumvents the industrial distribution channel and the national chain stores such as ComputerLand or Sears. At the product's introduction, the company had stocked and trained almost 200 dealers in 25 major cities. Data Systems group president Eric Jones says the TI terms are competitive with other small system manufacturers' and include a flat discount rate (which he declines to disclose), 30-day net payment, training and cooperative advertising.

Beyond the dealer channel, however, TI plans to mount a direct sales campaign to major end users

and will sell the system through its traditional system houses. The system house effort, TI officials say, is geared to specific vertical markets. The first major vertical contract was awarded in a competition with IBM before the Professional Computer's introduction. Farmland Industries Inc., a farmers cooperative, expects to resell the systems with special farm-management packages to farmers in its 500,000-member organization.

While the TI personal computer will act as a terminal for other TI systems, the company has not yet provided software tools to tie the computer to the Business Systems line. Professional Computer program manager Kevin Ellington says the company plans to add the RM COBOL package from Ryan-McFarland Corp. to the personal computer. The UCSD p-System, which is offered on the Business Systems line, can also provide links between the product lines, he notes. Another possible link, he says, is implementation of the UNIX operating system on both lines, which Ellington calls "a future possibility."

—Geoff Lewis

## IBM's 4-in. microfloppy turns heads as standard debate rages

While a Pacific storm ripped up the coastline recently, members of the American National Standards Institute X3B8 committee were treated to a different kind of storm inside a San Diego hotel meeting room, battering the already-cloudy microfloppy standard debate. Committee members who lingered after the meeting's adjournment were given an unofficial presentation by Roger Chenoweth of IBM Corp. on Big Blue's long-awaited OEM entry

into the microfloppy field.

During the meeting, and against the objections of Chenoweth and representatives of Dysan Corp. and others backing a 3¼-in. form factor, the committee decided to poll its members through letter ballots on establishing the 3½-in. form factor presented by an industry committee. The ballot process will take six weeks and requires two-thirds of the pro vote for adoption.

Committee members then lis-

tened in respectful silence as Chenoweth unveiled IBM's 4-in. form factor microfloppy. The media will be housed in a 4-in. plastic case with no shutter. The drive measures 2.6 × 6.7 × 4.5 in. The media inside the plastic case is 102 mm. in diameter and will rotate at speeds from 262 to 415 rpm, to keep a constant recording density on all tracks. While IBM's drive holds 358K bytes of unformatted information on a single side, other small drives hold 500K bytes. Tabor Corp.'s, for

# THE 8MBYTE FLOPPY SURPRISE

At last, a disk drive which accommodates both stand alone removable media data storage and Winchester backup applications — all with one device. The Amlyn drive is a superstar as the sole storage device on your system. It combines the benefits of high performance, high capacity data storage with removable, low cost user friendly media. All this for less than half the price of a Winchester drive and its backup device.

If you use Winchester drives, you need backup. Amlyn's drive is THE backup device which is interface, format and software compatible with the Winchester itself. So compatible, it can take over for your Winchester when it fails so that a Winchester failure doesn't shut your system down. Amlyn backs up your Winchester drive itself — not just the data on it. Now backup is more than something you hold in your hand when your Winchester fails.

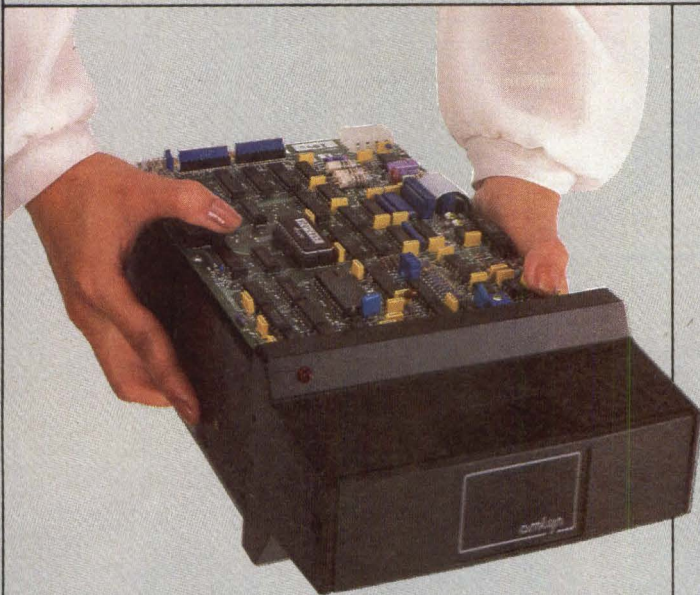

## Dynamic On-Line Operation

Amlyn drives provide 8 MBytes in the same space as a standard mini-floppy. Amlyn has combined the capacity of Winchester drives with the advantage of removable media.

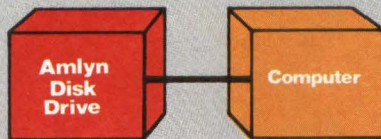

Available Now,  
Contact Us At 408-946-8616

**amlyn**

2450 Autumnvale Drive  
San Jose, CA 95131  
(408) 946-8616  
TWX 910-379-0029  
TLX 171627 Amlyn

## Random Access Winchester Back-Up

Now, you can have Winchester system backup, not just data backup with interface and software compatibility to your Winchester as well.



## Removable Media

Amlyn's 8 MByte removable MiniPac cartridge holds and protects diskettes from damage and mishandling, and is easily removed and replaced. Each cartridge holds five mini-floppy diskettes.



## Standard and Flush Mount Design

Amlyn drives allow OEM and systems house design flexibility with a variety of styles which assure form factor compatibility with standard mini-floppy dimensions.





The age of intelligent computing is here

# Introducing the sophisticated professional workstation.

## The Symbolics 3600 Lisp-based system puts unlimited computing at your fingertips

A new age of computing is here. The Symbolics 3600 Lisp-based processing system suddenly makes large-scale problem-solving simple. It makes the impractical become practical and manageable. With powerful software and hardware, the Symbolics 3600 puts a higher level of computing in your hands. A dedicated, single-user system, the Symbolics 3600 takes the technological advances from the last 25 years of research on artificial intelligence and makes them applicable to real-world, problem-solving applications. To the engineer, designer, scientist and researcher, this offers a new, powerful tool that significantly increases productivity.

Symbolics' innovations in symbolic computing extend the limits of solutions in traditional applications. For example, large-scale software system development and VLSI circuit design are massive undertakings. The Symbolics 3600 software environment takes care of many of the routine tasks a programmer or designer is now required to perform, dramatically reducing programming and design time while significantly increasing productivity. These bene-

fits apply to emerging applications areas such as development of expert systems, symbolic mathematics, robotics, CAD/CAM, genetic engineering, training simulators, and a broad range of research activities.

### Unlimited computing power

The Symbolics 3600 puts the level of computer power associated with supermini class computers in your hands

at a fraction of the usual cost. It has a 36-bit tagged architecture and executes programs at an average of one million high-level instructions per second. Our standard 3600 system software, a powerful and proven Lisp-based operating and program development environment, also supports FORTRAN, PASCAL, C, Interlisp compatibility and Flavors object-oriented programming.

### Full Ethernet capabilities

The standard Symbolics 3600 includes full 10 megabit/second Ethernet hardware and software support. An unlimited number of 3600 systems or peripheral devices can be linked together. Each user in a typical workstation environment has access to all other computing facilities on the network.

### Symbolics 3600 Capsule Specifications

#### System CPU

36-bit tagged, stack oriented architecture  
2.3 megabyte RAM with ECC, expandable to 34 megabytes  
1.125 gigabytes virtual memory  
20 million byte/second memory bus  
Floating point accelerator (optional)

#### Console and Keyboard

Bit-mapped raster display  
B&W 17-inch, landscape format, 1100 x 800 pixel  
88 keys with n-key rollover  
3-button mouse

50 KHz sample rate audio output  
Color: 1280 x 1024 with 8 to 32 bits/pixel, 10 bits/color RGB (optional)

#### Mass Storage

Built-in 169 megabyte Winchester  
Optional disk memory up to 1.8 gigabytes  
Optional cartridge or 9-track tape drives

#### Communications

10 megabit/second Ethernet local area network  
One parallel and three standard serial ports

Autodial/Autoanswer 1200 baud modem (optional)

#### Operating System

Enhanced Zetalisp with on-line edit, compile, inspect, debug, network file system, electronic mail  
Totally interactive with sophisticated display system

#### Languages

Lisp, Fortran-77, C, Pascal, Interlisp  
Flavors object-oriented programming

#### Printer

Laser Graphics Printer LGP-1 (optional)

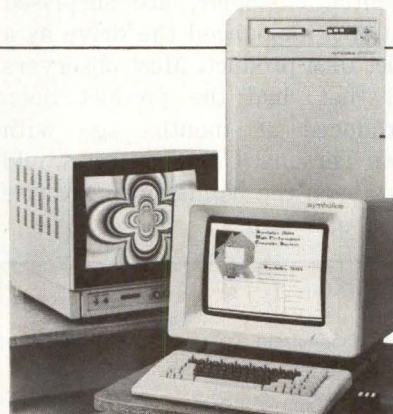

### Join the new age of computing

The Symbolics 3600 brings to you today a new age of computing—symbolic processing systems that are being used by a growing number of 3600 customers as the sophisticated means for problem-solving. Join them in this new age of computing. Call or write today. Symbolics, Inc., 9600 De Soto Avenue, Chatsworth, CA 91311 (213) 998-3600.

# symbolics inc.

Symbolics is a trademark of Symbolics, Inc., Cambridge, Massachusetts.

© 1983 Symbolics, Inc. Domestic sales offices: Chatsworth, CA (213) 998-3600 • Palo Alto, CA (415) 494-8081 • Cambridge, MA (617) 576-2600 • Houston, TX (713) 820-3001 International distributors: United Kingdom and Western Europe: Scientific Computers Ltd., England, Tel. (04446) 5101 • South Central Europe: Delphi Electronic Design Systems SpA, Italy, Tel. (0584) 31881 • Japan: Nichimen Corporation, Tel. (03) 277-5017

CIRCLE NO. 17 ON INQUIRY CARD

See the Symbolics 3600 at  
NCC Booth D2505-2508

# Mini-Micro World

NEWS

example, holds 500K bytes in a double-sided version. At NCC, Tabor is expected to introduce a 1M-byte version. In addition to physical dimensions differing from any other microfloppies proposed to date, the IBM drive uses a nonstandard interface. Sub-4-in. drives had all previously used a standard minifloppy interface.

Chenoweth admitted to the committee that "IBM alone will probably not set the standard for 4-in. or smaller floppies. There is likely to be more than one standard."

But as the specifications of IBM's drive ripple through the industry, the response appears to be something less than the spontaneous worship most IBM announcements draw. Most observers, mindful that they would like IBM as a future customer, attempted to find a kind way of expressing that this time the emperor is wearing no clothes. "There is only one thing good about this product—its name," says an executive of a media manufacturer, who wishes to remain nameless for obvious reasons. "The 800-lb. gorilla may be up a tree this time," says disk drive industry analyst Jim Porter. "Until IBM uses the product in a system, thereby creating a market, there will be little call for the drive as an OEM product."

George Sollmon, vice president of marketing for Shugart Associates, which offers a 3½-in. floppy built to the industry committee's specifications, notes IBM's OEM price for its drive—\$165 in quantities of 10,000

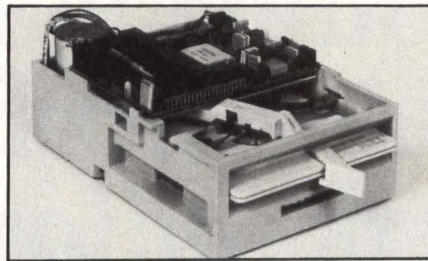

IBM's 4-in. microfloppy is throwing yet more confusion into efforts to standardize small drives.

—is "not exactly earthshaking." Shugart's price is expected to be \$135 in similar quantities.

Scott Holt, vice president of marketing at Seagate Technology, notes that, if the market embraces the IBM product, "Seagate and others may be expected to follow suit," but no plans are in the works.

Another industry analyst, Ray Freeman, of Freeman Associates, Santa Barbara, Calif., says the IBM product adds "extra confusion to an already-confused market." Freeman says IBM does not have as much clout at the low end of the disk drive market as it does at the high end. It is not therefore likely to make a contribution—at least with this product—to the eventual establishment of a 4-in. or smaller standard.

Many who refuse to be quoted for fear of losing IBM as a customer or a potential customer, are surprised that IBM announced the drive as a strict OEM product. Most observers feel that, had the product been introduced 18 months ago with IBM's Personal Computer, it would have been the hands-down favorite for a standard.

Not everyone is critical of the IBM drive. Andy Roman of Roman Associates International, Newark, Calif., hails the IBM product as a "rallying point for those manufacturers still undecided about which road to take." Roman believes that IBM still has the resources and market pressure to force a standard on the market, and he feels that it's about time someone did exactly that. "Out of all of the confusion, IBM walked in, opened its kimono and out dropped this little jewel."

Roman says IBM's use of cobalt media, unlike the ferrite media used in competitive products, can eventually be used to increase the drive's capacity. Cobalt allows high flux changes and thus higher recording densities. "I wouldn't be surprised to see a 3M-byte drive within four years," Roman says. In addition, he believes controller manufacturers can easily compensate for the nonstandard interface.

An IBM spokesman says the product was not built with anything else on the market in mind, but for "maximum reliability." He says evaluation units are being distributed to prospective customers. Production quantities will be available this year, but the company cannot be more specific. IBM has not yet negotiated a second source.

The spokesman refuses to speculate on whether IBM will eventually adapt the PC or another product to use the 4-in. drive in the near future. Industry sources, however, say the PC division's objections to using the new drive are much the same as those raised by competitors: lack of standardization.

The floppy drive is the latest offering in an increasingly important OEM sales section. The General Products division section in San Jose offers two 8-in. Winchester drives, including IBM's most popular OEM product, the Piccolo, as well as CRT terminals and a plasma display.

—Robert A. Sehr

## IBM vs. the Competition

	IBM	Shugart (Industry Committee)	Tabor/Seagate
Drive size (in.) H X W X D	2.6 x 4.5 x 6.7	3.25 x 5.75 x 8	1.6 x 4 x 5.50
Cartridge size (in.)	4;	3½;	3¼;
	hard jacket	hard jacket	soft jacket
Capacity (unformatted, single-sided)	358K bytes	250K bytes; 500K bytes (double-sided)	500K bytes
Tracks per side	46	80	80
Tracks per in.	68	135	140
No. of sides	2	2	2
Price (for 10,000 units)	\$165	\$135 (estimated)	\$165 (estimated)
Interface	IBM	5¼-in. standard	5¼-in. standard

# What's Behind the Supermux 380 Multiplexer?

# INFOTRON

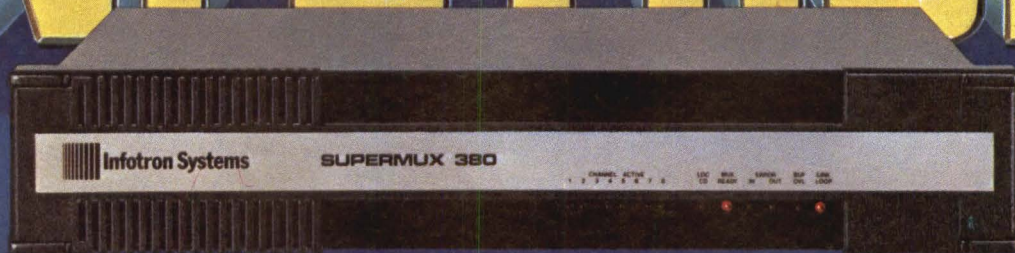

## The Foremost Company in Data Communications

Moving data over telephone lines is costly and hazardous. Supermux 380 statistical multiplexers reduce the costs. Infotron Systems Corporation eliminates the hazards.

Supermux 380 multiplexers reduce the costs by concentrating data from up to eight asynchronous terminals over a single telephone line. You save the cost of extra telephone lines and modems and you also enjoy protection from line "hits"

that can cause errors. Data is checked and retransmitted, if necessary, all transparent to your existing hardware and software.

Infotron Systems Corporation eliminates the hazards. For 14 years we have been building data communications systems for thousands of customers worldwide. Our products cover the full range, from simple LDMs to sophisticated network concentrators. You get the benefits of

our diverse experience—the Supermux 380 includes many large system features, capabilities and safeguards. Don't settle for less.

Infotron has also made it easy for you to get started by providing local support, before and after the sale. We've set up a network of qualified distributors with experience on IBM, DEC, Data General and other systems. Call the foremost company in data communications. Call Infotron.



### Infotron Systems

First in Performance and Reliability

Infotron Systems Corporation, Cherry Hill Industrial Center, Cherry Hill, New Jersey 08003  
Telephone: 800-257-8352 609-424-9400 TWX: 710-940-1247

**AL:** Hall-Mark (205) 837-8700 • **AZ:** Hall-Mark (602) 243-6601 • **CA:** ADvanced TEChnology (415) 785-8346/Dayton-Forester Assoc. Inc (714) 978-7455, (213) 701-0127/Hall-Mark (619) 268-1201, (408) 773-9990/The Helfrich Company (213) 926-7715, (415) 854-4554, (714) 631-2300, (619) 941-6050, (415) 938-9577 • **CO:** Hall-Mark (303) 694-1662 • **FL:** General Technology, Inc (305) 777-1133/Hall-Mark (305) 971-9280, (305) 855-4020, (813) 576-8691 • **GA:** Ethom Associates, Inc (404) 457-0161/General Technology, Inc (404) 433-0350/Hall-Mark (404) 447-8000 • **IL:** Hall-Mark (312) 860-3800/Interbusiness Corp (312) 459-8866 • **KS:** Hall-Mark (913) 888-4747 • **MD:** Erin Systems, Inc (301) 944-2520/Hall-Mark (301) 796-9300/Peripheral Integration, Inc (301) 944-2020, (301) 924-2140 • **MA:** Butler Associates, Inc (617) 964-5270/Marketechs, Inc (617) 237-4343 • **MN:** First Rep Co of Minnesota (612) 944-2097/Hall-Mark (612) 884-9056 • **MO:** Hall-Mark (314) 291-5350 • **NJ:** Hall-Mark (609) 424-7300, (201) 575-4415/Hansen & Hughes (201) 652-7055, (800) 526-5114 • **NY:** Reactive Systems, Inc (914) 368-0325 • **NC:** General Technology, Inc (919) 883-6523/Hall-Mark (919) 832-4465 • **OH:** C.G. Distributor Co (513) 435-4340/Hall-Mark (216) 473-2907, (614) 891-4555 • **OK:** Hall-Mark (918) 665-3200 • **PA:** C.G. Distributor Co (412) 366-5056/Infocore, Inc (215) 337-9611 • **TX:** Computer Associates, Inc (214) 634-1320, (713) 974-6002/Hall-Mark (512) 258-8848, (214) 341-1147, (713) 781-6100 • **VA:** Virginia Data Communications Service (804) 857-4433 • **WA:** S.J.I. Corporation (206) 763-8981, (206) 693-2085 • **WI:** Hall-Mark (414) 761-3000

CIRCLE NO. 18 ON INQUIRY CARD

## TeleVideo seeks to strengthen market leads with two new terminals

TeleVideo Systems Inc., which offering its high-performance, low-gained volume leadership among priced ASCII terminals through a independent VDT manufacturers by dense distributor network, is in

danger of falling behind in the low-end market, some observers say. Even TeleVideo's vice president of marketing and sales for CRTs, Steve Tatum, agrees that the competition is beating the models 910-plus and 925 in price/performance. Some observers believe TeleVideo has been sidetracked by its systems business. But at Comdex Spring this month, TeleVideo may reassert itself with two low-end terminals in a new case designed with European ergonomic requirements in mind: the \$699 915 and the \$895 924.

The 915, built in South Korea, is pitted mainly against other editing, block-mode terminals built in Taiwan—Qume Corp.'s \$695 QVT102, Liberty Electronic's \$595 Freedom 100 and Lear Siegler Inc.'s \$695 ADM-22. The \$695 Visual 50 from Tewksbury, Mass., manufacturer Visual Technology Inc. is the only completely American competitor. The 915 shares a tilt-and-swivel screen and smooth scroll with all of those but the ADM-22. Only the TeleVideo, Qume and Visual entries have low-profile keyboards. The 915 is the only terminal in the bunch to offer eight foreign-character sets and an accounting keypad with double-zero and clear-entry keys. The 915 is also the only one to offer vector graphics, an integral modem and a second page of memory as options.

The new 924, also built in South Korea, will compete with two other \$895 terminals—the Qume QVT108 and Applied Digital Data Systems' Viewpoint. The 924 offers a swiveling screen and a buffered auxiliary port, which the QVT108 lacks, while x-on/x-off and bidirectional communications on the auxil-



### A COST EFFECTIVE ALTERNATIVE TO LIVE TRAINING FOR: End Users Management Applications Staff Technical Support

- Professionally produced instructional video-based courses including workbooks with hands-on exercises.
- For UNIX, Xenix and other UNIX look-alike systems on a wide variety of hardware, including DEC, ONYX, PLEXUS, ZILOG, FORTUNE, VICTOR, NCR, ALTOS, PARADYNE, GOULD-SEL, PERKIN ELMER, RADIO SHACK MODEL 16 and many more.
- Flexible course design for either self-paced or group instruction.
- Available in your choice of video formats: 3/4" U-Matic, Beta or VHS.

#### NOW AVAILABLE

Call Toll-Free to Order or for Further Information  
**(800) 621-3155**  
or, in Illinois, (312) 987-4092  
8:30-5:30 central time

#### DISTRIBUTOR INQUIRIES INVITED

Ask also about our public and in-house seminars featuring hands-on workshops.

Computer Technology Group UNIX courses are developed by experts experienced in teaching UNIX as well as in designing and implementing UNIX-based systems.

™ UNIX is a trademark of Bell Laboratories

See us at COMDEX and Federal DP Expo.

**COMPUTER  
TECHNOLOGY  
GROUP**

**Telemedia, Inc.**

310 S. Michigan Ave., Chicago IL 60604

COMPUTER TECHNOLOGY GROUP—our business is UNIX training.

CIRCLE NO. 19 ON INQUIRY CARD



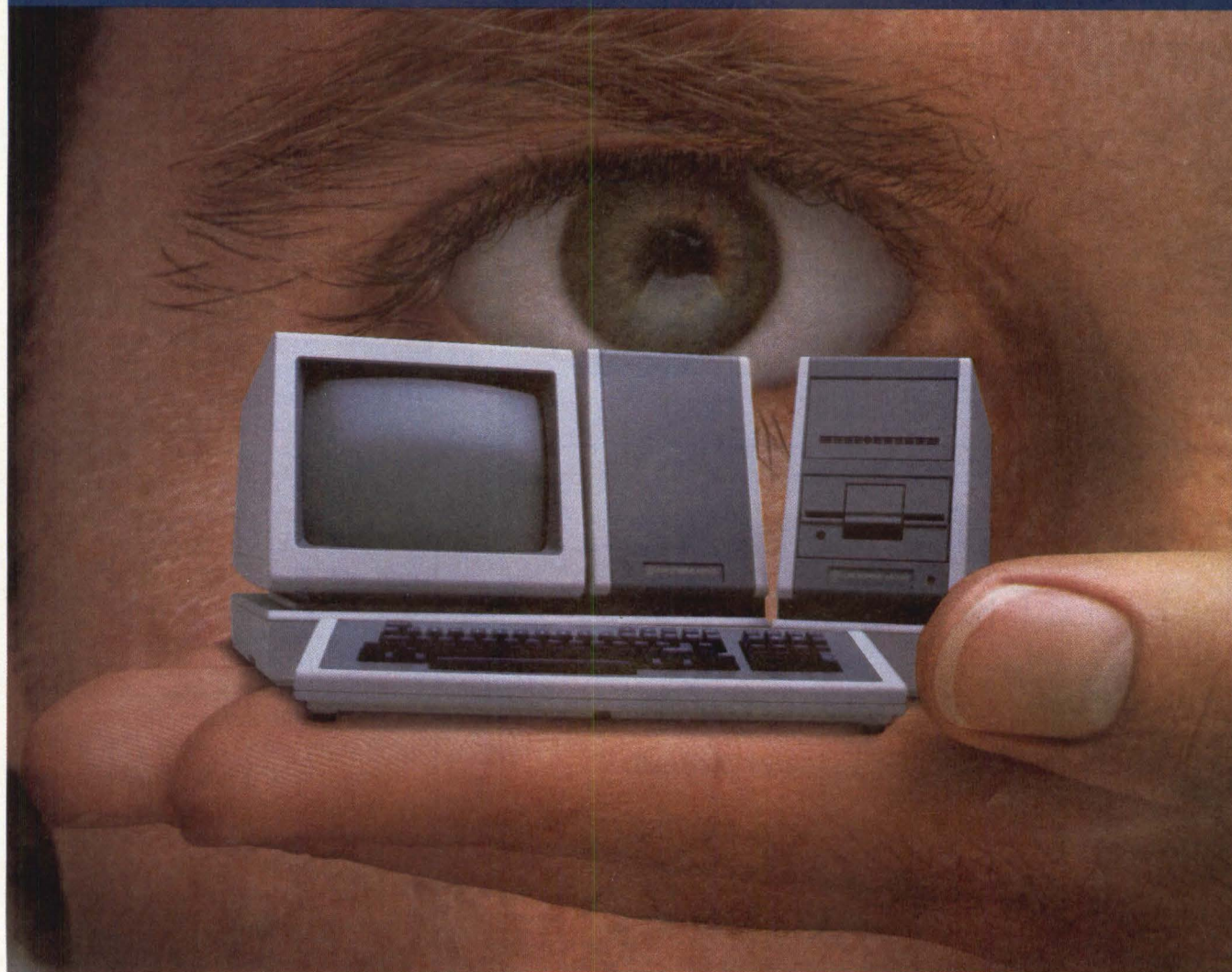

### CIES 680 Business Computer

## THE NEW GIANT IN MICROS

If we're calling ourselves "the new giant in micros," we had better be able to back it up. Which we can. And we should also have the wherewithal to back you up. Which we do.

CIE Systems makes the CIES 680 series of micro business computers.

At the heart of a 680 is the combination of the 32/16-bit 8MHz 68000 microprocessor and Intel's Multibus™ architecture for maximum configuration flexibility.

The 680 hardware is totally modular. And because we can supply OEMs with everything from boards on up, you can easily con-

figure your system for virtually any market.

CIES provides the software to match its 680 architecture.

The operating systems offered include UNIX,™ REGULUS™ (UNIX subset) and RM/COS.™

Prewritten applications cover a wide variety of business operations, ranging from general accounting modules to financial modeling and word processing systems.

Language processors include BASIC, FORTRAN, COBOL and PASCAL.

Even more, CIES offers PRO-IV,™ the latest in software technology. PRO-IV is an applications processor that allows you to easily and quickly develop customized applications without programming or code generation.

No computer maker has ever had greater financial or manufacturing support than CIE Systems.

We're backed by the gigantic resources of a 125-year-old, world-

wide corporation with well over \$50 billion in sales.

Our future is assured. Your future can be assured with the CIES 680 Business Computer Systems and our giant commitment to continuing state-of-the-art technology and quality in any quantity.

For more information, just call or write CIE Systems, Inc., 2515 McCabe Way, Irvine, CA 92713-6579 (714) 660-1800. Call toll free, 1 800 854-5959. In California call 1 800 432-3687.



## CIE SYSTEMS

TM Multibus is a Trademark of Intel Corporation.  
REGULUS is a Trademark of Alcyon Corporation.  
PRO-IV is a Trademark of Data Technical Analysts, Inc.  
UNIX is a Trademark of Bell Laboratories.  
RM/COS is a Trademark of Ryan-McFarland Corporation.

**CIRCLE NO. 20 ON INQUIRY CARD**

# Mini-Micro World

## NEWS

inary port and a low-profile keyboard give the 924 advantages over the Viewpoint. Neither Qume nor ADDS offers the 924's split screen and 32 nonvolatile function keys, a programmable send key, insert wrap-around or an accounting keypad.

Although Robert Sanekoff, head

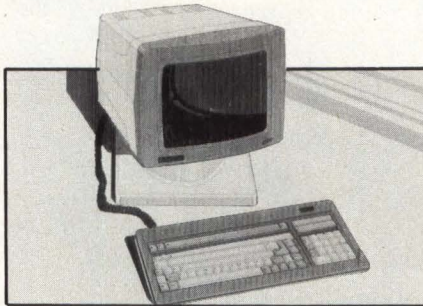

TeleVideo's model 915 terminal, which is list-priced at \$699, is part of an effort by the company to reassert itself as it gains strong competition for sales in the low-priced terminal market.

of Dataquest Inc.'s terminal market research group, doesn't see the 915 or 924 as having a substantial price/performance edge over the competition, he says just being even puts TeleVideo ahead. He places TeleVideo in a virtual tie with Digital Equipment Corp. in domestic shipments of ASCII terminals and as the undisputed leader among independents, with nearly 11,000 terminals shipped in January. ADDS, TeleVideo's closest competitor, shipped approximately 7000 terminals during January.

Tatum says the new TeleVideo terminals will eventually replace current products such as the 910-plus and 925 because of the new terminals' better value. But Craig Lynar, director of marketing for TeleVideo's new terminals, stresses it won't happen overnight. "A customer cannot take the 925 [off of a system] and put on a 924, for example," explains Lynar. "Their screen-handling codes, though similar, are different because visual attributes in the new terminals do not take up a space." Although such code is deemed an improvement, it means special software must be written to use the new products. Lynar therefore expects most of the demand for the terminals to be new business.

Volume shipments of the new terminals are scheduled for June. Margins will range to 48 percent for the 915 and 66 percent for the 924, both in quantities of 1000.

—Kevin Strehlo

Sritek, Inc., is located at 3637 S. Green Rd., Cleveland, Ohio, (216) 292-0011. The company's address was given incorrectly in the February issue.

## Mini-Micro Systems

### DIRECT RESPONSE POSTCARDS

the effective, low cost advertising medium

- Sell products and services directly
- Introduce new products
- Distribute catalogs and literature
- Investigate new applications
- Develop quality sales leads

#### 1983 POSTCARD SCHEDULE

Materials Closing Date:	2/7	4/11	8/8	10/17
Mailing Date:	March	May	Sept.	Nov.

#### FORMAT

Loose Card Deck / Card Size—3½" × 5½", Live Copy—3⅞" × 5⅞"

#### MECHANICAL REQUIREMENTS

Negatives—right reading emulsion side down. Camera ready mechanicals—110 line screen

1 card  
2 cards  
3 or more cards

#### RATES

Advertisers	Non-advertisers
1350	1600
1300	1550
1250	1500

#### CONTACT:

Carol Anderson, Sales Manager  
Direct Response Postcards  
Mini-Micro Systems  
221 Columbus Ave.  
Boston, MA 02116  
(617)536-7780

## INTRODUCING MIDDLEWARE

A NEW SOFTWARE CONCEPT  
THAT MAKES YOUR  
MICROCOMPUTER THE  
STRONGEST PERFORMER  
FOR ANY APPLICATION.

Now for the first time, you can integrate powerful software to boost the versatility of your 16- and 32-bit professional microcomputers to the same level as minis and mainframes.

With new Middleware from Rabbit.

Middleware gives your systems a competitive edge. With software components that fill the gap between microcomputer operating systems and applications software. Allowing your micro to communicate directly with minis and mainframes. Moving and manipulating data between your micro and the larger systems. In effect, giving your micro the power of a mini.

Middleware lets end users collect and edit data both for local and distributed processing. Analyze data and create special reports far faster than they ever could before. And enjoy a multitude of other functions they haven't been able to use up until now.

Middleware was created especially for business professionals by people who pioneered this type of software in the computer service industry, where complex applications must deliver the most functions quickly. And run continuously in distributed processing environments for thousands of users.

Middleware is compatible with all CTOS<sup>™\*</sup> and UNIX<sup>™\*\*</sup>-based systems.

For more information on how Middleware can make your microcomputer the strongest performer, call or write today. (Please include the name of your system): Rabbit Software Corporation, Great Valley Corporate Center, One Great Valley Parkway East, Malvern, PA 19355 (215) 647-0440.

### Middleware Product Classifications:

- Distributed Processing
- Data Handling and Presentation
- Data Collection and Screen Handling
- General End User Aids

\*A trademark of Convergent Technologies

\*\*A trademark of Bell Laboratories.



# MIDDLEWARE<sup>™</sup>

FILLING THE SOFTWARE VACUUM BETWEEN  
MICROCOMPUTERS AND THE BUSINESS WORLD.

**RABBIT**  
SOFTWARE CORPORATION

THE OEM SOFTWARE COMPANY

CIRCLE NO. 22 ON INQUIRY CARD



# An OEM Computer Company Of A Different Stripe.

Each of the computer systems on the left is different. Not just outside because of color. But inside as well, because each is configured for a totally different set of user needs.

They are Momentum 32/4s,<sup>™</sup> inside and out perhaps the most versatile desktop business systems ever offered to OEMs.

## Styled By Bertone. Powered By 68000<sup>™</sup> And System III UNIX.<sup>™</sup>

The look of the Momentum 32/4 gives you an immediate sense for its capabilities. Its lines wrap smartly around the most compact chassis in its class, a chassis really in a class by itself, thanks to the styling of Italian master designer, Bertone.

But while style can catch the attention of the OEM, only performance can keep it. And with the Momentum 32/4, that performance starts substantially with the industry-standard M68000 microprocessor and the enhanced System III UNIX operating system—but there's more of the same.

## More Innovation And Versatility: From The Graphics Package To The Storage Package.

For OEMs, market edge comes with system uniqueness. Uniqueness achieved with the least hassle for the fewest dollars.

The Momentum 32/4 performance features give OEMs that edge.

32/4 is a trademark of Momentum Computer Systems International.  
UNIX is a trademark of Bell Laboratories.  
68000 is a trademark of Motorola Corporation.

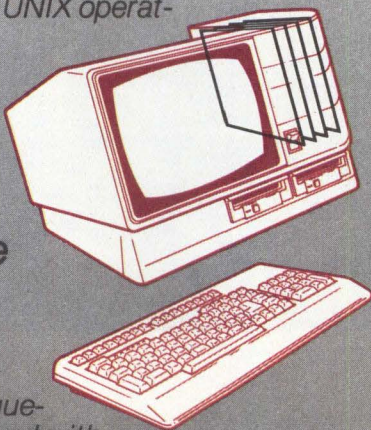

There's Direct Memory Access and the proprietary Memory Management Unit, both of which significantly enhance system throughput. There's 1/2 megabyte of RAM memory, standard. Three additional serial ports, standard. Word processing and spread-sheet, standard.

The versatility of the Momentum 32/4 is apparent everywhere. There's a completely customizable external I/O board. A powerful graphics board option, controlled by its own 68000 processor, features 256K of RAM and functions that are totally software definable. Even the storage package offers the versatility of two Winchester cartridge drives, delivering ten megabytes of on-line capacity as well as removable backup capability.

## Put Momentum Behind Your System.

The Momentum 32/4 provides plenty of reasons why you should. But there are others. One is the fact that the 32/4 is part of, and fully compatible with, the largest and highest quality line of UNIX-based 68000 computer systems in the industry. And the fact that the 32/4 is the product of a company that makes only UNIX-based 68000 computer systems. A company that can boast unmatched configuration versatility within its standard product line. But a company that also knows you have to work closely with OEMs—to be, wherever necessary, an extension of their operations, from custom design through quality control. And lastly, a company with the engineering and manufacturing resources to deliver these high-quality products in quantity, on time, at the lowest possible cost. Momentum. Put it behind your system today.

 **Momentum**

Computer Systems International

965 West Maude Avenue  
Sunnyvale, CA 94086  
(408) 245-4033  
Telex: 172509

CIRCLE NO. 23 ON INQUIRY CARD

# SPRING

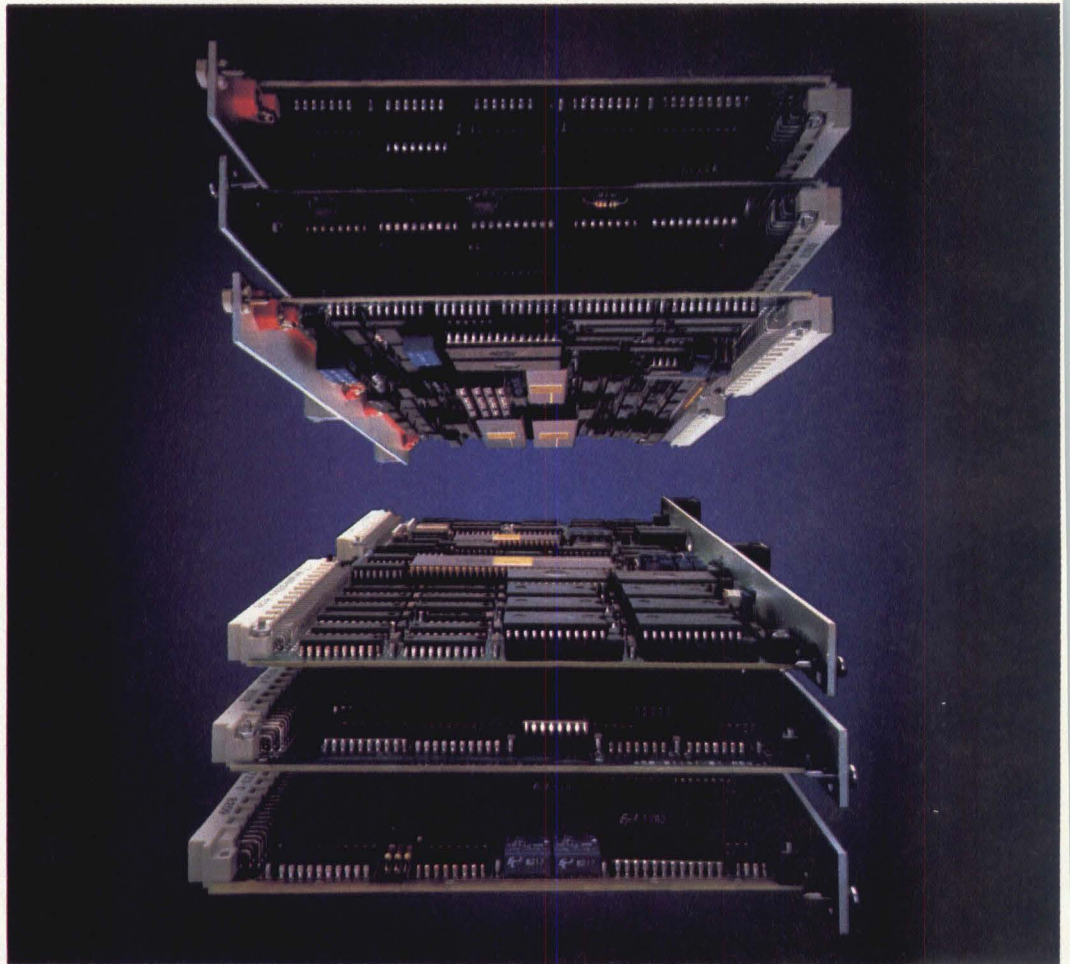

# BOARDS

Get ready to make a quantum leap past your competition. Because with our six new 68000 VMEbus boards and UNIX™ operating system, that's exactly what you'll be able to do. What's more, our new board-level solutions are just the first wave of the multi-user system solutions you'll be able to get from Mostek. So now, there's no reason not to be launching into the future with the Mostek MK68000.

What makes us so confident? First of all, consider the VMEbus, a very compact board structure with truly high-performance timing parameters. And inherent expansion to 32-bit address and data.

Second, look at the boards: VME-SBC: At the heart of it, an 8 MHz MK68000 with upgradeability to 10 or 12 MHz, SIO, BYTEWYDE™ memory and a firmware monitor. VME-SASI: A SASI™ controller with DMA. VME-FLP: A double-sided, double-density floppy disk controller with DMA and sector buffer. VME-SIO: Four-channel (RS-422/RS-232). VME-DRAM: ¼ MB DRAM with byte parity, plus full 32-bit VME interface. VME-MMCPU: Memory-managed CPU with on-board 128K bytes DRAM and full multiprocessor capability.

Third, there's our VME BASELINE System to get you started. It includes three boards (SBC, DRAM, SIO) and a power supply in a 10-slot card cage.

Finally, coming later this year will be UNIX, the high-performance, program-development operating system that opens the door to Pascal and C, as well as our Assembler/Linker software and RADIUS™ development station.

Together, it all adds up to the most powerful and versatile way yet to hit the ground running with a 68000 system solution. To find out more, contact Mostek Corp., 1215 W. Crosby Rd., MS2205, Carrollton, Texas 75006. (214) 466-6000. In Europe, Mostek International (32) 2.762.18.80. In Japan, Mostek Japan KK (81) 3.404.7261. In the Far East, Mostek Asia Ltd. (852) 5.296.866.

\*UNIX is a trademark of Bell Laboratories.  
\*SASI is a trademark of Shugart Associates, Inc.

\*BYTEWYDE is a trademark of United Technologies' Mostek Corp.  
\*RADIUS is a trademark of United Technologies' Mostek Corp.



CIRCLE NO. 24 ON INQUIRY CARD

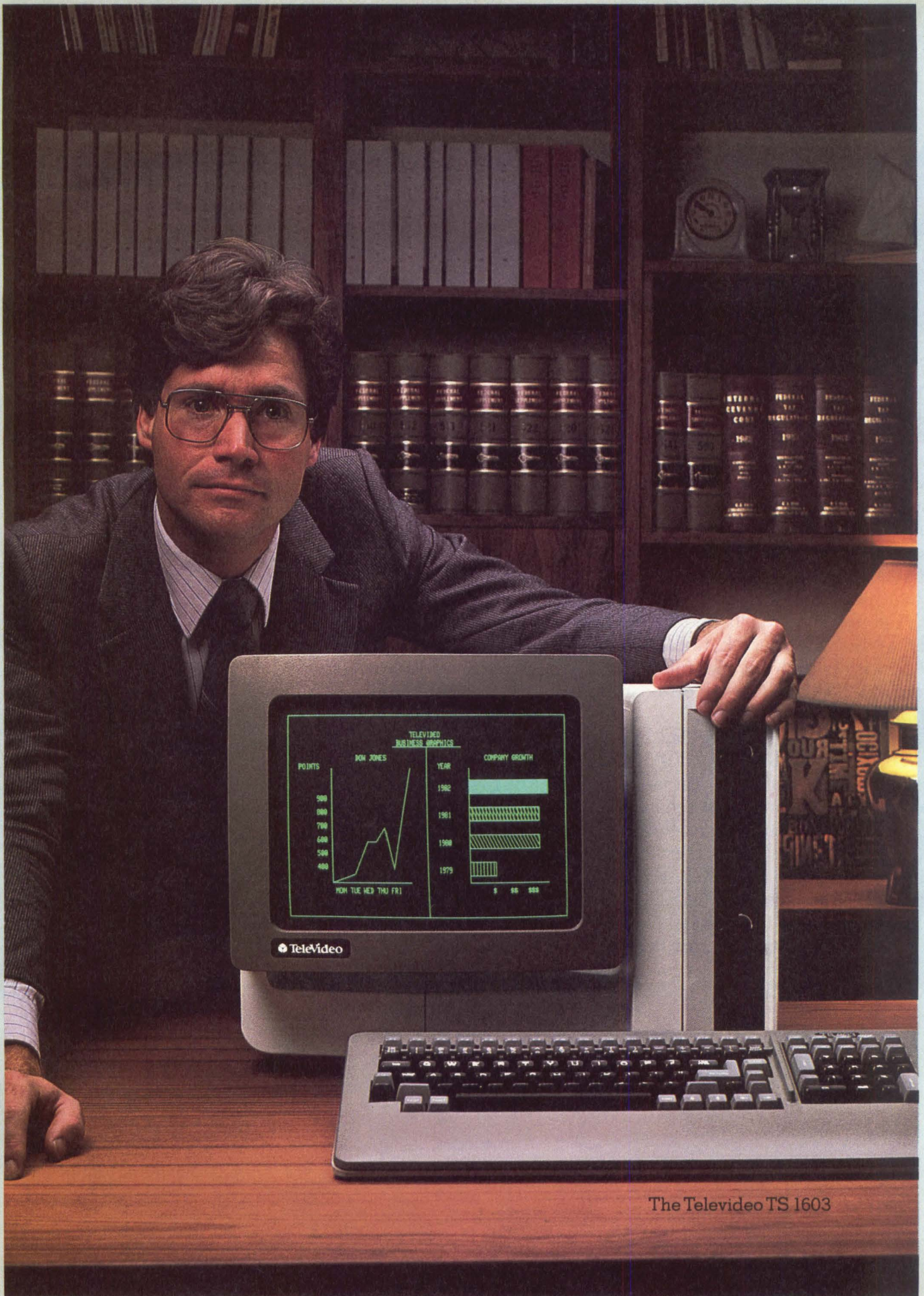

The Televideo TS 1603



# "I chose TeleVideo's Personal Computer for all the things IBM left out."

I didn't choose TeleVideo because it's \$1,000 less than IBM.\* It was because TeleVideo thought of everything.

To begin with, my TeleVideo has twice as much storage capacity as IBM, even with the extra cost IBM disk drive. I can use that extra capacity.

My TeleVideo came with a big 14" screen that's easier to read, and it tilts for the extra comfort that's so important when you use a computer as much as I do. With IBM, you pay more for a smaller 12" screen that doesn't tilt at all.

Another thing I like. TeleVideo's keyboard is so lightweight and comfortable my fingers hardly know they're working. IBM's keyboard? It's a little behind the times.

TeleVideo also gave me the choice of popular CP/M® or MS-DOS® operating systems — FREE — so I can pick from thousands of proven software programs. You can get the same option from IBM, but you have to pay for the privilege.

Last but not least, TeleVideo's network capabilities give me a real growth path

for the future, linking up to sixteen computers in one powerful network. You can't get that from IBM.

So before you choose any personal computer, do like I did and compare. You'll see that TeleVideo gives you a lot more computer for a lot less money. And you'll buy TeleVideo because they didn't leave anything out.

For more information, write TeleVideo Systems, Inc., 1170 Morse Ave., Sunnyvale, CA 94086, call toll-free 800-538-1780 (In California call 800-672-3470 Ext. 945), call one of our authorized distributors or dealers, or contact one of our regional sales offices, listed below.

Northeast Region, 617-369-9370

Eastern Region, 703-556-7764

Southeast Region, 404-447-1231

Midwest Region, 312-969-0112

South Central Region, 214-258-6776

Northwest Region, 408-745-7760

Southwest Region, 714-752-9488

European Sales (Holland), (31) 075-7461

UK/Scandinavia Sales, (44) 0908-668-778

TeleVideo Systems are fully serviced nationwide by TRW.

\*Based on manufacturer's suggested retail prices for comparably equipped computer

 **TeleVideo Systems, Inc.**

**CIRCLE NO. 26 ON INQUIRY CARD**

# Minicomputer TOTAL.<sup>®</sup> The only DBMS that combines

If you are designing a sophisticated, minicomputer based information system, you are probably facing a dilemma: How to build for the 80's with early 1970's data management tools. Traditional non-data base techniques lack the necessary power and flexibility. And the hardware vendors' approaches to DBMS are quite often system dependent, memory intensive, or simply not available. There is a solution—Minicomputer TOTAL. Only Minicomputer TOTAL offers you:

**POWERFUL DATA STRUCTURES.**

With Minicomputer TOTAL, you can choose from hierarchical, network, or multi-keyed data structures. This means you can build the simplest to the most sophisticated information system. And this kind of flexibility is important to your needs today—and as you grow. **LOW-OVERHEAD.** Even with all its power, Minicomputer TOTAL is extremely efficient. In fact, TOTAL has the lowest overhead requirements of any full facility DBMS available today. Its powerful design minimizes I/O, memory requirements, and disk space. This gives you all the benefits and flexibility of The TOTAL Approach while minimizing your hardware costs.

**EASE-OF-USE.** And Minicomputer TOTAL is easy to learn and use. Data base design and application programming can be mastered after only two days of technical training. The result: short learning curve, faster implementation and higher overall productivity.

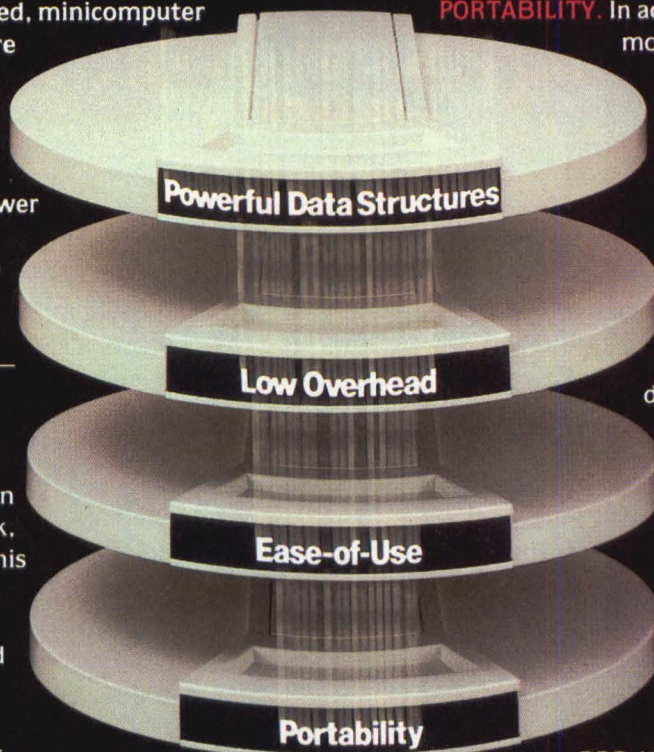

**PORTABILITY.** In addition, TOTAL is the industry's most portable DBMS. Only TOTAL offers horizontal data base portability across 18 different minicomputers and operating systems, while providing vertical compatibility to Series 80 TOTAL in the mainframe environment. This flexibility enables you to (1) develop applications centrally and distribute them to users with different target minicomputers, and (2) lay a solid foundation for distributed data base. So if a powerful, efficient, and portable information system is what you're looking for to meet the challenges of the '80's, you can't afford to overlook TOTAL.

If you're presently working with or considering... DEC PDP-11, WANG, DATA GENERAL, IBM System/3 or 34, GOULD, HARRIS, HIS DPS-6, PERKIN-ELMER, PRIME or SPERRY UNIVAC... you can use TOTAL now. OEM agreements also available. To see first hand if Minicomputer TOTAL is the solution to your specific needs:

Call our  
Marketing Services Department.  
800-543-3010.  
In Ohio: 513-661-6000.  
In Canada: 416-279-4220.

 **Cincom Systems**

Cincom Systems, 2300 Montana Ave., Cincinnati, OH 45211

CIRCLE NO. 27 ON INQUIRY CARD

# Mini-Micro World

INTERNATIONAL

## Software vendor transports accounting packages to P-E and other superminis

The adoption of 32-bit supermini-computers by commercial system integrators is encouraging vendors of powerful mainframe accounting software packages, which typically are operated in batch mode, to transport their products to the real-time processing environment of supermini hosts. For example, the real-time sales and purchase ledger updating packages of Northern Software Consultants Ltd., Manchester, England, are being distributed worldwide by Perkin-Elmer Data Systems, Oceanport, N.J. Northern also plans to transport its software to Digital Equipment Corp.'s VAX, and Prime Computer Inc.'s and Data General Corp.'s MV superminis.

Northern claims that its packages are one of the first of their kind to employ real-time sales and purchase ledger updating, a complete break from the batch updating still used by many mainframe packages.

Northern's packages, which P-E calls General Financial software GFS-32, have been integrated with P-E's Reliance transaction-processing system. Northern managing director Howard Sherrington stresses that the new sales and purchase packages, NOR-SAL2 and NOR-PURLA2 support a hierarchical database, enabling transactions to be recorded in real time on interrelated files. NOR-SAL2 features constant status checking of customer accounts, and NOR-PURLA2 offers control over purchase ledger functions of accounts payable. NOR-FLEX provides user-defined reports from any parts of the database.

Three related packages restricted to on-line operation—stock control, invoicing and general ledger—will



Northern Software Consultants Ltd. managing director Howard Sherrington says Northern's sales and purchase packages for superminis support a hierarchical database, enabling transactions to be recorded in real time on interrelated files.

be available in real-time form within 18 months, according to Northern technical director David Marsden.

To run the real-time packages, the host machine needs a real-time processing monitor, plus either an indexed-sequential-access method or a full database-management system, says Marsden.

Marsden stresses that the deal with P-E is nonexclusive and says there will be no technical problems in mounting the packages on other 32-bit superminis. Marsden explains that the transportability of Northern's packages between machines has been achieved using the NORBOL language tool. It incorporates COBOL instructions common to all environments, but provides special macroinstructions for environment-dependent operations, such as screen and database handling. To mount the packages in a certain environment, a macro translation

library must be created to generate full COBOL coding. Marsden notes the final COBOL coding is typically four times the length of the original NORBOL program. Marsden says it takes three to six months to create the macro library.

Sherrington is optimistic about the prospects for Northern's products in the U.S. He acknowledges competing packages from U.S. vendors are offered with front-end processors that provide on-line input and inquiry facilities, but argues those packages have been added to old file structures requiring batch update runs.

Andy Denver, marketing director with Software International Inc., Andover, Mass., says his company's accounting packages do not offer real-time updating like Northern's. Software International instead uses a holding file for later batch updating. The packages are available on Prime, DEC VAX and mainframe hosts.

Denver reveals that Software International is looking at real-time updating of non-numeric information such as company names. But he sees dangers in updating money values in real time, contending that might hinder the ability to perform audit trials. Northern real-time processing consultant Mike Higham counters by explaining that Northern's packages employ a security log file to facilitate auditing by accumulating pointers as the database is updated. The log file also accumulates batch totals for balancing journal inputs.

Sherrington notes that Northern plans to open a New York office in July to establish and support a distributor network.

—Keith Jones

# These people had the

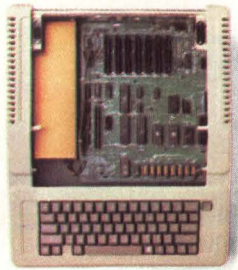

Borg-Warner Educational Systems  
Educational courseware

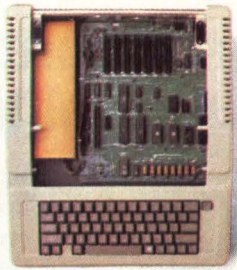

Advanced Information Systems  
Computer aided drafting

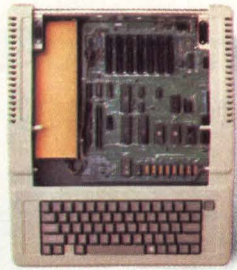

Varian Associates, Inc.  
UV Spectrophotometry



L&S Computers  
Personnel profiling systems



Rockwell International  
Truck fleet management



Gentech  
Interactive video training



Farm Plan, Inc.  
Agricultural software



Core Technology  
Burroughs terminal emulation

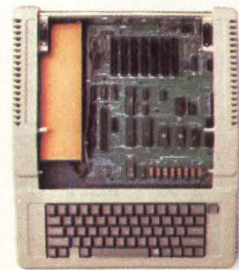

Gerber Scientific Products, Inc.  
Computerized engraver



TSI Inc.  
Particle sizer data analysis

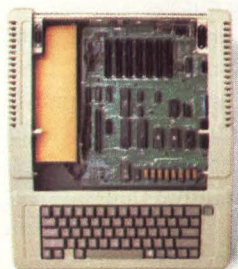

Enterprise Systems, Inc.  
Hospital on-line inventory

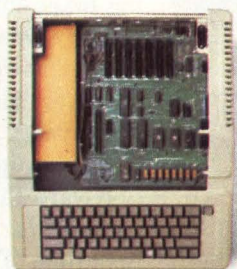

Sandu  
Industrial robotics

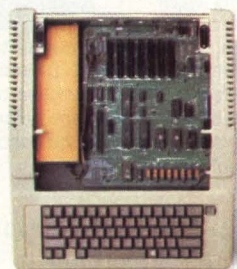

TCD, Inc.  
Life insurance illustrations



Cascade Graphics Development  
Computer aided drafting



CompCoWare Inc.  
Custom instructional software

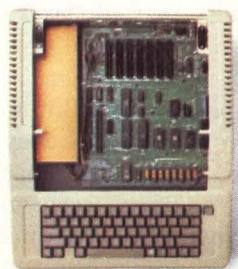

Autographix, Inc.  
Designs, graph slides



Software Resources  
Financial investment packages



American Zetler, Inc.  
Hospital nursing station



Basic Computer Literacy  
Courseware

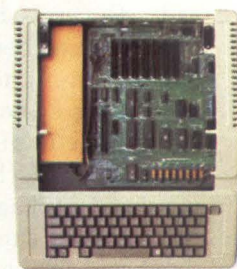

CPHA  
Hospital data entry systems

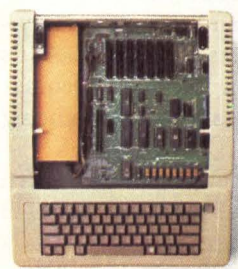

Transportation Concepts  
& Services  
Interstate tariff rates



Energy Management Service, Inc.  
Residential/commercial  
energy analysis

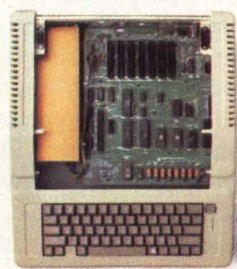

Vitalograph Ltd.  
Pulmonary systems,  
on-line spirometer

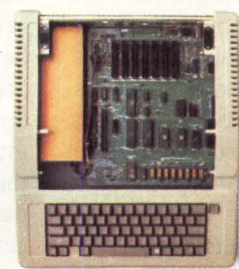

Fisher Scientific Company  
Intelligent color console  
for mass spectrophotometer

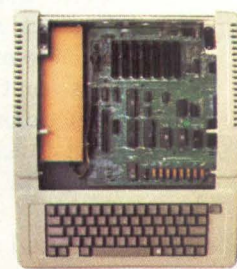

First Software Corp.  
Computer work station  
for children

# guts to be successful.

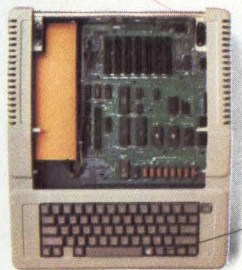

Alltech  
Scientific instrumentation

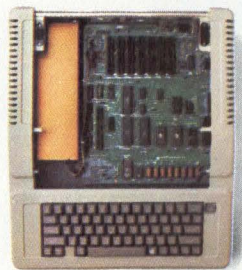

Kwik-Kopy Corporation  
Computerized pricing

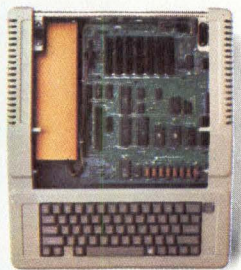

Warren E. Collins  
Medical electronics



HCI Data  
Agricultural software

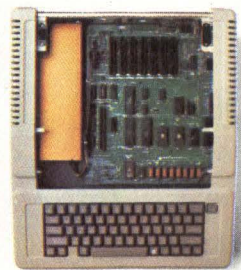

Northwest Instrument Sys., Inc.  
Digitizing oscilloscope

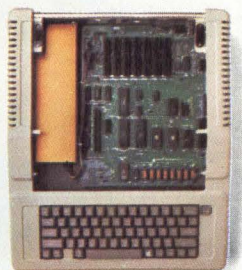

Federal Computer Systems Inc.  
Pharmacy package

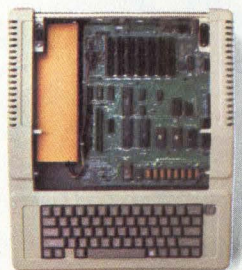

Cyborg Corporation  
Lab data acquisition

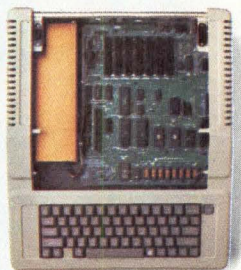

Medical Graphics  
Inhalation data analysis



Walman Optical  
Opticians systems

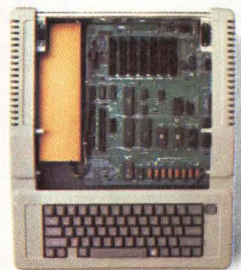

Acroloc, Inc.  
Milling machine control

There are more OEMs in more places doing more things with Apples<sup>®</sup> than with any other personal computer in the world.

Because Apples have more available software. More configuration versatility. And an OEM support program that will provide you with everything from our most basic computer products to complete, ready-to-roll systems.

All backed by technical documentation, software assistance, even hands-on training. And all part of a lasting commitment to this important marketplace.

So if you have the courage to succeed, but lack the guts, contact an Apple OEM Representative.

The most personal computer.  **apple**

Call (408) 973-3152 for more information, or for information regarding corporate purchases through our National Account Program.

Or write Apple Computer Inc., Advertising and Promotion Dept., 20525 Mariani Ave., Cupertino, California 95014. © 1983 Apple Computer Inc.

**FOR GENERAL INFORMATION CIRCLE NO. 148 ON INQUIRY CARD. FOR OEM INFORMATION, CIRCLE NO. 60 ON INQUIRY CARD.**

C. ITOH  
ELECTRONICS



**Our parent  
company said  
it's time we  
went out in the  
world and made  
a name for  
ourselves.**

**So we did.**

## ***CIE TERMINALS***

CIE Terminals, Inc., is video display and graphics terminals, line printers and ACRO Corporation all rolled into one new company of C. ITOH ELECTRONICS, INC.

New headquarters and Southern California sales office: 2505 McCabe Way, Irvine, CA 92713. (714) 557-5118. Or call toll-free, 1 800 854-3322. Other regional sales offices: San Jose, CA (408) 977-1146; Cherry Hill, NJ (609) 983-5075; Chicago, Ill (312) 992-2346; Houston, TX (713) 777-1640; Atlanta, GA (404) 257-1814; Denmark (02) 921100.

**SEE US AT COMDEX BOOTH #1512**

© CIE TERMINALS, INC., 1983

# THE UNPERSONAL

**UNEQUALLED PRICE/  
PERFORMANCE**

**UNLIMITED  
CONFIGURATIONS**

**UNSURPASSED  
RELIABILITY**

**UNMATCHED  
ERGONOMICS**

**AND  
UNIX™-OPTIMIZATION**

Meet the Series 2000 business system. We call it the UnPersonal Computer because it offers you the multi-user, multi-tasking performance and configurability that you can't get from any "personal computer."

The Series 2000 can start out as a powerful, single-user desktop system, and then become very "unpersonal" as you add intelligent workstations to share a common database. UNIX-optimized, this multi-user system streamlines business computing in any environment—from a one-man shop to the busy department of a large company.

Besides intelligent workstations, the highly-configurable Series 2000 includes optional Multibus™ attachment, and a choice of disk storage modules and high-speed dot-matrix printers.

The Series 2000 gives you, the OEM, many *unfair competitive advantages*:

**PRICE/PERFORMANCE.** Series 2000 costs less per workstation than a multiple configuration of personal computers. And you don't have to worry about incompatibilities, hidden upgrade costs or performance degradation when you need to expand.

**UNIX-OPTIMIZED.** Series 2000 has been optimized for the UNIX operating system. The hardware was designed with overlapped, high-speed disk operation and large memory capacity to run UNIX more efficiently.

**CHOICE OF SOFTWARE.** The UNIX operating system comes with the C compiler and a host of utilities as standard. Language processors, such as COBOL, FORTRAN, BASIC interpreter, and BASIC compiler, are optional.

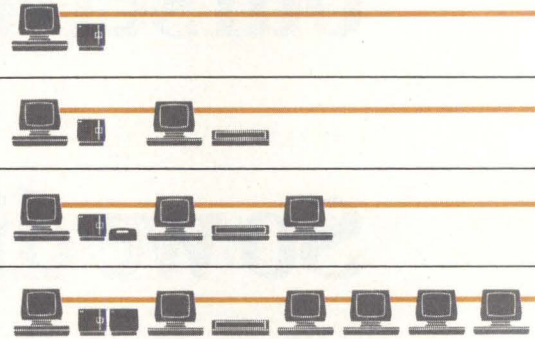



# COMPUTER.

**HIGHLY CONFIGURABLE.** Series 2000 expands easily—from single-user to multi-user operation. And there's a wide choice of disk storage modules and high-speed printers to optimize the selected configuration.

**FASTER DATA ACCESS.** The Series 2000 main processor breaks the access bottleneck by using tightly-coupled multiple microprocessors for concurrent processing, disk access and workstation access. Totally overlapped data transfer and processing means shorter response times and better throughput. If it's desktop power you want, we can really crunch numbers with our 8-MHz 8086 and its optional 8087 arithmetic coprocessor.

**WORKSTATION POWER.** Series 2000 workstations are available with 16 to 64 kbytes of user memory. Microprocessor-controlled, each station is capable of receiving down-loaded programs from the main processor to further improve response time.

**CHOICE OF DISK STORAGE.** Disk storage up to a total of 60 Mbytes may be attached to the Series 2000 main processor.

**PRINTERS.** Zentec-supplied dot-matrix printers operate at speeds from 180 to 500 characters per second, or, for near-letter quality, from 100 to 125 characters per second. Options include high-resolution graphics, multiple character sets and forms handling capabilities.



## A NAME TO RELY ON.

Our long experience serving demanding OEMs has made us aware of how important it is to maximize system uptime. Zentec has built its reputation as a supplier of reliable, high-quality products with some of the highest MTBF numbers in the business. For more information, contact our headquarters, or call any of the sales offices listed below.

ZENTEC Headquarters,  
2400 Walsh Avenue,  
Santa Clara, CA 95050  
(408) 727-7662.

### Sales Offices:

Fort Lee, NJ (201) 944-0670  
Long Grove, IL (312) 634-9550  
Playa Del Rey, CA (213) 822-0278  
Richardson, TX (214) 690-9265  
Rockville, MD (301) 762-7990  
Santa Clara, CA (408) 727-7662  
Waltham, MA (617) 890-7915  
West Palm Beach, FL (305) 684-8898.

UNIX is a registered trademark of Bell Laboratories.

Multibus is a registered trademark of Intel Corporation.

**CIRCLE NO. 29 ON INQUIRY CARD**



# SUPPORT THIS UNION AND AVOID A WORK SLOWDOWN.



Organize your DP operation around a VAX computer and Direct 831 terminals and enjoy an important benefit of a DEC-Direct union. More power. The kind that gets work done faster.

To the 831's VT100-compatible features you can add an optional integral modem to put the power of your VAX in the hands of anyone with a telephone.

Or add PLOT 10 graphics and deliver the big picture when there's no time to wade through words.

But that's just for starters.

The 831's block mode frees your VAX from the chore of creating and editing data. (That's why many users, including DEC itself, view block mode as an answer for overburdened CPUs.)

And if that's not enough, you can unite host and personal processing by field-upgrading the 831 to our Direct 1031, a self-contained terminal/personal computer. The 1031 makes the entire array of CP/M-compatible software available to off-load your host, leaving you more VAX processing power for the jobs only a VAX can handle.

To further our cause, we're prepared to stage a demonstration at your place of business. Contact us at Direct, Inc., 4201 Burton Drive, Santa Clara, CA 95054. Telephone 800-538-8404 (408-980-1414 in California). Direct and DEC. It's one union that gives you more than you bargained for.

**DIRECT**

DEC, VAX, and VT100 are registered trademarks of Digital Equipment Corporation. CP/M is a registered trademark of Digital Research, Inc. ©1982 Direct, Inc.

**CIRCLE NO. 30 ON INQUIRY CARD**

# Mini-Micro World

CORPORATE AND FINANCIAL

## MARKET BAROMETER

A column devoted to an expert's look at an industry

### Europe: an awakening market for business microcomputers

By Gordon Curran

Intelligent Electronics Europe

To a large group of American businessmen, Europe is a difficult place: a fragmented market of 13 countries, all seemingly speaking different languages, all having different standards and restrictions for business microcomputer imports.

All the countries of Western Europe are awakening to the opportunities of the computer age. For instance, the penetration per head of population of home and business microcomputers into the U.K. is already higher than in the U.S. Even in the current difficult economic

conditions, the markets in Europe are expected to increase by 150 percent by units between 1982 and 1986. Although the U.K. is by far the largest market for business microcomputers now, West Germany will take the lead by 1985, with 190,000 units priced at more than \$1000 each. The rate of growth expected in Italy is the most dramatic: 28,000 systems priced at more than \$1000 each last year growing to 110,000 units in 1986.

The market share percentages by units sold in the top three countries are as follows:

	U.K.	W. Germany	France
Apple	20	13	25
Commodore	17	22	21
Tandy	16	12	9

Apple Computer Inc., Commodore Business Machines Inc. and Tandy Corp. are expected to be joined in leadership positions during this year by IBM Corp. Digital Equipment Corp. also will take a significant share.

Japanese manufacturers have had little impact on the European market so far, but their presence and competitiveness this year is expected to increase. Some European manufacturers such as Triumph Adler in Germany, Micral in France, ICL in the U.K. and Olivetti in Italy are also expected to gain significant shares in their domestic markets.

Among the top three European markets, there are some interesting differences in people's attitudes and behavior toward microcomputers. While home use is at a fanatic pace, British businesses are looking ahead for microcomputers. But with Britain's economic environment, financial conditions are often a barrier. For the Germans, economic conditions will not be a barrier, once the market is

ripe. Until now, business users have taken a wait-and-see attitude. They are looking for the right product with good quality/reliability, good after-sales service and, above all, a good solution to their business problems. They are more interested in what a microcomputer can do for them than in how it does it. French businesses show a growing interest in "microcomputer help."

In the acceptability of imported products, the three main countries differ again. The U.K. is a very open market with no restrictions or currency controls. The French are primarily protectionists with import and technical difficulties imposed to protect home industry. (This is not government policy—that would be illegal under the Treaty of Rome). Germany, like the U.K., has an open market, but it also has many technical regulations designed to ensure that



Gordon Curran is director of Intelligent Electronics Europe, Paris, a research organization that has completed a study called "Marketing Opportunities in Europe," which covers business microcomputers, home computers and video games in each European country.

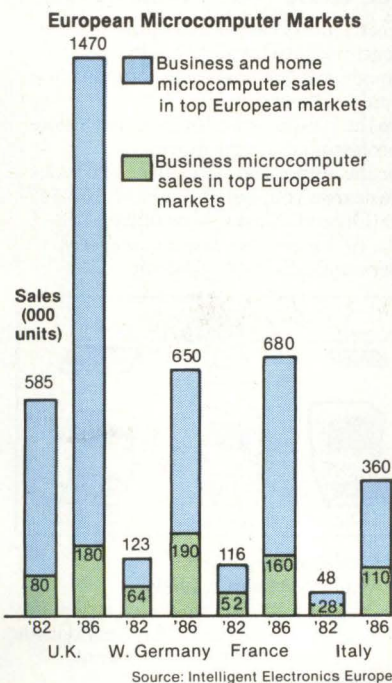

The four countries noted represent approximately 75 percent of total European sales figures. Business microcomputer sales apply to units priced at more than \$1000.

### DEC CUTS PRICES ON LSI 11/23, PDP 11/23 PLUS

Digital Equipment Corp., Maynard, Mass., has reduced prices on its LSI 11/23 CPU boards as much as 36 percent and on its PDP 11/23 Plus packaged CPU assemblies as much as 18 percent. Price for the LSI 11/23 CPU board with a memory-management unit has been reduced from \$2100 to \$1340. Without a memory-management unit, the board is reduced from \$1690 to \$1140. The price of a PDP 11/23 Plus with 256K bytes of RAM and a nine-slot backplane has been reduced from \$6950 to \$5690 for both 120V and 240V AC models. DEC claims the price reductions are made possible through the company's high-volume production of both boards and box assemblies.

# Introducing the portable computer for professionals on the move. Hewlett-Packard's new HP-75.

A decade ago, we introduced the world's first scientific pocket calculator and rendered the time-honored slide rule obsolete.

Now we're introducing the HP-75 portable computer. And if press reaction is any indication, history is about to repeat itself.

## As small as a book. As powerful as a personal.

Desktop-computer power in a handsome 26-ounce package. That's the HP-75. It's just 10 inches by 5 inches by 1¼ inches.

But don't let the compactness fool you. Inside its rugged case lies a 48K-byte, ROM-based operating system. With a comprehensive, 147-command instruction set that helps you write hard-working, memory-efficient BASIC programs.



Plug-in ROM ports let you add up to three 32K-byte software modules—modules that solve tough problems *without* sacrificing user memory.

And that user memory gives you up to 24K bytes of program and data storage.

It all adds up. A fully loaded HP-75 is a 168K-byte computing powerhouse in calculator clothing.

Want more? A built-in magnetic card reader provides a convenient, inexpensive way to store and retrieve programs or data.

The HP-75's typewriter-like keyboard means rapid, accurate entry of text or data. And when we say you can touch type on it, we *mean* you can touch type on it.

Those keys, by the way, can be redefined with your favorite commands or programs. Up to 196 unique key combinations in all.

## Immediate, convenient access to your most frequently used programs.

Thanks to the HP-75's multiple-file

structure, programs, data and text can be named, simultaneously stored in memory, and programmed to interact with each other.

Add continuous memory, and you've got a computer that's designed to solve problems on the go. Simply load your favorite files and enjoy immediate access to any or all of them. The files are retained in memory until you decide to delete them—even when the machine is turned off.

## Time and appointments to keep you on schedule.

The TIME key brings to display the day of the week, date and time to the nearest second.

The APPOINTMENT feature reminds you—an hour from now or a year from now—of things you have to do. You can have a silent message on the display, any one of six alarms, or a combination of both.

Even if the machine is turned off, it will "wake up" and alert you of an appointment. Or it will execute programs or control peripherals according to predetermined schedules.

In an environmental test, for instance, where readings are taken every half hour, the HP-75 can make sure its owner gets the weekend off.

## Software tailored to solve your specific problems.

HP-75 software is now available in areas such as math, engineering, finance, and statistics. With VisiCalc<sup>®</sup>\* on the way.

Our plug-in math module<sup>\*\*</sup> for instance, solves polynomial roots, evaluates integrals, and performs finite Fourier transforms.

With our text-formatter module<sup>\*\*</sup> you'll compose memos, letters, and short documents virtually anywhere; then print them out when you return to your home or office.

In addition, our third-party software program assures you of ever-expanding software variety.

If you're a volume purchaser or OEM, give us a call. We can help you create custom HP-75 systems with special plug-in modules, magnetic cards, digital cassettes, and keyboard overlays.

## Peripherals for a total computing package.

The HP-75 is equipped with the Hewlett-Packard Interface Loop, giving you a choice of 15 peripherals. (And that choice is expanding. The HP-75 can work simultaneously with up to 30.)

In a battery-powered briefcase system weighing about seven pounds, you might have the 24-character printer, digital cassette drive and acoustic modem<sup>\*\*\*</sup>.

A desktop system might include the 80-column impact printer, full-color graphics plotter, and 12-inch video monitor.

And the HP-75 can "talk to" other computers, peripherals, and instruments with our HP-IB (IEEE-488)<sup>\*\*</sup> RS-232<sup>\*\*</sup> and

GPIO interfaces.

In summary, the HP-75 is the heart of an extremely versatile system, in addition to its stand-alone capabilities.



## Manuals to make sure you get the most from your machine.

Chock-full of examples and helpful hints, our owner's manual will get you up and running in short order. And it's organized to help you access the information you need to get on with the job at hand.

A supplementary reference guide provides a concise summary of the computer's operating protocol and instruction set.

## The value you're looking for.

What is the price of all this power in this compact package? \$995<sup>\*\*\*\*</sup>. A lot less than you might pay for a personal computer you can't take with you.

See the HP-75 today. It's the smart choice for professionals on the move.

For the authorized HP dealer or HP sales office nearest you, call TOLL-FREE 800-547-3400 (Oregon, Alaska, Hawaii: 503-758-1010). TTY users with hearing or speech impairments, dial 503-758-5566.

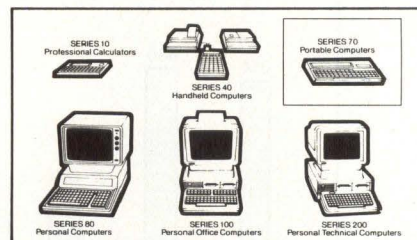

\* Available May 1, 1983.

\*\* Available March 1, 1983.

\*\*\* Call our toll-free number for availability.

\*\*\*\* Suggested retail price. May vary outside U.S. Peripherals and software not included.

VisiCalc<sup>®</sup> is a registered trademark of VISICORP.



1 1/4"

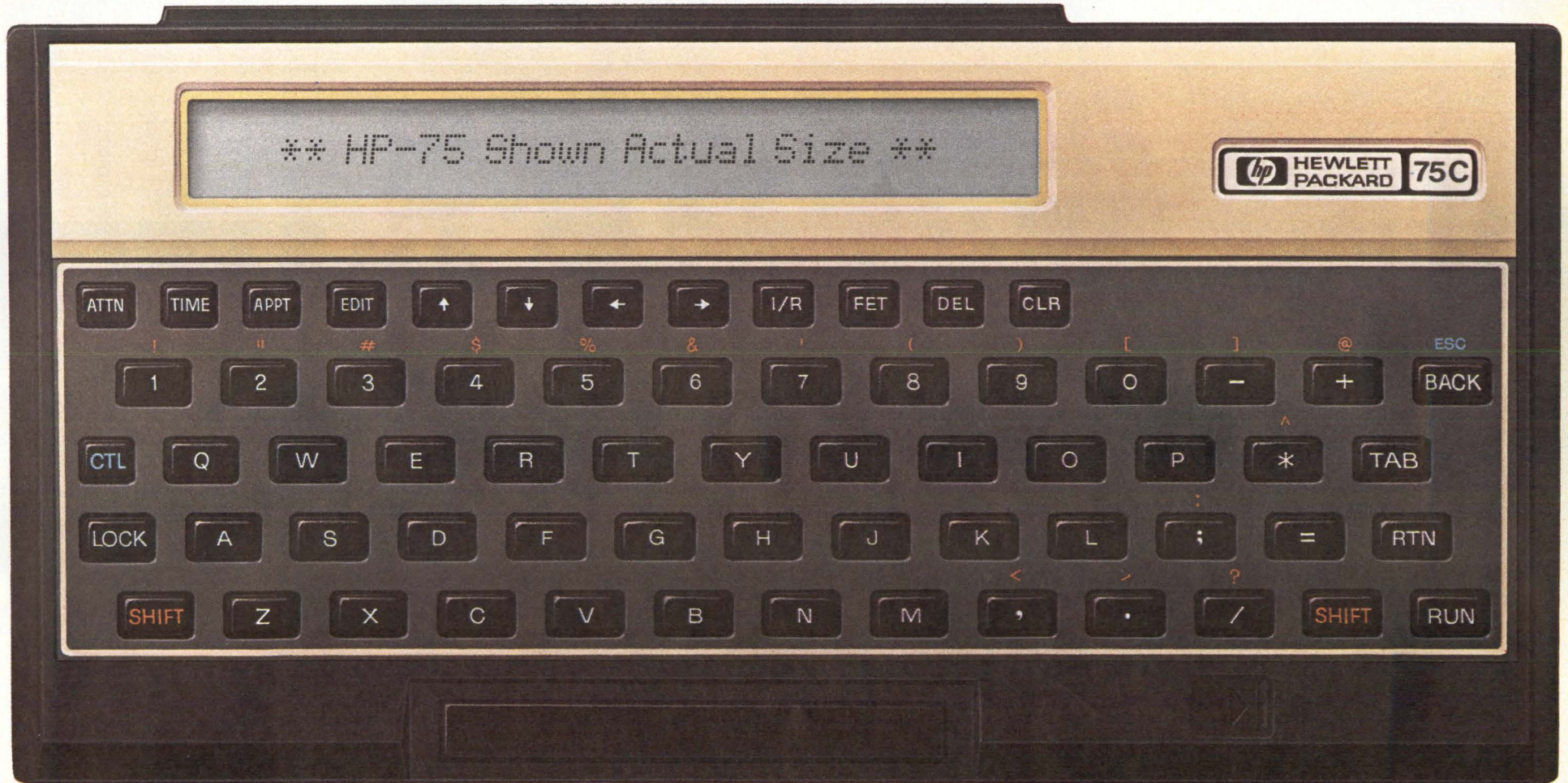

**HP-75 SPECIFICATIONS**

**Size and weight:** 10" X 5" X 1 1/4," 26 oz.

**48K-byte, ROM-based operating system:**  
• 8-bit CMOS CPU • Multiple file structure in continuous memory • Instruction set: 52 system commands, 43 BASIC commands, 41 numeric functions, 7 string functions, 6 time-mode commands, 16 arithmetic/logical/

relational operators

**Numeric precision:**

- Real—12 digits ( $\pm 9.99999999999 \times 10^{\pm 499}$ )
- Short—5 digits ( $\pm 9.9999 \times 10^{\pm 99}$ )
- Integer—5 digits ( $\pm 99999$ )

**Time/appointments:**

- Perpetual clock/calendar • 12- or 24-hour format • Appointment control of command/

program execution

**Memory:**

- User (RAM)—16K bytes, expandable to 24K bytes • Operating system (ROM)—48K bytes
- Plug-in software (ROM)—up to 96K bytes (3 32K-byte modules)

**Typewriter-like QWERTY keyboard:**

- 65 keys • 194 redefinable key combinations

• "Hidden" numeric keypad

**Integral mass storage:** hand-pulled card reader (1.3K bytes per card)

**Built-in interface:** HP-IL; choice of 15 peripherals  
**Power supply:** 3 AA NiCad batteries (AC adapter/charger included)

**Liquid-crystal display:** 32-character window on 96-character line

PG02308 287G



# CalComp's \$1 vs. their \$16,0

Why settle for a plodding plotter when you can double your throughput with an all-new Model 945 or Model 965 beltbed plotter from CalComp for approximately the same price?

Productivity gains can range from 25% to more than 500%. It's like having up to two plotters for the price of one.

*CalComp Model 945 beltbed plotter (left) for sheets up to ANSI size D (or ISO size A1), and Model 965 plotter for drawings up to sheet size E (or size A0).*



What's the difference? The basic philosophy behind each plotter design. Their plotters trade off speed for one-time economies of smaller size, lighter weight, less powerful components. *You* pay the price in plotting time with each pen and paper movement (their 24-ips maximum vs. CalComp's 42-ips) and each excursion of the single-pen carriage to a side-mounted carousel.

CalComp's Model 945 and Model 965 plotters, by comparison, allow you to map up to 16 logical pens to four physical pens continuously poised over the plot surface—ready to be activated



# 6,000 plotter 00 plodder.



in a fraction of a second. If more than four pens are needed, the plotter performs an automatic stop and prompts the operator to change pens.

Plus the user-friendly control panel provides local control and plot manipulation with easily understood English language messages.

The same interactive firmware gives the operator complete control

over plot parameters. Training time is all but eliminated.

Your CalComp Model 945 or Model 965 plotter starts delivering high-speed plots the day it is installed, without changing a line of industry-standard software. Industry-standard because it was developed by CalComp—world leader in computer graphics and CAD/CAM.

So write or phone today for your illustrated copy of "The Plotter and the

**CIRCLE NO. 32 ON INQUIRY CARD**

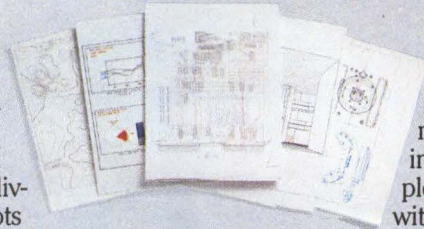

Plodder." Compare the performance specifications. Then make your own move into the fast track of plotter technology—with CalComp. California

Computer Products, Inc., 2411 West La Palma Avenue, Anaheim, CA 92801.  
714-821-2011 TWX: 910-951-1154

**CALCOMP**  
A Sanders Graphics Company



**SANDERS**

NCR

- Disk
- Communications
- Fault
- Battery

On  
Off

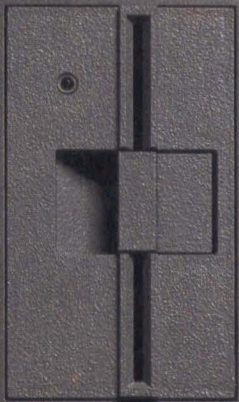



# TOWER™ 1632. IF YOU THINK IT'S BEAUTIFUL IN COLOR, LOOK AT IT IN BLACK & WHITE.

---

**PROCESSOR:**

16-bit 10MHz Motorola 68000 processor off-loads I/O functions to as many as six micro-processor-based controllers with Direct Memory Access (DMA) for powerful minicomputer performance. Memory management unit uses full 24-bit addressing. Clear migration path to 32-bit technology.

---

**USERS:**

1 to 16, local or remote.

---

**MEMORY:**

Up to 2 megabytes ECC memory, in 256K increments.

---

**MASS STORAGE:**

10 megabytes to one billion bytes.

---

**OPERATING SYSTEM & SOFTWARE:**

NCR enhanced operating system derived from UNIX.\* Five user personality levels. Dictionary driven applications generator.

---

**LANGUAGES:**

Cobol, Business BASIC, Fortran, C.

---

**INDUSTRY STANDARD INTERFACES:****I/O Bus:**

Multibus\*\* IEEE-796.

**Magnetic Media:**

SA400—5.25" floppy disks, ST506—5.25" Winchester, SMD—high performance  
8" Winchester, QIC II—streaming tape.

**Communications:**

RS232C [ASCII TTY, Bisync (2780/3780)],  
NCR DLC, SDLC/SNA, X.21/X.25,  
Networking.

---

**PRICE:**

Under \$10,000 in OEM quantities.

---

In the foregoing sketch you see the outline of the new shape in computing. Tower™ 1632.

Now that you know what it looks like in black & white, we invite you to see it in action. Call us at (800) 222-1235.



BUILT FOR SYSTEMS BUILDERS.  
TOWER 1632.

**NCR**  
OEM Marketing Division

NCR Corporation, World Headquarters, OEM Marketing Division, Dayton, OH 45479. Nationwide (800) 222-1235. In Ohio (513) 445-2380. In Canada (800) 268-3966.

\*UNIX is a trademark of Bell Laboratories. \*\*Multibus is a trademark of Intel Corporation. Products for delivery in U.S.A. will comply with appropriate FCC rules.

CIRCLE NO. 33 ON INQUIRY CARD

# SUPPORT

The Micro Five Dealer Program

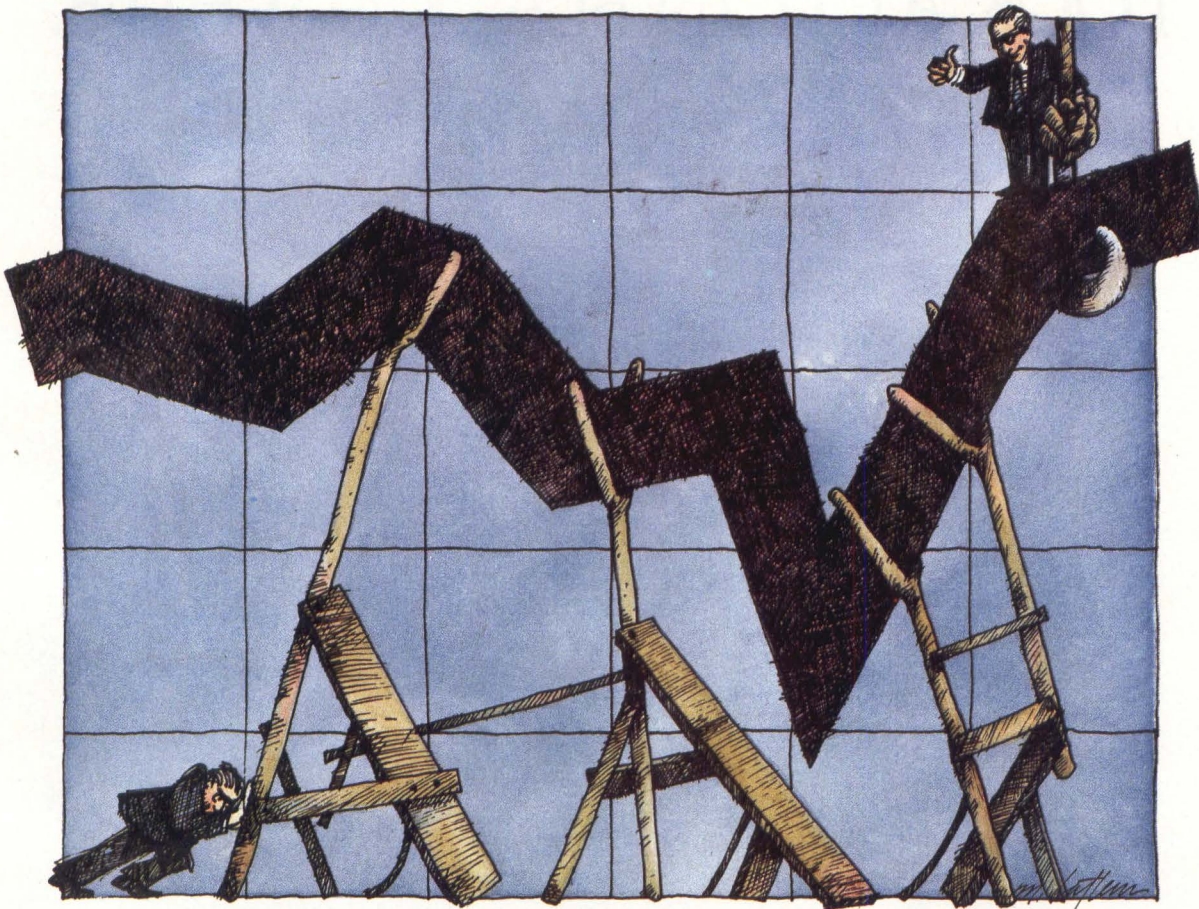

*Finally there's a company that supports your sales efforts with more than empty promises.*

As a Micro Five® dealer you can expect what many have promised, but few have delivered...real sales support. Support that is built around a versatile product line and whose aim is specific...to help you sell.

Our aggressive distribution system gives you the profit margins you need. And our marketing advertising and promotion (MAP) program pulls together national and local marketing efforts providing you with sales and training aids that can bolster your sales.

You'll be happy to learn that the Micro Five product line is as solid as our dealer support

program. Our state-of-the-art 16-bit microcomputer product line can help you appeal to a wider range of prospects...from the single station, floppy disk system to multi-user hard disk systems. And because the Micro Five product line supports a wide range of operating systems including CP/M, MP/M, MS-DOS, Business BASIC, MicroCOBOL and our proprietary STARDOS, there are many vertical application programs already available.

But don't just take our word for it. Put us to the test. For detailed information about how we can help you become a Micro Five dealer or distributor, call Paul Mitnick, Micro Five Corporation, at (714) 957-1517.



CIRCLE NO. 34 ON INQUIRY CARD

*Discover the Difference*

**Micro Five Computers**

# Mini-Micro World

SHOWS AND CONFERENCES

1983  
NATIONAL  
COMPUTER CONFERENCE

## NCC to highlight emerging information age

It's fitting that the 1983 National Computer Conference be held within a monorail ride of Disneyland, a legacy of the genius who manipulated technology to create fantastic art forms and new human environments. Walt Disney's fascination with the interplay between man and machine will undoubtedly be shared by the hundred-thousand-plus NCC participants expected May 16-19 at the Disneyland and Anaheim Convention Centers.

Disney would have approved of the conference theme, too. This year's subject, "The Emerging Information Age: Computers, Communications and People," will be explored through an exhaustive array of 84 technical sessions; 22 professional development seminars; and more than 600 computer hardware, software and services exhibits, films and special events. Another event to watch for, although it may be a long shot: Hollywood film crews obtaining "color" shots for the film version of Tracy Kidder's popular *The Soul of a New Machine*.

For the first time in NCC's history, the keynote address will be delivered by a computer software expert. John P. Imlay Jr., chairman and chief executive officer of Management Science America Inc., will deliver the opening address.

The technical program is divided into 11 program tracks, each chaired by a noted authority in the field. The tracks are scheduled so that an ambitious attendee could attend all in a field of interest. The program areas are software engineering; management/education; database/distributed systems; human and social issues; office automation; decision-support sys-

tems, hardware, telecommunications and applications; and personal computers. All technical sessions will be held at the Marriott Hotel. On-site registration is \$125.

Complementing the technical sessions are professional development seminars that focus on various computer applications and professional enhancement areas. These seminars are individually priced at \$75 per day, which includes a visit to the exhibit floor. Registration is limited to 100 participants per session. The professional development seminars are to be held at the Hilton on the Park.

The 600-plus exhibits are expected to sprawl over more than 313,000 sq. ft. in the two host convention facilities. Last year, the Houston show drew more than 680 exhibitors in 311,000-plus sq. ft. and attracted about 96,000 attendees.

### Technical session highlights

Keynote speaker Imlay promises to take a humorous look at software and the future interactions of people and personal computers. The session is scheduled from 10 to 11 AM on Monday in the Anaheim Marriott Ballroom. Imlay is past president of the American Data Processing Service Organization and, in 1981, was chosen by International Computer Programs Inc. as one of 15 people who will influence computers the most in the next five years.

Artificial intelligence is seen as one way to ease the interaction of machines and humans. That interaction ranges from the computer's input device to more intuitive logical interactions with the computer. The panel "Artificial Intelligence: Blue Sky or Tools of the

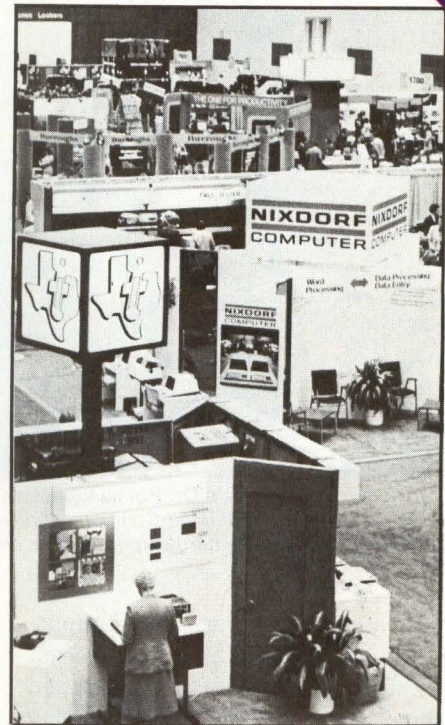

Last year's National Computer Conference in Houston had more than 680 exhibitors in 311,000-plus sq. ft. and attracted about 96,000 attendees. Sponsor the American Federation of Information Processing Societies expects more than 100,000 attendees at this year's show in Anaheim. The 600-plus exhibits will sprawl over 313,000 sq. ft. in the two convention halls and six temporary buildings.

Future?" a segment of the software engineering track, will explore the origins of artificial intelligence, look at applications and discuss how research projects will lead to pragmatic applications. Session leader Roy Maxion of Xerox Corp. will focus the session on a comparison of two types of intelligent help systems: natural language or empirical associations and "knowledge-based" systems. Panel representatives include speakers from Xerox Palo Alto Research Center and Carnegie-Mellon University, both locations of artificial-intelligence research. The session is scheduled on Monday from 3:30 to 5:30 PM in Salon 1, which has a capacity of 200 attendees.

A session almost guaranteed to

# Mini-Micro World

SHOWS AND CONFERENCES



Future Computing Inc.'s Dr. Portia Isaacson (left) and Dr. Egil Juliussen will participate in two sessions of "Personal Computer Industry: The Experts Predict the Future." Future Computing projects the hardware market alone will mushroom from \$8 billion in 1983 to \$28 billion in 1988.

draw a crowd is "Personal Computer Industry: The Experts Forecast the Future," which is scheduled from 3:30 to 5:30 PM on both Monday and Tuesday in Salons F and E, respectively. Both salons hold 580 persons. The panel, led by Future Computing Inc.'s Portia Isaacson, also will include Benjamin M. Rosen of Rosen Research Inc. Future Computing projects the hardware segment of the personal computer market, which was \$4.8 billion in 1982, will increase to \$8 billion this

year and to a whopping \$28 billion in 1988. The personal computer software market will grow 700 percent from \$1 billion in 1982 to \$8 billion in 1987. The panelists will elaborate on these projections. Additionally, they will focus talks of computer retailing, international markets and competitors, start-up opportunities and portable computers around the role of IBM's PC as a de facto standard.

## Anticipated product highlights

While last year's NCC could be categorized as the year of disk drive announcements, with activity particularly hot in microfloppy drives and standards thereof, this year's show does not appear to be taking one flavor yet. Most products, however, emphasize more compactness and lower price. Listed below are products tentatively scheduled to be introduced or showcased.

TeleVideo Systems Inc. (Booth A3008) is among the microcomputer suppliers that expect portable personal computers to be in the spotlight at this year's NCC. The Sunnyvale, Calif., terminal and microcomputer manufacturer is readying its first two entries in

what it hopes will be a high-volume complement to the existing micro-computer market. For the 8-bit market, TeleVideo will show the TeleTote I, priced at \$1795 and including a 9-in. CRT display. For the IBM PC market, the company will offer a TeleTote II version priced at \$2795 and using the MS/DOS operating system and probably based on the Intel 8088.

Plexus Computers Inc. (Booth S5384) is getting ready to extend the "distributed UNIX" concept it developed with its multiprocessor-based supermicrocomputers. Using Ethernet local-area network controllers on its Multibus systems and alterations to the UNIX kernel, Plexus has developed a networked UNIX option.

Digital Equipment Corp., Maynard, Mass. (Booth W6028), is rumored to be working on a new personal computer, which may be featured at the company's booth. Sources indicate DEC's new offering may be an office workstation to compete with Apple Computer Inc.'s Lisa. A DEC spokesman declines comment.

British-owned Torch Computers Inc., with U.S. offices in Boston, hopes to demonstrate Supertorch at NCC. This new machine incorporates the MC68000 processor in addition to the Zilog Z80 CPU in existing Torch computers. Torch spokesman Dick Tammadge, at the company's Cambridge, England, headquarters, notes the MC68000 will enable Supertorch to host the UNIX System III operating system in addition to Torch's own CP/N system. Torch also hopes to demonstrate Econet.

Torch will appear among a group of British firms in a joint exhibit sponsored by the government-run British Overseas Trade Board (S5114). Making its U.S. exhibition debut among that group will be Future Technology Ltd., Beith,

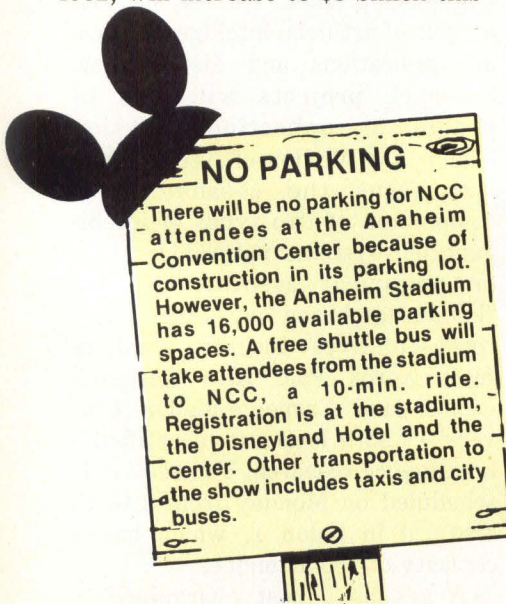

# NoHALT

## THE MICROTANDEM COMPUTER.

**YOU CAN'T STOP IT.** NoHALT'S NH-1000 is a totally redundant system with duplicate disc drives, duplicate system control processors, *even duplicate power supplies*. Catastrophic failures can't stop it; won't even cause records in process to be lost.

**YOU CAN'T OVERWORK IT.** The NH-1000, with its 16 slave microprocessors, can connect up to 64 separate work stations, each with the ability to access over 100 megabytes of duplicated, on-line storage. In addition, one NH-1000 can be linked to another over an LAN cable. There's more capacity than you'll ever outgrow.

**YOU CAN'T CONFUSE IT.** NoHALT'S NH-1000 is CP/M\* and MP/M\* compatible. Which means it won't require special programming. Also, an R.M. Cobol code generator makes it very easy to convert your existing programs.

**YOU CAN'T BEAT IT.** With all this power, redundancy and capacity, the NoHALT NH-1000 costs less than \$25K. Much less in dealer and OEM quantities. It's the next step up in microcomputer technology — the next step down in the cost of business computing.

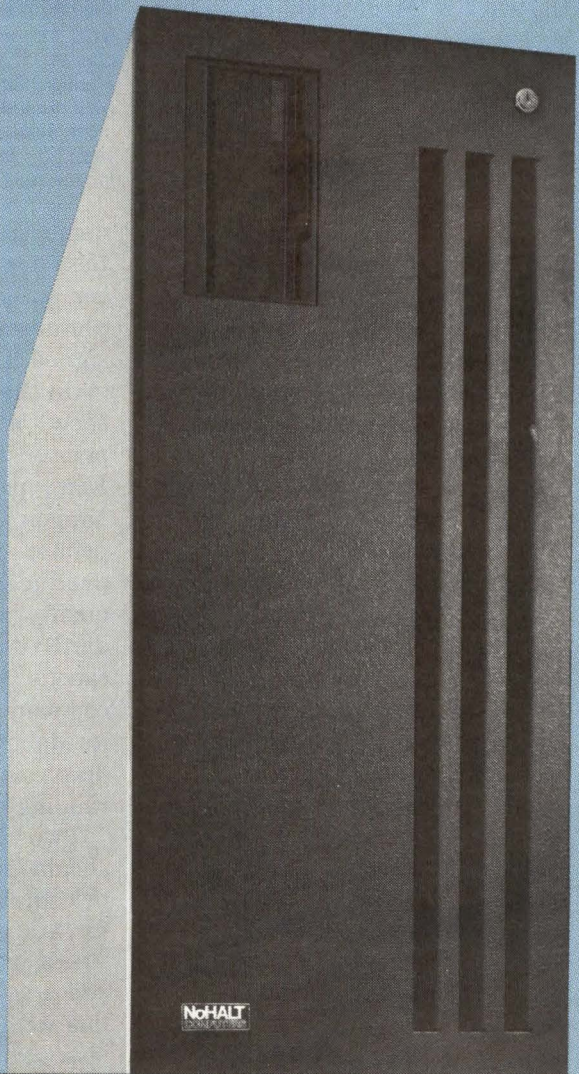

**NoHALT**  
COMPUTERS

NoHALT Computers  
1750 New Highway  
Farmingdale, N.Y. 11735  
(516) 420-9740

CALL TOLL FREE 800-528-6050 Ext. 1405  
Arizona 800-352-0458 Ext. 1405  
Alaska & Hawaii 800-528-0470 Ext. 1405

\*Registered trademark  
of Digital Research

See NoHalt at Spring Comdex—Booth 147-149

# Mini-Micro World

SHOWS AND CONFERENCES

Scotland, which hopes to find U.S. computer equipment suppliers interested in its service of designing and building microcomputers on a custom basis.

A new family of MC68000-based computer systems aimed at the business market is expected to be shown for the first time at NCC by Pertec Computer Corp., Irvine, Calif. (Booth N3848). Pertec vice president of marketing Soron Litman says the systems will have a proprietary operating system called the 3700-OS. Models will range from a low-end, desk-top, single-user system with one floppy disk drive to a high-end machine with a Winchester disk drive and multi-user capability.

Convergent Technologies Inc.'s booth should feature a host computer for the company's family of workstations, which is claimed to have 8-million-instruction-per-sec. performance out of as many as 32 MC68000 microprocessors. The system will run Convergent Technologies' CTOS operating system to handle I/O, while UNIX runs in parallel under languages and application-development tools.

Newcomer Pyramid Technology plans to invite potential OEM customers to a secret Anaheim hotel suite for a demonstration of its new TTL-based 32-bit minicomputer during the show. The proprietary architecture was designed to optimize performance of UNIX operating-system software.

NEC Information Systems (Booth S5162) is readying additions to its peripherals and systems lines. On the systems side, a new model of the Astra small-business computer line will be on display. According to NEC officials, the new Astra will extend the family down to the price range of multi-user microcomputers from vendors such as Altos Computer Systems. The company will also



**NCC keynote speaker John P. Imlay Jr.**, chairman and chief executive officer of Management Science America Inc., Atlanta, was named one of the 15 people who will most influence computing in the next five years by International Computer Programs Inc. in 1981.

demonstrate new graphics capabilities for its Advanced personal computer and an Astra-based telephone-management system designed to work with any digital PBX.

On the peripherals side, NEC will show a high-density dot-matrix printer that has been used as a Kanji printer in Japan by parent Nippon Electric Co. Ltd. The printer has an 18-pin head that produces low-speed, near-letter-quality output and graphics. Standard dot-matrix printing is at speeds as high as 180 cps. The company also is expected to make its debut as a 5¼-in. Winchester disk supplier with five models ranging from 6M to 25M bytes.

Two Japanese manufacturers should introduce low-speed, low-priced, daisy-wheel printers in time for NCC. Ricoh of America (Booths P7835, P7837, P7839, P7841) should add a 20-cps machine to its printer line with a target price of \$1200 or less. Prototypes of the new printer have been demonstrated privately by Ricoh, and it is believed that initial deliveries could be as early as May. The previous lowest priced

model was a 35-cps \$1800 machine. Fujitsu America Inc. (Booth W6478) should unveil a new 35-cps, daisy-wheel printer at NCC with an as-yet-undetermined price.

NCC likely will see the U.S. debut of two 80-column matrix printers from Siemens Corp., Anaheim, Calif. (Booth W6458). Both are called PT88. They differ in one fundamental respect—printing technology. One model comes with a needle print head for generating multiple copies and runs at 80 characters per sec., while the other employs non-impact ink-jet printer technology, achieving a speed of 150 cps. Wolfgang Weikl, vice president of the Siemens Terminal division in the U.S., quotes single-quantity prices from \$800 and volume prices of less than \$500.

Control Data Corp. (Booth S5428) is expected to become the second major disk drive manufacturer to endorse the industry-committee-proposed 3½-in. microfloppy disk standard started at last year's NCC. Shugart Associates endorsed the standard last fall. CDC's 3½-in. floppy, code-named "Jimminy," is expected to be introduced at NCC along with a companion 3½-in. Winchester code-named "Cricket."

Seagate Technology officials will not comment on reports that the company will show its first 3½-in. Winchester drive at NCC. A prototype of the 5M-byte drive was shown privately at last year's fall Comdex show, shortly after Seagate announced plans to license rights to manufacture a 3¼-in. floppy drive designed by Tabor Corp. Expected from Tabor is a double-sided version of its 3¼-in. drive providing as much as 1M byte of storage. Shugart (Booth N3856), Tandon Corp. (Booths P7057, P7059, P7061) and Miniscribe Corp. (Booths D2118, D2120, D2122) also are expected to show a 3½-in.

# New Amdek 3" micro-floppydisk drive system!

## AMDISK-III . . . the engineer's choice:

- New 3" hard plastic encased diskette.
- Up to 1 megabyte storage. (unformatted)
- Plug-in compatible with 5¼" drives.
- Compatible with - IBM-PC.

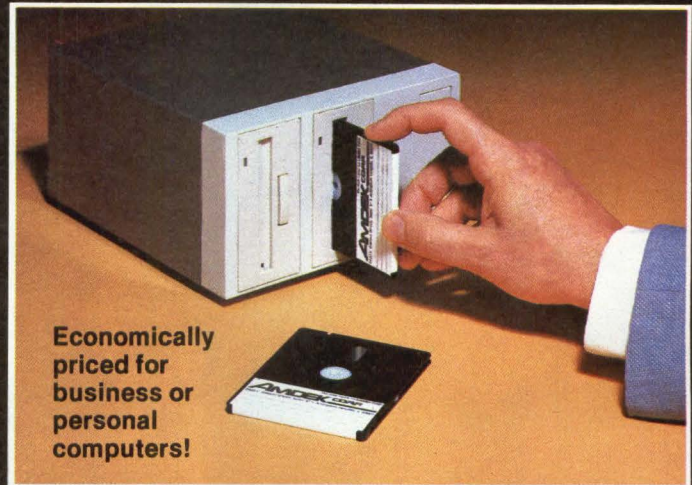

Economically priced for business or personal computers!

### Specifications

	Unit	Double Density
<b>Capacity</b>		
Unformatted Per Surface	Bytes	250K
<b>Media</b>		
Record Surfaces	2	
Tracks	80	
<b>Recording</b>		
Max Recording Density	Bpi	8946
Track Density	Tpi	100
Transfer Rate	bits/sec	250K
<b>Access Time</b>		
Average Access Time	msec	55
Track to Track	msec	3
Setting Time	msec	15
Average Latency Time	msec	100
Motor Start Time	sec	1
Disk Speed	rpm	300
<b>Reliability</b>		
Error Rates		
Soft Error		10 <sup>-9</sup>
Hard Error		10 <sup>-12</sup>
Seek Error		10 <sup>-6</sup>
<b>Media</b>		
	3 inch Cartridge	
<b>Drive Interface</b>		
	Plug Compatible with 5.25 inch FDD	

### External Interface

Connector: 37-pin "D" shell connector

Pin No.	Signal	Pin No.	Signal
1-5	Unused	13	Write data
6	Index	14	Write enable
7	Motor enable C	15	Track 00
8	Drive select D	16	Write protect
9	Drive select C	17	Read data
10	Motor enable D	18*	Select head 1
11	Direction	19	GND
12	Step pulse	20-37	GND

\*drives are single head

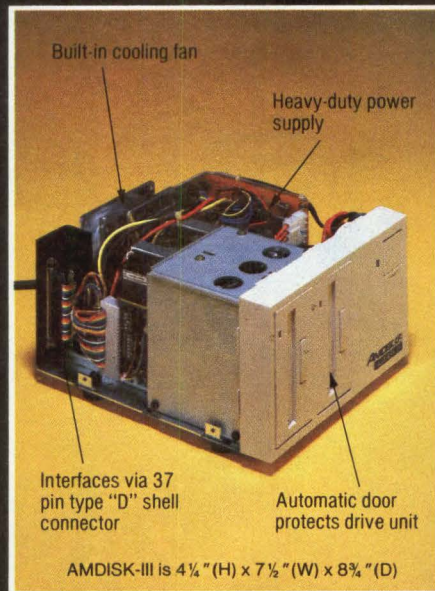

Built-in cooling fan

Heavy-duty power supply

Interfaces via 37 pin type "D" shell connector

Automatic door protects drive unit

AMDISK-III is 4¼" (H) x 7½" (W) x 8¼" (D)



Easy to mail, too!

## Evaluation samples \$480

Includes two-drive Amdisk unit with built-in power supply, 4 diskettes and application literature . . . Call (312) 364-1180.

The AMDISK-III Micro-floppydisk System is an engineering breakthrough in disk size, storage capacity, media protection and user convenience. Designed for microcomputers for many applications, the Amdek system is ruggedly constructed to provide years of trouble-free operation. Warranty is 90 days (parts & labor).

Put the new AMDISK-III to test . . . its recording format, data transfer rate and disk rotation speed are compatible with 5¼" floppydisk drives. Call, or write for evaluation samples at only \$480.00 . . . or circle the reader service number for full technical details.

CIRCLE NO. 36 ON INQUIRY CARD

2201 Lively Blvd. • Elk Grove Village, IL 60007  
(312) 364-1180 TLX: 25-4786

**AMDEK CORP.**

Amdek . . . your guide to innovative computing!

See us at NCC 83 Booth • P7636

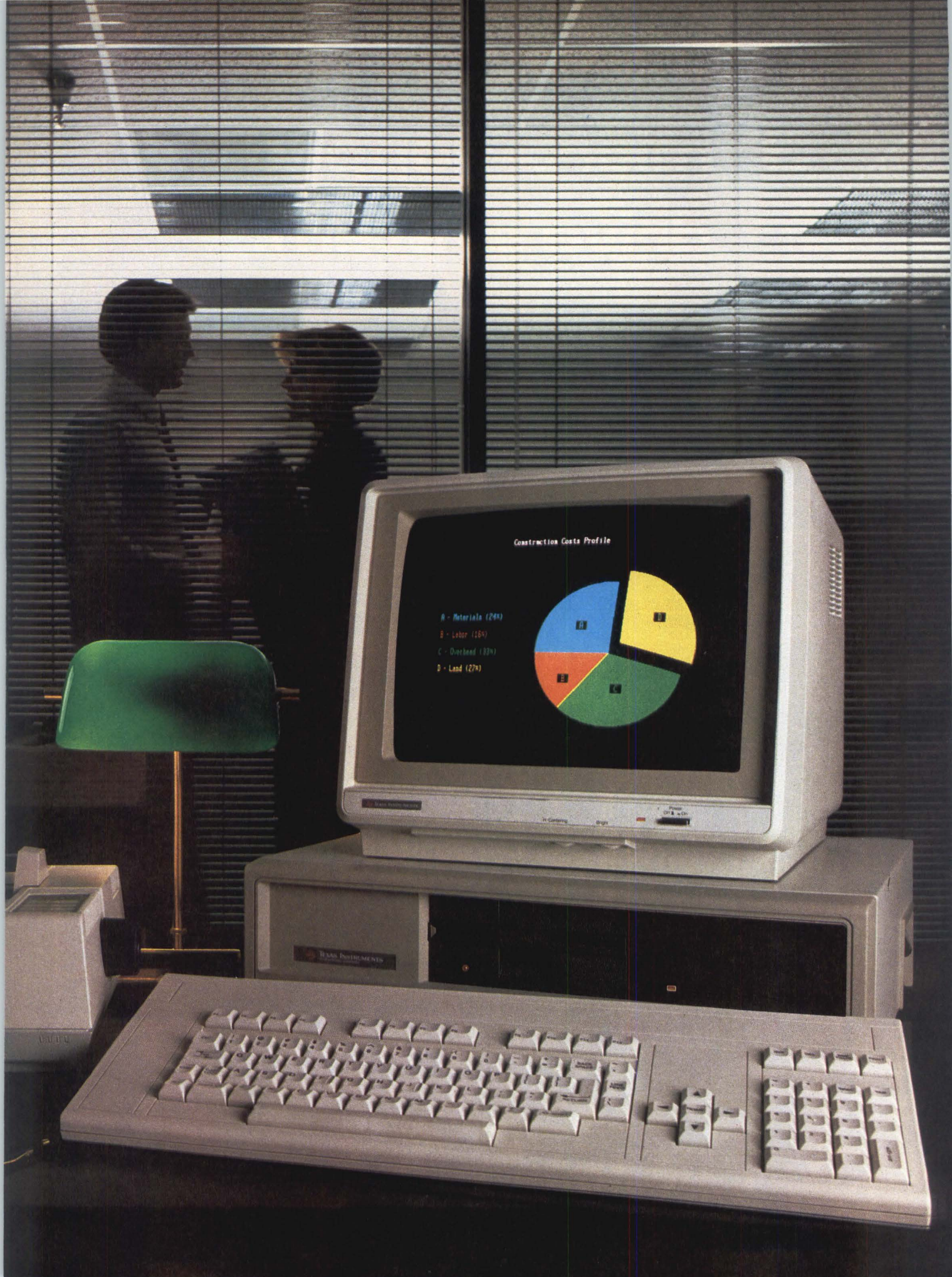

Construction Costs Profile

- A - Materials (24%)
- B - Labor (18%)
- C - Overhead (32%)
- D - Land (27%)

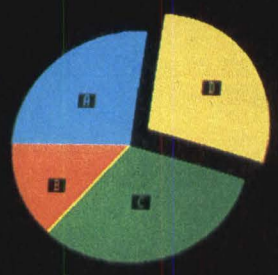



# The new TI Professional Computer. It's the answer for information systems managers.



When it's your responsibility to choose a professional computer, you look for the one that's not only powerful and easy to use, but is also expandable enough to meet your company's present and future needs. A computer that helps increase productivity. One with the advanced design to permit it to effectively co-exist with information systems, today and tomorrow. The new Texas Instruments Professional Computer is the answer.

**It works with you and your system.** The new TI Professional Computer has the memory, the software and the user-friendly design that will quickly help the unsophisticated user become more productive. Its versatile communications capabilities enable it to work well with mainframes and office automation systems.

**High resolution displays with dedicated memory.** You get brilliant full-color or monochromatic graphics and text displayed with extremely high resolution. And

since our graphics board has its own memory, using graphics doesn't tie up the main memory. As a result, graphic displays appear on the screen much faster than other desktop computers.

**An Easier-To-Use Low-Profile Keyboard.** The slim profile of our keyboard features the popular typewriter layout and infinite height adjustment from 5 to 15 degrees slope. It also provides separate numeric keypad and cursor control clusters, plus improved key tactile response for quick positive entries.

**It's the answer to your microcomputer needs. Now and in the future.** All the leading operating systems and programming languages are available. You can use many popular application programs from the best software suppliers to help your managers generate spreadsheets, do word processing, construct graphics, commu-

nicate with other data bases and create their own.

Future enhancements will include speech recognition, speech synthesis, telephone management, natural language query capability with a true relational data base package. All this means greater productivity in your company today and tomorrow.

**There's more information in store for you.** It's simple to get more answers about how the TI Professional Computer can meet your needs. Just complete the coupon below and mail to: Texas Instruments, Dept. 1B, P.O. Box 402430, Dallas, Texas 75240. Or call toll free: 1-800-527-3500.

Creating useful products  
and services for you.



## TEXAS INSTRUMENTS

### SPECIFICATIONS

#### System Unit

16-bit, 8088 microprocessor  
64K byte RAM, expandable to 256K bytes  
4K byte graphics display memory  
5-slot expansion bus

#### Keyboard

Specially designed low profile  
Popular typewriter layout  
97 keys, including 12 function keys  
Separate numeric keypad and cursor control clusters  
Tactile response, for quick positive entry  
Upper- and lowercase letters

#### Display Units

12-inch monochrome (green phosphor) or  
13-inch full-color, 25 lines x 80 columns  
High resolution, 720 x 300 pixels

#### Mass Storage

Built-in 320K byte diskette standard  
Additional internal storage of 320K byte  
diskette, or 5 or 10 Mbyte Winchester disks  
optional

#### Communications Options

300 BPS or 300/1200 BPS internal modem  
TTY, 3780  
3270 SNA stand-alone (Summer 1983)  
3270 BSC and SNA cluster (Fall 1983)

#### Operating Systems

MS™-DOS, Digital Research™ CP/M-86®, and  
Concurrent CP/M-86™, UCSD p-System™

#### Languages

BASIC, COBOL, FORTRAN, Pascal

#### Applications Software

Over 100 programs available from the most  
popular software vendors such as Micro-  
soft, Ashton-Tate, Micro-Pro, IUS, Sorcim,  
Peachtree, BPI, Lifeboat and others.

#### Printers (Available Spring 1983)

150-cps TI 850 Series for most applications

FOOTNOTES: MS-DOS is a trademark of Microsoft Corporation. CP/M-86 and Concurrent CP/M-86 are trademarks of Digital Research, Inc. UCSD p-System is a trademark of the Regents of the University of California.

**Get the Answer.** Please send more information about the new Texas Instruments Professional Computer.

Name: \_\_\_\_\_

Title: \_\_\_\_\_

Company: \_\_\_\_\_

Address: \_\_\_\_\_

City: \_\_\_\_\_

State: \_\_\_\_\_ Zip: \_\_\_\_\_

Phone: ( ) \_\_\_\_\_  Have Salesman Call.

**Return Coupon To:** Texas Instruments, Dept 1B,

P.O. Box 402430, Dallas, Texas 75240

DCA31BMY313C

# Mini-Micro World

SHOWS AND CONFERENCES

Winchester drive.

SyQuest Technology is set to introduce a second generation of its pioneer 3.9-in. cartridge drive, doubling the capacity to 12M bytes. The new drives will use the same

form factor and interface as the original. SyQuest will also introduce its first fixed media drive, a 25M-byte, 3.9-in. product.

Digital Research (Booth w6258) president Gary Kildall confirms that

the company has had a visually oriented user interface program similar to Visicorp's Visi<sup>on</sup> running in-house since January and will introduce it at NCC. The interface allows simultaneous display of several programs running under concurrent CP/M. Kildall says the DRI version, which, like Visi<sup>on</sup>, is designed to provide a common front end to a variety of application programs with an extensive window-management capability, will be slightly less capable than Visi<sup>on</sup>. He says Digital Research's user shell will run on an IBM PC configuration less expensive than required for Visi<sup>on</sup>. One twist to the visual interface is that it will be accessible through the firm's new DR Logo interpreter.

A local-area network product will be on display at the Computer Automation booth (S5340), at which the company's Commercial Systems division will introduce an Intel 8088-based workstation for CA's SyFAnet broadband cable network. In a network with CA's SyFA minicomputers, the new workstations can execute standard CA applications running under the CyCLOPS operating system or can run CP/M-86 applications. The SyFA minis have been adapted to serve as network resource managers for the new desk-top terminals and support IBM SNA connections to remote mainframes and other systems. SyFA customers will be able to upgrade their minis to network controllers with eight workstations for about \$30,000. A new system including the SyFA processor and the eight workstations would be \$51,000.

## SUPER PRINTERS FOR SUPER MINIS AT SUPER SAVINGS.

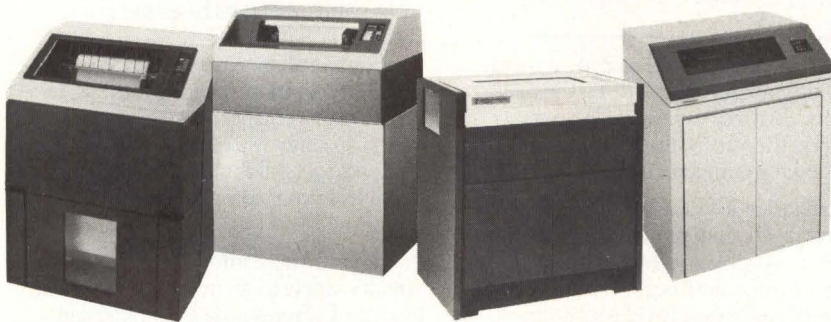

SYSTEM*	DEC VAX	DG MV	HP 3000/64		PRIME 50 Series	PERKIN-ELMER 3200
Model #	LP-27	4373/4374	2611A	2619A	3166	M46-304
You Save	\$8040	\$9750	\$5605	\$8205	\$4625	\$3495

\* Also IBM, Wang, Honeywell and other high-performance machines.

Mix and match any of our high-performance printer systems with your 32-bit minicomputer and get low price; guaranteed plug-compatibility; 30-day delivery and nationwide service and support.

Digital Associates offers the only complete line of heavy-duty, high-speed line printers capable of multi-shift operation at speeds

up to 2400 LPM, and RLPS, the only cost-effective solution to high-speed remote line printing requirements (three times the speed at half the cost).

We guarantee plug compatibility with many popular computer systems. Just call **800-243-9054** and our printer experts will help you pick the printer system that meets your exact requirements.

### The Printer Store<sup>®</sup>

**Digital Associates Corporation**

1039 E. Main Street, Stamford, CT 06902 TWX 710-474-4583  
(800) 243-9054 In CT call (203) 327-9210

CIRCLE NO. 38 ON INQUIRY CARD

—compiled by Lori Valigra; reported by David A. Bright, Edward S. Foster, Keith Jones, Geoff Lewis, Robert A. Sehr, Stephen J. Shaw and Kevin Strehlo

We've developed a new system based on the IBM Personal Computer that saves you lots of money.

By installing PERSYST's PC/HASP, you can use your IBM PC as a personal computer or a powerful corporate data processing subsystem. One that emulates a full-function IBM 360/20 Mod 5 HASP/Remote

Job Entry workstation. Now — all of the capability for a fraction of the cost of anything near as good.

PERSYST's PC/HASP can handle up to seven multi-leaved input and output job streams — is compatible with all host systems supporting HASP/RJE, and allows print spooling for off-line printing. Plus, PC/HASP

has features like fast line speed, 600 line-per-minute printer support and more.

Get a big name system at a small time cost. Call PERSYST right away to get in on the savings yourself.

**PERSYST**

15801 Rockfield Boulevard  
Irvine, CA 92714, (714) 859-8871

CIRCLE NO. 39 ON INQUIRY CARD

# How to get IBM<sup>®</sup> HASP Remote Job Entry stations at less \$\$ than anyone else's.



# Introducing:

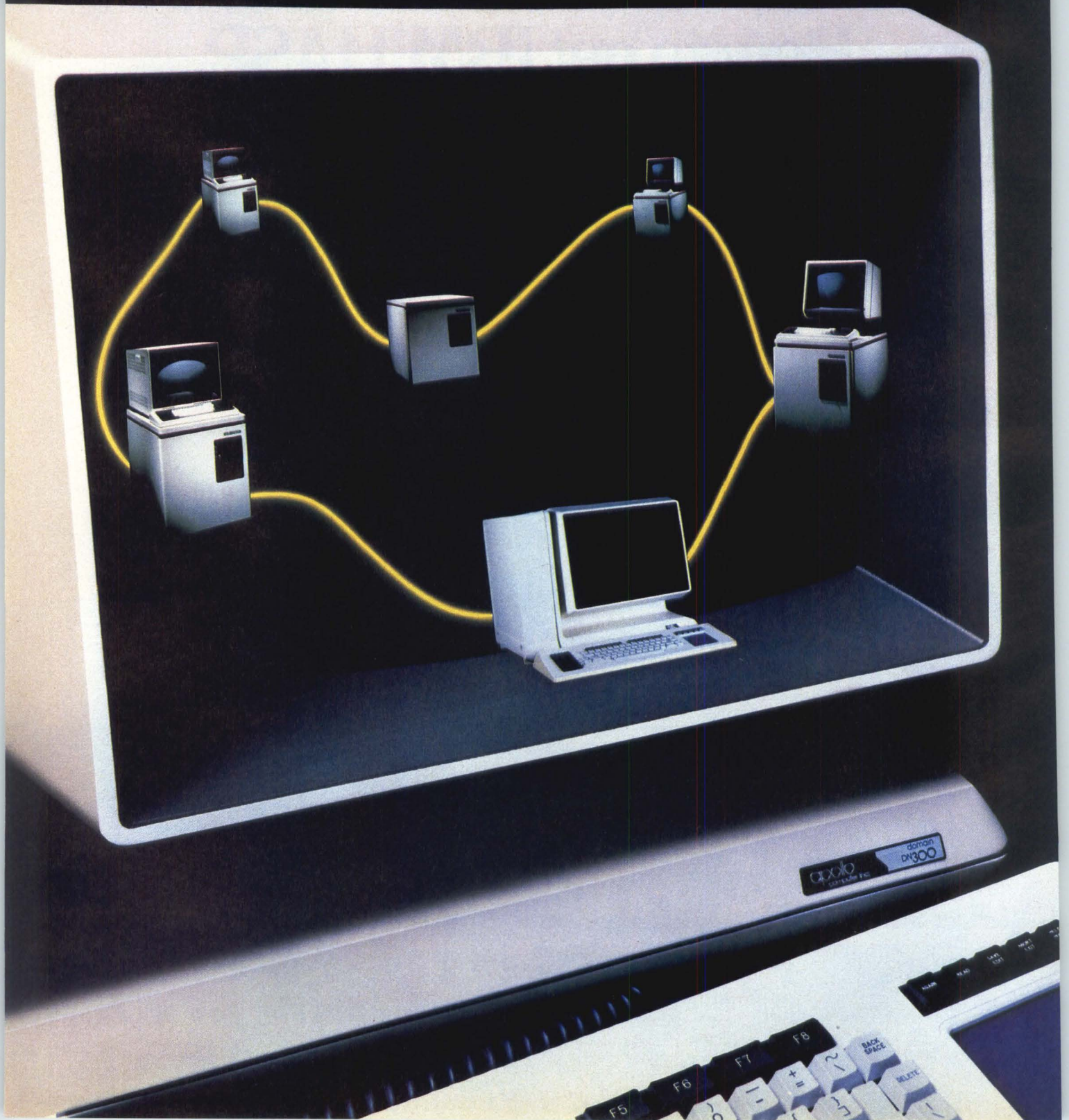

# the \$10,000 desktop mainframe.



## THE NEW APOLLO DN300 WILL COMPLETELY CHANGE THE WAY TECHNICAL PROFESSIONALS USE COMPUTERS.

The DN300 is quite possibly the single most important computer system ever introduced for the technical professional. For the first time ever, these technical professionals have fingertip access to a desktop mainframe, and all the power that goes with it. The power to utilize time in the most efficient possible way. The power to increase technical productivity and innovation. The power to try out and refine new ideas and concepts. The power to reduce design-time cycles. The power to create better, more cost-effective products.

In a unit that takes no more space than a daily newspaper, the DN300 gives you a high performance, 32-bit virtual memory processor, high resolution bit map graphics, and an integrated local area network that provides network-wide virtual memory access.

The DN300, latest in the family of DOMAIN processing nodes, supports up to 1.5 million bytes of main memory and 15 concurrent processes of 16 million bytes each, so you can execute large programs. Its 17-inch 1024 x 800 pixel landscape display provides the high-resolution graphics you need for technical

applications. The 12 million bit-per-second high speed token-passing network lets you access data anywhere in the network without sacrificing performance.

The DN300 is fully compatible with Apollo's DN400, 420, and 600 and supports multiprogramming environment, large virtual address space, network communications, multi-window display management, and extensive command library.

## SOFTWARE YOU NEVER THOUGHT YOU'D SEE ON YOUR DESKTOP.

Standard with every DN300 is AEGIS, the only network-wide virtual memory operating system available.

Optional software includes ANSI-FORTRAN 77, Pascal, C, SIGGRAPH Core Graphics, X.25, HASP, 3270, D3M distributed database system and AUX, a software environment based on UNIX™ System III.

## NEW DOMAIN SERVER PROCESSOR—A LOW COST WAY TO HANDLE NETWORK PERIPHERALS AND GATEWAYS.

The new DSP80 intelligent peripheral server lets DOMAIN users freely share the same, centrally located peripherals.

That relieves individual nodes of peripheral support. So nodes have more time and more power to handle applica-

tion-related computing.

And you save money by sharing disks, tape drives, printers and plotters. The DSP80 also provides every user with access to communication gateways, large-scale file storage, and print/plot spooling.

## FIND OUT MORE

The DOMAIN network gives you low entry cost, high performance, easy and natural incremental growth, reliability, and long-term investment protection. And it gives your technical staff the excitement and satisfaction of working with an innovative, highly productive new tool. For more information call Apollo's marketing department at (617) 256-6600, extension 608, or write Apollo Computer Inc., 15 Elizabeth Drive, Chelmsford, MA 01824.

UNIX is a trademark of Bell Laboratories.

USA price \$9,933, system builder, quantity 35 DN300 with .5Mb memory, 17-inch graphics display, network interface, and AEGIS operating system.

## A DOMAIN professional productivity network puts an application specific mainframe on every user's desktop.

The truly exciting aspect of a DOMAIN network is its ideal combination of individual initiative and teamwork. Users get not only the benefits of a high performance, 32-bit computer dedicated to their application, but also retain the benefit of shared resources.

For example, use the color DN600 or monochromatic DN420 nodes for solids modeling, VLSI CAD, finite element analysis, pre- and post-processing, and image analysis. . . . Use the DN300 for computer-aided software engineering, design documentation, high-quality presentation graphics, drafting, and electrical design capture and simulation.

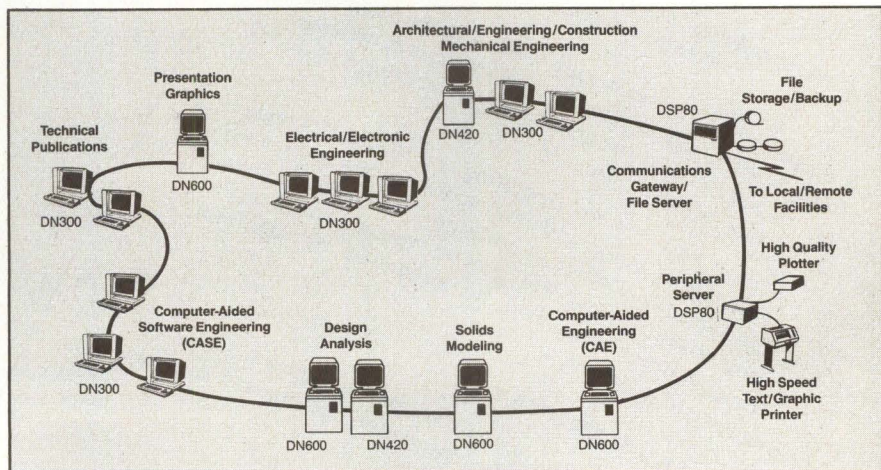

CIRCLE NO. 40 ON INQUIRY CARD

apollo  
computer inc.

Domain: The Next Generation

# 17,381 WORDS 0

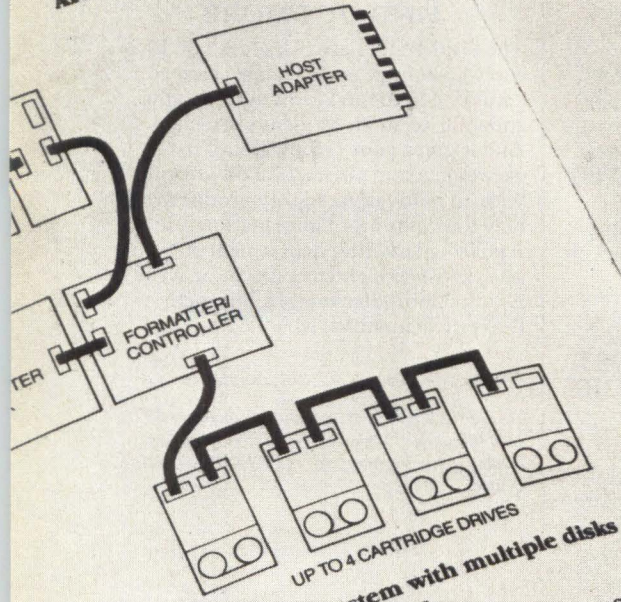

**Figure 8-1 Mass-storage system with multiple disks and tape drives.**

Integration requirements are generally limited to modifications in the existing disk I/O driver and optional changes in the operating system or application programs to take advantage of the combined disk-tape architecture.

Communication between the operating and storage system is through a sequence of commands and status reports relating to both disk and tape. A number of additional daisy-chained disks, in any combination of capacities, can be typically added to the system. Tape storage can also be expanded by additional streaming-cartridge drives.

**CONTROLLER HARDWARE**

The on-board microprocessor shown in Figure 8-2 controls the flow of data through the controller circuitry but does not

**Disk-Tape Storage**

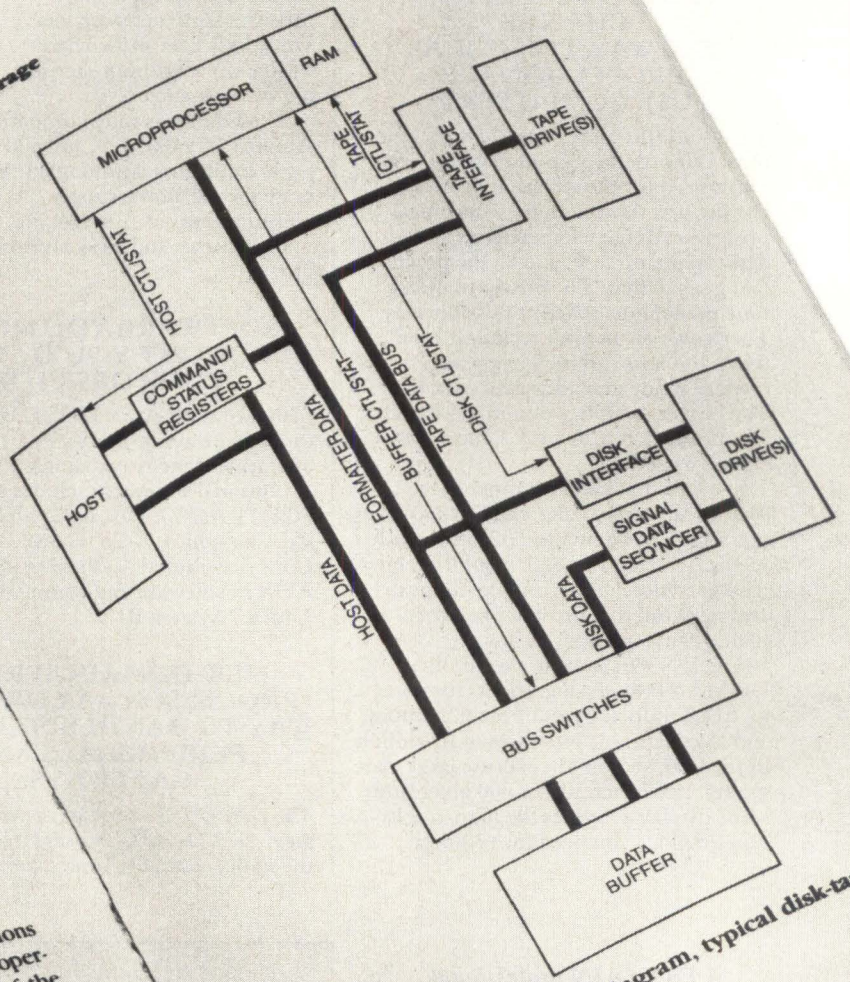

**Figure 8-2 Block diagram, typical disk-tape**

# FREE ADVICE ON STREAMERS.

What Archive knows about Winchester back-up could fill a book. Specifically, a free 176-page book. One that covers almost everything you could possibly want to know about 1/4-inch streaming tape drives and other back-up devices.

It's all there: Mass storage principles. Winchester technology. System considerations. Flexible disks. Disk-tape storage. Software. And of course, there's a thorough discussion of 1/4-inch streaming cartridges and drives.

Who else but Archive could offer you so much good advice? After all, we've shipped more streaming tape drives than anybody else.

What's more, Archive and the rest of the streaming tape industry have now adopted universal standards for Interface (QIC-02), Format (QIC-24), and Cartridge specs. Our book is the first system description based on these standards.

To receive your free streaming handbook, fill out the coupon and return it to Hamilton/Avnet, our national distributor. You'll receive your book in 4 to 6 weeks. For a faster response, call your nearest Hamilton/Avnet distributor. Or call (213) 615-3900.

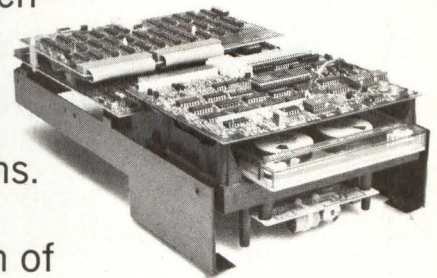

## FREE! STREAMING TAPE HANDBOOK.

To receive your copy, return this coupon to Hamilton/Avnet, 19515 S. Vermont, Torrance, CA 90502, Attn: Bob Claiborne. Or call Hamilton/Avnet now.



Name \_\_\_\_\_  
Title \_\_\_\_\_  
Company \_\_\_\_\_  
Address \_\_\_\_\_  
City \_\_\_\_\_ State \_\_\_\_\_ Zip \_\_\_\_\_  
Telephone (\_\_\_\_) \_\_\_\_\_

- Send me my free book.  
 Send me additional information about Archive 1/4" Streaming Tape Drives.
- Send an Archive sales representative.

3540 Cadillac Ave., Costa Mesa, CA 92626  
(714) 641-0279 Telex: 4722063 Domestic Telex: 183561

See us at NCC/83 Booth D2215

# ARCHIVE

CORPORATION

CIRCLE NO. 41 ON INQUIRY CARD

"The Bridge™ is software that creates a virtual microcomputer at every terminal connected to my mini. I have all the functions of a micro, but without micro limitations.

"The z-Board™ has four z-80a® microprocessors per board to execute programs at high speed. Faster than many dedicated micros. And it has 256K bytes of RAM, plus a bit slice

state machine. That's the guts of four micros for less than you might pay for one.

"With The Bridge, I can run CP/M® based programs. I like that. And micro programs like Supercalc® are easy to use, and inexpensive. I like that, too.

"But the best thing about The Bridge is systems integration. Now everyone in the office uses the same system — no more problems with disk formats, incompatible languages or programs. The Bridge provides each user with a

virtual microcomputer with the advantages of a mini's high-speed printers, hard disks, and communications.

"The Bridge with a z-Board gives me the performance of four microcomputers — at a fraction of the cost!"

The Bridge and z-Board are trademarks of Virtual Microsystems, Inc.  
z-80a is a registered trademark of Zilog, Inc.  
CP/M is a registered trademark of Digital Research.  
Supercalc is a registered trademark of Sorcim, Inc.

For information, call Jim Swanson  
(415) 841-9594.

**"The Bridge and a z-Board —  
the four best microcomputers  
I never bought!"**

CP/M For DEC® and DG® Minicomputers!



virtual  
microsystems

2150 Shattuck, Berkeley, CA 94704

CIRCLE NO. 42 ON INQUIRY CARD



# Mini-Micro Interpreter

An analysis of news, issues and trends affecting the computer industry

## Array-processor vendors calculate on market growth, product diversity

By Dwight B. Davis

Since the mid-1970s, the array-processor market has been relatively small, with respectable growth rates and limited competition. While still small compared to some other computer markets—in the \$125-million ballpark for 1982—the commercial array-processor market has recently become the scene of impressive performance and price breakthroughs. And, with promises of even more spectacular product developments on the horizon, the key vendors of these arithmetic peripherals believe array processors will gain widespread acceptance among customers that previously were ignorant or indifferent about these specialized machines.

Floating Point Systems Inc., Portland, Ore., has reigned as undisputed leader in the array-processor field for several years, and its products, especially the 38-bit AP-120B, have traditionally been the flagships of the industry and the main targets of competitors. But the array-processor market was never simple, and its makeup is growing more complex. While some vendors focus on making more powerful and less expensive alternatives to the AP-120B, others are pioneering territory not yet conquered by FPS. Still other companies, swayed by neither FPS's product lead nor its name, have avoided the full-floating-point approach, and have built block-floating-point or fixed-point array processors (see "Different approaches to different problems," p. 72).

With its \$86 million in revenues constituting about 70 percent of the array-processor market, however, FPS is still the one to beat. The company's 38-bit processors range in base price from about \$30,000 to \$100,000, and the 64-bit FPS-164 typically sells for about \$400,000. Competing with some of these products are processors from such vendors as CSP Inc., Billerica, Mass., and Analogic Corp., Wakefield, Mass.—both claiming second place behind FPS in the market—and Computer Design & Applications, Newton, Mass. These ensure that no vacuum exists between the Sky and the Star-Sky Computers Inc., Lowell, Mass., which sells board-level, 1-million-floating-point-operation-per-sec. processors, and Star Technologies Inc., Portland, Ore., which has just introduced a 100-MFLOPS machine.

Regardless of product specifications and main market niches, array-processor vendors all sell the same idea:

computational speed far beyond that available from customers' host processors. If the host is a microcomputer, the vendors promise superminicomputer performance through the addition of an array processor. If the host is a minicomputer or a superminicomputer, processing speeds common only in the rarified world of Cray and Cyber machines are sometimes claimed. And, although these quantum leaps in performance are restricted to the complex arithmetic functions array processors address, the gains come at prices much more palatable than those of stand-alone computers that the array processors challenge in speed.

It was only about six years ago that programmable array processors began supplanting their hard-wired predecessors. But if programmability gave the devices newfound flexibility, it also opened a Pandora's box of conflicting opinions. Both sides of the programming dilemma are articulated by David Birkner, vice president of engineering at Computer Design & Applications, which sells array processors as OEM and end-user units and bundles them into systems for sale into such applications as medical image processing. "When you've got an array processor, the whole reason you bought it

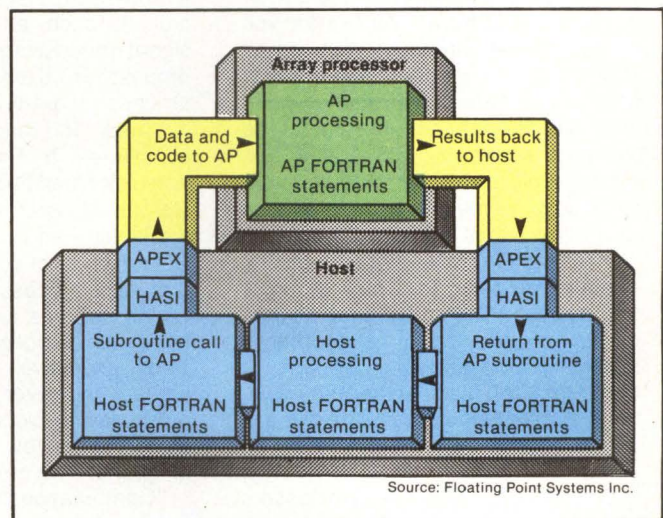

**Communications with Floating Point Systems' array processors** occur through the host/array processor software interface (HASI) subroutine, which resides in the host computer, and with an FPS library of host-resident routines called the array processor executive (APEX). These transfer program code and data to the array processor, inform the host program when the array processor has finished a task and return results to the host.

# The Interpreter

is for efficiency and speed," Birkner says. "And you're really fooling yourself if you think you're getting all the efficiency and speed out of it with a FORTRAN or other high-level language compiler." On the other hand, Birkner opines, "The array processor is there for performance, but, at a certain level, it comes down to how much time you are willing to put into programming to get that performance."

The problem reduces either to using a FORTRAN compiler—sacrificing program efficiency while simplifying the programming task—or to programming in a more difficult, but more efficient, lower level language. The options for customers preferring the former route are few—so far, only FPS offers a FORTRAN compiler on some of its machines.

FPS views the FORTRAN compiler as a way to attract less sophisticated customers, but Birkner considers it to be a "crutch" that FPS must supply because of the difficulty of microprogramming its machines. He believes the assembly-language programming available with CD&A's MSP-3000, a task "very similar to programming a PDP-11 in assembly language," represents a good compromise between a FORTRAN compiler and microprogramming.

Several other vendors, however, anticipate customer demand for FORTRAN compilers and plan to introduce them. A recent spin-off of CNR Inc., Numerix Corp., Newton, Mass., plans to add a full-floating-point array processor to its fixed-point line this month. Harold Messias, vice president of marketing and sales at Numerix, says the new machine will have between 200 and 300 math library functions on introduction. "We consider a FORTRAN compiler an absolute necessity for array processors," he says.

Messias admits FORTRAN compilers are rarely used with array processors because of efficiency problems but says it's possible to build a compiler with the required efficiency. For dedicated OEM applications in which an array processor performs just one task, there is no need for such compilers, he says. "But there's a much bigger class of people that wants to do a large number of things with array processors. There, it's more important that they can program in a reasonable amount of time and get a reasonable amount of efficiency. If there's a specific application that they really want to optimize, then they can march on down to some lower level languages."

Along with program efficiency, communications effi-

## DIFFERENT APPROACHES TO DIFFERENT PROBLEMS

The term "array processor" encompasses a diverse product spectrum of parallel architecture, pipelined devices. The best-known representatives of the genre are 32- and 38-bit machines that perform full-floating-point calculations. In floating-point notation, the number 493 might be expressed as  $4.93 \times 10^2$ . Adding two floating-point numbers with different radix exponents requires that the decimal point of the smaller expression "float" to the right until the exponent equals that of the larger expression. Array processors, as their name implies, perform algorithmic operations on arrays or vectors of numbers. In full-floating-point systems, each of the numbers involved in the calculation is represented by an exponential expression.

Full-floating-point array processors are highly precise and serve in seismic-, image- and signal-processing applications. But assigning an exponent to every number in calculations such as complex Fast Fourier Transforms and matrix inver-

sions can slow the processing of these machines. For applications in which high-speed processing is crucial, such as radar and sonar signal processing and video picture processing, fixed/block-floating-point processors are sometimes used.

There is debate as to what constitutes a fixed-point processor versus a block-floating-point machine. Harold Messias, vice president of marketing and sales at Numerix Corp., says his company's MARS-132 and -232 processors are fixed point, as, he believes are the products sold by Signal Processing Systems. SPS chief executive officer Joseph R. Fisher, however, says his firm's products are block floating point and says very few true fixed-point programmable array processors exist.

"Computationally, the machines are fixed point," Fisher says of the SPS line, "but when you do FFTs or other operations, they compute an exponent on each block of data." This single exponent per block—the requirement of a block-floating-point

machine—requires little processing time compared to full-floating-point operations, Fisher says. But it also prevents overflow and underflow problems that could result in a fixed-point machine if the calculated results surpass the word size of the array processor.

Word size is one other fundamental difference among array processors. The machines are traditionally in the 32-bit-word category, although Floating Point System Inc.'s basic product line uses a 38-bit-word configuration. Word size has little to do with speed—32-bit array processors range in speed from 1 to 100 million floating-point operations per sec.—but the length of the word can limit the usefulness of some processors for working on very large arrays that require very high precision. Scientific and simulation applications sometimes demand more than 32-bit machines can supply, and two companies—FPS and CSP Inc.—have introduced 64-bit machines for these markets.

# This is the Computer of the year. And here's why we call it the "Serious Business Solution."

The moment MultiNet came out in January, everyone knew it was something special.

Sure, the specs were great: the basic MultiNet system has a master microprocessor and two user micro's, 20 megabytes of 5¼ Winchester disk, 13.4 megabyte cartridge tape drive, 1.2 megabyte 8" floppy disk, distributed processing operating system, CP/M—all in one table-top unit and all for only \$9,995.

More importantly, however, the specs translated into a number of extremely practical user benefits, business benefits, that lead us to call it "the serious business solution."

For example, high disk capacity obviously means plenty of high-speed, fast access storage. The integrated cartridge drive lets you back-up the disk to protect critical data, or simply to store data. It runs concurrently without interruption to other work in progress. The 8" floppy offers convenient program loading and data storage. No need to convert existing programs to 5¼" formats. The distributed processing operating system lets each user have a dedicated processor (for far faster response) while sharing expensive common devices like disk, tape and printers. And the use of the industry standard CP/M operating system means you can use any of thousands of inexpensive programs on the market for accounts receivable and payable, general ledger, data base management, etc. Just load and go.

MultiNet can handle up to 8 users, with intermixing and simultaneous operation of both 8- and 16-bit programs, so you get a lot of flexibility and plenty of room to expand your operations. Install MultiNet for today's 8-bit programs and it will be ready for tomorrow's 16-bit programs.

And we've taken virtually every conceivable step to protect the system against power failures and other problems.

In summary, MultiNet gives you more efficient performance, higher storage capacity, backup for critical data, convenience, economical use of common devices, flexibility, growth and protection against downtime.

Now that's serious. The "serious business solution": MultiNet.

We're ready to demonstrate that we deserve your business. Call us now at (617) 655-9595. Or write Customer Information Services, MicroSystems International, 12 Mercer Road, Natick, MA 01760.

 **MicroSystems  
International**

# MultiNet.™

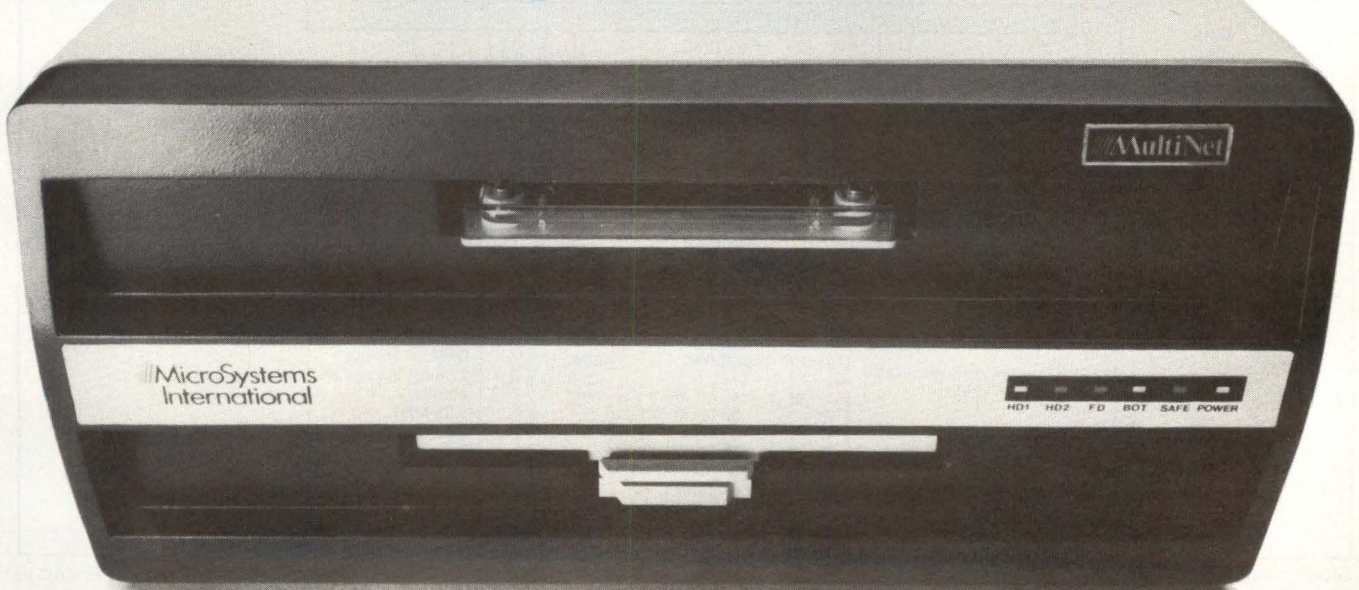

See us at Comdex/Spring-83  
CIRCLE NO. 43 ON INQUIRY CARD

# The Interpreter

ciency between host and array processors is crucial to good performance. In traditional array processor/host systems, a host-resident FORTRAN program issues subroutine calls to send instructions and data to and from an array processor (see illustration, p. 71). Data can come from the host's main memory or from peripheral storage devices. If communications channels are slow or poorly designed, the inefficient data flow can restrict the array processor's performance.

In a major step away from the traditional programming relationship, FPS designed its FPS-164 attached processor to operate in a highly independent fashion. "The 164 takes the entire program from the host and computes on it," explains Bob Schuhmann, vice president of marketing at FPS. Whereas a traditional subroutine would rarely exceed 2000 words, Schuhmann says, the FPS-164 is ideal for large-batch FORTRAN programs, and, Schuhmann estimates, "80 percent of all the large FORTRAN jobs in the world are still batch."

Some competitors question the FPS-164's usefulness in handling highly interactive real-time applications, which might require substantial host/array-processor interaction. But the FPS-164's high independence from its host represents a growing trend in the industry.

Analogic's AP500, for example, slated for availability last month, was designed to answer two problems common with array processors—overloading the host and a lack of I/O ports—says Roy Clites, Analogic's Computer Systems Division manager. To correct the first problem, he says, "You can block-transfer very large messages down into the array processor and off-load the host." For the I/O limitation, he adds, "In addition to the host port, we put an RS232 port in for remote diagnosis and development programming, two high-speed auxiliary ports, each running at 6 MHz, and a Multibus port for peripheral attachment." (See illustration, below)

The blurring of the host/array-processor relationship—evident in the increased intelligence and indepen-

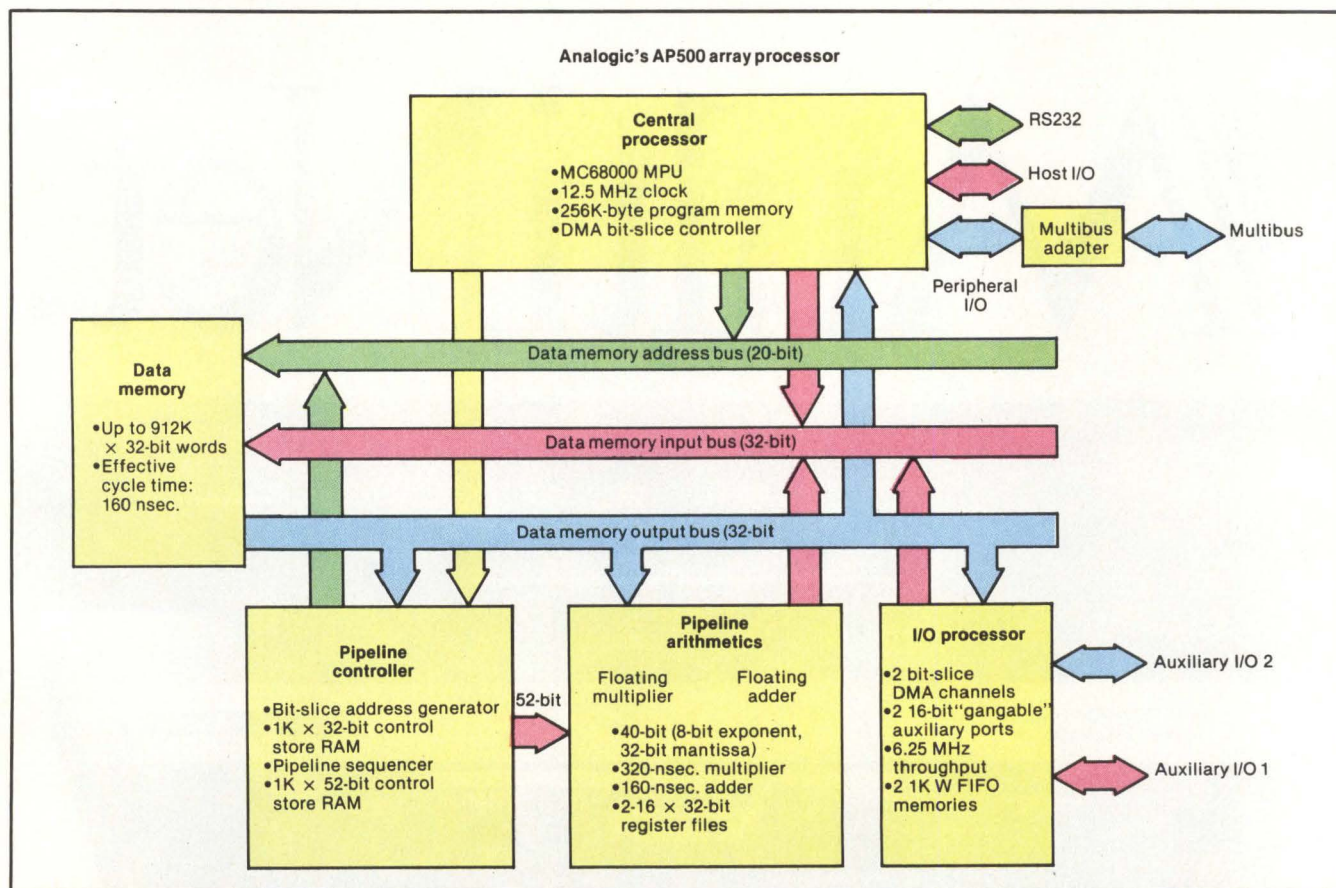

Block diagram indicates the AP500's parallel architecture, dominated by an MC68000 microprocessor and a 12.5-MHz clock. Priced at \$25,000, the basic AP500 includes 16K words of 32-bit memory, 128K bytes of program memory, 16K bytes of EPROM and an intelligent interface DMA controller.

# Use it.

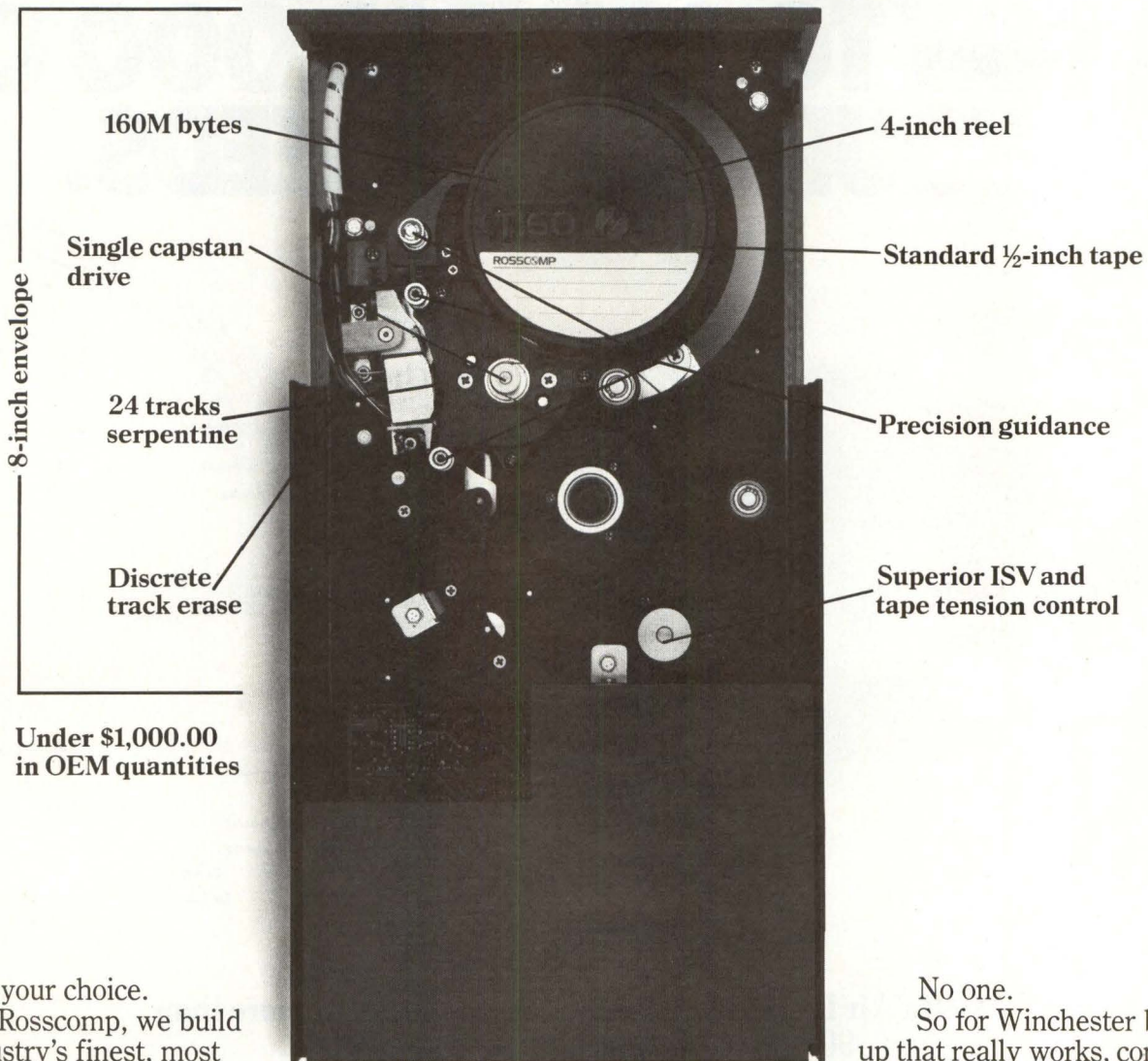

It's your choice.

At Rosscomp, we build the industry's finest, most dependable 1/2-inch magnetic tape drives to back up high-capacity Winchester. Our D160 records 160M bytes on 24 tracks in less than 20 minutes, uses standard 1/2-inch tape, and fits into an 8-inch envelope. No one else can say that.

No one.

So for Winchester back up that really works, come to the experts. Us. Write for

details on our Evaluator Package, and see for yourself how well we back you up.

Think about it. You've come a long way in storage capacity.

And that means you've got a lot more to lose.

# Or lose it.

See us at NCC,  
Booth D2427, D2429,  
D2431, and D2433.

**ROSSCOMP**  
**We're backing up your future.**

16643 Valley View Avenue, Cerritos, CA. 90701 (213) 926-5533

CIRCLE NO. 44 ON INQUIRY CARD

# DELTA'S MAPPED OUT A WAY TO SOLVE 10,000 OF YOUR CARGO NEEDS.

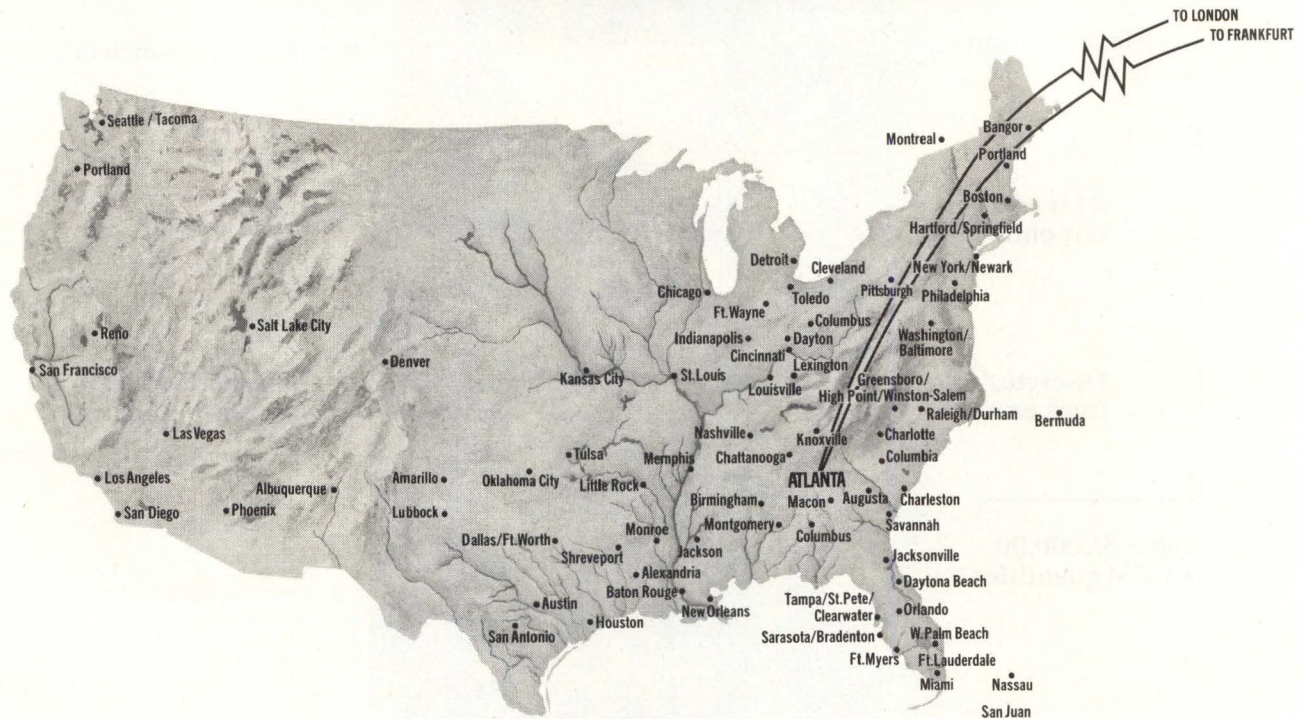

**Delta Air Freight ships door-to-door between more than 90 cities covering 10,000 communities.**

See this Delta map? You can ship just about anything, big or small, between any Delta cities shown. That covers over 10,000 communities. You can ship door-to-door. Or airport-to-airport. Delta can frequently give your shipment same-day delivery.

Delta can ship anywhere in the U.S. or the world, via interline connections. In many instances, Delta Air Freight rates are lower than other freight services. And Delta will quote you special low rates tailor-made

for your shipments. Also ask about Delta Air Express—we guarantee to get your shipment on the flight specified. And Delta 3-D™ Air Freight—40% off regular freight rates on high density shipments.

For full details, call the Delta Marketing Office in the city nearest you.

**DELTA**  
The airline run by professionals.



**DELTA AIR CARGO. READY ALL-AROUND.**

# The Interpreter

---

dence of machines such as the FPS-164 and the AP500—reaches its peak in the block-floating-point devices sold by Signal Processing Systems, Waltham, Mass. Joseph R. Fisher, chief executive officer of SPS, takes the concept of array processors as arithmetic peripherals to host minicomputers and turns it a full 180 degrees. "At the high speeds where we're involved, we really depart from the concept of a host and an attached processor," Fisher says of SPS's block-floating-point products. "Our processors are attached to a general-purpose computer, which supplies various support functions. Our processor does the work and the I/O. The minicomputer, which is really more like a smart controller, is perhaps sending over a few parameters, perhaps monitoring the output, but is very much out of the process."

With SPS's customers, who often want to fill military applications, "It's not an issue of having an XYZ computer and wanting to know what to attach to it to make it go faster," Fisher explains. "Rather, our customers decide they want to buy an SPS processor, and then they might ask us what kind of a minicomputer they should hang on it to support it effectively."

## Keeping memory up to speed

Few other array-processor vendors take as radical an approach to the host/array-processor relationship as Fisher, but all are concerned about optimizing their devices' interaction with the host memory and disk storage. CSP Inc. is a proponent of a shared-memory approach to avoid the delays sometimes associated with direct-memory access, says Martin Schrage, CSPI marketing manager. "With shared memory, the array processor's memory is on the bus of the host computer," Schrage explains, "and either the host CPU or the array processor is able to access that memory as if it were its own." He says this approach cuts 2 to 10 msec. of operating-system overhead associated with setting up a DMA transfer and can reduce the cycles required to move data from a disk to the array processor's memory. "With shared memory," Schrage explains, "you can read the disk directly to the array processor," rather than read data from the disk to the host memory and then into the array processor memory. CSPI's products, ranging from the board-level Mini-MAP to the 64-bit MAP-6400, all offer optional shared memory.

Birkner at CD&A agrees shared memory has some advantages in real-time applications, but notes that setting up shared memory under an operation system "is not a trivial task." CD&A refers to shared memory as dual-port memory, and Birkner notes, "It's not a situation where you just sell somebody an array

processor, and they start using the dual-port memory. Even under a simple operating system like RT-11, you cannot force a FORTRAN program to put a particular data array in a specific address. That means you can't have a shared memory at a specific address and expect to access it in any easy manner." Only about 10 percent of the customers offered shared memory actually implement it, Birkner says, because of the difficulty in programming its use.

In still another approach to memory management, Sky Computers' board-level Skymnk array processors use the host's memory. "Our approach is simpler than shared memory," says John Dunn, Sky's marketing manager, "because we just use whatever memory exists in the host. This approach isn't really a burden on the host memory because whatever data you're operating on is going to be there anyway."

Sky has the low end of the array processor market virtually to itself, and its higher end competitors agree that total dependence on a host's memory is acceptable in the performance range addressed by Sky. As processor speed increases, however, the consensus seems to be, the more array processor memory available, the better.

## Hot issue or nonissue?

Aside from promoting the shared-memory concept, CSPI is also an ardent proponent of the advantages of asynchronous architecture. Aside from Sky, which, Dunn says, also uses an asynchronous approach, CSPI is a lone voice heralding the benefits of asynchronous architecture. Schuhmann of FPS and others claim it was the choice of the uncommon asynchronous architecture that initially caused product reliability and availability problems for CSPI. Both Messiah of Numerix and Birkner of CD&A call asynchronous architecture a "nightmare."

SPS's Fisher, on the other hand, proclaims, "It's time to discard the synchronous/asynchronous comparison. It's totally inappropriate for anyone to categorize processors as synchronous or asynchronous," he says, "and the people who so classify the processors don't really understand the issues."

Despite Fisher's condemnation, the synchronous/asynchronous debate still has its vociferous participants. Schrage at CSPI admits the MAP processor's asynchronous architecture is difficult for some programmers to adopt, but he denies that the product line's early problems were related to the asynchronous design. He notes that CSPI has installed 600 to 700 MAP processors since the "ancient history" of the products' problems, and claims the benefits of asynchronous

# The Interpreter

architecture are real and very important.

In synchronous machines, Schrage says, arithmetic and addressing operations are typically coupled by one microcode field. "With asynch, we decouple that," he says. "The arithmetic operations are controlled by one assembly language field, and the addressing is controlled by another assembly language field. Programmers write them independently of each other, so programming is simpler." Schrage says this decoupling also permits CSPI to make system component swaps, such as adding a faster multiplier, without changing other system components.

Another advantage of asynchronous architecture, he says, is constant run times for any algorithm. "If you examine a standard software library from FPS, you will notice they give run times that vary—best case, worst case, normal case," Schrage says. "This arises from the fact that, on a synchronous machine, the memory system is interleaved, and the performance you get on any given algorithm depends on where the arrays are and how they line up in memory." In CSPI's asynchronous machines, Schrage says, "We isolate the arithmetic unit from the memory with data queues, so the run times are always the same." This regularity simplifies a programmer's task of writing software for optimum performance, he says.

But Birkner of CD&A points out that almost all processors have some asynchronous architecture and the proper mix of synchronous and asynchronous is the best of both worlds. CD&A's MSP-3000 is synchronous on the gross level, he says, in that it operates under the control of a common clock. But, he says, the processor is asynchronous in that it has different memories that operate at different speeds. With this combination of synchronous and asynchronous operation, "The programmer never has to worry about basic hardware pieces of timing or basic memory-sequence timing, yet the stacks and the FIFOs will try to keep everything as busy as possible," Birkner says.

## Stretching the limits

Architecture questions aside, all competitors in the market envision more processing speed for customers in different niches—both the microcomputer users addressed by Sky and the superminicomputer users targeted by FPS, CSPI and others. A recent entrant in the market, tracing its management roots to FPS, is Star Technologies. Star, with its 100-MFLOPS ST-100, has bounded past the former performance leaders. Targeted at the seismic and image-processing markets, the \$250,000 ST-100 incorporates dual MC68000 microprocessors, as much as 8 million words of main memory,

a 48K-word cache memory and a 100M-byte DMA channel.

Bob Hausman, vice president of engineering at Star, says the ST-100 can be accessed by multiple hosts—a virtual design requirement, he says, since few single hosts could keep the array processor fully occupied. "On previous machines, the I/O-to-compute ratio was balanced," he says. "But on our machine we might put three or four VAXs on it to keep the ST-100's utilization rate up." Hausman agrees with most in the industry that caution is necessary when using million-floating-point-operation-per-sec. ratings for comparison. "But we are even better from a throughput standpoint than would be indicated by our clock-rate improvement," he says.

Market leader FPS has been exploring a different high-end market with its 64-bit FPS-164. The only other 64-bit competition is CSPI's MAP-6400. The two machines rarely compete, however, because of the MAP-6400's lower memory capacity—64K words versus the FPS-164's 1856K words—and considerably lower price of \$89,000. Although much of FPS's attention has recently been devoted to this large-array/large-program, 64K-bit market, Schuhmann says, the company will eventually introduce 38-bit products "that will be higher megaflops than Star on one end and lower in megaflops and cheaper than Analogic's 9-MFLOPS AP500 on the other end." FPS hopes to introduce a 38-bit array processor indicative of this expansion at this year's National Computer Conference, Schuhmann says. □

*continues on page 83*

## DON'T MISS OUT

If you're reading a borrowed copy of **Mini-Micro Systems**, don't risk missing the next issue because you don't have your own copy. To receive your own subscription, take a few minutes to complete the reader qualification card at the back of this magazine. If the card is missing, request one from **Mini-Micro System's** subscription office, 270 St. Paul St., Denver, Col. 80206. Phone (303) 388-4511. And if you're already a subscriber, renewal time is fast approaching. So you won't miss an issue, look for the subscription renewal card in next month's issue. Please fill out and return it promptly.

## KEEP YOUR SUBSCRIPTION

To keep your free subscription to **MINI-MICRO SYSTEMS**, watch for the requalification card in next month's issue. Please fill it out and return it to us right away.



A new company entered the  
5¼" Winchester market.

And closed the door  
behind them.

140 megabytes.  
And it's only the beginning.

Who makes Winchesters with proven technology, eight platters, and the most capacity available? Maxtor. Our founders are people you already know. Industry veterans totally familiar with Winchester technology. So not only were we prepared to build a better drive, we knew what was important to OEMs. Price. Quality. Reliability. Availability. Support as you need it. We built Maxtor to satisfy those needs. And deliver the drives you've been waiting for . . . low-cost 5¼" Winchesters with the highest capacity on the market.

Our doors are always open to OEMs. Let's talk. Call Leon Malmed at (408) 748-7740. Maxtor Corporation, 5201 Lafayette Street, Santa Clara, California 95050.

CIRCLE NO. 45 ON INQUIRY CARD

**Maxtor**



# THE ONLY LITTLE 32-BIT COMPUTER EVEN WORTH DISCUSSING.

The problem with most low end 32-bit computers is that their usefulness is right down there with their price.

So we've come out with a low end 32-bit computer that has up to twice the performance and twice the memory of comparable machines.

Which means it can actually do the kinds of things you want a 32-bit computer to do.

## THE ECLIPSE MV/4000™ COMPUTER.

The ECLIPSE MV/4000 has 600K-Whetstone compute power. And an

I/O bandwidth of 5 megabytes per second.

And to make that performance easy to perform with, the ECLIPSE MV/4000 has virtual addressability, 16 KB of user microcode space, nine I/O slots, and a rack-mountable OEM chassis version. As well as the ability to handle up to 8MB of memory, 4.7 Gigabytes of on-line storage and 64 terminals. All of which you don't usually find on a low end 32-bit computer.

## THE SOFTWARE YOU NEED.

Unlike most low end 32-bit computers, the ECLIPSE MV/4000 gives you a choice of compatible operating sys-



tems: AOS/VS (our interactive advanced operating system with virtual storage). Or AOS/RT 32 (our lean, deterministic, real-time operating system). Plus a wide variety of industry and international standard communication protocols. As well as our XODIAC™ network management system, SNA, CEO™ (office automation) and data base management software. And an array of commercial and technical languages, productivity tools, and third party software packages.

### THE COMPATIBILITY YOU EXPECT.

Should you one day need even more of a computer, you can take all your code (and all your peripherals) onto the bigger members of the ECLIPSE family. Because the ECLIPSE MV/4000 is fully compatible with the entire Data General ECLIPSE MV product line.

Should you find yourself staying with the ECLIPSE MV/4000 system,

you'll find it stays with you. Partly because of our worldwide network of field service engineers. And partly because of some inherently reliable design considerations. Like extensive self diagnostics on power up. The simple, two board implementation. And

the 55°C burn-in test it goes through. In fact, we're offering an uptime guarantee of 96 to 99%. And a remote diagnostic program.

The way we see it, making a little 32-bit computer is no excuse for making any less of a computer.

Want to discuss the only little 32-bit computer worth discussing? Call your local Data General office. Or write us TPD, F134, 4400 Computer Drive, Westboro, MA 01580.

600K-Whetstone	✓
8MB Maximum memory	✓
5MB/sec I/O	✓
Virtual addressability	✓
Real-time operating system	✓
4.7 Gigabytes of On-Line Storage	✓
Multiple I/O slots	✓
User microcode space	✓
Low Price	✓

## Data General



CIRCLE NO. 46 ON INQUIRY CARD

# Five reasons why DEC users should buy Emulex communications controllers.

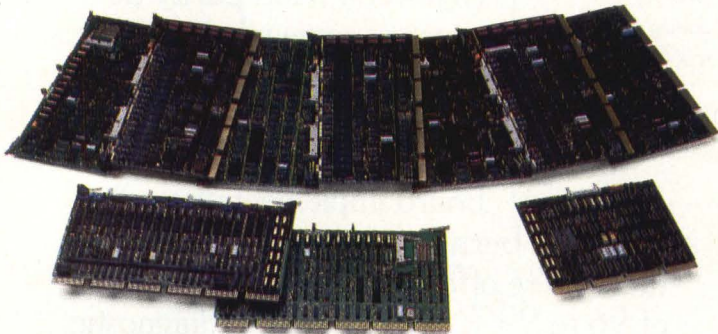

## Broad product line featuring our new DMF-32 emulation.

Nobody covers LSI-11, PDP-11, and VAX-11 users' needs like Emulex. More than 15 software-transparent controllers emulating DH11, DZ11, DV11 and DMF-32. All deliver improved line-handling capabilities, in a smaller package, at lower costs.

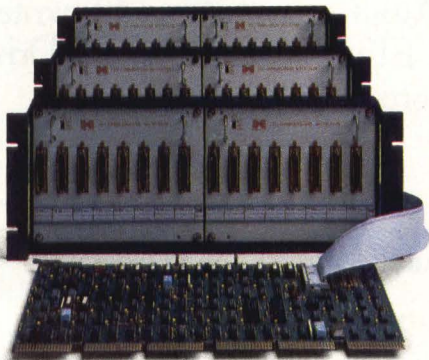

## More channels.

Emulex's new DMF-32 emulation is typical. One controller board handles up to 64 lines, vs. only eight per DEC module. And Emulex offers *all* lines with modem control, not just two. For even more lines, Emulex's Statcon Series is the answer. We simply add a low-cost port concentrator, so that with one controller board you can connect up to 256 remote *and* local terminals.

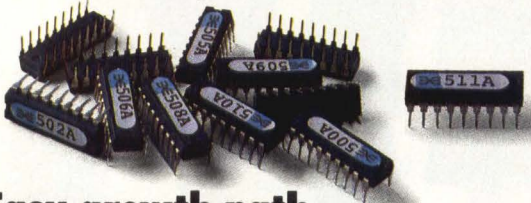

## Easy growth path.

As your system grows, upgrading is simple with Emulex controllers. Just change PROM sets. Example: DH to DMF for \$350. In addition, Emulex's advanced microprocessor architecture is consistent throughout the product line. Think of the inventory savings.

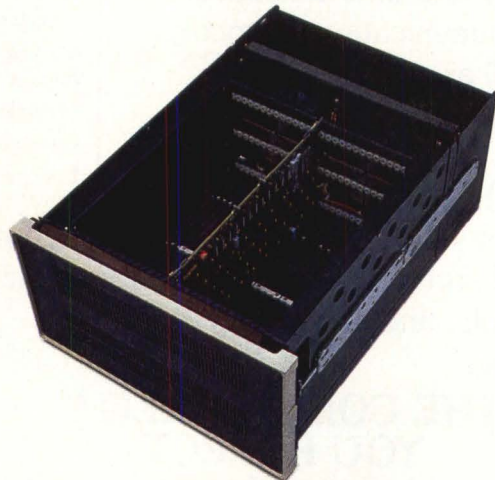

## Fewer backplane slots.

Emulex communications controllers pack so much capability onto each board that fewer boards are needed. Take a 64-line DH11 emulation. Emulex does on one board what it takes DEC to do on 36. Think of the savings in rack space, to say nothing of price.



## Lower prices.

For instance, a DEC DH11 controller lists at \$8,950 per 16 lines, with expansion chassis costing \$3,000 or more. Compare that to Emulex's CS11/H at \$4,500 for the first 16 lines and \$3,000 for each additional 16 lines. At 64 lines, you suddenly have savings of about \$23,000 and a lot of extra slots to boot.

Don't speculate with your communications controller dollars. Invest in Emulex. Phone toll free: (800) 854-7112. In California: (714) 662-5600. Or write: Emulex Corporation, 3545 Harbor Blvd., P.O. Box 6725, Costa Mesa, CA 92626.



**The genuine alternative.**

CIRCLE NO. 47 ON INQUIRY CARD

# The Interpreter

continues from page 78

## Representative array processors

Array processor	Base price	Speed (Mflops)	Architecture and computation	Main data memory (maximum)	Host interfaces	Memory access method	Performance 1024-point complex FFT	Performance 100 x 100 matrix inversion
<b>Analogics AP400</b>	\$14,500	8 MOPS <sup>1</sup>	24-bit synch, block floating point	64K words	PDP-11, Nova, Eclipse, HP21MX	DMA	7.4 msec.	NA <sup>2</sup>
<b>Analogics AP500</b>	\$24,000	9.3	32-bit synch, full floating point	528K words	PDP-11, VAX-11, Nova, Eclipse, HP1000	DMA	4.7 msec.	649 msec.
<b>CD&amp;A MSP-3</b>	\$6500	4 MOPS	24-bit synch, block floating point	4K words	PDP-11	DMA	13 msec.	NA
<b>CD&amp;A MSP-3000</b>	\$29,500	5	32-bit synch, full floating point	64K words	PDP-11, VAX-11	DMA	15 msec.	3.1 sec.
<b>CSPI MAP-200</b>	\$25,000 and up	6	32-bit asynch, full floating point	184K words	PDP-11, VAX-11, P-E 3200, HP1000, Eclipse	DMA; shared	16 msec. (170-nsec. memory), 23 msec. (500-nsec. memory)	1.6 sec.
<b>CSPI MAP-300</b>	\$30,000 and up	12	32-bit asynch, full floating point	184K words	PDP-11, VAX-11, P-E 3200, HP1000, Eclipse	DMA; shared	5.3 msec. (170-nsec. memory), 11.2 msec. (500-nsec. memory)	1 sec.
<b>CSPI MAP-400</b>	\$60,000 and up	24	32-bit asynch, full floating point	312K words	PDP-11, VAX-11, P-E 3200, HP1000, Eclipse	DMA; shared	2.7 msec. (170-nsec. memory), 5.6 msec. (500-nsec. memory)	0.5 sec. (performs two inverses per sec.)
<b>CSPI MAP-6400</b>	\$89,000	4.3	64-bit asynch, full floating point	64K words	PDP-11, VAX-11, P-E 3200, HP1000, Eclipse	DMA; shared	22.9 msec.	1.15 sec.
<b>CSPI Mini-MAP FPS-100</b>	\$30,000 \$40,500	7 8	32-bit asynch, full floating point 38-bit synch, full floating point	4M words 64K words	PDP-11 PDP-11, VAX-11, Nova, Eclipse, P-E 3200, SEL 32xx	DMA; shared DMA	7.8 msec. 7.13 msec. (not in-place)	NA 1.77 sec.
<b>FPS AP-120B</b>	\$59,700	12	38-bit synch, full floating point	448K words	PDP-11, VAX-11, HP1000, PE-3200, Prime, SEL	DMA	5.95 msec. (in-place); 4.75 msec. (not in-place)	1.18 sec.
<b>FPS-164</b>	\$210,000	12	64-bit synch, full floating point	7.25M words	VAX-11, IBM 370/303x/308x/4341	DMA	NA <sup>3</sup>	See note 4
<b>Numerix MARS-232</b>	\$50,000	50-300 MOPS	16- or 32-bit synch, fixed/block floating point	168K words (16-bit)	LSI-11, PDP-11, VAX-11, Multibus	DMA	1.05 msec.	NA
<b>Sky Skymnk-Q, -V, -M</b>	\$3990 (qty. 100)	1	32-bit asynch, full floating point	Uses host's memory	Q — LSI-11, PDP, MINC; V — MC68000; M — 8086, MC68000	DMA	Q — 53.1 msec.; V — 53.6 msec.; M — 53.9 msec.	Q — NA; V — 13.9 sec.; M — 13.9 sec.
<b>SPS-21</b>	\$35,000	20 MOPS	16-bit synch, fixed/block floating point	64K words	PDP-11	Shared (host memory)	7 msec.	NA
<b>SPS-61, -81</b>	\$31,000— \$51,000 (61), \$45,000— \$65,000 (81)	24 MOPS (61), 32 MOPS (81)	16-bit synch, fixed/block floating point	512K words	PDP-11, Nova, Eclipse	Shared (host memory)	61 — 4.85 msec., 81 — 2.93 msec.	NA
<b>SPS-1000</b>	\$60,000— \$89,000	60—300 MOPS	8-, 16-, 24-, 32-bit synch, fixed/block floating point	4M-plus words	Variable	DMA; shared (AP memory)	0.15—1.5 msec., (16-bit)	NA
<b>Star ST-100</b>	\$250,000	100	32-bit synch, full floating point	8M words	VAX-11, P-E 3200; SEL 32/40, 32/50; IBM 4331, 3081	DMA	0.864 msec.	84.28 msec.

Notes:

1. Million operations per second. Fixed/block floating point machines aren't measured in million floating point operations per sec. (Mflops).
2. Not applicable.
3. Although the FPS-164 can perform FFTs, the manufacturer prefers not to release performance figures for that algorithm, saying that the simulation applications in which the 164 serves have no need for the signal-processing oriented FFT.
4. Floating Point Systems says the FPS-164 typically deals with matrices much larger than 100 x 100. The FPS-164 uses a technique called the tri-diagonal matrix solution to solve a 10,000 x 10,000 matrix with 30,000 non-zero elements in 33 msec. A banded symmetric 10,000 x 10,000 matrix with a bandwidth of 200 elements (4 million non-zero elements) requires 36.4 sec. to solve.

YOU'RE LOOKING  
AT ALL 96  
OF OUR UNIX-BASED<sup>TM</sup>  
MICROCOMPUTER  
SYSTEMS.

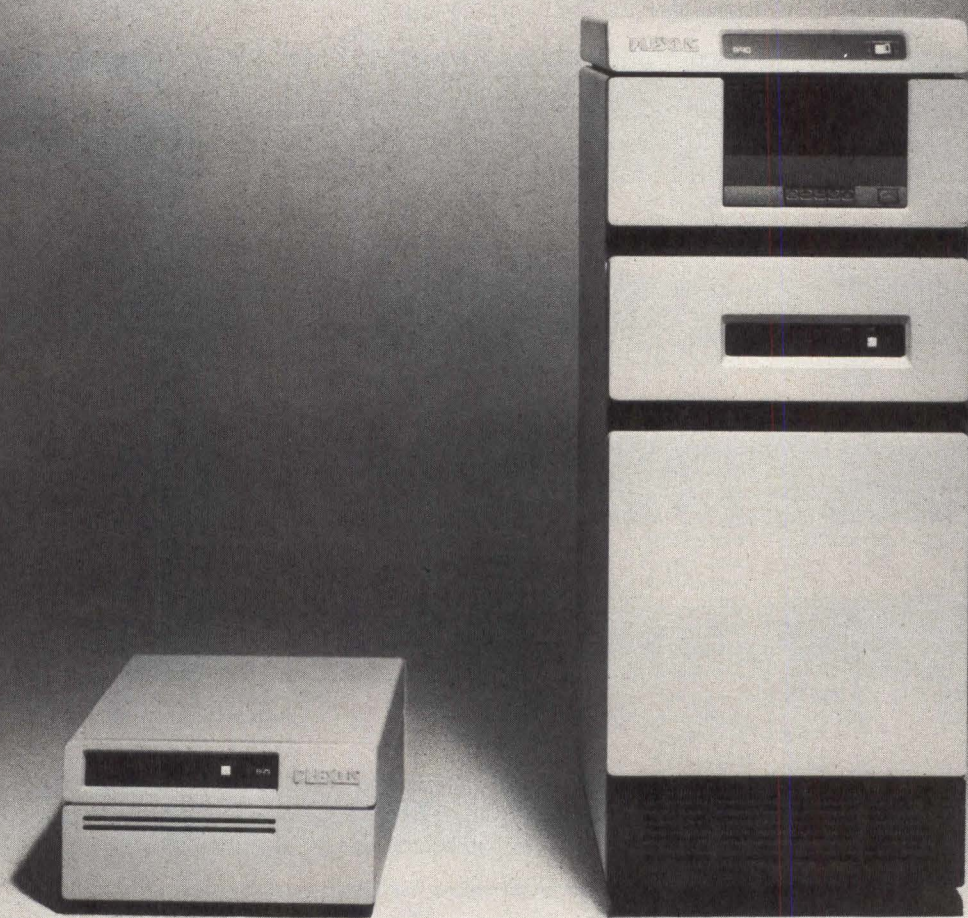

Your eyes are fine. You're just seeing everything in two.

The Plexus P/25.

And the Plexus P/40.

Two complete, UNIX-based microcomputer systems. Being delivered in volume, today.

We're totally committed to the UNIX operating system. Because of its simplicity, flexibility and popularity.

We're also totally committed to performance. Both our microcomputer systems deliver all the power of the largest minicomputer systems.

At two to five times less cost.

But where do we get 96 UNIX-based systems?

From disk sizes, RAM sizes and user configurations.

The options available to you, with the P/25 and the P/40.

The P/25 offers 24 possible system combinations. With three disk sizes. (22, 36 and 72 megabytes.) Four memory sizes. ( $\frac{1}{2}$ , 1,  $1\frac{1}{2}$  and 2 megabytes.) And two user configurations. (8 or 16 terminals.)

The P/40 offers an impressive 72 system combinations. With its three disk sizes. (72, 145 and 290 mega-

bytes.) Eight memory sizes. ( $\frac{1}{2}$ , 1,  $1\frac{1}{2}$ , 2,  $2\frac{1}{2}$ , 3,  $3\frac{1}{2}$  and 4 megabytes.) And three user configurations. (8, 16 and 24 terminals.)

All these options are offered with a single vision in mind.

Choice.

With 96 possible system combinations, Plexus gives you the opportunity to custom-build systems to your ideal specifications.

Allowing you to more accurately meet the demands of your customers. With the capability to expand, as their needs grow.

Helping you to more effectively control your costs.

So you can maximize your profits.

We think that shows our far-sightedness.

Contact us. Plexus, 2230 Martin Ave., Santa Clara, CA 95050. (408) 988-1755. TWX/ Telex 910-338-2223.

Compare our two systems to the others. Price, performance, delivery, support and configurations. Once you do, you'll see. There's more to Plexus, than what meets the eye.

# IPLEXUS

In the beginning, there was the printer.

And right on its heels came the first printer breakdown.

Unfortunately, the first printer service call didn't happen nearly so quickly, thus creating downtime – a problem that still plagues users today.

What's the answer? Non-Stop-Printing from Trilog.

### Two heads are better than one.

Most dot-matrix line printers use only a single print head. That's fine – unless something goes wrong with the head. Then you're out of business until a service representative shows up.

On the other hand, the Trilog TIP-300 uses an exclusive two-headed system. Both 150 lpm print heads run simultaneously. Giving

you a total output of 300 lpm.

Should one print head temporarily fail, the user simply flips a switch and the remaining head continues printing at 150 lpm.

Now that's Non-Stop-Printing!

Dual heads offer another advantage, too. Instead of being pushed to capacity like most single heads, each Trilog head runs at a 50% duty cycle. This makes them much

# Non-Stop-Printing.<sup>TM</sup> advance since the p





more reliable than conventional print heads.

**Advanced innovation isn't just in our heads.**

That's why we also gave Trilog printers dual tractors. They not only stabilize the paper and minimize friction, but allow the paper to move forward and backward. This gives you plotting capability and lets you generate forms. You can also print

bar codes. Plus business and engineering graphics.

**Five printers for the price of one.**

Besides graphics, the TIP-300 gives you four other types of printing: standard data processing characters. Letter quality characters that approach the sharpness of fully formed characters. And two versions of compressed characters for paper

savings and special formats.

For more information contact: Trilog, Inc., 17391 Murphy Ave., Irvine, CA 92714. Or call toll free in the continental U.S., except California: (800) 421-7164. In California call (714) 549-4079. TWX (910) 595-2798.

**Non-Stop-Printing starts with**

**TRILOG®**

# The single greatest printer was invented.



See us at COMDEX  
Booth 4622 and at  
NCC Booth A3109

For more information circle 55  
For a sales contact circle 175

**YOU CAN FIND A LOT OF  
COMPANIES WHEN YOU WANT  
TO BUY A MONITOR...**



# ...BUT HOW MANY CAN YOU FIND WHEN YOU WANT TO SERVICE IT?

There's one you won't have to search for. Conrac.

We're committed to giving OEMs the service and support you need—when you need it and where you need it. We're implementing an extensive network of regional and local technical centers throughout the country, and that means service and replacement parts along with sales support nearby, where you need it. And with our ongoing training program, the skills that our people can offer your people are constantly being polished and upgraded.

When you look at the total picture—our 36 years of expe-

rience, the broadest range of products in the industry, high quality, performance, reliability, serviceability, availability and responsive engineering and customer service—it's easy to see why Conrac is the first choice in OEM markets. You know that once you buy from us—you won't have to search for us.

For more details on Conrac's complete line of monitors, and our schedule of training programs, call or write:

Conrac Division, Conrac Corporation, 600 N. Rimsdale Ave., Covina, CA 91722.

Regional Offices:

Western (213) 966-3511,

Mid West (312) 833-3310,

Eastern (203) 348-2100,

New England (617) 272-6720.

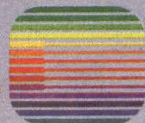

CONRAC

CIRCLE NO. 49 ON INQUIRY CARD



“All I did was  
order  
Genuine Diablo  
Supplies.”

When you order Genuine Diablo ribbon cartridges and printwheels, you're buying the very best. Because every Diablo product is designed and engineered to meet the highest standards of quality and reliability and to match the exacting performance specifications of Diablo printers.

It's the reason Diablo can't be matched for performance, dependability and cost-

effectiveness. And our commitment to evolving technology insures the continued innovation and the superiority of Diablo ribbon cartridges and printwheels, in years to come.

It's really no wonder that people who know their business ask for Genuine Diablo Supplies. And keep asking for them, time after time.

Because Diablo is the first name in quality ribbons and printwheels. And because Diablo also makes all sorts of other good things happen.

**Diablo<sup>®</sup> Supplies**  
Only Diablo is Diablo.

## Start-ups rush to establish high-capacity 5¼-in. drives

By Robert A. Sehr

In typical Silicon Valley entrepreneurial fashion, start-up companies are rushing in where their established competitors fear to tread to meet an apparent demand for higher capacity in smaller rigid disk drives. The start-ups, offering 5¼-in. drives with capacities from 30M bytes to more than 100M bytes, surfaced last summer at the National Computer Conference in Houston, and were joined by others at Comdex in Las Vegas later in the year.

Like the personal computer industry it serves, the 5¼-in. rigid disk industry has been fueled by the office-automation explosion. Multitasking, multi-user operating systems, such as Bell Laboratories' UNIX, and the requirements of local-area networking between computers within an office have increased capacity demands. "It's just like at home—the more closet space you have, the more you need," says one disk drive engineer.

Because the start-ups are still in the evaluation stages, no firm prices have been established. Prices are expected to range from \$50 to \$100 per megabyte in OEM quantities of 1000.

Independent disk drive authority James Porter, editor of *Disk Trend/Report*, predicts that manufacturers of high-capacity, 5¼-in. Winchester drives will sell 164,000 units by 1985. Only 1900 5¼-in. Winchester drives between 30M and 100M bytes were sold in 1982, and most were closer to the 30M-byte end.

Boosted by the improved availability of components and electronics in smaller packages and the improved outlook for the availability of plated media, manufacturers of high-capacity, 5¼-in. Winchesters are working on "closet space" that can hold as much as 144M bytes.

Just five years ago, a 144M-byte, 14-in. Winchester would have been considered a very high-capacity drive. Even today, few 8-in. drives with capacities higher than 100M bytes are available.

To meet these capacities in the limited space of 5¼-in. drives, manufacturers can no longer rely on traditional open-loop positioning systems and stepper motors that served low-end pioneers such as Seagate Technology.

### Scaling down technologies

The start-ups working to meet the demand for high

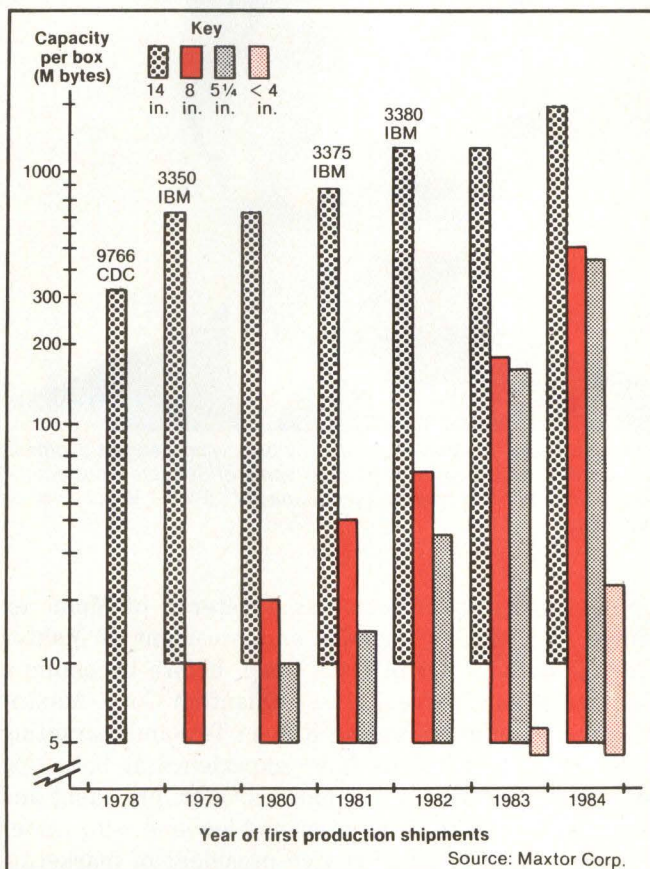

**Disk drive market shares.** Until International Memories Inc. announced the first 8-in. Winchester drive at the 1978 National Computer Conference, 14-in. Winchesters had the market to themselves. Now, 14-in. Winchesters have been forced out to applications requiring gigabytes of storage. Today's 8-in. Winchesters are being pushed into the 300M-byte and higher range as the new generation of high-capacity 5¼-in. Winchesters take over in the 30M- to 100M-byte range. By next year, high-capacity, sub-4-in. Winchesters may take over the 5M- to 10M-byte market that is now dominated by 5¼-in. Winchesters.

capacities and higher performance are for the first time bringing technologies from the 14- and 8-in. markets to the 5¼-in. market. These technologies include closed-loop servo motors instead of stepper motors and voice-coil actuators. It's not too surprising, therefore, that the start-ups are manned with talent from traditional 14- and 8-in. Winchester drive makers.

Atasi Corp. founder and president Frank Gibbeau is a veteran of IBM Corp., as is company vice president of engineering Donald R. Lundell. Evotek founder and

# The Interpreter

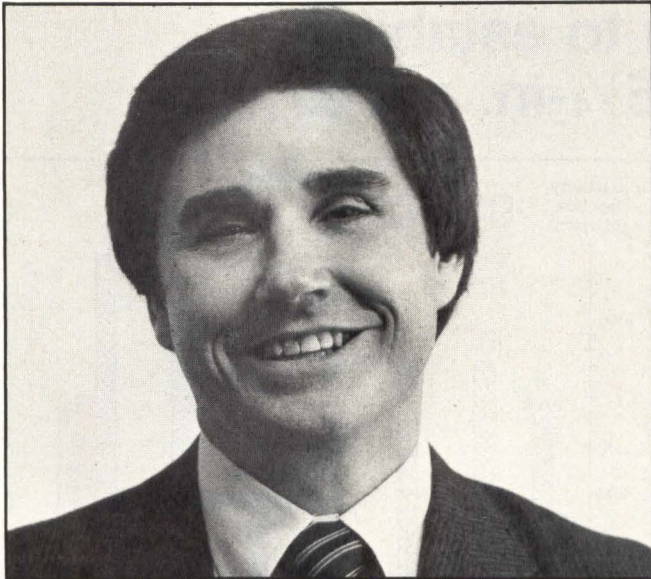

**Frank Gibbeau of Atasi** hopes that by borrowing Seagate's formula for success, Atasi can also "borrow" some of Seagate's customers. Atasi was the first with a high-capacity, 5¼-in. Winchester in production.

president George Brennan is a veteran of Memorex Corp.; Jim McCoy, founder and president of Maxtor Corp., was at Control Data Corp. before becoming a founder of 8-in. drive start-up Quantum Corp. Maxtor vice president of marketing Robert Teal and marketing manager Skip Kilsdonk have experience at both CDC and Quantum. Vertex Peripherals Corp. president and founder Joe Booker is a veteran of low-end 8-in. leader Shugart Associates, as is vice president of marketing Jim Adkisson.

"They all have very technically competent people," says Porter, referring to the organization of the start-ups. "I don't expect a lot of fumbling around." He expects it will be a while before a leader emerges in this market. "It's still a bit too early to call a winner; most shipments have been only evaluation numbers."

Atasi, the first of the four start-ups formed, is also the first to begin production shipments. Perhaps because of its preponderance of ex-IBM employees, the company is also the most conservative, using only tried and true technologies in its drives.

Don Pate, Atasi's vice president of marketing, says his company hopes to emulate Seagate and become a "blue-chip" company in the near future. "Our aim is to get our foot in the door with a very conservatively produced product and make a name for ourselves, then continually increase its performance," he says.

Pate says Atasi's emphasis is not necessarily on high capacity, but on high performance. The company's

products include 20M-, 30M- and 46M-byte drives with closed-loop servo motors to achieve an average 30-msec. access time. In keeping with its philosophy, the company began shipments of its lower end drives last October and has only recently begun evaluation of its high-end 46M-byte drives. Its low-end 19.84M-byte drive uses two platters, its 33M-byte drive uses three platters, and its 46M-byte drive uses four.

Evotek, on the other hand, uses a five-phase stepper motor and a linear actuator to achieve capacities ranging from 7.1M bytes to 51.6M bytes. Unlike Atasi, however, Evotek began production in January with its high-end drive. James Lawson, Evotek's vice president of marketing, says the 7M-byte drive is meant only as an option and does not figure heavily in the company's production plans.

Unlike the other start-ups, Evotek has a crutch in case the high-capacity, 5¼-in. market doesn't take off—the company has begun to manufacture plated media of its own design, primarily to serve its own needs. The media will not initially be sold outside the company, to protect Evotek's market advantage of having a secure media supply. "It would be ridiculous for us to make such a huge investment in plated-media technology and then sell it on the outside," Lawson says.

Although Evotek manufactures its own media because of a concern for "reliability management," the move also reflects an industry-wide distress about the availability of plated media. Because of its durability and structure, plated media allows higher track densities. Ampex, the chief supplier of plated media, has been able to supply only limited quantities in the past because of manufacturing limitations. To solve this problem, the company has opened its new San Jose manufacturing plant, which will allow production of 300,000 disks this year and will eventually supply as many as 2 million disks per year. Evotek, however, plans to use as many as 300,000 platters per year itself in its drives and consequently cannot depend on Ampex and its few competitors.

## Stalking lucrative IBM contracts

Sources say Evotek and Atasi have the inside line on supplying the industry's highest volume customer, IBM. The same sources say IBM has about 1000 Evotek drives under evaluation in various divisions. IBM theoretically could use such high-capacity 5¼-in. drives with its minicomputers and with future generations of its Personal Computer.

Evotek's Brennan remains noncommittal on negotiations with IBM, but says his company is preparing to

# OK OEMS

we're playing your game.

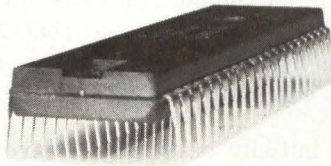

Our new Executive 10™ is factory programmed to meet your system application. So, you get a highly customized terminal instead of just an "off the shelf" product. And you get a long list of features:

- precision balanced ball-joint tilt and swivel
- detached keyboard
- split screen
- video attributes
- programmable function keys,

a unique combination of features for terminals in its price class.

Your system deserves a special display. We call it the Executive 10. But we designed it so that you can call it your own.

Esprit Systems, Inc.  
Hazeltine Terminals Division  
500 Commack Road  
Commack, NY 11725  
(516) 462-5598

*Esprit* Systems, Inc.  
Hazeltine Terminals Division

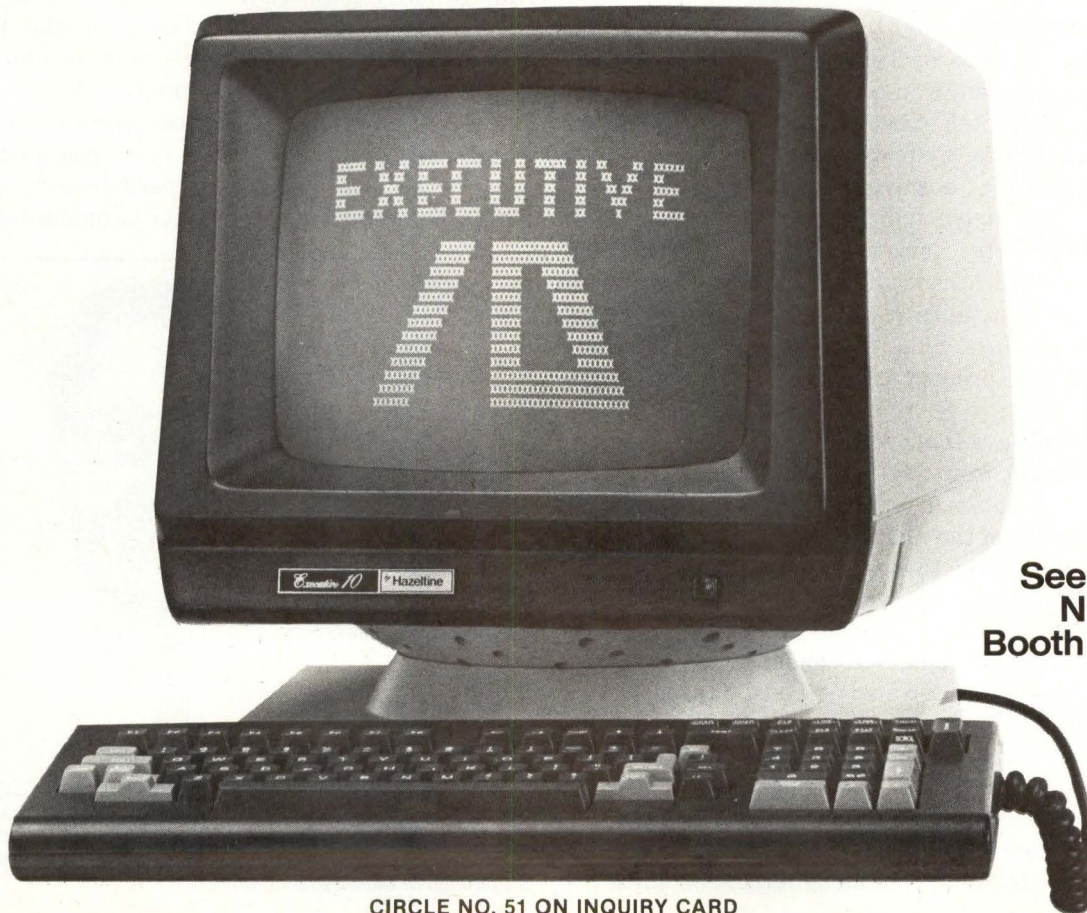

See us at  
NCC  
Booth W6288

CIRCLE NO. 51 ON INQUIRY CARD

# The Interpreter

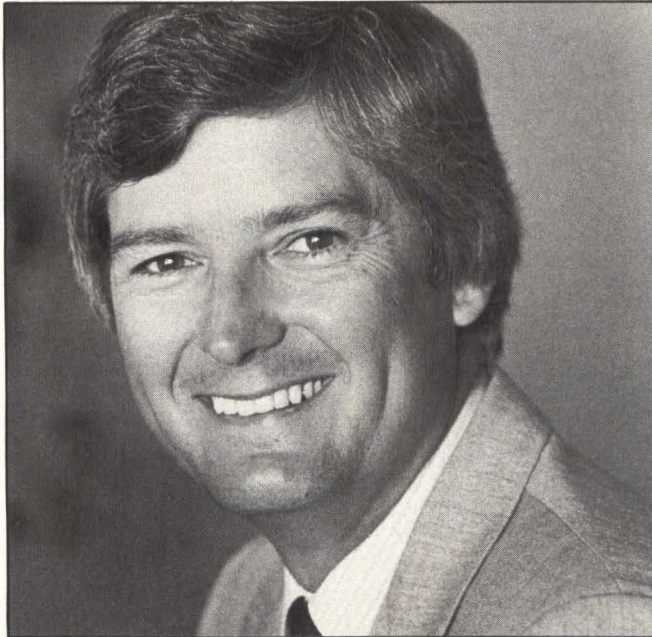

**Bob Teal of Maxtor** plans for the company to follow its eight-platter, 144M-byte, 5¼-in. Winchester with a half-height, four-platter, 72M-byte version this year.

meet the volumes required by IBM. The company will achieve these volumes by ramping up two production lines in the company's new 50,400-sq.-ft. plant in Fremont, Calif. Evotek expects to be ready to manufacture in high volumes by midyear.

Maxtor's McCoy, however, hopes that Evotek's 51.68M-byte disk drive will pale in comparison with Maxtor's 144M-byte voice-coil-actuator drive. The Maxtor drive, which caused a sensation when it was introduced at last fall's Comdex show, uses eight plated-media platters. Skeptic competitors at the show doubted that the product could ever be produced in volume, however.

Maxtor's Teal says that, while his company's product may look different from anything else on the market, it is not that revolutionary. "The only thing different about it is the use of the motor within the spindle of the drive," he notes. Even that is not entirely different, he adds, because IBM sold a two-platter, 14-in. drive with a spindle motor during the '60s. "It's just creative packaging, not revolutionary technology," Teal says.

Industry analyst Porter also defends Maxtor, calling the drive's design "very conservative." He says the only problem that he could envision in the drive was a heat rise between platters. However, Porter says he is assured, after studying the drive, that the heat-rise problem has been conquered. "That's not to say some other problem couldn't come along later," he adds.

Teal also admits that there will be some problems when the drive enters production in June. "Some of them could even be catastrophic to some companies, but I believe we have assembled the kind of team here that can overcome anything," he says.

Among the skeptics, however, is Booker, Teal's former colleague at Shugart and now a competitor at Vertex, San Jose. "I'm sure glad that Maxtor came around with its 144M-byte drive because now we don't look so radical anymore with our 71M-byte drive," he says.

Vertex will initially offer three drives in its V100 series, beginning with the 31M-byte V130. Above this model is the 52M-byte V150 and the 71.6M-byte V170.

Vertex was scheduled to begin shipments of production units in January and to be in full production by the second quarter. The company purposely delayed announcement of its products until just before shipments were available to maintain its credibility, Booker says.

Industry sources earlier believed that Vertex had planned a smaller Winchester drive—in the 3½-in. range. However, Booker denies that such a drive was under consideration. "When I first left Shugart, we frankly didn't know what we were going to do, although there was a lot of speculation in the press and elsewhere," he says. "It wasn't until we assembled the people that we decided on a product."

The Vertex drives will have an average access time of 30 msec. and a dual-frequency servo-positioning system that Vertex's Adkisson says permits continuous sampling while remaining insensitive to media defects. Like

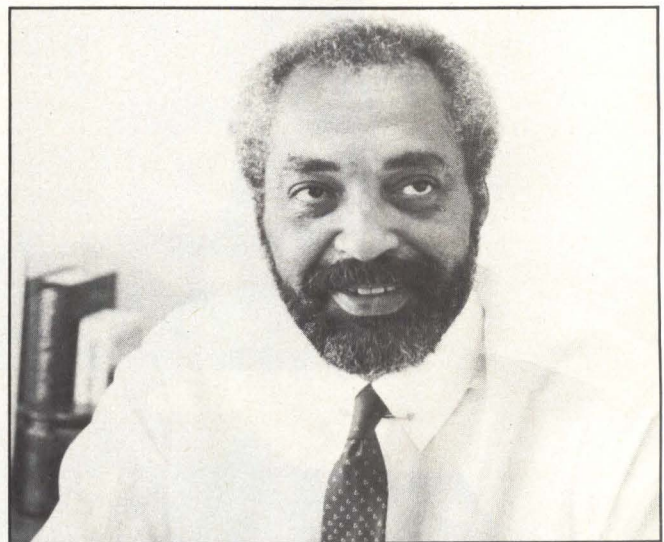

**Joe Booker, president of Vertex** and former executive vice president of Shugart Associates, expects his high-volume experience at the Xerox subsidiary to give Vertex a competitive edge in volume production of high-capacity drives.



New **WORD**  **SCRIBE**™ Printers from Anadex:  
**Lasting Impressions.**



Stan Gorman

Letter Quality and Finished Correspondence. High Speed Drafts. EDP Reports. Charts and Graphs. Now you can have them all in one very impressive package: Word/Scribe.

Our versatile new multi-mode printer, the Word/Scribe Model WP-6000, uses our new 18-wire print head and some exceptional engineering to produce crisp characters and razor-sharp graphics. Quality-built to meet your most exacting printing needs.

Word/Scribe gives you letter quality printing, with 10 or 12 pitch or proportional spacing, at speeds up to 150 CPS; correspondence quality up to 285 CPS; and draft/data processing up to 275 CPS.

For your graphics needs, dot-addressable graphics are provided at up to 144 x 144 dots-per-inch – impressive when you look at the photographs in this ad and realize they were reproduced using 133 line-per-inch screens.

Equally impressive are Word/Scribe's interfaces: RS-232-C Serial and Centronics compatible parallel with a sophisticated communications capability. And for word processing

\*Trademark of XEROX Corp.

modes, we've added a Diablo 630\* emulation package so you can save your software when you update your printers.

Friction feed, tractors, automatic sheet feeders, over 20K byte buffers, a variety of character sets (including your own, downloaded), the impressive list could go on – but unfortunately we have no more room here. For complete details contact us today...we think you'll be impressed.

 **Anadex**  
 ©Copyright 1982 Anadex, Inc.

**MADE IN USA**  
 FOR THE WORLD  
 A Quality Circle Member

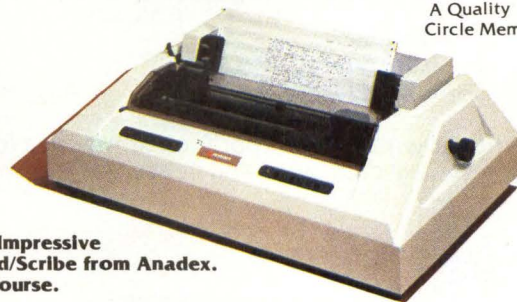

**The Impressive Word/Scribe from Anadex. Of Course.**

**ANADEx, INC.** • 9825 De Soto Avenue • Chatsworth, California 91311, U.S.A. • Telephone: (213) 998-8010 • TWX 910-494-2761  
**U.S. Sales Offices:** San Jose, CA (408) 247-3933 • Irvine, CA (714) 557-0457 • Schiller Park, IL (312) 671-1717 • Wakefield, MA (617) 245-9160  
 Hauppauge, New York, Phone: (516) 435-0222 • Atlanta, Georgia, Phone: (404) 255-8006 • Austin, Texas, Phone: (512) 327-5250  
**ANADEx, LTD.** • Weaver House, Station Road • Hook, Basingstoke, Hants RG27 9JY, England • Tel: Hook (025672) 3401 • Telex: 858762 ANADEx G  
**ANADEx GmbH** • Behringstrasse 5 • 8752 Mainaschaff • Frankfurt, W. Germany • Tel: 011-49-06021-7225 • Telex: 4188347

CIRCLE NO. 52 ON INQUIRY CARD

# HALF HIGH

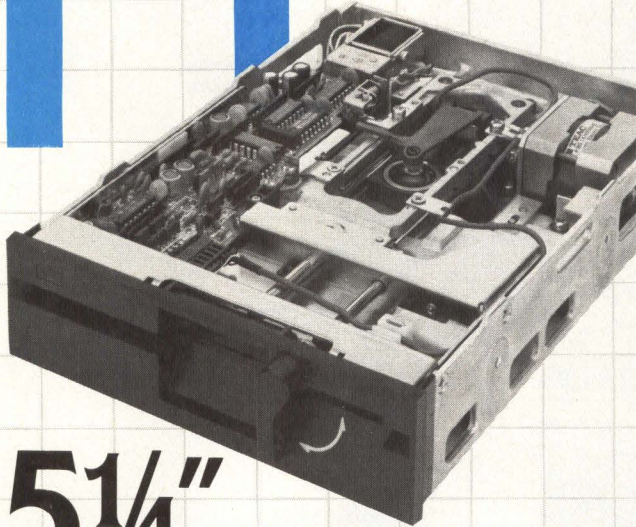

## 5 1/4" Floppy Disk Drives TEAC FD-55 Series

AT 1 5/8" HIGH, TEAC FD-55 SERIES 5 1/4" FLOPPY DISK drives use half the space and run cool at half the power of conventional drives. High-reliability, low-noise brushless DC motors provide an MTBF of over 10,000 hours, backed by a one-year parts and labor warranty.

FD-55A	FD-55B	FD-55E	FD-55F
• 48tpi	• 48tpi	• 96tpi	• 96tpi
• 40 track	• 40 track	• 80 track	• 80 track
• 250KB	• 500KB	• 500KB	• 1MB
• single side	• double side	• single side	• double side

#### Power Requirements:

DC +12V  $\pm$ 5% 0.3A typical, 0.7A max.  
DC + 5V  $\pm$ 5% 0.5A typical, 0.7A max.

Phone, write or wire TEAC Corporation of America for complete technical data, price and delivery.

TEAC Corporation of America  
Industrial Products Division  
7733 Telegraph Road  
Montebello, CA 90640  
213/726-0303

© 1982 TEAC Corp.  
MP82501M

CIRCLE NO. 53 ON INQUIRY CARD

## The Interpreter

all of the other start-ups' drives, the Vertex product will have a Seagate interface and will be compatible with most industry controllers for 5 1/4-in. drives.

Maxtor, however, is organizing an industry committee including drive and controller manufacturers to update the Seagate ST506 interface. The updated interface would allow higher transfer rates that will bring the drives to their optimum efficiency.

### Avoiding the low-end clutter

All four start-ups opted for the high-end market after determining there was no chance of success in the cluttered low-end Winchester disk market dominated by Seagate Technology, Tandon Corp., Shugart Associates and International Memories Inc.

Now, however, some of the high-end pioneers are concerned that all of the companies at the low end will make a move into the higher capacity market. Indeed, Seagate is preparing a high-capacity product for this year's NCC, and Tandon is working on a 31M-byte drive.

Seagate executive vice president Finis Conner says OEM customers are loyal and are more likely to get their high-end products from their established sources than from start-ups. But, if Conner's sentiments are traditionally on target, start-ups can take comfort in the fact that Seagate itself managed to succeed against established competitors in the 8-in. market when it introduced 5 1/4-in. rigid drives in 1980.

Seagate and Tandon may have their hands full taking care of the customers they now have without taking on new problems, says disk drive authority Porter. He also notes that Seagate and Tandon customers are more "price sensitive than performance sensitive."

One established company that already has its hands full is Priam Corp. The company recently announced that it is delaying its entry into the high-performance, 5 1/4-in. market because of the demands for its 8- and 14-in, high-performance drives. "We want to make it perfectly clear that we are not abandoning that [5 1/4-in.] marketplace," says Ben Taneguchi, Priam's vice president of marketing. "We've already poured millions of dollars into research, which is still ongoing." Priam expects to reenter the 5 1/4-in. market early in 1984, with a much higher capacity drive than the 30M-byte drive it prematurely announced last year.

Priam president William Schroder notes that caution may be called for in the disk drive industry. He recalls that the ranks of high-performance 8-in. disk drive manufacturers once included many big names, such as Pertec Computer Corp. and BASF Systems Corp., and have now dwindled to a precious few. "History may be repeating itself," he suggests. □

# Name one microsystem with

- multi-user capability
- a real-time operating system
  - 1 MIPS performance
  - integrated disc storage
- 3-D interactive graphics software
- 4.27 Mbytes/second I/O bandwidth
  - 12 interfaces
- memory expandable in 128kb, 512kb or 1Mb increments
  - data base management software
  - powerful networking capabilities
    - a starting price of just \$8,021.

# This is the one.

## The HP 1000 Model 6.

You'll be amazed at how much you can do with such a little computer. Because the HP 1000 Model 6 is only small in size and cost. When it comes to performance, it's another story.

By using our range of plug-in cards, you can easily put together a wide variety of configurations. You could, for example, plug in 8 terminals, 12 instruments, a plotter, printer, hard discs, machine tools and communications links with other computers—and have them all running at the same time. Mostly because of the way our multi-tasking operating system—RTE—takes advantage of the hardware, and delivers big system power. As a result, we can give you virtual memory capability. Dynamic memory positioning. And multiple real-time ways to schedule programs—by event, time, or operator. Not bad for a system that starts at only \$8,021.

And because it's a complete system, you don't have to hassle over compliance with the increasingly tight RFI regulations. Or go through all the paperwork it takes to get UL® approval. Or lie awake nights worrying whether the hardware and software will work together. When you use the HP Model 6, all those problems are behind you.

Even better, the architecture and operating system give you so much flexibility that you can fine-tune our micro to your application as if you'd built it yourself.

### It's so fast it makes you faster.

To get 1 MIPS performance, you'd expect to have to pay for a much more expensive minicomputer. But that's the kind of speed we're talking about in the

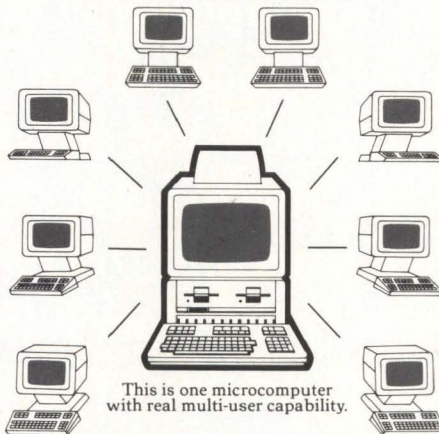

HP Model 6 microsystem. So you don't have to spend time optimizing your application. And with all the system integration, government testing, and government approvals already taken care of, you can get your system to market a lot faster.

With high-speed Direct Memory Access (total I/O bandwidth up to 4.27 Mbytes/second) and a powerful mem-

ory system, you're really flying. And our wide range of interfaces gives you 12 ways to communicate with the outside world. There's even an I/O processor built into every single interface. This takes a big load off the CPU, freeing it for more important tasks. By distributing intelligence in this way, our micro turns in macro performance.

### A growth path that's easy to follow.

HP offers the widest range of instruments and peripherals to fit into your system. They were all made to interface easily, and stand up to a lot of hard work.

And since the Model 6 is based on our A600 processor, it's easy to upgrade. Just move up to our A700 with optional floating point hardware and microprogramming. Both processors are 100% software compatible. That's another powerful argument in favor of HP microcomputers. And our competitive pricing discounts are another example of our commitment to OEMs.

For more information about the HP 1000 Model 6, call your local HP sales office listed in the white pages of your telephone directory. Ask for a technical computer representative. Or write for our OEM Information Kit to: Hewlett-Packard, Attn: Joe Schoendorf, Dept. 08152, 11000 Wolfe Road, Cupertino, CA 95014.



HEWLETT  
PACKARD

Prices U.S.A. list in OEM quantities of 100.  
Includes A600 processor, 128 Kb memory, RTE-A.1 license,  
dual minifloppy drives, 2623A graphics terminal.

TCG-209  
HPTC-170

Choice of integrated terminals  
with graphics, forms, scientific character sets,  
large characters, protected fields

8-channel multiplexer  
allows connection of 8 additional  
terminals, all managed by RTE

Optional hard-copy graphics

HP-IB card  
for connection  
to hundreds  
of instruments,  
14 at a time

Integrated graphics  
display, driven by CORE-  
compatible software

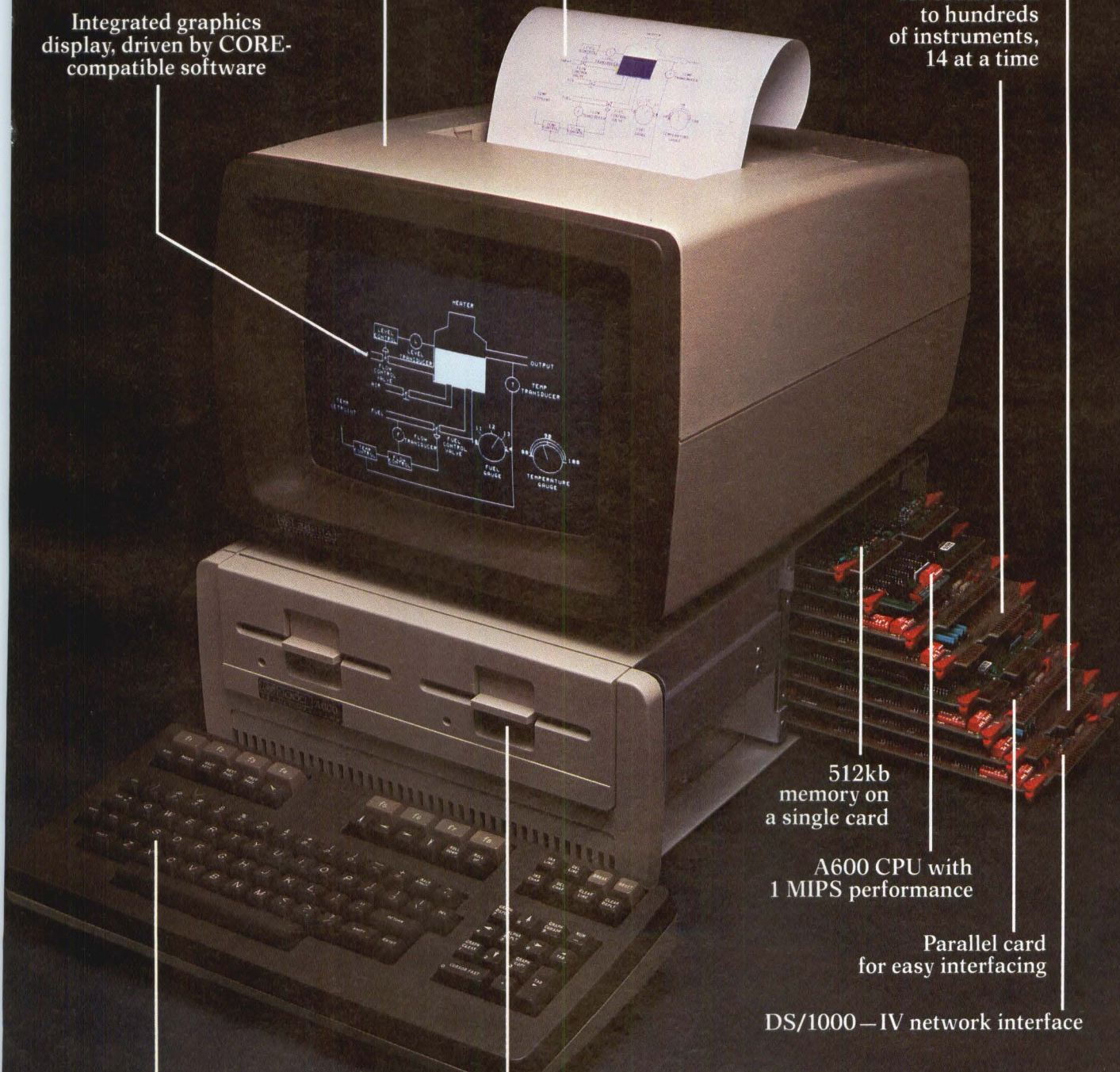

512kb  
memory on  
a single card

A600 CPU with  
1 MIPS performance

Parallel card  
for easy interfacing

DS/1000—IV network interface

Choice of keyboards with  
optional 'soft keys', numeric  
keypads, and international  
character sets

Integrated disc  
storage, augmentable with a wide  
range of Winchester discs

CIRCLE NO. 54 ON INQUIRY CARD



<sup>™</sup> StacPac, HyperDiagnostics, Rapid Module Exchange and HyperService are trademarks of Data Systems Design, Inc.  
<sup>®</sup> DEC is a registered trademark of Digital Equipment Corporation. <sup>®</sup> Multibus is a registered trademark of Intel Corporation.

# DSD STACKS THE DEC. AND THE MULTIBUS, TOO.

## Presenting StacPac™ systems and modules.

This is a brand new deal for systems integrators.

StacPac systems and modules. Modular storage and backplane units that stand alone or stack together to form the basis of a small but powerful tabletop computer.

They're available in either DEC®- or Multibus®-compatible versions. And there are lots of advantages to both.

On the DEC side, you can put a StacPac system in places a rack-mount just doesn't fit.

On the Multibus side, you can use our StacPac system to deliver serious minicomputer performance with microcomputer economy.

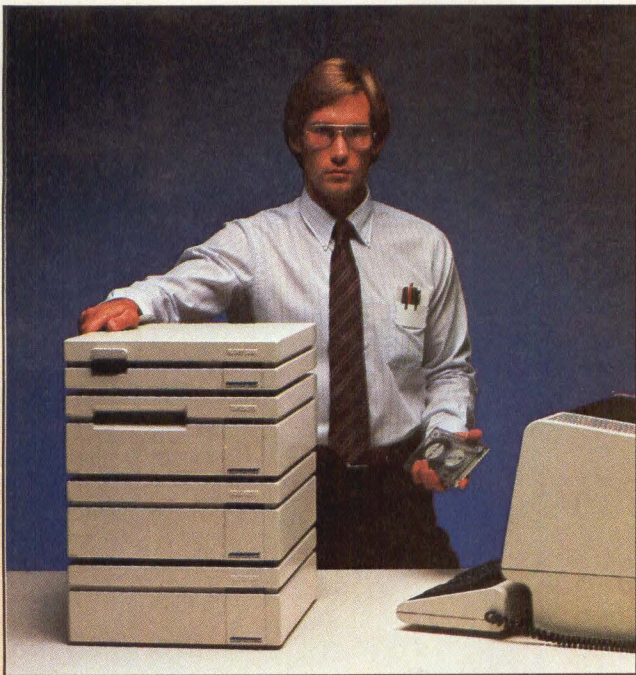

Either way you get greater flexibility to configure just the right system. And the easy upgradability to expand it whenever you like.

But perhaps one of the most important advantages is that you can protect your software investment—and your customers'—because inside, you're still selling the same system. You'd just never know it to look at it.

Which brings up another point.

Underneath that slick, compact exterior is the very latest in storage technology. 8" slimline floppy drives. High capacity, highly reliable 8" Winchester. Compact ¼" cartridge tape drives. And the best high performance controllers in the business. (Packaged systems are also available without controllers at your option.)

And if you're thinking about 5¼" storage, there's our 5¼" Winchester/floppy module. (Available in the Spring of 1983.)

Configuring an elegant system solution is a simple matter of picking out the storage option you want and adding your own CPU boards, I/O and memory to our uncommonly accommodating backplane units.

Naturally, we back it all up with HyperDiagnostics™, Rapid Module Exchange™ and HyperService™. Some of the most economical and intelligent service features ever devised.

And you can have more information about StacPac modules just by writing for our brochure.

But you just watch. You start marketing your systems in our StacPac modules and your competition will say you have an unfair advantage.

And you know something? They'll be right.

Corporate Headquarters: 2241 Lundy Avenue, San Jose, CA 95131. Eastern Region Sales and Service: Norwood, MA, (617) 769-7620. Central Region Sales and Service: Dallas, TX, (214) 980-4884. Western Region Sales: Santa Clara, CA, (408) 727-3163.

## DATA SYSTEMS DESIGN

**INTERNATIONAL SALES:** Australia 03/544 3444; Belgium and Luxembourg 02/7209038; Canada 416/625 1907; Denmark 02/63 22 33; Finland 90/88 50 11; France 03/411 5454; Hong Kong and Peoples Republic of China 03/696231; Israel 52-52444; Italy 02/4047648; Japan, Osaka 06/323 1707, Tokyo 03/345 1411; Netherlands 02977-22456; New Zealand 04/693 008; Norway 02/78 94 60; Singapore, Malaysia, and Indonesia 2241077; Spain 01/433 2412; Sweden 08/38 03 70; Switzerland 01/741 41 11; United Kingdom 7073/34774; West Germany and Austria 089/1204-0; Yugoslavia 61/263 261

CIRCLE NO. 56 ON INQUIRY CARD



# 0 to 60 without shifting



Alpha Micro introduces its 68000-based line of systems.

A line that provides a growth path from a one-terminal system to a system that supports over 60 terminals.

And it's growth that doesn't sacrifice your software investment because software developed for our one-user system can run on our 60-user system.

**The AM-1000. A 10 MB, multi-user system that fits on a desk.**

Alpha Micro's 68000-based product line begins with the AM-1000. A desk-top business system that supports two users and a printer, offers 10 MB of storage, and provides 128 KB of memory. And with its 32-bit capability, the AM-1000 offers you the kind of performance not available from 8- and 16-bit systems. In other words, it outperforms most of the currently available small business systems.

The price? Under \$10,000.

**From micro to mini to mainframe with one product line.**

Alpha Micro 68000-based computers move from the micro through the mini and even the mainframe categories. You can go from a one-user system with 128 KB of memory and 10 MB of disk storage to a 60-user

**ALPHA MICRO 68000-BASED SERIES OF SYSTEMS**

MODELS	DISK STORAGE		MEMORY		SERIAL I/O		SOFTWARE		OPERATING SYSTEM
	STD	MAX	STD	MAX	STD	MAX	STD	OPT	
1. AM-1000F (dual floppy)	1.6MB	40MB	128KB	256KB	3	3	A	B	AMOS*
2. AM-1000W (winchester; choice of floppy or VCR backup)	10MB	40MB	128KB	256KB	3	3	A	B	AMOS*
3. AM-1042 (winchester)	32MB	2.4GB	512KB	3MB	2	26	A	B	AMOS*
4. AM-1062 (winchester)	60MB	2.4GB	512KB	8MB	2	68	A	B	AMOS*

A AlphaBASIC,\* AlphaPASCAL,\* AlphaLISP,\*\* AMOS,\* Macro-assembler, Word Processing, 150 subroutines, utilities and diagnostics

\*Available 4th quarter, 1982.

B Programming languages FORTRAN and COBOL, in addition to over 100 AlphaBASIC\* turnkey applications are available from third-party sources.

system with 3 MB of memory and 2.4 gigabytes of disk storage.

A product line that starts so small and grows so large simplifies programming and technical support efforts.

**If your business needs a computer, you need Alpha Micro.**

The Alpha Micro 68000-based line is the latest, most competitive technology.

- Performance — The Alpha Micro 68000-based product line has the speed and versatility of the very latest and most powerful micro-processor chip.
- Software — The Alpha Micro Operating System... AMOS... is standard throughout the product line. That means software developed for the smallest system can run on the largest system. And AMOS is power-

ful. It's multi-user, multi-tasking and timesharing. Its device independence allows virtually any standard terminal or printer to be easily integrated into any Alpha Micro system. You choose the exact configuration that meets your needs and your budget.

Finally, AMOS is proven and field-tested, running on over 7000 Alpha Micro systems installed since 1977.

- Service — International service and support.
- Cost — For all these reasons and more, Alpha Micro products offer you an outstanding price/performance ratio.

**alpha micro**

17881 Sky Park North, Irvine, CA 92713

**software.**

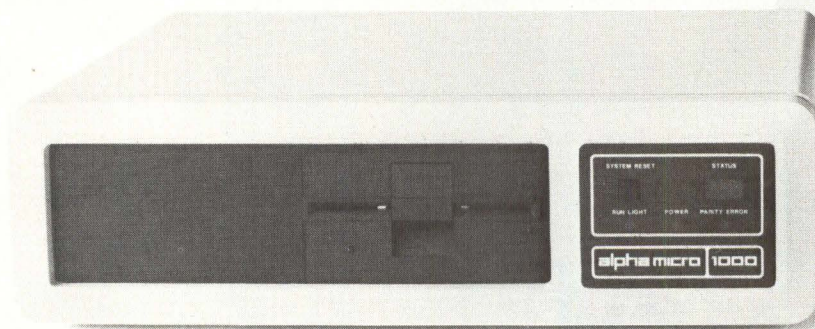

**Find out more about Alpha Micro.**

It makes sense to find out more about the 68000-based line from Alpha Micro. Call Alpha Micro at (800) 854-8406. In California, call collect (714) 641-0386. Or fill out and send us the coupon.

- Send the name of my nearest Alpha Micro Dealer.
- I'm interested in becoming an Alpha Micro Dealer.

Name \_\_\_\_\_  
 Title \_\_\_\_\_ Phone \_\_\_\_\_  
 Organization \_\_\_\_\_  
 Address \_\_\_\_\_  
 City \_\_\_\_\_ State \_\_\_\_\_ Zip \_\_\_\_\_

**ANNOUNCING...**

**An Indispensable Resource for Marketing,  
Research and Purchasing Decisions.**

# Microcomputer Review

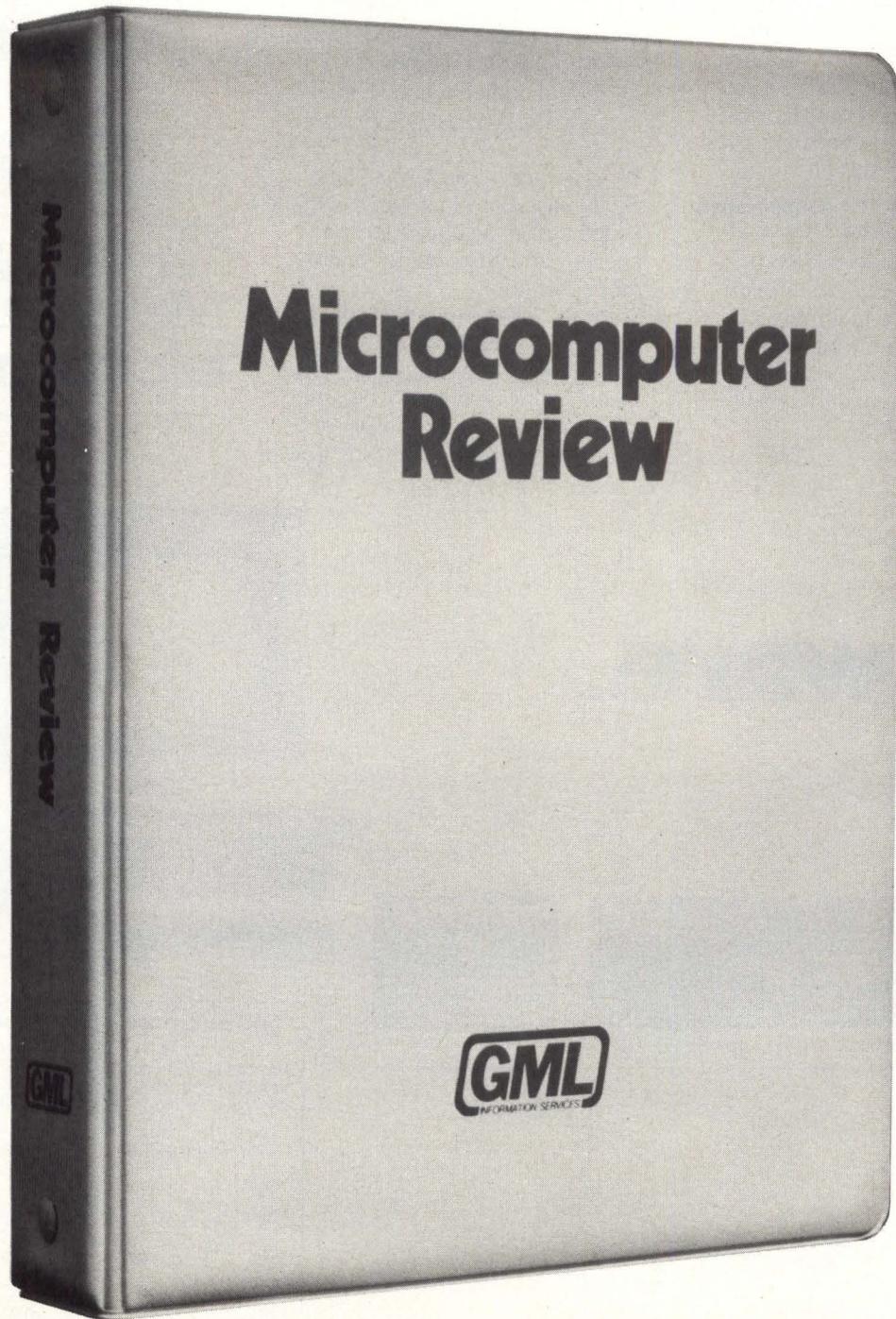

**NOT AVAILABLE  
ELSEWHERE**

# Product Reports on Over 800 Microcomputers Spanning All Applications and Price Ranges.

## Published from the World's Largest On-Line Computer Product Database. Updated Daily.

**Here is what you get with your subscription:**

CONTENTS	MICRO-COMPUTERS	CONTENTS	MICRO-COMPUTERS
<b>PRICES</b>		<b>HARDWARE</b>	
Microcomputer Price Index from \$50,000 to \$99 in price descending order . . . . .	820	Board-level Micros . . . . .	90
<b>APPLICATIONS</b>		Box-level Micros . . . . .	150
Business Micros . . . . .	550	System-level Micros . . . . .	400
Process Control Micros . . . . .	190	Desktop system Micros . . . . .	340
Engineering/Scientific Micros . . . . .	270	Portable Micros . . . . .	40
Personal Computing Micros . . . . .	140	Multiuser Micros . . . . .	210
Word Processing Micros . . . . .	290	Micros supporting Hard Disks . . . . .	440
Ruggedized/Military Micros . . . . .	45	Micros and CPU Type . . . . .	820
Special Application Micros . . . . .	85	Micros and Memory Capacity . . . . .	820
<b>SOFTWARE</b>		Micros and Word Size . . . . .	820
Micros supporting BASIC . . . . .	610	Micros with Floating Point . . . . .	155
Micros supporting FORTRAN . . . . .	460	<b>COMMUNICATIONS</b>	
Micros supporting COBOL . . . . .	375	Micros with RS232 Interface . . . . .	510
Micros supporting Pascal . . . . .	405	Micros with IEEE Interface . . . . .	315
Micros and their Operating Systems . . . . .	675	Micros with Special Interfaces . . . . .	280

### PLUS...

This professional reference can save you thousands of dollars in research costs. Over 500 pages of detailed product reports on over 800 microcomputers ranging from board-level micros to supermicro systems. Reports include information on hardware characteristics, interfacing, packaging, communications, peripherals, software, and prices.

Your subscription also includes free, customized on-line searches. This will give you access to *all* the information on our exclusive database. Customized searches can be requested by phone, and provided within 48 hours.

**ORDER NOW! SAVE \$25 off the \$175 subscription price.**

- Yes, I would like to subscribe to Microcomputer Review at the special introductory offer. Over 500 pages, in handy loose-leaf binder, updated three times a year and reprinted yearly in its entirety.
- Bill my company       Payment enclosed

Name \_\_\_\_\_  
 Title \_\_\_\_\_  
 Company \_\_\_\_\_  
 Address \_\_\_\_\_  
 City \_\_\_\_\_ State \_\_\_\_\_ Zip \_\_\_\_\_  
 Signature \_\_\_\_\_

Mail to **GML Corporation**  
 594 Marrett Road · Lexington, MA 02173 · (617) 861-0515  
*Information Services for Professionals*

# NO BAD MEMORIES

If buying magnetic media from the other guys has given you some bad memories, maybe you should be doing a lot more business with us.

Your customers are beginning to ask for OPUS by name because of the unheard of reliability we build into all our memory products — flexible diskettes, single-disk cartridges, multi-level disk packs and magnetic tape.

Dealers are remembering us because of our margins. The profits you'll make from selling OPUS are second to none, and frankly, better than most.

Besides our great product and generous margins, remember that we accept orders of all size, with virtually no restriction on how little or how much you can buy. And when you order from OPUS, we deliver what you need, when you need it.

Find out more. Circle us on the reader service card, or call or write.

Computer Resources, Inc.  
4650 W. 160th Street, Cleveland,  
Ohio 44135. Phone: 800/321-9330.

See Us At  
 **COMDEX/SPRING '83**  
Booth 2302

**OPUS**®  
NO BAD MEMORIES



# Systems in Manufacturing

Exploring the use of computers in the factory

## Programmable controllers take on new role in automated factory

By Frank Catalano

Ask someone what the factory of the future will include, and nine times out of 10 you'll hear talk about robots, CAD/CAM systems, Manufacturing Resource Planning packages and maybe Issac Asimov. Mention programmable controllers, however, and you might hear talk about the factory of the past.

Although programmable controllers have been around since the mid-'60s and used by both discrete and process manufacturers to control simple machining tasks and regulate temperature and pressure variables,

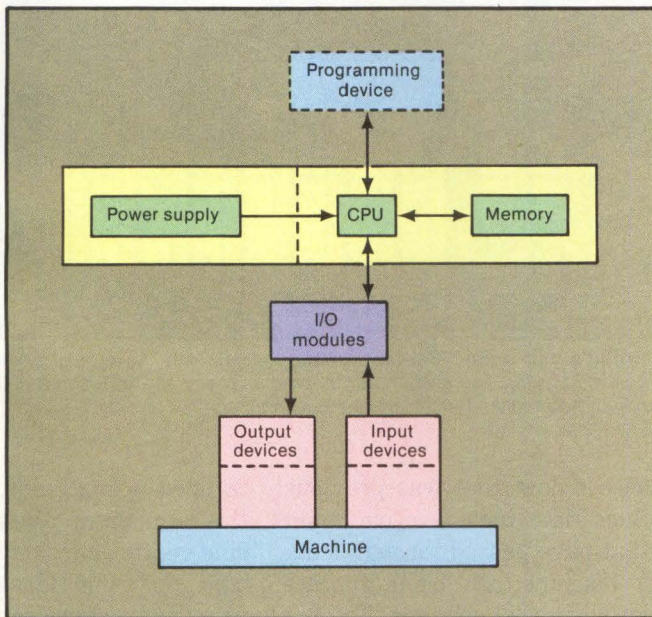

**A typical low-end programmable controller** has enough I/O modules to address all the control parameters of a single machine. A high-end system has enough I/O capability to control an entire production line.

they have taken on a more important role of late—interfacing shop-floor machines to one another and to central factory computers. “As the role of the computer is increasing in the factory, so is the role of the programmable controller,” notes Cliff Young, an analyst with Arthur D. Little Inc., Cambridge, Mass.

Equipped with network interfaces and math-solving capabilities, programmable controllers are giving users closed-loop control of their production processes and serving as sources of machine data for quality-control, machine-maintenance, inventory-planning, labor-

reporting and production-status monitoring applications.

As programmable controllers' importance increases, however, their prices are on the decline. A low-end system that sold for more than \$10,000 10 years ago could be purchased today for as little as \$400. New lower priced devices are being installed by first-time users who previously could not afford programmable controllers and by traditional users who are finding new applications for the products.

Young estimates that the programmable controller market was worth \$250 million in sales in 1982 and will be worth \$2 billion in 1992, reflecting a 20-percent annual growth rate. Although 26 vendors supply programmable controllers, John Davis, a market researcher with Creative Strategies Inc., San Jose, Calif., says that three vendors—Gould Inc.'s Modicom Division, Allen-Bradley Co. and Texas Instruments Inc.—control approximately 88 percent of the market. Davis lists Gould as the leading supplier with a 48-percent market share, Allen-Bradley as number two with a 29-percent share and TI third with an 11-percent share.

### The programmable alternative

The first programmable controllers were designed to replace electromechanical relay switches that controlled machinery at General Motors Corp.'s transmission-assembly plant. Those electromechanical devices were wired together by production engineers so that an event would occur at a machining center depending on whether a relay switch was open or closed. At a drilling station, for example, a proximity sensor would detect that a part was in place and would trigger a relay switch to send a current through a wire connected to a clamp. A relay switch connected to the clamp would then energize the clamp, causing it to close. Another relay switch would turn on the drill motor, and still another might cause the drill head to be lowered onto the part. When a hole was drilled to a specified depth, a limit switch would activate another relay to raise the drill off of the part.

Such a controller for a single machining center often encompassed a 30- × 40-ft. wall and consisted of a maze of complex wire connections. Not only were such controls difficult to troubleshoot, they were also inflexible. If a sequence of events had to be altered, an entire relay panel was rewired or replaced. “Every

# Systems in Manufacturing

model year when GM changed the specifications of a part, they had to throw out millions of dollars' worth of relay panels, even if they only wanted to make minor modifications," notes Rob Loomas, product group marketing manager for Gould programmable controllers. "The PC was designed to allow GM to accommodate changes in assembly operations with a minimum of effort and expense."

Like electromechanical relay controls, PCs control machining operations sequentially and depend on the open/closed status of relay switches connected to points of a machining center. Programmed in ladder logic, a language designed to emulate the wiring diagrams of electromechanical controls, programmable controllers cause events to occur through a series of if/then statements: if a part is in place, then close the clamp; if the clamp is closed; then start the drill motor; and so on. Input to the programmable controller is the open/closed status of a relay connected to the clamp, for instance, and output is the action that causes the clamp to close. "Not only did PCs make machine control more flexible by providing programmability, they were also easy to integrate into factories," notes Charles Juda, product marketing supervisor of Allen-Bradley's Programmable Controller Business Systems Division. "If a production engineer knew how to wire an electromechanical control together, he could program a PC. The program is simply a graphic illustration of wiring diagrams. But rather than physically connecting wires to relays, the engineer pushes a button on a keyboard and represents the wire connection in a programmed statement," says Juda.

## The product spectrum

While the three leading vendors supply a wide range of products, each programmable controller typically consists of the same basic components—a microprocessor, CMOS memory, I/O devices and a power supply. Available options include graphics terminals to program the controllers and monitor the status of a machine during operation, as well as network interfaces. Products differ in terms of memory size and in the number of machine parameters that a system can control.

Gould's low-end offering, for instance, the Micro 84, sells in the \$700 to \$1000 range, is based on the 4-bit Zilog Z8 microprocessor, provides as much as 8K bytes of user storage and can address 32 I/O points. On the opposite extreme, selling for around \$60,000 is the Gould 584 programmable controller, which uses the 16-bit AMD 2901 microprocessor, provides as much as 32K bytes of user storage and can handle as many as 8000 I/O points. "The Micro 84 is geared to handle the

various control parameters of a single machine," notes Loomas. "The 584 could handle all the parameters of every machine on an entire production line."

Similarly, Allen-Bradley's systems range from the Intel 8031-based Microtrol, which can handle 32 I/O points, to the AMD 2901-based PLC 3, which can handle as many as 4000 I/Os. TI's systems, based on its own microprocessors, range from the model 510 with 2K bytes of user memory and 20 I/O points to the PM 550 with 1023 I/O points and as much as 7K bytes of user storage.

## Data access and networking

Besides providing users with a programmable alternative to electromechanical controls, both large and small programmable controllers also allow users to

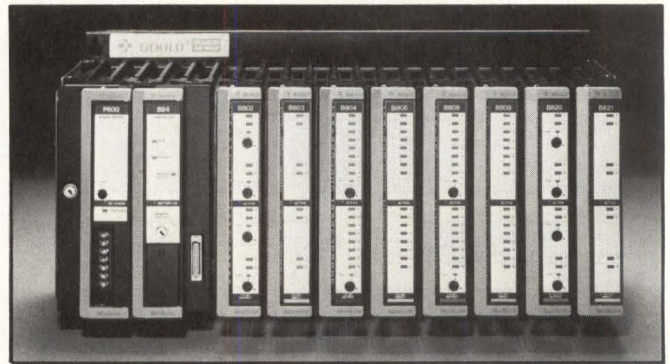

Gould's mid-range 884, announced last month, has a base price below \$10,000. The system can handle as many as 256 discrete I/O points and more than 16 analog I/O channels.

access data that was previously trapped in machines. Such data include cycle counts, the number of parts that have passed through a machining center, how long a machine has been operating and the time lapse between tool changes. To enable users to extract such data from machines, however, suppliers added higher level languages to their systems. "Relay ladder logic might be a convenient language with which to program a PC to control a machine," says Juda, "but it doesn't lend itself well to report generation or arithmetic functions." Most suppliers use BASIC to format production reports and FORTRAN to perform arithmetic functions such as calculating production efficiencies.

Although programmable controllers gave plant-floor personnel access to data from their machining centers, that data could not be stored in a central database or transferred from one programmable controller to another. Over the past year, all three of the top programmable controller vendors have addressed that problem by introducing networks. "PC vendors are recognizing the role of their products within the factory

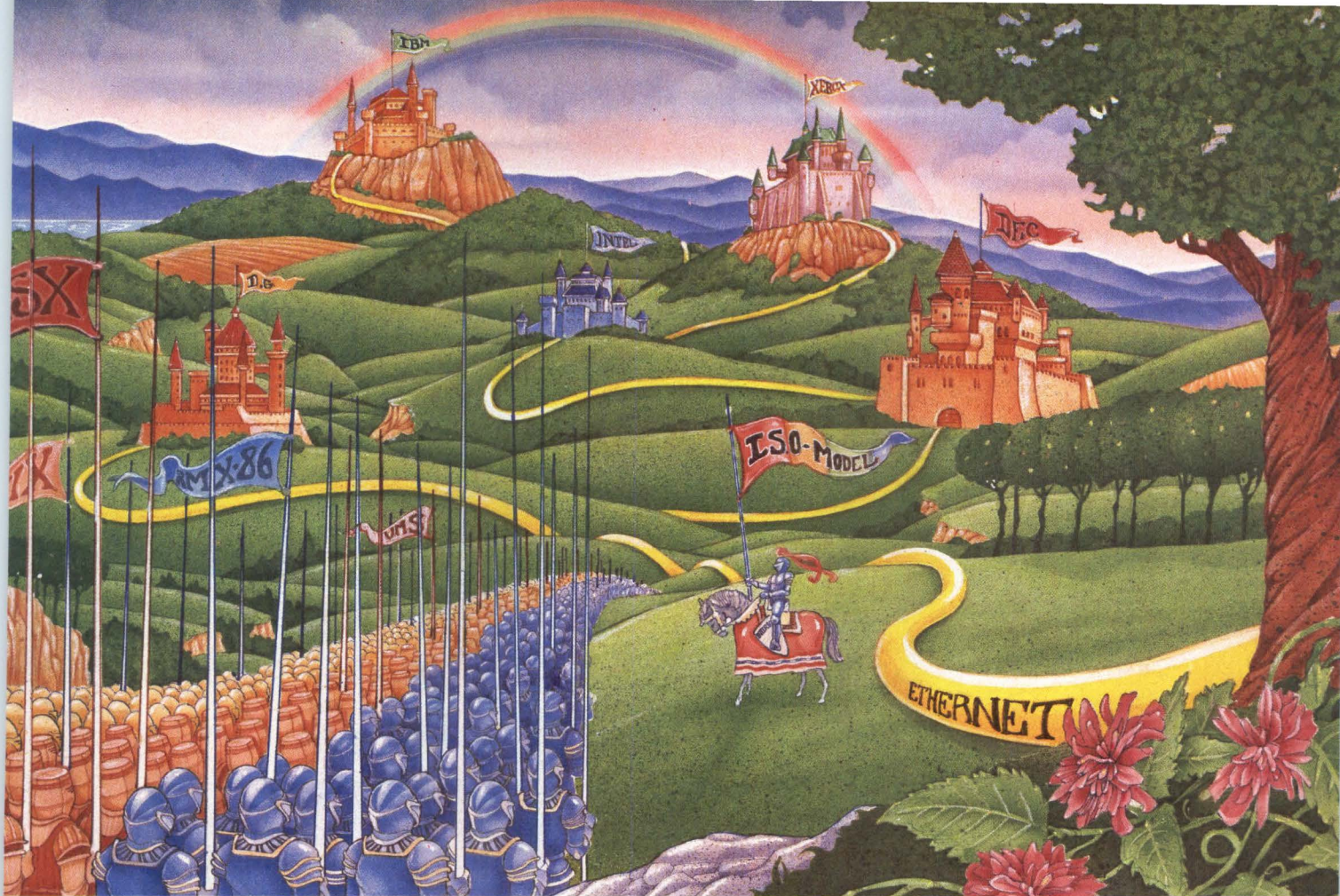

## MULTI-VENDOR LOCAL AREA NETWORK COMMUNICATIONS MARCHES TOWARD REALITY.

INTRODUCING ETHERNODE 1000 SERIES. COMPLETE ETHERNET DATA COMMUNICATIONS SYSTEMS LINKING DEC VAX's, PDP-11's AND UNIX BASED COMPUTERS.

High speed, reliable communications between computers with dissimilar system architectures is no longer just fantasy.

It's reality. And it's called ETHER-NODE 1000. From Interlan.

The ETHERNODE 1000 Series consists of all hardware and software required for high-performance, embedded Ethernet communications among DEC VAX, PDP-11 and UNIX based systems. Each offers a complete Ethernet transport service to user-written application programs.

An integral part of each ETHER-NODE is the NS4200 software, consisting of the Internet Transport Protocols (ITP). Because these protocols were modeled after the Xerox Network Systems ITP Specifications, communications can be

achieved between VAX, PDP-11 or UNIX based machines and ITP compatible systems manufactured by Xerox and other vendors.

### ETHERNODE 1000 Series features:

- Supports high bandwidth communications.
- Minimizes CPU loading.
- Supports internet communications.
- Provides virtual circuit communication services.
- Provides network management (NETMAN™).

NETMAN, an integral part of ETHERNODE, is a screen-oriented, menu-driven utility that displays a wide variety of performance, configuration and utilization parameters.

Other elements of the ETHER-NODE 1000 Series include Interlan's intelligent UNIBUS, QBUS, or MULTIBUS

Ethernet communications controller, a non-intrusive tapping transceiver unit, and transceiver cabling.

If you are presently using or evaluating Ethernet, and require reliable, program-to-program communications, call or write for details on how Interlan can provide the total data communications solution:

The ETHERNODE 1000 Series.

# INTERLAN

WE MAKE NETWORKS WORK.

3 Lyberty Way, Westford, MA 01886  
(617) 692-3900 TELEX 95-1909

EASTERN REGIONAL SALES OFFICE: 10 Kearney Rd., Suite 24, Needham, MA 02194, WESTERN REGIONAL SALES OFFICE: 2091 Business Center Drive, Suite 100, Irvine, CA 92715

INTERNATIONAL DISTRIBUTORS: ADCOMP Equipment Ltd., Switzerland 741-4111, ASR Arizona, Disc, Japan 781-2422-723, Data Translation Ltd., England 044-86-3412, Prosoftware, S.A., Spain 3-321-32-55, Stemmer Elektronik, West Germany 089-8060-61, Transduction Ltd., Canada 416-625-1907, Yrel, France 956-81-42

# WE'RE PLOTTING A REVOLUTION IN color

Now you can plot color faster, more easily, and more reliably than ever before. With a greater selection of brighter colors. In wider and longer formats. Create complex drawings and maps impossible to produce with any other machine. All with the revolutionary new Versatec electrostatic color plotter.

Produce an E-sized (34" by 44") full color drawing in eight minutes. And do it over and over again with all-electronic writing. This is a plotter that requires no operator intervention. It's perfect for remote and second-shift plotting. No pens. No jets. And no mess.

XEROX® is a trademark of XEROX CORPORATION

See us at AIDD and NMA

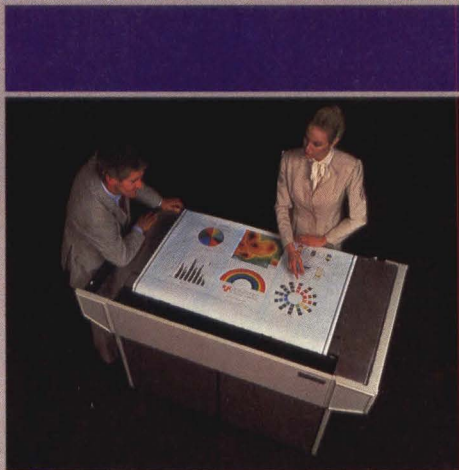

Draw plots of any complexity on 42-inch-wide paper in any length. Draw in full color or black & white. Use the full color spectrum with bright translucent toners. Gain the finest registration and plotting quality of any electrostatic plotter.

Versatec is plotting a revolution in color. So brighten up your world. Circle our readers' service number for a free brochure.

**VERSATEC**  
A XEROX COMPANY

2710 Walsh Avenue, Santa Clara, California 95051, (408) 988-2800  
27/35 London Road, Newbury, Berkshire, England (0635) 31221  
CIRCLE NO. 61 ON INQUIRY CARD

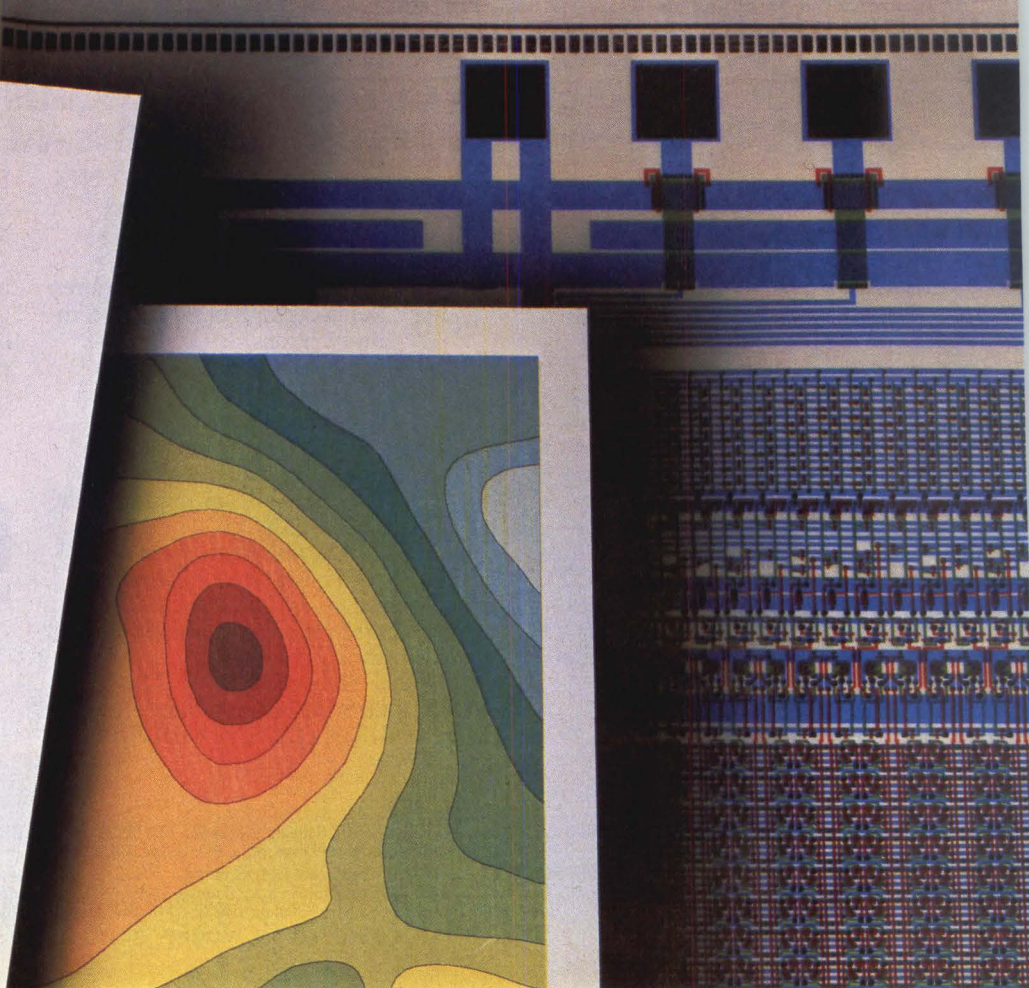
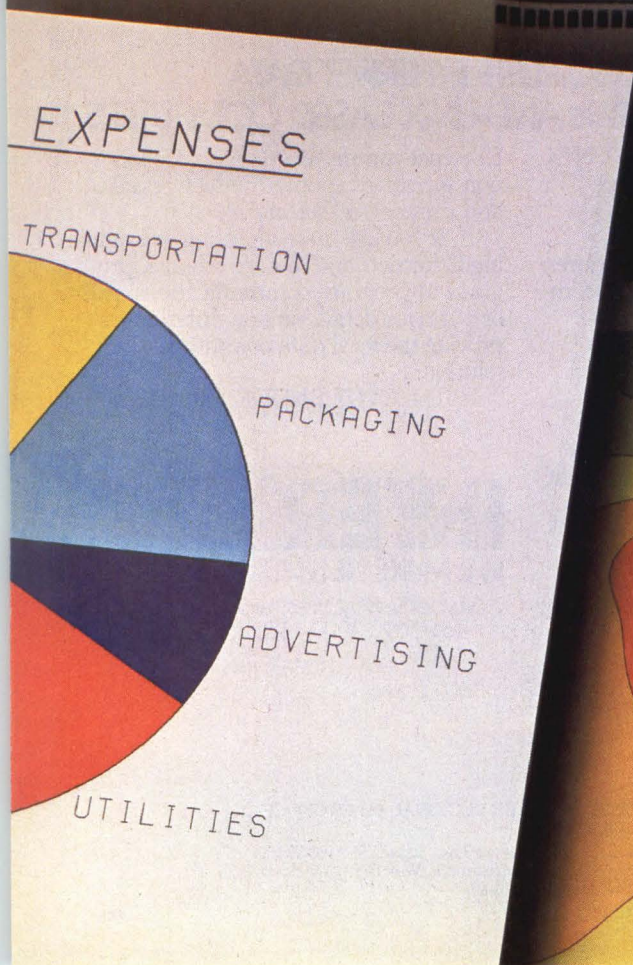



# Systems in Manufacturing



Allen-Bradley's new low-end system, the Microtrol, is available with an LCD terminal, which can be used as a programming device or a permanent data monitor. The system sells for less than \$1000.

and are taking the systems approach to integrating PCs with other factory systems," notes ADL's Young.

Last year, Gould announced a supervisory master/slave network called Modbus and a peer-to-peer network called Modway. Modbus allows a central computer, whether it be a high-end Gould programmable controller or an S.E.L. minicomputer, to store programs for as many as 30 programmable controllers on the factory floor. Any program changes are generated at the central computer, which downloads programs or program changes to the programmable controllers in the shop. Machine data accessed by the programmable controllers on the floor, conversely, are sent up-line to the supervisory computer for central storage.

Modway enables programmable controllers on the plant floor to talk and exchange information with each other. For example, once a machine on a production line performs its designated function on a part, Modway allows the programmable controller for that machine to tell the controller on the next machine to prepare to perform its operation on the part. If a machine breaks down, the programmable controller for that machine can signal the other programmable controllers in the plant to slow their machining operations to avoid building a backlog of parts or subassemblies within the factory.

Allen-Bradley's networking capability consists of a supervisory approach—the Data Highway. Unlike Gould's supervisory network, the Data Highway allows any network-compatible computer or programmable controller in the factory to serve as the master or

supervisory computer. As many as 64 PCs can be tied into the system. Should the programmable controller or computer performing the supervisory function break down, the function is automatically passed to another programmable controller or computer in the plant. Allen-Bradley's Juda says the approach alleviates the problem of an entire factory's closing because of a central computer breakdown.

TI offers a supervisory network called TIWAY I and has announced plans for the TIWAY II peer-to-peer network. All three companies offer gateways that enable their networks to be linked to other networks within a factory.

## Role of low-end systems increasing

ADL's Young notes that as more users install networks and distribute control functions in production facilities, low-end sales are increasing. Rather than controlling a large factory section with one high-end programmable controller, users are controlling machining stations with several smaller programmable controllers.

TI was first on the market with a small programmable controller system—the model 5TI—in 1974. It sold for \$1000—10 times less than any other system then available. TI's latest low-priced offering, the model 510, sells for prices starting at \$400. Allen-Bradley and Gould only recently introduced their low-priced systems selling for \$700 to \$1000. "TI identified a segment of the market early on that wasn't being addressed by the larger vendors," notes Michael Bradley, marketing manager of TI's industrial control division. "We sold primarily to first-time users who needed a PC to control a single machine in a small shop. Now, with network communications, larger users are installing the low-end systems as well."

To accommodate the sales of low-priced products, suppliers are turning to distributors rather than their traditional direct sales forces. "We'd have to sell as many as 60 Micro 84s to generate the same sales revenues as one 584," notes Gould's Loomas. Gould sells the Micro 84 through the company's network of 86 industrial distributors, while marketing its larger systems directly to OEMs and large end users. End users include companies such as GM and Ford Motor Co., and OEMs include machine-tool builders that integrate programmable controllers into their products.

TI also uses distributors to sell the company's low-priced systems and direct-sales channels to sell its larger systems. Allen-Bradley, however, sells the whole spectrum of its product line through a network of 206 distributors. □

FEBRUARY

19

2

79

Look into  
a computer  
for MRP!

# You'll be glad you waited!



If you've made a date to buy a computerized manufacturing control system and you're still looking, you'll be glad you waited!

Now, there's HiNet™/MRP — the affordable alternative. Matched feature-for-feature against those big ticket computer systems, HiNet™/MRP is a fraction of the cost.

HiNet™/MRP is a micro-based network designed exclusively for manufacturing management: cost control, material requirements planning, inventory control, and sales order entry.

And there are more reasons to make today the day you consider HiNet™/MRP ! Everything is ready to use. Even formal classroom training is included so you and your employees can learn the full potential of your new system. Quickly. Easily. Digital Microsystems' on-going support offers reliability that only a manufacturing-direct sales organization can supply.

Today's the day to find out more about computerized MRP. Call Judy Sappington at Digital Microsystems, (415) 532-3686. Or clip out and return the coupon.

Ask for the affordable system!

MMS 4/83

I'm glad I waited! Please send me more information on **HiNet™/MRP**.

Please have a salesperson call.       Information for reference only.      Currently using computerized MRP: \_\_\_\_\_

NAME \_\_\_\_\_

ADDRESS \_\_\_\_\_

CITY \_\_\_\_\_ STATE \_\_\_\_\_ ZIP \_\_\_\_\_

PHONE (\_\_\_\_) \_\_\_\_\_ AM  
PM

Best time to call

# OF EMPLOYEES: Less than 50   50-100   100-200   200-500   500+

**DIGITAL MICROSYSTEMS. Attn: Judy Sappington**  
1755 Embarcadero, Oakland, CA 94606

## HiNet™/MRP

*The Affordable System*

**DS** Digital Microsystems

1755 Embarcadero, Oakland, CA 94606 (415) 532-3686 TWX 910-366-7310  
England & Europe: Tavistock Industrial Estate, Ruscombe, Twyford, Berkshire Tel. 0734-343885

New York • Chicago • Dallas • San Francisco • London

MINI-MICRO SYSTEMS/April 1983

CIRCLE NO. 63 ON INQUIRY CARD

113

# Codata Announces a Major Improvement in OEM Micro



**THE CODATA DIFFERENCE**

AN UNDERSTANDING OF OEMs, LARGE & SMALL  
BEST PRICE/PERFORMANCE RATIO  
STRAIGHTFORWARD, EASY TO UNDERSTAND  
BUSINESS STYLE  
IMMEDIATE TECHNICAL SUPPORT  
THE INDUSTRY'S LONGEST WARRANTY

FOR TECHNICAL ASSISTANCE AND INFORMATION USE THIS TOLL-FREE NUMBER DURING REGULAR BUSINESS HOURS.

**1-800-521-6543**

**1-800-226-2265**

CODATA 3300

### **We're going to make it easy.**

We both know that when it comes to OEM microcomputers, Codata isn't your only choice. While you won't find a microcomputer more technologically advanced, there are a few technically similar.

So how do you choose?

Until now, it hasn't been easy. In fact, it has often been downright difficult. Technical information is hard to obtain. Policies pertaining to pricing, customer support, training, or service are routinely vague and defy comparison.

# Improvement in microcomputers.

We think that has gone on long enough. We are making it easier to make a choice by giving you a difference. We call it the

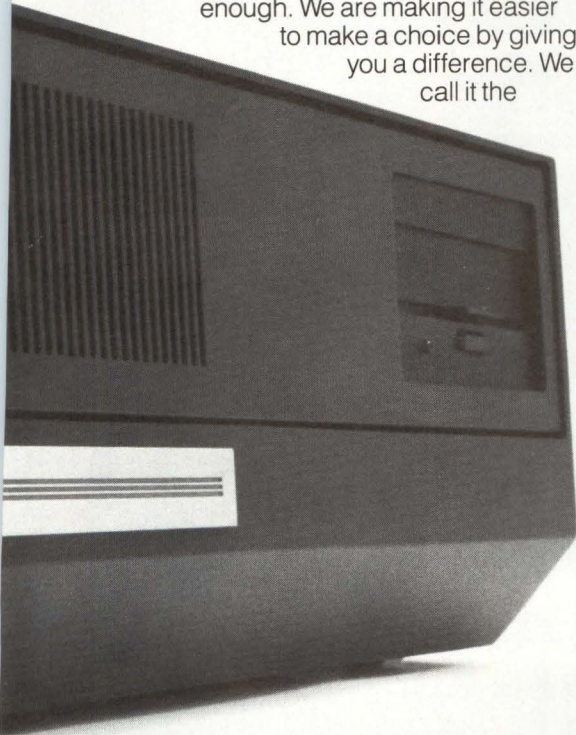

**CODATA DIFFERENCE.** The CODATA DIFFERENCE is a totally new approach to OEM marketing ... an approach based upon a very simple idea. Namely, make it easy for you to buy a quality product, and provide you with total support afterwards. Here's how it works:

### **More performance for the price.**

We've increased the performance of every OEM computer we make. And at the same time we've lowered their prices. As a result, the Codata multi-user, multi-tasking, 16-bit computer systems have price/performance ratios nobody else can match.

### **A fair and consistent pricing policy.**

No more hidden prices.

We will attach a price to every computer. The absolute lowest price possible. And we are publishing just two price sheets. One for suggested retail prices. And a second for OEM prices. Beyond that, there are no quantity commitments, no billbacks, and no hassle. And we are eliminating potential contract problems by eliminating OEM contracts. A simple sales agreement is all that's required to purchase a single system, or 1,000 systems.

### **Full support and technical assistance.**

While computers become functionally simpler every day, they still require technical support. We'll provide it. We'll supply all the evaluation information you need before the sale, and the technical support you require afterwards. And we'll make ourselves as accessible after the sale as before. Any question about a Codata microcomputer can be answered via our TOLL FREE telephone line

during normal business hours in every U.S. time zone.

### **An extended warranty.**

We've extended our warranty period to 180 days, the longest in the business. And it applies to every computer system we manufacture.

### **Here's some proof: a multi-user, 33 megabyte system for \$9,600.**

The CODATA 3300 is a powerful 16-bit, 68000-based, MULTIBUS system that can effectively accommodate as many as ten users. It's a complete UNIX system that runs full ANSI standard FORTRAN-77, RM/COBOL, BASIC+, SMC BASIC, APL, and PASCAL. The 3300 provides up to 33 megabytes of unformatted on-line storage via an integrated, high speed Winchester drive, and a removable, quad-density 5-1/4" floppy disk system. The 3300 features 320 K bytes of parity protected RAM.

The expandable MULTIBUS architecture of the Codata 3300 provides for a variety of expansion options, such as: eight additional users; additional 33 megabyte Winchester disk drives; removable cartridge tape unit; a nine-track magnetic tape unit; and additional 512 K byte memory boards for up to 1.5 megabytes of RAM. An expanded Codata 3300, with 84 megabytes of disk storage, is priced at \$13,500. The 3300 is also available as a 12 megabyte system for as low as \$7,800.

### **Let us show you the difference.**

Write or call us for more information. We'll send you "THE CODATA DIFFERENCE" package that includes all necessary product and language specifications, price lists, and ordering information.

So how's that for a major improvement in OEM microcomputers?

### **CODATA SYSTEMS**

285 North Wolfe Road  
Sunnyvale, CA 94086  
1-800-521-6543  
In California: 1-800-221-2265

**CIRCLE NO. 64 ON INQUIRY CARD**



910 PLUS

925

950

970



# We started out giving you more terminal for your money.

## We still do.

We know where we started, and we know where we're going. We first entered the terminal market by offering high quality terminals with more features and functionality for less money. Our approach helped reshape the entire industry, making TeleVideo the world's leading manufacturer of computer terminals.

But these days a good combination of price and performance is expected. Manufacturers must provide more in order to be taken seriously. So we've extended the lead of our entire product line through innovation. From the economical 910 PLUS, through our advanced design 925 and 950 series, up to today's revolutionary 970, we continue to anticipate and deliver exactly what you want in your terminals.

Though the world changes around us, we always stay ahead. But our philosophy of providing more terminal

for less money does not change. For information, call toll-free 800-538-8725 (in California call (408) 745-7760), or send us this coupon.

TeleVideo Systems, Inc.  
Dept. #216 J  
1170 Morse Avenue  
Sunnyvale, CA 94086

Yes, I'd like to know more about  
TeleVideo's family of terminals:

Name \_\_\_\_\_

Address \_\_\_\_\_

City \_\_\_\_\_

State \_\_\_\_\_ Zip \_\_\_\_\_

Telephone (\_\_\_\_\_) \_\_\_\_\_

Santa Ana/California 714-557-6095  
Sunnyvale/California 408-745-7760  
Atlanta/Georgia 404-399-6464  
Dallas/Texas 214-980-9978  
Chicago/Illinois 312-351-9350  
Boston/Massachusetts 617-668-6891  
New Jersey/New York 201-267-8805  
Woking, Surrey/United Kingdom 44-9905-6464

 **TeleVideo Systems, Inc.**

See us at Comdex Booth #2012

CIRCLE NO. 65 ON INQUIRY CARD

# NOW IS OUR TIME.



## Ithaca's Encore Computers, Designed For Those Who Desire The Best.

You've acquired a taste for computers. Now's the time to experience the benefits of America's finest.

Ithaca's ENCORE™ series offers matchless quality, performance, reliability, application versatility and expandability in 8 & 16 bit configurations.

### The Standard of Quality

In both hardware and software, Ithaca is the standard of quality. Five years of experience in the production of S-100 systems means unsurpassed quality and reliability. As you grow, your ENCORE system expands with you. Unlimited options for growth are available through a variety of configurations which will meet all of your peripheral, memory and I/O requirements.

### Proven Performance

ENCORE's unique design can provide up to a 500% increase in throughput on disk-intensive programs.

CP/M®, MP/M® and XENIX® operating systems as well as a selection of utility, development and application software, give the Ithaca ENCORE the increased programming capability you would expect from the best.

Ithaca's ENCORE™ . . . simply the finest price/performance, 8 & 16 bit computer systems available.

### So advanced, that Now is Our Time.

For immediate reply call toll-free (800) 847-2088, New York call 607-273-2500. Ithaca is backed by Docutel Olivetti nationwide service.

**Ithaca**  
Data Systems™  
200 E. Buffalo St. Ithaca, N.Y. 14851

TM ENCORE is a trademark of Ithaca Intersystems, Inc.

© CP/M and MP/M are registered trademarks of Digital Research, Inc.

© XENIX is a registered trademark of Microsoft.



# Systems in Manufacturing

## CAE system combines layout, simulation functions

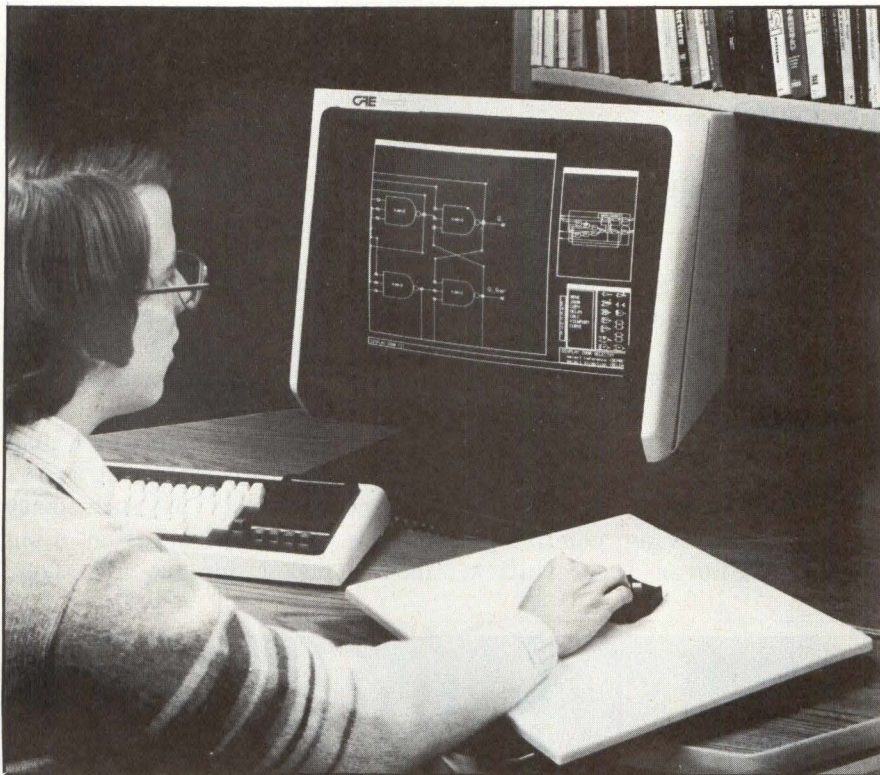

CAE's 2000 workstation is available with software to document IC or PC-board designs during layout, verify timing, analyze designs and simulate design functionality.

A system that reportedly allows engineers to design integrated circuits and printed-circuit boards as well as test the functional capabilities of those designs has been announced by CAE Systems Inc., Sunnyvale, Calif. Al Frugaletti, vice president of marketing at CAE, says the CAE 2000 will enable companies to save time and money in product design by integrating layout and simulation capabilities in a single local workstation.

Research firm Dataquest Inc., Cupertino, Calif., estimates that the market for IC-design workstations totaled \$21 million in sales last year and projects that the market will reach \$450 million by 1987.

The CAE Systems entry in that market is based on Apollo Computer Inc.'s 32-bit Domain, which incorporates a Motorola 68000 dual microprocessor and the UNIX operating system. A single workstation sells for \$39,900 and includes a 17-in. monochrome display, 1M byte of main memory, a 34M-byte Winchester disk, a bit pad and schematic capture software. A system that includes software for engineering documentation, timing verification, local analysis and local logic simulation sells for \$88,690. Options include a 1.2M-byte floppy disk drive, a 19-in. display screen, a 300- or 600-line-per-sec. letter-quality printer, one or two 300M-byte removable disk pack drives and a 25-in.-per-sec. tape drive. A

12M-bit-per-sec. local-area network available from CAE links the workstations with shared peripherals, and an RS232 interface provides access to a host computer.

Frugaletti says that the CAE 2000 is targeted for users who can't afford large mainframe- or minicomputer-based design and simulation systems as well as for users of more expensive equipment. "Most CAD systems on the market help engineers only in the drafting or layout stage of their work," notes Frugaletti. "The output is only a geometric model of the final IC or PC board and has no electrical meaning."

He adds that, although software to allow engineers to simulate their designs is available, it runs only on large minicomputers such as Digital Equipment Corp.'s VAX. Using such simulation software, he says, an engineer must first format a graphical design into computer-readable code and then reserve time on his company's central computer to run the simulation program. "What happens is that small companies can't afford to buy \$250-million minicomputers on which to run the simulation programs, and large companies can't provide their engineers immediate access to the central computers," notes Frugaletti. "And whether a company is large or small, engineers shouldn't have to take time to rework their geometric designs into a format that a computer can simulate."

By combining the design and simulation databases, the CAE 2000 avoids those problems, Frugaletti says. The system formats a PC board or an IC layout into computer-readable code that can be simulated locally at the CAE workstation or on a company's larger minicomputers using previously purchased simulation software. Frugaletti lists CAE's competition as Mentor Graph-

# Systems in Manufacturing

ics, Portland, Ore.; Daisy Systems, boro, Ore.; and Valid Logic, Sunnyvale, Calif.; Metheus, Hills-Sunnyvale, Calif. —Frank Catalano

## Workstation optimizes plant-design software

A software system dubbed the Plant Design Management System, long popular in Europe, is getting a boost in the U.S. by a Sunnyvale, Calif., company that has designed a graphics workstation to optimize the PDMS software. The Design Station One (DS1) workstation from Cadtrak Corp. includes a raster graphics engine and monitor along with ease-of-use software to exploit the power of PDMS, which has typically been accessed through a

dumb Tektronix Inc. storage tube display.

The PDMS software, targeted at users who design the piping, structural and equipment locations for process plants, is available for licensing or as a time-sharing service. Cadtrak has exclusive rights to offer PDMS as a time-sharing service in North America—a service it offers through established time-sharing companies. Prime Computer Inc., Natick,

Mass., gained the right to offer licenses to PDMS in the U.S. by acquiring the British firm Compeda Ltd. late last year. James Callan, Cadtrak's director of marketing, says his company and Prime are discussing the possibility of joining forces to market the DS1 to PDMS licensees.

Callan says the PDMS software commonly runs on Prime 750 computers, although it can also operate on VAX computers from Digital Equipment Corp. and on IBM mainframes. More plant owners are retrofitting and expanding their plants themselves, rather than going to outside builders, Callan says, and Cadtrak is focusing its DS1 marketing efforts on such plant owners. "Time sharing is not a big money maker for us," he says.

## At Last . . . An Industrial Strength Microcomputer for the OEM **MULTIBOX**

At last the OEM has a "super" microcomputer with industrial strength ingredients like UNIX™, MC68000, Multibus™, 1.5Mb memory and Ethernet™. The Multibox has all of the essential ingredients to meet tough mainframe-type applications for the cost of a micro. Add to these ingredients a unique heavy metal constructed cabinet with efficient cooling and up to 200 Megabytes of mass storage memory capacity. No other MC68000-based system on the market today can match Multibox for strength in microcomputing.

For your next tough computer application apply the industrial strength microcomputer . . . Multibox, the "Super" Microcomputer.

## cyb SYSTEMS

6448 Hwy. 290E., Suite D 106  
Austin, Texas 78723  
512-458-3224

UNIX is a trademark of Bell Laboratories  
Multibus is a trademark of Intel Corporation  
Ethernet is a trademark of Xerox Corporation  
MC68000 is a Motorola Product

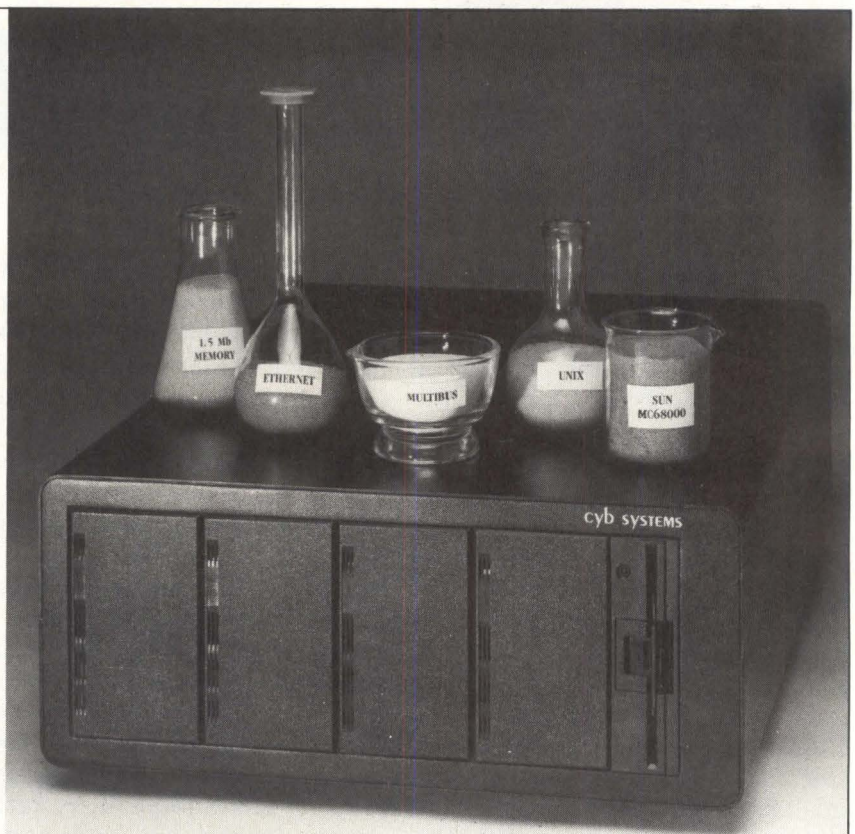

See Us At

**COMDEX/SRING '83** Booth #4539

# “What do I do now?”

## Increase your productivity with Cogen by as much as 10

Writing Cobol programs can be time-consuming and error-prone. But with Cogen, writing business applications is a breeze. Cogen is an automated Program Generator which produces bug-free Cobol code. You interact with Cogen through menus, prompts and data-entry screens. Once you've defined your programming task to Cogen, it does the rest... no more repetitive keying and other drudgery. You can create independent modules to link with your own programs, or you can have Cogen create a complete application program. You will be amazed at the combination of power and ease of use embodied in Cogen. As one of users puts it,

### “Cogen is a Dream”

A. R. Wade, West Covina Unified School District, California.

Having proved itself on mini-computers, Cogen is now available on microcomputers which run RM/COBOL and Micro Focus LEVEL II COBOL, two widely used business lan-

guages. Among the many systems under which Cogen runs are IMOS, IRX, PRIMOS, VAX/VMS, RT-11, CP/M, CP/M-86, MP/M II, MP/M-86, MmmOST, TurboDOS, RM/COS, OASIS, UNIX, ZEUS and PC-DOS. So besides improving your programming productivity, Cogen also improves your program portability.

#### Some Benefits of Cogen

- Cogen generates formal, structured programs automatically, so your code is standardized, self-documenting, efficient

and easy to maintain. And more important, a major source of bugs is eliminated.

- “Screen painting” techniques let you draw the screens exactly as you want to see them displayed by your program, accurately, efficiently and quickly. Moreover, multiple screens can be split and overlaid.

Extensive report writing facilities produce reports with optional headers, multiple detail lines and control breaks, conditional printing, data selection from several reference files, and more.

- Menu driven format gets to the heart of your programming and produces dozens of lines of bug-free code with a few keystrokes. This means decreased training periods for your new programmers.

- Code produced by Cogen is highly modular, so you can use the results of one ses-

sion for future applications, and in many different combinations.

- Using Cogen means complete transportability for your applications, because Cogen is written in and produces Cobol for a wide range of mini and microcomputers.

- For inexperienced users, Cogen contains tutorials and examples. For manufacturers, OEMs and distributors, Bytel provides “Cogen Self-Demo,” a demonstration package for use by non-technical sales personnel.

## COGEN™ the PROGRAM GENERATOR will save you so much time you may run out of things to do!

COGEN is now available under both Ryan McFarland RM/COBOL and Micro Focus LEVEL II COBOL

# bytel corporation

1730 Solano Avenue, Berkeley, CA 94707 (415) 527-1157

# Systems in Manufacturing

"Mainly, we're out to sell workstations."

Built using components from Convergent Technologies Inc., the DS1 also includes a raster display and the Cadtrak-developed graphics engine and software. The DS1 displays plant views in full color, and the displays can be rapidly moved, rescaled and, via multiple viewports, viewed simultaneously from several directions. High-resolution drawings of floor areas greater than 100 sq. ft. can be stored in the workstation and displayed on the 660- × 480-pixel monitor.

At the beginning of a session, database information is downloaded from the PDMS host to the DS1 memory. This information includes legal component libraries,

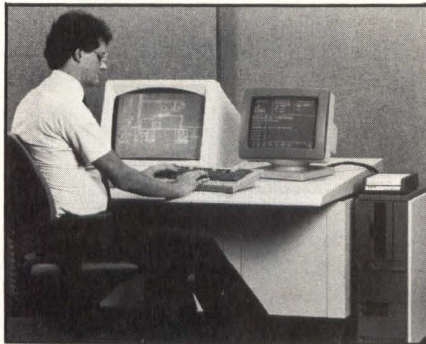

**Cadtrak's Design Station One** adds color displays, high-speed interaction, user friendliness and functionality to the Plant Design Management System software. Among other information, the alphanumeric monitor displays the legal components available to the designer in creating piping layouts on the raster graphics monitor.

which ensure that only compatible parts are used. As designers add and change piping components, the PDMS software monitors piping

alignment and connections. According to Cadtrak, correcting piping-design errors costs about \$1 billion a year. PDMS, which can aid in designs entailing more than 1 million components, can sharply reduce such errors and the resulting costs, Callan says.

The basic DS1 includes five 8086 microprocessors, a virtual database memory, pixel memory of 2M bytes (expandable to 16M bytes), 0.5M-byte floppy and 10M-byte Winchester disk storage, a 19-in. color monitor that displays 256 colors from a palette of 16 million colors, a data tablet, a trackball, a keyboard and function buttons and a monochromatic, 15-in. alphanumeric display. Price for this basic system is \$89,500, with volume discounts available.

—Dwight B. Davis

## NEW!

### HIGH RESOLUTION DEC LSI-11 GRAPHICS!

**VCH-Q 512 × 512 × 8**  
256 Colors on Screen

Dual-height card, plugs into Q-Bus.\*  
256 colors from 16M color palette.  
Direct-access, color-mapping RAM.

- CAD/CAM Graphics
- Process/Quality Control
- Robotics, Vision Systems
- Bio-Medical Imaging
- Business Graphics

\* Q-Bus is the registered trademark of Digital Equipment Corporation.

**VRH-Q 1024 × 1024 × 1**

Graphics + Hi-Density Alphanumerics

Dual-height card, plugs into Q-Bus.\*  
Suitable for portrait or landscape mode.  
128 line/128 character display memory  
RAM programmable character set.

**CALL TODAY!**

**Peritek Corporation**  
5550 Redwood Road  
Oakland, CA 94619

**Peritek**

Phone: (415) 531-6500  
TWX: 910-366-2029



# A great pick from Hall-Mark

Faced with a difficult small computer system decision? Let Cromemco make your job easier.

Whether you need the power of multi-user Cromix® or just CPM accessibility, Cromemco's standard software is the answer.

For hardware, take your pick from a wide selection of configured systems, personal

computer or board level components, all designed by Cromemco and stocked by Hall-Mark, Your Systems Source for the '80s.

## **Cromemco™**

NORTHEAST Cherry Hill 609/424-7300 Fairfield 201/575-4415 New York 516/737-0600 Philadelphia 215/355-7300 SOUTHEAST Atlanta 404/447-8000 Baltimore 301/796-9300 Ft. Lauderdale 305/971-9280 Huntsville 205/837-8700 Orlando 305/855-4020 Raleigh 919/872-0712 Tampa/St. Petersburg 813/576-8691 MIDWEST Chicago 312/860-3800 Cincinnati 513/563-5980 Cleveland 216/473-2907 Columbus 614/891-4555 Milwaukee 414/761-3000 Minneapolis 612/854-3223 SOUTH CENTRAL Austin 512/258-8848 Dallas 214/341-1147 Houston 713/781-6100 Kansas City 913/888-4747 St. Louis 314/291-5350 Tulsa 918/665-3200 WEST Denver 303/694-1662 Phoenix 602/243-6601 San Diego 619/268-1201 Sunnyvale 408/773-9990 © 1982 Hall-Mark Electronics Corp/5169

See us at  
**7<sup>th</sup> FEDERAL DP EXPO™**  
 Booth 522

# **HALL-MARK**

Buy or lease from Hall-Mark.

Hall-Mark Electronics Corp.—Dallas, Texas

Digital's new multi-user, multi-tasking Micro/PDP-11™ gives you all the microcomputer you need to solve your application problems. At a price almost anyone can afford - \$9,200.\*

The Micro/PDP-11 is a powerful micro that's small enough to fit just about anywhere. It's available in rack mount, floor mount, and table top versions. And includes CPU, a 10 Mb 5¼" Winchester, 800 Kb floppy back-up, and auto-self diagnostics for I/O, CPU and mass storage.

But what puts the Micro/PDP-11 in front of all the others is what's behind it.

More software. Over 2,000 developed applications are available for laboratories, factories, offices, and other businesses. And thousands of PDP-11 trained programmers ready to write even more.

A wide choice of operating systems. Including RSX-11, RSTS/E, RT-11, DSM-11, MicroPower/Pascal, and UNIX.\*\*

A variety of languages such as BASIC, FORTRAN-77, COBOL-81, C, DATATRIEVE, PASCAL and DIBOL.

Thousands of peripheral hardware interface products.

And the support of Digital's worldwide team of over 18,000 sales

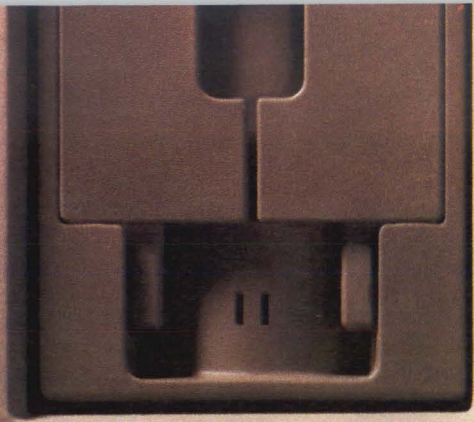
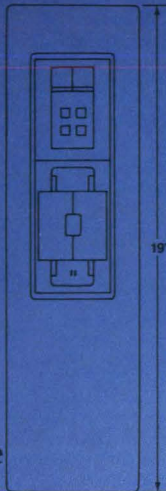

and service professionals. Ready to answer any question. Or solve any problem.

The Micro/PDP-11. No other micro can stand up to it.

For more information, send in the coupon. Or call 800-225-9222 and ask for information package MM-127

Send to: Digital Equipment Corporation,  
HL2-1/E10  
77 Reed Road, Hudson, MA 01749.

- Please send me more information on Digital's Micro/PDP-11.  
 Please have a Digital Sales Representative contact me.

My application is \_\_\_\_\_

Name \_\_\_\_\_

Title \_\_\_\_\_

Company \_\_\_\_\_

Street \_\_\_\_\_

City \_\_\_\_\_

State \_\_\_\_\_

Zip \_\_\_\_\_

Phone \_\_\_\_\_

**More than  
a micro.** MM-4-83

\*Quantity one, U.S. Prices only  
\*\*UNIX is a trademark of Bell Laboratories.  
©Digital Equipment Corporation 1983

**digital**

Actual size: 5¼" x 19"

No other micro  
can stand up to the Micro/PDP-11.

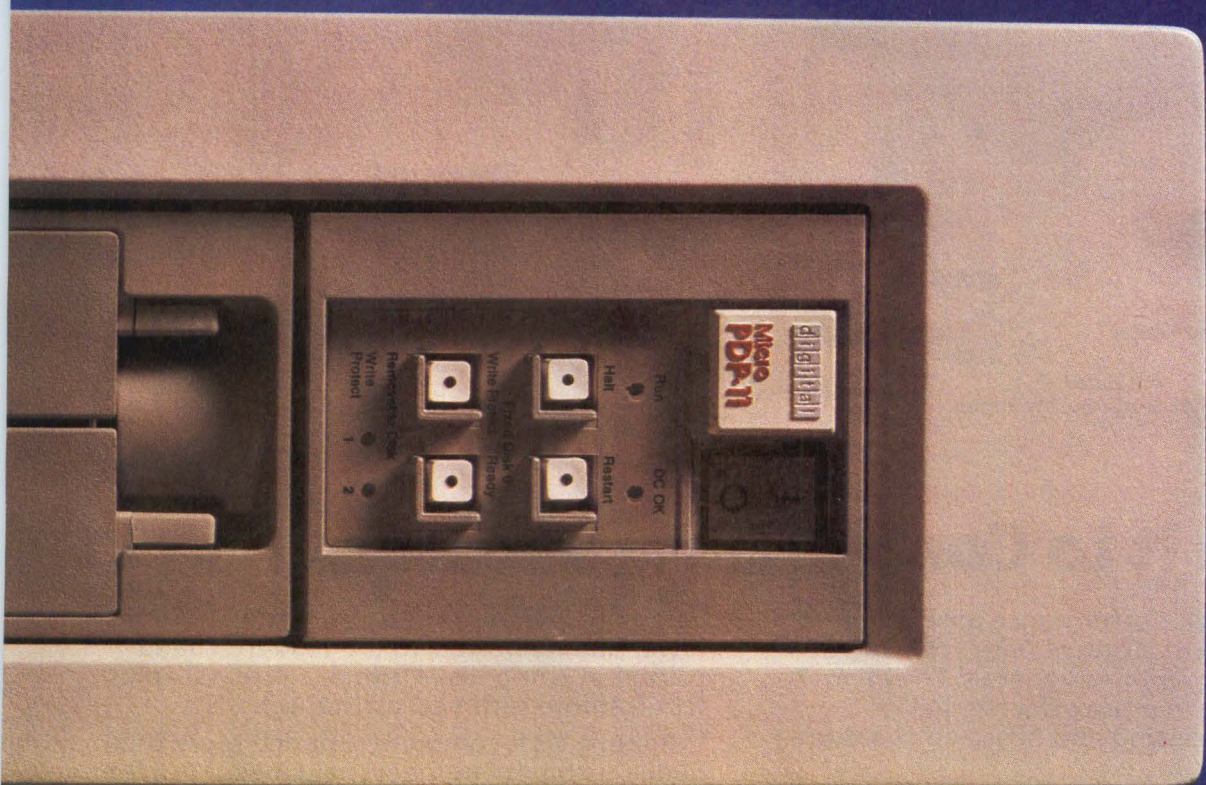

# NOW MAKE YOUR SERIES/1 EVEN MORE EFFECTIVE.



## Attach it to Control Data Miniperipherals.

Turn your price-performance problems into opportunities with Control Data's *full line* of Certainty® Series miniperipherals. They'll make your Series/1 even more effective for distributed processing and office automation—at a competitive price.

Why are Series/1 users linking up with Certainty Series products? The first benefit is exceptional capability for the price. You get printers that are faster than competitively priced units; disk drives with more storage for the money; removable media; even fixed and removable storage in one drive; integral controllers; full Series/1 compatibility.

Benefit #2: a full line—available right now. There's a complete family of disk drives. A

complete line of printers, from the 410 Series letter quality printer to the 1130-lpm band printer. A pair of user-friendly displays—plus RTA (remote technical assistance).

Benefit #3 is complete support. More than 5000 Customer Engineers help make sure that Certainty miniperipherals live up to their name in operation.

**Make increased effectiveness a Certainty.** No matter how you're using your Series/1—for insurance, broadcasting, health care, banking or dozens of other applications—there's a Control Data miniperipheral that'll pay off for you in price *and* performance.

Call today for more information, toll-free 800/328-3390.

**GD CONTROL DATA**

*Addressing society's major unmet needs  
as profitable business opportunities*

CIRCLE NO. 71 ON INQUIRY CARD



**ELECTRONIC ENGINEERS:** Be Sure to Attend

# "THE BOSTON P.C. PARTY"

Packaging • Production • Testing

**Printed  
Circuits &  
Microelectronics  
Exposition**

**nepcon  
east**

**May 24-26, 1983**

**John B. Hynes Veterans Auditorium  
Boston, Massachusetts**

## The More Production Problems You Bring to NEPCON EAST...the More Practical Solutions You'll Find!

### **MORE:**

Dynamic displays . . . over 350 in all . . . of the latest electronic manufacturing equipment, tools, hardware, supplies and test instruments

### **MORE:**

than 200 of the nations' leading suppliers participating

### **MORE:**

Technical help from qualified manufacturers' personnel, demonstrating efficient new equipment and processes

### **MORE:**

Technological aid, presented by industry experts in 12 Technical Sessions, 2 PACs, 2 Workshops

## **PLUS...FIRST EAST COAST PRESENTATION OF "THE P.C. BOARDWALK"**

Acclaimed at NEPCON WEST '83 as an outstanding educational experience for P.C. Specialists. A continuously-operating, automated printed circuit facility, producing sophisticated, "busy" bare boards to close manufacturing specifications. Each step explained and demonstrated by qualified technologists.

**FREE ADMISSION TO THE EXHIBITION FOR ELECTRONIC PRODUCTION PERSONNEL**

### **SPONSORED BY**

Electronic Packaging and Production magazine  
Semiconductor International magazine  
International Electronic Packaging Society, Inc.

### **ORGANIZED BY**



Cahners Plaza  
1350 E. Touhy Avenue  
P.O. Box 5060  
Des Plaines, IL 60018  
(312) 299-9311  
Telex 82882 CEG CHGO

**MAIL THIS COUPON TODAY TO: Cahners Exposition Group,  
Cahners Plaza, 1350 E. Touhy Ave., P.O. Box 5060,  
Des Plaines, Illinois 60018**

Please send application for FREE admission to the exhibits at NEPCON EAST '83; also, include further details of the Conference Program

Name \_\_\_\_\_ Title \_\_\_\_\_

Company \_\_\_\_\_

Address \_\_\_\_\_

City \_\_\_\_\_ State \_\_\_\_\_ Zip \_\_\_\_\_

Phone (\_\_\_\_\_) \_\_\_\_\_ Telex \_\_\_\_\_

**Make Photocopies for Your Associates**

D



## Minicomputer power pollution?

**Shape  
solves it best.**

**SHAPE**  
MAGNETRONICS, INC.



901 DuPage Avenue • Lombard, IL 60148  
(312) 620-8394 (TWX: 910-991-2352)

Minicomputer manufacturers and systems integrators recommend ferroresonant transformers for power line conditioning because they solve 99% of the power problems a mini will encounter.

Among the manufacturers of ferroresonant transformers, only Shape makes the single-enclosure sizes over 5K VA that most minicomputer systems require. Shape Line Tamer™ ferroresonant transformers provide your mini with the clean, constant power it needs for accurate performance. Other power line conditioners may cost more, but dollar for dollar, none perform better than Shape Line Tamers™.

Shape also makes Line Tamers™ in the sizes needed for small computers, office automation, electronic cash registers and other computerized equipment.

For applications assistance, call the Shape factory. For immediate delivery, call your local distributor or power specialist.

**Shape: The Solution to Power Pollution**

**CIRCLE NO. 72 ON INQUIRY CARD**

# FEATURE HIGHLIGHTS

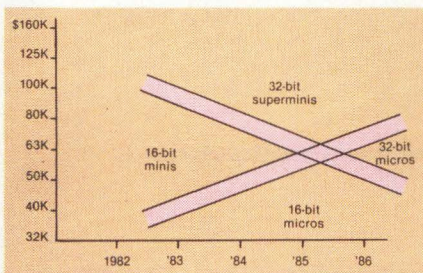

**MINICOMPUTERS:** For more than five years, industry pundits have predicted the demise of the traditional 16-bit minicomputer; that micros from below and **32-biters** from above would squeeze 16-bit minis out of the market. Some say the prediction is already a reality. For a closer look, see p. 133. . . On the other hand, some experts deny that the 16-bitter is already outdated. Although the **16-bit mini** may have lost some of its glamor, they say, it is still a workhorse in many OEM and system integrator product lines. For this different opinion, see p. 145.

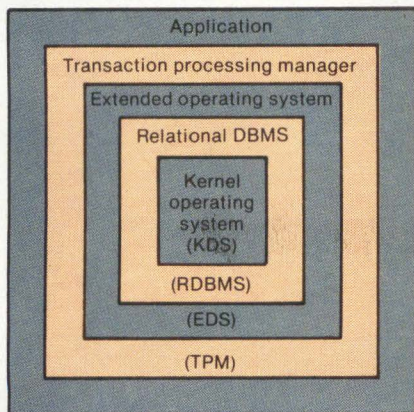

**SYSTEMS:** The distinctions between microcomputers and minicomputers have blurred in the past few years almost to the point of disappearance. Convergent Technologies Inc. has introduced the **Megaframe system** which now aims its sights at mainframe performance. Based on Motorola Inc.'s MC68000 family processors and Intel Corp's 186 processors, the system is field-upgradable to 128 users. For an in-depth look at this new system, see p. 157. . . Are you losing precious time and money because of hardware and software failures? Synapse Computer Corp. may have a solution to costly downtime. Its **N + 1 on-line transaction-processing system** integrates the relational database-management system, the transactional processing manager and the Synthesis operating system into a set of protection spheres. See p. 165 for a look at this entry into the "continuing processing" market.

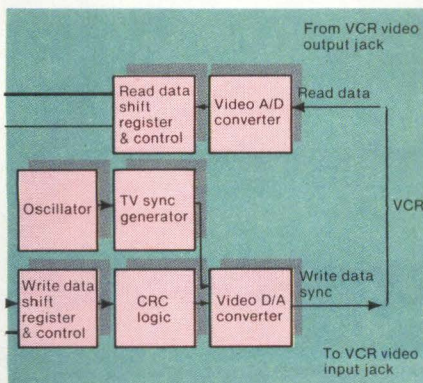

**DISK DRIVES:** Along with processors, printers and tape drives, **disk drives** continue to shrink in size. With current media at less than 5¼-in. sizes and 5M- to 10M-byte storage ranges, Winchester will soon find their way into a wide range of new microprocessor-based systems. However, the issue of diskette media standards remains a hot one. For more information, see p. 175. . . **Video cassette recorders** can store as much as 100M bytes on a single video cassette and offer a cheaper media cost than even streaming cartridge-tape drives. Despite size limitations and some time restrictions, VCRs, including a new offering from Alpha Micro Systems, are proving to be practical and reliable for many applications. See p. 179 for a closer look.

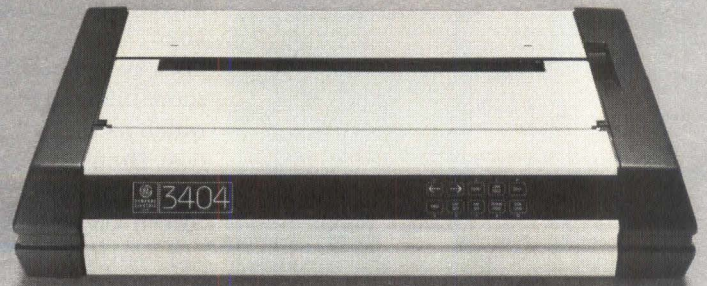
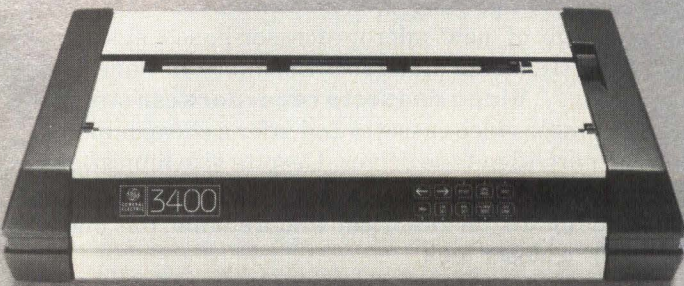
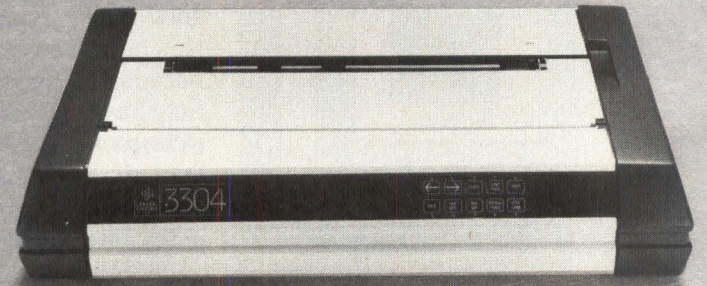
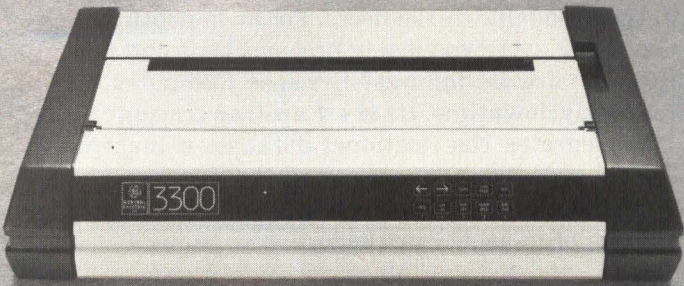
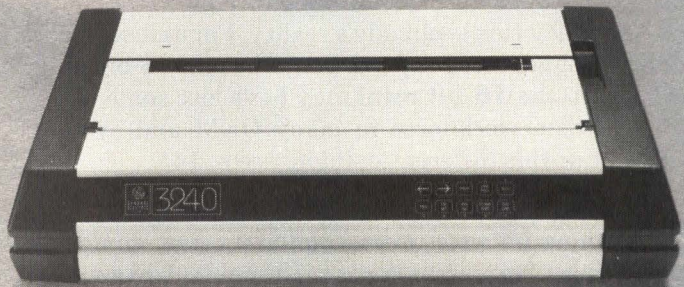
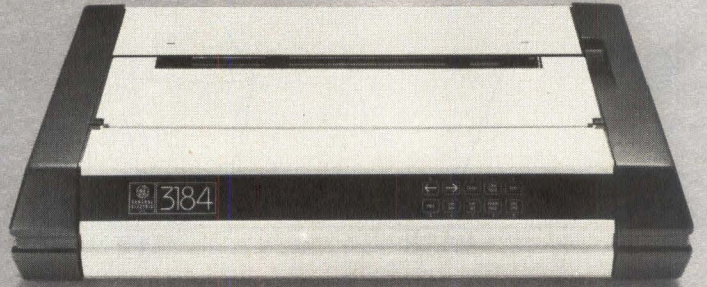
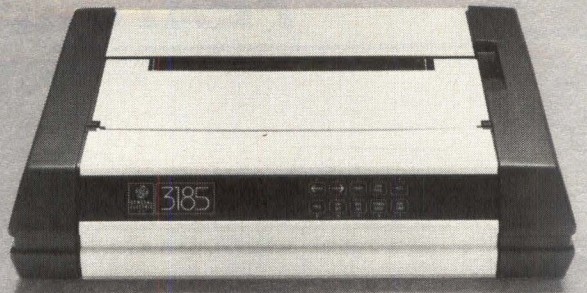
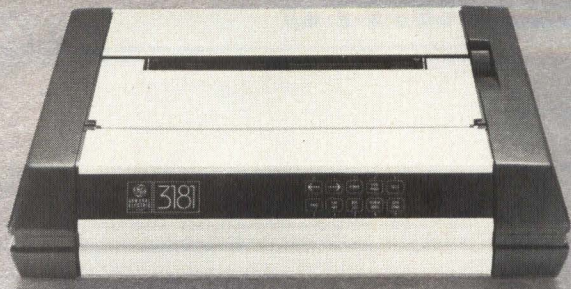

# The GE 3000 printer family.

## So many choices, it's the obvious choice.

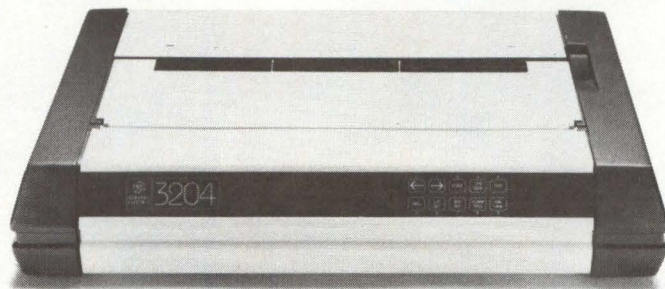

Speeds from 40 to over 400 cps. Accessible, easily programmable set up by either the operator or the system. Single or dual mode printing. Type quality from EDP to NLQ. Graphics. Multi-color printing. Selectable type fonts. 80 and 136 column models. Plus many more features and options to choose from.

All in a single printer series that's available in a wide selection of models to meet a diversity of needs...from main frames to mini's to micro-based personal computer systems.

Our basic concept is application driven price/performance matching. High parts commonality. Single source supply. Configuration and application flexibility.

At last, you can give your customers just what they need. With the GE 3000 series... printers that give you a choice.

General Electric. We introduced the first fully electronic printer with LSI circuitry in 1969. And our complete line today makes us the industry leader you should look to first.

## First In Electronic Printing.

For the solution to your printing needs, call  
**TOLL FREE 1-800-368-3182**

General Electric Company, Data Communication Products Department B311, Waynesboro, VA 22980. In Virginia, call 1-703-949-1170.

**GENERAL**  **ELECTRIC**

CIRCLE NO. 73 ON INQUIRY CARD

# Now you can build in seconds what used to take forever.

If you have been waiting to view your solid models, your waiting days (or even minutes) are over. Now there's SOLIDVIEW.™ A revolutionary, new display technology for viewing solid models that significantly increases system speed. And significantly decreases host overhead, software development time, and total system cost.

By processing tasks like hidden surface removal, visible surface shading, sectional views, contouring, and even piercing objects, SOLIDVIEW slashes image construction time from minutes to seconds. The host is then free to handle viewing transformations and clipping concurrently; system throughput is greatly improved.

What's more, SOLIDVIEW constructs images using polygons instead of pixels. These images are built piece by piece, instead of line by line. So you not only get more speed, but more information.

You can also do more with

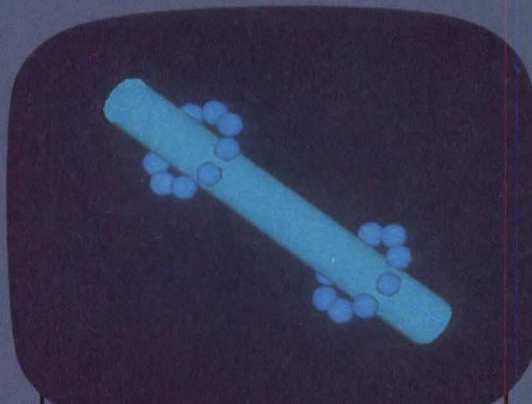

Construct images in less than four seconds.

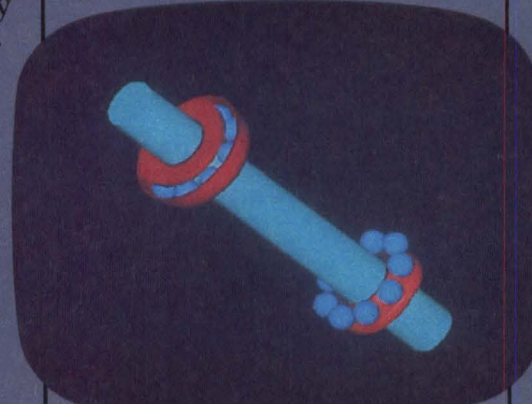

Then build incrementally. In seconds.

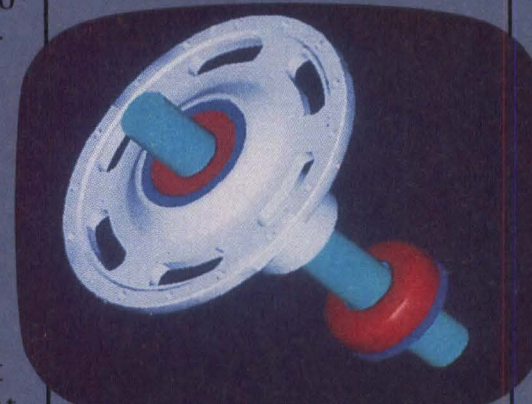

Create complex solids just as fast.



SOLIDVIEW by Lexidata.

SOLIDVIEW. You can add new parts without redrawing the entire screen. You can manipulate objects with a minimum of recalculating. You can make exploded or sectional views in seconds. You can even use translucent shading to see behind surfaces.

SOLIDVIEW is available in two models, with a wide array of features. Both offer you 12 × 24 color lookup table, 19" monitor, and the power required to view your images interactively for the first time. Options include pan/zoom, four overlays, hardware cursor, serial interface, and a selection of peripherals.

SOLIDVIEW from Lexidata. It's so fast, it will completely change the way you view your solid images. For fast and interactive response to all your questions, just call us at (617) 663-8550. Or write to us at 755 Middlesex Turnpike, Billerica, MA 01865. TWX 710-347-1574.

**LEXIDATA**

The clear choice in  
raster graphics.

## MINICOMPUTERS



# 32-bit minis press down from above

EFREM MALLACH, Contributing Editor

### *Superminis clash with micros and 'traditional' minis for price/performance dominance*

For more than five years, industry pundits have predicted the demise of the "traditional" 16-bit minicomputer, reasoning that it would be squeezed between increasingly sophisticated microcomputers from below and 32-bit minis from above. For this to happen, it was assumed that 32-biters would come down from their \$150,000+ heights. In recent months, they have been doing just that.

A "32-bit mini" is:

- a system intended, as indicated by its architecture, software and marketing emphasis, for on-line, interactive use. (This excludes mainframes.)
- a system in which the central processor is not based on a microprocessor chip or chip set.
- a system in which the dominant data lengths, buses, registers, etc. are 32 bits long.

There are probably about 20,000 systems shipped in 1983 that fit these criteria, with a market value in excess of \$2 billion. For people to spend this much on a product, it must have something to recommend it. The 32-bit superminis do. Their popularity is due to two factors: the perceived value of 32-bit capabilities is increasing, and the cost of providing these capabilities is decreasing.

#### **Value**

The value of a 32-bit system has been both pumped up and deflated over the past few years, mostly by people with an ax to grind, such as vendors of 32-bit systems and firms that don't have one. One way that 32-bit systems have an edge over 16-biters is in capability. A 32-bit system has a richer instruction set

than does a 16-bit system. It enables users to count higher, address more memory, index into larger arrays and specify a record in larger files. In short, it enables them to implement more sophisticated software. These statements aren't absolute. A user could string shorter data elements together and get the equivalent of a long one. But doing that can be awkward and isn't always practical. Using a longer word gives the user a head start.

Second, 32-bit systems have an edge in performance. For a given circuit technology, the more bits processed in one cycle, the fewer cycles an operation takes. This point is related to capability. If 32-bit data elements are common, 32-bit data paths and functional elements are useful. Designers tend to use 32-bit circuitry when there's a good deal of 32-bit software visibility, although the reverse is not necessarily true. Many firms have built low-cost, lower performance 16-bit hardware implementations of 32-bit instruction sets.



Honeywell Information Systems' DPS/6 32-bit models can be built up from 6-bit models in the field.

Going to 32 bits isn't the only way engineers can make a computer fast. They can use high-speed logic, pipelined instruction execution, cache memories and more. The decision on when to use 32 bits for performance is personal. A lot depends on what a design team is familiar with. That's why the performance of 16- and 32-bit systems overlaps. For instance, Hewlett-Packard Co.'s 16-bit 3000 Series 64, the top of that line, is much faster than Digital Equipment Corp.'s

## 32-BIT MINICOMPUTER COMPARISON CHART

Vendor	Canaan Computer	Data General Corp.	Digital Equipment Corp.
Product line	Fred	Eclipse MV	VAX-11
Line announced	5/83	4/80	10/77
Smallest model	Fred	MV/4000	VAX-11/730
Model announced	5/83	11/82	4/82
Packaging	24-in. cabinet	Rack or 40-in. cabinet	42-in. cabinet
Performance <sup>1</sup>	—	600(a), 0.6(c)	—
Main memory (M bytes)	1-4	1-8	1-5
Mass storage (M bytes)	40-160	15-4,700	20 up
Maximum workstations	1 (initially)	64	96
Software <sup>2</sup>	DP, WP, EM	All	All except TP
Networking	SNA, LAN	SNA, X.25, XODIAC	DECnet, X.25
Languages <sup>3</sup>	B, C, CB, F, L, P	APL, B, C, CB, F, L, P, RPG	B, Bliss-32, C, CB, Coral 66, F, L, MUMPS, P
16-bit compatibility	n/a <sup>5</sup>	Eclipse <sup>6</sup>	PDP-11 <sup>12</sup>
Purchase price <sup>4</sup>	\$55,000 <sup>11</sup>	\$92,700 <sup>9</sup>	\$98,825
Comments	Runs System/370 applications; includes 1024 x 1024 high-resolution graphics.	Broad range of software, peripherals available.	Information obtained from industry reference sources and not verified by vendor.
Vendor	Prime Computer Inc.	Pyramid Technology	Tandem Computers Inc.
Product line	50 Series	Pyramid	NonStop II
Line announced	1979	Summer 1983	3/81
Smallest model	2250	Pyramid	NonStop II
Model announced	8/82	Summer 1983	3/81
Packaging	30-in. cabinet	46-in. cabinet	Cabinet
Performance <sup>1</sup>	0.5(c)	—	—
Main memory (M bytes)	0.5-4	1-8	2-128
Mass storage (M bytes)	68-632	80-1,500	—
Maximum workstations	32	128	—
Software <sup>2</sup>	All	All	All but TS, DP
Networking	Primenet, X.25	SNA	SNA, EXPAND
Languages <sup>3</sup>	B, CB, F, L, P, RPG	C, F, P	CB, F, MUMPS
16-bit compatibility	n/a <sup>5</sup>	n/a <sup>5</sup>	NonStop
Purchase price <sup>4</sup>	\$84,160 <sup>13</sup>	TBD (over \$100,000)	n/a <sup>10</sup>
Comments	Designed for modern office environment; plugs into wall socket, does not require special air conditioning.	Designed for high-level scientific applications; features 32M-bytes-per-sec. bus, 528 programmable registers.	Systems provide high availability for on-line transaction processing.





The Wang VS 100 can be field-upgraded from the VS 90 and can be expanded further to 8M bytes of main memory.

32-bit VAX-11/730—the slowest and least expensive VAX-11. All other things being equal, though, the performance of most modern minis benefits from 32-bit hardware.

### Cost

At the same time that the value of longer words is rising, the cost of providing them is dropping. Electron-

*Going to 32 bits isn't the only way engineers can make a computer fast.*

ic logic, in the form of integrated circuits, costs less each year. This has a snowball effect on overall design costs. As more chips of a given type are produced, they become less expensive due to economies of scale in production and to the learning curve of experience. As denser chips with more capabilities become available, fewer chips are needed to implement a design. That reduction, in turn, affects printed-circuit-board area and the cost of power supplies, connectors, cooling, cabinetry and so on, further reducing the cost of a system.

This combined cost/value trend has dramatically changed the price/performance range and availability of 32-bit systems. The versions built during the 1970s sold for \$100,000 to \$150,000 for a CPU, 8192 words of memory and a console printer. DEC's VAX-11/780, announced in late 1977, provided more performance, eight times the memory, a disk drive and eight

Gould, Inc. (S.E.L.)	Harris Corp.	Honeywell Information Systems	Perkin-Elmer Corp.
Concept/32	Harris <sup>6</sup>	DPS 6/92-96	Series 3200
1/75	1975	12/80	2/79
32/27	H-700	DPS 6/92	3210
5/80	2/82	12/80	10/81
Rack or 63-in. cabinet	Rack or 72-in. cabinet	60-in. cabinet	30-in. cabinet
600(a)	0.65-0.85(c)	1200(a), 636(b)	1012(a)
0.25-16	0.384-12	1-4	0.5-4
32-675	80-6,000	67-2,048	32 up
64	128	64	32
TS, DB, WP, EM	All	All except DP	TS, TP, DB
—	SNA, X.25	DSA, SNA, X.25	PENnet
Ada, B, CB, F, P	B, C, CB, F, P	B, CB, F, P, RPG	C, F, P, Coral 66
n/a <sup>5</sup>	n/a <sup>5</sup>	DPS 6/30-76 <sup>8</sup>	Series 16 <sup>8</sup>
\$108,700	\$104,000 <sup>7</sup>	\$162,300	\$87,000
Family offers compatibility over performance range of 600 to 6600 Whetstones/sec.	The Harris line of 24/48-bit systems competes with 32-bit mini and superminicomputers.	Uses same CPU as DPS 6/94, 96; 16-bit DPS 6 models can be field-upgraded to 32-bit models.	

Wang Laboratories, Inc.
VS
1978
VS-90
1/82
30-in. cabinet
0.77(c)
1-4
as much as 2300
48
All but TS
Wangnet
B, CB, F
VS-25 through 80 <sup>8</sup>
\$122,500

### NOTES

- As supplied by vendor. (a) — single precision Whetstones (FORTRAN); (b) — U.S. Steel COBOL Productivity Index; (c) — millions of instructions per sec.
- TS — time sharing; TP — transaction processing; DP — demand paging; DB — database management; WP — word processing; EM — electronic mail.
- A — APL; B — BASIC; C — "C"; CB — COBOL; F — FORTRAN; L — PL/1; P — Pascal. Other names/acronyms are spelled out.
- Hardware purchase price for system with 2M-byte main memory, 80M-byte mass storage, 300-lpm printer, and 8 workstations. Major additions/exceptions to this configuration are noted.
- Vendor has no 16-bit product line with which to be compatible.
- These are 24/48-bit systems.
- With 1.5M-byte main memory.
- Instruction set of vendor's 16-bit line is subset of 32-bit line's native mode.
- Includes 1600-bpi tape drive.
- Not directly comparable as Tandem does not offer single-CPU systems.
- With one workstation.
- Via compatibility mode; some restrictions apply.
- Includes 158M bytes mass storage.

workstation ports for a comparable price. Today's entry point for useful configurations is around \$50,000. This decline is especially impressive when the fact that the CPU is only a small part of system cost is considered.

The drop means that 32-bit architectures are being built and bought to serve smaller applications than ever.

### Some specifics

During the past 18 months, six supermini vendors have extended their product lines downward. In the same period, not one has announced a new CPU at the

### WHERE ARE THE 32-BIT MICROCOMPUTERS?

The 32-bit microcomputers are coming, and coming fast. A variety of micros with some 32-bit characteristics is available. Many micro-based systems are aimed at the same markets as the 32-bit superminis. Because of the limits of micro power, all 32-bit micros can use multiple microprocessors to handle demanding jobs. Some examples include:

- Apollo Computer Inc.'s Domain system, which uses the Motorola 68000. Domain links powerful, individual workstations into a resource-sharing network. Using the Domain provides each of a group of engineers that would have to share a large VAX-11/780 with a dedicated, 68000-

based network node with its own high-resolution graphics display.

- Hewlett-Packard Co.'s 9000 series supermicro, which was announced in November, 1982. It uses proprietary NMOS III technology. HP's "engineering productivity network" approach to R&D applications is similar to Apollo's. In addition, HP can upgrade a 9000 with as many as three processors and can support a small design team on a single system.

- Stratus Computer Inc.'s and Synapse Corp.'s arrangements of multiple microcomputers, which provide high availability via immediate replacement of failed units. Their approaches feature modular expand-

ability, which involves the use of as many 68000s as a job requires, plus as many more for backup as an architecture needs. With 68000 chips selling for less than \$100 each (or a little more for the fastest versions), this approach is affordable.

- Intel Corp.'s iAPX-432 microprocessor, whose innovative, object-oriented architecture appeals to leading-edge technologists and computer scientists. Performance, however, is seen as somewhat slow. Multiprocessor capabilities were designed into the 432, and its successors will appear in commercially viable systems.

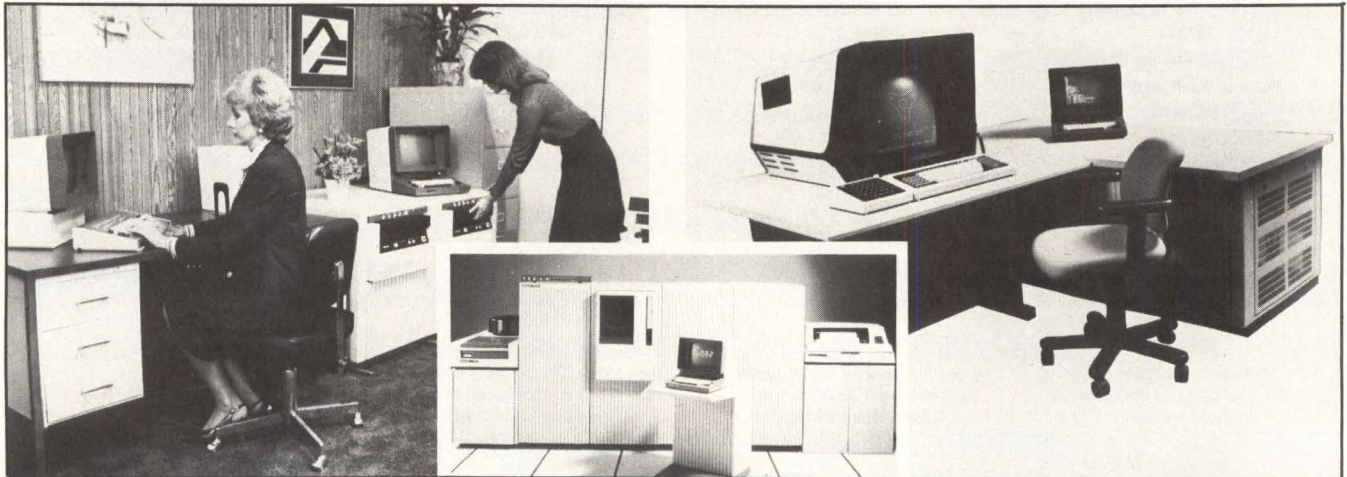

The Perkin-Elmer 3200 MPS (inset) was designed for high-speed real-time applications. Its smaller members include the 3210 commercial system (left) and a system for distributed CAD/CAM applications.

### IS 32 A MAGIC NUMBER?

Despite all the hoopla, there's nothing magic about the number 32. Honeywell Information Systems, Sperry Univac and Digital Equipment Corp. all market large-scale 36-bit systems. Harris Corp. has a 24-/48-bit line that does 32-bit applications, even though it doesn't have today's popular word length. And there's no reason why a system with data

elements of 29, 34 or any number of bits can't be built.

However, there is a reason why most superminis have settled on 32 bits. Today's systems generally process character data in the form of 8-bit bytes. So a word length that is a multiple of 8 bits makes sense. If the multiple is a power of 2, accessing individual bytes in the word is most

efficient. That's why virtually every new system uses data elements from the 8-/16-/32-/64-bit family. With today's microprocessor technology, the big capability jump comes in moving from 8 to 16 bits. With minis, it's in moving from 16 to 32. In either case, the value of the longer word length is significant for more and more applications.

# Computer OEMs: Now's the time to team with Altos.



As an OEM, you're aware there's a lot of 16-bit computers on the market. But what you may not be aware of are the many advantages to doing business with ALTOS® Computer Systems. Here's just a few:

- Altos currently offers the broadest range of cost-effective, single and multi-user 8086- and 68000-based computer systems.
- Altos supports the most popular commercial operating systems (XENIX™/UNIX,™ MP/M-86,™ MS™-DOS, OASIS-16, PICK, RM/COS,™ and UNIX System III™) plus most high-level languages.
- Altos microcomputers can run more existing applications software than any other computer in the world.
- Altos offers a large selection of utilities and compilers for converting existing Z80™ and mini-computer applications, such as those written in DEC's® DIBOL.™
- Altos provides full communications support; both local networking and remote communications.
- Altos provides the widest range of 5¼" and 8" storage options, including floppy, Winchester disk and mag tape backup.
- Since 1977, Altos has delivered more than 35,000 multi-user systems and peripherals to satisfied customers throughout the world.

- Altos backs its computers with responsive, world-wide service and support. (Customer Service Division of TRW, Inc. in the U.S.)

If you're an OEM looking to remain on top, now's the time to team with Altos. Call, write or clip the coupon today.

- Please send me more information on Altos' single and multi-user 8086- and 68000-based computer systems. MMS-4
- My application is \_\_\_\_\_
- Please have an Altos representative contact me.  
Name \_\_\_\_\_ Title \_\_\_\_\_  
Company \_\_\_\_\_  
Address \_\_\_\_\_  
City/State/Zip \_\_\_\_\_  
Phone (\_\_\_\_) \_\_\_\_\_

Mail to: Altos Computer Systems, Attn: Marketing Services, MMS-4  
2641 Orchard Park Way, San Jose, CA 95134, Telex 470642 ALTO UI  
**800-538-7872 (In Calif., 800-662-6265)**



Packed with more value for OEMs

ALTOS is a registered trademark of Altos Computer Systems. 8086 is a product of Intel Corporation. 68000 is a product of Motorola, Inc. Z80 is a trademark and product of Zilog, Inc. XENIX and MS are trademarks of Microsoft Corporation. XENIX is a microcomputer implementation of the UNIX operating system. UNIX is a trademark of Bell Laboratories. RM/COS is a trademark of Ryan-McFarland, Inc. MP/M-86 is a trademark of Digital Research, Inc. OASIS-16 is a product of Phase One Systems, Inc. PICK is a product of Pick & Associates and Pick Computer Works. DEC is a registered trademark and DIBOL is a trademark of Digital Equipment Corporation. UNIX System III is a trademark of Western Electric.

©1983 Altos Computer Systems

MINI-MICRO SYSTEMS/April 1983

CIRCLE NO. 75 ON INQUIRY CARD

137

top of its supermini line. (Such high-end models as the DEC VAX-11/782 and Prime Computer Inc.'s 850 are essentially multiprocessors based on existing CPUs.) Among the new products are:

- the Wang Laboratories Inc. VS-90, which is an excellent example of how to take advantage of an existing design. By removing the cache memory from the VS-100 and making other changes, Wang got a processor at a lower cost/performance point without a full-scale design project, with the ability to be field-upgraded to the VS-100 itself.

*The value of a 32-bit system has been both pumped up and deflated over the past few years, mostly by people with an ax to grind.*

- the Data General Corp. Eclipse MV/4000, which is, on the other hand, a new design. It was needed because the larger MV/6000 is based on the high-end MV/8000 design, which couldn't effectively be reduced further. The MV/4000 is a potent performer for its price.

- the DEC VAX-11/730, a new design developed for a reason different from DG: with DEC's larger production volumes, the savings of a design optimized for each performance point outweigh the engineering investment.

- the Canaan Computer FRED, which appears to be the first full-scale supermini designed specifically for one user; support for additional workstations will follow, however. Its scientific orientation shows in its standard high-resolution graphics display. At an entry price of less than \$50,000, it should be able to compete

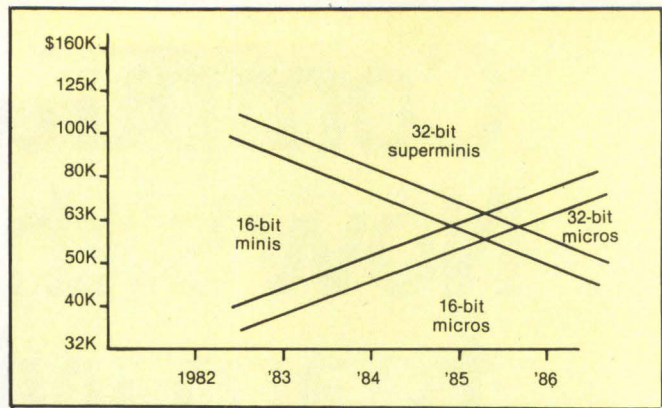

**Price ranges are dominated by architecture-technology pairs.** The 32-bit minis' prices will decrease for another two or three years, and then be pushed back up by the relentless advance of the supermicro.

effectively with microprocessor-based systems such as those from Apollo Computer Inc. FRED and a new system from Pyramid Technology prove that microcomputers aren't needed to start a computer company this year.

### Where next?

How low can 32-bit minis go in price and performance? Although there's no lower technological limit, there is an economic one: how low is it cost-effective to go? You don't need 32-bit capability to do single-user word processing. Trend lines and their causes provide a clue to the answer. Today's 32-bit superminis dominate the system price range from about \$90,000 (until mainframes take over), a figure that is dropping by about 15 percent annually. At the same time, microprocessors dominate the range from about \$40,000 and less, and this limit is rising. Traditional 16-bit minis are in the middle.

Because the lines are approaching each other, it is expected that the price range dominated by 32-bit minis will continue to extend downward only for another two or three years. At that time, their lower limit will be around \$50,000 to \$60,000. Below that, microcomputers

## WHERE IT ALL STARTED

The philosophical ancestors of today's superminis started to appear in the late 1960s. They were 32-bit systems, with clean, simple architectures, and were fast for their day. The first two were the Honeywell Information Systems' 632 and S.E.L.'s System 86. Interdata Corp. got into the act in 1974 with its 732.

The Honeywell 632 (not related to Honeywell's current DPS 6 line) was used primarily as a high-performance front-end processor in applications such as airline reservation networks. A virtual-memory version, the 832, was delivered to the National Aeronautics and Space Administration's

Electronics Research Center. The center had very sophisticated real-time software under development in 1970. The series was dropped following a merger of Honeywell's and General Electric Co.'s computer operations, before the 832 was announced commercially.

The S.E.L. System 86 and its virtual-memory cousin, the 88, were extremely fast machines for 1970. Most instructions executed in one or two 600-nsec. memory cycles. They were used in demanding applications such as pilot training simulators. S.E.L., now a division of Gould, is in the same markets today, and claims

to offer the highest raw speed of any supermini.

The Interdata 732 was a hybrid—a 32-bit architecture implemented with 16-bit hardware. It was quickly followed by the 832, which was much faster because it used 32-bit-wide hardware internally. Interdata became part of Perkin-Elmer Corp. in the late 1970s and no longer uses the Interdata name. Like S.E.L. (Gould), demanding, high-performance, real-time jobs have been P-E's major market, but the company has recently addressed commercial transaction processing as well.

# Here's Why Precision Visuals Is Now The Leader In Graphics Software Tools!

## One Program Drives Many Devices

This single advantage can save you hundreds of hours of programming time. It enables you to use your hardware (both host computer and graphics devices) to its fullest. It protects your software investment against obsolescence and frees you from exclusive ties to hardware vendors.

Precision Visuals currently offers tailored interfaces for over 30 graphics devices from these companies: AED  Applicon  Calcomp  Calcomp lookalikes  Chromatics  DEC  Digital Engineering  HP  Houston Instruments  IBM  Imlac  III  KMW  Megatek  Printronix  Ramtek  Raster Technologies  Sanders  Selanar  Servogor  Tektronix  Tektronix lookalikes  TI  Trilog  Versatec  Visual Technology  Zeta.

## They Run On Most Popular Computers

Including IBM, VAX, PRIME, Hewlett-Packard, CDC, Honeywell, Data General, DEC 10/20, Harris, Univac, Cray, and DEC PDP-11.

Precision Visuals software tools require a surprisingly small amount of computer resources. Even on smaller machines they provide access to the full capabilities of the CORE graphics standard.

*"At Martin Marietta, DI-3000 serves as a common interface between our numerous graphics devices and software applications. We use DI-3000 for applications including structural analysis, business charts, graphs, animation, 3D modeling, and general-purpose graphics."*

Karin Bruce  
Senior Graphics Software Engineer  
Martin Marietta Denver Aerospace

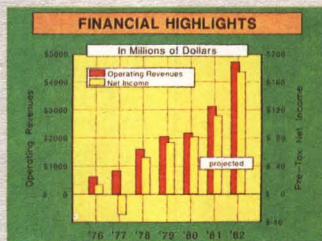

Make better decisions, faster, using GRAFMAKER's specially-placed annotation and color.

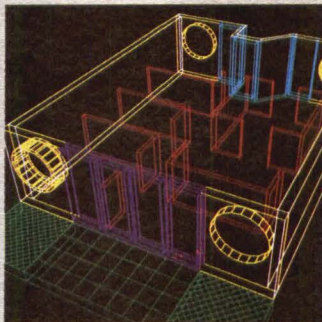

Build highly interactive computer-aided design applications with the DI-3000 core system.

## Rich Capabilities Mean Limitless Applications

Precision Visuals software tools are proven in applications such as computer-aided design, business graphics, process control, mapping, geological data analysis, document layout, plus many specialized applications. System integrators (OEMs) use them as the graphics nucleus in turnkey systems and as the graphics component of database management and financial modeling systems.

## \$12,000 For Our Most Popular System

DI-3000™, the core system, starts at \$8,000 and goes to \$12,000 for our most powerful and best-selling level. Add \$6,000 for GRAFMAKER™, the business presentation specialty system, and you'll have one of the most versatile graphics systems available at any price. Other popular options include the METAFILE SYSTEM for a device-independent

picture library, and our new CONTOURING SYSTEM for advanced surface graphics.

These are single-CPU, end-user, U.S. list prices. Multiple CPU and OEM discounts are also available.

Find out how Precision Visuals graphics software tools can open a new world of flexibility, economy, and standardization for your graphics applications. Call us at 303/530-9000.



**Precision Visuals**

6260 Lookout Road  
Boulder, Colorado 80301 USA  
303/530-9000  
TELEX 45-0364/TWX 910-940-2500

Amsterdam: Ponder Associates  
Phone 030445352 / TELEX 70634  
Sydney: Techway  
Phone 02920858 / TELEX 27987  
Tokyo: Nichimen Company Ltd.  
Phone 032775017 / TELEX 22329  
Zurich: Computer Graphix AG  
Phone 019323482 / TELEX 875447

CIRCLE NO. 76 ON INQUIRY CARD



Vendor Addresses

**Canaan Computer**  
13 Riverside Ave.  
Westport, Conn. 06880  
CIRCLE NO. 854

**Data General Corp.**  
4400 Computer Dr.  
Westboro, Mass. 01580  
CIRCLE NO. 855

**Digital Equipment Corp.**  
146 Main St.  
Maynard, Mass. 01754  
CIRCLE NO. 856

**Gould Inc.**  
S.E.L. Computer Systems Div.  
6901 W. Sunrise Blvd.  
P.O. Box 9418  
Ft. Lauderdale, Fla. 33310  
CIRCLE NO. 857

**Harris Corp.**  
2101 W. Cypress Creek Rd.  
Ft. Lauderdale, Fla. 33065  
CIRCLE NO. 858

**Honeywell Information Systems**  
200 Smith St.  
Waltham, Mass. 02154  
CIRCLE NO. 859

**Perkin-Elmer Corp.**  
2 Crescent Place  
Oceanport, N. J. 07757  
CIRCLE NO. 860

**Prime Computer, Inc.**  
Prime Park  
Natick, Mass. 01760  
CIRCLE NO. 861

**Pyramid Technology**  
2471 East Bay Shore Rd.  
Palo Alto, Calif. 94303  
CIRCLE NO. 862

**Tandem Computers Inc.**  
19333 Vallico Parkway  
Cupertino, Calif. 95014  
CIRCLE NO. 863

**Wang Laboratories, Inc.**  
1 Industrial Ave.  
Lowell, Mass. 01851  
CIRCLE NO. 864

will have taken over. The 16-bit mini will have been virtually eliminated as a factor, except when compatibility with earlier systems remains a major consideration. After that, the lower cost-effectiveness limit of the 32-bit mini will rise again, forced up by the increasing power of the supermicro.

*As more chips of a given type are produced, they become less expensive due to economies of scale in production and to the learning curve of experience.*

This doesn't necessarily mean that today's product lines will disappear. Many minicomputer lines from the mid-1970s are now largely microcomputer based: DEC's PDP-11, DG's Nova, HP's series 1000 and others. The same will happen with the 32-biters. A microprocessor version of DEC's VAX-11 has been widely discussed in the press, and others are sure to follow.

Upward extensions aren't dead either. The recent activity has been downward, but that is not permanent. High-end extensions of several supermini lines will move more and more into "mainframe territory." As this happens, 64-bit hardware can't be far behind, ensuring the minicomputer designers of continued work for many years. □

# Control at a touch.



New from Carroll, an advanced touch input system for the DEC VT100. Ideal for inventory control, process control, dispatching, data collection, training and other uses. No need for keyboarding or special computer skills. For information, contact the leader in touch technology.



## Carroll Touch Technology

2902 Farber Drive, Champaign, IL 61821  
217/351-1700 TWX 910 245-0149

Keeping computers in touch with people

© 1982 Carroll Touch Technology, Inc.

CIRCLE NO. 77 ON INQUIRY CARD

With the COMPLØT® Series 7000 Digitizers

## You get user configuration controls not ordinarily found in competitive digitizers



Prices start at \$2,950\*

*the Houston way*

Only the Series 7000 digitizers give you 40 user selectable or host computer controlled features for the ultimate in tailoring these microprocessor-based digitizers for specific applications.

- Variable digitizing rates up to 160 coordinate pairs per second in 8 selections.
- Resolutions of .001", .005" or .01".
- Incremental mode with 64 step sizes from 0.005" to 0.315".
- Manual or host computer control.
- Single point data averaging.
- Fixed or relocatable origin.
- English or metric dimensioned positions.
- Built-in annunciator on/off.
- Parity on/off.
- 8 Bit Parallel/BCD or Binary.
- Dual port RS-232-C.

These are a representative few of the multitude of combinations available. But the Series 7000 story isn't over yet. Consider four sizes from which to choose with active areas of 12"x12", 17"x24", 36"x48" and 42"x60" PLUS a complete border for user definable menus — no need for a separate extra-cost menu pad.

All COMPLØT Series 7000 digitizers are translucent for backlighting. And while the 12-button cursor is standard, single-button cursor, inking/non-inking stylus or magnifying cursors are available. You also get the Houston Instrument commitment to accuracy,  $\pm 0.005$ " right to the edge of the active area. And no demagnetizing (biasing) is ever necessary.

CIRCLE NO. 78 ON INQUIRY CARD

Wouldn't you like to finish the COMPLØT story? Get complete information on the COMPLØT Series 7000's scores of user configuration controls.

For the name, address and phone number of your nearest representative, write Houston Instrument, 8500 Cameron Road, Austin, Texas 78753. Phone 512-835-0900, or 1-800-531-5205 if outside Texas. In Europe contact Bausch & Lomb Belgium NV., Rochesterlaan 6, 8240 Gistel, Belgium. Tel 059-27-74-45. Tlx 846-81399.

**BAUSCH & LOMB**   
houston instrument division

\* Registered Trademark of Houston Instrument.  
\* U.S. Domestic Price only.  
FCC class B tested.

4N009A

**Who  
hella  
Pixel**

CIRCLE NO. 79 ON INQUIRY CARD



# It's the

**The world's best supermicro that's now 27% cheaper and 30% faster.**

**That's what.**

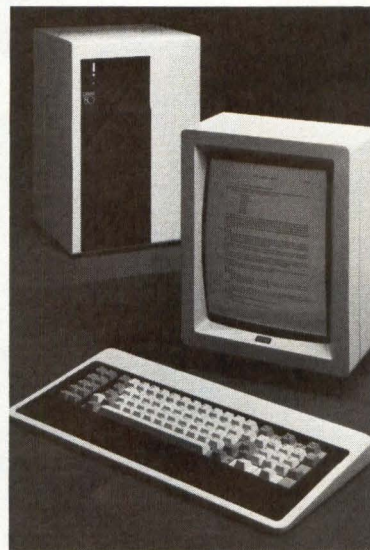

# is

# 80?™

Until today, if you wanted to buy the world's best supermicro, you bought Pixel's 100/AP™.

Now you can go one better with Pixel 80, a 68010-based supermicro with price-performance no one else can touch.

Pixel 80 has a virtual memory version of UNIX™ System III with Berkeley enhancements. And, it upgrades to 16 terminals, 6Mb RAM, and 720Mb of 5.25 inch Winchester storage in the same box with the same power supply.

You get unheard of freedom of choice in software, too. Like MicroINGRES™, Sequitur™, Mistress™ and Unify™. Not to mention MBDS III, SMC IDOL, SuperComp Twenty™, several word processing packages and a very wide range of high-level programming languages (10 at last count).

If you're an OEM/Systems Integrator, you can't afford to miss out on the virtual memory supermicro that's in a price/performance class all its own. Pixel 80. More information is yours for the asking.

Pixel 80 and Pixel 100/AP are trademarks of Instrumentation Laboratory, Inc. UNIX is a trademark and a service mark of Bell Laboratories. MicroINGRES is a trademark of Relational Technology, Inc. UNIFY is a trademark of North American Technology, Inc. MBDS III is a trademark of Micro Data Base Systems, Inc. Sequitur is a trademark of Pacific Software Manufacturing Company. Mistress is a trademark of Rhodnius Incorporated. SuperComp Twenty is a trademark of Access Technology, Inc.

- I'm asking. Send complete info on the remarkable Pixel 80 ASAP.
- Send the results of your latest comparative benchmark tests.

Name \_\_\_\_\_ Title \_\_\_\_\_

Company \_\_\_\_\_

Address \_\_\_\_\_

City \_\_\_\_\_ State \_\_\_\_\_ Zip \_\_\_\_\_

Telephone number \_\_\_\_\_

MM

## Pixel

One Burt Road, Andover, MA 01810

**CALL 617-470-1790**

**SEE US AT COMDEX, BOOTH #930**

# MICROFAZER THE "ANY COMPUTER ANY PRINTER" BUFFER™

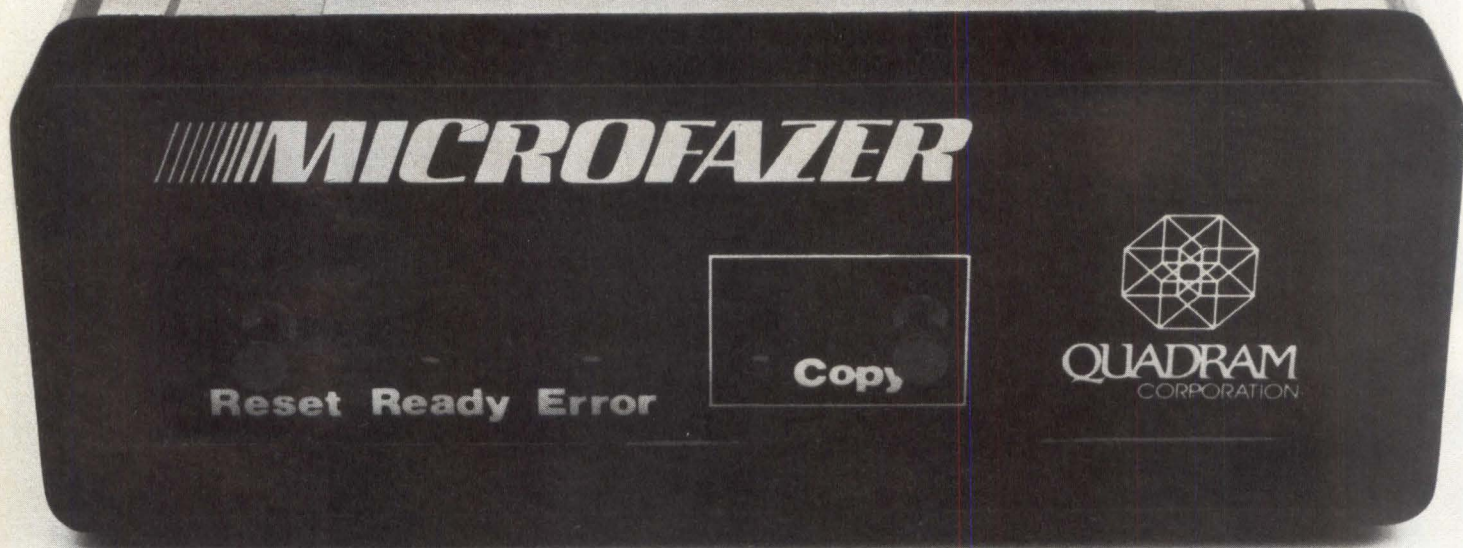

**Time is money.** You have a computer system because you know that it saves you money by simplifying procedures and reducing time normally involved in your work. Time is an important resource which should not be wasted. You are wasting valuable time if you ever wait for your printer.

**No waiting.** Now with Microfazer by Quadram there is no more waiting.

Microfazers are inexpensive universal printer buffers which any computer user cannot afford to be without. Any computer—any printer (or plotter!), whether parallel or serial. Microfazer receives information from the computer at ultra high speeds causing the computer to think the printer is printing just as fast as the computer can send. Microfazer holds the information until your printer can handle it, and then sends it on.



**More copies.** Microfazer is equipped with a copy feature allowing additional copies of the buffered information—from one to as many as you want—with the mere press of a button. When you

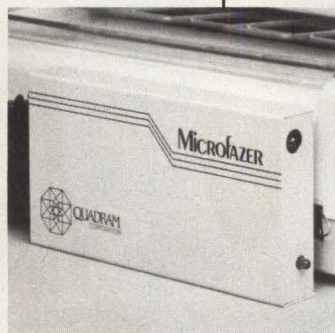

need your information repeated, for whatever reason, it's always right there—inside Microfazer.

**Microfazer™ stack.** Microfazer can be stacked with popular modems or other peripherals. Some models can plug directly onto the back of your printer. Install it in less than 60 seconds, and choose the amount of buffer

memory you need— 8K, 16K, 32K, or 64K. One model even comes with up to 512K! You may use several Microfazers in series to create just what's right for you. Take data in from a serial computer and out to a parallel printer. Or in from a parallel computer and out to a serial printer. Microfazer is just as flexible as you need it to be.

**Low price.** Only \$169 for 8K of buffering, \$189 (16K), \$225 (32K) and \$299 for a full 64K. Serial-to-Parallel, Parallel-to-Serial and Serial-to-Serial models have slightly higher prices.

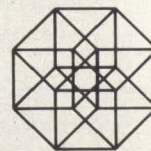

**QUADRAM**  
CORPORATION

4357 Park Drive / Norcross, Ga. 30093  
(404) 923-6666

## MINICOMPUTERS

# The 16-bit mini holds on

DAVID H. FREEDMAN, Associate Editor

*Despite the micro challenge, the aging 16-bit mini still packs an OEM punch*

Although the 16-bit minicomputer has lost much of the glamour it achieved in the late '60s, it is still a workhorse in many OEM and system integrator product lines. There are no immediate signs that this situation is changing, as the 16-bit mini industry continues to churn out a range of machines boasting features that could hold the supermicro at bay for a few more years.

### The industry

The 16-bit minicomputer industry hasn't changed a great deal in the past few years. Vendors offer the same product lines as they have in the past, give or take a few machines. Compared to the progress of the microcomputer and superminicomputer industries, the 16-bit mini industry seems to be moving backward. But many OEMs argue that there is no sense in changing something that works, and, despite its age, the 16-bit mini still works quite well.

The list of major 16-bit OEM mini vendors has for

years and in some cases, decades included Digital Equipment Corp., Data General Corp., Honeywell Information Systems and Hewlett-Packard Co. Each of these manufacturers offer broad, established 16-bit product lines that emphasize flexibility in configuring hardware and software and the ability to be upgraded. Customers of most of these vendors can follow upgrade paths that start with single-user desk-top computers and continue up through 32-bit systems supporting hundreds of users. Other 16-bit OEM system vendors include IBM Corp., whose value-added remarketing program accounts for 20 percent of all Series/1 sales, and Datapoint Corp., offering a desk-top mini and a more powerful mid-range processor.

System vendors are not restricted to selling systems. Most offer minicomputers as boxes or even boards, competing against box-level products such as Computer Automation Inc.'s Naked Mini and Bytronix Corp.'s DG Nova-compatible series. Minicomputers from these

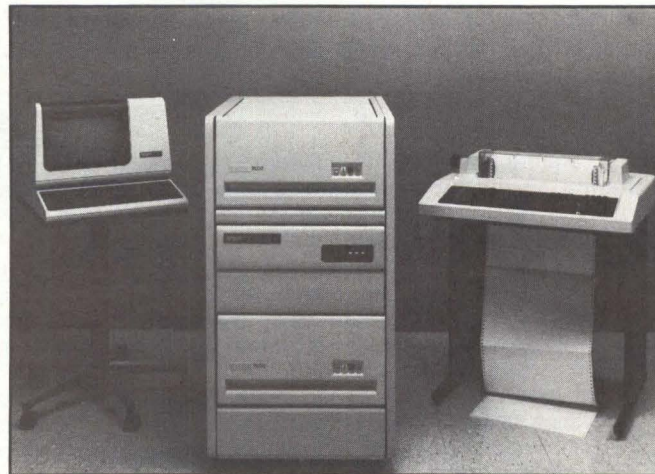

DEC PDP 11 minicomputers are available in board-, box- or system-level packaging. Shown are a PDP 11/24 (left) and a PDP 11/23 Plus system.

smaller companies generally boast architectures that are easily adapted to a variety of hardware and software modifications, and are often available only in stripped-down versions without such basics as disk controllers and operating systems. The bare-bones nature of these products is reflected in prices that start at less than \$1000. Such inexpensive boxes give a system integrator willing to develop software and configure peripherals a chance to undercut system manufacturers.



**Datapoint 8600** is a desk-top 16-bit minicomputer supporting as much as 256K bytes of memory. It can be used as a stand-alone machine or as a node in an ARC network.

Some manufacturers optimize their minicomputers for certain applications. Thus, HP's 1000 series offers its best price/performance profile in engineering applications that take advantage of its fast vector-processing capabilities, while Honeywell's DPS 6 machines are particularly effective in business applications calling for fast COBOL program execution. System integrators developing database-management systems for vertical markets often find box-level minicomputers provide sufficient performance at a low price. A number of vendors include industrial control in the markets at

which their 16-bit minis are aimed, and a few, such as Analog Devices Inc., design their products specifically for this application. But because machines installed in smaller companies—major users of 16-bit minicomputers—must often perform a variety of functions, most mini vendors have avoided overly narrowing their products' capabilities.

### Features

The 16-bit minicomputers range from desk-top units supporting a few megabytes of disk storage to large floor-standing units supporting gigabytes. In addition to such differences, these machines offer a range of characteristics and features that could affect an OEM's decision to choose a product.

Minicomputers vary more widely in processor characteristics than microcomputers (see "What is a mini?" below). Overall processor performance is an elusive quantity dependent on many variables, including application, but some features can provide a rough indication of the processor's ability to manipulate data. Processor cycle time, for example, measures how long the machine takes to perform a single stage of one instruction. This time ranges from less than 200 nsec. to more than 800 nsec. for most 16-bit minis, but short cycle times can be diluted by complex instruction sets and long memory cycle times.

The nature of an instruction set determines a processor's relative ability to perform processing. Machines with large instruction sets, such as the IBM Series/1, with more than 160 instructions, are generally well-suited for commercial or general-purpose applications, while smaller instruction sets are more effective for the simple, repetitive processing demands of engineering and control applications. This effectiveness is greatly increased by floating-point instructions, able to handle numbers as separate mantissas and exponents. Such instructions are standard with the HP 1000 model A9000, and are available as options with many other 16-bit machines. Instruction-set flexibility is improved through the use of microcoding, with which individual instructions are broken into microinstructions stored in ROM. Updating or modifying an instruction set then requires only swapping ROMs. Pipelined

### WHAT IS A MINI?

There are few problems in differentiating 16-bit minicomputers from mainframes, but distinguishing them from 16-bit microcomputers is another story.

Most 16-bit minis are based on processors that incorporate bit-slice technology, in which 2- or 4-bit-wide chips are stacked to yield full 16-bit-wide data paths. Other, older machines use proprietary integrated circuits. In either case, such machines are different from microcomputers based on single-chip processors. But

dealing with 16-bit minis in which proprietary ICs have been incorporated onto a few chips becomes ambiguous. This is the case with the Digital Equipment Corp. LSI 11 minicomputer. Such machines can be considered either microcomputers or minicomputers. Indeed, many manufacturers switch back and forth in labeling their own products, and the offer of "minicomputer power for microcomputer price" serves both microcomputer and minicomputer

vendors equally well.

As supermicro vendors incorporate more powerful chips into parallel architectures, and mini vendors place PDP 11/24-sized processors on a single chip, the difference between small minicomputers and large microcomputers will fade. Many people find the entire issue irrelevant. "The question is not one of architecture, but of capability," says Jim McCabe, product marketing manager at Hewlett-Packard Co.

When was the last time you felt like doing this?



Call CPX instead for all supplies and subassemblies. Everything you need to keep your DEC-compatible disk drives up and running is available from CPX. Whether your drives are brand new, or discontinued, we provide all sizes of disk packs and cartridges (made by CDC and 3M), all C.E. alignment packs and cartridges, absolute filters, and new disk heads.

In addition, CPX is renowned for locating hard-to-find and discontinued parts for all types of drives. We stock parts and subassemblies for almost every disk drive manufactured in America since 1961. And we offer repair on all of those same subassemblies.

CPX provides the same services to non-DEC-compatible peripherals, as well. You know you can rely on CPX to keep your system running.

CIRCLE NO. 81 ON INQUIRY CARD

CORPORATE OFFICE: 19821 Nordhoff Street • Northridge • CA 91324 • Phone (213) 341-3783 • Telex 18-1537  
NORTHEASTERN REGION: 3001 Hadley Road • Building 5B • South Plainfield • NJ 07080 • Phone (201) 756-8040  
SOUTHWESTERN REGION: 5250 Gulfton • Building 4 • Suite G • Houston • TX 77081 • Phone (713) 661-3424



# If you're in the market for communications modules, make the ABLE connection now. And join the thousands who already have.

We are known as the innovators. Most of our products are industry "firsts" which become popular quickly, then settle into a stage of steady long-term acceptance. These four DEC-compatible, communications devices fit the pattern perfectly. They are ABLE originals. They achieved instant success worldwide. They provide top performance. And they are very reliable. Read on to find the one for you.

## INCREASED VAX THROUGHPUT.

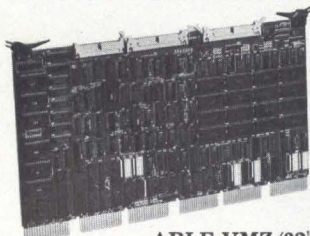

ABLE VMZ/32\*  
16-line DMF/32 subset

Here's an asynchronous microcontroller with programmable DMA, fully transparent to VAX/VMS as two 8-line DMF 32's and contained on a single board. Priced

below the DZ11-E, it outperforms DZ or DH devices under VMS v.3, has interrupt-driven modem control on every line, and includes an output throttle which lets peripheral devices optimize their own data rate.

## #1 UNIBUS DMA.

Then there's our DH/DM, the original multiplexer which puts 16 lines with modem control on a single board. This popular device meets UNIX VAX system needs for DMA communications requirements, serves UNIBUS systems equally well, and beats them all for MTBF, throughput and

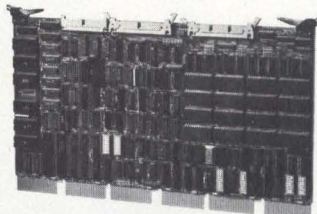

ABLE DH/DM\*  
16-line combination DH11  
& DM11 replacement

price. Other features include on-board diagnostics, modem control on all lines, superior on-board silo depth and variable prom-set. **SYNC/ASYNCH FLEXIBILITY.**

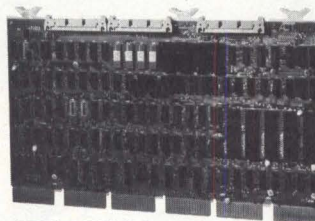

ABLE DV/16  
16-line DV11 replacement

A controller for the PDP-11 user, the DV/16 contributes microprocessor-derived flexibility, which permits mixing of sync and async lines in combinations

of 4 or 8 lines with modem control and full system software compatibility. It takes less than half the space of a DV11 and uses word transfer instead of byte DMA to gain a 2 to 1 speed advantage or permit operation in half the bandwidth required for data transfers.

## Q-BUS DMA.

The Q/DH is an asynchronous controller which makes DH-class performance possible on PDP-11/23 and LSI-11/23 Q-BUS systems. It connects the standard Q-BUS to as many as 16 async lines with DMA output capabilities and allows optimum Q-BUS utilization. Features include software compatibility with RSTS/E and RSX operating systems, large input silo, modem control on all lines.

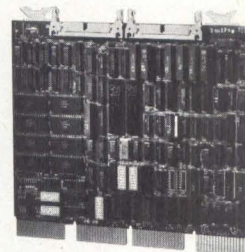

ABLE Q/DH\*  
8 or 16-line DH/DM  
for Q-BUS

Write for details on our complete line of DEC-compatible products. Be on the lookout for exciting new ABLE communications products soon to come.

**For Immediate, Toll-Free Information, Dial 800 332 ABLE.**



**CORPORATE OFFICES**  
ABLE COMPUTER  
1732 Reynolds Avenue  
Irvine, CA 92714 • (714) 979-7030

**NATIONAL OFFICES**  
Burlington, MA (617) 272-1330  
Rumson, NJ (201) 842-2009

**INTERNATIONAL OFFICES**  
Canada (Toronto) (416) 270-8086  
England (Newbury) (0635) 32125  
W. Germany (Munich) 089/463080

DEC, PDP, UNIBUS, Q-BUS, LSI, VAX and VMS are trademarks of Digital Equipment Corporation.  
Come see us at NCC—Anaheim and Dexpo East '83 in May

**CIRCLE NO. 82 ON INQUIRY CARD**

## MINICOMPUTERS

microcodes, such as that in the Datapoint 8800, speed execution by concurrently finding, fetching and executing microinstructions. User-programmable microcodes implemented in RAM allow modifying machines such as the HP 1000 model A700 without changing ROMs.

Other processor features that can improve performance include multiple hardware interrupt levels for fast response to high-priority data such as power-fail warnings and an ample set of registers to reduce memory operations. A number of minis, such as the NPL Series S from Evolution Computer Systems Corp., incorporate microprocessors to off-load I/O chores from the CPU.

Memory capacities vary greatly from machine to machine. Smaller processors typically provide only 128K-byte capacities, as do the IBM Series/1 and most of the Computer Automation Naked Minis, or 256K bytes in the case of the PDP-11/23 and 34A and the Datapoint

8600. Many minis increase memory capacity to several megabytes through memory mapping, by which memory addresses can specify areas of memory rather than just words. The DEC PDP-11/23 Plus and 44 processors use extended address word sizes of 22 bits to support as much as 1M byte of memory, while virtual-memory schemes allow machines such as the HP 1000 series to address 12M bytes or more of disk storage as memory by swapping segments in and out of main memory.

Memory access times can be an important factor in processor performance, ranging from 50-nsec. times obtainable with static RAMs to 1000 nsec. and more with slower dynamic RAMs. Some minis improve performance with memory pre-fetching, or locating a word in memory while the previous word is being read, while the DG Eclipse S/140 has an interleaved memory with a dual bus, allowing overlapping operations in different areas of memory. Cache memories can also shorten access times. These smaller (typically 2K to 8K bytes), faster memories retain the most frequently used data from main memory. The processor checks the cache first when looking for a word; in most schemes, the word is there more than 90 percent of the time. Other useful memory features found on many 16-bit minis include memory protection and segmentation. Memory protection prevents unauthorized users from reading and writing or just writing in specified areas of memory, while segmentation allows allocating areas of memory to users.

Communications capabilities of 16-bit minis range from a handful of asynchronous serial lines to an

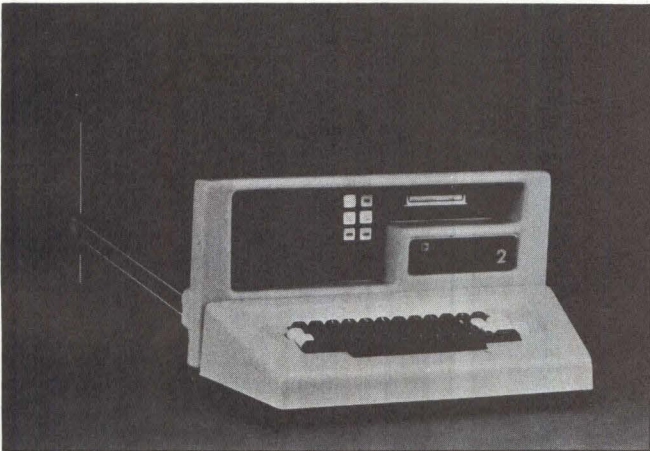

Analog Devices Macsym 2 is designed for industrial or laboratory control applications.



Hewlett-Packard 1000 model A700 is one of the more powerful 16-bit minicomputers with features such as user-microprogramming, 4M bytes of main memory and 12.6M bytes of virtual memory. Its high speed and vector instruction set make it well-suited for engineering applications.



Data General Eclipse S/20 (left) and S/140 use compatible instruction sets and operating systems, allowing users and system integrators to upgrade without changing software. The S/140 is about 40 percent more powerful than the S/20.

extensive selection of protocols. The Honeywell DPS 6 machines support remote job entry, batch, SDLC/HDLC, SNA, synchronous, binary synchronous and RS232C communications, while HP and Datapoint minicomputers can be configured in proprietary network schemes. Most larger 16-bit machines support direct-memory-access channels, providing disk-to-memory data-transfer rates of 2M bytes per sec. or higher.

Most machines are available with operator panels or consoles from which diagnostics can be run, and many execute self-test routines at power-on. A number provide for virtual consoles, allowing configuring a terminal as a temporary control console for diagnostics. Computer Automation's Naked Minis facilitate fault isolation with board lights that indicate failing modules. Disk crashes can be avoided and data loss can be minimized through power-fail sensing features avail-

able on many minis that shut down the computer in a noncatastrophic fashion when line voltage drops below a specified value.

Operating systems are less easily evaluated than hardware, but most of those available with popular 16-bit minis have been fine-tuned through years of use. An OEM with a box-level mini can generally obtain a basic operating system from the vendor or an independent software house, or develop its own. System-level 16-bit minis, on the other hand, are usually purchased with the system manufacturer's operating system. Vendors such as DEC and DG offer a variety of multi-user, multitasking operating systems for real-time, interactive and time-sharing applications. Many such operating systems extend across product lines; Honeywell's GCOS 6 runs on all the DPS 6 processors from the entry-level 6/30 to the 32-bit 6/96.

**16-bit mini versus microcomputer**

Rumors of the death of the 16-bit minicomputer are premature by several years. Sales of 16-bit minis still comprise a significant, if shrinking, share of the

**THE 16-BIT MINI MARKET**

The market for 16-bit minicomputers will continue healthy, although perhaps not as healthy as the 32-bit mini market, according to a study by International Data Corp., Framingham, Mass. The study divides minicomputers into three categories: "micromini," typified by Digital Equip-

ment Corp.'s board-level LSI 11, "traditional," exemplified by the DEC PDP-11 series through the 11/40 and including most 16-bit minicomputers, and "supermini," which includes machines such as the DEC VAX 11/780 as well as powerful 16-bit machines such as the PDP 11/70.

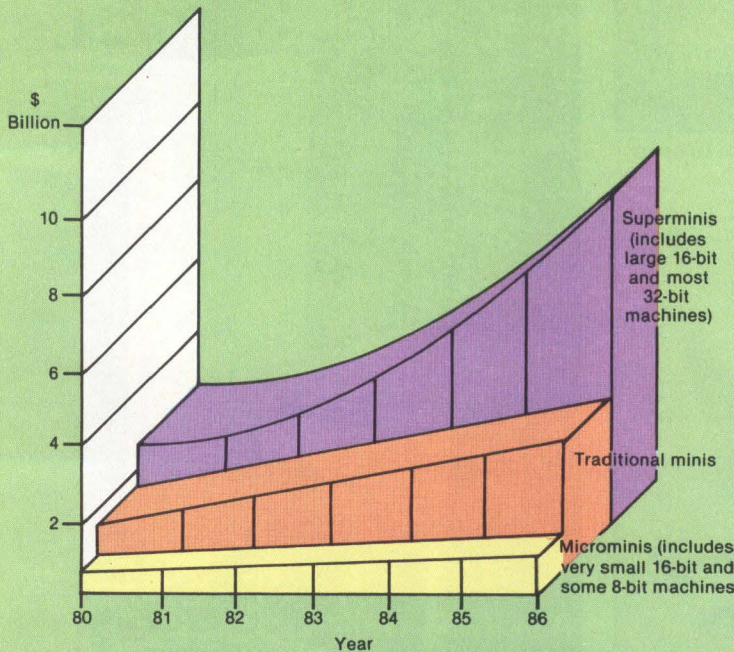

Source: International Data Corp.

The growth of the minicomputer market will be strongest for superminis, but the traditional mini market will more than double to almost \$4 billion by 1986.

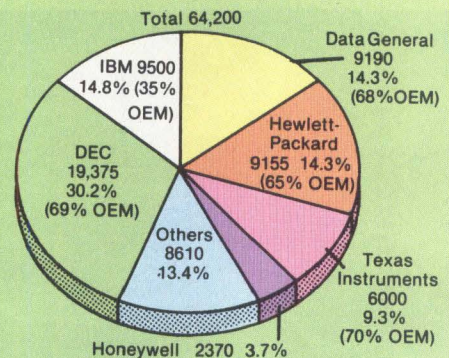

Worldwide traditional minicomputer shipments are dominated by a handful of system vendors, most of which do more than half their shipments through OEMs. The OEM percentages given above refer to shipments of all types of minicomputers.

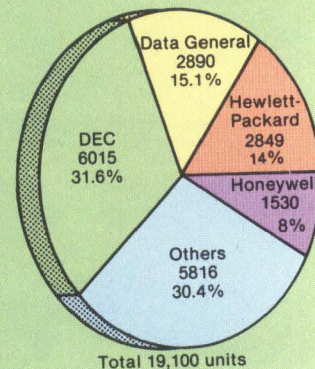

Shipments of 16-bit superminis are led by most of the same vendors, reflecting their broad 16-bit product lines.



# Emulex solves the age-old problem of communicating with a DEC computer.

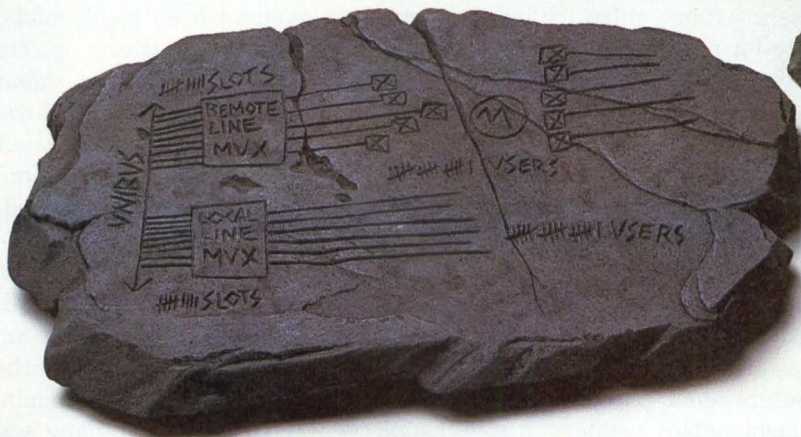

## The Stone-Age Way.

One line per remote terminal. Slow, noisy voice-grade lines, open-ended costs. Port-consuming, slot-consuming controllers for both local and remote terminals. Expensive custom software.

## The Middle-Ages Way.

Enter remote concentration. Lines and modems reduced. Cleaner, higher baud-rate lines. Re-transmission solves error-rate problem. Local and remote terminals still handled separately. Multiple controllers still required.

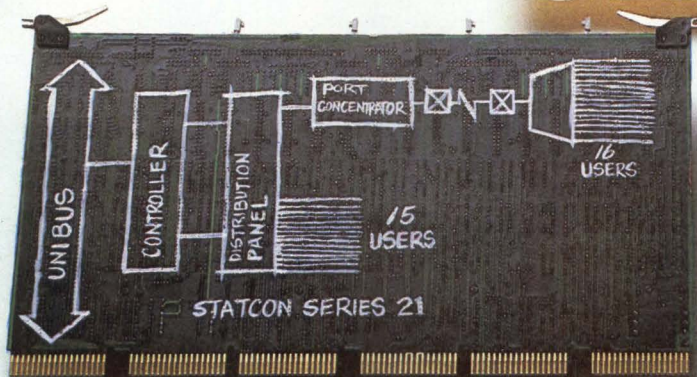
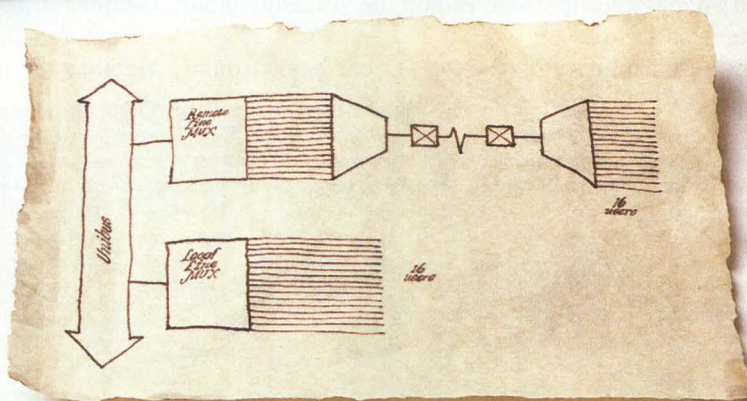

## The Emulex Way.

Introducing *statistical concentration*. Remote concentrated lines are handled by a simple, low-cost port concentrator. All data is funneled on one cable into a single MUX port. All those unused ports now freed to work local terminals.

Emulex announces two complete, software-transparent packaged solutions: STATCON Series 11 and 21.

Now you can connect up to 64 remote *and* local terminals through just one single-slot communications controller. No expansion chassis. No extra power supplies. No upgrade to a new computer needed. DH11 and DZ11 emulations available.

Proprietary controller firmware handles all the details. You're backed by proven Emulex quality, reliability and support.

Communicate with Emulex today. Phone toll-free: (800) 854-7112. In Calif: (714) 662-5600. Or write: Emulex Corporation, 3545 Harbor Blvd., P.O. Box 6725, Costa Mesa, CA 92626.

DEC and UNIBUS are registered Trademarks of Digital Equipment Corp.

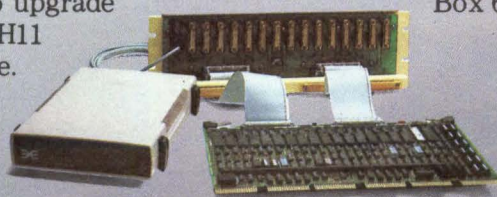

The genuine alternative.

CIRCLE NO. 83 ON INQUIRY CARD

computer market (see "The 16-bit mini market," p. 149) and major manufacturers continue to profess a strong commitment to their 16-bit mini lines. The 16-bit mini industry, however, faces a major challenge in the coming years from increasingly powerful microcomputers.

Microcomputers from vendors such as Charles River Data Systems and Plexus Computers Inc. that are based on the 68000 processor chip rival low-end minicomputers in performance at prices that are lower by as much as 40 percent. In addition, many of these systems are or soon will be available with popular industry-standard operating systems such as UNIX or Pick. By comparison, many 16-bit minicomputers seem outdated, nonglamorous and reliant on unfashionable proprietary software.

But the 16-bit mini's age (the PDP-11 has been around

some 15 years) is one of its greatest strengths. The hardware has had years to build a reputation of reliability, while software libraries have been expanded and refined by thousands of OEMs and system integrators. Many OEMs are not anxious to abandon the software investments they have made in 16-bit minis, and thus will slow any industry trend to micros, points out International Resource Development president Ken Bosomworth. "The 16-bit minis have a loyal customer base, not out of emotional attachment, but out of business sense," Bosomworth says. In addition, many users feel more comfortable with established, familiar products.

Minicomputers are also popular for the quality of the support available from well-established vendors. Microcomputer vendors have not yet earned a reputation for high-quality service, while price competition in the micro arena makes it difficult for vendors to match mini vendors in such supplemental services as training and documentation. Some OEMs even worry about the viability of microcomputer vendors. "A lot of these

### Representative 16-bit OEM minicomputers

The following table lists vendor-supplied data on a number of 16-bit OEM minicomputers. Machines based on single-chip processors have been excluded, as have minicomputers based on other manufacturers' processors and those not intended for the OEM market. The basic configuration price is for OEM single units for a processor with 128K bytes of memory, an operating system and minimum disk storage, without terminals or other peripherals and software, except as noted.

Company	Model	Year introduced	Minimum/maximum memory (K bytes)	Maximum number of concurrent users	Minimum/maximum disk (M bytes)	Applications
Analog Devices Inc.	Macsym 2	1978	128	1	0.32	Industrial and laboratory automation
BBN Computer	C60, 70	1980	256/2048	64	62/1200	General purpose
BTI Computer Systems	5000	1978	64/64	32	10/468	General purpose
Bytronic Corp.	500, 550, 600, 1000, 4000, 5000	1978	64/512	32+	0/4 x 96	Business
Data General Corp.	NOVA 4/C, X	1978	32/256	5	5/588	General purpose
	Eclipse S/120	1982	128/512	16	5/588	General purpose
	Eclipse S/130, 140	1977, 1979	16/2000		0.315/277	General purpose
	S/250, 280	1979, 1983	64/2000	NS	0.315/277	General purpose
Digital Equipment Corp.	Micro/PDP-11	1981	256/1000	4	10/50+	General purpose
	PDP-11/23, 23 plus, 23 S, 24, 34A	1980	64/4000	14	0/100	General purpose
	PDP-11/44	1980	256/1000	32	0/121+	General purpose

\*Processor with 128K bytes of memory, operating system and minimum disk storage NS = not specified

guys keep reading about the upcoming shakeout in the microcomputer industry," says International Data Corp. consultant Aaron Goldberg, "and OEMs expect some of their systems to last 30 years."

One of the major advantages of 16-bit minicomputers over microcomputers is minis' ability to be upgraded. Users of DEC, DG and Honeywell machines can often stay with the same software from a low-end, \$20,000, 16-bit system to a high-end supermini, with many upgrades requiring only the addition of a board. The microcomputer user who outgrows his machine, on the other hand, could be forced to break in a new set of hardware and software. Janpieter Scheerter, marketing manager of technical products at DG, says that the ability to be upgraded is particularly important to system integrators implementing new products. It allows the system integrator to increase or decrease power without abandoning development efforts.

Time is probably on the side of the microcomputer. Microcomputer vendors are quickly moving to establish reputations for reliability and support, expand soft-

ware offerings and provide for potential growth paths through operating systems such as UNIX. In addition, new chips will boost microcomputer performance to the 32-bit mini range. Minicomputer vendors, however, say they will not sit still and relinquish the 16-bit mini territories. "The microcomputer industry is moving fast," says Jim McCabe, product marketing manager for HP's 1000 series minicomputers, "but we have a head start." McCabe claims that mini vendors will be able to retain a performance edge over microcomputers while keeping prices competitive by incorporating new processor architectures onto a few chips: "There's no reason in the world why we can't take advantage of microcomputer technology," he says.

The pressure to keep 16-bit mini prices competitive will come as much from the lowering of 32-bit mini prices as from the increase in microcomputer performance. But whether they retain a separate niche in direct competition with microcomputers or evolve into proprietary chip-based microcomputers, 16-bit minis are likely to remain viable for years. □

Operating systems	Languages	Basic configuration price*	Typical configuration and price
	Mac BASIC	\$17,710	320K-byte printer, 16 digital inputs, 10 digital outputs, 4 analog outputs, 32-channel analog input: \$20,500
UNIX	C, FORTRAN 77, CBASIC-16, CDIBOL, COBOL Level II	C/60 with 256K-byte memory	C/70 with 1M-byte memory, 16 terminals, 160M-byte disk, magnetic tape, BBN-UNIX: \$83,050
proprietary	BASIC-X	\$29,950 with 64K-byte memory	CPU, 27M-byte disk, 3 terminals; \$41,650
IRIS, BITS, BLIS/COBOL (not from manufacturer)	Business BASIC	\$3600	Model 600 with 128K bytes of memory, 4-channel multiplexer, disk controller: \$5000
MP/OS, RDOS, RTOS	FORTRAN, BASIC, Pascal, Assembly	\$7947 (model 4/C with 64K-byte memory)	Nova 4X, terminal, 15M-byte disk, RDOS: \$18,364
RDOS, MP/AOS, AOS, RTOS	FORTRAN, BASIC, Pascal, Assembly	\$12,375	15M-byte disk, terminal, MP/AOS: \$16,470
AOS, RDOS, MP/AOS	FORTRAN IV/V/77, PL/1, Business BASIC, Extended BASIC, DG/L COBOL, Pascal, MP/BASIC	\$23,836 (S/140)	S/130, 25M-byte disk, 128K-byte memory, terminal, cabinet, language, RDOS: \$41,800
AOS, RDOS, MP/AOS	FORTRAN IV/V/77, PL/1, BASIC, DG/L COBOL, SP/Pascal, MP/Pascal, Extended BASIC, MP/BASIC	\$44,385 (S/250)	S/280, 1M-byte memory, 50M-byte disk, streaming tape, floating-point processor: \$56,500
RT-11, RSX-11M+, RSX-11M, Micropower/Pascal, CTS-300, DSM-11	BASIC, FORTRAN, COBOL, Pascal, MACRO-11	\$10,000	11/23 Plus CPU, 10M-byte Winchester 800K-byte floppy disk, VT100, 256K-byte main memory: \$12,000
RT-11, RSX-11M, RSX-11M+ Micropower/Pascal	BASIC, FORTRAN, COBOL, Pascal, MACRO-11	\$15,000 (11/23)	11/23 CPU, LA38 terminal/printer, 128K-byte memory, RSX-11M operating system, 2 10M-byte disks: \$20,900
RT-11, RSX-11M+, RSTS/E, Micropower/Pascal	BASIC, FORTRAN, COBOL, MACRO-11, Pascal	\$50,000	11/44 CPU, 512K-byte main memory, LA120 terminal, dual TN58 tape-cassette drives, 10M-byte disk, floating point processor, RSX-11M operating system: \$56,300

Company	Model	Year introduced	Minimum/maximum memory (K bytes)	Maximum number of concurrent users	Minimum/maximum disk (M bytes)	Applications
Hewlett-Packard Co.	HP 1000 S, G	1982	128/2048	NS	0.27/528	General purpose
	HP 1000 Model 17, 19	1982	128/6144	NS	16.1/528	General purpose, scientific, engineering
	HP 1000 60, 65	1983	256/2048	NS	16.1/528	General purpose, scientific, engineering
Honeywell Information Systems Inc.	DPS 6/30 series	1980	128/1024	24	13/1024	Business, office automation
	DPS 6/48, 54, 74, 76	1980	256/1024	64	67/1024	Business, office automation
	DPS 6/92, 96	1980	1024/1638	128	67/3072	Business, office automation
IBM Corp.	Series/1	1976	16/512	64	9.3/1024	General purpose
Texas Instruments Inc.	600 Series	1982	256/2048	16	10/127	General purpose
	800 Series	1982	512/2048	40	43/476	General purpose

### THE TOP 10 OEM MINICOMPUTER VENDORS

The health of an industry can often be gauged by the health of its leaders. In the case of the OEM minicomputer industry, such an examination should not be restricted to 16-bit machines.

The 10 companies listed below led the industry in 1981 revenues from the sale of all types of minicomputers and related supplies and services to OEMs. The OEM minicomputer revenue and shipment figures, supplied by International Data Corp., include sales to system houses and internal sales, but do not include distributor or high-volume end-user sales.

A comparison of 1981 and 1982 total revenues and earnings provides a rough indication of how these companies are faring in adverse economic conditions. The picture is somewhat mixed: there are many heavy gainers and losers, leading to an average increase in earnings among the top 10 companies of 2.7 percent.

Company	1981 minicomputer revenues* (\$ millions)			Total '81 minicomputer revenues	1981 minicomputer unit shipments		
	OEM	OEM %	End user		OEM	OEM %	End user
DEC	1336	40	2004	3340	50425	69	22655
HP	592	48	641	1233	7803	65	4201
DG	420	55	344	764	13348	68	6282
TI	257	64	145	402	7637	70	3273
Honeywell Information Systems	161	32	342	503	1640	41	2360
P-E	128	57	97	225	1193	65	642
IBM	89	25	267	356	3325	35	6175
Gould S.E.L.	74	61	48	122	420	60	280
Tandem	58	24	185	243	420	30	981
Computer Automation	43	60	29	72	3523	83	722

Source: International Data Corp. (minicomputer data). Total revenues and earnings are from annual reports.

\*Minicomputer revenues are for calendar year '81, and thus may exceed total company revenues for fiscal year '81. These revenues include those from minicomputer-related peripherals, service and software.

\*\*1982 figures are preliminary.

\*\*\*Includes revenues from all continuing Gould operations.

Operating systems	Languages	Basic configuration price	Typical configuration and price
-------------------	-----------	---------------------------	---------------------------------

RTE-A1, RTE-XL	FORTRAN 77, Pascal, BASIC, Macro assembler	\$9980	Model G with graphics terminal, 2D and 3D software, FORTRAN 77 compiler, 4.6M-byte Winchester disk, 270K-byte microfloppy disk: \$27,020
RTE-A1	FORTRAN 77, Pascal, BASIC, Macro assembler	\$32,990 (model 17 with 256K-byte memory, floating-point processor)	Model 19 with 3M-byte memory, color graphics terminal, 132.1M-byte disk, 400-lpm line printer, 2-pen plotter, FORTRAN 77 database-management system, 2D and 3D software: \$103,130
RTE-6/VM, RTE-6/RM	FORTRAN 77, Pascal, BASIC, C, Macro assembler	\$38,500 (model 60 with 256K-byte memory)	Model 65 with 2M-byte memory, black-and-white terminal, color graphics terminal, 132.1M-byte disk, 1600-bpi magnetic tape, 400-lpm printer, 8-pen plotter, FORTRAN 77, Pascal, Image data-base-management system, 2D and 3D graphics software: \$115,575
Mod 400	COBOL, BASIC, FORTRAN, RPG II	\$26,000 (model 6/32 with communications control, 26M-byte disk)	Model 6/31: 256K-byte memory, 13M-byte disk with 6.5M-byte cartridge, CRT, 100-cps printer, Mod 400 operating system: \$25,571
Mod 400	COBOL, BASIC, FORTRAN, RPG II	\$52,381 (model 6/48 with 256K-byte memory, communications control)	Model 6/74 with 1M-byte memory, 3 80M-byte cartridge disks, 16 CRTs, 600-lpm printer, Mod 400 operating system: \$162,001
Mod 400	COBOL, BASIC, FORTRAN, RPG II	\$149,881 (model 6/96 with 512K-byte memory, peripheral communication control)	Model 6/96 with 4M-byte memory, 2 256M-byte disks, 48 CRTs, 900-lpm printer, Mod 400 operating system: \$322,046
RPS, EDX, CPS	FORTRAN, COBOL, BASIC, EDL, Pascal, Assembler	\$13,123 (model 4952 CPU, quantity 50)	286K-byte 4954 CPU, 1.2M-byte diskette, 29M-byte disk, 2 communications adapters, 6 terminals, 2 printers, rack: \$31,293 (quantity 50)
DX10, DNOS	COBOL, BASIC, FORTRAN, Pascal, RPG II	\$20,200 with 256K-byte memory	Model S672 with 256K-byte memory, 43M-byte disk, 1 terminal, dual controller: \$30,950
DX10, DNOS	COBOL, BASIC, FORTRAN, Pascal, RPG II	\$46,650 with 512K-byte memory	Model S884 with 512K-byte memory, 476M-byte disk, 2 terminals, dual controller: \$86,000

Total company revenues (\$ millions)		Total company earnings (\$ millions)		% change in earnings	Period, ending
'81	'82	'81	'82		
3198	3881	343	417	+22	Fy, June
3578	4254	305	383	+26	Fy, October
737	806	51	25	-51	Fy, September
1039	1048	27	37	+36	9 mos., September
1774	1685	158	80	-49	12 mos., December
1116	1037	83	63	-24	Fy, July
29070	34364	3308	4409	+33	12 mos., December**
1562	1643	87	91	+3	12 mos., December***
208	312	27	30	+13	Fy, September
76	68	1.7	2.0	+18	12 mos., December

# 32-Bit Computer Breaks \$10K!

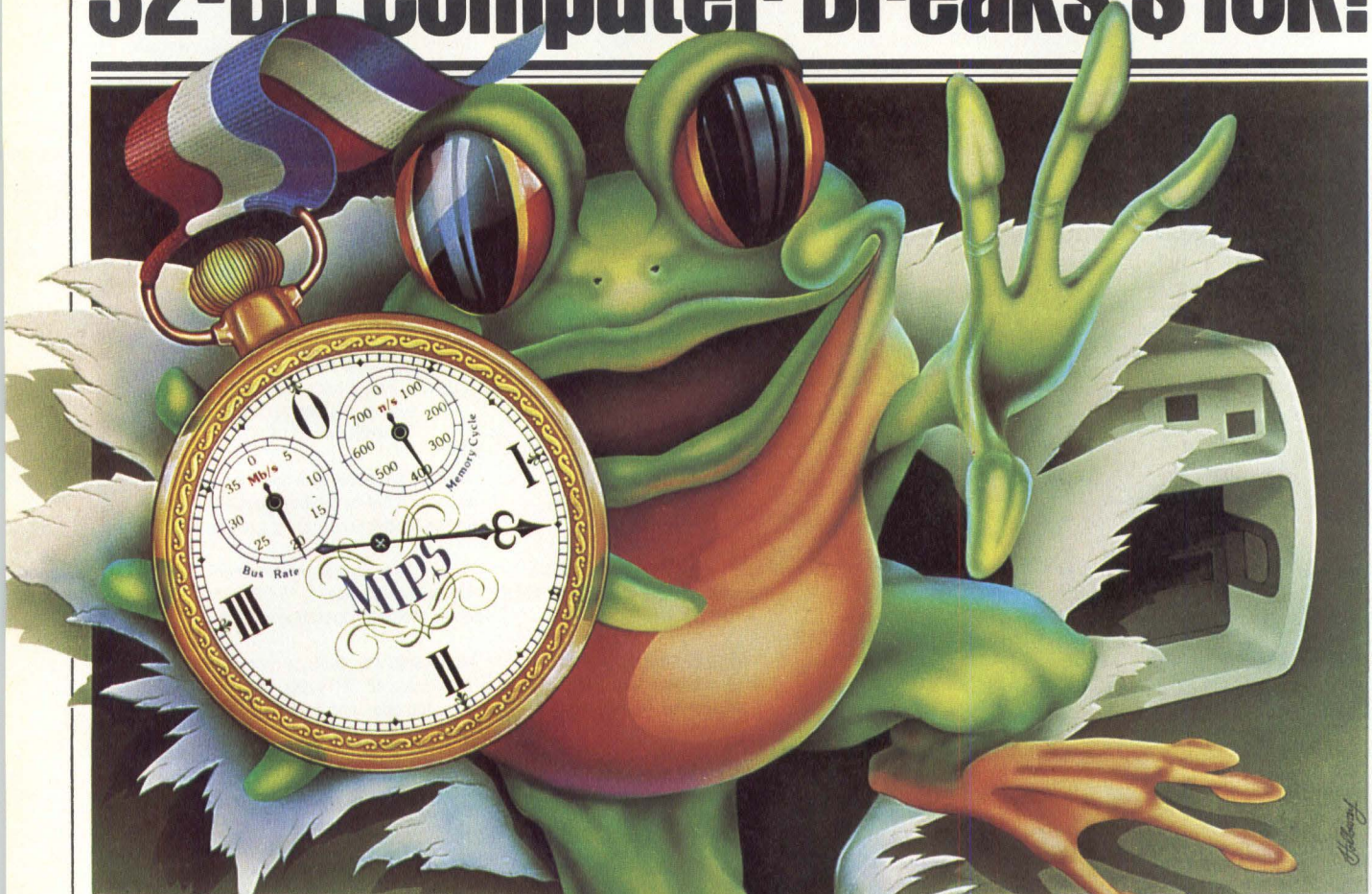

## Universe 68/05 First to Smash Price Barrier

The new Universe 68/05 is the first true 32-bit computer priced under \$10,000 (OEM quantity one). "True" because, unlike other 68000-based systems, the Universe 68/05 handles 32 bits in parallel on its VERSAbus.

## Outperforms VAX\*

Its price is even more impressive when you look at Universe 68/05

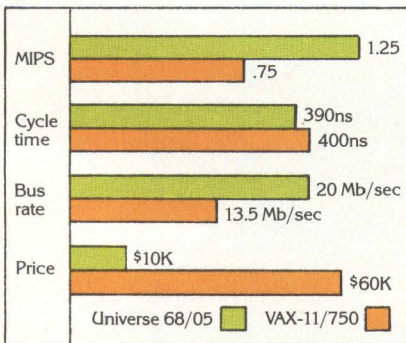

performance versus that of 32-bit "superminis" several times more expensive, like the VAX-11/750.

## High-Speed 68000, 4Kb Cache, 32-Bit Bus

The key to that performance is a 4Kb cache that eliminates processor wait-states and takes full advantage of a 12.5MHz 68000 processor. Also included are a separate 68000 I/O processor, four serial I/O ports (expandable to 64), 256Kb RAM (expandable to 3Mb), 20Mb/sec, 32-bit VERSAbus, 10Mb Winchester, 1.25Mb floppy disk, and 5-slot card cage. All in a 7-inch enclosure.

## UNIX-Compatible Real-Time OS, Too

UNOS\*, our UNIX\* Rev7-compatible operating system with real-time features, runs Pascal, Fortran, C, BASIC, DBMS, and third party application programs.

For more information, just attach your business card to this ad and mail to Charles River Data Systems, 4 Tech Circle, Natick, MA 01760. Or call us at (617) 655-1800. We'll send you a copy of "The Insider's Guide to the Universe," a detailed discussion of the technical concepts behind this remarkable new computer.

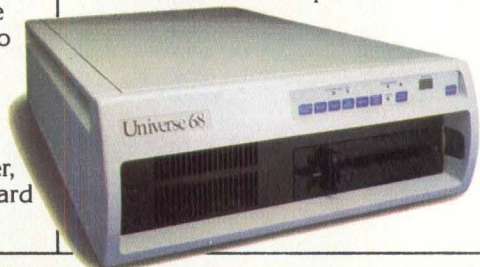

# CHARLES RIVER DATA SYSTEMS

\*VAX is a trademark of Digital Equipment Corporation. UNIX is a trademark of Bell Laboratories. UNOS is a trademark of Charles River Data Systems.

## SUPERMICROS

# 'MegaFrame' aims at mainframe performance

JONATHAN HUIE, RICHARD LOWENTHAL and STEVEN BLANK, Convergent Technologies Inc.

*System based on Motorola MC68000 family and Intel 186 processors allows field upgrades to 128 users*

The distinctions between microcomputers and mini-computers have become blurred almost to the point of disappearance. Now Convergent Technologies Inc. hopes to extend that blurring to mainframes with its "MegaFrame" system.

The MegaFrame is based on Motorola Inc.'s MC68000 family processors and Intel Corp.'s 186 processors, and it sells for less than \$20,000 in a basic eight-user configuration. It can be upgraded in the field to accommodate 128 users without software modification. Its architecture allows both Convergent Technologies' CTOS proprietary operating system and a virtual-memory version of UNIX to share resources, letting users run applications at workstations or terminals without knowing which operating system is in use.

Convergent attempts to transcend the limitations of shared-logic machines through the use of multiple parallel processors.

### Limitations of shared logic

Shared-logic architecture has dominated computer system design for 30 years. A drawback of this architecture is its inability to grow as users are added. New users draw against a single CPU with finite computing power. System growth thus has been constrained by three architectural bottlenecks: terminal and communications I/O, disk and file bandwidth and—most important—finite application-processing power.

Mainframe vendors recognized the first system bottleneck was terminal I/O. Terminals interrupting a CPU one character at a time drastically slowed the system. A partial solution was provided by dedicating a

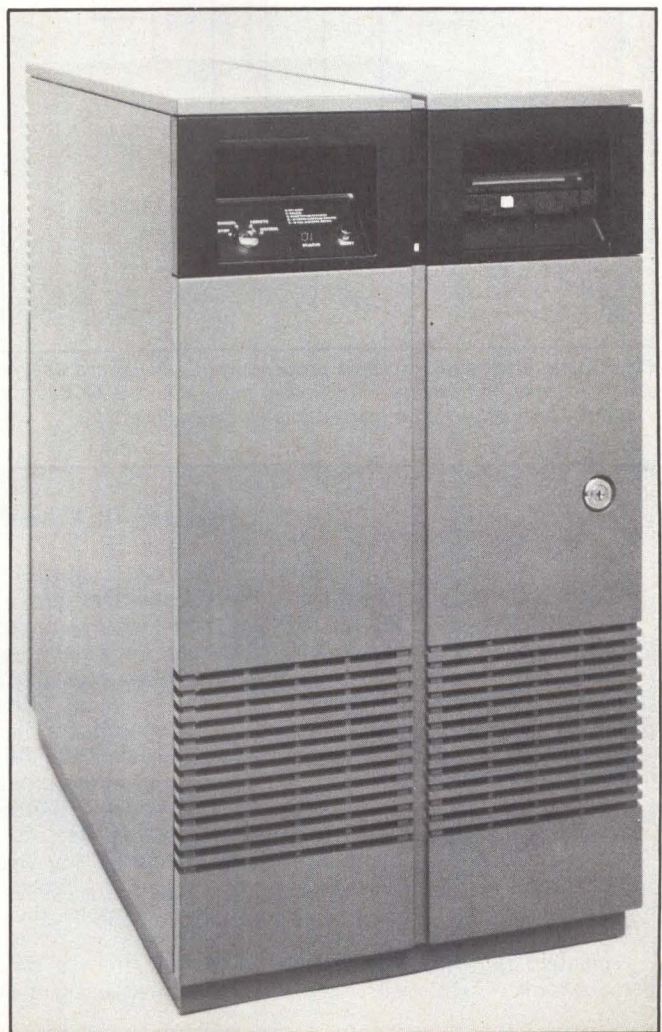

front-end processor to off-load communications overhead from the main CPU.

The second bottleneck, file I/O, involves file access, which requires that the CPU spend time handling the disk and file system rather than executing main code. Dedicating back-end processors to off-load the file-processing overhead from the main CPU helps.

Finally, many large-scale minicomputers and mainframes are limited to a fixed amount of processing power in a single CPU executing the application code, in turn limiting the amount of application processing available to a user.

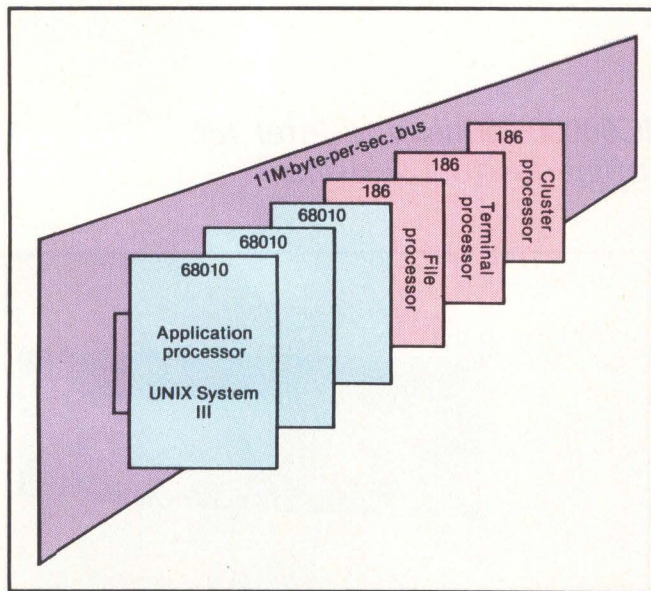

Fig. 1. One enclosure, multiple processors. Convergent's design allows multiple processors—in this case, three Motorola MC68010s and three Intel 186s—to be housed in a single enclosure.

Improving on shared logic

The MegaFrame reflects Convergent's belief that dependence on a single CPU is an inherent weakness of all shared-logic computers from IBM Corp.'s 3083 to the new supermicros. The MegaFrame uses multiple concurrent VLSI processors to permit expansion of file, communications and application processing power. As many as 36 independent processing units, each containing a CPU and memory and most having I/O interfaces, are linked by a high-speed, 32-bit-wide asynchronous bus (Fig. 1). The bus can be extended across multiple enclosures, each with a six-slot backplane to a maximum of six enclosures or 36 slots (Fig. 2). Each enclosure supports as much as 200M bytes of integral mass storage.

The MegaFrame's hardware and software is entirely modular, designed to provide OEMs with multiple entry points and upgrade paths. The systems support a mix of dumb terminals and Convergent workstations and high-speed intelligent terminals.

The key to this flexibility is the 11M-byte-per-sec. asynchronous backplane that lets all the system's processors operate in parallel and permits hardware and software to be bundled as subsystems. The processor boards can communicate without using the interrupt structure of conventional single-processor systems. The hardware provides a "doorbell" interrupt, enabling one processor to pass requests to another, separate hardware mailboxes for local and system bus memory access and dual- and triple-ported shared memory. Each processor board gains the attention of another as if it were accessing memory rather than interrupting an external processor. Bus traffic between CPUs consists of request and response blocks to and from processor boards and DMA transfers to and from the disks.

Processing elements operate in parallel

The MegaFrame consists of three main processing elements: the file, the application and the cluster

HOW DEMAND PAGING WORKS

Demand paging is a memory-swapping process based on the concept that only those program segments required for execution at a given time need reside in main memory. The set of segments, or pages, that resides in main memory for any process is called the process working set.

As a process executes, it may need to reference a page that is not in main memory. When this happens, a page fault occurs, and the operating system must bring the required page from the disk into memory, removing an unneeded page from main memory to make room. The MegaFrame's virtual

address space—that is, the total space available in main memory and on those segments of the disk that can be paged into main memory—is 4M bytes per processor.

On some virtual systems, each process has a maximum working set size, limiting the total number of pages of the process that can reside in physical memory at once. Such systems use "paging against the process," in which the least-used pages of a process are discarded to make room for new pages. The MegaFrame avoids taking pages away from a process' resident set, instead using a system-wide paging

technique called "paging against the system." When a page fault occurs, the system scans all its processes, not just the one executing, to find a page to discard.

The MegaFrame uses the Berkeley UNIX demand-page virtual-memory system integrated into UNIX System III. Under this system, pages allocated to a program can be thought of as arranged in a circle. When a page fault occurs, a pointer advances around the circle, selecting for replacement the first page that has not been referenced during a given number of memory accesses.



We planned our family  
of color terminals and printers  
to work the way you use them.



Together.

You're looking at the new Envision family of color terminals and printers. Built with all the features you've been waiting for—family compatibility, upgradeability, text with graphics.

How did we do it?

We made our terminals support everything from business applications to demanding CAD/CAM. We also made them upgradeable so you could change the amount of color graphics you need.

For instance. Our model 230 terminal includes distributed graphics processing features like local storage and manipulation of graphics objects. Local 2-D transformations. True zoom and pan. 16K x 16K virtual resolution. 16 colors from a palette of 4,096. And more.

We designed our letter quality color VectorPrinter™ like a printer/plotter, using 8 colors and a fast 300 cps print speed.

Finally, we put each and every product through intensive 100% reliability testing. And if that wasn't enough, we also made them affordable\*.

Best of all, you won't have to wait for Envision's color family. It's available now.

Amazing what a little planning can do.

**Envision**

631 River Oaks Parkway  
San Jose, CA 95134  
(408) 946-9755  
Telex: 176437

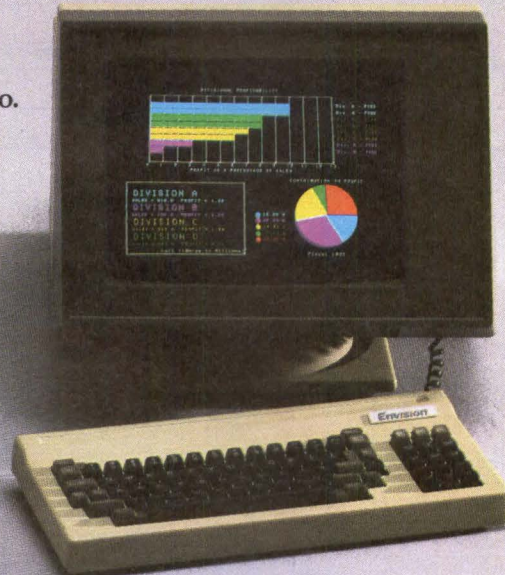

\*Envision 210 Color Terminal: \$2,750  
Envision 220 Color Graphics Terminal: \$4,950  
Envision 230 Advanced Color Graphics Terminal: \$6,950  
Envision 420 Color Printer: \$3,950  
Envision 430 Color VectorPrinter: \$4,950

OEM pricing available

VectorPrinter is a trademark of Envision Technology Inc.

CIRCLE NO. 85 ON INQUIRY CARD

processors. Optional elements include the SMD and terminal processors.

The heart of the MegaFrame is the application processor. Running both the UNIX kernel and UNIX applications, it contains a 10-MHz Motorola 68010 CPU, memory-management hardware to support a two-level virtual-paging scheme and 512K to 4M bytes of dual-ported, error-correcting RAM. The memory-management unit provides a high-speed, two-level paging scheme with 4M bytes of virtual address space per board and no wait states. The system handles multiple-processor addressing—as many as 16 CPUs are supported—via an extended address. When addressing off-board memory, the processors issue a 5-byte address. The appropriate CPU recognizes its number and uses the address as input to its map. The entire system, including the MMU and all data and address paths, is designed to accommodate the Motorola MC68020 32-bit processor when it becomes available.

The file processor, functionally equivalent to a back-end database processor, runs the UNIX file system while the application processor is executing applications; it also runs data-management tools such as ISAM programs and a relational database-management system. It contains an 8-MHz Intel 186 processor with 256K to 768K bytes of triple-ported error-correcting-circuitry RAM and the WD-1010 LSI Winchester disk

drive controller. The high-speed system bus and memory allow direct memory access to and by other processor boards.

The file processor supports as many as three 5¼-in., 50M-byte Winchester drives (100M- and 145M-byte drives will be supported later) and a removable, 5M-byte cartridge in the first MegaFrame enclosure. Additional file processors support as many as four drives in each expansion chassis (23 drives total), off-loading disk and file system overhead from the first file processor. A maximum of 6 file processors are supported.

*As many as 6 file processors and 16 terminal processors run under CTOS.*

The cluster and terminal processors, the functional equivalent of front-end communications processors, are dedicated to running dumb terminals and Convergent workstations and intelligent terminals. Both are based on the 8-MHz Intel 186 processor, contain 256K to 768K bytes of ECC RAM and run communications-oriented products under such protocols as SNA, 3270, X.25 and 2780/3780. The terminal processor contains 10 RS232 ports, four supporting synchronous or asynchronous operation and six supporting asynchronous only. Each RS232 line operates as fast as 19.2K bits per sec. As many as 16 terminal processors are supported. The cluster processor controls two RS422 ports and can run terminals at 307K bps and workstations at 1.8M bps.

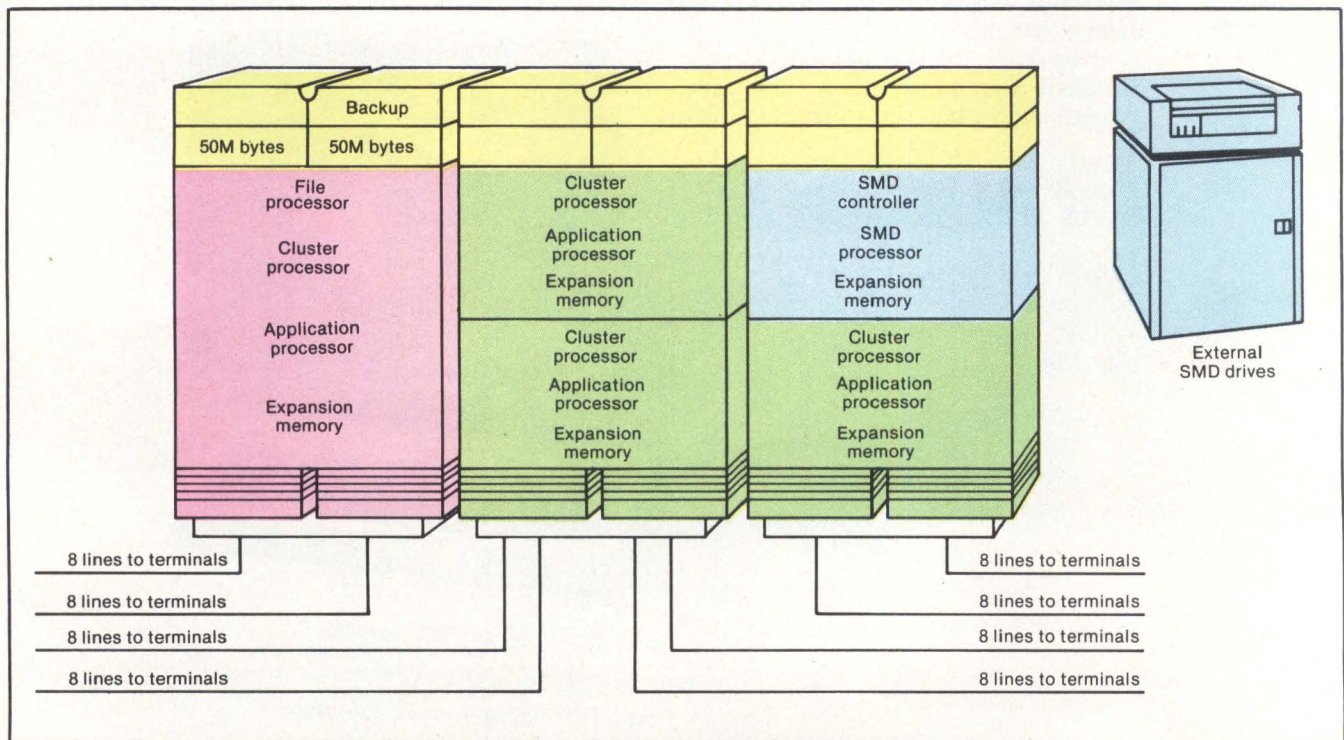

**Fig. 2. A system to serve 64 users.** A master chassis (left) and two expansion chassis, plus external mass storage, can be assembled into a system that supports 64 users. Such a system can be expanded to accommodate a maximum of 128 users, 28M bytes of ECC RAM and 1.5G bytes of integral Winchester disk storage.

# The 1/2" Tape Backup decision made easy... with the Alternative to Streaming.

**Use Microstreamer® where streaming software and systems applications permit... Use CacheTape™ where they don't... for only \$2,820\***

## Streaming or CacheTape — Your Choice

Cipher's CacheTape products are not just a new type of start/stop tape drive — they're much more. CacheTape goes beyond start/stop by incorporating a cache memory into the tape drive. The result: a systems approach to backup, which allows CacheTape to interact with the system as an easy-to-use tape drive without the performance limitations of streaming tape.

CacheTape is the alternative for backup when streaming is not feasible. By combining start/stop performance with streaming mechanics and such convenient features as fully automatic loading and compact package size, CacheTape provides the most cost-effective disk backup method for non-streaming system environments.

\*OEM Quantities

## Software Transparent

If you can't afford the time to develop streaming software and if your system applications won't support data streaming, CacheTape is your backup device.



Cipher's CacheTape products are completely software transparent with current vacuum column or tension arm start/stop tape software. Utilization of a cache memory in the tape drive means that CacheTape eliminates expensive software development time normally associated with streaming tape drives and still performs in transactional applications as well. Just plug CacheTape into your system now... and benefit from total software compatibility.

## Better Performance

CacheTape easily outperforms 100/25 ips streaming tape drives at 1600 BPI in start/stop applications.

## Measured Benchmark Time\*\*

Streaming Tape	..... 23.0 min.
(variable speed)	
CacheTape — Model 890	..... 10.8 min.
CacheTape — Model 891	..... 7.5 min.

\*\*on a DEC PDP-11/34 under RSTS™ using file save routines for 16MB with 4K blocks

Call or write for a free benchmark brochure that explains performance advantages and how to evaluate in advance the benefits of CacheTape.

RSTS is a registered Trademark of Digital Equipment Corporation.

## Tape Adapter Compatibility

CacheTape easily interfaces and operates with industry-standard tape adapters. With CacheTape, you can use your current controller investment wisely and effectively... Plug in CacheTape for immediate benefits.

## CacheTape...the streaming alternative

- Low cost
  - Start/stop performance
  - Tape adapter compatibility
  - No software changes
- Available Now**

CIRCLE NO. 86 ON INQUIRY CARD

**Cipher Goes Beyond**

# CacheTape

**cipher**<sup>®</sup>  
data products, inc.

10225 Willow Creek Road, P.O. Box 85170, San Diego, California 92138-9198  
Telephone: (619) 578-9100, TWX: 910-335-1251

**CIPHER DATA PRODUCTS (UK) LTD.**  
Camberley, Surrey, England  
Telephone: 0276-682912  
Telex: 858329

**CIPHER DATA PRODUCTS S.A.R.L.**  
Paris, France  
Telephone: (1) 668 87 87  
Telex: 203935

**CIPHER DATA PRODUCTS GmbH**  
Munich, West Germany  
Telephone: (089) 807001/02  
Telex: 521-4094

This processor also supports three RS232 ports—two synchronous or asynchronous and one asynchronous-only serial-printer interface.

Several other hardware options are available for expansion. An SMD controller handles as many as six 600M-byte SMD drives, memory boards add memory in 500K- or 1M-byte increments, and a Multibus adapter allows incorporation of as many as six interfaces for custom equipment in each enclosure.

**Multiple operating systems for multiple processors**

Convergent combined its proprietary CTOS message-passing operating system with a virtual-memory version of UNIX fully compatible with UNIX System III, with System V availability planned in the near future. UNIX and CTOS run concurrently and are virtually transparent to a user and the application. The virtual-memory hardware on the MegaFrame's processor—an MMU with a high-speed, two-level paging scheme and 4M bytes of virtual address space per board—permits a demand-page virtual memory system closely approximating the global LRU algorithm.

As many as 6 file processors and 16 terminal processors run under CTOS. Each application processor,

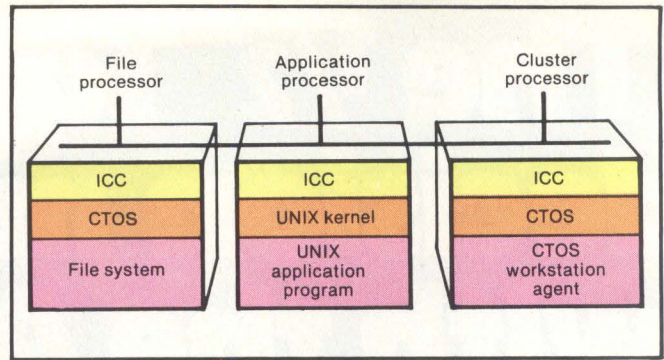

**Fig. 3. MegaFrame software organization.** To an application running on a MegaFrame, the computer appears as totally UNIX System III compatible. For example, if an application written in the C programming language were to require some file-system service, the application would make a system call that would be handled by the UNIX kernel. Then the inter-CPU communication module translates UNIX systems calls into CTOS messages, which are passed to the file processor. The file processor retrieves the file and passes it back through the ICC on the application processor, which responds to the systems call.

to the maximum of 16, runs its own copy of the UNIX kernel. To facilitate message-passing, Convergent has distributed UNIX functionally across multiple processors. Basically, UNIX is distributed in the following manner:

- a copy of the UNIX kernel runs on each application processor in the system,
- UNIX terminal-handling codes such as TermCap, TermLib and Curses use a separate processor running the CTOS operating system,
- the UNIX file system is built on the CTOS file system, which is running on the file processor, and
- all processors and applications communicate over the 11M-byte-per-sec. bus.

Each parallel processor communicates via short messages. Disk data are transferred via DMA into the memory of other processors. The only connection between the UNIX kernel and the other boards is the UNIX inter-CPU communication agent (Fig. 3), which provides request and response blocks to the kernel and all processes. Software running on the application processor communicates with the file system, paging and terminals via the ICC.

Convergent has decentralized UNIX's tree file structure and distributed it across multiple file processors. CTOS also offers multiple-sector data transfers, information kept in memory on open files, asynchronous process execution and redundant volume control structures.

The MegaFrame off-loads UNIX terminal-handling chores from the main processor to multiple independent front-end processors, each running its own operating system. This allows addressing one device, character, line or page at a time without main-CPU intervention. □

**Jonathan Huie** is manager of software engineering, **Richard Lowenthal** is manager of hardware engineering, and **Steven Blank** is marketing manager at Convergent Technologies Inc., Santa Clara, Calif.

## Single Board Computer



6 MHz  
Z80

DSB-4/6 is Fast, Powerful and Compact

- 4 MHz Z80-A\* or 6 MHz Z80-B\* Processor and I/O
- Full DMA for Both 5 1/4-inch and 8-inch Disk Drives
- High Speed Bi-directional Parallel Port
- 4 RS-232 Serial Ports (110-38,400 baud)
- Centronics Type Parallel Printer Port
- 64K of RAM and 2K of ROM

Davidge Corporation  
1951 Colony Street, Suite X  
Mountain View, CA 94043  
(415) 964-9497

\* Z80 is a registered trademark of Zilog

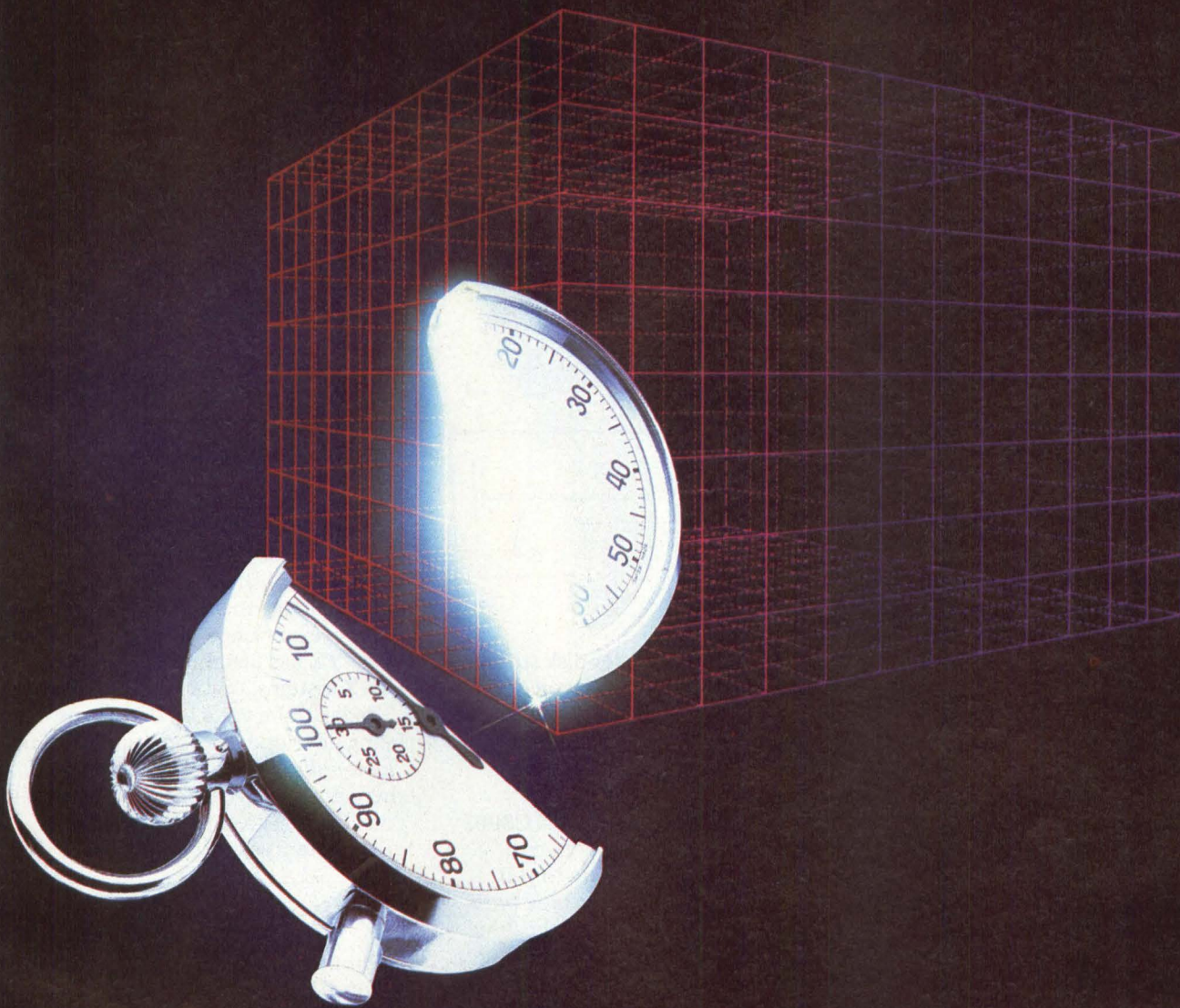

# Invest in Time

## Your Customers Can't Wait

Getting your project completed on time is critical. Investing in the right software tools puts time on your side.

We write software for a living. We understand the importance of time to the professional programmer. To complete projects on time you need good software tools. So we create high quality, timesaving tools for users of DEC and MC68000-based computer systems.

**Pascal-2 Compiler** It generates fast, compact code. Because the compiler does the optimizing, programmers can spend time on other programming tasks. Because Pascal is a structured language, other programmers can easily read your programs. Indeed, it's the language most programmers are learning today.

Additionally, programs written in Pascal-2 are portable. Now you can change hardware without having to rewrite your software.

**Additional TimeSavers** The time you save with our Pascal-2 compiler is only the beginning. We also provide a full line of other TimeSavers. *Pascal-2 source-level Debugger* for true high-level debugging ease. *SourceTools* for control and management of changes to source programs. *Concurrent Programming Package* for real-time scheduling and device drivers. *Profiler* for identifying performance bottlenecks in programs.

Call or write for our brochure about Pascal-2 and additional TimeSavers.

**TimeSavers from Oregon Software.**  
**Your customers can't wait. And neither can you.**

DEC is a trademark of the Digital Equipment Corporation. MC68000 is a trademark of Motorola Inc.

**Oregon  
Software**

**The Pioneer in Performance Pascal**

2340 SW Canyon Road  
Portland, Oregon 97201  
(503) 226-7760  
TWX: 910-464-4779

CIRCLE NO. 88 ON INQUIRY CARD

# How do you create a microcomputer to match the power of the UNIX™ operating system?

Imagine. You are perfecting a revolutionary operating system. In about two years, it will be the system of choice for 16-bit microcomputers.

It will be called the UNIX operating system.

But the breakthrough features of this operating system are going to make stringent demands on the computer.

The microcomputer developed specifically for the UNIX operating system more than two years before its commercial distribution is called ONYX™.

ONYX will live up to every demand and expectation.

To achieve the ultimate flexibility, simplicity, efficiency and productivity, the UNIX operating system will incorporate a file system of highly uniform sets and sub-sets of directories, arranged in a tree-like hierarchical structure.

And flexible directory and file protection modes, allowing all combinations of "read," "write," and "execute" access, independently for each file or directory, for a group of users.

But these advantages will require intensive disk access, and superior memory management. In simple language, disk access must be as fast as possible, and the disk must have an unusual capacity to maintain complex file systems on-line at all times.

Floppy disks with their low capacities and high access times won't do.

Winchester disk drives that utilize slow-moving stepper motor head positioning devices won't do.

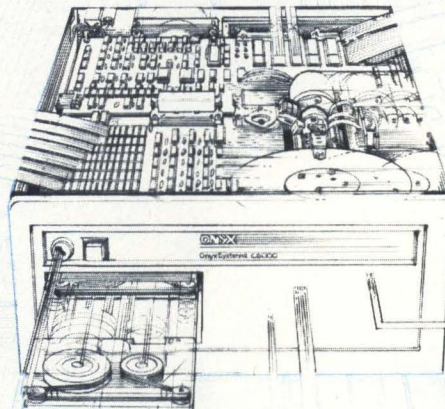

ONYX's IMI Winchester disk storage system, with its servo-driven voice coil head positioning, is more than twice as fast!

So, obviously the ONYX C8002 will do.

And, as developed, the ONYX C8002 features expandable memory up to 1 Mbyte, and disk storage up to 160 Mbytes on-line. Its cartridge tape backup offers cyclical redundancy checking on every backup. Both the Winchester disk storage system and the cartridge tape backup are *internal*.

In the UNIX operating system environment, the disk becomes an extension of main memory. "Swapping" programs between the disk and main memory



increases the number of operations that can run concurrently. ONYX's memory management system utilizes "scatter" instead of "contiguous" allocation, and the more efficient swapping minimizes demand on the disk channel. That's why ONYX assures a highly efficient environment for the UNIX operating system.

Now it's 1982. The UNIX system's pre-eminence among 16-bit operating systems is established. And ONYX is the only company that has significant production experience with UNIX systems.

ONYX has installed over 1500 UNIX systems.

Today there are a lot of systems being developed to operate UNIX (and "look-alike") operating systems. But there are many reasons why you should consider ONYX and the UNIX operating system as inseparable.

### System III available now for immediate delivery.

Phone this special number: (408) 946-6330 Ext. 251. Ask about these System III enhancements, including:

- Multi-key index sequential files under RM COBOL;
- "Term Cap" capability that supports a wide variety of terminal interfaces;
- Enhanced printer handling capability;
- SCCS to maintain edit histories in text management applications.

\*UNIX is a trademark of Bell Laboratories.

Make the Connection

CIRCLE NO. 89 ON INQUIRY CARD

# ONYX UNIX

OPERATING SYSTEM

Onyx Systems Inc., 25 East Trimble Road, San Jose, CA 95131

# Multiprocessor architecture ensures fault-tolerant transaction processing

ARMOND D. INSELBERG, Synapse Computer Corp.

*Synapse N+1 uses redundant hardware modules and software-protection spheres to achieve fault tolerance*

Hardware and software failures in transaction-oriented applications can cause severe losses of time and money. A recent entry in the expanding market for "continuous-processing" systems is a fail-safe computer comprised of tightly coupled general-purpose processors and specialized input/output processors. The processors in Synapse Computer Corp.'s N+1 on-line transaction-processing system use a proprietary non-write-through cache memory and can access reconfigurable, shared main memory over dual 32M-byte-per-sec. buses. Access protection is achieved by integrating the relational database-management system, the transaction-processing manager and the Synthesis operating system into a set of protection spheres. Synchronization of the database and transaction-processing systems provides automatic application checkpointing and recoverability.

## The Synapse expansion architecture

The basic Synapse expansion architecture (Fig. 1) consists of as many as 28 tightly coupled multiprocessors centered around the Synapse expansion bus. The processors can be either general-purpose or input/output processors, each of which incorporates a Motorola 68000 microprocessor. The Synapse expansion bus consists of two independent buses that provide a combined data-transfer rate of 64M bytes per sec.

The GPPs execute user programs and Synthesis operating-system software that reside in shared main memory. The IOPs use direct-memory access to access

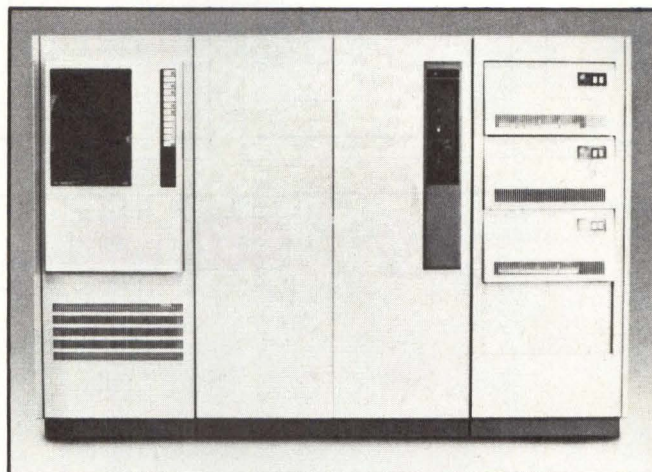

The Synapse N+1 on-line transaction-processing system is software- and hardware-designed for fault-tolerant operation. A minimum configuration is priced at \$340,000 and consists of two general-purpose processors, three input/output processors, 6M bytes of main memory on two main-memory controllers, two 151M-byte disks, a magnetic-tape subsystem and system software.

shared main memory for data transfers. Each IOP accesses its operating system software from its own 128K bytes of local memory. Each IOP supports as many as 16 I/O adapters that can be either:

- disk controllers, which interface to 151M- and 413M-byte disks,
- advanced communications subsystems, which handle terminal and communication lines or
- multipurpose controllers, which interface to mag-

netic tape, line printers, power systems and system clocks.

There are two paths to each I/O adapter via separate IOPs. The path to be used under normal circumstances is software selected, and the secondary path is automatically used in the event of a failure.

The N+1 system requires no more than one additional hardware component of each type beyond the number that is necessary for a specific level of performance. This scheme ensures fault tolerance and provides the additional performance contribution of the extra resource in a fully operational system. No single hardware failure renders the system inoperative.

**Tightly coupled multiprocessors**

The GPP (Fig. 2) is a single-board processor based on the 16-/32-bit, 10-MHZ Motorola 68000. The GPPs serve as execution units for the system software and

application programs. Interconnection with the Synapse system is made through the expansion bus. The GPP contains 16K bytes of memory cache. There are 32K bytes of EPROM for a bootstrap loader, diagnostics and a maintenance debugger. The 68000 operates at full speed with no wait states.

The IOP provides an intelligent connection between the expansion bus and the I/O devices (Fig. 3). The main data flow is between the expansion bus interfaces and the I/O bus interface through the DMA controller. The expansion bus interfaces connect the IOP to the expansion bus and the remainder of the Synapse system. The IOP is the master of the I/O bus, initiating all transfers with the adapters. The IOP manages as many as 16 I/O adapters including device controllers and communication subsystems. The adapters can report events to the IOP by generating an interrupt and waiting to be serviced by the IOP. Data are transferred between memory on the I/O adapter cards, IOP local memory and main shared memory. All adapters can transfer concurrently and asynchronously.

The IOP performs the scheduling and dispatching of processes at the completion of a process I/O activity. By

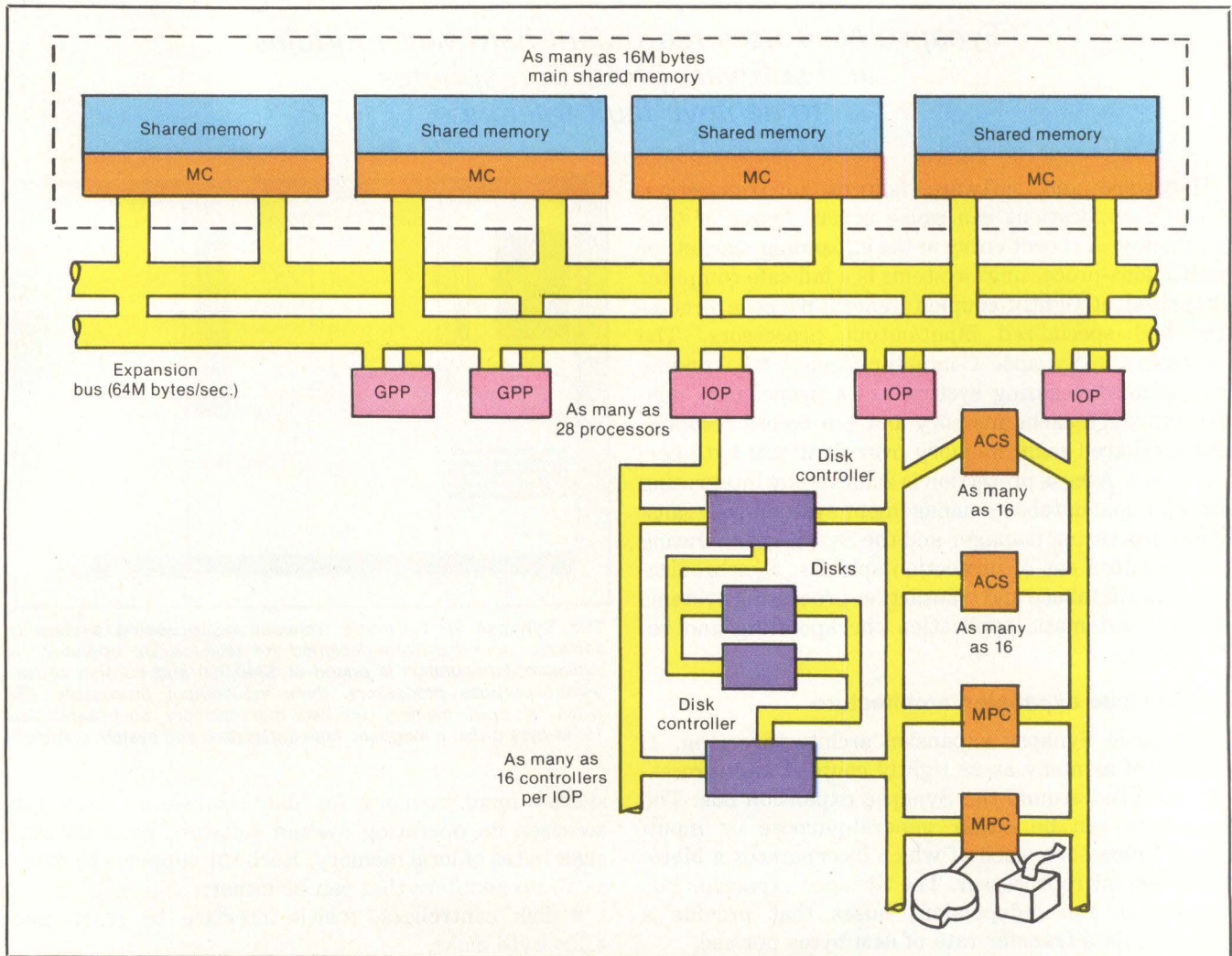

**Fig. 1. The Synapse expansion architecture consists of general-purpose processors (GPPs), input/output processors (IOPs), shared main-memory modules and memory controllers (MCs), disk controllers and advanced communications controllers (ACPs). The processors access the main memory via dual 32M-byte-per-sec. buses.**



NEW...

from DATARAM



# MOTOROLA VERSAbus 1.0 MB ADD-IN

## Not just more capacity; more capability

Motorola's 68000 is a winner, and using this popular microprocessor in a VERSAbus/VERSAbord configuration is a smart move. Dataram's new single-board 1.0 MB DR-680 can make it even smarter. Increased single-board memory capacity means lower power, less space, higher reliability, and lower cost...and the DR-680 provides a lot more!

**More speed:** Ability to perform match cycles reduces access/cycle times by allowing immediate reading of data registers when adjacent words/bytes are accessed.

**Advanced error handling:** The DR-680 provides an on-board control and status register (CSR) which allows program control of ECC functions and contains the diagnostic information required for error analysis. The CSR can be read or written via the VERSAbus. Additionally, the DR-680 greatly increases reliability by performing error "sniffing" and error "scrubbing" during refresh operations.

**Availability:** Best of all, the 1.0 MB DR-680 is available now. And it comes with Dataram's standard one-year warranty.

For more information, send in the adjacent coupon or, for faster response, call Dataram today at (609) 799-0071.

VERSAbus and VERSAbord are registered trademarks of Motorola, Inc.

Dataram • Princeton Road • Cranbury, NJ 08512

**MORE PERFORMANCE FROM MY VERSABUS!**

- Sounds great. Please call me with more details.
- I'm interested. Send more information.

Name \_\_\_\_\_  
Title \_\_\_\_\_  
Company \_\_\_\_\_  
Address \_\_\_\_\_ State \_\_\_\_\_ Zip \_\_\_\_\_  
City \_\_\_\_\_  
Telephone \_\_\_\_\_  
MM483

# DATARAM

DATARAM CORPORATION  
Princeton Road,  
Cranbury, NJ 08512

# EAGLE POWER

## Sky-high performance. Down-to-earth cost.

### Eagle clears the air on what it takes to buy a computer.

Forget the heavy price you thought you'd have to pay for a top-rated computer or word processor.

Nobody – but nobody – gives you more for the money than Eagle.

The era of unnecessary cost and confusion is over, once and for all.

#### **Eagle Power: a complete package.**

A self-contained system that is fully functional with no expensive “standard options” to buy later. Just plug it in, flip the switch, and you're in business.

You get *word processing* software that speeds letters, reports, mailing lists. And stores them for easy recall.

You get *financial planning* software, an “electronic worksheet” with full “what if?” capabilities.

You get the *CBASIC® programming language* that lets you create custom software for your special business needs.

You get the *CP/M® operating system* that allows you to choose

from the largest selections of software available today. And Eagle offers both flexible disk storage and integrated or add-on hard disk storage.

#### **New 16-bit Eagle Power: high-speed performance.**

Here's Eagle Power that's 3 to 4 times faster than the IBM PC. What's more, it is both disk-compatible and software-compatible with the IBM PC. And any board made for the IBM PC can be plugged in for the same operational capabilities. The new 16-bit Eagle is a multi-user system with networking capabilities.

**See Eagle Power in action today. For names of Eagle dealers nearest you, phone toll-free 800-538-8157, Ext. 938.**



## EAGLE COMPUTER

*Above and beyond.*

CP/M is a registered trademark of Digital Research, Inc.  
CBASIC is a registered trademark of Compiler Systems, Inc.

taking this responsibility for preparing a process to run, the IOP need not interrupt a GPP at normal I/O completions. The IOP includes 128K bytes of local dynamic RAM for storing IOP operating software and data. The memory has single-bit error correction and double-bit error detection on each 16-bit half-word.

The modularity of GPPs and IOPs allows Synapse systems to be expanded according to the number and types of processors needed. As transaction-processing demands increase on the system, additional GPPs or IOPs can be added on-line to an executing system. A minimum configuration consists of three IOPs and two GPPs.

The work queue containing the list of all processes awaiting a processor is a single queue serving all the tightly coupled processors. Processes are scheduled on a first-in-first-out basis within the context of a priority system. The processors are considered tightly coupled because they collectively share main memory, in contrast to loosely coupled architectures that require each process to be preassigned to a processor's work queue. Processes must be preassigned in loosely coupled architectures because each processor is paired with its memory, forming a multicomputer architec-

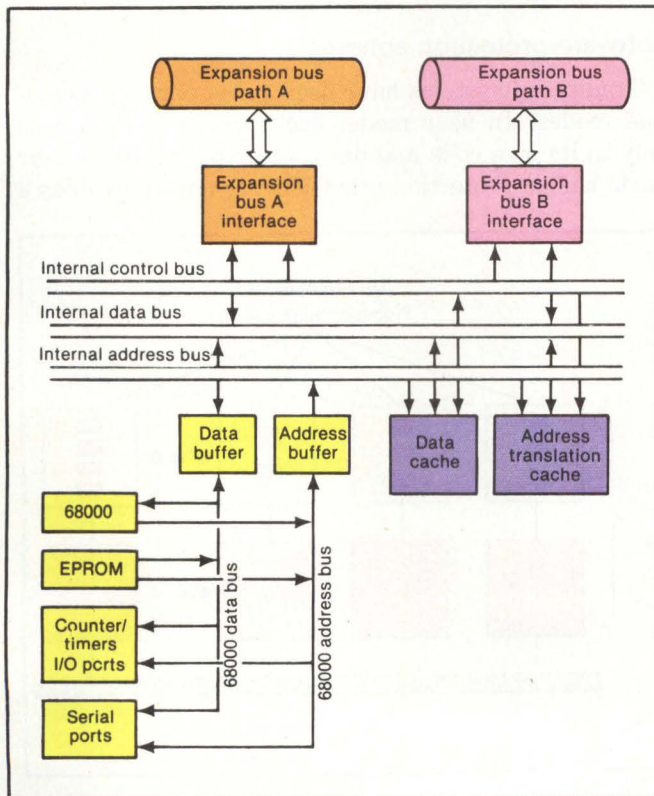

**Fig. 2. The GPP executes user programs and most Synthesis operating software.** The expansion bus connects the GPP to the Synapse system. Each GPP includes a 16-/32-bit 68000 micro-processor, 16K bytes of memory cache, counter/timers, I/O ports and 32K bytes of EPROM.

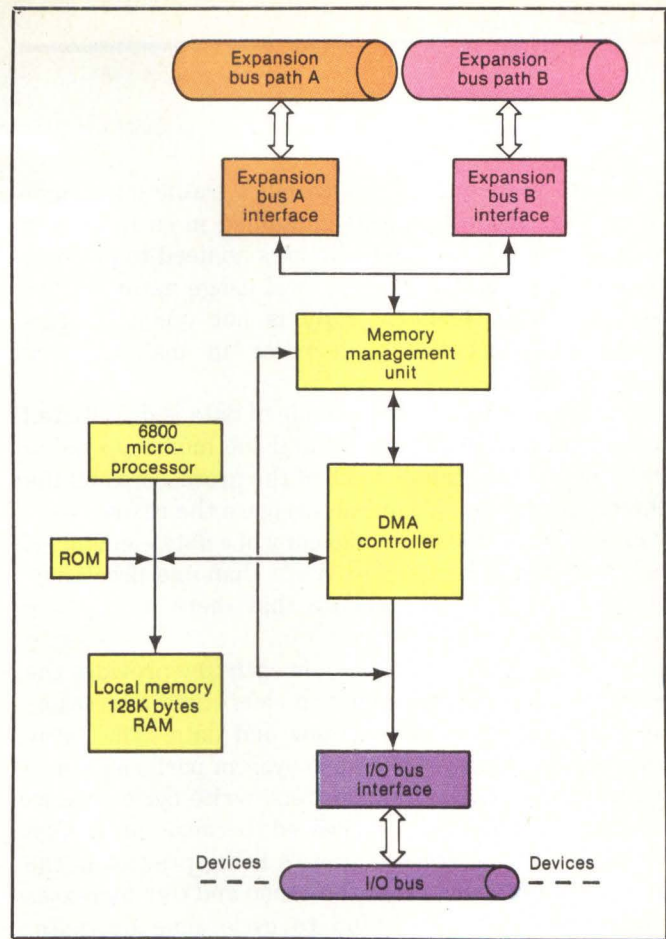

**Fig. 3. The IOP serves as the intelligent gateway between I/O devices and the Synapse expansion bus.** The DMA controller manages the data flow between the expansion bus interface (via the memory-management unit) and the I/O bus interface. The IOP is driven by a 68000 microprocessor and has 128K bytes of local dynamic RAM.

ture. By automatic load balancing, the Synapse approach provides higher throughput and facilitates concurrent software development (Fig. 4).

When I/O is required in a process, the I/O request is dispatched to the appropriate I/O processor, and the executing GPP goes to the work queue for another process. Because of the use of symmetric processors and a single work queue, adding a processor directly improves performance by accelerating the speed with which the single work queue is served. Using shared main memory allows all of the processors to have direct shared access to the entire Synapse relational database, eliminating cross talk and complex configuring.

**Non-write-through cache memory**

In the past, contention among processors and bus resources has plagued multiprocessor architectures. The recognition that not all data are required by all of the processors and their executing programs led Synapse to improve the typical cache write-through technique. In a write-through operation, any write to a local cache results in the updating of main memory at the time of the write. Synapse uses a proprietary

method to reduce the write-through traffic by assigning a usage mode to words contained in cache and in main memory. If the mode dictates no need to perform write-through because of the local usage nature of the data, the main memory copy is not updated. This results in a significant decrease in main-memory system usage.

The tracking of the usage mode of data is distributed throughout all the processors and the memory system itself. Logic is contained in all of the processors and the memory system to acquire and release the responsibility for the latest and only valid copy of a data element. If such data might be used by more than one processor, guarantees and checks ensure that there is only one copy of the latest valid data.

The 16K-byte cache memory in each GPP provides the 68000 with high-speed access to referenced addresses, page table entries, instructions and data. The cache significantly improves Synapse system performance in two ways. First, the average read/write cycle time as seen by the 68000 is decreased because of a high percentage of the accessed data's being present in the cache. The performance of the 68000 and GPP increases approximately in proportion to cycle time decrease. Second, the number of GPP requests to shared memory is significantly decreased, allowing additional GPPs to use the expansion bus and to share memory with minimal contention. Performance is further enhanced by the GPP cache memory using the non-write-through strategy that reduces bus contention and memory usage.

**Shared main memory**

The shared main memory provides as much as 16M bytes of common storage among all processors connected to the expansion bus. All user processes are contained in the main memory. As many as four shared main-memory controllers can operate in non-interleaved, two-way-interleaved or four-way-interleaved mode. Interleaving is software determined by the Synthesis operating system and can be mixed to allow for reconfiguration of a failed memory component.

The memory subsystem consists of reconfigurable multiple components with the same N+1 fault tolerance found throughout the system. Address ranges are loaded into registers on the memory boards at initial program load or at the time of a reconfiguration. A memory board can be configured to cover any part of the physical address space of the machine. Shared-memory controllers are likewise soft configurable relative to address ranges and interleaving. In the event of a failure on a memory board or controller board, Synthesis readdresses and reinterleaves the remaining resources to create a new, optimal configuration.

It is important to recognize that recoverability is a separate issue from memory failures and reconfigurability. In recovering from memory failures, Synthesis automatically routes around the defective component and then recovers the database and restarts all users. Recovery is always based on mirrored disks, never on memory contents.

**Software-protection spheres**

Traditional systems have user and supervisor execution modes. In user mode, each program has access only to its own code and data, whereas the supervisor mode has no protection provisions. Synapse provides a

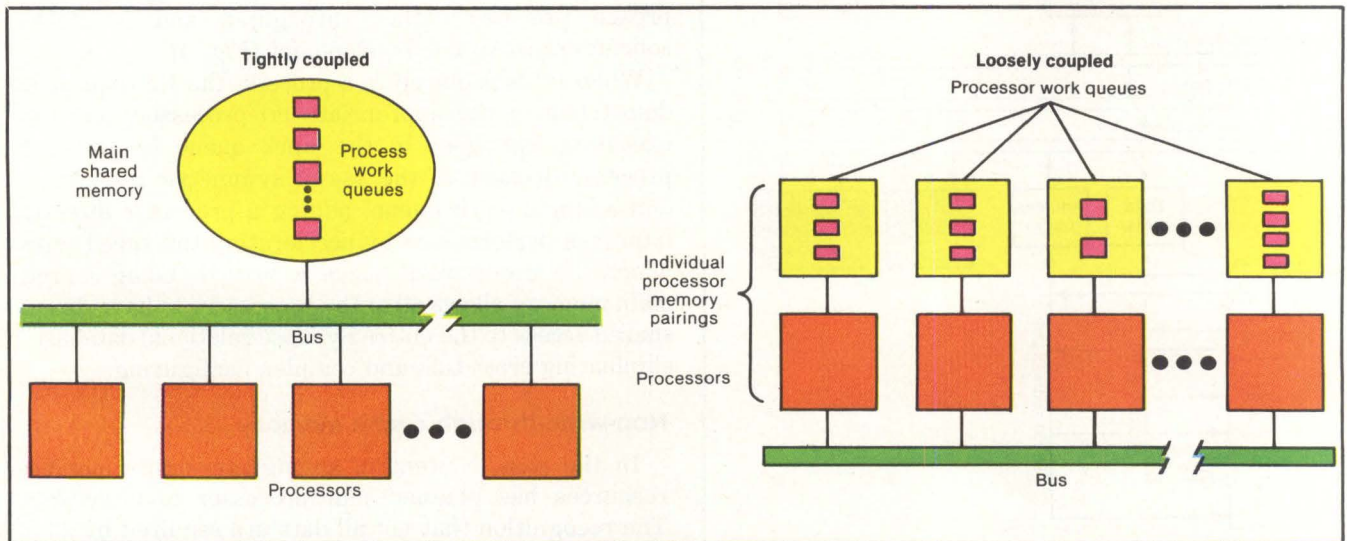

**Fig. 4. Two types of processor configurations and work-queue arrangements can be used in a transaction-processing system. Tightly coupled processors serving a single work queue, as employed in the Synapse N+1 system (left), share a common main memory and operate on a first-in-first-out basis. This arrangement allows any GPP to serve process needs, increasing throughput by quickly emptying the work queue. Loosely coupled processors serving multiple work queues (right) have dedicated pairings of processors and memory. This arrangement requires portions of the database to be committed to a particular processor/memory pair. When a processor needs data not resident in its memory, inter-processor communications must take place.**

# Put a little tape backup in your DEC microcomputer.

SMS' DSX-11 is a complete DEC microcomputer with 80Mb Winchester and 1/4" cartridge tape backup. With over 20Mb per tape cartridge, Winchester backup has never been so easy. Emulating DEC's latest TS11 tape device, standard RT-11 and RSX-11M software makes disk backup, system boot, media interchange, archiving and software distribution a snap!



256Kb main memory (expandable 4Mb)

Expansion space for 15 dual height modules.

LSI-11/23 16 bit CPU with memory management.

4 Serial ports.

Advanced disk controller with ECC, flaw management, bootstrap, error retry and non-interleaved data transfer.

PDP-11\* architecture compatible with RT-11, RSX-11M and UNIX\*\* software.

17.8Mb, 35.6Mb or 71.2Mb Winchester disk.

Self test with LED display of system faults.

Start/stop tape supports file operations.

Compact 3M Cartridge.

TAPE CONTROLLER ONLY AVAILABLE FOR VOLUME REQUIREMENTS.

**SMS**  
**Scientific Micro  
Systems, Inc.**

777 E. Middlefield Road  
Mountain View, California 94043  
(415) 964-5700

AUTHORIZED SMS DISTRIBUTOR FOR DEC  
Q-BUS PRODUCTS: FIRST COMPUTER  
CORPORATION (312) 920-1050

SMS SALES OFFICES:  
Phoenix, Arizona (602) 978-6621;  
Boston, MA (617) 246-2540; Atlanta, Georgia  
(404) 296-2029; Morton Grove, Illinois (312)  
966-2711; Yorba Linda, California (714) 993-3768.

\* Trademark of Digital Equipment Corporation. \*\* Trademark of Western Electric.  
CIRCLE NO. 92 ON INQUIRY CARD

more general and well-protected approach in which there are five protection spheres or system levels (see "Synthesis software organization," below).

An execution mode exists for each level of the system, providing a protected execution context. Each system layer manages its own data, making it inaccessible to "higher" layers except through predefined "cross-sphere" calls. A lower level may not "call out" to a higher level. Each process has a 16M-byte address space separated into 1M-byte code and data segments assigned to the various system levels. The access rights to each segment at any time are determined by the level that is currently executing. When a level is entered through a cross-sphere call, the process is given access to all appropriate segments at that level. When the level is exited, the accessibility is removed.

The access protection on a per-process basis is implemented in memory-management hardware in each GPP. Page tables of mapping information are maintained, tracking the location of each logical 2K-byte page in shared main memory. A segment mask register provides access protection for each segment, whereby each register bit indicates whether application access is permitted to the referenced segment. A segment-protection fault is initiated when an access is attempted to a protected segment. Also associated with each page table entry are protection flags, which describe the accessibility of each page as a function of read/write/execute and instruction/data. These are the flags used to permit the proper functioning of the non-write-through cache.

**Synchronizing database, transaction processing**

The relational DBMS enables transactions to access data associatively from data stored logically in tubular

form. The transaction is the unit of both recovery and concurrency. Transaction recovery requires that all updates associated with a transaction be applied or removed as a group. Transaction concurrency requires that other transactions do not see data from an uncompleted transaction.

Shared or exclusive locks can be placed on the data at record, block or table level of granularity to allow a high degree of concurrency. To ensure database integrity, any executing programs are restartable by providing database recovery and concurrency. To provide restartability of a program, points of database consistency must be achieved. This involves not only bringing the database to a known point, but also reestablishing the program and screen states so that the users can continue their work. This collection of information is known as a checkpoint.

The Synapse N+1 has automated the facility for checkpointing and the restartability of user applications. Automatic checkpointing occurs at the point in a process when a program invokes another program to continue processing of a transaction. These "commit points" considerably reduce the amount of checkpoint data needed for a restart. The recovery implementation is based on all changes to the database being recorded in a log file. The log files are mirrored to protect against disk failures. When a transaction is committed, a commit record reflecting all of the recorded changes is added to the log file. This synchronization of the relational database and transaction-processing manager activities enables uncommitted transactions to be removed from the system and committed transactions to be applied when recovery must be performed. □

**Armond Inselberg** is product manager at Synapse Computer Corp., Milpitas, Calif. He was previously manager of strategic planning at Boole and Babbage and has a Ph. D. in computer science from Washington University.

**SYNTHESIS SOFTWARE ORGANIZATION**

The Synthesis software is divided into five hierarchical layers, with the innermost layers being those of highest priority. Each of these layers, or "protection spheres," is protected from other layers by hardware. The innermost software layer, the kernel operating system, is responsible for process and memory management, processor queue and I/O queue management and reconfiguration management. The next most privileged layer is the relational DBMS, whose capabilities include relational database access, database integrity and deadlock protection, data validation and on-line backup/restore. The extended operating system maintains

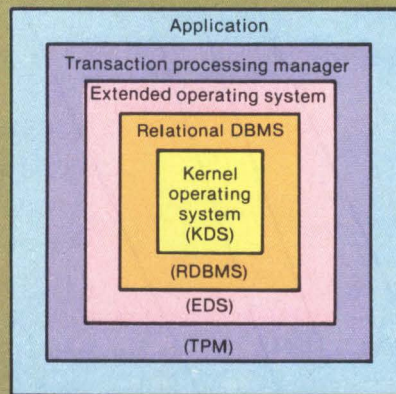

a hierarchical directory of all system objects, such as tables and forms, and provides device-independent I/O and other user services. The transaction-processing manager performs screen-forms management, screen-input validation and application management/recovery. The user's programs execute at the application level, manipulating the database as a set of related data elements, with integrity, recovery, concurrency and input validation automatically handled by Synthesis.

The protection spheres of the Synthesis operating software consist of several functional levels, protected from each other by protection mechanisms residing in hardware. Any sphere not within a process calling sequence remains protected from even the most privileged inner levels.

# Torn between 8-bit economy and 16-bit power?

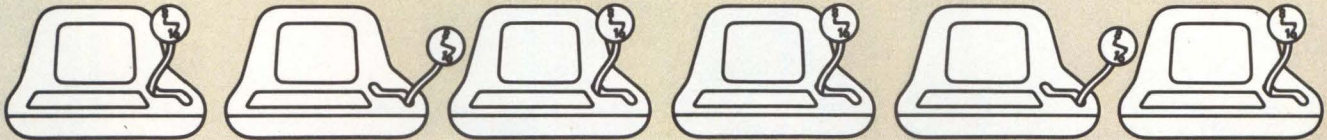

## Molecular gives you both.

### The Molecular Supermicro gives you the power you want—when you want it.

Molecular's Supermicro is the world's most responsive multi-user business computer. Now the AP/86 Performance Accelerator™ makes it the most flexible, too.

The Supermicro design provides each user with a CP/M® compatible 8-bit Application Processor: a Z80A and 64KB of RAM. The optional CP/M-86™ compatible Performance Accelerator allows any user to call up a powerful 16-bit 8086 CPU with up to 1MB of RAM—with a simple keyboard command. The Supermicro's unique high speed bus connects all users to a common data base (10 to 272MB), shared peripherals, and optional Performance Accelerators.

### Applications determine the CPU.

Small business users don't need 16-bit processors for most appli-

cations. In fact, for tasks like word processing, 8-bit CPUs are generally more efficient. But for applications where 16-bit power can be used effectively, the Performance Accelerator is instantly available.

The Performance Accelerator is ideal for number-crunching applications like complex modeling, extended spread sheets, graphics, and photocomposition.

With a choice of processors, up to 64 on-line Supermicro users can stand up to their larger competitors in computing muscle. And positively embarrass them on the bottom line.

### All for an entry level price under \$6,000.

To schedule a demonstration at a distributor in your area, call or write Molecular Computer, 251 River Oaks Parkway, San Jose, CA 95134. (408) 262-2122.

You don't have to choose between 8-bit economy and 16-bit power anymore. Molecular gives you both.

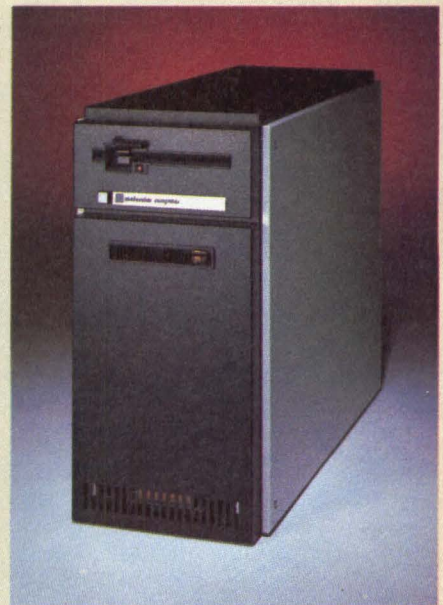

 **molecular  
computer™**

The Supermicro Company®

SEE US AT  
COMDEX, BOOTH #964

CP/M and CP/M-86 are trademarks of Digital Research.



# TEAM PLAYERS.

## Master/Slaves...

At Advanced Digital, we believe in co-operation between computers and their operators. That's why our new team of S-100 master and slave processors are designed with your team in mind and feature superlative reliability and ease of operation.

Our team captain is SUPER QUAD, a unique multi-function master processor combining 64K of bank selectable RAM, single- and double-density floppy disk controller, system monitor EPROM, Z80A CPU, two serial and two parallel communication ports on a single board.

The players consist of one or more SUPER-SLAVES, the latest addition to Advanced Digital's line of superior multi-function S-100 boards.

Each SUPER-SLAVE is a powerful single-board slave processor designed for use with the SUPER QUAD in either network or stand-alone configurations. The outstanding features of the SUPER-SLAVE include:

- A DEDICATED Z80A CPU FOR EACH USER
- IEEE-696 standard conformity
- 4 serial, 2 parallel interface ports
- 2/4K EPROM (monitor)
- 64/128K bank switchable RAM
- One year warranty
- Turbo-DOS™, the state-of-the-art operating system with an advanced failure detection and recovery facility that makes the master-slave network virtually crash-proof.
- Also, for the first time CP/NOS® operating system from Digital Research. Plug as many SUPER-SLAVES into the BUS as you need users.

Your team needs the strong support of the SUPER QUAD/SUPER SLAVE team from Advanced Digital Corporation. The Super System includes SUPER QUAD and CP/M operating system. The shugart SA-1000 or quantum Q2000 hard disks are also supported.



For more information write or call: Sales Dept.

12700-B Knott Street • Garden Grove, California 92641 • (714) 891-4004 TELEX 678401 tab Irin

® Registered Trademark of Digital Research Corp.  
™ Registered Trademark of Software 2000 Inc.

CIRCLE NO. 94 ON INQUIRY CARD

© Copyright 1981 Advanced Digital Corp





## DISK DRIVES

# Micro-Winchester market awaits micro-diskette standards

DAVID KALSTROM, Seagate Technology

*Upgrading to hard disks can't happen before manufacturers agree on sub-5¼-in. floppy standards*

Winchester disk drives using media less than 4 in. in diameter and capable of handling formatted storage capacities in the 5M- to 10M-byte range will soon find their way into a wide range of new microprocessor-based systems, but not until the issue of diskette media standards for companion sub-5¼-in. floppy drives is resolved and this media becomes available in volume.

### What's needed

The merchant market for sub-5¼-in. Winchester has yet to be fully defined. But given the packaging requirements of some system designers, particularly those planning down-sized desk-top and portable systems in which even greater reductions in disk drive volumes than those now possible through the use of half-height, 5¼-in. Winchester are required, their advent will be inevitable.

The relationship between micro-diskette media standards and micro-Winchesters can be seen in the parallel relationship between 5¼-in. floppy disk drives and 5¼-in. Winchester. The market for 5¼-in. Winchester disk drives was initially defined as an upgrade market for the lower capacity floppy disk drives widely used in desk-top systems.

The market for these Winchester continues to be driven principally by the need to upgrade floppy disk drive capacities, and it is this upgrade market that is responsible for the large volumes now characteristic of the business. Seagate Technology, for example, builds 1000 Winchester disk drives per day. For sub-5¼-in. fixed out line disk drives to be produced in the volumes needed to make them competitive, it will be necessary that they be marketed under the same premise—that is, as upgrades to existing sub-5¼-in. microfloppy disk-based systems. This presumes that a broadly based market for microfloppy disk drives is in place. For this market to be established, low-cost diskettes

must be readily available. This requires the establishment of a diskette media standard, but drive vendors, especially those in a position to consider the large-scale production of microfloppy disk drives and Winchester, have differing opinions about what this standard should be.

Five different types of diskettes for sub-5¼-in.

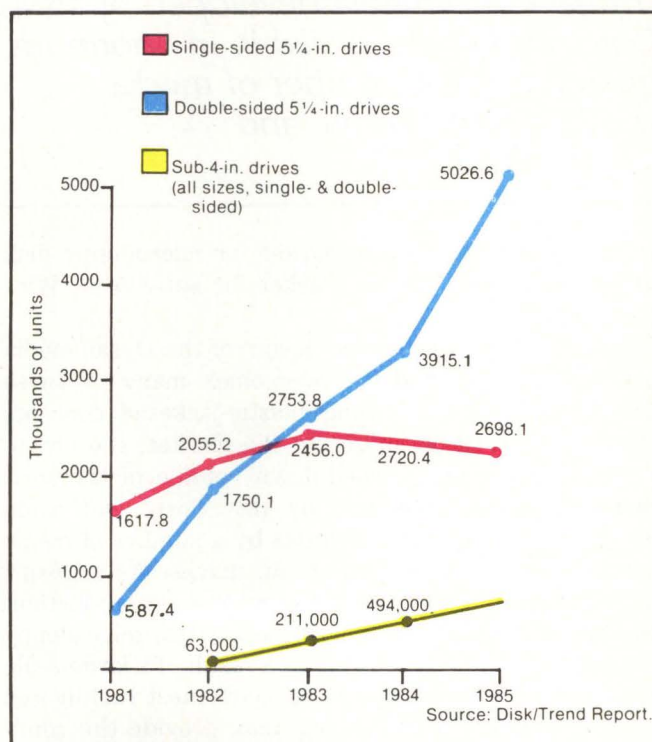

Floppy drive market will continue to be fueled by rising sales of desk-top systems, with shipments of single-sided drives peaking in 1984. The market for sub-5¼-in. floppy disk drives will not reach full potential until the issue of media standards is fully resolved, however. Also impacting shipments of these drives will be significant competition from half-height 5¼-in. floppy disk drives that offer many of the space savings of sub-5¼-in. drives while allowing the use of media designed for standard-height drives.

drives have been proposed.

- Sony Corp.'s plastic-jacketed 3½-in. diskette,
- a 3-in. plastic-jacketed diskette proposed in late 1981 by a consortium of Japanese companies,
- a 3½-in. plastic-jacketed diskette developed by a committee of drive and media vendors established at last year's National Computer Conference in Houston and
- a soft-jacketed, 3¼-in. design developed by Dysan Corp. and incorporated into a drive announced by Tabor Corp., and most recently, the 102mm (4.015-in.) diskette used on IBM's new OEM drive.

### Soft-jacketed media are more producible

Drive and media vendors are already considering which standard serves them best. Seagate has an agreement to second-source Tabor's drive, a decision that reflects the concern Seagate has for the stunting impact that the nonavailability of large quantities of low-cost diskette media would have on the establish-

---

*The Dysan diskette is simply a scaled-down version of the soft-jacketed media developed by IBM Corp. and made available in enormous quantities by a number of media vendors with both 8- and 5¼-in. drives.*

---

ment of a broadly based market for microfloppy disk drives and hence on the market for sub-5¼-in. Winchester.

Seagate believes that the design of the Dysan media used in the Tabor drive overcomes many of these concerns. Instead of using plastic-jacketed concepts that have yet to be proven in the market, the Dysan diskette is simply a scaled-down version of the soft-jacketed media developed by IBM Corp. and made available in enormous quantities by a number of media vendors with both 8- and 5¼-in. drives. As a result, even though this media is not in wide-scale production, Seagate anticipates that should demand for microfloppy disk drives suddenly explode as a result of a large-scale systems order, it would be the media most rapidly and readily producible. This alone may provide the confidence that system builders need to develop products based on the drive (Tabor has since signed a multi-year contract for these drives with Soroc Inc.)

### Other standards

In addition to a media standard, other considerations

must be addressed before a broad-based market for micro-Winchesters can be realized. Because the initial market for micro rigid disk drives will be a floppy-upgrade market, the form factor of both the Winchester and the floppy disk drive should be the same—a consideration dictated to a certain extent by media size. This is one of the major lessons of 8- and 5¼-in. Winchesters. Equally important are controller and data format standards. Given the amount of software that has been developed for small systems based on 5¼-in. Winchesters, system vendors planning to use sub-5¼-in. rigid disk drives must have the opportunity to leverage the investments made in industry-standard 5¼-in. Winchester controller and format designs. This will permit stored data and programs developed for one drive to be mapped over to another.

This will impose some constraints on micro-Winchesters. The controller design that was developed for Seagate's ST506 conventional-height 5¼-in. drive and that has come into almost universal use at the desk-top system level accommodates the MFM recording scheme and handles 10,416 bytes per disk track, divided into 32 sectors. Transfer rate is 5M bits per sec.

Based on these figures, it is possible to bring the per-platter capacities of a sub-5¼-in. drive up to the

---

*The form factor of both the Winchester and floppy disk drive should be the same—a consideration dictated to a certain extent by media size.*

---

5M-byte level without pushing the magnetic technologies involved. These drives would operate at slightly higher flux densities to maintain the 10,416-byte-per-track specification because this is calculated from the innermost track. Track densities will be in the 500-tpi range. Seagate proposes to use a disk with an 80-mm. outside diameter and a 40-mm. inside diameter.

The market for sub-5¼-in. Winchester disk drives will develop strongly as a natural complement to the 5¼-in. full- and half-height drives now on the market in volume once the overriding issues relating to diskette standards are resolved. The extent of this market is difficult to predict, and Seagate expects that this class of fixed-disk drives will be shipped only in evaluation quantities this year. Microfloppy disk drive shipments will be higher, however. According to Jim Porter's *Disk/Trend Report*, more than 200,000 drives of this class will be shipped this year, with almost 500,000 being shipped in 1984 and 952,000 in 1985. □

---

**David Kalstrom** is director of marketing, Seagate Technology, Inc., Scotts Valley, Calif.

---

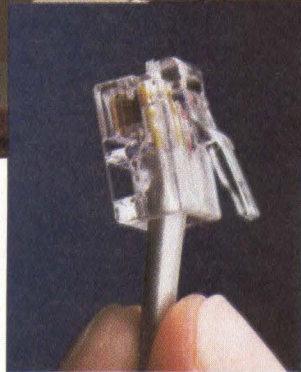

## “Today we installed 27 terminals but not a foot of data cable. We’re using Teltone’s DCS-2 instead.”

There’s only one thing you can count on these days. If anything can change, it will. And sooner than you think.

That may be why more than 300 companies have installed our DCS-2 Data Carrier System: to help them cut the cost of adding or moving terminals by using existing PABX wire to carry both voice and data traffic—simultaneously.

With DCS-2, a PABX (or Centrex) becomes a common communications network. From then on, making a computer hookup is as easy as plugging in a phone. Up to 9600 bps of dedicated-channel, full-duplex data can be transmitted or received by any RS-232C terminal in your system. But the data won’t interrupt phone service.

At a time when drilling one hole for cable can cost \$100 or more, the Data Carrier System is a smart choice economically. Logistically, it can make your next move faster and far less troublesome. Like the one you’ll probably be making next week?

For fast information call 1-800-227-3800 Ext. 1122 (in California 1-800-792-0990 Ext. 1122) or write Teltone Corp., PO Box 657, Kirkland, WA 98033. In Canada call (416) 475-0837 or write 91 Telson Road, Markham, Ontario L3R 1E4.

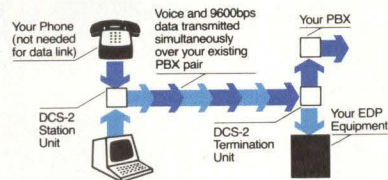

**TELSTONE**

CIRCLE NO. 95 ON INQUIRY CARD

FCC Part 68 registered. For users of DEC, Prime, Data General, Tandem, IBM Series/1, H-P and other asynchronous computers.

# MST copies floppies fast— automatically

**Automating your Software Production Means Greater Profits**—and that's what MST means to you. If you duplicate and distribute software, you need MST. We not only copy floppies fast, our systems format, duplicate, and 100% verify in one quick step. Our automatic processing not only saves you time and labor but reduces costly errors.

Whether you use 5.25" or 8" diskettes, 48 or 96 TPI, and whether your needs are great

or small, we can help. We have computer based systems for high volume production and desktop models for low to intermediate needs. And our copy centers provide duplication service for your overload or sporadic requirements.

Don't worry about formats. MST has a large library to choose from, including IBM, DEC, Apple, and HP, to name only a few.

Remember, when you need to duplicate software, we're the people who copy floppies fast—automatically. Give us a call at MST today, and your local sales rep will see you tomorrow.

**Media Systems Technology, Inc.**  
17791 Fitch Avenue  
Irvine, CA 92714  
(714) 957-0240

**MST**



**Simply push a button  
and walk away.**

# Video cassette recorders for disk backup

JOHN PROPER, Alpha Micro Systems

*Easily interfaced VCRs can provide slow but reliable backup for 5¼- and 8-in. Winchesters*

Video cassette recorders are being used for disk backup at nearly 1000 computer installations around the world, but their computer-related capabilities are still not generally known. Mass-market VCRs can store as much as 100M bytes on a single video cassette, yielding a media cost of 12¢ per megabyte and an equipment cost of 50¢ per megabyte, both equal to or better than corresponding costs for other backup devices, including streaming cartridge-tape drives (MMS, August, 1982, p. 213). VCRs have serious limitations as well. They are bigger and heavier than diskette, Philips cassette and tape-cartridge drives and, more importantly, can take hours to save or restore a complete video cassette's worth of data—with all users denied disk access while backup is in progress. Despite these limitations, Alpha Micro Systems has combined video interfacing, redundant recording and special software to create VCR disk-backup systems that are practical and reliable for many applications.

## The video connection

To the host computer, the VCR subsystem appears to be a comparatively low-performance but high-capacity disk. To the VCR, the host computer appears to be a TV camera that is generating a standard black-and-white video signal—including the usual horizontal and vertical synchronization signals (Fig. 1). The fact that a digital data stream is being reliably recorded in essentially analog form separates the VCR backup system from all other magnetic-tape applications.

The backup-and-restore data path between disk and cassette includes the host computer. During backup, selected files are read from disk stored in computer memory and transferred to the VCR at a rate that will sustain continuous "streaming" of the video tape. The process is reversed during a restore operation.

To achieve maximum data storage per cassette, data

must be transferred to the VCR at a rate of 60K bytes per sec. (If data are not available for recording, the video tape continues to stream, but without recording any data.) Assuming a 6:1 copy ratio, this is equivalent to 10K bytes of new data per sec.

The same figures apply to a restore operation. In most cases, therefore, host and disk can stay comfortably ahead of the VCR. To make disk-host and host-controller transfers more efficient, however, the controller is equipped with a 4K-byte RAM and is designed to accept and transmit data at rates as high as 43K bytes per sec.

VCRs are designed to store a video signal that represents (by U.S. standards) a series of television "fields" with a repetition rate of 60 fields per sec. and approximately 240 visible raster lines within each field. Assuming that, even with marginal performance, a VCR can record at least 200 distinguishable pixels (bits) along each raster line, the potential capacity of a two-hour video cassette is more than 2G bytes—far beyond the backup requirements for most microcomputer applications.

The VCR subsystem sacrifices potential capacity and performance for reliability. Instead of storing 20 or more bytes along each 200-bit raster line, only 5 bytes (separated by start and stop bits) are recorded. Most importantly, however, stored data are organized into 512-byte blocks, and each block is recorded six or more times to ensure that at least one copy of each block is error free. Two cyclic redundancy check characters at the end of each block validate the record during the restore operation.

## Reliable, redundant recording

The six-times redundancy results from extensive testing and field experience with dropouts and other types of media-related faults that can be encountered

with consumer-grade cassette tape. These faults tend to be randomly distributed along the length of the tape and are rarely concentrated within the span of a few contiguous blocks. Statistical analysis indicates that with just one repetition of a block record, the frequency of "hard" errors (all copies in error) drops below the equivalent figure for flexible disks. With three copies of each block, data integrity exceeds that of the Winchester itself. Doubling this number to six virtually eliminates any chance of a tape-fault error. Capacity of the tape is reduced to one-sixth its potential, but a single cassette still provides more than enough backup capacity for most applications.

This assumes that the tape has not been severely worn by repeated store-and-retrieve operations. To track this deterioration, common to all magnetic-tape media, the VCR controller monitors every read operation, counts the occurrence of "soft" CRC errors (when one of the copies is in error) and reports on demand the ratio between the total number of copies that have been read and the error count. A typical value for this soft-error "confidence test" is 300:1. When a cassette demonstrates a confidence-test value below 100:1, system software automatically sends a warning message to an operator.

The corrective action is to replace the worn cassette, but the user has other options. For added capacity, for

**Fig. 1. The VCR-to-computer interface** is a plug-in controller board that combines controller functions with a signal interface. The host computer sees the VCR as a low-performance disk, and the VCR sees the host computer as a video camera.

example, the tape speed of the VCR may have been set at "long play" or "extended long play." A new backup operation with the VCR switched to a "standard" tape-speed setting can enhance the reliability by spreading the data and blocks further along the tape.

Another alternative is to increase the number of copies of each block. The user can select any number as high as 255—escalating the theoretical integrity of the data toward infinity (except for equipment failure or physical destruction of the video cassette). Tape-speed setting and number of copies can be traded to meet special system requirements. For example, the user can increase the capacity of cassettes by switching to a longer playing mode and maintain data integrity by using a part of the added capacity to store extra copies of each block. Controller firmware prevents the user from decreasing redundancy below the six-copy minimum to expand capacity.

During normal operations, the fact that extra copies of each block have been recorded is completely transparent to the host computer but gives the user added interfacing flexibility. Each recorded data block

is prefaced by a sync byte and a 6-byte header containing a sequential identification number (Fig. 2). Only the first error-free copy containing the expected sequential number is transferred to the host and disk when the cassette is read. Preceding copies in error and all subsequent copies, with or without errors, are "discarded" by the controller's microprocessor. The CRC calculation that validates each block includes the header data to ensure that an incorrectly recorded identification number does not confuse the block count.

The controller's on-board RAM stores as many as seven unique data blocks (not copies) to buffer small mismatches between the data transfers and the rate at which data are being recorded or read. Larger differences can be accommodated by using extra copies of each block as "padding" to lower the rate at which "new" data are being written or read. In a "verify" restore operation, for example, the host reads and verifies blocks of data as they are stored on disk, significantly reducing the effective host-disk transfer rate.

Added padding is particularly important when data are backed up from one disk and restored on another, slower disk or are transferred to another system with an unknown disk. The number of copies, in this case, should reflect the worst-case condition. For reliability reasons, the same rule applies when cassette-stored data are to be read by another VCR, perhaps from a different manufacturer. A video cassette that is acceptable on one VCR may be marginally acceptable on another VCR with slightly different operating characteristics. Added redundancy usually compensates for

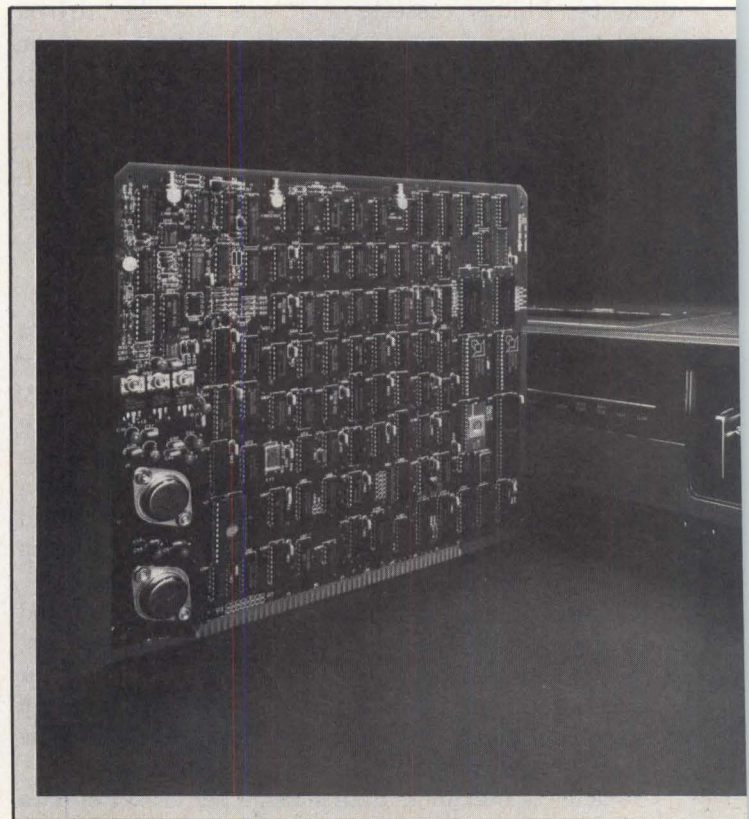

any increase in the soft-error rate that might occur.

### VCRs in action

Backup operations are initiated by a single host-computer command. Arguments included in this command specify the source disk, destination VCR and all the disk files that are to be transferred. The disk-file list serves as a directory, or "table of contents," for the backup video cassette and is automatically recorded at the beginning of each cassette. Subsequently, the system can read and display the contents of the cassette. The directory lists the number of blocks of data occupied by each file, allowing users or application programs to access a file or a file record by instructing the VCR subsystem to advance to a specified block number before transferring the data to the host. Moreover, the header at the front of each block (Fig. 2) also includes a "type" identification byte so that, by appropriate commands, the controller can be directed to search for and restore not only a selected group of files, but also files of a specific type. The controller reads intervening files and blocks of data but does not transfer them to the host. Data are transmitted to the host only when the desired files or blocks have been reached.

VCR tapes can also include warm-start data, allowing the VCR to be used as a system booting device. The controller (Fig. 1) includes a PROM containing the VCR controller firmware that can include an optional cold-start boot. In addition, standard system software permits the user to define a warm-start boot and store it on cassette tape immediately after the file directory.

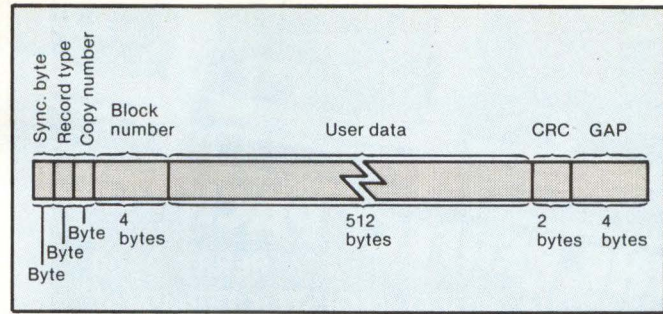
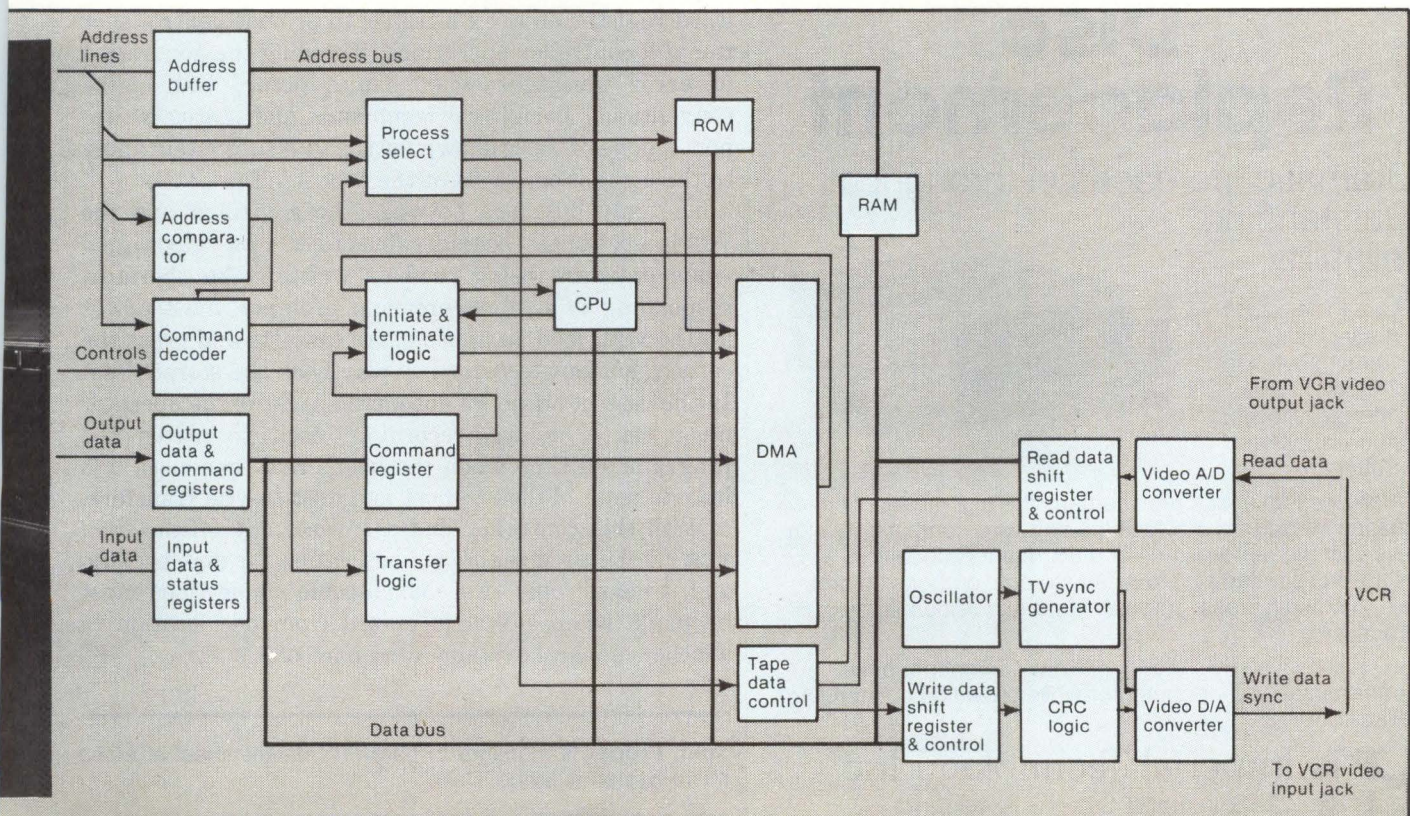

**Fig. 2. A VCR data block** combines 0.5M bytes of user data with 13 bytes of synchronization, address and error-correction information. Data blocks are recorded repeatedly in sequence for reliability through redundancy. During tape read operations, only the first error-free copy containing the expected block number is read. All subsequent copies are ignored.

To assure near-absolute integrity of this boot program, all of its data blocks are copied 16 times—independent of the number of copies the user specifies for the balance of data on the tape.

The user controls the VCR with Alpha Micro-supplied subroutines, including:

- **CRT610:** checks and verifies the quality of video cassettes for use as disk file backup media and optionally creates a warm-boot monitor cassette using a warm-boot monitor file built by WRMGEN.
- **SLEEP:** allows automatic file backup using a VCR that can be programmed to record at a specified time.
- **VCRDIR:** displays a list of the files on a video tape cassette and can create a disk file containing the video tape directory.
- **VCRRES:** writes files from video cassette tape to disk and allows a user to restore file-oriented disk





## THE PERFECT PACKAGE

**PERRY 9460**

### VIDEO REGISTER TERMINAL

- Software compatible for all point-of-sale and inventory control tasks
- Easy code access to the various terminal functions makes programming simpler
- Communications compatibility with most computers permits simple system interfacing
- Terminal, Register, Cash Drawer and Printer neatly packaged in a single unit
- Efficiency of single unit design and single board printed circuits allows the PERRY 9460 to be offered at a great savings

### The Perfect Package For Point-of-Sale

For all the details, call (919) 876-8100



3401 Spring Forest Road • Raleigh, N.C. 27658

CIRCLE NO. 97 ON INQUIRY CARD

# Solid-State Disc Replacement

Dramatic increases in throughput.  
Outstanding reliability.

- Capacities to 80 megabytes
- 10 megabytes in 7-inch chassis
- Interfaces to most minicomputers
- Battery back-up



When used as a disc replacement, the high speed, non-rotating MegaRam provides the software compatibility of a disc with the performance of main memory. Ideal for swapping, scratch files, overlay storage, process control, telecommunications, graphics, data acquisition, array processing, etc.

Let us show you how the MegaRam can enhance the performance of your computer while providing outstanding reliability.



**Imperial Technology, Inc.**

831 S. Douglas Street • El Segundo,  
California 90245 • Telephone: (213) 679-9501

CIRCLE NO. 98 ON INQUIRY CARD

## DISK DRIVES

backup from video cassette to disk.

- VCRSAV: writes copies of disk files to video tape cassettes.

- WRMGEM: creates a warm-boot monitor file on disk for transfer to a video tape cassette.

The six acronyms are part of the AMOS system-command language and can be entered at the keyboard in an interactive mode with prompts and help responses or incorporated into an application program.

The VCR system commands facilitate backing up and restoring data. Special training and programming techniques are not required. The characteristic file structures of AMOS are preserved intact, independent of whether the data are on disk, in host-computer memory or on video-cassette tape. The VCR controller responds to 17 single-byte commands that are used by the operating-system device driver to transfer data to and from the video cassette. These include: read tape record, read tape continuous, write tape record, write tape continuous, reset controller and parameters, read the user RAM pointer, load the user RAM pointer, read RAM indirectly via user RAM pointer, write RAM indirectly via user RAM pointer, execute RAM indirectly via user RAM pointer, turn off buffered tape-read flag, turn on buffered tape-read flag, read RAM current buffer - start at header area, read RAM current buffer - start at data area, read RAM parameters, write RAM parameters and abort read/write tape operation. The device-driver VCR commands interact with information stored in a status-word register on the controller to provide control over the VCR controller operations, including the generation of error messages when faults occur. But unlike conventional peripheral commands and status-bit reports, none of those shown for the VCR subsystem apply to the control or status of the VCR itself.

The only interface between the controller and the VCR is a set of two coaxial cables to carry a video signal when data are being read or written. An operator, responding to system-command prompts, must power up the VCR, load an appropriate cassette and press the correct buttons to record or play back the stored data. In the case of off-hours automatic backup, the operator must set a delayed-recording clock to match the programmed time when the host's real-time clock will initiate a set of disk-to-host and host-to-VCR transfers.

With this controller and software, any off-the-shelf VCR can be used without modification for disk backup, and, because only two coaxial-cable connections must be made when a VCR is moved from one location to another, several systems can share one VCR. □

**John Proper** is manager of hardware development at Alpha Micro Systems, Irvine, Calif.



# FINALLY—HIGH CAPACITY PLUS DATA INTEGRITY IN 1/4-INCH CARTRIDGE STREAMERS.

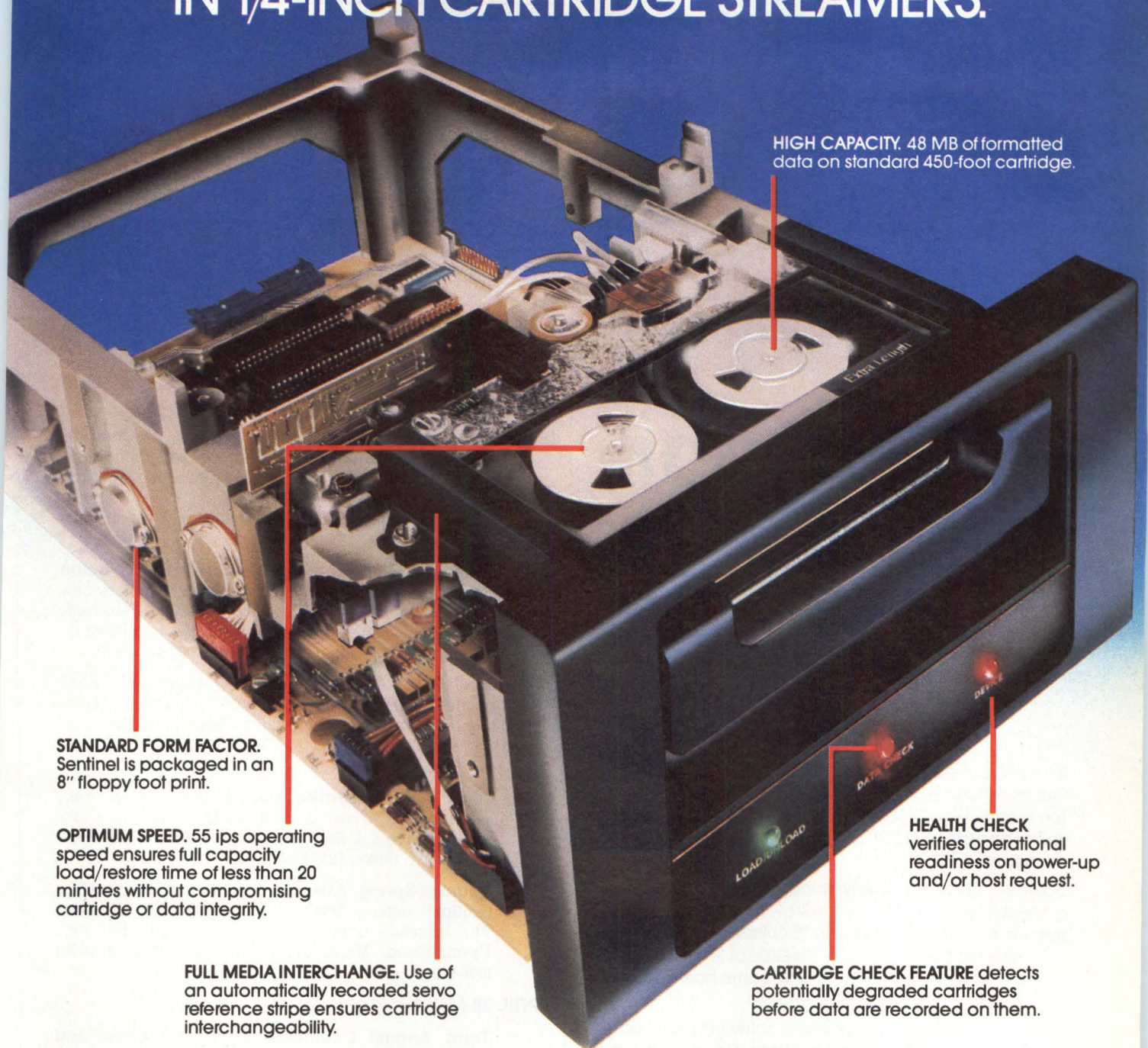

**HIGH CAPACITY.** 48 MB of formatted data on standard 450-foot cartridge.

**STANDARD FORM FACTOR.** Sentinel is packaged in an 8" floppy foot print.

**OPTIMUM SPEED.** 55 ips operating speed ensures full capacity load/restore time of less than 20 minutes without compromising cartridge or data integrity.

**FULL MEDIA INTERCHANGE.** Use of an automatically recorded servo reference stripe ensures cartridge interchangeability.

**CARTRIDGE CHECK FEATURE** detects potentially degraded cartridges before data are recorded on them.

**HEALTH CHECK** verifies operational readiness on power-up and/or host request.

## T H E S E N T I N E L

The Model 92190 Sentinel cartridge streamer delivers the data capacity needed to back up even today's higher-capacity 8" fixed disk drives. With a data rate (55 KBS) optimized for system requirements. Plus an optional ECC feature for applications requiring extremely high data integrity. For more information, call your local Control Data OEM Sales Representative or write: OEM Product Sales, HQN08H, Control Data Corporation, P.O. Box 0, Minneapolis, MN 55440.

CIRCLE NO. 99 ON INQUIRY CARD

**CD CONTROL DATA**

*Addressing society's major unmet needs  
as profitable business opportunities*

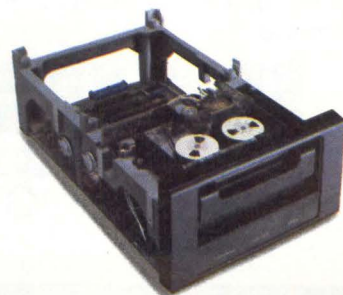

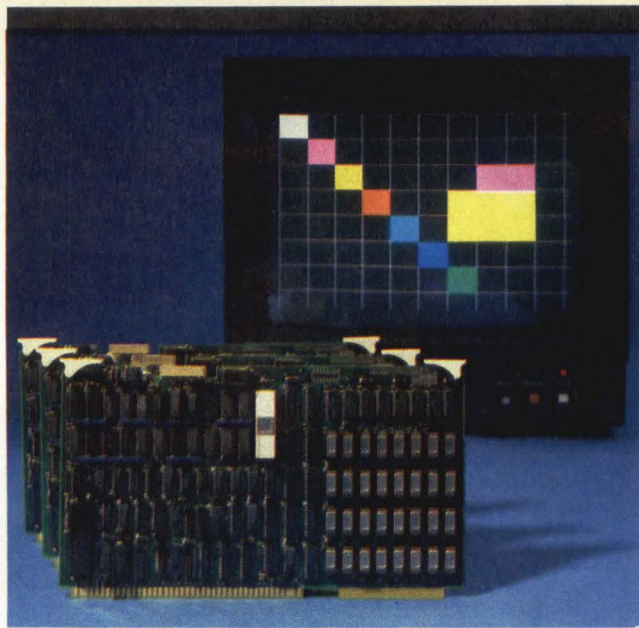

# 1024 x 1024 16 COLOR GRAPHICS CONTROLLER, \$4,100 in 100 QUANTITY.

It's a price breakthrough even at \$7,200 for a single unit. Our multibus display controller gives you performance too with 8, 16, or 256 colors; hardware, pan, scroll, and zoom; multiple plane BIT, BLT, and fast vector writing with the new NEC 7220.

Boards can be modularly configured to give you upgradeable options. You can start with a 2 board 8 color system; move to 3 boards with 16 colors, or grow to a 256 color set with overlay planes. Palettes of  $2^{12}$  or  $2^{24}$  can be selected for our look-up-table. The same boards can be configured for grey scale.

Hardware features don't become software pains either. Our Unix "C" driver and core package allows you to work above low level mental gymnastics.

Want more information? Circle the bingo or call us at (617) 275-4330 for an individual quote. Put some color in your systems life.

## IKIER TECHNOLOGY, INC.

7 Oak Park Bedford, MA 01730

CIRCLE NO. 100 ON INQUIRY CARD

## Calendar

### APRIL

- 13-20 Hanover Fair '83**, Hanover, Germany, organized by Hanover Fairs Information Center. Contact: Hanover Fairs Information Center, P.O. Box 338, Whitehouse, N.J. 08888-0338, (201) 534-9044 or (800) 526-5978.
- 14-17 Second Annual New York Computer Show and Software Exposition**, Nassau, Long Island, N.Y., sponsored by Northeast Expositions. Contact: Deborah C. Harkins, Northeast Expositions, 822 Boylston St., Chestnut Hill, Mass. 02167, (617) 739-2000.
- 18-21 IEEE Infocom '83**, San Diego, Calif., sponsored by the Computer Communications Committee of the IEEE Computer and Communications Societies. Contact: IEEE Infocom.
- 18-21 Fifth Annual International Conference on Computer Capacity Management**, New Orleans, sponsored by the Institute for Software Engineering. Contact: Institute for Software Engineering, 510 Oakmead Parkway, Sunnyvale, Calif. 94086, (408) 749-0133 or (800) 538-1872.
- 19-21 Electro '83 High-Technology Electronics Exhibition and Convention**, New York, sponsored by Electronic Conventions Inc. Contact: Jerry Fossler, Electronic Conventions Inc., 999 N. Sepulveda Blvd., El Segundo, Calif. 90245, (213) 772-2965 or (800) 421-6816.
- 19-21 Mini/Micro-Northeast**, New York, sponsored by Electronic Conventions Inc. Contact: Jerry Fossler, Electronic Conventions Inc., 999 N. Sepulveda Blvd., El Segundo, Calif. 90245, (213) 772-2965 or (800) 421-6816.
- 21-22 Local Area Networks '83**, St. Petersburg, Fla., sponsored by Frost & Sullivan Inc. Contact: Carol Sapchin, Frost & Sullivan Inc., 106 Fulton St., New York, N.Y. 10038, (212) 233-1080.
- 26-29 Comdex Spring**, Atlanta, organized by The Interface Group. Contact: Irwin Stern, Marketing Director, The Interface Group, 160 Speen St., P.O. Box 927, Framingham, Mass. 01701, (617) 879-4502 or (800) 225-4620.

### APRIL 28-MAY 1

**Third Annual Southwest Computer Show and Software Exposition**, Dallas, sponsored by Northeast Expositions. Contact: Deborah C. Harkins, Northeast Expositions, 822 Boylston St., Chestnut Hill, Mass. 02167, (617) 739-2000.

### MAY

- 4-6 Sixth Annual Rocky Mountain Data Processing Expo and Conference**, Denver, sponsored by the Mile High Chapter of the Data Processing Management Association. Contact: Mark Cramer, Show Manager, Industrial Presentations West, 3090 S. Jamaica Court, Suite 304, Aurora, Colo. 80014, (303) 696-6100.

# CANON OFFERS A SMALL SENSATION:

## The thinnest megabyte in the whole wide world.

Everybody else's half-height 5¼" floppy disk drive is at least 41 mm high.

Our new 1-megabyte 5¼" floppy disk drive (MDD 221) is a mere 33.5 mm.

And our 2-megabyte dual disk drives (MDD 422 and 423) are only 57.5 mm high — a mere 28.75 mm per megabyte!

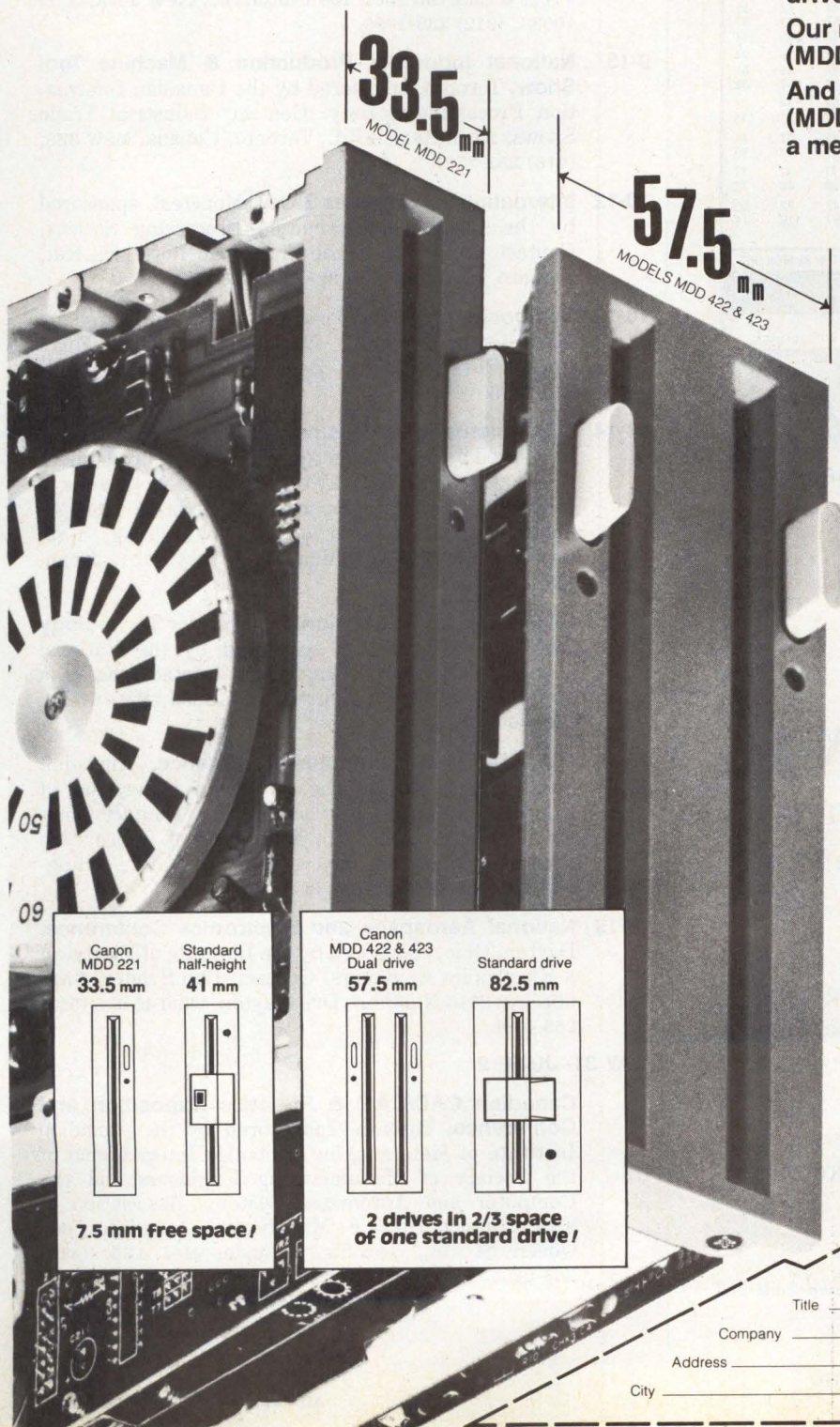

### User convenience

- Single-pushbutton media locking and ejection. Anti-crunch mechanism prevents damage to improperly inserted media. Pushbutton is locked while drive is in R/W operation.

### Reliability

- Wear and shock resistant thin head — *designed and manufactured by Canon.*
- Soft-landing head mechanism eliminates tap damage.
- Brushless direct drive motor.
- Low parts count.
- No lubrication required.
- Total head shielding.
- Circuitry designed for least amount of noise interference.

### Design Benefits

- Space savings.
- Front panel removable.
- Available with standard half-height panel as option.
- Industry compatible interface.
- Low power consumption.

### Dual Drives — MDD 422, MDD 423

- Two drives equal only 2/3 the height of standard 5¼" floppy drive.
- Cost savings: less than the cost of 2 separate drives.
- Power savings: two drives require approximately the same power as only one drive.
- MDD 422 has one stepper for both drives; MDD 423 has separate stepper for each drive.

We have a lot more to tell you about these drives. Call Lee Heller at (516) 488-6700, Ext. 4958, or mail the coupon to Canon U.S.A., Inc., Peripherals Division, One Canon Plaza, Lake Success, NY 11042. CIRCLE NO. 101 ON INQUIRY CARD

# Canon

Please send more information on your floppy drives.

Name \_\_\_\_\_  
 Title \_\_\_\_\_ Tel.: ( ) \_\_\_\_\_  
 Company \_\_\_\_\_  
 Address \_\_\_\_\_  
 City \_\_\_\_\_ State \_\_\_\_\_ Zip \_\_\_\_\_

mm

# TERMINALS FROM TRANSNET

PURCHASE PLAN • 12-24 MONTH FULL OWNERSHIP PLAN • 36 MONTH LEASE PLAN

	DESCRIPTION	PURCHASE PRICE	PER MONTH		
			12 MOS.	24 MOS.	36 MOS.
<b>* DEC</b>	LA34 DECwriter IV Forms Ctrl. ....	\$1,095	\$105	\$ 58	\$ 40
	LA100 Letter Printer RO. ....	1,995	190	106	72
	LA120 DECwriter III KSR. ....	2,295	220	122	83
	LA120 DECwriter III RO. ....	2,095	200	112	75
	LA12A Portable DECwriter. ....	2,950	280	155	106
	VT100 CRT DECscope. ....	1,695	162	90	61
	VT101 CRT DECscope. ....	1,195	115	67	43
	VT125 CRT Graphics. ....	3,295	315	185	119
	VT131 CRT DECscope. ....	1,745	167	93	63
	VT132 CRT DECscope. ....	1,995	190	106	72
<b>TEXAS INSTRUMENTS</b>	VT18XAC Personal Computer Option	2,395	230	128	86
	T1745 Portable Terminal. ....	1,595	153	85	58
	T1765 Bubble Memory Terminal. ....	2,595	249	138	93
	T1940 CRT. ....	1,795	173	96	65
<b>LEAR SIEGLER</b>	T1785 Portable KSR, 120 CPS. ....	2,795	273	153	101
	T1787 Portable KSR, 120 CPS. ....	2,195	211	117	80
	T1810 RO Printer. ....	1,695	162	90	61
	T1820 KSR Printer. ....	2,195	211	117	80
<b>C-ITOH</b>	ADM3A CRT Terminal. ....	595	57	34	22
	ADM5 CRT Terminal. ....	645	62	36	24
	ADM32 CRT Terminal. ....	1,165	112	65	42
<b>TELEVIDEO</b>	CIT-101 CRT. ....	1,525	147	82	55
	CIT-161 Color CRT. ....	2,675	257	143	97
	CIT-427 Color Graphic CRT. ....	3,095	297	165	112
<b>NEC SPINWRITER</b>	910 CRT Terminal. ....	650	62	36	24
	925 CRT Terminal. ....	850	82	46	31
	950 CRT Terminal. ....	1,075	103	57	39
<b>GENERAL ELECTRIC</b>	Letter Quality, 7715 RO. ....	2,695	259	144	98
	Letter Quality, 7725 KSR. ....	3,195	307	171	115
<b>EPSON</b>	2030 KSR Printer 30 CPS. ....	1,195	115	67	43
	2120 KSR Printer 120 CPS. ....	2,195	211	117	80
<b>TIMEPLEX</b>	MX-80 F/T Printer. ....	745	71	42	27
	MX-100 Printer. ....	895	86	48	32
<b>ACCESSORIES AND PERIPHERAL EQUIPMENT</b>	ED400 4 Channel Stat Mux. ....	1,525	147	82	55
	ED800 8 Channel Stat Mux. ....	2,050	197	110	74

\*DEC is the trademark of Digital Equipment Corporation

FULL OWNERSHIP AFTER 12 OR 24 MONTHS • 10% PURCHASE OPTION AFTER 36 MONTHS

## MICROCOMPUTERS

APPLE • COMMODORE • HP87 • DEC

## ACCESSORIES AND PERIPHERAL EQUIPMENT

ACOUSTIC COUPLERS • MODEMS • THERMAL PAPER • RIBBONS • INTERFACE MODULES • FLOPPY DISK UNITS



**TRANSNET CORPORATION**

1945 ROUTE 22 • UNION, N. J. 07083 • (201) 688-7800  
TWX 710-985-5485 800-526-4965 OUTSIDE N. J.

CIRCLE NO. 102 ON INQUIRY CARD

**NEW**

**IRCONV**

**ISIS-II\* ↔ iRMX-86\***

### FORMAT CONVERSION UTILITY

- Software access of ISIS diskettes on iRMX systems
- Replaces need for special transfer hardware
- Easy to use command line operation

IRCONV easily performs FORMAT, WRITE, READ and DIRECTORY LIST functions to access ISIS-II diskettes on the newer, lower cost iRMX-86 workstations.

\$350 + \$10 postage and handling  
Delivered on one 8" iRMX-86 diskette

\* Trademark of Intel Corporation

**mtp**  
SOFTWARE and  
SYSTEMS TECHNOLOGY INC.

7700 Edgewater Drive, Suite 360  
Oakland, CA 94621  
(415) 632-1555

CIRCLE NO. 103 ON INQUIRY CARD

# Calendar

**5-8 FutureWorld Expo '83**, Los Angeles, sponsored by FutureWorld '83. Contact: Todd Easton Mills, 5455 Castle Knoll, La Canada, Calif. 91011, (213) 957-3328.

**9-11 "Designing Advanced Production Machines" Seminar**, Atlanta, sponsored by Frost & Sullivan Inc. Contact: Carol Sapchin, Account Representative, Frost & Sullivan Inc., 106 Fulton St., New York, N.Y. 10038, (212) 233-1080.

**9-13 National Industrial Production & Machine Tool Show**, Toronto, sponsored by the Canadian Information Processing Society. Contact: Industrial Trade Shows, 20 Butterick Rd., Toronto, Canada, M8W 3Z8, (416) 252-7791.

**10-12 International Computer Show**, Montreal, sponsored by the Canadian Information Processing Society. Contact: Industrial Trade Shows, 20 Butterick Rd., Toronto, Canada, M8W 3Z8 (416) 252-7791.

**10-12 Symposium '83**, Boxborough, Mass., sponsored by Mitre Corp. Contact: Edward M. Sullivan, Mitre Corp., Burlington Rd., Bedford, Mass. 01730, (617) 271-7369.

**11-14 58th International Business Show**, Tokyo, Japan, sponsored by the Nippon Administrative Management Association and the Tokyo Chamber of Commerce & Industry. Contact: Nippon Administrative Management Association, Seikyo Kaikan Building, 1-13, Sendagaya 4-chome, Shibuya-ku, Tokyo 151, Japan, (03) 403-1331.

**11-15 COMPUTA '83 International Computer Technology Exhibition**, Singapore, sponsored by the National Computer Board of Singapore. Contact: Kallman Associates, 5 Maple Court, Ridgewood, N.J. 07450, (201) 652-7070.

**16-19 1983 National Computer Conference**, Anaheim, Calif., sponsored by the American Federation of Information Processing Societies Inc. Contact: Ann-Marie Bartels, American Federation of Information Processing Societies Inc., 1815 N. Lynn St., Arlington, Va. 22209, (703) 558-3612.

**17-19 National Aerospace and Electronics Conference**, Dayton, Ohio, sponsored by the Institute of Electrical & Electronics Engineers. Contact: Dan Synder, NAECON '83, 2046 Northern Dr., Dayton, Ohio 45431, (513) 255-4709.

## MAY 31- JUNE 2

**Canadian CAD/CAM & Robotics Exposition and Conference**, Toronto, sponsored by the Canadian Institute of Metalworking, Robotics International of the Society of Manufacturing Engineers and the Computer and Automated Systems Association of SME. Contact: Hugh F. Macgregor & Associates, 662 Queen St. W., Toronto, Canada, M6J 1E5, (416) 363-2201.

# SLIMLINE 3000



## YOUR SINGLE SYSTEM SOLUTION

California Computer System's new **Slimline 3000** is the compact solution to your business computing needs. A Z80 micro-processor, reliable S-100 bus, floppy drive, hard disk, 20MB tape backup, up to 1024K RAM, and a fully integrated power supply... all in one slim, attractive enclosure.

The low-cost **Slimline 3000** delivers high performance and versatility in a wide variety of applications: business, educational, engineering, scientific, pharmaceutical, medical/dental, and many more.

Available as a single-user system utilizing the popular CPM\* operating system, the **Slimline** is upgradeable to a multi-user system and will run either MP/M\* or OASIS\*. You can choose from any of thousands of single and multi-user applications

software packages currently available.

No longer is it necessary to buy more computer than you want, nor to settle for less computing power than you need. Start out with one double-sided, double-density floppy drive and expand upward to 27 megabytes of hard disk storage. The **Slimline 3000** allows you to upgrade your system as your computing needs grow. Future upgrade options include a 16-bit processor.

Find out what the **Slimline 3000** can do for you. For more information, write to our Sales Department, **California Computer Systems**, 250

Caribbean Drive, Sunnyvale, California 94086. Or give us a call at (408) 734-5811 and ask to speak to a Sales Representative.

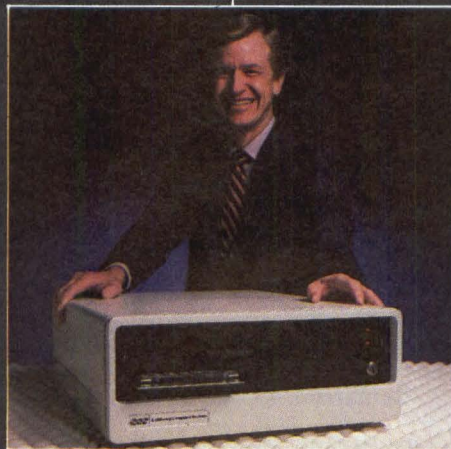

**California Computer Systems**

250 Caribbean Dr., Sunnyvale, CA 94086  
(408) 734-5811 Telex: 171959 CCS SUVL

Copyright 1983 California Computer Systems.  
Slimline 3000 is a Trademark of California Computer Systems.  
\*CP/M and MP/M are Registered Trademarks of Digital Research, Inc.  
OASIS is a Registered Trademark of Phase One Systems, Inc.

CIRCLE NO. 104 ON INQUIRY CARD

New from Cosmos Systems

# A Galaxy of Processing Solutions For The OEM & System Integrator

MC68000\* Microcomputer Systems with UNIX\*,  
Multibus\* & a Full Range of Capabilities.



## ANTARES

Our new "Starfield Series" offers you a universe of configuration alternatives for creating advanced processing systems.

Cornerstar of the series is ANTARES—a state-of-the-art system for major development projects. With 1M ECC memory, 40M 8" Winchester, 1/4" streamer tape backup and 16-channel intelligent I/O, ANTARES is the optimum solution for getting new applications developed quickly.

\* MC6800 is a trademark of Motorola, Inc.  
\* Ethernet is a trademark of Xerox.  
\* UNIX is a trademark of Bell Laboratories, Inc.  
\* MULTIBUS is a trademark of Intel Corp.

## ORION

Centerstar is ORION—designed with 474M mass storage, 1/2" streamer tape backup, 1M ECC memory plus floating-point hardware and optional Ethernet. \* ORION is your solution for rapidly developing and running scientific applications.



Winning combinations.

**COSMOS SYSTEMS, INC.**

A Subsidiary of C.M. Technologies, Inc.  
430 Toyama Drive, Sunnyvale, CA 94086  
(415) 326-9150/TELEX: 334417  
CABLE: CHIMINGCO

CIRCLE NO. 105 ON INQUIRY CARD

## LYRA

Targetstar is LYRA, comprised of 8" 20M Winchester, 8" 1M floppy and 1/2M ECC memory. This sophisticated target-system solution shares aggressive volume pricing with all Cosmos products.

The Starfield Series supports "C," COBOL, FORTRAN, PASCAL and BASIC languages.

Combine Starfield capabilities with your imagination and our market-oriented policies. We don't promise the moon, but we do promise right-now options for right-now solutions. Call us today for full details.

# Peripherals

NEW PRODUCTS

## Peripheral controllers provide high-performance Multibus capability

Xylogics Inc., a manufacturer of high-performance peripheral controllers for the OEM and system integrator markets, has introduced two intelligent controllers for Multibus-based applications: the model 450 disk controller for SMD-compatible disk drives and the model 472 tape controller for streaming and start-stop tape drives.

Each controller resides on one single-height Multibus PC board,

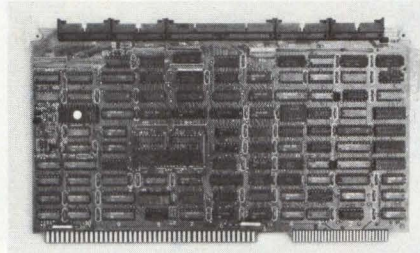

Xylogics Inc.'s model 450 disk peripheral controller is packaged on one IEEE-796 Multibus standard PC card and requires +5V and -5V power from the backplane. It meets all IEEE-796 environment specifications.

addresses as much as 16M bytes of memory and controls as many as four drives per board. The model 450 supports data-transfer speeds as high as 1.8M bytes per sec. When attached to four disk drives, it can access as much as 2.4G bytes of disk storage. The model 472 supports tape drives running at speeds from 12.5 to 100 ips with recording densities of 800, 1600 or 6250 bpi.

Because the model 450 has the SMD interface, it is compatible with a wide range of disk drives offered by Ampex Corp., Control Data Corp., Fujitsu America Inc., NEC Information Systems Inc. and Priam Corp. Software drivers for the model 450 include CP/M, RMX-86 and UNIX. The model 472 can interface to any tape drive that

conforms to the Pertec interface including drives from Pertec Computer Corp., Kennedy Co., CDC and Cipher Data Products Inc.

The controllers also feature 16-, 20- and 24-bit addressing, on-board diagnostics, programmable throttle and support for 8- and 16-bit microprocessors. The model 450 also features automatic error correction and has a 2K-byte FIFO buffer. The model 472 has a 1K-byte FIFO buffer, and its DMA circuitry can transfer data at speeds as high as 2M bytes per sec.

For optimum Multibus system performance with 16/32-bit processors, such as the 8086, 68000, 16032 and Z8000, the controllers use a channel-control technique. Channel control permits command chaining without operating-system intervention between commands and so allows concurrent processor and peripheral operation.

Prices for the models 450 and the 472 are less than \$1500 and \$1400, respectively, in quantity. Xylogics Inc., 144 Middlesex Turnpike, Burlington, Mass. 01803.

Circle No 300



### Interface ties instruments in a common bus

The models Q1488 microprocessor-based intelligent interfaces provide the ability to connect RS232 or 20-mA current-loop serial instruments to an IEEE-488 general-

purpose interface bus. Model Q1488S provides GPIB talker/listener capability and generates and accepts all required IEEE-488 data transfer and handshake signals. A 480-byte buffer is provided for each input. The Q1488S serial data rate is user-selectable from 110 to 9600 baud. The model Q1488C, RS232-to-IEEE-488 controller, includes all the features of the model Q1488S, but also allows a user to perform all GPIB controller functions except passing and receiving control. Each of the units includes LED status indicators for talking, listening, buffer three-quarters full, ready and power on. Prices are \$1250 for the model Q1488S and \$1500 for the model Q1488C. Quasitronics, Inc., 211 Vandale Dr., Houston, Pa. 15342.

Circle No 301

### Streaming-tape controller interfaces LSI-11 drives

The STV11 streaming-tape controller interfaces the Archive and Cipher ¼-in. streaming-tape drives to the DEC LSI-11 Q-bus. The controller is packaged as a dual-height LSI-module and emulates the DEC TM11 for full software compatibility with all DEC operating systems. A single 50-conductor ribbon cable connects the controller to as many as two Archive or Cipher streaming-tape drives with two or four recording tracks. From 10M to 45M bytes of data can be stored on a single 450-ft. tape cartridge, depending on the tape-drive model used. Data can be recorded at rates as fast as 87.2K bytes per sec. on 90-ips drives. Prices start at \$1500. General Robotics Corp., 57 N. Main St., Hartford, Wis. 53027

Circle No 302

**Introducing the  
money-making  
micro-mini  
DEC™-UNIX™-CP/M™-MUMPS™  
universal 16-bit  
workstation.**

**(Whew!)**





If you're selling small business systems and software, you're leaving money on the table.

Because you could pick up a lot more of what we're all here for with the Plessey Series/6000 Small Business Computers.

ACCOUNTS RECEIVABLE PLESSEY PERIPHERAL SYSTEMS

PLEASE SELECT █

1. SALESMAN FILE MAINTENANCE
2. CUSTOMER FILE MAINTENANCE
3. SALES AND CR/DR MEMO ENTRY
5. PRINT A/R AGING REPORT
6. APPLY OPEN CREDIT
7. CUSTOMER ACCOUNT INQUIRY
8. FINANCE CHARGES
9. PRINT STATEMENTS
10. PRINT COMMISSIONS DUE REPORT
11. PRINT A/R DISTRIBUTION TO G/L REPORT
12. PURGE A/R OPEN ITEM FILE
13. PRINT SPOOLED REPORTS

## Your business is our business.

With the 16-bit Plessey Series/6000, we've made it our business to support your business.

Our computers are based on DEC's LSI-11™ micros, so you start with proven hardware that's in thousands of systems world-wide.

We've made them available in a wide range of configurations, so you can provide exactly the power your customers need.

Start with the low-cost System 6100, a 64 kbyte single-user workstation. Or for multi-users, choose the economical System 6200 with 256 kbytes of main memory (expandable to a full megabyte). Both use the Q-bus and come in a compact 5¼" chassis available in desktop and rackmount configurations.

And for the big jobs, go to our System 6600 and System 6700 to get the full power of a 22-bit minicomputer. From 256 kbytes to 4 megabytes of main storage. An 84 megabyte 8" Winchester disk. Q-bus for communications and other peripheral interfacing. And all in a 10¼" chassis at a price that's easy to take.

Or choose anything in between, with or without floppies, hard disks, streamer

tapes, terminals, communications and any peripherals you need. (Peripherals are also available alone.)

All the Plessey Series/6000 computers support whatever you're doing (or will be doing) in software: DEC operating systems like RSX-11M/M+, RSTS/E™ and RT-11™ or TSX-Plus™. UNITY™ (System III UNIX) and the new crop of software. M-11 (MUMPS) and hordes of public domain applications. And even CP/M and all those low-cost programs.

You can use BASIC, COBOL, DIBOL™, C, PL/I, FORTRAN and MACRO™ languages.

And the programs you develop on the single-user system are just as useful on the most powerful Series/6000 configuration, so your customers have an easy growth path.

[A1] DTL: Net Profit Analysis  
Entry or / █

row:	A	B	C	D	E	F
1:	Net Profit Analysis	January	February	March	Total % of Gross	Margin
2:						
3:	Domestic Sales	900,000	927,000	954,810	2,781,810	
4:	Foreign Sales	300,000	309,000	318,270	927,270	
5:	Total Sales	1,200,000	1,236,000	1,273,080	3,709,080	
6:	Cost of Goods Sold	624,000	635,030	646,267	1,905,297	
7:	Gross Margin \$	576,000	600,970	626,813	1,803,783	
8:						
9:	Operating Expenses					
10:	Sales Expense	149,000	150,490	151,995	451,485	25.0
11:	Marketing Expense	142,000	143,420	144,854	430,274	23.9
12:	Admin Expense	99,000	99,990	100,990	299,980	16.6
13:	Total Operating Exp	390,000	393,900	397,839	1,181,739	65.5
14:	Interest Expense	21,000	21,000	21,000	63,000	3.5
15:	Fed and State Taxes	80,000	90,000	95,000	265,000	14.7
16:	Net profit	85,000	96,070	112,974	294,044	16.3

## The bottom line.

Plessey Series/6000 Small Business Computers are a quick way to improve your profits because they're reliable, versatile and cost up to 30% less than the DEC equivalents.

And they'll reduce your after-sale headaches because they're supported by our own international sales and service network.

For more details, contact Plessey Peripheral Systems, 17466 Daimler, Irvine, CA 92714.

Or better yet, call (800) 854-3581 or (714) 540-9945 in California today. Because we all know that time is money.



# QUARTER MEGABYTE OF RELIABLE MEMORY WITH PARITY

- 8/16 BIT DATA PATHS
- 24 BIT EXTENDED ADDRESSING
- 230 nS ACCESS TIME (from pSTVAL)—Runs in 4 MHz systems with no wait states.

## FOR 16 BIT IEEE-696 SYSTEMS

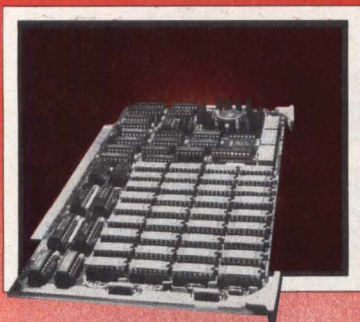

### DMEM

- TWO INDEPENDENTLY ADDRESSABLE 128 KB REGIONS.
  - PARITY ERROR DETECTION—Programmable read options: Latched vectored, pulsed vectored, bus error signal generated.
  - TRANSPARENT REFRESH, continuous operation w/o wait states or arbitration delays.
  - DATA INTEGRITY with added byte parity check-bit.
  - CERTIFIED RELIABLE: 168-hour burn-in dynamic memory test.
  - 64K DYNAMIC MEMORY CHIPS with large cell geometry delivers low soft error rate.
  - FIELD PROVEN—used in all Dual System 83 series 68000-based computer systems with UNIX\*.
- DMEM-256KP ..... \$1295

\*UNIX is a trademark of Bell Laboratories.

# DUAL

DUAL SYSTEMS CORPORATION  
2530 San Pablo Avenue • Berkeley  
CA 94702 • (415) 549-3854 • 172029 SPX

CIRCLE NO. 106 ON INQUIRY CARD

# Peripherals

NEW PRODUCTS

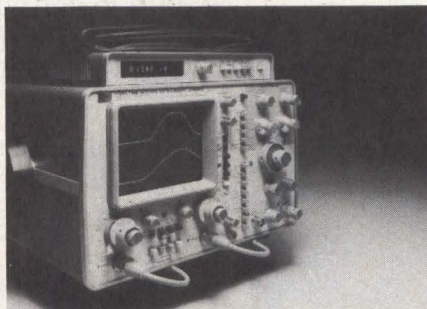

### Hybrid test device performs time-interval measurements

The model HP 1726A time-interval oscilloscope combines the crystal-referenced time base of a time-interval counter with the stable triggering circuits of high-performance oscilloscopes. The device can measure time intervals as long as 1.2  $\mu$ sec. with  $\pm$  10-picosec. resolution and 50-picosec. accuracy. The HP 1726A can be operated in two timing measurement modes, the overlap mode and the triggered mode. Both operating modes incorporate time-interval averaging that is automatically controlled through the Main Time/Div switch on the unit's front panel. Time-interval averaging allows the HP 1726A to measure any repetitive signal that can be displayed on an oscilloscope. A standard HP-IB interface can output data for production and record keeping. Single-quantity price is \$7675. **Hewlett-Packard Co.**, 1820 Embarcadero Rd., Palo Alto, Calif. 94303. **Circle No 400**

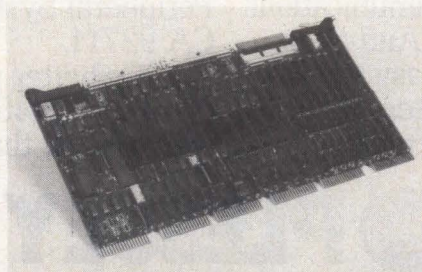

### Tape controller has on-board memory

The TS-6251 controller for DEC PDP-11 and VAX-11 Unibus comput-

ers can be used as a DEC TS11 or TM11 emulator, a 6250-bpi (GCR) controller, a software-compatible streamer controller, a 6250-bpi streamer controller or a single-board embedded stop/start controller. The TS-6251 features a 64K-byte on-board memory configured as a multi-block staging buffer that enables a user to run 1/2-in. streaming 1600- and 3200-bpi drives with unmodified software in a streaming mode. The controller also has a DMA auto-throttle feature that optimizes its use with GCR and tri-density drives at speeds as fast as 125 ips at 6250, 1600 and 800 bpi. Price is \$2250 in single-unit quantities. **Western Peripherals**, 14321 Myford Rd., Tustin, Calif. 92680.

**Circle No 401**

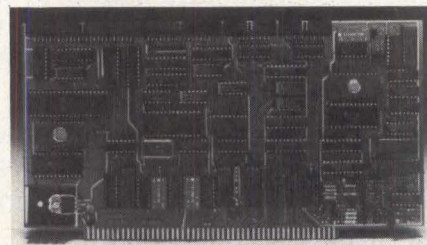

### Disk/tape controller works with S-100 bus systems

The model HD/CTC controller interfaces two ST506-compatible 5 1/4-in. hard disk drives and a Data Electronics Streaker cartridge-tape drive to an S-100 bus system. The intelligent controller features a Z80A CPU, 8K bytes of RAM, 16K bytes of ROM and a 2K-byte FIFO buffer. Different-sized hard disk drives and different cartridge-tape drives can be accommodated with minor alterations to the on-board hardware and firmware. Software support includes drivers for Teletek's CP/M, TurboDOS and Micro Mike's MDZ/OS. Price is \$461.10 each in quantities of 100. **Teletek Enterprises Inc.**, 9767F Business Park Dr., Sacramento, Calif. 95827.

**Circle No 402**

# For DEC\* Computers, 100% Compatible.

## For DEC Owners and Users, 100% Essential.

**Thousands of New Products.  
100% DEC-Compatible.**

All the latest hardware, software, services and supplies designed to run on your DEC computer. All the DEC-compatibles you've read about, heard about, but have never seen demonstrated. Plus, thousands more. Newer and better than anything on the market today. More DEC-compatibles than at any other show in the world!

**Over 250 Vendors.  
100% DEC-Friendly.**

Meet the vendors who can help your DEC system reach a new standard of performance. Because you never have to ask, "Is it DEC-Compatible?" you get fast answers to the really important questions. It's the one Show for everyone who owns, manages, or uses a DEC computer. So bring the entire decision-making team: top management, financial management, DP management and senior staff.

**Especially for DECUS\*  
Conference Registrants.  
100% Free.**

It's easy to attend DEXPO East 83. And hard to miss. Especially for DECUS members attending the St. Louis conference. Free shuttle buses will take you from the Show to the conference in just five minutes. And conference attendees will be able to use their DECUS badges to enter the Show without paying a registration fee.

Group Registration  
Discounts Available  
**Bring Your  
Boss for FREE!**  
Use Registration  
Form

\*DEC and DECUS are registered trademarks of Digital Equipment Corporation.

# DEXPO™ East 83

**The Third National  
DEC-Compatible  
Industry Exposition**

**Kiel Auditorium, St. Louis  
May 22-24, 1983**

MAIL TODAY FOR MONEY-SAVING REGISTRATION INFORMATION

I want to save time and money on my DEXPO East 83 registration, air fare, hotel accommodations and car rental. Send complete information.

Send \_\_\_\_\_ extra copies for my associates.

NAME \_\_\_\_\_

TITLE \_\_\_\_\_

COMPANY \_\_\_\_\_

ADDRESS \_\_\_\_\_

CITY \_\_\_\_\_ STATE \_\_\_\_\_ ZIP \_\_\_\_\_

I am interested in *exhibiting* in the Show. Call me at  
(\_\_\_\_\_) \_\_\_\_\_.

Send to: **Expoconsul International Inc.**, 55 Princeton-Hightstown Rd., Princeton Junction, NJ 08550

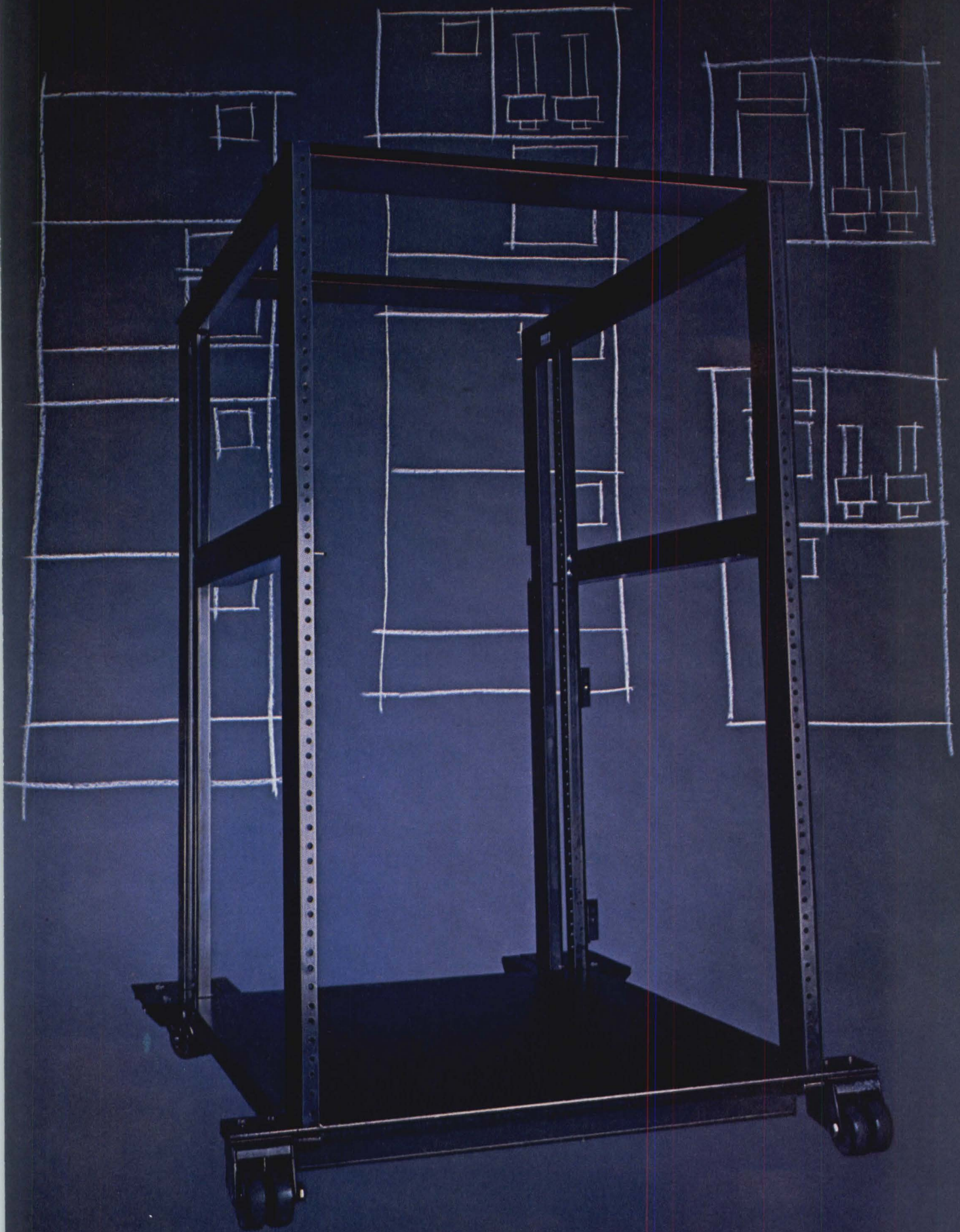

With the open architecture of the IBM Series/1

# You configure it out for yourself.

With an IBM Series/1 you get exactly what you need. When you need it. Where you need it. No more. No less. Thanks to the open architecture design of the Series/1, IBM can work with you to match the right configuration to the job you want to do. And what that means to you is the best value for your data processing dollar.

But whatever you configure, with the Series/1 you can feel secure in knowing that you can add to the system without sacrificing any of your initial investment. As your needs change or grow, you can add more memory, more storage, a larger processor, work stations and I/O devices. Almost everything can be mounted in convenient 19-inch racks. A fully expanded system can take up to 96 transmission lines, which can connect to both IBM and non-IBM hardware.

With the open architecture of the Series/1, you can benefit from new IBM enhancements simply by plugging them in, eliminating the expense and time of installing a totally new computer. And as your configurations change, you don't have to change programs, thanks again to the open architecture.

The IBM Series/1 proves its mettle in multiples, where larger organizations can benefit from its low price, strong communications capability, easy installation and its tailorability.

The great price/performance story of the Series/1 and its technical superiority go a long way toward explaining its popularity across the country, in everything from standalone data processing on Main Street, to distributed processing nodes in peer or host-attached networks, to communication controllers for local networks.

When you add on IBM service and support nationwide, it's easy to see why so many customers become more and more attached to their Series/1s every day.

To learn more, send us the coupon today.

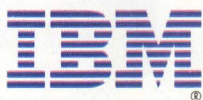

IBM  
DRM, Dept. 003/96  
400 Parson's Pond Drive  
Franklin Lakes, NJ 07417

4-83

Please send me more information on the price/performance and technical superiority of the IBM Series/1.

Name \_\_\_\_\_

Title \_\_\_\_\_ Phone \_\_\_\_\_

Company \_\_\_\_\_

Address \_\_\_\_\_

City \_\_\_\_\_ State \_\_\_\_\_ Zip \_\_\_\_\_

"I'M A  
STREAMER."

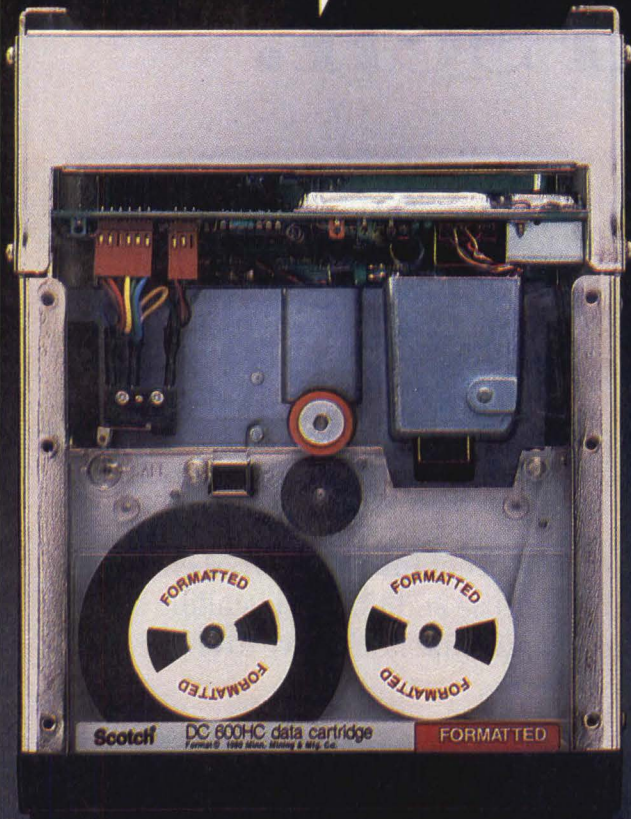

"I'M BLOCK  
ADDRESSABLE."

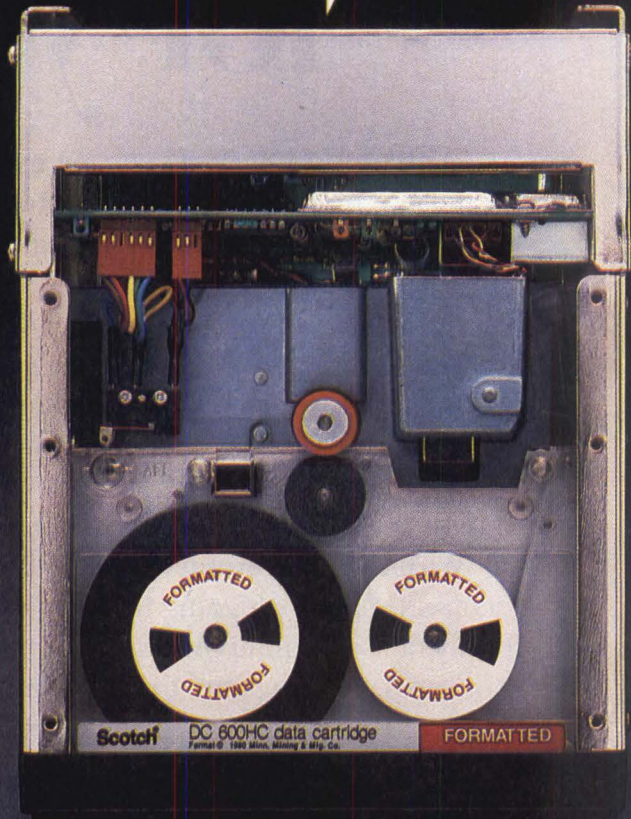

## The HCD-75. It's both.

Meet the high capacity  $\frac{1}{4}$ " cartridge back-up system with the split personality. The 3M HCD-75 does everything streamers do, and more! Now you don't have to choose between streaming and block addressability for data storage. The HCD-75 lets you design a reliable system that does both. Best of all, it's available right now — thousands of them are already in use — with the following high performance features:

**HIGH CAPACITY** — a full 67 megabytes of formatted back-up storage — more than any other  $\frac{1}{4}$ " system and most  $\frac{1}{2}$ " systems.

**DATA/CARTRIDGE INTERCHANGE** — unlike some other systems, every HCD-75 drive

will read every 3M formatted data cartridge, no matter where it originated. A unique combination of stepper head and edge seek features allows unlimited cartridge interchange between drive systems.

**COST EFFECTIVE** — you get more for less. Total cost per megabyte with the HCD-75 is significantly lower than any other tape system.

Put it all together and you have one of the best friends a computer designer ever had: the 3M HCD-75 back-up system. For more information call (612) 736-9003 or write: Data Recording Products Division/3M, 3M Center 223/5N, St. Paul, MN 55144.

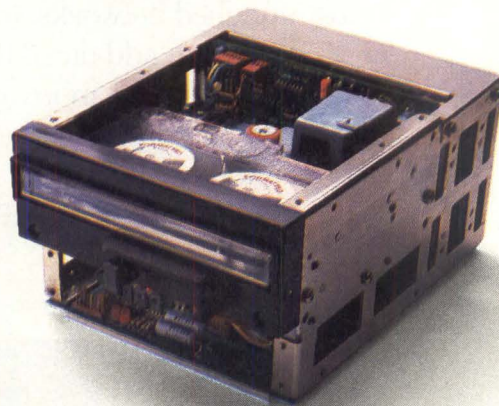

3M hears you...

CIRCLE 125 FOR FIELD REPRESENTATIVE CALL CIRCLE 135 FOR LITERATURE.

**3M**

# Peripherals

NEW PRODUCTS

## Adaptable terminals are Bertone-styled, customizable

The Vision series of adaptable CRT terminals features a proprietary, customizable, multiprocessor architecture that allows changes in protocols, data handling and CRT functions to be programmed in high-level languages without costly reengineering.

The Bertone-styled terminals have tiltable, low-profile keyboards that provide palm support and maintain full-depth key travel. The self-storing keyboards also offer programmable rollover, seven programmable LED indicators, 16 programmable function keys, serial output and built-in speakers. The volumes of the audible key click and bell are programmable. The vendor plans to sell the keyboard separately.

The Vision series incorporates a 12- or 15-in. video screen in amber, green or black on white. An electronically controlled tilt screen allows an operator to adjust the viewing angle without changing body position. The screen features a

24-line  $\times$  80- or 132-column display with a 25th status line, programmable brightness control and enhanced character formation using a dot-stretch and dot-delay technique to produce 512 character symbols.

The Vision series terminals are also equipped with as much as 48K bytes of combined RAM/ROM, high-level language function definition and 2K to 4K bytes of nonvolatile memory. As many as four RS232 communications ports supporting synchronous/asynchronous bit-oriented (HDLC, SDLC, X.25) protocols are available. Vision series terminals can handle as many as four DEC quad-sized boards, enabling the units to accommodate independently developed hardware such as graphics intelligence and cluster controllers.

The Vision 2000, a customized DEC VT100-compatible unit, is priced at \$1595 in single-unit quantities. **Northern Technologies Ltd.**, 85 Torbay Rd., Markham, Ontario L3R 1G7. **Circle No 303**



Northern Technologies' Vision series terminals have a casing of high-impact structural foam that can be custom painted. Hidden intake and exhaust vents provide cooling for the power supply and circuit boards.

MINI-MICRO SYSTEMS/April 1983

## One SPIKE Can Cost DOWNTIME!

Overvoltage transients can bring the biggest installation down in a microsecond, or damage it cumulatively.

Surge-Master Heavy Duty Power Line Protectors give complete protection against all transients.

All computers and computer-based systems are vulnerable to transients in AC power lines caused by heavy motors starting up, power company load adjustments, welding operations—and of course, lightning. Even if your equipment operates from batteries charged by a UPS, you're not safe. If lightning knocked out your UPS, how long could you keep going?

The MCG Surge-Master offers two stage protection. The first reacts in nanoseconds to absorb lesser transients and the leading edges of major ones. The second stage absorbs the big ones, and has three modules on each line. So, in the unlikely event that one module should be knocked out, there are still two protecting you. And a system of indicator lights tells you not only when a fault has occurred, but exactly where it is. Modular construction makes replacement of damaged modules quick and easy. Initial installation requires minimal power interruption.

Available with capacities from 100 to 3000 amps; for 120, 240, and 480 VAC; and for single, 3 phase, wye and delta power systems. For more information, contact Dept. 30201 at 515/586-5125 or at the address below.



See us at  
DEXPOTM East 83  
Booth 731

Protecting industry since 1967

**MCG**

**ELECTRONICS, INC.**  
160 Brook Avenue  
Deer Park, NY  
11729, U.S.A.

CIRCLE NO. 116 ON INQUIRY CARD

197

# Peripherals

NEW PRODUCTS

## Portable terminal has editing capability

The Execuport 4120 BSR is a 1200-bps/120-cps portable teleprinter with buffering and editing. The terminal's memory can store 43,000 characters. The terminal has a

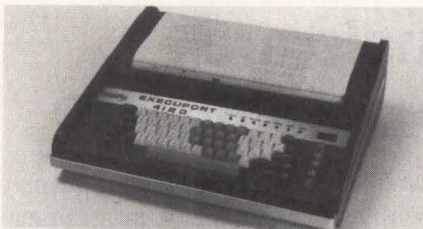

16-element columnar print head that produces two character fonts. With the  $9 \times 11$  font, the 4120 BSR prints standard and high-resolution copy at 10 cpi. The  $5 \times 7$  font produces  $16\frac{3}{4}$ -cpi compressed print that fits full 136-cpl printout on standard  $8\frac{3}{4}$ -in.-wide paper. The 4120 BSR is available with a choice of modems. The 3400/103 modem, acoustically coupled or hard-wired through a modular jack, operates only in the originate mode. The 212/103 modem, direct connect only, works in originate and answer modes. The 103 modem, acoustic only, operates at low speed (300 bps) in the originate mode. These built-in modems permit communication at 300 or 1200 bps, but the terminal communicates at rates as high as 9600 bps through the RS232 port. Single-quantity price is \$3995. **Computer Transceiver Systems, Inc.**, P.O. Box 15, E. 66 Midland Ave., Paramus, N.J. 07652.

Circle No 304

Introducing...

## DATAWAFER™ The New Generation of Digitizers

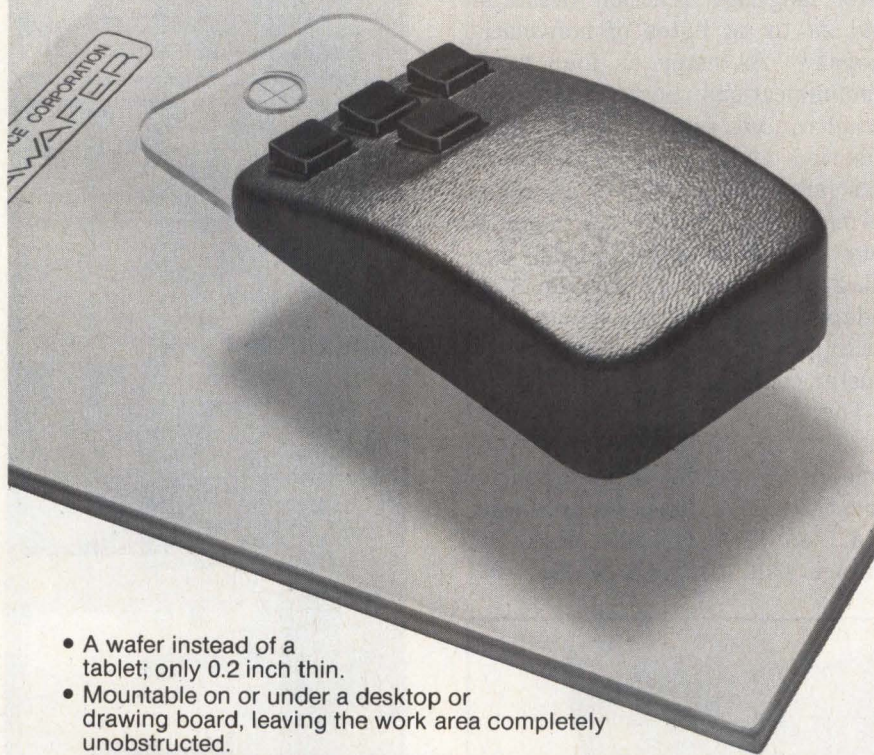

- A wafer instead of a tablet; only 0.2 inch thin.
- Mountable on or under a desktop or drawing board, leaving the work area completely unobstructed.
- A mouse without tail, a cursor without wire, a stylus without cable — completely interchangeable.
- Working areas as small as you'd like, as large as 20-by-20 inches.
- Designed for the man-display interface, for designing and menu selection directly on CRT.
- Replaces light pens, joysticks, trackballs, and clumsy cabled cursors and styluses.
- Priced for tomorrow's market. (We understand the need for low prices.)

If your system requires interaction between hand and display, contact DIC for more complete information on Datawafer, the successor to old-fashioned digitizers.



**DISPLAY INTERFACE CORPORATION**

525 Boston Post Road, P.O. Box 250  
Milford, Connecticut 06460 (203) 877-7661

CIRCLE NO. 110 ON INQUIRY CARD



## Terminals are 3278-, 3270-compatible

The 178 3278 plug-compatible display station features a 12-in. diagonal tilt screen with a 15-degree upward adjustment and an optional narrow movable keyboard. It operates in a 3270 cluster-controlled environment and attaches to a Telex 174 or 276 controller or an IBM 3274 or 3276 control unit. The terminal is designed for displaying alphanumeric data and for entering data into and receiving data from an IBM



# Why is it called the Electronics Industry, when there's more Plastics than Electronics?



Plastics have become the dominant material in the industry. Why? Because plastics provide the most cost-effective packaging material for electronics and computer systems.

For over 35 years, Data Packaging has worked with OEM's to develop innovative solutions for new applications, redesigns, and product enhancements. Today, Data Packaging is a worldwide company with vast material experience, financial strength, and manufacturing capacity.

Data Packaging can integrate your electronics with these proven plastic-forming techniques:

- Injection Molding
- Structural Foam
- Blow Molding
- Extrusions
- Vacuum Forming

Data Packaging has product experience in:

**Structures/Components**—CRT housings, keyboards, peripheral enclosures, and internal and structural supports.

**Ribbon Cartridges**—Our own high-yield matrix, direct replacements for RICOH, EPSON MX 80, and C-ITOH, and four-color ribbon.

**Media Packaging**—Removable disk packs and cartridges, tape reels and self-threading cartridges, and tape cassettes.

**Computer Accessories**—Dictation cassettes, tape reel and removable media storage units, and floppy disk boxes.

For more information on how Data Packaging can help you package your electronics or computer systems, call, write, or circle the number below.

See us at Booth  
D224 at NCC.



Data Packaging Corporation  
205 Broadway  
Cambridge, MA 02139  
(617) 868-6200 TWX 710-320-0885

CIRCLE NO. 115 ON INQUIRY CARD

# Peripherals

NEW PRODUCTS

S/360-370-303X-4300 or equivalent system. Display characters are formed with an 8 × 8 dot matrix on a non-glare screen. The screen accommodates 1920 characters with status indicators displayed on the screen's 25th line. A Telex 281B

message-printer attachment, a light pen, a response-time indicator and a security lock are optional. The 178 display is priced at \$2750. The Telex 279 model 4 color terminal attaches to a Telex 174/276 or an IBM 3274/3276 controller. It features a

14-in. diagonal screen that displays 3440 characters and a detachable keyboard with as many as 30 layouts. Options include a row and column indicator, a keystroke counter, a response-time indicator and a message printer. Price is \$4250. **Telex Computer Products, Inc.**, 6422 E. 41st St., Tulsa, Okla. 74135. **Circle No 305**

**WHEN YOUR COMPUTER'S  
DOWN AND OUT,  
WE'LL GET IT UP  
AND RUNNING. FAST.**

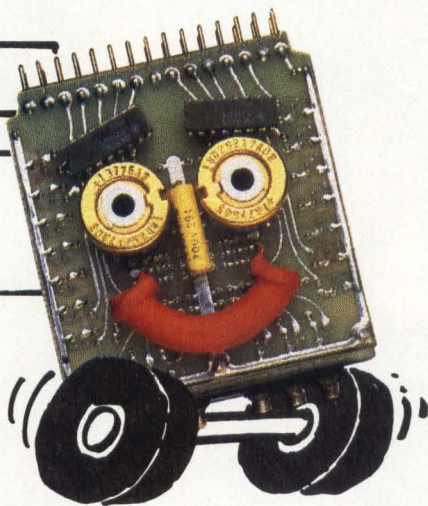

**CALL CONTROL DATA.  
800/328-3980**

IN MINNESOTA 612/931-3131

Nothing cuts downtime better than a responsive, results-oriented customer service organization—one committed to keeping your equipment in excellent condition. It's just what you'd expect from the largest independent supplier of computer peripherals in the world. Call us.

**GD CONTROL DATA**

*Addressing society's major unmet needs  
as profitable business opportunities*

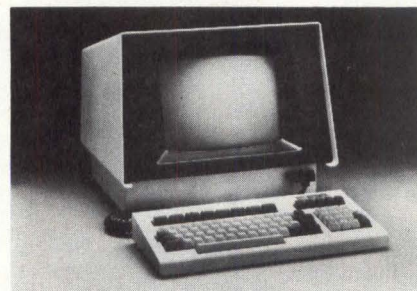

## **Terminals feature detached keyboard**

The Avant 250 and 251 terminals feature a movable keyboard and a green or white phosphor monitor that can be placed on the vendor's video tilt-turntable. The keyboard has editing keys, a 14-key numeric pad and eight (16 with shift) user- or host-programmable function keys (48-character capacity per function). The monitor displays 1920 characters on 24 lines, and a 25th status line displays messages from the host. The terminal also features a 10K-byte storage capacity, a bidirectional printer port, RS232C and 20-mA current-loop interfaces, and 16 independently settable baud rates on printer and main interface ports. The Avant 250 displays and transmits 18 video-attribute combinations using the reverse-video, half-intensity, underline, blinking and security (blanked) attributes. The Avant 251 is a hidden-attribute terminal using half-intensity as its hidden attribute. Single-unit price of either unit is \$1095. **General Terminal Corp.**, 14831 Franklin Ave., Tustin, Calif. 92680.

**Circle No 306**

# Want reliable power for office electronics without costly special wiring?



## Just plug in a Sola.

With minicomputers, terminals, word processors, disk memories and high-speed printers, you often get instructions to put in a "dedicated" power line. But, instead of breaking through walls, cutting trenches in floors, laying special conduit, pulling lots of wire and adding more breakers and switchgear to get reliable power, why not simply plug a portable Sola Power Protector into the outlet that's already there?

Dedicated lines can add anywhere from \$1200 to \$8000 or more per machine, even in new construction. For a fraction of that cost, a Sola Micro-Minicomputer Regulator not only replaces the dedicated line but does what dedicated lines can't do. It raises and lowers voltage to compensate for line fluctuations and brownouts. It blocks out electrical noise, and destructive power dips or surges. Our new Mini-UPS goes one step further. Its built-in battery maintains power when your electric utility fails. This keeps your electronics running smoothly until your generator comes on line. Both units are available in 60 Hz or 50 Hz.

Dedicated lines, at best, minimize power disturbances that are caused by other equipment in your building. Sola Power Protectors guard you against all kinds of power line disturbances regardless of where they originate. Check this chart to compare effectiveness.

	spikes and faults	dips and surges	line noise		Brownout	Blackout
			common-mode	transverse mode		
	momentary sharp voltage peaks or split-second power outages	short-term high or low voltages due to load start-up or shut-down	Unwanted voltages or frequencies due to bad grounding, switching, or radio-type interference	line-to-ground interference	Planned voltage reductions in response to high demand	Total loss of line power
Dedicated Line (with dedicated ground)	some, internal only	some, internal only	some, internal only	some, internal only	No	No
Isolation Transformer	No	No	Yes	No	No	No
Sola Micro-Minicomputer Regulator	Yes	Yes	Yes	Yes	Yes	No
Sola Mini-UPS	Yes	Yes	Yes	Yes	Yes	Yes

Don't go through another day risking electronic malfunction due to unreliable power. Talk to your local Sola Electric representative or distributor. Or contact Sola Electric, 1717 Busse Road, Elk Grove Village, IL 60007. (312) 439-2800. We're the people who invented power protection 50 years ago.

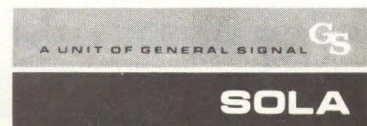

**The Power Protectors**

CIRCLE NO. 117 ON INQUIRY CARD

# Peripherals

NEW PRODUCTS

## Display terminal is IBM-compatible

The model P3278 display station operates in IBM 3270 networks as a



plug-compatible replacement for the IBM 3278 model 2 display station. The foundation for a family of IBM-compatible computer display stations, the P3278 attaches to a variety of IBM terminal controllers and computers through the IBM

3270 coax protocol. The P3278's three-piece modular design includes a detached low-profile keyboard and a 12-in., tilt-and-swivel, non-glare green screen. The display features 7 × 14 character matrix cells, reverse video and blinking fields. The keyboard features 24 program function keys and a 12-key numeric keypad. Its angle can be continuously adjusted from 5 to 11.5 degrees. Price is \$1995 in single-unit quantities. **Phase Information Machines Corp.**, 7650 E. Redfield Rd., Scottsdale, Ariz. 85260.

Circle No 307

## Display terminal features IBM look-alike keyboard

The model ADM 361 terminal is designed to be used with a protocol

converter to comprise an alternative to an IBM 3277 terminal. The ADM 361 features an IBM look-alike keyboard, a 2K-byte input buffer and a 25th status indicator line. It is also DEC VT100 compatible. Other features include an 80- or 132-column display, nonvolatile setup mode using English prompts, non-embedded visual attributes, protected fields, a serial printer port, seven selectable international character sets, 132 × 120 dot graphics, business graphics, a detached keyboard, four function keys and a 12- or 15-in. non-glare green screen. Options include an integral modem or vector-drawing graphics capability. Single-unit price is \$1800. **Lear Siegler, Inc./Data Products Division**, 714 N. Brookhurst, Anaheim, Calif. 92803.

Circle No 308

**PERRY**

## SLIP PRINTER



The One Slip Printer that meets all your needs from validating credit card slips, sales receipts and other forms to a compact design that saves counter space. The PERRY 2042 Validation Printer is designed for simple operation and rugged dependability using the latest technology.

**A Quality Slip Printer at a Competitive Price  
Makes This The One.**

**Call Today  
919/876-8100**

**PERRY DATA SYSTEMS, INC.**

3401 Spring Forest Road • Raleigh, N.C. 27658

CIRCLE NO. 113 ON INQUIRY CARD

## FAST 488!

**IEEE-488 1/2-inch magnetic tape recording systems.**

Recording solutions for users of H-P, Tektronix and other instrumentation and data logging systems.

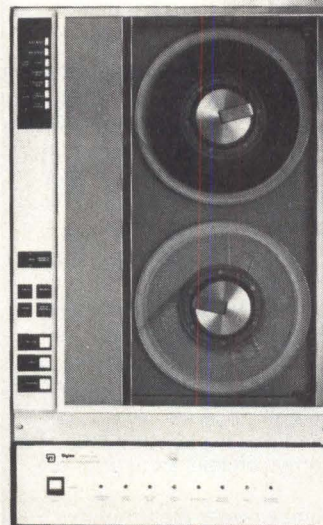

- Dual density, speeds to 75 ips.
- World-wide computer data interchange.
- Data acquisition, ATE, CAD, disc backup and more.
- IBM and ANSI compatible formats.
- Transfer rates to 100,000 bytes/sec.
- Dual buffer to 24K bytes.
- Over 40M bytes of storage.

1/4" CARTRIDGE  
ALSO AVAILABLE

**Dylon**

9561 Ridgehaven Court, San Diego, CA 92123  
(619) 292-5584 • TWX 910-335-1524

CIRCLE NO. 114 ON INQUIRY CARD

MINI-MICRO SYSTEMS/April 1983

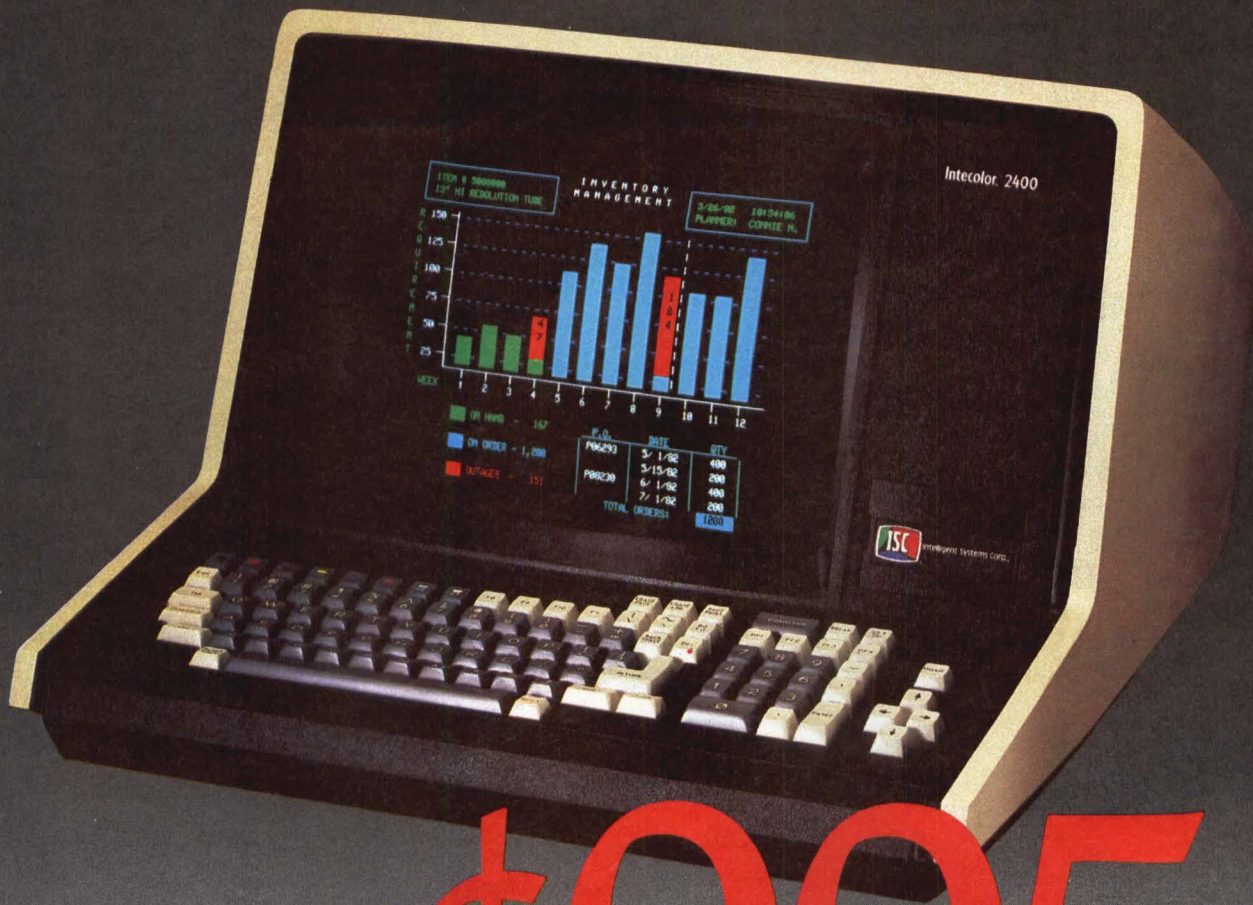

# \$995

**Special offer. Immediate delivery.**

The logical switch to color has never cost less. Now you can buy an Intecolor 2405 single evaluation unit at the 100-piece price of \$995 (U.S. domestic only). You get the advantage of vector graphics on an 80 column by 24 line screen, without sacrificing the most important capabilities you want from a VT100 terminal. Plus, the 2405's vibrant color conveys more information, more quickly and with greater comprehension than monochrome.

**ANSI X3.64 system compatibility.** The 2405 is the ideal replacement or add-on terminal. Highly compatible with VT100 and numerous other ANSI X3.64 terminals, the 2405 is easily integrated into any ANSI X3.64 environment. It also includes ASCII codes and a VT52 mode.

**With all the features you need.** Eight foreground and eight background colors. Terminal based

## Our ANSI X3.64 terminal has all the VT100 features you'll ever need in a conversational terminal. Plus color and vector graphics.

vector graphics. Data transmission baud rates from 50 to 19,200. English language menu set-up mode. Non-volatile set-up memory. Two full pages of screen RAM. In-line CRT. Auto degaussing. Powerful, 6 MHz 8085 microprocessor with four hardware interrupts. Plus, up to 72 function key definitions, optional.

**Introductory price good through May 31, 1983.** After that, our regular single-piece price of \$1195 goes into effect. So act now. Take full advantage of the color, vector graphics and flexibility of the Intecolor 2405—at the 100-piece price. Once you

do, we're confident that you'll enthusiastically agree with the growing number of OEMs and users who are making it dramatically clear that, "The future belongs to color!"

For the name of the distributor or sales representative in your area, or for complete specs, ask about our \$995 special: **Call 404/449-5961.**

 **Intecolor**<sup>®</sup>

AN INTELLIGENT SYSTEMS COMPANY

Intecolor Drive, 225 Technology Park, Norcross, GA 30092, TWX 810-766-1581

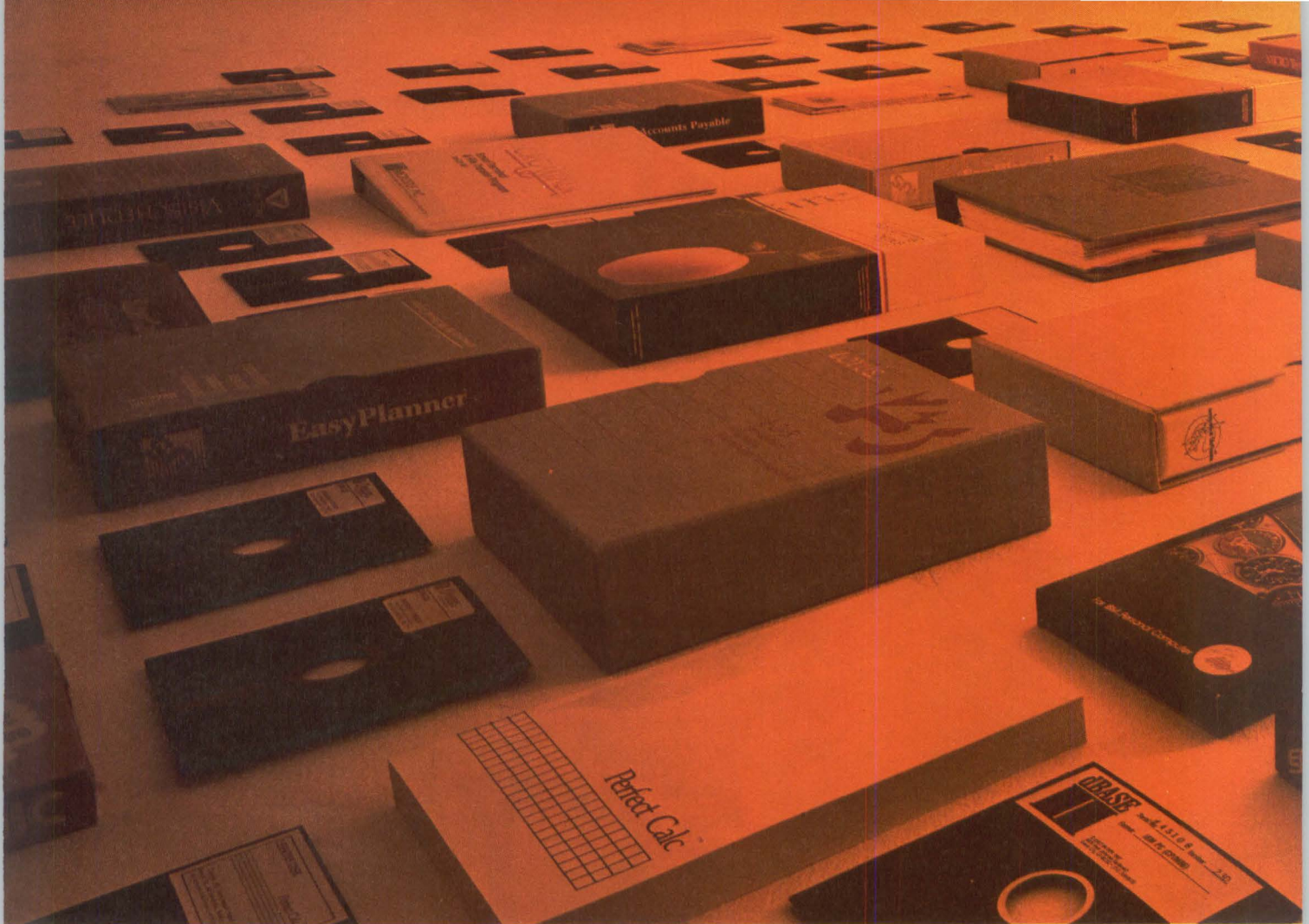

Shown are IBM-PC® compatible programs. The Columbia MPC runs MS-DOS® plus six other operating systems.



# THE COLUMBIA MPC WORKS WITH A WORLD OF SOFTWARE. \$3,000 WORTH COMES FREE WITH THE SYSTEM.

**World Headquarters:**  
8990 Route 108  
Columbia, MD 21045  
(301) 992-3400  
TWX 710-862-1891

**West Coast:**  
3901 MacArthur Blvd.  
Suite 211  
Newport Beach, CA 92663  
(714) 752-5245  
Telex 277778

**Europe:**  
Limitenstr. 94  
4050 Moenchengladbach 2  
West Germany  
Phone 02161-33159  
Telex 852452

**Call our distributor nearest you.**  
Access Systems  
Wellesley, MA  
(617) 237-7743

N.I.D.I. (National Instru-  
ment Distribution Inc.)  
Dayton, OH  
(513) 435-4503

Advanced Management  
Systems  
Aurora, CO  
(303) 752-2972

RPC Electronics  
Cleveland, OH  
(216) 461-2280

Central Microcomputer  
Distributors  
Montreal, Quebec, Canada  
(514) 849-7533

RPC Electronics  
Pittsburgh, PA  
(412) 782-3770

Distributors in Australia, Austria, Belgium, Colombia, Denmark, Hong Kong, Israel, Italy, Malaysia, Netherlands-Antilles, Norway, Portugal, Spain, Sweden, Switzerland, United Kingdom, Venezuela.

MINI-MICRO SYSTEMS/April 1983

CIRCLE NO. 112 ON INQUIRY CARD

204



Today, the Columbia MPC takes on hundreds of IBM-PC compatible software programs and IBM-PC add-ons or peripherals.

What's more, six other Columbia-supported operating systems are available — CP/M-80\*, CP/M-86\*, Concurrent CP/M-86\*, MP/M-86\* (OASIS-16\* and XENIX\* available soon) — stretching the Columbia MPC's software compatibility beyond any other personal computer.

**Farther, faster, for far less.**

The Columbia MPC is shipped with fully supported software that will save you \$3,000. Included is the entire self-teaching Perfect Software™ family: Perfect Writer™, a word processor; Perfect Speller™, a 50,000 word dictionary; Perfect Filer™, a data

base manager; and Perfect Calc™, a financial calculation system.

In addition you get MS-DOS, CP/M-86, Macro/86 Assembler, BASICA\*, Asynchronous Communications Support, Diagnostics and the Columbia Tutor program. This means your Columbia MPC is up and running right out of the box. Space Commanders and Fast Graphs show off the Columbia MPC's full-color graphics.

**Way out front in value and performance.**

With a list price of \$3,995 — including 128K RAM, 640K in dual disk drives, 8 IBM-PC compatible expansion slots, 2 serial and 1 parallel I/O, IBM-PC compatible keyboard, and color graphics monitor controller — the Columbia MPC is

ready to go. And a complete 12MB hard disk system lists for \$5,995 — software included! B/W or color monitors and printers optional.

**Made in U.S.A. — supported worldwide.**

All Columbia hardware and software are backed by the "Call for Columbia" national service program. So, call us or our distributor for the dealer nearest you — and start looking at the Columbia MPC. It'll show you a whole new world of performance and value.



Commerical Computer Sales  
Atlanta, GA  
(404) 256-9190

Empire Micro Products  
Rochester, NY  
(716) 626-3660

MP Systems  
Dallas, TX  
(214) 385-8885

Mid Tech Associates  
Desoto, KS  
(913) 441-6565

Mid Tech Associates  
Florissant, MO  
(314) 837-5200

Mytec, Inc.  
Sanford, FL  
(305) 321-2301

Renaissance Technology  
Corp.  
Concord, CA  
(415) 676-5757

Southeastern Data  
Products  
Lynchburg, VA  
(804) 237-6286

Tek-Aids Industries  
Arlington Heights, IL  
(312) 870-7401

Tele-Terminals  
Brooklyn Park, MN  
(612) 328-3072

Waybern Corporation  
Garden Grove, CA  
(714) 554-4520

Perfect Software, Perfect Writer, Perfect Speller, Perfect Filer, and Perfect Calc are trademarks of Perfect Software, Inc. IBM is a trademark of International Business Machines. CP/M and MP/M are registered trademarks of Digital Research, Inc. OASIS is a trademark of Phase One. MS-DOS and XENIX are trademarks of MICROSOFT.

# Peripherals

NEW PRODUCTS

## Printers have structural foam chassis

A family of impact serial matrix printers features multi-mode printing and a one-piece structural foam chassis that gives lower noise levels and better print quality than metal-chassis printers. The models 1100 and 1200 operate at 200 cps in a draft/data-processing mode, 100 cps in a correspondence mode and 40 cps in a near-letter-quality mode (optional on the model 1200). Both printers produce dot-addressable graphics with a resolution of 72 × 72 or 144 × 144 dots per in. In addition, the model 1200 uses a four-color ribbon to produce as many as eight colors for text highlighting and graphic presentations. The model 1500 prints at 400 cps in the draft/data-processing

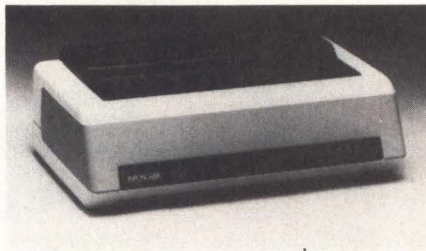

mode and 200 cps in the correspondence mode. It also provides dot-addressable graphics with a resolution of 72 × 72 dpi. Other features include a 96-character ASCII set; bidirectional printing; double-width printing; 10-, 12- or 16.5-cpi pitches; superscripts and subscripts; a 3500-character input buffer; self-test; and parallel and serial interfaces. Prices are \$1285, \$1396 and \$1676 for the models 1100, 1200 and 1500, respectively, in 100-unit quantities. **Infoscribe,**

2720 S. Croddy Way, Santa Ana, Calif. 92704. **Circle No 311**

## Dot-matrix printer uses dual-pass technique

The DP-9625A dual-pass dot-matrix printer has a maximum print speed of 200 cps in its data-processing mode and 50 cps in its near-letter-quality mode. Intermediate speeds of 150, 120 and 100 cps provide correspondence quality. The printer has graphics capabilities with a resolution of 72 or 144 dpi horizontally and vertically. Other features include double-width printing, horizontal and vertical tabbing and Centronics parallel and RS232C interfaces. Single-unit price is \$1995. **Anadex, Inc.,** 9825 De Soto Ave., Chatsworth, Calif. 91311.

**Circle No 312**

## GARBAGE IN?

PURIFIED POWER OUT!

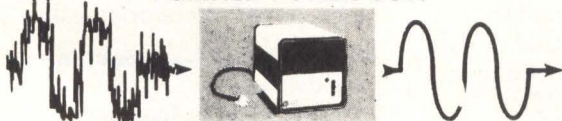

**FOR RELIABLE  
COMPUTER OPERATION**

**SERIES 800 POWER PURIFICATION SYSTEMS**

**GUARANTEED  
PROTECTION from**

- Transients
- Noise
- Brown Outs
- Line Surges
- Other Line Disturbances

**CONSTANT VOLTAGE TRANSFORMERS  
FOR LINE VOLTAGE REGULATION,  
CONDITIONING AND  
PURIFICATION. for**

- Mini Computers
- Micro Processors
- Numerical Control Systems
- Communication Systems
- Programmable Controllers
- Other Sensitive Electronic Equipment

**And other products to prevent costly malfunctions and  
downtime from input-power disturbances:**

Series 500—Line Voltage Regulators      Series 700—Line-Voltage Conditioners  
Series 600—Super-Isolation Transformers      Series 900—Electronic Line Voltage Regulators

**WRITE FOR FREE LITERATURE**



Call Toll Free 1-800-521-4792  
TWX 810-232-3401  
**CONTROLLED POWER COMPANY**  
1955 Stephenson Highway  
Troy, Michigan 48084, 313-528-3700

**CIRCLE NO. 118 ON INQUIRY CARD**

## OPTICAL MEMORY DRIVES MARKET IN THE U.S.

Frost & Sullivan has completed a 214-page report which assesses the Optical Memory Drive Market with particular emphasis on Direct Read After Write (DRAW) digital data storage applications. In addition, optical storage media and educational/institutional interactive optical disk players are examined. Since there is no commercial optical memory drive on the market, market forecasts through 1986 are based upon an analysis of announced timetables for product availability by 1983 and on an assessment of both the state of the art and the likely demand for systems with the projected capacity, data access time, read-write rates, and cost per megabit of stored data which optical memory systems will offer when they reach the marketplace.

**Price: \$1,000.** Send your check or we will bill you. For free descriptive literature, plus a detailed Table of Contents, contact:



**FROST & SULLIVAN**  
106 Fulton Street  
New York, New York 10038  
(212) 233-1080



# The Clear Advantage™ of an affordable graphics terminal

With the TAB 132/15-G you can be creating instead of waiting.

A lot of design productivity can be lost waiting for your turn at the company graphics terminal. Now the TAB 132/15-G gives you good reasons to have one right at your own desk. It's affordable. And it has big design capability.

**Full Featured And Tektronix Compatible.** The TAB 132/15-G offers full featured graphics with Tektronix 4010\* compatibility. Plus it has the advanced alphanumeric and user oriented features of the TAB 132/15 interactive terminal. 132 columns on a large 15 inch display. Bright crisp images for easy reading under most lighting conditions and a comfortable, uncomplicated, moveable keyboard.

**Outstanding Graphics Capability.** You can produce graphics with multiple character size, dot-dash lines, point plotting, vector arc drawing, circle and polygon drawing, area fill, selective erase and *more*. Because the graphics of the TAB 132/15-G are local in origin, they are not dependent on the host computer and response time is quicker. The 132/15-G is compatible with all leading graphic software packages.



## Graphics And Alphanumerics In One Package.

Add a TAB printer and you have a design workstation that allows operators to work quickly, accurately and with a great deal of flexibility. Whether you're an end user, OEM, or systems integrator...you must compare The Clear Advantage of the TAB 132/15-G Graphics Terminal.

Call or write: **TAB Products**, 1451 California Avenue, Palo Alto, California 94304, (415) 858-2500 Inside Calif.; 800-672-3109 Outside Calif.

In Europe: **TAB Products Europa B.V.** Ellermanstraat 5, 1099 BW Amsterdam, The Netherlands. Phone: 020-681691. Telex: 15329

In Canada: **TAB Products** 550 McNicoll Ave., Willowdale, Ontario M2H 2E1 Phone: (416) 494-0077

\*Trademark of Tektronix, Inc.

# TAB

PRODUCTS CO

Technology And Business

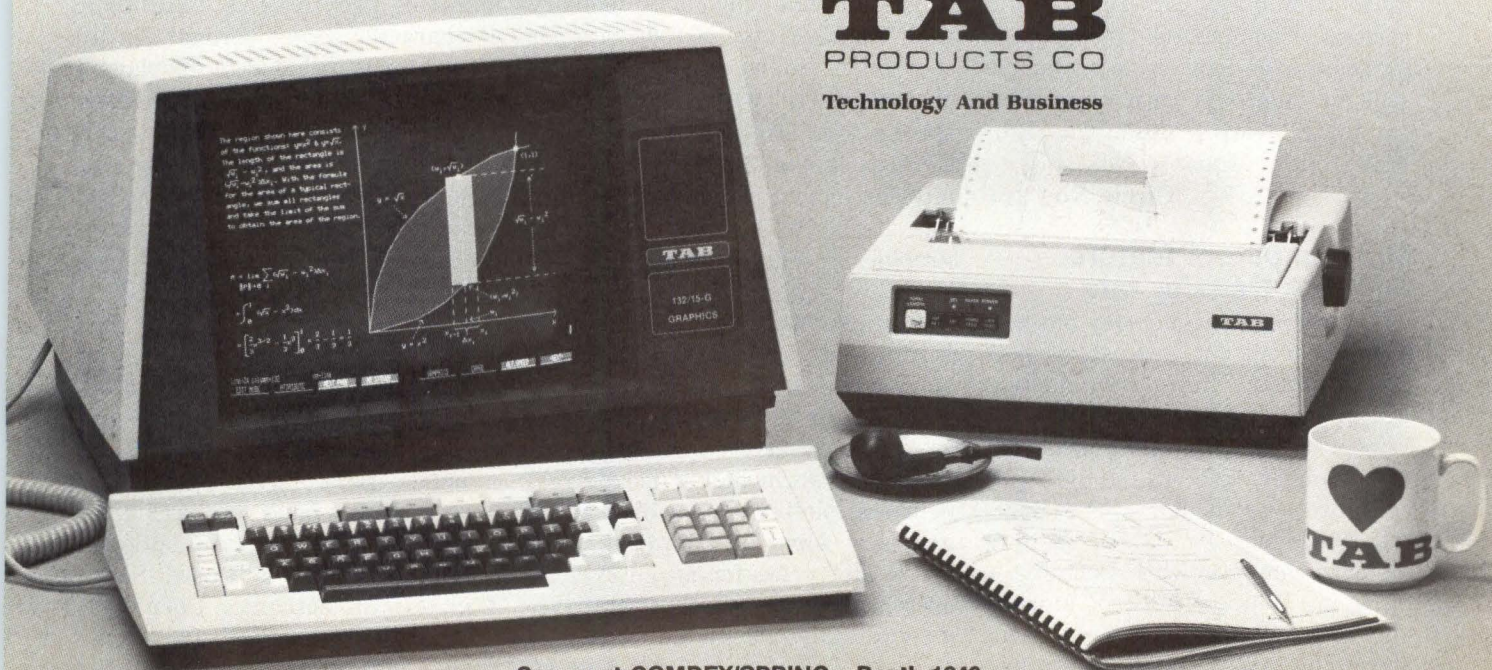

See us at COMDEX/SPRING—Booth 1240

CIRCLE NO. 121 ON INQUIRY CARD

# Systems

NEW PRODUCTS

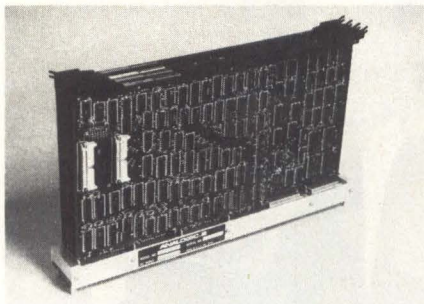

## Array processor performs 6.3 million adds per sec.

The AP490 array processor performs 6.3 million adds per sec., 2.1 million multiplies per sec. and 1 million I/O operations per sec., all of which can occur simultaneously. The AP490's basic configuration includes 2K of program memory and 4K × 24 bits of data memory and is expandable to 4K words of program memory and 64K words of data memory. Interfaces are available for the Hewlett-Packard 1000 series; Digital Equipment Corp.'s PDP-11, LSI-11 and VAX; and Data General's Nova/Eclipse. Software support is included for the host operating system as are a host function library, an AP executive, an AP function library, diagnostics and utilities. The four-card set with a DEC card-cage-mountable backplane sells for \$6450 in OEM quantities. **Analogic Corp.**, Audubon Rd., Wakefield, Mass. 01880.

Circle No 314

## Minicomputers feature fast disk-transfer rate

An independent memory bus and a transparent I/O processor allow the Spectrum Eleven JM and GCC LSI-11-based minicomputers with Winchester disk drives to achieve a disk-transfer rate of 1M byte per sec. direct to memory. The Spectrum Eleven JM is a 1M-byte memory computer with 132M bytes of 14-in. Winchester disk storage and 40M bytes of removable ½-in. streaming magnetic-tape storage

packaged in a waist-high system cabinet. The Spectrum Eleven GC desk-top minicomputer has a 30M-byte, 8-in. fixed Winchester disk and a 1.26M-byte, 8-in. floppy disk drive. Prices of the Spectrum Eleven JM range from \$31,000 to \$33,000, and prices of the Spectrum Eleven GC range from \$16,700 to \$18,700. **Saturn Systems**, 6875 Washington Ave. S., Suite 218, Minneapolis, Minn. 55435.

Circle No 315

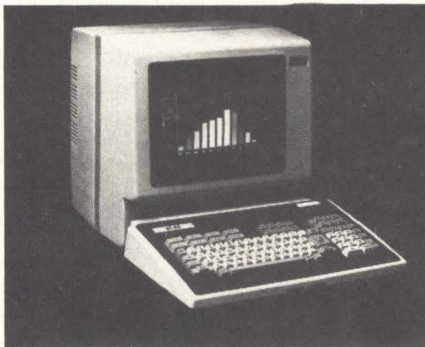

## Microcomputer features removable bubble memory

The BC-80 small-business computer system offers removable 32K- or 128K-byte bubble-memory cartridges that provide nonvolatile memory with transfer rates of 100K bits per sec. Built around the Z80A microprocessor with 64K bytes of RAM, the system also features RS232C, Centronics, light-pen and joystick interfaces; a 12-in., eight-color RGB CRT display with a 160 × 100 pixel graphics resolution; and full ASCII keyboard with numeric and user-programmable function keys. Operating under CP/M, the system supports extended versions of Microsoft BASIC and CBASIC, as well as COBOL and FORTRAN. A variety of peripherals including disk drives, printers, plotters and a bit pad for graphics input is optional. The single-unit price for an entry-level system including one bubble drive, a CRT display, a keyboard console, a 1M-byte floppy disk drive and an

80-cps dot-matrix printer is approximately \$6000. **South Coast Computer Systems**, 1116 W. Collins, Orange, Calif. 92668.

Circle No 316

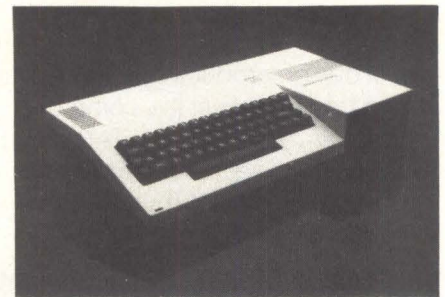

## Portable computer includes application software

The Pied Piper Communicator I CP/M-based portable computer features 64K bytes of RAM, weighs less than 15 lbs. and includes a full ASCII keyboard. Built around the Z80A microprocessor, the Pied Piper I has an integral 256K-byte, slimline minifloppy mass-storage unit and provides a connector for a second floppy disk drive. A 5M- or 10M-byte hard disk subsystem can also be added. For video display, the system can interface a standard CRT monitor providing a 24-line × 80-character screen format. An RF modulator is included for display on a television set. A Centronics-type parallel printer port is standard. Software provided with the system includes the CP/M operating system, WordStar and Mail Merge word-processing and mailing-list programs, an electronics spread-sheet program and CP/M utilities. The system is STD-bus compatible and has two free card slots for expansion boards. A 2-line × 80-character LCD, a thermal printer and an RS232C port with software-programmable baud rates as high as 19.2K bits per sec. are optional. Single-unit price is \$1299. **Semi-Tech Microelectronics Corp.**, 525 Middle Field Rd., Suite 130, Menlo Park, Calif. 94025. Circle No 317

# Nothing adds value to great software like Wang hardware.



If you'd like to expand your business by selling your value added software with our proven office automation hardware, Wang would like to help.

Our new ISO group is now making it easy for established systems houses, software vendors, and service bureaus to work with the world's best selling data processing and office automation products.

With Wang, you'll get the products to work with and the commitment to succeed. Our ISO staff is ready to support your efforts with comprehensive marketing assistance programs and software seminars.

To find out how you can add sales with value added

software, simply fill out and return the coupon below:

Attach your business card or fill in the coupon for more information: Send to: Wang Laboratories, Inc., ISO Marketing, MS 14081, One Industrial Avenue, Lowell, MA 01851.

Name \_\_\_\_\_

Title \_\_\_\_\_

Organization \_\_\_\_\_

Address \_\_\_\_\_

City \_\_\_\_\_

State \_\_\_\_\_ Zip \_\_\_\_\_ Phone \_\_\_\_\_

Type of Business \_\_\_\_\_

**WANG**

A549

The Office Automation Computer Company

## Application, financial packages run on Prime minis

Software Management Systems, Inc., has introduced two new programs, ESCAPE and Cybil, that run on Prime Computer, Inc., minicomputers. ESCAPE (English sentences creating application programs easily) reduces business-application development time by 10 to 100 times over development in high-level languages. Designed for multi-user, interactive environments, it automatically translates English statements into Prime InfoBASIC code. The program uses simple English-like sentences for data entry, file maintenance, inquiry and menu processing. The package features an on-line help facility, self-documentation, automatic screen generation, unlimited multiple-file validation, unlimited pre-defined field names or simple variables, a data dictionary and

automatic report formatting. End-user price is \$35,000, and dealer and OEM pricing are available.

The Cybil financial-modeling package is geared to profit-and-loss analysis, pricing studies, costing studies, cash-flow management, budgeting, market planning, forecasting and tax planning. The system uses "what if" questions to generate reports from spread sheets as large as 702 columns  $\times$  9999 rows. The reports can be based on any combination of columns and rows. Cybil includes a status-line display to indicate position on the spread sheet, an on-line help facility and a variety of algebraic and trigonometric functions. Cybil is priced at \$5000. **Software Management Systems, Inc.**, 84 Inverness Circle, E., Englewood, Colo. 80112.

Circle No 318

## Electronic card file kept on microcomputers

Cardfile is intended to store, retrieve and display information that is typically kept on index card files. Entries are created with a user-furnished text editor, such as Wordstar or Superwriter. Each record contains as many as 21 lines; the first three lines are treated as a key field that contains words or phrases to be searched for. The user can specify one or more phrases as arguments; the program displays each record that contains all specified words. It can also print selected records, write them to a disk or delete them. Cardfile runs on microcomputers under the CP/M or MP/M operating system. Price is \$89. **Digital Marketing Corp.**, 2670 Cherry Ln., Walnut Creek, Calif. 94596.

Circle No 320

## Graphics package has 260 functions

The iCORE graphics package, based on the George Washington University implementation of the SIGGRAPH 1979 Core Graphics proposal, has 2D and 3D and retained-segment capabilities. The iCORE package is implemented in FORTRAN 77 and can be linked to user programs written in FORTRAN. Its 260 functions provide the ability to create, view and store images. Graphic objects are formed with graphic primitives including lines, markers, polygons and text defined in world coordinates. Primitives have various attributes of color, line style and shade. A collection of graphic primitives, called a picture segment, forms the basic unit of modification for interactive applica-

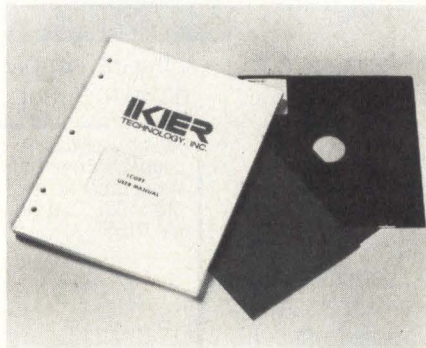

tions. Picture segments can be translated to different screen positions, rotated, scaled and made visible or invisible. They can be stored in memory or on disk. The package is priced at \$2000 per copy, with quantity discounts available. **Ikier Technology Inc.**, 7 Oak Park, Bedford, Mass. 01730.

Circle No 319

## Package helps programmers learn Pascal

SofTech, a computer-aided instruction package that runs on microcomputers to help programmers learn UCSD Pascal, provides quizzes and programming exercises. In a quiz, questions on a topic, such as syntax or identifiers, are displayed in random order. A student is told immediately if the keyed-in answer is correct; if it is wrong, the desired answer is displayed. The student is also asked to write a procedure to perform a task. The procedure is then executed in a special test environment; SofTech reports the errors it discovers in this testing. The price of \$125 includes the "UCSD handbook." **SofTech Microsystems, Inc.**, 3187-C Airway Ave., Costa Mesa, Calif. 92626. Circle No 321

Attention  
DEC™ Users

# Hand your customers an extra four bits without having to make any change.

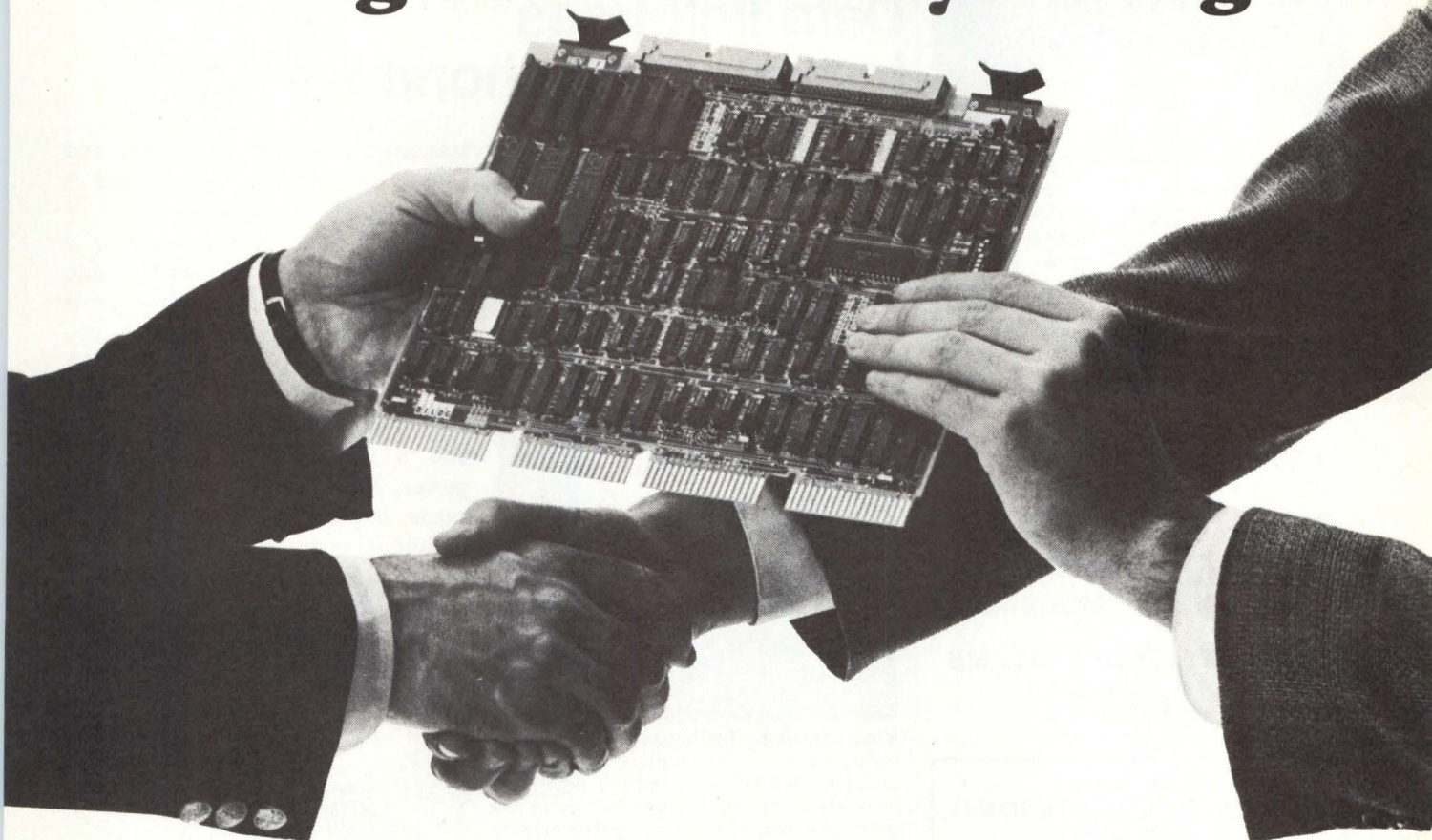

## DILOG introduces 22-bit Q-Bus controllers with Universal Formatting.™

If you want 22-bit addressing for your DEC\* Q-Bus systems—with all the memory that comes with it—you ought to talk to DILOG first. Because no one has a wider line of 22-bit disk and tape controllers than we do.

But even if we didn't, we'd still be the only company you'd need to talk to. And Universal Formatting is why.

Universal Formatting—another DILOG first—means our controllers record drive parameters directly onto the header of each sector in a drive, instead of into components of the controller itself. Not having to make formatting changes within the controller makes Universal Formatting a key to easier 22-bit upgrading.

It also means that regardless of the number of heads, tracks or the BPI configuration, any peripherals your customers want to add in the future will be compatible. No replacing PROMs. No costly, time consuming reprogramming. No extensive changes in hardware.

And no one but DILOG has it. So if you're contemplating an upgrade to 22-bit addressing, why not maximize your flexibility. Send for our catalog and specs now. Then cash in with an extra four bits.

Your customers will appreciate the change.

\*DEC is a registered-trademark of Digital Equipment Corporation

**DISTRIBUTED  
LOGIC CORP.**  
**DILOG**

Corporate Headquarters  
12800 Garden Grove Blvd., Garden Grove, CA 92643  
(714)534-8950, Telex: 681 399 DILOG GGVE, FAX: (714)534-3662

Eastern Regional Sales Office  
64-A White Street, Red Bank, New Jersey 07001 (201) 530-0044

European Sales/Service Office  
12 Temple Street, Aylesbury, Buckinghamshire, England  
44-296-34319 or 34310, Telex: 837 038 DILOGI G, FAX: (296)25133

# UNITRONIX means DIGITAL

PDP 11/23  
SYSTEMS  
with 256kB\*  
memory, 160 Mbyte  
winchester, std. 45 ips  
9-track tape backup, VT101  
CRT, LA120 printer.  
Runs RSX11, RSTS,  
TSX OR UNIX.  
\$32,000  
\*up to 4MB avail.

TERMINALS	CPU's	INTERFACES
VT100 LA12	PDP 11/23,	
VT101 LA34	11/44 & VAX	
VT102 LA50		
VT125 LA100		<b>MODEMS</b>
VT131 LA120		

**COMPLETE DATA SYSTEMS**  
with standard and  
custom software

**SPECIAL  
LSI-11 MODULES, PERSONAL  
COMPUTERS**

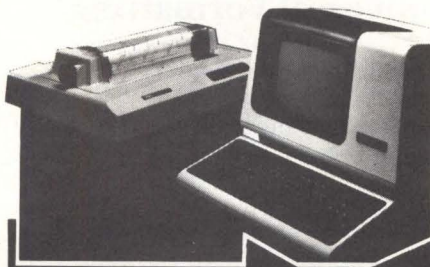

CALL FOR LATEST PRICES  
**(201) 231-9400**

**UNITRONIX  
CORPORATION**

197 Meister Ave., Somerville, NJ 08876  
TELEX: 833184

AUTHORIZED  
**digital**  
TERMINALS DISTRIBUTOR

CIRCLE NO. 120 ON INQUIRY CARD

## Datacomm

NEW PRODUCTS

### Data link uses in-house telephone wiring

The Instalink460 is designed to save users from needing extra sets of wires or cables when installing a local data-communications network. It allows users to use their existing in-house telephone network to connect asynchronous terminals to computers, data PABXs or devices with RS232C interfaces.



*Micom Systems' Instalink460 terminal unit measures 5½ × 1¼ × 8½ in. and can fit under a telephone. It is used to piggyback local data-communications transmissions over voice transmissions, converting existing in-house telephone wiring into data-communications lines.*

The Instalink460 plugs in between a terminal and a telephone; no additional wires are needed. The device piggybacks data transmissions onto voice lines by exploiting the unused high-frequency bandwidth above an average person's hearing. It neither interferes with nor alters the frequencies (less than 4000 Hz) that the telephone system uses for conversations, dial tones, busy signals and ringing. An Instalink central unit removes data from the line before it reaches a user's PABX or the outside telephone system. The data can be routed from the central unit to a computer port or other device.

The Instalink terminal unit transmits data at rates as fast as 19.2K bps full-duplex over 6000 ft. It is

transparent to the data rate and character code of the terminal it supports.

Central units, which consist of a chassis with power supply into which four-channel interface cards are inserted, are available in 12-, 24-, 36- and 48-link capacities. A 12-channel Instalink configuration, including 12 desk-top terminal units and a central unit chassis with power supply and three interface cards, is priced at \$5915. Prices of individual components start at \$250 for each terminal unit, \$1000 for a 12-channel capacity central unit and \$675 for each four-channel terminal card. **Micom Systems, Inc.**, 20151 Nordhoff St., Chatsworth, Calif. 91311. **Circle No 323**

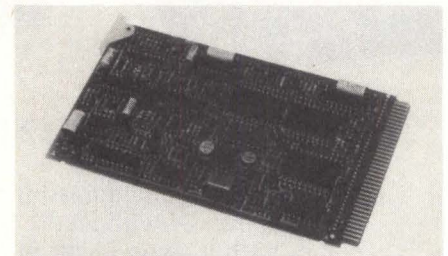

### Single-board modem operates at 2400 bps

The R24LL serial, synchronous, DPSK modem is intended for design-in as part of data systems, box- or rack-mount modems, statistical multiplexers, error correctors, terminals or other data-communication products. It features 2400-bps operation on leased lines or the dial-up, switched network. It can operate in full-duplex (four-wire) or half-duplex (two-wire) modes. The modem is compatible with Bell 201 B/C, CCITT, V.26 A/B and V.26 bis standards. The unit is housed on a single 100- × 160-mm. PC board and uses MOS/LSI technology. Price is

# COMPEC EUROPE '83

CENTRE INTERNATIONAL  
ROGIER BRUSSELS  
MAY 3-5 1983

## See all the latest advances in computer equipment and services.

For commercial and industrial end users, computer specialists, OEM traders, consultants and suppliers of computer systems and services Compec Europe '83 provides an ideal opportunity to see and examine a full range of equipment – small business systems – mini and microcomputers – peripherals and software.

This year's exhibition is the largest ever with an even greater number of exhibitors, and sees a major expansion to accent micros, software and CAD/CAM.

Open Tuesday May 3	10.00 – 18.00 hrs
Wednesday May 4	10.00 – 20.00 hrs
Thursday May 5	10.00 – 18.00 hrs

Entrance to the exhibition is by business registration on a ticket which is \*FREE if obtained in advance or 250 BFR if obtained at the door.

Compec Europe is presented by Computer Weekly in association with Ecopress.

**\*For your Free advance tickets fill in the coupon below–**

## COMPEC EUROPE '83

Compec Europe '83 Tickets,  
Reed Exhibitions  
Surrey House,  
1 Throwley Way,  
Sutton, Surrey  
SM1 4QQ, UK

Please send.....FREE tickets to:

Name .....

Job Title .....

Company .....

Address .....

.....

.....

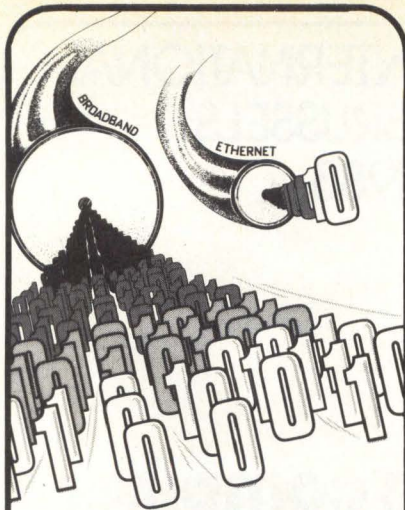

## BROADBAND VS. ETHERNET

### Broadband gives you 50 times the capacity.

So, if you're installing coax, why not go with the technology that gives you room to grow? With broadband you'll have an actual aggregate data capacity of over 350 MBS compared to Ethernet's much less than 10 MBS. You'll have a multi-drop capacity of up to 24,000 compared to Ethernet's 1,024. And, broadband gives you voice and video capability you just can't have with baseband.

Unlike other technologies, broadband equipment is readily available now. Over the past four years Comtech has delivered hundreds of broadband modems into networks around the world. Comtech is committed to broadband technology. We are continually enhancing our broadband product line.

Comtech's engineering excellence is helping networkers find solutions to their data communications problems. For help with yours, call Comtech. Applications notes, specifications, prices and delivery sent on request. Call or write Comtech Data Corporation, 350 North Hayden Road, Scottsdale, AZ 85257, (602) 949-1155 or TWX 910-950-0085.

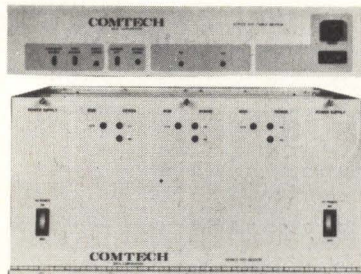

**COMTECH**  
Data Corporation

Creative Solutions in Data Communications

CIRCLE NO. 122 ON INQUIRY CARD

# Datacomm

NEW PRODUCTS

less than \$250 in 100- to 500-unit quantities. **Rockwell International, Electronic Devices Division**, 4311 Jamboree Rd., P.O. Box C, Newport Beach, Calif. 92660.

Circle No 324

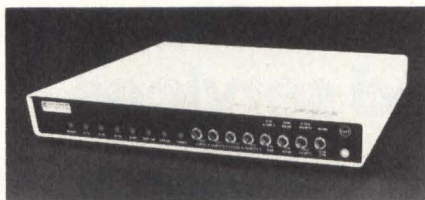

### Add-on upgrades data-comm networks

The turboMUX multiplexer is designed for use with the Bell 212A modem and attaches, via standard RS232C interfaces, between a modem and a data terminal. Combined with a turboMUX unit, the 212A's data-communications

rate is doubled to 2400 baud in full-duplex operation. The increased data speed can be used in two ways: as two separate 1200-baud, full-duplex channels or as a single 2400-baud, full-duplex channel. Both capabilities are provided and are selectable via front-panel switches. The device compacts the data for transmission over dial-up telephone lines by means of a proprietary data-compaction algorithm. For phone-line inconsistencies, the unit provides error detection and retransmission facilities. Self-diagnostics by means of front-panel switches and LED status indicators are also provided. Prices start at \$995 in single-unit quantities. **Chung Telecommunications Inc.**, 4046 Ben Lomond Dr., Palo Alto, Calif. 94306. Circle No 325

## More Room ... More Multibus® Cages.

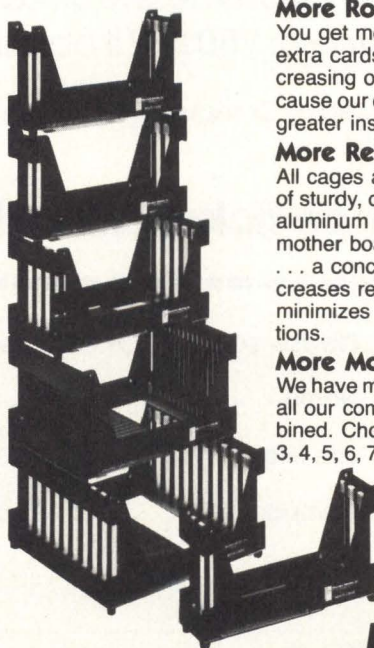

### More Room

You get more room for extra cards without increasing overall size, because our design gives you greater inside dimensions.

### More Reliability

All cages are constructed of sturdy, durable anodized aluminum with a single mother board backplane ... a concept that increases reliability and minimizes interconnections.

### More Models

We have more models than all our competitors combined. Choose a cage with 3, 4, 5, 6, 7, 8, 9, 12, 14, 15,

16, 20, 24 or 26 slots for the right solution to your problem. We have models with either 0.6" or 0.75" card centers and can even accommodate wirewrap cards.

### More Rack Mount Models

Standard 19-inch rack mounting available for all cages.

### More Warranty

A three year warranty is your assurance of quality.

### For Fast Delivery.

Call our toll free number (800) 854-7086

In Calif. call (619) 292-0242

In Canada Call: Transduction Ltd. (416) 625-1907



**Electronic Solutions**

5780 Chesapeake Court  
San Diego, CA 92123

Fully Multibus Compatible,  
Terminated Mother Board.

## MULTI-CAGE®

Note: Multi-Cage is a registered trademark of Electronic Solutions Multibus, trademark of Intel.

CIRCLE NO. 123 ON INQUIRY CARD



# **"Okay, IBM, you're smart. But you're not smart enough."**



**"Your 3278 terminals have a lot on the ball. But."**

"Now don't get us wrong. We know your 3278's have local storage. Cursor editing. Line delete. Not bad, IBM. But not up to where they could be.

Because our new AVATAR TC3278 can take any 3278 or any IBM plug-compatible terminal and move it up past smart, past intelligent and turn it into a functioning standalone interactive workstation with personal computing capability. For not much money. And it only takes five minutes to install. How's that for smarts?

**"Look at these plusses, IBM."**

"This TC3278 gives you all that power with your existing terminal. So it takes less space, requires less maintenance. There's no retraining because people work on their familiar IBM equipment.

Your terminal will be able to communicate with your main database, with other non-IBM host computers in your organization, even with public databases, to ensure you're using consistent and accurate information.

Our TC3278 comes complete with its own word processing and electronic spreadsheet software, fully functional on your existing 3278 terminal.

**"We're going to make you more productive."**

"The name of the game is that this AVATAR TC3278 is going to increase your productivity, IBM. For not much money and no trouble at all.

Contact one of our guys for more information. Write 3R Computers, 18 Lyman Street, Westboro, MA 01581. Or call us at (617) 366-5300.

## **AVATAR™**

**Making IBM smarter since 1983.**

© 1983 RRR Computers, Inc. Avatar is a trademark of RRR Computers. IBM is a registered trademark of International Business Machines Corp.

### Application notes cover speech-output device

Four application notes detail applications for the vendor's VoiceWare Development System, LISA speech-output device and VOPAC speech digitizer for the telecommunications industry. Applications include data entry and retrieval via Touch-Tone response, computer-aided instruction, voice mail and voiced annunciator systems. **Centigram Corp.**, 1153 Bordeaux, Sunnyvale, Calif. 94086.

Circle No 326

### Large-screen electrostatic CRT displays described

The vendor's large-screen electrostatic CRT displays for instrumentation and design graphics are described in a six-page, color brochure. The brochure lists specifications for displays and graphics-generator systems and includes pictures and descriptions of applications in design graphics, instrumentation systems, military/aerospace and radar training/simulation. The brochure has a product table listing type of interface, resolution, screen size, spot size, character generation and writing speeds. **Hewlett-Packard Co.**, 1820 Embarcadero Rd., Palo Alto, Calif. 94303.

Circle No 327

### Catalog describes Multibus-compatibles

The 28-page Multibus Data Mini catalog contains ordering information, dimensional drawings and specifications for the vendor's line of Multibus-compatible products and services. The catalog includes a six-slot version of the Multibus backplane and card-frame series, socket boards with the continuous groundplane on the wiring side, extender cards for testing and debugging and related accessories and services including customer

pinning and wire wrapping. **Hybricon Corp.**, 410 Great Rd., Littleton, Mass. 01460. Circle No 328



### Catalog covers data converters

The vendor's lines of data converters, hybrid modules, synchro instruments and data bus products are described in a 386-page application and product catalog. The catalog includes general technical and detailed product information and a description of the company's engineering, product assurance and manufacturing capabilities. Nine product categories contain summary tables, background information, technical data, features, applications, block diagrams and outline drawings for each product in that category. Categories include A/D and D/A converters, sample/hold and track/hold amplifiers, S/R-to-D and D-to-S/R converters, synchro instruments and SEM and MIL-STD-1553 data bus products. **ILC Data Device Corp.**, 105 Wilbur Place, Bohemia, N.Y. 11716.

Circle No 329

### Short-form catalog lists business, comm software

The vendor's microcomputer software for business and communications is described in a brochure. The catalog features invoice-driven, coordinated accounting systems that require no changes in data or procedures and communications systems that interface most microcomputers with any time-sharing computer with ASCII capability. The catalog also details various program

packages for electronic bulletin boards, electronic mail and remote-computer typesetting. **Small Business Systems Group**, 6 Carlisle Rd., Westford, Mass. 01886.

Circle No 330

### Catalogs list test equipment

Aimed at four of the vendor's vertical markets, a series of industrial catalogs introduces test-equipment rental to the electronics segment of the industrial market. The publications divide the products into four groups: data loggers and recorders, power-line recorders, sound and vibration equipment and temperature-measuring equipment. The catalogs list specifications for oscillographs; light-beam and magnetic recorders; data loggers; stress and motion recording devices; and sound, real-time and structural analyzers. **Leasametric Inc.**, 1164 Triton Dr., Foster City, Calif. 94404.

Circle No 331

### Directory lists software for Intel iAPX

The Intel Yellow Pages is an annual directory that lists software programs developed for all Intel iAPX microprocessors and industry consultants selling services to Intel customers. Modeled on a telephone book, the Intel Yellow Pages is divided into two sections. The first section (white pages) contains alphabetical corporate listings with a background paragraph about each supplier. The second section (yellow pages) contains product listings and advertisements of the various companies under approximately 450 headings. The directory lists system software, compilers and operating systems and application software written for IBM PC-DOS, XENIX/UNIX and CP/M. **Intel Corp.**, 3200 Lakeside Dr., Santa Clara, Calif. 95051.

Circle No 332

# MULTIBUS\* MEMORIES

## DYNAMIC RAM (IEEE P796-COMPATIBLE)

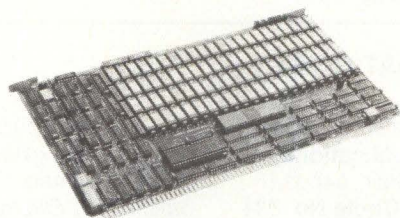

### MM-8086E

- 512K, 256K bytes
- Error detection and correction
- 1000<sub>H</sub> boundaries/16 Mbyte address
- Access/Cycle: 300/500 nsec
- CSR/ESR for EDC control and LED error correction indication
- Battery backup option

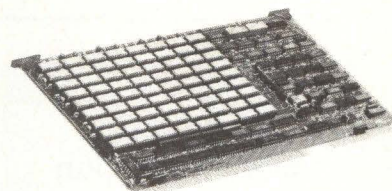

### MM-8086D

- 512K, 256K, 128K, 64K bytes
- For 8 and 16-bit processors
- 1000<sub>H</sub> boundaries/16 Mbyte address
- Even parity with output selectable to any of bus interrupts
- ACCESS/Cycle: 250/400 nsec

## NON-VOLATILE CMOS RAM (IEEE P796-COMPATIBLE)

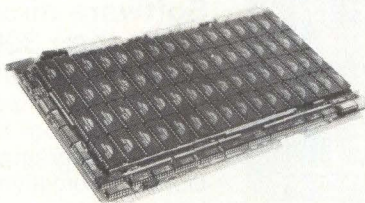

### MM-8000C

- 128K, 64K bytes
- Data retention (on-board batt.):  
2 weeks rechargeable batteries
- 4000<sub>H</sub> boundaries/16 Mbyte address
- Access/Cycle: 220/220 nsec
- Battery status line allows monitored battery condition
- Redundant batteries provide improved reliability
- Accommodates 2716 EROM

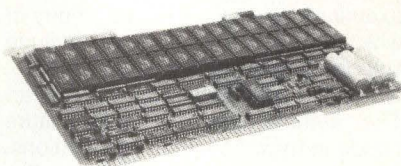

### MM-8086C

- 64K, 32K, 16K bytes
- Data retention (on-board batt.):  
3 weeks rechargeable batteries  
2 yrs. non-rechargeable batteries
- 1000<sub>H</sub> boundaries/16 Mbyte address
- On-board calendar/clock
- Access/Cycle: 250/250 nsec
- Redundant batteries provide improved reliability
- Accommodates 2716 EROM

## NON-VOLATILE CORE MEMORY

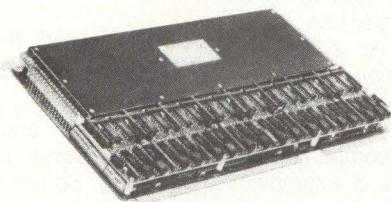

### MM-8086

- 32K bytes
- For 8 and 16-bit processors
- 1000<sub>H</sub> boundaries/1 Mbyte address
- Access/Cycle: 375/1200 nsec
- Power monitoring for data protection

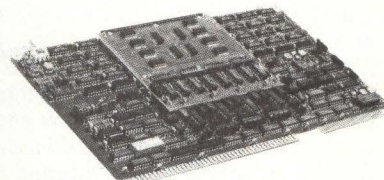

### MM-8086/16

- 16K bytes
- For 8 and 16-bit processors
- 4000<sub>H</sub> boundaries/1 Mbyte address
- Access/Cycle: 280/800 nsec
- Power monitoring for data protection

ONE YEAR WARRANTY ON PARTS AND LABOR

ALL BOARDS TEMPERATURE-CYCLED AND BURNED-IN DURING MEMORY DIAGNOSTICS

**micro  
memory  
inc**

9436 Irondale Ave.  
Chatsworth, CA 91311  
Phone: (213) 998-0070

\*Trademark of Intel Corp.

## Guide provides consumer information

With the information in the book *Database Management Systems*, readers can decide how to buy and use microcomputer database-management software for business needs. The 256-page publication defines the abilities of three categories of database-management systems: file, relational and network/hierarchical. Author David Kruglinski provides standards for evaluating database-management software and examines several packages, many of which run under CP/M. They include Condor Series 20, dBASE II, FMS-80, MDBS III, Pearl Level 3 and DataStar. The author also discusses future trends in microcomputer applications. Single-copy price is \$16.95. **Osborne/McGraw-Hill**, 630 Bancroft Way, Berkeley, Calif. 94710.

Circle No 333

## Guides offer advice on structuring networks

Written for those who need a working knowledge of design alternatives for efficient data-communication systems and networks, two books, *Packet Switching: Tomorrow's Communications Today* and *Distributed Telecommunications Networks via Satellites and Packet Switching*, are self-instructional and feature an application-oriented approach. *Packet Switching*, priced at \$34, describes packet-switched networks, how packet networks operate, how to choose a network configuration, topological designs, the x.25 protocol, switching technologies and the use of satellites and how they operate in a packet-switched network. *Distributed Telecommunications Networks*, priced at \$31.50, discusses the roles of satellite broadcasting and packet switching; necessary components, facilities and services for arranging modern networks; protection devices for maintaining the security of information in networks; and techniques for integrating voice, data, video and facsimile into common networks. Economic, market and regulatory trends affecting

## LITERATURE THAT COSTS

design decisions are also discussed. **Lifetime Learning Publications**, 10 Davis Dr., Belmont, Calif. 94002.

Circle No 334

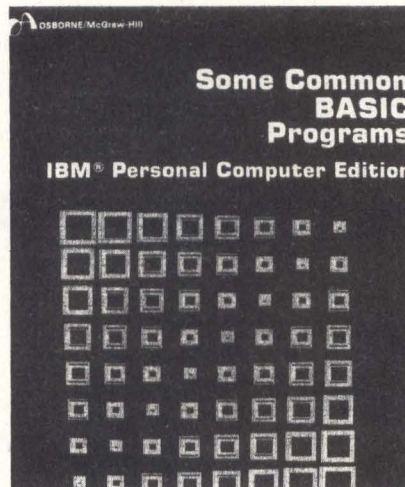

## Programming handbooks list math applications

IBM Personal Computer users and others can enlarge their software libraries with two 195-page books. *Some Common BASIC Programs, IBM Personal Computer Edition* and *Some Common Pascal Programs* contain 76 programs for business and home management written in IBM PC BASIC and standard Pascal, respectively. All programs have been tested and debugged and are ready to use. Each program in the IBM PC edition is presented with a functional description, BASIC source code and operating instructions. In the Pascal edition, program listings are accompanied by program descriptions and examples that aid users in following the logic of Pascal programming. Users can modify the programs to meet their needs. The books are priced at \$14.99 each. **Osborne/McGraw-Hill**, 630 Bancroft Way, Berkeley, Calif. 94710.

Circle No 335

## Glossary translates from English to Spanish

A glossary of electronic data-processing and computer terms for students, teachers, translators, interpreters, employees and computer

retail sales personnel has both Spanish-to-English and English-to-Spanish formats. The 205-page *Bola Glossary of Electronic Data Processing and Computer Terms* contains more than 10,000 terms, including "gate current," "terminal trunk," "dos," "optimized assembly language" and "user-oriented error message." Single-copy price is \$29.95, with discounts available for volume purchases. **Bola Publications**, 8769 Devon Ave., Hesperia, Calif., 92345.

Circle No 336

## Software directory lists more than 3000 packages

*The International Software Directory, Volume 2: Minicomputers* contains information on more than 3000 software packages for minicomputers. Each program is cross-indexed by subject, computer, operating system, language, vendor and price. Each program is also listed by International Standard Program Number, the industry standard used to identify software. Price is \$69.95. A companion volume containing information on more than 7000 software packages for microcomputers sells for \$59.95. **Imprint Software**, 1520 S. College Ave., Fort Collins, Colo. 80524.

Circle No 337

## Guidelines aid software acquisition

Aimed at both data-processing professionals and computer users, *The Guidelines for Evaluating and Selecting Software Packages* show how to determine user requirements, perform a make-versus-buy analysis, determine the major software contenders, evaluate operational performance and interface a product with other systems. The *Guidelines* complement whatever system development methodology is in place or planned in an organization. Published in a looseleaf format, *The Guidelines* are priced at \$95. The text is also available on 8-in. floppy disks for \$500. **Elsevier Science Publishing Co. Inc.**, 52 Vanderbilt Ave., New York, N.Y. 10017.

Circle No 338

# WE'VE GOT IT ALL

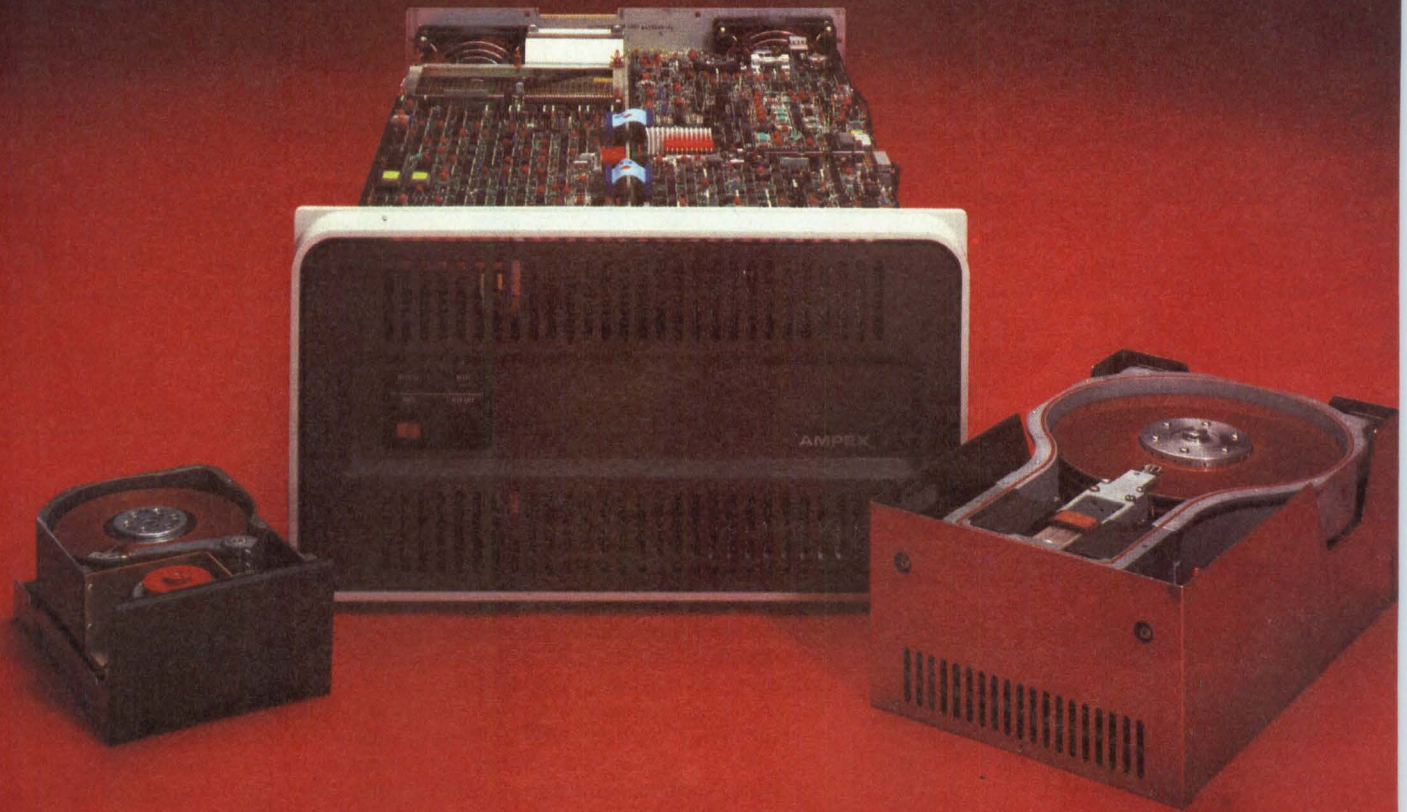

## FROM 7MB TO 330MB IN 5¼", 8" AND 14" WINCHESTER FAMILIES.

Ampex's Winchester families deliver the performance you need in today's competitive marketplace. There's 5¼" Pyxis with up to 27MB; 8" Scorpio with up to 83MB; and 14" Capricorn with up to 330MB. All offer the features you want, like automatic disk and head locking; industry-standard interfaces and packaging; power-up self-test and diagnostics; and capacity expansion. None requires any preventive maintenance.

Our Winchester disk drives are backed by a continuing Ampex commitment to leading-edge technology research, automated processes, and vertical

integration beginning with heads and media; by a highly professional worldwide service and support organization; and by manufacturing capacity in excess of a half-million square feet located in four countries.

That's why you can count on Ampex to deliver whatever you need in Winchester disk drives, today and tomorrow.

Ampex Corporation, Memory Products Division, 200 North Nash Street, El Segundo, CA 90245. 213-640-0150. TWX: 910-343-6243.

# AMPEX

Ampex Corporation • One of The Signal Companies   
CIRCLE NO. 128 ON INQUIRY CARD

# Literature

## NEW PRODUCTS

### Information guide describes print wheels

An eight-page print-wheel information guide helps readers select the correct print wheels for their printers. The guide has sections on print-wheel characteristics, how to identify compatible print wheels, daisy-wheel types and how to care for and handle the print wheels. **AGT Computer Products Inc.**, 20675 S. Western Ave., Torrance, Calif. 91335. **Circle No 339**

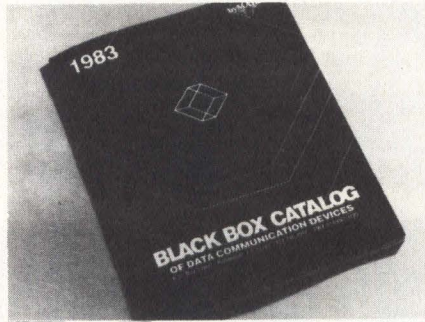

data switches, cables and cable parts, tools, test sets, protocol and

interface converters, printer adapters, concentrators and statistical multiplexers as well as short-haul and limited-distance modems, modem eliminators and modem-control devices. The catalog also includes hexadecimal and RS449, RS232C and CCITT V.24 equivalency charts. **Black Box Catalog Inc.**, Mayview Road at Park Drive, P.O. Box 12800, Pittsburgh, Pa. 15241.

**Circle No 341**

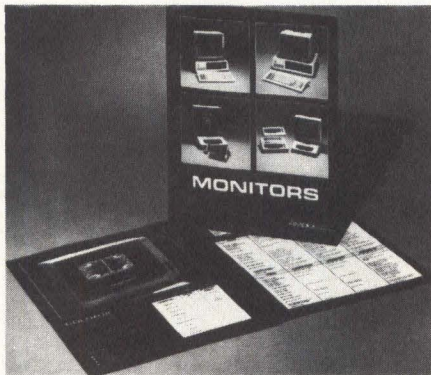

### Catalog describes six video monitors

Six video monitors with special interface cables are featured in a color, 10-page catalog. The monitors are designed for use with most personal computers including the IBM PC, Apple II, Apple III, Atari 800, VIC-20, TRS-80, Osborne, TI-99 and Commodore-64 models. The catalog includes compatibility charts and specifications for all the monitors. **Amdek Corp.**, 2201 Lively Blvd., Elk Grove Village, Ill. 60007. **Circle No 340**

### Catalog lists data-comm devices

The 80-page 1983 edition of the Black Box Catalog of Data Communications Devices contains 282 data-communications-oriented products. Every product is described and illustrated with photos, diagrams, specifications and price information. The catalog covers

## LITERATURE THAT COSTS

### Users guide lists resources

The 44-page *Watchmakers Guidebook to the Timex/Sinclair Computers* lists approximately 120 software suppliers, 50 hardware suppliers and 20 ancillary suppliers with a brief description of their products for use with the Timex/Sinclair family of computers. The guidebook also contains directories of user groups and Timex/Sinclair books and magazines and an index to articles appearing in general personal-computer magazines about the Timex/Sinclair computer. The guidebook also includes a chapter about writing a program in BASIC. Quarterly updates are available. Single-copy price is \$3.95. **TSG Enterprises**, 54 Richwood Place, Denville, N.J. 07834. **Circle No 342**

### Pocket guide is reference for Pick system users

*The Pick Pocket Guide* for users of Pick Systems' database-management operating system is an easy-to-use reference to the Pick operating system's verbs, syntax requirements, command formats and options. The guide can be used with all computer systems operating with Pick/Release 80, regardless of equipment manufacturer or vendor. The guide contains the latest Pick/Release 80 enhancements, and the publisher provides an update option. Single-copy price is \$50. **Pick Systems**, 17911 D Skypark Circle, Irvine, Calif. 92714. **Circle No 343**

### Handbook chronicles growth of Ethernet

The 408-page *Ethernet Handbook* explains what Ethernet is, who created it, which vendors support it and how information is passed along the network. The handbook also includes product descriptions for more than 40 vendors, Ethernet specifications, a designer's handbook, articles, company contacts and three case studies of Ethernet installations. Price is \$125. **Shotwell & Associates**, 680 Beach St., Suite 481, San Francisco, Calif. 94109. **Circle No 344**

### Reference details designing a system

*Real-Time Computing: with Applications to Data Acquisition and Control* includes everything a user must know to specify a real-time system, start it and keep it running smoothly. The 464-page book explains the fundamentals of computer systems for non-experts and compares real-time computing to data-processing applications. It explores multitasking programming, multitasking real-time operating systems, multiple computer systems and hierarchical configurations. Basic data-communications, analog and digital interfacing techniques, measurement and signal-handling practice and mathematical techniques for sampled-data control systems analysis design are discussed. Single-copy price is \$39.50. **Van Nostrand Reinhold**, 135 W. 50th St., New York, N.Y. 10020. **Circle No 345**

# Mini-Micro MARKETPLACE

A special section for advertisers of hardware, software and services.

**READERS:** Please circle reader service numbers for additional information.

## COMPLETE 68000 DEVELOPMENT TOOLS FOR VAX/VMS\*

MOTOROLA PASCAL → 68000  
optimizing cross-compiler.....\$2995  
MOTOROLA 68000 relocatable  
cross-assembler.....\$ 995  
MOTOROLA cross-linker.....\$ 995  
VMS ↔ VERSADOS†  
file transfer.....\$ 395

All products run in VAX native mode.  
Developed in cooperation with Motorola  
for guaranteed EXORMACS/VERSADOS†  
compatibility.

\*tm Digital Equipment Corp. †tm Motorola

**octal**  
INCORPORATED

1951 Colony Street, Mountain View, CA 94043  
(415) 962-8080 Telex: 172933

CIRCLE NO. 201 ON INQUIRY CARD

## IBM SERIES/1 VAR

- Customized Programming
- Message Switching
- Telex/Teletype Interface
- Freight Forwarding
- General Business Applications



Raymond G. Lorber,  
Incorporated  
Systems & Programming Design

333 Market Street, Suite 2840  
San Francisco, CA 94105  
(415) 434-2607

CIRCLE NO. 202 ON INQUIRY CARD

## CROSS SOFTWARE FOR MICROPROCESSORS

COMPILERS — PASCAL & C  
ASSEMBLERS & META-ASSEMBLERS  
LINKING LOADERS — LIBRARIANS  
INTERACTIVE SIMULATORS

8048 6800 1802 6500 F8  
8051 6801 1804 Z8 3870  
8080 6805 1806 Z80 Others  
8085 6809 2900 Z8002  
8086 68000 2901 2650

- Portable
- Affordable
- Compatible
- Professional
- Source Licenses

These programs written in Pascal  
and Fortran will run on most mini  
and mainframe computers

for more information, contact:

**microleo**

505 W. Olive Ave., Suite 325  
P.O. Box 60337  
Sunnyvale, California 94086  
Phone: (408) 733-2919 TLX: 4990808

CIRCLE NO. 203 ON INQUIRY CARD

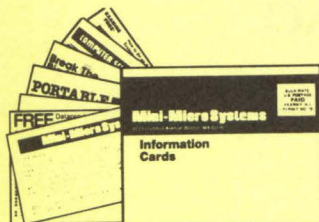

## HIGH INQUIRIES LOW COST

- Sell products and services directly
- Introduce new products
- Investigate new applications
- Develop new sales leads

## MINI-MICRO SYSTEMS DIRECT RESPONSE POSTCARDS

MAY MAILING CLOSES APRIL 11  
Call Lorraine Marden 617-536-7780

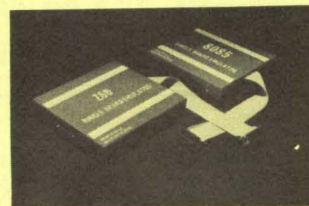

## Z80 and 8085 In-Circuit Emulators

- Real-time emulation to 6 MHz with hardware breakpoint or single-step
  - 16 K bytes of mappable memory
  - RS/232C interface for operation with a terminal or a host computer
  - In-line assembler and disassembler
  - Download or upload hex files
  - Complete debugging facilities
  - CP/M symbolic debug linking software via RS-232 optional
  - 8085 unit \$1895; Z80 unit \$1895
- HUNTSVILLE MICROSYSTEMS**  
PO Box 12415  
Huntsville, AL 35802  
(205) 881-6005

CIRCLE NO. 205 ON INQUIRY CARD

## NEW PRODUCT!

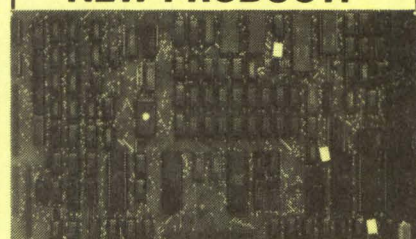

## CP/M Z80-A SINGLE BOARD COMPUTER

- On board video • Wide line and thin line graphics
- 128K of RAM • Sasi interface • Floppy disk controller for up to four 5-1/4 and four 8 inch drives, single/double density simultaneously • 4 serial ports • Full Centronics printer port • Expansion bus • Extended track buffer • 16K printer buffer
- DMA • Compact size

**\$750.00** Four to six  
weeks delivery

INSIGHT ENTERPRISES, CORPORATION  
373 N. Western Ave., Suite 12,  
Los Angeles, CA 90004 (213) 461-3262  
Dealer, OEM, International Inquiries Welcome



CIRCLE NO. 206 ON INQUIRY CARD



**LOW COST DATA TERMINAL**

The **TRANSFERM** has a two line LCD display with 32 characters/line, a 53 key membrane keyboard with audible keyclick and communicates in RS-232 serial asynchronous ASCII with 20 ma C/L or RS-422 optional. Four operating modes, baud rates and parity are switch selectable. Display supports 96 char. upper/lower case ASCII with cursor and audible bell code. Powered by 115VAC or 8-16 VDC. Only \$449.

**COMPUTERWISE, INC.**

(816)765-3330  
CIRCLE NO. 207 ON INQUIRY CARD

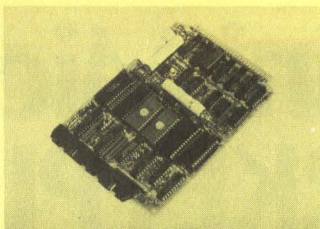

**DSTD-703** is a multifunction module containing crystal controlled calendar clock with battery backup, two 8-bit parallel I/O ports, programmable counter/timer channels, + 5V brown-out detector, four 28 pin Byte-wide sockets and NiCad batteries with charging circuitry.



888 Lady Ellen Place  
Ottawa, Ontario  
Canada K1Z 5M1  
TWX: 610-562-8967  
**dy-4 SYSTEMS INC.** TEL: 613-728-3711  
CIRCLE NO. 208 ON INQUIRY CARD

**THE INDOOR  
MULTIPLEXER**  
**\$495**

- Eight channel capacity
- Completely transparent up to 9600 bps for each channel
- No modem needed: 2000 ft. distance between muxes
- Free 30 day trial

**SOLANA  
ELECTRONICS**

249 SOUTH HIGHWAY 101  
SOLANA BEACH, CA 92075 (714)481-6384

CIRCLE NO. 209 ON INQUIRY CARD

**Promote  
New Literature**

**at a LOW  
COST**

If you've got catalogs or literature, distribute them at a low cost in the **MINI-MICRO MARKETPLACE**.

Call Lorraine Marden  
(617)536-7780

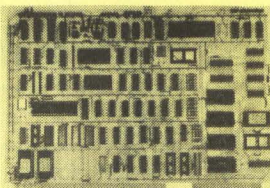

**ASI-200 MULTIBUS™ COLOR VIDEO BOARD**  
The ASI-200 utilizes the advantages of 8 foreground/background selectable colors to provide alphanumeric and graphics displays for Multibus™ users.

**Key features include:**

- 4K or 8K refresh RAM.
- 80 x 24 or 80 x 32 or 80 x 48 display format.
- Totally stand-alone using 8085 CPU.
- DEC VT-52 or ISC 8001 emulation firmware.
- Keyboard input port.
- RS-232 and 20ma current loop serial port.
- 75 - 19.2 K Baud transmission rate.
- Buffered serial input.
- TTL video output compatible with N.E.C., Mitsubishi, and Hitachi monitors.
- Optional R.G.B. output interface.
- Alternate graphics character generator.
- Price: OEM qty. 25 is \$525.00
- Evaluation unit available at \$525.00

Distributor and Dealer inquiries invited.

MULTIBUS is a Trademark of Intel Corporation.  
**ANTEK SYSTEMS INC.** 3005 East Main Street  
Waterbury, CT 06705  
(203) 573-1795

CIRCLE NO. 212 ON INQUIRY CARD

**EDGE-86  
AN INDUSTRIAL QUALITY  
8086 OEM SYSTEM**

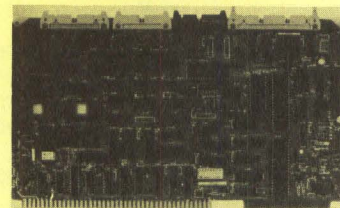

**• HARDWARE**

- A Multibus® COMPATIBLE 8086 CPU BOARD WITH DMA FLOPPY CONTROLLER, INTERRUPT CONTROLLER, PROGRAMMABLE TIMERS, 3 SERIAL PORTS, TWO PARALLEL I/O PORTS, AND 8K BYTES OF PROM WITH BOOT STRAP LOADER FOR CPM/86™.
- 128K BYTES DYNAMIC RAM BOARD.
- 4-SLOT MULTIBUS CARD CAGE, WITH COMPLETE DOCUMENTATION AND SCHEMATICS; ALL FOR.....\$1250.

**• SOFTWARE**

- CPM/86 O.S. WITH COMPLETE UTILITIES... \$250.
- OFF THE SHELF DELIVERY—

**EDGE MICRO SYSTEMS**

195 W. EL CAMINO REAL, SUNNYVALE, CA 94086  
TELEPHONE: 408-738-4729

\* Multibus TM of Intel,™CPM/86 TM of Digital Research.

CIRCLE NO. 213 ON INQUIRY CARD

**ORDER  
FORM**

Advertise in the **MINI-MICRO MARKETPLACE**

Please run my advertisement in the following issues

Please specify category:

- Software  Hardware  
 Literature  Services  
 Other \_\_\_\_\_

**1983 RATES**

1x	3x	6x	12x	18x
\$560	\$540	\$520	\$500	\$480

**MATERIALS**

- Glossy photo with 50-75 words.  
We will typeset your ad at no charge.
- Camera ready artwork.
- Film negatives: right reading emulsion side down.

**AD SIZE:** 2 1/4" x 3 1/16"

COMPANY \_\_\_\_\_

ADDRESS \_\_\_\_\_

CITY \_\_\_\_\_

STATE \_\_\_\_\_

ZIP \_\_\_\_\_

TELEPHONE \_\_\_\_\_

SIGNATURE \_\_\_\_\_

Space reservation by the first week of the month preceding issue date.

- Materials enclosed  Materials to come  Please send information

Send to: Lorraine Marden, **MINI-MICRO SYSTEMS**  
221 Columbus Ave.  
Boston, MA 02116

15% Agency commission to accredited agencies. Please specify agency.



# Classified Ads

## software

### MicroPERT® Project Management for Tektronix, IBM PC

For information, call or write  
**SHEPPARD SOFTWARE COMPANY**  
4750 Clough Creek Rd.  
Redding, CA 96002  
(916) 222-1553

CIRCLE NO. 231 ON INQUIRY CARD

### ISIS — CP/M®

CP/M users may transfer data bi-directionally to ISIS diskettes. The "ISIS-CP/M UTILITIES" provide complete high speed data transfer to/from ISIS diskettes to/from CP/M diskettes and also include a utility to display the ISIS directory. Will work in any version CP/M environment with any density drive.

\$250 on single density 8" diskette. Free brochure on other software development tools.

### Southern Computer Systems

2304 12th Avenue North  
Birmingham, AL 35234  
Phone: 205-933-1659

CP/M® is a registered trade mark of Digital Research. ISIS is a trade name of Intel Corp.

CIRCLE NO. 232 ON INQUIRY CARD

## software

### PLUG-INS

SUBROUTINES/FUNCTIONS

24 FORTRAN SUB-PROGRAMS NOW  
AVAILABLE FROM OUR LIBRARY  
FOR THE DATA GENERAL USER:

- STRING EDITING/  
MANIPULATION
- NUMBER CONVERSION
- SELECTIVE EDITING
- BIT MANIPULATION
- SEQUENCING

**SN** SOFTWARE  
NORTH  
3100 Glenn-Don Drive  
Anchorage, AK. 99504  
(907) 333-4412

CIRCLE NO. 233 ON INQUIRY CARD

## hardware



**HEWLETT  
PACKARD**  
Desktop & Mini  
Computer  
Products

### SAVINGS ALL MODELS

9845B/C 9000 Non-HP memory  
9836A 9826A and peripherals

CALL OR WRITE FOR FREE CATALOG

### digital resources inc.

Box 23051 Portland, OR 97223 USA  
503-246-0202  
International Sales Telex 360-143

CIRCLE NO. 234 ON INQUIRY CARD

## publications

### Exclusively UNIX\* and C Information

That's UNIQUE, the oldest and largest independent journal covering the UNIX\* and C marketplace.

- product reviews/listings/prices
- applications/tutorials/indexes
- industry inside information

Full year, \$54 (\$66 foreign) - write, call or circle reader service number for full brochure and FREE sample copy.

### InfoPro Systems

Dept. MM • Box 33 • E. Hanover NJ 07936  
(201) 625-2925

\*UNIX is a trademark of Bell Laboratories  
Formerly The UNIX Software List

CIRCLE NO. 236 ON INQUIRY CARD

## Copy Deadline:

Space reservations and advertising copy must be received by the 10th of the month preceding the issue date. Camera-ready mechanicals must be received by the

15th of the month preceding the issue date. For example, to appear in the February issue, copy must be received by January 10; mechanicals by January 15.

## business opportunities

### DISTRIBUTORS WANTED for MODULAR PROTOTYPING SYSTEM

based on modules with basic micro functions. The modules mask is then used to make the final PCB. More than 20 modules are available. An industrial BASIC system is used for software design. **MICRO RSC 95 rue VERBIST, 1030 BRUSSELS, BELGIUM**

CIRCLE NO. 235 ON INQUIRY CARD

## wanted to buy

### WANTED TO BUY

Data relating to floppy disk directories and disk layout to be able to "re-create" a blown disk. Interest in Personal Computers, Word Processors, ETC. Contact Bill Ott:

### ADC

14272 Chambers Road, Tustin, Cal. 92680  
(714) 731-9000

if you have any articles, books or your own documentation.

CIRCLE NO. 237 ON INQUIRY CARD

## CLASSIFIED ADVERTISING ORDER FORM

Mini-Micro Systems classifieds reach more mini-micro people

### Rates: \$80.00 per column inch

There is no charge for typesetting classified listings. Plan approximately 50 average words to a column inch, 8 lines of approximately 38 characters per line (3 inch maximum). Please send clean typewritten (double-spaced) copy.

**Category:** The following categories are available; be sure to specify the category you wish to be listed under: Business Opportunities, New Literature, Selling, Buying, Trading, Seminars, Services, Software, Supplies & Accessories. (Other categories may be employed at our discretion.)

Run this ad in \_\_\_\_\_ (number issues) Reader Inquiry No. YES  NO   
Ad size 1 col. wide by \_\_\_\_\_ inches deep Under \_\_\_\_\_ (category)  
Check enclosed for \$ \_\_\_\_\_ (Pre-paid orders only)

Signature \_\_\_\_\_

Name \_\_\_\_\_ Title \_\_\_\_\_

Company \_\_\_\_\_ Telephone No. \_\_\_\_\_

Address \_\_\_\_\_

City \_\_\_\_\_ State \_\_\_\_\_ Zip \_\_\_\_\_

MAIL TO: Linda L. Lovett, Classified Advertising, Mini-Micro Systems,  
221 Columbus Ave., Boston, MA 02116

# Mini-Micro Systems

## Career Opportunities/Recruitment Advertising

### 7-Day Closing

(Prior to Issue Mailing Date)

### Rates

\$75 per column inch.  
Column width 1 3/4" x 10" (4-column/page).  
Full page: \$2,800 (1 x B&W).

### Circulation

Over 95,000 technically sophisticated professionals in computer operations/systems management, data communications, engineering management, systems engineering/integrators, educators and systems programming specialists.

Recruitment  
Hot Line  
**(203) 964-0664**

Call your ad in—  
we'll set the type  
at no charge.

Mail Film to:  
**Stuart Tilt**  
Recruitment Manager  
**CAHNS PUBLISHING CO.**  
999 Summer St.  
P.O. Box 3809  
Stamford, CT 06905

#### PROFESSIONAL RESUME SERVICE

1125 S. Cedar Crest  
Allentown, PA 18103

Complete resume preparation for design engineers and design managers in electronics. Call or write:

**PROFESSIONAL RESUME SERVICE**  
(215) 433-4112

#### ENGINEERS...PROGRAMMERS

DES PROG • 6800/8080 • BIT SLICE •  
DATA/TELECOM • SIG PROC • ARCH VAX •  
UNIX • C • VMS • SYS-1 • DEC MODELING •  
CRYPTO • C • ATE • E/M LSI/VLSI • CAD •  
RF/MM/ECM • DIAG  
BUSINESS/SCIENTIFIC/MFGING APPS.

Forward Resume to: **IMR**  
18582 Marion Way, Suite 504  
Villa Park, CA 92667

Fees Assumed by NATIONAL Clients

#### ENGINEERS/SOUTHEAST

Our 12 Offices in NC, SC, GA and FL specialize in Control Systems, Instrumentation, Electronic Design and Engineering positions from 18 to 40K. Aggressive, confidential. Fee Paid service. Send resume to Ted F. McCulloch, **McCulloch & Co.**, P.O. Box 10211, Greenville, SC 29603.

### ELECTRONICS

Choice positions available in New England and Nationwide. Hardware, software, commercial and defense industries.

Real Time Prog.	45K
Circuit Design	60K
Software RSX-11M	55K
Firmware Dev.	40K
Magnetic Memory Des.	45K
Military Software	60K
Operating Systems	50K
Assembly Prog.	40K
Signal Processing	55K
CPU, I/O Processor	40K
Diagnostic Eng.	40K
Logic Design	38K

All fees and expenses paid.  
Call or send resume to:

**LARSEN Personnel**

1492 Highland Avenue  
Needham, MA 02192  
(617) 449-3840

### EMPLOYMENT SERVICE FOR PROGRAMMERS AND ANALYSTS

National Openings With Client Companies and Through Affiliated Agencies

Scientific and commercial applications • Software development and systems programming • Telecommunications • Control systems • Computer engineering • Computer marketing and support

Call or send resume or rough notes of objectives, salary, location restrictions, education and experience (including computers, models, operating systems and languages) to either one of our locations. Our client companies pay all of our fees. We guide, you decide.

**RSVP SERVICES, Dept. MM**  
Suite 700, One Cherry Hill Mall  
P.O. Box 5013  
Cherry Hill, New Jersey 08034  
(609) 667-4488

**RSVP SERVICES, Dept. MM**  
Suite 211, Dublin Hall  
1777 Walton Road  
Blue Bell, Penna. 19422  
(215) 629-0595

#### RSVP SERVICES

Employment Agents for Computer Professionals

CIRCLE NO. 245 ON INQUIRY CARD

More and more advertisers of minicomputers, microcomputers, CRT terminals, printers, disk drives, memories, modems, distributed data processing systems, etc., are consistently turning to **MINI-MICRO SYSTEMS**. Call **Stuart Tilt** at **203-964-0664**.

# Pitney who ?

And not only a Fortune 300 but one on the move. We're marching up the list and have hit #252, up 13 places in just one year. Our profits are up 20% in '82—and in an economic climate not known for its success stories.

Pitney Bowes, that's who. Now admit it, you think you know what we do for a living. Make machines that meter mail in all the back offices of the world. Right?

Wrong. That's just a piece of it. We're continuously developing electronic systems that take us into every part of the office. We're involved in office of the future technologies that will help businesses communicate more effectively.

As for the back office perception—those mailing and weighing systems turning out the office mail—samples of electromechanical technology. Right?

Wrong again. We have always worked at the forefront of technology—when it was electromechanical—we were there. When it became electronic—we were also there.

As a matter of fact we develop products which incorporate word and voice processing, optical character recognition technology, electronic printing technology, systems development and integration for postal and commercial markets worldwide.

**A Fortune 300  
electronics company  
and you ask  
Pitney who!**

We seek degreed experienced electronics engineers to participate in the design of microprocessor based systems that will change how business does business in the future. Expertise in one or more of the following areas is desired:

**CAD/CAM Systems Software  
CAD/CAM Systems Support  
(Training)  
Data Communications  
Diagnostics  
Electromagnetic Interference/Compatibility  
Hardware Engineering  
Integrated Circuits  
Manufacturing Process/Robotics  
Quality Engineering  
Software Engineering  
Systems Reliability  
Test Engineering**

The salaries offered are excellent and our benefits package includes not only medical and dental but tuition refund, profit sharing and stock purchase plan.

If Pitney Bowes sounds like your kind of company, write us or call Guy Beach, Monday-Friday, 9AM-6PM(EST). Call collect (203) 357-9111. Pitney Bowes, Professional Employment, (MMS), Walter H. Wheeler Jr. Drive, Stamford, CT 06926.

 **Pitney Bowes**

We aggressively support equal opportunity and affirmative action.

# HARRIS IN FLORIDA

Harris Controls/Composition Division is a world leader in the development and delivery of real-time process control systems for Utilities/Pipelines throughout the international markets.

## SOFTWARE ENGINEERS

Working from generalized customer requirements, within a team concept, you will be involved in performing a total software engineering task. Your responsibilities will involve design, documentation and implementation of real-time systems and furnishing technical direction and consultation to customers and in-house staff. Our environment is a network of real-time, redundant mini-computers in a distributed processing application, utilizing FORTRAN, and Assembly.

Immediate openings are available involving: Applications Software Development, Communications (high speed parallel data links and interprocessor interrupts), Operating Systems (RTOS & PPOS) and our DAC, MMI or Data Base Teams.

We are a division of the Harris Corporation, Florida's largest industrial employer, with over 9,000 Florida based employees and corporate sales in excess of \$1.6 billion, located in Melbourne, a Florida east coast resort area, where you will earn nationally competitive income while paying no state or local income taxes—and enjoy the generally lower cost of Florida living.

Send your resume to: **Don Quirk, Harris Corporation, Controls/Composition Division, P.O. Box 430, Melbourne, Florida 32901. OR CALL COLLECT (305) 242-4021.**



## HARRIS

An Equal Opportunity Employer, M/F/V/H.

CIRCLE NO. 239 ON INQUIRY CARD

## SYSTEMS ENGINEER

Our environment is a network of real-time, redundant computers. A background which combines applications software and customer interface, as well as the technical direction of project teams, is desirable. Your emphasis would be in the establishment of functional and testing requirements for Power Systems Application Software and in assuring the quality of the combined Hardware/Software end products. Experience with electric utilities, consultants or systems suppliers would be a plus.



## Call today.

### United States:

<b>Arizona</b> Phoenix	602/279-1010
<b>California</b> (Northern) Mountain View San Francisco Walnut Creek (Southern) Century City Fullerton Los Angeles Newport Beach San Diego Torrance Van Nuys	415/969-4910 415/434-2410 415/945-1910 213/203-8111 714/871-6500 213/688-0041 714/833-1730 619/231-1900 213/540-7500 213/781-4800
<b>Colorado</b> Denver Englewood	303/571-4450 303/773-3700
<b>Connecticut</b> Hartford Stratford	203/522-6590 203/375-7240
<b>District of Columbia</b> Washington D.C.	202/466-5890
<b>Florida</b> Miami	305/624-3536
<b>Georgia</b> Atlanta (Downtown) Atlanta (Northeast)	404/588-9350 404/325-8370
<b>Illinois</b> Chicago (West Loop) Oak Brook Rolling Meadows	312/782-0857 312/986-0422 312/392-0244
<b>Indiana</b> Indianapolis	317/631-2900
<b>Kansas</b> Overland Park	913/888-8885
<b>Kentucky</b> Louisville	502/581-9900
<b>Louisiana</b> New Orleans	504/561-6000
<b>Maryland</b> Baltimore Greenbelt Towson	301/727-4050 301/441-8700 301/321-7044
<b>Massachusetts</b> Boston Burlington Wellesley	617/482-7613 617/273-5160 617/237-3120
<b>Michigan</b> Detroit Southfield Troy	313/259-7607 313/352-6520 313/362-0070
<b>Minnesota</b> Minneapolis (Downtown) Minneapolis (West)	612/332-6460 612/544-3600
<b>Missouri</b> Clayton Kansas City	314/862-3800 816/474-3393
<b>New Hampshire</b> Nashua	603/880-4047
<b>New Jersey</b> Cherry Hill Edison Morristown Paramus Princeton	609/482-2600 201/494-2800 201/267-3222 201/845-3900 609/452-7277
<b>New York</b> New York City (Grand Central) (Penn Station) (Wall Street) Rochester Syosset, L.I. White Plains	212/557-8611 212/736-7445 212/962-8000 716/263-2670 516/364-0900 914/683-9300
<b>Ohio</b> Akron Cincinnati Cleveland Columbus Dayton	216/535-1150 513/769-5080 216/771-2070 614/224-0660 513/461-4660
<b>Oklahoma</b> Tulsa	918/599-7700
<b>Oregon</b> Portland	503/223-6160
<b>Pennsylvania</b> King of Prussia Philadelphia Pittsburgh	215/265-7250 215/665-1717 412/261-6540
<b>Texas</b> Dallas (Central) Dallas (North) Fort Worth Houston (Downtown) Houston (N. Loop West) Houston (W. Loop South) San Antonio	214/954-1100 214/387-1600 817/338-9300 713/751-0100 713/957-8555 713/439-0550 512/342-9898
<b>Virginia</b> McLean	703/790-5610
<b>Washington</b> Bellevue	206/454-6400
<b>Wisconsin</b> Milwaukee	414/277-0345
<b>Canada</b> <b>Ontario</b> Toronto downtown Don Mills Mississauga	416/865-1125 416/425-5730 416/272-3333

# Somehow, Did Your Last Raise Seem Insignificant?

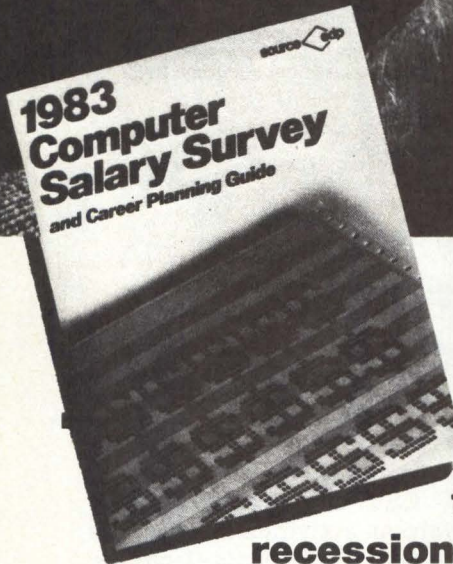
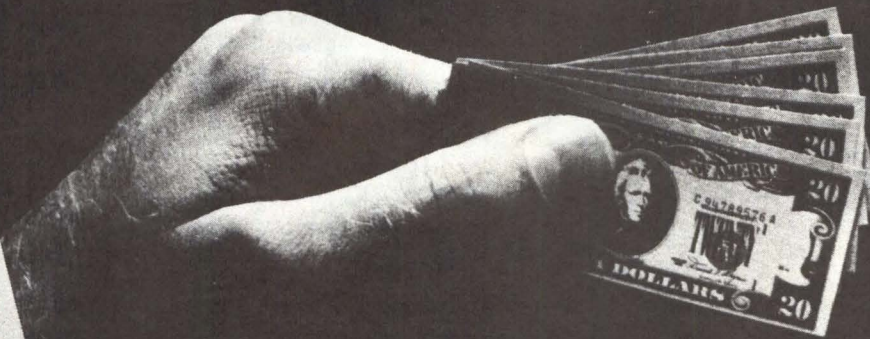

## New, Free Computer Salary Survey!

**Learn about compensation in the computer field, including the effects of inflation and recession, and which career paths offer the greatest compensation from a 28-page report prepared by Source Edp.**

Despite past inflation and recession, demand for computer systems and the people needed to support them continues to grow.

But which professionals, with what specialized experience and skills, are really in the best positions for long term career and salary growth? And is your salary really keeping pace?

In our new Survey, you'll get answers to these questions and much more.

### **Compare your salary with many others.**

The new Survey not only provides salary medians for 48 position categories, but it also shows "highs" and "lows" for each one as well. Figures are organized by types of professionals, including those ranging from commercial pro-

grammers to management and marketing positions; by experience level and by size of computer installation site. So you'll be able to compare your salary with those computer professionals who have similar responsibilities and skills and to learn who in computing, in what kinds of specialized disciplines, are earning the most.

No other Survey we know of is more comprehensive. It's based on contacts with more than 50,000 professionals and 25,000 organizations.

### **Learn about new growth areas.**

Most significantly, you'll also read about which specific areas of specialization are forecasted for unusual growth in this decade and beyond. The past year saw many

changes in the economy and has altered career prospects for some professionals who were not properly prepared, so the need to stay abreast of current trends and career planning has never been so critical.

Whatever computer specialty you're in, or plan to explore—programming, software, systems design, data communications, mini/micro systems, data base, computer marketing, sales, management or others—our Survey can help you make the most of your career. You'll be able to keep up with changes in the profession, establish career goals, develop action plans, evaluate your progress, spot potential dangers, take corrective action when needed, and in general, keep your career on the best possible course for growth.

### **Call for your free copy.**

The new *1983 Computer Salary Survey and Career Planning Guide* is available without charge. You owe it to yourself to get a copy of the report—especially if most of your career lies ahead of you.

Call today and our free 28-page Survey will be mailed to you in strict confidence, without obligation.

**source edp**  
Personnel Services

The world's largest recruitment firm that specializes exclusively in the computer profession.

Client companies assume our charges.

### **Call today.**

Call the office nearest you that is listed to the left. If you're unable to call, write:

Source Edp  
Department MM3  
P.O. Box 7100  
Mountain View, CA 94039

(When writing, be sure to include your title.)

**COMPUTER SCIENCES CORPORATION...**

# **Involved in all aspects of software, hardware and systems engineering for communications systems.**

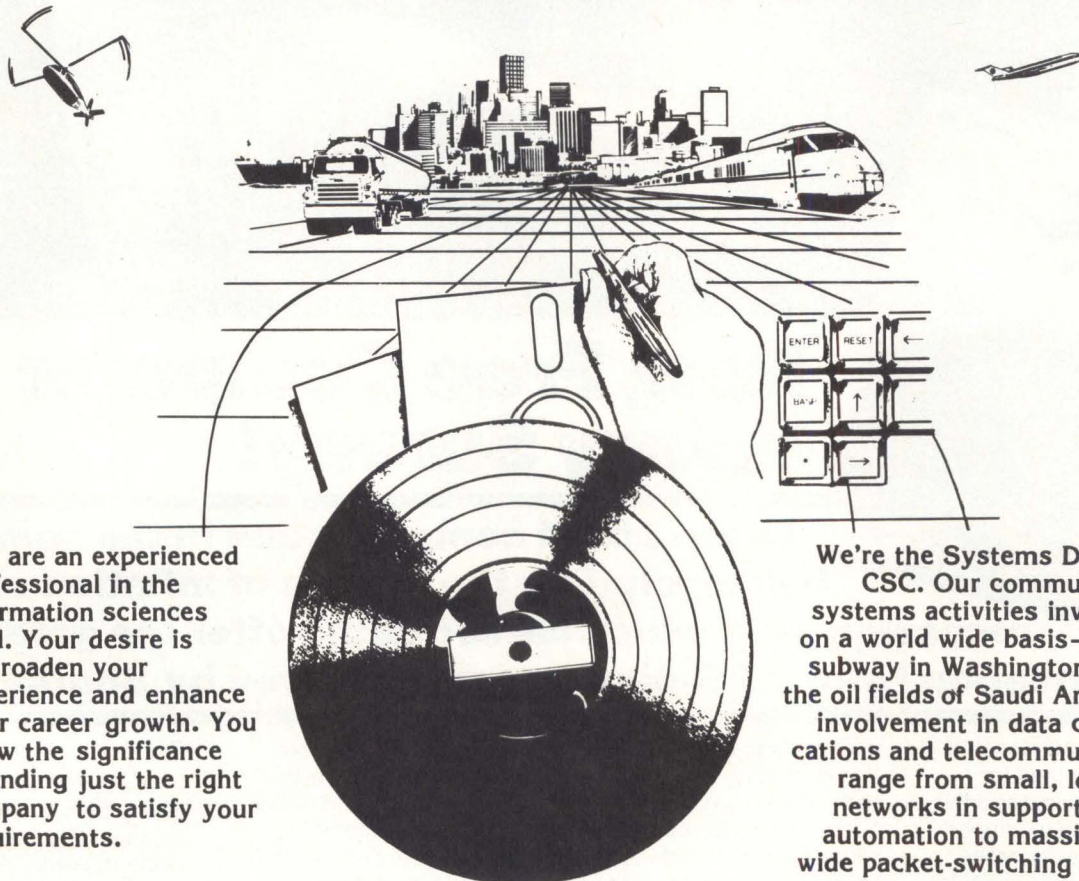

You are an experienced professional in the information sciences field. Your desire is to broaden your experience and enhance your career growth. You know the significance of finding just the right company to satisfy your requirements.

We're the Systems Division of CSC. Our communications systems activities involve jobs on a world wide basis—from the subway in Washington, D.C. to the oil fields of Saudi Arabia. Our involvement in data communications and telecommunications range from small, local-area networks in support of office automation to massive, world wide packet-switching systems.

We have designed and built communications systems that involve the most advanced technologies. Because of our continued growth in these areas we have immediate openings in **COMMUNICATIONS PROTOCOLS DESIGN AND DEVELOPMENT, TRANSMISSION SUBSYSTEMS, HARDWARE SIZING, SELECTION, ACQUISITION AND INSTALLATION, VAX 11/780 AND MICROPROCESSOR BASE SOFTWARE DESIGN AND DEVELOPMENT, SECURE COMMUNICATIONS SYSTEMS, AND MESSAGE PROCESSING.** Our communications expertise spans a wide variety of applications including **LARGE SCALE NETWORKS, INDUSTRIAL AUTOMATION, MASS-TRANSIT AUTOMATION, REAL TIME PROCESSING AND VOICE COMMUNICATIONS.**

If you are interested in a company that offers multiple career paths and many avenues for upward mobility; a company whose people are always encouraged to learn new skills and seek out the project and work location that best suit their interest and career goals, find out more about your future with Computer Sciences Corporation.

**Computer Sciences Corporation  
Systems Division (MC 218 MM 4)  
6565 Arlington Boulevard  
Falls Church, VA 22046**

# **CSC**

Equal Opportunity Employer

## **COMPUTER SCIENCES CORPORATION**

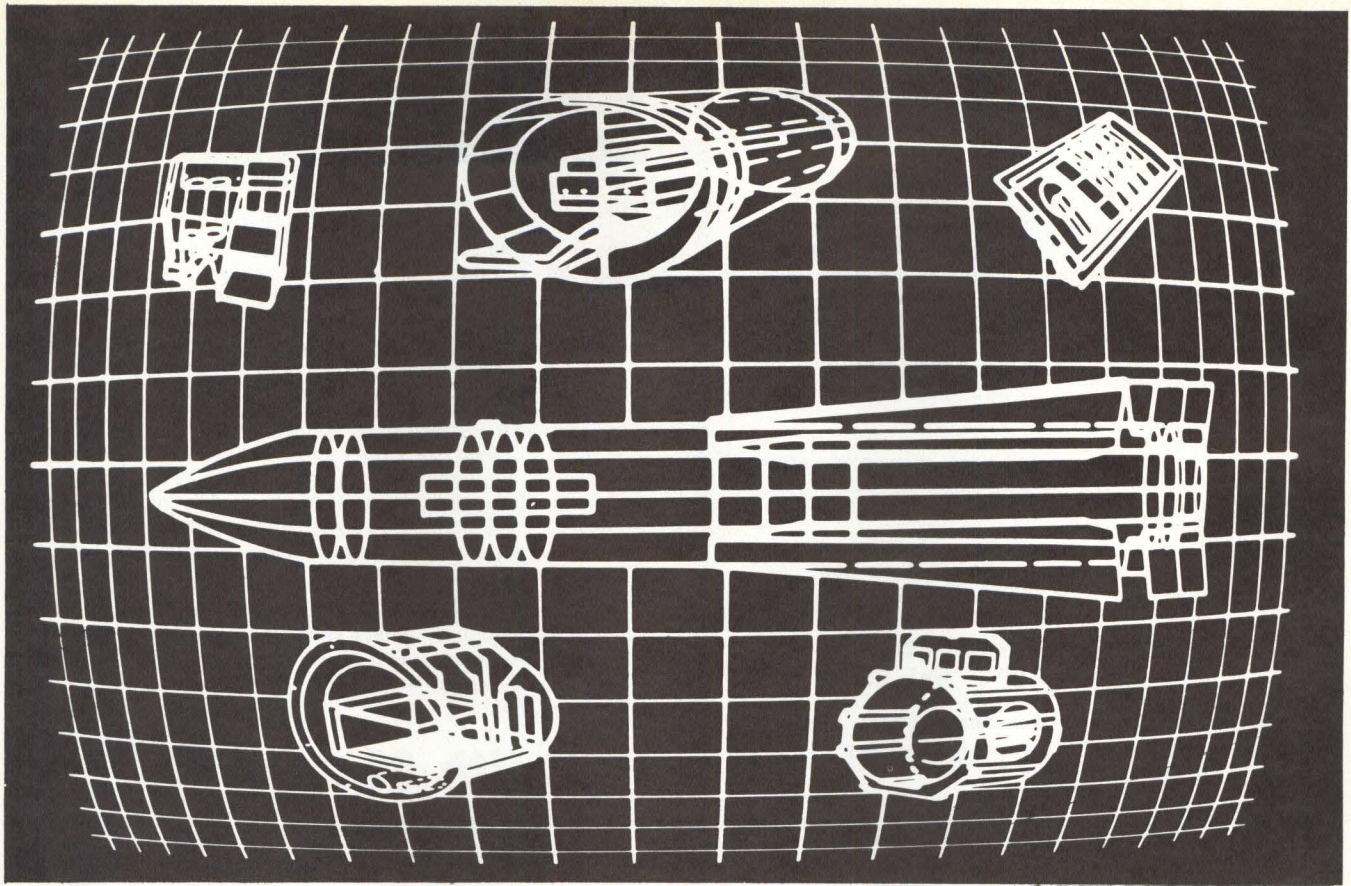

# Tucson. A Technological Oasis.

A place where the sun shines 360 days a year. Where the desert blossoms like no place else on earth.

Tucson. A technical oasis for state-of-the-art engineers. Where the Hughes Missile Systems Group has built a reputation for development and manufacturing of sophisticated electronics, starting with the radar/infrared-guided Falcon Missile. We have enhanced our place of leadership in this field with the electro-optical/laser/infrared-guided Maverick Missile, the radar-guided Phoenix, the wire-guided TOW, and now, the new radar-guided AMRAAM.

And there's more to Tucson. From rodeos, camping trips, desert hiking, and four-wheeling, to its own opera, symphony,

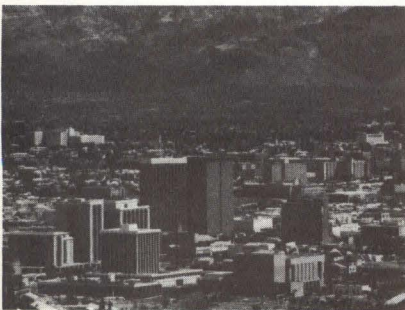
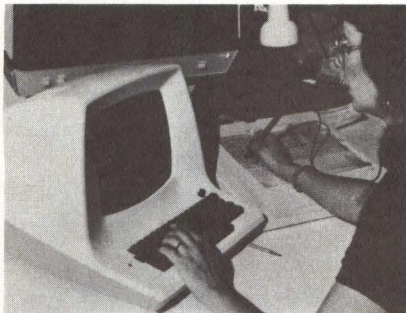

## A place in the sun.



and ballet companies, Tucson will delight you and your family.

And Tucson offers you affordable housing, good schools, the University of Arizona, and the freedom to enjoy the abundance of sunshine.

Hughes in Tucson is part of a company with 1,500 projects in the works. If you're an engineer with a BSEE, BSET, or Master's degree, we invite you to find out about these opportunities:

**RF/MW Test Equipment Design Engineer**  
**Microwave Engineering**  
 (components, devices, subsystems)  
**Circuit Design**  
 (analog, digital, hybrid)  
**Mechanical Design Engineer**  
**Missile System**  
 (analysis, design, test)  
**Missile System**  
 (test equipment, test software design)  
**Production Test Engineers**  
**Software Engineers/Scientific Programmers**  
**Quality Assurance Engineers**

Send your resume now to:

Hughes Aircraft Company,

Dept. MM-4,

P.O. Box 11337,

Tucson, Arizona 85734.

Call toll free 1-800-528-4927,

or collect from Arizona (602) 746-8925.

Proof of U.S. Citizenship required.

Hughes is an equal opportunity employer.

Tucson. A place in the sun.

*Creating a new world with electronics*

**HUGHES**

HUGHES AIRCRAFT COMPANY

**MISSILE SYSTEMS — TUCSON**

# Principal Software Engineer

General DataComm is recognized worldwide as a major force in the development of sophisticated data communications equipment. On-going, dynamic growth has created the need for a Principal Software Engineer who is capable of working across our product line—network management systems, multiplexers and voice band modems. You will be responsible for all aspects of software development including specification, design and documentation.

The selected candidate must have a BSCS or BSEE degree, 5 plus years real time assembler software experience with microprocessors and/or minis, plus a hardware understanding. Data communications background is desirable.

If you can meet the challenges of our fast paced, growing company in a dynamic and growing industry, please call or send your resume to:

**Michael Blaszcak**  
(203) 797-0711 Ext. 950



CIRCLE NO. 242 ON INQUIRY CARD

# SR. QUALITY ASSURANCE ENGINEER - SOFTWARE



## Erie, Pennsylvania

The Smith Meter Division of Geosource Inc. has been setting the standard for accurate and reliable petroleum measurement as well as excellent careers. As a worldwide, high technology organization, Smith Meter Division manufactures liquid flow measurement and control equipment for the petroleum and chemical process industries, with new products continually being added.

Based in Erie, Pennsylvania, you will assure that the quality of new software for new electronic products will meet customer requirements, and prepare software required to perform job function. BS in Math, Software Engineering or Electrical Engineering and 5 years programming and testing language required. You must possess a familiarity with a Tektronix model 8002 system.

This position offers excellent benefits and salary plus relocation amenities. **Please send resume to the Manager of Human Resources, Smith Meter Division, P.O. Box 10428, Erie, Pennsylvania 17614.** We are an equal opportunity employer, m/f.

**Smith Meter Division**



"Technical Innovation And Service Around The World"

CIRCLE NO. 243 ON INQUIRY CARD

# How to become a SUCCESSFUL CONSULTANT in your own field.

Have you ever wished you could quit your job and start working for yourself?

**Well, maybe you can!** Many people are amazed when they discover the tremendous amount of professional experience and specialized knowledge they've accumulated — experience and knowledge that others will gladly pay for. Literally thousands of people who made that discovery are now prospering as **independent consultants**.

The way to begin is by reading *How to Become a Successful Consultant in Your Own Field*, by Hubert Belmont.

**Clear, straightforward, packed with solid information and advice**, this authoritative manual tells you everything you need to know to establish your own independent consulting practice. Here's a sampling of the contents:

- What does it take to be a successful consultant? (See Chapter 1.)
- How to get started. (See Chapter 3.)
- How to operate your business — a collection of "tricks of the trade." (See Chapter 5.)
- What to charge your clients — plus five helpful rules on fees. (See Chapter 6.)
- Why you should **never** work on a contingency (speculative) basis. (See Chapter 7.)
- Ingenious ways to promote yourself — and make people want your services. (See Chapter 9.)
- Contracts: why you should **avoid** them at all costs. (See Chapter 10.)
- Just what do consultants do all day? (See Chapter 11.)
- How to market your ideas. (See Chapter 11.)
- Why you'll never have to worry about competition. (See Chapter 13.)
- And much more!

Perhaps no one is better qualified to have written this book than Hubert Belmont. He has served as consultant to more than 70 major corporations and trade associations, including the U.S. Chamber of Commerce, McGraw-Hill, the Electronic Industries Association, Evelyn Wood Reading Dynamics and the Smithsonian Institution. Yet he made the decision to become a consultant only after being fired from an executive position at the age of 43. You'll learn first-hand how he did it — and how you can do it, too!

*How to Become a Successful Consultant in Your Own Field* is just \$20 (tax-deductible if you use it for business purposes), and you're fully protected by this **unconditional money-back guarantee**: Keep the book for three weeks. If you're dissatisfied with it for any reason whatever, simply return it and **every penny of your \$20 will be promptly refunded** — no questions asked!

How many times have you told yourself that you're not getting anywhere — that it's time to think seriously about a major change in your career? **Don't put it off another day!** Clip and mail the coupon now!



Enclosed is my check or money order for \$20. Rush me, postpaid, *How to Become a Successful Consultant in Your Own Field*, by Hubert Belmont. I understand that I have the right to return the book within three weeks for a complete refund if I'm in any way unhappy with it.

Name \_\_\_\_\_  
Address \_\_\_\_\_  
City \_\_\_\_\_ State \_\_\_\_\_ Zip \_\_\_\_\_

**The Consultant's Library**  
Suite 1108  
815 15th St., N.W.  
Washington, D.C. 20005



# Computer Consultants Corner

## INDUSTRIAL APPLICATIONS

Automated QC Inspection  
Machine Control  
Measurement

Contact E.M. Gore, P.E.

**MG ASSOCIATES**

207-774-5290

## DEC COMPATIBLES

Specialist in all DEC  
compatible hardware and services

Rick Eriksen

**ERIKSEN & ASSOCIATES**

23461 Ridge Route S#H  
Laguna Hills, CA 92653  
714-859-6982

## Microprocessor-Based Product Development

BIT-SLICE • 8-BIT • 16-BIT  
2901 • 6502 • 8080 • 8085 • 8086  
8088 • Z80 • 68000 • LSI-11

Data Acquisition • Graphics • Networks  
Office Automation • Typesetting  
Word Processing

small system design 225A Lowell Road, Hudson, NH 03051  
Telephone 603-880-1322

Taking ideas from conception to production.

## MICRO-PROCESSOR SERVICES INC.

• Specializing in microcomputer software and hardware  
design for all INTEL MICROPROCESSOR FAMILIES (from  
8021 to 8086).

• We use our own development equipment and staff.

• Fixed price contract and warranty.

• Free initial consultation and quotation.

## MICRO-PROCESSOR SERVICES INC.

92 STONEHURST LANE  
DIX HILLS, L.I., NEW YORK 11746  
(516) 499-4461



## BASS-SNEED

ASSOCIATES INC.

Specialists in Microprogramming, Signal processor  
implementations, Image processing, Floating  
Point systems, Bit-slice machines, Real-time  
digital control systems design,  
Microprocessor applications

Integrated Hardware/Firmware/Software solutions

Lawrence P. Bass  
Box 646, Ridgewood, NJ 07451  
(201) 444-3411

## 6800/68000 Experts

• Microprocessor hardware and software design • Industrial  
control specialists • Hierarchical software design methodology

• Environmental testing • Complete prototype facilities

**CSA Computer System Associates**  
7562 Trade St., San Diego, CA 92121 (619) 566-3911

## HARDWARE—SOFTWARE—COMMUNICATIONS

High technology marketing services at  
realistic prices to create a cost effective  
return on investment.

**Pro-Spectrum**



P.O. Box 74 - SPRING VALLEY,  
OHIO 45370-0074  
(513) 885-4589

## VAX/VMS, RSX-11M, RT-11 USERS

- Short-Long Term Software Projects
- Real-Time, Lab. Automation & Security Systems
- Staffed by Former DEC<sup>®</sup> Specialists
- Recommendations from Major Corporations
- Call or Write for More Information

## DIGITAL CONSULTANTS

Box 3781 Englewood, CO 80155  
(303) 773-0717

## ELECTRICAL NOISE PROBLEMS

**SOLVED** in Electronic Data Processing

and Microprocessor Based Control

Systems **CALL (814) 466-6559**

Dr. E. Thomas Chesworth, P.E.

Seven Mountains Scientific Inc.

Boalsburg, PA 16827

## COMPUTER CONSULTANTS ORDER FORM

### INTRODUCTORY OFFER

1" 1x \$150

1" 3x's \$225

1" 12x's \$1,440

(There is no charge for typesetting)

Enclose check for \$ \_\_\_\_\_

Bill me monthly

Run this ad in \_\_\_\_\_ (number issues)

(Please print, type or attach business card)

Name \_\_\_\_\_ Title \_\_\_\_\_

Company \_\_\_\_\_ Telephone \_\_\_\_\_

Address \_\_\_\_\_

City \_\_\_\_\_ State \_\_\_\_\_ Zip \_\_\_\_\_

MAIL TO: Stuart Tilt

**MINI-MICRO SYSTEMS,**

999 Summer Street, P.O. Box 3809,

Stamford, CT 06905

or Call: **203-964-0664**

# Advertisers Index

Able Computer	148	Diablo Supplies, Inc. (A Xerox Co.)	90	3M Co.	196
Advanced Digital Corp.	174	Digital Associates	64	Molecular Computer	173
Alpha Micro Systems	102-103	Digital Equipment Corp.	124-125	Momentum Computer Systems	34-35
Altos Computer Systems	137	Digital Microsystems, Inc.	112-113	Mostek Corp.	36-37
Amdek Corp.	61	Dilog (Distributed Logic Corp.)	211	NCR, OEM Marketing Div.	54-55
Amlyn Corp.	25	Direct, Inc.	48	NEPCON East '83	127
Ampex Corp., Memory Products Div.	219	Display Interface Corp.	198	NoHalt Computers	59
Anadex, Inc.	95	Dual Systems	192	Onyx Systems	164
Apollo Computers	66-67	Dylon Corp.	202	Oregon Software	163
Apple Computer, Inc.	42-43	Eagle Computer	168	Peritek Corp.	122
Archive Corp.	68-69	Electronic Solutions	208	Perry Data Systems	182, 202
Bytel Corp.	121	Emulex Corp.	82, 151	Persyst	65
C. Itoh Electronics	13	Envision	159	Pixel (Instrumentation Laboratory)	142-143
Cahners Exposition Group	127	Esprit Systems, Hazeltine Terminals Div.	93	Plessey Peripheral Systems	190-191
CalComp	52-53	ExpoConsul International	193	Plexus Computers	84-85
California Computer Systems	187	Frost & Sullivan	206	Precision Visuals	139
Canon U.S.A.	185	General Electric Co.	130-131	Quadram Corp.	144
Carroll Touch Technology	140	GML Information Services	104-105	Rabbit Software Corp.	33
Charles River Data Systems	156	Gould Inc., S.E.L. Computer Systems Div.	5	Rosscorp Corp.	75
CIE Sytems	31	Hall-Mark Electronics	123	Scientific Micro Systems	171
CIE Terminals	44-45, Cover 3	Hewlett-Packard	50-51, 97-99	Shape Magnetronics, Inc.	128
Cincom Systems	40	Houston Instrument Div. of Bausch & Lomb	141	Software Ireland	4
Cipher Data Products, Inc.	161	IBM Corp.	194-195	Sola Electric	201
Codata Systems	114-115	Ikier Technology	184	Symbolics, Inc.	26-27
Columbia Data Products	204-205	Imperial Technology, Inc.	182	Tab Products Co.	207
Compaq Computer Corp.	1	Infotron Systems Corp.	29	Tandon Corp.	14-15
COMPEC Europe '83	213	Intelligent Systems Corp.	203	TEAC Corp. of America	96
Computer Resources, Inc.	106	Interlan	109	TeleVideo Systems, Inc.	38-39, 116-117
Computer Technology Group	30	Intertec Data Systems Corp.	23	Teltone Corp.	177
Comtech Data	214	IPC Exhibitions, Ltd.	213	Texas Instruments Inc.	62-63
Conrac Corp.	88-89	Ithaca InterSystems, Inc.	118	3R Computers	215
Control Data Corp.—Engineering Services	200	Kennedy Co.	6	TransNet Corp.	186
Control Data Corp.—MSD	126	Leading Edge Products	10	Trilog, Inc.	86-87
Control Data Corp.—OEM	183	Lexidata Corp.	132	Unitronix	212
Controlled Power	206	Maxtor Corp.	79	Ven-Tel	16
Cosmos Systems	188	MBP Software	186	Versatec, Inc., A Xerox Co.	110
CPX	147	MCG Electronics	197	Virtual Microsystems	70
CYB Systems	120	Media Systems Technology (MST)	178	Wang Laboratories	209
Data General Corp.	80-81	Megatek Corp.	9	Western Telematic, Inc.	4
Data Packaging	199	Micom Systems, Inc.	Cover 4	Zentec Corp.	46-47
Dataram	Cover 2, 167	Micro Five Corp.	56		
Data Systems Design, Inc.	100-101	Micro Memory, Inc.	217		
Davidge Corp.	162	Microsystems International	73		
Delta Airlines	76	Mini-Micro Systems	32		
DEXPO East '83	193				

See pages 224-231 for Career Opportunity Advertisers  
See page 231 for Computer Consultants Corner  
See pages 221-222 for Mini-Micro Marketplace.

This index is provided as an additional service. The publisher does not assume any liability for errors or omissions.

## REGIONAL SALES OFFICES

### BOSTON

John J. Fahey  
Eastern Regional Manager  
221 Columbus Ave.  
Boston, MA 02116  
(617) 536-7780

### PHILADELPHIA

Richard W. Molden  
Regional Manager  
999 Old Eagle School Rd.  
Wayne, PA 19087  
(215) 293-1212

### CHICAGO

Robert D. Wentz  
Regional Manager  
Cahners Plaza  
1350 E. Touhy Ave.  
P.O. Box 5080  
Des Plaines, IL 60018  
(312) 635-8800

### DALLAS

Don Ward, Regional Manager  
13740 Midway Suite 515  
Dallas, TX 75234  
(214) 980-0318

### DENVER

John Huff, Regional Manager  
270 St. Paul St.  
Denver, CO 80206  
(303) 388-4511

### LOS ANGELES

Robert Billhimer  
Regional Manager  
12233 West Olympic Blvd.  
Los Angeles, CA 90064  
(213) 826-5818

### ORANGE COUNTY

Debra Huiskens, Regional Manager  
2041 Business Center Drive  
Suite 109 Irvine, CA 92715  
(714) 851-9422

### SAN FRANCISCO

Frank Barbagallo  
Regional Manager  
Rick Jamison, Regional Manager  
Sherman Building, Suite 1000  
3031 Tisch Way  
San Jose, CA 95128  
(408) 243-8838

### AUSTRIA

Elan Marketing Group  
Neutor g. 2  
P.O. Box 84  
1010 Vienna, Austria  
Telephone: 43222-344466

### ENGLAND

Ian Hardman Systems International  
Quadrant House, The Quadrant  
Sutton Surrey, SM2 5AS England  
Tel: (01) 661-3022

### GERMANY

Elan Marketing Group  
7240 Horb/Neckar  
Sudring, 53 Germany  
Telephone: 497451-7828

### ISRAEL

Igal A. Elan  
Marketing Systems Development Co.,  
Ltd.  
13 Haifa St., P.O. Box 33439  
Tel Aviv, Israel  
Telephone: 25 29 67 Telex: 341667

### JAPAN

Tomoyuki Inatsuki  
General Manager  
Trade Media Japan Inc.  
R. 212 Azabu Heights  
1-5-10 Roppongi Minato-ku,  
Tokyo 106 Japan  
Tel: (03) 585-0581

### SWEDEN

Igal A. Elan  
Elan Marketing Group  
Humlegardsgatan Nr. 5  
11446 Stockholm, Sweden  
Telephone: (08) 676243

### Career Opportunities

Stuart Tilt  
Recruitment Advertising Manager  
999 Summer Street P.O. Box 3809  
Stamford, CT 06905  
(203) 964-0664

When you compare CIE matrix line printers with others, you'll find others either do a lot less. Or cost a lot more.

Or both.

Our CI-300 gives you 300 LPM for data processing and 85 LPM of letter quality. Our CI-600 increases DP to 600 LPM and letter quality to 170 LPM.

# We'll take on any other line printer in the magazine.

Both are plug-in compatible with virtually every type of computer system, including IBM.

Both have variable shuttle speeds.

Both give you graphics, up to 2400 DLPM on the 300 and up to 4800 DLPM on the 600.

Both bring high resolution to Bar Codes, Optical Character Recognition, Form Generation, Labels and Word Processing.

Both have an unusually small print head diameter for needle-sharp character clarity.

Both give you hundreds of unique character fonts. And you can even design your own characters through the RAM.

Both come with three built-in interfaces, two parallel and one serial.

Both give you flexible line spacing, line feed speed and three paper-loading points—front, bottom and back.

And because they're designed with a minimum of moving parts and have undergone rigorous testing, both give you unmatched reliability.

They're printers that could only come from CIE Terminals, a new company of C. Itoh Electronics, one of the most experienced printer companies in the world.

For more information about these low-cost line printers built to higher standards, and more of them, just write or call.

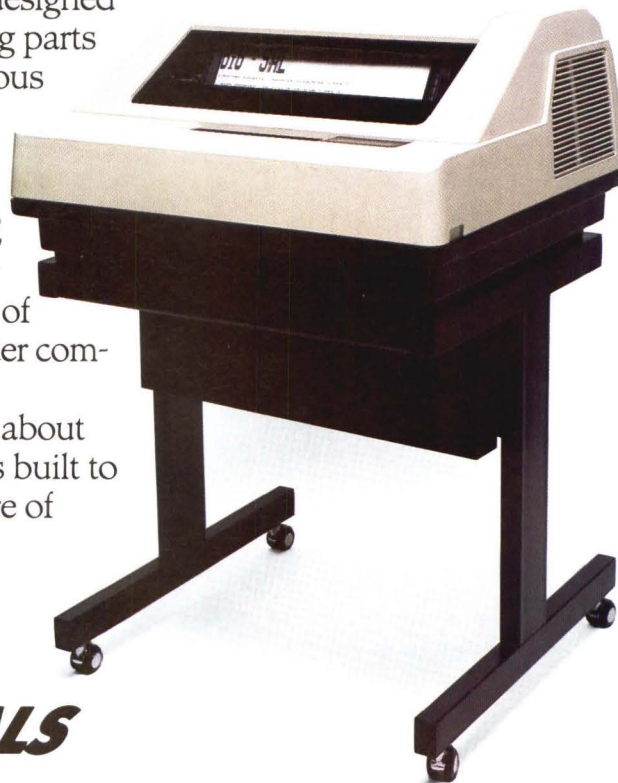

## **CIE TERMINALS**

A new company of  
C. ITOH ELECTRONICS, INC.

New headquarters and Southern California sales office: 2505 McCabe Way, Irvine, CA 92713. (714) 557-5118. Or call toll-free, 1 800 854-3322. Other regional sales offices: San Jose, CA (408) 977-1146; Cherry Hill, NJ (609) 983-5075; Chicago, Ill (312) 992-2346; Houston, TX (713) 777-1640; Atlanta, GA (404) 257-1814.

# You don't switch voice calls this way any more. Why should you do it for data?

Telephone switching long ago evolved beyond manual plugboards like this one, but many otherwise modern data processing installations still do their data switching in ways which are nearly as old-fashioned. MICOM's Micro600

offers those dp installations an easy way to modernize by providing a switching system specifically designed for their terminal and computer needs—a powerful but inexpensive data PABX.

**NOW WITH INTER-PABX  
NETWORKING !**



**Send for  
your free  
10-page  
brochure  
today.**

- **Contention** for applications with more terminals than computer ports
- **Selection** where a single terminal may access more than one computer
- **Load balancing** for automatically maximizing computer resource utilization
- **Management** for monitoring computer and terminal utilization and dynamically changing network configurations
- **Access control** for "approving" access to computer ports on a case-by-case basis
- **Fall-back**—automatic switching to one or more back-up computers
- **Minimal delay**—eliminates the delay associated with other switching systems
- **Local networking**—proven technology at low cost per port, without special cables or compatibility problems

**MICOM**<sup>®</sup> *MicroComputers for DataCommunications™*

MICOM SYSTEMS, INC. • 20151 Nordhoff Street • Chatsworth, CA 91311 • Telephone (213) 998-8844 • TWX 910/494-4910  
Regional Sales/Service • Atlanta, GA • (404) 435-2999 • Boston, MA • (617) 527-4010 • Chicago, IL • (312) 642-3603 • Dallas, TX  
(214) 258-0774 • Philadelphia, PA • (609) 778-0133 • St. Louis, MO • (314) 576-7626 • Woodbridge, NJ • (201) 750-1120  
MICOM-BORER LTD. • Bel Court • 15 Cradock Road • Reading, Berkshire RG20JT, England • (0734) 866801 • Telex 847135

CIRCLE NO. 4 ON INQUIRY CARD